

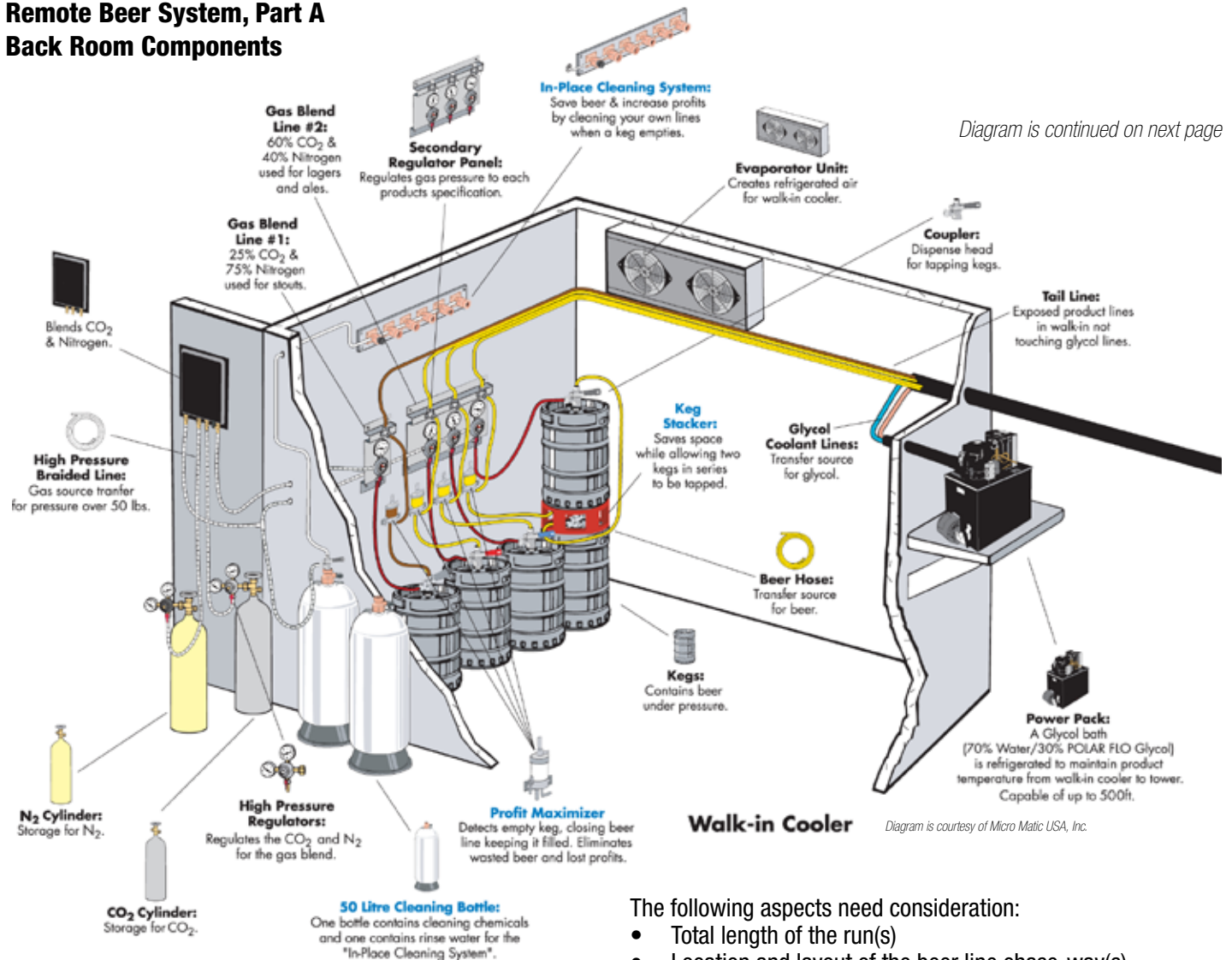

**Towers, Faucets, Handles, Medallions, Shanks, Drip Trays, Chillers, Glycol, Trunk Lines and Tubing, Line Labels, Tools, Installation Simplifiers, Visual Dispensers, Bar Guns, Ice Chests, Conversion and Leg Stands, Cold Plates, Couplers/Taps, Picnic Pumps, Picnic Coolers, Special Events, Branded Displays, Kegerators, Fridge Kits, Keg Accessories, FOB Stops, Gas and Electric Pumps, CO<sub>2</sub> Tanks & Detector/Alarm, Regulators, Compressors, Gas Blenders, Fittings, Cleaners, Under Bar, Cocktail Stations, Glasswashers, Mug Frosters, Back Bar Refrigeration, Back Bar Storage, Glass Display Units, Bar Accessories, Installer Checklist**

## Remote Beer System, Part A Back Room Components



To design your remote draft beer system, knowledge of your basic requirements is necessary. Our sales people are eager to discuss the various options to fit your needs and budget. Please feel free to contact us with any questions.

The following aspects need consideration:

- Total length of the run(s)
- Location and layout of the beer line chase-way(s)
- Net vertical lift or drop (distance from bottom of keg to beer faucet)
- Number of dispensing stations, the type of beer tower(s), and the number of faucets on each tower
- Number of kegs to be stored in the walk-in cooler
- Line chiller location and if a line chiller leg set, stand or wall rack is required
- Method of counter pressure: beer pumps or blended N<sub>2</sub>/CO<sub>2</sub>
- Type of primary CO<sub>2</sub> storage: tank or bulk
- If keg taps are required or supplied by others

## Remote Beer System, Part B

An installer checklist can be found on the last four pages of this section to help build a complete beer dispensing system.

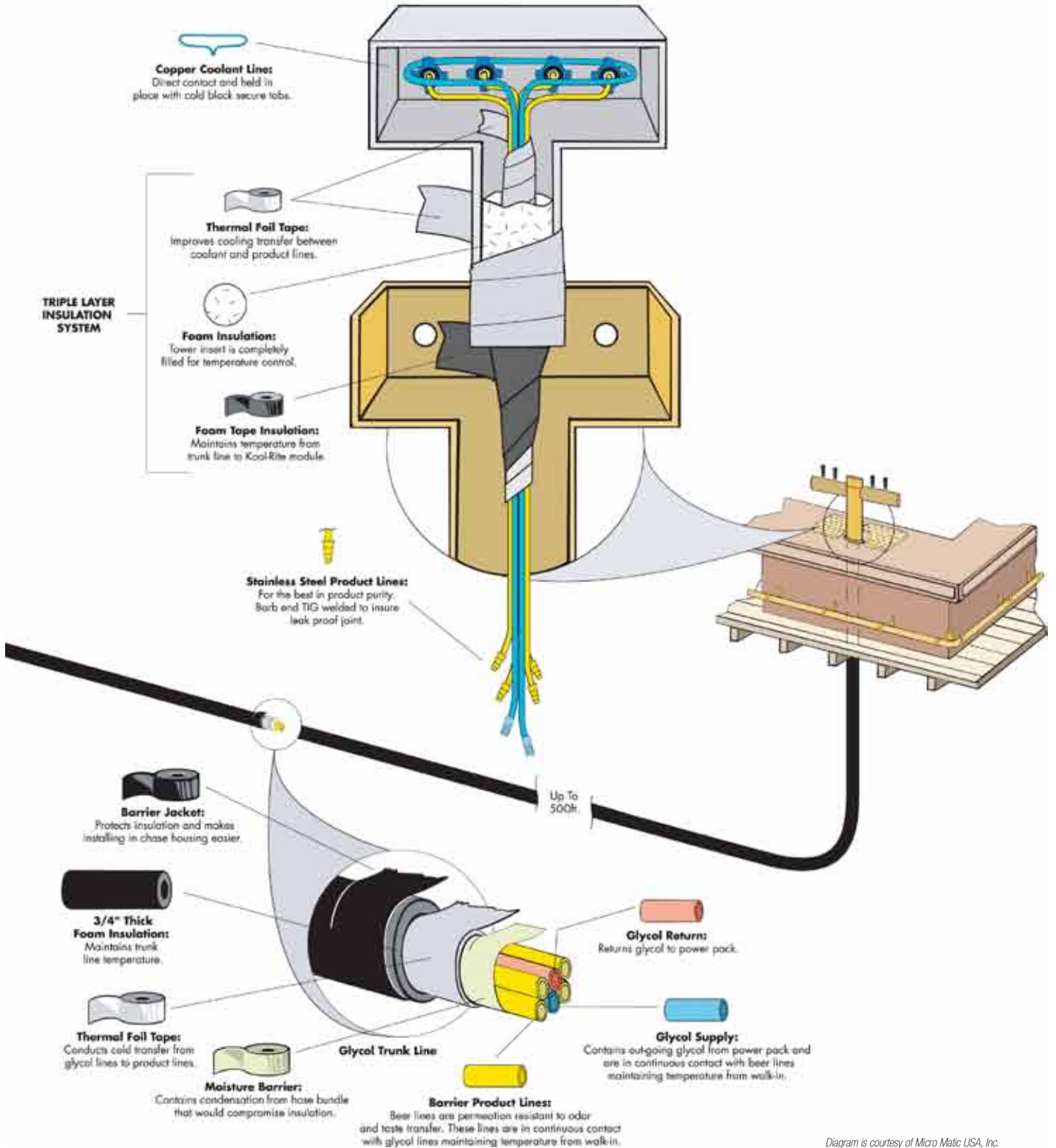

Diagram is courtesy of Micro Matic USA, Inc.



Advanced Beverage Solutions  
100 Gary Avenue, Suite C  
Roselle, IL 60172

[www.absone.com](http://www.absone.com)  
E-mail: [orders@absone.com](mailto:orders@absone.com)

877-814-2271  
Local: 847-524-1707  
Fax: 847-524-1710

## Wall Mounted Direct Draw System, Part A Back Room Components

An installer checklist can be found on the last four pages of this section to help build a complete beer dispensing system.

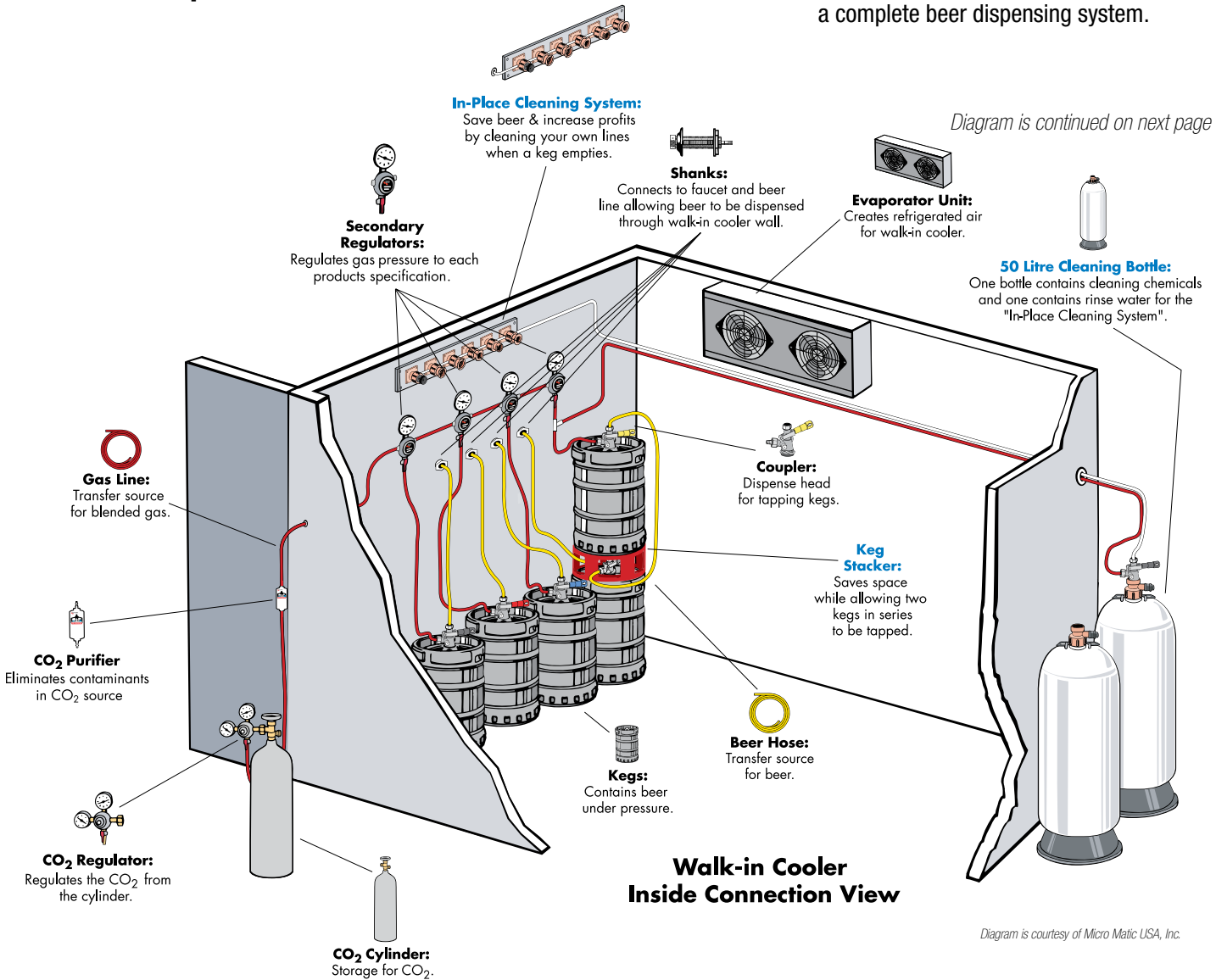

Beer Systems, Bar Equipment

To design your remote draft beer system, knowledge of your basic requirements is necessary. Our sales people are eager to discuss the various options to fit your needs and budget. Please feel free to contact us with any questions.

The following aspects need consideration:

- Total length of the run(s)
- Location and layout of the beer line chase-way(s)
- Net vertical lift or drop (distance from bottom of keg to beer faucet)
- Number of dispensing stations, the type of beer tower(s), and the number of faucets on each tower
- Number of kegs to be stored in the walk-in cooler
- Line chiller location and if a line chiller leg set, stand or wall rack is required
- Method of counter pressure: beer pumps or blended N<sub>2</sub>/CO<sub>2</sub>
- Type of primary CO<sub>2</sub> storage: tank or bulk
- If keg taps are required or supplied by others



Advanced Beverage Solutions  
100 Gary Avenue, Suite C  
Roselle, IL 60172

[www.absonone.com](http://www.absonone.com)  
E-mail: [orders@absonone.com](mailto:orders@absonone.com)

877-814-2271  
Local: 847-524-1707  
Fax: 847-524-1710

## Wall Mounted Direct Draw System, Part B

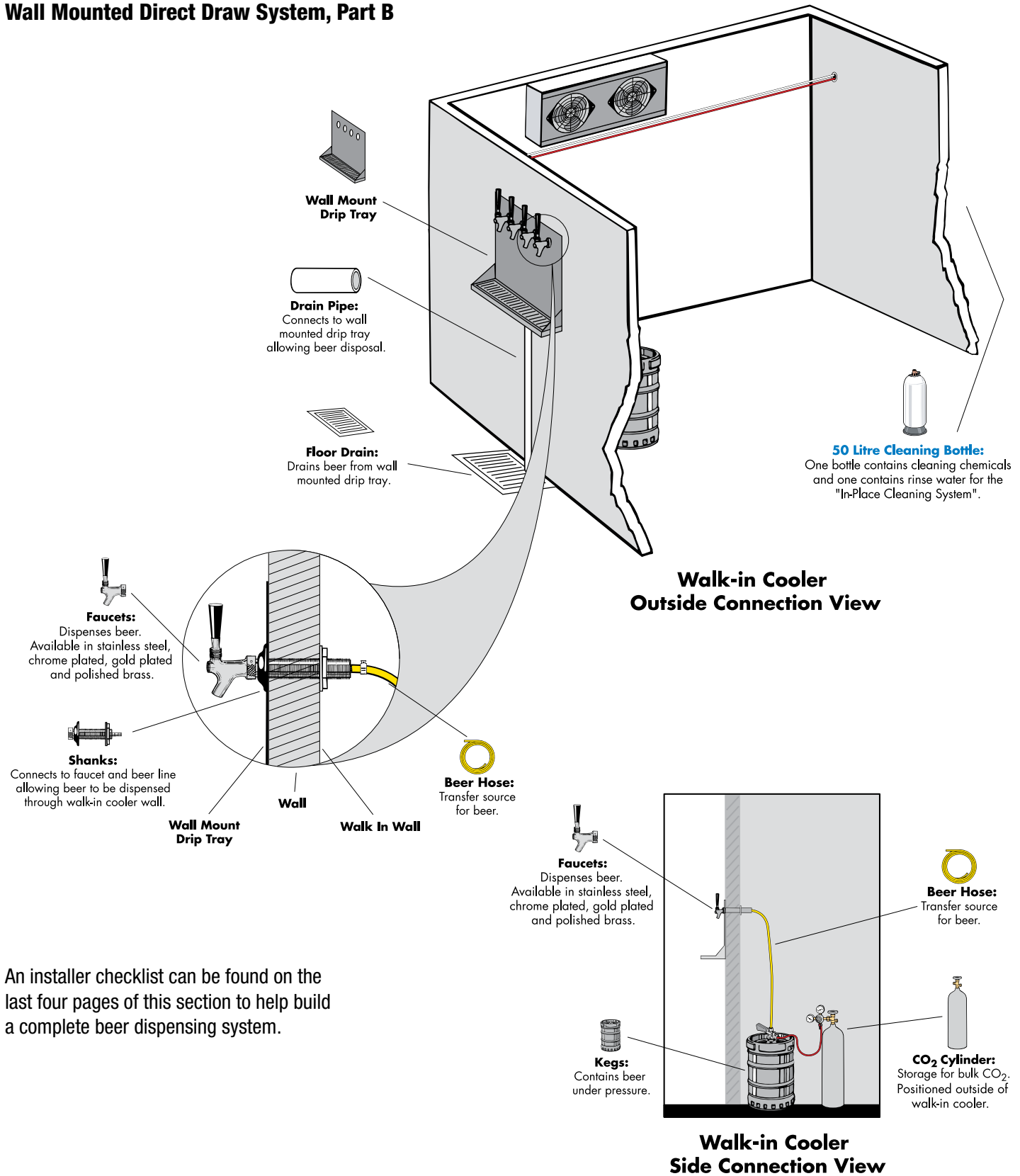

An installer checklist can be found on the last four pages of this section to help build a complete beer dispensing system.

Diagram is courtesy of Micro Matic USA, Inc.



Advanced Beverage Solutions  
100 Gary Avenue, Suite C  
Roselle, IL 60172

[www.absone.com](http://www.absone.com)  
E-mail: [orders@absone.com](mailto:orders@absone.com)

877-814-2271  
Local: 847-524-1707  
Fax: 847-524-1710

## Lancer Flooded Beer Dispensing Towers

All towers are glycol cooled, fully flooded, will condensate, and in the right conditions will ice over. High polished stainless finish is standard, other finishes are available. 3/16" restrictor lines. Decal disks optional.

Drip trays, Lancer Hilight faucets and Fatlock adaptors are sold separately.



Part Number	Faucets	Description	Drip Tray
23-1560-02-06	6	Goalpost 3" 6W 15" HP SS	36000011
23-1560-02-08	8	Goalpost 3" 8W 15" HP SS	36700001
23-1560-02-10	10	Goalpost 3" 10W 15" HP SS	36700001
23-1560-02-12	12	Goalpost 3" 12W 15" HP SS	36000170
23-1561-02-06	6	Bridge tower 6W	36639872
23-1561-02-08	8	Bridge tower 8W	36700001
23-1561-02-10	10	Bridge tower 10W	36700001
23-1563-02-04	4	Harbor tower 4W HP SS	36624285
23-1563-02-06	6	Harbor tower 6W HP SS	36639872
23-1563-02-08	8	Harbor tower 8W HP SS	36647522
23-1563-02-10	10	Harbor tower 10W HP SS	36700001
23-1563-02-12	12	Harbor tower 12W HP SS	
23-1566-01-04	4	Zenith tower LH 4W HP SS	36624285
23-1566-02-04	4	Zenith tower RH 4W HP SS	36624285
23-1566-01-05	5	Zenith tower LH 5W HP SS	36639872
23-1566-02-05	5	Zenith tower RH 5W HP SS	36639872
23-1574-06-04	4	Double Zenith 4W SS HP	36624285
23-1574-06-05	5	Double Zenith 5W SS HP	36624285
23-1574-06-06	6	Double Zenith 6W SS HP	36639872
23-1574-06-07	7	Double Zenith 7W SS HP	36000011
23-1574-06-08	8	Double Zenith 8W SS HP	
23-1574-06-09	9	Double Zenith 9W SS HP	
23-1574-06-10	10	Double Zenith 10W SS HP	
23-1574-06-12	12	Double Zenith 12W SS HP	36700001
23-1570-01-03	3	Jupiter tower 3W 15" LH HP	36624261
23-1570-02-03	3	Jupiter tower 3W 15" RH HP	36624261
82-4488	24	Boulevard tower	



Goalpost

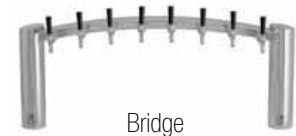

Bridge



Harbor

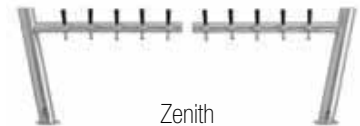

Zenith



Double Zenith



Jupiter

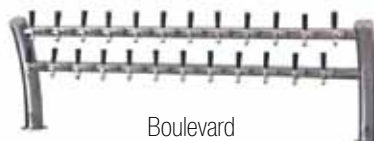

Boulevard



Advanced Beverage Solutions  
100 Gary Avenue, Suite C  
Roselle, IL 60172

**www.abstone.com**  
E-mail: [orders@abstone.com](mailto:orders@abstone.com)

877-814-2271  
Local: 847-524-1707  
Fax: 847-524-1710

## Lancer Flooded Beer Dispensing Towers

All towers are glycol cooled, fully flooded, will condensate, and in the right conditions will ice over. High polished stainless steel finish is standard, other finishes are available. 3/16" restrictor lines. Decal disks optional.

Drip trays, Lancer Hilight faucets and Fatlock adaptors are sold separately.

Part Number	Faucets	Description	Drip Tray
23-1588-02-04	4	Bondi tower 4W RH SS HP	36639872
23-1588-01-04	4	Bondi tower 4W LH SS HP	36639872
23-1574-04-04	4	Cooly tower 4W SS HP	36624285
23-1574-04-06	6	Cooly tower 6W SS HP	36639872
23-1574-04-08	8	Cooly tower 8W SS HP	36647522
23-1574-05-06	6	Whaletail tower 6W SS HP	36639872
23-1574-05-08	8	Whaletail tower 8W SS HP	36647522
23-1589-01-06	6	X-Treme tower 6W SS HP with faucets and adaptors	36000170
23-1573-04-02	2	T-Bar tower 2W 15" S/S HP	36641477
23-1573-04-03	3	T-Bar tower 3W 15" S/S HP	36639884
23-1573-04-04	4	T-Bar tower 4W 15" S/S HP	36624261
23-1573-04-05	5	T-Bar tower 5W 15" S/S HP	36624285
23-1573-04-06	6	T-Bar tower 6W 15" S/S HP	36624285
23-1574-01-04	4	Fat Boy 4 faucet SS HP	36624261
23-1565-01-02	2	Crisscross T Bar tower 2W 15" HP SS	36641477
23-1565-01-04	4	Crisscross T Bar tower 4W 15" HP SS	36624285

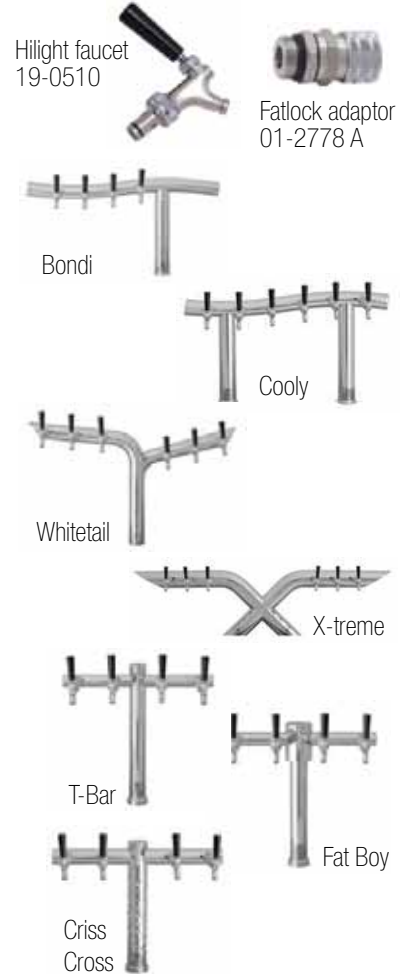

*Glycol is shown on page 37*

## Lancer Breeze

Ice cooled beer dispenser requires no refrigeration and no electricity. It has a small footprint, can be placed on any countertop, front bar or back bar — ideal for small restaurants. Ice lasts for 8 hours depending on use. Casual drink temperature is 36°F. There are no moving parts. Uses a special tap to create creamy foam. 2 year warranty.

Requires a drain for the water from melted ice, CO<sub>2</sub> bottle, CO<sub>2</sub> regulator, keg coupler and hoses. Weight: 63 lbs. Ice capacity: 22 lbs.



11.58" W x 15.55" H  
19.76" D without driptray, 24.88" D with driptray

Part Number	Description
85-51001	Breeze ice cooled beer dispenser



## Beer Dispensing Towers

All towers are 4" diameter, polished stainless steel, glycol cooled and cold blocked unless specified air cooled. American faucets are included. 3/16" restrictor lines. Metro T illuminated towers use an 80mm medallion. Gold, PVD, water, cider, wine and combination beer/wine versions of these towers are available upon request. Contact ABS for pricing and lead times.

Part Number	Faucets	Description	Drip Tray
BB102700-4SSCK	4	Metropolis "T" tower 4 faucet polished SS	24"
BB102700-6SSCK	6	Metropolis "T" tower 6 faucet polished SS	24"
BB102700-8SSCK	8	Metropolis "T" tower 8 faucet polished SS, 24"	24"
BB102701-08SSCK	8	Metropolis "T" tower 8 faucet polished SS, 30"	30"
BB102701-10SSCK	10	Metropolis "T" tower 10 faucet polished SS	30"
BB102703-4SSCK	4	Metropolis "T" tower 4 faucet polished SS, 80 mm LED medallions	24"
BB102703-6SSCK	6	Metropolis "T" tower 6 faucet polished SS, 80 mm LED medallions	24"
BB102703-8SSCK	8	Metropolis "T" tower 8 faucet polished SS, 80 mm LED medallions	30"
BB102700-4SS	4	Metropolis "T" tower 4 faucet air cooled	24"
BB102700-6SS	6	Metropolis "T" tower 6 faucet air cooled	24"
BB102700-8SS	8	Metropolis "T" tower 8 faucet air cooled, 24"	24"
BB102701-08SS	8	Metropolis "T" tower 8 faucet air cooled, 30"	30"
BB102710-08SSCK	8	Metropolis "H" tower 8 faucet polished SS	28"
BB102710-10SSCK	10	Metropolis "H" tower 10 faucet polished SS	34"
BB102710-12SSCK	12	Metropolis "H" tower 12 faucet polished SS	40"
BB102710-14SSCK	14	Metropolis "H" tower 14 faucet polished SS	46"
BB102710-16SSCK	16	Metropolis "H" tower 16 faucet polished SS	52"
BB102715-16SSCK	16	Metropolis "M" tower 16 faucet polished SS	
BB102715-18SSCK	18	Metropolis "M" tower 18 faucet polished SS	
BB102715-20SSCK	20	Metropolis "M" tower 20 faucet polished SS	
BB102715-24SSCK	24	Metropolis "M" tower 24 faucet polished SS	
BB102715-28SSCK	28	Metropolis "M" tower 28 faucet polished SS	
BB101379-06CK	6	4" Pass Thru tower 6 faucet brushed SS	30"
BB101379-08CK	8	4" Pass Thru tower 8 faucet brushed SS	30"
BB101379-10CK	10	4" Pass Thru tower 10 faucet brushed SS	36"
BB101379-12CK	12	4" Pass Thru tower 12 faucet brushed SS	45"
BB101379-14CK	14	4" Pass Thru tower 14 faucet brushed SS	45"
BB101379-16CK	16	4" Pass Thru tower 16 faucet brushed SS	51"
BB101379-06	6	4" Pass Thru 6 faucet air cooled brushed SS	30"
BB101379-08	8	4" Pass Thru 8 faucet air cooled brushed SS	30"
BB101379-10	10	4" Pass Thru 10 faucet air cooled brushed SS	36"
BB101379-12	12	4" Pass Thru 12 faucet air cooled brushed SS	45"
BB101379-14	14	4" Pass Thru 14 faucet air cooled brushed SS	45"
BB101382C-08CK	8	4" Pass Thru 8 faucet polished SS, 80 mm LED medallions	
BB101382C-10CK	10	4" Pass Thru 10 faucet polished SS, 80 mm LED medallions	
BB101382C-12CK	12	4" Pass Thru 12 faucet polished SS, 80 mm LED medallions	



Metropolis T



Metropolis T



Metropolis H



Metropolis M



4" Pass Thru



Advanced Beverage Solutions  
100 Gary Avenue, Suite C  
Roselle, IL 60172

[www.absone.com](http://www.absone.com)  
E-mail: [orders@absone.com](mailto:orders@absone.com)

877-814-2271  
Local: 847-524-1707  
Fax: 847-524-1710

## Beer Dispensing Towers

All towers are glycol cooled and cold blocked. American faucets are included. 3/16" restrictor lines. Gold, PVD, water, cider, wine and combination beer/wine versions of these towers are available upon request. Contact ABS for pricing and lead times.

Differentiations between the Bixby, Lions Gate, and Bridge: The Bixby and Bridge do not have a flange between the faucets, the Lions Gate does have a flange between the faucets. The Bridge is 3" diameter, all others on this page are 4" diameter.

Part Number	Faucets	Description	Drip Tray
BB102632-04SSCK	4	Bixby tower 4 faucet polished SS	
BB102632-05SSCK	5	Bixby tower 5 faucet polished SS	
BB102632-06SSCK	6	Bixby tower 6 faucet polished SS	
BB102632-07SSCK	7	Bixby tower 7 faucet polished SS	
BB102632-08SSCK	8	Bixby tower 8 faucet polished SS	
BB102632-09SSCK	9	Bixby tower 9 faucet polished SS	
BB102632-10SSCK	10	Bixby tower 10 faucet polished SS	
BB102637-04SSCK	4	Bixby 3 pedestal tower 4 faucet polished SS	
BB102637-06SSCK	6	Bixby 3 pedestal tower 6 faucet polished SS	
BB102637-08SSCK	8	Bixby 3 pedestal tower 8 faucet polished SS	
BB102637-10SSCK	10	Bixby 3 pedestal tower 10 faucet polished SS	
BB102637-12SSCK	12	Bixby 3 pedestal tower 12 faucet polished SS	
BB102637-14SSCK	14	Bixby 3 pedestal tower 14 faucet polished SS	
BB102637-16SSCK	16	Bixby 3 pedestal tower 16 faucet polished SS	
BB102637-18SSCK	18	Bixby 3 pedestal tower 18 faucet polished SS	
BB102637-20SSCK	20	Bixby 3 pedestal tower 20 faucet polished SS	
BB102630-04SSCK	4	Lions Gate tower 4 faucet polished SS	
BB102630-06SSCK	6	Lions Gate tower 6 faucet polished SS	
BB102630-08SSCK	8	Lions Gate tower 8 faucet polished SS	
BB102630-10SSCK	10	Lions Gate tower 10 faucet polished SS	
BB102630-12SSCK	12	Lions Gate tower 12 faucet polished SS	
BB102630-14SSCK	14	Lions Gate tower 14 faucet polished SS	
BB102630-16SSCK	16	Lions Gate tower 16 faucet polished SS	
BB102635-08SSCK	8	Lions gate column 8 faucet polished SS	
BB102635-12SSCK	12	Lions gate column 12 faucet polished SS	
BB102635-14SSCK	14	Lions gate column 14 faucet polished SS	
BB102635-16SSCK	16	Lions gate column 16 faucet polished SS	
BB102635-20SSCK	20	Lions gate column 20 faucet polished SS	
BB102635-24SSCK	24	Lions gate column 24 faucet polished SS	
BB102770-06SSCK	6	Bridge tower 6 faucet polished SS	
BB102770-08SSCK	8	Bridge tower 8 faucet polished SS	
BB102770-10SSCK	10	Bridge tower 10 faucet polished SS	
BB102770-12SSCK	12	Bridge tower 12 faucet polished SS	
BB102615-02SSCK	2	Linx L7 tower 2 faucet polished SS	12"
BB102615-03SSCK	3	Linx L7 tower 3 faucet polished SS	16"
BB102615-04SSCK	4	Linx L7 tower 4 faucet polished SS	20"
BB102615-05SSCK	5	Linx L7 tower 5 faucet polished SS	
BB102615-06SSCK	6	Linx L7 tower 6 faucet polished SS	24"
BB102617-02SSCK	2	Linx R7 tower 2 faucet polished SS	12"
BB102617-03SSCK	3	Linx R7 tower 3 faucet polished SS	16"
BB102617-04SSCK	4	Linx R7 tower 4 faucet polished SS	20"
BB102617-05SSCK	5	Linx R7 tower 5 faucet polished SS	
BB102617-06SSCK	6	Linx R7 tower 6 faucet polished SS	24"



Beer Systems, Bar Equipment





Advanced Beverage Solutions  
100 Gary Avenue, Suite C  
Roselle, IL 60172

[www.absone.com](http://www.absone.com)  
E-mail: [orders@absone.com](mailto:orders@absone.com)

877-814-2271  
Local: 847-524-1707  
Fax: 847-524-1710

## Beer Dispensing Towers

All towers are glycol cooled and cold blocked unless specified air cooled. American faucets are included. 3/16" restrictor lines. Gold, PVD, water, cider, wine and combination beer/wine versions of these towers are available upon request. Contact ABS for pricing and lead times.

Part Number	Faucets	Description	Drip Tray
BB102612-04SSCK	4	Condor tower 4 faucet polished SS	16"
BB102612-06SSCK	6	Condor tower 6 faucet polished SS	24"
BB102612-08SSCK	8	Condor tower 8 faucet polished SS	32"
BB102612-10SSCK	10	Condor tower 10 faucet polished SS	40"
BB102620-04SSCK	4	Albatross tower 4 faucet polished SS	
BB102620-06SSCK	6	Albatross tower 6 faucet polished SS	
BB102620-08SSCK	8	Albatross tower 8 faucet polished SS	
BB102620-10SSCK	10	Albatross tower 10 faucet polished SS	
BB102620-12SSCK	12	Albatross tower 12 faucet polished SS	
BB102625-08SSCK	8	Phoenix tower 8 faucet polished SS	
BB102625-10SSCK	10	Phoenix tower 10 faucet polished SS	
BB102625-12SSCK	12	Phoenix tower 12 faucet polished SS	
BB102625-14SSCK	14	Phoenix tower 14 faucet polished SS	
BB102625-16SSCK	16	Phoenix tower 16 faucet polished SS	
BB102625-18SSCK	18	Phoenix tower 18 faucet polished SS	
BB102625-20SSCK	20	Phoenix tower 20 faucet polished SS	
BB102625-24SSCK	24	Phoenix tower 24 faucet polished SS	
BB102640-12SSCK	12	Behemoth tower 12 faucet polished SS	
BB102640-18SSCK	18	Behemoth tower 18 faucet polished SS	
BB102640-24SSCK	24	Behemoth tower 24 faucet polished SS	
BB102640-30SSCK	30	Behemoth tower 30 faucet polished SS	
BB102640-36SSCK	36	Behemoth tower 36 faucet polished SS	
BB102765-06SSCK	6	Rail tower 6 faucet polished SS	
BB102765-08SSCK	8	Rail tower 8 faucet polished SS	
BB102765-10SSCK	10	Rail tower 10 faucet polished SS	
BB102765-12SSCK	12	Rail tower 12 faucet polished SS	
BB102765-06SS	6	Rail tower 6 faucet polished SS air cooled	
BB102765-08SS	8	Rail tower 8 faucet polished SS air cooled	
BB102765-10SS	10	Rail tower 10 faucet polished SS air cooled	
BB102765-12SS	12	Rail tower 12 faucet polished SS air cooled	

*Glycol is shown on page 37*





Advanced Beverage Solutions  
100 Gary Avenue, Suite C  
Roselle, IL 60172

**www.absonone.com**  
E-mail: [orders@absonone.com](mailto:orders@absonone.com)

877-814-2271  
Local: 847-524-1707  
Fax: 847-524-1710

## Beer Dispensing Towers

All towers are glycol cooled and cold blocked. American faucets are included. 3/16" restrictor lines. Water, cider, wine and combination beer/wine versions of these towers are available upon request. Contact ABS for pricing and lead times.

Part Number	Faucets	Description	Drip Tray
BB103373C-CK	3	Lantern wall mount tower chrome 3 faucets	
BB103374C-CK	4	Lantern wall mount tower chrome 4 faucets	
BB103375C-CK	5	Lantern wall mount tower chrome 5 faucets	
BB103373C	3	Lantern wall mount tower chrome 3 faucets air cooled	
BB103374C	4	Lantern wall mount tower chrome 4 faucets air cooled	
BB103375C	5	Lantern wall mount tower chrome 5 faucets air cooled	
BB101384C-CK	4	Mushroom large tower polished SS 4 faucets	19"
BB101385C-CK	5	Mushroom large tower polished SS 5 faucets	19"
BB101386C-CK	6	Mushroom large tower polished SS 6 faucets	24"
BB101384C	4	Mushroom large polished SS 4 faucets air cooled	19"
BB101385C	5	Mushroom large polished SS 5 faucets air cooled	19"
BB101386C	6	Mushroom large polished SS 6 faucets air cooled	24"
BB101373C-CK	3	Mushroom mini tower chrome 3 faucets	14"
BB101374C-CK	4	Mushroom mini tower chrome 4 faucets	18"
BB101375C-CK	5	Mushroom mini tower chrome 5 faucets	
BB101373C	3	Mushroom mini tower chrome 3 faucets air cooled	14"
BB101374C	4	Mushroom mini tower chrome 4 faucets air cooled	18"
BB101375C	5	Mushroom mini tower chrome 5 faucets air cooled	
BB101370CB-CK	3	Zeus tower chrome/black 3 faucet	20"
BB101370CG-CK	3	Zeus tower chrome/green 3 faucet	20"
BB101370CN-CK	3	Zeus tower chrome/blue 3 faucet	20"
BB101370CW-CK	3	Zeus tower chrome/white 3 faucet	20"
BB101370GB-CK	3	Zeus tower gold/black 3 faucet	20"
BB101370GG-CK	3	Zeus tower gold/green 3 faucet	20"
BB101370GN-CK	3	Zeus tower gold/blue 3 faucet	20"
BB101370GW-CK	3	Zeus tower gold/white 3 faucet	20"
BB101370CB	3	Zeus tower chrome/black 3 faucet air cooled	20"
BB101370CG	3	Zeus tower chrome/green 3 faucet air cooled	20"
BB101370CN	3	Zeus tower chrome/blue 3 faucet air cooled	20"
BB101370CW	3	Zeus tower chrome/white 3 faucet air cooled	20"
BB101370GB	3	Zeus tower gold/black 3 faucet air cooled	20"
BB101370GG	3	Zeus tower gold/green 3 faucet air cooled	20"
BB101370GN	3	Zeus tower gold/blue 3 faucet air cooled	20"
BB101370GW	3	Zeus tower gold/white 3 faucet air cooled	20"



Lantern



Mushroom



Zeus

Zeus towers are available with black, green, blue or white ceramic, and chrome or gold metal



Advanced Beverage Solutions  
100 Gary Avenue, Suite C  
Roselle, IL 60172

[www.absone.com](http://www.absone.com)  
E-mail: [orders@absone.com](mailto:orders@absone.com)

877-814-2271  
Local: 847-524-1707  
Fax: 847-524-1710

## European Dispensing Towers

All towers are glycol cooled and cold blocked. American faucets are included. 3/16" restrictor lines. Water, cider, wine and combination beer/wine versions of these towers are available upon request. Contact ABS for pricing and lead times.

Part Number	Faucets	Description	Drip Tray
BB101371CB-CK	4	Zeus tower chrome/black 4 faucet	20"
BB101371CG-CK	4	Zeus tower chrome/green 4 faucet	20"
BB101371CN-CK	4	Zeus tower chrome/blue 4 faucet	20"
BB101371CW-CK	4	Zeus tower chrome/white 4 faucet	20"
BB101371GB-CK	4	Zeus tower gold/black 4 faucet	20"
BB101371GG-CK	4	Zeus tower gold/green 4 faucet	20"
BB101371GN-CK	4	Zeus tower gold/blue 4 faucet	20"
BB101371GW-CK	4	Zeus tower gold/white 4 faucet	20"
BB101371CB	4	Zeus tower chrome/black 4 faucet air cooled	20"
BB101371CG	4	Zeus tower chrome/green 4 faucet air cooled	20"
BB101371CN	4	Zeus tower chrome/blue 4 faucet air cooled	20"
BB101371CW	4	Zeus tower chrome/white 4 faucet air cooled	20"
BB101371GB	4	Zeus tower gold/black 4 faucet air cooled	20"
BB101371GG	4	Zeus tower gold/green 4 faucet air cooled	20"
BB101371GN	4	Zeus tower gold/blue 4 faucet air cooled	20"
BB101371GW	4	Zeus tower gold/white 4 faucet air cooled	20"
BB101372CB-CK	5	Zeus tower chrome / black 5 faucet	20"
BB101372CG-CK	5	Zeus tower chrome/green 5 faucet	20"
BB101372CN-CK	5	Zeus tower chrome/blue 5 faucet	20"
BB101372CW-CK	5	Zeus tower chrome/white 5 faucet	20"
BB101372GB-CK	5	Zeus tower gold / black 5 faucet	20"
BB101372GG-CK	5	Zeus tower gold/green 5 faucet	20"
BB101372GN-CK	5	Zeus tower gold/blue 5 faucet	20"
BB101372GW-CK	5	Zeus tower gold/white 5 faucet	20"
BB101372CB	5	Zeus tower chrome / black 5 faucet air cooled	20"
BB101372CG	5	Zeus tower chrome/green 5 faucet air cooled	20"
BB101372CN	5	Zeus tower chrome/blue 5 faucet air cooled	20"
BB101372CW	5	Zeus tower chrome/white 5 faucet air cooled	20"
BB101372GB	5	Zeus tower gold / black 5 faucet air cooled	20"
BB101372GG	5	Zeus tower gold/green 5 faucet air cooled	20"
BB101372GN	5	Zeus tower gold/blue 5 faucet air cooled	20"
BB101372GW	5	Zeus tower gold/white 5 faucet air cooled	20"



Zeus towers are available with black, green, blue or white ceramic, and chrome or gold metal



Advanced Beverage Solutions  
100 Gary Avenue, Suite C  
Roselle, IL 60172

[www.absone.com](http://www.absone.com)  
E-mail: [orders@absone.com](mailto:orders@absone.com)

877-814-2271  
Local: 847-524-1707  
Fax: 847-524-1710

## European Dispensing Towers

All towers are glycol cooled and cold blocked unless specified air cooled. American faucets are included. 3/16" restrictor lines. Gold, PVD, water, cider, wine and combination beer/wine versions of these towers are available upon request. Contact ABS for pricing and lead times.

Part Number	Faucets	Description	Drip Tray
BB102050-3	3	Brigitte tower 3 faucet chrome glycol cooled, LED medallions	20"
BB102050-5	5	Brigitte tower 5 faucet chrome glycol cooled, LED medallions	24"
BB102050-7	7	Brigitte tower 7 faucet chrome glycol cooled, LED medallions	36"
BB102300A-CK	2	Monaco tower 2 faucet chrome	20"
BB102310A-CK	3	Monaco tower 3 faucet chrome	20"
BB102315A-CK	4	Monaco tower 4 faucet chrome	24"
BB102320A-CK	5	Monaco tower 5 faucet chrome	24"
BB102325A-CK	6	Monaco tower 6 faucet chrome	36"
BB102330A-CK	7	Monaco tower 7 faucet chrome	36"
BB102300A	2	Monaco tower 2 faucet chrome air cooled	20"
BB102310A	3	Monaco tower 3 faucet chrome air cooled	20"
BB102315A	4	Monaco tower 4 faucet chrome air cooled	24"
BB102320A	5	Monaco tower 5 faucet chrome air cooled	24"
BB102325A	6	Monaco tower 6 faucet chrome air cooled	36"
BB102330A	7	Monaco tower 7 faucet chrome air cooled	36"
BB102370A-CK	1	Idea tower 1 faucet chrome glycol cooled	10"
BB102373C-CK	1	Idea tower 1 faucet chrome glycol cooled, 82 mm LED medallion	10"
BB102375A-CK	2	Idea tower 2 faucet chrome glycol cooled	10"
BB102373C	1	Idea tower 1 faucet chrome air cooled, 82 mm LED medallion	10"
BB102370A	1	Idea tower 1 faucet chrome air cooled	10"
BB102375A	2	Idea tower 2 faucet chrome air cooled	10"
BB102140A-CK	1	Mongoose tower 1 faucet chrome	10"
BB102150A-CK	2	Mongoose tower 2 faucet chrome	10"
BB102160A-CK	3	Mongoose tower 3 faucet chrome	15"
BB102170A-CK	4	Mongoose tower 4 faucet chrome	15"
BB102140A	1	Mongoose tower 1 faucet chrome air cooled	10"
BB102150A	2	Mongoose tower 2 faucet chrome air cooled	10"
BB102160A	3	Mongoose tower 3 faucet chrome air cooled	15"
BB102170A	4	Mongoose tower 4 faucet chrome air cooled	15"
BB102175A-CK	4	Mongoose tower 4 faucet chrome, LED medallions	15"
BB102142A-CK	1	Mongoose tower 1 faucet black nickel	10"
BB102152A-CK	2	Mongoose tower 2 faucet black nickel	10"
BB102162A-CK	3	Mongoose tower 3 faucet black nickel	15"
BB102172A-CK	4	Mongoose tower 4 faucet black nickel	15"
BB102177A-CK	4	Mongoose tower 4 faucet black nickel, LED medallions	15"
BB102280A-CK	1	Milano tower chrome 1 faucet	10"
BB102290A-CK	1	Milano tower chrome 1 faucet, LED medallion	10"
BB102282A-CK	1	Milano tower black nickel 1 faucet	10"
BB102292A-CK	1	Milano tower black nickel 1 faucet, LED medallion	10"



Black nickel



Beer Systems, Bar Equipment



Advanced Beverage Solutions  
100 Gary Avenue, Suite C  
Roselle, IL 60172

**www.absone.com**  
E-mail: [orders@absone.com](mailto:orders@absone.com)

877-814-2271  
Local: 847-524-1707  
Fax: 847-524-1710

## European Dispensing Towers

All towers are glycol cooled and cold blocked unless specified air cooled. American brass faucets are included. 3/16" 304SS shanks and lines (except Sexy and Lucky air cooled). Gold, PVD, water, cider, wine and combination beer/wine versions of these towers are available upon request. Contact ABS for pricing and lead times.

BB701696 ice tower drain adapter is installed at the base of an ice tower to channel melting ice into the drip tray.



Part Number	Faucets	Description	Drip Tray
BB102060CA-1A	1	Sexy tower 1 faucet chrome air cooled for keg cooler	10"
BB102091A-CK	1	Sexy tower 1 faucet chrome glycol cooled	10"
BB102095A-CK	1	Sexy tower 1 faucet chrome glycol cooled, LED medallion	10"
BB102060CA-2A	2	Sexy tower 2 faucet chrome air cooled for keg cooler	10"
BB102092A-CK	2	Sexy tower 2 faucet chrome glycol cooled	10"
BB102096A-CK	2	Sexy tower 2 faucet chrome glycol cooled, LED medallions	10"
BB102060CA-3A	3	Sexy tower 3 faucet chrome air cooled for keg cooler	15"
BB102093A-CK	3	Sexy tower 3 faucet chrome glycol cooled	15"
BB102097A-CK	3	Sexy tower 3 faucet chrome glycol cooled, LED medallions	15"
BB102094A-CK	4	Sexy tower 4 faucet chrome glycol cooled	15"
BB102098A-CK	4	Sexy tower 4 faucet chrome glycol cooled, LED medallions	15"
BB102095A-ICE	1	Sexy ice tower 1 faucet chrome glycol cooled	10"
BB102061A-ICE	1	Sexy ice tower 1 faucet chrome glycol cooled, LED medallion	10"
BB102096A-ICE	2	Sexy ice tower 2 faucet chrome glycol cooled	10"
BB102062A-ICE	2	Sexy ice tower 2 faucet chrome glycol cooled, LED medallions	10"
BB102097A-ICE	3	Sexy ice tower 3 faucet chrome glycol cooled	15"
BB102063A-ICE	3	Sexy ice tower 3 faucet chrome glycol cooled, LED medallions	15"
BB102098A-ICE	4	Sexy ice tower 4 faucet chrome glycol cooled	15"
BB102064A-ICE	4	Sexy ice tower 4 faucet chrome glycol cooled, LED medallions	15"
BB102077C-CK	1	Super Sexy tower 1 faucet chrome glycol cooled	10"
BB102078C-CK	2	Super Sexy tower 2 faucet chrome glycol cooled	10"
BB102105A-3A	3	Panther tower 3 faucet chrome for Kegerator, air cooled	15"
BB102107A-CK	3	Panther tower 3 faucet chrome, LED medallions	15"
BB102105A-CK	3	Panther tower 3 faucet chrome	15"
BB102110A-CK	4	Panther tower 4 faucet chrome	15"
BB102108A-ICE	3	Panther ice tower 3 faucet chrome, LED medallions	15"
BB102105A-ICE	3	Panther ice tower 3 faucet chrome	15"
BB102110A-ICE	4	Panther ice tower 4 faucet chrome	15"
BB102123A-ICE	1	Lucky ice tower 1 faucet chrome glycol flooded	10"
BB102127A-ICE	2	Lucky ice tower 2 faucet chrome glycol flooded	10"
BB102122C-1A	1	Lucky tower 1 faucet chrome air cooled	10"
BB102122A-CK	1	Lucky tower 1 faucet chrome glycol cooled	10"
BB102123A-CK	1	Lucky tower 1 faucet chrome glycol cooled, LED medallion	10"
BB102122C-2A	2	Lucky tower 2 faucet chrome air cooled	10"
BB102125A-CK	2	Lucky tower 2 faucet chrome glycol cooled	10"
BB102130A-CK	2	Lucky tower 2 faucet chrome glycol cooled, LED medallions	10"
BB102132A-CK	3	Lucky tower 3 faucet chrome glycol cooled	15"
BB102133A-CK	3	Lucky tower 3 faucet chrome glycol cooled, LED medallions	15"

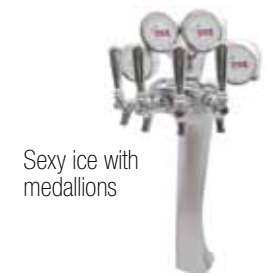



Advanced Beverage Solutions  
100 Gary Avenue, Suite C  
Roselle, IL 60172

**www.absonone.com**  
E-mail: [orders@absonone.com](mailto:orders@absonone.com)

877-814-2271  
Local: 847-524-1707  
Fax: 847-524-1710

## European Dispensing Towers

All towers are glycol cooled and cold blocked unless specified air cooled. American brass faucets are included. 3/16" 304SS lines and 304SS shanks. Gold, PVD, water, cider, wine and combination beer/wine versions of these towers are available upon request. Contact ABS for pricing and lead times.

BB701696 ice tower drain adapter is installed at the base of an ice tower to channel melting ice into the drip tray.



BB701696



Shield with medallions



Amsterdam



Tango



Apollo



Concept

Part Number	Faucets	Description	Drip Tray
BB101451A-CK	1	Cobra tower 1 faucet chrome glycol cooled	10"
BB101452A-CK	2	Cobra tower 2 faucet chrome glycol cooled	10"
BB101453A-CK	3	Cobra tower 3 faucet chrome glycol cooled	15"
BB101454A-CK	4	Cobra tower 4 faucet chrome glycol cooled	15"
BB101451A-ICE	1	Cobra ice tower 1 faucet chrome glycol cooled	10"
BB101452A-ICE	2	Cobra ice tower 2 faucet chrome glycol cooled	10"
BB101453A-ICE	3	Cobra ice tower 3 faucet chrome glycol cooled	15"
BB101454A-ICE	4	Cobra ice tower 4 faucet chrome glycol cooled	15"
BB102113AC-CK	1	Shield tower 1 faucet chrome glycol cooled lit teardrop	10"
BB102114AC-CK	2	Shield tower 2 faucet chrome glycol cooled lit teardrop	10"
BB102116AC-CK	2	Shield tower 2 faucet chrome glycol cooled lit teardrop, LED medallions	10"
BB102115AC-CK	3	Shield tower 3 faucet chrome glycol cooled lit teardrop	15"
BB102117AC-CK	3	Shield tower 3 faucet chrome glycol cooled lit teardrop, LED medallions	15"
BB102113A-ICE	1	Shield ice tower 1 faucet chrome glycol cooled lit teardrop	10"
BB102114A-ICE	2	Shield ice tower 2 faucet chrome glycol cooled lit teardrop	10"
BB102350A-CK	1	Amsterdam tower chrome 1 faucet glycol cooled	10"
BB102355A-CK	2	Amsterdam tower chrome 2 faucet glycol cooled	10"
BB102346A-CK	1	Tango tower chrome 1 faucet glycol cooled, 82 mm LED medallion	10"
BB102364A-CK	1	Apollo tower chrome 1 faucet, oval 82 mm LED medallion	10"
BB102340AB-CK	1	Concept tower SS with blue accent 1 faucet glycol cooled, embedded LED medallion	10"
BB102340AG-CK	1	Concept tower SS with green accent 1 faucet glycol cooled, embedded LED medallion	10"
BB102340AR-CK	1	Concept tower SS with red accent 1 faucet glycol cooled, embedded LED medallion	10"

*See page 22 for custom graphics lead times*

## Custom Branded and Designed Towers

Part Number	Description
CUSTBRANDDISP	Custom branded beverage dispenser
PADPRINT	Custom pad printing on beer dispensing tower
CUSTTOWER	Custom branded tower designed to your specifications (TV tower shown)



CUSTBRANDDISP



PADPRINT



CUSTTOWER

Beer Systems, Bar Equipment



Advanced Beverage Solutions  
100 Gary Avenue, Suite C  
Roselle, IL 60172

[www.absone.com](http://www.absone.com)  
E-mail: [orders@absone.com](mailto:orders@absone.com)

877-814-2271  
Local: 847-524-1707  
Fax: 847-524-1710

## Column Dispensing Towers

All towers are glycol cooled and cold blocked unless specified air cooled. American faucets are included. 3/16" restrictor lines. Premium column towers are 100% 304 stainless steel. Decal disks optional. Water, cider and wine versions of these towers are available upon request. Contact ABS for pricing and lead times.

Part Number	Faucets	Description	Drip Tray
BB101402CBS-CK	1	Premium 3" column tower 1 faucet brushed SS	10"
BB101406CBS-CK	2	Premium 3" column tower 2 faucet brushed SS	10"
BB101419CBS-CK	3	Premium 3" column tower 3 faucet brushed SS	15"
BB101402CBS	1	Premium 3" column tower 1 faucet brushed SS air cooled	10"
BB101406CBS	2	Premium 3" column tower 2 faucet brushed SS air cooled	10"
BB101419CBS	3	Premium 3" column tower 3 faucet brushed SS air cooled	15"
BB125402C-CK	1	Premium 3" column tower 1 faucet brushed SS, beer or cider	10"
BB125406C-CK	2	Premium 3" column tower 2 faucet brushed SS, beer or cider	10"
BB125419C-CK	3	Premium 3" column tower 3 faucet brushed SS, beer or cider	15"
BB125402C	1	Premium 3" tower 1 faucet brushed SS, beer or cider air cooled	10"
BB125406C	2	Premium 3" tower 2 faucet brushed SS, beer or cider air cooled	10"
BB125419C	3	Premium 3" tower 3 faucet brushed SS, beer or cider air cooled	15"
BB101402-CK	1	3" Column tower 1 faucet chrome, vinyl tubing	10"
BB101406-CK	2	3" Column tower 2 faucet chrome, vinyl tubing	10"
BB101419-CK	3	3" Column tower 3 faucet chrome, vinyl tubing	15"
BB101402	1	3" Column tower 1 faucet chrome, vinyl tubing air cooled	10"
BB101406	2	3" Column tower 2 faucet chrome, vinyl tubing air cooled	10"
BB101419	3	3" Column tower 3 faucet chrome, vinyl tubing air cooled	15"
BB101404	1	3" Column tower 1 faucet chrome, SS tubing, air cooled	10"
BB101408	2	3" Column tower 2 faucet chrome, SS tubing, air cooled	10"
BB103502-C	1	3" Column 1 faucet chrome, vinyl tubing, air cooled, lit 80 mm medallion	10"
BB103392-C	1	3" Column 1 faucet chrome, air cooled, 1-side non-lit medallion	10"
BB103396-C	2	3" Column 2 faucet chrome, air cooled, 1-side non-lit medallion	10"
BB103398-C	3	3" Column 3 faucet chrome, air cooled, 1-side non-lit medallion	15"
BB101412C-CK	3	4" Column tower polished SS, 3 faucets, vinyl tubing	15"
BB101422C-CK	4	4" Column tower polished SS, 4 faucets, vinyl tubing	15"
BB101412SS-CK	3	4" Column tower brushed SS, 3 faucets, vinyl tubing	15"
BB101422SS-CK	4	4" Column tower brushed SS, 4 faucets, vinyl tubing	15"
BB101412-C	3	4" Column tower 3 faucet polished SS, vinyl tubing, air cooled	15"
BB101422-C	4	4" Column tower 4 faucet polished SS, vinyl tubing, air cooled	15"
BB101412-SS	3	4" Column tower 3 faucet brushed SS, vinyl tubing, air cooled	15"
BB101422-SS	4	4" Column tower 4 faucet brushed SS, vinyl tubing, air cooled	15"
CUSTWRAPTOWER		Custom branded wrapped column towers	



Custom branded wrapped towers

## 3" Column Tower Accessories

Part Number	Description
BB101397-1	Add 1 tap to a 2 tap 3" tower, chrome
BB101397-2	Add 2 taps to a 1 tap 3" tower, chrome
BB101398	Add 1 tap to a 1 tap 3" tower, chrome





Advanced Beverage Solutions  
100 Gary Avenue, Suite C  
Roselle, IL 60172

[www.absonone.com](http://www.absonone.com)  
E-mail: [orders@absonone.com](mailto:orders@absonone.com)

877-814-2271  
Local: 847-524-1707  
Fax: 847-524-1710

## Clamp-On Dispensing Towers

All towers are glycol cooled and cold blocked unless specified air cooled. American faucets are included. 3/16" restrictor lines. Gold, PVD, water, cider and wine versions of these towers are available upon request. Contact ABS for pricing and lead times.

Part Number	Faucets	Description
BB103121CC	1	3" Cylinder tower 1 faucet chrome with chrome clamp-on bracket & drip tray
BB103122CC	2	3" Cylinder tower 2 faucet chrome with chrome clamp-on bracket & drip tray
BB103126CC	3	3" Cylinder tower 3 faucet chrome with chrome clamp-on bracket & drip tray
BB103171ACC	1	Mongoose tower chrome 1 US faucet with chrome clamp-on bracket & drip tray
BB103173ACC	2	Mongoose tower chrome 2 US faucets with chrome clamp-on bracket & drip tray
BB103191ACC	1	Sexy tower chrome 1 US faucet with chrome clamp-on bracket & drip tray
BB103193ACC	2	Sexy tower chrome 2 US faucet with chrome clamp-on bracket & drip tray

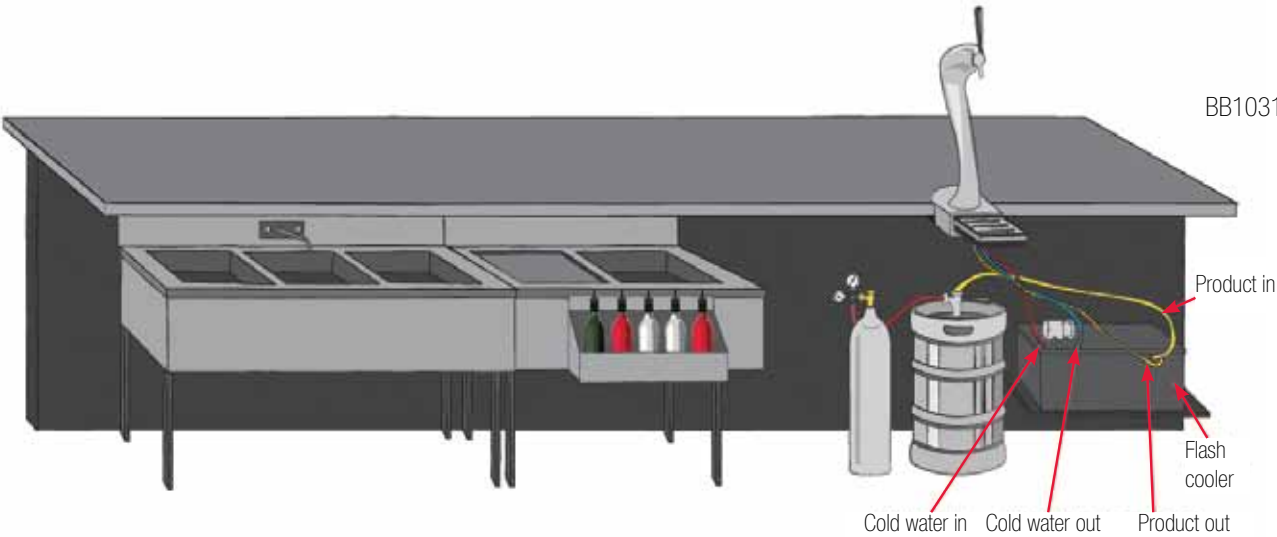

Beer Systems, Bar Equipment

## Kegeator Dispensing Towers

All towers are air cooled, have high polish chrome finish, American brass faucets and short center bolt to mount on kegeator.

Part Number	Faucets	Description
BB102060CA-1A	1	Sexy tower 1 faucet chrome air cooled
BB102060CA-2A	2	Sexy tower 2 faucet chrome air cooled
BB102060CA-3A	3	Sexy tower 3 faucet chrome air cooled
BB102122C-1A	1	Lucky tower 1 faucet chrome air cooled
BB102122C-2A	2	Lucky tower 2 faucet chrome air cooled
BB102105A-3A	3	Panther tower 3 faucet chrome air cooled
BB102140A-1A	1	Mongoose tower 1 faucet chrome air cooled
BB102150A-2A	2	Mongoose tower 2 faucet chrome air cooled







Advanced Beverage Solutions  
 100 Gary Avenue, Suite C  
 Roselle, IL 60172

[www.absone.com](http://www.absone.com)  
 E-mail: [orders@absone.com](mailto:orders@absone.com)

877-814-2271  
 Local: 847-524-1707  
 Fax: 847-524-1710

## American Box Dispensing Towers

All towers include American faucets.

Part Number	Faucets	Description	Drip Tray
82-4585	2	T box tower 2 faucet SS glycol cooled	10"
82-4586	3	T box tower 3 faucet SS glycol cooled	10"
82-4587	4	T box tower 4 faucet SS glycol cooled	15"
82-4588	5	T box tower 5 faucet SS glycol cooled	15"
82-4589	6	T box tower 6 faucet SS glycol cooled	20"
82-4590	8	T box tower 8 faucet SS glycol cooled	24"
82-4579	2	T box tower 2 faucet SS air cooled	10"
82-4580	3	T box tower 3 faucet SS air cooled	10"
82-4581	4	T box tower 4 faucet SS air cooled	15"
82-4582	5	T box tower 5 faucet SS air cooled	15"
82-4583	6	T box tower 6 faucet SS air cooled	20"
82-4584	8	T box tower 8 faucet SS air cooled	24"
82-4600	6	Pass Thru box tower 6 faucet SS glycol cooled	24"
82-4601	8	Pass Thru box tower 8 faucet SS glycol cooled	30"
82-4602	10	Pass Thru box tower 10 faucet SS glycol cooled	36"
82-4603	12	Pass Thru box tower 12 faucet SS glycol cooled	42"
82-4604	14	Pass Thru box tower 14 faucet SS glycol cooled	48"
82-4605	16	Pass Thru box tower 16 faucet SS glycol cooled	54"
82-4606	18	Pass Thru box tower 18 faucet SS glycol cooled	60"
82-4607	20	Pass Thru box tower 20 faucet SS glycol cooled	66"
82-4608	24	Pass Thru box tower 24 faucet SS glycol cooled	78"
82-4591	6	Pass Thru box tower 6 faucet SS air cooled	24"
82-4592	8	Pass Thru box tower 8 faucet SS air cooled	30"
82-4593	10	Pass Thru box tower 10 faucet SS air cooled	36"
82-4594	12	Pass Thru box tower 12 faucet SS air cooled	42"
82-4595	14	Pass Thru box tower 14 faucet SS air cooled	48"
82-4596	16	Pass Thru box tower 16 faucet SS air cooled	54"
82-4597	18	Pass Thru box tower 18 faucet SS air cooled	60"
82-4598	20	Pass Thru box tower 20 faucet SS air cooled	66"
82-4599	24	Pass Thru box tower 24 faucet SS air cooled	78"
82-4611	16	Dual side box tower 16 faucet SS glycol	(2) 30"
82-4612	18	Dual side box tower 18 faucet SS glycol	(2) 36"
82-4613	20	Dual side box tower 20 faucet SS glycol	(2) 36"
82-4614	24	Dual side box tower 24 faucet SS glycol	(2) 42"
82-4615	28	Dual side box tower 28 faucet SS glycol	(2) 48"
82-4616	32	Dual side box tower 32 faucet SS glycol	(2) 54"
82-4617	40	Dual side box tower 40 faucet SS glycol	(2) 66"
82-4618	48	Dual side box tower 48 faucet SS glycol	(2) 78"



T Box



T Box



Pass Thru



Pass Thru



Dual Side Pass Thru



## Under Bar and Wall Mount Dispensers

All dispensers have an attached drip tray. Air cooled under bar dispensers have a 3" OD brass tube 6" long attached to the bottom of the box for easy hook up to the flex pipe. Wall mount boxes are offset 1/2" from the top of the tray so when mounted the tray will be flush mounted to the wall.

8 and 10 faucet dispensers have 2 tubes for pass thru air flow. Box and drip tray are 16 gauge SS with attached 14 gauge SS bracket that wraps around and under the box. Faucets and 6' of tubing are included.

Part Number	Description
BB103614-03	Underbar 14" Space-Mizer dispenser 3 faucets air cooled
BB103614-03CK	Underbar 14" Space-Mizer dispenser 3 faucets glycol cooled
BB103614-04	Underbar 14" Space-Mizer dispenser 4 faucets air cooled
BB103614-04CK	Underbar 14" Space-Mizer dispenser 4 faucets glycol cooled
BB103620-05	Underbar 20" Space-Mizer dispenser 5 faucets air cooled
BB103620-05CK	Underbar 20" Space-Mizer dispenser 5 faucets glycol cooled
BB103620-06	Underbar 20" Space-Mizer dispenser 6 faucets air cooled
BB103620-06CK	Underbar 20" Space-Mizer dispenser 6 faucets glycol cooled
BB103720-04CK	Underbar 20" cabinet dispenser with drip tray, 4 faucets, glycol cooled
BB103720-05CK	Underbar 20" cabinet dispenser with drip tray, 5 faucets, glycol cooled
BB103720-06CK	Underbar 20" cabinet dispenser with drip tray, 6 faucets, glycol cooled
BB103730-08CK	Underbar 30" cabinet dispenser with drip tray, 8 faucets, glycol cooled
BB103740-10CK	Underbar 40" cabinet dispenser with drip tray, 10 faucets, glycol cooled
BB103740-12CK	Underbar 40" cabinet dispenser with drip tray, 12 faucets, glycol cooled



Space Mizer



Underbar cabinet

## Tower Bolts

Part Number	Description
BB810010	1.5" x 4.33" standard tower bolt for air drawn tower
BB810013	1.5" x 7" extended tower bolt for air drawn tower thru counter top
BB810016	1.5" x 10.95" extended tower bolt for air drawn tower thru counter top
BB810025	1.5" sealing nut for tower bolt
BB810028	1.5" counter nut for tower bolt



Advanced Beverage Solutions  
100 Gary Avenue, Suite C  
Roselle, IL 60172

[www.abstone.com](http://www.abstone.com)  
E-mail: [orders@abstone.com](mailto:orders@abstone.com)

877-814-2271  
Local: 847-524-1707  
Fax: 847-524-1710

## Faucets



Part #	Description
19-0510	Lancer Highlight tap with Fatlock shank and handle
19-0511	Lancer Highlight quick disconnect faucet only
BB101200-SS	TOF 304SS Euro faucet (US)
BB101212	304SS Perlick 630SS faucet w forward seat design
BB101214-SS	Perlick 650SS (304) flow cntl faucet w US threads
BB101218C	European chrome plated tap with black nozzle and shank
BB101218G	European gold plated tap with black nozzle and shank
BB101219C	European chrome plated tap with SS nozzle and shank
BB101219G	European gold plated tap with SS nozzle and shank
BB101220C	European chrome compensator tap with black nozzle & shank
BB101220G	European gold compensator tap with black nozzle & shank
BB101221C	European chrome compensator tap with SS nozzle & shank
BB101221G	European gold compensator tap with SS nozzle & shank
BB101223	Spherix tap with US threads
BB101225	Euro Alpha faucet chrome plated ball valve with SS nozzle
BB101228	Celli 304SS compensator tap gold, US threads
BB101229	European compensator tap chrome, fits US coupling nut
BB101231	QUIX tap with compensator
BB101232	QUIX tap
BB101233-55	European tap US threads gold plated with SS nozzle w shank
BB101234	European tap US threads chrome w SS nozzle no shank
BB101234-55	European tap US threads chrome w SS nozzle w shank
BB101236	Burgundy wine faucet with chrome nozzle
BB101236HD	Burgundy wine faucet w chrome nozzle & chrome tap handle
BB101237	Black faucet with chrome nozzle
BB101239	White wine faucet with chrome nozzle
BB101239HD	White wine faucet w chrome nozzle & chrome tap handle
WF099219	Chrome wine faucet with US thread
WF099227	Chrome wine faucet with flow control
WF099260	Chrome Euro wine compensator faucet, fits US coupling nut

Part #	Description
BB101249	Gold plated domestic faucet with brass lever
BB101250	Chrome plated domestic faucet w stainless steel lever
BB101251	Polished brass domestic faucet w stainless steel lever
BB101252	Chrome plated domestic faucet with brass lever
BB101253	Polished brass faucet with brass lever
BB101254	Stout 304 SS faucet free-flow
BB101254-G	Stout faucet gold plated 304 SS free-flow
BF1001	Beer faucet standard brass lever
BF1001SC	Beer faucet standard brass lever, self closing
BF1002	Beer faucet standard SS lever
BF1002SC	Beer faucet standard SS lever, self closing
BF1002SC-SS	Beer faucet SS body and lever, self closing
BF1002SS	Beer faucet SS body and lever, USA
BF1003	Beer faucet brass body and lever
BF1004	Beer faucet brass plated with SS lever
BFE3000	Euro faucet w shank, gold, flow control, self closing, SS spout
BFE3001	Euro faucet w shank, chrome, flow control, self closing, SS spout
70102-01	Lever standard beer faucet thread 3/8" -16 UNC
BB101248	303 SS standard beer faucet thread 3/8" -16 UNC
C257	Stout faucet, chrome plated brass
SF2000	Stout faucet, brass
SF2001	Stout faucet, chrome
5702625	Stout beer tap, stainless steel
520400S	Stout beer faucet, SS body, LE
CPP525PC	Perlick standard chrome plated beer faucet
CPP525SSTF	Perlick stainless steel beer faucet with tarnish free brass exterior
CPP545PC	Perlick flow control faucet
CPP575SS	Perlick stainless steel creamer faucet
CUSTFAUCET	Custom branded faucet



Advanced Beverage Solutions  
100 Gary Avenue, Suite C  
Roselle, IL 60172

**www.absonone.com**  
E-mail: [orders@absonone.com](mailto:orders@absonone.com)

877-814-2271  
Local: 847-524-1707  
Fax: 847-524-1710

**Unbranded Faucet Handles**

*See page 22 for custom graphics lead times*



Part #	Description
A-100	Ceramic tap handle without logo
A105	Ceramic tap handle A105, branded or blank
A107	Ceramic tap handle A107, branded or blank
A114	Ceramic tap handle A114, branded or blank
A151	Ceramic tap handle A151, branded or blank
A157	Ceramic tap handle A157, branded or blank
A171	Ceramic tap handle A171, branded or blank
A36	Ceramic tap handle A36, branded or blank
A54	Ceramic tap handle A54, branded or blank
A-57	Ceramic tap handle without logo
A-65	Ceramic tap handle without logo
A86	Ceramic tap handle A86, branded or blank
A99	Ceramic tap handle A99, branded or blank
BB100301-B	European black plastic tap handle
BB100301-C	European chrome plastic tap handle
BB101255	Plastic tap handle 2-5/8" black
BB101258	European chrome metal tap handle
BB101258-B	Plastic tap handle black
BB101259-B	VS clear tap handle with black base
BB101260	Chrome metal tap handle
BB101260-XL	Economical lightweight chrome metal tap handle
BB101261-BLK	Plastic tap handle 3-1/4" black
BB101261-CHR	Plastic tap handle 3-1/4" chrome
BB101261-GLD	Plastic tap handle 3-1/4" gold
C120	Beer faucet knob ball standard
C128	2" faucet handle extension
C129	Faucet handle angler/tilter for vertical position handles, chrome plated brass

Part #	Description
C184	Beer faucet handle std brass inserts thread 3/8"-16 UNC
C185	Beer faucet handle standard chrome plated brass
C186	Plastic knob, no brass insert
C190	Beer faucet extended handle standard chrome
C241	Finial standard tap handle
C242	Finial standard tap handle
C243	Ferrule beer tap handle
C244	Ferrule beer tap handle
C528	1" faucet handle extension, chrome
C680	Pub style handle, navy blue
C681	Pub style handle, white
C682	Pub style handle, red
C683	Pub style handle, black
C684	Pub style handle, green
C685	Pub style handle, yellow

*Some pictures are shown on the next page*

**Beer Systems, Bar Equipment**



Advanced Beverage Solutions  
100 Gary Avenue, Suite C  
Roselle, IL 60172

[www.abstone.com](http://www.abstone.com)  
E-mail: [orders@abstone.com](mailto:orders@abstone.com)

877-814-2271  
Local: 847-524-1707  
Fax: 847-524-1710

## Unbranded Faucet Handles

See page 22 for custom graphics lead times



Part #	Description
C690	Mini pub style handle, navy blue
C691	Mini pub style handle, white
C692	Mini pub style handle, red
C693	Mini pub style handle, black
C694	Mini pub style handle, green
C695	Mini pub style handle, yellow
C688	Finial top hat, polished brass
C689	Finial top hat, chrome
C686	Ferrule, large, for beer faucet, chrome plated brass
C687	Ferrule, large, for beer faucet, polished brass
C709	Disc ferrule - topper, chrome, screws on handle
C829	Faucet handle angler/filter for vertical handles, pol. brass
CPTA100B	Ceramic tap handle rectangular black
CPTA100R	Ceramic tap handle rectangular red
CPTA100W	Ceramic tap handle rectangular white
CPTA113B	Ceramic tap handle twirled black
CPTA113R	Ceramic tap handle twirled red
CPTA113W	Ceramic tap handle twirled white
CPTA57B	Ceramic tap handle shielded pub style black
CPTA57R	Ceramic tap handle shielded pub style red
CPTA57W	Ceramic tap handle shielded pub style white
CPTA5B	Ceramic tap knob oval black
CPTA5R	Ceramic tap knob oval red
CPTA5W	Ceramic tap knob oval white
X898798-BG	Black Tobie handle with gold fitting
X898798-WG	White Tobie handle with gold fitting
X898799-B	Black Tobie handle with chrome fitting
X898799-W	White Tobie handle with chrome fitting

Part #	Description
X920201	White large pub handle with chrome fittings
X920201-OS	White large pub handle with chrome oval shield and chrome fittings
X920201-RT	White large pub handle with chrome round top and chrome base
X920202	Black large pub handle with chrome fittings
X920202-OS	Black large pub handle with chrome oval shield and chrome fittings
X920202-RT	Black large pub handle with chrome round top and chrome base
X920203	White large pub handle with gold fittings
X920203-OS	White large pub handle with gold oval shield and gold fittings
X920203-RT	White large pub handle with gold round top and gold base
X920204	Black large pub handle with gold fittings
X920204-OS	Black large pub handle with gold oval shield & gold fittings
X920204-RT	Black large pub handle with gold round top and gold base
X920210B	Black round conical handle with chrome fittings
X920210B-G	Black round conical handle with gold fittings
X920210W	White round conical handle with chrome fittings
X920210W-G	White round conical handle with gold fittings
X920212B	Black oval conical handle with chrome fittings
X920212B-G	Black oval conical handle with gold fittings
X920212W	White oval conical handle with chrome fittings
X920212W-G	White oval conical handle with gold fittings
X920214B	Black paddle conical handle with chrome fittings
X920214B-G	Black paddle conical handle with gold fittings
X920214W	White paddle conical handle with chrome fittings
X920214W-G	White paddle conical handle with gold fittings



Advanced Beverage Solutions  
100 Gary Avenue, Suite C  
Roselle, IL 60172

**www.abstone.com**  
E-mail: [orders@abstone.com](mailto:orders@abstone.com)

877-814-2271  
Local: 847-524-1707  
Fax: 847-524-1710

### Custom Branded Faucet Handles



Part #	Description
SHOTGUN	Custom branded Shotgun tap handle
TOBIE	Custom branded Tobie tap handle
ERGONOMICAL	Custom branded Ergonomical tap handle
SMALLPUB	Custom branded Small Pub tap handle
LARGE PUB	Custom branded Large Pub tap handle
LG PUB SHIELD	Custom branded Large Pub Shield tap handle
CONFLATTOP	Custom branded conical with flat top tap handle
CONROUNDTOP	Custom branded conical with round top tap handle

Custom Graphics	Qty	Lead Time
Tap Handles, UV Printed	1-19	7 days
	20-49	10 days
	50-99	12 days
	100+	Confirmation
Tap Handles, Pad Printing	100+	Confirmation
	1-199	7 days
Medallions, 60, 80 & 82mm	200-499	10 days
	500 +	Confirmation
Shield Teardrop Plaques	1-99	7 days
	100+	Confirmation

### Custom Branded Medallions



X900220



Custom branded medallions

Part #	Description
X900206	Custom branded round fish-eye medallion 60mm diameter with 2 small tabs
X900210	Custom branded round fish-eye medallion 80mm diameter with 4 small tabs
X900215	Custom branded Shield tower medallion
X900220	Custom branded round fish-eye medallion 82mm diameter
X900223-OVAL	Custom branded oval medallion
X900500	Custom branded lit dome fits 80 and 82mm LED medallion holders

X900215



Shield tower

Beer Systems, Bar Equipment



Advanced Beverage Solutions  
100 Gary Avenue, Suite C  
Roselle, IL 60172

**www.absonone.com**  
E-mail: [orders@absonone.com](mailto:orders@absonone.com)

877-814-2271  
Local: 847-524-1707  
Fax: 847-524-1710

**Unbranded Medallions**

*See page 22 for custom graphics lead times*



Part #	Description
BB501200C	Chrome nickel 3 way round medallion holder assy
BB501220C	Chrome nickel 4 way round medallion holder assy
BB501113C	Chrome oval horizontal extra tall medallion holder
BB501110C	Chrome oval horizontal short medallion holder
BB501112C	Chrome oval horizontal tall medallion holder
BB501108C	Chrome oval vertical extra tall medallion holder
BB501100	Chrome oval vertical medallion holder w angled support
BB501105C	Chrome oval vertical short medallion holder
BB501107C	Chrome oval vertical tall medallion holder
BB501131C	Chrome round extra tall medallion holder
BB501320C	Chrome round faucet mount medallion holder
BB501101C	Chrome round medallion holder with angled support
BB501170	Chrome round medallion holder with screw for face mount applications
BB501125C	Chrome round short medallion holder
BB501130C	Chrome round tall medallion holder
BB201220G	Gold nickel 4 way round medallion holder assembly
BB501200G	Gold nickel 3 way round medallion holder assembly
BB501113G	Gold oval horizontal extra tall medallion holder
BB501110G	Gold oval horizontal short medallion holder
BB501112G	Gold oval horizontal tall medallion holder
BB501108G	Gold oval vertical extra tall medallion holder
BB501105G	Gold oval vertical short medallion holder
BB501107G	Gold oval vertical tall medallion holder
BB501131G	Gold round extra tall medallion holder
BB501101G	Gold round medallion holder with angled support
BB501125G	Gold round short medallion holder
BB501130G	Gold round tall medallion holder

Part #	Description
BB501200B	Black nickel 3 way round medallion holder assembly
BB501220B	Black nickel 4 way round medallion holder assembly
BB501113B	Black nickel oval horizontal extra tall medallion holder
BB501110B	Black nickel oval horizontal short medallion holder
BB501112B	Black nickel oval horizontal tall medallion holder
BB501108B	Black nickel oval vertical extra tall medallion holder
BB501105B	Black nickel oval vertical short medallion holder
BB501107B	Black nickel oval vertical tall medallion holder
BB501131B	Black nickel round extra tall medallion holder
BB501125B	Black nickel round short medallion holder
BB501130B	Black nickel round tall medallion holder
BB103440-BR	3" diameter brass tower cap w 1-side medallion holder
BB103440-C	3" diameter chrome tower cap w 1-side medallion holder
BB103442-BR	3" diameter brass tower cap w 2-side medallion holder
BB103442-C	3" diameter chrome tower cap w 2-side medallion holder
BB103470-C	3" dia, chrome tower cap w 2-side LED medallion holder
X900150	82mm diameter white ceramic medallion
BB502191-PP	Plug & Play chrome female connector
BB502177	Conical support for standard LED medallion holders
BB502182	Double chrome 80mm round LED medallion holder
BB502183PP	Double chrome plug & play LED medallion holder
BB502180	Single chrome 80mm round LED medallion holder
BB502181PP	Single chrome plug & play LED medallion holder
BB501999	Transformer for LED medallion holders
BB502185	Triple chrome 80mm round LED medallion holder
BB502186PP	Triple chrome plug & play LED medallion holder
C390	Brass medallion for chrome plated badge holder
C392	Brass medallion for gold plated badge holder

Beer Systems, Bar Equipment



Advanced Beverage Solutions  
100 Gary Avenue, Suite C  
Roselle, IL 60172

**www.abstone.com**  
E-mail: [orders@abstone.com](mailto:orders@abstone.com)

877-814-2271  
Local: 847-524-1707  
Fax: 847-524-1710

## Shanks

Part #	Finish	Size"	Description
CPSS212	SS	2	Standard shank, 1/4" bore, 304 SS good for wine or beer
CPSS213	SS	3-1/8	Standard shank, 1/4" bore, 304 SS good for wine or beer
CPSS214	SS	4-1/8	Standard shank, 1/4" bore, 304 SS good for wine or beer
CPSS234	SS	5-1/8	Standard shank, 1/4" bore, 304 SS good for wine or beer
C200	Chrome	1-3/4	Nipple shank, 1/4" bore, plastic flange
C318	Chrome	2-3/4	Nipple shank, 1/4" bore, plastic flange
C319	Chrome	3-1/2	Nipple shank, 1/4" bore, plastic flange
C320	Chrome	4-1/2	Nipple shank, 1/4" bore, plastic flange
C327	Chrome	5-1/2	Nipple shank, 1/4" bore, plastic flange
C322	Chrome	2-1/2	Nipple shank, 3/16" bore, plastic flange
C330	Chrome	2-3/4	Nipple shank, 3/16" bore, plastic flange
C323	Chrome	3-1/2	Nipple shank, 3/16" bore, plastic flange
C324	Chrome	4-1/2	Nipple shank, 3/16" bore, plastic flange
C326	Chrome	5-1/2	Nipple shank, 3/16" bore, plastic flange
C300	Chrome	1-3/4	Nipple shank, 3/16" bore, SS flange
C332	Chrome	1-7/8	Elbow nipple shank, 1/4" bore, 304 SS elbow soldered to shank
C328	Chrome	1-7/8	Elbow nipple shank, 3/16" bore, 304 SS elbow soldered to shank
C329	Pol. brass	1-7/8	Elbow nipple shank, 3/16" bore, 304 SS elbow soldered to shank
C331	SS	1-7/8	Elbow nipple shank with TIG welded bend tube for SS faucets
C307	Chrome	2	Elbow nipple compression shank, 1/4" bore, plastic flange
BE-DF2-3		2-1/4	Dual shank
BE-DF4-3		4-1/4	Dual shank
BE-DF6-3		6-1/4	Dual shank
BE-DF8-3		8-1/4	Dual shank
BE-DF10-3		10-1/4	Dual shank
BE-DF12-3		12-1/4	Dual shank
C301	Chrome	2-1/8	Tower/wall shank, 1/4" bore, plastic flange
C302	Chrome	3-1/8	Tower/wall shank, 1/4" bore, plastic flange
C303	Chrome	4-1/8	Tower/wall shank, 1/4" bore, plastic flange
C304	Chrome	5-1/8	Tower/wall shank, 1/4" bore, plastic flange
C305	Chrome	6-1/8	Tower/wall shank, 1/4" bore, plastic flange
C306	Chrome	8-1/8	Tower/wall shank, 1/4" bore, plastic flange
C10301	Chrome	10-1/8	Tower/wall shank, 1/4" bore, plastic flange
C12301	Chrome	12-1/8	Tower/wall shank, 1/4" bore, plastic flange



C311



SHSPMA



C125

Diagram for C125 extra long shank assembly

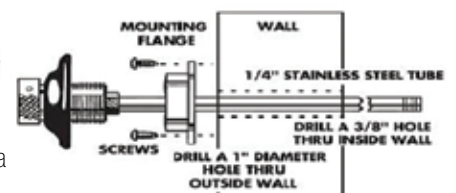





Advanced Beverage Solutions  
100 Gary Avenue, Suite C  
Roselle, IL 60172

**www.abstone.com**  
E-mail: [orders@abstone.com](mailto:orders@abstone.com)

877-814-2271  
Local: 847-524-1707  
Fax: 847-524-1710

## Shanks



Part #	Finish	Size"	Description
S301	SS	2-1/8	Tower/wall shank, 1/4" bore, SS flange
S302	SS	3-1/8	Tower/wall shank, 1/4" bore, SS flange
S303	SS	4-1/8	Tower/wall shank, 1/4" bore, SS flange
S304	SS	5-1/8	Tower/wall shank, 1/4" bore, SS flange
S305	SS	6-1/8	Tower/wall shank, 1/4" bore, SS flange
S306	SS	8-1/8	Tower/wall shank, 1/4" bore, SS flange
S10301	SS	10-1/8	Tower/wall shank, 1/4" bore, SS flange
S12301	SS	12-1/8	Tower/wall shank, 1/4" bore, SS flange
C312	Chrome	2-1/8	Tower/wall shank, 3/16" bore, plastic flange
C313	Chrome	3-1/8	Tower/wall shank, 3/16" bore, plastic flange
C314	Chrome	4-1/8	Tower/wall shank, 3/16" bore, plastic flange
C315	Chrome	5-1/8	Tower/wall shank, 3/16" bore, plastic flange
C316	Chrome	6-1/8	Tower/wall shank, 3/16" bore, plastic flange
C317	Chrome	8-1/8	Tower/wall shank, 3/16" bore, plastic flange
C10311	Chrome	10-1/8	Tower/wall shank, 3/16" bore, plastic flange
C12311	Chrome	12-1/8	Tower/wall shank, 3/16" bore, plastic flange
S312	SS	2-1/8	Tower/wall shank, 3/16" bore, SS flange
S313	SS	3-1/8	Tower/wall shank, 3/16" bore, SS flange
S314	SS	4-1/8	Tower/wall shank, 3/16" bore, SS flange
S315	SS	5-1/8	Tower/wall shank, 3/16" bore, SS flange
S316	SS	6-1/8	Tower/wall shank, 3/16" bore, SS flange
S317	SS	8-1/8	Tower/wall shank, 3/16" bore, SS flange
S10311	SS	10-1/8	Tower/wall shank, 3/16" bore, SS flange
S12311	SS	12-1/8	Tower/wall shank, 3/16" bore, SS flange
C125	Chrome	24	Extra long shank assy, 3/16" bore
C300A	Chrome	1-3/4	C300 shank only, no parts, 3/16" bore SS flange, nipple adds 1/2"
C311		1-5/8	Thread-in shank (replacement for Perlick towers)
CPC300.10	Chrome	1	1" shank extension - extends faucet out by 1"
CPC300.20	Pol. brass	1	1" shank extension - extends faucet out by 1"
CPC328.2			Lock nut for column shank (replacement part)
CPC300.12			Shank flanged lock nut (replacement part)
CPC300.11			Shank plastic flange (replacement part)
CPC300.12			Shank sleeve (replacement part)
C328.1			Shank snap ring (replacement part)
C328.1	Chrome		Flange for 3" column shank
C126	Brass		Locking flange for wall shank assy
C127	SS		Stainless steel flange (replacement part)
4346F	SS		Flange for std. shank
P1702	Plastic		Plastic Flange
4330	NP		Sleeve, nickel plated
4328			Lock ring for beer shank
SHSPMA			SPM shank and cold block assembly
C228	Brass		Cold block, fits 7/8" shank





Advanced Beverage Solutions  
100 Gary Avenue, Suite C  
Roselle, IL 60172

**www.abstone.com**  
E-mail: [orders@abstone.com](mailto:orders@abstone.com)

877-814-2271  
Local: 847-524-1707  
Fax: 847-524-1710

## Faucet Parts and Accessories

Part #	Description
BB101342	Euro flow control adapter connects to std US shank
4332	Coupling nut with knurl for standard faucet
4350	Spanner wrench no grip
4350S	Spanner wrench with black grip
70104	Ball washer
70105	Knob lever collar, chrome plated
70106	Knob lever collar, gold plated
70107	Faucet O-ring (body gasket)
70108	Friction washer
70109	Chrome faucet coupling nut
70110	Valve shaft seat
70380	Spanner wrench with red handle
01-2953	Faucet coupling nut
4350S	Spanner wrench with black grip
4353N-1	Faucet coupling nut
70103-04	Shaft assembly with seat for faucet
70166-01	Friction bonnet
81-0681	C spanner Grundy
BB101254-25	Stout faucet creamer plate .25mm
BB101254-BD	Stout faucet diaphragm
BB101254DS	Stout faucet creamer plate .30mm
BB101254FS	Stout faucet flow straightener
BB101254OR	Stout faucet BS 013 O-ring
BB101259-KIT	Stout faucet nozzle kit
BB101725	Euro faucet wrench
BB101727	6 in 1 Perlick combination wrench
BB700405	Metal slide-on faucet lock
BB700407	Black faucet lock Celli (US)
BB700415	Perlick faucet lock
BB700420	Stout faucet lock - padlock not included
BF1000SC-Kit	Retro kit - convert standard faucet to self closing

Part #	Description
C109	Adapter to connect faucet and quick disconnect
C119	Chrome faucet coupling nut
C123	Wrench, faucet
C130	Faucet plug seals shank when faucet is removed
CP101550	Beer faucet spout plug, box of 100
C187	Wrench, faucet
C201.20	Faucet shaft assembly (CP brass)
C201.40	Faucet friction washer
C201.50	Faucet friction ring
C226	Beer faucet spout extension
C227	Beer faucet SS spout extension converts US faucet to European faucet
C230	Stainless steel faucet lever
C239	Wrap around faucet lock
C245	Brass faucet lever
C257.04	Stout faucet sliding cap
C257.05	Stout faucet O-ring 17 x 25 (sliding cap)
C257.14	Stout faucet O-ring 10 x 2 (for nozzle)
C257.15	Stout faucet jet disk (restrictor plate)
C257.16	Stout faucet regulation core
C284	Brass insert for plastic knobs
C419	Brass faucet coupling nut
CP101525	Faucet hygiene plug
C696	Tap handle bolt 1-1/2" long
D4740-W	Wrench set for draft towers, side and center access, 1-1/16 x 1"
FT8612	Wrench, probe and beer hex nut
M34	Faucet body back gasket





## Drip Trays

### Part Number Description

#### Lancer Flooded Tower Stainless Steel Drip Trays - resin filled

23-1586	Lancer tower drip tray 16" L x 14" D
23-1581	Lancer tower drip tray 21.5" L x 14" D
23-1582	Lancer tower drip tray 30" L x 14" D
23-1585	Lancer tower drip tray 35.5" L x 14" D
23-1587	Lancer tower drip tray 43.5" L x 14" D
23-1600	Lancer tower drip tray 55.5" L x 14" D
23-1601	Lancer tower drip tray 71.5" L x 14" D

#### Stainless Steel European Drip Trays - with drain, no tower hole

BB700060	Euro drip tray 15.75" L x 15.75" D
BB700061	Euro drip tray 19.75" L x 15.75" D
BB700063	Euro drip tray 27.5" L x 15.75" D

#### Stainless Steel European Drip Trays - with drain, with tower hole

BB700060-1	Euro drip tray 1 tower hole 15.75" x 1-3/16" x 15.75"
BB700060-2	Euro drip tray 2 tower holes 15.75" x 1-3/16" x 15.75"
BB700061-1	Euro drip tray 1 tower hole 19.75" x 1-3/16" x 15.75"
BB700061-2	Euro drip tray 2 tower holes 19.75" x 1-3/16" x 15.75"
BB700061-3	Euro drip tray 3 tower holes 19.75" x 1-3/16" x 15.75"
BB700063-1	Euro drip tray 1 tower hole 27.5" x 1-3/16" x 15.75"
BB700063-2	Euro drip tray 2 tower holes 27.5" x 1-3/16" x 15.75"
BB700063-3	Euro drip tray 3 tower holes 27.5" x 1-3/16" x 15.75"

#### Stainless Steel Countertop Drip Trays - 5.5" depth

30-11592	Surface mount drip tray 8" L x 5.5" D x .75" H
30-11593	Surface mount drip tray 15" L x 5.5" D x .75" H
30-11594	Surface mount drip tray 24" L x 5.5" D x .75" H
30-11595	Surface mount drip tray 30" L x 5.5" D x .75" H
30-11596	Surface mount drip tray 36" L x 5.5" D x .75" H
30-11597	Surface mount drip tray 48" L x 5.5" D x .75" H
30-11598	Surface mount drip tray 60" L x 5.5" D x .75" H

#### Stainless Steel Countertop Drip Trays - 8" depth

30-11599	Surface mount drip tray 8" L x 8" D x .75" H
30-11600	Surface mount drip tray 15" L x 8" D x .75" H
30-11601	Surface mount drip tray 24" L x 8" D x .75" H
30-11602	Surface mount drip tray 30" L x 8" D x .75" H
30-11603	Surface mount drip tray 36" L x 8" D x .75" H
30-11604	Surface mount drip tray 48" L x 8" D x .75" H
30-11605	Surface mount drip tray 60" L x 8" D x .75" H

#### Clamp-on Drip Trays

BB701694	Clamp-on chrome plated tower bracket with 5 holes and drip tray
BB701695	Clamp-on chrome plated tower bracket with drip tray 1 hole
BB701701C	Chrome plated bracket with 10" drip tray for 2/3 faucet Euro tower
BB701702C	Chrome plated bracket w 10" drip tray, 5 holes for 3" column tower
30-11608	Clamp on tower base and drip tray

Other sizes, styles and finishes are available. If you don't find what you're looking for, please call customer service for assistance.

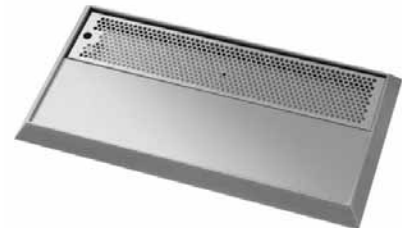

Flooded tower drip tray



Euro drip tray

European drip trays can be ordered with 1 to 4 tower holes, depending on the length of the tray.



Countertop drip tray

BB701699



30-11608



BB701695

Beer tower and faucets not included



## Drip Trays

Part Number	Description
<b>Stainless Steel Countertop Drip Trays with Plastic Insert</b>	
BB700800	Stainless steel drip tray with plastic grid no drain 5-3/8" x 3/4" x 10-3/8"
BB700810	Stainless steel drip tray with plastic grid no drain 5-3/8" x 3/4" x 15"
BB700815	Stainless steel drip tray with plastic grid no drain 5-3/8" x 3/4" x 20"
BB700820	Stainless steel drip tray with plastic grid no drain 5-3/8" x 3/4" x 24"
BB701900	Stainless steel drip tray with plastic grid with drain 5-3/8" x 3/4" x 10-3/8"
BB701910	Stainless steel drip tray with plastic grid with drain 5-3/8" x 3/4" x 15"
BB701915	Stainless steel drip tray with plastic grid with drain 5-3/8" x 3/4" x 20"
BB701920	Stainless steel drip tray with plastic grid with drain 5-3/8" x 3/4" x 24"
<b>Brass Countertop Drip Trays with Plastic Insert</b>	
BB700800B	Brass drip tray with black plastic grid no drain 5-3/8" x 3/4" x 8"
BB700810B	Brass drip tray with black plastic grid no drain 5-3/8" x 3/4" x 15"
BB701900-BR-P	Brass drip tray with black plastic grid with drain 5-3/8" x 3/4" x 8"
BB701912-BR-P	Brass drip tray with black plastic grid with drain 5-3/8" x 3/4" x 15"
BB701920-BR-P	Brass drip tray with black plastic grid with drain 5-3/8" x 3/4" x 24"
<b>Stainless Steel Countertop Drip Trays with Stainless Steel Insert</b>	
BB700795	Stainless steel drip tray with SS insert no drain 5-3/8" x 3/4" x 5"
BB700802	Stainless steel drip tray with SS insert no drain 5-3/8" x 3/4" x 10-3/8"
BB700812	Stainless steel drip tray with SS insert no drain 5-3/8" x 3/4" x 15"
BB700817	Stainless steel drip tray with SS insert no drain 5-3/8" x 3/4" x 20"
BB700822	Stainless steel drip tray with SS insert no drain 5-3/8" x 3/4" x 24"
BB700832	Stainless steel drip tray with SS insert no drain 5-3/8" x 3/4" x 30"
BB701902	Stainless steel drip tray with SS insert with drain 5-3/8" x 3/4" x 10-3/8"
BB701912	Stainless steel drip tray with SS insert with drain 5-3/8" x 3/4" x 15"
BB701917	Stainless steel drip tray with SS insert with drain 5-3/8" x 3/4" x 20"
BB701922	Stainless steel drip tray with SS insert with drain 5-3/8" x 3/4" x 24"
BB701932	Stainless steel drip tray with SS insert with drain 5-3/8" x 3/4" x 30-1/4"
BB701937	Stainless steel drip tray with SS insert with drain 5-3/8" x 3/4" x 33"
BB701942	Stainless steel drip tray with SS insert with drain 5-3/8" x 3/4" x 36"
BB701947	Stainless steel drip tray with SS insert with drain 5-3/8" x 3/4" x 39"
BB701952	Stainless steel drip tray with SS insert with drain 5-3/8" x 3/4" x 45-1/4"
BB701962	Stainless steel drip tray with SS insert with drain 5-3/8" x 3/4" x 51"
BB701967	Stainless steel drip tray with SS insert with drain 5-3/8" x 3/4" x 57"
BB701312	Stainless steel drip tray with SS insert with drain 7" x 7/8" x 12"
BB701316	Stainless steel drip tray with SS insert with drain 7" x 7/8" x 16"
BB701320	Stainless steel drip tray with SS insert with drain 7" x 7/8" x 20"
BB701324	Stainless steel drip tray with SS insert with drain 7" x 7/8" x 24"
BB701330	Stainless steel drip tray with SS insert with drain 7" x 7/8" x 30"
BB701336	Stainless steel drip tray with SS insert with drain 7" x 7/8" x 36"
BB701345	Stainless steel drip tray with SS insert with drain 7" x 7/8" x 45"
BB701351	Stainless steel drip tray with SS insert with drain 7" x 7/8" x 51"
BB701172	Stainless steel drip tray with SS insert with drain 8" x 3/4" x 16"
BB701174	Stainless steel drip tray with SS insert with drain 8" x 3/4" x 20"
BB701175	Stainless steel drip tray with SS insert with drain 8" x 3/4" x 24"
BB701177	Stainless steel drip tray with SS insert with drain 8" x 3/4" x 30"
BB701178	Stainless steel drip tray with SS insert with drain 8" x 3/4" x 33"
BB701180	Stainless steel drip tray with SS insert with drain 8" x 3/4" x 39"
BB701181	Stainless steel drip tray with SS insert with drain 8" x 3/4" x 45"



Stainless drip tray with plastic insert, no drain

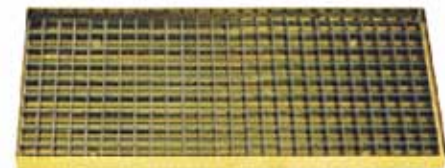

Brass drip tray with plastic insert, no drain



Stainless drip tray with stainless insert



Advanced Beverage Solutions  
100 Gary Avenue, Suite C  
Roselle, IL 60172

[www.abstone.com](http://www.abstone.com)  
E-mail: [orders@abstone.com](mailto:orders@abstone.com)

877-814-2271  
Local: 847-524-1707  
Fax: 847-524-1710

## Drip Trays

Part Number	Description
-------------	-------------

### Stainless Steel European Drip Trays - with rinser, no tower hole

BB700070	Euro rinser drip tray 15.75" L x 15.75" D
BB700071	Euro rinser drip tray 19.75" L x 15.75" D
BB700072	Euro rinser drip tray 23.38" L x 15.75" D
BB700073	Euro rinser drip tray 27.5" L x 15.75" D
BB700076	Euro rinser drip tray 39.5" L x 15.75" D
BB700077	Euro rinser drip tray 46.88" L x 15.75" D

### Stainless Steel European Drip Trays - with rinser, with tower hole(s)

BB700070-1	Euro rinser drip tray 1 tower hole 15.75" x 1-3/16" x 15.75"
BB700070-2	Euro rinser drip tray 2 tower holes 15.75" x 1-3/16" x 15.75"
BB700071-1	Euro rinser drip tray 1 tower hole 19.75" x 1-3/16" x 15.75"
BB700071-2	Euro rinser drip tray 2 tower holes 19.75" x 1-3/16" x 15.75"
BB700071-3	Euro rinser drip tray 3 tower holes 19.75" x 1-3/16" x 15.75"
BB700072-1	Euro rinser drip tray 1 tower hole 23.38" x 1-3/16" x 15.75"
BB700073-1	Euro rinser drip tray 1 tower hole 27.5" x 1-3/16" x 15.75"
BB700073-2	Euro rinser drip tray 2 tower holes 27.5" x 1-3/16" x 15.75"
BB700073-3	Euro rinser drip tray 3 tower holes 27.5" x 1-3/16" x 15.75"
BB700073-4	Euro rinser drip tray 4 tower holes 27.5" x 1-3/16" x 15.75"
BB700076-1	Euro rinser drip tray 1 tower hole 39.5" x 1-3/16" x 15.75"
BB700076-2	Euro rinser drip tray 2 tower holes 39.5" x 1-3/16" x 15.75"
BB700076-3	Euro rinser drip tray 3 tower holes 39.5" x 1-3/16" x 15.75"
BB700076-4	Euro rinser drip tray 4 tower holes 39.5" x 1-3/16" x 15.75"

### Stainless Steel Cut-out Drip Trays - with rinser and cut-out

BB701110-SPRAY	4-1/2" cutout radius, side rinser, 7-1/2" x 7/8" x 15"
BB701125-SPRAY	6-1/4" cutout radius, side rinser, 9" x 7/8" x 18"
BB701150-SPRAY	8-1/4" cutout radius, side rinser, 10" x 7/8" x 19.75"

### Stainless Steel Countertop Drip Trays - with rinser

BB701890-SPRAY	Surface mount drip tray with center rinser 8" x 7/8" x 8"
BB701907-SPRAY	Surface mount drip tray with center rinser 7" x 7/8" x 12"
BB701916-SPRAY	Surface mount drip tray with center rinser 7" x 7/8" x 16"
BB701917-SPRAY	Surface mount drip tray with side rinser 7" x 7/8" x 20"
BB701922-SPRAY	Surface mount drip tray with side rinser 7" x 7/8" x 24"
BB701932-SPRAY	Surface mount drip tray with side rinser 7" x 7/8" x 30"
BB701942-SPRAY	Surface mount drip tray with side rinser 7" x 7/8" x 36"
BB701952-SPRAY	Surface mount drip tray with side rinser 7" x 7/8" x 45"
BB701962-SPRAY	Surface mount drip tray with side rinser 7" x 7/8" x 51"

### Stainless Steel Undercountertop Drip Tray - with rinser

BB101177	Undercounter mount with glass rinser
----------	--------------------------------------

### Rinser Assemblies

BB101179	Glass rinser assembly
BB101179-BLK	Heavy duty glass rinser assembly
BB101178-MTL	Metal spray assembly with vinyl sleeves
82-4572	Heavy duty glass rinser assembly



Euro rinser drip tray



Cut-out drip tray with rinser



Surface mount drip tray with rinser



Undercounter drip tray with rinser



BB101179



BB101179-BLK



82-4572



## Drip Trays

Part Number	Description
<b>Stainless Steel Cut-out Drip Trays</b>	
BB700105	4.5" cutout radius, no drain 7.5" x .88" x 15.5"
BB701110	4.5" cutout radius, with drain 7.5" x .88" x 15"
BB700120	6.25" cutout radius, no drain 9" x .88" x 18"
BB701125	6.25" cutout radius, with drain 9" x .88" x 18"
BB701145	6.5" cutout radius, with drain 10" x .88" x 19.25"
BB701150	8.25" cutout radius, with drain 10" x 1" x 19.75"
BB701221	7.5" cutout radius, with drain 11" x .88" x 24"
BB701713	6.0" cutout radius, with drain 8" x .75" x 14"
BB701718	5.75" cutout radius, with drain 9" x .75" x 18"
BB701719	6.25" cutout radius, with drain 9" x .75" x 19"
<b>Brass Cut-out Drip Trays With Drain</b>	
BB701713BR	6" cutout radius, 8" x 3/4" x 14"
BB701718BR	5-3/4" cutout radius, 9" x 7/8" x 18"
BB701719BR	6-1/4" cutout radius, 9" x 7/8" x 19"
BB701721BR	7-1/2" cutout radius, 11" x 7/8" x 24"
<b>Stainless Steel Wall Mounted Drip Trays</b>	
30-11586	8" L x 6.5" D x 14" H maximum 3 holes
30-11587	15" L x 6.5" D x 14" H maximum 5 holes
30-11588	24" L x 6.5" D x 14" H maximum 8 holes
30-11589	30" L x 6.5" D x 14" H maximum 10 holes
30-11590	36" L x 6.5" D x 14" H maximum 12 holes
30-11591	48" L x 6.5" D x 14" H maximum 15 holes
BB700050	6" x 4" x 5"H, no drain
BB700051-0	8"W x 6-3/8"D x 14"H, with drain no faucet hole
BB700051-1	8"W x 6-3/8"D x 14"H, with drain 1 faucet hole
BB700051-2	8"W x 6-3/8"D x 14"H, with drain 2 faucet holes
BB700051-JB	6" x 6" x 11"H, with drain 1 faucet hole
BB700053-0	12"W x 6-3/8"D x 14"H, with drain no faucet hole
BB700053-1	12"W x 6-3/8"D x 14"H, with drain 1 faucet hole
BB700053-2	12"W x 6-3/8"D x 14"H, with drain 2 faucet holes
BB700053-3	12"W x 6-3/8"D x 14"H, with drain 3 faucet holes
BB700053-4	12"W x 6-3/8"D x 12"H, with drain 4 faucet holes
BB700055-4	16"W x 6-3/8"D x 12"H, with drain 4 faucet holes
BB700055-5	16"W x 6-3/8"D x 12"H, with drain 5 faucet holes
BB700056-6	24"W x 6-3/8"D x 12"H, with drain 6 faucet holes
BB700056-8	24"W x 6-3/8"D x 12"H, with drain 8 faucet holes
BB700057-08	30"W x 6-3/8"D x 12"H, with drain 8 faucet holes
BB700057-10	30"W x 6-3/8"D x 12"H, with drain 10 faucet holes
BB700058-12	36"W x 6-3/8"D x 12"H, with drain 12 faucet holes
BB700059-14	48"W x 6-3/8"D x 12"H, with drain 14 faucet holes

## Drain Fittings and Drip Tray Accessories

Part Number	Description
PM1-2-DK	Drain installation kit
BB101180	Drain nut with 1/2" nipple
BB101184	Drain assembly for True Direct Draw Cabinets
BB101185	Drain flange adaptor with 1/2" angled spout
BB101186	4" Brass drain with lock nut and washer
BB101187	2" Brass drain with lock nut and washer
BB101188	1-1/8" Brass drain with lock nut and washer
C610	Std drain nipple and nut, thread 1/2" BSP
C958	Std drain assy, 3-1/2" long, drain thread 5/8" x 18
C959	Std drain assy, 6" long, drain thread 5/8" x 18
C141	Std drain assy, 8" long, drain thread 5/8" x 18
C954	Drain assembly, 2" long, 1/2" MPT
C955	Drain assembly, 4" long, 1/2" MPT
QD100633	JG 1/2 BSP x 3/8" tube water connection
3998290	1/4" Inline plastic barb shut-off
5740990	3/8" Inline plastic barb shut-off
6885190	1/2" Inline plastic barb shut-off
01752300C	Inline water reg, 50 psi, quick disconnect, no ports
01752302C	Inline water reg, 50 psi, QD, 3/8" hose barbs
01752320C	Inline water reg, 30 psi, quick disconnect, no ports
01752322C	Inline water reg, 30 psi, QD, 3/8" hose barbs





Advanced Beverage Solutions  
100 Gary Avenue, Suite C  
Roselle, IL 60172

**www.absone.com**  
E-mail: orders@absone.com

877-814-2271  
Local: 847-524-1707  
Fax: 847-524-1710

## Lancer Glycol Chillers

The **Siberian Elite** can be located in ambient temperatures, allowing valuable walk-in space to be kept free for product storage. The Siberian Elite's improved technology reduces compressor cycle times by up to 15%, minimizing compressor wear, ensuring a longer life and energy savings. Easy access to the unit via the hinged, removable lid.

### Features

- Rotationally molded inner and outer polyethylene tank offering long life and corrosion resistance
- Tank insulated with environmentally responsible, water blown non-CFC polyurethane insulation
- Air tight design of tank and lid, keeping condensation to a minimum to eliminate dilution of glycol solution
- Tank molded legs allow for easy cleaning under the unit once installed
- Easy installation and service
- Single phase power requirement (220V/60Hz) to operate both refrigeration and pump(s)
- IP56 Electrical connection
- Semi-submersible single phase pumps

### Options

- Single or dual pump options available
- 60 gal/min or 120 gal/min pump as standard. Other options available. POA.
- Refrigeration capacities available in 1-3/4 HP and 2-1/4 HP @ 14oFSSST
- Manifolds complete with back check valves
- Glycol percentage check kit (refractometer)

**Polaris Beer Superchiller™** compact high performance design is an ideal option for smaller venues.

### Features

- Designed to operate in high ambient conditions up to 104°F ambient
- Long lasting stainless steel construction
- Easy to install and service with its fully insulated and sealed tank, a removeable access panel, and fully insulated circulation pump
- On-board electronics will shut the unit down should it overheat, freeze up or develop a glycol leak
- Optional 6" castors



Siberian Elite



Polaris Beer Superchiller

**R404a condensing unit required**

	<b>Siberian Elite 1-3/4 HP</b>	<b>Siberian Elite 2-1/4 HP</b>	<b>Siberian Elite</b>	<b>Siberian Elite</b>	<b>Polaris</b>
<b>Part Number</b>	82-4321	82-4332	82-4697	82-4699	85-3100
<b>Glycol Cap. Gal.</b>	42	42			
<b>BTU</b>	10,243	17,072	27,315	34,144	
<b>Electric</b>	220/60	220/60			
<b>Amps</b>	10	10			
<b>Compressor HP</b>	1-3/4 HP	2-1/4 HP			3/4 HP
<b>Pump Type</b>	SPK 2-11/8	SPK 2-11/8	1 x SPK2-11/8	2 x SPK4-11/8	Grundfos
<b>Thermostat</b>	Electronic	Electronic			
<b>Refrigerant</b>	R404A	R404A	R404A	R404A	
<b>Legs</b>	Molded	Molded			
<b>Size: W x D x H"</b>	22.9 x 22.9 x 47.2	22.9 x 22.9 x 47.2			

<b>Part Number</b>	<b>Description</b>
32L3238-2E	Condensing unit R404a, 11,700 BTU
32L2134-2E	Condensing unit R404a, 17,300 BTU



Beer Systems, Bar Equipment



## Vin Service Glycol Power Packs

ABS offers a powerful tried and true line of Glycol Power Packs from Vin Service that are used the world over. From 35' to 250' you can always depend on our glycol power packs to offer outstanding performance for a cold pour every time.

Rest assured that the Glycol Power Pack line from ABS are ETL approved. This gives you piece of mind that our products have been independently tested and meet global safety standards.

**EXTENDED WARRANTY** - Ask your ABS sales rep about our 4 year compressor extended warranty.

**The Flat** is a great small power pack rated for 35' and perfect for the Craft Brewer who may only have one or two lines on tap. It's also the perfect deck for wine dispensing and icing towers.

**The Super Flat** is by far our best selling power pack. It's tough and affordable making it the right choice to fit your budget. You can also use the Super Flat for wine dispensing and icing towers.

**The GD Series** has established itself as the work horses out in the field. The removable lid makes it easily accessible for maintenance. Single and double pump options.



GD 125  
BB989960



GD 250  
BB989975



Flat  
BB989950



Super Flat  
BB989955

	<b>Flat</b>	<b>Super Flat</b>	<b>GD 125</b>	<b>GD 250</b>
<b>Part Number</b>	<b>BB989950</b>	<b>BB989955</b>	<b>BB989960</b> (1 pump) <b>BB989963</b> (2 pumps)	<b>BB989971</b> (1 pump) <b>BB989975</b> (2 pumps)
Max. distance to tower	35 ft (10 m)	75 ft (23 m)	125 ft (38 m)	250 ft (76 m)
Max. distance to ice tower	10 ft (3 m)	30 ft (9.1m)		
Compressor	1/6 HP - air cooled	1/3 HP - air cooled	1/3 HP - air cooled	1/2 HP - air cooled
Electrical specification	115V 60Hz	115V 60Hz	115V 60Hz	115V 60Hz
Amperage	4A	5.7A	6A	8A
Plug & cord length	5-15P x 6'	5-15P x 6'	5-15P x 6'	5-15P x 6'
Refrigerant	R134a	R404a	R134a	R134a
Chilling capacity	936 BTU/hr (274 W)	1297 BTU/hr (380 W)	3568 BTU/hr (1045 W)	7030 BTU/hr (2060 W)
Bath capacity	3.2 Gal (12 L)	4.5 Gal (17 L)	13.2 Gal (50 L)	13.2 Gal (50 L)
Weight	51 lbs (23 kg)	93 lbs (42 kg)	77 lbs (35 kg)	82 lbs (37 kg)
Operational weight	80 lbs (36 kg)	130 lbs (59 kg)		
Dimensions l x d x h (including pump)	17 x 18 x 14" (432mm x 458mm x 356mm)	25 x 17 x 16" (635mm x 432mm x 406mm)	18 x 18 x 29" (458mm x 458mm x 737mm)	18 x 18 x 29" (458mm x 458mm x 737mm)
Recirculation pump(s)	N/A	N/A	75 GPH (284 LPH)	75 GPH (284 LPH)
Recirculation pump motor(s)	N/A	N/A	1/3hp - 1725 rpm 115V 60Hz 6.5A	1/3hp - 1725 rpm 115V 60Hz 6.5A
Thermostat	Digital	Digital	Digital	Digital
Default temperature setting	26°F (-3.3°C)	26°F (-3.3°C)	26°F (-3.3°C)	26°F (-3.3°C)
Default differential setting	2°	2°	2°	2°
Operational weight 1 pump			205 lbs (93 kg)	210 lbs (95 kg)
Operational weight 2 pumps			220 lbs (100 kg)	225 lbs (102 kg)
Inlet/outlet	1/2" OD push-in fittings	1/2" OD push-in fittings	3/8" (9.5mm) barbs	3/8" (9.5mm) barbs
Approval	ETL Listed	ETL Listed	ETL Listed	ETL Listed





Advanced Beverage Solutions  
100 Gary Avenue, Suite C  
Roselle, IL 60172

**www.abstone.com**  
E-mail: [orders@abstone.com](mailto:orders@abstone.com)

877-814-2271  
Local: 847-524-1707  
Fax: 847-524-1710

## Vin Service Glycol Power Pack 4 Year Extended Compressor Warranty

Part #	Description
875150-04	Flat - BB989950 compressor
875153-04	Super Flat - BB989955 compressor
875159-04	GD 125 single pump - BB989960 compressor
875162-04	GD 125 double pump - BB989963 compressor
875165-04	GD 250 single pump - BB989971 compressor
875168-04	GD 250 double pump - BB989975 compressor

*Glycol trunk line shown on page 39  
Glycol and glycol manifolds are shown on page 37  
Tape insulation is shown on page 51*



GD 250  
BB989971



## Pump Assembly & Parts for GD Power Packs

Part #	Description
BB989860	1/3 HP motor and 75GPH pump complete assembly
MP000485	Rotoflow pump, 75 gph, no barbs
MP000499	Rotoflow pump jacket (foam)
MP000448	Dumper coupling kit
MP000450	Clamp V-band
CO881742	Brass 3/8" MPT x 3/8" barb

*More rotary vane pumps are shown on page 35*



MP000448



MP000499

## Cold Kit Components

Part #	Description
BB431910	3/8" OD ACR copper cooling loop
1007042	SS 3/8" OD Tube Compression x 3/8" Barb
C228	Cold block, fits 7/8" shank



C228



BB996041

## Glycol Power Pack Replacement Parts

Part #	Description
MP000483	50 GPH brass rotary vane pump
MP000485	75 GPH brass rotary vane pump
MP000479	100 GPH brass rotary vane pump w strainer
MP000487	105 GPH brass rotary vane pump
BB996020	Flat - replacement pump
BB996001	Flat - replacement fan & motor
BB996041	Flat - replacement thermostat
BB996075	Flat - replacement probe
BB996061	Flat - 1/6 HP replacement compressor
BB996024	Super Flat - replacement pump
BB996004	Super Flat - replacement fan & motor
BB996075	Super Flat - replacement probe
BB996041	Super Flat - replacement thermostat
BB996067	Super Flat - 1/3 HP replacement compressor
BB996068	GD 125 - 1/3 HP replacement compressor
BB996008	GD 125 - replacement fan motor
BB996075	GD 125 - replacement probe
BB996041	GD 125 - replacement thermostat
BB996071	GD 250 - 1/2 HP replacement compressor
BB996008	GD 250 - replacement fan motor
BB996075	GD 250 - replacement probe
BB996041	GD 250 - replacement thermostat
MP551740	1/3 HP motor with cord for GD125 & 250

Beer Systems, Bar Equipment



Advanced Beverage Solutions  
100 Gary Avenue, Suite C  
Roselle, IL 60172

**www.absone.com**  
E-mail: orders@absone.com

877-814-2271  
Local: 847-524-1707  
Fax: 847-524-1710

## Vin Service Flash Coolers

Install a flash cooler to cool beer, wine, cider, water, juices or soda. Beverage in temperature 77°F, out temperature 42.8°F. John Guest Superseal fittings on page 103 are recommended for stainless steel tubing. Cold kit components are shown on previous page.



BB900205



BB900214



BB900219



BB900222

	<b>Flat</b>	<b>HE60</b>	<b>HE90V</b>	<b>HE120V</b>
<b>Part Number</b>	<b>BB900205</b>	<b>BB900214</b>	<b>BB900219</b>	<b>BB900222 (4 line)</b> <b>BB900224 (6 line)</b>
SS product lines	2	4	4	4/6
Cooling capacity	6.6 gal/hr	15.9 gal/hr	23.8 gal/hr	31.7 gal/hr
Drink rate (6.7 oz)	3/min	5/min	7/min	10/min
Compressor	1/6 HP	1/4 HP	1/3 HP	1/2 HP
Electrical specification	115V 60Hz	115V 60Hz	115V 60Hz	115V 60Hz
Refrigerant	R404a	R404a	R404a	R404a
Chilling capacity	936 BTU/hr (127 W)	1580 BTU/hr (260 W)	1809 BTU/hr (311 W)	2581 BTU/hr (415 W)
Bath capacity	3.2 gal	6.6 gal	9.5 gal	13.2
Ice bank	11 lbs	26 lbs	30 lbs	55 lbs
Weight	50 lbs	74 lbs	77 lbs	77 lbs
Dimensions l x d x h	16 x 16 x 11"	14.2 x 22 x 19.3"	15.4 x 15.4 x 28.4"	17.7 x 17.7 x 31.5"

*Glycol trunk line shown on page 39*  
*Glycol and glycol manifolds are shown on page 37*  
*Tape insulation is shown on page 51*

## Vin Service Flash Cooler Replacement Parts

<b>Part Number</b>	<b>Description</b>
BB996029	Pump assembly for flat flash cooler
BB996033	Pump assembly for HE60 flash cooler
BB996037	Pump assembly for HE90 & HE120 flash coolers
BB996041	Digital thermostat for flash coolers & glycol power packs
BB996045	Ice bank control for flash coolers
BB996075	Probe for digital thermostat - BB996041
BB996010	Fan blade for VS glycol and VS flash chillers
BB996064	1/4 HP R404A compressor for HE60 flash chiller
BB996079	VS probe wire for HE60 / HE90 / HE120





Advanced Beverage Solutions  
100 Gary Avenue, Suite C  
Roselle, IL 60172

**www.abstone.com**  
E-mail: [orders@abstone.com](mailto:orders@abstone.com)

877-814-2271  
Local: 847-524-1707  
Fax: 847-524-1710

### Glycol Power Packs



GD-033



GD-WA-12  
GD-WA-13  
GD-WA-34

Part #	Description
GD-033	Glycol power pack 1/3 HP Totten pump
GD-WA-12	Glycol power pack 1/2 HP standard pump
GD-WA-13	Glycol power pack 1/3 HP standard pump
GD-WA-34	Glycol power pack 3/4 HP standard pump

### Lancer Chiller Plates

Flash chillers ensure your customers will receive an **ICE COLD** beer, glass after glass. They reduce foam waste, retain beer gases, increase customer satisfaction and profit. Suitable for high and low volume, and cider. There are no moving parts, no need for service, and can be installed in small spaces in any position, or retro-fitted in an existing system.

316 grade stainless steel product coils and casing. Aluminum cold plate. Temperature probe housing. 3/8" stainless steel barbed beer connections. 1/2" barbed glycol line connections.



Lancer  
Chiller Plate  
17W x 24.5D x 6"H

Part Number	Description
82-4671	Chiller plate, 6 coil, 3/8" barbs
82-4672	Chiller plate, 8 coil, 3/8" barbs

### Chiller Parts and Accessories



Series 1



Series 2



Series 3



83000184



S48AB88B92P



AO-PUMP-ASSY



Grundfos Pump

Part Number	Description
6000520	Insulation block for Procon pumps
101A050F11AA170	Procon pump brass series 1 (CO1310) 50 GPH, 170 psi
111A100F11AA250	Procon pump brass series 1 (CO1304M250) 100 GPH, 250 psi
111A100F11BA170	Procon pump brass series 1 (CO1304X) 100 GPH, 170 psi
102A050F11AA170	Procon pump brass series 2 (CO1510) 50 GPH, 170 psi
102A100F11BD055	Procon pump brass series 2 (CO1504XD) 100 GPH, 55 psi
112A050F11AA100	Procon pump brass series 2, 50 GPH, 100 psi
112A050F11AA170	Procon pump brass series 2, 50 GPH, 170 psi
112A060F11DB130	Procon pump brass series 2 (CO1509BXL) 60 GPH, 130 psi
112A070F11AA170	Procon pump brass series 2 (CO1508) 70 GPH, 170 psi
112A100F11BA170	Procon pump brass series 2 (CO1504X) 100 GPH, 170 psi
113A050F31XX	Procon pump SS series 3 (CO1610A) 50 GPH
113A100F31BA170	Procon pump SS series 3 (CO1604X) 100 GPH, 170 psi
113A100F31XX	Procon pump SS series 3 (CO1604A)
113E100F31BA170	Procon pump SS series 3 (B01604X) 100 GPH, 170 psi
141A100F11AA250	Procon pump low lead series series 1, 100 GPH, 250 psi

Part Number	Description
AO-PUMP-ASSY	Add-on pump assembly
4406	1/3 HP GE recirculating motor, welded base, 115V
4805	1/3 HP GE recirculating motor, 115/230V (dual)
83000184	Carel PJ Easy Thermostat
HPR 6/8	Recirculating pump 5.5 GPM, 145 psi
3AGQ4468	Grundfos replacement pump SPK4-11/8
86-0182	Grundfos replacement pump SPK2-11/8
GP20/12	Recirculating pump 4.6 GPM, 36.3 psi
GP20/18	Recirculating pump 4.8 GPM, 36.3 psi
HPR 6/11	Recirculating pump 5.5 GPM, 145 psi
S48AB88B92P	1/3 HP recirculating motor & pump, 115V/60hz, 1725RPM, automatic overload, 48Y frame, resilient base, open drip proof construction
32L3238-2E	Condensing unit R404a, 11,700 BTU
32L2134-2E	Condensing unit R404a, 17,300 BTU
82-4426	Inline heat exchanger, 1 coil

Beer Systems, Bar Equipment



## Beer/Soda Centrifugal Chilling Pumps

Magnetically coupled and semisubmersible pumps for recirculating chilled water or water/glycol in beer coolers and carbonated water in soft drinks coolers. Produces heads up to 24m. Fluid temperature: -4° to +185° F.

### HPR

Application: continuous recirculation of carbonated water, aggressive chemicals, chilled water, pure or precious liquids in high pressure systems

- Manufactured from food grade thermoplastics
- Magnetic coupling provides an energy efficient thermal shield, minimizing heat transfer to the pumped fluid
- Temperature stability and product purity ensured
- Leak free continuous operation, low condensation
- Nitrile 'O' rings standard, other materials available
- Zero maintenance, long life
- PPS pump head

### GP

Application: cost effective high head, continuous low flow for the transfer and recirculation of water and glycol solutions

- Magnetic couplings provide an energy efficient thermal shield, minimising heat transfer to the pumped fluids
- Variable pump body orientation, IPX5 motor enclosure
- Adaptable mounting foot positions
- Compatible with standard fittings
- Deep groove ball bearings

### SPC

Application: continuous operation in, chillers, coolers, vending and general water applications

- Low maintenance and long life
- Available with plugs and leads to suit application
- Agitator propeller fitted as standard
- SPC 51 is top mounted with keyhole mounting plate and has IPX4 motor housing

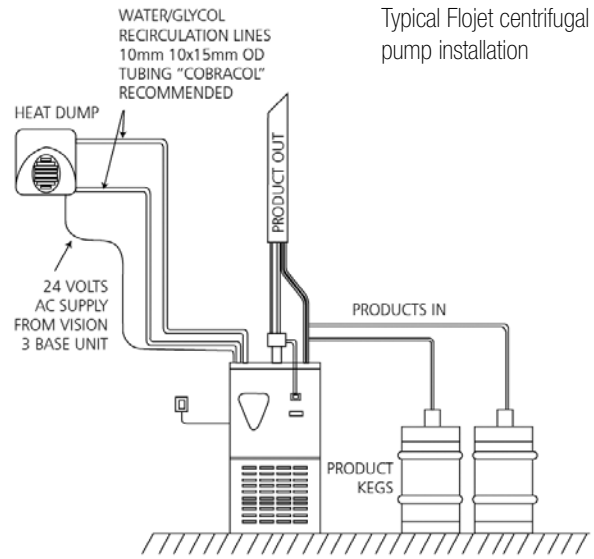

Part Number	Ports	PSI	Flow Rate	Size H x W x D"	Voltage
HPR 6/8	1/2" (12.5mm) or 15mm OD	145	5.5 GPM	3.86" H x 6.95" W x 4.45" D	110V 1Ph 50/60Hz
HPR 6/11	1/2" (12.5mm) or 15mm OD	145	5.5 GPM	3.86" H x 6.95" W x 4.45" D	110V 1Ph 50/60Hz
GP20/12	Plain 15 mm, 3/8" MPT, or 3/8" bsp Male	36.3	4.6 GPM	5.6" x 8.6" x 4.6"	110V 1Ph 50Hz
GP20/18	Plain 15 mm, 3/8" MPT, or 3/8" bsp Male	36.3	4.8 GPM	5.6" x 10.1" x 4.6"	110V 1Ph 50Hz
SPC 8/2	Plain 0.47 in (12 mm)	3	2.1 GPM	6.85"H x 8.82"L	110V 1Ph 50Hz
SPC 12/4	Plain 0.51 (13 mm)	5.3	3.4 GPM	3.1" x 8.5" x 4.3"	110V 1Ph 50Hz
SPC 42	1/2" (12.5mm) and 11mm	17.5	3.4 GPM	4.61"H x 12.56"L	110V 1Ph 50Hz
SPC 43	1/2" (12.5mm) and 11mm	26	2.1 GPM	5.39"H x 14.17"L	110V 1Ph 50Hz
SPC 44	1/2" (12.5mm) and 11mm	32	3.4 GPM	5.39"H x 14.7"L	110V 1Ph 50Hz
SPC 51	1/2" (12.5mm) and 11mm	9	4.17 GPM	5.27"H x 3.21"L	110V 1Ph 50Hz



Advanced Beverage Solutions  
100 Gary Avenue, Suite C  
Roselle, IL 60172

**www.absone.com**  
E-mail: [orders@absone.com](mailto:orders@absone.com)

877-814-2271  
Local: 847-524-1707  
Fax: 847-524-1710

## Propylene Glycol

Propylene glycol is a colorless, odorless, biodegradable heat transfer liquid commonly used as an anti-freeze or coolant. The products on this page are non-toxic, food quality (not food grade\*) and can be used in chillers, refrigeration and other mechanical systems where food is processed, but not where it will come in direct contact with food.



BB990300 Glycol tester reads the glycol/water ratio in the Power Pack bath

Part #	Description	% Glycol	Corrosion Inhibitor	Color Additive	Gallons	Units Per Carton
35714	Profrost	100%	No	No	5	1
35715	Profrost	100%	No	No	55	1
35720	Profrost - I	100%	Yes	No	5	1
35721	Profrost - I	100%	Yes	No	55	1
35723	Profrost - Cl	100%	Yes	Yes	5	1
35722	Profrost - Cl	100%	Yes	Yes	55	1
35760	Freeze Safe Valuline	80%	Yes	Yes	1	4
35761	Freeze Safe Valuline	80%	Yes	Yes	5	1
35762	Freeze Safe Valuline	80%	Yes	Yes	55	1
35711	PG Food Quality	40%	Yes	No	5	1
35712	PG Food Quality	40%	Yes	No	55	1
60703	Polar Flo glycol				1	
60705	Glycol concentrate pail				5	
35-711	Glycol, PG food quality				5	
4188-06	Glycol, 5 gallon pail				5	
60703PM	Glycol concentrate premix 10°F				1	
95-0232	Glycol 5 gallons				5	

## Glycol Manifolds

Lancer glycol manifolds allow you to dispense one product to multiple faucets and are available in 2 - 4 outlet versions. Manifolds can be mounted inside or out of the walk in cooler on either Nycel or stainless steel backing boards.

- All 304 grade stainless steel construction
- Check valves fitted to prevent water siphon
- 1/2" barbed glycol supply and return lines
- Fully insulated, temperature resistant brackets
- Option: 1 or 2 pump supply
- Option: 2, 4, 6, 8, 10 and 12 point supply and return manifolds



48-3051



48-3066

Part #	Description
35000205	Glycol manifold assy SS 1 pump supply, 10 way
35000206	Glycol manifold assy SS 1 pump supply, 12 way
35000213	Glycol manifold assy SS 2 pump supply, 6 way
35000214	Glycol manifold assy SS 2 pump supply, 8 way
35000215	Glycol manifold assy SS 2 pump supply, 10 way
35000216	Glycol manifold assy SS 2 pump supply, 12 way
35000225	Glycol manifold assy SS return, 10 way
35000226	Glycol manifold assy SS return, 12 way
48-3050	Glycol manifold assy SS 1 pump supply, 2 way
48-3051	Glycol manifold assy SS 1 pump supply, 4 way
48-3052	Glycol manifold assy SS 1 pump supply, 6 way
48-3053	Glycol manifold assy SS 1 pump supply, 8 way
48-3063	Glycol manifold assy SS return, 2 way
48-3064	Glycol manifold assy SS return, 4 way
48-3065	Glycol manifold assy SS return, 6 way
48-3066	Glycol manifold assy SS return, 8 way

Beer Systems, Bar Equipment



Advanced Beverage Solutions  
100 Gary Avenue, Suite C  
Roselle, IL 60172

**www.absone.com**  
E-mail: [orders@absone.com](mailto:orders@absone.com)

877-814-2271  
Local: 847-524-1707  
Fax: 847-524-1710

## Insulated Barrier Tubing Bundles with Coolant Lines

Bev-Seal Ultra® Series 971 non-cabled and Series 973 cabled insulated bundles are comprised of flushable Bev-Seal Ultra® Series 235 tubes.

Part Number	# Lines	OD"	Tube ID" x OD"	Std. Size	Clamp
971-0004002X250	6	3.0	(4) 3/8 x 1/2 (2) 3/8 x 1/2	250'	14.0
971-0006002X100	8	3.4	(6) 3/8 x 1/2 (2) 3/8 x 1/2	100'	14.0
971-0006002X250	8	3.4	(6) 3/8 x 1/2 (2) 3/8 x 1/2	250'	14.0
973-0008002X250	10	3.5	(8) 3/8 x 1/2 (2) 3/8 x 1/2	250'	14.0
973-0010004X250	14	3.5	(10) 3/8 x 1/2 (4) 3/8 x 1/2	250'	14.0
973-0012004X250	16	4.0	(12) 3/8 x 1/2 (4) 3/8 x 1/2	250'	14.0



All bundles have extruded jackets. Other jacket colors are available. Other bundle configurations are available, minimum order quantity may apply. Additional cutting charges for special lengths.

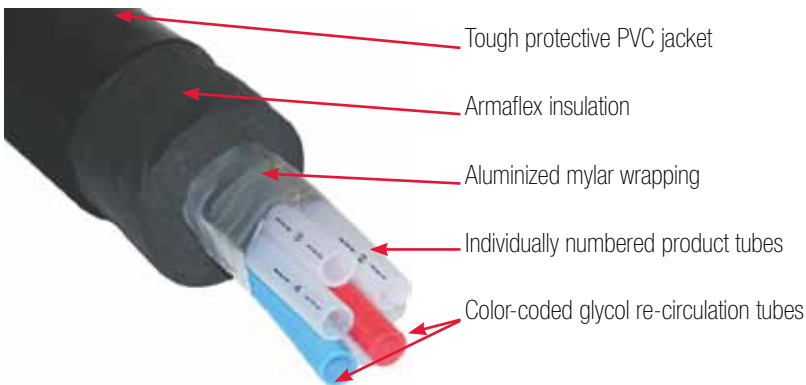

Part Number	# Lines	Product	Glycol	Insulation	Jacket
BT042260	4	(2) 5/16"	(2) 3/8"	3/4"	PVC jacket, fire rated
BT064260	6	(4) 5/16"	(2) 3/8"	3/4"	PVC jacket, fire rated
BT086260	8	(6) 5/16"	(2) 3/8"	3/4"	PVC jacket, fire rated
BT108260	10	(8) 5/16"	(2) 3/8"	3/4"	PVC jacket, fire rated
BT1410460	14	(10) 5/16"	(4) 3/8"	3/4"	PVC jacket, fire rated
BT1612460	16	(12) 5/16"	(4) 3/8"	3/4"	PVC jacket, fire rated
BT1814460	18	(14) 5/16"	(4) 3/8"	3/4"	PVC jacket, fire rated, <i>SPECIAL ORDER</i>
BT042290	4	(2) 3/8"	(2) 3/8"	3/4"	PVC jacket, fire rated
BT064290	6	(4) 3/8"	(2) 3/8"	3/4"	PVC jacket, fire rated
BT086290	8	(6) 3/8"	(2) 3/8"	3/4"	PVC jacket, fire rated
BT108290	10	(8) 3/8"	(2) 3/8"	3/4"	PVC jacket, fire rated
BT1410490	14	(10) 3/8"	(4) 3/8"	3/4"	PVC jacket, fire rated
BT1612490	16	(12) 3/8"	(4) 3/8"	3/4"	PVC jacket, fire rated
BT1814490	18	(14) 3/8"	(4) 3/8"	3/4"	PVC jacket, fire rated, <i>SPECIAL ORDER</i>

Beer Systems, Bar Equipment



Advanced Beverage Solutions  
100 Gary Avenue, Suite C  
Roselle, IL 60172

**www.absone.com**  
E-mail: [orders@absone.com](mailto:orders@absone.com)

877-814-2271  
Local: 847-524-1707  
Fax: 847-524-1710

Beer Systems, Bar Equipment

### Insulated Barrier Tubing Trunk Lines with Coolant Lines

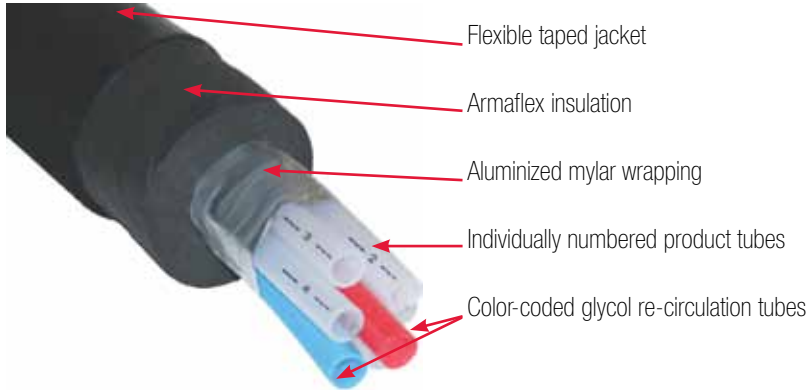

Part Number	# Lines	Product	Glycol	Insulation	Jacket
BT042257	4	(2) 5/16"	(2) 3/8"	3/4"	Flexible taped jacket, fire rated
BT064257	6	(4) 5/16"	(2) 3/8"	3/4"	Flexible taped jacket, fire rated
BT086257	8	(6) 5/16"	(2) 3/8"	3/4"	Flexible taped jacket, fire rated
BT108257	10	(8) 5/16"	(2) 3/8"	3/4"	Flexible taped jacket, fire rated
BT1410457	14	(10) 5/16"	(4) 3/8"	3/4"	Flexible taped jacket, fire rated
BT1612457	16	(12) 5/16"	(4) 3/8"	3/4"	Flexible taped jacket, fire rated
BT1814457	18	(14) 5/16"	(4) 3/8"	3/4"	Flexible taped jacket, fire rated, <i>SPECIAL ORDER</i>
BT042287	4	(2) 3/8"	(2) 3/8"	3/4"	Flexible taped jacket, fire rated
BT064287	6	(4) 3/8"	(2) 3/8"	3/4"	Flexible taped jacket, fire rated
BT086287	8	(6) 3/8"	(2) 3/8"	3/4"	Flexible taped jacket, fire rated
BT108287	10	(8) 3/8"	(2) 3/8"	3/4"	Flexible taped jacket, fire rated
BT1410487	14	(10) 3/8"	(4) 3/8"	3/4"	Flexible taped jacket, fire rated
BT1612487	16	(12) 3/8"	(4) 3/8"	3/4"	Flexible taped jacket, fire rated
BT1814487	18	(14) 3/8"	(4) 3/8"	3/4"	Flexible taped jacket, fire rated, <i>SPECIAL ORDER</i>

### Dual Core Wine Trunk Line

First trunk line in the wine industry with dedicated cooling lines for white wine, and separated by 1/2" insulation to two more lines for ambient controlled red wine. All lines are wrapped with mylar foil tape, 3/4" foam insulation and then covered by a durable taped protective jacket. FDA approved.

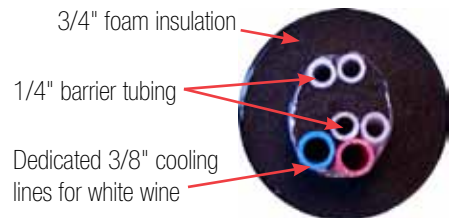

Part #	Description
BT040122	2+(2+2) dual core taped 1/4" ID x 3/4" OD barrier trunk line for wine
BT060133	3+(3+2) dual core taped 1/4" ID x 3/4" OD barrier trunk line for wine



### Glycol Power Pack Trunk Line

Use to connect glycol power pack to trunk line. Kit contains:

- 3/8" ID color coded glycol tubes (red + blue)
- Moisture barrier wrap
- Foil wrap
- 3/4" wall insulation

Part #	Description
BT020200	2 glycol lines, 3/4" insulation
BT020400	4 glycol lines, 3/4" insulation



Advanced Beverage Solutions  
100 Gary Avenue, Suite C  
Roselle, IL 60172

[www.absonone.com](http://www.absonone.com)  
E-mail: [orders@absonone.com](mailto:orders@absonone.com)

877-814-2271  
Local: 847-524-1707  
Fax: 847-524-1710

## Single Line Barrier Tubing

Bev-Seal Ultra® barrier tubing with Glas-Flex™ liner allows changeovers from even the most pungent flavors with simple flushing procedures. Dual-Barrier construction: flushable Glas-Flex™ inner liner is surrounded by a seamless extruded barrier layer in a coextruded polyolefin tube.

XX indicates the trace color and number to be imprinted: use 00 for unnumbered hose, 01=blue, 02=black, 03=red, 04=green, 05=yellow, 06=orange, 07=brown, 08=white, 09=pink, 10=purple, 11=blue, 12=black, 13=red, 14=green.

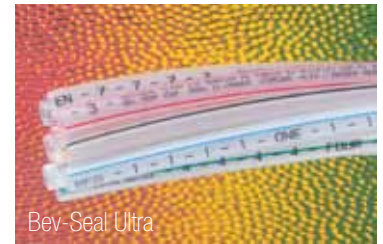
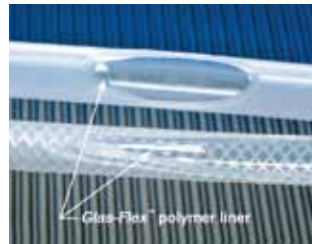

Part Number	Tube ID" x OD"	Std. Package	Clamp	Additional Information
235-05620-xx	3/16 x 5/16	500' spool	8.7	Glas-Flex liner
235-06620-xx	1/4 x 3/8	500' spool	10.0	Glas-Flex liner
235-07620-00	5/16 x 7/16	500' spool	11.3	Glas-Flex liner
235-08620-xx	3/8 x 1/2	500' spool	14.0	Glas-Flex liner
235-10620-xx	1/2 x 5/8	500' wrapped coil	17.0	Glas-Flex liner

## Single Line Braided Barrier Hose

Bev-Seal Ultra® barrier tubing with Glas-Flex™ liner allows changeovers with simple flushing procedures. Dual-Barrier construction: flushable Glas-Flex™ inner liner is surrounded by a seamless extruded barrier layer in a polyolefin core tube, reinforced with polyester yarn and protected by a smooth EVA (ethylene vinyl acetate) cover. XX indicates the imprinted number (see above).



Part Number	Tube ID" x OD"	Std. Package	Clamp	Additional Information
175-04500-xx	1/4 x 7/16	500' boxed spool	11.3	Yarn reinforced
175-06300-xx	3/8 x 1/2	300' boxed spool	14.5	Yarn reinforced

## Single Line Wire-Reinforced Braided Barrier Hose

Bev-Steel® Ultra barrier tubing with Glas-Flex™ liner allows changeovers from even the most pungent flavors with simple flushing procedures. All of the features of the Series 175 hose plus the superior protection and physical strength of a stainless steel wire mesh reinforcement layer. The wire mesh provides protection against rodent attack, while the Dual-Barrier construction prevents permeation of aromas that would attract rodents and other pests.



Part Number	Tube ID" x OD"	Std. Package	Clamp	Additional Information
178-04100	1/4 x 1/2	100' boxed coil	14.0	Wire reinforced
178-04300	1/4 x 1/2	300' boxed spool	14.0	Wire reinforced
178-06100	3/8 x 5/8	100' boxed coil	17.0	Wire reinforced
178-06300	3/8 x 5/8	300' boxed spool	17.0	Wire reinforced





Advanced Beverage Solutions  
100 Gary Avenue, Suite C  
Roselle, IL 60172

[www.abstone.com](http://www.abstone.com)  
E-mail: [orders@abstone.com](mailto:orders@abstone.com)

877-814-2271  
Local: 847-524-1707  
Fax: 847-524-1710

### Solid Color Single Line Braided Barrier Tubing

Reinforced Bevlex® Plus 180 hoses are ideal for pressure lines, while providing good kink resistance. They are recommended for use on filtered water and carbonated water lines where algae growth can be a concern, thus assuring good taste protection properties and pressure performance. Construction: Glas-Flex™ (PET) liner, polyester yarn reinforcement, opaque EVA blue/black (-BLU) or silver (-SIL) jacket.



Part Number	Tube ID" x OD"	Std. Package	Clamp	Additional Information
180-04500-BLU	1/4 x 1/2	500' boxed spool	13.3	Yarn reinforced
180-06300-BLU	3/8 x 5/8	300' boxed spool	15.7	Yarn reinforced
180-08300-BLU	1/2 x 3/4	300' boxed spool	19.8	Yarn reinforced
180-04100-SIL	1/4 x 1/2	100' boxed coil	13.3	Yarn reinforced
180-04500-SIL	1/4 x 1/2	500' boxed spool	13.3	Yarn reinforced
180-06100-SIL	3/8 x 5/8	100' boxed coil	15.7	Yarn reinforced
180-06300-SIL	3/8 x 5/8	300' boxed spool	15.7	Yarn reinforced
180-08100-SIL	1/2 x 3/4	100' boxed coil	19.8	Yarn reinforced
180-08300-SIL	1/2 x 3/4	300' boxed spool	19.8	Yarn reinforced

### Braided Non-Barrier Polyethylene Hose

Bev-Flex® Series 172 polyester-reinforced polyethylene beverage hose provides low odor and taste, excellent stress crack resistance and exceptional flexibility. Polyester reinforcement provides pressure performance and kink-resistance exceeding that of simple tubing. Smooth EVA (ethylene vinyl acetate) cover.



Replace X with tracer yarn color: white (0), red (1) and blue (2).

Part Number	Tube ID" x OD"	Std. Package	Clamp	Additional Information
172-041X4-00	1/4 x 3/8	100' boxed coil	10.5	Yarn reinforced
172-048X4-00	1/4 x 3/8	800' boxed spool	10.5	Yarn reinforced
172-041X3-00	1/4 x 7/16	100' boxed coil	11.3	Yarn reinforced
172-045X3-00	1/4 x 7/16	500' boxed spool	11.3	Yarn reinforced
172-041X2-00	1/4 x 15/32	100' boxed coil	12.3	Yarn reinforced
172-045X2-00	1/4 x 15/32	500' boxed spool	12.3	Yarn reinforced
172-061X3-00	3/8 x 5/8	100' boxed coil	15.7	Yarn reinforced
172-063X3-00	3/8 x 5/8	300' boxed spool	15.7	Yarn reinforced
172-061X0-00	3/8 x 19/32	100' boxed coil	15.7	Yarn reinforced
172-063X0-00	3/8 x 19/32	300' boxed spool	15.7	Yarn reinforced
172-081X0-00	1/2 x 3/4	100' boxed coil	19.8	Yarn reinforced
172-083X0-00	1/2 x 3/4	300' boxed spool	19.8	Yarn reinforced



### Braided Non-Barrier Polyethylene Hose

Bevlex® Series 170 polyester-reinforced polyethylene beverage hose LLDPE core tube construction provides excellent stress crack resistance. Polyester reinforcement provides pressure performance and kink-resistance exceeding that of simple tubing. Bonded abrasion-resistant copolymer jacket — will not separate or ripple in tight bends or during installation in conduits



Replace X with tracer yarn color: white (0), red (1) and blue (2).

Part Number	Tube ID" x OD"	Std. Package	Clamp	Additional Information
170-041X2-00	1/4 x 15/32	100' boxed coil	13.3	Yarn reinforced
170-045X2-00	1/4 x 15/32	500' boxed spool	13.3	Yarn reinforced
170-045X6-00	1/4 x 1/2	500' boxed spool	14.0	Yarn reinforced
170-063X0-00	3/8 x 19/32	300' boxed spool	15.7	Yarn reinforced
170-065X0-00	3/8 x 19/32	500' reel	15.7	Yarn reinforced
170-061X0-00	3/8 x 5/8	100' boxed coil	17.0	Yarn reinforced
170-063X0-00	3/8 x 5/8	300' boxed spool	17.0	Yarn reinforced
170-083X0-00	1/2 x 3/4	300' wrapped coil	19.8	Yarn reinforced
170-085X0-00	1/2 x 3/4	500' reel	19.8	Yarn reinforced

### Single Line Non-Barrier Beverage Tubing

Low density, LLDPE industrial grade colored, taste-free tubing for syrup, liquor, or glycol transfer. Excellent stress-crack and UV resistance. 222 Series has no numbers. 224 Series is numbered.

XX indicates the number to be imprinted, 1-12. For single digit numbers place a zero before the number. For example, if you want the printed number to be "2" replace "xx" with "02".



Part Number	Tube ID" x OD"	Std. Package	Clamp	Additional Information
222-0440X2K	3/16 x 1/4	2000' boxed spool	7.0	Natural
222-0440X500	3/16 x 1/4	500' boxed spool	7.0	Natural
222-0662X500	1/4 x 3/8	500' boxed spool	10.0	Natural
222-0862X500	3/8 x 1/2	500' boxed spool	14.0	Natural
222-1062X500	1/2 x 5/8	500' wrapped coil	17.0	Natural
224-06620-xx	1/4 x 3/8	500' boxed spool	10.0	Numbered
224-08620-xx	3/8 x 1/2	500' boxed spool	14.0	Numbered
224-10620-xx	1/2 x 5/8	500' wrapped coil	17.0	Numbered

Part Number	Tube ID" x OD"	Std. Package	Clamp	Additional Information
228-07620-00	3/16 x 5/16	500' wrapped coil	8.7	Barrier tubing for beer



Advanced Beverage Solutions  
100 Gary Avenue, Suite C  
Roselle, IL 60172

**www.absone.com**  
E-mail: [orders@absone.com](mailto:orders@absone.com)

877-814-2271  
Local: 847-524-1707  
Fax: 847-524-1710

## CLEARBRAID® PVC Hose

Blue-tinted crystal clear hose is ideal for flexible water or juice lines. Spiraled polyester yarn reinforcement with multiple longitudinal polyester yarns provide pressure performance and kink resistance. Glass smooth interior. K3150 Series has an orange tracer. Thick walled K3130 Series has a blue tracer.



Part Number	Tube ID" x OD"	Std. Package	Clamp	Additional Information
K3150-03	3/16 x 3/8	100'/300' coil	10.0	Yarn reinforced, orange tracer
K3150-04	1/4 x 7/16	100'/300' coil	11.8	Yarn reinforced, orange tracer
K3150-05	5/16 x 17/32	100'/300' coil	14.5	Yarn reinforced, orange tracer
K3150-06	3/8 x 5/8	100'/300' coil	15.7	Yarn reinforced, orange tracer
K3150-08	1/2 x 3/4	100'/300' coil	19.8	Yarn reinforced, orange tracer
K3150-10	5/8 x 7/8	100'/200' coil	22.6	Yarn reinforced, orange tracer
K3150-12	3/4 x 1	100'/200' coil	25.6	Yarn reinforced, orange tracer
K3150-16	1 x 1-5/16	100'/200' coil	33.1	Yarn reinforced, orange tracer
K3150-20	1-1/4 x 1-5/8	50'/100' coil	42.5	Yarn reinforced, orange tracer
K3150-24	1-1/2 x 2	50'/100' coil	50.0	Yarn reinforced, orange tracer
K3150-32	2 x 2-1/2	50'/100' coil	65.0	Yarn reinforced, orange tracer
K3130-06x100	3/8 x 9/16	100' coil	14.5	Heavy wall reinforced
K3130-12x100	3/4 x 1-1/8	100' coil	28.6	Heavy wall reinforced
K3130-12x200	3/4 x 1-1/8	200' coil	28.6	Heavy wall reinforced
K3130-24x100	1-1/2 x 2	100' coil	51.5	Heavy wall reinforced

## Polyspring Clear Reinforced PVC Vacuum & Transfer Hose

Embedded steel spring reinforcement provides flexibility and resistance to kinking, crushing and collapsing. Glass smooth interior.



Part Number	Hose ID" x OD"	Std. Package	Clamp
K7160-04	1/4 x 1/2	100'/300' coil	13.8
K7160-06	3/8 x 5/8	100'/300' coil	15.7
K7160-08	1/2 x 3/4	100'/300' coil	19.8
K7160-10	5/8 x 7/8	100'/300' coil	22.6
K7160-12	3/4 x 1	100'/300' coil	28.6
K7160-16	1 x 1-5/16	100'/300' coil	33.1
K7160-20	1-1/4 x 1-9/16	50'/100' coil	42.5
K7160-24	1-1/2 x 1-7/8	50'/100' coil	50.0
K7160-32	2 x 2-3/8	50'/100' coil	62.0
K7160-36	2-1/4 x 2-3/4	50'/100' coil	72.5
K7160-40	2-1/2 x 3	50'/100' coil	78.5
K7160-48	3 x 3-1/2	50'/100' coil	90.5



Advanced Beverage Solutions  
100 Gary Avenue, Suite C  
Roselle, IL 60172

**www.absone.com**  
E-mail: [orders@absone.com](mailto:orders@absone.com)

877-814-2271  
Local: 847-524-1707  
Fax: 847-524-1710

## Clear Food-Grade PVC Tubing

Klearon Series, K010, non-toxic blue-tinted, crystal clear, ozone resistant, self-extinguishing, flexible tubing has a glass smooth interior and is in compliance with FDA<sup>(03)</sup>, USDA<sup>(17)</sup>, 3A<sup>(01)</sup>, NSF<sup>(13)</sup>, UL<sup>(16)</sup>, RoHS<sup>(15)</sup> and USP<sup>(18)</sup> Class VI requirements. Excellent kink resistance and taste protection properties.



Part Number	Hose ID" x OD"	Std. Package	Clamp
K010-0204	1/8 x 1/4	100' payout carton	6.5
K010-0305	3/16 x 5/16	100' payout carton	8.0
K010-0406	1/4 x 3/8	100' payout carton	10.0
K010-0507	5/16 x 7/16	100' payout carton	11.3
K010-0609	3/8 x 9/16	100' payout carton	14.5
K010-0610	3/8 x 5/8	100' payout carton	17.0
K010-1012	5/8 x 3/4	100' boxed coil	19.8
K010-1418	7/8 x 1-1/8	100' boxed coil	28.6
K010-1620	1 x 1-1/4	100' wrapped coil	33.1
K010-1624	1 x 1-1/2	100' wrapped coil	38.1

## Clear and Colored PVC Tubing

Bevlex® Series 200 clear, flexible tubing is ideal for bag-in-box soft drink applications and draft beer transfer. Excellent kink resistance and taste protection properties. Series 203 black beer tubing is ideal for carbon dioxide supply lines. Series 204 red beer tubing is designed for air supply lines.

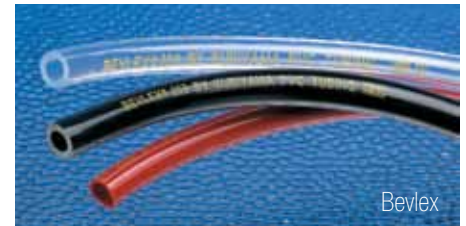

Part Number	Hose ID" x OD"	Std. Package	Clamp	Additional Information
200-0307x100	3/16 x 7/16	100' payout carton	12.3	Clear beverage line
200-0408x100	1/4 x 1/2	100' payout carton	13.3	Clear beverage line
200-0509x100	5/16 x 9/16	100' payout carton	15.7	Clear beverage line
200-0610x100	3/8 x 5/8	100' payout carton	17.0	Clear beverage line
200-0610x60	3/8 x 5/8	60"	17.0	Clear beverage line
200-0610x78	3/8 x 5/8	78"	17.0	Clear beverage line
200-0610x84	3/8 x 5/8	84"	17.0	Clear beverage line
200-0610x92	3/8 x 5/8	92"	17.0	Clear beverage line
200-0610x98	3/8 x 5/8	96"	17.0	Clear beverage line
200-0610x120	3/8 x 5/8	120"	17.0	Clear beverage line
200-0610x500	3/8 x 5/8	500'	17.0	Clear beverage line
200-0812x100	1/2 x 3/4	100' payout carton	19.8	Clear beverage line
203-0307x100	3/16 x 7/16	100' payout carton	12.3	Black, CO <sub>2</sub> supply line
203-0610x100	3/8 x 5/8	100' payout carton	17.0	Black, CO <sub>2</sub> supply line
204-0509x100	5/16 x 9/16	100' payout carton	15.7	Red, air supply line
209B-BE0509x100	5/16 x 9/16	100' payout carton	15.7	Blue, PVC tubing



### Reinforced PVC CO<sub>2</sub> Vent Hose

Ideal for venting excess carbon dioxide gas from bulk storage systems. The core and jacket are a proprietary PVC blend that has excellent low temperature operating properties that resists cracking at -109°F (-78°C). Heavy walled construction resists crushing and kinking, providing ease of handling during use.

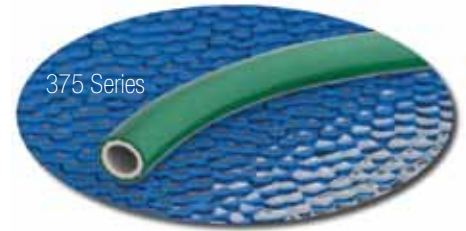

Part Number	Hose ID" x OD"	Std. Package	Clamp
375-08X300	1/2 x 3/4	300' coil	22.6

### Barrier Protected UV Resistant CO<sub>2</sub> Supply Hoses

Bev-Seal® Series 176 barrier hose is ideal for pressure regulated CO<sub>2</sub> supply lines up to 300 PSI WP @ RT. It is recommended for supplying regulated CO<sub>2</sub> gas to carbonators. It provides excellent barrier protection from environmental contamination. In addition to the exclusive custom formulated outer jacket compounds, the cover jacket is co-extruded with a unique Duo-Ex white over black combination that provides the optimum in UV and weather resistance.



Part Number	Hose ID" x OD"	Std. Package	Clamp
176-04502-NCW	1/4 x 1/2	500' boxed spool	13.3
176-06302-NCW	3/8 x 9/16	300' boxed spool	15.7

### Accuflex Beverage Transfer Products for Handling CO<sub>2</sub>

The following beverage hoses are approved for CO<sub>2</sub> transfer to beverage equipment.

- Bev-Flex® Series 172 polyester-reinforced polyethylene hose
- Bevlex® Series 170 polyester-reinforced polyethylene hose
- Bevlex® Plus 180 reinforced hose
- Bev-Seal Ultra® Series 175 barrier hose
- Bev-Steel® Ultra Series 178 wire-reinforced barrier hose
- CLEARBRAID® Series K3150 reinforced PVC hose

### Colored PVC Drain / General Purpose Tubing

General purpose, industrial grade PVC tube provides lightweight flexibility, kink resistance and economy.



Part Number	Tube ID" x OD"	Std. Package	Clamp	Additional Information
215-06100-00	3/8 x 5/8	100' payout carton	15.7	Gray
215-08120-00	1/2 x 3/4	100' payout carton	19.8	Gray
215-10140-00	5/8 x 7/8	100' boxed coil	22.6	Gray
215-12160-00	3/4 x 1	100' boxed coil	27.1	Gray
213-10140-00	5/8 x 7/8	100' boxed coil	22.6	Black
213-12160-00	3/4 x 1	100' boxed coil	27.1	Black
213-16200-00	1 x 1-1/4	100' wrapped coil	33.1	Black
213B-1216x100	3/4 x 1	100' boxed coil	27.1	Blue



Advanced Beverage Solutions  
100 Gary Avenue, Suite C  
Roselle, IL 60172

[www.abstone.com](http://www.abstone.com)  
E-mail: [orders@abstone.com](mailto:orders@abstone.com)

877-814-2271  
Local: 847-524-1707  
Fax: 847-524-1710

### Sani-Clean AM™ Drain Tubing

Proprietary anti-microbial additive discourages fungal growth on the inner and outer surfaces. Translucent metallic gray color looks sanitary while allowing visual inspection while in service. Ideal for ice machines, dispensing equipment, condensate drains, and wherever protection from microorganisms is needed.



Part Number	Tube ID" x OD"	Std. Package	Clamp
218-0610x100	3/8 x 5/8	100' payout carton	17.0
218-0812x100	1/2 x 5/8	100' payout carton	19.8
218-1014x100	5/8 x 7/8	100' boxed carton	22.6
218-1216x100	3/4 x 1	100' boxed carton	27.1
218-1620x100	1 x 1-1/4	100' boxed carton	33.1

### Tigerflex™ Drain Hose

Tigerflex has smooth bore flexible PVC to minimize internal flow restrictions, with rigid PVC helix reinforcement to provide exceptional kink resistance and a very tight bend radius for difficult installations. Tigerflex is generally used on ice maker and beverage dispenser drains.

Insulated Tigerflex is ideal for under-the-counter and fountain head areas because it keeps condensation from forming on the drain hose and then dripping on the floor. Antimicrobial insulation inhibits the growth of bacteria and other micro-organisms. Snug fitting insulation minimizes air entrapment beneath the insulation and condensation that might otherwise form. Insulated hoses are furnished in nominal 72" lengths.

Service Temperature: -4° to 150° F.



Tigerflex with anti-microbial insulation

Tigerflex without insulation

Part Number	Hose ID" x OD"	Std. Package	Clamp	Additional Information
A15-DHG50MM	1/2 x 11/16	72"	19.8	Antimicrobial insulation
A15-DHG20MM	3/4 x 1-1/16	72"	27.1	Antimicrobial insulation
A15-DHG27MM	1 x 1-3/8	72"	34.6	Antimicrobial insulation
DHG05MMX100	1/2 x 11/16	100'	19.8	Non-insulated
DHG20MMX100	3/4 x 1-1/16	100'	27.1	Non-insulated
DHG27MMX100	1 x 1-3/8	100'	34.6	Non-insulated



## Beer Hose Assemblies



08-0560



Hex and wing nut jumper line



C110

Part Number	Description
08-0560	Keg transfer lead, Masterflex 5/16" ID x 1/2" OD
364TX	Jumper line, pre-made PVC line with hex nut and wing nut end, 4' of 3/8" clear tubing
364TXX	Jumper line, pre-made PVC line with hex nuts both ends, 4' of 3/8" clear tubing
364X	Jumper line, pre-made PVC line with hex nut and wing nut end, 4' of 3/8" black tubing
364XX	Jumper line, pre-made PVC line with hex nuts both ends, 4' of 3/8" black tubing
365TX	Jumper line, pre-made PVC line with hex nut and wing nut end, 5' of 3/8" clear tubing
365TXX	Jumper line, pre-made PVC line with hex nuts both ends, 5' of 3/8" clear tubing
365X	Jumper line, pre-made PVC line with hex nut and wing nut end, 5' of 3/8" black tubing
365XX	Jumper line, pre-made PVC line with hex nuts both ends, 5' of 3/8" black tubing
366TX	Jumper line, pre-made PVC line with hex nut and wing nut end, 6' of 3/8" clear tubing
366TXX	Jumper line, pre-made PVC line with hex nuts both ends, 6' of 3/8" clear tubing
366X	Jumper line, pre-made PVC line with hex nut and wing nut end, 6' of 3/8" black tubing
366XX	Jumper line, pre-made PVC line with hex nuts both ends, 6' of 3/8" black tubing
C110	Beer hose assembly, 3/16" ID, 7/16" OD, 5' long, hex nut on one end
C111	Beer hose assembly, 3/16" ID, 7/16" OD, 5' long, hex nut on both ends

*Flooded beer manifolds are shown on page 102*

## Thickened Water Mixing Assembly

Part Number	Description
ABSTHKMFLD	Mixing tube for thickened product



## Air Cooling Components

Part #	Description
ES-265-3A	Blower assembly with bracket, 273 CFM
BE-1630-4	Flexible aluminum duct 4"OD



ES-265-3A



BE-1630-4



Advanced Beverage Solutions  
100 Gary Avenue, Suite C  
Roselle, IL 60172

**www.absone.com**  
E-mail: [orders@absone.com](mailto:orders@absone.com)

877-814-2271  
Local: 847-524-1707  
Fax: 847-524-1710

## Armaflex® Pipe Insulation

Helps control temperature, condensation and mold and mildew growth. Sold in 6' sections.



Part Number	ID"	Thickness"	Std. Package
3/8X3/8W	3/8	3/8	600 linear feet
3/8X1/2W	3/8	1/2	450
3/8X3/4W	3/8	3/4	240
1/2X3/8W	1/2	3/8	480
1/2X1/2W	1/2	1/2	396
1/2X3/4W	1/2	3/4	210
5/8X3/8W	5/8	3/8	390
5/8X1/2W	5/8	1/2	300
5/8X3/4W	5/8	3/4	144
5/8X1W	5/8	1	120
3/4X3/8W	3/4	3/8	330
3/4X1/2W	3/4	1/2	240
3/4X3/4W	3/4	3/4	138
3/4X1W	3/4	1	90
7/8X3/8W	7/8	3/8	270
7/8X1/2W	7/8	1/2	210
7/8X3/4W	7/8	3/4	120
7/8X1W	7/8	1	90
1-1/8X3/8W	1-1/8	3/8	210
1-1/8X1/2W	1-1/8	1/2	150
1-1/8X3/4W	1-1/8	3/4	90
1-1/8X1W	1-1/8	1	72
1-3/8X3/8W	1-3/8	3/8	180
1-3/8X1/2W	1-3/8	1/2	120
1-3/8X3/4W	1-3/8	3/4	72
1-3/8X1W	1-3/8	1	60
1-5/8X3/8W	1-5/8	3/8	120
1-5/8X1/2W	1-5/8	1/2	90
1-5/8X3/4W	1-5/8	3/4	60
1-5/8X1W	1-5/8	1	48
2-1/8X3/8W	2-1/8	3/8	96
2-1/8X1/2W	2-1/8	1/2	60
2-1/8X3/4W	2-1/8	3/4	54
2-1/8X1W	2-1/8	1	36
2-5/8X3/8W	2-5/8	3/8	72
2-5/8X1/2W	2-5/8	1/2	60
2-5/8X3/4W	2-5/8	3/4	48
2-5/8X1W	2-5/8	1	36
3-1/8X3/8W	3-1/8	3/8	54
3-1/8X1/2W	3-1/8	1/2	42
3-1/8X3/4W	3-1/8	3/4	36
3-1/8X1W	3-1/8	1	30
3-5/8X1/2W	3-5/8	1/2	36

Part Number	ID"	Thickness"	Std. Package
3-5/8X3/4W	3-5/8	3/4	30
3-5/8X1W	3-5/8	1	24
4-1/8X1/2W	4-1/8	1/2	24
4-1/8X3/4W	4-1/8	3/4	24
4-1/8X1W	4-1/8	1	18
5/8X1/2WSS	5/8	1/2	300 linear feet
5/8X3/4WSS	5/8	3/4	144
5/8X1WSS	5/8	1	120
3/4X1/2WSS	3/4	1/2	240
3/4X3/4WSS	3/4	3/4	138
3/4X1WSS	3/4	1	90
7/8X1/2WSS	7/8	1/2	210
7/8X3/4WSS	7/8	3/4	120
7/8X1WSS	7/8	1	90
1-1/8X1/2WSS	1-1/8	1/2	150
1-1/8X3/4WSS	1-1/8	3/4	90
1-1/8X1WSS	1-1/8	1	72
1-3/8X1/2WSS	1-3/8	1/2	120
1-3/8X3/4WSS	1-3/8	3/4	72
1-3/8X1WSS	1-3/8	1	60
1-5/8X1/2WSS	1-5/8	1/2	90
1-5/8X3/4WSS	1-5/8	3/4	60
1-5/8X1WSS	1-5/8	1	48
2-1/8X1/2WSS	2-1/8	1/2	60
2-1/8X3/4WSS	2-1/8	3/4	54
2-1/8X1WSS	2-1/8	1	36
2-5/8X1/2WSS	2-5/8	1/2	60
2-5/8X3/4WSS	2-5/8	3/4	48
2-5/8X1WSS	2-5/8	1	36
3-1/8X1/2WSS	3-1/8	1/2	42
3-1/8X3/4WSS	3-1/8	3/4	36
3-1/8X1WSS	3-1/8	1	30
3-5/8X1/2WSS	3-5/8	1/2	36
3-5/8X3/4WSS	3-5/8	3/4	30
3-5/8X1WSS	3-5/8	1	24
4-1/8X1/2WSS	4-1/8	1/2	24
4-1/8X3/4WSS	4-1/8	3/4	24
4-1/8X1WSS	4-1/8	1	18

Beer Systems, Bar Equipment





Advanced Beverage Solutions  
100 Gary Avenue, Suite C  
Roselle, IL 60172

[www.absone.com](http://www.absone.com)  
E-mail: [orders@absone.com](mailto:orders@absone.com)

877-814-2271  
Local: 847-524-1707  
Fax: 847-524-1710

## Cable Ties

All cable ties are priced per 100 and sell by the bag quantity.



Mini, standard, heavy duty, extra heavy duty ties



Screw mounts



Cable clamps



Cable tie mounts

	Part #	Size"	Color	Tensil	Bag Qty
<b>Mini</b>	CT4-18C9	4	Natural	18	100
	CT4-18COW	4	UV Black	18	100
	CT5-18C9	5.5	Natural	18	100
	CT5-18COW	5.5	UV Black	18	100
	CT8-18C9	8	Natural	18	100
	CT8-18COW	8	UV Black	18	100
<b>Standard</b>	CT8-50C9	8	Natural	08436-1	100
	CT8-50COW	8	UV Black	50	100
	CT11-50C9	11	Natural	50	100
	CT11-50M9	11	Natural	50	1,000
	CT14-50C9	14.5	Natural	50	100
	CT14-50COW	14.5	UV Black	50	100
	CT17-50C9	17	Natural	50	100
	CT17-50COW	17	UV Black	50	100
	CT24-50C9	24	Natural	50	100
	CT24-50COW	24	UV Black	50	100
	CT36-50K9	36	Natural	50	50
	CT36-50COW	36	UV Black	50	50
	CT8-120C9	8	Natural	120	100
	CT8-120COW	8	UV Black	120	100
	CT11-120C9	11	Natural	120	100
	CT11-120COW	11	UV Black	120	100
	CT14-120C9	14.5	Natural	10038-0	100
	CT14-120COW	14.5	UV Black	120	100
CT17-120C9	17	Natural	120	100	
CT17-120COW	17	UV Black	120	100	
<b>Heavy Duty</b>	CT17-175C9	17	Natural	175	100
	CT17-175COW	17	UV Black	175	100
	CT21-120C9	21	Natural	120	100
	CT21-120COW	21	UV Black	120	100
	CT21-175K9	21	Natural	175	50
	CT21-175KOW	21	UV Black	175	50
	CT24-175K9	24	Natural	175	50
	CT24-175KOW	24	UV Black	175	50
	CT32-175K9	32	Natural	175	50
	CT36-175KOW	36	UV Black	175	50
CT48-175K9	48	Natural	175	50	
CT48-175KOW	48	UV Black	175	50	

	Part #	Size"	Color	Ref.	Bag Qty
<b>Extra Heavy Duty</b>	CT9-250X9	9	Natural	250	25
	CT9-250XOW	9	UV Black	250	25
	CT18-250X9	18.5	Natural	250	25
	CT18-250XOW	18.5	UV Black	250	25
	CT23-250X9	23	Natural	250	25
	CT23-250XOW	23	UV Black	250	25
	CT29-250X9	29	Natural	250	25
	CT29-250XOW	29	UV Black	250	25
	CT35-250X9	35	Natural	250	25
	CT35-250XOW	35	UV Black	250	25
	CT40-250X9	40	Natural	250	25
	CT40-250XOW	40	UV Black	250	25
<b>Screw Mounts</b>	CTM4-18C9	4	Natural		100
	CTM4-18COW	4	UV Black		100
	CTM6-40C9	6	Natural	08484-1	100
	CTM6-40COW	6	UV Black		100
	CTM8-50C9	8	Natural	509912	100
	CTM8-50COW	8	UV Black		100
	CTM11-50C9	11	Natural	10350	100
	CTM11-50COW	11	UV Black		100
	CTM14-50C9	14.5	Natural	10035-0	100
	CTM14-50COW	14.5	UV Black		100
<b>Cable Clamps</b>	CC5-1/8	1/8	Natural		100
	CC5-1/4	1/4	Natural		100
	CC5-3/8	3/8	Natural		100
	CC5-1/2	1/2	Natural		100
	CC5-9/16	9/16	Natural		100
	CC5-3/4	3/4	Natural		100
	CC5-7/8	7/8	Natural		100
	CC5-1-1/8	1-1/8	Natural		100
<b>Cable Tie Mnts</b>	ACMB50C	1/2	Natural		100
	ACMB50C-0	1/2	UV Black		100
	ACMB75C	3/4	Natural		100
	ACMB75C-0	3/4	UV Black		100
	ACMB11C	1.1	Natural		100
	ACMB11C-0	1.1	UV Black		100

Beer Systems, Bar Equipment



Advanced Beverage Solutions  
100 Gary Avenue, Suite C  
Roselle, IL 60172

**www.abstone.com**  
E-mail: [orders@abstone.com](mailto:orders@abstone.com)

**877-814-2271**  
Local: 847-524-1707  
Fax: 847-524-1710



## Line Labels and Clips

Line markers clamp onto tubing and identify each line, which helps prevent mistakes when connecting new pumps, tubing, and BIB boxes. Line marker decals have 5 decals per sheet: line marker, pump, rack and two Flojet end caps. Labels for all major soft drink and beer brands, Air, CO<sub>2</sub> Gas, Nitrogen, Carb Water, Soda Water, Water, and blank (create your own label) are available.

*A complimentary Flavor Identification Label Packet is included with each new BIB rack!* Each kit contains 10 line maker clips for the 3/8" BIB syrup inlet tubes, 1 line marker clip for the 1/4" braided CO<sub>2</sub> line and an assortment of 10 popular flavor label sheets.

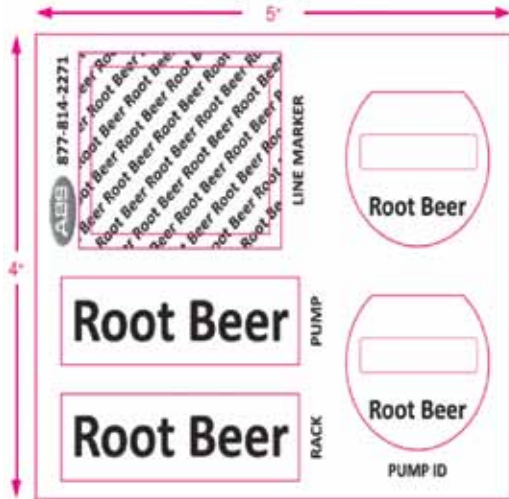

Flavor label sheet sample



Line clamp

Part Number	Marker Clip Size	Tubing Size
SM-4103	Small	1/4" poly tubing / 1/4" braided hose
SM-8304	Medium	3/8" poly tubing
SM-8301	Large	3/8" BIB tubing / 3/8" braided hose
SM-2102	Extra large	1/2" braided hose

Part #	Description	Part #	Description
FLS001	7UP	FLS047	Mtn Dew Code Red
FLS002	AIR	FLS048	Mountain Dew Diet
FLS003	Apple Juice	FLS049	Mug Root Beer
FLS004	Barq's Red Crème	FLS050	Orange
FLS005	Barq's Root Beer	FLS051	Orange Diet
FLS006	Birch Beer	FLS052	Orange Juice
FLS007	Blank	FLS053	Orange Soda
FLS008	Caf Free Diet Coke	FLS054	Orange Soda Diet
FLS009	Cherry	FLS055	Peach
FLS010	Cherry Coca-Cola	FLS056	Pepsi
FLS011	Cherry Coca-Cola Zero	FLS057	Pepsi Caffeine Free Diet
FLS012	Cherry Limeade	FLS058	Pepsi Diet
FLS013	Club Soda	FLS059	Pepsi Wild Cherry
FLS014	CO2 GAS	FLS060	Pineapple
FLS015	CO2 Water	FLS061	Pink Grapefruit
FLS016	Coca-Cola	FLS062	Pink Lemonade
FLS017	Cola	FLS063	Powerade Fruit Punch
FLS018	Cranberry	FLS064	Powerade Lemon-Lime
FLS019	Diet Coke	FLS065	Powerade Mtn Blast
FLS020	Diet Coke w/ Lime	FLS066	Raspberry Ice Tea
FLS021	Dr Pepper	FLS067	RC Cola
FLS022	Dr Pepper Diet	FLS068	RC Cola Diet
FLS023	Fresca	FLS069	Root Beer
FLS024	Fruit Punch	FLS070	Root Beer Diet
FLS025	Gatorade Cool Blue	FLS071	Sierra Mist
FLS026	Gatorade Fruit Punch	FLS072	Sierra Mist Diet
FLS027	Gatorade G2 Fruit Punch	FLS073	Soda
FLS028	Gatorade Lemon Lime	FLS074	Soda Water
FLS029	Gatorade Orange	FLS075	Sprite
FLS030	Gatorade Rain Cherry	FLS076	Sprite Zero
FLS031	Gingerale	FLS077	Squirt
FLS032	Grape	FLS078	Squirt Ruby Red
FLS033	Grapefruit	FLS079	Strawberry
FLS034	Green Tea	FLS080	Tahitian Treat Fruit Punch
FLS035	Hawaiian Punch	FLS081	Tea
FLS036	Kiwi Strawberry	FLS082	Tea Lemon
FLS037	Lemonade	FLS083	Tea Unsweet
FLS038	Lipt Brsk Joy Pch Gm Tea	FLS084	Tonic
FLS039	Lipt Brsk Lemon Iced Tea	FLS085	Trop Fruit Punch
FLS040	Lipton Brisk Lemonade	FLS086	Trop Lemonade
FLS041	Lipt Brsk Peach Iced Tea	FLS087	Trop Lemonade Sugar Free
FLS042	Lipt Brsk Rasp Iced Tea	FLS088	Trop Pink Lemonade
FLS043	Lipt Brsk Sweet Iced Tea	FLS089	Trop Twister Orange Soda
FLS044	Lipt Brsk Unsweet Iced Tea	FLS090	Vanilla Coke
FLS044	Tea	FLS091	Vernors
FLS045	Mello Yello	FLS092	Vernors Diet
FLS046	Mountain Dew	FLS093	Water

Beer Systems, Bar Equipment



Advanced Beverage Solutions  
100 Gary Avenue, Suite C  
Roselle, IL 60172

[www.absone.com](http://www.absone.com)  
E-mail: [orders@absone.com](mailto:orders@absone.com)

877-814-2271  
Local: 847-524-1707  
Fax: 847-524-1710

### Metal Tubing

Part Number	Description	Std. Length
0375020304096	3/8" OD stainless steel	300'
940004	5/16" stainless steel	10,000' coil
CPTUBE-4	1/4" OD copper	50' coil
CPTUBE-6	3/8" OD copper	50' coil



CPTUBE



0375020304096

### Tubing Tools

Part Number	Description
29	Vice grip pinch-off tool
14100083	Oetiker side-jaw pincers
C100	Pincers
C200	SS tube ID sizing rod: 3/16, 1/4, 5/16, 3/8"
951-01	Bundle jacket slicer
953-01000-00	Jumbo bundle cutter, cuts 2.5" diameter trunk lines
953-01	Jumbo bundle cutter blade replacement
954-01	Bundle tubing cutter
954-03	Replacement blade for bundle cutter
958-01	Hose cutter
958-03	Replacement blade for hose cutter
959-01	Accu-cutter
959-03	Replacement blade for Accu-cutter
8013-3	One hole replacement blade, Accu-cutter
BT135	Replacement blades SL135T



### Metal Hose Clamps



Part Number	Description	Inch Range
62602	Adjustable hose clamp	1/4 - 5/8
435032E	Adjustable hose clamp	3/8 - 7/8
HC5212	Adjustable hose clamp	1/2 - 1-1/4
600024	Adjustable hose clamp	1-1/16 x 2
600040	Adjustable hose clamp	2-1/16 x 3
600056	Adjustable hose clamp	3-1/16 x 4

### Plastic Hose Clamps



Part Number	Nominal OD"	Description
17007	7/16	Plastic hose clamp, white
17019	1/2	Plastic hose clamp, yellow
170211	9/16	Plastic hose clamp, red
170312	5/8	Plastic hose clamp, black
170415	3/4	Plastic hose clamp, blue

### Tapes



Part Number	Description
ME1795	Teflon tape
ME1985	Black electrical tape, 66 ft. roll
ME7015200	Silver duct tape
NA398B	Black duct tape
4219-12	Foam insulation tape, 2" x 30'
504189	Tape, black, PVC, 3" x 60'
MP100820	Sleeve (4 rolls) 2" x 60' vinyl tape

### Lubricants

Part Number	Description
4084-03	Food Grade Silicone spray
FT101L	1 oz. tin/can lubricant
FT938	8 oz. tin/can lubricant
95-0231	Food grade lubricant



Beer Systems, Bar Equipment



Advanced Beverage Solutions  
100 Gary Avenue, Suite C  
Roselle, IL 60172

**www.abstone.com**  
E-mail: [orders@abstone.com](mailto:orders@abstone.com)

877-814-2271  
Local: 847-524-1707  
Fax: 847-524-1710

## Kwik Blocks



Quick and secure way to fasten tubing to 2x4 or 2x6 studs, black or natural. Sold in cases of 100 or individually.



Part #	Description	Size L x W x H"
KB5400	Large, side mounting ears, for 2x6	5-3/8 x 2-1/4 x 1-7/8
KB3000	Small, side mounting ears	3 x 1-1/8 x 1
KB3400	Large, single center hole, no ears for 2x4 stud	3-3/8 x 2-1/4 x 1-7/8
KB2000	Small, single center hole, no ears	2 x 1-1/8 x 1

## Stainless Steel Chase

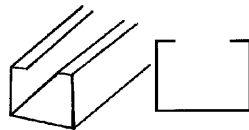

Part #	Size"	Description
26272	2.5 x 2.5 x 72	Chase, lid and hardware
25862	3 x 3 x 72	Chase, lid and hardware
608628	3 x 3 x 95	Chase with hardware
29915	4 x 4 x 48	Chase, lid and hardware, min. qty. 8
629919	4 x 4 x 72	Chase, lid and hardware
15629	6 x 6 x 72	Chase, lid and hardware
1070306	6 x 6 x 78	Chase, lid and hardware
629916	6 x 6 x 95	Chase, lid and hardware
600108	6 x 6 x 108	Chase, lid and hardware
608625	6 x 8 x 72	Chase, lid and hardware
629917	6 x 10 x 95	Chase, lid and hardware

*Beer line saddles can be found with fittings on page 101*

## Conduit Straps

Fasten tubing to walls or ceilings.

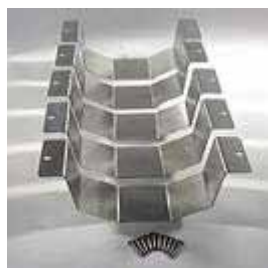

205968

Part #	Size"	Description
HS907	2-1/2	Conduit strap (2 hole)
HS909	3-1/2	Conduit strap (2 hole)
205968		Stainless conduit straps, 5 straps and mounting screws

## Backflow Preventing TRU-GAP Kits



When you cannot connect directly to your drain system and need to allow proper air gap, Tru-Gap is the perfect solution. It's designed for draining beverage dispensers, ice maker, filtration system and many other uses.

- Multiple installation configurations for different applications
- Can be connected by solvent weld glue to standard 2" PVC pipe
- Optional PVC reducer fittings can be adapted to smaller or larger piping easily
- Includes built in hook for floor grates & drains
- Helps prevents backed-up and potentially contaminated water from entering your system
- Ideal for a number of applications such as dish washers, beverage machines, eye-wash stations, ice machines, filtration systems, buffet tables, and many more applications
- Included pipe mount secures pipes and prevents them from wobbling or sagging also provides a clean and professional appearance
- Tested and fully compliant to the ASTM D2665-07 standard

Drain body and tubing support mount are (PVC) ASTM D2665, hardware is stainless steel.

Installation: TRU-GAP can be connected by solvent weld to a standard 2" PVC DWV pipe, and with PVC reducer fittings can be adapted to smaller or larger piping.

Part #	Description
925340	Tru-Gap air gap fixture with pipe mount
925341	Tru-Gap pipe mount

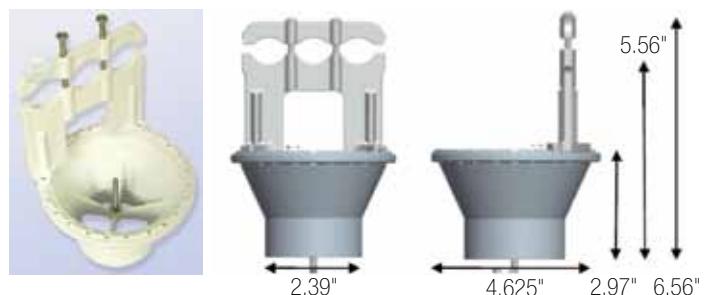



Advanced Beverage Solutions  
100 Gary Avenue, Suite C  
Roselle, IL 60172

**www.absone.com**  
E-mail: [orders@absone.com](mailto:orders@absone.com)

877-814-2271  
Local: 847-524-1707  
Fax: 847-524-1710

## Unicorn™ Soda Dispensing Towers

Designed with a sleek retro look, the Unicorn font adds character and style to your bar or restaurant dining experience. Products can be served with pinpoint accuracy by pulling the handle, holding the flavor button, or by the optional portion control buttons. Accommodates up to four brands and carbonated water. Features Lancer Flow Control Valve Recirculation (LFCV-R), 1.75 oz/sec. Through counter mounting. Carbonated water inlet: 3/8" quick disconnect. Syrup inlets: 1/4" barb. 24V/60Hz. Options: Power supply, chiller, and branding



Unicorn Tower:  
9.12"W x 14"D x 27.5"H  
Control Box (Valves):  
13.1"W x 8.12"D x 6.1"H  
Drip Tray Included



General Beverage



Coca-Cola

Pepsi

Part Number	Description
85-3161R-21-21222	Unicorn recirculating tower, portion control, LFCV-R valve, general beverage branding
85-3161R-21-23222	Unicorn recirculating tower, no portion control, LFCV-R valve, general beverage branding
85-3151R-21-11111	Unicorn recirculating tower, portion control, Volumetric valve,* Coca-Cola branding
85-3161R-21-11111	Unicorn recirculating tower, portion control, LFCV-R valve, Coca-Cola branding
85-3161R-21-31333	Unicorn recirculating tower, portion control, LFCV-R valve, Pepsi branding
85-3161R-21-33333	Unicorn recirculating tower, no portion control, LFCV-R valve, Pepsi branding

**\*Volumetric Valves are Coca-Cola exclusive.**

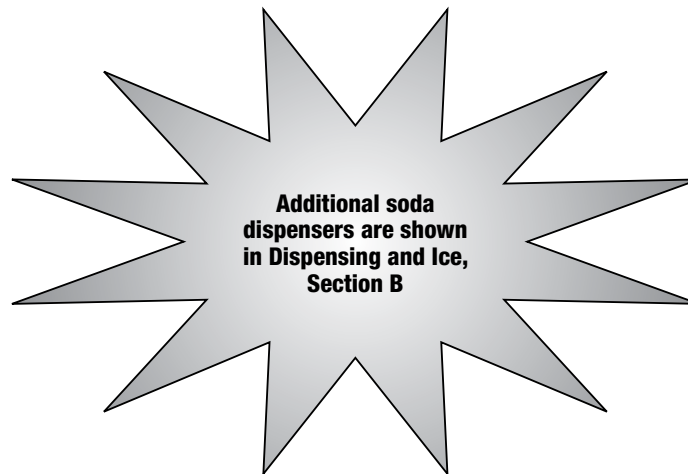



### Mark 4 Post-Mix Bar Guns

Wunder-Bar Mark 4 bar guns have the following features for ease of service and greater reliability.

- Locking hat plugs allow for service to one valve cavity at a time. Plugs stay put, even under pressure.



- Optional shut-off screw extensions allow the shut-off screws to be turned off/on with finger and thumb. Includes cover guard. Order with or without this feature.



Cover guard removed

Cover guard in place

- Manifold end of flex-hose assembly now includes a welded stainless steel bushing, not plastic. Optional barrier tubing prevents flavor cross-over from pungent beverage syrups.



- Replace stem seal O-ring from the top of the handle, not the bottom, even under pressure. Retainer plate is removed, then O-ring.



- New shut-off screw includes soft-tip for positive shut-off

Black and white shut-off screws should be finger tightened only - **Tools may cause damage** - Turning screws past the "On" and "Off" positions may cause damage to the input module and cause leaking



Old

New

- All handle heels now include split heel design.



10 button

12 button

14 button

- NEW Kwik Klip stays put. Won't pull out.



Old  
New

- Sanitary drip tray design catches any nozzle drip and provides sanitary air-gap from nozzle. Nozzle stays clean. New drip tray is NSF listed.





Advanced Beverage Solutions  
100 Gary Avenue, Suite C  
Roselle, IL 60172

[www.absone.com](http://www.absone.com)  
E-mail: [orders@absone.com](mailto:orders@absone.com)

877-814-2271  
Local: 847-524-1707  
Fax: 847-524-1710

## Mark 4 Bar Guns

The Wunder-Bar Mechanical Flex-Hose bar dispenser is available in 1, 2, 3, 4, 5, 6, 7, 8, 9, 10, 12, and 14 button models. All models can be configured for many combinations of carbonated, non-carbonated, non-carbonated pre-mix and energy drink products at any time. All of these combinations are field-convertible and can be modified without shutting off the dispenser. All seven, eight, and nine button dispensers have all the necessary valves and product tubes already installed into the dispenser, making the upgrade to up to ten buttons as easy as adding buttons on the handle and input modules and input fittings at the manifold.

Bar guns are available with permanent connections, quick disconnect or flow-regulated manifolds, optional barrier tubing, and in five colors. These units are field convertible from carbonated to non-carbonated and wine. Precision machined diffusers provide better carbonation, minimal brix stratification, faster flow rate and minimal foaming.

All Wunder-Bar post-mix type flex-hose dispensers include two water meter adjustment screws which allow 2:1 ratio products to be brixed independently from 4:1 or 5:1 ratios. No more sacrificing flow rates to obtain a 2:1 brix!

Bar guns include quick disconnect manifold, stainless steel input fittings, hose hanger and mounting hardware.

## Buttons and Butterfly Plates

The buttons and button plates can be removed while the dispenser is under pressure. After the button plate has been removed, buttons can be changed, as can the configuration of the dispenser. By removing the butterfly retainer and screws and lifting out the butterfly plates, various standard configurations and endless special configurations can be created. The butterfly plates' balls fit into indentations in the O-ring retainers located in the handle recess. The half moon cut out area of the butterfly plates are where the retainer and retainer screws are located when attaching the plates to the handle. When replacing butterfly plates, be careful not to overtighten the retainer screws.

Over-tightening the retainer screws can cause the butterfly plates to bind.

*Butterfly plate configurations are detailed in the Replacement Parts section of this catalog.*



## Typical Post-Mix Bag-In-Box System

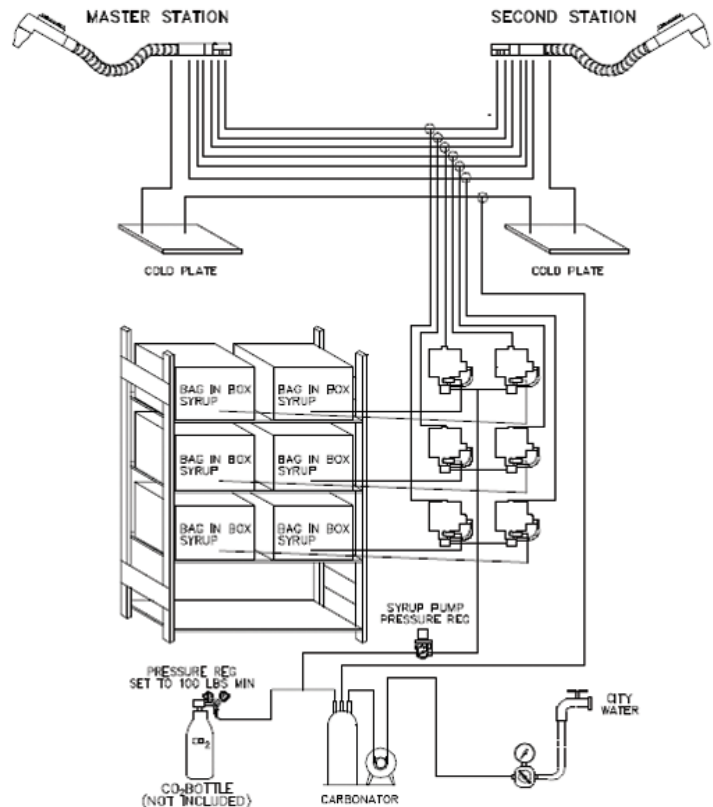

Standard manifold



Flow regulated manifold



## Mark 4 Bar Guns

MARK 4 dispenser model numbers will begin with the M4 designation, followed by a dash. There will be no more dashes, unless the model includes NSF designation.

For example, an M410620KSM3 is a... MARK4, 10 button, 6 carbonated, 2 non-carbonated, zero pre-mix non-carbonated, black(K), Series 2.5 (S), metering screw manifold (M), 3 ft. hose length.

***The following charts explain model numbers. Underlined letters must be filled in with the desired options...***

The model number will not be affected if shut-off screw extensions are requested. Upon request they are included at no charge.

4 barrier lines are standard. Upon request 8 barrier lines are available at no cost, and are not part of the model number.

New dispensers ordered without instructions will include the new sanitary drip tray and hanger. However, old style drip cups and hangers are available upon request at no cost, and are not reflected in the model number.

### Post-Mix and Energy Drink Dispensers Model Numbers

<b>M4</b>	<b>a</b>	<b>b</b>	<b>c</b>	<b>d</b>	<b>e</b>	<b>f</b>	<b>g</b>	<b>h</b>	<b>(N)</b>
Mark 4 dispenser	Total # of buttons	Number of carbonated products	Number of non-carb products	Number of pre-mix non-carb products	Color: <b>K</b> = Black <b>R</b> = Red <b>B</b> = Blue <b>G</b> = Green <b>C</b> = Cabana blue	Type: <b>S</b> = std 2.5 <b>2</b> = Series II <b>3</b> = Series III (large soda/ water tubing)	Manifold: <b>M</b> =metering screws <b>F</b> = flow reg. <b>FM</b> =flow reg + metering screws	Hose length: <b>3</b> = 3 ft. <b>4</b> = 4 ft. <b>5</b> = 5 ft. <b>6</b> = 6 ft.	Applies to NSF listed only (with plastic sheathing)

### Post-Mix Juice Dispensers\* Model Numbers

<b>M4</b>	<b>a</b>	<b>JD</b>	<b>e</b>	<b>f</b>	<b>h</b>	<b>(N)</b>
Mark 4 dispenser	Total # of buttons	Juice Dispenser	Color: <b>K</b> = Black <b>R</b> = Red <b>B</b> = Blue <b>G</b> = Green <b>C</b> = Cabana blue	Type: <b>S</b> = std 2.5 <b>2</b> = Series II <b>3</b> = Series III (large tubing)	Hose length: <b>3</b> = 3 ft. <b>4</b> = 4 ft. <b>5</b> = 5 ft. <b>6</b> = 6 ft.	Applies to NSF listed only (with plastic sheathing)

\*Juice dispensers are only available with metering screws.

### Please Note:

Mark 4 standard input module clip inserts should always be installed and kept in place on both sides of the Mark 4 standard input modules (input fitting and interconnect sides) **when the dispenser is under pressure**. (See fig. 1) These yellow clips ensure that the input module doesn't dislodge from the module frame. The clips should only be removed when servicing the manifold once the product (soda, water or syrup) has been depressurized or removed from the manifold position.

Also, it is important when mounting the dispenser that the manifold and the tube collector be mounted flush against the mounting surface using the (4) PM10-66 #10x2" that are provided with every dispenser in the hose hanger kit.

90° manifold block assemblies are available to assist in areas where tubing attachment or manifold/tube collector placement is difficult due to space constraints.

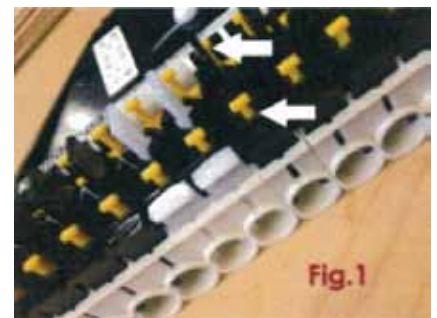





## Mark 4 Bar Guns

Please replace each asterisk (\*) with the appropriate number or letter to configure a new Mark 4 bar gun. Be sure to **USE THE PROPER SEQUENCE** detailed on page 56, and outlined below.

Post-Mix	Quick Disconnect
M48****M*	8 button dispenser, 6 flavors, soda and water
M410****M*	10 button dispenser, 8 flavors, soda and water
M412****M*	12 button dispenser, 10 flavors, soda and water
M414****M*	14 button dispenser, 12 flavors, soda and water
**** Specify number of carbonated, non-carb, pre-mix, accent color, disp., manifold (M), and hose length. Example: M410620KSM3 = 10 button, 6 carbonated, 2 non-carbonated, 0 pre-mix, black (K), Series 2.5 (S), metering screw manifold (M), 3 ft. hose length	
Accent Colors: K=Black, R=Red, B=Blue, G=Green, C=Cabana Blue	
Dispenser type: S=Standard (2.5), 2=Series II, 3=Series III	
Manifold type: M=metering screws	
Hose lengths: 3=3' (standard). Optional (upcharge): 4=4', 5=5', and 6=6'	
If NSF listed (with plastic sheathing) is desired, add (N) to the end of the part number	

Post-Mix	Flow Regulator (F) / Flow Regulator+Metering Screws (FM)
M48****F*	8 button dispenser, 6 flavors, soda and water, flow regulator
M410****F*	10 button dispenser, 8 flavors, soda and water, flow regulator
M412****F*	12 button dispenser, 10 flavors, soda and water, flow regulator
M414****F*	14 button dispenser, 12 flavors, soda and water, flow regulator
M48****FM*	8 button dispenser, 6 flavors, soda and water, flow regulator+metering screws
M410****FM*	10 button dispenser, 8 flavors, soda and water, flow regulator+metering screws
M412****FM*	12 button dispenser, 10 flavors, soda and water, flow regulator+metering screws
M414****FM*	14 button dispenser, 12 flavors, soda and water, flow regulator+metering screws
**** Specify number of carbonated, non-carb, pre-mix, accent color, type, manifold (M), and hose length. Example: M410620KSF3 = 10 button, 6 carbonated, 2 non-carbonated, 0 pre-mix, black (K), Series 2.5 (S), flow reg manifold (F), 3 ft. hose length	
Accent Colors: K=Black, R=Red, B=Blue, G=Green, C=Cabana Blue	
Dispenser type: S=Standard (2.5), 2=Series II, 3=Series III	
Manifold type: F=Flow reg., FM=Flow reg+Metering screws	
Hose lengths: 3=3' (standard). Optional (upcharge): 4=4', 5=5', and 6=6'	
If NSF listed (with plastic sheathing) is desired, add (N) to the end of the part number	

Energy Drink	Flex Hose
M41100KSM*	1 button energy drink dispenser
WBM2**	2 button energy drink dispenser
WBM3**	3 button energy drink dispenser
WBM4**	4 button energy drink dispenser
* Specify hose length: 3=3' (standard). Optional (upcharge): 4=4', 5=5', and 6=6'	
Accent color - BLACK only	

Post-mix and energy drink dispensers come with 1/4" SS inlet fittings

Exploded view diagrams and parts lists can be found in the Replacement Parts section of this catalog.

Post-mix



Energy drink



Juice



Pre-mix



Wine





Advanced Beverage Solutions  
100 Gary Avenue, Suite C  
Roselle, IL 60172

**www.absone.com**  
E-mail: [orders@absone.com](mailto:orders@absone.com)

877-814-2271  
Local: 847-524-1707  
Fax: 847-524-1710

## WBM Bar Guns

Juice	Quick Disconnect
M44JD***	4 button juice dispenser
M46JD***	6 button juice dispenser
M48JD***	8 button juice dispenser
M410JD***	10 button juice dispenser
M412JD***	12 button juice dispenser

\*\*\*Specify accent color, type, and hose length.

Example: M410JDKS4 = 10 button juice, black, Series 2.5 (S), 4 ft. hose length

Accent Colors: K=Black, R=Red, B=Blue, G=Green, C=Cabana Blue

Dispenser type: S=Standard (2.5), 2=Series II, 3=Series III

Hose lengths: 3=3' (standard). Optional (upcharge): 4=4', 5=5', and 6=6'

If NSF listed (with plastic sheathing) is desired, add (N) to the end of the part number

WBM juice dispensers come with 3/8" tubes.

## WBM Bar Guns

Pre-Mix	Flex Hose
WBM-PMX-5	5 button dispenser
WBM-PMX-5S	5 button dispenser with ice shield
WBM-PMX-6	6 button dispenser
WBM-PMX-6S	6 button dispenser with ice shield
WBM-PMX-7	7 button dispenser
WBM-PMX-7S	7 button dispenser with ice shield

Accent colors: Black (standard), R=Red, B=Blue

Hose lengths - 36" standard. 60", 72" and 84" available optional upcharge

Wine	Flex Hose
WBM-1WD	1 button dispenser
WBM-2WD	2 button dispenser
WBM-3WD	3 button dispenser
WBM-4WD	4 button dispenser

Fast Flow	Flex Hose
WBM-1-PM-FF	1 button fast flow dispenser postmix
WBM-2-PM-FF	2 button fast flow dispenser postmix
WBM-1-PMX-FF	1 button fast flow dispenser premix
WBM-2-PMX-FF	2 button fast flow dispenser premix

Hose lengths - 36" standard. 48", 56", 60", 72" and 84" available optional upcharge

Add an "S" to the end of the part number to include an ice/cold plate shield on a pre-mix dispenser. Wine guns dispense bag-in-box wine. All fast flow dispensers are for non-carbonated products. Four barrier lines per gun is standard. Other configurations are available. Please contact your ABS representative if you don't find what you're seeking.

Exploded view diagrams and parts lists can be found in the Replacement Parts section of this catalog.

Post-mix



Energy drink



Juice



Pre-mix



Wine





Advanced Beverage Solutions  
 100 Gary Avenue, Suite C  
 Roselle, IL 60172

**www.absone.com**  
 E-mail: [orders@absone.com](mailto:orders@absone.com)

877-814-2271  
 Local: 847-524-1707  
 Fax: 847-524-1710

## Wunder-Bar's Refurbishing Program

Effective January 1, 2014, Wunder-Bar has implemented a new program for all rebuilt/warranty Wunder-Bar dispensers.

Wunder-Bar now offers a 4-year warranty on all new bar guns and a 1-year warranty against defective parts and workmanship on remanufactured bar guns. The repair program is offered for bar guns less than 8 years old. To find the age of your bar gun check the serial number.

### Explanation of serial numbers:

Example: Serial # 01410-1052

- First two numbers (01) represent the month
- Third number (4) represents the week of the month
- Fourth and fifth numbers (10) represent the year
- Last four numbers (1052) represent the lot number

### Procedure:

Contact ABS Customer Service Department to obtain a Return Material Authorization (RMA). The following information is required to process the RMA request:

- Quantity of bar guns for repair
- Number of buttons on bar gun
- Flex hose only or Flex hose with fittings and hose hanger kit
- Type of dispenser - Postmix/Juice/Premix/Wine/Energy/Fast flow (premix or postmix type)

Repair requests will be process through ABS and the customer is responsible for all freight charges. All repairs are completed by Wunder-Bar using factory authorized parts. All available upgrades will be made to deliver the best product in the industry.

## Wunder-Bar Replacement Parts

ABS offers a complete array of replacement parts. Many are in stock. Call for availability.

Exploded view diagrams and parts lists can be found in the Replacement Parts section of this catalog.

Post-mix



Energy drink



Juice



Pre-mix



Wine





## Bar Gun Accessories

Part Number	Description
PM10-43	Hose hanger kit, complete
PH10-119	Hose hanger kit, sanitary drip cup, complete
PM10-74	Wire hose hanger kit, complete
PH10-121	Wire hose hanger kit, sanitary drip cup, complete
Q7-22	Stainless steel custom drip tray
PM10-44	Locking handle cover with lock
PMSA-15	Waitress station
PH10-36	O-ring insert tool, brass
M4PMPARTS	Mark 4 parts kit
M4FRPARTS	Mark 4 parts kit, flow reg
PM10-73	Parts kit, series III and II.5
PM10-38	Parts kit, series II
PH10-112	O-ring tool Mark 4
PH10-126	Hat plug tool Mark 4

## Bar Gun Round Snap-on Button Caps

Post-mix bar gun buttons (PH10-74- Series) have two parts; the button (PH1073), and snap-on cap. Snap-on caps come in a variety of colors, letters and abbreviations.

Part Number	Imprint	Letter Color	Cap Color
PH1073	N/A	N/A	N/A
PH10-74-001	A	White	Green
PH10-74-002	B	White	Brown
PH10-74-003	B	Black	White
PH10-74-004	C	Black	White
PH10-74-005	C	White	Red
PH10-74-006	D	Black	White
PH10-74-007	F	Black	White
PH10-74-008	G	White	Green
PH10-74-009	G	Black	Pink
PH10-74-010	G	Black	White
PH10-74-011	I	Black	White
PH10-74-012	J	Black	White
PH10-74-013	L	Black	Yellow
PH10-74-014	L	White	Green
PH10-74-015	L	Black	Pink
PH10-74-016	L	Black	White
PH10-74-017	M	Black	White
PH10-74-018	O	Black	White
PH10-74-019	O	Black	Orange
PH10-74-020	P	Black	Yellow

Exploded view diagrams and parts lists can be found in the Replacement Parts section of this catalog.



Part Number	Imprint	Letter Color	Cap Color
PH10-74-021	P	Black	White
PH10-74-022	P	White	Brown
PH10-74-023	P	White	Purple
PH10-74-024	Q	Black	White
PH10-74-025	THROTL	White	Blue
PH10-74-026	R	White	Brown
PH10-74-027	R	White	Orange
PH10-74-028	R	Black	White
PH10-74-029	R	Black	Pink
PH10-74-030	R	Black	Orange
PH10-74-031	S	Black	White
PH10-74-032	S	Black	Yellow
PH10-74-033	T	White	Brown
PH10-74-034	T	White	Red
PH10-74-035	T	Black	White
PH10-74-036	V	Black	White
PH10-74-037	W	Black	Pink
PH10-74-038	W	Black	White
PH10-74-039	X	Black	White
PH10-74-040	CR	White	Red
PH10-74-041	CR	White	Blue



Advanced Beverage Solutions  
100 Gary Avenue, Suite C  
Roselle, IL 60172

[www.absone.com](http://www.absone.com)  
E-mail: [orders@absone.com](mailto:orders@absone.com)

877-814-2271  
Local: 847-524-1707  
Fax: 847-524-1710

## Bar Gun Round Snap-on Button Caps



Exploded view diagrams and parts lists can be found in the Replacement Parts section of this catalog.

Part Number	Imprint	Letter Color	Cap Color
PH10-74-042	DC	Black	White
PH10-74-043	DV	White	Black
PH10-74-044	GF	Black	Yellow
PH10-74-045	GF	Black	Pink
PH10-74-046	OJ	Black	Orange
PH10-74-047	RC	Black	White
PH10-74-048	RC	White	Blue
PH10-74-049	SQ	Black	White
PH10-74-050	SQ	Black	Yellow
PH10-74-051	SS	Black	White
PH10-74-052	SS	Black	Yellow
PH10-74-053	SS	White	Green
PH10-74-054	1	Black	White
PH10-74-055	2	Black	White
PH10-74-056	7UP	White	Green
PH10-74-057	EXTRACT	Black	Orange
PH10-74-058	APPLE	White	Green
PH10-74-059	BMARY	Black	White
PH10-74-060	BMARY	White	Brown
PH10-74-061	BMARY	White	Red
PH10-74-062	COLA	Black	White
PH10-74-063	COLA	White	Blue
PH10-74-064	COCO	Black	White
PH10-74-065	CHERRY	White	Red
PH10-74-066	COKE	White	Red
PH10-74-067	COLLINS	White	Black
PH10-74-068	CRAN	White	Red
PH10-74-069	DIET	White	Blue
PH10-74-070	DIET	White	Red
PH10-74-071	DIET	Blue	White
PH10-74-072	DIET	Red	White
PH10-74-073	DIET	Black	White
PH10-74-074	D PEP	White	Blue
PH10-74-075	D PEP	White	Brown
PH10-74-076	D PEP	White	Red
PH10-74-077	ONE	White	Blue
PH10-74-078	DR P	White	Brown
PH10-74-079	ADRN	Black	White
PH10-74-080	DR P	White	Red
PH10-74-081	DRY	Black	White
PH10-74-082	GALE	White	Green
PH10-74-083	GALE	Black	White
PH10-74-084	GINGER	White	Green
PH10-74-085	GINGER	Black	White

Part Number	Imprint	Letter Color	Cap Color
PH10-74-086	GRAPE	White	Purple
PH10-74-087	GATOR	Black	White
PH10-74-088	GUAVA	Black	Pink
PH10-74-089	RAVE	Black	Purple
PH10-74-090	GRPFT	Black	White
PH10-74-091	GRPFT	Black	Pink
PH10-74-092	GRPFT	Black	Yellow
PH10-74-093	GRPFT	White	Green
PH10-74-094	SUN TZU	Black	Yellow
PH10-74-095	GUAVA	Black	White
PH10-74-096	EXTRACT	Yellow	Black
PH10-74-097	ITAL	Black	White
PH10-74-098	KONDI	White	Green
PH10-74-099	LADE	Black	White
PH10-74-100	LADE	Black	Pink
PH10-74-101	LADE	Black	Yellow
PH10-74-102	LEMON	Black	White
PH10-74-103	LEMON	Black	Yellow
PH10-74-104	LEMON	Black	Pink
PH10-74-105	EXTRACT	Black	Pink
PH10-74-106	LIFT	Black	White
PH10-74-107	MANGO	Black	Orange
PH10-74-108	MAX	White	Blue
PH10-74-109	MIST	White	Green
PH10-74-110	MTDEW	Black	Yellow
PH10-74-111	MTDEW	White	Green
PH10-74-112	D 7UP	White	Green
PH10-74-113	ONE	White	Blue
PH10-74-114	ORG	Black	Orange
PH10-74-115	ORG	Black	White
PH10-74-116	(blank)	(blank)	Orange
PH10-74-117	PAPAYA	White	Purple
PH10-74-118	PASS	White	Purple
PH10-74-119	PEACH	Black	Orange
PH10-74-120	PEACH	Black	Pink
PH10-74-121	PEACH	Black	White
PH10-74-122	PIBB	White	Brown
PH10-74-123	PEPSI	White	Blue
PH10-74-124	PEPSI	White	Green
PH10-74-125	PEPSI	Black	White
PH10-74-126	PINA	Black	White
PH10-74-127	PINE	Black	Yellow
PH10-74-128	PINE	Black	White
PH10-74-129	POG	White	Purple



Advanced Beverage Solutions  
100 Gary Avenue, Suite C  
Roselle, IL 60172

**www.absonone.com**  
E-mail: [orders@absonone.com](mailto:orders@absonone.com)

877-814-2271  
Local: 847-524-1707  
Fax: 847-524-1710

## Bar Gun Round Snap-on Button Caps



PH10-76 button

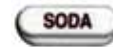

PH10-77-500, snap-on oval cap



PH10-77-501, snap-on oval cap

Part Number	Imprint	Letter Color	Cap Color
PH10-74-130	PRUNE	White	Brown
PH10-74-131	PRUNE	Black	White
PH10-74-132	PUNCH	White	Red
PH10-74-133	PUNCH	Black	Pink
PH10-74-134	PUNCH	Black	White
PH10-74-135	RASP	White	Red
PH10-74-136	RASP	Black	White
PH10-74-137	RASP	Black	Pink
PH10-74-138	RBEER	Black	White
PH10-74-139	RBEER	White	Brown
PH10-74-140	RED	White	Red
PH10-74-141	ROSE	Black	Pink
PH10-74-142	SLICE	Black	White
PH10-74-143	SLICE	Black	Orange
PH10-74-144	SLICE	White	Green
PH10-74-145	SOUR	Black	White
PH10-74-146	SOUR	Black	Yellow
PH10-74-147	SOUR	White	Green
PH10-74-148	SPRITE	White	Green
PH10-74-149	STORM	White	Green
PH10-74-150	SQUIRT	White	Green
PH10-74-151	STRAW	White	Red
PH10-74-152	STRAW	Black	Pink
PH10-74-153	STRAW	Black	White
PH10-74-154	(blank)	(blank)	Blue
PH10-74-155	SQUIRT	Black	White
PH10-74-156	SQUIRT	Black	Yellow
PH10-74-157	TEA	Black	White
PH10-74-158	TEA	White	Red
PH10-74-159	TEA	White	Brown
PH10-74-160	TOM	White	Red
PH10-74-161	TONIC	Black	White
PH10-74-162	WHITE	Black	White
PH10-74-163	SS	Black	Green
PH10-74-164	LION	Black	Yellow
PH10-74-165	BULL	White	Black
PH10-74-166	LION HEAD	Black picture	Yellow
PH10-74-167	SOBE	Black	Yellow
PH10-74-168	* (star)	Black	Yellow
PH10-74-169	TANGO	Black	Orange
PH10-74-170	ENERGY	Black	White

Part Number	Imprint	Letter Color	Cap Color
PH10-74-171	(blank)	(blank)	Brown
PH10-74-172	FUEL	White	Red
PH10-74-173	SPORT	Black	Yellow
PH10-74-174	SPORT	White	Red
PH10-74-175	SPORT	Black	Green
PH10-74-176	BONZAI	Yellow	Red
PH10-74-177	BONZAI	White	Blue
PH10-74-178	ZERO	Blue	White
PH10-74-179	TR	Black	Yellow
PH10-74-180	TSF	Black	Yellow
PH10-74-181	BL	White	Blue
PH10-74-182	POWER	White	Blue
PH10-74-183	POWER	White	Red
PH10-74-184	POWER	Black	White
PH10-74-185	RUSH	White	Red
PH10-74-186	(blank)	(blank)	Green
PH10-74-187	(blank)	(blank)	Pink
PH10-74-188	(blank)	(blank)	Purple
PH10-74-189	(blank)	(blank)	Red
PH10-74-190	(blank)	(blank)	Yellow
PH10-74-191	S	White	Green
PH10-74-192	(blank)	(blank)	White
PH10-74-193	D 7UP	Green	White
PH10-74-194	ENERGY	Black	White
PH10-74-195	(lightning bolt)	White	Black
PH10-74-196	(lightning bolt)	White	Blue
PH10-74-197	DT DEW	Green	White
PH10-74-198	DT DRP	Burgundy	White
PH10-74-199	CTHK	White	Red
PH10-74-200	LTHK	Black	Yellow
PH10-74-201	ATHK	White	Green
PH10-74-202	OTHK	Black	Orange

### Oval Button Caps

PH10-77S	SODA	Black	White
PH10-77W	WATER	Black	White
PH10-77-502	CARB	Black	White
PH10-77-503	(blank)	(blank)	White
PH10-77-504	THICK	Black	White
PH10-77-505	HONEY	Black	White
PH10-77-506	NECTAR	Black	White



Advanced Beverage Solutions  
100 Gary Avenue, Suite C  
Roselle, IL 60172

**www.abstone.com**  
E-mail: [orders@abstone.com](mailto:orders@abstone.com)

877-814-2271  
Local: 847-524-1707  
Fax: 847-524-1710

## Ice Chests

One inch molded polyurethane structural insulation on all sides and bottom retains cold. All stainless steel construction with 316L or 304 stainless steel available. NSF approved sliding lids.

- Available with or without sealed-in cold plate for post-mix
- 21" x 23" available with sealed-in cold plate;  
9 circuit post-mix
- 15" x 23" available with sealed-in cold plate;  
8 circuit post-mix
- Chests with 8 circuit cold plate have 1/2" drain

Stainless steel conversion and leg stands convert drop-in ice chests to free-standing units and are shown on page 65.



Free-standing  
Note: legs are not included



Drop-in

*See page 65 for conversion stands and leg kits*

Part Number	Type	Size W x D x H"	Capacity Lbs.	Cold Plate
95-0100	Drop-in	15 x 22 x 14.25	60	None
95-1100-7	Drop-in	15 x 22 x 14.25	60	7 circuit premix
95-1100-8	Drop-in	15 x 22 x 14.25	60	8 circuit postmix
85-0408	Drop-in	22 x 15 x 14.25	60	8 circuit postmix
95-1200-7	Drop-in	21 x 23 x 18	80	7 circuit premix
95-1200-9	Drop-in	21 x 23 x 18	80	9 circuit postmix
85-0402	Drop-in	23 x 21 x 18	100	9 circuit postmix
96-0100	Free-standing with leg set	15 x 22 x 14.25	60	None
96-1100-7	Free-standing with leg set	15 x 22 x 14.25	60	7 circuit premix
96-1100-8	Free-standing with leg set	15 x 22 x 14.25	60	8 circuit postmix
85-0461	Free-standing with legs	22 x 15 x 14.25 (+ 19.5H)	60	8 circuit postmix
96-1200-7	Free-standing with leg set	21 x 23 x	80	7 circuit premix
96-1200-9	Free-standing with leg set	21 x 23 x	80	9 circuit postmix
85-0462	Free-standing with legs	23 x 21 x 18 (+ 15.75H)	100	9 circuit postmix
30-10743	Ice chest top lid	15W x 22D	N/A	N/A
30-10742	Ice chest bottom lid	15W x 22D	N/A	N/A
30-8260	Ice chest top lid	15W x 23D	N/A	N/A
30-8259	Ice chest bottom lid	15W x 23D	N/A	N/A
30-8269	Ice chest top lid	21W x 23D	N/A	N/A
30-8268	Ice chest bottom lid	21W x 23D	N/A	N/A
Q8-30	Reverse lid set, FS2123	21W x 23D	N/A	N/A

## False Bottom Cold Plate Shields

Stainless steel false bottoms fit over the cold plate and allow ice to surround the cold plate while separating consumable ice from the ice used to chill the cold plate.

Part Number	Description	Size W x D x H"
30-9999-020602	False bottom CP shield	14W x 20D
30-9999-020603	False bottom CP shield	18.75W x 12D x 12H
30-9999-208003	False bottom CP shield	15.75W x 12D x 10H

False bottom cold plate shield





## Ice Chests

Stainless steel insulated ice bins are constructed with 18 gauge 304 stainless with drain, galvanized legs and adjustable high impact plastic feet. Lids are sold separately. Standard height is 32.5".

Mobile ice bins have 3" casters with toe activated brake, removable bottom tray and drain ball valve in the back of the unit.



Part Number	Size"	CP Circuit	Ice Bin Capacity
<b>Stainless Steel Ice Bins with Legs</b>			
BKIB-2412-18	24 X 18	None	60 lbs
BKIB-CP7-2412-18	24 X 18	7	60 lbs
BKIB-CP8-2412-18	24 X 18	8	60 lbs
BKIB-3012-18	30 X 18	None	80 lbs
BKIB-CP7-3012-18	30 X 18	7	80 lbs
BKIB-CP8-3012-18	30 X 18	8	80 lbs
BKIB-3612-18	36 X 18	None	100 lbs
BKIB-CP7-3612-18	36 X 18	7	100 lbs
BKIB-CP8-3612-18	36 X 18	8	100 lbs
BKIB-4812-18	48 X 18	None	140 lbs
BKIB-CP7-4812-18	48 X 18	7	140 lbs
BKIB-CP8-4812-18	48 X 18	8	140 lbs
BKIB-2412-21	24 X 21	None	76 lbs
BKIB-CP7-2412-21	24 X 21	7	76 lbs
BKIB-CP8-2412-21	24 X 21	8	76 lbs
BKIB-3012-21	30 X 21	None	100 lbs
BKIB-CP7-3012-21	30 X 21	7	100 lbs
BKIB-CP8-3012-21	30 X 21	8	100 lbs
BKIB-3612-21	36 X 21	None	125 lbs
BKIB-CP7-3612-21	36 X 21	7	125 lbs
BKIB-CP8-3612-21	36 X 21	8	125 lbs
BKIB-4812-21	48 X 21	None	175 lbs
BKIB-CP7-4812-21	48 X 21	7	175 lbs
BKIB-CP8-4812-21	48 X 21	8	175 lbs
<b>Stainless Steel Mobile Ice Bins</b>			
BK-MIB-2411	24 X 11	None	1.5 cu ft
BK-MIB-2422	24 X 22	None	3.0 cu ft
<b>Stainless Steel Ice Bin Lids</b>			
BKIB-L-2421	Fits BKIB-2412-21		N/A
BKIB-L-3021	Fits BKIB-3012-21		N/A
BKIB-L-3621	Fits BKIB-3612-21		N/A
BKIB-L-4821	Fits BKIB-4812-21		N/A
<b>Stainless Steel Drop-In Ice Bins</b>			
BK-DIBL-1218	12 X 18	Basin 9 X 13 X 10	
BK-DIBL-2218	22 X 18	Basin 18 X 13 X 10	
BK-DIBL-2818	28 X 18	Basin 24 X 13 X 10	
BK-DIBL-3418	34 X 18	Basin 30 X 13 X 10	
<b>Stainless Steel Drop-In Ice Bins with Water Station</b>			
BK-DIWSBL-2118G-P	21 X 18	Basin 9 X 13 X 11	
BK-DISWBL-2118X-P	21 x 18	Basin 9 X 13 X 11	
<b>Glass Filler Water Station</b>			
BK-WS-1SGF-G	Faucet and sink kit		
BK-SGF-G	Faucet only		
BK-WS	Sink only		





### Conversion Stands and Leg Stands

Stainless steel conversion and leg stands convert drop-in ice chests to free-standing units. Conversion stands include a bottom shelf for a carbonator, removable access panels, and 6" adjustable legs.

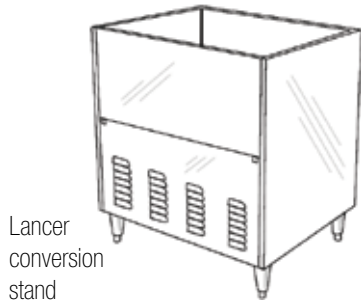

Lancer conversion stand



McCann's conversion stand



Leg stand 51-0389

Part Number	Description	Size W x D x H"
84-0006	Lancer conversion stand	17 x 25.25 x 36
84-0058	Lancer conversion stand	25 x 25 x 36
84-0059	Lancer conversion stand	31 x 25.5 x 36
16-1337	Conv. stand, knock down	17 x 25.25 x 36
16-1321	Conv. stand, knock down	25 x 25 x 36
16-1576	Conv. stand, knock down	32 x 25 x 36
16-1578	IBD stand, 22"	
16-1579	IBD stand, 30"	
LS-1522-KD	Leg stand, knock down	15 x 22 x 19.25
LS-2123-KD	Leg stand, knock down, 80 lb	21 x 23 x 19.25
51-0389	Leg stand, Lancer	15 x 22 x 19.25
51-0652	Leg stand, Lancer, 100 lb	21 x 23 x 15.75
LS-2123	Leg stand	21 x 23 x 19.25
LS-2123-100	Leg stand, 100 lb	21 x 23 x 15.25

### Cold Plates

Cold plates are placed in an ice bin. Ice chills the cold plate which chills beverages as they pass through the circuits in the cold plate before being dispensed by a bar gun. All cold plates include 5/16" MFL x 1/4" barbed fittings for each circuit, and can be special ordered with different fittings. Other sizes are available. **Designate Pre- or Post-mix when ordering.**



3016  
3018

Part Number	Description
17X19-5	5 circuit cold plate
13X20-8	8 circuit cold plate
12X18-8	8 circuit cold plate
12X18-7	7 circuit cold plate
12X18-6	6 circuit cold plate
10X15-8	8 circuit cold plate
10X15-7	7 circuit cold plate
10X15-6	6 circuit cold plate
10X15-5	5 circuit cold plate
10X15-4	4 circuit cold plate
10X15-3	3 circuit cold plate
10X15-2	2 circuit cold plate
10X15-1	1 circuit cold plate
8X14-8	8 circuit cold plate
8X14-7	7 circuit cold plate
8X14-6	6 circuit cold plate
8X14-5	5 circuit cold plate
8X14-4	4 circuit cold plate
8X14-3	3 circuit cold plate
8X14-2	2 circuit cold plate
8X12-8	8 circuit cold plate
8X12-7	7 circuit cold plate
8X12-6	6 circuit cold plate
8X12-5	5 circuit cold plate
8X12-4	4 circuit cold plate
8X12-3	3 circuit cold plate
8X12-2	2 circuit cold plate
3016	Cold plate fitting OUT to shank assy, SS, 1/2"-16 threads, 3/16" ID bore
3018	Cold plate fitting IN from coupler, SS, 3/8" OD barb



Advanced Beverage Solutions  
100 Gary Avenue, Suite C  
Roselle, IL 60172

**www.absone.com**  
E-mail: [orders@absone.com](mailto:orders@absone.com)

877-814-2271  
Local: 847-524-1707  
Fax: 847-524-1710

## Beer Couplers/Taps

Coupling heads can be used for single or series keg dispensing on single valve kegs. Picnic taps are for use with 4" hand pumps. Replacement parts are available.



Part #	Description
5821DBN	Type D, brass body, brass probe, lever black with pressure relief
5821DSS	Type D, SS body, SS probe, lever black with pressure relief valve
5821SSN	Type S, brass body, brass probe, lever black with pressure relief
5821SSS	Type S, SS body, SS probe, lever black with pressure relief valve
5841ASN	Type A, brass body, SS probe, lever black with pressure relief
5841ASS	Type A, SS body, SS probe, lever black with pressure relief valve
5841GSN	Type G, brass body, SS probe, lever black with pressure relief
5841GSS	Type G, SS body, SS probe, lever black with pressure relief valve
5841USN	Type U, brass body, SS probe, lever black with pressure relief
5841USS	Type U, SS body, SS probe, lever black with pressure relief valve
CH5000	Coupler, blue handle
CH5000SS	Coupler, stainless steel, gray handle
CH500045L	Lever tap with Kam-Loc barrel for US kegs
CH5001	Coupler, red handle
CH5003	Coupler, Sankey "D" gold handle
CH5004SS	Coupler, Sankey "D" with SS probe, blue handle
CH5100L	Lever tap with Kam-Loc barrel lock for European kegs
CH5200G	European G coupler, DSI (Bass)
CH5300U	European U coupler DSI (Guinness/Harp)
CH5400A	European A coupler DSI (Warensteiner/Pa)
CH5500K	KeyKeg Coupler - 30 Liter
FT86	Am. Sankey fast tap with metal wing handle
FT86P	Am. Sankey fast tap with plastic wing handle
FT90	Euro single valve tap with metal wing handle
FT90P	Euro single valve tap with plastic wing handle
FT37	Picnic tap with plastic wing handle
FT37M	Picnic tap with metal wing handle
FT50	Picnic tap with metal and plastic lever handle
FT44T	Low profile tap with threaded nipple
FT44TAB	Coupler, Sankey "D", low-profile, gold wing handle
FT85-8A	Sankey "D" metal wing handle assembly, chrome plated
375	SS turbo tap
CUSTCOUPLER	Custom branded keg coupler
95-0231	Food grade lubricant
1001056	Growler Adaptor - USA Faucet
759	Neoprene coupling beer washer
80219	Ball retainer
24253	Bottom seal
80220	Coupler ball
80221	Check valve coupler
80231	Coupler probe O-ring
FT40-15	Probe washer
01-2773	Adapter Fatlock 5/8"
01-2778	Adapter Fatlock 3/4"
01-2779	Growler adaptor - Highlight tap

Beer Systems, Bar Equipment



Advanced Beverage Solutions  
100 Gary Avenue, Suite C  
Roselle, IL 60172

**www.absone.com**  
E-mail: [orders@absone.com](mailto:orders@absone.com)

877-814-2271  
Local: 847-524-1707  
Fax: 847-524-1710

### Picnic Pumps



Part #	Description
PP501	Pony pump, American
PP601	Bronco pump, American
PP6014	Bronco pump with 4 faucets, American
PP602	Bronco pump, European
FT37PF	8" cylinder hand pump, wing tap, faucet/hose
FT42SP	Super pump
FT50PF	8" cylinder hand pump, handle tap, faucet/hose
BB089970	Perlick party pump with "D" system coupler
BB089973	Perlick party pump with "S" system coupler
C150	12" upright dispensing rod, no tap or knob
C151	Clamp set, holds picnic pump to upright rod
C383	Upright convertor assy, 4" metal pump, faucet, knob, all metal parts, (no coupler)
C384	Upright convertor assy, 8" metal pump, faucet, knob, all metal parts, (no coupler)
C385	D system coupler with 4" pump
C386	D system coupler with 8" pump
C393	Chrome plated brass 4" metal pump, no plastic
C393.1	4" Pump tube assembly
C393.2	Top cap
C393.22	4" Piston assembly
C393.5	Pump O-ring
C393.7	Piston spring
C393.8	Pump knob
C394	Chrome plated brass 8" metal pump, no plastic
C394.1	8" Pump tube assembly
C394.22	8" Piston assembly
C396	Connector, picnic pump to CO <sub>2</sub> inlet of coupler
C397	Vertical pump adapter, pump screws on top, coupler on bottom, air and beer line on sides
C399	Sankey pump adapter, chrome
CPSP386A	Side pump assy/coupler for import beers – A German
CPSP386D	Side pump assy/coupler for import beers – D American
CPSP386G	Side pump assy/coupler for import beers – G Bass
CPSP386S	Side pump assy/coupler for import beers – S European
CPSP386U	Side pump assy/coupler for import beers – U Guinness
UT101	Uber Tap 3 way splitter
UT102	Uber Tap foot pump
UT201D	3 way complete Uber Tap assembly – D Coupler
UT201S	3 way complete Uber Tap assembly – S Coupler
UT202D	1 Tap complete Uber Tap assembly – D coupler
UT202S	1 Tap complete Uber Tap assembly – S Coupler
UT203D	Upright complete assy with foot pump – D Coupler
UT203S	Upright complete assy with foot pump – S Coupler
C238H2	Picnic faucet with 2" hose
C238H4	Picnic faucet to beer coupler with 4" hose
1000004	CBT picnic pump faucet 5/16 barb in
0017	Beer tap figure 8 washer twin probe



Advanced Beverage Solutions  
 100 Gary Avenue, Suite C  
 Roselle, IL 60172

[www.absone.com](http://www.absone.com)  
 E-mail: [orders@absone.com](mailto:orders@absone.com)

877-814-2271  
 Local: 847-524-1707  
 Fax: 847-524-1710

## Picnic Coolers

Stainless steel coolers can be custom branded, add "BR" to the end of the part number. Lead times are shown on the next page.



CL105425



CL105435



Unbranded  
 55 qt SS cooler



Branded 55 qt SS cooler

Part Number	Description
CL105420	48 qt. picnic cooler with single 50' stainless steel coil, 1 faucet, shank, coupling, NPL fittings
CL105425	48 qt. picnic cooler with single 120' stainless steel coil, 1 faucet, shank, coupling, NPL fittings
CL105430	48 qt. picnic cooler with two 50' stainless steel coils, 2 faucets, shanks, couplings, NPL fittings
CL105435	48 qt. picnic cooler with two 120' stainless steel coils, 2 faucets, shanks, couplings, NPL fittings
CL105440	48 qt. picnic cooler with three 50' stainless steel coils, 3 faucets, shanks, couplings, NPL fittings
CL105520	48 qt picnic cooler with single faucet, 8 x 12" cold plate, shank, coupling, NPL fittings
CL105522	48 qt picnic cooler with two faucets, 8 x 12" cold plate, shanks, couplings, NPL fittings
CL105530	48 qt picnic cooler with single faucet, 10 x 15" cold plate, shank, coupling, NPL fittings
CL105540	48 qt picnic cooler with two faucets, 10 x 15" cold plate, shanks, couplings, NPL fittings
CL105542	48 qt picnic cooler with three faucets, 10 x 15" cold plate, shanks, couplings, NPL fittings
CL105545	48 qt picnic cooler with four faucets, 10 x 15" cold plate, shanks, couplings, NPL fittings
CL105450	100 qt picnic cooler with three 120' stainless steel coils, faucets, shanks, couplings
CL105550-1	54 qt SS picnic cooler with single 50' SS coil, 1 faucet, NPL fittings
CL105550-2	54 qt SS picnic cooler with two 50' SS coils, 2 faucets, NPL fittings
CL105550-3	54 qt SS picnic cooler with three 50' SS coils, 3 faucets, NPL fittings
CL105553-1	54 qt SS picnic cooler with single 120' SS coil, 1 faucet, NPL fittings
CL105553-2	54 qt SS picnic cooler with two 120' SS coils, 2 faucets, NPL fittings
CL105556-1	54 qt picnic cooler with 1 faucet, 10 x 15" cold plate, NPL fittings
CL105556-2	54 qt picnic cooler with 2 faucets, 10 x 15" cold plate, NPL fittings
CL105556-3	54 qt picnic cooler with 3 faucets, 10 x 15" cold plate, NPL fittings
CL105556-4	54 qt picnic cooler with 4 faucets, 10 x 15" cold plate, NPL fittings
CL115420-SS	48 qt. picnic cooler with single 50' stainless steel coil, 1 SS faucet, shank, coupling, 304SS fittings
CL115425-SS	48 qt. picnic cooler with single 120' stainless steel coil, 1 SS faucet, shank, coupling, 304SS fittings
CL115430-SS	48 qt. picnic cooler with two 50' stainless steel coils, 2 SS faucets, shanks, couplings, 304SS fittings
CL115435-SS	48 qt. picnic cooler with two 120' stainless steel coils, 2 SS faucets, shanks, couplings, 304SS fittings
CL115520-SS	48 qt picnic cooler with single faucet, 8 x 12" cold plate, shank, coupling, 304SS fittings
CL105522-SS	48 qt picnic cooler with two faucets, 8 x 12" cold plate, shanks, couplings, 304SS fittings
CL115530-SS	48 qt picnic cooler with single faucet, 10 x 15" cold plate, shank, coupling, 304SS fittings
CL115540-SS	48 qt picnic cooler with two faucets, 10 x 15" cold plate, shanks, couplings, 304SS fittings
CL105542-SS	48 qt picnic cooler with three faucets, 10 x 15" cold plate, shanks, couplings, 304SS fittings
CL115550-SS	54 qt SS picnic cooler with single 50' SS coil, 1 SS faucet, 304SS fittings
CL115552-SS	54 qt SS picnic cooler with two 50' SS coil, 2 SS faucets, 304SS fittings
CL115560-SS	54 qt SS picnic cooler with single 120' SS coil, 1 SS faucet, 304SS fittings
CL115562-SS	54 qt SS picnic cooler with two 120' SS coil, 2 SS faucets, 304SS fittings



Advanced Beverage Solutions  
100 Gary Avenue, Suite C  
Roselle, IL 60172

**www.absonone.com**  
E-mail: [orders@absonone.com](mailto:orders@absonone.com)

877-814-2271  
Local: 847-524-1707  
Fax: 847-524-1710

## Picnic Cooler Parts and Accessories



CL202054

CL105670-2TBR

Part Number	Description
CL202054	Custom branded SS picnic cooler, 54 qt
CL105566-BR	Custom branded CL105566 SS picnic cooler, single tap tower with branded fisheye on top of tower
CL105670-2TBR	Custom branded CL105570 SS picnic cooler, two tap tower with branded fisheye on top of tower
CL195100	D system tapping kit (CO2) for 1 tap picnic cooler
CL195105	D system tapping kit (CO2) for 2 tap picnic cooler
CL195110	D system tapping kit (CO2) for 3 tap picnic cooler
CL195115	D system tapping kit (CO2) for 4 tap picnic cooler
CL195150	D system tapping kit (N2) for 1 tap picnic cooler
CL195155	D system tapping kit (N2) for 2 tap picnic cooler
CL195160	D system tapping kit (N2) for 3 tap picnic cooler
CL106149X	50' left stainless steel coil, 5" coil diameter
CL106150L	50' left stainless steel coil, 9" coil diameter
CL106150R	50' right stainless steel coil, 9" coil diameter
CL106212L	120' left stainless steel coil (100' x 3/8" OD + 20' x 1/4" OD), 9" coil dia.
CL106212R	120' right stainless steel coil (100' x 3/8" OD + 20' x 1/4" OD), 9" coil dia.
C640	Jockey box drip tray with drain, SS, 6" x 6"
C301S	Special shank for Jockey Box, 3" long, 1/4" bore x 5/16" bore
C131	Wall coupling for coil cooler, 3/8" bore
C132	Wall coupling for coil cooler, 5/16" bore
C106	Grommet for stainless steel cooling, 1/4" ID
C107	Grommet for stainless steel cooling, 5/16" ID
C108	Grommet for stainless steel cooling, 3/8" ID
C207	Chrome ferrule for SS cooling, 1/4" ID
C208	Chrome ferrule for SS cooling, 5/16" ID
C216	Chrome ferrule for SS cooling, 3/8" ID
CL105200	8 qt SS coil cooler with a 50' coil and 2 cooler coupling shanks

Custom Graphics	Qty	Lead Time
Branded Coolers	1-4	7 days
	5-8	10 days
	9+	Confirmation
Fridges, Beverage Centers	1-19	7 days
	20-49	10 days
	50-99	13 days
	100+	Confirmation
Fridges, Solid Door	1-19	7 days
	20-49	10 days
	50 - 99	12 days
	100+	Confirmation



CL195105

\*Tapping kits include keg coupler(s), tubing, clamps, fittings, primary regulator with SS gauge guard, wrench



C640

C301S

C132

Grommet

Ferrule

CL105200

Beer Systems, Bar Equipment



## Special Events Dispensing and Custom Branded Displays

**Lancer's Multifill Beer System** is capable of pouring up to 1,800 beers in an hour, and can meet the demands of high traffic, high capacity situations in any venue. Can be manufactured for LEFT or RIGHT hand entry of beer and glycol lines. Cup size is pre-programmed during manufacture. Standard cup size is 15 oz.

- Reduces waiting queues in peak periods
- Metered dispense via electronic flow meters gives accurate dispense regardless of pressure
- Massive reduction in waste
- Available with chillerplate or icebank
- Manufactured to suit individual venues
- Available as bench mounted or mobile units
- Quick & easy installation – saves on installation costs
- Proven reliability in use in Australia and New Zealand's premier sporting, concert and event centres



Multifill



Multifill

**The MobiChill 50** beer cooler/flash chiller is designed for professional cooling, tapping and dispensing of chilled beer, both for home use and for outdoor parties or functions. Stainless steel product coil 5/16" OD. 115V/60Hz. R314a coolant.

- Built in air compressor means NO CO<sub>2</sub> and NO ice required
- Includes a drip tray and an adjustable temperature control with 7 different settings
- Chills within 2-4 minutes, pours 25-35 pints per hour
- Continuous cooling output: 4-7 gal/hr



MobiChill

Part Number	Description
MULTI-FILL	Multifill System microprocessor automatic dispensing system
MobiChill 50	MobiChill 50 cooler/flash chiller, 6-5/16W x 3-3/8D x 10 5/8"H
CUSTOMBLKEGDISP	Custom branded mobile keg dispenser
CUSTBANNER	Custom branded banner
CUSTEASEL	Custom branded easel
CUSTEQIPWRAP	Custom branded equipment wrap



Mobile keg dispenser



Custom branded easel

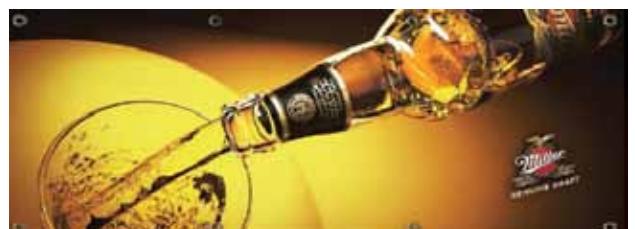

Custom branded banner



Advanced Beverage Solutions  
100 Gary Avenue, Suite C  
Roselle, IL 60172

[www.absonone.com](http://www.absonone.com)  
E-mail: [orders@absonone.com](mailto:orders@absonone.com)

877-814-2271  
Local: 847-524-1707  
Fax: 847-524-1710

**Branded and Unbranded Merchandisers**

*See page 69 for custom graphics lead times*



RE900017-BR



RE901252-BR



RE901276-BR



RE900071-BR



RE900071-BR

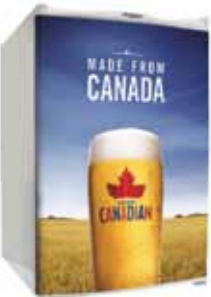

RE90005W-BR



RE90005B-BR



RE901275-BR



RE901285-BR



RE901255-BR



RE901257-BR



RE901273-BR



RE901288-BR



RE900110-BR



RE901288



RE900080



RE900083



RE901255



RE901252

**Beer Systems, Bar Equipment**



Advanced Beverage Solutions  
100 Gary Avenue, Suite C  
Roselle, IL 60172

[www.absone.com](http://www.absone.com)  
E-mail: [orders@absone.com](mailto:orders@absone.com)

877-814-2271  
Local: 847-524-1707  
Fax: 847-524-1710

## Branded and Unbranded Merchandisers

All of the models below can be custom branded by adding "-BR" to the end of the part number when ordering. See page 69 for custom graphics lead times.

Part Number	Description	Size W x H x D"
<b>Glass Door Countertop Models</b>		
RE901252	1 cu. ft. glass door merchandiser	13 x 23-1/2 x 15
RE901255	2 cu. ft. glass door merchandiser	16-1/2 x 29-1/4 x 17-7/8
RE901257	3 cu. ft. glass door merchandiser	19-1/8 x 36-1/2 x 21
RE900071	4.6 cu. ft. glass door merchandiser	20-1/2 x 31-3/8 x 21-1/4
RE901276	6 cu. ft. glass door merchandiser	22 x 36 x 27-13/16
<b>Glass Door Floor Models</b>		
RE901275	6 cu. ft. glass door merchandiser	23 x 40 x 23
RE901285	10 cu. ft. glass door merchandiser	23 x 54 x 23
RE901288	11 cu. ft. glass door merchandiser	23 x 62 x 23
RE900080	12 cu. ft. glass door merchandiser	23-3/8 x 66-15/16 x 25-7/16
RE900083	17 cu. ft. glass door merchandiser	27-9/16 x 79-3/16 x 25-7/16
RE900084	21 cu. ft. glass door merchandiser	27-9/16 x 79-3/16 x 31-15/16
<b>Sub Zero Glass Door Countertop Models</b>		
RE901272	2 cu. ft. Sub Zero fridge with glass door and temperature display	
RE901273	3 cu. ft. Sub Zero fridge with glass door and temperature display	
RE900104	S3 Sub Zero fridge with SS door	
RE900105	S2 Sub Zero fridge with solid door and lit merchandiser	
RE900115	S16 Sub Zero fridge with glass door and temperature display	
RE900110	S16 Sub Zero fridge with solid door and temperature display	
<b>Custom Branded Solid Door Mini Fridges</b>		
RE900017-BR	Custom branded 1.7 cu ft mini fridge	
RE90005W-BR	Custom branded 4.5 cu ft white mini fridge	
RE90005B-BR	Custom branded 4.5 cu ft black mini fridge	

Graphics	Qty	Lead Time
Fridges, Beverage Ccenters	1-19	7 days
	20-49	10 days
	50-99	13 days
	100+	Confirmation
Fridges, Solid Door	1-19	7 days
	20-49	10 days
	50-99	12 days
	100+	Confirmation



See page 69 for custom graphics lead times



Beer Systems, Bar Equipment





Advanced Beverage Solutions  
100 Gary Avenue, Suite C  
Roselle, IL 60172

[www.absonone.com](http://www.absonone.com)  
E-mail: [orders@absonone.com](mailto:orders@absonone.com)

877-814-2271  
Local: 847-524-1707  
Fax: 847-524-1710

## Exactap Mobile System with Tower

Only EXACTAP delivers revolutionary dispense speed with precision control. The patented exactap 'active-compensator' tap technology results in unprecedented dispense speed (0.5 L in under 3 seconds) and singular control and data collection features resulting in a perfect pour every time!

- Faster pours mean more transactions, 20%-55% increased beer sales
- Increased keg yield, 8%-24% more servings from every keg
- Eliminates pre-pouring, up to 67% reduction in labor
- Programmable in-glass presentation with digital foam control
- Metered dispense, UK weights and measures approved
- Data storage/retrieval, inventory control and management
- POS system integration
- Smart System Diagnostics
- On-Top LCD interface



EX2200



EX2200-SYSTEM

Part Number	Description
EX2200	Exactap high speed, precision control, data collection tower
EX2200-SYSTEM	Exactap mobile system with tower

## Kegerators



RE901059A

RE801024-KIT

*See page 69 for custom graphics lead times*



KegBar 100



KM-1/5CT1



KM-1/5GT2



KM-1/5NT

Part Number	Description
KegBar 100	KegBar 100 free-standing or built-in cooler
KM-1/5CT1	Kegerator with drip tray and 1 faucet column tower
KM-1/5CT2	Kegerator with drip tray and 2 faucet column tower
KM-1/5GT1	Kegerator with drip tray and 1 faucet Gefest tower
KM-1/5GT2	Kegerator with drip tray and 2 faucet Gefest tower
KM-1/5NT	Kegerator with drip tray without tower
RE901059A	Custom branded 6.4 cu ft Kegerator
RE801024-KIT	Custom branded direct draw keg cooler with drip tray and wheels, compressor cooled, 36-1/2" x 24" x 31-1/8"

Beer Systems, Bar Equipment



## Direct Draw Keg Coolers/Dispensers

All direct draw beer dispenser feature 304 series stainless steel countertop, reinforced stainless steel floor, stainless steel reinforced threshold sill for ease of loading, removable stainless steel drip tray, incandescent interior lighting, and self-closing doors with cylinder keyed security lock.

*See page 69 for custom graphics lead times*

Part Number	Description	Size"
RE901059A	Black single keg fridge, value line	
RE901111A	Stainless steel door, black single keg fridge, value line	
RE801024	1 Keg dispenser with black exterior and SS top	24 x 36 x 31-1/8
RE801024SS	1 Keg dispenser with SS exterior and SS top	24 x 36 x 31-1/8
RE801050	2 Keg dispenser with black exterior and SS top	50 x 36-3/4 x 27
RE801050SS	2 Keg dispenser with SS exterior and SS top	50 x 36-3/4 x 27
RE801059	3 Keg dispenser with black exterior and SS top	59 x 36-3/4 x 27
RE801059SS	3 Keg dispenser with SS exterior and SS top	59 x 36-3/4 x 27
RE801069	3 Keg dispenser with black exterior and SS top	69 x 36-3/4 x 27
RE801069SS	3 Keg dispenser with SS exterior and SS top	69 x 36-3/4 x 27
RE801079	4 Keg dispenser with black exterior and SS top	79 x 36-3/4 x 27
RE801079SS	4 Keg dispenser with SS exterior and SS top	79 x 36-3/4 x 27
RE801090	5 Keg dispenser with black exterior and SS top	90 x 36-3/4 x 27
RE801090SS	5 Keg dispenser with SS exterior and SS top	90 x 36-3/4 x 27



## Tapping Kits for Direct Draw Dispensers

Part Number	Description
RE801012-CO2	Tapping kit for keg cooler, 1 tap CO2 kit
RE801012-N2	Tapping kit for keg cooler, 1 tap N2 kit
RE801014-CO2	Tapping kit for keg cooler, 2 tap CO2 kit
RE801014-N2	Tapping kit for keg cooler, 2 tap N2 kit
RE801015-CO2	Tapping kit for keg cooler, 3 tap CO2 kit
RE801015-N2	Tapping kit for keg cooler, 3 tap N2 kit
RE801016-CO2	Tapping kit for keg cooler, 4 tap CO2 kit
RE801016-N2	Tapping kit for keg cooler, 4 tap N2 kit



RE801090

**Cleaning kits and cleaners are shown on pages 109-114**



## Refrigerator Conversion Kits

Enjoy cold, fresh draft beer at home and save money too! A glass of draft beer is about half the cost of cans or bottles. Our Kegerator Kits are ideal for the home bar, patio, college activities or custom installations. The kits make an excellent alternative to the more expensive Keg Refrigerator or Kegerators.

Door Mount Conversion Kits provide straight-forward beer dispensing: beer shank and faucet is mounted over or through faucet drip tray directly into the door of a refrigerated cabinet or the wall of a cold room. For wall mounted installations, keep wall thickness to a minimum so that the shank does not warm up in the un-insulated space. Mounting the shank and beer faucet on the door of a refrigerator typically ensures adequate cooling for beer in the beer line.



*Cleaning kits and cleaners are shown on pages 109-114*

Part Number	Description
RCK-LC-S	Standard Kit: chrome faucet, faucet knob, shank, door spacer, hoses with fittings, D System for North American beers, dual gauge CO <sub>2</sub> , durable 6" x 4" stainless steel drip tray with 2" tall backsplash without drain, instructions
RCK-LC-SG	Premium Kit: chrome faucet, faucet knob, shank, door spacer, hoses with fittings, D System for North American beers, dual gauge CO <sub>2</sub> , stainless steel 6" x 6" x 11" high backsplash with 1 hole, 1 qt cleaning bottle, faucet attachment, faucet wrench, faucet brush, 4 oz line cleaner, instructions
RCK-LC-V	Value Kit: chrome faucet, faucet knob, shank, door spacer, hoses with fittings, D System for North American beers, single gauge CO <sub>2</sub> , instructions
RCK-S	Standard Kit: chrome faucet, faucet knob, shank, door spacer, hoses with fittings, D System for North American beers, dual gauge CO <sub>2</sub> , durable 6" x 4" stainless steel drip tray with 2" tall backsplash and no drain (no hassle with drain hoses and bottles), the backsplash has keyhole shaped mounting holes that allow easy removal for cleaning, 5# aluminum CO <sub>2</sub> cylinder, instructions
RCK-SG	Premium Kit: chrome faucet, faucet knob, shank, door spacer, hoses with fittings, D System for North American beers, dual gauge CO <sub>2</sub> , stainless steel 6" x 6" x 11" high backsplash with 1 hole, 1 qt cleaning bottle, faucet attachment, faucet wrench, faucet brush, 4 oz line cleaner, 5# aluminum CO <sub>2</sub> cylinder, instructions
RCK-V	Value Kit: chrome faucet, faucet knob, shank, door spacer, hoses with fittings, D System for North American beers, single gauge CO <sub>2</sub> , 5# aluminum CO <sub>2</sub> cylinder, instructions
RK-1	Basic Kit: chrome faucet, faucet knob, brass shank, door spacer, hoses with fittings, instructions
RK-1S	Basic Kit: SS faucet, faucet knob, SS shank, door spacer, hoses with fittings, instructions
RK-SU	Basic Refrigerator Conversion Kit: chrome faucet, faucet knob, shank, door spacer, hoses with fittings, D System for North American beers, instructions



## Keg and Accessories



**INSULATED KEG JACKET:**  
A Keg Jacket covers the keg acting as an insulator to aid in keeping the keg cold during a special event. There is an opening at the top over the keg valve which allows for tapping the keg without removing the jacket.

Part Number	Description
CKN3	3 gallon keg, ball lock
C249	Keg lid O-ring
BB702600	Keg storage organizer
BB702603	Keg storage stacker
BB702604	Keg dolly
BB702710	20L insulated keg jacket
BB702718	58L insulated keg jacket
BB702785	Insulated keg wrap, long enough to wrap 4-58L kegs
C785	Keg cooler jacket, canvas



Beer Systems, Bar Equipment

*Flooded beer manifolds are shown on page 102*

## FOB Stop/Foam On Beer Detector

A FOB stop prevents unwanted foam when a new keg is tapped, and keeps the line primed when the keg empties. It eliminates waste, provides better beer presentation, reduces microbiological contamination, and saves time in keg changes. The FOB-Stop can be mounted directly on a keg coupler or on a wall mount bracket.

Part Number	Description
MP551025	Plastic FOB
MP551028	Stainless steel FOB
MP551035	TruPour SS FOB detector, 3/8" barb fittings
MP551050	Tecflo Classic FOB detector
MP551050-KIT	Tecflo Classic FOB detector, 2 3/8" barb fittings, 1' of drain tube, "Y" fitting to join the drain tubes
MP551055	Tecflo Deluxe FOB detector
MP551055-KIT	Tecflo Deluxe FOB detector, 2 3/8" barb fittings, 1' of drain tube, "Y" fitting to join the drain tubes
MP551058	Tecflo Deluxe FOB detector with 3/8" OD JG outlet in the bleed valve
SF087100	1/8" barb "Y" fitting for FOB drain tubing





Advanced Beverage Solutions  
100 Gary Avenue, Suite C  
Roselle, IL 60172

[www.absonone.com](http://www.absonone.com)  
E-mail: [orders@absonone.com](mailto:orders@absonone.com)

877-814-2271  
Local: 847-524-1707  
Fax: 847-524-1710

## Beer and Wine Pumps

Whether installed on a long or short draw system, beer pumps are a cost effective means of moving beer. They also increase the pressure in the product line which prevents the gas in the beer from breaking out, thus preserving the quality of the drink.



G56-1202E



FRV0001A

FRV0001A flow reversal valve fits into a Flojet G56 beer pump allowing beer line cleaners to run cleaning solution in both directions. Running solution in alternating directions enhances cleaning efficiency.



166-257-16  
average lifespan  
35,000 gallons



LF521402



FSP0002A

Part Number	Description
G56-1202E	Flojet air/CO <sub>2</sub> driven beer pump, straight outlet, 5 gpm flow rate, ave. lifetime 70,000 gallons
G56-1162	Flojet air/CO <sub>2</sub> driven beer pump, elbow outlet, 5 gpm flow rate, ave. lifetime 70,000 gallons
FRV0001A	Flow reversal valve for G56 beer pump
166-257-00	SHURflo Beer Ace II, air/CO <sub>2</sub> driven beer pump, no fittings
166-257-16	SHURflo Beer Ace II, air/CO <sub>2</sub> driven beer pump, 3/8" plastic barb liquid ports, 1/4" plastic barb elbow gas inlet w check valve
166-257-32	SHURflo Beer Ace II, air/CO <sub>2</sub> driven beer pump, 3/8" plastic barb liquid in, 3/8" John Guest adapter liquid out, 5/16" straight John Guest adapter with check valve gas inlet, 1/4" plastic barb elbow gas outlet
166-257-37	SHURflo Beer Ace II, air/CO <sub>2</sub> driven beer pump, 1/2" plastic barb elbow liquid in, 3/8" straight plastic barb liquid out, 3/8" straight plastic no check valve gas inlet
166-257-39	SHURflo Beer Ace II, air/CO <sub>2</sub> driven beer pump, 3/8" SS barb elbow liquid in, 3/8" SS barb elbow liquid out, 3/8" plastic elbow with check valve gas inlet, 1/4" plastic barb elbow gas outlet
166-257-40	SHURflo Beer Ace II, air/CO <sub>2</sub> driven beer pump, 3/8" SS barb elbow liquid in, 3/8" SS straight barb liquid out, 3/8" plastic barb elbow with check valve gas inlet
166-257-41	SHURflo Beer Ace II, air/CO <sub>2</sub> driven beer pump, 3/8" SS barb elbow liquid in, 3/8" SS barb elbow liquid out, 1/4" plastic elbow with check valve gas inlet, 1/4" plastic barb elbow gas outlet
FSP0002A	Flojet beer and wine bag-in-box pump, electric, If inlet exceeds 30 PSI pump requires 30 PSI water pressure regulator
LF521402	Flojet high speed motor, electric, 40 psi switch
LF521002	Flojet high speed motor, electric, no switch
LF521B02	Flojet high speed motor, electric, 40 psi switch, comes with 3/8" (9.5 mm) John Guest port fitting

## Flow Meters

Flow meters enable you to measure the amount of beer poured and compare it to the amount of beer your staff served in the sales report to detect waste or theft. The inline Flowmeter is to be used with a flow monitor.

Part Number	Description
MP551060	Inline flow control 5/16" OD
FM200215	Inline Flowmeter turbine 3/16" bore
FM200222	2-line flow monitor
FM200244	4-line flow monitor
FM200288	16-line flow monitor



MP551060



FM200215



FM200222



FM200288



FM200244



Advanced Beverage Solutions  
100 Gary Avenue, Suite C  
Roselle, IL 60172

**www.abstone.com**  
E-mail: orders@abstone.com

877-814-2271  
Local: 847-524-1707  
Fax: 847-524-1710

## Beer Pumps Panels

Part Number	Description
BPP-1F-2R-PFOB	1 Flojet beer pump, 2 regulator, 1 plastic FOB
BPP-1F-2R-SSFOB	1 Flojet beer pump, 2 regulator, 1 SS FOB
BPP-1S-2R-PFOB	1 Shurflo beer pump, 2 regulator, 1 plastic FOB
BPP-1S-2R-SSFOB	1 Shurflo beer pump, 2 regulator, 1 SS FOB
BPP-2F-1R	2 Flojet beer pumps 1 regulator
BPP-2F-2R-PFOB	2 Flojet beer pump, 2 regulator, 2 plastic FOB
BPP-2F-2R-SSFOB	2 Flojet beer pump, 2 regulator, 2 SS FOB
BPP-2S-1R	2 Shurflo beer pumps 1 regulator
BPP-2S-2R-PFOB	2 Shurflo beer pump, 2 regulator, 2 plastic FOB
BPP-2S-2R-SSFOB	2 Shurflo beer pump, 2 regulator, 2 SS FOB
BPP-3F-1R	3 Flojet beer pumps 1 regulator
BPP-3F-2R-PFOB	3 Flojet beer pump, 2 regulator, 3 plastic FOB
BPP-3F-2R-SSFOB	3 Flojet beer pump, 2 regulator, 3 SS FOB
BPP-3S-1R	3 Shurflo beer pumps 1 regulator
BPP-3S-2R-PFOB	3 Shurflo beer pump, 2 regulator, 3 plastic FOB
BPP-3S-2R-SSFOB	3 Shurflo beer pump, 2 regulator, 3 SS FOB
BPP-4F-1R	4 Flojet beer pumps 1 regulator
BPP-4F-2R-PFOB	4 Flojet beer pump, 2 regulator, 4 plastic FOB
BPP-4F-2R-SSFOB	4 Flojet beer pump, 2 regulator, 4 SS FOB
BPP-4S-1R	4 Shurflo beer pumps 1 regulator
BPP-4S-2R-PFOB	4 Shurflo beer pump, 2 regulator, 4 plastic FOB
BPP-4S-2R-SSFOB	4 Shurflo beer pump, 2 regulator, 4 SS FOB
C0869205T	12" Taprite 1P sec. reg. panel with 316SS FOB, beer pump, beer and gas tubing
C0869206T	23" Taprite 2P sec. reg. panel with 316SS FOB, beer pump, beer and gas tubing



## Equipment Mounting Boards



Part #	Size"	Description
18-0348	7" x 12"	Equip. mounting board, galvanized
18-0349	7" x 18"	Equip. mounting board, galvanized
18-0350	7" x 24"	Equip. mounting board, galvanized
18-0351	12" x 12"	Equip. mounting board, galvanized
18-0352	12" x 18"	Equip. mounting board, galvanized
18-0353	12" x 24"	Equip. mounting board, galvanized
97-0212	8' x 4' x 3/8"	Equip. mounting board, white PVC

*Floded beer manifolds are shown on page 102*

Beer Systems, Bar Equipment



## CO<sub>2</sub> Regulators

740 Series regulators have a polycarbonate bonnet that won't chip, break or fade. The non-adjustable "shut-down" safety can't be removed or easily circumvented. If the regulator seat fails the safety will respond instantly, isolating the product container from potentially dangerous high pressure. The product container pressure will not exceed the factory set blow-off of 55-65 PSI.

High pressure ports have left-hand female threads to prevent their use as a lo-pressure outlet... (If replacement parts are required, contact factory). The non-removable adjusting screw will never exceed 50 PSI. An internal relief valve opens whenever delivery pressure exceeds set pressure by 15 PSI. This feature serves as a warning that the seat or diaphragm may be worn or damaged and should be replaced. Seat assembly is easily replaceable in-field... no need to remove regulator from tank.

A sintered metal flow control filter in the inlet nipple prevents dirt and other particles from damaging internal parts. Permanent quad-ring seal on the inlet nipple eliminates a source of leaks, and there's no need to use a new fiber washer each time tank is changed.

The ball-type check valve helps prevent product back-up into the regulator. Hose barb end designed for use with 5/16" ID pressure tubing.

HP regulators are LH thread. LP regulators are RH thread unless otherwise specified.



Part Number	Type of Regulator	Gauge(s)	Mount	Additional Info
T741	Primary	60	Tank	Single gauge with 5/16" barb shut-off and check valve
T742	Primary	2000 x 60	Tank	Dual gauge with 5/16" barb shut-off and check valve
T742-2	Primary	2000 x 60	Tank	1 pressure x 2 products with 5/16" barb shut-off and check valve
T742HP	Primary	2000 x 60	Tank	Dual gauge, high flow, w 5/16" barb shut-off & check valve, 0-50 PSI
T752HP	Primary	2000 x 60	Tank	2 press x 2 prod, high performance 5/16" barb shut-off and check valve
T7430K3	Primary	3000 x 160	Wall	Twin cylinder, changeover valve, two 3' HP hoses
T7430K6	Primary	3000 x 160	Wall	Twin cylinder, changeover valve, two 6' HP hoses
T5741PMHPT	Primary	2000 x 160	Tank	Dual gauge, 5/16" barb outlet with check shutoff
FC741	Primary	12-18	Tank	Low pressure for underbar dispensing, no gauge
FC741H	Primary	30-45	Tank	Medium pressure for cold plate box dispensers, no gauge



Advanced Beverage Solutions  
100 Gary Avenue, Suite C  
Roselle, IL 60172

**www.absone.com**  
E-mail: [orders@absone.com](mailto:orders@absone.com)

877-814-2271  
Local: 847-524-1707  
Fax: 847-524-1710

## CO<sub>2</sub> Regulators and Regulator Panels

Part Number	Type of Regulator	Gauge	Mount	Additional Info
T1661ST	Secondary, 1P x 1P	60	Wall	Single gauge with shut-off and relief valve
T1661ST-2N	Secondary, 1P x 1P	60	Wall	Single gauge with 5/16" barb inlet/thru, 5/16" barb shutoff
T1661STC-01	Secondary, 1P x 1P	60	Wall	Single gauge with 5/16" barb inlet/thru, 5/16" barb shutoff w check
T1662ST	Secondary, 1P x 2P	60	Wall	Single gauge with shut-off and relief valve
T1672ST	Secondary, 2P x 2P	60	Wall	Two gauges with shut-off and relief valve
T1672ST-2N	Secondary, 2P x 2P	60	Wall	Two gauges with 5/16" barb inlet/thru, 5/16" barb shutoff
T1683ST	Secondary, 3P x 3P	60	Wall	Three gauges with shut-off and relief valve
T1683ST-2N	Secondary, 3P x 3P	60	Wall	Three gauges with 5/16" barb inlet/thru, 5/16" barb shutoff
T1694ST	Secondary, 4P x 4P	60	Wall	Four gauges with shut-off and relief valve
T1694ST-2N	Secondary, 4P x 4P	60	Wall	Four gauges with 5/16" barb inlet/thru, 5/16" barb shutoff
T1672STWMK	Secondary, 2P x 2P	60	Wall	Panel, 2 gauges with shut-off and relief valve
T1683STWMK	Secondary, 3P x 3P	60	Wall	Panel, 3 gauges with shut-off and relief valve
T1694STWMK	Secondary, 4P x 4P	60	Wall	Panel, 4 gauges with shut-off and relief valve
RP-1	Secondary, 1P x 1P	60	Wall	Panel, no tubing
RP-1-60	Secondary, 1P x 1P	60	Wall	Panel, 60" jumper and CO2 tubing
RP-1-60-PFOB	Secondary, 1P x 1P	60	Wall	Panel, plastic FOB
RP-1-60-SSFOB	Secondary, 1P x 1P	60	Wall	Panel, stainless steel FOB
RP-2	Secondary, 2P x 2P	60	Wall	Panel, no tubing
RP-2-60	Secondary, 2P x 2P	60	Wall	Panel, 60" jumper and CO2 tubing
RP-2-60-PFOB	Secondary, 2P x 2P	60	Wall	Panel, plastic FOB
RP-2-60-SSFOB	Secondary, 2P x 2P	60	Wall	Panel, stainless steel FOB
RP-3	Secondary, 3P x 3P	60	Wall	Panel, no tubing
RP-3-60	Secondary, 3P x 3P	60	Wall	Panel, 60" jumper and CO2 tubing
RP-3-60-PFOB	Secondary, 3P x 3P	60	Wall	Panel, plastic FOB
RP-3-60-SSFOB	Secondary, 3P x 3P	60	Wall	Panel, stainless steel FOB
RP-4	Secondary, 4P x 4P	60	Wall	Panel, no tubing
RP-4-60	Secondary, 4P x 4P	60	Wall	Panel, 60" jumper and CO2 tubing
RP-4-60-PFOB	Secondary, 4P x 4P	60	Wall	Panel, plastic FOB
RP-4-60-SSFOB	Secondary, 4P x 4P	60	Wall	Panel, stainless steel FOB
C0875001T	Secondary, 1P		Wall	15" Taprite deluxe regulator panel, 304SS fittings, beer & gas tubing
C0875002T	Secondary, 2P		Wall	15" Taprite deluxe regulator panel, 304SS fittings, beer & gas tubing
C0875003T	Secondary, 3P		Wall	15" Taprite deluxe regulator panel, 304SS fittings, beer & gas tubing
C0875004T	Secondary, 4P		Wall	20" Taprite deluxe regulator panel, 304SS fittings, beer & gas tubing
C0869426T	Secondary, 1P		Wall	15" Taprite reg, plastic FOB panel, beer & gas tubing
C0869427T	Secondary, 2P		Wall	15" Taprite reg, plastic FOB panel, beer & gas tubing
C0869428T	Secondary, 3P		Wall	20" Taprite reg, plastic FOB panel, beer & gas tubing
C0869429T	Secondary, 4P		Wall	20" Taprite reg, plastic FOB panel, beer & gas tubing
C0869436T	Secondary, 1P		Wall	15" Taprite reg, 316SS FOB panel, beer & gas tubing
C0869437T	Secondary, 2P		Wall	15" Taprite reg, 316SS FOB panel, beer & gas tubing
C0869438T	Secondary, 3P		Wall	20" Taprite reg, 316SS FOB panel, beer & gas tubing
C0869439T	Secondary, 4P		Wall	20" Taprite reg, 316SS FOB panel, beer & gas tubing





Advanced Beverage Solutions  
100 Gary Avenue, Suite C  
Roselle, IL 60172

**www.absonone.com**  
E-mail: orders@absonone.com

877-814-2271  
Local: 847-524-1707  
Fax: 847-524-1710

## Nitrogen Regulators



742N

Part Number	Type of Regulator	Gauge(s)	Mount	Additional Info
5741PMHPN	Primary Nitrogen	3000 x 160	Tank	0-120 PSI, 1/4" flare with check valve, black bonnet
5741PMHPNT	Primary Nitrogen	3000 x 160	Tank	0-120 PSI, 5/16" barb shut-off with check valve, black bonnet
741HPN-G	Primary Nitrogen	60	Tank	0-50 PSI, tank fitting, no outlet, no tank gauge, black bonnet
742N	Primary Nitrogen	3000 x 60	Tank	0-50 PSI, 5/16" barb shut-off with ball check, black bonnet
742HPN	Primary Nitrogen	3000 x 60	Tank	0-50 PSI, 5/16" barb shut-off with duck-bill check, black bonnet
742HPN-100	Primary Nitrogen	3000 x 100	Tank	0-50 PSI, 5/16" barb shut-off with duck-bill check, black bonnet

## Regulator Changeovers

Part Number	Description
7430	High pressure changeover valve assy, 1/4" MFL, Taprite
7431	CO <sub>2</sub> changeover kit
1421	High pressure changeover valve assy, 1/4" MFL, Chudnow



## DraftMore Beer Regulators

Reduce beer foaming, reduce waste and maximize earnings from each keg of beer with DraftMore beer regulators. It makes sure that the pressure in the keg is correct according to the temperature of the beer. That means the beer will foam with a regular consistency and makes it possible to get the last drops of beer out of the keg. With a DraftMore you will serve a perfect draft beer every time!



Part Number	Description
3010	DraftMore beer regulator, auto adjusting for Bass ale, Boulder beers, Firestone Walker
3020	DraftMore beer regulator, 2.5-2.6 carb level, auto adjusting reg for most American ales, American craft ales and most European lagers
3030	DraftMore beer regulator, 2.7-2.8 carb level, auto adjusting reg for most American brewery beers

Beer Systems, Bar Equipment

## Regulator Parts and Accessories



**More Carbonation Testers and parts are located in Water Systems on page E-7.**

Part Number	Description
7000-3A	3' High pressure hose assembly
7000-6A	6' High pressure hose assembly
7000-9A	9' High pressure hose assembly
3740-2PA	Bonnet, black, 3000 series
7700-6T	Replacement diaphragm assembly, new style
7700-3C	Replacement seat assembly, new style
600GPS	Gauge boot protector
03S07100	C133 Gorman gauge protector
RK1000-0051	Gauge guard, single body regulator
440-4PN	Guide nut tool
63	Fiber CO <sub>2</sub> washer
63NY	Nylon CO <sub>2</sub> flare washer
20W1005H02L30#	Gauge, 30 # PSIG RH thread
20W1005H02L60#	Gauge, 60 # PSIG RH thread
20W1005H02L100#	Gauge, 100 # PSIG RH thread
20W1005H02L160#	Gauge, 160 # PSIG RH thread
20W1005H02L300#	Gauge, 300 # PSIG RH thread
6603-2000	Gauge, 2000 # PSIG LH thread
5603	Gauge, 3000 # PSIG RH thread
6603	Gauge, 3000 # PSIG LH thread
440-18	Wrench, CO <sub>2</sub> regulator, Taprite zinc bonnet
440-19	Wrench, CO <sub>2</sub> regulator, Taprite poly bonnet
22-0016	Wrench, CO <sub>2</sub> regulator, Lancer
08-1080-00	Regulator mounting bracket for louvered rack
5201738506212	Lock washer for regulator bracket
1690-3S	Hex bolt
1690-2N-1	SS bracket for regulator mounting
REGMT-24	Regulator mount, 24", galvanized steel
PT1000	CO <sub>2</sub> pressure tester
2701-BCT	Beer carbonation tester with protective case
RBH-32	Economy Refractometer
440-12	Brass CO <sub>2</sub> inlet nipple RH thread
440-17Q	Inlet nipple quad ring
440-17R	O-ring for CO <sub>2</sub> nipple
740-12	CO <sub>2</sub> inlet nipple, O-ring seal, left hand
740-12N	Nitrogen inlet nipple 1/4" MPT left hand thread
740-13N	Nitrogen tank nut, male thread
740-16	MPT plug, 1/4" LH thread
740-19	Replacement CO <sub>2</sub> nut and nipple assy, LH
5460	Forged Y, (2) 1/4 FPT x 1/4 MPT
5232B	Brass cap, 1/4" SAE
1000730	Brass CO <sub>2</sub> nut, CGA 320
JO-11N	Regulator fitting RH thread
C296	CO <sub>2</sub> to nitrogen adapter
C295	Nitrogen to CO <sub>2</sub> adapter



## Regulator Parts and Accessories

Part Number	Description
6600	Shutoff outlet for BIB, no check, 1/4" SAE male
6600C	Shutoff outlet for BIB, with check, 1/4" SAE male
C0882015	Barbed shutoff, 1/4"
C0882020	Barbed shutoff, 5/16"
C0882029	Barbed shutoff, 5/16"
C0882028	Barbed shutoff with check valve, 5/16"
8100B	Brass shutoff, 1/4 MPT x 5/16 barb, w check valve
8101B	Brass shutoff, 1/4 MPT x 5/16 barb, no check valve
8120B	Brass shutoff, 1/4 MPT x 1/4 barb, w check valve
8121B	Brass shutoff, 1/4 MPT x 1/4 barb, no check valve
8160B	Brass shutoff, 1/4 MPT x 3/8 barb, w check valve
8161B	Brass shutoff, 1/4 MPT x 3/8 barb, no check valve
5153B	Inlet fitting for secondary reg., 1/4" MPT x 1/4" SAE
5436	Outlet fitting with check valve, S 1/4" AE male
5436H	Outlet fitting with check valve, 1/4" hose barb
617BN	Brass 5/16" barb x 1/4" MPT fitting
431-P44	Fitting, 1/4" MFL, 1/4" MPT, ball check w adaptor
618L	Brass nipple 1/4 RH MPT x 1/4 LH MPT
08-0564	1/4" gas hose blue self store
08-0578	1/4" gas hose yellow self store
STB78C12-12F	78 series coupler with wing-nut for bulk CO <sub>2</sub>
C02RS-C	Cornelius 160 lb CO <sub>2</sub> tank mount regulator, changeover valve, bulk system gauge with manifold check valve and shutoff



## CO<sub>2</sub> Tank Outside Storage Cabinet

Cabinet provides tank security and improved appearance. Accommodates all sizes of Chart Beverage outdoor tanks.

### Features:

- 60% open surface for cross ventilation
- 2 hinged lockable doors
- Port accommodates 2" conduit connections
- Tabs for bolting unit to concrete
- Removable roof panel protects against harsh weather
- Rustproof aluminum construction
- Powder coated gray primer is ready to paint
- Options: fill valve to fill box connection, vent kit to direct discharge to the floor

Cabinet comes un-assembled in an easy-to-ship package preventing damage in transit. Can be assembled on site in about an hour using screwdriver and small adjustable wrench. 32.6"W x 32.6"D x 76.5"H

Part Number	Description
20604733	CO <sub>2</sub> tank outside storage cabinet



Tank cabinet



Advanced Beverage Solutions  
100 Gary Avenue, Suite C  
Roselle, IL 60172

**www.absonone.com**  
E-mail: [orders@absonone.com](mailto:orders@absonone.com)

877-814-2271  
Local: 847-524-1707  
Fax: 847-524-1710

## CO<sub>2</sub> Cylinders

Catalina seamless aluminum alloy compressed gas cylinders are manufactured in accordance with U.S. DOT 3AL and TC 3ALM requirements and are stamped with required U.S. Department of Transportation (DOT) and Transport Canada (TC) Markings. Every cylinder is inspected and tested by a DOT and TC authorized independent inspection agency. Service pressure: 1800 psi / 124 bar.



Part Number	Description
B5	5 lb. / 2.3 kgs. cylinder, Catalina
B10	10 lb. / 4.5 kgs. cylinder, Catalina
B20	20 lb. / 9.1 kgs. cylinder, Catalina
B35	35 lb. / 15.9 kgs. cylinder, Catalina
B50	50 lb. / 22.7 kgs. cylinder, Catalina
CGA-320	Replacement valve

## CO<sub>2</sub> Purifier

Prevents off-tastes and aromas from spoiling soda and draft beer due to CO<sub>2</sub> contaminants, such as bacteria, yeasts, molds, and particles from gas (CO<sub>2</sub>) streams, even in the presence of humidity and moisture.

Part Number	Description
BCT-2409-ATO	2" x 10" stainless steel housing and CO <sub>2</sub> filter
ATO-9SS	Replacement cartridge for BCT-2409-ATO
BCT-2510-ATO	2" x 10" nylon housing and CO <sub>2</sub> filter
ATO-10P	Replacement cartridge for BCT-2510-ATO



BCT-2409-ATO

BCT-2510-ATO

## CO<sub>2</sub> Cylinder Parts and Accessories

Part Number	Description
H1BK	Carrying handle black, Catalina
H1RD	Carrying handle red, Catalina
H2BK	Carrying handle black, Luxfer
SR1	Snap ring, Catalina
SR2	Snap ring, Luxfer
22-0016	CO <sub>2</sub> wrench
7431	CO <sub>2</sub> changeover kit
20020104	Manifold, 3/8 x 1/4 (4)
20F05-103	Gas cylinder bracket, triple, 2"H x 4"W x 37"L
20F05-102	Gas cylinder bracket, double, 2"H x 4"W x 24"L
20F05-101	Gas cylinder bracket, single, 2"H x 4"W x 8"L



7431



20F05-101



20F05-102



20F05-103



CGA-320  
replacement valve





## Infinity™ Auto Changeover with EasyLink™ Telemetry

The Infinity™ Auto Changeover senses a depleted cylinder and automatically switches to the reserve cylinder. Within moments of the changeover, the supplier will receive an email or text notification via the EasyLink™ Telemetry system.

### Features

- Remote monitoring of cylinder changeover
- Priority Select™ feature allows service personnel to designate which cylinder is considered primary
- Complete system includes automatic changeover, hoses and telemetry unit
- Installation is quick and simple

### Benefits to Suppliers

- Eliminates emergency calls
- Requires no location involvement
- Increases customer loyalty
- Optimizes route planning

### Benefits to Customers

- Ensures a continuous supply of gas
- Eliminates the need to change cylinders
- Eliminates the need to call for service

### Ordering Instructions

Specify Infinity unit and CGA connections, and include EasyLink Telemetry monthly fee if applicable.

*Note: 2-6 Cylinders may be connected in any configuration using standard pigtails. Hose assemblies are priced individually.*

Part #	Description
3562	Infinity Auto Changeover with telemetry Input
3563	Infinity Auto Changeover without telemetry Input
ELE-104P	EasyLink telemetry with sim card
HKCO-580-1	Hose assembly single nitrogen cylinder CGA 580
HKCO-580-2	Hose assembly dual nitrogen cylinder CGA 580
HKCO-580-3	Hose assembly triple nitrogen cylinder CGA 580
HKCO-320-1	Hose assembly single CO <sub>2</sub> cylinder CGA 320
HKCO-320-2	Hose assembly dual CO <sub>2</sub> cylinder CGA 320
HKCO-320-3	Hose assembly triple CO <sub>2</sub> cylinder CGA 320
MTF-100	Monthly telemetry fee



Infinity™ Auto Changeover

Dimensions: 6"W x 4.6"H x 2"D  
Gas Service: Inert  
Inlet: 1/4" NPT (2)  
Outlet: 1/4" NPT (1)  
Safety: Self-resetting 175 psi



EasyLink™ Telemetry

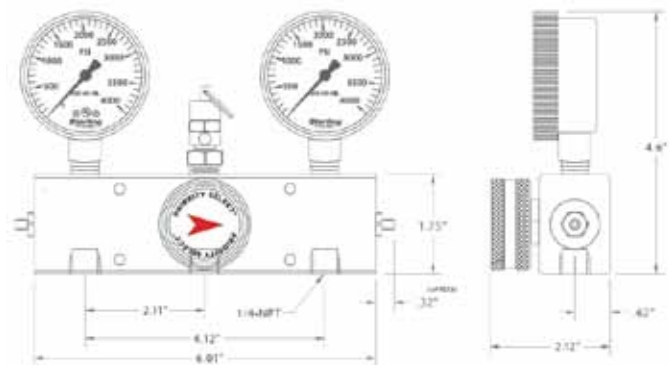



## LogiCO2 MK9/MK10 CO<sub>2</sub> Detectors/Alarms

CO<sub>2</sub> is a colorless, odorless gas which normally exists at a concentration of .04% in the air, but above 4% concentrations has dangerous effects:

- 4% = IDHL - immediate danger to health and life
- 7% = Dizziness, vomiting, headache, reduced blood supply to the brain
- 10% = Convulsions, unconsciousness, death
- 20% = Death in a few seconds

The MK9 and MK10 are the most cost effective CO<sub>2</sub> detection systems currently available. Four alarm levels fulfill ALL U.S. CO<sub>2</sub> safety codes and norms. Central unit makes non-smelling invisible CO<sub>2</sub> gas visible and advises what to do in different alarm situations. Automatic calibration is safer and zero maintenance. Plug and play components simplify installation. System is expandable up to eight sensors. System can be connected to an existing fire alarm system that is connected to the fire department.

### MK10 All-In-One Sensor

The MK10 is a CO<sub>2</sub> monitor for the area CO<sub>2</sub> equipment is used or distributed. It has an integrated sound and light alarm and can be used as a stand-alone unit or can be linked to a central unit for digital display of values. The MK10 performs self-calibration at regular intervals, eliminating the need for service calibration.

### MK9 Sensor

The MK9 sensor is a precision instrument that continuously monitors temperature and CO<sub>2</sub> gas concentration using infrared analysis. It has red, yellow and green LED lights and an intermittent buzzer for Low Alarm and continuous sound for High Alarm. The MK9 performs a self-calibration at regular intervals, eliminating the need for service calibration. MK9 is compatible with MK7.

### MK9 CO<sub>2</sub> Central Unit

The multi-lingual Central Unit controls the safety system and displays measurements from up to eight MK9 or MK10 sensors. It is mounted outside the area being monitored, such as a manager's office. An information and instructional text for all Alert/Alarm and Error conditions is shown on the display. If multiple sensors are connected, each value indicates which sensor the value is from. The Central Unit has an alarm memory that remembers and reactivates any alarm after a power interruption. On the right side there is a sound mute/reset and test button. The Central Unit can be linked to an existing fire alarm system that is connected to the fire department.

LED and sound indications...

- Green - the system is active, normal safe conditions
- Yellow - Error
- Red - CO<sub>2</sub> concentration alarm: Low >1.5%, or High >3%
- Beeping sound indicates Low Alarm (warning) or Error
- Continuous sound indicates High Alarm (danger)

### Horn/Strobe and Warning Beacon

Sensors are mounted 12" from the floor and therefore may not be visible from a distance. Horn/strobe and waterproof warning beacons are mounted high above sensors to provide greater visibility and audibility. Additional horn/strobes and beacons can be added.

### Cables and Splitters

Red cables and splitters are for power and communication, blue are for warning signaling.



CO<sub>2</sub> leaks are costly and dangerous



Fully Approved



MK10 Sensor



MK9 Sensor



Central Unit



Red Beacon



Horn/Strobe



Red/Blue Cables and Splitters



Advanced Beverage Solutions  
100 Gary Avenue, Suite C  
Roselle, IL 60172

[www.absone.com](http://www.absone.com)  
E-mail: [orders@absone.com](mailto:orders@absone.com)

877-814-2271  
Local: 847-524-1707  
Fax: 847-524-1710



**LogiCO2 MK9/MK10  
CO<sub>2</sub> Detectors/Alarms**

For more information contact  
[C02monitors@absone.com](mailto:C02monitors@absone.com)

**MK9 Detector Set # 2049**

**Includes:**

- MK9 CO<sub>2</sub> Central Unit
- MK9 CO<sub>2</sub> Sensor
- Horn/Strobe LED with 3 ft cable
- 1 Cable red 15 ft
- 1 Cable red 30 ft
- 1 Cable blue 15 ft
- RJ45 1-1 splitter
- RJ45 1-2 splitter
- Transformer 1A & Plug - UL
- Plug-lock
- Bag with 6 screws and plug
- CO<sub>2</sub> safety monitoring sign
- Sign horn/strobe MK9/10
- Installation manual MK9
- Quick-guide MK9

**MK9 Central Unit Specifications:**

- Operating temp: 0° to 104° F
- Operating humidity: 0-95% RH
- Power supply: 24V DC
- Power usage: No alarm status: 21 mA
- Alarm status: 32 mA
- Acoustic signal-strength: 80 dBA (1m)
- Size (LxWxD): 3.5" x 6.3" x 1.5"

**MK9 Sensor Specifications:**

- Operating temp: 0° to 104° F
- Operating humidity: 0-95% RH
- Power supply: 24V DC
- Power usage: No alarm status: 56 mA,
- Alarm status: 68 mA
- Acoustic signal-strength: 76 dBA (1m)
- Automatic calibration: 60 days
- Size (LxWxD): 3.5" x 6.3" x 1.5"

**Horn/Strobe Specifications:**

- Operating temp: 23° to 122°F
- Power supply: 18-24V DC
- Power usage: 120 mA @ 24V DC supply
- Acoustic signal-strength: 110 dB / 1 m
- Flash intensity: 115 CD
- Flash frequency: 65/min
- Size (LxWxD): 5.3" x 4.5" x 2.4"

**Includes:**

- MK10 CO<sub>2</sub> Detector/Alert
- Horn/strobe LED with 3 ft cable
- 1 Cable blue 30 ft
- 1 Cable red 15 ft
- Stainless steel protection bar for Sensor
- RJ45 1-1 splitter
- Transformer 1A & Plug-UL
- Plug-lock
- CO<sub>2</sub> safety monitoring sign
- Sign CO<sub>2</sub> Alert
- Sign horn/strobe MK9/10
- Installation manual MK10
- Quick-guide MK10

**Optional:**

- Part # 0328 - MK9 CO<sub>2</sub> Central Unit

**MK10 Detector Set # 2025**

**MK10 Specifications:**

- Operating temp: 0° to 122° F
- Operating humidity: 0-95% RH
- Power supply: 24V DC
- Power usage: 600 mA peak,
- 30 mA average
- Automatic calibration: 60 days
- Weight: 0.88 lbs
- Size: 3.54" diameter, height 4.75"

**Horn/Strobe Specifications:**

- Operating temp: 23° to 122°F
- Power supply: 18-24V DC
- Power usage: 120 mA @ 24V DC supply
- Acoustic signal-strength: 110 dB / 1 m
- Flash intensity: 115 CD
- Flash frequency: 65/min
- Size (LxWxD): 5.3" x 4.5" x 2.4"

Total distance between farthest components = less than 980 feet

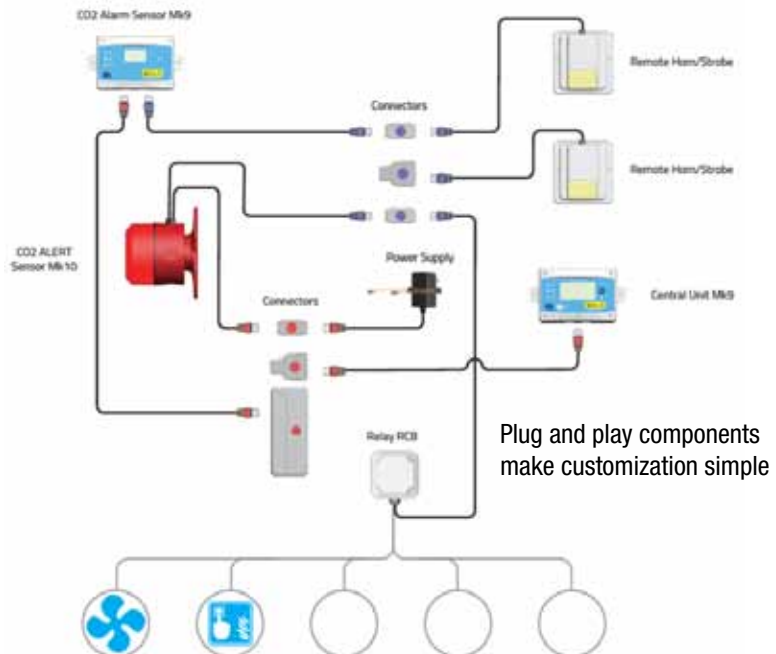

Plug and play components  
make customization simple

Beer Systems, Bar Equipment

## LogiCO2 MK9/MK10 CO<sub>2</sub> Detectors/Alarms



### CO<sub>2</sub> Safety System Parts and Accessories



Central Unit



MK9 Sensor



MK10 Sensor/Beacon/Horn



Red Beacon



Horn/Strobe



Red Cable



Extension 1-1



Extension 1-2



Blue Cable



Extension 1-4



Remote Connection to  
Fire Alarm System



Transformer



Battery Backup &  
Surge Protection

USB-MODBUS interface



CO<sub>2</sub> warning sign



Red Siren



MK10  
protection bar

Part #	Description
0328	Central unit add-on kit for MK7/MK9/MK10 system with 30' red cable, RJ45 1-2 splitter, CO <sub>2</sub> Safety System MK9 sign
0311	Central unit for MK7/MK9/MK10 system
2117	MK9 sensor add-on kit for MK7/MK9/MK10 system with horn/strobe, cables, connectors and signs
1134	MK9 sensor only
2100	MK10 sensor/beacon/horn add-on kit for MK7/MK9/MK10 system includes horn/strobe, SS protection bar, cables, connectors and signs
0199	MK10 stainless steel protection bar
0434	White horn/strobe
0403	Flash-24-R weather proof LED warning beacon
0458	Red siren for high alarm indication, includes cable
0717	Red cable, 15 ft
0724	Red cable, 30 ft
0731	Blue cable, 15 ft
0748	Blue cable, 30 ft
0519	Cable extension 1-1
0526	Cable extension 1-2
0540	Cable extension 1-4
0465	Remote connection to fire department thru fire alarm system
0021	Transformer 1 amp power supply
0953	USB-MODBUS interface and software to view and log CO <sub>2</sub> sensor levels on a computer
BE350G	Backup power/surge protection, 6 outlets: 3 battery/surge, 3 surge only, Energy Star, \$75K equip protection, 3 yr warranty
1240	MK9 central unit sign
1257	MK10 CO <sub>2</sub> alert sign
1264	Horn/strobe alert sign

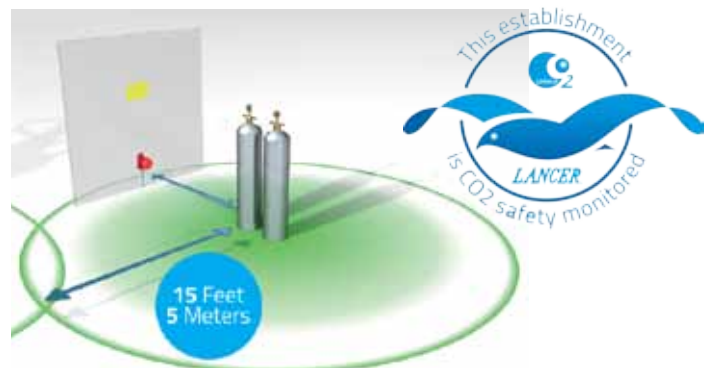

CO<sub>2</sub> detection distance = 15 feet radius





### Aluminum Air Distributors

Part #	Description
1741S	Aluminum air distributor, 1-way, safety
1742S	Aluminum air distributor, 2-way, safety
1743S	Aluminum air distributor, 3-way, safety
1744S	Aluminum air distributor, 4-way, safety
1741	Aluminum air distributor, 1-way
1742	Aluminum air distributor, 2-way
1743	Aluminum air distributor, 3-way
1744	Aluminum air distributor, 4-way
1741-1	Aluminum air distributor manifold, 1-way, 1-3/4" long
1742-1	Aluminum air distributor manifold, 2-way, 3-3/4" long
1743-1	Aluminum air distributor manifold, 3-way, 5-3/4" long
1744-1	Aluminum air distributor manifold, 3-way, 7-3/4" long



### Senco® Air Compressor

PC1010, 1 hp (peak), 1/2 hp (running) electric oil-less compressor is ultra-quiet and ultra-light (only 20 lbs.). Direct drive induction motor/pump for efficient operation. One gallon air capacity. 120 psi max output. 1/4" quick disconnect coupler. Individual gauges for tank and regulated output pressure. CSA approved. 1 year warranty.

- SCFM: 90 PSI: 0.7
- Pump Up-Time: 0-120 PSI: 128 seconds
- Recovery Time: 90-120 PSI: 35 seconds
- Max Pressure: 125 PSI
- Tank Capacity: 1 gallon
- Weight: 20 lbs.
- Dimensions: 13"H x 14"L x 10"W



Part Number	Description
0229558	Senco PC1010 oil-less air compressor, 115V



## ABS Air Compressor and Accessories

### Oil-less air compressor with air line filter/regulator:

- Motor: 5/8 HP
- Voltage: 110V/60hz
- Output: 2.6 CFM
- Maximum pressure: 100 psi
- Operating pressure: 70-100 psi
- Noise level: 62 decibels
- Tank size: 2 gallons
- Includes filter/regulator with gauge
- Dimensions: 16.5"L x 13"W x 16"H, Weight: 37 lbs.
- Shipping dimensions: 15" x 17" x 18", Shipping weight: 45 lbs.



### General Purpose Air Line Filter/Regulator

- 1/4" NPT female in/out ports 0-150 psi gauge
- 1/8" NPT female gauge port
- Maximum pressure 150 psi
- Adjustment range 0-120 psi
- Maximum flow 15 CFM
- 5 micron filter



### Automatic Condensate Drain Valve

- Timer specification: interval time 1-120 minutes, adjustable
- Supply voltage: 115V
- Valve specification: type 2/2 way direct acting
- In/out ports: 1/8" NPT female

Part Number	Description
CU012	Oil-less air compressor with filter/regulator
CU011	Oil-less air compressor with filter/regulator, auto drain valve and muffler
CU011-SC	Suitcase style compressor with auto drain and muffler
VAL039	General purpose air line filter/regulator
VAL038	Automatic condensate drain valve

Part Number	Description
82-4428	Air compressor, 6 gallon, oil free



Part Number	Description
99-2201	Air station, wall mount, 115V





### Nitro-Blend Mixed Gas Dispense System

From a clean compressed internal air supply, the system utilizes gas membrane technology to produce high purity food grade nitrogen which is then blended with CO<sub>2</sub> to give any pre-determined gas mix.

Stored N<sub>2</sub> may also be used for blanketing cask ales, line cleaning and direct air for driving pumps.

Mixes nitrogen produced with CO<sub>2</sub> from a gas cylinder. Produces 8.0 ltr/min of N<sub>2</sub>. This high output can dispense up to 500 pints per hour without the necessity for external nitrogen storage.

Produces nitrogen with an oxygen content down to 0.2% and can be adjusted to produce gas mixtures with nitrogen, oxygen and CO<sub>2</sub>.

- Compact and easy to use
- Generates 99.8% draught beer-grade nitrogen on-site, eliminating the need to purchase and store mixed gas cylinders
- Dispenses up to 36+\* pints per minute, 700 kegs per month\*
- Correct gas mixtures of CO<sub>2</sub> and N<sub>2</sub> for all products ensure all beers are dispensed to the highest standards every time
- Blends CO<sub>2</sub> with nitrogen using a McDantim "TrumixTM 200" blender to produce all the gas blends you require
- Each system has a reserve back-up which ensures that you can continue to dispense in the unlikely event of any problems
- Oil-free compressor is included

**Panel display:** hour meter, power on/off, N<sub>2</sub>, CO<sub>2</sub>, fan, control valve, alarm, tank psi, compressor psi, blend supply psi, individual blend regulators with selector valves

**Specifications:** 110V, 15 amp, storage vessel nitrogen pressure 138 psi, storage vessel capacity 4.55 ft<sup>3</sup> main-reserve (internal) with additional port for backup supply (standard), nitrogen production 17 ft<sup>3</sup> per hour, nitrogen purity 99.8%, noise level under 60dba, ambient temp-operation 40-95° F, purge rate: 1 hour keg surge – 23, 5 hour keg surge – 48.

\* The calculated formula for the amount of beer the Nitro-Blend unit will dispense was calculated using a 60% CO<sub>2</sub> blend ratio. These calculations are considered usable nitrogen in the storage tank at a pressure rating of above 80 psi.

Part Number	Description
GCS-NITROBLEND-CA	Nitrogen generator and blender



GCS-NITROBLEND-CA  
14W x 14D x 30"H



Advanced Beverage Solutions  
100 Gary Avenue, Suite C  
Roselle, IL 60172

**www.absone.com**  
E-mail: [orders@absone.com](mailto:orders@absone.com)

877-814-2271  
Local: 847-524-1707  
Fax: 847-524-1710

## McDantim Trumix™ Gas Blenders

The McDantim Trumix™ Blending Panel is a small wall-mounted unit that is easy to install, dependable, and requires no electricity, on-going maintenance or adjustment. It can be used with all sources of clean nitrogen and CO<sub>2</sub> including high pressure cylinders, bulk tanks or separators.

TM100 & TM100HF are for single blend (one beer) long draw beer systems. TM200 & TM200HF are for systems that dispense more than one type of beer requiring two separate blends of CO<sub>2</sub> and N<sub>2</sub>. TM300 is for triple blends.

Inlet Pressures: 55-150 psi, however, panel can be set to match any conditions (standard 55 and 70 psi). Outlet Pressures are adjustable from 0-60 psi. The maximum outlet pressure will always be 10 psi lower than the lowest inlet pressure. The panel can also be ordered with outlet pressure set to custom ranges.

MV013 (1/4") and MV042 (3/8") tee with check valve protects the blender from being filled with water when the blender is being using in conjunction with a carbonator. Trumix™ Blender warranty only covers water damage if a MV tee was installed.



TM100



TM200



TM300



BLIP  
Bypass Leak Detector



MV035



MV039



Tee with check valve  
Required for McDantim warranty

Part Number	Description
TM100	McDantim Trumix single blender, 15 kegs/hour
TM100HF	McDantim Trumix high flow single blender, 30 kegs/hour
TM200	McDantim Trumix double blender, 30 kegs/hour
TM200HF	McDantim Trumix high flow double blender, 60 kegs/hour
TM300	McDantim Trumix triple blender, 30 kegs/hour
MV013	1/4" tee with check valve
MV042	3/8" tee with check valve
MV044	1/4 x 1/4 x 3/8" tee with check valve
MV045	1/4 x 3/8 x 3/8" tee with check valve
MV073	1/4" check valve straight
MV020	Beer gas analyzer with adapter
MV022	Beer gas analyzer with adapter and leak sensor
MV035	Inline leak indicator, double gas
MV039	Inline leak indicator, single gas
BLIP	Bypass leak detector

Trumix blenders come with standard 1/4" female NPT fittings, hose barbs available at no additional cost. Specify size: 1/4", 5/16", or 3/8".



MV020

MV022

Beer gas analyzers



Advanced Beverage Solutions  
100 Gary Avenue, Suite C  
Roselle, IL 60172

**www.absonone.com**  
E-mail: [orders@absonone.com](mailto:orders@absonone.com)

877-814-2271  
Local: 847-524-1707  
Fax: 847-524-1710

## Oetiker Stepless Ear Clamps

Stepless ear clamps provide uniform compression and a 360° seal, ideal for securing beverage tubing to a fitting or outlet. -505R suffix means the band width is 5.0 mm and band thickness is .5 mm. -706R suffix means the band width is 7.0 mm and band thickness is .6 mm. Other sizes available, call customer service for more information.

When ordering always select the nominal size nearest to, but always larger than the outside diameter (OD) of the material to be clamped. Measurement should be determined with the connection fully assembled.

Part Number	Model	ABS Clamps	Closed-Open mm
16700983	7.0-505R		5.8 - 7
16700984	8.0-05R		6.8 - 8
16700985	8.7-505R		7 - 8.7
16700986	9.5-505R		7.8 - 9.5
16700987	10.0-505R	10.0	8.3 - 10
16700988	10.5-505R	10.5 / 10.5-BULK	8.8 - 10.5
16702614	10.9-505R		9.2 - 10.9
16700989	11.3-505R	11.3	9.6 - 11.3
16700990	11.8-505R		10.1 - 11.8
16700992	12.3-706R	12.3 / 12.3-BULK	9.8 - 12.3
16700993	13.3-706R	13.3 / 13.3-BULK	10.8 - 13.3
16700997	14.0-706R	14.0 / 14.0-BULK	11.5 - 14
16700999	14.5-706R	14.5 / 14.5-BULK	12 - 14.5
16701005	15.7-706R	15.7 / 15.7-BULK	13.2 - 15.7
16702494	16.2-706R		13.7 - 16.2
16701009	17.0-706R	17.0 / 17.0-BULK	14.5 - 17
16701015	18.5-706R	18.5	15.3 - 18.5
16701021	19.8-706R	19.8	16.6 - 19.8
16701029	21.0-706R	21.0	17.8 - 21
16701041	22.6-706R	22.6	19.4 - 22.6
16700029	24.1-706R		
16701072	25.6-706R		22.4 - 25.6
16701087	27.1-706R		23.9 - 27.1
16701103	28.6-706R		25.4 - 28.6
16701136	30.1-706R		26.9 - 30.1
16701203	33.1-706R		29.9 - 33.1
16701225	34.6-706R		31.4 - 34.6



Close clamp ear(s) fully.



opening permissible after crimping  
use of straight jaw pincer



use of side jaw pincer held parallel to hose



use of pneumatic power tool



Remove clamp by cutting through outer edge of ear with pincers.



To remove stainless or adjust

## Crimpers/Pincers

Part Number	Description
C100	Standard straight jaw pincers
14100083	Side-jaw pincers



C100

14100083



The following pictures are representations. Actual appearance may vary.  
Other fittings sizes and styles are available. Please call for details.

## Stainless Steel Fittings



Part #	Size"	Description
3196	1/4	Swivel nut, FFL, SS
3178	3/8	Swivel nut, FFL, SS
1000222	1/4	Swivel nut, FFL, nickel plate brass
1000227	5/16	Swivel nut, FFL, nickel plate brass
1000232	3/8	Swivel nut, FFL, nickel plate brass
1002118	1/2	Swivel nut, FFL, nickel plate brass



1000215	1/8	Barb stem for 1/4" swivel nut
1000221	1/4	Barb stem for 1/4" swivel nut
1000229	1/8	Barb stem for 5/16" swivel nut
1000226	1/4	Barb stem for 5/16" swivel nut
1000231	1/4	Barb stem for 3/8" swivel nut
1000234	3/8	Barb stem for 3/8" swivel nut
1002121	1/2	Barb stem for 1/2" swivel nut



050011	1/4	Flare washer, plastic, white
050012	5/16	Flare washer, plastic, red
050017	3/8	Flare washer, plastic, black
050018	1/2	Flare washer, plastic, white



1000204	1/4	Cap nut, flare
1000212	3/8	Cap nut, flare



7107	(2) 1/8	Splicer, barb, SS
3022	(2) 3/16	Splicer, barb, SS
1000590	(2) 1/4	Splicer, barb, SS
10000592	(2) 3/8	Splicer, barb, SS
1000481	(2) 1/2	Splicer, barb, SS



7217	(2) 1/4	Tube x barb, SS
7212	3/8 x 1/4	Tube x barb, SS
7216	(2) 3/8	Tube x barb, SS
7259	(2) 1/2	Tube x barb, SS



Part #	Size"	Description
3224	5/16 x 3/8	Splicer, reducing, SS
3292	3/8 x 7/16	Splicer, reducing, SS
1001723	3/8 x 1/2	Splicer, reducing, SS
7117	1/8 x 1/4	Splicer, reducing, SS
7118	1/8 x 3/8	Splicer, reducing, SS
1000594	1/4 x 3/8	Splicer, reducing, SS
3223	1/4 x 5/16	Splicer, reducing, SS
3137	1/4 x 1/2	Splicer, reducing, SS



7107	1/8	Plug, barb, SS
C194	3/16	Plug, barb, SS
1002119	1/4	Plug, barb, SS
3220	5/16	Plug, barb, SS
1002120	3/8	Plug, barb
1002150	1/2	Plug, barb



1000423	(2) 1/4	Elbow, barb, SS
1000431	(2) 3/8	Elbow, barb, SS
1002114	(2) 1/2	Elbow, barb, SS



1000429	1/4 x 3/8	Elbow, barb, reducing, SS
7132	1/4 x 1/2	Elbow, barb, reducing, SS
S29-68	3/8 x 1/2	Elbow, barb, reducing, SS



7014	(2) 1/4	Elbow, forged, 2 barbs
7156	(2) 3/8	Elbow, forged, 2 barbs
7249	(2) 1/2	Elbow, forged, 2 barbs



1002115	(3) 1/4	Y tee, barb, 90° branch, SS
7075	(2) 1/4x3/8	Y tee, barb, 90° branch, SS
1002348	(2) 1/4x3/8	Y tee, barb, 90° branch, SS
1002350	(2) 3/8x1/4	Y tee, barb, 90° branch, SS
1002117	(3) 3/8	Y tee, barb, 90° branch, SS
1002129	(3) 1/2	Y tee, barb, 90° branch, SS



Advanced Beverage Solutions  
100 Gary Avenue, Suite C  
Roselle, IL 60172

**www.abstone.com**  
E-mail: [orders@abstone.com](mailto:orders@abstone.com)

877-814-2271  
Local: 847-524-1707  
Fax: 847-524-1710

The following pictures are representations. Actual appearance may vary.  
Other fittings sizes and styles are available. Please call for details.

## Stainless Steel Fittings



Part #	Size"	Description
7115	(3) 1/8	Tee, barb, SS
1001280	(3) 1/4	Tee, barb, SS
1000526	(2) 1/4x3/8	Tee, barb, SS
7065	(2) 1/4x1/2	Tee, barb, SS
1000525	(3) 3/8	Tee, barb, SS
1000527	(2) 3/8x1/4	Tee, barb, SS
1002177	(2) 3/8x1/2	Tee, barb, SS
1001728	(2) 3/8x1/2	Tee, barb, SS
1002122	(3) 1/2	Tee, barb, SS
7097	(2) 1/2x1/4	Tee, barb, SS
1001724	(2) 1/2x3/8	Tee, barb, SS



7102	(4) 1/8	Cross, barb, SS
1000564	(4) 1/4	Cross, barb, SS
1000565	(4) 3/8	Cross, barb, SS
7081	(4) 1/2	Cross, barb, SS
7019	(3) 1/4x3/8	Cross, barb, SS
7180	(3) 1/4x1/2	Cross, barb, SS
7111	(3) 3/8x1/4	Cross, barb, SS



7106	(4) 1/4	Cross, barb, water fork, SS
7137	(3) 1/4x3/8	Cross, barb, water fork, SS
7144	(4) 3/8	Cross, barb, water fork, SS



1002123	(2) 1/4	U-bend, barb, SS
4047	(2) 5/16	U-bend, barb, SS
9019	(2) 3/8	U-bend, barb, SS
1002124	(2) 3/8	U-bend, barb, small radius, SS
4009	(2) 3/8	U-bend, barb, large radius, SS
1002125	(2) 1/2	U-bend, barb, SS
4050	(2) 3/4	U-bend, barb, SS



1002126	(3) 1/4	U-bend, barb, SS
1002128	(3) 3/8	U-bend, barb, SS
7066	(3) 1/2	U-bend, barb, SS



Part #	Size"	Description
7157	(2) 1/4x1/8	U-bend, barb manifold 1/8 port, SS
7126	(2) 1/4x3/8	U-bend, barb manifold 3/8 port, SS
1007126	(2) 1/4x3/8	U-bend, barb manifold 3/8 port, SS
7094	(2) 1/4x3/8	U-bend, barb manifold 3/8 port small radius, SS
1002127	(2) 3/8x1/4	U-bend, barb manifold 1/4 barb port, SS
7143	(2) 3/8x1/2	U-bend, barb manifold 1/2 port, SS
7067	(2) 1/2x3/8	U-bend, barb manifold 3/8 port, SS
7159	(2) 1/2x1/4	U-bend, barb manifold 1/4 barb port, SS



1002315	(2) 3/8 x (3) 3/8	U-bend, barb manifold 3/8 barb ports, SS
7139	(2) 1/2 x (2) 1/4	U-bend, barb manifold 1/4 barb ports, SS
7140	(2) 1/2 x (3) 1/4	U-bend, barb manifold 1/4 barb ports, SS
7154	(2) 1/2 x (5) 1/4	U-bend, barb manifold 1/4 barb ports, SS
7376	(2) 1/2 x (2) 3/8	U-bend, barb manifold 3/8 barb ports, SS



7155	(2) 1/4x1/4	U-bend, barb x 1/4 MFL port, SS
1000135	(2) 3/8x1/4	U-bend, barb x 1/4 MFL port, SS
7076	(2) 1/2x1/4	U-bend, barb x 1/4 MFL port, SS
1002358	(2) 1/2x1/4	U-bend, barb x 1/4 MFL port, SS



7086	(2) 3/8 x (3) 1/4	U-bend, barb x 1/4 MFL port, SS
7104	(2) 3/8 x (4) 1/4	U-bend, barb x 1/4 MFL port, SS
7087	(2) 3/8 x (5) 1/4	U-bend, barb x 1/4 MFL port, SS
7077	(2) 1/2 x (3) 1/4	U-bend, barb x 1/4 MFL port, SS
7078	(2) 1/2 x (5) 1/4	U-bend, barb x 1/4 MFL port, SS



7260	(2) 3/8x1/4	U-bend, barb x 1/4 MPT port, SS
MF38NSXL	3/8	MFL 3/8 nut & stem set, extra long stem
S21-44	1/4	Shallow nut 1/4 stem
S21-54	5/16	Stem 5/16 MFL for 1/4 nut



The following pictures are representations. Actual appearance may vary.  
Other fittings sizes and styles are available. Please call for details.

## Stainless Steel Fittings



Part #	Size"	Description
1000017	1/4	Plug, MFL, SS
3032	5/16	Plug, MFL, SS



S86-44	(2) 1/4	Adapter, MFL x FPT
S91A-46	1/4 x 3/8	Adapter, MFL x FFL
S86-66	(2) 3/8	Adapter MFL x FPT



1000347	(2) 1/4	Union, MFL x MFL
1000348	1/4 x 5/16	Union, MFL x MFL
3003	(2) 5/16	Union, MFL x MFL
3005	3/8 x 1/4	Union, MFL x MFL
1000356	(2) 3/8	Union, MFL x MFL



S88-42	1/4 x 1/8	Adapter, MFL x MPT
1000338	(2) 1/4	Adapter, MFL x MPT
S88-44	(2) 1/4	Adapter, MFL x MPT
S88-46	1/4 x 3/8	Adapter, MFL x MPT
1000335	1/4 x 3/8	Adapter, MFL x MPT
S88-64	3/8 x 1/4	Adapter, MFL x MPT
1000334	(2) 3/8	Adapter, MFL x MPT
S88-68	3/8 x 1/2	Adapter, MFL x MPT



1000244	(2) 1/4	Adapter, barb x 1/4 MFL, SS
3016	1/4 x 5/16	Adapter, barb x 5/16 MFL, SS
1000251	1/4 x 3/8	Adapter, barb x 3/8 MFL, SS
1000245	3/8 x 1/4	Adapter, barb x 1/4 MFL, SS
3018	3/8 x 5/16	Adapter, barb x 5/16 MFL, SS
1000252	(2) 3/8	Adapter, barb x 3/8 MFL, SS
7244	1/2 x 1/4	Adapter, barb x 1/4 MFL, SS



7055	(3) 1/4	Flare tee, 2 MFL x swivel nut, SS
------	---------	-----------------------------------



Part #	Size"	Description
1000520	(3) 1/4	Flare tee, full MFL, SS
1002359	(3) 5/16	Flare tee, full MFL, SS
7021	(3) 5/16	Flare tee, full MFL, SS
1000529	(3) 3/8	Flare tee, full MFL, SS



1000522	(3) 1/4	Flare tee, 2 barb x MFL, SS
7025	(2) 1/4x3/8	Flare tee, 2 barb x MFL, SS
7024	(3) 3/8	Flare tee, 2 barb x MFL, SS
7026	(2) 3/8x1/4	Flare tee, 2 barb x MFL, SS



7029	(4) 1/4	Cross, 3 barb x MFL, SS
7031	(3) 1/4x3/8	Cross, 3 barb x MFL, SS
7030	(3) 3/8x1/4	Cross, 3 barb x MFL, SS
7032	(4) 3/8	Cross, 3 barb x MFL, SS



7027	(4) 1/4	Cross, full MFL, SS
7028	(4) 3/8	Cross, full MFL, SS



7098	(2) 1/4	Union, elbow, FFL x MFL
7373	(2) 3/8	Union, elbow, FFL x MFL



7070	(3) 1/4	FFL swivel x 2 MFL
7276	(3) 3/8	FFL swivel x 2 MFL



7056	(2) 1/4	Union, FFL x FFL
7295	(2) 3/8	Union, FFL x FFL
S89-66	(2) 3/8	Union, FFL x FFL





Advanced Beverage Solutions  
100 Gary Avenue, Suite C  
Roselle, IL 60172

**www.abstone.com**  
E-mail: [orders@abstone.com](mailto:orders@abstone.com)

877-814-2271  
Local: 847-524-1707  
Fax: 847-524-1710

The following pictures are representations. Actual appearance may vary.  
Other fittings sizes and styles are available. Please call for details.

### Stainless Steel Fittings



Part #	Size"	Description
1002112	3/8 x 1/4	Adapter, barb x FFL



1001376	3/8 x 1/4	Adapter, barb x swivel nut
7114	1/2 x 3/8	Adapter, barb x swivel nut
7232	1/2 x 1/2	Adapter, barb x swivel nut



1000424	(2) 1/4	Elbow, swivel nut x barb, SS
1002113	1/4 x 3/8	Elbow, swivel nut x barb, SS
1002313	3/8 x 1/4	Elbow, swivel nut x barb, SS
1007059	3/8 x 1/4	Elbow, swivel nut x barb, SS
7153	5/16 x 1/4	Elbow, swivel nut x barb, SS
1002139	(2) 3/8	Elbow, swivel nut x barb, SS
1000434	(2) 3/8	Elbow, swivel nut x barb, SS
1003086	3/8 x 1/2	Elbow, swivel nut x barb, SS
7191	(2) 1/2	Elbow, swivel nut x barb, SS



7015	1/4x1/4	U-bend, 180°, swivel nut x barb, SS
------	---------	-------------------------------------



7219	1/4 x 1/8	Adapter, elbow, barb x MPT
7190	1/4 x 3/8	Adapter, elbow, barb x MPT
7184	(2) 1/4	Adapter, elbow, barb x MPT
7223	3/8 x 1/8	Adapter, elbow, barb x MPT
7162	3/8 x 1/4	Adapter, elbow, barb x MPT
7166	(2) 3/8	Adapter, elbow, barb x MPT
7175	3/8 x 1/2	Adapter, elbow, barb x MPT
7188	3/8 x 3/4	Adapter, elbow, barb x MPT
S318P8	(2) 1/2	Adapter, elbow, barb x MPT
7215	1/2 x 3/4	Adapter, elbow, barb x MPT



1000518	(3) 1/4	Flare tee, 2 barb x swivel nut, SS
7082	(2) 3/8x1/4	Flare tee, 2 barb x swivel nut, SS
7044	(2) 1/4x1/4	Flare tee, 2 barb x swivel nut SS
7045	(3) 3/8	Flare tee, 2 barb x swivel nut, SS



Part #	Size"	Description
S27-22	(2) 1/8	Adapter, barb x 1/8 MPT, SS
3273	1/4 x 1/8	Adapter, barb x 1/8 MPT, SS
S27-44	(2) 1/4	Adapter, barb x 1/4 MPT, SS
S27-46	1/4 x 3/8	Adapter, barb x 3/8 MPT, SS
3278	3/8 x 1/8	Adapter, barb x 1/8 MPT, SS
3243	3/8 x 1/4	Adapter, barb x 1/4 MPT, SS
S27-66	(2) 3/8	Adapter, barb x 3/8 MPT, SS
S27-68	3/8 x 1/2	Adapter, barb x 1/2 MPT, SS
7262	3/8 x 3/4	Adapter, barb x 3/4 MPT, SS
S27-86	3/8 x 1/2	Adapter, barb x 1/2 MPT, SS
S27-88	(2) 1/2	Adapter, barb x 1/2 MPT, SS
7170	1/2 x 3/4	Adapter, barb x 3/4 MPT, SS
S27-1212	3/4 x 3/4	Adapter, barb x 3/4 MPT, SS



7182	(3) 1/4	Tee, 2 barb x MPT, SS
C134	(3) 3/16	Tee, 2 barb x MPT, SS
7185	(2) 3/8x1/4	Tee, 2 barb x MPT, SS
7181	(2) 1/4x3/8	Tee, 2 barb x MPT, SS
7171	(3) 3/8	Tee, 2 barb x MPT, SS
7189	(2) 3/8x1/2	Tee, 2 barb x MPT, SS
7168	(3) 1/2	Tee, 2 barb x MPT, SS
7169	(2) 1/2x3/4	Tee, 2 barb x MPT, SS
1007169	(2) 1/2x3/4	Tee, 2 barb x MPT, SS



4016		Knurled cap nut, 10/24 thread
------	--	-------------------------------



3160		Knurled shoulder screw
------	--	------------------------



7263	(2) 1/4	Adapter, compression x barb
7280	3/8 x 1/4	Adapter, compression x barb
7264	3/8 x 3/8	Adapter, compression x barb



1002136	3/8 x 3/8	Adapter, compression x compression, SS
---------	-----------	--



The following pictures are representations. Actual appearance may vary.  
Other fittings sizes and styles are available. Please call for details.

## Stainless Steel Fittings



Part #	Size"	Description
7037	(2) 1/4	Adapter, compression x barb
1007037	(2) 1/4	Adapter, compression x barb
7039	5/16 x 1/4	Adapter, compression x barb
7038	1/4 x 3/8	Adapter, compression x barb
1007038	1/4 x 3/8	Adapter, compression x barb
1007039	5/16 x 1/4	Adapter, compression x barb
7040	5/16 x 3/8	Adapter, compression x barb
1007040	5/16 x 3/8	Adapter, compression x barb
7041	3/8 x 1/4	Adapter, compression x barb
1007041	3/8 x 1/4	Adapter, compression x barb
1002137	3/8 x 1/4	Adapter, compression x barb, no O-ring
7042	(2) 3/8	Adapter, compression x barb
1007042	(2) 3/8	Adapter, compression x barb



7069	1/4 x 1/4	Adapter, compression x MFL
7088	5/16 x 1/4	Adapter, compression x MFL
7043	1/4 x 5/16	Adapter, compression x MFL
7060	5/16 x 3/8	Adapter, compression x MFL
7061	3/8 x 3/8	Adapter, compression x MFL
3068	3/8	Compression spacer



3048		Valve plug, General Beverage
3049		Valve plug, Dole



7124	3/8	Outlet straight, GB
1002310	3/8 x 1/4	Dole 3/8 inlet x 1/4 barb



7128	1/4	Outlet 90° elbow, double O-rings, Dole/GB
7072	3/8	Outlet 90° elbow, double O-rings, Dole/GB
7064	1/2	Outlet 90° elbow, double O-rings, Dole/GB



1002306	1/4	Port, 90° elbow, Shurflo
1002309	3/8	Port, 90° elbow, Shurflo
94-178-51	1/2	Port, 90° elbow, Shurflo



Part #	Size"	Description
7245	1/4	Port, straight, Shurflo
94-178-19	3/8	Port, straight, Shurflo
94-178-27	1/2	Port, straight, Shurflo



1002307	1/4	Outlet straight, Flojet
1002308	3/8	Outlet straight, Flojet
20606-100	1/2	Outlet straight, Flojet



20607-100	1/4	Outlet 90° elbow, Flojet
20608-100	3/8	Outlet 90° elbow, Flojet
3143180	3/8	Outlet 180° U-bend, Flojet
7120	1/2	Outlet 90° elbow, Flojet
7049	1/4	Outlet 90° double ring, Flojet
7048	3/8	Outlet 90° double ring, Flojet
7064	1/2	Outlet 90° double ring, Flojet



PM10-9	1/4	Inlet, straight, Wunder-Bar
PM10-10	5/16	Inlet, straight, Wunder-Bar
PM10-11	3/8	Inlet, straight, Wunder-Bar



PM10-47	1/4	Inlet, straight long, Wunder-Bar
PM10-12	3/8	Inlet, straight long, Wunder-Bar
PM10-57	1/2	Inlet, straight long, Wunder-Bar



PM10-61	1/4	Inlet, 45°, Wunder-Bar
PM10-59	3/8	Inlet, 45°, Wunder-Bar
PM10-79	1/2	Inlet, 45°, Wunder-Bar



PM10-13	1/4	Inlet, 90°, Wunder-Bar
PM10-53	3/8	Inlet, 90°, Wunder-Bar
PM10-78	3/8	Inlet, long 90° Wunder-Bar
PM10-58	1/2	Inlet, 90°, Wunder-Bar



Advanced Beverage Solutions  
100 Gary Avenue, Suite C  
Roselle, IL 60172

[www.absonone.com](http://www.absonone.com)  
E-mail: [orders@absonone.com](mailto:orders@absonone.com)

877-814-2271  
Local: 847-524-1707  
Fax: 847-524-1710

### Stainless Steel Fittings



Part #	Size"	Description
S6510-6-1/8	6mm	6mm x G1/8 straight



6550-6	6mm	6mm union elbow
6550-8	8mm	8mm union elbow



S6520-6-1/8	6mm	6mm x G1/8 elbow
-------------	-----	------------------



S6430-6-1/8	6mm	6mm x G1/8 branch tee
-------------	-----	-----------------------



### Stainless Steel Fittings Kits

8012	Fittings starter kit
8025	Fittings starter kit, economy

### Stainless Steel Valves



V13-S	Needle valve 1/4 MFL x 1/4 MFL
-------	--------------------------------



V17-S	Needle valve 1/4 MFL x 1/4 swivel nut
-------	---------------------------------------



V6S-66	Needle valve 3/8 MFL x 3/8 MFL
--------	--------------------------------

### Stainless Steel Manifolds



Part #	Description
7017	Manifold 8.5" long (9) 1/4 MFL
7016	Manifold 8.5" long (7) 1/4 MFL
7050	Manifold 8.5" long (7) 1/4 MFL and (2) 3/8 MFL ends



7151	Manifold 8" long (5) 3/16 barb and (2) 1/4 MFL ends
7152	Manifold 8" long (4) 3/16 barb and (2) 1/4 MFL ends



7218-1	Manifold 3.5" long (2) 5/32 barbs (2) 3/8 barbs ends
7218-3	Manifold 4.5" long (3) 5/32 barbs (2) 3/8 barbs ends
7218-5	Manifold 5.5" long (4) 5/32 barbs (2) 3/8 barbs ends



2002891	Manifold 3/8 UNF w 2 port x 3/8 UNF
2002892	Manifold 3/8 UNF w 2 port x 5/8 UNF
2002893	Manifold 3/8 UNF w 2 port x 7/16 UNF



2002894	Manifold 3/8 UNF w 3 port x 3/8 UNF
2002895	Manifold 3/8 UNF w 3 port x 5/8 UNF
2002896	Manifold 3/8 UNF w 3 port x 7/16 UNF



2002897	Manifold 3/8 UNF w 6 port x 3/8 UNF
2002898	Manifold 3/8 UNF w 6 port x 5/8 UNF
2002899	Manifold 3/8 UNF w 6 port x 7/16 UNF



2003125	Manifold 3/8 5 port w valve
2003126	Manifold 3/8 6 port w valve
2003127	Manifold 1/2 5 port w valve
2003128	Manifold 1/2 6 port w valve

Beer Systems, Bar Equipment



Advanced Beverage Solutions  
100 Gary Avenue, Suite C  
Roselle, IL 60172

**www.abstone.com**  
E-mail: [orders@abstone.com](mailto:orders@abstone.com)

877-814-2271  
Local: 847-524-1707  
Fax: 847-524-1710

The following pictures are representations. Actual appearance may vary.  
Other fittings sizes and styles are available. Please call for details.

## Beer Fittings



Part #	Size"	Description
526A	3/16	Hose stem/nipple
526B	1/4	Hose stem/nipple
526E	5/16	Hose stem/nipple
526C	3/8	Hose stem/nipple
1014	7/16	Hose stem/nipple
526D	1/2	Hose stem/nipple



1020	7/8	Beer swivel nut, nickel
874		Coupling hex nut
80228		Beer hex nut



525	1/2	Beer wing nut
-----	-----	---------------



610B		Locking nut
------	--	-------------



1007997		Hex nut bulkhead
---------	--	------------------



8016		Beer washer
BWK100		Beer washer kit



0017		Beer tap figure 8 washer twin probe
------	--	-------------------------------------



1001975	1/4	Bulkhead fitting MFL
---------	-----	----------------------



C115	1/4	Tail piece with 1/4" MFL (easily change from commercial to homebrew keg)
------	-----	--



7269	1/4	Beer stem, MFL, SS
------	-----	--------------------



C118	19/32 x 1/4 FFL	Corny plug adapter, male end 19/32"-18 threads, other end 1/4" FFL
------	-----------------	--



457C	1/4	Cabinet fitting 1/4 MFL with nut
------	-----	----------------------------------



Part #	Size"	Description
7167	3/16	Hose stem/nipple elbow
7176	1/4	Hose stem/nipple elbow
7308	1/4	Hose stem/nipple elbow
7250	3/8	Hose stem/nipple elbow



C229	7 mm ID	Tailpiece for European faucet shank
C233	10 mm ID	Tailpiece for European faucet shank



C706		90° swivel elbow w O-ring for K & S keg couplers
C811	7 mm ID	Chrome elbow for European faucet shank
C812	10 mm ID	Chrome elbow for European faucet shank
C813	7 mm ID	SS elbow for European faucet shank
C814	10 mm ID	SS elbow for European faucet shank
C310	3/16	Gooseneck elbow for shank



4008	1/4	Barb x smooth elbow, SS
4031	3/16	Barb x smooth elbow, SS
4041	3/8	Barb x smooth elbow, SS
4090	1/2	Barb x smooth elbow, SS



9400		Beer lever
------	--	------------



C601		Chrome keg coupler elbow
FT872		Elbow fitting for FT86 and FT86P taps, nickel



01-2953		Beer shank coupling nut chrome
---------	--	--------------------------------



C308		Shank grommet, 100 pack
------	--	-------------------------



C192	1/2 x 5/8	Hex beer adapter, chrome, converts 5/8" keg coupler to 1/2" BSP
------	-----------	---

Beer Systems, Bar Equipment



Advanced Beverage Solutions  
100 Gary Avenue, Suite C  
Roselle, IL 60172

**www.abstone.com**  
E-mail: [orders@abstone.com](mailto:orders@abstone.com)

877-814-2271  
Local: 847-524-1707  
Fax: 847-524-1710

The following pictures are representations. Actual appearance may vary.  
Other fittings sizes and styles are available. Please call for details.

### Beer Fittings



Part #	Size"	Description
BWB-66	3/8	Wall bracket barb elbow, SS



BWB-66S	3/8	Wall bracket barb straight, SS
---------	-----	--------------------------------



BWB-67-45L	3/8	Wall bracket barb x male beer thread, SS
------------	-----	--



BWB-77-45L	3/8	Wall bracket male beer thread x male beer thread SS
------------	-----	---



BWB-66U	3/8	Wall bracket barb U-bend, SS
---------	-----	------------------------------



BWB-77U	7/8	Wall bracket male beer thread U-bend, SS
---------	-----	--



132	3/8	Beer "Y" fitting, 3/8" ID bore, 5/8" BSP thread, 2.5" H
-----	-----	---



271	7/8	2-way wall bracket, forged, MBT
-----	-----	---------------------------------



133	7/8	3-way wall bracket, forged, MBT
-----	-----	---------------------------------



01-2770		BSP adapter
---------	--	-------------



Part #	Size"	Description
C270	3/8	Beer shut-off, SS



7419	3/8	Beer shut-off
------	-----	---------------



131	7/8	3-way wall bracket, MBT with shut-offs
-----	-----	--



272	7/8	Beer shut-off, MPT x FPT
-----	-----	--------------------------



760	7/8	Wall bracket MBT x FBT with shut-off
-----	-----	--------------------------------------



03-0481	5/16	Beer line saddle, 1 way
---------	------	-------------------------

03-0487	3/8	Beer line saddle, 1 way
---------	-----	-------------------------

03-0488	3/8	Beer line saddle, 2 way
---------	-----	-------------------------

03-0489	3/8	Beer line saddle, 3 way
---------	-----	-------------------------

03-0490	3/8	Beer line saddle, 4 way
---------	-----	-------------------------

03-0493	1/2	Beer line saddle, 1 way
---------	-----	-------------------------

03-0494	1/2	Beer line saddle, 2 way
---------	-----	-------------------------

03-0495	1/2	Beer line saddle, 3 way
---------	-----	-------------------------

03-0496	1/2	Beer line saddle, 4 way
---------	-----	-------------------------

03-0499	5/8	Beer line saddle, 1 way
---------	-----	-------------------------

03-0500	5/8	Beer line saddle, 2 way
---------	-----	-------------------------

03-0501	5/8	Beer line saddle, 3 way
---------	-----	-------------------------

03-0502	5/8	Beer line saddle, 4 way
---------	-----	-------------------------



70030		Shut-off valve assembly
-------	--	-------------------------

01-2780	(2) 1/4	Brass tail BSP x barb
---------	---------	-----------------------

Beer Systems, Bar Equipment



Advanced Beverage Solutions  
100 Gary Avenue, Suite C  
Roselle, IL 60172

**www.absone.com**  
E-mail: [orders@absone.com](mailto:orders@absone.com)

877-814-2271  
Local: 847-524-1707  
Fax: 847-524-1710

The following pictures are representations. Actual appearance may vary.  
Other fittings sizes and styles are available. Please call for details.

## Beer Fittings



Part #	Size"	Description
01-2763		Gas valve 1/4" Fatlock



48-3070		Beer manifold, 2 way Fatlock, SS complete
48-3071		Beer manifold, 3 way Fatlock, SS complete
48-3072		Beer manifold, 4 way Fatlock, SS complete



FC28HB		Stainless beer manifold, 2 MBT outlets with 3/8" bore
FC36HB		Stainless beer manifold, 3 MBT outlets with 3/8" bore
FC48HB		Stainless beer manifold, 4 MBT outlets with 3/8" bore
BB101662		Stainless beer manifold w PRV, 2 MBT outlets with 3/8" bore
BB101663		Stainless beer manifold w PRV, 3 MBT outlets with 3/8" bore
BB101664		Stainless beer manifold w PRV, 4 MBT outlets with 3/8" bore



01-2773		Fatlock adapter, 5/8"
02-0134		5/8" Fatlock adaptor O-ring
02-0654		Fatlock 5/8" adapter service kit



01-2778		Fatlock adapter, 3/4"
02-0662		3/4" Fatlock adaptor O-ring
02-0653		Fatlock 3/4" adapter service kit



01-2774		Beer line check valve, SS, Fatlock 1/4" x 3/8"
01-2775		Beer line check valve, SS, Fatlock 3/8" x 5/8"
01-2776		Beer line check valve, SS, Fatlock 1/2"
01-2777		Beer line check valve, SS, Fatlock 3/8" x 1/2"



01-2779		Fatlock flushout/flowback snap on adapter
02-0219		Fatlock flushout adaptor O-ring

Part #	Size"	Description
01-2848		FOB manifold adaptor Fatlock
01-2847		FOB barb 1/2" tail
01-2772		FOB barb 3/8" tail

02-0099		Fatlock valve O-ring
02-0655		Fatlock beer valve service kit



08-0563		Transfer lead, S/S, Fatlock
---------	--	-----------------------------



01-2932		1/4 MPT x 1/4 barb shutoff
01-2933		1/4 MPT x 5/16 barb shutoff
01-2934		1/4 MPT x 3/8 barb shutoff

88776292		Flowback block nylon
----------	--	----------------------



66000004		Tap adaptor Fatlock shank
----------	--	---------------------------

**Complete line of  
brass and low-lead brass,  
are in Installation Products,  
Section H. O-Rings are in  
Replacement Parts,  
Section G**

Beer Systems, Bar Equipment



Advanced Beverage Solutions  
100 Gary Avenue, Suite C  
Roselle, IL 60172

**www.abstone.com**  
E-mail: [orders@abstone.com](mailto:orders@abstone.com)

877-814-2271  
Local: 847-524-1707  
Fax: 847-524-1710

For more information visit [www.johnguest.com](http://www.johnguest.com)

### John Guest Fittings (Bag of 10)



Superseal x Tube

Part #	Size"	Description
PI0406S	(2) 3/16	Union, tube OD
PI0408S	(2) 1/4	Union, tube OD
PM0408S	(2) 5/16	Union, tube OD
PI0412S	(2) 3/8	Union, tube OD
PI0416S	(2) 1/2	Union, tube OD
PI200806S	1/4 x 3/16	Reducing union, tube OD
PI201006S	5/16 x 3/16	Reducing union, tube OD
PI201008S	5/16 x 1/4	Reducing union, tube OD
PI201206S	3/8 x 3/16	Reducing union, tube OD
PI201208S	3/8 x 1/4	Reducing union, tube OD
PI201210S	3/8 x 5/16	Reducing union, tube OD
PI201610S	1/2 x 5/16	Reducing union, tube OD
PI201612S	1/2 x 3/8	Reducing union, tube OD
SI270808S	(2) 1/4	Union, Superseal x tube OD
SI041212S	(2) 3/8	Union, Superseal x tube OD
SI271008S	5/16 x 1/4	Union, Superseal x tube OD
SI271208S	3/8 x 1/4	Union, Superseal x tube OD



PI010822S	(2) 1/4	Tube OD x MPT
PI010823S	1/4 x 3/8	Tube OD x MPT
PI011222S	3/8 x 1/4	Tube OD x MPT
PI011223S	(2) 3/8	Tube OD x MPT
PI011224S	3/8 x 1/2	Tube OD x MPT
PI011623S	1/2 x 3/8	Tube OD x MPT
PI011624S	(2) 1/2	Tube OD x MPT
PI010802S	(2) 1/4	Male connector OD tube x BSPT
PI011203S	(2) 3/8	Male connector OD tube x BSPT
PI011603S	1/2 x 3/8	Male connector OD tube x BSPT



PI0108F4S	(2) 1/4	Tube OD x MFL
PI0112F4S	3/8 x 1/4	Tube OD x MFL
PI0112F6S	(2) 3/8	Tube OD x MFL
PI0112F8S	3/8 x 1/2	Tube OD x MFL
PI0116F8S	(2) 1/2	Tube OD x MFL



PI450822S	(2) 1/4	Connector, tube OD x FPT
PI451222S	3/8 x 1/4	Connector, tube OD x FPT



Superseal x Speedfit



Superseal x Superseal

Part #	Size"	Description
PI0306S	(2) 3/16	Elbow, tube OD
PI0308S	(2) 1/4	Elbow, tube OD
PM0308S	(2) 5/16	Elbow, tube OD
PI0312S	(2) 3/8	Elbow, tube OD
PI0316S	(2) 1/2	Elbow, tube OD
PI211006S	5/16 x 3/16	Reducing elbow, tube OD
PI211008S	5/16 x 1/4	Reducing elbow, tube OD
PI211206S	3/8 x 3/16	Reducing elbow, tube OD
PI211208S	3/8 x 1/4	Reducing elbow, tube OD
PI211210S	3/8 x 5/16	Reducing elbow, tube OD
PI211610S	1/2 x 5/16	Reducing elbow, tube OD
PI211612S	1/2 x 3/8	Reducing elbow, tube OD
SI031212S	(2) 3/8	Elbow, Superseal x Speedfit
SI401210S	3/8 x 5/16	Elbow, Superseal x Superseal
SI401212S	(2) 3/8	Elbow, Superseal x Superseal



PI220808S	1/4 x 1/4	Plug-in elbow, stem OD x tube OD
PI221208S	3/8 x 1/4	Plug-in elbow, stem OD x tube OD
PI221212S	3/8 x 3/8	Plug-in elbow, stem OD x tube OD
PI221616S	1/2 x 1/2	Plug-in elbow, stem OD x tube OD



NC35602	(2) 3/8	Dispensing valve elbow, tube OD x stem OD
---------	---------	---



NC73002	3/8	Dispensing valve stem, stem OD
---------	-----	--------------------------------



PI061208S	3/8 x 1/4	Reducer, stem OD x tube OD
PI061612S	1/2 x 3/8	Reducer, stem OD x tube OD



PI4608S	1/4	End stop, tube OD
---------	-----	-------------------



PI4512F4S	3/8 x 1/4	Connector, tube OD x FFL
PI4512F6S	(2) 3/8	Connector, tube OD x FFL
PI4516C5S	1/2 x 5/8	Connector, tube OD x BSPP cone end



Advanced Beverage Solutions  
100 Gary Avenue, Suite C  
Roselle, IL 60172

**www.abstone.com**  
E-mail: [orders@abstone.com](mailto:orders@abstone.com)

877-814-2271  
Local: 847-524-1707  
Fax: 847-524-1710

For more information visit [www.johnguest.com](http://www.johnguest.com)

### John Guest Fittings (Bag of 10)



Part #	Size"	Description
PI090802S	(2) 1/4	Swivel elbow, tube OD x BSPT
PI090822S	(2) 1/4	Swivel elbow, tube OD x MPT
PI091222S	3/8 x 1/4	Swivel elbow, tube OD x MPT
PM090822S	5/16 x 1/4	Swivel elbow, tube OD x MPT
PI091223S	(2) 3/8	Swivel elbow, tube OD x MPT
PI091622S	1/2 x 1/4	Swivel elbow, tube OD x MPT
PI091623S	1/2 x 3/8	Swivel elbow, tube OD x MPT
PI091624S	(2) 1/2	Swivel elbow, tube OD x MPT



PI110822S	1/4 x 1/4	Swivel male run tee, tube OD x MPT
PI111222S	3/8 x 1/4	Swivel male run tee, tube OD x MPT
PI111223S	3/8 x 3/8	Swivel male run tee, tube OD x MPT
PI111623S	1/2 x 3/8	Swivel male run tee, tube OD x MPT
PI111624S	1/2 x 1/2	Swivel male run tee, tube OD x MPT



PI480821S	1/4 x 1/8	Elbow, tube OD x MPT
PI480823S	1/4 x 3/8	Elbow, tube OD x MPT
PI481222S	3/8 x 1/4	Elbow, tube OD x MPT
PI481223S	(2) 3/8	Elbow, tube OD x MPT



PM2308S	5/16	Two-way divider, tube OD
PI2312S	3/8	Two-way divider, tube OD
PI2316S	1/2	Two-way divider, tube OD



PIUB12S	3/8	U-bend, tube OD
PIUB16S	1/2	U-bend, tube OD



PI491612S	1/2 x 3/8	3 way divider, tube OD inlet x tube OD outlet
-----------	-----------	---



PI291208S	3/8 x 1/4	Tube to hose elbow, stem OD x hose ID
-----------	-----------	---------------------------------------



Part #	Size"	Description
PI0206S	(3) 3/16	Tee, tube OD
PI0208S	(3) 1/4	Tee, tube OD
PM0208S	(3) 5/16	Tee, tube OD
PI0212S	(3) 3/8	Tee, tube OD
PI0216S	(3) 1/2	Tee, tube OD
PI301208S	3/8 x 1/4	Reducing tee, tube OD
PI301612S	1/2 x 3/8	Reducing tee, tube OD



PI100822S	1/4 x 1/4	Swivel tee, tube OD x MPT
PI101623S	1/2 x 3/8	Swivel tee, tube OD x MPT
PI101624S	1/2 x 1/2	Swivel tee, tube OD x MPT



PI250806S	1/4 x 3/16	Adapter, stem OD x hose ID
PI250808S	(2) 1/4	Adapter, stem OD x hose ID
PI250810S	1/4 x 5/16	Adapter, stem OD x hose ID
PM250808S	(2) 5/16	Adapter, stem OD x hose ID
PI251006S	5/16 x 3/16	Adapter, stem OD x hose ID
PI251012S	5/16 x 3/8	Adapter, stem OD x hose ID
PI251208S	3/8 x 1/4	Adapter, stem OD x hose ID
PI251210S	3/8 x 5/16	Adapter, stem OD x hose ID
PI251212S	(2) 3/8	Adapter, stem OD x hose ID
PI251216S	3/8 x 1/2	Adapter, stem OD x hose ID
PI251612S	1/2 x 3/8	Adapter, stem OD x hose ID
PI251616S	(2) 1/2	Adapter, stem OD x hose ID



PI0806S	3/16	Plug, stem OD
PI0808S	1/4	Plug, stem OD
PM0808S	5/16	Plug, stem OD
PI0812S	3/8	Plug, stem OD
PI0816S	1/2	Plug, stem OD



PI051222S	3/8 x 1/4	Adapter, stem OD x MPT
PI051223S	(2) 3/8	Adapter, stem OD x MPT
PI051623S	1/2 x 3/8	Adapter, stem OD x MPT
PI051604S	(2) 1/2	Adapter, stem OD x BSPT

Beer Systems, Bar Equipment





Advanced Beverage Solutions  
100 Gary Avenue, Suite C  
Roselle, IL 60172

**www.absone.com**  
E-mail: [orders@absone.com](mailto:orders@absone.com)

877-814-2271  
Local: 847-524-1707  
Fax: 847-524-1710

For more information visit [www.johnguest.com](http://www.johnguest.com)

### John Guest Fittings (Bag of 10)

Part #	Size"	Description
3/8SCV	3/8	Check valve, tube OD
		
CI0412W	3/8	White acetal union connector
		
PP010821W	1/4 x 1/8	Straight adapter, tube OD x MPT
PP010822W	(2) 1/4	Straight adapter, tube OD x MPT
PP011223W	(2) 3/8	Straight adapter, tube OD x MPT
PP011224W	3/8 x 1/2	Straight adapter, tube OD x MPT
		
PP3208U7W	1/4 x 7/16	Faucet connector tube OD x 7/16-24 UNS
		
PP451223W	(2) 3/8	Female adapter, tube OD x FPT
		
PP220808W	(2) 1/4	Plug-in elbow, stem OD x tube OD
PP221212W	(2) 3/8	Plug-in elbow, stem OD x tube OD
		
PP480821W	1/4 x 1/8	Elbow, tube OD x MPT
PP480822W	(2) 1/4	Elbow, tube OD x MPT
		
PP0308W	(2) 1/4	Elbow, tube OD
PP0312W	(2) 3/8	Elbow, tube OD
		
ASV3	15mm x 1/4	Acetal tee valve, tube OD x tube OD branch
ASV4	15mm x 3/8	Acetal tee valve, tube OD x tube OD branch
		
PP0208W	(3) 1/4	Tee, tube OD
PP30121208W	(2) 3/8 x 1/4	Tee, tube OD
PP0212W	(3) 3/8	Tee, tube OD
		
SVMC-10		Mounting clip acetal



Part #	Size"	Description
PPSV040808W	(2) 1/4	Speedfit to Speedfit
PPSV041212W	(2) 3/8	Speedfit to Speedfit



PPSV011223W	(2) 3/8	Speedfit to MPT
-------------	---------	-----------------



PISV0412CS	(2) 3/8	Shut-off valve short handle
------------	---------	-----------------------------



PISV0412S	(2) 3/8	Shut-off valve long handle
-----------	---------	----------------------------

PISV0416S	(2) 1/2	Shut-off valve long handle
-----------	---------	----------------------------



ASVPP1	3/8 x 3/8 x 1/4	Angle stop adapter valve, male compression x female compression x tube OD
--------	-----------------	---

ASVPP2	(3) 3/8	Angle stop adapter valve, male compression x female compression x tube OD
--------	---------	---

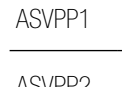

ASVPP5	1/2 x 3/8 x 1/4	Angle stop adapter valve, thread male female NPS x thread compression x tube OD
--------	-----------------	---



ASVPP6	1/2 x 3/8 x 3/8	Angle stop adapter valve, thread male female NPS x thread compression x tube OD
--------	-----------------	---

MI4508F4S	(2) 1/4	Brass flare connector, tube OD x FFL
-----------	---------	--------------------------------------

MI4512F4S	3/8 x 1/4	Brass flare connector, tube OD x FFL
-----------	-----------	--------------------------------------



NC2258	3/8 x 3/4-11.5 NH	Brass garden hose connector, tube OD x NH national hose thread
--------	-------------------	--

NC2098	1/4 x 3/4-11.5 NH	Brass garden hose connector, tube OD x NH national hose thread
--------	-------------------	--



NC2249	3/8 x 3/4	Brass OD tube x BSPP thread female connector
--------	-----------	--

PIC1808R	1/4	Locking clip
----------	-----	--------------

PIC1812R	3/8	Locking clip
----------	-----	--------------

PIC1816R	1/2	Locking clip
----------	-----	--------------



PIC1808R	1/4	Locking clip
----------	-----	--------------

PIC1812R	3/8	Locking clip
----------	-----	--------------

PIC1816R	1/2	Locking clip
----------	-----	--------------

Beer Systems, Bar Equipment



For more information visit [www.colder.com](http://www.colder.com)

## Colder Quick Couplings

Plastic couplings have two parts, body and insert, which are sold separately to provide more combination options. Coupling bodies feature a thumb latch which clicks when connected.

Inline ferruleless compression terminations are for use with semi-rigid plastic tubing which must meet stated inside and outside diameters. Compression terminations (ends) are for use with copper or semi-rigid plastic tubing. Elbows pivot to avoid kinks or unnecessary bends in the fluid lines.

### Coupling Bodies

Part #	Size"	Description
44400	1/4	Body, straight thru, MPT
45600	1/4	Body, shut-off, MPT
49200	3/8	Body, straight thru, MPT
45700	3/8	Body, shut-off, MPT
45500	3/8	Body, shut-off, 45° FFL
49300	1/4 OD .170 ID	Body, straight thru, inline compression
43200	1/4 OD .170 ID	Body, shut-off, inline compression
49400	3/8 OD .250 ID	Body, straight thru, inline compression
43300	3/8 OD .250 ID	Body, shut-off, inline compression
46000	1/4 ID	Body, shut-off, compression end
46100	3/8 ID	Body, shut-off, compression end
40700	1/4 ID	Body, straight thru, barb
42100	1/4 ID	Body, shut-off, barb
42200	3/8 ID	Body, shut-off, barb
70800	1/4	SS valved barb inline coupling body
76500	3/8	SS valved barb inline coupling body
99000	3/8 ID	Dispensing body, inline, barb
95600	1/2 ID	Dispensing body, inline, barb
99100	5/8 ID	Dispensing body, inline, barb
99200	3/4 ID	Dispensing body, inline, barb
99300	3/8 ID	Dispensing body, elbow, barb
95400	1/2 ID	Dispensing body, elbow, barb
95800	38 mm	Cap, valve, without thread seal
95801	38 mm	Cap, valve, with thread seal
96000	1/2 ID	Clean-in-place (CIP) adapter, inline, barb

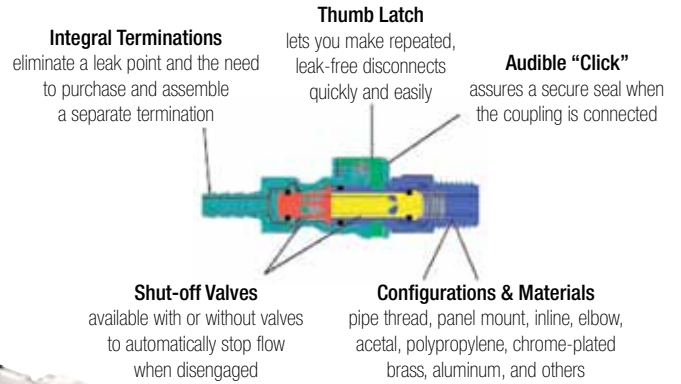
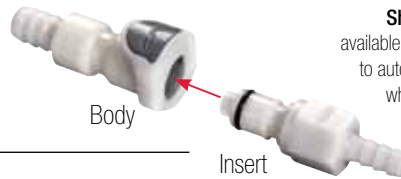

### Coupling Inserts

Part #	Size"	Description
42300	1/4	Insert, straight thru, MPT
42400	1/4	Insert, shut-off, MPT
42500	3/8	Insert, straight thru, MPT
48600	3/8	Insert, shut-off, MPT
43400	1/4 OD .170 ID	Insert, shut-off, inline compression
43500	3/8 OD .250 ID	Insert, shut-off, inline compression
44900	1/4	Insert, shut-off, compression end
45000	3/8	Insert, shut-off, compression end
40900	1/4 ID	Insert, straight thru, barb
42600	1/4 ID	Insert, shut-off, barb
41000	3/8 ID	Insert, straight thru, barb
42700	3/8 ID	Insert, shut-off, barb
49500	1/4 OD .170 ID	Insert, straight thru, elbow, compression end
43000	1/4 OD .170 ID	Insert, shut-off, elbow, compression end
49600	3/8 OD .250 ID	Insert, straight thru, elbow, compression end
43100	3/8 OD .250 ID	Insert, shut-off, elbow, compression end
46200	1/4 ID	Insert, straight thru, elbow, barb
44700	3/8 ID	Insert, straight thru, elbow, barb
42900	3/8 ID	Insert, shut-off, elbow, barb
70500	1/4	SS valved barb inline insert
70900	3/8	SS valved barb inline insert





Advanced Beverage Solutions  
100 Gary Avenue, Suite C  
Roselle, IL 60172

**www.absone.com**  
E-mail: orders@absone.com

877-814-2271  
Local: 847-524-1707  
Fax: 847-524-1710

## Plastic Fittings



430-101-45



830-101SR

Part #	Size"	Description
33005	(2) 1/4	Adapter, barb x MPT
33006	1/4 x 3/8	Adapter, barb x MPT
33007	1/4 x 1/2	Adapter, barb x MPT
33380	1/4 x 3/4	Adapter, barb x MPT
33011	3/8 x 1/8	Adapter, barb x MPT
33012	3/8 x 1/4	Adapter, barb x MPT
33013	3/8 x 3/8	Adapter, barb x MPT
33014	3/8 x 1/2	Adapter, barb x MPT
33026	3/8 x 3/4	Adapter, barb x MPT
33026B	3/8 x 3/4	Bulk adapter, barb x MPT
33015	1/2 x 1/4	Adapter, barb x MPT
33016	1/2 x 3/8	Adapter, barb x MPT
33017	(2) 1/2	Adapter, barb x MPT
33018	1/2 x 3/4	Adapter, barb x MPT
33019	5/8 x 3/8	Adapter, barb x MPT
33020	5/8 x 1/2	Adapter, barb x MPT
33021	5/8 x 3/4	Adapter, barb x MPT
33022	3/4 x 1/2	Adapter, barb x MPT
33023	(2) 3/4	Adapter, barb x MPT
33000	3/4 x 1	Adapter, barb x MPT
33024	1 x 3/4	Adapter, barb x MPT
33025	1 x 1	Adapter, barb x MPT
33029	1 x 1-1/4	Adapter, barb x MPT
33028	1-1/4 x 1	Adapter, barb x MPT

Part #	Size"	Description
430-101-45	3/4 x 1/2	FPT PVC SCH 40 coupling
830-101SR	3/4 x 1/2	FPT PVC SCH 80 SS reinforced
829101	3/4 x 1/2	Slip PVC SC 80 reducer



05-0011	1/4	Nylon flare washer
05-0012	5/16	Nylon flare washer
05-0017	3/8	Nylon flare washer
05-0018	1/2	Nylon flare washer



3998290	1/4	In-line plastic barb shut-off
5740990	3/8	In-line plastic barb shut-off
6885190	1/2	In-line plastic barb shut-off



28668P	3/4 x 1/2	Polypropylene hex bushing
TP-4006	3/8"	NPT plug, HDPE



05-2588	1/4, 3/8 & 1/2	Plug, barb, plastic
05-1385	1/8	Plastic elbow, Dole x 1/8 barb



## STOW 'N GO™ Tool Boxes

Durable Stow 'N Go™ Organizers are ideal for tools and small parts. Individual locking trays are partitioned for organization, and slide out for easy access.

### 135430 and 136430 Pro Racks

- Includes four ProLatch™ StowAway® organizers
- Bulk tool storage under the lid
- Graphite gray with sandstone accents

### 523201

- Removable dividers allow for 16-50 adjustable compartments
- 2-Sided convenience
- Bulk storage on both sides
- Lockjaw™ latches
- Porsche red w clear lids

### 523101

- Removable dividers allow for 15-52 adjustable compartments
- Double cover offers additional storage
- Large bulk storage area
- Lockjaw™ latches
- Porsche red w clear top

### 523002

- Removable dividers allow for 8-25 adjustable compartments
- Large bulk storage area
- Lockjaw™ latches
- Porsche red w clear lid

### 532430

- 24 Fixed Compartments
- Portable Organizer
- Clear



135430 Pro Rack



136430 Pro Rack



523201



523101



523002



532430

Part #	Description	Size"
1354-30	Stow 'N Go Pro Rack, graphite	11 x 7.25 x 10
1364-30	Stow 'N Go Pro Rack, graphite	13.375 x 10 x 14
5232-01	Stow 'N Go 2-Sided, red	14.5 x 4.63 x 11.75
5231-01	Stow 'N Go 1-Sided, red	14.5 x 3.38 x 11.75
5230-02	Stow 'N Go 1-Sided, red	14.5 x 2.38 x 11.75
5230-02	Stow 'N Go 1-Sided, clear	14.25 x 2.25 x 11.5



## Cleaners and Cleaning Equipment

Liquid sugar below 75° F forms sugar crystals. Syrup and juice sugar crystals build up and impair the performance of beverage dispensers, bag-in-box adapters, pumps, circulating coils, valves, mixing chambers and nozzles. Micro-organisms grow in any area exposed to sugar, water and air and can flush into drinks. Over time moving parts with sugar crystal and bacteria build-up fail to work properly and affect the quality of the drink.

### Without Cleaning

- Quality suffers, customers are dissatisfied, drinks are often repoured or discarded, profits decrease
- Syrup or juice concentrate can be mistakenly blamed for poor quality and good boxes of syrup or concentrate are returned or discarded
- Dispensing may be stopped depending on the severity of the problem, and service agents may not be able to respond quickly
- Brush cleaning will help but cannot reach all build-up areas

### With Regular Cleaning

- Consistent quality drinks are poured and customers are satisfied, profits increase
- Sugar crystals and bacteria are removed from the entire system, including areas brush cleaning can't reach
- Flow controls and metering stems operate at optimum performance
- BevClean's inhibitor prevents growth and deposits for 60-90 days after cleaning
- Cleaning time is scheduled during off hours, service calls are reduced; replacement parts and labor costs decrease

### Before and After Cleaning



Part #	Description
216578	BevClean BIB cleaner, 3 gallon box
219000	BevClean BIB cleaner, 55 gallon drum
216673	Super BevClean, 1 gallon
216701	WinterBev solution, 5 gallons
219701	WinterBev solution, 50 gallon drum

## BevClean™ No Rinse Bag-in-Box System Cleaner



Cleans everything from the rack to the dispensing point, one line at a time, or up to 8 lines at a time with the BevClean manifold.

**No More** buckets, mixing, waiting for powders to dissolve in the correct temperature of water, waiting for the cleaner to work and then flushing, which can take up to 1 hour per line.

Simply hook the bag connector to the BevClean BIB box, open the dispensing valve until clear BevClean is detected, re-attach the syrup BIB and dispense until the line is full of syrup again. With the manifold assembly you can clean up to 8 lines simultaneously in 15-20 minutes!

BevClean works on contact, is completely safe, leaves no residuals, and inhibits growth and deposits for 60-90 days after cleaning.



WinterBev is a beverage system antifreeze (propylene glycol base) packaged in 5 gallon BIB boxes, ideal for seasonal equipment, or equipment in cold storage. Protects to -11° F. Available in stronger concentrate for extreme low temperatures.

U.S. Dept. of Health and Human Services, Public Health Service, FDA 2001 Food Code Cleaning Requirement, updated April 2004:

4-701.10 Sanitization of Equipment and Utensils:

“Equipment food-contact surfaces and utensils shall be sanitized.”

4-601.11(C) Cleaning of Equipment and Utensils:

“Non-food contact surfaces of equipment shall be kept free of an accumulation of dust, dirt, food residue, and other debris.”

4-602.11 (E-4) Cleaning Frequency:

“In equipment such as ice bins and beverage dispensing nozzles and enclosed components of equipment such as ice makers ... beverage and syrup dispensing lines or tubes ... and water vending equipment:

(a) At a frequency specified by the manufacturer, or

(b) Absent manufacturer specifications, at a frequency necessary to preclude accumulation of soil or mold.”



**Cleaners and Cleaning Equipment**



1842: 1 quart cleaning kit includes 1841 cleaner, 905W 3/4" faucet brush, 904A 3/16" ID hose brush, 4350 faucet coupling nut, spanner wrench, BLC cleaning solution, Draft Beer booklet, ball lifter, and FT584 pump.



CP151040-KIT  
CP151060  
CP151061  
CP151054/55/56



2.5 gal cleaning can  
5.0 gal cleaning can



82-4354  
82-4355



CP151100  
Sockets sold separately

**Wall mount washouts page 113**



JS300



JS350



8005-913-289



MR-60



DSK-1000

Part #	Description
1842	1 quart complete cleaning kit with FT584 pump
1842G	1 quart complete gravity cleaning kit
CP151040	1 quart plastic cleaning bottle with metal pump
CP151040-KIT	1 quart plastic cleaning bottle with metal pump, faucet wrench and brush, 4 oz bottle of beer line cleaner
CP151054	1.3 gallon/5 liter plastic cleaning bottle
CP151055	15 Litre Cleaning Bottle
CP151056	30 Litre Cleaning Bottle
CP151060	"D" system plastic cap for plastic cleaning bottle
CP151061	"G" system plastic cap for plastic cleaning bottle
CP151062	"U" system plastic cap for plastic cleaning bottle
CP151063	"S" system plastic cap for plastic cleaning bottle
CP151064	"A" system plastic cap for plastic cleaning bottle
CP151065	"M" system plastic cap for plastic cleaning bottle
CP151003	5.0 gal SS cleaning can with 2 "U", 1 "A" and 1 "D" valve
CP151005	5.0 gal SS cleaning can with 2 "S" and 2 "U" valves
CP151007	5.0 gal SS cleaning can with 1 "S", 1 "A", 1 "G", 1 "U" valve
CP151009	5.0 gal SS cleaning can with 3 "D" and 1 "A" valve
CP151010	5.0 gal SS cleaning can with 2 "D", 1 "A", and 1 "U" valve
CP151012	5.0 gal SS cleaning can with 3 "D" and 1 "S" valve
CP151013	5.0 gal SS cleaning can with 2 "D", 1 "S", and 1 "A" valve
CP151014	5.0 gal SS cleaning can with 2 "D", 1 "S", and 1 "U" valve
CP151017	5.0 gal SS cleaning can with 2 "D" and 2 "A" valves
CP151020	5.0 gal SS cleaning can with 1 "S" and 3 "A" valves
CP151023	5.0 gal SS cleaning can with 1 "U" and 3 "D" valves
CP151025	5.0 gal SS cleaning can with 2 "D", 1 "A" and 1 "G" valve
CP151026	5.0 gal SS cleaning can with 2 "U", 1 "A" and 1 "G" valve
CP151031	5.0 gal SS cleaning can with 4 "D" system valves
CP150980	2.5 gal SS cleaning can with 2 "D" valves
CP150981	2.5 gal SS cleaning can with 1 "A" and 1 "D" valve
CP150982	2.5 gal SS cleaning can with 1 "D" and 1 "S" valve
CP150983	2.5 gal SS cleaning can with 1 "D" and 1 "G" valve
CP150984	2.5 gal SS cleaning can with 1 "D" and 1 "U" valve
CP150985	2.5 gal SS cleaning can with 1 "A" and 1 "S" valve
CP150987	2.5 gal SS cleaning can with 2 "A" valves
CP151100	In-place portable cleaning system SS mounting bd with handle
CP151130	In-place portable cleaning system "D" socket
CP151132	In-place portable cleaning system "S" socket
CP151133	In-place portable cleaning system "U" socket
CP151134	In-place portable cleaning system "A" socket
CP151135	In-place portable cleaning system "G" socket
CP151140	In-place portable cleaning system back plate
CP151142	In-place portable cleaning system end stop cap
82-4354	CIP chemical dosing board
82-4355	CIP pump board assy
82-4427	Washout pump assembly with Fatlock fittings
JS300	Line cleaning equipment, medium duty
JS350	Line cleaning equipment, heavy duty
8005-913-289	Electric pump, beer cleaning system
22010	Rieke MR-60 drum pump
22020	Rieke MR-50 drum pump
DSK-1000	Draft service repair kit

**Beer Systems, Bar Equipment**



Advanced Beverage Solutions  
100 Gary Avenue, Suite C  
Roselle, IL 60172

[www.absonone.com](http://www.absonone.com)  
E-mail: [orders@absonone.com](mailto:orders@absonone.com)

877-814-2271  
Local: 847-524-1707  
Fax: 847-524-1710

## Cleaners and Cleaning Equipment



Part #	Description
C157	Faucet cleaning jumper hose assembly, 2.5' long
FT8612	Wrench, probe and beer hex nut
4350	Spanner wrench no grip
4350S	Spanner wrench with black grip
BB101725	Euro faucet wrench
BB101727	6 in 1 Perlick combination wrench
D4740-W	Wrench set for draft towers, side and center access, 1-1/16 x 1"
C123	Wrench, faucet
C187	Wrench, faucet
905W	Faucet brush, nylon, 3/4" x 3" x 8-1/2" long
C217	Faucet cleaning brush - single sided
C237	Faucet and shank brush, double sided
1032	Nozzle brush
22-0017	Brush, valve nozzle
904A	Hose brush, 3/16" x 66" long
904B	Hose brush, 1/4" x 66" long
904C	Hose brush, 3/8" x 66" long
904D	Hose brush, 1/2" x 66" long
905WL	Brush 5/8" x 3" x 14" long
CP373521	3 head manual cleaning brush
CP373530	6 head manual cleaning brush
C148	Jet Carboy bottle washer
C169	Carboy handle, 5 gallon
C170	Carboy handle, 6.5 gallon
C248	Faucet adapter for Jet Carboy washer
C299	Faucet cleaning attachment - fixed
4353	Cleaning attachment, 5/16" barb
902	Duplex cleaning coupler
4352	Cleaning attachment, nickel plated, use with #901 or #901R slip coupling
4352T	Same as 4352 but with male beer thread on spout
48-3073	Washout tee assy, SS 1 way
48-3074	Washout tee assy, SS 2 way
CP101320	1/2" BSP European shank with US coupling nut
C156	Faucet and shank cleaning attachment
FT115BA	Series cleaning adapter
C395	Sankey cleaning adapter
2S2-005	Stainless steel series flusher with ball lifter
FT85-117	Keg coupler check ball lifter
FT108	Single flusher for single hole keg valve taps
FT110AB	Double flusher for single hole keg valve taps
FT109S	Double flusher adaptor. Beer thread ends permit 2 single flushers to be coupled to form a double flusher
FT874C	Cap and washer, used on male beer thread end of a single flusher to convert to series tap cleaning
FT48C	Cap & washer for use on male beer thread end of a single flusher
CP101525	Kleen plug with brush
CP101550	Black faucet spout cap, domestic



Advanced Beverage Solutions  
100 Gary Avenue, Suite C  
Roselle, IL 60172

**www.absone.com**  
E-mail: [orders@absone.com](mailto:orders@absone.com)

877-814-2271  
Local: 847-524-1707  
Fax: 847-524-1710

## Cleaners and Cleaning Equipment



CPC388

CC401L

CP101690

CP101693

CP101692

CP101694



CP101698



CP101699



CP101700



CP101716

Wall mount washout

Beer line cleaner is sold in case quantities, 12 bottles per case. Price breaks for 2-5 cases, 6-20 cases, and 21 or more cases. Pallet quantities are also available.

Hazardous material shipping charges apply when shipping UPS, FedEx, or LTL.



Draftec beer line cleaner



19065312



1055389



24041

Part #	Description
CPC388	Cleaning adapter with Sankey attachment
CPC389	Cleaning adapter without Sankey attachment
CC401L	Plastic series cleaning cup, no ball lifter
CP101690	SS series flusher "G"
CP101692	Plastic series flusher "U"
CP101693	SS series flusher "A"
CP101694	Single flusher "A"
CP101698	Lexan series flusher "D" and "S" no ball lifter
CP101699	SS series flusher "D" and "S" with integral ball lifter
CP101700	SS series flusher "D" and "S" no ball lifter
CP101716	Faucet cleaning attachment with barb
CP101716-22	Washer for CP101716 cleaning attachment
CP151068	5 litre dip tube
CP151069	15 litre dip tube
CP151070	30 litre dip tube
2955	"D" type wall mount washout
2956	"S" type wall mount washout
2957	"M" type wall mount washout
2958	"A" type wall mount washout
2959	"G" type wall mount washout

Part #	Description
39617	Draftec beer line cleaner, clear, 32 oz., case of 12
39620	Draftec beer line cleaner, clear, 50 gal. drum
39619	Draftec beer line cleaner, blue, 32 oz., case of 12
39622	Draftec beer line cleaner, blue, 50 gal. drum
39618	Draftec beer line cleaner, acid, 32 oz., case of 12
39621	Draftec beer line cleaner, acid, 50 gal. drum
222B-1	Draftec beer line cleaner, blue tracer, 32 oz, 12/case
222B-15	Draftec beer line cleaner, blue tracer, 15 gallon
222B-30	Draftec beer line cleaner, blue tracer, 30 gallon
222B-5	Draftec beer line cleaner, blue tracer, 5 gallon
222B-55	Draftec beer line cleaner, blue tracer, 55 gallon
444R-1	Draftec beer line cleaner, red tracer, 32 oz, 12/case
444R-15	Draftec beer line cleaner, red tracer, 15 gallon
444R-30	Draftec beer line cleaner, red tracer, 30 gallon
444R-5	Draftec beer line cleaner, red tracer, 5 gallon
444R-55	Draftec beer line cleaner, red tracer, 55 gallon
1055389	ScaleKleen deliming cleaner, 7 oz., 24 packs/case
24041	Kay-5 sanitizer, 8 packets, each 1 oz.
24041-S	Kay-5 sanitizer, 1oz., single pack
19065312	Clear 1 ice machine scale remover, 16 oz.
4287-34	Ice machine cleaner, 16 oz.

Beer Systems, Bar Equipment





Advanced Beverage Solutions  
100 Gary Avenue, Suite C  
Roselle, IL 60172

**www.absone.com**  
E-mail: [orders@absone.com](mailto:orders@absone.com)

**877-814-2271**  
Local: 847-524-1707  
Fax: 847-524-1710

## Cleaners and Cleaning Equipment



Part #	Description
4291-18	Nu-Brite® condenser coil cleaner, 18 oz. can
4291-08	Nu-Brite® condenser coil cleaner, 1 gallon bottle
4291-05	Nu-Brite® condenser coil cleaner, 2.5 gallon pail
4291-01	Nu-Brite® condenser coil cleaner, 55 gallon drum
4178-08	Foam-Brite® alkaline condenser coil cleaner, 1 gal bottle
4178-05	Foam-Brite® alkaline condenser coil cleaner, 2.5 gal pail
4178-01	Foam-Brite® alkaline condenser coil cleaner, 55 gal drum
4120-08	Alka-Brite® Plus non-acid, alkaline based condenser coil cleaner, 1 gallon bottle
4120-01	Alka-Brite® Plus non-acid, alkaline based condenser coil cleaner, 55 gallon drum
4171-75	Evap Foam No Rinse® detergent for cooling and evaporator coils, 18 oz. can
4290-75	Nu-Blast® condenser coil cleaner, 18 oz. can
4132-20	Cal-Blast® no rinse condenser cleaner, 20 oz. can
4190-08	Cal-Green™ condenser cleaner, 1 gallon bottle
4190-01	Cal-Green™ condenser cleaner, 55 gallon drum
4191-08	Evap-Green™ evaporator cleaner, 1 gallon bottle
4191-01	Evap-Green™ evaporator cleaner, 55 gallon drum
4166-75	Evap Fresh™ No Rinse evaporator coils cleaner and disinfectant, 18 oz. can
4081-75	CalClean® alkaline cleaner for fan blades, coils, metal filters, etc., 20 oz. can
4135-08	CalClean® alkaline cleaner for fan blades, coils, metal filters, etc., 1 gallon bottle
4135-06	CalClean® alkaline cleaner for fan blades, coils, metal filters, etc., 2.5 gallon pail
4135-01	CalClean® alkaline cleaner for fan blades, coils, metal filters, etc., 55 gallon drum
4186-24	Green Clean all-purpose cleaner, 1 qt spray bottle
4186-08	Green Clean all-purpose cleaner, 1 gallon bottle
4186-01	Green Clean all-purpose cleaner, 55 gallon drum
4185-05	Gel Tabs condensate drain pan treatment, 5 ton tab (6/tube)
4185-03	Gel Tabs condensate drain pan treatment, 3 ton tab (12/tube)
4185-15	Gel Tabs condensate drain pan treatment, 15 ton tab (1 ea)
4185-20	Gel Tabs condensate drain pan treatment, 20 ton tab (1 ea)
4082-03	Electrical Contact Cleaner spray, 11 oz. can
4082-04	Electrical Contact Cleaner spray, low VOC for CA, 14 oz. can
4083-75	Degreasing Solvent EF, 14 oz. can
4083-83	Degreasing Solvent EF, low VOC for CA, 14 oz. can
4287-34	Nickel-Safe ice machine cleaner, 16 oz. bottle
4287-08	Nickel-Safe ice machine cleaner, 1 gallon bottle
4207-47	Liquid ice machine cleaner, 8 oz. bottle
4207-08	Liquid ice machine cleaner, 1 gallon bottle
4211-34	IMS-II sanitizing concentrate, 16 oz. bottle

Beer Systems, Bar Equipment



## Underbar Ice Chests

Seamless top/backsplash has 2 tubing chase holes in the backsplash. Plastic breaker strip around the ice bin liner acts as a thermal barrier and makes the stainless steel covers slide easier. Fully insulated. Order with or without a 10 circuit cold plate. Models without cold plates have a 1.5" welded tailpiece so there's no drain fitting to break or come loose. All ice bins come with adjustable stainless steel bullet feet.

Prefixes: IBA = 19" deep, IBB = 24" deep, IB = pass-thru

Locking covers for speed rails are available: SSRC-X for single, DSRC-X for double speed rail. Replace X with the length needed.

More details available. Please visit [www.glastender.com](http://www.glastender.com)



Part #	Length"	Depth"	Cold Plate	Lbs. Ice Capacity
IBA6	6	19	N/A	17
IBA12	12	19	N/A	33
IBA18	18	19	N/A	50
IBA24	24	19	N/A	67
IBA30	30	19	N/A	84
IBA36	36	19	N/A	100
IBA42	42	19	N/A	117
IBA48	48	19	N/A	134
IBA24CP10	24	19	10 circuit	67
IBA30CP10	30	19	10 circuit	84
IBA36CP10	36	19	10 circuit	100
IBA42CP10	42	19	10 circuit	117
IBA48CP10	48	19	10 circuit	134
IBB6	6	24	N/A	21
IBB12	12	24	N/A	42
IBB18	18	24	N/A	64
IBB24	24	24	N/A	85
IBB30	30	24	N/A	106
IBB36	36	24	N/A	127
IBB42	42	24	N/A	149
IBB48	48	24	N/A	170
IBB24CP10	24	24	10 circuit	85
IBB30CP10	30	24	10 circuit	106
IBB36CP10	36	24	10 circuit	127
IBB42CP10	42	24	10 circuit	149
IBB48CP10	48	24	10 circuit	170
IB38X24*	38	24	N/A	175
IB38X24CP10	38	24	10 circuit	175

\*Made to order and not returnable.

Part #	Description
SSR12	12" single speed rail
SSR18	18" single speed rail
SSR24	24" single speed rail
SSR30	30" single speed rail
SSR36	36" single speed rail
SSR42	42" single speed rail
SSR48	48" single speed rail
SSR54	54" single speed rail
SSR60	60" single speed rail
DSR12	12" double speed rail
DSR18	18" double speed rail
DSR24	24" double speed rail
DSR30	30" double speed rail
DSR36	36" double speed rail
DSR42	42" double speed rail
DSR48	48" double speed rail
DSR54	54" double speed rail
DSR60	60" double speed rail
SSRC-X	Single speed rail cover, replace X with length
DSRC-X	Double speed rail cover, replace X with length
IBDHA	Ice bin divider, half, for 19" deep ice bin
IBDHB	Ice bin divider, half, for 24" deep ice bin
IBDHAED	Ice bin divider, half, for 19" extra deep ice bin
IBDHBED	Ice bin divider, half, for 24" extra deep ice bin
IBDHP	Ice bin divider, half, for IB38X24
IBDHPCP	Ice bin divider, half, for IB38X24CP10
IBDHPLR	Ice bin divider, half, left to right for IB38X24
CCD	Condiment dispenser



Advanced Beverage Solutions  
100 Gary Avenue, Suite C  
Roselle, IL 60172

**www.absone.com**  
E-mail: [orders@absone.com](mailto:orders@absone.com)

877-814-2271  
Local: 847-524-1707  
Fax: 847-524-1710

## Underbar Combo Ice Bin/Bottle Well

More details available. Please visit [www.glastender.com](http://www.glastender.com)

Separate draining ice bin and bottle well compartment are combined into one insulated stainless steel unit. Seamless top/backsplash has 2 tubing chase holes in the backsplash. Plastic breaker strip around the ice bin liner acts as a thermal barrier and makes the stainless steel covers slide easier. Order with or without a 10 circuit cold plate.

Fully insulated 12" bottle well has two wire racks for ice chilled storage of 6 or 8 bottles in 19" or 24" deep ice bins. The bottle well may be located on the left, right, or both sides of the ice bin.

*Please specify right (R) or left (L) when ordering.*



Combo ice bin with single speed rail



CCD condiment dispenser



BR3 bottle rack



BW3 bottle well

Part Number	Length"	Depth"	Cold Plate	Lbs. Ice Capacity	Bottle Capacity
CBA30	30	19	N/A	50	6
CBA36	36	19	N/A	67	6
CBA42	42	19	N/A	84	6
CBA48	48	19	N/A	100	6
CBA54	54	19	N/A	84	12
CBA60	60	19	N/A	100	12
CBA30CP10	30	19	10 circuit	67	6
CBA36CP10	36	19	10 circuit	84	6
CBA42CP10	42	19	10 circuit	67	12
CBA48CP10	48	19	10 circuit	100	6
CBA54CP10*	54	19	10 circuit	84	12
CBA60CP10*	60	19	10 circuit	100	12
CBB30	30	24	N/A	64	8
CBB36	36	24	N/A	85	8
CBB42	42	24	N/A	106	8
CBB48	48	24	N/A	127	8
CBB54	54	24	N/A	106	16
CBB60	60	24	N/A	127	16
CBB36CP10	36	24	10 circuit	85	8
CBB42CP10	42	24	10 circuit	106	8
CBB48CP10	48	24	10 circuit	127	8
CBB54CP10	54	24	10 circuit	106	16
CBB60CP10	60	24	10 circuit	127	16

\*Made to order and not returnable.

Part Number	Description
BW3	Bottle well for 19" deep ice bin
BW4	Bottle well for 24" deep ice bin
BR3	Bottle rack for 19" deep ice bin
BR4	Bottle rack for 24" deep ice bin
SHA4	19"D soda gun holder, 4" long, 1-10 buttons
SHA414	19"D soda gun holder, 4" long, 12-14 buttons
SHA6	19"D soda gun holder, 6" long, 1-10 buttons
SHA614	19"D soda gun holder, 6" long, 12-14 buttons
SHB4	24"D soda gun holder, 4" long, 1-10 buttons
SHB414	24"D soda gun holder, 4" long, 12-14 buttons
SHB6	24"D soda gun holder, 6" long, 1-10 buttons
SHB614	24"D soda gun holder, 6" long, 12-14 buttons
TCA	Tubing chase, 6" long, 19" deep
TCB	Tubing chase, 6" long, 24" deep
CCD	Condiment dispenser



SHA4 Wunder-Bar soda gun holder



TCA tubing chase



## Underbar Blender Stations

Blender stations come with a sink, faucet and wet waste strainer. Drainboard blender stations have a drainboard work surface consisting of a drain pan with separate removable perforated insert.

The integral blender shelf is 9" deep on the 24" deep models and 10" deep on the 29" models. The shelf stores the blender at the 19" high level. A grommeted cord access hole is provided in the front skirt.

Blender stations cannot have a speed rail mounted to them. Since speed rails are so common on the underbar, blender stations come in two depths to align with underbars with a speed rail: 24" (to align with 19" deep underbar) and 29" (to align with 24" deep underbar).

More details available. Please visit [www.glastender.com](http://www.glastender.com)



BSB18



DBSB18



IOS18



IBS12H



IBS12B



IBS12V

Part #	Length"	Depth"	Description
BSA12	12	24	Blender station with sink
BSA14	14	24	Blender station with sink
BSA18L	18	24	Blender station with sink, left faucet location
BSA18R	18	24	Blender station with sink, right faucet location
BSB12	12	29	Blender station with sink
BSB14	14	29	Blender station with sink
BSB18	18	29	Blender station with sink
DBSA12	12	24	Drainboard blender station
DBSA14	14	24	Drainboard blender station
DBSA18	18	24	Drainboard blender station
DBSA24*	24	24	Drainboard blender station
DBSB12*	12	29	Drainboard blender station
DBSB14*	14	29	Drainboard blender station
DBSB18*	18	29	Drainboard blender station
IBS12B	12	24	In-counter blender station for Blendtec™ Smoother, Titan or ABC
IBS12H	12	24	In-counter blender station for Hamilton Beach™ 91655 in-counter blender
IBS12V	12	24	In-counter blender station for Vita-Mix® Touch & Go Blending Station®
IOS18	18	29	Island Oasis® stand for Island Oasis® machine

\*Made to order and not returnable.

Part Number	Description
LS15F	15" D left side splash, BSA models
RS15F	15" D right side splash, BSA models
LS15D	15" D left side splash, DBSA models
RS15D	15" D right side splash, DBSA models
LSAD	19" deep left end splash, BSB & DBSB models
RSAD	19" deep right end splash, BSB & DBSB models
TR	Towel ring



Towel ring



## Blenders

Equipped with various blending cycles and intuitive controls, Omega blenders create fast and fresh fusions of your favorite ingredients into creams, soups, smoothies and iced beverages with ease. Perfect for restaurants and juice bars!

### 300 Series

- Toggle control with high/low speed
- BPA free Tritan Copolyester container
- Available with unbreakable stainless steel container
- 2 oz (60 ml) cap for measuring and adding ingredients
- Recessed coupling system
- Self lubricating ball bearings
- Large metal cooling fan
- Heavy duty locking ring
- 2 Year warranty
- Approvals: UL listed



### 400 Series

- Unbreakable BPA Free Eastman® Tritan copolyester container
- Removable cap for adding ingredients
- Stainless steel blade assembly
- Automatic shutoff for overload protection
- No plunger needed
- Available in 120V/60Hz and 240V/50-60Hz
- Approvals: ETL Commercial, ETL Sanitation & CE

### 600 Series

- Touch pad and variable controls for precision blending
- Innovative Infinity Function for the perfect blend
- Unbreakable BPA free Eastman® Tritan copolyester container
- Removable cap for adding ingredients
- Stainless steel blade assembly
- Automatic shutoff for overload protection
- No plunger needed
- Approvals: ETL Commercial, ETL Sanitation



Model	BL330/BL360/BL390	BL420/430/460/BL470	BL630/BL660
Description	1 HP blender	3 peak HP blender	3 peak HP blender
Finish	Silver and Red	Silver	Silver, White or Red
Speed	21,500 - 25,500 RPM	Variable speed with pulse	Variable speed with timer and pulse
Controls	On/Off and High/Low toggle	420/430: On/Off and High/Low toggle 460/470: Variable speed with pulse	Infinity controls
Container Type, Capacity	330: Copolyester, 48 oz 360: Stainless steel, 32 oz 390: Copolyester & SS	420/460: Copolyester, 64 oz 430/470: Copolyester, 82 oz	630: Copolyester, 64 oz 660: Copolyester, 82 oz
Power	600 watts	1500 watts	1400 watts
Voltage	120V/60Hz	120V/60Hz	220V/50Hz
Size	6-1/4W x 8-1/4D x 15-3/4"H	460: 7-3/4W x 9D x 18-1/4"H 470: 7-3/4W x 9D x 20-1/4"H	630: 8W x 8D x 19"H 660: 8W x 8D x 20.5"H
Weight	6.5 lb / 3 kg	15 lb / 6.8 kg	11.5 lb / 5.2 kg
Optional Voltage	240V/50Hz	240V/50-60Hz	N/A
Model Number	BL332/BL362/BL392	BL462/BL472	



## Underbar Drainboards

Glastender drainboards have an exclusive 1" deep sloped stainless steel drain pan with a separate removable perforated insert. The 1" high perforated insert allows air circulation beneath the glassware, and since the pan is sloped and not the insert, all glassware is stored on a level plane.

Drainboards are also available with a flat stainless steel fillerboard top in lieu of the drainboard top. Substitute an "F" for the "D" in the model number when ordering (same price). Fillerboards are manufactured to order and not returnable.

Recessed drainboards have the same drain pan with separate perforated insert, but the work surface has been lowered to allow glassware stacking. A perforated shelf is placed on top of the first level of glasses and a second layer is stacked on top (best if only one style of glassware is being stored).

More details available. Please visit [www.glastender.com](http://www.glastender.com)



DBA with single speed rail

DBA



RDBA

Part #	Length"	Depth"	Description
DBA12	12	19	Drainboard
DBA18	18	19	Drainboard
DBA24	24	19	Drainboard
DBA30	30	19	Drainboard
DBA36	36	19	Drainboard
DBA42	42	19	Drainboard
DBA48	48	19	Drainboard
DBB12	12	24	Drainboard
DBB18	18	24	Drainboard
DBB24	24	24	Drainboard
DBB30	30	24	Drainboard
DBB36	36	24	Drainboard
DBB42	42	24	Drainboard
DBB48	48	24	Drainboard
RDBA12S	12	24	Recessed DB, aligns w 19" UB, single speed rail
RDBA18S	18	24	Recessed DB, aligns w 19" UB, single speed rail
RDBA24S	24	24	Recessed DB, aligns w 19" UB, single speed rail
RDBA30S	30	24	Recessed DB, aligns w 19" UB, single speed rail
RDBB12	12	24	Recessed DB, aligns w 24" UB w/o speed rail
RDBB18	18	24	Recessed DB, aligns w 24" UB w/o speed rail
RDBB24	24	24	Recessed DB, aligns w 24" UB w/o speed rail
RDBB30	30	24	Recessed DB, aligns w 24" UB w/o speed rail
RDBA12D	12	29	Recessed DB, aligns w 19" UB, dbl speed rail
RDBA18D	18	29	Recessed DB, aligns w 19" UB, dbl speed rail
RDBA24D	24	29	Recessed DB, aligns w 19" UB, dbl speed rail
RDBA30D	30	29	Recessed DB, aligns w 19" UB, dbl speed rail
RDBB12S	12	29	Recessed DB, aligns w 24" UB, single speed rail
RDBB18S	18	29	Recessed DB, aligns w 24" UB, single speed rail
RDBB24S	24	29	Recessed DB, aligns w 24" UB, single speed rail
RDBB30S	30	29	Recessed DB, aligns w 24" UB, single speed rail

Part #	Description
SSR12	12" single speed rail
SSR18	18" single speed rail
SSR24	24" single speed rail
SSR30	30" single speed rail
SSR36	36" single speed rail
SSR42	42" single speed rail
SSR48	48" single speed rail
DSR12	12" double speed rail
DSR18	18" double speed rail
DSR24	24" double speed rail
DSR30	30" double speed rail
DSR36	36" double speed rail
DSR42	42" double speed rail
DSR48	48" double speed rail
TC*	4" x 4" x 6.5"H tubing chase

\*Units with tubing chase (TC) added are made to order and not returnable.



Advanced Beverage Solutions  
100 Gary Avenue, Suite C  
Roselle, IL 60172

**www.abstone.com**  
E-mail: [orders@abstone.com](mailto:orders@abstone.com)

877-814-2271  
Local: 847-524-1707  
Fax: 847-524-1710

## Underbar Corner Drainboards

Corner drainboards are used when an underbar line-up turns 90° or less. The direction of the turn may be toward (inside corner) or away (outside corner) from the bartender. Corner drainboards have a removable perforated insert, align with 19" or 24" deep underbars, and come with a front rail to match adjacent equipment.

Dimensional full corner drainboards are for 90° inside turns only. If the dimensions of each side are not the same, the longest dimension is specified second along with its location.

Clip corner drainboards have a larger chamfer than full corner drainboards, and are designed for inside or outside turns 90° or less.

Corner drainboards are designed to mount between two pieces of underbar, however they can be mounted between any two stable vertical surfaces. If one side does not have a vertical surface on which to mount, then a side and leg set must be ordered.

More details available. Please visit [www.glastender.com](http://www.glastender.com)



Clip corner drainboard



Full corner drainboard with chase and perforated insert removed



Full corner drainboard without chase

Part #	Angle	Turn	Description
ICCA90	90°	Inside	19" deep clip corner
OCCA90	90°	Outside	19" deep clip corner
ICCA75	75°	Inside	19" deep clip corner
OCCA75	75°	Outside	19" deep clip corner
ICCA60	60°	Inside	19" deep clip corner
OCCA60	60°	Outside	19" deep clip corner
ICCA45	45°	Inside	19" deep clip corner
OCCA45	45°	Outside	19" deep clip corner
ICCA30	30°	Inside	19" deep clip corner
OCCA30	30°	Outside	19" deep clip corner
ICCA15	15°	Inside	19" deep clip corner
OCCA15	15°	Outside	19" deep clip corner
ICCB90	90°	Inside	24" deep clip corner
OCCB90	90°	Outside	24" deep clip corner
ICCB75	75°	Inside	24" deep clip corner
OCCB75	75°	Outside	24" deep clip corner
ICCB60	60°	Inside	24" deep clip corner
OCCB60	60°	Outside	24" deep clip corner
ICCB45	45°	Inside	24" deep clip corner
OCCB45	45°	Outside	24" deep clip corner
ICCB30	30°	Inside	24" deep clip corner
OCCB30	30°	Outside	24" deep clip corner
ICCB15	15°	Inside	24" deep clip corner
OCCB15	15°	Outside	24" deep clip corner

Part #	Angle	Left"	Right"	Turn	Description
IFCA90	90°	19	19	Inside	90° full corner drainboard
OFCA90	90°	19	19	Outside	90° full corner drainboard
IFCB90	90°	24	24	Inside	90° full corner drainboard
OFCB90	90°	24	24	Outside	90° full corner drainboard
IFC19/19	90°	19	19	Inside	Dimensional full corner drainboard
IFC19/24L	90°	24	19	Inside	Dimensional full corner drainboard
IFC19/24R	90°	19	24	Inside	Dimensional full corner drainboard
IFC19/30L	90°	30	19	Inside	Dimensional full corner drainboard
IFC19/30R	90°	19	30	Inside	Dimensional full corner drainboard
IFC24/24	90°	24	24	Inside	Dimensional full corner drainboard
IFC24/30L	90°	30	24	Inside	Dimensional full corner drainboard
IFC24/30R	90°	24	30	Inside	Dimensional full corner drainboard
CALEG	N/A	N/A	N/A	N/A	Full side and leg set, 19" deep
CBLEG	N/A	N/A	N/A	N/A	Full side and leg set, 24" deep



## Underbar Drainboard Glassracks and Cabinets

More details available. Please visit [www.glastender.com](http://www.glastender.com)

Drainboard glassracks have a stationary or roll-out bottom shelf, adjustable or roll-out intermediate shelf, and drainboard work surface. All models are 24" deep. The 24" wide models hold 20" x 20" racks, and the 18" wide models hold the 16" round rack used with the Glastender GT18 glasswasher (racks not included). Since drainboard and glassrack shelves are solid, they can be used for non-glassrack storage. If a 19" deep drainboard glassrack is required, order a 19" deep drainboard glassrack less doors.

Drainboard cabinets are similar to glassracks, although the intermediate shelf is adjustable and available with or without doors. Models with doors come with a lock. The 12", 18" and 24" wide cabinets have one door, all others have two. Drainboard cabinets are also available with a flat stainless steel filler board in lieu of the drainboard top (substitute an "F" for the "D" in the model number), and made to order thus not returnable. Drainboard half cabinets are on 16" legs allowing cleaning underneath, and come with or without doors.



DBGR24RS



DBGR24



DBCB18



DBHA18LD

Part #	Length"	Depth"	Description
DBGR18	18	24	Drainboard glassrack
DBGR24	24	24	Drainboard glassrack
DBGR24RS	24	24	Drainboard glassrack
DBCA12*	12	19	Drainboard cabinet, 1 door
DBCA18*	18	19	Drainboard cabinet, 1 door
DBCA24*	24	19	Drainboard cabinet, 1 door
DBCA30*	30	19	Drainboard cabinet, 2 doors
DBCA36*	36	19	Drainboard cabinet, 2 doors
DBCA42*	42	19	Drainboard cabinet, 2 doors
DBCA48*	48	19	Drainboard cabinet, 2 doors
DBCB12	12	24	Drainboard cabinet, 1 door
DBCB18	18	24	Drainboard cabinet, 1 door
DBCB24	24	24	Drainboard cabinet, 1 door
DBCB30	30	24	Drainboard cabinet, 2 doors
DBCB36	36	24	Drainboard cabinet, 2 doors
DBCB42	42	24	Drainboard cabinet, 2 doors
DBCB48	48	24	Drainboard cabinet, 2 doors
DBCA12LD*	12	19	Drainboard cabinet
DBCA18LD*	18	19	Drainboard cabinet
DBCA24LD*	24	19	Drainboard cabinet
DBCA30LD*	30	19	Drainboard cabinet
DBCA36LD*	36	19	Drainboard cabinet
DBCA42LD*	42	19	Drainboard cabinet
DBCA48LD*	48	19	Drainboard cabinet
DBCB12LD	12	24	Drainboard cabinet
DBCB18LD	18	24	Drainboard cabinet
DBCB24LD	24	24	Drainboard cabinet
DBCB30LD	30	24	Drainboard cabinet
DBCB36LD	36	24	Drainboard cabinet
DBCB42LD	42	24	Drainboard cabinet
DBCB48LD	48	24	Drainboard cabinet
DBHA12*	12	19	Drainboard 1/2 cabinet, 1 door
DBHA18*	18	19	Drainboard 1/2 cabinet, 1 door
DBHA24*	24	19	Drainboard 1/2 cabinet, 1 door
DBHA12LD*	12	19	Drainboard 1/2 cabinet
DBHA18LD*	18	19	Drainboard 1/2 cabinet
DBHA24LD*	24	19	Drainboard 1/2 cabinet
DBHB12*	12	24	Drainboard 1/2 cabinet, 1 door
DBHB18*	18	24	Drainboard 1/2 cabinet, 1 door
DBHB24*	24	24	Drainboard 1/2 cabinet, 1 door
DBHB12LD*	12	24	Drainboard 1/2 cabinet
DBHB18LD*	18	24	Drainboard 1/2 cabinet
DBHB24LD*	24	24	Drainboard 1/2 cabinet

\*Made to order and not returnable.





Advanced Beverage Solutions  
100 Gary Avenue, Suite C  
Roselle, IL 60172

**www.absone.com**  
E-mail: [orders@absone.com](mailto:orders@absone.com)

877-814-2271  
Local: 847-524-1707  
Fax: 847-524-1710

## Underbar Glassracks, Drainboard Drawer Units, POS Cabinets, Add-On Cabinet Bases

More details available. Please visit [www.glastender.com](http://www.glastender.com)

Glassracks are designed to hold three racks of glassware; one on the bottom shelf and one on each of the two adjustable glass rack slides. The 24" wide models hold 20" x 20" racks (not included), and the 18" wide models hold the 16" round racks (not included) with the Glastender GT18 glasswasher.

Drainboard drawer units have a removable locking drawer and drainboard surface. This allows for more storage space without sacrificing the ability to have a speed rail. Special speed rails (listed below) are required with drawer units. 19" drainboard drawer units are made to order and not returnable.

The add-on cabinet base is installed beneath standard underbar equipment to provide additional storage and enhance the look of the bar by eliminating storage of loose items under the bar and makes plumbing less visible. The back of the cabinet provides access to plumbing. The removable stainless steel floor has radius corners for easy cleaning, and interior walls are dual panel for a smooth interior and cleaning ease.

POS cabinets have a 26" high work surface to accommodate a cash drawer and POS monitor. Left and right side splashes are standard, as well as a louvered door to ventilate the storage cabinet. The work surface has a grommeted cord access hole.



GRA24



DBDA18



PCB24



DBDA-SSR-ACB



ACB

Part #	Length"	Depth"	Description
GRA18	18	19	Glassrack
GRA24	24	19	Glassrack
GRB18	18	24	Glassrack
GRB24	24	24	Glassrack
DBDA18*	18	19	Drainboard drawer unit
DBDA24*	24	19	Drainboard drawer unit
DBDA30*	30	19	Drainboard drawer unit
DBDB18*	18	24	Drainboard drawer unit
DBDB24*	24	24	Drainboard drawer unit
DBDB30*	30	24	Drainboard drawer unit
ACB12*	12	24	Add-on cabinet base, 1 door
ACB14*	14	24	Add-on cabinet base, 1 door
ACB18*	18	24	Add-on cabinet base, 1 door
ACB24*	24	24	Add-on cabinet base, 2 doors
ACB30*	30	24	Add-on cabinet base, 2 doors
ACB36*	36	24	Add-on cabinet base, 2 doors
ACB42*	42	24	Add-on cabinet base, 2 doors
ACB48*	48	24	Add-on cabinet base, 2 doors
PCB18	18	24	Point of sale (POS) cabinet
PCB24	24	24	Point of sale (POS) cabinet
SSR18D	N/A	18 long	Speed rail, drainboard drawer
SSR24D	N/A	24 long	Speed rail, drainboard drawer
SSR30D	N/A	30 long	Speed rail, drainboard drawer

\*Made to order and not returnable.



## Underbar Single Bowl Sinks

More details available. Please visit [www.glastender.com](http://www.glastender.com)

Single bowl sinks are available as hand sinks and wet waste sinks. Wet sinks include a lift-out perforated plastic wet waste strainer. All sinks come with a mounted hot and cold gooseneck faucet.

Hand sink models HSA12D, HSB12D and HSB12AD include a soap dispenser (refill from above) front-skirt-mounted and C-fold paper towel dispenser. Models DHSA18, DHSB12 and DHSB18 include a soap dispenser and hinged front-access door to conceal C-fold paper towel dispenser, which are easily accessed below the door. (The access door is only opened for re-loading the paper towel dispenser.)

### Specialty Wet Waste Sinks:

Model SWB12C has a cabinet base with storage space for three 1-gallon chemical containers. Model SWB18DW has a cabinet base with work surface trash chute hole and front hinged access door (stainless steel trash container, model DWC, is available as an accessory). Model SWB18DB has a drainboard work surface with recessed wet waste sink below. Models SWB24LC and SWB24RC (L or R in the model number designates the sink location) include a 12" drain board section in the work surface and an open front cabinet base with center vertical divider.



SWB24LC



SWB12C



SWB18DW



DHSB12



SWB18DB



HSB12AD

Part #	Length"	Depth"	Description
HSA12	12	19	Hand sink
HSA18	18	19	Hand sink
HSA12D	12	19	Hand sink, soap & towel disp.
DHSA18	18	19	Hand sink
HSB12	12	24	Hand sink
HSB18	18	24	Hand sink
HSB12D	12	24	Hand sink, soap & towel disp.
HSB12AD	12	24	Hand sink, soap & towel disp.
DHSB12	12	24	Hand sink, soap & towel disp.
DHSB18	18	24	Hand sink, soap & towel disp.
SWA12	12	19	Wet waste sink
SWA18	18	19	Wet waste sink
SWB12	12	24	Wet waste sink
SWB18	18	24	Wet waste sink
SWB12C	12	24	Wet waste sink, cabinet base
SWB18DW	18	24	Wet waste sink, cabinet, chute
SWB18DB	18	24	Wet waste sink, cabinet w door, drainboard
SWB24LC	24	24	Wet waste sink, cabinet, drainboard, divider
SWB24RC	24	24	Wet waste sink, cabinet, drainboard, divider

Part #	Description
SSR12	12" single speed rail
SSR18	18" single speed rail
DSR12	12" double speed rail
SDR18	18" double speed rail
03000483	Wet waste sink strainer
TR	Towel ring
DWR12	Dry waste rail
DWC	Dry waste container
LSAD	19" deep left end splash
RSAD	19" deep right end splash
LSBD	24" deep left end splash
RSBD	24" deep right end splash
TDC	Paper towel dispenser, C-fold
03001873	Liquid soap dispenser, hand pump

Speed rails and dry waste rails cannot be mounted to models:  
HSA12D, DHSA18, HSB12D, HSB12AD, DHSB12, DHSB18,  
SWB12C, SWB18DW, SWB18DB, SWB24LC, SWB24RC

TDC paper towel dispenser cannot be mounted to models:  
SWB12C, SWB18DW, SWB18DB, SWB24LC, SWB24RC



Advanced Beverage Solutions  
100 Gary Avenue, Suite C  
Roselle, IL 60172

**www.absonone.com**  
E-mail: [orders@absonone.com](mailto:orders@absonone.com)

877-814-2271  
Local: 847-524-1707  
Fax: 847-524-1710

## Underbar Multiple Bowl Sinks

Multiple sinks come in three different styles: two, three and four compartment. They feature an exclusive one-piece 18 gauge stainless steel top that is seamless from the front rail all the way through the backsplash.

Each style is available with or without built-in drainboards on one or both sides of the sink compartments. Drainboards, where included, are a seamless and integral part of the work surface and have a lift-out perforated insert. The seamless weld bowls are 16 gauge fabricated stainless steel. An "L" or "R" designates the location of the sink compartment as left or right when there is only one drainboard.

All sinks include one overflow tube per bowl. 19" deep models have a backsplash mounted faucet. Perforated stainless steel inserts are available to cover sinks when not in use.



Part #	Description
SSR24	24" single speed rail
SSR36	36" single speed rail
SSR48	48" single speed rail
SSR60	60" single speed rail
SSR66	66" single speed rail
SSR72	72" single speed rail
SSR84	84" single speed rail
DSR24	24" double speed rail
DSR36	36" double speed rail
DSR48	48" double speed rail
DSR60	60" double speed rail
DSR66	66" double speed rail
DSR72	72" double speed rail
DSR84	84" double speed rail
TR	Towel ring
LWS	Large wet waste strainer
DWR12	Dry waste rail
03002552	Sink cover, perforated, DSA or DSB
03002553	Sink cover, perforated, TSA or TSB
03002554	Sink cover, perforated, FSA or FSB

Part Number	Number Sinks	Overall Length"	Depth"	Sink Location	Drain-Board"
DSA24S*	2	24	19	Center	N/A
DSA36LS*	2	36	19	Left	12
DSA36RS*	2	36	19	Right	12
DSA48S*	2	48	19	Center	2@12
DSB24S*	2	24	24	Center	N/A
DSB36LS*	2	36	24	Left	12
DSB36RS*	2	36	24	Right	12
DSB48S*	2	48	24	Center	2@12
TSA36S	3	36	19	Center	N/A
TSA48LS*	3	48	19	Left	12
TSA48RS*	3	48	19	Right	12
TSA60S	3	60	19	Center	2@12
TSA60LS*	3	60	19	Left	24
TSA60RS*	3	60	19	Right	24
TSA66LS*	3	66	19	Left	30
TSA66RS*	3	66	19	Right	30
TSA72S	3	72	19	Center	2@18
TSA84S	3	84	19	Center	2@24
TSA96S*	3	96	19	Center	2@30
TSB36S	3	36	24	Center	N/A
TSB48LS*	3	48	24	Left	12
TSB48RS*	3	48	24	Right	12
TSB60S	3	60	24	Center	2@12
TSB60LS*	3	60	24	Left	24
TSB60RS*	3	60	24	Right	24
TSB66LS*	3	66	24	Left	30
TSB66RS*	3	66	24	Right	30
TSB72S	3	72	24	Center	2@18
TSB84S	3	84	24	Center	2@24
TSB96S*	3	96	24	Center	2@30
FSA48S	4	48	19	Center	N/A
FSA60LS*	4	60	19	Left	12
FSA60RS*	4	60	19	Right	12
FSA66LS*	4	66	19	Left	18
FSA66RS*	4	66	19	Right	18
FSA72S	4	72	19	Center	2@12
FSA72LS*	4	72	19	Left	24
FSA72RS*	4	72	19	Right	24
FSA84S	4	84	19	Center	2@18
FSA96S*	4	96	19	Center	2@24
FSB48S	4	48	19	Center	N/A
FSB60LS*	4	60	19	Left	12
FSB60RS*	4	60	19	Right	12
FSB66LS*	4	66	19	Left	18
FSB66RS*	4	66	19	Right	18
FSB72S	4	72	19	Center	2@12
FSB72LS*	4	72	19	Left	24
FSB72RS*	4	72	19	Right	24
FSB84S	4	84	19	Center	2@18
FSB96S*	4	96	19	Center	2@24

\*Made to order and not returnable.



## Underbar Beer Drainers and Liquor Displays

More details available. Please visit [www.glastender.com](http://www.glastender.com)

Beer drainers have a 26" high, lowered work surface designed for use with an undercounter beverage dispenser. The work surface includes a drain pan with perforated insert to serve as the drip pan for the dispenser with a tubing chase notched rear deck for beverage line installation and access.

Liquor displays provide tiered liquor bottle storage at a convenient height for bartenders. Each step and rail has sound deadening

covers, and each rail includes a clear lift-off liquor identification cover, and radius interior corners for easy cleaning. The 24" deep models provide four tiers, and 29" deep models provide five. Liquor displays cannot have a speed rail mounted to them but align with underbar with a speed rail, and appearance matches a speed rail for continuity. Locking speed rail covers can be used on each row.

Slanted liquor displays are used with 20" x 20" racks. Cabinet model has a locking door and 2" casters.



Beer drainer



LDA18S



SLD24



SLDC24

Part #	Length"	Depth"	Description
BDA18*	18	19	Beer drainer
BDA24*	24	19	Beer drainer
BDA30*	30	19	Beer drainer
BDA36*	36	19	Beer drainer
BDB18*	18	24	Beer drainer
BDB24*	24	24	Beer drainer
BDB30*	30	24	Beer drainer
BDB36*	36	24	Beer drainer
LDA12S	12	24	Liquor display, aligns w 19" UB w speed rail
LDA18S	18	24	Liquor display, aligns w 19" UB w speed rail
LDA24S	24	24	Liquor display, aligns w 19" UB w speed rail
LDA30S	30	24	Liquor display, aligns w 19" UB w speed rail
LDA36S	36	24	Liquor display, aligns w 19" UB w speed rail
LDA42S	42	24	Liquor display, aligns w 19" UB w speed rail
LDB12	12	24	Liquor display, aligns w 24" UB w/o speed rail
LDB18	18	24	Liquor display, aligns w 24" UB w/o speed rail
LDB24	24	24	Liquor display, aligns w 24" UB w/o speed rail
LDB30	30	24	Liquor display, aligns w 24" UB w/o speed rail
LDB36	36	24	Liquor display, aligns w 24" UB w/o speed rail
LDB42	42	24	Liquor display, aligns w 24" UB w/o speed rail
LDA12D	12	29	Liquor display, aligns w 19" UB w dbl speed rail
LDA18D	18	29	Liquor display, aligns w 19" UB w dbl speed rail
LDA24D	24	29	Liquor display, aligns w 19" UB w dbl speed rail
LDA30D	30	29	Liquor display, aligns w 19" UB w dbl speed rail
LDA36D	36	29	Liquor display, aligns w 19" UB w dbl speed rail
LDA42D	42	29	Liquor display, aligns w 19" UB w dbl speed rail
LDB12S	12	29	Liquor display, aligns w 24" UB w sngl speed rail
LDB18S	18	29	Liquor display, aligns w 24" UB w sngl speed rail
LDB24S	24	29	Liquor display, aligns w 24" UB w sngl speed rail
LDB30S	30	29	Liquor display, aligns w 24" UB w sngl speed rail
LDB36S	36	29	Liquor display, aligns w 24" UB w sngl speed rail
LDB42S	42	29	Liquor display, aligns w 24" UB w sngl speed rail
SLD24	24	24	Slanted liquor display
SLDC24	24	24	Slanted liquor display with cabinet

\*Made to order and not returnable.



## Underbar Dry Waste and Wait Stations

More details available. Please visit [www.glastender.com](http://www.glastender.com)

The top lifts up on all dry waste chutes to empty the trash receptacle, and lifts off for cleaning. DWB12 mounts between two adjacent pieces of underbar. DWB15L and DWB15R include a left or right side and leg set, and mount to one side of the underbar. DWB18 is freestanding. All models are designed to house a Rubbermaid® Slim Jim™ trash receptacle.

Dry waste rail looks like a speed rail but is a chute for a 16"H (or less) trash receptacle. Dry waste rails cannot be used on cabinets, glassracks or ice cream freezers.

Ice cream freezers are fully insulated, have dipper well and faucet, 6' grounded cord and plug, and 5 year compressor warranty. 24" unit holds one 3 gallon container of ice cream, 36" holds two.

Wait stations mount to the server side of the bar die for convenient storage of common server items. Cabinet includes menu holder, welded bowl with removable plastic wash basin, intermediate shelf, and special compartment for vertical 14" or 16" round server tray storage with a hole in the bottom to prevent trays from rolling out. No plumbing required. Includes wall mounting brackets.



Part #	Length"	Depth"	Description
DWB12	12	24	Dry waste chute
DWB15L	15	24	Dry waste chute, L side & legs
DWB15R	15	24	Dry waste chute, R side & legs
DWB18*	18	24	Dry waste chute, freestanding
DWR12	12	5	Dry waste rail
WS24	24	15	Wait station
WS36	36	15	Wait station
WS36S	36	15	Wait station, SS bowl, removable plastic washrag basin

Part #	Description
DWC	SS dry waste container
03000497	Slim Jim plastic trash receptacle
SSR24	Single speed rail for ice cream freezer
SSR36	Single speed rail for ice cream freezer
DSR24	Double speed rail for ice cream freezer
DSR36	Double speed rail for ice cream freezer
CE220/50S	Converts ice cream freezer to 220V/50Hz
WPH	Wall-mounted pan holder
WPHLP	Wall-mounted pan holder, less pan
MHL	Menu holder, mounts left
MHR	Menu holder, mounts right
03003317	1/4th pan, SS, 6" deep
03003318	1/4th pan, plastic, 6" deep
03003294	Plastic washrag basin

\*Made to order and not returnable.



Advanced Beverage Solutions  
 100 Gary Avenue, Suite C  
 Roselle, IL 60172

**www.absonone.com**  
 E-mail: [orders@absonone.com](mailto:orders@absonone.com)

877-814-2271  
 Local: 847-524-1707  
 Fax: 847-524-1710

## Underbar All-In-One Stations

All-in-one stations combine different underbar components into one pre-assembled unit, and can be ordered with or without a cold plate. Stations are 29" deep. Sinks include goose neck faucet. All-in-one stations are made to order and are not returnable.

More details available. Please visit [www.glastender.com](http://www.glastender.com)



Beer Systems, Bar Equipment

Part Number w/o Cold Plate	Part Number with 10 Circuit Cold Plate	Width"	36" Combo Ice Bin	42" Combo Ice Bin	12" Single Wet Waste Sink	12" Single Wet Waste Sink, L Splash	12" Blender Shelf with Towel Ring	12" Liquor Display	18" Liquor Display	36" Double Speed Rail	42" Double Speed Rail	12" Dry Waste Rail	12" Recessed Drainboard	18" Recessed Drainboard	Condiment Dispenser
ALL60A	ALL60ACP10	60	X		X	X	X	X		X		X			X
ALL60B	ALL60BCP10	60	X			X	X			X		X	X		X
ALL66A	ALL66ACP10	66		X	X	X	X	X			X	X			X
ALL66B	ALL66BCP10	66		X	X	X					X	X	X		X
ALL66C	ALL66CCP10	66	X		X	X				X		X		X	X
ALL66D	ALL66DCP10	66	X		X	X		X	X	X		X			X
ALL72	ALL72CP10	72	X		X	X	X	X		X		X	X		X
ALL72A	ALL72ACP10	72		X	X	X		X			X	X			X
ALL72B	ALL72BCP10	72		X	X	X					X	X		X	X



Advanced Beverage Solutions  
100 Gary Avenue, Suite C  
Roselle, IL 60172

**www.absone.com**  
E-mail: [orders@absone.com](mailto:orders@absone.com)

877-814-2271  
Local: 847-524-1707  
Fax: 847-524-1710

## Underbar Drink Rails, Drain Pans and Speed Rails

More details available. Please visit [www.glastender.com](http://www.glastender.com)

Drink rails mount to the underside of the bar top and have a removable perforated insert. 30" and 36" models have one gusset, 42" and 48" rails have two gussets for added strength. 1/2" welded tailpiece drain exits from the back. Installation kit includes: 10' of clear vinyl drain tube, one 4" Ty-wrap, three #10 SS wood screws, three cable clamps and one 1/2" x 1/2" x 1/2" plastic tee.

Drop-in drain pans fit into the countertop and self rimming edges fit tightly to the work surface. Comes with the same installation kit as drink rail except there are two 1/2" elbows rather than one tee. Standard lengths are from 24" to 48". Custom sizes also available.

Drink rails and drop-in drain pans are made to order and not returnable

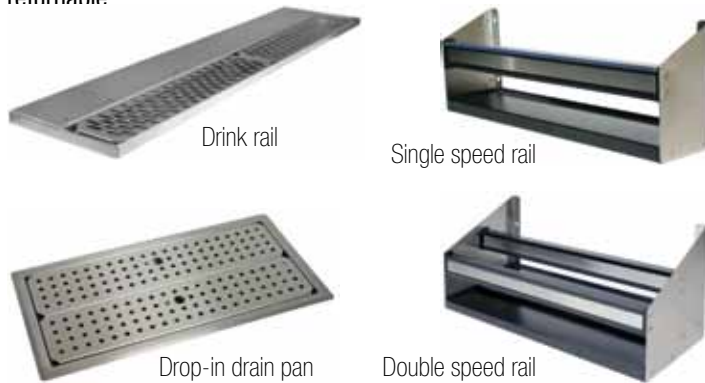

Part #	Size"	Description
DR12R	12	Drink rail, right side drain
DR18R	18	Drink rail, right side drain
DR24R	24	Drink rail, right side drain
DR30R	30	Drink rail, right side drain
DR36R	36	Drink rail, right side drain
DR42R	42	Drink rail, right side drain
DR48R	48	Drink rail, right side drain
DR12L	12	Drink rail, left side drain
DR18L	18	Drink rail, left side drain
DR24L	24	Drink rail, left side drain
DR30L	30	Drink rail, left side drain
DR36L	36	Drink rail, left side drain
DR42L	42	Drink rail, left side drain
DR48L	48	Drink rail, left side drain
DRIC45	N/A	45° inside corner filler
DRIC90	N/A	90° inside corner filler
DROC45	N/A	45° outside corner filler
DROC90	N/A	90° outside corner filler
DIDP12X24	12 x 24	Drop-in drain pan
DIDP12X30	12 x 30	Drop-in drain pan
DIDP12X36	12 x 36	Drop-in drain pan
DIDP12X42	12 x 42	Drop-in drain pan
DIDP12X48	12 x 48	Drop-in drain pan



Outside 45° corner



Inside 45° corner



Inside 90° corner

Speed rails are stainless steel with radius corners, easy to clean and view bottles. Each rail has sound deadening covers and a clear lift-off liquor ID cover. Locking covers for single speed rails include built-in storage hangers when ordered with original equipment.

Part #	Size"	Description
SSR12T017	12 - 17	Single speed rail
SSR18T023	18 - 23	Single speed rail
SSR24T029	24 - 29	Single speed rail
SSR30T035	30 - 35	Single speed rail
SSR36T041	36 - 41	Single speed rail
SSR42T047	42 - 47	Single speed rail
SSR48T053	48 - 53	Single speed rail
SSR54T059	54 - 59	Single speed rail
SSR60T065	60 - 65	Single speed rail
SSR66T071	66 - 71	Single speed rail
SSR72T077	72 - 77	Single speed rail
SSR78T083	78 - 83	Single speed rail
SSR84	84	Single speed rail
DSR12T017	12 - 17	Double speed rail
DSR18T023	18 - 23	Double speed rail
DSR24T029	24 - 29	Double speed rail
DSR30T035	30 - 35	Double speed rail
DSR36T041	36 - 41	Double speed rail
DSR42T047	42 - 47	Double speed rail
DSR48T053	48 - 53	Double speed rail
DSR54T059	54 - 59	Double speed rail
DSR60T065	60 - 65	Double speed rail
DSR66T071	66 - 71	Double speed rail
DSR72T077	72 - 77	Double speed rail
DSR78T083	78 - 83	Double speed rail
DSR84	84	Double speed rail
SSRC12T017	12 - 17	Single speed rail locking cover
SSRC18T023	18 - 23	Single speed rail locking cover
SSRC24T029	24 - 29	Single speed rail locking cover
SSRC30T035	30 - 35	Single speed rail locking cover
SSRC36T041	36 - 41	Single speed rail locking cover
SSRC42	42	Single speed rail locking cover
DSRC12T017	12 - 17	Double speed rail locking cover
DSRC18T023	18 - 23	Double speed rail locking cover
DSRC24T029	24 - 29	Double speed rail locking cover
DSRC30T035	30 - 35	Double speed rail locking cover
DSRC36T041	36 - 41	Double speed rail locking cover
DSRC42	42	Double speed rail locking cover
CSR12SR	12	Clip-on single speed rail to existing single
CSR18SR	18	Clip-on single speed rail to existing single
CSR24SR	24	Clip-on single speed rail to existing single
CSR30SR	30	Clip-on single speed rail to existing single
CSR36SR	36	Clip-on single speed rail to existing single
CSR42SR	42	Clip-on single speed rail to existing single



Advanced Beverage Solutions  
100 Gary Avenue, Suite C  
Roselle, IL 60172

**www.absone.com**  
E-mail: [orders@absone.com](mailto:orders@absone.com)

877-814-2271  
Local: 847-524-1707  
Fax: 847-524-1710

## Underbar Modular Bar Die

Underbar equipment is mounted to and supported on the bar die. All underbar equipment is pre-assembled and mounted to the bar die at the factory, then broken down into shippable sections. Installation of the bar die is simpler than a conventional millwork bar die and has many advantages...

### Benefits:

- Stainless steel from floor to the bar top on bartender side
- Floor can be sealed to the bar die to prevent moisture from seeping from the bartender side to the customer side
- Galvanized steel will not rot
- Eliminates all underbar legs for easy cleaning
- Built-in chaseways for beer, soda, plumbing and electrical lines provide a cleaner, more attractive bar
- Can be used in conjunction with removable front millwork finishing panels to provide easy access to beer, soda, plumbing and electrical lines for future modification, maintenance or repair
- Pre-engineered to exact dimensions to ensure a precise fit
- Pre-assembly from the factory lowers installation costs
- Millwork bar top and front panels can be pre-fabricated and easily attached

More details available. Please visit [www.glastender.com](http://www.glastender.com)

The total number of feet required is calculated by determining the overall outside dimension of the bar die wall. Please round to the nearest whole foot.



Underbar with modular bar die

Part #	Description
MD	Modular bar die, priced per foot



Underbar without modular bar die

Beer Systems, Bar Equipment





Advanced Beverage Solutions  
100 Gary Avenue, Suite C  
Roselle, IL 60172

**www.absone.com**  
E-mail: [orders@absone.com](mailto:orders@absone.com)

877-814-2271  
Local: 847-524-1707  
Fax: 847-524-1710

## Underbar Parts and Accessories

Part #	Description
BO	Bottle opener
CLEG	6" leg for underbar cabinet
ULEG	16" leg for standard underbar
03000495	12" leg for extra-deep ice bin
03005473	Light, plug-in fluorescent for bar die
03001871	Cup, condiment dispenser replacement
03000484	Flanged foot, fits all equipment
06001549	Bullet foot, fits all equipment
06001557	Pilaster for GRA and GRB
06001565	Clip for pilaster, SS, for GRA and GRB
06001574	Thumbscrew, SS, for pilaster or shelf angle
03001093	Shelf angle, for DBCA or DBCB
03001915	Lock and cam, drainboard cabinet, 2 keys
03000474	Lock w 2 keys, speed rail or MBR cover
03000475	J-hook, locking speed rail cover
03000476	J-hook, for MBR24LC
03000477	J-hook, for MBR24CTLC
03001923	10/32 x 3/4" black hand screw for bargun drip cup
03000457	Repl deck faucet, 7-3/8" gooseneck, UB unit 1 bowl
03000458	Repl deck faucet, 9" gooseneck, CS models
03000460	Repl deck faucet, 10" swing, DSB models
03000463	Repl backsplash faucet, 6" swing, for BSA12, HSA12, HSA12D, SWA12, DSA & WH models
03005754	Repl backsplash faucet, 10" swing, for TSA and 2-faucet FSA models
03000465	Repl backsplash faucet, 18" dbl joint, FSA models
03000466	Repl faucet, 7-3/8" gooseneck, spout only
03000467	Repl faucet, 9" gooseneck, spout only
03000468	Repl faucet, 6" swing, spout only
03002009	Repl faucet, 10" swing, spout only
03000469	Repl faucet, 12" swing, spout only
03000470	Repl faucet, 18" dbl joint, spout only
03000471	Repl faucet, deck mt, body only
03000472	Repl faucet, backsplash mt, body only
03000473	Repl faucet, glass filler, short
03001872	Repl faucet, glass filler, 9-3/8"H for DI-IW24
04000104	Repl faucet, dipper well
03000511	Wrist handles, set of two
03000441	Overflow tube for multiple sink
03001873	Liquid soap dispenser, hand-pump
01000766	1.5" IPS drain fitting kit
02000614	Drain screen, IDU, GDU, MIB, IBM, ice bins prior 8/03
02000616	Drain screen, stamped, ice bins post 8/03
03000443	18" open glass rack shelf
03000444	24" open glass rack shelf
BSS8	Bolt-on blender shelf, 8"
BSS12	Bolt-on blender shelf, 12"
BSS14	Bolt-on blender shelf, 14"
BSS16	Bolt-on blender shelf, 16"
BSS18	Bolt-on blender shelf, 18"
BSS24	Bolt-on blender shelf, 24"
BSS30	Bolt-on blender shelf, 30"

Part #	Description
LS15F	Side splash, 15" D left side, BSA models
RS15F	Side splash, 15" D right side, BSA models
LS15D	Side splash, 15" D left side, DBSA models
RS15D	Side splash, 15" D right side, DBSA models
LSAF	Side splash, 19" D left side for flat work surface
RSAF	Side splash, 19" D right side for flat work surface
LSBF	Side splash, 24" D left side for flat work surface
RSBF	Side splash, 24" D right side for flat work surface
03000422	12" W drainboard insert for 19" D unit
03000424	18" W drainboard insert for 19" D unit
03000426	24" W drainboard insert for 19" D unit
03000428	30" W drainboard insert for 19" D unit
03000430	36" W drainboard insert for 19" D unit
03000432	42" W drainboard insert for 19" D unit
03000434	48" W drainboard insert for 19" D unit
03000423	12" W drainboard insert for 24" D unit
03000425	18" W drainboard insert for 24" D unit
03000427	24" W drainboard insert for 24" D unit
03000429	30" W drainboard insert for 24" D unit
03000431	36" W drainboard insert for 24" D unit
03000433	42" W drainboard insert for 24" D unit
03000435	48" W drainboard insert for 24" D unit
IBCA12	Repl ice bin cover, 12" W for 19" D ice bin
IBCA18	Repl ice bin cover, 18" W for 19" D ice bin
IBCA24	Repl ice bin cover, 24" W for 19" D ice bin
IBCA30	Repl ice bin cover, 30" W for 19" D ice bin
IBCA36	Repl ice bin cover, 36" W for 19" D ice bin
IBCA42	Repl ice bin cover, 42" W for 19" D ice bin
IBCA48	Repl ice bin cover, 48" W for 19" D ice bin
IBCB12	Repl ice bin cover, 12" W for 24" D ice bin
IBCB18	Repl ice bin cover, 18" W for 24" D ice bin
IBCB24	Repl ice bin cover, 24" W for 24" D ice bin
IBCB30	Repl ice bin cover, 30" W for 24" D ice bin
IBCB36	Repl ice bin cover, 36" W for 24" D ice bin
IBCB42	Repl ice bin cover, 42" W for 24" D ice bin
IBCB48	Repl ice bin cover, 48" W for 24" D ice bin
03000163	Shelf, 12" W for 19" D cabinet
03000165	Shelf, 18" W for 19" D cabinet
03000167	Shelf, 24" W for 19" D cabinet
03000168	Shelf, 30" W for 19" D cabinet
03000169	Shelf, 36" W for 19" D cabinet
03000170	Shelf, 42" W for 19" D cabinet
03000171	Shelf, 48" W for 19" D cabinet
03000181	Shelf, 12" W for 24" D cabinet
03000184	Shelf, 18" W for 24" D cabinet
03000185	Shelf, 24" W for 24" D cabinet
03000186	Shelf, 30" W for 24" D cabinet
03000187	Shelf, 36" W for 24" D cabinet
03000188	Shelf, 42" W for 24" D cabinet
03000189	Shelf, 48" W for 24" D cabinet
03000525	Shelf, 12" W for add-on cabinet base
03000596	Shelf, 14" W for add-on cabinet base
03000657	Shelf, 18" W for add-on cabinet base
03000791	Shelf, 24" W for add-on cabinet base
03000894	Shelf, 30" W for add-on cabinet base
03000915	Shelf, 36" W for add-on cabinet base
03000927	Shelf, 42" W for add-on cabinet base
03000936	Shelf, 48" W for add-on cabinet base



## Pass-Thru Cocktail Stations

Designed to eliminate wasted steps and save time, the pass-thru cocktail station allows the bartender and cocktail servers to work more efficiently, and able to serve more drinks per hour.

Front and end finish panels to match the existing decor are provided, which hold up the tray shelf and optional single or double overshelves. Laminated panels are available in stainless steel, or any standard laminate color (please specify the manufacturer, color and catalog number when ordering). If you prefer to make your own finish panels, Glastender's specification guide has the drawings and details necessary for fabrication.

More details available. Please visit [www.glastender.com](http://www.glastender.com)

Orientation determines the work flow, and is usually dictated by the position of the glasswasher. Counterclockwise: the work flow is right to left with the glasswasher on the left. Clockwise: the work flow is left to right with the glasswasher on the bartender's right.

Cocktail stations are made to order and not returnable.



72" cocktail station, server side



42" cocktail station, bartender side



42" cocktail station, server side

Part Number	Size"	Rotation	Pass-Thru Ice Bin	Tubing Chase	Wet Waste Sink, Gooseneck Faucet, Strainer	Blender Shelf	Double Speed Rail	12" Wide SS Draining Tray Shelf	15" Wide SS Draining Tray Shelf	8 Bottle Insulated Storage Well	Laminated Front and End Panels
CS42X26CW	42 x 26	CW	X	X	X	X	X	X			X
CS42X26CCW	42 x 26	CCW	X	X	X	X	X	X			X
CS42X26CWS	42 x 26	CW	X	X	X	X	X	X			
CS42X26CCWS	42 x 26	CCW	X	X	X	X	X	X			
CS42X32CW	42 x 32	CW	X	X	2	X	X		X		X
CS42X32CCW	42 x 32	CCW	X	X	2	X	X		X		X
CS42X32CWS	42 x 32	CW	X	X	2	X	X		X		
CS42X32CCWS	42 x 32	CCW	X	X	2	X	X		X		
CS54X32CW	54 x 32	CW	X	X	2	X	X		X	X	X
CS54X32CCW	54 x 32	CCW	X	X	2	X	X		X	X	X
CS54X32CWS	54 x 32	CW	X	X	2	X	X		X	X	
CS54X32CCWS	54 x 32	CCW	X	X	2	X	X		X	X	
CS60X32CW	60 x 32	CW	2	X	2	X	X		X		X
CS60X32CCW	60 x 32	CCW	2	X	2	X	X		X		X
CS60X32CWS	60 x 32	CW	2	X	2	X	X		X		
CS60X32CCWS	60 x 32	CCW	2	X	2	X	X		X		



Advanced Beverage Solutions  
100 Gary Avenue, Suite C  
Roselle, IL 60172

**www.absonone.com**  
E-mail: [orders@absonone.com](mailto:orders@absonone.com)

877-814-2271  
Local: 847-524-1707  
Fax: 847-524-1710

## Pass-Thru Cocktail Stations

More details available. Please visit [www.glastender.com](http://www.glastender.com)



CS72CCW with optional SOS,  
SS72 single overshef and SG30  
sneeze guard



Part Number	Size"	Rotation	GT24 Auto Conveyor Glasswasher	GT30 Auto Conveyor Glasswasher	Wet Waste Sink, Gooseneck Faucet, Strainer	SS Removable Dry Waste Receptacle	Pass-Thru Ice Bin	Tubing Chase	Blender Shelf	Double Speed Rail	12" Wide SS Draining Tray Shelf	15" Wide SS Draining Tray Shelf	8 Bottle Insulated Storage Well	Laminated Front and End Panels
CS42X26GCW	42 x 26	CW	X		X						X			X
CS42X26GCCW	42 x 26	CCW	X		X						X			X
CS42X26GCWS	42 x 26	CW	X		X						X			
CS42X26GCCWS	42 x 26	CCW	X		X						X			
CS42X32GCW	42 x 32	CW	X		2	X					X			X
CS42X32GCCW	42 x 32	CCW	X		2	X					X			X
CS42X32GCWS	42 x 32	CW	X		2	X					X			
CS42X32GCCWS	42 x 32	CCW	X		2	X					X			
CS48X32GCW	48 x 32	CW		X	2							X		X
CS48X32GCCW	48 x 32	CCW		X	2							X		X
CS48X32GCWS	48 x 32	CW		X	2							X		
CS48X32GCCWS	48 x 32	CCW		X	2							X		
CS66X26CW	66 x 26	CW	X		X		X	X	X	X	X			X
CS66X26CCW	66 x 26	CCW	X		X		X	X	X	X	X			X
CS66X26CWS	66 x 26	CW	X		X		X	X	X	X	X			
CS66X26CCWS	66 x 26	CCW	X		X		X	X	X	X	X			
CS66X32CW	66 x 32	CW	X		2	X	X	X	X	X	X			X
CS66X32CCW	66 x 32	CCW	X		2	X	X	X	X	X	X			X
CS66X32CWS	66 x 32	CW	X		2	X	X	X	X	X	X			
CS66X32CCWS	66 x 32	CCW	X		2	X	X	X	X	X	X			
CS72CW	72 x 32	CW		X	2		X	X	X	X	X	X		X
CS72CCW	72 x 32	CCW		X	2		X	X	X	X	X	X		X
CS72CWS	72 x 32	CW		X	2		X	X	X	X	X	X		
CS72CCWS	72 x 32	CCW		X	2		X	X	X	X	X	X		
CS84CW	84 x 32	CW		X	2		X	X	X	X	X	X	X	X
CS84CCW	84 x 32	CCW		X	2		X	X	X	X	X	X	X	X
CS84CWS	84 x 32	CW		X	2		X	X	X	X	X	X	X	
CS84CCWS	84 x 32	CCW		X	2		X	X	X	X	X	X	X	

Cocktail stations are made to order and not returnable.



Advanced Beverage Solutions  
100 Gary Avenue, Suite C  
Roselle, IL 60172

**www.absonone.com**  
E-mail: [orders@absonone.com](mailto:orders@absonone.com)

877-814-2271  
Local: 847-524-1707  
Fax: 847-524-1710

## Cocktail Station Accessories

“SS, not laminate panels” converts laminated front and end panels to stainless steel panels at the factory, and includes foamed-in-place insulation.

Cold plates are built-in to pass-thru ice bin liner at the factory.

Clip-on condiment dispenser clips to either side of station. Clip-on single and double speed rails clip to bartender side. Clip-on dry waste receptacle clips to server side.

Overshelves mount to the end panels, brackets included.

More details available. Please visit [www.glastender.com](http://www.glastender.com)

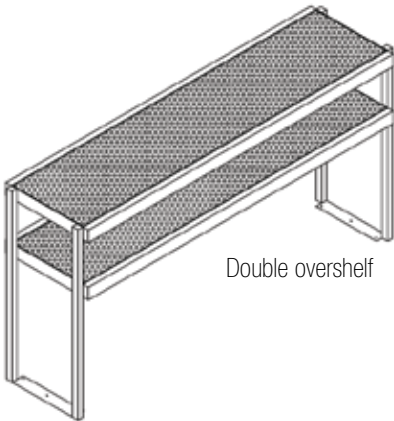

Double overshelf



Condiment dispenser



Clip-on single speed rail



Bolt-on blender shelf

Part Number	Description	CS42X26	CS42X32	CS54X32	CS60X32	CS42X26G	CS42X32G	CS48X32G	CS66X26	CS66X32	CS72	CS84
CPS42X26	SS, not laminate panels	X				X						
CPS42X32	SS, not laminate panels		X				X					
CPS48X32	SS, not laminate panels							X				
CPS54X32	SS, not laminate panels			X								
CPS60X32	SS, not laminate panels				X							
CPS66X26	SS, not laminate panels								X			
CPS66X32	SS, not laminate panels									X		
CPS72X32	SS, not laminate panels										X	
CPS84X32	SS, not laminate panels											X
O2000624	10 circuit cold plate	X				X			X			
O2000626	10 circuit cold plate		X	X	X		X	X		X	X	X
SOS/SS42	42" SS single overshelf	X	X			X	X					
SOS/SS48	48" SS single overshelf							X				
SOS/SS54	54" SS single overshelf			X								
SOS/SS60	60" SS single overshelf				X							
SOS/SS66	66" SS single overshelf								X	X		
SOS/SS72	72" SS single overshelf										X	
SOS/SS84	84" SS single overshelf											X
DOS/SS42	42" SS double overshelf	X	X			X	X					
DOS/SS48	48" SS double overshelf							X				
DOS/SS54	54" SS double overshelf			X								
DOS/SS60	60" SS double overshelf				X							
DOS/SS66	66" SS double overshelf								X	X		
DOS/SS72	72" SS double overshelf										X	
DOS/SS84	84" SS double overshelf											X
IBDHCS26	26"D ice bin divider, half	X				X			X			
IBDHCS32	32"D ice bin divider, half		X	X	X		X	X		X	X	X
CCD/T	Condiment disp, clip-on	X	X	X	X	X	X	X	X	X	X	X
O3000508	26"D sneeze guard	X				X			X			
O3000509	32"D sneeze guard		X	X	X		X	X		X	X	X
SSR16	16" single speed rail					X	X	X				
CSR16	16" clipon singl speedrail					X	X		X	X		
CSR22	22" clipon singl speedrail							X			X	X
DSR16	16" double speed rail					X	X	X				
CDSR16	16" clip-on dbl speed rail					X	X		X	X		
CDSR22	22" clip-on dbl speed rail							X			X	X
CDRY	SS clip-on dry waste	X	X	X	X	X	X	X	X	X	X	X
BBS16	16" bolt-on blender shelf					X	X	X				

Cocktail stations are made to order and not returnable.



Advanced Beverage Solutions  
100 Gary Avenue, Suite C  
Roselle, IL 60172

[www.absone.com](http://www.absone.com)  
E-mail: [orders@absone.com](mailto:orders@absone.com)

877-814-2271  
Local: 847-524-1707  
Fax: 847-524-1710

## Cocktail Station Accessories

More details available. Please visit [www.glastender.com](http://www.glastender.com)



Front panel

End panel



Kick rail



Tray shelf

Part #	Description
EP24	Laminated panel, 26" deep station end panel
EP30	Laminated panel, 32" deep station end panel
FP26	Laminated panel, 54" station front panel (2 required)
FP29	Laminated panel, 60" station front panel (2 required)
FP32	Laminated panel, 66" station front panel (2 required)
FP35	Laminated panel, 72" station front panel (2 required)
FP40	Laminated panel, 42" station front panel
FP41	Laminated panel, 84" station front panel (2 required)
FP46	Laminated panel, 48" station front panel
EP24SS	Stainless steel panel, 26" deep station end panel
EP32SS	Stainless steel panel, 32" deep station end panel
FP26SS	Stainless steel panel, 54" station front panel (2 required)
FP29SS	Stainless steel panel, 60" station front panel (2 required)
FP32SS	Stainless steel panel, 66" station front panel (2 required)
FP35SS	Stainless steel panel, 72" station front panel (2 required)
FP40SS	Stainless steel panel, 42" station front panel
FP41SS	Stainless steel panel, 84" station front panel (2 required)
FP46SS	Stainless steel panel, 48" station front panel
KR42	42" station kick rail
KR48	48" station kick rail
KR54	54" station kick rail
KR60	60" station kick rail
KR66	66" station kick rail
KR72	72" station kick rail
KR84	84" station kick rail
TSC__	12" wide tray shelf, sold in 12" lengths, __ specify length in inches
TSD__	15" wide tray shelf, sold in 12" lengths, __ specify length in inches
TS20X__	20" wide tray shelf, sold in 12" lengths, __ specify length in inches
TSCB	12" tray shelf bracket, set of 2
TSDB	15" tray shelf bracket, set of 2
TR24	Trim rail for GT24 station
TR30	Trim rail for GT30 station
EPC	End panel clips, set of 2
FPC	Front panel clips, set of 2
SOS/SSB*	Single overshelf bracket, set of 2, specify style: EP (end panel), BT (bar top) or WALL
DOS/SSB*	Double overshelf bracket, set of 2, specify style: EP (end panel), BT (bar top) or WALL

Cocktail stations are made to order and not returnable.



## GT24 and GT30 Rotary Glasswashers

More details available. Please visit [www.glastender.com](http://www.glastender.com)

A rotary glasswasher is a mechanized three-compartment sink that washes, rinses, and sanitizes glassware up to 11" high automatically. During operation 5 GPM of hot soapy water (130°-150° F) is sprayed in a thorough spray pattern across the moving glassware removing lipstick, dried-on fruit pulp and cream. The wash water is recirculated to conserve water and detergent, consuming only 1/4 GPM of hot water during operation. 3 minute cycle: 60 seconds wash and rinse.

### Features:

- 90 day labor warranty
- Removable top, front and conveyor for easy cleaning
- Set of 3 curtains included
- Switch panel can be relocated in the field
- Removable side panels for easy service
- Automatic peristaltic metering pumps accurately dispense detergent, sanitizer, and rinse aid
- Heater is encased in sheath to resist caustic detergents
- Digital temperature gauge built into switch panel
- Thermostat controlled wash tank
- Sensor activated low water cut off protects heater
- Sensor alerts operator when detergent or sanitizer are low

GT-24 washes up to 13 glasses per minute (800 per hour), and GT-30 washes 21 glasses per minute (1,260 per hour).

2 GPM of 75° F fresh rinse water with sanitizer is pumped in the rinse tank in a thorough spray pattern across the moving glassware. Cool rinse water means no waiting for a glass to cool. The rotary conveyor automatically stops when the clean glass touches the glass stop arm. Removing the glass starts the conveyor. Or, if extremely busy, the glass stop arm can be put aside so starting and stopping is controlled by the conveyor switch.

Rotation selection is based on work flow. If a side mounted switch panel is required, it must be specified when ordering. Please refer to spec sheets for details.

Part #	Length"	Depth"	Rotation	Volts
GT24CW208	24	24	Clockwise	208V
GT24CW240	24	24	Clockwise	240V
GT24CCW208	24	24	Counterclockwise	208V
GT24CCW240	24	24	Counterclockwise	240V
GT30CW208	30	30	Clockwise	208V
GT30CW240	30	30	Clockwise	240V
GT30CCW208	30	30	Counterclockwise	208V
GT30CCW240	30	30	Counterclockwise	240V



GT24



GT30



Stemware rack

Part #	Description
01000557	Export transformer, converts to 220V, 1 phase, 50 Hz
01000828	Mixing valve, mixes hot and cold water to 75° F
CWET24	Clip-on wet waste for GT24
CWET30	Clip-on wet waste for GT30
01000534	Stemware rack for GT24
01000535	Stemware rack for GT30



## GT18 Rotary Glasswashers

More details available. Please visit [www.glastender.com](http://www.glastender.com)

There are 10 different GT18 models to select from to optimize your glasswasher throughput. 10 glasses per minute (600 per hour) capacity. Maximum glass height is 10", including pitchers and wine carafes.

### Features:

- 90 day labor warranty
- Drive wheel and glass rack lift out for easy cleaning
- Two 16" diameter polypropylene racks are included
- 15 spray nozzles for maximum soil removal
- Automatic peristaltic metering pumps accurately dispense detergent, sanitizer, and rinse aid
- Digital temperature gauge built into switch panel
- Intelligent microprocessor control delays cycle start if incoming water is below 120° F
- Prime switch for quick chemical priming
- Recirculation pump for wash and rinse water
- 2 minute cycle, 70 second wash and 22 second rinse

Extended GT18+2 models have the drain table extended on one side of the glasswasher to hold more than one rack. This increases overall glasswasher throughput by allowing multiple racks of glassware to be pre-loaded for washing.

78" models come with three racks, and 90" models come with four. A leg set is included under the extended drain table.

Part #	Description
01000532	Glass rack
01000533	Dish rack
01000536	Glass rack insert for stemware
01000710	Clip-on chemical rail
01000706	Glass rack holder for GT18+1 only
01000708	Glass rack holder for GT18+2, +1L or 1R models
01000709	Glass rack holder w shelf, GT18+2, +1L or 1R models
01000557	Export transformer, converts to 220V, 1 phase, 50 Hz



GT18+2 with SWA12 wet waste sink and 01000709 glass rack holder

Part #	Description	Length"	Drain Table
GT18	Front load door type	18	N/A
GT18+1	Front-to-back pass thru	18	Back
GT18+1L	Front-to-side pass thru	36	Left
GT18+1R	Front-to-side pass thru	36	Right
GT18+2	Side-to-side pass thru	60	Left & right
GT18+2IC	Side-to-side corner pass thru	42 x 42	Left & right
GT18+278L	Side-to-side pass thru, left extended	78	Left & right
GT18+278R	Side-to-side pass thru, right extended	78	Left & right
GT18+290L	Side-to-side pass thru, left extended	90	Left & right
GT18+290R	Side-to-side pass thru, right extended	90	Left & right



Advanced Beverage Solutions  
100 Gary Avenue, Suite C  
Roselle, IL 60172

**www.absonone.com**  
E-mail: [orders@absonone.com](mailto:orders@absonone.com)

877-814-2271  
Local: 847-524-1707  
Fax: 847-524-1710

## Mug Frosters

Reach-in mug froster allows diverse glass storage and easy rotation of inventory while matching the look of the back bar coolers. Choose from black vinyl-clad, stainless front and sides, or all stainless. Matching backsplashes are available for a complete, consistent underbar design. All models have stainless steel top, sliding doors and interior, including evaporator housing and evaporator pan. 24" and 36" models have one door, 48" have two doors. Bottom rack is included on all models.

More details available. Please visit [www.glastender.com](http://www.glastender.com)

There are two defrost cycles: *automatic* occurs every six hours without affecting normal operation, *manual* is user selected six hour defrost with automatic restart.

Integrated toe kick and curb base mounts flat on all sides to seal to the floor. Condensate drains to an automatic evaporator so no drain connection is required. Condensing unit pulls out, and evaporator housing unplugs and lifts out for easy service. 5 year compressor warranty.

Capacity (based on 10 oz. mugs and 2 layers of shelves):  
24" = 105, 36" = 175, 48" = 252.



24" wide



48" wide



36" wide

Part #	Description
C4X4MF	4 casters, 3-3/4"
MFLS	4 legs, 6"
MFKR24	24" kick rail
MFKR36	36" kick rail
MFKR48	48" kick rail
SSR24	24" single speed rail
SSR36	36" single speed rail
SSR48	48" single speed rail
MFBS24	24" backsplash
MFBS36	36" backsplash
MFBS48	48" backsplash
CE220/50S	Convert self contained unit to 220V/50Hz electrical

Dimensions"	Black Vinyl-Clad	Stainless Front & Sides	All Stainless	# of Shelves
24W x 24D x 34.5H	MF24B	MF24SF	MF24S	0
24W x 24D x 34.5H	MF24B1	MF24SF1	MF24S1	1
24W x 24D x 34.5H	MF24B2	MF24SF2	MF24S2	2
36W x 24D x 34.5H	MF36B	MF36SF	MF36S	0
36W x 24D x 34.5H	MF36B1	MF36SF1	MF36S1	1
36W x 24D x 34.5H	MF36B2	MF36SF2	MF36S2	2
48W x 24D x 34.5H	MF48B	MF48SF	MF48S	0
48W x 24D x 34.5H	MF48B1	MF48SF1	MF48S1	1
48W x 24D x 34.5H	MF48B2	MF48SF2	MF48S2	2





Advanced Beverage Solutions  
100 Gary Avenue, Suite C  
Roselle, IL 60172

**www.absone.com**  
E-mail: [orders@absone.com](mailto:orders@absone.com)

877-814-2271  
Local: 847-524-1707  
Fax: 847-524-1710

## Back Bar Refrigeration

Back bar coolers are available with up to four doors, and as self-contained or remote refrigerated. Coolers have black vinyl-clad steel exterior front and sides, and 180° swinging door. Nine door styles are available to satisfy diverse needs and decor. Edge cap on the laminated doors and compressor compartment covers protect laminate from chipping. Coolers are available without a finished top for integrated installation below a customer supplied bar top. 2008 Energy Star approved (except glass door units).

Unique end wall refrigeration design with evaporator located above the compressor compartment frees up interior space for maximum storage capacity. Recessed compressor compartment back and 90° electrical plug enables flush wall placement. Easy to remove condenser filter can be regularly cleaned to maintain condenser coil efficiency. Automatic and manual defrost cycles prevent ice build-up from impacting operation.

Leg sockets are recessed into the base, and 1/2" thick plastic threshold scuff plate protects lower door sill. Optional leg sets employ a unique recessed cup design to enhance durability. 16 gauge galvanized steel interlocking multi-bend base provides incredible strength and rigidity.

The all stainless steel interior with radius corners is easy to keep clean and meets NSF Standard 7 for open food containers on BB and ND models. Adjustable shelves have radius corners.

More details available. Please visit [www.glastender.com](http://www.glastender.com)

Glass ice displays and lighted liquor displays add functionality as well as visual appeal to the back bar. When mounted on a cooler at the factory, the 16" glass display units (GDU) have a rear deck that raises the lighted liquor display (LLD) above the back of the GDU, and the LLD has a front light channel to help illuminate the GDU (shown below).

The following units are made to order and not returnable: remote narrow door coolers, self-contained and remote low profile coolers, self-contained and remote pass-thru coolers, and front venting coolers.

Model	Long Neck Bottles, Cases	Wine Bottles, 750 ml
BB24	4.6	56
BB36	7	66
BB48	13.83	120
BB60	14	138
BB72	22.5	198
BB84	21.9	216
BB96	30.25	276
BB108	29.8	294
ND40	10.8	102
ND52	12.3	120
ND60	16.9	174
ND72	18.4	192
ND80	22.3	246
ND92	24.5	264



Beer Systems, Bar Equipment



### Self-Contained Back Bar Coolers

More details available. Please visit [www.glastender.com](http://www.glastender.com)



BB24-N1GSN(L)

One door self-contained back bar cooler. Available in remote version.



Create a model number by selecting from the options below:

**BB24N** \_ \_ \_ \_ \_ **( )**

- Base Height:**  
1 = 1"  
6 = 6" legs
- Door Style:**  
B = Black vinyl-clad  
U = Unlaminated  
L = Laminated  
S = Stainless  
G = Glass  
X = Stainless glass  
Y = Laminated glass
- Top Style:**  
N = Not finished  
L = Laminated  
S = Stainless
- Refrigeration:**  
N = Self-contained  
R = Remote
- Door Hinge:**  
L = Left  
R = Right  
*left to right*



BB36L1BNH(L)

One door self-contained back bar cooler



**BB36** \_ \_ \_ \_ \_ **H( )**

- Refrigeration Compartment:**  
L = Left  
R = Right
- Base Height:**  
1 = 1"  
6 = 6" legs
- Door Style:**  
B = Black vinyl-clad  
U = Unlaminated  
L = Laminated  
S = Stainless  
G = Glass  
X = Stainless glass  
Y = Laminated glass
- Top Style:**  
N = Not finished  
L = Laminated  
S = Stainless
- Door Hinge:**  
L = Left  
R = Right  
*left to right*



BB60L1SSHRLR

Two door self-contained back bar cooler



**BB60** \_ \_ \_ \_ \_ **H( )**

- Refrigeration Compartment:**  
L = Left  
R = Right
- Base Height:**  
1 = 1"  
6 = 6" legs
- Door Style:**  
B = Black vinyl-clad  
U = Unlaminated  
L = Laminated  
S = Stainless  
G = Glass  
X = Stainless glass  
Y = Laminated glass
- Top Style:**  
N = Not finished  
L = Laminated  
S = Stainless
- Door Hinge:**  
L = Left  
R = Right  
*left to right*



### Self-Contained Back Bar Coolers

More details available. Please visit [www.glastender.com](http://www.glastender.com)



BR60L1XS(LR)

Create a model number by selecting from the options below:

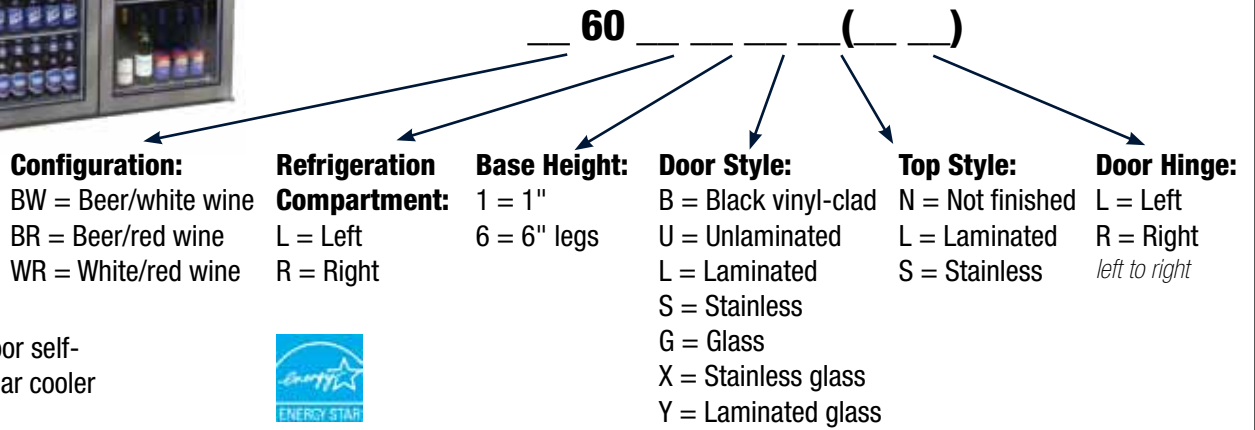

Dual zone two door self-contained back bar cooler



BB72R1LNN(LRR)

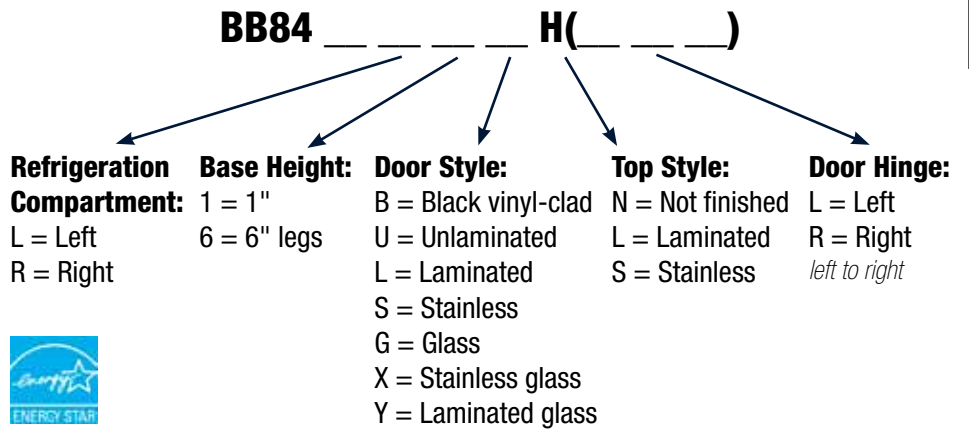

Three door self-contained back bar cooler

Four door self-contained back bar cooler

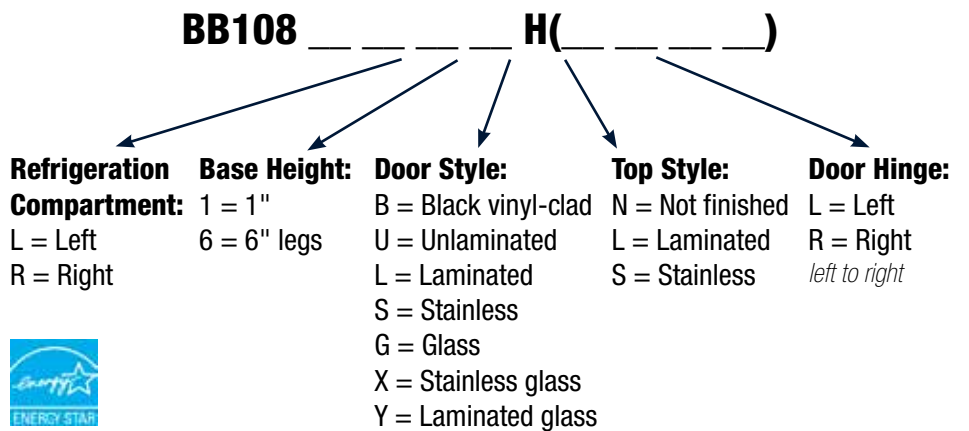



### Self-Contained Narrow Door Back Bar Coolers

More details available. Please visit [www.glastender.com](http://www.glastender.com)

Create a model number by selecting from the options below:



ND52BRL1GS(RL)

Two door self-contained narrow door back bar cooler



ND52 ( )

- Refrigeration Compartment:**  
L = Left  
R = Right
- Base Height:**  
1 = 1"  
6 = 6" legs
- Door Style:**  
B = Black vinyl-clad  
U = Unlaminated  
L = Laminated  
S = Stainless  
G = Glass  
X = Stainless glass  
Y = Laminated glass
- Top Style:**  
N = Not finished  
L = Laminated  
S = Stainless
- Door Hinge:**  
L = Left  
R = Right  
*left to right*



ND72R1GS(LRL)

Three door self-contained narrow door back bar cooler



ND72 ( )

- Refrigeration Compartment:**  
L = Left  
R = Right
- Base Height:**  
1 = 1"  
6 = 6" legs
- Door Style:**  
B = Black vinyl-clad  
U = Unlaminated  
L = Laminated  
S = Stainless  
G = Glass  
X = Stainless glass  
Y = Laminated glass
- Top Style:**  
N = Not finished  
L = Laminated  
S = Stainless
- Door Hinge:**  
L = Left  
R = Right  
*left to right*

Four door self-contained narrow door back bar cooler

ND92 ( )

- Refrigeration Compartment:**  
L = Left  
R = Right
- Base Height:**  
1 = 1"  
6 = 6" legs
- Door Style:**  
B = Black vinyl-clad  
U = Unlaminated  
L = Laminated  
S = Stainless  
G = Glass  
X = Stainless glass  
Y = Laminated glass
- Top Style:**  
N = Not finished  
L = Laminated  
S = Stainless
- Door Hinge:**  
L = Left  
R = Right  
*left to right*



Narrow door coolers are made to order and not returnable.



### Remote Back Bar Coolers

More details available. Please visit [www.glastender.com](http://www.glastender.com)

Create a model number by selecting from the options below:

**BB48** \_\_\_\_\_ **N**( \_\_\_\_\_ )

Two door remote back bar cooler

**Remote Hook-Up Side:**  
L = Left  
R = Right

**Base Height:**  
1 = 1"  
6 = 6" legs

**Door Style:**  
B = Black vinyl-clad  
U = Unlaminated  
L = Laminated  
S = Stainless  
G = Glass  
X = Stainless glass  
Y = Laminated glass

**Top Style:**  
N = Not finished  
L = Laminated  
S = Stainless

**Door Hinge:**  
L = Left  
R = Right  
*left to right*



**BB72** \_\_\_\_\_ **N**( \_\_\_\_\_ )



BB72R1LNN(LLR)

Three door remote back bar cooler

**Remote Hook-Up Side:**  
L = Left  
R = Right

**Base Height:**  
1 = 1"  
6 = 6" legs

**Door Style:**  
B = Black vinyl-clad  
U = Unlaminated  
L = Laminated  
S = Stainless  
G = Glass  
X = Stainless glass  
Y = Laminated glass

**Top Style:**  
N = Not finished  
L = Laminated  
S = Stainless

**Door Hinge:**  
L = Left  
R = Right  
*left to right*



**BB96** \_\_\_\_\_ **N**( \_\_\_\_\_ )

Four door remote back bar cooler

**Remote Hook-Up Side:**  
L = Left  
R = Right

**Base Height:**  
1 = 1"  
6 = 6" legs

**Door Style:**  
B = Black vinyl-clad  
U = Unlaminated  
L = Laminated  
S = Stainless  
G = Glass  
X = Stainless glass  
Y = Laminated glass

**Top Style:**  
N = Not finished  
L = Laminated  
S = Stainless

**Door Hinge:**  
L = Left  
R = Right  
*left to right*





### Remote Narrow Door Back Bar Coolers

More details available. Please visit [www.glastender.com](http://www.glastender.com)

Create a model number by selecting from the options below:

**ND40** \_ \_ \_ \_ ( \_ \_ )



ND40R1SSRR

Two door remote narrow door back bar cooler

**Remote Hook-Up Side:**  
L = Left  
R = Right

**Base Height:**  
1 = 1"  
6 = 6" legs

**Door Style:**  
B = Black vinyl-clad  
U = Unlaminated  
L = Laminated  
S = Stainless  
G = Glass  
X = Stainless glass  
Y = Laminated glass

**Top Style:**  
N = Not finished  
L = Laminated  
S = Stainless

**Door Hinge:**  
L = Left  
R = Right  
*left to right*



**ND60** \_ \_ \_ \_ ( \_ \_ )



ND60R1SSRRR

Three door remote narrow door back bar cooler

**Remote Hook-Up Side:**  
L = Left  
R = Right

**Base Height:**  
1 = 1"  
6 = 6" legs

**Door Style:**  
B = Black vinyl-clad  
U = Unlaminated  
L = Laminated  
S = Stainless  
G = Glass  
X = Stainless glass  
Y = Laminated glass

**Top Style:**  
N = Not finished  
L = Laminated  
S = Stainless

**Door Hinge:**  
L = Left  
R = Right  
*left to right*



**ND80** \_ \_ \_ \_ ( \_ \_ )

Four door remote narrow door back bar cooler

**Remote Hook-Up Side:**  
L = Left  
R = Right

**Base Height:**  
1 = 1"  
6 = 6" legs

**Door Style:**  
B = Black vinyl-clad  
U = Unlaminated  
L = Laminated  
S = Stainless  
G = Glass  
X = Stainless glass  
Y = Laminated glass

**Top Style:**  
N = Not finished  
L = Laminated  
S = Stainless

**Door Hinge:**  
L = Left  
R = Right  
*left to right*



Narrow door coolers are made to order and not returnable.



### Self-Contained Low Profile Back Bar Coolers

More details available. Please visit [www.glastender.com](http://www.glastender.com)

Create a model number by selecting from the options below:



LP60R1SS(LR)

Two door self-contained low profile back bar cooler

**LP60** \_\_\_\_\_ ( \_\_\_\_\_ )

- Refrigeration Compartment:**  
L = Left  
R = Right
- Base Height:**  
1 = 1"  
6 = 6" legs
- Door Style:**  
B = Black vinyl-clad  
U = Unlaminated  
L = Laminated  
S = Stainless  
G = Glass  
X = Stainless glass  
Y = Laminated glass
- Top Style:**  
N = Not finished  
L = Laminated  
S = Stainless
- Door Hinge:**  
L = Left  
R = Right  
*left to right*

Three door self-contained low profile back bar cooler

**LP84** \_\_\_\_\_ ( \_\_\_\_\_ )

- Refrigeration Compartment:**  
L = Left  
R = Right
- Base Height:**  
1 = 1"  
6 = 6" legs
- Door Style:**  
B = Black vinyl-clad  
U = Unlaminated  
L = Laminated  
S = Stainless  
G = Glass  
X = Stainless glass  
Y = Laminated glass
- Top Style:**  
N = Not finished  
L = Laminated  
S = Stainless
- Door Hinge:**  
L = Left  
R = Right  
*left to right*

Four door self-contained narrow door back bar cooler

**LP108** \_\_\_\_\_ ( \_\_\_\_\_ )

- Refrigeration Compartment:**  
L = Left  
R = Right
- Base Height:**  
1 = 1"  
6 = 6" legs
- Door Style:**  
B = Black vinyl-clad  
U = Unlaminated  
L = Laminated  
S = Stainless  
G = Glass  
X = Stainless glass  
Y = Laminated glass
- Top Style:**  
N = Not finished  
L = Laminated  
S = Stainless
- Door Hinge:**  
L = Left  
R = Right  
*left to right*

Low profile coolers are made to order and not returnable.



**Remote Low Profile Back Bar Coolers**

More details available. Please visit [www.glastender.com](http://www.glastender.com)



LP48L1BL(LR)

Two door remote low profile back bar cooler

**Create a model number by selecting from the options below:**

**LP48** \_\_\_\_\_ ( \_\_\_\_\_ )

- Remote Hook-Up Side:**  
L = Left  
R = Right
- Base Height:**  
1 = 1"  
6 = 6" legs
- Door Style:**  
B = Black vinyl-clad  
U = Unlaminated  
L = Laminated  
S = Stainless  
G = Glass  
X = Stainless glass  
Y = Laminated glass
- Top Style:**  
N = Not finished  
L = Laminated  
S = Stainless
- Door Hinge:**  
L = Left  
R = Right  
*left to right*

**LP72** \_\_\_\_\_ ( \_\_\_\_\_ )

- Remote Hook-Up Side:**  
L = Left  
R = Right
- Base Height:**  
1 = 1"  
6 = 6" legs
- Door Style:**  
B = Black vinyl-clad  
U = Unlaminated  
L = Laminated  
S = Stainless  
G = Glass  
X = Stainless glass  
Y = Laminated glass
- Top Style:**  
N = Not finished  
L = Laminated  
S = Stainless
- Door Hinge:**  
L = Left  
R = Right  
*left to right*

Three door remote low profile back bar cooler

**LP96** \_\_\_\_\_ ( \_\_\_\_\_ )

- Remote Hook-Up Side:**  
L = Left  
R = Right
- Base Height:**  
1 = 1"  
6 = 6" legs
- Door Style:**  
B = Black vinyl-clad  
U = Unlaminated  
L = Laminated  
S = Stainless  
G = Glass  
X = Stainless glass  
Y = Laminated glass
- Top Style:**  
N = Not finished  
L = Laminated  
S = Stainless
- Door Hinge:**  
L = Left  
R = Right  
*left to right*

Four door remote low profile back bar cooler

Low profile coolers are made to order and not returnable.





**Self-Contained Pass-Thru Coolers**

More details available. Please visit [www.glastender.com](http://www.glastender.com)



PT60L1LLH(LR/RL)

Four door self-contained pass-thru cooler

**Create a model number by selecting from the options below:**

**PT60** \_\_\_\_\_ **H**( \_\_\_\_\_ / \_\_\_\_\_ )

- |  |  |  |   |  |
|--|--|--|---|--|
| <b>Refrigeration Compartment:</b><br>L = Left<br>R = Right<br><i>determines cooler front</i> | <b>Base Height:</b><br>1 = 1"<br>6 = 6" legs | <b>Door Style:</b><br>B = Black vinyl-clad<br>U = Unlaminated<br>L = Laminated<br>S = Stainless<br>G = Glass<br>X = Stainless glass<br>Y = Laminated glass | <b>Top Style:</b><br>N = Not finished<br>L = Laminated<br>S = Stainless | <b>Door Hinge:</b><br>L = Left<br>R = Right<br><i>cooler front left to right / cooler back left to right</i> |
|--|--|--|---|--|

**PT84** \_\_\_\_\_ **H**( \_\_\_\_\_ / \_\_\_\_\_ )

- |  |  |  |   |  |
|--|--|--|---|--|
| <b>Refrigeration Compartment:</b><br>L = Left<br>R = Right<br><i>determines cooler front</i> | <b>Base Height:</b><br>1 = 1"<br>6 = 6" legs | <b>Door Style:</b><br>B = Black vinyl-clad<br>U = Unlaminated<br>L = Laminated<br>S = Stainless<br>G = Glass<br>X = Stainless glass<br>Y = Laminated glass | <b>Top Style:</b><br>N = Not finished<br>L = Laminated<br>S = Stainless | <b>Door Hinge:</b><br>L = Left<br>R = Right<br><i>cooler front left to right / cooler back left to right</i> |
|--|--|--|---|--|

**PT108** \_\_\_\_\_ **H**( \_\_\_\_\_ / \_\_\_\_\_ )

- |  |  |  |   |  |
|--|--|--|---|--|
| <b>Refrigeration Compartment:</b><br>L = Left<br>R = Right<br><i>determines cooler front</i> | <b>Base Height:</b><br>1 = 1"<br>6 = 6" legs | <b>Door Style:</b><br>B = Black vinyl-clad<br>U = Unlaminated<br>L = Laminated<br>S = Stainless<br>G = Glass<br>X = Stainless glass<br>Y = Laminated glass | <b>Top Style:</b><br>N = Not finished<br>L = Laminated<br>S = Stainless | <b>Door Hinge:</b><br>L = Left<br>R = Right<br><i>cooler front left to right / cooler back left to right</i> |
|--|--|--|---|--|

Eight door self-contained pass-thru cooler

Pass-thru coolers are made to order and not returnable.



**Remote Pass-Thru Coolers**

More details available. Please visit [www.glastender.com](http://www.glastender.com)



Four door remote pass-thru cooler

**Create a model number by selecting from the options below:**

**PT48** \_\_\_\_\_ **N**( \_\_\_\_\_ / \_\_\_\_\_ )

- |  |   |  |   |  |
|--|---|--|---|--|
| <p><b>Remote Hook-Up Side:</b><br/>L = Left<br/>R = Right<br/><i>determines cooler front</i></p> | <p><b>Base Height:</b><br/>1 = 1"<br/>6 = 6" legs</p> | <p><b>Door Style:</b><br/>B = Black vinyl-clad<br/>U = Unlaminated<br/>L = Laminated<br/>S = Stainless<br/>G = Glass<br/>X = Stainless glass<br/>Y = Laminated glass</p> | <p><b>Top Style:</b><br/>N = Not finished<br/>L = Laminated<br/>S = Stainless</p> | <p><b>Door Hinge:</b><br/>L = Left<br/>R = Right<br/><i>cooler front left to right / cooler back left to right</i></p> |
|--|---|--|---|--|

Six door remote pass-thru cooler

**PT72** \_\_\_\_\_ **N**( \_\_\_\_\_ / \_\_\_\_\_ )

- |  |   |  |   |  |
|--|---|--|---|--|
| <p><b>Remote Hook-Up Side:</b><br/>L = Left<br/>R = Right<br/><i>determines cooler front</i></p> | <p><b>Base Height:</b><br/>1 = 1"<br/>6 = 6" legs</p> | <p><b>Door Style:</b><br/>B = Black vinyl-clad<br/>U = Unlaminated<br/>L = Laminated<br/>S = Stainless<br/>G = Glass<br/>X = Stainless glass<br/>Y = Laminated glass</p> | <p><b>Top Style:</b><br/>N = Not finished<br/>L = Laminated<br/>S = Stainless</p> | <p><b>Door Hinge:</b><br/>L = Left<br/>R = Right<br/><i>cooler front left to right / cooler back left to right</i></p> |
|--|---|--|---|--|

Six door remote pass-thru cooler

**PT96** \_\_\_\_\_ **N**( \_\_\_\_\_ / \_\_\_\_\_ )

- |  |   |  |   |  |
|--|---|--|---|--|
| <p><b>Remote Hook-Up Side:</b><br/>L = Left<br/>R = Right<br/><i>determines cooler front</i></p> | <p><b>Base Height:</b><br/>1 = 1"<br/>6 = 6" legs</p> | <p><b>Door Style:</b><br/>B = Black vinyl-clad<br/>U = Unlaminated<br/>L = Laminated<br/>S = Stainless<br/>G = Glass<br/>X = Stainless glass<br/>Y = Laminated glass</p> | <p><b>Top Style:</b><br/>N = Not finished<br/>L = Laminated<br/>S = Stainless</p> | <p><b>Door Hinge:</b><br/>L = Left<br/>R = Right<br/><i>cooler front left to right / cooler back left to right</i></p> |
|--|---|--|---|--|

Pass-thru coolers are made to order and not returnable.



### Front Venting Coolers

More details available. Please visit [www.glastender.com](http://www.glastender.com)

**Create a model number by selecting from the options below:**



FV24SS(L)

One door self-contained front venting cooler

**FV24** \_ \_ ( )

**Door Style:**

- B = Black vinyl-clad
- U = Unlaminated
- L = Laminated
- S = Stainless
- G = Glass
- X = Stainless glass
- Y = Laminated glass

**Top Style:**

- N = Not finished
- L = Laminated
- S = Stainless

**Door Hinge:**

- L = Left
- R = Right



Two door self-contained front venting cooler

**FV48** \_ \_ (LR)

**Door Style:**

- B = Black vinyl-clad
- U = Unlaminated
- L = Laminated
- S = Stainless
- G = Glass
- X = Stainless glass
- Y = Laminated glass

**Top Style:**

- N = Not finished
- L = Laminated
- S = Stainless

*Door hinging is only available left-right*

### Self-Contained Reach-In Mug Chiller



MFV24SS(L)

One door self-contained front venting cooler

**MFV24** \_ \_ ( )

**Door Style:**

- B = Black vinyl-clad
- U = Unlaminated
- L = Laminated
- S = Stainless
- G = Glass
- X = Stainless glass
- Y = Laminated glass

**Top Style:**

- N = Not finished
- L = Laminated
- S = Stainless

**Door Hinge:**

- L = Left
- R = Right



## Self-Contained Keg Coolers

More details available. Please visit [www.glastender.com](http://www.glastender.com)



*Note: faucet handles are not included*

KC24NCBS2R  
Shown with optional 2-faucet column tower for use with 1/6 barrel mini kegs



KC60L1BS(LR)



KC72L1BS(LR)

**Create a model number by selecting from the options below:**

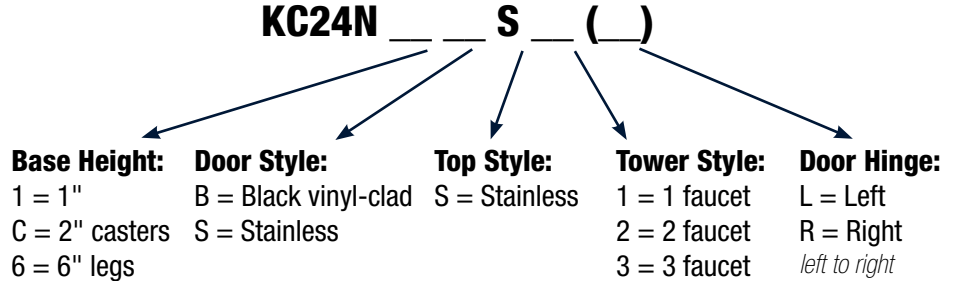

*Stainless steel top has full length recessed drainer*

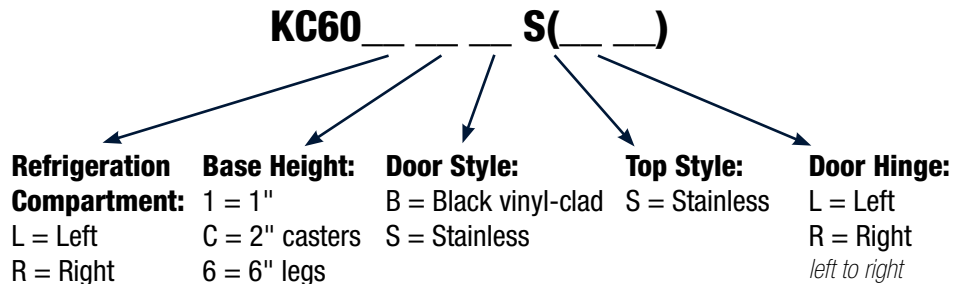

*Stainless steel top has full length recessed drainer*

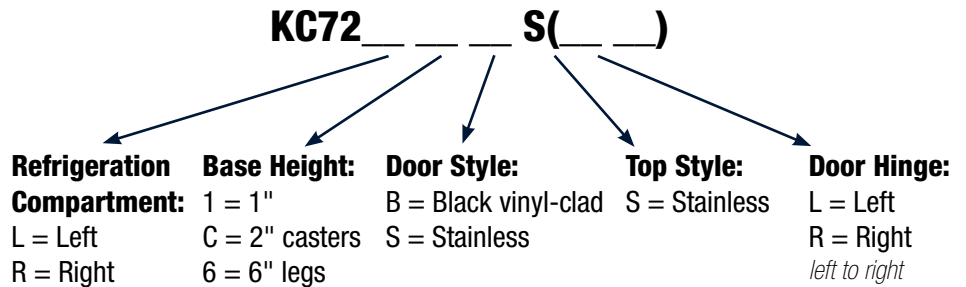

*Stainless steel top has full length recessed drainer*

## Convert a Back Bar Fridge to a Direct Draw Dispenser

Part #	Description
ES-265-3A	Blower assembly with bracket, 273 CFM
BE-1630-4	Flexible aluminum duct 4"OD
BB101402	3" diameter single faucet chrome tower

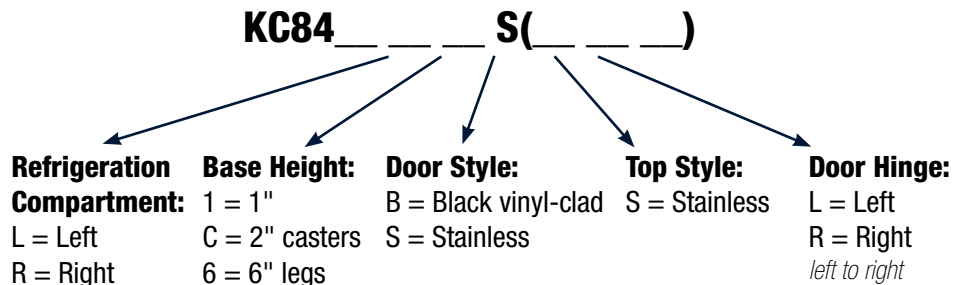

*Stainless steel top has full length recessed drainer*



ES-265-3A



BE-1630-4



Advanced Beverage Solutions  
100 Gary Avenue, Suite C  
Roselle, IL 60172

**www.absonone.com**  
E-mail: [orders@absonone.com](mailto:orders@absonone.com)

**877-814-2271**  
Local: 847-524-1707  
Fax: 847-524-1710

## Slide Top Coolers

More details available. Please visit [www.glastender.com](http://www.glastender.com)



ST60B



ST24S



ST48S

Part #	Description
C4X4ST	3-3/4" casters, set of four
C6X4ST	3-3/4" casters, set of six
STLS4	6" leg set, set of four
STLS6	6" leg set, set of six
BO/CC	Bottle opener/cap catcher
STKR24	24" kick rail
STKR36	36" kick rail
STKR48	48" kick rail
STKR60	60" kick rail
STKR72	72" kick rail
STKR96	96" kick rail
STBS24	24" slide top backsplash
STBS36	36" slide top backsplash
STBS48	48" slide top backsplash
STBS60	60" slide top backsplash
STBS72	72" slide top backsplash
STBS96	96" slide top backsplash
08000082	Chrome divider rack (extra)
CE220/50S	Convert self contained unit to 220V/50Hz electrical

## Galvanized Steel Interior with Stainless Steel Floor

Dimensions"	Black Vinyl-Clad	Stainless Front & Sides	All Stainless	Divider Racks	Case Capacity Bottles
24W x 24D x 34.5H	ST24BG	ST24SFG	ST24SG*	1	4.83
36W x 24D x 34.5H	ST36BG	ST36SFG	ST36SG*	2	7.25
48W x 24D x 34.5H	ST48BG	ST48SFG	ST48SG*	3	13.63
60W x 24D x 34.5H	ST60BG	ST60SFG	ST60SG*	4	19.82
72W x 24D x 34.5H	ST72BG	ST72SFG	ST72SG*	4	24.75
96W x 24D x 34.5H	ST96BG	ST96SFG*	ST96SG*	5	32.17

\*Made to order and not returnable.

## Stainless Steel Interior

Dimensions"	Black Vinyl-Clad	Stainless Front & Sides	All Stainless	Divider Racks	Case Capacity Bottles
24W x 24D x 34.5H	ST24B	ST24SF	ST24S	1	4.83
36W x 24D x 34.5H	ST36B	ST36SF	ST36S	2	7.25
48W x 24D x 34.5H	ST48B	ST48SF	ST48S	3	13.63
60W x 24D x 34.5H	ST60B	ST60SF	ST60S*	4	19.82
72W x 24D x 34.5H	ST72B	ST72SF	ST72S*	4	24.75
96W x 24D x 34.5H	ST96B	ST96SF*	ST96S*	5	32.17

Beer Systems, Bar Equipment



Advanced Beverage Solutions  
100 Gary Avenue, Suite C  
Roselle, IL 60172

**www.abstone.com**  
E-mail: [orders@abstone.com](mailto:orders@abstone.com)

877-814-2271  
Local: 847-524-1707  
Fax: 847-524-1710

## 24" Deep Back Bar Storage Units

Storage units have stainless steel interiors with black vinyl-clad or stainless steel exteriors. Stainless steel or laminated tops are sold separately. Bar liquor display (BLD) features a built-in light for illuminating bottles, radius step edges for easy cleaning, and step covers to reduce bottle noise. Bar glass storage (BGS) has four shelves for maximum storage capacity and radius shelf corners for easy cleaning.

More details available. Please visit [www.glastender.com](http://www.glastender.com)



Description	Black	Stainless	Length"
Bar glass storage	BGS18	BGS18S	18
Bar glass storage	BGS24	BGS24S	24
Bar glass storage	BGS30	BGS30S	30
Bar liquor display	BLD18	BLD18S	18
Bar liquor display	BLD24	BLD24S	24
Bar liquor display	BLD30	BLD30S	30
Bar liquor display	BLD36	BLD36S	36
Bar liquor display	BLD42	BLD42S	42
Bar liquor display	BLD48	BLD48S	48
BLD locking cover	BLC18	BLC18S	18
BLD locking cover	BLC24	BLC24S	24
BLD locking cover	BLC30	BLC30S	30
BLD locking cover	BLC36	BLC36S	36
BLD locking cover	BLC42	BLC42S	42
BLD locking cover	BLC48	BLC48S	48

Description	Laminate	Stainless	Length"
Finished top	TOP18L	TOP18S	18
Finished top	TOP24L	TOP24S	24
Finished top	TOP30L	TOP30S	30
Finished top	TOP36L	TOP36S	36
Finished top	TOP42L	TOP42S	42
Finished top	TOP48L	TOP48S	48
SS kick rail		CKR18	18
SS kick rail		CKR24	24
SS kick rail		CKR30	30
SS kick rail		CKR36	36
SS kick rail		CKR42	42
SS kick rail		CKR48	48
6" legs, set of 4		CLS4	6

## Margarita Machine Stand

Interior is galvanized steel with insulation for extra sturdiness. Stainless steel pull handle, and 180° door swing. Top is stainless with 1" high back and side splashes.

Replace the blank ( ) in the part number with R or L for door hinge.



Description	Black	Stainless	Length"
1 door margarita stand	MS20BS( )	MS20SS( )	20
1 door margarita stand	MS24BS( )	MS24SS( )	24
2 door margarita stand	MS44BS( )	MS44SS( )	44
2 door margarita stand	MS48BS( )	MS48SS( )	48

## Condensing Unit Storage Cabinet



Create a model number:  
**CS18N** \_ \_ \_ **N**

**Base Height:**  
1 = 1"  
6 = 6" legs

**Front Finish:**  
B = Black vinyl-clad  
S = Stainless

**Top Style:**  
N = Not finished  
L = Laminated  
S = Stainless

Beer Systems, Bar Equipment



## Dry Storage Cabinets

More details available. Please visit [www.glastender.com](http://www.glastender.com)



LPDS241BLR  
Low profile dry  
storage cabinet



DS241BSR  
One door dry  
storage cabinet

Create a model number by selecting from the options below:

**LPDS24** — — — — — ( )

<b>Base Height:</b>	<b>Door Style:</b>	<b>Top Style:</b>	<b>Door Hinge:</b>
1 = 1"	B = Black vinyl-clad	N = No finish	L = Left
6 = 6" legs	U = Unlaminated	L = Laminate	R = Right
	L = Laminated	S = Stainless	<i>left to right</i>
	S = Stainless		

**DS24N** — — — — — ( )

<b>Base Height:</b>	<b>Door Style:</b>	<b>Top Style:</b>	<b>Door Hinge:</b>
1 = 1"	B = Black vinyl-clad	N = No finish	L = Left
6 = 6" legs	U = Unlaminated	L = Laminate	R = Right
	L = Laminated	S = Stainless	<i>left to right</i>
	S = Stainless		

Two door dry  
storage cabinet

**DS48N** — — — — — N( — — — )

<b>Base Height:</b>	<b>Door Style:</b>	<b>Top Style:</b>	<b>Door Hinge:</b>
1 = 1"	B = Black vinyl-clad	N = No finish	L = Left
6 = 6" legs	U = Unlaminated	L = Laminate	R = Right
	L = Laminated	S = Stainless	<i>left to right</i>
	S = Stainless		

Three door dry  
storage cabinet

**DS72N** — — — — — N( — — — )

<b>Base Height:</b>	<b>Door Style:</b>	<b>Top Style:</b>	<b>Door Hinge:</b>
1 = 1"	B = Black vinyl-clad	N = No finish	L = Left
6 = 6" legs	U = Unlaminated	L = Laminate	R = Right
	L = Laminated	S = Stainless	<i>left to right</i>
	S = Stainless		

Part #	Description
DHPBU	Upgrade to brass handle
CKR24	24" kick rail
CKR48	48" kick rail
CKR72	72" kick rail
CKRL	Left side kick rail
CKRR	Right side kick rail
SL/LPL	Left side lamination, LPDS24
SL/LPR	Right side lamination, LPDS24
SLL	Left side lamination, DS
SLR	Right side lamination, DS
SS/LPL	Left side stainless steel, LPDS24
SS/LPR	Right side stainless steel, LPDS24
SSL	Left side stainless steel, DS
SSR	Right side stainless steel, DS
C4X4CO	4" casters, set of four, LPDS24
C6X4CO	4" casters, set of six, DS



Advanced Beverage Solutions  
100 Gary Avenue, Suite C  
Roselle, IL 60172

**www.absone.com**  
E-mail: [orders@absone.com](mailto:orders@absone.com)

877-814-2271  
Local: 847-524-1707  
Fax: 847-524-1710

## Cooler Accessories

More details available. Please visit [www.glastender.com](http://www.glastender.com)



Back bar coolers can be converted to draft beer dispensing and are available with many accessories.

The BB84 model shown has two doors converted to draft beer dispensing and a two-faucet column tower. Other accessories include raised panel wood doors, laminated finished top, ice display unit, and lighted liquor display.

Part #	Description
DHPBU	Upgrade to brass handle
CKR24	24" kick rail
CKR36	36" kick rail
CKR40	40" kick rail
CKR48	48" kick rail
CKR52	52" kick rail
CKR60	60" kick rail
CKR72	72" kick rail
CKR80	80" kick rail
CKR84	84" kick rail
CKR92	92" kick rail
CKR96	96" kick rail
CKR108	108" kick rail
CKRL	Left side kick rail
CKRR	Right side kick rail

Part #	Description
SLL	Left side lamination
SLR	Right side lamination
SSL	Left side stainless steel
SSR	Right side stainless steel
C4X4CO	4" casters, set of four, BB24, BB60, ND52, LP60, PT60, KC60
C5X4CO	4" casters, set of five, BB36
C6X4CO	4" casters, set of six, BB84, BB108, ND72, ND92, LP84, LP108, PT84, PT108, KC72, KC84
CBS/SS48	48" stainless backsplash for low profile cooler
CBS/SS60	60" stainless backsplash for low profile cooler
CBS/SS72	72" stainless backsplash for low profile cooler
CBS/SS84	84" stainless backsplash for low profile cooler
CBS/SS96	96" stainless backsplash for low profile cooler
CBS/SS108	108" stainless backsplash for low profile cooler
CE220/50S	Convert self contained unit to 220V/50Hz electrical





Advanced Beverage Solutions  
100 Gary Avenue, Suite C  
Roselle, IL 60172

**www.absone.com**  
E-mail: [orders@absone.com](mailto:orders@absone.com)

877-814-2271  
Local: 847-524-1707  
Fax: 847-524-1710

## Ice Display Units

Ice display units (IDU) can be factory mounted to the top of Back Bar, Narrow Door, Low Profile, Pass-Thru, Front Venting, and Rear Feed Coolers and Dry Storage Cabinets. IDUs are 7" high with 6" deep liner, 1/2" tall perforated bottom insert, and all stainless steel construction. Insulation and a breaker strip around the ice bin provide a thermal barrier. Stainless steel front, back and sides are standard; black vinyl-clad is optional.

Glass ice display units (GDU) have double pane glass front and back with stainless steel trim, perforated insert and insulated end panels. Units larger than 54" include a center partition. Factory installed ice displays include a special stainless steel 1.5" high (not the standard 1" high) insulated cooler top with a built-in drain pan. Field installed units include a stainless steel insulated drain pan to mount to an existing countertop.

All ice displays are made to order and not returnable.

More details available. Please visit [www.glastender.com](http://www.glastender.com)

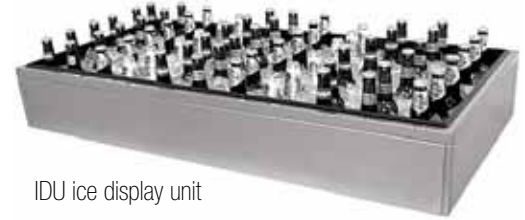

IDU ice display unit

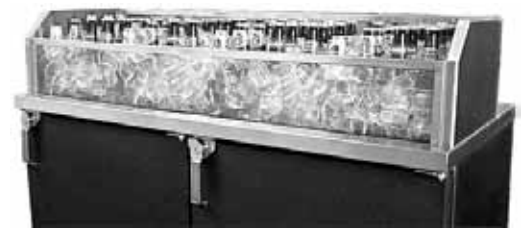

Factory installed GDU on 1.5" high insulated cooler top (not std 1" high) with built-in drain pan

Part #	Dimensions"	Part #	Dimensions"	Part #	Dimensions"	Part #	Dimensions"
IDU12X24	12D x 24L x 7H	IDU18X72	18D x 72L x 7H	GDU12X24	12D x 24L x 7H	GDU18X72	18D x 72L x 7H
IDU12X30	12D x 30L x 7H	IDU18X78	18D x 78L x 7H	GDU12X30	12D x 30L x 7H	GDU18X78	18D x 78L x 7H
IDU12X36	12D x 36L x 7H	IDU18X84	18D x 84L x 7H	GDU12X36	12D x 36L x 7H	GDU18X84	18D x 84L x 7H
IDU12X42	12D x 42L x 7H	IDU18X90	18D x 90L x 7H	GDU12X42	12D x 42L x 7H	GDU18X90	18D x 90L x 7H
IDU12X48	12D x 48L x 7H	IDU18X96	18D x 96L x 7H	GDU12X48	12D x 48L x 7H	GDU18X96	18D x 96L x 7H
IDU12X54	12D x 54L x 7H	IDU18X102	18D x 102L x 7H	GDU12X54	12D x 54L x 7H	GDU18X102	18D x 102L x 7H
IDU12X60	12D x 60L x 7H	IDU18X108	18D x 108L x 7H	GDU12X60	12D x 60L x 7H	GDU18X108	18D x 108L x 7H
IDU12X66	12D x 66L x 7H	IDU24X24	24D x 24L x 7H	GDU12X66	12D x 66L x 7H	GDU24X24	24D x 24L x 7H
IDU12X72	12D x 72L x 7H	IDU24X30	24D x 30L x 7H	GDU12X72	12D x 72L x 7H	GDU24X30	24D x 30L x 7H
IDU12X78	12D x 78L x 7H	IDU24X36	24D x 36L x 7H	GDU12X78	12D x 78L x 7H	GDU24X36	24D x 36L x 7H
IDU12X84	12D x 84L x 7H	IDU24X42	24D x 42L x 7H	GDU12X84	12D x 84L x 7H	GDU24X42	24D x 42L x 7H
IDU12X90	12D x 90L x 7H	IDU24X48	24D x 48L x 7H	GDU12X90	12D x 90L x 7H	GDU24X48	24D x 48L x 7H
IDU12X96	12D x 96L x 7H	IDU24X54	24D x 54L x 7H	GDU12X96	12D x 96L x 7H	GDU24X54	24D x 54L x 7H
IDU12X102	12D x 102L x 7H	IDU24X60	24D x 60L x 7H	GDU12X102	12D x 102L x 7H	GDU24X60	24D x 60L x 7H
IDU12X108	12D x 108L x 7H	IDU24X66	24D x 66L x 7H	GDU12X108	12D x 108L x 7H	GDU24X66	24D x 66L x 7H
IDU18X24	18D x 24L x 7H	IDU24X72	24D x 72L x 7H	GDU18X24	18D x 24L x 7H	GDU24X72	24D x 72L x 7H
IDU18X30	18D x 30L x 7H	IDU24X78	24D x 78L x 7H	GDU18X30	18D x 30L x 7H	GDU24X78	24D x 78L x 7H
IDU18X36	18D x 36L x 7H	IDU24X84	24D x 84L x 7H	GDU18X36	18D x 36L x 7H	GDU24X84	24D x 84L x 7H
IDU18X42	18D x 42L x 7H	IDU24X90	24D x 90L x 7H	GDU18X42	18D x 42L x 7H	GDU24X90	24D x 90L x 7H
IDU18X48	18D x 48L x 7H	IDU24X96	24D x 96L x 7H	GDU18X48	18D x 48L x 7H	GDU24X96	24D x 96L x 7H
IDU18X54	18D x 54L x 7H	IDU24X102	24D x 102L x 7H	GDU18X54	18D x 54L x 7H	GDU24X102	24D x 102L x 7H
IDU18X60	18D x 60L x 7H	IDU24X108	24D x 108L x 7H	GDU18X60	18D x 60L x 7H	GDU24X108	24D x 108L x 7H
IDU18X66	18D x 66L x 7H			GDU18X66	18D x 66L x 7H		



Advanced Beverage Solutions  
100 Gary Avenue, Suite C  
Roselle, IL 60172

**www.abstone.com**  
E-mail: [orders@abstone.com](mailto:orders@abstone.com)

877-814-2271  
Local: 847-524-1707  
Fax: 847-524-1710

## Lighted Liquor Displays

Lighted liquor displays (LLD) have illuminated 4" high and 4" deep steps with black vinyl-clad exterior, clear acrylic step cover, on/off switch, grounded cord and plug, and removable top for easy access to fluorescent light bulbs (included).

All ice displays are made to order and not returnable.

*R or L part number suffix designates power cord position.*

More details available. Please visit [www.glastender.com](http://www.glastender.com)

Glass display unit lighted liquor displays are taller than standard lighted liquor displays. The first step is 9.25" high to raise the bottles above the glass display unit, and it has a front light channel to help illuminate the GDU to add visual appeal. When mounted on a cooler at the factory, the 16" deep GDU models have a 8.25" rear deck space designed to fit the 8" deep LLD.

Factory mounted LLD behind glass display unit (GDU)



LLDS



LLD3



LLD

## Two Tier Displays

Part #	Part #	Dimensions"
LLDS24L	LLDS24R	24L x 8D x 8H
LLDS30L	LLDS30R	30L x 8D x 8H
LLDS36L	LLDS36R	36L x 8D x 8H
LLDS42L	LLDS42R	42L x 8D x 8H
LLDS48L	LLDS48R	48L x 8D x 8H
LLDS54L	LLDS54R	54L x 8D x 8H
LLDS60L	LLDS60R	60L x 8D x 8H
LLDS66L	LLDS66R	66L x 8D x 8H
LLDS72L	LLDS72R	72L x 8D x 8H
LLDS78L	LLDS78R	78L x 8D x 8H
LLDS84L	LLDS84R	84L x 8D x 8H
LLDS90L	LLDS90R	90L x 8D x 8H
LLDS96L	LLDS96R	96L x 8D x 8H
LLDS102L	LLDS102R	102L x 8D x 8H
LLDS108L	LLDS108R	108L x 8D x 8H

## Three Tier Displays

Part #	Part #	Dimensions"
LLD324L	LLD324R	24L x 8D x 12H
LLD330L	LLD330R	30L x 8D x 12H
LLD336L	LLD336R	36L x 8D x 12H
LLD342L	LLD342R	42L x 8D x 12H
LLD348L	LLD348R	48L x 8D x 12H
LLD354L	LLD354R	54L x 8D x 12H
LLD360L	LLD360R	60L x 8D x 12H
LLD366L	LLD366R	66L x 8D x 12H
LLD372L	LLD372R	72L x 8D x 12H
LLD378L	LLD378R	78L x 8D x 12H
LLD384L	LLD384R	84L x 8D x 12H
LLD390L	LLD390R	90L x 8D x 12H
LLD396L	LLD396R	96L x 8D x 12H
LLD3102L	LLD3102R	102L x 8D x 12H
LLD3108L	LLD3108R	108L x 8D x 12H

## GDU Two Tier Displays

Part #	Part #	Dimensions"
LLD24L	LLD24R	24L x 8D x 13H
LLD30L	LLD30R	30L x 8D x 13H
LLD36L	LLD36R	36L x 8D x 13H
LLD42L	LLD42R	42L x 8D x 13H
LLD48L	LLD48R	48L x 8D x 13H
LLD54L	LLD54R	54L x 8D x 13H
LLD60L	LLD60R	60L x 8D x 13H
LLD66L	LLD66R	66L x 8D x 13H
LLD72L	LLD72R	72L x 8D x 13H
LLD78L	LLD78R	78L x 8D x 13H
LLD84L	LLD84R	84L x 8D x 13H
LLD90L	LLD90R	90L x 8D x 13H
LLD96L	LLD96R	96L x 8D x 13H
LLD102L	LLD102R	102L x 8D x 13H
LLD108L	LLD108R	108L x 8D x 13H

Beer Systems, Bar Equipment



Advanced Beverage Solutions  
100 Gary Avenue, Suite C  
Roselle, IL 60172

**www.absonone.com**  
E-mail: [orders@absonone.com](mailto:orders@absonone.com)

877-814-2271  
Local: 847-524-1707  
Fax: 847-524-1710

## Back Bar and Underbar Miscellaneous

More details available. Please visit [www.glastender.com](http://www.glastender.com)



Back bar cash register



WRACK22

06003690



BO/CC



06001404 shelf divider

Part #	Description
06001419	Lighting, plug-in fluorescent light
06001425	Lighting, GE #F6T5 fluorescent light bulb
06001431	Lighting, rope light kit for BB24, BB36
06001432	Lighting, rope light kit BB60, ND48, ND52, LPT36
06001433	Lighting, rope light kit for BB84, ND72
06001434	Lighting, rope light kit for BB108
STLK1	Light kit for 1 mullion: ST48, ST60
STLK2	Light kit for 2 mullions: ST72, ST96
BBCR	Back bar cash register recess with locking drawer, fits between two adjoining self-contained back bar low profile coolers, 24" L x 24-7/8"
WRACK18	Wine racks, 2, for 18-1/16" shelf (not included)
WRACK20	Wine racks, 2, for 20-1/8" shelf (not included)
WRACK22	Wine racks, 2, for 23-7/8" shelf (not included)
06003690	Wine rack shelf, SS, slots for 9 bottles for 24" door
06003938	Wine rack shelf, SS, slots for 7 bottles for 20" door
06000041	Keg rack, SS, KC24
06001608	Keg rack, SS, BB & ND middle
06001609	Keg rack, SS, BB middle
06001610	Keg rack, SS, ND end
06000042	Keg rack, SS, PT end
06000043	Keg rack, SS, PT middle
BO	Bottle opener
CC	Cap catcher
BO/CC	Bottle opener & cap catcher

Part #	Description
06001654	Glass ice display panel, left, 12" GDU
06001655	Glass ice display panel, right, 12" GDU
06001411	Glass ice display panel, middle, 12" GDU
06001657	Glass ice display panel, left, 16" GDU
06001658	Glass ice display panel, right, 16" GDU
06001656	Glass ice display panel, middle, 16" GDU
06000044	Glass ice display panel, left, 18" GDU
06000045	Glass ice display panel, right, 18" GDU
06000352	Glass ice display panel, middle, 18" GDU
06001662	Glass ice display panel, left, 24" GDU
06001663	Glass ice display panel, right, 24" GDU
06001660	Glass ice display panel, middle, 24" GDU
06001661	Glass ice display panel, front, 24"
06001659	Glass ice display panel, back, 24"
06001665	Glass ice display panel, front, 30"
06001664	Glass ice display panel, back, 30"
06001667	Glass ice display panel, front, 36"
06001666	Glass ice display panel, back, 36"
06001669	Glass ice display panel, front, 42"
06001668	Glass ice display panel, back, 42"
06001674	Glass ice display panel, front, 48"
06001670	Glass ice display panel, back, 48"
06001672	Glass ice display panel, front, 54"
06001671	Glass ice display panel, back, 54"



Advanced Beverage Solutions  
100 Gary Avenue, Suite C  
Roselle, IL 60172

**www.absone.com**  
E-mail: [orders@absone.com](mailto:orders@absone.com)

877-814-2271  
Local: 847-524-1707  
Fax: 847-524-1710

## Back Bar Refrigeration Parts and Accessories

More details available. Please visit [www.glastender.com](http://www.glastender.com)

Part #	Description
06004055	Condensing unit, 1/3 HP R134a, use within 25' of 1 remote cooler with 4 doors or less
06004054	Condensing unit, 1/2 HP R134a, use within 25' of 2 remote cooler with 6 doors or less
06001541	Condensing unit field installation kit for 2 remote units on 1 condensing unit: 1 filter dryer, 1 sight glass, 2 solenoids with 120V coils, 1 pressure control
06001542	Condensing unit field installation kit for 1 remote unit on 1 condensing unit: 1 filter dryer, 1 sight glass
06001589	Condensing unit solenoid (coil required)
06001590	Condensing unit coil (solenoid required)
CROSSRR	Crossover tube assy w 100 CFM blower motor from one refrigerator to another, 30"
CROSSWR	Crossover tube assy w 100 CFM blower motor from a walk-in cooler to refrigerator, 30"
CROSSWT	Crossover tube assy w 100 CFM blower motor from a walk-in cooler to wall mount tower, 30"
SHAFTRT	Air shaft assy w 100 CFM blower motor from refrigerator to beer tower, 72"
SHAFTWT	Air shaft assy w 100 CFM blower motor from walk-in cooler to beer tower, 72"
06001446	Blower motor, 15 CFM
06001447	Blower motor, 60 CFM
06001450	Blower motor, 100 CFM
06001547	Replacement clip for mounting kick rail to leg
CLEG	Replacement leg, 6"
06001560	Caster, swivel, 2.5" high
06001561	Caster, swivel w lock, 2.5" high
06001568	Caster, swivel, 3.75" high
06001559	Caster, swivel w lock, 3.75" high
06001566	Caster, swivel, 5" high
06001567	Caster, swivel w lock, 5" high
06001557	Pilaster
06001565	Clip, SS for pilaster
06001574	Thumb screw, SS for pilaster
00000018	Nut, acorn, 8/32" natural nylon
06001404	Shelf divider
06001281	Shelf, SS, fits BGS18
06001282	Shelf, SS, fits BGS24
06001283	Shelf, SS, fits BGS30
06001284	Shelf angle for BGS
06001278	Shelving floor, SS, fits BGS18
06001279	Shelving floor, SS, fits BGS24
06001280	Shelving floor, SS, fits BGS30

Part #	Description
06001399	Shelf, vinyl-coated, 18-7/8" x 20-1/8", fits BB24, BB36, FV24, ND72 middle door, end of remote PT
06001400	Shelf, vinyl-coated w corner notch, 18-7/8" x 22-1/16", fits end doors on BB, LP, both FV48 doors
06001401	Shelf, vinyl-coated, 18-7/8" x 23-7/8", fits middle doors on BB, LP, PT and RF models
06001402	Shelf, vinyl-coated, 18-7/8" x 18-1/16", fits end doors on ND models
06001403	Shelf, vinyl-coated, 18-7/8" x 22-1/16", fits end doors on PT and RF models
06001195	Shelf, galvanized, fits DS24
06000169	Shelf, galvanized, DS48, DS72 end door
06000170	Shelf, galvanized, DS72 middle door
CBS/SS_	SS backsplash, _ specify needed length in inches
CBS/SSL	SS side splash, left, 4"
CBS/SSR	SS side splash, right, 4"
SB24	SS back upgrade for 24" cooler
SB36	SS back upgrade for 36" cooler
SB48	SS back upgrade for 48" cooler
SB52	SS back upgrade for 52" cooler
SB60	SS back upgrade for 60" cooler
SB72	SS back upgrade for 72" cooler
SB84	SS back upgrade for 84" cooler
SB96	SS back upgrade for 96" cooler
SB108	SS back upgrade for 108" cooler
02000614	Drain screen for IDU, GDU
BB800005	15CFM blower, converts back bar refrigerator into direct draw system
BB800007	12CFM blower with shroud for direct draw



06001565



06001574



Advanced Beverage Solutions  
100 Gary Avenue, Suite C  
Roselle, IL 60172

**www.absone.com**  
E-mail: [orders@absone.com](mailto:orders@absone.com)

877-814-2271  
Local: 847-524-1707  
Fax: 847-524-1710

## Bar Accessories

Part #	Description
C160	Cocktail shaker, 200 ml
C161	Cocktail shaker, 500 ml
C197	Cocktail shaker, 250 ml
C198	Cocktail shaker, 300 ml
C199	Cocktail shaker, 400 ml
C551	SS jigger, one side 1 oz, other side 1/2 oz
C552	SS jigger, one side 1 oz, other side 2 oz
C561	SS ice bucket with lid, dbl wall, 1.5 litre capacity
C570	Hand held bottle opener, chrome w vinyl grip
C571	Wall mount bottle opener, SS brushed or polished
C572	Wall mount bottle opener, premium, SS polished
C573	SS bottle cap catcher, wall mount
C775	Sink mounted single touch spout
C776	Single touch aerator, saves water, saves time
C777	Wall mounted single touch spout



C561



Cocktail shaker



C573



C775



C776

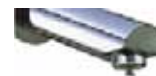

C777



Jigger



C571



C572



C570

The diagrams on pages 1-4 are courtesy of Micro Matic USA, Inc., Northridge, California.

Lancer, Highlight, Fatlock, Siberian Elite, Polaris Beer Superchiller, Multifill and Unicorn are trademarks or registered trademarks of Hoshizaki Lancer Corporation, San Antonio, Texas.

Vin Service and QUIX tap are trademarks of Vin Service Srl, Zanica, Italy

Perlick is a registered trademark of Perlick Corporation, Milwaukee, Wisconsin.

Procon is a registered trademark of Procon Products, Standex International Corporation, Murfreesboro, Tennessee.

Bev-Seal, Bev-Steel, Bevlex, Bev-Flex, Clearbraid and Glas-Flex are registered trademarks of Accuflex Industrial Hose, Ltd., Guelph, ON, Canada, a subsidiary of Kuriyama of America, Inc. Bev-Seal Ultra, Polyspring, Klearon, Tigerflex and Sani-Clean AM are registered trademarks of Kuriyama of America, Inc., Schaumburg, Illinois.

Armiflex is a registered trademark of Armacell LLC, Mebane, North Carolina.

Kwik Block is a trademark of Kwik Block Fastening Systems, Rogue River, Oregon.

Tru-Gap is a trademark of Tru-Gap LLC, St. Paul, Minnesota.

Omega is a registered trademark of Omega Products, Inc., Harrisburg, Pennsylvania.

Wunder-Bar and Mark 4 are registered trademarks of Automatic Bar Controls, Inc., Vacaville, California.

McCann's and TruPour are registered trademarks of The Manitowoc Company, Manitowoc, Wisconsin.

Exactap is a registered trademark of DigitalDispense, London, United Kingdom.

Tecflo is a registered trademark of Tecflo Energy Services Ltd, Norfolk, United Kingdom.

Flojet is a registered trademark of ITT Industries, Foothill Ranch, California.

SHURflo is a registered trademark of SHURflo, LLC, Cypress, California.

Taprite is a registered trademark of Taprite-Fassco Mfg., Inc., San Antonio, Texas.

Catalina is a registered trademark of Catalina Cylinders, Inc., Garden Grove, California.

DraftMore is a registered trademark of DraftMore APS, Nordborgvej, Denmark.

Senco is a registered trademark of Senco Brands Inc., Cincinnati, Ohio.

Nitro-Blend is a trademark of Green CO2 Systems, Fort Collins, Colorado.

Trumix is a registered trademark of McDantim Gas Blending Technologies, Helena, Montana.

Oetiker is a registered trademark of Oetiker International, Marlette, Michigan.

John Guest and Speedfit are registered trademarks of John Guest International Ltd., Fairfield, New Jersey.

Colder is a registered trademark of Colder Products Company, St. Paul, Minnesota.

Stow 'N Go, ProLatch, StowAway and Lockjaw are trademarks of Plano Molding Company, Plano, Illinois.

BevClean and WinterBev are trademarks of Very Fresh Juice Company, Dayton, Ohio.

Drafter is a trademark of Applied Cleaning Technologies, Inc., Scottsdale, Arizona.

ScaleKleen is a registered trademark of Everpure, Inc., Hanover Park, Illinois.

Clear1 is a trademark of Scotsman Ice Systems, Vernon Hills, Illinois.

Nu-Brite, Foam-Brite, Alka-Brite, Evap Foam No Rinse, Nu-Blast, Cal-Blast, Cal-Green, Evap-Green, Evap Fresh No Rinse, and CalClean are trademarks or registered trademarks of NuCalgon, St. Louis, Missouri.

Glastender is a registered trademark of Glastender, Inc., Saginaw, Michigan.

INFINITY and EasyLink are trademarks of Sterling Pressure Systems, San Antonio, Texas.

LogiCO2, MK7, MK9 and MK10 are trademarks of LogiCO2 International AB, Västra Frölunda, Sweden.



Advanced Beverage Solutions  
 100 Gary Avenue, Suite C  
 Roselle, IL 60172

**www.absone.com**  
 E-mail: orders@absone.com

877-814-2271  
 Local: 847-524-1707  
 Fax: 847-524-1710

### Installer Order Checklist

Qty	Description	Part Number	Comments
	Tower 1		
	Tower 2		
	Tower 3		
	Faucets		
	Faucet handles		
	Medallions		
	Shanks & grommets		
	Drip tray 1		
	Drip tray 2		
	Drip tray 3		
	Glycol chiller		
	Flash chiller		
	Glycol		
	Glycol manifold		
	Insulated trunk line		
	Single line barrier tubing		
	PVC hose		
	Drain tubing		
	Beer hose assemblies		
	Thickened water assembly		
	Armaflex pipe insulation		
	Cable ties		
	Line labels and clips		
	Tubing cutter & pincer		
	Hose clamps		
	Tape		
	Tubing chase		
	Conduit straps		
	Kwik blocks		
	Tru-gap backflow preventer		
	Omega juice/Granita dispenser		
	Unicorn soda tower		
	Bar guns		
	Bar gun button caps		
	Ice chest		
	Cold plate and ice shield		
	Conversion stand/leg kit		
	Couplers/taps		
	FOB stops/empty keg detectors		

Beer Systems, Bar Equipment



Advanced Beverage Solutions  
 100 Gary Avenue, Suite C  
 Roselle, IL 60172

**www.absone.com**  
 E-mail: orders@absone.com

877-814-2271  
 Local: 847-524-1707  
 Fax: 847-524-1710

### Installer Order Checklist

Qty	Description	Part Number	Comments
	Beer and wine pumps		
	Pump panels		
	Flow reversal valve		
	Flow meter		
	Equipment mounting boards		
	CO <sub>2</sub> tanks, handles & brackets		
	CO <sub>2</sub> tank changeover/telemetry		
	CO <sub>2</sub> purifier		
	CO <sub>2</sub> detector/alarm		
	Regulator panel		
	Primary regulators		
	Secondary regulators		
	Nitrogen regulator		
	Changeovers valves		
	DraftMore beer regulators		
	High pressure hose assy		
	Gauge guards		
	Regulator wrench		
	CO <sub>2</sub> pressure tester		
	Carbonation tester/refractometer		
	CO <sub>2</sub> shutoff valves		
	Ceiling mt, self-store gas hose		
	Air distributors		
	Air compressor		
	Nitro-blend N <sub>2</sub> generator/blender		
	Gas blender		
	Gas leak detector		
	Beer gas analyzer		
	Stepless clamps		
	Swivel nuts & wing nuts		
	Stems/nipples		
	Splicers		
	Plugs		
	Elbows		
	Y fittings		
	U bends / 90° bend		
	Tees		
	Crosses		
	Forks		

Beer Systems, Bar Equipment



Advanced Beverage Solutions  
 100 Gary Avenue, Suite C  
 Roselle, IL 60172

**www.absone.com**  
 E-mail: orders@absone.com

877-814-2271  
 Local: 847-524-1707  
 Fax: 847-524-1710

### Installer Order Checklist

Qty	Description	Part Number	Comments
	Manifolds		
	Hose nipples		
	Hose clamps		
	Hex nuts		
	Unions		
	Adapters		
	Compression fittings		
	Inlet/outlet fittings		
	Washers		
	Wall brackets		
	Beer shut-off valves		
	SS needle valves		
	Fatlock valves & adapters		
	Fatlock transfer lead		
	Beer line saddles		
	John Guest fittings		
	Colder quick couplings		
	Plastic fittings & shutoffs		
	STOW 'N GO tool box		
	Cleaners		
	Cleaning bottle/can & adapters		
	Washout pump		
	Clean-in-place (CIP) system		
	CIP chemical dosing board		
	Faucet brush & wrench		
	Faucet locks		
	Hose brush		
	3 or 6 head cleaning brush		
	Cleaning/flusher adapters		
	Keg coupler check ball lifter		
	Underbar ice chest/bin/bottle well		
	Underbar blender station		
	Blender		
	Underbar drainboard		
	Underbar glass rack		
	Underbar glass cabinet		
	Underbar glass washer		
	Underbar sink		

Beer Systems, Bar Equipment



