



Application Chart - Headlights, Signal and Sundry Lights for Cars and Light Trucks	1.01-1.206	1
Application chart - Headlights, Signal and Sundry Lights for Commercial Vehicles	2.01-2.122	2
Application chart - Headlights, Signal and Sundry Lights for Tractors	3.01-3.124	3
Fog Lights, Driving Lights, Headlights, Work Lights and Search Lights	4.01-4.112	4
Signal and Sundry Lights, Reflectors and Cabling	5.01-5.238	5
Optical and Acoustic Warning Systems	6.01-6.63	6
Beamsetters	7.01-7.05	7
Bulbs	8.01-8.23	8
List of Part Numbers Vehicle Manufacturer's No. - Hella No.	9.01-9.60	9

A		C	
Accessories for beamsetters series IV	7.02-7.03	Serie "963 959"	5.97
Accessories for built-in headlights	4.41	Serie "964 169"	5.65-5.69
Accessories for fog- and driving lights	4.30	Serie "964 295"	5.102-5.103
Accessories for old-type of rotating/flashing beacons	6.17-6.19	Serie "965 039"	5.63-5.64
Accessories for rotating/flashing beacons	6.15-6.16	Serie "996 012"	5.84
Accessories for work lights	4.108-4.111	Serie "997 006"	5.44
Additional lights and cabling	5.205-5.207	Serie "997 027"	5.93
Assortments of bulbs for garages	8.07	Serie "997 131"	5.43
Auxiliary indicators	5.142-5.144	Serie "998 232"	5.36-5.37
B		Serie "998 233"	5.38-5.39
Beamsetters series IV and Economy	7.02-7.05	Connectors	8.23
Built-in headlights	4.32-4.50	D	
Bulbs with plastic sockets	8.19-8.22	Daytime running lights	5.113-5.115
Bulb holders	8.23	Door lights	5.168-5.169
Bulb overview	8.02	Driving lights	4.03-4.29
Bulb sets	8.04-8.06	E	
Bulbs for headlights	8.08-8.12	Emergency triangles	5.174
Bulbs for signal lights	8.13-8.19	External fitting headlights	4.51-4.52
C		F	
Cabling EasyConn	5.208-5.213	Failure control for LED indicators	5.215-5.216
Clearance lights	5.121-5.125	Flashing beacons	6.10-6.13
Combinable lights		Flashing spotlight	6.19
Series "001 240"	5.77	Fog lights	4.03-4.29, 4.31
Series "001 259"	5.78-5.79	H	
Series "001 423"	5.70	Handlamps	5.164-5.167
Series "002 582"	5.40	Handlebar indicator lights	5.142
Series "002 776"	5.46	Hazard flasher lights	5.172-5.173
Series "003 014"	5.82-5.83	Headlights, signal and sundry lights - application chart for cars and light trucks	1.01-1.206
Series "003 057"	5.80	Headlights, signal and sundry lights - application chart for tractors	3.01-3.124
Series "003 167"	5.23	Headlights, signal and sundry lights - application chart for commercial vehicles	2.01-2.122
Series "003 182"	5.45	Hella bulb no. - UK bulb no.	8.03
Series "003 184"	5.41	I	
Series "003 236"	5.24-5.25	Indicator lights	5.137-5.142
Series "003 389"	5.121	Indicator-side lights	5.46, 5.49, 5.53
Series "003 734"	5.89-5.90	Interior lights	5.145-5.161
Series "003 748"	5.96	L	
Series "004 119"	5.88	LED beacons	6.14
Series "004 361"	5.98	Licence plate lights	5.116-5.121
Series "004 431/004 432"	5.27	Light series "5760"	4.53-4.54
Series "005 200"	5.26	Light series "Oval 100"	4.55-4.61
Series "005 603"	5.87	Light series "Oval 120"	4.62
Series "006 040"	5.20-5.21	Light series "Module 120"	4.63-4.65
Series "006 717"	5.92	Light series "Module 6213"	4.66-4.70
Series "007 547"	5.22	Light series "7145"	4.71
Series "008 221"	5.56-5.57	List of part numbers	9.02-9.18
Series "008 645"	5.100-5.101	M	
Series "008 805"	5.86	Multifunction lights	5.05-5.17, 5.28-5.33, 5.51
Series "008 982"	5.85		
Series "009 001"	5.58-5.62		
Series "340 000"	5.99		
Series "340 001"	5.95		
Series "343 130"	5.72-5.76		
Series "343 390"	5.71		
Series "343 640"	5.18-5.19		
Series "344 169"	5.66-5.68		
Series "959 010/011"	5.54		
Series "959 037/050/060/070"	5.35		
Series "959 590/610/640/790"	5.110		
Series "959 820/821/822/950"	5.55		
Series "962 964"	5.91		
Series "963 639"	5.94-5.95		



O	
Optical warning system OWS 4: Spare parts for old-type systems	6.36
Optical warning systems OWS 540 up to 1600: Product descriptions, accessories and spare parts	6.30-6.35
Optical warning systems OWS-QS : Product descriptions, accessories and spare parts	6.24-6.29
R	
Reading lights	5.162-5.163
Rear lights	5.107-5.109, 5.111
Rear fog lights	5.127-5.129
Rear side lights	5.126
Reflectors	5.175-5.179
Reverse lights	5.127-5.131
Rotating beacon and siren combination RTK 6 SL: Product descriptions, modules and spare parts	6.40-6.50
Rotating beacon and siren combination RTK-VE: Product descriptions and accessories	6.61-6.63
Rotating beacons, accessories and spare parts	6.03-6.09
Rotating beacon and siren combination RTK 5: Product descriptions, spare parts and accessories	6.37-6.39
Rotating-/flashing beacon and siren combination RTK-QS: Product descriptions, modules and spare parts	6.51-6.60
S	
Safety brake lights	5.132-5.135
Search lights	4.112
Side lights	5.106-5.112
Side-marker lights	5.97-5.105
Signal lights	6.13, 6.23
Signal lights and cabling - front	5.198-5.200
Signal lights and cabling - rear	5.182-5.197
Signal lights and cabling - side	5.201-5.1204
Signal lights and cabling for trailers and semi-trailers	5.225-5.232
Signal lights for trucks	5.217-5.224
Signal lights for buses	5.233
Signal lights and cabling for car trailers	5.234-5.235
Signal lights and cabling for 12V trailers	5.214-5.216
Spare parts for beamsetters series III	7.05
Spare parts for beamsetters series IV and Economy	7.02-7.05
Spare parts for old-type rotating/flashing beacons	6.17-6.19
Strobe beacons	6.20-6.21
T	
Track-control lights	5.126
V	
Vehicle manufacturer's no. - Hella no.	9.19-9.60
W	
Warning equipment	6.24-6.25
Warning lights	5.170-5.171, 6.22
Work lights	4.02, 4.72-4.107



What does GGVS/ADR mean?

Some headlights and lights in the range are marked with this symbol. This means that these products are approved for mounting to transport equipment which complies with the requirements of GGVS/ADR B Rn 10251 and Rn 11251 for electrical equipment.

GGVS

Gefahrgutverordnung Straße

ADR

Accord européen relatif au transport international des marchandises dangereuses par route

What do the IP protective ratings mean?

Protective rating IP5K4K

Dust may only penetrate to such an extent that function and safety are not impaired. Water being sprayed against the housing at increased pressure may not have a harmful effect; water pressure approx. 4 bar.

Protective rating IP6K4K

Dust must not penetrate. Water being sprayed against the housing at increased pressure may not have a harmful effect; water pressure approx. 4 bar.

Protective rating IPX9K

Water that is directed against the housing during high-pressure/steam jet cleaning may not have a harmful effect; water pressure approx. 80 bar.

Decisive for the specification of the protective rating are the splashwater test and the dust test.

The splash-water test provides information about how headlights, lights and beacons resist rain, splashwater, mud and high-pressure cleaners.

For this purpose, water is sprayed constantly onto the test specimen in a closed chamber as if through a high-pressure cleaner.

The dust test examines the degree to which the test specimen is protected against penetration by solid particles including dust.

For this purpose, the test sample is exposed to a flow of dust/air mixture for a certain length of time in the chamber.

Lighting technology - examples for terminal descriptions according to DIN 72552

54	Trailer signals, trailer plug fitting and light combinations, stop light
54g	Trailer signals, compressed air valve for permanent brake in the trailer, electromagnetic actuation
55	Fog lights
56	Headlight
56a	Headlight, spotlight and spotlight control
56b	Headlight, low beam
56d	Headlight, flashing lights
57	Parking light for motorbikes (outside Germany also for cars and trucks)
57a	Parking light
57L	Parking light left
57R	Parking light right
58	Position light, tail light, licence plate lighting and instrument lighting
58b	Tail light switchover for single-axle tractors
58c	Trailer plug fitting for tail light laid with a single wire and fused in the trailer
58d	Adjustable instrument lighting, tail light and position light
58L	Position light left
58R	Position light right



Headlights, Signal and Sundry Lights for Cars and Light Trucks



1



List of Manufacturers/Page

1.02 - 1.05

Headlights, Signal and Sundry Lights -
Application Chart for Cars and Light Trucks

1.06 - 1.206



List of Manufacturers/Page



Manufacturer Model	Model year	Page	Manufacturer Model	Model year	Page
Alfa Romeo			BMW		
145, 146 (930)	07/94->01/01	1.06	6 (E24)	04/76->09/90	1.40 - 1.41
Audi			7 (E23)	05/77->08/86	1.41
A2 (8Z0)	02/00->08/05	1.06	7 (E32)	09/86->09/94	1.41 - 1.42
A3 (8L1)	09/96->05/03	1.06 - 1.07	7 (E38)	10/94->11/01	1.42
A3 (8P1)	05/03->	1.07	7 (E65, E66)	11/01->	1.43
A4 (8D2, 8D5, B5)	01/95->09/01	1.07 - 1.08	Chrysler		
A4 (8E2, 8E5, B6)	11/00->12/04	1.08	PT Cruiser	06/00->	1.43
A4 (8EC, 8ED)	11/04->04/08	1.09	Citroën		
A4 Cabriolet (8H7, 8HE)	08/06->	1.09	Berlingo (MF, M_)	11/02->	1.44
A6 (4A, C4)	06/94->12/97	1.10 - 1.11	C2 (JM_)	09/03->	1.44
A6 (4B, C5)	01/97->01/05	1.11 - 1.13	C4 (LC_)	11/04->08/08	1.44 - 1.45
A6 Allroad (4BH)	05/00->08/05	1.13	C4 Coupé (LA_)	11/04->08/08	1.45
A6 (4F2, 4F5)	05/04->	1.13 - 1.14	C4 Picasso (UD_,UA_)	10/06->	1.46
A6 Allroad (4FH)	05/06->	1.14 - 1.15	Fiat		
A8 (4D2, 4D8)	01/99->	1.15	Multipla (186)	04/99->09/04	1.46
A8 (4E_)	10/02->	1.16	Punto (176)	09/93->	1.47
Cabriolet (B4)	05/91->08/00	1.16	Ford		
Coupé (89, 8B)	10/88->12/96	1.17	C-Max	02/07->	1.48
Q7	03/06->	1.17	Escort V	07/90->09/92	1.48
TT (8N)	10/98->	1.17	Escort VI	09/92->01/95	1.48 - 1.49
V8 (D1)	10/88->02/94	1.17 - 1.18	Escort VII	01/95->02/99	1.49
80 (81, 85, B2)	08/78->08/86	1.18	F-150	04/04->	1.49
80 (89, 89Q, 8A, B3)	06/86->10/91	1.18 - 1.19	Fiesta III (GFJ)	01/89->12/95	1.49 - 1.50
80 (8C, B4)	09/91->01/96	1.19 - 1.20	Fiesta IV (JA_, JB_)	08/95->01/02	1.50 - 1.51
90 (81, 85, B2)	10/84->03/87	1.20	Fiesta V (JH_)	11/01->	1.51 - 1.52
90 (89, 89Q, 8A, B3)	04/87->09/91	1.20 - 1.21	Fiesta Courier, Box	02/96->	1.52
100 (44, 44Q, C3)	08/82->11/90	1.21	Focus	10/98->11/04	1.52 - 1.56
100 (4A, C4)	12/90->07/94	1.22 - 1.24	Focus II	11/04->02/08	1.56 - 1.60
200 (44, 44Q)	06/83->12/91	1.24	Focus C-MAX	10/03->03/07	1.61
BMW			Fusion (JU_)	08/02->	1.61
3 (E21)	09/79->03/84	1.24	Galaxy (VX, VY)	03/95->05/06	1.62
3 (E30)	09/82->06/94	1.24 - 1.26	Galaxy	05/06->	1.63
3 (E36)	09/90->08/00	1.26 - 1.27	Kuga	03/08->	1.63
3 (E46) Saloon, Touring	02/98->02/05	1.27 - 1.28	Maverick (UDS, UNS)	02/93->06/96	1.63
3 (E90) Saloon	01/05->09/08	1.28	Mondeo II	01/98->11/00	1.63
5 (E28)	06/81->12/87	1.29	Mondeo III	11/00->03/07	1.64
5 (E34)	01/88->01/97	1.29 - 1.31	Mondeo IV	03/07->	1.65 - 1.67
5 (E39)	11/95->06/04	1.31 - 1.36	Orion III (GAL)	09/91->12/93	1.67
5 (E60, E61)	07/03->	1.36 - 1.40			



Manufacturer Model	Model year	Page	Manufacturer Model	Model year	Page
Ford			Mercedes-Benz		
S-MAX	05/06->	1.67	207 D - 410 (T1, TN)	05/77->02/96	1.97 - 1.98
Transit (T_)	09/85->09/92	1.68	Nissan		
Transit (E_)	01/91->07/00	1.68 - 1.69	Terrano II (R20)	10/92->03/05	1.98 - 1.99
Transit (F_)	01/00->07/06	1.69 - 1.70	Opel		
Transit	07/06->	1.70	Astra F	09/91->01/98	1.99
Honda			Astra G	02/98->10/05	1.99 - 1.100
Accord V (CC7)	03/93->02/96	1.70 - 1.71	Astra H	03/04->	1.101 - 1.103
KIA			Calibra	06/90->07/97	1.103 - 1.104
Cee'd	12/06->	1.71	Combo II	10/01->02/03	1.104
Land Rover			Corsa C	10/00->02/03	1.104
Freelander II	02/06->	1.71 - 1.72	Corsa D	07/06->	1.104
Mazda			Kadett E	09/84->08/91	1.104 - 1.105
121 III (JASM, JBSM)	03/96->02/00	1.72	Omega A	09/86->05/94	1.105 - 1.106
Mercedes-Benz			Omega B	03/94->07/03	1.106 - 1.107
C-Class (W/S 202)	03/93->03/01	1.73	Signum	05/03->08/05	1.107 - 1.108
C-Class (W/S 203)	05/00->02/04	1.73 - 1.74	Vectra A	04/88->11/95	1.108
C-Class Sports Coupé (CL 203)	03/01->02/04	1.75	Vectra B	02/99->07/03	1.108
CLK (C 208)	06/97->02/03	1.75 - 1.76	Vectra C	04/02->08/05	1.109
CLK (C 209)	06/02->05/05	1.76	Zafira (F75_)	04/99->	1.109
CLS (C 219)	10/04->	1.76 - 1.77	Zafira	07/05->	1.110
E-Class (W/S 124)	06/93->03/98	1.77 - 1.78	Peugeot		
E-Class (W/S 210)	06/95->03/03	1.78 - 1.80	107	06/05->	1.110
E-Class (W/S 211)	03/02->	1.80 - 1.84	207	02/06->	1.110
G-Class (W 460)	05/79->07/93	1.84 - 1.85	Partner (5F, 5)	11/02->	1.111
G-Class (W 461)	02/90->	1.85	Puch		
G-Class (W 463)	09/89->	1.85	G-Class (W 460)	05/79->07/93	1.111 - 1.112
M-Class (W 163)	09/01->06/05	1.86	G-Class (W 461)	02/90->	1.112
S-Class Coupé (C 215)	03/99->03/06	1.86 - 1.87	G-Class (W 463)	09/89->	1.112
SLK (R 170)	09/96->04/04	1.87	Renault		
SLK (R 171)	03/04->	1.87	Avantime (DE0)	09/01->05/03	1.112
Vaneo (414)	02/02->	1.88	Clio II (B/C/B0/1_)	09/98->	1.113 - 1.114
Viano, Vito (W 639)	09/03->	1.88	Espace III (JE_)	11/96->10/02	1.114
190 (W 201)	10/82->08/93	1.89	Grand Scénic	04/04->	1.114 - 1.115
200 - 300 (W 123)	02/76->	1.90 - 1.92	Kangoo (FC0/1_, KC0/1_)	03/98->01/08	1.115
200 - 500 (W 124)	12/84->06/93	1.93 - 1.94	Laguna (B56_, 556_, K56_)	11/93->03/01	1.116
Sprinter 901/902/903/904	02/95->05/06	1.94 - 1.96	Laguna II (BG0/1_, KG0/1_)	03/01->	1.116
Sprinter (906)	06/06->	1.96	Mastermaxi (FH/HH/UH)	04/98->	1.116



List of Manufacturers/Page



Manufacturer Model	Model year	Page	Manufacturer Model	Model year	Page
Renault			Skoda		
Mégane I	01/96->08/03	1.117	Felicia II (6U1/6U5)	01/98->06/01	1.134 - 1.135
Mégane II	09/03->	1.117	Octavia (1U2/1U5)	09/96->	1.135 - 1.136
Safrane I (B54_)	04/92->07/96	1.118	Octavia (1Z3/1Z5)	02/04->12/08	1.136 - 1.137
Safrane II (B54_)	07/96->12/00	1.118	Roomster (5J), Praktik	05/06->	1.137 - 1.138
Scénic (JA0/1_)	09/99->08/03	1.118	Superb (3U4)	02/02->	1.138
Scénic II (JM0/1_)	06/03->	1.118 - 1.119	Vauxhall		
Twingo (C06_/S06_)	03/93->	1.119	Astra Mk I	08/79->	1.138
Twingo (CN0_)	03/07->	1.119 - 1.120	Astra Mk II, Belmont	10/84->08/91	1.139
Vel Satis (BJ0)	06/02->	1.120	Astra Mk III	09/91->	1.139 - 1.140
19 II	04/92->12/95	1.120	Astra Mk IV	02/98->03	1.140 - 1.141
Master II	07/98->10/03	1.120	Astra Mk V	03/04->02/07	1.141 - 1.143
Trafic (JL/EL/FL)	03/01->	1.121	Calibra	06/90->07/97	1.144
Saab			Carlton Mk I	11/82->09/86	1.144
900 I	08/86->06/94	1.121	Cavalier Mk II	81->84	1.144
9000	04/88->08/94	1.121	Cavalier Mk III	10/88->09/95	1.144 - 1.145
Seat			Corsa Mk II	10/00->03/03	1.145
Alhambra (7V8, 7V9)	04/96->	1.121 - 1.122	Corsa Mk III	07/06->	1.145
Altea (5P1)	03/04->	1.122	Corsavan Mk II	10/00->03/03	1.145
Altea XL (5P5)	10/06->	1.123	Nova Mk I	03/83->02/93	1.145 - 1.146
Arosa (6H)	05/97->06/04	1.123 - 1.124	Omega	03/94->07/03	1.146 - 1.147
Cordoba I	02/93->06/99	1.124	Signum	05/03->08/05	1.148
Cordoba II Hatchback	06/99->10/02	1.124	Vectra	02/99->	1.148
Cordoba II Vario (6K5)	06/99->12/03	1.125	Vectra Mk II	04/02->08/05	1.149
Cordoba III (6L2)	09/02->	1.125	Zafira	04/99->	1.149
Ibiza I (021A)	03/91->12/93	1.125	Zafira Mk II	07/05->	1.150
Ibiza II (6K1)	03/93->08/99	1.125 - 1.126	Volkswagen		
Ibiza III (6K1)	08/99->02/02	1.126	Bora (1J2, 1J6)	10/98->07/05	1.150 - 1.151
Ibiza IV (6L1)	02/02->	1.127	Caddy I (14)	08/82->07/92	1.152
Inca (6K9)	11/95->	1.127	Caddy II (9KA9, 9K9B, 9U7)	11/95->	1.152
Leon (1M1)	11/99->	1.127 - 1.128	Caddy III (2KA, 2KB)	03/04->	1.152 - 1.153
Leon (1P1)	09/05->	1.128	Corrado (53I)	09/88->12/95	1.153 - 1.154
Toledo I (1L)	05/91->03/99	1.128 - 1.130	Derby II (86C, 80)	08/81->12/84	1.154
Toledo II (1M2)	04/99->05/06	1.131	Eos	05/06->	1.155
Toledo III (5P2)	10/04->	1.131	Golf I (17, 155)	07/74->08/93	1.155 - 1.156
Skoda			Golf II (19E, 1G1)	08/83->12/92	1.156 - 1.157
Fabia (6Y)	08/99->	1.132 - 1.133	Golf III (1H1, 1H5, 1E7)	08/91->06/02	1.158 - 1.164
Fabia II	12/06->	1.133 - 1.134	Golf IV (1J1, 1J5)	08/97->06/05	1.164 - 1.167
Felicia I	10/94->03/98	1.134	Golf V (1K1)	10/94->06	1.167 - 1.171
			Golf V Plus (5M1), CrossGolf	01/05->02/09	1.172 - 1.173





Manufacturer Model	Model year	Page
Volkswagen		
Jetta I (17)	08/78->02/84	1.173
Jetta II (19E, 1G2)	01/84->10/91	1.173 - 1.174
Jetta III (1K2)	08/05->	1.175 - 1.176
Lupo (6X1, 6E1)	09/98->07/05	1.176
Passat (32B)	08/80->03/88	1.176
Passat (3A2, 3A5, 35I)	02/88->05/97	1.176 - 1.180
Passat (3B2, 3B5)	08/96->11/00	1.180 - 1.181
Passat (3B3, 3B6)	11/00->08/05	1.181
Passat (3C2, 3C5)	03/05->	1.181 - 1.182
Polo I (86)	03/75->09/81	1.183
Polo II (86C, 80)	10/81->09/94	1.183 - 1.184
Polo III (6N1)	10/94->10/99	1.185 - 1.187
Polo III (6N2)	10/99->10/01	1.187 - 1.188
Polo IV (9N_)	10/01->04/05	1.188
Polo IV (9N2)	05/05->	1.189
Scirocco (53B)	06/81->07/92	1.189
Sharan (7M8, 7M9, 7M6)	09/95->	1.189 - 1.191
Tiguan	09/07->	1.191
Touareg (7LA, 7L6, 7L7)	10/02->	1.192
Touran, CrossTouran (1T1, 1T2)	02/03->	1.192 - 1.193
Vento (1H2)	11/91->09/98	1.193 - 1.194
Crafter (2E)	04/06->	1.195
LT I	04/75->	1.195 - 1.197
LT II	05/96->	1.197
Transporter (T2)	08/71->07/79	1.198
Transporter (T3)	05/79->07/92	1.198 - 1.199
Transporter (T4)	09/90->04/03	1.199 - 1.200
Multivan, Transporter (T5)	04/03->	1.201 - 1.202
Volvo		
C70	03/97->09/02	1.202
S40 I (VS)	07/95->12/03	1.203
S70	01/97->11/00	1.203 - 1.204
S80	05/98->12/00	1.204
V40 (VW)	07/95->06/04	1.204 - 1.205
V70 I Estate	01/97->11/00	1.205
850 (LS, LW)	08/93->10/97	1.205
940 (944)	08/90->12/94	1.206
960 (964)	08/90->07/94	1.206







Alfa Romeo - Audi



Manufacturer Model	Model year	Part no.	Pk.	Note
Alfa Romeo				
145, 146 (930)		2BA 007 042-031	1	Indicator light (white), left
145 (930)	07/94->01/01	2BA 007 042-041	1	Indicator light (white), right
146 (930)	12/94->01/01			(E1) 0126  1x12V21W (PY21W) 8GA 006 841-121
				
Audi				
A2 (8Z0)		6NM 007 878-041	1	Setting element, headlight levelling
A2 (8Z0)	02/00->12/03			
				
A2 (8Z0)		9EL 270 107-011	1	Body/lens for auxiliary indicator light (white)
A2 (8Z0)	02/00->08/05			(E26) 002  1x12V5W (W5W) 8GP 003 594-121
				
A3 (8L1)		1LL 008 306-151	1	DE-H1/H7 headlight, left, with indicator light, without headlight leveller actuator, with bulbs
A3	09/00->05/03	1LL 008 306-161	1	DE-H1/H7 headlight, right, with indicator light, without headlight leveller actuator, with bulbs
				(E1) 1077 (E1) 1078  1x12V55W (H1) 8GH 002 089-133  1x12V55W (H7) 8GH 007 157-121  1x12V5W (W5W) 8GP 003 594-121  1x12V21W (PY21W) 8GA 006 841-121
A3	09/96->08/00	6NM 007 878-531	1	Setting element, headlight levelling
				
A3	09/00->05/03	6NM 007 878-541	1	Setting element, headlight levelling
				









Manufacturer Model	Model year	Part no.	Pk.	Note
Audi				
A3 (8L1) A3 (-) S3	09/96->08/00	9EL 963 111-011 9EL 963 112-011	1 1	Body/lens for indicator light (clear), left Body/lens for indicator light (clear), right E1 390 1x12V21W (PY21W) 8GA 006 841-121
				
A3 (8P1) A3 A3 Sportback A3 Convertible	07/08-> 07/08-> 04/08->	1LJ 009 648-031 1LJ 009 648-041	1 1	FF®-H7 headlight, left, with indicator light, with daytime running light, with electr. headlight leveller actuator, with bulbs FF®-H7 headlight, right, with indicator light, with daytime running light, with electr. headlight leveller actuator, with bulbs 2x12V55W (H7) 8GH 007 157-121 1x12V19W (P24W) 1x12V24W (PY24W) 1x12V5W (W5W) 8GP 003 594-121
				
A3 A3 Sportback	05/03->06/08 09/04->06/08	1N0 247 003-011 1N0 247 003-021	1 1	FF®-H7 fog light, left, with bulb FF®-H7 fog light, right, with bulb E1 1559 1x12V55W (H7) 8GH 007 157-121
for PR no. 2JB, 2JW (standard bumper, not painted)				
				
A4 (8D2, 8D5, B5) A4	06/99->09/01	6NM 007 878-041	1	Setting element, headlight levelling (for halogen headlight)
from chassis no. 8D-X-200 001				
				



Audi



Manufacturer Model	Model year	Part no.	Pk.	Note
Audi				
A4 (8D2, 8D5, B5) A4 chassis no. 8D-X-200 001 -> 8D-1-200 000	06/99->09/01	6NM 007 878-041	1	Setting element, headlight levelling (for xenon headlight)
				
A4	01/95->05/99	9EL 158 254-011 9EL 158 254-021	1 1	Body/lens for indicator light (white), left Body/lens for indicator light (white), right E4 474  1x12V21W (PY21W) 8GA 006 841-121
				
A4	05/99->09/01	9EL 270 107-011	1	Body/lens for auxiliary indicator light (white) E26 002  1x12V5W (W5W) 8GP 003 594-121
				
A4 (8E2, 8E5, B6) A4 up to chassis no. 8E-5-400 000	11/00->12/04	6NM 007 878-041	1	Setting element, headlight levelling (for halogen headlight)
				
A4 (-) S4 quattro	11/00->12/04	1N0 009 594-011 1N0 009 594-021	1 1	FF®-H11 fog light, left, with bulb FF®-H11 fog light, right, with bulb E4 19259  1x12V55W (H11) 8GH 008 358-121
				
A4 (-) Avant, S4	11/00->12/04	9EL 153 923-021 9EL 153 924-021	1 1	Body/lens for combination rearlight, left, with reverse and rear fog light Body/lens for combination rearlight, right, with reverse and rear fog light E1 1110 1x12V5W (R5W) 8GA 002 071-121 1x12V21W (P21W) 8GA 002 073-121 1x12V21W (PY21W) 8GA 006 841-121 1x12V21/5W (P21/5W) 8GD 002 078-121
				



Manufacturer Model	Model year	Part no.	Pk.	Note
Audi				
A4 (8EC, 8ED) A4 for PR no. VJ2, VJ3, VJ4, VK1, 2K2, 2K3, 2K4, 2K7, 2K8	11/04->04/08	1N0 009 594-011 1N0 009 594-021 1N0 010 380-011 1N0 010 380-021	1 1 1 1	FF®-H11 fog light, left, with bulb FF®-H11 fog light, right, with bulb Manufacturer restriction: AL E4 19259 FF®-H11 fog light, left, with bulb FF®-H11 fog light, right, with bulb Manufacturer restriction: Valeo E4 19507 1x12V55W (H11) 8GH 008 358-121
A4 (-) Avant	11/04->11/07	2VP 965 037-051 2VP 965 037-061	1 1	Combination rearlight with reverse light, left, with bulbs Combination rearlight with reverse light, right, with bulbs E1 1789 4x12V21W (P21W) 8GA 002 073-121
A4 (-) Avant	11/04->11/07	2SA 965 038-031 2SA 965 038-041	1 1	Rear-rear fog light, left, with bulb Rear-rear fog light, right, with bulb E1 1789 1x12V21W (P21W) 8GA 002 073-121
A4 Cabriolet (8H7, 8HE) A4 Cabriolet	08/06->	1N0 010 380-011 1N0 010 380-021	1 1	H11 fog light, left, with bulb H11 fog light, right, with bulb E4 19507 1x12V55W (H11) 8GH 008 358-121



Audi



Manufacturer Model	Model year	Part no.	Pk.	Note
Audi				
A6 (4A, C4) A6	06/94->12/97		9ES 145 599-001 9ES 145 600-001	1 1 DE-H1 headlight, with DE-H3 fog light, spare parts available only E1 17199 E1 44478 Spare Parts: Lens, left Lens, right 2x12V55W (H1) 8GH 002 089-133 1x12V55W (H3) 8GH 002 090-133 1x12V5W (W5W) 8GP 003 594-121
A6	06/94->12/97		6NM 007 282-211	1 Setting element, headlight levelling
A6	06/94->12/97		9EL 145 833-021 9EL 145 834-021	1 1 Body/lens for indicator light (white), left Body/lens for indicator light (white), right E4 455 1x12V21W (PY21W) 8GA 006 841-121
A6	06/94->12/97		2BM 003 647-021	1 Auxiliary indicator light E1 151 1x12V5W (W5W) 8GP 003 594-121
A6 (-) Avant	06/94->10/97		9EL 138 567-061 9EL 138 568-061	1 1 Body/lens for combination rearlight, left Body/lens for combination rearlight, right E1 63256 E1 63266 1x12V21/5W (P21/5W) 8GD 002 078-121 1x12V21W (P21W) 8GA 002 073-121
A6 Avant	06/94->12/97		9EL 140 063-021 9EL 140 064-021	1 1 Body/lens for combination rearlight, left Body/lens for combination rearlight, right E1 63256 1x12V21/5W (P21/5W) 8GD 002 078-121 1x12V21W (P21W) 8GA 002 073-121



Manufacturer Model	Model year	Part no.	Pk.	Note
Audi				
A6 (4A, C4)		9EL 145 997-021	1	Body/lens for rear fog and reverse light, left
A6	06/94->10/97	9EL 145 998-021	1	Body/lens for rear fog and reverse light, right
(-) S6				281 2x12V21W (P21W) 8GA 002 073-121
A6 Avant	06/94->12/97			
(-) S6				
A6 (4B, C5)		1LL 007 821-291	1	DE-H1/FF®-H7 headlight, left, with indicator light
A6	01/97->08/99	1LL 007 821-301	1	DE-H1/FF®-H7 headlight, right, with indicator light
except 8 cyl.				590 591 1x12V55W (H1) 8GH 002 089-133 1x12V55W (H7) 8GH 007 157-121 1x12V5W (W5W) 8GP 003 594-121 1x12V21W (PY21W) 8GA 006 841-121
A6	01/97->05/01	6NM 007 878-531	1	Setting element, headlight levelling
except 8 cyl. except allroad				
A6	05/01->05/03	6NM 007 878-521	1	Setting element, headlight levelling (for halogen headlight)
A6	01/97->08/99	1NL 007 906-031	1	DE-H3 fog light, left
except 8 cyl.		1NL 007 906-041	1	DE-H3 fog light, right
A6 8 cyl.	11/98->01/05			123 1x12V55W (H3) 8GH 002 090-133



Audi



Manufacturer Model	Model year	Part no.	Pk.	Note
Audi				
A6 (4B, C5) A6 except 8 cyl.	06/01->01/05	1N0 246 039-011 1N0 246 039-021	1 1	FF®-H7 fog light, left, with bulb FF®-H7 fog light, right, with bulb 1266 1x12V55W (H7) 8GH 007 157-121
A6	01/99->01/05	9EL 270 107-011	1	Body/lens for auxiliary indicator light (white) 002 1x12V5W (W5W) 8GP 003 594-121
A6 (-) Avant	01/97->05/01	9EL 148 141-021 9EL 148 142-021	1 1	Body/lens for combination rearlight (grey/red), left, with reverse light Body/lens for combination rearlight (grey/red), right, with reverse light 475 1x12V21/5W (P21/5W) 8GD 002 078-121 2x12V21W (P21W) 8GA 002 073-121
A6 (-) Avant	06/01->01/05	2VP 008 468-051 2VP 008 468-061	1 1	Combination rearlight, left, with reverse light, with bulbs Combination rearlight, right, with reverse light, with bulbs 1142 1x12V21/5W (P21/5W) 8GD 002 078-121 2x12V21W (P21W) 8GA 002 073-121
A6 (-) Avant	01/97->01/05	9EL 007 727-801 8RA 004 412-041	1 10	Design combination rearlight set (black) without bulb holder 475 Spare Parts: Reflex-reflector (red) 2x12V21/5W (P21/5W) 8GD 002 078-121 4x12V21W (P21W) 8GA 002 073-121













Manufacturer Model	Model year	Part no.	Pk.	Note
Audi				
A6 (4B, C5) A6 (-) Avant	01/97->01/05	9EL 007 727-811 8RA 004 412-041	1 10	Design combination rearlight set (brilliant silver) without bulb holder (E1) 475 Spare Parts: Reflex-reflector (red) 2x12V21/5W (P21/5W) 8GD 002 078-121 4x12V21W (P21W) 8GA 002 073-121
A6 Allroad (4BH) A6 Allroad (4BH)	05/00->08/05	9EL 270 107-011	1	Body/lens for auxiliary indicator light (white) (E26) 002 1x12V5W (W5W) 8GP 003 594-121
A6 (4F2, 4F5) A6 (-) S6, RS6	05/04->10/08	1LE 008 880-031 1LE 008 880-041	1 1	FF®-H7/H1 headlight, left, with indicator light, with electr. headlight leveller actuator, with bulbs FF®-H7/H1 headlight, right, with indicator light, with electr. headlight leveller actuator, with bulbs (E1) 1755 2x12V55W (H7) 8GH 007 157-121 1x12V55W (H1) 8GH 002 089-133 1x12V21W (PY21W) 8GA 006 841-121 1x12V5W (W5W) 8GP 003 594-121
A6 Special equipment (-) S6, RS6 (-) bend lighting	05/04->10/08	1LL 008 881-431 1LL 008 881-441	1 1	Bi-Xenon® headlight, left, with indicator light, with daytime running light, with headlight leveller actuator, without xenon ballast, without gas discharge bulb, with bulbs Bi-Xenon® headlight, right, with indicator light, with daytime running light, with headlight leveller actuator, without xenon ballast, without gas discharge bulb, with bulbs (E1) 1755 1x35W (D2S) 8GS 007 949-101 1x12V21W (P21W) 8GA 002 073-121 1x12V21W (PY21W) 8GA 006 841-121 1x12V5W (W5W) 8GP 003 594-121



Audi



Manufacturer Model	Model year	Part no.	Pk.	Note
Audi				
A6 (4F2, 4F5) A6 (-) S6, RS6 for PR no. 8BD, AV0	10/08->	1LJ 009 925-031 1LJ 009 925-041	1 1	FF®-H7/H15 headlight, left, with indicator light, with daytime running light, with electric headlight leveller actuator, with bulbs FF®-H7/H15 headlight, right, with indicator light, with daytime running light, with electric headlight leveller actuator, with bulbs  1x12V55W (H7) 8GH 007 157-201 Long Life  1x12V55/15W (H15)  1x12V21W (PY21W) 8GA 006 841-121  1x12V5W (W5W) 8GP 003 594-121
A6	05/04->10/08	5DV 008 290-004	1	Ballast unit 
A6	05/04->10/08	1N0 354 013-011 1N0 354 013-021	1 1	H7 fog light, left H7 fog light, right Ⓔ19052  1x12V55W (H7) 8GH 007 157-121
A6 Allroad (4FH) A6 Allroad	05/06->10/08	1LE 008 880-031 1LE 008 880-041	1 1	H1/H7 headlight, left, with indicator light, with electr. headlight leveller actuator, with bulbs H1/H7 headlight, right, with indicator light, with electr. headlight leveller actuator, with bulbs Ⓔ1755  2x12V55W (H7) 8GH 007 157-121  1x12V55W (H1) 8GH 002 089-133  1x12V21W (PY21W) 8GA 006 841-121  1x12V5W (W5W) 8GP 003 594-121



Manufacturer Model	Model year	Part no.	Pk.	Note
Audi				
A6 Allroad (4FH) A6 Allroad (-) bend lighting	05/06->10/08	1LL 008 881-431 1LL 008 881-441	1 1	Bi-Xenon® headlight, left, with indicator light, with daytime running light, with headlight leveller actuator, without xenon ballast, without gas discharge bulb, with bulbs Bi-Xenon® headlight, right, with indicator light, with daytime running light, with headlight leveller actuator, without xenon ballast, without gas discharge bulb, with bulbs ⓔ1 1755 1x35W (D2S) 8GS 007 949-101 1x12V21W (P21W) 8GA 002 073-121 1x12V21W (PY21W) 8GA 006 841-121 1x12V5W (W5W) 8GP 003 594-121
A6 Allroad for PR no. 8BD, AV0	10/08->	1LJ 009 925-031 1LJ 009 925-041	1 1	FF®-H7/H15 headlight, left, with indicator light, with daytime running light, with electric headlight leveller actuator, with bulbs FF®-H7/H15 headlight, right, with indicator light, with daytime running light, with electric headlight leveller actuator, with bulbs 1x12V55W (H7) 8GH 007 157-201 Long Life 1x12V55/15W (H15) 1x12V21W (PY21W) 8GA 006 841-121 1x12V5W (W5W) 8GP 003 594-121
A6 Allroad	05/06->10/08	5DV 008 290-004	1	Ballast unit
A6 Allroad	05/06->10/08	1N0 354 013-011 1N0 354 013-021	1 1	H7 fog light, left H7 fog light, right ⓔ4 19052 1x12V55W (H7) 8GH 007 157-121
A8 (4D2, 4D8) A8	01/99->	9EL 270 107-011	1	Body/lens for auxiliary indicator light (white) ⓔ26 002 1x12V5W (W5W) 8GP 003 594-121



Audi



Manufacturer Model	Model year	Part no.	Pk.	Note
Audi				
A8 (4E_) A8 (-) W12 up to chassis no. 4E-5-030 000	10/02->05/05	1EL 008 540-551 1EL 008 540-561	1 1	Bi-Xenon®/H7 headlight, left, with indicator light, with dynam. headlight leveller, without xenon ballast, without gas discharge bulb, without bulbs Bi-Xenon®/H7 headlight, right, with indicator light, with dynam. headlight leveller, without xenon ballast, without gas discharge bulb, without bulbs E1 1475 1x35W (D2S) 8GS 007 949-101 1x12V55W (H7) 8GH 007 157-121 1x12V5W (W5W) 8GP 003 594-121
A8 (-) W12 from chassis no. 4E-6-000 001	06/05->	1EL 009 236-611 1EL 009 236-621	1 1	Bi-Xenon® headlight, left, with indicator light, with daytime running light, with headlight leveller actuator, without xenon ballast, without gas discharge bulb, with bulbs Bi-Xenon® headlight, right, with indicator light, with daytime running light, with headlight leveller actuator, without xenon ballast, without gas discharge bulb, with bulbs E1 1773 E1 1994 1x35W (D2S) 8GS 007 949-101 1x12V21W (P21W) 8GA 002 073-121 1x12V5W (W5W) 8GP 003 594-121
S8	06/06->	1N0 354 013-011 1N0 354 013-021	1 1	H7 fog light, left H7 fog light, right E4 19052 1x12V55W (H7) 8GH 007 157-121
Cabriolet (B4) Cabriolet	05/91->01/98	1NL 005 150-111 1NL 005 150-121	1 1	DE-H3 fog light, left DE-H3 fog light, right E1 18242 1x12V55W (H3) 8GH 002 090-133
Cabriolet all models with auxiliary indicators as standard feature	05/91->08/00	2BM 003 647-021	1	Auxiliary indicator light E1 151 1x12V5W (W5W) 8GP 003 594-121



Manufacturer Model	Model year	Part no.	Pk.	Note
Audi				
Coupé (89, 8B) Coupé	10/88->08/91	1NL 005 150-051 1NL 005 150-061	1 1	DE-H3 fog light, left DE-H3 fog light, right E1 18208 1x12V55W (H3) 8GH 002 090-133
Coupé	09/91->12/96	1NL 005 150-111 1NL 005 150-121	1 1	DE-H3 fog light, left DE-H3 fog light, right E1 18242 1x12V55W (H3) 8GH 002 090-133
Q7 Q7	03/06->	6NM 007 878-041	1	Setting element, headlight levelling (for halogen headlight)
Q7	03/06->	1N0 247 003-011 1N0 247 003-021	1 1	FF®-H7 fog light, left, with bulb FF®-H7 fog light, right, with bulb E1 1559 1x12V55W (H7) 8GH 007 157-121
TT (8N) TT (8N)	10/98->	9EL 270 107-011	1	Body/lens for auxiliary indicator light (white) E26 002 1x12V5W (W5W) 8GP 003 594-121
V8 (D1) V8 all models with auxiliary indicators as standard feature	10/88->02/94	2BM 003 647-021	1	Auxiliary indicator light E1 151 1x12V5W (W5W) 8GP 003 594-121









Audi



Manufacturer Model	Model year	Part no.	Pk.	Note
Audi				
V8 (D1) V8	10/88->02/94	9EL 126 339-061 9EL 126 340-061	1 1	Body/lens for combination rearlight, left Body/lens for combination rearlight, right E1 42762 E1 53344 1x12V10W (R10W) 8GA 002 071-131 1x12V21/5W (P21/5W) 8GD 002 078-121 1x12V21W (P21W) 8GA 002 073-121
80 (81, 85, B2) 80	08/84->08/86	9EL 129 161-011 9EL 129 162-011	1 1	Body/lens for indicator light, left Body/lens for indicator light, right E1 42691 1x12V21W (P21W) 8GA 002 073-121
80 all models with auxiliary indicators as standard feature	08/84->08/86	2BM 003 647-021	1	Auxiliary indicator light E1 151 1x12V5W (W5W) 8GP 003 594-121
80	08/84->08/86	9EL 129 149-021 9EL 129 150-021	1 1	Body/lens for combination rearlight, left Body/lens for combination rearlight, right E1 53367 1x12V10W (R10W) 8GA 002 071-131 1x12V21/5W (P21/5W) 8GD 002 078-121 1x12V21W (P21W) 8GA 002 073-121
80	08/78->08/86	2JA 002 931-031	5	Interior light 1x12V10W (K) 8GM 002 091-131
80 (89, 89Q, 8A, B3) 80	06/86->10/91	9EL 135 007-001 9EL 135 008-001	1 1	Body/lens for indicator light (amber), left Body/lens for indicator light (amber), right E1 42750 1x12V21W (P21W) 8GA 002 073-121









Manufacturer Model	Model year	Part no.	Pk.	Note
Audi				
80 (89, 89Q, 8A, B3) 80	06/86->10/91	2BA 005 296-031 2BA 005 296-041	1 1	Indicator light (white), left, with bulb Indicator light (white), right, with bulb E1 52610 1x12V21W (PY21W) 8GA 006 841-121
				
80 all models with auxiliary indicators as standard feature	06/86->10/91	2BM 003 647-021	1	Auxiliary indicator light E1 151 1x12V5W (W5W) 8GP 003 594-121
				
80	06/86->10/91	9EL 131 651-031 9EL 131 652-031	1 1	Body/lens for combination rearlight, left Body/lens for combination rearlight, right E1 53399 1x12V10W (R10W) 8GA 002 071-131 1x12V21/5W (P21/5W) 8GD 002 078-121 1x12V21W (P21W) 8GA 002 073-121
				
80	06/86->10/91	9EM 131 613-021 9EM 131 614-021 9EL 131 613-031 9EL 131 614-031	1 1 1 1	Body/lens for rear fog and reverse light, left Body/lens for rear fog and reverse light, right Body/lens for reverse light, left Body/lens for reverse light, right E1 8760 E1 18430 2x12V21W (P21W) 8GA 002 073-121
				
80 (8C, B4) 80	09/91->01/96	1NL 005 150-111 1NL 005 150-121	1 1	DE-H3 fog light, left DE-H3 fog light, right E1 18242 1x12V55W (H3) 8GH 002 090-133
				
80 4/5 cyl.	09/91->01/96	9EL 141 605-011 9EL 141 606-011	1 1	Body/lens for indicator light (white), left Body/lens for indicator light (white), right E1 52627 1x12V21W (PY21W) 8GA 006 841-121
				
















Audi



Manufacturer Model	Model year	Part no.	Pk.	Note
Audi				
80 (8C, B4) 80 all models with auxiliary indicators as standard feature	09/91->01/96	2BM 003 647-021	1	Auxiliary indicator light E1 151 1x12V5W (W5W) 8GP 003 594-121 
80 (-) Avant	09/91->12/94	9EL 140 347-021 9EL 140 348-021	1 1	Body/lens for combination rearlight, left Body/lens for combination rearlight, right E1 63269 1x12V21/5W (P21/5W) 8GD 002 078-121 1x12V21W (P21W) 8GA 002 073-121 
90 (81, 85, B2) 90 all models with auxiliary indicators as standard feature	10/84->03/87	2BM 003 647-021	1	Auxiliary indicator light E1 151 1x12V5W (W5W) 8GP 003 594-121 
90	10/84->03/87	9EL 129 149-021 9EL 129 150-021	1 1	Body/lens for combination rearlight, left Body/lens for combination rearlight, right E1 53367 1x12V10W (R10W) 8GA 002 071-131 1x12V21/5W (P21/5W) 8GD 002 078-121 1x12V21W (P21W) 8GA 002 073-121 
90	10/84->03/87	2JA 002 931-031	5	Interior light 1x12V10W (K) 8GM 002 091-131 
90 (89, 89Q, 8A, B3) 90	04/87->09/91	1NL 005 150-051 1NL 005 150-061	1 1	DE-H3 fog light, left DE-H3 fog light, right E1 18208 1x12V55W (H3) 8GH 002 090-133 





Manufacturer Model	Model year	Part no.	Pk.	Note
Audi				
90 (89, 89Q, 8A, B3) 90 all models with auxiliary indicators as standard feature 	04/87->09/91	2BM 003 647-021	1	Auxiliary indicator light (E1) 151  1x12V5W (W5W) 8GP 003 594-121
90 	04/87->09/91	9EL 131 651-031 9EL 131 652-031	1 1	Body/lens for combination rearlight, left Body/lens for combination rearlight, right (E1) 53399  1x12V10W (R10W) 8GA 002 071-131  1x12V21/5W (P21/5W) 8GD 002 078-121  1x12V21W (P21W) 8GA 002 073-121
100 (44, 44Q, C3) 100	08/82->11/90	9EL 127 353-011 9EL 127 354-011	1 1	Body/lens for indicator light (amber), left Body/lens for indicator light (amber), right (E1) 42246  1x12V21W (P21W) 8GA 002 073-121
100 all models with auxiliary indicators as standard feature 	08/82->11/90	2BM 003 647-021	1	Auxiliary indicator light (E1) 151  1x12V5W (W5W) 8GP 003 594-121
100 (-) Avant 	08/82->11/90	9EL 126 339-021 9EL 126 340-021	1 1	Body/lens for combination rearlight, left Body/lens for combination rearlight, right (E1) 53344  1x12V10W (R10W) 8GA 002 071-131  1x12V21/5W (P21/5W) 8GD 002 078-121  1x12V21W (P21W) 8GA 002 073-121


















Audi



Manufacturer Model	Model year	Part no.	Pk.	Note
Audi				
100 (4A, C4) 100 (-) S4, TDI	12/90->07/94		9ES 137 169-015 9ES 137 170-015	H4 headlight, spare parts available only E1 17183 left E1 17184 right Spare Parts: 3 Lens, left 3 Lens, right  1x12V60/55W (H4) 8GJ 002 525-131  1x12V4W (T4W) 8GP 002 067-121
100	12/90->06/94		6NM 007 282-211	1 Setting element, headlight levelling
100 (-) S4, TDI	12/90->06/94		1NL 006 150-071 1NL 006 150-081	1 DE-H3 fog light, left, with bulb 1 DE-H3 fog light, right, with bulb E1 18235  1x12V55W (H3) 8GH 002 090-133
100 (-) S4, TDI	12/90->06/94		9EL 139 383-031 9EL 139 384-031	1 Body/lens for indicator light (amber), left 1 Body/lens for indicator light (amber), right E1 52604  1x12V21W (P21W) 8GA 002 073-121
100 (-) S4, TDI	12/90->06/94		2BA 006 386-071 2BA 006 386-081	1 Indicator light (white), left, with bulb, for conversion 1 Indicator light (white), right, with bulb, for conversion E1 52617  1x12V21W (PY21W) 8GA 006 841-121
100 S4, TDI	09/91->06/94		2BA 006 386-071 2BA 006 386-081	1 Indicator light (white), left, with bulb 1 Indicator light (white), right, with bulb E1 52617  1x12V21W (PY21W) 8GA 006 841-121



Manufacturer Model	Model year	Part no.	Pk.	Note
Audi				
100 (4A, C4) 100 all models with auxiliary indicators as standard feature 	12/90->06/94	2BM 003 647-021	1	Auxiliary indicator light (E1) 151  1x12V5W (W5W) 8GP 003 594-121
100 (-) Avant, S4 	12/90->06/94	9EL 138 567-031 9EL 138 568-031	1 1	Body/lens for combination rearlight, left Body/lens for combination rearlight, right (E1) 63256  1x12V21/5W (P21/5W) 8GD 002 078-121  1x12V21W (P21W) 8GA 002 073-121
100 (-) Avant, S4  	12/90->06/94	9EL 138 567-061 9EL 138 568-061	1 1	Body/lens for combination rearlight (red), left, for conversion Body/lens for combination rearlight (red), right, for conversion (E1) 63256 (E1) 63266  1x12V21/5W (P21/5W) 8GD 002 078-121  1x12V21W (P21W) 8GA 002 073-121
100 S4 (-) Avant 	09/91->06/94	9EL 138 567-061 9EL 138 568-061	1 1	Body/lens for combination rearlight (red), left Body/lens for combination rearlight (red), right (E1) 63256 (E1) 63266  1x12V21/5W (P21/5W) 8GD 002 078-121  1x12V21W (P21W) 8GA 002 073-121
100 Avant 	09/91->06/94	9EL 140 063-021 9EL 140 064-021	1 1	Body/lens for combination rearlight, left Body/lens for combination rearlight, right (E1) 63256  1x12V21/5W (P21/5W) 8GD 002 078-121  1x12V21W (P21W) 8GA 002 073-121










Audi - BMW










Manufacturer Model	Model year	Part no.	Pk.	Note
Audi				
100 (4A, C4) 100, Avant (-) S4	09/91->06/94	9EL 138 463-031 9EL 138 464-031	1 1	Body/lens for rear fog and reverse light, left Body/lens for rear fog and reverse light, right (E1) 8787 (E1) 18444 2x12V21W (P21W) 8GA 002 073-121
200 (44, 44Q) 200 all models with auxiliary indicators as standard feature	06/83->12/91	2BM 003 647-021	1	Auxiliary indicator light (E1) 151 1x12V5W (W5W) 8GP 003 594-121
200	06/83->12/91	9EL 126 339-021 9EL 126 340-021	1 1	Body/lens for combination rearlight, left Body/lens for combination rearlight, right (E1) 53344 1x12V10W (R10W) 8GA 002 071-131 1x12V21/5W (P21/5W) 8GD 002 078-121 1x12V21W (P21W) 8GA 002 073-121
BMW				
3 (E21) 3 (E21)	09/79->03/84	2JA 003 388-001	1	Interior light 1x12V10W (K) 8GM 002 091-131
3 (E30) 3 (E30) 316, 318i, 320i, 323i, 324d, 325e, 325i 325i Convertible	09/82->08/87 09/82->08/87 04/86->08/87	1K3 126 046-001 1K3 126 680-001 9AG 126 547-005	1 1 12	H1 headlight, spare parts available only (E1) 14464/1 (E1) 17050 Spare Parts: Main-beam unit, left Main-beam unit, right Lens-retaining rim 1x12V55W (H1) 8GH 002 089-133 1x12V4W (T4W) 8GP 002 067-121













Manufacturer Model	Model year	Part no.	Pk.	Note
BMW				
3 (E30)		1DL 005 630-011	1	DE-H1 headlight, left, not suitable for headlight leveller
3 (E30)	09/87->08/88	1DL 005 630-021	1	DE-H1 headlight, right, not suitable for headlight leveller
M3, 316i, 318i, 320i, 324d, 324td, 325i Saloon, Convertible	09/87->08/88			(E1) 7405 (E1) 34572
Touring	04/88->08/88	9BG 134 888-011 1K3 134 855-011 1K3 134 856-011	1 1 1	Spare Parts: Body with lens for dipped-beam, right Main-beam unit, left Main-beam unit, right
				
3 (E30)	09/88->06/94	1DL 005 930-371	1	Super DE-H1 headlight, left, for vehicles with or without headlight leveller
M3, 316i, 318i, 320i, 324d, 324td, 325i, 325iX Saloon	09/88->01/92	1DL 005 930-381	1	Super DE-H1 headlight, right, for vehicles with or without headlight leveller
Convertible	09/88->10/93			(E1) 7407 (E1) 34572
Touring	09/88->06/94	9BG 135 941-011 9BG 135 942-011 9DR 136 958-021 1K3 134 855-011 1K3 134 856-011	1 1 1 1 1	Spare Parts: Body with lens for dipped-beam, left Body with lens for dipped-beam, right Reflector with lens (module) for dipped-beam light Main-beam unit, left Main-beam unit, right
				
3 (E30)	09/82->08/87	1NB 123 581-001 1NB 123 582-001	1 1	H3 fog light unit, left H3 fog light unit, right
				
3 (E30)	09/82->08/87	9EL 146 607-001	5	Lens for indicator light
				
3 (E30)	09/87->06/94	2BA 007 275-011 2BA 007 275-021	1 1	Indicator light (amber), left Indicator light (amber), right
(-) M3				(E1) 42766
				
3 (E30)	09/82->06/94	2BM 003 933-031 2BM 003 933-041	1 1	Auxiliary indicator light, left Auxiliary indicator light, right
				
		(E1) 42627  1x12V5W (W5W) 8GP 003 594-121		

**BMW**

Manufacturer Model	Model year	Part no.	Pk.	Note
BMW				
3 (E30) 3 (E30)	09/82->06/94	2KA 004 331-031	4	Licence plate light  E1 22890 1x12V5W (C5W) 8GM 002 092-121
3 (E30) Saloon, Touring	09/82->06/94	2JA 003 388-001	1	Interior light  1x12V10W (K) 8GM 002 091-131
3 (E36) 3 (E36) Compact 316i, 318ti, 318tds, 323ti Compact	03/94->08/00 03/94->08/00	1LJ 007 143-051 1LJ 007 143-061 9ES 145 251-005 9ES 145 252-005 9GD 142 757-031	1 1 4 4 4	FF@-HB3/HB4 fog light, left, with electr. headlight leveller, with bulbs FF@-HB3/HB4 fog light, right, with electr. headlight leveller, with bulbs E1 80 left E1 81 right Spare Parts: Cover lens, left (without optical pattern) Cover lens, right (without optical pattern) Seal  1x12V51W (HB4) 8GH 005 636-121  1x12V60W (HB3) 8GH 005 635-121  1x12V5W (W5W) 8GP 003 594-121
3 (E36) M3, 316i, 318i, 318is, 318tds, 320i, 323i 2.5, 325i, 325td, 325tds, 328i Saloon Coupé Convertible Compact Touring	09/90->08/00 09/90->02/98 03/92->04/99 03/93->04/99 03/94->08/00 01/95->10/99	1LL 008 875-811 1LL 008 875-031 1LL 008 875-041	1 1 1	DE-H7/FF@-H7 headlight set (Upgrade) bright-metallized, with CELIS@ position lights, with bulbs E1 1563 left E1 1564 right Spare Parts: DE-H7/FF@-H7 headlight, left DE-H7/FF@-H7 headlight, right  4x12V55W (H7) 8GH 007 157-121
 Design				













Manufacturer Model	Model year	Part no.	Pk.	Note
BMW				
3 (E36)		6NM 004 375-311	1	Setting element, headlight levelling
3 (E36)	09/90->08/00			
Saloon	09/90->02/98			
Coupé	03/92->04/99			
Convertible	03/93->04/99			
Compact	03/94->08/00			
Touring	01/95->10/99			
				
3 (E36)	09/90->08/00	1NB 006 270-051	1	FF®-H1 fog light, left
Saloon	09/90->02/98	1NB 006 270-061	1	FF®-H1 fog light, right
Coupé	03/92->04/99			 18236
Convertible	03/93->04/99			 1x12V55W (H1) 8GH 002 089-133
Compact	03/94->08/00			
Touring	01/95->10/99			
				
3 (E46) Saloon, Touring		1LL 009 554-811	1	Upgrade headlight set, with integrated cornering light DynaView® Evo2, with bulbs
3 (E46)	02/98->09/01			
316i, 318i, 320d, 320i, 323i Saloon	02/98->09/01			 4x12V55W (H7) 8GH 007 157-121
Touring	10/99->09/01			
				
3 (E46)	09/01->02/05	1LG 009 059-031	1	H7 headlight, left, with electr. headlight leveller, with headlight leveller actuator, with bulbs
316i, 318d, 318i, 320d, 320i, 325i, 325iX, 330d, 330dX, 330i, 330iX Saloon, Touring	09/01->02/05	1LG 009 059-041	1	H7 headlight, right, with electr. headlight leveller, with headlight leveller actuator, with bulbs
		 9176		
		 2x12V55W (H7) 8GH 007 157-121		
		 1x12V5W (W5W) 8GP 003 594-121		
				



BMW



Manufacturer Model	Model year	Part no.	Pk.	Note
BMW				
3 (E46) Saloon, Touring		1ND 007 646-011	1	FF®-HB4 fog light, left, with bulb FF®-HB4 fog light, right, with bulb (E13) 0305  1x12V51W (HB4) 8GH 005 636-121
3 (E46)	02/98->09/01	1ND 007 646-021	1	
Saloon	02/98->09/01			
Touring	10/99->09/01			
				
3 (E46)	02/98->09/01	2BA 008 404-011	1	Indicator light (amber), left, with bulb Indicator light (amber), right, with bulb (E13) 193 left (E13) 194 right  1x12V21W (P21W) 8GA 002 073-121
Saloon	02/98->09/01	2BA 008 404-021	1	
Touring	10/99->09/01			
				
3 (E46)	02/98->09/01	2BA 008 404-031	1	Indicator light (white), left, with bulb, for conversion Indicator light (white), right, with bulb, for conversion  1x12V21W (PY21W) 8GA 006 841-121
Saloon	02/98->09/01	2BA 008 404-041	1	
Touring	10/99->09/01			
	 Design			
3 (E90) Saloon		2SK 010 083-801	1	Upgrade combination rearlight set (red/white) (E1) 2334  10x12V21W (P21W) 8GA 002 073-121  2x12V21W (PY21W) 8GA 006 841-121  2x12V21W (H21W) 8GH 008 417-001
3 (E90) Saloon 318d, 318i, 320d, 320i, 320si, 325d, 325i, 325xi, 330d, 330i, 330xd, 330xi, 335d, 335i, 335xi	01/05->09/08			
	 Design			














Manufacturer Model	Model year	Part no.	Pk.	Note
BMW				
5 (E28) 5 (E28)	06/81->12/87			H3 fog light, spare parts available only (E1) 8358 left (E1) 8359 right Spare Parts: 1 Light unit, left 1 Light unit, right 1x12V55W (H3) 8GH 002 090-133
		1NB 123 581-001 1NB 123 582-001	1 1	
5 (E28)	06/81->12/87	2BM 003 933-031 2BM 003 933-041	1 1	Auxiliary indicator light, left Auxiliary indicator light, right (E1) 42627 1x12V5W (W5W) 8GP 003 594-121
5 (E28) 518, 518i, 520i, 524d, 524td, 525e, 525i, 528i	06/81->12/87	2VP 003 685-071 2VP 003 685-081	1 1	Combination rearlight, left, with reverse and rear fog light Combination rearlight, right, with reverse and rear fog light (E1) 53321 1x12V5W (R5W) 8GA 002 071-121 4x12V21W (P21W) 8GA 002 073-121
5 (E28)	06/81->12/87	2KA 004 331-031	4	Licence plate light (E1) 22890 1x12V5W (C5W) 8GM 002 092-121
5 (E34) 5 (E34) 520i, 524td, 525i, 530i, 535i	01/88->08/88	9BG 136 027-011 9BG 136 028-011 1K3 132 253-011 1K3 132 266-011 9AH 131 741-011 9AH 131 740-011	1 1 1 1 2 2	DE-H1 headlight, spare parts available only (E1) 7401 (E1) 34572 Spare Parts: 1 Body with lens for dipped-beam, left 1 Body with lens for dipped-beam, right 1 Main-beam unit, left 1 Main-beam unit, right 2 Supporting frame, left 2 Supporting frame, right 2x12V55W (H1) 8GH 002 089-133 1x12V5W (W5W) 8GP 003 594-121



BMW



Manufacturer Model	Model year	Part no.	Pk.	Note
BMW				
5 (E34)				
5 (E34)	09/88->01/97			
M5, 518i, 520i, 524td, 525td, 525tds, 525i, 525iX, 530i, 535i, 540i Saloon	09/88->11/95			
Touring	01/92->01/97			
		9BG 135 927-011 9BG 135 928-011 9DR 135 926-015 1K3 132 253-011 1K3 132 266-011 9AG 144 019-005 9AH 131 741-011 9AH 131 740-011	1 1 1 1 1 10 2 2	<p>Super DE-H1 headlight, for vehicles with or without headlight leveller, spare parts available only</p> <p>Ⓔ1 7407 Ⓔ1 34572</p> <p>Spare Parts:</p> <p>Body with lens for dipped-beam, left Body with lens for dipped-beam, right Reflector with lens (module) for dipped-beam light Main-beam unit, left Main-beam unit, right Lens-retaining rim Supporting frame, left Supporting frame, right</p> <p> 2x12V55W (H1) 8GH 002 089-133</p> <p> 1x12V5W (W5W) 8GP 003 594-121</p>
5 (E34)	09/88->01/97	6NM 004 375-311	1	Setting element, headlight levelling
				
5 (E34)	01/88->11/95	2VA 005 553-111	1	Combination rearlight (amber/red), left
M5, 518i, 520i, 524td, 525td, 525tds, 525i, 525iX, 530i, 535i, 540i Saloon	01/88->11/95	2VA 005 553-121	1	Combination rearlight (amber/red), right
				<p>Ⓔ1 63215</p> <p> 1x12V10W (R10W) 8GA 002 071-131  2x12V21W (P21W) 8GA 002 073-121</p>
				
5 (E34)	01/88->11/95	2VA 005 553-131	1	Combination rearlight (red/white), left, for conversion
M5, 518i, 520i, 524td, 525td, 525tds, 525i, 525iX, 530i, 535i, 540i Saloon	01/88->11/95	2VA 005 553-141	1	Combination rearlight (red/white), right, for conversion
				<p>Ⓔ1 237 Ⓔ1 63215</p> <p> 1x12V10W (R10W) 8GA 002 071-131  1x12V21W (P21W) 8GA 002 073-121  1x12V21W (PY21W) 8GA 006 841-121</p>
				













Manufacturer Model	Model year	Part no.	Pk.	Note
BMW				
5 (E34)		2NR 005 554-111	1	Rear fog and reverse light, left
5 (E34)	01/88->11/95	2NR 005 554-121	1	Rear fog and reverse light, right
M5, 518i, 520i, 524td, 525td, 525tds, 525i, 525iX, 530i, 535i, 540i Saloon	01/88->11/95			(E1) 8769 (E1) 18437 1x12V10W (K) 8GM 002 091-131 1x12V21W (P21W) 8GA 002 073-121
				
5 (E39)		1LL 007 250-011	1	DE-HB4/HB3 headlight, left, with body/lens for indicator light, with electr. headlight leveller actuator, with bulbs
5 (E39)	11/95->08/00	1LL 007 250-021	1	DE-HB4/HB3 headlight, right, with body/lens for indicator light, with electr. headlight leveller actuator, with bulbs
520d, 520i, 523i, 525d, 525td, 525tds, 528i, 530d, 535i, 540i Saloon	11/95->08/00			(E1) 297 (E1) 298
Touring	03/97->08/00			Spare Parts:
except M5		9ES 152 179-001	1	Cover lens, left (without optical pattern)
		9ES 152 180-001	1	Cover lens, right (without optical pattern)
				1x12V51W (HB4) 8GH 005 636-121 1x12V60W (HB3) 8GH 005 635-121 1x12V5W (W5W) 8GP 003 594-121 1x12V21W (P21W) 8GA 002 073-121
5 (E39)	11/95->08/00			Conversion for vehicles ->08/2000 with halogen dipped-beam light as standard
520d, 520i, 523i, 525d, 525td, 525tds, 528i, 530d, 535i, 540i Saloon	11/95->08/00			DE-H7/FF®-H7 headlight with clear indicator light lenses, the following components must be ordered:
Touring	03/97->08/00	1LL 008 053-591	1	DE-H7/FF®-H7 headlight, left, with indicator light (clear lens), with headlight leveller actuator, with bulbs
		1LL 008 053-601	1	DE-H7/FF®-H7 headlight, right, with indicator light (clear lens), with headlight leveller actuator, with bulbs
		8KB 157 198-801	1	Harness
				(E1) 1182
		9DX 153 746-011	1	Spare Parts: Reflectorgroup (CELIS®)
				2x12V55W (H7) 8GH 007 157-121 1x12V21W (PY21W) 8GA 006 841-121



BMW



Manufacturer Model	Model year	Part no.	Pk.	Note
BMW				
5 (E39)		1LL 008 053-591	1	DE-H7/FF®-H7 headlight, left, with indicator light (clear lens), with headlight leveller actuator, with bulbs
5 (E39)	09/00->06/04	1LL 008 053-601	1	DE-H7/FF®-H7 headlight, right, with indicator light (clear lens), with headlight leveller actuator, with bulbs
M5, 520i, 525d, 525i, 525td, 525tds, 530d, 535i, 540i Saloon	09/00->07/03			Ⓔ1 1182
Touring	09/00->06/04	9DX 153 746-011	1	Spare Parts: Reflectorgroup (CELIS®)  2x12V55W (H7) 8GH 007 157-121  1x12V21W (PY21W) 8GA 006 841-121
				
5 (E39) M5	09/00->07/03	1LL 008 052-591	1	Xenon/FF®-H7 headlight, left, with indicator light (clear lens), with headlight leveller actuator, with xenon ballast, with gas discharge bulb, with bulbs
		1LL 008 052-601	1	Xenon/FF®-H7 headlight, right, with indicator light (clear lens), with headlight leveller actuator, with xenon ballast, with gas discharge bulb, with bulbs
		5DV 007 760-651	1	Ballast unit
		9DX 153 746-011	1	Reflectorgroup (CELIS®)  1x35W (D2S) 8GS 007 949-101  2x12V55W (H7) 8GH 007 157-121  1x12V21W (PY21W) 8GA 006 841-121
				
5 (E39)	11/95->06/04	5DV 007 760-651	1	Ballast unit
				
5 (E39)	11/95->08/00	9ES 152 179-801	1	Cover lens set for headlights (without optical pattern), with lenses for indicator light (clear) and 12V21W (PY21W)-Long Life-bulbs, for conversion
		9ES 152 179-001	1	Cover lens (without optical pattern), left, with lens for indicator light (clear) and 12V21W (PY21W)-Long Life-bulb
		9ES 152 180-001	1	Cover lens (without optical pattern), right, with lens for indicator light (clear) and 12V21W (PY21W)-Long Life-bulb  2x12V21W (PY21W) Long Life
 Design				













Manufacturer Model	Model year	Part no.	Pk.	Note
BMW				
5 (E39) 5 (E39)	09/97->08/00	1NA 009 026-011 1NA 009 026-021	1 1	FF®-H7 fog light, left, with bulb FF®-H7 fog light, right, with bulb (E12) 19094 1x12V55W (H7) 8GH 007 157-121
5 (E39) 520d, 520i, 523i, 525d, 525td, 525tds, 528i, 530d, 535i, 540i Saloon (-) M5	11/95->08/00 11/95->08/00	9EL 146 293-031 9EL 146 294-031	1 1	Body/lens for combination rearlight (amber/red), left, with reverse and rear fog light Body/lens for combination rearlight (amber/red), right, with reverse and rear fog light (E1) 285 2x12V5W (R5W) 8GA 002 071-121 4x12V21W (P21W) 8GA 002 073-121
5 (E39) 520d, 520i, 523i, 525d, 525td, 525tds, 528i, 530d, 535i, 540i Saloon (-) M5	11/95->08/00 11/95->08/00	2VP 007 240-091 2VP 007 240-101	1 1	Combination rearlight (red/white), left, with reverse and rear fog light, with 12V21W (PY21W) bulb, for conversion Combination rearlight (red/white), right, with reverse and rear fog light, with 12V21W (PY21W) bulb, for conversion (E1) 567 2x12V5W (R5W) 8GA 002 071-121 1x12V21W (PY21W) 8GA 006 841-121 3x12V21W (P21W) 8GA 002 073-121
5 (E39) M5 Saloon	12/98->08/00	2VP 007 240-091 2VP 007 240-101	1 1	Combination rearlight (red/white), left, with reverse and rear fog light, with 12V21W (PY21W) bulb Combination rearlight (red/white), right, with reverse and rear fog light, with 12V21W (PY21W) bulb (E1) 567 2x12V5W (R5W) 8GA 002 071-121 1x12V21W (PY21W) 8GA 006 841-121 3x12V21W (P21W) 8GA 002 073-121





BMW



Manufacturer Model	Model year	Part no.	Pk.	Note
BMW				
5 (E39)		2VP 008 272-821	1	CELIS® LED combination rearlight set (black/red), with LED tail light
5 (E39)	11/95->08/00			E1 1070 E1 1071
520d, 520i, 523i, 525d, 525td, 525tds, 528i, 530d, 535i, 540i Saloon	11/95->08/00	9EL 153 567-061	1	Spare Parts: Body/lens, left  4x12V21W (P21W) 8GA 002 073-121  2x12V21W (PY21W) 8GA 006 841-121  2x12V16W (W16W) 8GA 008 246-001
 <div style="text-align: right; color: white; background-color: red; padding: 2px 5px; font-weight: bold;">Design</div>				
5 (E39)		2VP 008 272-861	1	CELIS® LED combination rearlight set (white/red), with LED tail light
5 (E39)	11/95->08/00			E1 1070 E1 1071
520d, 520i, 523i, 525d, 525td, 525tds, 528i, 530d, 535i, 540i Saloon	11/95->08/00	9EL 153 567-101	1	Spare Parts: Body/lens, left Body/lens, right  6x12V21W (P21W) 8GA 002 073-121  2x12V21W (PY21W) 8GA 006 841-121
 <div style="text-align: right; color: white; background-color: red; padding: 2px 5px; font-weight: bold;">Design</div>				
5 (E39)		2SK 008 272-831	1	CELIS® LED combination rearlight set (brilliant silver), with LED tail light
5 (E39)	11/95->08/00			E1 1070 E1 1071
520d, 520i, 523i, 525d, 525td, 525tds, 528i, 530d, 535i, 540i Saloon	11/95->08/00			 6x12V21W (P21W) 8GA 002 073-121  2x12V21W (PY21W) 8GA 006 841-121
 <div style="text-align: right; color: white; background-color: red; padding: 2px 5px; font-weight: bold;">Design</div>				




Manufacturer Model	Model year	Part no.	Pk.	Note
BMW				
5 (E39) 5 (E39) 520i, 525d, 525i, 525td, 525tds, 530d, 535i, 540i Saloon (-) M5	09/00->07/03	2VP 008 272-231	1	Combination rearlight, left, with reverse and rear fog light, with LED tail light, with bulbs, indicator light with amber lens Combination rearlight, right, with reverse and rear fog light, with LED tail light, with bulbs, indicator light with amber lens
		2VP 008 272-241	1	(E1) 1070 4x12V21W (P21W) 8GA 002 073-121
5 (E39) 520i, 525d, 525i, 525td, 525tds, 530d, 535i, 540i Saloon (-) M5	09/00->07/03	2VP 008 272-211	1	Combination rearlight, left, with reverse and rear fog light, with LED tail light, with bulbs, indicator light with clear lens, for conversion Combination rearlight, right, with reverse and rear fog light, with LED tail light, with bulbs, indicator light with clear lens, for conversion
		2VP 008 272-221	1	(E1) 1070 (E1) 1071 3x12V21W (P21W) 8GA 002 073-121 1x12V21W (PY21W) 8GA 006 841-121
5 (E39) M5 Saloon	09/00->07/03	2VP 008 272-211	1	Combination rearlight, left, with reverse and rear fog light, with LED tail light, with bulbs, indicator light with clear lens Combination rearlight, right, with reverse and rear fog light, with LED tail light, with bulbs, indicator light with clear lens
		2VP 008 272-221	1	(E1) 1070 (E1) 1071 3x12V21W (P21W) 8GA 002 073-121 1x12V21W (PY21W) 8GA 006 841-121
5 (E39) 520i, 525d, 525i, 525td, 525tds, 530d, 535i, 540i Saloon	09/00->07/03	2VP 008 272-811	1	CELIS® LED combination rearlight set (grey/red), with LED tail light
				(E1) 1070 (E1) 1071 6x12V21W (P21W) 8GA 002 073-121 2x12V21W (PY21W) 8GA 006 841-121












BMW












Manufacturer Model	Model year	Part no.	Pk.	Note
BMW				
5 (E39) 5 (E39) 520i, 525d, 525i, 525td, 525tds, 530d, 535i, 540i Saloon	09/00->07/03	2SK 008 272-801	1	CELIS® LED combination rearlight set (brilliant silver), with LED tail light (E1) 1070 (E1) 1071 6x12V21W (P21W) 8GA 002 073-121 2x12V21W (PY21W) 8GA 006 841-121
				
5 (E60, E61) 5 (E60, E61) 520d, 520i, 523i, 525d, 525i, 525xi, 530d, 525xd, 530i, 530xd, 530xi, 535d, 540i, 545i, 550i Saloon Touring	07/03->03/07 07/03->03/07 06/04->03/07	1LF 008 673-091 1LF 008 673-101	1 1	FF®-H7 headlight, left, with indicator light (white lens), with white LED side-marker light, with dynam. headlight leveller actuator, with bulbs FF®-H7 headlight, right, with indicator light (white lens), with white LED side-marker light, with dynam. headlight leveller actuator, with bulbs (E1) 1490 left (E1) 1491 right (E1) 1492 left (E1) 1493 right 2x12V55W (H7) 8GH 007 157-121 1x12V21W (PY21W) 8GA 006 841-121 2x12V5W (W5W) 8GP 003 594-121
				
5 (E60, E61) M5, 520i, 525d, 525i, 530d, 530i, 530xd, 535d, 545i, 545i Saloon Touring (-) bend lighting	07/03->12/04 07/03->12/04 06/04->12/04	1LL 160 695-001 1LL 160 696-001	1 1	Bi-Xenon®/FF®-H7 headlight, left, with indicator light (white lens), with white LED side-marker light, with dynam. headlight leveller actuator, without xenon ballast, without gas discharge bulb, with bulbs Bi-Xenon®/FF®-H7 headlight, right, with indicator light (white lens), with white LED side-marker light, with dynam. headlight leveller actuator, without xenon ballast, without gas discharge bulb, with bulbs (E1) 1490 left (E1) 1491 rechts (E1) 1494 left and right (E1) 1495 left and right 1x35W (D2S) 8GS 007 949-101 1x12V55W (H7) 8GH 007 157-121 1x12V21W (PY21W) 8GA 006 841-121
				



Manufacturer Model	Model year	Part no.	Pk.	Note
BMW				
5 (E60, E61)	01/05->03/07	1LL 163 081-001	1	Bi-Xenon®/FF®-H7 headlight, left, with indicator light (white lens), with static bend lighting, with white LED side-marker light, with dynam. headlight leveller actuator, without xenon ballast, without gas discharge bulb, with bulbs Bi-Xenon®/FF®-H7 headlight, right, with indicator light (white lens), with static bend lighting, with white LED side-marker light, with dynam. headlight leveller actuator, without xenon ballast, without gas discharge bulb, with bulbs
5 (E60, E61) 520d, 520i, 523i, 525d, 525i, 525xi, 530d, 525xd, 530i, 530xd, 530xi, 535d, 550i Saloon, Touring (-) bend lighting		1LL 163 082-001	1	(E1) 1494 (E1) 1495  1x35W (D1S) 8GS 009 028-001  1x12V55W (H7) 8GH 007 157-121  1x12V21W (PY21W) Silver Vision
5 (E60, E61)	04/07->	1LL 009 449-031	1	DE-H7 headlight, left, with indicator light (white lens), with white LED side-marker light, with bulbs
520d, 520i, 523i, 525d, 525i, 525xi, 525xd, 530d, 530xd, 530xi, 535d, 540i, 545i, 550i Saloon, Touring	04/07->	1LL 009 449-041	1	DE-H7 headlight, right, with indicator light (white lens), with white LED side-marker light, with bulbs
				(E1) 2306 left and right (E1) 2307 right  2x12V55W (H7) 8GH 007 157-121  1x12V21W (PY21W) 8GA 006 841-121  1x12V10W (H10W)
5 (E60, E61)	04/07->	1LL 164 909-001	1	Bi-Xenon® headlight, left, with indicator light (clear lens), with H8 daytime running light, with white LED side-marker light, with dynam. headlight leveller actuator, without xenon ballast, without gas discharge bulb, with bulbs
M5, 520d, 520i, 523i, 525d, 525i, 525xi, 525xd, 530d, 530xi, 535d, 540i, 545i, 550i, 530xd, Saloon, Touring (-) bend lighting	04/07->	1LL 164 910-001	1	Bi-Xenon® headlight, right, with indicator light (clear lens), with H8 daytime running light, with white LED side-marker light, with dynam. headlight leveller actuator, without xenon ballast, without gas discharge bulb, with bulbs
				 1x35W (D1S) 8GS 009 028-001  1x12V35W (H8) 8GH 008 356-121  1x12V21W (PY21W) 8GA 006 841-121

**BMW**

Manufacturer Model	Model year	Part no.	Pk.	Note
BMW				
5 (E60, E61) 5 (E60, E61) 04/07-> M5, 520d, 520i, 523i, 525d, 525i, 525xi, 525xd, 530d, 530xd, 530xi, 535d, 540i, 545i, 550i Saloon, Touring		1ZS 169 009-131 1ZS 169 009-141	1 1	Bi-Xenon®/H3 headlight, left, with indicator light (clear lens), with cornering light, with H8 daytime running light, with white LED side-marker light, with dynam. headlight leveller actuator, without xenon ballast, without gas discharge bulb, with bulbs Bi-Xenon®/H3 headlight, right, with indicator light (clear lens), with cornering light, with H8 daytime running light, with white LED side-marker light, with dynam. headlight leveller actuator, without xenon ballast, without gas discharge bulb, with bulbs  1x35W (D1S) 8GS 009 028-001  1x12V55W (H3) 8GH 002 090-133  1x12V35W (H8) 8GH 008 356-121  1x12V21W (PY21W) 8GA 006 841-121
5 (E60, E61) Saloon, Touring	07/03->12/04	5DV 008 290-004	1	Ballast unit
				
5 (E60, E61) Saloon, Touring	07/03->03/07	1N0 010 345-011 1N0 010 345-021	1 1	HB4 fog light, left, with bulb HB4 fog light, right, with bulb  1x12V51W (HB4) 8GH 005 636-121
				
5 (E60) M5, 520d, 520i, 523i, 525i, 525xi, 530d, 525xd, 530i, 530xd, 530xi, 535d, 540i, 545i, 550i Saloon	07/03->03/07	2VP 008 679-111 2VP 008 679-121	1 1	Combination rearlight (clear/red), left, with reverse and rear fog light, with bulbs Combination rearlight (clear/red), right, with reverse and rear fog light, with bulbs (E4) 10139  1x12V16W (W16W) 8GA 008 246-001
				









Manufacturer Model	Model year	Part no.	Pk.	Note
BMW				
5 (E60, E61) 5 (E60) M5, 520d, 520i, 523i, 525i, 525xi, 530d, 525xd, 530i, 530xd, 530xi, 535d, 540i, 545i, 550i Saloon	07/03->03/07	2SK 008 679-811 9EL 158 251-061 9EL 158 252-061	1 1 1	Upgrade combination rearlight set (brilliant), with Diadem bulbs (E4) 10139 Spare Parts: Body/lens, left Body/lens, right
				
5 (E60) M5, 520d, 520i, 523i, 525i, 525xi, 530d, 525xd, 530i, 530xd, 530xi, 535d, 540i, 545i, 550i Saloon	07/03->03/07	2SK 008 679-831 9EL 158 251-071 9EL 158 252-071	1 1 1	Upgrade combination rearlight set (brilliant/red), with Diadem bulbs (E4) 10139 Spare Parts: Body/lens, left Body/lens, right
				
5 (E60) M5, 520d, 520i, 523i, 525i, 525xi, 530d, 525xd, 530i, 530xd, 530xi, 535d, 540i, 545i, 550i Saloon	07/03->03/07	9EL 008 679-841 9EL 158 251-101 9EL 158 252-101	1 1 1	Upgrade combination rearlight set (black), without bulb holder (E4) 10139 Spare Parts: Body/lens, left Body/lens, right
				



BMW

















Manufacturer Model	Model year	Part no.	Pk.	Note
BMW				
5 (E60, E61) 5 (E60) M5, 520d, 520i, 523i, 525d, 525i, 525xi, 525xd, 530d, 530xd, 530xi, 535d, 540i, 545i, 550i Saloon	04/07->	2VP 009 425-111	1	Combination rearlight, left, with reverse and rear fog light, with LED flasher light and LED tail light, with bulbs
		2VP 009 425-121	1	Combination rearlight, right, with reverse and rear fog light, with LED flasher light and LED tail light, with bulbs
				 3x12V21W (P21W) 8GA 002 073-271 Long Life
				 1x12V16W (W16W) 8GA 008 246-001
5 (E60) M5, 520d, 520i, 523i, 525d, 525i, 525xi, 525xd, 530d, 530xd, 530xi, 535d, 540i, 545i, 550i Touring	04/07->	2VA 009 426-111	1	Combination rearlight, left, with LED flasher light and LED tail light, with bulbs
		2VA 009 426-121	1	Combination rearlight, right, with LED flasher light and LED tail light, with bulbs
				 2x12V21W (P21W) 8GA 002 073-271 Long Life
5 (E60) M5, 520d, 520i, 523i, 525d, 525i, 525xi, 525xd, 530d, 530xd, 530xi, 535d, 540i, 545i, 550i Touring	04/07->	2TZ 009 427-111	1	Combination rearlight, left, with reverse and rear fog light, with bulbs
		2TZ 009 427-121	1	Combination rearlight, right, with reverse and rear fog light, with bulbs
				 2x12V16W (W16W) 8GA 008 246-001
6 (E24) 6 (E24) 628 CSi, 635 CSi	06/82->05/87	1K3 126 680-001	1	H1 spotlight unit, right
				 14464
				



Manufacturer Model	Model year	Part no.	Pk.	Note
BMW				
6 (E24) 6 (E24)	06/82->05/87	1NB 123 581-001 1NB 123 582-001	1 1	H3 fog light unit, left H3 fog light unit, right 8358 left 8359 right 1x12V55W (H3) 8GH 002 090-133
6 (E24)	04/76->09/90	2BM 003 933-031 2BM 003 933-041	1 1	Auxiliary indicator light, left Auxiliary indicator light, right 42627 1x12V5W (W5W) 8GP 003 594-121
6 (E24)	04/76->09/90	2KA 004 331-031	4	Licence plate light 22890 1x12V5W (C5W) 8GM 002 092-121
7 (E23) 7 (E23)	07/82->08/86	1NB 123 581-001 1NB 123 582-001	1 1	H3 fog light unit, left H3 fog light unit, right 8358 left 8359 right 1x12V55W (H3) 8GH 002 090-133
7 (E23)	05/77->08/86	2KA 004 331-031	4	Licence plate light 22890 1x12V5W (C5W) 8GM 002 092-121
7 (E32) 7 (E32) 730i, 735i, 750i	09/86->08/88	9BG 136 027-011 9BG 136 028-011 1K3 132 253-011 1K3 132 266-011 9AH 131 741-011 9AH 131 740-011	1 1 1 1 2 2	DE-H1 headlight, spare parts available only 7401 34572 Spare Parts: Body with lens for dipped-beam, left Body with lens for dipped-beam, right Main-beam unit, left Main-beam unit, right Supporting frame, left Supporting frame, right 2x12V55W (H1) 8GH 002 089-133 1x12V5W (W5W) 8GP 003 594-121

**BMW**

Manufacturer Model	Model year	Part no.	Pk.	Note
BMW				
7 (E32) 7 (E32) 730i, 735i, 740i, 750i	09/88->09/94	 9BG 135 927-011 9BG 135 928-011 9DR 135 926-015 1K3 132 253-011 1K3 132 266-011 9AG 144 019-005 9AH 131 741-011 9AH 131 740-011		Super DE-H1 headlight, for vehicles with or without headlight leveller, spare parts available only (E1) 7407 (E1) 34572 Spare Parts: 1 Body with lens for dipped-beam, left 1 Body with lens for dipped-beam, right 1 Reflector with lens (module) for dipped-beam light 1 Main-beam unit, left 1 Main-beam unit, right 10 Lens-retaining rim 2 Supporting frame, left 2 Supporting frame, right  2x12V55W (H1) 8GH 002 089-133  1x12V5W (W5W) 8GP 003 594-121
7 (E32)	09/88->09/94	 6NM 004 375-311	1	Setting element, headlight levelling
7 (E32)	09/86->12/88	 1NL 005 230-051 1NL 005 230-061	1 1	DE-H1 fog light, left DE-H1 fog light, right (E1) 18206 (E1) 18221  1x12V55W (H1) 8GH 002 089-133
7 (E32)	01/89->09/94	 1NL 005 230-111 1NL 005 230-121	1 1	DE-H1 fog light, left DE-H1 fog light, right (E1) 18206 (E1) 18221  1x12V55W (H1) 8GH 002 089-133
7 (E32)	09/86->09/94	 2BM 003 933-031 2BM 003 933-041	1 1	Auxiliary indicator light, left Auxiliary indicator light, right (E1) 42627  1x12V5W (W5W) 8GP 003 594-121
7 (E32)	09/86->09/94	 2KA 004 331-031	4	Licence plate light (E1) 22890  1x12V5W (C5W) 8GM 002 092-121
7 (E38) 7 (E38) (-) Diesel	10/94->11/01	 1NA 007 039-011 1NA 007 039-021	1 1	FF®-H3 fog light, left, with bulb FF®-H3 fog light, right, with bulb (E1) 41  1x12V55W (H3) 8GH 002 090-133












Manufacturer Model	Model year	Part no.	Pk.	Note
BMW				
7 (E65, E66) 7 (E65, E66) 730d, 730i, 735i, 740d, 745d, 745i, 760i	11/01->04/05	1LL 008 420-331 1LL 008 420-341	1 1	DE-H7/FF®-H7 headlight, left, with indicator light (clear lens), with headlight leveller actuator, with bulbs DE-H7/FF®-H7 headlight, right, with indicator light (clear lens), with headlight leveller actuator, with bulbs (E1) 1284 (E1) 1285 2x12V55W (H7) 8GH 007 157-121 1x12V21W (P21W) 8GA 002 073-121 1x12V5W (W5W) 8GP 003 594-121
7 (E65, E66) 730d, 730i, 735i, 740d, 745d, 745i, 760i	11/01->04/05	1LL 158 085-011 1LL 158 086-011	1 1	Bi-Xenon®/H7 headlight, left, with indicator light (clear lens), with electr. headlight leveller actuator, without xenon ballast, without gas discharge bulb, with bulbs Bi-Xenon®/H7 headlight, right, with indicator light (clear lens), with electr. headlight leveller actuator, without xenon ballast, without gas discharge bulb, with bulbs (E1) 1284 (E1) 1285 1x35W (D2S) 8GS 007 949-101 1x12V55W (H7) 8GH 007 157-121 1x12V21W (PY21W) 8GA 006 841-121
7 (E65, E66)	11/01->04/05	5DV 008 290-004	1	Ballast unit
Chrysler				
PT Cruiser PT Cruiser	06/00->		1	Setting element, headlight levelling



Citroën












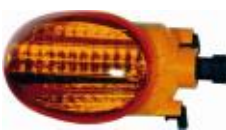


Manufacturer Model	Model year	Part no.	Pk.	Note
Citroën				
Berlingo (MF, M_) Berlingo	11/02-> 	1LG 010 196-031	1	H4 headlight, left, with indicator light, with electr. headlight leveller actuator
		1LG 010 196-041	1	H4 headlight, right, with indicator light, with electr. headlight leveller actuator
(E4) 9849  1x12V60/55W (H4) 8GJ 002 525-131  1x12V21W (PY21W) 8GA 006 841-121  1x12V5W (W5W) 8GP 003 594-121				
C2 (JM_) C2 (JM_)	09/03->07/05 	2VP 354 030-011	1	Combination rearlight, left, with reverse and rear fog light
		2VP 354 030-021	1	Combination rearlight, right, with reverse and rear fog light
 1x12V21/5W (P21/5W) 8GD 002 078-121 2x12V21W (P21W) 8GA 002 073-121 1x12V21W (PY21W) 8GA 006 841-121				
C2 (JM_)	08/05-> 	2VP 354 030-031	1	Combination rearlight, left, with reverse and rear fog light
		2VP 354 030-041	1	Combination rearlight, right, with reverse and rear fog light
 1x12V21/5W (P21/5W) 8GD 002 078-121 2x12V21W (P21W) 8GA 002 073-121 1x12V21W (PY21W) 8GA 006 841-121				
C4 (LC_) C4 (LC_) 5-doors	11/04->08/08 	9EL 354 050-011	1	Body/lens for combination rearlight, left
		9EL 354 050-021	1	Body/lens for combination rearlight, right
 1x12V21/5W (P21/5W) 8GD 002 078-121 1x12V21W (PY21W) 8GA 006 841-121  1x12V5W (W5W) 8GP 003 594-121				



Manufacturer Model	Model year	Part no.	Pk.	Note
Citroën				
C4 (LC_) C4 (LC_) 5-doors	11/04->08/08	2NE 354 051-021	1	Rear fog light, right  1x12V21W (P21W) 8GA 002 073-121
				
C4 (LC_) 5-doors	11/04->08/08	2ZR 354 052-011	1	Reversing light, left  1x12V21W (P21W) 8GA 002 073-121
				
C4 (LC_) 5-doors	11/04->08/08	2XX 354 033-011 2XX 354 033-021	1 1	Reflex-reflector (red), left Reflex-reflector (red), right
				
C4 Coupé (LA_) C4 Coupé (LA_) 3-doors	11/04->08/08	2SK 354 032-011 2SK 354 032-021	1 1	Combination rearlight, left Combination rearlight, right  1x12V21/5W (P21/5W) 8GD 002 078-121 1x12V21W (P21W) 8GA 002 073-121 1x12V21W (PY21W) 8GA 006 841-121
				
C4 Coupé (LA_) 3-doors	11/04->08/08	2NE 354 053-011 2NE 354 053-021	1 1	Rear fog light, left Rear fog light, right  1x12V21W (P21W) 8GA 002 073-121
				



Manufacturer Model	Model year	Part no.	Pk.	Note
Citroën				
C4 Picasso (UD_,UA_)		1LF 009 237-031	1	FF®-H7/FF®-H1 headlight, left, with indicator light, with electr. headlight leveller actuator, with bulbs  1x12V55W (H7) 8GH 007 157-121  1x12V55W (H1) 8GH 002 089-133  1x12V6W (H6W) 8GH 007 643-121  1x12V21W (H21W) 8GH 008 417-001
C4 Picasso (UD_)	02/07->			
C4 Grand Picasso (UA_)	10/06->	1LF 009 237-041	1	
				
C4 Grand Picasso (UA_) 7 seats	10/06->	2SK 009 466-131	1	Combination rearlight, left, with LED tail light and reverse light Combination rearlight, right, with LED tail light and reverse light (E1) 2120  2x12V21W (P21W) 8GA 002 073-121  1x12V21W (PY21W) 8GA 006 841-121
		2SK 009 466-141	1	
				
C4 Picasso (UD_) 5 seats	02/07->	2NR 982 008-111	1	Rear fog light, left, with bulb Rear fog light, right, with bulb (E1) 2088  1x12V21W (P21W) 8GA 002 073-121
C4 Grand Picasso (UA_) 7 seats	10/06->	2NR 982 008-121	1	
				
Fiat				
Multipla (186)		2BA 270 016-031	1	Indicator light (amber), left, with bulb Indicator light (amber), right, with bulb (E26) 004  1x12V21W (H21W) 8GH 008 417-001
Multipla (186)	04/99->09/04	2BA 270 016-041	1	
				













Manufacturer Model	Model year	Part no.	Pk.	Note
Fiat				
Punto (176) Punto (176) AP, Elegant, Elegant XL, ELX, GT (-) Sporting	09/93->09/99	1LF 006 826-251 1LF 006 826-261	1 1	FF®-H1 headlight, left, with manual headlight leveller, also suitable for vehicles with electr. headlight leveller FF®-H1 headlight, right, with manual headlight leveller, also suitable for vehicles with electr. headlight leveller (E1) 27054 left (E1) 27055 right 2x12V55W (H1) 8GH 002 089-133 1x12V5W (W5W) 8GP 003 594-121
Punto (176)	09/93->09/99	6NM 007 282-661	1	Setting element, headlight levelling
Punto (176) EL, S, SX (-) Sporting	09/93->09/99	2BA 006 749-071 2BA 006 749-081	1 1	Indicator light (amber), left Indicator light (amber), right (E1) 017 1x12V21W (P21W) 8GA 002 073-121
Punto (176) EL, S, SX (-) Sporting	09/93->09/99	2BA 006 749-051 2BA 006 749-061	1 1	Indicator light (white), left, for conversion Indicator light (white), right, for conversion (E1) 017 1x12V21W (P21W) 8GA 002 073-121
Punto (176) AP, Elegant, Elegant XL, ELX, GT (-) Sporting	09/93->09/99	2BA 006 749-051 2BA 006 749-061	1 1	Indicator light (white), left Indicator light (white), right (E1) 017 1x12V21W (P21W) 8GA 002 073-121





Ford



Manufacturer Model	Model year	Part no.	Pk.	Note
Ford				
C-Max C-Max	02/07->	1LJ 009 587-631 1LJ 009 587-641	1 1	FF®-H7/FF®-H1 headlight, left, with indicator light, with electr. headlight leveller actuator, with bulbs FF®-H7/FF®-H1 headlight, right, with indicator light, with electr. headlight leveller actuator, with bulbs  1x12V55W (H7) 8GH 007 157-121  1x12V55W (H1) 8GH 002 089-133  1x12V21W (PY21W) 8GA 006 841-121  1x12V5W (W5W) 8GP 003 594-121
Escort V Escort V Hatchback	09/91->09/92	9EL 148 345-011 9EL 148 345-021	1 1	Body/lens for combination rearlight, left, with reverse and rear fog light Body/lens for combination rearlight, right, with reverse and rear fog light (E1) 223  1x12V5W (R5W) 8GA 002 071-121  3x12V21W (P21W) 8GA 002 073-121
Escort V Estate	07/90->09/92	9EL 137 819-031 9EM 137 820-021	1 1	Body/lens for combination rearlight, left, with reverse light Body/lens for combination rearlight, right, with reverse and rear fog light (E1) 63257  1x12V5W (R5W) 8GA 002 071-121  3x12V21W (P21W) 8GA 002 073-121
Escort VI Escort VI Sedan	08/93->01/95	9EL 148 345-011 9EL 148 345-021	1 1	Body/lens for combination rearlight, left, with reverse and rear fog light Body/lens for combination rearlight, right, with reverse and rear fog light (E1) 223  1x12V5W (R5W) 8GA 002 071-121  3x12V21W (P21W) 8GA 002 073-121







Manufacturer Model	Model year	Part no.	Pk.	Note
Ford				
Escort VI Escort VI Estate	09/92->01/95	9EL 137 819-031 9EM 137 820-021	1 1	Body/lens for combination rearlight, left, with reverse light Body/lens for combination rearlight, right, with reverse and rear fog light (E1) 63257 1x12V5W (R5W) 8GA 002 071-121 3x12V21W (P21W) 8GA 002 073-121
Escort VII Escort VII	01/95->10/98	1NE 007 517-051 1NE 007 517-061	1 1	FF®-H3 fog light, left FF®-H3 fog light, right (E1) 215 1x12V55W (H3) 8GH 002 090-133
Escort VII Estate	01/95->02/99	9EL 137 819-031 9EM 137 820-021	1 1	Body/lens for combination rearlight, left, with reverse light Body/lens for combination rearlight, right, with reverse and rear fog light (E1) 63257 1x12V5W (R5W) 8GA 002 071-121 3x12V21W (P21W) 8GA 002 073-121
F-150 F-150	04/04->	1F3 009 906-001 1F3 009 906-011	1 1	Grille with halogen H1 spotlight, with bulbs 2x12V55W (H1) 8GH 002 089-133 Grille set with Xenon spotlight, with xenon ballasts, with gas discharge bulbs 1x35W (D1S) 8GS 009 028-001
Fiesta III (GFJ) Fiesta III (GFJ)	01/89->12/93	9EL 919 370-111 9EL 919 370-121	1 1	Indicator light (amber), left, with bulb Indicator light (amber), right, with bulb (E1) 42777 1x12V21W (P21W) 8GA 002 073-121





Ford



Manufacturer Model	Model year	Part no.	Pk.	Note
Ford				
Fiesta III (GFJ) Fiesta III (GFJ)	01/89->12/93	2BA 919 370-051 2BA 919 370-061	1 1	Indicator light, left, with bulb Indicator light, right, with bulb E9 5048 1x12V21W (PY21W) 8GA 006 841-121
				
Fiesta III (GFJ) Fiesta III (GFJ)	01/94->12/95	2BA 919 370-051 2BA 919 370-061	1 1	Indicator light (white), left, with bulb Indicator light (white), right, with bulb E9 5048 1x12V21W (PY21W) 8GA 006 841-121
				
Fiesta III (GFJ) Fiesta III (GFJ)	01/89->12/95	9EL 961 255-011 9EL 961 256-011	1 1	Body/lens for combination rearlight (amber/red), left, with reverse light Body/lens for combination rearlight (amber/red), right, with rear fog light E1 63220 1x12V21/5W (P21/5W) 8GD 002 078-121 2x12V21W (P21W) 8GA 002 073-121
				
Fiesta IV (JA_, JB_) Fiesta IV (JA_, JB_)	08/95->09/99	1LJ 008 041-031 1LJ 008 041-041	1 1	H1/H7 headlight, left, with indicator light H1/H7 headlight, right, with indicator light 1x12V55W (H7) 8GH 007 157-121 1x12V55W (H1) 8GH 002 089-133 1x12V21W (PY21W) 8GA 006 841-121 1x12V5W (W5W) 8GP 003 594-121
				









Manufacturer Model	Model year	Part no.	Pk.	Note
Ford				
Fiesta IV (JA_, JB_) Fiesta IV (JA_, JB_)	09/99->01/02	1LE 009 058-031 1LE 009 058-041 1LE 009 058-071 1LE 009 058-081	1 1 1 1	H4 headlight, left, with indicator light, without headlight leveller, without headlight leveller actuator H4 headlight, right, with indicator light, without headlight leveller, without headlight leveller actuator H4 headlight, left, with indicator light, with electr. headlight leveller, with headlight leveller actuator H4 headlight, right, with indicator light, with electr. headlight leveller, with headlight leveller actuator (E1) 933 left (E1) 934 right 1x12V60/55W (H4) 8GJ 002 525-131 1x12V21W (PY21W) 8GA 006 841-121 1x12V5W (W5W) 8GP 003 594-121
Fiesta V (JH_) Fiesta V (JH_)	11/01->10/05	1LF 010 197-031 1LF 010 197-041	1 1	H4 headlight, left, with indicator light, with electr. headlight leveller actuator H4 headlight, right, with indicator light, with electr. headlight leveller actuator (E4) 9817 1x12V60/55W (H4) 8GJ 002 525-131 1x12V21W (PY21W) 8GA 006 841-121 1x12V5W (W5W) 8GP 003 594-121
Fiesta V (JH_) 3-doors	10/05->	9EL 354 055-011 9EL 354 055-021	1 1	Body/lens for combination rearlight, left, with reverse and rear fog light Body/lens for combination rearlight, right, with reverse and rear fog light 1x12V21W (PY21W) 8GA 006 841-121 1x12V21W (P21W) 8GA 002 073-121 1x12V5W (W5W) 8GP 003 594-121 1x12V16W (W16W) 8GA 008 246-001



Ford



Manufacturer Model	Model year	Part no.	Pk.	Note
Ford				
Fiesta V (JH_)	10/05->	9EL 354 054-011	1	Body/lens for combination rearlight, left, with reverse and rear fog light
Fiesta V (JH_)	10/05->	9EL 354 054-021	1	Body/lens for combination rearlight, right, with reverse and rear fog light
5-doors				 1x12V21W (PY21W) 8GA 006 841-121 1x12V21W (P21W) 8GA 002 073-121
				 1x12V5W (W5W) 8GP 003 594-121 1x12V16W (W16W) 8GA 008 246-001
Fiesta Courier, Box		2VP 354 034-011	1	Combination rearlight, left, with reverse and rear fog light
Fiesta Courier (J5_, J3_)	02/96->	2VP 354 034-021	1	Combination rearlight, right, with reverse and rear fog light
Fiesta Box (JV_)	05/98->			 1x12V21/5W (P21/5W) 8GD 002 078-121 3x12V21W (P21W) 8GA 002 073-121
Focus		1LE 010 199-031	1	H4 headlight, left
Focus	10/98->09/01	1LE 010 199-041	1	H4 headlight, right
				 E4 9798
				 1x12V60/55W (H4) 8GJ 002 525-131
				 1x12V21/5W (P21/5W) 8GD 002 078-121













Manufacturer Model	Model year	Part no.	Pk.	Note
Ford				
Focus				
Focus (-) ST170/RS	10/01->11/04	1LE 010 198-051 1LE 010 198-061	1 1	H1/H7 headlight, left, with indicator light, for vehicles with headlight leveller H1/H7 headlight, right, with indicator light, for vehicles with headlight leveller (E4) 9787 1x12V55W (H7) 8GH 007 157-121 1x12V55W (H1) 8GH 002 089-133 1x12V21W (P21W) 8GA 002 073-121 1x12V5W (W5W) 8GP 003 594-121
Focus RS	10/02->11/04	1LE 010 198-091 1LE 010 198-101	1 1	H1/H7 headlight, left, with indicator light H1/H7 headlight, right, with indicator light (E4) 9798 1x12V55W (H7) 8GH 007 157-121 1x12V55W (H1) 8GH 002 089-133 1x12V21W (PY21W) 8GA 006 841-121 1x12V5W (W5W) 8GP 003 594-121
Focus ST170	03/02->11/04	1LE 010 198-151 1LE 010 198-161	1 1	H1/H7 headlight, left, with indicator light H1/H7 headlight, right, with indicator light (E4) 9798 1x12V55W (H7) 8GH 007 157-121 1x12V55W (H1) 8GH 002 089-133 1x12V21W (P21W) 8GA 002 073-121 1x12V5W (W5W) 8GP 003 594-121


















Ford



Manufacturer Model	Model year	Part no.	Pk.	Note
Ford				
Focus				
Focus	10/98->11/04	1ZL 009 488-851		Upgrade headlight set with halogen dipped-beam/main-beam, with dynam. bend lighting Dynabeam, with bulbs
		1LL 009 488-811	1	Upgrade headlight set with halogen dipped-beam/main-beam, without dynam. bend lighting, with bulbs
		1ZL 009 488-111	1	Spare Parts: Upgrade headlight, left (for -851), with bulbs
		1ZL 009 488-121	1	Upgrade headlight, right (for -851), with bulbs
		1LL 009 488-031	1	Upgrade headlight, left (for -811), with bulbs
		1LL 009 488-041	1	Upgrade headlight, right (for -811), with bulbs
		9XX 166 909-001	1	Indicator light adapter set for vehicles 10/98->09/01 (to be ordered separately)
				 2x12V55W (H7) 8GH 007 157-201 Long Life  2x12V21W (PY21W) Silver Vision
Focus	10/98->11/04	1LL 009 488-831		Upgrade headlight set with xenon dipped-beam, halogen main-beam, without dynam. bend lighting, with bulbs
		8WS 008 559-001	1	Lens cleaning system (if vehicle is already equipped with lens cleaning system as standard equipment, it is not necessary to order this item)
		1LL 009 488-471	1	Spare Parts: Upgrade headlight, left, with bulbs
		1LL 009 488-481	1	Upgrade headlight, right, with bulbs
		9XX 166 909-001	1	Indicator light adapter set for vehicles 10/98->09/01 (to be ordered separately)
				 2x12V35W (D2S) 8GS 007 949-101  2x12V55W (H7) 8GH 007 157-201 Long Life  2x12V21W (PY21W) Silver Vision
Focus (-) ST170/RS	10/01->11/04	1NA 010 205-011 1NA 010 205-021	1 1	H1 fog light, left H1 fog light, right  19038  1x12V55W (H1) 8GH 002 089-133
				




















Manufacturer Model	Model year	Part no.	Pk.	Note
Ford				
Focus		9EL 354 059-011	1	Body/lens for indicator light (amber), left
Focus	10/98->09/01	9EL 354 059-021	1	Body/lens for indicator light (amber), right
(-) RS				 1x12V21W (P21W) 8GA 002 073-121
Focus	10/01->11/04	9EL 354 060-011	1	Body/lens for indicator light (clear), left
(-) RS		9EL 354 060-021	1	Body/lens for indicator light (clear), right
				 1x12V21W (PY21W) 8GA 006 841-121
Focus	10/98->09/01	2BA 008 467-801	1	Indicator light set (white), with bulbs
(-) RS		2BA 008 221-001	1	Indicator light
				 2x12V21W (PY21W) 8GA 006 841-121 
Focus	10/98->09/01	9EL 354 056-001	1	Body/lens for auxiliary indicator light (amber)
				 1x12V5W (W5W) 8GP 003 594-121
Focus	10/01->11/04	9EL 354 058-001	1	Body/lens for auxiliary indicator light (clear)
				 1x12V5W (WY5W) 8GP 003 594-541
Focus Hatchback	10/98->11/04	9EL 354 061-011	1	Body/lens for combination rearlight, left
		9EL 354 061-021	1	Body/lens for combination rearlight, right
				 2x12V21W (P21W) 8GA 002 073-121  1x12V5W (W5W) 8GP 003 594-121



Ford



Manufacturer Model	Model year	Part no.	Pk.	Note
Ford				
Focus Focus Hatchback	10/98->11/04	2NE 354 062-021	1	Rear fog light, right  1x12V21W (P21W) 8GA 002 073-121
				
Focus Hatchback	10/98->11/04	2ZR 354 063-011	1	Reversing light, left  1x12V21W (P21W) 8GA 002 073-121
				
Focus Sedan	02/99->11/04	9EL 354 057-011 9EL 354 057-021	1 1	Body/lens for combination rearlight, left, with reverse and rear fog light Body/lens for combination rearlight, right, with reverse and rear fog light  3x12V21W (P21W) 8GA 002 073-121  1x12V5W (W5W) 8GP 003 594-121
				
Focus Estate	02/99->11/04	9EL 171 556-031 9EL 171 556-041	1 1	Body/lens for combination rearlight, left, with reverse light Body/lens for combination rearlight, right, with rear fog light  2x12V21W (P21W) 8GA 002 073-121  1x12V5W (W5W) 8GP 003 594-121
				
Focus II Focus II	11/04->02/08	1LL 010 201-031 1LL 010 201-041	1 1	H1/H7 headlight, left, with indicator light, with chrome-plated cover, with electr. headlight leveller actuator H1/H7 headlight, right, with indicator light, with chrome-plated cover, with electr. headlight leveller actuator  10178  10179  1x12V55W (H7) 8GH 007 157-121  1x12V55W (H1) 8GH 002 089-133  1x12V5W (W5W) 8GP 003 594-121  1x12V5W (W5W) 8GP 003 594-121
				



Manufacturer Model	Model year	Part no.	Pk.	Note
Ford				
Focus II Focus II	11/04->02/08	1LL 010 201-071 1LL 010 201-081	1 1	H1/H7 headlight, left, with indicator light, with black cover, with electr. headlight leveller actuator H1/H7 headlight, right, with indicator light, with black cover, with electr. headlight leveller actuator (E4) 10178 (E4) 10179 1x12V55W (H7) 8GH 007 157-121 1x12V55W (H1) 8GH 002 089-133 1x12V5W (W5W) 8GP 003 594-121 1x12V5W (W5W) 8GP 003 594-121
Focus II	11/04->02/08	1LL 010 201-191 1LL 010 201-201	1 1	H1/H7 headlight, left, with indicator light, with cornering light (AFS), with chrome-plated cover, with electr. headlight leveller actuator H1/H7 headlight, right, with indicator light, with cornering light (AFS), with chrome-plated cover, with electr. headlight leveller actuator (E4) 10178 (E4) 10179 1x12V55W (H7) 8GH 007 157-121 1x12V55W (H1) 8GH 002 089-133 1x12V5W (W5W) 8GP 003 594-121 1x12V5W (W5W) 8GP 003 594-121
Focus II	11/04->02/08	1LL 010 201-231 1LL 010 201-241	1 1	H1/H7 headlight, left, with indicator light, with cornering light (AFS), with black cover, with electr. headlight leveller actuator H1/H7 headlight, right, with indicator light, with cornering light (AFS), with black cover, with electr. headlight leveller actuator (E4) 10178 (E4) 10179 1x12V55W (H7) 8GH 007 157-121 1x12V55W (H1) 8GH 002 089-133 1x12V5W (W5W) 8GP 003 594-121 1x12V5W (W5W) 8GP 003 594-121













Ford



Manufacturer Model	Model year	Part no.	Pk.	Note
Ford				
Focus II Focus II	11/04->02/08	1LL 010 201-111 1LL 010 201-121	1 1	Xenon/H1 headlight, left, with indicator light, with chrome-plated cover, with electr. headlight leveller actuator, without xenon ballast, without gas discharge bulb, without bulbs Xenon/H1 headlight, right, with indicator light, with chrome-plated cover, with electr. headlight leveller actuator, without xenon ballast, without gas discharge bulb, without bulbs Ⓔ4 10178 Ⓔ4 10179  1x35W (D1S) 8GS 009 028-001  1x12V55W (H1) 8GH 002 089-133  1x12V21W (PY21W) 8GA 006 841-121  1x12V5W (W5W) 8GP 003 594-121
Focus II	11/04->02/08	1LL 010 201-151 1LL 010 201-161	1 1	Xenon/H1 headlight, left, with indicator light, with black cover, with electr. headlight leveller actuator, without xenon ballast, without gas discharge bulb, without bulbs Xenon/H1 headlight, right, with indicator light, with black cover, with electr. headlight leveller actuator, without xenon ballast, without gas discharge bulb, without bulbs Ⓔ4 10178 Ⓔ4 10179  1x35W (D1S) 8GS 009 028-001  1x12V55W (H1) 8GH 002 089-133  1x12V21W (PY21W) 8GA 006 841-121  1x12V5W (W5W) 8GP 003 594-121
Focus II (-) ST	11/04->02/08	1N0 354 016-011 1N0 354 016-021	1 1	H8 fog light, left H8 fog light, right  1x12V35W (H8) 8GH 008 356-121
Focus II	11/04->02/08	1N0 009 436-811 1N0 009 295-011 1N0 009 295-021	1 1 1	H7 fog light set with covers, with bulbs Ⓔ1 1951 Spare Parts: Fog light, left, with standard bracket and bulb Fog light, right, with standard bracket and bulb  2x12V55W (H7) 8GH 007 157-121













Manufacturer Model	Model year	Part no.	Pk.	Note
Ford				
Focus II Focus II 	11/04->02/08	1N0 009 436-821 1N0 009 295-011 1N0 009 295-021 5DF 009 244-007	1 1 1 24	DynaView® Evo2 additive cornering light set, with fog light function, with covers, control unit, harness and bulbs (E1) 1951 Spare Parts: Fog light, left, with standard bracket and bulb Fog light, right, with standard bracket and bulb IntelliBeam® control electronics  2x12V55W (H7) 8GH 007 157-121
Focus II (-) ST 	11/04->02/08	2PT 010 177-811 2PT 009 599-011 2PT 009 599-021	1 1 1	LED daytime running light set, 2 daytime running lights with harness and covers (E1) 2372 Spare Parts: LED daytime running light, left LED daytime running light, right
Focus II Hatchback 	11/04->02/08	9EL 354 067-011 9EL 354 067-021	1 1	Body/lens for combination rearlight, left Body/lens for combination rearlight, right  1x12V21W (PY21W) 8GA 006 841-121  1x12V5W (W5W) 8GP 003 594-121
Focus II Hatchback 	11/04->02/08	2NE 354 068-021	1	Rear fog light, right  1x12V21W (P21W) 8GA 002 073-121
Focus II Hatchback 	11/04->02/08	2ZR 354 069-011	1	Reversing light, left  1x12V21W (P21W) 8GA 002 073-121



Ford



Manufacturer Model	Model year	Part no.	Pk.	Note
Ford				
Focus II	11/04->02/08	9EL 354 066-011	1	Body/lens for combination rearlight, left, with reverse and rear fog light
Focus II Sedan	11/04->02/08	9EL 354 066-021	1	Body/lens for combination rearlight, right, with reverse and rear fog light
				 1x12V21/4W (P21/4W) 8GD 004 772-121  1x12V21W (PY21W) 8GA 006 841-121  2x12V21W (P21W) 8GA 002 073-121
Focus II Estate	11/04->02/08	9EL 354 065-011	1	Body/lens for combination rearlight, left, with reverse light
Focus II Estate	11/04->02/08	9EL 354 065-021	1	Body/lens for combination rearlight, right, with rear fog light
				 1x12V21W (PY21W) 8GA 006 841-121  1x12V21W (P21W) 8GA 002 073-121  1x12V5W (W5W) 8GP 003 594-121
Focus II Convertible	10/06->02/08	2SD 010 230-011	1	Combination rearlight, left, with bulbs
Focus II Convertible	10/06->02/08	2SD 010 230-021	1	Combination rearlight, right, with bulbs
				 1x12V21/5W (P21/5W) 8GD 002 078-121  1x12V21W (PY21W) 8GA 006 841-121  1x12V5W (W5W) 8GP 003 594-121
Focus II Convertible	10/06->02/08	2NR 010 229-011	1	Rear fog and reverse light, left, with bulbs
Focus II Convertible	10/06->02/08	2NR 010 229-021	1	Rear fog and reverse light, right, with bulbs
				 2x12V21W (P21W) 8GA 002 073-121








Manufacturer Model	Model year	Part no.	Pk.	Note
Ford				
Focus C-MAX Focus C-MAX	10/03->03/07	1LE 270 600-191 1LE 270 600-201	1 1	FF®-H7/FF®-H1 headlight, left, with indicator light, without headlight leveller actuator FF®-H7/FF®-H1 headlight, right, with indicator light, without headlight leveller actuator (E1) 1589 left (E1) 1590 right (E1) 1591 left (E1) 1592 right 1x12V55W (H7) 8GH 007 157-121 1x12V55W (H1) 8GH 002 089-133 1x12V5W (W5W) 8GP 003 594-121 1x12V5W (W5W) 8GP 003 594-121
Focus C-MAX	10/03->03/07	1N0 354 016-011 1N0 354 016-021	1 1	H8 fog light, left H8 fog light, right 1x12V35W (H8) 8GH 008 356-121
Focus C-MAX	10/03->03/07	8RA 354 031-011 8RA 354 031-021	1 1	Reflex-reflector (red), left Reflex-reflector (red), right
Fusion (JU_) Fusion (JU_)	08/02->11/05	1LD 246 044-231 1LD 246 044-241	1 1	H4 headlight, left, with indicator light, with electr. headlight leveller actuator H4 headlight, right, with indicator light, with electr. headlight leveller actuator (E4) 9837 (E4) 9838 1x12V60/55W (H4) 8GJ 002 525-131 1x12V21W (PY21W) 8GA 006 841-121 1x12V5W (W5W) 8GP 003 594-121
Fusion (JU_)	11/05->	9EL 354 070-011 9EL 354 070-021	1 1	Body/lens for combination rearlight, left, with reverse and rear fog light Body/lens for combination rearlight, right, with reverse and rear fog light 1x12V21W (P21W) 8GA 002 073-121 1x12V21W (PY21W) 8GA 006 841-121 1x12V5W (W5W) 8GP 003 594-121 1x12V16W (W16W) 8GA 008 246-001



Ford



Manufacturer Model	Model year	Part no.	Pk.	Note
Ford				
Galaxy (VX, VY) Galaxy (VX, VY)	03/95->05/06	9EL 147 073-001	2	Body/lens for auxiliary indicator light (amber) E1 52636 1x12V5W (W5W) 8GP 003 594-121
				
Galaxy (VX, VY)	03/95->05/06	9EL 147 073-801	1	Body/lens set for auxiliary indicator light (grey) E1 105 2x12V5W (W5W) 8GP 003 594-121
				
Galaxy (VX, VY)	03/95->04/00	9EL 962 585-051 9EL 962 586-051	1 1	Body/lens for combination rearlight (grey/red), left Body/lens for combination rearlight (grey/red), right E1 153 E1 391 1x12V5W (R5W) 8GA 002 071-121 1x12V21/5W (P21/5W) 8GD 002 078-121 1x12V21W (P21W) 8GA 002 073-121
				
Galaxy (VX, VY)	04/00->05/06	9EL 964 483-011 9EL 964 484-011	1 1	Body/lens for combination rearlight (transparent/red), left Body/lens for combination rearlight (transparent/red), right E1 1062 1x12V5W (R5W) 8GA 002 071-121 2x12V21W (P21W) 8GA 002 073-121
				
Galaxy (VX, VY)	04/00->05/06	9EL 964 479-011 9EL 964 480-011	1 1	Body/lens for combination rearlight (red/clear), left, with reverse and rear fog light Body/lens for combination rearlight (red/clear), right, with reverse and rear fog light E1 1063 4x12V21W (P21W) 8GA 002 073-121
				



Manufacturer Model	Model year	Part no.	Pk.	Note
Ford				
Galaxy Galaxy	05/06->	1LJ 009 250-771 1LJ 009 250-781	1 1	FF®-H7/FF®-H1 headlight, left, with indicator light, with electr. headlight leveller actuator, with bulbs FF®-H7/FF®-H1 headlight, right, with indicator light, with electr. headlight leveller actuator, with bulbs (E1) 2105 1x12V55W (H7) 8GH 007 157-121 1x12V55W (H1) 8GH 002 089-133 2x12V21W (PY21W) 8GA 006 841-121
Kuga Kuga	03/08->	1LJ 009 696-731 1LJ 009 696-741	1 1	FF®-H7/FF®-H1 headlight, left, with indicator light, with electr. headlight leveller actuator, with bulbs FF®-H7/FF®-H1 headlight, right, with indicator light, with electr. headlight leveller actuator, with bulbs 1x12V55W (H7) 8GH 007 157-121 1x12V55W (H1) 8GH 002 089-133 1x12V21W (H21W) 8GH 008 417-001 1x12V5W (W5W) 8GP 003 594-121
Maverick (UDS, UNS) Maverick (UDS, UNS)	02/93->06/96	1LD 962 060-131 1LD 962 060-141	1 1	H4 headlight, left, for vehicles with or without headlight leveller H4 headlight, right, for vehicles with or without headlight leveller (E1) 27007 left (E1) 27008 right 1x12V60/55W (H4) 8GJ 002 525-131 1x12V5W (W5W) 8GP 003 594-121
Mondeo II Mondeo II	01/98->11/00	1NL 007 594-031 1NL 007 594-041	1 1	DE-H3 fog light, left DE-H3 fog light, right (E1) 440 1x12V55W (H3) 8GH 002 090-133













Ford



Manufacturer Model	Model year	Part no.	Pk.	Note
Ford				
Mondeo III		9EL 171 558-011	1	Body/lens for combination rearlight, left, with reverse and rear fog light
Mondeo III (-) Estate	11/00->06/03	9EL 171 558-021	1	Body/lens for combination rearlight, right, with reverse and rear fog light
				1x12V21W (H21W) 8GH 008 417-001 1x12V21/4W (P21/4W) 8GD 004 772-121 2x12V21W (P21W) 8GA 002 073-121 2x12V5W (W5W) 8GP 003 594-121
Mondeo III (-) Estate	06/03->05/05	9EL 171 558-051	1	Body/lens for combination rearlight, left, with reverse and rear fog light
		9EL 171 558-061	1	Body/lens for combination rearlight, right, with reverse and rear fog light
				1x12V21W (H21W) 8GH 008 417-001 1x12V21/4W (P21/4W) 8GD 004 772-121 2x12V21W (P21W) 8GA 002 073-121 2x12V5W (W5W) 8GP 003 594-121
Mondeo III (-) Estate	05/05->03/07	9EL 171 558-031	1	Body/lens for combination rearlight, left, with reverse and rear fog light
		9EL 171 558-041	1	Body/lens for combination rearlight, right, with reverse and rear fog light
				1x12V21W (H21W) 8GH 008 417-001 1x12V21/4W (P21/4W) 8GD 004 772-121 2x12V21W (P21W) 8GA 002 073-121 2x12V5W (W5W) 8GP 003 594-121
Mondeo III Estate	11/00->03/07	9EL 354 071-011	1	Body/lens for combination rearlight, left, with reverse and rear fog light
		9EL 354 071-021	1	Body/lens for combination rearlight, right, with reverse and rear fog light
				1x12V21/4W (P21/4W) 8GD 004 772-121 3x12V21W (P21W) 8GA 002 073-121



Manufacturer Model	Model year	Part no.	Pk.	Note
Ford				
Mondeo IV	03/07->	1LF 010 541-031	1	H7/H1 headlight, left, with indicator light, with electr. headlight leveller actuator, with bulbs
Mondeo IV	03/07->	1LF 010 541-041	1	H7/H1 headlight, right, with indicator light, with electr. headlight leveller actuator, with bulbs
				
		 1x12V55W (H7) 8GH 007 157-121  1x12V55W (H1) 8GH 002 089-133  1x12V21W (PY21W) 8GA 006 841-121  1x12V5W (W5W) 8GP 003 594-121		
Mondeo IV	03/07->	1ZL 010 541-071	1	H1/H7 headlight, left, with indicator light, with bend lighting (AFS), with electr. headlight leveller actuator, with bulbs
Mondeo IV	03/07->	1ZL 010 541-081	1	H1/H7 headlight, right, with indicator light, with bend lighting (AFS), with electr. headlight leveller actuator, with bulbs
				
		 1x12V55W (H7) 8GH 007 157-121  2x12V55W (H1) 8GH 002 089-133  1x12V21W (PY21W) 8GA 006 841-121  1x12V5W (W5W) 8GP 003 594-121		



Ford



Manufacturer Model	Model year	Part no.	Pk.	Note
Ford				
Mondeo IV	03/07->	1LL 010 541-111	1	Bi-Xenon®/H1 headlight, left, with indicator light, cornering light, with electr. headlight leveller actuator, without xenon ballast, with gas discharge bulb, with bulbs
		1LL 010 541-121	1	Bi-Xenon®/H1 headlight, right, with indicator light, cornering light, with electr. headlight leveller actuator, without xenon ballast, with gas discharge bulb, with bulbs
				1x35W (D1S) 8GS 009 028-001
				1x12V55W (H1) 8GH 002 089-133
				1x12V21W (PY21W) 8GA 006 841-121
				1x12V5W (W5W) 8GP 003 594-121
Mondeo IV Sedan	03/07->	9EL 176 574-011	1	Combination rearlight, left, with bulbs
		9EL 176 574-021	1	Combination rearlight, right, with bulbs
				1x12V21/5W (P21/5W) 8GD 002 078-121
				1x12V21W (PY21W) 8GA 006 841-121
Mondeo IV Hatchback	03/07->	9EL 176 575-011	1	Combination rearlight, left, with bulbs
		9EL 176 575-021	1	Combination rearlight, right, with bulbs
				1x12V21/5W (P21/5W) 8GD 002 078-121
				1x12V21W (PY21W) 8GA 006 841-121



















Manufacturer Model	Model year	Part no.	Pk.	Note
Ford				
Mondeo IV		9EL 176 576-011	1	Rear fog and reverse light, left, with bulbs
Mondeo IV Hatchback	03/07->	9EL 176 576-021	1	Rear fog and reverse light, right, with bulbs
Mondeo IV Sedan	03/07->			 1x12V21/5W (P21/5W) 8GD 002 078-121 1x12V21/4W (P21/4W) 8GD 004 772-121 1x12V21W (PY21W) 8GA 006 841-121
Mondeo IV Estate	03/07->	9EL 176 577-011	1	Combination rearlight, left, with bulbs
		9EL 176 577-021	1	Combination rearlight, right, with bulbs
				 1x12V21/5W (P21/5W) 8GD 002 078-121 1x12V21W (PY21W) 8GA 006 841-121
Orion III (GAL)		9EL 148 345-011	1	Body/lens for combination rearlight, left, with reverse and rear fog light
Orion III (GAL)	09/91->12/93	9EL 148 345-021	1	Body/lens for combination rearlight, right, with reverse and rear fog light
				 (E1) 223 1x12V5W (R5W) 8GA 002 071-121 3x12V21W (P21W) 8GA 002 073-121
S-MAX		1LJ 009 250-771	1	FF®-H7/FF®-H1 headlight, left, with indicator light, with electr. headlight leveller actuator, with bulbs
S-MAX	05/06->	1LJ 009 250-781	1	FF®-H7/FF®-H1 headlight, right, with indicator light, with electr. headlight leveller actuator, with bulbs
				  1x12V55W (H7) 8GH 007 157-121  1x12V55W (H1) 8GH 002 089-133  2x12V21W (PY21W) 8GA 006 841-121







Ford



Manufacturer Model	Model year	Part no.	Pk.	Note
Ford				
Transit (T_) Transit Bus, Box	09/85->09/92	2VP 354 034-011 2VP 354 034-021	1 1	Combination rearlight, left, with reverse and rear fog light Combination rearlight, right, with reverse and rear fog light   1x12V21/5W (P21/5W) 8GD 002 078-121  3x12V21W (P21W) 8GA 002 073-121
Transit (E_) Transit	08/94->07/00	1LG 354 023-031 1LG 354 023-041	1 1	H4 headlight, left, for vehicles with headlight leveller (black body, plastic lens) H4 headlight, right, for vehicles with headlight leveller (black body, plastic lens)   489  1x12V60/55W (H4) 8GJ 002 525-131  1x12V5W (W5W) 8GP 003 594-121
Transit	08/94->07/00	1LG 354 023-071 1LG 354 023-081	1 1	H4 headlight, left, for vehicles without headlight leveller (black body, plastic lens) H4 headlight, right, for vehicles without headlight leveller (black body, plastic lens)   491  1x12V60/55W (H4) 8GJ 002 525-131  1x12V5W (W5W) 8GP 003 594-121
Transit	06/94->07/00	1NE 007 517-051 1NE 007 517-061	1 1	FF®-H3 fog light, left FF®-H3 fog light, right   215  1x12V55W (H3) 8GH 002 090-133
Transit	01/91->07/00	9EL 354 072-011 9EL 354 072-021	1 1	Body/lens for indicator light (amber), left Body/lens for indicator light (amber), right   1x12V21W (P21W) 8GA 002 073-121










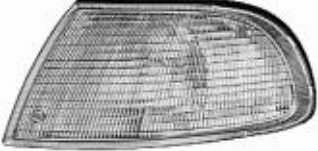


Manufacturer Model	Model year	Part no.	Pk.	Note
Ford				
Transit (E_) Transit Bus, Box	01/91->07/00	2VP 354 034-011 2VP 354 034-021	1 1	Combination rearlight, left, with reverse and rear fog light Combination rearlight, right, with reverse and rear fog light 1x12V21/5W (P21/5W) 8GD 002 078-121 3x12V21W (P21W) 8GA 002 073-121
				
Transit (F_) Transit	12/01->07/06	1LG 354 024-071 1LG 354 024-081 1LG 354 024-051 1LG 354 024-061	1 1 1 1	H4 headlight, left, with indicator light, with black cover, for vehicles without headlight leveller H4 headlight, right, with indicator light, with black cover, for vehicles without headlight leveller H4 headlight, left, with indicator light, with black cover, with electr. headlight leveller actuator, for vehicles with headlight leveller H4 headlight, right, with indicator light, with black cover, with electr. headlight leveller actuator, for vehicles with headlight leveller 8478 1x12V60/55W (H4) 8GJ 002 525-131 1x12V21/5W (P21/5W) 8GD 002 078-121 1x12V5W (W5W) 8GP 003 594-121
				
Transit	01/00->07/06	1LG 354 024-131 1LG 354 024-141	1 1	H4 headlight, left, with indicator light, with chrome-plated cover, with electr. headlight leveller actuator, for vehicles with headlight leveller H4 headlight, right, with indicator light, with chrome-plated cover, with electr. headlight leveller actuator, for vehicles with headlight leveller 9476 1x12V60/55W (H4) 8GJ 002 525-131 1x12V21/5W (P21/5W) 8GD 002 078-121 1x12V5W (W5W) 8GP 003 594-121
				
Transit Flatbed, Chassis with long wheelbase 350 R series	01/00->07/06	2BA 010 231-011 2BA 010 231-021	1 1	Auxiliary indicator light (amber), left Auxiliary indicator light (amber), right 1x12V5W (W5W) 8GP 003 594-121
				



Ford - Honda



Manufacturer Model	Model year	Part no.	Pk.	Note
Ford				
Transit (F_) Transit Flatbed, Chassis 2-doors	09/02->07/06	2BA 010 232-011 2BA 010 232-021	1 1	Auxiliary indicator light (amber), left Auxiliary indicator light (amber), right  1x12V5W (W5W) 8GP 003 594-121
				
Transit Bus, Box	01/00->07/06	2VP 354 037-011 2VP 354 037-021	1 1	Combination rearlight, left, with reverse and rear fog light Combination rearlight, right, with reverse and rear fog light  1x12V21/5W (P21/5W) 8GD 002 078-121 3x12V21W (P21W) 8GA 002 073-121
				
Transit Transit Bus, Box Transit Tourneo	07/06->	9EL 171 968-011 9EL 171 968-021	1 1	Body/lens for combination rearlight, left, with reverse and rear fog light Body/lens for combination rearlight, right, with reverse and rear fog light  2x12V21W (P21W) 8GA 002 073-121 1x12V21W (PY21W) 8GA 006 841-121  1x12V5W (W5W) 8GP 003 594-121
				
Honda				
Accord V (CC7) Accord V (CC7)	03/93->02/96	9EL 236 217-011 9EL 236 218-011	1 1	Body/lens for indicator light (white), left Body/lens for indicator light (white), right  52633  1x12V21W (PY21W) 8GA 006 841-121
				



Manufacturer Model	Model year	Part no.	Pk.	Note
Honda				
Accord V (CC7) Accord V (CC7)	03/93->02/96	9EL 236 238-011	1	Body/lens for combination rearlight, right (E1) 63285 1x12V21/5W (P21/5W) 8GD 002 078-121 1x12V21W (P21W) 8GA 002 073-121
KIA				
Cee'd Cee'd	12/06->	1LJ 009 547-231 1LJ 009 547-241	1 1	FF®-H7 headlight, left, with indicator light, with electr. headlight leveller actuator, with bulbs FF®-H7 headlight, right, with indicator light, with electr. headlight leveller actuator, with bulbs 1x12V55W (H7) 8GH 007 157-121 1x12V21W (H21W) 8GH 008 417-001 1x12V5W (W5W) 8GP 003 594-121
Land Rover				
Freelander II Freelander II	02/06->	1LF 354 025-111 1LF 354 025-121	1 1	H7 headlight, left, with indicator light, with electr. headlight leveller actuator H7 headlight, right, with indicator light, with electr. headlight leveller actuator (E4) 10233 left (E4) 10234 right 2x12V55W (H7) 8GH 007 157-121 1x12V21W (PY21W) 8GA 006 841-121 1x12V5W (W5W) 8GP 003 594-121
Freelander II	02/06->	1LL 354 025-071 1LL 354 025-081	1 1	Xenon/H7 headlight, left, with indicator light, with dynam. headlight leveller actuator, with xenon ballast, with gas discharge bulb, with bulbs Xenon/H7 headlight, right, with indicator light, with dynam. headlight leveller actuator, with xenon ballast, with gas discharge bulb, with bulbs (E4) 10233 left (E4) 10234 right 1x35W (D1S) 8GS 009 028-001 1x12V55W (H7) 8GH 007 157-121 1x12V21W (PY21W) 8GA 006 841-121 1x12V5W (W5W) 8GP 003 594-121



Land Rover - Mazda









Manufacturer Model	Model year	Part no.	Pk.	Note
Land Rover				
Freelander II Freelander II	02/06->	1LL 354 025-031 1LL 354 025-041	1 1	<p>Xenon/H7 headlight, left, with indicator light, with bend lighting, with dynam. headlight leveller actuator, with xenon ballast, with gas discharge bulb, with bulbs</p> <p>Xenon/H7 headlight, right, with indicator light, with bend lighting, with dynam. headlight leveller actuator, with xenon ballast, with gas discharge bulb, with bulbs</p> <p>Ⓔ4 10233 left Ⓔ4 10234 right</p> <p> 1x35W (D1S) 8GS 009 028-001</p> <p> 1x12V55W (H7) 8GH 007 157-121</p> <p> 1x12V21W (PY21W) 8GA 006 841-121</p> <p> 1x12V5W (W5W) 8GP 003 594-121</p>
Freelander II	02/06->	2SK 354 035-011 2SK 354 035-021	1 1	<p>Combination rearlight, left, with reverse and rear fog light</p> <p>Combination rearlight, right, with reverse and rear fog light</p> <p> 1x12V21/5W (P21/5W) 8GD 002 078-121</p> <p> 2x12V21W (P21W) 8GA 002 073-121</p> <p> 1x12V21W (PY21W) 8GA 006 841-121</p>
Mazda				
121 III (JASM, JBSM) 121 III (JASM, JBSM)	03/96->02/00	1LJ 008 041-031 1LJ 008 041-041	1 1	<p>H1/H7 headlight, left, with indicator light</p> <p>H1/H7 headlight, right, with indicator light</p> <p> 1x12V55W (H7) 8GH 007 157-121</p> <p> 1x12V55W (H1) 8GH 002 089-133</p> <p> 1x12V21W (PY21W) 8GA 006 841-121</p> <p> 1x12V5W (W5W) 8GP 003 594-121</p>











Manufacturer Model	Model year	Part no.	Pk.	Note
Mercedes-Benz				
C-Class (W/S 202)				
C 180 - C 280 (C-Class, W/S 202)	03/93->08/96	1LJ 008 040-071	1	H1 headlight, left, with H3 fog light, with body/lens for indicator light (white), with headlight leveller, with bulbs H1 headlight, right, with H3 fog light, with body/lens for indicator light (white), with headlight leveller, with bulbs (E13) 2567 left (E13) 2568 right (E1) 52638 left and right Spare Parts: Body/lens for indicator light (white), left Body/lens for indicator light (white), right 2x12V55W (H1) 8GH 002 089-133 1x12V55W (H3) 8GH 002 090-133 1x12V21W (PY21W) 8GA 006 841-121 1x12V5W (W5W) 8GP 003 594-121
C 180, C 200, C 200 D, C 220, C 220 D, C 230 Kompressor, C 250 D, C 250 Turbodiesel, C 280		1LJ 008 040-081	1	
Saloon	03/93->08/96			
Estate	06/96->08/96	9EL 150 867-001 9EL 150 868-001	1 1	
C 180 - C 280 (C-Class, W/S 202)	03/93->08/96	9EL 150 987-001 9EL 150 988-001	1 1	Body/lens for indicator light (amber), left Body/lens for indicator light (amber), right (E1) 52637 1x12V21W (P21W) 8GA 002 073-121
C 180 - C 280 (C-Class, W/S 202)	03/93->03/01	9EL 150 867-001 9EL 150 868-001	1 1	Body/lens for indicator light (white), left Body/lens for indicator light (white), right (E1) 52638 1x12V21W (PY21W) 8GA 006 841-121
C 180 - C 280 (C-Class, W 202)	03/93->05/00	2KA 004 983-011	4	Licence plate light (E1) 22870 1x12V5W (C5W) 8GM 002 092-121
up to chassis no. A 406838, F 419816				
C-Class (W/S 203)				
C 180 - C 320 (C-Class, W 203) Saloon	05/00->05/02	1NA 007 976-071	1	HB4 fog light, left, with bulb HB4 fog light, right, with bulb (E1) 839 1x12V51W (HB4) 8GH 005 636-121
C 180 T - C 320 T 4-matic (C-Class, S 203) Estate	03/01->05/02	1NA 007 976-081	1	



Manufacturer Model	Model year	Part no.	Pk.	Note
Mercedes-Benz				
C-Class (W/S 203)				
C 180 Kompressor - C 320 4-matic (C-Class, W 203) Saloon C 180 T Kompressor - C 320 T 4-matic (C-Class, S 203) Estate	05/02->02/04	1NA 007 976-111	1	HB4 fog light, left, with bulb HB4 fog light, right, with bulb (E1) 1215  1x12V51W (HB4) 8GH 005 636-121
	05/02->02/04	1NA 007 976-121	1	
C 180 Kompressor - C 350 4-matic (C-Class, W 203) Saloon C 180 T Kompressor - C 350 T 4-matic (C-Class, S 203) Estate	03/04->	1NA 007 976-231	1	HB4 fog light, left, with bulb HB4 fog light, right, with bulb (E1) 839  1x12V51W (HB4) 8GH 005 636-121
	03/04->	1NA 007 976-241	1	
C 180 T - C 320 T 4-matic (C-Class, S 203) Estate C 180 T, C 180 Kompressor, C 200 CDI T, C 200 CGI T, C 200 Kompressor T, C 220 CDI T, C 240 T, C 240 4-matic T, C 270 CDI T, C 320 T, C 320 4-matic T, C 32 AMG T Estate	03/01->02/04	2VP 008 048-051	1	Combination rearlight, left, with reverse and rear fog light, with side-marker reflex-reflector, with bulbs Combination rearlight, right, with reverse and rear fog light, with side-marker reflex-reflector, with bulbs (E1) 1091  1x12V21/4W (P21/4W) 8GD 004 772-121 2x12V21W (P21W) 8GA 002 073-121 1x12V21W (PY21W) 8GA 006 841-121
	03/01->02/04	2VP 008 048-061	1	
				
				
				



Manufacturer Model	Model year	Part no.	Pk.	Note
Mercedes-Benz				
C-Class Sports Coupé (CL 203)				
C 160 - C 320 Kompressor (C-Class, CL 203) Sports Coupé	03/01->05/02	1NA 007 976-071 1NA 007 976-081	1 1	HB4 fog light, left, with bulb HB4 fog light, right, with bulb (E1) 839  1x12V51W (HB4) 8GH 005 636-121
				
C 160 - C 320 (C-Class, CL 203) Sports Coupé	05/02->02/04	1NA 007 976-111 1NA 007 976-121	1 1	HB4 fog light, left, with bulb HB4 fog light, right, with bulb (E1) 1215  1x12V51W (HB4) 8GH 005 636-121
				
C 160 - C 320 (C-Class, CL 203) Sports Coupé	03/01->02/04	2VP 008 031-051 2VP 008 031-061	1 1	Combination rearlight, left, with reverse and rear fog light, with bulbs Combination rearlight, right, with reverse and rear fog light, with bulbs (E1) 1014  1x12V21/4W (P21/4W) 8GD 004 772-121  3x12V21W (P21W) 8GA 002 073-121
C 160 Kompressor, C 180, C 180 Kompressor, C 200 CDI, C 200 Kompressor, C 200 CGI Kompressor, C 220, C 220 CDI, C 230 Kompressor, C 30 CDI, C 320 Sports Coupé	03/01->02/04			
				
CLK (C 208)				
CLK 200 - CLK 430 (CLK, C 208)	06/97->02/03	1NB 007 555-031 1NB 007 555-041	1 1	H1 fog light, left, with bulb H1 fog light, right, with bulb (E13) 141  1x12V55W (H1) 8GH 002 089-133
				













Manufacturer Model	Model year	Part no.	Pk.	Note
Mercedes-Benz				
CLK (C 208) CLK 200 - CLK 430 (CLK, C 208) CLK 200, CLK 230 Kompressor, CLK 320 CLK 430	06/97->02/03 06/97->02/03 08/98->02/03	9EL 147 845-021 9EL 147 846-021	1 1	Body/lens for combination rearlight, left Body/lens for combination rearlight, right E1 487 1x12V5W (R5W) 8GA 002 071-121 1x12V21W (P21W) 8GA 002 073-121 1x12V21W (PY21W) 8GA 006 841-121
CLK (C 209) CLK 200 - CLK 500 (CLK, C 209)	06/02->05/05	1NA 007 976-111 1NA 007 976-121	1 1	HB4 fog light, left, with bulb HB4 fog light, right, with bulb E1 1215 1x12V51W (HB4) 8GH 005 636-121
CLK 200 - CLK 500 (CLK, C 209) CLK 200 CGI, CLK 240, CLK 270 CDI, CLK 320, CLK 320 CDI, CLK 500, CLK 32 AMG	06/02->05/05	2VP 008 326-051 2VP 008 326-061	1 1	Combination rearlight, left, with reverse and rear fog light, with side-marker reflex-reflector, with bulbs Combination rearlight, right, with reverse and rear fog light, with side-marker reflex-reflector, with bulbs E1 1152 1x12V5W (R5W) 8GA 002 071-121 1x12V21/4W (P21/4W) 8GD 004 772-121 3x12V21W (P21W) 8GA 002 073-121
CLS (C 219) CLS 350 - CLS 500 (CLS, C 219) CLS 350, CLS 500 CLS 55 AMG CLS 63 AMG	10/04-> 10/04-> 01/05-> 04/06->	1LS 008 821-331 1LS 008 821-341 5DV 008 290-004	1 1 1	Bi-Xenon®/H7 headlight, left, with indicator light, with bend lighting, with electr. headlight leveller actuator, with xenon ballast, with gas discharge bulb, with bulbs Bi-Xenon®/H7 headlight, right, with indicator light, with bend lighting, with electr. headlight leveller actuator, with xenon ballast, with gas discharge bulb, with bulbs E1 1814 Spare Parts: Ballast unit 1x35W (D2S) 8GS 007 949-101 1x12V55W (H7) 8GH 007 157-201 1x12V5W (W5W) 8GP 003 594-121 1x12V21W (PY21W) Osram Diadem



Manufacturer Model	Model year	Part no.	Pk.	Note
Mercedes-Benz				
CLS (C 219) CLS 350 - CLS 500 (CLS, C 219)	10/04->	5DV 008 290-004	1	Ballast unit
E-Class (W/S 124) E 420, E 500 (E-class, W 124) (Also suitable for conversion of E 200 - E 320)	06/93->06/95	1LJ 007 219-371 1LJ 007 219-381	1 1	H4 headlight, left, with H3 spotlight, with white indicator light, with headlight leveller H4 headlight, right, with H3 spotlight, with white indicator light, with headlight leveller (E1) 30 left (E1) 31 right Spare Parts: 2BA 004 693-031 1 Indicator light (white), left, with bulb 2BA 004 693-041 1 Indicator light (white), right, with bulb 9EL 129 615-021 1 Lens for indicator light (white), left 9EL 129 614-021 1 Lens for indicator light (white), right 9AH 144 863-021 1 Lens retaining rim with lens, left 9AH 144 864-021 1 Lens retaining rim with lens, right 9DE 129 975-021 1 Reflector for H4 headlight, left 9DE 129 974-021 1 Reflector for H4 headlight, right 9FF 137 580-005 200 Bulb socket for side light 1x12V60/55W (H4) 8GJ 002 525-131 1x12V55W (H3) 8GH 002 090-133 1x12V21W (PY21W) 8GA 006 841-121 1x12V4W (T4W) 8GP 002 067-121
E 200 - E 500 (E-Class, W/S 124) Saloon Estate Convertible Coupé	06/93->03/98 06/93->06/95 06/93->06/96 06/93->03/98 06/93->06/97	2BA 004 693-031 2BA 004 693-041 9EL 129 615-021 9EL 129 614-021	1 1 1 1	Indicator light (white), left, with bulb Indicator light (white), right, with bulb (E1) 52609 Spare Parts: Lens, left Lens, right 1x12V21W (PY21W) 8GA 006 841-121









Manufacturer Model	Model year	Part no.	Pk.	Note
Mercedes-Benz				
E-Class (W/S 124)		2VP 004 686-151	1	Combination rearlight (grey/red), left, with reverse and rear fog light
E 200 - E 500 (E-Class, W/S 124)	06/93->03/98	2VP 004 686-181	1	Combination rearlight (grey/red), right, with reverse and rear fog light
Saloon	06/93->06/95			(E1) 53378 (E1) 63290
Convertible	06/93->03/98			Spare Parts:
Coupé	06/93->06/97	9EL 129 763-021 9EL 129 762-031	1 1	Lens, left Lens, right
				  1x12V10W (R10W) 8GA 002 071-131  3x12V21W (P21W) 8GA 002 073-121  1x12V21W (PY21W) 8GA 006 841-121
E 200 - E 500 (E-Class, W/S 124) Saloon, Coupé, Convertible	06/93->03/98	2KA 004 983-011	4	Licence plate light
				 (E1) 22870  1x12V5W (C5W) 8GM 002 092-121
E-Class (W/S 210)		1L9 007 095-111	1	H7 headlight, left, with indicator light, with headlight leveller, with bulbs
E 200 - E 430 (E-Class, W/S 210)	06/95->06/99	1L9 007 095-121	1	H7 headlight, right, with indicator light, with headlight leveller, with bulbs
E 200, E 200 D, E 200 CDI, E 220 D, E 220 CDI, E 230, E 240, E 250 D, E 280, E 290 Turbo-D, E 300 D, E 300 Turbo-D, E 320, E 420, E 430				(E1) 227 left and right (E1) 229 left (E1) 230 right
Saloon	06/95->06/99	9AH 144 231-041 9AH 144 232-041	1 1	Spare Parts: Lens retaining rim with double lens, left Lens retaining rim with double lens, right
Estate	05/96->06/99			  2x12V55W (H7) 8GH 007 157-201 Long Life  1x12V6W (H6W) 8GH 007 643-171 Long Life  1x12V21W (PY21W) Long Life



Manufacturer Model	Model year	Part no.	Pk.	Note
Mercedes-Benz				
E-Class (W/S 210)		1L9 378 176-001	1	Xenon/H7 headlight, left, with indicator light, with electr. headlight leveller actuator, with gas discharge bulb, with bulbs
E 200 - E 430 (E-Class, W/S 210)	06/95->06/99	1L9 378 177-001	1	Xenon/H7 headlight, right, with indicator light, with electr. headlight leveller actuator, with gas discharge bulb, with bulbs
E 50, E 55, E 200, E 200 D, E 200 CDI, E 220 D, E 220 CDI, E 230, E 240, E 250 D, E 280, E 290 Turbo-D, E 300 D, E 300 Turbo-D, E 320, E 420, E 430				(E1) 229 left and right (E1) 277 left and right Spare Parts: 1 Lens retaining rim with double lens, left 1 Lens retaining rim with double lens, right 1 Ignitor, gas discharge bulb 1x35W (D2R) 8GS 007 001-121 1x12V55W (H7) 8GH 007 157-201 Long Life 1x12V6W (H6W) 8GH 007 643-171 Long Life 1x12V21W (PY21W) 8GA 006 841-121
Saloon	06/95->06/99	9AH 378 393-001	1	
Estate	05/96->06/99	9AH 378 392-001 5DD 008 319-501	1	
E 200 - E 430 (E-Class, W/S 210)	07/99->03/03	1L9 378 158-001	1	H7 headlight, left, with indicator light, with pneum. headlight leveller actuator, with bulbs
E 200, E 200 CDI, E 220 CDI, E 240, E 270 CDI, E 280, E 320, E 320 CDI, E 430		1L9 378 159-001	1	H7 headlight, right, with indicator light, with pneum. headlight leveller actuator, with bulbs
Saloon	07/99->03/02			(E1) 227 left and right
Estate	07/99->03/03			(E1) 229 left and right (E1) 230 right
				2x12V55W (H7) 8GH 007 157-201 Long Life 1x12V6W (H6W) 8GH 007 643-171 Long Life 1x12V21W (PY21W) 8GA 006 841-121
E 200 - E 430 (E-Class, W/S 210)	06/95->03/03	5DD 008 319-501	1	Ignitor, gas discharge bulb
Saloon	06/95->03/02			
Estate	05/96->03/03			











Manufacturer Model	Model year	Part no.	Pk.	Note
Mercedes-Benz				
E-Class (W/S 210)		1NB 007 555-031	1	H1 fog light, left, with bulb
E 200 - E 430 (E-Class, W/S 210)	07/99->03/03	1NB 007 555-041	1	H1 fog light, right, with bulb
Saloon	07/99->03/02			(E13) 141
Estate	07/99->03/03			 1x12V55W (H1) 8GH 002 089-133
				
E-Class (W/S 211)		1LL 008 369-171	1	H7 headlight, left, with indicator light, with electr. headlight leveller actuator, with bulbs
E 200 CDI - E 500 (E-Class, W/S 211)	03/02->05/06	1LL 008 369-181	1	H7 headlight, right, with indicator light, with electr. headlight leveller actuator, with bulbs
E 200 CDI, E 200 CGI, E 200 Kompressor, E 200 NGT, E 220 CDI, E 240, E 240 4-matic, E 270 CDI, E 280, E 280 CDI, E 320, E 320 4-matic, E 320 CDI, E 350, E 400 CDI, E 420 CDI, E 500, E 500 4-matic, E 55 AMG				(E1) 1313 (E1) 1314
Saloon	03/02->05/06			 2x12V55W (H7) 8GH 007 157-201 Long Life
Estate	03/03->05/06			 1x12V5W (W5W) Long Life
				
		 1x12V21W (PY21W) Long Life		











Manufacturer Model	Model year	Part no.	Pk.	Note
Mercedes-Benz				
E-Class (W/S 211)		1LL 008 369-271	1	Bi-Xenon®/H7 headlight, left, with indicator light, with electr. headlight leveller actuator, with xenon ballast, with gas discharge bulb, with bulbs
E 200 CDI - E 500 (E-Class, W/S 211)	03/02->05/06			
E 200 CDI, E 200 CGI, E 200 Kompressor, E 200 NGT, E 220 CDI, E 240, E 240 4-matic, E 270 CDI, E 280, E 280 CDI, E 320, E 320 4-matic, E 320 CDI, E 350, E 400 CDI, E 420 CDI, E 500, E 500 4-matic, E 55 AMG		1LL 008 369-281	1	Bi-Xenon®/H7 headlight, right, with indicator light, with electr. headlight leveller actuator, with xenon ballast, with gas discharge bulb, with bulbs
				(E1) 1313 (E1) 1314
Saloon	03/02->05/06			
Estate	03/03->05/06			
		5DV 008 290-004	1	Spare Parts: Ballast unit
				1x35W (D2S) 8GS 007 949-101
				1x12V55W (H7) 8GH 007 157-201 Long Life
				1x12V5W (W5W) Long Life
				1x12V21W (PY21W) Long Life
E 200 CDI - E 500 (E-Class, W/S 211)	03/02->05/06	1LS 008 369-491	1	Bi-Xenon®/H7 headlight, left, with indicator light, with bend lighting, with electr. headlight leveller actuator, with xenon ballast, with gas discharge bulb, with bulbs
E 200 CDI, E 200 CGI, E 200 Kompressor, E 200 NGT, E 220 CDI, E 240, E 240 4-matic, E 270 CDI, E 280, E280 CDI, E 320, E 320 4-matic, E 320 CDI, E 350, E 400 CDI, E 420 CDI, E 500, E 500 4-matic, E 55 AMG				
		1LS 008 369-501	1	Bi-Xenon®/H7 headlight, right, with indicator light, with bend lighting, with electr. headlight leveller actuator, with xenon ballast, with gas discharge bulb, with bulbs
				(E1) 1313 (E1) 1314
Saloon	03/02->05/06			
Estate	03/03->05/06			
		5DV 008 290-004	1	Spare Parts: Ballast unit
				1x35W (D2S) 8GS 007 949-101
				1x12V55W (H7) 8GH 007 157-121
				1x12V5W (W5W) 8GP 003 594-121
				1x12V21W (PY21W) 8GA 006 841-121













Manufacturer Model	Model year	Part no.	Pk.	Note
Mercedes-Benz				
E-Class (W/S 211)				
E 200 K - E 500 (E-Class, W/S 211)	06/06->	1LL 009 260-091	1	H7 headlight, left, with indicator light, with electr. headlight leveller actuator, with bulbs
E 220 CDI, E 200 K, E 220 CDI, E 230, E 270 CDI, E 280, E 280 4M, E 280 CDI, E 280 CDI 4M, E 320 CDI, E 320 4M, E 350, E 350 4M, E 500, E 500 4M, E 63 AMG		1LL 009 260-101	1	H7 headlight, right, with indicator light, with electr. headlight leveller actuator, with bulbs
Saloon, Estate	06/06->			 2x12V55W (H7) 8GH 007 157-121  1x12V5W (W5W) 8GP 003 594-121  1x12V21W (PY21W) 8GA 006 841-121
				
E 200 K - E 500 (E-Class, W/S 211)	06/06->	1LL 009 260-571	1	Bi-Xenon®/H7 headlight, left, with indicator light, with electr. headlight leveller actuator, without xenon ballast, with gas discharge bulb, with bulbs
E 220 CDI, E 200 K, E 220 CDI, E 230, E 270 CDI, E 280, E 280 4M, E 280 CDI, E 280 CDI 4M, E 320 CDI, E 320 4M, E 350, E 350 4M, E 500, E 500 4M, E 63 AMG		1LL 009 260-581	1	Bi-Xenon®/H7 headlight, right, with indicator light, with electr. headlight leveller actuator, without xenon ballast, with gas discharge bulb, with bulbs
Saloon, Estate	06/06->			 1x35W (D1S) 8GS 009 028-001  2x12V55W (H7) 8GH 007 157-121  1x12V21W (PY21W) 8GA 006 841-121
				



Manufacturer Model	Model year	Part no.	Pk.	Note
Mercedes-Benz				
E-Class (W/S 211)		1ZT 009 260-671	1	Bi-Xenon®/H7-AFS headlight, left, with indicator light, with bend lighting, with electr. headlight leveller actuator, without xenon ballast, with gas discharge bulb, with bulbs
E 200 K - E 500 (E-Class, W/S 211)	06/06->			
E 220 CDI, E 200 K, E 220 CDI, E 230, E 270 CDI, E 280, E 280 4M, E 280 CDI, E 280 CDI 4M, E 320 CDI, E 320 4M, E 350, E 350 4M, E 500, E 500 4M, E 63 AMG		1ZT 009 260-681	1	Bi-Xenon®/H7-AFS headlight, right, with indicator light, with bend lighting, with electr. headlight leveller actuator, without xenon ballast, with gas discharge bulb, with bulbs
Saloon, Estate	06/06->			
				(E1) 2077  1x35W (D1S) 8GS 009 028-001  2x12V55W (H7) 8GH 007 157-121  1x12V21W (PY21W) 8GA 006 841-121
E 200 CDI - E 500 (E-Class, W/S 211)	03/02->06/06	5DV 008 290-004	1	Ballast unit
Saloon	03/02->06/06			
Estate	03/03->06/06			
				
E 200 K - E 500 (E-Class, W/S 211)	06/06->	5DC 009 060-011	1	Ballast unit
Saloon, Estate	06/06->			
				
E 200 CDI - E 500 (E-Class, W/S 211)	03/02->05/04	1NB 008 275-031	1	H11 fog light, left, with bulb
Saloon	03/02->05/04	1NB 008 275-041	1	H11 fog light, right, with bulb
Estate	03/03->05/04			
				(E1) 1325  1x12V55W (H11) 8GH 008 358-121



Manufacturer Model	Model year	Part no.	Pk.	Note
Mercedes-Benz				
E-Class (W/S 211)		1NB 008 275-071	1	H11 fog light, left, with bulb
E 200 CDI - E 500 (E-Class, W/S 211)	06/04->06/06	1NB 008 275-081	1	H11 fog light, right, with bulb
Saloon	06/04->06/06			(E1) 1325
Estate	06/04->06/06			 1x12V55W (H11) 8GH 008 358-121
				
G-Class (W 460)		1L8 003 060-561	1	Headlight, not suitable for headlight leveller
230 G - 300 GD (G-Class, W 460)	05/79->08/89			(E1) 7097
230 G, 230 GE, 240 GD, 250 GD, 280 GE, 300 GD		9GH 116 966-011	10	Spare Parts: Cap
		9FF 126 444-001	10	Bulb socket for side light (to be ordered separately)
				 1x12V45/40W (R2) 8GD 002 088-131
				 1x12V4W (T4W) 8GP 002 067-121
		1L8 003 060-691	1	H4 headlight, not suitable for headlight leveller
				(E1) 7144
		9GH 116 966-011	10	Spare Parts: Cap
		9FF 126 444-001	10	Bulb socket for side light (to be ordered separately)
				 1x12V60/55W (H4) 8GJ 002 525-131
				 1x12V4W (T4W) 8GP 002 067-121
230 G - 300 GD (G-Class, W 460)	09/89->07/93	1L8 004 148-017	120	H4 headlight, suitable for headlight leveller
230 G, 230 GE, 250 GD, 300 GD	09/89->07/93			(E1) 7144
		1L8 139 474-015	1	Spare Parts: Light unit
		9GH 116 966-011	10	Cap
		9FF 126 444-001	10	Bulb socket for side light
				 1x12V60/55W (H4) 8GJ 002 525-131
				 1x12V4W (T4W) 8GP 002 067-121








Manufacturer Model	Model year	Part no.	Pk.	Note
Mercedes-Benz				
G-Class (W 460) 230 G - 300 GD (G-Class, W 460)	05/79->03/90	2NE 002 589-047 9EL 112 763-001	10 5	Rear fog light (E1) 8444 Spare Parts: Lens with screws 1x12V21W (P21W) 8GA 002 073-121
G-Class (W 461) 230 GE - G 290 TD (G-Class, W 461) 230 GE, 250 GD, 290 GD, 290 GD, G 290 D, G 290 TD	02/90->	1L8 004 148-017 1L8 139 474-015 9GH 116 966-011 9FF 126 444-001	120 1 10 10	H4 headlight, suitable for headlight leveller (E1) 7144 Spare Parts: Light unit Cap Bulb socket for side light 1x12V60/55W (H4) 8GJ 002 525-131 1x12V4W (T4W) 8GP 002 067-121
G-Class (W 463) 230 GE - G 55 AMG (G-Class, W 463) 230 GE, 250 GD, G 270 CDI, 300 GD, 300 GE, G 300 TD, G 320, G 320 350 G Turbo D, G 36 AMG, G 400 CDI, G 500, G 500 E, G 55 AMG	09/89->	1L8 004 148-017 1L8 139 474-015 9GH 116 966-011 9FF 126 444-001	120 1 10 10	H4 headlight, suitable for headlight leveller (E1) 7144 Spare Parts: Light unit Cap Bulb socket for side light 1x12V60/55W (H4) 8GJ 002 525-131 1x12V4W (T4W) 8GP 002 067-121



Manufacturer Model	Model year	Part no.	Pk.	Note
Mercedes-Benz				
M-Class (W 163)				
ML 230 - ML 500 (M-Class, W 163)	09/01->06/05	1LL 223 151-031	1	DE-H7/FF®-H7 headlight, left, with indicator light, with electr. headlight leveller actuator, with bulbs DE-H7/FF®-H7 headlight, right, with indicator light, with electr. headlight leveller actuator, with bulbs (E4) 9815 2x12V55W (H7) 8GH 007 157-121 1x12V5W (W5W) 8GP 003 594-121 1x12V21W (PY21W) 8GA 006 841-121
ML 230, ML 270 CDI, ML 320	09/01->06/05	1LL 223 151-041	1	
ML 350	08/02->06/05			
ML 400 CDI, ML 430, ML 500	09/01->06/05			
ML 230 - ML 500 (M-Class, W 163)	09/01->06/05	1LL 223 151-091	1	Bi-Xenon®/H7 headlight, left, with indicator light, with electr. headlight leveller actuator, with xenon ballast, with gas discharge bulb, with bulbs Bi-Xenon®/H7 headlight, right, with indicator light, with electr. headlight leveller actuator, with xenon ballast, with gas discharge bulb, with bulbs (E4) 9815 (E4) 9816 Spare Parts: Ballast unit 1x35W (D2S) 8GS 007 949-101 1x12V55W (H7) 8GH 007 157-121 1x12V5W (W5W) 8GP 003 594-121 1x12V21W (PY21W) 8GA 006 841-121
ML 230, ML 270 CDI, ML 320	09/01->06/05	1LL 223 151-101	1	
ML 350	08/02->06/05			
ML 400 CDI, ML 430, ML 500	09/01->06/05			
ML 230 - ML 500 (M-Class, W 163)	09/01->06/05	5DV 008 290-004	1	Ballast unit
S-Class Coupé (C 215)				
CL 55 - CL 600 (S-Class Coupé, C 215)	03/99->09/02	1NA 007 976-071	1	HB4 fog light, left, with bulb HB4 fog light, right, with bulb (E1) 839 1x12V51W (HB4) 8GH 005 636-121
(-) AMG Styling		1NA 007 976-081	1	












Manufacturer Model	Model year	Part no.	Pk.	Note
Mercedes-Benz				
S-Class Coupé (C 215) CL 55 - CL 600 (S-Class Coupé, C 215) (-) AMG Styling	10/02->03/06	1NA 007 976-111 1NA 007 976-121	1 1	HB4 fog light, left, with bulb HB4 fog light, right, with bulb (E1) 1215  1x12V51W (HB4) 8GH 005 636-121
SLK (R 170) SLK 200 - SLK 230 (R 170) (-) AMG optic package	09/96->03/00	1NB 007 555-031 1NB 007 555-041	1 1	H1 fog light, left, with bulb H1 fog light, right, with bulb (E13) 141  1x12V55W (H1) 8GH 002 089-133
SLK 200 - SLK 230 (R 170) (-) AMG optic package	04/00->04/04	1NA 007 976-071 1NA 007 976-081	1 1	HB4 fog light, left, with bulb HB4 fog light, right, with bulb (E1) 839  1x12V51W (HB4) 8GH 005 636-121
SLK (R 171) SLK 200 Kompressor - SLK 55 AMG (R 171) SLK 200 Kompressor SLK 280, SLK 350, SLK 55 AMG	03/04->04/08	2VP 008 427-091 2VP 008 427-101	1 1	Combination rearlight, left, with reverse and rear fog light, with bulbs Combination rearlight, right, with reverse and rear fog light, with bulbs (E1) 1571  2x12V21W (P21W) 8GA 002 073-121  1x12V21W (PY21W) 8GA 006 841-121













Manufacturer Model	Model year	Part no.	Pk.	Note
Mercedes-Benz				
Vaneo (414)		2VP 008 406-031	1	Combination rearlight, left, with reverse and rear fog light, with bulbs
Vaneo (414)	02/02->	2VP 008 406-041	1	Combination rearlight, right, with reverse and rear fog light, with bulbs
<p>Ⓔ1 1236</p> <p>1x12V5W (R5W) 8GA 002 071-121 1x12V21/4W (P21/4W) 8GD 004 772-121 2x12V21W (P21W) 8GA 002 073-121 1x12V21W (PY21W) 8GA 006 841-121</p>				
Viano, Vito (W 639)		1LG 246 041-031	1	H7 headlight, left, with indicator light, with H7 fog light, with electr. headlight leveller actuator, with bulbs
Viano, Vito (W 639)	09/03->	1LG 246 041-041	1	H7 headlight, right, with indicator light, with H7 fog light, with electr. headlight leveller actuator, with bulbs
<p>Ⓔ1 1516 left Ⓔ1 1517 right Ⓔ1 1518 left Ⓔ1 1519 right</p> <p> 3x12V55W (H7) 8GH 007 157-121 1x12V5W (W5W) 8GP 003 594-121 1x12V21W (P21W) 8GA 002 073-121</p>				
Viano, Vito (W 639)		2SK 964 596-011	1	Combination rearlight, left, with reverse and rear fog light, with bulbs
	09/03->	2SK 964 596-021	1	Combination rearlight, right, with reverse and rear fog light, with bulbs
<p>Ⓔ1 1480</p> <p> 1x12V21/5W (P21/5W) 8GD 002 078-121 2x12V21W (P21W) 8GA 002 073-121 1x12V21W (PY21W) 8GA 006 841-121</p>				



Manufacturer Model	Model year	Part no.	Pk.	Note
Mercedes-Benz				
190 (W 201) 190 (W 201)	10/82->08/93	 2BA 004 257-011 2BA 004 257-021 9EL 127 689-001 9EL 127 688-001 9FT 129 176-001	1 1 1 1 10	Indicator light (amber), left Indicator light (amber), right (E1) 42665 Spare Parts: Body/lens, left Body/lens, right Bulb holder  1x12V21W (P21W) 8GA 002 073-121
190 (W 201)	10/82->08/93	 2BA 004 257-801 2BA 004 257-031 2BA 004 257-041 	1 1 1	Indicator light set (white), with bulbs (E1) 52611 Spare Parts: Indicator light (white), left, with bulb Indicator light (white), right, with bulb  2x12V21W (PY21W) 8GA 006 841-121
190 (W 201)	09/85->08/93		4	Licence plate light (E1) 22870  1x12V5W (C5W) 8GM 002 092-121
190 (W 201) Special equipment	10/82->03/87		1	Front interior light, with delayed action switch-off  1x12V10W (K) 8GM 002 091-131



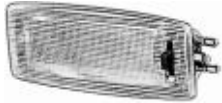



Manufacturer Model	Model year	Part no.	Pk.	Note	
Mercedes-Benz					
200 - 300 (W 123)					
200 - 300 (W 123)	02/76->08/79			H4 headlight, with H3 fog light, with indicator light, without headlight leveller, spare parts available only (E1) 7130 left (E1) 7131 right (E1) 24425 left and right Spare Parts: 1 Indicator light, left 1 Indicator light, right 1 Lens for indicator light, left 1 Lens for indicator light, right 1 Reflector for H4 headlight, right 10 Bulb socket for side light  1x12V60/55W (H4) 8GJ 002 525-131  1x12V55W (H3) 8GH 002 090-133  1x12V21W (P21W) 8GA 002 073-121  1x12V4W (T4W) 8GP 002 067-121	
200, 200 D	02/76->08/79				
220 D	02/76->03/79				
230	02/76->08/79				
230 T	03/78->08/79				
240 D	02/76->08/79	2BA 003 110-011	1		
240 TD	03/78->08/79	2BA 003 110-021	1		
250	02/76->08/79	9EL 120 651-001	1		
250 T	03/78->08/79	9EL 120 652-001	1		
300 D	02/76->08/79	9DR 118 666-001	1		
300 TD	03/78->08/79	9FF 085 642-001	10		
					
200 - 300 (W 123)					
200, 200 D	09/79->08/82				H4 headlight, with H3 fog light, with indicator light, with headlight leveller, spare parts available only (E1) 7130 left (E1) 7131 right (E1) 24425 left and right Spare Parts: 1 Indicator light, left 1 Indicator light, right 1 Lens for indicator light, left 1 Lens for indicator light, right 10 Bulb socket for side light  1x12V60/55W (H4) 8GJ 002 525-131  1x12V55W (H3) 8GH 002 090-133  1x12V21W (P21W) 8GA 002 073-121  1x12V4W (T4W) 8GP 002 067-121
200 T	06/80->08/82				
230	09/79->06/80				
230 E	07/80->08/82				
230 T	09/79->05/80				
230 TE	06/80->08/82	2BA 003 110-011	1		
240 D, 240 TD, 250, 250 T, 300 D, 300 TD	09/79->08/82	2BA 003 110-021	1		
300 TD Turbo-Diesel	09/80->08/82	9EL 120 651-001	1		
		9EL 120 652-001	1		
		9FF 085 642-001	10		
					













Manufacturer Model	Model year	Part no.	Pk.	Note
Mercedes-Benz				
200 - 300 (W 123)				
200 - 300 (W 123)	09/79->12/85			H4 headlight, with H3 fog light, with indicator light, with headlight leveller, spare parts available only (E1) 17077 left (E1) 17076 right (E1) 34461 left and right Spare Parts: Lens for indicator light, left Lens for indicator light, right 1x12V60/55W (H4) 8GJ 002 525-131 1x12V55W (H3) 8GH 002 090-133 1x12V21W (P21W) 8GA 002 073-121 1x12V4W (T4W) 8GP 002 067-121
200, 200 D	09/82->12/85			
200 T	09/82->12/85			
230 C	09/79->06/80			
230 CE	07/80->12/85	9EL 120 651-001	1	
230 E	09/82->12/85	9EL 120 652-001	1	
230 TE	09/82->12/85			
240 D	09/82->12/85			
240 TD	09/82->12/85			
250	09/82->12/85			
280, 280 C	09/79->08/82			
280 CE, 280 E	09/79->12/85			
280 TE	09/79->12/85			
300 D	09/82->12/85			
300 TD Turbo-Diesel	09/82->12/85			
200 - 300 (W 123)	02/76->12/85	2BA 003 110-011 2BA 003 110-021	1 1	Indicator light, left Indicator light, right (E1) 32744 Spare Parts: Lens, left Lens, right 1x12V21W (P21W) 8GA 002 073-121
		9EL 120 651-001 9EL 120 652-001	1 1	






Manufacturer Model	Model year	Part no.	Pk.	Note
Mercedes-Benz				
200 - 300 (W 123)		2VP 003 069-011	1	Combination rearlight, left, with reverse and rear fog light
200 - 300 (W 123)	02/76->12/85	2VP 003 069-021	1	Combination rearlight, right, with reverse light
200, 200 D	02/76->12/85			(E1) 53248
220 D	02/76->03/79			Spare Parts:
230	02/76->06/80	9EL 118 059-001	1	Lens, left
230 C	03/77->06/80	9EL 118 060-001	1	Lens, right
230 CE, 230 E	07/80->12/85	9GD 117 451-006	160	Seal
240 D, 250	02/76->12/85			1x12V10W (R10W) 8GA 002 071-131 4x12V21W (P21W) 8GA 002 073-121
280	02/76->08/82			
280 C	03/77->08/82			
280 CE	03/77->12/85			
280 E, 300 D	02/76->12/85			
				
200 - 300 (W 123)		2KA 003 102-011	4	Licence plate light
Saloon, Coupé	02/76->05/79			(E1) 22803
Estate	09/77->12/85			1x12V5W (C5W) 8GM 002 092-121
				
200 - 300 (W 123)	02/76->08/82	2JA 003 115-001	2	Interior light
				
200 - 300 (W 123)	09/82->12/85	2JA 004 252-031	1	Interior light, with delayed action switch-off
				



Manufacturer Model	Model year	Part no.	Pk.	Note
Mercedes-Benz				
200 - 500 (W 124) 200 - 300 (W 124) 12/84->08/89 200, 200 D, 200 E, 200 T, 200 TD, 200 TE, 230 CE, 230 E, 230 E, 230 TE, 250 D, 250 D Turbo, 250 TD, 260 E, 300 CE, 300 D, 300 D Turbo, 300 E, 300 TD, 300 TD Turbo, 300 TE		1LJ 004 440-611 1LJ 004 440-621 9FF 137 580-005	1 1 200	H4 headlight, left, with H3 fog light, without indicator light, with headlight leveller (grey cover behind lens) H4 headlight, right, with H3 fog light, without indicator light, with headlight leveller (grey cover behind lens) (E1) 17111 left (E1) 17112 right (E1) 34531 left and right Spare Parts: Bulb socket for side light  1x12V60/55W (H4) 8GJ 002 525-131  1x12V55W (H3) 8GH 002 090-133  1x12V4W (T4W) 8GP 002 067-121
200 - 500 (W 124) 12/84->06/93 		9EL 129 615-011 9EL 129 614-011 9FT 129 176-001	1 1 10	Body/lens for indicator light (amber), left Body/lens for indicator light (amber), right Bulb holder (E1) 42706  1x12V21W (P21W) 8GA 002 073-121
200 - 500 (W 124) 12/84->06/93 		2BA 004 693-801 2BA 004 693-031 2BA 004 693-041 9EL 129 615-021 9EL 129 614-021	1 1 1 1 1	Indicator light set (white), with bulbs (E1) 52609 Spare Parts: 1 Indicator light (white), left, with bulb 1 Indicator light (white), right, with bulb 1 Body/lens (white), left 1 Body/lens (white), right  2x12V21W (PY21W) 8GA 006 841-121
200 - 500 (W 124) 12/84->06/93 200, 200 D, 200 E, 220 CE, 220 E, 230 CE, 230 E, 250 D, 250 D Turbo, 260 E, 280 E, 300 CE, 300 D, 300 D Turbo, 300 E, 300 TD Turbo, 320 CE, 320 E, 400 E, 500 E Saloon, Convertible, Coupé 		2VP 004 686-111 2VP 004 686-141 2VP 004 686-131 2VP 004 686-121 9EL 129 763-001 9EL 129 762-001	1 1 1 1 1 1	Combination rearlight, left, with reverse and rear fog light Combination rearlight, right, with reverse and rear fog light Combination rearlight, left, with reverse light Combination rearlight, right, with reverse light (E1) 53378 Spare Parts: 1 Lens, left 1 Lens, right  1x12V10W (R10W) 8GA 002 071-131  4x12V21W (P21W) 8GA 002 073-121



Manufacturer Model	Model year	Part no.	Pk.	Note
Mercedes-Benz				
200 - 500 (W 124) 200 - 500 (W 124) 200, 200 D, 200 E, 220 CE, 220 E, 230 CE, 230 E, 250 D, 250 D Turbo, 260 E, 280 E, 300 CE, 300 D, 300 D Turbo, 300 E, 300 TD Turbo, 320 CE, 320 E, 400 E, 500 E Saloon, Convertible, Coupé	12/84->06/93	2VP 004 686-151 2VP 004 686-181 9EL 129 763-021 9EL 129 762-031	1 1 1 1	Combination rearlight (grey/red), left, with reverse and rear fog light Combination rearlight (grey/red), right, with reverse and rear fog light (E1) 53378 (E1) 63290 Spare Parts: Lens, left Lens, right 1x12V10W (R10W) 8GA 002 071-131 3x12V21W (P21W) 8GA 002 073-121 1x12V21W (PY21W) 8GA 006 841-121
				
200 - 500 (W 124) Saloon, Coupé, Convertible	12/84->06/93	2KA 004 983-011	4	Licence plate light (E1) 22870 1x12V5W (C5W) 8GM 002 092-121
				
Sprinter 901/902/903/904 Sprinter 901/902/903/904 208 D, 210 D, 212 D, 214 308 D, 310 D, 312 D, 314 408 D, 410 D, 412 D, 414	02/95->03/00	1LH 006 900-031 1LH 006 900-041 9ES 143 775-011 9ES 143 776-011	1 1 4 4	H1 headlight, left, without fog light, with pneum. headlight leveller actuator, with bulbs H1 headlight, right, without fog light, with pneum. headlight leveller actuator, with bulbs (E1) 46 lefts (E1) 47 right Spare Parts: Lens, left Lens, right 2x12V55W (H1) 8GH 002 089-133 1x12V5W (W5W) 8GP 003 594-121
				



Manufacturer Model	Model year	Part no.	Pk.	Note
Mercedes-Benz				
Sprinter 901/902/903/904				
Sprinter 901/902/903/904	04/00->08/02	1LH 008 010-031	1	H1/H7 headlight, left, with indicator light, without fog light, with electr. headlight leveller actuator, with bulbs
208 CDI, 211 CDI, 213 CDI, 214, 216 CDI, 308 CDI, 311 CDI, 313 CDI, 314, 316 CDI, 408 CDI, 411 CDI, 413 CDI, 414, 416 CDI		1LH 008 010-041	1	H1/H7 headlight, right, with indicator light, without fog light, with electr. headlight leveller actuator, with bulbs
				(E1) 924 left and right (E1) 925 left (E1) 926 right 1x12V55W (H7) 8GH 007 157-121 1x12V55W (H1) 8GH 002 089-133 1x12V5W (W5W) 8GP 003 594-121 1x12V21W (PY21W) 8GA 006 841-121
Sprinter 901/902/903/904				
Sprinter 901/902/903/904	08/02->05/06	1LH 246 047-031	1	FF®-H7/H3 headlight, left, with indicator light, without fog light, with electr. headlight leveller actuator, with bulbs
208 CDI, 211 CDI, 213 CDI, 214, 216 CDI, 308 CDI, 311 CDI, 313 CDI, 314, 316 CDI, 408 CDI, 411 CDI, 413 CDI, 414, 416 CDI		1LH 246 047-041	1	FF®-H7/H3 headlight, right, with indicator light, without fog light, with electr. headlight leveller actuator, with bulbs
		1LH 246 047-071	1	FF®-H7/H3 headlight, left, with indicator light, with H7 fog light, with electr. headlight leveller actuator, with bulbs
		1LH 246 047-081	1	FF®-H7/H3 headlight, right, with indicator light, with H7 fog light, with electr. headlight leveller actuator, with bulbs
				(E1) 1524 left (E1) 1525 right 2x12V55W (H7) 8GH 007 157-121 1x12V55W (H3) 8GH 002 090-133 1x12V5W (W5W) 8GP 003 594-121 1x12V21W (PY21W) 8GA 006 841-121
Sprinter 901/902/903/904				
Sprinter 901/902/903/904	02/95->03/00	2BA 007 016-031	1	Indicator light (white), left
		2BA 007 016-041	1	Indicator light (white), right
				(E13) 3561 1x12V21W (PY21W) 8GA 006 841-121
Sprinter 901/902/903/904				
Sprinter 901/902/903/904	02/95->05/06	2BM 006 692-011	1	Auxiliary indicator light, left
		2BM 006 692-021	1	Auxiliary indicator light, right
				(E1) 52621 1x12V21W (P21W) 8GA 002 073-121







Manufacturer Model	Model year	Part no.	Pk.	Note
Mercedes-Benz				
Sprinter 901/902/903/904		2VD 008 204-111	1	Combination rearlight, left, with licence plate, rear fog, reverse, clearance light, side-marker light, with reflex-reflector and marker reflex-reflector, without centre plug
Sprinter 901/902/903/904	02/95->03/00	2VP 008 204-101	1	Combination rearlight, right, with reverse, clearance light, side-marker light, with reflex-reflector and marker reflex-reflector, without centre plug
208 D, 210 D, 212 D, 214 308 D, 310 D, 312 D, 314 408 D, 410 D, 412 D, 414				(E4) 3179 (E4) 4060 (E4) 9809 (E4) 9810
Flatbed		9EL 152 891-001	1	Spare Parts: Lens with screws 3x12V5W (R5W) 8GA 002 071-121 4x12V21W (P21W) 8GA 002 073-121
Sprinter 901/902/903/904	04/00->05/06			
208 CDI, 211 CDI, 213 CDI, 214, 216 CDI 308 CDI, 311 CDI, 313 CDI, 314, 316 CDI 408 CDI, 411 CDI, 413 CDI, 414, 416 CDI				
Flatbed				
Sprinter (906)		1LB 247 012-031	1	FF®-H7 headlight, left, with indicator light, without fog light, with electr. headlight leveller actuator, with bulbs
Sprinter (906)	06/06->	1LB 247 012-041	1	FF®-H7 headlight, right, with indicator light, without fog light, with electr. headlight leveller actuator, with bulbs
209 CDI, 211 CDI, 215 CDI, 218 CDI, 224		1LB 247 012-071		FF®-H7 headlight, left, with indicator light, with H7 fog light, with electr. headlight leveller actuator, with bulbs
309 CDI, 311 CDI, 315 CDI, 318 CDI, 324		1LB 247 012-081		FF®-H7 headlight, right, with indicator light, with H7 fog light, with electr. headlight leveller actuator, with bulbs
				(E1) 10881 3x12V55W (H7) 8GH 007 157-121 1x12V5W (W5W) 8GP 003 594-121 1x12V21W (PY21W) 8GA 006 841-121
Sprinter (906)		1NB 008 275-031	1	H11 fog light, left, with bulb
	06/06->12/06	1NB 008 275-041	1	H11 fog light, right, with bulb
				(E1) 1325 1x12V55W (H11) 8GH 008 358-121



Manufacturer Model	Model year	Part no.	Pk.	Note
Mercedes-Benz				
207 D - 410 (T1, TN)				Headlight, spare parts available only
207 D - 410 (T1, TN-series)	01/81->02/96			(E1) 7165 left (E1) 7166 right
207 D, 208, 307 D, 308	01/81->12/88	9ES 120 723-001	2	Spare Parts: Lens, left
209 D, 210, 309 D, 310, 310 D, 407 D, 409 D, 410	08/81->12/88			1x12V45/40W (R2) 8GD 002 088-131
208 D, 210 D, 210, 308 D, 310 D, 310, 408 D, 410 D, 410	01/89->02/96			1x12V4W (T4W) 8GP 002 067-121
				H4 headlight, spare parts available only
		9ES 120 725-001 9ES 120 726-001	2 2	(E1) 17001 left (E1) 17002 right
				Spare Parts: Lens, left Lens, right
				1x12V60/55W (H4) 8GJ 002 525-131
				1x12V4W (T4W) 8GP 002 067-121
207 D - 410 (T1, TN-series)	01/81->02/96	1ND 122 390-001	1	H3 fog light unit
				(E1) 8336
				1x12V55W (H3) 8GH 002 090-133
				1x24V70W (H3) 8GH 002 090-251
207 D - 410 (T1, TN-series)	05/77->02/96	2BA 003 197-011 2BA 003 197-021	1 1	Indicator light, left Indicator light, right
				(E1) 32757
				1x12V21W (P21W) 8GA 002 073-121
				1x24V21W (P21W) 8GA 002 073-241
207 D - 410 (T1, TN-series)	05/77->02/96	2BM 002 652-051	1	Auxiliary indicator light
				(E1) 32785
				1x12V21W (P21W) 8GA 002 073-121
				1x24V21W (P21W) 8GA 002 073-241
208 D - 410 (T1, TN-series)	05/94->02/96	2BM 006 692-011 2BM 006 692-021	1 1	Auxiliary indicator light, left Auxiliary indicator light, right
				(E1) 52621
				1x12V21W (P21W) 8GA 002 073-121
				1x24V21W (P21W) 8GA 002 073-241



Manufacturer Model	Model year	Part no.	Pk.	Note
Mercedes-Benz				
207 D - 410 (T1, TN)		2SD 001 680-271	1	Combination rearlight, left, without licence plate light
207 D - 410 (T1, TN-series)	05/77->02/89	2SE 001 680-301	1	Combination rearlight, right, without licence plate light
207 D, 208, 307 D, 308	05/77->02/89			(E1) 31482 (E1) 43222
209 D, 210, 309 D, 310, 407 D, 409 D, 410	08/81->02/89			(E1) 53335
Chassis, Dump truck, Flatbed		9EL 107 368-001 9EL 111 647-001	2 2	Spare Parts: Lens with seal and screws, left Lens with seal and screws, right
				1x12V10W (R10W) 8GA 002 071-131 2x12V21W (P21W) 8GA 002 073-121
				
208 D - 410 (T1, TN-series)	03/89->02/96	2VB 004 887-011	1	Combination rearlight, left, with licence plate and rear fog light
208 D, 210 D, 210, 308 D, 310 D, 310, 408 D, 410 D, 410		2VA 004 887-031	1	Combination rearlight, left, with rear fog light
Chassis, Dump truck, Flatbed		2VP 004 887-021	1	Combination rearlight, right, with reverse light
				(E1) 53384
		9EL 131 420-001 9EL 131 420-011 9GT 141 941-001	1 1 10	Spare Parts: Lens with screws, left Lens with screws, right Grommet (to be ordered separately)
				1x12V10W (R10W) 8GA 002 071-131 1x24V10W (R10W) 8GA 002 071-251 3x12V21W (P21W) 8GA 002 073-121 3x24V21W (P21W) 8GA 002 073-241
				
207 D - 410 (T1, TN-series)	05/77->02/96	2JA 001 357-012	6	Interior light without switch
				2x12V10W (K) 8GM 002 091-131 2x24V10W (K) 8GM 002 091-251
				
Nissan				
Terrano II (R20)		1LD 962 060-131	1	H4 headlight, left, for vehicles with or without headlight leveller
Terrano II (R20)	10/92->06/96	1LD 962 060-141	1	H4 headlight, right, for vehicles with or without headlight leveller
				(E1) 27007 left (E1) 27008 right
				1x12V60/55W (H4) 8GJ 002 525-131
				1x12V5W (W5W) 8GP 003 594-121
				



Manufacturer Model	Model year	Part no.	Pk.	Note
Nissan				
Terrano II (R20) Terrano II (R20)	09/99->03/05	2BA 964 255-011 2BA 964 255-021	1 1	Indicator light (black), left, with bulb Indicator light (black), right, with bulb E1 01968 1x12V21W (PY21W) 8GA 006 841-121
				
Terrano II (R20)	09/99->03/05	2BA 964 255-031 2BA 964 255-041	1 1	Indicator light (chrome-plated), left, with bulb Indicator light (chrome-plated), right, with bulb E1 01968 1x12V21W (PY21W) 8GA 006 841-121
				
Opel				
Astra F Astra F GSi	09/91->01/98	1NL 006 580-051 1NL 006 580-061	1 1	DE-H3 fog light, left DE-H3 fog light, right E1 18239 1x12V55W (H3) 8GH 002 090-133
				
Astra F	09/91->08/94	2BM 003 563-111	1	Auxiliary indicator light E1 42621 1x12V5W (W5W) 8GP 003 594-121
				
Astra G Astra G (-) Convertible, Coupé	02/98->04/05	1LG 007 640-331 1LG 007 640-341	1 1	FF@-H7/HB3 headlight, left, with body/lens for indicator light FF@-H7/HB3 headlight, right, with body/lens for indicator light E1 615 left E1 616 right E1 617 left E1 618 right 1x12V60W (HB3) 8GH 005 635-121 1x12V55W (H7) 8GH 007 157-121 1x12V21W (PY21W) 8GA 006 841-121 1x12V5W (W5W) 8GP 003 594-121
				



Opel



Manufacturer Model	Model year	Part no.	Pk.	Note
Opel				
Astra G Astra G, CC, Estate Special models Astra G Coupé Astra G Convertible	02/98->04/05 03/00->05/05 03/01->10/05	1LG 007 640-631 1LG 007 640-641	1 1	FF®-H7/HB3 headlight, left, with body/lens for indicator light and black frame behind the cover lens FF®-H7/HB3 headlight, right, with body/lens for indicator light and black frame behind the cover lens Ⓔ 615 left Ⓔ 616 right Ⓔ 617 left Ⓔ 618 right 1x12V60W (HB3) 8GH 005 635-121 1x12V55W (H7) 8GH 007 157-121 1x12V21W (PY21W) 8GA 006 841-121 1x12V5W (W5W) 8GP 003 594-121
Astra G	02/98->10/05 	6NM 007 878-351	1	Setting element, headlight levelling
Astra G (-) Convertible, Coupé, OPC	02/98->04/05 	1NA 009 029-011 1NA 009 029-021	1 1	FF®-H3 fog light, left, with bulb FF®-H3 fog light, right, with bulb Ⓔ 19096 1x12V55W (H3) 8GH 002 090-133
Astra G Hatchback	03/98->01/05 	2VP 008 863-801 2SA 008 405-021 2XA 008 221-021 2BA 008 221-041 2ZR 008 221-051 2NE 008 221-031 8RA 008 405-001 9XX 161 115-001	1 1 1 1 1 1 1 1	Design combination rearlight set with LED tail light, with 8 module lights, 2 circular ring reflector modules, 2 retaining parts, lead groups and accessories Ⓔ 878 Ⓔ 1196 Ⓔ 1048 Ⓔ 1049 Ⓔ 1050 Ⓔ 1051 Spare Parts: LED rear light Stop light Indicator light (grey) Reverse light (grey) Rear fog light Reflex-reflector (red) Adapter for bulb monitor (to be ordered separately) 6x12V21W (P21W) 8GA 002 073-121 2x12V21W (PY21W) 8GA 006 841-121



Manufacturer Model	Model year	Part no.	Pk.	Note
Opel				
Astra H		1LG 270 370-331	1	FF®-H7/H1 headlight, left, with integrated indicator light, with electr. headlight leveller actuator
Astra H	03/04->02/07	1LG 270 370-341	1	FF®-H7/H1 headlight, right, with integrated indicator light, with electr. headlight leveller actuator
Astra H Sport	02/07->			(E1) 1770 left and right (E1) 1771 left and right 1x12V55W (H7) 8GH 007 157-121 1x12V55W (H1) 8GH 002 089-133 1x12V21W (H21W) 8GH 008 417-001 1x12V5W (W5W) 8GP 003 594-121
Astra H	02/07->	1LG 270 370-631	1	FF®-H7/H1 headlight, left, with integrated indicator light, with electr. headlight leveller actuator
(-) Sport		1LG 270 370-641	1	FF®-H7/H1 headlight, right, with integrated indicator light, with electr. headlight leveller actuator
				(E1) 1770 1x12V55W (H7) 8GH 007 157-121 1x12V55W (H1) 8GH 002 089-133 1x12V21W (H21W) 8GH 008 417-001 1x12V5W (W5W) 8GP 003 594-121
Astra H	03/04->	1LL 008 700-331	1	Bi-Xenon®/FF®-H7 headlight, left, with integrated indicator light, without xenon ballast, without gas discharge bulb, without bulbs
		1LL 008 700-341	1	Bi-Xenon®/FF®-H7 headlight, right, with integrated indicator light, without xenon ballast, without gas discharge bulb, without bulbs
				(E1) 1778 left and right 1x35W (D2S) 8GS 007 949-101 1x12V55W (H7) 8GH 007 157-121 1x12V21W (PY21W) 8GA 006 841-121 1x12V5W (W5W) 8GP 003 594-121
Astra H	03/04->	5DV 008 290-004	1	Ballast unit



Opel



Manufacturer Model	Model year	Part no.	Pk.	Note
Opel				
Astra H Astra H	03/04->	1ZL 009 487-811 1ZL 009 487-031 1ZL 009 487-041	1 1	Upgrade headlight set with halogen dipped-beam/main-beam, with dynam. bend lighting Dynabeam, with bulbs Spare Parts: Upgrade headlight, left, with bulbs Upgrade headlight, right, with bulbs 2x12V55W (H7) 8GH 007 157-201 Long Life 2x12V21W (PY21W) Silver Vision 2x12V5W (W5W) 8GP 003 594-121
Astra H Hatchback 5-doors Astra H Estate (-) OPC	03/04->01/07 08/04->01/07	2PT 009 305-821 2PT 008 935-001	1 1	Daytime running light set, 2 daytime running lights with bulbs, with harness and covers E1 1722 Spare Parts: Daytime running light
Astra H	03/04->	2BM 964 988-801	1	Auxiliary indicator light set (black) 2x12V5W (W5W) 8GP 003 594-121
Astra H Hatchback 5-doors up to chassis no. 72094718, 75086479, 78048187	03/04->02/07	9EL 160 467-011 9EL 160 468-011	1 1	Body/lens for combination rearlight, left, with reverse and rear fog light Body/lens for combination rearlight, right, with reverse and rear fog light E1 1776 1x12V21W (PY21W) 8GA 006 841-121 4x12V21W (P21W) 8GA 002 073-121








Manufacturer Model	Model year	Part no.	Pk.	Note
Opel				
Astra H Astra H Hatchback 5-doors from chassis no. 72094719, 75086480, 78048188	03/07->	9EL 354 073-011 9EL 354 073-021	1 1	Body/lens for combination rearlight, left, with reverse and rear fog light Body/lens for combination rearlight, right, with reverse and rear fog light 1x12V21W (PY21W) 8GA 006 841-121 4x12V21W (P21W) 8GA 002 073-121
Astra H GTC 3-doors	03/05->	9EL 161 421-011 9EL 161 422-011	1 1	Body/lens for combination rearlight, left, with reverse and rear fog light Body/lens for combination rearlight, right, with reverse and rear fog light (E1) 1845 1x12V21W (PY21W) 8GA 006 841-121 2x12V21W (P21W) 8GA 002 073-121
Astra H GTC 3-doors	03/05->	2SK 008 748-801	1	Upgrade combination rearlight set (Icegrey) 1x12V21W (P21W) 8GA 002 073-121 1x12V21W (PY21W) 8GA 006 841-121 3x12V21W (P21W) 8GA 002 073-121
Calibra Calibra	06/90->07/97	1LL 006 110-351 1LL 006 110-361	1 1	DE-H1 headlight, left, with DE-H3 fog light, with indicator light, suitable for headlight leveller DE-H1 headlight, right, with DE-H3 fog light, with indicator light, suitable for headlight leveller (E4) 380 (E4) 404 (E4) 460 (E4) 984 2x12V55W (H1) 8GH 002 089-133 1x12V55W (H3) 8GH 002 090-133 1x12V21W (P21W) 8GA 002 073-121 1x12V5W (W5W) 8GP 003 594-121



Opel



Manufacturer Model	Model year	Part no.	Pk.	Note
Opel				
Calibra Calibra	06/90->07/97	2BM 003 563-111	1	Auxiliary indicator light E1 42621  1x12V5W (W5W) 8GP 003 594-121
Combo II Combo II	10/01->02/03	1NA 009 031-011 1NA 009 031-021	1 1	FF®-H3 fog light, left, with bulb FF®-H3 fog light, right, with bulb E12 19105  1x12V55W (H3) 8GH 002 090-133
Corsa C Corsa C	10/00->02/03	1NA 009 031-011 1NA 009 031-021	1 1	FF®-H3 fog light, left, with bulb FF®-H3 fog light, right, with bulb E12 19105  1x12V55W (H3) 8GH 002 090-133
Corsa D Corsa D	07/06->	2BM 964 988-801	1	Auxiliary indicator light set (black)  2x12V5W (W5W) 8GP 003 594-121
Kadett E Kadett E (-) GSi, Convertible	09/84->08/91	9EL 128 949-011 9EL 128 948-011	1 1	Body/lens for indicator light (amber), left Body/lens for indicator light (amber), right E1 42690  1x12V21W (P21W) 8GA 002 073-121
















Manufacturer Model	Model year	Part no.	Pk.	Note
Opel				
Kadett E Kadett E GSi, Convertible	09/84->08/91	9EL 128 959-011 9EL 128 958-011	1 1	Body/lens for indicator light (white), left Body/lens for indicator light (white), right E1 42697 1x12V21W (P21W) 8GA 002 073-121
Kadett E	10/85->08/91	2BM 003 563-111	1	Auxiliary indicator light E1 42621 1x12V5W (W5W) 8GP 003 594-121
Kadett E Hatchback, Sedan	09/84->08/91	2KA 003 485-021	1	Licence plate light with bulb E1 22824 1x12V10W (R10W) 8GA 002 071-131
Kadett E Estate, Combo	09/84->08/91	2KA 004 434-031	1	Licence plate light E1 22851 1x12V4W (T4W) 8GP 002 067-121
Omega A Omega A	09/86->09/90	2BA 006 091-011 2BA 006 091-021	1 1	Indicator light, left Indicator light, right E4 361 1x12V21W (P21W) 8GA 002 073-121
Omega A	10/90->05/94	2BA 007 249-011 2BA 007 249-021	1 1	Indicator light, left Indicator light, right E4 467 1x12V21W (P21W) 8GA 002 073-121













Opel



Manufacturer Model	Model year	Part no.	Pk.	Note
Opel				
Omega A Omega A	09/86->05/94	2BM 003 563-111	1	Auxiliary indicator light E1 42621  1x12V5W (W5W) 8GP 003 594-121
Omega B Omega B	03/94->08/97	1LG 006 920-231 1LG 006 920-241	1 1	H1 headlight, left, with indicator light, suitable for electr. headlight leveller H1 headlight, right, with indicator light, suitable for electr. headlight leveller E1 53 left and right E1 55 left E1 56 right  2x12V55W (H1) 8GH 002 089-231 UV-Cut  1x12V21W (PY21W) 8GA 006 841-121  1x12V5W (W5W) 8GP 003 594-121
Omega B Basic, CD	09/97->09/99	1LL 008 020-271 1LL 008 020-281	1 1	DE-H1/H7 headlight, left, with body/lens for indicator light DE-H1/H7 headlight, right, with body/lens for indicator light E1 672 E1 673  1x12V55W (H1) 8GH 002 089-133  1x12V55W (H7) 8GH 007 157-121  1x12V21W (PY21W) 8GA 006 841-121  1x12V5W (W5W) 8GP 003 594-121
Omega B	10/99->08/01	1LL 009 020-231 1LL 009 020-241	1 1	DE-H1/H7 headlight, left, with body/lens for indicator light DE-H1/H7 headlight, right, with body/lens for indicator light E1 672 E1 673  1x12V55W (H1) 8GH 002 089-133  1x12V55W (H7) 8GH 007 157-121  1x12V21W (PY21W) 8GA 006 841-121  1x12V5W (W5W) 8GP 003 594-121
Omega B	03/94->07/03	6NM 007 282-641	1	Setting element, headlight levelling (for halogen headlight) 



Manufacturer Model	Model year	Part no.	Pk.	Note
Opel				
Omega B Omega B	09/97->07/03	5DV 007 760-651	1	Ballast unit
				
Omega B Estate	03/94->09/99	9EL 143 579-021 9EL 143 580-021	1 1	Body/lens for combination rearlight, left, with reverse and rear fog light Body/lens for combination rearlight, right, with reverse and rear fog light (E1) 40  1x12V21/4W (P21/4W) 8GD 004 772-121 1x12V21W (PY21W) 8GA 006 841-121 2x12V21W (P21W) 8GA 002 073-121
				
Omega B Estate	03/94->09/99	8RA 007 051-031 8RA 007 051-041	1 1	Reflex-reflector, left Reflex-reflector, right (E1) 0249
				
Omega B Estate	10/99->07/03	9EL 152 051-011 9EL 152 052-011	1 1	Body/lens for combination rearlight, left, with reverse and rear fog light Body/lens for combination rearlight, right, with reverse and rear fog light (E1) 962  1x12V21/4W (P21/4W) 8GD 004 772-121 1x12V21W (PY21W) 8GA 006 841-121 2x12V21W (P21W) 8GA 002 073-121
				
Signum Signum	05/03->08/05	1LL 008 320-251 1LL 008 320-261	1 1	DE-H7/FF®-H7 headlight, left, with indicator light, suitable for headlight leveller DE-H7/FF®-H7 headlight, right, with indicator light, suitable for headlight leveller (E1) 1356 (E1) 1357  2x12V55W (H7) 8GH 007 157-121  1x12V5W (W5W) 8GP 003 594-121  1x12V21W (PY21W) 8GA 006 841-121
				





Opel
















Manufacturer Model	Model year	Part no.	Pk.	Note
Opel				
Signum Signum	05/03->08/05	1LL 008 320-331 1LL 008 320-341	1 1	DE-H7/FF®-H7 headlight (black), left, with indicator light, suitable for headlight leveller, for conversion DE-H7/FF®-H7 headlight (black), right, with indicator light, suitable for headlight leveller, for conversion E1 1356 E1 1357 2x12V55W (H7) 8GH 007 157-121 1x12V5W (W5W) 8GP 003 594-121 1x12V21W (PY21W) 8GA 006 841-121
 Design				
Vectra A Vectra A	09/92->08/93	9EL 145 801-001 9EL 145 802-001	1 1	Body/lens for indicator light (white), left Body/lens for indicator light (white), right E12 6100 1x12V21W (P21W) 8GA 002 073-121
				
Vectra A	09/93->11/95	9EL 146 021-001 9EL 146 022-001	1 1	Body/lens for indicator light (white), left Body/lens for indicator light (white), right E12 6100 1x12V21W (P21W) 8GA 002 073-121
				
Vectra A	04/88->11/95	2BM 003 563-111	1	Auxiliary indicator light E1 42621 1x12V5W (W5W) 8GP 003 594-121
				
Vectra B Vectra B (-) Sport	02/99->07/03	1NA 009 032-011 1NA 009 032-021	1 1	FF®-H3 fog light, left, with bulb FF®-H3 fog light, right, with bulb E12 19099 1x12V55W (H3) 8GH 002 090-133
				















Manufacturer Model	Model year	Part no.	Pk.	Note
Opel				
Vectra C		1LL 008 320-251	1	DE-H7/FF®-H7 headlight, left, with indicator light, suitable for headlight leveller
Vectra C Saloon	04/02->08/05	1LL 008 320-261	1	DE-H7/FF®-H7 headlight, right, with indicator light, suitable for headlight leveller
Vectra C Estate	10/03->08/05			
				(E1) 1356 (E1) 1357  2x12V55W (H7) 8GH 007 157-121  1x12V5W (W5W) 8GP 003 594-121  1x12V21W (PY21W) 8GA 006 841-121
Vectra C Saloon	04/02->08/05	1LL 008 320-331	1	DE-H7/FF®-H7 headlight (black), left, with indicator light, suitable for headlight leveller, for conversion
Vectra C Estate	10/03->08/05	1LL 008 320-341	1	DE-H7/FF®-H7 headlight (black), right, with indicator light, suitable for headlight leveller, for conversion
				(E1) 1356 (E1) 1357  2x12V55W (H7) 8GH 007 157-121  1x12V5W (W5W) 8GP 003 594-121  1x12V21W (PY21W) 8GA 006 841-121
Vectra C Edition	04->08/05	1LL 008 320-331	1	DE-H7/FF®-H7 headlight (black), left, with indicator light, suitable for headlight leveller
Vectra C GTS	08/02->08/05	1LL 008 320-341	1	DE-H7/FF®-H7 headlight (black), right, with indicator light, suitable for headlight leveller
				(E1) 1356 (E1) 1357  2x12V55W (H7) 8GH 007 157-121  1x12V5W (W5W) 8GP 003 594-121  1x12V21W (PY21W) 8GA 006 841-121
Zafira (F75_)		1NA 009 033-011	1	FF®-H3 fog light, left, with bulb
Zafira	04/99->	1NA 009 033-021	1	FF®-H3 fog light, right, with bulb
(-) GSi, OPC				(E12) 19098  1x12V55W (H3) 8GH 002 090-133



Manufacturer Model	Model year	Part no.	Pk.	Note
Opel				
Zafira Zafira	07/05->	2BM 964 988-801	1	Auxiliary indicator light set (black)  2x12V5W (W5W) 8GP 003 594-121
				
Peugeot				
107 107	06/05->	2SK 010 133-801	1	Upgrade combination rearlight set (brilliant silver) E1 4043  2x12V21/5W (P21/5W) 8GD 002 078-121  4x12V21W (P21W) 8GA 002 073-121
				
207 207 (-) CC	02/06->	2VP 354 038-011 2VP 354 038-021	1 1	Combination rearlight, left, with reverse and rear fog light Combination rearlight, right, with reverse and rear fog light  1x12V21W (PY21W) 8GA 006 841-121  3x12V21W (P21W) 8GA 002 073-121  1x12V5W (W5W) 8GP 003 594-121
				
207 CC	02/07->	2VP 354 039-011 2VP 354 039-021	1 1	Combination rearlight, left, with reverse and rear fog light Combination rearlight, right, with reverse and rear fog light  1x12V21W (PY21W) 8GA 006 841-121  3x12V21W (P21W) 8GA 002 073-121  1x12V5W (W5W) 8GP 003 594-121
				








Manufacturer Model	Model year	Part no.	Pk.	Note
Peugeot				
Partner (5F, 5) Partner (5F, 5)	11/02-> 	1LG 010 196-031	1	H4 headlight, left, with indicator light, with electr. headlight leveller actuator
		1LG 010 196-041	1	H4 headlight, right, with indicator light, with electr. headlight leveller actuator
(E4) 9849  1x12V60/55W (H4) 8GJ 002 525-131  1x12V21W (PY21W) 8GA 006 841-121  1x12V5W (W5W) 8GP 003 594-121				
Puch				
G-Class (W 460) 230 G - 300 GD (G-Class, W 460) 230 G, 230 GE, 240 GD, 250 GD, 280 GE, 300 GD	05/79->08/89 	1L8 003 060-561	1	Headlight, not suitable for headlight leveller (E1) 7097 Spare Parts: Cap Bulb socket for side light (to be ordered separately)  1x12V45/40W (R2) 8GD 002 088-131  1x12V4W (T4W) 8GP 002 067-121
		9GH 116 966-011 9FF 126 444-001	10 10	1L8 003 060-691 H4 headlight, not suitable for headlight leveller (E1) 7144 Spare Parts: Cap Bulb socket for side light (to be ordered separately)  1x12V60/55W (H4) 8GJ 002 525-131  1x12V4W (T4W) 8GP 002 067-121
230 G - 300 GD (G-Class, W 460) 230 G, 230 GE, 250 GD, 300 GD	09/89->07/93 	1L8 004 148-017	120	H4 headlight, suitable for headlight leveller (E1) 7144 Spare Parts: Light unit Cap Bulb socket for side light  1x12V60/55W (H4) 8GJ 002 525-131  1x12V4W (T4W) 8GP 002 067-121
		1L8 139 474-015 9GH 116 966-011 9FF 126 444-001	1 10 10	
















Puch - Renault



Manufacturer Model	Model year	Part no.	Pk.	Note
Puch				
G-Class (W 460) 230 G - 300 GD (G-Class, W 460)	05/79->03/90	2NE 002 589-047 9EL 112 763-001	10 5	Rear fog light (E1) 8444 Spare Parts: Lens with screws  1x12V21W (P21W) 8GA 002 073-121
G-Class (W 461) 230 GE - G 290 TD (G-Class, W 461) 230 GE, 250 GD, 290 GD, 290 GD, G 290 D, G 290 TD	02/90->	1L8 004 148-017 1L8 139 474-015 9GH 116 966-011 9FF 126 444-001	120 1 10 10	H4 headlight, suitable for headlight leveller (E1) 7144 Spare Parts: Light unit Cap Bulb socket for side light  1x12V60/55W (H4) 8GJ 002 525-131  1x12V4W (T4W) 8GP 002 067-121
G-Class (W 463) 230 GE - G 55 AMG (G-Class, W 463) 230 GE, 250 GD, G 270 CDI, 300 GD, 300 GE, G 300 TD, G 320, G 320 350 G Turbo D, G 36 AMG, G 400 CDI, G 500, G 500 E, G 55 AMG	09/89->	1L8 004 148-017 1L8 139 474-015 9GH 116 966-011 9FF 126 444-001	120 1 10 10	H4 headlight, suitable for headlight leveller (E1) 7144 Spare Parts: Light unit Cap Bulb socket for side light  1x12V60/55W (H4) 8GJ 002 525-131  1x12V4W (T4W) 8GP 002 067-121
Renault				
Avantime (DE0) Avantime (DE0)	09/01->05/03	6NM 007 878-501	1	Setting element, headlight levelling (for halogen headlight)












Manufacturer Model	Model year	Part no.	Pk.	Note
Renault				
Clio II (B/C/B0/1_) Clio II (B/C/B0/1_) RN, RT, RXE, SI	09/98->05/01	1LE 007 350-111	1	H4 headlight, left, with indicator light, without headlight leveller actuator, without bulbs
		1LE 007 350-121	1	H4 headlight, right, with indicator light, without headlight leveller actuator, without bulbs
				(E13) 9219 left (E13) 9220 right  1x12V60/55W (H4) 8GJ 002 525-131  1x12V5W (W5W) 8GP 003 594-121  1x12V21W (PY21W) 8GA 006 841-121
Clio II (B/C/B0/1_) Initiale, 16V	09/98->05/01	1LL 007 510-071	1	DE-HB3/H7 headlight, left, with indicator light, without headlight leveller actuator, without bulbs
		1LL 007 510-081	1	DE-HB3/H7 headlight, right, with indicator light, without headlight leveller actuator, without bulbs
				(E13) 9222 Spare Parts: Lead for converting from H4 headlight to DE-HB3/H7 headlight (to be ordered separately)
		8KA 152 601-001	1	 1x12V60W (HB3) 8GH 005 635-121  1x12V55W (H7) 8GH 007 157-121  1x12V5W (W5W) 8GP 003 594-121  1x12V21W (PY21W) 8GA 006 841-121
Clio II (B/C/B0/1_)	06/01->12/03	1LB 008 461-551	1	H1/H7 headlight, left, with indicator light, without headlight leveller actuator, with bulbs
		1LB 008 461-561	1	H1/H7 headlight, right, with indicator light, without headlight leveller actuator, with bulbs
				(E4) 9792 left (E4) 9793 right (E4) 9794 left (E4) 9795 right
				 1x12V55W (H7) 8GH 007 157-121  1x12V55W (H1) 8GH 002 089-133  1x12V5W (W5W) 8GP 003 594-121  1x12V21W (PY21W) 8GA 006 841-121







Renault



Manufacturer Model	Model year	Part no.	Pk.	Note
Renault				
Clio II (B/C/B0/1_) Clio II (B/C/B0/1_)	01/04->	1LB 008 461-751 1LB 008 461-761	1 1	H1/H7 headlight, left, with indicator light, without headlight leveller actuator, with bulbs H1/H7 headlight, right, with indicator light, without headlight leveller actuator, with bulbs E4 9792 left E4 9793 right E4 9794 left E4 9795 right  1x12V55W (H7) 8GH 007 157-121  1x12V55W (H1) 8GH 002 089-133  1x12V5W (W5W) 8GP 003 594-121  1x12V21W (PY21W) 8GA 006 841-121
Clio II (B/C/B0/1_)	09/98->	6NM 007 878-501	1	Setting element, headlight levelling 
Espace III (JE_) Espace III (JE_)	11/96->09/00	1LG 006 560-211 1LG 006 560-221	1 1	FF®-H1 headlight, left, without headlight leveller actuator, for vehicles with electr. headlight leveller FF®-H1 headlight, right, without headlight leveller actuator, for vehicles with electr. headlight leveller E4 257 left E4 258 right  2x12V55W (H1) 8GH 002 089-133 UV-cut  1x12V5W (W5W) 8GP 003 594-121
Espace III (JE_)	11/96->10/02	6NM 007 878-501	1	Setting element, headlight levelling (for halogen headlight) 
Grand Scénic Grand Scénic	04/04->07/06	6NM 007 878-501	1	Setting element, headlight levelling (for halogen headlight) 



Manufacturer Model	Model year	Part no.	Pk.	Note
Renault				
Grand Scénic		2SK 008 659-091	1	Combination rearlight (red/pink/red), left, with reverse and rear fog light, with bulbs Combination rearlight (red/pink/red), right, with reverse and rear fog light, with bulbs (E1) 1483 1x12V21/5W (P21/5W) 8GD 002 078-121 2x12V21W (P21W) 8GA 002 073-121 1x12V21W (PY21W) 8GA 006 841-121
Grand Scénic	04/04->01/05	2SK 008 659-101	1	
				
Grand Scénic		2SK 008 659-111	1	Combination rearlight (red/clear/red), left, with reverse and rear fog light, with bulbs Combination rearlight (red/clear/red), right, with reverse and rear fog light, with bulbs (E1) 1483 1x12V21/5W (P21/5W) 8GD 002 078-121 2x12V21W (P21W) 8GA 002 073-121 1x12V21W (PY21W) 8GA 006 841-121
Grand Scénic	01/05->07/06	2SK 008 659-121	1	
				
Grand Scénic		2SK 009 467-111	1	Combination rearlight, left, with reverse and rear fog light, with LED tail light, with bulbs Combination rearlight, right, with reverse and rear fog light, with LED tail light, with bulbs (E1) 2045 2x12V21W (P21W) 8GA 002 073-121 1x12V21W (PY21W) 8GA 006 841-121
Grand Scénic	08/06->	2SK 009 467-121	1	
				
Kangoo (FC0/1_, KC0/1_)		6NM 007 878-501	1	Setting element, headlight levelling
Kangoo (FC0/1_, KC0/1_)	03/98->01/08			
				







Renault



Manufacturer Model	Model year	Part no.	Pk.	Note
Renault				
Laguna (B56_, 556_, K56_) Laguna (B56_, 556_, K56_)	11/93->05/98	1LG 006 560-211 1LG 006 560-221	1 1	FF®-H1 headlight, left, without headlight leveller actuator, for vehicles with electr. headlight leveller FF®-H1 headlight, right, without headlight leveller actuator, for vehicles with electr. headlight leveller 257 left 258 right 2x12V55W (H1) 8GH 002 089-133 UV-cut 1x12V5W (W5W) 8GP 003 594-121
Laguna (B56_, 556_, K56_)	05/98->03/01	1LJ 007 833-111 1LJ 007 833-121	1 1	H7 headlight, left, with body/lens for indicator light H7 headlight, right, with body/lens for indicator light 712 left 713 right 714 left 715 right 2x12V55W (H7) 8GH 007 157-121 1x12V21W (PY21W) 8GA 006 841-121 1x12V5W (W5W) 8GP 003 594-121
Laguna (B56_, 556_, K56_)	05/98->03/01	6NM 007 878-501	1	Setting element, headlight levelling
Laguna (B56_, 556_, K56_)	04/94->05/98	9BG 142 247-021 9BG 142 248-021	1 1	Body/lens for indicator light, left Body/lens for indicator light, right 426 1x12V21W (P21W) 8GA 002 073-121
Laguna II (BG0/1_, KG0/1_) Laguna II (BG0/1_, KG0/1_)	03/01->	6NM 007 878-501	1	Setting element, headlight levelling (for halogen headlight)
Mastermaxi (FH/HH/UH) Mastermaxi (FH/HH/UH)	04/98->	6NM 007 878-501	1	Setting element, headlight levelling










Manufacturer Model	Model year	Part no.	Pk.	Note
Renault				
Mégane I		6NM 007 878-501	1	Setting element, headlight levelling
Mégane Hatchback (BA0/1_)	01/96->08/03			
Mégane Convertible (EA0/1_)	10/96->08/03			
Mégane Coach (DA0/1_)	03/96->08/03			
Mégane Classic (LA0/1_)	09/96->08/03			
Mégane Scenic (JA0/1_)	01/97->09/99			
				
Mégane Hatchback (BA0/1_)	03/99->08/03	2VP 008 101-031 2VP 008 101-041	1 1	Combination rearlight, left, with reverse and rear fog light Combination rearlight, right, with reverse and rear fog light E1 808 1x12V5W (R5W) 8GA 002 071-121 1x12V21/5W (P21/5W) 8GD 002 078-121 2x12V21W (P21W) 8GA 002 073-121 1x12V21W (PY21W) 8GA 006 841-121
				
Mégane II		2VP 008 736-111 2VP 008 736-121	1 1	Combination rearlight, left, with reverse and rear fog light, with bulbs Combination rearlight, right, with reverse and rear fog light, with bulbs 1x12V21/5W (P21/5W) 8GD 002 078-121 2x12V21W (P21W) 8GA 002 073-121 1x12V21W (PY21W) 8GA 006 841-121
Mégane II CC (EM0/1_)	09/03->			
				
Mégane II Sport Tourer (KM0/1_)	01/06->	2VP 982 006-011 2VP 982 006-021	1 1	Combination rearlight, left, with reverse and rear fog light, with bulbs Combination rearlight, right, with reverse and rear fog light, with bulbs E1 1949 1x12V21/5W (P21/5W) 8GD 002 078-121 2x12V21W (P21W) 8GA 002 073-121 1x12V21W (PY21W) 8GA 006 841-121
				



Renault



Manufacturer Model	Model year	Part no.	Pk.	Note
Renault				
Safrane I (B54_) Safrane I (B54_)	04/92->07/96	6NM 007 878-501	1	Setting element, headlight levelling (for halogen headlight)
				
Safrane II (B54_) Safrane II (B54_)	07/96->12/00	6NM 007 878-501	1	Setting element, headlight levelling (for halogen headlight)
				
Scénic (JA0/1_) Scénic (JA0/1_)	09/99->08/03	6NM 007 878-501	1	Setting element, headlight levelling
				
Scénic II (JM0/1_) Scénic II (JM0/1_)	06/03->07/06	6NM 007 878-501	1	Setting element, headlight levelling (for halogen headlight)
				
Scénic II (JM0/1_)	06/03->01/05	2SK 008 659-091 2SK 008 659-101	1 1	Combination rearlight (red/pink/red), left, with reverse and rear fog light, with bulbs Combination rearlight (red/pink/red), right, with reverse and rear fog light, with bulbs  1483  1x12V21/5W (P21/5W) 8GD 002 078-121 2x12V21W (P21W) 8GA 002 073-121 1x12V21W (PY21W) 8GA 006 841-121
				








Manufacturer Model	Model year	Part no.	Pk.	Note
Renault				
Scénic II (JM0/1_) Scénic II (JM0/1_)	01/05->07/06	2SK 008 659-111 2SK 008 659-121	1 1	Combination rearlight (red/clear/red), left, with reverse and rear fog light, with bulbs Combination rearlight (red/clear/red), right, with reverse and rear fog light, with bulbs (E1) 1483 1x12V21/5W (P21/5W) 8GD 002 078-121 2x12V21W (P21W) 8GA 002 073-121 1x12V21W (PY21W) 8GA 006 841-121
Scénic II (JM0/1_)	08/06->	2SK 009 467-111 2SK 009 467-121	1 1	Combination rearlight, left, with reverse and rear fog light, with LED tail light, with bulbs Combination rearlight, right, with reverse and rear fog light, with LED tail light, with bulbs (E1) 2045 2x12V21W (P21W) 8GA 002 073-121 1x12V21W (PY21W) 8GA 006 841-121
Twingo (C06_/S06_) Twingo (C06_/S06_)	03/93->	6NM 007 878-501	1	Setting element, headlight levelling
Twingo (C06_/S06_)	03/93->04/96	1NL 007 186-027 9HD 149 253-007 8JD 156 150-807	30 160 1	DE-H3 fog light with bulb (E1) 20 Spare Parts: Plastic cap Counterplug set (to be ordered separately) 1x12V55W (H3) 8GH 002 090-133
Twingo (CN0_) Twingo (CN0_)	03/07->	1L7 271 510-331 1L7 271 510-341	1 1	FF®-H4 headlight, left, with indicator light, with chrome-plated cover, without electr. headlight leveller actuator FF®-H4 headlight, right, with indicator light, with chrome-plated cover, without electr. headlight leveller actuator 1x12V60/55W (H4) 8GJ 002 525-131 1x12V5W (W5W) 8GP 003 594-121 1x12V21W (PY21W) 8GA 006 841-121



Renault



Manufacturer Model	Model year	Part no.	Pk.	Note
Renault				
Twingo (CN0_) Twingo (CN0_)	03/07->	1L7 271 510-371 1L7 271 510-381	1 1	FF®-H4 headlight, left, with indicator light, with black cover, without electr. headlight leveller actuator FF®-H4 headlight, right, with indicator light, with black cover, without electr. headlight leveller actuator  1x12V60/55W (H4) 8GJ 002 525-131  1x12V5W (W5W) 8GP 003 594-121  1x12V21W (PY21W) 8GA 006 841-121
Vel Satis (BJ0) Vel Satis (BJ0)	06/02->		1	Setting element, headlight levelling (for halogen headlight)
19 II 19 II Hatchback 16V (B/C53_) 19 II Chamade 16V (L53_) 19 II Convertible 16V (D53_, 853_)	04/92->12/95 04/92->12/95 04/92->06/96		1	Setting element, headlight levelling
19 II Hatchback (B/C53_) 19 II Convertible (D53_, 853_)	04/92->12/95 04/92->06/96	9EL 144 131-001 9EL 144 132-001	1 1	Body/lens for combination rearlight, left, with reverse light Body/lens for combination rearlight, right, with reverse light (E4) 227  1x12V21/5W (P21/5W) 8GD 002 078-121  2x12V21W (P21W) 8GA 002 073-121
Master II Master II (ED/FD/HD/JD/ND/UD)	07/98->10/03		1	Setting element, headlight levelling













Manufacturer Model	Model year	Part no.	Pk.	Note
Renault				
Trafic (JL/EL/FL) Trafic (JL/EL/FL)	03/01->	6NM 007 878-501	1	Setting element, headlight levelling
Saab				
900 I 900 I	08/86->06/94	9ES 133 383-005 9ES 133 384-005	5 5	H4 headlight for vehicles with or without headlight leveller, spare parts available only (E1) 17133 left (E1) 17134 right Spare Parts: Lens, left Lens, right 1x12V60/55W (H4) 8GJ 002 525-131
9000 9000 9000 CD	09/90->08/91 04/88->08/94	9ES 134 049-005	4	H4 headlight for vehicles with or without headlight leveller, spare parts available only (E1) 17147 left (E1) 17148 right Spare Parts: Lens, left 1x12V60/55W (H4) 8GJ 002 525-131
9000 CD	04/88->08/94	9EL 133 785-005 9EL 133 786-005	60 40	Body/lens for combination rearlight (grey/red), left, with reverse and rear fog light Body/lens for combination rearlight (grey/red), right, with reverse and rear fog light (E1) 63211 (E1) 63212 1x12V5W (R5W) 8GA 002 071-121 1x12V21/4W (P21/4W) 8GD 004 772-121 3x12V21W (P21W) 8GA 002 073-121
Seat				
Alhambra (7V8, 7V9) Alhambra (7V8, 7V9)	04/96->06/00	9EL 147 073-001	2	Body/lens for auxiliary indicator light (amber) (E1) 52636 1x12V5W (W5W) 8GP 003 594-121



Seat



Manufacturer Model	Model year	Part no.	Pk.	Note
Seat				
Alhambra (7V8, 7V9) Alhambra (7V8, 7V9)	04/96->06/00	9EL 147 073-801	1	Body/lens set for auxiliary indicator light (grey) (E1) 105  2x12V5W (W5W) 8GP 003 594-121
	 Design			
Alhambra (7V8, 7V9)	06/00->	9EL 156 099-801	1	Body/lens set for auxiliary indicator light (clear), with 2 amber bulbs (E13) 550  2x12V5W (WY5W) 8GP 003 594-541
	 Design			
Alhambra (7V8, 7V9)	04/96->06/00	9EL 907 325-001 9EL 907 326-001	1 1	Body/lens for combination rearlight (red), left Body/lens for combination rearlight (red), right (E1) 151 (E1) 392  1x12V5W (R5W) 8GA 002 071-121 1x12V21/5W (P21/5W) 8GD 002 078-121 1x12V21W (P21W) 8GA 002 073-121
				
Alhambra (7V8, 7V9)	06/00->	9EL 964 501-011 9EL 964 502-011	1 1	Body/lens for combination rearlight (red/pink), left Body/lens for combination rearlight (red/pink), right (E1) 1060  1x12V5W (R5W) 8GA 002 071-121 2x12V21W (P21W) 8GA 002 073-121
				
Altea (5P1) Altea	03/04->	1N0 271 022-051 1N0 271 022-061	1 1	H3 fog light, left, with bulb H3 fog light, right, with bulb (E26) 004  1x12V55W (H3) 8GH 002 090-133
				












Manufacturer Model	Model year	Part no.	Pk.	Note
Seat				
Altea XL (5P5) Altea XL	10/06->	1N0 271 022-051 1N0 271 022-061	1 1	H3 fog light, left, with bulb H3 fog light, right, with bulb 004 1x12V55W (H3) 8GH 002 090-133
Altea XL (-) Sport	10/06->	9EL 354 080-011 9EL 354 080-021	1 1	Body/lens for combination rearlight, left Body/lens for combination rearlight, right 1x12V21W (P21W) 8GA 002 073-121 1x12V21W (PY21W) 8GA 006 841-121
Altea XL (-) Sport	10/06->	9EL 354 081-011 9EL 354 082-021	1 1	Body/lens for reverse light, left Body/lens for rear fog light, right 1x12V21W (P21W) 8GA 002 073-121 1x12V5W (W5W) 8GP 003 594-121
Arosa (6H) Arosa (6H)	05/97->12/03	6NM 007 878-041	1	Setting element, headlight levelling (for halogen headlight)
Arosa (6H)	05/97->06/04	1N0 270 204-051 1N0 270 204-061	1 1	FF®-H3 fog light, left, with bulb FF®-H3 fog light, right, with bulb 003 1x12V55W (H3) 8GH 002 090-133


















Seat















Manufacturer Model	Model year	Part no.	Pk.	Note
Seat				
Arosa (6H) Arosa (6H)	05/97->06/04	9EL 156 099-801	1	Body/lens set for auxiliary indicator light (clear), with 2 amber bulbs E13 550  2x12V5W (WY5W) 8GP 003 594-541
				
Cordoba I Cordoba I 4-doors	02/93->03/97	1NA 961 557-751 1NA 961 557-761	1 1	H3 fog light, left H3 fog light, right E9 0019  2x12V55W (H3) 8GH 002 090-133
				
Cordoba I 2/4-doors, Cordoba Vario (-) Cupra	04/97->06/99	1NA 907 312-111 1NA 907 312-121	1 1	H3 fog light, left H3 fog light, right E9 0019  1x12V55W (H3) 8GH 002 090-133
				
Cordoba I	02/93->06/99	9EL 147 073-001	2	Body/lens for auxiliary indicator light (amber) E1 52636  1x12V5W (W5W) 8GP 003 594-121
				
Cordoba I	02/93->06/99	9EL 147 073-801	1	Body/lens set for auxiliary indicator light (grey) E1 105  2x12V5W (W5W) 8GP 003 594-121
				
Cordoba II Hatchback Cordoba II Hatchback	06/99->10/02	6NM 007 878-041	1	Setting element, headlight levelling
from chassis no. 6K-X-400 000				
Cordoba II Hatchback (-) Cupra	06/99->10/02	1NA 963 965-051 1NA 963 965-061	1 1	FF®-H7 fog light, left, with bulb FF®-H7 fog light, right, with bulb E1 838  1x12V55W (H7) 8GH 007 157-121
				



Manufacturer Model	Model year	Part no.	Pk.	Note
Seat				
Cordoba II Vario (6K5) Cordoba II Vario (6K5) from chassis no. 6K-X-400 000	06/99->12/03	6NM 007 878-041	1	Setting element, headlight levelling
				
Cordoba III (6L2) Cordoba III (6L2)	09/02->	6NM 007 878-041	1	Setting element, headlight levelling (for halogen headlight)
				
Cordoba III (6L2)	09/02->	9EL 964 949-001 9EL 964 950-001	1 1	Body/lens for combination rearlight, left Body/lens for combination rearlight, right
				(E1) 1353  1x12V21/5W (P21/5W) 8GD 002 078-121  1x12V16W (W16W) 8GA 008 246-001
Ibiza I (021A) Ibiza I (021A)	03/91->12/93	1NA 961 557-731 1NA 961 557-741	1 1	H3 fog light, left H3 fog light, right
				(E9) 0019  1x12V55W (H3) 8GH 002 090-133
Ibiza I (021A)	03/91->12/93	9EL 961 831-011 9EL 961 832-021	1 1	Body/lens for combination rearlight, left, with reverse and rear fog light Body/lens for combination rearlight, right, with reverse and rear fog light
				(E1) 63262  1x12V5W (R5W) 8GA 002 071-121  1x12V21/5W (P21/5W) 8GD 002 078-121  3x12V21W (P21W) 8GA 002 073-121
Ibiza II (6K1) Ibiza II (6K1) 5-doors	03/93->03/97	1NA 961 557-751 1NA 961 557-761	1 1	H3 fog light, left H3 fog light, right
				(E9) 0019  2x12V55W (H3) 8GH 002 090-133
Ibiza II (6K1) 3/5-doors (-) Cupra	04/97->08/99	1NA 907 312-111 1NA 907 312-121	1 1	H3 fog light, left H3 fog light, right
				(E9) 0019  1x12V55W (H3) 8GH 002 090-133

**Seat**

Manufacturer Model	Model year	Part no.	Pk.	Note
Seat				
Ibiza II (6K1) Ibiza II (6K1)	03/93->08/99	9EL 147 073-001	2	Body/lens for auxiliary indicator light (amber) E1 52636  1x12V5W (W5W) 8GP 003 594-121
				
Ibiza II (6K1)	03/93->08/99	9EL 147 073-801	1	Body/lens set for auxiliary indicator light (grey) E1 105  2x12V5W (W5W) 8GP 003 594-121
				
Ibiza III (6K1) Ibiza III (6K1) from chassis no. 6K-X-400 000	08/99->02/02	6NM 007 878-041	1	Setting element, headlight levelling
				
Ibiza III (6K1) (-) Cupra	08/99->02/02	1NA 963 965-051 1NA 963 965-061	1 1	FF®-H7 fog light, left, with bulb FF®-H7 fog light, right, with bulb E1 838  1x12V55W (H7) 8GH 007 157-121
				
Ibiza III (6K1)	08/99->02/02	9EL 964 023-011 9EL 964 024-011	1 1	Body/lens for combination rearlight, left, with reverse light Body/lens for combination rearlight, right, with reverse light E1 915  1x12V21/5W (P21/5W) 8GD 002 078-121  2x12V21W (P21W) 8GA 002 073-121
				
Ibiza III (6K1)	08/99->02/02	9EL 964 055-011 9EL 964 056-011	1 1	Body/lens for rear fog light, left Body/lens for rear fog light, right E1 898  1x12V21W (P21W) 8GA 002 073-121
				
















Manufacturer Model	Model year	Part no.	Pk.	Note
Seat				
Ibiza IV (6L1) Ibiza IV (6L1)	02/02->	6NM 007 878-041	1	Setting element, headlight levelling (for halogen headlight)
				
Ibiza IV (6L1) for PR-no. 2JG, 2JQ (painted bumper, painted bumper Sport) (-) Formula Racing	02/02->	1N0 009 617-011	1	FF®-H3 fog light, left and right, with bulb E4 19037 E4 19289  1x12V55W (H3) 8GH 002 090-133
				
Ibiza IV (6L1)	02/02->	8RA 354 036-011 8RA 354 036-021	1 1	Reflex-reflector (red), left Reflex-reflector (red), right
				
Inca (6K9) Inca (6K9)	11/95->	1NA 961 557-751 1NA 961 557-761	1 1	H3 fog light, left H3 fog light, right E9 0019  2x12V55W (H3) 8GH 002 090-133
				
Inca (6K9)	11/95->	9EL 147 073-001	2	Body/lens for auxiliary indicator light (amber) E1 52636  1x12V5W (W5W) 8GP 003 594-121
				
Leon (1M1) Leon (1M1)	11/99->	6NM 007 878-041	1	Setting element, headlight levelling
				
Leon (1M1) 1.8 T Cupra R, Limited Edition for PR-no. E5K, E7S	02/02->	1NL 007 906-031 1NL 007 906-041	1 1	DE-H3 fog light, left DE-H3 fog light, right E1 123  1x12V55W (H3) 8GH 002 090-133
				




Seat



Manufacturer Model	Model year	Part no.	Pk.	Note
Seat				
Leon (1M1) Leon (1M1)	11/99->	9EL 156 099-801	1	Body/lens set for auxiliary indicator light (clear), with 2 amber bulbs (E13) 550  2x12V5W (WY5W) 8GP 003 594-541 
Leon (1P1) Leon (1P1)	09/05->	1N0 271 022-051	1	H3 fog light, left, with bulb H3 fog light, right, with bulb (E26) 004  1x12V55W (H3) 8GH 002 090-133 
		1N0 271 022-061	1	
Leon (1P1)	09/05->	9EL 982 000-051 9EL 982 000-061	1 1	Body/lens for combination rearlight, left Body/lens for combination rearlight, right (E1) 1927  2x12V21/5W (P21/5W) 8GD 002 078-121 
Leon (1P1)	09/05->	9EL 982 001-111 9EL 982 001-121	1 1	Body/lens for rear and reverse light, left Body/lens for rear and rear fog light, right (E1) 1927  1x12V21W (P21W) 8GA 002 073-121  1x12V5W (W5W) 8GP 003 594-121 
Toledo I (1L) Toledo I (1L)	05/91->08/95	1NA 961 557-731 1NA 961 557-741	1 1	H3 fog light, left H3 fog light, right (E9) 0019  1x12V55W (H3) 8GH 002 090-133 
Toledo I (1L)	09/95->03/99	1NA 963 022-031 1NA 963 022-041	1 1	H3 fog light, left H3 fog light, right (E9) 0019  1x12V55W (H3) 8GH 002 090-133 



Manufacturer Model	Model year	Part no.	Pk.	Note
Seat				
Toledo I (1L) Toledo I (1L) CL, GL	05/91->08/95	9EL 144 443-001 9EL 144 444-001	1 1	Body/lens for indicator light (amber), left Body/lens for indicator light (amber), right E1 42796 1x12V21W (P21W) 8GA 002 073-121
				
Toledo I (1L) CL, GL	05/91->08/95	2BA 961 554-111 2BA 961 554-121	1 1	Indicator light (white), left, with bulb, for conversion Indicator light (white), right, with bulb, for conversion E9 15034 1x12V21W (PY21W) 8GA 006 841-121
 Design				
Toledo I (1L) GLX, GT, GT 16V	05/91->08/95	2BA 961 554-111 2BA 961 554-121	1 1	Indicator light (white), left, with bulb Indicator light (white), right, with bulb E9 15034 1x12V21W (PY21W) 8GA 006 841-121
				
Toledo I (1L)	09/95->03/99	9EL 963 261-011 9EL 963 262-011	1 1	Body/lens for indicator light (white), left Body/lens for indicator light (white), right E1 353 1x12V21W (PY21W) 8GA 006 841-121
				
Toledo I (1L)	09/95->03/99	9EL 147 073-001	2	Body/lens for auxiliary indicator light (amber) E1 52636 1x12V5W (W5W) 8GP 003 594-121
				
Toledo I (1L)	09/95->03/99	9EL 147 073-801	1	Body/lens set for auxiliary indicator light (grey) E1 105 2x12V5W (W5W) 8GP 003 594-121
 Design				






Seat



Manufacturer Model	Model year	Part no.	Pk.	Note
Seat				
Toledo I (1L) Toledo I (1L) CL, GL	05/91->08/95	9EL 962 025-011 9EL 962 026-011	1 1	Body/lens for combination rearlight (amber/red), left Body/lens for combination rearlight (amber/red), right E1 63251 1x12V21/5W (P21/5W) 8GD 002 078-121 1x12V21W (P21W) 8GA 002 073-121
Toledo I (1L) CL, GL	05/91->08/95	9EL 962 027-011 9EL 962 028-011	1 1	Body/lens for combination rearlight (red), left, for conversion Body/lens for combination rearlight (red), right, for conversion E1 63251 1x12V21/5W (P21/5W) 8GD 002 078-121 1x12V21W (P21W) 8GA 002 073-121
Toledo I (1L) GLX, GT, GT 16V	09/91->08/95	9EL 962 027-011 9EL 962 028-011	1 1	Body/lens for combination rearlight (red), left Body/lens for combination rearlight (red), right E1 63251 1x12V21/5W (P21/5W) 8GD 002 078-121 1x12V21W (P21W) 8GA 002 073-121
Toledo I (1L)	09/95->03/99	9EL 962 025-031 9EL 962 026-031	1 1	Body/lens for combination rearlight (grey/red), left Body/lens for combination rearlight (grey/red), right E1 42795 E1 63251 1x12V21/5W (P21/5W) 8GD 002 078-121 1x12V21W (P21W) 8GA 002 073-121
Toledo I (1L)	09/95->03/99	9EL 963 335-021 9EL 963 336-021	1 1	Body/lens for rear fog and reverse light (red/grey), left Body/lens for rear fog and reverse light (red/grey), right E1 349 E1 362 2x12V21W (P21W) 8GA 002 073-121



Manufacturer Model	Model year	Part no.	Pk.	Note
Seat				
Toledo II (1M2) Toledo II (1M2)	04/99->05/06	6NM 007 878-041	1	Setting element, headlight levelling
				
Toledo II (1M2) Cupra R	02/02->05/06	1NL 007 906-031 1NL 007 906-041	1 1	DE-H3 fog light, left DE-H3 fog light, right
				 123  1x12V55W (H3) 8GH 002 090-133
Toledo II (1M2)	04/99->05/06	9EL 156 099-801	1	Body/lens set for auxiliary indicator light (clear), with 2 amber bulbs
				 550  2x12V5W (WY5W) 8GP 003 594-541
Toledo II (1M2) (-) Sport	04/99->05/06	9EL 963 701-011 9EL 963 702-011	1 1	Body/lens for combination rearlight (red/white), left Body/lens for combination rearlight (red/white), right
				 683  1x12V21/5W (P21/5W) 8GD 002 078-121  1x12V21W (PY21W) 8GA 006 841-121
Toledo II (1M2) (-) Sport	04/99->05/06	9EL 964 599-001	1	Body/lens with rear panel (red/white), with reverse and rear fog light left and right, licence plate light and auxiliary brake light
				 684  685  2x12V5W (R5W) 8GA 002 071-121  4x12V21W (P21W) 8GA 002 073-121
Toledo III (5P2) Toledo III (5P2)	10/04->	1N0 271 022-051 1N0 271 022-061	1 1	H3 fog light, left, with bulb H3 fog light, right, with bulb
				 004  1x12V55W (H3) 8GH 002 090-133



Skoda



Manufacturer Model	Model year	Part no.	Pk.	Note
Skoda				
Fabia (6Y) Fabia (6Y)	12/99->12/03	6NM 007 878-521	1	Setting element, headlight levelling
				
Fabia (6Y) chassis no. -> 6Y-54421 759	08/04->	1N0 270 481-051 1N0 270 481-061	1 1	HB4 fog light, left, with bulb HB4 fog light, right, with bulb  007  1x12V51W (HB4) 8GH 005 636-121
				
Fabia (6Y) (-) RS chassis no. 6Y-54421 760 -> 6Y-7B452 577		1N0 271 247-051 1N0 271 247-061	1 1	FF®-HB4 fog light, left, with bulb FF®-HB4 fog light, right, with bulb  004  1x12V51W (HB4) 8GH 005 636-121
				
Fabia RS (6Y)	06/03->	1N0 270 204-051 1N0 270 204-061	1 1	FF®-H3 fog light, left, with bulb FF®-H3 fog light, right, with bulb  003  1x12V55W (H3) 8GH 002 090-133
				
Fabia Hatchback (6Y2)	08/99->08/04	9EL 171 976-011 9EL 171 976-021	1 1	Body/lens for combination rearlight, left, with reverse and rear fog light Body/lens for combination rearlight, right, with reverse and rear fog light  1x12V21/4W (P21/4W) 8GD 004 772-121 2x12V21W (P21W) 8GA 002 073-121 1x12V21W (PY21W) 8GA 006 841-121
				








Manufacturer Model	Model year	Part no.	Pk.	Note
Skoda				
Fabia (6Y)		9EL 171 977-011	1	Body/lens for combination rearlight, left, with reverse and rear fog light
Fabia Saloon (6Y3)	10/99->08/04	9EL 171 977-021	1	Body/lens for combination rearlight, right, with reverse and rear fog light
Fabia Estate (6Y5)	04/00->08/04			1x12V21/4W (P21/4W) 8GD 004 772-121 2x12V21W (P21W) 8GA 002 073-121 1x12V21W (PY21W) 8GA 006 841-121
Fabia Praktik	04/02->08/04			
Fabia Hatchback (6Y2)	08/04->	9EL 171 974-011	1	Body/lens for combination rearlight, left, with reverse and rear fog light
		9EL 171 974-021	1	Body/lens for combination rearlight, right, with reverse and rear fog light
				1x12V21/4W (P21/4W) 8GD 004 772-121 2x12V21W (P21W) 8GA 002 073-121 1x12V21W (PY21W) 8GA 006 841-121
Fabia Saloon (6Y3)	08/04->	9EL 171 975-011	1	Body/lens for combination rearlight, left, with reverse and rear fog light
Fabia Estate (6Y5)	08/04->	9EL 171 975-021	1	Body/lens for combination rearlight, right, with reverse and rear fog light
Fabia Praktik	08/04->			1x12V21/4W (P21/4W) 8GD 004 772-121 2x12V21W (P21W) 8GA 002 073-121 1x12V21W (PY21W) 8GA 006 841-121
Fabia II		1N0 271 247-051	1	FF®-HB4 fog light, left, with bulb
Fabia II	12/06->	1N0 271 247-061	1	FF®-HB4 fog light, right, with bulb
				(E26) 004
				1x12V51W (HB4) 8GH 005 636-121



Skoda



Manufacturer Model	Model year	Part no.	Pk.	Note
Skoda				
Fabia II Fabia II	12/06->	1N0 354 018-011 1N0 354 018-021	1 1	H8 fog light, left, with cornering light H8 fog light, right, with cornering light (E4) 4119  1x12V35W (H8) 8GH 008 356-121
Felicia I Felicia I	10/94->03/98	9EL 246 151-021 9EL 246 152-021	1 1	Body/lens for indicator light (white), left Body/lens for indicator light (white), right (E4) 464  1x12V21W (PY21W) 8GA 006 841-121
Felicia I (-) Pickup	10/94->03/98	9EL 246 201-011 9EL 246 202-011	1 1	Body/lens for combination rearlight (grey/red), left, with reverse and rear fog light Body/lens for combination rearlight (grey/red), right, with reverse and rear fog light (E13) 3534  1x12V5W (R5W) 8GA 002 071-121 1x12V21/5W (P21/5W) 8GD 002 078-121 2x12V21W (P21W) 8GA 002 073-121 1x12V21W (PY21W) 8GA 006 841-121
Felicia II (6U1/6U5) Felicia II (6U1/6U5)	01/98->06/01	1N0 270 204-051 1N0 270 204-061	1 1	FF®-H3 fog light, left, with bulb FF®-H3 fog light, right, with bulb (E26) 003  1x12V55W (H3) 8GH 002 090-133
Felicia II (6U1/6U5)	01/98->06/01	9EL 246 151-021 9EL 246 152-021	1 1	Body/lens for indicator light (white), left Body/lens for indicator light (white), right (E4) 464  1x12V21W (PY21W) 8GA 006 841-121



Manufacturer Model	Model year	Part no.	Pk.	Note
Skoda				
Felicia II (6U1/6U5) Felicia II (6U1/6U5) (-) Pickup	01/98->06/01	9EL 246 201-011 9EL 246 202-011	1 1	Body/lens for combination rearlight (grey/red), left, with reverse and rear fog light Body/lens for combination rearlight (grey/red), right, with reverse and rear fog light Ⓔ13 3534 1x12V5W (R5W) 8GA 002 071-121 1x12V21/5W (P21/5W) 8GD 002 078-121 2x12V21W (P21W) 8GA 002 073-121 1x12V21W (PY21W) 8GA 006 841-121
Octavia (1U2/1U5) Octavia (1U2/1U5) LX	08/00->	1LJ 010 202-051 1LJ 010 202-061	1 1	H4 headlight, left, without fog light, with electr. headlight leveller actuator H4 headlight, right, without fog light, with electr. headlight leveller actuator Ⓔ4 9758 left Ⓔ4 9759 right 1x12V60/55W (H4) 8GJ 002 525-131 1x12V5W (W5W) 8GP 003 594-121
Octavia (1U2/1U5) GLX, SLX	08/00->	1LL 010 202-071 1LL 010 202-081	1 1	H4 headlight, left, with DE-H3 fog light, with electr. headlight leveller actuator H4 headlight, right, with DE-H3 fog light, with electr. headlight leveller actuator Ⓔ4 9756 left Ⓔ4 9758 right 1x12V60/55W (H4) 8GJ 002 525-131 1x12V55W (H3) 8GH 002 090-133 1x12V5W (W5W) 8GP 003 594-121
Octavia (1U2/1U5)	08/00->	1LL 010 202-111 1LL 010 202-121	1 1	Xenon/H1 headlight, left, with DE-H3 fog light, with electr. headlight leveller actuator, without xenon ballast, without gas discharge bulb, without bulbs Xenon/H1 headlight, right, with DE-H3 fog light, with electr. headlight leveller actuator, without xenon ballast, without gas discharge bulb, without bulbs Ⓔ4 9761 left Ⓔ4 9762 right 1x35W (D2S) 8GS 007 949-101 1x12V55W (H1) 8GH 002 089-133 1x12V55W (H3) 8GH 002 090-133 1x12V5W (W5W) 8GP 003 594-121



Skoda



Manufacturer Model	Model year	Part no.	Pk.	Note
Skoda				
Octavia (1U2/1U5) Octavia (1U2/1U5) from chassis no. 1U-Y-375 001	01/00->08/00	6NM 007 878-531	1	Setting element, headlight levelling
				
Octavia (1U2/1U5)	09/96->08/00	9EL 246 175-011 9EL 246 176-011	1 1	Body/lens for indicator light (clear), left Body/lens for indicator light (clear), right E4 6478 1x12V21W (PY21W) 8GA 006 841-121
				
Octavia (1U2/1U5)	08/00->	9EL 354 075-011 9EL 354 075-021	1 1	Body/lens for indicator light (clear), left Body/lens for indicator light (clear), right 1x12V21W (PY21W) 8GA 006 841-121
				
Octavia (1U2) (-) Estate	08/00->	9EL 354 074-011 9EL 354 074-021	1 1	Body/lens for combination rearlight, left, with reverse and rear fog light Body/lens for combination rearlight, right, with reverse and rear fog light 1x12V21/4W (P21/4W) 8GD 004 772-121 2x12V21W (P21W) 8GA 002 073-121 1x12V21W (PY21W) 8GA 006 841-121
				
Octavia (1Z3/1Z5) Octavia (1Z3/1Z5) Ambiente	02/04->12/08	1LL 354 027-051 1LL 354 027-061	1 1	H1/H7 headlight, left, with indicator light, with electr. headlight leveller actuator H1/H7 headlight, right, with indicator light, with electr. headlight leveller actuator E8 3575 1x12V55W (H7) 8GH 007 157-121 1x12V55W (H1) 8GH 002 089-133 1x12V21W (PY21W) 8GA 006 841-121 1x12V5W (W5W) 8GP 003 594-121
				











Manufacturer Model	Model year	Part no.	Pk.	Note
Skoda				
Octavia (1Z3/1Z5) Octavia (1Z3/1Z5)	02/04->12/08	1LL 354 027-091 1LL 354 027-101	1 1	Xenon/H1 headlight, left, with indicator light, with electr. headlight leveller actuator, without gas discharge bulb, without xenon ballast, without bulbs Xenon/H1 headlight, right, with indicator light, with electr. headlight leveller actuator, without gas discharge bulb, without xenon ballast, without bulbs (E8) 3575 1x35W (D1S) 8GS 009 028-001 1x12V55W (H1) 8GH 002 089-133 1x12V21W (PY21W) 8GA 006 841-121 1x12V5W (W5W) 8GP 003 594-121
Octavia (1Z3/1Z5)	02/04->12/08	1N0 354 017-011 1N0 354 017-021	1 1	H8 fog light, left H8 fog light, right (E8) 3573 1x12V35W (H8) 8GH 008 356-121
Octavia (1Z3) (-) Estate	02/04->12/08	9EL 354 076-011 9EL 354 076-021	1 1	Body/lens for combination rearlight, left, with reverse and rear fog light Body/lens for combination rearlight, right, with reverse and rear fog light 2x12V21/4W (P21/4W) 8GD 004 772-121 1x12V21W (P21W) 8GA 002 073-121 1x12V21W (PY21W) 8GA 006 841-121 1x12V3W (W3W) 8GP 003 594-141
Roomster (5J), Praktik Roomster (5J) Praktik	05/06-> 03/07->	1N0 354 018-011 1N0 354 018-021	1 1	H8 fog light, left, with cornering light H8 fog light, right, with cornering light (E4) 4119 1x12V35W (H8) 8GH 008 356-121
Roomster (5J) Praktik	05/06-> 03/07->	1N0 271 247-051 1N0 271 247-061	1 1	FF®-HB4 fog light, left, with bulb FF®-HB4 fog light, right, with bulb (E26) 004 1x12V51W (HB4) 8GH 005 636-121



Skoda - Vauxhall



Manufacturer Model	Model year	Part no.	Pk.	Note
Skoda				
Roomster (5J), Praktik		9EL 354 077-011	1	Body/lens for combination rearlight, left, with reverse and rear fog light
Roomster (5J)	05/06->	9EL 354 077-021	1	Body/lens for combination rearlight, right, with reverse and rear fog light
Praktik	03/07->			 1x12V21W (PY21W) 8GA 006 841-121 3x12V21W (P21W) 8GA 002 073-121  2x12V5W (W5W) 8GP 003 594-121
				
Superb (3U4)		9EL 354 078-011	1	Body/lens for combination rearlight, left, with reverse and rear fog light
Superb (3U4)	02/02->08/06	9EL 354 078-021	1	Body/lens for combination rearlight, right, with reverse and rear fog light
				
Superb (3U4)		9EL 354 079-011	1	Body/lens for combination rearlight, left, with reverse and rear fog light
Superb (3U4)	09/06->06/08	9EL 354 079-021	1	Body/lens for combination rearlight, right, with reverse and rear fog light
				
Vauxhall				
Astra Mk I		2KA 003 485-021	1	Licence plate light with bulb
Astra Mk I	08/79->			 E1 22824
(UK-built models)				 1x12V10W (R10W) 8GA 002 071-131
				



Manufacturer Model	Model year	Part no.	Pk.	Note
Vauxhall				
Astra Mk II, Belmont Astra Mk II, Belmont (-) GTE, Convertible	10/84->08/91	9EL 128 949-011 9EL 128 948-011	1 1	Body/lens for indicator light (amber), left Body/lens for indicator light (amber), right E1 42690 1x12V21W (P21W) 8GA 002 073-121
Astra Mk II GTE, Convertible	10/84->08/91	9EL 128 959-011 9EL 128 958-011	1 1	Body/lens for indicator light (white), left Body/lens for indicator light (white), right E1 42697 1x12V21W (P21W) 8GA 002 073-121
Astra Mk II, Belmont	10/85->08/91	2BM 003 563-111	1	Auxiliary indicator light E1 42621 1x12V5W (W5W) 8GP 003 594-121
Astra Mk II, Belmont	10/84->08/91	2KA 003 485-021	1	Licence plate light with bulb E1 22824 1x12V10W (R10W) 8GA 002 071-131
Astra II Mk Estate	10/84->08/91	2KA 004 434-031	1	Licence plate light E1 22851 1x12V4W (T4W) 8GP 002 067-121
Astra Mk III Astra Mk III GTE	09/91->	1NL 006 580-051 1NL 006 580-061	1 1	DE-H3 fog light, left DE-H3 fog light, right E1 18239 1x12V55W (H3) 8GH 002 090-133



Vauxhall



Manufacturer Model	Model year	Part no.	Pk.	Note
Vauxhall				
Astra Mk III Astra Mk III	09/91->	2BM 003 563-111	1	Auxiliary indicator light E1 42621  1x12V5W (W5W) 8GP 003 594-121
Astra Mk IV Astra Mk IV	02/98->	1LG 007 640-331 1LG 007 640-341	1 1	FF®-H7/HB3 headlight, left, with body/lens for indicator light FF®-H7/HB3 headlight, right, with body/lens for indicator light E1 615 left E1 616 right E1 617 left E1 618 right  1x12V60W (HB3) 8GH 005 635-121  1x12V55W (H7) 8GH 007 157-121  1x12V21W (PY21W) 8GA 006 841-121  1x12V5W (W5W) 8GP 003 594-121
Astra Mk IV, CC, Estate Special models Astra Mk IV Coupé Astra Mk IV Convertible	02/98-> 03/00-> 03/01->	1LG 007 640-631 1LG 007 640-641	1 1	FF®-H7/HB3 headlight, left, with body/lens for indicator light and black frame behind the cover lens FF®-H7/HB3 headlight, right, with body/lens for indicator light and black frame behind the cover lens E1 615 left E1 616 right E1 617 left E1 618 right  1x12V60W (HB3) 8GH 005 635-121  1x12V55W (H7) 8GH 007 157-121  1x12V21W (PY21W) 8GA 006 841-121  1x12V5W (W5W) 8GP 003 594-121
Astra Mk IV	02/98->	6NM 007 878-351	1	Setting element, headlight levelling 
Astra Mk IV (-) Convertible, Coupé, OPC	02/98->	1NA 009 029-011 1NA 009 029-021	1 1	FF®-H3 fog light, left, with bulb FF®-H3 fog light, right, with bulb E12 19096  1x12V55W (H3) 8GH 002 090-133



Manufacturer Model	Model year	Part no.	Pk.	Note
Vauxhall				
Astra Mk IV Astra Mk IV Hatchback	02/98->	2VP 008 863-801	1	Design combination rearlight set with LED tail light, with 8 module lights, 2 circular ring reflector modules, 2 retaining parts, lead groups and accessories (E1) 878 (E1) 1196 (E1) 10048 (E1) 10049 (E1) 10050 (E1) 10051 Spare Parts: 1 LED rear light 1 Stop light 1 Indicator light (grey) 1 Reverse light (grey) 1 Rear fog light 1 Reflex-reflector (red) 1 Adapter for bulb monitor (to be ordered separately) 6x12V21W (P21W) 8GA 002 073-121 2x12V21W (PY21W) 8GA 006 841-121
Astra Mk V Astra Mk V Astra Mk V Sport	03/04->02/07 02/07->	1LG 270 370-331 1LG 270 370-341	1 1	FF®-H7/H1 headlight, left, with integrated indicator light, with electr. headlight leveller actuator FF®-H7/H1 headlight, right, with integrated indicator light, with electr. headlight leveller actuator (E1) 1770 left and right (E1) 1771 left and right 1x12V55W (H7) 8GH 007 157-121 1x12V55W (H1) 8GH 002 089-133 1x12V21W (H21W) 8GH 008 417-001 1x12V5W (W5W) 8GP 003 594-121
Astra Mk V (-) Sport	02/07->	1LG 270 370-631 1LG 270 370-641	1 1	FF®-H7/H1 headlight, left, with integrated indicator light, with electr. headlight leveller actuator FF®-H7/H1 headlight, right, with integrated indicator light, with electr. headlight leveller actuator (E1) 1770 1x12V55W (H7) 8GH 007 157-121 1x12V55W (H1) 8GH 002 089-133 1x12V21W (H21W) 8GH 008 417-001 1x12V5W (W5W) 8GP 003 594-121



Manufacturer Model	Model year	Part no.	Pk.	Note
Vauxhall				
Astra Mk V Astra Mk V	03/04->	1LL 008 700-331 1LL 008 700-341	1 1	Bi-Xenon®/FF®-H7 headlight, left, with integrated indicator light, without xenon ballast, without gas discharge bulb, without bulbs Bi-Xenon®/FF®-H7 headlight, right, with integrated indicator light, without xenon ballast, without gas discharge bulb, without bulbs E1 1778 left and right 1x12V55W (D2S) 8GS 007 949-101 1x12V55W (H7) 8GH 007 157-121 1x12V21W (PY21W) 8GA 006 841-121 1x12V5W (W5W) 8GP 003 594-121
Astra Mk V	03/04->	5DV 008 290-004	1	Ballast unit
Astra Mk V	03/04->	1ZL 009 487-811 1ZL 009 487-031 1ZL 009 487-041	1 1	Upgrade headlight set, with halogen dipped-beam light and dynam. bend lighting Spare Parts: Upgrade headlight, left Upgrade headlight, right 4x12V55W (H7) 8GH 007 157-121 1x12V21W (PY21W) 8GA 006 841-121 1x12V5W (W5W) 8GP 003 594-121
Astra Mk V Hatchback 5-doors Astra Mk V Estate	03/04->01/07 08/04->01/07	2PT 009 305-821 2PT 008 935-001	1 1	Daytime running light set, 2 daytime running lights with bulbs, with harness and covers E1 1722 Spare Parts: Daytime running light
Astra Mk V	03/04->	2BM 964 988-801	1	Auxiliary indicator light set (black) 2x12V5W (W5W) 8GP 003 594-121
















Manufacturer Model	Model year	Part no.	Pk.	Note
Vauxhall				
Astra Mk V Astra Mk V Hatchback 5-doors	03/04->02/07	9EL 160 467-011 9EL 160 468-011	1 1	Body/lens for combination rearlight, left, with reverse and rear fog light Body/lens for combination rearlight, right, with reverse and rear fog light (E1) 1776 1x12V21W (PY21W) 8GA 006 841-121 2x12V21W (P21W) 8GA 002 073-121
Astra Mk V Hatchback 5-doors	03/07->	9EL 354 073-011 9EL 354 073-021	1 1	Body/lens for combination rearlight, left, with reverse and rear fog light Body/lens for combination rearlight, right, with reverse and rear fog light 1x12V21W (PY21W) 8GA 006 841-121 4x12V21W (P21W) 8GA 002 073-121
Astra Mk V GTC 3-doors	03/05->	9EL 161 421-011 9EL 161 422-011	1 1	Body/lens for combination rearlight, left, with reverse and rear fog light Body/lens for combination rearlight, right, with reverse and rear fog light (E1) 1885 1x12V21W (PY21W) 8GA 006 841-121 2x12V21W (P21W) 8GA 002 073-121
Astra Mk V GTC 3-doors	03/05->	2SK 008 748-801	1	Upgrade combination rearlight set (Icegrey) 1x12V21W (P21W) 8GA 002 073-121 1x12V21W (PY21W) 8GA 006 841-121 3x12V21W (P21W) 8GA 002 073-121





Vauxhall







Manufacturer Model	Model year	Part no.	Pk.	Note
Vauxhall				
Calibra Calibra 	06/90->07/97	1LL 006 110-351 1LL 006 110-361	1 1	DE-H1 headlight, left, with DE-H3 fog light, with indicator light, suitable for headlight leveller DE-H1 headlight, right, with DE-H3 fog light, with indicator light, suitable for headlight leveller (E4) 380 (E4) 404 (E4) 460 (E4) 984  2x12V55W (H1) 8GH 002 089-133  1x12V55W (H3) 8GH 002 090-133  1x12V21W (P21W) 8GA 002 073-121  1x12V5W (W5W) 8GP 003 594-121
Calibra 	06/90->07/97	2BM 003 563-111	1	Auxiliary indicator light (E1) 42621  1x12V5W (W5W) 8GP 003 594-121
Carlton Mk I Carlton Mk I 	11/82->09/86	2KA 003 485-021	1	Licence plate light with bulb (E1) 22824  1x12V10W (R10W) 8GA 002 071-131
Cavalier Mk II Cavalier Mk II 	81->84	2KA 003 485-021	1	Licence plate light with bulb (E1) 22824  1x12V10W (R10W) 8GA 002 071-131
Cavalier Mk III Cavalier Mk III 	09/92->08/93	9EL 145 801-001 9EL 145 802-001	1 1	Body/lens for indicator light (white), left Body/lens for indicator light (white), right (E12) 6100  1x12V21W (P21W) 8GA 002 073-121



Manufacturer Model	Model year	Part no.	Pk.	Note
Vauxhall				
Cavalier Mk III Cavalier Mk III	09/93->09/95	9EL 146 021-001 9EL 146 022-001	1 1	Body/lens for indicator light (white), left Body/lens for indicator light (white), right E12 6100 1x12V21W (P21W) 8GA 002 073-121
				
Cavalier Mk III	10/88->09/95	2BM 003 563-111	1	Auxiliary indicator light E1 42621 1x12V5W (W5W) 8GP 003 594-121
				
Corsa Mk II Corsa Mk II	10/00->03/03	1NA 009 031-011 1NA 009 031-021	1 1	FF®-H3 fog light, left, with bulb FF®-H3 fog light, right, with bulb E12 19105 1x12V55W (H3) 8GH 002 090-133
				
Corsa Mk III Corsa Mk III	07/06->	2BM 964 988-801	1	Auxiliary indicator light set (black) 1x12V5W (W5W) 8GP 003 594-121
 Design				
Corsavan Mk II Corsavan Mk II	10/00->03/03	1NA 009 031-011 1NA 009 031-021	1 1	FF®-H3 fog light, left, with bulb FF®-H3 fog light, right, with bulb E12 19105 1x12V55W (H3) 8GH 002 090-133
				
Nova Mk I Nova Mk I	03/83->02/93	2BM 003 563-111	1	Auxiliary indicator light E1 42621 1x12V5W (W5W) 8GP 003 594-121
				



Manufacturer Model	Model year	Part no.	Pk.	Note
Vauxhall				
Nova Mk I Nova Mk I	03/83->02/93	2KA 003 485-021	1	Licence plate light with bulb E1 22824 1x12V10W (R10W) 8GA 002 071-131
				
Omega Omega	03/94->08/97	1LG 006 920-231 1LG 006 920-241	1 1	H1 headlight, left, with indicator light, suitable for electr. headlight leveller H1 headlight, right, with indicator light, suitable for electr. headlight leveller E1 53 left and right E1 55 left E1 56 right 2x12V55W (H1) 8GH 002 089-231 UV-cut 1x12V21W (P21W) 8GA 002 073-121 1x12V5W (W5W) 8GP 003 594-121
				
Omega Basic, CD	09/97->09/99	1LL 008 020-271 1LL 008 020-281	1 1	DE-H1/H7 headlight, left, with body/lens for indicator light DE-H1/H7 headlight, right, with body/lens for indicator light E1 672 E1 673 1x12V55W (H1) 8GH 002 089-133 1x12V55W (H7) 8GH 007 157-121 1x12V21W (PY21W) 8GA 006 841-121 1x12V5W (W5W) 8GP 003 594-121
				
Omega Omega Sport, MV6 standard Omega Basic, CD Special equipment	09/97->09/99	1LL 007 950-251 1LL 007 950-261	1 1	Xenon/H7 headlight, left, with body/lens for indicator light, without headlight leveller actuator, without xenon ballast, without gas discharge bulb, without bulbs Xenon/H7 headlight, right, with body/lens for indicator light, without headlight leveller actuator, without xenon ballast, without gas discharge bulb, without bulbs E1 601 E1 602 E1 672 E1 673 1x35W (D2S) 8GS 007 949-101 1x12V55W (H7) 8GH 007 157-121 1x12V21W (PY21W) 8GA 006 841-121 1x12V5W (W5W) 8GP 003 594-121
				



Manufacturer Model	Model year	Part no.	Pk.	Note
Vauxhall				
Omega		1LL 009 020-231	1	DE-H1/H7 headlight, left, with body/lens for indicator light DE-H1/H7 headlight, right, with body/lens for indicator light (E1) 672 (E1) 673 1x12V55W (H1) 8GH 002 089-133 1x12V55W (H7) 8GH 007 157-121 1x12V21W (PY21W) 8GA 006 841-121 1x12V5W (W5W) 8GP 003 594-121
Omega	10/99->08/01	1LL 009 020-241	1	
Omega	03/94->07/03	6NM 007 282-641	1	Setting element, headlight levelling (for halogen headlight)
Omega	09/97->07/03	5DV 007 760-651	1	Ballast unit
Omega Estate	03/94->09/99	9EL 143 579-021	1	Body/lens for combination rearlight, left, with reverse and rear fog light Body/lens for combination rearlight, right, with reverse and rear fog light (E1) 40 1x12V21/4W (P21/4W) 8GD 004 772-121 1x12V21W (PY21W) 8GA 006 841-121 2x12V21W (P21W) 8GA 002 073-121
		9EL 143 580-021	1	
Omega Estate	03/94->09/99	8RA 007 051-031	1	Reflex-reflector, left Reflex-reflector, right (E1) 0249
		8RA 007 051-041	1	
Omega Estate	10/99->07/03	9EL 152 051-011	1	Body/lens for combination rearlight, left, with reverse and rear fog light Body/lens for combination rearlight, right, with reverse and rear fog light (E1) 962 1x12V21/4W (P21/4W) 8GD 004 772-121 1x12V21W (PY21W) 8GA 006 841-121 2x12V21W (P21W) 8GA 002 073-121
		9EL 152 052-011	1	



Vauxhall



Manufacturer Model	Model year	Part no.	Pk.	Note
Vauxhall				
Signum Signum	05/03->08/05	1LL 008 320-251 1LL 008 320-261	1 1	DE-H7/FF®-H7 headlight, left, with indicator light, suitable for headlight leveller DE-H7/FF®-H7 headlight, right, with indicator light, suitable for headlight leveller E1 1356 E1 1357 2x12V55W (H7) 8GH 007 157-121 1x12V5W (W5W) 8GP 003 594-121 1x12V21W (PY21W) 8GA 006 841-121
Signum	05/03->08/05	1LL 008 320-331 1LL 008 320-341	1 1	DE-H7/FF®-H7 headlight (black), left, with indicator light, suitable for headlight leveller, for conversion DE-H7/FF®-H7 headlight (black), right, with indicator light, suitable for headlight leveller, for conversion E1 1356 E1 1357 2x12V55W (H7) 8GH 007 157-121 1x12V5W (W5W) 8GP 003 594-121 1x12V21W (PY21W) 8GA 006 841-121
Signum	04->08/05	1LL 008 320-331 1LL 008 320-341	1 1	DE-H7/FF®-H7 headlight (black), left, with indicator light, suitable for headlight leveller DE-H7/FF®-H7 headlight (black), right, with indicator light, suitable for headlight leveller E1 1356 E1 1357 2x12V55W (H7) 8GH 007 157-121 1x12V5W (W5W) 8GP 003 594-121 1x12V21W (PY21W) 8GA 006 841-121
Vectra Vectra (-) Sport	02/99->	1NA 009 032-011 1NA 009 032-021	1 1	FF®-H3 fog light, left, with bulb FF®-H3 fog light, right, with bulb E12 19099 1x12V55W (H3) 8GH 002 090-133












Manufacturer Model	Model year	Part no.	Pk.	Note
Vauxhall				
Vectra Mk II		1LL 008 320-251	1	DE-H7/FF®-H7 headlight, left, with indicator light, suitable for headlight leveller
Vectra Mk II Saloon	04/02->08/05	1LL 008 320-261	1	DE-H7/FF®-H7 headlight, right, with indicator light, suitable for headlight leveller
Vectra Mk II Estate	09/03->08/05			(E1) 1356 (E1) 1357 2x12V55W (H7) 8GH 007 157-121 1x12V5W (W5W) 8GP 003 594-121 1x12V21W (PY21W) 8GA 006 841-121
Vectra Mk II Saloon	04/02->08/05	1LL 008 320-331	1	DE-H7/FF®-H7 headlight (black), left, with indicator light, suitable for headlight leveller, for conversion
Vectra Mk II Estate	10/03->08/05	1LL 008 320-341	1	DE-H7/FF®-H7 headlight (black), right, with indicator light, suitable for headlight leveller, for conversion
				(E1) 1356 (E1) 1357 2x12V55W (H7) 8GH 007 157-121 1x12V5W (W5W) 8GP 003 594-121 1x12V21W (PY21W) 8GA 006 841-121
Vectra Mk II Edition	04->08/05	1LL 008 320-331	1	DE-H7/FF®-H7 headlight (black), left, with indicator light, suitable for headlight leveller
Vectra Mk II GTS	08/02->08/05	1LL 008 320-341	1	DE-H7/FF®-H7 headlight (black), right, with indicator light, suitable for headlight leveller
				(E1) 1356 (E1) 1357 2x12V55W (H7) 8GH 007 157-121 1x12V5W (W5W) 8GP 003 594-121 1x12V21W (PY21W) 8GA 006 841-121
Zafira		1NA 009 033-011	1	FF®-H3 fog light, left, with bulb
Zafira	04/99->	1NA 009 033-021	1	FF®-H3 fog light, right, with bulb
(-) GSi, OPC				(E12) 19098 1x12V55W (H3) 8GH 002 090-133



Vauxhall - Volkswagen



Manufacturer Model	Model year	Part no.	Pk.	Note
Vauxhall				
Zafira Mk II Zafira Mk II	07/05->	2BM 964 988-801	1	Auxiliary indicator light set (black)  2x12V5W (W5W) 8GP 003 594-121
				
Volkswagen				
Bora (1J2, 1J6) Bora (-) GTI, TDI	10/98->07/05	1NL 008 383-861 1NL 008 090-031 9HB 162 205-001 9HB 162 206-001	1	Micro DE-H3 fog light set with bulbs, with covers and remote control system (E1) 877 Spare Parts: 1 Micro DE-H3 fog light 1 Outer trim, left 1 Outer trim, right  2x12V55W (H3) 8GH 002 090-133
				
Bora	10/98->07/05	9EL 156 099-801	1	Body/lens set for auxiliary indicator light (clear), with 2 amber bulbs (E13) 550  2x12V5W (WY5W) 8GP 003 594-541
				
Bora (-) Estate Basic, Trendline, Comfortline	10/98->07/05	9EL 963 669-081 9EL 963 670-081	1 1	Body/lens for combination rearlight (red/clear), left, with reverse and rear fog light Body/lens for combination rearlight (red/clear), right, with reverse and rear fog light (E4) 9457  1x12V5W (R5W) 8GA 002 071-121  4x12V21W (P21W) 8GA 002 073-121
				



Manufacturer Model	Model year	Part no.	Pk.	Note
Volkswagen				
Bora (1J2, 1J6) Bora (-) Estate Basic, Trendline, Comfortline	10/98->07/05	9EL 963 669-091	1	Body/lens for combination rearlight (grey/red), left, with reverse and rear fog light, for conversion
		9EL 963 670-091	1	Body/lens for combination rearlight (grey/red), right, with reverse and rear fog light, for conversion (E4) 9457 1x12V5W (R5W) 8GA 002 071-121 4x12V21W (P21W) 8GA 002 073-121
Bora Highline (-) Estate	10/98->07/05	9EL 963 669-091	1	Body/lens for combination rearlight (grey/red), left, with reverse and rear fog light
		9EL 963 670-091	1	Body/lens for combination rearlight (grey/red), right, with reverse and rear fog light (E4) 9457 1x12V5W (R5W) 8GA 002 071-121 4x12V21W (P21W) 8GA 002 073-121
Bora (-) Estate	10/98->07/05	9EL 963 561-801	1	Design combination rearlight set (black) without bulb holder
		8RA 004 412-041	10	Spare Parts: Reflex-reflector (red) 2x12V5W (R5W) 8GA 002 071-121 8x12V21W (P21W) 8GA 002 073-121
Bora (-) Estate	10/98->07/05	9EL 963 561-811	1	Design combination rearlight set (brilliant silver) without bulb holder
		8RA 004 412-041	10	Spare Parts: Reflex-reflector (red) 2x12V5W (R5W) 8GA 002 071-121 8x12V21W (P21W) 8GA 002 073-121



Volkswagen



Manufacturer Model	Model year	Part no.	Pk.	Note
Volkswagen				
Caddy I (14) Caddy I (14)	08/82->07/92	1L8 003 060-561 9GH 116 966-011 9FF 126 444-001	1 10 10	Headlight E1 7097 Spare Parts: Cap Bulb socket for side light (to be ordered separately) 1x12V45/40W (R2) 8GD 002 088-131 1x12V4W (T4W) 8GP 002 067-121
		 1L8 003 060-691 9GH 116 966-011 9FF 126 444-001	1 10 10	H4 headlight E1 7144 Spare Parts: Cap Bulb socket for side light (to be ordered separately) 1x12V60/55W (H4) 8GJ 002 525-131 1x12V4W (T4W) 8GP 002 067-121
Caddy I (14)	08/82->07/92	2BA 002 939-171 9EL 116 771-031	1 2	Indicator light (amber) E1 32710 Spare Parts: Lens 1x12V21W (P21W) 8GA 002 073-121
 Caddy II (9KA9, 9K9B, 9U7) Caddy II Pick-up (9U7)	09/96->12/00	9EL 246 151-021 9EL 246 152-021	1 1	Body/lens for indicator light (white), left Body/lens for indicator light (white), right E4 464 1x12V21W (PY21W) 8GA 006 841-121
Caddy II (9KA9, 9K9B, 9U7)	11/95->	9EL 147 073-001	2	Body/lens for auxiliary indicator light (amber) E1 52636 1x12V5W (W5W) 8GP 003 594-121
Caddy III (2KA, 2KB) Caddy III (2KA, 2KB)	03/04->	1LL 010 203-031 1LL 010 203-041	1 1	H1/H7 headlight, left, with indicator light, with electr. headlight leveller actuator H1/H7 headlight, right, with indicator light, with electr. headlight leveller actuator E4 10184 left E4 10170 right 1x12V55W (H7) 8GH 007 157-121 1x12V55W (H1) 8GH 002 089-133 1x12V21W (PY21W) 8GA 006 841-121 1x12V5W (W5W) 8GP 003 594-121

















Manufacturer Model	Model year	Part no.	Pk.	Note
Volkswagen				
Caddy III (2KA, 2KB) Caddy III (2KA, 2KB) up to chassis no. 2K-5-060 000	03/04->12/04	1N0 270 596-051 1N0 270 596-061	1 1	DE-H11 fog light, left, with bulb DE-H11 fog light, right, with bulb 008 1x12V55W (H11) 8GH 008 358-121
Caddy III (2KA, 2KB) from chassis no. 2K-5-060 001	12/04->	1N0 271 289-031 1N0 271 289-041	1 1	FF®-HB4 fog light, left, with bulb FF®-HB4 fog light, right, with bulb 015 1x12V51W (HB4) 8GH 005 636-121
Caddy III Estate (2KB) Vehicles with tailgate	03/04->	2VP 354 043-011 2VP 354 043-021	1 1	Combination rearlight, left, with reverse and rear fog light Combination rearlight, right, with reverse and rear fog light 1x12V21/4W (P21/4W) 8GD 004 772-121 2x12V21W (P21W) 8GA 002 073-121 1x12V21W (PY21W) 8GA 006 841-121
Caddy III Box (2KA) Vehicles with hatch door	03/04->	2VP 354 042-011 2VP 354 042-021	1 1	Combination rearlight, left, with reverse and rear fog light Combination rearlight, right, with reverse and rear fog light 1x12V21/4W (P21/4W) 8GD 004 772-121 2x12V21W (P21W) 8GA 002 073-121 1x12V21W (PY21W) 8GA 006 841-121
Corrado (53I) Corrado (53I)	09/88->07/91	1NB 005 394-051 1NB 005 394-061	1 1	H3 fog light, left H3 fog light, right 18209 1x12V55W (H3) 8GH 002 090-133



Manufacturer Model	Model year	Part no.	Pk.	Note
Volkswagen				
Corrado (53I) Corrado (53I)	09/88->07/91	2BA 005 398-031 2BA 005 398-041	1 1	Indicator light, left Indicator light, right E1 42746 1x12V21W (P21W) 8GA 002 073-121
Corrado (53I) all models with auxiliary indicators as standard feature	09/88->08/91	2BM 003 647-021	1	Auxiliary indicator light E1 151 1x12V5W (W5W) 8GP 003 594-121
Corrado (53I)	09/91->12/95	2BM 003 647-801 2BM 003 647-021	1 1	Auxiliary indicator light set (amber), with bulbs E1 151 Spare Parts: Auxiliary indicator light (amber) 2x12V5W (W5W) 8GP 003 594-121
Corrado (53I)	09/91->12/95	2BM 006 759-801 2BM 006 759-001	1 5	Auxiliary indicator light set (grey), with bulbs E13 1299 Spare Parts: Auxiliary indicator light (grey), with bulbs 2x12V5W (W5W) 8GP 003 594-121
Derby II (86C, 80) Derby II (86C, 80)	08/81->12/84	2BA 002 939-171 9EL 116 771-031	1 2	Indicator light (amber) E1 32710 Spare Parts: Lens 1x12V21W (P21W) 8GA 002 073-121
Derby II (86C, 80)	08/81->12/84	9EL 125 909-031 9EL 125 910-041	1 1	Body/lens for combination rearlight, left, with reverse and rear fog light Body/lens for combination rearlight, right, with reverse light E1 53342 1x12V21/5W (P21/5W) 8GD 002 078-121 3x12V21W (P21W) 8GA 002 073-121 1x12V5W (C5W) 8GM 002 092-121
Derby II (86C, 80)	08/81->12/84	2JA 002 931-031	5	Interior light 1x12V10W (K) 8GM 002 091-131









Manufacturer Model	Model year	Part no.	Pk.	Note
Volkswagen				
Eos		1N0 271 289-031	1	FF®-HB4 fog light, left, with bulb
Eos	05/06->	1N0 271 289-041	1	FF®-HB4 fog light, right, with bulb
				(E26) 015  1x12V51W (HB4) 8GH 005 636-121
Golf I (17, 155)		1L8 003 060-561	1	Headlight
Golf I (17)	07/74->07/83			(E1) 7097
Golf I Convertible (155)	05/79->07/87	9GH 116 966-011 9FF 126 444-001	10 10	Spare Parts: Cap Bulb socket for side light  1x12V45/40W (R2) 8GD 002 088-131  1x12V4W (T4W) 8GP 002 067-121
		1L8 003 060-691	1	H4 headlight
		9GH 116 966-011 9FF 126 444-001	10 10	(E1) 7144 Spare Parts: Cap Bulb socket for side light (to be ordered separately)  1x12V60/55W (H4) 8GJ 002 525-131  1x12V4W (T4W) 8GP 002 067-121
Golf I Convertible (155)	09/91->08/93	2BM 003 647-801	1	Auxiliary indicator light set (amber), with bulbs
		2BM 003 647-021	1	(E1) 151 Spare Parts: Auxiliary indicator light (amber)  2x12V5W (W5W) 8GP 003 594-121
Golf I Convertible (155)	09/91->08/93	2BM 006 759-801	1	Auxiliary indicator light set (grey), with bulbs
	 	2BM 006 759-001	5	(E13) 1299 Spare Parts: Auxiliary indicator light (grey), with bulbs  2x12V5W (W5W) 8GP 003 594-121
Golf I (17)	10/78->07/83	2KA 002 445-111	1	Licence plate light
Golf I Convertible (155)	05/79->08/93			(E1) 22810
				 1x12V4W (T4W) 8GP 002 067-121















Volkswagen



Manufacturer Model	Model year	Part no.	Pk.	Note
Volkswagen				
Golf I (17, 155) Golf I (17)	07/74->07/83	2JA 002 532-011	5	Interior light  1x12V10W (K) 8GM 002 091-131
				
Golf II (19E, 1G1) Golf II (19E, 1G1) (-) Golf Rallye	08/83->12/92	1L8 004 190-111 9GH 116 966-011 9FF 126 444-001	1 10 10	H4 headlight for vehicles with or without headlight leveller (E1) 7144 Spare Parts: Cap Bulb socket for side light ->05/89 (to be ordered separately)  1x12V60/55W (H4) 8GJ 002 525-131  1x12V4W (T4W) 8GP 002 067-121
				
Golf II (19E, 1G1) GL, GT, GTI	09/89->12/92	1NL 006 315-051 1NL 006 315-061	1 1	DE-H3 fog light, left, with bulb DE-H3 fog light, right, with bulb (E1) 18226  1x12V55W (H3) 8GH 002 090-133
				
Golf II (19E, 1G1) GL, GT, GTI	09/89->12/92	1NL 006 315-111 1NL 006 315-121	1 1	DE-H3 fog light (black), left, with bulb DE-H3 fog light (black), right, with bulb (E1) 18226  1x12V55W (H3) 8GH 002 090-133
 Design				
Golf II (19E, 1G1) C, CL Golf II (19E, 1G1) GL, GT, GTI	08/83->12/92 08/83->08/89	2BA 002 939-171 9EL 116 771-031	1 2	Indicator light (amber) (E1) 32710 Spare Parts: Lens  1x12V21W (P21W) 8GA 002 073-121
				
Golf II GL, GT, GTI	09/89->12/92	9EL 141 701-001 9EL 141 702-001 9EL 141 705-001	2 2 1	Body/lens for indicator light (amber), left Body/lens for indicator light (amber), right (E15) 31 Body/lens for indicator light (white), left (E4) 402  1x12V21W (P21W) 8GA 002 073-121
				











Manufacturer Model	Model year	Part no.	Pk.	Note
Volkswagen				
Golf II (19E, 1G1) Golf II GL, GT, GTI	09/89->12/92	 Design	2BA 006 728-801 9EL 141 705-001	1 Indicator light set (white), with bulbs (E4) 402 Spare Parts: Body/lens (white), left  2x12V21W (P21W) 8GA 002 073-121
Golf II	08/83->12/92		2BM 003 647-801 2BM 003 647-021	1 Auxiliary indicator light set (amber), with bulbs (E1) 151 Spare Parts: Auxiliary indicator light (amber)  2x12V5W (W5W) 8GP 003 594-121
Golf II	08/83->12/92	 Design	2BM 006 759-801 2BM 006 759-001	1 Auxiliary indicator light set (grey), with bulbs (E13) 1299 Spare Parts: Auxiliary indicator light (grey), with bulbs  2x12V5W (W5W) 8GP 003 594-121
Golf II (19E, 1G1) except models with M-equipment and Golf Rallye	08/83->12/92		2VP 004 220-061 2VP 004 220-081 9EL 127 010-021	1 Combination rearlight, right, with reverse light 1 Combination rearlight, right, with reverse and rear fog light (E1) 53355 Spare Parts: Body/lens for 2VP 004 220-061  1x12V5W (R5W) 8GA 002 071-121  4x12V21W (P21W) 8GA 002 073-121
Golf II (19E, 1G1) with M-equipment Golf Rallye	01/89->12/92 07/89->		9EM 127 010-061	1 Body/lens for combination rearlight (grey/red), right, with reverse and rear fog light (E1) 53355  1x12V5W (R5W) 8GA 002 071-121  4x12V21W (P21W) 8GA 002 073-121







Volkswagen



Manufacturer Model	Model year	Part no.	Pk.	Note
Volkswagen				
Golf III (1H1, 1H5, 1E7) Golf III 01/94->08/97 Golf III Estate 01/94->04/99 (-) GT, GTI, VR6 		1LJ 007 235-251 1LJ 007 235-261	1 1	H4 headlight, left, for vehicles with or without headlight leveller H4 headlight, right, for vehicles with or without headlight leveller (E1) 17191 left (E1) 17192 right  1x12V60/55W (H4) 8GJ 002 525-131  1x12V5W (W5W) 8GP 003 594-121
Golf III GT, GTI, VR6 08/91->08/97 Golf III Convertible 07/93->05/98 Golf III Estate GT, GTI, VR6 07/93->04/99 		1LJ 006 360-671 1LJ 006 360-681 8KA 146 152-001	1 1 2	H1 headlight, left, for vehicles with or without headlight leveller H1 headlight, right, for vehicles with or without headlight leveller (E1) 27001 left (E1) 27002 right (E1) 44468 left (E1) 44469 right Spare Parts: Lead with adapter for vehicles ->12/92 (to be ordered separately)  2x12V55W (H1) 8GH 002 089-133  1x12V5W (W5W) 8GP 003 594-121
Golf III 08/91->08/97 Golf III Convertible 07/93->05/98 Golf III Estate 07/93->04/99 		6NM 007 282-211	1	Setting element, headlight levelling
Golf III Convertible 06/98->06/02 		6NM 007 878-041	1	Setting element, headlight levelling










Manufacturer Model	Model year	Part no.	Pk.	Note
Volkswagen				
Golf III (1H1, 1H5, 1E7)		1LJ 008 758-011	1	H7 headlight, left, with clear cover lens, with bulbs
Golf III	08/91->08/97	1LJ 008 758-021	1	H7 headlight, right, with clear cover lens, with bulbs
Golf III Convertible	07/93->05/98			
Golf III Estate	07/93->04/99	8KA 146 152-001	2	Spare Parts: Lead with adapter for vehicles ->12/92 (to be ordered separately) 2x12V55W (H7) 8GH 007 157-121 1x12V3W (W3W) 8GP 003 594-141
 Design				
Golf III	08/91->08/97	1LL 009 213-811	1	DE-H7/FF®-H7 headlight set (Upgrade), in clear glass design with CELIS® position lights, with bulbs
Golf III Convertible	07/93->05/98			
Golf III Estate	07/93->04/99	1LL 009 213-031	1	Spare Parts: DE-H7/FF®-H7 headlight, left, with bulbs
 Design				
		1LL 009 213-041	1	DE-H7/FF®-H7 headlight, right, with bulbs 4x12V55W (H7) 8GH 007 157-121
Golf III Convertible	06/98->06/02	1LJ 009 292-821	1	Upgrade headlight set with up-to-date look, with clear glass design, with chrome-plated covers, with bulbs
 Design				
		1LJ 009 292-051	1	Spare Parts: Upgrade headlight, left, with chrome-plated cover
		1LJ 009 292-061	1	Upgrade headlight, right, with chrome-plated cover 4x12V55W (H7) 8GH 007 157-121 2x12V21W (H21W) 8GH 008 417-001 2x12V5W (W5W) 8GP 003 594-121
Golf III Convertible	06/98->06/02	1LL 009 300-831	1	Upgrade headlight set with CELIS® position light rings, with fog lights, with bulbs Ⓔ4 2032 Ⓔ4 2033
 Design				
		1LL 009 300-071	1	Spare Parts: Upgrade headlight, left, with fog light, with bulbs
		1LL 009 300-081	1	Upgrade headlight, right, with fog light, with bulbs 4x12V55W (H7) 8GH 007 157-121 2x12V35W (H8) 8GH 008 356-121



Manufacturer Model	Model year	Part no.	Pk.	Note
Volkswagen				
Golf III (1H1, 1H5, 1E7)		1NL 007 220-031	1	DE-H3 fog light, left
Golf III	08/91->08/97	1NL 007 220-041	1	DE-H3 fog light, right
Golf III Convertible	07/93->05/98			18238
Golf III Estate	07/93->04/99			2x12V55W (H3) 8GH 002 090-133
Golf III	08/91->08/97	2PT 008 956-801	1	Design lighting front set, 2 daytime running lights and 2 indicator lights with silver bulbs (amber signal colour). Lenses are glass clear and without pattern. With harness.
Golf III Convertible	07/93->05/98			2x12V21W (PY21W) silver (indicator light)
Golf III Estate	07/93->04/99			2x12V21W (P21W) 8GA 002 073-121 (daytime running light)
Golf III CL, GL	08/91->08/97	9EL 144 425-001	1	Body/lens for indicator light (amber), left
Golf III Estate CL, GL	07/93->04/99	9EL 144 426-001	1	Body/lens for indicator light (amber), right
Golf III CL, GL	08/91->08/97	9EL 144 425-811	1	Body/lens set for indicator light (white)
Golf III Estate CL, GL	07/93->04/99			440
		9EL 144 425-011	1	Spare Parts: Body/lens (white), left
		9EL 144 426-011	1	Body/lens (white), right
		2x12V21W (P21W) 8GA 002 073-121		
Golf III GT, GTI, VR6	08/91->08/97	9EL 144 425-011	1	Body/lens for indicator light (white), left
Golf III Convertible	07/93->05/98	9EL 144 426-011	1	Body/lens for indicator light (white), right
Golf III Estate GT, GTI, VR6	07/93->04/99			440
		1x12V21W (P21W) 8GA 002 073-121		



Manufacturer Model	Model year	Part no.	Pk.	Note
Volkswagen				
Golf III (1H1, 1H5, 1E7)		2BA 007 177-801	1	Indicator light set (black), with bulbs, with two covers
Golf III	08/91->08/97			(E1) 52618
Golf III Convertible	07/93->05/98			
Golf III Estate	07/93->04/99	2BA 007 177-011 2BA 007 177-021 8XU 144 427-011 8XU 144 428-011	1 1 1 1	Spare Parts: Indicator light (black), left Indicator light (black), right Cover (black), left Cover (black), right 2x12V21W (PY21W) 8GA 006 841-121
				
		Design		
Golf III	08/91->08/97	8XU 144 427-001	2	Large cover (silver), left
Golf III Convertible	07/93->05/98	8XU 144 428-001	2	Large cover (silver), right (next to indicator light)
Golf III Estate	07/93->04/99			
				
Golf III	08/91->08/97	8XU 144 429-001	1	Small cover (silver), left
Golf III Convertible	07/93->05/98	8XU 144 430-001	1	Small cover (silver), right (between indicator and fog light)
Golf III Estate	07/93->04/99			
				
Golf III	08/91->08/95	9EL 144 431-001	2	Body/lens for auxiliary indicator light (amber)
				(E4) 01441 1x12V5W (W5W) 8GP 003 594-121
Golf III	08/91->08/95	9EL 144 431-801	1	Body/lens set for auxiliary indicator light (black)
				(E4) 01441 2x12V5W (W5W) 8GP 003 594-121
		Design		
Golf III	09/95->04/99	9EL 147 073-001	2	Body/lens for auxiliary indicator light (amber)
				(E1) 52636 1x12V5W (W5W) 8GP 003 594-121
Golf III	09/95->04/99	9EL 147 073-801	1	Body/lens set for auxiliary indicator light (grey)
				(E1) 105 2x12V5W (W5W) 8GP 003 594-121
		Design		







Volkswagen



Manufacturer Model	Model year	Part no.	Pk.	Note
Volkswagen				
Golf III (1H1, 1H5, 1E7) Golf III CL, GL	08/91->08/97		9EL 139 137-061 1 9EL 139 138-061 1 9EL 139 137-051 1 9EL 139 138-051 1	Body/lens for combination rearlight (amber/red), left, with reverse and rear fog light Body/lens for combination rearlight (amber/red), right, with reverse and rear fog light Body/lens for combination rearlight (amber/red), left, with reverse light Body/lens for combination rearlight (amber/red), right, with reverse light (E1) 63264 1x12V5W (R5W) 8GA 002 071-121 4x12V21W (P21W) 8GA 002 073-121
Golf III CL, GL	08/91->08/97		9EL 139 137-081 1 9EL 139 138-081 1 9EL 139 137-071 1 9EL 139 138-071 1	Body/lens for combination rearlight (grey/red), left, with reverse and rear fog light Body/lens for combination rearlight (grey/red), right, with reverse and rear fog light Body/lens for combination rearlight (grey/red), left, with reverse light Body/lens for combination rearlight (grey/red), right, with reverse light (E1) 63278 1x12V5W (R5W) 8GA 002 071-121 4x12V21W (P21W) 8GA 002 073-121
Golf III GT, GTI, VR6 Golf III Convertible	08/91->08/97 07/93->06/02		9EL 139 137-081 1 9EL 139 138-081 1 9EL 139 137-071 1 9EL 139 138-071 1	Body/lens for combination rearlight (grey/red), left, with reverse and rear fog light Body/lens for combination rearlight (grey/red), right, with reverse and rear fog light Body/lens for combination rearlight (grey/red), left, with reverse light Body/lens for combination rearlight (grey/red), right, with reverse light (E1) 63278 1x12V5W (R5W) 8GA 002 071-121 4x12V21W (P21W) 8GA 002 073-121
Golf III Golf III Convertible	08/91->08/97 07/93->06/02		9EL 006 220-851 1 9EL 139 137-091 1 9EL 139 138-091 1 8RA 004 412-041 10	Design combination rearlight set (black) without bulb holder (E1) 63295 Spare Parts: Body/lens (black), left Body/lens (black), right Reflex-reflector (red) 2x12V5W (R5W) 8GA 002 071-121 8x12V21W (P21W) 8GA 002 073-121



Manufacturer Model	Model year	Part no.	Pk.	Note
Volkswagen				
Golf III (1H1, 1H5, 1E7)		9EL 006 220-931	1	Design combination rearlight set (stratosilver) without bulb holder
Golf III	08/91->08/97			
Golf III Convertible	07/93->06/02			
		8RA 004 412-041	10	Spare Parts: Reflex-reflector (red) 2x12V5W (R5W) 8GA 002 071-121 8x12V21W (P21W) 8GA 002 073-121
Golf III	08/91->08/97	9EL 006 220-921	1	Design combination rearlight set (red/white) without bulb holder
Golf III Convertible	07/93->06/02			
		8RA 004 412-041	10	Spare Parts: Reflex-reflector (red) 2x12V5W (R5W) 8GA 002 071-121 8x12V21W (P21W) 8GA 002 073-121
Golf III Estate C, CL	07/93->04/99	9EL 142 825-021	1	Body/lens for combination rearlight (amber/red), left, with reverse and rear fog light
		9EL 142 826-021	1	Body/lens for combination rearlight (amber/red), right, with reverse and rear fog light
				(E1) 63296 (E1) 63298 1x12V21/4W (P21/4W) 8GD 004 772-121 3x12V21W (P21W) 8GA 002 073-121
Golf III Estate C, CL	07/93->04/99	9EL 142 825-031	1	Body/lens for combination rearlight (grey/red), left, with reverse and rear fog light, for conversion
		9EL 142 826-031	1	Body/lens for combination rearlight (grey/red), right, with reverse and rear fog light, for conversion
				(E1) 63296 (E1) 63298 1x12V21/4W (P21/4W) 8GD 004 772-121 3x12V21W (P21W) 8GA 002 073-121








Volkswagen



Manufacturer Model	Model year	Part no.	Pk.	Note
Volkswagen				
Golf III (1H1, 1H5, 1E7) Golf III Estate GT, 'Movie'	07/93->04/99	9EL 142 825-031 9EL 142 826-031	1 1	Body/lens for combination rearlight (grey/red), left, with reverse and rear fog light Body/lens for combination rearlight (grey/red), right, with reverse and rear fog light E1 63296 E1 63298 1x12V21/4W (P21/4W) 8GD 004 772-121 3x12V21W (P21W) 8GA 002 073-121
Golf IV (1J1, 1J5) Golf IV	08/97->	1LJ 009 292-821 1LJ 009 292-051 1LJ 009 292-061	1 1 1	Upgrade headlight set with up-to-date look, with clear glass design, with chrome-plated covers, with bulbs Spare Parts: Upgrade headlight, left, with chrome-plated cover Upgrade headlight, right, with chrome-plated cover 4x12V55W (H7) 8GH 007 157-121 2x12V21W (H21W) 8GH 008 417-001 2x12V5W (W5W) 8GP 003 594-121
Golf IV	08/97->	1LL 009 300-831 1LL 009 300-071 1LL 009 300-081	1 1 1	Upgrade headlight set with CELIS® position light rings, with fog lights, with bulbs E4 2032 E4 2033 Spare Parts: Upgrade headlight, left, with fog light, with bulbs Upgrade headlight, right, with fog light, with bulbs 4x12V55W (H7) 8GH 007 157-121 2x12V35W (H8) 8GH 008 356-121
Golf IV	08/97->	6NM 007 878-041	1	Setting element, headlight levelling (for H7/H1 headlight)
Golf IV (-) GTI, TDI	08/97->	1NL 008 383-821 1NL 008 090-031 9HD 149 253-007 8JD 156 150-807	1 1 160 1	Micro DE-H3 fog light set with bulbs, with covers E1 877 Spare Parts: Micro DE-H3 fog light Cap Counterplug set (to be ordered separately) 2x12V55W (H3) 8GH 002 090-133









Manufacturer Model	Model year	Part no.	Pk.	Note
Volkswagen				
Golf IV (1J1, 1J5) Golf IV 	08/97->	2PT 009 305-811 2PT 008 935-011	1 1	Daytime running light set, with harness and retaining parts (E1) 1722 Spare Parts: Daytime running light
Golf IV 	08/97->	9EL 156 099-801	1	Body/lens set for auxiliary indicator light (clear), with 2 amber bulbs (E13) 550 2x12V5W (WY5W) 8GP 003 594-541
Golf IV (-) Estate Basic 	08/97->06/05	9EL 151 875-021 9EL 151 876-021	1 1	Body/lens for combination rearlight (amber/red), left, with reverse and rear fog light Body/lens for combination rearlight (amber/red), right, with reverse and rear fog light (E1) 1012 1x12V10W (R10W) 8GA 002 071-131 4x12V21W (P21W) 8GA 002 073-121
Golf IV (-) Estate Basic 	08/97->06/05	9EL 148 179-031 9EL 148 180-031	1 1	Body/lens for combination rearlight (grey/red), left, with reverse and rear fog light, for conversion Body/lens for combination rearlight (grey/red), right, with reverse light, for conversion (E1) 630 1x12V10W (R10W) 8GA 002 071-131 4x12V21W (P21W) 8GA 002 073-121
Golf IV (-) Estate Trendline, Comfortline, Highline, GTI, V6 	08/97->06/05	9EL 148 179-031 9EL 148 180-031	1 1	Body/lens for combination rearlight (grey/red), left, with reverse and rear fog light Body/lens for combination rearlight (grey/red), right, with reverse and rear fog light (E1) 630 1x12V10W (R10W) 8GA 002 071-131 4x12V21W (P21W) 8GA 002 073-121



Volkswagen



Manufacturer Model	Model year	Part no.	Pk.	Note
Volkswagen				
Golf IV (1J1, 1J5) Golf IV (-) Estate	08/97->06/05	9EL 148 179-021 9EL 148 180-021	1 1	Body/lens for combination rearlight (black/red), left, with reverse and rear fog light Body/lens for combination rearlight (black/red), right, with reverse and rear fog light (E1) 630  1x12V10W (R10W) 8GA 002 071-131  4x12V21W (P21W) 8GA 002 073-121
Golf IV (-) Estate	08/97->06/05	9EL 007 720-821 9EL 007 720-831 9EL 007 720-851 9EL 148 179-101 9EL 148 180-101 9EL 148 179-111 9EL 148 180-111 9EL 148 179-131 9EL 148 180-131 8RA 004 412-041	1 1 1 1 1 1 1 1 1 1 10	Design combination rearlight set (brilliant black) without bulb holder Design combination rearlight set (blue-white brilliant) without bulb holder (E13) 9493 Design combination rearlight set (red-white brilliant) without bulb holder (E13) 9492 Spare Parts: Body/lens (brilliant black), left Body/lens (brilliant black), right Body/lens (blue-white brilliant), left Body/lens (blue-white brilliant), right Body/lens (red-white brilliant), left Body/lens (red-white brilliant), right Reflex-reflector (red)  2x12V10W (R10W) 8GA 002 071-131  8x12V21W (P21W) 8GA 002 073-121
Golf IV (-) Estate	08/97->06/05	9EL 007 720-871	1	Design combination rearlight set (silver) without bulb holder (E13) 9493  2x12V10W (R10W) 8GA 002 071-131  8x12V21W (P21W) 8GA 002 073-121











Manufacturer Model	Model year	Part no.	Pk.	Note
Volkswagen				
Golf IV (1J1, 1J5) Golf IV (-) Estate	08/97->06/05	9EL 008 980-801	1	Design combination rearlight set, transparent/brilliant (silver) without bulb holder (E4) 10549 2x12V10W (R10W) 8GA 002 071-131 8x12V21W (P21W) 8GA 002 073-121
Golf IV (-) Estate	08/97->06/05	9EL 008 980-811	1	Design combination rearlight set, transparent/brilliant (black) without bulb holder (E4) 10549 2x12V10W (R10W) 8GA 002 071-131 8x12V21W (P21W) 8GA 002 073-121
Golf V (1K1) Golf V (1K1)	10/03->05/04	1LG 247 007-031 1LG 247 007-041	1 1	FF®-H7 headlight, left, with indicator light, with electr. headlight leveller actuator, with bulbs FF®-H7 headlight, right, with indicator light, with electr. headlight leveller actuator, with bulbs (E1) 1747 (E1) 1748 left and right 2x12V55W (H7) 8GH 007 157-121 1x12V21W (PY21W) 8GA 006 841-121 1x12V5W (W5W) 8GP 003 594-121
Golf V (1K1) (-) GTI	05/04->	1LG 247 007-191 1LG 247 007-201	1 1	FF®-H7 headlight, left, with indicator light, with electr. headlight leveller actuator, with bulbs FF®-H7 headlight, right, with indicator light, with electr. headlight leveller actuator, with bulbs (E1) 1747 (E1) 1748 left and right 2x12V55W (H7) 8GH 007 157-121 1x12V21W (PY21W) 8GA 006 841-121 1x12V5W (W5W) 8GP 003 594-121















Volkswagen



Manufacturer Model	Model year	Part no.	Pk.	Note
Volkswagen				
Golf V (1K1) Golf V GTI (1K1)	10/94->	1LG 247 007-231 1LG 247 007-241	1 1	<p>FF®-H7 headlight (black), left, with indicator light, with electr. headlight leveller actuator, with bulbs</p> <p>FF®-H7 headlight (black), right, with indicator light, with electr. headlight leveller actuator, with bulbs</p> <p>(E1) 1748</p> <p> 2x12V55W (H7) 8GH 007 157-121</p> <p> 1x12V21W (PY21W) 8GA 006 841-121</p> <p> 1x12V5W (W5W) 8GP 003 594-121</p>
Golf V (1K1)	05/04->	1LL 009 476-031 1LL 009 476-041	1 1	<p>Upgrade headlight, left, with patterned lens, with bulbs</p> <p>Upgrade headlight, right, with patterned lens, with bulbs</p> <p>Note: For registered design reasons, the headlight may only be used to replace lenticular-shaped Golf V headlights.</p> <p>(E1) 1663</p> <p> 2x12V55W (H7) 8GH 007 157-121</p> <p> 1x12V21W (PY21W) 8GA 006 841-121</p> <p> 1x12V5W (W5W) 8GP 003 594-121</p>
Golf V (1K1) all models without xenon headlights	10/03->	1ZL 009 489-851 1LL 009 489-811 1ZL 009 489-111 1ZL 009 489-121 1LL 009 489-031 1LL 009 489-041	1 1 1 1 1 1	<p>Upgrade headlight set with halogen dipped-beam/main-beam, with dynam. bend lighting Dynabeam, with bulbs</p> <p>Upgrade headlight set with halogen dipped-beam/main-beam, without dynam. bend lighting, with bulbs</p> <p>Spare Parts:</p> <p>Upgrade headlight, left (for -851), with bulbs</p> <p>Upgrade headlight, right (for -851), with bulbs</p> <p>Upgrade headlight, left (for -811), with bulbs</p> <p>Upgrade headlight, right (for -811), with bulbs</p> <p> 4x12V55W (H7) 8GH 007 157-201 Long Life</p> <p> 2x12V21W (PY21W) Silver Vision</p>





Manufacturer Model	Model year	Part no.	Pk.	Note
Volkswagen				
Golf V (1K1) Golf V (1K1) all models without xenon headlights for vehicles without bulb monitor for low beam 	10/03->	1LL 009 489-831 8WT 009 904-801 1LL 009 489-471 1LL 009 489-481	1 1 1 1	Upgrade headlight set with xenon dipped-beam, halogen main-beam, without dynam. bend lighting, with bulbs Lens cleaning system (to be ordered separately) Spare Parts: Upgrade headlight, left, with bulbs Upgrade headlight, right, with bulbs  2x35W (D1S) 8GS 009 028-001  2x12V55W (H7) 8GH 007 157-201 Long Life  2x12V21W (PY21W) Silver Vision
Golf V (1K1) (-) GTI 	10/03->11/04	1N0 270 595-011 1N0 270 595-021	1 1	DE-H11 fog light, left, with bulb DE-H11 fog light, right, with bulb  012  1x12V55W (H11) 8GH 008 358-121
Golf V (1K1) (-) GTI, Estate 	11/04->	1N0 271 284-031 1N0 271 284-041	1 1	FF®-HB4 fog light, left, with bulb FF®-HB4 fog light, right, with bulb  017  1x12V51W (HB4) 8GH 005 636-121
Golf V GTI (1K1) Golf V Estate 	10/04-> 06/07->	1N0 271 295-031 1N0 271 295-041	1 1	FF®-HB4 fog light, left, with bulb FF®-HB4 fog light, right, with bulb  015  1x12V51W (HB4) 8GH 005 636-121



Volkswagen














Manufacturer Model	Model year	Part no.	Pk.	Note
Volkswagen				
Golf V (1K1) Golf V (1K1) (-) GT, GTI, R32 (-) Estate	10/03->	1NL 008 383-911 1NL 008 090-031 6ZN 160 705-001	1 1 1	Micro DE-H3 fog light set with bulbs, with covers and remote control system (E1) 877 Spare Parts: Micro DE-H3 fog light Radio remote control system  2x12V55W (H3) 8GH 002 090-133
Golf V (1K1) (-) GT, GTI, R32 (-) Estate	10/03->	1N0 009 436-801 1N0 009 295-011 1N0 009 295-021 5DF 009 244-007	1 1 1 24	DynaView® Evo2 additive cornering light set, with fog light function, with covers, control unit, harness and bulbs (E1) 1951 Spare Parts: Fog light, left, with standard bracket and bulb Fog light, right, with standard bracket and bulb IntelliBeam® control electronics  2x12V55W (H7) 8GH 007 157-121
Golf V (1K1) (-) GT, GTI, R32 (-) Estate	10/03->	2PT 010 177-801 2PT 009 599-011 2PT 009 599-021	1 1 1	LED daytime running light set, 2 daytime running lights with harness and covers (E1) 2372 Spare Parts: LED daytime running light, left LED daytime running light, right
Golf V (1K1) (-) GT, GTI, R32 (-) Estate	10/03->	2PT 009 305-801 2PT 008 935-001	1 1	Daytime running light set, 2 daytime running lights with bulbs, with harness and covers (E1) 1722 Spare Parts: Daytime running light



Manufacturer Model	Model year	Part no.	Pk.	Note
Volkswagen				
Golf V (1K1) Golf V (1K1) (-) Estate	10/03->	2SD 354 040-011 2SD 354 040-021	1 1	Combination rearlight, left Combination rearlight, right 2x12V21W (P21W) 8GA 002 073-121 1x12V6W (H6W) 8GH 007 643-121
Golf V (1K1) (-) Estate	10/03->	2VP 009 500-811	1	LED Upgrade combination rearlight set (silver/red) E1 2090 2x12V21W (P21W) 8GA 002 073-121
Golf V (1K1) (-) Estate	10/03->	2VP 009 500-821	1	LED Upgrade combination rearlight set (black/silver) E1 2090 2x12V21W (P21W) 8GA 002 073-121
Golf V (1K1) (-) GTI, R32 Golf V Estate	10/03-> 06/07->	2DA 010 415-001	1	Upgrade safety brake light (black)



Manufacturer Model	Model year	Part no.	Pk.	Note
Volkswagen				
Golf V Plus (5M1), CrossGolf		1LE 247 013-071	1	FF®-H7 headlight, left, with indicator light, with electr. headlight leveller actuator, with bulbs
Golf V Plus (5M1)	01/05->02/09			
CrossGolf	01/07->02/09	1LE 247 013-081	1	FF®-H7 headlight, right, with indicator light, with electr. headlight leveller actuator, with bulbs
				(E1) 10222 (E1) 10223  2x12V55W (H7) 8GH 007 157-121  1x12V21W (P21W) 8GA 002 073-121  1x12V5W (W5W) 8GP 003 594-121
Golf V Plus (5M1)	01/05->02/09	1LE 247 013-851	1	Upgrade headlight set in black design
CrossGolf	01/07->02/09			
				 4x12V55W (H7) 8GH 007 157-121  2x12V21W (PY21W) Silver Vision  2x12V5W (W5W) 8GP 003 594-121
Golf V Plus (5M1)	01/05->02/09	1N0 271 289-031	1	FF®-HB4 fog light, left, with bulb
CrossGolf	01/07->02/09	1N0 271 289-041	1	FF®-HB4 fog light, right, with bulb
				(E26) 015  1x12V51W (HB4) 8GH 005 636-121
Golf V Plus (5M1)	01/05->02/09	2SD 964 961-011	1	LED combination rearlight, left
CrossGolf	01/07->02/09	2SD 964 961-021	1	LED combination rearlight, right
				(E1) 1868








Manufacturer Model	Model year	Part no.	Pk.	Note
Volkswagen				
Golf V Plus (5M1), CrossGolf		2ZR 964 962-031	1	Reversing light, left, with bulb Rear fog light, right, with bulb (E1) 1869 1x12V21W (P21W) 8GA 002 073-121
Golf V Plus (5M1)	01/05->02/09	2NE 964 962-041	1	
CrossGolf	01/07->02/09			
Golf V Plus (5M1)	01/05->	2DA 010 415-001	1	Upgrade safety brake light (black)
CrossGolf	01/07->			
				Design
Jetta I (17)		9EL 123 323-011	1	Body/lens for indicator light, left Body/lens for indicator light, right (E1) 42612 1x12V21W (P21W) 8GA 002 073-121
Jetta I	08/78->02/84	9EL 123 324-011	1	
Jetta I	08/78->02/84	2JA 002 532-011	5	Interior light 1x12V10W (R10W) 8GA 002 071-131
Jetta II (19E, 1G2)		1NL 006 315-051	1	DE-H3 fog light, left, with bulb DE-H3 fog light, right, with bulb (E1) 18226 1x12V55W (H3) 8GH 002 090-133
Jetta II	09/89->10/91	1NL 006 315-061	1	
Jetta II	09/89->10/91	1NL 006 315-111	1	DE-H3 fog light (black), left, with bulb DE-H3 fog light (black), right, with bulb (E1) 18226 1x12V55W (H3) 8GH 002 090-133
		1NL 006 315-121	1	
				Design



Volkswagen



Manufacturer Model	Model year	Part no.	Pk.	Note
Volkswagen				
Jetta II (19E, 1G2) Jetta II	01/84->08/89	 2BA 002 939-171 9EL 116 771-031	1 2	Indicator light (amber) E1 32710 Spare Parts: Lens 1x12V21W (P21W) 8GA 002 073-121
Jetta II	09/89->10/91	 9EL 141 701-001 9EL 141 702-001 9EL 141 705-001	2 2 1	Body/lens for indicator light (amber), left Body/lens for indicator light (amber), right E15 31 Body/lens for indicator light (white), left E4 402 1x12V21W (P21W) 8GA 002 073-121
Jetta II	09/89->10/91	 2BA 006 728-801 9EL 141 705-001	1 1	Indicator light set (white), with bulbs E4 402 Spare Parts: Body/lens (white), left 2x12V21W (P21W) 8GA 002 073-121
Jetta II	01/84->10/91	 2BM 003 647-801 2BM 003 647-021	1 1	Auxiliary indicator light set (amber), with bulbs E1 151 Spare Parts: Auxiliary indicator light (amber) 2x12V5W (W5W) 8GP 003 594-121
Jetta II	01/84->10/91	 2BM 006 759-801 2BM 006 759-001	1 5	Auxiliary indicator light set (grey), with bulbs E13 11299 Spare Parts: Auxiliary indicator light (grey), with bulbs 2x12V5W (W5W) 8GP 003 594-121
Jetta II	01/84->10/91	 2VP 004 401-091 9EL 128 385-041	1 1	Combination rearlight, left, with reverse and rear fog light E1 53360 Spare Parts: Body/lens, left 1x12V10W (R10W) 8GA 002 071-131 4x12V21W (P21W) 8GA 002 073-121



Manufacturer Model	Model year	Part no.	Pk.	Note
Volkswagen				
Jetta III (1K2) Jetta III (1K2)	08/05->	1LG 247 007-191 1LG 247 007-201	1 1	FF®-H7 headlight, left, with indicator light, with electr. headlight leveller actuator, with bulbs FF®-H7 headlight, right, with indicator light, with electr. headlight leveller actuator, with bulbs E1 1747 E1 1748 left and right 2x12V55W (H7) 8GH 007 157-121 1x12V21W (PY21W) 8GA 006 841-121 1x12V5W (W5W) 8GP 003 594-121
Jetta III (1K2)	08/05->	1LL 009 476-031 1LL 009 476-041	1 1	Upgrade headlight, left, with patterned lens, with bulbs Upgrade headlight, right, with patterned lens, with bulbs Note: For registered design reasons, the headlight may only be used to replace lenticular-shaped Jetta III headlights. E1 1663 2x12V55W (H7) 8GH 007 157-121 1x12V21W (PY21W) 8GA 006 841-121 1x12V5W (W5W) 8GP 003 594-121
Jetta III (1K2) all models without xenon headlights	08/05->	1ZL 009 489-851 1LL 009 489-811 1ZL 009 489-111 1ZL 009 489-121 1LL 009 489-031 1LL 009 489-041	1 1 1 1	Upgrade headlight set with DynaBeam bend lighting Upgrade headlight set with halogen low beam Spare Parts: Upgrade headlight, left (for -851) Upgrade headlight, right (for -851) Upgrade headlight, left (for -811) Upgrade headlight, right (for -811) 4x12V55W (H7) 8GH 007 157-201 Long Life 2x12V21W (PY21W) Silver Vision
Jetta III (1K2) all models without xenon headlights for vehicles without bulb monitor for low beam	08/05->	1LL 009 489-831 8WT 009 904-801 1LL 009 489-471 1LL 009 489-481	1 1 1 1	Upgrade headlight set with xenon dipped-beam, halogen main-beam, without dynam. bend lighting, with bulbs Lens cleaning system (to be ordered separately) Spare Parts: Upgrade headlight, left Upgrade headlight, right 2x35W (D1S) 8GS 009 028-001 2x12V55W (H7) 8GH 007 157-201 Long Life 2x12V21W (PY21W) Silver Vision



Volkswagen



Manufacturer Model	Model year	Part no.	Pk.	Note
Volkswagen				
Jetta III (1K2) Jetta III (1K2)	08/05->	1N0 271 295-031 1N0 271 295-041	1 1	FF®-HB4 fog light, left, with bulb FF®-HB4 fog light, right, with bulb 015 1x12V51W (HB4) 8GH 005 636-121
Lupo (6X1, 6E1) Lupo (6X1, 6E1)	09/98->12/03	6NM 007 878-041	1	Setting element, headlight levelling (for xenon headlight)
Lupo (6X1, 6E1) (-) 1.2 TDI 3L	09/98->07/05	1N0 270 204-051 1N0 270 204-061	1 1	FF®-H3 fog light, left, with bulb FF®-H3 fog light, right, with bulb 003 1x12V55W (H3) 8GH 002 090-133
Passat (32B) Passat	02/85->03/88	2BA 004 528-051 2BA 004 528-061	1 1	Indicator light, left Indicator light, right 42689 1x12V21W (P21W) 8GA 002 073-121
Passat all models with auxiliary indicators as standard feature	08/80->03/88	2BM 003 647-021	1	Auxiliary indicator light 151 1x12V5W (W5W) 8GP 003 594-121
Passat (3A2, 3A5, 35I) Passat	02/88->08/93	1LH 005 454-311 1LH 005 454-321	1 1	H4 headlight, left, for vehicles with or without headlight leveller H4 headlight, right, for vehicles with or without headlight leveller 17149 left 17150 right 1x12V60/55W (H4) 8GJ 002 525-131 1x12V4W (T4W) 8GP 002 067-121



Manufacturer Model	Model year	Part no.	Pk.	Note
Volkswagen				
Passat (3A2, 3A5, 35I) Passat	08/91->08/93		6NM 007 282-211 1	1 Setting element, headlight levelling
Passat	02/88->08/93		1NL 005 566-051 1NL 005 566-061 1 1	DE-H3 fog light (white), left DE-H3 fog light (white), right E1 18210  1x12V55W (H3) 8GH 002 090-133
Passat CL	02/88->08/93		9EL 133 713-011 9EL 133 714-011 1 1	Body/lens for indicator light (amber), left Body/lens for indicator light (amber), right E1 42756  1x12V21W (P21W) 8GA 002 073-121
Passat GL, GT	02/88->08/93		9EL 133 719-011 9EL 133 720-011 1 1	Body/lens for indicator light (white), left Body/lens for indicator light (white), right E1 42767  1x12V21W (P21W) 8GA 002 073-121
Passat (-) Estate	02/88->08/93		9EL 133 577-011 9EL 133 578-011 1 1	Body/lens for combination rearlight, left Body/lens for combination rearlight, right E1 63213  1x12V5W (R5W) 8GA 002 071-121  1x12V21/5W (P21/5W) 8GD 002 078-121  1x12V21W (P21W) 8GA 002 073-121
Passat (-) Estate	02/88->08/93		9EM 133 319-031 9EM 133 320-031 1 1	Body/lens for rear fog and reverse light, left Body/lens for rear fog and reverse light, right E1 8767 E1 18436  2x12V21W (P21W) 8GA 002 073-121








Volkswagen



Manufacturer Model	Model year	Part no.	Pk.	Note
Volkswagen				
Passat (3A2, 3A5, 35I)		1LH 006 840-271	1	FF®-H1 headlight, left, for vehicles with or without headlight leveller FF®-H1 headlight, right, for vehicles with or without headlight leveller (E1) 27026 left (E1) 27027 right  2x12V55W (H1) 8GH 002 089-133 1x12V5W (W5W) 8GP 003 594-121
Passat	09/93->05/97	1LH 006 840-281	1	
				
Passat	09/93->05/97	6NM 007 282-211	1	Setting element, headlight levelling
				
Passat	09/93->05/97	9HB 006 948-031 9HB 006 948-041	1 1	Dummy, left Dummy, right (next to headlight)
				
Passat	09/93->05/97	1NA 006 790-811	1	FF®-H1 fog light set with bulbs (E1) 11 Spare Parts: 1NA 006 790-071 1 FF®-H1 fog light, left 1NA 006 790-081 1 FF®-H1 fog light, right 8XU 006 945-031 1 Cover, left 8XU 006 945-041 1 Cover, right 6EH 004 406-032 1 On/off switch with bulb  2x12V55W (H1) 8GH 002 089-133
				
Passat	09/93->05/97	9EL 142 459-011 9EL 142 460-011	1 1	Body/lens for indicator light (white), left Body/lens for indicator light (white), right (E1) 019  1x12V21W (PY21W) 8GA 006 841-121
				
Passat	09/93->05/97	8XU 006 946-031 8XU 006 946-041	1 1	Large cover (silver), left Large cover (silver), right (next to indicator light)
				
Passat	09/93->05/97	8XU 006 945-031 8XU 006 945-041	1 1	Small cover (silver), left Small cover (silver), right (between indicator and fog light)
				



Manufacturer Model	Model year	Part no.	Pk.	Note
Volkswagen				
Passat (3A2, 3A5, 35I) Passat	09/93->05/97	9EL 147 073-001	2	Body/lens for auxiliary indicator light (amber) E1 52636 1x12V5W (W5W) 8GP 003 594-121
				
Passat	09/93->05/97	9EL 147 073-801	1	Body/lens set for auxiliary indicator light (grey) E1 105 2x12V5W (W5W) 8GP 003 594-121
				
Passat (-) Estate	09/93->09/96	9EL 141 889-031 9EL 141 890-031	1 1	Body/lens for combination rearlight (amber/red), left Body/lens for combination rearlight (amber/red), right E1 63294 1x12V5W (R5W) 8GA 002 071-121 2x12V21W (P21W) 8GA 002 073-121
				
Passat (-) Estate	09/93->09/96	9EL 141 889-041 9EL 141 890-041	1 1	Body/lens for combination rearlight (grey/red), left, for conversion Body/lens for combination rearlight (grey/red), right, for conversion E1 63294 E1 63301 1x12V5W (R5W) 8GA 002 071-121 2x12V21W (P21W) 8GA 002 073-121
				
Passat Biker, Classic Line, Highland (-) Estate	09/93->09/96	9EL 141 889-041 9EL 141 890-041	1 1	Body/lens for combination rearlight (grey/red), left Body/lens for combination rearlight (grey/red), right E1 63294 E1 63301 1x12V5W (R5W) 8GA 002 071-121 2x12V21W (P21W) 8GA 002 073-121
				



Manufacturer Model	Model year	Part no.	Pk.	Note
Volkswagen				
Passat (3A2, 3A5, 35I) Passat (-) Estate	09/93->09/96	9EL 141 907-071 9EL 141 908-071	1 1	Body/lens for rear fog and reverse light (amber/red), left Body/lens for rear fog and reverse light (amber/red), right 8796 2x12V21W (P21W) 8GA 002 073-121
Passat (3B2, 3B5) Passat standard	08/96->11/00	1LF 007 620-071 1LF 007 620-081	1 1	FF®-H7/H1 headlight, left, without fog light, with 5W bulb for side light FF®-H7/H1 headlight, right, without fog light, with 5W bulb for side light 9377 left 9378 right 1x12V55W (H7) 8GH 007 157-121 1x12V55W (H1) 8GH 002 089-133 1x12V5W (W5W) 8GP 003 594-121
Passat Special equipment	08/96->11/00	1LF 007 520-071 1LF 007 520-081	1 1	FF®-H7/H4 headlight, left, with H4 fog light, with pre-fitted 5W bulb for side light FF®-H7/H4 headlight, right, with H4 fog light, with pre-fitted 5W bulb for side light 9377 left 9378 right 1x12V55W (H7) 8GH 007 157-121 1x12V60/55W (H4) 8GJ 002 525-131 1x12V5W (W5W) 8GP 003 594-121
Passat	08/96->11/00	6NM 007 282-211	1	Setting element, headlight levelling (for halogen headlight)
Passat chassis no. 3B-V-000 001 -> 3B-Y-500 000	08/96->11/00	6NM 007 282-631	1	Setting element, headlight levelling (for xenon headlight)
Passat	08/96->11/00	5DV 007 760-651	1	Ballast unit



Manufacturer Model	Model year	Part no.	Pk.	Note
Volkswagen				
Passat (3B2, 3B5) Passat all models without xenon headlights	08/96->11/00	9EL 151 829-011 9EL 151 830-011	1 1	Body/lens for indicator light (white), left Body/lens for indicator light (white), right E1 513 1x12V21W (PY21W) 8GA 006 841-121
Passat	08/96->11/00	9EL 156 099-801	1	Body/lens set for auxiliary indicator light (clear), with 2 amber bulbs E13 550 2x12V5W (WY5W) 8GP 003 594-541
Passat (3B3, 3B6) Passat	11/00->08/05	1LL 008 350-031 1LL 008 350-041 6NM 007 878-041	1 1 1	FF®-H7 headlight, left, with indicator light, with headlight leveller actuator, with bulbs FF®-H7 headlight, right, with indicator light, with headlight leveller actuator, with bulbs E1 1202 E1 1203 Spare Parts: Setting element, headlight levelling 2x12V55W (H7) 8GH 007 157-121 1x12V5W (W5W) 8GP 003 594-121 1x12V21W (PY21W) 8GA 006 841-121
Passat	11/00->08/05	1NL 009 034-011 1NL 009 034-021	1 1	DE-H3 fog light, left, with bulb DE-H3 fog light, right, with bulb E12 19111 1x12V55W (H3) 8GH 002 090-133
Passat (3C2, 3C5) Passat	03/05->	1LL 247 014-031 1LL 247 014-041	1 1	DE-H7/FF®-H7 headlight, left, with electr. headlight leveller actuator, with bulbs DE-H7/FF®-H7 headlight, right, with electr. headlight leveller actuator, with bulbs E4 10224 E4 10225 2x12V55W (H7) 8GH 007 157-121 1x12V5W (W5W) 8GP 003 594-121



Manufacturer Model	Model year	Part no.	Pk.	Note
Volkswagen				
Passat (3C2, 3C5) Passat	03/05->	1LL 247 014-841	1	Upgrade headlight set with black design, with bulbs (E4) 10225  4x12V55W (H7) 8GH 007 157-121  2x12V5W (W5W) 8GP 003 594-121
Passat	03/05->	1N0 271 296-031 1N0 271 296-041	1 1	FF®-HB4 fog light, left, with bulb FF®-HB4 fog light, right, with bulb (E26) 016  1x12V51W (HB4) 8GH 005 636-121
Passat Trendline, Blue Motion, Individual Chrom	03/05->	2BA 010 118-011 2BA 010 118-021	1 1	Indicator light (amber), left, with bulb Indicator light (amber), right, with bulb  1x12V21W (P21W) 8GA 002 073-121
Passat Trendline, Blue Motion, Individual Chrom Special equipment Comfortline, Sportline, Highline standard	03/05->	2BA 010 118-031 2BA 010 118-041	1 1	Indicator light (white), left, with bulb Indicator light (white), right, with bulb  1x12V21W (PY21W) 8GA 006 841-121
Passat	03/05->	2BA 010 103-801	1	Indicator light set (black)  2x12V21W (H21W) 8GH 008 417-001
Passat Estate	06/05->	2DA 010 415-001	1	Upgrade safety brake light (black)









Manufacturer Model	Model year	Part no.	Pk.	Note
Volkswagen				
Polo I (86) Polo I (86)	03/75->09/81	2BA 002 939-171 9EL 116 771-031	1 2	Indicator light (amber) E1 32710 Spare Parts: Lens 1x12V21W (P21W) 8GA 002 073-121
Polo I (86)	03/75->09/81	2JA 002 931-031	5	Interior light 1x12V10W (K) 8GM 002 091-131
Polo II (86C, 80) Polo II (86C, 80)	10/90->09/94	1NL 006 280-051 1NL 006 280-061	1 1	DE-H3 fog light, left, with bulb DE-H3 fog light, right, with bulb E1 18234 1x12V55W (H3) 8GH 002 090-133
Polo II (86C, 80)	10/81->09/90	2BA 002 939-171 9EL 116 771-031	1 2	Indicator light (amber) E1 32710 Spare Parts: Lens 1x12V21W (P21W) 8GA 002 073-121
Polo II CL, Fox, GT	10/90->09/94	9EL 137 839-011 9EL 137 840-011	1 1	Body/lens for indicator light (amber), left Body/lens for indicator light (amber), right E1 42794 1x12V21W (P21W) 8GA 002 073-121
Polo II CL, Fox, GT	10/90->09/94	2BA 006 334-051 2BA 006 334-061	1 1	Indicator light (white), left, with bulb Indicator light (white), right, with bulb E1 52624 2x12V21W (PY21W) 8GA 006 841-121
 Design				
Polo II Coupé G40	10/90->09/94	2BA 006 334-051 2BA 006 334-061	1 1	Indicator light (white), left, with bulb Indicator light (white), right, with bulb E1 52624 1x12V21W (PY21W) 8GA 006 841-121



Volkswagen



Manufacturer Model	Model year	Part no.	Pk.	Note
Volkswagen				
Polo II (86C, 80) Polo II all models with auxiliary indicators as standard feature	10/81->08/91	2BM 003 647-021	1	Auxiliary indicator light E1 151 1x12V5W (W5W) 8GP 003 594-121
				
Polo II (86C, 80)	09/91->09/94	2BM 003 647-801	1	Auxiliary indicator light set (amber), with bulbs E1 0151 Spare Parts: Auxiliary indicator light (amber) 2x12V5W (W5W) 8GP 003 594-121
		2BM 003 647-021	1	
Polo II (86C, 80)	09/91->09/94	2BM 006 759-801	1	Auxiliary indicator light set (grey), with bulbs E13 1299 Spare Parts: Auxiliary indicator light (grey), with bulbs 2x12V5W (W5W) 8GP 003 594-121
 Design		2BM 006 759-001	5	
Polo II Saloon	01/85->07/88	9EL 125 909-031	1	Body/lens for combination rearlight, left, with rear fog light
		9EL 125 910-041	1	Body/lens for combination rearlight, right, with reverse and rear fog light E1 53342 1x12V21/5W (P21/5W) 8GD 002 078-121 3x12V21W (P21W) 8GA 002 073-121 1x12V5W (C5W) 8GM 002 092-121
Polo II Square-back, Coupé	10/81->09/90	2KA 002 445-171	1	Licence plate light E1 22810 1x12V4W (T4W) 8GP 002 067-121
				
Polo II (86C, 80)	10/81->07/85	2JA 002 931-031	5	Interior light 1x12V10W (R10W) 8GA 002 071-131
				



Manufacturer Model	Model year	Part no.	Pk.	Note
Volkswagen				
Polo III (6N1) Polo III (-) Classic, Estate	10/94->10/99	1LF 962 489-151 1LF 962 489-161 1LF 962 489-171 1LF 962 489-181	1 1 1 1	H4 headlight, left, with electr. headlight leveller, with 5W bulb for side light H4 headlight, right, with electr. headlight leveller, with 5W bulb for side light H4 headlight, left, without electr. headlight leveller, with 5W bulb for side light H4 headlight, right, without electr. headlight leveller, with 5W bulb for side light (E1) 93 left (E1) 94 right  1x12V60/55W (H4) 8GJ 002 525-131  1x12V5W (W5W) 8GP 003 594-121
Polo III all models with small bumper, except Classic and Estate	10/94->10/99	1NA 962 530-011 1NA 962 530-021	1 1	FF®-H3 fog light, left, with bulb FF®-H3 fog light, right, with bulb (E1) 77  1x12V55W (H3) 8GH 002 090-133
Polo III all models with large bumper, except Classic and Estate	10/94->10/99	1NA 962 490-011 1NA 962 490-021	1 1	FF®-H3 fog light, left, with bulb FF®-H3 fog light, right, with bulb (E1) 76  1x12V55W (H3) 8GH 002 090-133
Polo III Basic (-) Classic, Estate	10/94->10/99	9EL 962 839-031 9EL 962 840-031	1 1	Body/lens for indicator light (amber), left Body/lens for indicator light (amber), right (E1) 101  1x12V21W (P21W) 8GA 002 073-121











Volkswagen



Manufacturer Model	Model year	Part no.	Pk.	Note
Volkswagen				
Polo III (6N1) Polo III Basic (-) Classic, Estate	10/94->10/99	2BA 962 625-821 9EL 962 839-021 9EL 962 840-021	1 1 1	Indicator light set (white), with bulbs E1 100 Spare Parts: Body/lens (white), left Body/lens (white), right 2x12V21W (PY21W) 8GA 006 841-121
Polo III Basic with special equipment Styling except Classic and Estate	10/94->10/99	9EL 962 839-021 9EL 962 840-021	1 1	Body/lens for indicator light (white), left Body/lens for indicator light (white), right E1 100 1x12V21W (PY21W) 8GA 006 841-121
Polo III	10/94->10/99	9EL 147 073-001	2	Body/lens for auxiliary indicator light (amber) E1 52636 1x12V5W (W5W) 8GP 003 594-121
Polo III	10/94->10/99	9EL 147 073-801	1	Body/lens set for auxiliary indicator light (grey) E1 105 2x12V5W (W5W) 8GP 003 594-121
Polo III Basic (-) Classic, Estate	10/94->10/99	9EL 962 541-041 9EL 962 542-051	1 1	Body/lens for combination rearlight (amber/red/white), left, with reverse light Body/lens for combination rearlight (amber/red), right, with rear fog light E1 97 1x12V5W (R5W) 8GA 002 071-121 3x12V21W (P21W) 8GA 002 073-121








Manufacturer Model	Model year	Part no.	Pk.	Note
Volkswagen				
Polo III (6N1) Polo III Basic with special equipment Styling except Classic and Estate	10/94->10/99	9EL 962 542-071	1	Body/lens for combination rearlight (grey/red with black trim stripes), right, with rear fog light (E13) 4719 1x12V5W (R5W) 8GA 002 071-121 3x12V21W (P21W) 8GA 002 073-121
				
Polo III (6N2) Polo III (-) GTI, Classic, Estate	10/99->10/01	1LF 963 709-071 1LF 963 709-081	1 1	H1/H7 headlight, left, for vehicles with or without headlight leveller H1/H7 headlight, right, for vehicles with or without headlight leveller (E1) 845 left and right (E1) 847 left (E1) 848 right  1x12V55W (H7) 8GH 007 157-121  1x12V55W (H1) 8GH 002 089-133  1x12V5W (W5W) 8GP 003 594-121
				
Polo III chassis no. 6N-Y-500 001 -> 6N-2-010 000	10/99->10/01	6NM 007 878-041	1	Setting element, headlight levelling
				
Polo III (-) GTI, Classic, Estate	10/99->10/01	1NA 963 981-031 1NA 963 981-041	1 1	FF®-H7 fog light, left, with bulb FF®-H7 fog light, right, with bulb (E1) 901  1x12V55W (H7) 8GH 007 157-121
				



Volkswagen









Manufacturer Model	Model year	Part no.	Pk.	Note
Volkswagen				
Polo III (6N2) Polo III (-) Classic, Estate	10/99->10/01	9EL 964 005-021 9EL 964 006-021	1 1	Body/lens for indicator light (white), left Body/lens for indicator light (white), right E1 805 1x12V21W (PY21W) 8GA 006 841-121
				
Polo III	10/99->10/01	9EL 156 099-801	1	Body/lens set for auxiliary indicator light (clear), with 2 amber bulbs E13 550 2x12V5W (WY5W) 8GP 003 594-541
				
Polo III (-) Classic, Estate	10/99->10/01	9EL 964 116-121	1	Body/lens for combination rearlight (red), right, with rear fog light E13 9438 1x12V5W (R5W) 8GA 002 071-121 3x12V21W (P21W) 8GA 002 073-121
				
Polo IV (9N_) Polo IV	10/01->05/04	1N0 270 255-051 1N0 270 255-061	1 1	FF®-H3 fog light, left, with bulb FF®-H3 fog light, right, with bulb E26 004 1x12V55W (H3) 8GH 002 090-133
				
Polo IV	10/01->04/05	9EL 156 099-801	1	Body/lens set for auxiliary indicator light (clear), with 2 amber bulbs E13 550 2x12V5W (WY5W) 8GP 003 594-541
				









Manufacturer Model	Model year	Part no.	Pk.	Note
Volkswagen				
Polo IV (9N2) Polo IV (-) GTI	05/05->	1LE 247 019-191 1LE 247 019-201	1 1	FF®-H7/H1 headlight, left, with indicator light, with electr. headlight leveller actuator, with bulbs FF®-H7/H1 headlight, right, with indicator light, with electr. headlight leveller actuator, with bulbs E1 1974 E1 1975 1x12V55W (H7) 8GH 007 157-121 1x12V55W (H1) 8GH 002 089-133 1x12V21W (PY21W) 8GA 006 841-121 1x12V5W (W5W) 8GP 003 594-121
Polo IV	05/05->	1N0 271 247-051 1N0 271 247-061	1 1	FF®-HB4 fog light, left, with bulb FF®-HB4 fog light, right, with bulb E26 004 1x12V51W (HB4) 8GH 005 636-121
Scirocco (53B) Scirocco GT, GTI	06/81->07/82	1LB 003 177-511 1KB 003 177-597 9GH 116 966-011	1 36 10	H4/H1 headlight, spare parts available only E1 7197 E1 24504 Spare Parts: H4 dipped beam headlight H1 spotlight unit Cap 1x12V60/55W (H4) 8GJ 002 525-131 1x12V55W (H1) 8GH 002 089-133 1x12V4W (T4W) 8GP 002 067-121
Scirocco	06/81->07/92	2BA 003 727-071 2BA 003 727-081	1 1	Indicator light, left Indicator light, right E1 42625 1x12V21W (P21W) 8GA 002 073-121
Sharan (7M8, 7M9, 7M6) Sharan	09/95->04/00	9EL 147 073-001	2	Body/lens for auxiliary indicator light (amber) E1 52636 1x12V5W (W5W) 8GP 003 594-121



Manufacturer Model	Model year	Part no.	Pk.	Note
Volkswagen				
Sharan (7M8, 7M9, 7M6) Sharan	09/95->04/00	9EL 147 073-801	1	Body/lens set for auxiliary indicator light (grey) E1 105 2x12V5W (W5W) 8GP 003 594-121
				
Sharan	04/00->	9EL 156 099-801	1	Body/lens set for auxiliary indicator light (clear), with 2 amber bulbs E13 550 2x12V5W (WY5W) 8GP 003 594-541
				
Sharan (-) Trendline	09/95->04/00	9EL 962 585-041 9EL 962 586-041	1 1	Body/lens for combination rearlight (amber/red), left Body/lens for combination rearlight (amber/red), right E1 151 1x12V5W (R5W) 8GA 002 071-121 1x12V21/5W (P21/5W) 8GD 002 078-121 1x12V21W (P21W) 8GA 002 073-121
				
Sharan (-) Trendline	04/00->10/03	9EL 964 501-011 9EL 964 502-011	1 1	Body/lens for combination rearlight (red/pink), left Body/lens for combination rearlight (red/pink), right E1 1060 1x12V5W (R5W) 8GA 002 071-121 2x12V21W (P21W) 8GA 002 073-121
				
Sharan (-) Trendline	04/00->10/03	9EL 964 541-021 9EL 964 542-021	1 1	Body/lens for combination rearlight (grey/red), left, with reverse and rear fog light Body/lens for combination rearlight (grey/red), right, with reverse and rear fog light E1 1061 4x12V21W (P21W) 8GA 002 073-121
				
Sharan	04/00->10/03	8XU 964 435-021	1	Cover (black/red) for retaining the licence plate
				



Manufacturer Model	Model year	Part no.	Pk.	Note
Volkswagen				
Sharan (7M8, 7M9, 7M6)		2VA 964 957-011	1	Combination rearlight (red/white), left, with bulbs
Sharan	11/03->	2VA 964 957-021	1	Combination rearlight (red/white), right, with bulbs
				 (E1) 1668 1x12V21/5W (P21/5W) 8GD 002 078-121 1x12V21W (P21W) 8GA 002 073-121
Sharan	11/03->	8XU 964 981-001	1	Cover (base-coated) for retaining the licence plate
				
Tiguan		1LD 247 038-231	1	H7 headlight, left, with indicator light, with electr. headlight leveller actuator, with bulbs
Tiguan	09/07->	1LD 247 038-241	1	H7 headlight, right, with indicator light, with electr. headlight leveller actuator, with bulbs
				 1x12V55W (H7) 8GH 007 157-121 1x12V55W (H7) 8GH 007 157-201 Long Life 1x12V21W (PY21W) 8GA 006 841-121 1x12V5W (W5W) 8GP 003 594-121
Tiguan	09/07->	1N0 271 289-031	1	FF®-HB4 fog light, left, with bulb
		1N0 271 289-041	1	FF®-HB4 fog light, right, with bulb
				 (E26) 015 1x12V51W (HB4) 8GH 005 636-121
Tiguan	09/07->	2SD 009 691-091	1	Combination rearlight, left, with bulbs
		2SD 009 691-101	1	Combination rearlight, right, with bulbs
				 2x12V21W (P21W) 8GA 002 073-271 Long Life 1x12V21W (WY21W) 8GP 009 021-002
Tiguan	09/07->	2DA 010 415-001	1	Upgrade safety brake light (black)
				 Design



Manufacturer Model	Model year	Part no.	Pk.	Note
Volkswagen				
Touareg (7LA, 7L6, 7L7)		1N0 271 247-051	1	FF®-HB4 fog light, left, with bulb
Touareg	10/02->	1N0 271 247-061	1	FF®-HB4 fog light, right, with bulb
Individual				004 1x12V51W (HB4) 8GH 005 636-121
Touran, CrossTouran (1T1, 1T2)		1LL 010 203-031	1	H1/H7 headlight, left, with indicator light, with electr. headlight leveller actuator
Touran	02/03->10/06	1LL 010 203-041	1	H1/H7 headlight, right, with indicator light, with electr. headlight leveller actuator
from chassis no. 1T-5-000 001				10184 left 10170 right 1x12V55W (H7) 8GH 007 157-121 1x12V55W (H1) 8GH 002 089-133 1x12V21W (PY21W) 8GA 006 841-121 1x12V5W (W5W) 8GP 003 594-121
Touran	02/03->10/04	1N0 270 596-051	1	DE-H11 fog light, left, with bulb
up to chassis no. 1T-5-083 127		1N0 270 596-061	1	DE-H11 fog light, right, with bulb
				008 1x12V55W (H11) 8GH 008 358-121
Touran	11/04->	1N0 271 289-031	1	FF®-HB4 fog light, left, with bulb
from chassis no. 1T-5-083 128		1N0 271 289-041	1	FF®-HB4 fog light, right, with bulb
				015 1x12V51W (HB4) 8GH 005 636-121
Touran	02/03->10/06	2VP 008 759-051	1	Combination rearlight, left, with reverse and rear fog light, with bulbs
		2VP 008 759-061	1	Combination rearlight, right, with reverse and rear fog light, with bulbs
				1364 1x12V5W (R5W) 8GA 002 071-121 3x12V21W (P21W) 8GA 002 073-121 1x12V21W (PY21W) 8GA 006 841-121














Manufacturer Model	Model year	Part no.	Pk.	Note
Volkswagen				
Touran, CrossTouran (1T1, 1T2)		2SK 009 477-051	1	Combination rearlight, left, with reverse and rear fog light, with bulbs Combination rearlight, right, with reverse and rear fog light, with bulbs 1x12V5W (R5W) 8GA 002 071-121 3x12V21W (P21W) 8GA 002 073-121 1x12V21W (PY21W) 8GA 006 841-121
Touran (-) CrossTouran	11/06->	2SK 009 477-061	1	
Touran	02/03->	9EL 008 759-811	1	Design combination rearlight set (grey/silver/red), with 2 21W indicator light bulbs (Silver Vision) without bulb holder 1364 2x12V10W (R10W) 8GA 002 071-131 8x12V21W (P21W) 8GA 002 073-121
Vento (1H2)		1LH 006 546-611	1	H4 headlight, left, for vehicles with or without headlight leveller H4 headlight, right, for vehicles with or without headlight leveller. Lead with adapter for vehicles 01/92->12/92 to be ordered separately. 27003 left 27004 right 1x12V60/55W (H4) 8GJ 002 525-131 1x12V5W (W5W) 8GP 003 594-121
Vento	11/91->09/98	1LH 006 546-621	1	
Vento	11/91->09/98	6NM 007 282-211	1	Setting element, headlight levelling
Vento	11/91->09/98	1NL 007 220-031 1NL 007 220-041	1 1	DE-H3 fog light, left DE-H3 fog light, right 18238 1x12V55W (H3) 8GH 002 090-133



Manufacturer Model	Model year	Part no.	Pk.	Note
Volkswagen				
Vento (1H2) Vento	11/91->09/98	2PT 008 956-801	1	Design lighting front set, 2 daytime running lights and 2 indicator lights with silver bulbs (amber signal colour). Lenses are glass clear and without pattern. With harness. 2x12V21W (PY21W) silver (indicator light) 2x12V21W (P21W) 8GA 002 073-121 (daytime running light)
Vento CL, GL	11/91->09/98	9EL 144 425-001 9EL 144 426-001	1 1	Body/lens for indicator light (amber), left Body/lens for indicator light (amber), right E4 439 1x12V21W (P21W) 8GA 002 073-121
Vento GT, VR6	11/91->09/98	9EL 144 425-011 9EL 144 426-011	1 1	Body/lens for indicator light (white), left Body/lens for indicator light (white), right E4 440 1x12V21W (P21W) 8GA 002 073-121
Vento	11/91->09/98	8XU 144 427-001 8XU 144 428-001	2 2	Large cover (silver), left Large cover (silver), right (next to indicator light)
Vento	11/91->09/98	8XU 144 429-001 8XU 144 430-001	1 1	Small cover (silver), left Small cover (silver), right (between indicator and fog light)
Vento	11/91->08/95	9EL 144 431-001	2	Body/lens for auxiliary indicator light (amber) E4 01441 1x12V5W (W5W) 8GP 003 594-121
Vento	09/95->09/98	9EL 147 073-001	2	Body/lens for auxiliary indicator light (amber) E1 52636 1x12V5W (W5W) 8GP 003 594-121







Manufacturer Model	Model year	Part no.	Pk.	Note
Volkswagen				
Crafter (2E) Crafter (2E)	04/06->		1LR 247 017-071	1 FF®-H7 headlight, left, with indicator light, with electr. headlight leveller actuator, with bulbs
			1LR 247 017-081	1 FF®-H7 headlight, right, with indicator light, with electr. headlight leveller actuator, with bulbs
				(E1) 2100 (E1) 2101  2x12V55W (H7) 8GH 007 157-121  1x12V21W (PY21W) 8GA 006 841-121  1x12V5W (W5W) 8GP 003 594-121
Crafter (2E)	04/06->		1N0 271 247-051	1 FF®-HB4 fog light, left, with bulb
			1N0 271 247-061	1 FF®-HB4 fog light, right, with bulb
				(E26) 004  1x12V51W (HB4) 8GH 005 636-121
LT I LT I	08/75->08/85		1L8 003 060-561	1 Headlight
			9GH 116 966-011 9FF 126 444-001	10 Cap 10 Bulb socket for side light
				(E1) 7097 Spare Parts:  1x12V45/40W (R2) 8GD 002 088-131  1x12V4W (T4W) 8GP 002 067-121
			1L8 003 060-691	1 H4 headlight
			9GH 116 966-011 9FF 126 444-001	10 Cap 10 Bulb socket for side light (to be ordered separately)
				(E1) 7144 Spare Parts:  1x12V60/55W (H4) 8GJ 002 525-131  1x12V4W (T4W) 8GP 002 067-121



Volkswagen



Manufacturer Model	Model year	Part no.	Pk.	Note
Volkswagen				
LT I LT I Van	10/75->01/93	 9EL 113 065-001	1	Combination rearlight with reverse light, spare parts available only E1 43346 E1 2318 Spare Parts: Lens 1x12V21/5W (P21/5W) 8GD 002 078-121 2x12V21W (P21W) 8GA 002 073-121
LT I Van	83->04/96	 9BG 121 587-031	2	Licence plate light E1 22819 Spare Parts: Body/lens with screw 1x12V10W (R10W) 8GA 002 071-131
LT I Flatbed	83->04/96	 9EL 122 689-051 9EL 122 689-021	2 2	Combination rearlight, spare parts available only E4 377 E4 397 E4 421 E4 3880 E4 23215 Spare Parts: Lens for rear, reflex-reflector, stop, indicator and reverse light Lens for rear, reflex-reflector, stop, indicator, reverse and rear fog light 1x12V10W (R10W) 8GA 002 071-131 4x12V21W (P21W) 8GA 002 073-121
LT I Flatbed Chassis with cab	04/75->07/78	 9BG 101 230-001 9GT 005 166-001	2 2 10	Licence plate light E1 12820 Spare Parts: Body with lens Grommet 1x12V5W (C5W) 8GM 002 092-121



Manufacturer Model	Model year	Part no.	Pk.	Note
Volkswagen				
LT I LT I Flatbed Chassis with cab	08/78->82	2KA 003 389-061 9BG 121 587-031	2 2	Licence plate light (E1) 22819 Spare Parts: Body/lens with screw 1x12V10W (R10W) 8GA 002 071-131
LT I LT I	04/75->04/96	2JA 002 931-031	5	Interior light 1x12V10W (K) 8GM 002 091-131
LT II LT II Bus, Van	05/96->	9EL 270 197-011 9EL 270 198-011	1 1	Body/lens for combination rearlight, left, with reverse and rear fog light Body/lens for combination rearlight, right, with reverse and rear fog light (E26) 901 1x24V21/5W (P21/5W) 8GD 002 078-241 3x24V21W (P21W) 8GA 002 073-241
LT II Flatbed Chassis with cab	05/96->	2VD 008 204-131 2VP 008 204-121 9EL 152 889-001	1 1 1	Combination rearlight, left, with licence plate, rear fog, reverse, clearance light, side-marker light, with reflex-reflector and marker reflex-reflector Combination rearlight, right, with reverse, clearance light, side-marker light, with reflex-reflector and marker reflex-reflector (E4) 3178 (E4) 4060 (E4) 9808 (E4) 9810 Spare Parts: Lens with screws 3x24V5W (R5W) 8GA 002 071-241 4x24V21W (P21W) 8GA 002 073-241












Volkswagen



Manufacturer Model	Model year	Part no.	Pk.	Note
Volkswagen				
Transporter (T2) Transporter (T2) Bus, Transporter	08/73->07/79	1L8 003 060-561 9GH 116 966-011 9FF 126 444-001 1L8 003 060-691 9GH 116 966-011 9FF 126 444-001	1 10 10 1 10 10	Headlight E1 7097 Spare Parts: Cap Bulb socket for side light 1x12V45/40W (R2) 8GD 002 088-131 1x12V4W (T4W) 8GP 002 067-121 H4 headlight E1 7144 Spare Parts: Cap Bulb socket for side light (to be ordered separately) 1x12V60/55W (H4) 8GJ 002 525-131 1x12V4W (T4W) 8GP 002 067-121
Transporter (T2) Bus, Transporter	08/71->07/79	9EL 113 065-001	1	Combination rearlight with reverse light, spare parts available only E1 43346 E1 2318 Spare Parts: Lens 1x12V21/5W (P21/5W) 8GD 002 078-121 2x12V21W (P21W) 8GA 002 073-121
Transporter (T3) Transporter (T3)	05/79->07/92	9EL 122 377-011 9EL 122 378-011	1 1	Indicator light, spare parts available only E1 32798 Spare Parts: Body/lens, left Body/lens, right 1x12V21W (P21W) 8GA 002 073-121
Transporter (T3) Bus, Caravelle, Transporter	05/79->07/92	2VP 003 529-131 2VP 003 529-141 9EL 122 149-011 9EL 122 150-011	1 1 1 1	Combination rearlight, left, with reverse and rear fog light Combination rearlight, right, with reverse and rear fog light E1 53300 Spare Parts: Body/lens, left Body/lens, right 1x12V10W (R10W) 8GA 002 071-131 4x12V21W (P21W) 8GA 002 073-121






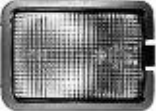








Manufacturer Model	Model year	Part no.	Pk.	Note
Volkswagen				
Transporter (T3) Transporter (T3)	05/79->07/92	2JA 002 931-031	5	Interior light  1x12V10W (K) 8GM 002 091-131
 Transporter (T4) Transporter (T4) California, Caravelle, Multivan, Transporter PR no. ACO with short front-end	09/90->04/03	1LJ 006 051-191 1LJ 006 051-201	1 1	H4 headlight, left H4 headlight, right (E1) 17176 left (E1) 17177 right  1x12V60/55W (H4) 8GJ 002 525-131  1x12V4W (T4W) 8GP 002 067-121
Transporter (T4) California, Caravelle, Multivan chassis no. 70-T-200 001 -> 70-1-048 000	01/96->01	6NM 007 282-211	1	Setting element, headlight levelling 
Transporter (T4) California, Caravelle, Multivan up to 1.65t (short wheelbase) Transporter up to 1.65t (short wheelbase)	09/90->04/03 09/90->12/95 09/90->	1NL 006 250-051 1NL 006 250-061	1 1	DE-H3 fog light, left DE-H3 fog light, right (E1) 18232  1x12V55W (H3) 8GH 002 090-133
 Transporter (T4) California, Caravelle, Multivan	01/96->04/03	1NB 008 122-011 1NB 008 122-021	1 1	FF®-H3 fog light, left FF®-H3 fog light, right (E26) 001 left (E26) 002 right  1x12V55W (H3) 8GH 002 090-133
				



Volkswagen



Manufacturer Model	Model year	Part no.	Pk.	Note
Volkswagen				
Transporter (T4) Transporter (T4) California, Caravelle, Multivan, Transporter PR no. ACO with short front-end 	09/90->04/03	9EL 136 401-011 9EL 136 402-011	1 1	Body/lens for indicator light (amber), left Body/lens for indicator light (amber), right (E1) 42787  1x12V21W (P21W) 8GA 002 073-121
Transporter (T4) California, Caravelle, Multivan, Transporter 	09/90->04/03	9EL 146 371-001 9EL 146 372-001	1 1	Body/lens for combination rearlight (amber/red), left Body/lens for combination rearlight (amber/red), right (E1) 63250  1x12V21/5W (P21/5W) 8GD 002 078-121  2x12V21W (P21W) 8GA 002 073-121
Transporter (T4) California, Caravelle, Multivan, Transporter 	09/90->04/03	9EL 146 373-001	1	Body/lens for rear fog light (E1) 389  1x12V21W (P21W) 8GA 002 073-121
Transporter (T4) Flatbed 	09/90->04/03	9EL 122 689-051 9EL 122 689-021	2 2	Combination rearlight, spare parts available only (E4) 377 (E4) 397 (E4) 421 (E4) 3880 (E4) 23215 Spare Parts: 2 Lens for rear, reflex-reflector, stop, indicator and reverse light 2 Lens for rear, reflex-reflector, stop, indicator, reverse and rear fog light  1x12V10W (R10W) 8GA 002 071-131  4x12V21W (P21W) 8GA 002 073-121
Transporter (T4) Flatbed 	09/90->04/03	2KA 003 389-061 9BG 121 587-031	2 2	Licence plate light (E1) 22819 Spare Parts: 2 Body/lens with screw  1x12V10W (R10W) 8GA 002 071-131







Manufacturer Model	Model year	Part no.	Pk.	Note
Volkswagen				
Multivan, Transporter (T5)		1N0 270 481-051	1	FF®-HB4 fog light, left, with bulb
Multivan, Transporter (T5)	04/03->	1N0 270 481-061	1	FF®-HB4 fog light, right, with bulb
up to chassis no. 7H-5-020 000, 7J-5-015 000				(E26) 007 1x12V51W (HB4) 8GH 005 636-121
Multivan, Transporter (T5)	04/03->	1N0 271 247-051	1	FF®-HB4 fog light, left, with bulb
from chassis no. 7H-5-020 001, 7J-5-015 001		1N0 271 247-061	1	FF®-HB4 fog light, right, with bulb
				(E26) 004 1x12V51W (HB4) 8GH 005 636-121
Multivan, Transporter (T5)	04/03->	2SK 008 579-091	1	Combination rearlight (amber/red), left, with reverse and rear fog light, with bulbs
Vehicles with tailgate		2SK 008 579-101	1	Combination rearlight (amber/red), right, with reverse and rear fog light, with bulbs
				(E1) 515 3x12V21W (P21W) 8GA 002 073-121 1x12V21/4W (P21/4W) 8GD 004 772-121
Multivan, Transporter (T5)	04/03->	2SK 008 579-131	1	Combination rearlight (red/white), left, with reverse and rear fog light, with bulbs
Vehicles with tailgate		2SK 008 579-141	1	Combination rearlight (red/white), right, with reverse and rear fog light, with bulbs
				(E1) 515 3x12V21W (P21W) 8GA 002 073-121 1x12V21/4W (P21/4W) 8GD 004 772-121



Volkswagen - Volvo



Manufacturer Model	Model year	Part no.	Pk.	Note
Volkswagen				
Multivan, Transporter (T5) Multivan, Transporter (T5) 04/03-> Vehicles with tailgate		2SK 008 579-151 2SK 008 579-161	1 1	Design combination rearlight (silver/red), left, with reverse and rear fog light, with 1 21W indicator light bulb (Silver Vision) Design combination rearlight (silver/red), right, with reverse and rear fog light, with 1 21W indicator light bulb (Silver Vision) E1 515 1x12V21/5W (P21/5W) 8GD 002 078-121 2x12V21W (P21W) 8GA 002 073-121
				
Transporter (T5) Vehicles with gull-wing doors	04/03->	2SK 008 579-111 2SK 008 579-121	1 1	Combination rearlight (amber/red), left, with reverse and rear fog light, with bulbs Combination rearlight (amber/red), right, with reverse and rear fog light, with bulbs E1 515 3x12V21W (P21W) 8GA 002 073-121 1x12V21/4W (P21/4W) 8GD 004 772-121
				
Transporter (T5) Flatbed	04/03->	9BG 121 587-031	2	Licence plate light, spare parts available only E1 22819 Spare Parts: Body/lens with screw 1x12V10W (R10W) 8GA 002 071-131
				
Volvo				
C70 C70 Coupé 03/97->09/02 C70 Convertible 03/98->10/05		9EL 147 723-071 9EL 147 724-071 *)	1 1	Body/lens for indicator light (white), left Body/lens for indicator light (white), right E1 477 1x12V21W (PY21W) 8GA 006 841-121
				

*) The products marked are available only in countries of the European Union



Manufacturer Model	Model year	Part no.	Pk.	Note
Volvo				
S40 I (VS) S40 I (VS)	07/95->07/00	1LG 007 302-191 *) 1LG 007 302-201 *)	1 1	H4 headlight, left, suitable for headlight leveller H4 headlight, right, suitable for headlight leveller 1x12V60/55W (H4) 8GJ 002 525-131 1x12V4W (T4W) 8GP 002 067-121
S40 I (VS)	08/00->12/03	1LG 007 861-451 *) 1LG 007 861-461 *)	1 1	FF®-H7 headlight, left, with chrome-plated cover, with electr. headlight leveller actuator, with bulbs FF®-H7 headlight, right, with chrome-plated cover, with electr. headlight leveller actuator, with bulbs Ⓔ1 631 left Ⓔ1 632 right Ⓔ1 633 left Ⓔ1 634 right 2x12V55W (H7) 8GH 007 157-121 1x12V4W (T4W) 8GP 002 067-121
S40 I (VS)	07/95->12/03	6NM 007 282-651	1	Headlight leveller actuator, electr. (for H4 headlight)
S40 I (VS)	07/95->12/03	6NM 007 878-551	1	Headlight leveller actuator, electr. (for H7 and xenon headlight)
S40 I (VS)	07/95->07/00	2BA 007 924-071 *) 2BA 007 924-081 *)	1 1	Indicator light (white), left, with bulb Indicator light (white), right, with bulb Ⓔ1 704 1x12V21W (PY21W) 8GA 006 841-121
S70 S70	01/97->11/00	9EL 147 723-071 *) 9EL 147 724-071 *)	1 1	Body/lens for indicator light (white), left Body/lens for indicator light (white), right Ⓔ1 477 1x12V21W (PY21W) 8GA 006 841-121

*) The products marked are available only in countries of the European Union














Volvo



Manufacturer Model	Model year	Part no.	Pk.	Note
Volvo				
S70 S70	01/97->11/00	9EL 341 325-311 9EL 341 325-321)	1 1	Body/lens for combination rearlight, left Body/lens for combination rearlight, right (E17) 9602 1x12V5W (R5W) 8GA 002 071-121 2x12V21W (P21W) 8GA 002 073-121
S70	01/97->11/00	9EL 341 326-311 9EL 341 326-321)	1 1	Body/lens for rear fog and reverse light, left Body/lens for rear fog and reverse light, right (E17) 9603 1x12V5W (R5W) 8GA 002 071-121 2x12V21W (P21W) 8GA 002 073-121
S80 S80	05/98->12/00	9EL 149 957-121) 9EL 149 958-121)	1 1	Body/lens for combination rearlight, left, with reverse and rear fog light Body/lens for combination rearlight, right, with reverse and rear fog light (E1) 1716 1x12V5W (R5W) 8GA 002 071-121 1x12V21W (P21W) 8GA 002 073-121 1x12V21W (PY21W) 8GA 006 841-121 1x12V21/4W (P21/4W) 8GD 004 772-121
V40 (VW) V40 (VW)	07/95->07/00	1LG 007 302-191) 1LG 007 302-201)	1 1	H4 headlight, left, suitable for headlight leveller H4 headlight, right, suitable for headlight leveller 1x12V60/55W (H4) 8GJ 002 525-131 1x12V4W (T4W) 8GP 002 067-121

*) The products marked are available only in countries of the European Union



Manufacturer Model	Model year	Part no.	Pk.	Note
Volvo				
V40 (VW) V40 (VW)	08/00->06/04	 1LG 007 861-451 *) 1LG 007 861-461 *)	1 1	FF®-H7 headlight, left, with chrome-plated cover, with electr. headlight leveller actuator, with bulbs FF®-H7 headlight, right, with chrome-plated cover, with electr. headlight leveller actuator, with bulbs E1 631 left E1 632 right E1 633 left E1 634 right  2x12V55W (H7) 8GH 007 157-121  1x12V4W (T4W) 8GP 002 067-121
V40 (VW)	07/95->		1	Headlight leveller actuator, electr. (for H4 headlight)
V40 (VW)	07/95->		1	Headlight leveller actuator, electr. (for H7 and xenon headlight)
V40 (VW)	07/95->07/00	 2BA 007 924-071 *) 2BA 007 924-081 *)	1 1	Indicator light (white), left, with bulb Indicator light (white), right, with bulb E1 704  1x12V21W (PY21W) 8GA 006 841-121
V70 I Estate V70 I Estate	01/97->11/00	 9EL 147 723-071 *) 9EL 147 724-071 *)	1 1	Body/lens for indicator light (white), left Body/lens for indicator light (white), right E1 477  1x12V21W (PY21W) 8GA 006 841-121
850 (LS, LW) 850 (LS), 850 Estate (LW)	08/93->10/97	 9EL 142 723-011 *) 9EL 142 724-011 *)	1 1	Body/lens for indicator light (white), left Body/lens for indicator light (white), right E1 477  1x12V21W (P21W) 8GA 002 073-121

*) The products marked are available only in countries of the European Union



Volvo



Manufacturer Model	Model year	Part no.	Pk.	Note
Volvo				
940 (944) 940 (944)	08/90->12/94	9EL 138 601-031 9EL 138 602-031 *)	1 1	Body/lens for combination rearlight, left Body/lens for combination rearlight, right (E4) 195 1x12V5W (R5W) 8GA 002 071-121 2x12V21W (P21W) 8GA 002 073-121
940 (944)	08/90->12/94	9EL 138 649-031 9EL 138 650-031 *)	1 1	Body/lens for rear fog and reverse light, left Body/lens for rear fog and reverse light, right (E4) 410 (E4) 2319 (E4) 3884 1x12V5W (R5W) 8GA 002 071-121 2x12V21W (P21W) 8GA 002 073-121
960 (964) 960 (964)	08/90->07/94	9EL 138 601-041 9EL 138 602-041 *)	1 1	Body/lens for combination rearlight, left Body/lens for combination rearlight, right (E4) 195 (E4) 4449 2x12V21W (P21W) 8GA 002 073-121
960 (964)	08/90->07/94	9EL 138 649-041 9EL 138 650-041 *)	1 1	Body/lens for rear fog and reverse light, left Body/lens for rear fog and reverse light, right (E4) 410 (E4) 2319 (E4) 3884 2x12V21W (P21W) 8GA 002 073-121

*) The products marked are available only in countries of the European Union



Headlights, Signal and Sundry Lights for Commercial Vehicles



List of Manufacturers/Page

2.02 - 2.03

Headlights, Signal and Sundry Lights -
Application Chart for Commercial Vehicles

2.04 - 2.122



List of Manufacturers/Page



Manufacturer Model	Model year	Page	Manufacturer Model	Model year	Page
DAF			MAN		
Older models		2.04	10.136 F, 10.150 F (G, G 90)	10/79->91/00	2.31
CF 65, CF 75, CF 85	01/01->	2.04 - 2.05	11.136 - 38.320	09/69->	2.31 - 2.32
F 900 - N 2800	10/74->	2.05	12.163 - 18.285 (M 2000 L)	08/95->	2.32
F 2100 - F 2800		2.05	14.224 - 25.264 (M 2000 M)	08/95->	2.33
LF 45, LF 55	01/01->	2.06	12.136 - 48.321 (F8, F9)	01/84->	2.34 - 2.36
XF 95	09/02->12/06	2.06 - 2.07	12.192 - 24.272 (M 90)	08/88->	2.37 - 2.39
XF 105	10/05->	2.07 - 2.08	19.242 - 48.462 (F 90)	06/86->91/00	2.40 - 2.44
65, 75, 85	01/93->02/98	2.08 - 2.09	19.233 - 41.463 (F 2000)	01/94->	2.44 - 2.45
65 CF, 75 CF, 85 CF	02/98->12/00	2.09 - 2.10	18.310 - 41.660 (TGA)	04/00->05/05	2.46 - 2.47
95	09/87->01/98	2.10 - 2.11	MAN/VW		
95 XF	01/97->09/02	2.11 - 2.12	6.90 F - 9.136 F	10/79->08/87	2.47
Iveco			6.90 F - 9.150 F	10/79->91/00	2.47 - 2.48
Daily II	05/99->12/06	2.12	Mercedes-Benz		
EuroCargo 60 E - 320 E	01/91->	2.12	Actros	09/96->10/02	2.48 - 2.49
EuroStar LD 190 - LD 440	01/93->	2.13	Actros MP2/MP3	10/02->	2.49 - 2.51
EuroTech MH 180 - MT 400	01/92->	2.13	Atego	01/98->10/04	2.51 - 2.52
EuroTrakker MP 190 - MP 410	01/93->	2.13	Atego II	10/04->	2.52
Stralis	02/02->	2.14	Axor	01/02->10/04	2.53
Turbo Star		2.14	Axor II	10/04->	2.53 - 2.54
Iveco Ford			L 405 D - L 911 (T2/L)	01/68->12/88	2.54 - 2.57
190 - 210		2.14	Cab-behind-engine vehicles 911 - 2624		2.57 - 2.59
Iveco Magirus			LP 608 - LP 1113 (LP)	10/69->12/84	2.60 - 2.62
M 2000	09/79->12/82	2.14 - 2.15	LP 1113 - LP 1519	00/67->	2.62 - 2.63
75-9 A - 160 M13 FS	09/75->	2.15 - 2.16	O 303	10/74->	2.63
120-13 ANW - 330-30 ANW	01/83->	2.17 - 2.18	O 305 VÖV	04/73->12/83	2.64
130 D - 310 D (P/PA-series)	01/71->12/82	2.19 - 2.20	O 309	01/68->02/89	2.65 - 2.66
130 D 9 FL - 340 D 22	05/73->	2.21 - 2.22	O 404	09/91->10/99	2.66 - 2.67
130 L 81 - 230 R 120	12/68->12/79	2.23	O 405	09/84->	2.67
180-24 - 320 M (T-series)		2.24 - 2.25	O 405 VÖV II	01/84->	2.68 - 2.69
MAN			O 407	03/87->11/01	2.69 - 2.70
EL 202		2.25	Unimog	00/90->	2.70 - 2.71
Lion's Family		2.26	Vario 512 D - 816 DA	09/96->	2.71 - 2.72
NG 242 - SÜ 240		2.27 - 2.28	507 D - 814 D (T2/LN1)	04/86->12/94	2.72 - 2.73
ÜL 242, ÜL 292, Bus VÖV		2.28	709 - 2024 (LK/LN2)	01/84->12/98	2.74 - 2.76
ÜL 313/353		2.28 - 2.29	1013 - 3850 (NG)	08/73->08/88	2.77 - 2.82
8.103 - 12.225 (L 2000)	10/93->	2.29	1222 - 4850 (MK, SK)	07/87->09/96	2.83 - 2.89
7.150 - 12.240 (TGL)	04/05->	2.30	Neoplan		
10.136 F (G)	10/79->08/87	2.30	Centroliner	10/98->	2.89 - 2.90











Manufacturer Model	Model year	Page
Neoplan		
Cityliner - Spaceliner	11/79->	2.90 - 2.96
Euroliner N 3316	10/98->	2.96 - 2.97
Bus (SK 1) N 407	83->	2.97 - 2.98
Bus SL II, Ü 80	82->	2.98 - 2.100
Metroliner N 8008, N 8012		2.100 - 2.102
Low-level-entry bus N 4010		2.102 - 2.103
Low-level-entry bus N 4014		2.103 - 2.104
Regioliner		2.105
Starliner N 516	09/96->	2.105 - 2.107
Transliner N 316	91->	2.107 - 2.108
Unibus N 906, N 907	81->	2.108 - 2.110
Renault Trucks		
Magnum	01->	2.110
Premium		2.111
Premium II	10/05->	2.111
Scania		
Older models		2.112
LB 81 - LBT 141(series 1)	02/68->	2.112
G 82 - T 142 (series 2)	05/80->03/88	2.112
P 93 - T 143 (series 3)	01/88->12/96	2.113
P 94 - T 164 (series 4)	09/95->09/04	2.114
P 230 - T 470	03/04->09/06	2.114 - 2.115
Volvo		
F 4, F 6	71->09/85	2.115
F 10 - F 16	08/77->07/93	2.115 - 2.116
F 86 - F 89	->07/77	2.116
FH 12, FH 16	10/93->04/05	2.116 - 2.117
FL	03/00->	2.118
FL 4, FL 6	10/85->	2.118
FL 7 - FL 12	10/85->07/93	2.119
FLC	09/96->09/00	2.119
FM 7	10/98->12/01	2.119 - 2.120
FM 9	12/01->09/05	2.120
FM 12	10/98->09/05	2.121
FS 7		2.121 - 2.122
N 7 - N 12	01/73->	2.122



DAF



Manufacturer Model	Model year	Part no.	Pk.	Note
DAF				
Older models	Older models	2SE 997 088-001	1	Combination rearlight with licence plate light (E12) 4035 (E12) 6066 (E12) 27092  2x24V10W (R10W) 8GA 002 071-251  2x24V21W (P21W) 8GA 002 073-241
CF 65, CF 75, CF 85 CF 65, CF 75, CF 85	01/01->	1LJ 247 046-071 1LJ 247 046-081 1LJ 247 046-051 1LJ 247 046-061	1 1 1 1	H1/H7 headlight, left, with indicator light, without headlight leveller, with bulbs H1/H7 headlight, right, with indicator light, without headlight leveller, with bulbs H1/H7 headlight, left, with indicator light, with headlight leveller, with bulbs H1/H7 headlight, right, with indicator light, with headlight leveller, with bulbs (E1) 1133 (E1) 1134  1x24V70W (H7) 8GH 007 157-231 Long Life  1x24V70W (H1) 8GH 002 089-251  1x24V21W (P21W) 8GA 002 073-251  1x24V5W (W5W) 8GP 003 594-251
CF 65, CF 75, CF 85	01/01->	9BG 147 497-002 9BG 147 498-002	1 1	H1 fog light/H3 spotlight, with bulbs, spare parts available only (E1) 518 Spare Parts: Body with headlight unit and bulbs, left, carrier frame is not part of scope of supply Body with headlight unit and bulbs, right, carrier frame is not part of scope of supply  1x24V70W (H1) 8GH 002 089-251  1x24V70W (H3) 8GH 002 090-251



Manufacturer Model	Model year	Part no.	Pk.	Note
DAF				
CF 65, CF 75, CF 85 CF 65, CF 75, CF 85	01/01->	2VD 008 204-251 2VP 008 204-241 9EL 152 889-001	1 1 1	Combination rearlight, left, with licence plate, rear fog, reverse, clearance light, side-marker light, with reflex-reflector and marker reflex-reflector Combination rearlight, left/right, with rear fog, reverse, clearance light, side-marker light, with reflex-reflector and marker reflex-reflector (E4) 3178 (E4) 4060 (E4) 9808 (E4) 9810 Spare Parts: Lens with screws 3x24V5W (R5W) 8GA 002 071-241 4x24V21W (P21W) 8GA 002 073-241
F 900 - N 2800 F 900 - F 2805 N 2800	10/74-> 10/80->	2PF 001 647-031	4	Side light (E1) 11780 1x24V10W (R10W) 8GA 002 071-251
F 2100 - F 2800 F 2100 - F 2800 F 2100, F 2200, F 2300, F 2400, F 2500 F 2800	08/85-> ->08/87	1F6 003 939-031	1	H1 spotlight unit (E1) 24565 1x24V70W (H1) 8GH 002 089-251
F 2100 - F 2800	10/86->	2BA 005 407-001	1	Indicator light (E1) 42743 1x24V21W (P21W) 8GA 002 073-241



DAF



Manufacturer Model	Model year	Part no.	Pk.	Note
DAF				
LF 45, LF 55 LF 45, LF 55	01/01->	1LJ 247 046-071 1LJ 247 046-081 1LJ 247 046-051 1LJ 247 046-061	1 1 1 1	<p>H1/H7 headlight, left, with indicator light, without headlight leveller, with bulbs</p> <p>H1/H7 headlight, right, with indicator light, without headlight leveller, with bulbs</p> <p>H1/H7 headlight, left, with indicator light, with headlight leveller, with bulbs</p> <p>H1/H7 headlight, right, with indicator light, with headlight leveller, with bulbs</p> <p>Ⓔ 1133 Ⓔ 1134</p> <p> 1x24V70W (H7) 8GH 007 157-231 Long Life</p> <p> 1x24V70W (H1) 8GH 002 089-251</p> <p> 1x24V21W (P21W) 8GA 002 073-251</p> <p> 1x24V5W (W5W) 8GP 003 594-251</p>
LF 45, LF 55	01/01->	9BG 147 497-002 9BG 147 498-002	1 1	<p>H1 fog light/H3 spotlight, with bulbs, spare parts available only</p> <p>Ⓔ 518</p> <p>Spare Parts: Body with headlight unit and bulbs, left, carrier frame is not part of scope of supply</p> <p>Body with headlight unit and bulbs, right, carrier frame is not part of scope of supply</p> <p> 1x24V70W (H1) 8GH 002 089-251</p> <p> 1x24V70W (H3) 8GH 002 090-251</p>
XF 95 XF 95	09/02->12/06	1LJ 247 046-071 1LJ 247 046-081 1LJ 247 046-051 1LJ 247 046-061	1 1 1 1	<p>H1/H7 headlight, left, with indicator light, without headlight leveller, with bulbs</p> <p>H1/H7 headlight, right, with indicator light, without headlight leveller, with bulbs</p> <p>H1/H7 headlight, left, with indicator light, with headlight leveller, with bulbs</p> <p>H1/H7 headlight, right, with indicator light, with headlight leveller, with bulbs</p> <p>Ⓔ 1133 Ⓔ 1134</p> <p> 1x24V70W (H7) 8GH 007 157-231 Long Life</p> <p> 1x24V70W (H1) 8GH 002 089-251</p> <p> 1x24V21W (P21W) 8GA 002 073-251</p> <p> 1x24V5W (W5W) 8GP 003 594-251</p>



Manufacturer Model	Model year	Part no.	Pk.	Note
DAF				
XF 95 XF 95	09/02->12/06			H1 fog light/H3 spotlight, with bulbs, spare parts available only (E1) 518 Spare Parts: Body with headlight unit and bulbs, left, carrier frame is not part of scope of supply Body with headlight unit and bulbs, right, carrier frame is not part of scope of supply 1x24V70W (H1) 8GH 002 089-251 1x24V70W (H3) 8GH 002 090-251
		9BG 147 497-002	1	
		9BG 147 498-002	1	
XF 95	09/02->12/06	2VD 008 204-251 2VP 008 204-241	1 1	Combination rearlight, left, with licence plate, rear fog, reverse, clearance light, side-marker light, with reflex-reflector and marker reflex-reflector Combination rearlight, left/right, with rear fog, reverse, clearance light, side-marker light, with reflex-reflector and marker reflex-reflector (E4) 3178 (E4) 4060 (E4) 9808 (E4) 9810 Spare Parts: Lens with screws 3x24V5W (R5W) 8GA 002 071-241 4x24V21W (P21W) 8GA 002 073-241
		9EL 152 889-001	1	
XF 105 XF 105	10/05->	1LJ 247 046-071 1LJ 247 046-081 1LJ 247 046-051 1LJ 247 046-061	1 1 1 1	H1/H7 headlight, left, with indicator light, without headlight leveller, with bulbs H1/H7 headlight, right, with indicator light, without headlight leveller, with bulbs H1/H7 headlight, left, with indicator light, with headlight leveller, with bulbs H1/H7 headlight, right, with indicator light, with headlight leveller, with bulbs (E1) 1133 (E1) 1134 1x24V70W (H7) 8GH 007 157-231 Long Life 1x24V70W (H1) 8GH 002 089-251 1x24V21W (P21W) 8GA 002 073-251 1x24V5W (W5W) 8GP 003 594-251



DAF



Manufacturer Model	Model year	Part no.	Pk.	Note
DAF				
XF 105	10/05->	1PE 965 410-111	1	H3 fog light/spotlight, left, with bulbs
XF 105		1PE 965 410-121	1	H3 fog light/spotlight, right, with bulbs
		(E1) 2042 2x24V70W (H3) Long Life		
XF 105	10/05->	2VD 008 204-251	1	Combination rearlight, left, with licence plate, rear fog, reverse, clearance light, side-marker light, with reflex-reflector and marker reflex-reflector
		2VP 008 204-241	1	Combination rearlight, left/right, with rear fog, reverse, clearance light, side-marker light, with reflex-reflector and marker reflex-reflector
		9EL 152 889-001	1	Spare Parts: Lens with screws 3x24V5W (R5W) 8GA 002 071-241 4x24V21W (P21W) 8GA 002 073-241
65, 75, 85	01/93->10/95			H4 headlight, spare parts available only
65				
75, 85	01/92->10/95			(E1) 17193 left (E1) 17194 right
		9ES 140 721-015 1 9ES 140 722-015 1 9DE 133 697-015 2 9DE 133 698-015 2 9HD 121 297-001 5	Spare Parts: Lens, left Lens, right Reflector, left Reflector, right Cap 1x24V75/70W (H4) 8GJ 002 525-251 1x24V4W (T4W) 8GP 002 067-241	
65, 75, 85	11/95->02/98	1LG 007 660-031	1	H4 headlight, left without electr. headlight leveller, with bulbs
		1LG 007 660-041	1	H4 headlight, right, without electr. headlight leveller, with bulbs
		9ES 147 313-011 1 9ES 147 314-011 1 9HD 121 297-001 5	(E1) 356 left (E1) 357 right Spare Parts: Lens, left Lens, right Cap 1x24V75/70W (H4) 8GJ 002 525-251 1x24V5W (W5W) 8GP 003 594-251	



Manufacturer Model	Model year	Part no.	Pk.	Note
DAF				
65, 75, 85 65 75, 85	01/93->02/98 01/92->02/98	2PF 961 167-021 9EL 137 241-001	2 4	Side light (E1) 31446 Spare Parts: Lens 1x24V5W (C5W) 8GM 002 092-241
65 75, 85	01/93->02/98 01/92->02/98	2VD 008 204-171	1	Combination rearlight, left, with licence plate, rear fog, reverse, clearance light, side-marker light, with reflex-reflector and marker reflex-reflector Combination rearlight, left/right, with rear fog, reverse, clearance light, side-marker light, with reflex-reflector and marker reflex-reflector (E4) 3178 (E4) 4060 (E4) 9808 (E4) 9810 Spare Parts: Lens with screws 3x24V5W (R5W) 8GA 002 071-241 4x24V21W (P21W) 8GA 002 073-241
		2VP 008 204-161 9EL 152 889-001	1 1	
65 CF, 75 CF, 85 CF 65 CF, 75 CF, 85 CF	02/98->12/00	1LG 007 660-031 1LG 007 660-041 9ES 147 313-011 9ES 147 314-011 9HD 121 297-001	1 1 1 1 5	H4 headlight, left without electr. headlight leveller, with bulbs H4 headlight, right, without electr. headlight leveller, with bulbs (E1) 356 left (E1) 357 right Spare Parts: Lens, left Lens, right Cap 1x24V75/70W (H4) 8GJ 002 525-251 1x24V5W (W5W) 8GP 003 594-251
65 CF, 75 CF, 85 CF	02/98->12/00	2PF 961 167-021 9EL 137 241-001	2 4	Side light (E1) 31446 Spare Parts: Lens 1x24V5W (C5W) 8GM 002 092-241



DAF



Manufacturer Model	Model year	Part no.	Pk.	Note
DAF				
65 CF, 75 CF, 85 CF 65 CF, 75 CF, 85 CF	02/98->12/00	2VD 008 204-251 2VP 008 204-241 9EL 152 889-001	1 1 1	<p>Combination rearlight, left, with licence plate, rear fog, reverse, clearance light, side-marker light, with reflex-reflector and marker reflex-reflector</p> <p>Combination rearlight, left/right, with rear fog, reverse, clearance light, side-marker light, with reflex-reflector and marker reflex-reflector</p> <p>(E4) 3178 (E4) 4060 (E4) 9808 (E4) 9810</p> <p>Spare Parts: Lens with screws</p> <p> 3x24V5W (R5W) 8GA 002 071-241 4x24V21W (P21W) 8GA 002 073-241</p>
95 95	09/87->10/95	1LG 005 480-031 1LG 005 480-041 1LG 005 480-075 2BA 005 481-001 9ES 133 571-005 9ES 133 572-005 9DE 133 697-015 9DE 133 698-015 9HD 121 297-001	1 1 1 1 4 4 2 2 5	<p>H4 headlight, left, with indicator light, not suitable for headlight leveller</p> <p>H4 headlight, right, with indicator light, not suitable for headlight leveller</p> <p>H4 headlight, left, with indicator light and suitable for headlight leveller</p> <p>H4 headlight, right, with indicator light and suitable for headlight leveller, spare parts available only</p> <p>For vehicles up to chassis no. OE 338142 and OE 379839 adapter 9XD 146 600-001 (Pk. 1) is needed when replacing the headlight.</p> <p>(E1) 17135 left (E1) 17136 right</p> <p>Spare Parts: Indicator light with 24V bulb Lens, left Lens, right Reflector, left Reflector, right Cap</p> <p> 1x24V75/70W (H4) 8GJ 002 525-251 1x24V21W (P21W) 8GA 002 073-241 1x24V4W (T4W) 8GP 002 067-241</p>
95	09/87->01/98	2BA 005 481-001	1	<p>Indicator light (amber) with 24V bulb</p> <p>(E1) 42745</p> <p> 1x24V21W (P21W) 8GA 002 073-241</p>



Manufacturer Model	Model year	Part no.	Pk.	Note
DAF				
95 95	09/87->01/98	2VD 008 204-171 2VP 008 204-161 9EL 152 889-001	1 1 1	Combination rearlight, left, with licence plate, rear fog, reverse, clearance light, side-marker light, with reflex-reflector and marker reflex-reflector Combination rearlight, left/right, with rear fog, reverse, clearance light, side-marker light, with reflex-reflector and marker reflex-reflector (E4) 3178 (E4) 4060 (E4) 9808 (E4) 9810 Spare Parts: Lens with screws 3x24V5W (R5W) 8GA 002 071-241 4x24V21W (P21W) 8GA 002 073-241
95 XF 95 XF	01/97->09/02	1LG 007 660-111 1LG 007 660-121 9ES 147 315-015 9ES 147 316-015 9HD 121 297-001	1 1 1 1 5	H4 headlight, left, for vehicles with or without headlight leveller, with bulbs H4 headlight, right, for vehicles with or without headlight leveller, with bulbs (E1) 356 left (E1) 357 right Spare Parts: Lens, left Lens, right Cap 1x24V75/70W (H4) 8GJ 002 525-251 1x24V5W (W5W) 8GP 003 594-251
95 XF	01/97->09/02	9BG 147 497-002 9BG 147 498-002	1 1	H1 fog light/H3 spotlight, with bulbs, spare parts available only (E1) 518 Spare Parts: Body with headlight unit and bulbs, left, carrier frame is not part of scope of supply Body with headlight unit and bulbs, right, carrier frame is not part of scope of supply 1x24V70W (H1) 8GH 002 089-251 1x24V70W (H3) 8GH 002 090-251
95 XF	01/97->09/02	2BA 005 481-011	1	Indicator light (white) with 24V bulb (E1) 42745 1x24V21W (P21W) 8GA 002 073-241



Manufacturer Model	Model year	Part no.	Pk.	Note
DAF				
95 XF 95 XF	01/97->09/02	2VD 008 204-251 2VP 008 204-241 9EL 152 889-001	1 1 1	<p>Combination rearlight, left, with licence plate, rear fog, reverse, clearance light, side-marker light, with reflex-reflector and marker reflex-reflector</p> <p>Combination rearlight, left/right, with rear fog, reverse, clearance light, side-marker light, with reflex-reflector and marker reflex-reflector</p> <p>(E4) 3178 (E4) 4060 (E4) 9808 (E4) 9810</p> <p>Spare Parts: Lens with screws</p> <p> 3x24V5W (R5W) 8GA 002 071-241 4x24V21W (P21W) 8GA 002 073-241</p>
Iveco				
Daily II Daily II 29 L 9 V, 29 L 10 V, 29 L 11 V, 29 L 12 V, 29 L 13 V, 35 S 9 V, 35 C 9 V, 35 S 10 V, 35 C 10 V, 35 S 11 V, 35 C 11 V, 35 S 12 V, 35 C 12 V, 35 S 13 V, 35 C 13 V, 35 S 15 V, 35 C 15 V, 50 C 11, 50 C 13	05/99->12/06	2SK 008 208-051 2SK 008 208-061	1 1	<p>Combination rearlight, left, with reverse and rear fog light, with bulbs</p> <p>Combination rearlight, right, with reverse and rear fog light, with bulbs</p> <p>(E4) 9500</p> <p> 1x12V5W (R5W) 8GA 002 071-121 1x12V21W (PY21W) 8GA 006 841-121 3x12V21W (P21W) 8GA 002 073-121</p>
Van				
EuroCargo 60 E - 320 E EuroCargo 60 E - 320 E 60 E, 65 E, 75 E, 80 E, 95 E, 100 E, 120 E, 130 E, 135 E, 150 E, 170 E, 180 E, 260 E, 280 E, 320 E	01/91->	2VD 008 204-191 2VP 008 204-181 9EL 152 889-001	1 1 1	<p>Combination rearlight, left, with licence plate, rear fog, reverse, clearance light, side-marker light, with reflex-reflector and marker reflex-reflector</p> <p>Combination rearlight, left/right, with rear fog, reverse, clearance light, side-marker light, with reflex-reflector and marker reflex-reflector</p> <p>(E4) 9808 (E4) 4060 (E4) 3178 (E4) 9810</p> <p>Spare Parts: Lens with screws</p> <p> 3x24V5W (R5W) 8GA 002 071-241 4x24V21W (P21W) 8GA 002 073-241</p>



Manufacturer Model	Model year	Part no.	Pk.	Note
Iveco				
EuroStar LD 190 - LD 440		2VD 008 204-191	1	Combination rearlight, left, with licence plate, rear fog, reverse, clearance light, side-marker light, with reflex-reflector and marker reflex-reflector Combination rearlight, left/right, with rear fog, reverse, clearance light, side-marker light, with reflex-reflector and marker reflex-reflector (E4) 3179 (E4) 4060 (E4) 9809 (E4) 9810 Spare Parts: Lens with screws 3x24V5W (R5W) 8GA 002 071-241 4x24V21W (P21W) 8GA 002 073-241
EuroStar LD 190 - LD 440	01/93->	2VP 008 204-181	1	
LD 190, LD 240, LD 260 LD 400, LD 440		9EL 152 889-001	1	
EuroTech MH 180 - MT 400		2VD 008 204-191	1	Combination rearlight, left, with licence plate, rear fog, reverse, clearance light, side-marker light, with reflex-reflector and marker reflex-reflector Combination rearlight, left/right, with rear fog, reverse, clearance light, side-marker light, with reflex-reflector and marker reflex-reflector (E4) 3179 (E4) 4060 (E4) 9809 (E4) 9810 Spare Parts: Lens with screws 3x24V5W (R5W) 8GA 002 071-241 4x24V21W (P21W) 8GA 002 073-241
EuroTech MH 180 - MT 400	01/92->	2VP 008 204-181	1	
MH 180, MH 190, MH 260, MH 400	09/98->	9EL 152 889-001	1	
MP 180, MP 190, MP 240, MP 400, MP 440	01/92->			
MT 180, MT 190, MT 400	01/92->			
EuroTrakker MP 190 - MP 410		2VD 008 204-191	1	Combination rearlight, left, with licence plate, rear fog, reverse, clearance light, side-marker light, with reflex-reflector and marker reflex-reflector Combination rearlight, left/right, with rear fog, reverse, clearance light, side-marker light, with reflex-reflector and marker reflex-reflector (E4) 3179 (E4) 4060 (E4) 9809 (E4) 9810 Spare Parts: Lens with screws 3x24V5W (R5W) 8GA 002 071-241 4x24V21W (P21W) 8GA 002 073-241
EuroTrakker MP 190 - MP 410	01/93->	2VP 008 204-181	1	
MP 190, MP 260, MP 340, MP 380, MP 410		9EL 152 889-001	1	







Iveco - Iveco Magirus



Manufacturer Model	Model year	Part no.	Pk.	Note
Iveco				
Stralis Stralis	02/02->	2VD 008 204-191	1	Combination rearlight, left, with licence plate, rear fog, reverse, clearance light, side-marker light, with reflex-reflector and marker reflex-reflector Combination rearlight, left/right, with rear fog, reverse, clearance light, side-marker light, with reflex-reflector and marker reflex-reflector (E4) 3179 (E4) 4060 (E4) 9809 (E4) 9810 Spare Parts: Lens with screws 3x24V5W (R5W) 8GA 002 071-241 4x24V21W (P21W) 8GA 002 073-241
		2VP 008 204-181	1	
		9EL 152 889-001	1	
Turbo Star Turbo Star		1ND 003 590-001	1	H3 fog light (E1) 8361 H3 spotlight (E1) 24556 Spare Parts: Light unit 1x24V70W (H3) 8GH 002 090-251
		1FD 003 590-017	98	
		1FD 124 291-001	1	
Iveco Ford				
190 - 210 190 - 210		1LG 003 434-187	4	H4 headlight (E1) 17016 Spare Parts: Lens Reflector 1x24V75/70W (H4) 8GJ 002 525-251 1x24V4W (T4W) 8GP 002 067-241
		9ES 122 221-007 9DE 131 520-017	7 2	
Iveco Magirus				
M 2000 M 2000	09/79->12/82	2SA 003 236-041	1	Rear light (E1) 11591 1x24V5W (R5W) 8GA 002 071-241
		2DA 003 236-031	1	
		9EL 119 544-031	4	Stop light (E1) 240 Spare Parts: Lens 1x24V21W (P21W) 8GA 002 073-241



Manufacturer Model	Model year	Part no.	Pk.	Note
Iveco Magirus				
M 2000 M 2000	09/79->12/82	2BA 003 236-021 9EL 119 544-021	1 4	Indicator light E1 32764 Spare Parts: Lens 1x24V21W (P21W) 8GA 002 073-241
				
M 2000	09/79->12/82	2NE 003 236-001 9EL 119 544-001 9DX 119 545-011	1 4 2	Rear fog light e1 18 411 Spare Parts: Lens Reflector 1x24V21W (P21W) 8GA 002 073-241
				
M 2000	09/79->12/82	2ZR 003 236-051 9EL 119 544-111 9DX 119 545-051	1 4 2	Reverse light E1 8728 Spare Parts: Lens Reflector 1x24V21W (P21W) 8GA 002 073-241
				
75-9 A - 160 M13 FS 75-9 A - 160 M13 FS (MK-series)	09/75->	2BA 003 022-001 2BA 003 022-021 9EL 116 907-001 9FT 117 109-007	1 1 1 1	Indicator light, with lead Indicator light, without lead E1 32719 Spare Parts: Lens Bulb holder 1x12V21W (P21W) 8GA 002 073-121 1x24V21W (P21W) 8GA 002 073-241
				



Manufacturer Model	Model year	Part no.	Pk.	Note
Iveco Magirus				
75-9 A - 160 M13 FS		2SE 002 578-701	2	Combination rearlight with licence plate light
80-13 A - 160 M13 FS (MK-series)	09/75->			(E17) 9401
80-13 A, AT	01/83->07/84	9EL 146 491-001	2	Spare Parts: Body/lens with screws
80-13 AH	01/83->			1x12V10W (R10W) 8GA 002 071-131
80-16 A	01/83->07/84			1x24V10W (R10W) 8GA 002 071-251
90 M7 FK, FL, 90 M8 FK, FL, FS, 90 M9 FL	09/75->12/82			2x12V21W (P21W) 8GA 002 073-121
90-13 A, AT	01/83->07/84			2x24V21W (P21W) 8GA 002 073-241
90-13 AH	01/83->			
110-13 A	01/83->07/84			
110-13 AH	01/83->			
110-16 A, AT	01/83->07/84			
110-16 AH	01/83->			
130 M8 FK, FL, FS, 130 M9 FK, FL, FS, 130 M11 FK, FL, 130 M13 FK, FL	09/75->12/82			
130-13 A	01/83->07/84			
130-13 AH	01/83->			
130-16 A, AT	01/83->07/84			
130-16 AH	01/83->			
160 M11 FK, FL, FS, 160 M13 FK, FL, FS	09/75->12/82			





Manufacturer Model	Model year	Part no.	Pk.	Note
Iveco Magirus				
120-13 ANW - 330-30 ANW		1LG 003 434-187	4	H4 headlight
120-13 ANW - 330-30 ANW (P/PA-Cab-behind-engine vehicles)	01/83->			Ⓔ1 17016
120-13 ANW	01/83->	9ES 122 221-007	7	Spare Parts: Lens
120-16 ANW		9DE 131 520-017	2	Reflector
150-16 AN, ANW				1x24V75/70W (H4) 8GJ 002 525-251
160-23 ANW				1x24V4W (T4W) 8GP 002 067-241
190-25 AN, ANW, ANT				
190-30 N, NT	05/86->			
260-25 AN, ANW	01/83->			
330-30 AN, ANW	05/86->			
120-13 ANW - 330-30 ANW (P/PA-Cab-behind-engine vehicles)		2BA 003 022-001 2BA 003 022-021	1 1	Indicator light, with lead Indicator light, without lead
	01/83->			Ⓔ1 32719
		9EL 116 907-001	1	Spare Parts: Lens
		9FT 117 109-007	1	Bulb holder
				1x24V21W (P21W) 8GA 002 073-241



Manufacturer Model	Model year	Part no.	Pk.	Note
Iveco Magirus				
120-13 ANW - 330-30 ANW		2SE 001 699-071	1	Combination rearlight, left, with licence plate light Combination rearlight, right, without licence plate light (E1) 196 (E1) 43332 Spare Parts: Lens with screws Grommet 1x24V10W (R10W) 8GA 002 071-251 2x24V21W (P21W) 8GA 002 073-241
120-13 ANW - 330-30 ANW (P/PA-Cab-behind-engine vehicles)	01/83->	2SD 001 699-061	1	
120-13 ANW	01/83->			
120-16 ANW				
150-16 AN, ANW		9EL 109 139-001	2	
160-23 ANW		9GT 074 132-001	10	
190-25 AN, ANT, ANW				
190-30 N, NT	05/86->			
260-25 AN, ANW	01/83->			
330-30 AN, ANW	05/86->			
120-13 ANW - 330-30 ANW (P/PA-Cab-behind-engine vehicles)		2SE 003 167-031	1	Combination rearlight, left, with licence plate light Combination rearlight, right, without licence plate light (E1) 264 Spare Parts: Lens with screws Seal 1x24V10W (R10W) 8GA 002 071-251 2x24V21W (P21W) 8GA 002 073-241
120-13 ANW - 330-30 ANW (P/PA-Cab-behind-engine vehicles)	01/83->	2SD 003 167-021	1	
120-13 ANW	01/83->			
120-16 ANW				
150-16 AN, ANW		9EL 147 747-001	1	
160-23 ANW		9GD 087 883-355	10	
190-25 AN, ANT, ANW				
190-30 N, NT	05/86->			
260-25 AN, ANW	01/83->			
330-30 AN, ANW	05/86->			
120-13 ANW - 330-30 ANW (P/PA-Cab-behind-engine vehicles)		2JA 001 357-002	6	Interior light with switch Interior light without switch 1x24V10W (K) 8GM 002 091-251
	01/83->	2JA 001 357-012	6	




Manufacturer Model	Model year	Part no.	Pk.	Note
Iveco Magirus				
130 D - 310 D (P/PA-series)		1LG 003 434-187	4	H4 headlight
130 D - 310 D (P/PA-series)	01/71->12/82			17016 Spare Parts: Lens Reflector 1x24V75/70W (H4) 8GJ 002 525-251 1x24V4W (T4W) 8GP 002 067-241
130 D 12 AK 130 D 15 K, AK 160 D 12 AK 160 D 15 K, AK 170 D 12 AK 170 D 15 K, AK 230 D 16 AK 230 D 22 AK 230 D 26 AK 232 D 16 AK 232 D 26 K, AK 256 D 16 K, AK 256 D 26 K, AK 270 D 16 K, AK, S 310 D 16 K, AK, S 310 D 26 K, AK, AS		9ES 122 221-007 9DE 131 520-017	7 2	
130 D - 310 D (P/PA-series)		2BA 003 022-001 2BA 003 022-021	1 1	Indicator light, with lead Indicator light, without lead
	01/71->12/82			32719 Spare Parts: Lens Bulb holder 1x24V21W (P21W) 8GA 002 073-241
		9EL 116 907-001 9FT 117 109-007	1 1	








Manufacturer Model	Model year	Part no.	Pk.	Note
Iveco Magirus				
130 D - 310 D (P/PA-series)				
130 D - 310 D (P/PA-series)	01/71->12/82	2SE 001 699-071	1	Combination rearlight, left, with licence plate light Combination rearlight, right, without licence plate light (E1) 196 (E1) 43332
130 D 12 AK 130 D 15 AK, K 160 D 12 AK 160 D 15 AK, K 170 D 12 AK 170 D 15 AK, K 230 D 16 AK 230 D 22 AK 230 D 26 AK 232 D 16 AK 232 D 26 AK, K 256 D 16 AK, K 256 D 26 AK, K 270 D 16 AK, K, S 310 D 16 AK, K, S 310 D 26 AK, AS, K		2SD 001 699-061	1	
		9EL 109 139-001	2	Spare Parts: Lens with screws Grommet 1x24V10W (R10W) 8GA 002 071-251 2x24V21W (P21W) 8GA 002 073-241
		9GT 074 132-001	10	
130 D - 310 D (P/PA-series)				
130 D - 310 D (P/PA-series)	01/71->12/82	2SE 003 167-031	1	Combination rearlight, left, with licence plate light Combination rearlight, right, without licence plate light (E1) 264
130 D 12 AK 130 D 15 AK, K 160 D 12 AK 160 D 15 AK, K 170 D 12 AK 170 D 15 AK, K 230 D 16 AK 230 D 22 AK 230 D 26 AK 232 D 16 AK 232 D 26 AK, K 256 D 16 AK, K 256 D 26 AK, K 270 D 16 AK, K, S 310 D 16 AK, K, S 310 D 26 AK, AS, K		2SD 003 167-021	1	
		9EL 147 747-001	1	Spare Parts: Lens with screws Seal 1x24V10W (R10W) 8GA 002 071-251 2x24V21W (P21W) 8GA 002 073-241
		9GD 087 883-355	10	
130 D - 310 D (P/PA-series)				
130 D - 310 D (P/PA-series)	01/71->12/82	2JA 001 357-002	6	Interior light with switch Interior light without switch 1x24V10W (K) 8GM 002 091-251
		2JA 001 357-012	6	





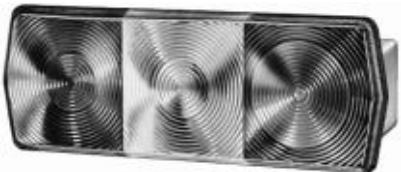








Manufacturer Model	Model year	Part no.	Pk.	Note
Iveco Magirus				
130 D 9 FL - 340 D 22		2BA 003 022-001 2BA 003 022-021	1 1	Indicator light, with lead Indicator light, without lead
130 D 9 FL - 340 D 22 (Forward-control vehicles)	05/73->	9EL 116 907-001 9FT 117 109-007	1 1	(E1) 32719 Spare Parts: Lens Bulb holder  1x24V21W (P21W) 8GA 002 073-241



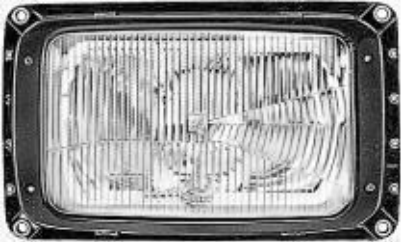





Manufacturer Model	Model year	Part no.	Pk.	Note
Iveco Magirus				
130 D 9 FL - 340 D 22		2SD 001 699-061	1	Combination rearlight
130 D 9 FL - 340 D 22 (Forward-control vehicles)	05/73->			(E1) 196 (E1) 43332 Spare Parts: Lens with screws Grommet  1x24V10W (R10W) 8GA 002 071-251  2x24V21W (P21W) 8GA 002 073-241
130 D 9 FL, 130 D 11 FL, 130 D 14 FL, 130 D 16 FL, FLL, 160 D 11 FL	01/75->	9EL 109 139-001 9GT 074 132-001	2 10	
160 D 16 FL	05/73->			
170 D 11 FL	01/75->			
170 D 14 FL, FS, 170 D 15 FAK, FK	05/73->			
170 D 16 FL, 170 D 19 FL, 232 D 13 FL	01/75->			
232 D 15 FAK, FK, FLL, 232 D 15,5 FL, FLL, FS	05/73->			
232 D 16 FL, 232 D 19 FAK, FK, FL, 232 D 22 FAK, FK, FL, 256 D 16 FL, 256 D 22 FLL, 270 D 16 FK, FL, FLL, 270 D 22 FAK, FL, FLL, 270 D 26 FAK	01/75->			
310 D 16 FS, FSL, 310 D 16 FAK, FK	05/73->			
310 D 16 FL, FLL, 310 D 19 FL, FS	01/75->			
310 D 22 FAK, FSL	05/73->			
310 D 22 FL, FLL, FS	01/75->			
310 D 26 FK	05/73->			
340 D 16 FL, FLL, 340 D 22 FL, FLL	01/75->			
				
130 D 9 FL - 340 D 22 (Forward-control vehicles)	05/73->	2KA 001 386-231	2	Licence plate light
				(E1) 12820 Spare Parts: Body with lens Grommet  1x12V5W (C5W) 8GM 002 092-121
		9BG 101 230-001 9GT 005 166-001	2 10	
				



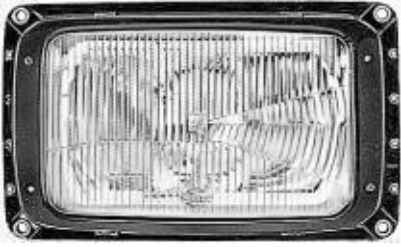




Manufacturer Model	Model year	Part no.	Pk.	Note
Iveco Magirus				
130 L 81 - 230 R 120 130 L 81 - 160 R 81	10/77->12/79	 9EL 110 737-001 9EL 110 736-001	2 2	Indicator light, spare parts available only (E1) 32617 Spare Parts: Lens, left Lens, right  1x24V21W (P21W) 8GA 002 073-241
130 L 81 - 160 R 81 130 L 81, 130 R 81, 160 R 81	10/77->12/79	2SD 001 693-011  9GT 074 132-001	1 10	Combination rearlight (E1) 31436 (E1) 53234 Spare Parts: Grommet  1x24V10W (R10W) 8GA 002 071-251  2x24V21W (P21W) 8GA 002 073-241
170 R 100 - 230 R 120	12/68->09/79	2SB 001 240-311  9EM 128 230-001 2BA 001 240-301 9EM 128 229-011 9EL 128 228-021	1 1 1 10	Rear-stop light (E1) 11549 Spare Parts: Lens with reflector and rim  1x24V10W (R10W) 8GA 002 071-251  1x24V21W (P21W) 8GA 002 073-241 Indicator light (E1) 22786 Spare Parts: Lens with reflector and rim Lens with rim  1x24V21W (P21W) 8GA 002 073-241



Manufacturer Model	Model year	Part no.	Pk.	Note
Iveco Magirus				
180-24 - 320 M (T-series)		1LG 003 434-187	4	H4 headlight
180-24 - 240-38, 256 M - 320 M (T-series)				(E1) 17016
180-24, T, 190-26, T 190-30, P, T, PT 190-33, P, T, PT 190-36, P, T 190-39, P, T, PT 190-42, P, T, PT 220-30 PT, 220-36 PT 220-38 PT, 240-30 P 240-36 P, 240-38 P	09/85->	9ES 122 221-007 9DE 131 520-017	7 2	Spare Parts: Lens Reflector
256 M 19 FK, FAK, FKS-FF 256 M 26 FK, FAK, FKS-FF 320 M 19 FK, FAK, FKS-FF 320 M 26 FK, FAK, FKS-FF	05/78->			 1x24V75/70W (H4) 8GJ 002 525-251  1x24V4W (T4W) 8GP 002 067-241
				
180-24 - 240-38, 256 M - 320 M (T-series)		2SE 003 167-031	1	Combination rearlight, left, with licence plate light
180-24, T, 190-26, T 190-30, P, T, PT 190-33, P, T, PT 190-36, P, T 190-38, P, T, PT 190-42, P, T, PT 220-30 PT, 220-36 PT 220-38 PT, 240-30 P 240-36 P, 240-38 P	09/85->	2SD 003 167-021	1	Combination rearlight, right, without licence plate light
256 M 19 FAK, FK, FKS-FF 256 M 26 FAK, FK, FKS-FF 320 M 19 FAK, FK, FKS-FF 320 M 26 FAK, FK, FKS-FF	05/78->	9EL 147 747-001 9GD 087 883-355	1 10	(E1) 264 Spare Parts: Lens with screws Seal
				 1x24V10W (R10W) 8GA 002 071-251  2x24V21W (P21W) 8GA 002 073-241











Manufacturer Model	Model year	Part no.	Pk.	Note
Iveco Magirus				
180-24 - 320 M (T-series) 180-24 - 240-38, 256 M - 320 M (T-series)	05/78->	2NE 003 236-001 9EL 119 544-001 9DX 119 545-011	1 4 2	Rear fog light Ⓔ1 18 411 Spare Parts: Lens Reflector 1x24V21W (P21W) 8GA 002 073-241
				
180-24 - 240-38, 256 M - 320 M (T-series)	05/78->	2ZR 003 236-051 9EL 119 544-111 9DX 119 545-051	1 4 2	Reverse light Ⓔ1 8728 Spare Parts: Lens Reflector 1x24V21W (P21W) 8GA 002 073-241
				
MAN				
EL 202 EL 202		1LG 003 434-237 9ES 122 221-007 9HD 121 297-035	1 7 70	H4 headlight, suitable for headlight leveller Ⓔ1 17016 Spare Parts: Lens Cap 1x24V75/70W (H4) 8GJ 002 525-251 1x24V4W (T4W) 8GP 002 067-241
				
EL 202		2SD 003 167-531 2SD 003 167-541 9EL 147 747-001 9GD 087 883-355	1 1 1 10	Combination rearlight, left Combination rearlight, right Ⓔ1 264 Spare Parts: Lens with screws Seal 1x24V10W (R10W) 8GA 002 071-251 2x24V21W (P21W) 8GA 002 073-241
				
EL 202		2KA 003 389-081 9BG 121 587-031	1 2	Licence plate light Ⓔ1 22819 Spare Parts: Body/lens with screw 1x24V10W (R10W) 8GA 002 071-251
				



MAN



Manufacturer Model	Model year	Part no.	Pk.	Note
MAN				
Lion's Family		1FE 005 478-011	1	H1 spotlight unit, left
Lion's Family		1FE 005 478-021	1	H1 spotlight unit, right
Lion's Comfort Lion's Star FRH 422				(E1) 44408 (E1) 34517  1x24V70W (H1) 8GH 002 089-251
Lion's Family		1NL 004 840-081	1	DE-H3 fog light
Lion's Coach FRH 353 Lion's Comfort Lion's Star FRH 422				(E1) 18212  1x24V70W (H3) 8GH 002 090-251
Lion's Family		2BA 005 603-001	1	Indicator light, for front mounting
Lion's Coach FRH 353 Lion's Comfort Lion's Star FRH 422				(E1) 42748  1x24V21W (P21W) 8GA 002 073-241
Lion's Family		2KA 001 388-051	1	Licence plate light
Lion's Coach FRH 353 Lion's Comfort Lion's Star FRH 422				(E1) 22902  1x24V5W (C5W) 8GM 002 092-241








Manufacturer Model	Model year	Part no.	Pk.	Note
MAN				
NG 242 - SÜ 240 NG 242 - SL 202 NG 242, NG 272 NL 202, NM 152 SG 242, SG 292 SL 202	07/90-> 05/91-> 03/88->	1LG 003 434-237 9ES 122 221-007 9HD 121 297-035	1 7 70	H4 headlight, suitable for headlight leveller (E1) 17016 Spare Parts: Lens Cap 1x24V75/70W (H4) 8GJ 002 525-251 1x24V4W (T4W) 8GP 002 067-241
SG 242 - SL 202 SG 242, SG 292, SL 202		1NB 003 367-137	36	H3 fog light (E1) 8345 1x24V70W (H3) 8GH 002 090-251
NG 242 - SÜ 240 NG 242, NG 272, NL 202, NM 152, SG 242, SG 292 SL 200, SL 202, SÜ 240	07/82->	2SD 003 167-531 2SD 003 167-541 9EL 147 747-001 9GD 087 883-355	1 1 1 10	Combination rearlight, left Combination rearlight, right (E1) 264 Spare Parts: Lens with screws Seal 1x24V10W (R10W) 8GA 002 071-251 2x24V21W (P21W) 8GA 002 073-241
NG 242 - SL 202 NG 242, NG 272 SG 242, SG 292, SL 202	09/91->	2KA 003 010-007	1	Licence plate light (E1) 12809 2x24V5W (R5W) 8GA 002 071-241














MAN



Manufacturer Model	Model year	Part no.	Pk.	Note
MAN				
NG 242 - SÜ 240 SG 242 - SL 202 SG 242, SG 292 SL 202	02/86->	2KA 003 389-081 9BG 121 587-031	1 2	Licence plate light Spare Parts: Body/lens with screw 1x24V10W (R10W) 8GA 002 071-251
				
ÜL 242, ÜL 292, Bus VÖV ÜL 242, ÜL 292 Bus VÖV		1NB 003 367-137	36	H3 fog light E1 8345 1x24V70W (H3) 8GH 002 090-251
				
ÜL 313/353 ÜL 313/353		1FE 005 478-011 1FE 005 478-021	1 1	H1 spotlight unit, left H1 spotlight unit, right E1 44408 E1 34517 1x24V70W (H1) 8GH 002 089-251
				
ÜL 313/353		1NL 004 840-081	1	DE-H3 fog light E1 18212 1x24V70W (H3) 8GH 002 090-251
				
ÜL 313/353		2BA 005 603-001	1	Indicator light, for front mounting E1 42748 1x24V21W (P21W) 8GA 002 073-241
				












Manufacturer Model	Model year	Part no.	Pk.	Note
MAN				
ÜL 313/353 ÜL 313/353 		2KA 001 388-051	1	Licence plate light (E1) 22902  1x24V5W (C5W) 8GM 002 092-241
8.103 - 12.225 (L 2000) 8.103 - 12.225 (L 2000-series) 10/93-> 		2BA 007 839-001	1	Indicator light (E12) 6101  1x24V21W (P21W) 8GA 002 073-241
8.103 - 12.225 (L 2000-series) 10/93-> 		2BM 006 692-011 2BM 006 692-021	1 1	Auxiliary indicator light, left Auxiliary indicator light, right (E1) 52621  1x24V21W (P21W) 8GA 002 073-241
8.103 - 12.225 (L 2000-series) 10/93->08/00 8.103, 8.113, 8.145, 8.150, 8.153, 8.163, 8.185, 8.220, 8.223, 8.224, 8.225 9.145, 9.153, 9.163, 9.185, 9.223, 9.224, 9.225 10.145, 10.150, 10.153, 10.163, 10.185, 10.220, 10.223, 10.224, 10.225 12.185, 12.225 		2VD 008 204-051 2VP 008 204-041 2VD 008 204-071 2VP 008 204-061 9EL 152 889-001	1 1 1 1 1	Combination rearlight, left, with licence plate, rear fog, reverse and clearance light, with reflex-reflector and centre plug Combination rearlight, left/right, with rear fog, reverse and clearance light, with reflex-reflector and centre plug Combination rearlight, left, with licence plate, rear fog, reverse, clearance light, side-marker light, with reflex-reflector, marker reflex-reflector and centre plug Combination rearlight, left/right, with rear fog, reverse, clearance light, side-marker light, with reflex-reflector, marker reflex-reflector and centre plug (E4) 3178 (E4) 4060 (E4) 9808 (E4) 9810 Spare Parts: 1 Lens with screws  3x24V5W (R5W) 8GA 002 071-241  4x24V21W (P21W) 8GA 002 073-241
8.103 - 12.225 (L 2000-series) 10/03-> 		2XS 005 020-041 9EL 132 215-011	10 2	Clearance light (red) (E1) 31407 Spare Parts: 2 Body/lens with screws  1x24V4W (T4W) 8GP 002 067-241







MAN











Manufacturer Model	Model year	Part no.	Pk.	Note
MAN				
7.150 - 12.240 (TGL) 7.150 - 12.240 (TGL)	04/05->	 2KA 003 389-081 9BG 121 587-031	1 2	Licence plate light (E1) 22819 Spare Parts: Body/lens with screw  1x24V10W (R10W) 8GA 002 071-251
7.150 - 12.240 (TGL)	04/05->	 2XS 005 020-041 9EL 132 215-011	10 2	Clearance light (red) (E1) 31407 Spare Parts: Body/lens with screws  1x24V4W (T4W) 8GP 002 067-241
10.136 F (G) 10.136 F (G-series)	10/79->08/87	 1L8 003 060-561 9GH 116 966-011 9FF 126 444-001 1L8 003 060-691 9GH 116 966-011 9FF 126 444-001	1 10 10 1 10 10	Headlight (E1) 7097 Spare Parts: Cap Bulb socket for side light  1x24V55/50W (R2) 8GD 002 088-251  1x24V4W (T4W) 8GP 002 067-241 H4 headlight (E1) 7144 Spare Parts: Cap Bulb socket for side light (to be ordered separately)  1x24V75/70W (H4) 8GJ 002 525-251  1x24V4W (T4W) 8GP 002 067-241




Manufacturer Model	Model year	Part no.	Pk.	Note
MAN				
10.136 F, 10.150 F (G, G 90) 10.136 F, 10.150 F (G, G 90-series) Large local authority road vehicles	10/79->09/93	1G4 004 480-001 1G4 129 089-011 9XD 130 261-001	1 2 5	H3 worklight Spare Parts: Light unit Bracket  1x24V70W (H3) 8GH 002 090-251
10.136 F, 10.150 F (G, G 90-series) 10.136 F 10.150 F	10/79->91 10/79->08/87 09/87->91	9BG 130 945-001 9BG 130 946-001 9EL 122 689-051 9EL 122 689-021 9GP 003 995-801	2 2 2 2 1	Combination rearlight available as separate parts only as follows (modular system). Body with central plug, left Body with central plug, right (The existing licence plate window in the body should be closed if not required with cover 9HB 126 601-001) Suitable lenses: Lens for rear, reflex-reflector, stop, indicator and reverse light Lens for rear, reflex-reflector, stop, indicator, reverse-rear fog light Vibration damper set (to be ordered and delivered separately) (E4) 377 (E4) 397 (E4) 421 (E4) 3880 (E4) 23215  1x24V10W (R10W) 8GA 002 071-251  4x24V21W (P21W) 8GA 002 073-241
11.136 - 38.320 11.136 - 38.320 for forward-control vehicles	09/69->	2PF 001 647-031	4	Side light (E1) 11780  1x24V10W (R10W) 8GA 002 071-251

**MAN**

Manufacturer Model	Model year	Part no.	Pk.	Note
MAN				
11.136 - 38.320		2SE 001 699-071	1	Combination rearlight, left, with licence plate light
11.136 - 38.320	09/69->	2SD 001 699-061	1	Combination rearlight, right, without licence plate light
11.136, 13.136, 13.168, 14.168, 14.192, 15.168, 15.192, 15.240, 16.168, 16.192, 16.240, 19.192, 19.240, 19.280, 19.320, 22.240, 22.280, 22.320, 26.240, 26.280, 26.320, 30.240, 32.320, 38.320		9EL 109 139-001 9GT 074 132-001	2 10	(E1) 196 (E1) 43332 Spare Parts: Lens with screws Grommet  1x24V10W (R10W) 8GA 002 071-251  2x24V21W (P21W) 8GA 002 073-241
				
12.163 - 18.285 (M 2000 L)		2BA 007 839-001	1	Indicator light
12.163 - 18.285 (M 2000 L-series) with compact cab	08/95->			(E12) 6101  1x24V21W (P21W) 8GA 002 073-241
				
12.163 - 18.284 (M 2000 L-series)		2VD 008 204-051	1	Combination rearlight, left, with licence plate, rear fog, reverse and clearance light, with reflex-reflector and centre plug
12.163, 12.224	08/95->	2VP 008 204-041	1	Combination rearlight, left/right, with rear fog, reverse and clearance light, with reflex-reflector and centre plug
14.163, 14.224, 14.264, 14.284		2VD 008 204-071	1	Combination rearlight, left, with licence plate, rear fog, reverse, clearance light, side-marker light, with reflex-reflector, marker reflex-reflector and centre plug
15.163, 15.224, 15.264, 15.284		2VP 008 204-061	1	Combination rearlight, left/right, with rear fog, reverse, clearance light, side-marker light, with reflex-reflector, marker reflex-reflector and centre plug
18.224, 18.264, 18.284		9EL 152 889-001	1	(E4) 3178 (E4) 4060 (E4) 9808 (E4) 9810 Spare Parts: Lens with screws  3x24V5W (R5W) 8GA 002 071-241  4x24V21W (P21W) 8GA 002 073-241
				



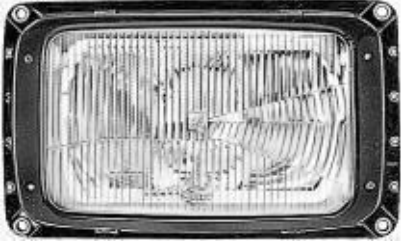




Manufacturer Model	Model year	Part no.	Pk.	Note
MAN				
14.224 - 25.264 (M 2000 M)		2VD 008 204-051	1	Combination rearlight, left, with licence plate, rear fog, reverse and clearance light, with reflex-reflector and centre plug
14.224 - 25.264 (M 2000-series)	08/95->	2VP 008 204-041	1	Combination rearlight, left/right, with rear fog, reverse and clearance light, with reflex-reflector and centre plug
14.224, 14.264, 14.284		2VD 008 204-071	1	Combination rearlight, left, with licence plate, rear fog, reverse, clearance light, side-marker light, with reflex-reflector, marker reflex-reflector and centre plug
18.224, 18.264, 18.284		2VP 008 204-061	1	Combination rearlight, left/right, with rear fog, reverse, clearance light, side-marker light, with reflex-reflector, marker reflex-reflector and centre plug
25.224, 25.264				(E4) 3178 (E4) 4060 (E4) 9808 (E4) 9810
		9EL 152 889-001	1	Spare Parts: Lens with screws 3x24V5W (R5W) 8GA 002 071-241 4x24V21W (P21W) 8GA 002 073-241



MAN



Manufacturer Model	Model year	Part no.	Pk.	Note
MAN				
12.136 - 48.321 (F8, F9)		1LG 003 434-237	1	H4 headlight, suitable for headlight leveller
12.136 - 48.321 (F8, F9-series)				E1 17016
12.136, 12.170, 12.192				Spare Parts:
14.170, 14.192, 14.220		9ES 122 221-007	7	Lens
15.168, 15.192, 15.220, 15.240		9HD 121 297-035	70	Cap
16.136, 16.168, 16.170, 16.192, 16.220, 16.240				 1x24V75/70W (H4) 8GJ 002 525-251
17.136, 17.170, 17.192, 17.220, 17.240				 1x24V4W (T4W) 8GP 002 067-241
19.240, 19.281, 19.291, 19.321, 19.331, 19.361				
20.281, 20.321, 20.361				
22.192, 22.220, 22.240, 22.281, 22.291, 22.321, 22.331, 22.361				
26.240, 26.281, 26.291, 26.321, 26.331, 26.361, 26.365				
30.281, 30.291, 30.321, 30.331				
32.240, 32.281, 32.291, 32.321, 32.331, 32.361, 32.365				
40.440, 40.365, 40.400				
48.321				
				
12.136 - 48.321 (F8, F9-series)		9DF 112 246-001	1	H3 fog light, spare parts available only
				E4 914
				Spare Parts: Reflector with lens
				 1x24V70W (H3) 8GH 002 090-251



Manufacturer Model	Model year	Part no.	Pk.	Note
MAN				
12.136 - 48.321 (F8, F9)		2VP 003 567-111	1	Combination rearlight, left, with reverse and rear fog light
12.136 - 48.321 (F8, F9-series)	->12/83	2VP 003 567-121	1	Combination rearlight, right, with reverse and rear fog light
12.136, 12.170, 12.192				(E4) 377 (E4) 397 (E4) 421
14.170, 14.192, 14.220				(E4) 3880 (E4) 23215
15.168, 15.192, 15.220, 15.240		9EL 122 689-021	2	Spare Parts: Lens with screws
16.136, 16.168, 16.170, 16.192, 16.220, 16.240		9GT 074 132-001	10	Grommet (to be ordered separately)
17.136, 17.170, 17.192, 17.220, 17.240		9GP 003 995-801	1	Vibration damper set (to be ordered separately)
19.240, 19.281, 19.291, 19.321, 19.331, 19.361				1x24V10W (R10W) 8GA 002 071-251 4x24V21W (P21W) 8GA 002 073-241
20.281, 20.321, 20.361				
22.192, 22.220, 22.240, 22.281, 22.291, 22.321, 22.331, 22.361				
26.240, 26.281, 26.291, 26.321, 26.331, 26.361, 26.365				
30.281, 30.291, 30.321, 30.331				
32.240, 32.281, 32.291, 32.321, 32.331, 32.361, 32.365				
40.365, 40.400, 48.321				
48.321				





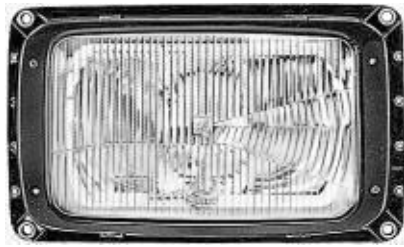
MAN












Manufacturer Model	Model year	Part no.	Pk.	Note
MAN				
12.136 - 48.321 (F8, F9)	01/84->	9BG 130 945-001 9BG 130 946-001	2 2	Combination rearlight available as separate parts only as follows (modular system).
12.136 - 48.321 (F8, F9-series)				2 Body with central plug, left 2 Body with central plug, right (The existing licence plate window in the body should be closed if not required with cover 9HB 126 601-001)
12.136, 12.170, 12.192				
14.170, 14.192, 14.220				
15.168, 15.192, 15.220, 15.240				Suitable lenses:
16.136, 16.168, 16.170, 16.192, 16.220, 16.240		9EL 122 689-051	2	2 Lens for rear, reflex-reflector, stop, indicator and reverse light
17.136, 17.170, 17.192, 17.220, 17.240		9EL 122 689-021	2	2 Lens for rear, reflex-reflector, stop, indicator, reverse-rear fog light
19.240, 19.281, 19.291, 19.321, 19.331, 19.361		9GP 003 995-801	1	1 Vibration damper set (to be ordered and delivered separately)
20.281, 20.321, 20.361				(E4) 377 (E4) 397 (E4) 421
22.192, 22.220, 22.240, 22.281, 22.291, 22.321, 22.331, 22.361				(E4) 3880 (E4) 23215
26.240, 26.281, 26.291, 26.321, 26.331, 26.361, 26.365				1x24V10W (R10W) 8GA 002 071-251 4x24V21W (P21W) 8GA 002 073-241
30.281, 30.291, 30.321, 30.331				
32.240, 32.281, 32.291, 32.321, 32.331, 32.361, 32.365				
40.365, 40.400, 48.321				
48.321				
12.136 - 48.321 (F8, F9-series)		2KA 003 389-081	1	Licence plate light
				(E1) 22819
		9BG 121 587-031	2	Spare Parts: Body/lens with screw
				1x24V10W (R10W) 8GA 002 071-251



Manufacturer Model	Model year	Part no.	Pk.	Note
MAN				
12.192 - 24.272 (M 90) 12.192 - 24.272 (M 90-series) 12.192, 12.222, 12.232, 12.262, 12.272 14.152, 14.162, 14.192, 14.222, 14.232, 14.262, 14.272 17.192, 17.232, 17.272 18.192, 18.222, 18.232, 18.262, 18.272 24.192, 24.222, 24.232, 24.262, 24.272	08/88->12/98	1LG 003 434-237 9ES 122 221-007 9HD 121 297-035	1 7 70	H4 headlight, suitable for headlight leveller (E1) 17016 Spare Parts: Lens Cap 1x24V75/70W (H4) 8GJ 002 525-251 1x24V4W (T4W) 8GP 002 067-241
12.192 - 24.272 (M 90-series) Large local authority road vehicles	08/88->	1G4 004 480-001 1G4 129 089-011 9XD 130 261-001	1 2 5	H3 worklight Spare Parts: Light unit Bracket 1x24V70W (H3) 8GH 002 090-251
12.192 - 24.272 (M 90-series)	08/88->09/90	9AG 129 328-001 9DF 112 246-001	7 1	H3 fog light, spare parts available only (E4) 914 Spare Parts: Lens-retaining rim Reflector with lens 1x24V70W (H3) 8GH 002 090-251



**MAN**

Manufacturer Model	Model year	Part no.	Pk.	Note
MAN				
12.192 - 24.272 (M 90) 12.192 - 24.272 (M 90-series)	10/90->04/93	1NE 006 300-051 1NE 138 555-011 9AG 138 131-011	1 1 5	H3 fog light (E1) 18231 Spare Parts: Light unit Lens-retaining rim  1x24V70W (H3) 8GH 002 090-251
				
12.192 - 24.272 (M 90-series)	05/93->12/98	1NE 006 300-231 1NE 138 555-011 9AG 138 131-011	1 1 5	H3 fog light (E1) 18231 Spare Parts: Light unit Lens-retaining rim  1x24V70W (H3) 8GH 002 090-251
				
12.192 - 24.272 (M 90-series)	08/88->12/98	2BA 007 840-001	1	Indicator light (E12) 6069  1x24V21W (P21W) 8GA 002 073-241
				
12.192 - 24.272 (M 90-series) 12.192, 12.222, 12.232, 12.262, 12.272 14.152, 14.162, 14.192, 14.222, 14.232, 14.262, 14.272 17.192, 17.232, 17.272 18.192, 18.222, 18.232, 18.262, 18.272 24.192, 24.232, 24.272 24.262, 24.272	08/88->91	9BG 130 945-001 9BG 130 946-001 9EL 122 689-051 9EL 122 689-021 9GP 003 995-801	2 2 2 2 1	Combination rearlight available as separate parts only as follows (modular system). Body with central plug, left Body with central plug, right (The existing licence plate window in the body should be closed if not required with cover 9HB 126 601-001) Suitable lenses: Lens for rear, reflex-reflector, stop, indicator and reverse light Lens for rear, reflex-reflector, stop, indicator, reverse-rear fog light Vibration damper set (to be ordered and delivered separately) (E4) 377 (E4) 397 (E4) 421 (E4) 3880 (E4) 23215  1x24V10W (R10W) 8GA 002 071-251  4x24V21W (P21W) 8GA 002 073-241
				



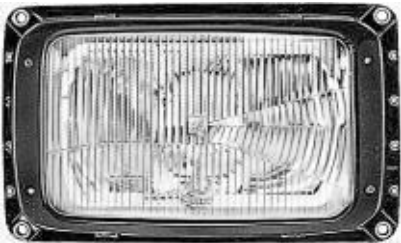


Manufacturer Model	Model year	Part no.	Pk.	Note
MAN				
12.192 - 24.272 (M 90)		2KA 003 389-081	1	Licence plate light
12.192 - 24.272 (M 90-series)	08/88->91			(E1) 22819
		9BG 121 587-031	2	Spare Parts: Body/lens with screw 1x24V10W (R10W) 8GA 002 071-251
12.192 - 24.272 (M 90-series)	08/88->12/98	2XS 005 020-041	10	Clearance light (red)
				(E1) 31407
		9EL 132 215-011	2	Spare Parts: Body/lens with screws 1x24V4W (T4W) 8GP 002 067-241







MAN



Manufacturer Model	Model year	Part no.	Pk.	Note
MAN				
19.242 - 48.462 (F 90)		1LG 003 434-237	1	H4 headlight, suitable for headlight leveller
19.242 - 48.462 (F 90-series)	06/86->			(E1) 17016
19.242, 19.262, 19.272, 19.292, 19.322, 19.332, 19.342, 19.362, 19.372, 19.402, 19.422, 19.462, 19.502		9ES 122 221-007 9HD 121 297-035	7 70	Spare Parts: Lens Cap
24.242, 24.262, 24.272, 24.292, 24.302, 24.322, 24.332, 24.342, 24.362, 24.372, 24.402, 24.422, 24.462, 24.502				 1x24V75/70W (H4) 8GJ 002 525-251
25.272, 25.302, 25.322, 25.372, 25.422, 25.502				 1x24V4W (T4W) 8GP 002 067-241
26.242, 26.262, 26.272, 26.292, 26.302, 26.322, 26.332, 26.342, 26.362, 26.372, 26.402, 26.422, 26.462, 26.502				
32.262, 32.272, 32.292, 32.302, 32.322, 32.332, 32.342, 32.362, 32.372, 32.402, 32.422				
33.242, 33.262, 33.272, 33.292, 33.322, 33.332, 33.342, 33.362, 33.372, 33.402, 33.422, 33.462, 33.502				
35.262, 35.272, 35.292, 35.302, 35.322, 35.332, 35.342, 35.362, 35.372, 35.402, 35.422				
40.372, 40.402, 40.422, 40.462, 40.502				
41.262, 41.272, 41.292, 41.322, 41.332, 41.342, 41.362, 41.372, 41.402, 41.422				
48.292, 48.332, 48.362, 48.462				
				





Manufacturer Model	Model year	Part no.	Pk.	Note
MAN				
19.242 - 48.462 (F 90) 19.242 - 48.462 (F 90-series) Large local authority road vehicles	06/86->	1G4 004 480-001 1G4 129 089-011 9XD 130 261-001	1 2 5	H3 worklight Spare Parts: Light unit Bracket  1x24V70W (H3) 8GH 002 090-251
19.242 - 48.462 (F 90-series)	06/86->06/88	9DF 112 246-001	1	H3 fog light, spare parts available only (E4) 914 Spare Parts: Reflector with lens  1x24V70W (H3) 8GH 002 090-251
19.242 - 48.462 (F 90-series)	07/88->09/90	9AG 129 328-001 9DF 112 246-001	7 1	H3 fog light, spare parts available only (E4) 914 Spare Parts: Lens-retaining rim Reflector with lens  1x24V70W (H3) 8GH 002 090-251
19.242 - 48.462 (F 90-series)	10/90->04/93	1NE 006 300-051 1NE 138 555-011 9AG 138 131-011	1 1 5	H3 fog light (E1) 18231 Spare Parts: Light unit Lens-retaining rim  1x24V70W (H3) 8GH 002 090-251





MAN






Manufacturer Model	Model year	Part no.	Pk.	Note
MAN				
19.242 - 48.462 (F 90) 19.242 - 48.462 (F 90-series)	05/93->12/97	1NE 006 300-231 1NE 138 555-011 9AG 138 131-011	1 1 5	H3 fog light (E1) 18231 Spare Parts: Light unit Lens-retaining rim  1x24V70W (H3) 8GH 002 090-251
19.242 - 48.462 (F 90-series)	06/86->12/97	2BA 007 840-001	1	Indicator light (E12) 6069  1x24V21W (P21W) 8GA 002 073-241



Manufacturer Model	Model year	Part no.	Pk.	Note
MAN				
19.242 - 48.462 (F 90)				Combination rearlight available as separate parts only as follows (modular system).
19.242 - 48.462 (F 90-series)	06/86->91	9BG 130 945-001	2	Body with central plug, left
19.242, 19.262, 19.272, 19.292, 19.322, 19.332, 19.342, 19.362, 19.372, 19.402, 19.422, 19.462, 19.502		9BG 130 946-001	2	Body with central plug, right (The existing licence plate window in the body should be closed if not required with cover 9HB 126 601-001)
24.242, 24.262, 24.272, 24.292, 24.302, 24.322, 24.332, 24.342, 24.362, 24.372, 24.402, 24.422, 24.462, 24.502		9EL 122 689-051	2	Suitable lenses: Lens for rear, reflex-reflector, stop, indicator and reverse light
25.272, 25.302, 25.322, 25.372, 25.422, 25.502		9EL 122 689-021	2	Lens for rear, reflex-reflector, stop, indicator, reverse-rear fog light
26.242, 26.262, 26.272, 26.292, 26.302, 26.322, 26.332, 26.342, 26.362, 26.372, 26.402, 26.422, 26.462, 26.502		9GP 003 995-801	1	Vibration damper set (to be ordered and delivered separately) Ⓔ4 377 Ⓔ4 397 Ⓔ4 421 Ⓔ4 3880 Ⓔ4 23215 1x24V10W (R10W) 8GA 002 071-251 4x24V21W (P21W) 8GA 002 073-241
32.262, 32.272, 32.292, 32.302, 32.322, 32.332, 32.342, 32.362, 32.372, 32.402, 32.422				
33.242, 33.262, 33.272, 33.292, 33.322, 33.332, 33.342, 33.362, 33.372, 33.402, 33.422, 33.462, 33.502				
35.262, 35.272, 35.292, 35.302, 35.322, 35.332, 35.342, 35.362, 35.372, 35.402, 35.422				
40.372, 40.402, 40.422, 40.462, 40.502				
41.262, 41.272, 41.292, 41.322, 41.332, 41.342, 41.362, 41.372, 41.402, 41.422				
48.292, 48.332, 48.362, 48.462				
				
19.242 - 48.462 (F 90-series)	06/86->91	2KA 003 389-081	1	Licence plate light Ⓔ1 22819
		9BG 121 587-031	2	Spare Parts: Body/lens with screw 1x24V10W (R10W) 8GA 002 071-251

**MAN**

Manufacturer Model	Model year	Part no.	Pk.	Note
MAN				
19.242 - 48.462 (F 90) 19.242 - 48.462 (F 90-series)	06/86->12/97	2XS 005 020-041 9EL 132 215-011	10 2	Clearance light (red) E1 31407 Spare Parts: Body/lens with screws P 1x24V4W (T4W) 8GP 002 067-241
				
19.233 - 41.463 (F 2000) 19.233 - 41.463 (F 2000-series) 19.233, 19.273, 19.293, 19.314, 19.323, 19.343, 19.364, 19.373, 19.403, 19.414, 19.423, 19.463, 19.464, 19.603 23.293, 23.343, 23.403, 23.463 24.273, 24.293, 24.323, 24.343, 24.373, 24.403, 24.423, 24.463 26.233, 26.273, 26.293, 26.323, 26.343, 26.373, 26.403, 26.423, 26.463, 26.603 27.273, 27.293, 27.323, 27.343, 27.373, 27.403, 27.423, 27.463, 27.603 32.293, 32.343, 32.403, 32.463 33.323, 33.343, 33.373, 33.403, 33.423, 33.463, 33.603 35.343, 35.403, 35.463 41.343, 41.403, 41.463	01/94->	2VD 008 204-051 2VP 008 204-041 2VD 008 204-071 2VP 008 204-061 9EL 152 889-001	1 1 1 1	Combination rearlight, left, with licence plate, rear fog, reverse and clearance light, with reflex-reflector and centre plug Combination rearlight, left/right, with rear fog, reverse and clearance light, with reflex-reflector and centre plug Combination rearlight, left, with licence plate, rear fog, reverse, clearance light, side-marker light, with reflex-reflector, marker reflex-reflector and centre plug Combination rearlight, left/right, with rear fog, reverse, clearance light, side-marker light, with reflex-reflector, marker reflex-reflector and centre plug E4 3178 E4 4060 E4 9808 E4 9810 Spare Parts: Lens with screws P 3x24V5W (R5W) 8GA 002 071-241 4x24V21W (P21W) 8GA 002 073-241
				
19.233 - 41.463 (F 2000)	01/94->	2KA 003 389-081 9BG 121 587-031	1 2	Licence plate light E1 22819 Spare Parts: Body/lens with screw P 1x24V10W (R10W) 8GA 002 071-251
				





Manufacturer Model	Model year	Part no.	Pk.	Note
MAN				
19.233 - 41.463 (F 2000)	01/94->	2XS 005 020-041	10	Clearance light (red)
19.233 - 41.463 (F 2000)		9EL 132 215-011	2	(E1) 31407 Spare Parts: Body/lens with screws (P) 1x24V4W (T4W) 8GP 002 067-241



MAN






Manufacturer Model	Model year	Part no.	Pk.	Note
MAN				
18.310 - 41.660 (TGA)		2VD 008 204-251	1	Combination rearlight, left, with licence plate, rear fog, reverse, clearance light, side-marker light, with reflex-reflector and marker reflex-reflector Combination rearlight, left/right, with rear fog, reverse, clearance light, side-marker light, with reflex-reflector and marker reflex-reflector (E4) 3178 (E4) 4060 (E4) 9808 (E4) 9810
18.310 - 41.660 (TGA)	04/00->05/05	2VP 008 204-241	1	
18.310, 18.320, 18.350, 18.360, 18.390, 18.400, 18.410, 18.430, 18.440, 18.460, 18.480, 18.510, 18.530				Spare Parts: Lens with screws  3x24V5W (R5W) 8GA 002 071-241  4x24V21W (P21W) 8GA 002 073-241
19.360, 19.410, 19.460, 19.480		9EL 152 889-001	1	
24.350, 24.360, 24.390, 24.400, 24.410, 24.430, 24.440, 24.460, 24.480, 24.510, 24.530				
26.280, 26.310, 26.320, 26.330, 26.350, 26.360, 26.390, 26.400, 26.410, 26.430, 26.440, 26.460, 26.480, 26.510, 26.530				
28.310, 28.350, 28.360, 28.390, 28.400, 28.410, 28.430, 28.440, 28.460, 28.480, 28.510, 28.530				
32.310, 32.350, 32.360, 32.390, 32.400, 32.410, 32.430, 32.440, 32.460, 32.480				
33.350, 33.360, 33.390, 33.400, 33.410, 33.430, 33.440, 33.460, 33.480, 33.510, 33.530				
35.310, 35.320, 35.350, 35.360, 35.390, 35.400, 35.410, 35.430, 35.440, 35.460, 35.480, 35.530				
37.310, 37.320, 37.350, 37.360, 37.390, 37.400, 37.430, 37.440				
40.390, 40.410, 40.460, 40.480				
41.350, 41.360, 41.390, 41.400, 41.410, 41.430, 41.440, 41.460, 41.530, 41.660				











Manufacturer Model	Model year	Part no.	Pk.	Note
MAN				
18.310 - 41.660 (TGA) 18.310 - 41.660 (TGA)	04/00->	2KA 003 389-081 9BG 121 587-031	1 2	Licence plate light 22819 Spare Parts: Body/lens with screw 1x24V10W (R10W) 8GA 002 071-251
MAN/VW				
6.90 F - 9.136 F 6.90 F - 9.136 F Cooperation programme 6.90 F, 8.90 F, 8.136 F, 9.136 F	10/79->08/87	1L8 003 060-561 9GH 116 966-011 9FF 126 444-001 1L8 003 060-691 9GH 116 966-011 9FF 126 444-001	1 10 10 1 10 10	Headlight 7097 Spare Parts: Cap Bulb socket for side light 1x24V55/50W (R2) 8GD 002 088-251 1x24V4W (T4W) 8GP 002 067-241 H4 headlight 7144 Spare Parts: Cap Bulb socket for side light (to be ordered separately) 1x24V75/70W (H4) 8GJ 002 525-251 1x24V4W (T4W) 8GP 002 067-241
6.90 F - 9.150 F 6.90 F - 9.150 F Cooperation programme Large local authority road vehicles	10/79->09/93	1G4 004 480-001 1G4 129 089-011 9XD 130 261-001	1 2 5	H3 worklight Spare Parts: Light unit Bracket 1x24V70W (H3) 8GH 002 090-251



Manufacturer Model	Model year	Part no.	Pk.	Note
MAN/VW				
6.90 F - 9.150 F				Combination rearlight available as separate parts only as follows (modular system).
6.90 F - 9.150 F Cooperation programme	10/79->91	9BG 130 945-001	2	Body with central plug, left
6.90 F, 8.90 F, 8.136 F, 9.136 F	10/79->08/87	9BG 130 946-001	2	Body with central plug, right (The existing licence plate window in the body should be closed if not required with cover 9HB 126 601-001)
6.100 F, 8.100 F, 8.150 F, 9.150 F	09/87->91			Suitable lenses:
		9EL 122 689-051	2	Lens for rear, reflex-reflector, stop, indicator and reverse light
		9EL 122 689-021	2	Lens for rear, reflex-reflector, stop, indicator, reverse-rear fog light
		9GP 003 995-801	1	Vibration damper set (to be ordered and delivered separately)
				(E4) 377 (E4) 397 (E4) 421 (E4) 3880 (E4) 23215 1x24V10W (R10W) 8GA 002 071-251 4x24V21W (P21W) 8GA 002 073-241
Mercedes-Benz				
Actros				
Actros 1831 - 4148	09/96->10/02	2BM 006 692-011 2BM 006 692-021	1 1	Auxiliary indicator light, left Auxiliary indicator light, right
				(E1) 52621
				1x24V21W (P21W) 8GA 002 073-241
Actros 1831 - 4148	09/96->10/02	2VD 007 500-411	1	Combination rearlight, left, with licence plate, rear fog, reverse, clearance light, side-marker light, with reflex-reflector and marker reflex-reflector, with bulbs and centre plug
1831, 1835, 1840, 1843, 1848, 1853, 1857				Combination rearlight, right, with licence plate, rear fog, reverse, clearance light, side-marker light, with reflex-reflector and marker reflex-reflector, with bulbs and centre plug, spare parts available only
2031, 2035, 2040, 2043, 2048, 2053				Combination rearlight, left, with reverse, clearance light, side-marker light, with reflex-reflector and marker reflex-reflector, with bulbs and centre plug, spare parts available only
2531, 2535, 2540, 2543, 2548, 2553, 2557				
2631, 2635, 2640, 2643, 2648, 2653, 2657				
3231, 3235, 3240, 3243				
3331, 3335, 3340, 3343, 3346, 3348, 3353, 3357				
4140, 4143, 4148		2VP 007 500-421	1	Combination rearlight, right, with reverse, clearance light, side-marker light, with reflex-reflector and marker reflex-reflector, with bulbs and centre plug
				(E1) 31432 (E1) 63217
				(E1) 280
				Spare Parts:
			9EL 134 296-041	1
		9EL 134 296-051	1	Lens with screws, right
		9EL 134 301-001	1	Lens for licence plate light
		9EL 146 838-001	2	Side-marker light with reflector
				3x24V10W (R10W) 8GA 002 071-251 4x24V21W (P21W) 8GA 002 073-241



Manufacturer Model	Model year	Part no.	Pk.	Note
Mercedes-Benz				
Actros				
Actros 1831 - 4148	09/96->10/02	2VB 004 887-011	1	Combination rearlight, left, with licence plate and rear fog light
1831, 1835, 1840, 1843, 1848, 1853, 1857		2VA 004 887-031	1	Combination rearlight, left, with rear fog light
2031, 2035, 2040, 2043, 2048, 2053		2VP 004 887-021	1	Combination rearlight, right, with reverse light
2531, 2535, 2540, 2543, 2548, 2553, 2557				(E1) 53384
2631, 2635, 2640, 2643, 2648, 2653, 2657		9EL 131 420-001	1	Lens with screws, left
3231, 3235, 3240, 3243		9EL 131 420-011	1	Lens with screws, right
3331, 3335, 3340, 3343, 3346, 3348, 3353, 3357		9GT 141 941-001	10	Grommet (to be ordered separately)
4140, 4143, 4148				1x24V10W (R10W) 8GA 002 071-251 3x24V21W (P21W) 8GA 002 073-241
various models				
				
Actros MP2/MP3				
Actros MP3 1832 - 4160	06/08->	1LH 009 513-051	1	H1/H7 headlight, left, with indicator light, without headlight leveller, with bulbs
1832, 1836, 1841, 1844, 1846, 1848, 1850, 1854, 1855, 1858, 1860		1LH 009 513-061	1	H1/H7 headlight, right, with indicator light, without headlight leveller, with bulbs
2032, 2036, 2041, 2044, 2046, 2048, 2050, 2051, 2055		1LH 009 513-071	1	H1/H7 headlight, left, with indicator light, with headlight leveller, with bulbs
2532, 2536, 2541, 2544, 2546, 2548, 2551, 2555, 2560		1LH 009 513-081	1	H1/H7 headlight, right, with indicator light, with headlight leveller, with bulbs
2632, 2636, 2641, 2644, 2646, 2648, 2650, 2651, 2654, 2655, 2658, 2660				 1x24V70W (H7) 8GH 007 157-201 Long Life  1x24V70W (H1) 8GH 002 089-251  1x24V5W (W5W) 8GP 003 594-251  1x24V21W (PY21W) 8GA 006 841-241
2732, 2736, 2741, 2744, 2746, 2748				
3232, 3236, 3241, 3244, 3246, 3248				
3331, 3332, 3336, 3341, 3344, 3346, 3348, 3350, 3351, 3354, 3355, 3360				
4140, 4141, 4144, 4146, 4148, 4151, 4160				
				











Manufacturer Model	Model year	Part no.	Pk.	Note
Mercedes-Benz				
Actros MP2/MP3				
Actros MP2/MP3 1832 - 4160	10/02->	2VD 007 500-411	1	Combination rearlight, left, with licence plate, rear fog, reverse, clearance light, side-marker light, with reflex-reflector and marker reflex-reflector, with bulbs and centre plug
1832, 1836, 1841, 1844, 1846, 1848, 1850, 1854, 1855, 1858, 1860				Combination rearlight, right, with licence plate, rear fog, reverse, clearance light, side-marker light, with reflex-reflector and marker reflex-reflector, with bulbs and centre plug, spare parts available only
2032, 2036, 2041, 2044, 2046, 2048, 2050, 2051, 2055				Combination rearlight, left, with reverse, clearance light, side-marker light, with reflex-reflector and marker reflex-reflector, with bulbs and centre plug, spare parts available only
2532, 2536, 2541, 2544, 2546, 2548, 2551, 2555, 2560		2VP 007 500-421	1	Combination rearlight, right, with reverse, clearance light, side-marker light, with reflex-reflector and marker reflex-reflector, with bulbs and centre plug
2632, 2636, 2641, 2644, 2646, 2648, 2650, 2651, 2654, 2655, 2658, 2660				E1 31432 E1 63217
2732, 2736, 2741, 2744, 2746, 2748				E1 280
3232, 3236, 3241, 3244, 3246, 3248		9EL 134 296-041	1	Spare Parts:
3331, 3332, 3336, 3341, 3344, 3346, 3348, 3350, 3351, 3354, 3355, 3360		9EL 134 296-051	1	Lens with screws, left
4140, 4141, 4144, 4146, 4148, 4151, 4160		9EL 134 301-001	1	Lens with screws, right
		9EL 146 838-001	1	Lens for licence plate light
			2	Side-marker light with reflector
				3x24V10W (R10W) 8GA 002 071-251 4x24V21W (P21W) 8GA 002 073-241









Manufacturer Model	Model year	Part no.	Pk.	Note
Mercedes-Benz				
Actros MP2/MP3		2VB 004 887-011	1	Combination rearlight, left, with licence plate and rear fog light
Actros MP2/MP3 1832 - 4160	10/02->	2VA 004 887-031	1	Combination rearlight, left, with rear fog light
1832, 1836, 1841, 1844, 1846, 1848, 1850, 1854, 1855, 1858, 1860		2VP 004 887-021	1	Combination rearlight, right, with reverse light
2032, 2036, 2041, 2044, 2046, 2048, 2050, 2051, 2055				(E1) 53384
2532, 2536, 2541, 2544, 2546, 2548, 2551, 2555, 2560		9EL 131 420-001	1	Lens with screws, left
2632, 2636, 2641, 2644, 2646, 2648, 2650, 2651, 2654, 2655, 2658, 2660		9EL 131 420-011	1	Lens with screws, right
2732, 2736, 2741, 2744, 2746, 2748		9GT 141 941-001	10	Grommet (to be ordered separately)
3232, 3236, 3241, 3244, 3246, 3248				1x24V10W (R10W) 8GA 002 071-251 3x24V21W (P21W) 8GA 002 073-241
3331, 3332, 3336, 3341, 3344, 3346, 3348, 3350, 3351, 3354, 3355, 3360				
4140, 4141, 4144, 4146, 4148, 4151, 4160				
various models				
Atego		2VD 008 204-091	1	Combination rearlight, left, with licence plate, rear fog, reverse, clearance light, side-marker light, with reflex-reflector, marker reflex-reflector and centre plug (middle)
Atego 712 - 1528	01/98->10/04	2VP 008 204-081	1	Combination rearlight, right, with reverse, clearance light, side-marker light, with reflex-reflector, marker reflex-reflector and centre plug (middle)
712, 714, 715, 717				(E4) 3179 (E4) 4060
812, 814, 815, 817, 823				(E4) 9809 (E4) 9810
917, 923, 925				
1017, 1023				
1214, 1215, 1217, 1223, 1225, 1228				
1317, 1323, 1325, 1328		9EL 152 891-001	1	Spare Parts: Lens with screws
1517, 1523, 1525, 1528				3x24V5W (R5W) 8GA 002 071-241 4x24V21W (P21W) 8GA 002 073-241













Manufacturer Model	Model year	Part no.	Pk.	Note
Mercedes-Benz				
Atego Atego 1823 - 2628 1823, 1828 2523, 2528 2628 except dump truck 	01/98->10/04	2VD 007 500-411	1	Combination rearlight, left, with licence plate, rear fog, reverse, clearance light, side-marker light, with reflex-reflector and marker reflex-reflector, with bulbs and centre plug Combination rearlight, right, with licence plate, rear fog, reverse, clearance light, side-marker light, with reflex-reflector and marker reflex-reflector, with bulbs and centre plug, spare parts available only Combination rearlight, left, with reverse, clearance light, side-marker light, with reflex-reflector and marker reflex-reflector, with bulbs and centre plug, spare parts available only
		2VP 007 500-421	1	Combination rearlight, right, with reverse, clearance light, side-marker light, with reflex-reflector and marker reflex-reflector, with bulbs and centre plug (E1) 31432 (E1) 63217 (E1) 280 Spare Parts: 1 Lens with screws, left 1 Lens with screws, right 1 Lens for licence plate light 2 Side-marker light with reflector  3x24V10W (R10W) 8GA 002 071-251  4x24V21W (P21W) 8GA 002 073-241
Atego 1823 - 2628 1823, 1828 2523, 2528 2628 Dump truck 	01/98->10/04	2VB 004 887-011	1	Combination rearlight, left, with licence plate and rear fog light
		2VA 004 887-031	1	Combination rearlight, left, with rear fog light
		2VP 004 887-021	1	Combination rearlight, right, with reverse light (E1) 53384 Spare Parts: 1 Lens with screws, left 1 Lens with screws, right 10 Grommet (to be ordered separately)  1x24V10W (R10W) 8GA 002 071-251  3x24V21W (P21W) 8GA 002 073-241
Atego II Atego II 712 - 1529 	10/04->	2BA 247 016-031 2BA 247 016-041	1 1	Indicator light, left Indicator light, right (E1) 1788  1x24V21W (PY21W) 8GA 006 841-241



Manufacturer Model	Model year	Part no.	Pk.	Note
Mercedes-Benz				
Axor		2VD 007 500-411	1	Combination rearlight, left, with licence plate, rear fog, reverse, clearance light, side-marker light, with reflex-reflector and marker reflex-reflector, with bulbs and centre plug
Axor 1823 - 3228	01/02->10/04			Combination rearlight, right, with licence plate, rear fog, reverse, clearance light, side-marker light, with reflex-reflector and marker reflex-reflector, with bulbs and centre plug, spare parts available only
1823, 1835, 1840, 1843				Combination rearlight, left, with reverse, clearance light, side-marker light, with reflex-reflector and marker reflex-reflector, with bulbs and centre plug, spare parts available only
2523, 2528, 2535, 2540, 2543		2VP 007 500-421	1	Combination rearlight, right, with reverse, clearance light, side-marker light, with reflex-reflector and marker reflex-reflector, with bulbs and centre plug
2623, 2628				Ⓔ 31432 Ⓔ 63217
3228				Ⓔ 280
		9EL 134 296-041	1	Spare Parts:
		9EL 134 296-051	1	Lens with screws, left
		9EL 134 301-001	1	Lens with screws, right
		9EL 146 838-001	2	Lens for licence plate light
				Side-marker light with reflector
				3x24V10W (R10W) 8GA 002 071-251 4x24V21W (P21W) 8GA 002 073-241
Axor II		1LB 247 011-051	1	H1/H7 headlight, left, without indicator light, without headlight leveller, without lens cleaning system, with bulbs
Axor II 1824 - 3343	10/04->	1LB 247 011-061	1	H1/H7 headlight, right, without indicator light, without headlight leveller, without lens cleaning system, with bulbs
1824, 1826, 1828, 1829, 1833, 1836, 1840, 1843				Ⓔ 1836 Ⓔ 1838
2436, 2440, 2443		9ES 247 753-001	1	Spare Parts:
2528, 2529, 2533, 2536, 2540, 2543		9ES 247 754-001	1	Cover lens, left
2628, 2629, 2633, 2636, 2640, 2643		9XD 247 755-001	1	Cover lens, right
3236, 3240, 3243		9XD 247 756-001	1	Base for indicator light, left
3335, 3340, 3343		8HG 247 376-011	1	Base for indicator light, right
		8HG 247 377-011	1	Base top
		9GH 156 191-001	1	Base bottom
			1	Cap
				 1x24V70W (H7) 8GH 007 157-241
				 1x24V70W (H1) 8GH 002 089-251
				 1x24V5W (W5W) 8GP 003 594-251
Axor II 1824 - 3343	10/04->	2BA 247 015-031	1	Indicator light, left, with bulb
		2BA 247 015-041	1	Indicator light, right, with bulb
				Ⓔ 1787
				 1x24V21W (PY21W) 8GA 006 841-241



Manufacturer Model	Model year	Part no.	Pk.	Note
Mercedes-Benz				
Axor II	10/04->	2VD 007 500-411	1	<p>Combination rearlight, left, with licence plate, rear fog, reverse, clearance light, side-marker light, with reflex-reflector and marker reflex-reflector, with bulbs and centre plug</p> <p>Combination rearlight, right, with licence plate, rear fog, reverse, clearance light, side-marker light, with reflex-reflector and marker reflex-reflector, with bulbs and centre plug, spare parts available only</p> <p>Combination rearlight, left, with reverse,clearance light, side-marker light, with reflex-reflector and marker reflex-reflector, with bulbs and centre plug, spare parts available only</p>
<p>Axor II 1824 - 3343</p> <p>1824,1826, 1828, 1829, 1833, 1836, 1840, 1843</p> <p>2436, 2440, 2443</p> <p>2528, 2529, 2533, 2536, 2540, 2543</p> <p>2628, 2629, 2633, 2636, 2640, 2643</p> <p>3236, 3240, 3243</p> <p>3335, 3340, 3343</p>		2VP 007 500-421	1	<p>Combination rearlight, right, with reverse, clearance light, side-marker light, with reflex-reflector and marker reflex-reflector, with bulbs and centre plug</p> <p>(E1) 31432 (E1) 63217</p> <p>(E1) 280</p> <p>Spare Parts:</p> <p>1 Lens with screws, left</p> <p>1 Lens with screws, right</p> <p>1 Lens for licence plate light</p> <p>2 Side-marker light with reflector</p> <p>3x24V10W (R10W) 8GA 002 071-251</p> <p>4x24V21W (P21W) 8GA 002 073-241</p>
		<p>9EL 134 296-041</p> <p>9EL 134 296-051</p> <p>9EL 134 301-001</p> <p>9EL 146 838-001</p>		
L 405 D - L 911 (T2/L)	08/81->12/88	<p>9ES 120 723-001</p> <p>9FH 113 447-011</p>	<p>2</p> <p>5</p>	<p>Headlight, spare parts available only</p> <p>(E1) 7165 left (E1) 7166 right</p> <p>Spare Parts:</p> <p>2 Lens, left</p> <p>5 Bulb holder</p> <p> 1x12V45/40W (R2) 8GD 002 088-131</p> <p> 1x24V55/50W (R2) 8GD 002 088-251</p> <p> 1x12V4W (T4W) 8GP 002 067-121</p> <p> 1x24V4W (T4W) 8GP 002 067-241</p> <p>H4 headlight, spare parts available only</p> <p>(E1) 17001 left (E1) 17002 right</p>
<p>L 407 D, L 409, L 410, L 508 D, L 608 D, L 613 D, L 911</p>		<p>9ES 120 725-001</p> <p>9ES 120 726-001</p> <p>9FH 113 447-011</p>	<p>2</p> <p>2</p> <p>5</p>	<p>Spare Parts:</p> <p>2 Lens, left</p> <p>2 Lens, right</p> <p>5 Bulb holder</p> <p> 1x12V60/55W (H4) 8GJ 002 525-131</p> <p> 1x24V75/70W (H4) 8GJ 002 525-251</p> <p> 1x12V4W (T4W) 8GP 002 067-121</p> <p> 1x24V4W (T4W) 8GP 002 067-241</p>
				










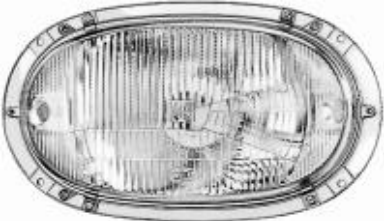


Manufacturer Model	Model year	Part no.	Pk.	Note
Mercedes-Benz				
L 405 D - L 911 (T2/L) L 405 D - L 911 (T2/L)	->03/83	2BA 001 275-011 2BA 001 275-021 9EL 101 899-001 9EL 101 900-001	2 2 5 5	Indicator light, left Indicator light, right Ⓔ 22764 Spare Parts: Lens, left Lens, right 1x12V21W (P21W) 8GA 002 073-121 1x24V21W (P21W) 8GA 002 073-241
L 405 D - L 911 (T2/L)	04/83->12/88	2BA 004 499-001	2	Indicator light Ⓔ 42679 1x12V21W (P21W) 8GA 002 073-121 1x24V21W (P21W) 8GA 002 073-241
L 405 D - L 911 (T2/L) L 405 D, L 406 D, L 407 D, L 408, L 409, L 410, L 508 D, L 608 D, L 613 D, L 911 Van	->06/77	2SD 001 680-271 2SD 001 680-281 9EL 107 368-001 9EL 111 647-001	1 1 2 2	Combination rearlight, left Combination rearlight, right Ⓔ 31482 Ⓔ 53335 Spare Parts: Lens with seal and screws, left Lens with seal and screws, right 1x12V10W (R10W) 8GA 002 071-131 2x12V21W (P21W) 8GA 002 073-121
L 405 D - L 911 (T2/L) L 405 D, L 406 D, L 407 D, L 408, L 409, L 410, L 508 D, L 608 D, L 613 D, L 911 Van	07/77->12/88	9EL 119 874-001	2	Combination rearlight, spare parts available only Ⓔ 53276 Spare Parts: Lens with screws 1x12V10W (R10W) 8GA 002 071-131 1x24V10W (R10W) 8GA 002 071-251 2x12V21W (P21W) 8GA 002 073-121 2x24V21W (P21W) 8GA 002 073-241















Manufacturer Model	Model year	Part no.	Pk.	Note
Mercedes-Benz				
L 405 D - L 911 (T2/L) L 405 D - L 911 (T2/L) L 405 D, L 406 D, L 407 D, L 408, L 409, L 410, L 508 D, L 608 D, L 613 D L 911 Flatbed	01/68->12/88	2SD 001 680-271	1	Combination rearlight, left, without licence plate light Combination rearlight, right, with licence plate light (E1) 31482 (E1) 43222 (E1) 53335 Spare Parts: 2 Lens with seal and screws, left 2 Lens with seal and screws, right 1x12V10W (R10W) 8GA 002 071-131 2x12V21W (P21W) 8GA 002 073-121
		2SE 001 680-301	1	
L 405 D - L 911 (T2/L) Flatbed	07/77->12/88	2NE 002 589-001	1	Rear fog light (E1) 8444 Spare Parts: 5 Lens with screws 1x12V21W (P21W) 8GA 002 073-121 1x24V21W (P21W) 8GA 002 073-241
		9EL 112 763-001	5	
L 405 D - L 911 (T2/L) Flatbed	07/77->12/88	2ZR 002 589-011	1	Reverse light (E1) 8725 Spare Parts: 2 Lens with screws 1x12V21W (P21W) 8GA 002 073-121 1x24V21W (P21W) 8GA 002 073-241
		9EL 112 858-011	2	
L 405 D - L 911 (T2/L) Van	01/68->12/88	2KA 001 378-041	4	Licence plate light (E1) 12958 1x12V5W (C5W) 8GM 002 092-121 1x24V5W (C5W) 8GM 002 092-241
L 405 D - L 911 (T2/L) Van	01/68->12/88	2KA 003 389-061	2	Licence plate light (E1) 22819 Spare Parts: 2 Body/lens with screw 1x12V10W (R10W) 8GA 002 071-131 1x24V10W (R10W) 8GA 002 071-251
		9BG 121 587-031	2	



Manufacturer Model	Model year	Part no.	Pk.	Note
Mercedes-Benz				
L 405 D - L 911 (T2/L) L 405 D - L 911 (T2/L) Van	01/68->12/88	2JA 001 357-002 2JA 001 357-012	6 6	Interior light with switch Interior light without switch 2x12V10W (K) 8GM 002 091-131 2x24V10W (-) 8GM 002 091-251
				
Cab-behind-engine vehicles 911 - 2624 Cab-behind-engine vehicles 911 - 1924		9ES 091 489-001 9DR 080 706-015	5 1	Headlight, spare parts available only Lens-retaining rim chrome-plated (E1) 7035 left (E1) 7034 right Spare Parts: Lens, left Reflector, left  1x12V45/40W (R2) 8GD 002 088-131  1x12V4W (T4W) 8GP 002 067-121
				
Cab-behind-engine vehicles 911 - 1924		9ES 091 489-001 9DR 080 706-015	5 1	Headlight, spare parts available only Lens-retaining rim and grille grey coloured (E1) 7035 left (E1) 7034 right Spare Parts: Lens, left Reflector, left  1x12V45/40W (R2) 8GD 002 088-131  1x12V4W (T4W) 8GP 002 067-121
				
Cab-behind-engine vehicles 2624		9ES 084 374-001 9GD 052 710-021 9DE 089 102-011 9FF 085 642-001	1 5 10 1 10	Headlight, spare parts available only (E1) 7004 Spare Parts: Lens Seal for lens Reflector Bulb socket for side light  1x12V45/40W (R2) 8GD 002 088-131  1x12V4W (T4W) 8GP 002 067-121
				
















Manufacturer Model	Model year	Part no.	Pk.	Note
Mercedes-Benz				
Cab-behind-engine vehicles 911 - 2624		2BA 001 234-251	2	Indicator light, left
		2BA 001 234-261	2	Indicator light, right
		9EL 109 440-002	5	(E1) 32633 Spare Parts: Body/lens with cap and screw  1x12V21W (P21W) 8GA 002 073-121
Cab-behind-engine vehicles 911 - 2624		2PF 001 638-011	2	Side light (clear) (E1) 11779 Spare Parts: Body/lens with screw  1x12V5W (R5W) 8GA 002 071-121
		2SA 001 638-021	2	Rear light (red) (E1) 31450 Spare Parts: Body/lens with screw  1x12V5W (W5W) 8GP 003 594-121
		9EL 107 443-061	2	Spare Parts: Body/lens with screw  1x12V5W (W5W) 8GP 003 594-121
		2PF 001 638-067	40	Side light (amber)  1x12V5W (R5W) 8GA 002 071-121
Cab-behind-engine vehicles 911 - 2624		2BA 001 259-618	108	Indicator light (amber) K 23267
		9EL 088 150-001	2	Spare Parts: Body/lens with screws  1x12V18W (K) 8GM 002 091-121
		2PF 001 259-631	2	Side light (clear) (E1) 21624 Spare Parts: Body/lens with screws
		9EL 109 208-011	2	Spare Parts: Body/lens with screws
		2PF 001 259-677 2PF 001 259-687 2SA 001 259-757	108 108 108	Side light (green) Side light (blue) Side light (red)  1x12V5W (C5W) 8GM 002 092-121
Cab-behind-engine vehicles 911 - 2624		2PF 001 647-031	4	Side light (E1) 11780  1x12V10W (R10W) 8GA 002 071-131






Manufacturer Model	Model year	Part no.	Pk.	Note
Mercedes-Benz				
Cab-behind-engine vehicles 911 - 2624 Cab-behind-engine vehicles 911 - 2624		2SE 001 685-201	1	Combination rearlight, left, with licence plate light
		2SD 001 685-211	1	Combination rearlight, right, without licence plate light
		9EL 113 324-001	2	(E12) 7146 Spare Parts: Lens with screws 1x12V5W (R5W) 8GA 002 071-121 2x12V21W (P21W) 8GA 002 073-121
Cab-behind-engine vehicles 911 - 2624		2SE 001 699-071	1	Combination rearlight, left, with licence plate light
		2SD 001 699-061	1	Combination rearlight, right, without licence plate light
		9EL 109 139-001 9GT 074 132-001	2 10	(E1) 196 (E1) 43332 Spare Parts: Lens with screws Grommet 1x12V10W (R10W) 8GA 002 071-131 2x12V21W (P21W) 8GA 002 073-121
Cab-behind-engine vehicles 911 - 2624		2SE 003 167-031	1	Combination rearlight, left, with licence plate light
		2SD 003 167-021	1	Combination rearlight, right, without licence plate light
		9EL 147 747-001 9GD 087 883-355	1 10	(E1) 264 Spare Parts: Lens with screws Seal 1x12V10W (R10W) 8GA 002 071-131 2x12V21W (P21W) 8GA 002 073-121
Cab-behind-engine vehicles 911 - 2624		2JA 001 357-002	6	Interior light with switch
		2JA 001 357-012	6	Interior light without switch
				2x12V10W (R10W) 8GA 002 071-131








Manufacturer Model	Model year	Part no.	Pk.	Note
Mercedes-Benz				
LP 608 - LP 1113 (LP) LP 709 - LP 1113 (LP) LP 608 LP 709 LP 808, LP 809, LP 813 LP 913 LP 1013 LP 1113	08/81->12/84	9ES 120 723-001 9FH 113 447-011 9ES 120 725-001 9ES 120 726-001 9FH 113 447-011	2 5 2 2 5	Headlight, spare parts available only (E1) 7165 left (E1) 7166 right Spare Parts: Lens, left Bulb holder  1x12V45/40W (R2) 8GD 002 088-131  1x24V55/50W (R2) 8GD 002 088-251  1x12V4W (T4W) 8GP 002 067-121  1x24V4W (T4W) 8GP 002 067-241 H4 headlight, spare parts available only (E1) 17001 left (E1) 17002 right Spare Parts: Lens, left Lens, right Bulb holder  1x12V60/55W (H4) 8GJ 002 525-131  1x24V75/70W (H4) 8GJ 002 525-251  1x12V4W (T4W) 8GP 002 067-121  1x24V4W (T4W) 8GP 002 067-241
LP 608 - LP 1013 (LP)	08/73->10/77	9EL 110 737-001 9EL 110 736-001	2 2	Indicator light, spare parts available only (E1) 32617 Spare Parts: Lens, left Lens, right  1x12V21W (P21W) 8GA 002 073-121
LP 709 - LP 1113 (LP)	11/77->12/84	2BA 003 411-001	1	Indicator light (E1) 32781  1x12V21W (P21W) 8GA 002 073-121  1x24V21W (P21W) 8GA 002 073-241
LP 608 - LP 1113 (LP)	10/69->12/84	9EL 132 403-001 9EL 132 404-001	2 2 2	Rear-side light, for side mounting (E1) 11553 (E1) 11554 (E1) 11786 (E1) 31416 Spare Parts: Lens (clear) with screw Lens (red) with screw  1x12V5W (C5W) 8GM 002 092-121  1x24V5W (C5W) 8GM 002 092-241









Manufacturer Model	Model year	Part no.	Pk.	Note
Mercedes-Benz				
LP 608 - LP 1113 (LP) LP 608 - LP 1013 (LP) LP 608 LP 709 LP 808, LP 809, LP 811, LP 813 LP 911, LP 913 LP 1013	10/69->10/77	2SE 001 685-201 2SD 001 685-211 9EL 113 324-001	1 1 2	Combination rearlight, left, with licence plate light Combination rearlight, right, without licence plate light (E12) 7146 Spare Parts: Lens with screws 1x12V5W (R5W) 8GA 002 071-121 2x12V21W (P21W) 8GA 002 073-121
				
LP 608 - LP 1013 (LP) LP 608 LP 709 LP 808, LP 809, LP 811, LP 813 LP 911, LP 913 LP 1013	10/69->10/77	2SE 001 699-071 2SD 001 699-061 9EL 109 139-001 9GT 074 132-001	1 1 2 10	Combination rearlight, left, with licence plate light Combination rearlight, right, without licence plate light (E1) 196 (E1) 43332 Spare Parts: Lens with screws Grommet 1x12V10W (R10W) 8GA 002 071-131 2x12V21W (P21W) 8GA 002 073-121
				
LP 608 - LP 1113 (LP) LP 608 LP 709 LP 808, LP 809, LP 813 LP 913 LP 1013 LP 1113	11/77->12/84	2SE 003 167-031 2SD 003 167-021 9EL 147 747-001 9GD 087 883-355	1 1 1 10	Combination rearlight, left, with licence plate light Combination rearlight, right, without licence plate light (E1) 264 Spare Parts: Lens with screws Seal 1x12V10W (R10W) 8GA 002 071-131 1x24V10W (R10W) 8GA 002 071-251 2x12V21W (P21W) 8GA 002 073-121 2x24V21W (P21W) 8GA 002 073-241
				








Manufacturer Model	Model year	Part no.	Pk.	Note
Mercedes-Benz				
LP 608 - LP 1113 (LP) LP 608 - LP 1113 (LP)	11/77->12/84	2NE 003 236-001 9EL 119 544-001 9DX 119 545-011	1 4 2	Rear fog light Ⓔ1 18 411 Spare Parts: Lens Reflector 1x12V21W (P21W) 8GA 002 073-121 1x24V21W (P21W) 8GA 002 073-241
				
LP 608 - LP 1113 (LP)	11/77->12/84	2ZR 003 236-051 9EL 119 544-111 9DX 119 545-051	1 4 2	Reverse light Ⓔ1 8728 Spare Parts: Lens Reflector 1x12V21W (P21W) 8GA 002 073-121 1x24V21W (P21W) 8GA 002 073-241
				
LP 608 - LP 1113 (LP)	10/69->12/84	2JA 001 357-002 2JA 001 357-012	6 6	Interior light with switch Interior light without switch 2x12V10W (K) 8GM 002 091-131 2x24V10W (-) 8GM 002 091-251
				
LP 1113 - LP 1519 LP 1113 - LP 1519	08/73->	9EL 110 737-001 9EL 110 736-001	2 2	Indicator light, spare parts available only Ⓔ1 32617 Spare Parts: Lens, left Lens, right 1x12V21W (P21W) 8GA 002 073-121
				
LP 1113 - LP 1519	67->	2TJ 001 633-211 9EL 132 403-001 9EL 132 404-001	2 2 2	Rear-side light, for side mounting Ⓔ1 11553 Ⓔ1 11554 Ⓔ1 11786 Ⓔ1 31416 Spare Parts: Lens (clear) with screw Lens (red) with screw 1x12V5W (C5W) 8GM 002 092-121
				



Manufacturer Model	Model year	Part no.	Pk.	Note
Mercedes-Benz				
LP 1113 - LP 1519 LP 1113 - LP 1519 LP 1113, LP 1313, LP 1319, LP 1513, LP 1519 	67->	2SE 001 699-071 2SD 001 699-061 9EL 109 139-001 9GT 074 132-001	1 1 2 10	Combination rearlight, left, with licence plate light Combination rearlight, right, without licence plate light (E1) 196 (E1) 43332 Spare Parts: Lens with screws Grommet 1x12V10W (R10W) 8GA 002 071-131 2x12V21W (P21W) 8GA 002 073-121
LP 1113 - LP 1519 	67->	2JA 001 357-002 2JA 001 357-012	6 6	Interior light with switch Interior light without switch 2x12V10W (K) 8GM 002 091-131
O 303 O 303 	10/74->	2PF 002 452-017	25	Side light (E1) 11791 1x24V5W (R5W) 8GA 002 071-241
O 303 	10/74->	2PF 002 860-031 9EL 116 380-035 9GD 128 553-007	1 5 10	Side light, for front mounting (E1) 21688 Spare Parts: Body/lens Base (to be ordered separately) 1x24V10W (R10W) 8GA 002 071-251
O 303 	10/74->	2SA 002 860-041 9EL 116 380-045	1 5	Side light, for rear mounting (E1) 31451 Spare Parts: Body/lens 1x24V10W (R10W) 8GA 002 071-251
O 303 	10/74->	2KA 001 388-051	1	Licence plate light (E1) 22902 1x24V5W (C5W) 8GM 002 092-241



Manufacturer Model	Model year	Part no.	Pk.	Note
Mercedes-Benz				
O 305 VÖV O 305 VÖV	04/73->12/83	 9EL 110 737-001 9EL 110 736-001	2 2	Indicator light, spare parts available only E1 32617 Spare Parts: Lens, left Lens, right 1x24V21W (P21W) 8GA 002 073-241
O 305 VÖV	04/73->12/83	 9EM 128 229-031 2DA 001 240-341 9EM 128 229-001	1 1 1	Rear light E1 11550 Spare Parts: Lens with reflector and rim 1x24V5W (R5W) 8GA 002 071-241 Stop light E1 11551 Spare Parts: Lens with reflector and rim 1x24V21W (P21W) 8GA 002 073-241
O 305 VÖV	04/73->12/83	 9EL 112 763-001	1 5	Rear fog light E1 8444 Spare Parts: Lens with screws 1x24V21W (P21W) 8GA 002 073-241
O 305 VÖV	04/73->12/83	 9EL 112 858-011	1 2	Reverse light E1 8725 Spare Parts: Lens with screws 1x24V21W (P21W) 8GA 002 073-241
O 305 VÖV	04/73->12/83	 2KA 003 010-007	1	Licence plate light E1 12809 2x24V5W (R5W) 8GA 002 071-241








Manufacturer Model	Model year	Part no.	Pk.	Note
Mercedes-Benz				
O 309				Headlight, spare parts available only
O 309	08/81->02/89	9ES 120 723-001 9FH 113 447-011	2 5	(E1) 7165 left (E1) 7166 right Spare Parts: Lens, left Bulb holder 1x12V45/40W (R2) 8GD 002 088-131 1x24V55/50W (R2) 8GD 002 088-251 1x12V4W (T4W) 8GP 002 067-121 1x24V4W (T4W) 8GP 002 067-241 H4 headlight, spare parts available only (E1) 17001 left (E1) 17002 right Spare Parts: Lens, left Lens, right Bulb holder 1x12V60/55W (H4) 8GJ 002 525-131 1x24V75/70W (H4) 8GJ 002 525-251 1x12V4W (T4W) 8GP 002 067-121 1x24V4W (T4W) 8GP 002 067-241
O 309	01/68->03/83	2BA 001 275-011 2BA 001 275-021	2 2	Indicator light, left
		9EL 101 899-001 9EL 101 900-001	5 5	Indicator light, right (E1) 22764 Spare Parts: Lens, left Lens, right 1x12V21W (P21W) 8GA 002 073-121
O 309	04/83->02/89	2BA 004 499-001	2	Indicator light
				(E1) 42679 1x12V21W (P21W) 8GA 002 073-121
O 309	01/68->06/77	2KA 001 378-041	4	Licence plate light
				(E1) 12958 1x12V5W (C5W) 8GM 002 092-121
O 309	07/77->02/89	9EL 119 874-001	2	Combination rearlight, spare parts available only
				(E1) 53276 Spare Parts: Lens with screws 1x12V10W (R10W) 8GA 002 071-131 1x24V10W (R10W) 8GA 002 071-251 2x12V21W (P21W) 8GA 002 073-121 2x24V21W (P21W) 8GA 002 073-241



Manufacturer Model	Model year	Part no.	Pk.	Note
Mercedes-Benz				
O 309 O 309	07/77->02/89	2NE 002 589-001 9EL 112 763-001	1 5	Rear fog light (E1) 8444 Spare Parts: Lens with screws 1x12V21W (P21W) 8GA 002 073-121 1x24V21W (P21W) 8GA 002 073-241
O 309	07/77->02/89	2ZR 002 589-011 9EL 112 858-011	1 2	Reverse light (E1) 8725 Spare Parts: Lens with screws 1x12V21W (P21W) 8GA 002 073-121 1x24V21W (P21W) 8GA 002 073-241
O 309	07/77->02/89	2KA 003 389-061 9BG 121 587-031	2 2	Licence plate light (E1) 22819 Spare Parts: Body/lens with screw 1x12V10W (R10W) 8GA 002 071-131 1x24V10W (R10W) 8GA 002 071-251
O 309	01/68->02/89	2JA 001 357-002 2JA 001 357-012	6 6	Interior light with switch Interior light without switch 2x12V10W (K) 8GM 002 091-131 2x24V10W (-) 8GM 002 091-251
O 404 O 404	09/91->10/99	2BA 003 236-541 9EL 139 898-005 9BG 139 863-007	1 4 150	Flasher clearance lamp (E1) 63253 Spare Parts: Lens Body 1x12V10W (R10W) 8GA 002 071-131 1x24V10W (R10W) 8GA 002 071-251 1x12V21W (P21W) 8GA 002 073-121 1x24V21W (P21W) 8GA 002 073-241
O 404	09/91->10/99	2BM 006 692-011 2BM 006 692-021	1 1	Auxiliary indicator light, left Auxiliary indicator light, right (E1) 52621 1x12V21W (P21W) 8GA 002 073-121 1x24V21W (P21W) 8GA 002 073-241



Manufacturer Model	Model year	Part no.	Pk.	Note
Mercedes-Benz				
O 404 O 404	09/91->10/99	2AB 004 532-051 9EL 128 922-011	5 10	Reading light, with 28V xenon bulb Spare Parts: Lens (red) (to be ordered separately) 1x28V7,5W (-) 8GP 008 285-001 (Xenon)
				
O 405 O 405	09/84->	2BA 004 119-001	1	Indicator light, for front mounting E1 42680 1x24V21W (P21W) 8GA 002 073-241
				
O 405	09/84->	2BA 003 236-021 9EL 119 544-021	1 4	Indicator light, for rear mounting E1 32764 Spare Parts: Lens 1x24V21W (P21W) 8GA 002 073-241
				
O 405	09/84->	2NE 003 236-001 9EL 119 544-001 9DX 119 545-011	1 4 2	Rear fog light e1 18 411 Spare Parts: Lens Reflector 1x24V21W (P21W) 8GA 002 073-241
				
O 405	09/84->	2ZR 003 236-051 9EL 119 544-111 9DX 119 545-051	1 4 2	Reverse light E1 8728 Spare Parts: Lens Reflector 1x24V21W (P21W) 8GA 002 073-241
				








Manufacturer Model	Model year	Part no.	Pk.	Note
Mercedes-Benz				
O 405 VÖV II O 405 VÖV II	01/84->	2PF 002 860-031 9EL 116 380-035 9GD 128 553-007	1 5 10	Side light, for front mounting E1 21688 Spare Parts: Body/lens Base (to be ordered separately) 1x24V10W (R10W) 8GA 002 071-251
O 405 VÖV II	01/84->	2BA 002 324-011 2BA 002 324-021 9EL 110 918-001 9EL 110 918-011	1 1 5 5	Indicator light, left Indicator light, right E1 32621 Spare Parts: Lens with screws, left Lens with screws, right 1x24V21W (P21W) 8GA 002 073-241
O 405 VÖV II	01/84->	2SA 002 860-041 9EL 116 380-045	1 5	Side light, for rear mounting E1 31451 Spare Parts: Body/lens 1x24V10W (R10W) 8GA 002 071-251
O 405 VÖV II	01/84->	9EL 118 445-001 9GD 087 883-355 9GD 118 983-021	1 10 10	Combination rearlight, spare parts available only E1 53250 Spare Parts: Lens with screws Seal Bodywork seal for flush-fitting (to be ordered separately) 1x24V10W (R10W) 8GA 002 071-251 2x24V21W (P21W) 8GA 002 073-241
O 405 VÖV II	01/84->	2BA 003 236-027	6	Indicator light, for rear, top mounting E1 32764 1x24V21W (P21W) 8GA 002 073-241








Manufacturer Model	Model year	Part no.	Pk.	Note
Mercedes-Benz				
O 405 VÖV II O 405 VÖV II	01/84->	2KA 003 389-061 9BG 121 587-031	2 2	Licence plate light (E1) 22819 Spare Parts: Body/lens with screw 1x24V10W (R10W) 8GA 002 071-251
O 405 VÖV II	01/84->	2AB 004 532-051 9EL 128 922-011	5 10	Reading light, with 28V xenon bulb Spare Parts: Lens (red) (to be ordered separately) 1x28V7,5W (-) 8GP 008 285-001 (Xenon)
O 407 O 407	03/87->11/01	2BA 004 119-001	1	Indicator light, for front mounting (E1) 42680 1x24V21W (P21W) 8GA 002 073-241
O 407	03/87->11/01	2BA 003 236-021 9EL 119 544-021	1 4	Indicator light, for rear mounting (E1) 32764 Spare Parts: Lens 1x24V21W (P21W) 8GA 002 073-241
O 407	03/87->11/01	2NE 003 236-001 9EL 119 544-001 9DX 119 545-011	1 4 2	Rear fog light (e1) 18 411 Spare Parts: Lens Reflector 1x24V21W (P21W) 8GA 002 073-241





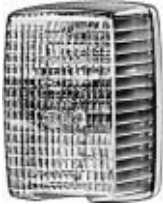



Manufacturer Model	Model year	Part no.	Pk.	Note
Mercedes-Benz				
O 407 O 407	03/87->11/01	2ZR 003 236-051 9EL 119 544-111 9DX 119 545-051	1 4 2	Reverse light E1 8728 Spare Parts: Lens Reflector 1x24V21W (P21W) 8GA 002 073-241
				
Unimog Unimog U 600 - U 900 U 600, U 800, U 900	08/90->05/92	1L8 003 060-691 9GH 116 966-011 9FF 126 444-001	1 10 10	H4 headlight E1 7144 Spare Parts: Cap Bulb socket for side light (to be ordered separately) 1x24V75/70W (H4) 8GJ 002 525-251 1x24V4W (T4W) 8GP 002 067-241
				
Unimog U 1000 - U 1700		2XS 004 237-291 2XS 004 237-301	1 1	Clearance light (white), left, for front mounting Clearance light (white), right, for front mounting E1 21668 1x12V5W (R5W) 8GA 002 071-121 1x24V5W (R5W) 8GA 002 071-241
				
Unimog U 95, U 120, U 150 (425) Unimog U 1300, U 1500, U 1700	->12/76	2SE 001 699-071 2SD 001 699-061 9EL 109 139-001 9GT 074 132-001	1 1 2 10	Combination rearlight, left, with licence plate light Combination rearlight, right, without licence plate light E1 196 E1 43332 Spare Parts: Lens with screws Grommet 1x12V10W (R10W) 8GA 002 071-131 1x24V10W (R10W) 8GA 002 071-251 2x12V21W (P21W) 8GA 002 073-121 2x24V21W (P21W) 8GA 002 073-241
				
Unimog U 1000 - U 1700		2ZR 003 236-051 9EL 119 544-111 9DX 119 545-051	1 4 2	Reverse light E1 8728 Spare Parts: Lens Reflector 1x12V21W (P21W) 8GA 002 073-121 1x24V21W (P21W) 8GA 002 073-241
				








Manufacturer Model	Model year	Part no.	Pk.	Note
Mercedes-Benz				
Unimog Unimog U 52 - U 150 Unimog U 1000 - U 1700	->12/76 01/77->	2JA 001 357-002 2JA 001 357-012	6 6	Interior light with switch Interior light without switch 2x12V10W (K) 8GM 002 091-131 2x24V10W (-) 8GM 002 091-251
				
Vario 512 D - 816 DA Vario 512 D - 816 DA	09/96->	2BA 007 775-051 2BA 007 775-061	1 1	Indicator light (amber), left Indicator light (amber), right E1 486 1x12V21W (P21W) 8GA 002 073-121 1x24V21W (P21W) 8GA 002 073-241
				
Vario 512 D - 816 DA	09/96->	2BM 006 692-011 2BM 006 692-021	1 1	Auxiliary indicator light, left Auxiliary indicator light, right E1 52621 1x12V21W (P21W) 8GA 002 073-121 1x24V21W (P21W) 8GA 002 073-241
				
Vario 512 D - 816 DA 512 D 612 D, 613 D, 614 D, 615 D, 616 D, 618 D 810 DT, 812 D, 813 D/DA, 814 D/DA, 815 D/DA, 816 D/DA, 818 D/DA O 810, O 812, O 814, O 815	09/96->	2VD 008 204-091 2VP 008 204-081 9EL 152 891-001	1 1 1	Combination rearlight, left, with licence plate, rear fog, reverse, clearance light, side-marker light, with reflex-reflector, marker reflex-reflector and centre plug (middle) Combination rearlight, right, with reverse, clearance light, side-marker light, with reflex-reflector, marker reflex-reflector and centre plug (middle) E4 3179 E4 4060 E4 9809 E4 9810 Spare Parts: Lens with screws 3x24V5W (R5W) 8GA 002 071-241 4x24V21W (P21W) 8GA 002 073-241
				
Vario 512 D - 816 DA 512 D 612 D, 613 D, 614 D, 615 D, 616 D, 618 D 810 DT, 812 D, 813 D/DA, 814 D/DA, 815 D/DA, 816 D/DA, 818 D/DA O 810, O 812, O 814, O 815 Special equipment	09/96->	2VB 004 887-011 2VA 004 887-031 2VP 004 887-021 9EL 131 420-001 9EL 131 420-011 9GT 141 941-001	1 1 1 1 1 10	Combination rearlight, left, with licence plate and rear fog light Combination rearlight, left, with rear fog light Combination rearlight, right, with reverse light E1 53384 Spare Parts: Lens with screws, left Lens with screws, right Grommet (to be ordered separately) 1x12V10W (R10W) 8GA 002 071-131 1x24V10W (R10W) 8GA 002 071-251 3x12V21W (P21W) 8GA 002 073-121 3x24V21W (P21W) 8GA 002 073-241
				








Manufacturer Model	Model year	Part no.	Pk.	Note
Mercedes-Benz				
Vario 512 D - 816 DA Vario 512 D - 816 DA	09/96->	2KA 003 389-061 9BG 121 587-031	2 2	Licence plate light Spare Parts: Body/lens with screw 1x12V10W (R10W) 8GA 002 071-131 1x24V10W (R10W) 8GA 002 071-251
				
Vario 512 D - 816 DA	09/96->	2JA 001 357-012	6	Interior light without switch 2x12V10W (K) 8GM 002 091-131 2x12V10W (K) 8GM 002 091-131
				
507 D - 814 D (T2/LN1) 507 D - 814 D (T2/LN1)	04/86->12/94	1ND 122 390-001	1	H3 fog light unit E1 8336 1x12V55W (H3) 8GH 002 090-133 1x24V70W (H3) 8GH 002 090-251
				
507 D - 814 D (T2/LN1) Flatbed	04/86->12/94	2BM 002 652-051	1	Auxiliary indicator light E1 32785 1x12V21W (P21W) 8GA 002 073-121 1x24V21W (P21W) 8GA 002 073-241
				
507 D - 814 D (T2/LN1) Van	04/86->12/94	2BM 002 652-071 2BM 002 652-081	1 1	Auxiliary indicator light, left Auxiliary indicator light, right E1 32785 1x12V21W (P21W) 8GA 002 073-121 1x24V21W (P21W) 8GA 002 073-241
				
507 D - 814 D (T2/LN1)	05/94->12/94	2BM 006 692-011 2BM 006 692-021	1 1	Auxiliary indicator light, left Auxiliary indicator light, right E1 52621 1x12V21W (P21W) 8GA 002 073-121 1x24V21W (P21W) 8GA 002 073-241
				





Manufacturer Model	Model year	Part no.	Pk.	Note
Mercedes-Benz				
507 D - 814 D (T2/LN1)		2VB 004 887-011	1	Combination rearlight, left, with licence plate and rear fog light
507 D - 814 D (T2/LN1)	04/86->12/94	2VA 004 887-031	1	Combination rearlight, left, with rear fog light
507 D, 508 D, 510, 609 D, 611 D, 709 D, 711 D, 714 D, 809 D, 811 D, 814 D		2VP 004 887-021	1	Combination rearlight, right, with reverse light
Platform truck Van				(E1) 53384
O 609 D, O 611 D, O 614 D	07/87->12/92	9EL 131 420-001 9EL 131 420-011 9GT 141 941-001	1 1 10	Spare Parts: Lens with screws, left Lens with screws, right Grommet (to be ordered separately)
				1x12V10W (R10W) 8GA 002 071-131 1x24V10W (R10W) 8GA 002 071-251 3x12V21W (P21W) 8GA 002 073-121 3x24V21W (P21W) 8GA 002 073-241
507 D - 814 D (T2/LN1)	04/86->12/94	2KA 003 389-061	2	Licence plate light
Van				(E1) 22819
O 609 D, O 611 D, O 614 D	07/87->12/92	9BG 121 587-031	2	Spare Parts: Body/lens with screw
				1x12V10W (R10W) 8GA 002 071-131 1x24V10W (R10W) 8GA 002 071-251
507 D - 814 D (T2/LN1)	04/86->12/94	2XS 004 237-291	1	Clearance light (white), left, for front mounting
		2XS 004 237-301	1	Clearance light (white), right, for front mounting
				(E1) 21668
				1x12V5W (R5W) 8GA 002 071-121 1x24V5W (R5W) 8GA 002 071-241
507 D - 814 D (T2/LN1)	04/86->12/94	2XS 004 237-311	1	Clearance light (red), left, for rear mounting
		2XS 004 237-321	1	Clearance light (red), right, for rear mounting
				(E1) 21441
				1x12V5W (R5W) 8GA 002 071-121 1x24V5W (R5W) 8GA 002 071-241
507 D - 814 D (T2/LN1)	04/86->12/94	2JA 001 357-002 2JA 001 357-012	6 6	Interior light with switch Interior light without switch
				2x12V10W (K) 8GM 002 091-131







Manufacturer Model	Model year	Part no.	Pk.	Note
Mercedes-Benz				
709 - 2024 (LK/LN2) 709 - 2024 (LK/LN2)	01/84->12/98	1ND 122 390-001	1	H3 fog light unit E1 8336  1x24V70W (H3) 8GH 002 090-251
709 - 2024 (LK/LN2)	01/84->12/98	2BA 003 975-031 2BA 003 975-041	1 1	Indicator light, left Indicator light, right E1 42650  1x24V21W (P21W) 8GA 002 073-241
709 - 2024 (LK/LN2)	01/84->12/98	2XS 004 237-291 2XS 004 237-301	1 1	Clearance light (white), left, for front mounting Clearance light (white), right, for front mounting E1 21668  1x24V5W (R5W) 8GA 002 071-241
709 - 2024 (LK/LN2)	01/84->12/98	2BM 004 312-051 2BM 004 312-061 9EL 127 855-001 9EL 127 856-001	1 1 5 5	Auxiliary indicator light, left Auxiliary indicator light, right E1 42669 Spare Parts: Lens, left Lens, right  1x24V21W (P21W) 8GA 002 073-241
709 - 2024 (LK/LN2)	05/94->12/98	2BM 006 692-011 2BM 006 692-021	1 1	Auxiliary indicator light, left Auxiliary indicator light, right E1 52621  1x24V21W (P21W) 8GA 002 073-241



Manufacturer Model	Model year	Part no.	Pk.	Note
Mercedes-Benz				
709 - 2024 (LK/LN2)				Combination rearlight, spare parts available only
709 - 2024 (LK/LN2)	01/84->08/88			(E1) 53250
709				Spare Parts:
809, 814, 817		9EL 118 445-001	1	Lens with screws
914, 917		9GD 087 883-355	10	Seal
1114, 1117, 1120				1x12V10W (R10W) 8GA 002 071-131
1214				1x24V10W (R10W) 8GA 002 071-251
1314, 1317, 1320, 1324				2x12V21W (P21W) 8GA 002 073-121
1514, 1517, 1520, 1524				2x24V21W (P21W) 8GA 002 073-241
1720, 1724				
2020, 2024				
				
709 - 2024 (LK/LN2)	09/88->12/98	2VD 005 300-551	1	Combination rearlight, left, with licence plate, rear fog, reverse, clearance light and lateral marker reflex-reflector
709, 711				
809, 811, 814, 817		2VD 005 300-581	1	Combination rearlight, right, with licence plate, rear fog, reverse, clearance light and lateral marker reflex-reflector
914, 917				
1114, 1117, 1120, 1124				(in the case of use in left-hand traffic, the number plate window of the black glare shield 9EL 134 301-011, order separately)
1214, 1217				(E1) 31432 (E1) 63217
1314, 1317, 1320, 1324				Spare Parts:
1514, 1517, 1520, 1524		9EL 134 296-041	1	Lens with screws, left
1720, 1724		9EL 134 296-051	1	Lens with screws, right
2020, 2024		9EL 134 301-001	1	Lens for licence plate light
		9EL 134 301-011	1	Glare shield, black (order separately)
		8RA 003 326-011	20	Reflector (amber)
				
				3x12V10W (R10W) 8GA 002 071-131
				3x24V10W (R10W) 8GA 002 071-251
				4x12V21W (P21W) 8GA 002 073-121
				4x24V21W (P21W) 8GA 002 073-241






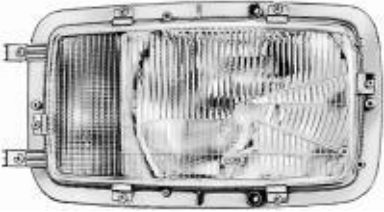
Manufacturer Model	Model year	Part no.	Pk.	Note
Mercedes-Benz				
709 - 2024 (LK/LN2) 709 - 2024 (LK/LN2)	01/84->12/98	2TJ 003 168-151	2	Clearance light, for side mounting (E1) 31417 1x12V5W (C5W) 8GM 002 092-121 1x24V5W (C5W) 8GM 002 092-241
				
709 - 2024 (LK/LN2)	01/84->12/98	2NE 003 236-001	1	Rear fog light (e1) 18 411 Spare Parts: 4 Lens 2 Reflector 1x24V21W (P21W) 8GA 002 073-241
		9EL 119 544-001 9DX 119 545-011	4 2	
709 - 2024 (LK/LN2)	01/84->12/98	2ZR 003 236-051	1	Reverse light (E1) 8728 Spare Parts: 4 Lens 2 Reflector 1x24V21W (P21W) 8GA 002 073-241
		9EL 119 544-111 9DX 119 545-051	4 2	
709 - 2024 (LK/LN2)	01/84->12/98	2JA 001 357-002 2JA 001 357-012	6 6	Interior light with switch Interior light without switch 2x12V10W (K) 8GM 002 091-131
				















Manufacturer Model	Model year	Part no.	Pk.	Note
Mercedes-Benz				
1013 - 3850 (NG)				Headlight, with indicator, not suitable for headlight leveller, spare parts available only
1013 - 3850 (NG)	08/73->08/88			(E1) 7108 left (E1) 7109 right
1013, 1017, 1019				(E1) 14540 left (E1) 14541 right
1213, 1217, 1219, 1222, 1225, 1228				Spare Parts:
1413, 1414, 1417, 1419, 1420, 1422, 1424, 1425, 1428, 1429		9ES 113 919-001	1	Lens, left
		9ES 113 918-001	1	Lens, right
		9EV 113 436-005	10	Auxiliary lens for indicator light (amber)
		9GD 113 431-005	10	Seal for lens
		9DE 116 734-007	1	Reflector, left
		9DE 116 735-007	1	Reflector, right
1613, 1614, 1617, 1619, 1620, 1622, 1624, 1625, 1626, 1628, 1632, 1633, 1635, 1636, 1638, 1644				1x12V45/40W (R2) 8GD 002 088-131
				1x24V55/50W (R2) 8GD 002 088-251
1719				1x12V21W (P21W) 8GA 002 073-121
1814				1x24V21W (P21W) 8GA 002 073-241
1919, 1922, 1926, 1928, 1932, 1933, 1935, 1936, 1938, 1944				1x12V4W (T4W) 8GP 002 067-121
				1x24V4W (T4W) 8GP 002 067-241
2025, 2026, 2028, 2032, 2033, 2035, 2036				
2219, 2220, 2222, 2224, 2225, 2226, 2228, 2232, 2233, 2235, 2236, 2238, 2244				
2422, 2425, 2428, 2433, 2438, 2444				
2528, 2536				
2626, 2628, 2632, 2633, 2635, 2636, 2638, 2644				
3025, 3028, 3033, 3036, 3038				
3235, 3250				
3328, 3333, 3335, 3336, 3338				
3528, 3535, 3536, 3544				
3836, 3850				





Manufacturer Model	Model year	Part no.	Pk.	Note
Mercedes-Benz				
1013 - 3850 (NG)				H4 headlight, with indicator, not suitable for headlight leveller, spare parts available only
1013 - 3850 (NG)	08/73->08/88			(E1) 7128 left (E1) 7129 right
1013, 1017, 1019				Spare Parts:
1213, 1217, 1219, 1222, 1225, 1228		9ES 118 403-001	1	Lens, left
		9ES 118 402-001	1	Lens, right
1413, 1414, 1417, 1419, 1420, 1422, 1424, 1425, 1428, 1429		9EV 113 436-005	10	Auxiliary lens for indicator light (amber)
		9GD 113 431-005	10	Seal for lens
		9DE 118 423-001	1	Reflector, left
		9DE 118 424-001	1	Reflector, right
1613, 1614, 1617, 1619, 1620, 1622, 1624, 1625, 1626, 1628, 1632, 1633, 1635, 1636, 1638, 1644				 1x12V60/55W (H4) 8GJ 002 525-131 1x24V75/70W (H4) 8GJ 002 525-251
1719				 1x12V21W (P21W) 8GA 002 073-121 1x24V21W (P21W) 8GA 002 073-241
1814				 1x12V4W (T4W) 8GP 002 067-121 1x24V4W (T4W) 8GP 002 067-241
1919, 1922, 1926, 1928, 1932, 1933, 1935, 1936, 1938, 1944				
2025, 2026, 2028, 2032, 2033, 2035, 2036				
2219, 2220, 2222, 2224, 2225, 2226, 2228, 2232, 2233, 2235, 2236, 2238, 2244				
2422, 2425, 2428, 2433, 2438, 2444				
2528, 2536				
2626, 2628, 2632, 2633, 2635, 2636, 2638, 2644				
3025, 3028, 3033, 3036, 3038				
3228, 3235, 3250				
3328, 3333, 3335, 3336, 3338				
3528, 3535, 3536, 3544				
3836, 3850				
				



Manufacturer Model	Model year	Part no.	Pk.	Note
Mercedes-Benz				
1013 - 3850 (NG) 1013 - 3850 (NG)	08/73->08/88	 9DF 117 504-007 1FE 125 510-011	2 1	H3 fog light, spare parts available only (E4) 914 Spare Parts: Reflector with lens H3 spotlight, spare parts available only (E1) 24586 Spare Parts: Light unit  1x12V55W (H3) 8GH 002 090-133  1x24V70W (H3) 8GH 002 090-251
1013 - 3850 (NG)	08/73->08/88	 2PF 961 167-021 9EL 137 241-001	2 4	Side light, for vehicles without external sun visor (E1) 31446 Spare Parts: Lens  1x12V5W (C5W) 8GM 002 092-121  1x24V5W (C5W) 8GM 002 092-241
1013 - 3850 (NG)	08/73->08/88	 2BM 002 847-011 2BM 002 847-021 9EL 115 830-001	1 1 5	Auxiliary indicator light, left Auxiliary indicator light, right (E1) 32692 Spare Parts: Lens  1x12V21W (P21W) 8GA 002 073-121  1x24V21W (P21W) 8GA 002 073-241
1013 - 3850 (NG)	08/73->08/88	 2TJ 003 168-151	2	Clearance light, for side mounting (E1) 31417  1x12V5W (C5W) 8GM 002 092-121  1x24V5W (C5W) 8GM 002 092-241



Manufacturer Model	Model year	Part no.	Pk.	Note
Mercedes-Benz				
1013 - 3850 (NG)		2SE 001 699-071	1	Combination rearlight, left, with licence plate light Combination rearlight, right, without licence plate light (E1) 196 (E1) 43332
1013 - 3850 (NG)	08/73->08/88	2SD 001 699-061	1	
1013, 1017, 1019				
1213, 1217, 1219, 1222, 1225, 1228				
1413, 1414, 1417, 1419, 1420, 1422, 1424, 1425, 1428, 1429		9EL 109 139-001 9GT 074 132-001	2 10	Spare Parts: Lens with screws Grommet 1x12V10W (R10W) 8GA 002 071-131 1x24V10W (R10W) 8GA 002 071-251 2x12V21W (P21W) 8GA 002 073-121 2x24V21W (P21W) 8GA 002 073-241
1613, 1614, 1617, 1619, 1620, 1622, 1624, 1625, 1626, 1628, 1632, 1633, 1635, 1636, 1638, 1644				
1719				
1814				
1919, 1922, 1926, 1928, 1932, 1933, 1935, 1936, 1938, 1944				
2025, 2026, 2028, 2032, 2033, 2035, 2036				
2219, 2220, 2222, 2224, 2225, 2226, 2228, 2232, 2233, 2235, 2246, 2238, 2244				
2422, 2425, 2428, 2433, 2438, 2444				
2528, 2536				
2626, 2628, 2632, 2633, 2635, 2636, 2638, 2644				
3025, 3028, 3033, 3036, 3038				
3228, 3235, 3250				
3328, 3333, 3335, 3336, 3338				
3528, 3535, 3536, 3544				
3836, 3850				





Manufacturer Model	Model year	Part no.	Pk.	Note
Mercedes-Benz				
1013 - 3850 (NG)		2SE 003 167-031	1	Combination rearlight, left, with licence plate light
1013 - 3850 (NG)	08/73->08/88	2SD 003 167-021	1	
1013, 1017, 1019				(E1) 264
1213, 1217, 1219, 1222, 1225, 1228				Spare Parts:
1413, 1414, 1417, 1419, 1420, 1422, 1424, 1425, 1428, 1429		9EL 147 747-001	1	Lens with screws
1613, 1614, 1617, 1619, 1620, 1622, 1624, 1625, 1626, 1628, 1632, 1633, 1635, 1636, 1638, 1644		9GD 087 883-355	10	Seal
1719				1x12V10W (R10W) 8GA 002 071-131
1814				1x24V10W (R10W) 8GA 002 071-251
1919, 1922, 1926, 1928, 1932, 1933, 1935, 1936, 1938, 1944				2x12V21W (P21W) 8GA 002 073-121
2025, 2026, 2028, 2032, 2033, 2035, 2036				2x24V21W (P21W) 8GA 002 073-241
2219, 2220, 2222, 2224, 2225, 2226, 2228, 2232, 2233, 2235, 2246, 2238, 2244				
2422, 2428, 2425, 2433, 2438, 2444				
2528, 2536				
2626, 2628, 2632, 2633, 2635, 2636, 2638, 2644				
3025, 3028, 3033, 3036, 3038				
3228, 3235, 3250				
3328, 3333, 3335, 3336, 3338				
3528, 3535, 3536, 3544				
3836, 3850				

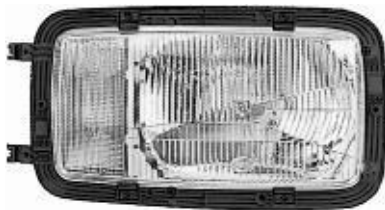




Manufacturer Model	Model year	Part no.	Pk.	Note
Mercedes-Benz				
1013 - 3850 (NG) 1013 - 3850 (NG)	08/73->08/88	2NE 003 236-001 9EL 119 544-001 9DX 119 545-011	1 4 2	Rear fog light (e1) 18 411 Spare Parts: Lens Reflector 1x12V21W (P21W) 8GA 002 073-121 1x24V21W (P21W) 8GA 002 073-241
1013 - 3850 (NG)	08/73->08/88	2ZR 003 236-051 9EL 119 544-111 9DX 119 545-051	1 4 2	Reverse light (E1) 8728 Spare Parts: Lens Reflector 1x12V21W (P21W) 8GA 002 073-121 1x24V21W (P21W) 8GA 002 073-241
1013 - 3850 (NG)	08/73->08/88	2JA 002 661-001 9EL 116 607-005	1 12	Interior light with switch Spare Parts: Lens 2x12V21W (P21W) 8GA 002 073-121 2x24V21W (P21W) 8GA 002 073-241
1013 - 3850 (NG)	08/73->08/88	2JA 001 357-012	6	Interior light without switch, for vehicles with sleeping cab 2x12V10W (K) 8GM 002 091-131 2x24V10W (K) 8GM 002 091-251

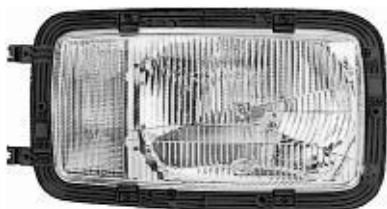


Manufacturer Model	Model year	Part no.	Pk.	Note
Mercedes-Benz				
1222 - 4850 (MK, SK)		1LH 002 658-451	1	Headlight, left, with indicator light, not suitable for headlight leveller
1222 - 4850 (MK, SK)	07/87->09/96	1LH 002 658-461	1	Headlight, right, with indicator light, not suitable for headlight leveller holder for headlight leveller
1222, 1224, 1226, 1227, 1231, 1234				Ⓔ 7108 left Ⓔ 7109 right
1417, 1420, 1422, 1424, 1426, 1427, 1429				Ⓔ 14540 left Ⓔ 14541 right
1627				Spare Parts:
1717, 1720, 1722, 1726, 1729, 1733, 1735, 1748		9ES 113 919-001	1	Lens, left
		9ES 113 918-001	1	Lens, right
1820, 1824, 1827, 1831, 1834, 1838, 1840, 1844 1850, 1853		9EV 113 436-005	10	Auxiliary lens for indicator light (amber)
		9GD 113 431-005	10	Seal for lens
		9DE 116 734-007	1	Reflector, left
		9DE 116 735-007	1	Reflector, right
1922, 1926, 1929, 1935, 1945, 1948				1x12V45/40W (R2) 8GD 002 088-131
				1x24V55/50W (R2) 8GD 002 088-251
2024, 2027, 2031, 2038, 2044, 2050, 2055				1x12V21W (P21W) 8GA 002 073-121
				1x24V21W (P21W) 8GA 002 073-241
2420, 2422, 2426, 2429, 2431, 2433, 2434, 2435, 2448				1x12V4W (T4W) 8GP 002 067-121
				1x24V4W (T4W) 8GP 002 067-241
2524, 2527, 2531, 2534, 2538, 2544, 2550, 2553				
2629, 2631, 2634, 2635, 2638, 2644, 2645, 2648, 2650, 2653				
3050, 3053				
3229, 3233, 3234, 3235, 3236, 3238, 3244, 3248, 3250, 3253, 3255				
3534, 3535, 3538, 3544, 3548, 3550, 3553				
4050				
4844, 4850				















Manufacturer Model	Model year	Part no.	Pk.	Note
Mercedes-Benz				
1222 - 4850 (MK, SK)		1LH 002 658-511	1	H4 headlight, left, with indicator light, not suitable for headlight leveller
1222 - 4850 (MK, SK)	07/87->09/96	1LH 002 658-521	1	H4 headlight, right, with indicator light, not suitable for headlight leveller
1222, 1224, 1226, 1227, 1231, 1234				
1417, 1420, 1422, 1424, 1426, 1427, 1429		1LH 002 658-571	1	H4 headlight, left, with indicator light, suitable for headlight leveller and holder for headlight leveller
1627				H4 headlight, right, with indicator light, suitable for headlight leveller, spare parts available only
1717, 1720, 1722, 1726, 1729, 1733, 1735, 1748				ⓔ1 7128 left ⓔ1 7129 right
1820, 1824, 1827, 1831, 1834, 1838, 1840, 1844, 1850, 1853				Spare Parts:
1922, 1926, 1929, 1935, 1945, 1948		9ES 118 403-001	1	Lens, left
		9ES 118 402-001	1	Lens, right
		9EV 113 436-005	10	Auxiliary lens for indicator light (amber)
2024, 2027, 2031, 2038, 2044, 2050, 2055		9GD 113 431-005	10	Seal for lens
		9DE 118 423-001	1	Reflector, left
		9DE 118 424-001	1	Reflector, right
2420, 2422, 2426, 2429, 2431, 2433, 2434, 2435, 2448				1x12V60/55W (H4) 8GJ 002 525-131 1x24V75/70W (H4) 8GJ 002 525-251
2524, 2527, 2531, 2534, 2538, 2544, 2550, 2553				1x12V21W (P21W) 8GA 002 073-121 1x24V21W (P21W) 8GA 002 073-241
2629, 2631, 2634, 2635, 2638, 2644, 2645, 2648, 2650, 2653				1x12V4W (T4W) 8GP 002 067-121 1x24V4W (T4W) 8GP 002 067-241
3050, 3053				
3229, 3233, 3234, 3235, 3236, 3238, 3244, 3248, 3250, 3253, 3255				
3534, 3535, 3538, 3544, 3548, 3550 3553				
4050				
4844, 4850				





Manufacturer Model	Model year	Part no.	Pk.	Note
Mercedes-Benz				
1222 - 4850 (MK, SK)				
1222 - 4850 (MK, SK) For models with steel bumpers only	07/87->04/94	9DF 117 504-007 9AG 129 328-001	2 7	H3 fog light, spare parts available only (E4) 914 Spare Parts: Reflector with lens Lens-retaining rim
		1FE 125 510-011 9AG 129 328-001	1 7	H3 spotlight, spare parts available only (E1) 24586 Spare Parts: Light unit Lens-retaining rim  1x12V55W (H3) 8GH 002 090-133 1x24V70W (H3) 8GH 002 090-251
1222 - 4850 (MK, SK)	07/87->04/94	1NE 002 537-301	1	H3 fog light (E4) 914 Spare Parts: Reflector with lens Lens-retaining rim
For models with plastic bumpers only		9DF 117 504-007 9AG 129 328-001	2 7	
		1FE 002 537-311	1	H3 spotlight (E1) 24586 Spare Parts: Light unit Lens-retaining rim  1x12V55W (H3) 8GH 002 090-133 1x24V70W (H3) 8GH 002 090-251
1222 - 4850 (MK, SK)	05/94->09/96	1NE 006 300-201	1	H3 fog light (E1) 18231
For models with plastic bumpers only		1FE 006 300-191	1	H3 spotlight (E1) 44445  1x12V55W (H3) 8GH 002 090-133 1x24V70W (H3) 8GH 002 090-251
				



Manufacturer Model	Model year	Part no.	Pk.	Note
Mercedes-Benz				
1222 - 4850 (MK, SK) 1222 - 4850 (MK, SK) For models with plastic bumpers only	07/87->09/96	1FE 002 537-481 1FE 152 896-011 9AG 126 942-031 5DV 007 810-171 5DD 008 319-501	1	Xenon spotlight, with 24V xenon ballast and gas discharge bulb D2S E1 880 Spare Parts: 1 Light unit 5 Lens-retaining rim 1 Xenon ballast 24V 1 Ignitor, gas discharge bulb  1x35W (D2S) 8GS 007 949-101
1222 - 4850 (MK, SK)	07/87->09/96	2PF 961 167-021 9EL 137 241-001	2	Side light, for vehicles without external sun visor E1 31446 Spare Parts: 4 Lens  1x12V5W (C5W) 8GM 002 092-121 1x24V5W (C5W) 8GM 002 092-241
1222 - 4850 (MK, SK)	05/94->09/96	2BM 006 692-011 2BM 006 692-021	1 1	Auxiliary indicator light, left Auxiliary indicator light, right E1 52621  1x24V21W (P21W) 8GA 002 073-241
1222 - 4850 (MK, SK)	07/87->09/96	2XS 004 237-291 2XS 004 237-301	1 1	Clearance light (white), left, for front mounting Clearance light (white), right, for front mounting E1 21668  1x12V5W (R5W) 8GA 002 071-121 1x24V5W (R5W) 8GA 002 071-241



Manufacturer Model	Model year	Part no.	Pk.	Note
Mercedes-Benz				
1222 - 4850 (MK, SK)		2VD 005 300-551	1	Combination rearlight, left, with licence plate, rear fog, reverse, clearance light and lateral marker reflex-reflector
1222 - 4850 (MK, SK)	07/87->10/94			
1222, 1224, 1226, 1227, 1231, 1234		2VD 005 300-581	1	Combination rearlight, right, with licence plate, rear fog, reverse, clearance light and lateral marker reflex-reflector
1417, 1420, 1422, 1424, 1426, 1427, 1429				
1627				
1717, 1720, 1722, 1726, 1729, 1733, 1735, 1748				
1820, 1824, 1827, 1831, 1834, 1838, 1840, 1844, 1850, 1853				
1922, 1926, 1929, 1935, 1945, 1948		9EL 134 296-041	1	Lens with screws, left
		9EL 134 296-051	1	Lens with screws, right
		9EL 134 301-001	1	Lens for licence plate light
		9EL 134 301-011	1	Glare shield, black (order separately)
2024, 2027, 2031, 2038, 2044, 2050, 2055		8RA 003 326-011	20	Reflector (amber)
2420, 2422, 2426, 2429, 2431, 2433, 2434, 2435, 2448				3x12V10W (R10W) 8GA 002 071-131 3x24V10W (R10W) 8GA 002 071-251 4x12V21W (P21W) 8GA 002 073-121 4x24V21W (P21W) 8GA 002 073-241
2524, 2527, 2531, 2534, 2538, 2544, 2550, 2553				
2629, 2631, 2634, 2635, 2638, 2644, 2645, 2648, 2650, 2653				
3050, 3053				
3229, 3233, 3234, 3235, 3236, 3238, 3244, 3248, 3250, 3253, 3255				
3534, 3535, 3538, 3544, 3548, 3550, 3553				
4050				
4844, 4850				





Manufacturer Model	Model year	Part no.	Pk.	Note
Mercedes-Benz				
1222 - 4850 (MK, SK)		2VD 007 500-091	1	Combination rearlight, left, with licence plate, rear fog, reverse, clearance light, with side-marker reflex-reflector and bulbs
1222 - 4850 (MK, SK)	11/94->09/96			
1222, 1224, 1226, 1227, 1231, 1234		2VD 007 500-201	1	Combination rearlight, right, with licence plate, rear fog, reverse, clearance light, with side-marker reflex-reflector and bulbs
1417, 1420, 1422, 1424, 1426, 1427, 1429				
1627				(in the case of use in left-hand traffic, the number plate window of the black glare shield 9EL 134 301-011, order separately)
1717, 1720, 1722, 1726, 1729, 1733, 1735, 1748				(E1) 31432 (E1) 63217
1820, 1824, 1827, 1831, 1834, 1838, 1840, 1844, 1850, 1853		2VD 007 500-111	1	Combination rearlight, left, with licence plate, rear fog, reverse, clearance light, side-marker light, with side-marker reflex-reflector and bulbs
1922, 1926, 1929, 1935, 1945, 1948				
2024, 2027, 2031, 2038, 2044, 2050, 2055		2VD 007 500-221	1	Combination rearlight, right, with licence plate, rear fog, reverse, clearance light, side-marker light, with side-marker reflex-reflector and bulbs
2420, 2422, 2426, 2429, 2431, 2433, 2434, 2435, 2448				(in the case of use in left-hand traffic, the number plate window of the black glare shield 9EL 134 301-011, order separately)
2524, 2527, 2531, 2534, 2538, 2544, 2550, 2553				(E1) 31432 (E1) 63217
2629, 2631, 2634, 2635, 2638, 2644, 2645, 2648, 2650, 2653				(E1) 280
3050, 3053		9EL 134 296-041	1	Spare Parts: Lens with screws, left
3229, 3233, 3234, 3235, 3236, 3238, 3244, 3248, 3250, 3253, 3255		9EL 134 296-051	1	Lens with screws, right
3534, 3535, 3538, 3544, 3548, 3550, 3553		9EL 146 838-001	2	Lens for side-marker light for -111/-221
4050		9EL 134 301-001	1	Lens for licence plate light
4844, 4850		9EL 134 301-011	1	Glare shield, black (order separately)
except vehicles with hazardous goods		9GT 074 132-001	10	Grommet
		8RA 003 326-041	20	Reflector (amber) for -091/-201
				3x12V10W (R10W) 8GA 002 071-131
				3x24V10W (R10W) 8GA 002 071-251
				4x12V21W (P21W) 8GA 002 073-121
				4x24V21W (P21W) 8GA 002 073-241





Manufacturer Model	Model year	Part no.	Pk.	Note
Mercedes-Benz				
1222 - 4850 (MK, SK) 1222 - 4850 (MK, SK)	07/87->09/96	2XW 002 897-041	1	Hazard flasher lamp K 13931 1x6V2,4W (F) 8GP 002 096-061
Neoplan				
Centroliner Centroliner	10/98->	1BL 007 834-007 9GH 145 943-001 9HD 155 239-001 1KL 007 834-027	8 24 12 8	DE-H1 dipped-beam headlight 550 Spare Parts: Rubber cap (to be ordered and delivered separately) Cap (plastic) with leads and plugs (to be ordered and delivered separately) DE-H1 spotlight 549 1x24V70W (H1) 8GH 002 089-251
Centroliner	10/98->	1NL 007 186-047 9HD 149 253-007 8JD 156 150-807	30 160 1	DE-H3 fog light with bulb 20 Spare Parts: Plastic cap Counterplug set (to be ordered separately) 1x24V70W (H3) 8GH 002 090-251
Centroliner	10/98->	2BE 004 119-021 9GT 134 655-007 9GT 143 133-007	10 10 10	Indicator-side light (white), for front mounting 536 Spare Parts: Grommet Grommet 1x24V21W (P21W) 8GA 002 073-241 1x24V5W (W5W) 8GP 003 594-251
Centroliner	10/98->	2BM 006 692-011 2BM 006 692-021	1 1	Auxiliary indicator light, left Auxiliary indicator light, right 52621 1x24V21W (P21W) 8GA 002 073-241









Neoplan



Manufacturer Model	Model year	Part no.	Pk.	Note
Neoplan				
Centroliner Centroliner	10/98->	2SA 005 603-021	1	Rear light E1 31423 1x24V5W (R5W) 8GA 002 071-241
		2DA 005 603-031	1	Stop light E1 31422 1x24V21W (P21W) 8GA 002 073-241
Centroliner	10/98->	2BA 005 603-117	32	Indicator light (red), for rear mounting E1 586
		9FF 121 000-001	5	Spare Parts: Bulb socket 1x24V21W (P21W) 8GA 002 073-241
Centroliner	10/98->	2NE 005 603-071	1	Rear fog light E1 18438 1x24V21W (P21W) 8GA 002 073-241
Centroliner	10/98->	2ZR 005 603-061	1	Reverse light E1 8770 1x24V21W (P21W) 8GA 002 073-241
Centroliner	10/98->	2KA 005 049-011	2	Licence plate light with bulb E1 22871 1x24V5W (C5W) 8GM 002 092-241
Cityliner - Spaceliner Cityliner N 116 - Spaceliner N 117	->10/79	2PF 001 647-031	4	Side light E1 11780 1x24V10W (R10W) 8GA 002 071-251
Cityliner N 116 - Spaceliner N 117	->10/79	2BM 002 847-011	1	Auxiliary indicator light, left E1 32692
		2BM 002 847-021	1	
		9EL 115 830-001	5	









Manufacturer Model	Model year	Part no.	Pk.	Note
Neoplan				
Cityliner - Spaceliner Cityliner N 116 - Spaceliner N 117	->10/79	2SA 003 236-041	1	Rear light for bottom mounting E1 11591 1x24V5W (R5W) 8GA 002 071-241
				
Cityliner N 116 - Spaceliner N 117	->10/79	2SA 001 647-041	1	Rear light for top mounting K 11580 1x24V10W (R10W) 8GA 002 071-251
				
Cityliner N 116 - Spaceliner N 117	->10/79	2BA 003 236-321 9EL 119 544-021 9BG 121 740-001	1 4 1	Indicator light, for rear mounting E1 32764 Spare Parts: Lens Rubber body 1x24V21W (P21W) 8GA 002 073-241
				
Cityliner N 116 - Spaceliner N 117	->10/79	2KA 001 378-041	4	Licence plate light E1 12958 1x24V5W (C5W) 8GM 002 092-241
				
Cityliner N 116 - Spaceliner N 117	->10/79	2JA 003 236-357	60	Interior light 1x24V15W (F) 8GA 002 083-251 1x24V4W (T4W) 8GP 002 067-241
				
Cityliner N 116 - Spaceliner N 117	11/79->08/81	2BA 002 939-171 9EL 116 771-031	1 2	Indicator light E1 32710 Spare Parts: Lens with screws 1x24V21W (P21W) 8GA 002 073-241
				



Neoplan








Manufacturer Model	Model year	Part no.	Pk.	Note
Neoplan				
Cityliner - Spaceliner Cityliner N 116 - Spaceliner N 117 	09/81->12/83	2BA 003 734-061	1	Indicator light (E1) 42641 1x24V21W (P21W) 8GA 002 073-241
Cityliner N 116 - Spaceliner N 117 	11/79->09/83	2PF 001 647-031	4	Side light (E1) 11780 1x24V10W (R10W) 8GA 002 071-251
Cityliner N 116 - Spaceliner N 117 	10/83->08/87	2PF 961 167-021	2	Side light (E1) 31446 Spare Parts: Lens 1x24V5W (C5W) 8GM 002 092-241
Cityliner N 116 - Spaceliner N 117 	09/87->	2PF 002 860-031	1	Side light (E1) 21688 Spare Parts: Body/lens Base (to be ordered separately) 1x24V10W (R10W) 8GA 002 071-251
Cityliner N 116 - Spaceliner N 117 	09/85->	2XS 005 020-001	10	Clearance light (E1) 31407 Spare Parts: Lens with screws 1x24V4W (T4W) 8GP 002 067-241
Cityliner N 116 - Spaceliner N 117 	11/79->12/91	2BM 002 847-011 2BM 002 847-021	1 1	Auxiliary indicator light, left Auxiliary indicator light, right (E1) 32692 Spare Parts: Lens 1x24V21W (P21W) 8GA 002 073-241



Manufacturer Model	Model year	Part no.	Pk.	Note
Neoplan				
Cityliner - Spaceliner Cityliner N 116 - Spaceliner N 117	01/92->	2BM 006 692-011 2BM 006 692-021	1 1	Auxiliary indicator light, left Auxiliary indicator light, right (E1) 52621 1x24V21W (P21W) 8GA 002 073-241
Cityliner N 116 - Spaceliner N 117		2PS 962 964-012 9GT 963 129-001 9GD 963 281-001	1 60 60	Side-marker light with reflector (amber), with bulb (E4) 4 (E4) 3153 Spare Parts: Grommet (to be ordered separately) Seal (to be ordered separately) 1x24V3W (W3W) 8GP 003 594-241
Cityliner N 116 - Spaceliner N 117	11/79->04/82	2SA 001 647-041	1	Rear light for top mounting K 11580 1x24V10W (R10W) 8GA 002 071-251
Cityliner N 116 - Spaceliner N 117	05/82->06/89	2SB 003 236-537 9BG 121 740-001	24 1	Rear-stop light for top mounting (E1) 243 Spare Parts: Rubber body 1x24V21/5W (P21/5W) 8GD 002 078-241
Cityliner N 116 - Spaceliner N 117 Cityliner N 116, Combiliner N 316, Jetliner N 208 - N 216, Metroliner N 317, Skyliner N 122, Spaceliner N 117	07/89->	2SD 002 582-117 2SD 002 582-127	32 32	Combination rearlight, left Combination rearlight, right (E1) 116 (E1) 53345 1x24V10W (R10W) 8GA 002 071-251 2x24V21W (P21W) 8GA 002 073-241

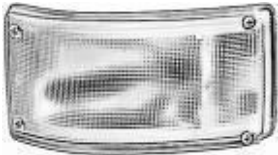


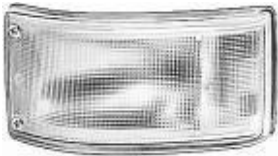



Manufacturer Model	Model year	Part no.	Pk.	Note
Neoplan				
Cityliner - Spaceliner Cityliner N 116 - Spaceliner N 117	11/79->08/89		2SA 003 236-041 2DA 003 236-031 9EL 119 544-031	1 Rear light for bottom mounting E1 11591 1x24V5W (R5W) 8GA 002 071-241 1 Stop light for bottom mounting E1 240 Spare Parts: Lens 1x24V21W (P21W) 8GA 002 073-241
Cityliner N 116 - Spaceliner N 117	11/79->08/89		2BA 003 236-021 9EL 119 544-021	1 Indicator light, for rear mounting E1 32764 Spare Parts: Lens 1x24V21W (P21W) 8GA 002 073-241
Cityliner N 116 - Spaceliner N 117	11/79->08/89		2NE 003 236-001 9EL 119 544-001 9DX 119 545-011	1 Rear fog light e1 18 411 Spare Parts: Lens 2 Reflector 1x24V21W (P21W) 8GA 002 073-241
Cityliner N 116 - Spaceliner N 117	11/79->08/89		2ZR 003 236-051 9EL 119 544-111 9DX 119 545-051	1 Reverse light E1 8728 Spare Parts: Lens 2 Reflector 1x24V21W (P21W) 8GA 002 073-241
Cityliner N 116 - Spaceliner N 117	11/79->09/91		2KA 001 378-041	4 Licence plate light E1 12958 1x24V5W (C5W) 8GM 002 092-241



Manufacturer Model	Model year	Part no.	Pk.	Note
Neoplan				
Cityliner - Spaceliner Cityliner N 116 - Spaceliner N 117	10/91->	2KA 005 049-011	2	Licence plate light with bulb (E1) 22871 1x24V5W (C5W) 8GM 002 092-241
Cityliner N 116 - Spaceliner N 117	11/79->08/85	2JA 003 236-357	60	Interior light 1x24V15W (F) 8GA 002 083-251 1x24V4W (T4W) 8GP 002 067-241
Cityliner N 116 - Spaceliner N 117	09/89->	2BA 005 603-001	1	Indicator light, for front mounting (E1) 42748 1x24V21W (P21W) 8GA 002 073-241
		2BA 005 603-011	1	Indicator light, for rear mounting (E1) 42749 1x24V21W (P21W) 8GA 002 073-241
Cityliner N 116 - Spaceliner N 117	09/89->	2SA 005 603-021	1	Rear light (E1) 31423 1x24V5W (R5W) 8GA 002 071-241
		2DA 005 603-031	1	Stop light (E1) 31422 1x24V21W (P21W) 8GA 002 073-241
Cityliner N 116 - Spaceliner N 117	09/89->	2NE 005 603-071	1	Rear fog light (E1) 18438 1x24V21W (P21W) 8GA 002 073-241



Manufacturer Model	Model year	Part no.	Pk.	Note
Neoplan				
Cityliner - Spaceliner Cityliner N 116 - Spaceliner N 117	09/89->	2ZR 005 603-061	1	Reverse light E1 8770 1x24V21W (P21W) 8GA 002 073-241
				
Euroliner N 3316 Euroliner N 3316	10/98->	1BL 007 834-007	8	DE-H1 dipped-beam headlight E1 550 Spare Parts: Rubber cap (to be ordered and delivered separately) Cap (plastic) with leads and plugs (to be ordered and delivered separately)
		9GH 145 943-001 9HD 155 239-001 1KL 007 834-027	24 12 8	DE-H1 spotlight E1 549 1x24V70W (H1) 8GH 002 089-251
Euroliner N 3316	10/98->	1NL 007 834-017	8	DE-H1 fog light Spare Parts: Cap (plastic) with leads and plugs (to be ordered and delivered separately) E1 548 1x24V70W (H1) 8GH 002 089-251
		9HD 155 239-001	12	
Euroliner N 3316	10/98->	2BE 004 119-021	10	Indicator-side light (white), for front mounting E1 536 Spare Parts: Grommet Grommet 1x24V21W (P21W) 8GA 002 073-241 1x24V5W (W5W) 8GP 003 594-251
		9GT 134 655-007 9GT 143 133-007	10 10	
Euroliner N 3316	10/98->	2BM 006 692-011 2BM 006 692-021	1 1	Auxiliary indicator light, left Auxiliary indicator light, right E1 52621 1x24V21W (P21W) 8GA 002 073-241
				

















Manufacturer Model	Model year	Part no.	Pk.	Note
Neoplan				
Euroliner N 3316 Euroliner N 3316	10/98->	2SA 005 603-021	1	Rear light E1 31423 1x24V5W (R5W) 8GA 002 071-241
		2DA 005 603-031	1	Stop light E1 31422 1x24V21W (P21W) 8GA 002 073-241
Euroliner N 3316	10/98->	2BA 005 603-117	32	Indicator light (red), for rear mounting E1 586
		9FF 121 000-001	5	Spare Parts: Bulb socket 1x24V21W (P21W) 8GA 002 073-241
Euroliner N 3316	10/98->	2NE 005 603-071	1	Rear fog light E1 18438 1x24V21W (P21W) 8GA 002 073-241
Euroliner N 3316	10/98->	2ZR 005 603-061	1	Reverse light E1 8770 1x24V21W (P21W) 8GA 002 073-241
Euroliner N 3316	10/98->	2KA 005 049-011	2	Licence plate light with bulb E1 22871 1x24V5W (C5W) 8GM 002 092-241
Bus (SK 1) N 407 Bus (SK 1) N 407	83->	2BA 003 236-321	1	Indicator light, for rear mounting E1 32764
		9EL 119 544-021 9BG 121 740-001	4 1	Spare Parts: Lens Rubber body 1x24V21W (P21W) 8GA 002 073-241



Manufacturer Model	Model year	Part no.	Pk.	Note
Neoplan				
Bus (SK 1) N 407 Bus (SK 1) N 407	83->	2NE 003 236-001 9EL 119 544-001 9DX 119 545-011	1 4 2	Rear fog light (E1) 18 411 Spare Parts: Lens Reflector 1x24V21W (P21W) 8GA 002 073-241
Bus (SK 1) N 407	83->	2ZR 003 236-311 9EL 119 544-111 9BG 121 740-001	1 4 1	Reverse light (E1) 8728 Spare Parts: Lens Rubber body 1x24V21W (P21W) 8GA 002 073-241
Bus (SK 1) N 407	83->	2SA 003 236-341 9EL 120 201-001 9BG 121 740-001 2DA 003 236-031 9EL 119 544-031	1 4 1 4	Rear light for bottom mounting (E1) 11591 Spare Parts: Lens Rubber body 1x24V5W (R5W) 8GA 002 071-241 Stop light (E1) 240 Spare Parts: Lens 1x24V21W (P21W) 8GA 002 073-241
Bus SL II, Ü 80 Bus SL II N 416, Ü 80 N 420/3	82->		4	Side light (E1) 11780 1x24V10W (R10W) 8GA 002 071-251
Bus SL II N 416, Ü 80 N 420/3	82->03/89		1	Indicator light (E1) 42641 1x24V21W (P21W) 8GA 002 073-241









Manufacturer Model	Model year	Part no.	Pk.	Note
Neoplan				
Bus SL II, Ü 80 Bus SL II N 416, Ü 80 N 420/3	82->12/91	2BM 002 847-011	1	Auxiliary indicator light, left
		2BM 002 847-021	1	Auxiliary indicator light, right
		9EL 115 830-001	5	Spare Parts: Lens  1x24V21W (P21W) 8GA 002 073-241
Bus SL II N 416, Ü 80 N 420/3 Bus SL II N 416, Ü 80 N 420/3	01/92->	2BM 006 692-011	1	Auxiliary indicator light, left
		2BM 006 692-021	1	Auxiliary indicator light, right
				 52621  1x24V21W (P21W) 8GA 002 073-241
Bus SL II N 416, Ü 80 N 420/3 Bus SL II N 416, Ü 80 N 420/3	82->	2SA 003 236-041	1	Rear light for bottom mounting  11591  1x24V5W (R5W) 8GA 002 071-241
		2DA 003 236-031	1	Stop light for bottom mounting  240
		9EL 119 544-031	4	Spare Parts: Lens  1x24V21W (P21W) 8GA 002 073-241
Bus SL II N 416, Ü 80 N 420/3 Bus SL II N 416, Ü 80 N 420/3	82->	2BA 003 236-021	1	Indicator light, for rear, bottom mounting  32764
		9EL 119 544-021	4	Spare Parts: Lens  1x24V21W (P21W) 8GA 002 073-241
Bus SL II N 416, Ü 80 N 420/3 Bus SL II N 416, Ü 80 N 420/3	82->	2NE 003 236-001	1	Rear fog light  18 411
		9EL 119 544-001 9DX 119 545-011	4 2	Spare Parts: Lens Reflector  1x24V21W (P21W) 8GA 002 073-241
				



Neoplan








Manufacturer Model	Model year	Part no.	Pk.	Note
Neoplan				
Bus SL II, Ü 80 Bus SL II N 416, Ü 80 N 420/3	82->	2ZR 003 236-051 9EL 119 544-111 9DX 119 545-051	1 4 2	Reverse light (E1) 8728 Spare Parts: Lens Reflector  1x24V21W (P21W) 8GA 002 073-241
Bus SL II N 416, Ü 80 N 420/3	82->	9EL 118 445-001 9GD 087 883-355 9GD 118 983-021	1 10 10	Combination rearlight spare parts available only, for top mounting (E1) 53250 Spare Parts: Lens with screws Seal Bodywork seal for flush-fitting (to be ordered separately)  1x24V10W (R10W) 8GA 002 071-251  2x24V21W (P21W) 8GA 002 073-241
Bus SL II N 416, Ü 80 N 420/3	-->09/91	2KA 001 378-041	4	Licence plate light (E1) 12958  1x24V5W (C5W) 8GM 002 092-241
Bus SL II N 416, Ü 80 N 420/3	10/91->	2KA 005 049-011	2	Licence plate light with bulb (E1) 22871  1x24V5W (C5W) 8GM 002 092-241
Metroliner N 8008, N 8012 Metroliner N 8008, N 8012		2PS 962 964-012 9GT 963 129-001 9GD 963 281-001	1 60 60	Side-marker light with reflector (amber), with bulb (E4) 4 (E4) 3153 Spare Parts: Grommet (to be ordered separately) Seal (to be ordered separately)  1x24V3W (W3W) 8GP 003 594-241









Manufacturer Model	Model year	Part no.	Pk.	Note
Neoplan				
Metroliner N 8008, N 8012 Metroliner N 8008, N 8012 	06/91->	2SD 002 582-117	32	Combination rearlight, left, for top mounting
		2SD 002 582-127	32	Combination rearlight, right, for top mounting (E1) 116 (E1) 53345 1x24V10W (R10W) 8GA 002 071-251 2x24V21W (P21W) 8GA 002 073-241
Metroliner N 8008, N 8012 	06/91->	2SA 005 603-021	1	Rear light (E1) 31423 1x24V5W (R5W) 8GA 002 071-241
		2DA 005 603-031	1	Stop light (E1) 31422 1x24V21W (P21W) 8GA 002 073-241
Metroliner N 8008, N 8012 	06/91->	2BA 005 603-001	1	Indicator light, for front mounting (E1) 42748 1x24V21W (P21W) 8GA 002 073-241
		2BA 005 603-011	1	Indicator light, for rear mounting (E1) 42749 1x24V21W (P21W) 8GA 002 073-241
Metroliner N 8008, N 8012 	06/91->	2NE 005 603-071	1	Rear fog light (E1) 18438 1x24V21W (P21W) 8GA 002 073-241
Metroliner N 8008, N 8012 	06/91->	2ZR 005 603-061	1	Reverse light (E1) 8770 1x24V21W (P21W) 8GA 002 073-241














Manufacturer Model	Model year	Part no.	Pk.	Note
Neoplan				
Metroliner N 8008, N 8012 Metroliner N 8008, N 8012	06/91->	2XS 005 020-001 9EL 132 215-001	10 2	Clearance light (E1) 31407 Spare Parts: Lens with screws 1x24V4W (T4W) 8GP 002 067-241
				
Low-level-entry bus N 4010 Low-level-entry bus N 4010		2BA 005 603-001	1	Indicator light (E1) 42748 1x24V21W (P21W) 8GA 002 073-241
				
Low-level-entry bus N 4010		2PF 961 167-021 9EL 137 241-001	2 4	Side light (E1) 31446 Spare Parts: Lens 1x24V5W (C5W) 8GM 002 092-241
				
Low-level-entry bus N 4010		2BM 002 847-011 2BM 002 847-021 9EL 115 830-001	1 1 5	Auxiliary indicator light, left Auxiliary indicator light, right (E1) 32692 Spare Parts: Lens 1x24V21W (P21W) 8GA 002 073-241
				
Low-level-entry bus N 4010		2PS 962 964-012 9GT 963 129-001 9GD 963 281-001	1 60 60	Side-marker light with reflector (amber), with bulb (E4) 4 (E4) 3153 Spare Parts: Grommet (to be ordered separately) Seal (to be ordered separately) 1x24V3W (W3W) 8GP 003 594-241
				









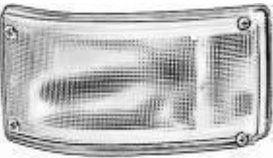





Manufacturer Model	Model year	Part no.	Pk.	Note
Neoplan				
Low-level-entry bus N 4010 Low-level-entry bus N 4010 		9EL 118 445-001 9GD 087 883-355 9GD 118 983-021	1 10 10	Combination rearlight spare parts available only, for top mounting (E1) 53250 Spare Parts: Lens with screws Seal Bodywork seal for flush-fitting (to be ordered separately) 1x24V10W (R10W) 8GA 002 071-251 2x24V21W (P21W) 8GA 002 073-241
Low-level-entry bus N 4010 		2BA 003 236-021 9EL 119 544-021	1 4	Indicator light, for rear mounting (E1) 32764 Spare Parts: Lens 1x24V21W (P21W) 8GA 002 073-241
Low-level-entry bus N 4010 		2DA 003 236-031 9EL 119 544-031	1 4	Stop light for bottom mounting (E1) 240 Spare Parts: Lens 1x24V21W (P21W) 8GA 002 073-241
Low-level-entry bus N 4010 		2KA 003 010-007	1	Licence plate light (E1) 12809 2x24V5W (R5W) 8GA 002 071-241
Low-level-entry bus N 4014 Low-level-entry bus N 4014 		2PF 961 167-021 9EL 137 241-001	2 4	Side light (E1) 31446 Spare Parts: Lens 1x24V5W (C5W) 8GM 002 092-241
Low-level-entry bus N 4014 		2BM 006 692-011 2BM 006 692-021	1 1	Auxiliary indicator light, left Auxiliary indicator light, right (E1) 52621 1x24V21W (P21W) 8GA 002 073-241


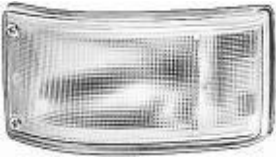






Manufacturer Model	Model year	Part no.	Pk.	Note
Neoplan				
Low-level-entry bus N 4014 Low-level-entry bus N 4014		2PS 962 964-012 9GT 963 129-001 9GD 963 281-001	1 60 60	Side-marker light with reflector (amber), with bulb (E4) 4 (E4) 3153 Spare Parts: Grommet (to be ordered separately) Seal (to be ordered separately)  1x24V3W (W3W) 8GP 003 594-241
Low-level-entry bus N 4014		9EL 118 445-001 9GD 087 883-355 9GD 118 983-021	1 10 10	Combination rearlight spare parts available only, for top mounting (E1) 53250 Spare Parts: Lens with screws Seal Bodywork seal for flush-fitting (to be ordered separately)  1x24V10W (R10W) 8GA 002 071-251  2x24V21W (P21W) 8GA 002 073-241
Low-level-entry bus N 4014		2BA 003 236-027	6	Indicator light, for top mounting (E1) 32764  1x24V21W (P21W) 8GA 002 073-241
Low-level-entry bus N 4014		2DA 003 236-031	1	Stop light for top mounting (E1) 240 Spare Parts: Lens  1x24V21W (P21W) 8GA 002 073-241
Low-level-entry bus N 4014		2KA 003 010-007	1	Licence plate light (E1) 12809  2x24V5W (R5W) 8GA 002 071-241



Manufacturer Model	Model year	Part no.	Pk.	Note
Neoplan				
Regioliner Regioliner		2BA 005 603-001	1	Indicator light, for front mounting ⓔ1 42748  1x24V21W (P21W) 8GA 002 073-241
		2BA 005 603-011	1	Indicator light, for rear mounting ⓔ1 42749  1x24V21W (P21W) 8GA 002 073-241
Regioliner		2BM 006 692-011 2BM 006 692-021	1 1	Auxiliary indicator light, left Auxiliary indicator light, right ⓔ1 52621  1x24V21W (P21W) 8GA 002 073-241
Regioliner		2SA 005 603-021	1	Rear light ⓔ1 31423  1x24V5W (R5W) 8GA 002 071-241
		2DA 005 603-031	1	Stop light ⓔ1 31422  1x24V21W (P21W) 8GA 002 073-241
Regioliner		2ZR 005 603-061	1	Reverse light ⓔ1 8770  1x24V21W (P21W) 8GA 002 073-241
Starliner N 516 Starliner N 516	09/96-> 	1BL 007 834-007 9GH 145 943-001 9HD 155 239-001 1KL 007 834-027	8 24 12 8	DE-H1 dipped-beam headlight ⓔ1 550 Spare Parts: Rubber cap (to be ordered and delivered separately) Cap (plastic) with leads and plugs (to be ordered and delivered separately) DE-H1 spotlight ⓔ1 549  1x24V70W (H1) 8GH 002 089-251



Manufacturer Model	Model year	Part no.	Pk.	Note
Neoplan				
Starliner N 516 Starliner N 516	09/96->	1NL 007 834-017 9HD 155 239-001	8 12	DE-H1 fog light (E1) 548 Spare Parts: Cap (plastic) with leads and plugs (to be ordered and delivered separately) 1x24V70W (H1) 8GH 002 089-251
				
Starliner N 516	09/96->	2BE 004 119-021 9GT 134 655-007 9GT 143 133-007	10 10 10	Indicator-side light (white), for front mounting (E1) 536 Spare Parts: Grommet Grommet 1x24V21W (P21W) 8GA 002 073-241 1x24V5W (W5W) 8GP 003 594-251
				
Starliner N 516	09/96->	2BM 006 692-011 2BM 006 692-021	1 1	Auxiliary indicator light, left Auxiliary indicator light, right (E1) 52621 1x24V21W (P21W) 8GA 002 073-241
				
Starliner N 516	09/96->	2SA 005 603-021 2DA 005 603-031	1 1	Rear light (E1) 31423 1x24V5W (R5W) 8GA 002 071-241 Stop light (E1) 31422 1x24V21W (P21W) 8GA 002 073-241
				
Starliner N 516	09/96->	2BA 005 603-117 9FF 121 000-001	32 5	Indicator light (red), for rear mounting (E1) 586 Spare Parts: Bulb socket 1x24V21W (P21W) 8GA 002 073-241
				
Starliner N 516	09/96->	2NE 005 603-071	1	Rear fog light (E1) 18438 1x24V21W (P21W) 8GA 002 073-241
				



Manufacturer Model	Model year	Part no.	Pk.	Note
Neoplan				
Starliner N 516 Starliner N 516	09/96->	2ZR 001 240-377	30	Reverse light (E4) 2336 1x24V21W (P21W) 8GA 002 073-241
Starliner N 516	09/96->	8XU 007 842-017 8XU 007 842-027	20 20	Rear panel, left Rear panel, right
Starliner N 516	09/96->	2KA 005 049-011	2	Licence plate light with bulb (E1) 22871 1x24V5W (C5W) 8GM 002 092-241
Transliner N 316 Transliner N 316	07/91->	2BM 006 692-011 2BM 006 692-021	1 1	Auxiliary indicator light, left Auxiliary indicator light, right (E1) 52621 1x24V21W (P21W) 8GA 002 073-241
Transliner N 316		2PS 962 964-012 9GT 963 129-001 9GD 963 281-001	1 60 60	Side-marker light with reflector (amber), with bulb (E4) 4 (E4) 3153 Spare Parts: Grommet (to be ordered separately) Seal (to be ordered separately) 1x24V3W (W3W) 8GP 003 594-241



Neoplan



Manufacturer Model	Model year	Part no.	Pk.	Note
Neoplan				
Transliner N 316 Transliner N 316	07/91->	2SA 005 603-021	1	Rear light E1 31423 1x24V5W (R5W) 8GA 002 071-241
		2DA 005 603-031	1	Stop light E1 31422 1x24V21W (P21W) 8GA 002 073-241
Transliner N 316	07/91->	2BA 005 603-011	1	Indicator light, for rear mounting E1 42749 1x24V21W (P21W) 8GA 002 073-241
Transliner N 316	07/91->	2NE 005 603-071	1	Rear fog light E1 18438 1x24V21W (P21W) 8GA 002 073-241
Transliner N 316	07/91->	2ZR 005 603-061	1	Reverse light E1 8770 1x24V21W (P21W) 8GA 002 073-241
Transliner N 316	07/91->	2XS 005 020-001	10	Clearance light E1 31407
		9EL 132 215-001	2	Spare Parts: Lens with screws 1x24V4W (T4W) 8GP 002 067-241
Unibus N 906, N 907 Unibus N 906	81->	2PF 001 638-011	2	Side light E1 11779
		9EL 107 443-011	2	Spare Parts: Body/lens with screw
		9GD 082 716-001	10	Base for flat surfaces (to be ordered separately)
		9GD 100 140-001	10	Base for curved surfaces (to be ordered separately)
				1x24V5W (R5W) 8GA 002 071-241




Manufacturer Model	Model year	Part no.	Pk.	Note
Neoplan				
Unibus N 906, N 907 Unibus N 906	81->	2SA 001 638-021	2	Rear light for top mounting E1 31450 Spare Parts: Body/lens with screw Base for flat surfaces (to be ordered separately) Base for curved surfaces (to be ordered separately) 1x24V5W (W5W) 8GP 003 594-251
		9EL 107 443-061	2	
		9GD 082 716-001 9GD 100 140-001	10 10	
Unibus N 906, N 907	81->	2BM 002 847-011 2BM 002 847-021	1 1	Auxiliary indicator light, left Auxiliary indicator light, right E1 32692 Spare Parts: Lens 1x24V21W (P21W) 8GA 002 073-241
		9EL 115 830-001	5	
Unibus N 906, N 907	81->	2SA 003 236-041	1	Rear light for bottom mounting E1 11591 1x24V5W (R5W) 8GA 002 071-241
		2DA 003 236-031	1	Stop light for bottom mounting E1 240 Spare Parts: Lens 1x24V21W (P21W) 8GA 002 073-241
		9EL 119 544-031	4	
Unibus N 906, N 907	81->	2BA 003 236-021	1	Indicator light, for rear mounting E1 32764 Spare Parts: Lens 1x24V21W (P21W) 8GA 002 073-241
		9EL 119 544-021	4	
Unibus N 906, N 907	81->	2ZR 003 236-051	1	Reverse light E1 8728 Spare Parts: Lens Reflector 1x24V21W (P21W) 8GA 002 073-241
		9EL 119 544-111 9DX 119 545-051	4 2	


















Neoplan - Renault Trucks







Manufacturer Model	Model year	Part no.	Pk.	Note
Neoplan				
Unibus N 906, N 907 Unibus N 906, N 907	81->	2KA 003 389-061	2	Licence plate light E1 22819
		9BG 121 587-031	2	Spare Parts: Body/lens with screw 1x24V10W (R10W) 8GA 002 071-251
Unibus N 907	82->	2PF 001 647-031	4	Side light E1 11780 1x24V10W (R10W) 8GA 002 071-251
				Unibus N 907
Renault Trucks				
Magnum Magnum Vehicles with air suspension/ levelling system	06/01->	1LR 246 046-531	1	H1/H7 headlight, left, with indicator light, without headlight leveller, without lens cleaning system, with bulbs
		1LR 246 046-541	1	H1/H7 headlight, right, with indicator light, without headlight leveller, without lens cleaning system, with bulbs E1 1327 E1 1328 1x24V70W (H7) 8GH 007 157-241 1x24V70W (H1) 8GH 002 089-251 1x24V21W (PY21W) 8GA 006 841-251 1x24V5W (W5W) 8GP 003 594-251
Magnum		2VD 008 204-231	1	Combination rearlight, left, with licence plate, rear fog, reverse, clearance light, side-marker light, with reflex-reflector and marker reflex-reflector
		2VP 008 204-221	1	Combination rearlight, left/right, with rear fog, reverse, clearance light, side-marker light, with reflex-reflector and marker reflex-reflector E4 3178 E4 9808 E4 9809 E4 9810
		9EL 152 889-001	1	Spare Parts: Lens with screws 3x24V5W (R5W) 8GA 002 071-241 4x24V21W (P21W) 8GA 002 073-241






Manufacturer Model	Model year	Part no.	Pk.	Note
Renault Trucks				
Premium Premium 		2VD 008 204-231	1	Combination rearlight, left, with licence plate, rear fog, reverse, clearance light, side-marker light, with reflex-reflector and marker reflex-reflector
		2VP 008 204-221	1	Combination rearlight, left/right, with rear fog, reverse, clearance light, side-marker light, with reflex-reflector and marker reflex-reflector (E4) 3178 (E4) 9808 (E4) 9809 (E4) 9810
		9EL 152 889-001	1	Spare Parts: Lens with screws  3x24V5W (R5W) 8GA 002 071-241  4x24V21W (P21W) 8GA 002 073-241
Premium II Premium II Distribution 10/05-> 		1LL 247 010-311	1	H1/H7 headlight, left, with indicator light, without fog light, without headlight leveller, with bulbs
		1LL 247 010-321	1	H1/H7 headlight, right, with indicator light, without fog light, without headlight leveller, with bulbs
		1LL 247 010-331	1	H1/H7 headlight, left, with indicator light, with H3 fog light, without headlight leveller, with bulbs
		1LL 247 010-341	1	H1/H7 headlight, right, with indicator light, with H3 fog light, without headlight leveller, with bulbs (E1) 1877 (E1) 1878  1x24V70W (H7) 8GH 007 157-231 Long Life  1x24V70W (H1) 8GH 002 089-251  1x24V70W (H3) 8GH 002 090-251  1x24V21W (PY21W) 8GA 006 841-241  1x24V5W (W5W) 8GP 003 594-251
Premium II Route 10/05-> 		1LL 247 010-391	1	H1/H7 headlight, left, with indicator light, with H3 fog light, without headlight leveller, with bulbs
		1LL 247 010-401	1	H1/H7 headlight, right, with indicator light, with H3 fog light, without headlight leveller, with bulbs (E1) 1877 (E1) 1878  1x24V70W (H7) 8GH 007 157-231 Long Life  1x24V70W (H1) 8GH 002 089-251  1x24V70W (H3) 8GH 002 090-251  1x24V21W (PY21W) 8GA 006 841-241  1x24V5W (W5W) 8GP 003 594-251



Manufacturer Model	Model year	Part no.	Pk.	Note
Scania				
Older models Older models		2SE 997 088-001	1	Combination rearlight with licence plate light (E12) 4035 (E12) 6066 (E12) 27092 2x24V10W (R10W) 8GA 002 071-251 2x24V21W (P21W) 8GA 002 073-241
				
LB 81 - LBT 141 (series 1) LB 81 - LBT 141 (series 1)	02/68->	2PS 004 361-001	1	Side-marker light with reflector (amber) (E4) 2 (E4) 3 (E4) 3152 Spare Parts: 1 Lens with screws 105 Baseplate with grommet (to be ordered separately) 1x24V5W (R5W) 8GA 002 071-241
		9EL 114 401-001 9BP 128 032-017		
LB 81 - LBT 141 (series 1) LB 81 LB/LBS/LBT 110 LB/LBS/LBT 111 LB/LBS/LBT 140 LB/LBS/LBT 141	02/68-> 02/68-> 02/68->	2SE 001 688-151 2SE 001 688-161	1 1	Combination rearlight, left, with licence plate light Combination rearlight, right, with licence plate light (E1) 43207 Spare Parts: 1 Lens with screws 10 Seal 10 Grommet 2x24V5W (R5W) 8GA 002 071-241 2x24V21W (P21W) 8GA 002 073-241
		9EL 092 435-011 9GD 102 484-001 9GT 074 132-001		
G 82 - T 142 (series 2) G 82 - T 142 (series 2)	05/80->03/88	2BE 003 649-011 2BE 003 649-021	1 1	Indicator-side light, left, with auxiliary indicator light Indicator-side light, right, with auxiliary indicator light (E1) 53312 Spare Parts: 5 Lens, left 5 Lens, right 1x24V5W (R5W) 8GA 002 071-241 1x24V21W (P21W) 8GA 002 073-241
		9EL 123 209-005 9EL 123 210-005		











Manufacturer Model	Model year	Part no.	Pk.	Note
Scania				
P 93 - T 143 (series 3) P 93 - T 143 (series 3)	01/88->12/96			Indicator-side light, with auxiliary indicator light, side-marker light and reflector, spare parts available only (E4) 278 (E4) 311 (E4) 3092 Spare Parts: Body/lens, left Body/lens, right 1x24V5W (R5W) 8GA 002 071-241 1x24V21W (P21W) 8GA 002 073-241
		9EL 151 127-001 9EL 151 128-001	5 5	
P 93 - T 143 (series 3) P 93, P 113 R 93, R 113, R 143 T 93, T 113, T 143	01/88->12/96			Combination rearlight, left, with licence plate, rear fog, reverse, clearance light, side-marker light, with reflex-reflector and marker reflex-reflector Combination rearlight, right, with licence plate, rear fog, reverse, clearance light, side-marker light, with reflex-reflector and marker reflex-reflector (E4) 3178 (E4) 4060 (E4) 9808 (E4) 9810 Spare Parts: Lens with screws 3x24V5W (R5W) 8GA 002 071-241 4x24V21W (P21W) 8GA 002 073-241
		2VD 008 204-151 2VD 008 204-141 9EL 152 889-001	1 1 1	
P 93 - T 143 (series 3) P 93, P 113 R 93, R 113, R 143 T 93, T 113, T 143 Streamline	01/88->12/96			Combination rearlight, left, with licence plate, rear fog, reverse and clearance light, with reflex-reflector and centre plug Combination rearlight, left/right, with rear fog, reverse and clearance light, with reflex-reflector and centre plug Combination rearlight, left, with licence plate, rear fog, reverse, clearance light, side-marker light, with reflex-reflector, marker reflex-reflector and centre plug Combination rearlight, left/right, with rear fog, reverse, clearance light, side-marker light, with reflex-reflector, marker reflex-reflector and centre plug (E4) 3178 (E4) 4060 (E4) 9808 (E4) 9810 Spare Parts: Lens with screws 3x24V5W (R5W) 8GA 002 071-241 4x24V21W (P21W) 8GA 002 073-241
		2VD 008 204-051 2VP 008 204-041 2VD 008 204-071 2VP 008 204-061 9EL 152 889-001	1 1 1 1 1	




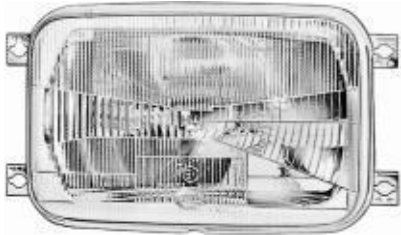


Scania



Manufacturer Model	Model year	Part no.	Pk.	Note
Scania				
P 94 - T 164 (series 4) P 94 - T 164 (series 4) P 94, P 114, P 124 R 94, R 114, R 124, R 144, R 164 T 94, T 114, T 124, T 144, T 164	09/95->09/04	1LG 007 150-111	1	H4 headlight, left, with indicator-side light (white) and suitable for electr. headlight leveller H4 headlight, right, with indicator-side light (white) and suitable for electr. headlight leveller (E1) 113 left (E1) 114 right (E4) 273 Spare Parts: 1 Lens, left 1 Lens, right 1 Reflector, left 1 Reflector, right 1 Body/lens for with indicator-side light, left 1 Body/lens for with indicator-side light, right  1x24V75/70W (H4) 8GJ 002 525-251 2x24V10W (R10W) 8GA 002 071-271 Heavy Duty  2x24V21W (P21W) 8GA 002 073-251 Heavy Duty
		 9ES 144 433-031 1 9ES 144 434-031 1 9DE 145 675-011 1 9DE 145 676-011 1 9EL 145 103-011 1 9EL 145 104-011 1	1LG 007 150-121	
P 94 - T 164 (series 4) P 94, P 114, P 124 R 94, R 114, R 124, R 144, R 164 T 94, T 114, T 124, T 144, T 164	09/95->09/04	2VD 008 205-011	1	Combination rearlight, left, with licence plate, rear fog, reverse, clearance light, side-marker light, with reflex-reflector and marker reflex-reflector Combination rearlight, right, with licence plate, rear fog, reverse, clearance light, side-marker light, with reflex-reflector and marker reflex-reflector (E4) 3178 (E4) 4060 (E4) 9808 (E4) 9811 Spare Parts: 1 Lens with screws  3x24V5W (R5W) 8GA 002 071-241 1x24V10W (R10W) 8GA 002 071-251 4x24V21W (P21W) 8GA 002 073-241
		 9EL 152 884-001 1	2VD 008 205-021	
P 230 - T 470 P 230 - T 470 (series P, G, R, T) P 230, P 270, P 310, P 340, P 380, P 420 G 230 R 340, R 380, R 420, R 470, R 500, R 580, R 620 T 470	03/04->	1LG 007 150-111	1	H4 headlight, left, with indicator-side light (white) and suitable for electr. headlight leveller H4 headlight, right, with indicator-side light (white) and suitable for electr. headlight leveller (E1) 113 left (E1) 114 right (E4) 273 Spare Parts: 1 Lens, left 1 Lens, right 1 Reflector, left 1 Reflector, right 1 Body/lens for with indicator-side light, left 1 Body/lens for with indicator-side light, right  1x24V75/70W (H4) 8GJ 002 525-251 2x24V10W (R10W) 8GA 002 071-271 Heavy Duty  2x24V21W (P21W) 8GA 002 073-251 Heavy Duty
		 9ES 144 433-031 1 9ES 144 434-031 1 9DE 145 675-011 1 9DE 145 676-011 1 9EL 145 103-011 1 9EL 145 104-011 1	1LG 007 150-121	


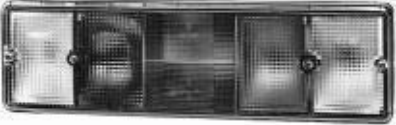




Manufacturer Model	Model year	Part no.	Pk.	Note
Scania				
P 230 - T 470 P 230 - T 470 (series P, G, R, T) P 230, P 270, P 310, P 340, P 380, P 420 G 230 R 340, R 380, R 420, R 470, R 500, R 580, R 620 T 470	03/04->09/06	2VD 008 205-011	1	Combination rearlight, left, with licence plate, rear fog, reverse, clearance light, side-marker light, with reflex-reflector and marker reflex-reflector Combination rearlight, right, with licence plate, rear fog, reverse, clearance light, side-marker light, with reflex-reflector and marker reflex-reflector (E4) 3178 (E4) 4060 (E4) 9808 (E4) 9811 Spare Parts: Lens with screws 3x24V5W (R5W) 8GA 002 071-241 1x24V10W (R10W) 8GA 002 071-251 4x24V21W (P21W) 8GA 002 073-241
		2VD 008 205-021	1	
		9EL 152 884-001	1	
				
P 230 - T 470 (series P, G, R, T)	03/04->	2KA 003 389-061	2	Licence plate light (E1) 22819 Spare Parts: Body/lens with screw 1x24V10W (R10W) 8GA 002 071-251
		9BG 121 587-031	2	
				
Volvo				
F 4, F 6 F 6	71->09/85	2NE 001 423-011	1	Rear fog light (E1) 8496 Spare Parts: Lens with screws 1x12V21W (P21W) 8GA 002 073-121 1x24V21W (P21W) 8GA 002 073-241
		9EL 101 353-001	5	
				
F 10 - F 16 F 10, F 12, F 16	10/87->	1LG 004 679-051	1	H4 headlight (E1) 17088 1x24V75/70W (H4) 8GJ 002 525-251
				









Volvo



Manufacturer Model	Model year	Part no.	Pk.	Note
Volvo				
F 10 - F 16 F 10, F 12	08/77->09/87	 9EL 119 097-021 9EL 119 098-021	1 1	Indicator-side light, spare parts available only E1 53275 Spare Parts: Lens, left Lens, right 1x24V5W (R5W) 8GA 002 071-241 1x24V21W (P21W) 8GA 002 073-241
F 10, F 12, F 16	10/87->07/93	 2SL 005 883-031 2SL 005 883-041 2SK 005 883-011 2SK 005 883-021 9EL 135 548-001	1 1 1 1 1	Combination rearlight, left, with licence plate, rear fog and reverse light Combination rearlight, right, with licence plate, rear fog and reverse light Combination rearlight, left, with rear fog and reverse light Combination rearlight, right, with rear fog and reverse light E4 1247 E4 1305 E4 3848 E4 4026 E4 23167 Spare Parts: Lens 2x24V5W (R5W) 8GA 002 071-241 4x24V21W (P21W) 8GA 002 073-241
F 86 - F 89 F 86, F 88, F 89	->07/77	 2BA 001 221-031 2BA 001 221-041 9EL 110 013-001 9EL 110 014-001	4 4 4 4	Indicator light, left Indicator light, right E1 32611 Spare Parts: Lens with screws, left Lens with screws, right 1x12V21W (P21W) 8GA 002 073-121 1x24V21W (P21W) 8GA 002 073-241
FH 12, FH 16 FH 12, FH 16	10/93->09/97	 1LG 006 898-051	1	H4 headlight E1 4 1x24V75/70W (H4) 8GJ 002 525-251



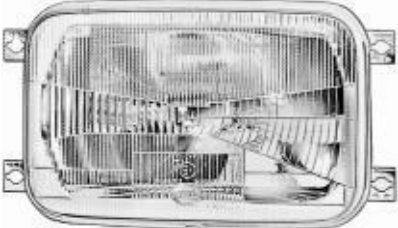

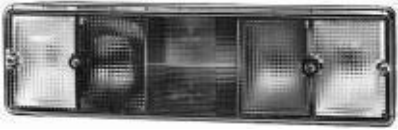



Manufacturer Model	Model year	Part no.	Pk.	Note
Volvo				
FH 12, FH 16 FH 12 FH 16	10/97->12/01 10/97->12/01	1LG 006 898-091	1	H4 headlight (E1) 4  1x24V75/70W (H4) 8GJ 002 525-251
				
FH 12, FH 16	10/93->12/01	1FE 006 300-251	1	H3 spotlight (E1) 44444 Spare Parts: 1 Light unit 5 Lens-retaining rim  1x24V70W (H3) 8GH 002 090-251
		1FE 138 520-011 9AG 138 131-011	1 5	
FH 12, FH 16	10/93->04/05	2VD 008 205-051	1	Combination rearlight, left, with licence plate, rear fog, reverse, clearance light, side-marker light, with reflex-reflector and marker reflex-reflector Combination rearlight, right, with licence plate, rear fog, reverse, clearance light, side-marker light, with reflex-reflector and marker reflex-reflector Combination rearlight, left/right, with rear fog, reverse, clearance light, side-marker light, with reflex-reflector and marker reflex-reflector (E4) 3178 (E4) 4060 (E4) 9808 (E4) 9811 Spare Parts: 1 Lens with screws  3x24V5W (R5W) 8GA 002 071-241 2x24V10W (R10W) 8GA 002 071-251 4x24V21W (P21W) 8GA 002 073-241
		2VD 008 205-041	1	
		2VP 008 205-031	1	
		9EL 152 884-001	1	

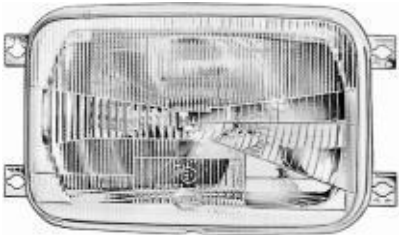

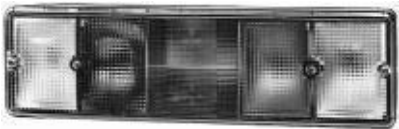


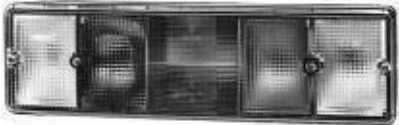






Volvo



Manufacturer Model	Model year	Part no.	Pk.	Note
Volvo				
FL		2VD 008 205-051	1	Combination rearlight, left, with licence plate, rear fog, reverse, clearance light, side-marker light, with reflex-reflector and marker reflex-reflector
FL	03/00->	2VD 008 205-041	1	Combination rearlight, right, with licence plate, rear fog, reverse, clearance light, side-marker light, with reflex-reflector and marker reflex-reflector
		2VP 008 205-031	1	Combination rearlight, left/right, with rear fog, reverse, clearance light, side-marker light, with reflex-reflector and marker reflex-reflector
		9EL 152 884-001	1	Spare Parts: Lens with screws  3x24V5W (R5W) 8GA 002 071-241 2x24V10W (R10W) 8GA 002 071-251 4x24V21W (P21W) 8GA 002 073-241
FL 4, FL 6		1LG 004 679-051	1	H4 headlight
FL 4, FL 6	->10/90			 (E1) 17088  1x24V75/70W (H4) 8GJ 002 525-251
FL 4, FL 6	10/85->	2SL 005 883-031	1	Combination rearlight, left, with licence plate, rear fog and reverse light
		2SL 005 883-041	1	Combination rearlight, right, with licence plate, rear fog and reverse light
		2SK 005 883-011	1	Combination rearlight, left, with rear fog and reverse light
		2SK 005 883-021	1	Combination rearlight, right, with rear fog and reverse light
		9EL 135 548-001	1	Spare Parts: Lens  2x24V5W (R5W) 8GA 002 071-241 4x24V21W (P21W) 8GA 002 073-241








Manufacturer Model	Model year	Part no.	Pk.	Note
Volvo				
FL 7 - FL 12 FL 7, FL 10 FL 12 	10/85->	1LG 004 679-051	1	H4 headlight (E1) 17088  1x24V75/70W (H4) 8GJ 002 525-251
FL 7, FL 10 	10/85->07/93	2SL 005 883-031 2SL 005 883-041 2SK 005 883-011 2SK 005 883-021 9EL 135 548-001	1 1 1 1 1	Combination rearlight, left, with licence plate, rear fog and reverse light Combination rearlight, right, with licence plate, rear fog and reverse light Combination rearlight, left, with rear fog and reverse light Combination rearlight, right, with rear fog and reverse light (E4) 1247 (E4) 1305 (E4) 3848 (E4) 4026 (E4) 23167 Spare Parts: Lens  2x24V5W (R5W) 8GA 002 071-241  4x24V21W (P21W) 8GA 002 073-241
FLC FLC 	09/96->09/00	2SL 005 883-031 2SL 005 883-041 2SK 005 883-011 2SK 005 883-021 9EL 135 548-001	1 1 1 1 1	Combination rearlight, left, with licence plate, rear fog and reverse light Combination rearlight, right, with licence plate, rear fog and reverse light Combination rearlight, left, with rear fog and reverse light Combination rearlight, right, with rear fog and reverse light (E4) 1247 (E4) 1305 (E4) 3848 (E4) 4026 (E4) 23167 Spare Parts: Lens  2x24V5W (R5W) 8GA 002 071-241  4x24V21W (P21W) 8GA 002 073-241
FM 7 FM 7 	10/98->12/01	1LG 006 898-091	1	H4 headlight (E1) 4  1x24V75/70W (H4) 8GJ 002 525-251







Volvo



Manufacturer Model	Model year	Part no.	Pk.	Note
Volvo				
FM 7 FM 7	10/98->12/01	1FE 006 300-251 1FE 138 520-011 9AG 138 131-011	1 1 5	H3 spotlight E1 44444 Spare Parts: Light unit Lens-retaining rim  1x24V70W (H3) 8GH 002 090-251
FM 7	10/98->12/01	 9EL 152 884-001	1 1 1 1	Combination rearlight, left, with licence plate, rear fog, reverse, clearance light, side-marker light, with reflex-reflector and marker reflex-reflector Combination rearlight, right, with licence plate, rear fog, reverse, clearance light, side-marker light, with reflex-reflector and marker reflex-reflector Combination rearlight, left/right, with rear fog, reverse, clearance light, side-marker light, with reflex-reflector and marker reflex-reflector E4 3178 E4 4060 E4 9808 E4 9811 Spare Parts: Lens with screws  3x24V5W (R5W) 8GA 002 071-241 2X24V10W (R10W) 8GA 002 071-251 4x24V21W (P21W) 8GA 002 073-241
FM 9 FM 9	12/01->09/05	 9EL 152 884-001	1 1 1 1	Combination rearlight, left, with licence plate, rear fog, reverse, clearance light, side-marker light, with reflex-reflector and marker reflex-reflector Combination rearlight, right, with licence plate, rear fog, reverse, clearance light, side-marker light, with reflex-reflector and marker reflex-reflector Combination rearlight, left/right, with rear fog, reverse, clearance light, side-marker light, with reflex-reflector and marker reflex-reflector E4 3178 E4 4060 E4 9808 E4 9811 Spare Parts: Lens with screws  3x24V5W (R5W) 8GA 002 071-241 2X24V10W (R10W) 8GA 002 071-251 4x24V21W (P21W) 8GA 002 073-241



Manufacturer Model	Model year	Part no.	Pk.	Note
Volvo				
FM 12 FM 12	10/98->12/01	1LG 006 898-091	1	H4 headlight (E1) 4  1x24V75/70W (H4) 8GJ 002 525-251
FM 12	10/98->12/01	1FE 006 300-251 1FE 138 520-011 9AG 138 131-011	1 5	H3 spotlight (E1) 44444 Spare Parts: Light unit Lens-retaining rim  1x24V70W (H3) 8GH 002 090-251
FM 12	10/98->09/05	2VD 008 205-051 2VD 008 205-041 2VP 008 205-031 9EL 152 884-001	1 1 1	Combination rearlight, left, with licence plate, rear fog, reverse, clearance light, side-marker light, with reflex-reflector and marker reflex-reflector Combination rearlight, right, with licence plate, rear fog, reverse, clearance light, side-marker light, with reflex-reflector and marker reflex-reflector Combination rearlight, left/right, with rear fog, reverse, clearance light, side-marker light, with reflex-reflector and marker reflex-reflector (E4) 3178 (E4) 4060 (E4) 9808 (E4) 9811 Spare Parts: Lens with screws  3x24V5W (R5W) 8GA 002 071-241 2x24V10W (R10W) 8GA 002 071-251 4x24V21W (P21W) 8GA 002 073-241
FS 7 FS 7		1LG 004 679-051	1	H4 headlight (E1) 17088  1x24V75/70W (H4) 8GJ 002 525-251



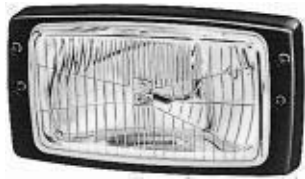
Volvo



Manufacturer Model	Model year	Part no.	Pk.	Note
Volvo				
FS 7		2SL 005 883-031	1	Combination rearlight, left, with licence plate, rear fog and reverse light
FS 7		2SL 005 883-041	1	Combination rearlight, right, with licence plate, rear fog and reverse light
		2SK 005 883-011	1	Combination rearlight, left, with rear fog and reverse light
		2SK 005 883-021	1	Combination rearlight, right, with rear fog and reverse light
				Ⓔ 1247 Ⓔ 1305
				Ⓔ 3848 Ⓔ 4026
				Ⓔ 23167
		9EL 135 548-001	1	Spare Parts: Lens 2x24V5W (R5W) 8GA 002 071-241 4x24V21W (P21W) 8GA 002 073-241
N 7 - N 12		2BA 001 221-031	4	Indicator light, left
N 7 - N 12	01/73->	2BA 001 221-041	4	Indicator light, right
				Ⓔ 32611
		9EL 110 013-001	4	Spare Parts: Lens with screws, left
		9EL 110 014-001	4	Lens with screws, right
				1x12V21W (P21W) 8GA 002 073-121 1x24V21W (P21W) 8GA 002 073-241
N 7	08/78->	2SE 001 688-151	1	Combination rearlight, left, with licence plate light
N 10, N 12	01/73->08/77	2SE 001 688-161	1	Combination rearlight, right, with licence plate light
				Ⓔ 43207
		9EL 092 435-011	1	Spare Parts: Lens with screws
		9GD 102 484-001	10	Seal
		9GT 074 132-001	10	Grommet
				2x12V5W (R5W) 8GA 002 071-121 2x24V5W (R5W) 8GA 002 071-241 2x12V21W (P21W) 8GA 002 073-121 2x24V21W (P21W) 8GA 002 073-241



Headlights, Signal and Sundry Lights for Tractors



List of Manufacturers/Page

3.02 - 3.04

Headlights, Signal and Sundry Lights -
Application Chart for Tractors

3.05 - 3.124



List of Manufacturers/Page



Manufacturer Model	Model year	Page	Manufacturer Model	Model year	Page
Ahlmann various models		3.05	Claas Unitrac	06/85->	3.29 - 3.30
Atlas various models		3.05 - 3.06	Xerion	01/04->	3.30 - 3.31
Bomag various models		3.06	Claas (Bautz) Jaguar		3.31 - 3.32
Case IH various models		3.07 - 3.08	Rapido wagen		3.32
Argus		3.08 - 3.09	John Deere various models		3.32 - 3.34
D 8-41 - D 8-62		3.09	MD 330 - MD 970	->07/74	3.34
D 215 - D 514		3.09 - 3.10	MD 925 - MD 1188 H 4	08/74->	3.34 - 3.35
E 303 - E 340	01/92->	3.10	Z-series	01/94->	3.35 - 3.36
E 323 - E 724	->01/06	3.11	820 - 4020	10/74->	3.36 - 3.37
FP 16 - FP 21	12/92->	3.11 - 3.12	840 - 4240		3.37 - 3.38
Mammut		3.12 - 3.13	3200 - 3400		3.39
433 - 833	06/73->	3.13	6120 - 6920 S	11/01->	3.39
521		3.14	6610 - 6910	01/93->	3.39 - 3.40
525, 527		3.14 - 3.15	7200 - 7500	10/02->	3.40
530 - 550	01/92->	3.15	M-series 6000	07/92->	3.40 - 3.41
644 - 1455 XL	86->	3.16 - 3.17	Series 7000	07/92->	3.41
Case Poclain various models		3.17	Deutz-Fahr various models		3.42 - 3.43
Caterpillar various models		3.17 - 3.18	D 2506 - D 13006	08/73->	3.43 - 3.44
Claas various models		3.18 - 3.20	D 2807 - D 7807 C	05/80->12/90	3.45
Classic 78 - 108 SL		3.20	DX 3.10 - DX 6.07		3.45 - 3.46
Commandor 112 - 228 CS	10/85->	3.20 - 3.21	DX 4.61 - DX 6.61	01/91->12/96	3.46
Compact 25 - Consul	09/77->12/87	3.21 - 3.22	DX 36V - DX 55V	05/78->	3.46
Dominator 38 - 116	09/78->12/87	3.22	Intrac 2003 - 2006	09/74->12/79	3.47
Dominator 78 S - 118 SL Maxi	10/85->	3.22 - 3.23	M 600 - M 1630		3.47 - 3.48
Dominator 85, 105	01/73->	3.23 - 3.24	M 2385 - M 2780	01/85->	3.48 - 3.49
Jaguar 675 - 695	12/87->	3.25 - 3.26	Powerliner 4030	92->	3.49
Jaguar 820 - 880	01/94->	3.26	Powerpress 120 H	01/94->	3.49
Lexion 405 - 460	96->	3.26 - 3.27	Starliner 4040, 4045 H	91->	3.49
Lexion 2004	10/03->	3.27	Topliner 8XL	91->	3.50
Maxi, Mega		3.28	Dexheimer AL 222 - AL 370 turbo	01/82->	3.50 - 3.52
Mercator 50 - 75	01/73->12/87	3.28 - 3.29	Fendt various models		3.52 - 3.53
			Farmer Fix 2 E - 2 S	->06/08	3.53 - 3.54



Manufacturer Model	Model year	Page	Manufacturer Model	Model year	Page
Fendt			Hako		
Farmer 102 S - 201 S		3.54 - 3.55	Trac 4100		3.78 - 3.79
Farmer 200 V - 205 P	83->	3.55 - 3.56	Trac 8014 - 8022		3.79 - 3.80
Farmer 240 S - 280 P		3.56 - 3.57	Variotrac 1850 V, 2150 D		3.80 - 3.81
Farmer 303 LS - 312 LSA	01/83->	3.57 - 3.59	Holder		
Favorit 509 C - 515 C	94->	3.59 - 3.60	A 14 - B 25	01/66->	3.81
Favorit 610 LS - 615 LSA	06/82->	3.60 - 3.61	A 40 - A 60 Turbo	10/78->	3.82
Favorit 626 LSA-Turbo	06/82->	3.61 - 3.62	A 550 - A 600	01/91->	3.82
Favorit 816 LSE - 824 LSE	12/93->	3.62 - 3.63	A 750 - A 760	03/94->	3.82 - 3.83
Favorit 926 Vario	93->	3.63 - 3.64	C 30 - C 6000	01/91->	3.83
F 220 GT - F 275 GT	->02/74	3.64	C 760 - C 870 H	03/94->	3.83 - 3.84
F 231 GT - F 395 GT		3.65 - 3.66	C 9600, C 9700 H	10/94->	3.84
Xylon 520 - 524	05/95->	3.66	Park 30, 70	91->	3.84 - 3.85
Fenwick-Linde			P 20	01/91->	3.85
various models		3.67	Hyster		
Fuchs			various models		3.85
various models		3.67	JCB		
GP (Nobas)			various models		3.86 - 3.87
various models		3.68	Jungheinrich		
Gutbrod			various models		3.87 - 3.88
Superior 1017 - 2060		3.68	Kramer		
Superior 2350 DS - 2850 DA		3.69	various models		3.89
Superior 4000 - 4350		3.69	Krieger		
1012 S		3.70	KS 28 - KS 65 A		3.89 - 3.90
1200 H		3.70 - 3.71	KT 52 - KT 72 A	10/89->	3.90 - 3.91
Hako			Landini		
Mobil 4000 - 6000 D	73->	3.71 - 3.72	various models		3.91
Mobil 8081		3.72	Laverda		
Trac 1400		3.72 - 3.73	various models		3.92
Trac 1400 V		3.73	Liebherr		
Trac 1500 D		3.73 - 3.74	various models		3.92 - 3.94
Trac 1650		3.74	Linde		
Trac 1800 D, DA		3.75	various models		3.94 - 3.95
Trac 2250		3.75 - 3.76	Lindner		
Trac 2300 D		3.76	various models		3.95
Trac 2700 D, DA		3.77			
Trac 2750		3.77			
Trac 3500, 3800 D		3.78			














List of Manufacturers/Page













Manufacturer Model	Model year	Page	Manufacturer Model	Model year	Page
Manitou various models		3.95	Timberjack various models		3.113 - 3.114
Massey-Ferguson various models		3.95 - 3.97	Valtra various models		3.114 - 3.115
MB 186, MB 187		3.98	Valtra (Valmet) 205 - 665	91->	3.116
MF 30, MF 30-6		3.98	605 - 955, 6000 - 8600	91->	3.116
MF 31 - MF 187-6		3.98	Joseph Vögele various models		3.116 - 3.117
MF 186, MF 187		3.99	VME DM 5350		3.117
MF 203, MF 205		3.99	GM 616, GM 646		3.117
MF 487	70->	3.99 - 3.100	LM 621 - LM 642		3.117 - 3.118
MF 510		3.100	LM 841		3.118
various models	07/86->	3.100	LM 846		3.119
MF 3165 S		3.101	LM 1240		3.119
Mercedes-Benz MB-Trac 700 - 1500	09/85->	3.101	LM 1641		3.119
Neuson various models		3.101	LM 4200 - LM 4600		3.120
New Holland (Fiatagri) various models		3.102 - 3.104	MK 693		3.120
Partek Forest various models		3.104 - 3.105	S 830		3.120
O&K various models		3.106	SM 462, SM 868		3.121
Same various models		3.106 - 3.108	SM 969		3.121
Schaeff various models		3.108 - 3.109	T 500, T 650		3.121 - 3.122
Steyr various models		3.109 - 3.110	T 700		3.122
430, 1100		3.111	T 2650, T 2654	05/79->	3.123
Still various models		3.111	Volvo CE various models		3.123
Terex Demag various models		3.112 - 3.113	Yale various models		3.124



Manufacturer Model	Model year	Part no.	Pk.	Note
Ahlmann				
various models various models		1GA 007 506-001 1GA 998 525-001 9GH 993 984-001	1 1 20	FF®-H3 worklight 'Ultra Beam Standard' with optics for large-area ground illumination, with AMP plug-connection Spare Parts: Light unit Rubber cap  1x12V55W (H3) 8GH 002 090-371  1x12V55W (H3) 8GH 002 090-133
				
various models		1G3 005 760-041 1G3 141 019-011 6EB 005 633-001	1 1 10	H3 worklight with optics for close-range illumination Spare Parts: Light unit Switch  1x12V55W (H3) 8GH 002 090-371  1x12V55W (H3) 8GH 002 090-133
				
various models		1G5 003 241-081 1G5 120 510-001 6ED 708 919-001 9GD 120 670-001	1 1 5 10	H3 worklight, with optics for close-range illumination, with switch Spare Parts: Light unit with seal Switch Seal  1x12V55W (H3) 8GH 002 090-371  1x12V55W (H3) 8GH 002 090-133  1x24V70W (H3) 8GH 002 090-251
				
Atlas				
various models		1GA 006 991-041 1GA 998 524-011 9XD 990 298-001	1 1 5	FF®-H3 worklight 'Double Beam' with optics for large-area ground illumination Spare Parts: Light unit Angle bracket  1x12V55W (H3) 8GH 002 090-371  1x12V55W (H3) 8GH 002 090-133
				



Manufacturer Model	Model year	Part no.	Pk.	Note
Atlas				
various models various models		1G3 996 001-301 9AG 990 006-017	1 24	H3 worklight with optics for close-range illumination, without switch Spare Parts: Lens-retaining rim with protective grid  1x12V55W (H3) 8GH 002 090-371  1x12V55W (H3) 8GH 002 090-133
various models		1G4 003 470-051 9DS 121 707-001 9XD 130 261-001	1 5	H3 worklight with optics for for close-range illumination, without switch Spare Parts: Light unit Angle bracket  1x12V55W (H3) 8GH 002 090-371  1x12V55W (H3) 8GH 002 090-133
Bomag				
various models		1GD 003 590-701	1	H3 worklight  1x12V55W (H3) 8GH 002 090-133
various models		1GB 006 213-101 1GB 006 213-111	1 1	H3 worklight with optics for long-range illumination H3 worklight with optics for close-range illumination  1x12V55W (H3) 8GH 002 090-371  1x12V55W (H3) 8GH 002 090-133
various models		1GA 006 876-001	1	FF®-H3 worklight with optics for ground illumination, with rotating base  1x12V55W (H3) 8GH 002 090-371  1x12V55W (H3) 8GH 002 090-133  1x24V70W (H3) 8GH 002 090-251



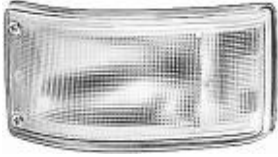













Manufacturer Model	Model year	Part no.	Pk.	Note
Case IH				
various models various models		1GA 996 020-001	1	H3 worklight 'Corner Light', with 12V55W bulb 1x12V55W (H3) 8GH 002 090-371 1x12V55W (H3) 8GH 002 090-133
various models		1GA 996 083-011 1GA 998 525-001	1 1	FF®-H3 worklight with optics for large-area ground illumination Spare Parts: Light unit 1x12V55W (H3) 8GH 002 090-371 1x12V55W (H3) 8GH 002 090-133
various models		1GA 007 506-681 1GA 998 525-001	1 1	FF®-H3 worklight with optics for large-area ground illumination, with bulb Spare Parts: Light unit 1x24V70W (H3) 8GH 002 090-251
various models		1GA 996 083-021 1GA 998 525-001	1 1	FF®-H3 worklight with optics for large-area ground illumination Spare Parts: Light unit 2x12V35W (H3) 8GH 002 090-271 2x12V55W (H3) 8GH 002 090-133
various models		1GA 998 522-011	1	FF®-H3 worklight with optics for ground illumination 1x12V55W (H3) 8GH 002 090-371 1x12V55W (H3) 8GH 002 090-133



Manufacturer Model	Model year	Part no.	Pk.	Note
Case IH				
various models various models		1GB 996 080-021	1	FF®-H3 worklight 'Double Beam' with optics for long-range off-road illumination 2x12V35W (H3) 8GH 002 090-271 2x12V55W (H3) 8GH 002 090-133
various models		1GA 006 875-001	1	FF®-H3 worklight with optics for ground illumination 1x12V55W (H3) 8GH 002 090-371 1x12V55W (H3) 8GH 002 090-133 1x24V70W (H3) 8GH 002 090-251
various models		1GA 006 991-091 9XD 990 298-001	1 5	FF®-H3 worklight 'Double Beam' with optics for intensive close-range illumination Spare Parts: Angle bracket 2x12V35W (H3) 8GH 002 090-271 2x12V55W (H3) 8GH 002 090-133
various models		2SE 996 030-011 2SD 996 030-021 9EL 990 142-001	1 1 1	Combination rearlight, left, with licence plate light, with bulbs Combination rearlight, right, without licence plate light, with bulbs (E12) 7133 (E12) 4054 Spare Parts: Lens 1x12V5W (R5W) 8GA 002 071-121 1x12V21W (P21W) 8GA 002 073-121
Argus Argus		1DL 007 872-037 1DL 007 872-047 9AH 149 259-015 9AH 149 260-015	18 18 4 4	DE-H1 headlight, left, suitable for headlight leveller and bulbs DE-H1 headlight, right, suitable for headlight leveller and bulbs (E1) 7411 Spare Parts: Supporting frame with adj. devices, left Supporting frame with adj. devices, right 2x24V70W (H1) 8GH 002 089-251 1x24V4W (T4W) 8GP 002 067-241








Manufacturer Model	Model year	Part no.	Pk.	Note
Case IH				
Argus Argus 		1GA 006 991-041 1GA 998 524-011 9XD 990 298-001	1 1 5	FF@-H3 worklight 'Double Beam' with optics for large-area ground illumination Spare Parts: Light unit Angle bracket  2x24V70W (H3) 8GH 002 090-251
Argus 		2BA 004 119-017 9GT 143 133-007	10 10	Indicator light (white)  405 Spare Parts: Grommet  1x24V21W (PY21W) 8GA 006 841-241
D 8-41 - D 8-62 D 8-41, D 8-61, D 8-62 		9ES 012 060-011 9GD 023 639-001 9DR 090 206-001 9FF 090 500-001	10 10 1 2	Headlight, spare parts available only K 11103/1 Spare Parts: Lens Seal Reflector Bulb socket  1x12V35/35W (S2) 8GD 002 084-131  1x12V4W (T4W) 8GP 002 067-121
D 215 - D 514 D 215 - D 514 D 215, D 219, D 322, D 326, D 432, D 439, D 514 		9ES 012 060-011 9GD 023 639-001 9DR 090 206-001 9FF 090 500-001	10 10 1 2	Headlight, spare parts available only K 11103/1 Spare Parts: Lens Seal Reflector Bulb socket  1x12V35/35W (S2) 8GD 002 084-131  1x12V4W (T4W) 8GP 002 067-121
D 215 - D 514 		2BE 001 259-061 9EL 088 538-001 9FT 088 047-001	2 2 10	Indicator-side light K 23269 Spare Parts: Body/lens with screws Bulb holder  1x12V3W (M) 8GM 002 094-121  1x12V18W (K) 8GM 002 091-121



Case IH












Manufacturer Model	Model year	Part no.	Pk.	Note
Case IH				
D 215 - D 514 D 215 - D 514 D 215, D 219, D 322, D 326, D 432, D 439, D 514		2ST 001 259-321	2	Combination rearlight with licence plate light Combination rearlight without licence plate light K 23270 Spare Parts: Body/lens with screws for 2SB 001 259-261 Bulb holder 1x12V10W (K) 8GM 002 091-131 1x12V18W (K) 8GM 002 091-121
		2SB 001 259-261	2	
D 215 - D 514		8HG 002 247-001	2	Adapter for surface-mounting to bodywork surfaces inclined at 45°, for lights in model range '1259'.
E 303 - E 340 E 303 - E 340 E 303, E 304, E 340	10/94-> 	2BA 002 652-111 2BA 002 652-121 9EL 134 659-001 9EL 134 660-001	2 2 2 2	Indicator light, left Indicator light, right (E1) 42764 Spare Parts: Lens with screw, left Lens with screw, right 1x12V21W (P21W) 8GA 002 073-121
E 303 - E 340 E 303, E 304, E 340	01/92-> 	2SD 002 776-231 2SD 002 776-241 9EL 137 307-001 9EL 137 308-001	1 1 2 2	Combination rearlight, left Combination rearlight, right (E1) 273 (E1) 63230 Spare Parts: Lens, left Lens, right 1x12V10W (R10W) 8GA 002 071-131 2x12V21W (P21W) 8GA 002 073-121
E 303 - E 340 E 303, E 304, E 340	01/92-> 	2KA 003 389-061 9BG 121 587-031	2 2	Licence plate light (E1) 22819 Spare Parts: Body/lens with screw 1x12V10W (R10W) 8GA 002 071-131

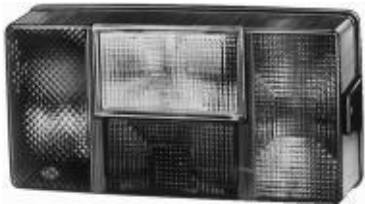














Manufacturer Model	Model year	Part no.	Pk.	Note
Case IH				
E 323 - E 724 E 323 - E 724 E 323, E 353, E 423, E 523, E 624, E 724		9ES 093 815-001 9GD 100 711-021	10 10	Headlight, spare parts available only (E1) 4488 Spare Parts: Lens Seal 1x12V45/40W (R2) 8GD 002 088-131
E 323 - E 724 E 323 E 353, E 423 E 523 E 624 E 724 all models with flashers	01/66->05/74 06/65->02/75 ->03/75 06/65->12/71 10/69->12/74	9EL 089 527-001	2	Combination rearlight, spare parts available only K 23366 Spare Parts: Lens 1x12V3W (M) 8GM 002 094-121 1x12V18W (K) 8GM 002 091-121
FP 16 - FP 21 FP 16 - FP 21	12/92->	2SE 004 623-001 9EL 129 519-001	1 1	Combination rearlight (E17) 408 (E17) 630 (E17) 763 Spare Parts: Lens 1x12V10W (R10W) 8GA 002 071-131 2x12V21W (P21W) 8GA 002 073-121
FP 16 - FP 21	12/92->	2KA 003 389-061 9BG 121 587-031	2 2	Licence plate light (E1) 22819 Spare Parts: Body/lens with screw 1x12V10W (R10W) 8GA 002 071-131











Manufacturer Model	Model year	Part no.	Pk.	Note
Case IH				
FP 16 - FP 21	12/92->	2XS 005 020-011	10	Clearance light (red/white)
FP 16 - FP 21		9EL 132 215-001	2	(E1) 31407 Spare Parts: Body/lens with screws  1x12V4W (T4W) 8GP 002 067-121
				
Mammut		1LB 007 145-047	36	H4 headlight with bulbs
Field chopper Mammut 8790				(E1) 639  1x12V60/55W (H4) 8GJ 002 525-131  1x12V4W (T4W) 8GP 002 067-121
				
Field chopper Mammut 8790		1GB 007 145-107	36	H3 worklight with honeycombe optical pattern for close-range illumination
				 1x12V55W (H3) 8GH 002 090-133
				
Field chopper Mammut 6900, 7400, 7800		1GA 006 991-021	1	FF®-H3 worklight with optics for close-range illumination
		1GA 998 524-001 9XD 130 261-001	1 5	Spare Parts: Light unit Angle bracket  2x12V55W (H3) 8GH 002 090-133
				



Manufacturer Model	Model year	Part no.	Pk.	Note
Case IH				
Mammut Field chopper Mammut 6900, 7400, 7800 		2VP 006 040-111	1	Combination rearlight, left, with reverse light Combination rearlight, right, with reverse light (E13) 9385 (E13) 9531 Spare Parts: 1 Lens, left 1 Lens, right 10 Seal for lens (to be ordered separately)  1x12V10W (R10W) 8GA 002 071-131  3x12V21W (P21W) 8GA 002 073-121
		2VP 006 040-121	1	
433 - 833 433 - 833 433, 533, 633, 733, 833 	07/86->	1LB 003 177-081	1	H4 headlight unit (E1) 7197  1x12V60/55W (H4) 8GJ 002 525-131
433 - 833 	06/73->	2BE 002 776-251 2BE 002 776-261	1 1	Indicator-side light, left Indicator-side light, right (E1) 63225 Spare Parts: 2 Lens, left 2 Lens, right  1x12V10W (R10W) 8GA 002 071-131  1x12V21W (P21W) 8GA 002 073-121
433 - 833 433, 533, 633, 733, 833 	06/73->	2SD 002 776-231 2SD 002 776-241	1 1	Combination rearlight, left Combination rearlight, right (E1) 273 (E1) 63230 Spare Parts: 2 Lens, left 2 Lens, right  1x12V10W (R10W) 8GA 002 071-131  2x12V21W (P21W) 8GA 002 073-121
433 - 833 	06/73->90	2KA 001 389-147	66	Licence plate light K 12824/1  1x12V5W (C5W) 8GM 002 092-121







Manufacturer Model	Model year	Part no.	Pk.	Note
Case IH				
521 521		1GA 007 506-001 1GA 998 525-001 9GH 993 984-001	1 1 20	FF®-H3 worklight with optics for large-area ground illumination Spare Parts: Light unit Rubber cap (black)  1x12V55W (H3) 8GH 002 090-133
521		2BE 003 014-251 9EL 115 003-055	2 2	Indicator-side light (E1) 42712 Spare Parts: Lens with screws  1x12V21W (P21W) 8GA 002 073-121  1x12V5W (C5W) 8GM 002 092-121
521		2SE 002 578-701 9EL 146 491-001	2 2	Combination rearlight with licence plate light (E17) 9401 Spare Parts: Body/lens with screws  1x24V10W (R10W) 8GA 002 071-251  2x24V21W (P21W) 8GA 002 073-241
525, 527 525, 527		9ES 120 725-001 9ES 120 726-001 9FH 113 447-011	2 2 5	H4 headlight, spare parts available only (E1) 17001 left (E1) 17002 right Spare Parts: Lens, left Lens, right Bulb holder  1x24V75/70W (H4) 8GJ 002 525-251  1x24V4W (T4W) 8GP 002 067-241
525, 527		1GA 005 060-041 9AG 132 453-005	1 5	H3 worklight with optics for close-range illumination Spare Parts: Lens-retaining rim  1x24V70W (H3) 8GH 002 090-251



Manufacturer Model	Model year	Part no.	Pk.	Note
Case IH				
525, 527 525, 527		2BA 003 975-031 2BA 003 975-041	1 1	Indicator light, left Indicator light, right 42650 1x24V21W (P21W) 8GA 002 073-241
525, 527		2BA 001 277-011 2BA 001 277-021	1 1	Indicator light, left Indicator light, right 22796 1x12V21W (P21W) 8GA 002 073-121
525, 527		2SE 002 578-701	2	Combination rearlight with licence plate light 9401 Spare Parts: Body/lens with screws 1x24V10W (R10W) 8GA 002 071-251 2x24V21W (P21W) 8GA 002 073-241
530 - 550 530 - 550 530, 540, 550	01/92->	2SD 002 776-231 2SD 002 776-241	1 1	Combination rearlight, left Combination rearlight, right 273 63230 Spare Parts: Lens, left Lens, right 1x12V10W (R10W) 8GA 002 071-131 2x12V21W (P21W) 8GA 002 073-121
530 - 550 530, 540, 550	01/92->	2KA 003 389-061	2	Licence plate light 22819 Spare Parts: Body/lens with screw 1x12V10W (R10W) 8GA 002 071-131



Manufacturer Model	Model year	Part no.	Pk.	Note
Case IH				
644 - 1455 XL 644 - 1455 XL 644, 743, XL, 744, 745, XL, 844, XL, 856, XL, 955, 956, XL, 1055, 1056, XL, 1255, XL, 1455	07/86->	1LB 003 177-081 9GH 126 647-011	1 10	H4 headlight unit (E1) 7197 Spare Parts: Cap  1x12V60/55W (H4) 8GJ 002 525-131
644 - 1455 XL 		2BE 003 014-251 9EL 115 003-055	2 2	Indicator-side light (E1) 42712 Spare Parts: Lens with screws  1x12V21W (P21W) 8GA 002 073-121  1x12V5W (C5W) 8GM 002 092-121
743 - 1455 		2BE 002 582-031 9EL 112 744-001	1 1	Indicator-side light (E1) 43388 Spare Parts: Lens  1x12V5W (R5W) 8GA 002 071-121  1x12V21W (P21W) 8GA 002 073-121
644 - 1455 XL 644, 743 XL, 744, 745 XL, 844 XL, 856 XL, 955, 956 XL, 1055, 1056 XL, 1246, 1255 XL, 1455 XL		2SD 002 844-131 2SD 002 844-061 9EL 115 662-021 9EL 115 662-011	1 1 2 2	Combination rearlight, left, without licence plate light Combination rearlight, right, without licence plate light (E1) 53221 Spare Parts: Lens, left Lens, right  2x12V21W (P21W) 8GA 002 073-121  2x12V5W (C5W) 8GM 002 092-121
743 XL - 1455 XL 743 XL, 745 XL, 844 XL, 856 XL, 956 XL, 1056 XL, 1255 XL, 1455 XL		2SD 002 582-011 2SD 002 582-021 9EL 112 743-001 9EL 112 741-001	1 1 1 1	Combination rearlight, left Combination rearlight, right (E1) 116 (E1) 53345 Spare Parts: Lens, left Lens, right  1x12V10W (R10W) 8GA 002 071-131  2x12V21W (P21W) 8GA 002 073-121












Manufacturer Model	Model year	Part no.	Pk.	Note
Case IH				
644 - 1455 XL 644 - 1455 XL	91->	2KA 003 389-061 9BG 121 587-031	2 2	Licence plate light 22819 Spare Parts: Body/lens with screw 1x12V10W (R10W) 8GA 002 071-131
Case Poclain				
various models various models		1GA 998 522-011	1	FF®-H3 worklight with optics for ground illumination 1x12V55W (H3) 8GH 002 090-371 1x12V55W (H3) 8GH 002 090-133
Caterpillar				
various models		1GA 007 506-001 1GA 998 525-001 9GH 993 984-001	1 1 20	FF®-H3 worklight 'Ultra Beam Standard' with optics for large-area ground illumination, with AMP plug-connection Spare Parts: Light unit Rubber cap 1x12V55W (H3) 8GH 002 090-371 1x12V55W (H3) 8GH 002 090-133
various models		1GB 006 213-101	1	H3 worklight with optics for long-range illumination, with sheet-metal reflector 1x12V55W (H3) 8GH 002 090-371 1x12V55W (H3) 8GH 002 090-133 1x24V70W (H3) 8GH 002 090-251
various models		1GA 006 875-001	1	FF®-H3 worklight with optics for ground illumination 1x12V55W (H3) 8GH 002 090-371 1x12V55W (H3) 8GH 002 090-133 1x24V70W (H3) 8GH 002 090-251



Manufacturer Model	Model year	Part no.	Pk.	Note
Caterpillar				
various models various models		1GA 998 522-011	1	FF®-H3 worklight with optics for ground illumination 1x12V55W (H3) 8GH 002 090-371 1x12V55W (H3) 8GH 002 090-133 1x24V70W (H3) 8GH 002 090-251 
				
various models		1GA 006 991-051	1	FF®-H3 worklight 'Double Beam' with optics for long-range off-road illumination Spare Parts: Angle bracket 2x12V35W (H3) 8GH 002 090-271 2x12V55W (H3) 8GH 002 090-133 2x24V70W (H3) 8GH 002 090-251 
		9XD 130 261-001	5	
various models		1GL 008 090-211	1	DE-H3 worklight with optics for close-range illumination, with bulb Spare Parts: Rubber cap 1x24V70W (H3) 8GH 002 090-251 
		9GH 147 009-007	30	
various models		1G4 003 470-051	1	H3 worklight with optics for close-range illumination Spare Parts: Light unit Angle bracket 1x12V55W (H3) 8GH 002 090-371 1x12V55W (H3) 8GH 002 090-133 1x24V70W (H3) 8GH 002 090-251 
		9DS 121 707-001 9XD 130 261-001	1 5	
Claas				
various models		1GA 007 506-001	1	FF®-H3 worklight 'Ultra Beam Standard' with optics for large-area ground illumination, with AMP plug-connection Spare Parts: Light unit Rubber cap 1x12V55W (H3) 8GH 002 090-371 1x12V55W (H3) 8GH 002 090-133 
		1GA 998 525-001 9GH 993 984-001	1 20	











Manufacturer Model	Model year	Part no.	Pk.	Note
Claas				
various models various models		1GA 998 522-011	1	FF®-H3 worklight with optics for ground illumination  1x12V55W (H3) 8GH 002 090-371 1x12V55W (H3) 8GH 002 090-133
various models		1GB 006 213-101	1	H3 worklight with optics for long-range illumination
		1GB 006 213-111	1	H3 worklight with optics for close-range illumination  1x12V55W (H3) 8GH 002 090-371 1x12V55W (H3) 8GH 002 090-133
various models		1GB 996 080-021	1	FF®-H3 worklight 'Double Beam' with optics for long-range off-road illumination  2x12V35W (H3) 8GH 002 090-271 2x12V55W (H3) 8GH 002 090-133
various models		1GD 005 700-511	1	H3 worklight with optics for close-range illumination
		1GD 137 355-011	1	Spare Parts: Light unit  1x12V55W (H3) 8GH 002 090-371 1x12V55W (H3) 8GH 002 090-133
various models		1G3 005 760-001	1	H3 worklight with optics for long-range illumination
		1G3 135 211-011	1	Spare Parts: Light unit
		6EB 005 633-001	10	Switch  1x12V55W (H3) 8GH 002 090-371 1x12V55W (H3) 8GH 002 090-133


















Claas



Manufacturer Model	Model year	Part no.	Pk.	Note
Claas				
various models various models		1G3 005 760-041 1G3 141 019-011 6EB 005 633-001	1 1 10	H3 worklight with optics for close-range illumination Spare Parts: Light unit Switch  1x12V55W (H3) 8GH 002 090-371  1x12V55W (H3) 8GH 002 090-133
Classic 78 - 108 SL Classic 78 - 108 SL		2BE 003 347-001 9EL 120 224-001	1 5	Indicator-side light E1 53274 Spare Parts: Body/lens with screw  1x12V21W (P21W) 8GA 002 073-121  1x12V5W (C5W) 8GM 002 092-121
Classic 78 - 108 SL		2BM 002 652-031	1	Auxiliary indicator light E1 42781  1x12V5W (R5W) 8GA 002 071-121
Commandor 112 - 228 CS Commandor 112 - 228 CS	10/85->	2BE 003 347-001 9EL 120 224-001	1 5	Indicator-side light E1 53274 Spare Parts: Body/lens with screw  1x12V21W (P21W) 8GA 002 073-121  1x12V5W (C5W) 8GM 002 092-121
Commandor 112 - 228 CS	10/85->	2BM 002 652-031	1	Auxiliary indicator light E1 42781  1x12V5W (R5W) 8GA 002 071-121



Manufacturer Model	Model year	Part no.	Pk.	Note
Claas				
Commandor 112 - 228 CS Commandor 112 - 116 10/85->12/87 Commandor 112, 114, 115, Commandor 116 		2SW 003 185-041 9EL 118 633-001	1 4	Rear-indicator light (E1) 53256 Spare Parts: Body/lens with screw  1x12V21W (P21W) 8GA 002 073-121  1x12V5W (C5W) 8GM 002 092-121
Compact 25 - Consul Compact 25 - Consul ->08/77 		2BE 001 259-061 9EL 088 538-001 9FT 088 047-001	2 2 10	Indicator-side light K 23269 Spare Parts: Body/lens with screws Bulb holder  1x12V3W (M) 8GM 002 094-121  1x12V18W (K) 8GM 002 091-121
Compact 25 - Consul 09/77->12/87 		2BE 003 185-051 9EL 119 397-001	1 4	Indicator-side light (E1) 53259 Spare Parts: Body/lens with screw  1x12V21W (P21W) 8GA 002 073-121  1x12V5W (C5W) 8GM 002 092-121
Compact 25 - Consul 09/77->12/87 		9EL 119 397-001	4	Indicator-side light, spare parts available only (E1) 53259 Spare Parts: Body/lens with screw  1x12V21W (P21W) 8GA 002 073-121  1x12V5W (C5W) 8GM 002 092-121
Compact 25 - Consul Compact 25, 30 Consul 09/77->12/87 		2SW 003 185-041 9EL 118 633-001	1 4	Rear-indicator light (E1) 53256 Spare Parts: Body/lens with screw  1x12V21W (P21W) 8GA 002 073-121  1x12V5W (C5W) 8GM 002 092-121

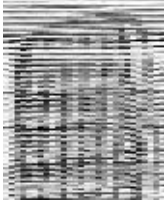














Claas



Manufacturer Model	Model year	Part no.	Pk.	Note
Claas				
Compact 25 - Consul Compact 25 - Consul	->08/77	2SA 001 259-751 9EL 135 266-001 9FT 088 047-001	2 2 10	Rear light (E1) 31438 Spare Parts: Body/lens with screws Bulb holder 1x12V5W (C5W) 8GM 002 092-121
Dominator 38 - 116 Dominator 38 - 116	09/78->	2BE 003 185-051 9EL 119 397-001	1 4	Indicator-side light (E1) 53259 Spare Parts: Body/lens with screw 1x12V21W (P21W) 8GA 002 073-121 1x12V5W (C5W) 8GM 002 092-121
Dominator 38 - 116	09/78->10/84	2BM 002 652-031	1	Auxiliary indicator light (E1) 42781 1x12V5W (R5W) 8GA 002 071-121
Dominator 38 - 116 Dominator 38, 48, 56 Dominator 58 Dominator 66, 68, 76, Dominator 96, 106, 114, Dominator 116	09/78->12/87 09/78->12/87 10/85->12/87 09/78->12/87	2SW 003 185-041 9EL 118 633-001	1 4	Rear-indicator light (E1) 53256 Spare Parts: Body/lens with screw 1x12V21W (P21W) 8GA 002 073-121 1x12V5W (C5W) 8GM 002 092-121
Dominator 78 S - 118 SL Maxi Dominator 78 S - 118 SL Maxi	10/85->	2BE 003 347-001 9EL 120 224-001	1 5	Indicator-side light (E1) 53274 Spare Parts: Body/lens with screw 1x12V21W (P21W) 8GA 002 073-121 1x12V5W (C5W) 8GM 002 092-121



Manufacturer Model	Model year	Part no.	Pk.	Note
Claas				
Dominator 78 S - 118 SL Maxi Dominator 78 S - 108 SL 10/85-> 		2BM 002 652-031	1	Auxiliary indicator light (E1) 42781  1x12V5W (R5W) 8GA 002 071-121
Dominator 78 S - 108 SL 10/85->12/87 Dominator 78 S, SL, Dominator 88 S, SL, Dominator 98 S, SL, Dominator 108 SL 		2SW 003 185-041	1	Rear-indicator light (E1) 53256 Spare Parts: 4 Body/lens with screw  1x12V21W (P21W) 8GA 002 073-121  1x12V5W (C5W) 8GM 002 092-121
Dominator 118 SL Maxi 10/90-> 		2SA 001 259-751	2	Rear light (E1) 31438 Spare Parts: 2 Body/lens with screws 10 Bulb holder  1x12V5W (C5W) 8GM 002 092-121
Dominator 85, 105 Dominator 85 01/73->06/85 Dominator 105 10/74->06/85 		1S0 001 430-011	1	Headlight (E1) 352 Spare Parts: 10 Lens 10 Seal 1 Reflector 2 Bulb socket  1x12V35/35W (S2) 8GD 002 084-131  1x12V4W (T4W) 8GP 002 067-121
Dominator 85, 105 ->08/77 		2BE 001 259-061	2	Indicator-side light K 23269 Spare Parts: 2 Body/lens with screws 10 Bulb holder  1x12V3W (M) 8GM 002 094-121  1x12V18W (K) 8GM 002 091-121



Claas



Manufacturer Model	Model year	Part no.	Pk.	Note
Claas				
Dominator 85, 105 Dominator 85, 105	09/77->10/89	2BE 003 185-051	1	Indicator-side light E1 53259
		9EL 119 397-001	4	Spare Parts: Body/lens with screw 1x12V21W (P21W) 8GA 002 073-121 1x12V5W (C5W) 8GM 002 092-121
Dominator 85, 105	11/89->	2BE 003 347-001	1	Indicator-side light E1 53274
		9EL 120 224-001	5	Spare Parts: Body/lens with screw 1x12V21W (P21W) 8GA 002 073-121 1x12V5W (C5W) 8GM 002 092-121
Dominator 85, 105	->08/77	2SB 001 259-261	2	Combination rearlight K 23270
		9EL 088 525-001 9FT 088 047-001	2 10	Spare Parts: Body/lens with screws Bulb holder 1x12V10W (K) 8GM 002 091-131 1x12V18W (K) 8GM 002 091-121
Dominator 85	->08/77	2SA 001 259-751	2	Rear light E1 31438
		9EL 135 266-001 9FT 088 047-001	2 10	Spare Parts: Body/lens with screws Bulb holder 1x12V5W (C5W) 8GM 002 092-121
Dominator 85, 105	09/77->12/87	2SW 003 185-041	1	Combination rearlight E1 53256
		9EL 118 633-001	4	Spare Parts: Body/lens with screw 1x12V21W (P21W) 8GA 002 073-121 1x12V5W (C5W) 8GM 002 092-121


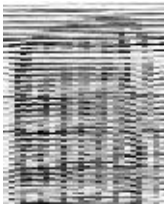
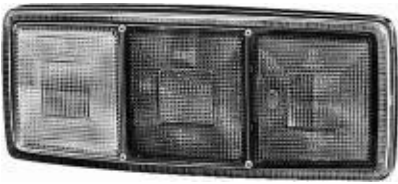
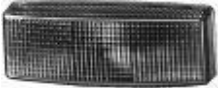




Manufacturer Model	Model year	Part no.	Pk.	Note
Claas				
Jaguar 675 - 695 Jaguar 675 - 690	12/87->	1GA 005 060-001 1GA 132 459-011 9AG 132 453-005	1 1 5	H3 worklight with optics for long-range illumination Spare Parts: Light unit Lens-retaining rim 1x12V55W (H3) 8GH 002 090-133
Jaguar 675 - 690	->12/87	2BE 003 185-051 9EL 119 397-001	1 4	Indicator-side light (E1) 53259 Spare Parts: Body/lens with screw 1x12V21W (P21W) 8GA 002 073-121 1x12V5W (C5W) 8GM 002 092-121
Jaguar 675 - 695	01/88->	2BE 003 347-001 9EL 120 224-001	1 5	Indicator-side light (E1) 53274 Spare Parts: Body/lens with screw 1x12V21W (P21W) 8GA 002 073-121 1x12V5W (C5W) 8GM 002 092-121
Jaguar 675 - 690	01/88->	2BM 002 652-031	1	Auxiliary indicator light (E1) 42781 1x12V5W (R5W) 8GA 002 071-121
Jaguar 675 - 690 Jaguar 675, 680, 685, Jaguar 690	->12/87	2SW 003 185-041 9EL 118 633-001	1 4	Rear-indicator light (E1) 53256 Spare Parts: Body/lens with screw 1x12V21W (P21W) 8GA 002 073-121 1x12V5W (C5W) 8GM 002 092-121



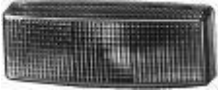





Claas



Manufacturer Model	Model year	Part no.	Pk.	Note
Claas				
Jaguar 675 - 695 Jaguar 682 - 695		2KA 001 386-281 9BG 101 230-001 9GT 005 166-001	2 2 10	Licence plate light E1 12820 Spare Parts: Body with lens Grommet 1x12V5W (C5W) 8GM 002 092-121
				
Jaguar 820 - 880 Jaguar 820 - 880	01/94->	2BM 002 652-031	1	Auxiliary indicator light E1 42781 1x12V5W (R5W) 8GA 002 071-121
				
Jaguar 820 - 880 Jaguar 820, 840, 860, Jaguar 880	01/98->	2SD 003 167-011 2SD 003 167-021 9EL 147 747-001 9GD 087 883-355	1 1 1 10	Combination rearlight, left, without licence plate light Combination rearlight, right, without licence plate light E1 264 Spare Parts: Lens with screws Seal 1x12V10W (R10W) 8GA 002 071-131 2x12V21W (P21W) 8GA 002 073-121
				
Jaguar 820 - 880	01/94->12/97	2TM 006 717-047	100	Rear light with reflex-reflector (red) E17 378 E1 787 1x12V5W (W5W) 8GP 003 594-121
				
Jaguar 820 - 880	01/94->	2SA 001 259-751 9EL 135 266-001 9FT 088 047-001	2 2 10	Rear light E1 31438 Spare Parts: Body/lens with screws Bulb holder 1x12V5W (C5W) 8GM 002 092-121
				
Lexion 405 - 460 Lexion 405 - 460	96->	2BE 003 347-001 9EL 120 224-001	1 5	Indicator-side light E1 53274 Spare Parts: Body/lens with screw 1x12V21W (P21W) 8GA 002 073-121 1x12V5W (C5W) 8GM 002 092-121
				




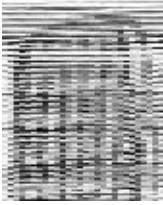












Manufacturer Model	Model year	Part no.	Pk.	Note
Claas				
Lexion 405 - 460 Lexion 405 - 460	96->	2BM 003 647-021	1	Auxiliary indicator light E1 151 1x12V5W (W5W) 8GP 003 594-121 
Lexion 405 - 460 Lexion 405, 410, 420, Lexion 430, 440, 450, Lexion 460	96->	2SD 003 167-011 2SD 003 167-021 9EL 147 747-001 9GD 087 883-355	1 1 1 10	Combination rearlight, left, without licence plate light Combination rearlight, right, without licence plate light E1 264 Spare Parts: Lens with screws Seal 1x12V10W (R10W) 8GA 002 071-131 2x12V21W (P21W) 8GA 002 073-121 
Lexion 405 - 460	96->	2TM 006 717-047	100	Rear light with reflex-reflector (red) E17 378 E1 787 1x12V5W (W5W) 8GP 003 594-121 
Lexion 2004 Lexion 2004	10/03->	2BA 008 221-107	20	Indicator light, with bulb E1 878 1x12V21W (PY21W) 8GA 006 841-121 
Lexion 2004	10/03->	2PF 008 221-177	20	Side light, with bulb E1 879 1x12V5W (R5W) 8GA 002 071-121 
Lexion 2004	10/03->	2BM 003 563-111	1	Auxiliary indicator light E1 42621 1x12V5W (W5W) 8GP 003 594-121 








Claas



Manufacturer Model	Model year	Part no.	Pk.	Note
Claas				
Maxi, Mega Maxi, Mega		2BE 003 347-001 9EL 120 224-001	1 5	Indicator-side light E1 53274 Spare Parts: Body/lens with screw  1x12V21W (P21W) 8GA 002 073-121  1x12V5W (C5W) 8GM 002 092-121
Maxi, Mega		2BM 002 652-031	1	Auxiliary indicator light E1 42781  1x12V5W (R5W) 8GA 002 071-121
Mercator 50 - 75 Mercator 50, 60, 75	01/73->12/78 	1S0 001 430-011 9ES 012 060-011 9GD 023 639-001 9DR 090 206-001 9FF 090 500-001	1 10 10 1 2	Headlight K 11103/1 Spare Parts: Lens Seal Reflector Bulb socket  1x12V35/35W (S2) 8GD 002 084-131  1x12V4W (T4W) 8GP 002 067-121
Mercator 50, 60, 75	->08/77 	2BE 001 259-061 9EL 088 538-001 9FT 088 047-001	2 2 10	Indicator-side light K 23269 Spare Parts: Body/lens with screws Bulb holder  1x12V3W (M) 8GM 002 094-121  1x12V18W (K) 8GM 002 091-121
Mercator 50, 60, 75	09/77->12/87 	2BE 003 185-051 9EL 119 397-001	1 4	Indicator-side light E1 53259 Spare Parts: Body/lens with screw  1x12V21W (P21W) 8GA 002 073-121  1x12V5W (C5W) 8GM 002 092-121








Manufacturer Model	Model year	Part no.	Pk.	Note
Claas				
Mercator 50 - 75 Mercator 50, 60, 75	->08/77	2SB 001 259-261 9EL 088 525-001 9FT 088 047-001	2 2 10	Combination rearlight K 23270 Spare Parts: Body/lens with screws Bulb holder 1x12V10W (K) 8GM 002 091-131 1x12V18W (K) 8GM 002 091-121
				
Mercator 50, 60, 75	09/77->12/87	2SW 003 185-041 9EL 118 633-001	1 4	Rear-indicator light E1 53256 Spare Parts: Body/lens with screw 1x12V21W (P21W) 8GA 002 073-121 1x12V5W (C5W) 8GM 002 092-121
				
Mercator 75	->08/77	2SA 001 259-751 9EL 135 266-001 9FT 088 047-001	2 2 10	Rear light E1 31438 Spare Parts: Body/lens with screws Bulb holder 1x12V5W (C5W) 8GM 002 092-121
				
Unitrac Unitrac	11/89->	1LB 006 213-057 9GH 116 966-011 9BG 993 345-001	30 10 1	H4 headlight E1 639 Spare Parts: Cap Rubber body (to be ordered separately) 1x12V60/55W (H4) 8GJ 002 525-131
				
Unitrac	06/85->	2BA 003 014-111 9EL 110 536-011	2 3	Indicator light E1 32661 Spare Parts: Lens with screws 1x12V21W (P21W) 8GA 002 073-121
				
















Claas















Manufacturer Model	Model year	Part no.	Pk.	Note
Claas				
Unitrac Unitrac	->10/89 	2BE 003 185-051 9EL 119 397-001	1 4	Indicator-side light E1 53259 Spare Parts: Body/lens with screw 1x12V21W (P21W) 8GA 002 073-121 1x12V5W (C5W) 8GM 002 092-121
Unitrac	11/89-> 	2BE 003 014-251 9EL 115 003-055	2 2	Indicator-side light E1 42712 Spare Parts: Lens with screws 1x12V21W (P21W) 8GA 002 073-121 1x12V5W (C5W) 8GM 002 092-121
Xerion Xerion	01/04-> 	1LB 996 157-201	1	H4 headlight 1x12V60/55W (H4) 8GJ 002 525-131 1x12V4W (T4W) 8GP 002 067-121
Xerion	01/04-> 	1GA 998 534-221 1GA 998 525-071 5DV 008 855-001 8KB 990 299-221	1 1 1 1	Xenon worklight 'Ultra Beam' with optics for large-area and long-range illumination, with gas discharge bulb, with 12V ballast, without connection cable Spare Parts: Light unit with ballast, with gas discharge bulb 12V ballast unit Connection cable (to be ordered separately) 1x35W (D1S) 8GS 009 028-001
Xerion	01/04-> 	2SD 964 169-111 9EL 964 536-001	1 1	Combination rearlight E17 9903 Spare Parts: Lens with screws 1x12V21/5W (P21/5W) 8GD 002 078-121 2x12V21W (P21W) 8GA 002 073-121








Manufacturer Model	Model year	Part no.	Pk.	Note
Claas				
Xerion Xerion	01/04->		2ZR 964 169-031 9EL 964 529-001	1 Reverse light Ⓔ17 2311 Spare Parts: Lens with screws  2x12V21W (P21W) 8GA 002 073-121
Claas (Bautz)				
Jaguar Jaguar 70 SF	->12/77		ISO 001 430-011 9ES 012 060-011 9GD 023 639-001 9DR 090 206-001 9FF 090 500-001	1 Headlight Ⓔ1 352 Spare Parts: 10 Lens 10 Seal 1 Reflector 2 Bulb socket  1x12V35/35W (S2) 8GD 002 084-131  1x12V4W (T4W) 8GP 002 067-121
Jaguar 70 SF, 80 SF	->12/79		2BE 003 014-251 9EL 115 003-055	2 Indicator-side light Ⓔ1 42712 Spare Parts: 2 Lens with screws  1x12V21W (P21W) 8GA 002 073-121  1x12V5W (C5W) 8GM 002 092-121
Jaguar 70 SF, 80 SF	->12/79		2PF 003 014-071 9EL 110 542-001	2 Side light Ⓔ1 11793 Spare Parts: 3 Lens with screws  1x12V5W (C5W) 8GM 002 092-121
Jaguar 70 SF, 80 SF Jaguar 70 SF Jaguar 80 SF	->12/77 ->12/79		2SW 003 014-131 9EL 115 003-011	2 Rear-indicator light Ⓔ1 31452 Ⓔ1 53211 Spare Parts: 2 Lens with screws  1x12V21W (P21W) 8GA 002 073-121  1x12V5W (C5W) 8GM 002 092-121









Manufacturer Model	Model year	Part no.	Pk.	Note
Claas (Bautz)				
Jaguar Jaguar 70 SF, 80 SF	-->12/79 	2SA 003 014-051	2	Rear light, auxiliary lamp for excess width (E1) 31418
		9EL 110 540-001	1	Spare Parts: Lens with screws  1x12V5W (C5W) 8GM 002 092-121
Rapido wagen Rapido wagen		2SB 001 301-021	2	Combination rearlight K 23318
		9EL 090 411-001	5	Spare Parts: Lens with screw  1x12V10W (K) 8GM 002 091-131 1x12V18W (K) 8GM 002 091-121
Rapido wagen		2SD 002 776-231	1	Combination rearlight, left, without licence plate light
		2SE 002 776-221	1	Combination rearlight, right, with licence plate light (E1) 273 (E1) 63230
		9EL 137 307-001 9EL 134 740-001	2 2	Spare Parts: Lens, left Lens, right  1x12V10W (R10W) 8GA 002 071-131 2x12V21W (P21W) 8GA 002 073-121
John Deere				
various models various models		1GA 007 506-111	1	FF@-H3 worklight 'Ultra Beam Standard' with optics for large-area ground illumination, with AMP plug-connection
		1GA 998 525-001 9GH 993 984-001 8KB 990 299-001 8JD 008 151-011	1 20 1 10	Spare Parts: Light unit Rubber cap Lead with plug for external connection (to be ordered separately) Socket housing (to be ordered separately)  1x12V55W (H3) 8GH 002 090-371  1x12V55W (H3) 8GH 002 090-133
various models		1GA 007 506-081	1	FF@-H3 worklight 'Ultra Beam Standard' with optics for large-area ground illumination
		1GA 007 506-391	1	FF@-H3 worklight 'Ultra Beam Standard' with optics for large-area ground illumination, with DEUTSCH plug-connection
		1GA 998 525-001	1	Spare Parts: Light unit  1x12V55W (H3) 8GH 002 090-371  1x12V55W (H3) 8GH 002 090-133







Manufacturer Model	Model year	Part no.	Pk.	Note
John Deere				
various models various models		1GA 998 534-001	1	Xenon worklight 'Ultra Beam' with optics for large-area and long-range illumination, with gas discharge bulb and 12V ballast Spare Parts: 1 Light unit 1 12V ballast unit 1 Ignitor, gas discharge bulb 1 Lead  1x35W (D2S) 8GS 007 949-101
		1GA 998 525-011 5DV 990 264-001 5DD 008 319-501 8KB 149 147-001	1 1 1 1	
various models		1GA 998 534-061	1	Ultra Beam Xenon worklight with optics for large-area and long-range illumination, with gas discharge bulb and xenon ballast, without fixing base and without connection cable Spare Parts: 1 Light unit 1 Xenon ballast, 12V 1 Ignitor, gas discharge bulb 1 Lead assembly  1x35W (D2S) 8GS 007 949-101
		1GA 998 525-011 5DV 990 264-001 5DD 008 319-501 8KB 990 299-101	1 1 1 1	
various models		1GA 006 876-001	1	FF®-H3 worklight with optics for ground illumination, with rotating base  1x12V55W (H3) 8GH 002 090-371 1x12V55W (H3) 8GH 002 090-133 1x24V70W (H3) 8GH 002 090-251
various models		1GB 006 213-101	1	H3 worklight with optics for long-range illumination
		1GB 006 213-111	1	H3 worklight with optics for close-range illumination  1x12V55W (H3) 8GH 002 090-371 1x12V55W (H3) 8GH 002 090-133
various models		1GB 996 080-011	1	FF®-H3 worklight 'Double Beam' with optics for large-area ground illumination
		1GB 996 080-031	1	FF®-H3 worklight 'Double Beam' with optics for wide close-range illumination  2x12V35W (H3) 8GH 002 090-271 2x12V55W (H3) 8GH 002 090-133



Manufacturer Model	Model year	Part no.	Pk.	Note
John Deere				
various models various models		1GM 996 135-071 5DD 008 319-501	1 1	Xenon worklight with optics for long-range illumination, with 12V ballast, with gas discharge bulb, without fixing base, without connection cable Spare Parts: Ignitor, gas discharge bulb  1x35W (D2S) 8GS 007 949-101
various models		1G3 005 760-001 1G3 135 211-011 6EB 005 633-001	1 1 10	H3 worklight with optics for long-range illumination Spare Parts: Light unit Switch  1x12V55W (H3) 8GH 002 090-371  1x12V55W (H3) 8GH 002 090-133
MD 330 - MD 970 MD 330 - MD 970	->07/74	2BE 001 259-061 9EL 088 538-001 9FT 088 047-001	2 2 10	Indicator-side light K 23269 Spare Parts: Body/lens with screws Bulb holder  1x12V3W (M) 8GM 002 094-121  1x12V18W (K) 8GM 002 091-121
MD 925 - MD 1188 H 4 MD 1072 - MD 1085 Special equipment		1GD 003 590-701	1	H3 worklight  1x12V55W (H3) 8GH 002 090-133



Manufacturer Model	Model year	Part no.	Pk.	Note
John Deere				
MD 925 - MD 1188 H 4 MD 925 - MD 1188 H 4	08/74->	2BE 003 014-251 9EL 115 003-055	2 2	Indicator-side light Ⓔ1 42712 Spare Parts: Lens with screws 1x12V21W (P21W) 8GA 002 073-121 1x12V5W (C5W) 8GM 002 092-121
				
MD 925 - MD 1188 H 4 MD 925, MD 935, MD 945, MD 955, MD 965, MD 975 MD 1032, MD 1042, MD 1052, MD 1055, MD 1056, MD 1068 H MD 1072, MD 1075, MD 1085 MD 1133, MD 1144, MD 1155, MD 1157, MD 1158, MD 1166, H, MD 1166 H 4 MD 1174, MD 1177, H, H 4, MD 1188, H 4	08/74-> 08/74->10/82 05/84->04/85 08/87-> 01/87->	2SD 002 776-231 2SE 002 776-221 9EL 137 307-001 9EL 134 740-001	1 1 2 2	Combination rearlight, left, without licence plate light Combination rearlight, right, with licence plate light Ⓔ1 273 Ⓔ1 63230 Spare Parts: Lens, left Lens, right 1x12V10W (R10W) 8GA 002 071-131 2x12V21W (P21W) 8GA 002 073-121
				
Z-series Z-series	01/94->	2BA 002 652-111 2BA 002 652-121 9EL 134 659-001 9EL 134 660-001	2 2 2 2	Indicator light, left Indicator light, right Ⓔ1 42764 Spare Parts: Lens with screw, left Lens with screw, right 1x12V21W (P21W) 8GA 002 073-121
				
Z-series	01/94->	2XS 005 020-001 9EL 132 215-001	10 2	Clearance light Ⓔ1 31407 Spare Parts: Lens with screws 1x12V4W (T4W) 8GP 002 067-121
				



Manufacturer Model	Model year	Part no.	Pk.	Note
John Deere				
Z-series Z-series Z-2054, Z-2056, Z-2058, Z-2064, Z-2066	11/98->	2VA 006 356-101 9EL 147 992-001	1 1	Combination rearlight, with bulbs, lead and centre plug (E1) 02350 (E1) 63255 Spare Parts: Body/lens with screw 1x12V21W (P21W) 8GA 002 073-121 1x12V21/5W (P21/5W) 8GD 002 078-121
Z-series	01/94->	2KA 003 389-061 9BG 121 587-031	2 2	Licence plate light (E1) 22819 Spare Parts: Body/lens with screw 1x12V10W (R10W) 8GA 002 071-131
820 - 4020 820 - 4020 820, 920, 1010, 1120, 1630, 2020, 2030, 2130, 3020, 3130, 4020	->06/75	9ES 012 060-011 9GD 023 639-001 9DR 090 206-001 9FF 090 500-001	10 10 1 2	Headlight, spare parts available only K 11103/1 Spare Parts: Lens Seal Reflector Bulb socket 1x12V35/35W (S2) 8GD 002 084-131 1x12V4W (T4W) 8GP 002 067-121
820 - 4020	->09/74	9EL 088 538-001 9FT 088 047-001	2 2 10	Indicator-side light K 23269 Spare Parts: Body/lens with screws Bulb holder 1x12V3W (M) 8GM 002 094-121 1x12V18W (K) 8GM 002 091-121
820 - 4020	10/74->	9EL 115 003-055	2 2	Indicator-side light (E1) 42712 Spare Parts: Lens with screws 1x12V21W (P21W) 8GA 002 073-121 1x12V5W (C5W) 8GM 002 092-121



Manufacturer Model	Model year	Part no.	Pk.	Note
John Deere				
820 - 4020 820 - 4020 820, 920, 1010, 1120, 1630, 2020, 2030, 2130, 3020, 3130, 4020 Vehicles with strip-type mudguards	10/74->	2SD 002 776-231 2SD 002 776-241 9EL 137 307-001 9EL 137 308-001	1 1 2 2	Combination rearlight, left Combination rearlight, right (E1) 273 (E1) 63230 Spare Parts: Lens, left Lens, right 1x12V10W (R10W) 8GA 002 071-131 2x12V21W (P21W) 8GA 002 073-121
840 - 4240 840 - 3140		2BE 003 014-251 9EL 115 003-055	2 2	Indicator-side light (E1) 42712 Spare Parts: Lens with screws 1x12V21W (P21W) 8GA 002 073-121 1x12V5W (C5W) 8GM 002 092-121
3640 - 4240		2PF 003 014-071 9EL 110 542-001	2 3	Side light (E1) 11793 Spare Parts: Lens with screws 1x12V5W (C5W) 8GM 002 092-121
840 - 4240 840, 940, 1040, 1140, 1640, 2040, 2140, 3040, 3140, 3640, 4040, 4240 Vehicles with standard equipment	09/79->05/86	2SD 003 184-031 2SE 003 184-101 9EL 118 700-001 9EL 121 431-001 8RA 123 251-005 9XD 132 749-005	1 1 1 1 50 8	Combination rearlight, left, without licence plate light Combination rearlight, right, with licence plate light (E1) 130 (E1) 53253 Spare Parts: Body/lens with screws, left Body/lens with screws, right Reflex-reflector (to be ordered separately) Adapter with fastening material (to be ordered separately) 1x12V10W (R10W) 8GA 002 071-131 2x12V21W (P21W) 8GA 002 073-121 1x12V5W (C5W) 8GM 002 092-121



Manufacturer Model	Model year	Part no.	Pk.	Note
John Deere				
840 - 4240 840 - 4240 06/86-> 840, 940, 1040, 1140, 1640, 2040, 2140, 3040, 3140, 3640, 4040, 4240 Vehicles with standard equipment		2SD 003 184-031 2SD 003 184-041 9EL 118 700-001 9EL 118 701-001 8RA 123 251-005 9XD 132 749-005	1 1 1 1 50 8	Combination rearlight, left, without licence plate light Combination rearlight, right, without licence plate light (E1) 130 (E1) 53253 Spare Parts: Body/lens, left Body/lens, right Reflex-reflector (to be ordered separately) Adapter with fastening material (to be ordered separately) 1x12V10W (R10W) 8GA 002 071-131 2x12V21W (P21W) 8GA 002 073-121
840 - 4240 Vehicles with standard equipment	06/86->	2KA 003 738-057	40	Licence plate light (E1) 22916 1x12V5W (C5W) 8GM 002 092-121
840 - 4240 840, 940, 1040, 1140, 1640, 2040, 2140, 3040, 3140, 3640, 4040, 4240 Vehicles with strip-type mudguards		2SD 002 776-231 2SD 002 776-241 9EL 137 307-001 9EL 137 308-001	1 1 2 2	Combination rearlight, left Combination rearlight, right (E1) 273 (E1) 63230 Spare Parts: Lens, left Lens, right 1x12V10W (R10W) 8GA 002 071-131 2x12V21W (P21W) 8GA 002 073-121
840 - 4240 Vehicles with strip-type mudguards		2KA 003 389-061 9BG 121 587-031	2 2	Licence plate light (E1) 22819 Spare Parts: Body/lens with screw 1x12V10W (R10W) 8GA 002 071-131








Manufacturer Model	Model year	Part no.	Pk.	Note
John Deere				
3200 - 3400 3200 - 3400 Telescope loader				H7/H3 headlight, with flasher light and bulbs, spare parts available only (E4) 9496 (E4) 6495 (E4) 6505 Spare Parts: 1 Light unit 4 Lens for indicator light (front) 4 Lens for indicator light (rear) 1x12V55W (H7) 8GH 007 157-121 1x12V55W (H3) 8GH 002 090-133 1x12V21W (P21W) 8GA 002 073-121 1x12V4W (T4W) 8GP 002 067-121
6120 - 6920 S 6120 - 6920 S	11/01->	2KA 998 523-117	90	Licence plate light with lead and bulb (E12) 4031 1x12V10W (R10W) 8GA 002 071-131
6610 - 6910 6610, 6710, 6810, 6910 Field chopper	01/93->	1LB 003 177-081 1VB 005 444-037	1 20	H4 headlight, spare parts available only (E1) 7197 Spare Parts: 1 Light unit 20 Headlight receiving unit 1x12V60/55W (H4) 8GJ 002 525-131
6610, 6710, 6810, 6910 Field chopper	01/93->	2BE 003 347-001 9EL 120 224-001	1 5	Indicator-side light (E1) 53274 Spare Parts: 5 Body/lens with screw 1x12V21W (P21W) 8GA 002 073-121 1x12V5W (C5W) 8GM 002 092-121











Manufacturer Model	Model year	Part no.	Pk.	Note
John Deere				
6610 - 6910 6610, 6710, 6810, 6910 Field chopper	11/98->	2VA 006 356-101	1	Combination rearlight, with bulbs, lead and centre plug (E1) 02350 (E1) 63255 Spare Parts: Body/lens with screw 1x12V21W (P21W) 8GA 002 073-121 1x12V21/5W (P21/5W) 8GD 002 078-121
		9EL 147 992-001	1	
6610, 6710, 6810, 6910 Field chopper	01/93->	2KA 003 389-061	2	Licence plate light (E1) 22819 Spare Parts: Body/lens with screw 1x12V10W (R10W) 8GA 002 071-131
		9BG 121 587-031	2	
7200 - 7500 7200 - 7500 Field chopper	10/02->	2BE 997 131-081	1	Indicator-side light (E12) 6085 (E12) 7113 Spare Parts: Lens 1x12V5W (R5W) 8GA 002 071-121 1x12V21W (P21W) 8GA 002 073-121
		9EL 997 459-001	2	
M-series 6000 M-series 6000 6100, 6200, 6300, 6400, 6800	07/92->	1AB 007 145-001	1	H4 headlight (E1) 44439 1x12V60/55W (H4) 8GJ 002 525-131 1x12V4W (T4W) 8GP 002 067-121















Manufacturer Model	Model year	Part no.	Pk.	Note
John Deere				
M-series 6000 M-series 6000 6100, 6200, 6300, 6400, 6800	07/92->11/98	2VA 006 356-081 9EL 147 992-001	1 1	Combination rearlight Spare Parts: Body/lens with screw 1x12V21W (P21W) 8GA 002 073-121 1x12V21/5W (P21/5W) 8GD 002 078-121
				
M-series 6000 6100, 6200, 6300, 6400, 6800	11/98->10/02	2VA 006 356-101 9EL 147 992-001	1 1	Combination rearlight, with bulbs, lead and centre plug Spare Parts: Body/lens with screw 1x12V21W (P21W) 8GA 002 073-121 1x12V21/5W (P21/5W) 8GD 002 078-121
				
M-series 6000	07/92->	2KA 003 738-057	40	Licence plate light 1x12V5W (C5W) 8GM 002 092-121
				
Series 7000 Series 7000 7600, 7700, 7800	07/92->	1AB 007 145-001	1	H4 headlight 1x12V60/55W (H4) 8GJ 002 525-131 1x12V4W (T4W) 8GP 002 067-121
				
Series 7000	07/92->	2KA 003 738-057	40	Licence plate light 1x12V5W (C5W) 8GM 002 092-121
				










Manufacturer Model	Model year	Part no.	Pk.	Note
Deutz-Fahr				
various models various models		1GA 007 506-001 1GA 998 525-001 9GH 993 984-001	1 1 20	FF®-H3 worklight 'Ultra Beam Standard' with optics for large-area ground illumination, with AMP plug-connection Spare Parts: Light unit Rubber cap  1x12V55W (H3) 8GH 002 090-371  1x12V55W (H3) 8GH 002 090-133
various models		1GA 007 506-111 1GA 007 506-121 1GA 998 525-001 9GH 993 984-001 8KB 990 299-001 8JD 008 151-011	1 1 1 10	FF®-H3 worklight 'Ultra Beam Standard' with optics for large-area ground illumination, with AMP plug-connection FF®-H3 worklight 'Ultra Beam Standard' with optics for extreme large-area and equal ground illumination Spare Parts: Light unit Rubber cap for -111 Lead with plug for external connection for -111 (to be ordered separately) Socket housing for -111 (to be ordered separately)  1x12V55W (H3) 8GH 002 090-371  1x12V55W (H3) 8GH 002 090-133
various models		1GA 007 506-061 1GA 998 525-001 8KB 990 299-001 8JD 008 151-011	1 1 10	FF®-H3 worklight with optics for large-area ground illumination and bulb Spare Parts: Light unit Lead with plug for external connection (to be ordered separately) Socket housing (to be ordered separately)  1x12V55W (H3) 8GH 002 090-133
various models		1GA 007 506-101 1GA 998 525-001 9GH 993 984-001 9XD 130 261-001	1 1 20 5	FF®-H3 worklight 'Ultra Beam Heavy Duty' with optics for large-area ground illumination, with AMP plug-connection, protective cap and grommet Spare Parts: Light unit Protective cap for AMP plug-connection Angle bracket for 4-point fastening  1x12V55W (H3) 8GH 002 090-371  1x12V55W (H3) 8GH 002 090-133  1x24V70W (H3) 8GH 002 090-251







Manufacturer Model	Model year	Part no.	Pk.	Note
Deutz-Fahr				
various models various models 		1GA 998 522-011	1	FF@-H3 worklight with optics for ground illumination  1x12V55W (H3) 8GH 002 090-371  1x12V55W (H3) 8GH 002 090-133
various models 		1GB 006 213-111	1	H3 worklight with optics for close-range illumination  1x12V55W (H3) 8GH 002 090-371  1x12V55W (H3) 8GH 002 090-133
various models 		1G3 996 001-271	1	H3 worklight with optics for close-range illumination, without switch  1x12V55W (H3) 8GH 002 090-371  1x12V55W (H3) 8GH 002 090-133
D 2506 - D 13006 D 2506 - D 13006 D 2506, D 3006, D 4006, D 4506, D 5006, D 5206, D 5506, D 6006, D 6206, D 6806, D 7206, D 7506, D 8006, D 9006, D 10006, D 13006 		9GD 100 711-021 9DR 113 199-005	10 1	Headlight, permanently dipped-beam, spare parts available only K 21059 Spare Parts: Seal Reflector with retaining spring  1x12V15W (Q) 8GA 002 081-121  1x12V4W (T4W) 8GP 002 067-121














Manufacturer Model	Model year	Part no.	Pk.	Note
Deutz-Fahr				
D 2506 - D 13006 D 2506 - D 13006 D 2506, D 3006, D 4006, D 4506, D 5006, D 5206, D 5506, D 6006, D 6206, D 6806, D 7206, D 7506, D 8006, D 9006, D 10006, D 13006	-->03/76	9GD 100 711-021 9DR 113 199-005	10 1	Headlight, spare parts available only K 21038 Spare Parts: Seal Reflector  1x12V35/35W (S2) 8GD 002 084-131
D 2506 - D 13006	08/73->	2BE 002 776-251 2BE 002 776-261 9EL 134 741-021 9EL 134 742-021	1 1 2 2	Indicator-side light, left Indicator-side light, right  63225 Spare Parts: Lens, left Lens, right  1x12V10W (R10W) 8GA 002 071-131 1x12V21W (P21W) 8GA 002 073-121
D 2506 - D 13006 D 2506, D 3006, D 4006, D 4506, D 5006, D 5206, D 5506, D 6006, D 6206, D 6806, D 7206, D 7506, D 8006, D 9006, D 10006, D 13006	-->07/73	2SE 001 306-051 2SD 001 306-061 9EL 104 571-031 9EL 104 571-041	2 2 1 1	Combination rearlight, left, with licence plate light Combination rearlight, right, without licence plate light K 33375 Spare Parts: Lens with screws, left Lens with screws, right  1x12V5W (C5W) 8GM 002 092-121 2x12V18W (K) 8GM 002 091-121
D 2506 - D 13006 D 2506, D 3006, D 4006, D 4506, D 5006, D 5206, D 5506, D 6006, D 6206, D 6806, D 7206, D 7506, D 8006, D 9006, D 10006, D 13006	08/73->	2SD 002 776-231 2SE 002 776-221 9EL 137 307-001 9EL 134 740-001	1 1 2 2	Combination rearlight, left, without licence plate light Combination rearlight, right, with licence plate light  273  63230 Spare Parts: Lens, left Lens, right  1x12V10W (R10W) 8GA 002 071-131 2x12V21W (P21W) 8GA 002 073-121


















Manufacturer Model	Model year	Part no.	Pk.	Note
Deutz-Fahr				
D 2807 - D 7807 C D 2807 - D 7207	05/80->12/90	 2BE 002 776-251 2BE 002 776-261 9EL 134 741-021 9EL 134 742-021	1	Indicator-side light, left
			1	Indicator-side light, right (E1) 63225 Spare Parts: 2 Lens, left 2 Lens, right 1x12V10W (R10W) 8GA 002 071-131 1x12V21W (P21W) 8GA 002 073-121
D 6007 C - D 7807 C	05/80->12/90	 9EL 115 003-055	2	Indicator-side light (E1) 42712 Spare Parts: 2 Lens with screws 1x12V21W (P21W) 8GA 002 073-121 1x12V5W (C5W) 8GM 002 092-121
D 2807 - D 7807 C D 2807, D 3607, D 4507, D 4807, D 5207, D 6007, C, D 6507, C, D 7207, C, D 7807, C	05/80->12/90	 2SD 002 776-231 2SE 002 776-221 9EL 137 307-001 9EL 134 740-001	1	Combination rearlight, left, without licence plate light
			1	Combination rearlight, right, with licence plate light (E1) 273 (E1) 63230 Spare Parts: 2 Lens, left 2 Lens, right 1x12V10W (R10W) 8GA 002 071-131 2x12V21W (P21W) 8GA 002 073-121
DX 3.10 - DX 6.07 DX 3.10 - DX 3.65 with Vario-cab		 2BE 002 776-251 2BE 002 776-261 9EL 134 741-021 9EL 134 742-021	1	Indicator-side light, left
			1	Indicator-side light, right (E1) 63225 Spare Parts: 2 Lens, left 2 Lens, right 1x12V10W (R10W) 8GA 002 071-131 1x12V21W (P21W) 8GA 002 073-121



Manufacturer Model	Model year	Part no.	Pk.	Note
Deutz-Fahr				
DX 3.10 - DX 6.07 DX 3.10 - DX 3.65 DX 3.10, DX 3.30, DX 3.50, DX 3.60, DX 3.65 with Vario-cab 		2SD 002 776-231 2SE 002 776-221 9EL 137 307-001 9EL 134 740-001	1 1 2 2	Combination rearlight, left, without licence plate light Combination rearlight, right, with licence plate light (E1) 273 (E1) 63230 Spare Parts: Lens, left Lens, right  1x12V10W (R10W) 8GA 002 071-131  2x12V21W (P21W) 8GA 002 073-121
DX 4.61 - DX 6.61 DX 4.61 - DX 6.61 01/91->12/96 		2KA 003 389-061 9BG 121 587-031	2 2	Licence plate light (E1) 22819 Spare Parts: Body/lens with screw  1x12V10W (R10W) 8GA 002 071-131
DX 36V - DX 55V DX 36V, DX 50V, DX 55V Narrow track 05/78-> 		2BE 002 776-251 2BE 002 776-261 9EL 134 741-021 9EL 134 742-021	1 1 2 2	Indicator-side light, left Indicator-side light, right (E1) 63225 Spare Parts: Lens, left Lens, right  1x12V10W (R10W) 8GA 002 071-131  1x12V21W (P21W) 8GA 002 073-121
DX 36V, DX 50V, DX 55V Narrow track 05/78-> 		2SD 002 776-231 2SE 002 776-221 9EL 137 307-001 9EL 134 740-001	1 1 2 2	Combination rearlight, left, without licence plate light Combination rearlight, right, with licence plate light (E1) 273 (E1) 63230 Spare Parts: Lens, left Lens, right  1x12V10W (R10W) 8GA 002 071-131  2x12V21W (P21W) 8GA 002 073-121

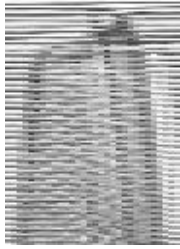





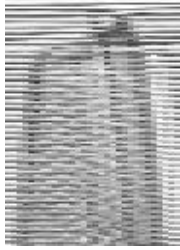





Manufacturer Model	Model year	Part no.	Pk.	Note
Deutz-Fahr				
Intrac 2003 - 2006 Intrac 2003, 2006	09/74->12/79	 9ES 093 815-001 9GD 024 183-001 9DR 073 862-011 9KS 071 571-001	10 10 1 10	Headlight, spare parts available only (E1) 4488 Spare Parts: Lens Seal Reflector Lens-retaining spring  1x12V45/40W (R2) 8GD 002 088-131  1x12V4W (T4W) 8GP 002 067-121
Intrac 2003 - 2006	09/74->12/79	 9EL 115 003-055	2 2	Indicator-side light (E1) 42712 Spare Parts: Lens with screws  1x12V21W (P21W) 8GA 002 073-121  1x12V5W (C5W) 8GM 002 092-121
Intrac 2003, 2006	09/74->12/79	 2SD 002 776-231 2SE 002 776-221 9EL 137 307-001 9EL 134 740-001	1 1 2 2	Combination rearlight, left, without licence plate light Combination rearlight, right, with licence plate light (E1) 273 (E1) 63230 Spare Parts: Lens, left Lens, right  1x12V10W (R10W) 8GA 002 071-131  2x12V21W (P21W) 8GA 002 073-121
M 600 - M 1630 M 600 - M 1002 M 600, M 750, M 900, M 922, M 1002	->09/77	 9ES 093 815-001 9GD 024 183-001	10 10	Headlight, spare parts available only (E1) 4488 Spare Parts: Lens Seal  1x12V45/40W (R2) 8GD 002 088-131  1x12V4W (T4W) 8GP 002 067-121
M 660 - M 1080	->12/87	 9EL 088 538-001 9FT 088 047-001	2 2 10	Indicator-side light K 23269 Spare Parts: Body/lens with screws Bulb holder  1x12V3W (M) 8GM 002 094-121  1x12V18W (K) 8GM 002 091-121





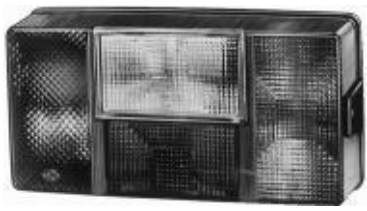



Deutz-Fahr














Manufacturer Model	Model year	Part no.	Pk.	Note
Deutz-Fahr				
M 600 - M 1630 M 1102 - M 1630	->12/92 	2BA 002 324-011 2BA 002 324-021 9EL 110 918-001 9EL 110 918-011	1 1 5 5	Indicator light, left Indicator light, right  32621 Spare Parts: Lens with screws, left Lens with screws, right  1x12V21W (P21W) 8GA 002 073-121
M 1102 - M 1630		2PF 003 014-071 9EL 110 542-001	2 3	Side light  11793 Spare Parts: Lens with screws  1x12V5W (C5W) 8GM 002 092-121
M 2385 - M 2780 M 2385 - M 2780		2BE 003 347-001 9EL 120 224-001	1 5	Indicator-side light  53274 Spare Parts: Body/lens with screw  1x12V21W (P21W) 8GA 002 073-121  1x12V5W (C5W) 8GM 002 092-121
M 2385 - M 2780	->12/92 	2BA 002 324-011 2BA 002 324-021 9EL 110 918-001 9EL 110 918-011	1 1 5 5	Indicator light, left Indicator light, right  32621 Spare Parts: Lens with screws, left Lens with screws, right  1x12V21W (P21W) 8GA 002 073-121
M 2385 - M 2780		2BA 003 014-011 9EL 110 536-001	2 1	Indicator light, for rear mounting  32619 Spare Parts: Lens with screws  1x12V21W (P21W) 8GA 002 073-121







Manufacturer Model	Model year	Part no.	Pk.	Note
Deutz-Fahr				
M 2385 - M 2780 M 2385 - M 2780	->12/84 	2TM 003 057-031	1	Rear-reflex-reflector light E1 11583 IA E1 31315 1x12V5W (C5W) 8GM 002 092-121
M 2385 - M 2780	01/85->12/91 	2SA 003 057-021 9EL 117 330-011	1 2	Rear light E1 11584 Spare Parts: Lens 1x12V5W (C5W) 8GM 002 092-121
Powerliner 4030 Powerliner 4030	92-> 	2BE 003 347-001 9EL 120 224-001	1 5	Indicator-side light E1 53274 Spare Parts: Body/lens with screw 1x12V21W (P21W) 8GA 002 073-121 1x12V5W (C5W) 8GM 002 092-121
Powerpress 120 H Powerpress 120 H	01/94-> 	2BE 003 347-001 9EL 120 224-001	1 5	Indicator-side light E1 53274 Spare Parts: Body/lens with screw 1x12V21W (P21W) 8GA 002 073-121 1x12V5W (C5W) 8GM 002 092-121
Powerpress 120 H	01/94-> 	2SD 006 040-337 2SD 006 040-141 9EL 136 819-041 9EL 137 792-031 9GD 102 484-001	64 1 1 1 10	Combination rearlight, left Combination rearlight, right E13 9385 Spare Parts: Lens, left Lens, right Seal (to be ordered separately) 1x12V10W (R10W) 8GA 002 071-131 2x12V21W (P21W) 8GA 002 073-121
Starliner 4040, 4045 H Starliner 4040, 4045 H	91-> 	2BE 003 347-001 9EL 120 224-001	1 5	Indicator-side light E1 53274 Spare Parts: Body/lens with screw 1x12V21W (P21W) 8GA 002 073-121 1x12V5W (C5W) 8GM 002 092-121



Manufacturer Model	Model year	Part no.	Pk.	Note
Deutz-Fahr				
Topliner 8XL Topliner 8XL 91-> 		2BE 003 347-001 9EL 120 224-001	1 5	Indicator-side light (E1) 53274 Spare Parts: Body/lens with screw  1x12V21W (P21W) 8GA 002 073-121  1x12V5W (C5W) 8GM 002 092-121
Topliner 8XL 91-> 		2SD 006 040-337 2SD 006 040-141 9EL 136 819-041 9EL 137 792-031 9GD 102 484-001	64 1 1 1 10	Combination rearlight, left Combination rearlight, right (E13) 9385 Spare Parts: 1 Lens, left 1 Lens, right 10 Seal (to be ordered separately)  1x12V10W (R10W) 8GA 002 071-131  2x12V21W (P21W) 8GA 002 073-121
Dexheimer				
AL 222 - AL 370 turbo AL 222 - AL 370 turbo AL 222, AL 230, AL 240 01/84-> AL 240 SSK 02/83-> AL 250 SC 04/83-> AL 342 SC 12/86-> AL 345 01/82-> AL 345 K 04/83-> AL 345 SC, AL 360 SC 12/86-> AL 370 turbo 01/84-> 		1TA 003 570-001 1TA 122 718-001	1 1	Headlight, permanently dipped-beam K 21090 Spare Parts: Light unit  1x12V15W (Q) 8GA 002 081-121  1x12V4W (T4W) 8GP 002 067-121
AL 222 - AL 370 turbo 		2BA 001 227-201 9EL 074 484-011	2 2	Indicator light K 12642 Spare Parts: Body/lens  1x12V18W (K) 8GM 002 091-121







Manufacturer Model	Model year	Part no.	Pk.	Note
Dexheimer				
AL 222 - AL 370 turbo AL 222 - AL 370 turbo	01/82->	2BA 002 652-111 2BA 002 652-121 9EL 134 659-001 9EL 134 660-001	2 2 2 2	Indicator light, left Indicator light, right Spare Parts: Lens with screw, left Lens with screw, right 1x12V21W (P21W) 8GA 002 073-121
				
AL 222 SC - AL 370 SC	01/88->	2PF 004 081-001	2	Side light E1 21656 1x12V5W (C5W) 8GM 002 092-121
				
AL 222 - AL 370 turbo AL 222, AL 230, AL 232, AL 242, AL 350 AL 370 turbo	->12/81 ->01/84	2SB 001 301-021 9EL 090 411-001	2 5	Combination rearlight K 23318 Spare Parts: Lens with screw 1x12V10W (K) 8GM 002 091-131 1x12V18W (K) 8GM 002 091-121
				
AL 222 - AL 370 SC turbo AL 222, AL 230, AL 240 AL 240 SSK AL 342 SC AL 345 AL 345 K AL 345 SC, AL 360 SC, AL 370 SC turbo	01/82-> 02/83-> 01/82-> 04/83->	2SW 003 014-131 9EL 115 003-011	2 2	Rear-indicator light E1 31452 E1 53211 Spare Parts: Lens with screws 1x12V21W (P21W) 8GA 002 073-121 1x12V5W (C5W) 8GM 002 092-121
				



Manufacturer Model	Model year	Part no.	Pk.	Note
Dexheimer				
AL 222 - AL 370 turbo AL 222 SC - AL 370 SC AL 222 SC, AL 240 SC, AL 250 SC, AL 342 SC, AL 345 SC, AL 360 SC, AL 370 SC	01/88->	2SD 002 776-231 2SD 002 776-241 9EL 137 307-001 9EL 137 308-001	1 1 2 2	Combination rearlight, left Combination rearlight, right (E1) 273 (E1) 63230 Spare Parts: Lens, left Lens, right 1x12V10W (R10W) 8GA 002 071-131 2x12V21W (P21W) 8GA 002 073-121
AL 222 - AL 370 turbo		2KA 001 389-101 9BG 119 721-001	10 5	Licence plate light (E1) 12815 Spare Parts: Body with lens 1x12V5W (C5W) 8GM 002 092-121
Fendt				
various models various models		1GA 996 020-001	1	H3 worklight 'Corner Light', with 12V55W bulb 1x12V55W (H3) 8GH 002 090-133
various models		1GA 007 506-081 1GA 998 525-001	1 1	FF®-H3 worklight 'Ultra Beam Standard' with optics for large-area ground illumination Spare Parts: Light unit 1x12V55W (H3) 8GH 002 090-371 1x12V55W (H3) 8GH 002 090-133
various models		1GD 003 690-287	108	H3 worklight 1x12V55W (H3) 8GH 002 090-133










Manufacturer Model	Model year	Part no.	Pk.	Note
Fendt				
various models various models		1GD 996 018-541	1	H3 worklight with optics for close-range illumination  1x12V55W (H3) 8GH 002 090-371 1x12V55W (H3) 8GH 002 090-133
various models		1GB 996 080-011	1	FF®-H3 worklight 'Double Beam' with optics for large-area ground illumination  2x12V35W (H3) 8GH 002 090-271 2x12V55W (H3) 8GH 002 090-133
various models		1GA 998 522-011	1	FF®-H3 worklight with optics for ground illumination  1x12V55W (H3) 8GH 002 090-371 1x12V55W (H3) 8GH 002 090-133
various models		1GA 006 991-051 9XD 130 261-001	1 5	FF®-H3 worklight 'Double Beam' with optics for long-range off-road illumination Spare Parts: Angle bracket  2x12V35W (H3) 8GH 002 090-271 2x12V55W (H3) 8GH 002 090-133
Farmer Fix 2 E - 2 S Farmer Fix 2 E - 2 S Farmer Fix 2 E, 1 E, 2 DE, 2 E, 2 S	-->05/68	1S3 001 442-001 9GD 024 183-001 9DR 066 847-001 9AG 071 903-001 9FF 090 500-001	1 10 1 5 2	Headlight K 21047 Spare Parts: Seal Reflector Lens-retaining rim Bulb socket  1x12V35/35W (S2) 8GD 002 084-131  1x12V4W (T4W) 8GP 002 067-121



Fendt



Manufacturer Model	Model year	Part no.	Pk.	Note
Fendt				
Farmer Fix 2 E - 2 S Farmer Fix 2 E - 2 S Farmer Fix 2 E, 1 E Farmer 2 DE, 2 E Farmer 2 S	-->05/68 -->05/68	2SB 001 673-002 9EL 110 928-001	1 10	Combination rearlight without licence plate light K 23256/1 Spare Parts: Lens with screw  1x12V10W (R10W) 8GA 002 071-131 1x12V18W (R) 8GA 002 072-121
Farmer Fix 2 E - 2 S Farmer Fix 2 E, 1 E Farmer 2 DE, 2 E Farmer 2 S	06/68-> 06/68->	2ST 001 673-011 9EL 110 928-001	1 10	Combination rearlight with licence plate light K 23256/1 Spare Parts: Lens with screw  1x12V10W (R10W) 8GA 002 071-131 1x12V18W (R) 8GA 002 072-121
Farmer 102 S - 201 S Farmer 102 S - 201 S Farmer 102 S, 103 S, Farmer 104 S, 105 S Farmer 200 S, 201 S	-->12/87	1LA 004 109-217 9AH 131 494-015 9FF 111 606-021	36 6 10	H4 headlight  17116 Spare Parts: Supporting frame Bulb socket for side light (to be ordered separately)  1x12V60/55W (H4) 8GJ 002 525-131
Farmer 102 S - 201 S		2BE 003 347-001 9EL 120 224-001	1 5	Indicator-side light  53274 Spare Parts: Body/lens with screw  1x12V21W (P21W) 8GA 002 073-121  1x12V5W (C5W) 8GM 002 092-121









Manufacturer Model	Model year	Part no.	Pk.	Note
Fendt				
Farmer 102 S - 201 S Farmer 102 S - 201 S Farmer 102 S, 103 S, Farmer 104 S, 105 S, Farmer 106 S, 108 S, Farmer 200 S, 201 S		2SD 003 184-031 2SE 003 184-101 9EL 118 700-001 9EL 121 431-001 8RA 123 251-005 9XD 132 749-005	1 1 1 2 50 8	Combination rearlight, left, without licence plate light Combination rearlight, right, with licence plate light (E1) 130 (E1) 53253 Spare Parts: Body/lens with screws, left Body/lens with screws, right Reflex-reflector (to be ordered separately) Adapter with fastening material (to be ordered separately) 1x12V10W (R10W) 8GA 002 071-131 2x12V21W (P21W) 8GA 002 073-121
Farmer 200 V - 205 P Farmer 200 V - 205 P Farmer 200 V, Farmer 203 P, P II, V, V II, Farmer 204 P, V, 205 P	01/83->01/88	1LA 004 109-217 9AH 131 494-015 9FF 111 606-021	36 6 10	H4 headlight (E1) 17116 Spare Parts: Supporting frame Bulb socket for side light (to be ordered separately) 1x12V60/55W (H4) 8GJ 002 525-131
Farmer 200 V - 204 V		2BE 003 014-251 9EL 115 003-055	2 2	Indicator-side light (E1) 42712 Spare Parts: Lens with screws 1x12V21W (P21W) 8GA 002 073-121 1x12V5W (C5W) 8GM 002 092-121
Farmer 203 P II - 205 P		2BE 002 776-251 2BE 002 776-261 9EL 134 741-021 9EL 134 742-021	1 1 2 2	Indicator-side light, left Indicator-side light, right (E1) 63225 Spare Parts: Lens, left Lens, right 1x12V10W (R10W) 8GA 002 071-131 1x12V21W (P21W) 8GA 002 073-121







Fendt



Manufacturer Model	Model year	Part no.	Pk.	Note
Fendt				
Farmer 200 V - 205 P Farmer 200 V - 205 P Farmer 200 V, Farmer 203 P, P II, V, V II, Farmer 204 P, V, 205 P		2SD 002 776-231 2SD 002 776-241 9EL 137 307-001 9EL 137 308-001	1 1 2 2	Combination rearlight, left Combination rearlight, right (E1) 273 (E1) 63230 Spare Parts: Lens, left Lens, right  1x12V10W (R10W) 8GA 002 071-131  2x12V21W (P21W) 8GA 002 073-121
Farmer 200 V - 205 P		2KA 001 389-101 9BG 119 721-001	10 5	Licence plate light (E1) 12815 Spare Parts: Body with lens  1x12V5W (C5W) 8GM 002 092-121
Farmer 240 S - 280 P Farmer 240 S - 280 P Farmer 240 S 01/88-> Farmer 250 K Farmer 250 S, SA 01/88-> Farmer 250 V, 260 P 02/88-> Farmer 260 S, SA 01/88-> Farmer 260 V, 270 P, V 02/88-> Farmer 275 S 02/88-> Farmer 275 V Farmer 280 P 01/88->		1LB 006 213-057 9GH 116 966-011 9BG 993 345-001	30 10 1	H4 headlight (E1) 639 Spare Parts: Cap Rubber body (to be ordered separately)  1x12V60/55W (H4) 8GJ 002 525-131
Farmer 240 S - 280 P	01/88->	2BE 003 014-251 9EL 115 003-055	2 2	Indicator-side light (E1) 42712 Spare Parts: Lens with screws  1x12V21W (P21W) 8GA 002 073-121  1x12V5W (C5W) 8GM 002 092-121




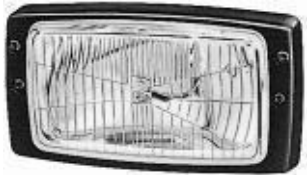





Manufacturer Model	Model year	Part no.	Pk.	Note
Fendt				
Farmer 240 S - 280 P		2SD 002 776-277	72	Combination rearlight, left
Farmer 240 S - 280 P	01/88->	2SD 002 776-287	72	Combination rearlight, right
Farmer 240 S	01/88->			Ⓔ1 273 Ⓔ1 63230
Farmer 250 K				1x12V10W (R10W) 8GA 002 071-131 2x12V21W (P21W) 8GA 002 073-121
Farmer 250 S, SA	01/88->			
Farmer 250 V, 260 P	02/88->			
Farmer 260 S, SA	01/88->			
Farmer 260 V, 270 P, V	02/88->			
Farmer 275 S	02/88->			
Farmer 275 V				
Farmer 280 P	01/88->			
				
Farmer 240 S - 280 P	01/88->	2KA 003 168-021	2	Licence plate light
				
Farmer 303 LS - 312 LSA		1LA 004 109-217	36	H4 headlight
Farmer 303 LS - 312 LSA	01/83->02/88			Ⓔ1 17116
Farmer 303 LS, Farmer 304 LS, LSA, Farmer 305 LS, LSA, Farmer 306 LS, LSA, Farmer 307 LS, LSA, Farmer 308 LS, LSA, Farmer 309 LS, LSA, Farmer 310 LSA, 311 LSA, Farmer 312 LSA		9AH 131 494-015 9FF 111 606-021	6 10	Spare Parts: Supporting frame Bulb socket for side light (to be ordered separately)
				
		 1x12V60/55W (H4) 8GJ 002 525-131		



Fendt



Manufacturer Model	Model year	Part no.	Pk.	Note
Fendt				
Farmer 303 LS - 312 LSA	->02/88	1LB 003 177-081	1	H4 headlight unit
Farmer 303 LS - 312 LSA Farmer 303 LS, Farmer 304 LS, LSA, Farmer 305 LS, LSA, Farmer 306 LS, LSA, Farmer 307 LS, LSA, Farmer 308 LS, LSA, Farmer 309 LS, LSA, Farmer 310 LSA, 311 LSA, Farmer 312 LSA		9GH 126 647-011	10	(E1) 7197 Spare Parts: Cap  1x12V60/55W (H4) 8GJ 002 525-131
Special equipment				
				
Farmer 303 LS - 312 LSA	03/88->	1LB 006 213-057	30	H4 headlight
Farmer 303 LS, Farmer 304 LS, LSA, Farmer 305 LS, LSA, Farmer 306 LS, LSA, Farmer 307 LS, LSA, Farmer 308 LS, LSA, Farmer 309 LS, LSA, Farmer 310 LSA, 311 LSA, Farmer 312 LSA		9GH 116 966-011 9BG 993 345-001	10 1	(E1) 639 Spare Parts: Cap Rubber body (to be ordered separately)  1x12V60/55W (H4) 8GJ 002 525-131
				
Farmer 303 LS - 312 LSA		2BE 003 014-251	2	Indicator-side light
		9EL 115 003-055	2	(E1) 42712 Spare Parts: Lens with screws  1x12V21W (P21W) 8GA 002 073-121  1x12V5W (C5W) 8GM 002 092-121
				










Manufacturer Model	Model year	Part no.	Pk.	Note
Fendt				
Farmer 303 LS - 312 LSA Farmer 303 LS - 312 LSA Farmer 303 LS, Farmer 304 LS, LSA, Farmer 305 LS, LSA, Farmer 306 LS, LSA, Farmer 307 LS, LSA, Farmer 308 LS, LSA, Farmer 309 LS, LSA, Farmer 310 LSA, 311 LSA, Farmer 312 LSA		2SD 003 184-031 2SE 003 184-101 9EL 118 700-001 9EL 121 431-001 8RA 123 251-005 9XD 132 749-005	1 1 1 2 50 8	Combination rearlight, left, without licence plate light Combination rearlight, right, with licence plate light (E1) 130 (E1) 53253 Spare Parts: 1 Body/lens with screws, left 2 Body/lens with screws, right 50 Reflex-reflector (to be ordered separately) 8 Adapter with fastening material (to be ordered separately) 1x12V10W (R10W) 8GA 002 071-131 2x12V21W (P21W) 8GA 002 073-121
Farmer 303 LS - 312 LSA	93->	2KA 003 389-061 9BG 121 587-031	2 2	Licence plate light (E1) 22819 Spare Parts: 2 Body/lens with screw 1x12V10W (R10W) 8GA 002 071-131
Favorit 509 C - 515 C Favorit 509 C - 515 C Favorit 509 C, 510 LSE, Favorit 511 C, 512 LSE, Favorit 514 LSE, 515 C	94->	1LB 006 213-057 9GH 116 966-011 9BG 993 345-001	30 10 1	H4 headlight (E1) 639 Spare Parts: 10 Cap 1 Rubber body (to be ordered separately) 1x12V60/55W (H4) 8GJ 002 525-131
Favorit 509 C - 515 C Favorit 509 C, 510 LSE, Favorit 511 C, 512 LSE, Favorit 514 LSE, 515 C Special equipment	94->	1LA 004 109-217 9AH 131 494-015 9FF 111 606-021	36 6 10	H4 headlight (E1) 17116 Spare Parts: 6 Supporting frame 10 Bulb socket for side light (to be ordered separately) 1x12V60/55W (H4) 8GJ 002 525-131 1x12V4W (T4W) 8GP 002 067-121



Fendt



Manufacturer Model	Model year	Part no.	Pk.	Note
Fendt				
Favorit 509 C - 515 C	94->	2BE 003 014-251	2	Indicator-side light
Favorit 509 C - 515 C	94->	9EL 115 003-055	2	(E1) 42712 Spare Parts: Lens with screws  1x12V21W (P21W) 8GA 002 073-121  1x12V5W (C5W) 8GM 002 092-121
Favorit 509 C - 515 C	94->	2KA 003 389-061	2	Licence plate light
	94->	9BG 121 587-031	2	(E1) 22819 Spare Parts: Body/lens with screw  1x12V10W (R10W) 8GA 002 071-131
Favorit 610 LS - 615 LSA	06/82->	1LA 004 109-217	36	H4 headlight
Favorit 610 LSA - 615 LSA	06/82->	9AH 131 494-015 9FF 111 606-021	6 10	(E1) 17116 Spare Parts: Supporting frame Bulb socket for side light (to be ordered separately)  1x12V60/55W (H4) 8GJ 002 525-131
Favorit 610 LSA, Favorit 611 LSA, Favorit 612 LSA, Favorit 614 LSA, Favorit 615 LSA	Special equipment			
Favorit 610 LSA - 615 LSA	06/82->	1LB 003 177-081	1	H4 headlight unit
Favorit 610 LSA, Favorit 611 LSA, Favorit 612 LSA, Favorit 614 LSA, Favorit 615 LSA	Special equipment	9GH 126 647-011	10	(E1) 7197 Spare Parts: Cap  1x12V60/55W (H4) 8GJ 002 525-131
				



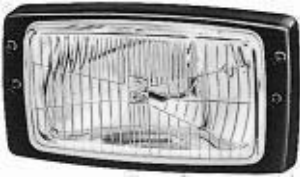



Manufacturer Model	Model year	Part no.	Pk.	Note
Fendt				
Favorit 610 LS - 615 LSA Favorit 610 LS - 615 LSA	06/82->	2BE 003 014-251 9EL 115 003-055	2 2	Indicator-side light (E1) 42712 Spare Parts: Lens with screws 1x12V21W (P21W) 8GA 002 073-121 1x12V5W (C5W) 8GM 002 092-121
Favorit 610 LS - 615 LSA Favorit 610 LS, LSA, Favorit 611 LS, LSA, Favorit 612 LS, LSA, Favorit 614 LS, LSA, Favorit 615 LS, LSA	06/82->	2SD 003 184-031 2SE 003 184-101 9EL 118 700-001 9EL 121 431-001 8RA 123 251-005 9XD 132 749-005	1 1 1 2 50 8	Combination rearlight, left, without licence plate light Combination rearlight, right, with licence plate light (E1) 130 (E1) 53253 Spare Parts: Body/lens with screws, left Body/lens with screws, right Reflex-reflector (to be ordered separately) Adapter with fastening material (to be ordered separately) 1x12V10W (R10W) 8GA 002 071-131 2x12V21W (P21W) 8GA 002 073-121
Favorit 626 LSA-Turbo Favorit 626 LSA-Turbo	06/82->	1LA 004 109-217 9AH 131 494-015 9FF 111 606-021	36 6 10	H4 headlight (E1) 17116 Spare Parts: Supporting frame Bulb socket for side light (to be ordered separately) 1x12V60/55W (H4) 8GJ 002 525-131
Favorit 626 LSA-Turbo Special equipment	06/82->	1LB 003 177-081 9GH 126 647-011	1 10	H4 headlight unit (E1) 7197 Spare Parts: Cap 1x12V60/55W (H4) 8GJ 002 525-131
Favorit 626 LSA-Turbo	06/82->	2BE 003 347-001 9EL 120 224-001	1 5	Indicator-side light (E1) 53274 Spare Parts: Body/lens with screw 1x12V21W (P21W) 8GA 002 073-121 1x12V5W (C5W) 8GM 002 092-121



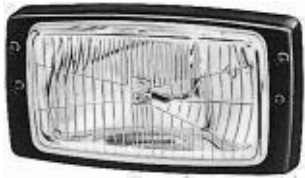




Fendt



Manufacturer Model	Model year	Part no.	Pk.	Note
Fendt				
Favorit 626 LSA-Turbo Favorit 626 LSA-Turbo	06/82->12/84	2SD 003 167-011 2SE 003 167-041 9EL 147 747-001 9GD 087 883-355	1 1 1 10	Combination rearlight, left, without licence plate light Combination rearlight, right, with licence plate light E1 264 Spare Parts: Lens with screws Seal 1x12V10W (R10W) 8GA 002 071-131 2x12V21W (P21W) 8GA 002 073-121
				
Favorit 626 LSA-Turbo	06/82->12/84	2ZR 005 200-051 9EL 119 544-111 9GT 134 130-001	1 4 10	Reverse light E1 8728 Spare Parts: Lens Grommet (to be ordered separately) 1x12V21W (P21W) 8GA 002 073-121
				
Favorit 816 LSE - 824 LSE Favorit 816 LSE - 824 LSE Favorit 816 LSE, 818 LSE Favorit 822 LSE, 824 LSE	12/93->	1LB 006 213-057 9GH 116 966-011 9BG 993 345-001	30 10 1	H4 headlight E1 639 Spare Parts: Cap Rubber body (to be ordered separately) 1x12V60/55W (H4) 8GJ 002 525-131
				
Favorit 816 LSE - 824 LSE Favorit 816 LSE, 818 LSE Favorit 822 LSE, 824 LSE Special equipment	12/93->	1LA 004 109-217 9AH 131 494-015 9FF 111 606-021	36 6 10	H4 headlight E1 17116 Spare Parts: Supporting frame Bulb socket for side light (to be ordered separately) 1x12V60/55W (H4) 8GJ 002 525-131 1x12V4W (T4W) 8GP 002 067-121
				







Manufacturer Model	Model year	Part no.	Pk.	Note
Fendt				
Favorit 816 LSE - 824 LSE Favorit 816 LSE - 824 LSE	12/93->	2BE 003 014-251 9EL 115 003-055	2 2	Indicator-side light E1 42712 Spare Parts: Lens with screws 1x12V21W (P21W) 8GA 002 073-121 1x12V5W (C5W) 8GM 002 092-121
				
Favorit 816 LSE - 824 LSE	12/93->	2KA 003 389-061 9BG 121 587-031	2 2	Licence plate light E1 22819 Spare Parts: Body/lens with screw 1x12V10W (R10W) 8GA 002 071-131
				
Favorit 926 Vario Favorit 926 Vario	96->	1LB 006 213-057 9GH 116 966-011 9BG 993 345-001	30 10 1	H4 headlight E1 639 Spare Parts: Cap Rubber body (to be ordered separately) 1x12V60/55W (H4) 8GJ 002 525-131
				
Favorit 926 Vario Special equipment	96->	1LA 004 109-217 9AH 131 494-015 9FF 111 606-021	36 6 10	H4 headlight E1 17116 Spare Parts: Supporting frame Bulb socket for side light (to be ordered separately) 1x12V60/55W (H4) 8GJ 002 525-131 1x12V4W (T4W) 8GP 002 067-121
				
Favorit 926 Vario	93->	2BE 003 014-251 9EL 115 003-055	2 2	Indicator-side light E1 42712 Spare Parts: Lens with screws 1x12V21W (P21W) 8GA 002 073-121 1x12V5W (C5W) 8GM 002 092-121
				











Fendt



Manufacturer Model	Model year	Part no.	Pk.	Note
Fendt				
Favorit 926 Vario Favorit 926 Vario	96->	 2KA 003 389-061 9BG 121 587-031	2 2	Licence plate light E1 22819 Spare Parts: Body/lens with screw 1x12V10W (R10W) 8GA 002 071-131
F 220 GT - F 275 GT F 220 GT - F 275 GT F 220 GT, F 225 GT, F 230 GT, F 250 GT, F 275 GT	->02/74	 9ES 012 060-011 9GD 023 639-001 9DR 090 206-001 9FF 090 500-001	10 10 1 2	Headlight, spare parts available only K 11103/1 Spare Parts: Lens Seal Reflector Bulb socket 1x12V35/35W (S2) 8GD 002 084-131 1x12V4W (T4W) 8GP 002 067-121
F 220 GT - F 275 GT	->05/68	 2BA 001 244-001 9EL 085 478-001	5 5	Indicator light, for front and rear mounting K 12753 Spare Parts: Body/lens 1x12V18W (K) 8GM 002 091-121
F 220 GT - F 275 GT F 220 GT, F 225 GT, F 230 GT, F 250 GT, F 275 GT	->05/68	 2ST 001 673-011 2SB 001 673-002 9EL 110 928-001	1 1 10	Combination rearlight, left, with licence plate light Combination rearlight, right, without licence plate light K 23256/1 Spare Parts: Lens with screw 1x12V10W (R10W) 8GA 002 071-131 1x12V18W (R) 8GA 002 072-121



Manufacturer Model	Model year	Part no.	Pk.	Note
Fendt				
F 231 GT - F 395 GT F 231 GT - F 395 GT F 231 GT, F 345 GT, F 345 GTA, F 360 GHA, F 360 GT, F 360 GTA, F 365 GTA, F 380 GHA, F 380 GT, F 380 GTA, F 390 GT, F 395 GT		1LA 004 109-217 9AH 131 494-015 9FF 111 606-021	36 6 10	H4 headlight (E1) 17116 Spare Parts: Supporting frame Bulb socket for side light (to be ordered separately)  1x12V60/55W (H4) 8GJ 002 525-131
F 231 GT - F 395 GT F 345 GT, F 360 GT, GTH, F 365 GTH, F 380 GTH, F 390 GTH, F 395 GTH		1LB 006 213-057 9GH 116 966-011 9BG 993 345-001	30 10 1	H4 headlight (E1) 639 Spare Parts: Cap Rubber body (to be ordered separately)  1x12V60/55W (H4) 8GJ 002 525-131
F 231 GT - F 380 GTA F 231 GT, F 345 GT, F 345 GTA, F 360 GHA, F 360 GT, F 360 GTA, F 365 GTA, F 380 GHA, F 380 GT, F 380 GTA Special equipment		1LB 003 177-081 9GH 126 647-011	1 10	H4 headlight unit (E1) 7197 Spare Parts: Cap  1x12V60/55W (H4) 8GJ 002 525-131
F 231 GT 4048, 4056, 4066, 4072		2BA 001 259-611 9EL 088 150-001 9FT 088 047-001	2 2 10	Indicator light, for front and rear mounting K 23267 Spare Parts: Body/lens with screws Bulb holder  1x12V18W (K) 8GM 002 091-121















Fendt



Manufacturer Model	Model year	Part no.	Pk.	Note
Fendt				
F 231 GT - F 395 GT F 255 - F 380 GTH		2BE 003 014-251 9EL 115 003-055	2 2	Indicator-side light E1 42712 Spare Parts: Lens with screws 1x12V21W (P21W) 8GA 002 073-121 1x12V5W (C5W) 8GM 002 092-121
F 231 GT - F 380 GTH F 231 GT, F 265 GT, F 275 GT, F 345 GT, GTA, F 360 GHA, GT, GTA, GTH, F 365 GTA, F 380 GHA, GT, GTA, GTH		2SD 003 184-031 2SE 003 184-101 9EL 118 700-001 9EL 121 431-001 8RA 123 251-005 9XD 132 749-005	1 1 1 2 50 8	Combination rearlight, left, without licence plate light Combination rearlight, right, with licence plate light E1 130 E1 53253 Spare Parts: Body/lens with screws, left Body/lens with screws, right Reflex-reflector (to be ordered separately) Adapter with fastening material (to be ordered separately) 1x12V10W (R10W) 8GA 002 071-131 2x12V21W (P21W) 8GA 002 073-121
Xylon 520 - 524 Xylon 520, 522, 524	05/95->	1LB 006 213-057 9GH 116 966-011 9BG 993 345-001	30 10 1	H4 headlight E1 639 Spare Parts: Cap Rubber body (to be ordered separately) 1x12V60/55W (H4) 8GJ 002 525-131
Xylon 520, 522, 524	05/95->	2BE 003 014-251 9EL 115 003-055	2 2	Indicator-side light E1 42712 Spare Parts: Lens with screws 1x12V21W (P21W) 8GA 002 073-121 1x12V5W (C5W) 8GM 002 092-121
Xylon 520, 522, 524	05/95->	2KA 003 389-061 9BG 121 587-031	2 2	Licence plate light E1 22819 Spare Parts: Body/lens with screw 1x12V10W (R10W) 8GA 002 071-131











Manufacturer Model	Model year	Part no.	Pk.	Note
Fenwick-Linde				
various models various models		1G4 003 470-001 9DS 121 707-001 6EB 005 633-001 9XD 130 261-001	1 1 10 5	H3 worklight 'Matador' with optics for close-range illumination, with switch Spare Parts: Light unit Switch Angle bracket for 4-point fastening  1x12V55W (H3) 8GH 002 090-371  1x12V55W (H3) 8GH 002 090-133  1x24V70W (H3) 8GH 002 090-251
				
Fuchs				
various models		1GA 007 506-001 1GA 998 525-001 9GH 993 984-001	1 1 20	FF®-H3 worklight 'Ultra Beam Standard' with optics for large-area ground illumination, with AMP plug-connection Spare Parts: Light unit Rubber cap  1x12V55W (H3) 8GH 002 090-371  1x12V55W (H3) 8GH 002 090-133
				
various models		1GA 996 142-011 1GA 990 305-001 9GH 993 984-001 8KB 990 299-121	1 1 20 1	Xenon worklight with optics for wide ground illumination, with gas discharge bulb, 24V ballast and AMP plug-connection Spare Parts: Light unit Protective cap for AMP plug-connection Lead for AMP plug-connection  1x35W (D2S) 8GS 007 949-101
				
various models		1G3 996 001-271	1	H3 worklight with optics for close-range illumination, without switch  1x12V55W (H3) 8GH 002 090-371  1x12V55W (H3) 8GH 002 090-133
				



GP (Nobas) - Gutbrod



Manufacturer Model	Model year	Part no.	Pk.	Note
GP (Nobas)				
various models various models		1GA 006 876-001	1	FF®-H3 worklight with optics for ground illumination, with rotating base  1x12V55W (H3) 8GH 002 090-371 1x12V55W (H3) 8GH 002 090-133 1x24V70W (H3) 8GH 002 090-251
				
various models		1GA 998 522-011	1	FF®-H3 worklight with optics for ground illumination  1x12V55W (H3) 8GH 002 090-371 1x12V55W (H3) 8GH 002 090-133
				
Gutbrod				
Superior 1017 - 2060 Superior 1017 - 2060		2BA 001 227-211	2	Indicator light K 12642 Spare Parts: Body/lens  1x12V18W (K) 8GM 002 091-121
		9EL 074 484-031	2	
Superior 1017 - 2060 Superior 1017, 1026, Superior 1032, 1050, D, Superior 1200, 2060		2ST 003 018-061	1	Combination rearlight with licence plate light K 23260/1 Spare Parts: Lens with rim  1x12V10W (K) 8GM 002 091-131 1x12V18W (K) 8GM 002 091-121
		9EL 089 114-001	2	
























Manufacturer Model	Model year	Part no.	Pk.	Note
Gutbrod				
Superior 2350 DS - 2850 DA Superior 2350 DS - 2850 DA Superior 2350 DS, Superior 2400 DS, Superior 2500 S, Superior 2600 DS/DAS, Superior 2850 D/DA		1TA 003 570-001	1	Headlight, permanently dipped-beam K 21090
		1TA 122 718-001	1	Spare Parts: Light unit 1x12V15W (Q) 8GA 002 081-121 1x12V4W (T4W) 8GP 002 067-121
Superior 2350 DS - 2850 DA 		2BA 002 652-111	2	Indicator light, left Indicator light, right (E1) 42764 Spare Parts: Lens with screw, left Lens with screw, right 1x12V21W (P21W) 8GA 002 073-121
		2BA 002 652-121	2	
Superior 2350 DS - 2850 DA Superior 2350 DS, Superior 2400 DS, Superior 2500 S, Superior 2600 DAS/DS, Superior 2850 D/DA		2SY 003 014-121	2	Combination rearlight with licence plate light (E1) 31452 (E1) 53211 Spare Parts: Lens with screws 1x12V21W (P21W) 8GA 002 073-121 1x12V5W (C5W) 8GM 002 092-121
		9EL 115 003-001	2	
Superior 4000 - 4350 Superior 4000 - 4350 Superior 4000, 4200/H, Superior 4250/H, 4300, Superior 4350		1TA 003 570-001	1	Headlight, permanently dipped-beam K 21090 Spare Parts: Light unit 1x12V15W (Q) 8GA 002 081-121 1x12V4W (T4W) 8GP 002 067-121
		1TA 122 718-001	1	








Gutbrod



Manufacturer Model	Model year	Part no.	Pk.	Note
Gutbrod				
1012 S 1012 S		2BE 003 182-091 2BE 003 182-101 9EL 118 614-021	1 1 2	Indicator-side light, left Indicator-side light, right  53270 Spare Parts: Lens  1x12V21W (P21W) 8GA 002 073-121  1x12V5W (C5W) 8GM 002 092-121
1012 S		2SD 003 182-051 2SD 003 182-061 9EL 118 614-011	1 1 2	Combination rearlight, left Combination rearlight, right  53257  31445 Spare Parts: Lens  1x12V10W (R10W) 8GA 002 071-131  2x12V21W (P21W) 8GA 002 073-121
1200 H 1200 H		2BE 003 182-091 2BE 003 182-101 9EL 118 614-021	1 1 2	Indicator-side light, left Indicator-side light, right  53270 Spare Parts: Lens  1x12V21W (P21W) 8GA 002 073-121  1x12V5W (C5W) 8GM 002 092-121
1200 H		2SD 003 184-031 2SD 003 184-041 9EL 118 700-001 9EL 118 701-001	1 1 1 1	Combination rearlight, left Combination rearlight, right  130  53253 Spare Parts: Body/lens, left Body/lens, right  1x12V10W (R10W) 8GA 002 071-131  2x12V21W (P21W) 8GA 002 073-121
1200 H		2PF 003 057-041 9EL 117 330-001	1 2	Side light  21626 Spare Parts: Lens  1x12V5W (C5W) 8GM 002 092-121









Manufacturer Model	Model year	Part no.	Pk.	Note
Gutbrod				
1200 H 1200 H		2TM 003 057-031	1	Rear light with reflex-reflector (E1) 11583 IA (E1) 31315 1x12V5W (C5W) 8GM 002 092-121
				
Hako				
Mobil 4000 - 6000 D Mobil 4000	09/73->	2BA 003 014-111	2	Indicator light (E1) 32661 Spare Parts: Lens with screws 1x12V21W (P21W) 8GA 002 073-121
		9EL 110 536-011	3	
				
Mobil 4000	09/73->	2SD 002 776-231 2SD 002 776-241	1 1	Combination rearlight, left Combination rearlight, right (E1) 273 (E1) 63230 Spare Parts: 2 Lens, left 2 Lens, right 1x12V10W (R10W) 8GA 002 071-131 2x12V21W (P21W) 8GA 002 073-121
		9EL 137 307-001 9EL 137 308-001	2 2	
				
Mobil 4800 D, 6000 D		2BA 001 277-011 2BA 001 277-021	1 1	Indicator light, left Indicator light, right (E1) 22796 1x12V21W (P21W) 8GA 002 073-121
				
Mobil 4800 D, 6000 D		2SD 003 184-031 2SD 003 184-041	1 1	Combination rearlight, left Combination rearlight, right (E1) 130 (E1) 53253 Spare Parts: 1 Body/lens, left 1 Body/lens, right 1x12V10W (R10W) 8GA 002 071-131 2x12V21W (P21W) 8GA 002 073-121
		9EL 118 700-001 9EL 118 701-001	1 1	
				








Hako



Manufacturer Model	Model year	Part no.	Pk.	Note
Hako				
Mobil 4000 - 6000 D Mobil 4800 D, 6000 D		2KA 003 168-021	2	Licence plate light E1 22808 1x12V5W (C5W) 8GM 002 092-121
				
Mobil 8081 Mobil 8081		2BA 001 277-011 2BA 001 277-021	1 1	Indicator light, left Indicator light, right E1 22796 1x12V21W (P21W) 8GA 002 073-121
				
Mobil 8081	06/86->	2SD 003 184-031 2SD 003 184-041	1 1	Combination rearlight, left Combination rearlight, right E1 130 E1 53253 Spare Parts: Body/lens, left Body/lens, right 1x12V10W (R10W) 8GA 002 071-131 2x12V21W (P21W) 8GA 002 073-121
		9EL 118 700-001 9EL 118 701-001	1 1	
Mobil 8081		2KA 003 168-021	2	Licence plate light E1 22808 1x12V5W (C5W) 8GM 002 092-121
				
Trac 1400 Trac 1400				Headlight unit, spare parts available only K 21057 Spare Parts: Lens Reflector 1x12V35/35W (S2) 8GD 002 084-131 1x12V4W (T4W) 8GP 002 067-121
		9ES 069 831-001 9DE 077 356-021	1 1	
Trac 1400		2BA 002 652-111 2BA 002 652-121	2 2	Indicator light, left Indicator light, right E1 42764 Spare Parts: Lens with screw, left Lens with screw, right 1x12V21W (P21W) 8GA 002 073-121
		9EL 134 659-001 9EL 134 660-001	2 2	
















Manufacturer Model	Model year	Part no.	Pk.	Note
Hako				
Trac 1400 Trac 1400		8XS 113 389-001	2	Protective cover for 2BA 002 652-...
				
Trac 1400		2SD 003 182-051 2SD 003 182-061	1 1	Combination rearlight, left Combination rearlight, right E1 53257 E1 31445
				
		9EL 118 614-011	2	Spare Parts: Lens 1x12V10W (R10W) 8GA 002 071-131 2x12V21W (P21W) 8GA 002 073-121
Trac 1400		2KA 001 378-001	4	Licence plate light E1 12958 1x12V5W (C5W) 8GM 002 092-121
				
Trac 1400 V Trac 1400 V		2SE 003 182-021	1	Combination rearlight with licence plate light E1 53257 E1 31445
				
		9EL 118 613-001	2	Spare Parts: Lens 1x12V10W (R10W) 8GA 002 071-131 2x12V21W (P21W) 8GA 002 073-121
Trac 1500 D Trac 1500 D		1TA 003 570-101	1	Headlight, permanently dipped-beam K 21090
				
		1TA 122 718-021	1	Spare Parts: Light unit 1x12V15W (Q) 8GA 002 081-121 1x12V4W (T4W) 8GP 002 067-121























Hako



Manufacturer Model	Model year	Part no.	Pk.	Note
Hako				
Trac 1500 D Trac 1500 D		2BA 002 652-111 2BA 002 652-121 9EL 134 659-001 9EL 134 660-001	2 2 2 2	Indicator light, left Indicator light, right (E1) 42764 Spare Parts: Lens with screw, left Lens with screw, right  1x12V21W (P21W) 8GA 002 073-121
Trac 1500 D		2SD 003 182-051 2SE 003 182-021 9EL 118 614-011 9EL 118 613-001	1 1 2 2	Combination rearlight, left, without licence plate light Combination rearlight, right, with licence plate light (E1) 53257 (E1) 31445 Spare Parts: Lens, left Lens, right  1x12V10W (R10W) 8GA 002 071-131  2x12V21W (P21W) 8GA 002 073-121
Trac 1650 Trac 1650		1TA 003 570-101 1TA 122 718-021	1 1	Headlight, permanently dipped-beam K 21090 Spare Parts: Light unit  1x12V15W (Q) 8GA 002 081-121  1x12V4W (T4W) 8GP 002 067-121
Trac 1650		2BA 002 652-111 2BA 002 652-121 9EL 134 659-001 9EL 134 660-001	2 2 2 2	Indicator light, left Indicator light, right (E1) 42764 Spare Parts: Lens with screw, left Lens with screw, right  1x12V21W (P21W) 8GA 002 073-121
Trac 1650		2SE 002 578-701 9EL 146 491-001	2 2	Combination rearlight with licence plate light (E17) 9401 Spare Parts: Body/lens with screws  1x12V10W (R10W) 8GA 002 071-131  2x12V21W (P21W) 8GA 002 073-121



Manufacturer Model	Model year	Part no.	Pk.	Note
Hako				
Trac 1800 D, DA Trac 1800 D, DA		1TA 003 570-101	1	Headlight, permanently dipped-beam K 21090
		1TA 122 718-021	1	Spare Parts: Light unit  1x12V15W (Q) 8GA 002 081-121  1x12V4W (T4W) 8GP 002 067-121
Trac 1800 D, DA		2BA 002 652-111	2	Indicator light, left Indicator light, right  42764
		2BA 002 652-121	2	
Trac 1800 D, DA		9EL 134 659-001	2	Spare Parts: Lens with screw, left Lens with screw, right  1x12V21W (P21W) 8GA 002 073-121
		9EL 134 660-001	2	
Trac 1800 D, DA		2SD 003 182-051	1	Combination rearlight, left, without licence plate light Combination rearlight, right, with licence plate light  53257  31445
		2SE 003 182-021	1	
Trac 1800 D, DA		9EL 118 614-011	2	Spare Parts: Lens, left Lens, right  1x12V10W (R10W) 8GA 002 071-131  2x12V21W (P21W) 8GA 002 073-121
		9EL 118 613-001	2	
Trac 2250 Trac 2250		1TA 003 570-101	1	Headlight, permanently dipped-beam K 21090
		1TA 122 718-021	1	Spare Parts: Light unit  1x12V15W (Q) 8GA 002 081-121  1x12V4W (T4W) 8GP 002 067-121
Trac 2250		2BA 002 652-111	2	Indicator light, left Indicator light, right  42764
		2BA 002 652-121	2	
Trac 2250		9EL 134 659-001	2	Spare Parts: Lens with screw, left Lens with screw, right  1x12V21W (P21W) 8GA 002 073-121
		9EL 134 660-001	2	







Hako



Manufacturer Model	Model year	Part no.	Pk.	Note
Hako				
Trac 2250 Trac 2250		2SE 002 578-701 9EL 146 491-001	2 2	Combination rearlight with licence plate light E17 9401 Spare Parts: Body/lens with screws 1x12V10W (R10W) 8GA 002 071-131 2x12V21W (P21W) 8GA 002 073-121
Trac 2300 D Trac 2300 D		1TA 003 570-101 1TA 122 718-021	1 1	Headlight, permanently dipped-beam K 21090 Spare Parts: Light unit 1x12V15W (Q) 8GA 002 081-121 1x12V4W (T4W) 8GP 002 067-121
Trac 2300 D		2BA 002 652-111 2BA 002 652-121 9EL 134 659-001 9EL 134 660-001	2 2 2 2	Indicator light, left Indicator light, right E1 42764 Spare Parts: Lens with screw, left Lens with screw, right 1x12V21W (P21W) 8GA 002 073-121
Trac 2300 D		2SE 003 182-011 9EL 118 613-001	1 2	Combination rearlight with licence plate light E1 53257 E1 31445 Spare Parts: Lens 1x12V10W (R10W) 8GA 002 071-131 2x12V21W (P21W) 8GA 002 073-121
Trac 2300 D		2SE 002 578-701 9EL 146 491-001	2 2	Combination rearlight with licence plate light E17 9401 Spare Parts: Body/lens with screws 1x12V10W (R10W) 8GA 002 071-131 2x12V21W (P21W) 8GA 002 073-121








Manufacturer Model	Model year	Part no.	Pk.	Note
Hako				
Trac 2700 D, DA Trac 2700 D, DA		2SE 002 578-701 9EL 146 491-001	2 2	Combination rearlight with licence plate light E17 9401 Spare Parts: Body/lens with screws 1x12V10W (R10W) 8GA 002 071-131 2x12V21W (P21W) 8GA 002 073-121
				
Trac 2750 Trac 2750		1TA 003 570-101 1TA 122 718-021	1 1	Headlight, permanently dipped-beam K 21090 Spare Parts: Light unit 1x12V15W (Q) 8GA 002 081-121 1x12V4W (T4W) 8GP 002 067-121
				
Trac 2750		2BA 002 652-111 2BA 002 652-121 9EL 134 659-001 9EL 134 660-001	2 2 2 2	Indicator light, left Indicator light, right E1 42764 Spare Parts: Lens with screw, left Lens with screw, right 1x12V21W (P21W) 8GA 002 073-121
				
Trac 2750		2SE 002 578-701 9EL 146 491-001	2 2	Combination rearlight with licence plate light E17 9401 Spare Parts: Body/lens with screws 1x12V10W (R10W) 8GA 002 071-131 2x12V21W (P21W) 8GA 002 073-121
				














Hako



Manufacturer Model	Model year	Part no.	Pk.	Note
Hako				
Trac 3500, 3800 D Trac 3500, 3800 D		1TA 003 570-101 1TA 122 718-021	1 1	Headlight, permanently dipped-beam K 21090 Spare Parts: Light unit 1x12V15W (Q) 8GA 002 081-121 1x12V4W (T4W) 8GP 002 067-121
				
Trac 3500, 3800 D		2BA 002 652-111 2BA 002 652-121 9EL 134 659-001 9EL 134 660-001	2 2 2 2	Indicator light, left Indicator light, right (E1) 42764 Spare Parts: Lens with screw, left Lens with screw, right 1x12V21W (P21W) 8GA 002 073-121
				
Trac 3500, 3800 D		2SY 003 014-121 9EL 115 003-001	2 2	Rear-indicator-licence plate light (E1) 31452 (E1) 53211 Spare Parts: Lens with screws 1x12V21W (P21W) 8GA 002 073-121 1x12V5W (C5W) 8GM 002 092-121
				
Trac 3800 D		2SE 002 578-701 9EL 146 491-001	2 2	Combination rearlight with licence plate light (E17) 9401 Spare Parts: Body/lens with screws 1x12V10W (R10W) 8GA 002 071-131 2x12V21W (P21W) 8GA 002 073-121
				
Trac 4100 Trac 4100		1TA 003 570-101 1TA 122 718-021	1 1	Headlight, permanently dipped-beam K 21090 Spare Parts: Light unit 1x12V15W (Q) 8GA 002 081-121 1x12V4W (T4W) 8GP 002 067-121
				









Manufacturer Model	Model year	Part no.	Pk.	Note
Hako				
Trac 4100 Trac 4100 		2BA 002 652-111 2BA 002 652-121 9EL 134 659-001 9EL 134 660-001	2 2 2 2	Indicator light, left Indicator light, right (E1) 42764 Spare Parts: Lens with screw, left Lens with screw, right  1x12V21W (P21W) 8GA 002 073-121
Trac 4100 		2SE 002 578-701 9EL 146 491-001	2 2	Combination rearlight with licence plate light (E17) 9401 Spare Parts: Body/lens with screws  1x12V10W (R10W) 8GA 002 071-131  2x12V21W (P21W) 8GA 002 073-121
Trac 8014 - 8022 Trac 8014 - 8022 Trac 8014, 8017, 8018, Trac 8020, 8021, 8022 		9ES 069 831-001 9DE 077 356-021	1 1	Headlight unit, spare parts available only K 21057 Spare Parts: Lens Reflector  1x12V35/35W (S2) 8GD 002 084-131  1x12V4W (T4W) 8GP 002 067-121
Trac 8014 - 8022 		2BA 002 652-111 2BA 002 652-121 9EL 134 659-001 9EL 134 660-001	2 2 2 2	Indicator light, left Indicator light, right (E1) 42764 Spare Parts: Lens with screw, left Lens with screw, right  1x12V21W (P21W) 8GA 002 073-121
Trac 8014 - 8022 		8XS 113 389-001	2	Protective cover for 2BA 002 652-...








Hako



Manufacturer Model	Model year	Part no.	Pk.	Note
Hako				
Trac 8014 - 8022 Trac 8014		2SD 002 776-231	1	Combination rearlight, left
		2SD 002 776-241	1	Combination rearlight, right
				(E1) 273 (E1) 63230 Spare Parts: 2 Lens, left 2 Lens, right 1x12V10W (R10W) 8GA 002 071-131 2x12V21W (P21W) 8GA 002 073-121
Trac 8014		2KA 001 378-001	4	Licence plate light (E1) 12958 1x12V5W (C5W) 8GM 002 092-121
Trac 8020		2BA 001 227-211	2	Indicator light K 12642 Spare Parts: 2 Body/lens 1x12V18W (K) 8GM 002 091-121
Trac 8020		2SA 001 259-751	2	Rear light (E1) 31438 Spare Parts: 2 Body/lens with screws 10 Bulb holder 1x12V5W (C5W) 8GM 002 092-121
Trac 8020		2KA 001 378-001	4	Licence plate light (E1) 12958 1x12V5W (C5W) 8GM 002 092-121
Variotrac 1850 V, 2150 D Variotrac 1850 V, 2150 D		1TA 003 570-101	1	Headlight, permanently dipped-beam K 21090 Spare Parts: 1 Light unit 1x12V15W (Q) 8GA 002 081-121 1x12V4W (T4W) 8GP 002 067-121
		1TA 122 718-021	1	








Manufacturer Model	Model year	Part no.	Pk.	Note
Hako				
Variotrac 1850 V, 2150 D Variotrac 1850 V, 2150 D		2BE 003 014-251 9EL 115 003-055	2 2	Indicator-side light (E1) 42712 Spare Parts: Lens with screws 1x12V21W (P21W) 8GA 002 073-121 1x12V5W (C5W) 8GM 002 092-121
				
Variotrac 1850 V, 2150 D		2SW 003 014-131 9EL 115 003-011	2 2	Rear-indicator light (E1) 31452 (E1) 53211 Spare Parts: Lens with screws 1x12V21W (P21W) 8GA 002 073-121 1x12V5W (C5W) 8GM 002 092-121
				
Holder				
A 14 - B 25 A 14 - B 25	01/66->	2BA 001 227-211 9EL 074 484-031	2 2	Indicator light K 12642 Spare Parts: Body/lens 1x12V18W (K) 8GM 002 091-121
				
A 14 - B 25 A 14, A 15, A 35 A 55, F AG 3, AG 35, F, AM 2, B 14, B 25	01/66-> 10/72->08/75 01/66->	2SB 001 259-261 9EL 088 525-001 9FT 088 047-001	2 2 10	Combination rearlight K 23270 Spare Parts: Body/lens with screws Bulb holder 1x12V10W (K) 8GM 002 091-131 1x12V18W (K) 8GM 002 091-121
				
A 14 - B 25	01/66->	2KA 001 389-101 9BG 119 721-001	10 5	Licence plate light (E1) 12815 Spare Parts: Body with lens 1x12V5W (C5W) 8GM 002 092-121
				



Holder



Manufacturer Model	Model year	Part no.	Pk.	Note
Holder				
A 40 - A 60 Turbo A 40, A 50, A 60, F, Turbo	10/78->	2BE 003 014-251 9EL 115 003-055	2 2	Indicator-side light Ⓔ1 42712 Spare Parts: Lens with screws 1x12V21W (P21W) 8GA 002 073-121 1x12V5W (C5W) 8GM 002 092-121
				
A 40 - A 60 Turbo	10/78->	2KA 003 168-021	2	Licence plate light Ⓔ1 22808 1x12V5W (C5W) 8GM 002 092-121
				
A 550 - A 600 A 550 - A 600 A 550, A 600	01/91->	1LB 006 213-057 9GH 116 966-011 9BG 993 345-001	30 10 1	H4 headlight Ⓔ1 639 Spare Parts: Cap Rubber body (to be ordered separately) 1x12V60/55W (H4) 8GJ 002 525-131
				
A 750 - A 760 A 750 - A 760 A 750, A 750 S, A 760	03/94->	1LB 006 213-057 1LB 006 213-047 9GH 116 966-011 9BG 993 345-001	30 30 10 1	H4 headlight, without side light H4 headlight, with side light Ⓔ1 639 Spare Parts: Cap Rubber body (to be ordered separately) 1x12V60/55W (H4) 8GJ 002 525-131
				
A 750 - A 760	03/94->	2BE 003 014-251 9EL 115 003-055	2 2	Indicator-side light Ⓔ1 42712 Spare Parts: Lens with screws 1x12V21W (P21W) 8GA 002 073-121 1x12V5W (C5W) 8GM 002 092-121
				



Manufacturer Model	Model year	Part no.	Pk.	Note
Holder				
A 750 - A 760 A 750 - A 760 A 750, A 750 S, A 760	03/94->	2SE 004 623-001 9EL 129 519-001	1 1	Combination rearlight (E17) 408 (E17) 630 (E17) 763 Spare Parts: Lens 1x12V10W (R10W) 8GA 002 071-131 2x12V21W (P21W) 8GA 002 073-121
A 750 - A 760	03/94->	2KA 003 168-021	2	Licence plate light (E1) 22808 1x12V5W (C5W) 8GM 002 092-121
C 30 - C 6000 C 30 - C 6000 C 30, 560, C 600, C 6000	01/91->	1LB 006 213-057 9GH 116 966-011 9BG 993 345-001	30 10 1	H4 headlight (E1) 639 Spare Parts: Cap Rubber body (to be ordered separately) 1x12V60/55W (H4) 8GJ 002 525-131
C 760 - C 870 H C 760 - C 870 H C 760, C 860, C 860 F, C 870 H	03/94->	1LB 006 213-057 1LB 006 213-047 9GH 116 966-011 9BG 993 345-001	30 30 10 1	H4 headlight, without side light H4 headlight, with side light (E1) 639 Spare Parts: Cap Rubber body (to be ordered separately) 1x12V60/55W (H4) 8GJ 002 525-131
C 760 - C 870 H	03/94->	2BE 003 014-251 9EL 115 003-055	2 2	Indicator-side light (E1) 42712 Spare Parts: Lens with screws 1x12V21W (P21W) 8GA 002 073-121 1x12V5W (C5W) 8GM 002 092-121



Holder



Manufacturer Model	Model year	Part no.	Pk.	Note
Holder				
C 760 - C 870 H C 760 - C 870 H C 760, C 860, C 860 F, C 870 H	03/94->	2SE 004 623-001 9EL 129 519-001	1 1	Combination rearlight 408 630 763 Spare Parts: Lens 1x12V10W (R10W) 8GA 002 071-131 2x12V21W (P21W) 8GA 002 073-121
C 760 - C 870 H	03/94->	2KA 003 168-021	2	Licence plate light 22808 1x12V5W (C5W) 8GM 002 092-121
C 9600, C 9700 H C 9600, C 9700 H	10/94->	1LB 006 213-047 9GH 116 966-011 9BG 993 345-001	30 10 1	H4 headlight 639 Spare Parts: Cap Rubber body (to be ordered separately) 1x12V60/55W (H4) 8GJ 002 525-131 1x12V4W (T4W) 8GP 002 067-121
C 9600, C 9700 H	10/94->	2BE 003 014-251 9EL 115 003-055	2 2	Indicator-side light 42712 Spare Parts: Lens with screws 1x12V21W (P21W) 8GA 002 073-121 1x12V5W (C5W) 8GM 002 092-121
Park 30, 70 Park 70	01/91->	1LB 006 213-057 9GH 116 966-011 9BG 993 345-001	30 10 1	H4 headlight 639 Spare Parts: Cap Rubber body (to be ordered separately) 1x12V60/55W (H4) 8GJ 002 525-131













Manufacturer Model	Model year	Part no.	Pk.	Note
Holder				
Park 30, 70 Park 30, 70		2BE 003 014-251 9EL 115 003-055	2 2	Indicator-side light (E1) 42712 Spare Parts: Lens with screws 1x12V21W (P21W) 8GA 002 073-121 1x12V5W (C5W) 8GM 002 092-121
Park 30, 70		2KA 003 168-021	2	Licence plate light (E1) 22808 1x12V5W (C5W) 8GM 002 092-121
P 20 P 20	01/91->	1LB 006 213-057 9GH 116 966-011 9BG 993 345-001	30 10 1	H4 headlight (E1) 639 Spare Parts: Cap Rubber body (to be ordered separately) 1x12V60/55W (H4) 8GJ 002 525-131
Hyster				
various models various models		1GA 006 876-001	1	FF®-H3 worklight with optics for ground illumination, with rotating base 1x12V55W (H3) 8GH 002 090-371 1x12V55W (H3) 8GH 002 090-133 1x24V70W (H3) 8GH 002 090-251
various models		1GA 006 991-031 1GA 998 524-011 9XD 130 261-001	1 1 5	FF®-H3 worklight with optics for large-area ground illumination Spare Parts: Light unit Angle bracket 2x12V55W (H3) 8GH 002 090-133



JCB





Manufacturer Model	Model year	Part no.	Pk.	Note
JCB				
various models various models		1GA 007 506-001	1	FF®-H3 worklight 'Ultra Beam Standard' with optics for large-area ground illumination, with AMP plug-connection
		1GA 007 506-391	1	FF®-H3 worklight 'Ultra Beam Standard' with optics for large-area ground illumination, with DEUTSCH plug-connection
		1GA 998 525-001 9GH 993 984-001	1 20	Spare Parts: Light unit Rubber cap for -001  1x12V55W (H3) 8GH 002 090-371  1x12V55W (H3) 8GH 002 090-133
various models		1GA 006 875-001	1	FF®-H3 worklight with optics for ground illumination  1x12V55W (H3) 8GH 002 090-371  1x12V55W (H3) 8GH 002 090-133
various models		1GA 998 522-011	1	FF®-H3 worklight with optics for ground illumination  1x12V55W (H3) 8GH 002 090-371  1x12V55W (H3) 8GH 002 090-133
various models		1GA 996 082-001	1	FF®-H3 worklight with optics for ground illumination  1x12V55W (H3) 8GH 002 090-371  1x12V55W (H3) 8GH 002 090-133
various models		1GB 996 080-001	1	FF®-H3 worklight 'Double Beam' with optics for object illumination
		1GB 996 080-011	1	FF®-H3 worklight 'Double Beam' with optics for large-area ground illumination  2x12V35W (H3) 8GH 002 090-271  2x12V55W (H3) 8GH 002 090-133



Manufacturer Model	Model year	Part no.	Pk.	Note
JCB				
various models various models		1GA 006 991-041 1GA 998 524-011 9XD 990 298-001	1 1 5	FF®-H3 worklight 'Double Beam' with optics for large-area ground illumination Spare Parts: Light unit Angle bracket 1x12V55W (H3) 8GH 002 090-371 1x12V55W (H3) 8GH 002 090-133
various models		1GA 996 161-281 9GH 993 984-001	1 20	FF®-H3 worklight 'Oval 100' with optics for wide, long-range illumination, with pattern-free lens, with single reflector, AMP plug-connection, protective cap and 12V55W bulb Spare Parts: Protective cap for AMP plug-connection 2x12V35W (H3) 8GH 002 090-271 2x12V55W (H3) 8GH 002 090-133 2x24V70W (H3) 8GH 002 090-251
Jungheinrich				
various models		1GA 007 506-001 1GA 998 525-001 9GH 993 984-001	1 1 20	FF®-H3 worklight 'Ultra Beam Standard' with optics for large-area ground illumination, with AMP plug-connection Spare Parts: Light unit Rubber cap 1x12V55W (H3) 8GH 002 090-371 1x12V55W (H3) 8GH 002 090-133
various models		1GA 007 506-011 1GA 998 525-001 9GH 993 984-001 9XD 130 261-001	1 1 20 5	FF®-H3 worklight 'Ultra Beam Heavy Duty' with optics for large-area ground illumination, with AMP plug-connection Spare Parts: Light unit Rubber cap Angle bracket 1x12V55W (H3) 8GH 002 090-371 1x12V55W (H3) 8GH 002 090-133 1x24V70W (H3) 8GH 002 090-251



Manufacturer Model	Model year	Part no.	Pk.	Note
Jungheinrich				
various models various models		1GA 007 506-021 1GA 998 525-001 9GH 993 984-001 9XD 990 298-001	1 1 20 5	FF®-H3 worklight 'Ultra Beam Heavy Duty' with optics for large-area ground illumination, with AMP plug-connection and protective cap Spare Parts: Light unit Protective cap for AMP plug-connection Angle bracket for 4-point fastening 1x12V55W (H3) 8GH 002 090-371 1x12V55W (H3) 8GH 002 090-133 1x24V70W (H3) 8GH 002 090-251 
various models		1G4 003 470-031	1	H3 worklight with optics for close-range illumination, with switch  1x12V55W (H3) 8GH 002 090-133 1x24V70W (H3) 8GH 002 090-251
various models		1G3 005 760-001 1G3 005 760-011 1G3 135 211-011 6EB 005 633-001	1 1 1 10	H3 worklight with optics for long-range illumination, with switch H3 worklight with optics for long-range illumination, without switch Spare Parts: Light unit Switch  1x12V55W (H3) 8GH 002 090-371 1x12V55W (H3) 8GH 002 090-133 1x24V70W (H3) 8GH 002 090-251
various models		1G3 996 001-131 1G3 990 008-001	1 1	Worklight 'W131' with optics for close-range illumination, with switch Spare Parts: Light unit  1x12V35W (F2) 8GA 002 083-131 1x24V35W (F2) 8GA 002 083-251











Manufacturer Model	Model year	Part no.	Pk.	Note
Kramer				
various models various models		1GA 007 506-001 1GA 998 525-001 9GH 993 984-001	1 1 20	FF®-H3 worklight 'Ultra Beam Standard' with optics for large-area ground illumination, with AMP plug-connection Spare Parts: Light unit Rubber cap 1x12V55W (H3) 8GH 002 090-371 1x12V55W (H3) 8GH 002 090-133
various models		1GM 996 134-271 1GM 996 134-371	1 1	FF®-H3 worklight 'Mega Beam', left, with optics for large-area ground illumination FF®-H3 worklight 'Mega Beam', right, with optics for large-area ground illumination 1x12V55W (H3) 8GH 002 090-371 1x12V55W (H3) 8GH 002 090-133
Krieger				
KS 28 - KS 65 A KS 28 - KS 65 A KS 28, A, KS 33, A, KS 40, A, KS 42, A, KS 50, A KS 55, A, KS 65, A	07/76->12/90 ->05/86	9GD 023 639-001 9DR 090 206-001	10 1	Headlight, permanently dipped-beam, spare parts available only K 11095/1 Spare Parts: Seal Reflector 1x12V15W (Q) 8GA 002 081-121 1x12V4W (T4W) 8GP 002 067-121
KS 33 - KS 65 A KS 33, A, KS 42, A, KS 45, A KS 55, A, KS 65, A	12/90->06/94 06/86->06/94	1TA 003 570-001 1TA 122 718-001	1 1	Headlight, permanently dipped-beam K 21090 Spare Parts: Light unit 1x12V15W (Q) 8GA 002 081-121 1x12V4W (T4W) 8GP 002 067-121



Krieger



Manufacturer Model	Model year	Part no.	Pk.	Note
Krieger				
KS 28 - KS 65 A KS 28 - KS 65 A	-->06/94	2BA 001 227-211 9EL 074 484-031	2 2	Indicator light K 12642 Spare Parts: Body/lens  1x12V18W (K) 8GM 002 091-121
KS 28 - KS 65 A KS 28, A, KS 30, A, KS 33, A, KS 40, A, KS 42, A, KS 45, A, KS 50, A, KS 55, A, KS 65, A	-->12/91	2SW 003 014-131 9EL 115 003-011	2 2	Rear-indicator light E1 31452 E1 53211 Spare Parts: Lens with screws  1x12V21W (P21W) 8GA 002 073-121  1x12V5W (C5W) 8GM 002 092-121
KS 55, A, KS 65, A	-->06/94	2SD 003 182-051 2SD 003 182-061 9EL 118 614-011	1 1 2	Combination rearlight, left Combination rearlight, right E1 53257 E1 31445 Spare Parts: Lens  1x12V10W (R10W) 8GA 002 071-131  2x12V21W (P21W) 8GA 002 073-121
KS 28 - KS 65 A		2KA 001 389-101 9BG 119 721-001	10 5	Licence plate light E1 12815 Spare Parts: Body with lens  1x12V5W (C5W) 8GM 002 092-121
KT 52 - KT 72 A KT 52, A, KT 60, A	10/89->06/94	1TA 003 570-001 1TA 122 718-001	1 1	Headlight, permanently dipped-beam K 21090 Spare Parts: Light unit  1x12V15W (Q) 8GA 002 081-121  1x12V4W (T4W) 8GP 002 067-121



Manufacturer Model	Model year	Part no.	Pk.	Note
Krieger				
KT 52 - KT 72 A KT 52, A, KT 60, A	->06/94	2BA 001 227-211 9EL 074 484-031	2 2	Indicator light K 12642 Spare Parts: Body/lens 1x12V18W (K) 8GM 002 091-121
KT 52, A, KT 60, A	->12/91	2SW 003 014-131 9EL 115 003-011	2 2	Rear-indicator light E1 31452 E1 53211 Spare Parts: Lens with screws 1x12V21W (P21W) 8GA 002 073-121 1x12V5W (C5W) 8GM 002 092-121
KT 52, A, KT 60, A, KT 72 A	->06/94	2SD 003 182-051 2SD 003 182-061 9EL 118 614-011	1 1 2	Combination rearlight, left Combination rearlight, right E1 53257 E1 31445 Spare Parts: Lens 1x12V10W (R10W) 8GA 002 071-131 2x12V21W (P21W) 8GA 002 073-121
KT 52, A, KT 60, A		2KA 001 389-101 9BG 119 721-001	10 5	Licence plate light E1 12815 Spare Parts: Body with lens 1x12V5W (C5W) 8GM 002 092-121
Landini				
various models various models		1LB 003 177-637	36	Headlight unit with bulb E1 17127 1x12V45/40W (R2) 8GD 002 088-131








Laverda - Liebherr











Manufacturer Model	Model year	Part no.	Pk.	Note
Laverda				
various models various models		1GA 006 991-021 1GA 998 524-001 9XD 130 261-001	1 1 5	FF®-H3 worklight with optics for intensive close-range illumination Spare Parts: Light unit Angle bracket  2x12V55W (H3) 8GH 002 090-133
				
Liebherr				
various models		1GA 007 506-121 1GA 998 525-001 9GT 990 338-001	1 1 20	FF®-H3 worklight 'Ultra Beam Standard' with optics for large-area ground illumination Spare Parts: Light unit Grommet  1x12V55W (H3) 8GH 002 090-371 1x12V55W (H3) 8GH 002 090-133 1x24V70W (H3) 8GH 002 090-251
				
various models		1GA 007 506-391 1GA 998 525-001	1 1	FF®-H3 worklight 'Ultra Beam Standard' with optics for large-area ground illumination, with DEUTSCH plug-connection Spare Parts: Light unit  1x12V55W (H3) 8GH 002 090-371 1x12V55W (H3) 8GH 002 090-133 1x24V70W (H3) 8GH 002 090-251
				
various models		1GA 007 506-011 1GA 998 525-001 9GH 993 984-001 9XD 130 261-001	1 1 20 5	FF®-H3 worklight 'Ultra Beam Heavy Duty' with optics for large-area ground illumination, with AMP plug-connection Spare Parts: Light unit Rubber cap Angle bracket  1x12V55W (H3) 8GH 002 090-371 1x12V55W (H3) 8GH 002 090-133 1x24V70W (H3) 8GH 002 090-251
				
various models		1GA 998 534-011 1GA 998 525-011 5DV 990 264-011 5DD 008 319-501	1 1 1 1	Xenon worklight 'Ultra Beam' with optics for large-area and long-range illumination, with gas discharge bulb and 24V ballast Spare Parts: Light unit 24V ballast unit Ignitor, gas discharge bulb  1x35W (D2S) 8GS 007 949-101
				







Manufacturer Model	Model year	Part no.	Pk.	Note
Liebherr				
various models various models		1GB 006 213-101	1	H3 worklight with optics for long-range illumination, with sheet-metal reflector  1x12V55W (H3) 8GH 002 090-371 1x12V55W (H3) 8GH 002 090-133 1x24V70W (H3) 8GH 002 090-251
various models		1GD 996 018-541	1	H3 worklight with optics for close-range illumination with plastic reflector  1x12V55W (H3) 8GH 002 090-371 1x12V55W (H3) 8GH 002 090-133
various models		1GB 996 080-021	1	FF®-H3 worklight 'Double Beam' with optics for long-range off-road illumination  1x12V55W (H3) 8GH 002 090-371 1x12V55W (H3) 8GH 002 090-133 1x24V70W (H3) 8GH 002 090-251
various models		1GA 006 876-001	1	FF®-H3 worklight with optics for ground illumination, with rotating base  1x12V55W (H3) 8GH 002 090-371 1x12V55W (H3) 8GH 002 090-133 1x24V70W (H3) 8GH 002 090-251
various models		1GA 998 522-011	1	FF®-H3 worklight with optics for ground illumination, with swivelling base  1x12V55W (H3) 8GH 002 090-371 1x12V55W (H3) 8GH 002 090-133 1x24V70W (H3) 8GH 002 090-251








Manufacturer Model	Model year	Part no.	Pk.	Note
Liebherr				
various models various models		1G8 002 340-001	1	H3 worklight with optics for long-range illumination, with angle bracket for 4-point fastening
		1G8 002 340-011	1	H3 worklight with optics for long-range illumination, with bracket for fastening to standard stud
		1G8 132 233-011 6ED 708 919-001	1 5	Spare Parts: Light unit with lens-retaining rim Switch
				 1x12V55W (H3) 8GH 002 090-371 1x12V55W (H3) 8GH 002 090-133 1x24V70W (H3) 8GH 002 090-251
Linde				
various models		1GA 007 506-001	1	FF@-H3 worklight 'Ultra Beam Standard' with optics for large-area ground illumination, with AMP plug-connection
		1GA 998 525-001 9GH 993 984-001	1 20	Spare Parts: Light unit Rubber cap
				 1x12V55W (H3) 8GH 002 090-371 1x12V55W (H3) 8GH 002 090-133
various models		1GA 007 506-021	1	FF@-H3 worklight 'Ultra Beam Heavy Duty' with optics for large-area ground illumination, with AMP plug-connection and protective cap
		1GA 998 525-001 9GH 993 984-001 9XD 990 298-001	1 20 5	Spare Parts: Light unit Protective cap for AMP plug-connection Angle bracket for 4-point fastening
				 1x12V55W (H3) 8GH 002 090-371 1x12V55W (H3) 8GH 002 090-133 1x24V70W (H3) 8GH 002 090-251
various models		1G3 005 760-001	1	H3 worklight with optics for long-range illumination, with switch
		1G3 005 760-011	1	H3 worklight with optics for long-range illumination, without switch
		1G3 135 211-011 6EB 005 633-001	1 10	Spare Parts: Light unit Switch
				 1x12V55W (H3) 8GH 002 090-371 1x12V55W (H3) 8GH 002 090-133 1x24V70W (H3) 8GH 002 090-251



Manufacturer Model	Model year	Part no.	Pk.	Note
Linde				
various models various models		1G3 996 001-001	1	Worklight 'W131' with optics for close-range illumination, without switch  1x12V35W (F2) 8GA 002 083-131 1x24V35W (F2) 8GA 002 083-251
Lindner				
various models		1GA 006 875-001	1	FF®-H3 worklight with optics for ground illumination  1x12V55W (H3) 8GH 002 090-371 1x12V55W (H3) 8GH 002 090-133 1x24V70W (H3) 8GH 002 090-251
Manitou				
various models		1GA 006 875-001	1	FF®-H3 worklight with optics for ground illumination  1x12V55W (H3) 8GH 002 090-371 1x12V55W (H3) 8GH 002 090-133 1x24V70W (H3) 8GH 002 090-251
Massey-Ferguson				
various models		1GA 006 876-001	1	FF®-H3 worklight with optics for ground illumination  1x12V55W (H3) 8GH 002 090-371 1x12V55W (H3) 8GH 002 090-133















Manufacturer Model	Model year	Part no.	Pk.	Note
Massey-Ferguson				
various models various models		1GA 998 522-011	1	FF®-H3 worklight with optics for ground illumination, with swivelling base  1x12V55W (H3) 8GH 002 090-371 1x12V55W (H3) 8GH 002 090-133 1x24V70W (H3) 8GH 002 090-251
various models		1GA 005 060-001	1	H3 worklight with optics for long-range illumination Spare Parts: 1 Light unit 5 Lens-retaining rim  1x12V55W (H3) 8GH 002 090-133
various models		1GA 006 875-001	1	FF®-H3 worklight with optics for ground illumination  1x12V55W (H3) 8GH 002 090-371 1x12V55W (H3) 8GH 002 090-133 1x24V70W (H3) 8GH 002 090-251
various models		1GB 996 080-001	1	FF®-H3 worklight 'Double Beam' with optics for object illumination Spare Parts: 1 Light unit  2x12V35W (H3) 8GH 002 090-271 2x12V55W (H3) 8GH 002 090-133
various models		1GA 006 991-041	1	FF®-H3 worklight 'Double Beam' with optics for large-area ground illumination Spare Parts: 5 Angle bracket  2x12V35W (H3) 8GH 002 090-271 2x12V55W (H3) 8GH 002 090-133



Manufacturer Model	Model year	Part no.	Pk.	Note
Massey-Ferguson				
various models various models		1G3 005 760-001 1G3 005 760-011 1G3 135 211-011 6EB 005 633-001	1 1 1 10	<p>H3 worklight with optics for long-range illumination, with switch</p> <p>H3 worklight with optics for long-range illumination, without switch</p> <p>Spare Parts: Light unit Switch</p> <p>1x12V55W (H3) 8GH 002 090-371 1x12V55W (H3) 8GH 002 090-133 1x24V70W (H3) 8GH 002 090-251</p>
various models		1GA 996 161-101 9GH 993 984-001	1 20	<p>FF®-H3 worklight 'Oval 100' with optics for long-range illumination, with pattern-free lens, with AMP plug-connection, protective cap and 12V55W bulb</p> <p>Spare Parts: Protective cap for AMP plug-connection</p> <p>1x12V55W (H3) 8GH 002 090-371 1x12V55W (H3) 8GH 002 090-133 1x24V70W (H3) 8GH 002 090-251</p>
various models		1GA 996 161-121 1GA 996 161-291 9GH 993 984-001	1 1 20	<p>FF®-H3 worklight 'Oval 100' with optics for wide ground illumination, with single reflector, AMP plug-connection, protective cap and 12V55W bulb</p> <p>with twin reflector and 12V55W bulb</p> <p>Spare Parts: Protective cap for AMP plug-connection</p> <p>1(2)x12V55W (H3) 8GH 002 090-371 1(2)x12V55W (H3) 8GH 002 090-133 1(2)x24V70W (H3) 8GH 002 090-251</p>
various models		1G5 003 241-021 1G5 120 510-001 6ED 708 919-001 9GD 120 670-001	1 1 5 10	<p>H3 worklight, with optics for long-range illumination, with switch</p> <p>Spare Parts: Light unit with seal Switch Seal</p> <p>1x12V55W (H3) 8GH 002 090-371 1x12V55W (H3) 8GH 002 090-133 1x24V70W (H3) 8GH 002 090-251</p>



Manufacturer Model	Model year	Part no.	Pk.	Note
Massey-Ferguson				
MB 186, MB 187 MB 186, MB 187 		2PF 001 259-631 9EL 109 208-011 9FT 088 047-001	2 2 10	Side light (E1) 21624 Spare Parts: Body/lens with screws Bulb holder  1x12V5W (C5W) 8GM 002 092-121
MB 186, MB 187 		2SB 001 259-261 9EL 088 525-001 9FT 088 047-001	2 2 10	Combination rearlight K 23270 Spare Parts: Body/lens with screws Bulb holder  1x12V10W (K) 8GM 002 091-131  1x12V18W (K) 8GM 002 091-121
MF 30, MF 30-6 MF 30, MF 30-6 		2BA 001 227-201 9EL 074 484-011	2 2	Indicator light K 12642 Spare Parts: Body/lens  1x12V18W (K) 8GM 002 091-121
MF 31 - MF 187-6 MF 31 - MF 187-6 MF 31, MF 31-6, MF 86, MF 87, MF 99, MF 186-6, MF 187-6 		9GD 023 639-001 9DR 090 206-001	10 1	Headlight, permanently dipped-beam, spare parts available only K 11095/1 Spare Parts: Seal Reflector  1x12V15W (Q) 8GA 002 081-121  1x12V4W (T4W) 8GP 002 067-121
MF 31 - MF 187-6 		2BA 001 227-201 9EL 074 484-011	2 2	Indicator light K 12642 Spare Parts: Body/lens  1x12V18W (K) 8GM 002 091-121















Manufacturer Model	Model year	Part no.	Pk.	Note
Massey-Ferguson				
MF 186, MF 187 MF 186, MF 187		2PF 001 259-631 9EL 109 208-011 9FT 088 047-001	2 2 10	Side light E1 21624 Spare Parts: Body/lens with screws Bulb holder 1x12V5W (C5W) 8GM 002 092-121
MF 203, MF 205 MF 203, MF 205		2BE 001 278-011 2BE 001 278-021 9EL 087 769-001 9FT 087 771-001	1 1 1 5	Indicator-side light, left Indicator-side light, right K 23246 Spare Parts: Lens Bulb holder 1x12V18W (K) 8GM 002 091-121 1x12V3W (M) 8GM 002 094-121
MF 487 MF 487		9GD 023 639-001 9DR 090 206-001	10 1	Headlight, permanently dipped-beam, spare parts available only K 11095/1 Spare Parts: Seal Reflector 1x12V15W (Q) 8GA 002 081-121 1x12V4W (T4W) 8GP 002 067-121
MF 487	70->	2BA 001 227-201 9EL 074 484-011	2 2	Indicator light K 12642 Spare Parts: Body/lens 1x12V18W (K) 8GM 002 091-121
MF 487	70->	2SA 001 259-751 9EL 135 266-001 9FT 088 047-001	2 2 10	Rear light E1 31438 Spare Parts: Body/lens with screws Bulb holder 1x12V5W (C5W) 8GM 002 092-121
















Manufacturer Model	Model year	Part no.	Pk.	Note
Massey-Ferguson				
MF 487	70->	2SB 001 301-021	2	Combination rearlight
MF 487		9EL 090 411-001	5	K 23318 Spare Parts: Lens with screw 1x12V10W (K) 8GM 002 091-131 1x12V18W (K) 8GM 002 091-121
MF 510				Headlight, permanently dipped-beam, spare parts available only
MF 510		9GD 023 639-001 9DR 090 206-001	10 1	K 11095/1 Spare Parts: Seal Reflector 1x12V15W (Q) 8GA 002 081-121 1x12V4W (T4W) 8GP 002 067-121
MF 510		2BA 001 227-201	2	Indicator light
		9EL 074 484-011	2	K 12642 Spare Parts: Body/lens 1x12V18W (K) 8GM 002 091-121
various models	07/86->	1LB 003 177-637	36	Headlight unit with bulb
MF 3000 - MF 3090				E1 17127 1x12V45/40W (R2) 8GD 002 088-131



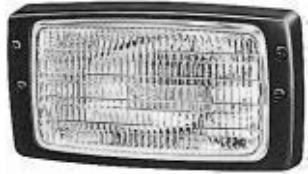









Manufacturer Model	Model year	Part no.	Pk.	Note
Massey-Ferguson				
MF 3165 S MF 3165 S 		9ES 015 675-001 9GD 024 183-001 9DR 060 567-001 9FF 090 500-001	1 10 1 2	Headlight, spare parts available only K 21032 K 21037 Spare Parts: 1 Lens 10 Seal 1 Reflector 2 Bulb socket  1x12V35/35W (S2) 8GD 002 084-131  1x12V4W (T4W) 8GP 002 067-121
Mercedes-Benz				
MB-Trac 700 - 1500 MB-Trac 700 - 1500 MB-Trac 700, 800, 900, MB-Trac 1000, 1100, MB-Trac 1300, 1500 	09/85->	1LA 004 109-217 9AH 131 494-015 9FF 111 606-021	36 6 10	H4 headlight (E1) 17116 Spare Parts: Supporting frame Bulb socket for side light (to be ordered separately)  1x12V60/55W (H4) 8GJ 002 525-131  1x12V4W (T4W) 8GP 002 067-121
Neuson				
various models various models 		1GA 007 506-001 1GA 998 525-001 9GH 993 984-001	1 1 20	FF®-H3 worklight 'Ultra Beam Standard' with optics for large-area ground illumination, with AMP plug-connection Spare Parts: 1 Light unit 20 Rubber cap  1x12V55W (H3) 8GH 002 090-371  1x12V55W (H3) 8GH 002 090-133
various models 		1GD 996 018-541	1	H3 worklight with optics for close-range illumination  1x12V55W (H3) 8GH 002 090-371  1x12V55W (H3) 8GH 002 090-133















Manufacturer Model	Model year	Part no.	Pk.	Note
New Holland (Fiatagri)				
various models various models		1GA 996 020-001	1	H3 worklight 'Corner Light', with 12V55W bulb  1x12V55W (H3) 8GH 002 090-371  1x12V55W (H3) 8GH 002 090-133
various models		1GA 996 083-011	1	FF®-H3 worklight with optics for large-area ground illumination
		1GA 998 525-001	1	Spare Parts: Light unit  1x12V55W (H3) 8GH 002 090-371  1x12V55W (H3) 8GH 002 090-133
various models		1GA 996 083-021	1	FF®-H3 worklight with optics for large-area ground illumination
		1GA 998 525-001	1	Spare Parts: Light unit  2x12V35W (H3) 8GH 002 090-271  2x12V55W (H3) 8GH 002 090-133
various models		1GA 007 506-681	1	FF®-H3 worklight with optics for large-area ground illumination, with bulb
		1GA 998 525-001	1	Spare Parts: Light unit  1x24V70W (H3) 8GH 002 090-251
various models		1GA 998 522-011	1	FF®-H3 worklight with optics for ground illumination
				 1x12V55W (H3) 8GH 002 090-371  1x12V55W (H3) 8GH 002 090-133







Manufacturer Model	Model year	Part no.	Pk.	Note
New Holland (Fiatagri)				
various models various models		1GA 006 875-001	1	FF®-H3 worklight with optics for ground illumination  1x12V55W (H3) 8GH 002 090-371 1x12V55W (H3) 8GH 002 090-133 1x24V70W (H3) 8GH 002 090-251 
various models		1GB 006 213-101	1	H3 worklight with optics for long-range illumination  1x12V55W (H3) 8GH 002 090-371 1x12V55W (H3) 8GH 002 090-133 
various models		1GB 996 080-021	1	FF®-H3 worklight 'Double Beam' with optics for long-range off-road illumination  2x12V35W (H3) 8GH 002 090-271 2x12V55W (H3) 8GH 002 090-133 
various models		1GA 006 991-091 9XD 990 298-001	1 5	FF®-H3 worklight 'Double Beam' with optics for intensive close-range illumination  Spare Parts: Angle bracket 2x12V35W (H3) 8GH 002 090-271 2x12V55W (H3) 8GH 002 090-133 
various models		1GA 006 991-061 9XD 990 298-001	1 5	FF®-H3 worklight with optics for long-range off-road illumination  Spare Parts: Angle bracket 2x12V35W (H3) 8GH 002 090-271 2x12V55W (H3) 8GH 002 090-133 
















Manufacturer Model	Model year	Part no.	Pk.	Note
New Holland (Fiatagri)				
various models various models		1G3 005 760-001 1G3 135 211-011 6EB 005 633-001	1 1 10	H3 worklight with optics for long-range illumination Spare Parts: Light unit Switch  1x12V55W (H3) 8GH 002 090-371  1x12V55W (H3) 8GH 002 090-133
				
various models		2BE 003 014-251 9EL 115 003-055	2 2	Indicator-side light E1 42712 Spare Parts: Lens with screws  1x12V21W (P21W) 8GA 002 073-121  1x12V5W (C5W) 8GM 002 092-121
				
various models		2KA 001 389-101 9BG 119 721-001	10 5	Licence plate light E1 12815 Spare Parts: Body with lens  1x12V5W (C5W) 8GM 002 092-121
				
Partek Forest				
various models		1GA 998 534-011 1GA 998 525-011 5DV 990 264-011 5DD 008 319-501	1 1 1 1	Xenon worklight 'Ultra Beam' with optics for large-area and long-range illumination, with gas discharge bulb and 24V ballast Spare Parts: Light unit 24V ballast unit Ignitor, gas discharge bulb  1x35W (D2S) 8GS 007 949-101
				
various models		1GA 996 142-011 1GA 990 305-001 9GH 993 984-001 8KB 990 299-121	1 1 20 1	Xenon worklight with optics for wide ground illumination, with gas discharge bulb, 24V ballast and AMP plug-connection Spare Parts: Light unit Protective cap for AMP plug-connection Lead for AMP plug-connection  1x35W (D2S) 8GS 007 949-101
				















Manufacturer Model	Model year	Part no.	Pk.	Note
Partek Forest				
various models various models		1GA 005 060-001 1GA 132 459-011 9AG 132 453-005	1 1 5	H3 worklight with optics for long-range illumination Spare Parts: Light unit Lens-retaining rim  1x12V55W (H3) 8GH 002 090-133
various models		1GA 006 991-041 1GA 998 524-011 9XD 990 298-001	1 1 5	FF®-H3 worklight 'Double Beam' with optics for large-area ground illumination Spare Parts: Light unit Angle bracket  1x12V55W (H3) 8GH 002 090-371 1x12V55W (H3) 8GH 002 090-133 1x24V70W (H3) 8GH 002 090-251
various models		1G3 005 760-221 1G3 135 211-011	1 1	H3 worklight 'Torero 5760' with optics for long-range illumination, without switch Spare Parts: Light unit with lens-retaining rim  1x12V55W (H3) 8GH 002 090-371 1x12V55W (H3) 8GH 002 090-133 1x24V70W (H3) 8GH 002 090-251
various models		1G8 002 340-001 1G8 002 340-011 1G8 132 233-011 6ED 708 919-001	1 1 1 5	H3 worklight with optics for long-range illumination, with angle bracket for 4-point fastening H3 worklight with optics for long-range illumination, with bracket for fastening to standard stud Spare Parts: Light unit with lens-retaining rim Switch  1x12V55W (H3) 8GH 002 090-371 1x12V55W (H3) 8GH 002 090-133 1x24V70W (H3) 8GH 002 090-251

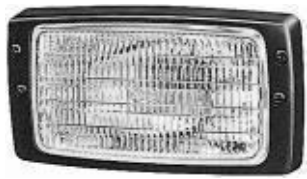






Manufacturer Model	Model year	Part no.	Pk.	Note
O&K				
various models	various models	1GA 998 534-011	1	Xenon worklight 'Ultra Beam' with optics for large-area and long-range illumination, with gas discharge bulb and 24V ballast
		1GA 998 525-011 5DV 990 264-011 5DD 008 319-501	1 1 1	Spare Parts: 1 Light unit 1 24V ballast unit 1 Ignitor, gas discharge bulb  1x35W (D2S) 8GS 007 949-101
various models		1GA 996 142-011	1	Xenon worklight with optics for wide ground illumination, with gas discharge bulb, 24V ballast and AMP plug-connection
		1GA 990 305-001 9GH 993 984-001 8KB 990 299-121	1 20 1	Spare Parts: 1 Light unit 20 Protective cap for AMP plug-connection 1 Lead for AMP plug-connection  1x35W (D2S) 8GS 007 949-101
various models		1GA 006 991-041	1	FF@-H3 worklight 'Double Beam' with optics for large-area ground illumination
		1GA 998 524-011 9XD 990 298-001	1 5	Spare Parts: 1 Light unit 5 Angle bracket  1x12V55W (H3) 8GH 002 090-371  1x12V55W (H3) 8GH 002 090-133
various models		1GA 998 522-011	1	FF@-H3 worklight with optics for ground illumination
				 1x12V55W (H3) 8GH 002 090-371  1x12V55W (H3) 8GH 002 090-133  1x24V70W (H3) 8GH 002 090-251
Same				
various models		1GA 007 506-001	1	FF@-H3 worklight 'Ultra Beam Standard' with optics for large-area ground illumination, with AMP plug-connection
		1GA 998 525-001 9GH 993 984-001	1 20	Spare Parts: 1 Light unit 20 Rubber cap  1x12V55W (H3) 8GH 002 090-371  1x12V55W (H3) 8GH 002 090-133


















Manufacturer Model	Model year	Part no.	Pk.	Note
Same				
various models various models		<p>1GA 007 506-111</p> <p>1GA 007 506-121</p> <p>1GA 998 525-001 9GH 993 984-001 8KB 990 299-001</p> <p>8JD 008 151-011</p>	<p>1</p> <p>1</p> <p>1</p> <p>20</p> <p>1</p> <p>10</p>	<p>FF®-H3 worklight 'Ultra Beam Standard' with optics for large-area ground illumination, with AMP plug-connection</p> <p>FF®-H3 worklight 'Ultra Beam Standard' with optics for extreme large-area and equal ground illumination</p> <p>Spare Parts: 1 Light unit 20 Rubber cap for -111 1 Lead with plug for external connection for -111 (to be ordered separately) 10 Socket housing for -111 (to be ordered separately)</p> <p> 1x12V55W (H3) 8GH 002 090-371  1x12V55W (H3) 8GH 002 090-133</p>
various models		<p>1GA 007 506-061</p> <p>1GA 998 525-001 8KB 990 299-001</p> <p>8JD 008 151-011</p>	<p>1</p> <p>1</p> <p>1</p> <p>10</p>	<p>FF®-H3 worklight with optics for large-area ground illumination and bulb</p> <p>Spare Parts: 1 Light unit 1 Lead with plug for external connection (to be ordered separately) 10 Socket housing (to be ordered separately)</p> <p> 1x12V55W (H3) 8GH 002 090-133</p>
various models		<p>1GA 007 506-101</p> <p>1GA 998 525-001 9GH 993 984-001 9XD 130 261-001</p>	<p>1</p> <p>1</p> <p>20</p> <p>5</p>	<p>FF®-H3 worklight 'Ultra Beam Heavy Duty' with optics for large-area ground illumination, with AMP plug-connection, protective cap and grommet</p> <p>Spare Parts: 1 Light unit 20 Protective cap for AMP plug-connection 5 Angle bracket for 4-point fastening</p> <p> 1x12V55W (H3) 8GH 002 090-371  1x12V55W (H3) 8GH 002 090-133  1x24V70W (H3) 8GH 002 090-251</p>
various models		<p>1GA 998 522-011</p>	<p>1</p>	<p>FF®-H3 worklight with optics for ground illumination</p> <p> 1x12V55W (H3) 8GH 002 090-371  1x12V55W (H3) 8GH 002 090-133</p>



Manufacturer Model	Model year	Part no.	Pk.	Note
Same				
various models various models		1GB 006 213-111	1	H3 worklight with optics for close-range illumination  1x12V55W (H3) 8GH 002 090-371 1x12V55W (H3) 8GH 002 090-133
various models		1G3 996 001-271	1	H3 worklight with optics for close-range illumination, without switch  1x12V55W (H3) 8GH 002 090-371 1x12V55W (H3) 8GH 002 090-133
Schaeff				
various models		1GA 007 506-011 1GA 998 525-001 9GH 993 984-001 9XD 130 261-001	1 1 20 5	FF®-H3 worklight 'Ultra Beam Heavy Duty' with optics for large-area ground illumination, with AMP plug-connection  Spare Parts: Light unit Rubber cap Angle bracket 1x12V55W (H3) 8GH 002 090-371 1x12V55W (H3) 8GH 002 090-133
various models		1GA 006 991-041 1GA 998 524-011 9XD 990 298-001	1 1 5	FF®-H3 worklight 'Double Beam' with optics for large-area ground illumination  Spare Parts: Light unit Angle bracket 2x12V35W (H3) 8GH 002 090-271 2x12V55W (H3) 8GH 002 090-133
various models		1G3 003 710-021 9DS 121 707-001 9BG 127 179-001	1 1 1	H3 worklight with optics for close-range illumination  Spare Parts: Light unit Rubber body 1x12V55W (H3) 8GH 002 090-371 1x12V55W (H3) 8GH 002 090-133











Manufacturer Model	Model year	Part no.	Pk.	Note
Schaeff				
various models various models		1G3 996 001-271	1	H3 worklight with optics for close-range illumination, without switch  1x12V55W (H3) 8GH 002 090-371  1x12V55W (H3) 8GH 002 090-133 
				
Steyr				
various models		1GA 996 020-001	1	H3 worklight 'Corner Light', with 12V55W bulb  1x12V55W (H3) 8GH 002 090-371  1x12V55W (H3) 8GH 002 090-133 
				
various models		1GA 006 875-001	1	FF®-H3 worklight with optics for ground illumination  1x12V55W (H3) 8GH 002 090-371  1x12V55W (H3) 8GH 002 090-133 
				
various models		1GA 007 506-681 1GA 998 525-001	1 1	FF®-H3 worklight with optics for large-area ground illumination, with bulb Spare Parts: Light unit  1x24V70W (H3) 8GH 002 090-251 
				



Steyr



Manufacturer Model	Model year	Part no.	Pk.	Note
Steyr				
various models various models		1GA 996 083-021 1GA 998 525-001	1 1	FF®-H3 worklight with optics for large-area ground illumination Spare Parts: Light unit  2x12V35W (H3) 8GH 002 090-271  2x12V55W (H3) 8GH 002 090-133
various models		1GA 996 083-011 1GA 998 525-001	1 1	FF®-H3 worklight with optics for large-area ground illumination Spare Parts: Light unit  1x12V55W (H3) 8GH 002 090-371  1x12V55W (H3) 8GH 002 090-133
various models		1GB 996 080-021	1	FF®-H3 worklight 'Double Beam' with optics for long-range off-road illumination  2x12V35W (H3) 8GH 002 090-271  2x12V55W (H3) 8GH 002 090-133
various models		1GA 998 522-011	1	FF®-H3 worklight with optics for ground illumination  1x12V55W (H3) 8GH 002 090-371  1x12V55W (H3) 8GH 002 090-133
various models		2SE 996 030-011 2SD 996 030-021 9EL 990 142-001	1 1 1	Combination rearlight, left, with licence plate light, with bulbs Combination rearlight, right, without licence plate light, with bulbs (E12) 7133 (E12) 4054 Spare Parts: Lens  1x12V5W (R5W) 8GA 002 071-121  1x12V21W (P21W) 8GA 002 073-121











Manufacturer Model	Model year	Part no.	Pk.	Note
Steyr				
430, 1100 430, 1100		9ES 069 831-001	1	Headlight, spare parts available only K 11135/1 Spare Parts: Lens 1x12V15W (Q) 8GA 002 081-121
Still				
various models various models		1GA 007 506-001 1GA 998 525-001 9GH 993 984-001	1 1 20	FF®-H3 worklight 'Ultra Beam Standard' with optics for large-area ground illumination, with AMP plug-connection Spare Parts: Light unit Rubber cap 1x12V55W (H3) 8GH 002 090-371 1x12V55W (H3) 8GH 002 090-133
various models		1GA 998 522-011	1	FF®-H3 worklight with optics for ground illumination 1x12V55W (H3) 8GH 002 090-371 1x12V55W (H3) 8GH 002 090-133
various models		1G3 005 760-001 1G3 005 760-011 1G3 135 211-011 6EB 005 633-001	1 1 1 10	H3 worklight with optics for long-range illumination, with switch H3 worklight with optics for long-range illumination, without switch Spare Parts: Light unit Switch 1x12V55W (H3) 8GH 002 090-371 1x12V55W (H3) 8GH 002 090-133 1x24V70W (H3) 8GH 002 090-251











Manufacturer Model	Model year	Part no.	Pk.	Note
Terex Demag				
various models various models		1GA 007 506-451 1GA 998 525-001	1 1	FF®-H3 worklight 'Ultra Beam Heavy Duty' with optics for large-area ground illumination, with PG screw connection and M10 fixing screw, without bulb Spare Parts: Light unit  1x12V55W (H3) 8GH 002 090-371  1x12V55W (H3) 8GH 002 090-133
various models		1GA 998 522-011	1	FF®-H3 worklight with optics for ground illumination, with swivelling base  1x12V55W (H3) 8GH 002 090-371  1x12V55W (H3) 8GH 002 090-133  1x24V70W (H3) 8GH 002 090-251
various models		1GA 007 506-681 1GA 998 525-001	1 1	FF®-H3 worklight with optics for large-area ground illumination, with bulb Spare Parts: Light unit  1x24V70W (H3) 8GH 002 090-251
various models		1GM 996 135-051 5DV 990 264-011 5DD 008 319-501 8GS 007 949-101	1 1 1 1	Xenon worklight with optics for long-range illumination, with 24V ballast, with gas discharge bulb Spare Parts: Ballast Ignitor, gas discharge bulb Gas discharge bulb  1x35W (D2S) 8GS 007 949-101



Manufacturer Model	Model year	Part no.	Pk.	Note
Terex Demag				
various models various models		1G8 002 340-001	1	H3 worklight with optics for long-range illumination, with angle bracket for 4-point fastening
		1G8 002 340-011	1	H3 worklight with optics for long-range illumination, with bracket for fastening to standard stud
		1G8 132 233-011 6ED 708 919-001	1 5	Spare Parts: Light unit with lens-retaining rim Switch
				1x12V55W (H3) 8GH 002 090-371 1x12V55W (H3) 8GH 002 090-133 1x24V70W (H3) 8GH 002 090-251 
Timberjack				
various models		1GA 007 506-011	1	FF@-H3 worklight 'Ultra Beam Heavy Duty' with optics for large-area ground illumination, with AMP plug-connection
		1GA 998 525-001 9GH 993 984-001 9XD 990 298-001	1 20 5	Spare Parts: Light unit Rubber cap Angle bracket
				1x12V55W (H3) 8GH 002 090-371 1x12V55W (H3) 8GH 002 090-133 1x24V70W (H3) 8GH 002 090-251 
various models		1GA 007 506-001	1	FF@-H3 worklight 'Ultra Beam Standard' with optics for large-area ground illumination, with AMP plug-connection
		1GA 007 506-391	1	FF@-H3 worklight 'Ultra Beam Standard' with optics for large-area ground illumination, with DEUTSCH plug-connection
		1GA 998 525-001 9GH 993 984-001	1 20	Spare Parts: Light unit Rubber cap for -001
				1x12V55W (H3) 8GH 002 090-371 1x12V55W (H3) 8GH 002 090-133 1x24V70W (H3) 8GH 002 090-251 
various models		1GA 998 534-011	1	Xenon worklight 'Ultra Beam' with optics for large-area and long-range illumination, with gas discharge bulb and 24V ballast
		1GA 998 525-011 5DV 990 264-011 5DD 008 319-501	1 1 1	Spare Parts: Light unit 24V ballast unit Ignitor, gas discharge bulb
				 1x35W (D2S) 8GS 007 949-101

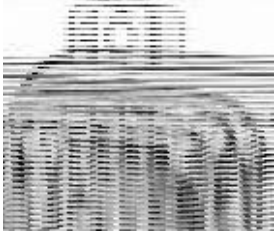




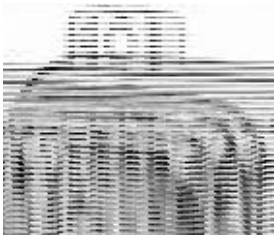






Manufacturer Model	Model year	Part no.	Pk.	Note
Timberjack				
various models various models		1GA 998 532-011	1	FF@-H3 worklight with optics for ground illumination
		1GA 990 183-001	1	Spare Parts: Light unit 1x12V55W (H3) 8GH 002 090-371 1x12V55W (H3) 8GH 002 090-133 1x24V70W (H3) 8GH 002 090-251 
various models		1GA 006 991-041	1	FF@-H3 worklight 'Double Beam' with optics for large-area ground illumination
		1GA 998 524-011 9XD 990 298-001	1 5	Spare Parts: Light unit Angle bracket 1x12V55W (H3) 8GH 002 090-371 1x12V55W (H3) 8GH 002 090-133 1x24V70W (H3) 8GH 002 090-251 
various models		1GM 996 135-041	1	Xenon worklight with optics for close-range illumination, with 24V ballast, with gas discharge bulb
		8GS 007 949-101 5DD 008 319-501	1 1	Spare Parts: Gas discharge bulb Ignitor, gas discharge bulb  1x35W (D2S) 8GS 007 949-101
Valtra				
various models		1GA 007 506-001	1	FF@-H3 worklight 'Ultra Beam Standard' with optics for large-area ground illumination, with AMP plug-connection
		1GA 007 506-391	1	FF@-H3 worklight 'Ultra Beam Standard' with optics for large-area ground illumination, with DEUTSCH plug-connection
		1GA 998 525-001 9GH 993 984-001	1 20	Spare Parts: Light unit Rubber cap for -001 1x12V55W (H3) 8GH 002 090-371 1x12V55W (H3) 8GH 002 090-133 1x24V70W (H3) 8GH 002 090-251 



Manufacturer Model	Model year	Part no.	Pk.	Note
Valtra				
various models various models		1GA 998 522-011	1	FF®-H3 worklight with optics for ground illumination  1x12V55W (H3) 8GH 002 090-371 1x12V55W (H3) 8GH 002 090-133
				
various models		1GA 006 876-001	1	FF®-H3 worklight with optics for ground illumination, with rotating base  1x12V55W (H3) 8GH 002 090-371 1x12V55W (H3) 8GH 002 090-133 1x24V70W (H3) 8GH 002 090-251
				
various models		1GA 006 875-001	1	FF®-H3 worklight with optics for ground illumination  1x12V55W (H3) 8GH 002 090-371 1x12V55W (H3) 8GH 002 090-133
				
various models		1GB 996 213-511	1	H3 worklight 'Modul 6213' with optics for close-range illumination, with vibration damping Spare Parts: 5 Angle bracket for 4-point fastening  1x12V55W (H3) 8GH 002 090-371 1x12V55W (H3) 8GH 002 090-133 1x24V70W (H3) 8GH 002 090-251
		9XD 990 298-001	5	
various models		1GA 006 991-041	1	FF®-H3 worklight 'Double Beam' with optics for large-area ground illumination Spare Parts: 1 Light unit 5 Angle bracket  1x12V55W (H3) 8GH 002 090-371 1x12V55W (H3) 8GH 002 090-133
		1GA 998 524-011 9XD 990 298-001	1 5	



Manufacturer Model	Model year	Part no.	Pk.	Note
Valtra (Valmet)				
205 - 665 205 - 665	91-> 	1LB 006 277-137 9GH 126 647-011 9FF 126 444-001	36 10 10	H4 headlight unit with 12V60/55W (H4) bulb E1 7197 Spare Parts: Cap Bulb socket for side light  1x12V60/55W (H4) 8GJ 002 525-131  1x12V4W (T4W) 8GP 002 067-121
205 - 555		2JA 001 330-001	2	Interior light  2x12V5W (C5W) 8GM 002 092-121
605 - 955, 6000 - 8600 605 - 955 605, 655, 705, 755, 805, 855, 955 6000 - 8600 6000 - 8400, 8600	91-> 	1LB 006 277-137 9GH 126 647-011 9FF 126 444-001	36 10 10	H4 headlight unit with 12V60/55W (H4) bulb E1 7197 Spare Parts: Cap Bulb socket for side light  1x12V60/55W (H4) 8GJ 002 525-131  1x12V4W (T4W) 8GP 002 067-121
Joseph Vögele				
various models various models		1GA 006 991-031 1GA 998 524-011 9XD 130 261-001	1 1 5	FF®-H3 worklight with optics for large-area ground illumination Spare Parts: Light unit Angle bracket  2x12V55W (H3) 8GH 002 090-133



Manufacturer Model	Model year	Part no.	Pk.	Note
Joseph Vögele				
various models various models		1G3 005 760-001	1	H3 worklight with optics for long-range illumination, with switch
		1G3 005 760-011	1	H3 worklight with optics for long-range illumination, without switch
		1G3 135 211-011	1	Spare Parts: Light unit Switch 1x12V55W (H3) 8GH 002 090-371 1x12V55W (H3) 8GH 002 090-133 1x24V70W (H3) 8GH 002 090-251
		6EB 005 633-001	10	
VME				
DM 5350 DM 5350		2BE 002 582-031	1	Indicator-side light E1 43388
		9EL 112 744-001	1	Spare Parts: Lens 1x24V5W (R5W) 8GA 002 071-241 1x24V21W (P21W) 8GA 002 073-241
DM 5350		2KA 001 389-101	10	Licence plate light E1 12815
		9BG 119 721-001	5	Spare Parts: Body with lens 1x24V5W (C5W) 8GM 002 092-241
GM 616, GM 646 GM 616, GM 646		2SD 002 582-011	1	Combination rearlight, left Combination rearlight, right E1 116 E1 53345
		2SD 002 582-021	1	
		9EL 112 743-001	1	Spare Parts: Lens, left Lens, right 1x24V10W (R10W) 8GA 002 071-251 2x24V21W (P21W) 8GA 002 073-241
		9EL 112 741-001	1	
LM 621 - LM 642 LM 621, LM 641		2SD 001 685-211	1	Combination rearlight E12 7146
		9EL 113 324-001	2	Spare Parts: Lens with screws 1x24V5W (R5W) 8GA 002 071-241 2x24V21W (P21W) 8GA 002 073-241



VME



Manufacturer Model	Model year	Part no.	Pk.	Note
VME				
LM 621 - LM 642 LM 622, LM 642		2SD 001 688-171 2SD 001 688-141	1 1	Combination rearlight, left Combination rearlight, right (E1) 43207 Spare Parts: Lens with screws Seal Grommet 2x24V5W (R5W) 8GA 002 071-241 2x24V21W (P21W) 8GA 002 073-241
		9EL 092 435-011 9GD 102 484-001 9GT 074 132-001	1 10 10	
LM 621, LM 622, LM 641, LM 642		2KA 001 389-101	10	Licence plate light (E1) 12815
		9BG 119 721-001	5	Spare Parts: Body with lens 1x24V5W (C5W) 8GM 002 092-241
LM 841 LM 841		2BA 001 227-211	2	Indicator light K 12642
		9EL 074 484-031	2	Spare Parts: Body/lens 1x24V18W (K) 8GM 002 091-241
LM 841		2PF 001 648-161	4	Side light (E1) 11794
		9EL 108 435-001	5	Spare Parts: Lens with screw 1x24V5W (R5W) 8GA 002 071-241
LM 841		2SD 001 685-211	1	Combination rearlight (E12) 7146
		9EL 113 324-001	2	Spare Parts: Lens with screws 1x24V5W (R5W) 8GA 002 071-241 2x24V21W (P21W) 8GA 002 073-241











Manufacturer Model	Model year	Part no.	Pk.	Note
VME				
LM 846 LM 846		2BA 001 227-211 9EL 074 484-031	2 2	Indicator light K 12642 Spare Parts: Body/lens 1x24V18W (K) 8GM 002 091-241
LM 846		2SD 001 685-211 9EL 113 324-001	1 2	Combination rearlight (E12) 7146 Spare Parts: Lens with screws 1x24V5W (R5W) 8GA 002 071-241 2x24V21W (P21W) 8GA 002 073-241
LM 1240 LM 1240		2BA 001 227-211 9EL 074 484-031	2 2	Indicator light K 12642 Spare Parts: Body/lens 1x24V18W (K) 8GM 002 091-241
LM 1240		2SD 001 688-171 2SD 001 688-141 9EL 092 435-011 9GD 102 484-001 9GT 074 132-001	1 1 1 10 10	Combination rearlight, left Combination rearlight, right (E1) 43207 Spare Parts: Lens with screws Seal Grommet 2x24V5W (R5W) 8GA 002 071-241 2x24V21W (P21W) 8GA 002 073-241
LM 1641 LM 1641		2SD 001 685-211 9EL 113 324-001	1 2	Combination rearlight (E12) 7146 Spare Parts: Lens with screws 1x24V5W (R5W) 8GA 002 071-241 2x24V21W (P21W) 8GA 002 073-241



VME



Manufacturer Model	Model year	Part no.	Pk.	Note
VME				
LM 4200 - LM 4600 LM 4200 - LM 4600		2BA 001 227-211	2	Indicator light K 12642
		9EL 074 484-031	2	Spare Parts: Body/lens  1x24V18W (K) 8GM 002 091-241
LM 4200 - LM 4600 LM 4200, LM 4300, LM 4400, LM 4500, LM 4600		2SD 001 688-171 2SD 001 688-141	1 1	Combination rearlight, left Combination rearlight, right
		9EL 092 435-011 9GD 102 484-001 9GT 074 132-001	1 10 10	E1 43207 Spare Parts: Lens with screws Seal Grommet  2x24V5W (R5W) 8GA 002 071-241 2x24V21W (P21W) 8GA 002 073-241
LM 4200 - LM 4600		2KA 001 389-101	10	Licence plate light
		9BG 119 721-001	5	E1 12815 Spare Parts: Body with lens  1x24V5W (C5W) 8GM 002 092-241
MK 693 MK 693		2BE 002 582-031	1	Indicator-side light
		9EL 112 744-001	1	E1 43388 Spare Parts: Lens  1x12V5W (R5W) 8GA 002 071-121 1x12V21W (P21W) 8GA 002 073-121
S 830 S 830		2BE 001 259-061	2	Indicator-side light
		9EL 088 538-001 9FT 088 047-001	2 10	K 23269 Spare Parts: Body/lens with screws Bulb holder  1x24V3W (M) 8GM 002 094-241 1x24V18W (K) 8GM 002 091-241
				








Manufacturer Model	Model year	Part no.	Pk.	Note
VME				
SM 462, SM 868 SM 462, SM 868		2SD 001 679-001 9EL 126 294-001	1 2	Combination rearlight K 53397 Spare Parts: Lens with screws 1x24V10W (K) 8GM 002 091-251 2x24V18W (K) 8GM 002 091-241
SM 969 SM 969		2SB 001 301-021 9EL 090 411-001	2 5	Combination rearlight K 23318 Spare Parts: Lens with screw 1x24V10W (K) 8GM 002 091-251 1x24V18W (K) 8GM 002 091-241
SM 969		2SD 001 679-001 9EL 126 294-001	1 2	Combination rearlight K 53397 Spare Parts: Lens with screws 1x24V10W (K) 8GM 002 091-251 2x24V18W (K) 8GM 002 091-241
T 500, T 650 T 500, T 650		2BE 002 582-031 9EL 112 744-001	1 1	Indicator-side light E1 43388 Spare Parts: Lens 1x12V5W (R5W) 8GA 002 071-121 1x12V21W (P21W) 8GA 002 073-121
T 500, T 650		2PF 001 648-161 9EL 108 435-001	4 5	Side light E1 11794 Spare Parts: Lens with screw 1x12V5W (R5W) 8GA 002 071-121



VME



Manufacturer Model	Model year	Part no.	Pk.	Note
VME				
T 500, T 650 T 500, T 650		2SD 002 582-011	1	Combination rearlight, left
		2SD 002 582-021	1	Combination rearlight, right
				(E1) 116 (E1) 53345 Spare Parts: 1 Lens, left 1 Lens, right 1x12V10W (R10W) 8GA 002 071-131 2x12V21W (P21W) 8GA 002 073-121
T 700 T 700		2BE 002 582-031	1	Indicator-side light
		9EL 112 744-001	1	(E1) 43388 Spare Parts: 1 Lens 1x12V5W (R5W) 8GA 002 071-121 1x12V21W (P21W) 8GA 002 073-121
T 700		2SD 002 582-011 2SD 002 582-021	1 1	Combination rearlight, left Combination rearlight, right
		9EL 112 743-001 9EL 112 741-001	1 1	(E1) 116 (E1) 53345 Spare Parts: 1 Lens, left 1 Lens, right 1x12V10W (R10W) 8GA 002 071-131 2x12V21W (P21W) 8GA 002 073-121
T 700		2SD 001 688-171 2SE 001 688-161	1 1	Combination rearlight, left, without licence plate light Combination rearlight, right, with licence plate light
		9EL 092 435-011 9GD 102 484-001 9GT 074 132-001	1 10 10	(E1) 43207 Spare Parts: 1 Lens with screws 10 Seal 10 Grommet 2x12V5W (R5W) 8GA 002 071-121 2x12V21W (P21W) 8GA 002 073-121
T 700		2KA 001 386-281	2	Licence plate light
		9BG 101 230-001 9GT 005 166-001	2 10	(E1) 12820 Spare Parts: 2 Body with lens 10 Grommet 1x12V5W (C5W) 8GM 002 092-121







Manufacturer Model	Model year	Part no.	Pk.	Note
VME				
T 2650, T 2654 T 2650, T 2654	05/79->	2BE 002 582-031 9EL 112 744-001	1 1	Indicator-side light E1 43388 Spare Parts: Lens 1x12V5W (R5W) 8GA 002 071-121 1x12V21W (P21W) 8GA 002 073-121
				
T 2650, T 2654	05/79->	2SD 001 688-171 2SD 001 688-141 9EL 092 435-011 9GD 102 484-001 9GT 074 132-001	1 1 1 10 10	Combination rearlight, left Combination rearlight, right E1 43207 Spare Parts: Lens with screws Seal Grommet 2x12V5W (R5W) 8GA 002 071-121 2x12V21W (P21W) 8GA 002 073-121
				
Volvo CE				
various models various models		1GA 007 506-011 1GA 998 525-001 9GH 993 984-001 9XD 990 298-001	1 1 20 5	FF®-H3 worklight 'Ultra Beam Heavy Duty' with optics for large-area ground illumination, with AMP plug-connection Spare Parts: Light unit Rubber cap Angle bracket 1x12V55W (H3) 8GH 002 090-371 1x12V55W (H3) 8GH 002 090-133
				
various models		1GA 006 876-001	1	FF®-H3 worklight with optics for ground illumination 1x12V55W (H3) 8GH 002 090-371 1x12V55W (H3) 8GH 002 090-133
				
various models		1GA 006 991-071 9XD 990 298-001	1 5	FF®-H3 worklight 'Double Beam' with optics for object illumination Spare Parts: Angle bracket 2x12V35W (H3) 8GH 002 090-271 2x12V55W (H3) 8GH 002 090-133
				



Yale



Manufacturer Model	Model year	Part no.	Pk.	Note
Yale				
various models various models		1GA 006 876-001	1	FF®-H3 worklight with optics for ground illumination, with rotating base  1x12V55W (H3) 8GH 002 090-371  1x12V55W (H3) 8GH 002 090-133  1x24V70W (H3) 8GH 002 090-251
various models		1GA 006 991-031	1	FF®-H3 worklight with optics for large-area ground illumination
		1GA 998 524-011 9XD 130 261-001	1 5	Spare Parts: 1 Light unit 5 Angle bracket  2x12V55W (H3) 8GH 002 090-133



Fog Lights, Driving Lights, Headlights, Work Lights and Search Lights



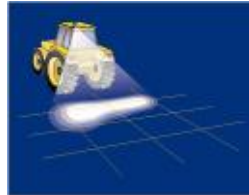
Accessories for built-in headlights	4.41
Accessories for fog- and driving lights	4.30
Accessories for work lights	4.108-4.111
Built-in headlights	4.32-4.50
Driving lights	4.03-4.29
External-fitting headlights	4.51-4.52
Fog lights	4.03-4.29, 4.31
"5760" light series	4.53-4.54
"Oval 100" light series	4.55-4.61
"Oval 120" light series	4.62
"Module 120" light series	4.63-4.65
"Module 6213" light series	4.66-4.70
"7145" light series	4.71
Search lights	4.112
Work lights	4.02, 4.72-4.107

Why worklights?

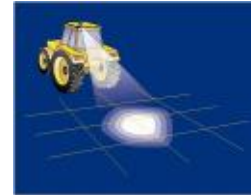
**Working at night -
no problem with the right headlights.**

Special headlight types have been developed for this purpose:
 Low-beam headlights and spotlights:
 for illuminating the road in road traffic.
 Fog lights:
 for poor visibility conditions in road traffic.
 Worklights:
 for the illumination of a working area near the vehicle and away
 from public road traffic.

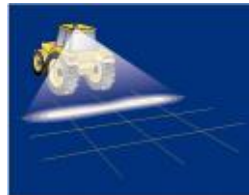
At the mounting height typical for work lighting (2.50 m), only
 worklights provide sufficient illumination of the working area.
 Standard vehicle lighting is nowhere near good enough!
 Outstanding features of a good worklight include the
 homogeneous illumination of as large an area as possible and
 a soft transition at the edge.



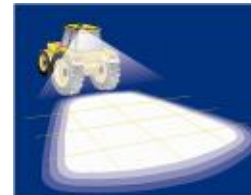
Low beam



Spotlight



Fog light



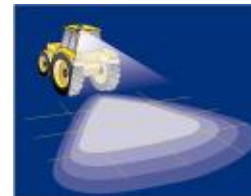
Work light

Active safety through proper illumination!

It's not only the selection of the correct type of headlight that is
 decisive for the choice of optimum worklight, but its correct
 positioning on the vehicle, too. Worklights shine at an angle to the
 surface they are illuminating. This means that even small changes
 in the angle of inclination and the mounting height have a great
 influence on the illumination of the working area. For large-surface
 illumination, the higher the mounting position the better.



**low
mounting position**



**high
mounting position**

Legal notes:

According to FMVSS § 52 (7) [Germany], all multi-track vehicles may be equipped with one or more worklights.

Worklights must not be used when these vehicles are being driven on public roads, only when they are at a standstill,
 e.g. during loading and unloading.

Exceptions to this are made for vehicles used for constructing, maintaining or cleaning the roads or for waste disposal vehicles,
 if the action of driving is part of a working process.


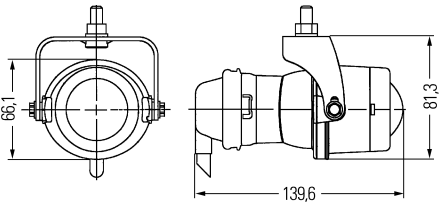

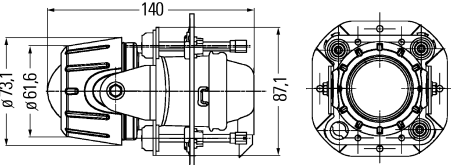



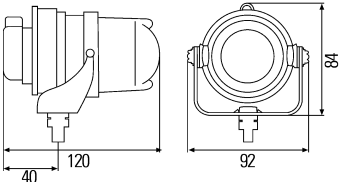

Worklights may only be switched on as long as they do not dazzle other road users.

Worklights must be able to be switched on independently of all other headlights or lights, e.g. joint circuitry with the reverse light
 is not permitted. Hella provides special reversing spotlights for this purpose.

There are no special approval regulations, e.g. according to ECE or EC, since worklights may only be used when driving away
 from public roads.


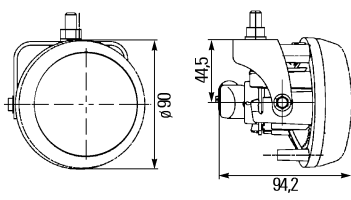

	Part no.	Pk.	Built-in lights
			Micro DE® *)
			(E1) 877
	1NL 008 090-821	1	DE®-H3 fog light set with 12V bulbs, black decorative rings, black brackets, caps and relay with lead
	1NL 008 090-831	1	with universal radio remote control unit
	1NL 008 090-031	1	DE®-H3 fog light with 12V bulb, black decorative ring, black bracket, cap and fixing screws
	1NL 008 090-037	60	
	1NL 008 090-117	1	with 24V bulb and black decorative ring
	9GH 147 009-007	30	Spare parts: Rubber sealing cap
	9HD 149 253-007	1	Accessories: Plastic sealing cap with cover, lead and plug
	8JD 156 150-807	1	Socket set (20 pcs.)
			 1x12V55W (H3) 8GH 002 090-133 1x24V70W (H3) 8GH 002 090-251
	Ref. 17.5		DE®-Xenon
			(E1) 1120
	1F0 008 390-801	1	DE®-Xenon driving light set with black decorative rings, gas discharge bulbs, 12V ballast units, relays and lead set
	1F0 008 390-001	1	DE®-Xenon driving light with black decorative ring, gas discharge bulb, 12V ballast unit, relay and lead set
	1F0 160 197-001	1	Spare parts: Light unit without gas discharge bulb and ballast unit
	5DV 007 760-631	1	Ballast unit, 12V
	8JD 156 151-807	1	Accessories: Socket set (20 pcs.)
	6EH 007 946-001	1	Switch
	8HG 153 152-001	1	Convenience mount with adjustment screw
			 1x35W (D2S) 8GS 007 949-101


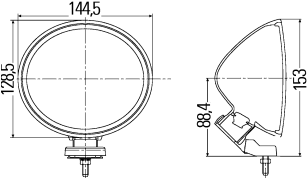


*) Micro work lights see page 4.97


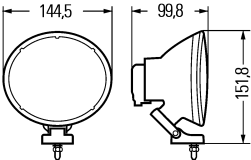


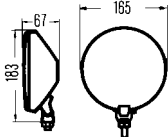

	Part no.	Pk.	Built-in lights
 			Micro DE® Premium *) (E1) 877
	1NL 008 090-871	1	DE®-H3-fog light set with 12V bulbs, black housing, cap, alu-ring, designpanels, universal radio remote control unit, brackets and relays with cable
	1NL 008 090-301	1	DE®-H3 fog light with 12V bulb, black housing, cap, alu-ring, designpanel and bracket
 	1NL 008 090-317 **)	24	DE®-H3 fog light with 12V bulb, black housing, cap, alu-ring and bracket, without designpanel
	1NL 008 090-327 **)	24	DE®-H3 fog light with 24V bulb, black housing, cap, alu-ring and bracket, without designpanel
	9GH 147 009-007	30	Spare parts: Rubber sealing cap
	9HD 149 253-007	1	Accessories: Plastic sealing cap with cover, lead and plug
	9AH 161 786-017	12	Supporting frame for -317/-327
	8JD 156 150-807	1	Socket set (20 pcs.)
			 1x12V55W (H3) 8GH 002 090-133  1x24V70W (H3) 8GH 002 090-251
 	Ref. 17.5		Micro DE®-Xenon Premium (E1) 1120
	1F0 008 390-821	1	DE®-Xenon driving light set with black housing, alu-ring, designpanels, gas discharge bulbs and 12V ballast units
	1F0 008 390-301	1	DE®-Xenon driving light with black housing, alu-ring, designpanel, gas discharge bulb and 12V ballast unit
	1F0 160 197-001	1	Spare parts: Light unit
	5DV 007 760-631	1	Ballast unit, 12V
			 1x35W (D2S) 8GS 007 949-101


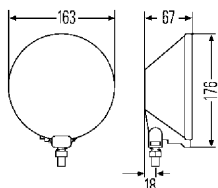

*) Micro work lights see page 4.97


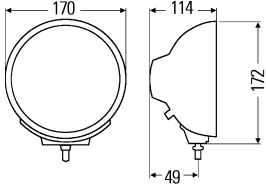


**) Supporting frame not supplied with light, see accessories



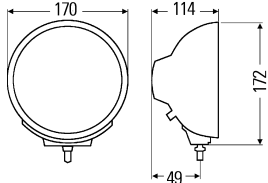




	Part no.	Pk.	For pendant mounting
 			<p>Cornering Light</p> <p>(E1) 1951</p>
	1N0 009 295-801	1	H7-fog-/tracking headlight set with 12V bulbs and tracking headlight unit
	1N0 009 295-011	1	H7-fog-/tracking headlight with bracket and 12V bulb, left
	1N0 009 295-021	1	right
	1N0 009 295-031	1	with supporting frame and 12V bulb, left
	1N0 009 295-037	36	
	1N0 009 295-041	1	right
	1N0 009 295-047	36	
	1N0 009 295-057	1	with supporting frame and 24V bulb, left
	1N0 009 295-067	1	right
	5DF 009 244-007	24	<p>Accessories: Tracking headlight unit</p> <p> 1x12V55W (H7) 8GH 007 157-121 1x24V70W (H7) 8GH 007 157-241</p>

	Part no.	Pk.	For upright mounting	
			Comet FF® 200	
			Ⓔ1 645	
	1N4 007 893-821	1	H3 fog light set with 12V bulbs, relay, cable set, on/off switch and ivory body	
	1N4 007 893-001	1	H3 fog light with 12V bulb and ivory body	
	1N4 007 893-181	1	without 12V bulb, with chrome-plated body	
	1N4 149 531-011	1	Spare parts: Light unit with 12V bulb for -821/-001	
	4RA 003 510-081	1	Normally-open relay for -821	
	6EH 007 946-001	1	Switch for -821	
	Ref. 37.5		Ⓔ1 646 Ref. 37.5 Ⓔ1 647 Ref. 17.5	
	1F4 007 893-811	1	H3 driving light set with 12V bulbs, relay, cable set, on/off switch and ivory body	
	1F4 007 893-841	1	with 12V bulbs, relay, cable set, on/off switch and basalt grey body	
	1F4 007 893-021	1	H3 driving light with 12V bulb and ivory body	
	1F4 007 893-081	1	with 12V bulb and basalt grey body	
	1F4 007 893-191	1	without 12V bulb, with chrome-plated body	
	Ref. 17.5		H3 driving light set with 12V bulbs, relay, cable set, on/off switch and ivory body	
	1F4 007 893-921	1	with 12V bulbs, relays, cable set, on/off switch and basalt grey body	
	1F4 007 893-201	1	H3 driving light without 12V bulb, with chrome-plated body	
	1F4 007 893-241	1	without 12V bulb, with chrome-plated body and blue lens	
	1F4 149 537-011	1	Spare parts: Light unit with 12V bulb for -811/-841/-021/-081	
	1F4 162 883-011	1	for -241	
	1F4 160 300-011	1	Light unit without 12V bulb for -191	
	1F4 160 302-011	1	for -201	
	4RA 003 510-081	1	Normally-open relay for -811/-841/-921/-911	
	6EH 007 946-001	1	Switch for -811/-841/-921/-911	
				 1x12V55W (H3) 8GH 002 090-133


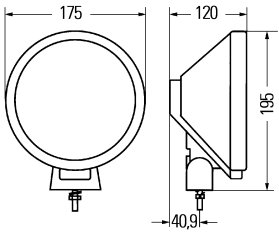


 	<p>Part no.</p> <p>Ref. 37.5</p> <p>1F4 007 893-871</p> <p>1F4 007 893-141</p> <p>1F4 157 022-011</p> <p>5DV 007 760-631</p>	<p>Pk.</p> <p>1</p> <p>1</p> <p>1</p> <p>1</p> <p>1</p> <p>1</p>	<p>For upright mounting</p> <p>Comet 200 Xenon</p> <p>With antracit body, silver coloured rim.</p> <p>Ⓔ1 646</p> <p>Xenon driving light set, gas discharge bulbs and 12V ballast unit</p> <p>Xenon driving light, gas discharge bulb and 12V ballast unit</p> <p>Spare parts:</p> <p>Light unit</p> <p>Ballast unit, 12V</p>  1x35W (D2S) 8GS 007 949-101
 	<p>1N4 002 608-021</p> <p>1F4 002 608-001</p>	<p>1</p> <p>1</p>	<p>Classic 160</p> <p>With chrome-plated body.</p> <p>Ⓔ4 915</p> <p>H3 fog light, 12V</p> <hr/> <p>Ⓔ1 14521</p> <p>H3 driving light, 12V</p>  1x12V55W (H3) 8GH 002 090-133


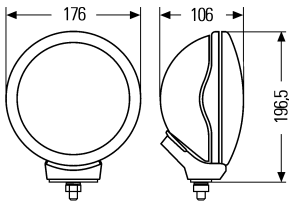




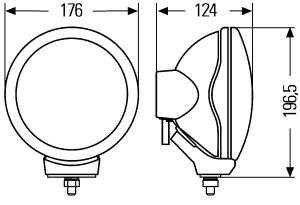
	Part no.	Pk.	For upright mounting
 			<p>Comet 500 Black plastic body. Ⓔ1 18213</p>
	1N4 005 750-801	1	H3 fog light set, 12V, with bulbs, relay, cable and on/off switch
	1N4 005 750-001	1	H3 fog light, 12V/24V, without bulb
	1N4 005 750-041	1	H3 fog light, 12V, without bulb, yellow
	1N4 135 224-011 6EG 001 567-041	1 10	<p>Spare parts: Light unit, white On/off switch for -801</p>
	Ref. 37.5		Ⓔ1 44404 Ref. 37.5 Ⓔ1 44405 Ref. 17.5
	Ref. 37.5 1F4 005 750-811	1	H3 driving light set, 12V, with bulbs, white
	Ref. 17.5 1F4 005 750-871	1	H3 driving light set, 12V, with bulbs, white
	Ref. 37.5 1F4 005 750-301	1	H3 driving light, 12V, with bulb, white
	Ref. 17.5 1F4 005 750-071	1	H3 driving light, 12V, without bulb, white
	1F4 135 230-011	1	<p>Spare parts: Light unit for -811</p>  <p>1x12V55W (H3) 8GH 002 090-133</p>


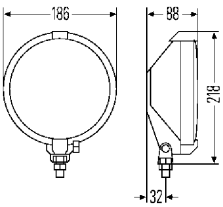




	Part no.	Pk.	For upright mounting
 	<p>Ref. 37.5</p> <p>1F1 009 094-041</p>	<p>1</p>	<p>Luminator Compact CELIS®</p> <p>Black die-cast zinc body, rim and bracket. Lens with clear-glass look.</p> <p>(E1) 1901</p> <p>H1 driving light, 12V/24V, with CELIS® side light incl. LEDs, without bulb</p>
	<p>Ref. 37.5</p> <p>1F1 009 094-051</p> <p>Ref. 17.5</p> <p>1F1 009 094-091</p> <p>1F1 161 825-021</p> <p>1F1 161 825-041</p> <p>9AG 161 844-011</p> <p>9AG 161 844-021</p>	<p>1</p> <p>1</p> <p>1</p> <p>1</p> <p>1</p> <p>1</p>	<p>Chrome-plated die-cast zinc body, rim and bracket. Lens with clear-glass look.</p> <p>H1 driving light, 12V/24V, with CELIS® side light incl. LEDs, without bulb</p> <p>H1 driving light, 12V/24V, with CELIS® side light incl. LEDs, without bulb</p> <p>Spare parts:</p> <p>Light unit for -041/-051 for -091</p> <p>Rim black chrome-plated</p> <p> 1x12V55W (H1) 8GH 002 089-133 1x24V70W (H1) 8GH 002 089-251</p>

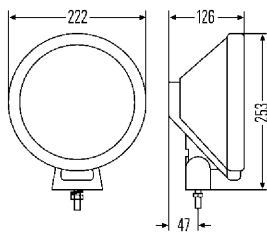
	Part no.	Pk.	For upright mounting
	1N3 009 094-001 Ref. 37.5 1F3 009 094-021 Ref. 17.5 1F3 009 094-061	1 1 1	Luminator Compact Black die-cast zinc body, rim and bracket. Lens with clear-glass look. (E1) 1901 H7 fog light, 12V/24V (E1) 1901 Ref. 37.5 (E1) 1902 Ref. 17.5 H1 driving light, 12V/24V H1 driving light, 12V/24V
	1N3 009 094-011 Ref. 37.5 1F3 009 094-031 1F3 009 094-171 Ref. 17.5 1F3 009 094-071	1 1 1	Chrome plated die-cast zinc body, rim and bracket. Lens with clear-glass look. (E1) 1901 H7 fog light, 12V/24V (E1) 1901 Ref. 37.5 (E1) 1902 Ref. 17.5 H1 driving light, 12V/24V with blue lens, 12V/24V H1 driving light, 12V/24V
	1N3 161 825-001 1F3 161 825-011 1F3 161 825-031 1F3 161 825-081 9AG 161 844-011 9AG 161 844-021	1 1 1 1 1 1	Spare parts: Light unit for -001/-011 for -021/-031 for -061/-071 for -171 Rim black chrome-plated  1x12V55W (H1) 8GH 002 089-133  1x24V70W (H1) 8GH 002 089-251  1x12V55W (H7) 8GH 007 157-121  1x24V70W (H7) 8GH 007 157-241

		<p>Part no.</p> <p>Ref. 37.5</p> <p>1F0 010 186-001</p> <p>1F0 172 787-011 9AG 172 638-001</p>	<p>Pk.</p> <p>1</p> <p>1</p> <p>1</p> <p>1</p>	<p>For upright mounting</p> <p>Luminator X Xenon</p> <p>Black die-cast zinc body, chrome-plated rim. Lens with clear-glass look.</p> <p>Ⓔ4 0009</p> <p>Xenon driving light with gas discharge bulb and 12V ballast unit integrated into body</p> <p>Spare parts: Light unit Rim</p> <p> 1x35W (D1S) 8GS 009 028-001</p>
		<p>Ref. 37.5</p> <p>1F3 009 094-142</p> <p>1F3 161 825-071 9AG 161 844-011</p>	<p>1</p> <p>1</p>	<p>Luminator Compact Xenon</p> <p>Black die-cast zinc body, rim and bracket. Lens with clear-glass look.</p> <p>Ⓔ1 2087</p> <p>Xenon driving light with gas discharge bulb and 12V ballast unit</p> <p>Spare parts: Light unit Rim</p> <p> 1x35W (D1S) 8GS 009 028-001</p>
		<p>Ref. 37.5</p> <p>1F3 009 094-311</p> <p>9AG 161 844-031</p>	<p>1</p> <p>1</p>	<p>Black die-cast zinc body and bracket. Chrome-plated rim. Lens with clear-glass look.</p> <p>Ⓔ1 2087</p> <p>Xenon driving light with gas discharge bulb and 12V ballast unit integrated into body</p> <p>Spare parts: Rim</p> <p> 1x35W (D1S) 8GS 009 028-001</p>

	Part no.	Pk.	For upright mounting
 	1N3 009 390-001	1	Rallye 3000 Compact Black plastic body, silver coloured rim with chrome applications. Lens with clear-glass look. (E1) 1901 H7 fog light, 12V/24V, without bulb
	Ref. 37.5		(E1) 1901 Ref. 37.5 (E1) 1902 Ref. 17.5
	1F3 009 390-011	1	H1 driving light, 12V/24V, without bulb
	1F3 009 390-051	1	with blue lens, 12V/24V, without bulb
	Ref. 17.5		
	1F3 009 390-031	1	H1 driving light, 12V/24V, without bulb
	Ref. 37.5		
	1F1 009 390-021	1	H1 driving light, 12V/24V, with CELIS® side light incl. LEDs, without bulb
	Ref. 17.5		
	1F1 009 390-041	1	H1 driving light, 12V/24V, with CELIS® side light incl. LEDs, without bulb
	1N3 161 825-001 1F3 161 825-011 1F3 161 825-081 1F3 161 825-031 1F1 161 825-021 9AG 162 940-001	Spare parts: Light unit for -001 for -011 for -051 for -031 for -021 Rim	
		 1x12V55W (H1) 8GH 002 089-133 1x24V70W (H1) 8GH 002 089-251  1x12V55W (H7) 8GH 007 157-121 1x24V70W (H7) 8GH 007 157-241	

	Part no.	Pk.	For upright mounting
	<p>Ref. 37.5</p> <p>1F5 008 273-001</p> <p>1F5 008 273-071</p>	<p>1</p> <p>1</p>	<p>Rallye 1000 FF®</p> <p>With black/silver coloured body. Lens with clear-glass look.</p> <p>(E1) 999</p> <p>H1 driving light, 12V/24V, without side light</p> <p>with side light</p>
	<p>Ref. 17.5</p> <p>1F5 008 273-011</p> <p>8HG 157 007-001</p>	<p>1</p> <p>1</p>	<p>H1 driving light, 12V/24V, without side light</p> <p>Accessories:</p> <p>Holder with gasket for 90° mounting</p> <p> 1x12V55W (H1) 8GH 002 089-133 1x24V70W (H1) 8GH 002 089-251</p> <p> 1x12V5W (W5W) 8GP 003 594-121 1x24V5W (W5W) 8GP 003 594-251</p>
	<p>Ref. 37.5</p> <p>1F5 008 273-041</p> <p>1F5 154 875-011</p> <p>5DV 007 760-631</p>	<p>1</p> <p>1</p>	<p>Rallye 1000 Xenon</p> <p>Black/red body. Lens with clear-glass look.</p> <p>(E1) 999</p> <p>Xenon driving light with gas discharge bulb and 12V ballast unit</p> <p>Spare parts:</p> <p>Light unit</p> <p>Ballast unit, 12V</p> <p> 1x35W (D2S) 8GS 007 949-101</p>
			

		Part no.	Pk.	For upright or pendant mounting
 		1N7 004 700-281	1	Rallye 1000 Black plastic body and rim. (E1) 8390 H3 fog light, with rim and 12V bulb, white  1x12V55W (H3) 8GH 002 090-133
		Ref. 17.5		(E1) 34553 (E1) 348
		1F7 004 700-321	1	H2 driving light, 12V, with rim, without bulb, white
		Ref. 37.5		(E1) 34518
		1F7 004 700-391	1	H2 driving light, 12V, with rim, without bulb, white
		1F7 004 700-031	1	with 12V bulb, without rim, white
		1F7 004 700-071	1	with 12V bulb, without rim, yellow
 		Ref. 17.5		(E1) 34553 (E1) 348
		1F7 004 700-431	1	H2 driving light, 12V, with black lens (Colour-Design), and rim, without bulb, white
		1F7 146 713-001	1	Spare parts: Light unit  1x12V55W (H2) 8GH 002 857-121



Part no. **Pk.** **For upright or pendant mounting**

Rallye 3000

Black plastic body and rim.

(E1) 18245

1N8 006 800-001

1

H3 fog light, 12V/24V

1x12V55W (H3) 8GH 002 090-133
 1x24V70W (H3) 8GH 002 090-251

Ref. 37.5

(E1) 44484 Ref. 37,5 (E1) 303 Ref. 17,5

1F8 006 800-191

1

H1 driving light, 12V/24V, with side light

1F8 006 800-301

1

H1 driving light, 12V/24V, lens with clear-glass look, without side light

1F8 006 800-311

1

lens with clear-glass look, with side light

Ref. 17.5

1F8 006 800-181

1

H1 driving light, 12V/24V, lens with clear-glass look, without side light

1F8 006 800-361

1

lens with clear-glass look, without side light

1F8 006 800-341

1

lens with clear-glass look, with side light

1F8 006 800-401

1

lens with clear-glass look, with CELIS® side light, incl. LEDs

Rallye 3000 Blue

Black plastic body, silver lens-retaining rim with blue stripes.

Ref. 37.5

1F8 006 800-221

1

H1 driving light, 12V/24V, with blue lens and side light

1F8 006 800-321

1

blue lens with clear-glass look, with side light

Ref. 17.5

1F8 006 800-331

1

blue lens with clear-glass look, without side light

1F8 006 800-351

1

blue lens with clear-glass look, with side light

Spare parts:

Light unit

1F8 147 077-011

1

for -191

1F8 162 872-011

1

for -301

1F8 162 873-011

1

for -311

1F8 157 042-011

1

for -221

1F8 162 874-011

1

for -321

1F8 165 940-011

1

for -331

1F8 165 941-011

1

for -341

1F8 165 942-011

1

for -351

1F8 165 943-011

1

for -361

1F8 161 326-011

1

for -401

Lens-retaining rim

9AG 141 819-001

6

for -011/-181/-191

9AG 141 819-011

6

for -221/-321

9AG 141 819-041

1

for -301/-311/-331/-341/-351/-361

9AG 162 938-001

1

for -401

Accessories:

8HG 116 741-801

1

Bracket for two-point fixing (2 pcs.)


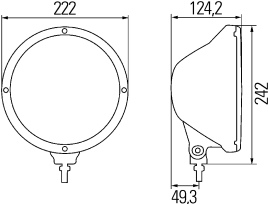



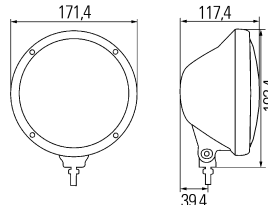

8KA 002 309-811





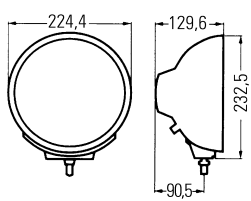




1



Cable set




1x12V55W (H1) 8GH 002 089-133
 1x24V70W (H1) 8GH 002 089-251

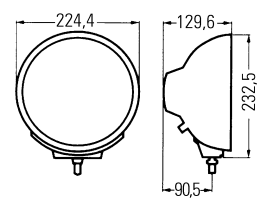
1x12V5W (W5W) 8GP 003 594-121
 1x24V5W (W5W) 8GP 003 594-251

 	<p>Part no.</p> <p>Ref. 37.5</p> <p>1F8 009 797-021</p> <p>1F8 009 797-031</p> <p>Ref. 17.5</p> <p>1F8 009 797-121</p> <p>1F8 009 797-131</p> <p>9AG 168 666-001</p>	<p>Pk.</p> <p>For upright or pendant mounting</p> <p>Rallye 3003</p> <p>Black body, silver lens-retaining rim.</p> <p>Ⓔ1 1928 Ref. 37.5 Ⓔ1 2254 Ref. 17.5</p> <p>H1 driving light, 12V/24V, lens with clear-glass look, with side light</p> <p>blue lens with clear-glass look, with side light</p> <p>H1 driving light, 12V/24V, lens with clear-glass look, with side light</p> <p>blue lens with clear-glass look, with side light</p> <p>Spare parts:</p> <p>Lens-retaining rim</p> <p> 1x12V55W (H1) 8GH 002 089-133 1x24V70W (H1) 8GH 002 089-251</p> <p> 1x12V5W (W5W) 8GP 003 594-121 1x24V5W (W5W) 8GP 003 594-251</p>
 	<p>Ref. 37.5</p> <p>1F3 010 119-011</p> <p>1F3 010 119-021</p> <p>Ref. 17.5</p> <p>1F3 010 119-001</p>	<p>Rallye 3003 Compact</p> <p>Black body, silver lens-retaining rim.</p> <p>Ⓔ1 1902</p> <p>H1 driving light, 12V/24V, lens with clear-glass look</p> <p>blue lens with clear-glass look</p> <p>H1 driving light, 12V/24V, lens with clear-glass look</p> <p> 1x12V55W (H1) 8GH 002 089-133 1x24V70W (H1) 8GH 002 089-251</p>


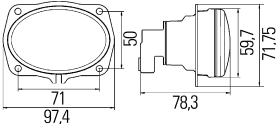



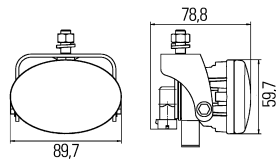



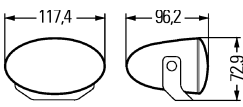

	Part no.	Pk.	For upright mounting
	1N8 007 560-031 1N8 148 103-011 9AG 147 939-011	1 1 1	Luminator-Metal Black die-cast zinc body and lens-retaining rim. (E1) 18245 H3 fog light, 12V/24V, with bracket Sparte parts: Light unit Lens-retaining rim  1x12V55W (H3) 8GH 002 090-133  1x24V70W (H3) 8GH 002 090-251 <hr/> (E1) 44484 Ref. 37.5 (E1) 303 Ref. 17.5
 	Ref. 37.5 1F8 007 560-041 1F8 007 560-301 Ref. 17.5 1F8 007 560-011 1F8 148 131-011 1F8 162 870-011 1F8 148 009-011 9AG 147 939-011 8HG 116 741-801 8KA 148 541-001	1 1 1 1 1 1 1 1 1 1 1	H1 driving light, 12V/24V, patterned cover lens, with side light lens with clear-glass look, with side light H1 driving light, 12V/24V, patterned cover lens, with side light Spare parts: Light unit for -041 for -301 for -011 Lens-retaining rim Accessories: Bracket for two-point fixing (2 pcs.) Cable set with relay for electrical connection, 12V  1x12V55W (H1) 8GH 002 089-133  1x24V70W (H1) 8GH 002 089-251  1x12V5W (W5W) 8GP 003 594-121  1x24V5W (W5W) 8GP 003 594-251

 	<p>Part no.</p> <p>Ref. 17.5</p> <p>1F8 007 560-201</p> <p>1F8 161 326-011</p>	<p>Pk.</p> <p>1</p> <p>1</p>	<p>For upright mounting</p> <p>Luminator-Metal CELIS®</p> <p>Black die-cast zinc body and lens-retaining rim.</p> <p>(E1) 1753</p> <p>H1 driving light, 12V24V, with side light in CELIS® technology incl. LEDs</p> <p>Spare parts: Light unit</p> <p> 1x12V55W (H1) 8GH 002 089-133 1x24V70W (H1) 8GH 002 089-251</p>
 	<p>Ref. 17.5</p> <p>1F8 007 560-211</p> <p>1F8 161 326-011</p>	<p>1</p> <p>1</p>	<p>Luminator-Chromium CELIS®</p> <p>Chrome-plate die-cast zinc body and lens-retaining rim. Lens with clear-glass look.</p> <p>(E1) 1753</p> <p>H1 driving light, 12V24V, with side light in CELIS® technology incl. LEDs</p> <p>Spare parts: Light unit</p> <p> 1x12V55W (H1) 8GH 002 089-133 1x24V70W (H1) 8GH 002 089-251</p>




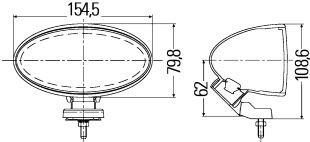


Part no.	Pk.	For upright mounting
Luminator-Chromium		
Chrome-plated, die-cast zinc body and lens-retaining rim.		
Ⓔ1 18245		
1N8 007 560-021	1	H3 fog light, 12V
1N8 148 103-011	1	Spare parts: Light unit
9AG 147 939-021	1	Lens-retaining rim
 1x12V55W (H3) 8GH 002 090-133 1x24V70W (H3) 8GH 002 090-251		
<hr/>		
Ⓔ1 44484 Ref. 37.5 Ⓔ1 303 Ref. 17.5		
Ref. 37.5		
1F8 007 560-051	1	H1 driving light, 12V, with side light and patterned cover lens
1F8 007 560-311	1	lens with clear-glass look
Ref. 17.5		
1F8 007 560-341	1	lens with clear-glass look, with side light, without bulb
<hr/>		
Ref. 37.5		
1F8 007 560-131	1	With side light and blue, patterned cover lens
1F8 007 560-321	1	with blue lens and clear-glass look
Ref. 17.5		
1F8 007 560-331	1	with side light and blue lens with clear-glass look
Spare parts:		
1F8 148 131-011	1	Light unit for -051
1F8 162 870-011	1	for -311
1F8 158 926-011	1	for -131
1F8 162 871-011	1	for -321
1F8 165 946-011	1	for -331
1F8 165 947-011	1	for -341
9AG 147 939-021	1	Lens-retaining rim
Accessories:		
8HG 116 741-801	1	Bracket for two-point fixing (2 pieces)
8KA 148 541-001	1	Cable set with relay for electrical connection, 12V
 1x12V55W (H1) 8GH 002 089-133 1x24V70W (H1) 8GH 002 089-251		
 1x12V5W (W5W) 8GP 003 594-121 1x24V5W (W5W) 8GP 003 594-251		


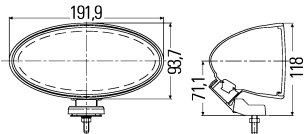





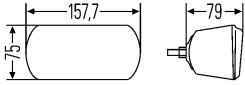

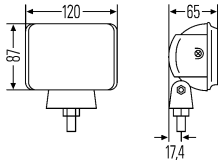



	Part no.	Pk.	For upright mounting
	<p>Ref. 37.5</p> <p>1F8 007 560-561</p> <p>1F8 007 560-571</p> <p>1F8 149 644-011</p> <p>9AG 147 939-031</p> <p>5DV 007 760-631</p> <p>5DV 007 810-171</p>	<p>1</p> <p>1</p> <p>1</p> <p>1</p> <p>1</p> <p>1</p>	<p>Luminator Xenon</p> <p>Red/black body, red lens-retaining rim and bracket made of die-cast cinc.</p> <p>(E1) 844</p> <p>Xenon driving light, with gas discharge bulb and 12V ballast unit</p> <p>with gas discharge bulb and 24V ballast unit</p> <p>Spare parts:</p> <p>Light unit</p> <p>Lens-retaining rim</p> <p>Ballast unit,</p> <p>12V</p> <p>24V</p> <p> 1x35W (D2S) 8GS 007 949-101</p>
	<p>Ref. 37.5</p> <p>1F8 007 560-621</p> <p>1F8 007 560-631</p> <p>1F8 165 949-011</p> <p>9AG 147 939-031</p> <p>5DV 008 855-001</p> <p>5DV 008 856-001</p>	<p>1</p> <p>1</p> <p>1</p> <p>1</p> <p>1</p> <p>1</p>	<p>(E1) 2255</p> <p>Xenon driving light, lens with clear-glass look, with gas discharge bulb and 12V ballast unit</p> <p>with gas discharge bulb and 24V ballast unit</p> <p>Spare parts:</p> <p>Light unit</p> <p>Lens-retaining rim</p> <p>Ballast unit,</p> <p>12V</p> <p>24V</p>
	<p>8HG 116 741-801</p>	<p>1</p>	<p>Accessories:</p> <p>Bracket for two-point fixing (2 pieces)</p> <p> 1x35W (D1S) 8GS 009 028-001</p>
 	<p>Ref. 37.5</p> <p>1F8 007 560-721</p> <p>1F8 007 560-731</p> <p>1F8 173 055-021</p> <p>9AG 147 939-061</p>	<p>1</p> <p>1</p> <p>1</p> <p>1</p>	<p>Xenon driving light, with gas discharge bulb and 12V ballast unit integrated into housing</p> <p>with 24V ballast unit integrated into housing</p> <p>Reservedele:</p> <p>Light unit</p> <p>Lens-retaining rim</p> <p> 1x35W (D2S) 8GS 007 949-101</p>


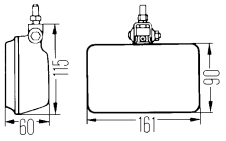


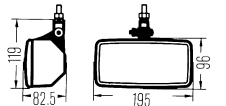


	Part no.	Pk.	Built-in lights
 	1NA 010 047-101 Ref. 12.5 1FA 010 047-001	1 1 1	FF® 40 Mounting with supporting frame in the vehicle front. (E1) 2529 H8 fog light, 12V, with bulb *) H11 driving light, 12V, with bulb *)  1x12V35W (H8) 8GH 008 356-121  1x12V55W (H11) 8GH 008 358-121
 	1NA 010 047-811 1NA 010 047-111 Ref. 12.5 1FA 010 047-801 1FA 010 047-011	1 1 1 1	For mounting (E1) 2529 H8 fog light set, 12V, with brackets, bulbs, relay with cable and accessories H8 fog light, 12V, with bracket and bulb *) H11 driving light set, 12V, with brackets, bulbs, relay with cable and accessories H11 driving light, 12V, with bracket and bulb*)  1x12V35W (H8) 8GH 008 356-121  1x12V55W (H11) 8GH 008 358-121
 	1NA 008 283-801 1NA 008 283-001 Ref. 12.5 1FA 008 283-811 1FA 008 283-011 1FA 008 283-861 1FA 008 283-031	1 1 1 1 1 1	For upright or pendant mounting FF® 50 Black plastic body. (E1) 1209 H7 fog light set, 12V, with bulbs, relay, switch and cable set H7 fog light, 12V, with bulb (E1) 1210 H7 driving light set, 12V, with bulbs, relay, switch and cable set H7 driving light, 12V, with bulb H7 driving light set, 12V, with blue lenses, bulbs, relay, switch and cable set H7 driving light, 12V, with blue lens and bulb  1x12V55W (H7) 8GH 007 157-121

Matching daytime running lights see page 5.113.

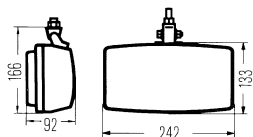
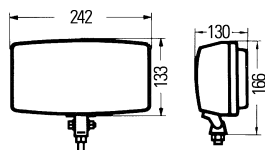
	Part no.	Pk.	For upright mounting
 			FF® 75 Black plastic body. (E1) 1211
	1NA 008 284-801	1	H7 fog light set, 12V, with bulbs, relay, switch and cable set
	1NA 008 284-001	1	H7 fog light, 12V, with bulb
	Ref. 12.5		(E1) 1212
	1FA 008 284-811	1	H7 driving light set, 12V, with bulbs, relay, switch and cable set
	Ref. 12.5		
	1FA 008 284-011	1	H7 driving light, 12V, with bulb
 			Comet FF® 100 (E1) 650
	1NA 007 891-821	1	H3 fog light set, 12V, basalt grey body, with bulbs, relay and on/off switch
	1NA 007 891-041	1	H3 fog light, 12V, basalt grey body, with bulb
	4RA 003 510-081	1	Spare parts: Normally-open relay for -821
	Ref. 17.5		(E1) 651
	1FA 007 891-811	1	H3 driving light set, 12V, ivory body, with bulbs, relay and on/off switch
	1FA 007 891-841	1	H3 driving light set, 12V, basalt grey body, with bulbs, relay and on/off switch
	1FA 007 891-061	1	H3 driving light, 12V, basalt grey body, with bulb
	1FA 149 504-011	1	Spare parts: Light unit with 12V bulb
	4RA 003 510-081	1	Normally-open relay for -811/-841  1x12V55W (H3) 8GH 002 090-133

	Part no.	Pk.	For upright or pendant mounting
	<p>1NB 007 892-821</p> <p>1NB 007 892-001</p> <p>1NB 007 892-041</p> <p>4RA 003 510-081</p>	<p>1</p> <p>1</p> <p>1</p> <p>1</p>	<p>Comet FF® 300</p> <p>Ⓔ1 648</p> <p>H3 fog light set, 12V, basalt grey body, with bulbs, relay and on/off switch</p> <p>H3 fog light, 12V, ivory body, with bulb</p> <p>H3 fog light, 12V, basalt grey body, with bulb</p> <p>Spare parts: Normally-open relay for -821</p>
	<p>Ref. 17.5</p>		<p>Ⓔ1 649</p>
	<p>1FB 007 892-811</p> <p>1FB 007 892-841</p> <p>1FB 007 892-011</p> <p>1FB 007 892-071</p> <p>1FB 007 892-131</p> <p>1FB 149 519-011</p> <p>1FB 162 881-011</p> <p>4RA 003 510-081</p>	<p>1</p> <p>1</p> <p>1</p> <p>1</p> <p>1</p> <p>1</p> <p>1</p> <p>1</p> <p>1</p>	<p>H3 driving light set, 12V, ivory body, with bulbs, relay and on/off switch</p> <p>H3 driving light set, 12V, basalt grey body, with bulbs, relay and on/off switch</p> <p>H3 driving light, 12V, ivory body, with bulb</p> <p>H3 driving light, 12V, basalt grey body, with bulb</p> <p>H3 driving light, 12V, basalt grey body, with blue lens, without bulb</p> <p>Spare parts: Light unit with 12V bulb for -811/-841/-011 without bulb for -131 Normally-open relay for -811/-841</p> <p> 1x12V55W (H3) 8GH 002 090-133</p>

	Part no.	Pk.	For upright mounting
 			Comet 300 (E1) 15
	1NB 007 360-011	1	H3 fog light, 12V, without bulb, left
	1NB 007 360-021	1	H3 fog light, 12V, without bulb, right
	Ref. 12.5		(E1) 44511
	1FB 007 360-031	1	H3 driving light, 12V, without bulb, left
 	1FB 007 360-041	1	H3 driving light, 12V, without bulb, right
			 1x12V55W (H3) 8GH 002 090-133  1x24V70W (H3) 8GH 002 090-251
			Micro FF® (E1) 122 (E1) 488
	1NA 007 133-801	1	H3 fog light set, 12V, with bulbs
	1NA 007 133-001	1	H3 fog light, 12V, without bulb
	6EG 001 567-041	10	On/off switch for -801
4RA 003 510-081	1	Normally-open relay for -801	
		Spare parts: On/off switch for -801 Normally-open relay for -801	
Ref. 12.5		(E1) 122 (E1) 488	
1FA 007 133-811	1	H3 driving light set, 12V, with bulbs	
1FA 007 133-021	1	H3 driving light, 12V, without bulb	
6EG 001 567-041	10	On/off switch for -811	
4RA 003 510-081	1	Normally-open relay for -811	
		Spare parts: On/off switch for -811 Normally-open relay for -811  12V55W (H3) 8GH 002 090-133	

	Part no.	Pk.	For upright or pendant mounting
 	<p>1NB 005 860-801</p> <p>1NB 005 860-001</p> <p>1NB 005 860-021</p> <p>1NB 137 001-021</p> <p>6EG 001 567-041</p>	<p>1</p> <p>1</p> <p>1</p> <p>2</p> <p>10</p>	<p>Comet 450</p> <p>Black plastic body.</p> <p>(E1) 18227</p> <p>H3 fog light set, 12V, with bulbs, relay with cable and switch, white</p> <p>H3 fog light, 12V, with bulb, white</p> <p>H3 fog light, 12V, with bulb, yellow</p> <p>Spare parts: Light unit, white On/off switch for -801</p>
	<p>Ref. 17.5</p> <p>1FB 005 860-831</p> <p>1FB 005 860-031</p> <p>1FB 005 860-061</p> <p>1FB 137 006-021</p>	<p>1</p> <p>1</p> <p>1</p> <p>2</p>	<p>(E1) 44442</p> <p>H3 driving light set, 12V, with bulbs and relay with cable, white</p> <p>H3 driving light, 12V, with bulb, white</p> <p>H3 driving light, 12V, with bulb, yellow</p> <p>Spare parts: Light unit, white</p> <p> 1x12V55W (H3) 8GH 002 090-133</p>
 	<p>1ND 003 590-401</p> <p>Ref. 17.5</p> <p>1FD 003 590-411</p> <p>1FD 135 198-011</p>	<p>1</p> <p>1</p> <p>1</p>	<p>For pendant mounting</p> <p>181 Chrome</p> <p>Chrome-plated plastic body.</p> <p>(E1) 18216</p> <p>H3 fog light, 12V/24V, without bulb</p> <p>(E1) 44410</p> <p>H3 driving light, 12V/24V, without bulb</p> <p>Spare parts: Light unit</p> <p> 1x12V55W (H3) 8GH 002 090-133  1x24V70W (H3) 8GH 002 090-251</p>

	Part no.	Pk.	For upright or pendant mounting
			Comet 550 Black plastic body. (E1) 18216
	1ND 005 700-841	1	H3 fog light set, 12V, with bulbs, relay with cable and switch, white
	1ND 005 700-001	1	H3 fog light, 12V, with bulb, white
	1ND 005 700-061	1	with hardened lens, 12V/24V, without bulb, white
	1ND 005 700-021	1	H3 fog light, 12V, with bulb, yellow
	6EG 001 567-041	10	Spare parts: Switch for -841
	Ref. 17.5		(E1) 44410
	1FD 005 700-851	1	H3 driving light set, 12V, with bulbs and relay with cable, white
	1FD 005 700-051	1	H3 driving light, 12V, without bulb, white
	1FD 005 700-301	1	H3 driving light, 12V, with bulb, white
1FD 005 700-031	1	H3 driving light, 12V, with bulb, yellow	
1FD 135 198-011	1	Spare parts: Light unit, white, for -851/-051	
		1x12V55W (H3) 8GH 002 090-133 1x24V70W (H3) 8GH 002 090-251	



Part no.

Pk.

For upright mounting

Jumbo 210 Xenon

Black/red body and red lens-retaining rim.

(E1) 880

Xenon driving light, with gas discharge bulb and 12V ballast unit

Ref. 37.5

1FE 002 537-471

1

1FE 002 537-461

1

with gas discharge bulb and 24V ballast unit

Spare parts:

1FE 152 896-011

1

Light unit

9AG 126 942-031

5

Lens-retaining rim

Ballast unit,

5DV 007 760-631

1

12V

5DV 007 810-171

1

24V



1x35W (D2S) 8GS 007 949-101

For upright or pendant mounting

Jumbo 210 Chrome

Silver body and lens-retaining rim.

(E4) 914

1NE 002 537-201

1

H3 fog light, 12V/24V, without bulb

9DF 112 246-001

1

Spare parts:

Light unit

(E1) 14520

1FE 002 537-191

1

H3 driving light, 12V/24V, without bulb

9DF 112 247-001

1


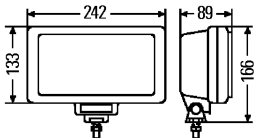

Spare parts:

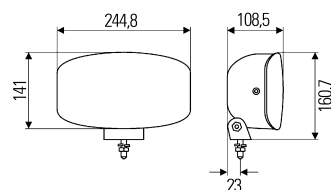
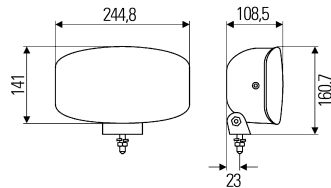
Light unit



1x12V55W (H3) 8GH 002 090-133

1x24V70W (H3) 8GH 002 090-251






	Part no.	Pk.	For upright or pendant mounting
			Jumbo 220 Black plastic body.
			(E1) 18231
	1NE 006 300-051	1	H3 fog light, 12V/24V, with black lens-retaining rim
	1NE 006 300-071	1	with black lens-retaining rim
	1NE 006 300-101	1	with black lens-retaining rim, yellow
	1NE 006 300-011	1	with chrome-plated lens-retaining rim
	1NE 138 555-011	1	Spare parts: Light unit for -051/-011
	1NE 138 575-011	1	for -101
	9AG 138 131-011	5	Lens-retaining rim, black
	9AG 138 131-001	5	chrome-plated
	Ref. 37.5		(E1) 44444 Ref. 37.5 (E1) 44445 Ref. 17.5
	1FE 006 300-041	1	H3 driving light, 12V/24V, with black lens-retaining rim
	1FE 006 300-121	1	with black lens-retaining rim
	Ref. 17.5		
	1FE 006 300-081	1	with black lens-retaining rim
	Ref. 37.5		
	1FE 006 300-001	1	with chrome-plated lens-retaining rim
	1FE 006 300-261	1	with blue lens
	1FE 138 520-011	1	Spare parts: Light unit for -041/-001/-121
	1FE 158 578-011	1	for -081
1FE 158 877-011	1	for -261	
9AG 138 131-011	5	Lens-retaining rim, black	
9AG 138 131-001	5	chrome-plated	
			 1x12V55W (H3) 8GH 002 090-133 1x24V70W (H3) 8GH 002 090-251


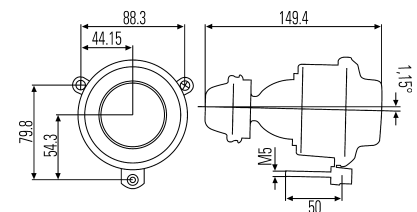

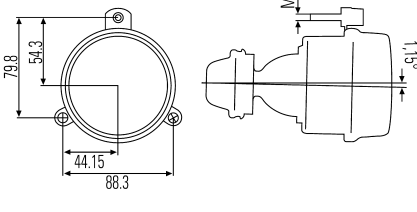




Part no.	Pk.	For upright or pendant mounting
		Jumbo 320 FF®
		Black body, lens with clear-glass look.
		(E1) 1689
1NE 008 773-031	1	H7 fog light, 12V/24V
1NE 161 643-011	1	Spare parts: Light unit
Ref 37.5		(E1) 1655 Ref. 37.5 (E1) 1740 Ref. 17.5
1FE 008 773-001	1	H7 driving light, 12V/24V, without side light
1FE 008 773-041	1	with side light in bulb technology
1FE 008 773-081	1	with side light in LED-technology incl. LEDs
1FE 008 773-061	1	with blue lens, without side light
Ref. 17.5		
1FE 008 773-011	1	without side light
		Spare parts: Light unit
1FE 161 641-011	1	for -001
1FE 161 641-021	1	for -061
1FE 161 642-011	1	for -011
1FE 161 644-011	1	for -041
		1x12V55W (H7) 8GH 007 157-121 1x24V70W (H7) 8GH 007 157-241
		1x12V5W (W5W) 8GP 003 594-121 1x24V5W (W5W) 8GP 003 594-251
		Jumbo 320 Xenon
		(E1) 1741
Ref. 37.5		
1FE 008 773-021	1	Xenon driving light with gas discharge bulb and 12V ballast unit. Side light in LED technology, incl. LEDs.
1FE 008 773-051	1	with gas discharge bulb and 24V ballast unit. Side light in LED technology, incl. LEDs.
1FE 161 576-011	1	Spare parts: Light unit
5DV 008 855-001	1	Ballast unit, 12V
5DV 008 856-001	1	24V
		1x35W (D2S) 8GS 007 949-101

Accessories for Fog Lights and Driving Lights




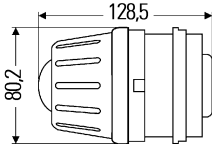


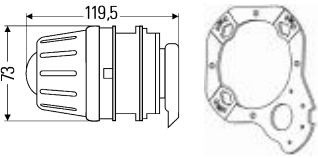
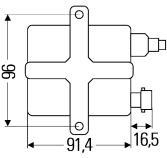


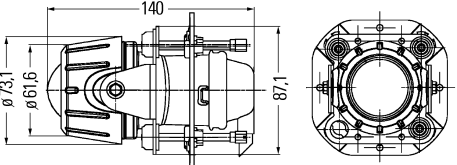

	<p>Part no.</p> <p>6ZN 160 705-001</p> <p>6ZN 160 705-011</p>	<p>Pk.</p> <p>1</p> <p>1</p>	<p>Universal radio remote control unit</p> <p>The Hella remote control is ECE type tested and carries the RF suppression symbol. The alternating code feature excludes interference with other remote controls. The convenient way to switch auxiliary lights by remote control. Maximum switching capacity: 2 x 12W. With green control diode for on-off switching control.</p> <p>Universal radio remote control unit, 12V</p> <p>Universal radio remote control unit, 24V</p>
	<p>8HG 116 741-801</p>	<p>1</p>	<p>Two-point fixing</p> <p>Fixing system made of stainless steel which can be shortened, bent or twisted as required. Length: 80 - 240 mm.</p> <p>Two-point fixing (2 pieces)</p>
	<p>8KA 002 309-811</p>	<p>1</p>	<p>Universal lead set</p> <p>For 1 to 2 auxiliary lights. Including 16A relay with fuse, leads and installation material.</p> <p>Universal lead set</p>
	<p>4RA 003 510-361</p> <p>4RA 003 510-651</p>	<p>1</p> <p>1</p>	<p>Normally-open relays</p> <p>With bracket and blade-type fuse.</p> <p>With three 6.3 mm blade terminal contacts. Max. load (at +80 °C): 15A at 12V and 24V.</p> <p>Normally-open relay, 4-pin 12V</p> <p>Normally-open relay, 4-pin 24V</p>
	<p>6EH 007 946-001</p>	<p>1</p>	<p>On-off switch</p> <p>Rocker switch with green warning light and 12V bulb.</p> <p>With three 6.3 mm blade terminal contacts. Max. load: 10A at 12V.</p> <p>On-off switch</p>


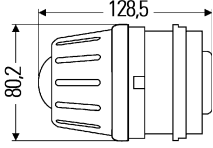


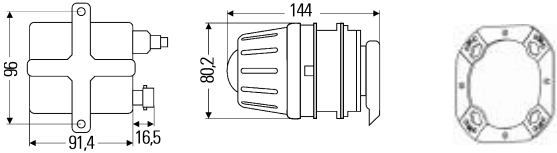


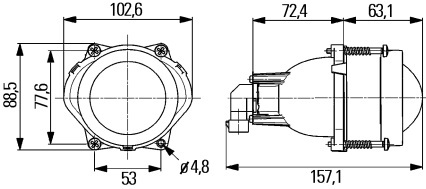

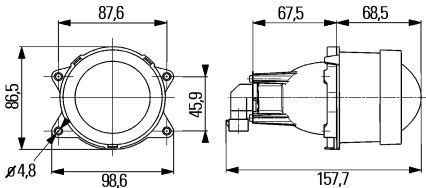



	Part no.	Pk.	Built-in fog lights
 	<p>1NL 007 186-061 1NL 007 186-067</p>	<p>1 30</p>	<p>With H3 light. For flush mounting in front apron or front spoiler. Mounting depth: 105 mm. With 12V bulb. Light aperture: 54 mm dia.</p> <p>Ⓔ 20</p> <p>DE®-H3 fog light with plastic sealing cap</p>
	<p>1NL 007 186-027</p> <p>9GH 147 009-007 9HD 149 253-007 8JD 156 150-807</p>	<p>1 30 1 1</p>	<p>Light aperture: 80 mm dia.</p> <p>Without plastic sealing cap</p> <p>Accessories: Rubber sealing cap Plastic sealing cap with cover, lead and plug Socket set (20 pcs.)</p>
	<p>1NL 007 186-047</p> <p>9HD 149 253-007 8JD 156 150-807</p>	<p>1 1 1</p>	<p>Light aperture: 80 mm dia.</p> <p>With 24V bulb, plastic sealing cap, cover and lead</p> <p>Spare parts for -047: Plastic sealing cap with cover and lead</p> <p>Accessories: Socket set (20 pcs.)</p> <p> 1x12V55W (H3) 8GH 002 090-133  1x24V70W (H3) 8GH 002 090-251</p>

Headlights

44 mm dia.




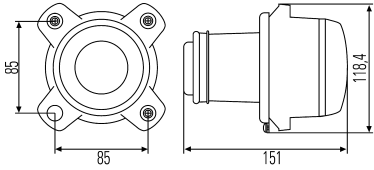


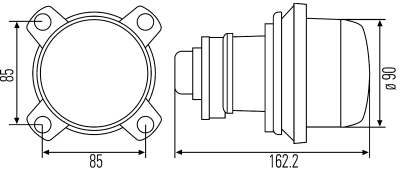


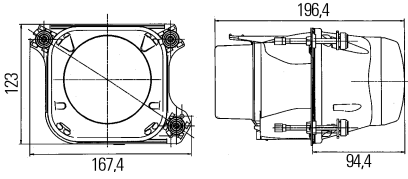

	Part no.	Pk.	Built-in headlights
 	<p>1ML 009 071-011 1</p> <p>1ML 009 071-037 24</p>		<p>Premium Module</p> <p>H7 dipped-beam headlight, with bulb. Light aperture: 44 mm dia.</p> <p>(E1) 1904</p> <p>DE@-H7 headlight, 12V</p> <p>24V</p> <p> 1x12V55W (H7) 8GH 007 157-121 1x24V70W (H7) 8GH 007 157-241</p>
  	<p>1ML 009 071-057 12</p> <p>1ML 009 071-077 12</p> <p>5DV 007 760-631 1 5DV 007 810-171 1</p> <p>6NM 007 282-221 1 6NM 007 282-231 1 9AH 161 784-017 12</p>		<p>With gas discharge bulb.</p> <p>Xenon headlight with 12V ballast unit</p> <p>with 24V ballast unit</p> <p>Spare parts: Ballast unit, 12V 24V</p> <p>Accessories: Actuator for headlight levellers for -017 for -057 Supporting frame</p> <p> 1x35W (D2S) 8GS 007 949-101</p>
 	<p>1NL 009 071-317 24</p> <p>1NL 009 071-327 24</p> <p>9AH 161 786-017 12 9GH 147 009-007 30 9HD 149 253-007 1 8JD 156 150-807 1</p>		<p>With H3 bulb.</p> <p>(E1) 877</p> <p>DE@-H3 fog light, 12V</p> <p>24V</p> <p>Accessories: Supporting frame Rubber cap Plastic cap Socket set, 2-pole, for plastic cap</p> <p> 1x12V55W (H3) 8GH 002 090-133 1x24V70W (H3) 8GH 002 090-251</p>

Part no.	Pk.	Built-in headlights
 	<p>Ref. 12.5</p> <p>1KL 009 486-001 1</p>	<p>Premium Module</p> <p>H9 driving light with 12V bulb. Light aperture: 44 mm dia.</p> <p>(E1) 1903</p> <p>DE®-H9 driving light</p>  1x12V65W (H9) 8GH 008 357-001
 	<p>Ref. 17.5</p> <p>1F0 008 390-317 12</p> <p>1F0 008 390-327 12</p> <p>5DV 007 760-631 1</p> <p>5DV 007 810-171 1</p> <p>9AH 161 786-017 12</p> <p>8HG 153 152-001 1</p>	<p>With gas discharge bulb.</p> <p>(E1) 1120</p> <p>DE®-Xenon driving light with 12V ballast unit</p> <p>with 24V ballast unit</p> <p>Spare parts: Ballast unit, 12V 24V</p> <p>Accessories: Supporting frame Holder with adjusting devices</p>  1x35W (D2S) 8GS 007 949-101
   	<p>1ML 998 570-011 1</p> <p>Ref. 12.5</p> <p>1KL 998 570-021 1</p> <p>1KL 998 570-031 1</p> <p>8JA 990 295-217 10</p>	<p>Modul 60</p> <p>DE® dipped-beam headlight with 12V bulb. Light aperture: 60 mm dia.</p> <p>(E4) 10894</p> <p>DE® dipped-beam headlight</p>  1x12V60W (HB3) 8GH 005 635-121 <hr/> <p>DE® driving light with 12V bulb.</p> <p>(E4) 10892</p> <p>DE® driving light without side light</p> <p>with side light</p> <p>Accessories: Plug for HB3 bulb</p>  1x12V60W (HB3) 8GH 005 635-121  1x12V3W (W3W) 8GP 003 594-141

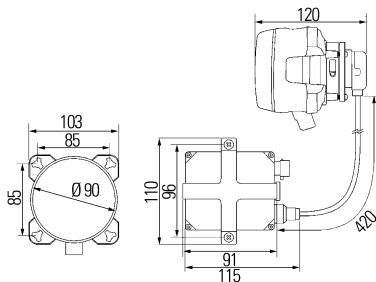
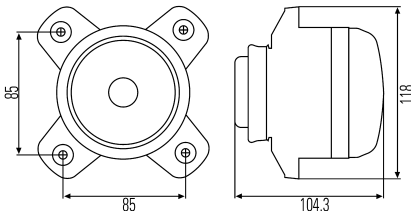
Headlights

90 mm dia.



	Part no.	Pk.	Built-in headlights
 	<p>1LL 008 193-117</p> <p>1LL 008 193-127</p> <p>9GH 152 654-007</p> <p>9AH 157 659-007</p>	<p>36</p> <p>36</p> <p>1</p> <p>1</p>	<p>H7 dipped-beam headlight. Lens with reflector bonded. Light aperture: 90 mm dia.</p> <p>E1 917</p> <p>DE-H7 headlight with 12V bulb</p> <p>with 24V bulb</p> <p>Accessories: Rubber cap Supporting frame</p> <p> 1x12V55W (H7) 8GH 007 157-121 1x24V70W (H7) 8GH 007 157-241</p>
 	<p>1LL 008 194-017</p> <p>1LL 008 194-051</p> <p>1LL 158 060-031</p> <p>5DV 007 760-631</p> <p>5DV 007 810-171</p> <p>8HG 151 866-001</p> <p>8JD 156 151-807</p> <p>9AH 157 659-007</p>	<p>8</p> <p>1</p> <p>1</p> <p>1</p> <p>1</p> <p>1</p> <p>5</p> <p>1</p> <p>1</p>	<p>Xenon dipped-beam headlight with gas discharge bulb and ballast unit.</p> <p>Xenon headlight, 12V, for Japan</p> <p>24V</p> <p>Spare parts: Light unit without ballast unit and gas discharge bulb Ballast unit, 12V 24V Holder for ballast unit</p> <p>Accessories: Socket set (20 pcs.) Supporting frame</p> <p> 1x35W (D2S) 8GS 007 949-101</p>
 	<p>Ref. 12.5</p> <p>1LL 008 934-011</p> <p>1LL 008 934-031</p> <p>5DV 008 855-001</p> <p>5DV 008 855-007</p> <p>5DV 008 856-001</p> <p>5DV 008 856-007</p> <p>8JD 162 211-801</p> <p>8JA 990 295-127</p> <p>8KB 990 299-221</p> <p>8KB 990 299-231</p>	<p></p> <p>1</p> <p>1</p> <p>1</p> <p>24</p> <p>1</p> <p>24</p> <p>1</p> <p>10</p> <p>1</p> <p>1</p>	<p>Bi-Xenon® dipped- and main beam headlight. With gas discharge bulb. Light aperture: 90 mm dia.</p> <p>E1 1677</p> <p>Bi-Xenon headlight with 12V ballast unit</p> <p>with 24V ballast unit</p> <p>Spare parts: Ballast unit, 12V 24V</p> <p>Accessories: Socket set (20 pcs.) DEUTSCH plug, 2-pole Cable, 3100 mm, with DEUTSCH plug, relay and fuse, 12V 24V</p> <p> 1x35W (D2S) 8GS 007 949-101</p>

Matching lights 008 221-..., see page 5.57.


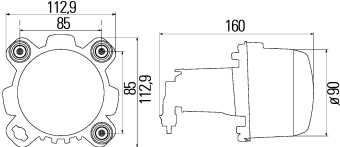




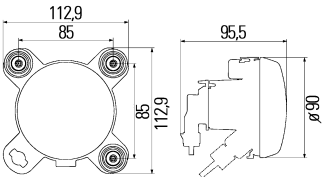








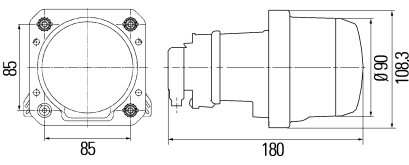


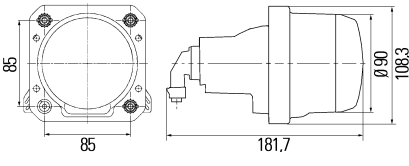

Part no.	Pk.	Built-in headlights
Ref. 12.5		FF@-H7 main-beam headlight with side light. Lens with reflector bonded. Light aperture: 90 mm dia.
		(E1) 917
1K0 008 191-001	1	FF@-H7 headlight with 12V bulb
1K0 008 191-007	36	
1K0 008 191-021	1	with 24V bulb
1K0 008 191-027	36	
1K0 008 191-212	1	with 24V Heavy Duty bulb for trucks and buses
Ref. 12.5		Without side light.
1K0 008 191-011	1	FF@-H7 headlight with 12V bulb
1K0 008 191-017	36	
1K0 008 191-041	1	with 24V bulb
1K0 008 191-047	36	
9GH 152 654-007	1	Accessories:
8JD 156 150-807	1	Sealing cap
9AH 157 659-007	1	Socket set for 007/-021/-027 (20 pcs.)
		Supporting frame
		1x12V55W (H7) 8GH 007 157-121
		1x24V70W (H7) 8GH 007 157-241
		1x12V4W (T4W) 8GP 002 067-121
		1x24V4W (T4W) 8GP 002 067-241
Ref. 37.5		Xenon main-beam headlight with side light and gas discharge bulb.
1K0 008 192-001	1	Xenon headlight with 12V ballast unit
1K0 008 192-007	8	
1K0 008 192-027	1	with 24V ballast unit
Ref. 37.5		Without side light.
1K0 008 192-011	1	Xenon headlight with 12V ballast unit
1K0 008 192-017	8	
1K0 158 059-061	1	Spare parts:
		Light unit for -007/-027 without gas discharge bulb and ballast unit
1K0 158 059-071	1	Light unit for -017 without gas discharge bulb and ballast unit
5DV 007 760-631	1	Ballast unit
5DV 007 810-171	1	12V
8HG 151 866-001	5	24V
		Holder for ballast unit
8JD 156 150-807	1	Accessories:
8JD 156 151-807	1	Socket set for side light (20 pcs.)
9AH 157 659-007	1	Socket set for ballast unit (20 pcs.)
		Supporting frame
		1x35W (D2S) 8GS 007 949-101
		1x12V4W (T4W) 8GP 002 067-121
		1x24V4W (T4W) 8GP 002 067-241

Headlights

90 mm dia.




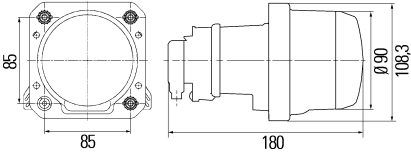


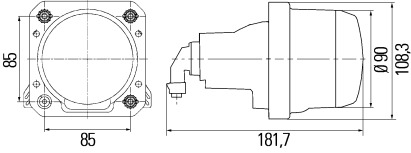

	Part no.	Pk.	Built-in headlights
  	<p>1ML 247 042-027 36</p> <p>1ML 247 042-037 36</p> <p>6NM 007 282-221 1</p> <p>6NM 008 299-501 1</p> <p>8JD 156 151-807 1</p> <p>9AH 254 228-012 2</p> <p>9AH 254 228-017 36</p>		<p>H1 dipped-beam headlight. Reflector made of die cast aluminium with hardened lens bonded. Plug connector HB4. Light aperture: 90 mm dia. 3 attachment elements are enclosed.</p> <p>(E1) 2397</p> <p>DE@-H1 dipped-beam headlight with 12V bulb</p> <p>with 24V bulb</p> <p>Accessories: Headlight levelling, 12V 24V Plug set (HB4)</p> <p>Supporting frame</p> <p> 1x12V55W (H1) 8GH 002 089-133  1x24V70W (H1) 8GH 002 089-251</p>
  	<p>Ref. 12.5</p> <p>1K0 247 043-001 1</p> <p>1K0 247 043-007 36</p> <p>1K0 247 043-021 1</p> <p>1K0 247 043-027 36</p> <p>Ref. 12.5</p> <p>1K0 247 043-011 1</p> <p>1K0 247 043-017 36</p> <p>1K0 247 043-031 1</p> <p>1K0 247 043-037 36</p> <p>9AH 254 228-012 2</p> <p>9AH 254 228-017 36</p>		<p>H1 driving light with side light. Reflector made of die cast aluminium with hardened lens bonded. Plug connector HB4. Light aperture: 90 mm dia. 3 attachment elements are enclosed.</p> <p>(E1) 2397</p> <p>FF@-H1 driving light with 12V bulb</p> <p>with 24V bulb</p> <p>Without side light.</p> <p>FF@-H1 driving light with 12V bulb</p> <p>with 24V bulb</p> <p>Accessories: Supporting frame</p> <p> 1x12V55W (H1) 8GH 002 089-133  1x24V70W (H1) 8GH 002 089-251</p> <p> 1x12V4W (T4W) 8GP 002 067-121  1x24V4W (T4W) 8GP 002 067-241</p>


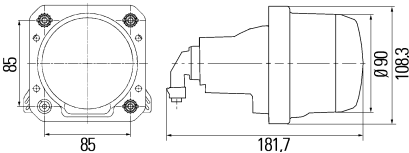


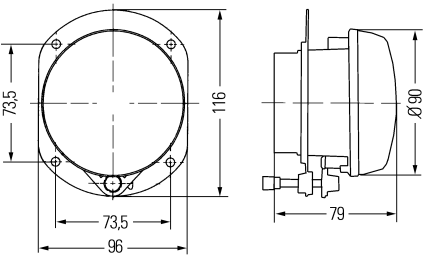


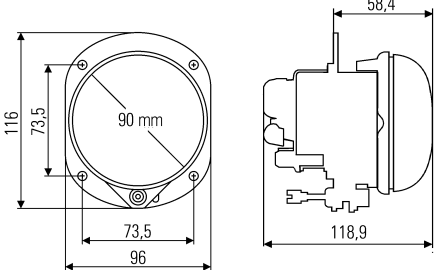

	Part no.	Pk.	Built-in headlights
 	<p>Ref. 20</p> <p>1AL 009 997-001</p> <p>1AL 009 997-041</p> <p>5DV 007 760-631</p> <p>9AH 169 580-011</p> <p>6NM 007 282-221</p> <p>8JD 156 151-807</p>	<p>1</p> <p>1</p> <p>1</p> <p>20</p> <p>1</p> <p>1</p>	<p>Bi-Xenon® dipped-beam headlight with gas discharge bulb, can be changed over to LES tourist solution (right hand drive). Reflector made of die-cast aluminium with hardened lens bonded. Light aperture: 90 mm dia. 3 attachment elements are enclosed.</p> <p>Ⓔ1 2484</p> <p>Bi-Xenon® headlight with 12V ballast unit</p> <p>with 24V ballast unit</p> <p>Spare parts: Ballast unit, 12V</p> <p>Accessories: Supporting frame Headlight levelling incl. bracket, 12V Plug set (HB4)</p> <p> 1x35W (D2S) 8GS 007 949-101</p>
 	<p>Ref. 12.5</p> <p>1AL 009 998-001</p> <p>1AL 009 998-041</p> <p>9AH 169 580-011</p> <p>6NM 007 282-221</p> <p>8JD 156 151-807</p>	<p>1</p> <p>1</p> <p>20</p> <p>1</p> <p>1</p>	<p>Bi-Halogen dipped-beam headlight, can be changed over to LES tourist solution (right hand drive). Reflector made of die-cast aluminium with hardened lens bonded. Light aperture: 90 mm dia.</p> <p>Ⓔ1 2484</p> <p>Bi-Halogen headlight with 12V bulb</p> <p>with 24V bulb</p> <p>Accessories: Supporting frame Headlight levelling incl. bracket, 12V Plug set (HB4)</p> <p> 1x12V55W (H7) 8GH 007 157-121</p>

Headlights

90 mm dia.






	Part no.	Pk.	Built-in headlights
 	<p>1LL 009 997-011</p> <p>1LL 009 997-051</p> <p>5DV 007 760-631</p> <p>9AH 169 580-011</p> <p>6NM 007 282-221</p> <p>8JD 156 151-807</p>	<p>1</p> <p>1</p> <p>1</p> <p>20</p> <p>1</p> <p>1</p>	<p>Bi-Xenon® dipped-beam headlight with gas discharge bulb, can be changed over to ES tourist solution (left hand drive). Reflector made of die-cast aluminium with hardened lens bonded. Light aperture: 90 mm dia. 3 attachment elements are enclosed.</p> <p>(E1) 2484</p> <p>Bi-Xenon® headlight with 12V ballast unit</p> <p>with 24V ballast unit</p> <p>Spare parts: Ballast unit, 12V</p> <p>Accessories: Supporting frame Headlight levelling incl. bracket, 12V Plug set (HB4)</p> <p> 1x35W (D2S) 8GS 007 949-101</p>
 	<p>1LL 009 998-011</p> <p>1LL 009 998-051</p> <p>9AH 169 580-011</p> <p>6NM 007 282-221</p> <p>8JD 156 151-807</p>	<p>1</p> <p>1</p> <p>20</p> <p>1</p> <p>1</p>	<p>Bi-Halogen dipped-beam headlight, can be changed over to ES tourist solution (left hand drive). Reflector made of die-cast aluminium with hardened lens bonded. Light aperture: 90 mm dia.</p> <p>(E1) 2484</p> <p>Bi-Halogen headlight with 12V bulb</p> <p>with 24V bulb</p> <p>Accessories: Supporting frame Headlight levelling incl. bracket, 12V Plug set (HB4)</p> <p> 1x12V55W (H7) 8GH 007 157-121</p>

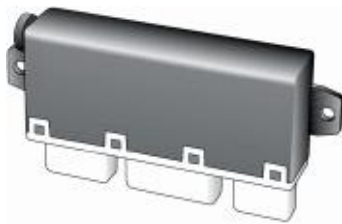



	Part no.	Pk.	Built-in headlights
 	<p>1ML 009 999-011</p> <p>1ML 009 999-051</p> <p>9AH 169 580-011</p> <p>6NM 007 282-221</p> <p>8JD 156 151-807</p>	<p>1</p> <p>1</p> <p>20</p> <p>1</p> <p>1</p>	<p>DE@-H7 dipped-beam headlight. Reflector made of die-cast aluminium with hardened lens bonded. Light aperture: 90 mm dia. 3 attachment elements are enclosed.</p> <p>Ⓔ1 2486</p> <p>DE@-H7 headlight with 12V bulb</p> <p>with 24V bulb</p> <p>Accessories: Supporting frame Headlight levelling incl. bracket, 12V Plug set (HB4)</p> <p> 1x12V55W (H7) 8GH 007 157-121 1x24V70W (H7) 8GH 007 157-241</p>
 	<p>1N0 008 582-001</p> <p>1N0 008 582-007</p> <p>1N0 008 582-011</p> <p>1N0 008 582-017</p> <p>9GH 158 051-007</p>	<p>1</p> <p>24</p> <p>1</p> <p>24</p> <p>1</p>	<p>With H7 light. Light aperture: 90 mm dia.</p> <p>Ⓔ1 1342</p> <p>H7 fog light with 12V bulb</p> <p>with 24V bulb</p> <p>Accessories: Cap</p> <p> 1x12V55W (H7) 8GH 007 157-121 1x24V70W (H7) 8GH 007 157-241</p>
 	<p>1N0 010 294-001</p> <p>1F0 010 293-001</p>	<p>1</p> <p>1</p>	<p>Modul H15 Auxiliary light/daytime running light combination. With 12V bulb. Light aperture: 90 mm dia. For mounting in the front apron or in combination with 90 mm dia. headlights.</p> <p>Ⓔ1 2681</p> <p>H15 fog light/daytime running light</p> <p>H15 driving light/daytime running light</p> <p> 1x12V55/15W (H15)</p>

Headlights

100 mm dia.




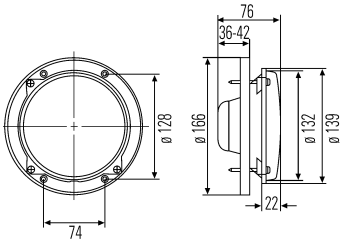




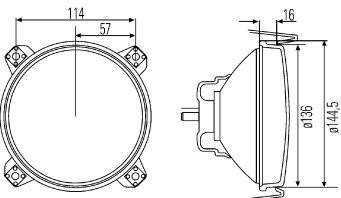


	Part no.	Pk.	Built-in headlights
	<p>Ref. 17.5</p> <p>1KL 007 834-097</p> <p>5DV 007 810-171</p> <p>8JD 156 151-807</p>	<p>1</p> <p>1</p> <p>1</p>	<p>For buses and mobile homes with 24V operating voltage. Xenon or halogen headlights with arched lens. Light aperture: 100 mm dia.</p> <p>Xenon headlight without side light. With gas discharge bulb and 24V ballast unit.</p> <p>(E1) 549</p> <p>Xenon main-beam headlight</p> <p>Spare parts: Ballast unit, 24V</p> <p>Accessories: Socket set (20 pcs.)</p> <p> 1x35W (D2S) 8GS 007 949-101</p>
	<p>1BL 007 834-007</p> <p>Ref. 17.5</p> <p>1KL 007 834-027</p>	<p>1</p> <p>1</p> <p>1</p>	<p>DE@-H1 dipped-beam headlight without side light and bulb.</p> <p>(E1) 550</p> <p>DE@-H1 dipped-beam headlight</p> <p>(E1) 549</p> <p>DE@-H1 main-beam headlight</p> <p>(E1) 548</p> <p>DE@-H1 fog lamp</p> <p> 1x24V70W (H1) 8GH 002 089-251</p>
	<p>1BL 007 834-047</p> <p>6NM 004 375-541</p> <p>Ref. 17.5</p> <p>1KL 007 834-067</p>	<p>1</p> <p>3</p> <p>1</p>	<p>For trucks, buses and vehicle tuners. DE@-H1 headlight with flat lens, without side light and bulb.</p> <p>(E1) 550</p> <p>DE@-H1 dipped-beam headlight suitable for headlight leveller</p> <p>Accessories: Electr. headlight leveller, 12V</p> <p>(E1) 549</p> <p>DE@-H1 main-beam headlight</p>
	<p>1NL 007 834-057</p> <p>8WS 008 549-001</p> <p>8WS 008 549-501</p> <p>9GH 145 943-001</p> <p>9HD 155 239-001</p>	<p>1</p> <p>1</p> <p>1</p> <p>1</p> <p>12</p>	<p>(E1) 548</p> <p>DE@-H1 fog light</p> <p>Accessories: Lens cleansing system with spray system, 12V 24V Rubber sealing cap for -027/-067 Plastic sealing cap with cable and plug for -007/-017/-047/-057</p> <p> 1x24V70W (H1) 8GH 002 089-251</p>








Part no.	Pk.	Accessories
		<p>Ultra-sonic headlight levellers for 90 mm dia. and 100 mm dia. built-in Xenon headlights (see pages 4.34-4.40)</p> <p>Contents: Ultra-sonic sensor, electronic control, actuator motors, lead set and installation instructions</p> <p>The ultra-sonic sensor can be mounted on the floor of the car with a bracket and connected to the central electronic control. This control transfers its adjustment values to the actuator motors on the headlights. The actuators then position the headlights in accordance with the specific load. If the vehicle height is reduced at the rear as well as the front axle when loaded, a second sensor is required (supplement kit). The control module is laid out for two-sensor operation.</p> <p>e1 1926</p> <p>Universal ultra-sonic headlight leveller with 2 sensors, 24V</p> <p>8XX 008 614-101 1</p> <p>8XX 008 614-031 1 for converting mobile homes, 12V</p>
  		<p>Headlight cleaning system for 90 mm dia. and 100 mm dia. built-in headlights (see pages 4.34-4.40)</p> <p>For cleaning from 2 to 4 headlights.</p> <p>Contents: Pump, control module, lead set, nozzle and reinforced hose.</p> <p>Headlight cleaning system with fixed nozzles, 12V</p> <p>8WS 008 549-001 1</p> <p>8WS 008 549-501 1 24V</p> <hr/> <p>With single telescopic nozzles, 12V</p> <p>8WT 008 549-101 1</p> <p>8WT 008 549-601 1 24V</p> <hr/> <p>With double telescopic nozzles, 12V</p> <p>8WT 008 549-201 1</p> <p>8WT 008 549-701 1 24V</p> <p>Accessories: Hose</p> <p>9GS 146 999-727 5</p>

Headlights

132 mm dia., 135 mm dia.








	Part no.	Pk.	Built-in headlights
 	<p>1L3 996 002-411</p> <p>1L3 996 002-221</p> <p>9HD 990 044-001</p>	<p>1</p> <p>1</p> <p>2</p>	<p>With H4 light. Light aperture: 132 mm dia. With supporting frame.</p> <p> 20005</p> <p>H4 headlight with side light</p> <p>without side light</p> <p>Spare parts: Sealing cap</p> <p> 1x12V60/55W (H4) 8GJ 002 525-131 1x24V75/70W (H4) 8GJ 002 525-251</p> <p> 1x12V4W (T4W) 8GP 002 067-121 1x24V4W (T4W) 8GP 002 067-241</p>
 	<p>1L3 005 649-017</p>	<p>84</p>	<p>With H4 light, without side light. With 12V bulb. Light aperture: 135 mm dia. Dipped and main beam in one light.</p> <p> 17031</p> <p>H4 headlight</p> <p> 1x12V60/55W (H4) 8GJ 002 525-131</p>

	Part no.	Pk.	Built-in headlights
	<p>Ref. 12.5 1L3 002 850-068 9GH 126 647-011</p>	<p>1 10</p>	<p>H4 headlight with side light, sealing cap and 12V bulb for side light. For vehicles with 5¾" light units, e. g. for American and Japanese cars. In accordance with SAE dimensions J 571. Light aperture: 135 mm dia.</p> <p>Ⓔ 17031</p> <p>H4 headlight</p> <p>Spare parts: Cap</p> <p> 1x12V60/55W (H4) 8GJ 002 525-131</p> <p> 1x12V4W (T4W) 8GP 002 067-121</p>
 	<p>1M3 114 178-001 1K3 114 155-001 9HD 140 977-001</p>	<p>1 1 5</p>	<p>H1 dipped-beam headlight. Without side light, without sealing cap. For vehicles with 5¾" light units. In accordance with SAE 4002 and 4005. Can be used with 1K3 114 155-001. Light aperture: 135 mm dia.</p> <p>Ⓔ 7076</p> <p>H1 dipped-beam headlight, 12V</p> <hr/> <p>H1 main-beam headlight. Without sealing cap. For vehicles with 5¾" light units. In accordance with SAE 4001. Can be used with 1M3 114 178-001. Light aperture: 135 mm dia.</p> <p>Ⓔ 14464</p> <p>H1 main-beam headlight, 12V and 24V</p> <p>Spare parts: Sealing cap</p> <p> 1x12V55W (H1) 8GH 002 089-133 1x24V70W (H1) 8GH 002 089-251</p> <p> 1x12V4W (T4W) 8GP 002 067-121 1x24V4W (T4W) 8GP 002 067-241</p>


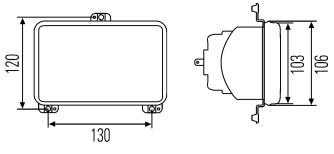
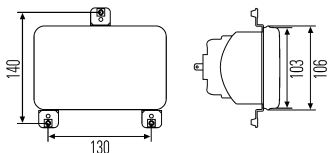



Headlights

165 mm dia.



	Part no.	Pk.	Built-in headlights
	<p>Ref. 12.5</p> <p>1L6 002 395-261</p> <p>1L6 002 395-842</p>	<p>1</p> <p>1</p>	<p>H4 dipped-beam headlight. With side light and sealing cap. For vehicles with 7" light units, e.g. for American and Japanese cars. In accordance with SAE 6006, SAE 6012, SAE 6013. Also for cars with "700 headlamps". Light aperture: 165 mm dia.</p> <p>Ⓔ4 10</p> <p>H4 headlight</p> <hr/> <p>Set comprises: 2 H4 headlights with side light</p> <p>H4 headlight set</p> <p> 1x12V60/55W (H4) 8GJ 002 525-131</p> <p> 1x12V4W (T4W) 8GP 002 067-121</p>
	<p>ISO 440 LUS-121 *)</p>	<p>1</p>	<p>4" double filament tractor sealed-beam light unit 12V45/40W.</p> <p>Headlight, left or right</p>
	<p>1V6 001 LOO-101 *)</p> <p>9AB 001 LOO-111 *)</p>	<p>1</p> <p>1</p>	<p>7" headlamp retaining shell</p> <p>Headlamp retaining shell, left or right</p> <p>Spare parts: Chrome trim ring</p>

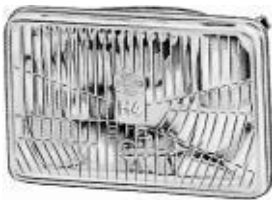
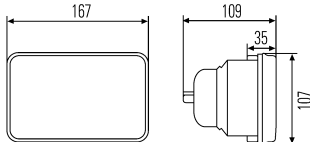


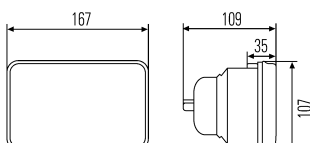


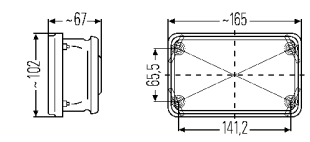


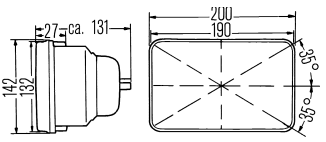


*) For UK


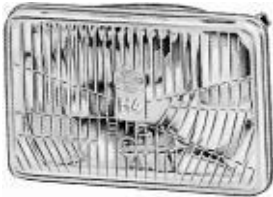

  	Part no. Ref. 12.5 1LB 006 277-137	Pk. 36	Built-in headlights With H1 light. With three-point fixing and 12V bulbs. Light aperture: 164 x 103 mm. (E1) 24461 (E1) 24460 H4 headlight with side light  1x12V60/55W (H4) 8GJ 002 525-131 1x24V75/70W (H4) 8GJ 002 525-251  1x12V4W (T4W) 8GP 002 067-121 1x24V4W (T4W) 8GP 002 067-241
	Ref. 12.5 1LB 003 177-637	210	With normal light, without side light, with 12V bulb. Light aperture: 164 x 103 mm. Headlight  1x12V45/40W (R2) 8GD 002 088-131

Headlights

164 x 103 mm, 190 x 132 mm






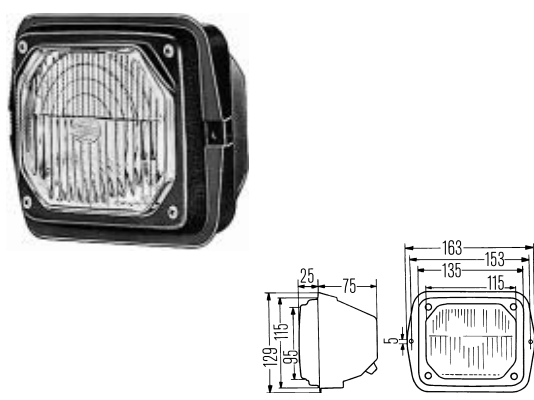


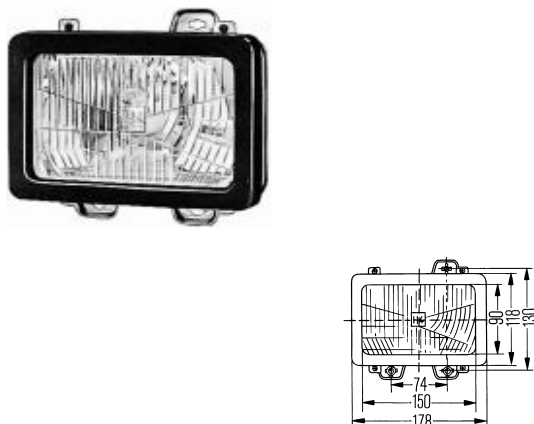



Part no.	Pk.	Built-in headlights
 	<p>Ref. 12,5</p> <p>1LB 003 177-081 1</p> <p>1LB 003 177-511 1</p> <p>9NS 140 045-005 500</p> <p>9NS 140 046-005 500</p> <p>9KX 143 492-005 1000</p>	<p>H4 dipped-beam headlight, for outer units. With sealing cap. For American and Japanese cars with rectangular 4-headlamp system. In accordance with SAE J 571. Light aperture: 164 x 103 mm.</p> <p>(E1) 7197</p> <p>H4 headlight without side light</p> <p>H4 headlight with side light</p> <p>Accessories: 500 Adjusting screw 500 Fixed point 1000 Clamp</p> <p> 1x12V60/55W (H4) 8GJ 002 525-131</p>
 	<p>Ref. 25</p> <p>1KB 003 177-061 1</p>	<p>(E1) 24504</p> <p>H1 main-beam headlight, for inner units. With sealing cap. Mounting depth: 124 mm.</p> <p> 1x12V55W (H1) 8GH 002 089-133</p>
 	<p>1NB 004 691-147 1</p>	<p>(E1) 8371</p> <p>H2 fog lamp unit for inner units, with sealing cap.</p> <p> 1x12V55W (H2) 8GH 002 857-121</p>
 	<p>Ref. 17.5</p> <p>1LE 003 427-041 1</p>	<p>H4 dipped-beam headlight with side light and sealing cap. For American and Japanese cars with rectangular 2-headlamp system. Light aperture: 190 x 132 mm.</p> <p>(E1) 17009</p> <p>H4 headlight</p> <p> 1x12V60/55W (H4) 8GJ 002 525-131</p> <p> 1x12V4W (T4W) 8GP 002 067-121</p>

	Part no. 9AL 118 027-007 9AL 118 028-007 9AG 084 320-005 9NS 114 014-106 9NS 119 463-005 9XS 118 079-005	Pk. 20 20 15 3000 500 50	SAE-Conversions Headlamp receiving units for 5¾" headlamps with SAE-fixing points, without supporting frame. Adjusting frame I (inner) Adjusting frame II (outer) Lens-retaining rim Screw Adjustment screw assembly Fixed point
	9AL 120 514-001 9AL 120 515-001 9AG 120 516-005 9NS 114 014-106 9NS 124 485-001 9XS 118 079-005	8 8 17 3000 5 50	Headlamp receiving units for rectangular headlamps 164 x 103 mm with SAE-fixing points, without supporting frame. Adjusting frame I Adjusting frame II Lens-retaining rim Screw Adjustment screw assembly Fixed point
	1VB 005 444-037	20	Headlamp receiving units for rectangular headlamps 164 x 103 mm without rotation lock, without supporting frame. Receiving part (assembled)
	9AL 132 293-027	8	Headlamp receiving unit for rectangular headlamps 190 x 132 mm with SAE-fixing points, without supporting frame. Adjusting frame (assembled)


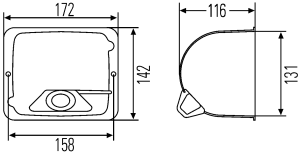


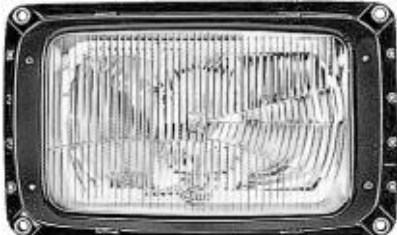
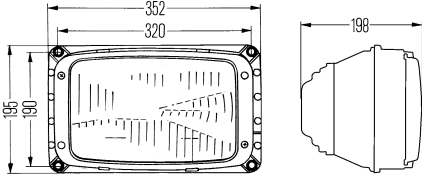


Headlights

130 mm dia., 115 x 95 mm, 150 x 90 mm



	Part no.	Pk.	Built-in headlights
	<p>1S3 001 442-001</p> <p>9GD 024 183-001 9KS 071 571-001 9AG 071 903-001 9DR 066 847-001 9FF 090 500-001</p>	<p>1 10 10 5 1 2</p>	<p>With symmetrical light and side light. Chrome plated lens-retaining rim. Light aperture: 130 mm dia.</p> <p>K 21047 *)</p> <p>Built-in headlight</p> <p>Spare parts: Seal Lens-retaining spring Lens-retaining rim Reflector Bulb holder for side light</p> <p> 1x12V35/35W (S2) 8GD 002 084-131</p> <p> 1x12V4W (T4W) 8GP 002 067-121</p>
	<p>1TA 003 570-001</p> <p>1TA 122 718-001</p>	<p>1 1</p>	<p>For vehicles with max. speed of 25 km/h, e.g. for agricultural machines. With symmetrical light and side light. Black plastic housing and lens-retaining rim. Mounting depth: 75 mm. Light aperture: 115 x 95 mm.</p> <p>K 21090 *)</p> <p>Built-in headlight with permanently dipped-beam</p> <p>Spare parts: Light unit</p> <p> 1x12V15W (Q)</p> <p> 1x12V4W (T4W) 8GP 002 067-121</p>
	<p>1LB 005 444-017</p> <p>1LB 003 177-081</p>	<p>16 1</p>	<p>E. g. for Case tractors and construction machines. With halogen H4 main light, without side light. Headlight receiving unit with bonded black seal. Mounting depth: 110 mm. Light aperture: 150 x 90 mm.</p> <p> 7197</p> <p>H4 built-in headlight</p> <p>Spare parts: Light unit</p> <p> 1x12V60/55W (H4) 8GJ 002 525-131  1x24V75/70W (H4) 8GJ 002 525-251</p>


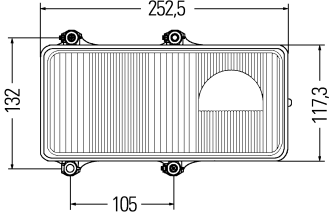



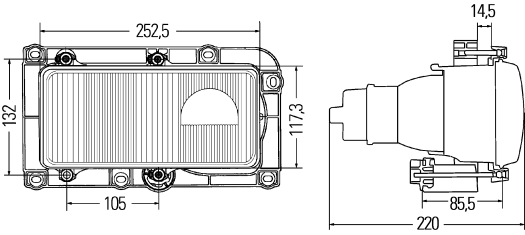


*) National type test for Germany


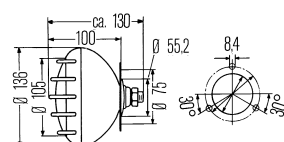


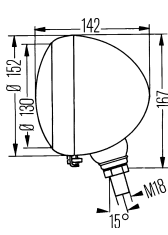



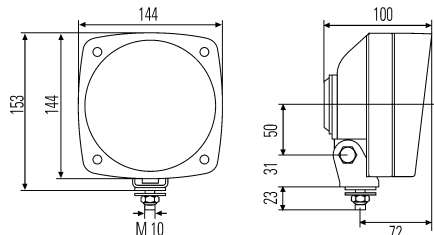






 	<p>Part no.</p> <p>Ref. 10</p> <p>1LA 004 109-217</p> <p>1LA 004 109-227</p> <p>9AH 131 494-015</p> <p>9FF 111 606-021</p>	<p>Pk.</p> <p>36</p> <p>36</p> <p>6</p> <p>10</p>	<p>Built-in headlights</p> <p>With H4 main light. Supporting frame made of black plastic. Mounting depth: 99 mm. Type of protection: IP5K4K Light aperture: 138 x 124 mm.</p> <p>Ⓔ 17116</p> <p>H4 headlight with side light</p> <p>with hardened lens</p> <p>Spare parts: Supporting frame</p> <p>Accessories: Bulb holder for side light for -217</p> <p> 1x12V60/55W (H4) 8GJ 002 525-131 1x24V75/70W (H4) 8GJ 002 525-251</p> <p> 1x12V4W (T4W) 8GP 002 067-121 1x24V4W (T4W) 8GP 002 067-241</p>
 	<p>Ref. 25/37.5</p> <p>1LG 003 434-187</p> <p>9ES 122 221-007</p> <p>9DE 131 520-017</p> <p>9GT 067 751-001</p>	<p>4</p> <p>7</p> <p>2</p> <p>10</p>	<p>For trucks and buses. With halogen H4 main light and side light. Plastic support frame, black enamel finish. Mounting depth: 117 mm. Light aperture: 270 x 170 mm.</p> <p>Ⓔ 7016</p> <p>H4 built-in headlight</p> <p>Spare parts: Lens Reflector Grommet</p> <p> 1x12V60/55W (H4) 8GJ 002 525-131 1x24V75/70W (H4) 8GJ 002 525-251</p> <p> 1x12V4W (T4W) 8GP 002 067-121 1x24V4W (T4W) 8GP 002 067-241</p>

Headlights

248 x 117 mm



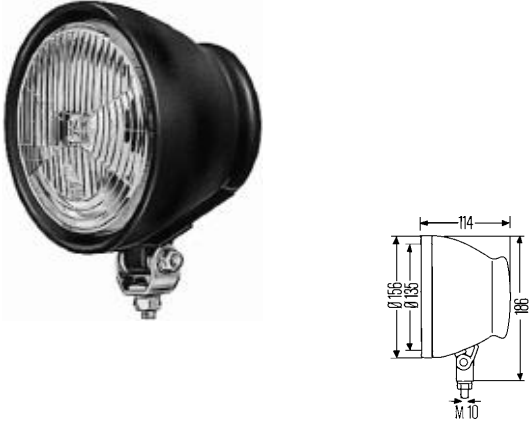


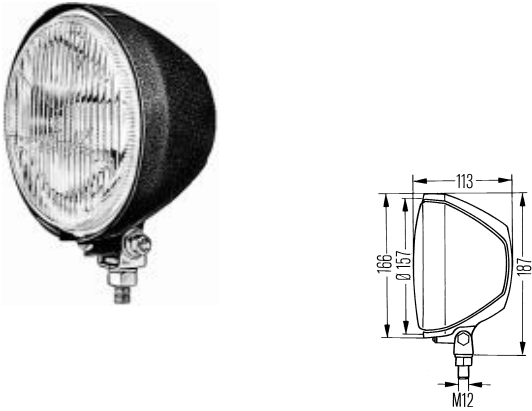





Part no.	Pk.	Built-in headlights
 	<p>Ref. 27.5</p> <p>1DL 005 600-097 1</p> <p>1DL 005 600-107 1</p>	<p>Dipped-beam units must be turned 15° making it suitable for left-hand traffic.</p> <p>With H1 dipped-beam and main-beam light. With side light, sealing cap and 24V bulbs. Light aperture: 248 x 117 mm.</p> <p>(E1) 7411</p> <p>DE®-H1 headlight, without lead, left</p> <p>right</p> <p> 2x24V70W (H1) 8GH 002 089-251</p> <p> 1x24V4W (T4W) 8GP 002 067-241</p>
 	<p>Ref. 27.5</p> <p>1DL 007 872-017 1</p> <p>1DL 007 872-027 1</p> <p>Ref. 27.5</p> <p>1DL 007 872-037 1</p> <p>1DL 007 872-047 1</p> <p>1DL 007 872-077 1</p> <p>1DL 007 872-087 1</p> <p>9AH 149 259-015 4</p> <p>9AH 149 260-015 4</p> <p>6NM 007 231-037 36</p>	<p>With H1 dipped-beam and main-beam light. With side light. Light aperture: 248 x 117 mm.</p> <p>(E1) 7411</p> <p>DE®-H1 headlight with electric headlight leveller and 24V bulbs, without lead, left</p> <p>right</p> <hr/> <p>Without electric headlight leveller, suitable for headlight leveller, with 24V bulbs, without lead, left</p> <p>right</p> <p>with lead, left</p> <p>right</p> <p>Spare parts: Supporting frame with adj. devices, left</p> <p>right</p> <p>Headlight leveller, 24V for -017/-027</p> <p> 2x12V55W (H1) 8GH 002 089-133 2x24V70W (H1) 8GH 002 089-251</p> <p> 1x12V4W (T4W) 8GP 002 067-121 1x24V4W (T4W) 8GP 002 067-241</p>

	Part no.	Pk.	External-fitting headlights
 	<p>1X0 001 515-021</p> <p>9GD 023 639-001 9KS 075 139-001</p>	<p>1 10 10</p>	<p>Suitable for various tractors. Symmetrical light, without side light. Black housing and lens-retaining rim with protective grille. M14 x 1.5 hollow fixing bolt. Light aperture: 105 mm dia. K 21055 *)</p> <p>External-fitting headlight with permanently dipped beam</p> <p>Spare parts: Seal Lens-retaining spring</p> <p> 1x12V35W (F2) 8GA 002 083-131 1x24V35W (F2) 8GA 002 083-251</p>
 	<p>1S3 001 117-041</p> <p>9AG 017 970-001 9ES 015 675-001 9GD 024 183-001 9DR 060 567-001 9FF 090 500-001 9KS 075 307-001</p>	<p>1 5 1 10 1 2 10</p>	<p>Symmetrical light, with side light. Black housing, with M18 x 32 hollow fixing bolt. Light aperture: 130 mm dia. K 21032 *) K 21037 *)</p> <p>External-fitting headlight</p> <p>Spare parts: Lens-retaining rim Lens Seal Reflector Bulb holder for side light Lens-retaining spring</p> <p> 1x12V35W (S2) 8GD 002 084-131  1x12V4W (T4W) 8GP 002 067-121</p>
  	<p>1L3 996 026-041</p> <p>9HD 990 101-001</p> <p>8JA 990 065-001</p>	<p>1 2 10</p>	<p>With H4 light and side light. Black plastic housing and lens-retaining rim. With plug. Universal bracket with M10 fixing screw. Light aperture: 131 mm dia.</p> <p> 20005</p> <p>H4 headlight</p> <p>Spare parts: Cap</p> <p>Accessories: Plug</p> <p> 1x12V60/55W (H4) 8GJ 002 525-131  1x24V75/70W (H4) 8GJ 002 525-251</p> <p> 1x12V4W (T4W) 8GP 002 067-121  1x24V4W (T4W) 8GP 002 067-241</p>

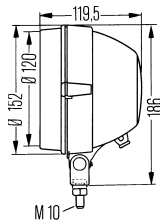
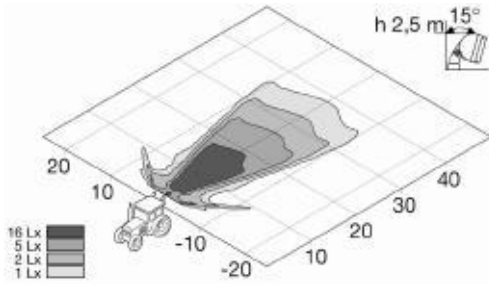
Headlights

135 mm dia., 157 mm dia., 115 x 95 mm



	Part no.	Pk.	External-fitting headlights
	<p>Ref. 12.5</p> <p>1L3 002 850-068</p> <p>9BG 127 179-001</p>	<p>1</p> <p>1</p>	<p>With H4 main light and side light. Light aperture: 135 mm dia.</p> <p>Ⓔ 17031</p> <p>H4 light unit</p> <p>Rubber housing</p> <p> 1x12V60/55W (H4) 8GJ 002 525-131</p> <p> 1x12V4W (T4W) 8GP 002 067-121</p>
	<p>1S5 003 178-431</p>	<p>1</p>	<p>For delivery vans and tractors. With symmetrical light and side light. Black plastic housing and lens-retaining rim, with universal bracket and solid M12 screw. Light aperture: 157 mm dia.</p> <p>K 21085 *)</p> <p>Headlight with universal bracket and solid M12 screw</p> <p> 1x12V35/35W (S2) 8GD 002 084-131 1x24V45/40W (S2) 8GD 002 084-251</p> <p> 1x12V4W (T4W) 8GP 002 067-121 1x24V4W (T4W) 8GP 002 067-241</p>
	<p>1TA 003 570-101</p> <p>1TA 122 718-021</p>	<p>1</p> <p>1</p>	<p>For vehicles with max. speed of 25 km/h; e. g. for agricultural machines. With symmetrical light and side light. Black plastic housing and lens-retaining rim. Universal bracket with M10 fixing screw. Type of protection: IP5K4K. Light aperture: 115 x 95 mm.</p> <p>K 21090 *)</p> <p>Headlight with permanently dipped beam</p> <p>Spare parts: Light unit</p> <p>1x12V15W (Q) 1x24V30W (Q)</p> <p> 1x12V4W (T4W) 8GP 002 067-121 1x24V4W (T4W) 8GP 002 067-241</p> <p></p>

*) National type test for Germany



Part no.

Pk.

External-fitting work lights

5760

Lens pattern for far-reaching illumination.
 Recommended angle of inclination: 15° - 20°.
 Reflector made of sheet metal, glued to glass lens.
 Black plastic housing with extending edge to protect lens.
 Pivot base with M10 fixing screw.
 Without vibration damping.
 For upright or pendant mounting.
 Type of protection: IP5K4K.
Light aperture: 120 mm dia.

1G3 005 760-221
 1G3 005 760-227

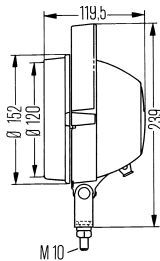
1
 27

H3 work light without handle, protective grill and switch

1G3 005 760-021

1

With handle, protective grill, switch and longer bracket holder



- 1x12V35W (H3) 8GH 002 090-271
- 1x12V55W (H3) 8GH 002 090-133
- 1x24V70W (H3) 8GH 002 090-251



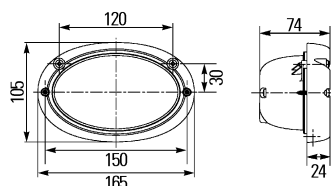
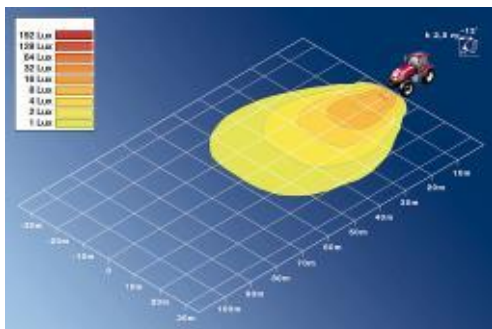
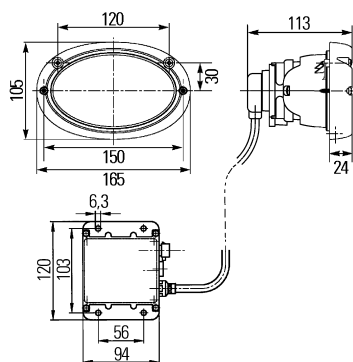
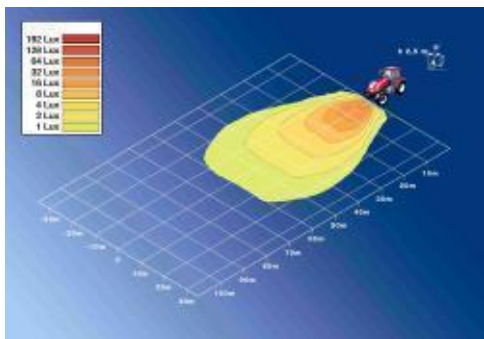
"5760" Light Series

120 mm dia.



Part no.	Pk.	External-fitting work lights
5760 Lens pattern for far-reaching illumination. Recommended angle of inclination: 15° - 20°. Reflector made of sheet steel, glued to glass lens. Black plastic housing with extending edge to protect lens. Pivot base with M10 fixing screw. Without vibration damping. For upright or pendant mounting. Type of protection: IP5K4K. Light aperture: 120 mm dia.		
1G3 005 760-001	1	H3 work light with handle and switch
1G3 005 760-011	1	Without switch and protective grill
1G3 005 760-031	1	Without switch and protective grill
1G3 005 760-201	1	Without handle, switch and protective grill
1G3 005 760-207	27	
1G3 005 760-211	1	with switch and longer bracket holder
1G3 135 211-011	1	Spare parts:
6EB 005 633-001	10	Light unit Switch
Lens pattern for close-range illumination. Recommended angle of inclination: 20° - 30°. With handle, switch and grommet. Light aperture: 120 mm dia.		
1G3 005 760-041	1	H3 work light
6EB 005 633-001	10	Spare parts: Switch
1G3 005 760-057	1	Mounting bracket for four-point mounting. Distance between screws: 32 mm or 82 mm.
6EB 005 633-001	10	Spare parts:
9XD 130 261-001	5	Switch U-bracket
1x12V35W (H3) 8GH 002 090-271 1x12V55W (H3) 8GH 002 090-133 1x24V70W (H3) 8GH 002 090-251		

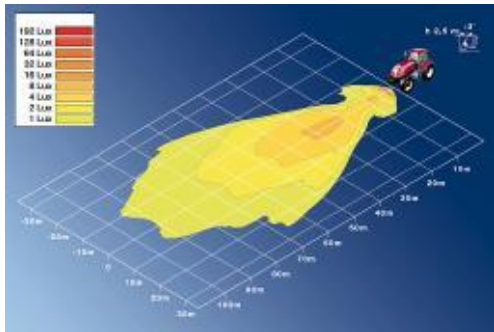
Accessories see page 4.111



Part no.	Pk.	Built-in work lights
		Oval 100 Xenon Lens pattern for close-range illumination. Recommended angle of inclination: 10° - 15°. Reflector made of die-cast aluminium, glued to hardened glass lens. Black plastic housing with extending edge to protect lens. Two 4.2 x 45 mm fixing screws. Distance between screws: 150 mm. Mounting area: 142 x 92 mm. Type of protection: IP5K4K. With gas discharge bulb. Light aperture: 130 x 75 mm.
1GA 996 361-581	1	Xenon work light with single reflector and 24V ballast unit Spare parts: Ballast unit, 24V Plug set (20 pcs.)
5DV 007 810-171	1	
8JD 156 151-807	1	
		1x35W (D2S) 8GS 007 949-101
		Oval 100 with FF® reflector Lens pattern for ground illumination. Recommended angle of inclination: 10° - 15°. Reflector made of die-cast aluminium, glued to hardened glass lens. Black plastic housing with extending edge to protect lens. Two 4.2 x 45 mm fixing screws. Distance between screws: 150 mm. Mounting area: 142 x 92 mm. Type of protection: IP5K4K. Light aperture: 130 x 75 mm.
1GA 996 161-111	1	FF® H3 work light with double reflector, AMP plug connector and 12V55W bulbs
1GA 996 161-351	1	with single reflector, AMP plug connector and 12V55W bulb
9GH 993 984-001	1	Spare parts: Sealing cap for AMP plug connector
8JD 008 151-011	10	Accessories: Socket for AMP plug connector
8KW 701 235-033	100	Blade receptacles, 6.3 mm
8KB 990 299-001	1	2000 mm long connection lead for AMP plug connector with cap
		2x12V35W (H3) 8GH 002 090-271 2x12V55W (H3) 8GH 002 090-133 2x24V70W (H3) 8GH 002 090-251

"Oval 100" Light Series

130 x 75 mm



1GA 996 161-101

1

Built-in work lights

Oval 100 with FF®-technik

Lens pattern for long-range illumination.

Recommended angle of inclination: 10° - 15°.
Reflector made of diecast aluminium, glued to hardened glass lens.
Black plastic body with extending edge to protect lens.
Two 4 x 40 mm fixing screws.
Distance between screws: 150 mm.
Mounting area: 142 x 92 mm.
Type of protection: IP5K4K.
Light aperture: 130 x 75 mm.

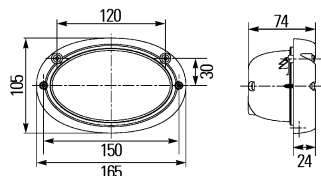
FF® H3 work light

with oval lens-retaining rim, lens without optical pattern, single reflector, AMP plug connector with cap and 12V55W bulb

with oval lens-retaining rim, lens without optical pattern, single reflector and grommet, without bulb

1GA 996 361-431

1



1GA 996 161-671

1

With angular lens-retaining rim, fits into mounting holes of headlights 1AB/1GD 006 213-... Inclination 6°. AMP plug connector with cap and 12V55W bulb



9GH 993 984-001

1

Spare parts:

Sealing cap for AMP plug connector

Accessories:

Socket for AMP plug connector

Blade receptacles, 6.3 mm

2000 mm connection lead for AMP plug connector with cap

8JD 008 151-011

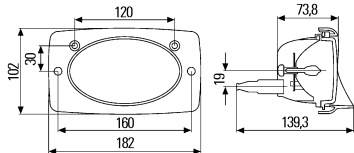
10

8KW 701 235-033

100

8KB 990 299-001

1

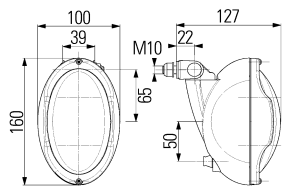
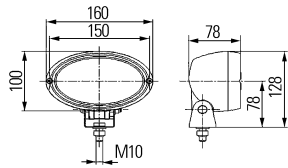
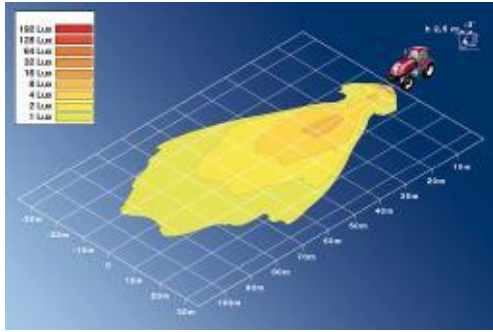


1(2)x12V35W (H3) 8GH 002 090-271

1(2)x12V55W (H3) 8GH 002 090-133

1(2)x24V70W (H3) 8GH 002 090-251





Part no.

Pk.

External-fitting work lights

Oval 100 with FF® reflector

Lens pattern for long-range illumination.

Recommended angle of inclination: 5° - 10°.

Reflector made of die-cast aluminium glued to hardened glass lens.

Black plastic housing with extending edge to protect lens.

Pivot base with M10 fixing screws for upright or pendant mounting.

Without vibration damping.

Type of protection: IP5K4K.

With oval lens-retaining rim, lens without optical pattern, single reflector, AMP plug connector and 12V55W bulb.

Light aperture: 130 x 75 mm.

1GA 996 161-281

1

FF® H3 work light

9GH 993 984-001

1

Spare parts:

Sealing cap for AMP plug connector

8JD 008 151-011

10

Accessories:

Socket for AMP plug connector

8KW 701 235-033

100

Blade receptacles, 6.3 mm

8KB 990 299-001

1

2000 mm connection lead for AMP connection lead

8HG 990 263-111

1

Mounting bracket for tubular mount on 15 mm - 28 mm dia. pipes

1(2)x12V35W (H3) 8GH 002 090-271

1(2)x12V55W (H3) 8GH 002 090-133

1(2)x24V70W (H3) 8GH 002 090-251



Oval 100 FL

For vertical surface-mounting to forklifts.

Lens pattern for wide close-range and object illumination.

Recommended angle of inclination: 0°.

Double reflector made of die-cast aluminium glued to hardened lens.

Black plastic housing and lens-retaining rim.

Pivot base with M10 fixing screw.

Without vibration damping.

With 430 mm long connection lead.

Type of protection: IP6K4K or IPX9K.

With grommet.

Light aperture: 130 x 75 mm.

1GN 996 361-461

1

H3 work light with 12V55W bulb

1GN 996 361-651

1

With 24V70W bulb

2x12V35W (H3) 8GH 002 090-271

2x12V55W (H3) 8GH 002 090-133

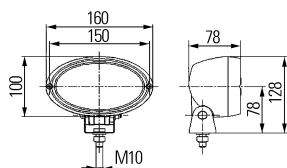
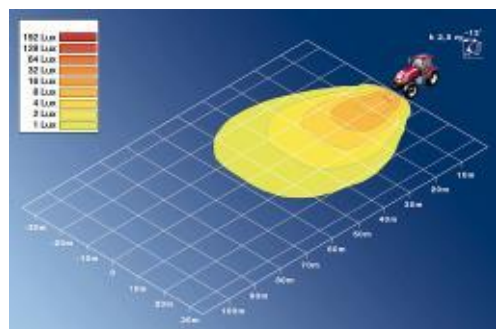
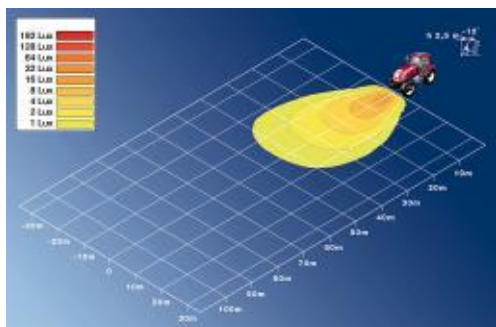
2x24V70W (H3) 8GH 002 090-251



Accessories see page 4.110-4.111.

"Oval 100" Light Series

130 x 75 mm



Part no.

Pk.

External-fitting work lights

Oval 100 with FF® reflector

Lens pattern for wide close-range illumination.

Recommended angle of inclination: 10° - 15°.
 Reflector made of die-cast aluminium, glued to hardened glass lens.
 Black plastic housing with extending edge to protect lens.
 Pivot base with M10 fixing screw for upright and pendant mounting.
 Without vibration damping.
 Pivot range vertical 105°.
 Type of protection: IP5K4K.
Light aperture: 130 x 75 mm.

1GA 996 361-421

1

FF® H3 work light with single reflector and grommet, without bulb

1GA 996 161-121

1

with AMP plug connector and cap, single reflector and 12V55W bulb

1GA 996 161-581

1

Pivot base with vibration damping and mounting bracket for four-point mounting, with single reflector and 24V70W bulb

1GA 996 361-171

1

Pivot base made of yellow chromised steel, with vibration damping, single reflector and 24V70W bulb

Type of protection: IP5K4K and IPX9K.

Lens pattern for wide ground illumination.

Recommended angle of inclination: 10° - 15°.

1GA 996 161-291

1

With double reflector and 12V55W bulbs. Pivot base with M10 fixing screw, without vibration damping



9GH 993 984-001

1

Spare parts:

Sealing cap for AMP plug connector

8JD 008 151-011

10

Socket for AMP plug connector

8KW 701 235-033

100

Blade receptacles, 6.3 mm

8KB 990 299-001


1

2000 mm long connection lead, for AMP plug connector

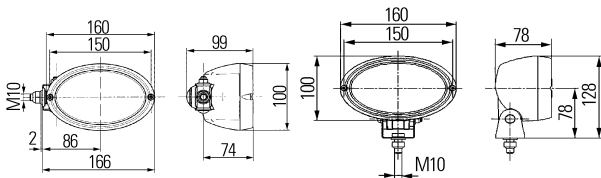
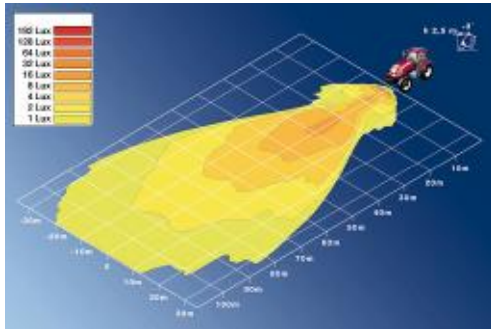
8HG 990 263-111

1

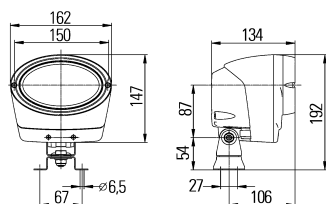
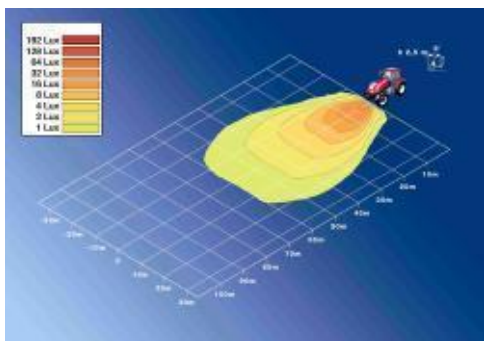
Mounting bracket for tubular mount on 15 mm - 28 mm dia. pipes

- 
 1(2)x12V35W (H3) 8GH 002 090-271
 1(2)x12V55W (H3) 8GH 002 090-133
 1(2)x24V70W (H3) 8GH 002 090-251

Accessories see page 4.110-4.111.



for 1GA 996 131-331

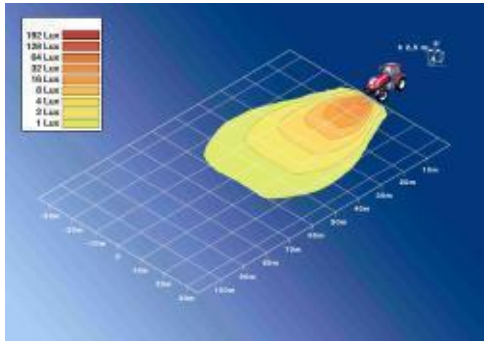


Part no.	Pk.	External-fitting headlights
		Oval 100 with FF® reflector
		Lens pattern for wide, far-reaching illumination.
		Recommended angle of inclination: 4° - 10°.
		Reflector made of die-cast aluminium, glued to hardened glass lens.
		Black plastic housing with extending edge to protect lens.
		Pivot base with M10 fixing screw for upright or pendant mounting.
		Without vibration damping.
		Pivot range vertical 105°.
		Type of protection: IP5K4K.
		With AMP plug connector and cap.
		Light aperture: 130 x 75 mm.
		FF® H3 work light, lens without optical pattern, with double reflector and 12V55W bulbs
1GA 996 161-131	1	
1GA 996 361-011	1	with 24V70W bulbs
1GA 996 161-331	1	same as -131, but with side pivot base for left mounting, also suitable for mounting on the right when the unit is turned through 180°
		Spare parts:
9GH 993 984-001	1	Sealing cap for AMP plug connector
		Accessories:
8JD 008 151-011	10	Socket for AMP plug connector
8KW 701 235-033	100	Blade receptacles, 6.3 mm
8KB 990 299-001	1	2000 mm long lead for AMP plug connector
8HG 990 263-111	1	Mounting bracket for tubular mount on 15 - 28 mm dia. pipes
		2x12V35W (H3) 8GH 002 090-271
		2x12V55W (H3) 8GH 002 090-133
		2x24V70W (H3) 8GH 002 090-251
		Oval 100 Xenon Integral
		Lens pattern for wide, close-range illumination.
		Recommended angle of inclination: 8° - 15°.
		Reflector made of die-cast aluminium, glued to hardened glass lens.
		Black plastic housing with extending edge to protect lens.
		Xenon-electronic unit integrated into housing.
		Without connecting lead (see accessories).
		Pivot bracket and bracket for four-point mounting made of stainless steel.
		Pivot range vertical 105°.
		Type of protection: IP5K4K.
		With gas discharge bulb and DEUTSCH plug connector.
		Light aperture: 130 x 75 mm.
		Xenon work light with 12V ballast unit and black lens-retaining rim, for upright mounting
1GA 996 261-511	1	
1GA 996 261-521	1	for pendant mounting, pivot base with M10 fixing screw
		Accessories:
8KB 990 299-221	1	3100 mm long connecting lead with relay, 15A fuse and DEUTSCH plug connector, 12V
8HG 990 263-111	1	Mounting bracket for tubular mount on 15 - 28 mm dia. pipes
		1x35W (D1S) 8GS 009 028-001

Accessories see page 4.110-4.111.

"Oval 100" Light Series

130 x 75 mm



1GA 996 261-531

1

External-fitting work lights

Oval 100 Xenon Integral

Lens pattern for bride close-range illumination.

Recommended angle of inclination: 8° - 15°.

Reflector made of diecast aluminium, glued to hardened glass lens.

Black plastic body with extending edge to protect lens.

Xenon-electronic unit integrated into body.

Without connecting lead (see accessories).

Pivot base with bracket for four-point mounting made of stainless steel.

Pivot range vertical 105°.

Type of protection: IP5K4K.

With gas discharge bulb.

Light aperture: 130 x 75 mm.

Xenon work light

with DEUTSCH plug connector, 24V ballast unit and red lens-retaining rim, for upright mounting

1GA 996 261-691

1

for pendant mounting

A black lens-retaining rim is enclosed with 1GA 996 261-531/-691

For upright mounting

With AMP plug connector, 12V ballast unit and red lens-retaining rim, for upright mounting

1GA 996 261-561

1

with 24V ballast unit

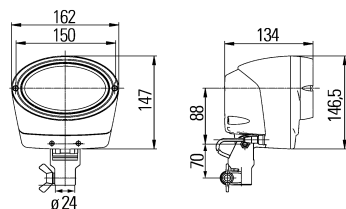
1GA 996 261-571

1

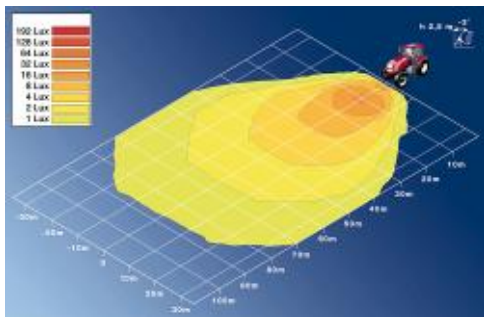
with 24V ballast unit and mounting bush for 24 mm dia. standard pin

1GA 996 261-701

1



for 1GA 996 261-701



1GA 996 261-581

1

Lens pattern for wide off-road illumination.

Recommended angle of inclination: 3° -10°.

Xenon work light

with AMP plug connector and 12V ballast. With red lens-retaining rim, for upright mounting

5DV 008 856-001

1



Spare parts:

Start electronic, 24V

Accessories:

3100 mm long connecting lead with relay, 15A fuse and DEUTSCH plug connector with cap,

12V

1 24V

10 Socket for AMP plug connector

100 Blade receptacles, 6.3 mm

1 Blade type fuse, 15A (5 pcs.)

1 Mounting bracket for tubular mount on 15 mm - 28 mm dia. pipes

8KB 990 299-221

1

8KB 990 299-231

1

8JD 008 151-011

10

8KW 701 235-033

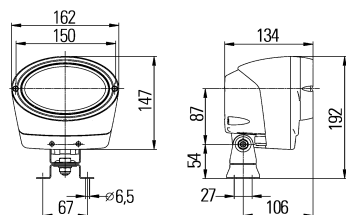
100

8JS 711 687-821

1

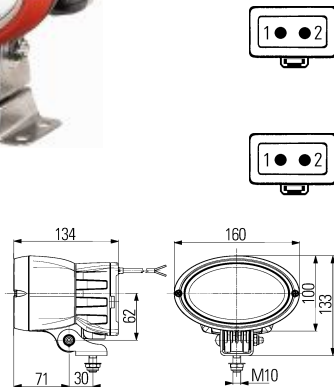
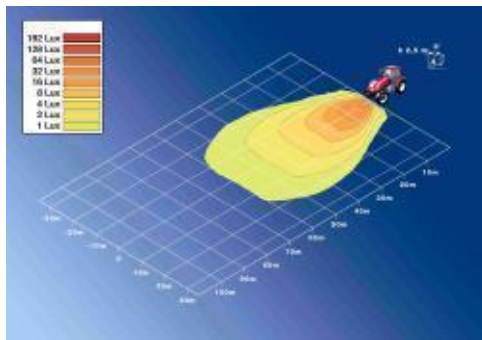
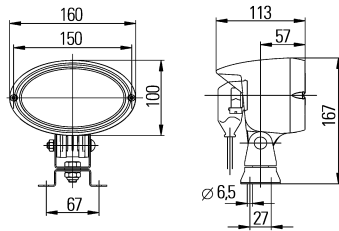
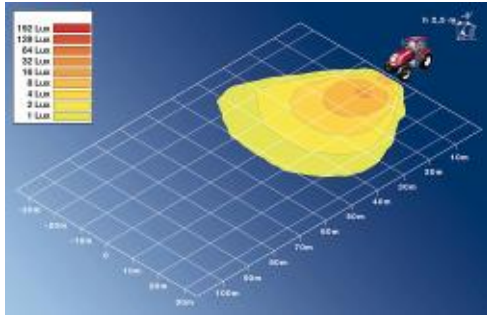
8HG 990 263-111

1



1x35W (D1S) 8GS 009 028-001

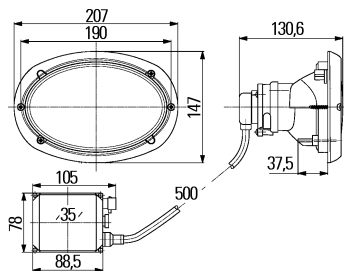
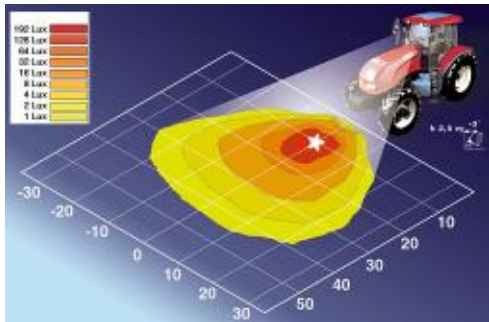
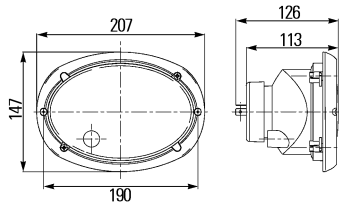
Accessories see page 4.110-4.111.



Part no.	Pk.	External-fitting work lights
		<p>Oval 100 H9 with FF® reflector Lens pattern for wide off-road illumination. Recommended angle of inclination: 3° - 10°. Reflector made of diecast aluminium, glued to hardened glass lens. Black plastic body with extending edge to protect lens. Vibration-damped pivot base with bracket for four-point mounting. Pivot range vertical 105°. For upright mounting. With 2000 mm long connecting cable. Type of protection: IP5K4K. With 12V bulb, accessible from the outside. Light aperture: 130 x 75 mm.</p>
1GA 996 161-391	1	FF®-H9 work light
9XD 990 298-001	5	Spare parts: Bracket for four-point fixing
8KB 990 299-311	1	Accessories: 2000 mm long connecting lead, with plug for connecting the H9 bulb
9GH 990 334-011	1	Rubber cap for H9 socket
8HG 990 263-111	1	Mounting bracket for tubular mount on 15 mm - 28 mm dia. pipes
		1x12V65W (H9) 8GH 008 375-001
		<p>Oval 100 Xenon-Powerpack Lens pattern for bride close-range illumination. Recommended angle of inclination: 3° - 10°. Reflector made of diecast aluminium, glued to hardened glass lens. Black plastic body with red extending edge to protect lens. Rear of housing made of black diecast aluminium with 500 mm cable and 2-pole AMP plug. Xenon electronic unit 42W integrated into housing. Vibration-damped pivot base with bracket for four-point mounting. Additionally enclosed, displaceable bracket for single-point attachment. Type of protection: IP5K4K. With gas discharge bulb. Light aperture: 130 x 75 mm.</p>
1GA 996 461-311	1	Xenon work light for upright mounting, with 12V ballast unit
1GA 996 461-331	1	with 24V ballast unit
1GA 996 461-321	1	for pendant mounting, with 12V ballast unit
1GA 996 461-341	1	with 24V ballast unit
		1x35W (D1S) 8GS 009 028-001

"Oval 120" Light Series

161 x 100 mm



Part no.

Pk.

Built-in headlight

Oval 120

With H4 light and side light.
Mounting frame made of plastic, with inclination adjustment 4°. Reflector made of plastic, glued to non-patterned glass lens. With fixing screws M5 x 35 mm.
With 12V bulbs and sealing cap.
Light aperture: 161 x 100 mm.

(E1) 1502 SAE/FMVSS 108

Ref. 12.5

1LB 996 157-201

1 H4 headlight

5DV 008 856-001

1 Spare parts:
24V ballast unit



1x12V60/55W (H4) 8GJ 002 525-131
1x24V75/70W (H4) 8GJ 002 525-251



1x12V4W (T4W) 8GP 002 067-121
1x24V4W (T4W) 8GP 002 067-241

Built-in work light

Oval 120 Xenon


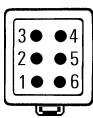
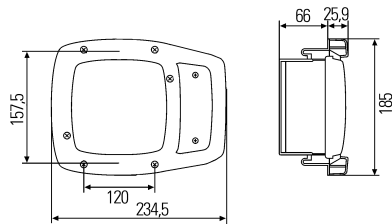

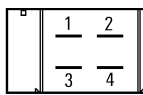
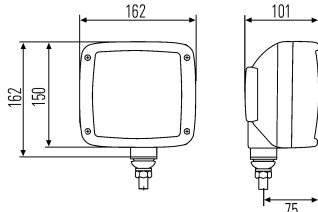
Lens pattern for off-road illumination.
Recommended angle of inclination: 3° - 10°. Lens with plastic reflector bonded. Black plastic mounting frame with inclination adjustment 4°. With two fixing screws 50 x 35 mm. The work light is firmly connected to the ballast unit by 500 mm long lead. Type of protection: IP5K4K.
With gas discharge bulb.
Light aperture: 161 x 100 mm.

1GB 996 158-081

1 Xenon-work light
with 12V ballast unit

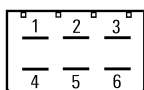
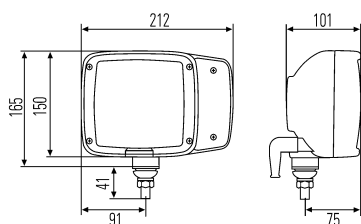


1x35W (D2S) 8GS 007 949-101

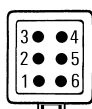
	Part no.	Pk.	Built-in headlights
  	<p>Module 120 With H7 dipped-beam light, H3 driving-beam light and side light, with attached amber flasher light. With black rubber housing. Black plastic lens-retaining rim with extending edge to protect lens. With grommet. Type of protection: IPX9K. Light aperture: 120 x 120 mm.</p> <p>④ 9496 Headlight ④ 6495 Flasher light</p> <p>H7/H3 built-in headlight, left right</p> <hr/> <p>Without side light, With black rubber body, 24V bulbs and DEUTSCH plug connector, left right</p> <p>Spare parts: Lens for flasher lamp</p> <p>1x12V55W (H7) 8GH 007 157-121 1x24V70W (H7) 8GH 007 157-241</p> <p>1x12V55W (H3) 8GH 002 090-133 1x24V70W (H3) 8GH 002 090-251</p> <p>1x12V4W (T4W) 8GP 002 067-121 1x24V4W (T4W) 8GP 002 067-241</p> <p>1x12V21W (P21W) 8GA 002 073-121 1x24V21W (P21W) 8GA 002 073-241</p>	<p>30 30 30 30 4</p>	
  	<p>External-fitting headlight Module 120 With H7 dipped-beam light, H3 driving-beam light and side light. Black plastic housing and lens-retaining rim with extending edge to protect lens. Universal bracket with M12 fixing screws for upright mounting. Type of protection: IPX9K. Light aperture: 120 x 120 mm.</p> <p>④ 9496</p> <p>H7/H3 external-fitting headlight with AMP 4-pole plug connector and 12V bulbs</p> <p>Spare parts: Light unit</p> <p>For bulbs and accessories see next page.</p>	<p>54 1</p>	

"Module 120" Light Series

120 x 120 mm



AMP plug connector,
6-pole



DEUTSCH plug connector,
6-pole

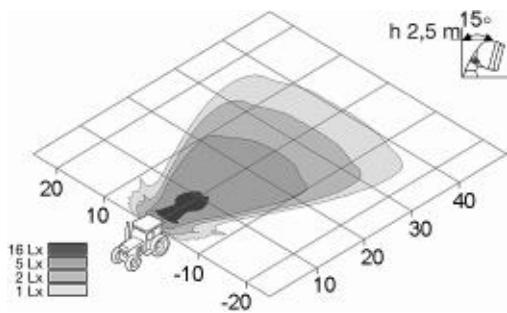
Part no.	Pk.	External-fitting headlights
Module 120 With H7 dipped-beam light, H3 driving-beam light and side light, with attached amber flasher lamp. Flasher light with one lens each toward front and rear. Black plastic housing and lens-retaining rim with extending edge to protect lens. Universal bracket with M12 fixing screws for upright mounting. Type of protection: IPX9K. Light aperture: 120 x 120 mm.		
		(E4) 9496 Headlight (E4) 6495 Flasher light (E4) 6505 Flasher light rear
Ref. 12.5 H7/H3 external-fitting headlight with AMP 6-pole plug connector and 12V bulbs, left		
1LA 993 975-037	40	
1LA 993 975-047	40	right
with DEUTSCH 6-pole plug connector and 12V bulbs, left		
1LA 993 975-117	40	
1LA 990 185-011	1	Spare parts: Light unit
9EL 990 186-001	4	Lens for flasher lamp, front
Accessories:		
8JD 008 151-051	10	Socket for AMP plug connector,
9GH 993 988-007	1	Rubber cap for AMP plug connector
8KW 701 235-033	100	Blade receptacles, 6.3 mm
9GH 990 316-031	20	Rubber cap for Deutsch plug connector, 6-pole

1x12V55W (H7) 8GH 007 157-121
 1x24V70W (H7) 8GH 007 157-241

1x12V55W (H3) 8GH 002 090-133
 1x24V70W (H3) 8GH 002 090-251

1x12V4W (T4W) 8GP 002 067-121
 1x24V4W (T4W) 8GP 002 067-241

1x12V21W (P21W) 8GA 002 073-121
 1x24V21W (P21W) 8GA 002 073-241



1	2
3	4

Part no.

Pk.

External-fitting work lights

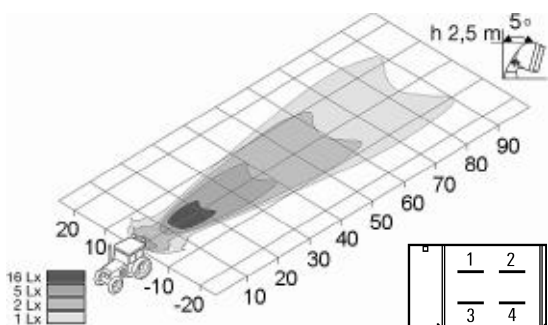
Module 120 with FF reflector

Lens pattern for close-range illumination.
 Recommended angle of inclination: 20°.
 Lens with plastic reflector bonded.
 Black plastic housing and lens-retaining rim with extending edge to protect lens.
 Universal bracket with M12 fixing screw.
 For upright mounting.
 Type of protection: IPX9K.
With AMP plug connector, 4-pole.
Light aperture: 120 x 120 mm.

1GA 996 140-021

1

FF-H3 work light



16 Lx
5 Lx
2 Lx
1 Lx

1	2
3	4

1GA 996 140-041

1

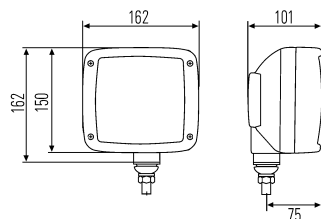
Lens pattern for long-range illumination.
 Recommended angle of inclination: 5°-10°.

8JD 008 151-041
9GH 993 988-007
8KW 701 235-033

10
1
100

Accessories:
 4-pole socket for AMP plug connector
 Rubber cap for AMP plug connector
 Blade receptacles, 6.3 mm

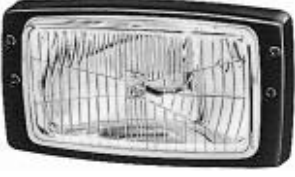
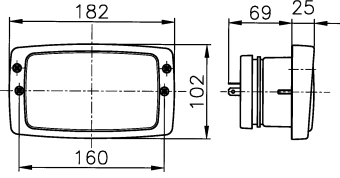


1x12V35W (H3) 8GH 002 090-271
 1x12V55W (H3) 8GH 002 090-133

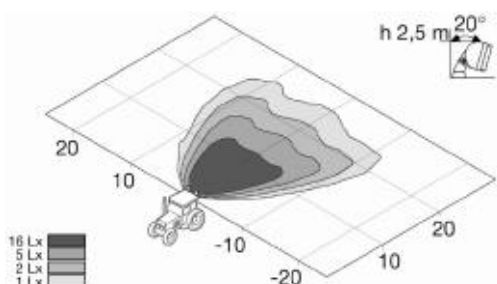
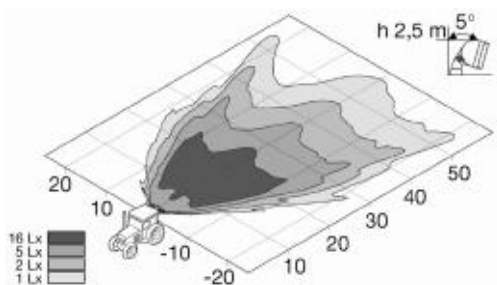
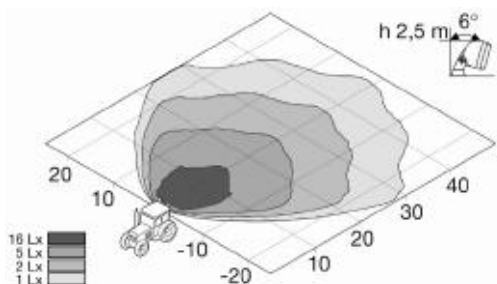
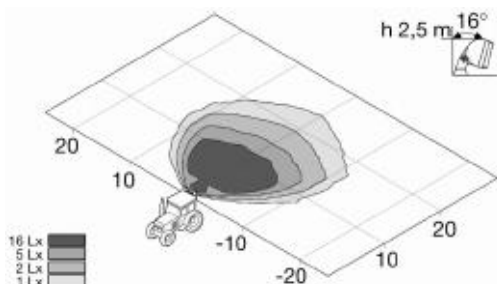
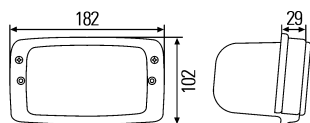


"Module 6213" Light Series

148 x 84 mm



 	<p>Part no.</p> <p>Ref. 10</p> <p>1LB 006 213-057</p> <p>1LB 006 213-047</p>	<p>Pk.</p> <p>Built-in headlights</p> <p>6213</p> <p>E. g. for tractors. With H4 main light and cap. Supporting frame made of black plastic. Mounting depth: 76 mm. Type of protection: IP5K4K. Light aperture: 148 x 84 mm.</p> <p>ⓔ1 44439</p> <p>H4 built-in headlight without side light, 12V 30</p> <p>with side light, 12V 30</p> <p> 1x12V60/55W (H4) 8GJ 002 525-131 1x24V75/70W (H4) 8GJ 002 525-251</p> <p> 1x12V4W (T4W) 8GP 002 067-121 1x24V4W (T4W) 8GP 002 067-241</p>



Part no.

Pk.

Built-in work lights

**Module 6213
Double Beam with FF® reflector**

With lens pattern for object illumination for vertical surfaces.

For horizontal flush-mounting.
Double reflector made of diecast aluminium, glued to glass lens.
Black plastic body and supporting frame, with pan-head tapping screws made of stainless steel 4.2 x 45 mm.
Inclination (6° up and downwards) can be adjusted.
Mounting area: 148 x 88 mm.
With 250 mm long connecting lead.
Type of protection: IP5K4K.

**With grommet.
Light aperture: 148 x 84 mm.**

For front or rear flush mounting in vehicle roof.
Recommended angle of inclination: 15° - 35°.

**FF®-H3 work light
without bulbs**

Lens pattern for ground illumination.
For front or rear flush mounting in vehicle roof.
Recommended angle of inclination: 5° - 15°.

With 2 bulbs 12V55W

Lens pattern for off-road illumination.

For front flush mounting in vehicle roof.
Light falling on the engine of the bonnet reduced to a minimum in order to avoid dazzling off the driver.
Recommended angle of inclination: 2° - 10°.

Without bulbs

Lens pattern for close-range illumination.

For front flush mounting in vehicle roof.
Recommended angle of inclination: 20° - 30°.

Without bulbs

Accessories:

Rubber housing for sealing installation opening

For all versions:

Black plastic housing with mounting bracket for use lights as external-fitting work lights without handle, with grommet

1GB 996 080-001

1

1GB 996 080-011

1

1GB 996 080-021

1

1GB 996 080-031

1

9BG 993 345-001

1

9BG 990 178-011

1

8JD 008 151-041

10

8KW 701 235-033

100

9XD 990 298-001

5

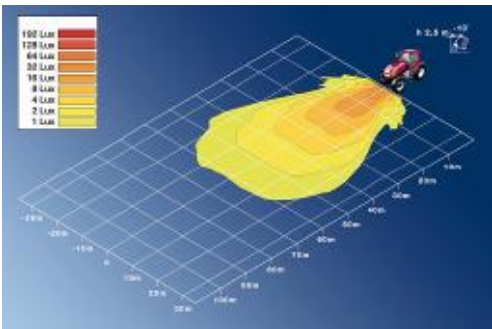


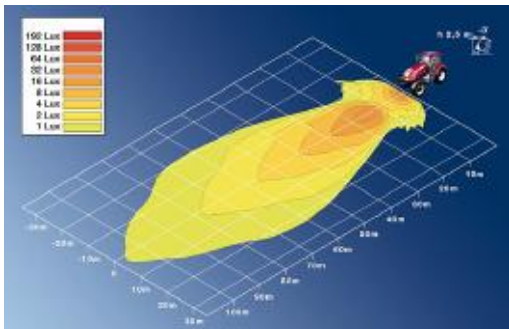
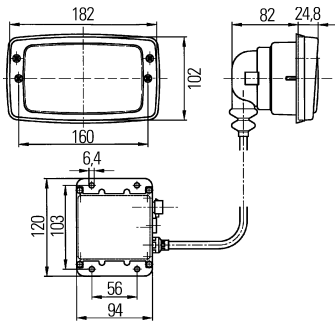

- 2x12V35W (H3) 8GH 002 090-271
- 2x12V55W (H3) 8GH 002 090-133
- 2x24V70W (H3) 8GH 002 090-251



"Module 6213" Light Series

148 x 84 mm

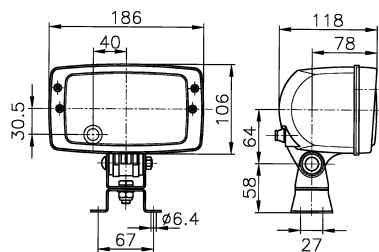
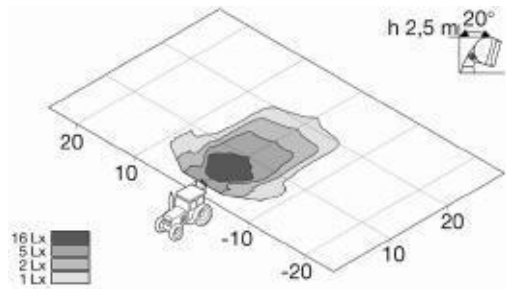


	Part no.	Pk. Built-in work lights
 	1GB 996 147-011	<p>Module 6213 Xenon Lens pattern for close-range illumination. Recommended angle of inclination: 10° - 20°. Lens with plastic reflector bonded. With pan-head tapping screws made of stainless steel 4.2 x 45 mm. Inclination (6° up and downwards) can be adjusted. Rubber housing for sealing installation opening 148 x 88 mm. The ballast unit is firmly connected to work light by a 300 mm long lead. With 3700 mm long connection lead, relay and 15A fuse. Type of protection: IP5K4K. With gas discharge bulb. Light aperture: 148 x 84 mm.</p> <p>Xenon-work light with 12V ballast unit and red supporting frame</p>  1x35W (D2S) 8GS 007 949-101
 	<p>1GB 996 147-011</p> <p>9BG 990 297-001 8JS 711 687-821</p> <p>8KB 149 147-001</p>	<p>Lens pattern for long-range illumination.</p> <p>Xenon-work light with 12V ballast unit and black supporting frame, without connection lead</p> <p>Spare parts: 1 Housing for ballast unit 12V 1 Blade-type fuse, 15A (5 pcs.)</p> <p>Accessories: 1 3000 mm long connection lead from ballast unit to battery, with relay and fuse, 12V</p>  1x35W (D2S) 8GS 007 949-101

	Part no.	Pk.	Built-in work lights
	<p>1GB 006 213-101 1GB 006 213-107</p>	<p>1 30</p>	<p>Module 6213 with FF® reflector Lens pattern for far-reaching illumination. Recommended angle of inclination: 10° - 20°. Lens with metal reflector bonded. Black plastic supporting frame with pan-head tapping screws made of stainless steel 4.2 x 45 mm. Inclination (6° up and downwards) can be adjusted. Mounting area: 148 x 88 mm. Type of protection: IP5K4K. Light aperture: 148 x 84 mm.</p> <p>H3 work light with cap</p>
	<p>1GB 006 213-111 1GB 006 213-117</p>	<p>1 30</p>	<p>Lens pattern for close-range illumination.</p> <p>H3 work light with cap</p>
	<p>1GD 996 018-541</p>	<p>1</p>	<p>Lens with plastic reflector bonded, with cap, only for 12V</p>
	<p>9BG 993 345-001 9BG 990 042-061</p>	<p>1 1</p>	<p>Accessories: Rubber housing for sealing installation opening for -101/-107/-111/-117 for -541</p>
	<p>9BG 990 178-011</p>	<p>1</p>	<p>For all versions: Black plastic housing with mounting bracket for use lights as external-fitting work lights without handle, with grommet</p>
	<p>8JD 008 151-041 8KW 701 235-033 9XD 990 298-001</p>	<p>10 100 5</p>	<p>4-pole socket for AMP plug connector Blade receptacles, 6.3 mm Bracket for four-point fixing</p>
			<p>1x12V35W (H3) 8GH 002 090-271 1x12V55W (H3) 8GH 002 090-133 1x24V70W (H3) 8GH 002 090-251</p>

"Module 6213" Light Series

148 x 84 mm



Part no.

Pk.

External-fitting work light

Module 6213

Lens pattern for close-range illumination.

Recommended angle of inclination: 10° - 20°.

Lens with metal reflector bonded.

Black plastic housing and lens-retaining rim.

Pivot base with bracket for four-point mounting.

For upright or pendant mounting.

Type of protection: IP5K4K.

With grommet and vibration damping.

Light aperture: 148 x 84 mm.

1GB 996 213-511

1

H3 work light

1GB 006 213-111

1

Spare parts:

Light unit with lens-retaining rim

9XD 990 298-001

5


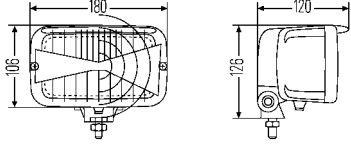



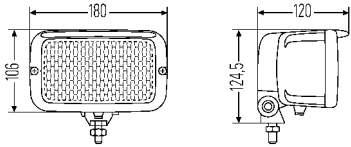
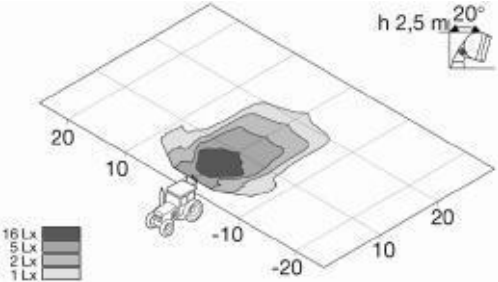

Bracket for four-point mounting

1x12V35W (H3) 8GH 002 090-271

1x12V55W (H3) 8GH 002 090-133

1x24V70W (H3) 8GH 002 090-251



 	<p>Part no.</p> <p>1LB 007 145-047</p>	<p>Pk.</p> <p>36</p>	<p>External-fitting headlight</p> <p>7145 With H4 main light and side light. Black plastic housing and lens-retaining rim. Universal bracket with M10 fixing screw. For upright or pendant mounting. Light aperture: 148 x 84 mm.</p> <p>(E1) 44439</p> <p>H4 external-fitting headlight</p>  1x12V60/55W (H4) 8GJ 002 525-131  1x12V4W (T4W) 8GP 002 067-121
  	<p>Part no.</p> <p>1GB 007 145-101 1GB 007 145-107</p>	<p>Pk.</p> <p>1 36</p>	<p>External-fitting work lights</p> <p>7145 Lens pattern for wide close-range illumination. Recommended angle of inclination: 10° - 20°. Lens with metal reflector bonded. Black plastic housing and lens-retaining rim. Pivot base with M10 fixing screw for upright or pendant mounting. Light aperture: 148 x 84 mm.</p> <p>H3 work light</p>  1x12V35W (H3) 8GH 002 090-271 1x12V55W (H3) 8GH 002 090-133 1x24V70W (H3) 8GH 002 090-251

Accessories see page 4.110-4.111.

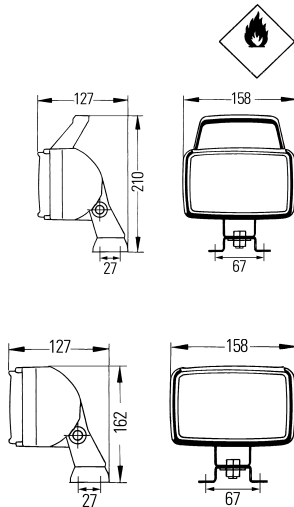
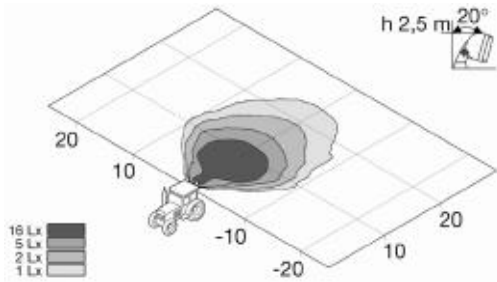
Work Lights

136 x 88 mm



	Part no.	Pk.	External-fitting work lights
	<p>1GA 006 991-021</p>	<p>1</p>	<p>Double-Beam with FF®-reflector Lens pattern for intensive close-range illumination. Recommended angle of inclination: 25° - 35°. Double reflector made of diecast aluminium, glued to glass lens. Black plastic housing with extending edge to protect lens. With 250 mm long silicone connection lead. Pivot base with bracket for four-point mounting. For upright or pendant mounting. Height of mounting bracket: 22 mm. Without vibration damping. Type of protection: IP5K4K. With grommet. Light aperture: 136 x 88 mm.</p> <p>FF®-H3 work light with handle</p>
	<p>1GA 006 991-091</p>	<p>1</p>	<p>without handle</p> <p>Spare parts: Light unit Bracket for four-point mounting</p>
	<p>1GA 006 991-061</p> <p>1GA 006 991-051</p>	<p>1</p> <p>1</p>	<p>Lens pattern for far-reaching off-road illumination. Recommended angle of inclination: 5° - 15°. Type of protection: IP5K4K.</p> <p>FF®-H3 work light with handle</p> <p>without handle</p> <p>Spare parts: Bracket for four-point mounting</p>
	<p>1GA 006 991-031</p> <p>1GA 006 991-041</p>	<p>1</p> <p>1</p>	<p>Lens pattern for large-area, uniform close-range illumination. Recommended angle of inclination: 15° - 25°. Type of protection: IP5K4K.</p> <p>FF®-H3 work light with handle</p> <p>without handle</p> <p>Spare parts: Light unit Bracket for four-point mounting</p>
	<p>1GA 998 524-011 9XD 990 298-001</p>	<p>1 5</p>	<p>Spare parts: Light unit Bracket for four-point mounting</p> <p>2x12V35W (H3) 8GH 002 090-271 2x12V55W (H3) 8GH 002 090-133 2x24V70W (H3) 8GH 002 090-251</p>

Accessories see page 4.110-4.111.



Part no.

Pk.

External-fitting work lights

Double-Beam with FF®-reflector

Lens pattern for object illumination for vertically surfaces.

Recommended angle of inclination:

for vertically surfaces 0° - 5°,

for horizontally surfaces 25° - 45°.

Double reflector made of diecast aluminium, glued to glass lens.

Black plastic housing with extending edge to protect lens.

With 250 mm long silicone connection lead.

Pivot base with bracket for four-point mounting.

For upright or pendant mounting.

Without vibration damping.

Type of protection: IP5K4K.

With grommet.

Light aperture: 136 x 88 mm.

1GA 006 991-081

1

FF®-H3 work light with handle

1GA 006 991-071

1

without handle

9XD 990 298-001

5

Spare parts:

Bracket for four-point mounting

2x12V35W (H3) 8GH 002 090-271

2x12V55W (H3) 8GH 002 090-133

2x24V70W (H3) 8GH 002 090-251



Work Lights

135 x 75 mm



	Part no.	Pk.	External-fitting work lights
	<p>1GA 005 060-001</p> <p>1GA 132 459-011 9AG 132 453-005</p>	<p>1</p>	<p>Master 5060 Lens pattern for far-reaching illumination. Recommended angle of inclination: 15° - 20°. Lens with metal reflector bonded. Black plastic housing. Pivot base with M10 fixing screw for upright or pendant mounting. Without vibration damping. Type of protection: IP5K4K. Light aperture: 135 x 75 mm.</p> <p>H3 work light with pivot base for external-fitting</p> <p>Spare parts: Light unit Lens-retaining rim</p>
	<p>1GA 005 060-041</p>	<p>1</p>	<p>Lens pattern for close-range illumination. Recommended angle of inclination: 20° - 25°.</p> <p>H3 work light with pivot base for external-fitting</p>
	<p>1GA 005 060-337</p> <p>9AG 132 453-005</p>	<p>30</p> <p>5</p>	<p>Built-in work light</p> <p>Sealed housing. With 2 fixing screws 3.5 x 25 mm and 12V55W bulb. Mounting area: 152 x 92 mm.</p> <p>H3 work light</p> <p>Spare parts: Lens-retaining rim</p> <p>1x12V35W (H3) 8GH 002 090-271 1x12V55W (H3) 8GH 002 090-133 1x24V70W (H3) 8GH 002 090-251</p>

Accessories see page 4.110-4.111.

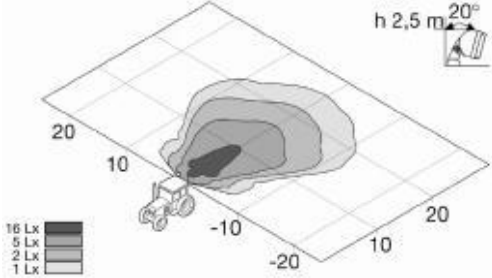

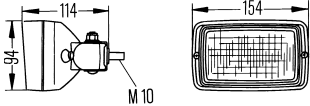

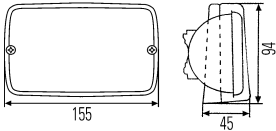

	Part no.	Pk.	External-fitting work lights
	<p>1GA 006 876-001</p>	<p>1</p> <p>Picador 6876 with FF® reflector Lens pattern for ground illumination. Recommended angle of inclination: 20° - 25°. Lens with plastic reflector bonded. Black plastic housing and lens-retaining rim. Lens-retaining rim with extending edge to protect lens. Universal bracket with M10 fixing screw for upright or pendant mounting. Pivot range: horizontal 130°, vertical 90°. Type of protection: IP5K4K. With grommet. Light aperture: 125 x 75 mm.</p>	
	<p>1GA 998 522-011</p>	<p>1</p> <p>Picador 8522 with FF® reflector Recommended angle of inclination: 20° - 25°. Universal bracket with M10 fixing screw for upright or pendant mounting. Pivot range: horizontal 130°.</p> <p>FF®-H3 work light with pivot base</p>	
	<p>1GB 996 102-101</p> <p>8HG 990 263-111</p> <p>8HG 004 806-001</p> <p>9XD 130 261-001</p>	<p>1</p> <p>With FF® reflector Lens pattern for far-reaching illumination. Recommended angle of inclination: 15° - 20°. Universal bracket with M10 fixing screw for upright or pendant mounting. Pivot range: horizontal 130°.</p> <p>FF®-H3 work light with pivot base</p> <p>Accessories:</p> <ul style="list-style-type: none"> 1 Mounting bracket for tubular mount on 15 - 28 mm dia. pipes 1 Magnetic base 1 U-bracket <p>1x12V35W (H3) 8GH 002 090-271 1x12V55W (H3) 8GH 002 090-133 1x24V70W (H3) 8GH 002 090-251</p>	

Accessories see page 4.110-4.111.

Work Lights

125 x 75 mm



	Part no.	Pk.	External-fitting work light
  	<p>1GA 006 875-001</p>	<p>1</p> <p>Picador 6875 with FF® reflector Lens pattern for ground illumination. Recommended angle of inclination: 20° - 25°. Lens with plastic reflector bonded. Black plastic housing and lens-retaining rim. Lens-retaining rim with extending edge to protect lens. Universal side bracket with M10 mounting screw for attachment to vertical surfaces. Pivot range: horizontal 150°, vertical 90°. Type of protection: IP5K4K. With grommet. Light aperture: 125 x 75 mm.</p> <hr/> <p>FF®-H3 work light with side rotary pivot base</p>	
 	<p>1GA 996 082-001</p>	<p>1</p> <p>Picador 6082 with FF® reflector Lens pattern for ground illumination. Recommended angle of inclination: 20° - 25°. Lens with plastic reflector bonded. Black plastic housing and lens-retaining rim. Lens-retaining rim with extending edge to protect lens. With two 3.9 x 55 mm fixing screws. Distance between screws: 142 mm. Foam rubber seal for sealing dust and water-tight to outside on even attachment surfaces. Front inclination 5.2°, mounting aperture: 130 x 76 mm. Type of protection: IP5K4K. Light aperture: 125 x 75 mm.</p> <p>FF®-H3 work light</p> <p>1x12V35W (H3) 8GH 002 090-271 1x12V55W (H3) 8GH 002 090-133 1x24V70W (H3) 8GH 002 090-251</p> 	

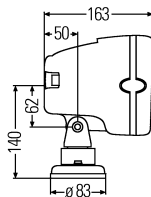
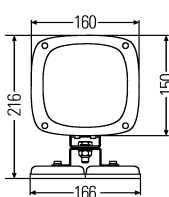
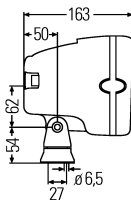
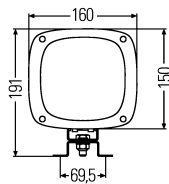
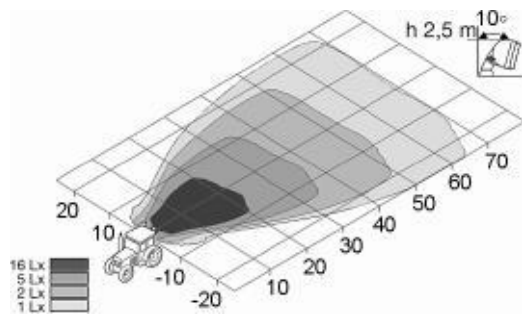
Accessories see page 4.110-4.111.

Part no.	Pk.	External-fitting work lights
	<p>1GD 005 700-501 1</p> <p>1GD 137 355-011 1</p>	<p>Torero 5700 Lens pattern for close-range illumination. Recommended angle of inclination: 15° - 25°. Lens with steel reflector bonded. Black plastic housing. Pivot base with M10 fixing screw. For upright or pendant mounting. Without vibration damping. Type of protection: IP5K4K. Light aperture: 195 x 96 mm.</p> <p>H3 work lights</p> <p>Spare parts: Light unit</p> <p> 1x12V35W (H3) 8GH 002 090-271 1x12V55W (H3) 8GH 002 090-133 1x24V70W (H3) 8GH 002 090-251 </p>
	<p>1GA 996 179-021 1</p> <p>1GA 996 179-001 1</p>	<p>ECO 21 Lens pattern for close-range illumination Lens with plastic reflector bonded. Black plastic housing. Pivot base with M10 fixing screw. With bulb, gasket and 200 mm connection lead. Bulb accessible from the outside. Type of protection: IP5K9K. Light aperture: 88 x 88 mm.</p> <p>Work light, 12V</p> <p>24V</p> <p> 1x12V21W (P21W) 8GA 002 073-121 1x24V21W (P21W) 8GA 002 073-241 </p>
	<p>1GA 996 020-001 1</p>	<p>Built-in work light For installation on side next to headlight. For illumination to front and side. Four 3.9 x 13 fixing screws. With 12V55W bulb.</p> <p>H3 work light</p> <p> 1x12V35W (H3) 8GH 002 090-271 1x12V55W (H3) 8GH 002 090-133 </p>

Accessories see page 4.110-4.111.

Work Lights

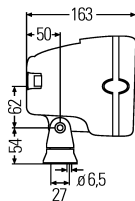
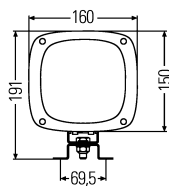
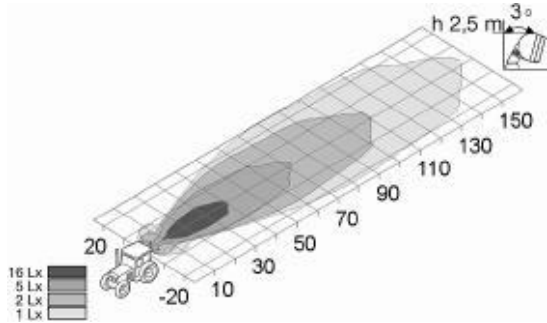
123 x 123 mm



Part no.	Pk.	External-fitting work lights
AS 200 Xenon		
Lens pattern for wide close-range illumination.		
Recommended angle of inclination: 10° - 25°.		
Lens with plastic reflector bonded.		
Black plastic housing with extending edge to protect lens. With red decorative ring.		
Handle recessed into housing.		
Xenon electronic unit 42W integrated into housing.		
Pivot base with bracket for four-point mounting.		
Type of protection: IP5K4K and IPX9K.		
With gas discharge bulb.		
Light aperture: 123 x 123 mm.		
Xenon-work light		
1GA 996 142-001	1	with 12V ballast unit, AMP plug connector and 3100 mm long connecting lead, relay and fuse
1GA 996 142-011	1	with 24V ballast unit, AMP plug connector and 3100 mm long connecting lead, relay and fuse
1GA 996 142-021	1	with 12V ballast unit, DEUTSCH plug connector and 3100 mm long connecting lead with relay and fuse
1GA 996 142-311	1	with 24V ballast unit, DEUTSCH plug connector and black decorative ring, without connecting lead
Spare parts:		
1GA 990 305-001	1	Light unit
9GH 993 984-001	20	Rubber cap for AMP plug connector
8KB 990 299-121	1	3100 mm connecting lead with relay and fuse for AMP plug connector, 24V
		3100 mm long connecting lead with relay and fuse for DEUTSCH plug connector,
8KB 990 299-221	1	12V
8KB 990 299-231	1	24V
8JS 711 687-821	1	Blade-type fuses, 15A (5 pcs.)
Accessories:		
8JD 008 151-011	10	Socket for AMP plug connector
8KW 701 235-033	100	Blade receptacles, 6.3 mm
8HG 990 320-001	1	Bracket attachment foot
8HG 990 263-111	1	Mounting bracket for tubular mount on 15 mm - 28 mm dia. pipes
<hr/>		
1GA 996 142-141	1	With 24V ballast unit, PG-screw connection and 3000 mm long connection lead, without relay and fuse. Sealed version.
<hr/>		
1GA 996 142-241	1	With 230V ballast unit, PG-screw connection and 10.000 mm rubber cable with ground contact. Suitable in connection with current generator 230V-VSG 40W.
<hr/>		
1GA 990 305-001	1	Spare parts: Light unit
<hr/>		
1GA 996 142-041	1	With 12V ballast unit, magnet holder, PG-screw connection and 2500 mm long connection lead with plug 8JA 001 915-001. (Suitable sockets in compliance with DIN 4165)
<hr/>		
Spare parts:		
1GA 990 305-001	1	Light unit
8HG 004 806-001	1	Magnet holder with fixing material
9XD 130 261-001	5	Mounting bracket for magnet holder
8JS 711 687-821	1	Blade type fuse, 15A (5 pcs.)
8JA 001 915-001	10	Plug, 2-pole



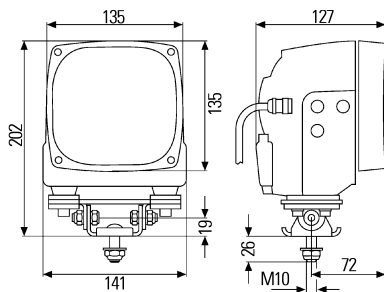
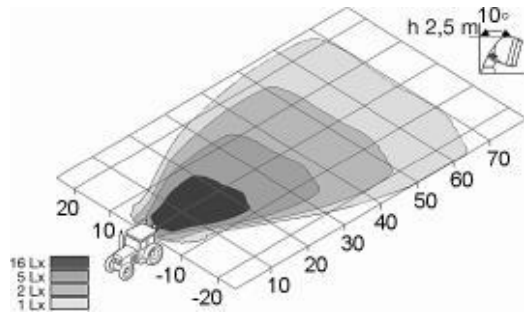
1x35W (D2S) 8GS 007 949-101



Part no.	Pk.	External-fitting work lights
AS 200 Xenon		
Lens pattern for long-range illumination. Recommended angle of inclination: 3° - 10°. Lens with plastic reflector bonded. Black plastic housing with extending edge to protect lens. With red decorative ring. Handle recessed into housing. Xenon electronic unit 42W integrated into housing. Pivot base with bracket for four-point mounting. Type of protection: IP5K4K and IPX9K.		
With gas discharge bulb. Light aperture: 123 x 123 mm.		
Xenon-work light		
1GA 996 142-061	1	Xenon-work light with 12V ballast unit, AMP plug connector and 3100 mm long connecting lead, relay and fuse
1GA 996 142-071	1	with 24V ballast unit, AMP plug connector and 3100 mm long connecting lead, relay and fuse
1GA 996 142-081	1	with 12V ballast unit, AMP plug connector, switch with integrated fuse and 2500 mm long connecting lead
1GA 996 142-091	1	with 24V ballast unit, AMP plug connector, switch with integrated fuse and 2500 mm long connecting lead
1GA 996 142-131	1	with 24V ballast unit, AMP plug connector and black decorative ring, without connecting lead
Spare parts:		
1GA 990 305-011	1	Light unit
9GH 993 984-001	1	Rubber cap for AMP plug connector
8KB 990 299-121	1	3100 mm long connecting lead with relay and fuse for AMP plug connector, 24V (for -071)
8JS 711 687-821	1	Blade-type fuse, 15A (5 pcs.)
Accessories:		
8JD 008 151-011	10	Socket for AMP plug connector
8KW 701 235-033	100	Blade receptacles, 6.3 mm
8HG 990 320-001	1	Bracket attachment foot
8HG 990 263-111	1	Mounting bracket for tubular mount on 15 mm - 28 mm dia. pipes
1GA 996 142-151	1	With 24V ballast unit, PG-screw connection and 3000 mm long connecting lead, without relay and fuse. Sealed version
1GA 996 142-251	1	With 230V ballast unit, PG-screw connection and 10.000 mm rubber cable with ground contact. Suitable in connection with current generator 230V-VSG 40W
		1x35W (D2S) 8GS 007 949-101

Work Lights

123 x 123 mm



Part no.

Pk.

External-fitting work lights

AS 400 Xenon

Lens pattern for ground illumination.

Recommended angle of inclination: 10° - 25°.

Lens with plastic reflector bonded.

Black housing and red lens-retaining rim made of diecast aluminium.

Handle recessed into housing.

Xenon electronic unit 42W integrated into housing.

Pivot base with M10 fixing screw made of stainless steel.

With vibration damping.

Type of protection: IP5K4K and IPX9K.

With gas discharge bulb.

Light aperture: 123 x 123 mm.

Xenon-work light

with 24V ballast unit and

200 mm connecting lead with

DEUTSCH plug connector

1GA 996 242-111

1

with 24V ballast unit,

pivot base with M12 fixing screw

made of stainless steel,

without vibration damping,

with AMP plug connector and

200 mm connecting lead

1GA 996 242-521

1

Spare parts:

Light unit

1GA 990 305-001

1

3100 mm long connecting lead

for DEUTSCH plug connector,

with 24V relay and fuse

8KB 990 299-231

1

3100 mm long connection lead for

AMP plug connector with 24V relay and fuse

8KB 990 299-121

1

DEUTSCH plug connector, 2-pole

8JA 990 295-127

1

Blade-type fuse, 15A (5 pcs.)

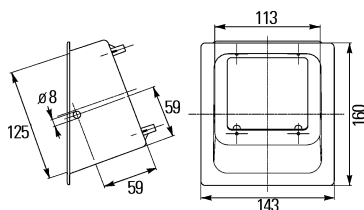
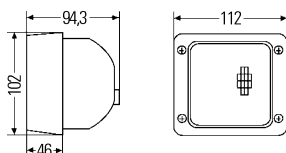
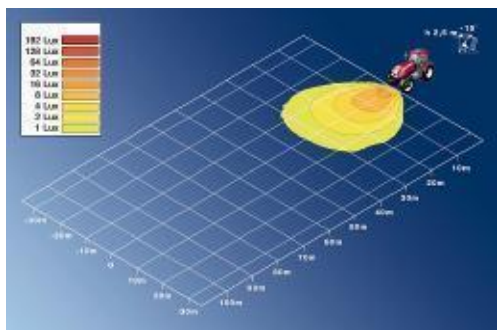
8JS 711 687-821

1



1x35W (D1S) 8GS 009 028-001

Accessories see page 4.110-4.111.



Part no.

Pk.

Built-in work lights

Ultra Beam Standard with FF® reflector

Lens pattern for wide close-range illumination.

Recommended angle of inclination: 15° - 20°.
 Double reflector made of diecast aluminium, glued to hardened glass lens.
 Black plastic housing with extending edge to protect lens.
 With four 3.9 x 60 mm fixing screws.
 Distance between screws: 66 x 95 mm.
 Mounting area: 85 x 85 mm.
Light aperture: 83 x 83 mm.

1GA 007 506-121

1

FF®-H3 work light with grommet

Type of protection: IP5K4K

1GA 007 506-111

1

With AMP plug connector and cap.

Type of protection: IP6K4K and IPX9K

1GA 007 506-061

1

With AMP plug connector and 12V55W bulb, without cap and fixing screws.

Type of protection: IP6K4K and IPX9K

1GA 007 506-431

1

With AMP plug connector and 24V70W bulb, without cap

Spare parts:

Light unit

1GA 998 525-001

1

Cap for AMP plug connector

9GH 993 984-001

20

Accessories:

2000 mm long connecting lead for AMP plug connector

8KB 990 299-001

1

Socket for AMP plug connector

8JD 008 151-011

10

Blade receptacles, 6.3 mm

8KW 701 235-033

100

9BG 990 353-001

1

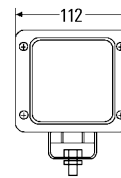
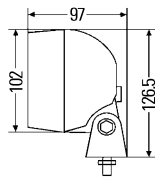
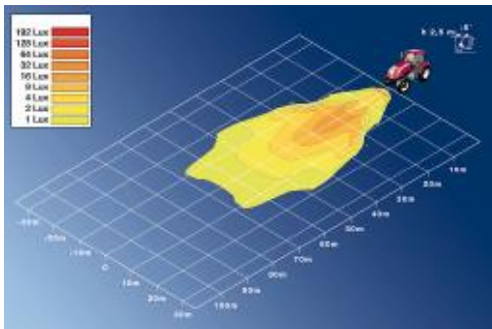
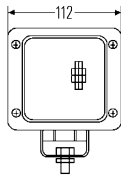
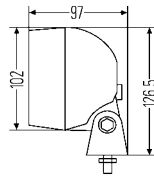
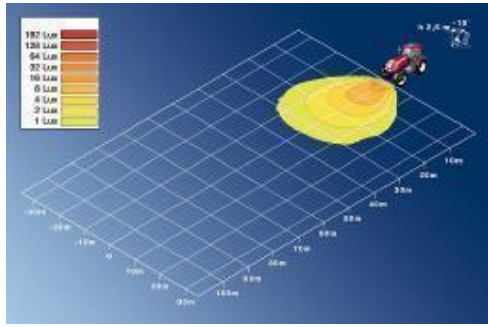
Mounting hollow, inclination 20°, (supplied without work light)

- 1x12V35W (H3) 8GH 002 090-271
- 1x12V55W (H3) 8GH 002 090-133
- 1x24V70W (H3) 8GH 002 090-251



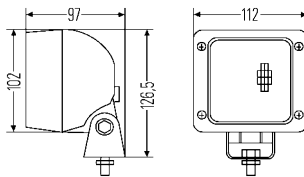
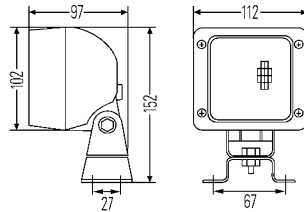
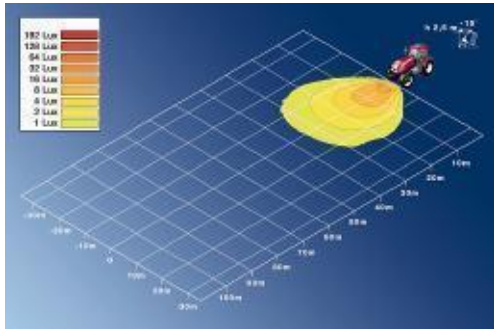
Work Lights

83 x 83 mm



Part no.	Pk.	External-fitting work lights
		Ultra Beam Standard with FF® reflector Lens pattern for wide ground illumination. Recommended angle of inclination: 15° - 20°. Reflector made of diecast aluminium, glued to hardened glass lens. Black plastic housing with extending edge to protect lens. Pivot base with M10 fixing screw, for upright or pendant mounting. Without vibration damping. Pivot range vertical 130°. Light aperture: 83 x 83 mm.
1GA 007 506-081	1	FF®-H3 work light with grommet Type of protection: IP5K4K
1GA 007 506-001	1	With AMP plug connector and cap Type of protection: IP6K4K and IPX9K
1GA 007 506-391	1	With DEUTSCH plug connector and cap
1GA 997 506-371 1GA 997 506-377	1 18	With magnet holder, vibration damping, PG-screw connection, 3500 mm long connecting lead with 2-pole plug and 12V35W bulb Spare parts: Light unit Cap for AMP plug connector Magnet bracket Plug, 2-pole 1x12V35W (H3) 8GH 002 090-271 1x12V55W (H3) 8GH 002 090-133 1x24V70W (H3) 8GH 002 090-251
1GA 998 525-001 9GH 993 984-001 8HG 004 806-001 8JA 001 915-001	1 1 1 1	
		Lens pattern for long-range illumination. Hardened lens without optical pattern. With M10 fixing screw for upright or pendant mounting. Without vibration damping.
1GA 997 506-021	1	FF®-H3 work light with AMP plug connector and cap Type of protection: IP6K4K and IPX9K
8JD 008 151-011 8KW 701 235-033 8HG 990 263-111	10 100 1	Accessories: Socket for AMP plug connector Blade receptacles, 6.3 mm Mounting bracket for tubular mount on 15 mm - 28 mm dia. pipes
8KB 990 299-001 8KB 990 299-011	1 1	2000 mm long connecting lead for AMP plug connector with cap 2000 mm long connecting lead for DEUTSCH plug connector with cap 1x12V35W (H3) 8GH 002 090-271 1x12V55W (H3) 8GH 002 090-133 1x24V70W (H3) 8GH 002 090-251

Accessories see page 4.110-4.111.



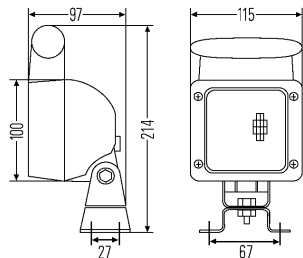
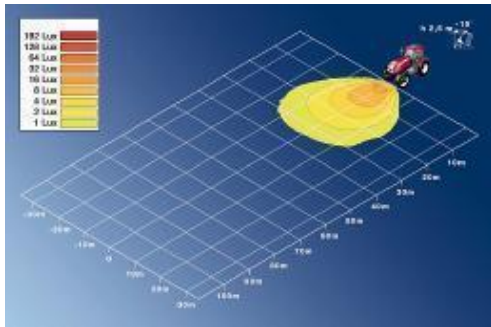
Part no.	Pk.	External-fitting work lights
		Ultra Beam Heavy Duty with FF® reflector Lens pattern for wide close-range illumination. Recommended angle of inclination: 15° - 20°. Reflector made of diecast aluminium, glued to hardened glass lens. Black plastic housing with extending edge to protect lens. Pivot base with vibration damping and bracket for four-point mounting. For upright or pendant mounting. Pivot range vertical 130°. Light aperture: 83 x 83 mm.
1GA 007 506-011	1	FF®-H3 work light with AMP plug connector and cap, without bulb Type of protection: IP6K4K and IPX9K
1GA 997 506-601	1	with half the lens pattern-free
1GA 007 506-091	1	With grommet, without bulb. Type of protection: IP5K4K
1GA 007 506-651	1	With DEUTSCH plug connector, 12V55W bulb and M10 fixing screw, without cap
1GA 007 506-491	1	With DEUTSCH plug connector and M10 fixing screw, without bulb and cap
1GA 007 506-451	1	With PG-cable retention and M10 fixing screw, without bulb.
1GA 998 525-001	1	Spare parts: Light unit (except -601)
9GH 993 984-001	1	Cap for AMP plug connector
8JD 008 151-011	10	Accessories: Socket for AMP plug connector
8KW 701 235-033	100	Blade receptacles, 6.3 mm
8KB 990 299-001	1	2000 mm long connecting lead for AMP plug connector with cap
8KB 990 299-011	24	2000 mm long connecting lead for DEUTSCH plug connector with cap

- 1x12V35W (H3) 8GH 002 090-271
- 1x12V55W (H3) 8GH 002 090-133
- 1x24V70W (H3) 8GH 002 090-251



Work Lights

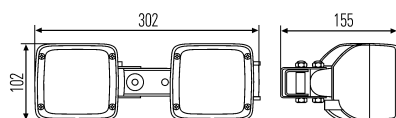
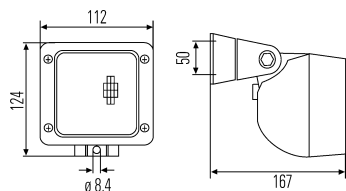
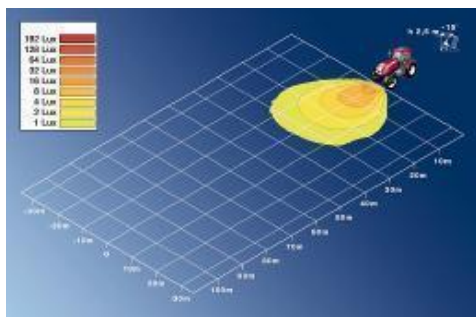
83 x 83 mm



Part no.	Pk.	External-fitting work lights
		Ultra Beam Heavy Duty with FF® reflector
		Lens pattern for wide close-range illumination. Recommended angle of inclination: 15° - 20°. Reflector made of diecast aluminium, glued to hardened glass lens. Black plastic housing with extending edge to protect lens. With handle. Pivot base with vibration damping and bracket for four-point mounting. For upright or pendant mounting. Pivot range vertical 130°. Light aperture: 83 x 83 mm.
1GA 007 506-021	1	FF®-H3 work light with AMP plug connector and protective cap Type of protection: IP6K4K and IPX9K
1GA 007 506-101	1	With grommet Type of protection: IP5K4K
1GA 998 525-001	1	Spare parts: Light unit
9GH 993 984-001	1	Protective cap for AMP plug connector
9XD 990 298-001	5	U-bracket
8JD 008 151-011	10	Accessories: 2-pole socket for AMP plug connector
8KW 701 235-033	100	Blade receptacles, 6.3 mm
8KB 990 299-001	1	2000 mm long connecting lead for AMP plug connector
8HG 990 263-111	1	Mounting bracket for tubular mount on 15 mm - 28 mm dia. pipes
1GA 997 506-157	12	With magnet base, cable retention, 24V70W bulb and spirally coiled cable, stretched length of cable 3500 mm, with 3-pole plug
1GA 997 506-557	12	with 2-pole plug
1GA 998 525-001	1	Spare parts: Light unit
8JA 002 263-031	1	Plug, 3-pole
8JA 001 915-001	1	2-pole
8JB 001 933-031	1	Accessories: Socket, 3-pole for -157
		1x12V35W (H3) 8GH 002 090-271 1x12V55W (H3) 8GH 002 090-133 1x24V70W (H3) 8GH 002 090-251



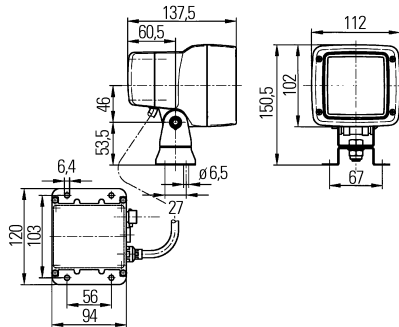
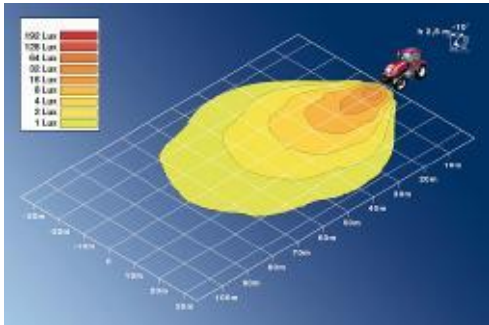
Accessories see page 4.110-4.111.



Part no.	Pk.	External-fitting work lights
		Ultra Beam Standard with FF® reflector Lens pattern for wide close-range illumination. Recommended angle of inclination: 15° - 20°. Reflector made of diecast aluminium, glued to hardened glass lens. Black plastic housing with extending edge to protect lens. With side rotary pivot base. With M10 fixing screw for mounting on vertical surfaces. Pivot range: horizontal 130°, inclination range: vertical 90°. Light aperture: 83 x 83 mm.
1GA 996 083-011	1	FF®-H3 work light with grommet Type of protection: IP5K4K
1GA 996 083-001	1	With AMP plug connector and protective cap Type of protection: IP6K4K and IPX9K
1GA 998 525-001	1	Spare parts: Light unit
9GH 993 984-001	1	Cap for AMP plug connector
8HG 990 263-111	1	Accessories: Mounting bracket for tubular mount on 15 - 28 mm dia. pipes
9XD 990 298-001	5	U-bracket
8KB 990 299-001	1	2000 mm long connecting lead for AMP plug connector
8JD 008 151-011	10	Socket for AMP plug connector
8KW 701 235-033	100	Blade receptacles, 6.3 mm
1GA 996 083-021	1	With swivelling bow for double equipment and grommet Type of protection: IP5K4K
1GA 998 525-001	1	Spare parts: Light unit
		1(2)x12V35W (H3) 8GH 002 090-271 1(2)x12V55W (H3) 8GH 002 090-133 1(2)x24V70W (H3) 8GH 002 090-251

Work Lights

83 x 83 mm



Part no.

Pk.

External-fitting work lights

Ultra Beam Xenon

Lens pattern for extremely wide, intense and far-reaching illumination.

Reflector made of diecast aluminium, glued to hardened glass lens.

Black plastic housing and red lens-retaining rim.

Lens-retaining rim with extending edge to protect lens.

Pivot base with vibration damping and bracket for four-point mounting.

Mounting bracket made of stainless steel. Pivot range vertical 105°.

For upright or pendant mounting.

With 3700 mm long connecting lead, relay and 15A fuse.

Type of protection: IP5K4K.

With gas discharge bulb.

Light aperture: 83 x 83 mm.

1GA 998 534-001

1

Xenon work light with 12V ballast unit

1GA 998 534-011

1

with 24V ballast unit

Spare parts:

1GA 998 525-011

1

Light unit

5DV 990 264-001

1

Ballast unit, 12V

5DV 990 264-011

1

24V

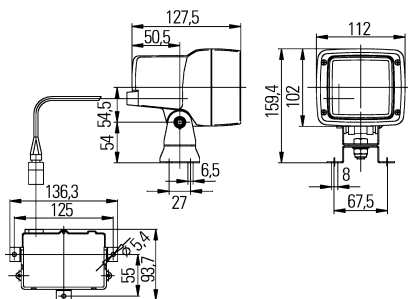
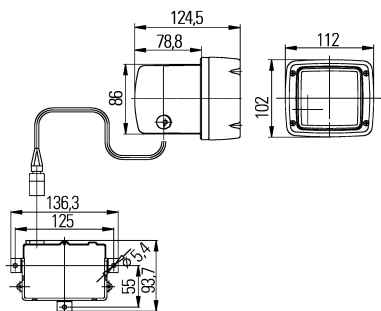
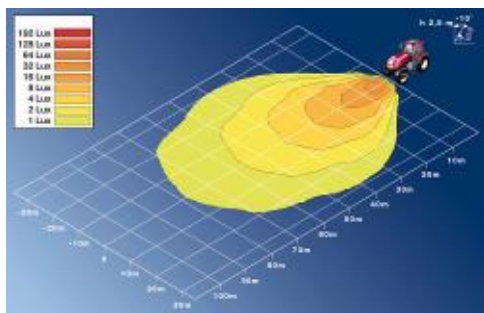
8KB 149 147-001

1

3700 mm long connecting lead from ballast unit to battery, with relay and fuse, 12V



1x35W (D2S) 8GS 007 949-101



Part no.

Vp.

Built-in work lights

Ultra Beam Xenon

Lens pattern for wide, intense and far-reaching illumination.

Reflector made of diecast aluminium, glued to hardened glass lens.

Black housing and red lens-retaining rim made of plastic.

Work light permanently connected by 3000 mm long lead with ballast unit 42W.

The lead can be disconnected from the ballast unit by means of a plug-connection.

Type of protection: IP5K4K.

With DEUTSCH plug connector and gas discharge bulb.

Light aperture: 83 x 83 mm.

1GA 998 534-541

1

Xenon work light with 24V ballast unit, without connecting lead

Accessories:

Connector lead between work light and ballast unit,

1000 mm

3000 mm

8KB 990 299-241

1

8KB 990 299-251

1

External-fitting work lights

Pivot base with vibration damping and bracket for four-point mounting made of stainless steel.

Pivot range vertical 105 °.

For upright mounting.

Work light permanently connected by 3000 mm long lead with ballast unit 42W.

The lead can be disconnected from the ballast unit by means of a plug-connection.

Type of protection: IP5K4K.

1GA 998 534-221

1

Xenon work light with 12V ballast unit, without connecting lead

1GA 998 534-231

1

with 24V ballast unit, without connecting lead

1GA 998 534-271

1

with 24V ballast unit and 500 mm long connector lead, without connecting lead

Spare parts:

Light unit

Ballast unit,

12V

1GA 998 525-071

1

5DV 008 855-001

1

5DV 008 855-007

24

5DV 008 856-001

1

5DV 008 856-007

24

24V

Accessories:

3100 mm long connecting lead with relay, DEUTSCH plug connector and 15A fuse,

12V

8KB 990 299-221

1

8KB 990 299-231

1

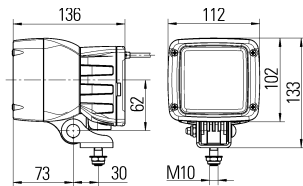
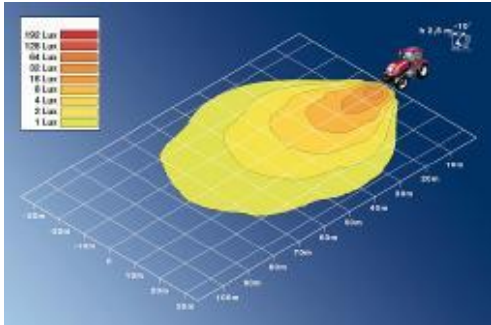
24V



1x35W (D1S) 8GS 009 028-001

Work Lights

83 x 83 mm



Part no.

Pk.

External fitting work lights

Ultra Beam Xenon-Powerpack

Lens pattern for bride close-range illumination.

Recommended angle of inclination: 3° - 10°.

Reflector made of diecast aluminium, glued to hardened glass lens.

Black plastic body with red extending edge to protect lens.

Rear of housing made of black die-cast aluminium with 500 mm cable and 2-pole AMP plug.

Xenon electronic unit 42W integrated into housing.

Vibration-damped pivot base with bracket for four-point mounting.

Additionally enclosed, displaceable bracket for single-point attachment.

Type of protection: IP5K4K.

With gas discharge bulb.

Light aperture: 83 x 83 mm.

Xenon work light for upright mounting, with 12V ballast unit

1GA 998 534-431

1

1GA 998 534-451

1

with 24V ballast unit

1GA 998 534-441

1

for pendant mounting, with 12V ballast unit

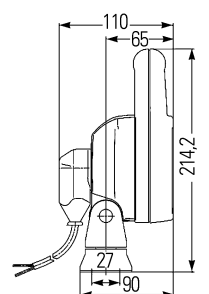
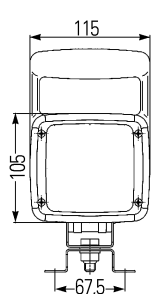
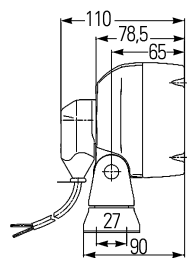
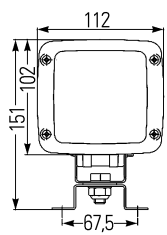
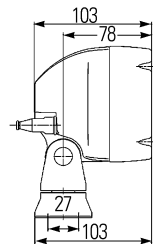
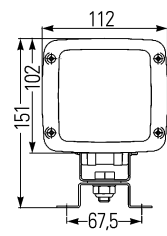
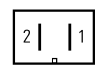
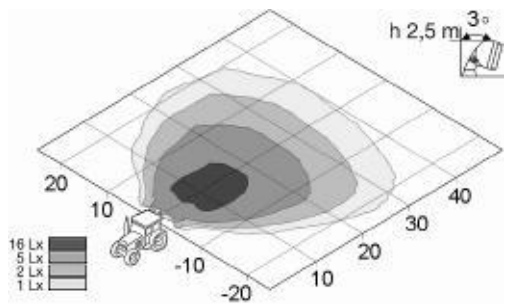
1GA 998 534-461

1

with 24V ballast unit



1x35W (D1S), 85 402

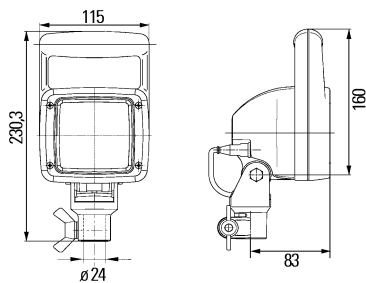
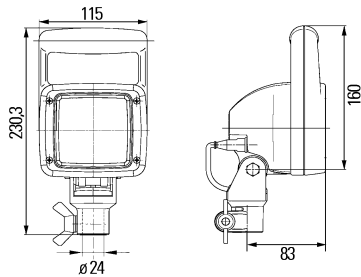
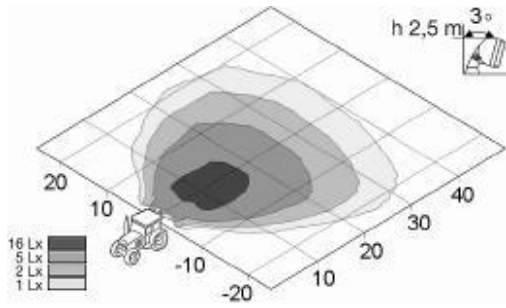


Part no.	Pk.	External-fitting work lights
		Ultra Beam H9 with FF® reflector Lens pattern for wide close-range illumination. Recommended angle of inclination: 3° - 10°. Reflector made of diecast aluminium, glued to hardened glass lens. Black plastic housing with extending edge to protect lens. Pivot base with bracket for four-point mounting, without vibration damping. For upright mounting. Type of protection: IP5K4K and IPX9K. With 12V bulb. Light aperture: 83 x 83 mm.
1GA 996 150-081	1	FF®-H9 work light with AMP plug connector and cap
1GA 998 525-041	1	Spare parts: Light unit
9GH 993 984-001	1	Cap for AMP plug connector
8KB 990 299-001	1	Accessories: 2000 mm long connecting lead for AMP plug connector
		1x12V65W (H9) 8GH 008 357-001
1GA 996 150-021	1	With 12V bulb, 2000 mm long connecting lead and rubber cap to cover the bulb. 12V bulb accessible from the outside
8JD 158 175-807	1	Accessories: Socket (20 pcs.)
1GA 996 150-071	1	With handle
1GA 998 525-041	1	Spare parts: Light unit
8HG 990 263-111	1	Accessories: Mounting bracket for tubular mount on 15 mm - 28 mm dia. pipes
		1x12V65W (H9) 8GH 008 357-001

Accessories see page 4.110-4.111.

Work Lights

83 x 92 mm



Part no.

Pk.

External-fitting work lights

Ultra Beam H9

Lens pattern for wide close-range illumination.

Recommended angle of inclination: 3° - 10°.

Reflector made of diecast aluminium, glued to hardened glass lens.

Black plastic housing and lens-retaining rim with extending edge to protect lens.

With spigot mount 24 mm dia. with integrated electrical contacts (DIN 72591).

For pendant mounting.

Type of protection: IP5K4K and IPX9K.

Light aperture: 83 x 83 mm.

1GA 996 150-151

1

FF®-H9-work light

with AMP plug connector and cap, with handle and 12V bulb

1GA 998 525-041

1

Spare parts:

Light unit

8HG 990 320-001

1

Bracket attachment foot

8HG 006 294-021

1

Accessories:

Mounting bush, 24 mm dia.



1x12V65W (H9) 8GH 008 357-001

Ultra Beam Heavy Duty with FF® reflector

Recommended angle of inclination: 15° - 20°.

Spigot mount 24 mm dia. with integrated electrical contacts (DIN 72591).

1GA 007 506-681

1

With handle and 24V bulb

1GA 998 525-001

1

Spare parts:

Light unit

8HG 990 320-001

1

Bracket attachment foot



1x12V35W (H3) 8GH 002 090-271

1x12V55W (H3) 8GH 002 090-133

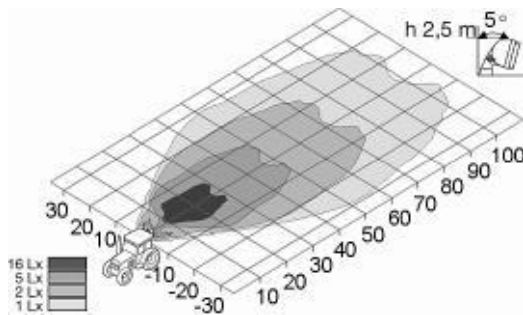
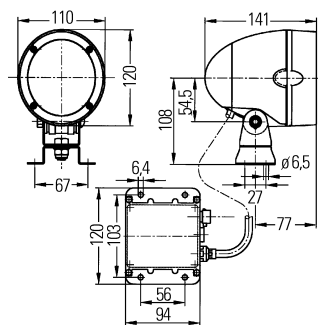
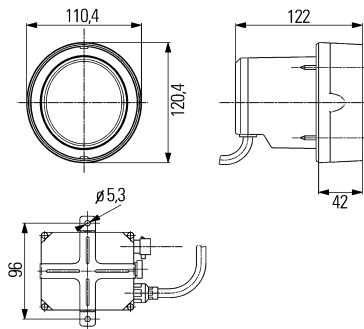
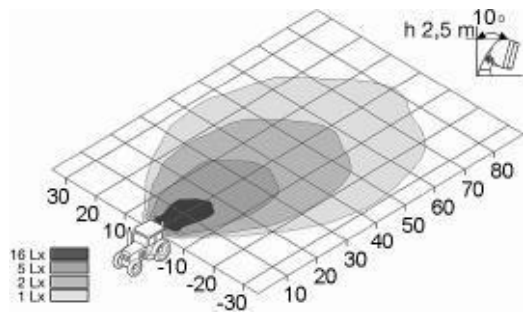
1x24V70W (H3) 8GH 002 090-251

	<p>Part no.</p> <p>1GM 996 134-311</p> <p>9GH 993 984-001</p>	<p>Pk.</p> <p>Built-in work lights</p> <p>Mega Beam with FF® reflector</p> <p>Lens pattern for wide close-range illumination. Recommended angle of inclination: 15° - 25°. Reflector made of diecast aluminium, glued to hardened glass lens. Housing and cover ring grey. Black plastic lens-retaining rim with extending edge to protect lens. With four 3.9 x 50 mm fixing screws. Distance between screws: 70 x 70 mm. Mounting area: 83 x 93 mm. Type of protection: IP5K4K. Light aperture: 83 x 92 mm.</p> <p>FF®-H3 work light with AMP plug connector and cap</p> <p>Spare parts: Cap for AMP plug connector</p>
	<p>1GM 996 134-091</p>	<p>Lens pattern for off-road illumination. Recommended angle of inclination: 10° - 15°.</p> <p>FF®-H3 work light with grommet</p> <p>1x12V35W (H3) 8GH 002 090-271 1x12V55W (H3) 8GH 002 090-133 1x24V70W (H3) 8GH 002 090-251</p>
	<p>1GM 996 136-101</p> <p>1GM 996 136-111</p> <p>1GM 996 136-131</p>	<p>External-fitting work lights</p> <p>Mega Beam LED</p> <p>Lens pattern for close-range illumination. Recommended angle of inclination: 3° - 10°. 4-part reflector glued to pattern-free glass lens. Black finish aluminium housing with cooling ribs. Black lens-retaining rim. Blue plastic cover- and intermediate ring. Pivot base with M10 fixing screw. Without vibration damping. With 2000 mm long connection lead. Voltage range: 12V - 24V. 7W. Type of protection: IP5K9K. With 4 LEDs. Light aperture: 83 x 92 mm.</p> <p>LED work light for upright mounting</p> <p>for pendant mounting</p> <p>for upright mounting Voltage range: 36V - 80V, 7W. Type of protection: IP5K4K and IPX9K</p>

Accessories see page 4.110-4.111.

Work Lights

83 x 92 mm



Part no.

Pk.

Built-in work light

Mega Beam Xenon

Lens pattern for close-range illumination.
Recommended angle of inclination: 10° - 15°.
Reflector made of diecast aluminium, glued to hardened glass lens.
Red housing and screw cover rim.
Black lens-retaining rim.
Without connecting lead.
Work light permanently connected to ballast unit 42W by a 310 mm long lead.
Type of protection: IP5K4K.
With gas discharge bulb.
Light aperture: 83 x 92 mm.

1GM 996 135-551

1

Xenon work light with 24V ballast unit



1x35W (D2S) 8GS 007 949-101

External-fitting work lights

Mega Beam-Xenon

Lens pattern for close-range illumination.
Recommended angle of inclination: 10° - 15°.
Reflector made of diecast aluminium, glued to hardened glass lens.
Black plastic housing and lens-retaining rim.
Red plastic cover rim with extending edge to protect lens.
Pivot base with vibration damping and bracket for four-point mounting made of stainless steel.
Pivot range vertical 70°.
For upright mounting.
Work light permanently connected to ballast unit 42W by a 300 mm long lead.
With 3700 mm long connecting lead, relay and 15A fuse. Type of protection: IP5K4K.
With gas discharge bulb.
Light aperture: 83 x 92 mm.

1GM 996 135-001

1

Xenon work light with 12V ballast unit

1GM 996 135-041

1

with 24V ballast unit

1GM 996 135-051

1

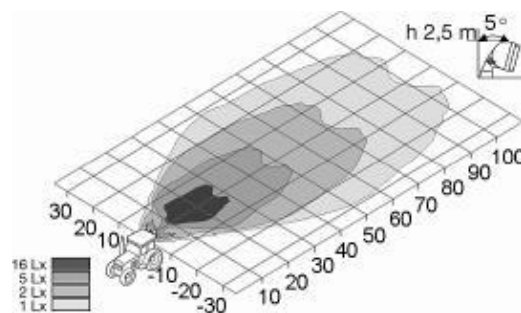
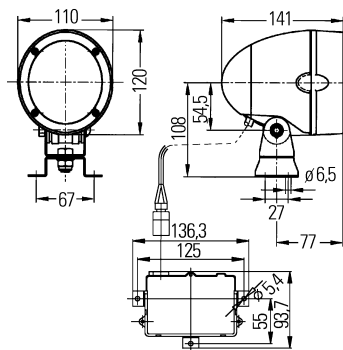
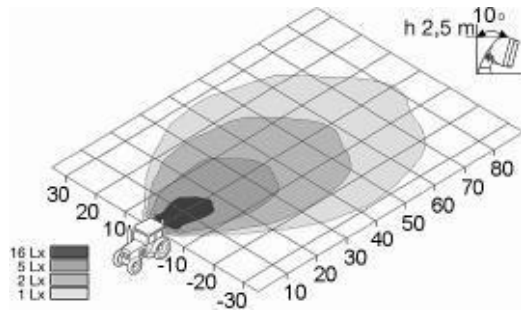
Xenon work light with 24V ballast unit

Spare parts:

Ballast unit,
12V
24V
3000 mm long connecting lead from ballast unit to battery, with relay and fuse, 12V



1x35W (D2S) 8GS 007 949-101



Part no.

Pk.

External-fitting work lights

Mega-Beam Xenon

With optical pattern for close-range illumination.

Recommended angle of inclination: 10° - 20°.
 Reflector made of diecast aluminium, glued to hardened glass lens.
 Black housing and lens-retaining rim, red cover rim with extending edge to protect lens.
 Pivot base with vibration damping and bracket for four-point mounting made of stainless steel.
 Pivot range vertical 70°.
 For upright mounting.
 Work light permanently connected to ballast unit 42W by a 3000 mm long lead.
 The lead can be disconnected from the ballast unit by means of a plug-connection.
 Type of protection: IP5K4K.
Light aperture: 83 x 92 mm.

1GM 996 135-101

1

Xenon work light with gas discharge bulb, without ballast unit and connecting lead (see accessories)

1GM 990 303-151

1

Spare parts:

Light unit
 3000 mm connecting lead between work light and ballast unit

8KB 990 299-251

1

5DV 008 855-001

1

5DV 008 855-007

24

5DV 008 856-001

1

5DV 008 856-007

24

Accessories:

Ballast unit 42W, with DEUTSCH plug connector, 12V

24V

3100 mm connecting lead with relay, DEUTSCH plug connector and fuse 15A, 12V

24V

8KB 990 299-221

1

8KB 990 299-231

1



1x35W (D1S) 8GS 009 028-001

Optical pattern for long-range illumination.

Recommended angle of inclination: 5° - 10°.

1GM 996 135-111

1

Xenon work light with gas discharge bulb, without ballast unit and connecting lead (see accessories)

8KB 990 299-251

1

Spare parts:

3000 mm connecting lead between work light and ballast unit

5DV 008 855-001

1

5DV 008 855-007

24

5DV 008 856-001

1

5DV 008 856-007

24

Accessories:

Ballast unit 42W, with DEUTSCH-plug connector 12V

24V

3100 mm connecting lead with relay, DEUTSCH plug connector and fuse 15A, 12V

24V

8KB 990 299-221

1

8KB 990 299-231

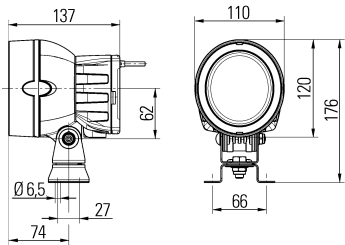
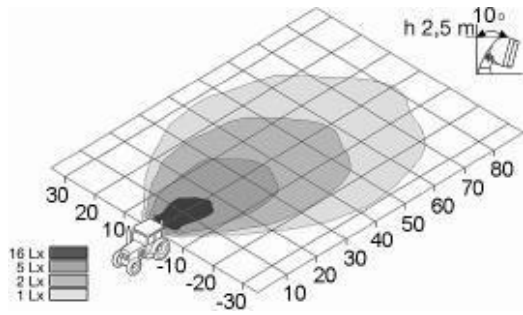
1



1x35W (D1S) 8GS 009 028-001

Work Lights

83 x 92 mm



Part no.

Pk.

External-fitting work lights

Mega Beam Xenon-Powerpack

Lens pattern for close-range illumination.

Recommended angle of inclination: 3° - 10°.

Reflector made of diecast aluminium, glued to hardened glass lens.

Black plastic body with red extending edge to protect lens.

Rear of housing made of black die-cast aluminium with 500 mm cable and 2-pole AMP plug.

Xenon electronic unit 42W integrated into housing.

Vibration-damped pivot base with bracket for four-point mounting.

Additionally enclosed, displaceable bracket for single-point attachment.

Type of protection: IP5K4K.

With gas discharge bulb.

Light aperture: 83 x 92 mm.

Xenon work light for upright mounting, with 12V ballast unit

1GM 996 135-231

1

1GM 996 135-251

1

with 24V ballast unit

1GM 996 135-241

1

for pendant mounting, with 12V ballast unit

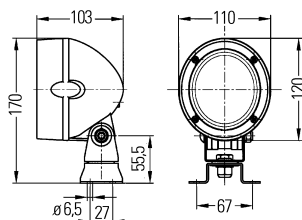
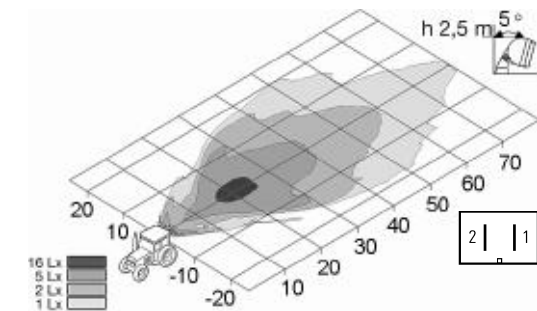
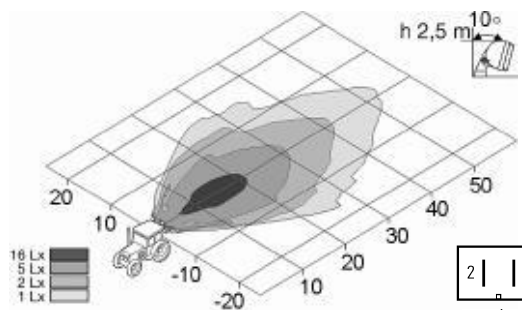
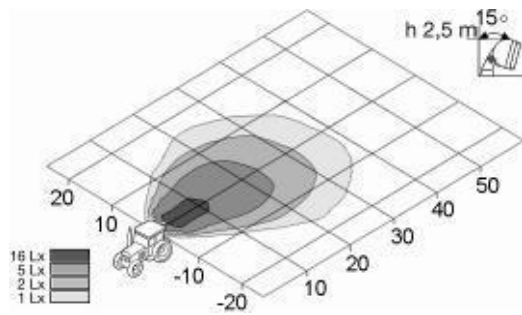
1GM 996 135-261

1

with 24V ballast unit



1x35W (D1S), 85 402



Part no.	Pk.
1GM 996 134-321	1
1GM 996 134-171	1
9GH 993 984-001	1
1GM 996 134-061	1
1GM 996 134-081	1
9GH 993 984-001	1
9XD 990 298-001	5
1GM 996 134-051	1
1GM 996 134-071	1
9GH 993 984-001	1
9XD 990 298-001	5
8JD 008 151-011	10
8KW 701 235-033	100
8HG 990 263-111	1
8KB 990 299-001	1

External-fitting work lights

Mega-Beam with FF® reflector
Lens pattern for close-range illumination.
 Recommended angle of inclination: 15° - 25°.
 Reflector made of diecast aluminium, glued to hardened glass lens.
 Grey housing and cover rim.
 Black lens-retaining rim with extending edge to protect lens.
 Pivot base with vibration damping and bracket for four-point mounting.
 Pivot range vertical 145°. For upright or pendant mounting.
 Type of protection: IP5K4K and IPX9K.
Light aperture: 83 x 92 mm.

FF®-H3 work light with grommet

with AMP plug connector and cap

Spare parts:
 Sealing cap for AMP plug connector

Lens pattern for off-road illumination.
 Recommended angle of inclination: 10° - 15°.

FF®-H3 work light with grommet and lens without optical pattern

with AMP plug connector and cap

Spare parts:
 Cap for AMP plug connector
 Bracket for four-point mounting

Lens pattern for long-range illumination.
 Recommended angle of inclination: 2° - 5°.

FF®-H3 work light with grommet and lens without optical pattern

with AMP plug connector and cap

Spare parts:
 Cap for AMP plug connector
 Bracket for four-point mounting

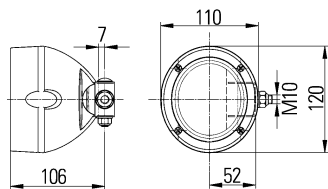
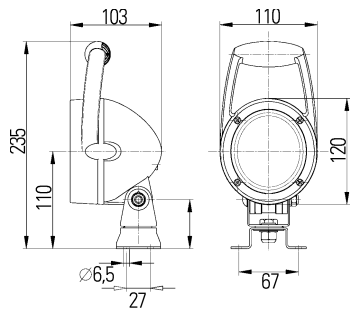
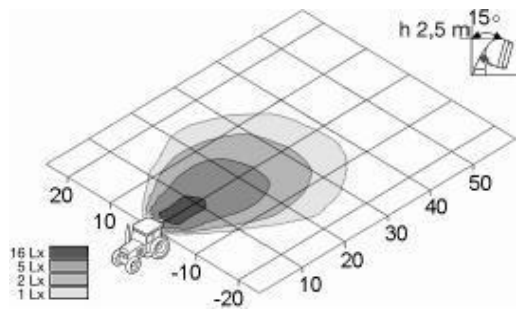
Accessories:
 Socket for AMP plug connector
 Blade receptacles, 6.3 mm
 Mounting bracket for tubular mount on 15 mm - 28 mm dia. pipes
 2000 mm long connection lead for AMP plug connector with cap

- 1x12V35W (H3) 8GH 002 090-271
- 1x12V55W (H3) 8GH 002 090-133
- 1x24V70W (H3) 8GH 002 090-251

Accessories see page 4.110-4.111.

Work Lights

83 x 92 mm



Part no.

Pk.

External-fitting work lights

Mega Beam with FF®-reflector

Len pattern for close-range illumination.

Recommended angle of inclination: 15° - 25°.

Reflector made of diecast aluminium, glued to hardened glass lens.

Grey plastic housing and cover rim, black plastic lens-retaining rim with extending edge to protect lens.

Type of protection: IP5K4K and IPX9K.

With grommet.

Light aperture: 83 x 92 mm.

1GM 996 134-241

1

FF®-H3 work light

with handle, pivot base with vibration damping and mounting bracket for four-point mounting. For upright or pendant mounting.

Pivot range vertical 145°.

1GM 996 134-271

1

With pivoting joint at the side. Fixing screw M10 for mounting on vertical surfaces.

Pivot range vertical 90°, inclination range horizontal 170°.

Without vibration damping, left

1GM 996 134-371

1

right

8HG 990 263-111

1

Accessories:

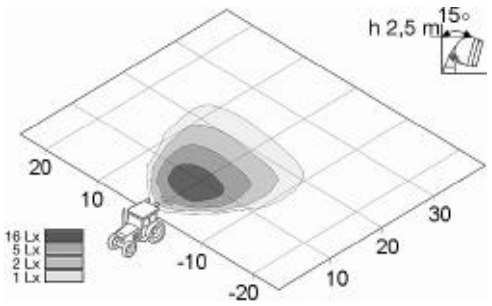

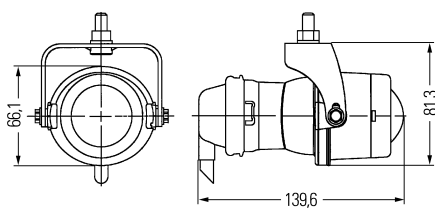
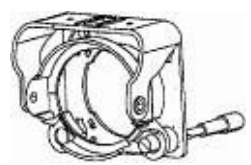



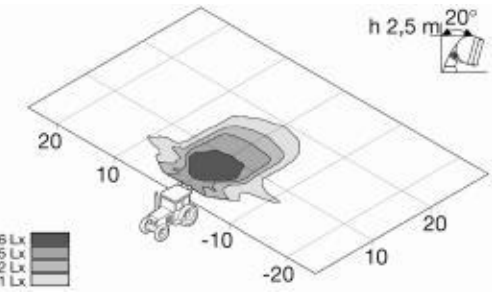

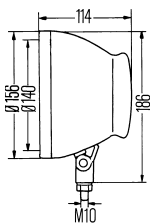



Mounting bracket for tubular mount on 15 mm - 28 mm dia. pipes

1x12V35W (H3) 8GH 002 090-271

1x12V55W (H3) 8GH 002 090-133

1x24V70W (H3) 8GH 002 090-251



Part no.	Pk.	External-fitting work lights
   	<p>1GL 008 090-201 1 1GL 008 090-207 60</p> <p>1GL 008 090-211 1 1GL 008 090-217 60</p> <p>9GH 147 009-007 30</p> <p>9HD 149 253-007 1 8JD 156 150-807 1</p> <p>8HG 153 152-001 1</p>	<p>Micro DE® *) Lens pattern for close-range illumination. Recommended angle of inclination: 15° - 20°. Black housing and lens-retaining rim. Lens with housing and supporting frame bonded. Black bracket with M8 fixing screw. Light aperture: 40 mm dia.</p> <p>DE®-H3 work light with 12V55W bulb and rubber cap for cable entry</p> <p>with 24V70W bulb</p> <p>Spare parts: Rubber cap for cable entry</p> <p>Accessories: Plastic cap with plug connector Socket set with contacts and gaskets (20 pcs.)</p> <p>8HG 153 152-001 1 Convenience mount with adjustment screw</p> <p>  1x12V35W (H3) 8GH 002 090-271  1x12V55W (H3) 8GH 002 090-133  1x24V70W (H3) 8GH 002 090-251 </p>
  	<p>1G3 003 710-021 1</p> <p>9DS 121 707-001 1 9BG 127 179-001 1</p>	<p>Proflex-Gladicator **) Lens pattern for close-range illumination. Recommended angle of inclination: 20° - 30°. Lens with steel reflector bonded. Flexible rubber housing with extending edge to protect lens. Pivot base with M10 fixing screw. For upright or pendant mounting. Type of protection: IP5K4K. Light aperture: 140 mm dia.</p> <p>H3 work light</p> <p>Spare parts: Light unit Rubber housing</p> <p>  1x12V35W (H3) 8GH 002 090-271  1x12V55W (H3) 8GH 002 090-133  1x24V70W (H3) 8GH 002 090-251 </p>

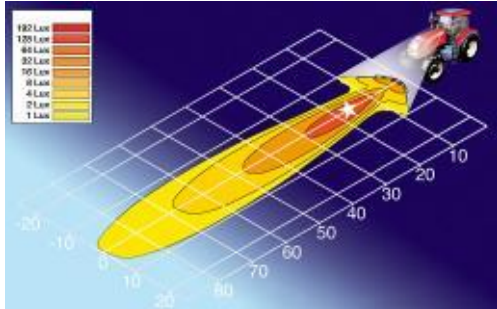
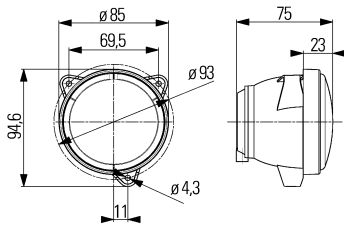
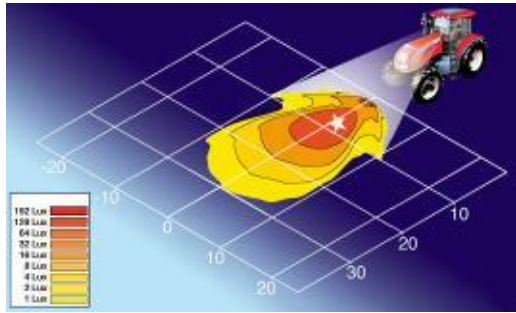
*) Fog lights Micro DE see page .4.03-4.04

**) Headlights see page 4.43.

Accessories see page 4.110-4.111.

Work Lights

77 mm dia.



Part no.

Pk.

Built-in work lights

Module 70 H3

Reflector made of diecast aluminium, glued to hardened glass lens. Black plastic housing with three-point mounting. With rubber cap to cover the bulb and for cable entry. Type of protection: IP5K4K.

Without bulb.

Light aperture: 77 mm dia.

1G0 996 176-021

1

H3 work light

with lens pattern for close-range illumination

1G0 996 176-031

1

Lens pattern for long-range illumination

9HD 990 101-001

1

Spare parts:

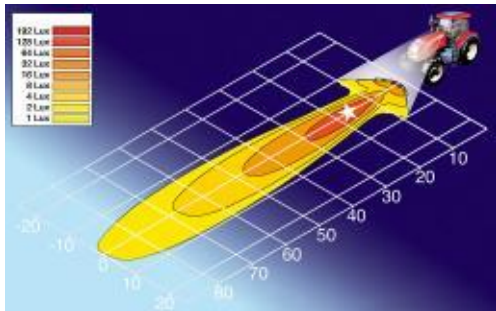
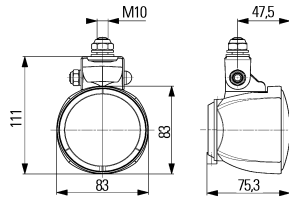
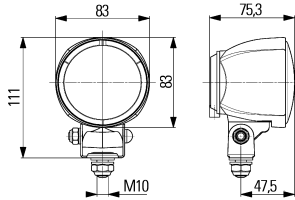
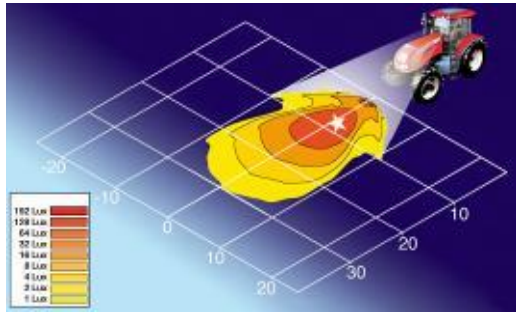
Rubber cap

1x12V35W (H3) 8GH 002 090-271

1x12V55W (H3) 8GH 002 090-133

1x24V70W (H3) 8GH 002 090-251





Part no.

Pk.

External-fitting work lights

Module 70 H3

Lens pattern for close-range illumination.
 Recommended angle of inclination: 10° - 20°.
 Reflector made of diecast aluminium, glued to hardened glass lens.
 Black plastic body.
 Pivot base with M10 fixing screw.
 With rubber cap to cover the bulb.
 Type of protection: IP5K4K.
Without bulb.
Light aperture: 77 mm dia.

1G0 996 176-001
 1G0 996 176-007

1
 24

H3 work light for upright mounting

1G0 996 176-111

1

for pendant mounting

Lens pattern for long-range illumination.
 Recommended angle of inclination: 5° - 10°.

1G0 996 176-011

1

H3 work light for upright mounting

1G0 996 176-121

1

for pendant mounting

Spare parts:
 Rubber cap

9HD 990 101-001

1

Accessories:
 Mounting bracket for four-point mounting
 Mounting bracket for tubular mount on 15 mm - 28 mm dia. pipes

9XD 990 298-001
 8HG 990 263-111

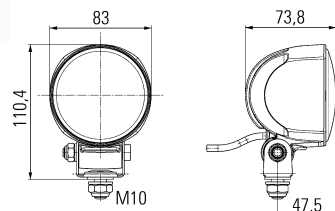
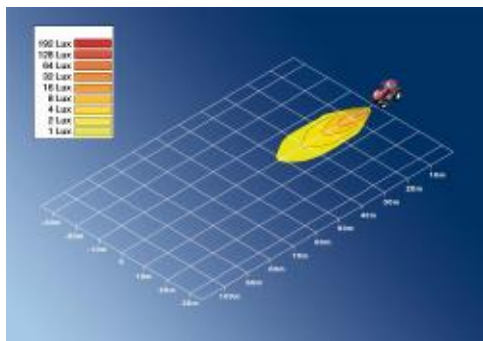
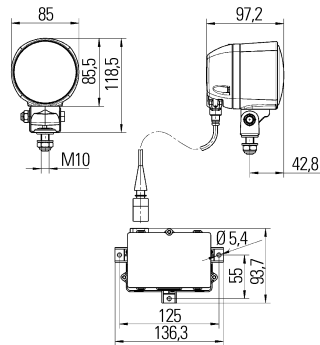
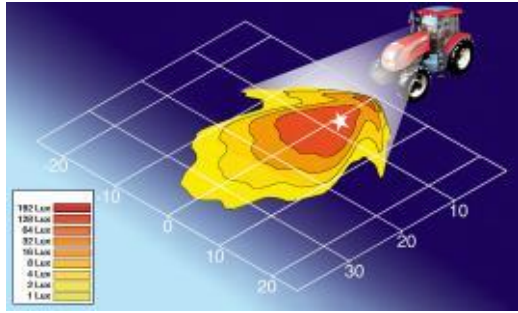
5
 1

1x12V35W (H3) 8GH 002 090-271
 1x12V55W (H3) 8GH 002 090-133
 1x24V70W (H3) 8GH 002 090-251



Work Lights

77 mm dia., 63 mm dia.



Part no.

Pk.

External-fitting work lights

Module 70 Xenon

Lens pattern for close-range illumination.

Recommended angle of inclination: 10° - 20°.

Reflector made of diecast aluminium,

glued to hardened glass lens.

Black plastic housing.

Pivot base with M10 fixing screw.

For upright mounting.

Work light permanently connected to

ballast unit 42W by a 1000 mm long lead.

The lead can be disconnected from the ballast unit

by means of a plug-connection.

Without connecting lead.

Type of protection: IP5K4K.

With gas discharge bulb.

Light aperture: 77 mm dia.

1G0 996 176-361

1

**Xenon work light
with DEUTSCH plug connector and
12V ballast unit**

5DV 008 855-001

1

Spare parts:

Ballast unit, 12V42W

8KB 990 299-221

1

Accessories:

3100 mm connecting lead with relay,
DEUTSCH plug connector and fuse 15A, 12V



1x35W (D1S) 8GS 009 028-001

1G0 996 176-701

1

Modul 70 LED

Lens pattern for close-range illumination.

4-part reflector made of plastic,

glued to hardened glass lens.

Black finish aluminium housing.

Pivot base with M10 fixing screw.

Without vibration damping.

With 2000 mm long connecting lead.

Voltage range: 12V - 24V, 7W.

Type of protection: IP5K4K.

With four LEDs.

Light aperture: 63 mm dia.

**LED work light
for upright mounting**

1G0 996 176-711

1

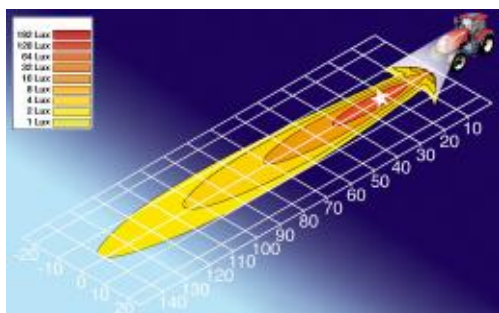
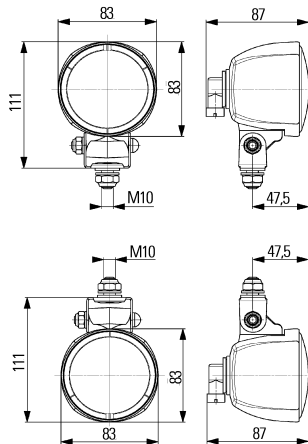
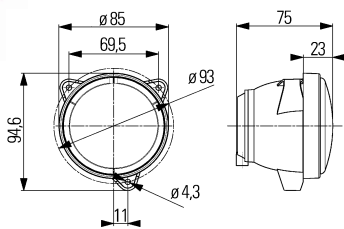
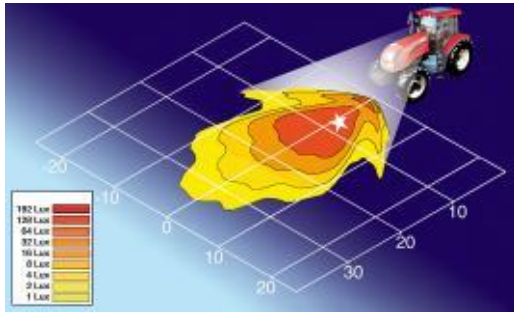
for pendant mounting

1G0 996 176-721

1

for upright mounting

Voltage range: 12V - 24V, 15W.



Part no.

Pk.

Built-in work lights

Module 70 H9

Lens pattern for close-range illumination.
 Reflector made of diecast aluminium, glued to hardened glass lens.
 Black plastic housing with three-point mounting.
 With rubber cap to cover the bulb and for cable entry.
 Type of protection: IP5K4K.
With 12V bulb.
Light aperture: 77 mm dia.

1G0 996 176-061

1

H9 work light

External-fitting work lights

Recommended angle of inclination: 10° - 20°.
 Black plastic housing.
 Pivot base with M10 fixing screw.
 Type of protection: IP5K4K.
With 12V bulb, accessible from the outside.

1G0 996 176-041

1

H9 work light for upright mounting

1G0 996 176-131

1

for pendant mounting

1G0 996 176-171

1

with 2000 mm long connecting lead and H9 plug, for upright mounting

1G0 996 176-181

1

for pendant mounting

Lens pattern for long-range illumination.

Recommended angle of inclination: 5° - 10°.
 Without connecting lead.

1G0 996 176-051

1

H9 work light for upright mounting

1G0 996 176-141

1

for pendant mounting

Accessories:

9XD 990 298-001

5

Mounting bracket for four-point mounting

8HG 990 263-111

1

Mounting bracket for tubular mount on 15 mm - 28 mm dia. pipes

8JD 158 175-807

1

Socket (20 pcs.)



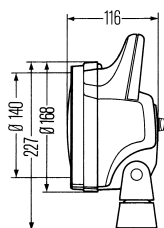
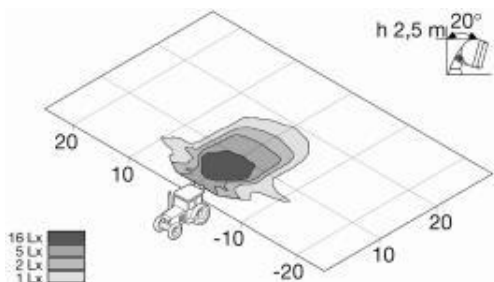
1x12V65W (H9) 8GH 008 357-001

Work Lights

129 mm dia.



	Part no.	Pk.	External-fitting work lights
			<p>W131 Lens pattern for close-range illumination. Recommended angle of inclination: 20° - 30°. Plastic lens with steel reflector bonded. Black plastic housing and handle, with extending edge to protect lens. Pivot base with M10 fixing screw for upright or pendant mounting. Without vibration damping. With grommet. Light aperture: 129 mm dia.</p>
	<p>1G3 996 001-131</p> <p>1G3 996 001-001 *)</p>	<p>1</p> <p>1</p>	<p>Work light with switch</p> <p>without switch</p> <p> 1x12V35W (F2) 8GA 002 083-131 1x24V35W (F2) 8GA 002 083-251</p>
	<p>1G3 996 001-391</p> <p>1G3 996 001-041 *)</p>	<p>1</p> <p>1</p>	<p>With H3 light.</p> <p>H3 work light with switch</p> <p>without switch</p> <p> 1x12V35W (H3) 8GH 002 090-271 1x12V55W (H3) 8GH 002 090-133</p>
	<p>1G3 996 001-331</p> <p>1G3 996 001-271 *)</p>	<p>1</p> <p>1</p>	<p>Lens pattern for close-range illumination. With glass lens.</p> <p>H3 work light with switch</p> <p>without switch</p>
	<p>1G3 996 001-351</p> <p>1G3 996 001-301 *)</p>	<p>1</p> <p>1</p>	<p>H3 work light with protective grill and switch</p> <p>without switch</p> <p>Spare parts: Lens-retaining rim with protective grill</p> <p> 1x12V35W (H3) 8GH 002 090-271 1x12V55W (H3) 8GH 002 090-133 1x24V70W (H3) 8GH 002 090-251</p>
<p>*) All work lights without switch are suitable for GGVS application</p>	<p>8HG 990 003-001</p>	<p>2</p>	<p>Accessories: Mounting bracket</p> <p>Accessories see page 4.110-4.111.</p>



Part no.

Pk.

External-fitting work lights

Matador

Lens pattern for close-range illumination.
 Recommended angle of inclination: 20° - 30°.
 Steel reflector with glass lens bonded.
 Black plastic housing and protective grille with extending edge to protect lens.
 Pivot base with bracket for four-point mounting for upright or pendant mounting.
 Without vibration damping.
 Pivot range vertical 130°.
 Type of protection: IP5K4K.
With grommet.
Light aperture: 140 mm dia.

1G4 003 470-001

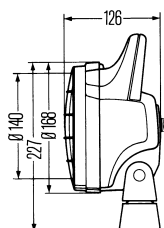
1

H3 work light without protective grill, with splash-proof rotary switch

1G4 003 470-011

1

without switch



1G4 003 470-031

1

With protective grill and splash-proof rotary switch

1G4 003 470-051

1

without switch

Spare parts:

9DS 121 707-001

1

Light unit

6EB 005 633-001

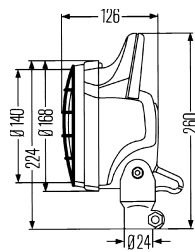
10

Rotary switch

9XD 130 261-001

5

U-bracket



1G4 003 470-147

1

With spigot mount and 24V bulb, without switch.

Electrical contacts inside tubular mount over socket (DIN 72 591).

9DS 121 707-001

1

Spare parts:

Light unit

- 1x12V35W (H3) 8GH 002 090-271
- 1x12V55W (H3) 8GH 002 090-133
- 1x24V70W (H3) 8GH 002 090-251

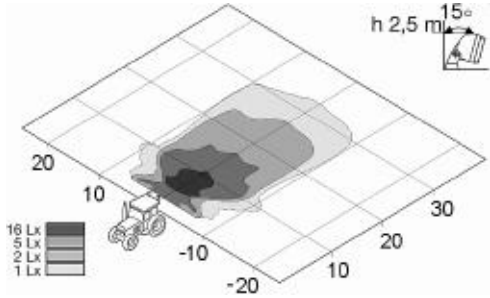

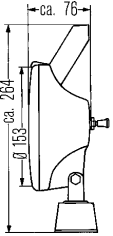

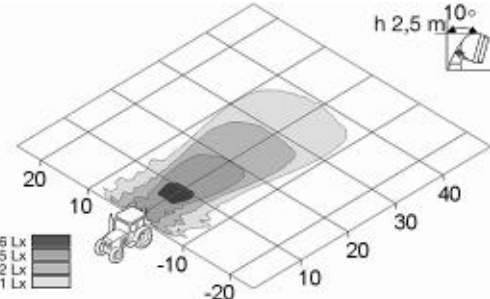

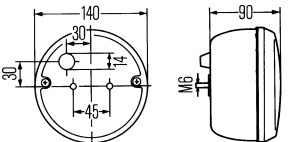



Accessories see page 4.110-4.111.

Work Lights

133 mm dia.



Part no.	Pk.	External-fitting work lights
  	<p>1G4 004 480-001 1</p> <p>9XD 130 261-001 5</p> <p>1G4 004 480-011 1</p>	<p>Model Torro II Lens pattern for close-range illumination. Recommended angle of inclination: 15° - 30°. Lens with steel reflector bonded. Black plastic housing and handle. Pivot base with bracket for four-point mounting, for upright or pendant mounting. Without vibration damping. Pivot range vertical 130°. Type of protection: IP5K4K. With grommet. Light aperture: 133 mm dia.</p> <p>H3 work light with splash-proof switch</p> <p>Spare parts: U-bracket</p> <hr/> <p>Without switch and U-bracket, pivot base with M10 fixing screw</p> <p>1x12V35W (H3) 8GH 002 090-271 1x12V55W (H3) 8GH 002 090-133 1x24V70W (H3) 8GH 002 090-251</p> 
  	<p>1G4 997 033-011 1</p>	<p>7033 Lens pattern for close-range illumination. Recommended angle of inclination: 10° - 30°. Black plastic housing. Two M6 fixing screws. Light aperture: 140 mm dia.</p> <p>H3 work light</p> <p>1x12V35W (H3) 8GH 002 090-271 1x12V55W (H3) 8GH 002 090-133</p> 

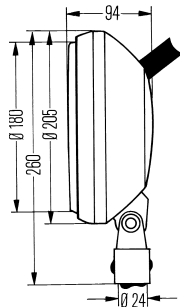
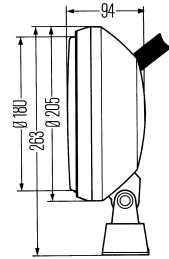
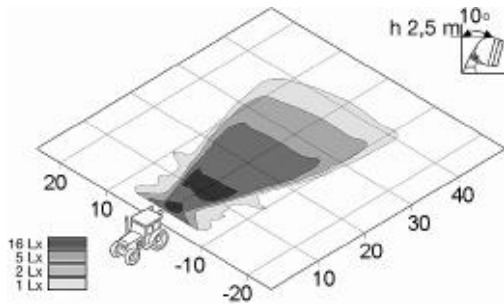
Accessories see page 4.110-4.111.

	Part no.	Pk.	External-fitting work lights
	<p>1G5 003 241-081</p> <p>1G5 003 241-071</p> <p>1G5 120 510-001 6ED 708 919-001 9GD 120 670-001</p>	<p>1</p> <p>1</p> <p>1 5 10</p>	<p>3241 Lens pattern for close-range illumination. Recommended angle of inclination: 20° - 25°. Steel housing with matt black finish. Steel reflector with glass lens bonded. Rubber boot prevents lateral scattered light. Pivot base with bracket for four-point mounting, for upright or pendant mounting. Without vibration damping. Pivot range vertical 130°. Type of protection: IP5K4K. With grommet. Light aperture: 152 mm dia.</p> <p>H3 work light with handle and splash-proof switch</p> <p>Pivot base with M10 fixing screw, without handle and switch</p> <p>Spare parts: Light unit with seal Switch Seal</p>
	<p>1G5 003 241-021</p> <p>1G5 119 738-001 6ED 708 919-001 9GD 120 670-001</p>	<p>1</p> <p>1</p> <p>1 5 10</p>	<p>Lens pattern for far-reaching illumination. Recommended angle of inclination: 15° - 20°. Type of protection: IP5K4K.</p> <p>With handle and splash-proof switch</p> <p>Spare parts: Light unit with seal Switch Seal</p> <p>1x12V35W (H3) 8GH 002 090-271 1x12V55W (H3) 8GH 002 090-133 1x24V70W (H3) 8GH 002 090-251</p>

Accessories see page 4.110-4.111.

Work Lights

180 mm dia.



Part no.

Pk.

External-fitting work lights

Lens pattern for far-reaching illumination.

Recommended angle of inclination: 10° - 20°.
Steel reflector with glass lens bonded.
Steel housing with mat black finish, with handle and splash-proof switch.
Pivot base with bracket for four-point mounting.
For upright or pendant mounting.
Without vibration damping.
Pivot range vertical 130°.
Type of protection: IP5K4K.

With grommet.

Light aperture: 180 mm dia.

1G8 002 340-001

1

H3 work light

1G8 132 233-011

1

Spare parts:

Light unit with lens-retaining rim

1G8 002 340-011

1

With mounting clamp for mounting on 24 mm dia. standard pin, as well as on 30 mm dia. standard pin after removing reducing sleeve from pipe fitting. 2500 mm long lead with low voltage plug 8JA 001 925-001 (Pk.2).

Type of protection: IP5K4K.

1G8 132 233-011

1

Spare parts:

Light unit with lens-retaining rim

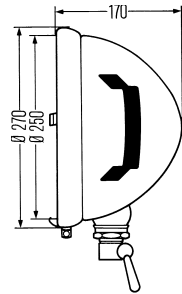
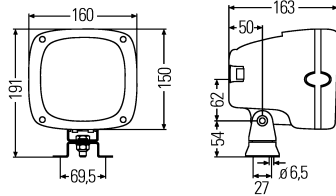
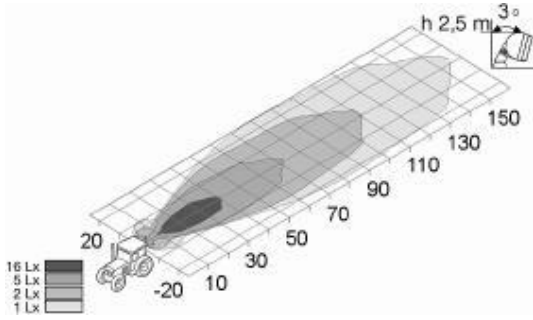
1x12V35W (H3) 8GH 002 090-271

1x12V55W (H3) 8GH 002 090-133

1x24V70W (H3) 8GH 002 090-251



Accessories see page 4.110-4.111.



Part no.

Pk.

External-fitting work lights

AS 200 Xenon

Lens pattern for long-range illumination.

Recommended angle of inclination: 3° - 10°.
 Plastic reflector with glass lens bonded.
 Black plastic housing with extending edge to protect lens. With red decorative ring.
 Handle recessed into housing.
 Xenon electronic unit 24V42W integrated into housing.
 With pivot base and bracket for four-point mounting.
 Switch with integrated fuse 15A.
 With 2500 mm rubber tube and 2-pole low voltage plug 8JA 001 925-001.
 Easy-to-loosen pipe fitting mount 24 mm dia., fits 30 mm dia. attachment pin in combination with joint 9XS 027 639-001.
 Can be used with tripod 8XT 002 117-001 and 8XT 002 120-001 as well as socket 8XT 002 121-001.
 Type of protection: IP5K4K and IPX9K.

With gas discharge bulb.

Light aperture: 123 x 123 mm.

1GA 996 142-221

1

Xenon work light

1GA 990 305-011
 8JA 001 925-001
 8JS 711 687-821

1
 1
 1

Spare parts:

Light unit
 Plug, 2 pole
 Blade-type fuse, 15A (5 pcs.)

9XS 027 639-001

1

Accessories:

Joint



1x35W (D2S) 8GS 007 949-101

Conforms to DIN 14 644.

Flat lens without optical pattern. Steel reflector.
 Black finish steel housing and lens retaining rim.
 Two side handles, built-in switch.
 2500 mm long lead with low voltage plug 8JA 001 925-001 (Pk. 2).
 Easy-to-loosen pipe fitting mount 24 mm dia., fits 30 mm dia. attachment pin in combination with joint 9XS 027 639-001.
 Can be used with tripod 8XT 002 117-001 and 8XT 002 120-001 as well as socket 8XT 002 121-001.
 Type of protection: IP5K4K.
Light aperture: 250 mm dia.

**750 m range with 12V55W
 800 m range with 24V70W.**






1G9 001 523-021










1

H3 work light



1x12V35W (H3) 8GH 002 090-271
 1x12V55W (H3) 8GH 002 090-133
 1x24V70W (H3) 8GH 002 090-251

    	Part no.	Pk.	<p>For work lights 1G9 001 523-021 and 1G8 002 340-011</p> <p>Tubular steel pipe Extends from 1263 mm to 2200 mm, with 30 mm dia. attachment pin, can be welded onto vehicle or fastened with clights.</p>
	8XT 002 120-001	1	Tubular steel pipe
	8XT 002 117-001	1	<p>Tubular steel tripod Extends from 1051 mm to 1650 mm. 30 mm dia. attachment pin.</p> <p>Tubular steel tripod</p>
	9XS 027 639-001	1	<p>Joint/reducer Can be swivelled and pivoted as required, with arresting device through handle, with 24 mm dia. attachment pin and 30 mm dia. attachment sleeve.</p> <p>Joint</p>
	8HG 159 455-001	1	<p>Universal holder for work lgts. 30 mm dia. attachment sleeve.</p> <p>Universal holder</p>
8XT 002 121-001	1	<p>Socket For mounting work light on vehicle roof or other horizontal body surface, with 30 mm dia. attachment pin.</p> <p>Socket</p>	

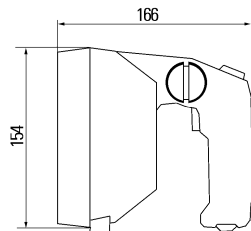
	Part no.	Pk.	
	<p>8HG 002 365-001</p> <p>8HG 006 294-101</p> <p>8HG 096 531-007 8JB 850 434-011 9GH 096 532-001</p>	<p>1</p> <p>1</p> <p>2 10 10</p>	<p>Mounting bushes 24 mm dia. for Matador 1G4 003 470-147, Ultra Beam 1GA 007 506-681 and bracket attachment foot 8HG 990 320-001. With socket to DIN 72 591 and rubber protective cap.</p> <p>Ground contact through the pipe. For mounting beacon on support side of the vehicle or for welding to a flange, 24 mm dia., approx. 100 mm.</p> <p>Mounting bush, complete with separate ground connection</p> <p>Spare parts: Mounting bush for -001 Socket for -001 Rubber cap</p>
	<p>8HG 006 294-051 8HG 006 294-091</p>	<p>1 1</p>	<p>With screw fixing with separate ground connection</p>
	<p>8HG 006 294-011</p>	<p>1</p>	<p>For screwing onto horizontal cabin roofs (on top)</p>
	<p>8HG 006 294-021 8HG 006 294-111</p>	<p>1 1</p>	<p>For screwing onto horizontal cabin roofs (on side)</p> <p>With 90 mm mounting bracket with 50 mm mounting bracket</p>
	<p>8HG 006 294-031</p>	<p>1</p>	<p>Swivelling holder, for screwing onto horizontal cabin roofs (on top or on side)</p>
	<p>8HG 006 294-041</p>	<p>1</p>	<p>Telescopic holder for screwing onto back of cabin roof</p> <p>Length: 1000 mm. Extension: 700 mm.</p>
	<p>8HG 990 368-001 8HG 990 368-007</p>	<p>1 50</p>	<p>Black mounting bush with M8 thread</p> <p>Length: 220 mm.</p>
	<p>9XD 990 284-001</p>	<p>1</p>	<p>Push-on pipe With stopper for screwing to vertical vehicle surfaces (side). With protective cap, 1-pole socket and wiring harness with ground contact. Attachment using two M8 bolts.</p> <p>Spare parts: Socket Rubber stopper</p>
	<p>9NM 863 332-001</p>	<p>1</p>	<p>Accessory group</p> <p>For work lights with tubular fitting or flexible base. Contents: Wing nut with screw and washer.</p>

	<p>Part no.</p> <p>8HG 990 320-001</p>	<p>Pk.</p> <p>1</p>	<p>Bracket attachment foot</p> <p>For combination with attachment tubes 8HG 002 365-001 and 8HG 006 294-...</p> <p>To fit surface-mount work lights Ultra-Beam FF® 1GA 007 506-..., 1GA 997 506-... Ultra Beam H9 1GA 996 150-... Mega-Beam FF® 1GA 996 134-... Oval 100 FF® 1GA 996 161-... AS 200 FF® 1GA 998 532-... AS 200 Xenon 1GA 996 142-... with AMP plug connector or grommet.</p> <p>Electrical contacting within the pipe socket via socket in accordance with DIN 72 591.</p>
 	<p>Part no.</p> <p>8HG 990 263-111</p>	<p>Pk.</p> <p>1</p>	<p>Universal bracket</p> <p>To fit surface mount work lights Oval 100 FF® 1GA 996 161-..., 1GA 996 361-... Oval Xenon Integral 1GA 996 261-... Picador FF® 1GA 006 876-..., 1GA 998 522-... AS 200 FF® 1GA 998 532-... AS 200 Xenon 1GA 996 142-... Ultra-Beam FF® 1GA 007 506-..., 1GA 997 506-... Ultra Beam H9 1GA 996 150-... Mega-Beam FF® 1GA 996 134-... Modul 70 H3/H9 1G0 996 176-...</p> <p>Rotatable universal bracket for attachment to 15 mm - 28 mm dia. pipes. For replacement on worklights with 36 mm bracket attachment. With 2 additional narrow spacers for exchange against wide spacers with/without vibration damping on worklights with 42 mm bracket attachment.</p>

		Part no. 8HG 004 806-001	Pk. 1	Magnet base For work lights with U-bracket. Consists of: 2 magnets and fixing material Magnet base for U-bracket 9XD 130 261-001
		9XD 130 261-001	5	U-bracket for four-point mounting for external-fitting headlights and work lights with M10 fixing screw. U-bracket made of stainless steel
		9XD 990 298-001	5	U-bracket made of yellow chromised steel
		6ZN 160 705-001	1	Universal radio remote control unit The remote control unit is ECE type tested and carries the RF suppression symbol. The alternating code feature excludes interference with other remote controls. The convenient way to switch work lights by remote control. Maximum switching capacity: 2 x 120W. With green control diode for on-off switching control. Universal radio remote control unit, 12V
		6ZN 160 705-011	1	

Searchlights

139 mm dia.



Part no.

Pk.

Hand-held searchlight

Black plastic housing, lens-retaining rim, handle and supporting base.
 Extending lens-retaining rim protects the lens.
 Glass lens without optical pattern.
 Double reflector made of aluminium.
 Two light sources, can be switched via switches which are independent of each other.
 Flip switch for continuous light and pistol switch in the handle with Morse function for additional light.
 Handle can be swivelled vertically by 70°. With closable opening for plugging onto the separate supporting base. Can be swivelled horizontally by 360° on the supporting base.
 Supporting base with 3 fixing screws.
 With 12V bulbs, conversion to 24V is possible.
 Spiral cable 3500 mm long with universal plug for cigarette lighter sockets or ISO sockets.
 Type of protection: IPX6K.
Light aperture: 139 mm dia.

Range at 12V:

**Continuous light 330 m,
 additional light 350 m,
 continuous light with additional light 480 m**

1H5 998 502-002

1

Hand-held searchlight

Spare parts:

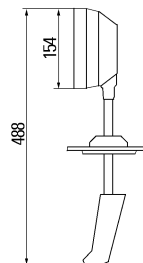
8HG 998 519-002
 9SG 998 005-002
 8JA 001 921-102

1
 1
 12

Supporting base with fixing screws
 Handle with switch, spirally cable and plug
 Plug



12V55W (H3) 8GH 002 090-133
 24V70W (H3) 8GH 002 090-251



1H5 998 502-022

1

Cabin-controlled searchlight

Black plastic housing, lens-retaining rim, handle and tie rod end.
 Guide tube made of stainless steel.
 Projecting lens-retaining rim protects the lens.
 Glass lens without optical pattern.
 Double reflector made of aluminium.
 Flip switch in the handle switches both bulbs simultaneously.
 The searchlight can be swivelled through 360° in the horizontal range and through 30° in the vertical range. Mounting area: 72 mm dia.
 Connecting cable 330 mm long with grommet led out of the guide tube.
 Type of protection: IP5K4K.
Light aperture: 139 mm dia.

**Range at 12V: 460 m,
 range at 24V: 520 m.**

1H5 998 502-051

1

**Cabin-controlled searchlight
 with 181 mm long guide tube
 and 12V55W bulbs**

**with 233 mm long guide tube
 and 24V70W bulbs**




2x12V55W (H3) 8GH 002 090-133
 2x24V70W (H3) 8GH 002 090-251



Auxiliary indicators	5.142-5.144
Clearance lights	5.121-5.125
Daytime running lights	5.113-5.115, 5.127
Door lights	5.168-5.169
Emergency triangles	5.174
Handlamps	5.164-5.167
Handlebar indicator lights	5.142
Handlights	5.168
Hazard flasher lights	5.172-5.173
Indicator lights	5.137-5.142
Indicator-side lights	5.46, 5.49, 5.53
Interior lights	5.145-5.161
Licence plate lights	5.116-5.121
Multifunction lights	5.05-5.17, 5.28-5.34, 5.51
Reading lights	5.162-5.163
Rear fog lights	5.127-5.129
Rear lights	5.107-5.109, 5.111
Rear-side light	5.126
Reflectors	5.175-5.179
Reverse lights	5.127-5.131
Safety break lights	5.132-5.135
Side lights	5.106-5.112
Side-marker lights	5.97-5.105
Track-control lights	5.126
Warning lights	5.170-5.171
Signal Lights and Cabling	5.182-5.235
Regulations and information on LED signal lights	5.236-5.238

Combinable Lights















		Serie "343 640"	5.18-5.19
		Serie "006 040"	5.20-5.21
		Serie "007 547"	5.22
		Serie "003 167"	5.23
		Serie "003 236" Serie "005 200"	5.24-5.25 5.26
		Serie "004 431" Serie "004 432"	5.27
		Serie "959 050" Serie "959 060" Serie "959 070" Serie "959 037"	5.35
		Serie "998 232"	5.36-5.37
		Serie "998 233"	5.38-5.39
		Serie "002 582"	5.40
		Serie "003 184"	5.41
		Serie "997 131"	5.43
		Serie "997 006"	5.44
		Serie "003 182"	5.45
		Serie "002 776"	5.46

		Serie "959 010" Serie "959 011"	5.54
		Serie "959 820" Serie "959 821" Serie "959 822" Serie "959 950"	5.55
		Serie "008 221"	5.56-5.57
		Serie "009 001"	5.58-5.62
		Serie "965 039"	5.63-5.64
		Serie "344 200" Serie "964 169" Serie "344 169"	5.65 5.65-5.69 5.66-5.68
		Serie "001 423"	5.70
		Serie "343 390" Serie "343 130"	5.71 5.72-5.76
		Serie "001 240"	5.77
		Serie "001 259"	5.78-5.79
		Serie "003 057"	5.80
		Serie "003 014"	5.82-5.83
		Serie "996 012"	5.84
		Serie "008 982"	5.85
		Serie "008 805"	5.86
		Serie "005 603" Serie "004 119"	5.87 5.88
		Serie "003 734"	5.89-5.90

Combinable Lights



		Serie "962 964"	5.91
		Serie "006 717"	5.92
		Serie "997 027"	5.93
		Serie "963 639"	5.94-5.95
		Serie "340 001"	5.95
		Serie "003 748"	5.96
		Serie "963 959"	5.97
		Serie "004 361"	5.98
		Serie "340 000"	5.99
		Serie "008 645"	5.100-5.101
		Serie "964 295"	5.102-5.103
		Serie "959 790"	5.110
		Serie "959 590"	
		Serie "959 640"	
		Serie "003 389"	5.121



Part no.

Pk.

For horizontal or vertical flush mounting in towing vehicles and mobile homes

Red reflector, rear, stop, rear fog and clearance light, amber indicator light and clear reverse light.
Two M8 fixing screws.

Ⓔ4 279 Ⓔ4 280 Ⓔ4 4039

2VP 007 323-091

1

Rear-reflector-stop-indicator-rear fog-reverse-clearance light, left

2VP 007 323-101

1

right

2x12V5W (R5W) 8GA 002 071-121
2x24V5W (R5W) 8GA 002 071-241
1x12V10W (R10W) 8GA 002 071-131
1x24V10W (R10W) 8GA 002 071-251
4x12V21W (P21W) 8GA 002 073-121
4x24V21W (P21W) 8GA 002 073-241



For horizontal surface mounting on towing vehicles

Rear-reflector-stop-indicator-rear fog-reverse-clearance light and side-marker light with reflector, left

2VP 007 323-011

1

2VP 007 323-021

1

right

with 8-pole, black Schlemmer-plug and 24V bulbs, left

2VP 007 323-111

1

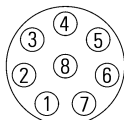
2VP 007 323-121

1

right



1	BL	yellow
2	S/K/UR/SMLR	brown
3	B	red
4	NES	blue
5	ZR	black
6	---	not used
7	---	not used
8	Ground	white



Pin configuration:

BL = indicator
S = rear
K = licence plate
UR = clearance
SM = side-maker
B = stop
NES = rear fog
ZR = reverse

With illumination for 520 x 120 mm and 340 x 240 mm licence plates, left

2VD 007 323-031

1

2VD 007 323-041

1

right

with 8-pole, black Schlemmer-plug and 24V bulbs, left

2VD 007 323-131

1

2VD 007 323-141

1

right



5

Spare parts:

1 Lens
2 Side-marker light with reflector

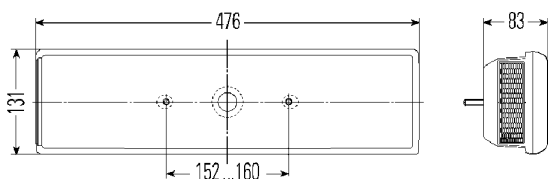
9EL 146 887-001

1

9EL 146 838-001

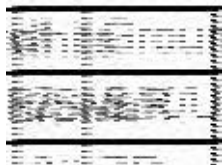
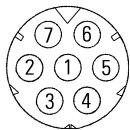
2

2x12V5W (R5W) 8GA 002 071-121
2x24V5W (R5W) 8GA 002 071-241
2(1)x12V10W (R10W) 8GA 002 071-131
2(1)x24V10W (R10W) 8GA 002 071-251
4x12V21W (P21W) 8GA 002 073-121
4x24V21W (P21W) 8GA 002 073-241



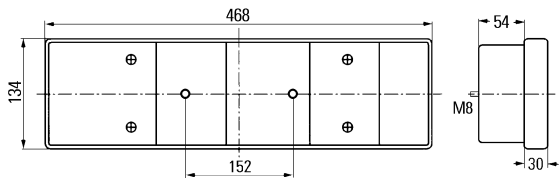
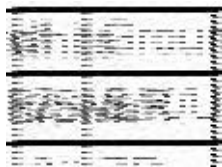
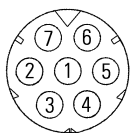
Signal Lights

for rear mounting



Pin configuration:

- BL = indicator
- S = rear
- K = licence plate
- UR = clearance
- SM = side-maker
- B = stop
- NES = rear fog
- ZR = reverse



Part no.

Pk.

For horizontal surface mounting on towing vehicles

Red reflector, rear, stop, rear fog and clearance light, amber indicator and side-marker light with reflector, white reverse light, with illumination for 520 x 120 mm licence plates. Black plastic body. Two M8 fixing screws.

(E4) 9808 (E4) 9810

(E4) 3178 (E4) 4060

Rear-reflector-stop-indicator-rear fog-reverse-clearance light with licence plate illumination and 7-pole, side-mounted AMP-plug for RVI vehicles, left

2VD 008 204-231 1

without licence plate illumination, right (contact 2/K not used)

2VP 008 204-221 1

Same as 2VD/2VP 008 204-231/-221, without plug, however with PG fitting, cable input and two M8 fixing screws, left

2VD 008 204-211 1

without licence plate illumination, right

2VP 008 204-201 1

Same as 2VD/2VP 008 204-231/-221, however with 7-pole, side-mounted AMP-plug for DAF and MAN vehicles, left

2VD 008 204-251 1

without licence plate illumination, right (contact 2/K not used)

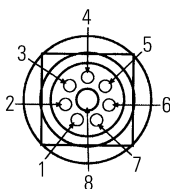
2VP 008 204-241 1

Spare parts:

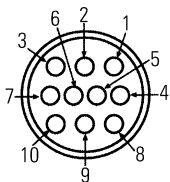
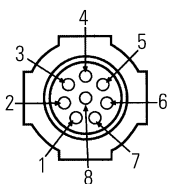
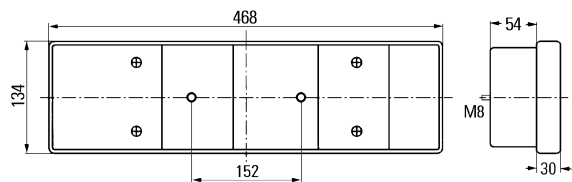
Lens with screws

9EL 152 889-001 1

- 3(2)x12V5W (R5W) 8GA 002 071-121
- 3(2)x24V5W (R5W) 8GA 002 071-241
- 1x12V10W (R10W) 8GA 002 071-131
- 1x24V10W (R10W) 8GA 002 071-251
- 4x12V21W (P21W) 8GA 002 073-121
- 4x24V21W (P21W) 8GA 002 073-241



Pin configuration:
 BL = indicator
 S = rear
 K = licence plate
 UR = clearance
 SM = side-maker
 B = stop
 NES = rear fog
 ZR = reverse



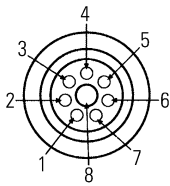
1	UR/SML	green
2	BL	yellow
3	B	red
4	ZR	black
5	---	not used
6	---	not used
7	---	not used
8	Ground	white
9	NES	blue
10	S	brown



Part no.	Pk.	For horizontal surface mounting on towing vehicles
		Red reflector, rear, stop, rear fog and clearance light, amber indicator light, white reverse light, with illumination for 520 x 120 mm licence plates. Black plastic body. Two M8 fixing screws.
		(E4) 9808 (E4) 9810
		(E4) 3178 (E4) 4060
2VD 008 204-051	1	Rear-reflector-stop-indicator-rear fog-reverse-clearance light with licence plate illumination and 8-pole AMP-plug for MAN and Scania vehicles, left and right
2VP 008 204-041	1	without licence plate illumination, left and right
2VD 008 204-071	1	Same as 2VD 008 204-051, but with side-marker light and reflector, left
2VP 008 204-061	1	without licence plate illumination, left and right
2VD 008 204-131	1	Same as 2VD 008 204-071, but without plug, left
2VP 008 204-121	1	without rear fog light and licence plate illumination, left and right
2VD 008 204-151	1	Same as 2VD 008 204-071, but with Scania cable input, without plug, left
2VP 008 204-141	1	right
2VD 008 204-171	1	Same as 2VD 008 204-071, but with 8-pole special-plug for DAF vehicles, left
2VP 008 204-161	1	without licence plate illumination, left and right
2VD 008 204-191	1	Same as 2VD 008 204-071, but with 10-pole AMP-plug for Iveco-vehicles, left
2VP 008 204-181	1	without licence plate illumination, right
9EL 152 889-001	1	Spare parts: Lens with screws
		3(2)x24V5W (R5W) 8GA 002 071-121 3(2)x24V5W (R5W) 8GA 002 071-241 4x12V21W (P21W) 8GA 002 073-121 4x24V21W (P21W) 8GA 002 073-241

Signal Lights

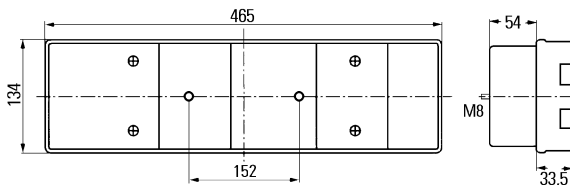
for rear mounting



1	BL	yellow
2	S/K/UR/SMLR	black/ green-red /brown
3	B	red
4	NES	blue
5	ZR	grey
6	---	not used
7	---	not used
8	Ground	white

Pin configuration:

- BL = indicator
- S/K/UR/SM = rear/license plate/clearance/side-marker
- B = stop
- NES = rear fog
- ZR = reverse



Part no.

Pk.

For horizontal surface mounting on towing vehicles

Red reflector, rear, stop, rear fog and clearance light, amber indicator and side-marker light with reflector, white reverse light, with illumination for 520 x 120 mm licence plates. Black plastic body. Cable entry through central housing opening. Two M8 fixing screws.

(E4) 9809 (E4) 9810

(E4) 3179 (E4) 4060

Rear-reflector-stop-indicator-rear fog-reverse-clearance light, with side-marker light and reflector, with licence plate illumination, for Mercedes-Benz vehicles, left

2VD 008 204-111

1

without licence plate illumination and rear fog light, right

2VP 008 204-101

1

Same as 2VD 008 204-111, but with 8-pole Schlemmer-plug for Mercedes-Benz vehicles, left

2VD 008 204-091

1

without licence plate illumination, right

2VP 008 204-081

1

Spare parts:

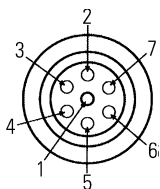
Lens with screws

9EL 152 891-001

1

- 3x12V5W (R5W) 8GA 002 071-121
- 3x24V5W (R5W) 8GA 002 071-241
- 4(3)x12V21W (P21W) 8GA 002 073-121
- 4(3)x24V21W (P21W) 8GA 002 073-241



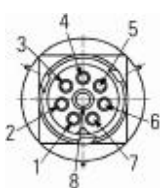
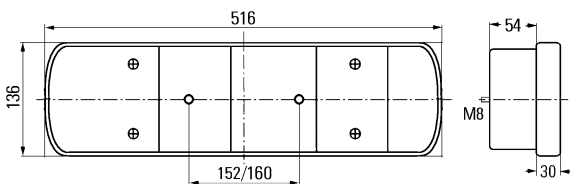


1	Ground	white
2	BL	green
3	B	red
4	S/K/UR/SMLR	brown
5	ZR	yellow
6	NES	blue
7	—	not used

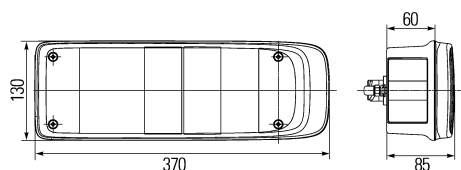


Pin configuration:

- BL = indicator
- S/K/UR/SM = rear/license plate/clearance/side-marker
- B = stop
- NES = rear fog
- ZR = reverse



1	BL	yellow/green
2	S	brown
3	B	red
4	NES	blue
5	ZR	pink
6	—	not used
7	—	not used
8	Ground	white



Part no. Pk.

For horizontal surface mounting on towing vehicles

Red reflector, rear, stop, rear fog and clearance light, amber indicator and side-marker light with reflector, white reverse light, with illumination for 520 x 120 mm licence plates. Black plastic body. Two M8 fixing screws. Distance between screws 152 mm.

- Ⓔ 9808 Ⓔ 9811
- Ⓔ 3178 Ⓔ 4060

Rear-reflector-stop-indicator-rear fog-reverse-clearance light, with side-marker light and reflector, with licence plate illumination, left

2VD 008 205-011 1
2VD 008 205-021 1

right

For Volvo FH/FM.

Same as 2VD 008 205-011, but with 7-pole AMP-plug and distance between screws 160 mm, left

2VD 008 205-051 1
2VD 008 205-041 1

right

without licence plate illumination, left and right

2VP 008 205-031 1
9EL 152 884-001 1

Spare parts:
Lens with screws

- 3x12V5W (R5W) 8GA 002 071-121
- 3x24V5W (R5W) 8GA 002 071-241
- 1x12V10W (R10W) 8GA 002 071-131
- 1x24V10W (R10W) 8GA 002 071-251
- 4x12V21W (P21W) 8GA 002 073-121
- 4x24V21W (P21W) 8GA 002 073-241

Red reflector, rear, stop, rear fog and clearance light, amber indicator and side marker light with reflector, white reverse light. Black plastic body. Two M8 fixing screws.

With 4 vibration dampers, 8-pole Schlemmer-plug and 24V bulbs. Two bulbs for rear and stop light.

- Ⓔ 10218 Ⓔ 10219

Rear-reflector-stop-indicator-rear fog-reverse light and side-marker light with reflector, left

2VP 340 888-011 1
2VP 340 888-017 12

right

2VP 340 888-001 1
2VP 340 888-007 12

- 4x24V21W (P21W) 8GA 002 073-241
- 2x24V10W (R10W) 8GA 002 071-251

- 1x24V4W (T4W) 8GP 002 067-241

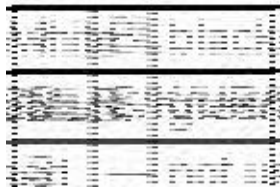
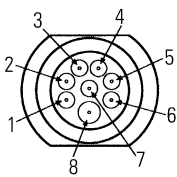
Signal Lights

for rear mounting



Caution:

When used in right-hand traffic, the licence plate window in the right-hand light must be covered with the black cover plate 9EL 134 301-011 (Pk. 1), order separately!



Pin configuration:

- BL = indicator
- S/K/UR = rear/licence plate/reflector
- SMLR = side-markering light
- NES = rear fog
- ZR = reverse
- B = stop

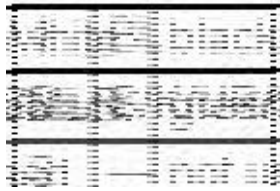
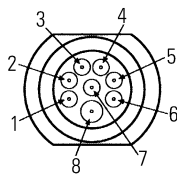
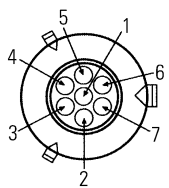


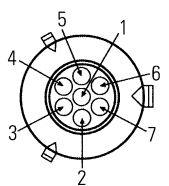
Fig. 1



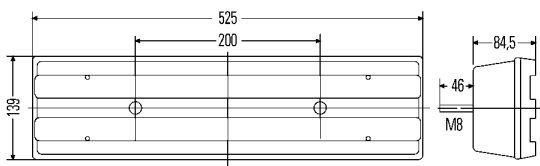
1	Ground	brown
2	S/UR/SMLR	green
3	ZR	black
4	BL	red
5	B	yellow
6	NES	white
7	K	green



Fig. 2



1	Ground	brown
2	S/UR/SMLR	green
3	ZR	black
4	BL	red
5	B	yellow
6	---	not used
7	---	not used



Part no.

Pk.

For horizontal surface mounting on towing vehicles

Also permissible for trailers in combination with valid EC component homologation for lighting.

Red reflector, rear, stop, rear fog and clearance light, amber indicator light, white reverse light, with illumination for 520 x 120 mm licence plates. With side mounted amber reflector. Black plastic body. Two M8 fixing screws. With 1200 mm lead, AMP-round plug, vibration dampers and 24V bulbs.

(E1) 31432 (E1) 63217

Rear-reflector-stop-indicator-rear fog-reverse-clearance light with licence plate illumination, left

2VD 007 500-091

1

2VD 007 500-201

1

right

With amber side-marker light and reflector.

(E1) 31432 (E1) 63217 (E1) 280

Rear-reflector-stop-indicator-rear fog-reverse-clearance light, with side-marker light, reflector and licence plate illumination, left

2VD 007 500-111

1

2VD 007 500-221

1

right

Accessories:

Cover plate, black

9EL 134 301-011

1

With 7-pole, amber AMP-centre plug and grommets on side.

Rear-reflector-stop-indicator-rear fog-reverse-clearance light, with side-marker light and reflector, with licence plate illumination, left (fig. 1)

2VD 007 500-411

1

without licence plate illumination and rear fog light, right (fig. 2)

2VP 007 500-421

1

Spare parts:

- Lens with screws, left
- right
- Lens for side-marker light for -111/-221/-411/-421
- Lens for licence plate illumination, for -091/-111/-201/-221/-411
- Reflector for -091/-201
- Grommet for -091/-201/-111/-221

9EL 134 296-041

1

9EL 134 296-051

1

9EL 146 838-001

2

9EL 134 301-001

1

8RA 003 326-041

20

9GT 074 132-001

10

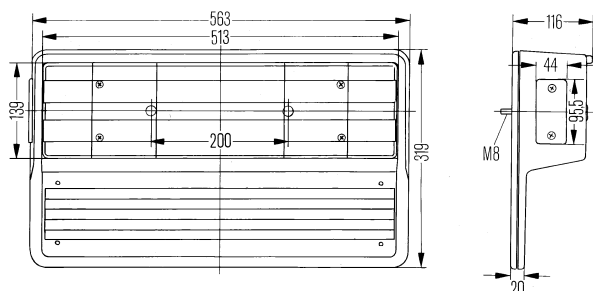
- 3x12V10W (R10W) 8GA 002 071-131
- 3x24V10W (R10W) 8GA 002 071-251
- 4x12V21W (P21W) 8GA 002 073-121
- 4x24V21W (P21W) 8GA 002 073-241





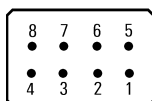
Caution:

When used in right-hand traffic, the licence plate window in the right-hand light must be covered with the black cover plate 9EL 134 301-011 (pk. 1), order separately!

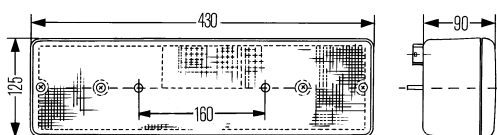


Pin configuration:

- S = rear
- NES = rear fog
- B = stop
- BL = indicator
- ZR = reverse



1	Ground
2	S
3	S
4	NES
5	B
6	BL
7	ZR
8	Ground




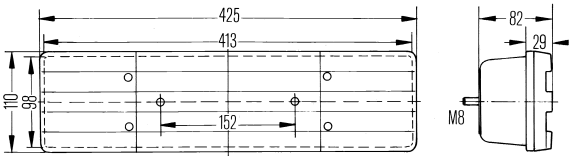


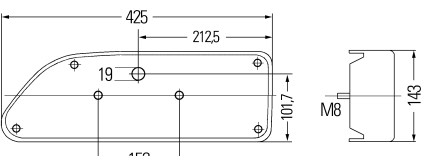


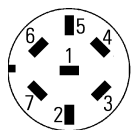
Part no.	Pk.	For horizontal surface mounting
		Red reflector, rear, stop, rear fog and clearance light, amber indicator light, white reverse light, with illumination for 520 x 120 mm licence plates. With amber side-marker reflector. Grey plastic body. Two M8 fixing screws.
		(E1) 31432
		Rear-reflector-stop-indicator-rear fog-reverse-clearance light, with side-marker reflector and licence plate illumination, left
2VD 005 300-551	1	
2VD 005 300-581	1	right
		Spare parts:
		Lens with screws,
9EL 134 296-041	1	left
9EL 134 296-051	1	right
9EL 134 301-001	1	Lens for licence plate illumination
8RA 003 326-011	20	Reflector
		Accessories:
9EL 134 301-011	1	Cover plate, black
		3x12V10W (R10W) 8GA 002 071-131
		3x24V10W (R10W) 8GA 002 071-251
		4x12V21W (P21W) 8GA 002 073-121
		4x24V21W (P21W) 8GA 002 073-241
		Red rear, stop and rear fog light, amber indicator light, white reverse light, with illumination for 520 x 120 mm and 340 x 240 mm licence plates. Black plastic body. Two M6 fixing screws. With rectangular Volvo-central plug.
		(E4) 1305 (E4) 3848 (E4) 4026
		(E4) 1247 (E1) 23167
		Rear-stop-indicator-rear fog-reverse light with licence plate illumination, left
2SL 005 883-031	1	
2SL 005 883-041	1	right
		For horizontal or vertical surface mounting
		Without licence plate illumination, left
2SK 005 883-011	1	
2SK 005 883-021	1	right
		Spare parts:
9EL 135 548-001	3	Lens
		2x12V5W (R5W) 8GA 002 071-121
		2x24V5W (R5W) 8GA 002 071-241
		4x12V21W (P21W) 8GA 002 073-121
		4x24V21W (P21W) 8GA 002 073-241

Signal Lights

for rear mounting



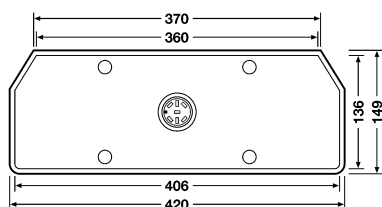
	Part no.	Pk.	For horizontal surface mounting
   	<p>2VB 004 887-011 1</p> <p>2VA 004 887-031 1</p> <p>2VP 004 887-021 1</p> <p>9EL 131 420-001 1 9EL 131 420-011 1</p> <p>9GT 141 941-001 10</p>		<p>Red reflector, rear, stop and rear fog light, amber flasher light, white reverse light and licence plate illumination. Black plastic body, without grommet. Two M8 fixing screws.</p> <p>(E1) 53384</p> <p>Rear-reflector-stop-indicator-rear fog light with illumination for 520 x 120 mm licence plates, left</p> <p>without licence plate illumination, left</p> <p>with reflector and reverse light, without rear fog light and licence plate illumination, right</p> <p>Spare parts: Lens with screws, left, for -011/-031 right, for -021</p> <p>Accessories: Grommet</p> <p>3x12V21W (P21W) 8GA 002 073-121 3x24V21W (P21W) 8GA 002 073-241 1x12V10W (R10W) 8GA 002 071-131 1x24V10W (R10W) 8GA 002 071-251</p>
  	<p>2VP 007 907-031 1 2VP 007 907-037 12</p> <p>2VP 007 907-041 1 2VP 007 907-047 12</p> <p>9EL 150 965-001 1 9EL 150 966-001 1</p>		<p>For horizontal surface mounting on trailers</p> <p>Rear Logic Red reflector, rear, stop and rear fog light, clear indicator light (with auxiliary lens) and reverse light. Black plastic body. Two M8 fixing screws. With vibration dampers and grommet.</p> <p>(E17) 9701</p> <p>Rear-stop-indicator-rear fog-reverse light with triangular reflector, left</p> <p>right</p> <p>Spare parts: Lens, left right</p> <p>3x24V21W (P21W) 8GA 002 073-251 1x24V21/5W (P21/5W) 8GD 002 078-241 1x24V21/5W (P21/5W) 8GD 002 078-011 (Heavy Duty)</p>



1	Ground	white
2	B	red
3	BL	yellow
4	ZRS	grey
5	NES	blue
6	S	black
7	SM/LUL/K	brown

Pin configuration:

- B = stop
- BL = indicator
- ZR = reverse
- NES = rear fog
- S = rear
- SM/UR/K = side-marker/clearance/licence plate



Part no.

Pk.

For horizontal surface mounting on trailers

Europoint

Red reflector, rear, stop, rear fog and clearance light, amber indicator light and side-marker light with reflector, white reverse light, with licence plate illumination. Black plastic body. Two M8 fixing screws. **With 7-pole plug and double vibration damping. Two bulbs for rear and stop light. With 24V bulbs.**

Ⓔ 5167 Ⓔ 7078

Rear-stop-indicator-rear fog-reverse-clearance light, with side-marker light, with triangular reflector and licence plate illumination, left

2VD 008 789-011

1

without licence plate illumination, left

2VP 008 789-051

1

right

2VP 008 789-021

1

With PG- screwed connections, without plug, bulbs and licence plate illumination, left

2VP 008 789-071

1

right

2VP 008 789-041

1

Spare parts:

Lens with additional yellow lens and expansion dowel

9EL 158 993-001

1

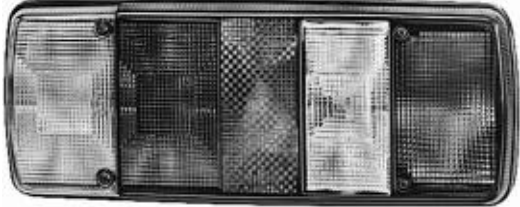
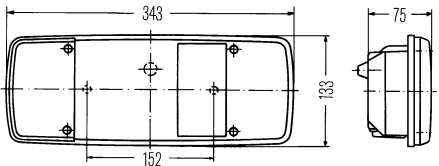
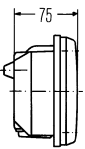
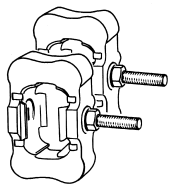
- 2x24V5W (R5W) 8GA 002 071-241
- 1x24V10W (R10W) 8GA 002 071-251
- 4x24V21W (P21W) 8GA 002 073-241
- 1x24V21/5W (P21/5W) 8GD 002 078-241



Signal Lights


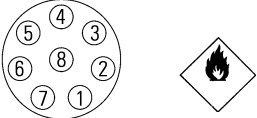
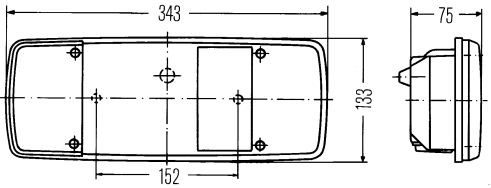
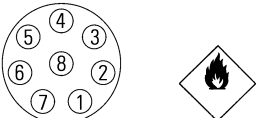
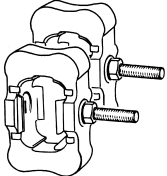
for rear mounting



	Part no.	Pk.	For horizontal flush/surface (indicator light above) mounting on towing vehicles **) Without licence plate illumination also for vertical attachment. Red reflector, rear, stop and rear fog light, amber indicator light, white reverse light. Black plastic body. Two M8 fixing screws. (E4) 421 (E4) 397 (E4) 377 (E4) 23215 (E4) 3880 (E4) 3134 Rear-reflector-stop-indicator-rear fog-reverse light, left right Spare parts: Lens with screws <hr/> With licence plate illumination, left <hr/> For horizontal flush/surface mounting on trailers Without licence plate illumination also for vertical attachment. Red rear, stop and rear fog light, amber indicator light, white reverse light. Two M8 fixing screws. (E4) 421 (E4) 397 (E4) 377 (E4) 23215 (E4) 3880 Rear-stop-indicator-rear fog-reverse light, left right <hr/> (E4) 4033 for licence plate illumination Rear-stop-indicator-rear fog-reverse light, with licence plate illumination, left (for surface mounting) left Spare parts: Lens with screws 1(2)x12V10W (R10W) 8GA 002 071-131 1(2)x24V10W (R10W) 8GA 002 071-251 4x12V21W (P21W) 8GA 002 073-121 4x24V21W (P21W) 8GA 002 073-241 <hr/> Rear-stop-indicator-rear fog-reverse light, left right Spare parts: Lens with screws Accessories: External vibration dampers Kit comprising: 2 each with M8 fixing screw. 2x12V10W (R10W) 8GA 002 071-131 2x24V10W (R10W) 8GA 002 071-251 4x12V21W (P21W) 8GA 002 073-121 4x24V21W (P21W) 8GA 002 073-241
	2VP 003 567-111	1	2VP 003 567-121 2VP 003 567-127
	9EL 122 689-021	2	
	2VD 003 567-377 *)	18	2SK 003 567-331 2SK 003 567-321
	2SL 003 567-311	1	
	2SL 003 567-691 *)	1	2SK 003 567-651 *) 2SK 003 567-661 *)
	9EL 122 772-001	2	
	9GP 003 995-801	1	

*) Two bulbs for rear light.


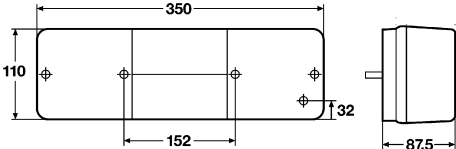

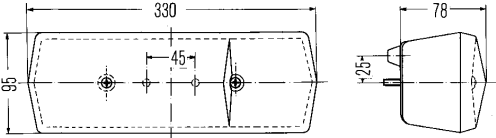

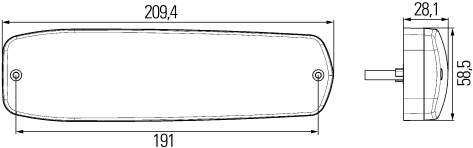
**) Also permissible for trailers in combination with valid EC component homologation for lighting.




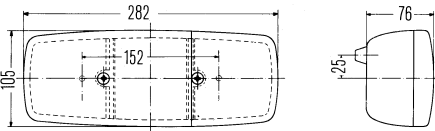

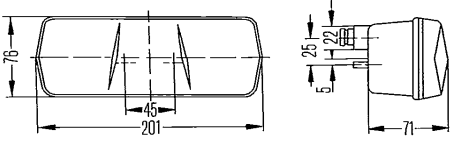
	Part no.	Pk. For horizontal flush/surface mounting on towing vehicles and trailers
    	9EL 122 689-051	2 For horizontal flush/surface mounting on towing vehicles and trailers Modular system for meeting special individual light requirements: Black plastic housing, with centre plug, left or right Caution! Please plug the existing licence plate opening with cover 9HB 126 601-001 if not used. Lens with various functions, left or right. Red rear, reflector, stop and rear fog light, amber indicator light, white reverse light. Complete light can be fitted vertically (indicator light at the top) or horizontally (indicator light outside).
	9EL 122 689-021	2 Modular parts for towing vehicles (E4) 421 (E4) 397 (E4) 377 (E4) 23215 (E4) 3880 (E4) 3134 Lenses with reflector: (fixing screws included) for rear-reflector-stop-indicator-reverse light
	9BG 130 945-001	2 for rear-reflector-stop-indicator-rear fog-reverse light Housing for lenses with reflector: (fixing screws included) with centre plug, left
	9BG 130 946-001	2 right
	9EL 122 772-051	2 For trailers Lenses without reflector: (fixing screws included) for rear-stop-indicator-reverse light
	9EL 122 772-001	2 for rear-stop-indicator-rear fog-reverse light
	9HB 126 601-001	2 Accessories: Cover for licence plate opening (without illumination)
	9GP 003 995-801	1 External vibration dampers Contains: 2 each with M8 fixing screws. 1x12V10W (R10W) 8GA 002 071-131 1x24V10W (R10W) 8GA 002 071-251 4x12V21W (P21W) 8GA 002 073-121 4x24V21W (P21W) 8GA 002 073-241

Signal Lights

for rear mounting

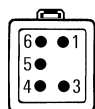


 	Part no.	Pk.	<p>For horizontal or vertical flush/surface mounting</p> <p>Red rear and stop light, amber indicator light. Licence plate opening can be replaced with red lens included loose. Black plastic body. Two M8 fixing screws. Two bulbs for tail light. With PG11- screwed connections. For older Scania models.</p> <p>(E12) 27092 (E12) 16066 (E12) 4035</p>
 	2SD 001 688-171	1	<p>For horizontal surface mounting</p> <p>Red rear and stop light, amber indicator light. Black plastic body. Two M6 fixing screws. Two bulbs for rear light.</p> <p>(E1) 43207</p>
	2SD 001 688-141	1	<p>Rear-stop-indicator light, left</p>
	2SE 001 688-151	1	<p>right</p>
	2SE 001 688-161	1	<p>With illumination for 520 x 120 mm and 340 x 240 mm licence plates, left</p>
	9EL 092 435-011	1	<p>right</p>
	9GD 102 484-001	10	<p>Spare parts:</p> <p>Lens with screws</p>
	9GT 074 132-001	10	<p>Gasket for lens</p> <p>Grommet</p>
			<p>1(2)x12V5W (R5W) 8GA 002 071-121 1(2)x24V5W (R5W) 8GA 002 071-241 2x12V21W (P21W) 8GA 002 073-121 2x24V21W (P21W) 8GA 002 073-241</p>
 	2SD 343 910-001	1	<p>For horizontal or vertical surface mounting on Fork-lift</p> <p>LeanLED</p> <p>In LED-technology. Clear lens. With 24 LEDs.</p> <p>Black plastic body. Two 3.0 mm dia. holes for fixing screws. Voltage range: 9V - 31V. Consumption: 0.38A at 12V, 0.19A at 24V. Rearlight: 1.0W. Stoplight: 1.5W. Indicator light: 2.0W.</p>
	2SD 343 910-007	48	<p>(E4) 12393</p>
	2SD 343 910-041	48	<p>Rear-stop-indicator light with 500 mm long lead</p>
	2SD 343 910-017	48	<p>same as -001, but partly metallised</p>
	2SD 343 910-027	48	<p>with 200 mm long lead and 4-pole AMP Superseal plug</p>
			<p>with integrated 4-pole AMP Superseal plug</p>

	Part no.	Pk.	For horizontal surface mounting
   	<p>2SD 001 699-511 1</p> <p>2SD 001 699-061 1</p> <p>2SE 001 699-071 1</p> <p>9EL 109 139-001 2 9GT 074 132-001 10</p>		<p>Red rear and stop light, amber indicator light. Black plastic body, with gasket. Bulb holder with vibration damping. Two M8 fixing screws.</p> <p>(E1) 43332 (E1) 196</p> <p>Rear-stop-indicator-light, left</p> <p>right</p> <hr/> <p>With illumination for 340 x 240 mm and 240 x 130 mm licence plates, left</p> <p>Spare parts: Lens with screws Grommet</p> <p>1x12V10W (R10W) 8GA 002 071-131 1x24V10W (R10W) 8GA 002 071-251 2x12V21W (P21W) 8GA 002 073-121 2x24V21W (P21W) 8GA 002 073-241</p>
 	<p>2SD 001 680-271 1</p> <p>2SD 001 680-281 1</p> <p>2SD 001 680-391 1</p> <p>2SD 001 680-401 1</p> <p>2SE 001 680-291 1</p> <p>2SE 001 680-301 1</p> <p>9EL 107 368-001 2 9EL 111 647-001 2</p>		<p>Red rear and stop light, amber indicator light. Black plastic body. With grommet. With packing gland. Two M6 fixing screws.</p> <p>(E1) 53335 (E1) 31482 (E1) 43322</p> <p>Rear-stop-indicator light, left</p> <p>right</p> <p>with PC-body, left</p> <p>right</p> <hr/> <p>With illumination for 520 x 120 mm, 340 x 240 mm and 240 x 130 mm licence plates, left</p> <p>right</p> <p>Spare parts: Lens with screws and gasket, left right</p> <p>1x12V10W (R10W) 8GA 002 071-131 2x12V21W (P21W) 8GA 002 073-121</p>

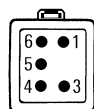
Signal Lights

for rear mounting



1	B
3	S
4	Ground
5	ZR/NES
6	BL

left

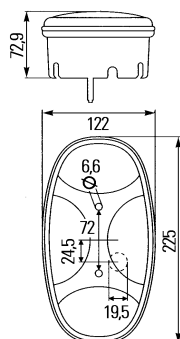


1	ZR
3	S
4	Ground
5	B
6	BL

right

Pin configuration:

- B = stop
- BL = flasher
- ZR = reversing
- NES = rear fog
- S = tail
- K = licence plate



Part no.

Pk.

For vertical surface mounting on towing vehicles and trailers **)

Cargoluna

Red rear, stop light and reflector, amber indicator light, clear reverse light. Black base plate. PC-lens. Four M6 x 25 fixing screws. Distance between screws: 72 mm.

Water drain hole broken out.

Completely mounted with seal.

Vertical attachment: direction indicator on inside.

(E17) 0303

Rear-reflector-stop-indicator and reverse light, with DEUTSCH plug and 12V bulbs, left

2VP 343 640-277

1

2VP 343 640-267

1

right

2VP 343 640-257

64

with 24V bulbs, left

2VP 343 640-247

64

right

Spare parts:

Lens

for -257/-277

for -247/-267

9EL 343 143-001

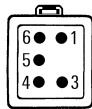
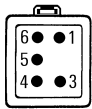
1

9EL 343 142-001

1

- 1x12V10W (R10W) 8GA 002 071-131
- 1x24V10W (R10W) 8GA 002 071-251
- 3x12V21W (P21W) 8GA 002 073-121
- 3x24V21W (P21W) 8GA 002 073-241

**) Also permissible for trailers in combination with valid EC component homologation for lighting.



1	B
3	S
4	Ground
5	ZR/NES
6	BL

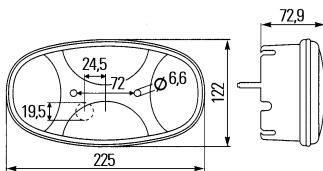
1	ZR
3	S
4	Ground
5	B
6	BL

left

right

Pin configuration:

- B = stop
- BL = flasher
- ZR = reversing
- NES = rear fog
- S = tail
- K = licence plate

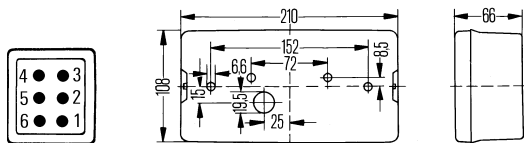


Part no.	Pk.	For horizontal or vertical surface mounting on towing vehicles and trailers **)
Cargoluna		
Caution:		
Depending on the attachment position, the water drainage opening must be knocked out! Please refer to the installation instructions.		
Horizontal attachment: direction indicator on top. Vertical attachment: direction indicator on inside.		
Red reflector, rear, stop and rear fog light, amber indicator light, clear reverse and licence plate illumination. Black base plate. PC-lens. With gasket. Four M6 x 25 fixing screws. Distance between screws: 72 mm.		
E17 0303		
2VP 343 640-051 2VP 343 640-057	1 64	Rear-reflector-stop-indicator and reverse light, with DEUTSCH plug and 12V bulbs, left
2VP 343 640-041 2VP 343 640-047	1 64	right
2VP 343 640-091 2VP 343 640-097	1 64	with 24V bulbs, left
2VP 343 640-081 2VP 343 640-087	1 64	right
2VA 343 640-131 2VA 343 640-137	1 64	with 12V bulbs and rear fog light, without reverse light, left
2VA 343 640-117	64	with 24V bulbs, left
2VA 343 640-207	64	right
2VB 343 640-127	64	with 12V bulbs, rear fog light and licence plate illumination, without reverse light, left
2VB 343 640-297	32	with 24V bulbs, rear fog light and licence plate illumination, without reverse light, left
Lights are not pre-assembled. With grommet, without bulbs.		
2VB 343 640-011 2VB 343 640-017	1 72	Rear-reflector-stop-indicator-rear fog light with licence plate illumination, 12V/24V, left
2VP 343 640-031	1	without rear fog light and licence plate illumination, with reverse light, without bulbs, 12V/24V, left
2VP 343 640-021 2VP 343 640-027	1 64	12V/24V, right
2VA 343 640-071 2VA 343 640-077	1 64	with rear fog light, without reverse light, 12V/24V, left
2VA 343 640-067	64	12V/24V, right
2VA 343 640-237	64	without rear fog light and reverse light, 12V/24V, left
2VA 343 640-101 2VA 343 640-107	1 64	12V/24V, right
Spare parts:		
Lens		
9EL 343 143-001	1	for -031/-037/-051/-057/-091/-097
9EL 343 143-011	1	for -017/-071/-077/-117/-127/-131/-137/-297
9EL 343 142-001	1	for -021/-027/-041/-047/-081/-087
<ul style="list-style-type: none"> 1x12V10W (R10W) 8GA 002 071-131 1x24V10W (R10W) 8GA 002 071-251 3x12V21W (P21W) 8GA 002 073-121 3x24V21W (P21W) 8GA 002 073-241 		

**) Also permissible for trailers in combination with valid EC component homologation for lighting.

Signal Lights

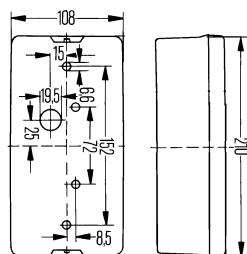
for rear mounting



1	B	
2	BL	
3	S	
4	ZR	
5	Ground	black
6	—	not used

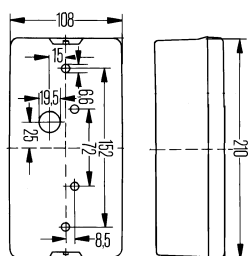
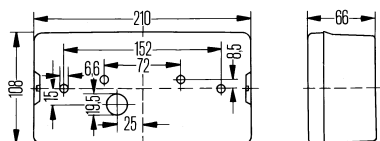
Pin configuration:

- B = stop
- BL = indicator
- S = rear
- ZR = reverse



Part no.	Pk.	For horizontal surface mounting on towing vehicles **)
2VB 006 040-051	1	<p>Red reflector, rear, stop and rear fog light, amber indicator light, with illumination for 520 x 120 mm and 340 x 240 mm licence plates. With black base plate. Four 6 mm dia. holes for fixing screws.</p> <p>(E13) 9385 (E13) 9531</p> <p>Rear-reflector-stop-indicator-rear fog light with licence plate illumination, left</p> <p>Spare parts: Lens</p>
9EL 136 833-011	1	
2VA 006 040-071 2VA 006 040-077	1 10	<p>Without licence plate illumination, left</p> <p>Spare parts: Lens</p>
9EL 136 819-031	1	
2VP 006 040-111 2VP 006 040-117	1 25	<p>Rear-reflector-stop-indicator-reverse light, left</p> <p>right</p>
2VP 006 040-121 2VP 006 040-127	1 25	
2VP 006 040-437 2VP 006 040-447	20 20	<p>Same as 2VP 006 040-111/121, but with DEUTSCH plug and 1 m lead, with 12V bulbs, without gasket, left</p> <p>right</p>
2VP 006 040-397 2VP 006 040-407	20 20	
2VA 006 040-457 2VP 006 040-467	20 20	<p>with 24V bulbs, 6 pole plug, with gasket, left</p> <p>right</p>
2VA 006 040-457 2VP 006 040-467	20 20	
2VP 006 040-477 2VP 006 040-487	20 20	<p>with PC lens, 24V bulbs and 6-pole plug, left</p> <p>right</p> <p>with PC lens, 24V bulbs, DEUTSCH plug and gasket, left</p> <p>right</p> <p>Spare parts: Lens left, for -111/-117/-397/-437 right, for -121/-127/-407/-447</p>
9EL 136 825-001 9EL 136 825-011	1 1	
2VA 006 040-291 2VA 006 040-297	1 64	<p>For vertical surface mounting on towing vehicles **)</p> <p>(E13) 9385 (E13) 9531</p> <p>Rear-reflector-stop-indicator-rear fog light, left</p> <p>with reverse light, without rear fog light, right</p>
2VP 006 040-301 2VP 006 040-307	1 64	
2VP 006 040-351 2VP 006 040-357	1 64	<p>With reverse light, without rear fog light, left</p> <p>Accessories: Gasket for extreme loads</p> <p>1x12V10W (R10W) 8GA 002 071-131 1x24V10W (R10W) 8GA 002 071-251 3x12V21W (P21W) 8GA 002 073-121 3x24V21W (P21W) 8GA 002 073-241</p>
9GD 102 484-001	10	

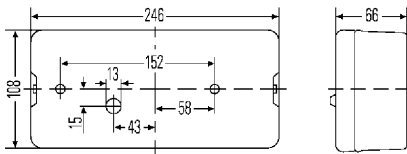
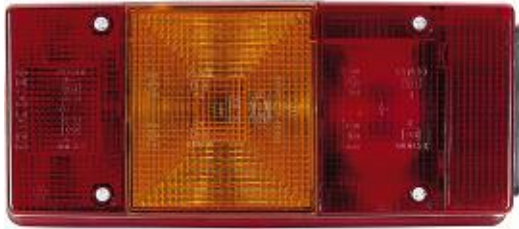
**) Also permissible for trailers in combination with valid EC component homologation for lighting.



Part no.	Pk.	For horizontal surface mounting on trailers
		Red rear, stop and rear fog light, amber indicator light, with illumination for 520 x 120 mm and 340 x 240 mm licence plates. With black base plate. Four 6 mm dia. holes for fixing screws.
		(E13) 9385
2SE 006 040-011	1	Rear-stop-indicator-licence plate-rear fog light, left
9EL 136 833-001	1	Spare parts: Lens
2SD 006 040-031	1	Without licence plate illumination, left
2SD 006 040-037	10	
2SD 006 040-041	1	right
9EL 136 819-011	1	Spare parts: Lens, left
9EL 137 792-011	1	right
2SD 006 040-161	1	Without licence plate illumination and rear fog light, right
2SD 006 040-167	10	
9EL 137 792-011	1	Spare parts: Lens
		For vertical surface mounting on trailers
		(E13) 9385
2SD 006 040-331	1	Rear-stop-indicator light, left
2SD 006 040-337	64	
2SD 006 040-131	1	with rear fog light, left
2SD 006 040-137	10	
2SD 006 040-141	1	without rear fog light, right
2SD 006 040-147	10	
9EL 136 819-041	1	Spare parts: Lens, left
9EL 137 792-031	1	right
9GD 102 484-001	10	Accessories: Gasket for extreme loads
		1x12V10W (R10W) 8GA 002 071-131 1x24V10W (R10W) 8GA 002 071-251 3x12V21W (P21W) 8GA 002 073-121 3x24V21W (P21W) 8GA 002 073-241

Signal Lights

for rear mounting



Part no.	Pk.	For horizontal or vertical (indicator light above) surface mounting
		Red rear, stop and rear fog light, amber indicator light, with illumination for 520 x 120 mm and 340 x 240 mm licence plates. With black base plate, with grommet. Two M6 fixing screws. Distance between screws 72 mm or 152 mm. Licence plate opening can be replaced with red lens included loose (for use as rear-stop-indicator light).
		<p>(E6) 450 (E6) 451 (E6) 452</p> <p>(E6) 453 (E6) 3018</p>
2SE 007 547-011	1	Rear-stop-indicator-rear fog light with licence plate illumination, without reflector, left
2SE 007 547-017	30	
2SE 007 547-021	1	right
2SE 007 547-027	30	
2VB 007 547-171	1	with reflector, left
		<p> 1x12V10W (R10W) 8GA 002 071-131</p> <p> 1x12V21/5W (P21/5W) 8GD 002 078-121</p> <p> 2x12V21W (P21W) 8GA 002 073-121</p>
2SE 007 547-041	1	Without rear fog light, right
		Spare parts:
9EL 147 096-001	1	Lens with licence plate window and red lens for -011/-017/-021/-027/-041
9EL 147 096-031	1	for -171
		<p> 1x12V10W (R10W) 8GA 002 071-131</p> <p> 1x12V21/5W (P21/5W) 8GD 002 078-121</p> <p> 1x12V21W (P21W) 8GA 002 073-121</p>
		<p>(E6) 450 (E6) 451 (E6) 452</p> <p>(E6) 1375 (E6) 3018</p>
2SL 007 547-061	1	With reverse light, without rear fog light and reflector, right
2SL 007 547-067	30	
2VD 007 547-181	1	with reflector, right
		Spare parts:
9EL 147 097-001	1	Lens with licence plate window and red lens for -061/-067
9EL 147 096-021	1	for -181
		<p> 1x12V10W (R10W) 8GA 002 071-131</p> <p> 1x12V21/5W (P21/5W) 8GD 002 078-121</p> <p> 2x12V21W (P21W) 8GA 002 073-121</p>



















Part no.	Pk.	For horizontal or vertical flush/surface mounting
		Red rear and stop light, amber indicator light. Black plastic body. Two M8 fixing screws.
		(E1) 264
2SD 003 167-011	1	Rear-stop-indicator light, left
2SD 003 167-021	1	right
		With PC housing, particularly suitable for high heat development, e.g. for buses, left
2SD 003 167-531	1	
2SD 003 167-541	1	right
		With illumination for 520 x 120 mm and 340 x 240 mm licence plates, for horizontal surface mounting, left
2SE 003 167-031	1	
2SE 003 167-041	1	right
		Spare parts:
9EL 147 747-001	1	Lens with screws
9EL 147 747-007	306	
9GD 087 883-355	10	Gasket
		<ul style="list-style-type: none"> 1x12V10W (R10W) 8GA 002 071-131 1x24V10W (R10W) 8GA 002 071-251 2x12V21W (P21W) 8GA 002 073-121 2x24V21W (P21W) 8GA 002 073-241
		(E1) 53250
		Same as 2SD 003 167-011, but for double-filament bulb in stop-light section for additional rear-light function, left
2SD 003 167-371	1	*)
		Same as 2SD 003 167-371, however with internal vibration damping and illumination for 520 x 120 mm and 340 x 240 mm licence plates, for horizontal surface mounting, left
2SE 003 167-511	3	*)
2SD 003 167-521	3	without licence plate illumination, right
		Spare parts:
9EL 118 445-001	1	Lens with screws
9GD 087 883-355	10	Gasket
		Accessories:
9GD 118 983-021	1	Body gasket for flush mounting
9GP 003 995-801	1	External vibration dampers Comprising: 2 vibration dampers with reinforcing plates and M8 fixing screws.
		<ul style="list-style-type: none"> 1x12V10W (R10W) 8GA 002 071-131 1x24V10W (R10W) 8GA 002 071-251 1x12V21W (P21W) 8GA 002 073-121 1x24V21W (P21W) 8GA 002 073-241 1x12V21/5W (P21/5W) 8GD 002 078-121 1x24V21/5W (P21/5W) 8GD 002 078-241 1x24V21/5W (P21/5W) 8GD 002 078-011 (Heavy Duty)

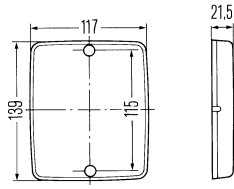
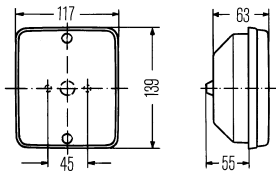
*) Only for spare parts requirements





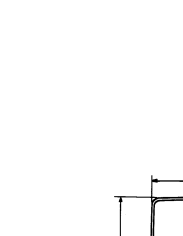

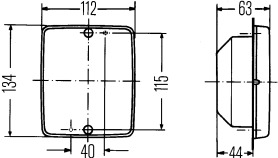















Signal Lights

for rear or side mounting



		Part no.	Pk.	For horizontal or vertical flush/surface mounting
		2SA 003 236-041 2SA 003 236-047 2SA 003 236-048	1 6 48	Red lens. Black plastic body. Two M6 fixing screws. (E1) 11591 Rear light
		9EL 120 201-001	4	Spare parts: Lens  1x12V5W (R5W) 8GA 002 071-121  1x24V5W (R5W) 8GA 002 071-241
		2DA 003 236-031 2DA 003 236-037	1 6	Stop light
		2NE 003 236-001 2NE 003 236-008	1 48	Rear fog light
		9EL 119 544-001 9DX 119 545-011	1 2	Spare parts: Lens Reflector  1x12V21W (P21W) 8GA 002 073-121  1x24V21W (P21W) 8GA 002 073-241
		2BA 003 236-021 2BA 003 236-027 2BA 003 236-177	1 6 48	Indicator light for rear (category 2a) or (as auxiliary light) side mounting (category 2a) for front (category 1) or side mounting (category 5)
		2BA 003 236-177	48	Spare parts: Lens for -021/-027  1x12V21W (P21W) 8GA 002 073-121  1x24V21W (P21W) 8GA 002 073-241
		9EL 119 544-021	4	Amber lens. (E1) 32764
		2ZR 003 236-051 2ZR 003 236-057	1 48	Reverse light
		9EL 119 544-111 9DX 119 545-051	1 2	Spare parts: Lens Reflector  1x12V21W (P21W) 8GA 002 073-121  1x24V21W (P21W) 8GA 002 073-241
		8RA 003 660-007	8	Reflector for surface mounting Reflector red, with black plastic base plate. (E1) 02 31242
		9EL 119 544-001 9DX 119 545-011	1 2	Spare parts: Lens Reflector  1x12V21W (P21W) 8GA 002 073-121  1x24V21W (P21W) 8GA 002 073-241


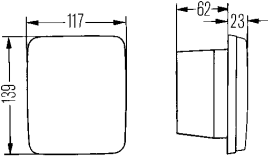

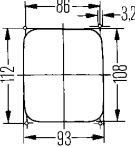



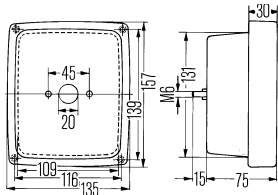
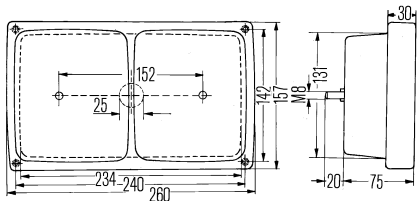
	Part no.	Pk.	For horizontal or vertical flush mounting
 	2SA 003 236-341 9EL 120 201-001 9BG 121 740-001	1 1 1	Red lens, black rubber body. Two BZ4.2 fixing screws. Mounting depth: 44 mm. (E1) 11591 Rear light Spare parts: Lens Rubber body  1x12V5W (R5W) 8GA 002 071-121  1x24V5W (R5W) 8GA 002 071-241
 	2DA 003 236-331 9EL 119 544-031 9BG 121 740-001	1 4 1	(E1) 240 Stop light Spare parts: Lens Rubber body
 	2NE 003 236-301 2NE 003 236-307 9EL 119 544-001 9BG 121 740-001	1 38 1 1	(E1) 18411 Rear fog light Spare parts: Lens Rubber body
 	2BA 003 236-321 9EL 119 544-021 9BG 121 740-001	1 4 1	Amber lens. For rear or (as auxiliary light) side mounting (category 2a and 5). (E1) 32764 Indicator light Spare parts: Lens Rubber body  1x12V21W (P21W) 8GA 002 073-121  1x24V21W (P21W) 8GA 002 073-241
 	2BA 003 236-541 9EL 119 544-212 9BG 139 863-007	1 1 150	Red-amber lens. Two holes for M4 x 25 fixing screws. (E1) 63253 Indicator-clearance light, also indicator-rear light for vertical mounting Spare parts: Lens with screws Rubber body  1x12V10W (R10W) 8GA 002 071-131  1x24V10W (R10W) 8GA 002 071-251  1x12V21W (P21W) 8GA 002 073-121  1x24V21W (P21W) 8GA 002 073-241
 	2ZR 003 236-311 9EL 119 544-111 9BG 121 740-001	1 1 1	Clear lens. Two BZ4.2 fixing screws. (E1) 8728 Reverse light Spare parts: Lens Rubber body  1x12V21W (P21W) 8GA 002 073-121  1x24V21W (P21W) 8GA 002 073-241

Signal Lights

for rear mounting



	Part no.	Pk.	For horizontal or vertical flush mounting
 	<p>2SA 005 200-331</p>	<p>1</p>	<p>Red lens. With double reflector for two bulbs. Black plastic body. Four 4.2 x 16 fixing screws.</p> <p>(E1) 31443</p> <p>Rear light</p> <p>2x12V10W (R10W) 8GA 002 071-131 2x24V10W (R10W) 8GA 002 071-251</p>
 	<p>2DA 005 200-321</p> <p>2BA 005 200-311</p> <p>9EL 135 718-001</p>	<p>1</p> <p>1</p> <p>4</p>	<p>Stop light</p> <p>2x12V21W (P21W) 8GA 002 073-121 2x24V21W (P21W) 8GA 002 073-241</p> <p>Amber lens (category 2a).</p> <p>(E1) 42770</p> <p>Indicator light</p> <p>Spare parts: Lens with screws</p> <p>2x12V21W (P21W) 8GA 002 073-121 2x24V21W (P21W) 8GA 002 073-241</p>
	<p>2ZR 005 200-301</p> <p>9EL 135 717-001</p> <p>9GH 136 698-007</p>	<p>1</p> <p>4</p> <p>8</p>	<p>Clear lens.</p> <p>(E1) 8772</p> <p>Reverse light</p> <p>Spare parts: Lens with screws</p> <p>Accessories: Rubber body for additional rear cover</p> <p>2x12V21W (P21W) 8GA 002 073-121 2x24V21W (P21W) 8GA 002 073-241</p>


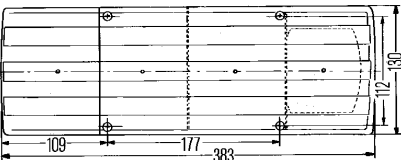


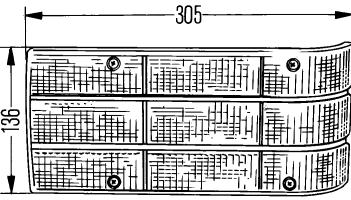



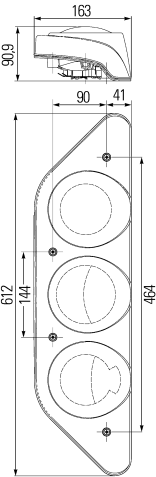

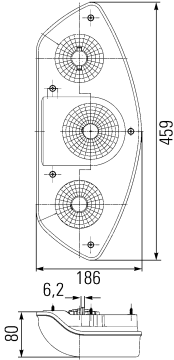
Part no.	Pk.	For horizontal or vertical flush/surface mounting
2SD 004 431-011	1	<p>Red rear and stop light, amber indicator light. Black rubber body. For surface mounting: two M8 fixing screws. For flush mounting: four holes for fixing screws. Depth required for flush mounting: 45 mm.</p> <p>Ⓔ 32764 Ⓔ 243</p> <p>Rear-stop-indicator light</p> <p>Spare parts: Lens 4 for rear/stop light 4 for indicator light 2 Reflector for two bulbs 2 Reflector for one bulb</p> <hr/> <p>Red stop light, amber indicator light.</p> <p>Ⓔ 2240 Ⓔ 32764</p> <p>Stop- and indicator light</p> <p>Spare parts: Lens for stop light 4 for indicator light 2 Reflector for one bulb</p> <hr/> <p>Red rear and rear fog light. Rear light for two bulbs.</p> <p>Ⓔ 31443 Ⓜ 18411</p> <p>Rear-rear fog light</p> <p>Spare parts: Lens for rear fog light</p> <p>1x12V10W (R10W) 8GA 002 071-131 1x24V10W (R10W) 8GA 002 071-251 2x12V21W (P21W) 8GA 002 073-121 2x24V21W (P21W) 8GA 002 073-241</p> <hr/> <p>Red lens, black rubber body. For surface mounting: two M6 fixing screws. For flush mounting: four holes for fixing screws. Depth required for flush mounting: 45 mm.</p> <p>Ⓜ 18411</p> <p>Rear fog light</p> <p>Spare parts: Lens</p> <p>1x12V21W (P21W) 8GA 002 073-121 1x24V21W (P21W) 8GA 002 073-241</p> <hr/> <p>Clear lens.</p> <p>Ⓔ 8728</p> <p>Reverse light *)</p> <p>Spare parts: Lens</p> <p>1x12V21W (P21W) 8GA 002 073-121 1x24V21W (P21W) 8GA 002 073-241</p>
2DB 004 431-061	1	
2SA 004 431-071	1	
2NE 004 432-011	1	
2ZR 004 432-001	1	

Signal Lights

for rear mounting



	Part no.	Pk.	For horizontal flush mounting
			<p>Red rear, stop and rear fog light, amber indicator light. Four B4.8 x 25 x 15 fixing screws. With 12V bulbs.</p> <p>(E17) 9301</p>
	<p>2SD 004 460-001 2SD 004 460-007</p>	<p>1 16</p>	<p>Rear-stop-indicator-rear fog light</p>
	<p>2SD 004 460-011 2SD 004 460-017</p>	<p>1 16</p>	<p>without rear fog light</p>
		<p>2SB 004 460-061</p>	<p>1</p>
<p>2SK 004 460-031 2SK 004 460-037</p>		<p>1 16</p>	<p>With reverse light and rear fog light</p>
	<p>2SK 004 460-041</p>	<p>1</p>	<p>without rear fog light</p> <p>1x12V21/5W (P21/5W) 8GD 002 078-121 3x12V21W (P21W) 8GA 002 073-121</p>
			
<p>2SD 006 459-031</p>		<p>1</p>	<p>Rear-stop-indicator-rear fog light</p>
<p>2SD 006 459-021 2SD 006 459-027</p>		<p>1 18</p>	<p>without rear fog light</p>
		<p>2SK 006 459-041</p>	<p>1</p>

	Part no.	Pk.	For vertical flush mounting
 	<p>2VP 343 520-017</p> <p>2VP 343 520-027</p> <p>2VP 343 520-037</p> <p>2VP 343 520-047</p>	<p>18</p> <p>18</p> <p>18</p> <p>18</p>	<p>Caraluna Modular For caravan-trailers and mobile homes.</p> <p>Red rear, stop, rear fog and side marker light, clear indicator light (with yellow bulb), and reverse light.</p> <p>(E4) 12677</p> <p>Rear-stop-indicator-rear fog light with reflector and side-marker light with reflektor, with 12V bulbs, left</p> <p>right</p> <p>with 24V bulbs, left</p> <p>right</p> <p>3x12V21W (P21W) 8GA 002 073-121 3x24V21W (P21W) 8GA 002 073-241 1x12V10W (R10W) 8GA 002 071-131 1x24V10W (R10W) 8GA 002 071-251 1x12V21W (PY21W) 8GA 006 841-121 1x24V21W (PY21W) 8GA 006 841-241</p>
 	<p>2SD 343 440-017</p> <p>2SK 343 440-027</p> <p>2SK 343 440-037</p> <p>2SD 343 440-047</p>	<p>10</p> <p>10</p> <p>10</p> <p>10</p>	<p>For horizontal surface mounting</p> <p>Caraluna Vertikal For caravan-trailers and mobile homes.</p> <p>Red rear, stop and rear fog light, clear indicator light (with yellow bulb). With 12V bulbs.</p> <p>(E17) 0501</p> <p>Rear-stop-indicator and rear fog light, left</p> <p>without rear fog light, with reverse light, right</p> <p>Rear-stop-indicator and reverse light, left</p> <p>without reverse light, with rear fog light, right</p> <p>1x12V21/5W (P21/5W) 8GD 002 078-121 1x12V21W (P21W) 8GA 006 841-121 1x12V21W (P21W) 8GA 002 073-121</p>

Signal Lights

for rear mounting





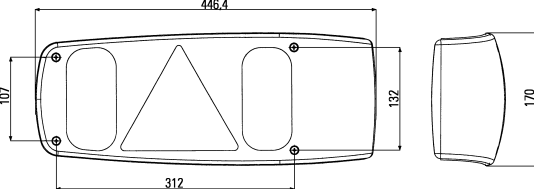

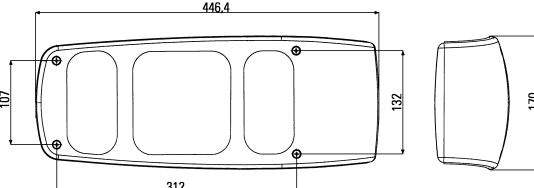

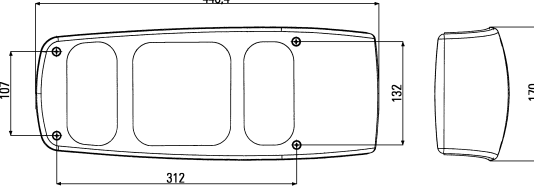


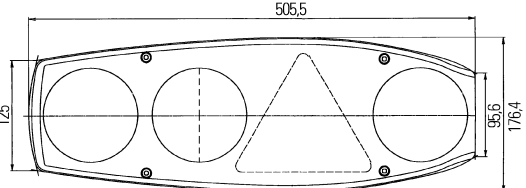


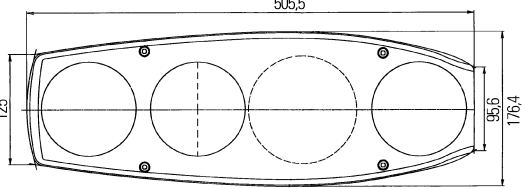


	Part no.	Pk.	For horizontal flush mounting
	<p>2VA 007 502-011 2VA 007 502-017</p> <p>2VA 007 502-061 2VA 007 502-067</p>	<p>1 12</p> <p>1 12</p>	<p>Caraluna I For caravan-trailers. With triangular reflector.</p> <p>Red reflector, rear, stop, rear fog light, and side-marker light with reflector. Clear indicator light and white reverse light. With 12V bulbs.</p> <p> 9604</p> <p>Rear-reflector-stop-indicator-rear fog light and side-marker light with reflector, left</p> <p>right</p>
	<p>2VP 007 502-031 2VP 007 502-037</p> <p>2VP 007 502-041 2VP 007 502-047</p>	<p>1 12</p> <p>1 12</p>	<p>with reverse light, without rear fog light, left</p> <p>right</p> <p> 1x12V21/5W (P21/5W) 8GD 002 078-121 1x12V21W (PY21W) 8GA 006 841-121 1x12V21W (P21W) 8GA 002 073-121</p>
	<p>2VA 007 502-021 2VA 007 502-027</p>	<p>1 12</p>	<p>Without reverse and rear fog light, left</p> <p> 1x12V21/5W (P21/5W) 8GD 002 078-121 1x12V21W (PY21W) 8GA 006 841-121</p>
	<p>2VA 007 502-111 2VA 007 502-117</p> <p>2VP 007 502-121 2VP 007 502-127</p>	<p>1 12</p> <p>1 12</p>	<p>For mobile homes. With rectangular reflector.</p> <p>Rear-reflector-stop-indicator-rear fog light and side-marker light with reflector, left</p> <p>with reverse light, without rear fog light, right</p> <p> 1x12V21/5W (P21/5W) 8GD 002 078-121 1x12V21W (PY21W) 8GA 006 841-121 1x12V21W (P21W) 8GA 002 073-121</p>

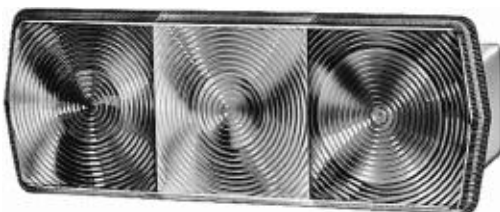
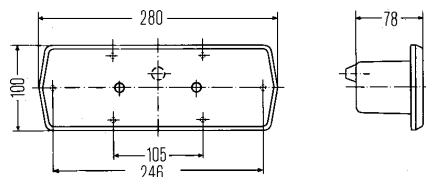

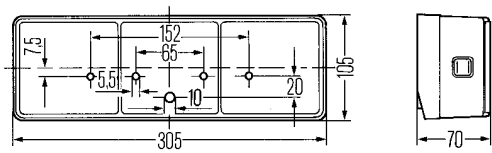
Image	Part no.	Pk.	For horizontal flush mounting
	2VA 341 419-011 2VA 341 419-017	1 10	Caraluna II For caravan-trailers. With triangular reflector. Red reflector, rear, stop, rear fog light, and side-marker reflector, clear indicator light (with yellow bulb), white reverse light. With 12V bulbs. (E4) 9836
	2VA 341 419-061 2VA 341 419-067	1 10	Rear-stop-triangular reflector-indicator- rear fog and side-marker light with red lens, left right without rear fog light, right
	2VA 341 419-097 2VA 341 419-167	10 10	without rear fog light, right with reverse light, without rear fog light, left right
	2VA 341 419-157 2VP 341 419-107	10 10	Without side-marker light. Chrome-plating applied in the housing shimmers through the lens. With smoke coloured lens, left right with reverse light, without rear fog light, left right
	2VA 341 419-111 2VA 341 419-117	1 10	For mobile homes. With red lens and round reflector. Rear-stop-indicator- rear fog and side-marker light with reflector, left
	2VA 341 419-147	1	right with reverse light, without rear fog light, left
	2VP 341 419-137	1	right with reverse light, without rear fog light, left
	2VP 341 419-121 2VP 341 419-127	1 10	right Without side-marker light. Chrome-plating applied in the housing shimmers through the lens.
	2VA 341 419-077	10	With smoke coloured lens, left
	2VA 341 419-187	10	right
	2VP 341 419-177	10	with reverse light, without rear fog light, left
	2VP 341 419-087	10	right
	1x12V21/5W (P21/5W) 8GD 002 078-121 1x12V21W (PY21W) 8GA 006 841-121 1x12V21W (P21W) 8GA 002 073-121		1x12V21/5W (P21/5W) 8GD 002 078-121 1x12V21W (PY21W) 8GA 006 841-121 1x12V21W (P21W) 8GA 002 073-121

Signal lights

for rear mounting



	Part no.	Pk.	For horizontal flush mounting
			<p>Caraluna II Plus For caravan-trailers. With triangular reflector. Red reflector rear, stop, rear fog light, and side-marker light with reflector, clear indicator light (with yellow bulb), white reverse light. With 12V bulbs.</p>
	2VP 343 590-017	10	<p>Rear-stop-indicator-rear fog-reverse and side-marker light, with red lens, left</p>
	2VP 343 590-027	10	<p>right</p>
	2VP 343 590-057	10	<p>Without side-marker light. Chrome-plating applied in the housing shimmers through the lens.</p>
	2VP 343 590-067	10	<p>With smoke coloured lens, left</p>
			<p>rechts</p>
	2VP 343 590-037	10	<p>For mobile homes. With red lens and round reflector.</p>
	2VP 343 590-047	10	<p>Rear-stop-indicator-rear fog-reverse and side-marker light with reflector, left</p>
			<p>right</p>
	2VP 343 590-077	10	<p>Without side-marker light. Chrome-plating applied in the housing shimmers through the lens.</p>
	2VP 343 590-087	10	<p>With smoke coloured lens, left</p>
			<p>right</p>
			<p> 1x12V21/5W (P21/5W) 8GD 002 078-121 1x12V21W (PY21W) 8GA 006 841-121 2x12V21W (P21W) 8GA 002 073-121</p>

 	<p>Part no.</p> <p>2SD 001 693-011 *)</p> <p>9GT 074132-001</p>	<p>Pk.</p> <p>1</p> <p>10</p>	<p>For horizontal or vertical flush mounting</p> <p>Red rear and stop light, amber indicator light. Six B4.2 x 13 self-tapping fixing screws.</p> <p>(E1) 31436 (E1) 53234</p> <p>Rear-stop-indicator light</p> <p>Spare parts: Grommet</p> <p>1x12V10W (R10W) 8GA 002 071-131 1x24V10W (R10W) 8GA 002 071-251 2x12V21W (P21W) 8GA 002 073-121 2x24V21W (P21W) 8GA 002 073-241</p>
 	<p>2SE 003 409-191 2SE 003 409-197 *)</p> <p>2SD 003 409-201 2SD 003 409-207 *)</p> <p>9EL 121 260-051 9EL 121 260-061</p>	<p>1</p> <p>5</p> <p>1</p> <p>5</p> <p>1</p> <p>1</p>	<p>For horizontal surface mounting</p> <p>Red rear and stop light, amber indicator light. Lens with snap fastening. Black base plate. Red plexiglass frame. Four 5.5 mm dia. holes for fixing screws.</p> <p>(E1) 11596 (E1) 53288</p> <p>Rear-stop-indicator light, with illumination for 520 x 120 mm and 340 x 240 mm licence plates, left</p> <p>without licence plate illumination, right</p> <p>Spare parts: Lens, left right</p> <p>1x12V5W (R5W) 8GA 002 071-121 1x12V10W (R10W) 8GA 002 071-131 2x12V21W (P21W) 8GA 002 073-121</p>
<p>2SD 003 409-317 *)</p> <p>2SD 003 409-327 *)</p> <p>2SE 003 409-171 *)</p> <p>2SD 003 409-181 *)</p>	<p>1</p> <p>1</p> <p>1</p> <p>1</p>	<p>1</p> <p>1</p> <p>1</p> <p>1</p>	<p>Rear-stop-indicator-rear fog light, left</p> <p>right</p> <p>1x12V21/5W (P21/5W) 8GD 002 078-121 2x12V21W (P21W) 8GA 002 073-121</p> <p>With illumination for 520 x 120 mm and 340 x 240 mm licence plates, black base plate, left</p> <p>without licence plate illumination and rear fog light, right</p> <p>1x12V21/5W (P21/5W) 8GD 002 078-121 2x12V21W (P21W) 8GA 002 073-121 1x12V10W (R10W) 8GA 002 071-131</p>


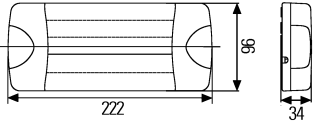

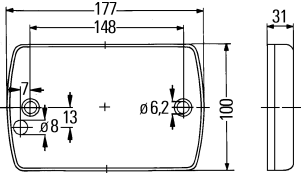

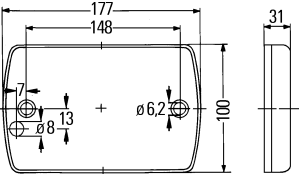

*) Only for spare parts requirements

Signal Lights

for rear mounting

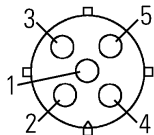


Part no.	Pk.	For horizontal flush/surface mounting
	2VA 997 113-001	Red rear, reflector and stop light, amber indicator light. Black plastic body. Two M6 fixing screws. With blade terminal contacts.
	1	(E12) 7103 (E12) 6077 (E12) 3021
9EL 997 453-001	2	Rear-reflector-stop-indicator light Spare parts: Lens 1x12V21W (P21W) 8GA 002 073-121 1x24V21W (P21W) 8GA 002 073-241 1x12V21/5W (P21/5W) 8GD 002 078-121 1x24V21/5W (P21/5W) 8GD 002 078-241 1x24V21/5W (P21/5W) 8GD 002 078-011 (Heavy Duty)
	2SD 002 844-031	Red rear and stop light, amber indicator light. Lens with snap fastening. Two 5.5 mm dia. holes for fixing screws.
	1	(E1) 53221
2SD 002 844-021	1	Rear-stop-indicator light with white base plate, left
2SD 002 844-131	1	right
2SD 002 844-061	1	with black base plate, left
2SD 002 844-067	18	right
9EL 115 662-021	2	Spare parts:
9EL 115 662-011	2	Lens, left
2SE 002 844-011	1	With illumination for 340 x 240 mm licence plates and white base plate, left
2SE 002 844-051	1	with black base plate, left
2SE 002 844-057	18	Spare parts:
9EL 115 662-001	2	Lens, left
	2VB 341 032-111	Red rear, stop, rear fog light and triangular reflector, white indicator light (yellow bulb) and licence plate light. With fixing material and grommet, without wiring harness.
	1	(E17) 0005 (E17) 418
2VB 341 032-117	10	Rear-reflector-stop-indicator-rear fog light with licence plate illumination, left
2VB 341 032-121	1	without rear fog light, right
2VB 341 032-127	10	without rear fog light, left
2VB 341 032-131	1	without rear fog light, left
2VB 341 032-141	1	with rear fog light, right
2VB 341 032-111	1	1x12V21/5W (P21/5W) 8GD 002 078-121
2VB 341 032-117	1	1x12V21W (P21W) 8GA 002 073-121
2VB 341 032-121	1	1x12V21W (PY21W) 8GA 006 841-121
2VB 341 032-127	1	1x12V5W (C5W) 8GM 002 092-121

Part no.	Pk.	For horizontal surface mounting
 	2SD 959 050-401	<p>DuraLED Combi In LED-technology. Clear lens. With 40 LEDs and connecting cable 2500 mm with stripped cable ends. Black body. Voltage range: 8V - 28V. Consumption: 0.92A at 12V, 0.46A at 24V. See page 5.236, instruction 1.</p> <p>Ⓔ4 10176 ⓔ4 1586</p> <p>1 Rear-stop-indicator light</p> <p>Rear light : 1W Stop light: 5W Indicator light: 5W</p>
 	2SP 959 060-601	<p>For horizontal or vertical surface mounting</p> <p>DuraLED In LED-technology. With 36 red LEDs. Clear lens. Black body. Voltage range: 9V - 33V. Consumption: 1.08A at 12V, 0.54A at 24V. See page 5.236, instruction 2.</p> <p>Ⓔ13 533</p> <p>1 Rear-stop-parking light</p> <p>Rear light: 2W Stop light: 9W Park light: 2W</p>
 	2BA 959 070-631	<p>In LED-technology. With 36 yellow LEDs 9W. Clear lens. Black body. Voltage range: 9V - 33V. Consumption: 0.75A at 12V, 0.38A at 24V. See page 5.236, instruction 3.</p> <p>Ⓔ13 363</p> <p>1 Indicator light, for rear mounting (category 2a) with indicator control unit, only in connection with 5DS 008 828-001.</p>
	2JA 959 037-511	<p>DuraLED In LED-technology. With 36 white LEDs 9W and connecting cable 2500 mm. Clear lens. White body. Voltage range: 9V - 33V. Consumption: 0.75A at 12V, 0.38A at 24V.</p> <p>1 Interior light</p>

Signal Lights

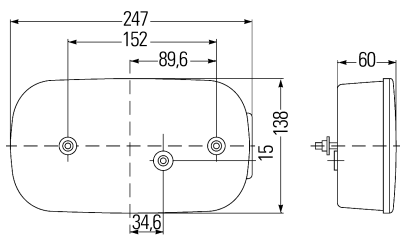
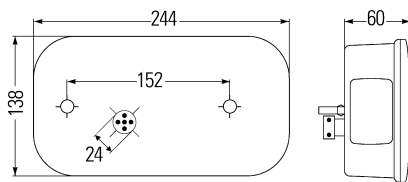
for rear mounting



1	Ground	white
2	BL	green/yellow
3	B	red
4	S/K/SLMR	black
5	NES or ZR	blue

Pin configuration:

- BL = indicator
- B = stop
- S = rear
- K = licence plate
- SM = marker
- NES = rear fog
- ZR = reverse



Part no.

Pk.

For horizontal surface mounting

Red rear, stop, rear fog light and triangular reflector.
Amber indicator light and side marker light.
White licence plate light.
Black plastic body.
Two M6 fixing screws.
With 5-pole central plug and 12V bulbs.

Ⓔ 5447

2VA 998 232-271

1

Rear-stop-indicator-rear fog light with triangular reflector, left

2VA 998 232-281

1

without rear fog lamp, right

2VB 998 232-011

1

With rear fog light and illumination for 520 x 120 mm licence plates, left

2VB 998 232-021

1

without rear fog light, right

2VB 998 232-057

36

Same as 2VB 998 232-011/-021, but with side-marker light, left

2VA 998 232-497

36

without rear fog light and licence plate illumination, right

With grommet, without bulbs and 5-pole central plug.

2VB 998 232-211

1

Rear-stop-indicator-rear fog light with licence plate illumination, left

2VB 998 232-221

1

without rear fog light, right

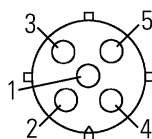
9EL 990 632-001

1

Spare parts:
Lens amber/red

1x12V21/5W (P21/5) 8GD 002 078-121
 2x12V21W (P21W) 8GA 002 073-121

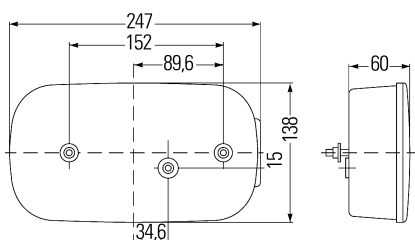
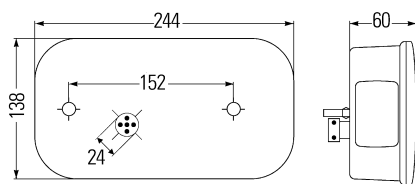
2x12V5W (C5W) 8GM 002 092-121



1	Ground	white
2	BL	green/yellow
3	B	red
4	SK/SLMR	black
5	NES or ZR	blue

Pin configuration:

BL = indicator
 B = stop
 S = rear
 K = licence plate
 SM = marker
 NES = rear fog
 ZR = reverse



Part no.

Pk.

For horizontal surface mounting

Red rear, stop, rear fog light and triangular reflector.
 Reverse light and indicator light white (yellow bulb).
 Amber side marker light.
 With illumination for 520 x 120 mm licence plates.
 Black plastic body.
 With two M6 fixing screws.
With 5-pole central plug and 12V bulbs.

Ⓔ 5447

2VB 998 232-131

1

Rear-stop-triangular reflector, indicator, rear fog light and licence plate illumination, left

2VB 998 232-101

1

without rear fog light, right

2VB 998 232-171

1

With side-marker light, left

2VB 998 232-201

1

without rear fog light, right

For horizontal flush/surface mounting

With two fixing screws M6, grommet and bulbs.

Rear-stop-triangular reflector, indicator, rear fog light, left

2VA 998 232-251

1

with reverse light, without rear fog light, right

2VP 998 232-261

1

With side-marker reflector, left

2VA 998 232-291

1

with reverse light and side-marker reflector, without rear fog light, right

2VP 998 232-301

1

For horizontal surface mounting

Same as 2VA 998 232-251 and 2VP 998 232-261, but with illumination for 520 x 120 mm licence plates, left

2VB 998 232-231

1

without rear fog light, right

2VB 998 232-241

1

Spare parts:

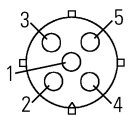
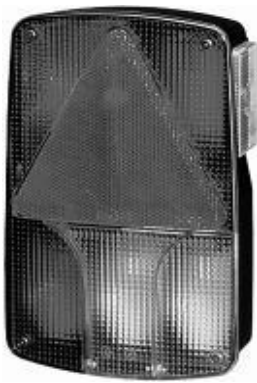
Lens white/red

1x12V21/5W (P21/5W) 8GD 002 078-121
 2x12V21W (P21W) 8GA 002 073-121
 1x12V21W (PY21W) 8GA 006 841-121

2x12V5W (C5W) 8GM 002 092-121

Signal Lights

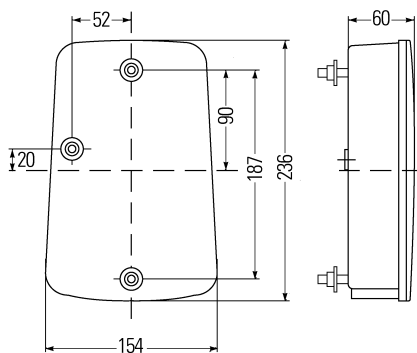
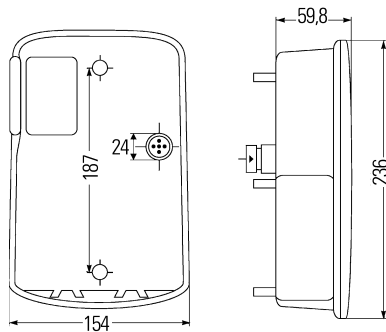
for side mounting



1	Ground	white
2	BL	green/yellow
3	B	red
4	S/K/SLMR	black
5	NES or ZR	blue

Pin configuration:

- BL = indicator
- B = stop
- S = rear
- K = licence plate
- SM = marker
- NES = rear fog
- ZR = reverse



Part no.

Pk.

For vertical surface mounting

Red rear, stop, rear fog light and triangular reflector. Amber indicator light and side marker reflector. White side light. Black plastic body. With two M8 fixing screws.
With 5-pole central plug, quick mounting plate and 12V bulbs.

Ⓔ4 10162

2VA 998 233-051

1

Rear-stop-indicator-rear fog light with side-marker reflector and side light, left

2VA 998 233-061

1

without rear fog light, right

With 5-pole central plug and 12V bulbs, without quick mounting plate.

2VA 998 233-367

36

Rear-stop-indicator light with triangular reflector, right

With 200 mm lead, 5-pole central plug and 12V bulbs.

2VA 998 233-357

36

With rear fog light, left

With grommet and quick mounting plate. Without fixing screws, bulbs and central plug.

2VA 998 233-211

1

Rear-stop-indicator-rear fog light with triangular reflector, left

2VA 998 233-221

1

without rear fog light, right

Spare parts:

Lens amber/red,
 left
 right

9EL 990 633-011

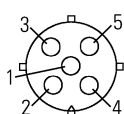
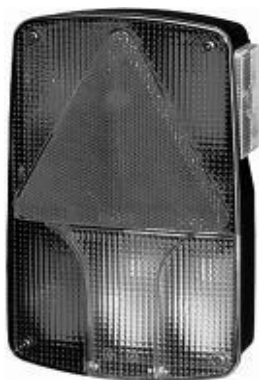
1

9EL 990 633-021

1

3x12V21W (P21W) 8GA 002 073-121

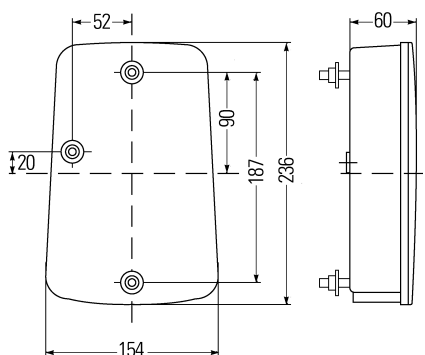
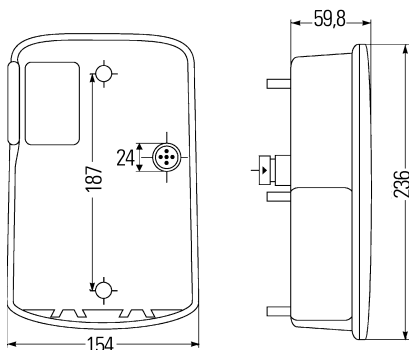
1x12V5W (C5W) 8GM 002 092-121



1	Ground	white
2	BL	green/yellow
3	B	red
4	S/K/SLMR	black
5	NES or ZR	blue

Pin configuration:

- BL = indicator
- B = stop
- S = rear
- K = licence plate
- SM = marker
- NES = rear fog
- ZR = reverse



Part no.

Pk.

For vertical surface mounting

Red rear, stop, rear fog light and triangular reflector.
 White indicator light (yellow bulb), reverse light and side light, amber side marker reflector.
 Black plastic body.
 With two M8 fixing screws.
With 5-pole central plug, quick mounting plate and 12V bulbs.

Ⓔ 10162

2VA 998 233-171

1

Rear-stop-indicator-rear fog light with triangular reflector, side marker reflector and side light, left

2VP 998 233-161

1

with reverse light, without rear fog light, right

2VA 998 233-201

1

without rear fog light and reverse light, right

With grommet and quick mounting plate. Without fixing screws, bulbs and central plug.

2VA 998 233-231

1

Rear-stop-indicator-rear fog light and triangular reflector, left

2VA 998 233-241

1

without rear fog light, right

With 12V bulbs, two M6 fixing screws and central plug, 5-pole. Without quick mounting plate.

2VA 998 233-271

1

With rear fog light and side marker light, left

2VP 998 233-281

1

without rear fog light, with reverse light, right

With grommet, 12V bulbs and two M6 fixing screws. Without quick mounting plate and 5-pole central plug.

2VA 998 233-251

1

Rear-stop-indicator-rear fog light and triangular reflector, left

2VP 998 233-261

1

with reverse light, without rear fog light, right

Spare parts:

Lens red/white,
 left
 right


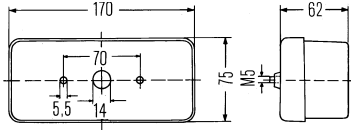


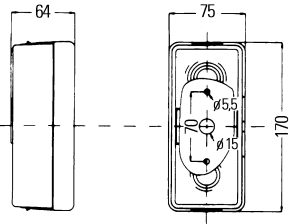
⚡ 2x12V21W (P21W) 8GA 002 073-121
 1x12V21W (PY21W) 8GA 006 841-121

⚡ 2x12V5W (C5W) 8GM 002 092-121

Signal Lights

for rear or front mounting




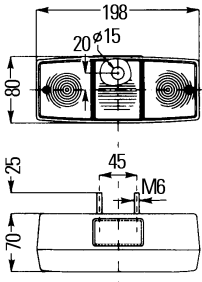

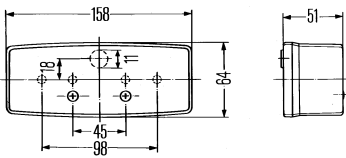
	Part no.	Pk.	For horizontal surface mounting
	<p>2SD 002 582-011 2SD 002 582-017</p> <p>2SD 002 582-021 2SD 002 582-027</p> <p>9EL 112 743-001 9EL 112 741-001</p>	<p>1 32</p> <p>1 32</p> <p>1 1</p>	<p>Red rear and stop light, amber indicator light, clear licence plate light. Lens with snap fastening. Two 5.5 mm dia. holes for fixing screws.</p> <p>(E1) 116</p> <p>Rear-stop-indicator light, left</p> <p>right</p> <p>Spare parts: Lens with divider, left right</p>
	<p>2SE 002 582-071</p> <p>9EL 116 844-001</p>	<p>1 1</p>	<p>(E1) 116 (E1) 53345</p> <p>With illumination for 520 x 120 mm and 340 x 240 mm licence plates, left</p> <p>Spare parts: Lens with divider, left</p> <p>1x12V10W (R10W) 8GA 002 071-131 1x24V10W (R10W) 8GA 002 071-251 2x12V21W (P21W) 8GA 002 073-121 2x24V21W (P21W) 8GA 002 073-241</p>
	<p>2BE 002 582-031</p> <p>9EL 112 744-001</p>	<p>1 1</p>	<p>Amber indicator light, clear side light. For front mounting.</p> <p>(E1) 43388</p> <p>Indicator-side light</p> <p>Spare parts: Lens with divider</p> <p>1x12V5W (R5W) 8GA 002 071-121 1x24V5W (R5W) 8GA 002 071-241 1x12V21W (P21W) 8GA 002 073-121 1x24V21W (P21W) 8GA 002 073-241</p>
	<p>2VA 998 531-031</p> <p>9EL 997 310-001</p>	<p>1 1</p>	<p>Red reflector, rear and stop light, amber indicator light. Lens with snap fastening. Two holes for M5 fixing screws. With blade terminal contacts.</p> <p>(E12) 7111 (E12) 6081 (E12) 3024</p> <p>Rear-stop-indicator light with reflector</p> <p>Spare parts: Lens</p> <p>1x12V21W (P21W) 8GA 002 073-121 1x24V21W (P21W) 8GA 002 073-241 1x12V21/5W (P21/5W) 8GD 002 078-121 1x24V21/5W (P21/5W) 8GD 002 078-241</p>
	<p>2SD 998 531-057</p> <p>2SD 998 531-067</p> <p>9EL 998 001-031 9EL 998 001-041</p>	<p>1 1</p> <p>2 2</p>	<p>For horizontal or vertical surface mounting</p> <p>(E12) 7064 (E12) 6046</p> <p>With PC lens, without reflector, left</p> <p>right</p> <p>Spare parts: Lens, left right</p> <p>2x12V21W (P21W) 8GA 002 073-121 2x24V21W (P21W) 8GA 002 073-241 1x12V10W (R10W) 8GA 002 071-131 1x24V10W (R10W) 8GA 002 071-251</p>

	Part no.	Pk.	For horizontal surface mounting
			Red rear and stop light, amber indicator light, clear licence plate light. Two B3.9 x 16 fixing screws. With grommet.
			(E1) 53253 (E1) 130
	2SD 003 184-031	1	Rear-stop-indicator light, left
	2SD 003 184-037	45	
	2SD 003 184-041	1	right
	2SD 003 184-047	45	
			Spare parts:
			Lens with screws,
	9EL 118 700-001	1	left
	9EL 118 701-001	1	right
			(E1) 53253 (E1) 130 (E1) 22831
	2SE 003 184-011	1	With illumination for 340 x 240 mm licence plates, left
	2SE 003 184-017	45	
	2SE 003 184-101	1	right
			Spare parts:
			Lens with screws,
	9EL 118 697-001	1	left
	9EL 121 431-001	1	right
	9XD 132 749-005	8	Accessories:
	8RA 123 251-005	50	Adapter with fixing material Reflector
			1x12V10W (R10W) 8GA 002 071-131 1x24V10W (R10W) 8GA 002 071-251 2x12V21W (P21W) 8GA 002 073-121 2x24V21W (P21W) 8GA 002 073-241
			Amber indicator light, clear side light. For front mounting. With grommet.
			(E1) 53254 (E1) 102
	2BE 003 184-051	1	Indicator-side light, left
	2BE 003 184-061	1	right
			Spare parts:
			Lens with screws,
	9EL 118 703-001	1	left
	9EL 118 705-001	1	right
			1x12V5W (R5W) 8GA 002 071-121 1x24V5W (R5W) 8GA 002 071-241 1x12V21W (P21W) 8GA 002 073-121 1x24V21W (P21W) 8GA 002 073-241

Signal Lights

for rear mounting



 	<p>Part no.</p> <p>2SE 997 005-011</p> <p>2SD 997 005-021</p> <p>9EL 997 313-001</p>	<p>Pk.</p> <p>1</p> <p>1</p> <p>2</p>	<p>For horizontal flush/surface mounting</p> <p>Red rear and stop light, amber indicator light. Black plastic body. Bulb holder with vibration damping. Two M6 fixing screws. With grommet.</p> <p>ⓔ12 7010 ⓔ12 6007 ⓔ12 4003</p> <p>Rear-stop-indicator-licence plate light, left</p> <p>without licence plate illumination, right</p> <p>Spare parts: Lens with screws</p> <p>2x12V10W (R10W) 8GA 002 071-131 2x24V10W (R10W) 8GA 002 071-251 2x12V21W (P21W) 8GA 002 073-121 2x24V21W (P21W) 8GA 002 073-241</p>
 	<p>2SE 997 111-011</p> <p>2SE 997 111-021</p> <p>9EL 997 451-001</p> <p>9EL 997 452-001</p>	<p>1</p> <p>1</p> <p>1</p> <p>1</p>	<p>For horizontal or vertical surface mounting</p> <p>Red rear and stop light, amber indicator light, white licence plate light. Plastic body. Four holes for M5 fixing screws. With grommet.</p> <p>ⓔ12 7098 ⓔ12 6072 ⓔ12 4038</p> <p>Rear-stop-indicator-licence plate light, left</p> <p>right</p> <p>Exchangeable lens insert for licence plate lighting / no licence plate lighting</p> <p>Spare parts: Lens with screws and red lens insert, left right</p> <p>2x12V10W (R10W) 8GA 002 071-131 2x24V10W (R10W) 8GA 002 071-251 2x12V21W (P21W) 8GA 002 073-121 2x24V21W (P21W) 8GA 002 073-241</p>


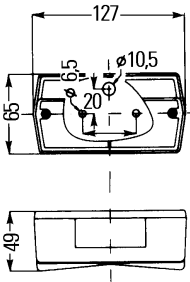





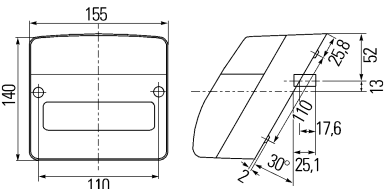

	Part no.	Pk.	For horizontal or vertical surface mounting
	2SD 001 305-021	1	Red rear and stop light, amber indicator light. Four holes 3 mm dia. for fixing screws.
	9EL 052 476-001	2	Spare parts: Lens with screws 1x12V5W (C5W) 8GM 002 092-121 1x24V5W (C5W) 8GM 002 092-241 2x12V18W (K) 8GM 002 091-131 2x24V18W (K) 8GM 002 091-241
	2SD 997 131-051	1	For horizontal surface mounting Red rear and stop light, amber indicator light. Black plastic body. Two M5 fixing screws. With blade terminal contacts. For rear mounting.
	9EL 997 469-001	2	(E12) 7114 (E12) 6089 Rear-stop-indicator light Spare parts: Lens 1x12V21W (P21W) 8GA 002 073-121 1x12V21/5W (P21/5W) 8GD 002 078-121
2BE 997 131-081	1	Amber indicator light, clear side light. For front mounting.	
2BE 997 131-207	168	(E12) 6085 (E12) 7113	
9EL 997 459-001	2	Indicator-side light without blade terminal contacts with blade terminal contacts Spare parts: Lens 1x12V21W (P21W) 8GA 002 073-121 1x12V5W (R5W) 8GA 002 071-121	


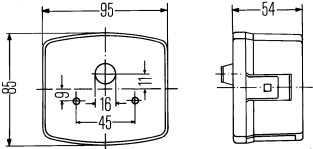

*) National type test for Germany

Signal Lights

for rear or front mounting



	Part no.	Pk.	For horizontal surface mounting
 	<p>2SD 997 006-031</p> <p>2SD 997 006-021</p> <p>9EL 997 318-001</p> <p>2SE 997 006-011</p> <p>2SE 997 006-041</p> <p>9EL 997 315-001</p>	<p>1</p> <p>1</p> <p>2</p> <p>1</p> <p>1</p> <p>2</p>	<p>Red rear and stop light, amber indicator light. Steel base plate. Two M6 fixing screws.</p> <p>(E12) 7058 (E12) 6040 (E12) 4023</p> <p>Rear-stop-indicator light, left</p> <p>right</p> <p>Spare parts: Lens with screws, right</p> <hr/> <p>With licence plate illumination, left</p> <p>right</p> <p>Spare parts: Lens with screws, left</p> <p> 1x12V21W (P21W) 8GA 002 073-121 1x24V21W (P21W) 8GA 002 073-241</p> <p> 1x12V5W (C5W) 8GM 002 092-121 1x24V5W (C5W) 8GM 002 092-241</p>
	<p>2BE 997 006-101</p> <p>9EL 997 320-001</p>	<p>1</p> <p>2</p>	<p>Amber indicator light, clear side light. With blade terminal contacts. For front mounting.</p> <p>(E8) 7305 (E8) 7306</p> <p>Indicator-side light</p> <p>Spare parts: Lens with screws</p> <p> 1x12V5W (R5W) 8GA 002 071-121 1x24V5W (R5W) 8GA 002 071-241 1x12V21W (P21W) 8GA 002 073-121 1x24V21W (P21W) 8GA 002 073-241</p>
 	<p>2SE 996 030-011</p> <p>2SD 996 030-021</p> <p>9EL 990 142-001</p>	<p>1</p> <p>1</p> <p>2</p>	<p>Red reflector, rear and stop light, amber indicator light, white licence plate light. With blade terminal contacts and 4 PT screws KB 40 x 20. With 12V bulbs.</p> <p>(E12) 7133 (E12) 4054</p> <p>Rear-stop-indicator-licence plate light with reflector, left</p> <p>without licence plate illumination, right</p> <p>Spare parts: Lens incl. black cover and licence plate window</p> <p> 1x12V5W (R5W) 8GA 002 071-121 1x12V21W (P21W) 8GA 002 073-121</p>


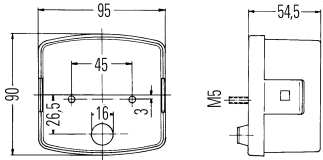


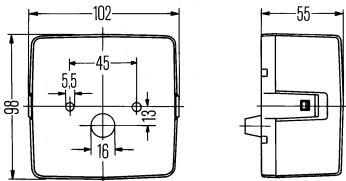
	Part no.	Pk.	For horizontal or vertical surface mounting
	<p>2SD 003 182-051 2SD 003 182-057)</p> <p>2SD 003 182-061 2SD 003 182-067)</p> <p>9EL 118 614-011</p>	<p>1 120</p> <p>1 120</p> <p>2</p>	<p>Red rear and stop light, amber indicator light. Lens with snap fastening. Two holes for M5 fixing screws. With grommet.</p> <p>(E1) 31445 (E1) 53257</p> <p>Rear-stop-indicator light, left</p> <p>right</p> <p>Spare parts: Lens</p>
	<p>2SE 003 182-011 2SE 003 182-017)</p> <p>2SE 003 182-021 2SE 003 182-027)</p> <p>9EL 118 613-001</p>	<p>1 120</p> <p>1 120</p> <p>2</p>	<p>With illumination for 520 x 120 mm, 340 x 240 mm and 240 x 130 mm licence plates (above licence plates), or mounting to left and right of 520 x 120 mm licence plate (amber indicator light outside), left</p> <p>right</p> <p>Spare parts: Lens</p> <p>1x12V10W (R10W) 8GA 002 071-131 1x24V10W (R10W) 8GA 002 071-251 2x12V21W (P21W) 8GA 002 073-121 2x24V21W (P21W) 8GA 002 073-241</p>
	<p>2BE 003 182-091)</p> <p>2BE 003 182-101)</p> <p>9EL 118 614-021</p>	<p>1 1 2</p>	<p>Amber indicator light, white side light. For front horizontal mounting.</p> <p>(E1) 53270</p> <p>Indicator-side light, left</p> <p>right</p> <p>Spare parts: Lens</p> <p>1x12V21W (P21W) 8GA 002 073-121 1x24V21W (P21W) 8GA 002 073-241</p> <p>1x12V5W (C5W) 8GM 002 092-121 1x24V5W (C5W) 8GM 002 092-241</p>

*) Only for spare parts requirements

Signal Lights

for rear or front mounting


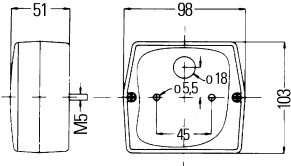

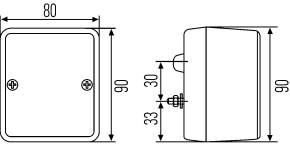

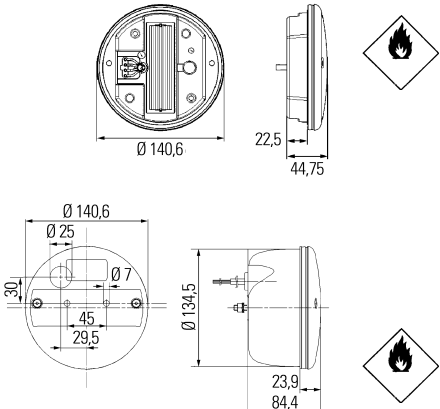




	Part no.	Pk.	For horizontal or vertical surface mounting
	<p>2SD 002 776-231 2SD 002 776-237</p> <p>2SD 002 776-241 2SD 002 776-247</p> <p>9EL 137 307-001 9EL 137 308-001</p>	<p>1 110</p> <p>1 110</p> <p>2 2</p>	<p>Red rear and stop light, amber indicator light. Lens with snap fastening. Two holes for M5 fixing screws. With grommet.</p> <p>(E1) 63230 (E1) 273</p> <p>Rear-stop-indicator light, left</p> <p>right</p> <p>Spare parts: Lens with heat dissipation plate, left right</p>
	<p>2SE 002 776-211 2SE 002 776-217</p> <p>2SE 002 776-221</p> <p>9EL 134 739-001 9EL 134 740-001</p>	<p>1 110</p> <p>1</p> <p>2 2</p>	<p>With illumination for 520 x 120 mm, 340 x 240 mm and 240 x 130 mm licence plates (above licence plates), or mounting to left and right of 520 x 120 mm licence plate (amber flasher light at the top), left</p> <p>right</p> <p>Spare parts: Lens, left right</p> <p>1x12V10W (R10W) 8GA 002 071-131 2x12V21W (P21W) 8GA 002 073-121</p>
	<p>2BE 002 776-251 2BE 002 776-257</p> <p>2BE 002 776-261 2BE 002 776-267</p> <p>9EL 134 741-021 9EL 134 742-021</p>	<p>1 72</p> <p>1 72</p> <p>2 2</p>	<p>Amber indicator light, white side light. For front horizontal surface mounting.</p> <p>(E1) 63225</p> <p>Indicator-side light, left</p> <p>right</p> <p>Spare parts: Lens, left right</p> <p>1x12V10W (R10W) 8GA 002 071-131 1x12V21W (P21W) 8GA 002 073-121</p>
 	<p>2SD 004 623-028</p> <p>2SE 004 623-001 2SE 004 623-007</p> <p>9EL 129 519-001</p>	<p>1000</p> <p>1 50</p> <p>1</p>	<p>Red rear and stop light, amber indicator light. Lens with snap fastening. Two 5.5 mm dia. holes for fixing screws. With grommet.</p> <p>(E17) 408 (E17) 763 (E17) 630</p> <p>Rear-stop-indicator light</p> <p>With illumination for 520 x 120 mm, 340 x 240 mm and 240 x 130 mm licence plates (above licence plates)</p> <p>Lens for illumination of licence plate can be replaced with red lens included (for use as rear-stop-indicator-light).</p> <p>Spare parts: Lens</p> <p>1x12V10W (R10W) 8GA 002 071-131 2x12V21W (P21W) 8GA 002 073-121</p>

		Part no.	Pk.	For horizontal or vertical surface mounting
		2SE 002 578-701	2	Rear-stop-indicator-licence plate light
		2SE 002 578-707	18	
		9EL 146 491-001	2	Spare parts: Lens (also suitable for old-type lights of model range 002 578-...) 1x12V10W (R10W) 8GA 002 071-131 1x24V10W (R10W) 8GA 002 071-251 2x12V21W (P21W) 8GA 002 073-121 2x24V21W (P21W) 8GA 002 073-241
		2SE 997 008-001	1	For horizontal surface mounting
		9EL 997 332-001	1	Red rear and stop light, amber indicator light, clear licence plate light. Steel base plate. Two M6 fixing screws. With blade terminal contacts. Lens for illumination of licence plate can be replaced with red lens included (for use as rear-stop-indicator light). (E8) 71-26 (E8) 71-27 (E8) 71-28 Rear-stop-indicator-licence plate light
				Spare parts: Lens 1x12V10W (R10W) 8GA 002 071-131 1x24V10W (R10W) 8GA 002 071-251 2x12V21W (P21W) 8GA 002 073-121 2x24V21W (P21W) 8GA 002 073-241
		2SD 002 514-161	1	Red rear and stop light, amber indicator light, clear licence plate light. Black plastic body. Two M6 fixing screws. With grommet.
		2SE 002 514-171	1	Rear-stop-indicator light with illumination for 520 x 120 mm, 340 x 240 mm and 240 x 130 mm licence plates
		9EL 119 614-031	2	Spare parts: Lens with screws 1x12V10W (R10W) 8GA 002 071-131 1x24V10W (R10W) 8GA 002 071-251 2x12V21W (P21W) 8GA 002 071-121 2x24V21W (P21W) 8GA 002 073-241

Part no.	Pk.	Universal light mounts
		<p>With rear-stop-indicator-licence plate lights.</p> <p>Can be used at rear of towing vehicles with triple-chamber and dual-chamber (stop/indicator switch-over) light equipment.</p> <p>Cross bar extendable from 1.32 to 2.08 m. With 7-pole plug for connection of an additional trailer.</p> <p>Particularly suited for dumper trailers, load trailers, harvesting trailers, fertilizer spreaders, working equipment.</p> <p>Set includes: 1 cross bar 2 mounted lights with pre-fitted 12V bulbs 2 triangular reflectors, red 1 socket, 7-pole (for additional trailer) 1 connection lead, 7500 mm long, with 7-pole plug</p> <p>Universal light mount</p> <p>Spare parts: 1 Rear-stop-indicator-licence plate light 1 Lens 25 Triangular reflector, red 1 7-pole socket 1 7-pole plug</p> <p> 2x12V10W (R10W) 8GA 002 071-131 4x12V21W (P21W) 8GA 002 073-121 </p>
<p>2XL 004 762-001 *)</p> <p>2SE 004 623-001 9EL 129 519-001 8RA 002 020-001 8JB 001 943-001 8JA 001 930-001</p>	<p>1 1 25 1 1</p>	
	<p>1 1</p>	<p>Light mounts for trailers</p> <p>Set includes: 1 plastic mount 1 rear-stop-indicator light with pre-fitted 12V bulbs 1 triangular reflector, red 1 connection lead with 4-pole plug housing</p> <p>Light mount, left</p> <p>Light mount, right</p> <p>Spare parts: Lens, left right 25 Triangular reflector, red</p> <p> 1x12V10W (R10W) 8GA 002 071-131 2x12V21W (P21W) 8GA 002 073-121 </p>
<p>2XL 005 194-011 *)</p> <p>2XL 005 194-021 *)</p> <p>9EL 118 700-001 9EL 118 701-001 8RA 002 020-001</p>	<p>1 1 25</p>	


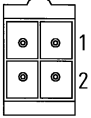

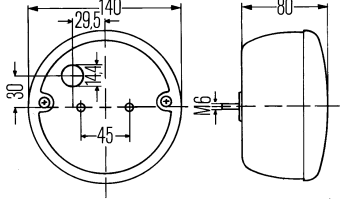

*) When light mounts are attached to vehicles not used for agricultural or forestry applications installation of a rear fog light is necessary for new registration of vehicles. Please see also our range of these lights.


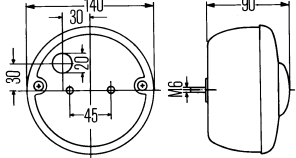

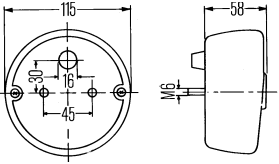

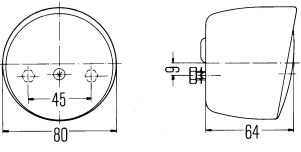

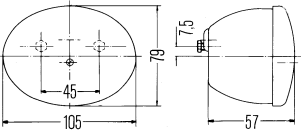
 	<p>Part no.</p> <p>2SE 998 530-061 2SE 998 530-067</p> <p>9EL 998 002-031</p>	<p>Pk.</p> <p>1 108 2</p>	<p>For horizontal or vertical surface mounting</p> <p>Red rear and stop light, amber indicator light. With illumination for 520 x 120 mm licence plates. Two 5.5 mm dia. holes for fixing screws. Grommet, fixing screws for lens, one clear and one red lens for illumination of licence plate provided loose.</p> <p>(E4) 6484 (E4) 7504</p> <p>Rear-stop-indicator-licence plate light with PC lens</p> <p>Spare parts: Lens with screws</p> <p>1x12V21W (P21W) 8GA 002 073-121 1x24V21W (P21W) 8GA 002 073-241 1x12V21/5W (P21/5W) 8GD 002 078-121 1x24V21/5W (P21/5W) 8GD 002 078-241 1x24V21/5W (P21/5W) 8GD 002 078-011 (Heavy Duty)</p>
 	<p>2BE 996 029-021</p> <p>9EL 990 071-001</p>	<p>2 1</p>	<p>For horizontal surface mounting</p> <p>Amber indicator light, white side light. Black plastic body. Two M4 fixing screws. For front mounting.</p> <p>(E12) 6070 (E12) 7095</p> <p>Indicator-side light</p> <p>Spare parts: Lens</p> <p>1x12V21W (P21W) 8GA 002 073-121 1x24V21W (P21W) 8GA 002 073-241</p> <p>1x12V5W (C5W) 8GM 002 092-121 1x24V5W (C5W) 8GM 002 092-241</p>
   	<p>2SD 344 100-001 2SD 344 100-007</p> <p>2SD 344 100-101</p>	<p>1 40 1</p>	<p>For horizontal flush mounting</p> <p>In LED-technology. With 4 LEDs. Lens red/yellow/red with spare part lens clear.</p> <p>Black plastic housing. With two holes for fixing screws ST 4,8 and 500 mm long lead. Voltage range: 9V - 32V. Consumption: 0.75A at 12V, 0.38A at 24V. Light may be installed 2 x per vehicle side. See page 5.236, instruction 1.</p> <p>(E4) 13136</p> <p>Rear-stop-indicator light</p> <p>Rearlight: 2.0W Stoplight: 3.0W Indicator: 4.0W</p> <hr/> <p>For horizontal surface mounting</p> <p>With 2 fixed attachment screws M6 x 20.</p> <p>Light may be installed 2 x per vehicle side.</p> <p>Rear-stop-indicator light</p>

Signal Lights

for rear mounting



	Part no.	Pk.	For horizontal surface mounting
 <p>Pin configuration: 1 red = stop light 2 white = ground 3 yellow = indicator light 4 brown = rear light</p>    <p>Pin configuration: 1 black/red = stop light 2 grey = rear light 3 brown = ground 4 black/white = indicator light</p> 	<p>2SD 001 685-211 2SD 001 685-218</p> <p>2SE 001 685-201</p> <p>2SD 001 685-277</p> <p>9EL 113 324-001</p> <p>2SD 001 685-231 2SD 001 685-232</p> <p>2SE 001 685-221 2SE 001 685-227</p> <p>9EL 113 324-001 9FT 998 007-011</p> <p>2SD 001 685-317</p> <p>2SD 001 685-307</p> <p>9EL 151 494-001</p> <p>9XD 997 909-801</p>	<p>1 8</p> <p>1</p> <p>1</p> <p>2</p> <p>1 8</p> <p>1 8</p> <p>2 5</p> <p>60</p> <p>8</p> <p>6</p> <p>1</p>	<p>Red rear and stop light, amber indicator light. Black plastic body. Two M6 fixing screws. Without vibration damping and bulbs. With grommet.</p> <p>(E12) 7146</p> <p>Rear-stop-indicator light</p> <p>with illumination for 520 x 120 mm and 340 x 240 mm licence plates</p> <hr/> <p>Same as 2SD 001 685-211, but with 150 mm long cable set, 4-pole plug and 12V bulbs. Without grommet.</p> <p>Spare parts: Lens with screws and joint</p> <hr/> <p>With vibration damping and grommet, without bulbs.</p> <p>Rear-stop-indicator light</p> <p>with illumination for 520 x 120 mm and 340 x 240 mm licence plates</p> <p>Spare parts: Lens with screws and joint Bulb holder with vibration damping</p> <hr/> <p>Same as 2SD 001 685-231, but with 4-pole plug, 12V bulbs and vibration damping. Without grommet.</p> <hr/> <p>With heat-resistant lens e. g. for continuous operation. Black metal body. Without vibration damping, grommet and bulbs.</p> <p>(E12) 7136</p> <p>Rear-stop-indicator light</p> <p>Spare parts: PC lens</p> <p>Accessories: Chrome-type mounted frame with mounting bracket for flush mounting, for -211/-218/-231/-232</p> <p>1x12V5W (R5W) 8GA 002 071-121 1x24V5W (R5W) 8GA 002 071-241 2x12V21W (P21W) 8GA 002 073-121 2x24V21W (P21W) 8GA 002 073-241</p>


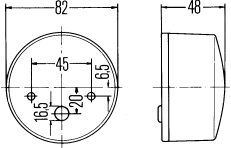




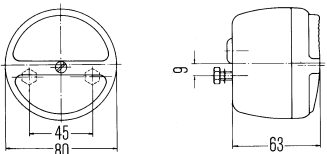



 	<p>Part no.</p> <p>2SD 001 686-101</p> <p>2SE 001 686-142</p> <p>9EL 102 240-031</p>	<p>Pk.</p> <p>1</p> <p>1</p> <p>2</p>	<p>For horizontal surface mounting</p> <p>Red rear and stop light, amber indicator light. Black plastic body. Bulb holder with vibration damping. Two M6 fixing screws.</p> <p>Ⓔ1 43261</p> <p>Rear-stop-indicator light</p> <p>with illumination for 520 x 120 mm and 340 x 240 mm licence plates</p> <p>Spare parts: Lens with screws</p> <p>1x12V5W (R5W) 8GA 002 071-121 1x24V5W (R5W) 8GA 002 071-241 2x12V21W (P21W) 8GA 002 073-121 2x24V21W (P21W) 8GA 002 073-241</p>
 	<p>2SD 001 679-001</p> <p>2SE 001 679-051</p> <p>9EL 126 294-001</p>	<p>1</p> <p>1</p> <p>2</p>	<p>Red rear and stop light, amber indicator light. Black body. Two M6 fixing screws.</p> <p>K 53397 *) K 43322 *)</p> <p>Rear-stop-indicator light</p> <p>with illumination for 520 x 120 mm, 340 x 240 mm and 240 x 130 mm licence plates</p> <p>Spare parts: Lens with screws</p> <p>1x12V10W (K) 8GM 002 091-131 2x12V18W (K) 8GM 002 091-121</p>
 	<p>2SB 001 301-021</p> <p>9EL 090 411-001</p>	<p>2</p> <p>5</p>	<p>Red rear light, amber stop-(indicator) light. Black, powder finished housing. Two M6 fixing screws. With grommet.</p> <p>K 23318 *)</p> <p>Rear-stop-(indicator) light</p> <p>Spare parts: Lens with screw</p> <p>1x12V10W (K) 8GM 002 091-131 1x12V18W (K) 8GM 002 091-121</p>
 	<p>2SB 001 673-002</p> <p>2ST 001 673-011</p> <p>9EL 110 928-001</p>	<p>1</p> <p>1</p> <p>1</p>	<p>Red rear-light, amber stop-(indicator) light. Matt black housing. Two M6 fixing screws. With grommet.</p> <p>K 23256/1 *)</p> <p>Rear-stop-(indicator) light</p> <p>with illumination for 340 x 240 mm licence plates with 0°, 25° and 30° inclination or 240 x 130 mm with 0°-30° inclination</p> <p>Spare parts: Lens with screw</p> <p>1x12V10W (R10W) 8GA 002 071-131 1x12V18W (R) 8GA 002 072-121</p>

*) National type test for Germany








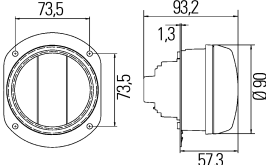


Signal Lights

for rear or front mounting



	Part no.	Pk.	For horizontal surface mounting
 	2SW 003 185-041 2SW 003 185-047	1 33	<p>Red rear light, amber indicator light, Two 5.2 mm dia. holes for fixing screws.</p> <p>(E1) 53526</p> <p>Rear-indicator light</p>
	2BE 003 185-031	1	<p>Spare parts: Lens with screws</p> <hr/> <p>Amber indicator light, white side light. For front mounting.</p> <p>(E1) 53259</p> <p>Indicator-side light</p> <p>Spare parts: Lens with screws</p> <p>  1x12V5W (C5W) 8GM 002 092-121 1x24V5W (C5W) 8GM 002 092-241 </p> <p>  1x12V21W (P21W) 8GA 002 073-121 1x24V21W (P21W) 8GA 002 073-241 </p>
 	2SB 003 018-031 2ST 003 018-061	1 1	<p>Red rear light, amber stop-(indicator) light. Matt black housing. Two M6 fixing screws.</p> <p>K 23260/1 *)</p> <p>Rear-stop-(indicator) light</p> <p>with illumination for 520 x 120 mm, 340 x 240 mm and 240 x 130 mm licence plates with 0°-20° inclination</p> <p>Spare parts: Lens with rim and screw</p> <p>  1x12V10W (K) 8GM 002 091-131 1x12V18W (K) 8GM 002 091-121 </p>
	2BE 003 018-011	1	<p>K 23237 *)</p> <p>Indicator-side light</p> <p>Spare parts: Lens</p> <p>  1x12V18W (K) 8GM 002 091-121 1x12V5W (C5W) 8GM 002 092-121 </p>


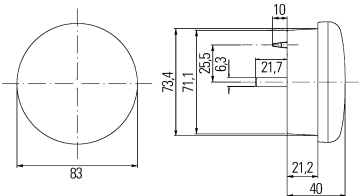







*) National type test for Germany


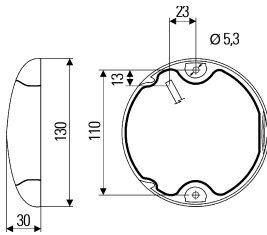





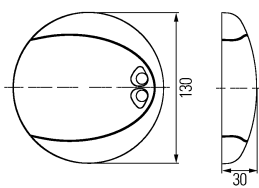
	Part no.	Pk.	For horizontal surface mounting
			<p>Identical 90 mm headlights see page 4.34-4.39.</p> <p>Indicator light with bulb. Side light in LED-technology. Clear lens. Four 5.5 mm dia. holes for fixing screws. With 3-pole AMP-plug. Consumption: 0.03A at 12V, 0.04A at 24V.</p> <p>(E1) 2586</p>
	 <p>2BE 010 102-001</p>	1	<p>Indicator-side light, with 12V bulb, silver and 2 LEDs 0.4W, white</p>
	 <p>2BE 010 102-011</p>	1	<p>With 24V bulb, yellow and 2 LEDs 0.85W, white</p> <p> 1x24V21W (PY21W) 8GA 006 841-241</p>
 	 <p>2BE 010 102-101</p> <p>9AH 165 968-001 8JD 162 581-802</p>	1 1	<p>Indicator light and Daytime running light with bulb technology</p> <p>Daytime running light, indicator and side light with 12V bulb, white and 2 LEDs 0.4W, white</p> <p>Accessories: Supporting frame Plug set, 3-poles</p> <p> 1x12V21W (P21W) 8GA 002 073-121</p>

Signal Lights

for rear or front mounting








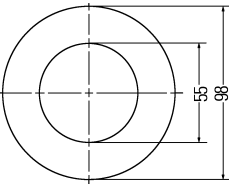
	Part no.	Pk.	For flush mounting
  	<p>2SB 959 010-301 2SB 959 010-307</p>	<p>1 10</p>	<p>In LED-technology. With 12 LEDs 24V3W and 2500 mm lead. Red lens. Consumption: 0.13A. See page 5.236, instruction 2.</p> <p>Rear light: 1W Stop light: 3W</p> <p>Ⓔ4 12373</p> <p>Rear-stop light</p>
 	<p>2BA 959 011-301 2BA 959 011-307</p>	<p>1 10</p>	<p>In LED-technology. With 12 LEDs 24V3W and 2500 mm lead. Amber lens. Consumption: 0.13A. For rear mounting. See page 5.236, instruction 3.</p> <p>Ⓔ4 12373</p> <p>Indicator light</p>
 	<p>2NE 959 011-501 2NE 959 011-507</p>	<p>1 10</p>	<p>In LED-technology. With 24 red LEDs 3W and 2500 mm lead. Clear lens. Voltage range: 9V - 33V. Consumption: 0.25A at 12V, 0.13A at 24V. See page 5.236, instruction 2.</p> <p>Ⓔ4 11391</p> <p>Rear fog light</p>
 	<p>2ZR 959 010-501 2ZR 959 010-507</p>	<p>1 10</p>	<p>In LED-technology. With 24 white LEDs 4W and 2500 mm lead. Clear lens. Voltage range: 9V - 33V. Consumption: 0.33A at 12V, 0.17A at 24V. See page 5.236, instruction 2.</p> <p>Ⓔ4 11391</p> <p>Reverse light</p>

	Part no.	Pk.	For horizontal surface mounting
 	2SB 959 821-601	1	<p>EuroLED In LED-technology. With 1 Power-LED. Red lens. Firmly sealed with black base plate. Electrical connection by means of a 2500 mm long lead. Two 5.3 mm dia. holes for fixing screws. Voltage range: 9V - 33V. Consumption: 0.21A at 12V, 0.10A at 24V. See page 5.236, instruction 2.</p> <p>(E4) 10208</p> <p>Tail-stop light, 2.5W</p>
	2BA 959 822-601	1	<p>Amber lens. Consumption: 0.21A at 12V, 0.10A at 24V. See page 5.236, instruction 3.</p> <p>(E4) 10208</p> <p>Indicator light, 2.5W</p>
	2NE 959 821-201	1	<p>Clear lens. Consumption: 0.33A at 12V, 0.17A at 24V. See page 5.236, instruction 2.</p> <p>(E4) 10208</p> <p>Rear fog light, 4.0W</p>
	2ZR 959 820-601	1	<p>White lens. Consumption: 0.21A at 12V, 0.10A at 24V. See page 5.236, instruction 2.</p> <p>(E4) 10208</p> <p>Reverse light, 2.5W</p>
	2JA 959 820-501	1	<p>White lens. Consumption: 0.33A at 12V, 0.17A at 24V.</p> <p>(E4) 10208</p> <p>Interior light, 4.0W</p>
 	2JA 959 950-031 2JA 959 950-017	1 12	<p>EuroLED Touch In LED-technology. Clear lens. With 1 white and 8 red LEDs. With sensitive switch, for on/off and dimming function, also change between white and red night light. Electrical connection by means of a 2500 mm long lead. Two 5.3 mm dia holes for fixing screws. Voltage range: 9V - 33V. Consumption: 0.25A at 12V, 0.13A at 24V.</p> <p>Interior light, 3.W, with black cover plate</p>
	2JA 959 950-041	1	<p>with white cover plate</p>

Signal Lights


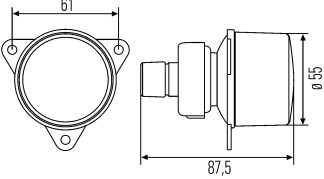




for rear or front mounting



	Part no.	Pk.	For rear flush mounting In LED-technology. With 12 red LEDs 1.8W. Clear lens. Consumption: 0.15A at 12V, 0.08A at 24V. For lights in model range 008 221-... See page 5.236, instruction 2. (E1) 1197 Rear light, 12V 24V Accessories: Heat deflector shield **)
	2SA 008 405-021 2SA 008 405-027	1 60	
	2SA 008 405-011 2SA 008 405-017	1 60	Accessories: Heat deflector shield **)
	2SB 008 405-101 2SB 008 405-091	1 1	In LED-technology. With 12 red LEDs 2.1W. Clear lens. Consumption: 0.18A at 12V, 0.09A at 24V. For lights in model range 008 221-... See page 5.236, instruction 2. (E1) 1892 Rear-stop light, 12V 24V Accessories: Heat deflector shield **)
	2PF 008 405-061 2PF 008 405-067	1 60	For front flush mounting In LED-technology. With 12 white LEDs 1.8W. Clear lens. Consumption: 0.15A at 12V, 0.08A at 24V. For lights in model range 008 221-... See page 5.236, instruction 2. (E1) 1696 Side light, 12V 24V Accessories: Heat deflector shield **)
	2PF 008 405-051 2PF 008 405-057	1 60	Accessories: Heat deflector shield **)
	9XB 161 749-007	60	Reflector red, with additional lens clear. For lights in model range 008 221-... (E1) 1196 Reflector

**) When the ring 008 405-... is mounted in an assembly with the lights 008 221-..., the heat deflector shield has to be used (to be ordered separately). Use of the heat deflector shield is required at an ambient temperature of > 50 °C.

*) To fit 90 mm dia. headlamps, see page 4.34-4.39.



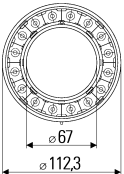
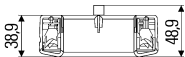

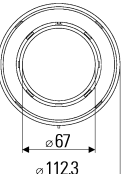
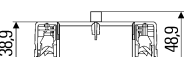


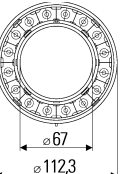
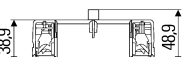



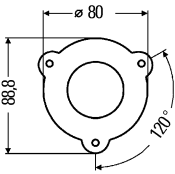
	Part no.	Pk.	For rear flush mounting
	2XA 008 221-021 2XA 008 221-027	1 20	Red lens. (E1) 1048 (R5W) (E1) 1049 (P21W) Signal light optional use as rear light (R5W) or stop light (P21W)
	2SA 008 221-127	20	Rear light with 12V5W bulb
	2DA 008 221-167	1	Stop light with 12V21W bulb 1x12V5W (R5W) 8GA 002 071-121 1x24V5W (R5W) 8GA 002 071-241 1x12V21W (P21W) 8GA 002 073-121 1x24V21W (P21W) 8GA 002 073-241
	2NE 008 221-031 2NE 008 221-037	1 20	Red lens. (E1) 1050 Rear fog light
	2NE 008 221-137	20	with 12V bulb 1x12V21W (P21W) 8GA 002 073-121 1x24V21W (P21W) 8GA 002 073-241
	2BA 008 221-001 2BA 008 221-007	1 20	For front flush mounting *) (E1) 878 (clear) (E1) 1051 (grey)
	2BA 008 221-107 2BA 008 221-217	20 20	Indicator light with clear lens with clear lens and 12V bulb with clear lens and 24V-HD bulb, yellow
	2BA 008 221-041 2BA 008 221-047	1 20	For rear flush mounting Indicator light with grey lens
	2BA 008 221-147	20	with grey lens and 12V bulb 1x12V21W (PY21W) 8GA 006 841-121 1x24V21W (PY21W) 8GA 006 841-241 1x24V21W (PY21W) 8GA 006 841-251 (HD)
	2PF 008 221-011 2PF 008 221-017	1 20	For front flush mounting *) Clear lens. (E1) 879
	2PF 008 221-177	20	Side light with 12V bulb 1x12V5W (R5W) 8GA 002 071-121 1x24V5W (R5W) 8GA 002 071-241
	2ZR 008 221-051 2ZR 008 221-057	1 20	For rear flush mounting Grey lens. (E1) 1052
	2ZR 008 221-157	20	Reverse light with 12V bulb
	8KA 152 134-007	1	Accessories:
	8XU 008 405-031	1	Lead with grommet, 500 mm long
	8XU 008 405-037	60	Decorative moulding (illustration similar to reflector) 1x12V21W (P21W) 8GA 002 073-121 1x24V21W (P21W) 8GA 002 073-241


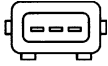

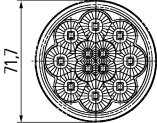
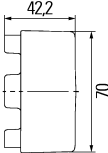

*) To fit 90 mm dia. headlamps, see page 4.34-4.39.

Signal Lights

for rear or front mounting




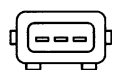
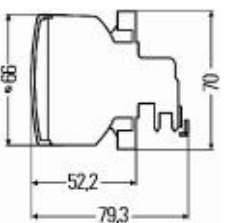



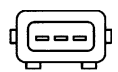










	Part no.	Pk.	For flush mounting
   	<p>2SB 009 362-021</p> <p>2SB 009 362-041</p> <p>2SB 009 362-011</p>	<p>1</p> <p>1</p> <p>1</p>	<p>In LED-technology. Red rear and stop light with 16 LEDs 2.3W. Consumption: 0.19A at 12V, 0.10A at 24V. For lights in model range 009 001-... See page 5.236, instruction 2.</p> <p>Ⓔ4 7747 Ⓔ4 7748</p> <p>Rear-stop light with clear lens, 12V</p> <p>with red lens, 12V</p> <p>with red lens, 24V</p>
  	<p>8RA 009 362-001</p> <p>9XD 161 119-017</p>	<p>1</p> <p>1</p>	<p>Ⓔ4 3302</p> <p>Reflector, red for lights in model range 009 001-...</p> <p>Accessories: Adapter rim for mounting</p>
   	<p>8XU 009 362-101</p> <p>8XU 009 362-111</p>	<p>1</p> <p>1</p>	<p>Accessories: Decorative strip, red</p> <p>clear</p>
 	<p>9HB 163 085-001</p> <p>9HB 163 085-012</p>	<p>1</p> <p>1</p>	<p>Design rim silver coloured</p> <p>Design rim chrome coloured</p>
 	<p>9XD 161 119-017</p>	<p>30</p>	<p>Adapter rim</p>


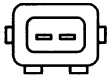


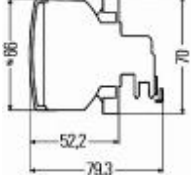





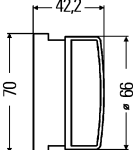


	Part no.	Pk.	For flush mounting
 	<p>2SB 009 001-401</p> <p>2SB 009 001-501</p>	<p>1</p> <p>1</p>	<p>In LED-technology. Clear lens, with 12 red Power LEDs. Rear light: 0.5W. Stop light: 2.5W. With 3-pole AMP plug. See page 5.236, instruction 2.</p> <p>Ⓔ 12390</p> <p>Rear-stop light, 12V</p> <p>24V</p>
   	<p>2BA 009 001-411</p> <p>2BA 009 001-511</p> <p>2PF 009 001-421</p> <p>2PF 009 001-521</p> <p>8JD 162 581-802</p> <p>8JD 156 150-807</p>	<p>1</p> <p>1</p> <p>1</p> <p>1</p> <p>1</p> <p>1</p>	<p>In LED-technology. Clear lens, with 12 yellow Power LEDs, 2.4W. With 2-pole AMP plug. See page 5.236, instruction 3.</p> <p>Ⓔ 12390</p> <p>Indicator-light for rear mounting, 12V</p> <p>24V</p> <p>In LED-technology. Clear lens, with 12 white Power LEDs, 1.8W. With 3-pole AMP plug. See page 5.236, instruction 2.</p> <p>Ⓔ 12390</p> <p>Side light for front mounting, 12V</p> <p>24V</p> <p>Accessories: Plug-set, 3-poles</p> <p>2-poles</p>

Signal Lights

for rear or front mounting










	Part no.	Pk.	For flush mounting
      	2SA 009 001-041 2SA 009 001-047 2SA 009 001-137	1 60 1	Red lens without optical pattern, bonded to housing, facet reflector. With 3-pole AMP plug. (E4) 7613 Rear light with 12V bulb with 24V bulb  1x12V21/5W (P21/5W) 8GD 002 078-121  1x24V21/5W (P21/5W) 8GD 002 078-241
	2SB 009 001-061 2SB 009 001-067 2SB 009 001-157	1 60 60	With 3-pole AMP plug. (E4) 7613 Rear-stop light with 12V bulb with 24V bulb  1x12V21/5W (P21/5W) 8GD 002 078-121  1x24V21/5W (P21/5W) 8GD 002 078-241
	2DA 009 001-051 2DA 009 001-057 2DA 009 001-147	1 60 1	With 2-pole AMP plug. (E4) 7613 Stop light with 12V bulb with 24V bulb  1x12V21W (P21W) 8GA 002 073-121  1x24V21W (P21W) 8GA 002 073-241
	2NE 009 001-021 2NE 009 001-027 2NE 009 001-127	1 60 1	With 2-pole AMP plug. (E4) 3917 Rear fog light with 12V bulb with 24V bulb  1x12V21W (H21W) 8GH 008 417-001  1x24V21W (H21W) 8GH 008 417-012
	2PF 009 001-081 2PF 009 001-087 2PF 009 001-177	1 60 60	Clear lens. With 3-pole AMP plug. (E4) 7613 Side light for front mounting, with 12V bulb with 24V bulb
	8JD 162 581-802 8JD 156 150-807	1 1	Accessories: Plug-set, 3-poles 2-poles  1x12V21/5W (P21/5W) 8GD 002 078-121  1x24V21/5W (P21/5W) 8GD 002 078-241

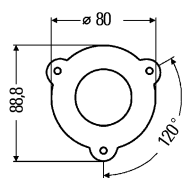
		Part no.	Pk.	For flush mounting
		2BA 009 001-001	1	Grey lens without optical pattern, bonded to housing, facet reflector. With 2-pole AMP plug. (E4) 6546 Indicator light for rear mounting with yellow 12V bulb with yellow 24V bulb
		2BA 009 001-007	60	
		2BA 009 001-107	1	
	 	2BA 009 001-071	1	Clear lens. With 2-pole AMP plug. (E4) 6546 Indicator light for front mounting, with yellow 12V bulb with yellow 24V bulb  1x12V21W (PY21W) 8GA 006 841-121  1x24V21W (PY21W) 8GA 006 841-241 With 2-pole AMP plug. (E4) 6546 Indicator light for rear mounting, with silver 12V bulb, grey lens for front mounting, with silver 12V bulb, clear lens
		2BA 009 001-077	60	
		2BA 009 001-167	60	
		2ZR 009 001-011	1	Grey lens. With 2-pole AMP plug. (E4) 23255 Reverse light with 12V bulb with 24V bulb
		2ZR 009 001-017	60	
		2ZR 009 001-117	60	
		8JD 156 150-807	1	Accessories: Plug-set, 2-poles  1x12V21W (P21W) 8GD 002 073-121  1x24V21W (P21W) 8GD 002 073-241 (E4) 3189 Reflector, red for lights in model range 009 001-...
		8RA 009 001-031	1	
		8RA 009 001-037	60	




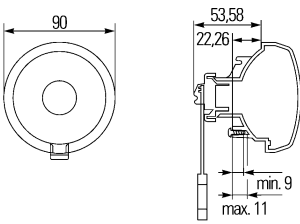











Signal Lights

for rear or front mounting



	Part no.	Pk.	Accessories for lights in model range 009 001-... (except LED)
	9HB 161 122-007	1	Design rim silver coloured
	9HB 161 122-012	10	Design rim chrome coloured
	9HB 164 168-002	10	Premium design rim comet silver coloured
	8HG 162 530-002	60	Locking ring comet-silver coloured
	9XD 161 119-007	30	Adapter rim with gasket, for front fixing
	8JD 156 150-807	1	Plug-set, 2-poles
	8JD 162 581-802	1	3-poles






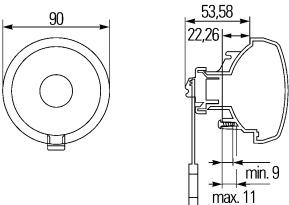






	Part no.	Pk.	For flush mounting (max. depth required up to lens gradient)
	2SA 965 039-001 2SA 965 039-007 2SA 965 039-081 2SA 965 039-087 2SA 965 039-307	1 20 1 20 20	Red lens, without optical pattern. With 100 mm long lead, blade receptacles and insulating sleeves. *) For screw- or clip fixing. ⓔ4 10215 Rear light with 12V bulb with 24V bulb with clip fixing and 12V bulb  1x12V5W (R5W) 8GA 002 071-121  1x24V5W (R5W) 8GA 002 071-241
<div style="text-align: center;"> <p>(max. depth required)</p>  </div>	2SB 965 039-051 2SB 965 039-057 2SB 965 039-131 2SB 965 039-137	1 20 1 20	ⓔ4 10215 Rear-stop light with 12V bulb with 24V bulb  1x12V21/5W (P21/5W) 8GD 002 078-121  1x24V21/5W (P21/5W) 8GD 002 078-241
	2DA 965 039-011 2DA 965 039-091 2DA 965 039-317	1 1 20	ⓔ4 10215 Stop light with 12V bulb with 24V bulb with clip fixing and 12V bulb  1x12V21W (P21W) 8GA 002 073-121  1x24V21W (P21W) 8GA 002 073-241
	2NE 965 039-031 2NE 965 039-037 2NE 965 039-111 2NE 965 039-117 2NE 965 039-327	1 20 1 20 20	ⓔ4 10215 Rear fog light with 12V bulb with 24V bulb with clip fixing and 12V bulb  1x12V21W (P21W) 8GA 002 073-121  1x24V21W (P21W) 8GA 002 073-241
	2PF 965 039-071 2PF 965 039-077 2PF 965 039-151 2PF 965 039-157	1 20 1 20	Clear lens ⓔ4 10215 Side light with 12V bulb with 24V bulb  1x12V5W (R5W) 8GA 002 071-121  1x24V5W (R5W) 8GA 002 071-241

*) For the screw on the clip fixing, a Torx TX20 is required.



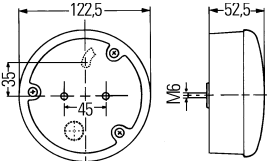

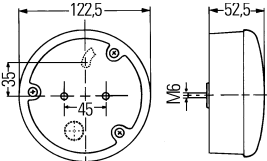







Signal Lights

for rear or front mounting



	Part no.	Pk.	For flush mounting (max. depth required up to lens gradient)
	2PT 965 039-161 2PT 965 039-171 2PT 965 039-177	1 1 20	Clear lens, without optical pattern. With 100 mm lead, blade receptacles and insulating sleeves. *) For screw- or clip fixing. For front mounting. (E4) 10215 Daytime running light with 12V bulb with 24V bulb  1x12V21W (P21W) 8GA 002 073-121  1x24V21W (P21W) 8GA 002 073-241
<div style="text-align: center;"> <p>(max. depth required)</p>  </div>	2BA 965 039-021 2BA 965 039-027 2BA 965 039-101 2BA 965 039-107	1 20 1 20	Smoke coloured lens. (E4) 10215 Indicator light for rear mounting, with yellow 12V bulb with yellow 24V bulb
	2BA 965 039-061 2BA 965 039-067 2BA 965 039-141 2BA 965 039-147	1 20 1 20	Clear lens. (E4) 10215 Indicator light for front mounting, with yellow 12V bulb with yellow 24V bulb  1x12V21W (PY21W) 8GA 006 841-121  1x24V21W (PY21W) 8GA 006 841-241
	2ZR 965 039-041 2ZR 965 039-047 2ZR 965 039-121 2ZR 965 039-127 2ZR 965 039-337	1 20 1 20 20	Smoke coloured lens. (E4) 10215 Reverse light with 12V bulb with 24V bulb with clip fixing and 12V bulb  1x12V21W (P21W) 8GA 002 073-121  1x24V21W (P21W) 8GA 002 073-241





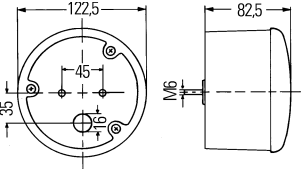








*) For the screw on the clip fixing, a Torx TX20 is required.





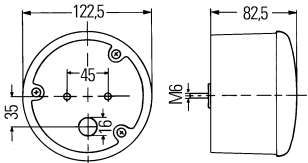




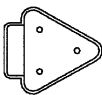
	Part no.	Pk.	For flush/surface mounting
 	2SD 344 200-001 2SD 344 200-007	1 20	<p>In LED-technology. With 24 LEDs and 500 mm lead. Clear lens. Black plastic body. Voltage range: 9V - 31V. Consumption: 0.08A at 12V, 0.04A at 24V. See page 5.236, instruction 1.</p> <p>(E4) 12371</p> <p>Rear-stop and indicator light with two M6 x 25 fixing screws</p> <p>Rear light: 1W, Stop light: 1.5W, Indicator light: 2W</p>
 	2SB 344 200-027	36	<p>In LED-technology. With 24 LEDs and 500 mm lead. Clear lens. Consumption: 0.34A at 12V, 0.17A at 24V. See page 5.236, instruction 2.</p> <p>(E4) 12658</p> <p>Rear-stop light with two M6 x 25 fixing screws</p> <p>Rear light: 1.0W, Stop light: 3.0W</p>
 	2BA 344 200-037	36	<p>In LED-technology. With 24 LEDs and 500 mm lead. Clear lens. Consumption: 0.25A at 12V, 0.13A at 24V. See page 5.236, instruction 3.</p> <p>(E4) 12658</p> <p>Indicator light, 3W, with two M6 x 25 fixing screws</p>
 	2SB 964 169-301 2SB 964 169-307	1 36	<p>In LED-technology. With 37 LEDs and 500 mm lead. Red lens. Black plastic body. Consumption: 0.24A. See page 5.236, instruction 2.</p> <p>(E17) 814</p> <p>Rear-stop light, 24V, with two M6 x 25 fixing screws</p> <p>Rear light: 0.7W, Stop light: 5W.</p>
 	2NE 964 169-341	1	<p>In LED-technology. With 37 LEDs. Red lens. Consumption: 0.17A. See page 5.236, instruction 2.</p> <p>(E17) 3810</p> <p>Rear fog light, 24V4W, with two M6 x 25 fixing screws</p>
 	2ZR 964 169-351 2ZR 964 169-361	1 1	<p>In LED-technology. With 37 LEDs. Clear lens. Consumption: 0.21A. See page 5.236, instruction 2.</p> <p>(E4) 23254</p> <p>Reverse light, 24V5.0W, with two M6 x 25 fixing screws, left</p> <p>right</p>

Signal Lights

for rear mounting







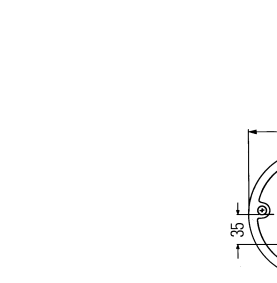

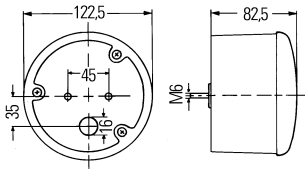


	Part no.	Pk.	For flush/surface mounting
    	<p>2SB 964 169-531 2SB 964 169-537</p>	<p>1 20</p>	<p>Caution: The water drainage opening must be knocked out according to the attachment position!</p>
	<p>2SB 964 169-677</p>	<p>20</p>	<p>Red lens, without optical pattern. With grommet. Black plastic body.</p>
	<p>2SB 344 169-017</p>	<p>20</p>	<p>Rear-stop light with two M6 x 25 fixing screws</p>
	<p>9EL 964 800-011</p>	<p>1</p>	<p>without fixing screws with two M6 x 25 fixing screws, 200 mm lead, 24V bulb and 3-pole DEUTSCH plug</p>
	<p>Spare parts: Lens with screws for -531/-537/-017</p>	<p>1</p>	<p>E17 9805</p> <p>1x12V21/5W (P21/5W) 8GD 002 078-121 1x24V21/5W (P21/5W) 8GD 002 078-241</p>
 	<p>2NE 964 169-521 2NE 964 169-527</p>	<p>1 20</p>	<p>Red lens, without optical pattern. With grommet.</p>
	<p>2NE 964 169-667</p>	<p>20</p>	<p>Rear fog light with two M6 x 25 fixing screws</p>
	<p>2NE 964 169-667</p>	<p>20</p>	<p>without fixing screws</p> <p>1x12V21W (P21W) 8GA 002 073-121 1x24V21W (P21W) 8GA 002 073-241</p>
   	<p>2BA 964 169-501 2BA 964 169-507</p>	<p>1 20</p>	<p>Amber lens, without optical pattern. With grommet.</p>
	<p>2BA 964 169-647</p>	<p>20</p>	<p>Indicator light with two M6 x 25 fixing screws</p>
	<p>2BA 344 169-007</p>	<p>20</p>	<p>without fixing screws with two M6 x 25 fixing screws, 200 mm lead, 24V bulb and 2-pole DEUTSCH plug</p>
	<p>9EL 964 527-011</p>	<p>1</p>	<p>Spare parts: Lens with screws for -501/-507/-007</p> <p>1x12V21W (P21W) 8GA 002 073-121 1x24V21W (P21W) 8GA 002 073-241</p>
 	<p>2ZR 964 169-511 2ZR 964 169-517</p>	<p>1 20</p>	<p>Clear lens, without optical pattern. With grommet.</p>
	<p>2ZR 964 169-657</p>	<p>20</p>	<p>Reverse light with two M6 x 25 fixing screws</p>
	<p>2ZR 964 169-657</p>	<p>20</p>	<p>without fixing screws</p>
	<p>9EL 964 529-011</p>	<p>1</p>	<p>Spare parts: Lens with screws for -511/-517</p>
<p>9GT 341 438-007</p>	<p>9GT 341 438-007</p>	<p>200</p>	<p>Accessories: Grommet</p>
	<p>9GT 341 438-007</p>	<p>200</p>	<p>1x12V21W (P21W) 8GA 002 073-121 1x24V21W (P21W) 8GA 002 073-241</p>

	Part no.	Pk.	For flush/surface mounting
 	2SD 964 169-111 2SD 964 169-117 2SD 344 169-037 9EL 964 536-001	1 20 20 1	Caution: The water drainage opening must be knocked out according to the attachment position! Red rear and stop light, amber indicator light. With grommet. Black plastic body. (E17) 9903 Rear-stop-indicator light with two M6 x 25 fixing screws with two M6 x 12 fixing screws Spare parts: Lens with screws 1x12V21/5W (P21/5W) 8GD 002 078-121 1x24V21/5W (P21/5W) 8GD 002 078-241 1x12V21W (P21W) 8GA 002 073-121 1x24V21W (P21W) 8GA 002 073-241
 	2SA 964 169-091 2SA 964 169-097 2SA 964 169-277 9EL 964 535-001	1 20 20 1	Red lens. With grommet. (Two lights can be fitted next to each other) (E17) 810 Rear light with two M6 x 25 fixing screws without fixing screws Spare parts: Lens with screws 2x12V5W (R5W) 8GA 002 071-121 2x24V5W (R5W) 8GA 002 071-241
	2TA 964 169-061 2TA 964 169-067 2TA 964 169-767 2TA 964 169-797 2TA 964 169-251 2TA 964 169-257 9EL 964 532-001	1 20 20 20 1 20 1	Red lens. With grommet. (E17) 9805 Rear-stop light with reflector with two M6 x 25 fixing screws with two M6 x 25 fixing screws, 150 mm lead, 12V bulb and 3-pole DEUTSCH plug with two M6 x 45 fixing screws, 150 mm lead, 12V bulb and 3-pole DEUTSCH plug, left without fixing screws Spare parts: Lens with screws
    	2SB 964 169-287 2SB 964 169-717 9GT 341 438-007	20 20 200	For two-wheeled vehicles. With grommet. (E17) 9805 Rear-stop light with two M6 x 25 fixing screws without fixing screws Accessories: Grommet 1x12V21/5W (P21/5W) 8GD 002 078-121 1x24V21/5W (P21/5W) 8GD 002 078-241

Signal Lights

for rear mounting




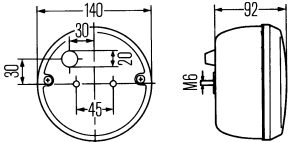



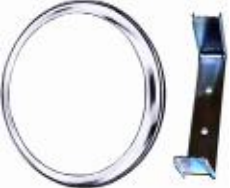
	Part no.	Pk.	For flush/surface mounting
 	<p>2SW 964 169-081 2SW 964 169-087</p> <p>9EL 964 534-001</p>	<p>1 20</p> <p>1</p>	<p>Caution: The water drainage opening must be knocked out according to the attachment position!</p> <p>Red rear light, amber indicator light. With grommet. Black plastic body.</p> <p>(E17) 9803</p> <p>Rear-indicator light with two M6 x 25 fixing screws</p> <p>Spare parts: Lens with screws</p> <p>1x12V5W (R5W) 8GA 002 071-121 1x24V5W (R5W) 8GA 002 071-241 1x12V21W (R21W) 8GA 002 073-121 1x24V21W (R21W) 8GA 002 073-121</p> <hr/> <p>Red lens. With grommet.</p> <p>(E17) 808</p>
 	<p>2DA 964 169-001 2DA 964 169-007</p> <p>2DA 964 169-727</p> <p>9EL 964 526-001</p>	<p>1 20</p> <p>20</p> <p>1</p>	<p>Stop light with two M6 x 25 fixing screws (Two lights can be fitted next to each other)</p> <p>without fixing screws</p> <p>Spare parts: Lens with screws</p> <hr/> <p>Red lens. With grommet.</p> <p>(E17) 3808</p>
  	<p>2NE 964 169-021 2NE 964 169-027</p> <p>2NE 964 169-227</p> <p>2NE 344 169-047</p>	<p>1 20</p> <p>20</p> <p>20</p>	<p>Rear fog light with two M6 x 25 fixing screws</p> <p>without fixing screws</p> <p>without fixing screws, with hexagonal recess</p> <p>1x12V21W (R21W) 8GA 002 073-121 1x24V21W (R21W) 8GA 002 073-121</p> <hr/> <p>Amber lens (category 1a and 2a). With grommet.</p> <p>(E17) 648</p>
 	<p>2BA 964 169-011 2BA 964 169-017</p> <p>2BA 344 169-027</p> <p>9EL 964 527-001</p>	<p>1 20</p> <p>20</p> <p>1</p>	<p>Indicator light with two M6 x 25 fixing screws (Two lights can be fitted next to each other)</p> <p>without fixing screws</p> <p>Spare parts: Lens with screws</p> <p>1x12V21W (R21W) 8GA 002 073-121 1x24V21W (R21W) 8GA 002 073-121</p>


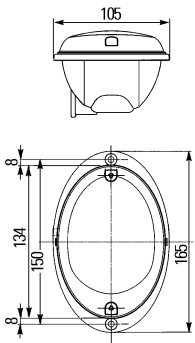



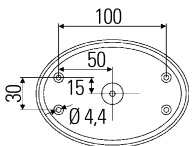
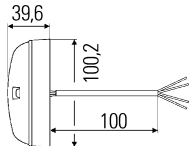
Part no.	Pk.	For flush/surface mounting
Caution: The water drainage opening must be knocked out according to the attachment position!		
Amber indicator light, red rear fog light. With grommet. Black plastic body.		
		(E17) 9804
2BA 964 169-041 2BA 964 169-047	1 20	Indicator-rear fog light with two M6 x 25 fixing screws
2BA 964 169-237	20	without fixing screws
9EL 964 530-001	1	Spare parts: Lens with screws
Amber indicator light, clear reverse light. With grommet.		
		(E17) 9801
2BN 964 169-051 2BN 964 169-057	1 20	Indicator-reverse light with two M6 x 25 fixing screws
2BN 964 169-777	20	with two M6 x 25 fixing screws, 150 mm lead, 12V bulb and 3-pole DEUTSCH plug, left
2BN 964 169-787	20	with two M6 x 45 fixing screws, 150 mm lead, 12V bulb and 3-pole DEUTSCH plug, right
2BN 964 169-247	20	without fixing screws
9EL 964 531-001	1	Spare parts: Lens with screws 2x12V21W (P21W) 8GA 002 073-121 2x24V21W (P21W) 8GA 002 073-241
For front flush/surface mounting. Amber indicator light, clear side light. With grommet.		
		(E17) 9802
2BE 964 169-071 2BE 964 169-077	1 20	Indicator-side light with two M6 x 25 fixing screws
9EL 964 533-001	1	Spare parts: Lens with screws 1x12V5W (R5W) 8GA 002 071-121 1x24V5W (R5W) 8GA 002 071-241 1x12V21W (P21W) 8GA 002 073-121 1x24V21W (P21W) 8GA 002 073-241
Clear lens. With grommet.		
		(E17) 2311
2ZR 964 169-031 2ZR 964 169-037	1 20	Reverse light with two M6 x 25 fixing screws
2ZR 964 169-737	20	without fixing screws
2ZR 964 169-107	20	with two M6 x 25 fixing screws, 160 mm lead, blade terminals and 12V bulb
9EL 964 529-001	1	Spare parts: Lens with screws
9GT 341 438-007	200	Accessories: Grommet 1x12V21W (P21W) 8GA 002 073-121 1x24V21W (P21W) 8GA 002 073-241

Signal Lights

for rear mounting









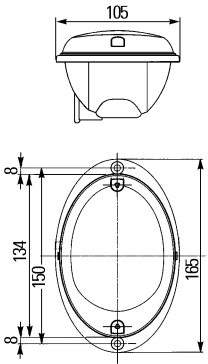






	Part no.	Pk.	For horizontal surface mounting
	2SB 001 423-097	1	<p>Red lens. Black plastic body. For mounting to vertical surfaces. Two M6 fixing screws.</p> <p>(E1) 681</p> <p>Rear-stop light (Two lights can be fitted next to each other)</p> <p>1x12V21/5W (P21/5W) 8GD 002 078-121 1x24V21/5W (P21/5W) 8GD 002 078-241 1x12V21/5W (P21/5W) 8GD 002 078-011 (Heavy Duty)</p>
	2DA 001 423-077	24	<p>Stop light</p> <p>(E1) 21434</p> <p>(E1) 8496</p>
	2NE 001 423-011	1	<p>Rear fog light</p> <p>Spare parts: Lens with screws Reflector</p>
	2BA 001 423-087	1	<p>Amber lens.</p> <p>(E1) 42657</p> <p>Indicator light</p>
	2ZR 001 423-001	1	<p>Clear lens.</p> <p>(E1) 8704</p> <p>Reverse light</p> <p>Spare parts: Lens with screws</p>
	9XD 997 909-801	1	<p>Accessories: Mounting frame for flush mounting</p> <p>1x12V21W (P21W) 8GA 002 073-121 1x24V21W (P21W) 8GA 002 073-241</p>



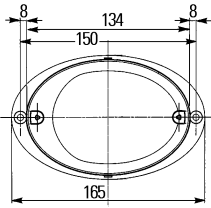
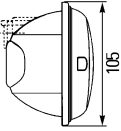







	Part no.	Pk.	For vertical surface mounting
  	2SD 343 390-401	1	<p>AgrolunaLED In LED-technology. Clear lens. With integrated electronic for cancellation control of indicator light. 12 red LEDs for rear and stop light (rear light with reduced power), 12 amber LEDs for indicator light. Two 6 mm dia. holes for fixing screws. Voltage range: 9V - 32V. Consumption: 0.34A at 12V, 0.17A at 24V. See page 5.236, instruction 1, 2, 3.</p> <p>Rear light: 0.5W Stop light: 1.6W Indicator light: 2.0W</p> <p>Ⓔ4 11785</p> <p>Rear-stop-indicator light with 4-pole DEUTSCH plug connector, left and right</p>
	2SD 343 390-011	1	<p>For horizontal or vertical surface mounting</p> <p>Consumption: 0.5A at 12V, 0.25A at 24V. See page 5.236, instruction 1, 2, 3.</p> <p>Rear light: 0.6W Stop light: 2.5W Indicator light: 2.9W</p> <p>With 100 mm lead, left and right</p>
  	2SB 343 390-091	1	<p>In LED-technology. Clear lens. With 24 red LEDs and 100 mm lead.</p> <p>Voltage range: 9V - 32V. Consumption: 0.24A at 12V, 0.12A at 24V. See page 5.236, instruction 1, 2, 3.</p> <p>Rear light: 0.5W Stop light: 2.4W</p> <p>Ⓔ4 7698</p> <p>Rear-stop light, left and right</p>
	2BA 343 390-071	1	<p>In LED-technology. Clear lens. With integrated electronic for cancellation control of indicator light. With 24 red LEDs 3.2W and 100 mm lead.</p> <p>Voltage range: 9V - 32V. Consumption: 0.26A at 12V, 0.13A at 24V. See page 5.236, instruction 2.</p> <p>Ⓔ4 6550</p> <p>Indicator light, left and right</p>

Signal Lights

for rear mounting




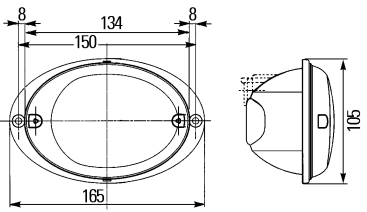


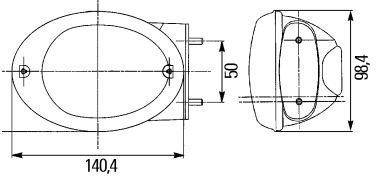



	Part no.	Pk.	For vertical flush mounting
        	<p>2SD 343 130-377</p> <p>2SD 343 130-337</p> <p>2ZR 343 130-387</p>	<p>24</p> <p>24</p> <p>24</p>	<p>Agroluna Red rear and stop light, amber indicator light. Two 6 mm dia. holes for fixing screws.</p> <p> 10203</p> <p>Rear-stop-indicator light with 4-pole DEUTSCH plug connector, and 12V bulbs, left and right</p> <p> 1x12V21/5W (P21/5W) 8GD 002 078-121 1x24V21/5W (P21/5W) 8GD 002 078-241 1x12V21W (P21W) 8GA 002 073-121 1x24V21W (P21W) 8GA 002 073-241</p> <hr/> <p>With 4-pole DEUTSCH plug connector and 24V HD bulbs, left and right</p> <p> 1x24V21/5W HD (P21/5W) 8GD 002 078-011 1x24V21W HD (P21W) 8GA 002 073-251</p> <hr/> <p>Clear lens.</p> <p>Reverse light with 4-pole DEUTSCH plug connector and 12V bulbs, left and right</p> <p> 1x12V21W (P21W) 8GA 002 073-121</p>


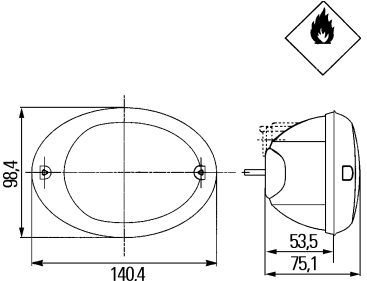


	Part no.	Pk.	For horizontal flush mounting
 	<p>Agroluna Red rear and stop light, amber indicator light. Two 6 mm dia. holes for fixing screws.</p> <p>(E4) 10203</p> <p>Rear-stop-indicator light, with DEUTSCH plug connector, and 12V bulbs, left</p> <p>2SD 343 130-737 24</p> <p>2SD 343 130-747 24</p> <p>right</p> <p>with grommet and 24V HD bulbs, left</p> <p>2SD 343 130-397 24</p> <p>2SD 343 130-227 24</p> <p>right</p> <p>1x12V21W (P21W) 8GA 002 073-121 1x12V21/5W (P21/5W) 8GD 002 078-121 1x24V21W (P21W) 8GA 002 073-251 1x24V21/5W (P21/5W) 8GD 002 078-011</p>		
 			
	<p>Red lens. With grommet, 12V bulb and 120 mm lead with 6.3 mm blade terminals.</p> <p>(E4) 7705</p> <p>Stop light, left</p> <p>2DA 343 130-257 24</p> <p>2DA 343 130-267 24</p> <p>right</p>		
	<p>Rear fog light, left</p> <p>2NE 343 130-277 24</p> <p>2NE 343 130-287 24</p> <p>right</p>		
	<p>with DEUTSCH plug connector and 12V bulbs, left</p> <p>2NE 343 130-177 30</p>		<p>(E4) 3919</p> <p>1x12V21W (P21W) 8GA 002 073-121 1x24V21W (P21W) 8GA 002 073-241</p>
 	<p>Amber indicator light, clear side light.</p> <p>(E4) 10202</p> <p>Indicator-side light with DEUTSCH plug connector, and 12V bulbs, left</p> <p>2BE 343 130-657 24</p> <p>2BE 343 130-667 24</p> <p>right</p>		
	<p>With grommet, without bulbs, left</p> <p>2BE 343 130-777 24</p> <p>2BE 343 130-787 24</p> <p>right</p>		
	<p>1x12V10W (R10W) 8GA 002 071-131 1x12V21W (P21W) 8GA 002 073-121</p>		

Signal Lights

for rear mounting







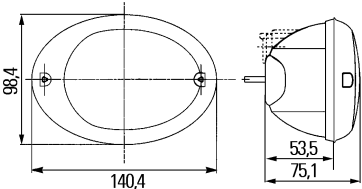







	Part no.	Pk.	For horizontal flush mounting
 	<p>Agroluna</p> <p>Amber lens. With grommet, 100 mm lead and 6.3 mm blade terminals.</p> <p>Ⓔ E4 6550</p> <p>Indicator light with 12V bulbs, left</p> <p>2BA 343 130-297 24</p> <p>right</p> <p>2BA 343 130-307 24</p> <p>with 24V bulb, left</p> <p>2BA 343 130-537 24</p> <p>right</p> <p>2BA 343 130-547 24</p>		
	<p>Reverse light, left</p> <p>2ZR 343 130-317 24</p> <p>right</p> <p>2ZR 343 130-327 24</p>		<p>Clear lens. With grommet, 12V bulbs and 120 mm lead with 6.3 mm blade terminals.</p> <p>Reverse light, left</p> <p>2ZR 343 130-317 24</p> <p>right</p> <p>2ZR 343 130-327 24</p> <p>⚡ 1x12V21W (P21W) 8GA 002 073-121 1x24V21W (P21W) 8GA 002 073-241</p>
  	<p>Red rear and stop light, amber indicator light. Two M5 x 40 fixing screws, distance between screws: 50 mm, for side (mirror) mounting.</p> <p>Rear-stop-indicator light, left</p> <p>2SD 343 130-797 30</p> <p>right</p> <p>2SD 343 130-807 30</p>		<p>For horizontal surface mounting</p> <p>Red rear and stop light, amber indicator light. Two M5 x 40 fixing screws, distance between screws: 50 mm, for side (mirror) mounting.</p> <p>Rear-stop-indicator light, left</p> <p>2SD 343 130-797 30</p> <p>right</p> <p>2SD 343 130-807 30</p> <p>⚡ 1x12V21/5W (P21/5W) 8GD 002 078-121 1x24V21/5W (P21/5W) 8GD 002 078-011 1x12V21W (P21W) 8GA 002 073-121 1x24V21W (P21W) 8GA 002 073-241</p>
 	<p>Amber indicator light, clear side light. With 12V bulbs and 6.3 mm blade terminals.</p> <p>Indicator-side light, left</p> <p>2BE 343 130-417 30</p> <p>right</p> <p>2BE 343 130-427 30</p>		<p>Amber indicator light, clear side light. With 12V bulbs and 6.3 mm blade terminals.</p> <p>Indicator-side light, left</p> <p>2BE 343 130-417 30</p> <p>right</p> <p>2BE 343 130-427 30</p> <p>⚡ 1x12V10W (R10W) 8GA 002 071-131 1x12V21W (P21W) 8GA 002 073-121</p>


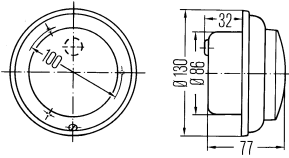




	Part no.	Pk.	For horizontal or vertical flush/surface mounting
			Caution: Depending on the attachment position, the water drainage opening must be knocked out! Please refer to the installation instructions.
	2SD 343 130-011 2SD 343 130-017	1 30	Agroluna Red rear and stop light, amber indicator light. Two M6 x16 fixing screws.
	2SD 343 130-071	1	Rear-stop-indicator light with grommet, 12V/24V
	2SD 343 130-157	30	With 4-pole DEUTSCH plug and 12V bulbs, left
	2SD 343 130-167	30	right
	2SD 343 130-137	30	with 24V bulbs, left
	2SD 343 130-147	30	right
	2SB 343 130-027	30	Red lens with grommet. Rear-stop light
	2SB 343 130-757	30	with 4-pole DEUTSCH plug and 12V bulbs, for horizontal mounting, left
	2SB 343 130-767	30	right
	2NE 343 130-031 2NE 343 130-037	1 30	For horizontal or vertical flush/surface mounting. Red lens with grommet. Rear fog light
			(E4) 3919
			1x12V21W (P21W) 8GA 002 073-121 1x24V21W (P21W) 8GA 002 073-241

Signal Lights

for rear or front mounting




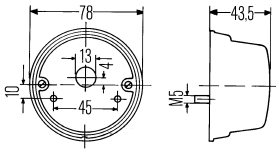
	Part no.	Pk.	For horizontal or vertical flush/surface mounting
    	<p>2BE 343 130-001 2BE 343 130-007</p> <p>2BE 343 130-081</p> <p>2BE 343 130-657 2BE 343 130-667</p>	<p>1 30</p> <p>1</p> <p>24 24</p>	<p>Caution: Depending on the attachment position, the water drainage opening must be knocked out! Please refer to the installation instructions.</p> <p>Agroluna Amber indicator light, clear side light.</p> <p>(E4) 10202</p> <p>Indicator-side light, 12V/24V, with grommet and M6 x 16 fixing screws, distance between fixing screws: 45 mm</p> <p>with M6 x 16 fixing screws, distance between fixing screws: 58 mm</p> <p>with 4-pole DEUTSCH plug connector, and 12V bulbs, left</p> <p>right</p> <p>1x12V10W (R10W) 8GA 002 071-131 1x24V10W (R10W) 8GA 002 071-251 1x12V21W (P21W) 8GA 002 073-121 1x24V21W (P21W) 8GA 002 073-241</p> <hr/> <p>Amber lens, with grommet.</p> <p>(E4) 6550</p>
   	<p>2BA 343 130-051 2BA 343 130-057</p> <p>2BA 343 130-577 2BA 343 130-587</p>	<p>1 30</p> <p>30 30</p>	<p>Indicator light</p> <p>with 4-pole DEUTSCH plug connector, and 12V bulbs, left</p> <p>right</p> <hr/> <p>Clear lens with grommet.</p> <p>(E4) 23257</p>
  	<p>2ZR 343 130-041 2ZR 343 130-047</p> <p>2ZR 343 130-607</p>	<p>1 30</p> <p>1</p>	<p>Reverse light</p> <p>with 4-pole DEUTSCH plug connector, and 12V bulbs, right</p> <p>1x12V21W (P21W) 8GA 002 073-121 1x24V21W (P21W) 8GA 002 073-241</p>

	Part no.	Pk.	For flush mounting
	2SB 001 240-311	1	Red lens. Chrome rim. Rubber housing. Mounting depth 45 mm. Three M4 fixing screws. Bulb holder with vibration damping. (E1) 11549
	2SA 001 240-331	1	Rear-stop light (Two lights can be fitted next to each other) Spare parts: Lens with rim and reflector 1x12V10W (R10W) 8GA 002 071-131 1x24V10W (R10W) 8GA 002 071-251 1x12V21W (P21W) 8GA 002 073-121 1x24V21W (P21W) 8GA 002 073-241 (E1) 11550
	2DA 001 240-341	1	Stop light Spare parts: Lens with rim and reflector 1x12V5W (R5W) 8GA 002 071-121 1x24V5W (R5W) 8GA 002 071-241 (E1) 11551
	2BA 001 240-301	1	Indicator light Spare parts: Lens with rim and reflector Lens with rim 1x12V21W (P21W) 8GA 002 073-121 1x24V21W (P21W) 8GA 002 073-241
	2ZR 001 240-351	1	Reverse light Spare parts: Lens with rim and reflector
	2ZR 001 240-377	30	With black plastic rim (not resistant to UV-radiation; frame must be covered when installed) 1x12V21W (P21W) 8GA 002 073-121 1x24V21W (P21W) 8GA 002 073-241

Signal Lights

for rear or front mounting



		Part no.	Pk.	For rear surface mounting
				Red rear light, amber stop (indicator) light. Two M5 fixing screws. K 23270 **)
		2SB 001 259-261 *)	2	Rear-stop-(indicator) light
		2ST 001 259-321 *)	2	With illumination for 340 x 240 mm and 240 x 130 mm licence plates with 0°, 15° and 30° inclination. Spare parts: Lens with screws for -261 Bulb holder 1x12V10W (K) 8GM 002 091-131 1x12V18W (K) 8GM 002 091-121
		9EL 088 525-001	2	
		9FT 088 047-001	10	
		2SA 001 259-751	2	Red lens. (E1) 31438
		2SA 001 259-757	90	Rear light (Two lights can be fitted next to each other)
		9EL 135 266-001	2	
		9FT 088 047-001	10	Spare parts: Lens with screws Bulb holder 1x12V5W (C5W) 8GM 002 092-121
		2TF 001 259-761	2	With illumination for 340 x 240 mm, 240 x 130 mm and 520 x 120 mm licence plates. Spare parts: Bulb holder 1x12V10W (K) 8GM 002 091-131
		9FT 088 047-001	10	
		2PF 001 259-631	2	For front surface mounting Clear lens. (E1) 21624
		2PF 001 259-677	1	Side light Spare parts: Lens with screws Bulb holder
		9EL 109 208-011	2	
		9FT 088 047-001	10	
		2PF 001 259-677	1	Green lens. Side light Vehicles whose trailers are equipped with ABS and do not yet have plug connectors to ISO 3731 (24S), ISO 7683 or ISO 1185 (24N) are required to equip the trailer with a green side light located in the field of vision of the outside mirror on the driver side for indicating the function of the ABS.
		9FT 088 047-001	10	Spare parts: Bulb holder 1x12V5W (C5W) 8GM 002 092-121

*) Only for spare parts requirement

**) National type test for Germany

		Part no.	Pk.	For front surface mounting
				Amber indicator light, white side light. Two M5 fixing screws.
				K 23269 **)
		2BE 001 259-061	2	Indicator-side light
		9EL 088 538-001	2	Spare parts: Lens with screws
		9FT 088 047-001	10	Bulb holder
				1x12V18W (K) 8GM 002 091-121 1x12V3W (M) 8GM 002 094-121
				For rear or front surface mounting
				Amber lens (category 1 and 2a).
				K 23267 **)
		2BA 001 259-611	2	Indicator light
		2BA 001 259-618	108	
		9EL 088 150-001	2	Spare parts: Lens with screws
		9FT 088 047-001	10	Bulb holder
				1x12V18W (K) 8GM 002 091-121
				For rear mounting
				Clear lens. Two M5 fixing screws.
				8750
		2ZR 001 421-101	4	Reverse light
				1x12V21W 8GM 002 091-181
				Adapter
				for surface-mounting to bodywork surfaces inclined at 45°. For 001 259-061/-261/-321
		8HG 002 247-001	2	Adapter

**) National type test for Germany


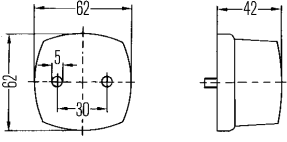

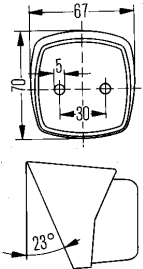

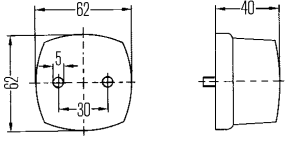

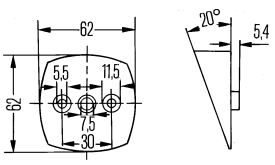

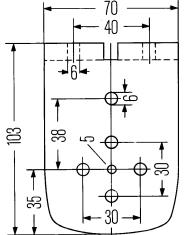
Signal Lights

for rear or front mounting



Image	Technical drawing (front view)	Technical drawing (side view)	Part no.	Pk.	For horizontal or vertical rear surface mounting
			2SA 003 057-021	1	Red lens. Black plastic base plate. Two holes for M5 fixing screws. (E1) 11584 Rear light without reflector (Two lights can be fitted next to each other)
			9EL 117 330-011	2	Spare parts: Lens
			2TM 003 057-031)	1	(E1) 11583 IA (E1) 31315 Rear light with reflector
			2PF 003 057-001	1	For front mounting Clear lens.
			2PF 003 057-002	1	(E1) 21626
			2PF 003 057-041	1	Side light with white base plate
			9EL 117 330-001	2	Pro-fit pack with black base plate
					Spare parts: Lens
			2PG 003 057-011	1	Clear lens with reflector.
			2PG 003 057-067	1	(E1) 21629 IA (E1) 31315
			9EL 117 334-001	2	Side light with reflector and white base plate and black base plate
					Spare parts: Lens
			2PS 003 057-051	1	For side surface mounting Amber lens with reflector, with white base plate.
			2PS 003 057-057	60	(E1) 31315 (E1) 280
			2PS 003 057-052	1	Side-marker light with reflector
			9EL 117 334-021	2	Pro-fit pack Spare parts: Lens
					1x12V5W (C5W) 8GM 002 092-121 1x24V5W (C5W) 8GM 002 092-241


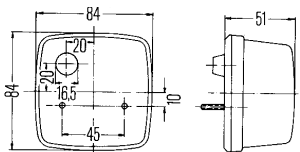




*) Only for spare parts requirement

	Part no.	Pk.	For horizontal front surface mounting
 	<p>2PF 004 081-001 2 2PF 004 081-007 50</p> <p>2PF 004 081-011 2 2PF 004 081-017 50</p>		<p>Clear lens. Plastic base plate. Vertical attachment tolerance: + 15°/- 30°. Two holes for M5 fixing screws.</p> <p>(E1) 21656</p> <p>Side light with black base plate</p> <p>with white base plate</p>
 	<p>2PF 004 081-107 1 2PF 004 081-117 1</p>		<p>For mounting on surfaces inclined at 23°.</p> <p>Side light with black base plate</p> <p>with white base plate</p> <p>1x12V5W (C5W) 8GM 002 092-121 1x24V5W (C5W) 8GM 002 092-241</p>
 	<p>2XS 005 639-001 24 2XS 005 639-002 1</p>		<p>For horizontal rear/side surface mounting</p> <p>Front lens clear, rear lens red. Black plastic base plate. Two holes for M5 fixing screws.</p> <p>(E12) 7106</p> <p>Clearance light</p> <p>Pro-fit pack</p> <p>1x12V5W (C5W) 8GM 002 092-121 1x24V5W (C5W) 8GM 002 092-241</p>
 	<p>9XD 127 264-007 50</p>		<p>Adapter</p> <p>White, for surface mounting of lights in model ranges 2PF 004 081-... and 2PF 003 057-... to body work surfaces inclined at 20°</p> <p>Adapter</p>
 	<p>8HG 003 799-001 2 8HG 003 799-007 100 8HG 003 799-017 1</p>		<p>Holder</p> <p>Black, for side lights in model ranges 2PF 003 057-..., 2PF 004 081-... or reflectors in model ranges 8RA 002 014-... and 8RA 002 015-...</p> <p>Rubber holder</p> <p>Hard rubber holder</p>

Signal Lights

for rear mounting



	Part no.	Pk.	For horizontal or vertical surface mounting
	2SB 003 014-151 9EL 115 003-035	2 2	Red lens. Black plastic base plate. Two holes for M4 fixing screws. With grommet. (E1) 31453 Rear-stop light Spare parts: Lens with screws
	2ST 003 014-141 9EL 115 003-021	2 2	With illumination for 340 x 240 mm and 240 x 130 mm licence plates (above licence plates), or mounting to right and left of 520 x 120 mm licence plate Spare parts: Lens with screws (E1) 31453 (E1) 53210
	2SW 003 014-131 9EL 115 003-011	2 2	Red rear light, amber indicator light. (E1) 31452 (E1) 53211 Rear-indicator light Spare parts: Lens with screws
	2SY 003 014-121 9EL 115 003-001	2 2	With illumination for 340 x 240 mm and 240 x 130 mm licence plates (above licence plates), or mounting to right and left of 520 x 110 mm licence plate Spare parts: Lens with screws 1x12V5W (C5W) 8GM 002 092-121 1x24V5W (C5W) 8GM 002 092-241 1x12V21W (P21W) 8GA 002 073-121 1x24V21W (P21W) 8GA 002 073-241
	2SA 003 014-051 9EL 110 540-001	2 1	For horizontal surface mounting Red lens. (E1) 31418 Rear light (Two lights can be fitted next to each other) Spare parts: Lens with screws 1x12V5W (C5W) 8GM 002 092-121 1x24V5W (C5W) 8GM 002 092-241
	2DA 003 014-031 2DA 003 014-037	2 36	Red lens. (E1) 242 Stop light 1x12V21W (P21W) 8GA 002 073-121 1x24V21W (P21W) 8GA 002 073-241







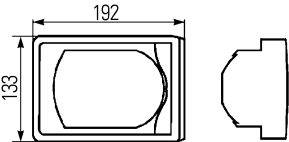

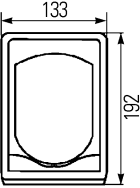


		Part no.	Pk.	For horizontal front surface mounting
		2PF 003 014-071	2	Clear lens. Black plastic base plate. Two holes for M4 fixing screws. With grommet. (E1) 11793
		9EL 110 542-001	3	Side light Spare parts: Lens with screws 1x12V5W (C5W) 8GM 002 092-121 1x24V5W (C5W) 8GM 002 092-241
		2PF 003 014-301	1	Green lens. Used on forklifts in combination with yellow and red lights for traffic signal function for cheking height of fork. Side light 1x12V21W (P21W) 8GA 002 073-121 1x24V21W (P21W) 8GA 002 073-241
		2BE 003 014-251 2BE 003 014-257	2 36	Amber indicator light, white side light. (E1) 42712 (E1) 53209 Indicator-side light
		9EL 115 003-055	2	Spare parts: Lens with screws 1x12V5W (C5W) 8GM 002 092-121 1x24V5W (C5W) 8GM 002 092-241 1x12V21W (P21W) 8GA 002 073-121 1x24V21W (P21W) 8GA 002 073-241
		2BA 003 014-111	2	Amber lens. (E1) 32661 Indicator light (category 1)
		9EL 110 536-011	3	Spare parts: Lens with screws
		2BA 003 014-011	2	For horizontal rear surface mounting Amber lens.
		9EL 110 536-001	1	(E1) 32619 Indicator light (category 2a) Spare parts: Lens with screws
		2ZR 003 014-091	2	Clear lens. (E1) 8703
		9EL 110 544-001	3	Reverse light Spare parts: Lens with screws 1x12V21W (P21W) 8GA 002 073-121 1x24V21W (P21W) 8GA 002 073-241

Signal Lights

for rear or front mounting






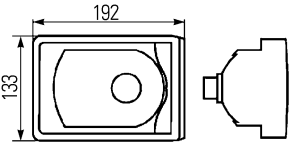




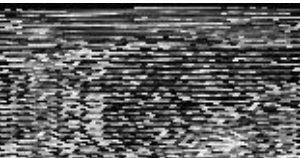








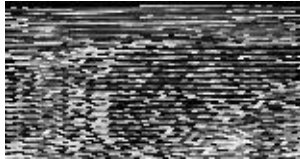


Image	Diagram	Part no.	Pk.	For horizontal surface mounting
		2SA 996 012-091	2	Red lens. Black plastic body. Two M5 fixing screws. With grommet.
		9EL 990 034-051	1	<p>(E12) 7075</p> <p>Rear light</p> <p>Spare parts: Lens</p> <p> 1x12V10W (R10W) 8GA 002 071-131 1x24V10W (R10W) 8GA 002 071-251</p>
		2DA 996 012-041	2	<p>(E12) 7154</p> <p>Stop light</p> <hr/> <p>With 2 rubber spacers for 8° or 12° inclination.</p>
		2NE 996 012-021	2	<p>(E12) 38007</p> <p>Rear fog light</p> <p> 1x12V21W (P21W) 8GA 002 073-121 1x24V21W (P21W) 8GA 002 073-241</p>
		2PF 996 012-051	2	<p>Clear lens.</p> <p>(E12) 7093</p> <p>Side light</p> <p> 1x12V5W (R5W) 8GA 002 071-121 1x24V5W (R5W) 8GA 002 071-241</p>
		2BA 996 012-061	2	<p>For rear or front surface mounting. Amber lens.</p>
		2BA 996 012-071	1	<p>(E12) 6041</p> <p>Indicator light with rubber spacer for 8° inclination</p>
		2BA 996 012-147	45	with PMMA lens, 24V bulb, 500 mm lead and plug
		9EL 990 034-041	1	<p>Spare parts: Lens</p>
		2ZR 996 012-111	2	<p>Clear lens. With 2 rubber spacers for 8° or 12° inclination.</p>
		2ZR 996 012-101	1	<p>(E12) 23003</p>
		2JB 996 012-121	1	<p>Reverse light without rubber spacers</p> <p>Boot light with switch and rubber spacers</p>
		9EL 990 122-001	1	<p>Spare parts: Lens</p> <p> 1x12V21W (P21W) 8GA 002 073-121 1x24V21W (P21W) 8GA 002 073-241</p>

	Part no.	Pk.	For horizontal flush mounting
			<p>In LED-technology. With 32 LEDs 3.0W. Red lens, without optical pattern. Grey plastic body. With 450 mm lead with stripped cable ends. Consumption: 0.25A at 12V, 0.13A at 24V. See page 5.236, instruction 2.</p>
	<p>2SB 008 982-301 1 2SB 008 982-307 32</p>	<p>1 32</p>	<p>Rear-stop light, 12V</p>
	<p>2SB 008 982-001 1 2SB 008 982-007 32</p>	<p>1 32</p>	<p>24V</p>
	<p>2SB 008 982-367 32</p>	<p>32</p>	<p>With clear lens, without optical pattern, 12V</p> <hr/> <p>With 32 LEDs 2.0W. Amber light. Clear lens, without optical pattern. With failure check for LED indicators. Consumption: 0.17A at 12V, 0.08A at 24V. See page 5.236, instruction 3.</p>
	<p>2BA 008 982-341 1 2BA 008 982-347 32</p>	<p>1 32</p>	<p>Indicator light, 12V</p>
	<p>2BA 008 982-041 1 2BA 008 982-047 32</p>	<p>1 32</p>	<p>24V</p>
			
	<p>2SB 008 982-207 32</p>	<p>32</p>	<p>For vertical surface mounting</p> <p>In LED-technology. With 32 LEDs 3.0W. Red light. Clear lens with optical pattern. Grey plastic body. With 100 mm lead and Supersealed plug. Consumption: 0.25A at 12V. See page 5.236, instruction 2.</p>
			<p>Bag- og stoplygte, 12V</p>
	<p>2BA 008 982-217 32</p>	<p>32</p>	<p>With 32 LEDs 2,0W. Amber light. Clear lens with optical pattern. With failure check for LED indicators. Consumption: 0,17A at 12V. See page 5.236, instruction 3.</p>
	<p>2BA 008 982-217 32</p>	<p>32</p>	<p>Indicator light, 12V</p>

Signal Lights

for front or rear mounting




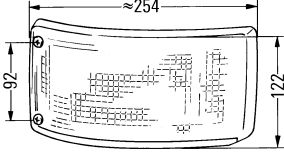


	Part no.	Pk.	For horizontal flush mounting
	2SB 008 805-021 2SB 008 805-027	1 32	Red lens, without optical pattern. Grey plastic body, with optical pattern. (E4) 10151 Rear-stop light  1x12V21/5W (P21/5W) 8GD 002 078-121  1x24V21/5W (P21/5W) 8GD 002 078-241
	2SA 008 805-001 2SA 008 805-007	1 32	Rear light  1x12V5W (R5W) 8GA 002 071-121  1x24V5W (R5W) 8GA 002 071-241
	2DA 008 805-011 2DA 008 805-017	1 32	Stop light  1x12V21W (P21W) 8GA 002 073-121  1x24V21W (P21W) 8GA 002 073-241
	2BA 008 805-051 2BA 008 805-057	1 32	Clear lens, without optical pattern. For rear or front mounting. Indicator light  1x12V21W (PY21W) 8GA 006 841-121  1x24V21W (PY21W) 8GA 006 841-241
	2BA 008 805-187	32	Amber lens, without optical pattern.  1x12V21W (P21W) 8GA 002 073-121  1x24V21W (P21W) 8GA 002 073-241
	2NE 008 805-031 2NE 008 805-037	1 32	Red lens, without optical pattern. Rear fog light  1x12V21W (P21W) 8GA 002 073-121  1x24V21W (P21W) 8GA 002 073-241
	2ZR 008 805-041 2ZR 008 805-047	1 32	Clear lens, without optical pattern. Reverse light
	9GD 159 740-007	1	Accessories: Self-adhesive gasket, black  1x12V21W (P21W) 8GA 002 073-121  1x24V21W (P21W) 8GA 002 073-241

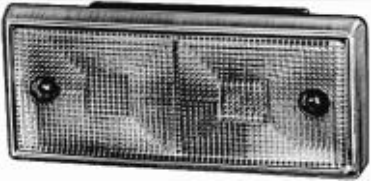
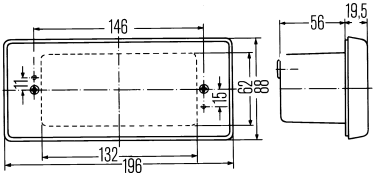

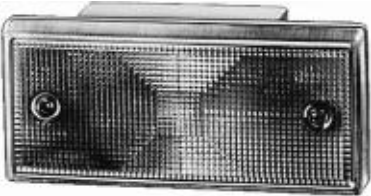





	Part. no.	Pk.	For horizontal flush mounting
	2SA 005 603-021 2SA 005 603-027	1 32	Red lens. Four holes for B4.2 x 13 fixing screws. (E1) 31423 Rear light (Two lights can be fitted next to each other)
	2SA 005 603-227	1	with PC lens 1x12V5W (R5W) 8GA 002 071-121 1x24V5W (R5W) 8GA 002 071-241
	2SB 005 603-137	1	Rear-stop light 1x12V21/5W (P21/5W) 8GD 002 078-121 1x24V21/5W (P21/5W) 8GD 002 078-241
	2DA 005 603-031 2DA 005 603-037	1 32	(E1) 31422 Stop light (Two lights can be fitted next to each other)
	2DA 005 603-237	1	with PC lens
	2NE 005 603-071 2NE 005 603-077	1 32	Rear fog light
	2BA 005 603-011 2BA 005 603-017	1 32	Amber lens. (E1) 42749 Indicator light for rear mounting (category 2a)
	2BA 005 603-217	1	with PC lens
	2BA 005 603-001 2BA 005 603-007	1 32	For front or side mounting (category 1a and 5)
	2BA 005 603-117	1	Red lens, with filter. (E1) 586 For rear mounting (category 2a)
	2ZR 005 603-061 2ZR 005 603-067	1 32	Clear lens. (E1) 8770 Reverse light 1x12V21W (P21W) 8GA 002 073-121 1x24V21W (P21W) 8GA 002 073-241

Signal Lights

for front or side mounting



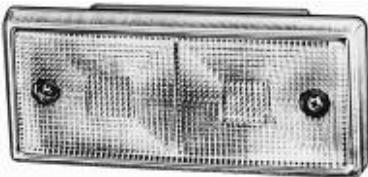
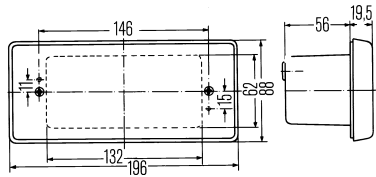
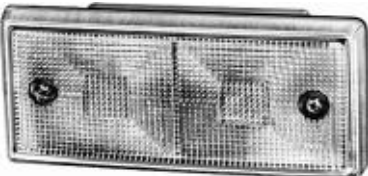
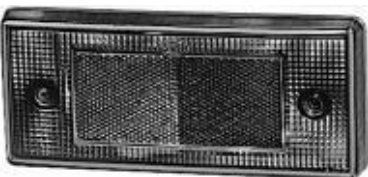
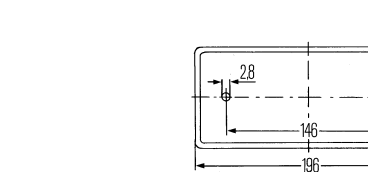
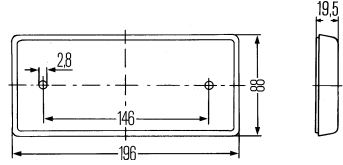
	Part no.	Pk.	For horizontal flush mounting
	2BA 004 119-001	1	<p>Amber lens. Two holes for B4.2 x 28 fixing screws.</p> <p>(E1) 42680</p> <p>Indicator light for front mounting (category 1)</p> <p>1x12V21W (P21W) 8GA 002 073-121 1x24V21W (P21W) 8GA 002 073-241 1x24V21W (P21W) 8GA 002 073-251 (Heavy Duty)</p>
	2BA 004 119-017	10	<p>Clear lens. With base plate and grommet. Can be used only in combination with yellow bulb PY21W (not supplied with lamp).</p> <p>(E1) 405</p> <p>Indicator light for front or side mounting (category 1 and 5)</p>
	9GT 143 133-007	10	<p>Spare parts: Grommet</p> <p>1x12V21W (PY21W) 8GA 006 841-121 1x24V21W (PY21W) 8GA 006 841-241</p>
	2BE 004 119-021	1	<p>Clear lens. With amber filter for indicator light.</p> <p>(E1) 536</p> <p>Indicator-side light for front mounting (category 1)</p> <p>Spare parts: Grommet</p> <p>1x12V21W (P21W) 8GA 002 073-121 1x24V21W (P21W) 8GA 002 073-241 1x24V21W (P21W) 8GA 002 073-251 (Heavy Duty)</p> <p>1x12V5W (W5W) 8GP 003 594-121 1x24V5W (W5W) 8GP 003 594-251</p>


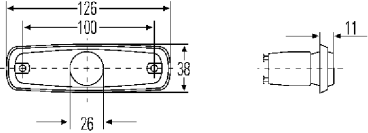






















	Part no.	Pk.	For horizontal or vertical flush mounting
 	<p>2SA 003 734-121</p>	<p>1</p>	<p>Rear light</p> <p>Red lens. Two bulbs connected in parallel. (not supplied with lamp). Two holes for B4.2 x 13 fixing screws. With grommet.</p> <p>(E1) 31433</p>
<p>9EL 135 060-001</p>	<p>2</p>		<p>Spare parts: Lens with screws</p> <p> 2x12V5W (R5W) 8GA 002 071-121 2x24V5W (R5W) 8GA 002 071-241</p>
	<p>2DA 003 734-011</p>	<p>1</p>	<p>Stop light</p> <p>(E1) 21406</p>
<p>9EL 123 632-001</p>	<p>2</p>		<p>Spare parts: Lens with screws</p> <p> 1x12V21W (P21W) 8GA 002 073-121 1x24V21W (P21W) 8GA 002 073-241</p>
	<p>2NE 003 734-091</p>	<p>1</p>	<p>Rear fog light</p> <p>(E1) 18421</p>
<p>9EL 123 635-001</p>	<p>2</p>		<p>Spare parts: Lens with screws</p> <p> 1x12V21W (P21W) 8GA 002 073-121 1x24V21W (P21W) 8GA 002 073-241</p>
	<p>2ZR 003 734-041</p>	<p>1</p>	<p>Reverse light</p> <p>(E1) 8731</p>
<p>9EL 123 635-001</p>	<p>2</p>		<p>Spare parts: Lens with screws</p> <p> 2x12V21W (P21W) 8GA 002 073-121 2x24V21W (P21W) 8GA 002 073-241</p>

Signal Lights

for front or rear mounting







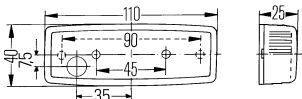












	Part no.	Pk.	
 	<p>2PF 003 734-031</p>	<p>1</p>	<p>For horizontal or vertical flush mounting</p> <p>Clear lens. Two bulbs connected in parallel. (not supplied with lamp) Two holes for B4.2 x 13 fixing screws. With grommet.</p> <p>(E1) 21647</p> <p>Side light</p> <p>2x12V5W (R5W) 8GA 002 071-121 2x24V5W (R5W) 8GA 002 071-241</p>
	<p>2BA 003 734-001</p>	<p>1</p>	<p>Amber lens.</p> <p>(E1) 42623</p> <p>Indicator light for rear mounting (category 2a)</p> <p>Spare parts: Lens with screws</p> <p>2x12V21W (P21W) 8GA 002 073-121 2x24V21W (P21W) 8GA 002 073-241</p>
	<p>2BA 003 734-061</p>	<p>1</p>	<p>For 1 bulb.</p> <p>(E1) 42641</p> <p>Indicator light for front mounting (category 1)</p> <p>1x12V21W (P21W) 8GA 002 073-121 1x24V21W (P21W) 8GA 002 073-241</p>
 	<p>8RA 003 734-101</p>	<p>1</p>	<p>For horizontal or vertical surface mounting</p> <p>Red, reflecting surface 54 sq. cm. With rubber base plate. Two B3.9 x 22 fixing screws.</p> <p>(E1) 01 31298</p> <p>Reflector</p>


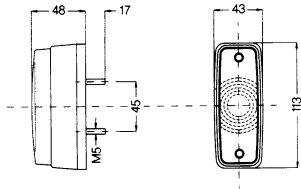












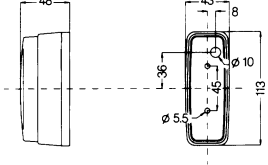


	Part no.	Pk.	For horizontal flush mounting
			<p>For rear mounting. Red lens, without reflector. Red plastic base plate. Two 4 mm dia. holes for fixing screws. Gasket and grommet are not supplied with lamp.</p>
	<p> 2SA 962 964-091</p>	<p>1</p>	<p>Rear light with 24V bulb</p> <p> 1x12V5W (W5W) 8GP 003 594-121  1x24V5W (W5W) 8GP 003 594-251</p>
	<p> 2PF 962 964-061</p>	<p>1</p>	<p>For horizontal or vertical flush mounting</p> <p>For front mounting. Clear lens, without reflector.</p> <p>Side light, with 12V bulb and white base plate, for wavy outer surfaces e.g. on caravans</p>
	<p> 2PF 962 964-071</p>	<p>1</p>	<p>with 24V bulb and clear base plate, for flat outer surfaces</p>
	<p> 2PG 962 964-041</p>	<p>1</p>	<p>With reflector.</p> <p> 7499  3153</p> <p>Side light with 12V bulb and white base plate, for wavy outer surfaces e.g. on caravans</p>
	<p> 2PG 962 964-051 2PG 962 964-057</p>	<p>1 120</p>	<p>with 24V bulb and clear base plate, for flat outer surfaces</p>
	<p> 2PS 962 964-031 2PS 962 964-037</p>	<p>1 120</p>	<p>For side mounting. Amber lens, with reflector.</p> <p> 0004  3153</p> <p>Side-marker light with 12V bulb and white base plate, for wavy outer surfaces e.g. on caravans</p>
	<p> 2PS 962 964-012 2PS 962 964-018</p>	<p>1 120</p>	<p>with 24V bulb and clear base plate, for flat outer surfaces</p>
<p>9GD 963 281-001 9GT 963 129-001</p>	<p>1 1</p>	<p>1 1</p>	<p>Accessories: Gasket Grommet</p>
			<p> 1x12V3W (W3W) 8GP 003 594-141  1x24V3W (W3W) 8GP 003 594-241</p>

Signal Lights

for rear, front or side mounting



	Part. no.	Pk.	For horizontal or vertical surface mounting
 	<p>2SA 006 717-001 2SA 006 717-007</p>	<p>1 100</p>	<p>For rear mounting. Red lens, without reflector. Black plastic body. Two 5 mm dia. holes for fixing screws. ± 10° inclination.</p> <p>(E17) 804</p> <p>Rear light</p>
	<p>9EL 141 135-001</p>	<p>1</p>	<p>Spare parts: Lens</p>
  	<p>2TM 006 717-047</p>	<p>1</p>	<p>With reflector</p> <hr/> <p>For front mounting. Clear lens. Can be mounted either vertically or horizontally (± 15° inclination).</p> <p>(E17) 803</p>
 	<p>2PF 006 717-011</p>	<p>1 20</p>	<p>Side light without reflector</p> <p>Spare parts: Lens</p>
 	<p>2PG 006 717-021 2PG 006 717-027 2PG 006 717-022</p>	<p>20 100 1</p>	<p>Side light with reflector</p> <p>Pro-fit-pack</p> <p>Spare parts: Lens</p>
 	<p>2PS 006 717-031 2PS 006 717-037 2PS 006 717-032</p>	<p>20 100 1</p>	<p>For side mounting. Amber lens.</p> <p>(E1) 86 (E17) 378</p> <p>Side-marker light with reflector</p> <p>Pro-fit-pack</p>
 	<p>2PS 006 717-051 2PS 006 717-057</p>	<p>8 100</p>	<p>With adhesive foil for fixing</p>
 	<p>2PS 006 717-071</p>	<p>20</p>	<p>With closed fixing holes</p> <p>Spare parts: Lens</p>
 	<p>2PS 006 717-061 2PS 006 717-067</p>	<p>1 100</p>	<p>For horizontal surface mounting</p> <p>With bracket for fixing below load surface.</p> <p>(E1) 86 (E17) 378</p> <p>Side-marker light with reflector</p> <p>Spare parts: Lens</p> <p>1x12V5W (W5W) 8GP 003 594-121 1x24V5W (W5W) 8GP 003 594-251</p>

	Part no.	Pk.	For horizontal surface mounting
 	2SA 997 027-001 *)	1	For rear mounting. Red lens. Plastic base plate. Two holes for M5 fixing screws. With blade terminal contacts. (E12) 7048
	9EL 997 387-001	1	Spare parts: Lens with screws  1x12V5W (C5W) 8GM 002 092-121  1x24V5W (C5W) 8GM 002 092-241
	2DA 997 027-021	1	Stop light  1x12V21W (P21W) 8GA 002 073-121  1x24V21W (P21W) 8GA 002 073-241
	2BA 997 027-031	1	For front mounting. Amber lens. (E12) 6044 Indicator light  1x12V21W (P21W) 8GA 002 073-121  1x24V21W (P21W) 8GA 002 073-241
	2PF 997 027-011 *)	1	Clear lens. (E12) 7048 Side light Spare parts: Lens with screws  1x12V5W (C5W) 8GM 002 092-121  1x24V5W (C5W) 8GM 002 092-241
 	2JA 997 027-051	1	Clear lens. Chrome-type body, with switch. Plastic base plate. Interior light  1x12V18W (K) 8GM 002 091-121  1x24V18W (K) 8GM 002 091-241


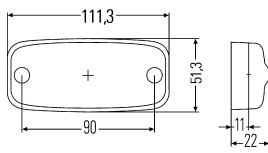
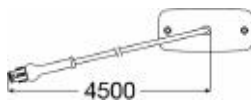

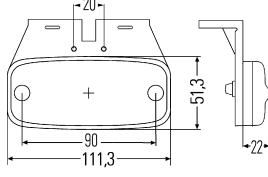





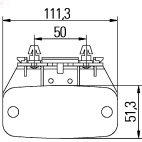
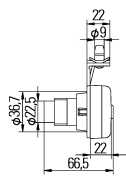

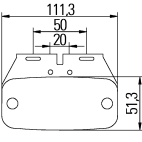
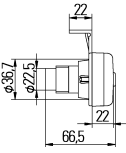
*) Only for spare parts requirement

Signal Lights

for front, side or rear mounting




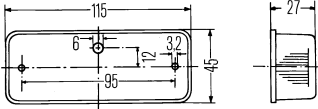

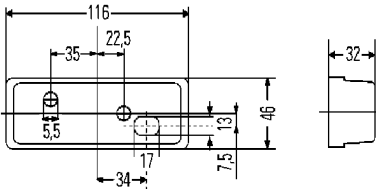





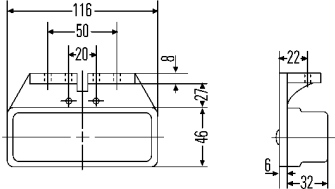


	Part no.	Pk.	For horizontal surface mounting
	2PG 963 639-401 2PG 963 639-411	1 1	<p>In LED-technology. White light. With 2 white LEDs. White base plate. Two 5.5 mm dia. holes for fixing screws. Consumption: 0.02A at 24V. See page 5.236, instruction 2.</p> <p>(E17) 0002</p> <p>Side light with reflector, without bracket, with 500 mm lead, 24V0.5W with 5000 mm lead, 24V0.5W</p>
	2TM 963 639-307 2TM 963 639-317	20 1	<p>Red light. With 2 LEDs. Black base plate. Consumption: 0.02A at 12V, 0.04A at 24V.</p> <p>(E17) 9808</p> <p>Rear light with reflector, without bracket, with 5000 mm lead, 12V0.5W with 5000 mm lead, 24V1.0W</p>
	2PS 963 639-001 2PS 963 639-007	1 12	<p>Amber light. With 2 LEDs. Consumption: 0.06A at 12V, 0.05A at 24V.</p> <p>(E17) 9605</p> <p>Side-marker light with reflector, without bracket, with 500 mm lead, 12V0.7W</p>
	2PS 963 639-011 2PS 963 639-017 2PS 963 639-197 2PS 963 639-207	1 12 1 20	<p>with 500 mm lead, 24V1.3W with 1500 mm lead and Superseal plug, 24V1.3W with 200 mm lead, 24V1.3W</p>
	2PS 963 639-061 2PS 963 639-067 2PS 963 639-071 2PS 963 639-077 2PS 963 639-127 2PS 963 639-167	1 20 1 20 20 20	<p>With bracket and 500 mm lead, 12V0.7W 24V1.3W without lead, 24V1.3W with 1500 mm lead, 24V1.3W</p>
	2PS 963 639-101	1	<p>Consumption: 0.05A at 24V.</p> <p>With 2000/500 mm lead with cut-off ends, without bracket, 24V1.3W</p>
	2PS 963 639-111 2PS 963 639-117	1 20	<p>with bracket, 24V1.3W</p>
	2PS 963 639-041 2PS 963 639-047	1 20	<p>Consumption: 0.05A at 24V.</p> <p>With 4000/500 mm lead and system plug, without bracket, 24V1.3W</p>
	2PS 963 639-021 2PS 963 639-027	1 20	<p>with bracket, 24V1.3W</p>
	2PS 963 639-081	1	<p>Consumption: 0.05A at 24V.</p> <p>With 5500/500 mm lead and 6.3 mm blade terminal contacts, without bracket, 24V1.3W</p>
	2PS 963 639-091 2PS 963 639-097	1 20	<p>with bracket, 24V1.3W</p>

	Part no.	Pk.	For horizontal surface mounting
        	<p>2PS 963 639-051 2PS 963 639-057</p> <p>2PS 963 639-031 2PS 963 639-037</p> <p>2PS 963 639-137 2PS 963 639-147</p> <p>2PS 963 639-177</p> <p>2PS 963 639-157</p> <p>9GD 341 063-007</p>	<p>1 20</p> <p>1 20</p> <p>1 1</p> <p>1</p> <p>1</p> <p>20</p>	<p>In LED-technology. Amber light. With 2 LEDs. Black base plate. Two 5.5 mm dia. holes for fixing screws. Consumption: 0.05A at 24V. See page 5.236, instruction 2.</p> <p>(E17) 9605</p> <p>Side-marker light with reflector, with 4500 mm lead and system plug, without bracket, 24V1.3W</p> <p>with bracket, 24V1.3W</p> <hr/> <p>Without bracket, with 5000 mm lead, 24V1.3W</p> <p>with 10000 mm lead, 24V1.3W</p> <hr/> <p>With 1500 mm lead and base, without bracket, 24V1.3W</p> <hr/> <p>With 1500 mm lead, plug and bracket, 24V1.3W</p> <p>Accessoires: Gasket</p>
     	<p>2PS 340 001-001</p> <p>2PS 340 001-011</p> <p>9XX 340 220-011</p>	<p>1</p> <p>1</p> <p>10</p>	<p>In LED-technology. Amber light. With 2 LEDs. Mounted on a holder. With transverse clip angle, front. Consumption: 0.05A at 24V. See page 5.236, instruction 2.</p> <p>(E17) 9605</p> <p>Side-marker light with reflector, 24V1.3W</p> <hr/> <p>Mounted on a universal holder, angled backwards.</p> <p>Side-marker light with reflector, 24V1.3W</p> <p>Accessoires: 2-pin connection set</p>

Signal Lights

for rear, front or side mounting



	Part no.	Pk.	
 	<p>2TM 003 748-011</p>	<p>4</p>	<p>For horizontal or vertical surface mounting</p> <p>For rear mounting. Red lens. Black rubber base and two ST4.2 x 32 x 18 fixing screws.</p> <p>(E1) 31410</p> <p>Rear light with reflector</p>
  	<p>2PG 003 748-151 *)</p> <p>9EL 148 274-001</p>	<p>4</p> <p>2</p>	<p>For horizontal surface mounting</p> <p>For front mounting. Clear lens. With black plastic base plate and insert gasket. Two ST4.2 x 16 fixing screws.</p> <p>(E1) 31410 (E1) 21682</p> <p>Side light with reflector</p> <p>Spare parts: Lens</p>
 	<p>2PS 003 748-121 2PS 003 748-127 *)</p>	<p>4</p> <p>80</p>	<p>For side mounting. Amber lens.</p> <p>(E1) 31410 (E1) 291</p> <p>Side-marker light with reflector</p>
  	<p>2PS 003 748-161 2PS 003 748-167 *)</p> <p>2PS 003 748-177 *)</p> <p>9EL 147 910-001</p>	<p>4</p> <p>60</p> <p>1</p> <p>2</p>	<p>With black plastic base, inserted gasket and reinforced plate, four PT4 x 16 fixing screws and rubber mount.</p> <p>(E1) 31410 (E1) 291</p> <p>Side-marker light with reflector, holder mounting surface points towards the front</p> <p>Holder rotated by 180°. Holder mounting surface points towards the back</p> <p>Spare parts: Lens for -121/-127/-161/-167/-177</p> <p> 1x12V4W (T4W) 8GP 002 067-121  1x24V4W (T4W) 8GP 002 067-241</p>



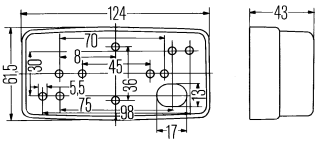






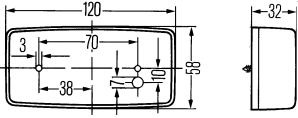

*) Type of protection: IP54K and IP59K.

		Part no.	Pk.	For horizontal or vertical surface mounting
		2PS 963 959-001 2PS 963 959-007	4 50	For side mounting. Amber lens. With 2 PG screw connections and 2 lens fixing screws are included separately in the package.
		2PS 963 959-011 2PS 963 959-017	4 40	Side-marker light with reflector, without rubber bracket
		9EL 963 982-001	2	With rubber bracket
		2PG 963 959-021 2PG 963 959-027	4 50	Spare parts: Lens with screws
		9EL 963 983-001	2	For front mounting. Clear lens. With 1 PG screw connection.
		2XS 963 959-031 2XS 963 959-037	4 50	Side light with reflector
		9EL 963 984-001	2	Spare parts: Lens with screws
		2XS 963 959-031 2XS 963 959-037	4 50	For rear mounting. Red lens. Without reflector. With 1 PG screw connection.
		9EL 963 984-001	2	(E17) 805
		2XS 963 959-031 2XS 963 959-037	4 50	Clearance light
		9EL 963 984-001	2	Spare parts: Lens with screws 1x12V4W (T4W) 8GP 002 067-121 1x24V4W (T4W) 8GP 002 067-241 1x24V4W (T4W) 8GP 002 067-261 (Heavy Duty)
		2PS 007 972-011 2PS 007 972-017	4 100	For horizontal flush mounting
		2PS 007 972-011 2PS 007 972-017	4 100	For side mounting. In LED-technology. Amber light. With 500 mm long lead and 4 LEDs. Consumption: 0.04A at 24V. See page 5.236, instruction 2.
		2PS 007 972-011 2PS 007 972-017	4 100	(E1) 508
		2PS 007 972-011 2PS 007 972-017	4 100	Side-marker light with reflector, 24V1.0W

Signal Lights

for rear, front or side mounting




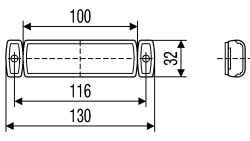















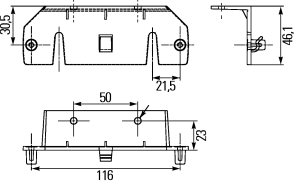

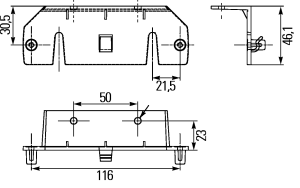
	Part no.	Pk.	For horizontal or vertical surface mounting
  	<p>2TM 004 361-021</p> <p>9EL 114 401-041</p>	<p>1</p> <p>1</p>	<p>Base plate with black edge. With grommet. Ten 5.5 mm dia. holes for fixing as required. When cable retention is used the base plate listed below is required.</p> <p>Approved for vehicles carrying hazardous goods when diagonal 98 hole interval is used.</p> <p>Ⓔ4 3152 Ⓔ4 466 Ⓔ4 467</p> <p>Rear light with reflector, red</p> <p>Spare parts: Lens with screws</p>
 	<p>2PG 004 361-011 2PG 004 361-017</p> <p>9EL 114 401-031</p>	<p>1</p> <p>70</p> <p>1</p>	<p>Ⓔ4 3152 Ⓔ4 468 Ⓔ4 469</p> <p>Side light with reflector, clear</p> <p>Spare parts: Lens with screws</p>
 	<p>2PS 004 361-001 2PS 004 361-007</p> <p>9EL 114 401-001</p> <p>9BP 128 032-017</p>	<p>1</p> <p>70</p> <p>1</p> <p>1</p>	<p>Ⓔ4 3152 Ⓔ4 0002 Ⓔ4 0003</p> <p>Side-marker light with reflector, amber</p> <p>Spare parts: Lens with screws</p> <p>Accessories: Base plate for cable retention</p> <p>⚡ 1x12V5W (R5W) 8GA 002 071-121 ⚡ 1x24V5W (R5W) 8GA 002 071-241</p>
   	<p>2PG 002 727-021</p> <p>9EL 114 400-015</p> <p>2PS 002 727-001 2PS 002 727-007</p> <p>9EL 114 401-001</p>	<p>5</p> <p>1</p> <p>5</p> <p>126</p> <p>1</p>	<p>Black base plate. Four 5.5 mm dia. holes for fixing screws.</p> <p>Ⓔ4 3152 Ⓔ4 468 Ⓔ4 469</p> <p>Side light with reflector, clear</p> <p>Spare parts: Lens with screws</p> <p>Ⓔ4 3152 Ⓔ4 0002 Ⓔ4 0003</p> <p>Side-marker light with reflector, amber</p> <p>Spare parts: Lens with screws</p> <p>⚡ 1x12V5W (C5W) 8GM 002 092-121 ⚡ 1x24V5W (C5W) 8GM 002 092-241</p>

		Part no.	Pk.	For horizontal or vertical surface mounting
				<p>For rear mounting. Red lens. Two fixing screws. With 24V bulb. Contacting via splice clamp connection.</p> <p>(E1) 2544</p>
		2XS 340 000-101	1	<p>Clearance light</p> <hr/> <p>For front mounting. Clear lens.</p> <p>(E1) 2439</p>
		2PF 340 000-111 2PG 340 000-121	1 1	<p>Side light without reflector with reflector</p> <hr/> <p>For side mounting. Amber lens.</p> <p>(E1) 439</p>
		2PS 340 000-001 2PS 340 000-171	1 1	<p>Side-marker light with reflector with 35 mm mounting bracket</p>
		9EL 340 002-011	1	<p>Spare parts: Lens</p> <hr/> <p>For horizontal mounting</p> <p>For side mounting.</p>
		2PS 340 000-011	1	<p>Side-marker light with reflector, with transverse clip angle, front</p>
		9EL 340 002-011	1	<p>Spare parts: Lens</p> <hr/> <p>Side-marker light with reflector, with longitudinal clip angle, rear</p>
		2PS 340 000-021 2PS 340 000-051	1 1	<p>with PC lens</p>
		9EL 340 002-011	1	<p>Spare parts: Lens for -021</p> <hr/> <p>2PS 340 000-041</p>
		2PS 340 000-061	1	<p>Holder mounting surface points towards the back</p>
		2PS 340 000-061	1	<p>with PC lens</p>
		9EL 340 002-011	1	<p>Spare parts: Lens for -031/-041</p>
				<p> 1x24V5W (C5W) 8GM 002 092-241</p>








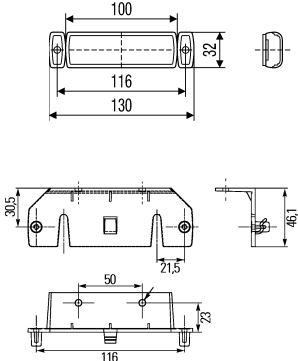
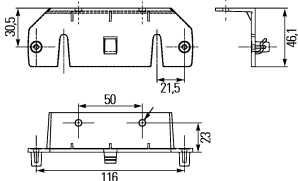

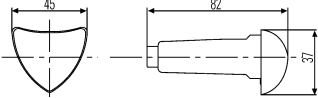

Signal Lights

for rear, front or side mounting



	Part no.	Pk.	For horizontal or vertical surface mounting
  	2TM 008 645-081 2TM 008 645-087	1 30	When attached horizontally, the optical field must point toward the outside of the vehicle. In LED-technology. With 3 LEDs. Red light. Black housing. Two holes for B4.2 fixing screws. Consumption: 0.05A at 12V/24V. See page 5.236, instruction 2. (E1) 1395 (E1) 1398 Rear light with reflector, *) with 500 mm lead, 12V0.6W
	2TM 008 645-091	1	with 5000 mm lead, 12V0.6W
	2TM 008 645-061 2TM 008 645-067	1 50	with 500 mm lead, 24V1.2W
	2TM 008 645-071 2TM 008 645-077	1 50	with 5000 mm lead, 24V1.2W
 	2TM 008 645-651	1	With 1 LED. Red light. with 300 mm lead and quick-contact incl. clamping piece for contacting a two-core flat lead, 24V1.2W
	2TM 008 645-661	1	with 5000 mm lead and quick-contact incl. clamping piece for contacting a two-core flat lead, 24V1.2W
 	2PG 008 645-041 2PG 008 645-047	1 50	With 3 LEDs. White light. Black housing. Consumption: 0.04A at 24V. Side light with reflector, and 500 mm lead, 24V0.9W
	2PG 008 645-051 2PG 008 645-057	1 40	with 5000 mm lead, 24V0.9W
	2PG 008 645-167	40	with white housing and 5000 mm lead, 24V0.9W
 	2PG 008 645-631	1	With 1 LED. White light. Consumption: 0.054A at 24V. with 300 mm lead and quick-contact incl. clamping piece for contacting a two-core flat lead, 24V1.2W
	2PG 008 645-641	1	with 5000 mm lead and quick-contact incl. clamping piece for contacting a two-core flat lead, 24V1.2W
  	2PS 008 645-031 2PS 008 645-021	1 1	For vertical surface mounting With 1 LED. Amber light. Black housing. Consumption: 0.04A at 12V/24V. (E1) 1397 Side-marker light with reflector, with 1500 mm lead, 12V0.5W with 1500 mm lead, 24V1.0W
	9GD 157 876-007 8PE 008 932-001 8HG 340 489-001 8HG 340 413-001 8KW 998 602-002 8HG 160 409-002	1 1 1 10 1 10	Accessories: Gasket Mounting pliers for quick-link cable attachment Holder, angled back Clip angle, rear Mounting pliers for quick-link lead attachment Holder with 2 fixing screws

*) Also usable as clearance light with reflector


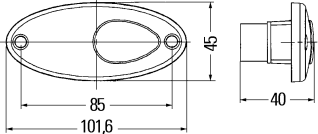


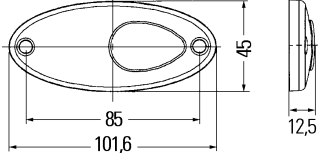


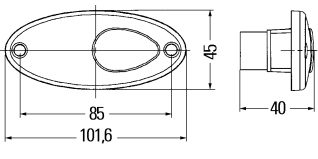

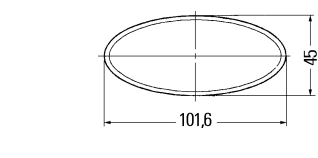


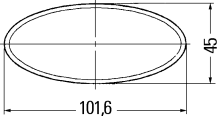
	Part no.	Pk.	For horizontal surface mounting
			<p>When attached horizontally, the optical field must point toward the outside of the vehicle.</p> <p>In LED-technology. With 1 LED. Amber light. Black housing. Two holes for B4.2 fixing screws. Consumption: 0.04A at 12V/24V. See page 5.236, instruction 2.</p>
	<p>2PS 008 645-011</p>	1	<p>Side-marker light with reflector, with 1500 mm lead, 12V0.5W</p>
	<p>2PS 008 645-001 2PS 008 645-007</p>	1 50	<p>with 1500 mm lead, 24V1.0W</p>
	<p>2PS 008 645-187 2PS 008 645-497</p>	50 50	<p>with 5000 mm lead, 24V1.0W with 10000 mm lead, 24V1.0W</p>
	<p>2PS 008 645-601 2PS 008 645-607</p>	1 50	<p>with 150 mm lead and quick-contact incl. clamping piece for contacting a two-core flat lead, 24V1.0W</p>
	<p>2PS 008 645-611 2PS 008 645-617</p>	1 50	<p>with 300 mm lead and quick-contact incl. clamping piece for contacting a two-core flat lead, 24V1.0W</p>
	<p>2PS 008 645-621 2PS 008 645-627</p>	1 50	<p>with 1300 mm lead and quick-contact incl. clamping piece for contacting a two-core flat lead, 24V1.0W</p>
	<p>9GD 157 876-007 8PE 008 932-001 8HG 340 489-001 8HG 340 413-001 8KW 998 602-002</p>	1 1 1 10 1	<p>Accessories: Gasket Mounting pliers for quick-link cable attachment Holder, angled back Clip angle, rear Mounting pliers for quick-link lead attachment</p>
	<p>8HG 160 409-002</p>	10	<p>Holder with two fixing screws</p>
 	<p>2PS 008 541-801</p>	1	<p>Side-marker light set for retrofitting passenger cars. For flush mounting installation in front or rear plastic bumpers.</p> <p>Set comprises: 4 side-marker lights with clear lens, 4 yellow bulbs 12V5W, leads and installation material.</p> <p>(E1) 1223</p> <p>Side-marker light set</p> <p> 4x12V5W (WY5W) 8GP 003 594-541</p>

Signal Lights

for front, side or rear mounting



		Part no.	Pk.	Bulb versions for horizontal flush mounting. LED versions for horizontal surface mounting
		2PS 964 295-001 2PS 964 295-007	1 50	For side mounting. Amber lens. With gasket.
				(E17) 9807
				Side-marker light with reflector and 12V bulb
				1x12V5W (W5W) 8GP 003 594-121
				For side mounting. In LED-technology. Amber lens. With 2 LEDs. Consumption: 0.04A at 12V/24V. See page 5.236, instruction 2.
				(E17) 0202
		2PS 964 295-061 2PS 964 295-067	1 80	Side-marker light with reflector, with two 500 mm leads, gasket and screw fixing, 12V0.5W
		2PS 964 295-051 2PS 964 295-057	1 80	24V1.0W
				without gasket, self-adhesive, with covers for fixing holes, 12V0.5W
		2PS 964 295-081 2PS 964 295-087	1 80	
		2PS 964 295-071 2PS 964 295-077	1 80	24V1.0W
	LED versions			
				For front mounting. Clear lens.
				(E17) 9806
		2PG 964 295-011 2PG 964 295-017 2PG 964 295-012	1 50 1	Side light with reflector and 12V bulb
				Pro-fit-pack
		9GT 343 367-002	30	Accessories: Grommet (except LED versions)
				1x12V5W (W5W) 8GP 003 594-121
				For front mounting. In LED-technology. Clear lens. With screw fixing and 2 LEDs. Consumption: 0.03A at 12V/24V.
				(E17) 0301
		2PG 964 295-121 2PG 964 295-127	1 20	Side light with reflector, gasket and 5000 mm lead, 12V0.3W
		2PG 964 295-111 2PG 964 295-117	1 20	24V0.6W
				For front mounting. In LED-technology. Clear lens. With loose angular bracket (RAL 9010) for mounting to surfaces with an inclination of 20° and 2 LEDs. Consumption: 0.03A at 12V. See page 5.236, instruction 2.
				(E17) 817
		2PF 964 295-257	20	Side light without reflector, with 100 mm PVC lead and 2.8 mm blade terminal contacts with insulating sleeve, 12V0.3W

 	Part no.	Pk.	Bulb versions for horizontal flush mounting. LED versions for horizontal surface mounting
	2PF 964 295-021 2PF 964 295-027	1 50	<p>For front mounting. Clear lens.</p> <p>(E17) 811</p> <p>Side light without reflector, with 12V bulb</p>
  <p>LED versions</p>	2XS 964 295-031 2XS 964 295-037	1 50	<p>For rear mounting. Red lens.</p> <p>(E17) 812</p> <p>Clearance light with 12V bulb</p> <p> 1x12V5W (W5W) 8GP 003 594-121</p>
 	2TM 964 295-101 2TM 964 295-107 2TM 964 295-091 2TM 964 295-097	1 20 1 20	<p>For rear mounting. In LED-technology. Red lens. With 2 LEDs. Consumption: 0.04A at 12V/24V. See page 5.236, instruction 2.</p> <p>(E17) 0302</p> <p>Rear light with reflector, gasket and 5000 mm lead, 12V0.5W</p> <p>24V1.0W</p>
 	2BM 964 295-041 2BM 964 295-047 9GT 343 367-002	1 50 30	<p>For side mounting. Amber lens. With gasket.</p> <p>(E17) 651</p> <p>Auxiliary indicator with 12V bulb</p> <p>Accessories: Grommet (except LED versions)</p> <p> 1x12V5W (W5W) 8GP 003 594-121</p>
 	8RA 343 160-002 8RA 343 160-007 8RA 343 160-012 8RA 343 160-017 8RA 343 160-022 8RA 343 160-027	20 150 20 150 20 150	<p>Reflector for horizontal or vertical surface mounting</p> <p>Self-adhesive. For lights in model range 964 295-...</p> <p>(E4) 3190</p> <p>Reflector, red</p> <p>white</p> <p>amber</p>

Signal Lights

for side mounting





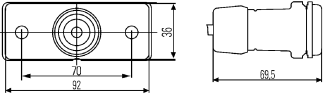


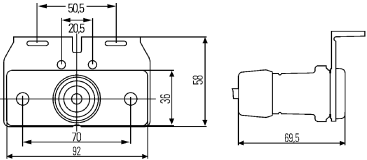


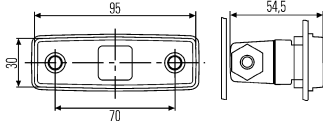
			Part no.	Pk.	For horizontal surface mounting
			2PS 007 943-311 2PS 007 943-317	1 105	In LED-technology. Amber light. With 3 LEDs. Grey base plate. With 500 mm lead with stripped cable ends. Two 4.5 mm dia. holes for fixing screws. Consumption: 0.06A at 12V/24V. See page 5.236, instruction 2. (E4) 9417
			2PS 007 943-011 2PS 007 943-017	8 105	Side-marker light with reflector, without bracket, 12V0.7W 24V1.4W
			2PS 007 943-321	10	With bracket, 12V0.7W
			2PS 007 943-021	10	24V1.4W
			2PS 007 943-027	124	
			2PS 009 226-017	300	For horizontal or vertical surface mounting
			2PS 009 226-027	300	In LED-technology. Amber light. With 2 LEDs and 195 mm lead. Black body. Self-adhesive. Consumption: 0.06A at 12V/24V. See page 5.236, instruction 2. (E4) 10236
			2PS 009 226-037	300	Side-marker light with reflector and AMP plug connector, 24V1.0W without AMP plug connector, 12V0.5W without AMP plug connector, 24V1.0W
			2PS 008 138-801	1	For flush mounting in front or rear plastic bumpers
			2PS 008 138-811	1	In LED-technology. Amber light, for retrofitting passengers cars < 6 m. Consumption: 0.06A at 12V. See page 5.236, instruction 2. Set comprises: 4 side-marker lights, each with 3 LEDs and installation material. (E4) 9110
			2PS 008 138-821	1	Side-marker light set, 12V0.7W, with amber lens, silver grey shields with light grey lens, black shields with light grey lens, silver grey shields
			2PS 008 138-001	1	Spare parts: Side-maker light for -801
			2PS 008 138-101	1	for -811
			2PS 008 138-111	1	for -821
			2PS 008 050-007	1	For flush mounting in rear spoiler
			2PS 008 050-027	1	In LED-technology. Amber light. With 3 LEDs. Consumption: 0.06A at 12V. See page 5.236, instruction 2. (E4) 9109
					Side-marker light set, 12V0.7W, with amber lens, black shields with light grey lens, silver grey shields


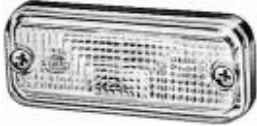

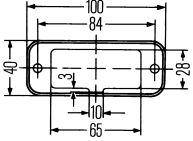

Image	Part no.	Pk.	Description
			<p>For surface mounting</p> <p>In LED-technology. With 2 LEDs. Amber light. Mounted on a bracket. With traverse clip angle. Contacting via splice clamp connection. Consumption: 0.06A at 12V/24V. See page 5.236, instruction 2.</p>
	<p>2PS 008 643-011 2PS 008 643-017</p>	<p>1 30</p>	<p>(E1) 1429</p> <p>Side-marker light with reflector, 24V1.4W</p>
	<p>2PS 008 643-021 2PS 008 643-027</p>	<p>1 30</p>	<p>With longitudinal clip angle, 24V1.4W</p>
	<p>2PS 008 643-031 2PS 008 643-037</p>	<p>1 30</p>	<p>Mounted on a universal holder, angled backwards, 24V1.4W</p>
	<p>2PS 008 643-331</p>	<p>1</p>	<p>12V0.7W</p>
	<p>8KL 340 050-001</p>	<p>1</p>	<p>Accessoires : Flat lead, 100 m drum</p>
			<p>For horizontal surface mounting</p> <p>In LED-technology. With 2 LEDs. Amber light. With plug-type connection. It is possible to request completely pre-wired chains with a variable number/spacing of side-marker lights with side lamp. Faulty lights are easy to replace thanks to the plug-type connection. Consumption: 0.04A at 24V. See page 5.236, instruction 2.</p>
	<p>2PS 008 616-011 2PS 008 616-017</p>	<p>1 24</p>	<p>(E1) 1410</p> <p>Side-marker light with reflector, with bracket, angled backwards, 24V1.0W</p>
	<p>2PS 008 616-001</p>	<p>1</p>	<p>Replacement light without bracket, 24V1.0W</p>
	<p>8JA 008 658-011 8JA 008 658-017</p>	<p>2 24</p>	<p>Accessories: Plug, 2-hole (for parthing through cables)</p>

Signal Lights

for rear or side mounting



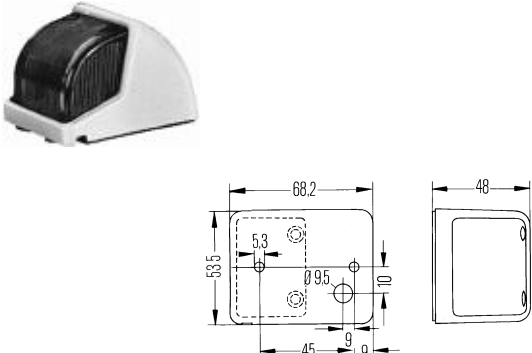

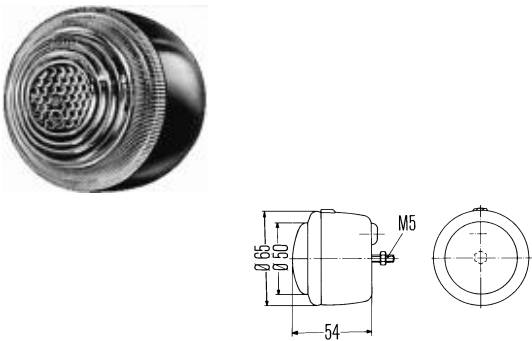

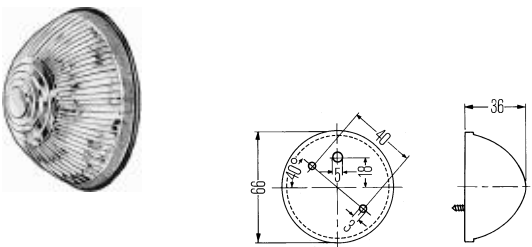
	Part no.	Pk.	For flush mounting
  	<p>2PS 008 382-001 2PS 008 382-007</p>	<p>1 60</p>	<p>In LED-technology. With 4 LEDs. Amber lens, without reflector. Consumption: 0.04A at 24V. See page 5.236, instruction 2.</p> <p>(E4) 3169</p> <p>Side-marker light without bracket, 24V1.0W (in combination with reflector 9EL 154 637-001)</p> <hr/> <p>Set comprises: Side-marker lights without reflector, with separate reflector.</p> <p>Side-marker light set without bracket, 24V1.0W</p>
  	<p>2PS 008 382-811 2PS 008 382-817</p> <p>2PS 008 382-007 9EL 154 637-001</p>	<p>1 72</p> <p>60 1</p>	<p>For surface mounting</p> <p>With bracket, angled forwards, 24V1.0W</p> <p>Spare parts: Side-marker light without reflector Reflector</p>
  	<p>2PG 008 434-001</p>	<p>2</p>	<p>For flush mounting</p> <p>Clear lens, with reflector. Contacting via 2.8 mm blade terminals. Two 5 mm dia. holes for fixing screws. With 24V bulb.</p> <p>(E17) 0001</p> <p>Side light</p> <p>1x24V4W (T4W) 8GP 002 067-241</p>


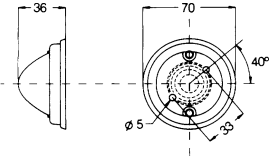


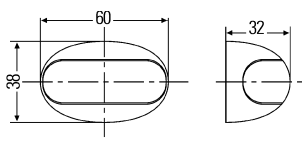



	Part no.	Pk.	For horizontal flush mounting
	2SA 961 167-011	2	<p>Red lens. Black rubber body. Two holes for B4.2 x 19 fixing screws.</p> <p>(E1) 31468</p> <p>Rear light for installation positions 0° - 4°</p>
	2PF 961 167-021	2	<p>Clear lens.</p> <p>(E1) 31446</p> <p>Side light for installation positions 60° - 67°</p>
 	9EL 137 241-001	4	<p>Spare parts: Lens with contact springs</p> <p> 1x12V5W (C5W) 8GM 002 092-121 1x24V5W (C5W) 8GM 002 092-241</p> <hr/> <p>In LED-technology. With 2 white Power LEDs 0.5W. Clear lens. 2 holes in the lens for attachment of the light using 2 PT screws 5 x 25 Torx and 2 washers Ø 4.2 mm (not part of the scope of supply). Tightening torque max. 2 Nm. Consumption: 0.02A at 24V. See page 5.236, instruction 2.</p> <p>(E1) 2300</p> <p>Side light for installation positions 10° - 20°</p> <p>Side light for installation positions 20° - 30°</p>

Signal Lights

for rear or front mounting





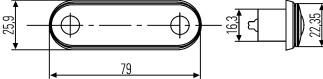


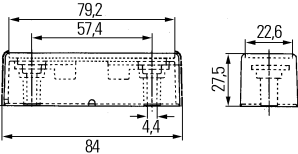




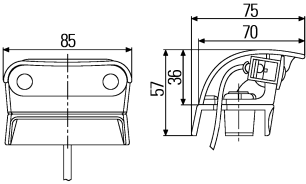
	Part no.	Pk.	For surface mounting
	<p>2SA 006 679-027</p>	<p>1</p>	<p>For roof mounting. Red lens. Grey plastic body. Roof inclination (0° - 90°) can be compensated. With rubber base. Two 5.3 mm dia. holes for fixing screw.</p> <p>(E1) 31470</p> <p>Rear light</p> <hr/> <p>Clear lens.</p> <p>(E1) 21691</p>
	<p>2PF 006 679-007</p>	<p>20</p>	<p>Side light</p> <p>1x12V10W (R10W) 8GA 002 071-131 1x24V10W (R10W) 8GA 002 071-251</p>
	<p>2SA 001 634-121</p> <p>9EL 132 404-001</p>	<p>2</p> <p>2</p>	<p>Red lens. Black housing. Central M5 fixing screw.</p> <p>(E1) 31416</p> <p>Rear light</p> <p>Spare parts: Lens with screw</p> <hr/> <p>Clear lens.</p> <p>(E1) 11786</p>
	<p>2PF 001 634-101</p> <p>9EL 132 403-001</p>	<p>2</p> <p>2</p>	<p>Side light</p> <p>Spare parts: Lens with screws</p> <p>1x12V5W (C5W) 8GM 002 092-121 1x24V5W (C5W) 8GM 002 092-241</p>
	<p>2PF 001 650-001</p> <p>9EL 084 110-001</p>	<p>2</p> <p>5</p>	<p>Clear lens. Two holes for B3.9 x 9.5 fixing screws.</p> <p>(E1) 11761</p> <p>Side light</p> <p>Spare parts: Lens</p> <p>1x12V5W (C5W) 8GM 002 092-121 1x24V5W (C5W) 8GM 002 092-241</p>


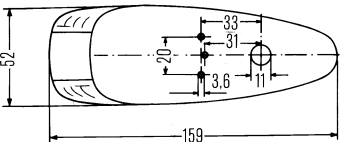

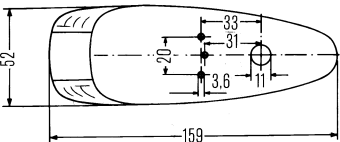



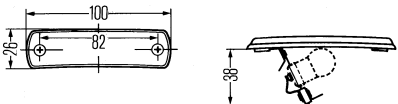



	Part no.	Pk.	For surface mounting
 	<p>2SA 997 022-001</p> <p>2SA 997 023-001</p> <p>2PF 997 022-011</p> <p>2PF 997 023-011</p>	<p>1</p> <p>1</p> <p>1</p> <p>1</p>	<p>Red lens. Steel base plate with soft plastic backing. Lens fastened with chrome-plated rim. Two holes for M4 fixing screws. Screw-contact.</p> <p>(E12) 7039</p> <p>Rear light with chrome-plated rim</p> <p>without chrome-plated rim</p> <hr/> <p>Side light with clear lens and chrome-plated rim</p> <p>with clear lens, without chrome-plated rim</p> <p> 1x12V5W (C5W) 8GM 002 092-121 1x24V5W (C5W) 8GM 002 092-241</p>
  	<p>2XA 959 560-401</p> <p>2XA 959 560-407</p> <p>2XA 959 560-411</p> <p>2XA 959 560-417</p>	<p>2</p> <p>16</p> <p>2</p> <p>10</p>	<p>In LED-technology. With 2 LEDs 0.5W. Red light, clear lens. Inner lens red. Black housing. Voltage range: 8V - 28V. Consumption: 0.04A at 12V, 0.02A at 24V. See page 5.236, instruction 2.</p> <p>(E4) 7574</p> <p>Clearance light with 500 mm lead</p> <p>with 5000 mm lead</p>
 	<p>2PF 959 570-401</p> <p>2PF 959 570-407</p> <p>2PF 959 570-411</p> <p>2PF 959 570-417</p> <p>2PF 959 570-427</p> <p>8HG 959 571-007</p>	<p>2</p> <p>16</p> <p>2</p> <p>10</p> <p>16</p> <p>80</p>	<p>White light, clear lens. Black housing. Voltage range: 10V - 33V. Consumption: 0.04A at 12V, 0.02A at 24V. See page 5.236, instruction 2.</p> <p>(E4) 7575</p> <p>Side light with 500 mm lead</p> <p>with 5000 mm lead</p> <p>with white housing and 500 mm lead</p> <p>Accessories: White bracket, for -427 for mounting on surfaces with 25° inclination</p>

Signal Lights

for front or side mounting



	Part no.	Pk.	For horizontal or vertical flush mounting
  	<p>2XA 959 790-401 2XA 959 790-407</p> <p>2XA 959 790-411</p>	<p>2 30</p> <p>2</p>	<p>In LED-technology. Red light, clear lens. With 2 red LEDs 0.5W and gasket. Voltage range: 8V - 28V. Consumption: 0.04A at 12V, 0.02A at 24V. See page 5.236, instruction 2.</p> <p>(E4) 7597</p> <p>Signal light for optional use as rear light or clearance light, with 500 mm lead and caps</p> <hr/> <p>with 5000 mm lead and caps</p> <hr/> <p>White light, clear lens. With 2 white LEDs 0.5W and gasket. Voltage range: 10V - 33V. Consumption: 0.04A at 12V, 0.02A at 24V. See page 5.236, instruction 2.</p>
  	<p>2PF 959 590-401 2PF 959 590-407</p> <p>2PF 959 590-411 2PF 959 590-417</p> <p>2PF 959 590-437</p> <p>2PF 959 590-457</p> <p>9XD 160 867-007</p>	<p>2 30</p> <p>2 10</p> <p>48</p> <p>30</p> <p>16</p>	<p>Side light with 500 mm lead and caps</p> <p>with 5000 mm lead and caps</p> <p>with 8000 mm lead and caps</p> <p>with 100 mm lead, caps, 2-pole AMP plug and two 6.3 mm blade terminal contacts</p> <p>Accessories: Bracket (adapter) for mounting the lights</p> <hr/> <p>For surface mounting</p> <p>In LED-technology, clear lens. With 2 white LEDs 0.5W. Black plastic body. With 2500 mm lead, bracket for mounting the light to the body, cover, fixing screws and caps for screws. Voltage range: 10V - 33V. Consumption: 0.04A at 12V, 0.02A at 24V. See page 5.236, instruction 2.</p> <p>(E4) 4068</p>
 	<p>2KA 959 640-102</p>	<p>3</p>	<p>Licence plate for mounting above 520 x 120 mm licence plates (3 lights)</p> <hr/> <p>With a spacer for various mounting situations.</p>
  	<p>2KA 959 640-607</p>	<p>8</p>	<p>For mounting to the left and right of 520 x 120 mm licence plates</p>

	Part no.	Pk.	For surface mounting
 	2SA 001 638-021	2	Red lens. Chrome-type body. Two B4.8 x 19 fixing screws. Rubber base 9GD 082 716-001 (Pk. 10) for flat surface and rubber base. 9GD 100 140-001 (Pk. 10) for curved surfaces (to be ordered separately). (E1) 31450
 	2PF 001 638-011	2	Rear light Spare parts: Lens with screw  1x12V5W (W5W) 8GP 003 594-121  1x24V5W (W5W) 8GP 003 594-251 <hr/> Clear lens. Chrome-type body. (E1) 11779
  	2SA 001 647-041	1	Red lens. Two holes for B4.2 x 16 fixing screws. K 11580 *) Rear light
	2PF 001 647-031 2PF 001 647-037	4 80	<hr/> Clear lens. (E1) 21693 Side light  1x12V10W (R10W) 8GA 002 071-121  1x24V10W (R10W) 8GA 002 071-251

*) National type test for Germany

Signal Lights

for front or rear mounting




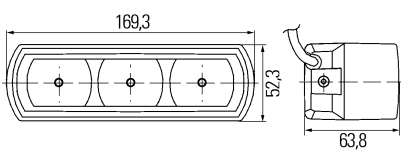


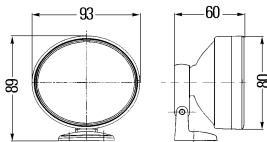

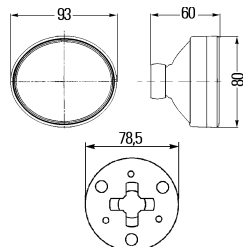
		Part no.	Pk.	<p>For flush mounting</p> <p>Clear lens.</p> <p>Ⓔ1 584</p> <p>2PF 003 563-151 10 Side light with 800 mm long earth lead and 1800 mm long positive lead</p> <hr/> <p>With plastic nut M20 x 1.5 and 6.3 mm blade terminal contact. The light is fastened by rear screwing of the plastic nut.</p> <p>Without lead, with 12V bulb</p> <p>2PF 003 563-177 100</p> <p>Without lead, with 24V bulb</p> <p>2PF 003 563-187 100</p> <p> 1x12V5W (W5W) 8GP 003 594-121 1x24V5W (W5W) 8GP 003 594-251 </p>
		Part no.	Pk.	<p>For flush mounting in trailer</p> <p>Milky-white lens, With rubber housing and preinstalled wiring harness.</p> <p>Ⓔ4 453</p> <p>2PF 007 205-007 10 Side light</p> <p>2PF 007 205-001 1 Pro-fit pack</p> <p>Spare parts: Lead with bulb holder</p> <p>8KA 950 073-001 10</p> <hr/> <p>2PF 007 205-017 1 With green lens.</p> <p>Trucks and trailers equipped with ABS which do not yet have plug connectors to ISO 3731 (24S), ISO 7638 or ISO 1185 (24N) are required to equip the trailer with a green side light mounted in the field of vision of the outside rear view mirror on the driver's side for indicating the function of the ABS.</p> <p> 1x12V5W (R5W) 8GA 002 071-121 1x24V5W (R5W) 8GA 002 071-241 </p>
		Part no.	Pk.	<p>For surface mounting</p> <p>Clear lens. Black plastic body. M10 hollow fixing bolt and cable entry.</p> <p>Ⓔ1 11794</p> <p>2PF 001 648-161 4 Side light</p> <p>Spare parts: Lens with screws</p> <p>9EL 108 435-001 5</p> <hr/> <p>2PF 001 648-171 4 With chrome-plated rim.</p> <p> 1x12V5W (R5W) 8GA 002 071-121 1x24V5W (R5W) 8GA 002 071-241 </p>


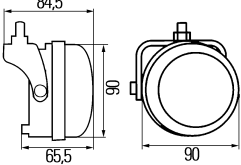
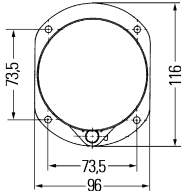

	<p>Part no.</p> 2PT 008 362-801	<p>Pk.</p> 1	<p>For surface mounting</p> <p>Clear lens. Black plastic body. With M6 x 20 fixing screw.</p> <p>(E1) 1032</p> <p>Contents: 2 lights incl. wiring harness, bulbs and universal bracket for mounting on front bumper.</p> <p>Daytime running light set</p> <p> 1x12V6W (H6W) 8GH 007 643-121</p>
	<p>2PT 010 047-821</p> 2PT 010 047-211	<p>1</p> 1	<p>Clear lens. Housing made of diecast aluminium. With universal hoop bracket for mounting to the vehicle front.</p> <p>(E1) 2578</p> <p>Contents: 2 lights with wiring harness and 12V bulb</p> <hr/> <p>Daytime running light set, 12V</p> <hr/> <p>Daytime running light, with 12V bulb</p> <p>Identical headlights see page 4.21</p>
	<p>2PT 010 047-201</p>	<p>1</p>	<p>For flush mounting Mounting by means of carrier frame in the front apron</p> <p>Daytime running light, 12V</p> <p>Identical headlights see page 4.21</p> <p> 1x12V21W (P21W) 8GA 002 073-121</p>
	<p>2PT 010 043-801</p> 2PT 010 043-011 2PT 010 043-021 2PT 010 043-031 2PT 010 043-041 8JA 746 184-032 8KW 744 837-002 9GD 746 185-002	<p>1</p> 1 1 1 1 1 50 50	<p>For flush mounting</p> <p>LEDayLine</p> <p>In LED-technology. Clear lens. With side light and 5 white LEDs 8W. Black plastic body. Mounting by means of carrier frame in the front apron With AMP Superseal connector. Consumption: 0.67A at 12V, 0.33A at 24V. See page 5.236, instruction 2.</p> <p>(E1) 2578</p> <p>Contents: 2 lights 2PT 010 043-011/-021 with wiring harness</p> <hr/> <p>Daytime running light set, 12V</p> <hr/> <p>Daytime running light, 12V, left</p> right <hr/> <p>Daytime running light, 24V, left</p> right <p>Accessories:</p> <p>AMP Superseal bush housing, 3-pole</p> <p>Bush contact for lead 1.0-1.5 sq. mm</p> <p>Single conductor seal 1.8-2.4 mm dia.</p>

Signal Lights

for front mounting



	Part no.	Pk.	For flush mounting
 	<p>2PT 009 496-801</p>	<p>1</p>	<p>In LED-technology. Clear lens. With 3 white LEDs. Housing made of silver-coloured aluminium. Mounting by means of bracket on or in the front apron. For upright or pendant mounting. Voltage range: 9V - 33V. Consumption: 0.36A at 12V/24V. Power consumption: 12V < 5.5W, 24V < 11.0W. See page 5.236, instruction 2.</p> <p>Ⓔ1 2344</p> <p>Contents: 2 lights without side light, with three LEDs, 200 mm long wiring harness with Supersealed plug connector and brackets</p> <p>Daytime running light set</p>
	<p>2PT 009 496-007</p>	<p>54</p>	<p>Daytime running light without bracket, with side light and 500 mm long wiring harness with Superseal plug connector</p> <p>Accessories: 10 AMP Superseal bush housing, 3-pole 50 Bush contact for lead 1.0-1.5 sq. mm 50 Single conductor seal 1.8-2.4 mm dia.</p>
   	<p>2PT 008 935-801</p> <p>2PT 008 935-811</p> <p>2PT 008 935-001 4RA 940 010-671</p> <p>2PT 008 935-011 2PT 008 935-017</p>	<p>1</p> <p>1</p> <p>1</p> <p>1</p> <p>1</p> <p>30</p>	<p>For flush or surface mounting</p> <p>Clear lens, without optical pattern.</p> <p>Ⓔ1 1722</p> <p>Contents: 2 lights with 12V/16W bulbs, 2 brackets with connecting leads, accessories and installation material.</p> <p>Daytime running light set, 12V for flush or surface mounting</p> <p>with voltage reducer for 24V</p> <p>Spare parts: Light unit contains: reflector with bulb, connecting lead with plug Relay, 12V</p> <p>Daytime running light with bracket, lead with plug and 12V/16W bulb, for flush mounting</p>


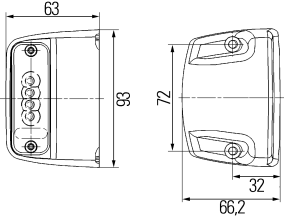

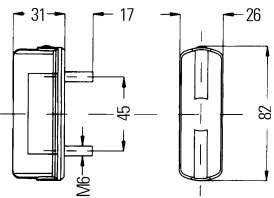


	Part no.	Pk.	For flush mounting
			<p>In LED-technology. Clear lens. With three LEDs. Black aluminium housing. Attachment by means of carrier frame in front aprons (see accessories for carrier frames). 500 mm connection lead with 3-pin waterproof plug. Voltage range: 9V - 33V. Consumption: 0,36A at 12V / 24V. Power consumption: 12V < 5 W, 24V < 11 W.</p> <p>See page 5.236, instruction 2.</p>
	<p>2PT 009 599-011</p> <p>2PT 009 599-021</p>	<p>1</p> <p>1</p>	<p>Daytime running light, left</p> <p>right</p>
	<p>2PT 009 599-031</p> <p>2PT 009 599-041</p>	<p>1</p> <p>1</p>	<p>With side light, left</p> <p>right</p>
	<p>8HG 165 967-001</p> <p>9AH 165 968-001</p>	<p>1</p> <p>1</p>	<p>Accessories: Bracket</p> <p>Supporting frame</p>
	<p>2PT 009 599-801</p> <p>8JA 746 184-032</p> <p>8KW 744 837-002</p> <p>9GD 746 185-002</p>	<p>1</p> <p>10</p> <p>50</p> <p>50</p>	<p>For pendant flush or surface mounting</p> <p>Mounting by means of bracket on or in the front apron.</p> <p>Contents: 2 lights with three LEDs, pre-assembled lead set and mounting instructions</p> <p>Daytime running light set, 90 mm</p> <p>Accessories for all versions: AMP Superseal bush housing, 3-pole Bush contact for lead 1.0-1.5 sq. mm Single conductor seal 1.8-2.4 mm dia.</p>

Signal Lights

for rear mounting




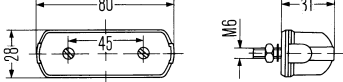

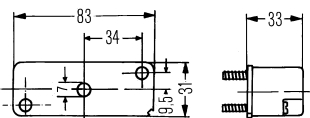

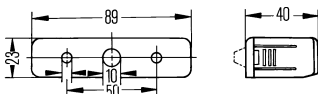

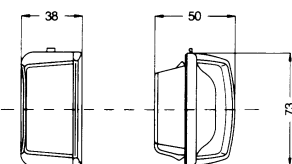
		<p>Part no.</p> <p>2KA 001 378-001</p> <p>2KA 001 378-041</p> <p>2KA 001 378-127</p>	<p>Pk.</p> <p>4</p> <p>4</p> <p>1</p>	<p>Licence plate lights</p> <p>Clear lens. For flush mounting above or below 520 x 120 mm (2 or 3 lights) and 340 x 240 mm (2 lights) licence plates. Two M4 fixing screws. Depth required for flush fitting: 25 mm.</p> <p>(E1) 12958</p> <p>Licence plate light with chrome-type rim</p> <p>with silver-coloured finish, without fixing screw</p> <p>with black edge and 12V bulb, without fixing screw</p> <p> 1x12V5W (C5W) 8GM 002 092-121 1x24V5W (C5W) 8GM 002 092-241</p>
		<p>2KA 005 049-008</p> <p>2KA 005 049-011</p> <p>2KA 005 049-017</p>	<p>18</p> <p>2</p> <p>42</p>	<p>Clear lens. For flush mounting above (2 lights) of 520 x 120 mm licence plates. Black plastic body. Depth required for flush fitting: 25 mm.</p> <p>(E1) 22871</p> <p>Licence plate light with 12V bulb and two fixing screws B4.2 x 16</p> <p>with 24V bulb, without fixing screws</p> <p> 1x12V5W (C5W) 8GM 002 092-121 1x24V5W (C5W) 8GM 002 092-241</p>
		<p>2KA 004 331-061</p> <p>2KA 004 331-067</p>	<p>5</p> <p>100</p>	<p>Clear lens. For flush mounting above or below (2 lights) 520 x 120 mm licence plates. Two holes for fixing screws. Depth required for flush fitting: 20 mm. With 12V bulb.</p> <p>(E1) 22848</p> <p>Licence plate light</p> <p> 1x12V5W (C5W) 8GM 002 092-121</p>
		<p>2KA 010 278-311</p> <p>2KA 010 278-317</p> <p>2KA 010 278-011</p> <p>2KA 010 278-017</p>	<p>1</p> <p>196</p> <p>1</p> <p>196</p>	<p>In LED-technology. Clear lens. With 4 LEDs 1.0W. For flush mounting above or below (2 lights) 520 x 120 mm licence plates. With black plastic rim. Two dia. holes for St3.9 fixing screws. With blade terminal contact 6.3 x 0.8 mm. Consumption: 0.08A at 12V, 0.04A at 24V. See page 5.236, instruction 2.</p> <p>(E1) 2609</p> <p>Licence plate light, 12V</p> <p>24V</p>


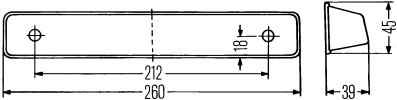


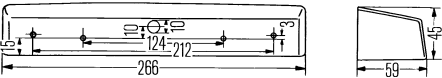



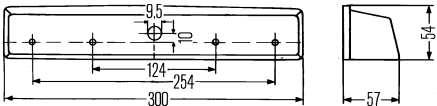

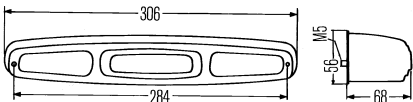


	Part no.	Pk.	Licence plate lights
 	<p>2KA 010 278-321</p> <p>2KA 010 278-021</p> <hr/> <p>2KA 010 278-031</p> <p>2KA 010 278-041</p> <p>2KA 010 278-051</p>	<p>1</p> <p>1</p> <hr/> <p>1</p> <p>1</p> <p>1</p>	<p>In LED-technology. Clear lens. With 4 LEDs 1.0W. For surface mounting to left or right of 520 x 120 mm licence plates (1 light). Black plastic body. 2 fixing screws M5 x 35. Consumption: 0.08A at 12V, 0.04A at 24V.</p> <p>Ⓔ1 2609</p> <p>Licence plate light, 12V</p> <p>24V</p> <hr/> <p>With two-core 2000 mm long lead with blade receptacles 6.3 mm, 24V</p> <p>With two-core 2000 mm long lead with Quick-Link lead attachment, 24V</p> <p>With two-core 2000 mm long lead with 2-pin EasyConn central plug, 24V</p>
 	<p>2KA 997 011-011</p> <p>2KA 997 011-001</p> <hr/> <p>2KA 997 011-021</p>	<p>1</p> <p>1</p> <hr/> <p>1</p>	<p>Clear lens. For surface mounting. Two M6 fixing screws. With screw-contact.</p> <p>Ⓔ2 4004</p> <p>Licence plate light with chrome-type steel body</p> <p>with black steel body</p> <hr/> <p>With blade terminal contact.</p> <p>Ⓔ2 4033</p> <p>Licence plate light with black plastic body</p> <p>  1x12V5W (C5W) 8GM 002 092-121  1x24V5W (C5W) 8GM 002 092-241 </p>

Signal Lights

for rear mounting





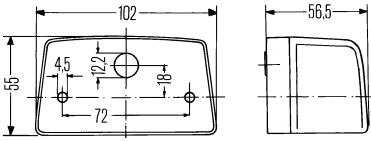


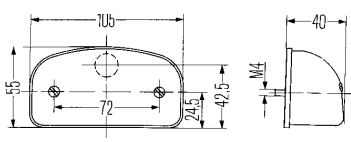

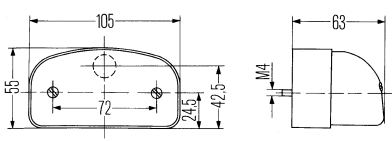

	Part no.	Pk.	Licence plate lights
 	<p>2KA 001 389-101</p> <p>9BG 119 721-001</p>	<p>10</p> <p>5</p>	<p>Clear lens. For surface mounting above or below 520 x 120 mm (2 or 3 lights), 340 x 240 mm (2 lights) and 240 x 130 mm (1 light) licence plates, or mounting to left and right of 520 x 120 mm licence plates. Black body. Two M6 fixing screws.</p> <p>(E1) 12815</p> <p>Licence plate light</p> <p>Spare parts: Body with lens</p> <p>1x12V5W (C5W) 8GM 002 092-121 1x24V5W (C5W) 8GM 002 092-241</p>
 	<p>2KA 003 168-021</p>	<p>2</p>	<p>Clear lens. For surface mounting above 520 x 120 mm and 340 x 240 mm (2 lights) licence plates or mounting above/below, left and right of 240 x 130 mm licence plates. Black body. Two B3.9 x 38 fixing screws.</p> <p>(E1) 22808</p> <p>Licence plate light</p> <p>1x12V5W (C5W) 8GM 002 092-121 1x24V5W (C5W) 8GM 002 092-241</p>
 	<p>2KA 006 896-001 2KA 006 896-007</p>	<p>4</p> <p>102</p>	<p>Clear lens. For surface mounting above (2 lights) or mounting to left and right of 520 x 120 mm licence plates. Black body. Two 5.5 mm dia. holes for fixing screws.</p> <p>(E1) 22910</p> <p>Licence plate light</p> <p>1x12V5W (C5W) 8GM 002 092-121 1x24V5W (C5W) 8GM 002 092-241</p>
 	<p>2KA 997 122-001</p>	<p>1</p>	<p>Clear lens. For flush mounting. Plastic housing with integrated bulb carrier. Quick mount lens light fixed with snap mount. With blade terminal contact.</p> <p>(E12) 4043</p> <p>Licence plate light</p> <p>1x12V10W (R10W) 8GA 002 071-121</p>


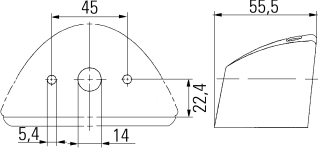




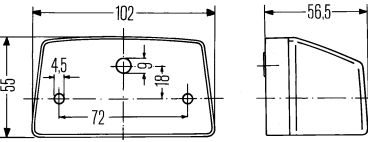




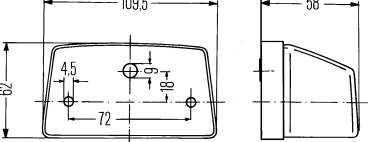




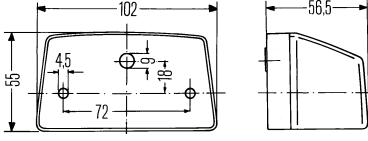







 	<p>Part no.</p> 2KA 001 610-001	<p>Pk.</p> 1	<p>Licence plate lights</p> <p>Clear lens. For surface mounting above 520 x 120 mm or 340 x 240 mm licence plates. Silver coloured finish. Two 4.5 mm dia. holes for fixing screws.</p> <p>(E1) 12949</p> <p>Licence plate light</p>  2x12V5W (C5W) 8GM 002 092-121
 	<p>Part no.</p> 2KA 004 525-001	<p>Pk.</p> 1	<p>Licence plate lights</p> <p>Clear lens. For surface mounting above 520 x 120 mm or 340 x 240 mm licence plates. Black body. Four holes for B4.2 x 16 fixing screws.</p> <p>(E1) 22861</p> <p>Licence plate light</p>  2x12V5W (C5W) 8GM 002 092-121  2x24V5W (C5W) 8GM 002 092-241
 	<p>Part no.</p> 2KA 001 622-001	<p>Pk.</p> 2	<p>Licence plate lights</p> <p>Clear lens. For surface mounting above 520 x 120 mm or 340 x 240 mm licence plates. Silver coloured finish. Four 5.5 mm dia. holes for fixing screws.</p> <p>(E1) 12969</p> <p>Licence plate light</p>
 	<p>Part no.</p> 2KA 003 010-007	<p>Pk.</p> 1	<p>Licence plate lights</p> <p>Clear lens. For surface mounting above 520 x 120 mm or 340 x 240 mm licence plates. Black body. Two M5 fixing screws.</p> <p>(E1) 12809</p> <p>Licence plate light</p>  2x12V5W (R5W) 8GA 002 071-121  2x24V5W (R5W) 8GA 002 071-241

Signal Lights

for rear mounting




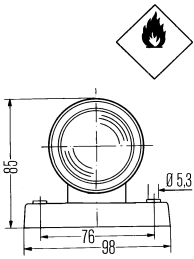
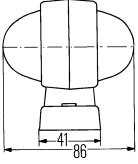



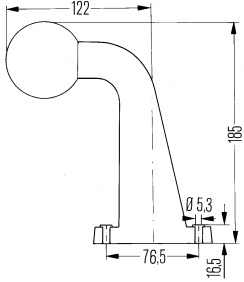



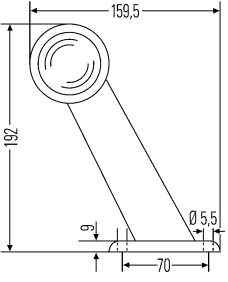



	Part no.	Pk.	Licence plate lights
  	<p>2KA 998 523-001 2KA 998 523-007</p> <p>2KA 998 523-117</p>	<p>1 160 90</p>	<p>Clear lens. For surface mounting above or below 520 x 120 mm (1 or 2 lights) and 340 x 240 mm (1 light) licence plates, or mounting to left and right of 520 x 120 mm and 340 x 240 mm licence plates. Black plastic body and base plate. Bulb holder with vibration damping. Two holes for M5 fixing screws.</p> <p>(E12) 4031</p> <p>Licence plate light for mounting above licence plates</p> <p>with 12V bulb and lead, for mounting below licence plates</p> <p> 1x12V10W (R10W) 8GA 002 071-131 1x24V10W (R10W) 8GA 002 071-251</p>
 	<p>2KA 001 386-231</p> <p>9BG 101 230-001 9GT 005 166-001</p> <p>2KA 001 386-241</p> <p>9BG 101 230-011 9GT 005 166-001</p>	<p>2 2 10</p> <p>2 2 10</p>	<p>Clear lens. For surface mounting to left and right of 520 x 120 mm and 340 x 240 mm licence plates. Black plastic body. With blade terminal contacts and grommet. Two 4.5 mm dia. holes for fixing screws.</p> <p>(E1) 12820</p> <p>Licence plate light</p> <p>Spare parts: Body with lens Grommet</p> <hr/> <p>With chrome-plated body</p> <p>Spare parts: Body with lens Grommet</p> <hr/>
 	<p>2KA 001 386-281</p> <p>2KA 001 386-497</p> <p>9BG 101 230-001 9GT 005 166-001</p> <p>2KA 001 386-291</p> <p>9BG 101 230-011 9GT 005 166-001</p> <p>2KA 001 386-301</p>	<p>2 120</p> <p>2 10</p> <p>2 10</p> <p>2 10</p>	<p>With distance base and fixing material, black body, 2 AM4 x 40 fixing screws</p> <p>with loss-protection for fixing screws</p> <p>Spare parts: Body with lens Grommet</p> <hr/> <p>With chrome-plated body</p> <p>Spare parts: Body with lens Grommet</p> <hr/> <p>With grey body</p> <p>Spare parts: Grommet</p>
	<p>9GT 005 166-001</p>	<p>10</p>	<p> 1x12V5W (C5W) 8GM 002 092-121</p>

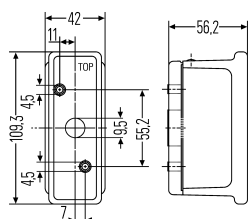
	Part no.	Pk.	Licence plate lights
  	2KA 007 929-001 2KA 007 929-007	2 72	<p>Rear-Logic Clear lens. For surface mounting above 340 x 240 mm and 520 x 120 mm (2 lights) licence plates or mounting to left and right of 340 x 240 mm and 520 x 120 mm licence plates. Black plastic body. With grommet. Two 5.4 mm dia. holes for fixing screws.</p> <p>(E1) 597</p> <p>Licence plate light</p> <p> 1x12V5W (C5W) 8GM 002 092-121  1x24V5W (C5W) 8GM 002 092-241</p>
  	2KA 003 389-011 2KA 003 389-001	1 1	<p>Clear lens. For surface mounting above 340 x 240 mm (1 light) and 520 x 120 mm (1 or 2 lights) licence plates or mounting to left and right of 340 x 240 mm and 520 x 120 mm licence plates. Grey plastic body and black base plate. Two 4.5 mm dia. holes for fixing screws.</p> <p>(E1) 22819</p> <p>Licence plate light with 45 mm distance between screws</p> <p>Licence plate light with 72 mm distance between screws</p> <p>Spare parts: Body with lens and screws for -001/-011</p>
 	2KA 003 389-061 2KA 003 389-068 2KA 003 389-062	2 56 1	<p>With 72 mm distance between screws, body and base plate of black plastic</p> <p>Pro-fit pack</p> <p>with 26 mm dia. opening in base plate for cable retention</p> <p>Spare parts: Body with lens and screws for -061/-068/-062/-081</p>
 	2KA 003 389-211 2KA 003 389-217	2 48	<p>With black rubber base plate and vibration damping</p> <p>Spare parts: Body with lens and screws for -211/-217</p> <p> 1x12V10W (R10W) 8GA 002 071-131  1x24V10W (R10W) 8GA 002 071-251  1x24V10W (R10W) 8GA 002 071-271 (Heavy-Duty)</p>
  	2PF 003 389-037	1	<p>Clearance lights Body and base plate of black plastic.</p> <p>(E1) 21639</p> <p>Clearance light with clear lens</p> <p> 1x12V10W (R10W) 8GA 002 071-131  1x24V10W (R10W) 8GA 002 071-251</p>
 	2PF 003 389-041	1	<p>With red lens</p> <p> 1x12V5W (R5W) 8GA 002 071-121  1x24V5W (R5W) 8GA 002 071-241</p>

Signal Lights

for side mounting



	Part no.	Pk.	Clearance lights
   	<p>2XS 955 031-001</p> <p>9EL 950 315-061 9EL 950 315-001 9EL 950 315-031</p>	<p>2</p>	<p>Clearance lights</p> <p>Front-facing part of lens milky-white, rear-facing part red. Black rubber housing. Snap-in fitting, pre-wired. Two 5.3 mm dia. holes for fixing screws.</p> <p>(E13) 9401</p> <p>Clearance light for upright mounting</p> <p>Spare parts: Lens, 5 red, for upright mounting 5 red, for pendant mounting 5 milky-white</p> <p> 1x12V5W (R5W) 8GA 002 071-121 1x24V5W (R5W) 8GA 002 071-241</p> <hr/> <p>(E13) 9401</p>
  	<p>2XS 950 071-031</p> <p>9EL 950 315-061 9EL 950 315-031 8KA 950 073-001</p> <p>8KA 962 886-001</p>	<p>2</p>	<p>With rubber bracket for upright mounting</p> <p>Spare parts: Lens 5 red, for upright mounting 5 milky-white 10 Lead with plastic bulb holder</p> <p>Accessories: 10 Lead with metal bulb holder</p> <p> 1x12V5W (R5W) 8GA 002 071-121 1x24V5W (R5W) 8GA 002 071-241</p> <hr/> <p>(E13) 9401</p>
   	<p>2XS 955 232-001</p> <p>2XS 955 232-017</p> <p>9EL 950 315-061 9EL 950 315-031 8KA 950 073-001</p> <p>8KA 962 886-001</p>	<p>2</p> <p>40</p>	<p>With straight rubber arm and 75 mm long lead for upright mounting</p> <p>with straight rubber arm, 150 mm long lead with flute tube, crimped blade connectors 6.3 mm and mounted plug housings like AMP, for upright mounting</p> <p>Spare parts: Lens, 5 red 5 milky-white 10 Lead with plastic bulb holder</p> <p>Accessories: 10 Lead with metal bulb holder</p> <p> 1x12V5W (R5W) 8GA 002 071-121 1x24V5W (R5W) 8GA 002 071-241</p>



Part no.

Pk.

Clearance lights

Rear Logic

For mounting on trailer with tarpaulin. Mounting on trailer with box body is prohibited. Front-facing part of lens clear, rear-facing part red, side marker light with integrated yellow reflector.

Black plastic body, with grommet. Two 4.5 mm dia. holes for fixing screws. When the light is used on towing vehicles it is necessary to replace the glass-clear lens with a black lens 9EL 148 673-021, as accessory available.

Ⓔ4 9374 Ⓔ4 280

Clearance light with side marker light with reflector, left

2XS 007 841-011 10

2XS 007 841-017 104

right

2XS 007 841-021 10

2XS 007 841-027 104

Spare parts:

Side-marker light
Grommet

9EL 146 838-001 2

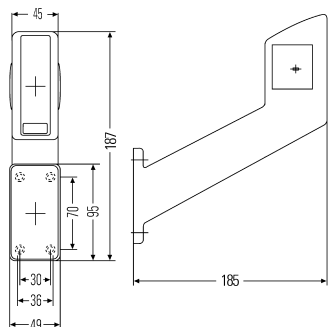
9GT 005 166-001 10

Accessories:

Lens, black

9EL 148 673-021 2

1x12V10W (R10W) 8GA 002 071-131
1x24V10W (R10W) 8GA 002 071-251



2XS 955 260-001 2

2XS 955 260-007 50

Rear Logic

For upright attachment on trailer. Mounting on trailer with box body is prohibited. Front-facing part of lens clear, rear-facing part red (not mounted), for side marker light with integrated yellow reflector (mounted).

Black rubber housing. Four 5.3 mm dia. holes for fixing screws. When the light is used on towing vehicles it is necessary to replace the glass-clear lens with a black lens 9EL 964 291-001, as accessory available.

Ⓔ13 9428

Clearance light with side marker light with reflector

9EL 964 289-001 10

9EL 964 290-001 10

8RA 964 292-001 10

Spare parts:

Lens, clear
red
Reflector, amber

9EL 964 291-001 10

Accessories:


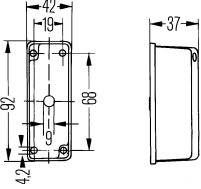



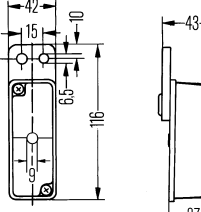



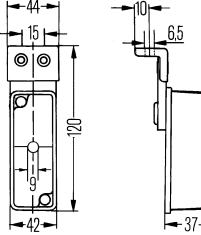



Lens, black


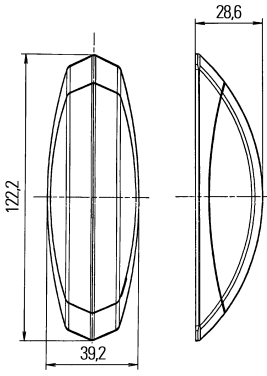


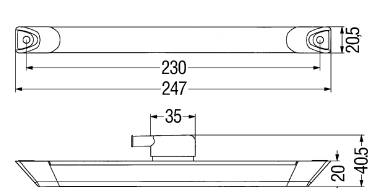

1x12V5W (R5W) 8GA 002 071-121
1x24V5W (R5W) 8GA 002 071-241

Signal Lights

for side mounting



	Part no.	Pk.	Clearance lights
	<p>2XS 005 020-001 2XS 005 020-002 2XS 005 020-003</p> <p>2XS 005 020-057</p> <p>2XS 005 020-137</p>	<p>10 90 1</p> <p>1</p> <p>168</p>	<p>Front-facing part of lens clear, rear-facing part red. Two ST3.5 x 16-C fixing screws.</p> <p>(E1) 31407</p> <p>Clearance light without bulb, with grommet</p> <p>Pro-fit pack with 12V bulb, without grommet, with 8.2 mm dia. hole for wire (without approval for hazardous goods)</p> <p>same as -057, but without fixing screws</p>
	<p>9EL 132 215-001</p>	<p>2</p>	<p>Spare parts: Lens with screws</p> <hr/> <p>Version 2XS 005 020-041 with 15.5 mm dia. hole for wire.</p>
	<p>2XS 005 020-041 2XS 005 020-047</p> <p>2XS 005 020-081</p>	<p>10 168</p> <p>2</p>	<p>Front-facing part of lens black, rear-facing part red, with grommet</p> <p>with grommet</p> <p>Spare parts: Lens with screws</p>
	<p>9EL 132 215-011</p>	<p>2</p>	<p>Spare parts: Lens with screws</p>
	<p>2XS 005 020-077</p> <p>2XS 005 020-011 2XS 005 020-017</p> <p>2XS 005 020-067</p>	<p>8</p> <p>10 140</p> <p>6</p>	<p>Front-facing part of lens clear, rear-facing part black, without grommet. With 8.2 mm dia. hole for wire.</p> <p>With flexible rubber support 55 x 42 mm.</p> <p>Front-facing part of lens clear, rear-facing part red, with grommet</p> <p>without grommet, for PG9-cable retention</p> <p>Spare parts: Lens with screws</p>
	<p>2XS 005 020-147</p>	<p>1</p>	<p>Front-facing part of lens clear, rear-facing part black, with grommet</p>
	<p>2XS 005 020-091</p>	<p>2</p>	<p>Front-facing part lens black, rear facing part red, with grommet</p> <p>Spare parts: Lens with screws</p>
	<p>9EL 132 215-011</p>	<p>2</p>	<p>Spare parts: Lens with screws</p>
	<p>2XS 005 020-021</p>	<p>10</p>	<p>Front-facing part of lens clear, rear-facing part red, with grommet</p> <p>Spare parts: Lens with screws</p>
	<p>9EL 132 215-001</p>	<p>2</p>	<p>Spare parts: Lens with screws</p>
	<p>2XS 005 020-111</p>	<p>2</p>	<p>Front-facing part of lens black, rear-facing part red, with grommet</p> <p>Spare parts: Lens with screws</p>
	<p>9EL 132 215-011</p>	<p>2</p>	<p>Spare parts: Lens with screws</p>
	<p>2XS 005 020-121</p>	<p>2</p>	<p>Front-facing part of lens clear, rear-facing part black, with grommet</p> <p>1x12V4W (T4W) 8GP 002 067-121 1x24V4W (T4W) 8GP 002 067-241</p>

	Part no.	Pk.	Clearance lights
 	<p>For caravans. Front-facing part of lens clear, rear-facing part red. Lens is arrested on base plate.</p> <p>(E1) 1201</p> <p>Clearance light without bulb, with dark grey base plate, left</p> <p>2XS 008 479-061 1 2XS 008 479-071 1 right</p> <hr/> <p>With 12V bulb and dark grey base plate, left</p> <p>2XS 008 479-001 1 2XS 008 479-007 90</p> <p>right</p> <p>2XS 008 479-011 1 2XS 008 479-017 90</p> <hr/> <p>With 12V bulb and light grey base plate, left</p> <p>2XS 008 479-081 1 2XS 008 479-087 90</p> <p>right</p> <p>2XS 008 479-091 1 2XS 008 479-097 90</p> <hr/> <p>With 24V bulb and dark grey base plate, left</p> <p>2XS 008 479-041 1 2XS 008 479-047 90</p> <p>right</p> <p>2XS 008 479-051 1 2XS 008 479-057 90</p> <hr/> <p>Rear-facing part of lens red, front-facing part silver coloured, arrested on housing.</p> <p>With 12V bulb and dark grey base plate, left</p> <p>2XS 008 479-107 90</p> <p>right</p> <p>2XS 008 479-117 90</p> <p> 1x12V5W (C5W) 8GM 002 092-121 1x24V5W (C5W) 8GM 002 092-241</p>		
  	<p>For horizontal or vertical surface mounting on trailers and semi-trailers with box body. With LED light guide technology. Lens clear. Grey plastic base plate and covers. Two 5.4 mm dia. holes for fixing screws. Consumption: 0.06A at 12V/24V. With 2 red LEDs and grommet. See page 5.236, instruction 2.</p> <p>(E13) 0515</p> <p>Clearance light, 12V0.7W</p> <p>2XS 008 078-011 1</p> <p>24V1.4W</p> <p>2XS 008 078-001 1 2XS 008 078-007 60</p>		


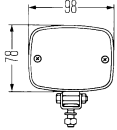
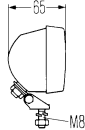


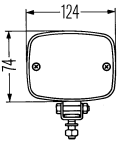
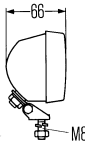

Signal Lights

for side mounting



	<p>Part no.</p> <p>2XS 003 168-071</p> <p>2XS 003 168-081</p> <p>2XS 003 168-131</p>	<p>Pk.</p> <p>2</p> <p>2</p> <p>2</p>	<p>Track-control lights</p> <p>Front-facing part of lens milky-white, rear-facing part blacked off. Two 3.9 x 32 fixing screws.</p> <p>K 4106 *)</p> <p>Track-control light</p> <hr/> <p>Two 6.5 mm dia. holes for fixing screws.</p> <p>With flexible rubber support 110 x 33 mm.</p> <hr/> <p>Two 6.5 mm dia. holes for fixing screws.</p> <p>With rubber holder for surface-fitting under vehicle platform, etc.</p> <p> 1x12V5W (C5W) 8GM 002 092-121 1x24V5W (C5W) 8GM 002 092-241</p>
	<p>2TJ 001 633-211</p> <p>9EL 132 403-001</p> <p>9EL 132 404-001</p>	<p>2</p> <p>2</p> <p>2</p>	<p>Rear-side light</p> <p>Can be mounted either vertically or horizontally. Red rear light, white side light. With M10 x 1 fixing screw.</p> <p>(E1) 31416 (E1) 11786</p> <p>(E1) 11553 (E1) 11554</p> <p>Rear-side light</p> <p>Spare parts: Lens with screw, clear red</p> <p> 1x12V5W (C5W) 8GM 002 092-121 1x24V5W (C5W) 8GM 002 092-241</p>



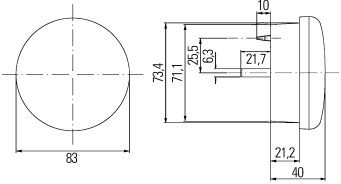



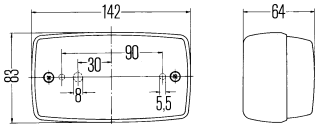



*) National type test for Germany


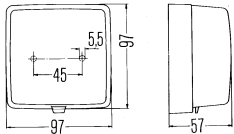



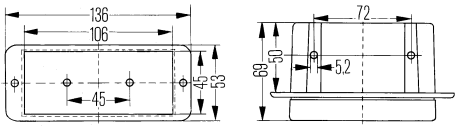


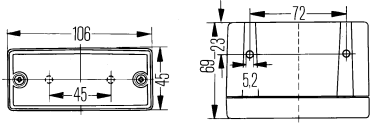


	Part no.	Pk.	Rear fog and reverse lights
  	2NE 003 030-151	1	<p>Rear fog and reverse lights</p> <p>For mounting to vertical and horizontal surfaces. Red lens. Chrome-type housing. Bracket with M8 fixing screw.</p> <p>(E1) 18406</p> <p>Rear fog light (NES 100)</p> <hr/> <p>Clear lens.</p> <p>(E1) 8726</p>
	2ZR 003 030-171	1	<p>Reverse light (ZR 100)</p> <p>Spare parts: Lens with screws</p> <p>1x12V21W (P21W) 8GA 002 073-121 1x24V21W (P21W) 8GA 002 073-241</p>
  	2NE 002 985-001	1	<p>For mounting to vertical and horizontal surfaces. Red lens. Black housing. Bracket with M8 fixing screw.</p> <p>(E1) 8465</p> <p>Rear fog light (NES 80)</p> <p>Spare parts: Lens with screws</p>
	9EL 117 094-001	5	
	2ZR 002 985-081	1	<p>Reverse light (ZR 80) with chrome-type housing</p>
	2ZR 002 985-261	1	<p>with black housing</p> <hr/> <p>Amber lens. For front mounting.</p> <p>Daytime running light with black housing</p> <p>1x12V21W (P21W) 8GA 002 073-121 1x24V21W (P21W) 8GA 002 073-241</p>

Signal Lights

for rear mounting



	Part no.	Pk.	Rear fog and reverse lights
  	<p>2NE 959 011-501 2NE 959 011-507</p>	<p>1 10</p>	<p>For flush mounting In LED-technology. With 24 red LEDs 3W and 2500 mm lead. Clear lens. Voltage range: 9V - 33V. Consumption: 0.25A at 12V, 0.13A at 24V. See page 5.236, instruction 2.</p> <p>Ⓔ4 11391</p> <p>Rear fog light</p> <hr/> <p>In LED-technology. With 24 white LEDs 4W and 2500 mm lead. Clear lens. Voltage range: 9V - 33V. Consumption: 0.33A at 12V, 0.17A at 24V. See page 5.236, instruction 2.</p> <p>Ⓔ4 11391</p>
 	<p>2ZR 959 010-501 2ZR 959 010-507</p>	<p>1 10</p>	<p>Reverse light</p>
 	<p>2NE 002 589-001</p> <p>9EL 112 763-001</p>	<p>1 5</p>	<p>For mounting to horizontal or vertical surfaces. Red lens. Chrome-type housing. Light unit is horizontally adjustable. Two 5.5 mm dia. holes for fixing screws.</p> <p>Ⓔ1 8444</p> <p>Rear fog light (NES 5)</p> <p>Spare parts: Lens with screws</p> <p> 1x12V21W (P21W) 8GA 002 073-121</p> <hr/> <p>Clear lens.</p> <p>Ⓔ1 8725</p>
	<p>2ZR 002 589-011</p> <p>9EL 112 858-011</p>	<p>1 2</p>	<p>Reverse light (ZR 5)</p> <p>Spare parts: Lens with screws</p> <p> 1x12V21W (P21W) 8GA 002 073-121</p>


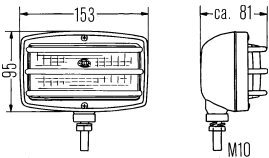


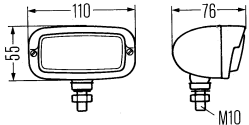


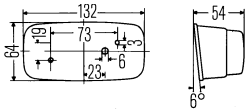

	Part no.	Pk.	Rear fog and reverse lights
 	<p>2NE 003 315-011</p> <p>9EL 119 977-001</p>	<p>1</p> <p>1</p>	<p>For surface mounting. Red lens. Black plastic body and rim. Two B4.8 x 19 fixing screws.</p> <p>(E1) 8486</p> <p>Rear fog lights (NES 9)</p> <p>Spare parts: Lens</p>
	<p>2ZR 003 315-041</p>	<p>1</p>	<p>Clear lens.</p> <p>(E1) 8732</p> <p>Reverse light (ZR 9)</p> <p> 1x12V21W (P21W) 8GA 002 073-121</p>
 	<p>2NE 006 609-017</p> <p>2NE 006 609-011</p>	<p>20</p> <p>1</p>	<p>For flush mounting. Red lens. Black plastic body. Two 5.2 mm dia. holes for fixing screws.</p> <p>(E17) 3806</p> <p>Rear fog light</p> <p>Pro-fit pack</p>
	<p>2ZR 006 609-171</p>	<p>1</p>	<p>For flush mounting. Clear lens.</p> <p>(E17) 2309</p> <p>Reverse light</p>
 	<p>2NE 006 609-007</p> <p>2NE 006 609-001</p> <p>2NE 006 609-187</p> <p>9EL 141 612-001</p>	<p>30</p> <p>1</p> <p>30</p> <p>10</p>	<p>For horizontal or vertical attachment at rear or vertical attachment on side of passenger car trailer. Red lens.</p> <p>(E17) 3806</p> <p>Rear fog light without 12V bulb</p> <p>Pro-fit pack</p> <p>with 12V bulb</p> <p>Spare parts: Lens</p>
	<p>2ZR 006 609-087</p> <p>2ZR 006 609-081</p>	<p>30</p> <p>1</p>	<p>For surface mounting. Clear lens.</p> <p>(E17) 2309</p> <p>Reverse light</p> <p>Pro-fit pack</p> <p> 1x12V21W (P21W) 8GA 002 073-121</p>

Signal Lights


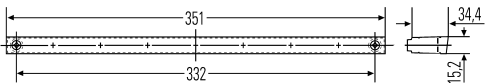

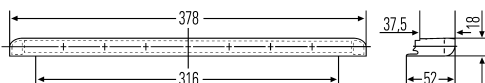

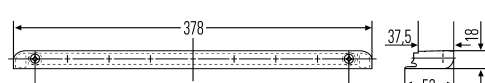

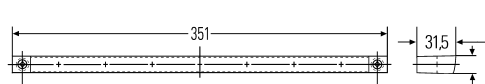


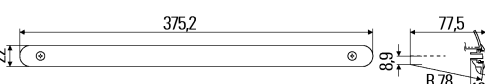
for rear mounting


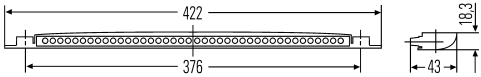

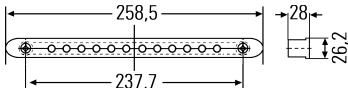

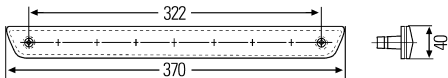





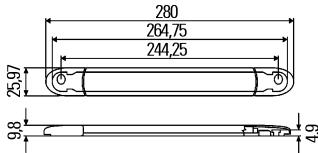

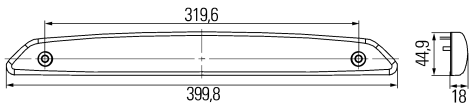
	<p>Part no.</p> <p>2ZR 997 506-391</p> <p>2ZR 997 506-501</p> <p>9GH 993 984-001</p> <p>8JD 008 151-011</p> <p>8KW 701 235-033</p> <p>8KB 990 299-001</p>	<p>Pk.</p> <p>1</p> <p>1</p> <p>1</p> <p>10</p> <p>100</p> <p>1</p>	<p>Reverse lights</p> <p>Clear lens. With AMP plug connector, without cap. Black fibre-glass reinforced plastic housing With M10 fixing screw and vibration damping. For upright or pendant mounting. Type of protection: IP6K4K and IPX9K. With 24V bulb.</p> <p>(E12) 23005</p> <p>Reverse light (Ultra Beam FF®), clear lens with optik with clear lens, half of which is pattern-free</p> <p>Accessories:</p> <p>1 Cap for AMP plug connector</p> <p>10 Socket for AMP plug connector</p> <p>100 Blade receptacles</p> <p>1 2 m long connecting lead for AMP plug connector</p> <p> 1x24V70W (H3) 8GH 002 090-251</p>
	<p>2ZR 996 179-701</p>	<p>1</p>	<p>Clear lens without optical pattern. For upright mounting. Black plastic housing. Pivot base with M10 fixing screws. With 500 mm lead. Schutzart: IP5K9K With 24V bulb.</p> <p>(E4) 23262</p> <p>Reverse light (ECO 21)</p> <p> 1x12V21W (P21W) 8GA 002 073-121 1x24V21W (P21W) 8GA 002 073-241</p>
	<p>2ZR 005 700-191</p> <p>9EL 135 000-021</p>	<p>1</p> <p>1</p>	<p>For upright mounting. Clear lens, black housing.</p> <p>(E1) 2185</p> <p>Reverse light (Comet 550)</p> <p>Spare parts: Lens</p> <p> 1x12V55W (H3) 8GH 002 090-133 1x24V70W (H3) 8GH 002 090-251</p>
	<p>2ZR 005 860-151</p> <p>9EL 145 660-021</p>	<p>1</p> <p>1</p>	<p>For pendant mounting. Clear lens, black housing.</p> <p>(E1) 2186</p> <p>Reverse light (Comet 450)</p> <p>Spare parts: Lens</p> <p> 1x24V70W (H3) 8GH 002 090-251</p>

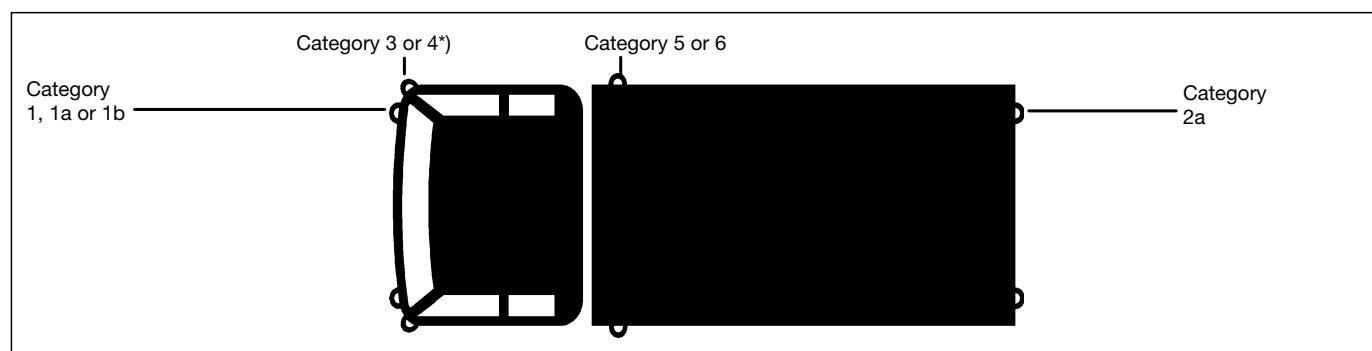
	Part no.	Pk.	Reverse lights
 	2ZR 004 542-001	1	<p>Reverse lights</p> <p>Clear lens. Black housing. Chrome-type rim and protective grill. For upright mounting, also for pendant attachment after turning insert. Spherical base with M10 x 1 hollow screw.</p> <p>(E1) 8743</p> <p>Reverse light (ZR 138)</p> <p> 1x12V21W (P21W) 8GA 002 073-121</p>
 	2ZR 001 193-011	1	<p>Reverse light (ZR 92)</p> <p>Clear lens. Chrome-type body and rim. Spherical base with M10 hollow screw, for attachment to bumper or horizontal surfaces.</p> <p>(E1) 8709</p> <p>Spare parts: Lens</p> <p> 1x12V21W (P21W) 8GA 002 073-121</p>
 	2ZR 002 694-001 2ZR 002 694-002	1 1	<p>Reverse light (ZR 106)</p> <p>Pro-fit pack</p> <p>Spare parts: Lens with screws</p> <p> 1x12V21W (P21W) 8GA 002 073-121</p>

		Part no.	Pk.	<p>For interior mounting</p> <p>In Matrix-technology. Red lens. Black housing. For mounting at the rear window. For rear window inclination 26° - 75°. With 12V bulbs and mounting accessories.</p> <p>(E17) 795</p> <p>2DA 007 428-001 1 2DA 007 428-007 40</p> <p>Safety brake light</p> <p> 4x12V5W (W5W) 8GP 003 594-121</p>
		2DA 007 592-101	1	<p>In LED-technology. Clear lens. With 16 red LEDs 12V3.0W and 3000 mm long lead. For stick-down attachment to inside surface or rear window. For rear window inclination 25° - 67°. Consumption: 0.25A at 12V. See page 5.236, instruction 2.</p> <p>(E1) 332</p> <p>Safety brake light</p>
		2DA 007 541-001	1	<p>For exterior mounting</p> <p>In Matrix-technology. Red lens. For surface-mounting on boot lid or vehicle roof. With 12V bulbs and mounting accessories.</p> <p>(E1) 343</p> <p>Safety brake light</p> <p> 4x12V5W (W5W) 8GP 003 594-121</p>
		2DA 007 657-001	1	<p>In LED-technology. Clear lens. With 16 red LEDs 3.0W and mounting accessories. For surface-mounting on boot lid or vehicle roof. One hole fixing with cable entry. For mounting surfaces with -1° to +9° inclination. Consumption: 0.25A at 12V. See page 5.236, instruction 2.</p> <p>(E1) 363</p> <p>Safety brake light</p>

	Part no.	Pk.	For flush mounting in rear spoiler
 	2DA 007 421-001 2DA 007 421-007	1 56	<p>In Matrix-technology. Red lens. Black housing. Without lead (see accessories) Two B3.9 x 22 fixing screws with red head. With 12V bulbs.</p> <p>(E1) 198</p> <p>Safety brake light to screw attachment from the front; for flush-fitting into rear spoiler or body parts</p>
 	2DA 007 421-017	1	<p>(E1) 199</p> <p>For screw-attachment from below, with rounded lens. Two B3.9 x 22 fixing screws. For flush-fitting from below into the rear spoiler. Screws not visible from outside.</p>
 	2DA 007 421-027	1	<p>Same as 2DA 007 421-017, but for screw-attachment from front, with fixing screws</p>
 	2DA 005 739-111 2DA 005 739-117	1 56	<p>(E1) 65</p> <p>Safety brake light to screw attachment from the front, two 6 mm dia. holes for fixing screws</p> <p>Accessories: Lead without gasket Lead with gasket for electrical connection Grommet</p> <p> 7x12V2,3W (W2,3W) 8GP 938 026-001</p>
 	2DA 007 858-037	1	<p>In LED-technology. Clear PMMA lens, fixing from outside. With 20 red LEDs and fixing screws. Consumption: 0.25A at 12V. See page 5.236, instruction 2.</p> <p>(E1) 1224</p> <p>Safety brake light, 12V3.0W</p> <p>Accessories: Lead with grommet</p>
8KA 144 707-007 8KA 146 751-007 9GT 146 757-007	56 56 1000		

	Part no.	Pk.	For flush mounting in rear spoiler
 	<p>2DA 959 380-111</p> <p>2DA 959 380-511</p>	<p>1</p> <p>1</p>	<p>In LED-technology. With 20 LEDs 12V3.0W and lead. Consumption: 0.25A at 12V. See page 5.236, instruction 2.</p> <p>(E1) 7515</p> <p>Safety brake light with red lens</p> <p>with grey lens</p>
 	<p>2DA 959 071-537</p> <p>2DA 959 071-737</p> <p>2DA 959 071-757</p> <p>2DA 959 071-037</p> <p>2DA 959 071-237</p>	<p>1</p> <p>1</p> <p>10</p> <p>1</p> <p>1</p>	<p>In LED-technology. With 12 LEDs and lead. Consumption: 0.16A at 12V, 0.08A at 24V. See page 5.236, instruction 2.</p> <p>(E4) 7547</p> <p>Safety brake light with red lens, 12V2.0W</p> <p>with red lens, 24V2.0W</p> <p>with red lens and installation material, 24V2.0W</p> <p>with clear lens, 12V2.0W</p> <p>with clear lens, 24V2.0W</p>
 	<p>2DA 008 136-007</p> <p>2DA 008 136-017</p> <p>2DA 008 136-027</p>	<p>60</p> <p>60</p> <p>60</p>	<p>For flush mounting in caravan-trailers and mobile homes</p> <p>In Matrix-technology. Red lens. With 12V bulbs.</p> <p>(E1) 799</p> <p>Safety brake light with screw-connected to the casing</p> <p>with screw-connected to the lens (Screws not supplied with lamp)</p> <p>with PE foam gasket coated with glue on both sides</p>
	<p>2DA 008 136-031</p> <p>9HB 152 021-007</p> <p>9HB 152 421-007</p> <p>8KA 146 751-007</p> <p>8KA 144 707-007</p> <p>9GT 146 757-007</p> <p>9BG 154 271-001</p>	<p>1</p> <p>60</p> <p>60</p> <p>56</p> <p>56</p> <p>1000</p> <p>2</p>	<p>With housing, wiring harness and sealant (for retrofitting)</p> <p>Accessories: Cover for -007 for wall thickness 10 mm for wall thickness 5 mm Lead with grommet without grommet Grommet Housing</p> <p> 7x12V2.3W (T5/13.5) 8GP 938 026-001</p>

	Part no.	Pk.	For horizontal or vertical exterior mounting
 	<p>In LED-technology. Lens and caps red. With 10 LEDs and 3000 mm long lead. Two holes 3 mm dia. for fixing screws Consumption: 0.06A at 12V/24V. See page 5.236, instruction 2.</p> <p>Ⓔ 7696</p> <p>Safety brake light, 12V0.7W</p> <p>2DA 343 106-001 1 2DA 343 106-007 30</p> <p>2DA 343 106-011 1 2DA 343 106-017 30</p> <hr/> <p>Self-adhesive, 12V0.7W</p> <p>2DA 343 106-201 1 2DA 343 106-207 30</p> <p>2DA 343 106-211 1 2DA 343 106-217 30</p> <hr/> <p>Smoked lens coloured cap, 12V0.7W</p> <p>2DA 343 106-021 1 2DA 343 106-027 30</p> <p>2DA 343 106-031 1 2DA 343 106-037 30</p> <hr/> <p>Self-adhesive, 12V0.7W</p> <p>2DA 343 106-221 1 2DA 343 106-227 30</p> <p>2DA 343 106-231 1 2DA 343 106-237 30</p>		
 	<p>In LED-technology. Red lens with brilliant look with 3D effect by embedding each LED in a separate reflector. With 12 LEDs and 200 mm long lead. Two holes for fixing screws. Consumption: 0.15A at 12V, 0.30A at 24V. See page 5.236, instruction 2.</p> <p>Ⓔ 7715</p> <p>Safety brake light, 12V1.8W</p> <p>2DA 343 800-001 1 2DA 343 800-007 48</p> <hr/> <p>Seal fixed in place by double-sided adhesive tape, 12V1.8W</p> <p>2DA 343 800-057 48</p> <p>2DA 343 800-047 48</p>		<p>For horizontal exterior mounting</p>



Front direction indicators

Category	Interval to dipped beam headlamp/front fog lamp	Luminous	Direction
1	> 40 mm	min. 175 cd	Towards front
1a	< 40 mm and > 20 mm	min. 250 cd	
1b	< 20 mm	min. 400 cd	

Front side direction indicators

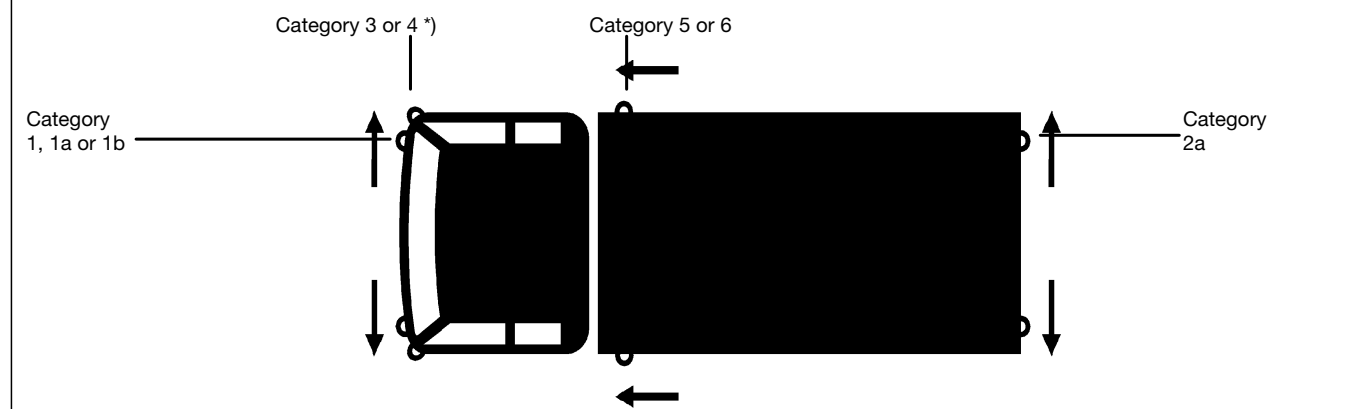
Category	Replaces category	To be mounted with category	Luminous	Direction
3*)	1, 5 and 2a	-	min. 175 cd min. 50 cd	Towards front Towards rear
4*)	1 and 5	2a	min. 175 cd min. 0,6 cd	Towards front Towards rear

Side direction indicators

Category	Replaces category	To be mounted with category	Luminous	Direction
5	-	1 (1a) (1b) and 2a	min. 0,6 cd	Towards rear side
6	-	1 (1a) (1b) and 2a	min. 50 cd	

Rear direction indicators


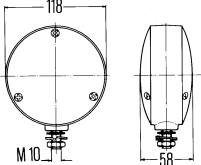

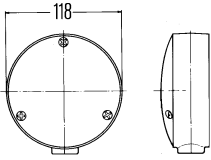




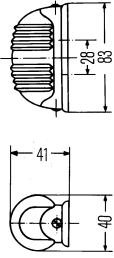


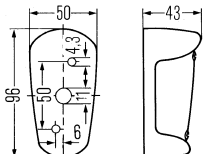

Category	Remarks	Luminous	Direction
2a	One luminous intensity for day and night	min. 50 cd	Towards rear
2b	at day at night	min. 175 cd min. 40 cd	Towards rear Towards rear




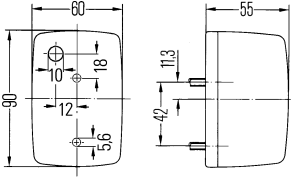

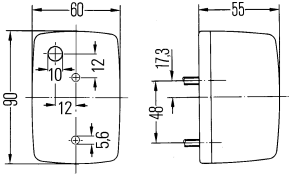

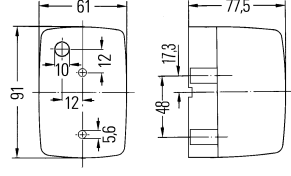



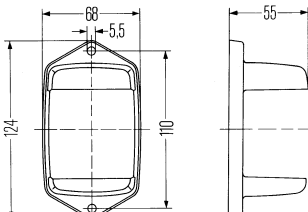

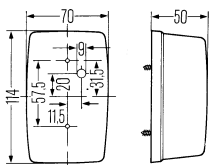

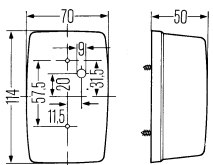


Meaning of arrow on direction indicators

With arrow	Mounting is permissible on one side only (left or right)
Without arrow	Mounting is permissible on left or right

*) Only usable, if vehicle is approved for use in Germany, e.g. farm vehicles and machines.

	Part no.	Pk.	For surface mounting
 	<p>2BA 003 022-001</p> <p>2BA 003 022-021</p>	<p>1</p> <p>1</p>	<p>For front, front/side or rear mounting (category 1, 2a, 3 and 4). Amber lens. Black plastic body. M10 hollow screw for fixing.</p> <p>(E1) 32719</p> <p>Indicator light with lead</p> <p>without lead</p>
 	<p>2BA 003 022-057</p> <p>9EL 116 907-001</p> <p>9FT 117 109-007</p>	<p>1</p> <p>1500</p>	<p>For rear mounting. Front-facing part of lens black, rear-facing part amber, with lead and blade terminal contacts</p> <p>Spare parts: Lens Bulb holder</p> <p> 1x12V21W (P21W) 8GA 002 073-121  1x24V21W (P21W) 8GA 002 073-241</p> <hr/> <p>Indicator light for school buses</p> <p>Amber lens. Black plastic body.</p> <p>(E1) 32719</p> <p>Indicator light</p> <p>Spare parts: Lens Bulb holder</p> <p> 1x12V21W (P21W) 8GA 002 073-121</p>
 	<p>2BA 001 227-201</p> <p>9EL 074 484-011</p> <p>9FT 117 109-007</p> <p>2BA 001 227-211</p> <p>9EL 074 484-031</p>	<p>2</p> <p>2</p> <p>1500</p> <p>2</p> <p>2</p>	<p>For front, side or rear mounting. Amber lens. Two M4 fixing screws.</p> <p>K 12642 *)</p> <p>Indicator light with chrome type rim</p> <p>Spare parts: Lens Bulbholder</p> <hr/> <p>Without chrome-type rim.</p> <p>Spare parts: Lens</p> <p> 1x12V18W (K) 8GM 002 091-121</p>
 	<p>2BA 001 248-001</p>	<p>4</p>	<p>For front, side or rear mounting. Amber lens. Die-cast housing, silver coloured. Two M4 fixing screws.</p> <p>K 12793 *)</p> <p>Indicator light</p> <p> 1x12V18W (K) 8GM 002 091-121</p>

*) National type test for Germany

	Part no.	Pk.	For surface mounting
 	2BA 002 652-101 2BA 002 652-107 9EL 134 658-001	2 96 2	For front mounting (category 1). Amber lens. Two holes for M5 fixing screws. Distance between screws: 42 mm. (E1) 42763 Indicator light Spare parts: Lens with screw
 	2BA 002 652-111 2BA 002 652-117 2BA 002 652-121 2BA 002 652-127 9EL 134 659-001 9EL 134 660-001	2 96 2 96 2 96	For front/side mounting (category 1, 4 and 5). Distance between screws: 48 mm. (E1) 42764 Indicator light, left right Spare parts: Lens with screws, left right
 	2BM 002 652-051	1	For side mounting (category 5). With black plastic base plate. Distance between screws: 48 mm. (E1) 32785 Auxiliary indicator  1x12V21W (P21W) 8GA 002 073-121  1x24V21W (P21W) 8GA 002 073-241
 	8XS 113 389-001	2	Protective cap. Silver coloured, for lamps in model range 2BA 002 652-...
 	2BA 002 324-001 9EL 110 910-001	1 5	For front mounting (category 1). Amber lens. Two holes for B4.2 x 9.5 fixing screws. (E1) 32623 Indicator light Spare parts: Lens with screws
 	2BA 002 324-011 2BA 002 324-021 9EL 110 918-001 9EL 110 918-011	1 1 5 5	For front/side mounting (category 3 and 4 for Germany), with additional filter. (E1) 32621 Indicator light, left right Spare parts: Lens with screws, left right  1x12V21W (P21W) 8GA 002 073-121  1x24V21W (P21W) 8GA 002 073-241

	<p>Part no.</p> <p>2BA 001 277-011</p> <p>2BA 001 277-021</p>	<p>Pk.</p> <p>1</p> <p>1</p>	<p>For surface mounting</p> <p>For front/side mounting (category 4 for Germany). Amber lens. Two holes for 4.2 fixing screws.</p> <p>(E1) 22796</p> <p>Indicator light, left</p> <p>Indicator light, right</p> <p>1x12V21W (P21W) 8GA 002 073-121 1x24V21W (P21W) 8GA 002 073-241</p>
	<p>2BA 001 221-031</p> <p>2BA 001 221-041</p> <p>9EL 110 013-001</p> <p>9EL 110 014-001</p>	<p>4</p> <p>4</p> <p>4</p> <p>4</p>	<p>For front/side mounting (category 1 and 5). Amber lens. Two holes for B4.2 x 13 fixing screws.</p> <p>(E1) 32611</p> <p>Indicator light, left</p> <p>Indicator light, right</p> <p>Spare parts: Lens with screws, left right</p> <p>1x12V21W (P21W) 8GA 002 073-121</p>
	<p>2BA 002 939-251</p>	<p>1</p>	<p>For flush mounting</p> <p>For front or rear mounting (category 1 and 2a). Amber lens. Grey plastic body.</p> <p>(E1) 42788</p> <p>Indicator light</p> <p>1x12V21W (P21W) 8GA 002 073-121</p>
	<p>2BA 996 027-001</p> <p>9EL 990 068-001</p>	<p>1</p> <p>5</p>	<p>For front, side or rear flush mounting (category 1, 2a and 5). Amber lens. Black plastic body. Two holes for B4.s or M4 fixing screws.</p> <p>(E12) 6060</p> <p>Indicator light for horizontal mounting</p> <p>Spare parts: Lens</p> <p>1x12V21W (P21W) 8GA 002 073-121 1x24V21W (P21W) 8GA 002 073-241</p>

		<p>Part no.</p> <p>2BA 001 416-011 2BA 001 416-021 9EL 110 737-001 9EL 110 736-001</p>	<p>Pk.</p> <p>1 1 2 2</p>	<p>For surface mounting</p> <p>For front/side mounting (category 1 and 4). Amber lens. Two holes for M6 fixing screws.</p> <p>Ⓔ1 32617</p> <p>Indicator light, left</p> <p>Indicator light, right</p> <p>Spare parts: Lens with screws, left right</p> <p>⚡ 1x12V21W (P21W) 8GA 002 073-121 1x24V21W (P21W) 8GA 002 073-241</p>
		<p>2BA 009 204-041 2BA 009 204-051</p>	<p>2 1</p>	<p>For rear mounting (category 2a) of lifttype loading platforms. In LED-technology. With 2 amber LEDs. Clear lens.</p> <p>Die-cast zinc housing. Two M6 fixing screws. With 190 mm long potted lead. Type of protection: IP5K9K. Consumption: 0.33A at 12V/24V.</p> <p>Ⓔ1 989</p> <p>Indicator light, 12V4.0W</p> <p>Indicator light, 24V8.0W</p> <p>"Without patented electronics for indicator failure control. Indicator failure control is not mandatory for lifting loading platforms."</p>
		<p>2BA 008 260-017 2BA 008 260-001 2BA 008 260-007</p>	<p>1 2 20</p>	<p>For rear mounting (category 2a) of lifttype loading platforms. In LED-technology. With 12 amber LEDs 2.8W. Clear lens.</p> <p>Die-cast zinc housing. Two M6 fixing screws. With potted leads. Type of protection: IP5K9K. Consumption: 0.24A at 12V, 0.12A at 24V.</p> <p>Ⓔ1 989</p> <p>Indicator light, 12V</p> <p>Indicator light, 24V</p> <p>"Without patented electronics for indicator failure control. Indicator failure control is not mandatory for lifting loading platforms."</p>

	Part no.	Pk.	For surface mounting
	<p>2BA 007 135-001</p> <p>9EL 146 073-001</p> <p>2BA 007 135-021</p> <p>9EL 146 073-001</p> <p>2BA 007 135-011</p> <p>4AZ 003 787-001</p> <p>4AZ 003 787-021</p>	<p>2</p> <p>6</p> <p>2</p> <p>6</p> <p>2</p> <p>1</p> <p>1</p>	<p>For rear mounting (category 2a) of lift type loading platforms. Amber lens. Die-cast zinc housing. Four 5.4 mm dia. holes for fixing screws. With gland.</p> <p>(E1) 016</p> <p>Indicator light</p> <p>Spare parts: Lens with reflector</p> <hr/> <p>Without gland</p> <p>Spare parts: Lens with reflector</p> <hr/> <p>With heavy-duty lens and mounting bolts M5 x 35 extending all the way through</p> <p>Also required for installation: Flasher unit, 12V or Flasher unit, 24V</p> <p> 2x12V5W (W5W) 8GP 003 594-121 2x24V5W (W5W) 8GP 003 594-251</p>

Indicator Lights

Auxiliary Indicators



	<p>Part no.</p> <p>2BA 001 236-001</p> <p>9EL 085 408-001</p>	<p>Pk.</p> <p>1</p> <p>10</p>	<p>Handlebar indicator lights for two-wheeled vehicles</p> <p>Amber lens. Frame polished. Fixed with clamping screw with 17.8 mm dia. pin.</p> <p>K 12749 *)</p> <p>Indicator light</p> <p>Spare parts: Lens</p> <p>1x6V18W (K) - 1x12V18W (K) 8GM 002 091-121</p>
	<p>2BA 001 263-001</p> <p>9EL 088 744-001</p>	<p>4</p> <p>10</p>	<p>Amber lens, with 17.8 mm dia. fixing fitting.</p> <p>K 22609 *)</p> <p>Indicator light</p> <p>Spare parts: Lens</p> <p>1x6V18W (K) - 1x12V18W (K) 8GM 002 091-121</p>
	<p>2BM 003 563-111</p>	<p>1</p>	<p>Auxiliary indicators</p> <p>For side flush mounting (category 5). Amber lens, with connecting cable.</p> <p>Ⓔ1 42621</p> <p>Auxiliary indicator</p> <p>1x12V5W (W5W) 8GP 003 594-121</p>
	<p>2BM 009 320-807</p>	<p>1</p>	<p>For side flush mounting (category 5). Set comprises: Two indicators with amber lenses and 12V bulbs.</p> <p>Ⓔ4 1365</p> <p>Auxiliary indicator</p> <p>2x12V4W (T4W) 8GP 002 067-121</p>
	<p>2BM 004 965-801</p>	<p>1</p>	<p>For side flush mounting (category 5). Set comprises: Two indicators with amber lenses and 12V bulbs.</p> <p>Ⓔ1 42710</p> <p>Auxiliary indicator</p> <p>2x12V5W (W5W) 8GP 003 594-121</p>













*) National type test for Germany


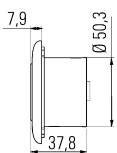
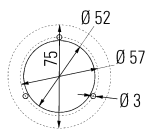

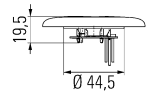
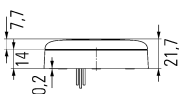
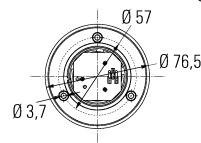
	<p>Part no.</p> <p>2BM 004 312-051</p> <p>2BM 004 312-061</p> <p>9EL 127 855-001</p> <p>9EL 127 856-001</p>	<p>Pk.</p> <p>1</p> <p>1</p> <p>5</p> <p>5</p>	<p>Auxiliary indicators</p> <p>For side mounting (category 5). Amber lens.</p> <p>(E1) 42669</p> <p>Auxiliary indicator, left</p> <p>right</p> <p>Spare parts: Lens, left right</p> <p>1x12V21W (P21W) 8GA 002 073-121 1x24V21W (P21W) 8GA 002 073-241</p>
	<p>2BM 003 647-021</p> <p>2BM 003 647-067</p> <p>2BM 003 647-801</p>	<p>1</p> <p>288</p> <p>1</p>	<p>For side mounting (category 5). Amber lens.</p> <p>(E1) 151</p> <p>Auxiliary indicator with 12V bulb</p> <hr/> <p>Complete set: Two amber indicators with 12V bulbs, cable with two grommets and one cable holder.</p> <p>Auxiliary indicator set</p> <p>1(2x)12V5W (W5W) 8GP 003 594-121</p>
	<p>2BM 003 933-031</p> <p>2BM 003 933-041</p>	<p>1</p> <p>1</p>	<p>For side mounting (category 5). Amber lens, black body, with 2-pole cable.</p> <p>(E1) 42627</p> <p>Auxiliary indicator, left</p> <p>right</p> <p>1x12V5W (W5W) 8GP 003 594-121</p>
	<p>2BM 002 847-011</p> <p>2BM 002 847-021</p> <p>9EL 115 830-001</p>	<p>1</p> <p>1</p> <p>5</p>	<p>For side mounting (category 5). Amber lens. With wiring harness.</p> <p>(E1) 32692</p> <p>Auxiliary indicator, left</p> <p>right</p> <p>Spare parts: Lens</p> <p>1x12V21W (P21W) 8GA 002 073-121</p>
	<p>2BM 001 318-001</p>	<p>5</p>	<p>For side mounting (category 5). Amber lens, chrome-type rim. Two M3 fixing screws.</p> <p>(E1) 32639</p> <p>Auxiliary indicator</p> <p>1x12V4W (T4W) 8GP 002 067-121</p>



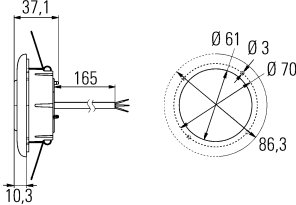




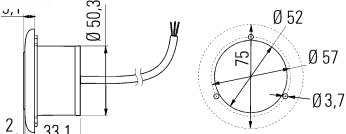

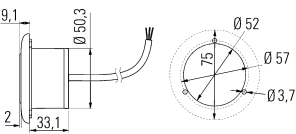
	Part no.	Pk.	Auxiliary indicators
	2BM 001 313-001 2BM 001 313-002	2 1	<p>For side mounting (category 5). Amber lens. Two B2.9 fixing screws.</p> <p>(E1) 32779</p> <p>Auxiliary indicator Pro-fit pack</p>
	2BM 001 313-821	1	<p>Complete set: Two indicators with amber lenses and 12V bulbs.</p> <p>Auxiliary indicator set carded</p> <p>1x12V4W (T4W) 8GP 002 067-121 Suitable 1x12V2W (T8/2) 8GP 002 068-121</p>
	2BM 008 771-001 2BM 008 771-007	1 30	<p>For side mounting (category 5). Also suitable for installation in the external mirror. In LED-technology. Clear lens. Black body. With 3 amber LEDs 12V0.7W and 800 mm lead. Consumption: 0.06A at 12V. See page 5.236, instruction 2.</p> <p>(E1) 1423</p> <p>Auxiliary indicator, 12V0.7W</p>
	2BM 008 355-001 2BM 008 355-007	1 30	<p>For side mounting (category 6). Amber lens. Black body. Three 3.5 x 35 mm fixing screws. For use in splashwater-protected area.</p> <p>(E1) 1059</p> <p>Auxiliary indicator</p> <p>1x24V21W (P21W) 8GA 002 073-241</p>
	2BM 008 355-017 8KA 157 425-007	30 1	<p>(E1) 1848</p> <p>With clear lens</p> <p>Accessories: Cable set, 2-conductor for non-splashwater-protected area, 1200 mm long with two 6.3 mm blade terminals.</p> <p>1x24V21W (PY21W) 8GA 006 841-241</p>
	2BM 006 692-011 2BM 006 692-017 2BM 006 692-021 2BM 006 692-027	1 18 1 18	<p>For side mounting (category 5 and 6). Amber lens. Two B4.2 x 19 fixing screws.</p> <p>(E1) 52621</p> <p>Auxiliary indicator, left</p> <p>right</p> <p>1x12V21W (P21W) 8GA 002 073-121 1x24V21W (P21W) 8GA 002 073-241</p>

	Part no. 2JA 001 357-002 2JA 001 357-012	Pk. 6 5	For flush mounting Clear lens. Lamp fastened with catch at side. Interior light with switch without switch 2x12V10W (K) 8GM 002 091-131 2x24V10W (K) 8GM 002 091-251
	2JA 996 038-001	1	Milky-white lens. With switch. Interior light 2x12V10W (K) 8GM 002 091-131 2x24V10W (K) 8GM 002 091-251
	2JA 002 661-001 9EL 116 607-005	1 1	Clear lens. Two 7 mm dia. holes for fixing screws. With switch and ON/OFF door contact. Interior light Spare parts: Lens 2x12V21W (P21W) 8GA 002 073-121 2x24V21W (P21W) 8GA 002 073-241
	2JA 959 073-001 2JA 959 073-201	1 1	In LED-technology. Clear lens. With 10 LEDs 1.7W and 2500 mm long lead. Consumption: 0.17A at 12V, 0.09A at 24V. Interior light, 12V 24V



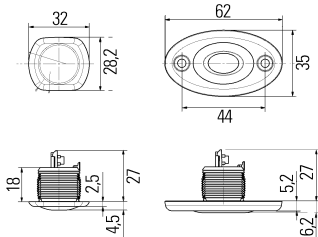

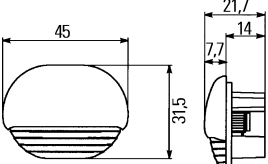
	Part no. 2JA 006 447-041	Pk. 1	For flush mounting Clear lens, with spot light. Switch for interior light and spot. Grey body. Interior light Interior light 1x12V21W (P21W) 8GA 002 073-121 1x24V21W (P21W) 8GA 002 073-241 Reading light 1x12V10W (R10W) 8GA 002 071-131 1x24V10W (R10W) 8GA 002 071-251
	2JA 006 447-251	1	Without spot, with switch and ON/OFF door contact 2x12V10W (R10W) 8GA 002 071-131 2x24V10W (R10W) 8GA 002 071-251 Suitable 2x12V21W (P21W) 8GA 002 073-121 2x24V21W (P21W) 8GA 002 073-241
	2JA 009 037-017 2JA 009 037-027	1 1	Clear lens, with spot. Switch for interior light and spot. Grey body. Interior light with 12V bulbs with 24V bulbs Interior light 1x12V21W (P21W) 8GA 002 073-121 1x24V21W (P21W) 8GA 002 073-241 Reading light 1x12V10W (R10W) 8GA 002 071-131 1x24V10W (R10W) 8GA 002 071-251
	2JA 006 487-261 2JA 006 487-347	1 56	Clear lens, grey body. With switch and ON/OFF door contact. Interior light without bulb with 12V bulb 1x12V10W (R10W) 8GA 002 071-131 1x24V10W (R10W) 8GA 002 071-251 Suitable 1x12V21W (P21W) 8GA 002 073-121 1x24V21W (P21W) 8GA 002 073-241
	2JA 003 236-357	1	Clear lens. Grey rubber body. With economy circuit. It is only permissible for one bulb to be connected. Two BZ4.2 fixing screws . Interior light 1x12V4W (T4W) 8GP 002 067-121 1x24V4W (T4W) 8GP 002 067-241 1x12V15W (-) 1x24V15W (-)


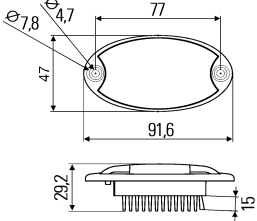

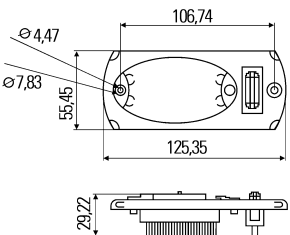

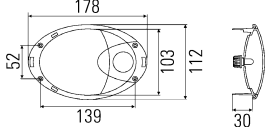

	Part no.	Pk.	For flush mounting
			<p>SpotLED</p> <p>In LED-technology. Clear lens. With 1 white Luxeon Power LED and 200 mm long connection lead. Black body. Voltage range: 9V - 31V.</p> <p>With adjustable spot, 20° to each side. Suitable with screws or spring fixing.</p> <p>Spot: 12V/24V2.5W. Consumption: 0.21A at 12V, 0.10A at 24V. Celis® ring light: 12V0.5W, 24V1.0W. Consumption: 0.04A at 12V, 0.02A at 24V.</p>
	2JA 343 700-051	1	
	2JA 343 700-221	1	with blue Celis® ring light and white installation frame
	2JA 343 700-251	1	without Celis® ring light, with black installation frame
	2JA 343 700-271	1	with blue Celis® ring light and black installation frame
	2JA 343 700-167	30	with red Celis® ring light and black installation frame
	2JA 343 680-177	1	With fixed spotlight, fixing with screws. Interior light with blue Celis® ring light and black installation frame
	2JA 343 680-127	30	with blue Celis® ring light and grey installation frame
	2JA 343 680-067	1	with red Celis® ring light and white installation frame
	2JA 343 860-031	1	<p>Spot</p> <p>Clear lens. Black body with black installation frame Suitable with screw or spring fixing. With 12V5W halogen bulb.</p>
	2JA 343 865-031	1	Interior light with fixed spotlight
			with adjustable spot

	Part no.	Pk.	For flush mounting
  	<p>SpotLED</p> <p>In LED-technology. Clear lens. With 1 white LED. Fixed spotlight. Suitable with screw or spring fixing. Electrical connection through 4-pole plug housing. Type of protection: IP3X. Voltage range: 10V - 31V.</p> <p>Spot: 12V2.5W Consumption: 0.20A at 12V.</p> <p>Wide range illumination: 40°.</p> <p>Interior light with white installation frame</p> <p>2JA 344 040-701 1</p> <p>with black installation frame</p> <p>2JA 344 040-711 1</p> <p>with silver installation frame</p> <p>2JA 344 040-721 1</p> <p>with gold installation frame</p> <p>2JA 344 040-731 1</p>		<p>Close range illumination: 20°.</p> <p>Interior light with white installation frame</p> <p>2JA 344 040-741 1</p> <p>with black installation frame</p> <p>2JA 344 040-751 1</p> <p>with silver installation frame</p> <p>2JA 344 040-761 1</p> <p>with gold installation frame</p> <p>2JA 344 040-771 1</p>
   	<p>SpotLED</p> <p>In LED-technology. Brilliant-clear lens. With 1 white Power-LED. Fixed spotlight. Electrical connection through 2 x 500 mm cables. Three 3.7 mm dia. holes for fixing screws. Type of protection: IP20.</p> <p>Spot: 5V1.5W Consumption: 0.30A at 5V.</p> <p>Interior light with white installation frame</p> <p>2JA 344 199-001 1</p> <p>with black installation frame</p> <p>2JA 344 199-011 1</p>		<p>For flush/surface mounting</p> <p>With warm tone Celis® ring light</p> <p>with white installation frame</p> <p>2JA 344 199-101 1</p> <p>with black installation frame</p> <p>2JA 344 199-111 1</p>

	Part no.	Pk.	For flush mounting
			<p>SpotLED In LED-technology. Clear lens. With 1 warm tone LED. Adjustable spot. Wide range illumination: 40°. Electrical connection by 4-pole plug housing. Suitable with screw or spring fixing. Voltage range: 10V - 31V. Type of protection: IP3X.</p>
 	<p>2JA 343 790-301 2JA 343 790-701 2JA 343 790-311 2JA 343 790-711</p>	<p>1 1 1 1</p>	<p>SpotLED In LED-technology. Clear lens. With 1 warm tone LED. Adjustable spot. Wide range illumination: 40°. Electrical connection by 4-pole plug housing. Suitable with screw or spring fixing. Voltage range: 10V - 31V. Type of protection: IP3X.</p> <p>Spot: 12V/24V 2.5W. Consumption: 0.20A at 12V, 0.10V at 24V. Celis® ring light: 12V0.5W, 24V1.0W. Consumption: 0.04A at 12V, 0.02A at 24V.</p> <p>Interior light with white installation frame without Celis® ring light</p> <p>2JA 343 790-301 1 with white Celis® ring light</p> <p>2JA 343 790-701 1 with black installation frame without Celis® ring light</p> <p>2JA 343 790-311 1 with white Celis® ring light</p> <p>2JA 343 790-711 1 with silver installation frame without Celis® ring light</p> <p>2JA 343 790-341 1 with white Celis® ring light</p> <p>2JA 343 790-741 1 with gold installation frame without Celis® ring light</p>
	<p>2JA 343 790-351 2JA 343 790-751</p>	<p>1 1</p>	<p>with gold installation frame without Celis® ring light</p> <p>2JA 343 790-351 1 with white Celis® ring light</p> <p>2JA 343 790-751 1 with gold installation frame without Celis® ring light</p>
	<p>2JA 343 790-401 2JA 343 790-411 2JA 343 790-441 2JA 343 790-451</p>	<p>1 1 1 1</p>	<p>Close range illumination: 20°. Without Celis® ring light.</p> <p>Interior light with white installation frame with black installation frame with silver installation frame with gold installation frame</p>
	<p>2JA 343 790-601 2JA 343 790-611 2JA 343 790-641 2JA 343 790-651</p>	<p>1 1 1 1</p>	<p>With white Celis® ring light.</p> <p>Interior light with white installation frame with black installation frame with silver installation frame with gold installation frame</p>
 	<p>2JA 343 790-107</p>	<p>30</p>	<p>Adjustable spot. Close range illumination: 20°. Possible to switch between white functional lighting and blue night design.</p> <p>Interior light with blue Celis® ring light and white installation frame</p>
 	<p>2JA 343 980-217</p>	<p>48</p>	<p>In LED-technology. Clear lens. With 1 warm tone LED and 200 mm lead. Fixed spot. Close range illumination: 20°. Three 3.7 mm dia holes for fixing screws. Voltage range: 10V - 31V.</p> <p>Spot: 12V/24V 2.5W. Consumption: 0.20A at 12V, 0.10V at 24V. Celis® ring light: 12V0.5W, 24V1.0W. Consumption: 0.04A at 12V, 0.02A at 24V.</p> <p>Interior light with white Celis® ring light and black installation frame</p>

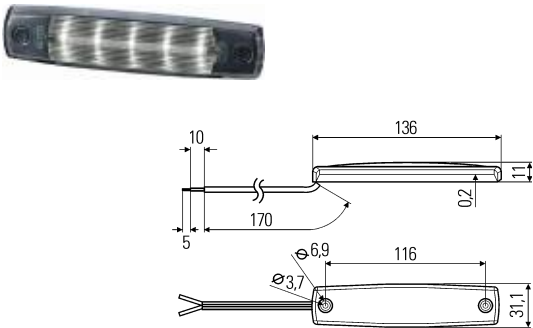
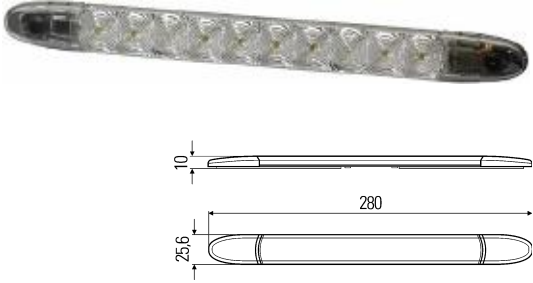
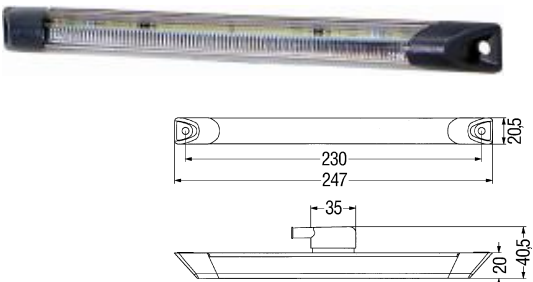
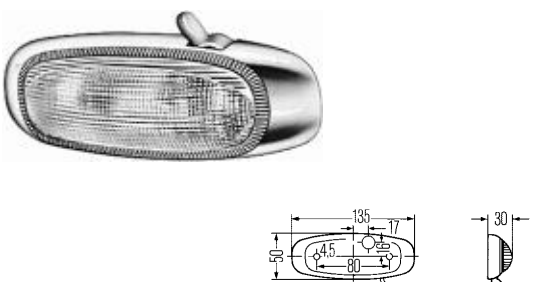


	Part no.	Pk.	For flush mounting
	2JA 343 795-001	1	SpotBulb With adjustable spot. Clear lens. With 12V bulb. Wide range illumination: 35°. <p>Electrical connection by blade receptables 6.3 mm. Suitable with screw or spring fixing. Type of protection: IP3X.</p>
	2JA 343 795-011	1	Interior light with white installation frame
	2JA 343 795-011	1	With black installation frame
	2JA 343 795-021	1	With silver installation frame
	2JA 343 795-031	1	With gold installation frame
	2JA 343 985-001	1	Fixed spotlight. Fixing with screws. Interior light with white installation frame
	2JA 343 985-011	1	With black installation frame
	2JA 343 985-041	1	With silver installation frame
	2JA 343 985-021	1	With gold installation frame
			1x12V5W (W5W) 8GP 003 594-121

	Part no.	Pk.	For flush mounting
  	<p>2JA 344 170-001</p> <p>2JA 344 170-101</p> <p>2JA 344 170-011</p> <p>2JA 344 170-111</p> <p>2JA 344 170-021</p> <p>2JA 344 170-121</p> <p>2JA 344 170-031</p> <p>2JA 344 170-131</p>	<p>1</p> <p>1</p> <p>1</p> <p>1</p> <p>1</p> <p>1</p> <p>1</p> <p>1</p>	<p>In LED-technology. Brilliant clear lens. With 1 LED 12V0.3W or 24V0.3W. Suitable with three installation frames, black, white and grey. Installation with fixing ring, or alternativ 2 holes for ST3.5 fixing screws. Electrical connection with 4-pole AMP micro plug housing. Type of protection: 3X. Operating temperature: -40 °C to + 60 °C. Consumption: 0.025A at 12V/24V</p> <p>Interior light with ambient red lighting, 12V</p> <p>24V</p> <p>with ambient blue lighting, 12V</p> <p>24V</p> <p>with ambient white lighting, 12V</p> <p>24V</p> <p>with ambient yellow lighting, 12V</p> <p>24V</p>
 	<p>2JA 998 560-017</p> <p>2JA 998 560-057</p>	<p>20</p> <p>20</p>	<p>In LED-technology. Clear lens. With white cap. With 100 mm long lead. Consumption: 0.04A at 12V, 0.02A at 24V.</p> <p>Interior light with 1 white LED, 12V0.3W</p> <p>with 1 blue LED, 12V0.3W</p>


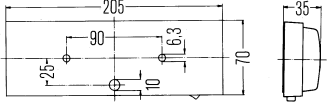


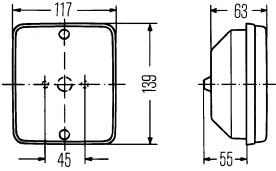


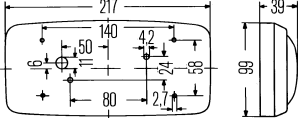

	Part no.	Pk.	For flush mounting
 	<p>2JA 343 570-011</p> <p>2JA 343 570-117</p> <p>2JA 343 570-001</p>	<p>1</p> <p>48</p> <p>1</p>	<p>Mini OvalLED</p> <p>In LED-technology. Brilliant clear lens. With 4 white LEDs and 1 red (or blue) LED. Black body with 150 mm lead. Operating temperature: -40°C to +60°C. Consumption: 0.05A at 12V, 0.15A at 24V.</p> <p>Interior light without frame, without switch, ambient red lighting can be switched on/off, 12V6.0W</p> <p>ambient blue lighting can be switched on/off, 12V6.0W</p> <p>ambient red lighting can be switched on/off, 24V3.6W</p> <hr/> <p>Consumption: 0.14A at 12V, 0.07A at 24V.</p> <p>Interior light without frame, without switch, ambient red lighting can be switched on/off, 12V1.7W</p> <p>without frame, without switch, ambient red lighting can be switched on/off, 24V1.7W</p> <hr/> <p>Consumption: 0.5A at 12V, 0.15A at 24V.</p>
 	<p>2JA 343 570-051</p> <p>2JA 343 570-157</p> <p>2JA 343 570-071</p> <p>2JA 343 570-061</p> <p>2JA 343 570-141</p> <p>2JA 343 570-041</p>	<p>1</p> <p>48</p> <p>1</p> <p>1</p> <p>1</p> <p>1</p>	<p>2JA 343 570-051</p> <p>With frame, ambient red lighting can be switched on/off, 12V6.0W</p> <p>ambient blue lighting can be switched on/off, 12V6.0W</p> <hr/> <p>Consumption: 0.14A at 12V, 0.07A at 24V.</p> <p>With frame, ambient red lighting can be switched on/off, 12V1.7W</p> <p>ambient red lighting can be switched on/off, 24V1.7W</p> <p>ambient blue lighting can be switched on/off, 24V1.7W</p> <p>Same as -061, but with Power LEDs, 24V1.7W</p>
 	<p>2JA 009 294-001</p> <p>2JA 009 294-021</p> <p>2JA 009 294-241</p> <p>2JA 009 294-261</p>	<p>1</p> <p>1</p> <p>1</p> <p>1</p>	<p>Clear lens. Black body. With switch, ON/OFF door contact and blade terminalcontacts. Suitable with screws or spring fixing. Operating temperature: - 40 °C to + 60 °C. Type of protection: IP 3. With 12V5W bulb.</p> <p>Interior light with reading light</p> <p> 1x12V5W (W5W) 8GP 003 594-121</p> <hr/> <p>With 24V4W bulb.</p> <p>Interior light with reading light</p>


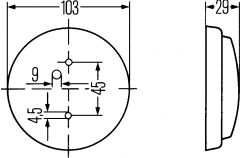

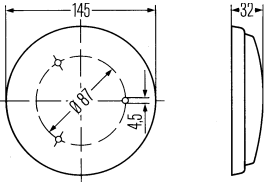

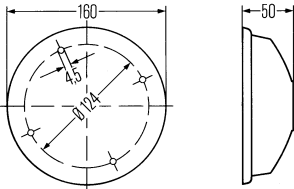
		Part no.	Pk.	For flush mounting
		2JB 343 227-001	1	CargoLED
		2JB 343 227-041	1	In LED-technology. Clear lens. With 4 white LEDs, 6.0W.
		2JB 343 227-047	12	Silver-coloured frame with four 4 mm dia. holes for fixing screws. 310 mm long connecting lead with stripped cable ends. Temperature range: - 40 °C to + 60 °C. Voltage range: 9V - 31V. Consumption: 0.5A at 12V, 0.25A at 24V.
		2PF 008 405-061	1	In LED-technology. Clear lens. With 12 LEDs 12V1.8W. Consumption: 0.15A at 12V.
		2JA 008 405-081	1	Interior light with white LEDs
				with blue LEDs
		2JA 009 208-001	1	White body, silver-coloured rim. With halogen bulb 12V10W and 300 mm long connecting lead.
		2JA 009 208-011	1	Interior light with milky-white lens
				with clear lens


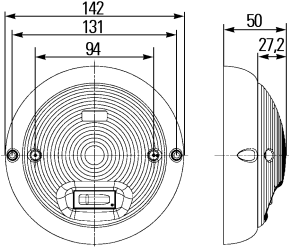


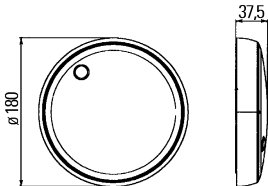
	Part no.	Pk.	For flush mounting
	2JA 008 615-001	1	<p>Clear PC lens. Steel housing and reflector. Four 4 mm dia. holes for fixing screws. With 24V bulb.</p> <p>Caution: High temperatures. Please use silicon leads. The lamp must not come into contact with easily inflammable insulating material!</p> <p>Interior light</p> <p> 1x24V21W (P21W) 8GA 002 073-241</p>
	2JA 005 590-001	1	<p>Clear lens, white base plate. With economy circuit. Four holes for M4 fixing screws. 2 x 10W (full power) or 1 x 4W/ 1 x 5W (economy circuit) bulbs as required.</p> <p>Interior light</p>
	2JA 005 590-157	1	<p>With clear lens and angular frame for flush-mounting</p> <p>Suitable bulbs:</p> <p> 2x12V10W (R10W) 8GA 002 071-131 2x24V10W (R10W) 8GA 002 071-251</p> <p> 1x12V4W (T4W) 8GP 002 067-121 1x24V4W (T4W) 8GP 002 067-241</p> <p>Halogen bulb if required 1x12V5W (-) 8GH 002 473-151</p>

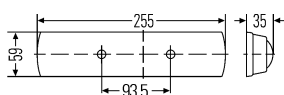

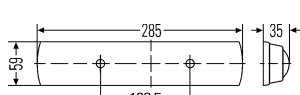

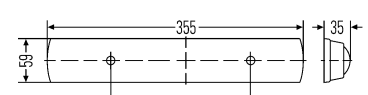
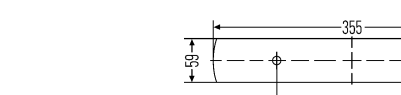
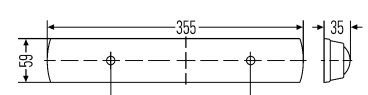

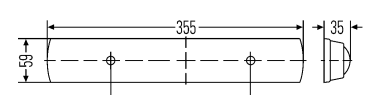

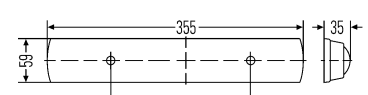

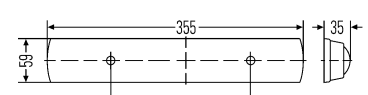
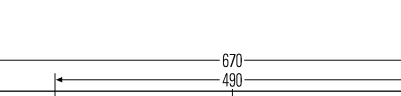
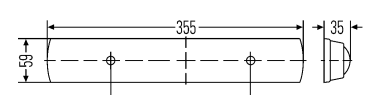

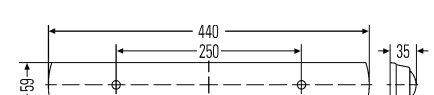

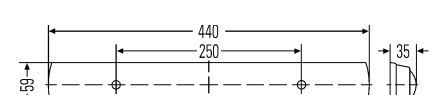
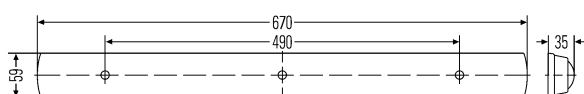
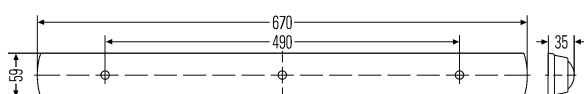
 <p>Technical drawings showing dimensions: 10, 5, 170, 136, 0.2, 11, 6.9, 116, 3.7, 31.1.</p>	Part no. 2JA 343 660-101 2JA 343 660-107 2JA 343 660-117	Pk. 1 30 30	For surface mounting Mini ThinLED In LED-technology. Clear lens. With 5 LEDs and 170 mm long lead. With grey caps. Two holes for M3 fixing screws. Consumption: 0.06A at 12V, 0.1A at 24V. Interior light, 12V, 0.7W 24V, 2.3W
 <p>Technical drawings showing dimensions: 10, 25.6, 280.</p>	2JA 343 606-007 2JA 343 606-017 2JA 343 606-217	1 1 30	ThinLite In LED-technology. Clear lens. With 10 LEDs and 500 mm long lead. With grey caps. Consumption: 0.15A at 12V/24V. Interior light, 12V, 1.8W 24V, 3.6W Consumption: 0.15A at 24V. With 10 blue LEDs and 500 mm long lead, 24V3.6W.
 <p>Technical drawings showing dimensions: 230, 247, 35, 20.5, 20, 40.5.</p>	2JA 008 078-021 2JA 008 078-031	1 1	With LED light guide technology. Lens clear. Grey plastic base plate and covers. Two 5.4 mm dia. holes for fixing screws. Consumption: 0.06A at 12V. Interior light, with 2 blue LEDs 12V0.7W. with 2 white LEDs 12V0.7W.
 <p>Technical drawings showing dimensions: 135, 17, 4.5, 80, 30.</p>	2JA 001 346-011	2	Clear lens, chrome-type rim, with switch. Two 4.5 mm dia. holes for fixing screws. Interior light  1x12V10W (K) 8GM 002 091-131  1x24V10W (K) 8GM 002 091-251


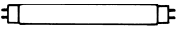

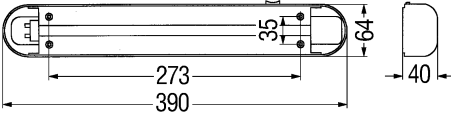
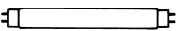
	Part no. 2JA 997 027-051	Pk. 1	For surface mounting Clear lens, chrome-type rim, with switch. Plastic base plate. Interior light 1x12V18W (K) 8GM 002 091-121 1x24V18W (K) 8GM 002 091-241
	2JA 001 330-001 2JA 001 330-007 2JA 001 330-031	2 102 2	Milky-white lens. Two 5 mm dia. holes for fixing screws. Interior light with switch without switch 2x12V5W (C5W) 8GM 002 092-121 2x24V5W (C5W) 8GM 002 092-241
	2JA 001 364-001	2	Clear lens, chrome-type rim, with switch. Switched on and off by sliding the lens. Two holes for B4.2 x 13 fixing screws. Interior light 2x12V10W (K) 8GM 002 091-131 2x24V10W (K) 8GM 002 091-251
	2JA 004 192-001	1	Clear lens, with switch. Black shutter adjusts light aperture. Light is switched off mechanically when shutter angle is 45°. Two 5.5 mm dia. holes for fixing screws. Interior light 1x12V10W (K) 8GM 002 091-131 1x24V10W (K) 8GM 002 091-251
	2JA 001 360-001	1	Milky-white lens, black body, with 2 switches. Economy circuit, for switching on 1, 2 or 3 bulbs, as required. Two 6 mm dia. holes for fixing screws. Interior light 3x12V10W (K) 8GM 002 091-131 3x24V10W (K) 8GM 002 091-251


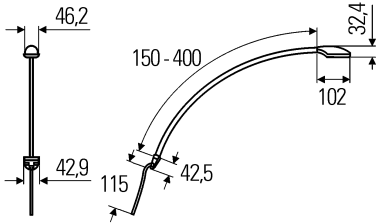

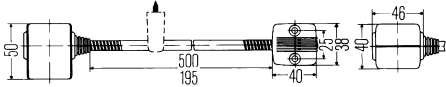


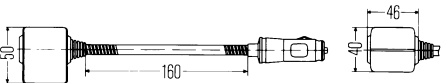




 	<p>Part no.</p> <p>2JA 003 354-001</p> <p>9AR 120 266-001</p> <p>9EL 120 240-011</p> <p>2JA 003 354-051</p> <p>2JA 003 354-031</p>	<p>Pk.</p> <p>1</p> <p>4</p> <p>2</p> <p>1</p> <p>1</p>	<p>For surface mounting</p> <p>Clear lens and rim, with switch. 3 switch positions. Two 6 mm dia. holes for fixing screws.</p> <p>Interior light</p> <p>Frame (to be ordered separately)</p> <p>Spare parts: Lens</p> <hr/> <p>Without switch</p> <hr/> <p>With switch and chrome-type rim</p> <p> 2x12V10W (K) 8GM 002 091-131 2x24V10W (K) 8GM 002 091-251</p>
 	<p>2ZR 003 236-051</p> <p>9EL 119 544-111</p> <p>9DX 119 545-051</p>	<p>1</p> <p>1</p> <p>2</p>	<p>Clear lens, without switch. Black plastic body. Two M6 x 12 fixing screws.</p> <p>Interior light</p> <p>Spare parts: Lens Reflector</p> <p> 1x12V21W (P21W) 8GA 002 073-121 1x24V21W (P21W) 8GA 002 073-241</p>
 	<p>2JA 001 331-011</p> <p>9EL 091 749-011</p>	<p>5</p> <p>5</p>	<p>Milky-white lens, chrome-type rim. Without switch. Four 3.2 mm dia. holes for fixing screws.</p> <p>Interior light</p> <p>Spare parts: Lens</p> <p> 2x12V10W (R10W) 8GA 002 071-131 2x24V10W (R10W) 8GA 002 071-251</p>


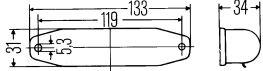


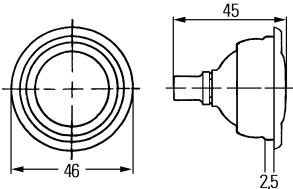


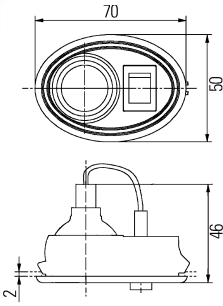

 	<p>Part no.</p> <p>2JA 003 231-001</p> <p>2JA 003 231-011</p>	<p>Pk.</p> <p>1</p> <p>1</p>	<p>For surface mounting</p> <p>Clear macrolon lens and frame. With switch. Switched on and off by rotating the lens. 3 switch positions. Two holes for M4 fixing screws.</p> <p>Interior light with clear lens surround</p> <p>with aluminium-anodized effect lens surround</p> <p>1x12V10W (K) 8GM 002 091-131 1x24V10W (K) 8GM 002 091-251 or 1x12V15W (-) 8GM 002 091-141 1x24V15W (-) 8GM 002 091-261</p>
 	<p>2JA 003 232-001</p> <p>2JA 003 232-011</p>	<p>1</p> <p>1</p>	<p>Clear macrolon lens and frame. With switch. Switched on and off by rotating the lens. 3 switch positions. Three holes for M4 fixing screws.</p> <p>Interior light with clear lens surround</p> <p>with aluminium-anodized effect lens surround</p> <p>2x12V10W (K) 8GM 002 091-131 2x24V10W (K) 8GM 002 091-251 or 1x12V15W (-) 8GM 002 091-141 1x24V15W (-) 8GM 002 091-261</p>
 	<p>2JA 001 335-001</p> <p>2JA 001 335-011</p> <p>2JA 001 335-121</p>	<p>1</p> <p>1</p> <p>1</p>	<p>Clear lens, chrome-type grille and rim. Switch with 2 switch positions. Four holes for M4 fixing screws.</p> <p>Interior light with switch</p> <p>without switch</p> <hr/> <p>With milky-white lens, white grille and frame, with switch</p> <p>Suitable bulbs 1x12V5W (R5W) 8GA 002 071-121 1x24V5W (R5W) 8GA 002 071-241 or 1x12V10W (R10W) 8GA 002 071-131 1x24V10W (R10W) 8GA 002 071-251 or 1x12V15W (F) (-)</p>






 	<p>Part no.</p> <p>2JA 998 569-017</p>	<p>Pk.</p> <p>36</p>	<p>For surface mounting</p> <p>Clear lens. With switch. Black body. With 12V bulb.</p> <p>Interior light</p> <p> 1x12V21W (P21W) 8GA 002 073-121</p>
 	<p>Part no.</p> <p>2JA 998 565-012 2JA 998 565-032</p>	<p>Pk.</p> <p>1 1</p>	<p>Milky-white lens. With 120 mm long connecting lead incl. overvoltage and undervoltage protection. Splash-water proof. Voltage range: 10V - 30V. Three holes for fixing screws. With 7W fluorescent bulb.</p> <p>Interior light with switch without switch</p>

	Part no.	Pk.	For surface mounting
	2JA 007 373-001	1	Clear lens. With switch and compact fluorescent tube 7W. Consumption: 300 mA.
	2JA 007 373-011	1	Transistorized ceiling light, 12V, fully suppressed
	2JA 007 373-031	1	24V, fully suppressed
	2JA 007 373-041	1	Spare parts: Compact fluorescent tube 7W, white
	2JA 007 373-061	1	With compact fluorescent tube 9W. Consumption: 385 mA.
	2JA 007 373-031	1	12V, fully suppressed
	2JA 007 373-041	1	24V, fully suppressed
	8GS 861 955-011	1	Spare parts: Compact fluorescent tube 9W, white
	2JA 007 373-061	1	With compact fluorescent tube 11W. Consumption: 550 mA.
	2JA 007 373-117	1	12V, fully suppressed, without switch. Colour temperature 4000° Kelvin
	2JA 007 373-127	1	12V, fully suppressed, without switch. Colour temperature 4000° Kelvin
	2JA 007 373-071	1	24V, fully suppressed
	2JA 007 373-107	1	24V, fully suppressed, without switch. Colour temperature 4000° Kelvin
	2JA 007 373-137	1	24V, fully suppressed, without switch, with 2 x 6.3 mm blade receptacles. Colour temperature 4000° Kelvin
	8GS 861 955-021	1	Spare parts: Compact fluorescent tube 11W, white, for -061/-071
	8GS 861 955-031	1	for -117/-107/-127/-137
	2JA 007 372-001	1	Clear lens. With switch and compact fluorescent tube 8W. Consumption: 390 mA.
	2JA 007 372-011	1	Transistorized ceiling light, 12V, fully suppressed
	8GS 002 296-101	1	Spare parts: Compact fluorescent tube 8W, warm tone
	8GS 002 296-111	1	Compact fluorescent tube 8W, white
	2JA 007 372-041	1	With switch and compact fluorescent tube 13W. Consumption: 580 mA.
	2JA 007 372-051	1	12V, fully suppressed
	8GS 861 953-011	1	24V, fully suppressed
	8GS 861 953-011	1	Spare parts: Compact fluorescent tube 13W, white




	Part no.	Pk.	For surface mounting
	<p>2JA 004 531-001</p> <p>2JA 004 531-011</p>	<p>1</p> <p>1</p>	<p>Clear lens. With built-in, electronically-operated converter. With switch, partially suppressed. Blocking diode prevents damage to electronic components caused by incorrect polarity connection. Two 3.5 mm dia. holes for fixing screws. With fluorescent tube/8W. Fully suppressed.</p> <p>Transistorized ceiling light, 12V</p> <p>24V</p> <p>Spare parts: Lens</p> <div style="display: flex; align-items: center;">  <p>Fluorescent tube 8W, warm tone 8GS 002 296-101</p> </div> <p>White 8W fluorescent tube 8GS 002 296-111 can be used if required.</p>
 	<p>2JA 340 111-001</p>	<p>1</p>	<p>Clear lens. White body, without switch. RF-suppressed = suppression class N (semi-suppressed). With fluorescent tube 8W. Power consumption approx. 800 mA. With connection junction box 8JE 340 061-... see page 5.206</p> <p>Transistorized ceiling light, 24V</p> <div style="display: flex; align-items: center;">  <p>Fluorescent tube 8W, white 8GS 002 296-111</p> </div>

 	<p>Part no.</p> <p>Pk.</p> <p>2JA 343 720-011 1</p> <p>2JA 343 720-111 1</p> <p>2JA 343 720-021 1</p> <p>2JA 343 720-121 1</p> <hr/> <p>2JA 343 720-157 12</p> <p>2JA 343 720-291 1</p> <p>2JA 343 720-191 1</p>	<p>For surface mounting</p> <p>SpotLED In LED-technology. With 1 white LED 3.0W. With flexible arm, screw fixing and 115 mm long connecting lead. Voltage range: 9V - 31V. Consumption: 0.25A at 12V, 0.13A at 24V.</p> <p>Reading light with white cap and 150 mm long arm</p> <p>Reading light with white cap and 400 mm long arm</p> <p>Reading light with black cap and 150 mm long arm</p> <p>Reading light with black cap and 400 mm long arm</p> <hr/> <p>Reading light with 1 red LED 3.0W, black cap and 400 mm long arm</p> <p>Reading light with silver cap and 400 mm long arm</p> <p>Reading light with silver cap and 150 mm long arm</p>
 	<p>2AB 004 532-001 1</p> <p>2AB 004 532-061 1</p> <p>2AB 004 532-257 40</p> <hr/> <p>2AB 004 532-051 1</p> <p>2AB 004 532-057 40</p> <p>9XB 136 202-005 1</p>	<p>Clear lens, black body. Integrated ON/OFF switch in lamp head. Black flexible metal arm with holder for permanent mounting. Red lens 9EL 128 922-011 (Pk. 10), as accessories available.</p> <p>Reading light with 500 mm long arm, holder and 12V5W halogen bulb</p> <p>Reading light with 12V4W normal bulb</p> <p>same as -001, but with 60 mm long lead and round plug 8KW 044 040-003</p> <hr/> <p>With 28V7.5W Xenon bulb</p> <p>Spare parts: Bracket</p>
 	<p>2AB 004 532-011 1</p> <p>2AB 004 532-031 1</p> <p>2AB 004 532-267 40</p> <hr/> <p>2AB 004 532-021 1</p> <p>9EL 128 922-011 10</p>	<p>With 195 mm long arm, 12V5W halogen bulb and 100 mm long lead</p> <p>with 12V4W normal bulb</p> <p>same as -011, but with 60 mm long lead and round plug 8KW 044 040-003</p> <hr/> <p>With plug for cigarette lighter socket.</p> <p>With 160 mm long arm and 12V5W halogen bulb</p> <p>Accessories: Red lens</p>
		<p> 1x12V5W (-) 8GH 002 473-151</p> <p> 1x28V7.5W (-) 8GP 008 285-001</p> <p> 1x12V4W (T4W) 8GP 002 067-121</p> <p> 1x24V4W (T4W) 8GP 002 067-241</p>






	Part no.	Pk.	For flush mounting
 	2AB 001 208-001	1	<p>Black body and anti-glare fitment. Switched on and off by anti-glare fitment. Two 5.3 mm dia. holes for fixing screws.</p> <p>Reading light</p> <p>  1x12V5W (C5W) 8GM 002 092-121 1x24V5W (C5W) 8GM 002 092-241 suitable 1x12V10W (K) 8GM 002 091-131 1x24V10W (K) 8GM 002 091-251 </p>
 	2AB 004 074-027	1	<p>Clear lens. Black plastic housing. With 12V bulb and two connection leads.</p> <p>Reading light</p> <p>  1x12V5W (W5W) 8GP 003 594-121 </p>
 	2AB 004 074-087	90	<p>With 12V bulb, switch and 140 mm lead with 2-pole pin housing.</p> <p>Reading light</p> <p>  1x12V5W (WY5W) 8GP 003 594-541 </p>

	Part no. 2XM 001 974-151	Pk. 1	Hobby handlamps With rectifying ballast EVG. Handle and cap made of blue plastic with flexible rotating hook. Impact-proof, oil- and petrol resistant, transparent protective tube. With 5000 mm long lead and plain plug. Type of protection: IP20, protection class II. With fitted fluorescent tube, 230V8W.
	2XM 008 779-001 8GS 002 823-011 8GS 002 823-041	1 1 1	Professional handlamps With rectifying ballast GVG. Type of protection: IP64, protection class II. With 5000 mm long lead and shaped plug. With splinter-proof foil and flexible hook. With fitted fluorescent lamp 220-240V8W (T5/8W) on plastic rail, replaceable. Spare parts: Fluorescent lamp on plastic rail -> 6/06 7/06 ->
	2XM 001 974-031	1	With rectifying ballast GVG. Handle and cap made of blue plastic, without hook. Impact-proof protective tube. Type of protection: IP20. With 5000 mm long lead and plain plug. With fitted fluorescent tube, 230V4W.
	2XM 001 974-041 8GS 008 823-001	1 1	With electronic ballast EVG. Handle and cap made of blue rubber, with flexible rotating hook, PMMA protective tube with splinter-proof foil. Oil- and petrol resistant. Type of protection: IP64, protection class II. With 5000 mm long lead and shaped plug. With fitted fluorescent tube, 220-240V8W (T5/8W) on plastic rail, replaceable. Spare parts: Fluorescent tube on plastic rail
	2XM 001 974-051 8GS 008 822-001	1 1	With electronic ballast EVG. Hexagonal handle and cap made of blue rubber. With flexible rotating hook made of black plastic. Impact-proof PMMA protective tube. Type of protection: IP64, protective class II. With 5000 mm long lead and shaped plug. With fluorescent tube, 230V11W, on plastic rail, replaceable. Spare parts: PL fluorescent tube on plastic rail

Accessories see page 5.167

	Part no.	Pk.	Professional handlamps
	<p>2XM 001 974-101</p>	<p>1</p>	<p>With electronic ballast EVG. Handle, cap and hook made of blue plastic. Impact-proof, oil- and petrol resistant PMMA protective tube with splinter-proof foil. With electronic fuse, radio interference suppression and switch-off. Type of protection: IP64, protection class II. With 5000 mm long lead and shaped plug. With fluorescent tube 220-240V13W (T5/13W), replaceable.</p>
	<p>8GS 008 823-031</p>	<p>1</p>	<p>Spare parts: Fluorescent tube</p>
	<p>2XM 001 974-111</p>	<p>1</p>	<p>With electronic ballast EVG. Handle, cap and hook made of blue plastic. Oil- and petrol resistant. Type of protection: IP64, protection class II. With 5000 mm long lead and shaped plug. With electronic fuse, radio interference suppression, switch-off and splinter-proof foil. With fluorescent tube, 220-240V21W (T5/21W), replaceable.</p>
	<p>8GS 008 823-021</p>	<p>1</p>	<p>Spare parts: Fluorescent tube with splinter-proof foil</p>
	<p>2XM 001 974-121</p>	<p>1</p>	<p>With automatic clamping, quick fastening bracket for bonnets 1100 - 1900 mm. Tight fit thanks to non-slip profile. With 5000 mm long lead and shaped plug. With fluorescent tube, 220-240V21W (T5/21W), replaceable.</p>
	<p>2XM 001 974-111 8GS 008 823-021</p>	<p>1 1</p>	<p>Spare parts: Handlamp HL 21-1120 Fluorescent tube with splinter-proof foil</p>

Accessories see page 5.167

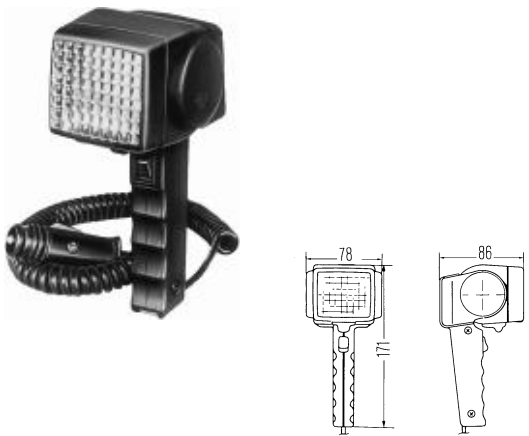






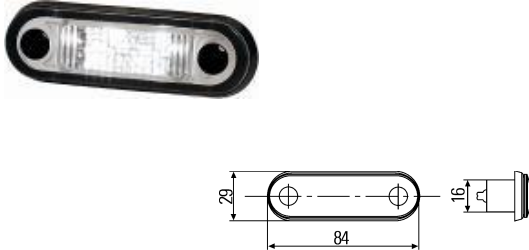
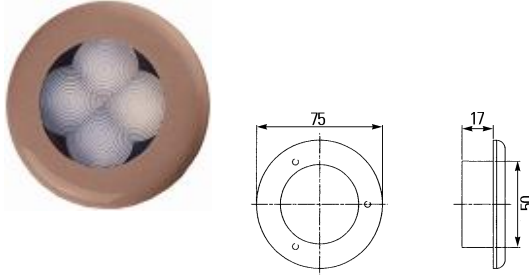
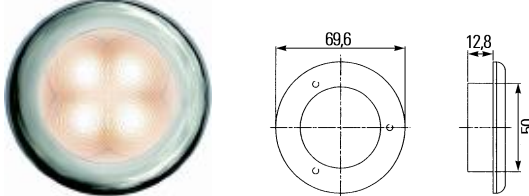
	Part no.	Pk.	Professional handlamps
	2XM 001 974-161	1	<p>In LED-technology. With 30 LEDs, battery and charger. Impact-proof hard rubber protective tube with rotating hook. Charger with Euro flat plug. Type of protection: IP54. 1 hour charging time - 5 hours work light.</p> <p>LED-Handlamp HL 04-400, 400 mm long</p> <p>Spare parts: Battery charger</p>
	2XM 001 974-201	1	<p>In LED-technology. With 42 LEDs, 220V-240V. Protective glass transparent, resistant to oil, petrol and UV-light with rotating hook. With 5 m lead and shaped plug. Type of protection: IP64, II.</p> <p>LED-Handlamp</p>
	2XM 001 974-211	1	<p>In LED-technology. With 30 LEDs, 12V battery and charger with Euro flat plug. Impact-resistant housing and rotating hook. Charger with Euro flat plug 110V-240V. Charger 12V for cigarette lighter. Type of protection: IP54. 1,5 hour charging time - 5 hours work light.</p> <p>LED-Handlamp</p>
	2XM 001 974-221	1	<p>In LED-technology. With 60 LEDs, 12V battery and charger. Impact-resistant housing, rotating hook, extra non-slip handle. Charger with Euro flat plug 110V - 240V. Charger 12V for cigarette lighter. Type of protection: IP54. 1,5 hour charging time - 5 hours work light.</p> <p>LED-Handlamp</p>
	2XM 001 974-181	1	<p>In LED-technology. Black housing made of aluminium. With flexible swan-neck. Continuous operation: up to 60 hours. Dustproof and waterproof. Length: 345 mm, bent: 172 mm. With 1 white high-quality, breakproof LED and 3 (AAAA) batteries.</p> <p>LED inspection light, 345 mm</p>


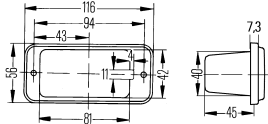


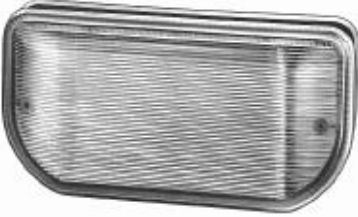
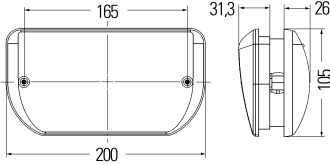
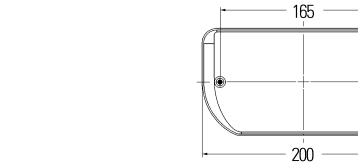
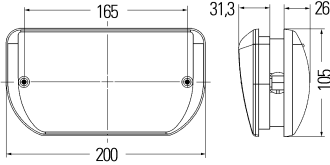


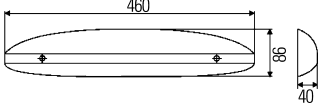

Accessories see page 5.167

Part no.	Pk.	Professional handlamps
	1	<p>With 2 conventional ballast units. Body and handle made of blue plastic. With additional socket with hinged cover for connection of additional equipment. 5000 mm lead with earthed plug. Type of protection: IP54, protection class II. With two 220-240V24W fluorescent tubes, replaceable. Twistable tripod 8XT 863 316-001 (Pk. 1). Height adjustable from 1550 mm to 2550 mm. Handle with cable roller. With clip joint, including mounting plate and screws.</p>
2XM 001 974-131	1	Garage lamp flood light
8GS 008 822-011	1	<p>Spare parts: PL fluorescent tube, 24W</p>
	1	<p>With an additional rear socket with hinged lid for connecting additional devices. 2500 mm lead with earthed plug. Twistable tripod 8XT 863 316-001 (Pk. 1). Type of protection: IP54, protection class II.</p>
2XM 009 266-001	1	Garage lamp flood light 24
8GS 009 469-001	1	<p>Spare parts: PL fluorescent tube, 24W</p>
9XD 863 958-001	1	<p>Accessories: Retaining rail (tripod connection)</p>
	1	<p>Accessories: Holder, smal for 2XM 001 974-031</p>
8HG 861 916-001	1	<p>Magnetic holder for 2XM 001 974-021/-031</p>
	1	<p>Magnetic clamp with steel spring for 2XM 008 779-001 and 2XM 001 974-041/-051/-071/-081/-091/ -101/-111/-141</p>
8HG 861 918-001	1	<p>Tripod, height adjustable from 1550 mm to 2550 mm.</p>
	1	<p>Tripod for 2XM 001 974-131 and 2XM 009 266-001</p>
8XT 863 316-001	1	

Handlights Door Lights


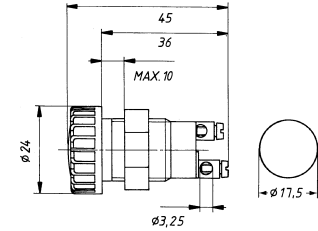

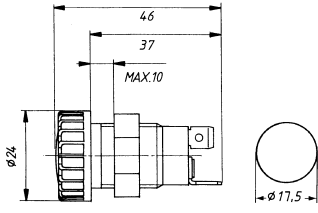

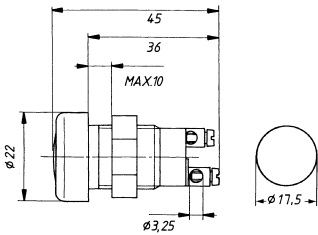


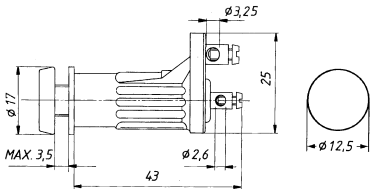




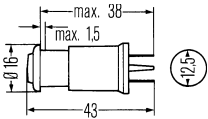


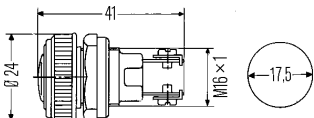

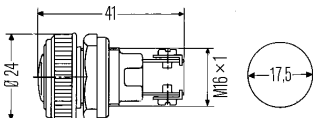


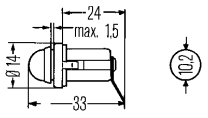


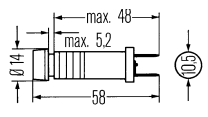

	Part no.	Pk.	Hand-held work lights
	2XM 004 444-001 2XM 004 444-011	1 1	<p>With stepless regulation from map to working, from pinpoint to wide-spread light. Clear lens. Swiveling lamp head. Fixing of the lamp with holder or magnet to the bodywork. With spirally coiled cable (from 400 up to 3000 mm) and plug 8JA 004 667-001 (Pk. 10) for cigarette lighter socket.</p> <p>Handlight with 12V Xenon bulb</p> <p>Handlight with 28V Xenon bulb and plug 8JA 007 158-001 (Pk.1)</p> <p>  1x12V6W (-) 8GP 007 676-121  1x28V7.5W (-) 8GP 008 285-001  for older models  1x12V5W (-) 8GH 002 473-151 </p>
	2XM 001 975-001	1	<p>Magnetic inspection light</p> <p>Clear lens. Powerful, permanent magnets hold it firmly in place on metal surfaces. With 4.5 m flat lead and universal plug 8JA 002 252-102 (Pk.1) for cigarette-lighter or 2-pole socket. With 12V bulb.</p> <p>Handlight</p> <p>  1x12V5W (R5W) 8GA 002 071-121 </p>
	2XT 959 510-427 2XT 959 510-467 2XT 959 510-657	36 24 36	<p>Door lights</p> <p>In LED-technology. For use as incremental light, emergency and night illumination. Clear lens. With gasket, 2 fixing screws and screw caps, dust and water-proof, with polarity reversal protection. Voltage range: 10V - 33V. Consumption: 0.04A at 12V, 0.02A at 24V.</p> <p>Door light with 2 white LEDs 0.5W</p> <p>Door light with 2 white LEDs 0.5W, 150 mm long lead and 2-pole Packard plug</p> <p>Door light with 2 blue LEDs 0.5W</p>
	2XT 959 500-677 2XT 959 500-207	1 24	<p>In LED-technology. For use as cockpit and map reading light, emergency and night illumination. Clear lens. With white ring for covering the 3 fixing screws. With 120 mm long lead, gasket and fixing screws. Dust and water-proof, with polarity reversal protection. Voltage range: 10V - 33V. Consumption: 0.08A at 12V, 0.04A at 24V.</p> <p>Door light with 4 white LEDs 1.0W</p> <p>Door light with 4 blue LEDs 1.0W</p>
	2XT 980 500-227	24	<p>Built-in orientation light. In LED-technology. Milky-white lens. With polished stainless-steel ring. Consumption: 0.08A at 12V.</p> <p>Orientation light with 4 white LEDs 12V1.0W</p>






 	Part no. 2XT 002 452-037	Pk. 1	Door lights For caravans and buses. Milky-white lens. Black rubber body. Flush mounting for curves surfaces. 2 holes for B4.2 x 16 fixing screws. Door light  1x12V5W (R5W) 8GA 002 071-121  1x24V5W (R5W) 8GA 002 071-241
 	2XT 007 945-007 2XT 007 945-057	30 30	For caravans. Clear lens. Grey plastic body and glass-clear lens, for screwing into one another. With grille opening for replacing bulb. For walls of 25 to 35 mm thickness. Door light, with cable entry right, without ON/OFF switch with cable entry left Suitable bulbs, 220V max. 40W E14 socket available via stockist.
 	2XT 007 945-027 2XT 007 945-077	30 30	With cable entry right and 12V bulb, without switch with two pole safety switch  1x12V21W (P21W) 8GA 002 073-121
 	2XT 008 929-001 2XT 008 929-007	1 24	For surface mounting. Clear lens. Silver coloured body. Two ST3.9x38-C fixing screws. With 12V bulbs and gasket. Door light  3x12V5W (C5W) 8GM 002 091-121

Warning Lights



	Part no.	Pk.	Warning lights
 	<p>2AA 008 592-001</p> <p>2AA 008 592-011</p> <p>2AA 008 592-021</p> <p>2AA 008 592-031</p>	<p>15</p> <p>15</p> <p>15</p> <p>15</p>	<p>Screw-type fixing, for dashboards with thickness of 0.3 to 1.8 mm. Screw-type connections.</p> <p>Warning light, blue</p> <p>amber</p> <p>green</p> <p>red</p>
 	<p>2AA 008 594-001</p> <p>2AA 008 594-011</p> <p>2AA 008 594-021</p> <p>2AA 008 594-031</p>	<p>15</p> <p>15</p> <p>15</p> <p>15</p>	<p>With blade terminal connections.</p> <p>Warning light, blue</p> <p>amber</p> <p>green</p> <p>red</p>
 	<p>2AA 008 595-001</p> <p>2AA 008 595-011</p> <p>2AA 008 595-021</p> <p>2AA 008 595-031</p>	<p>15</p> <p>15</p> <p>15</p> <p>15</p>	<p>With steel rim and screw-type connections.</p> <p>Warning light, blue</p> <p>amber</p> <p>green</p> <p>red</p> <p> 1x12V2W (H) 8GP 002 068-121 1x24V2W (H) 8GP 002 068-241</p>
 	<p>2AA 008 593-001</p> <p>2AA 008 593-011</p> <p>2AA 008 593-021</p> <p>2AA 008 593-031</p>	<p>15</p> <p>15</p> <p>15</p> <p>15</p>	<p>With blade terminal connections.</p> <p>Warning light, blue</p> <p>amber</p> <p>green</p> <p>red</p> <p> 1x12V2W (J) 8GP 002 066-121 1x24V3W (J) 8GP 002 066-241</p>

	Part no.	Pk.	Warning lights
 	<p>2AA 001 204-001</p> <p>2AA 001 204-011</p> <p>2AA 001 204-031</p>	<p>10</p> <p>10</p> <p>10</p>	<p>Push-in fitting, for dashboards with thickness of 0.8 to 1.5 mm. Blade terminal connections.</p> <p>Warning light, red</p> <p>Warning light, amber</p> <p>Warning light, green</p> <p> 1x12V2W (J) 8GP 002 066-121 1x24V3W (J) 8GP 002 066-241</p>
 	<p>2AA 001 200-001</p> <p>2AA 001 200-002</p> <p>2AA 001 200-011</p> <p>2AA 001 200-012</p> <p>2AA 001 200-021</p> <p>2AA 001 200-023</p> <p>2AA 001 200-031</p> <p>2AA 001 200-032</p>	<p>5</p> <p>1</p> <p>5</p> <p>1</p> <p>5</p> <p>1</p> <p>5</p> <p>1</p>	<p>For dashboards with thickness of up to 4 mm. Combined screw/blade terminal connections.</p> <p>Warning light, blue</p> <p>Warning light, blue, Pro-fit pack</p> <p>Warning light, red</p> <p>Warning light, red, Pro-fit pack</p> <p>Warning light, green</p> <p>Warning light, green, Pro-fit pack</p> <p>Warning light, amber</p> <p>Warning light, amber, Pro-fit pack</p>
 	<p>2AA 001 200-041</p> <p>2AA 001 200-042</p> <p>2AA 001 200-131</p> <p>2AA 001 200-141</p> <p>2AA 001 200-151</p>	<p>5</p> <p>1</p> <p>5</p> <p>5</p> <p>5</p>	<p>With blade terminal connections,</p> <p>Warning light, blue</p> <p>Warning light, blue, Pro-fit pack</p> <p>Warning light, red</p> <p>Warning light, green</p> <p>Warning light, amber</p> <p> 1x12V1.2W (W5/1.2) 8GP 002 095-121 1x24V1.2W (W5/1.2) 8GP 002 095-241</p>
 	<p>2AA 001 201-011</p> <p>9EL 043 137-001</p>	<p>10</p> <p>10</p>	<p>Spring-clamp fixing, for dashboards with thickness of up to 1.5 mm. Blade terminal connections.</p> <p>Warning light, red</p> <p>Spare parts:</p> <p>Lens</p> <p> 1x12V2W (J) 8GP 002 066-121 1x24V3W (J) 8GP 002 066-241</p>
 	<p>2AA 003 257-001</p> <p>2AA 003 257-011</p> <p>2AA 003 257-021</p> <p>2AA 003 257-031</p> <p>2AA 003 257-041</p> <p>2AA 003 257-042</p>	<p>10</p> <p>10</p> <p>10</p> <p>10</p> <p>10</p> <p>1</p>	<p>Dust and waterproof. Metal body, screw-type fixing, for dashboards with thickness of up to 5.2 mm. With blade terminal connections.</p> <p>Warning light, red</p> <p>Warning light, blue</p> <p>Warning light, green</p> <p>Warning light, yellow</p> <p>With 4 lenses (red, blue, green, yellow) included loose. With pre-fitted 12V bulb.</p> <p>Carded</p> <p>Pro-fit pack</p> <p> 1x12V2W (J) 8GP 002 066-121 1x24V3W (J) 8GP 002 066-241</p>

	Part no.	Pk.	Hazard flasher lights
			<p>3003</p> <p>Combined hazard warning flasher and work light with black mounting bracket. Yellow lens for hazard flasher, white for work light. The bulb and reflector pivot to the desired function when the switch above the lens is actuated. The light exit angle on the work light can be varied by moving the feet to three different positions. The light is stable up to a wind velocity of 9. Housing orange-coloured plastic, feet black plastic with rubber nubs. 5 x 1.5 mono cells (R20 or LR20) not included with light. With built-in tester for battery capacity.</p> <p>With 6V bulb. Flash frequency > 60 flashes per minute. Operating time with new alkaline batteries: Hazard flasher approx. 40 hours Work light approx. 25 hours.</p>
	2XW 007 146-001	1	<p>Hazard flasher light</p>
			<p>3003 Accu</p> <p>With sulphur-yellow plastic housing, maintenance-free, rechargeable lead gel battery and charging holder, for connecting to terminal 15 (ignition on) and terminal 31 (earth). As soon as the light catches in the holder, the battery in the light starts being charged. The charger operates with 12V and 24V systems. Switch-over is automatic.</p> <p>With 6V bulb. Flash frequency > 60 flashes per minute. Power supply: 6V, 3,0AH rechargeable battery. Nominal voltage 12V and 24V. Power supply for charger circuit 10V to 32V.</p> <p>Operating time with fully charged battery: Hazard flasher approx. 40 hours Work light approx. 7 hours.</p>
	2XW 007 146-011	1	<p>Hazard flasher light</p>
		<p> 1x6V2.4W (F) 8GP 002 096-061</p>	




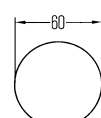

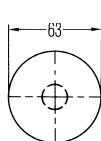
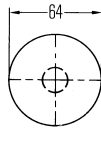
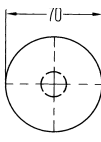

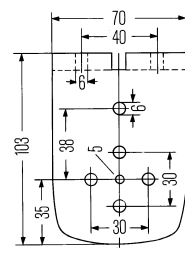
*) National type test for Germany


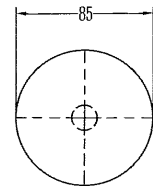
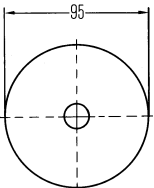

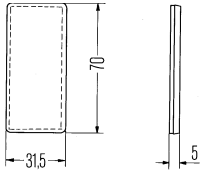

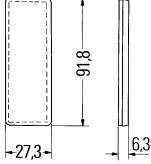

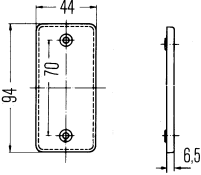

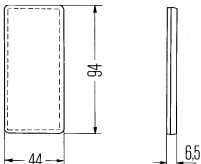
	Part no.	Pk.	<p>Hazard flasher lights</p> <p>2002 Europa</p> <p>Combined hazard flasher light and inspection light with mounting bracket.</p> <p>With folding supporting legs; rubber shoes ensure extreme stability (up to gale force 9). Amber lens for hazard flasher light. Light can be switched over to a powerful white repair light. Owing to its extremely flat design, the light can be stowed under the driver's seat. For use with five U2-type, single-cell, leak proof, 1.5V batteries. Batteries are not supplied with light. With 6V bulbs.</p> <p>K 13932 *)</p>
2XW 003 146-001	1	<p>Hazard flasher light</p> <p> 2x6V2.4W (F) 8GP 002 096-061</p>	
	2XW 002 897-051	1	<p>2897</p> <p>Combined hazard flasher light and inspection light with mounting bracket.</p> <p>With folding supporting legs; rubber shoes ensure extreme stability (up to gale force 9). For use with five U2-type, single-cell, leak proof, 1.5V batteries. Batteries are not supplied with light. With 6V bulb.</p> <p>K 13931 *)</p>
2XW 002 897-041	1	<p>Hazard flasher light with plastic container</p> <p>without plastic container</p>	
8XH 002 975-017	10	<p>Accessories: Plastic container</p> <p> 1x6V2.4W (F) 8GP 002 096-061</p>	



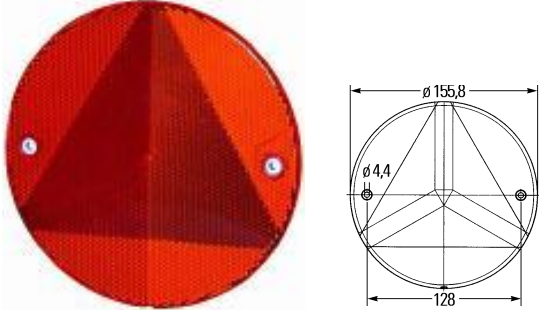
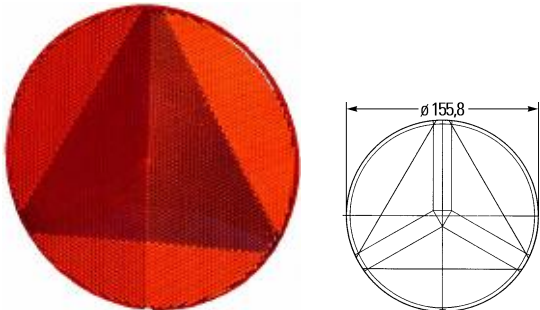
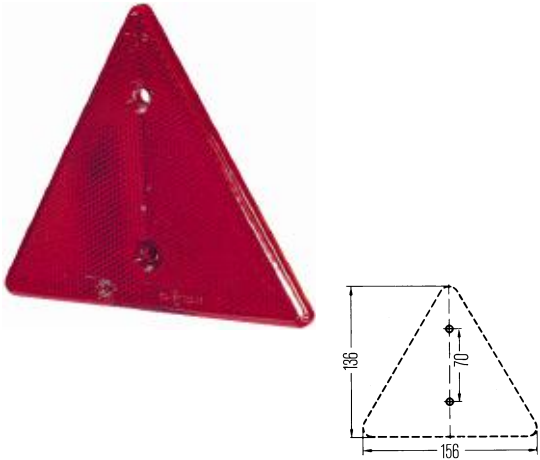
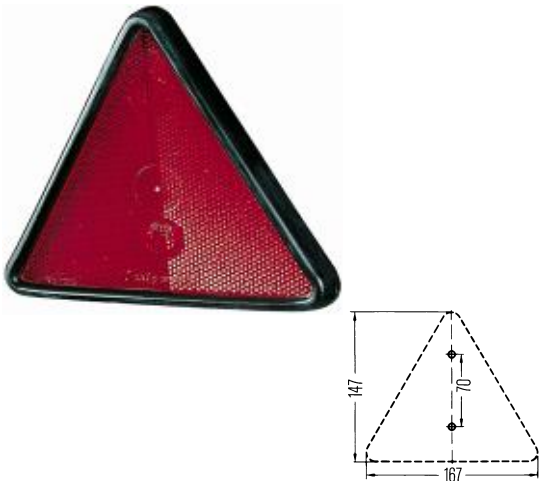
*) National type test for Germany

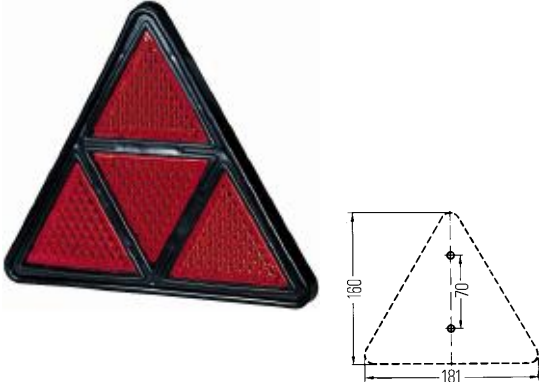

	Part no.	Pk.	Emergency triangle
			<p>Precision-built, ultra-effective reflectors hit the eye both day and night. Sturdy four-point base keeps triangle in place. Very light weight. Folds compactly away into its box for space-saving storage.</p> <p>(E17) 03 278</p>
	<p>8RW 341 421-001</p>	<p>1</p>	<p>Emergency triangle</p>
			<p>Emergency triangle for slow-moving vehicles</p> <p>Precision-built, ultra-effective reflectors hit the eye both day and night. Very light in weight. Easy to store. Fastened with metal bracket and strip.</p> <p>(E17) 01 6901</p>
	<p>8RW 341 235-007 8HG 341 300-007 8HG 341 301-007</p>	<p>20 10 10</p>	<p>Emergency triangle</p> <p>Accessories: Strip Holder</p>

	Part no.	Pk.	Reflectors
 	<p>8RA 002 014-031 25 8RA 002 014-032 200 8RA 002 014-831 1 8RA 002 014-832 1</p> <p>8RA 002 014-051 25 8RA 002 014-052 200 8RA 002 014-851 1 8RA 002 014-852 1</p> <p>8RA 002 014-041 25 8RA 002 014-042 200 8RA 002 014-841 1 8RA 002 014-842 1</p>		<p>Reflecting surface 22 sq. cm. With plastic base plate. One 6 mm dia. hole for fixing screw. With central fixing.</p> <p>Ⓔ1 02 21353</p> <p>Reflector, red</p> <p>carded (2 pieces) Pro-fit pack (2 pieces)</p> <hr/> <p>Amber</p> <p>carded (2 pieces) Pro-fit pack (2 pieces)</p> <hr/> <p>White</p> <p>carded (2 pieces) Pro-fit pack (2 pieces)</p> <hr/> <p>With rubber holder 8HG 003 799-001 (Illustration see below)</p> <p>8RA 002 014-127 100 White</p>
 	<p>8RA 002 014-081 25 8RA 002 014-101 25 8RA 002 014-091 25</p>		<p>Self-adhesive.</p> <p>Ⓔ13 02 3535</p> <p>Reflector, red</p> <p>amber</p> <p>white</p>
   	<p>8RA 002 015-001 20 8RA 002 015-021 20 8RA 002 015-031 20</p>		<p>Reflecting surface 20 sq. cm. With metal base plate. Central M5 x 15 fixing screw.</p> <p>Ⓔ1 02 31291</p> <p>Reflector with metal base plate, red</p> <hr/> <p>With aluminium rim, red</p> <hr/> <p>With rubber rim, red</p>
 	<p>8HG 003 799-001 2 8HG 003 799-007 100 8HG 003 799-017 1</p>		<p>Holder for side or pendant mounting of reflectors in model ranges 8RA 002 014-..., 8RA 002 015-... or side lights in model ranges 2PF 003 057-..., 2PF 004 081-...</p> <p>Rubber holder</p> <p>Hard rubber holder</p>

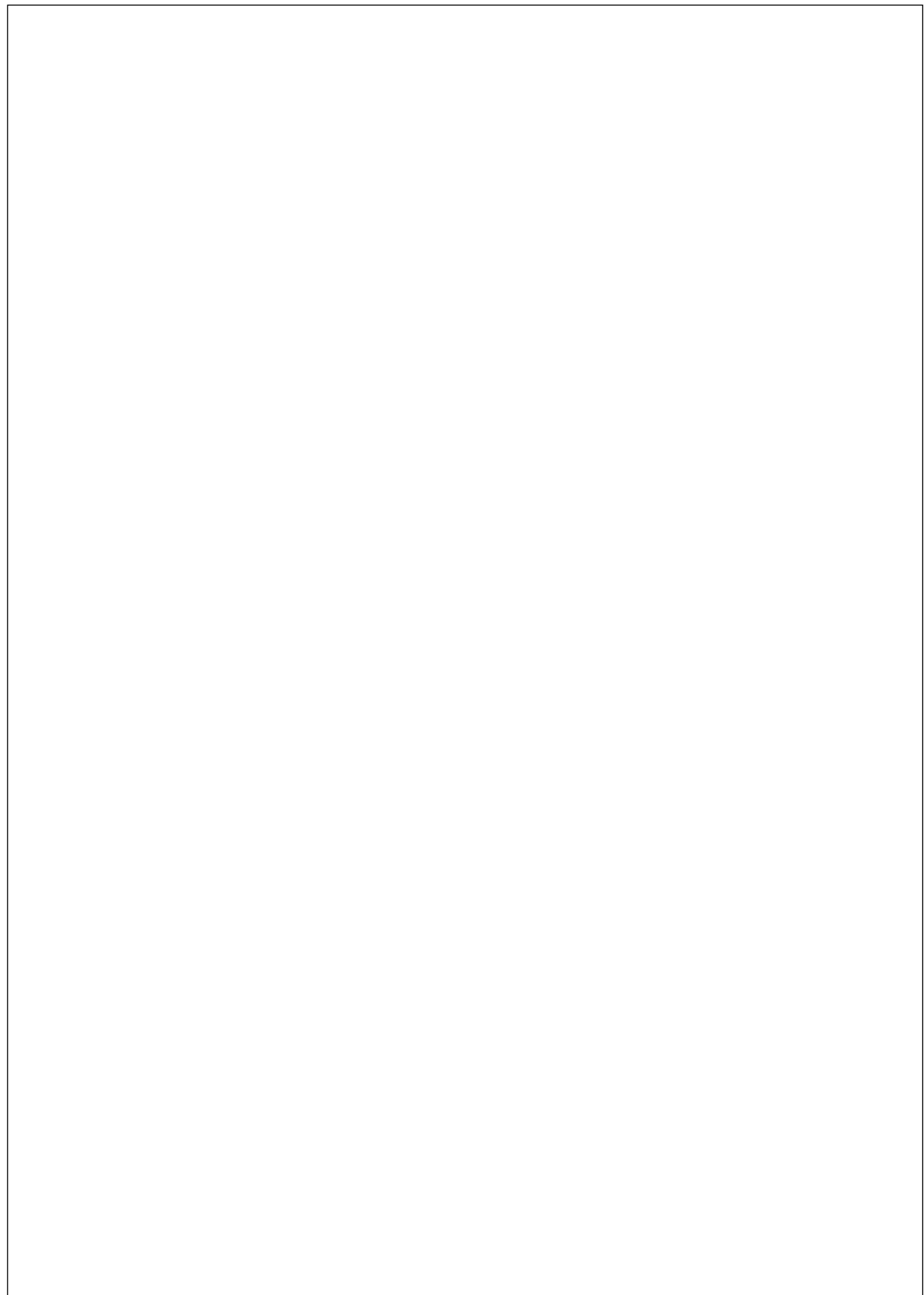
		Part no.	Pk.	Reflectors
	 	8RA 002 016-111	32	Reflecting surface 38 sq. cm. With plastic base plate and rim. With central M5 x 15 fixing screw. (E1) 01 31290
		8RA 002 016-101	20	Reflector, red <hr/> white
		8RA 002 016-121	20	(E17) 01 339 With PVC rim and base plate, red
		8RA 004 412-001	20	Reflecting surface 18 sq. cm. Self-adhesive. For horizontal or vertical mounting. (E17) 01 338
		8RA 004 412-011	20	Reflector, amber
		8RA 004 412-021	20	white red
		8RA 342 014-157	100	Reflecting surface 20.9 sq. cm. Self-adhesive. For horizontal or vertical mounting. (E17) 402
		8RA 003 326-001	20	Reflecting surface 29 sq. cm. With plastic base plate. Two 4.3 m dia. holes for fixing screws. For horizontal or vertical mounting. (E1) 02 21395
		8RA 003 326-002	200	Reflector, red
		8RA 003 326-011 8RA 003 326-017	20 200	Amber
8RA 003 326-021	20	White		
		8RA 003 326-031	20	Self-adhesive. For horizontal or vertical mounting. (E2) 02 92031
		8RA 003 326-931	1	Reflector, red Carded (2 pieces)
		8RA 003 326-041 8RA 003 326-047 8RA 003 326-941	20 200 1	Amber Carded (2 pieces)
8RA 003 326-051	20	White		

	Part no. 8RB 004 713-001	Pk. 20	Reflectors Reflecting surface 50 sq. cm. With plastic base plate. Self-adhesive. For horizontal or vertical mounting. (E17) 01 353 Reflector, amber
	8RA 002 023-001 8RA 002 023-011 8RA 002 023-021	20 20 20	Reflecting surface 47 sq. cm. With plastic base plate. Two 6 mm dia. holes for fixing screws. For horizontal or vertical mounting. (E17) 02379 Reflector, red white amber
	8RL 002 009-021 8RL 002 009-011 8RL 002 009-001	20 20 20	Reflecting surface 60 sq. cm. With plastic base plate. Two 6.5 mm dia. holes for fixing screws. For horizontal or vertical mounting. (E1) 02 21340 Reflector, red amber white
	8RA 003 660-007	8	Reflecting surface 101 sq. cm. With plastic base plate. Two M6 x 12 fixing screws. For horizontal or vertical mounting. (E1) 02 31242 Reflector, red
	8RA 003 734-101	1	Reflecting surface 54 sq. cm. With rubber base plate. Can be mounted either vertically or horizontally. Two B3.9 x 22 fixing screws. (E1) 01 31298 Reflector, red

	Part no.	Pk.	Reflectors
	8RA 343 220-017	30	<p>Reflecting surface 95 sq. cm. Reflector thickness 8.2 mm.</p> <p>(E4) 02 3191</p> <p>Reflector with two 8.2 mm dia. holes for fixing screws, red</p>
	8RA 343 220-007	30	<p>Self-adhesive, red</p>
	8RA 002 020-001 8RA 002 020-002 8RA 002 020-003 8RA 002 020-051	25 120 1 10	<p>Reflecting surface 85 sq. cm. With plastic base plate. Two 6 mm dia. holes for fixing screws.</p> <p>(E17) 01 346</p> <p>Reflector, red</p> <p>carded</p> <hr/> <p>With additional metal base plate. Two M5 x 20 fixing screws.</p> <p>Red</p> <hr/> <p>With plastic base plate and sendzimir galvanized mounting bracket for compensating inclination. Two 3.7 mm dia. holes for fixing screws.</p> <p>Red</p>
	8RA 002 010-011	20	<p>Reflecting surface 101 sq. cm. With protective rubber rim. Two M6 x 15 fixing screws.</p> <p>(E1) 02 13463</p> <p>Reflector, red</p>

	Part no. 8RA 003 503-001	Pk. 16	Reflectors Reflecting surface 57 sq. cm. Black body in shock-resistant and rustproof PVC. Two M5 fixing screws. K 13487 *) Reflector, quadrifid, red
		8HG 002 240-001 8HG 002 240-011 8HG 002 240-021 8HG 002 240-031	10 10 10 10

*) National type test for Germany





System for trailers and semi-trailers (24V)

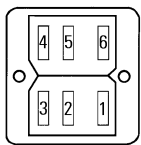
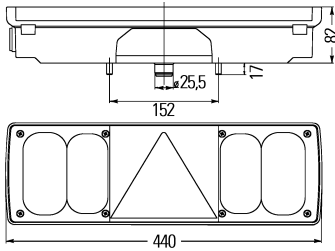
Signal Lights and Cabling - Rear	5.182-5.197
Signal Lights and Cabling - Front	5.198-5.1200
Signal Lights and Cabling - Side	5.201-5.204
Additional Lights and Cabling	5.205-5.207
Cabling EasyConn	5.208-5.213

System for trailers (12V)

Signal Lights - Rear	5.214
Cabling	5.214-5.216

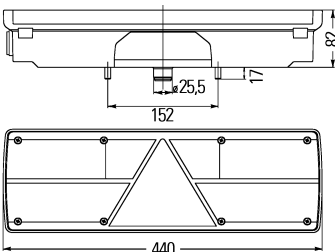
Possible equipment for trucks, trailers and semi-trailers

Lighting equipment for trucks	5.217-5.224
Lighting equipment for trailers	5.225-5.228
Lighting equipment for semi-trailers	5.229-5.232
Lighting equipment for buses	5.233
Lighting equipment and cabling for car trailers	5.234-5.235



1	Ground	white
2	B	red
3	ZR	pink
4	NES	blue
5	BL	yellow/green
6	S/SMLR	black/brown

Pin configuration:
B = stop light
BL = indicator light
ZR = reverse light
NES = rear fog light
S = rear light
SMLR = side-marking light



Part no.

Pk.

For horizontal surface mounting on trailers

Red reflector, rear, stop, rear fog and side-marker light, reverse light and indicator light (with yellow filter), smoke colour. Black plastic body.

Two M8 fixing screws.

With vibration dampers.

Two bulbs for rear light.

Cable entrance over PG fitting.

Type of protection: IP5K4K and IPX9K.

(E1) 1072 (E4) 280

Rear-stop-indicator-rear fog-reverse light with triangular reflector and side-marker light with reflector, left

2VP 340 450-031 1
 2VP 340 450-037 12

right

2VP 340 450-021 1
 2VP 340 450-027 12

with 24V bulbs, 500 mm lead and 7-pin EasyConn plug, right

2VP 340 450-441 1

with 24V bulbs, 500 mm lead and 7-pin EasyConn plug, to fit rear adapter lead 8KA 340 819-..., left

2VP 340 450-451 1

with licence plate illumination, left

2VD 340 450-491 1

Spare parts:

1 Lens with fixing screws
 2 Lens for side-marker light

9EL 340 208-001 1
 9EL 146 838-001 2

Lens with horizontal optical fields. With vibration dampers and 24V bulbs. With 6-conductor, 1700 mm long lead with 6-pin plug. To fit combination distributor 8JE 340 060-..., left

2VP 340 450-151 1

right

2VP 340 450-141 1

with 500 mm lead and 7-pin EasyConn plug, to fit rear adapter lead 8KA 340 819-..., left

2VP 340 450-511 1

right

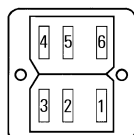
2VP 340 450-501 1

Spare parts:

1 Lens with fixing screws
 2 Lens for side-marker light

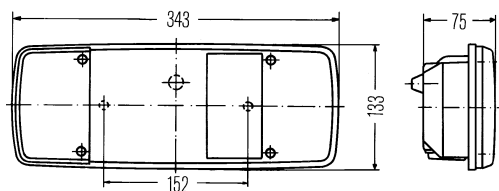
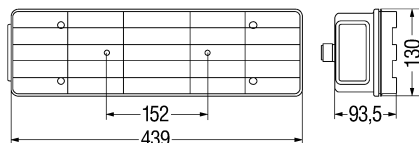
9EL 340 208-021 1
 9EL 146 838-001 2

- 4x24V21W (P21W) 8GA 002 073-241
- 4x24V21W (P21W) 8GA 002 073-251 (Heavy Duty)
- 2x24V5W (R5W) 8GA 002 071-241
- 1x24V10W (R10W) 8GA 002 071-252
- 1x24V5W (C5W) 8GM 002 092-241



1	Ground	white
2	B	red
3	ZR	pink
4	NES	blue
5	BL	yellow/green
6	S/SMLR	black/brown

Pin configuration:
 B = stop light
 BL = indicator light
 ZR = reverse light
 NES = rear fog light
 S = rear light
 SMLR = side-markering light



Part no.

Pk.

For horizontal surface mounting on trailers

Red rear, stop and rear fog light.
 Amber indicator light, clear reverse light.
 Black plastic body.
 Two fixing screws.
With vibration dampers, 6-conductor, 1400 mm long lead with 6-pin plug and 24V bulbs. Two bulbs for rear light. To fit combination distributor 8JE 340 060-... With earth lead mounted.

Ⓔ1 71

2SK 340 101-001

1

Rear-stop-indicator-rear fog-reverse light, left and right

without wiring harness, with earth lead mounted, rear of housing with thread, union nut, sealing ring and sealing plug, left and right

2SK 340 101-021

1

2SK 340 101-011

1

with side-marker light and reflector, left and right

without wiring harness, with earth lead mounted, rear of housing with thread, union nut, sealing ring and sealing plug, left and right

2SK 340 101-031

1

Spare parts:

9EL 340 201-001 1 Lens
 9XX 340 222-001 1 6-pin connection kit

4x24V21W (P21W) 8GA 002 073-241
 2x24V10W (R10W) 8GA 002 071-251

1x24V5W (C5W) 8GM 002 092-241

For horizontal flush/surface mounting on trailers

Red rear, stop, rear fog light, amber indicator light, white reverse light.
 Black plastic body.
 Two fixing screws M8.

With 24V bulbs. Two bulbs for rear light. With 500 mm long lead and 7-pin EasyConn-central plug.

Ⓔ4 377 Ⓔ4 396 Ⓔ4 397 Ⓔ4 23215

Ⓔ4 3880 Ⓔ4 421 Ⓔ4 3134 Ⓔ4 4033

Rear-stop-indicator-rear fog-reverse light, left

2SK 340 103-131




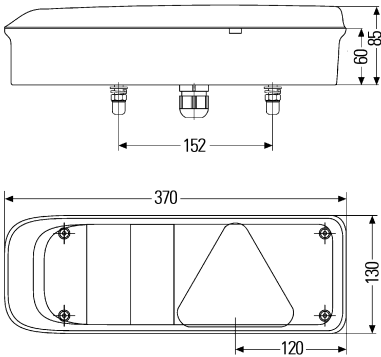


1

right

2SK 340 103-121

1

4x24V21W (P21W) 8GA 002 073-241
 2x24V10W (R10W) 8GA 002 071-251

   	<p>Part no.</p> <p>2VP 340 831-011</p> <p>2VP 340 831-001</p> <p>2VP 340 931-011</p> <p>2VP 340 931-001</p> <p>9EL 340 829-011</p> <p>9EL 340 829-001</p> <p>9EL 340 829-031</p> <p>9EL 340 829-021</p> <p>9XX 340 173-801</p>	<p>Pk.</p> <p>1</p> <p>1</p> <p>1</p> <p>1</p> <p>1</p> <p>1</p> <p>1</p> <p>1</p> <p>1</p>	<p>For horizontal surface mounting on trailers</p> <p>Red rear, stop, rear fog light and triangular reflector, amber indicator light, clear reverse light. Two M8 fixing screws. With screwed cable gland and 4 vibration dampers. Without central plug and bulbs.</p> <p>Ⓔ4 10218 Ⓔ4 10219 Ⓔ4 10211</p> <p>Rear-reflector-stop-indicator-rear fog-reverse light, left</p> <p>right</p> <p>with two bulbs for rear light, left</p> <p>right</p> <p>Spare parts: Lens with screws, for 340 831-..., left right for 340 931-..., left right</p> <p>Accessories: LED module retrofit set for converting the rear light from bulbs to LED technology</p> <p> 1(2)x24V10W (R10W) 8GA 002 071-251  4x24V21W (P21W) 8GA 002 073-241</p>
---	---	---	---



2VP 340 830-011

1

2VP 340 830-001

1



2VP 340 930-011

1

2VP 340 930-001

1



2VP 340 932-011

1

2VP 340 932-001

1



2VP 340 830-031

1

2VP 340 830-021

1



2VP 340 930-031

1

2VP 340 930-021

1

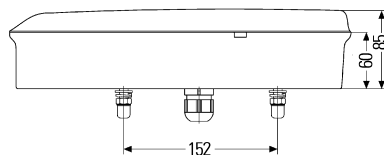


2VP 340 930-157

12

2VP 340 930-147

1

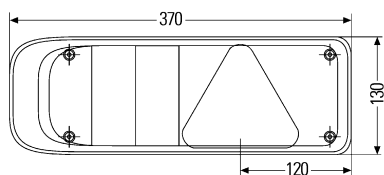


9EL 340 829-011

1

9EL 340 829-001

1



9EL 340 829-031

1

9EL 340 829-021

1

9XX 340 173-801

1

For horizontal surface mounting on trailers

EasyConn I

Red rear, stop, rear fog light and triangular reflector, amber indicator light, clear reverse light. Two M8 fixing screws.

With central plug, 4 vibration dampers and 24V bulbs.

Ⓔ4 10219 Ⓔ4 10218 Ⓔ4 10211

Rear-reflector-stop-indicator-rear fog-reverse light, left

right

With two bulbs for rear light, left

right

Rear light in LED-technology, 2 x 2 red LEDs for rear light, left

right

See page 5.236, instruction 1.

With side-marker-light and reflector.

Rear-reflector-stop-indicator-rear fog-reverse light with side marker light, left

right

With two bulbs for rear light, left

right

With 2-pole output for reverse light, left

right

Spare parts:

Lens with screws, for 340 830-...

left

right

for 340 930-..., 340 932-...

left

right

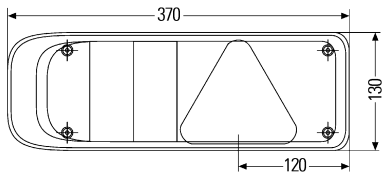
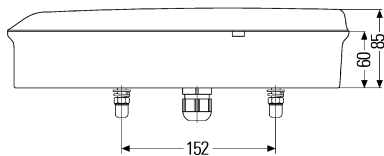
Accessories:

LED module retrofit set for converting the rear light from bulbs to LED technology.

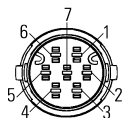
For 2VP 340 830/930-...



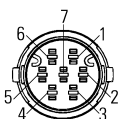
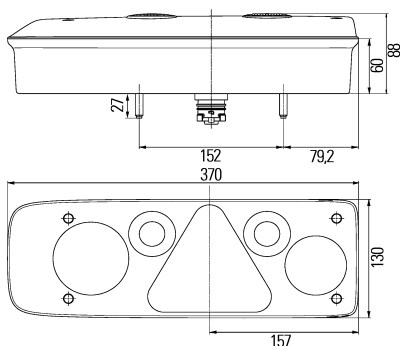
1(3)x24V10W (R10W) 8GA 002 071-251
4x24V21W (P21W) 8GA 002 073-241



Part no.	Pk.	For horizontal surface mounting on trailers
		EasyConn I Red rear, stop, rear fog light and triangular reflector, amber indicator light, clear reverse light. Rubber arm with clearance light and amber side-marker light. Front-facing part of lens clear, rear-facing part red. Two M8 fixing screws. With central plug, 4 vibrations dampers and 24V bulbs.
		Ⓔ4 10219 Ⓔ4 10218 Ⓔ4 10211
2VP 340 830-111	1	Rear-reflector-stop-indicator-rear fog-reverse-clearance light and side marker light, left
2VP 340 830-101	1	right
2VP 340 930-111	1	With two bulbs for rear light, left
2VP 340 930-101	1	right
2VP 340 931-111	1	Same as 2VP 340 930-111/-101, but with PG fitting, without bulbs, left
2VP 340 931-101	1	right
2VP 340 934-111	1	Inclusive rubber arm with clearance light, side marker light and position light in LED-technology. 1 red LED for clearance light, 2 white LEDs for position light and 2 amber LEDs for side-marker light, left
2VP 340 934-101	1	right
		See page 5.236, instruction 1.
		Spare parts:
9EL 340 829-011	1	Lens with screws, for 340 830-...
9EL 340 829-001	1	left
		right
9EL 340 829-031	1	for 340 930-..., 340 931-...
9EL 340 829-021	1	left
		right
9EL 303 581-001	1	Lens for clearance/side-marker light
2XS 340 418-071	1	Rubber-arm clearance light in LED technology with integrated side marker light and 300 mm connection lead. left
2XS 340 418-061	1	with 150 mm connection lead, right
		Also as a replacement for rubber-arm clearance lights fitted with bulbs
9XX 340 173-801	1	Accessories: LED module retrofit set for converting the rear light from bulbs to LED technology. For 2VP 340 830/930/931-...
		1(2)x24V10W (R10W) 8GA 002 071-251 4x24V21W (P21W) 8GA 002 073-241 2x24V4W (T4W) 8GP 002 067-241



1	Ground	white
2	B	red
3	S	brown (black)
4	ZR	pink
5	---	not used
6	NES	blue
7	BL	green/yellow



1	Ground	white
2	B	red
3	S	brown (black)
4	ZR	pink
5	UR	black (brown)
6	NES	blue
7	BL	green/yellow



Pin configuration:
 B = stop light
 S = rear light
 ZR = reverse light
 UR = clearance light
 NES = rear fog light
 BL = indicator light



Part no. Pk. **For horizontal surface mounting on trailers**

EasyConn II

Red rear, stop, rear fog light and triangular reflector, amber indicator light, clear reverse light. Two M8 fixing screws.

Rear light in LED-technology. With 7-pin EasyConn-central plug, vibration dampers, 24V bulbs and 10 red LEDs 2.0W. See page 5.236, instruction 1.

Ⓔ 11779

2VP 340 942-011 1

Rear-reflector-stop-indicator-rear fog-reverse light, left

2VP 340 942-001 1

right

Inclusive rubber arm with clearance light and amber side-marker light in LED-technology. Lens clear to the front, red to the rear, amber at the side.

Ⓔ 11779

2VP 340 942-111 1

Rear-reflector-stop-indicator-rear fog-reverse-clearance light with side marker light, left

2VP 340 942-101 1

right

Lens clear to the front, red to the rear, amber at the side. With 340 mm long lead, 24V bulbs and 15 LEDs 3.5W, left

2VP 340 944-131 1

right

2VP 340 944-141 1

Inclusive rubber arm with clearance light, side marker light and position light in LED-technology. Lens clear to the front, red to the rear, amber at the side. With 24V bulb and 15 red LEDs 3.5W.

2VP 340 940-111 1

Rear-reflector-stop-indicator-rear fog-reverse-clearance light with side-marker light and position light, left

2VP 340 940-101 1

right

Spare parts:

Lens with screws,
 left
 right

9EL 340 829-051 1

9EL 340 829-061 1

Rubber-arm clearance light in LED technology with integrated side marker light and 300 mm connection lead.

2XS 340 418-071 1

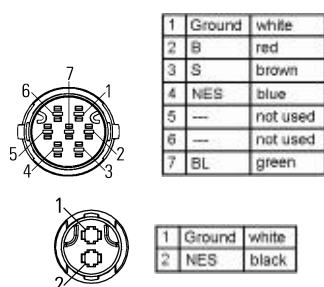
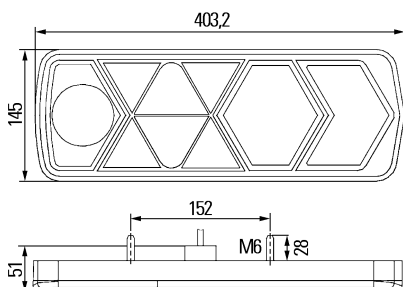
left

2XS 340 418-061 1

with 150 mm connection lead,
right

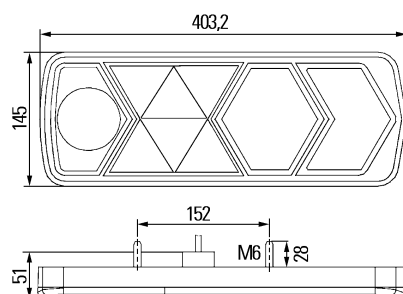
Also as a replacement for rubber-arm clearance lights fitted with bulbs

- Ⓔ 4x24V21W (P21W) 8GA 002 073-241
- 1x24V21W (PY21W) 8GA 006 841-241
- 1x24V4W (T4W) 8GP 002 067-241



Left light -011
also with 2-pole plug

Pin configuration:
 B = stop light
 S = rear light
 NES = rear fog light
 BL = indicator light



Part no.

Pk.

For horizontal surface mounting on trailers

100% in LED-technology.

Red rear, stop light and triangular reflector, amber indicator light, white reverse light. Black body. Two M8 fixing screws.

With 500 mm long cable, 7-pin plug housing and 2-pin EasyConn plug for the additional connection of a rear fog light.

Rear/stop light with 15 red LEDs, Rear light: 0.7W, stop light: 5.0W.

Consumption: 0.03A at 24V.
Consumption: 0.21A at 24V.

Indicator light with 15 yellow LEDs 3.0W.

Consumption: 0.125A at 24V.

Reverse light with 1 white LED 5.5W.

Consumption: 0.23A at 24V.

See page 5.236, instruction 1.

Ⓔ 2376

2VP 340 950-011

1

Rear-, reflector-, stop-, indicator-
reverse light,

2VP 340 950-021

1

right., 24V

2VP 340 950-031

1

With 5-wire lead, 1550 mm long
with 5 blade sliders attached,
left, 24V

2VP 340 950-041






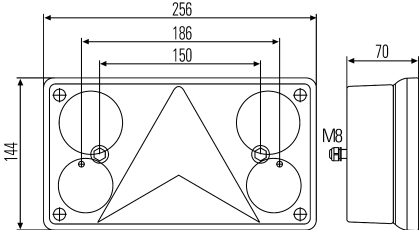
1


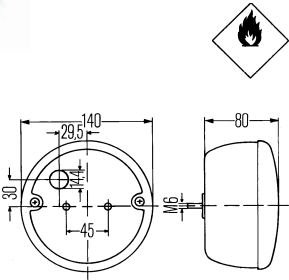

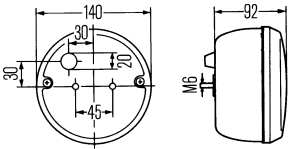


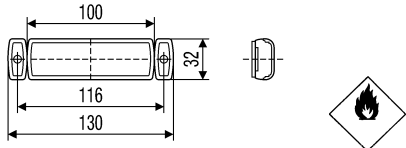
With 5-wire lead, 2550 mm long
with 5 blade sliders attached,
right, 24V

2VP 340 950-051

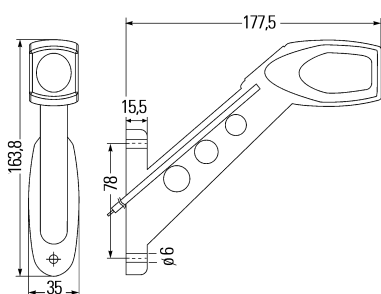
1

With X-reflector,
5-wire lead, 1550 mm long
with 5 blade sliders attached,
left and right, 24V

	Part no.	Pk.	<p>For horizontal surface mounting on trailers</p> <p>Red rear, stop, rear fog light and triangular reflector, amber indicator light, white reverse light. Black plastic body. Two M8 fixing screws. With grommet.</p> <p>(E1) 864</p> <p>Rear-stop-indicator-rear fog-reverse light with triangular reflector,</p> <p>left</p> <p>right</p> <hr/> <p>With side-marker light and reflector,</p> <p>left</p> <p>right</p> <hr/> <p>With side-marker light, reflector, and illumination for 520 x 120 mm and 340 x 240 mm licence plates,</p> <p>left</p> <p>without side-marker light with reflector,</p> <p>left</p> <p>Spare parts: Lens with screws, left right</p> <p>3x12V21W (P21W) 8GA 002 073-121 3x24V21W (P21W) 8GA 002 073-241 1x12V21/5W (P21/5W) 8GD 002 078-121 1x24V21/5W (P21/5W) 8GD 002 078-241 suitable 1x24V21/5W (P21/5W) 8GD 002 078-011 (Heavy Duty)</p>
     	<p>2VP 340 400-151 2VP 340 400-157</p> <p>2VP 340 400-141 2VP 340 400-147</p> <p>2VP 340 400-131 2VP 340 400-121</p> <p>2VD 340 400-451 2VD 340 400-471</p> <p>9EL 340 203-011 9EL 340 203-001</p>	<p>1 15</p> <p>1 15</p> <p>1 1</p> <p>1 1</p> <p>1 1</p> <p>1 1</p>	<p>For horizontal surface mounting on trailers</p> <p>Red rear, stop, rear fog light and triangular reflector, amber indicator light, white reverse light. Black plastic body. Two M8 fixing screws. With grommet.</p> <p>(E1) 864</p> <p>Rear-stop-indicator-rear fog-reverse light with triangular reflector,</p> <p>left</p> <p>right</p> <hr/> <p>With side-marker light and reflector,</p> <p>left</p> <p>right</p> <hr/> <p>With side-marker light, reflector, and illumination for 520 x 120 mm and 340 x 240 mm licence plates,</p> <p>left</p> <p>without side-marker light with reflector,</p> <p>left</p> <p>Spare parts: Lens with screws, left right</p> <p>3x12V21W (P21W) 8GA 002 073-121 3x24V21W (P21W) 8GA 002 073-241 1x12V21/5W (P21/5W) 8GD 002 078-121 1x24V21/5W (P21/5W) 8GD 002 078-241 suitable 1x24V21/5W (P21/5W) 8GD 002 078-011 (Heavy Duty)</p>

 	<p>Part no.</p> 2SD 001 685-501	<p>Pk.</p> 1	<p>For horizontal surface mounting</p> <p>Red rear and stop light, amber indicator light. Black plastic housing. Two M6 fixing screws.</p> <p>With 7-pin EasyConn central plug, vibration dampers and 24V bulbs.</p> <p>ⓔ12 7146</p> <p>Rear-stop-indicator light</p> <p>1x24V5W (R5W) 8GA 002 071-241 2x24V21W (P21W) 8GA 002 073-241</p>
 	<p>2NE 001 423-211</p>	<p>1</p>	<p>Red lens. Black plastic housing. For mounting to vertical surfaces. Two M6 fixing screws. With 2-pin EasyConn central plug and 24V bulb.</p> <p>ⓔ1 8496</p> <p>Rear fog light (NES 2) (Two lights can be fitted next to each other.)</p>
	<p>2ZR 001 423-221</p>	<p>1</p>	<p>Clear lens. With 2-pin EasyConn central plug and 24V bulb.</p> <p>ⓔ1 8704</p> <p>Reverse light (ZR 2)</p> <p>1x24V21W (P21W) 8GA 002 073-241</p>
 	<p>2TM 008 645-351</p> <p>9GD 157 876-007 8HG 160 409-002</p>	<p>1 1 1</p>	<p>For horizontal or vertical surface mounting</p> <p>In LED-technology. With 1 LED. Red light. With 5000 mm lead and 2-pin EasyConn central plug. Black housing. Two holes for fixing screws B4.2. Consumption: 0.05A.</p> <p>ⓔ1 1395 ⓔ1 1398</p> <p>Rear light with reflector, 24V1.2W</p> <p>Accessories: Seal Holder with 2 fixing screws</p>

	Part no.	Pk.	For upright surface mounting on trailers and semi-trailers with tarpaulin
 	 2XS 340 108-011 2XS 340 108-001	1 1	<p>Front-facing part of lens milky-white, rear-facing part red. Black rubber housing. Two 5.3 mm dia. holes for fixing screws. With 1700 mm long, 2-conductor round lead with 2-pin plug and 24V bulbs. To fit combination distributor 8JE 340 060-...</p> <p>(E13) 9401</p> <p>Clearance light, left right</p>
 	 2XS 340 107-011 2XS 340 107-001 9EL 950 315-031 9EL 950 315-061 9XX 340 220-001	1 1 5 5 1	<p>Front-facing part of lens milky-white, rear-facing part red. Black rubber housing. Two 5.3 mm dia. holes for fixing screws. With 1700 mm long, 2-conductor lead with 2-pin plug and 24V bulb. To fit combination distributor 8JE 340 060-...</p> <p>(E13) 9401</p> <p>Clearance light, left right</p> <p>Spare parts (for 340 108/340 107): Lens, milky-white red 2-pin connection kit</p> <p> 1x24V5W (R5W) 8GA 002 071-241</p>
 	2XS 302 240-031 2XS 302 240-051 9EL 303 581-001	1 1 1	<p>Front-facing part of lens for clearance light clear, rear-facing part red. Lens for side-marker light amber. With 500 mm lead and 24V bulb. With black rubber arm and frame. Type of protection: IP6K9K.</p> <p>(E4) 10211</p> <p>Clearance light with side-marker light and Quick Link lead attachment, left and right</p>
 	 2XS 340 447-001 2XS 340 447-021 2XS 340 447-071 2XS 340 447-061	1 1 1 1	<p>With 2-pin EasyConn plug, left and right</p> <p>Spare parts: Lens</p> <p> 1x24V4W (T4W) 8GP 002 067-241</p> <p>In LED-technology, 24V. 1 red LED for clearance light, 2 amber LEDs for side-marker light and 2 white LEDs for position light. Consumption: 0.06A. See page 5.236, instruction 2.</p>
 	2XS 340 447-001 2XS 340 447-021 2XS 340 447-071 2XS 340 447-061	1 1 1 1	<p>With 500 mm lead and Quick Link lead attachment, left and right</p> <p>With 500 mm lead and 2-pin EasyConn plug, left and right</p> <p>With 2000 mm lead and flat receptacles, left right</p>



Part no.

Pk.

For upright surface mounting on trailers and semi-trailers with tarpaulin

Front-facing part of lens for clearance light clear, rear-facing part red.
 Lens for side-marker light amber.
 With 500 mm lead and 24V bulb.
 With black rubber arm and frame.
 Type of protection: IP6K9K.

E4 10211

Clearance light with side-marker light and 2-pin EasyConn-plug, left

2XS 340 827-011

1

2XS 340 827-001

1

right

With 500 mm lead and Quick Link lead attachment, left

2XS 340 827-131

1

2XS 340 827-121

1

right

Spare parts:
 Lens

9EL 303 581-001

1

1x24V4W (T4W) 8GP 002 067-241

In LED-technology, 24V1.5W.
 1 red LED for clearance light,
 2 amber LEDs for side-marker light and
 2 white LEDs for position light.
 Consumption: 0.06A.

See page 5.236, instruction 2.

With 500 mm lead and 2 pin EasyConn-plug, left

2XS 340 418-031

1

2XS 340 418-021

1

right

With 500 mm lead and Quick Link lead attachment, left

2XS 340 418-131

1

2XS 340 418-121

1

right

With 3000 mm lead and flat receptacles, left

2XS 340 418-091

1

2XS 340 418-081



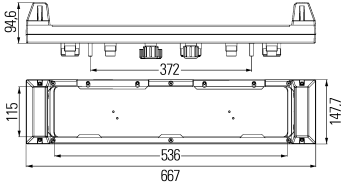


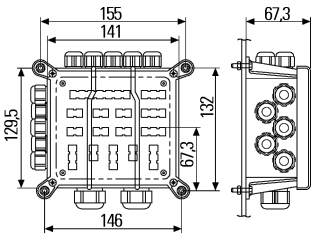

1


right



For pendant mounting, use the left-hand side-maker light, right version, or the right-hand side-marker light, left version.


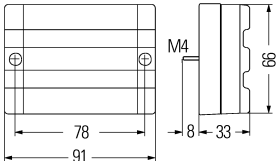


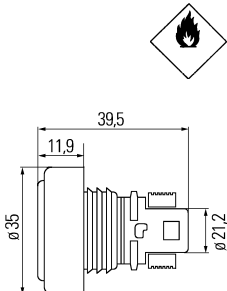

	Part no.	Pk.	For upright surface mounting on trailers and semi-trailers with tarpaulin
	2XS 302 241-071	1	<p>Front-facing part of lens for clearance light clear, rear-facing part red. Lens for side-marker light amber. With 500 mm lead and 24V bulb. Black rubber arm and frame. Type of protection: IP6K9K.</p>
	2XS 302 241-081	1	<p>E4 10211</p> <p>Clearance light with side-marker light, with 2-pin EasyConn plug, left</p>
	2XS 302 241-091	1	<p>With 500 mm lead and Quick Link lead attachment, left</p>
	2XS 302 241-101	1	right
	9EL 303 581-001	1	<p>Spare parts: Lens</p> <p> 1x24V4W (T4W) 8GP 002 067-241</p>
	2XS 340 448-011	1	<p>With 500 mm lead and 2-pin EasyConn plug, left</p>
	2XS 340 448-001	1	right
	2XS 340 448-031	1	<p>With 500 mm lead and Quick Link lead attachment, left</p>
	2XS 340 448-021	1	right
<p>For pendant mounting, use the left-hand side-marker light, right version, or the right-hand side-maker light, left version.</p>			
	2XS 340 109-011	1	<p>For surface mounting on trailers and semi-trailers with tarpaulin</p> <p>Front-facing part of lens clear, rear-facing part red. With flexible rubber support 55 x 42 mm. With 2-conductor, 1700 mm long lead, 2-pin plug and 24V bulb. To fit combination distributor 8JE 340 060-...</p>
	2XS 340 109-001	1	<p>E1 31407</p> <p>Clearance light, left</p>
	9EL 132 215-001	2	<p>Spare parts: Lens with screws</p>
	9XX 340 220-001	1	2-pin connection kit
			<p> 1x24V4W (T4W) 8GP 002 067-241</p>



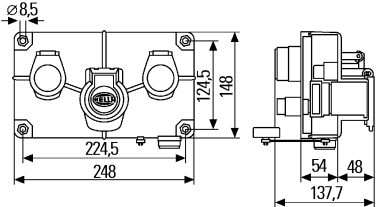






		Part no.	Pk.	For horizontal or vertical surface mounting on trailers and semi-trailers with tarpaulin
				Red lens. With 24V bulb. Connecting via splice clamp connection. Two fixing screws.
				(E1) 2544
		2XS 340 000-101	1	Clearance light
		8KA 340 040-001	1	Accessories: 2-conductor PVC flat lead with 2-pin plug, 10 m long, for trailers
		8KL 340 050-001	1	without plug, 100 m long
		9XX 340 220-001	1	2-pin connection kit
		9GS 340 051-001	20	Hot-shrink end cap
				1x24V5W (C5W) 8GM 002 092-241
				For surface mounting
				Clear lens.
				For mounting to left and right of 340 x 240 mm and 520 x 120 mm license plates. Black plastic body. With M5 fixing screws.
				With 24V bulb.
				(E1) 597
		2KA 340 828-001	1	License plate light with 500 mm lead and 2-pin EasyConn plug
		2KA 340 828-041	1	with 500 mm lead and Quick Link lead attachment
				1x24V5W (C5W) 8GM 002 092-241
				In LED-technology. With 2 white LEDs 0.5W.
				Clear lens.
				For mounting above 520 x 120 mm license plates (3 lights) or mounting to left and right of 520 x 120 mm license plates (1 light).
				Black plastic body.
				Bulb holder with vibration damper.
				Voltage range: 10 - 33V.
				Consumption: 0.04A at 12V, 0.02A at 24V.
				See page 5.236, instruction 2.
				(E4) 4068
		2KA 959 640-661	1	License plate light with 500 mm lead and 2-pin EasyConn plug





	Part no.	Pk.	Combination distributor
  	<p>8JE 340 060-001</p> <p>8JE 340 060-011</p> <p>2KA 340 118-001</p>	<p>1</p> <p>1</p> <p>1</p>	<p>For connection of all technical light functions. With built-in licence plate illumination and mounting section for licence plate 520 x 120 mm. Incl. cover for protection of connections.</p> <p>(E1) 534</p> <p>Combination distributor with black cover at front and rear. With 6-pin socket for additional illumination functions. Terminal 9-15 interior lights, work lights and rotating beacons.</p> <p>Combination distributor with black cover at front and rear. With two 6-pin sockets 1x for additional illumination functions: Terminal 9-15 interior lights, work lights and rotating beacons 1x for special functions: steering axle, axle lift, starting aid, ABS.</p> <p>Spare parts: Licence plate light with mounting sections for fuses and 24V bulbs</p> <p> Bulbs for licence plate illumination 2x24V5W (C5W) 8GM 002 092-241</p>
  	<p>8JE 340 151-001</p>	<p>1</p>	<p>Combination distributor as an alternative to 8JE 340 060-001</p> <p>Universal contact and installation thanks to plain sliders 6.3 x 0.8 mm: 1 plain connector strip with 14 terminals, 6 plain connector strips with 6 terminals, 8 plain connector strips with 4 terminals. Fitted with 12 cable glands: 10 x clamping range 3.5-10 mm, 2 x clamping range 9-18 mm. Type of protection: IP68.</p> <p>Combination distributor with plug-type connections</p>


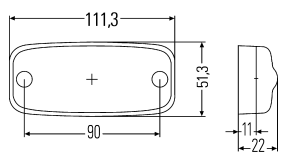
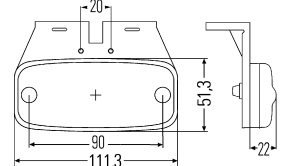



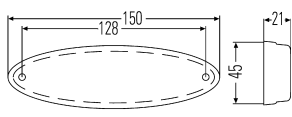
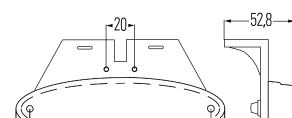



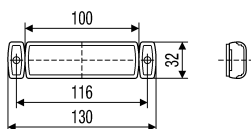


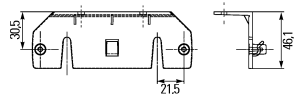
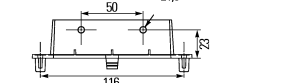

	Part no.	Pk.	Main supply leads
 	8KA 340 010-001	1	<p>14-conductor (11 x 1.5 mm², 3 x 2.5 mm²) with 15-pin plug and socket. To fit combination distributor 8JE 340 060-...</p> <p>Main supply lead, 15.5 m long</p>
	8KA 340 010-011	1	<p>12 m long</p>
	9XX 340 223-001	1	<p>Spare parts: 15-pin connection kit</p>
 	8KA 340 010-241	1	<p>14-conductor (11 x 1.5 mm², 3 x 2.5 mm²) with 2 x 15-pin plugs. To fit front distributor 8JE 340 165-001 as input module or for combination distributor 8JE 340 060-...</p> <p>Main supply lead, 15.5 m long</p>
	8KA 340 028-061	1	<p>15-conductor (12 x 1.5 mm², 3 x 2.5 mm²) with blade receptacles and 15-pin socket with cover. To fit combination distributor 8JE 340 151-...</p> <p>Main supply lead, 15.5 m long</p>
 	8KA 340 817-077	1	<p>Main supply lead</p> <p>15-conductor lead (12 x 1.0 mm²/3 x 2.5 mm²), with two 15-pole EasyConn sockets and one 2-pole outlet, 300 mm long, with EasyConn socket, assembled and extrusion-coated.</p> <p>Main supply lead, 9.0 m long</p>


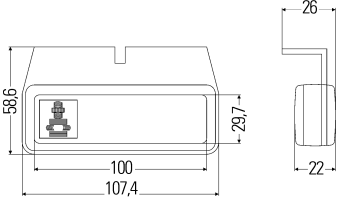


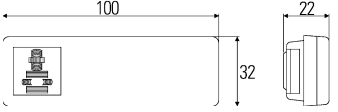

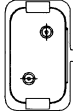

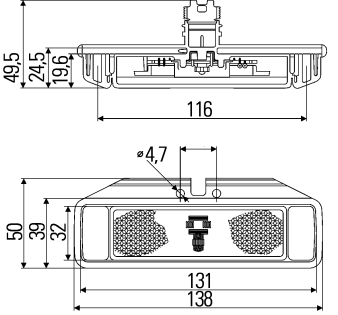




 	Part no. 8KA 340 846-067	Pk. 1	Adapter leads 15-conductor lead (12 x 1.0 mm ² /3 x 2.5 mm ²), with two 15-pole EasyConn sockets and 2-pole outlets, each 300 mm long, with two EasyConn sockets each for connecting additional functions (rear light left/right). Adapter lead, 500 mm long
 	8KA 340 896-027	1	7-conductor lead (6 x 1.0 mm ² / 1 x 1.5 mm ²), with two 7-pole EasyConn sockets and 2-pole outlets, each 500 mm long, with two EasyConn sockets each for connecting additional functions (rear fog light and reverse light). Adapter lead, 500 mm long
 	8KA 340 910-007	1	4-conductor lead (4 x 1.0 mm ²), with one 7-pole EasyConn socket and two 4-pole outlets with one 7-pole EasyConn socket, each 500 mm long. Adapter lead, 500 mm long
 	8KA 340 040-001	1	Flat leads for signal lamps with contacting via splice connection or with quick-link cabling Black PVC, 2-conductor (2 x 1.5 mm ²), with 2-pin plug. To fit combination distributor 8JE 340 060-... and front distributor 8JE 340 161-... End of lead with hot-shrink end cap. Flat lead, 10 m long, for trailers
 	8KL 340 050-001 9XX 340 220-001 9GS 340 051-001	1 1 20	Without 2-pin plug and hot-shrink end cap. 100 m drum Accessories: 2-pin connection kit Hot-shrink end cap
	9XX 340 220-001	1	Connection kits For 2-conductor flat lead or round lead, to match combination distributor 8JE 340 060-... and front distributor 8JE 340 165-... and for 2-conductor flat lead 8KL 340 050-... 2-pin connection kit
	9XX 340 222-001	1	For 6-conductor lead. To fit combination distributor 8JE 340 060-... and front distributor 8JE 340 165-..., as replacement part for combination rear lights with 6-conductor lead and plug as well as for distribution socket 8JE 340 061-... 6-pin connection kit

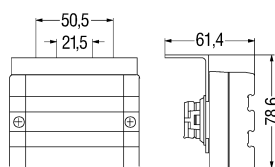
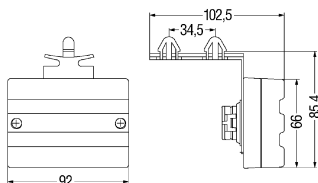
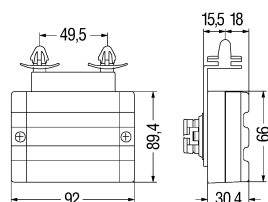
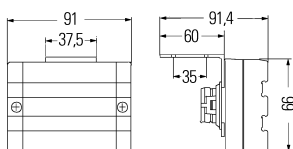
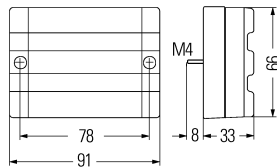
 	<p>Part no.</p> <p>2PF 340 000-111</p> <p>2PG 340 000-121</p> <p>8KA 340 040-001</p> <p>8KL 340 050-001</p> <p>9XX 340 220-001</p> <p>9GS 340 051-001</p>	<p>Pk.</p> <p>1</p> <p>1</p> <p>1</p> <p>1</p> <p>1</p> <p>1</p> <p>20</p>	<p>For horizontal or vertical surface mounting on trailers</p> <p>Clear lens. Two fixing screws. With 24V bulb. Contacting via splice clamp connection.</p> <p>ⓔ1 2439</p> <p>Side light without reflector</p> <p>with reflector</p> <p>Also can be used as clearance light for front attachment.</p> <p>Accessories: 2-conductor PVC flat lead with 2-pin plug, 10 m long, for trailer</p> <p>without plug, 100 m long (from roll)</p> <p>2-pin connection kit</p> <p>Hot-shrink end cap</p> <p> 1x24V5W (C5W) 8GM 002 092-241</p>
  	<p>2PF 340 825-001</p> <p>2PF 340 825-041</p> <p>2PF 340 825-047</p>	<p>1</p> <p>1</p> <p>50</p>	<p>For flush mounting on trailers</p> <p>In LED-technology. Clear lens, without reflector. With 2 white LEDs and 2-pin EasyConn central plug. Consumption: 0.04A See page 5.236, instruction 2.</p> <p>ⓔ4 11371</p> <p>Side light, 24V0.9W</p> <hr/> <p>With adhesive tape and 150 mm long lead, 12V0.6W</p> <p>Light is independent of polarity.</p>

  	Part no. 8JE 340 165-001	Pk. 1	Front distributor For front mounting. For connection of all technical light functions of trailers. Front distributor with 3 sockets on the front (24-N-socket, 7-pin, acc. to DIN-ISO 1185 and 24-S-socket, 7-pin, acc. to DIN-ISO 3731 as well as 15-pin socket acc. to DIN-ISO 12098) as an input module for trailers and semi-trailers with or without tarpaulin. On the reverse 1 x 15-pin jack suitable for main supply lead 8KA 340 010-241 or adapter 8KA 340 010-251 with 2 x 2-pin jack for optional connection of the side-marker lights/side lights/clearance lights protected by 2 flat fuses (2A).
	9XX 340 223-001	1	Connection kit 15-pin connection set for main distribution lead. To fit combination distributor 8JE 340 060-... and front distributor 8JE 340 165-... and as replacement part for the following leads: 8KA 340 010-.../8KA 340 020-.../8KA 340 021-.../8KA 340 030-.../8KA 340 031-... Connection kit, 15-pin
 	8KA 340 040-001	1	Flat leads for signal lamps with contacting via splice clamp connection Black PVC, 2-conductor (2 x 1.5 mm ²), with 2-pin plug. To fit combination distributor 8JE 340 060-... and front distributor 8JE 340 165-... End of lead with hot-shrink end cap. Flat lead, 10 m long, for trailer
 	8KL 340 050-001	1	100 m drum Accessories: 2-pin connection kit Hot-shrink end cap
	9XX 340 220-001	1	Connection kit For 2-conductor flat lead or round lead. To fit combination distributor 8JE 340 060-... and front distributor 8JE 340 165-... and for 2-conductor flat lead 8KL 340 050-... Connection kit, 2-pin

 	<p>Part no.</p> <p>8KA 340 031-001</p> <p>9XX 340 223-001</p>	<p>Pk.</p> <p>1</p> <p>1</p>	<p>Adapter leads for trailers</p> <p>3500 mm long, 14-conductor (11 x 1.5 mm², 3 x 2.5 mm²), with 15-pin plug. To fit main distribution lead 8KA 340 010-... as well as 15-pin plug (DIN-ISO 12098).</p> <p>Adapter lead</p> <p>Spare parts: 15-pin connection kit</p> <hr/> <p>500 mm long, 15--conductor (12 x 1,0 mm²/3 x 2,5 mm²), with two 15-pole EasyConn sockets and 2-pole outlets, each 300 mm long, with two EasyConn sockets each for connecting additional functions (rear light left/right).</p> <p>8KA 340 846-067</p> <p>Adapter lead</p>
 			

	Part no.	Pk.	For horizontal surface mounting
    	<p>2PS 963 639-011 2PS 963 639-017</p> <p>2PS 963 639-071 2PS 963 639-077</p>	<p>1 12</p> <hr/> <p>1 20</p>	<p>In LED-technology. Amber light. With 2 LEDs 1.3W. Black base plate. 500 mm lead with stripped ends. Two 5.5 mm dia. holes for fixing screws. Consumption: 0.05A See page 5.236, instruction 2.</p> <p>(E17) 9605</p> <p>Side-marker light with reflector, without bracket, 24V</p> <hr/> <p>With bracket, 24V</p>
    	<p>2PS 007 943-011 2PS 007 943-017</p> <p>2PS 007 943-021 2PS 007 943-027</p>	<p>8 105</p> <hr/> <p>10 124</p>	<p>In LED-technology. Amber light. With 3 LEDs 1.4W. Black base plate. 500 mm lead with stripped ends. Two 4.5 mm dia. holes for fixing screws. Consumption: 0.06A See page 5.236, instruction 2.</p> <p>(E4) 9417</p> <p>Side-marker light with reflector, without bracket, 24V</p> <hr/> <p>With bracket, 24V</p>
  	<p>2PG 008 645-321 2PG 008 645-331 2PG 008 645-341</p>	<p>1 1 1</p>	<p>In LED-technology. With 1 LED 1.2W. White light. Black housing. With 2-pin EasyConn plug. Consumption: 0.05A See page 5.236, instruction 2.</p> <p>(E1) 1395 (E1) 1398</p> <p>Side light with reflector, with 300 mm lead, 24V with 1300 mm lead, 24V with 3000 mm lead, 24V</p>
   	<p>2PS 008 645-301 2PS 008 645-311 2PS 008 645-377 2PS 008 645-361</p> <p>9GD 157 876-007 8HG 160 409-002</p>	<p>1 1 50 1</p> <p>1 10</p>	<p>With 1 LED 1.0W. Amber light. Consumption: 0.04A</p> <p>Side-marker light with reflector, with 300 mm lead, 24V with 1300 mm lead, 24V with 1300 mm lead and Holder, 24V with 2000 mm lead, 24V</p> <p>Accessories: Gasket Holder with two fixing screws</p>

	Part no.	Pk.	For horizontal surface mounting
  	<p>2PS 008 616-011 2PS 008 616-017</p>	<p>1 24</p>	<p>In LED technology. Amber light. With 2 LEDs 1.0W. With plug-type connection. It is possible to request completely pre-wired chains with a variable number/spacing of side-marker lights with side lights. Faulty lights are easy to replace thanks to the plug-type connection. Consumption: 0.04A. See page 5.236, instruction 2.</p> <p>Ⓔ1 1410</p> <p>Side-marker light with reflector, with bracket, 24V</p>
   	<p>2PS 008 616-001 8JA 008 658-011 8JA 008 658-017</p>	<p>1 2 24</p>	<p>Replacement lamp without bracket, 24V</p> <p>Accessories: Plug, 2-hole (for parthing through cables)</p>
     	<p>2PS 340 836-011 2PS 340 837-031 2PS 340 837-101 2PS 340 836-051 2PS 340 837-041 2PS 340 837-111 9EL 343 273-001 8HG 340 489-001 8HG 340 413-001 8PE 008 932-001 8KW 998 602-002</p>	<p>1 1 1 1 1 1 1 1 1 1 15</p>	<p>In LED-technology. Amber light. With 1300 mm lead and 2-pin EasyConn plug. Fastening by means of fixing holes at the side. With 2 LEDs 1.4W. Consumption: 0.06A. See page 5.236, instruction 2.</p> <p>Ⓔ4 10213</p> <p>Side-marker light with reflector, 24V with Quick Link lead attachment, 24V with sealed lead, 24V</p> <p>With bracket.</p> <p>Side-marker light with reflector, 24V with Quick Link lead attachment, 24V with sealed lead, 24V</p> <p>Spare parts: Lens</p> <p>Accessories: Universalholder with clip mounting for 340 836-.../340 837-... for 340 836-... Mounting pliers for quick-link lead attachment Clamping piece for quick link lead attachment</p>



Part no.

Pk.

For horizontal or vertical surface mounting

Amber lens.
Two fixing screws.
With 24V bulb.
Contacting via splice clamp connection.

Ⓔ1 2544

2PS 340 000-001

1

Side-marker light with reflector

2PS 340 000-171

1

With 35 mm mounting bracket

For horizontal surface mounting

2PS 340 000-011

1

With transverse clip angle, front.

2PS 340 000-021

1

With longitudinal clip angle, rear.

2PS 340 000-051

1

With PC lens.

2PS 340 000-041

1

Holder mounting surface points towards the back

2PS 340 000-061

1

With PC lens.

Spare parts:

9EL 340 002-011

1

Lens for -001/-011/-021/-031/-041/-171

Accessories:

8KA 340 040-001

1

2-conductor PVC flat lead with 2-pin plug,
10 m long, for trailer

8KL 340 050-001

1

without plug,
100 m long (from roll)

9XX 340 220-001

1

2-pin connection kit


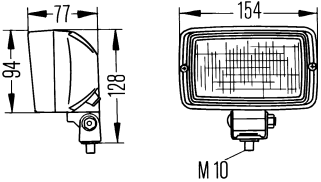


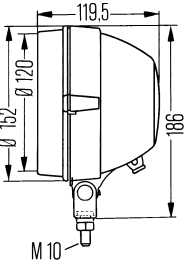


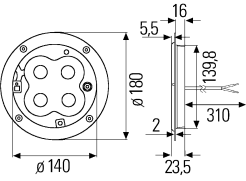
9GS 340 051-001


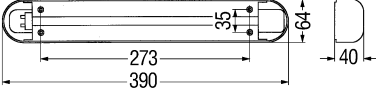
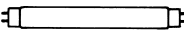


20


Hot-shrink end cap

1x24V5W (C5W) 8GM 002 092-241



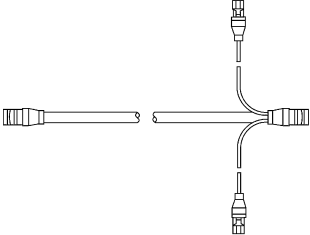


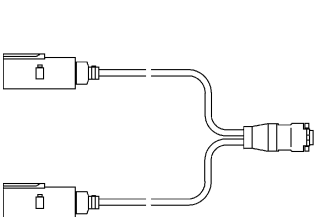


		Part no. 8KA 340 040-001	Pk. 1	Flat leads for signal lights with contacting via splice clamp connection Black PVC, 2-conductor (2 x 1.5 mm ²), with 2-pin plug. To match combination distributor 8JE 340 060-... and front distributor 8JE 340 165-... End of lead with hot-shrink end cap. Flat lead 10 m long, for trailers
		Part no. 8KL 340 050-001 9XX 340 220-001 9GS 340 051-001	Pk. 1 1 20	Without 2-pin plug and hot-shrink end cap. 100 m drum Accessories: Connection set, 2-pin Hot-shrink end cap
		Part no. 8KL 340 055-001	Pk. 1	Round lead Black, 2-conductor (2 x 1.5 mm ²), Only for LED-side-marker lights with reflector 2PS 340 001-... Usable 2-pin connection set 9XX 340 220-801. Round lead, 100 m drum
		Part no. 8KB 340 820-057	Pk. 32	Lead With chain for connecting side-marker reflector lights with four 2-pin EasyConn sockets. L1 = 3.3 m, L2 = 3.0 m, L3 = 3.0 m, L4 = 3.0 m Lead
		Part no. 9XX 340 220-001	Pk. 1	Connection kits For 2-conductor flat lead or round lead, to match combination distributor 8JE 340 060-... and front distributor 8JE 340 165-... and for 2-conductor flat lead 8KL 340 050-... 2-pin connection kit
		Part no. 9XX 340 220-011	Pk. 10	2-pin connection set for 2-conductor round lead. 1 connection set for LED side-marker lights with reflector 2PS 340 001-... and 1 connection set for combination distributor 8JE 340 060-... and front distributor 8JE 340 165-... Connection set, 2-pin
		Part no. 9XX 340 220-801	Pk. 1	2-pin connection set for 2-conductor round lead. For connection of 10 LED side-marker lights 2PS 340 001-... To fit combination distributor 8JE 340 060-... and front distributor 8JE 340 165-... Connection set, 2-pin

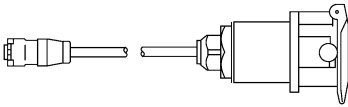
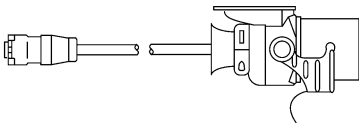






 	<p>Part no.</p> <p>1GA 340 110-001</p> <p>1GA 340 861-001</p> <p>9XD 130 261-001</p>	<p>Pk.</p> <p>1</p> <p>1</p> <p>5</p>	<p>For upright or pendant surface mounting</p> <p>Picador with FF® reflector</p> <p>Lens pattern for long-range illumination. Black fibre-glass reinforced plastic housing. Universal bracket with M10 fixing screw. Connection to distribution box 8JE 340 061-... Type of protection: IP5K4K.</p> <p>With 24V bulb. Light aperture: 125 x 75 mm.</p> <p>H3 work light with 2 conductor, 8 m long lead</p> <p>with 1600 mm long lead and 2-pin EasyConn plug</p> <p>Accessories: Mounting bracket</p>  <p>1x24V70W (H3) 8GH 002 090-251</p>
 	<p>1G3 005 760-241</p>	<p>1</p>	<p>Torero 5760</p> <p>Lens pattern for long-range illumination. Black plastic housing, with extending edge to protect lens. Universal bracket with M10 fixing screws. With 160 mm long lead and 2-pin EasyConn plug. Type of protection: IP5K4K.</p> <p>With switch and 24V bulb. Light aperture: Ø 120 mm.</p> <p>H3 work light</p>  <p>1x24V70W (H3) 8GH 002 090-251</p>
 	<p>2JB 343 227-001</p>	<p>1</p>	<p>For flush mounting</p> <p>In LED-technology. Clear lens. With 4 white LEDs, 6.0W.</p> <p>With silver coloured rim. Four holes for fixing screws. With 310 mm long lead with stripped cable ends. Voltage range: 10V - 31V.</p> <p>Interior light</p>

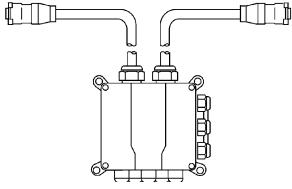



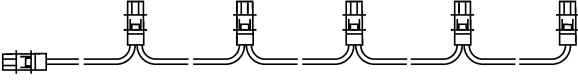
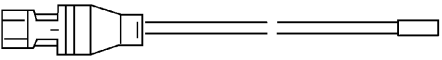
 	<p>Part no.</p> <p>2JA 340 111-001</p>	<p>Pk.</p> <p>1</p>	<p>For surface mounting</p> <p>Clear lens. White body, without switch.</p> <p>RF-suppressed = supression class N (semi-suppressed). With fluorescent tube 8W. Power consumption approx. 800 mA. With connection junction box 8JE 340 061-...</p> <p>Transistorized ceiling light, 24V</p>  <p>Fluorescent tube 8W, white 8GS 002 296-111</p>
 	<p>8JE 340 061-001</p> <p>9XX 340 222-001</p> <p>9XX 340 222-001</p>	<p>1</p> <p>1</p> <p>1</p>	<p>Distribution box</p> <p>For additional illumination functions: e. g. interior lights, work lamps, rotating beacons. With 6-conductor (5 x 1 mm²/1 x 2.5 mm²), 2 m long lead and 6-pin plug. To fit combination distributor 8JE 340 060-... and front distributor 8JE 340 165-...</p> <p>Distribution box</p> <p>Spare parts: 6-pin connection set</p> <p>Connection set</p> <p>For 6-conductor leads. To fit combination distributor 8JE 340 060-... and front distributor 8JE 340 165-... as replacement part for combination rear lights with 6-conductor lead and plug as well as for distribution socket 8JE 340 061-...</p> <p>6-pin connection set</p>


	Part no.	Pk.	Lead sets
			2 x 1.0 mm ² , black, white
	8KL 340 009-001	100	Lead set
			4 x 1.0 mm ² , black, white, brown, red
	8KL 340 052-001	50	Lead set
			3 x 2.5 mm ² , white, brown, black 4 x 1.5 mm ² , red, green, amber, white-brown
	8KL 340 054-001	100	Lead set
			2 x 0.5 mm ² , black, white
8KL 340 055-021	100	Lead set	
		12 x 1.0 mm ² green, pink, blue, black, brown, grey, red, amber, white-green, white-blue, white-black, white-brown 3 x 2.5 mm ² white-red, white, orange	
8KL 340 059-001	100	Lead set	
		8 x 1.0 mm ² , amber, green, blue, black, brown, red, pink, grey, 2 x 2.5 mm ² white, orange	
8KL 340 093-011	25	Lead set	
		6 x 1.0 mm ² , black, brown, red, blue, pink, amber-green, 1 x 1.5 mm ² , white	
8KL 340 412-001	50	Lead set	







	Part no.	Pk.	Combination distributor
	8JE 340 060-251	1	<p>For connection of all technical light functions of trailers. With built-in licence plate illumination and mounting section for licence plate.</p>
	8JE 340 898-001	1	<p>Combination distributor with one 15-pin, five 7-pin and six 2-pin EasyConn-connections. With separately protected lighting circuits.</p> <p> Bulbs for licence plate illumination 2x24V5W (C5W) 8GM 002 092-241</p> <hr/> <p>Front distributor</p> <p>For front mounting. For connection of all technical light functions of trailers.</p>
	8JE 340 867-001	1	<p>Front distributor with three sockets on the front (socket acc. to DIN-ISO 12098, 7N socket, acc. to DIN-ISO 1185 and 7S socket, acc. to DIN-ISO 3731), as well as 15-pin EasyConn connection (for main supply), as well as two closed cable screwed connections on the underside (for additional functions)</p> <hr/> <p>Distribution box</p> <p>With 15-pin EasyConn connection for main supply, 7-pin EasyConn connection for additional functions, 3 x 2-pin EasyConn connection (for licence plate-, clearance light or additional functions) and cable screwed connections. Wired completely via terminal block.</p>
	8JE 340 867-011	1	<p>Distribution box with 8 x 2-pin EasyConn connection</p>

	Part no.	Pk.	Main supply leads
	8KA 340 815-001	1	15 conductor lead (12 x 1.0 mm ² /3 x 2.5 mm ²) with two 15-pin EasyConn sockets, assembled and overmoulded.
	8KA 340 815-011	1	Main supply lead, 15.5 m long
	8KA 340 815-021	1	Main supply lead, 10.0 m long
	8KA 340 816-001	1	Main supply lead, 12.0 m long
	8KA 340 816-011	1	Main supply lead, 9.0 m long
	8KA 340 817-001	1	15-conductor lead (12 x 1.0 mm ² /3 x 2.5 mm ²) with two 15-pin EasyConn-sockets and two 2-pole outlets, each 300 mm long, with two EasyConn sockets each assembled and overmoulded, (for connecting 58L/R, 58R =brown).
	8KA 340 817-011	1	Main supply lead, 14.0 m long
	8KA 340 817-001	1	Main supply lead, 15.0 m long
	8KA 340 817-011	1	15-conductor lead (12 x 1.0 mm ² /3 x 2.5 mm ²) with 3000 mm long (work length) coiled lead. With 15-pin EasyConn plug and 15-pin EasyConn socket. As adapter lead between main supply lead and rear or front adapter lead.
	8KA 340 845-031	1	Main supply lead with flexible helical cable
	8KA 340 818-001	1	Front adapter leads
	8KA 340 818-011	1	2 x 7 conductor lead, with 15-pin EasyConn plug, suitable for main supply leads 8KA 340 815-..., 8KA 340 816-..., 8KA 340 817-... and 8KA 340 845-..., as well as 7-N socket (DIN-ISO 1185) lead 3 x 2.5 mm ² and 4 x 1.5 mm ² and 7-S socket (DIN-ISO 3731) lead 7 x 1.5 mm ² . For semi-trailer.
	8KA 340 818-031	1	Front adapter lead 1.70 m long
	8KA 340 818-011	1	Front adapter lead 0.60 m long
	8KA 340 818-031	1	Front adapter lead 6.0 m long
	8KA 340 841-001	1	2 x 7-conductor lead, with 15-pin EasyConn plug, suitable for main supply leads 8KA 340 815-..., 8KA 340 816-..., 8KA 340 817-... and 8KA 340 845-..., as well as 7-N socket (DIN-ISO 1185) lead 3 x 2.5 mm ² and 4 x 1.5 mm ² and 7-S socket (DIN-ISO 3731) lead 7 x 1.5 mm ² . For trailer.
	8KA 340 841-001	1	Front adapter lead, 3.50 m long
	8KA 340 841-021	1	Front adapter lead, 6.0 m long

	Part no.	Pk.	Front adapter leads
	8KA 340 842-001	1	<p>15-conductor lead (12 x 1.0 mm²/3 x 2.5 mm²) with 15-pin EasyConn plug, suitable for main supply leads 8KA 340 815-..., 8KA 340 816-..., 8KA 340 817-... and 8KA 340 845-..., as well as 15-pin plug (DIN-ISO 12098). For semi-trailer.</p> <p>Front adapter lead, 0.6 m long</p>
	8KA 340 842-011	1	<p>1.7 m long</p> <hr/> <p>15-conductor lead (12 x 1.0 mm²/3 x 2.5 mm²) with 15-pin EasyConn plug, suitable for main supply leads 8KA 340 815-..., 8KA 340 816-..., 8KA 340 817-... and 8KA 340 845-..., as well as 15-pin socket (DIN-ISO 12098). For trailer.</p> <p>Front adapter lead, 3.5 m long</p>
	8KA 340 843-001	1	<p>4.5 m long</p>
	8KA 340 843-011	1	<p>6.0 m long</p>
	8KA 340 843-021	1	<p>Adapter leads</p> <p>15-conductor lead (12 x 1.0 mm²/3 x 2.5 mm²) 0.5 m long, with a 15-pin EasyConn plug and a 15-pin EasyConn socket and two 2-pole outlets, each 0.3 m long, with two EasyConn sockets each for connecting additional functions (e.g. reverse light and stop light).</p> <p>Adapter lead</p> <hr/> <p>For connecting to EasyConn system, with 1.0 m long lead.</p> <p>Adapter lead with 2-pin EasyConn socket</p>
	8KA 340 846-001	1	<p>with 2-pin EasyConn socket</p>
	8KA 340 852-051	1	<p>Adapter lead with 2-pin EasyConn socket</p>
	8KA 340 854-021	1	<p>Rear adapter lead with three 2-pin EasyConn plugs per side (e.g. for licence plate and rubber arm lights), connected by two leads per side (2 x 0.5 mm²). Cable length between the individual plugs 0.5 m.</p> <hr/> <p>With two 2-pin EasyConn plugs per side (e.g. for licence plate and rubber arm lights), connected by two leads per side (2 x 0.5 mm²). Lead length between the individual plugs 0.5 m.</p> <hr/> <p>With one two-pole EasyConn plug housing per side (e.g. for SMLR chains), connected with one 3 m long flat lead (2 x 1.5 mm²) per side.</p>

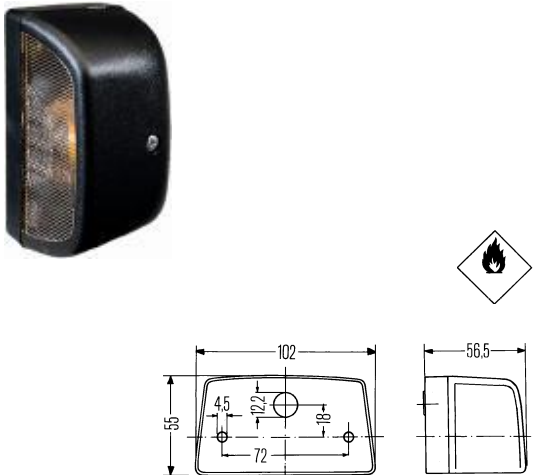


	Part no. 8JE 340 847-001	Pk. 1 Distribution box Distribution box with PG-screwing and two 15-core (12 x 1.0 mm ² /3 x 2.5 mm ²) lead ends, each 500 mm long, with 15-pin EasyConn socket and 15-pin EasyConn plug. Distribution box
	8KA 340 859-001 8KA 340 859-011	1 1 Intermediate adapter 2-wire Y-adapter cable with one 2-pole EasyConn plug housing and two 150 mm long outputs with one 2-pole EasyConn plug housing and one receptacle housing each. Intermediate adapter Outputs with one 2-pole EasyConn receptacle housing each
	8KA 340 864-001	1 Cable distributor Y-cable distributor with one 15-pole EasyConn plug on one end and two 15-pole EasyConn receptacle housings in the other end. Can be used as an adapter for the front and rear. Cable distributor
	8KB 340 820-001	1 Leads With chain for connecting side-marker reflector lights with five 2-pin EasyConn sockets and parklight. L1 = 5.30 m, L2 = 3.50 m, L3 = 3.70 m, L4 = 3.60 m, L5 = 3.70 m. Wiring harness
	8KB 340 820-061	1 Wiring harness With chain for connecting side-marker reflector lights with five 2-pin EasyConn sockets. L1 = 5.30 m, L2 = 3.50 m, L3 = 3.70 m, L4 = 3.60 m, L5 = 3.70 m. Wiring harness
	8KA 340 822-001	1 Flat wiring harness With a 2-pin EasyConn socket for connecting side-marker reflector lights. Length 21.0 m. Cable ends with heat-shrinkable cap. Flat wiring harness



	Part no.	Pk.	Main supply leads
			With 2-pole EasyConn socket and hot-shrink end cap.
	8KA 340 822-051	1	Lead set 13.5 m long
	8KA 340 822-061	1	15.0 m long
	8KA 340 822-071	1	6.0 m long
	8KA 340 822-081	1	10.0 m long
	8KA 340 822-091	1	19.0 m long
			Leads
	8KL 340 009-001	100	2 x 1.0 mm ² , black, white Lead set
	8KL 340 052-001	50	4 x 1.0 mm ² , black, white, brown, red Lead set
8KL 340 054-001	100	3 x 2.5 mm ² , white, brown, black 4 x 1.5 mm ² , red, green, amber, white-brown Lead set	
8KL 340 055-021	100	2 x 0.5 mm ² , black, white Lead set	
8KL 340 059-001	100	12 x 1.0 mm ² green, pink, blue, black, brown, grey, red, amber, white-green, white-blue, white-black, white-brown 3 x 2.5 mm ² white-red, white, orange Lead set	
8KL 340 093-011	25	8 x 1.0 mm ² , amber, green, blue, black, brown, red, pink, grey, 2 x 2.5 mm ² white, orange Lead set	
8KL 340 412-001	50	6 x 1.0 mm ² , black, brown, red, blue, pink, amber-green, 1 x 1.5 mm ² , white Lead set	
8KW 998 602-002	15	Clamping element for Quick Link lead attachment	





	Part no.	Pk.	EasyConn-Service-Sets
	9XX 340 879-001	1	<p>EasyConn Service Set with 2-pin socket</p> <p>For connecting to EasyConn system. With cablestrips and contacts. To fit leads 8KL 340 009-001, 8KL 340 412-001 and 8KL 340 059-001.</p>
	9XX 340 880-001	1	<p>EasyConn Service Set with 7-pin socket</p>
	9XX 340 881-001	1	<p>EasyConn Service Set with 15-pin socket</p>
	9XX 340 882-001	1	<p>EasyConn Service Set with 2-pin socket</p>
	9XX 340 883-001	1	<p>EasyConn Service Set with 7-pin socket</p>
	9XX 340 884-001	1	<p>EasyConn Service Set with 15-pin socket</p>
 	9HV 340 812-007	20	<p>Caps</p> <p>For tight sealing of a 2-pole EasyConn receptacle housing that is not required.</p> <p>Cap, 2-pin</p>
 	9XX 340 870-007	20	<p>For tight sealing of a 2-pole EasyConn receptacle housing that is not required. With O-Ring.</p> <p>Cap for 2-pin EasyConn socket</p>
	9XX 340 871-007	10	<p>Cap for 7-pin EasyConn socket</p>
	9XX 340 872-007	5	<p>Cap for 15-pin EasyConn socket</p>
	9XX 340 876-007	20	<p>Fuse sets</p> <p>For additional protection of EasyConn plug connections under high tensile load. With sliding ring and union nut.</p> <p>Fuse set for 2-pin EasyConn socket</p>
	9XX 340 877-007	10	<p>Fuse set for 7-pin EasyConn socket</p>
	9XX 340 878-007	5	<p>Fuse set for 15-pin EasyConn socket</p>



Signal Lights and Cabling for 12V Trailers



	<p>Part no.</p> <p>2KA 998 523-131</p>	<p>Pk.</p> <p>Signal lights, rear</p> <p>Clear lens. For surface mounting above or below of 340 x 240 mm (1 light) and 520 x 120 mm (1 or 2 lights) licence plates or mounting left or right of 340 x 240 mm and 520 x 120 mm licence plates. Black plastic body and base plate. Lamp holder with vibration damping. Two holes for M5 fixing screws.</p> <p>With grommet.</p> <p>(E12) 4031</p> <p>Licence plate light</p> <p>1x12V10W (R10W) 8GA 002 071-131</p>
	<p>8KA 998 230-001</p> <p>8KA 998 230-011</p>	<p>Standard main supply leads</p> <p>With 7-pin plug ISO 1724 for connection to the towing vehicle. On 7-pin plug with 400 mm protective tube. On the left side with 5-core lead and on the right side with 4-core lead. 5-pin central plug for connection to the combination rear light 2.. 998 232-... and 2.. 998 233-... with bayonet lock and double bush. Right-hand side with green central plug, left-hand side with yellow central plug.</p> <p>Note: The lead cannot be used if a light with rear fog light is to be used on the left side and a light with reverse light is to be used on the right side. In this case, please use a 13-pole lead.</p> <p>Standard main supply lead,</p> <p>1 4.0 m long</p> <p>1 5.0 m long</p>
	<p>8KA 998 231-071</p> <p>8KA 998 231-081</p> <p>8KA 998 231-091</p>	<p>Main supply leads Option 1</p> <p>With 7-pin plug ISO 1724 for connection to the towing vehicle. On 7-pin plug with 400 mm protective tube. On the left side with 5-core lead and on the right side with 4-core lead. 5-pin central plug for connection to the combination rear lights 2.. 998 232-... and 2.. 998 233-... with bayonet lock and double bush.. Right-hand side with green central plug, left-hand side with yellow central plug. In addition, one 2-wire lead from each double bush, length 0.50 m with quick-line attachment incl. clamp for feeding into a 2-wire flat lead.</p> <p>Note: The lead cannot be used if a light with rear fog light is to be used on the left side and a light with reverse light is to be used on the right side. In this case, please use a 13-pole lead.</p> <p>Main supply lead,</p> <p>1 6.0 m long</p> <p>1 8.0 m long</p> <p>1 10.0 m long</p>

	Part no.	Pk.	Flat leads
	8KL 998 228-011	1	2-wire flat lead for supplying various lights (side-marker reflector lights, clearance-, side-, side-reflector-, licence plate and interior lights). End protected by hot-shrink end cap.
	8KL 998 228-021	1	Flat lead, 7.0 m long 9.0 m long
	8KL 340 050-001	1	Without 2-pin plug and hot-shrink end cap. Flat lead, 100 m drum
	9GS 340 051-001	20	Accessories: Hot-shrink end cap
			Round leads
	8KA 998 229-011	1	2-wire round lead with quick-link-attachment incl. clamp for contacting a 2-wire flat lead. Free end for the supply of diverse single-function lights.
	8KA 998 229-061	1	Round lead, 0.50 m long 5.0 m long
	8PE 008 932-001	1	Accessories: Mounting pliers for quick-link cable attachment

Part no.	Pk.	Main supply leads Option 2
	8KA 998 231-001 1	<p>With 7-pin plug ISO 1724 for connection to the towing vehicle. On 7-pin plug with 400 mm protective tube. On the left side with 5-core lead and on the right side with 4-core lead. 5-pin central plug for connection to the combination rear lights 2.. 998 232-... and 2.. 998 233-... with bayonet lock and double bush. Right-hand side with green central plug, left-hand side with yellow central plug. In addition, one 2-wire lead from each double bush, length 500 mm, 2-pin central plug with bayonet lock for direct feeding into diverse single-function lamps or the T-distributor 8KV 998 225-101.</p> <p>Note: The lead cannot be used if a light with rear fog light is to be used on the left side and a light with reverse light is to be used on the right side. In this case, please use a 13-pole lead.</p> <p>Main supply lead, 4.0 m long</p>
	8KA 998 231-051 1	<p>With 13-pin plug ISO 11446 for connection to the towing vehicle. On 13-pin plug with 400 mm protective tube. On the left and right side with 5-core lead.</p> <p>Note: This lead can be used if a light with rear fog light is to be used on the left side and a light with reverse light is to be used on the right side.</p> <p>Main supply lead, 8.0 m long</p>
	8KA 998 229-081 1	<p>Round leads 2-wire round lead with 1 x 2 pin central plug with pins suitable for T-distributor 8KV 998 225-101. Free end for supply of diverse single-function lights.</p> <p>Round lead, 1.0 m long</p>
	8KA 998 226-001 1	<p>Extension leads 2-wire round leads as extension. One side with 2-plug, the other with 2-hole jack. Suitable for T-distributor 8KV 998 225-101 or diverse lights with 2-pin plug 2.. 998 523-... and 2.. 996 112-...</p> <p>Extension lead, 0.5 m long</p>
	8KV 998 225-101 1	<p>T-distributor T-distributor, 2-pin. One 2-pin input (contact pins) suitable for connection to a main supply lead Option 2 (jack contacts). Two 2-pin outputs suitable for extension lead 8KA 998 226-..., diverse lights with 2-pin plug 2.. 998 523-... and 2.. 996 112-... or round lead 8KA 998 229-...</p> <p>T-distributor</p>

Length < 6 m				Width < 2.1 m			
							
Rear	Page	Front, above windscreen	Page	Side	Page	Additional lighting	Page
2VP 007 323-011/111	5.05			2BA 002 652-111/121	5.139	2PT 009 496-007	5.114
2VP 007 323-021/121	5.05			2BA 996 027-001	5.140		
2VD 007 323-031/131	5.05					See program lights and rotating beacons	
2VD 007 323-041/141	5.05						
2.. 008 204/008 205-...	5.06-5.09						
2VP 340 888-...	5.09						
2VD 007 500-091/201	5.10						
2.. 005 300-...	5.11						
2.. 004 887-...	5.12						
2.. 003 567-...	5.14						
2SD 343 910-...	5.16						
2.. 343 640-...	5.18-5.19						
2.. 006 040-...	5.20-5.21						
2.. 003 167-...	5.23						
2.. 344 100-...	5.49						
2.. 001 685-...	5.50						
2.. 959 821-...	5.55						
2.. 964 169-...	5.66-5.69						
2.. 344 169-007/017	5.66						
2.. 344 169-037	5.67						
2.. 344 169-027	5.68						
2.. 343 390-011/-071/ 091/401	5.71						
2.. 340 950-...	5.188						
Also bottom rear		Also bottom front					
2NE/2ZR 003 236-...	5.24-5.25	2BA 344 169-027	5.68				
2NE 959 821-201	5.55	2BA 964 169-011/017	5.68				
2ZR 959 820-601	5.55						
2NE/2ZR 964 169-...	5.66-5.69						
2.. 344 169-007/017	5.66						
2.. 344 169-037	5.67						
2.. 344 169-027/047	5.68						
2.. 001 423-...	5.70						
8RA 343 160-007	5.103						
2KA 959 640-607/102	5.110						
2KA 998 523-001	5.120						
2KA 007 929-001	5.121						
2KA 003 389-...	5.121						
2ZR 997 506-391	5.130						
2ZR 005 700-191	5.130						
2ZR 005 860-151	5.130						
8RA 003 326-001/031	5.177						
8RA 003 660-007	5.178						
Also top rear/rear side							
2.. 344 169-007	5.66						
2.. 344 169-027	5.68						
Top rear/top side							
2.. 344 169-007	5.66						
2.. 344 169-027	5.68						

Lighting Equipment for Trucks and Box Body



Length < 6 m



Width >= 2.1 m



Rear	Page	Front, above windscreen	Page	Side	Page	Additional lighting	Page
2VP 007 323-011/111	5.05	2PF 962 964-...	5.91	2BA 002 652-111/121	5.139	2PT 009 496-007	5.114
2VP 007 323-021/121	5.05	2PG 962 964-051	5.91	2BA 996 027-001	5.140	See program lights and rotating beacons	
2VD 007 323-031/131	5.05	2PF 997 027-011	5.93				
2VD 007 323-041/141	5.05	2PG 963 639-401/411	5.94				
2.. 008 204/ 008 205-...	5.06-5.09	2PG 003 748-151	5.96				
2VP 340 888-...	5.09	2PG 008 645-041/051	5.100				
2VD 007 500-091/201	5.10	2PG 964 295-111	5.102				
2.. 005 300-...	5.11	2PF 961 167-021	5.107				
2.. 004 887-...	5.12	2PF 006 679-007	5.108				
2.. 003 567-...	5.14	2PF 959 570-401/411	5.109				
2.. 343 910-...	5.16	2PF 959 590-401/411	5.110				
2.. 343 640-...	5.18-5.19	2XS 955 031-001	5.122				
2.. 006 040-...	5.20-5.21	2TJ 001 633-211	5.126				
2.. 003 167-...	5.23						
2.. 344 100-...	5.49						
2.. 001 685-...	5.50						
2.. 959 821-...	5.55						
2.. 964 169-...	5.66-5.69						
2.. 343 390-071/091/401	5.71						
2.. 340 950-...	5.188						
Also bottom rear		Also bottom front					
2NE/2ZR 003 236-...	5.24-5.25	2BA 344 169-027	5.68				
2NE 959 821-201	5.55	2BA 964 169-011/017	5.68				
2ZR 959 820-601	5.55						
2NE/2ZR 964 169-...	5.66-5.69						
2.. 344 169-007	5.66						
2.. 344 169-027/047	5.68						
2.. 001 423-...	5.70						
8RA 343 160-007	5.103						
2KA 959 640-607/102	5.110						
2KA 998 523-001	5.120						
2KA 007 929-001	5.121						
2KA 003 389-...	5.121						
2ZR 997 506-391	5.130						
2ZR 005 700-191	5.130						
2ZR 005 860-151	5.130						
8RA 003 326-001/031	5.177						
8RA 003 660-007	5.178						
Also top rear/rear side							
2.. 344 169-007	5.66						
2.. 344 169-027	5.68						
Top rear/top side							
2.. 344 169-007	5.66						
2.. 344 169-027	5.68						
2SA 962 964-...	5.91						
2SA 997 027-001	5.93						
2TM 963 639-317	5.94						
2TM 003 748-011	5.96						
2TM 004 361-021	5.98						
2TM 008 645-061/071	5.100						
2TM 964 295-...	5.102						
2SA 006 679-027	5.108						
2XA 959 560-...	5.109						
2XA 959 790-...	5.110						
2XS 005 020-041/081	5.124						
2XS 008 479-...	5.125						
2XS 008 078-001/007	5.125						

Length \geq 6 m				Width $<$ 2.1 m			
Rear	Page	Front, above windscreen	Page	Side	Page	Additional lighting	Page
2VP 007 323-011/111	5.05			2ZR 003 236-...	5.24-	2PT 009 496-007	5.114
2VP 007 323-021/121	5.05				5.25		
2VD 007 323-031/131	5.05			2ZR 959 820-601	5.55	See program lights and rotating beacons	
2VD 007 323-041/141	5.05			2ZR 964 169-...	5.69		
2.. 008 204/008 205-...	5.06-5.09			2ZR 001 423-001	5.70		
2VP 340 888-...	5.09			2PS 962 964-...	5.91		
2VD 007 500-111/221/ 411	5.10			2PS 963 639-...	5.94- 5.95		
2VP 007 500-421	5.10			2PS 003 748-121/161	5.96		
2.. 005 300-...	5.11			2PS 963 959-...	5.97		
2.. 004 887-...	5.12			2PS 004 361-...	5.98		
2.. 003 567-...	5.14			2PS 964 295-...	5.102		
2.. 343 640-...	5.18-5.19			2PS 007 943-...	5.104		
2.. 006 040-...	5.20-5.21			2ZR 997 506-391	5.130		
2.. 003 167-...	5.23			2ZR 005 700-191	5.130		
2.. 344 100-...	5.49			2ZR 005 860-151	5.130		
2.. 001 685-...	5.50			2BM 006 692-...	5.144		
2.. 959 821-...	5.55			2BM 008 355-001/007/017	5.144		
2.. 964 169-...	5.66-5.69						
2.. 343 390-071/091/401	5.71						
2.. 340 950-...	5.188						
Also bottom rear		Also bottom front					
2NE/2ZR 003 236-...	5.24-5.25	2BA 344 169-027	5.68				
2ZR 959 820-601	5.55	2BA 964 169-011/017	5.68				
2NE 959 821-201	5.55						
2NE/2ZR 964 169-...	5.66-5.69						
2.. 344 169-007	5.66						
2.. 344 169-027/047	5.68						
2.. 001 423-...	5.70						
8RA 343 160-007	5.103						
2KA 959 640-607/102	5.110						
2KA 998 523-001	5.120						
2KA 007 929-001	5.121						
2KA 003 389-...	5.121						
2ZR 997 506-391	5.130						
2ZR 005 700-191	5.130						
2ZR 005 860-151	5.130						
8RA 003 326-001/031	5.177						
8RA 003 660-007	5.178						
Also top rear/rear side							
2.. 344 169-007	5.66						
2.. 344 169-027	5.68						
Top rear/top side							
2.. 344 169-007	5.66						
2.. 344 169-027	5.68						

Lighting Equipment for Trucks with Box Body



Length \geq 6 m



Width \geq 2.1 m



Rear	Page	Front, above windscreen	Page	Side	Page	Additional lightning	Page
2VP 007 323-011/111	5.05	2PF 962 964-...	5.91	2ZR 003 236-...	5.24-	2PT 009 496-007 See program lights and rotating beacons	5.114
2VP 007 323-021/121	5.05	2PG 962 964-051	5.91		5.25		
2VD 007 323-031/131	5.05	2PF 006 717-011	5.92	2ZR 959 820-601	5.55		
2VD 007 323-041/141	5.05	2PF 997 027-011	5.93	2ZR 964 169-...	5.69		
2.. 008 204/008 205-...	5.06-5.09	2PG 963 639-401/411	5.94	2ZR 001 423-001	5.70		
2VP 340 888-...	5.09	2PG 003 748-151	5.96	2PS 962 964-...	5.91		
2VD 007 500-111/221/411	5.10	2PG 008 645-041/051	5.100	2PS 963 639-...	5.94-		
2VP 007 500-421	5.10	2PG 964 295-111	5.102		5.95		
2.. 005 300-...	5.11	2PF 961 167-021	5.107	2PS 003 748-121/161	5.96		
2.. 004 887-...	5.12	2PF 006 679-007	5.108	2PS 963 959-...	5.97		
2.. 003 567-...	5.14	2PF 959 570-401/411	5.109	2PS 004 361-...	5.98		
2.. 343 910-...	5.16	2PF 959 590-401/411	5.110	2PS 964 295-...	5.102		
2.. 343 640-...	5.18-5.19	2XS 955 031-001	5.122	2PS 007 943-...	5.104		
2.. 006 040-...	5.20-5.21	2TJ 001 633-211	5.126	2ZR 997 506-391	5.130		
2.. 003 167-...	5.23	2PF 340 825-041	5.198	2ZR 005 700-191	5.130		
2.. 344 100-...	5.49			2ZR 005 860-151	5.130		
2.. 001 685-...	5.50			2BM 006 692-...	5.144		
2.. 959 821-...	5.55			2BM 008 355-001/007/017	5.144		
2.. 964 169-...	5.66-5.69						
2.. 343 390-071/091/401	5.71						
2.. 340 950-...	5.188						
Also bottom rear		Also bottom front					
2NE/2ZR 003 236-...	5.24-5.25	2BA 344 169-027	5.68				
2ZR 959 820-601	5.55	2BA 964 169-011/017	5.68				
2NE 959 821-201	5.55						
2NE/2ZR 964 169-...	5.66-5.69						
2.. 344 169-007	5.66						
2.. 344 169-027/047	5.68						
2.. 001 423-...	5.70						
8RA 343 160-007	5.103						
2KA 959 640-607/102	5.110						
2KA 998 523-001	5.120						
2KA 007 929-001	5.121						
2KA 003 389-...	5.121						
2ZR 997 506-391	5.130						
2ZR 005 700-191	5.130						
2ZR 005 860-151	5.130						
8RA 003 326-001/031	5.177						
8RA 003 660-007	5.178						
Also top rear/top side							
2.. 344 169-007/017	5.66						
2.. 344 169-027/047	5.68						
Top rear/top side							
2.. 344 169-007/017	5.66						
2.. 344 169-027/047	5.68						
2SA 962 964-...	5.91						
2SA 997 027-001	5.93						
2TM 963 639-317	5.94						
2TM 003 748-011	5.96						
2TM 004 361-021	5.98						
2TM 008 645-061/071	5.100						
2SA 006 679-027	5.108						
2XA 959 790-...	5.110						
2XS 005 020-041/081	5.123						
2XS 008 078-001	5.125						
2XS 008 479-041/051/ 081/091	5.125						



Lighting Equipment for Trucks with Tarpaulin

Length < 6 m				Width < 2.1 m			
							
Rear	Page	Front, above windscreen	Page	Side	Page	Additional lighting	Page
2.. 007 323-...	5.05			2BA 002 652-111/121	5.139	2PT 009 496-007	5.114
2.. 008 204/008 205-...	5.06-5.09			2BA 996 027-001	5.140	See program lights and rotating beacons	
2VP 340 888-...	5.09						
2VD 007 500-091/201	5.10						
2.. 005 300-...	5.11						
2.. 004 887-...	5.12						
2.. 003 567-...	5.14						
2.. 343 910-...	5.16						
2.. 343 640-...	5.18-5.19						
2.. 006 040-...	5.20-5.21						
2.. 003 167-...	5.23						
2.. 344 100-...	5.49						
2.. 001 685-...	5.50						
2.. 959 821-...	5.55						
2.. 964 169-...	5.66-5.69						
2.. 343 390-071/091/401	5.71						
2.. 340 950-...	5.188						
Also bottom rear		Also bottom front					
2NE/2ZR 003 236-...	5.24-5.25	2BA 344 169-027	5.68				
2NE 959 821-201	5.55	2BA 964 169-011/017	5.68				
2ZR 959 820-601	5.55						
2NE/2ZR 964 169-...	5.66-5.69						
2.. 344 169-007	5.66						
2.. 344 169-027/047	5.68						
2.. 001 423-...	5.70						
2KA 959 640-607/102	5.110						
2KA 998 523-001	5.120						
2KA 007 929-001	5.121						
2KA 003 389-...	5.121						
2ZR 997 506-391	5.130						
2ZR 005 700-191	5.130						
2ZR 005 860-151	5.130						
8RA 003 326-001/031	5.177						
8RA 003 660-007	5.178						
Also top rear/rearside							

Lighting Equipment for Trucks with Tarpaulin



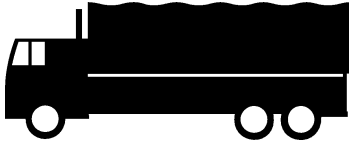

Length < 6 m



Width >= 2.1 m



Rear	Page	Front, above windscreen	Page	Side	Page	Additional lighting	Page		
2.. 007 323-...	5.05	2PF 962 964-...	5.91	2BA 002 652-111/121	5.139	2PT 009 496-007	5.114		
2.. 008 204/008 205-...	5.06-5.09	2PG 962 964-051	5.91	2BA 996 027-001	5.140	See program lights and rotating beacons			
2VP 340 888-...	5.09	2PF 997 027-011	5.93						
2VD 007 500-091/201	5.10	2PG 963 639-401/411	5.94						
2.. 005 300-...	5.11	2PG 003 748-151	5.96						
2.. 004 887-...	5.12	2PG 008 645-041/051	5.100						
2.. 003 567-...	5.14	2PG 964 295-111	5.102						
2.. 343 910-...	5.16	2PF 961 167-021	5.107						
2.. 343 640-...	5.18-5.19	2PF 959 570-407/417	5.109						
2.. 006 040-...	5.20-5.21	2PF 959 590-407/417/457	5.110						
2.. 003 167-...	5.23	2XS 005 020-077	5.124						
2.. 344 100-...	5.47	2TJ 001 633-211	5.126						
2.. 001 685-...	5.48								
2.. 959 821-...	5.53								
2.. 964 169-...	5.66-5.69								
2.. 343 390-071/091/401	5.70								
2.. 340 950-...	5.184								
Also bottom rear		Also bottom front							
2NE/2ZR 003 236-...	5.24-5.25	2BA 344 169-027	5.68						
2NE 959 821-201	5.55	2BA 964 169-011/017	5.68						
2ZR 959 820-601	5.55								
2NE/2ZR 964 169-...	5.66-5.69								
2.. 344 169-007	5.66								
2.. 344 169-027/047	5.68								
8RA 343 160-007	5.103								
2KA 959 640-607/102	5.110								
2KA 998 523-001	5.120								
2KA 007 929-001	5.121								
2KA 003 389-...	5.121								
2ZR 997 506-391	5.130								
2ZR 005 700-191	5.130								
2ZR 005 860-151	5.130								
8RA 003 326-001/031	5.177								
8RA 003 660-007	5.178								
Rear bottom side									
2XS 007 841-... (replace black lens 9EL 148 673-021 with clear lens)	5.123								
2XS 005 020-041	5.124								
2XS 005 020-081	5.124								

Length \geq 6 m				Width $<$ 2.1 m					
									
Rear	Page	Front, above windscreen	Page	Side	Page	Additional lighting	Page		
2.. 007 323-...	5.05			2ZR 003 236-...	5.24-5.25	2PT 009 496-007	5.114		
2.. 008 204/008 205-...	5.06-5.09			2ZR 959 820-601	5.55	See program lights and rotating beacons			
2VP 340 888-...	5.09			2ZR 964 169-...	5.69				
2VD 007 500-111/221/411	5.10			2ZR 001 423-001	5.70				
2VP 007 500-421	5.10			2PS 962 964-...	5.91				
2.. 005 300-...	5.11			2PS 963 639-...	5.94-5.95				
2.. 004 887-...	5.12			2PS 003 748-121/161	5.96				
2.. 003 567-...	5.14			2PS 963 959-...	5.97				
2.. 343 910-...	5.16			2PS 004 361-...	5.98				
2.. 343 640-...	5.18-5.19			2PS 964 295-...	5.102				
2.. 006 040-...	5.20-5.21			2PS 007 943-...	5.104				
2.. 003 167-...	5.23			2ZR 997 506-391	5.130				
2.. 344 100-...	5.49			2ZR 005 700-191	5.130				
2.. 001 685-...	5.50			2ZR 005 860-151	5.130				
2.. 959 821-...	5.55			2BM 008 355-001/007/017	5.144				
2.. 964 169-...	5.66-5.69			2BM 006 692-...	5.144				
2.. 343 390-071/091/401	5.71								
2.. 340 950-...	5.188								
Also bottom rear		Also bottom front							
2NE/2ZR 003 236-...	5.24-5.25	2BA 344 169-027	5.68						
2ZR 959 820-601	5.55	2BA 964 169-011/017	5.68						
2NE 959 821-201	5.55								
2NE/2ZR 964 169-...	5.66-5.69								
2.. 344 169-007	5.66								
2.. 344 169-027/047	5.68								
2.. 001 423-...	5.70								
8RA 343 160-007	5.103								
2KA 959 640-607/102	5.110								
2KA 998 523-001	5.120								
2KA 007 929-001	5.121								
2KA 003 389-...	5.121								
2ZR 997 506-391	5.130								
2ZR 005 700-191	5.130								
2ZR 005 860-151	5.130								
8RA 003 326-001/031	5.177								
8RA 003 660-007	5.178								
Rear bottomside									

Lighting Equipment for Trucks with Tarpaulin



Length \geq 6 m



Width \geq 2.1 m



Rear	Page	Front, above windscreen	Page	Side	Page	Additional lighting	Page
2.. 007 323-...	5.05	2PF 962 964-...	5.91	ZZR 003 236-...	5.24-5.25	2PT 009 496-007 See program lights and rotating beacons	5.114
2.. 008 204/008 205-...	5.06-5.09	2PG 962 964-051	5.91				
2VP 340 888-...	5.09	2PF 997 027-011	5.93	ZZR 959 820-601	5.55		
2VD 007 500-111/201/411	5.10	2PG 963 639-401/411	5.94	ZZR 964 169-...	5.69		
2VP 007 500-421	5.10	2PG 003 748-151	5.96	ZZR 001 423-001	5.70		
2.. 005 300-...	5.11	2PG 008 645-041/051	5.100	2PS 962 964-...	5.91		
2.. 004 887-...	5.12	2PG 964 295-111	5.102	2PS 963 639-...	5.94-5.95		
2.. 003 567-...	5.14	2PF 961 167-021	5.107	2PS 003 748-121/161	5.96		
2.. 343 640-...	5.18-5.19	2PF 006 679-007	5.108	2PS 963 959-...	5.97		
2.. 006 040-...	5.20-5.21	2PF 959 570-407/417	5.109	2PS 004 361-...	5.98		
2.. 003 167-...	5.23	2PF 959 590-407/417	5.110	2PS 964 295-...	5.102		
2.. 344 100-...	5.49	2XS 005 020-077	5.124	2PS 007 943-...	5.104		
2.. 959 821-...	5.55	2TJ 001 633-211	5.126	ZZR 997 506-391	5.130		
2.. 964 169-...	5.66-5.69	2PF 340 825-041	5.198	ZZR 005 700-191	5.130		
2.. 344 169-007/017	5.66			ZZR 005 860-151	5.130		
2.. 344 169-037	5.67			2BM 008 355-001/017/007	5.144		
2.. 344 169-027	5.68			2BM 006 692-...	5.144		
2.. 343 390-071/091/401	5.71						
2.. 340 950-...	5.188						
Also bottom rear		Also bottom front					
2NE/ZZR 003 236-...	5.24-5.25	2BA 344 169-027	5.68				
ZZR 959 820-601	5.55	2BA 964 169-011/017	5.68				
2NE 959 821-201	5.55						
2NE/ZZR 964 169-...	5.66-5.69						
2.. 344 169-007	5.66						
2.. 344 169-027/047	5.68						
2.. 001 423-...	5.70						
8RA 343 160-007	5.103						
2KA 959 640-607/102	5.110						
2KA 998 523-001	5.120						
2KA 007 929-001	5.121						
2KA 003 389-...	5.121						
ZZR 997 506-391	5.130						
ZZR 005 700-191	5.130						
ZZR 005 860-151	5.130						
8RA 003 326-001/031	5.177						
8RA 003 660-007	5.178						
Rear bottom side							
2XS 007 841-... (replace black lens 9EL 148 673-021 with clear lens)	5.123						
2XS 005 020-041	5.124						
2XS 005 020-081	5.124						

Length \geq 6 m



Width \geq 2.1 m



Rear	Page	Top front (max. 900 mm above roadway)	Page	Side	Page	Additional lighting	Page
2.. 004 887-...	5.12	2PG 963 639-401/411	5.94	2ZR 003 236-...	5.24-	2JA 959 037-511	5.35
2VP 007 907-...	5.12	2PG 003 748-151	5.96		5.25	2JA 959 950-...	5.55
2.. 008 789-...	5.13	2PG 963 959-021	5.97	2ZR 959 820-601	5.55	2JA 343 680-177	5.147
2.. 003 567-...	5.14	2PG 004 361-011	5.98	2ZR 964 169-...	5.69	2JA 343 700-...	5.147
2.. 343 910-...	5.16	2PG 340 000-121	5.99	2ZR 001 423-001	5.70	2JA 008 615-001	5.154
2.. 003 167-...	5.23	2PG 008 645-...	5.100	2PS 963 639-011/071	5.94	2JA 005 590-001/157	5.154
2SD 959 050-401	5.35	2PG 964 295-111	5.102	2PS 340 001-...	5.95	2JA 343 606-017	5.155
2.. 001 685-...	5.50			2PS 003 748-121/161	5.96	2JA 998 565-...	5.159
2.. 959 821-...	5.55			2PS 963 959-001/011	5.97	2JA 007 373-071/ 041/137	5.160
2.. 964 169-...	5.66-5.69			2PS 004 361-001	5.98	2JA 007 372-011/051	5.160
2.. 344 169-007/017	5.66			2PS 340 000-...	5.99	1GA 340 110-001	5.205
2.. 344 169-037	5.67			2PS 008 645-...	5.100-	1G3 005 760-241	5.205
2.. 344 169-027	5.68				5.101	1GA 340 861-001	5.205
2.. 343 390-071/091/401	5.71			2PS 964 295-051/071	5.102	2JB 343 227-001	5.205
2VP 340 450-...	5.182			2PS 007 943-011/021	5.104	2JA 340 111-001	5.206
2SK 340 103-...	5.183			2PS 008 643-...	5.105		
2SK 340 101-...	5.183			2PS 008 616-...	5.105		
2.. 340 831/340 931-...	5.184			2PS 008 382-...	5.106		
2.. 340 830/340 930-...	5.185-5.186			2ZR 997 506-391	5.130		
2.. 340 932-...	5.185			2ZR 005 700-191	5.130		
2VP 340 942-001/011	5.187			2ZR 005 860-151	5.130		
2VP 340 400-...	5.189			2PS 340 836-...	5.202		
2.. 340 950-...	5.188			2PS 340 837-...	5.202		
2.. 001 423-...	5.190						
2SD 001 685-501	5.190						
		Top front/top side					
Also bottom rear		2PG 963 639-401/411	5.94				
		2PG 003 748-151	5.96				
2.. 003 236-...	5.24-5.25	2PG 963 959-021	5.97				
2NE 959 821-201	5.55	2PG 004 361-011	5.98				
2ZR 959 820-601	5.55	2PF 340 000-111	5.99				
2.. 964 169-...	5.66-5.69	2PG 340 000-121	5.99				
2.. 344 169-007	5.66	2PG 008 645-...	5.100				
2.. 344 169-027/047	5.68	2PG 964 295-111	5.102				
2.. 001 423-...	5.70	2PF 006 679-007	5.108				
2KA 959 640-607/102	5.110	2PF 959 570-401/411	5.109				
2KA 998 523-001	5.120	2PF 959 590-401/411	5.110				
2KA 007 929-001	5.121	2PF 003 389-037	5.121				
2KA 003 389-...	5.121	2XS 005 020-077	2.124				
2ZR 997 506-391	5.130	2PF 340 825-001	5.198				
2ZR 005 700-191	5.130	2PF 340 825-041	5.198				
2ZR 005 860-151	5.130						
8RA 002 010-011	5.179						
8RA 002 020-001	5.179						
2KA 340 828-001	5.194						
Also top rear/rear side							
2.. 344 169-007	5.66						
2.. 344 169-027	5.68						
Top rear/top side							
2TM 963 639-317	5.94						
2TM 003 748-011	5.96						
2XS 963 959-031	5.97						
2TM 004 361-021	5.98						
2XS 340 000-101	5.99						
2TM 008 645-...	5.100						
2TM 964 295-091	5.103						
2SA 006 679-027	5.108						
2XA 959 560-401/411	5.109						
2XA 959 790-...	5.109						
2PF 003 389-041	5.121						
2XS 005 020-001/041/081	5.124						
2XS 008 078-001	5.125						

Cabling for Trailers with Box Body



Rear	Page	Front	Page	Side	Page	Additional lighting	Page
8JE 340 060-001	5.195	8JE 340 165-001	5.199	8KA 340 040-001	5.204	8HG 340 413-001	5.202
8JE 340 060-011	5.195	8KA 340 040-001	5.199	8KL 340 050-001	5.204	8HG 340 489-001	5.202
8JE 340 151-001	5.195	8KL 340 050-001	5.199	8KL 340 055-001	5.204	8KL 340 050-001	5.204
8KA 340 010-001	5.196	9XX 340 220-001	5.199	9XX 340 220-001/011/ 801	5.204	9GS 340 051-001	5.204
8KA 340 010-011	5.196	9GS 340 051-001	5.199	9GS 340 051-001	5.204	9XX 340 222-001	5.206
8KA 340 010-241	5.196	9XX 340 223-001	5.199	8KB 340 820-001/057/ 061	5.204, 5.211	8JE 340 898-001	5.208
8KA 340 028-061	5.196	8KA 340 031-001	5.200	8KB 340 822-001/051/ 061/071/081/091	5.211- 5.212	8KA 340 852-051	5.210
9XX 340 223-001	5.196	8JE 340 867-001/011	5.208	8KA 340 859-011	5.211	8KA 340 854-021	5.210
8KA 340 817-077	5.196	8KA 340 841-001	5.209			8KL 340 009-001	5.212
8KA 340 040-001	5.197	8KA 340 818-001	5.209			8KL 340 052-001	5.212
8KL 340 050-001	5.197	8KA 340 815-001/011/ 021	5.209			8KL 340 054-001	5.212
9GS 340 051-001	5.197	8KA 340 816-001/011	5.209			8KL 340 055-021	5.212
9XX 340 220-001	5.197	8KA 340 817-001/011/ 167	5.209			8KL 340 059-001	5.212
9XX 340 222-001	5.197	8KA 340 841-021	5.209			8KL 340 093-011	5.212
8KA 340 846-067	5.197	8KA 340 842-001/011	5.210			8KL 340 412-001	5.212
8KA 340 896-027/067	5.197	8KA 340 843-001/011/ 021	5.210			9XX 340 870-007	5.213
8KA 340 910-007	5.197	8KA 340 846-001/067/ 227	5.200, 5.210			9XX 340 871-007	5.213
8JE 340 060-251	5.208	8JE 340 847-001	5.211			9XX 340 872-007	5.213
8KA 340 815-011/021	5.209	8KA 340 864-001	5.211			9XX 340 876-007	5.213
8KA 340 816-011	5.209					9XX 340 877-007	5.213
8KA 340 817-011	5.209					9XX 340 878-007	5.213
8KA 340 819-001/011/ 041	5.210					9XX 340 879-001	5.213
8KA 340 859-001	5.211					9XX 340 880-001	5.213
8KA 340 864-001	5.211					9XX 340 881-001	5.213
9HV 340 812-007	5.213					9XX 340 882-001	5.213
9XX 340 870-007	5.213					9XX 340 883-001	5.213
						9XX 340 884-001	5.213

Length \geq 6 m



Width \geq 2.1 m



Rear	Page	Top front (max. 900 mm above roadway)	Page	Side	Page	Additional lighting	Page
2.. 004 887-...	5.12	2PG 963 639-401/411	5.94	2ZR 003 236-...	5.24-	1GA 340 110-001	5.205
2VP 007 907-...	5.12				5.25		
2.. 008 789-...	5.13	2PG 003 748-151	5.96	2ZR 959 820-601	5.55		
2.. 003 567-...	5.14	2PG 963 959-021	5.97	2ZR 964 169-...	5.69		
2.. 343 910-...	5.16	2PG 004 361-011	5.98	2ZR 001 423-001	5.70		
2.. 003 167-...	5.23	2PG 340 000-121	5.99	2PS 963 639-011/071	5.94		
2SD 959 050-401	5.35	2PG 008 645-...	5.100	2PS 340 001-...	5.95		
2.. 001 685-...	5.50	2PG 964 295-111	5.102	2PS 003 748-121/161	5.96		
2.. 959 821-...	5.55			2PS 963 959-001/011	5.97		
2.. 964 169-...	5.66-5.69			2PS 004 361-001	5.98		
2.. 344 169-007/017	5.66			2PS 340 000-...	5.99		
2.. 344 169-037	5.67			2PS 008 645-...	5.100-		
2.. 344 169-027	5.68				5.101		
2.. 343 390-071/091/401	5.71			2PS 964 295-051/071	5.102		
2VP 340 450-...	5.182			2PS 007 943-011/021	5.104		
2SK 340 101-...	5.183			2PS 008 643-...	5.105		
2SK 340 103-...	5.183			2PS 008 616-...	5.105		
2.. 340 831/340 931-...	5.184			2PS 008 382-...	5.106		
2.. 340 830/340 930-...	5.185-5.186			2ZR 997 506-391	5.130		
2VP 340 934-101/111	5.186			2ZR 005 700-191	5.130		
2VP 340 940-101/111	5.187			2ZR 005 860-151	5.130		
2VP 340 942-...	5.187			2PS 340 836-...	5.202		
2VP 340 400-...	5.189			2PS 340 837-...	5.202		
2.. 340 950-...	5.188						
2.. 001 423-...	5.190						
2SD 001 685-501	5.190						
Also bottom rear		Top front/top side					
2.. 003 236-...	5.24-5.25	2XS 005 020-077/121	5.124				
2ZR 959 820-601	5.55						
2NE 959 821-201	5.55						
2.. 964 169-...	5.66-5.69						
2.. 344 169-007	5.66						
2.. 344 169-027/-047	5.68						
2.. 001 423-...	5.70						
2KA 959 640-607/102	5.110						
2KA 998 523-001	5.120						
2KA 007 929-001	5.121						
2KA 003 389-...	5.121						
2ZR 997 506-391	5.130						
2ZR 005 700-191	5.130						
2ZR 005 860-151	5.130						
8RA 002 010-011	5.179						
8RA 002 020-001	5.179						
2KA 340 828-001	5.194						
Bottom rear side							
2XS 950 071-...	5.122						
2XS 955 232-...	5.122						
2XS 955 031-001	5.122						
2XS 007 841-011/021	5.123						
2XS 955 260-001	5.123						
2XS 005 020-001/011	5.124						
2XS 005 020-021/041	5.124						
2XS 005 020-081/091/111	5.124						
2XS 302 240-...	5.191						
2XS 340 107-001/011	5.191						
2XS 340 108-001/011	5.191						
2XS 340 447-...	5.191						
2XS 340 827-...	5.192						
2XS 340 418-...	5.192						
2XS 340 109-001/011	5.193						
2XS 302 241-...	5.193						
2XS 340 448-...	5.193						

Cabling for Trailers with Tarpaulin



Rear	Page	Front	Page	Side	Page	Additional lighting	Page
8JE 340 060-001	5.195	8KA 340 040-001	5.199	8KA 340 040-001	5.204	8JE 340 151-001	5.195
8JE 340 060-011	5.195	8KL 340 050-001	5.199	8KL 340 050-001	5.204	8HG 340 413-001	5.202
8JE 340 151-001	5.195	9XX 340 220-001	5.199	8KL 340 055-001	5.204	8HG 340 489-001	5.202
8KA 340 010-001	5.196	9GS 340 051-001	5.199	9XX 340 220-001/011/ 801	5.204	8JE 340 898-001	5.208
8KA 340 010-011	5.196	9XX 340 223-001	5.199	9GS 340 051-001	5.204	8KA 340 852-051	5.210
8KA 340 040-001	5.196	8KA 340 031-001	5.200	8KB 340 820-001/057/ 061	5.204, 5.211	8KA 340 854-021	5.210
8KL 340 028-061	5.196	8JE 340 867-001/011	5.208	8KB 340 822-001/051/ 061/071/081/091	5.211- 5.212	8KL 340 009-001	5.212
8KL 340 817-077	5.196	8KA 340 815-001/011/ 021	5.209	8KA 340 859-011	5.211	8KL 340 052-001	5.212
9XX 340 223-001	5.196	8KA 340 816-001/011	5.209			8KL 340 054-001	5.212
9GS 340 051-001	5.197	8KA 340 817-001/011/ 167	5.209			8KL 340 055-021	5.212
8KA 340 846-067	5.197	8KA 340 818-001	5.209			8KL 340 059-001	5.212
8KA 340 896-027/057/ 067	5.197	8KA 340 841-001/021	5.209			8KL 340 093-011	5.212
8KA 340 910-007	5.197	8KA 340 842-001/011	5.210			8KL 340 412-001	5.212
8KL 340 050-001	5.197	8KA 340 843-001/011/ 021	5.210			9XX 340 870-007	5.213
9XX 340 220-001	5.197	8KA 340 846-001/067/ 227	5.200, 5.210			9XX 340 871-007	5.213
8JE 340 060-251	5.208	8JE 340 847-001	5.211			9XX 340 872-007	5.213
8KA 340 815-011/021	5.209	8KA 340 864-001	5.211			9XX 340 876-007	5.213
8KA 340 816-011	5.209					9XX 340 877-007	5.213
8KA 340 817-011	5.209					9XX 340 878-007	5.213
8KA 340 819-001/011/ 041	5.210					9XX 340 879-001	5.213
8KA 340 859-001	5.211					9XX 340 880-001	5.213
8KA 340 864-001	5.211					9XX 340 881-001	5.213
9HV 340 812-007	5.213					9XX 340 882-001	5.213
9XX 340 870-007	5.213					9XX 340 883-001	5.213
						9XX 340 884-001	5.213

Length \geq 6 m



Width \geq 2.1 m



Rear	Page	Top front (max. 900 mm above roadway)	Page	Side	Page	Additional lighting	Page
2VP 007 907-...	5.12	2PG 003 748-151	5.94	2ZR 003 236-...	5.24-	2JA 959 037-511	5.35
2.. 004 887-...	5.12	2PG 963 639-401/411	5.96		5.25	2JA 959 950-...	5.55
2.. 008 789-...	5.13	2PG 963 959-021	5.97	2ZR 959 820-601	5.55	2JA 343 680-177	5.147
2.. 003 567-...	5.14	2PG 004 361-011	5.98	2ZR 964 169-...	5.69	2JA 343 700-...	5.147
2.. 343 910-...	5.16	2PG 340 000-121	5.99	2ZR 001 423-001	5.70	2JA 008 615-001	5.154
2.. 003 167-...	5.23	2PG 008 645-...	5.100	2PS 963 639-011/071	5.94	2JA 005 590-001/157	5.154
2SD 959 050-401	5.35	2PG 964 295-111	5.102	2PS 340 001-...	5.95	2JA 343 606-017	5.155
2.. 001 685-...	5.50			2PS 003 748-121/161	5.96	2JA 998 565-...	5.159
2.. 959 821-...	5.55			2PS 963 959-001/011	5.97	2JA 007 373-071/041	5.160
2.. 964 169-...	5.66-5.69			2PS 004 361-001	5.98	/137	
2.. 344 169-007/017	5.66			2PS 340 000-...	5.99	2JA 007 372-011/051	5.160
2.. 344 169-037	5.67			2PS 008 645-...	5.100-	1GA 340 110-001	5.205
2.. 344 169-027	5.68				5.101	1GA 340 861-001	5.205
2.. 343 390-071/091/401	5.71				5.101	1G3 005 760-241	5.205
2VP 340 450-...	5.182			2PS 964 295-051/071	5.102	2JB 343 227-001	5.205
2SK 340 101-...	5.183			2PS 007 943-011/021	5.104	2JA 340 111-001	5.206
2SK 340 103-...	5.183			2PS 008 643-...	5.105		
2.. 340 831/340 931-...	5.184			2PS 008 616-...	5.105		
2.. 340 932-...	5.185			2PS 008 382-...	5.106		
2.. 340 830/340 930-...	5.185-5.186			2ZR 997 506-391	5.130		
2VP 340 942-001/011	5.187			2ZR 005 700-191	5.130		
2VP 340 400-...	5.189			2ZR 005 860-151	5.130		
2VP 340 950-...	5.188			2PS 340 836-...	5.202		
2.. 001 423-...	5.190			2PS 340 837-...	5.202		
2SD 001 685-501	5.190						
Also bottom rear		Top front/top side					
		2PG 963 639-401/411	5.94				
		2PG 003 748-151	5.96				
		2PG 963 959-021	5.97				
2.. 003 236-...	5.24-5.25	2PG 004 361-011	5.98				
2NE 959 821-201	5.55	2PF 340 000-111	5.99				
2ZR 959 821-601	5.55	2PG 340 000-121	5.99				
2.. 964 169-...	5.66-5.69	2PG 008 645-...	5.100				
2.. 344 169-007	5.66	2PG 964 295-111	5.102				
2.. 344 169-027/047	5.68	2PF 006 679-007	5.108				
2.. 001 423-...	5.70	2PF 959 570-401/411	5.109				
2KA 959 640-607	5.110	2PF 959 590-401/411	5.110				
2KA 998 523-001	5.120	2PF 003 389-037	5.121				
2KA 007 929-001	5.121	2XS 005 020-077	5.124				
2KA 003 389-...	5.121	2PF 340 825-001/041	5.198				
2ZR 997 506-391	5.130						
2ZR 005 700-191	5.130						
2ZR 005 860-151	5.130						
8RA 002 010-011	5.179						
8RA 002 020-001	5.179						
2KA 340 828-001	5.194						
Also top rear/rear side							
2..344 169-007	5.66						
2..344 169-027	5.68						
Top rear/top side							
2TM 003 748-011	5.96						
2XS 963 959-031	5.97						
2TM 004 361-021	5.98						
2XS 340 000-101	5.99						
2TM 008 645-...	5.100						
2SA 006 679-027	5.108						
2XA 959 790-...	5.109						
2PF 003 389-041	5.121						
2XS 005 020-001/041/081	5.124						
2XS 008 078-001	5.125						

Cabling for Semi-Trailers with Box Body



Rear	Page	Front	Page	Side	Page	Additional lighting	Page
8JE 340 060-001/011	5.195	8JE 340 165-001	5.199	8KA 340 040-001	5.204	8HG 340 413-001	5.202
8JE 340 151-001	5.195	8KA 340 040-001	5.199	8KL 340 050-001	5.204	8HG 340 489-001	5.202
8KA 340 010-001/011/ 241	5.196	8KL 340 050-001	5.199	8KL 340 055-001	5.204	9XX 340 222-001	5.206
8KA 340 028-061	5.196	9GS 340 051-001	5.199	9XX 340 220-001/011/ 801	5.204	8JE 340 898-001	5.208
8KA 340 817-077	5.196	9XX 340 220-001	5.199	9GS 340 051-001	5.204	8KA 340 852-051	5.210
9XX 340 223-001	5.196	9XX 340 223-001	5.199	8KB 340 820-001/057/ 061	5.204, 5.211	8KA 340 854-021	5.210
8KL 340 050-001	5.197	8KA 340 031-001	5.200	8KB 340 822-001/051/ 061/071/081/091	5.211- 5.212	8KL 340 009-001	5.212
9GS 340 051-001	5.197	8JE 340 867-001/011	5.208	8KA 340 859-011	5.211	8KL 340 052-001	5.212
8KA 340 040-001	5.197	8KA 340 815-001/011/ 021	5.209			8KL 340 054-001	5.212
9XX 340 220-001	5.197	8KA 340 816-001/011	5.209			8KL 340 055-021	5.212
9XX 340 222-001	5.197	8KA 340 817-001/011/ -227	5.209			8KL 340 059-001	5.212
8KA 340 846-067	5.197	8KA 340 818-001/011/ 031	5.209			8KL 340 093-011	5.212
8KA 340 896-027/057/ 067	5.197	8KA 340 818-011/031	5.209			8KL 340 412-001	5.212
8KA 340 910-007	5.197	8KA 340 841-001	5.209			9XX 340 870-007	5.213
8JE 340 060-251	5.208	8KA 340 842-001	5.210			9XX 340 871-007	5.213
8KA 340 815-011/021	5.209	8KA 340 843-001	5.210			9XX 340 872-007	5.213
8KA 340 816-011	5.209	8KA 340 846-001/067/ 227	5.200, 5.210			9XX 340 876-007	5.213
8KA 340 817-011	5.209	8JE 340 847-001	5.211			9XX 340 877-007	5.213
8KA 340 819-001/011/ 041	5.210	8KA 340 864-001	5.211			9XX 340 878-007	5.213
8KA 340 859-001	5.211					9XX 340 879-001	5.213
8KA 340 864-001	5.211					9XX 340 880-001	5.213
9HV 340 812-007	5.213					9XX 340 881-001	5.213
9XX 340 870-007	5.213					9XX 340 882-001	5.213
						9XX 340 883-001	5.213
						9XX 340 884-001	5.213

Length \geq 6 m



Width \geq 2.1 m





Rear	Page	Top front (max. 900 mm above roadway)	Page	Side	Page	Additional lighting	Page		
2.. 004 887-...	5.12	2PG 003 748-151	5.94	2ZR 003 236-...	5.24-	1GA 340 110-001	5.205		
2VP 007 907-...	5.12	2PG 963 959-021	5.96		5.25				
2.. 008 789-...	5.13	2PG 963 639-401/411	5.97	2ZR 959 820-601	5.55				
2.. 003 567-...	5.14	2PG 004 361-011	5.98	2ZR 964 169-...	5.69				
2.. 003 167-...	5.23	2PG 340 000-121	5.99	2ZR 001 423-001	5.70				
2SD 959 050-401	5.35	2PG 008 645-...	5.100	2PS 963 639-011/071	5.94				
2.. 001 685-...	5.50	2PG 964 295-111	5.102	2PS 340 001-...	5.95				
2.. 959 821-...	5.55			2PS 003 748-121/161	5.96				
2.. 964 169-...	5.66-5.69			2PS 963 959-001/011	5.97				
2.. 344 169-007/017	5.66			2PS 004 361-001	5.98				
2.. 344 169-037	5.67			2PS 340 000-...	5.99				
2.. 344 169-027	5.68			2PS 008 645-...	5.100-				
2.. 343 390-071/091/401	5.71				5.101				
2VP 340 450-...	5.182				5.101				
2SK 340 101-...	5.183			2PS 964 295-051/071	5.102				
2SK 340 103-...	5.183			2PS 007 943-011/021	5.104				
2.. 340 831/340 931-...	5.184			2PS 008 643-...	5.105				
2.. 340 830/340 930-...	5.185-5.186			2PS 008 616-...	5.105				
2VP 340 934-101/111	5.186			2PS 008 382-...	5.106				
2VP 340 940-101/111	5.187			2ZR 997 506-391	5.130				
2VP 340 942-...	5.187			2ZR 005 700-191	5.130				
2.. 340 950-...	5.188			2ZR 005 860-151	5.130				
2VP 340 400-...	5.189			2PS 340 836-...	5.202				
2.. 001 423-...	5.190			2PS 340 837-...	5.202				
2SD 001 685-501	5.190								
Also bottom rear		Top front/top side							
2.. 003 236-...	5.24-5.25	2XS 005 020-077/121	5.124						
2ZR 959 820-601	5.55								
2NE 959 821-201	5.55								
2.. 964 169-...	5.66-5.69								
2.. 344 169-007	5.66								
2.. 344 169-027/047	5.68								
2.. 001 423-...	5.70								
2KA 959 640-607/102	5.110								
2KA 998 523-001	5.120								
2KA 007 929-001	5.121								
2KA 003 389-...	5.121								
2ZR 997 506-391	5.130								
2ZR 005 700-191	5.130								
2ZR 005 860-151	5.130								
8RA 002 010-011	5.179								
8RA 002 020-001	5.179								
2KA 340 828-001	5.194								
Bottom rear side									
2XS 950 071-...	5.122								
2XS 955 232-...	5.122								
2XS 955 031-001	5.122								
2XS 955 260-001	5.123								
2XS 007 841-011/021	5.123								
2XS 005 020-001/011/ 021/041/081/091/111	5.124								
2XS 340 447-...	5.191								
2XS 302 240-...	5.191								
2XS 340 107-001/011	5.191								
2XS 340 108-001/011	5.191								
2XS 340 418-...	5.192								
2XS 340 827-...	5.192								
2XS 302 241-...	5.193								
2XS 340 109-001/011	5.193								
2XS 340 448-...	5.193								

Cabling for Semi-Trailers with Tarpaulin











Rear	Page	Front	Page	Side	Page	Additional lighting	Page
8JE 340 060-001	5.195	8JE 340 165-001	5.199	8KA 340 040-001	5.204	8HG 340 413-001	5.202
8JE 340 060-011	5.195	8KA 340 040-001	5.199	8KL 340 050-001	5.204	8HG 340 489-001	5.202
8JE 340 151-001	5.195	8KL 340 050-001	5.199	8KL 340 055-001	5.204	9XX 340 222-001	5.206
8KA 340 010-001/011/ 241	5.196	9GS 340 051-001	5.199	9XX 340 220-001/011/ 801	5.204	8JE 340 898-001	5.208
8KA 340 028-061	5.196	9XX 340 220-001	5.199	9GS 340 051-001	5.204	8KA 340 852-051	5.210
8KA 340 040-001	5.196	9XX 340 223-001	5.199	8KB 340 820-001/057/ 061	5.204, 5.211	8KA 340 854-021	5.210
9XX 340 223-001	5.196	8KA 340 031-001	5.200	8KB 340 822-001/051/ 061/071/081/091	5.211- 5.212	8KL 340 009-001	5.212
8KA 340 817-077	5.196	8JE 340 867-001/011	5.208	8KA 340 859-011	5.211	8KL 340 052-001	5.212
8KL 340 050-001	5.197	8KA 340 815-001/011/ 021	5.209			8KL 340 054-001	5.212
9GS 340 051-001	5.197	8KA 340 816-001/011	5.209			8KL 340 055-021	5.212
9XX 340 220-001	5.197	8KA 340 817-001/011/ -167	5.209			8KL 340 059-001	5.212
9XX 340 222-001	5.197	8KA 340 818-001/011/ 031	5.209			8KL 340 093-011	5.212
8KA 340 846-067	5.197	8KA 340 841-001	5.209			8KL 340 412-001	5.212
8KA 340 896-027/-057/ -067	5.197	8KA 340 842-001	5.210			9XX 340 870-007	5.213
8KA 340 910-007	5.197	8KA 340 843-001	5.210			9XX 340 871-007	5.213
8JE 340 060-251	5.208	8KA 340 846-001/-067/ -227	5.200, 5.210			9XX 340 872-007	5.213
8KA 340 815-011/021	5.209	8JE 340 847-001	5.211			9XX 340 876-007	5.213
8KA 340 816-011	5.209	8KA 340 864-001	5.211			9XX 340 877-007	5.213
8KA 340 817-011	5.209					9XX 340 878-007	5.213
8KA 340 819-001/011/ 041	5.210					9XX 340 879-001	5.213
8KA 340 859-001	5.211					9XX 340 880-001	5.213
8KA 340 864-001	5.211					9XX 340 881-001	5.213
9HV 340 812-007	5.213					9XX 340 882-001	5.213
9XX 340 870-007	5.213					9XX 340 883-001	5.213
						9XX 340 884-001	5.213

Length \geq 6 m				Width \geq 2.1 m			
							
Rear	Page	Top front	Page	Side	Page	Additional lighting	Page
2VP 007 323-091/101	5.05	2PF 001 259-631	5.78	2ZR 003 236-...	5.25	2JA 959 037-511	5.35
2.. 003 236-...	5.24-5.25	2PF 962 964-061	5.91	2ZR 959 821-601	5.55	2JA 959 820-501	5.55
2SP 959 060-601	5.35	2PG 962 964-051	5.91	2PS 962 964-012	5.91	2JA 959 950-...	5.55
2BA 959 070-631	5.35	2PG 963 639-401/411	5.94	2PS 963 639-177	5.95	2JA 959 073-201	5.145
2.. 959 821-...	5.55	2PG 008 645-041/051	5.100	2PS 007 972-011	5.97	2JA 006 447-041	5.146
2.. 008 405-...	5.56	2PG 964 295-011/111/ 121/257	5.100	2PS 008 645-001/021	5.100-	2JA 343 680-177	5.147
2.. 008 221-...	5.57				5.101	2JA 343 700-...	5.147
2.. 009 001-...	5.59-5.62	2PF 964 295-021	5.103	2PS 964 295-051/057/ 071/077	5.102	2JA 998 560-...	5.151
2.. 965 039-...	5.63-5.64	2PF 961 167-021	5.107	8RA 343 160-027	5.103	2JA 343 606-017	5.155
2.. 964 169-...	5.66-5.69	2PF 959 570-401/411/427	5.109	2PS 009 226-017/-037	5.104	2JA 003 354-001	5.157
2.. 344 169-007/017	5.66	2PF 959 590-401/411	5.110	2ZR 997 506-391	5.130	2JA 998 565-...	5.159
2.. 344 169-037	5.67	2PF 340 825-041	5.198	2ZR 005 700-191	5.130	2AB 004 532-...	5.162
2.. 344 169-027	5.68			2ZR 005 860-151	5.130	2JA 343 720-...	5.162
2.. 343 390-071/091/401	5.71			2ZR 005 860-151	5.130	2XT 959 500-...	5.168
2.. 343 130-...	5.72-5.76			2BM 008 355-001/017	5.144	2XT 959 510-...	5.168
2.. 008 805-...	5.86			2BM 006 692-...	5.144		
2.. 005 603-...	5.87						
2.. 003 734-...	5.89-5.90						
2.. 340 950-...	5.188						
Also bottom rear		Also bottom front					
2NE 959 821-201	5.55	2PF 008 405-...	5.56				
2ZR 959 820-601	5.55	2BA 008 221-...	5.57				
8RA 008 405-001	5.56	2PF 008 221-...	5.57				
2.. 344 169-007	5.66	2BA 965 039-...	5.63				
2.. 344 169-027/047	5.68	2.. 344 169-007	5.66				
8RA 343 160-027	5.103	2.. 344 169-027/047	5.68				
2KA 959 640-607/102	5.110	2BA 343 130-...	5.72-				
2KA 001 378-...	5.116		5.75				
2KA 005 049-011/017	5.116	2BA 004 119-017	5.88				
2KA 998 523-001	5.120	2BE 004 119-021	5.88				
2KA 003 389-...	5.121	8RA 343 160-027	5.103				
2ZR 005 700-191	5.130	2PF 003 563-151/187	5.112				
2ZR 005 860-151	5.130	2PT 008 362-801	5.113				
2ZR 997 506-391	5.130	2PT 009 496-007	5.114				
8RA 002 014-081	5.175						
8RA 003 326-001/031	5.176						
8RA 003 660-007	5.177						
Also top rear/rear side							
2.. 344 169-007	5.66						
2.. 344 169-027	5.68						
Top rear/top side							
2BA 003 236-541	5.25						
8RA 008 405-001	5.56						
2XA 008 221-027	5.57						
2.. 344 169-007	5.66						
2.. 344 169-027	5.68						
2SA 962 964-091	5.91						
2TM 963 639-317	5.94						
2TM 008 645-061/071	5.100						
2TM 964 295-091	5.103						
2SA 961 167-011	5.107						
2XA 959 560-401/411	5.109						
2XA 959 790-...	5.110						
2XS 008 479-041/051/ 081/091	5.125						
2XS 008 078-001	5.125						
2DA 959 071-737/237	5.134						
2DA 343 106-...	5.135						





Lighting Equipment for Car Trailers 12V



Length < 6 m 				Width < 1.6 m 				Length < 6 m 				Width >= 1.6 m 			
Rear	Page	Side	Page	Rear	Page	Side	Page	Rear	Page	Side	Page	Rear	Page	Side	Page
2.. 343 640-...	5.18-5.19	8RA 343 160-...	5.103	2.. 343 640-...	5.18-5.19	8RA 343 160-...	5.103	2.. 343 640-...	5.18-5.19	8RA 343 160-...	5.103	2.. 343 640-...	5.18-5.19	8RA 343 160-...	5.103
2.. 007 547-...	5.22	8RA 002 014-051/101/127	5.175	2.. 007 547-...	5.22	8RA 002 014-051/101/127	5.175	2.. 007 547-...	5.22	8RA 002 014-051/101/127	5.175	2.. 007 547-...	5.22	8RA 002 014-051/101/127	5.175
2.. 341 032-...	5.34	8RA 003 326-011/041	5.176	2.. 341 032-...	5.34	8RA 003 326-011/041	5.176	2.. 341 032-...	5.34	8RA 003 326-011/041	5.176	2.. 341 032-...	5.34	8RA 003 326-011/041	5.176
2.. 998 232-... 2.. 998 233-...	5.36-5.39	8RA 002 023-011	5.177	2.. 998 232-... 2.. 998 233-...	5.36-5.39	8RA 002 023-011	5.177	2.. 998 232-... 2.. 998 233-...	5.36-5.39	8RA 002 023-011	5.177	2.. 998 232-... 2.. 998 233-...	5.36-5.39	8RA 002 023-011	5.177
2.. 003 184-...	5.41			2.. 003 184-...	5.41			2.. 003 184-...	5.41			2.. 003 184-...	5.41		
2SE 002 578-701	5.47			2SE 002 578-701	5.47			2SE 002 578-701	5.47			2SE 002 578-701	5.47		
2.. 998 530-...	5.49			2.. 998 530-...	5.49			2.. 998 530-...	5.49			2.. 998 530-...	5.49		
2SD 343 130-157/167	5.75			2SD 343 130-157/167	5.75			2SD 343 130-157/167	5.75			2SD 343 130-157/167	5.75		
Also bottom rear		Front		Also bottom rear		Front		Also bottom rear		Front		Also bottom rear		Front	
2KA 959 640-607	5.110	8RA 343 160-...	5.103	2KA 959 640-607	5.110	2PG 006 717-021	5.92	2KA 959 640-607	5.110	2PG 006 717-021	5.92	2KA 959 640-607	5.110	2PG 006 717-021	5.92
2KA 007 929-001	5.121	8RA 002 014-041/091	5.175	2KA 007 929-001	5.121	2PF 006 717-011	5.92	2KA 007 929-001	5.121	2PF 006 717-011	5.92	2KA 007 929-001	5.121	2PF 006 717-011	5.92
2NE 006 609-001	5.129	8RA 003 326-021/051	5.176	2NE 006 609-001	5.129	2PG 964 295-121	5.102	2NE 006 609-001	5.129	2PG 964 295-121	5.102	2NE 006 609-001	5.129	2PG 964 295-121	5.102
2ZR 006 609-081/171	5.129	8RA 002 023-021	5.177	2ZR 006 609-081/171	5.129	2PF 007 205-001	5.112	2ZR 006 609-081/171	5.129	2PF 007 205-001	5.112	2ZR 006 609-081/171	5.129	2PF 007 205-001	5.112
8RA 002 020-001	5.178			8RA 002 020-001	5.178			8RA 002 020-001	5.178			8RA 002 020-001	5.178		
2KA 998 523-131	5.214			2KA 998 523-131	5.214			2KA 998 523-131	5.214			2KA 998 523-131	5.214		
Length < 6 m 				Width >= 1.6 m til < 2.1 m 				Length >= 6 m 				Width >= 1.6 m til < 2.1 m 			
Rear	Page	Side	Page	Rear	Page	Side	Page	Rear	Page	Side	Page	Rear	Page	Side	Page
2.. 343 640-...	5.18-5.19	8RA 002 014-051/101/127	5.175	2.. 343 640-...	5.18-5.19	2PS 006 717-031/051	5.92	2.. 343 640-...	5.18-5.19	2PS 006 717-031/051	5.92	2.. 343 640-...	5.18-5.19	2PS 006 717-031/051	5.92
2.. 007 547-...	5.22	8RA 003 326-011/041	5.176	2.. 007 547-...	5.22	2PS 008 645-031	5.100	2.. 007 547-...	5.22	2PS 008 645-031	5.100	2.. 007 547-...	5.22	2PS 008 645-031	5.100
2.. 341 032-...	5.34	8RA 002 023-011	5.177	2.. 341 032-...	5.34	2PS 008 645-011	5.101	2.. 341 032-...	5.34	2PS 008 645-011	5.101	2.. 341 032-...	5.34	2PS 008 645-011	5.101
2.. 998 232-... 2.. 998 233-...	5.36-5.39			2.. 998 232-... 2.. 998 233-...	5.36-5.39	2PS 964 295-061/081	5.102	2.. 998 232-... 2.. 998 233-...	5.36-5.39	2PS 964 295-061/081	5.102	2.. 998 232-... 2.. 998 233-...	5.36-5.39	2PS 964 295-061/081	5.102
2.. 003 184-...	5.41			2.. 003 184-...	5.41	2PS 009 226-017	5.104	2.. 003 184-...	5.41	2PS 009 226-017	5.104	2.. 003 184-...	5.41	2PS 009 226-017	5.104
2SE 002 578-701	5.47			2SE 002 578-701	5.47	2PS 008 643-331	5.105	2SE 002 578-701	5.47	2PS 008 643-331	5.105	2SE 002 578-701	5.47	2PS 008 643-331	5.105
2.. 998 530-...	5.49			2.. 998 530-...	5.49	2ZR 006 609-081/171	5.129	2.. 998 530-...	5.49	2ZR 006 609-081/171	5.129	2.. 998 530-...	5.49	2ZR 006 609-081/171	5.129
2SD 343 130-157/167	5.75			2SD 343 130-157/167	5.75	2ZR 005 700-191	5.130	2SD 343 130-157/167	5.75	2ZR 005 700-191	5.130	2SD 343 130-157/167	5.75	2ZR 005 700-191	5.130
Also bottom rear		Front		Also bottom rear		Front		Also bottom rear		Front		Also bottom rear		Front	
2KA 959 640-607	5.110	2PG 006 717-021	5.92	2KA 959 640-607	5.110	2PG 006 717-021	5.92	2KA 959 640-607	5.110	2PG 006 717-021	5.92	2KA 959 640-607	5.110	2PG 006 717-021	5.92
2KA 007 929-001	5.121	2PF 006 717-011	5.92	2KA 007 929-001	5.121	2PF 006 717-011	5.92	2KA 007 929-001	5.121	2PF 006 717-011	5.92	2KA 007 929-001	5.121	2PF 006 717-011	5.92
2NE 006 609-001	5.129	2PG 964 295-121	5.102	2NE 006 609-001	5.129	2PG 964 295-121	5.102	2NE 006 609-001	5.129	2PG 964 295-121	5.102	2NE 006 609-001	5.129	2PG 964 295-121	5.102
2ZR 006 609-081/171	5.129	2PF 007 205-001	5.112	2ZR 006 609-081/171	5.129	2PF 007 205-001	5.112	2ZR 006 609-081/171	5.129	2PF 007 205-001	5.112	2ZR 006 609-081/171	5.129	2PF 007 205-001	5.112
8RA 002 020-001	5.173	2PF 340 825-041	5.198	8RA 002 020-001	5.173	2PF 340 825-041	5.198	8RA 002 020-001	5.173	2PF 340 825-041	5.198	8RA 002 020-001	5.173	2PF 340 825-041	5.198
2KA 998 523-131	5.214			2KA 998 523-131	5.214			2KA 998 523-131	5.214			2KA 998 523-131	5.214		



Lighting Equipment and Cabling for Car Trailers 12V

Length < 6 m		Width >= 2.1 m		Length >= 6 m		Width >= 2.1 m	
							
Rear	Page	Side	Page	Rear	Page	Side	Page
2.. 343 640-...	5.18-5.19	8RA 343 160-...	5.103	2.. 343 640-...	5.18-5.19	2PS 006 717-031/051	5.92
2.. 007 547-...	5.22	8RA 002 014-051/101/127	5.175	2.. 007 547-...	5.22	2PS 008 645-031	5.100
2.. 341 032	5.34	8RA 003 326-011/041	5.176	2.. 341 032-...	5.34	2PS 008 645-011	5.101
2.. 998 232-...	5.36-	8RA 002 023-011	5.177	2.. 998 232-...	5.36-	2PS 964 295-061/081	5.102
2.. 998 233-...	5.39			2.. 998 233-...	5.39	2PS 009 226-017	5.104
2.. 003 184-...	5.41			2.. 003 184-...	5.41	2PS 008 643-331	5.105
2SE 002 578-701	5.47			2SE 002 578-701	5.47	2ZR 006 609-087/171	5.129
2.. 998 530-...	5.49			2.. 998 530-...	5.49	2ZR 005 700-191	5.130
2.. 003 185-041/047	5.52			2.. 003 185-041/047	5.52	2ZR 005 860-151	5.130
2SD 343 130-157/167	5.75			2SD 343 130-157/167	5.75		
Also bottom rear		Front		Also bottom rear		Front	
2KA 959 640-607	5.110	2PF 006 717-011	5.92	2KA 959 640-607	5.110	2PF 006 717-011	5.92
2KA 007 929-001	5.121	2PG 006 717-021	5.92	2KA 007 929-001	5.121	2PG 006 717-021	5.92
2NE 006 609-001	5.129	2PS 964 295-121	5.102	2NE 006 609-001	5.129	2PS 964 295-121	5.102
2ZR 006 609-087/171	5.129	2PF 007 205-001	5.112	2ZR 006 609-087/171	5.129	2PF 007 205-001	5.112
8RA 002 020-001	5.178	2PF 340 825-041	5.198	2ZR 005 700-191	5.130	2PF 340 825-041	5.198
2KA 998 523-131	5.214			2ZR 005 860-151	5.130		
				8RA 002 020-001	5.178		
				2KA 998 523-131	5.214		
Also rear/rear side				Also rear/rear side			
2SA 006 717-001/047	5.92			2SA 006 717-001/047	5.92		
2TM 008 645-081/087	5.100			2TM 008 645-081/087	5.100		
2TM 008 645-091	5.100			2TM 008 645-091	5.100		
2TM 964 295-101	5.103			2TM 964 295-101	5.103		
2XS 955 031-001	5.122			2XS 955 031-001	5.122		
2XS 950 071-031	5.122			2XS 950 071-031	5.122		
2XS 955 232-001	5.122			2XS 955 232-001	5.122		
2XS 005 020-001/011	5.124			2XS 005 020-001/011	5.124		
Standard main supply cable	Page	Main supply cable (Option 1)	Page	Main supply cable (Option 2)	Page		
8KA 998 230-001	5.214	8KA 998 231-071/081/091	5.214	8KA 998 231-001	5.216		
8KA 998 230-011	5.214	8KA 998 228-011/021	5.215	8KA 998 231-051	5.216		
		8KL 340 050-001	5.215	8KA 998 226-001	5.216		
		9GS 340 051-001 (Hot-shrink end cap)	5.215	8KA 998 229-081	5.216		
		8KA 998 229-011	5.215	8KA 998 229-121	5.216		
		8KA 998 229-021	5.215	8KV 998 225-101 (T-distributor)	5.216		
		8KA 998 229-061	5.215				
		8PE 008 932-001 (Mounting pliers)	5.215				

Instruction 1

In connection with these low powers, which are very different from bulb versions, there can be problems with the bulb failure check during operation on various traction vehicles.

Since indicator failure checks are required by legislation, we recommend only operating the light in combination with an indicator control unit part no. "5DS 009 602-..., 5DS 009 552-... or LED flasher unit 4.. 009 492".

In addition, further lighting functions are detected by some traction vehicles. This is a vehicle comfort function which is not required

by legislation and does not release drivers from their obligation to see for themselves that the lighting equipment is working. Here, too, faulty diagnoses can be a result of the lower power levels involved (instrument panel in the driver cab indicates a bulb failure although the function is working).

The functional ability of these light failure checks can only be established by the vehicle manufacturer.

The power specifications must be adapted to the respective lights!!!!

Operation of the light with alternating current or pulsed direct current is not permitted!

The functional ability of these light failure checks can only be established by the vehicle manufacturer.

The individual light functions may only be operated with a vehicle fuse of max. 3A.

Instruction 2

In connection with these low powers, which are very different from bulb versions, there can be problems during operation on various traction vehicles because further lighting functions are detected by some traction vehicles.

This is a vehicle comfort function which is not required by legislation and does not release drivers from their obligation to see for themselves that the lighting equipment is working.

Here, too, faulty diagnoses can be a result of the lower power levels involved (instrument panel in the driver cab indicates a bulb failure although the function is working).

The functional ability of these light failure checks can only be established by the vehicle manufacturer.

The power specifications must be adapted to the respective lights!!!!

Operation of the light with alternating current or pulsed direct current is not permitted!

The individual light functions may only be operated with a vehicle fuse of max. 3A.

Instruction 3

In connection with these low powers, which are very different from bulb versions, there can be problems with the bulb failure check during operation on various traction vehicles.

Since indicator failure checks are required by legislation, we recommend only operating the light in combination with an indicator control unit part no. "5DS 009 602-..., 5DS 009 552-... or LED flasher unit 4.. 009 492".

The power specifications must be adapted to the respective lights!!!!

Operation of the light with alternating current or pulsed direct current is not permitted!

The individual light functions may only be operated with a vehicle fuse of max. 3A.

Legal requirement in all ECE states

In the case of vehicles approved for use on public roads, the indicators must be monitored: The failure of an indicator must be shown optically or acoustically in the vehicle. This applies in all ECE states. In other words, the potential failure of the indicator must be monitored by the vehicle. Manufacturers use various failure control systems. The failure control systems currently in use cannot detect simple LED lights and displays a fault. All Hella LED indicators have integrated electronics for failure control. The indicators are selfmonitoring. They generate a pulse that is evaluated by the electronic ballast. The ballast simulates a 21W bulb, which makes operation with conventional flasher units possible.

As soon as one single LED fails, the light can be considered faulty, the pulse is not generated. The ballast then switches the bulb simulation off and the flasher unit indicates the fault to the driver.

Safe conversion to LED indicators now possible thanks patented Hella electronics

Hella supplies electronic ballasts for all Hella LED indicators which make it possible to convert the indicator failure display for various vehicles. This is necessary if the vehicle manufacturer does not guarantee indicator bulb failure control via the vehicle wiring system. The method has been patented for Hella. At the moment, there are three different ballasts and several different LED indicator types available.

LED indicator failure control: Background information

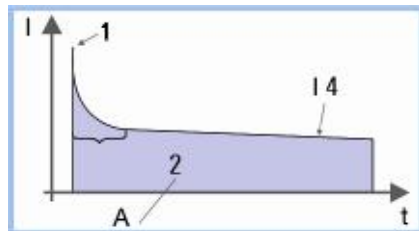


Fig. 1

Why does the failure detection required by law work with various LED lights with some flasher units and not with others?

Fig. 1 illustrates the typical current pattern when a bulb is switched on. Different flasher units detect this in different ways, for example by
 a) measuring the pulse peak or
 b) measuring the current at some point during the switch-on pulse or
 c) measuring the current after the pulse, when the current is constant and has a certain intensity, or
 d) determining the total energy flowing through the light (size of area A)

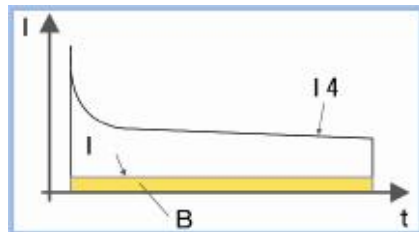


Fig. 2

Fig. 2 shows the LED current (I_{LED}) in relation to this. None of the methods mentioned above can work here, because there is neither a switch-on pulse available nor is the current intensity high enough or the total energy through both lights is identical (area B is as large as A).

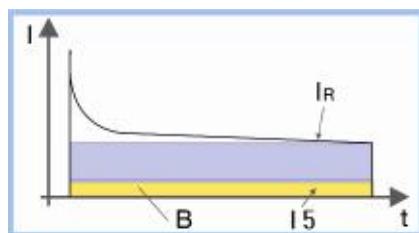


Fig. 3

If a simple Ohmic resistor is inserted, e.g. a resistor cable, the current is increased by a certain value (I_R) and the curve illustrated in Fig. 3 is the result. In this case, only a flasher unit according to principle c) would work. If the resistance is chosen somewhat higher, principle d) could also possibly work. If the light fails afterwards due to mechanical damage, the flasher unit could detect the insert resistor as a functional bulb. In this case, a light working perfectly would be indicated although this is not the case! This means: In this case the vehicle would lose this approval for use on public roads.

The only solution conceivable for universal use is one that works with all the flasher units on the market. As the above considerations have shown, this can practically only be guaranteed if the current pattern of a bulb is simulated exactly by means of an electronic circuit.

- I = Current
- t = Time
- 1 = Pulse peak
- 2 = Switch-on pulse
- 3 = Individual pulse
- 4 = Bulb
- 5 = LED

Since such a circuit is extremely complex, it is not possible to integrate this in the LED light. In order to be able to benefit from the advantages of LED lights despite this fact, a ballast is required to the circuit. This combination provides the perfect - and above all legally conform - solution to the problem.

Hella patent for the perfect problem solution

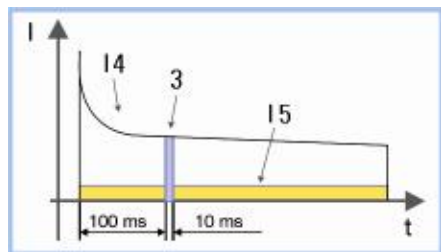


Fig. 4

I = Current
t = Time
1 = Pulse peak
2 = Switch-on pulse
3 = Individual pulse
4 = Bulb
5 = LED

All Hella LED indicators with integrated electronics for failure control are self-monitoring and generate an individual pulse. This pulse is evaluated by the electronic ballasts. The ballasts simulate a 21 W bulb.

This makes operation with conventional flasher units possible.

If the light is faulty, which can be the case if only a single LED fails, the above-mentioned pulse is not generated. The ballasts then switch the bulb simulation off and the flasher unit indicates the LED fault to the driver.

By measuring the light current during a time window of 10 ms (Fig. 4), direct exchange between the Hella LED light and a bulb version is possible.

Hella ballasts are straightforward to convert even at a later date.

Vehicle manufacturers can also ensure ECE-conform failure control by evaluating the pulse of the Hella LED indicators shown in the adjacent diagram directly in their control units.

The exact specification can be obtained from Hella.

Which Hella ballast for which vehicle?



1. Vehicles that use the cold scan for indicator failure control.

Description of fault indication:

Is a faulty light indicated when the ignition is switched on or directly when the fault occurs, or when the bulb is screwed out without the indicator being triggered?

Solution: Simulation device for cold scan

	Simulation device for cold scan,
5DS 009 602-011	12V
5DS 009 602-001	24V



2. Vehicles without flasher unit that carry out current measurement as failure control.

Description of fault indication:

Is a fault only determined during flashing (e.g. double flashing frequency)?

Solution: Indicator control unit

5DS 009 552-001	Indicator control unit for trucks and trailers, 24V, with one 15-pole EasyConn plug and one 15-pole Easy-Conn socket.
-----------------	---

5DS 009 552-011	Lead end with blade terminal contact 6.3 mm No separate power supply necessary. Protective rating: IP 6K9K
-----------------	--



3. Vehicles with flasher unit



Solution: Replacement of the existing flasher unit by an LED flasher unit

4DN 009 492-101	LED-flasher unit, 12V 2+1+1
4DW 009 492-111	LED-flasher unit, 12V 3+1
4DM 009 492-001	LED-flasher unit, 24V 2+1
4DW 009 492-011	LED-flasher unit, 24V 3+1



Rotating beacons, flashing beacons, warning lights	
Accessories for old-type rotating- and flashing beacons	6.17-6.19
Accessories for rotating- and flashing beacons	6.15-6.16
LED beacons	6.14
Flashing beacons	6.10-6.13
Rotating beacons	6.03-6.09
Signal lights	6.23
Spare parts for old-type rotating- and flashing beacons	6.17-6.19
Strobe beacons	6.20-6.21
Warning lights	6.22
Codes	6.02
Optical warning systems	
OWS-QS: Product descriptions, accessories and spare parts	6.24-6.29
OWS 540 up to 1600: Product descriptions, accessories and spare parts	6.30-6.35
OWS 4: Spare parts for old-type systems	6.36
Rotating-/flashing beacon and siren combination	
RTK 5: Product descriptions, spare parts and accessories	6.37-6.39
RTK 6-SL: Product descriptions, modules and spare parts	6.40-6.50
RTK-QS: Product descriptions, modules and spare parts	6.51-6.60
RTK-VE: Product descriptions and accessories	6.61-6.63

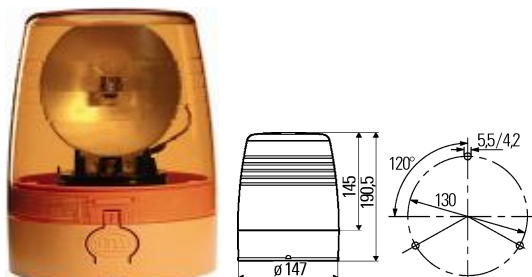
Code	Explanation
ASG	Stop signal
ASG-GL	Stop signal with built-in incandescent bulbs
ASG-LED	Stop signal in LED-technology
ASG-LED-Matrix	Stop signal in Matrix-technology (programmable)
AZD	Push-pull-rotary alarm switch (mechanical operating concept)
BSX	Strobe beacons (Product lines: BSX-Micro, -Multi and -Compact)
C-LED	Corner light
eAZD	Electronic control unit
EMV	Electromagnetic compatibility
eNF-switching unit	Electronic operating concept for the control of communication functions in special signal systems
FL	Rotating beacon with tubular fitting for support
FuG 7/8	Standardised two-way radio
HWL	Warning light
HWL-LED	Warning light in LED-technology
HWL-X	Warning light in xenon-technology
Info-G	Information sign (Traffic jam sign on RTK 6-SL)
KL	Rotating beacon
KL-A	Tripod for fitting a high-mounted beacon (for RTK 6-SL)
K-LED	LED beacon
KL-ER	Beacon with single reflector system (for roof bar systems)
KL-MR	Beacon with multiple reflector system (for roof bar systems)
KLX	Strobe beacon
KL-XL	Beacon with xenon-double flashing system (for RTK 6-SL)
KL-XL2	Beacon with xenon-double flashing system (for RTK 5, RTK-QS, OWS and OWS-QS)
KL-XR	Beacon with xenon-parabolic trough reflector system (for RTK 6-SL)
KL-XR2	Beacon with xenon-parabolic trough reflector system (for RTK-QS and OWS-QS)
LSP-H	Loudspeaker, rear
LSP-V	Loudspeaker, front
M	Beacon attachment variant with magnetic attachment
OWS	Optical warning system (Product lines: OWS and OWS-QS)
OWS 4	Optical warning system (old-type)
OWS-MR	Optical warning system with multiple reflector system
OWS-X	Optical warning system with xenon system
PC	Polycarbonate
R	Rotating beacon with tubular fitting for support
RTK	Rotating beacon and siren combinations (Product lines: RTK 6-SL, RTK 5 and RTK-QS)
RTK-VE	Sound warning system
SB	Rotating beacon with single bolt for fitting
Teledux 9	non-standardised two-way radio
WL-LED	Warning light in LED-technology
ZSE	Control unit light
ZSE L	Control unit light (for RTK-QS)
ZSE L/A	Control unit light and acoustic (for RTK-QS)
ZSE-VE	Control unit (for RTK-VE)

Part no.	Pk.	Rotating beacons with halogen H1 light
<p>KL Rotaflex FL According to DIN 14 620, shape A. Black rubber housing with tubular fitting for support, max. inclination 90°. With built-in bulb. Light aperture (reflector dia.): 76.5 mm.</p> <p>Total power consumption: 12V55W = 5.5A, 24V70W = 3.5A. Operating temperature: -40 °C to +60 °C. RF suppression: CISPR 25, class 5 (conducted). Resistant to high pressure cleaning.</p>		
<p>Ⓔ4 6513 blue Ⓔ4 6509 amber Ⓛ1 2181</p>		
<p>Rotating beacon, dome with optical pattern, blue, 12V</p>		
2RL 006 846-101	1	
2RL 006 846-111	1	blue, 24V
2RL 006 846-001	1	amber, 12V
2RL 006 846-011	1	amber, 24V
<p>KL Rotafix F According to DIN 14 620 form B1. With black base for permanent mounting on level surface,</p>		
2RL 007 337-101	1	blue, 12V
2RL 007 337-111	1	blue, 24V
2RL 007 337-001	1	amber, 12V
2RL 007 337-011	1	amber, 24V
2RL 007 337-041	1	amber, 12V/24V, with 24V bulb and belt drive
<p>KL Rotafix M With magnetic attachment, spirally-coiled lead extends up to 2.5 m and 2-pole plug for connecting to the cigarette lighter socket,</p>		
2RL 007 337-121	1	blue, 12V
2RL 007 337-021	1	amber, 12V
2RL 007 337-031	1	amber, 24V
2RL 007 337-057	1	amber, with spirit level, 24V
9EL 859 020-101	1	Spare parts: Dome with optical pattern, blue
9EL 859 020-001	1	amber (PC)
9GP 859 115-001	1	Rubber housing for 2RL 006 846-...
<p>Motor, 12V 24V 12V/24V for -041 Drive belts (2 pieces) for -041</p>		
9MN 858 114-001	1	
9MN 858 114-011	1	
9MN 862 741-001	1	
9XR 854 840-001	1	
<p>Reflector for 2RL 006 846-... for 2RL 007 337-... (except -041) for 2RL 007 337-041</p>		
9DX 860 438-001	1	
9DX 860 271-001	1	
9DX 862 844-001	1	
<p> 12V55W (H1) 8GH 002 089-133  24V70W (H1) 8GH 002 089-251</p>		

Accessories see page 6.15-6.16

Rotating Beacons

180 rpm



Part no.

Pk.

Rotating beacons with halogen H1 light

KL JuniorPlus F

According to DIN 14 620, shape B1.

Blue rotating beacon with black base, amber rotating beacon with amber base.

With built-in bulb.

Light aperture (reflector dia.): 95 mm.

Total power consumption:

12V55W = 4,7A, 24V70W = 3A.

Operating temperature: -40 °C to +60 °C.

RF suppression: CISPR 25, class 3 (conducted).

Resistant to high pressure cleaning.

Ⓔ1 2140 blue Ⓔ1 1419 amber e1 2954

Rotating beacon for permanent mounting, blue, 12V

2RL 008 965-031 1

2RL 008 965-041 1

2RL 008 965-001 1

2RL 008 965-011 1

2RL 008 965-021 1

without bulb, amber, 12V/24V

KL JuniorPlus M

With magnetic attachment, spirally-coiled lead extends up to 3.5 m and 2-pole plug for connecting to the cigarette lighter socket,

2RL 008 966-031 1

2RL 008 966-001 1

2RL 008 966-021 1

blue, 12V

amber, 12V

without bulb, amber, 12V/24V

KL JuniorPlus FL

According to DIN 14 620 shape A.

With flexible tubular fitting for support tube.

Max. inclination 90°,

2RL 008 967-031 1

2RL 008 967-041 1

2RL 008 967-001 1

2RL 008 967-011 1

2RL 008 967-021 1

blue, 12V

blue, 24V

amber, 12V

amber, 24V

without bulb, amber, 12V/24V

KL Junior Plus SB

Single bolt for fitting,

2RL 008 990-001 1

2RL 008 990-011 1

2RL 008 990-021 1

amber, 12V

amber, 24V

amber, 12V/24V, without bulb

Spare parts:

9EL 863 100-041 1

9EL 863 100-001 1

9NM 863 332-001 1

9MN 745 023-001 1

9XR 855 975-001 1

Dome,

blue

amber

Wing nut mount (Junior Plus FL)

Motor, 12V/24V

Drive belts (2 pieces)



1x12V55W (H1) 8GH 002 089-133

1x24V70W (H1) 8GH 002 089-251

Accessories see page 6.15-6.16


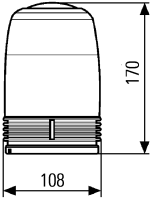

	Part no.	Pk.	Rotating beacons with halogen H1 light
	<p>2RL 007 550-001 2RL 007 550-011 2RL 007 550-021</p>	<p>1 1 1</p>	<p>KL Junior F According to DIN 14 620, shape B1. With amber base for permanent mounting. With built-in bulb. Light aperture (reflector dia.): 103 mm.</p> <p>Total power consumption: 12V55W = 5.5A, 24V70W = 3.5A. Operating temperature: -20 °C to +60 °C. RF suppression: CISPR 25, class 3 (conducted). Resistant to high pressure cleaning.</p> <p>Ⓔ4 6514 Ⓛ1 2182</p>
	<p>2RL 007 552-001 2RL 007 552-011 2RL 007 552-021</p>	<p>1 1 1</p>	<p>KL Junior M Amber base with magnetic attachment, spirally-coiled lead extends up to 3.5 m and 2-pole plug for connecting to the cigarette lighter socket,</p> <p>1 amber, 12V 1 amber, 24V 1 without bulb, amber, 12V/24V</p>
	<p>2RL 007 551-001 2RL 007 551-011 2RL 007 551-021</p>	<p>1 1 1</p>	<p>KL Junior R According to DIN 14 620 shape A. Amber base with tubular fitting for support,</p> <p>1 amber, 12V 1 amber, 24V 1 without bulb, amber, 12V/24V</p>
	<p>2RL 007 553-001 2RL 007 553-011 2RL 007 553-021</p> <p>9EL 860 627-001 9EL 860 627-011 9EL 860 628-021</p> <p>9NU 858 004-001</p> <p>9MN 860 677-001 9MN 860 677-011 9MN 860 677-021</p>	<p>1 1 1</p> <p>1 1 1</p> <p>10</p> <p>1 1 1</p>	<p>KL Junior FL With PC light dome, base with flexible tubular fitting for support tube. Max. inclination 90°.</p> <p>Spare parts: Dome with optical pattern, amber, for 2RL 007 550-.../551-.../552-... amber (PC), for 2RL 007 553-... blue</p> <p>Protective foil for magnet</p> <p>Motor, 12V 24V 12V/24V</p> <p> 12V55W (H1) 8GH 002 089-133 24V70W (H1) 8GH 002 089-251</p>

Accessories see page 6.15-6.16

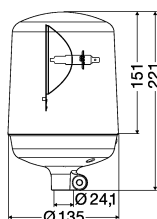
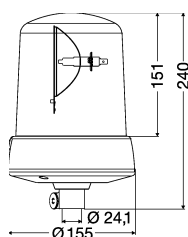
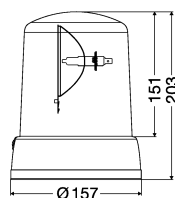
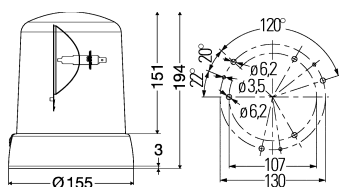
Rotating Beacons

160 rpm



 	<p>Part no.</p> <p>2RL 008 364-021</p> <p>9EL 862 267-031</p> <p>9XR 854 840-001</p> <p>8JB 004 777-002</p> <p>8JB 004 777-001</p>	<p>Pk.</p> <p>1</p> <p>1</p> <p>1</p> <p>1</p> <p>5</p>	<p>Rotating beacon with halogen H1 light</p> <p>KL 5000 M According to DIN 14 620, shape B1. With black base. With magnetic attachment, spirally-coiled lead extends up to 2.5 m and 2-pole plug for connecting to the cigarette lighter socket or boardsocket to DIN-ISO 4165. With built-in 12V bulb. Light aperture (reflector dia.): 76 mm.</p> <p>Total power consumption: 12V55W = 4.5A. Operating temperature: -40 °C to +60 °C. RF suppression: CISPR 25, class 5 (conducted). Resistant to high pressure cleaning.</p> <p>E1 1289 e1 1774</p> <p>Rotating beacon, blue, 12V</p> <p>Spare parts: Dome Drive belts (2 pieces)</p> <p>Accessories: Boardsocket, 2-pole</p> <p> 1x12V55W (H1) 8GH 002 089-133</p>

Accessories see page 6.15-6.16



Part no.

Pk.

Rotating beacons with halogen H1 light

KL 7000 F

According to DIN 14 620, shape B1.
Blue rotating beacon with black base, amber rotating beacon with amber base.
With built-in bulb.
Light aperture (reflector dia.): 84 mm.

Total power consumption:
12V55W = 5.5A, 24V70W = 3.5A.
Operating temperature: -40 °C to +60 °C.
RF suppression: CISPR 25, class 5 (conducted).
Resistant to high pressure cleaning.

Ⓔ 1240 blue Ⓔ 1241 amber e1 1740

Rotating beacon for permanent mounting, with rubber gasket,

- 2RL 008 061-001 1 blue, 12V, without optical pattern
- 2RL 008 061-011 1 blue, 24V, without optical pattern
- 2RL 008 061-101 1 amber, 12V, with optical pattern
- 2RL 008 061-111 1 amber, 24V, with optical pattern

KL 7000 M

With magnetic attachment, spirally-coiled lead extends up to 2.5 m and 2-pole plug for connecting to the cigarette lighter socket,

- 2RL 008 062-001 1 blue, 12V, without optical pattern
- 2RL 008 062-011 1 blue, 24V, without optical pattern
- 2RL 008 062-101 1 amber, 12V, with optical pattern
- 2RL 008 062-111 1 amber, 24V, with optical pattern

KL 7000 FL

According to DIN 14 620 shape A.
With flexible tubular fitting for support tube. Max. inclination 90°,

- 2RL 008 063-001 1 blue, 12V, without optical pattern
- 2RL 008 063-011 1 blue, 24V, without optical pattern
- 2RL 008 063-101 1 amber, 12V, with optical pattern
- 2RL 008 063-111 1 amber, 24V, with optical pattern

KL 7000 R

With tubular fitting for support tube,

- 2RL 008 060-001 1 blue, 12V, without optical pattern
- 2RL 008 060-011 1 blue, 24V, without optical pattern
- 2RL 008 060-101 1 amber, 12V, with optical pattern
- 2RL 008 060-111 1 amber, 24V, with optical pattern

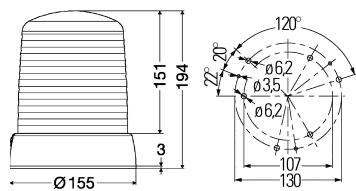
Spare parts:

- Dome,
- 9EL 862 140-001 1 blue
- 9EL 862 141-001 1 amber
- 9EL 862 141-021 1 amber, PC
- 9MN 862 741-001 1 Motor 12V/24V
- 9XR 854 840-001 1 Drive belts (2 pieces)
- 9DX 862 740-001 1 Reflector
- 9GD 862 164-001 1 Rubber gasket for KL 7000 F
- 9NM 863 332-001 5 Wing nut mount for KL 7000 FL and R

- 1x12V55W (H1) 8GH 002 089-133
- 1x24V70W (H1) 8GH 002 089-251

Rotating Beacons

160 rpm



Part. no.

Pk.

**Rotating beacons
with standard light, 230V
for stationary operation**

KL 7000 230V

According to DIN 14 620, shape B1.

With base for mounting on emergency call box, fire-alarm box etc.

With rubber gasket and built-in bulb 230V25W.

Light aperture (reflector dia.): 84 mm.

Total power consumption:

230V with 25W bulb = 0.2A.

Operating temperature: -30 °C to +60 °C.

Resistant to high pressure cleaning.

(E1) 1241

**Rotating beacon, 230V,
with amber base,
amber**

2RL 008 064-101

1

**with black base,
red**

2RL 008 064-001

1

Spare parts:

Dome with optical pattern,

amber

amber, PC

red

9EL 862 141-001

1

9EL 862 141-021

1

9EL 862 141-011

1

9MN 854 290-001

1

Motor with gear unit, 240V

9DX 852 902-001

1

Reflector

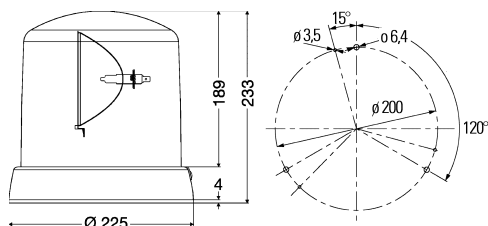
9GD 862 164-001

1

Gasket




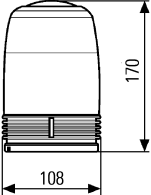

230V25W (C2) 8GS 002 383-001


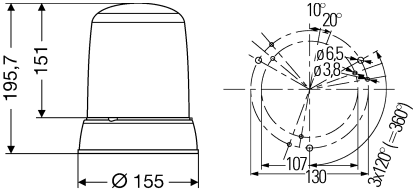

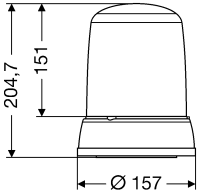

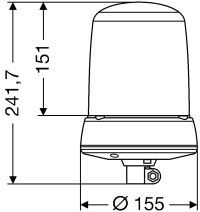


Part no.	Pk.	Rotating beacons with halogen H1 light
		KL 8000 F According to DIN 14 620, shape B2. With base for permanent mounting. With rubber gasket and built-in bulb. Light aperture (reflector dia.): 111.6 mm. Motor power consumption: 12V55W = 5.5A, 24V70W = 3.5A. Operating temperature: -40 °C to +60 °C. RF suppression: CISPR 25, class 5 (conducted). Resistant to high pressure cleaning.
		(E1) 1242 (e1) 1740
2RL 008 065-001	1	Rotating beacon with black base, blue, 12V
2RL 008 065-011	1	blue, 24V
<hr/>		
		(E1) 1243 (e1) 1740
2RL 008 065-101	1	Rotating beacon with amber base and dome with optical pattern, amber, 12V
2RL 008 065-107	48	
2RL 008 065-111	1	amber, 24V
		Spare parts: Dome, blue amber
9EL 862 171-001	1	
9EL 862 172-001	1	
9MN 862 741-001	1	Motor 12V/24V
9XR 854 840-001	1	Drive belts (2 pieces)
9DX 862 742-001	1	Reflector
9GD 862 178-001	1	Rubber spacer, flat
		1x12V55W (H1) 8GH 002 089-133 1x24V70W (H1) 8GH 002 089-251
<hr/>		
		Accessories:
9GD 862 178-001	1	Rubber spacer, flat
9GD 862 734-001	1	high
9GD 859 037-011	1	wedge-shaped

	Part no.	Pk.	Electronic flashing beacons
			<p>KLX Junior Plus F According to DIN 14 620, shape B1. PC dome. With built-in xenon tube (gas discharge bulb with plug-in base). Light aperture: 95 mm dia.</p> <p>Total power consumption: 12V = 3,3A, 24V = 1,7A. Operating temperature: -40 °C to +60 °C. Electrical strobe power: 10 + 2 Ws. Strobe frequency: 2 Hz = double flashes. RF suppression: CISPR 25, class 3 (conducted). Resistant to high pressure cleaning.</p> <p>Ⓔ1 2141 blue Ⓔ1 1765 amber Ⓛe1 3486</p>
	2XD 009 051-021	1	blue, 12V
	2XD 009 051-031	1	blue, 24V
	2XD 009 051-001	1	amber, 12V
	2XD 009 051-011	1	amber, 24V
	2XD 009 053-021	1	blue, 12V
	2XD 009 053-001	1	amber, 12V
	2XD 009 052-021	1	blue, 12V
	2XD 009 052-031	1	blue, 24V
	2XD 009 052-001	1	amber, 12V
	2XD 009 052-011	1	amber, 24V
	2XD 009 054-001	1	amber, 12V
	9EL 863 100-051	1	Spare parts: PC-dome, blue
	9EL 863 100-031	1	amber
	9EL 862 678-001	1	Ring lens with Fresnel optics
	8GS 863 261-001	1	Xenon tube
	9NM 863 332-001	1	Wing nut mount (for KLX Junior Plus FL)

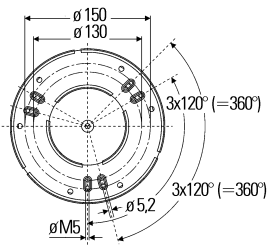
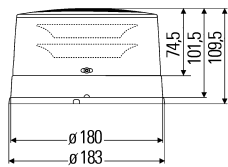
Accessories see page 6.15-6.16

	Part no.	Pk. Electronic flashing beacons
  	<p>KLX 5000 M</p> <p>2RL 008 366-021</p> <p>2RL 008 366-031</p> <p>9EL 862 267-001</p> <p>8GS 859 634-001</p> <p>8JB 008 839-001</p>	<p>Rapidly attachable strobe beacon for use by police with unmarked vehicles. With black die-cast aluminium housing, magnet and integrated power supply.</p> <p>With built-in xenon tube (gas discharge bulb). Shielding basket over xenon bulb reduces high-frequency interference radiation and ensures good radio reception.</p> <p>Light aperture: 80 mm dia.</p> <p>Power consumption: 3A. Electrical strobe power: 10 + 2 Ws. Strobe frequency: 2.1 Hz = approx. 120 double flashes/min. Operating temperature: -40 °C to +60 °C. RF suppression: CISPR 25, class 5 (conducted). Resistant to high pressure cleaning.</p> <p>Ⓔ1 1290 Ⓔ1 1775</p> <p>Flashing beacon with blue dome, 12V, with magnetic attachment, integrated power supply, spirally-coiled lead and 2-pole plug for connecting to the cigarette lighter socket</p> <hr/> <p>With Lemo plug, 12V</p> <p>Spare parts: 1 PC-dome with lens 1 Xenon tube</p> <p>Accessories: 1 Socket for -031</p>

	Part no.	Pk.	Electronic flashing beacons
 	<p>KLX 7000 F According to DIN 14 620, shape B1. With silver coloured metal housing. With built-in xenon tube (gas discharge bulb with plug-in base). Light aperture: 90 mm dia.</p> <p>Total power consumption: 12V 3.3A, 24V 1.6A. Operating temperature: -40 °C to +60 °C. Electrical strobe power: 12 + 2 Ws. Strobe frequency: 2.05 Hz = double flashes. RF suppression: CISPR 25, class 5 (conducted). Resistant to high pressure cleaning.</p> <p>Ⓔ1 1240 blue Ⓔ1 1399 amber Ⓛ1 1889</p> <p>Flashing beacon for permanent mounting, with rubber gasket,</p> <p>2RL 008 181-001 1 blue, 12V 2RL 008 181-011 1 blue, 24V</p> <p>2RL 008 181-101 1 amber, 12V 2RL 008 181-111 1 amber, 24V</p>		
 	<p>KLX 7000 M With magnetic attachment, spirally-coiled lead extends up to 2.5 m and 2-pole plug for connecting to cigarette lighter socket,</p> <p>2RL 008 182-001 1 blue, 12V 2RL 008 182-011 1 blue, 24V</p> <p>2RL 008 182-101 1 amber, 12V 2RL 008 182-111 1 amber, 24V</p>		
 	<p>KLX 7000 FL According to DIN 14 620, shape A. With flexible tubular fitting for support tube. Max. inclination 90°,</p> <p>2RL 008 183-001 1 blue, 12V 2RL 008 183-011 1 blue, 24V</p> <p>2RL 008 183-101 1 amber, 12V 2RL 008 183-111 1 amber, 24V</p> <p>Spare parts: PC-dome, blue 9EL 862 140-021 1 amber 9EL 862 140-031 1 Ring lens with Fresnel optics 9EL 862 678-001 1 Dome seal 9GD 862 679-001 1 Xenon tube 8GS 859 634-001 1 EMC shield for strobe lights 9HB 862 864-001 1</p> <p>Circuit board (replacement set), 12V 9MK 862 863-001 1 24V 9MK 862 862-001 1 Rubber spacer for KLX 7000 F, flat 9GD 862 164-001 1</p> <p>Accessories: Wing nut mount (for KLX 7000 FL) 9NM 863 332-001 1</p>		

Accessories see page 6.15-6.16

	Part no.	Pk.	Electronic flashing beacons
			<p>KLX Double flasher beacon. According to DIN 14 620, shape B1. With black plastic housing and rubber base plate for mounting on vehicle roof. Three holes for M6 x 35 or M5 x 35 fixing screws.</p> <p>With built-in xenon tube (gas discharge bulb). Light aperture: 85 mm dia.</p> <p>Total power consumption: 12V 3.3A, 24V 1.7A. Electrical strobe power: 10+2 Ws. Strobe frequency: 2.0 Hz = 120 flashes/min. Operating temperature: -40 °C to +60 °C. RF suppression: CISPR 25, class 3 (conducted). Resistant to high pressure cleaning.</p> <p>Ⓔ4 6510 Ⓛ1 3486</p>
	<p>2RL 007 017-041</p> <p>2RL 007 017-051</p>	<p>1</p> <p>1</p>	<p>Flashing beacon, blue, 12V</p> <p>blue, 24V</p>
	<p>2RL 007 017-061</p> <p>2RL 007 017-071</p> <p>9EL 859 658-001</p> <p>9EL 859 658-011</p> <p>9GD 856 466-001</p> <p>8GS 863 261-001</p>	<p>1</p> <p>1</p> <p>1</p> <p>1</p> <p>1</p> <p>1</p>	<p>Ⓔ4 6511 Ⓛ1 3486</p> <p>amber, 12V</p> <p>amber, 24V</p> <p>Spare parts: PC-dome, blue amber Rubber spacer Xenon tube X1</p>
	<p>9GD 856 863-001</p>	<p>1</p>	<p>Rubber spacer</p> <p>For mounting KLX on convex mounting surfaces.</p> <p>Rubber spacer (wedge-shaped)</p>
	<p>8HG 005 436-011</p>	<p>1</p>	<p>Holder for tubular fitting</p> <p>For mounting KLX on 24 mm dia. attachment tube.</p> <p>Holder</p>
 	<p>5KG 007 629-001</p> <p>5KG 007 629-011</p>	<p>1</p> <p>1</p>	<p>Control units for KLX</p> <p>With contact for control lamp and one beacon.</p> <p>Control unit, 4-pin, 12V</p> <p>24V</p>



Part no.

Pk. LED beacons

K-LED

According to DIN 14 620, shape B1.
 In LED-technology.
 High-power LEDs in connection with high-sheen vapour-plated reflectors.
 Clear-glass light dome with bayonet lock.
 Unique 360° signal image.
 Aluminium housing.

With 2 amber LED discs, rubber base and 265 mm cable.

Rated voltage: 12V / 24V.
 Supply voltage: 10V - 32V.
 Average current consumption: 12V 1.5A, 24V 1.0A.
 Operating temperature: -40 °C to +60 °C.
 RF suppression: CISPR 25, class 5 (conducted).
 Resistant to high pressure cleaning.

Ⓔ1 2373 e1 4882

2XD 009 386-021

1 LED beacon with amber base

2XD 009 386-121

1 with silver base

2XD 009 386-421

1 with black base









Spare parts:

9EL 863 943-071

1 Dome, amber, for -021

9EL 863 943-061

1 silver, for -121

	Part no.	Pk.	Mounting bushes for beacons with tubular fitting
	8HG 002 365-001 8HG 006 294-101 8HG 096 531-007 8JB 850 434-011 9GH 096 532-001	1 1 2 10 10	With built-in electrical socket to DIN 72 591 and rubber protecting cap. For mounting beacon on support at side of vehicle or for welding to a flange, 24 mm dia., approx 100 mm. Mounting bush, complete with separate ground connection Spare parts: Holder for -001 Socket Rubber protecting cap
	8HG 006 294-051 8HG 006 294-091	1 1	With screw fixing with separate ground connection
	8HG 006 294-011	1	For screwing onto horizontal cabin roofs (on top)
	8HG 006 294-021 8HG 006 294-111	1 1	For screwing onto horizontal cabin roofs (on side) With 90 mm mounting bracket with 50 mm mounting bracket
	8HG 006 294-131	1	With 90° angle of rotation
	8HG 006 294-031 8HG 006 294-141	1 1	Swivelling holder for screwing onto horizontal and vertical cabin roofs Swivelling holder for screwing onto horizontal and vertical cabin roofs (Bracket can be adjusted on sloped surfaces)
	8HG 006 294-041	1	Telescopic holder for screwing onto back of cabin roof. Length: 1000 mm Extension: 700 mm.
	8HG 990 368-001 8HG 990 368-007 8JB 850 434-011 9GH 096 532-001	1 50 10 10	Black push-on pipe with thread M8 Length: 220 mm. Spare parts: Socket Rubber protecting cap






Accessories

for beacons



	<p>Part no.</p> <p>9XD 990 284-001</p> <p>8JB 850 434-011</p> <p>9GH 096 532-001</p> <p>9NM 863 332-001</p>	<p>Pk.</p> <p>1</p> <p>10</p> <p>10</p> <p>1</p>	<p>Mounting bushes for beacons with tubular fitting</p> <p>With stopper for screwing to vertical vehicle surfaces (side). With protective cap, 1-pole socket and wire harness with ground contact. Attachment using two M8 bolts.</p> <p>Push-on pipe</p> <p>Spare parts: Socket Rubber protecting cap</p> <hr/> <p>Accessory group</p> <p>For KL with tubular fitting or flexible base. Contents: Wing nut with screw and washer.</p>
	<p>9GD 860 396-001</p> <p>9GD 860 772-001</p> <p>9GD 862 164-001</p> <p>9GD 863 033-001</p>	<p>1</p> <p>1</p> <p>1</p> <p>1</p>	<p>Rubber spacer</p> <p>For mounting on convex mounting surfaces.</p> <p>Rubber spacer, wedge-shaped, for KL Rotafix</p> <p>for KL Junior</p> <hr/> <p>Rubber spacer for KL/KLX 7000, flat</p> <p>wedge-shaped</p>
	<p>5KG 007 629-001</p> <p>5KG 007 629-011</p>	<p>1</p> <p>1</p>	<p>Control units</p> <p>With contact for control lamp and one beacon.</p> <p>Control unit, 12V</p> <p>24V</p>
	<p>8JB 004 777-001</p>	<p>5</p>	<p>2-pole socket</p> <p>for beacons with magnetic attachment.</p> <p>According to DIN EN ISO 4165, with cover. Max. load: 8A at 12V. 2 blade terminal contacts 6.3 mm.</p> <p>2-pole socket</p>
	<p>2AA 003 257-031</p>	<p>10</p>	<p>Warning light</p> <p>for all beacons.</p> <p>Dust and waterproof screw-type fixing, for dashboards with thickness of up to 5.2 mm. With blade terminal connections.</p> <p>Warning light, amber</p>

Spare parts for old-type rotating beacons

	Rotating beacon	Dome	1) Body		Motor with		Bulb		
			2) Drive belt	3) Base plate	1) Screw-fixing	2) Snap-in fixing			
			Pk.		Pk.		Pk.	Pk.	
KL 600 	2RL 004 957-001 blue, 12V 2RL 004 957-011 blue, 24V	9EL 856 415-001 blue	1	1) for -101 9BG 859 695-101	1	1) 9MN 857 622-001 12V	1	8GH 002 089-133 12V55W (H1)	1
	2RL 004 957-101 amber, 12V 2RL 004 957-111 amber, 24V	9EL 856 416-001 amber	1	for -111 9BG 859 695-111	1	9MN 857 622-011 24V	1	8GH 002 089-251 24V70W (H1)	1
KL 610 	2RL 005 446-00 amber, 12V 2RL 005 446-01 amber, 24V	9EL 856 416-001 amber	1	2) 9XR 854 840-001 (2 pieces)	1	Reflector with drive belt 9DX 859 560-001	1		
						2) with drive belt and reflector 9MN 858 616-001 12V	1		
						9MN 858 616-011 24V	1		
KL 700 	2RL 004 958-001 blue, 12V 2RL 004 958-04 blue, 12V 2RL 004 958-011 blue, 24V	9EL 856 417-001 blue	1	2) 9XR 854 840-001	1				
	2RL 004 958-101 amber, 12V 2RL 004 958-14 amber, 12V 2RL 004 958-111 amber, 24V	9EL 856 418-001 amber	1	3) 9GD 856 562-001	1				
KL 710 	2RL 006 295-001 blue, 12V 2RL 006 295-011 blue, 24V	9EL 856 415-001 blue	1	2) 9XR 854 840-001	1				
	2RL 006 295-101 amber, 12V 2RL 006 295-111 amber, 24V	9EL 856 416-001 amber	1	3) 9GD 858 013-001	1				
KL 800 	2RL 004 102-001 blue, 12V 2RL 004 102-011 blue, 24V	9EL 857 801-001 blue	1	2) 9XR 854 840-001 (2 pieces)	1	1) 9MN 857 622-001 12V	1		
	2RL 004 102-101 amber, 12V 2RL 004 102-111 amber, 24V	9EL 857 803-001 amber	1			9MN 857 622-011 24V	1		
						Reflector 9DX 859 625-001	1		
						Contact ring with brush 9MK 854 066-001	1		

Accessories for old-type rotating beacons







	9GD 856 863-001	1	Rubber spacer for KL 700 for KL 710		9GD 859 037-001	1	Rubber spacer for KL 800
	9GD 858 086-001	1					

Rotating Beacons

old-type




Spare parts for old-type rotating beacons




Image	Rotating beacon	Dome	1) Reflector 2) Base plate		Motor and accessories	Bulb		
			Pk.	Pk.		Pk.	Pk.	
	2RL 003 134-00 blue, 12V 2RL 003 134-01 blue, 24V	9EL 852 061-001 blue	1	1) 9DX 859 560-001 *)	9MN 857 622-001 12V*)	1	8GH 002 089-133 12V55W (H1)	1
	2RL 003 134-12 amber, 12V 2RL 003 134-13 amber, 24V	9EL 854 912-001 amber	1		9MN 857 622-011 24V*)	1	8GH 002 089-251 24V70W (H1)	1
	2RL 003 130-08 blue, 12V 2RL 003 130-09 blue, 24V				Drive belt (2pieces) 9XR 854 840-001	1		
	2RL 003 130-12 amber, 12V 2RL 003 130-14 amber, 24V				Contact ring with brush 9MK 854 066-001	1		
	2RL 003 129-00 blue, 12V 2RL 003 129-01 blue, 24V	9EL 852 820-001 blue	1	1) 9DX 859 625-001 *)				
	2RL 003 129-10 amber, 12V 2RL 003 129-11 amber, 24V	9EL 855 097-001 amber	1					
	2RL 002 472-00 amber, 220V	9EL 854 912-001 gelb	1	-	-	Motor with gear unit, 240V 9MN 854 290-001	1	-
	2RL 002 472-01 red, 220V	9EL 852 061-021 red	1					
	2RL 002 472-02 green, 220V							
	2RL 005 403-00 amber, 220V	9EL 856 418-001 amber	1	2) 9GD 856 562-001	1			
	2RL 005 403-10 red, 220V	9EL 856 418-011 red	1					
	2RL 006 811-00 amber, 220V	9EL 856 416-001 amber	1	2) 9GD 858 013-001	1			
	2RL 006 811-01 red, 220V	9EL 856 416-011 red	1					

*) If motor base plate is metal, order reflector and motor (2 parts),
if plastic, order only defective part (reflector or motor)




Accessories for old-type rotating beacons


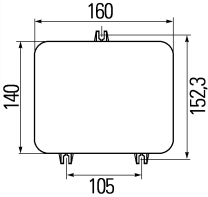

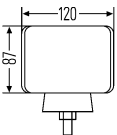
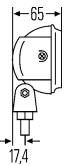


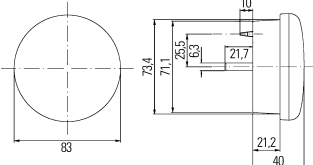
	9GD 854 019-001	5	Rubber spacer for 2RL 003 129-...
---	-----------------	---	--------------------------------------

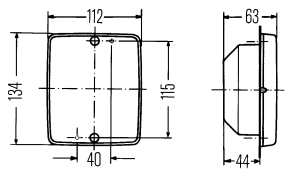
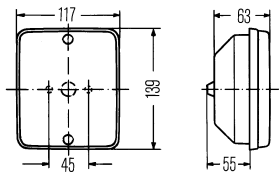
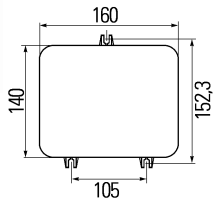
Spare parts for old-type flashing beacons

	Flashing beacon	Dome	Rubber spacer		Power supply		Xenon strobe with reflector	
			Pk.	Pk.	Pk.	Pk.		
KLX 	2RL 007 017-00 blue, 12V 2RL 007 017-02 blue, 24V	9EL 859 658-001 blue	1	9GD 856 466-001 1	-	-	-	-
	2RL 007 017-011 amber, 12V 2RL 007 017-031 amber, 12V	9EL 859 658-011 amber	1	-	-	-	-	-
BSX-Micro 	2XD 008 605-80 blue, 12V 2XD 008 605-81 blue, 24V	Strobe beacon, blue 2XD 861 423-031	1	-	-	-	8GS 861 710-001 1	
BSX-Compact 	2XD 007 853-80 blue, 12V 2XD 007 853-81 blue, 24V	-	-	-	8ES 861 420-001 12V 8ES 861 420-011 24V	1 1	-	-

Accessories for old-type flashing beacons

	9GD 856 863-001	1	Rubber spacer		5KG 007 629-001 5KG 007 629-011	1 1	Control unit, 12V 24V
	8HG 005 436-011	1	Holder for tubular fitting				

	Part no.	Pk.	Strobe beacons
 			<p>BSX-Micro with push-in adapter mounting set. Black plastic housing. Light aperture: 90 x 60 mm. Power supply for synchronous strobe sequence, in stable extruded aluminium housing.</p> <p>Technical data: Rated voltage: 12V/24V. Operating voltage: 10-30V. Strobe frequency: 2.1 Hz = approx. 120 double flashes/min. Electrical strobe power: 2 x (6 + 1,5 Ws). Power consumption: 3.3A at 12V, 1.5A at 24V. Operating temperature: -40 °C to +60 °C. RF suppression: CISPR 25, class 5 (conducted). Type of protection strobe beacon: resistant to high pressure cleaning. Type of protection power supply VSE-X: dustproof.</p>
  	<p>2XD 007 854-801</p>	1	<p>Strobe beacon set with blue light, 12V</p>
	<p>2XD 007 854-811</p>	1	<p>24V</p>
	<p>2XD 007 854-821 2XD 007 854-831</p>	1 1	<p>Strobe beacon set with amber light, 12V 24V</p>
<p>2XD 861 423-011 2XD 861 423-021 9ES 861 711-001 8GS 861 710-001 8ES 861 420-001 8ES 861 420-011</p>		1 1 1 1 1 1	<p>Spare parts: Strobe beacon, blue amber Lens, blue, with screws and gasket Xenon strobe with reflector Power supply, 12V 24V</p>
 	<p>2XD 959 011-021</p>	1	<p>Strobe beacon for flush mounting In LED-technology. Amber lens. With twelve LEDs 3W and connecting cable 2500 mm. Multivoltage: 9V - 33V. Consumption: 0.13A at 12V/24V.</p>



Part no.

Pk.

Strobe beacons

BSX-Multi

with push-in adapter mounting set.
Black plastic housing. Two M6 fixing screws.

Light aperture: 110 x 130 mm.

Power supply for synchronous strobe sequence,
in stable extruded aluminium housing.

Technical data:

Rated voltage: 12V/24V.

Operating voltage: 10-15V/20-30V.

Strobe frequency:

2.1 Hz = approx. 120 double flashes/min

Electrical strobe power: 2 x (6.5 + 1.5 Ws)

Power consumption: 3.8A at 12V, 1.8 at 24V.

Operating temperature: -40 °C to +60 °C.

RF suppression: CISPR 25, class 5 (conducted).

Type of protection strobe beacon:

resistant to high pressure cleaning.

Type of protection power supply VSE-X: dustproof.

Contents:

2 blue strobe beacons with built-in xenonflash
tubes, connecting lead and power supply.

Ⓔ 1982 Ⓔ 1169

**Strobe beacon set with blue light,
for front flush or surface mounting,
12V**

2XD 008 135-801 1

24V

2XD 008 135-811 1

Spare parts:

- 2XD 862 019-011 1 Strobe beacon, blue
- 9ES 862 011-001 1 Lens, blue
- 9DX 862 013-011 1 Reflector
- 8GS 862 014-001 1 Xenon tube
- Power supply,
- 8ES 861 420-001 1 12V
- 8ES 861 420-011 1 24V

Black rubber housing.
Two BZ 4.2 fixing screws.
Light aperture: 110 x 130 mm.

Ⓔ 1982 Ⓔ 1169

**Strobe beacon set with blue light,
for front flush mounting,
12V**

2XD 008 135-821 1


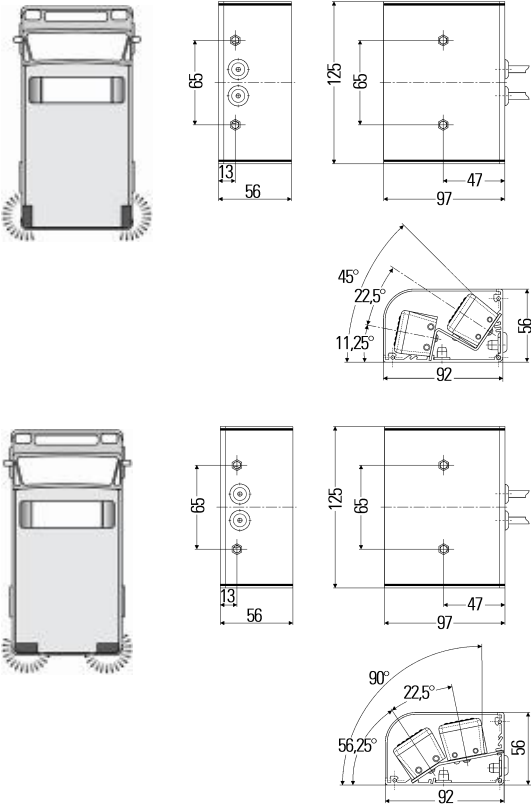
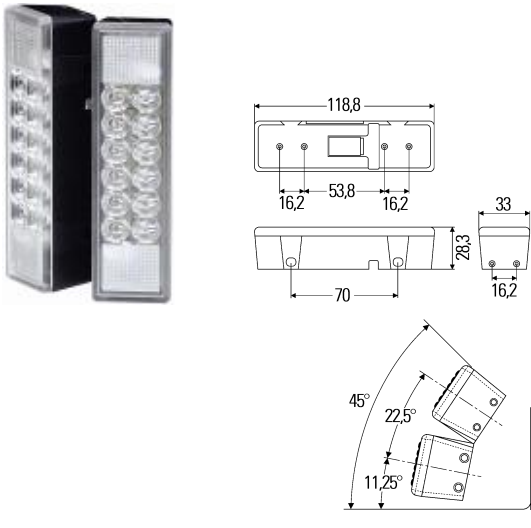
24V

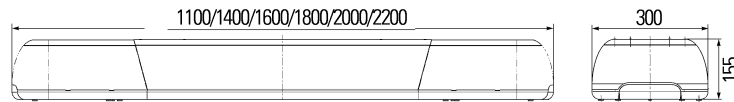
2XD 008 135-831 1

Spare parts:

- 2XD 862 111-011 1 Strobe beacon, blue
- 9ES 862 011-001 5 Lens, blue
- 9DX 862 013-011 1 Reflector
- 9BG 121 740-001 1 Rubber body
- 8GS 862 014-001 1 Xenon tube
- Power supply,
- 8ES 861 420-001 1 12V
- 8ES 861 420-011 1 24V

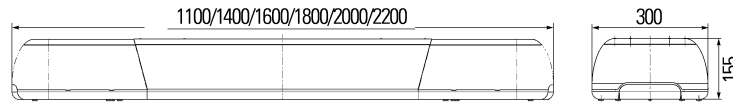
	<p>Part no.</p> <p>2XD 861 421-021</p> <p>8GS 861 631-001</p> <p>8ES 861 420-001</p>	<p>Pk.</p> <p>1</p> <p>1</p> <p>1</p>	<p>Rear warning lights Provides a warning to the rear when the rear hatch is open.</p> <p>HWL-X For vertically or horizontally installation in the rear hatch of the vehicle (inside). Black plastic housing and mounting frame. Two 5.2 mm dia. holes for fixing screws. Power supply in stable extruded aluminium housing.</p> <p>Technical data: Rated voltage: 12V. Operating voltage: 10 - 15V. Strobe frequency: 2.1 Hz = approx. 120 double flashes/min. Electrical strobe power: 2 x (6 + 1.5 Ws). Power consumption: 3.5A. Operating temperature: -40 °C to +60 °C. RF suppression: CISPR 25, class 5 (conducted). Type of protection strobe beacon: resistant to high pressure cleaning. Type of protection power supply VSE-X: dustproof.</p> <p>Contents: Two blue warning lights with blue xenon tubes, 3.5 m lead and power supply.</p> <p>e1 1169</p> <p>Rear warning light with blue light, 12V</p> <p>Spare parts: Xenon tube Power supply, 12V</p>
	<p>2XD 008 997-001</p> <p>2XD 009 048-001</p> <p>2XD 008 997-201</p> <p>2XD 009 048-201</p> <p>9XD 863 533-001</p> <p>9XD 863 828-001</p>	<p>1</p> <p>1</p> <p>1</p> <p>1</p> <p>1</p> <p>1</p>	<p>For installation in tailgate or attachment to vehicle front end or side.</p> <p>WL-LED Clear lens. Black plastic body. With 12 built-in LEDs.</p> <p>Up to 8 strobe sequences can be coded, synchronous as well as alternating, for synchronisation of 2, 3 or 4 lamps.</p> <p>Technical data: Rated voltage: 12V/24V. Operating voltage: 12V: 10 - 15V. Operating voltage: 24V: 20 - 30V. Power consumption: 0.7A at 12V, 0.35A at 24V. Strobe frequency: 2 Hz. Polarity reversal protection: yes. Operating temperature: -40 °C to +60 °C. RF suppression: CISPR 25, class 5 (conducted).</p> <p>e1 3686</p> <p>Warning light without mounting frame, with blue light, 12V</p> <p>24V</p> <p>with mounting frame and blue light, 12V</p> <p>blue, 24V</p> <p>Accessories: Angular bracket (2 pcs.) including 4 screws</p> <p>Built-in frame of black coated aluminium, adjustable bracket, including 4 screws</p>



	Part no.	Pk.	Signal lights
 	<p>2XD 009 475-021 1</p> <p>2XD 009 475-001 1</p> <p>2XD 009 475-031 1</p> <p>2XD 009 475-011 1</p> <p>5KG 009 713-001 1</p>	<p>Corner light system for protection of emergency vehicles</p> <p>C-LED</p> <p>In connection with two blue beacons in the front area, the C-LED corner light system achieves a 360° all-around warning effect.</p> <p>Technical data: Rated voltage: 12V / 24V. Operating voltage: 12V - 30V at 12V, 18V - 32V at 24V. Power consumption: (each C-LED modul) 300 mA at 12V, 150 mA at 24V. Operating temperature: -40 °C to +60 °C. RF suppression: CISPR 25, class 5 (conducted). Resistant to high pressure cleaning.</p> <p>Ⓔ1 2113 Ⓛ1 3686</p> <p>Corner light for installation in pairs at the vehicle rear, silver coloured aluminium housing, with PC lens and 24 LEDs.</p> <p>Installation variant 1 blue, 12V</p> <p>Installation variant 2 blue, 12V</p> <p>Accessories: Control unit, 12V / 24V (one control unit is necessary for every C-LED corner light)</p>	
	<p>2XD 008 997-101 1</p> <p>2XD 009 048-101 1</p> <p>5KG 009 713-001 1</p> <p>6ED 004 778-001 1</p>	<p>C-LED</p> <p>Single component for vertical, installation in pairs at the vehicle rear. (4 C-LED modules are required). Please observe defined angle arrangement. With 24 LEDs.</p> <p>Ⓔ1 2113 Ⓛ1 3686</p> <p>C-LED module, blue, 12V</p> <p>Accessories: Control unit, 12V / 24V (one control unit is necessary for every 2 C-LED modules) Switch with warning light (for connection to the control unit)</p>	



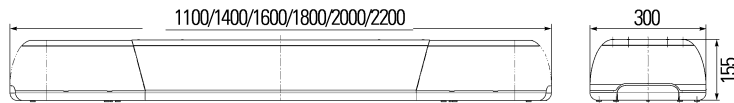
Part no.	Pk.	OWS-QS Optical warning systems KL-ER, 1100 mm, 1400 mm, 1600 mm, 1800 mm, 2200 mm
		<p>For medium-sized to large special-purpose vehicles from the areas of breakdown service, building and construction industry, heavy goods vehicles, street-cleaning vehicles, etc.</p> <p>Modular design with a length range from 1100 mm to a possible 2200 mm for individual configuration possibilities. As auxiliary lighting systems, adjustable H7 alley lights for side illumination or integrated H3 worklights (facing the front or rear) can be optionally selected. Housing silver-coloured; white inscribable panel. A 6 m (4.2 m for OWS-QS 1100 mm) long connecting cable is included in the scope of supply.</p> <p>With two PC domes and H1 bulbs. Light aperture (reflector dia.): 84 mm.</p> <p>Technical data: Rated voltage: 12V / 24V. Operating voltage range: 10.8V - 13.8V at 12V, 21.6V - 27.6V at 24V. Power consumption of rotating beacons: 9.4A at 12V, 5.4A at 24V. Power consumption illumination middle panel: 4A at 12V, 2A at 24V. Belt drive: n = 160 rpm. Operating temperature: - 40 °C to + 60 °C. RF suppression: CISPR 25, class 5 (conducted). Resistant to high pressure cleaning. Weight: max. 25 kg.</p> <p> E1 1719 e1 3829 </p>
		<p>Optical warning system with single reflector system KL-ER,</p>
2RL 009 688-001	1	amber, 12V, 1100 mm
2RL 009 688-131	1	amber, 12V, 1100 mm, with two side-mounted lights incl. H7-bulbs
2RL 009 688-251	1	amber, 24V, 1100 mm
2RL 009 688-041	1	blue, 12V, 1100 mm
2RL 009 688-091	1	blue, 12V, 1100 mm, with two side-mounted lights incl. H7-bulbs
2RL 009 279-001	1	amber, 12V, 1400 mm
2RL 009 279-691	1	amber, 12V, 1400 mm, with two side-mounted lights incl. H7-bulbs
2RL 009 279-011	1	amber, 24V, 1400 mm
2RL 009 279-041	1	blue, 12V, 1400 mm
2RL 009 279-051	1	blue, 24V, 1400 mm
2RL 009 279-101	1	amber, 12V, 1600 mm
2RL 009 279-111	1	amber, 24V, 1600 mm
2RL 009 279-601	1	amber, 24V, 1600 mm, with two work lamps to the back incl. H3 bulbs
2RL 009 279-141	1	blue, 12V, 1600 mm
2RL 009 279-151	1	blue, 24V, 1600 mm
2RL 009 279-211	1	amber, 24V, 1800 mm
2RL 009 279-241	1	blue, 12V, 1800 mm
2RL 009 279-251	1	blue, 24V, 1800 mm
2RL 009 279-411	1	amber, 24V, 2200 mm
2RL 009 279-401	1	amber, 24V, 2200 mm, with two side-mounted lights incl. H7-bulbs and two work lamps to the back incl. H3 bulbs
2RL 009 279-791	1	blue, 12V, 2200 mm
		<p>Further versions with additional light modules, or with a length of 2000 mm on request.</p>
		<p>Spare parts:</p>
9EL 863 117-071	1	Dome, amber
		Rotating mirror module,
2RL 863 132-021	1	12V
2RL 863 132-031	1	24V
9XR 855 975-001	1	Drive belts (2 pieces)
1GA 008 284-101	1	Side-mounted light Alley Light
		2x12V55W (H1) 8GH 002 089-133 2x24V70W (H1) 8GH 002 089-251

Accessories see page 6.29



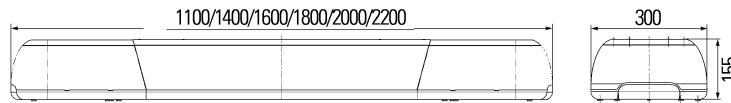
Part no.	Pk.	OWS-QS Optical warning systems KL-MR, 1100 mm, 1400 mm, 1600 mm, 1800 mm, 2000 mm For medium-sized to large special-purpose vehicles from the areas of breakdown service, building and construction industry, heavy goods vehicles, street-cleaning vehicles, etc. Modular design with a length range from 1100 mm to a possible 2200 mm for individual configuration possibilities. As auxiliary lighting systems, adjustable H7 alley lights for side illumination or integrated H3 worklights (facing the front or rear) can be optionally selected. Housing silver-coloured; white inscribable panel. A 6 m (4.2 m for OWS-QS 1100 mm) long connecting cable is included in the scope of supply. With two PC domes and H1 bulbs. Light aperture (reflector dia.): 2 x 84 mm. Technical data: Rated voltage: 12V / 24V. Operating voltage range: 10.8V - 13.8V at 12V, 21.6V - 27.6V at 24V. Power consumption of rotating beacons: 18.8A at 12V, 10.8A at 24V. Power consumption illumination middle panel: 4A at 12V, 2A at 24V. Belt drive: n = 160 rpm. Operating temperature: - 40 °C to + 60 °C. RF suppression: CISPR 25, class 5 (conducted). Resistant to high pressure cleaning. Weight: max. 16 kg. (E1) 1720 e1 3829 Optical warning system with multiple reflector system KL-MR, 2RL 009 688-031 1 amber, 12V, 1100 mm 2RL 009 688-121 1 amber, 12V, 1100 mm, with two side-mounted lights incl. H7-bulbs 2RL 009 688-081 1 blue, 12V, 1100 mm, with two work lamps to the back incl. H3 bulbs 2RL 009 279-081 1 amber, 12V, 1400 mm 2RL 009 279-581 1 amber, 12V, 1400 mm, with two work lamps to the back incl. H3 bulbs 2RL 009 279-091 1 amber, 24V, 1400 mm 2RL 009 279-591 1 amber, 24V, 1400 mm, with two work lamps to the back incl. H3 bulbs 2RL 009 279-501 1 blue, 12V, 1400 mm 2RL 009 279-181 1 amber, 12V, 1600 mm 2RL 009 279-191 1 amber, 24V, 1600 mm 2RL 009 279-511 1 amber, 24V, 1600 mm, with two work lamps to the back incl. H3 bulbs 2RL 009 279-521 1 blue, 12V, 1600 mm 2RL 009 279-291 1 amber, 24V, 1800 mm 2RL 009 279-721 1 amber, 24V, 1800 mm, with two work lamps to the back incl. H3 bulbs 2RL 009 279-541 1 blue, 24V, 1800 mm 2RL 009 279-391 1 amber, 24V, 2000 mm 2RL 009 279-551 1 blue, 24V, 2000 mm Further versions with additional light modules, or with a length of 2200 mm on request. Spare parts: 9EL 863 117-071 1 Dome, amber 1GA 008 284-101 1 Side-mounted light Alley Light  4x12V55W (H1) 8GH 002 089-133  4x24V70W (H1) 8GH 002 089-251
----------	-----	---

Accessories see page 6.29



Part no.	Pk.	
		OWS-QS Optical warning systems KL-XL2, 1100 mm, 1400 mm, 1600 mm, 1800 mm, 2000 mm, 2200 mm For medium-sized to large special-purpose vehicles from the areas of breakdown service, building and construction industry, heavy goods vehicles, street-cleaning vehicles, etc. Modular design with a length range from 1100 mm to a possible 2200 mm for individual configuration possibilities. As auxiliary lighting systems, adjustable H7 alley lights for side illumination or integrated H3 worklights (facing the front or rear) can be optionally selected. Housing silver-coloured; white inscribable panel. A 6 m (4.2 m for OWS-QS 1100 mm) long connecting cable is included in the scope of supply. With two PC domes and built-in xenon tubes. Technical data: Rated voltage: 12V / 24V. Operating voltage range: 10V - 15V at 12V, 20V - 31V at 24V. Power consumption of flashing beacons: 7A at 12V, 3.2A at 24V. Power consumption illumination middle panel: 4A at 12V, 2A at 24V. Strobe frequency: 2Hz. Operating temperature: - 40 °C to + 60 °C. RF suppression: CISPR 25, class 5 (conducted). Resistant to high pressure cleaning. Weight: max. 20 kg. (E1) 1721 (e1) 3829
2RL 009 688-011	1	Optical warning system with xenon double flashing system KL-XL2, amber, 12V, 1100 mm
2RL 009 688-141	1	amber, 12V, 1100 mm, with two side-mounted lights incl. H7-bulbs
2RL 009 688-051	1	blue, 12V, 1100 mm
2RL 009 688-101	1	blue, 12V, 1100 mm, with two side-mounted lights incl. H7-bulbs
2RL 009 688-201	1	blue, 12V, 1100 mm, with two work lamps to the back incl. H3 bulbs
2RL 009 279-021	1	amber, 12V, 1400 mm
2RL 009 279-031	1	amber, 24V, 1400 mm
2RL 009 279-751	1	amber, 12V, 1400 mm, with two side-mounted lights incl. H7-bulbs
2RL 009 279-841	1	amber, 12V, 1400 mm, with two work lamps to the back incl. H3 bulbs
2RL 009 279-061	1	blue, 12V, 1400 mm
2RL 009 279-071	1	blue, 24V, 1400 mm
2RL 009 279-121	1	amber, 12V, 1600 mm
2RL 009 279-131	1	amber, 24V, 1600 mm
2RL 009 279-451	1	amber, 24V, 1600 mm, with two work lamps to the back incl. H3 bulbs
2RL 009 279-161	1	blue, 12V, 1600 mm
2RL 009 279-281	1	blue, 12V, 1600 mm, with two side-mounted lights incl. H7-bulbs
2RL 009 279-171	1	blue, 24V, 1600 mm
2RL 009 279-231	1	amber, 24V, 1800 mm
2RL 009 279-271	1	blue, 24V, 1800 mm
2RL 009 279-331	1	amber, 24V, 2000 mm
2RL 009 279-371	1	blue, 24V, 2000 mm
2RL 009 279-431	1	amber, 24V, 2200 mm
2RL 009 279-481	1	blue, 24V, 2200 mm
		Further versions with additional light modules on request.
		Spare parts:
9EL 863 117-071	1	Dome, amber
		Double flashing module,
2RL 863 106-001	1	12V
2RL 863 106-011	1	24V
8GS 859 634-001	1	Xenon tube
1GA 008 284-101	1	Side-mounted light Alley Light

Accessories see page 6.29



Part no.

Pk.

**OWS-QS Optical Warning Systems KL-XR2,
1100 mm, 1400 mm, 1600 mm, 1800 mm**

For medium-sized to large special-purpose vehicles from the areas of breakdown service, building and construction industry, heavy goods vehicles, street-cleaning vehicles, etc.

Modular design with a length range from 1100 mm to a possible 2200 mm for individual configuration possibilities.

As auxiliary lighting systems, adjustable H7 alley lights for side illumination or integrated H3 worklights (facing the front or rear) can be optionally selected. Housing silver-coloured; white inscribable panel.

A 6 m (4.2 m for OWS-QS 1100 mm) long connecting cable is included in the scope of supply.

With two PC domes and built-in xenon tubes.

Technical data:

Rated voltage: 12V / 24V.

Operating voltage range: 10V - 15V at 12V, 20V - 31V at 24V.

Power consumption of flashing beacons: 12V 8A / 24V 4A.

Power consumption illumination middle panel: 4A at 12V, 2A at 24V.

Strobe frequency: 2.1Hz. (8 flash frequencies).

Luminous power: \geq 350 cd.

Integrated polarity reversal protection.

Operating temperature: - 40 °C to + 60 °C.

RF suppression: CISPR 25, class 5 (conducted).

Resistant to high pressure cleaning.

Weight: max. 13,5 kg.

Ⓔ1 2139 blue Ⓔ1 2243 amber e1 3829

Optical warning system with parabolic trough reflector system KL-XR2,

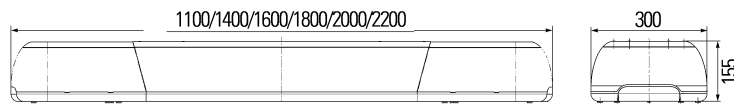
2RL 009 688-021	1	amber, 12V, 1100 mm
2RL 009 688-151	1	amber, 12V, 1100 mm, with two side-mounted lights incl. H7-bulbs
2RL 009 688-061	1	blue, 12V, 1100 mm
2RL 009 688-111	1	blue, 12V, 1100 mm, with two side-mounted lights incl. H7-bulbs
2RL 009 279-611	1	amber, 12V, 1400 mm
2RL 009 279-631	1	blue, 12V, 1400 mm
2RL 009 279-571	1	blue, 12V, 1400 mm, with two side-mounted lights incl. H7-bulbs and amber indicator lights to the back
2RL 009 279-801	1	blue, 12V, 1400 mm, with two work lamps to the back incl. H3 bulbs
2RL 009 279-831	1	blue, 12V, 1400 mm, with two side-mounted lights incl. H7-bulbs
2RL 009 279-651	1	amber, 12V, 1600 mm
2RL 009 279-661	1	amber, 24V, 1600 mm
2RL 009 279-671	1	blue, 12V, 1600 mm
2RL 009 279-781	1	blue, 12V, 1600 mm, with two side-mounted lights incl. H7-bulbs
2RL 009 279-321	1	amber, 24V, 1800 mm
2RL 009 279-341	1	amber, 24V, 1800 mm, with two work lamps to the back incl. H3 bulbs

Further versions with additional light modules, or with a length of 2000 mm or 2200 mm on request.

Spare parts:









9EL 863 117-071	1	Dome, amber
		Flashing module,
2RL 863 123-001	1	12V
2RL 863 123-011	1	24V
8GS 863 889-001	1	Xenon tube
1GA 008 284-101	1	Side-mounted light Alley Light

Accessories see page 6.29



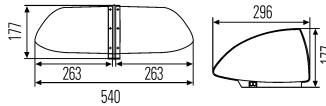
Part no.	Pk.	OWS-QS Optical Warning Systems KL-LR2, 1100 mm, 1400 mm
<p>For medium-sized to large special-purpose vehicles from the areas of breakdown service, building and construction industry, heavy goods vehicles, street-cleaning vehicles, etc. Modular design with a length range from 1100 mm to a possible 2200 mm for individual configuration possibilities. As auxiliary lighting systems, adjustable H7 alley lights for side illumination or integrated H3 worklights (facing the front or rear) can be optionally selected. Housing silver-coloured; white inscribable panel. A 6 m (4.2 m for OWS-QS 1100 mm) long connecting cable is included in the scope of supply. With 2 clear PC domes and 2 x 2 reflectors with 24 amber LEDs each for amber light or 2 blue PC light domes and 24 blue LEDs each for blue light.</p> <p>Technical data: Rated voltage: 12V / 24V. Operating voltage range: 10V - 15V at 12V, 20V - 31V at 24V. Average current consumption with double flash: with blue LEDs 2,6A at 12V, with amber LEDs 1,6A at 12V, 1,3A at 24V. Strobe frequency: 2Hz. ECE flashing sequences: single, double. Other flashing frequencies: triple, quadruple. Function output: yes. Synchronisation: yes. Sectional operation: yes. Self-diagnosis: available. Operating temperature: - 40 °C to + 60 °C. RF suppression: CISPR 25, class 3 (conducted). Resistant to high pressure cleaning. Weight: max. 12,5 kg.</p> <p>(E1) 2466</p>		
2RL 009 688-231	1	Optical warning system with LED trough module system KL-LR2, amber, 12V, 1100 mm, with two side-mounted lights incl. H7-bulbs
2RL 009 688-211	1	blue, 12V, 1100 mm, with two side-mounted lights incl. H7-bulbs
2RL 009 279-441	1	amber, 12V, 1400 mm
2RL 009 279-901	1	amber, 12V, 1400 mm, with two side-mounted lights incl. H7-bulbs
2RL 009 279-471	1	blue, 12V, 1400 mm
2RL 009 279-861	1	blue, 12V, 1400 mm, with two side-mounted lights incl. H7-bulbs
2RL 009 279-911	1	amber, 12V, 1600 mm
2RL 009 279-921	1	amber, 12V, 1600 mm, with two side-mounted lights incl. H7-bulbs
2RL 009 279-871	1	blue, 12V, 1600 mm
2RL 009 279-881	1	blue, 12V, 1600 mm, with two side-mounted lights incl. H7-bulbs
2RL 009 279-261	1	amber, 24V, 1800 mm, with two side-mounted lights incl. H7-bulbs
<p>Further versions with additional light modules, or with a length of 2000 mm or 2200 mm on request.</p>		
1GA 008 284-101	1	<p>Spare parts: Side-mounted light Alley Light</p>



Accessories see page 6.29

	<p>Part no. 6ED 004 778-011</p>	<p>Pk. 2</p>	<p>Push-pull switch With red warning light, without bulb. Push-pull switch  1x12V1,2W (W5/1,2) 8GP 002 095-121  1x24V1,2W (W5/1,2) 8GP 002 095-241</p>
	<p>9FT 861 790-021 9FT 861 790-031</p>	<p>1 1</p>	<p>Bulb holder For illumination of the middle panel (2 pieces for OWS-QS 1400 mm/1600 mm/1800 mm) Bulb holder with 12V bulb with 24V bulb  10x12V5W (W5W) 8GP 003 594-121  10x24V5W (W5W) 8GP 003 594-251</p>
	<p>9GD 864 285-001 9GD 864 286-001 9GD 864 286-011 9GD 864 286-021</p>	<p>1 1 1 1</p>	<p>Rubber bases For OWS-QS 1100 mm, flat wedge-shaped For OWS-QS 1400 mm, wedge-shaped For OWS-QS 1600 mm, wedge-shaped</p>
	<p>9GD 863 122-001</p>	<p>1</p>	<p>Installation kit For OWS-QS 1400 mm - 2200 mm Installation kit</p>

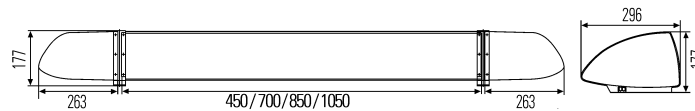
Optical Warning Systems

OWS 540



Part no.	Pk.	Optical warning systems OWS 540, 540 mm
		<p>For tow-service vehicles, public-authority vehicles and excessively long or excessively wide trucks. With two domes and rubber gasket. Amber and blue domes with optical pattern. One 4 m long connection lead is supplied with optical warning system. With built-in H1 bulbs. Light aperture (reflector dia.): 83 mm.</p> <p>Technical data: Rated voltage: 12V / 24V. Operating voltage range: 10V - 15.5V at 12V, 20V - 31V at 24V. Power consumption (rated voltage) of rotating beacons: 9.4A at 12V, 5.4A at 24V. Operating temperature: -40 °C to +60 °C. RF suppression: CISPR 25, class 5 (conducted). Resistant to high pressure cleaning. Weight: max. 5 kg.</p> <p>Ⓔ1 817 e1 1309</p>
2RL 007 900-501	1	Optical warning system OWS 540, 540 mm, amber, 12V
2RL 007 900-511	1	amber, 24V
2RL 007 900-521	1	amber, 12V, with magnetic attachment
2RL 007 900-551	1	OWS 540, 540 mm, blue, 12V
2RL 007 900-561	1	blue, 24V
2RL 007 900-571	1	blue, 12V, with magnetic attachment
		Spare parts:
9EL 861 912-001	1	Dome, amber, left
9EL 861 913-001	1	right
		Dome, blue,
9EL 861 912-021	1	left
9EL 861 913-021	1	right
		Reflector
9DX 861 872-001	1	for amber version, with reflector made of plastic (for systems up to model year 2002)
9DX 862 849-001	1	for amber version, with reflector made of metal
9DX 861 976-001	1	for blue version
9MN 860 677-021	1	Motor 12V/24V
9GD 862 086-001	1	Rubber gasket
		 2x12V55W (H1) 8GH 002 089-133  2x24V70W (H1) 8GH 002 089-251

Accessories see page 6.34 - 6.35



Part no. Pk. **Optical warning systems**
OWS 1000, 1000 mm. OWS 1250, 1250 mm. OWS 1400, 1400 mm. OWS 1600, 1600 mm

For tow-service vehicles, public-authority vehicles and excessively long or excessively wide trucks.

With two domes and white panels designed to take lettering.

Can be illuminated with bulb holder (accessories).

Amber and blue domes with optical pattern.

One 4 m long connection lead is supplied with optical warning system.

With built-in H1 bulbs. Light aperture (reflector dia.): 83 mm.

Technical data:

Rated voltage: 12V / 24V.

Operating voltage range: 10V - 15.5V at 12V, 20V - 31V at 24V.

Power consumption of rotating beacons: 9.4A at 12V, 5.4A at 24V.

For consumption illumination middle panel: 4A at 12V, 2A at 24V.

Operating temperature: -40 °C to +60 °C.

RF suppression: CISPR 25, class 5 (conducted).

Resistant to high pressure cleaning.

Weight: max. 5 kg.

(E1) 817

e1 1309

2RL 007 900-001	1	Optical warning system OWS 1000, 1000 mm, amber, 12V
2RL 007 900-151	1	blue, 12V
2RL 007 900-191	1	OWS 1250, 1250 mm, amber, 12V, with amber panel (FLN colour 1641)
2RL 007 900-201	1	OWS 1400, 1400 mm, amber, 12V
2RL 007 900-291	1	amber, 12V, with amber panel (FLN colour 1641)
2RL 007 900-211	1	amber, 24V
2RL 007 900-251	1	blue, 12V
2RL 007 900-601	1	OWS 1600, 1600 mm, amber, 12V
2RL 007 900-611	1	amber, 24V
2RL 007 900-651	1	blue, 12V

Spare parts:

Dome, amber,

9EL 861 912-001	1	left
9EL 861 913-001	1	right

Dome, blue,

9EL 861 912-021	1	left
9EL 861 913-021	1	right

White panel,

9EL 861 498-001	1	for OWS 1000 mm
9EL 861 498-011	1	for OWS 1400 mm
9EL 861 498-021	1	for OWS 1600 mm

Reflector

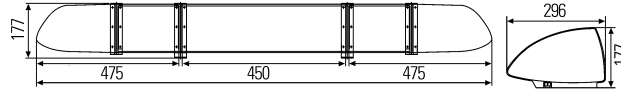
9DX 861 872-001	1	for OWS amber, plastic reflector (for systems up to model year 2002)
9DX 862 849-001	1	for OWS amber, metal reflector
9DX 861 976-001	1	for OWS blue
9MN 860 677-021	1	Motor 12V/24V



2x12V55W (H1) 8GH 002 089-133
 2x24V70W (H1) 8GH 002 089-251

Optical Warning Systems

OWS-MR 1400



Part no.

Pk. **Optical warning systems OWS-MR, 1400 mm**

For tow-service vehicles, public-authority vehicles and excessively long or excessively wide trucks.

With two domes and white panels designed to take lettering.

Can be illuminated with bulb holder (accessories).

Amber dome with optical pattern.

One 4 m long connection lead is supplied with optical warning system.

With built-in H1 bulbs.

Light aperture (reflector dia.): 2 x 83 mm.

Technical data:

Rated voltage: 12V.

Operating voltage range: 10V - 15.5V at 12V.

Power consumption: 19.5 A.

Operating temperature: -40 °C to +60 °C.

RF suppression: CISPR 25, class 5 (conducted).

Resistant to high pressure cleaning.

Weight: 7 kg.

6516

1309

2RL 007 900-701

1 **Optical warning system OWS-MR, 1400 mm, amber, 12V**

Spare parts:

9EL 861 912-001

1 Dome, amber, left

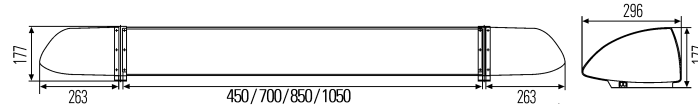
9EL 861 913-001

1 right



4x12V55W (H1) 8GH 002 089-133

Accessories see page 6.34 - 6.35



Part no.	Pk.	Optical warning systems with flashing beacons. OWS-X 1000, 1000 mm. OWS-X 1400, 1400 mm. OWS-X 1600, 1600 mm For tow-service vehicles, public-authority vehicles and excessively long or excessively wide trucks. With two domes and white panels designed to take lettering. Can be illuminated with bulb holder (accessories). Amber and blue domes with optical pattern. One 4 m long connection lead is supplied with optical warning system. With built-in xenon tubes. Technical data: Rated voltage: 12V / 24V. Strobe frequency: 2.05 Hz double flashes. Power consumption of flashing beacons: 3.3A at 12V, 1.6A at 24V. Power consumption of the illuminated panels: 4A at 12V, 2A at 24V. Operating temperature: -40 °C to +60 °C. RF suppression: CISPR 25, class 5 (conducted). Resistant to high pressure cleaning. Weight: max. 9 kg. (E1) 774 amber (E1) 817 blue e1 1309
2RL 007 900-121	1	Optical warning system OWS-X 1000, 1000 mm, amber, 12V
2RL 007 900-171	1	Optical warning system OWS-X 1000, 1000 mm, blue, 12V
2RL 007 900-221	1	OWS-X 1400, 1400 mm, amber, 12V
2RL 007 900-241	1	OWS-X 1400, 1400 mm, amber, 24V
2RL 007 900-271	1	OWS-X 1400, 1400 mm, blue, 12V
2RL 007 900-281	1	OWS-X 1400, 1400 mm, blue, 24V
2RL 007 900-631	1	OWS-X 1600, 1600 mm, amber, 24V
2RL 007 900-681	1	OWS-X 1600, 1600 mm, blue, 24V
9EL 861 912-041	1	Spare parts: Dome, amber, left
9EL 861 913-041	1	right
9EL 861 912-051	1	Dome, blue, left
9EL 861 913-051	1	right
2RL 863 106-001	1	Double flashing module, 12V
2RL 863 106-011	1	24V
8GS 859 634-001	1	Xenon tube X1
9EL 861 498-001	1	White panel, for OWS 1000 mm
9EL 861 498-011	1	for OWS 1400 mm
9EL 861 498-021	1	for OWS 1600 mm

Accessories see page 6.34 - 6.35

Accessories

for OWS- and OWS-X 540 to 1600







	Part no.	Pk.	Panels
 	9HB 862 827-031 9HB 862 827-041 9HB 862 827-011 9HB 862 827-051 9HB 862 827-071 9HB 862 827-091 9HB 862 827-021 9HB 862 827-061 9HB 862 827-081	1 1 1 1 1 1 1 1 1	Panels For OWS- and OWS-X 1000 with tail lights with work lights For OWS- and OWS-X 1400 with flasher lights with work lights with flasher lights and work lights with tail- and flasher lights For OWS- and OWS-X 1600 with flasher lights with work lights with flasher lights and work lights
	9FT 861 790-001 9FT 861 790-011	1 1	Bulb holders For illumination of the sign surface are for OWS 1000/1250 = 1 bulb holder, for OWS 1400 = 2 bulb holders and for OWS 1600 = 2 bulb holders necessary. Bulb holder with 12V bulb with 24V bulb  12V5W (W5W) 8GP 003 594-121  24V5W (W5W) 8GP 003 594-251
	6ED 004 778-011	2	ON/OFF switch With red warning light, without bulb. ON/OFF switch  1x12V1.2W (W5/1.2) 8GP 002 095-121  1x24V1.2W (W5/1.2) 8GP 002 095-241
	9GD 882 080-001 9GD 882 081-001 9GD 882 085-001	1 1 1	Rubber gaskets for OWS 1000 for OWS 1400 for OWS 1600

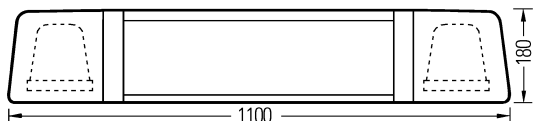
	Part no. 9XD 857 445-801	Pk. 1 Fixing system Suitable for permanent mounting on trucks and cars. Contents: 2 pieces with hardware. Fixing system set
	9XD 861 995-801	Mounting set For welding on to existing bracket. Contents: 2 mounts and hardware Mounting set
	9XD 861 990-001 9XD 861 990-011 9XD 861 990-021	Bracket set for direct mounting for OWS 1000 for OWS 1400 for OWS 1600

Optical Warning Systems OWS 4

Spare parts for old-type systems



	Optical warning system	Dome	1) Motor 2) Reflector 3) Drive belt 4) Contact ring		Bulb		
			Pk.	Pk.	Pk.	Pk.	
	2RL 005 410-02 12V	9EL 857 576-021 amber	1	1) 9MN 857 622-101 12V	1 8GH 002 089-133 12V55W (H1)	1	
		9EL 856 989-001 white, can be printed as required (2 pieces)	1				9MN 857 622-111 24V
		2RL 005 410-03 24V	9EL 857 576-031 amber	1	2) with drive belt 9DX 859 626-001	1 8GM 002 091-131 12V10W (K)	10
			9EL 856 989-001 white, can be printed as required (2 pieces)	1			
		2RL 005 410-00 12V	9EL 856 989-001 white, can be printed as required (2 pieces)	1	4) with brush 9MK 854 066-001	1	
	2RL 005 410-08 12V	9EL 857 576-021 amber	1				
	2RL 005 410-09 24V	9EL 857 576-031 amber	1				
	2RL 005 410-14 24V	9EL 857 576-031 amber	1	1) 9MN 857 622-111 24V	1 8GH 002 089-251 24V70W (H1)	1	
				2) 9XR 855 975-001 (2 pieces)	1		
				3) with brush 9MK 854 066-001	1		



Part no.	Pk.	Rotating beacon and siren combinations RTK 5
		<p>Technical data: Rated voltage: 12V. Operating voltage: 9V - 16V. Strobe frequency: 2,05Hz = double flashes. Operating temperature: -40 °C to +60 °C. RF suppression: CISPR 25, class 5 (conducted). Resistant to high pressure cleaning. Weight: max. 20 kg.</p> <p>Ⓔ1 1413 e1 2293</p>
2RM 008 858-221	1	Rotating beacon and siren combinations with blue light and xenon strobes 12V, white panel, 1100 mm long, without ASG-GL signal, loudspeaker toward front
2RM 008 858-241	1	12V, white panel, 1400 mm long, without ASG-GL signal, loudspeaker toward front
		<p>Spare parts:</p> <p>2RL 863 106-001 1 Double-flash module Dome, blue for 1100 mm long version 9EL 863 136-001 1 for 1400 mm long version 9EL 863 137-001 1 Panel with gasket, green 9AB 860 796-001 1 white 9AB 860 796-021 1 5XA 008 198-031 1 Central control unit 9MM 863 165-001 1 Loudspeaker, front 8GS 859 634-001 1 Xenon tube</p>
		<p>Ⓔ1 1482 e1 2293</p>
2RM 008 858-211	1	Rotating beacon and siren combinations with blue light and H1 bulbs 12V, white panel, 1100 mm long, without ASG-GL signal, loudspeaker toward front
2RM 008 858-251	1	12V, green panel, 1100 mm long, with STOP POLIZEI and BITTE FOLGEN signal, loudspeaker toward front and back (text for specific countries on request)
2RM 008 858-231	1	12V, white panel, 1400 mm long, without ASG-GL signal, loudspeaker toward front
2RM 008 858-291	1	12V, blue panel (RAL 5017), 1400 mm long, without ASG-GL signal, loudspeaker toward front
2RM 008 858-401	1	12V, green panel, 1400 mm long, without ASG-GL signal, loudspeaker toward front with mounting system for VW T5 including interior wiring
		<p>Spare parts:</p> <p>2RL 863 132-001 1 Rotating mirror module Dome, blue for 1100 mm long version 9EL 863 136-011 1 for 1400 mm long version 9EL 863 137-011 1 Panel with gasket, green 9AB 860 796-001 1 white 9AB 860 796-021 1 5XA 008 198-031 1 Central control unit 9MM 863 165-001 1 Loudspeaker, front 9MM 863 164-011 1 Loudspeaker, rear 9XR 855 975-001 1 Drive belts (2 pieces)</p>
		<p>1x12V55W (H1) 8GH 002 089-133</p>
9XB 010 081-001	1	Accessories: Cable adapter for the connection of 2 loudspeakers 9MM 863 164-011 to a cable assembly 8KB 862 346-001 2 m and 8KB 346-011 4 m







Accessories see page 6.38-6.39

Rotating Beacon and Siren Combinations

Accessories for RTK 5

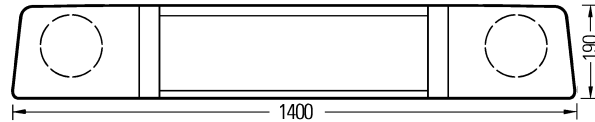
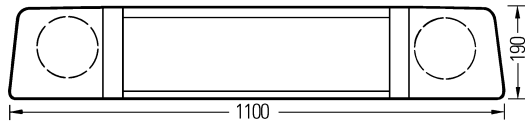


	<p>Part no.</p> <p>9SX 008 902-021</p> <p>8KB 864 105-801</p> <p>8HG 863 383-001</p>	<p>Pk.</p> <p>1</p> <p>1</p> <p>1</p>	<p>Control units</p> <p>eAZD control unit with programmable keys with function, indicator and background illumination for control of optical and acoustic signals from RTK 5.</p> <p>eAZD control unit, 12V with 300 mm lead</p> <p>Accessories: 2 extension leads, 3.5 m</p> <p>Installation frame (DIN) shaft for installation of eAZD and eNF (delivered with eNF blind cover)</p>
	<p>9SX 863 114-001</p> <p>8HG 863 383-001</p> <p>8KB 863 322-001</p> <p>8KB 863 322-011</p> <p>8KB 863 323-001</p> <p>8KB 863 323-011</p> <p>8KB 863 325-001</p> <p>8KB 863 324-001</p>	<p>1</p> <p>1</p> <p>1</p> <p>1</p> <p>1</p> <p>1</p> <p>1</p>	<p>eNF switching unit for control of communication functions: Radio switch on (for standardised and non-standardised two-way radios). Microphone switch (up to 2 microphones), CD player connection, multiple stage volume control, function illumination, background illumination.</p> <p>Technical data: Rated voltage: 12V / 24V. Supply voltage: 9V - 32V. Power consumption: max. 500 mA. NF level microphone 1: USS up to 4 mV / 450 mV, Microphone 2: USS up to 4 mV / 450 mV, Radio: USS to 800 mV, Recorder: 2000 mV. Operating temperature: -40 °C to +90 °C. Type of protection: dustproof.</p> <p> 3313</p> <p>Contents: Control unit, operating panel and 2 m connection lead.</p> <p>eNF switching unit can be used separately or in combination with eAZD control unit</p> <p>Installation frame (DIN) shaft for installation of eAZD and eNF (delivered with eNF blind cover)</p> <p>Accessories: eNF cable for handset, 1 m eNF cable for handset, 3 m eNF cable for FuG 7/8, 1 m eNF cable for FuG 7/8, 3 m eNF cable for Teldux FuG 9, 1,5 m eNF cable for microphone, 1 m</p>
	<p>9MM 862 358-801</p> <p>8HG 854 516-001</p> <p>8KB 862 689-001</p> <p>9MK 860 255-001</p> <p>9MM 859 358-801</p> <p>8KB 862 689-001</p> <p>9MK 860 255-001</p>	<p>1</p> <p>4</p> <p>1</p> <p>1</p> <p>1</p> <p>1</p> <p>1</p>	<p>Microphones</p> <p>With ON / OFF switch, 0.5 m spiral lead, plug and volume control including holder.</p> <p>Rod-type microphone</p> <p>Spare parts: Holder</p> <p>Accessories: Adapter lead, 1 m Device socket</p> <hr/> <p>Hand-held microphone with holder and 0.5 m lead</p> <p>Accessories: Adapter lead, 1 m Device socket</p>







	Part no.	Pk.	Push-pull-rotary alarm switches With built-in 12V bulb and spare 24V bulb. 3 switch positions: 0 = off, left = flashing (rotating) beacon on, successive-tone signal ready for operation, pulled out = rotating beacon on, operating of successive-tone signal.
	6ZE 001 759-071	1	Alarm switch
	6ZE 001 759-051	1	With 4 switch positions: 0 = off, right = flashing (rotating) beacon on, normal horn ready for operation, left = flashing (rotating) beacon on, successive-tone signal ready for operation, pulled out = rotating beacon on, operating of successive-tone signal.
	9SG 703 965-007	1	Spare parts: Knob  1x12V1,2W (W5/1,2) 8GP 002 095-121  1x24V1,2W (W5/1,2) 8GP 002 095-241 See the Hella switch range in the Electrics catalogue for alternatives
	9GD 861 810-001	1	Rubber bases Straight, for mounting on roof attachments, for RTK 5 1100 mm long
	9GD 860 936-001	1	For slightly arched roofs, for RTK 5 1100 mm long
	9GD 861 531-001	1	for RTK 5 1400 mm long
(without illustration)	8KB 863 462-001	1	Vehicle wiring harness for all RTK 5-models, except -401
	8KB 863 462-011	1	for -401
	8KB 863 462-031	1	Harness for stepped loudspeakers
	9XB 010 081-001	1	Cable adapter for the connection of 2 loudspeakers 9MM 863 164-011 to a cable assembly 8KB 862 346-001 2 m or 8KB 346-011 4 m
	9XD 863 521-001	1	Mounting system for 1400 mm systems For Mercedes Benz Vito and Viano 01/03 -> without roof rails Mounting system (2 mounting plates)
	9XD 863 403-801	1	For 1400 mm systems Contents: 2 steel supports with plastic bases For VW T5 Multivan, only for vehicles with fastening rails Mounting system
			

Rotating Beacon and Siren Combinations

RTK 6-SL for police, fire brigade, rescue vehicles, ambulances



Part no.	Pk.	Rotating beacon and siren combinations, RTK 6-SL
		<p>The modular design of the RTK 6-SL allows the basic version to be equipped with various accessory modules right up to the maximum version to meet all ranges of application. The microprocessor-controlled central control unit and electronic bus system significantly reduce the vehicle wiring and facilitate installation.</p> <p>The entire system can be completed with an intelligent control unit.</p> <p>Erroneous operation as well as malfunctions in the system are indicated optically and acoustically.</p> <p>Light aperture (reflector dia.): 111.6 mm.</p> <p>The RTK 6-SL fulfils all legal regulations for acoustic and optical warning devices in accordance with specifications to ECE and ISO.</p> <p>Technical data: Rated voltage: 12V. Operating voltage: 9V - 16V at 12V. Quiescent current consumption: 1.0 mA. Operating temperature: -40 °C to +60 °C. RF suppression: CISPR 25, class 5 (conducted). Resistant to high pressure cleaning. Weight: max. 22 kg.</p> <p>Power consumption: Rotating beacons (2 or 4 per system): 5.0A at 12V. Strobe-type beacons (2 per system): 4.5A at 12V. Attachable rotating beacon: 4.5A. Loudspeaker, front: 5.5A. Loudspeaker, rear: 2.5A.</p> <p>Ⓔ1 433 RTK 6-SL with rotating beacons</p> <p>Ⓔ1 434 RTK 6-SL with strobe-type beacons</p> <p>Ⓛ1 0995</p>
2RM 007 200-...	1	<p>RTK 6-SL for police A survey of the 12V equipment versions is given on pages 6.44-6.45</p>
2RM 007 200-...	1	<p>RTK 6-SL for fire brigade, rescue vehicles, ambulances A survey of the 12V equipment versions are given on pages 6.46-6.47</p>

	Part no.	Pk.	Basic equipment
	2RM 007 200-...	1	RTK 6-SL with blue beacons or strobe beacons, 1100 mm or 1400 mm long (see next pages)
	8KB 007 896-801 8KB 007 896-811	1 1	Vehicle wiring harness Comprises: Power supply and BUS-lead RTK 6 SL, power lead for control unit, plug for HWL and BSX.
	9SX 007 609-001 9SX 007 609-031 9SX 007 609-041 9SX 007 609-051 9SX 007 609-021 9SX 007 609-011 9SX 007 609-041 9SX 007 609-051 8KB 861 218-037	1 1 1 1 1 1 1 1 25	BE control units For police, 12V, with DIN signals 12V, with programming function for RTK 6-SL with ASG matrix 12V, for control of US tone sequence signals (Wail, Yelp) and for ASG-LED or ASG-GL 12V, for control of US tone sequence signals (Wail, Yelp etc.) and for ASG matrix <hr/> For fire brigade, rescue vehicles and ambulances, 12V 24V 12V, for control of US tone sequence signals (Wail, Yelp) 12V, for control of US tone sequence signals (Wail, Yelp) and for ASG-Matrix Accessories: Lead, 6 m, for separate control unit
 <p>Standard</p>	9GD 861 470-001 9GD 861 810-001 9GD 860 936-001 9GD 861 531-001	1 1 1 1	Rubber bases Straight, for mounting on roof attachments, 900 mm 1055 mm <hr/> Standard, for slightly arched roofs, 1100 mm 1400 mm
	9XD 863 521-001	1	Mounting system for 1400 mm systems For Mercedes Benz Vito and Viano 01/03 -> without roof rails Mounting system (2 mounting plates)
	9XD 863 403-801	1	For 1400 mm systems Contents: 2 steel supports with plastic bases For VW T5 Multivan, only for vehicles with fastening rails Mounting system

Rotating Beacon and Siren Combinations

RTK 6-SL Special Equipment







	<p>Part no.</p> <p>8KB 007 895-801</p> <p>8KB 007 895-811</p> <p>8KB 007 895-821</p>	<p>Pk.</p> <p>1</p> <p>1</p> <p>1</p>	<p>Wiring harness</p> <p>For hand and standard two-way radio FUG 7/8, 1 m long</p> <p>3 m long</p> <p>1.5 m and 0.5 m long</p>
	<p>8KB 007 897-801</p> <p>8KB 007 897-811</p>	<p>1</p> <p>1</p>	<p>For hand and standard two-way radio Teledux 9, 1.5 m long</p> <p>3 m long</p>
	<p>8KB 861 596-001</p>	<p>1</p>	<p>Wiring harness for mounting additional beacon</p>
	<p>9MM 860 814-801</p>	<p>1</p>	<p>Microphone</p> <p>Rod-type microphone with holder (see adapter cable)</p>
	<p>8HG 854 516-001</p>	<p>4</p>	<p>Spare parts: Holder</p>
	<p>9MM 859 358-801</p>	<p>1</p>	<p>Hand-held microphone with holder (see adapter cable)</p>
	<p>8KB 861 213-011</p>	<p>1</p>	<p>Adapter cables</p> <p>For connecting microphone to control unit.</p> <p>For rod-type microphone 9MM 860 814-801, 1 m</p> <p>For hand-held microphone 9MM 859 358-801, 1 m</p> <p>2 m</p>
	<p>8KB 861 213-001</p>	<p>1</p>	<p>For hand-held microphone 9MM 859 358-801, 1 m</p>
	<p>9SX 861 562-001</p> <p>9SX 861 562-011</p>	<p>1</p> <p>1</p>	<p>Installation sets</p> <p>For separate control unit, 2 m</p> <p>5 m</p>

	Part no. 2RL 860 880-001	Pk. 1	KL-XR Strobe-type beacon with built-in strobe tube, 12V
	2XD 860 910-001	1	ASG-GL Stop signal with built-in incandescent bulbs, 12V, with normal lettering: STOP POLIZEI
	2XD 860 910-021	1	with mirror-image lettering: STOP POLIZEI
	2XD 860 910-011	1	with normal lettering: BITTE FOLGEN
	2XD 860 910-031	1	with normal lettering: NOTARZT NOTARZT
	2XD 860 618-011	1	ASG-LED Stop signal LED-type, 12V, with normal lettering: STOP POLIZEI/BITTE FOLGEN
	2XD 860 618-001	1	with mirror-image lettering: STOP POLIZEI
	2XD 860 618-021	1	ASG-Matrix Various messages and languages can be selected and displayed in combination with control module 9SX 007 609-031. Stop signal in Matrix-technology, 12V
	9MM 853 518-001	1	Loudspeaker LSP-V Loudspeaker pointing toward front, for use with central control unit 5XA 860 907-031
	9MM 853 518-021	1	Loudspeaker pointing toward front, for use with central control unit 5XA 860 907-021 (old part)
	9MM 862 206-011	1	LSP-H Loudspeaker pointing toward rear
	5XA 860 907-031	1	Central control unit Central control unit only for use with loudspeaker pointing toward front 9MM 863 518-001 and pointing toward rear 9MM 862 206-041

Rotating Beacon and Siren Combinations

RTK 6-SL Module equipment for police



Part no.	Volt	Width	Beacons with DC-motor KL-ER (single reflector) KL-MR (multiple reflector)	Strobe-type beacons with parabolic trough type-reflector KL-XR	Strobe headlights BSX	Stop signal with incandescent bulbs ASG-GL *)
						
2RM 007 200-001	12V	1100 mm	●			
2RM 007 200-011	12V	1100 mm	●			● STOP POLIZEI *) mirror image a. norm. ● Bitte FOLGEN norm.
2RM 007 200-121	12V	1100 mm	●			● STOP POLIZEI *) with offset ASG cable
2RM 007 200-091	12V	1400 mm	●			
2RM 007 200-041	12V	1100 mm		●		
2RM 007 200-111	12V	1100 mm		●	●	
2RM 007 200-221 ****)	12V	1100 mm		●	●	● STOP POLIZEI *) mirror image a. norm. ● Bitte FOLGEN norm.
2RM 007 200-131	12V	1100 mm		●		
2RM 007 200-161	12V	1400 mm		●		
2RM 007 200-231	12V	1100 mm		●	●	
2RM 007 200-261 ***)	12V	1100 mm		●	●	● STOP POLIZEI *) mirror image a. norm. ● Bitte FOLGEN norm.
2RM 007 200-271	12V	1100 mm		●	●	with offset ASG cable
2RM 007 200-371 **)	12V	1400 mm		●		
2RM 007 200-391	12V	1400 mm		●	●	3 leads for AS-GL 1x front, 2x rear






*) ASG-GL: other signs available on request ***) With mounting system for VW T5 (interior wiring) ****) With video lead
*****) Amber flasher lights rear

The part numbers for the modular equipment are given on page 6.43



Rotating Beacon and Siren Combinations





RTK 6-SL Module equipment for police

Stop signal 1) ASG-LED 2) ASG-Matrix	Front loudspeaker LSP-V	Rear loudspeaker LSP-H	Attachable rotating beacons KL-A	Information sign Info-G	Colour of panel and cover
					
	●				pure white
	●				mint green
	●				mint green
	●				pure white
	●				
	●				
	●		Pre-equipped	Pre-equipped	mint green
	●				
	●				pure white
1) ● STOP POLIZEI mirror image a. norm. ● STOP POLIZEI / Bitte FOLGEN norm.	●				Cover pure white, without panel
	●	●	Pre-equipped	Pre-equipped	mint green
	●	●	Pre-equipped	Pre-equipped	mint green
	●				mint green
	●	●		Pre-equipped	mint green

Rotating Beacon and Siren Combinations

RTK 6-SL Module equipment for fire brigade, rescue vehicles and ambulances



Part no.	Volt	Width	Beacons with DC motor KL-ER (single reflector) KL-MR (multiple reflector) 	Strobe-type beacons with parabolic trough type reflector KL-XR 	Strobe headlights BSX 	Identification sign with incandescent bulbs ASG-GL 
2RM 007 200-001	12V	1100 mm	●			
2RM 007 200-201	12V	1100 mm	●			● 2x *)
2RM 007 200-071	12V	1100 mm	●			
2RM 007 200-041	12V	1100 mm		●		
2RM 007 200-111	12V	1100 mm		●	●	
2RM 007 200-061	12V	1100 mm		●	●	● 1x *)
2RM 007 200-141	12V	1100 mm		●		
2RM 007 200-151	12V	1100 mm		●		● 2x *)
2RM 007 200-191	12V	1100 mm		●		
2RM 007 200-091	12V	1400 mm	●			
2RM 007 200-161	12V	1400 mm		●		

*) ASG-GL: other signs available on request

The part numbers for the modular equipment are given on page 6.43



Rotating Beacon and Siren Combinations

RTK 6-SL Module equipment for fire brigade, rescue vehicles and ambulances

Front loudspeaker LSP-V	Rear loudspeaker LSP-H	Attachable rotating beacon KL-A	Color of panel and cover
			
•			pure white
•			pure white
•	•		pure white, lett.: FEUERWEHR
•			pure white
•			pure white
•			pure white
•		Pre-equipped	pure white, lett.: FEUERWEHR
•			pure white
•			pure white, lett.: FEUERWEHR
•			pure white
•			pure white

Spare Parts for RTK 6-SL

for police



Version	Panel	1) Dome 2) Reflector		Foam rubber gasket	1) Motor 2) Drive belt		Bulbs Strobe tube		
		Pk.	Pk.		Pk.	Pk.	Pk.	Pk.	
2RM 007 200-001 12V KL-ER	9AB 860 796-021	1	1) 9EL 860 743-011 9EL 860 743-021 red **)	1	9GD 862 868-001 Replace foam rubber gasket each time the central control module is disassembled	1	1) 9MN 857 622-101 2) 9XR 855 975-001 (2 pieces)	1	8GH 002 089-133 H1
2RM 007 200-011 12V KL-ER	9AB 860 796-001	1	2) 9DX 859 626-001	1				1	8GH 002 089-133 H1
2RM 007 200-091 12V KL-ER	9AB 860 796-021	1	1) 9EL 861 597-011 2) 9DX 859 626-001	1				10	8GA 002 073-121 4 each per stop signal
2RM 007 200-10 12V KL-ER	9AB 860 796-001	1	1) 9EL 860 743-011 2) 9DX 859 626-001	1				1	8GH 002 089-133 H1
2RM 007 200-121 12V KL-ER	9AB 860 796-001	1	1) 9EL 860 743-011 9EL 860 743-021 red **) 2) 9DX 859 626-001	1 1 1					
2RM 007 200-18 12V KL-MR	9AB 860 796-021	1	1) 9EL 861 597-011 2) 2x 9DX 861 976-001	1 1		1) 9MN 859 116-101	1	1	8GH 002 089-133 H1
2RM 007 200-041 12V KL-XR	9AB 860 796-021	1	1) 9EL 860 743-001	1		-	-	-	-
2RM 007 200-02 12V KL-XR	9AB 860 796-001 9AB 860 796-061 **)	1 1						1	8GS 860 848-001 Strobe tube *)
2RM 007 200-111 12V KL-XR	9AB 860 796-021 9AB 860 796-071 **)	1 1							
2RM 007 200-131 12V KL-XR	9AB 860 796-001	1						10	8GA 002 073-121 4 each per stop signal
2RM 007 200-21 12V KL-XR	9AB 860 796-001 9AB 860 796-061	1 1						1	8GS 860 848-001 Strobe tube *)
2RM 007 200-05 12V KL-XR	9AB 860 796-001	1	1) 9EL 860 743-001	1					-
2RM 007 200-161 12V KL-XR	9AB 860 796-021	1	1) 9EL 861 597-001	1					-

*) For strobe headlights BSX-F **) With cut-out for strobe headlights BSX-F

**) This product does not have an ECE marking and is therefore not authorized for use on public highways in the area of the European Union.



Spare Parts for RTK 6-SL

for police

Version	Panel		1) Dome 2) Reflector		Foam rubber gasket	1) Motor 2) Drive belt		Bulbs Strobe tube		
		Pk.		Pk.			Pk.		Pk.	
2RM 007 200-231 12V KL-XR	-	-	9EL 860 743-001	1	9GD 862 868-001 Replace foam rubber gasket each time the central control module is disassembled	1	-	-	8GS 860 848-001 Strobe tube *)	1
2RM 007 200-251 12V KL-XR	9AB 860 796-001	1	9EL 860 743-001	1					8GA 002 073-121 4 each per stop signal	10
	9AB 860 796-061 **)	1							8GS 860 848-001 Strobe tube *)	1
2RM 007 200-261 12V KL-XR	9AB 860 796-001	1	9EL 860 743-001	1					8GA 002 073-121 4 each per stop signal	10
	9AB 860 796-061 **)	1							8GS 860 848-001 Strobe tube *)	1
2RM 007 200-271 12V KL-XR	9AB 860 796-001	1	9EL 860 743-001	1					-	-
	9AB 860 796-061 **)	1							-	-
2RM 007 200-371 12V KL-XR	9AB 860 796-001	1	9EL 861 597-001	1						
2RM 007 200-391 12V KL-XR	9AB 860 796-001	1	9EL 861 597-001	1						
	9AB 860 796-061 **)	1								

*) For strobe headlights BSX-F **) With cut-out for strobe headlights BSX-F

KL-ER = Single reflector sytem
KL-MR = Multiple reflector sytem
KL-XR = Parabolic trough reflector system

Spare Parts for RTK 6-SL

for fire brigade, rescue vehicles and ambulances



Version	Panel	1) Dome 2) Reflector		Foam rubber gasket	1) Motor 2) Drive belt		Bulbs Strobe tube			
		Pk.	Pk.		Pk.	Pk.	Pk.	Pk.		
2RM 007 200-001 12V KL-ER	9AB 860 796-021	1	1) 9EL 860 743-011	1	9GD 862 868-001 Replace foam rubber gasket each time the central control module is disassembled	1	1) 9MN 857 622-101	1	8GH 002 089-133 H1	1
2RM 007 200-071 12V KL-ER	9AB 860 796-011	1	9EL 860 743-021 red **)	1			2) 9XR 855 975-001 (2 pieces)	1		
2RM 007 200-201 12V KL-ER	9AB 860 796-021	1	2) 9DX 859 626-001	1					8GH 002 089-133 H1	1
									8GA 002 073-121 4 each per stop signal	10
2RM 007 200-08 12V KL-ER	9AB 860 796-021 9AB 860 796-071	1 1							8GH 002 089-133 H1	1
									8GS 860 848-001 Strobe tube *)	1
2RM 007 200-091 12V KL-ER	9AB 860 796-021	1	1) 9EL 861 597-011	1					8GH 002 089-133 H1	1
			2) 9DX 859 626-001	1						
2RM 007 200-18 12V KL-MR			1) 9EL 861 597-011	1		1) 9MN 859 116-101	1			
			2) 2x 9DX 861 976-001	1						
2RM 007 200-041 12V KL-XR			1) 9EL 860 743-001	1		-	-	-	-	-
2RM 007 200-141 12V KL-XR	9AB 860 796-011	1								
2RM 007 200-191 12V KL-XR	9AB 860 796-011	1								
2RM 007 200-111 12V KL-XR	9AB 860 796-021 9AB 860 796-071	1 1							8GS 860 848-001 Strobe tube *)	1
2RM 007 200-061 12V KL-XR									8GS 860 848-001 Strobe tube *)	1
									8GA 002 073-121 4 each per stop signal	10
2RM 007 200-151 12V KL-XR	9AB 860 796-021	1							8GA 002 073-121 4 each per stop signal	10
2RM 007 200-161 12V KL-XR			1) 9EL 861 597-001	1					-	-

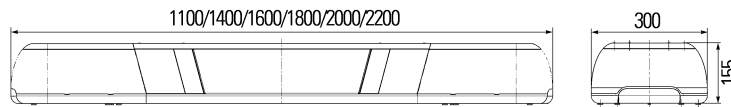
*) For strobe headlamps BSX-F

***) This product does not have an ECE marking and is therefore not authorized for use on public highways in the area of the European Union.

KL-ER = Single reflector sytem

KL-MR = Multiple reflector sytem

KL-XR = Parabolic trough reflector system

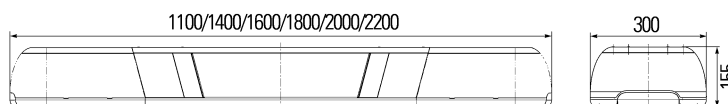
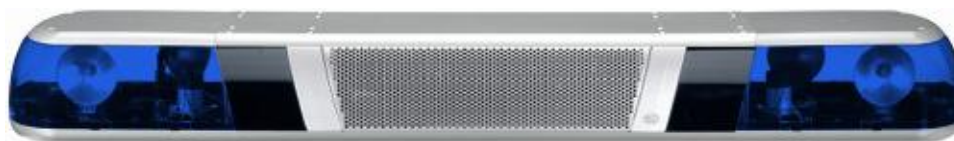


Part no.	Pk.	Rotating beacon and siren combinations RTK-QS with single reflector system KL-ER, 1100 mm, 1400 mm, 1600 mm, 1800 mm, 2000 mm
		<p>The modular and flexible set-up allows the RTK-QS to be designed tailor made to customer requirements. The variable lengths make the unit particularly suitable for large official vehicles. Five different widths are available with light domes in the colour combinations blue / blue.</p> <p>The control concept for this system processes conventional, analogue signals as well as modern data bus systems (e.g. CAN bus). Control of the system is accomplished optionally with the eAZD control unit, standard button or vehicle interface. As an option to the two speakers pointing forward, a third speaker pointing to the rear is also available.</p> <p>Light aperture (reflector dia.): 84 mm.</p> <p>Ⓔ1 1719 Ⓔ1 3312</p> <p>Technical data: Rated voltage: 12V / 24V. Operating voltage: 10.8V - 15V at 12V, 21.6V - 30V at 24V. Function voltage: 10V - 16V at 12V, 20V - 32V at 24V. Undervoltage: 12V <10V, 24V <20V. Overvoltage: 12V >16V, 24V >32V. Quiescent current consumption: <- 1 mA. Operating temperature: - 40 °C to + 60 °C. RF suppression: CISPR 25, class 5 (conducted). Resistant to high pressure cleaning. Weight: max. 22.5 kg.</p> <p>Configuration possibilities: Voltage: 12V / 24V. Type of control: analogue/CAN. Width: 1100 / 1400 / 1600 / 1800 / 2000 mm. Light systems main beacons: KL-ER single reflector system. Optional light modules (exterior): Side mounted lights Alley Lights, connection lead for one 3rd and 3rd and 4th beacons. Light dome colours: blue / blue. Loudspeakers: towards front, towards front and rear.</p> <p>Current consumption of modular equipment: KL-ER (2 per system): 5.5A at 12V, 3.0A at 24V. Side-mounted lights: 4.5A at 12V, 2.7A at 24V. Loudspeaker front: 1.7A at 12V / 24V. Loudspeaker rear: 1.7A at 12V / 24V.</p> <p>Control units/roof attachment interface Unidirectional NF-BU: 5V 100 kHz.</p>
2RM 379 500-...	1	Rotating beacon and siren combinations RTK-QS with single reflector system KL-ER
9EL 863 117-011	1	Spare parts: Dome blue
2RL 863 132-001	1	Rotating mirror module,
2RL 863 132-011	1	12V
9XR 855 975-001	1	24V
	1	Drive belts (2 pieces)
8GH 002 089-133	1	H1 bulb,
8GH 002 089-251	1	12V55W
	1	24V70W
5XA 008 877-001	1	Control unit light and acoustic ZSE L/A,
5XA 008 877-011	1	12V
	1	24V
5XA 863 115-001	1	Control unit light ZSE L,
5XA 863 115-011	1	12V
	1	24V
9MM 863 165-001	1	Loudspeaker,
9MM 863 164-011	1	front
	1	rear
1GA 008 284-101	1	Side mounted light Alley Light
8KB 863 243-001	1	Lead set for main beacons, 1050 mm
8KB 863 120-011	1	Lead set incl. possibility for public address (NF)

Examples with various module equipment can be found on pages 6.56

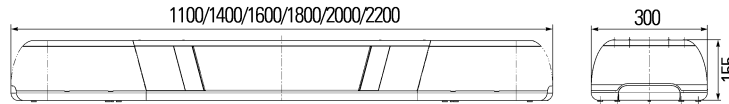
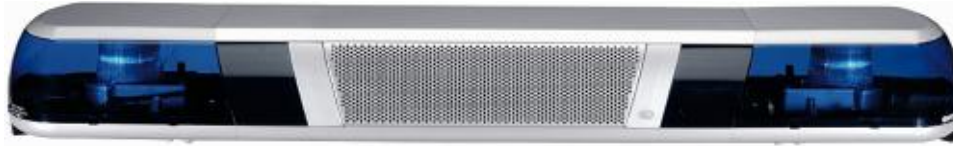
Rotating Beacon and Siren Combinations

RTK-QS for fire brigades and rescue vehicles



Part no.	Pk. Rotating beacon and siren combinations RTK-QS with multiple reflector system KL-MR, 1100 mm, 1400 mm, 1600 mm, 1800 mm, 2000 mm
	<p>The modular and flexible set-up allows the RTK-QS to be designed tailor made to customer requirements. The variable lengths make the unit particularly suitable for large official vehicles. Five different widths are available with light domes in the colour combinations blue / blue.</p> <p>The control concept for this system processes conventional, analogue signals as well as modern data bus systems (e.g. CAN bus). Control of the system is accomplished optionally with the eAZD control unit, standard button or vehicle interface. As an option to the two speakers pointing forward, a third speaker pointing to the rear is also available. Light aperture (reflector dia.): 2 x 84 mm.</p>
	<p>Ⓔ1 1720 Ⓔ1 3312</p> <p>Technical data: Rated voltage: 12V / 24V. Operating voltage: 10.8V - 15V at 12V, 21.6V - 30V at 24V. Function voltage: 10V - 16V at 12V, 20V - 32V at 24V. Undervoltage: 12V <10V, 24V <20V. Overvoltage: 12V >16V, 24V >32V. Quiescent current consumption: <- 1 mA. Operating temperature: - 40 °C to + 60 °C. RF suppression: CISPR 25, class 5 (conducted). Resistant to high pressure cleaning. Weight: max. 24 kg.</p> <p>Current consumption of modular equipment: KL-MR (2 per system): 11A at 12V, 6A at 24V. Side-mounted lights: 4.5A at 12V, 2.7A at 24V. Work lamps: 5.5A at 12V, 3A at 24V. Loudspeaker front: 1.7A at 12V / 24V. Loudspeaker rear: 1.7A at 12V / 24V.</p> <p>Control units/roof attachment interface Unidirectional NF-BU: 5V 100 kHz.</p>
	<p>Configuration possibilities: Voltage: 12V / 24V. Type of control: analogue/CAN. Width: 1100 / 1400 / 1600 / 1800 / 2000 mm. Light systems main beacons: KL-MR multiple reflector system. Optional light modules (exterior): Side mounted lights Alley Lights, connection lead for one 3rd and 3rd and 4th beacons. Light dome colours: blue / blue. Loudspeakers: towards front, towards front and rear.</p>
2RM 379 500-...	1 Rotating beacon and siren combinations RTK-QS with multiple reflector system KL-MR
9EL 863 117-011	1 Spare parts: Dome blue
8GH 002 089-133	1 H1 bulb,
8GH 002 089-251	1 12V55W
	1 24V70W
5XA 008 877-001	1 Control unit light and acoustic ZSE L/A,
5XA 008 877-011	1 12V
	1 24V
5XA 863 115-001	1 Control unit light ZSE L,
5XA 863 115-011	1 12V
	1 24V
9MM 863 165-001	1 Loudspeaker,
9MM 863 164-011	1 front
	1 rear
1GA 008 284-101	1 Side mounted light Alley Light
8KB 863 243-001	1 Lead set for main beacons, 1050 mm
8KB 863 120-011	1 Lead set incl. possibility for public address (NF)

Examples with various module equipment can be found on pages 6.56



Part no. Pk. **Flashing beacon and siren combinations RTK-QS with double strobe system KL-XL2, 1100 mm, 1400 mm, 1600 mm, 1800 mm, 2000 mm, 2200 mm**

The modular and flexible set-up allows the RTK-QS to be designed tailor made to customer requirements. The variable lengths make the unit particularly suitable for large official vehicles. Six different widths are available with light domes in the colour combinations blue / blue.

The control concept for this system processes conventional, analogue signals as well as modern data bus systems (e.g. CAN bus).

Control of the system is accomplished optionally with the eAZD control unit, standard button or vehicle interface. As an option to the two speakers pointing forward, a third speaker pointing to the rear is also available.

Ⓔ 1721 e1 3312

Technical data:

Rated voltage: 12V / 24V.
 Operating voltage: 10.8V - 15V at 12V, 21.6V - 30V at 24V.
 Function voltage: 10V - 16V at 12V, 20V - 32V at 24V.
 Undervoltage: 12V <10V, 24V <20V.
 Overvoltage: 12V >16V, 24V >32V.
 Quiescent current consumption: <- 1 mA.
 Operating temperature: - 40 °C to + 60 °C.
 RF suppression: CISPR 25, class 5 (conducted).
 Resistant to high pressure cleaning.
 Weight: max. 26 kg.

Current consumption of modular equipment:
 KL-XL2 (2 per system): 3.5A at 12V, 1.8A at 24V.
 Side-mounted lights: 4.5A at 12V, 2.7A at 24V.
 Loudspeaker front: 1.7A at 12V/24V.
 Loudspeaker rear: 1.7A at 12V/24V.

Control units/roof attachment interface
 Unidirectional NF-BU: 5V 100 kHz.

Configuration possibilities:

Voltage: 12V/24V.
 Type of control: analogue/CAN.
 Width: 1100 / 1400 / 1600 / 1800 / 2000 / 2200 mm.
 Light systems main beacons: KL-XL2 double strobe system.
 Optional light modules (interior): work lights.
 Optional light modules (exterior): Side mounted lights Alley Lights, connection lead for one 3rd and 3rd and 4th beacons.
 Light dome colours: blue / blue, amber / amber.
 Loudspeakers: towards front, towards front and rear.

2RM 379 500-... 1 **Flashing beacon and siren combinations RTK-QS with double strobe system KL-XL2**

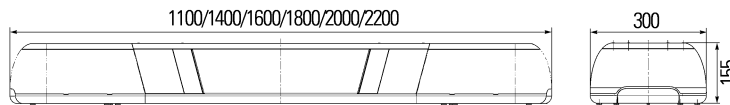
Spare parts:

9EL 863 117-001	1	Dome blue
		Double flashing module,
2RL 863 106-001	1	12V
2RL 863 106-011	1	24V
8GS 859 634-001	1	Xenon tube X1
		Control unit light and acoustic ZSE L/A,
5XA 008 877-001	1	12V
5XA 008 877-011	1	24V
		Control unit light ZSE L,
5XA 863 115-001	1	12V
5XA 863 115-011	1	24V
		Loudspeaker,
9MM 863 165-001	1	front
9MM 863 164-011	1	rear
1GA 008 284-101	1	Side mounted light Alley Light
8KB 863 243-001	1	Lead set for main beacons, 1050 mm
8KB 863 120-011	1	Lead set incl. possibility for public address (NF)

Examples with various module equipment can be found on pages 6.56-6.57

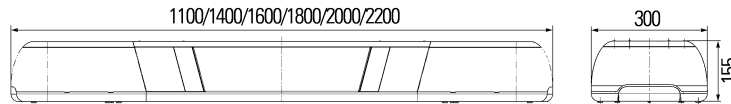
Flashing Beacon and Siren Combinations

RTK-QS for fire brigades and rescue vehicles



Part no.	Pk.	Flashing beacon and siren combinations RTK-QS with parabolic trough reflector system KL-XR2, 1100 mm, 1400 mm, 1600 mm, 1800 mm, 2000 mm
		<p>The modular and flexible set-up allows the RTK-QS to be designed tailor made to customer requirements. The variable lengths make the unit particularly suitable for large official vehicles. Five different widths are available with light domes in the colour combinations blue / blue.</p> <p>The control concept for this system processes conventional, analogue signals as well as modern data bus systems (e.g. CAN bus). Control of the system is accomplished optionally with the eAZD control unit, standard button or vehicle interface.</p> <p>Ⓔ1 2139 Ⓔ1 3312</p> <p>Technical data: Rated voltage: 12V / 24V. Operating voltage: 10.8V - 15V at 12V, 21.6V - 30V at 24V. Function voltage: 10V - 16V at 12V, 20V - 32V at 24V. Undervoltage: 12V <10V, 24V <20V. Overvoltage: 12V >16V, 24V >32V. Quiescent current consumption: </- 1 mA. Luminous power: >/= 350 cd. Integrated polarity reversal protection. Operating temperature: - 40 °C to + 60 °C. RF suppression: CISPR 25, class 5 (conducted). Resistant to high pressure cleaning. Weight: max. 26 kg.</p> <p>Configuration possibilities: Voltage: 12V / 24V. Type of control: analogue/CAN. Width: 1100 / 1400 / 1600 / 1800 / 2000 mm. Light systems main beacons: KL-XR2 parabolic trough reflector system with 8 different flash frequencies and integrated day / night change-over.. Optional light modules (exterior): Side mounted lights Alley Lights, connection lead for one 3rd and 3rd and 4th beacons. Light dome colours: blue / blue. Loudspeakers: towards front.</p> <p>Current consumption of modular equipment: KL-XR2 (2 per system): 4A at 12V, 1.8A at 24V. Side-mounted lights: 4.5A at 12V, 2.7A at 24V. Loudspeaker front: 1.7A at 12V/24V. Loudspeaker rear: 1.7A at 12V/24V.</p> <p>Control units/roof attachment interface Unidirectional NF-BU: 5V 100 kHz.</p>
2RM 379 500-...	1	Flashing beacon and siren combinations RTK-QS with parabolic trough reflector system KL-XR2
9EL 863 117-001	1	Spare parts: Dome blue Flashing module,
2RL 863 123-001	1	12V
2RL 863 123-011	1	24V
8GS 863 889-001	1	Xenon tube
5XA 008 877-001	1	Control unit light and acoustic ZSE L/A, 12V
5XA 008 877-011	1	24V
5XA 863 115-001	1	Control unit light ZSE L, 12V
5XA 863 115-011	1	24V
9MM 863 165-001	1	Loudspeaker, front
9MM 863 164-011	1	rear
1GA 008 284-101	1	Side mounted light Alley Light
8KB 863 243-001	1	Lead set for main beacons, 1050 mm
8KB 863 120-011	1	Lead set incl. possibility for public address (NF)

Examples with various module equipment can be found on pages 6.58



Part no.	Pk.	Flashing Beacon and Siren Combinations RTK-QS with LED trough module KL-LR2, 1100 mm, 1400 mm, 1600 mm, 1800 mm, 2000 mm
		<p>The modular and flexible set-up allows the RTK-QS to be designed tailor made to customer requirements. The control concept for this system processes conventional, analogue signals as well as modern data bus systems (e.g. CAN bus). Control of the system is accomplished optionally with the eAZD control unit, standard button or vehicle interface.</p> <p>Technical data: Rated voltage: 12V / 24V. Operating voltage: 10V - 15V at 12V, 20V - 30V at 24V. Strobe frequency: 2Hz. ECE flashing sequences: single, double. Other flashing frequencies: triple, quadruple. Function output: yes. Synchronisation: yes. Sectional operation: yes Self-diagnosis: available Operating temperature: - 40 °C to + 60 °C. RF suppression: CISPR 25, class 3 (conducted). Resistant to high pressure cleaning. Weight: max. 25 kg.</p> <p>Configuration possibilities: Voltage: 12V / 24V. Type of control: analogue. Width: 1100 / 1400 / 1600 / 1800 / 2000 mm. Lighting system main beacons: KL-LR2 trough module system with 2 x 2 reflectors and 24 blue LEDs each. Optional light modules (exterior): Side mounted lights Alley Lights, connection lead for one 3rd and 3rd and 4th beacons. Light dome colours: blue / blue. Loudspeakers: towards front.</p> <p>(E1) 2466</p> <p>Current consumption of modular equipment: KL-LED (2 per system): 2,6A at 12V, 1,3A at 24V. Side-mounted lights: 4.5A at 12V, 2.7A at 24V. Loudspeaker front: 1.7A at 12V / 24V.</p> <p>Control units/roof attachment interface Unidirectional NF-BU: 5V 100 kHz.</p>
2RM 379 500-...	1	Flashing beacon and siren combinations RTK-QS with LED trough module KL-LR2
		<p>Spare parts:</p>
2RL 171 067-101	1	LED module, blue, 12V / 24V
9EL 863 117-131	1	Glas
5XA 008 877-001	1	Central styreenhed lys og akustik ZSE L/A, 12V
5XA 008 877-011	1	24V
5XA 863 115-001	1	Central styreenhed lys ZSE L, 12V
5XA 863 115-011	1	24V
9MM 863 164-001	1	Loudspeaker, front, for 1100 mm systems
9MM 863 165-001	1	front, for 1400 mm systems and larger
9MM 863 164-011	1	bag
1GA 008 284-101	1	Side-mounted light Alley Light
8KB 863 243-001	1	Lead set for main beacons, 1050 mm
8KB 863 120-011	1	Lead set incl. possibility for public address (NF)

Eksempler med forskelligt moduludstyr finder du på siderne 6.58

Flashing Beacon and Siren Combinations

RTK-QS for fire brigades and rescue vehicles



Part no.	Volt	Rotating beacon	Dome	Width	Auxiliary light module	Loud-speaker	ZSE L/A **)	ZSE L **)	Pre-equipped for PA system
2RM 379 500-571	12V	KL-ER	blue / blue	1100 mm		front			●
2RM 379 500-841	12V	KL-ER	blue / blue	1100 mm		without ***)			●
2RM 379 500-631	12V	KL-ER	blue / blue	1100 mm	Side-mounted lights	front			●
2RM 379 500-221	12V	KL-ER	blue / blue	1400 mm	Side-mounted lights	front	●		●
2RM 379 500-081	12V	KL-ER	blue / blue	1400 mm	3./4. KL *)	front	●		●
2RM 379 500-391	12V	KL-ER	blue / blue	1400 mm	3./4. KL *)	front and rear	●		●
2RM 379 500-101	12V	KL-ER	blue / blue	1400 mm	Side-mounted lights / 3./4. KL *)	front	●	●	●
2RM 379 500-121	12V	KL-ER	blue / blue	1600 mm	3./4. KL *)	front	●		●
2RM 379 500-141	24V	KL-ER	blue / blue	1600 mm	3./4. KL *)	front	●		●
2RM 379 500-161	24V	KL-ER	blue / blue	1800 mm	3./4. KL *)	front	●		●
2RM 379 500-741	24V	KL-ER	blue / blue	2000 mm	3./4. KL *)	front	●		●
2RM 379 500-581	12V	KL-MR	blue / blue	1100 mm		front	●		●
2RM 379 500-301	12V	KL-MR	blue / blue	1400 mm		front	●		●
2RM 379 500-691	12V	KL-MR	blue / blue	1400 mm	3./4. KL *)	front and rear	●	●	●
2RM 379 500-401	24V	KL-MR	blue / blue	1600 mm		front	●		●
2RM 379 500-261	24V	KL-MR	blue / blue	1800 mm	3./4. KL *)	front	●	●	●
2RM 379 500-361	24V	KL-MR	blue / blue	2000 mm	Side-mounted lights / 3./4. KL *)	front	●	●	●
2RM 379 500-411	24V	KL-MR	blue / blue	2000 mm		front	●		●
2RM 379 500-591	12V	KL-XL2	blue / blue	1100 mm		front	●		●
2RM 379 500-811	12V	KL-XL2	blue / blue	1100 mm		without ***)			●
2RM 379 500-641	12V	KL-XL2	blue / blue	1100 mm	Side-mounted lights	front	●		●
2RM 379 500-661	12V	KL-XL2	blue / blue	1100 mm	Work lights front	front	●		●
2RM 379 500-181	12V	KL-XL2	blue / blue	1400 mm	Side-mounted lights	front	●	●	●
2RM 379 500-191	12V	KL-XL2	blue / blue	1400 mm	3. KL *)	front	●		●

KL-ER (single reflector) KL-MR (multiple reflector) KL-XL2 (double flashing)

*) **) ***) Explanation see 6.58



Flashing Beacon and Siren Combinations

RTK-QS for fire brigades and rescue vehicles

Part no.	Volt	Rotating beacon	Dome	Width	Auxiliary light module	Loud-speaker	ZSE L/A **)	ZSE L **)	Pre-equipped for PA system
2RM 379 500-091	12V	KL-XL2	blue / blue	1400 mm	3./4. KL *)	front	●		●
2RM 379 500-111	12V	KL-XL2	blue / blue	1400 mm	Side-mounted lights / 3./4. KL *)	front	●	●	●
2RM 379 500-271	12V	KL-XL2	blue / blue	1400 mm	Side-mounted lights	front	●		●
2RM 379 500-381	12V	KL-XL2	blue / blue	1400 mm	3./4. KL *)	front and rear	●		●
2RM 379 500-671	12V	KL-XL2	gul/gul	1400 mm		front and rear	●		●
2RM 379 500-421	12V	KL-XL2	blue / blue	1600 mm		front	●		
2RM 379 500-131	12V	KL-XL2	blue / blue	1600 mm	3./4. KL *)	front	●		●
2RM 379 500-331	12V	KL-XL2	blue / blue	1600 mm	Side-mounted lights	front	●		●
2RM 379 500-151	24V	KL-XL2	blue / blue	1600 mm	3./4. KL *)	front	●		●
2RM 379 500-211	12V	KL-XL2	blue / blue	1800 mm	3./4. KL *)	front	●		●
2RM 379 500-171	24V	KL-XL2	blue / blue	1800 mm	3./4. KL *)	front	●		●
2RM 379 500-241	24V	KL-XL2	blue / blue	2000 mm	3. KL *)	front	●		●
2RM 379 500-351	24V	KL-XL2	blue / blue	2000 mm	Side-mounted lights / 3./4. KL *)	front	●	●	●
2RM 379 500-371	24V	KL-XL2	blue / blue	2000 mm	3./4. KL *)	front	●		●
2RM 379 500-531	24V	KL-XL2	blue / blue	2000 mm		front	●		●
2RM 379 500-321	24V	KL-XL2	blue / blue	2200 mm	3./4. KL *)	front	●		●
2RM 379 500-601	12V	KL-XR2	blue / blue	1100 mm		front	●		●
2RM 379 500-651	12V	KL-XR2	blue / blue	1100 mm	Side-mounted lights	front	●		●
2RM 379 500-431	12V	KL-XR2	blue / blue	1400 mm	3./4. KL *)	front	●		●
2RM 379 500-501	12V	KL-XR2	blue / blue	1400 mm	Side-mounted lights / 3./4. KL *)	front and rear	●	●	●
2RM 379 500-701	12V	KL-XR2	blue / blue	1400 mm	Side-mounted lights	front	●		●
2RM 379 500-711	12V	KL-XR2	blue / blue	1400 mm	3./4. KL *)	front and rear	●		●
2RM 379 500-541	24V	KL-XR2	blue / blue	1400 mm	3./4. KL *)	front	●		●

KL-XL2 (double flashing)

KL-XR2 (parabolic trough reflector system)

*) **) ***) Explanation see 6.58

Flashing Beacon and Siren Combinations

RTK-QS for fire brigades and rescue vehicles



Part no.	Volt	Rotating beacon	Dome	Width	Auxiliary light module	Loud-speaker	ZSE L/A **)	ZSE L **)	Pre-equipped for PA system
2RM 379 500-721	12V	KL-XR2	blue / blue	1600 mm	3./4. KL *)	front	●		●
2RM 379 500-781	12V	KL-XR2	blue / blue	1600 mm	Side-mounted lights	front and rear	●		●
2RM 379 500-771	24V	KL-XR2	blue / blue	1600 mm	3./4. KL *)	front	●		●
2RM 379 500-761	24V	KL-XR2	blue / blue	1800 mm	3./4. KL *)	front	●		●
2RM 379 500-511	24V	KL-XR2	blue / blue	2000 mm	3./4. KL *)	front	●		●
2RM 379 500-831	24V	KL-XR2	blue / blue	2200 mm	3./4. KL *)	front	●		●
2RM 379 500-911	12V	KL-LR2	blue / blue	1100 mm	Side-mounted lights	front	●		●
2RM 379 500-991	12V	KL-LR2	blue / blue	1400 mm		without ***)			●
2RM 379 500-861	12V	KL-LR2	blue / blue	1400 mm	3. KL*)	front	●		●
2RM 379 500-921	12V	KL-LR2	blue / blue	1400 mm	3./4. KL*)	front	●		●
2RM 379 500-931	12V	KL-LR2	blue / blue	1400 mm	Side-mounted lights	front	●		●
2RM 379 500-491	12V	KL-LR2	blue / blue	1600 mm	3./4. KL*)	without ***)	●		●
2RM 379 500-941	12V	KL-LR2	blue / blue	1600 mm	3./4. KL*)	front	●		●
2RM 379 500-901	12V	KL-LR2	blue / blue	1600 mm	Side-mounted lights	front	●		●
2RM 379 500-871	12V	KL-LR2	blue / blue	1800 mm	3./4. KL*)	front	●		●
2RM 379 500-961	24V	KL-LR2	blue / blue	2000 mm	3./4. KL*)	front	●		●

KL-XR2 (parabolic trough reflector system) KL-LR2 (LED trough module system)

*) With wiring harness for connection of one 3rd or 3rd and 4th beacon (including switching and monitoring functions).

**) The light/acoustic module ZSE L/A allows, as central control unit with programmable microcontroller, operation of 4 light modules as well as various alarm sequences. For model versions with more than 4 light modules, the control unit can be supplemented with an additional ZSE L electronic module for up to 6 light modules.

***) With loudspeaker cable for external installation













Part no.	Pk.	Control units
9SX 008 902-001	1	eAZD control unit with programmable keys with function, indicator and background illumination for control of optical and acoustic signals from RTK-QS.
8HG 863 383-001	1	eAZD control unit 12V/24V with 2 m lead Installation frame (DIN) shaft for installation of eAZD and eNF (delivered with eNF blind cover) As an alternative to the eAZD control unit, see the range of Hella switches in the Electrics catalogue
		eNF switching unit for control of communication functions: Radio switch on (for standardised and non-standardised two-way radios). Microphone switch (up to 2 microphones), CD player connection, multiple stage volume control, function illumination, background illumination.
		Technical data: Rated voltage: 12V / 24V. Supply voltage: 9 - 32V. Power consumption: max. 500 mA. NF level microphone 1: USS up to 4 mV / 450 mV, Microphone 2: USS up to 4 mV / 450 mV, Radio: USS to 800 mV, Recorder: 2000 mV. Operating temperature: -40 °C to +90 °C. Type of protection: dustproof.
		<input type="checkbox"/> 3313
		Contents: Control unit, operating panel and 2 m connection cable.
9SX 863 114-001	1	eNF switching unit Can be used separately or in combination with eAZD control unit
8HG 863 383-001	1	Installation frame (DIN) shaft for installation of eAZD and eNF (delivered with eNF blind cover)
8KB 863 116-001	1	Spare parts: Connection line for 3rd KL
8KB 863 120-011	1	Device lead for the possibility of public address NF
8KB 863 243-001	1	Lead for main beacons
5XA 863 850-801	1	Accessories: Programming set consisting of: 1xUSB/CAN adapter, 1 x cable 4 m, 1 x software CD
8KB 863 322-001	1	eNF cable for handset, 1 m
8KB 863 322-011	1	3 m
8KB 863 323-001	1	eNF cable for FuG 7/8, 1 m
8KB 863 323-011	1	3 m
8KB 863 325-001	1	eNF cable for Teldux FuG 9, 1,5 m
8KB 863 324-001	1	eNF cable for microphone, 1 m
8KB 863 119-001	1	Standard vehicle wiring harness, 4 m
8KB 863 119-011	1	Standard vehicle wiring harness including pre-equipped public address system (NF), 4 m
8KB 863 119-031	1	Standard vehicle wiring harness and light/acoustic module (ZSE L), 4 m
8KB 863 119-041	1	Standard vehicle wiring harness including pre-equipped public address system (NF) and light acoustic module (ZSE L), 4 m Wiring harnesses for CAN available on request.

Rotating Beacon and Siren Combinations

Accessories for RTK-QS








	<p>Part no.</p> <p>9MM 862 358-801</p> <p>8HG 854 516-001</p> <p>8KB 862 689-001</p>	<p>Pk.</p> <p>1</p> <p>4</p> <p>1</p>	<p>Microphones</p> <p>With ON/OFF switch, 0.5 m spiral lead, plug and volume control including holder</p> <p>Rod-type microphone</p> <p>Spare parts: Holder</p> <p>Accessories: Adapter lead, 1 m</p>
	<p>9MM 859 358-801</p> <p>8KB 862 689-001</p>	<p>1</p> <p>1</p>	<p>Hand-held microphone with holder and 0,5 m lead</p> <p>Accessories: Adapter lead, 1 m</p>
	<p>9GD 864 285-001</p> <p>9GD 864 286-001</p> <p>9GD 864 286-011</p> <p>9GD 864 286-021</p>	<p>1</p> <p>1</p> <p>1</p> <p>1</p>	<p>Rubber bases</p> <p>For RTK-QS 1100 mm, flat</p> <p>wedge-shaped</p> <p>For RTK-QS 1400 mm, wedge-shaped</p> <p>For RTK-QS 1600 mm, wedge-shaped</p>
	<p>9GD 863 122-001</p>	<p>1</p>	<p>Installation kit</p> <p>For RTK-QS 1400 mm - 2200 mm.</p> <p>Installation kit</p>
	<p>9AB 864 273-001</p> <p>9AB 864 273-011</p>	<p>1</p> <p>1</p>	<p>Trim panels</p> <p>Trim panel, black with white lettering 'FEUERWEHR'</p> <p>with white lettering 'NOTARZT'</p>

	Part no.	Pk.	Sound Warning System For concealed installation in cars, trucks and motorcycles.
		RTK-VE The unit can easily be combined with all Hella KL, KLX and OWS. Technical data - power unit ZSE-VE: Rated voltage: 12V. Operating voltage: 9V - 16V. Operating temperature: -40 °C to +85 °C. Total power consumption: max. 20A. Acoustic pressure level: >/- 112 dB at distance of 3.5 m. Frequency, city signal: 410Hz low, 547Hz high. Frequency, country signal: 362Hz low, 483Hz high. Other frequencies are programmed for specific countries. Control of the tone sequence and rotating beacons is accomplished over separate individual switches or alarm pull/rotary switches. Type of protection loudspeaker: resistant to high pressure cleaning. Type of protection ZSE-VE: dustproof and splash-waterproof with heightened pressure. Contents: 1 control unit 12V ZSE-VE 1 mounting kit and installation instructions e1 21772	
 	3SL 008 604-821 9MM 863 164-011 8KB 863 514-001 8KB 862 346-001 8KB 862 346-011 9XB 167 882-001	1 1 1 1 1 1	Signal-warning set, 12V To be ordered separately: Loudspeaker (2 off required, max. 3) Loudspeaker cable (1 cable required per loudspeaker) 6 m, unshielded, for self-assembly 2 m, shielded, pre-assembled 4 m, shielded, pre-assembled Cable adapter for 8KB 862 346-001/-011
 <p style="text-align: center;">eNF</p>	9SX 008 902-021 8KB 864 105-801 9SX 863 114-001 8HG 863 383-001	1 1 1 1	Control unit eAZD control unit with 300 mm lead Accessories: Extension cable set Contents: 2 cables, each 3.5 m long eNF switching unit Installation frame (DIN) shaft for installation of eAZD and eNF (delivered with eNF blind cover) See RTK 5 for technical data and details.
	6ZE 001 759-051 6ZE 001 759-071	1 1	Push-pull-rotary alarm switches as an alternative to the control unit Alarm switch with 4 switch positions for police with 3 switch positions for rescue and fire brigade See RTK 5 for technical data and details. As an alternative Hella switches in the Electrics catalogue

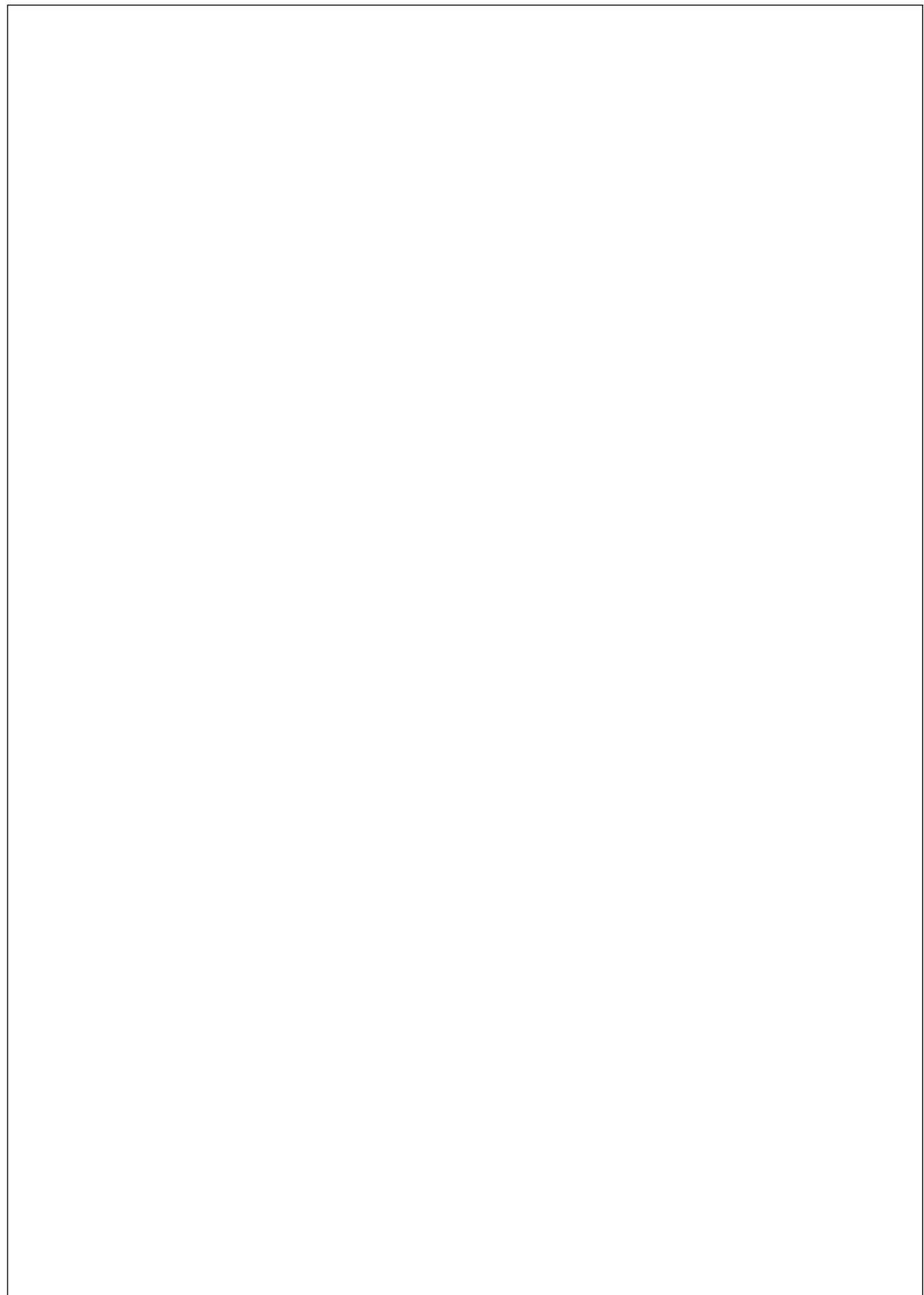
Sound Warning System RTK-VE

for police, rescue and fire brigade



	Part no.	Pk.	Option Sprachdurchsage
	9MM 862 358-801	1	<p>With ON/OFF switch, holder, 0.5 m spiral lead, plug and volume control including holder.</p> <p>Rod-type microphone</p>
	8HG 854 516-001	1	<p>Spare parts: Holder</p>
	8KB 862 689-001	1	<p>Accessories: Adapter lead, 1 m</p>
	9MK 860 255-001	1	<p>Device socket</p>
	9MM 859 358-801	1	<p>Hand-held microphone with holder and 0,5 m lead</p>
	8KB 862 689-001	1	<p>Accessories: Adapter lead, 1 m</p>
	9MK 860 255-001	1	<p>Device socket</p>
	9SX 863 114-001	1	<p>Public address option and radio or recorder override</p> <p>eNF switching unit</p> <p>See RTK 5 for technical data and details.</p>
	3AG 003 399-081	1	<p>Acoustic components for basic requirements</p> <p>B 133 Black metal body, with blade terminal contacts, Bracket on horn for M10 fixing screw. Teflon seal protects against damp.</p> <p>Sound pressure level 2 m away: 118 dB(A).</p> <p>Comprises: 2 supertone horns 375/500 Hz</p> <p>B 08 (12V) B 09 (24V)</p> <p>Supertone horn-set, 12V, power consumption: 80W per horn</p>
	3AG 003 399-101	1	<p>24V, power consumption: 84W per horn</p>
	5AB 005 944-001	1	<p>Tone sequence control module, 12V</p>
	5AB 005 944-011	1	<p>24V</p>

	Part no.	Pk.	Rotating- and flashing beacons
	2RL 008 364-021	1	Rotating beacon KL 5000 M Description see page 6.06
	2RL 008 366-021 2RL 008 366-031	1 1	Flashing beacon KLX 5000 M with Lemo plug Description see page 6.11
	8JB 004 777-001	5	2-pole socket For flush mounting, with cover DIN ISO 4165. Mounting aperture 18.5 mm. For dashboards up to 7 mm. Max. load: 8A at 12V. 2-pole socket with 2 blade terminal contacts 6.3 mm
	8XS 008 633-001	1	Crimping pliers case





SEG IV C, spare parts and accessories

7.02

SEG IV DLX, DL, D, spare parts and accessories

7.03

SEG IV AL, A, spare parts and accessories

7.04

SEG-Economy D and spare parts

7.05



Spare parts for SEG III

7.05

	<p>Part no.</p> <p>8PA 007 732-123</p> <p>8XT 861 234-023</p> <p>8PV 861 112-011</p> <p>9EV 861 038-001</p> <p>9ST 861 074-001</p> <p>9SG 855 498-001</p> <p>9SG 855 454-011</p> <p>8XT 861 234-023</p> <p>9XD 857 744-001</p> <p>9XS 862 004-001</p>	<p>Pk.</p> <p>1</p> <p>1</p> <p>1</p> <p>1</p> <p>1</p> <p>5</p> <p>1</p> <p>1</p> <p>1</p> <p>1</p>	<p>Beamsetters for testing all types of headlights systems</p> <p>SEG IV C The beamsetter is microprocessor-controlled. The headlight settings are checked and evaluated with the aid of a camera. The settings are made on the device using the operating panel with LCD display, where the light values of the headlights are also shown. An optical and acoustic setting mode makes adjustment at the vehicle headlight easier. Alignment of the beamsetter box to the vehicle's longitudinal axis is by means of a laser sight. Headlights installed at heights between 250 mm and 1450 mm can be checked using the beamsetter.</p> <p>SEG IV C Contents: beamsetter box, laser sight and wheel-mounted base</p> <p>Column (to be ordered separately)</p> <p>Spare parts: Laser sight Window for console Button Handwheel for sight holder Handwheel for fixing the column in place Column Clamp for column Set of wheels (3 pieces)</p> <p>Further spare parts are available. Replacement requires readjustment of the beamsetter. This is carried out by a specially equipped Hella agency or wholesaler.</p>



Part no.	Pk.	Beamsetters for testing all types of headlights systems
		<p>SEG IV DLX With digital luxmeter. The laser positioning aid makes precise alignment of the beamsetter box to the headlight possible. This means that bulbs can be sighted directly, particularly for free-form headlights. Eccentric axle and spirit level to compensate uneven surfaces. With a deflection mirror to enable the test monitor to be seen from behind.</p>
8PA 007 732-083	1	<p>SEG IV DLX Contents: beamsetter box, broad-band sight and wheel-mounted base</p>
8XT 861 234-003	1	<p>Column (to be ordered separately)</p>
8PA 007 732-093	1	<p>Same as SEG IV DLX, but without eccentric axle and spirit level</p> <p>SEG IV DL Contents: beamsetter box, broad-band sight and wheel-mounted base</p>
8XT 861 234-003	1	<p>Column (to be ordered separately)</p>
8PA 007 732-103	1	<p>Same as SEG IV DLX, but without eccentric axle, spirit level and laser positioning aid</p> <p>SEG IV D Contents: beamsetter box, broad-band sight and wheel-mounted base</p>
8XT 861 234-003	1	<p>Column (to be ordered separately)</p>
8PL 863 005-001	1	<p>Spare parts: Luxmeter</p>
9ST 863 241-001	1	<p>Switch for luxmeter</p>
9EV 861 038-001	1	<p>Window for console</p>
9ST 861 074-001	1	<p>Button</p>
8PV 861 112-001	1	<p>Broad-band sight without holder</p>
9SG 855 498-001	1	<p>Handwheel for sight holder</p>
9SG 855 454-011	5	<p>Handwheel for fixing the column in place</p>
8XT 861 234-001	1	<p>Column</p>
9XD 857 744-001	1	<p>Clamp for column</p>
9XS 862 004-001	1	<p>Set of wheels (3 pieces)</p>
9XS 861 127-051	1	<p>Red cover, with deflection mirror and attachment material</p>
8PV 861 112-011	1	<p>Accessories: Laser sight</p>
		<p>Further spare parts are available. Replacement requires readjustment of the beamsetter. This is carried out by a specially equipped Hella agency or wholesaler.</p>

	Part no.	Pk.	Beamsetters
			<p>SEG IV AL With analogue display and deflection mirror to enable the test monitor to be seen from behind. The laser positioning aid makes precise alignment of the beamsetter box to the headlight possible. This means that bulbs can be sighted directly, particularly for free-form headlights.</p>
	8PA 007 732-003	1	<p>SEG IV AL Contents: beamsetter box, broad-band sight and wheel-mounted base</p>
	8XT 861 234-003	1	<p>Column (to be ordered separately)</p>
			<p>Same as SEG IV AL, but without laser positioning aid.</p>
	8PA 007 732-013	1	<p>SEG IV A Contents: beamsetter box, broad-band sight and wheel-mounted base</p>
	8XT 861 234-003	1	<p>Column (to be ordered separately)</p>
	8PL 861 660-001	1	<p>Spare parts: Lux-/Voltmeter</p>
	9EV 861 038-001	1	Window for console
	9ST 861 074-001	1	Button
	8PV 861 112-001	1	Broad-band sight without holder
9SG 855 498-001	1	Handwheel for sight holder	
9SG 855 454-011	5	Handwheel for fixing the column in place	
8XT 861 234-001	1	Column	
9XD 857 744-001	1	Clamp for column	
9XS 862 004-001	1	Set of wheels (3 pieces)	
9XS 861 127-051	1	Red cover, with deflection mirror and attachment material	
		<p>Accessories: Laser sight</p>	
8PV 861 112-011	1	<p>Further spare parts are available. Replacement requires readjustment of the beamsetter. This is carried out by a specially equipped Hella agency or wholesaler.</p>	
	8PD 860 755-001	1	<p>Accessories: Adjusting device Adjusting device for all beamsetters.</p> <p>Adjusting device</p>
	9XS 861 736-001	1	<p>Rail kit for SEG IV For workshops with a large vehicle volume, it makes sense to mount the beamsetter on rails. The recommended rail length is min. 3 m.</p> <p>Rail kit, 1,5 m with fixing materials</p>
	8XS 002 500-011	1	<p>Protective hood Protects beamsetter from dust, dirt and moisture when not in use.</p> <p>Protective hood</p>

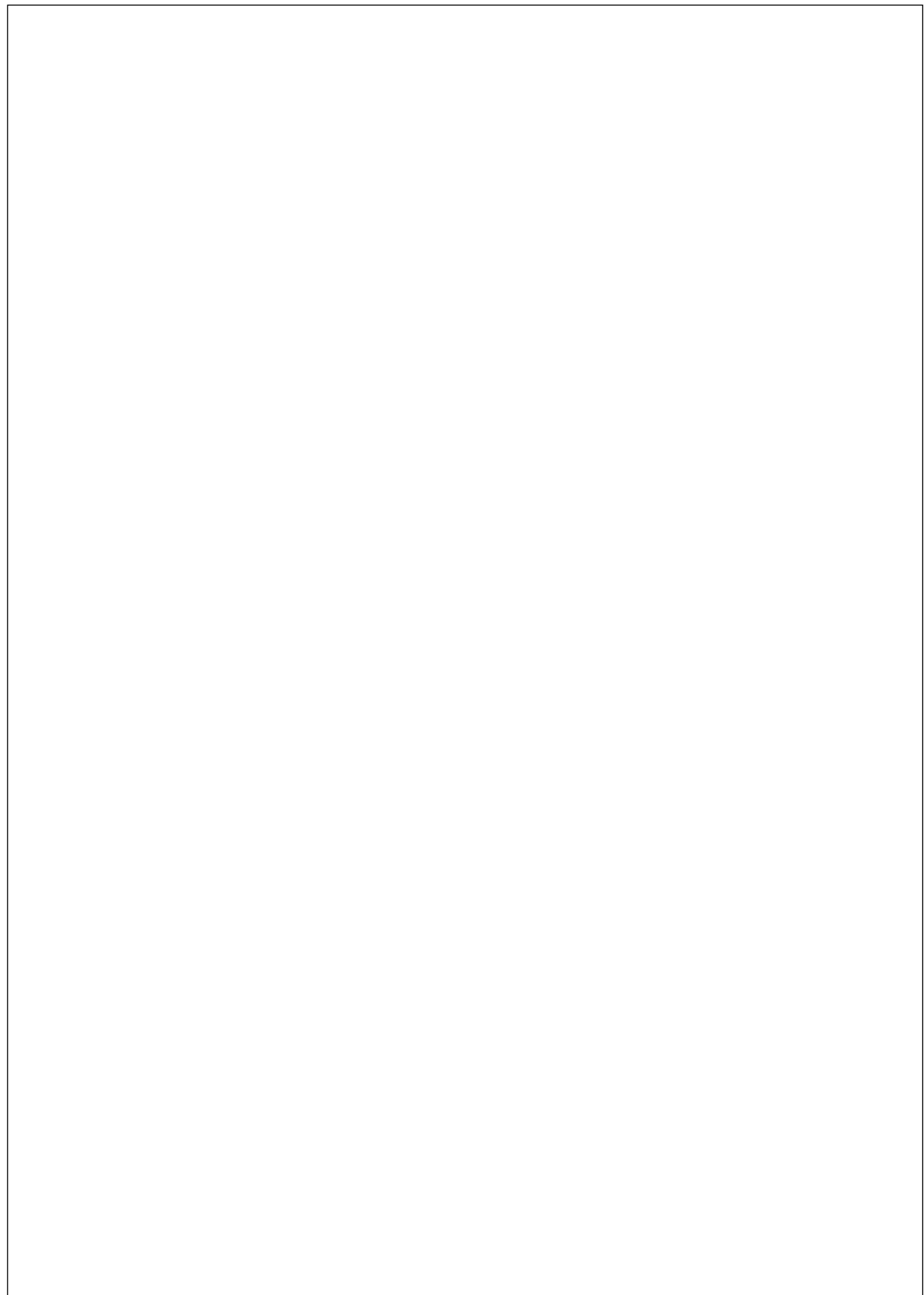
	Part no.	Pk.	Beamsetters
			Economy With wheel-mounted base, broad-band sight and luxmeter. Red beamsetter box.
	8PA 006 796-031	1	SEG-Economy D with digital display
	8PA 006 796-041	1	with silver beamsetter box and sight and base painted in an anthracite colour.
	9EV 859 051-011	1	Spare parts: Window for console ->04/06 Further spare parts are available. Replacement requires readjustment of the beamsetter. This is carried out by a specially equipped Hella agency or wholesaler.

Spare parts for old-type beamsetters

SEG III

Part no.	Pk.	Description	Part no.	Pk.	Description
9SG 855 454-011	5	Handwheel for fixing the column in place	9EL 857 597-001	1	Fresnel lens *)
8XT 857 740-001	1	Column	9EV 857 067-011	1	Protective glass cover for fresnel lens *)
9XD 857 744-001	1	Clamp for column	9XS 857 588-001	1	Column guide *)
8PV 855 390-001	1	Broad-band sight *)	8PL 859 418-001	1	Luxmeter with test screen *)
9SG 855 498-001	1	Handwheel for sight holder	9XS 854 769-001	1	Set of wheels for wheel-mounted base
9EV 855 455-001	1	Window for console	9XS 855 646-001	1	Set of wheels for rail-mounted base
9ST 855 447-001	1	Button for beamsetter box brake			
9XD 857 579-001	10	Clamp for beamsetter box brake			
9XS 857 585-001	10	Clamp with axle for beamsetter box brake			

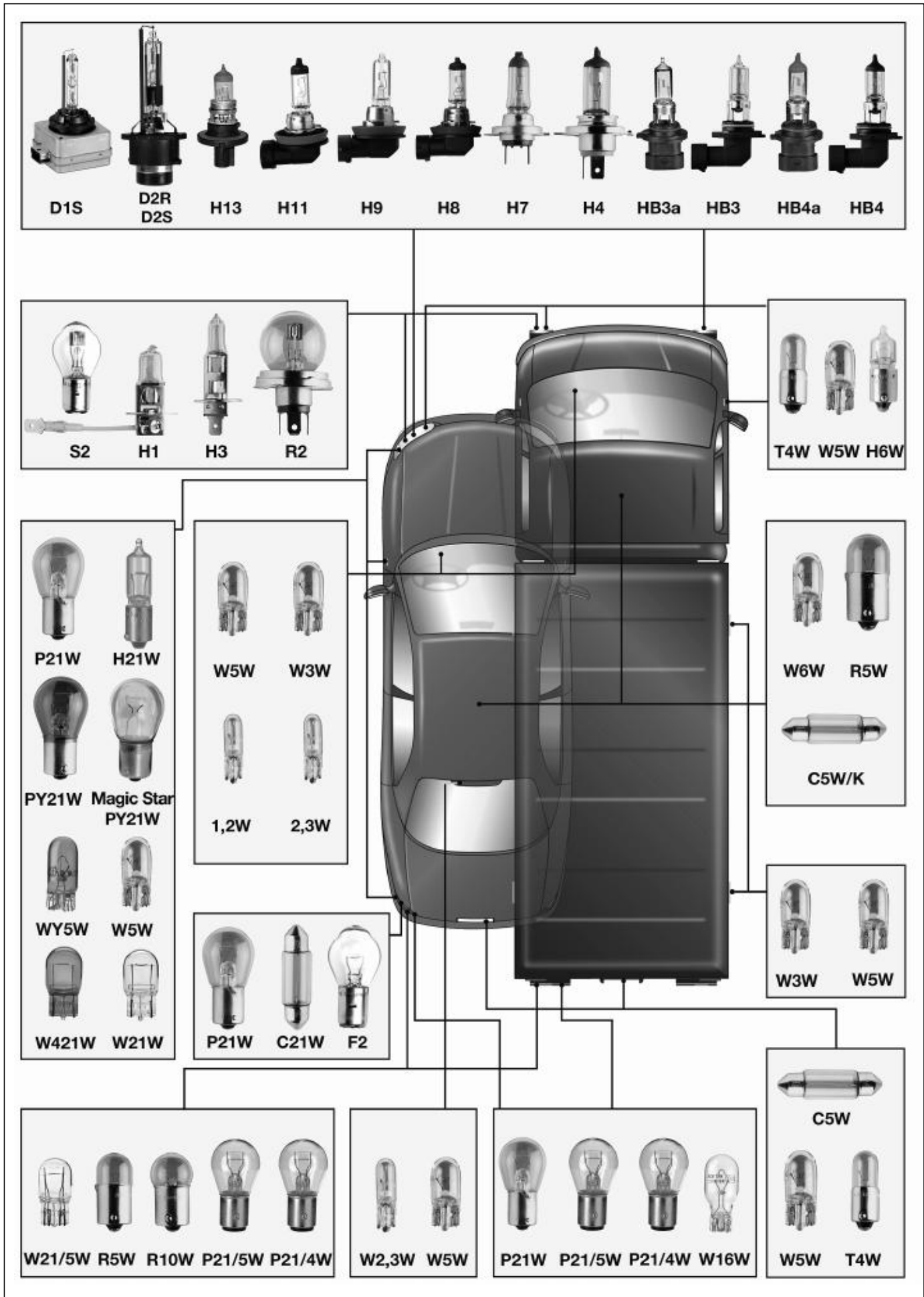
*) Replacement of these spare parts requires readjustment of the beamsetter. This is carried out by a specially equipped Hella agency or wholesaler.





Bulb overview	8.02
Hella bulb no. - UK bulb no.	8.03
Bulb sets	8.04-8.06
Assortments of bulbs for garages	8.07
Bulbs for headlights	8.08-8.12
Bulbs for signal lights	8.13-8.19
Bulb with glass socket	8.19
Bulbs with plastic sockets for dashboard and interior lighting	8.19-8.22
Bulb holders	8.23
Connectors	8.23
Explanations	
<p>+ 50 = up to 50% more light. Better detection of hazards and obstacles</p> <p>Blue Light = Xenon-look bulbs</p> <p>Yellow Light = Lower subjective self-glare in rain, snow and fog</p> <p>Double Power = Service life increased by up to 100%. For commercial vehicles</p> <p>Heavy Duty = Particularly resistant to blows and vibrations</p> <p>Long Life = Service life increased by up to 100%</p>	






Bulb overview for Cars and Trucks












Hella Bulb no. - UK Bulb no. Cross-Reference

8GA 002 071-121	HB207	8GH 002 857-121	HB479
8GA 002 071-131	HB245	8GH 002 857-241	HB482
8GA 002 071-241	HB149	8GH 005 635-121	HB3
8GA 002 071-251	HB246	8GH 005 635-181	-
8GA 002 071-261	HB248	8GH 005 636-121	HB4
8GA 002 071-271	-	8GH 007 157-121	HB7
8GA 002 071-341	-	8GH 007 157-181	HB7B
8GA 002 071-351	-	8GH 007 157-201	-
8GA 002 071-361	HB150	8GH 007 157-231	-
8GA 002 072-121	-	8GH 007 157-241	HB17
8GA 002 072-241	-	8GH 007 157-471	-
8GA 002 073-121	HB382	8GH 007 157-801	-
8GA 002 073-241	HB241	8GH 007 643-121	HB434
8GA 002 073-251	HB290	8GH 007 643-171	-
8GA 002 073-271	-	8GH 008 356-121	HB708
8GA 002 074-121	-	8GH 008 357-001	HB709
8GA 002 074-241	HB623	8GH 008 358-121	HB711
8GA 002 083-131	-	8GH 008 358-251	-
8GA 002 083-251	-	8GH 008 417-001	-
8GA 006 841-121	HB8381	8GH 008 417-012	-
8GA 006 841-241	HB290A	8GJ 002 525-001	HB472H
8GA 006 841-251	-	8GJ 002 525-131	HB472
8GA 006 841-801	-	8GJ 002 525-251	HB475
8GA 007 997-001	-	8GJ 002 525-281	-
8GA 007 997-011	-	8GJ 002 525-301	HB472HD
8GA 007 997-021	-	8GJ 002 525-361	HB472B
8GA 007 997-031	HB286T	8GJ 002 525-471	-
8GA 007 997-041	-	8GJ 002 525-481	-
8GA 007 997-051	HB2730	8GJ 002 525-511	-
8GA 007 997-061	-	8GJ 002 525-801	-
8GA 007 997-071	HB508T	8GJ 002 525-821	-
8GA 007 997-081	-	8GJ 003 133-242	HB024
8GA 007 997-091	-	8GJ 004 173-121	HB012
8GA 007 997-101	-	8GM 002 091-121	HB270
8GA 007 997-111	HB64124	8GM 002 091-131	HB264
8GA 007 997-121	-	8GM 002 091-141	-
8GA 007 997-131	-	8GM 002 091-181	HB273
8GA 007 997-141	-	8GM 002 091-241	HB276
8GA 007 997-151	-	8GM 002 091-251	HB274
8GA 007 997-161	-	8GM 002 091-261	-
8GA 007 997-171	-	8GM 002 092-121	HB239
8GA 007 997-181	-	8GM 002 092-171	-
8GA 007 997-191	-	8GM 002 092-241	HB242
8GA 007 997-201	-	8GM 002 094-121	HB202
8GA 007 997-211	-	8GM 002 094-241	HB1202
8GA 007 997-221	-	8GP 002 066-121	HB281
8GA 007 997-231	-	8GP 002 066-241	HB283
8GA 007 997-241	-	8GP 002 067-011	-
8GA 007 997-251	-	8GP 002 067-061	HB293
8GA 007 997-261	-	8GP 002 067-121	HB233
8GA 007 997-272	-	8GP 002 067-241	HB249
8GA 008 246-001	-	8GP 002 067-261	-
8GA 008 892-002	HB582	8GP 002 067-831	-
8GA 008 899-061	-	8GP 002 068-121	HB288
8GA 008 901-241	-	8GP 002 068-131	-
8GD 002 078-011	-	8GP 002 068-241	HB289
8GD 002 078-121	HB380	8GP 002 095-121	HB286
8GD 002 078-221	-	8GP 002 095-241	HB509
8GD 002 078-241	HB294	8GP 002 096-061	-
8GD 002 084-131	HB395	8GP 003 594-002	-
8GD 002 084-151	-	8GP 003 594-121	HB501
8GD 002 084-251	HB398	8GP 003 594-141	HB504
8GD 002 088-071	-	8GP 003 594-241	HB505
8GD 002 088-131	HB410	8GP 003 594-251	HB507
8GD 002 088-251	HB429	8GP 003 594-261	-
8GD 004 772-121	HB566	8GP 003 594-541	HB501A
8GD 004 772-151	-	8GP 007 676-121	-
8GD 008 893-002	HB580	8GP 008 285-001	-
8GD 008 897-061	-	8GP 009 021-002	-
8GD 008 897-121	-	8GP 938 026-001	-
8GD 008 898-061	-	8GS 002 296-101	-
8GD 008 899-121	-	8GS 002 296-111	-
8GH 002 089-133	HB448UV	8GS 002 383-001	-
8GH 002 089-141	HB448B	8GS 006 677-121	-
8GH 002 089-251	HB466	8GS 007 001-121	-
8GH 002 089-351	-	8GS 007 949-101	-
8GH 002 089-361	-	8GS 009 028-001	-
8GH 002 089-471	-	8GS 859 634-001	-
8GH 002 089-491	-	8GS 861 953-011	-
8GH 002 089-801	-	8GS 861 955-001	-
8GH 002 090-133	HB453	8GS 861 955-011	-
8GH 002 090-251	HB460	8GS 861 955-021	-
8GH 002 090-271	-	8GS 861 955-031	-
8GH 002 090-371	HB453B	8GS 863 261-001	-
8GH 002 090-471	-	8XS 002 525-961	-
8GH 002 473-132	HB433	8XS 007 157-911	-
8GH 002 473-151	HB431		


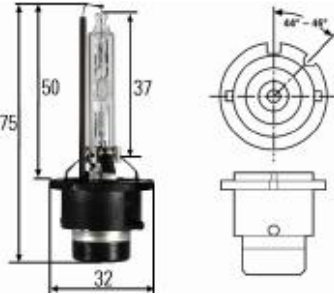



	Part no.	Pk.	Bulb sets
	8GH 007 157-901	1	<p>For 12V vehicles with H7 lighting.</p> <p>Contains: 1 each of 12V55W (H7) 12V21/5W (P21/5W) 12V21/4W (P21/4W) 12V21W (P21W) 12V21W (PY21W) 12V5W (R5W) 12V5W (W5W) 12V5W (C5W)</p> <p>Blade-type fuses 10A, 15A and 30A</p>
	8GH 007 157-913	1	<p>H7 bulb set, 12V</p> <hr/> <p>Contains: 1 each of 12V55W (H7) 12V21/5W (P21/5W) 12V21W (P21W) 12V5W (R5W) 12V5W (W5W) 12V5W (C5W)</p> <p>Blade-type fuses 10A, 15A and 30A</p>
	8GH 007 157-941	1	<p>H7 Mini bulb set, 12V</p> <hr/> <p>Contains: 1 each of 12V55W (H7) 12V21W (P21W) 12V5W (R5W) 12V4W (T4W)</p> <p>Blade-type fuses 10A, 15A and 30A</p>
	8GH 007 157-931	1	<p>For 12V vehicles with H7 lighting.</p> <p>Contains: 2 each of 24V70W (H7) 24V21/5W (P21/5W) 24V21W (P21W) 24V10W (R10W) 24V5W (W5W) 24V5W (C5W)</p> <p>2 each of blade-type fuses 10A, 15A and 30A</p>
	8GH 007 157-921	1	<p>For 12V vehicles with H7/HB3 lighting.</p> <p>Contains: 1 each of 12V55W (H7) 12V60W (HB3) 12V21/5W (P21/5W) 12V21W (P21W) 12V21W (PY21W) 12V5W (R5W) 12V5W (W5W) 12V5W (C5W)</p> <p>Blade-type fuses 10A, 15A and 30A</p>

Part no.	Pk.	Bulb sets
	1	<p>Bulb sets</p> <p>For 12V vehicles with H7/H1 lighting.</p> <p>Contains: 1 each of 12V55W (H7) 12V55W (H1) 12V21W (P21W) 12V21W (PY21W) 12V5W (R5W) 12V5W (W5W) 12V5W (C5W) Blade-type fuses 10A, 15A and 30A</p>
	1	<p>For 12V vehicles with H4 lighting.</p> <p>Contains: 1 each of 12V60/55W (H4) 12V21/5W (P21/5W) 12V21W (P21W) 12V5W (R5W) 12V4W (T4W) Blade-type fuses 10A, 15A and 30A</p>
	1	<p>Contains: 1 each of 12V60/55W (H4) 12V21W (P21W) 12V5W (R5W) 12V4W (T4W) Blade-type fuses 10A, 15A and 30A</p>
	1	<p>For 24V vehicles with H4 lighting.</p> <p>Contains: 2 each of 24V75/70W (H4) 24V21/5W (P21/5W) 24V21W (P21W) 24V10W (R10W) 24V5W (C5W) 24V4W (T4W) 2 each of blade-type fuses 10A, 15A and 30A</p>

	Part no.	Pk.	Bulb sets
	8GH 002 089-921	1	<p>For 12V vehicles with H1 light.</p> <p>Contains: 1 each of 12V55W (H1) 12V21/5W (P21/5W) 12V21W (P21W) 12V5W (R5W) 12V5W (C5W) 12V4W (T4W)</p> <p>Blade-type fuses 10A, 15A and 30A</p>
	8GH 002 089-941	1	<p>H1 bulb set, 12V</p> <hr/> <p>Contains: 1 each of 12V55W (H1) 12V21W (P21W) 12V5W (R5W) 12V4W (T4W)</p> <p>Blade-type fuses 10A, 15A and 30A</p>
	8GH 002 089-931	1	<p>For 24V vehicles with H1 light.</p> <p>Contains: 2 each of 24V70W (H1) 24V21/5W (P21/5W) 24V21W (P21W) 24V10W (R10W) 24V5W (C5W) 24V4W (T4W)</p> <p>2 each of blade-type fuses 10A, 15A and 30A</p>

Part no.	Pk.	Assortments of bulbs for garages
8GA 007 997-901	1	<p>For cockpit-dashboards and interior lighting</p> <p>Contains: 10 each of 8GA 007 997-101, B 10d, 12V3W 8GA 007 997-111, B 10d, 12V5W 8GA 007 997-121, BX 8.4d, 12V1.2W 8GA 007 997-041, B 8.3d, 12V1.2W 8GA 007 997-001, B 8.3d, 12V2W 8GA 007 997-141, BX 8.4d, 12V1.5W 8GA 007 997-031, B 8.5d, 12V1.2W 8GA 007 997-081, B 8.5d, 12V2W 8GA 007 997-051, BX 8.7d, 12V1.2W 8GA 007 997-091, BX 8.7d, 12V2W</p>
		<p>Assortment of bulbs for garages 1, 12V</p> <hr/> <p>Contains: 10 each of 8GA 007 997-131, BX 8.4d, 12V1.3W 8GS 006 677-121, BX 8.5d, 12V2W 8GA 007 997-171, BX 8.4d, 12V1.2W 8GA 007 997-151, BX 8.5d, 12V0.36W 8GA 007 997-161, B 8.5d, 12V1.5W 8GA 007 997-211, BX 8.5d, 12V1.2W 8GA 007 997-221, BX 8.5d, 12V2W 8GA 007 997-231, BG 8.5 - 5.5d, 12V1.2W 8GA 007 997-241, BG 8 - 5.5d, 12V1.2W 8GA 007 997-251, B 8.5 S - 4d, 12V1.2W</p>
		<p>Assortment of bulbs for garages 2, 12V</p> <hr/> <p>Contains: 10 each of 8GP 002 095-241, W 2x4.6d, 24V1.2W (W5/1.2) 8GA 007 997-181, W 2x4.6d, 24V2W 8GP 003 594-241, W 2.1x9.5d, 24V3W (W3W) 8GA 008 901-241, W 2.1x9.5d, 24V2W 8GP 003 594-251, W 2.1x9.5d, 24V5W (W5W) 8GA 007 997-061, B 8.3d, 24V1.2W 8GA 007 997-071, B 8.5d, 24V1.2W 8GA 007 997-261, BX 8.5d, 24V1.2W 8GA 007 997-191, EBS R4, 24V1.2W 8GA 007 997-201, EBS R6, 24V1.2W</p>
8GA 007 997-921	1	<p>Assortment of bulbs for garages 3, 24V</p>



	Part no.	Pk.	Part no. GB	Bulbs for headlights
	8GS 009 028-001	1	-	Gas discharge bulb for headlights, driving lights and work lights D1S, bulb cap PK 32 d-2, 12/24V35W
	8GS 007 949-101	1	-	Gas discharge bulb for headlights, driving lights and work lights D2S, bulb cap P 32 d-2, 12/24V35W
	8GS 007 001-121	1	-	Gas discharge bulb for headlights D2R, bulb cap P 32 d-3, 12/24V35W
	8GJ 008 837-121	1	-	For H13 headlights (2-headlight system) H13, ECE-R 37, bulb cap P 26.4T, 12V60/55W
	8GH 008 358-121 8GH 008 358-151 8GH 008 358-181 8GH 008 358-241 8GH 008 358-251	1 1 1 1 1	HB 711 - - - -	For H11 headlights H11, ECE-R 37, bulb cap PGJ 19-2, 12V55W 12V55W H11 + 30 12V55W blue *) 24V70W 24V70W Double Power

*) Convert in pairs only

	Part no.	Pk.	Part no. GB	Bulbs for headlights
	8GH 008 357-001 8GH 008 357-151	1 1	HB 709 -	For H9-headlights and driving lights H9, ECE-R 37, bulb cap PGJ 19-5, 12V65W 12V65W H9 + 30 *)
	8GH 008 356-121 8GH 008 356-151 8GH 008 356-181	1 1 1	HB 708 - -	For H8-headlights H8, ECE-R 37, bulb cap PGJ 19-1, 12V35W 12V35W H8 + 30 *) 12V35W Blue Light *)
	8GH 007 157-121 8GH 007 157-181 8GH 007 157-201 8GH 007 157-471 8GH 007 157-531 8GH 007 157-481 8GH 007 157-801 8GH 007 157-241 8GH 007 157-231	1 1 1 1 1 1 1 1 1	HB 7 H 7B - - - - - - HB 17 -	For H7 headlights and fog lights H7, ECE-R 37, bulb cap PX 26 d, 12V55W 12V55W blue *) 12V55W Long Life 12V55W H7 + 50 *) 12V55W H7 + 90 *) 12V55W yellow 12V55W set H7 + 50 *) 24V70W 24V70W Double Power
	8GJ 002 525-131 8GJ 002 525-133 8GJ 002 525-001 8GJ 002 525-471 8GJ 002 525-531 8GJ 002 525-821 8XS 002 525-961 8GJ 002 525-361 8GJ 002 525-801 8GJ 002 525-301 8GJ 002 525-481 8GJ 002 525-341 8GJ 002 525-251 8GJ 002 525-253 8GJ 002 525-281 8GJ 002 525-511	1 1 1 1 1 1 1 1 1 1 1 1 1 1 1 1	HB 472 - HB 472H - - - - HB 472B - HB 472HD - - - HB 475 - - -	For H4 headlights H4, ECE-R 37, bulb cap P 43 t-38, 12V60/55W 12V60/55W 12V60/55W H4 + 30 Long Life *) 12V60/55W H4 + 50 *) 12V60/55W H4 + 90 *) 12V60/55W H4 + 50, set *) 12V60/55W 10 sets H4 + 50 *) 12V60/55W blue *) 12V60/55W blue, set *) 12V60/55W Heavy Duty 12V60/55W Long Life 12V60/55W yellow 24V75/70W 24V75/70W 24V75/70W Heavy Duty 24V75/70W Double Power
	8GJ 004 173-121 8GJ 003 133-242	1 1	HB 012 HB 024	H4, ECE-R 37, bulb cap P 45t, 12V60/55W 24V75/70W





*) Convert in pairs only

	Part no.	Pk.	Part no. GB	Bulbs for headlights
	8GH 005 636-201	1	-	For HB4a dipped-beam headlights HB4a, ECE-R 37, bulb cap P 22 d, 12V51W
	8GH 005 636-121	1	HB 4	For HB4 dipped-beam headlights HB4, ECE-R 37, bulb cap P 22 d, 12V51W
	8GH 005 635-161	1	-	For HB3a main-beam headlights HB3a, ECE-R 37, bulb cap P 20 d, 12V60W
	8GH 005 635-121 8GH 005 635-181	1 1	HB 3 -	For HB3 main-beam headlights HB3, ECE-R 37, bulb cap P 20 d, 12V60W 12V60W Long Life
	8GH 002 090-133 8GH 002 090-371 8GH 002 090-481 8GH 002 090-251 8GH 002 090-253 8GH 002 090-471	1 1 1 1 1 1	HB 453 HB 453B - HB 460 - -	For H3 dipped-beam headlights, driving, fog and work lights H3, ECE-R 37, bulb cap PK 22 s, 12V55W 12V55W blue light *) 12V55W yellow light 24V70W 24V70W 24V70W Double Power

*) Convert in pairs only







	Part no.	Pk.	Part no. GB	Bulbs for headlights
	8GH 002 857-121 8GH 002 857-241	1 1	HB 479 HB 482	Bulbs for headlights For H2 driving and fog lights H2, DIN 72 601, bulb cap X 511 12V55W 24V70W
	8GH 002 089-133 8GH 002 089-141 8GH 002 089-501 8GH 002 089-351 8GH 002 089-471 8GH 002 089-801 8GH 002 089-251 8GH 002 089-253 8GH 002 089-361 8GH 002 089-491	1 1 1 1 1 1 1 1 1 1	HB 448UV HB 448B - - - - HB 466 - - -	For H1 headlights, fog lights and rotating beacons H1, ECE-R 37, bulb cap P 14,5 s, 12V55W 12V55W blue light *) 12V55W yellow light 12V55W Long Life 12V55W H1 + 50 *) 12V55W set H1 + 50 *) 24V70W 24V70W 24V70W Heavy Duty 24V70W Double Power
	8GD 002 088-071 8GD 002 088-131 8GD 002 088-251	1 1 1	- HB 410 HB 429	For asymmetrical R2 headlights R2, ECE-R 37, bulb cap P 45 t-41, 6V45/40W 12V45/40W 24V55/50W
	8GD 008 897-061 8GD 008 897-121	1 1	- -	For symmetrical S1 headlights (for two wheeled vehicles) S1, ECE-R 37, bulb cap BA 20 d, 6V25/25W 12V25/25W
	8GD 008 898-061 8GD 002 084-131 8GD 002 084-151 8GD 002 084-251	1 1 1 1	- HB 395 - HB 398	For symmetrical S2 headlights S2, ECE-R 37, bulb cap BA 20 d, 6V35/35W 12V35/35W 12V45/40W 24V45/40W

*) Convert in pairs only

	Part no.	Pk.	Part no. GB	Bulbs for headlights
	<p>8GA 008 899-061 8GA 008 899-121</p>	<p>10 - 10 -</p>		<p>For S3 driving lights for two wheeled vehicles</p> <p>S3, ECE-R 37, bulb cap P 26 s, 6V15W 12V15W</p>
	<p>8GA 002 083-131 8GA 002 083-251</p>	<p>1 - 1 -</p>		<p>For F2 work lights, fog lights, rear fog lights and reversing lights</p> <p>F2, DIN 72 601, bulb cap BA 20 s, 12V35W 24V35W</p>
	<p>8GH 008 417-001 8GH 008 417-012</p>	<p>1 - 1 -</p>		<p>For indicator lights</p> <p>H21W, ECE-R 37, bulb cap BAY 9 s, 12V21W Long Life 24V21W</p>
	<p>8GP 002 067-061 8GP 002 067-121 8GP 002 067-281 8GP 002 067-011 8GP 002 067-241 8GP 002 067-261</p>	<p>10 10 10 10 10 10</p>	<p>HB 293 HB 233 - - HB 249 -</p>	<p>For side lights</p> <p>T4W, ECE-R 37, bulb cap BA 9 s, 6V4W 12V4W 12V4W Long Life 12V4W blue light *) 24V4W 24V4W Heavy Duty</p>

*) Convert in pairs only

	Part no.	Pk.	Part no. GB	Bulbs for signal lights
	8GA 002 074-121 8GA 002 074-241	1 1	- HB 623	For rotating beacons U, DIN 72 601, bulb cap BA 15 s, 12V45W 24V45W
	8GD 002 078-121 8GD 002 078-221 8GD 002 078-112 8GD 002 078-241 8GD 002 078-011	10 10 10 10 10	HB 380 - - HB 294 -	For rear-stop or rear-indicator lights P21/5W, ECE-R 37, bulb cap BAY 15 d, 12V21/5W 12V21/5W Long Life 12V21/5W Heavy Duty 24V21/5W 24V21/5W Heavy Duty
	8GD 004 772-121 8GD 004 772-151	10 10	HB 566 -	For rear and stop lights P21/4W, ECE-R 37, bulb cap BAZ 15 d, 12V21/4W 12V21/4W Long Life
	8GD 008 893-002	10	HB 580	For rear and stop lights W21/5W, bulb cap W 3 x 16 g 12V21/5W
	8GA 002 073-121 8GA 002 073-271 8GA 002 073-241 8GA 002 073-251	10 10 10 10	HB 382 - HB 241 HB 290HD	For indicator, stop, rear fog and reverse lights P21W, ECE-R 37, bulb cap BA 15 s, 12V21W 12V21W Long Life 24V21W 24V21W Heavy Duty

	Part no.	Pk.	Part no. GB	Bulbs for signal lights
	<p>8GA 006 841-121 10 8GA 006 841-801 1 8GA 006 841-241 10 8GA 006 841-251 10</p>	<p>10 1 10 10</p>	<p>HB 381 - HB 290A -</p>	<p>Bulbs for indicator lights</p> <p>For indicator lights</p> <p>PY21W, ECE-R 37, bulb cap BAU 15 s, 12V21W amber 12V21W Magic Star (2 pieces) 24V21W amber 24V21W amber Heavy Duty</p>
<p>(older types)</p> 	<p>8GA 002 072-121 10 8GA 002 072-241 10</p>	<p>10 10</p>	<p>- -</p>	<p>For indicator and stop lights</p> <p>R, DIN 72 601, bulb cap BA 15 s, 12V18W 24V18W</p>
	<p>8GA 002 071-121 10 8GA 002 071-351 10 8GA 002 071-241 10 8GA 002 071-261 10</p> <p>8GA 002 071-361 10</p>	<p>10 10 10 10</p> <p>10</p>	<p>HB 207 - HB 149 HB 248HD</p> <p>HB 150</p>	<p>For rear, license plate, side, clearance and interior lights</p> <p>R5W, ECE-R 37, bulb cap BA 15 s, 12V5W 12V5W Long Life 24V5W 24V5W Heavy Duty</p> <p>bulb cap BA 15 d, 24V5W</p>
	<p>8GA 002 071-131 10 8GA 002 071-341 10 8GA 002 071-251 10 8GA 002 071-271 10</p>	<p>10 10 10 10</p>	<p>HB 245 - HB 246 -</p>	<p>For rear, license plate, side, clearance and interior lights</p> <p>R10W, ECE-R 37, bulb cap BA 15 s, 12V10W 12V10W Long Life 24V10W 24V10W Heavy Duty</p>
	<p>8GH 002 473-132 1 8GH 002 473-151 1</p>	<p>1 1</p>	<p>- -</p>	<p>For reverse, interior and reading lights</p> <p>YL, bulb cap BA 9s, 12V20W 12V5W</p>
	<p>8GH 007 643-121 10 8GH 007 643-171 10</p>	<p>10 10</p>	<p>HB 434 -</p>	<p>For halogen side lights and daytime running lights</p> <p>H6W, ECE-R 37, bulb cap BAX 9 s, 12V6W 12V6W Long Life</p>

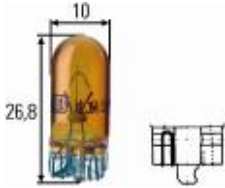

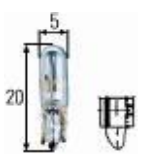
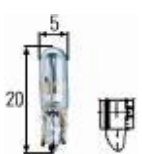


	Part no.	Pk.	Part no. GB	Bulbs for signal lights
	8GH 008 417-001 8GH 008 417-012	1 1	- -	Bulbs for signal lights For indicator lights H21W, bulb cap BAY 9 s, 12V21W 12V21W
	8GM 002 091-121 8GM 002 091-241	10 10	HB 270 HB 276	For stop and indicator lights K, DIN 72 601, bulb cap SV 8,5, 12V18W 24V18W
	8GM 002 092-121 8GM 002 092-171 8GM 002 092-241	10 10 10	HB 239 - HB 242	For rear, licence plate, side, clearance and interior lights C5W, ECE-R 37, bulb cap SV 8,5, 12V5W 12V5W Long Life 24V5W
	8GM 002 091-131 8GM 002 091-251	10 10	HB 264 HB 274	For signal and sundry lights K, DIN 72 601, bulb cap SV 8,5, 12V10W 24V10W
	(older types) 8GM 002 091-141 8GM 002 091-261 8GM 002 091-121	10 10 10	- - -	For reverse lights Bulb cap SV 8,5, 12V15W 24V15W 12V18W
	8GM 002 091-181	10	HB 273	C21W, ECE-R 37, bulb cap SV 8,5, 12V21W


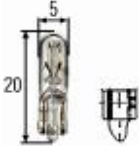





	Part no.	Pk.	Part no. GB	Bulbs for signal lights
	8GM 002 094-121 8GM 002 094-241	10 10	HB 202 HB 1202	Bulbs for signal lights For signal and sundry lights M, bulb cap SV 7-8, 12V3W 24V3W
	8GP 002 067-061 8GP 002 067-121 8GP 002 067-281 8GP 002 067-011 8GP 002 067-241 8GP 002 067-261	10 10 10 10 10 10	HB 293 HB 233 - - HB 249 -	For interior and reading lights T4W, ECE-R 37, bulb cap BA 9 s, 6V4W 12V4W 12V4W Long Life 12V4W blue light *) 24V4W 24V4W Heavy Duty
	8GP 007 676-121	10	-	For interior and reading lights Xenon, T6W, ECE-R37, bulb cap BA 9 s, 12V6W
	8GP 008 285-001	1	-	For reading lights and hand lamps Xenon, bulb cap BA 9 s, 24V7,5W
	8GP 002 068-121 8GP 002 068-131 8GP 002 068-241	10 10 10	HB 288 - HB 289	For interior lights and dashboard lighting H, (T2W/T3W) DIN 49 715, bulb cap BA 9 s, 12V2W 12V3W 24V2W










*) Convert in pairs only

	Part no.	Pk.	Part no. GB	Bulbs for signal lights
	8GP 002 096-061	10	-	For hazard warning flasher lights B2,4W, DIN 49 848, bulb cap EP 10, 6V2,4W
	8GP 002 066-121	10	HB 281	For warning lights and switches J, DIN 72 601, bulb cap BA 7 s, 12V2W 24V3W
8GP 002 066-241	10	HB 283		
	8GA 008 246-001	10	-	For side lights W16W, ECE-R 37, bulb cap W 2,1 x 9,5 d, 12V16W
	8GA 008 892-002	10	HB 582	For stop lights W21W, ECE-R 37, bulb cap W 3 x 16 d, 12V21W
	8GP 003 594-141	10	HB 504	For side lights and numberplate lights W3W, ECE-R37, bulb cap W 2,1 x 9,5 d, 12V3W 24V3W
8GP 003 594-241	10	HB 505		
	8GP 003 594-121	10	HB 501	W5W, ECE-R 37, bulb cap W 2,1 x 9,5 d, 12V5W 12V5W blue light *) 24V5W
8GP 003 594-261	1	-		
8GP 003 594-251	10	HB 507		
	8GP 003 594-002	10	-	W6W, bulb cap W 2,1 x 9,5 d, 12V6W
	8GA 008 901-241	10	-	For dashboard lighting Bulb cap W 2,1 x 9,5 d, 24V2W







*) Convert in pairs only


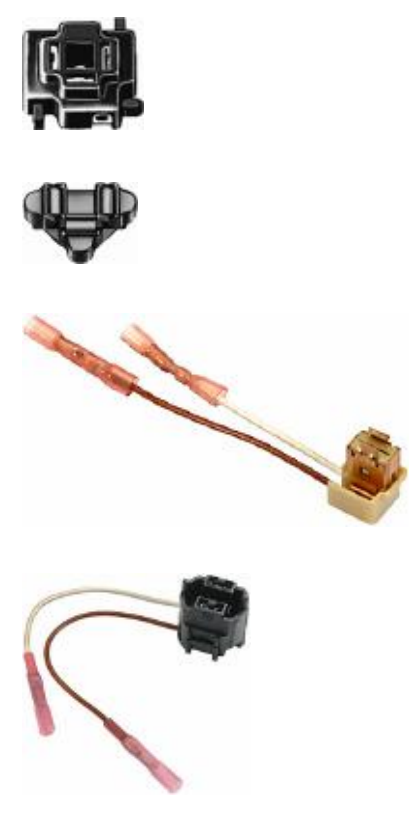
	Part no.	Pk.	Part no. GB	Bulbs for signal lights
	8GP 003 594-541	10	HB 501A	For side lights WY5W, ECE-R 37, bulb cap W 2,1 x 9,5 d, 12V5W amber
	8GP 009 021-002	10	-	For indicator lights WY21W, ECE-R 37, bulb cap W 3 x 16 d, 12V21W amber
	8GP 002 095-121 8GP 002 095-241	10 10	HB 286 HB 509	For warning lights and switches W1,2W, DIN 72 601, bulb cap W 2 x 4,6 d, 12V1,2W 24V1,2W
	8GP 938 026-001	10	-	For safety brake lights W2,3W, ECE-R 37, bulb cap W 2 x 4,6 d, 12V2,3W
	8GS 002 296-111 8GS 002 296-101	1 1	- -	Fluorescent tubes For ceiling lights TL, bulb cap G5/11x15 Light flux 450 lm, 4000 Kelvin, 8W, Light colour 25, cold white Light flux > 300 lm, 2950 Kelvin, 8W, Light colour 32, soft glow
	8GS 861 953-011	1	-	For ceiling lights TL, bulb cap G5/11x15, Light flux 850 lm, 3450 Kelvin, 13W, Light colour 35, white

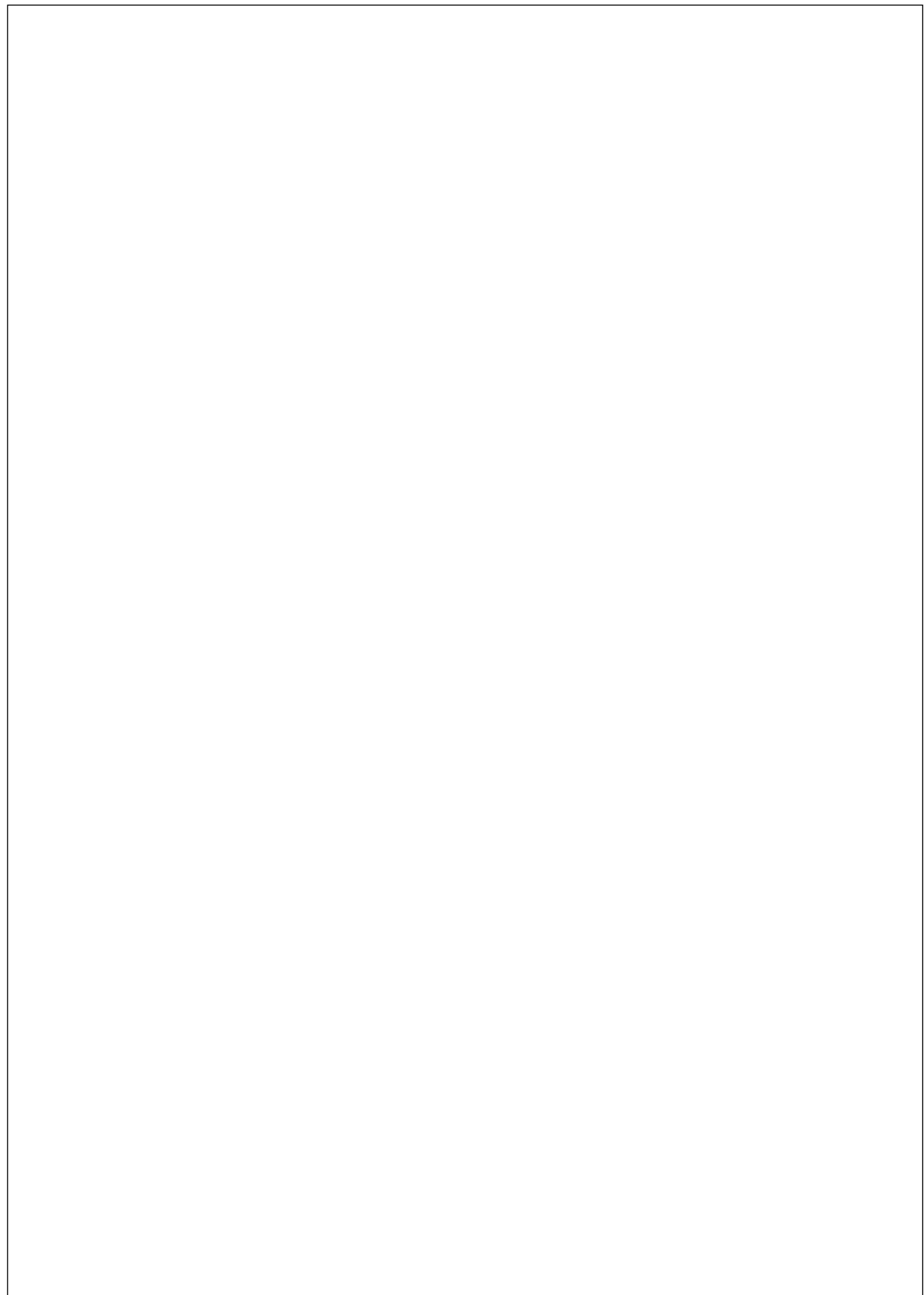
	Part no.	Pk.	Part no. GB	Bulbs for signal lights Fluorescent tubes For interior lights PL, bulb cap 2G7, 12V/24V7W, 4000Kelvin, cold white, 113 mm, 12V/24V9W, 4000 Kelvin, cold white, 144 mm 12V/24V11W, 4000 Kelvin, cold white, 212 mm 12V/24V11W, 2700 Kelvin, cold white, 212 mm
	8GS 861 955-001	1	-	Bulb with glass cap For dashboard lighting Bulb cap W 2 x 4,6 d, 24V2W
	8GS 861 955-011	1	-	Bulb with plastic sockets for dashboard and interior lighting Bulb cap B 8,3 d, white, 12V2W
	8GS 861 955-021	1	-	Bulb cap W 2 x 4,6 d, white, 12V1,2W
	8GS 861 955-031	1	-	Bulb cap W 2 x 4,6 d, white, 24V1W
	8GA 007 997-031	10	-	Bulb cap B 8,5 d, black, 12V1,2W
	8GA 007 997-041	10	-	Bulb cap B 8,3 d, black, 12V1,2W
	8GA 007 997-051	10	-	Bulb cap B 8,7 d, grey, 12V1,2W

	Part no.	Pk.	Part no. GB	Bulbs with plastic sockets for dashboard and interior lighting
	8GA 007 997-061	10	-	Bulb cap B 8,3 d, grey, 24V1,2W
	8GA 007 997-071	10	-	Bulb cap B 8,5 d, grey, 24V1,2W
	8GA 007 997-081	10	-	Bulb cap B 8,5 d, green, 12V2W
	8GA 007 997-091	10	-	Bulb cap B 8,7 d, green, 12V2W
	8GA 007 997-101	10	-	Bulb cap B 10 d, brown, mini-halogen, 12V3W
	8GA 007 997-111	10	-	Bulb cap B 10 d, black, mini-halogen, 12V5W
	8GA 007 997-121	10	-	Bulb cap BX 8,4 d, black, 12V1,2W
	8GA 007 997-131	10	-	Bulb cap BX 8,4 d, green, 12V1,3W

	Part no.	Pk.	Part no. GB	Bulbs with plastic sockets for dashboard and interior lighting
	8GA 007 997-141	10	-	Bulb cap BX 8,4 d, beige, 12V1,5W
	8GA 007 997-151	10	-	Bulb cap BX 8,5 d, blue violet, 12V0,36W
	8GA 007 997-161	10	-	Bulb cap B 8,5 d, beige, 12V1,5W
	8GA 007 997-171	10	-	Bulb cap BX 8,4 d, amber, 12V1,1W
	8GA 007 997-191	10	-	Bulb cap EBS R4, yellow, 24V1,2W
	8GA 007 997-201	10	-	Bulb cap EBS R6, brown, 24V1,2W
	8GA 007 997-211	10	-	Bulb cap BX 8,5 d, light blue, 12V1,2W
	8GA 007 997-221	10	-	Bulb cap BX 8,5 d, light green, 12V2W

	Part no.	Pk.	Part no. GB	Bulbs with plastic sockets for dashboard and interior lighting
	8GA 007 997-231	10	-	Bulb cap BG 8,5 - 5,5 d, black, 12V1,2W
	8GA 007 997-241	10	-	Bulb cap SG 8 - 5,5 d, black, 12V1,2W
	8GA 007 997-251	10	-	Bulb cap B 8,5 S - 40, black, 12V1,2W
	8GA 007 997-261	10	-	Bulb cap BX 8,5 d, brown, 24V1,2W
	8GA 007 997-272	10	-	Bulb cap EBS N10, beige, 24V1,2W
	8GS 006 677-121	10	-	Bulb cap BX 8,4 d, white/green 12V2W

	Part no.	Pk.	Bulb holders	
	9FF 085 081-001	10	Bulb cap BA 15 s, 1-pole, DIN 49 725, blade terminal contacts	
	9FF 138 324-001	10	Bulb cap BA 15 s, 1-pole, blade terminal contacts	
	9FF 133 025-007	20	Bulb cap BA 15 s, 1-pole, screw-type contacts	
	9FF 071 116-001	10	Bulb cap BAY 15 d, 2-pole, screw-type contacts	
	9FF 078 830-001	10	Bulb cap BA 9 s, 1-pole,	
9FF 042 509-001	10	Bulb cap BA 7 s, 1-pole, blade terminal contacts		
9FF 135 906-021	10	Bulb cap X 511, blade terminal contacts		
	8JA 001 909-001	10	Connectors Connector for H4- or R2-bulbs. For cable cross-section. 2,5 sq. mm. Cable connection via clamping, can be released via push-buttons. 3-pole connector, without earthing cable 8JA 001 909-011 10 with earthing cable 130 mm long 8JA 001 914-011 10 with earthing cable 130 mm long	
	8KB 863 949-001	1		Plug with preinstalled leads and butt connectors for H1 bulbs. To fit leads with max. cross-section up to 1.0 mm ² . Crimped lead connections. Length of brown lead (earth): 60 mm. Length of white lead: 40 mm.
	8KB 863 949-011	1		Plug with preinstalled leads and butt connectors for H7 bulbs. To fit leads with max. cross-section up to 1.0 mm ² . Crimped lead connections. Length of brown lead (earth): 120 mm. Length of white lead: 100 mm.





List of Part Numbers Vehicle Manufacturer's No. - Hella No.

—	—	—
—	—	—
—	—	—
—	—	—
—	—	—
—	—	—
—	—	—
—	—	—
—	—	—
—	—	—
—	—	—
—	—	—

List of part numbers

9.02-9.18

Vehicle manufacturer's no. - Hella no.

9.19-9.60

Note:

The original numbers listed in the manufacturer number - Hella number comparison serve exclusively for comparison purposes and are not to be used otherwise.

List of Part Numbers



Part number	Page	Part number	Page	Part number	Page	Part number	Page
1AB...		1F4...		1FA...		1G3...	
1AB 007 145-001	3.40-3.41	1F4 157 022-011	4.07	1FA 010 047-801	4.21	1G3 005 760-201	4.54
1AL...		1F4 160 300-011	4.06	1FA 149 504-011	4.22	1G3 005 760-207	4.54
1AL 009 997-001	4.37	1F4 160 302-011	4.06	1FB...		1G3 005 760-211	4.54
1AL 009 997-041	4.37	1F4 162 883-011	4.06	1FB 005 860-031	4.25	1G3 005 760-221	3.105, 4.53
1AL 009 998-001	4.37	1F5...		1FB 005 860-061	4.25	1G3 005 760-227	4.53
1AL 009 998-041	4.37	1F5 008 273-001	4.13	1FB 007 360-031	4.24	1G3 005 760-241	5.205
1BL...		1F5 008 273-011	4.13	1FB 007 360-041	4.24	1G3 135 211-011	3.19, 3.34, 3.88, 3.94, 3.97, 3.104-3.105, 3.111, 3.117, 4.54
1BL 007 834-007	2.89, 2.96, 2.105, 4.40	1F5 008 273-041	4.13	1FB 007 892-011	4.23	1G3 141 019-011	3.05, 3.20
1BL 007 834-047	4.40	1F5 008 273-071	4.13	1FB 007 892-071	4.23	1G3 990 008-001	3.88
1DL...		1F5 154 875-011	4.13	1FB 007 892-131	4.23	1G3 996 001-001	3.95, 4.102
1DL 005 600-097	4.50	1F6...		1FB 007 892-811	4.23	1G3 996 001-041	4.102
1DL 005 600-107	4.50	1F6 003 939-031	2.05	1FB 007 892-841	4.23	1G3 996 001-131	3.88, 4.102
1DL 005 630-011	1.25	1F7...		1FB 137 006-021	4.25	1G3 996 001-271	3.43, 3.67, 3.108-3.109, 4.102
1DL 005 630-021	1.25	1F7 004 700-031	4.14	1FB 149 519-011	4.23	1G3 996 001-301	3.06, 4.102
1DL 005 930-371	1.25	1F7 004 700-071	4.14	1FB 162 881-011	4.23	1G3 996 001-331	4.102
1DL 005 930-381	1.25	1F7 004 700-321	4.14	1FD...		1G3 996 001-351	4.102
1DL 007 872-017	4.50	1F7 004 700-391	4.14	1FD 003 590-017	2.14	1G3 996 001-391	4.102
1DL 007 872-027	4.50	1F7 004 700-431	4.14	1FD 003 590-411	4.25	1G4...	
1DL 007 872-037	3.08, 4.50	1F7 146 713-001	4.14	1FD 005 700-031	4.26	1G4 003 470-001	3.67, 4.103
1DL 007 872-047	3.08, 4.50	1F8...		1FD 005 700-051	4.26	1G4 003 470-011	4.103
1DL 007 872-077	4.50	1F8 006 800-181	4.15	1FD 005 700-301	4.26	1G4 003 470-031	3.88, 4.103
1DL 007 872-087	4.50	1F8 006 800-191	4.15	1FD 005 700-851	4.26	1G4 003 470-051	3.06, 3.18, 4.103
1EL...		1F8 006 800-221	4.15	1FD 124 291-001	2.14	1G4 003 470-147	4.103
1EL 008 540-551	1.16	1F8 006 800-301	4.15	1FD 135 198-011	4.25-4.26	1G4 004 480-001	2.31, 2.37, 2.41, 2.47, 4.104
1EL 008 540-561	1.16	1F8 006 800-311	4.15	1FE...		1G4 004 480-011	4.104
1EL 009 236-611	1.16	1F8 006 800-321	4.15	1FE 002 537-191	4.27	1G4 129 089-011	2.31, 2.37, 2.41, 2.47
1EL 009 236-621	1.16	1F8 006 800-331	4.15	1FE 002 537-311	2.85	1G4 997 033-011	4.104
1F0...		1F8 006 800-341	4.15	1FE 002 537-461	4.27	1G5...	
1F0 008 390-001	4.03	1F8 006 800-351	4.15	1FE 002 537-471	4.27	1G5 003 241-021	3.97, 4.105
1F0 008 390-301	4.04	1F8 006 800-361	4.15	1FE 002 537-481	2.86	1G5 003 241-071	4.105
1F0 008 390-317	4.33	1F8 006 800-401	4.15	1FE 005 478-011	2.26, 2.28	1G5 003 241-081	3.05, 4.105
1F0 008 390-327	4.33	1F8 007 560-011	4.17	1FE 005 478-021	2.26, 2.28	1G5 119 738-001	4.105
1F0 008 390-801	4.03	1F8 007 560-041	4.17	1FE 006 300-001	4.28	1G5 120 510-001	3.05, 3.97, 4.105
1F0 008 390-821	4.04	1F8 007 560-051	4.19	1FE 006 300-041	4.28	1G8...	
1F0 010 186-001	4.11	1F8 007 560-131	4.19	1FE 006 300-081	4.28	1G8 002 340-001	3.94, 3.105, 3.113, 4.106
1F0 010 293-001	4.39	1F8 007 560-201	4.18	1FE 006 300-121	4.28	1G8 002 340-011	3.94, 3.105, 3.113, 4.106
1F0 160 197-001	4.03-4.04	1F8 007 560-211	4.18	1FE 006 300-191	2.85	1G8 132 233-011	3.94, 3.105, 3.113, 4.106
1F0 172 787-011	4.11	1F8 007 560-301	4.17	1FE 006 300-251	2.117, 2.120-2.121	1G9...	
1F1...		1F8 007 560-311	4.19	1FE 006 300-261	4.28	1G9 001 523-021	4.107
1F1 009 094-041	4.09	1F8 007 560-321	4.19	1FE 008 773-001	4.29	1GA...	
1F1 009 094-051	4.09	1F8 007 560-331	4.19	1FE 008 773-011	4.29	1GA 005 060-001	3.25, 3.96, 3.105, 4.74
1F1 009 094-091	4.09	1F8 007 560-341	4.19	1FE 008 773-021	4.29	1GA 005 060-041	3.14, 4.74
1F1 009 390-021	4.12	1F8 007 560-561	4.20	1FE 008 773-051	4.29	1GA 005 060-337	4.74
1F1 009 390-041	4.12	1F8 007 560-571	4.20	1FE 008 773-061	4.29	1GA 006 875-001	3.08, 3.17, 3.86, 3.95-3.96, 3.103, 3.109, 3.115, 4.76
1F1 161 825-021	4.09, 4.12	1F8 007 560-621	4.20	1FE 008 773-081	4.29	1GA 006 876-001	3.06, 3.33, 3.68, 3.85, 3.93, 3.95, 3.115, 3.123-3.124, 4.75
1F1 161 825-041	4.09	1F8 007 560-631	4.20	1FE 125 510-011	2.79, 2.85	1GA 006 991-021	3.12, 3.92, 4.72
1F3...		1F8 007 560-721	4.20	1FE 161 642-011	4.29	1GA 006 991-031	3.85, 3.116, 3.124, 4.72
1F3 009 094-021	4.10	1F8 007 560-731	4.20	1FE 161 644-011	4.29	1GA 006 991-041	3.05, 3.09, 3.87, 3.96, 3.105-3.106, 3.108, 3.114-3.115, 4.72
1F3 009 094-031	4.10	1F8 009 797-021	4.16	1G0...		1GA 006 991-051	3.18, 3.53, 4.72
1F3 009 094-061	4.10	1F8 009 797-031	4.16	1G0 996 176-001	4.99	1GA 006 991-061	3.103, 4.72
1F3 009 094-071	4.10	1F8 009 797-121	4.16	1G0 996 176-007	4.99	1GA 006 991-071	3.123, 4.73
1F3 009 094-142	4.11	1F8 009 797-131	4.16	1G0 996 176-011	4.99	1GA 006 991-081	4.73
1F3 009 094-171	4.10	1F8 147 077-011	4.15	1G0 996 176-021	4.98	1GA 006 991-091	3.08, 3.103, 4.72
1F3 009 094-311	4.11	1F8 148 009-011	4.17	1G0 996 176-031	4.98	1GA 007 506-001	3.05, 3.14, 3.17-3.18, 3.42, 3.67, 3.86-3.87, 3.89, 3.94, 3.101, 3.106, 3.111, 3.113-3.114, 4.82
1F3 009 094-311	4.11	1F8 148 131-011	4.17, 4.19	1G0 996 176-041	4.101	1GA 007 506-021	3.88, 3.94, 4.84
1F3 009 094-311	4.11	1F8 149 644-011	4.20	1G0 996 176-051	4.101	1GA 007 506-061	3.42, 3.107, 4.81
1F3 009 390-011	4.12	1F8 150 042-011	4.15	1G0 996 176-061	4.101	1GA 007 506-081	3.32, 3.52, 4.82
1F3 009 390-031	4.12	1F8 157 042-011	4.15	1G0 996 176-061	4.101	1GA 007 506-091	4.83
1F3 009 390-051	4.12	1F8 158 926-011	4.19	1G0 996 176-111	4.99	1GA 007 506-101	3.42, 3.107, 4.84
1F3 009 906-001	1.49	1F8 161 326-011	4.15, 4.18	1G0 996 176-121	4.99	1GA 007 506-111	3.32, 3.42, 3.107, 4.81
1F3 009 906-011	1.49	1F8 162 870-011	4.17, 4.19	1G0 996 176-131	4.101	1GA 007 506-121	3.42, 3.92, 3.107, 4.81
1F3 010 119-001	4.16	1F8 162 871-011	4.19	1G0 996 176-141	4.101	1GA 007 506-391	3.32, 3.86, 3.92, 3.113-3.114, 4.82
1F3 010 119-011	4.16	1F8 162 872-011	4.19	1G0 996 176-171	4.101	1GA 007 506-431	4.81
1F3 010 119-021	4.16	1F8 162 873-011	4.15	1G0 996 176-181	4.101	1GA 007 506-451	3.112, 4.83
1F3 161 825-011	4.10, 4.12	1F8 162 874-011	4.15	1G0 996 176-361	4.100	1GA 007 506-491	4.83
1F3 161 825-031	4.10, 4.12	1F8 165 940-011	4.15	1G0 996 176-701	4.100	1GA 007 506-651	4.83
1F3 161 825-071	4.11	1F8 165 941-011	4.15	1G0 996 176-711	4.100	1GA 007 506-681	3.07, 3.102, 3.109, 3.112, 4.90
1F3 161 825-081	4.10, 4.12	1F8 165 942-011	4.15	1G0 996 176-721	4.100	1GA 008 284-101	6.24-6.28, 6.51-6.55
1F4...		1F8 165 943-011	4.15	1G3...			
1F4 002 608-001	4.07	1F8 165 946-011	4.19	1G3 003 710-021	3.108, 4.97		
1F4 005 750-071	4.08	1F8 165 947-011	4.19	1G3 005 760-001	3.19, 3.34, 3.88, 3.94, 3.97, 3.104, 3.111, 3.117, 4.54		
1F4 005 750-301	4.08	1F8 165 949-011	4.20				
1F4 005 750-811	4.08	1F8 173 055-021	4.20	1G3 005 760-011	3.88, 3.94, 3.97, 3.111, 3.117, 4.54		
1F4 005 750-871	4.08	1FA...		1G3 005 760-021	4.53		
1F4 007 893-021	4.06	1FA 007 133-021	4.24	1G3 005 760-031	4.54		
1F4 007 893-081	4.06	1FA 007 133-811	4.24	1G3 005 760-041	3.05, 3.20, 4.54		
1F4 007 893-081	4.06	1FA 007 891-061	4.22	1G3 005 760-057	4.54		
1F4 007 893-141	4.07	1FA 007 891-811	4.22				
1F4 007 893-191	4.06	1FA 007 891-841	4.22				
1F4 007 893-201	4.06	1FA 008 283-011	4.21				
1F4 007 893-241	4.06	1FA 008 283-031	4.21				
1F4 007 893-811	4.06	1FA 008 283-811	4.21				
1F4 007 893-841	4.06	1FA 008 283-861	4.21				
1F4 007 893-871	4.07	1FA 008 284-011	4.22				
1F4 007 893-911	4.06	1FA 008 284-031	4.22				
1F4 007 893-921	4.06	1FA 008 284-811	4.22				
1F4 135 230-011	4.08	1FA 008 284-861	4.22				
1F4 149 537-011	4.06	1FA 010 047-001	4.21				
		1FA 010 047-011	4.21				



List of Part Numbers

Part number	Page	Part number	Page	Part number	Page	Part number	Page
1GA...		1GA...		1K0...		1LB...	
1GA 132 459-011	3.25, 3.96, 3.105, 4.74	1GA 998 525-011	3.33, 3.92, 3.104, 3.106, 3.113, 4.86	1K0 008 191-017	4.35	1LB 003 177-081	3.13, 3.16, 3.39, 3.58, 3.60-3.61, 3.65, 4.46, 4.48
1GA 340 110-001	5.205	1GA 998 525-041	4.89-4.90	1K0 008 191-021	4.35	1LB 003 177-511	1.189, 4.46
1GA 340 861-001	5.205	1GA 998 525-071	3.30, 4.87	1K0 008 191-027	4.35	1LB 003 177-637	3.91, 3.100, 4.45
1GA 990 183-001	3.114	1GA 998 532-011	3.114	1K0 008 191-041	4.35	1LB 005 444-017	4.48
1GA 990 305-001	3.67, 3.104, 3.106, 4.78, 4.80	1GA 998 534-001	3.33, 4.86	1K0 008 191-212	4.35	1LB 006 213-047	3.82-3.84, 4.66
1GA 990 305-011	4.79, 4.107	1GA 998 534-011	3.92, 3.104, 3.106, 3.113, 4.86	1K0 008 192-001	4.35	1LB 006 213-057	3.29, 3.56, 3.58-3.59, 3.62-3.63, 3.65-3.66, 3.82-3.85, 4.66
1GA 996 020-001	3.07, 3.52, 3.102, 3.109, 4.77	1GA 998 534-061	3.33	1K0 008 192-007	4.35	1LB 006 277-137	3.116, 4.45
1GA 996 082-001	3.86, 4.76	1GA 998 534-221	3.30, 4.87	1K0 008 192-011	4.35	1LB 007 145-047	3.12, 4.71
1GA 996 083-001	4.85	1GA 998 534-231	4.87	1K0 008 192-017	4.35	1LB 008 461-551	1.113
1GA 996 083-011	3.07, 3.102, 3.110, 4.85	1GA 998 534-271	4.87	1K0 158 059-061	4.35	1LB 008 461-561	1.113
1GA 996 083-021	3.07, 3.102, 3.110, 4.85	1GA 998 534-431	4.88	1K0 158 059-071	4.35	1LB 008 461-571	1.114
1GA 996 140-021	4.65	1GA 998 534-441	4.88	1K0 247 043-001	4.36	1LB 008 461-761	1.114
1GA 996 140-041	4.65	1GA 998 534-451	4.88	1K0 247 043-007	4.36	1LB 247 011-051	2.53
1GA 996 142-001	4.78	1GA 998 534-461	4.88	1K0 247 043-011	4.36	1LB 247 011-061	2.53
1GA 996 142-011	3.67, 3.104, 3.106, 4.78	1GA 998 534-541	4.87	1K0 247 043-017	4.36	1LB 247 012-031	1.96
1GA 996 142-021	4.78	1GB...		1K0 247 043-021	4.36	1LB 247 012-041	1.96
1GA 996 142-041	4.78	1GB 006 213-101	3.06, 3.17, 3.19, 3.33, 3.93, 3.103, 4.69	1K0 247 043-027	4.36	1LB 247 012-071	1.96
1GA 996 142-061	4.79	1GB 006 213-107	4.69	1K0 247 043-031	4.36	1LB 247 012-081	1.96
1GA 996 142-071	4.79	1GB 006 213-111	3.06, 3.19, 3.33, 3.43, 3.108, 4.69-4.70	1K0 247 043-037	4.36	1LB 996 157-201	3.30, 4.62
1GA 996 142-081	4.79	1GB 006 213-117	4.69	1K3...		1LD...	
1GA 996 142-091	4.79	1GB 007 145-101	4.71	1K3 114 155-001	4.43	1LD 246 044-231	1.61
1GA 996 142-131	4.79	1GB 007 145-107	3.12, 4.71	1K3 126 046-001	1.24	1LD 246 044-241	1.61
1GA 996 142-141	4.78	1GB 990 182-001	3.96	1K3 126 680-001	1.24, 1.40	1LD 247 038-231	1.191
1GA 996 142-151	4.79	1GB 996 080-001	3.86, 3.96, 4.67	1K3 132 253-011	1.29-1.30, 1.41-1.42	1LD 247 038-241	1.191
1GA 996 142-221	4.107	1GB 996 080-011	3.33, 3.53, 3.86, 4.67	1K3 132 266-011	1.29-1.30, 1.41-1.42	1LD 962 060-131	1.63, 1.98
1GA 996 142-241	4.78	1GB 996 080-021	3.08, 3.19, 3.93, 3.103, 3.110, 4.67	1K3 134 855-011	1.25	1LD 962 060-141	1.63, 1.98
1GA 996 142-251	4.79	1GB 996 080-031	3.33, 4.67	1K3 134 856-011	1.25	1LE...	
1GA 996 142-311	4.78	1GB 996 102-101	4.75	1KB...		1LE 003 427-041	4.46
1GA 996 150-021	4.89	1GB 996 102-107	4.68	1KB 003 177-061	4.46	1LE 007 350-111	1.113
1GA 996 150-071	4.89	1GB 996 147-101	4.68	1KB 003 177-597	1.189	1LE 007 350-121	1.113
1GA 996 150-081	4.89	1GB 996 158-081	4.62	1KL...		1LE 008 880-031	1.13-1.14
1GA 996 150-151	4.90	1GB 996 213-511	3.115, 4.70	1KL 007 834-027	2.89, 2.96, 2.105, 4.40	1LE 008 880-041	1.13-1.14
1GA 996 161-101	3.97, 4.56	1GD...		1KL 007 834-067	4.40	1LE 009 058-031	1.51
1GA 996 161-111	4.55	1GD 003 590-701	3.06, 3.34	1KL 007 834-097	4.40	1LE 009 058-041	1.51
1GA 996 161-121	3.97, 4.58	1GD 003 690-287	3.52	1KL 009 486-001	4.33	1LE 009 058-071	1.51
1GA 996 161-131	4.59	1GD 005 700-501	4.77	1KL 998 570-021	4.33	1LE 009 058-081	1.51
1GA 996 161-281	3.87, 4.57	1GD 005 700-511	3.19	1KL 998 570-031	4.33	1LE 010 198-051	1.53
1GA 996 161-291	3.97, 4.58	1GD 137 355-011	3.19, 4.77	1L3...		1LE 010 198-061	1.53
1GA 996 161-331	4.59	1GD 996 018-541	3.53, 3.93, 3.101, 4.69	1L3 002 850-068	4.43, 4.52	1LE 010 198-091	1.53
1GA 996 161-351	4.55	1GL...		1L3 005 649-017	4.42	1LE 010 198-101	1.53
1GA 996 161-391	4.61	1GL 008 090-201	4.97	1L3 996 002-221	4.42	1LE 010 198-151	1.53
1GA 996 161-581	4.58	1GL 008 090-207	4.97	1L3 996 002-411	4.42	1LE 010 198-161	1.53
1GA 996 161-671	4.56	1GL 008 090-211	3.18, 4.97	1L3 996 026-041	4.51	1LE 010 199-031	1.52
1GA 996 179-001	4.77	1GL 008 090-217	4.97	1L6...		1LE 010 199-041	1.52
1GA 996 179-021	4.77	1GM...		1L6 002 395-261	4.44	1LE 247 013-071	1.172
1GA 996 242-111	4.80	1GM 990 303-151	4.93	1L6 002 395-842	4.44	1LE 247 013-081	1.172
1GA 996 242-521	4.80	1GM 996 134-051	4.95	1L7...		1LE 247 013-851	1.172
1GA 996 261-511	4.59	1GM 996 134-061	4.95	1L7 271 510-331	1.119	1LE 247 019-191	1.189
1GA 996 261-521	4.59	1GM 996 134-071	4.95	1L7 271 510-341	1.119	1LE 247 019-201	1.189
1GA 996 261-531	4.60	1GM 996 134-081	4.95	1L7 271 510-371	1.120	1LE 270 600-191	1.61
1GA 996 261-561	4.60	1GM 996 134-091	4.91	1L7 271 510-381	1.120	1LE 270 600-201	1.61
1GA 996 261-571	4.60	1GM 996 134-171	4.95	1L8...		1LF...	
1GA 996 261-581	4.60	1GM 996 134-241	4.96	1L8 003 060-561	1.84, 1.111, 1.152, 1.155, 1.195, 1.198, 2.30, 2.47	1LF 006 826-251	1.47
1GA 996 261-691	4.60	1GM 996 134-271	3.89, 4.96	1L8 003 060-691	1.84, 1.111, 1.152, 1.155, 1.195, 1.198, 2.30, 2.47, 2.70	1LF 006 826-261	1.47
1GA 996 261-701	4.60	1GM 996 134-311	4.91	1L8 004 148-017	1.84-1.85, 1.111-1.112	1LF 007 520-071	1.180
1GA 996 361-011	4.59	1GM 996 134-321	4.95	1L8 004 190-111	1.156	1LF 007 520-081	1.180
1GA 996 361-171	4.58	1GM 996 134-371	3.89, 4.96	1L8 139 474-015	1.84-1.85, 1.111-1.112	1LF 007 620-071	1.180
1GA 996 361-421	4.58	1GM 996 135-001	4.92	1L9...		1LF 007 620-081	1.180
1GA 996 361-431	4.56	1GM 996 135-041	3.114, 4.92	1L9 007 095-111	1.78	1LF 008 673-091	1.36
1GA 996 361-431	4.56	1GM 996 135-051	3.112, 4.92	1L9 007 095-121	1.78	1LF 008 673-101	1.36
1GA 996 361-581	4.55	1GM 996 135-071	3.34	1L9 378 158-001	1.79	1LF 009 237-031	1.46
1GA 996 461-311	4.61	1GM 996 135-101	4.93	1L9 378 159-001	1.79	1LF 009 237-041	1.46
1GA 996 461-321	4.61	1GM 996 135-111	4.93	1L9 378 176-001	1.79	1LF 010 197-031	1.51
1GA 996 461-331	4.61	1GM 996 135-101	4.93	1L9 378 177-001	1.79	1LF 010 197-041	1.51
1GA 996 461-341	4.61	1GM 996 135-231	4.94	1LA...		1LF 010 541-031	1.65
1GA 996 461-341	4.61	1GM 996 135-241	4.94	1LA 004 109-217	3.54-3.55, 3.57, 3.59-3.63, 3.65, 3.101, 4.49	1LF 010 541-041	1.65
1GA 996 461-341	4.61	1GM 996 135-251	4.94	1LA 004 109-227	4.49	1LF 354 025-111	1.71
1GA 997 506-021	4.82	1GM 996 135-261	4.94	1LA 990 185-011	3.39, 4.63-4.64	1LF 354 025-121	1.71
1GA 997 506-157	4.84	1GM 996 135-551	4.92	1LA 993 975-037	4.64	1LF 962 489-151	1.185
1GA 997 506-371	4.82	1GM 996 136-101	4.91	1LA 993 975-047	4.64	1LF 962 489-161	1.185
1GA 997 506-377	4.82	1GM 996 136-111	4.91	1LA 996 074-037	4.63	1LF 962 489-171	1.185
1GA 997 506-557	4.84	1GM 996 136-131	4.91	1LA 996 074-047	4.63	1LF 962 489-181	1.185
1GA 997 506-601	4.83	1GN...		1LA 996 074-197	4.63	1LF 963 709-071	1.187
1GA 998 522-011	3.07, 3.17-3.19, 3.43, 3.53, 3.68, 3.86, 3.93, 3.96, 3.102, 3.106-3.107, 3.110-3.112, 3.115, 4.75	1GN 996 361-461	4.57	1LA 996 074-207	4.63	1LF 963 709-081	1.187
1GA 998 524-001	3.12, 3.92, 4.72	1GN 996 361-651	4.57	1LA...		1LG...	
1GA 998 524-011	3.05, 3.09, 3.85, 3.87, 3.105-3.106, 3.108, 3.114-3.116, 3.124, 4.72	1H5...		1LA 004 109-217	3.54-3.55, 3.57, 3.59-3.63, 3.65, 3.101, 4.49	1LG 003 434-187	2.14, 2.17, 2.19, 2.24, 4.49
1GA 998 525-001	3.05, 3.07, 3.14, 3.17-3.18, 3.32, 3.42, 3.52, 3.67, 3.86-3.89, 3.92, 3.94, 3.101-3.102, 3.106-3.114, 3.123, 4.81-4.85, 4.90	1H5 998 502-002	4.112	1LA 990 185-011	3.39, 4.63-4.64	1LG 003 434-237	2.25, 2.27, 2.34, 2.37, 2.40
		1H5 998 502-022	4.112	1LA 993 975-037	4.64	1LG 004 679-051	2.115, 2.118-2.119, 2.121
		1H5 998 502-051	4.112	1LA 993 975-047	4.64	1LG 005 480-031	2.10
		1K0...		1LA 993 975-117	4.64	1LG 005 480-041	2.10
		1K0 008 191-001	4.35	1LA 996 074-037	4.63	1LG 005 480-075	2.10
		1K0 008 191-007	4.35	1LA 996 074-047	4.63	1LG 006 560-211	1.114, 1.116
		1K0 008 191-011	4.35	1LA 996 074-197	4.63		
				1LA 996 074-207	4.63		
				1LA 996 127-017	4.63		

List of Part Numbers



Part number	Page	Part number	Page	Part number	Page	Part number	Page
1LG...		1LJ...		1LL...		1NO...	
1LG 006 560-221	1.114, 1.116	1LJ 009 250-771	1.63, 1.67	1LL 009 489-041	1.168, 1.175	1NO 009 295-021	1.58-1.59, 1.170, 4.05
1LG 006 898-051	2.116	1LJ 009 250-781	1.63, 1.67	1LL 009 489-471	1.169, 1.175	1NO 009 295-031	4.05
1LG 006 898-091	2.117, 2.119, 2.121	1LJ 009 292-051	1.159, 1.164	1LL 009 489-481	1.169, 1.175	1NO 009 295-037	4.05
1LG 006 920-231	1.106, 1.146	1LJ 009 292-061	1.159, 1.164	1LL 009 489-811	1.168, 1.175	1NO 009 295-041	4.05
1LG 006 920-241	1.106, 1.146	1LJ 009 292-821	1.159, 1.164	1LL 009 489-831	1.169, 1.175	1NO 009 295-047	4.05
1LG 007 150-111	2.114	1LJ 009 547-231	1.71	1LL 009 554-811	1.27	1NO 009 295-057	4.05
1LG 007 150-121	2.114	1LJ 009 547-241	1.71	1LL 009 997-011	4.38	1NO 009 295-067	4.05
1LG 007 302-191	1.203-1.204	1LJ 009 587-631	1.48	1LL 009 997-051	4.38	1NO 009 295-801	4.05
1LG 007 302-201	1.203-1.204	1LJ 009 587-641	1.48	1LL 009 998-011	4.38	1NO 009 436-801	1.170
1LG 007 640-331	1.99, 1.140	1LJ 009 648-031	1.07	1LL 009 998-051	4.38	1NO 009 436-811	1.58
1LG 007 640-341	1.99, 1.140	1LJ 009 648-041	1.07	1LL 010 201-031	1.56	1NO 009 436-821	1.59
1LG 007 640-631	1.100, 1.140	1LJ 009 696-731	1.63	1LL 010 201-041	1.56	1NO 009 594-011	1.08-1.09
1LG 007 640-641	1.100, 1.140	1LJ 009 696-741	1.63	1LL 010 201-071	1.57	1NO 009 594-021	1.08-1.09
1LG 007 660-031	2.08-2.09	1LJ 009 925-031	1.14-1.15	1LL 010 201-081	1.57	1NO 009 617-011	1.127
1LG 007 660-041	2.08-2.09	1LJ 009 925-041	1.14-1.15	1LL 010 201-111	1.58	1NO 010 294-001	4.39
1LG 007 660-111	2.11	1LJ 010 202-051	1.135	1LL 010 201-121	1.58	1NO 010 345-011	1.38
1LG 007 660-121	2.11	1LJ 010 202-061	1.135	1LL 010 201-151	1.58	1NO 010 345-021	1.38
1LG 007 861-451	1.203, 1.205	1LJ 247 046-051	2.04, 2.06-2.07	1LL 010 201-161	1.58	1NO 010 380-011	1.09
1LG 007 861-461	1.203, 1.205	1LJ 247 046-061	2.04, 2.06-2.07	1LL 010 201-191	1.57	1NO 010 380-021	1.09
1LG 009 059-031	1.27	1LJ 247 046-071	2.04, 2.06-2.07	1LL 010 201-201	1.57	1NO 246 039-011	1.12
1LG 009 059-041	1.27	1LJ 247 046-081	2.04, 2.06-2.07	1LL 010 201-231	1.57	1NO 246 039-021	1.12
1LG 010 196-031	1.44, 1.111	1LL...		1LL 010 201-241	1.57	1NO 247 003-011	1.07, 1.17
1LG 010 196-041	1.44, 1.111	1LL 006 110-351	1.103, 1.144	1LL 010 202-071	1.135	1NO 247 003-021	1.07, 1.17
1LG 246 041-031	1.88	1LL 006 110-361	1.103, 1.144	1LL 010 202-081	1.135	1NO 270 204-051	1.123, 1.132, 1.134, 1.176
1LG 246 041-041	1.88	1LL 007 250-011	1.31	1LL 010 202-111	1.135	1NO 270 204-061	1.123, 1.132, 1.134, 1.176
1LG 247 007-031	1.167	1LL 007 250-021	1.31	1LL 010 202-121	1.135	1NO 270 255-051	1.188
1LG 247 007-041	1.167	1LL 007 510-071	1.113	1LL 010 203-031	1.152, 1.192	1NO 270 255-061	1.188
1LG 247 007-191	1.167, 1.175	1LL 007 510-081	1.113	1LL 010 203-041	1.152, 1.192	1NO 270 481-051	1.132, 1.201
1LG 247 007-201	1.167, 1.175	1LL 007 821-291	1.11	1LL 010 541-111	1.66	1NO 270 481-061	1.132, 1.201
1LG 247 007-231	1.168	1LL 007 821-301	1.11	1LL 010 541-121	1.66	1NO 270 595-011	1.169
1LG 247 007-241	1.168	1LL 007 950-251	1.146	1LL 158 060-031	4.34	1NO 270 595-021	1.169
1LG 270 370-331	1.101, 1.141	1LL 007 950-261	1.146	1LL 158 085-011	1.43	1NO 270 596-051	1.153, 1.192
1LG 270 370-341	1.101, 1.141	1LL 008 020-271	1.106, 1.146	1LL 158 086-011	1.43	1NO 270 596-061	1.153, 1.192
1LG 270 370-631	1.101, 1.141	1LL 008 020-281	1.106, 1.146	1LL 160 695-001	1.36	1NO 271 022-051	1.122-1.123, 1.128, 1.131
1LG 270 370-641	1.101, 1.141	1LL 008 052-591	1.32	1LL 160 696-001	1.36	1NO 271 022-061	1.122-1.123, 1.128, 1.131
1LG 354 023-031	1.68	1LL 008 052-601	1.32	1LL 163 081-001	1.37	1NO 271 247-051	1.132-1.133, 1.137, 1.189, 1.192, 1.195, 1.201
1LG 354 023-041	1.68	1LL 008 053-591	1.31-1.32	1LL 163 082-001	1.37	1NO 271 247-061	1.132-1.133, 1.137, 1.189, 1.192, 1.195, 1.201
1LG 354 023-071	1.68	1LL 008 053-601	1.31-1.32	1LL 164 909-001	1.37	1NO 271 284-031	1.169
1LG 354 023-081	1.68	1LL 008 193-117	4.34	1LL 164 910-001	1.37	1NO 271 284-041	1.169
1LG 354 024-051	1.69	1LL 008 193-127	4.34	1LL 223 151-031	1.86	1NO 271 289-031	1.153, 1.155, 1.172, 1.191-1.192
1LG 354 024-061	1.69	1LL 008 194-017	4.34	1LL 223 151-041	1.86	1NO 271 289-041	1.153, 1.155, 1.172, 1.191-1.192
1LG 354 024-071	1.69	1LL 008 194-051	4.34	1LL 223 151-091	1.86	1NO 271 295-031	1.169, 1.176
1LG 354 024-081	1.69	1LL 008 306-151	1.06	1LL 223 151-101	1.86	1NO 271 295-041	1.169, 1.176
1LG 354 024-131	1.69	1LL 008 306-161	1.06	1LL 247 010-311	2.111	1NO 271 296-031	1.182
1LG 354 024-141	1.69	1LL 008 320-251	1.107, 1.109, 1.148-1.149	1LL 247 010-321	2.111	1NO 271 296-041	1.182
1LH...		1LL 008 320-261	1.107, 1.109, 1.148-1.149	1LL 247 010-331	2.111	1NO 354 013-011	1.14-1.16
1LH 002 658-451	2.83	1LL 008 320-331	1.108-1.109, 1.148-1.149	1LL 247 010-341	2.111	1NO 354 013-021	1.14-1.16
1LH 002 658-461	2.83	1LL 008 320-341	1.108-1.109, 1.148-1.149	1LL 247 010-391	2.111	1NO 354 016-011	1.58, 1.61
1LH 002 658-511	2.84	1LL 008 350-031	1.181	1LL 247 010-401	2.111	1NO 354 016-021	1.58, 1.61
1LH 002 658-521	2.84	1LL 008 350-041	1.181	1LL 247 014-031	1.181	1NO 354 017-011	1.137
1LH 002 658-571	2.84	1LL 008 369-171	1.80	1LL 247 014-041	1.181	1NO 354 017-021	1.137
1LH 005 454-311	1.176	1LL 008 369-181	1.80	1LL 247 014-841	1.182	1NO 354 018-011	1.134, 1.137
1LH 005 454-321	1.176	1LL 008 369-271	1.81	1LL 354 025-031	1.72	1NO 354 018-021	1.134, 1.137
1LH 006 546-611	1.193	1LL 008 369-281	1.81	1LL 354 025-041	1.72	1N3...	
1LH 006 546-621	1.193	1LL 008 420-331	1.43	1LL 354 025-071	1.71	1N3 009 094-001	4.10
1LH 006 840-271	1.178	1LL 008 420-341	1.43	1LL 354 025-081	1.71	1N3 009 094-011	4.10
1LH 006 840-281	1.178	1LL 008 700-331	1.101, 1.142	1LL 354 027-051	1.136	1N3 009 390-001	4.12
1LH 006 900-031	1.94	1LL 008 700-341	1.101, 1.142	1LL 354 027-061	1.136	1N3 161 825-001	4.10, 4.12
1LH 006 900-041	1.94	1LL 008 875-031	1.26	1LL 354 027-091	1.137	1N4...	
1LH 008 010-031	1.95	1LL 008 875-041	1.26	1LL 354 027-101	1.137	1N4 002 608-021	4.07
1LH 008 010-041	1.95	1LL 008 875-811	1.26	1LR...		1N4 005 750-001	4.08
1LH 009 513-051	2.49	1LL 008 881-431	1.13, 1.15	1LR 246 046-531	2.110	1N4 005 750-041	4.08
1LH 009 513-061	2.49	1LL 008 881-441	1.13, 1.15	1LR 246 046-541	2.110	1N4 007 893-001	4.06
1LH 009 513-071	2.49	1LL 008 934-011	4.34	1LR 247 017-071	1.195	1N4 007 893-181	4.06
1LH 009 513-081	2.49	1LL 008 934-031	4.34	1LR 247 017-081	1.195	1N4 007 893-821	4.06
1LH 246 047-031	1.95	1LL 009 020-231	1.106, 1.147	1LS...		1N4 135 224-011	4.08
1LH 246 047-041	1.95	1LL 009 020-241	1.106, 1.147	1LS 008 369-491	1.81	1N4 149 531-011	4.06
1LH 246 047-071	1.95	1LL 009 213-031	1.159	1LS 008 369-501	1.81	1N7...	
1LH 246 047-081	1.95	1LL 009 213-041	1.159	1LS 008 821-331	1.76	1N7 004 700-281	4.14
1LJ...		1LL 009 213-811	1.159	1LS 008 821-341	1.76	1N8...	
1LJ 004 440-611	1.93	1LL 009 260-091	1.82	1M3...		1N8 006 800-001	4.15
1LJ 004 440-621	1.93	1LL 009 260-101	1.82	1M3 114 178-001	4.43	1N8 007 560-021	4.19
1LJ 006 051-191	1.199	1LL 009 260-571	1.82	1ML...		1N8 007 560-031	4.17
1LJ 006 051-201	1.199	1LL 009 260-581	1.82	1ML 009 071-011	4.32	1N8 148 103-011	4.17, 4.19
1LJ 006 360-671	1.158	1LL 009 300-071	1.159, 1.164	1ML 009 071-037	4.32	1NA...	
1LJ 006 360-681	1.158	1LL 009 300-081	1.159, 1.164	1ML 009 071-057	4.32	1NA 006 790-071	1.178
1LJ 007 143-051	1.26	1LL 009 300-831	1.159, 1.164	1ML 009 071-077	4.32	1NA 006 790-081	1.178
1LJ 007 143-061	1.26	1LL 009 449-031	1.37	1ML 009 999-011	4.39	1NA 006 790-811	1.178
1LJ 007 219-371	1.77	1LL 009 449-041	1.37	1ML 009 999-051	4.39	1NO...	
1LJ 007 219-381	1.77	1LL 009 476-031	1.168, 1.175	1ML 247 042-027	4.36	1NO 009 295-021	1.58-1.59, 1.170, 4.05
1LJ 007 235-251	1.158	1LL 009 476-041	1.168, 1.175	1ML 247 042-037	4.36	1NO 009 295-031	4.05
1LJ 007 235-261	1.158	1LL 009 488-031	1.54	1ML 998 570-011	4.33	1NO 009 295-037	4.05
1LJ 007 833-111	1.116	1LL 009 488-041	1.54	1NO...		1NO 009 295-041	4.05
1LJ 007 833-121	1.116	1LL 009 488-471	1.54	1NO 008 582-001	4.39	1NO 009 295-047	4.05
1LJ 008 040-071	1.73	1LL 009 488-481	1.54	1NO 008 582-007	4.39	1NO 009 295-057	4.05
1LJ 008 040-081	1.73	1LL 009 488-811	1.54	1NO 008 582-011	4.39	1NO 009 295-067	4.05
1LJ 008 041-031	1.50, 1.72	1LL 009 488-831	1.54	1NO 008 582-017	4.39	1NO 009 295-801	4.05
1LJ 008 041-041	1.50, 1.72	1LL 009 489-031	1.168, 1.175	1NO 009 295-011	1.58-1.59, 1.170, 4.05	1NO 009 436-801	1.170
1LJ 008 758-011	1.159					1NO	



List of Part Numbers

Part number	Page	Part number	Page	Part number	Page	Part number	Page
1NA...		1NE...		1VB...		2BA...	
1NA 007 039-011	1.42	1NE 006 300-101	4.28	1VB 005 444-037	3.39, 4.47	2BA 001 248-001	5.137
1NA 007 039-021	1.42	1NE 006 300-201	2.85	1X0...		2BA 001 259-611	3.65, 5.79
1NA 007 133-001	4.24	1NE 006 300-231	2.38, 2.42	1X0 001 515-021	4.51	2BA 001 259-618	2.58, 5.79
1NA 007 133-801	4.24	1NE 007 517-051	1.49, 1.68	1ZL...		2BA 001 263-001	5.142
1NA 007 891-041	4.22	1NE 007 517-061	1.49, 1.68	1ZL 009 487-031	1.102, 1.142	2BA 001 275-011	2.55, 2.65
1NA 007 891-821	4.22	1NE 008 773-031	4.29	1ZL 009 487-041	1.102, 1.142	2BA 001 275-021	2.55, 2.65
1NA 007 976-071	1.73, 1.75, 1.86-1.87	1NE 138 555-011	2.38, 2.41-2.42, 4.28	1ZL 009 487-811	1.102, 1.142	2BA 001 277-011	3.15, 3.71-3.72, 5.139
1NA 007 976-081	1.73, 1.75, 1.86-1.87	1NE 138 575-011	4.28	1ZL 009 488-111	1.54	2BA 001 277-021	3.15, 3.71-3.72, 5.139
1NA 007 976-111	1.74-1.76, 1.87	1NE 161 643-011	4.29	1ZL 009 488-121	1.54	2BA 001 416-011	5.140
1NA 007 976-121	1.74-1.76, 1.87	1NL...		1ZL 009 488-851	1.54	2BA 001 416-021	5.140
1NA 007 976-231	1.74	1NL 004 840-081	2.26, 2.28	1ZL 009 489-111	1.168, 1.175	2BA 001 423-087	5.70
1NA 007 976-241	1.74	1NL 005 150-051	1.17, 1.20	1ZL 009 489-121	1.168, 1.175	2BA 002 324-001	5.138
1NA 008 283-001	4.21	1NL 005 150-061	1.17, 1.20	1ZL 009 489-851	1.168, 1.175	2BA 002 324-011	2.68, 3.48, 5.138
1NA 008 283-801	4.21	1NL 005 150-111	1.16-1.17, 1.19	1ZL 010 541-071	1.65	2BA 002 324-021	2.68, 3.48, 5.138
1NA 008 284-001	4.22	1NL 005 150-121	1.16-1.17, 1.19	1ZL 010 541-081	1.65	2BA 002 652-...	3.73, 3.79
1NA 008 284-801	4.22	1NL 005 230-051	1.42	1ZS...		2BA 002 652-101	5.138
1NA 009 026-011	1.33	1NL 005 230-061	1.42	1ZS 169 009-131	1.38	2BA 002 652-107	5.138
1NA 009 026-021	1.33	1NL 005 230-111	1.42	1ZS 169 009-141	1.38	2BA 002 652-111	3.10, 3.35, 3.51, 3.69, 3.72, 3.74-3.79, 5.138
1NA 009 029-011	1.100, 1.140	1NL 005 230-121	1.42	1ZT...		2BA 002 652-117	5.138
1NA 009 029-021	1.100, 1.140	1NL 005 566-051	1.177	1ZT 009 260-671	1.83	2BA 002 652-121	3.10, 3.35, 3.51, 3.69, 3.72, 3.74-3.79, 5.138
1NA 009 031-011	1.104, 1.145	1NL 005 566-061	1.177	1ZT 009 260-681	1.83	2BA 002 939-177	5.138
1NA 009 031-021	1.104, 1.145	1NL 006 150-071	1.22	2AA...		2BA 002 939-251	5.139
1NA 009 032-011	1.108, 1.148	1NL 006 150-081	1.22	2AA 001 200-001	5.171	2BA 003 014-011	3.48, 5.83
1NA 009 032-021	1.108, 1.148	1NL 006 250-051	1.199	2AA 001 200-002	5.171	2BA 003 014-111	3.29, 3.71, 5.83
1NA 009 033-011	1.109, 1.149	1NL 006 250-061	1.199	2AA 001 200-011	5.171	2BA 003 022-001	5.137
1NA 009 033-021	1.109, 1.149	1NL 006 280-051	1.183	2AA 001 200-012	5.171	2BA 003 022-021	2.15, 2.17, 2.19, 2.21, 5.137
1NA 010 047-101	4.21	1NL 006 280-061	1.183	2AA 001 200-021	5.171	2BA 003 022-057	5.137
1NA 010 047-111	4.21	1NL 006 315-051	1.156, 1.173	2AA 001 200-023	5.171	2BA 003 110-011	1.90-1.91
1NA 010 047-811	4.21	1NL 006 315-061	1.156, 1.173	2AA 001 200-031	5.171	2BA 003 110-021	1.90-1.91
1NA 010 205-011	1.54	1NL 006 315-111	1.156, 1.173	2AA 001 200-032	5.171	2BA 003 197-011	1.97
1NA 010 205-021	1.54	1NL 006 315-121	1.156, 1.173	2AA 001 200-041	5.171	2BA 003 197-021	1.97
1NA 907 312-111	1.124-1.125	1NL 006 580-051	1.99, 1.139	2AA 001 200-042	5.171	2BA 003 236-021	2.15, 2.67, 2.69, 2.94, 2.99, 2.103, 2.109, 5.24
1NA 907 312-121	1.124-1.125	1NL 006 580-061	1.99, 1.139	2AA 001 200-131	5.171	2BA 003 236-027	2.68, 2.104, 5.24
1NA 961 557-731	1.125, 1.128	1NL 007 186-027	1.119, 4.31	2AA 001 200-141	5.171	2BA 003 236-177	5.24
1NA 961 557-741	1.125, 1.128	1NL 007 186-047	2.89, 4.31	2AA 001 201-011	5.171	2BA 003 236-321	2.91, 2.97, 5.25
1NA 961 557-751	1.124-1.125, 1.127	1NL 007 186-061	4.31	2AA 001 204-001	5.171	2BA 003 236-541	2.66, 5.25
1NA 961 557-761	1.124-1.125, 1.127	1NL 007 186-067	4.31	2AA 001 204-011	5.171	2BA 003 411-001	2.60
1NA 962 490-011	1.185	1NL 007 220-031	1.160, 1.193	2AA 001 204-031	5.171	2BA 003 727-071	1.189
1NA 962 490-021	1.185	1NL 007 220-041	1.160, 1.193	2AA 001 204-057	5.171	2BA 003 727-081	1.189
1NA 962 530-021	1.185	1NL 007 594-031	1.63	2AA 001 204-061	5.171	2BA 003 734-001	5.90
1NA 963 022-031	1.128	1NL 007 594-041	1.63	2AA 001 204-067	5.171	2BA 003 734-061	2.92, 2.98, 5.90
1NA 963 022-041	1.128	1NL 007 834-017	2.96, 2.106, 4.40	2AA 001 204-071	5.171	2BA 003 975-031	2.74, 3.15
1NA 963 965-051	1.124, 1.126	1NL 007 834-057	4.40	2AA 001 204-081	5.171	2BA 003 975-041	2.74, 3.15
1NA 963 965-061	1.124, 1.126	1NL 007 906-031	1.11, 1.127, 1.131	2AA 001 204-091	5.171	2BA 004 119-001	2.67, 2.69, 5.88
1NA 963 981-031	1.187	1NL 007 906-041	1.11, 1.127, 1.131	2AA 003 257-011	5.171	2BA 004 119-017	3.09, 5.88
1NA 963 981-041	1.187	1NL 008 090-031	1.150, 1.164, 1.170, 4.03	2AA 003 257-021	5.171	2BA 004 257-011	1.89
1NB...		1NL 008 090-037	4.03	2AA 003 257-031	5.171, 6.16	2BA 004 257-021	1.89
1NB 003 367-137	2.27-2.28	1NL 008 090-117	4.03	2AA 003 257-041	5.171	2BA 004 257-031	1.89
1NB 004 691-147	4.46	1NL 008 090-301	4.04	2AA 003 257-042	5.171	2BA 004 257-041	1.89
1NB 005 394-051	1.153	1NL 008 090-317	4.04	2AA 008 592-001	5.170	2BA 004 257-801	1.89
1NB 005 394-061	1.153	1NL 008 090-327	4.04	2AA 008 592-011	5.170	2BA 004 499-001	2.55, 2.65
1NB 005 860-001	4.25	1NL 008 090-821	4.03	2AA 008 592-021	5.170	2BA 004 528-051	1.176
1NB 005 860-021	4.25	1NL 008 090-831	4.03	2AA 008 592-031	5.170	2BA 004 528-061	1.176
1NB 005 860-801	4.25	1NL 008 090-871	4.04	2AA 008 593-001	5.170	2BA 004 528-061	1.77, 1.93
1NB 006 270-051	1.27	1NL 008 383-821	1.164	2AA 008 593-011	5.170	2BA 004 693-041	1.77, 1.93
1NB 006 270-061	1.27	1NL 008 383-861	1.150	2AA 008 593-021	5.170	2BA 004 693-801	1.93
1NB 007 360-011	4.24	1NL 008 383-911	1.170	2AA 008 593-031	5.170	2BA 005 200-311	5.26
1NB 007 360-021	4.24	1NL 009 034-011	1.181	2AA 008 594-001	5.170	2BA 005 296-031	1.19
1NB 007 555-031	1.75, 1.80, 1.87	1NL 009 034-021	1.181	2AA 008 594-011	5.170	2BA 005 296-041	1.19
1NB 007 555-041	1.75, 1.80, 1.87	1NL 009 071-317	4.32	2AA 008 594-021	5.170	2BA 005 398-031	1.154
1NB 007 892-001	4.23	1NL 009 071-327	4.32	2AA 008 595-001	5.170	2BA 005 398-041	1.154
1NB 007 892-041	4.23	1PE...		2AA 008 595-011	5.170	2BA 005 407-001	2.05
1NB 007 892-821	4.23	1PE 965 410-111	2.08	2AA 008 595-021	5.170	2BA 005 481-001	2.10
1NB 008 122-011	1.199	1PE 965 410-121	2.08	2AA 008 595-031	5.170	2BA 005 481-011	2.11
1NB 008 122-021	1.199	1SO...		2AB...		2BA 005 603-001	2.26, 2.28, 2.95, 2.101-2.102, 2.105, 5.87
1NB 008 275-031	1.83, 1.96	1SO 001 430-011	3.23, 3.28, 3.31	2AB 001 208-001	5.163	2BA 005 603-007	5.87
1NB 008 275-041	1.83, 1.96	1S3...		2AB 004 074-027	5.163	2BA 005 603-011	2.95, 2.101, 2.105, 2.108, 5.87
1NB 008 275-071	1.84	1S3 001 442-001	3.53, 4.48	2AB 004 074-087	5.163	2BA 005 603-017	5.87
1NB 008 275-081	1.84	1S5...		2AB 004 532-001	5.162	2BA 005 603-217	5.87
1NB 123 581-001	1.25, 1.29, 1.41	1S5 003 178-431	4.52	2AB 004 532-011	5.162	2BA 006 091-011	1.105
1NB 123 582-001	1.25, 1.29, 1.41	1SO...		2AB 004 532-021	5.162	2BA 006 091-021	1.105
1NB 137 001-021	4.25	1SO 440 LUS-121	4.44	2AB 004 532-031	5.162	2BA 006 334-051	1.183
1ND...		1TA...		2AB 004 532-051	2.67, 2.69, 5.162	2BA 006 334-061	1.183
1ND 003 590-001	2.14	1TA 003 570-001	3.50, 3.69, 3.89-3.90, 4.48	2AB 004 532-061	5.162	2BA 006 386-071	1.22
1ND 003 590-401	4.25	1TA 003 570-101	3.73-3.78, 3.80, 4.52	2AB 004 532-071	5.162	2BA 006 386-081	1.22
1ND 005 700-001	4.26	1TA 122 718-001	3.50, 3.69, 3.89-3.90, 4.48	2AB 004 532-257	5.162	2BA 006 728-801	1.157, 1.174
1ND 005 700-021	4.26	1TV6...		2AB 004 532-267	5.162	2BA 006 749-051	1.47
1ND 005 700-061	4.26	1TV6 001 LOO-101	4.44	2BA...		2BA 006 749-061	1.47
1ND 005 700-841	4.26			2BA 001 221-031	2.116, 2.122, 5.139	2BA 006 749-071	1.47
1ND 007 646-011	1.28			2BA 001 221-041	2.116, 2.122, 5.139	2BA 006 749-081	1.47
1ND 007 646-021	1.28			2BA 001 227-201	3.50, 3.98-3.100, 5.137	2BA 007 016-031	1.95
1ND 122 390-001	1.97, 2.72, 2.74			2BA 001 227-211	3.68, 3.80-3.81, 3.90-3.91, 3.118-3.120, 5.137	2BA 007 016-041	1.95
1NE...							
1NE 002 537-201	4.27						
1NE 002 537-301	2.85						
1NE 006 300-011	4.28						
1NE 006 300-051	2.38, 2.41, 4.28						
1NE 006 300-071	4.28						

List of Part Numbers



Part number	Page	Part number	Page	Part number	Page	Part number	Page
2BA...		2BA...		2BM...		2DA...	
2BA 007 042-031	1.06	2BA 964 169-047	5.69	2BM 003 647-021	1.10, 1.16-1.21, 1.23-1.24,	2DA 343 106-027	5.135
2BA 007 042-041	1.06	2BA 964 169-237	5.69		1.154-1.155, 1.157,	2DA 343 106-031	5.135
2BA 007 135-001	5.141	2BA 964 169-501	5.66		1.174, 1.176, 1.184,	2DA 343 106-037	5.135
2BA 007 135-011	5.141	2BA 964 169-507	5.66		3.27, 5.143	2DA 343 106-201	5.135
2BA 007 135-021	5.141	2BA 964 169-647	5.66	2BM 003 647-067	5.143	2DA 343 106-207	5.135
2BA 007 177-011	1.161	2BA 964 255-011	1.99	2BM 003 647-801	1.154-1.155, 1.157,	2DA 343 106-211	5.135
2BA 007 177-021	1.161	2BA 964 255-021	1.99		1.174, 1.184, 5.143	2DA 343 106-217	5.135
2BA 007 177-801	1.161	2BA 964 255-031	1.99	2BM 003 933-031	1.25, 1.29, 1.41-1.42,	2DA 343 106-221	5.135
2BA 007 249-011	1.105	2BA 964 255-041	1.99		5.143	2DA 343 106-227	5.135
2BA 007 249-021	1.105	2BA 965 039-021	5.64	2BM 003 933-041	1.25, 1.29, 1.41-1.42,	2DA 343 106-231	5.135
2BA 007 275-011	1.25	2BA 965 039-027	5.64		5.143	2DA 343 106-237	5.135
2BA 007 275-021	1.25	2BA 965 039-061	5.64	2BM 004 312-051	2.74, 5.143	2DA 343 130-257	5.73
2BA 007 775-051	2.71	2BA 965 039-067	5.64	2BM 004 312-061	2.74, 5.143	2DA 343 130-267	5.73
2BA 007 775-061	2.71	2BA 965 039-101	5.64	2BM 004 965-801	5.142	2DA 343 130-267	5.135
2BA 007 839-001	2.29, 2.32	2BA 965 039-107	5.64	2BM 006 692-011	1.95, 1.97, 2.29, 2.48,	2DA 343 800-007	5.135
2BA 007 840-001	2.38, 2.42	2BA 965 039-141	5.64		2.66, 2.71-2.72, 2.74,	2DA 343 800-047	5.135
2BA 007 924-071	1.203, 1.205	2BA 965 039-147	5.64		2.86, 2.89, 2.93, 2.96,	2DA 343 800-057	5.135
2BA 007 924-081	1.203, 1.205	2BA 996 012-061	5.84		2.99, 2.103,	2DA 959 071-037	5.134
2BA 008 221-001	1.55, 5.57	2BA 996 012-071	5.84		2.105-2.107, 5.144	2DA 959 071-237	5.134
2BA 008 221-007	5.57	2BA 996 012-147	5.84	2BM 006 692-017	5.144	2DA 959 071-537	5.134
2BA 008 221-041	1.100, 1.141, 5.57	2BA 996 027-001	5.139	2BM 006 692-021	1.95, 1.97, 2.29, 2.48,	2DA 959 071-737	5.134
2BA 008 221-047	5.57	2BA 997 027-031	5.93		2.66, 2.71-2.72, 2.74,	2DA 959 071-757	5.134
2BA 008 221-107	3.27, 5.57	2BE...			2.86, 2.89, 2.93, 2.96,	2DA 959 380-111	5.134
2BA 008 221-147	5.57	2BE 001 259-061	3.09, 3.21, 3.23, 3.28,	2BM 006 692-027	2.99, 2.103,	2DA 959 380-511	5.134
2BA 008 221-217	5.57		3.34, 3.36, 3.47,		2.105-2.107, 5.144	2DA 964 169-001	5.68
2BA 008 260-001	5.140		3.120, 5.79	2BM 006 759-001	5.144	2DA 964 169-007	5.68
2BA 008 260-007	5.140	2BE 001 278-011	3.99		1.154-1.155, 1.157,	2DA 964 169-727	5.68
2BA 008 260-017	5.140	2BE 001 278-021	3.99	2BM 006 759-801	1.154-1.155, 1.157,	2DA 965 039-011	5.63
2BA 008 404-011	1.28	2BE 002 582-031	3.16, 3.117,		1.174, 1.184	2DA 965 039-091	5.63
2BA 008 404-021	1.28		3.120-3.123, 5.40	2BM 008 355-001	5.144	2DA 965 039-317	5.63
2BA 008 404-031	1.28	2BE 002 776-251	3.13, 3.44-3.46, 3.55,	2BM 008 355-007	5.144	2DA 996 012-041	5.84
2BA 008 404-041	1.28		5.46	2BM 008 355-017	5.144	2DA 997 027-021	5.93
2BA 008 467-801	1.55	2BE 002 776-257	5.46	2BM 008 771-001	5.144	2DB...	
2BA 008 805-051	5.86	2BE 002 776-261	3.13, 3.44-3.46, 3.55,	2BM 008 771-007	5.144	2DB 004 431-061	5.27
2BA 008 805-057	5.86		5.46	2BM 009 320-807	5.142	2JA...	
2BA 008 805-187	5.86	2BE 002 776-267	5.46	2BM 964 295-041	5.103	2JA 001 330-001	3.116, 5.156
2BA 008 982-041	5.85	2BE 003 014-251	3.14, 3.16, 3.30-3.31,	2BM 964 295-047	5.103	2JA 001 330-007	5.156
2BA 008 982-047	5.85		3.35-3.37, 3.45, 3.47,	2BM 964 988-801	1.102, 1.104, 1.110,	2JA 001 330-031	5.156
2BA 008 982-217	5.85		3.55-3.56, 3.58,		1.142, 1.145, 1.150	2JA 001 331-011	5.157
2BA 008 982-341	5.85		3.60-3.61, 3.63, 3.66,	2BN...		2JA 001 335-001	5.158
2BA 008 982-347	5.85		3.81-3.85, 3.104, 5.83	2BN 964 169-051	5.69	2JA 001 335-011	5.158
2BA 009 001-001	5.61	2BE 003 014-257	5.83	2BN 964 169-057	5.69	2JA 001 335-121	5.158
2BA 009 001-007	5.61	2BE 003 018-011	5.52	2BN 964 169-247	5.69	2JA 001 346-011	5.155
2BA 009 001-071	5.61	2BE 003 182-091	3.70, 5.45	2BN 964 169-777	5.69	2JA 001 357-002	2.18, 2.20, 2.57, 2.59,
2BA 009 001-077	5.61	2BE 003 182-101	3.70, 5.45	2BN 964 169-787	5.69		2.62-2.63, 2.66, 2.71,
2BA 009 001-107	5.61	2BE 003 184-051	5.41	2DA...			2.73, 2.76, 5.145
2BA 009 001-167	5.61	2BE 003 184-061	5.41	2DA 001 240-341	2.64, 5.77	2JA 001 357-012	1.98, 2.18, 2.20, 2.57,
2BA 009 001-197	5.61	2BE 003 185-031	5.52	2DA 001 423-077	5.70		2.59, 2.62-2.63, 2.66,
2BA 009 001-197	5.61	2BE 003 185-031	5.52	2DA 003 014-031	5.82		2.71-2.73, 2.76, 2.82,
2BA 009 001-201	5.61	2BE 003 185-051	3.21-3.22, 3.24-3.25,	2DA 003 014-037	5.82		5.145
2BA 009 001-411	5.59		3.28, 3.30	2DA 003 236-031	2.14, 2.94, 2.98-2.99,	2JA 001 360-001	5.156
2BA 009 001-511	5.59	2BE 003 347-001	3.20, 3.22, 3.24-3.26,		2.103-2.104, 2.109,	2JA 001 364-001	5.156
2BA 009 204-041	5.140		3.28, 3.39, 3.48-3.50,	2DA 003 236-037	5.24	2JA 001 364-007	1.156, 1.173
2BA 009 204-051	5.140		3.54, 3.61	2DA 003 734-011	5.24	2JA 002 661-001	2.82, 5.145
2BA 010 103-801	1.182	2BE 003 649-011	2.112	2DA 005 200-321	5.26	2JA 002 931-031	1.18, 1.20, 1.154,
2BA 010 118-011	1.182	2BE 003 649-021	2.112	2DA 005 603-031	2.90, 2.95, 2.97,		1.183-1.184, 1.197,
2BA 010 118-021	1.182	2BE 004 119-021	2.89, 2.96, 2.106, 5.88		2.101, 2.105-2.106,		1.199
2BA 010 118-031	1.182	2BE 010 102-001	5.53	2DA 005 603-037	2.108, 5.87	2JA 003 115-001	1.92
2BA 010 118-041	1.182	2BE 010 102-011	5.53	2DA 005 603-237	5.87	2JA 003 231-001	5.158
2BA 010 231-011	1.69	2BE 010 102-101	5.53	2DA 005 739-111	5.133	2JA 003 231-011	5.158
2BA 010 231-021	1.69	2BE 343 130-001	5.76	2DA 005 739-117	5.133	2JA 003 232-001	5.158
2BA 010 232-011	1.70	2BE 343 130-007	5.76	2DA 007 421-001	5.133	2JA 003 232-011	5.158
2BA 010 232-021	1.70	2BE 343 130-081	5.76	2DA 007 421-007	5.133	2JA 003 236-357	2.91, 2.95, 5.146
2BA 247 015-031	2.53	2BE 343 130-417	5.74	2DA 007 421-017	5.133	2JA 003 354-001	5.157
2BA 247 015-041	2.53	2BE 343 130-427	5.74	2DA 007 421-027	5.133	2JA 003 354-031	5.157
2BA 247 016-031	2.52	2BE 343 130-657	5.73, 5.76	2DA 007 428-001	5.132	2JA 003 354-051	5.157
2BA 247 016-041	2.52	2BE 343 130-667	5.73, 5.76	2DA 007 428-007	5.132	2JA 003 388-001	1.24, 1.26
2BA 270 016-031	1.46	2BE 343 130-777	5.73	2DA 007 541-001	5.132	2JA 004 192-001	5.156
2BA 270 016-041	1.46	2BE 343 130-787	5.73	2DA 007 541-007	5.132	2JA 004 252-031	1.89, 1.92
2BA 343 130-051	5.76	2BE 964 169-071	5.69	2DA 007 592-101	5.132	2JA 004 531-001	5.161
2BA 343 130-057	5.76	2BE 964 169-077	5.69	2DA 007 592-107	5.132	2JA 004 531-011	5.161
2BA 343 130-297	5.74	2BE 996 029-021	5.49	2DA 007 657-001	5.132	2JA 005 590-001	5.154
2BA 343 130-307	5.74	2BE 997 006-101	5.44	2DA 007 858-037	5.133	2JA 005 590-157	5.154
2BA 343 130-537	5.74	2BE 997 131-061	3.40, 5.43	2DA 008 136-007	5.134	2JA 006 447-041	5.146
2BA 343 130-547	5.74	2BE 997 131-207	5.43	2DA 008 136-017	5.134	2JA 006 447-251	5.146
2BA 343 130-577	5.76	2BM...		2DA 008 136-027	5.134	2JA 006 487-261	5.146
2BA 343 130-587	5.76	2BM 001 313-001	5.144	2DA 008 136-031	5.134	2JA 006 487-347	5.146
2BA 343 390-071	5.71	2BM 001 313-002	5.144	2DA 008 221-167	5.57	2JA 007 372-001	5.160
2BA 344 169-007	5.66	2BM 001 313-821	5.144	2DA 008 805-011	5.86	2JA 007 372-011	5.160
2BA 344 169-027	5.68	2BM 001 318-001	5.143	2DA 008 805-017	5.86	2JA 007 372-041	5.160
2BA 344 200-037	5.65	2BM 002 652-031	3.20, 3.22-3.23,	2DA 009 001-051	5.60	2JA 007 372-051	5.160
2BA 919 370-051	1.50		3.25-3.26, 3.28	2DA 009 001-057	5.60	2JA 007 373-001	5.160
2BA 919 370-061	1.50	2BM 002 652-051	1.97, 2.72, 5.138	2DA 009 001-147	5.60	2JA 007 373-011	5.160
2BA 959 011-301	5.54	2BM 002 652-071	2.72	2DA 010 415-001	1.171, 1.173, 1.182,	2JA 007 373-061	5.160
2BA 959 011-307	5.54	2BM 002 652-081	2.72		1.191	2JA 007 373-071	5.160
2BA 959 070-631	5.35	2BM 002 847-011	2.79, 2.90, 2.92, 2.99,	2DA 343 106-001	5.135	2JA 007 373-071	5.160
2BA 959 822-601	5.55		2.102, 2.109, 5.143	2DA 343 106-007	5.135	2JA 007 373-107	5.160
2BA 961 554-111	1.129	2BM 002 847-021	2.79, 2.90, 2.92, 2.99,	2DA 343 106-011	5.135	2JA 007 373-117	5.160
2BA 961 554-121	1.129		2.102, 2.109, 5.143	2DA 343 106-017	5.135	2JA 007 373-127	5.160
2BA 962 625-821	1.186	2BM 003 563-111	1.99, 1.104-1.106,	2DA 343 106-021	5.135	2JA 007 373-137	5.160
2BA 964 169-011	5.68		1.108, 1.139-1.140,				
2BA 964 169-017	5.68		1.144-1.145, 3.27,				
2BA 964 169-041	5.69		5.14				



List of Part Numbers

Part number	Page	Part number	Page	Part number	Page	Part number	Page
2JA...		2JA...		2KA...		2PF...	
2JA 008 078-021	5.155	2JA 344 199-111	5.148	2KA 959 640-607	5.110	2PF 001 650-001	5.108
2JA 008 078-031	5.155	2JA 959 037-511	5.35	2KA 959 640-661	5.194	2PF 002 452-017	2.63
2JA 008 405-081	5.153	2JA 959 073-001	5.145	2KA 997 011-001	5.117	2PF 002 860-031	2.63, 2.68, 2.92
2JA 008 615-001	5.154	2JA 959 073-201	5.145	2KA 997 011-011	5.117	2PF 002 985-291	5.127
2JA 009 037-017	5.146	2JA 959 820-501	5.55	2KA 997 011-021	5.117	2PF 003 014-071	3.31, 3.37, 3.48, 5.83
2JA 009 037-027	5.146	2JA 959 950-017	5.55	2KA 997 122-001	5.118	2PF 003 014-301	5.83
2JA 009 208-001	5.153	2JA 959 950-031	5.55	2KA 998 523-001	5.120	2PF 003 057-001	5.80
2JA 009 208-011	5.153	2JA 959 950-041	5.55	2KA 998 523-007	5.120	2PF 003 057-002	5.80
2JA 009 294-001	5.152	2JA 996 038-001	5.145	2KA 998 523-117	3.39, 5.120	2PF 003 057-041	3.70, 5.80
2JA 009 294-021	5.152	2JA 997 027-051	5.93, 5.156	2KA 998 523-131	5.214	2PF 003 389-037	5.121
2JA 009 294-241	5.152	2JA 998 560-017	5.151	2NE...		2PF 003 389-041	5.121
2JA 009 294-261	5.152	2JA 998 560-057	5.151	2NE 001 423-011	2.115, 5.70	2PF 003 563-151	5.112
2JA 340 111-001	5.161, 5.206	2JA 998 565-012	5.159	2NE 001 423-211	5.190	2PF 003 563-177	5.112
2JA 343 570-001	5.152	2JA 998 565-032	5.159	2NE 002 589-001	2.56, 2.64, 2.66, 5.128	2PF 003 734-031	5.90
2JA 343 570-011	5.152	2JA 998 569-017	5.159	2NE 002 589-047	1.85, 1.112	2PF 004 081-001	3.51, 5.81
2JA 343 570-021	5.152	2JB...		2NE 002 985-001	5.127	2PF 004 081-007	5.81
2JA 343 570-031	5.152	2JB 343 227-001	5.153, 5.205	2NE 003 030-151	5.127	2PF 004 081-011	5.81
2JA 343 570-041	5.152	2JB 343 227-041	5.153	2NE 003 236-001	2.15, 2.25, 2.62, 2.67, 2.69, 2.76, 2.82, 2.94, 2.98-2.99, 5.24	2PF 004 081-017	5.81
2JA 343 570-051	5.152	2JB 343 227-047	5.153			2PF 004 081-107	5.81
2JA 343 570-061	5.152	2JB 996 012-121	5.84			2PF 004 081-117	5.81
2JA 343 570-071	5.152	2KA...		2NE 003 236-008	5.24	2PF 004 081-117	5.81
2JA 343 570-117	5.152	2KA 001 378-001	3.73, 3.80, 5.116	2NE 003 236-301	5.25	2PF 006 679-007	5.108
2JA 343 570-141	5.152	2KA 001 378-041	2.56, 2.65, 2.91, 2.94, 2.100, 5.116	2NE 003 236-307	5.25	2PF 007 717-011	5.92
2JA 343 570-157	5.152			2NE 003 315-011	5.129	2PF 007 205-001	5.112
2JA 343 606-007	5.155	2KA 001 378-127	5.116	2NE 003 734-091	5.89	2PF 007 205-007	5.112
2JA 343 606-017	5.155	2KA 001 386-231	1.196, 2.22, 5.120	2NE 004 432-011	5.27	2PF 007 205-017	5.112
2JA 343 606-217	5.155	2KA 001 386-241	5.120	2NE 005 603-071	2.90, 2.95, 2.97, 2.101, 2.106, 2.108, 5.87	2PF 008 221-011	5.57
2JA 343 660-101	5.155	2KA 001 386-281	3.26, 3.122, 5.120			2PF 008 221-017	5.57
2JA 343 660-107	5.155	2KA 001 386-291	5.120	2NE 005 603-077	5.87	2PF 008 221-177	3.27, 5.57
2JA 343 660-117	5.155	2KA 001 386-301	5.120	2NE 006 609-001	5.129	2PF 008 405-051	5.56
2JA 343 680-067	5.147	2KA 001 386-301	5.120	2NE 006 609-007	5.129	2PF 008 405-057	5.56
2JA 343 680-127	5.147	2KA 001 386-497	5.120	2NE 006 609-011	5.129	2PF 008 405-061	5.56, 5.153
2JA 343 680-177	5.147	2KA 001 388-051	2.26, 2.29, 2.63	2NE 006 609-017	5.129	2PF 008 405-067	5.56
2JA 343 700-051	5.147	2KA 001 389-101	3.52, 3.56, 3.81, 3.90-3.91, 3.104, 3.117-3.118, 3.120, 5.118	2NE 006 609-187	5.129	2PF 009 001-081	5.80
2JA 343 700-167	5.147			2NE 008 221-031	1.100, 1.141, 5.57	2PF 009 001-087	5.80
2JA 343 700-221	5.147	2KA 001 389-147	3.13	2NE 008 221-037	5.57	2PF 009 001-177	5.60
2JA 343 700-251	5.147	2KA 001 610-001	5.119	2NE 008 221-137	5.57	2PF 009 001-421	5.59
2JA 343 700-271	5.147	2KA 001 622-001	5.119	2NE 008 805-031	5.86	2PF 009 001-521	5.59
2JA 343 720-011	5.162	2KA 002 445-111	1.155	2NE 008 805-037	5.86	2PF 009 514-001	5.107
2JA 343 720-021	5.162	2KA 002 445-171	1.184	2NE 009 001-021	5.60	2PF 009 514-011	5.107
2JA 343 720-111	5.162	2KA 003 010-007	2.27, 2.64, 2.103-2.104, 5.119	2NE 009 001-027	5.60	2PF 340 000-111	5.99, 5.198
2JA 343 720-121	5.162			2NE 009 001-127	5.60	2PF 340 825-001	5.198
2JA 343 720-157	5.162	2KA 003 102-011	1.92	2NE 343 130-031	5.75	2PF 340 825-041	5.198
2JA 343 720-191	5.162	2KA 003 168-021	3.57, 3.72, 3.82-3.85, 5.118	2NE 343 130-037	5.75	2PF 959 570-401	5.109
2JA 343 720-291	5.162			2NE 343 130-177	5.73	2PF 959 570-407	5.109
2JA 343 790-107	5.149	2KA 003 389-001	5.121	2NE 343 130-277	5.73	2PF 959 570-411	5.109
2JA 343 790-301	5.149	2KA 003 389-011	5.121	2NE 344 169-047	5.68	2PF 959 570-417	5.109
2JA 343 790-311	5.149	2KA 003 389-061	1.196-1.197, 1.200, 2.56, 2.66, 2.69, 2.72-2.73, 2.110, 2.115, 3.10-3.11, 3.15, 3.17, 3.36, 3.38, 3.40, 3.46, 3.59-3.60, 3.63-3.64, 3.66, 5.121	2NE 354 051-021	1.45	2PF 959 570-427	5.109
2JA 343 790-341	5.149			2NE 354 053-011	1.45	2PF 959 590-401	5.110
2JA 343 790-351	5.149	2KA 003 389-062	5.121	2NE 354 053-021	1.45	2PF 959 590-407	5.110
2JA 343 790-401	5.149	2KA 003 389-068	5.121	2NE 354 062-021	1.56	2PF 959 590-411	5.110
2JA 343 790-411	5.149	2KA 003 389-081	2.25, 2.28, 2.30, 2.36, 2.39, 2.43-2.44, 2.47, 5.121	2NE 354 068-021	1.59	2PF 959 590-417	5.110
2JA 343 790-441	5.149			2NE 959 011-501	5.54, 5.128	2PF 959 590-437	5.110
2JA 343 790-451	5.149	2KA 003 389-211	5.121	2NE 959 011-507	5.54, 5.128	2PF 959 590-457	5.110
2JA 343 790-601	5.149	2KA 003 389-217	5.121	2NE 959 821-201	5.55	2PF 961 167-021	2.09, 2.79, 2.86, 2.92, 2.102-2.103, 5.107
2JA 343 790-611	5.149	2KA 003 485-021	1.105, 1.138-1.139, 1.144, 1.146	2NE 964 169-021	5.68	2PF 962 964-061	5.91
2JA 343 790-641	5.149			2NE 964 169-027	5.68	2PF 962 964-071	5.91
2JA 343 790-651	5.149	2KA 003 738-057	3.38, 3.41	2NE 964 169-227	5.68	2PF 964 295-021	5.103
2JA 343 790-701	5.149	2KA 004 331-031	1.26, 1.29, 1.41-1.42	2NE 964 169-341	5.65	2PF 964 295-027	5.103
2JA 343 790-711	5.149	2KA 004 331-061	5.116	2NE 964 169-521	5.66	2PF 964 295-257	5.102
2JA 343 790-741	5.149	2KA 004 434-031	1.105, 1.139	2NE 964 169-527	5.66	2PF 965 039-071	5.63
2JA 343 790-751	5.149	2KA 004 525-001	5.119	2NE 964 169-667	5.66	2PF 965 039-077	5.63
2JA 343 795-001	5.150	2KA 004 983-011	1.73, 1.78, 1.89, 1.94	2NE 964 962-041	1.173	2PF 965 039-151	5.63
2JA 343 795-011	5.150	2KA 005 049-008	5.116	2NE 965 039-031	5.63	2PF 965 039-157	5.63
2JA 343 795-021	5.150	2KA 005 049-011	2.90, 2.95, 2.97, 2.100, 2.107, 5.116	2NE 965 039-037	5.63	2PF 966 012-051	5.84
2JA 343 795-031	5.150			2NE 965 039-111	5.63	2PF 997 022-011	5.109
2JA 343 860-031	5.147	2KA 005 049-017	5.116	2NE 965 039-117	5.63	2PF 997 023-011	5.109
2JA 343 865-031	5.147	2KA 006 896-001	5.118	2NE 965 039-327	5.63	2PF 997 027-011	5.93
2JA 343 865-031	5.147	2KA 006 896-007	5.118	2NE 996 012-021	5.84		
2JA 343 980-217	5.149	2KA 007 929-001	5.121	2NR...			
2JA 343 985-001	5.150	2KA 007 929-007	5.121	2NR 005 554-111	1.31	2PG 002 727-021	5.98
2JA 343 985-011	5.150	2KA 010 278-011	5.116	2NR 005 554-121	1.31	2PG 003 057-011	5.80
2JA 343 985-021	5.150	2KA 010 278-017	5.116	2NR 010 229-011	1.60	2PG 003 057-067	5.80
2JA 343 985-041	5.150	2KA 010 278-021	5.117	2NR 010 229-021	1.60	2PG 003 748-151	5.96
2JA 344 040-701	5.148	2KA 010 278-021	5.117	2NR 982 008-111	1.46	2PG 004 361-011	5.98
2JA 344 040-711	5.148	2KA 010 278-031	5.117	2NR 982 008-121	1.46	2PG 006 717-021	5.92
2JA 344 040-721	5.148	2KA 010 278-041	5.117			2PG 006 717-022	5.92
2JA 344 040-731	5.148	2KA 010 278-051	5.117	2PF 001 259-631	2.58, 3.98-3.99, 5.78	2PG 006 717-027	5.92
2JA 344 040-741	5.148	2KA 010 278-311	5.116	2PF 001 259-677	2.58, 5.78	2PG 008 434-001	5.106
2JA 344 040-751	5.148	2KA 010 278-317	5.116	2PF 001 259-687	2.58	2PG 008 645-041	5.100
2JA 344 040-761	5.148	2KA 010 278-321	5.117	2PF 001 634-101	5.108	2PG 008 645-051	5.100
2JA 344 040-771	5.148	2KA 340 118-001	5.195	2PF 001 638-011	2.58, 2.108, 5.111	2PG 008 645-057	5.100
2JA 344 170-001	5.151	2KA 340 828-001	5.194	2PF 001 638-067	2.58	2PG 008 645-167	5.100
2JA 344 170-011	5.151	2KA 340 828-041	5.194	2PF 001 647-031	2.05, 2.31, 2.58, 2.90, 2.92, 2.98, 2.110-2.111	2PG 008 645-321	5.201
2JA 344 170-021	5.151	2KA 959 640-102	5.110			2PG 008 645-331	5.201
2JA 344 170-031	5.151			2PF 001 647-037	5.111	2PG 008 645-341	5.201
2JA 344 170-101	5.151			2PF 001 648-161	3.118, 3.121, 5.112	2PG 008 645-631	5.100
2JA 344 170-111	5.151			2PF 001 648-171	5.112	2PG 008 645-641	5.100
2JA 344 170-121	5.151						
2JA 344 170-131	5.151						
2JA 344 199-001	5.148						
2JA 344 199-011	5.148						
2JA 344 199-101	5.1						

List of Part Numbers



Part number	Page	Part number	Page	Part number	Page	Part number	Page
2PG...		2PS...		2PT...		2RL...	
2PG 340 000-121	5.99, 5.198	2PS 340 000-011	5.99, 5.203	2PT 965 039-161	5.64	2RL 008 183-101	6.12
2PG 962 964-041	5.91	2PS 340 000-021	5.99, 5.203	2PT 965 039-171	5.64	2RL 008 183-111	6.12
2PG 962 964-051	5.91	2PS 340 000-041	5.99, 5.203	2PT 965 039-177	5.64	2RL 008 364-021	6.06, 6.63
2PG 962 964-057	5.91	2PS 340 000-051	5.99, 5.203	2RL...		2RL 008 366-021	6.11, 6.63
2PG 963 639-401	5.94	2PS 340 000-061	5.99, 5.203	2RL 006 846-001	6.03	2RL 008 366-031	6.11, 6.63
2PG 963 639-411	5.94	2PS 340 000-171	5.99, 5.203	2RL 006 846-011	6.03	2RL 008 965-001	6.04
2PG 963 959-021	5.97	2PS 340 001-001	5.95	2RL 006 846-101	6.03	2RL 008 965-011	6.04
2PG 963 959-027	5.97	2PS 340 001-011	5.95	2RL 006 846-111	6.03	2RL 008 965-021	6.04
2PG 964 295-011	5.102	2PS 340 836-011	5.202	2RL 007 017-041	6.13	2RL 008 965-031	6.04
2PG 964 295-012	5.102	2PS 340 836-051	5.202	2RL 007 017-051	6.13	2RL 008 965-041	6.04
2PG 964 295-017	5.102	2PS 340 837-031	5.202	2RL 007 017-061	6.13	2RL 008 966-001	6.04
2PG 964 295-111	5.102	2PS 340 837-041	5.202	2RL 007 017-071	6.13	2RL 008 966-021	6.04
2PG 964 295-117	5.102	2PS 340 837-101	5.202	2RL 007 337-001	6.03	2RL 008 966-031	6.04
2PG 964 295-121	5.102	2PS 340 837-111	5.202	2RL 007 337-011	6.03	2RL 008 967-001	6.04
2PG 964 295-127	5.102	2PS 962 964-012	2.93, 2.100, 2.102, 2.104, 2.107, 5.91	2RL 007 337-021	6.03	2RL 008 967-011	6.04
2PS...		2PS 962 964-018	5.91	2RL 007 337-031	6.03	2RL 008 967-021	6.04
2PS 002 727-001	5.98	2PS 962 964-031	5.91	2RL 007 337-041	6.03	2RL 008 967-031	6.04
2PS 002 727-007	5.98	2PS 962 964-037	5.91	2RL 007 337-057	6.03	2RL 008 967-041	6.04
2PS 003 057-051	5.80	2PS 963 639-001	5.94	2RL 007 337-101	6.03	2RL 008 990-001	6.04
2PS 003 057-052	5.80	2PS 963 639-007	5.94	2RL 007 337-111	6.03	2RL 008 990-011	6.04
2PS 003 057-057	5.80	2PS 963 639-011	5.94, 5.201	2RL 007 337-121	6.03	2RL 009 279-001	6.24
2PS 003 748-121	5.96	2PS 963 639-017	5.94, 5.201	2RL 007 550-001	6.05	2RL 009 279-011	6.24
2PS 003 748-127	5.96	2PS 963 639-021	5.94	2RL 007 550-011	6.05	2RL 009 279-021	6.26
2PS 003 748-161	5.96	2PS 963 639-027	5.94	2RL 007 550-021	6.05	2RL 009 279-031	6.26
2PS 003 748-167	5.96	2PS 963 639-031	5.95	2RL 007 551-001	6.05	2RL 009 279-041	6.24
2PS 003 748-177	5.96	2PS 963 639-037	5.95	2RL 007 551-011	6.05	2RL 009 279-051	6.24
2PS 004 361-001	2.112, 5.98	2PS 963 639-041	5.94	2RL 007 551-021	6.05	2RL 009 279-061	6.26
2PS 004 361-007	5.98	2PS 963 639-047	5.94	2RL 007 552-001	6.05	2RL 009 279-071	6.26
2PS 006 717-031	5.92	2PS 963 639-051	5.95	2RL 007 552-011	6.05	2RL 009 279-081	6.25
2PS 006 717-032	5.92	2PS 963 639-057	5.95	2RL 007 552-021	6.05	2RL 009 279-091	6.25
2PS 006 717-037	5.92	2PS 963 639-061	5.94	2RL 007 553-001	6.05	2RL 009 279-101	6.24
2PS 006 717-051	5.92	2PS 963 639-067	5.94	2RL 007 553-011	6.05	2RL 009 279-111	6.24
2PS 006 717-057	5.92	2PS 963 639-071	5.94, 5.201	2RL 007 553-021	6.05	2RL 009 279-121	6.26
2PS 006 717-061	5.92	2PS 963 639-077	5.94, 5.201	2RL 007 900-001	6.31	2RL 009 279-131	6.26
2PS 006 717-067	5.92	2PS 963 639-081	5.94	2RL 007 900-121	6.33	2RL 009 279-141	6.24
2PS 006 717-071	5.92	2PS 963 639-091	5.94	2RL 007 900-151	6.31	2RL 009 279-151	6.24
2PS 007 943-011	5.104, 5.201	2PS 963 639-097	5.94	2RL 007 900-171	6.33	2RL 009 279-161	6.26
2PS 007 943-017	5.104, 5.201	2PS 963 639-101	5.94	2RL 007 900-191	6.31	2RL 009 279-171	6.26
2PS 007 943-021	5.104, 5.201	2PS 963 639-111	5.94	2RL 007 900-201	6.31	2RL 009 279-181	6.25
2PS 007 943-027	5.104, 5.201	2PS 963 639-117	5.94	2RL 007 900-211	6.31	2RL 009 279-191	6.25
2PS 007 943-311	5.104	2PS 963 639-127	5.94	2RL 007 900-221	6.33	2RL 009 279-211	6.24
2PS 007 943-317	5.104	2PS 963 639-137	5.95	2RL 007 900-241	6.33	2RL 009 279-231	6.26
2PS 007 943-321	5.104	2PS 963 639-147	5.95	2RL 007 900-251	6.31	2RL 009 279-241	6.24
2PS 007 972-011	5.97	2PS 963 639-157	5.95	2RL 007 900-271	6.33	2RL 009 279-251	6.24
2PS 007 972-017	5.97	2PS 963 639-167	5.94	2RL 007 900-281	6.33	2RL 009 279-261	6.28
2PS 008 050-007	5.104	2PS 963 639-177	5.95	2RL 007 900-291	6.31	2RL 009 279-271	6.26
2PS 008 050-027	5.104	2PS 963 639-197	5.94	2RL 007 900-501	6.30	2RL 009 279-281	6.26
2PS 008 138-001	5.104	2PS 963 639-207	5.94	2RL 007 900-511	6.30	2RL 009 279-291	6.25
2PS 008 138-101	5.104	2PS 963 959-001	5.97	2RL 007 900-521	6.30	2RL 009 279-321	6.27
2PS 008 138-111	5.104	2PS 963 959-007	5.97	2RL 007 900-551	6.30	2RL 009 279-331	6.26
2PS 008 138-801	5.104	2PS 963 959-011	5.97	2RL 007 900-561	6.30	2RL 009 279-341	6.27
2PS 008 138-811	5.104	2PS 963 959-017	5.97	2RL 007 900-571	6.30	2RL 009 279-371	6.26
2PS 008 138-821	5.104	2PS 964 295-001	5.102	2RL 007 900-601	6.31	2RL 009 279-391	6.25
2PS 008 382-001	5.106	2PS 964 295-007	5.102	2RL 007 900-611	6.31	2RL 009 279-401	6.24
2PS 008 382-007	5.106	2PS 964 295-051	5.102	2RL 007 900-631	6.33	2RL 009 279-411	6.24
2PS 008 382-801	5.106	2PS 964 295-057	5.102	2RL 007 900-651	6.31	2RL 009 279-431	6.26
2PS 008 382-807	5.106	2PS 964 295-061	5.102	2RL 007 900-681	6.33	2RL 009 279-441	6.28
2PS 008 382-811	5.106	2PS 964 295-067	5.102	2RL 007 900-701	6.32	2RL 009 279-451	6.26
2PS 008 382-817	5.106	2PS 964 295-071	5.102	2RL 008 060-001	6.07	2RL 009 279-471	6.28
2PS 008 541-801	5.101	2PS 964 295-077	5.102	2RL 008 060-011	6.07	2RL 009 279-481	6.26
2PS 008 616-001	5.105, 5.202	2PS 964 295-081	5.102	2RL 008 060-101	6.07	2RL 009 279-501	6.25
2PS 008 616-011	5.105, 5.202	2PS 964 295-087	5.102	2RL 008 060-111	6.07	2RL 009 279-511	6.25
2PS 008 616-017	5.105, 5.202	2PT...		2RL 008 061-001	6.07	2RL 009 279-521	6.25
2PS 008 643-011	5.105	2PT 008 362-801	5.113	2RL 008 061-011	6.07	2RL 009 279-541	6.25
2PS 008 643-017	5.105	2PT 008 935-001	1.102, 1.142, 1.170, 5.114	2RL 008 061-101	6.07	2RL 009 279-551	6.25
2PS 008 643-021	5.105	2PT 008 935-011	1.165, 5.114	2RL 008 061-111	6.07	2RL 009 279-571	6.27
2PS 008 643-027	5.105	2PT 008 935-017	5.114	2RL 008 062-001	6.07	2RL 009 279-581	6.25
2PS 008 643-031	5.105	2PT 008 935-801	5.114	2RL 008 062-011	6.07	2RL 009 279-591	6.25
2PS 008 643-037	5.105	2PT 008 935-811	5.114	2RL 008 062-101	6.07	2RL 009 279-601	6.24
2PS 008 643-331	5.105	2PT 008 956-801	1.160, 1.194	2RL 008 062-111	6.07	2RL 009 279-611	6.27
2PS 008 645-001	5.101	2PT 009 305-801	1.170	2RL 008 063-001	6.07	2RL 009 279-631	6.27
2PS 008 645-007	5.101	2PT 009 305-811	1.165	2RL 008 063-011	6.07	2RL 009 279-651	6.27
2PS 008 645-011	5.101	2PT 009 305-821	1.102, 1.142	2RL 008 063-101	6.07	2RL 009 279-661	6.27
2PS 008 645-021	5.100	2PT 009 496-007	5.114	2RL 008 063-111	6.07	2RL 009 279-671	6.27
2PS 008 645-031	5.100	2PT 009 496-801	5.114	2RL 008 064-001	6.08	2RL 009 279-691	6.24
2PS 008 645-187	5.101	2PT 009 599-011	1.59, 1.170, 5.115	2RL 008 064-101	6.08	2RL 009 279-721	6.25
2PS 008 645-301	5.201	2PT 009 599-021	1.59, 1.170, 5.115	2RL 008 065-001	6.09	2RL 009 279-751	6.26
2PS 008 645-311	5.201	2PT 009 599-031	5.115	2RL 008 065-011	6.09	2RL 009 279-781	6.27
2PS 008 645-361	5.201	2PT 009 599-041	5.115	2RL 008 065-101	6.09	2RL 009 279-791	6.24
2PS 008 645-377	5.201	2PT 009 599-801	5.115	2RL 008 065-107	6.09	2RL 009 279-801	6.27
2PS 008 645-497	5.101	2PT 010 043-011	5.113	2RL 008 065-111	6.09	2RL 009 279-831	6.27
2PS 008 645-601	5.101	2PT 010 043-021	5.113	2RL 008 181-001	6.12	2RL 009 279-841	6.26
2PS 008 645-607	5.101	2PT 010 043-031	5.113	2RL 008 181-011	6.12	2RL 009 279-861	6.28
2PS 008 645-611	5.101	2PT 010 043-041	5.113	2RL 008 181-101	6.12	2RL 009 279-871	6.28
2PS 008 645-617	5.101	2PT 010 043-801	5.113	2RL 008 182-001	6.12	2RL 009 279-881	6.28
2PS 008 645-621	5.101	2PT 010 047-201	5.113	2RL 008 182-011	6.12	2RL 009 279-901	6.28
2PS 009 226-017	5.104	2PT 010 047-211	5.113	2RL 008 182-101	6.12	2RL 009 279-911	6.28
2PS 009 226-027	5.104	2PT 010 047-821	5.113	2RL 008 182-111	6.12	2RL 009 279-921	6.28
2PS 009 226-037	5.104	2PT 010 177-801	1.170	2RL 008 183-001	6.12	2RL 009 688-001	6.24
2PS 340 000-001	5.99, 5.203	2PT 010 177-811	1.59	2RL 008 183-011	6.12	2RL 009 688-011	6.26
						2RL 009 688-021	6.27



List of Part Numbers

Part number	Page	Part number	Page	Part number	Page	Part number	Page
2RL...		2RM...		2SB...		2SD...	
2RL 009 688-031	6.25	2RM 379 500-601	6.57	2SB 005 603-137	5.87	2SD 003 167-021	2.18, 2.20, 2.24, 2.59, 2.61, 2.81, 3.26-3.27, 5.23
2RL 009 688-041	6.24	2RM 379 500-631	6.56	2SB 008 405-091	5.56	2SD 003 167-371	5.23
2RL 009 688-051	6.26	2RM 379 500-641	6.56	2SB 008 405-101	5.56	2SD 003 167-521	5.23
2RL 009 688-061	6.27	2RM 379 500-651	6.57	2SB 008 805-021	5.86	2SD 003 167-531	2.25, 2.27, 5.23
2RL 009 688-081	6.25	2RM 379 500-661	6.56	2SB 008 805-027	5.86	2SD 003 167-541	2.25, 2.27, 5.23
2RL 009 688-091	6.24	2RM 379 500-671	6.57	2SB 008 982-001	5.85	2SD 003 182-051	3.70, 3.73-3.75, 3.90-3.91, 5.45
2RL 009 688-101	6.26	2RM 379 500-691	6.56	2SB 008 982-007	5.85	2SD 003 182-057	5.45
2RL 009 688-111	6.27	2RM 379 500-701	6.57	2SB 008 982-207	5.85	2SD 003 182-061	3.70, 3.73, 3.90-3.91, 5.45
2RL 009 688-121	6.25	2RM 379 500-711	6.57	2SB 008 982-301	5.85	2SD 003 182-067	5.45
2RL 009 688-131	6.24	2RM 379 500-721	6.58	2SB 008 982-307	5.85	2SD 003 184-031	3.37-3.38, 3.55, 3.59, 3.61, 3.66, 3.70-3.72, 5.41
2RL 009 688-141	6.26	2RM 379 500-741	6.56	2SB 008 982-367	5.85	2SD 003 184-037	5.41
2RL 009 688-151	6.27	2RM 379 500-761	6.58	2SB 009 001-061	5.60	2SD 003 184-041	3.38, 3.70-3.72, 5.41
2RL 009 688-201	6.26	2RM 379 500-771	6.58	2SB 009 001-067	5.60	2SD 003 184-047	5.41
2RL 009 688-211	6.28	2RM 379 500-781	6.58	2SB 009 001-157	5.60	2SD 003 409-181	5.33
2RL 009 688-231	6.28	2RM 379 500-811	6.56	2SB 009 001-401	5.59	2SD 003 409-201	5.33
2RL 009 688-251	6.24	2RM 379 500-831	6.58	2SB 009 001-501	5.59	2SD 003 409-207	5.33
2RL 171 067-101	6.55	2RM 379 500-841	6.56	2SB 009 362-011	5.58	2SD 003 409-317	5.33
2RL 860 880-001	6.43	2RM 379 500-861	6.58	2SB 009 362-021	5.58	2SD 003 409-327	5.33
2RL 863 106-001	6.26, 6.33, 6.37, 6.53	2RM 379 500-871	6.58	2SB 009 362-041	5.58	2SD 004 431-011	5.27
2RL 863 106-011	6.26, 6.33, 6.53	2RM 379 500-901	6.58	2SB 343 130-027	5.75	2SD 004 460-001	5.28
2RL 863 123-001	6.27, 6.54	2RM 379 500-911	6.58	2SB 343 130-757	5.75	2SD 004 460-007	5.28
2RL 863 123-011	6.27, 6.54	2RM 379 500-921	6.58	2SB 343 130-767	5.75	2SD 004 460-011	5.28
2RL 863 132-001	6.37, 6.51	2RM 379 500-931	6.58	2SB 343 390-091	5.71	2SD 004 460-017	5.28
2RL 863 132-011	6.51	2RM 379 500-941	6.58	2SB 344 169-017	5.66	2SD 004 460-017	5.28
2RL 863 132-021	6.24	2RM 379 500-961	6.58	2SB 344 200-027	5.65	2SD 004 623-028	5.46
2RL 863 132-031	6.24	2RM 379 500-991	6.58	2SB 959 010-301	5.54	2SD 006 040-031	5.21
2RM...		2SA...		2SD...			
2RM 007 200-001	6.44, 6.46	2SA 001 240-331	2.64, 5.77	2SD 001 305-021	5.43	2SD 006 459-021	5.28
2RM 007 200-011	6.44	2SA 001 259-751	3.22-3.24, 3.26, 3.29, 3.80, 3.99, 5.78	2SD 001 306-061	3.44	2SD 006 459-027	5.28
2RM 007 200-041	6.44, 6.46	2SA 001 259-757	2.58, 5.78	2SD 001 679-001	3.121, 5.51	2SD 006 459-031	5.28
2RM 007 200-061	6.46	2SA 001 634-121	5.108	2SD 001 680-271	1.98, 2.55-2.56, 5.17	2SD 009 691-091	1.191
2RM 007 200-071	6.46	2SA 001 638-021	2.58, 2.109, 5.111	2SD 001 680-281	2.55, 5.17	2SD 009 691-101	1.191
2RM 007 200-091	6.44, 6.46	2SA 001 647-041	2.91, 2.93, 2.110-2.111	2SD 001 680-391	5.17	2SD 010 230-011	1.60
2RM 007 200-111	6.44, 6.46	2SA 002 860-041	2.63, 2.68	2SD 001 680-401	5.17	2SD 010 230-021	1.60
2RM 007 200-121	6.44	2SA 003 014-051	3.32, 5.82	2SD 001 685-211	2.59, 2.61, 3.117-3.119, 5.50	2SD 010 230-011	5.75
2RM 007 200-131	6.44	2SA 003 057-021	3.49, 5.80	2SD 001 685-218	5.50	2SD 343 130-017	5.75
2RM 007 200-141	6.46	2SA 003 236-041	2.14, 2.91, 2.94, 2.99, 2.109, 5.24	2SD 001 685-231	5.50	2SD 343 130-071	5.75
2RM 007 200-151	6.46	2SA 003 236-047	5.24	2SD 001 685-232	5.50	2SD 343 130-137	5.75
2RM 007 200-161	6.44, 6.46	2SA 003 236-048	5.24	2SD 001 685-277	5.50	2SD 343 130-147	5.75
2RM 007 200-191	6.46	2SA 003 236-341	2.98, 5.25	2SD 001 685-307	5.50	2SD 343 130-157	5.75
2RM 007 200-201	6.46	2SA 003 734-121	5.89	2SD 001 685-317	5.50	2SD 343 130-167	5.75
2RM 007 200-221	6.44	2SA 004 431-071	5.27	2SD 001 685-501	5.190	2SD 343 130-227	5.73
2RM 007 200-231	6.44	2SA 005 200-331	5.26	2SD 001 686-101	5.51	2SD 343 130-337	5.72
2RM 007 200-261	6.44	2SA 005 603-021	2.90, 2.95, 2.97, 2.101, 2.105-2.106, 2.108, 5.87	2SD 001 688-101	3.118-3.120, 3.123,5.16	2SD 343 130-377	5.72
2RM 007 200-271	6.44	2SA 005 603-027	5.87	2SD 001 688-141	3.118-3.120, 3.122-3.123, 5.16	2SD 343 130-397	5.73
2RM 007 200-371	6.44	2SA 005 603-227	5.87	2SD 001 688-171	2.23, 5.33	2SD 343 130-737	5.73
2RM 007 200-391	6.44	2SA 006 679-027	5.108	2SD 001 693-011	2.18, 2.20, 2.22, 2.32,	2SD 343 130-747	5.73
2RM 008 858-211	6.37	2SA 006 717-001	5.92	2SD 001 699-061	2.59, 2.61, 2.63, 2.70, 2.80, 5.17	2SD 343 130-797	5.74
2RM 008 858-221	6.37	2SA 006 717-007	5.92	2SD 002 514-161	5.17	2SD 343 130-807	5.74
2RM 008 858-221	6.37	2SA 008 221-127	5.57	2SD 002 582-011	5.47	2SD 343 390-011	5.71
2RM 008 858-241	6.37	2SA 008 405-011	5.56	2SD 002 582-017	3.16, 3.117, 3.122,	2SD 343 390-401	5.71
2RM 008 858-251	6.37	2SA 008 405-017	5.56	2SD 002 582-021	5.40	2SD 343 440-017	5.29
2RM 008 858-291	6.37	2SA 008 405-021	1.100, 1.141, 5.56	2SD 002 582-027	5.40	2SD 343 440-047	5.29
2RM 008 858-401	6.37	2SA 008 405-027	5.56	2SD 002 582-117	2.93, 2.101	2SD 343 910-001	5.16
2RM 379 500-081	6.56	2SA 008 805-001	5.86	2SD 002 582-127	2.93, 2.101	2SD 343 910-007	5.16
2RM 379 500-091	6.57	2SA 008 805-007	5.86	2SD 002 776-231	3.10, 3.13, 3.15, 3.32, 3.35, 3.37-3.38, 3.44-3.47, 3.52, 3.56, 3.71, 3.80, 5.46	2SD 343 910-017	5.16
2RM 379 500-101	6.56	2SA 009 001-041	5.80	2SD 002 776-237	5.46	2SD 343 910-027	5.16
2RM 379 500-111	6.57	2SA 009 001-047	5.80	2SD 002 776-241	3.10, 3.13, 3.15, 3.37-3.38, 3.52, 3.56, 3.71, 3.80, 5.46	2SD 343 910-041	5.16
2RM 379 500-121	6.56	2SA 009 001-137	5.60	2SD 002 776-247	5.46	2SD 344 100-001	5.49
2RM 379 500-131	6.57	2SA 009 001-171	5.107	2SD 002 776-277	3.57	2SD 344 100-007	5.49
2RM 379 500-141	6.56	2SA 009 001-177	5.92	2SD 002 844-021	5.34	2SD 344 100-101	5.49
2RM 379 500-151	6.57	2SA 009 001-181	5.91	2SD 002 844-031	5.34	2SD 344 169-037	5.67
2RM 379 500-161	6.56	2SA 009 001-187	5.91	2SD 002 844-061	3.16, 5.34	2SD 344 200-001	5.65
2RM 379 500-171	6.57	2SA 009 001-191	5.67	2SD 002 844-067	5.34	2SD 344 200-007	5.65
2RM 379 500-181	6.56	2SA 009 001-197	5.67	2SD 002 844-131	3.16, 5.34	2SD 354 040-011	1.171
2RM 379 500-191	6.56	2SA 009 001-211	5.67	2SD 002 844-137	3.16, 5.34	2SD 354 040-021	1.171
2RM 379 500-211	6.57	2SA 009 001-221	5.66	2SD 002 844-161	5.34	2SD 959 050-401	5.35
2RM 379 500-221	6.56	2SA 009 001-241	5.67	2SD 002 844-167	5.34	2SD 964 169-111	3.30, 5.67
2RM 379 500-241	6.57	2SA 009 001-261	5.67	2SD 002 844-171	5.34	2SD 964 169-117	5.67
2RM 379 500-261	6.56	2SA 009 001-271	5.66	2SD 002 844-201	3.16, 5.34	2SD 964 961-011	1.172
2RM 379 500-271	6.57	2SA 009 001-281	5.65	2SD 002 844-207	5.34	2SD 964 961-021	1.172
2RM 379 500-281	6.56	2SA 009 001-291	5.65	2SD 002 844-211	5.34	2SD 996 030-021	3.08, 3.110, 5.44
2RM 379 500-291	6.56	2SA 009 001-301	5.65	2SD 002 844-217	5.34	2SD 997 005-021	5.42
2RM 379 500-301	6.56	2SA 009 001-311	5.65	2SD 002 844-221	5.34	2SD 997 006-021	5.44
2RM 379 500-311	6.57	2SA 009 001-321	6.57	2SD 002 844-227	5.34	2SD 997 006-031	5.44
2RM 379 500-321	6.57	2SA 009 001-331	6.57	2SD 002 844-231	5.34	2SD 997 131-051	5.43
2RM 379 500-331	6.57	2SA 009 001-341	6.57	2SD 002 844-237	5.34	2SD 998 531-057	5.40
2RM 379 500-351	6.57	2SA 009 001-351	6.57	2SD 002 844-241	5.34	2SD 998 531-067	5.40
2RM 379 500-361	6.56	2SA 009 001-361	6.56	2SD 002 844-247	5.34		
2RM 379 500-371	6.57	2SA 009 001-371	6.57	2SD 002 844-251	5.34		
2RM 379 500-381	6.57	2SA 009 001-381	6.57	2SD 002 844-257	5.34		
2RM 379 500-391	6.56	2SA 009 001-391	6.56	2SD 002 844-261	5.34		
2RM 379 500-401	6.56	2SA 009 001-401	6.56	2SD 002 844-267	5.34		
2RM 379 500-411	6.56	2SA 009 001-411	6.56	2SD 002 844-271	5.34		
2RM 379 500-421	6.57	2SA 009 001-421	6.57	2SD 002 844-277	5.34		
2RM 379 500-431	6.57	2SA 009 001-431	6.57	2SD 002 844-281	5.34		
2RM 379 500-491	6.58	2SA 009 001-491	6.58	2SD 002 844-287	5.34		
2RM 379 500-501	6.57	2SA 009 001-501	6.57	2SD 002 844-291	5.34		
2RM 379 500-511	6.58	2SA 009 001-511	6.58	2SD 002 844-297	5.34		
2RM 379 500-531	6.57	2SA 009 001-531	6.57	2SD 002 844-301	5.34		
2RM 379 500-541	6.57	2SA 009 001-541	6.57	2SD 002 844-307	5.34		
2RM 379 500-571	6.56	2SA 009 001-571	6.56	2SD 002 84			

List of Part Numbers



Part number	Page	Part number	Page	Part number	Page	Part number	Page
2SE...		2SK...		2VA...		2VB...	
2SE 001 306-051	3.44	2SK 009 466-141	1.46	2VA 004 887-031	1.98, 2.49, 2.51-2.52, 2.71, 2.73, 5.12	2VB 998 232-241	5.37
2SE 001 679-051	5.51	2SK 009 467-111	1.115, 1.119	2VA 005 553-111	1.30	2VD...	
2SE 001 680-291	5.17	2SK 009 467-121	1.115, 1.119	2VA 005 553-121	1.30	2VD 003 567-377	5.14
2SE 001 680-301	1.98, 2.56, 5.17	2SK 009 477-051	1.193	2VA 005 553-131	1.30	2VD 005 300-551	2.75, 2.87, 5.11
2SE 001 685-201	2.59, 2.61, 5.50	2SK 009 477-061	1.193	2VA 005 553-141	1.30	2VD 005 300-581	2.75, 2.87, 5.11
2SE 001 685-221	5.50	2SK 010 083-801	1.28	2VA 006 040-071	5.20	2VD 007 323-031	5.05
2SE 001 685-227	5.50	2SK 010 133-801	1.110	2VA 006 040-077	5.20	2VD 007 323-041	5.05
2SE 001 686-142	5.51	2SK 340 101-001	5.183	2VA 006 040-291	5.20	2VD 007 323-131	5.05
2SE 001 688-151	2.112, 2.122, 5.16	2SK 340 101-011	5.183	2VA 006 040-297	5.20	2VD 007 323-141	5.05
2SE 001 688-161	2.112, 2.122, 3.122, 5.16	2SK 340 101-021	5.183	2VA 006 040-457	5.20	2VD 007 500-091	2.88, 5.10
2SE 001 699-071	2.18, 2.20, 2.32, 2.59, 2.61, 2.63, 2.70, 2.80, 5.17	2SK 340 101-031	5.183	2VA 006 356-081	3.41	2VD 007 500-111	2.88, 5.10
2SE 002 514-171	5.47	2SK 340 103-121	5.183	2VA 006 356-101	3.36, 3.40-3.41	2VD 007 500-201	2.88, 5.10
2SE 002 578-701	2.16, 3.14-3.15, 3.74, 3.76-3.79, 5.47	2SK 340 103-131	5.183	2VA 007 502-011	5.30	2VD 007 500-221	2.88, 5.10
2SE 002 578-707	5.47	2SK 343 440-027	5.29	2VA 007 502-017	5.30	2VD 007 500-411	2.48, 2.50, 2.52-2.54, 5.10
2SE 002 582-071	5.40	2SK 343 440-037	5.29	2VA 007 502-021	5.30	2VD 007 547-181	5.22
2SE 002 776-211	5.46	2SK 354 032-011	1.45	2VA 007 502-027	5.30	2VD 008 204-051	2.29, 2.32-2.33, 2.44, 2.113, 5.07
2SE 002 776-217	5.46	2SK 354 032-021	1.45	2VA 007 502-061	5.30	2VD 008 204-071	2.29, 2.32-2.33, 2.44, 2.113, 5.07
2SE 002 776-221	3.32, 3.35, 3.44-3.47, 5.46	2SK 354 035-011	1.72	2VA 007 502-067	5.30	2VD 008 204-091	2.51, 2.71, 5.08
2SE 002 844-011	5.34	2SK 354 035-021	1.72	2VA 007 502-111	5.30	2VD 008 204-111	1.96, 5.08
2SE 002 844-051	5.34	2SK 964 596-011	1.88	2VA 007 502-117	5.30	2VD 008 204-131	1.197, 5.07
2SE 002 844-057	5.34	2SK 964 596-021	1.88	2VA 009 426-111	1.40	2VD 008 204-141	2.113, 5.07
2SE 003 167-031	2.18, 2.20, 2.24, 2.59, 2.61, 2.81, 5.23	2SL...		2VA 009 426-121	1.40	2VD 008 204-151	2.113, 5.07
2SE 003 167-041	3.62, 5.23	2SL 003 567-311	5.14	2VA 031 419-011	5.31	2VD 008 204-171	2.09, 2.11, 5.07
2SE 003 167-511	5.23	2SL 003 567-691	5.14	2VA 031 419-017	5.31	2VD 008 204-191	2.12-2.14, 5.07
2SE 003 182-011	3.76, 5.45	2SL 005 883-031	2.116, 2.118-2.119, 2.122, 5.11	2VA 031 419-021	5.31	2VD 008 204-211	5.06
2SE 003 182-017	5.45	2SL 005 883-041	2.116, 2.118-2.119, 2.122, 5.11	2VA 031 419-027	5.31	2VD 008 204-231	2.110-2.111, 5.06
2SE 003 182-021	3.73-3.75, 5.45	2SP 007 547-061	5.22	2VA 031 419-061	5.31	2VD 008 204-251	2.05, 2.07-2.08, 2.10, 2.12, 2.46, 5.06
2SE 003 182-027	5.45	2SP 007 547-067	5.22	2VA 031 419-077	5.31	2VD 008 205-011	2.114-2.115, 5.09
2SE 003 184-011	5.41	2SP...		2VA 031 419-097	5.31	2VD 008 205-021	2.117-2.118, 2.120-2.121, 5.09
2SE 003 184-017	5.41	2SP 959 060-601	5.35	2VA 031 419-111	5.31	2VD 008 205-041	2.117-2.118, 2.120-2.121, 5.09
2SE 003 184-101	3.37, 3.55, 3.59, 3.61, 3.66, 5.41	2ST...		2VA 031 419-117	5.31	2VD 008 789-011	5.13
2SE 003 409-171	5.33	2ST 001 259-321	3.10, 5.78	2VA 031 419-147	5.31	2VD 340 400-451	5.189
2SE 003 409-191	5.33	2ST 001 673-011	3.54, 3.64, 5.51	2VA 031 419-167	5.31	2VD 340 400-471	5.189
2SE 003 409-197	5.33	2ST 003 014-141	5.82	2VA 031 419-187	5.31	2VD 340 450-491	5.182
2SE 004 623-001	3.11, 3.83-3.84, 5.46, 5.48	2ST 003 018-061	3.68, 5.52	2VA 343 640-067	5.19	2VP...	
2SE 004 623-007	5.46	2SW...		2VA 343 640-071	5.19	2VP 003 069-011	1.92
2SE 006 040-011	5.21	2SW 003 014-131	3.31, 3.51, 3.81, 3.90-3.91, 5.82	2VA 343 640-077	5.19	2VP 003 069-021	1.92
2SE 007 547-011	5.22	2SW 003 185-041	3.21-3.25, 3.29, 5.52	2VA 343 640-101	5.19	2VP 003 529-131	1.198
2SE 007 547-017	5.22	2SW 003 185-047	5.52	2VA 343 640-107	5.19	2VP 003 529-141	1.198
2SE 007 547-021	5.22	2SW 964 169-081	5.68	2VA 343 640-117	5.19	2VP 003 567-111	2.35, 5.14
2SE 007 547-027	5.22	2SW 964 169-087	5.68	2VA 343 640-131	5.19	2VP 003 567-121	2.35, 5.14
2SE 007 547-041	5.22	2SY...		2VA 964 957-011	1.191	2VP 003 567-127	5.14
2SE 996 030-011	3.08, 3.110, 5.44	2SY 003 014-121	3.69, 3.78, 5.82	2VA 964 957-021	1.191	2VP 003 685-071	1.29
2SE 997 005-011	5.42	2TA...		2VA 997 113-001	5.34	2VP 003 685-081	1.29
2SE 997 006-011	5.44	2TA 964 169-061	5.67	2VA 998 232-251	5.37	2VP 004 220-061	1.157
2SE 997 006-041	5.44	2TA 964 169-067	5.67	2VA 998 232-271	5.36	2VP 004 220-081	1.157
2SE 997 008-001	5.47	2TA 964 169-067	5.67	2VA 998 232-281	5.36	2VP 004 401-091	1.174
2SE 997 088-001	2.04, 2.112, 5.16	2TA 964 169-251	5.67	2VA 998 232-291	5.37	2VP 004 686-111	1.93
2SE 997 111-011	5.42	2TA 964 169-257	5.67	2VA 998 232-497	5.36	2VP 004 686-121	1.93
2SE 997 111-021	5.42	2TA 964 169-257	5.67	2VA 998 233-051	5.38	2VP 004 686-131	1.93
2SE 998 530-061	5.49	2TA 964 169-767	5.67	2VA 998 233-061	5.38	2VP 004 686-141	1.93
2SE 998 530-067	5.49	2TA 964 169-797	5.67	2VA 998 233-171	5.39	2VP 004 686-151	1.78, 1.94
2SK...		2TF...		2VA 998 233-201	5.39	2VP 004 686-181	1.98, 2.49, 2.51-2.52, 2.71, 2.73, 5.12
2SK 003 567-321	5.14	2TF 001 259-761	5.78	2VA 998 233-211	5.38	2VP 004 887-021	2.71, 2.73, 5.12
2SK 003 567-331	5.14	2TJ...		2VA 998 233-221	5.38	2VP 006 040-111	3.13, 5.20
2SK 003 567-651	5.14	2TJ 001 633-211	2.60, 2.62, 5.126	2VA 998 233-231	5.39	2VP 006 040-117	5.20
2SK 003 567-661	5.14	2TJ 003 168-151	2.76, 2.79	2VA 998 233-241	5.39	2VP 006 040-121	3.13, 5.20
2SK 004 460-031	5.28	2TM...		2VA 998 233-251	5.39	2VP 006 040-127	5.20
2SK 004 460-037	5.28	2TM 003 057-031	3.49, 3.71, 5.80	2VA 998 233-271	5.39	2VP 006 040-301	5.20
2SK 004 460-041	5.28	2TM 003 748-011	5.96	2VA 998 233-357	5.38	2VP 006 040-307	5.20
2SK 005 883-011	2.116, 2.118-2.119, 2.122, 5.11	2TM 004 361-021	5.98	2VA 998 233-367	5.38	2VP 006 040-351	5.20
2SK 005 883-021	2.116, 2.118-2.119, 2.122, 5.11	2TM 006 717-047	3.26-3.27, 5.92	2VA 998 531-031	5.40	2VP 006 040-357	5.20
2SK 006 459-041	5.28	2TM 008 645-061	5.100	2VB...		2VP 006 040-397	5.20
2SK 008 208-051	2.12	2TM 008 645-067	5.100	2VB 004 887-011	1.98, 2.49, 2.51-2.52, 2.71, 2.73, 5.12	2VP 006 040-407	5.20
2SK 008 208-061	2.12	2TM 008 645-071	5.100	2VB 006 040-051	5.20	2VP 006 040-437	5.20
2SK 008 272-801	1.36	2TM 008 645-077	5.100	2VB 007 547-171	5.22	2VP 006 040-447	5.20
2SK 008 272-831	1.34	2TM 008 645-081	5.100	2VB 341 032-111	5.34	2VP 006 040-467	5.20
2SK 008 579-091	1.201	2TM 008 645-087	5.100	2VB 341 032-121	5.34	2VP 006 040-477	5.20
2SK 008 579-101	1.201	2TM 008 645-087	5.100	2VB 341 032-127	5.34	2VP 006 040-487	5.20
2SK 008 579-111	1.202	2TM 008 645-091	5.100	2VB 341 032-131	5.34	2VP 007 240-091	1.33
2SK 008 579-121	1.202	2TM 008 645-351	5.190	2VB 341 032-141	5.34	2VP 007 240-101	1.33
2SK 008 579-131	1.201	2TM 008 645-651	5.100	2VB 343 640-011	5.19	2VP 007 323-011	5.05
2SK 008 579-141	1.201	2TM 008 645-661	5.100	2VB 343 640-017	5.19	2VP 007 323-021	5.05
2SK 008 579-151	1.202	2TM 963 639-307	5.94	2VB 343 640-127	5.19	2VP 007 323-091	5.05
2SK 008 579-161	1.202	2TM 963 639-317	5.94	2VB 343 640-297	5.19	2VP 007 323-101	5.05
2SK 008 659-091	1.115, 1.118	2TM 964 295-091	5.103	2VB 998 232-011	5.36	2VP 007 323-111	5.05
2SK 008 659-101	1.115, 1.118	2TM 964 295-097	5.103	2VB 998 232-021	5.36	2VP 007 323-121	5.05
2SK 008 659-111	1.115, 1.119	2TM 964 295-101	5.103	2VB 998 232-057	5.36	2VP 007 500-421	2.48, 2.50, 2.52-2.54, 5.10
2SK 008 659-121	1.115, 1.119	2TM 964 295-107	5.103	2VB 998 232-101	5.37	2VP 007 502-031	5.30
2SK 008 679-811	1.39	2TZ...		2VB 998 232-131	5.37	2VP 007 502-037	5.30
2SK 008 679-831	1.39	2TZ 009 427-111	1.40	2VB 998 232-171	5.37	2VP 007 502-041	5.30
2SK 008 748-801	1.103, 1.143	2TZ 009 427-121	1.40	2VB 998 232-201	5.37	2VP 007 502-047	5.30
2SK 009 466-131	1.46			2VB 998 232-211	5.36	2VP 007 502-121	5.30
				2VB 998 232-221	5.36		
				2VB 998 232-231	5.37		



List of Part Numbers

Part number	Page	Part number	Page	Part number	Page	Part number	Page
2VP...		2VP...		2XA...		2XS...	
2VP 007 502-127	5.30	2VP 340 931-011	5.184	2XA 959 790-407	5.110	2XS 005 020-041	2.29-2.30, 2.39, 2.44-2.45, 5.124
2VP 007 907-003	5.12	2VP 340 931-101	5.186	2XA 959 790-411	5.110	2XS 005 020-047	5.124
2VP 007 907-037	5.12	2VP 340 931-111	5.186	2XD...		2XS 005 020-057	5.124
2VP 007 907-041	5.12	2VP 340 932-001	5.185	2XD 003 022-061	5.137	2XS 005 020-067	5.124
2VP 007 907-047	5.12	2VP 340 932-011	5.185	2XD 007 854-801	6.20	2XS 005 020-077	5.124
2VP 008 031-051	1.75	2VP 340 934-101	5.186	2XD 007 854-811	6.20	2XS 005 020-081	5.124
2VP 008 031-061	1.75	2VP 340 934-111	5.186	2XD 007 854-821	6.20	2XS 005 020-091	5.124
2VP 008 048-051	1.74	2VP 340 940-101	5.187	2XD 007 854-831	6.20	2XS 005 020-111	5.124
2VP 008 048-061	1.74	2VP 340 940-111	5.187	2XD 008 135-801	6.21	2XS 005 020-121	5.124
2VP 008 101-031	1.117	2VP 340 942-001	5.187	2XD 008 135-811	6.21	2XS 005 020-137	5.124
2VP 008 101-041	1.117	2VP 340 942-011	5.187	2XD 008 135-821	6.21	2XS 005 020-147	5.124
2VP 008 204-041	2.29, 2.32-2.33, 2.44, 2.113, 5.07	2VP 340 942-101	5.187	2XD 008 135-831	6.21	2XS 005 639-001	5.81
2VP 008 204-061	2.29, 2.32-2.33, 2.44, 2.113, 5.07	2VP 340 942-111	5.187	2XD 008 997-001	6.22	2XS 005 639-002	5.81
2VP 008 204-081	2.51, 2.71, 5.08	2VP 340 944-131	5.187	2XD 008 997-101	6.23	2XS 007 841-011	5.123
2VP 008 204-101	1.96, 5.08	2VP 340 944-141	5.187	2XD 008 997-201	6.22	2XS 007 841-017	5.123
2VP 008 204-121	1.197, 5.07	2VP 340 950-011	5.188	2XD 009 048-001	6.22	2XS 007 841-021	5.123
2VP 008 204-161	2.09, 2.11, 5.07	2VP 340 950-021	5.188	2XD 009 048-101	6.23	2XS 007 841-027	5.123
2VP 008 204-181	2.12-2.14, 5.07	2VP 340 950-031	5.188	2XD 009 048-201	6.22	2XS 008 078-001	5.125
2VP 008 204-201	5.06	2VP 340 950-041	5.188	2XD 009 051-001	6.10	2XS 008 078-007	5.125
2VP 008 204-221	2.110-2.111, 5.06	2VP 341 419-031	5.31	2XD 009 051-011	6.10	2XS 008 078-011	5.125
2VP 008 204-241	2.05, 2.07-2.08, 2.10, 2.12, 2.46, 5.06	2VP 341 419-037	5.31	2XD 009 051-021	6.10	2XS 008 479-001	5.125
2VP 008 205-031	2.117-2.118, 2.120-2.121, 5.09	2VP 341 419-041	5.31	2XD 009 051-031	6.10	2XS 008 479-007	5.125
2VP 008 272-211	1.35	2VP 341 419-047	5.31	2XD 009 052-001	6.10	2XS 008 479-011	5.125
2VP 008 272-221	1.35	2VP 341 419-087	5.31	2XD 009 052-011	6.10	2XS 008 479-017	5.125
2VP 008 272-231	1.35	2VP 341 419-107	5.31	2XD 009 052-021	6.10	2XS 008 479-041	5.125
2VP 008 272-241	1.35	2VP 341 419-121	5.31	2XD 009 052-031	6.10	2XS 008 479-047	5.125
2VP 008 272-811	1.35	2VP 341 419-127	5.31	2XD 009 053-001	6.10	2XS 008 479-051	5.125
2VP 008 272-821	1.34	2VP 341 419-137	5.31	2XD 009 053-021	6.10	2XS 008 479-057	5.125
2VP 008 272-861	1.34	2VP 341 419-157	5.31	2XD 009 054-001	6.10	2XS 008 479-061	5.125
2VP 008 326-051	1.76	2VP 341 419-177	5.31	2XD 009 386-021	6.14	2XS 008 479-071	5.125
2VP 008 326-061	1.76	2VP 343 520-017	5.29	2XD 009 386-121	6.14	2XS 008 479-081	5.125
2VP 008 406-031	1.88	2VP 343 520-027	5.29	2XD 009 386-421	6.14	2XS 008 479-087	5.125
2VP 008 406-041	1.88	2VP 343 520-037	5.29	2XD 009 475-001	6.23	2XS 008 479-091	5.125
2VP 008 427-091	1.87	2VP 343 520-047	5.29	2XD 009 475-011	6.23	2XS 008 479-097	5.125
2VP 008 427-101	1.87	2VP 343 590-017	5.32	2XD 009 475-021	6.23	2XS 008 479-107	5.125
2VP 008 468-051	1.12	2VP 343 590-027	5.32	2XD 009 475-031	6.23	2XS 008 479-117	5.125
2VP 008 468-061	1.12	2VP 343 590-037	5.32	2XD 860 618-001	6.43	2XS 302 240-031	5.191
2VP 008 679-111	1.38	2VP 343 590-047	5.32	2XD 860 618-011	6.43	2XS 302 240-051	5.191
2VP 008 679-121	1.38	2VP 343 590-057	5.32	2XD 860 618-021	6.43	2XS 302 241-071	5.193
2VP 008 736-111	1.117	2VP 343 590-067	5.32	2XD 860 910-001	6.43	2XS 302 241-081	5.193
2VP 008 736-121	1.117	2VP 343 590-077	5.32	2XD 860 910-011	6.43	2XS 302 241-091	5.193
2VP 008 759-051	1.192	2VP 343 590-087	5.32	2XD 860 910-021	6.43	2XS 302 241-101	5.193
2VP 008 759-061	1.192	2VP 343 640-021	5.19	2XD 860 910-031	6.43	2XS 340 000-101	5.99, 5.194
2VP 008 789-021	5.13	2VP 343 640-027	5.19	2XD 861 421-021	6.22	2XS 340 107-001	5.191
2VP 008 789-041	5.13	2VP 343 640-031	5.19	2XD 861 423-011	6.20	2XS 340 107-011	5.191
2VP 008 789-051	5.13	2VP 343 640-041	5.19	2XD 861 423-021	6.20	2XS 340 108-001	5.191
2VP 008 789-071	5.13	2VP 343 640-047	5.19	2XD 861 423-031	6.19	2XS 340 108-011	5.191
2VP 008 863-801	1.100, 1.141	2VP 343 640-051	5.19	2XD 862 019-011	6.21	2XS 340 109-001	5.193
2VP 009 425-111	1.40	2VP 343 640-057	5.19	2XD 862 111-011	6.21	2XS 340 109-011	5.193
2VP 009 425-121	1.40	2VP 343 640-081	5.19	2XD 959 011-021	6.20	2XS 340 418-021	5.192
2VP 009 500-811	1.171	2VP 343 640-087	5.19	2XL...		2XS 340 418-031	5.192
2VP 009 500-821	1.171	2VP 343 640-091	5.19	2XL 004 762-001	5.48	2XS 340 418-061	5.186-5.187
2VP 340 400-121	5.189	2VP 343 640-097	5.19	2XL 005 194-011	5.48	2XS 340 418-071	5.186-5.187
2VP 340 400-131	5.189	2VP 343 640-247	5.18	2XL 005 194-021	5.48	2XS 340 418-081	5.192
2VP 340 400-141	5.189	2VP 343 640-257	5.18	2XM...		2XS 340 418-091	5.192
2VP 340 400-147	5.189	2VP 343 640-267	5.18	2XM 001 974-031	5.164	2XS 340 418-121	5.192
2VP 340 400-151	5.189	2VP 343 640-277	5.18	2XM 001 974-041	5.164	2XS 340 418-131	5.192
2VP 340 450-021	5.182	2VP 354 030-011	1.44	2XM 001 974-041	5.164	2XS 340 447-001	5.191
2VP 340 450-027	5.182	2VP 354 030-021	1.44	2XM 001 974-051	5.164	2XS 340 447-021	5.191
2VP 340 450-031	5.182	2VP 354 030-031	1.44	2XM 001 974-101	5.165	2XS 340 447-061	5.191
2VP 340 450-037	5.182	2VP 354 030-041	1.44	2XM 001 974-111	5.165	2XS 340 447-071	5.191
2VP 340 450-141	5.182	2VP 354 034-011	1.52, 1.68-1.69	2XM 001 974-111	5.165	2XS 340 448-001	5.193
2VP 340 450-151	5.182	2VP 354 034-021	1.52, 1.68-1.69	2XM 001 974-121	5.165	2XS 340 448-011	5.193
2VP 340 450-441	5.182	2VP 354 037-011	1.70	2XM 001 974-131	5.167	2XS 340 448-021	5.193
2VP 340 450-501	5.182	2VP 354 037-021	1.70	2XM 001 974-151	5.164	2XS 340 448-031	5.193
2VP 340 450-511	5.182	2VP 354 038-011	1.110	2XM 001 974-161	5.166	2XS 340 827-001	5.192
2VP 340 830-001	5.185	2VP 354 038-021	1.110	2XM 001 974-181	5.166	2XS 340 827-011	5.192
2VP 340 830-011	5.185	2VP 354 039-011	1.110	2XM 001 974-201	5.166	2XS 340 827-121	5.192
2VP 340 830-021	5.185	2VP 354 039-021	1.110	2XM 001 974-211	5.166	2XS 340 827-131	5.192
2VP 340 830-031	5.185	2VP 354 042-011	1.153	2XM 001 974-221	5.166	2XS 950 071-031	5.122
2VP 340 830-101	5.186	2VP 354 042-021	1.153	2XM 001 975-001	5.168	2XS 955 031-001	5.122
2VP 340 830-111	5.184	2VP 354 043-011	1.153	2XM 004 444-001	5.168	2XS 955 232-001	5.122
2VP 340 831-001	5.184	2VP 354 043-021	1.153	2XM 004 444-011	5.168	2XS 955 232-017	5.122
2VP 340 831-011	5.09	2VP 965 037-051	1.09	2XM 008 779-001	5.164	2XS 955 260-001	5.123
2VP 340 888-001	5.09	2VP 965 037-061	1.09	2XM 009 266-001	5.167	2XS 955 260-007	5.123
2VP 340 888-007	5.09	2VP 982 006-011	1.117	2XS...		2XS 963 959-031	5.97
2VP 340 888-011	5.09	2VP 982 006-021	1.117	2XS 003 168-071	5.126	2XS 963 959-037	5.97
2VP 340 888-017	5.09	2VP 998 232-261	5.37	2XS 003 168-081	5.126	2XS 964 295-031	5.103
2VP 340 930-001	5.185	2VP 998 233-161	5.39	2XS 003 168-131	5.126	2XS 964 295-037	5.103
2VP 340 930-011	5.185	2VP 998 233-261	5.39	2XS 004 237-291	2.70, 2.73-2.74, 2.86	2XT...	
2VP 340 930-021	5.185	2VP 998 233-281	5.39	2XS 004 237-301	2.70, 2.73-2.74, 2.86	2XT 002 452-037	5.169
2VP 340 930-031	5.185	2XA...		2XS 004 237-311	2.73	2XT 007 945-007	5.169
2VP 340 930-101	5.186	2XA 008 221-021	1.100, 1.141, 5.57	2XS 004 237-321	2.73	2XT 007 945-027	5.169
2VP 340 930-111	5.186	2XA 008 221-027	5.57	2XS 005 020-001	2.92, 2.102, 2.108, 3.35, 5.124	2XT 007 945-057	5.169
2VP 340 930-147	5.185	2XA 959 560-401	5.109	2XS 005 020-002	5.124	2XT 007 945-077	5.169
2VP 340 930-157	5.185	2XA 959 560-407	5.109	2XS 005 020-003	5.124	2XT 008 929-001	5.169
2VP 340 931-001	5.184	2XA 959 560-411	5.109	2XS 005 020-011	3.12, 5.124	2XT 008 929-007	5.169
		2XA 959 560-417	5.109	2XS 005 020-017	5.124	2XT 959 500-207	5.168
		2XA 959 790-401	5.110	2XS 005 020-021	5.124	2XT 959 500-677	5.168
						2XT 959 510-427	5.168

List of Part Numbers



Part number	Page	Part number	Page	Part number	Page	Part number	Page
2XT...		3SL...		6EH...		8GA...	
2XT 959 510-467	5.168	3SL 008 604-821	6.61	6EH 007 946-001	4.03, 4.06, 4.30	8GA 007 997-911	8.07
2XT 959 510-657	5.168	4AZ...		6NM...		8GA 007 997-921	8.07
2XT 980 500-227	5.168	4AZ 003 787-001	5.141	6NM 004 375-311	1.27, 1.30, 1.42	8GA 008 246-001	8.03, 8.17
2XW...		4AZ 003 787-021	5.141	6NM 004 375-541	4.40	8GA 008 892-002	8.03, 8.17
2XW 002 897-041	2.89, 5.173	4DM...		6NM 007 231-037	4.50	8GA 008 899-061	8.03, 8.12
2XW 002 897-051	5.173	4DM 009 492-001	5.238	6NM 007 282-211	1.10, 1.22, 1.158, 1.177-1.178, 1.180, 1.193, 1.199	8GA 008 899-121	8.12
2XW 003 146-001	5.173	4DN...		6NM 007 282-221	4.32, 4.36-4.39	8GA 008 901-241	8.03, 8.17
2XW 007 146-001	5.172	4DN 009 492-101	5.238	6NM 007 282-231	4.32	8GD...	
2XW 007 146-011	5.172	4DW...		6NM 007 282-631	1.180	8GD 002 078-011	8.03, 8.13
2XX...		4DW 009 492-011	5.238	6NM 007 282-641	1.106, 1.147	8GD 002 078-112	8.13
2XX 354 033-011	1.45	4DW 009 492-111	5.238	6NM 007 282-651	1.203, 1.205	8GD 002 078-121	8.03, 8.13
2XX 354 033-021	1.45	4RA...		6NM 007 282-661	1.47	8GD 002 078-221	8.03, 8.13
2ZR...		4RA 003 510-081	4.06, 4.22-4.24	6NM 007 878-041	1.06-1.08, 1.17, 1.123-1.127, 1.131, 1.158, 1.164, 1.176, 1.181, 1.187	8GD 002 078-241	8.03, 8.13
2ZR 001 193-011	5.131	4RA 003 510-361	4.30	6NM 007 878-351	1.43, 1.100, 1.140	8GD 002 084-131	8.03, 8.11
2ZR 001 240-351	5.77	4RA 003 510-651	4.30	6NM 007 878-501	1.112, 1.114-1.121	8GD 002 084-151	8.03, 8.11
2ZR 001 240-377	2.107, 5.77	4RA 940 010-671	5.114	6NM 007 878-521	1.11, 1.132	8GD 002 084-251	8.03, 8.11
2ZR 001 421-101	5.79	5AB...		6NM 007 878-531	1.06, 1.11, 1.136	8GD 002 088-071	8.03, 8.11
2ZR 001 423-001	5.70	5AB 005 944-001	6.62	6NM 007 878-541	1.06	8GD 002 088-131	8.03, 8.11
2ZR 001 423-221	5.190	5AB 005 944-011	6.62	6NM 007 878-551	1.203, 1.205	8GD 002 088-251	8.03, 8.11
2ZR 002 589-011	2.56, 2.64, 2.66, 5.128	5DC...		6NM 008 299-501	4.36	8GD 004 772-121	8.03, 8.13
2ZR 002 694-001	5.131	5DC 009 060-011	1.83	6ZE...		8GD 004 772-151	8.03, 8.13
2ZR 002 694-002	5.131	5DD...		6ZE 001 759-051	6.39, 6.61	8GD 008 893-002	8.03, 8.13
2ZR 002 985-081	5.127	5DD 008 319-501	1.79, 2.86, 3.33-3.34, 3.92, 3.104, 3.106, 3.112-3.114	6ZE 001 759-071	6.39, 6.61	8GD 008 897-061	8.03, 8.11
2ZR 002 985-261	5.127	5DF...		6ZN...		8GD 008 897-121	8.03, 8.11
2ZR 003 014-091	5.83	5DF 009 244-007	1.59, 1.170, 4.05	6ZN 160 705-001	1.170, 4.30, 4.111	8GD 008 899-061	8.03, 8.11
2ZR 003 030-171	5.127	5DS...		6ZN 160 705-011	4.30, 4.111	8GD 008 899-121	8.03
2ZR 003 236-051	2.15, 2.25, 2.62, 2.67, 2.70, 2.76, 2.82, 2.94, 2.100, 2.109, 5.24, 5.157	5DS 009 552-001	5.238	8ES...		8GH...	
2ZR 003 236-057	5.24	5DS 009 552-011	5.238	8ES 004 417-241	5.166	8GH 002 089-133	6.17-6.18, 6.36, 6.48, 6.50-6.52, 8.03, 8.11
2ZR 003 236-311	2.98, 5.25	5DS 009 602-001	5.238	8ES 861 420-001	6.19-6.22	8GH 002 089-141	8.03, 8.11
2ZR 003 315-041	5.129	5DS 009 602-011	5.238	8ES 861 420-011	6.19-6.21	8GH 002 089-151	6.17-6.18, 6.36, 6.51-6.52, 8.03, 8.11
2ZR 003 734-041	5.89	5DV...		8GA...		8GH 002 089-253	8.11
2ZR 004 432-001	5.27	5DV 007 760-631	4.03-4.04, 4.07, 4.13, 4.20, 4.27, 4.32-4.35, 4.37-4.38	8GA 002 071-121	8.03, 8.14	8GH 002 089-351	8.03, 8.11
2ZR 004 542-001	5.131	5DV 007 760-651	1.32, 1.107, 1.147, 1.180	8GA 002 071-131	8.03, 8.14	8GH 002 089-361	8.03, 8.11
2ZR 005 200-051	3.62	5DV 007 810-171	2.86, 4.20, 4.27, 4.32-4.35, 4.40, 4.55	8GA 002 071-241	8.03, 8.14	8GH 002 089-471	8.03, 8.11
2ZR 005 200-301	5.26	5DV 008 290-004	1.14-1.15, 1.38, 1.43, 1.76-1.77, 1.81, 1.83, 1.86, 1.101, 1.142	8GA 002 071-251	8.03, 8.14	8GH 002 089-491	8.03, 8.11
2ZR 005 603-061	2.90, 2.96-2.97, 2.101, 2.105, 2.108, 5.87	5DV 008 855-001	3.30, 4.20, 4.29, 4.34, 4.87, 4.93, 4.100	8GA 002 071-261	8.03, 8.14	8GH 002 089-501	8.11
2ZR 005 603-067	5.87	5DV 008 855-007	4.34, 4.87, 4.93	8GA 002 071-271	8.03, 8.14	8GH 002 089-801	8.03, 8.11
2ZR 005 700-191	5.130	5DV 008 856-001	4.20, 4.29, 4.34, 4.60, 4.62, 4.87, 4.93	8GA 002 071-341	8.03, 8.14	8GH 002 089-801	8.03, 8.11
2ZR 005 860-151	5.130	5DV 008 856-007	4.34, 4.87, 4.93	8GA 002 071-351	8.03, 8.14	8GH 002 089-921	8.06
2ZR 006 609-081	5.129	5DV 990 264-001	3.33, 4.86, 4.92	8GA 002 072-121	8.03, 8.14	8GH 002 089-931	8.06
2ZR 006 609-087	5.129	5DV 990 264-011	3.92, 3.104, 3.106, 3.112-3.113, 4.86, 4.92	8GA 002 072-241	8.03, 8.14	8GH 002 089-941	8.06
2ZR 006 609-171	5.129	5KG...		8GA 002 073-121	6.48-6.50, 8.03, 8.13	8GH 002 089-941	8.06
2ZR 006 609-171	5.129	5KG 007 629-001	6.13, 6.16, 6.19	8GA 002 073-241	8.03, 8.13	8GH 002 090-133	8.03, 8.10
2ZR 008 221-051	1.100, 1.141, 5.57	5KG 007 629-011	6.13, 6.16, 6.19	8GA 002 073-251	8.03, 8.13	8GH 002 090-251	8.03, 8.10
2ZR 008 221-051	5.57	5KG 009 713-001	6.23	8GA 002 073-271	8.03, 8.13	8GH 002 090-253	8.10
2ZR 008 221-157	5.57	5XA...		8GA 002 074-121	8.03, 8.13	8GH 002 090-271	8.03
2ZR 008 805-041	5.86	5XA 008 198-031	6.37	8GA 002 074-241	8.03, 8.14	8GH 002 090-371	8.03, 8.10
2ZR 008 805-047	5.86	5XA 008 877-001	6.51-6.55	8GA 002 074-251	8.03, 8.14	8GH 002 090-471	8.03, 8.10
2ZR 009 001-011	5.61	5XA 008 877-011	6.51-6.55	8GA 002 074-271	8.03, 8.13	8GH 002 090-481	8.10
2ZR 009 001-017	5.61	5XA 860 907-031	6.43	8GA 002 075-121	6.48-6.50, 8.03, 8.13	8GH 002 473-132	8.03, 8.14
2ZR 009 001-117	5.61	5XA 863 115-001	6.51-6.55	8GA 002 075-241	8.03, 8.13	8GH 002 473-151	8.03, 8.14
2ZR 343 130-041	5.76	5XA 863 115-011	6.51-6.55	8GA 002 075-251	8.03, 8.13	8GH 002 857-121	8.03, 8.11
2ZR 343 130-047	5.76	5XA 863 850-801	6.59	8GA 002 076-121	8.03, 8.14	8GH 002 857-241	8.03, 8.11
2ZR 343 130-317	5.74	6EB...		8GA 002 076-241	8.03, 8.13	8GH 005 635-121	8.03, 8.10
2ZR 343 130-327	5.74	6EB 005 633-001	3.05, 3.19-3.20, 3.34, 3.67, 3.88, 3.94, 3.97, 3.104, 3.111, 3.117, 4.54, 4.103	8GA 002 076-251	8.03, 8.13	8GH 005 635-161	8.10
2ZR 343 130-387	5.72	6ED...		8GA 002 077-121	8.03, 8.12	8GH 005 635-181	8.03, 8.10
2ZR 343 130-607	5.76	6ED 004 778-001	6.23	8GA 002 077-241	8.03, 8.12	8GH 005 636-121	8.03, 8.10
2ZR 354 052-011	1.45	6ED 004 778-011	6.29, 6.34	8GA 006 841-121	8.03, 8.14	8GH 005 636-201	8.10
2ZR 354 063-011	1.56	6ED 708 919-001	3.05, 3.94, 3.97, 3.105, 3.113, 4.105	8GA 006 841-241	8.03, 8.14	8GH 007 157-121	8.03, 8.09
2ZR 354 069-011	1.59	6EG...		8GA 006 841-251	8.03, 8.14	8GH 007 157-181	8.03, 8.09
2ZR 959 010-501	5.54, 5.128	6EG 001 567-041	4.08, 4.24-4.26	8GA 006 841-801	8.03, 8.14	8GH 007 157-201	8.03, 8.09
2ZR 959 010-507	5.54, 5.128	6EH...		8GA 006 841-801	8.03, 8.14	8GH 007 157-231	8.03, 8.09
2ZR 959 820-601	5.55	6EH 004 406-032	1.178	8GA 007 997-001	8.03, 8.19	8GH 007 157-241	8.03, 8.09
2ZR 964 169-031	3.31, 5.69	6EG...		8GA 007 997-011	8.03, 8.19	8GH 007 157-471	8.03, 8.09
2ZR 964 169-037	5.69	6EG 004 778-001	6.23	8GA 007 997-021	8.03, 8.19	8GH 007 157-481	8.09
2ZR 964 169-107	5.69	6EG 004 778-011	6.29, 6.34	8GA 007 997-031	8.03, 8.19	8GH 007 157-531	8.09
2ZR 964 169-351	5.65	6EG 708 919-001	3.05, 3.94, 3.97, 3.105, 3.113, 4.105	8GA 007 997-041	8.03, 8.19	8GH 007 157-801	8.03, 8.09
2ZR 964 169-361	5.65	6EG...		8GA 007 997-051	8.03, 8.19	8GH 007 157-901	8.04
2ZR 964 169-511	5.66	6EG 001 567-041	4.08, 4.24-4.26	8GA 007 997-061	8.03, 8.20	8GH 007 157-913	8.04
2ZR 964 169-517	5.66	6EG...		8GA 007 997-071	8.03, 8.20	8GH 007 157-921	8.04
2ZR 964 169-657	5.66	6EG 004 778-001	6.23	8GA 007 997-081	8.03, 8.20	8GH 007 157-931	8.04
2ZR 964 169-737	5.69	6EG 004 778-011	6.29, 6.34	8GA 007 997-091	8.03, 8.20	8GH 007 157-941	8.04
2ZR 964 962-031	1.173	6ED 708 919-001	3.05, 3.94, 3.97, 3.105, 3.113, 4.105	8GA 007 997-101	8.03, 8.20	8GH 007 157-951	8.05
2ZR 965 039-041	5.64	6EG...		8GA 007 997-111	8.03, 8.20	8GH 007 643-121	8.03, 8.14
2ZR 965 039-047	5.64	6EG 001 567-041	4.08, 4.24-4.26	8GA 007 997-121	8.03, 8.20	8GH 008 356-121	8.03, 8.09
2ZR 965 039-121	5.64	6EG...		8GA 007 997-131	8.03, 8.20	8GH 008 356-151	8.09
2ZR 965 039-127	5.64	6EG 004 778-001	6.23	8GA 007 997-141	8.03, 8.21	8GH 008 356-181	8.09
2ZR 965 039-337	5.64	6EG 004 778-011	6.29, 6.34	8GA 007 997-151	8.03, 8.21	8GH 008 357-001	8.03, 8.09
2ZR 996 012-101	5.84	6ED 004 778-011	6.29, 6.34	8GA 007 997-161	8.03, 8.21	8GH 008 357-151	8.09
2ZR 996 012-111	5.84	6ED 708 919-001	3.05, 3.94, 3.97, 3.105, 3.113, 4.105	8GA 007 997-171	8.03, 8.21	8GH 008 358-121	8.03, 8.08
2ZR 996 179-701	5.130	6EG...		8GA 007 997-181	8.03, 8.19	8GH 008 358-151	8.08
2ZR 997 506-391	5.130	6EG 001 567-041	4.08, 4.24-4.26	8GA 007 997-191	8.03, 8.21	8GH 008 358-181	8.08
2ZR 997 506-501	5.130	6EG...		8GA 007 997-201	8.03, 8.21	8GH 008 358-241	8.08
3AG...		6EG 001 567-041	4.08, 4.24-4.26	8GA 007 997-211	8.0		

List of Part Numbers



Part number	Page	Part number	Page	Part number	Page	Part number	Page
8PV...		8WS...		9AH...		9DE...	
8PV 855 390-001	7.05	8WS 008 549-501	4.40-4.41	9AH 131 494-015	3.54-3.55, 3.57, 3.59-3.63, 3.65, 3.101, 4.49	9DE 129 975-021	1.77
8PV 861 112-001	7.03-7.04	8WS 008 559-001	1.54	9AH 131 740-011	1.29-1.30, 1.41-1.42	9DE 131 520-017	2.14, 2.17, 2.19, 2.24, 4.49
8PV 861 112-011	7.02-7.04			9AH 131 741-011	1.29-1.30, 1.41-1.42	9DE 133 697-015	2.08, 2.10
8RA...		8WT...		9AH 144 231-041	1.78	9DE 133 698-015	2.08, 2.10
8RA 002 010-011	5.178	8WT 008 549-101	4.41	9AH 144 232-041	1.78	9DE 145 675-011	2.114
8RA 002 014-031	5.175	8WT 008 549-201	4.41	9AH 144 863-021	1.77	9DE 145 676-011	2.114
8RA 002 014-032	5.175	8WT 008 549-601	4.41	9AH 144 864-021	1.77		
8RA 002 014-041	5.175	8WT 008 549-701	4.41	9AH 149 259-015	3.08, 4.50	9DF...	
8RA 002 014-042	5.175	8WT 009 904-801	1.169, 1.175	9AH 149 260-015	3.08, 4.50	9DF 112 246-001	2.34, 2.37, 2.41, 4.27
8RA 002 014-051	5.175			9AH 157 659-007	4.34-4.35	9DF 112 247-001	4.27
8RA 002 014-052	5.175	8XH...		9AH 161 784-017	4.32	9DF 117 504-007	2.79, 2.85
8RA 002 014-081	5.175	8XH 002 975-017	5.173	9AH 161 786-017	4.04, 4.32-4.33		
8RA 002 014-091	5.175			9AH 165 968-001	5.53, 5.115	9DR...	
8RA 002 014-101	5.175	8XS...		9AH 169 580-011	4.37-4.39	9DR 060 567-001	3.101, 4.51
8RA 002 014-127	5.175	8XS 002 500-011	7.04	9AH 254 228-012	4.36	9DR 066 847-001	3.53, 4.48
8RA 002 014-831	5.175	8XS 002 525-961	8.03, 8.09	9AH 254 228-017	4.36	9DR 073 862-011	3.47
8RA 002 014-832	5.175	8XS 007 157-911	8.03	9AH 254 228-017	4.36	9DR 080 706-015	2.57
8RA 002 014-841	5.175	8XS 008 633-001	6.63	9AH 378 392-001	1.79	9DR 090 206-001	3.09, 3.23, 3.28, 3.31, 3.36, 3.64, 3.89, 3.98-3.100
8RA 002 014-842	5.175	8XS 113 389-001	3.73, 3.79, 5.138	9AH 378 393-001	1.79	9DR 113 199-005	3.43-3.44
8RA 002 014-851	5.175			9AL...		9DR 118 666-001	1.90
8RA 002 014-852	5.175	8XT...		9AL 118 027-007	4.47	9DR 135 926-015	1.30, 1.42
8RA 002 015-001	5.175	8XT 002 117-001	4.108	9AL 118 028-007	4.47	9DR 136 958-021	1.25
8RA 002 015-021	5.175	8XT 002 120-001	4.108	9AL 120 514-001	4.47		
8RA 002 015-021	5.175	8XT 002 121-001	4.108	9AL 120 515-001	4.47	9DS...	
8RA 002 015-031	5.175	8XT 857 740-001	7.05	9AL 132 293-027	4.47	9DS 121 707-001	3.06, 3.18, 3.67, 3.108, 4.97, 4.103
8RA 002 016-101	5.176	8XT 861 234-001	7.03-7.04				
8RA 002 016-111	5.176	8XT 861 234-003	7.03-7.04	9AR...		9DX...	
8RA 002 016-121	5.176	8XT 861 234-023	7.02	9AR 120 266-001	5.157	9DX 101 355-007	5.70
8RA 002 020-001	5.48, 5.178	8XT 863 316-001	5.167			9DX 119 545-011	2.15, 2.25, 2.62, 2.67, 2.69, 2.76, 2.82, 2.94, 2.98-2.99, 5.24
8RA 002 020-002	5.178			9BG...		9DX 119 545-051	2.15, 2.25, 2.62, 2.67, 2.70, 2.76, 2.82, 2.94, 2.100, 2.109, 5.24, 5.157
8RA 002 020-003	5.178	8XU...		9BG 101 230-001	1.196, 2.22, 3.26, 3.122, 5.120		
8RA 002 020-031	5.178	8XU 006 945-031	1.178	9BG 101 230-011	5.120	9DX 153 746-011	1.31-1.32
8RA 002 020-051	5.178	8XU 006 945-041	1.178	9BG 119 721-001	3.52, 3.56, 3.81, 3.90-3.91, 3.104, 3.117-3.118, 3.120, 5.118	9DX 852 902-001	6.08
8RA 002 023-001	5.177	8XU 006 946-031	1.178			9DX 859 560-001	6.17-6.18
8RA 002 023-011	5.177	8XU 006 946-041	1.178	9BG 121 581-001	5.121	9DX 859 625-001	6.17-6.18
8RA 002 023-021	5.177	8XU 007 842-017	2.107	9BG 121 587-031	1.196-1.197, 1.200, 1.202, 2.25, 2.28, 2.30, 2.36, 2.39, 2.43-2.44, 2.47, 2.56, 2.66, 2.69, 2.72-2.73, 2.110, 2.115, 3.10-3.11, 3.15, 3.17, 3.36, 3.38, 3.40, 3.46, 3.59-3.60, 3.63-3.64, 3.66, 5.121	9DX 859 626-001	6.36, 6.48, 6.50
8RA 003 326-001	5.176	8XU 007 842-027	2.107			9DX 860 271-001	6.03
8RA 003 326-002	5.176	8XU 008 405-031	5.57	9BG 121 587-071	5.121	9DX 860 438-001	6.03
8RA 003 326-002	5.176	8XU 008 405-037	5.57	9BG 121 740-001	2.91, 2.93, 2.97-2.98, 5.25, 6.21	9DX 861 872-001	6.30-6.31
8RA 003 326-011	2.75, 2.87, 5.11, 5.176	8XU 009 362-101	5.58	9BG 127 179-001	3.108, 4.52, 4.97	9DX 861 976-001	6.30-6.31, 6.48, 6.50
8RA 003 326-017	5.176	8XU 009 362-111	5.58	9BG 130 945-001	2.31, 2.36, 2.38, 2.43, 2.48, 5.15	9DX 862 013-011	6.21
8RA 003 326-021	5.176	8XU 144 427-001	1.161, 1.194	9BG 130 946-001	2.31, 2.36, 2.38, 2.43, 2.48, 5.15	9DX 862 740-001	6.07
8RA 003 326-041	2.88, 5.10, 5.176	8XU 144 427-011	1.161			9DX 862 742-001	6.09
8RA 003 326-041	5.176	8XU 144 428-001	1.161, 1.194	9BG 134 888-011	1.25	9DX 862 844-001	6.03
8RA 003 326-051	5.176	8XU 144 428-011	1.161	9BG 135 827-011	1.30, 1.42	9DX 862 849-001	6.30-6.31
8RA 003 326-051	5.176	8XU 144 428-011	1.161	9BG 135 927-011	1.30, 1.42		
8RA 003 326-931	5.176	8XU 144 429-001	1.161, 1.194	9BG 135 928-011	1.25	9EL...	
8RA 003 326-941	5.176	8XU 144 430-001	1.161, 1.194	9BG 135 941-011	1.25	9EL 006 220-851	1.162
8RA 003 503-001	5.179	8XU 964 435-021	1.190	9BG 135 942-011	1.25	9EL 006 220-921	1.163
8RA 003 660-007	5.24, 5.177	8XU 964 981-001	1.191	9BG 136 027-011	1.29, 1.41	9EL 006 220-931	1.166
8RA 003 734-101	5.90, 5.177			9BG 136 028-011	1.29, 1.41	9EL 007 720-821	1.166
8RA 004 412-001	5.176	8XX...		9BG 139 863-007	2.66, 5.25	9EL 007 720-831	1.166
8RA 004 412-011	5.176	8XX 008 614-031	4.41	9BG 142 247-021	1.116	9EL 007 720-851	1.166
8RA 004 412-021	5.176	8XX 008 614-101	4.41	9BG 142 248-021	1.116	9EL 007 720-871	1.166
8RA 004 412-041	1.12-1.13, 1.151, 1.162-1.163, 1.166			9BG 147 497-002	2.04, 2.06-2.07, 2.11	9EL 007 727-801	1.12
		9AB...		9BG 147 498-002	2.04, 2.06-2.07, 2.11	9EL 007 727-811	1.13
8RA 007 051-031	1.107, 1.147	9AB 001 LOO-111	4.44	9BG 154 271-001	5.134	9EL 008 679-841	1.39
8RA 007 051-041	1.107, 1.147	9AB 860 796-001	6.37, 6.48-6.49	9BG 859 695-101	6.17	9EL 008 679-841	1.39
8RA 008 405-001	1.100, 1.141, 5.56	9AB 860 796-011	6.50	9BG 859 695-111	6.17	9EL 008 759-811	1.193
8RA 008 405-007	5.56	9AB 860 796-021	6.37, 6.48, 6.50	9BG 990 042-061	4.69	9EL 008 980-801	1.167
8RA 009 001-031	5.61	9AB 860 796-061	6.48-6.49	9BG 990 178-011	4.67, 4.69	9EL 008 980-811	1.167
8RA 009 001-037	5.61	9AB 860 796-071	6.48, 6.50	9BG 990 297-001	4.68	9EL 043 137-001	5.171
8RA 009 362-001	5.58	9AB 864 273-001	6.60	9BG 990 353-001	4.81	9EL 052 476-001	5.43
8RA 123 251-005	3.37-3.38, 3.55, 3.59, 3.61, 3.66, 5.41	9AB 864 273-011	6.60	9BG 993 345-001	3.29, 3.56, 3.58-3.59, 3.62-3.63, 3.65-3.66, 3.82-3.85, 4.67, 4.69	9EL 074 484-011	3.50, 3.98-3.100, 5.137
						9EL 074 484-031	3.68, 3.80-3.81, 3.90-3.91, 3.118-3.120, 5.137
8RA 342 014-157	5.176	9AG...		9BP...		9EL 084 110-001	5.108
8RA 343 160-002	5.103	9AG 017 970-001	4.51	9BP 128 032-017	2.112, 5.98	9EL 085 408-001	5.142
8RA 343 160-007	5.103	9AG 071 903-001	3.53, 4.48			9EL 085 478-001	3.64
8RA 343 160-012	5.103	9AG 084 320-005	4.47	9DE...		9EL 087 769-001	3.99
8RA 343 160-017	5.103	9AG 120 516-005	4.47	9DE 077 356-021	3.72, 3.79	9EL 088 150-001	2.58, 3.65, 5.79
8RA 343 160-022	5.103	9AG 126 547-005	1.24	9DE 089 102-011	2.57	9EL 088 525-001	3.10, 3.24, 3.29, 3.81, 3.98, 5.78
8RA 343 160-027	5.103	9AG 126 942-031	2.86, 4.27	9DE 116 734-007	2.77, 2.83	9EL 088 538-001	3.09, 3.21, 3.23, 3.28, 3.34, 3.36, 3.47, 3.120, 5.79
8RA 343 220-007	5.178	9AG 129 328-001	2.37, 2.41, 2.85	9DE 116 735-007	2.77, 2.83	9EL 088 744-001	5.142
8RA 343 220-017	5.178	9AG 132 453-005	3.14, 3.25, 3.96, 3.105, 4.74	9DE 118 423-001	2.78, 2.84	9EL 089 114-001	3.68, 5.52
8RA 354 031-011	1.61			9DE 118 424-001	2.78, 2.84	9EL 089 475-001	5.52
8RA 354 031-021	1.61	9AG 138 131-001	4.28	9DE 128 657-001	5.27	9EL 089 527-001	3.11
8RA 354 036-011	1.127	9AG 138 131-011	2.38, 2.41-2.42, 2.117, 2.120-2.121, 4.28	9DE 128 658-001	5.27	9EL 090 411-001	3.32, 3.51, 3.100, 3.121, 5.51
8RA 354 036-021	1.127			9DE 129 974-021	1.77	9EL 091 749-011	5.157
8RA 964 292-001	5.123	9AG 141 819-001	4.15			9EL 092 435-011	2.112, 2.122, 3.118-3.120, 3.122-3.123, 5.16
		9AG 141 819-011	4.15			9EL 101 353-001	2.115, 5.70
		9AG 141 819-041	4.15				
8RB...		9AG 144 019-005	1.30, 1.42				
8RB 004 713-001	5.177	9AG 147 939-011	4.17				
		9AG 147 939-021	4.19				
8RL...		9AG 147 939-031	4.20				
8RL 002 009-001	5.177	9AG 147 939-061	4.20				
8RL 002 009-011	5.177	9AG 161 844-011	4.09-4.11				
8RL 002 009-021	5.177	9AG 161 844-021	4.09-4.10				
		9AG 161 844-031	4.11				
8RW...		9AG 162 938-001	4.15				
8RW 341 235-007	5.174	9AG 162 940-001	4.12				
8RW 341 421-001	5.174	9AG 168 666-001	4.16				
		9AG 172 638-001	4.11				
8WS...		9AG 990					



List of Part Numbers

Part number	Page	Part number	Page	Part number	Page	Part number	Page
9EL...		9EL...		9EL...		9EL...	
9EL 101 899-001	2.55, 2.65	9EL 119 397-001	3.21-3.22, 3.24-3.25, 3.28, 3.30, 5.52	9EL 131 651-031	1.19, 1.21	9EL 139 138-071	1.162
9EL 101 900-001	2.55, 2.65			9EL 131 652-031	1.19, 1.21	9EL 139 138-081	1.162
9EL 102 240-031	5.51	9EL 119 544-001	2.15, 2.25, 2.62, 2.67, 2.69, 2.76, 2.82, 2.94, 2.98-2.99, 5.24-5.25, 5.27	9EL 132 215-001	2.92, 2.102, 2.108, 3.12, 3.35, 5.124, 5.193	9EL 139 138-091	1.162
9EL 104 571-031	3.44					9EL 139 383-031	1.22
9EL 104 571-041	3.44	9EL 119 544-021	2.15, 2.67, 2.69, 2.91, 2.94, 2.97, 2.99, 2.103, 2.109, 5.24-5.25, 5.27	9EL 132 215-011	2.29-2.30, 2.39, 2.44-2.45, 5.124	9EL 139 384-031	1.22
9EL 107 368-001	1.98, 2.55-2.56, 5.17			9EL 132 403-001	2.60, 2.62, 5.108, 5.126	9EL 139 898-005	2.66
9EL 107 443-011	2.58, 2.108, 5.111					9EL 140 063-021	1.10, 1.23
9EL 107 443-061	2.58, 2.109, 5.111			9EL 132 404-001	2.60, 2.62, 5.108, 5.126	9EL 140 064-021	1.10, 1.23
9EL 108 435-001	3.118, 3.121, 5.112	9EL 119 544-031	2.14, 2.94, 2.98-2.99, 2.103-2.104, 2.109, 5.24-5.25, 5.27			9EL 140 347-021	1.20
9EL 108 651-001	5.119			9EL 133 577-011	1.177	9EL 140 348-021	1.20
9EL 109 139-001	2.18, 2.20, 2.22, 2.32, 2.59, 2.61, 2.63, 2.70, 2.80, 5.17	9EL 119 544-101	5.27	9EL 133 578-011	1.177	9EL 141 135-001	5.92
		9EL 119 544-111	2.15, 2.25, 2.62, 2.67, 2.70, 2.76, 2.82, 2.94, 2.98, 2.100, 2.109, 3.62, 5.24-5.25, 5.27, 5.157	9EL 133 713-011	1.177	9EL 141 135-011	5.92
9EL 109 208-011	2.58, 3.98-3.99, 5.78			9EL 133 714-011	1.177	9EL 141 135-021	5.92
9EL 109 440-002	2.58	9EL 119 544-212	5.25	9EL 133 719-011	1.177	9EL 141 135-031	5.92
9EL 110 013-001	2.116, 2.122, 5.139	9EL 119 614-031	5.47	9EL 133 720-011	1.177	9EL 141 605-011	1.19
9EL 110 014-001	2.116, 2.122, 5.139	9EL 119 874-001	2.55, 2.65	9EL 133 785-005	1.121	9EL 141 606-011	1.19
9EL 110 536-001	3.48, 5.83	9EL 119 977-001	5.129	9EL 133 786-005	1.121	9EL 141 612-001	5.129
9EL 110 536-011	3.29, 3.71, 5.83	9EL 120 201-001	2.98, 5.24-5.25	9EL 134 296-041	2.48, 2.50, 2.52-2.54, 2.75, 2.87-2.88, 5.10-5.11	9EL 141 701-001	1.156, 1.174
9EL 110 540-001	3.32, 5.82	9EL 120 224-001	3.20, 3.22, 3.24-3.26, 3.28, 3.39, 3.48-3.50, 3.54, 3.61			9EL 141 702-001	1.156, 1.174
9EL 110 542-001	3.31, 3.37, 3.48, 5.83			9EL 134 296-051	2.48, 2.50, 2.52-2.54, 2.75, 2.87-2.88, 5.10-5.11	9EL 141 705-001	1.156-1.157, 1.174
9EL 110 544-001	5.83	9EL 120 240-011	5.157			9EL 141 889-031	1.179
9EL 110 736-001	2.23, 2.60, 2.62, 2.64, 5.140	9EL 120 651-001	1.90-1.91	9EL 134 301-001	2.48, 2.50, 2.52-2.54, 2.75, 2.87-2.88, 5.10-5.11	9EL 141 889-041	1.179
		9EL 120 652-001	1.90-1.91			9EL 141 890-031	1.179
9EL 110 737-001	2.23, 2.60, 2.62, 2.64, 5.140	9EL 121 260-051	5.33	9EL 134 301-011	2.75, 2.87-2.88, 5.10-5.11	9EL 141 890-041	1.179
		9EL 121 260-061	5.33			9EL 141 907-071	1.180
9EL 110 910-001	5.138	9EL 121 431-001	3.37, 3.55, 3.59, 3.61, 3.66, 5.41	9EL 134 658-001	5.138	9EL 141 908-071	1.180
9EL 110 918-001	2.68, 3.48, 5.138	9EL 122 149-011	1.198	9EL 134 659-001	3.10, 3.35, 3.51, 3.69, 3.72, 3.74-3.79, 5.138	9EL 141 909-071	1.180
9EL 110 918-011	2.68, 3.48, 5.138	9EL 122 150-011	1.198	9EL 134 739-001	5.46	9EL 142 459-011	1.178
9EL 110 928-001	3.54, 3.64, 5.51	9EL 122 268-001	5.127	9EL 134 740-001	3.32, 3.35, 3.44-3.47, 5.46	9EL 142 460-011	1.178
9EL 111 647-001	1.98, 2.55-2.56, 5.17	9EL 122 377-011	1.198	9EL 134 741-021	3.13, 3.44-3.46, 3.55, 5.46	9EL 142 723-011	1.205
9EL 112 741-001	3.16, 3.117, 3.122, 5.40	9EL 122 378-011	1.198	9EL 134 742-021	3.13, 3.44-3.46, 3.55, 5.46	9EL 142 724-011	1.205
		9EL 122 689-021	1.196, 1.200, 2.31, 2.35-2.36, 2.38, 2.43, 2.48, 5.14-5.15	9EL 135 000-021	5.130	9EL 142 825-021	1.163
9EL 112 743-001	3.16, 3.117, 3.122, 5.40	9EL 122 689-051	1.196, 1.200, 2.31, 2.36, 2.38, 2.43, 2.48, 5.15	9EL 135 007-001	1.18	9EL 142 825-031	1.163-1.164
				9EL 135 008-001	1.18	9EL 142 826-021	1.163
9EL 112 744-001	3.16, 3.117, 3.120-3.123, 5.40	9EL 122 772-001	5.14-5.15	9EL 135 060-001	5.89	9EL 142 826-031	1.163-1.164
		9EL 122 772-051	5.15	9EL 135 266-001	3.22-3.24, 3.26, 3.29, 3.80, 3.99, 5.78	9EL 142 826-041	1.163-1.164
9EL 112 763-001	1.85, 1.112, 2.56, 2.64, 2.66, 5.128	9EL 123 209-005	2.112	9EL 135 548-001	2.116, 2.118-2.119, 2.122, 5.11	9EL 143 579-021	1.107, 1.147
		9EL 123 210-005	2.112			9EL 144 131-001	1.120
9EL 112 858-011	2.56, 2.64, 2.66, 5.128	9EL 123 323-011	1.173	9EL 135 717-001	5.26	9EL 144 132-001	1.120
9EL 113 065-001	1.196, 1.198	9EL 123 324-011	1.173	9EL 135 718-001	5.26	9EL 144 425-001	1.160, 1.194
9EL 113 324-001	2.59, 2.61, 3.117-3.119, 5.50	9EL 123 631-001	5.90	9EL 136 401-011	1.200	9EL 144 425-011	1.160, 1.194
		9EL 123 632-001	5.89	9EL 136 402-011	1.200	9EL 144 425-811	1.160
9EL 113 928-001	5.131	9EL 123 635-001	5.89	9EL 136 819-011	5.21	9EL 144 426-001	1.160, 1.194
9EL 114 400-015	5.98	9EL 125 909-031	1.154, 1.184	9EL 136 819-031	5.20	9EL 144 426-011	1.160, 1.194
9EL 114 401-001	5.98	9EL 125 910-041	1.154, 1.184	9EL 136 819-041	3.49-3.50, 5.21	9EL 144 431-001	1.161, 1.194
9EL 114 401-041	5.98	9EL 126 294-001	3.121, 5.51	9EL 136 825-001	3.13, 5.20	9EL 144 431-801	1.161
9EL 115 003-001	3.69, 3.78, 5.82	9EL 126 339-021	1.21, 1.24	9EL 136 825-011	3.13, 5.20	9EL 144 443-001	1.129
9EL 115 003-011	3.31, 3.51, 3.81, 3.90-3.91, 5.82	9EL 126 339-061	1.18	9EL 136 833-001	5.21	9EL 144 443-001	1.129
		9EL 126 340-021	1.21, 1.24	9EL 136 833-011	5.20	9EL 145 103-011	2.114
9EL 115 003-021	5.82	9EL 127 010-021	1.157	9EL 137 241-001	2.09, 2.79, 2.86, 2.92, 2.102-2.103, 5.107	9EL 145 660-021	5.130
9EL 115 003-035	5.82	9EL 127 353-011	1.21	9EL 137 307-001	3.10, 3.13, 3.15, 3.32, 3.35, 3.37-3.38, 3.44-3.47, 3.52, 3.56, 3.71, 3.80, 5.46	9EL 145 801-001	1.108, 1.144
9EL 115 003-055	3.14, 3.16, 3.30-3.31, 3.35-3.37, 3.45, 3.47, 3.55-3.56, 3.58, 3.60-3.61, 3.63, 3.66, 3.81-3.85, 3.104, 5.83	9EL 127 354-011	1.21			9EL 145 802-001	1.108, 1.144
		9EL 127 688-001	1.89	9EL 137 308-001	3.10, 3.13, 3.15, 3.37-3.38, 3.52, 3.56, 3.71, 3.80, 5.46	9EL 145 833-021	1.10
9EL 115 662-001	5.34	9EL 127 689-001	1.89			9EL 145 834-021	1.10
9EL 115 662-011	3.16, 5.34	9EL 127 855-001	2.74, 5.143	9EL 137 792-011	5.21	9EL 145 997-021	1.11
9EL 115 662-021	3.16, 5.34	9EL 127 856-001	2.74, 5.143	9EL 137 792-031	3.49-3.50, 5.21	9EL 145 998-021	1.11
9EL 115 830-001	2.79, 2.90, 2.92, 2.99, 2.102, 2.109, 5.143	9EL 128 228-021	2.23, 5.77	9EL 137 839-011	1.183	9EL 146 021-001	1.108, 1.145
		9EL 128 385-041	1.174	9EL 137 839-011	1.183	9EL 146 022-001	1.108, 1.145
9EL 116 380-035	2.63, 2.68, 2.92	9EL 128 922-011	2.67, 2.69, 5.162	9EL 137 840-011	1.183	9EL 146 073-001	5.141
9EL 116 380-045	2.63, 2.68	9EL 128 948-011	1.104, 1.139	9EL 138 463-031	1.24	9EL 146 293-031	1.33
9EL 116 607-005	2.82, 5.145	9EL 128 949-011	1.104, 1.139	9EL 138 464-031	1.24	9EL 146 294-031	1.33
9EL 116 771-031	1.152, 1.154, 1.156, 1.174, 1.183, 2.91	9EL 128 958-011	1.105, 1.139	9EL 138 567-031	1.23	9EL 146 371-001	1.200
		9EL 128 959-011	1.105, 1.139	9EL 138 567-061	1.10, 1.23	9EL 146 372-001	1.200
9EL 116 844-001	5.40	9EL 129 149-021	1.18, 1.20	9EL 138 568-031	1.23	9EL 146 373-001	1.200
9EL 116 907-001	2.15, 2.17, 2.19, 2.21, 5.137	9EL 129 150-021	1.18, 1.20	9EL 138 568-061	1.10, 1.23	9EL 146 491-001	2.16, 3.14-3.15, 3.74, 3.76-3.79, 5.47
		9EL 129 161-011	1.18			9EL 146 607-001	1.25
9EL 117 094-001	5.127	9EL 129 162-011	1.18	9EL 137 792-011	3.49-3.50, 5.21	9EL 146 838-001	2.48, 2.50, 2.52-2.54, 2.88, 5.05, 2.10, 5.123, 5.182
9EL 117 330-001	3.70, 5.80	9EL 129 519-001	3.11, 3.83-3.84, 5.46, 5.48	9EL 137 792-031	1.48-1.49		
9EL 117 330-011	3.49, 5.80	9EL 129 614-011	1.93	9EL 137 819-031	1.183	9EL 146 887-001	5.05
9EL 117 334-001	5.80	9EL 129 614-021	1.77, 1.93	9EL 137 839-011	1.183	9EL 147 073-001	1.62, 1.121, 1.124, 1.126-1.127, 1.129, 1.152, 1.161, 1.179, 1.186, 1.189, 1.194
9EL 117 334-021	5.80	9EL 129 615-011	1.93	9EL 138 602-031	1.206		
9EL 118 059-001	1.92	9EL 129 615-021	1.77, 1.93	9EL 138 602-041	1.206	9EL 147 073-001	1.62, 1.122, 1.124, 1.126, 1.129, 1.161, 1.179, 1.186, 1.194
9EL 118 060-001	1.92	9EL 129 762-001	1.93	9EL 138 649-031	1.206		
9EL 118 445-001	2.68, 2.75, 2.100, 2.103-2.104, 5.23	9EL 129 762-031	1.78, 1.94	9EL 138 649-041	1.206	9EL 147 073-801	1.62, 1.122, 1.124, 1.126, 1.129, 1.161, 1.179, 1.186, 1.190
		9EL 129 763-001	1.93	9EL 138 650-031	1.206		
9EL 118 613-001	3.73-3.76, 5.45	9EL 129 763-021	1.78, 1.94	9EL 138 650-041	1.206	9EL 147 096-001	5.22
9EL 118 614-011	3.70, 3.73-3.75, 3.90-3.91, 5.45	9EL 131 420-001	1.98, 2.49, 2.51-2.52, 2.71, 2.73, 5.12	9EL 139 137-051	1.162	9EL 147 096-021	5.22
				9EL 139 137-061	1.162	9EL 147 096-031	5.22
9EL 118 614-021	3.70, 5.45	9EL 131 420-011	1.98, 2.49, 2.51-2.52, 2.71, 2.73, 5.12	9EL 139 137-071	1.162	9EL 147 097-001	5.22
9EL 118 633-001	3.21-3.25, 3.29, 5.52			9EL 139 137-081	1.162	9EL 147 723-071	1.202-1.2

List of Part Numbers



Part number	Page	Part number	Page	Part number	Page	Part number	Page
9EL...		9EL...		9EL...		9EL...	
9EL 148 142-021	1.12	9EL 246 175-011	1.136	9EL 857 803-001	6.17	9EL 963 983-001	5.97
9EL 148 179-021	1.166	9EL 246 176-011	1.136	9EL 859 020-001	6.03	9EL 963 984-001	5.97
9EL 148 179-031	1.165	9EL 246 201-011	1.134-1.135	9EL 859 020-101	6.03	9EL 964 005-021	1.188
9EL 148 179-101	1.166	9EL 246 202-011	1.134-1.135	9EL 859 658-001	6.13, 6.19	9EL 964 006-021	1.188
9EL 148 179-111	1.166	9EL 270 107-011	1.06, 1.08, 1.12-1.13, 1.15, 1.17	9EL 859 658-011	6.13, 6.19	9EL 964 023-011	1.126
9EL 148 179-131	1.166			9EL 860 627-001	6.05	9EL 964 024-011	1.126
9EL 148 180-021	1.166	9EL 270 197-011	1.197	9EL 860 627-011	6.05	9EL 964 055-011	1.126
9EL 148 180-031	1.165	9EL 270 198-011	1.197	9EL 860 628-021	6.05	9EL 964 056-011	1.126
9EL 148 180-101	1.166	9EL 303 581-001	5.186, 5.191-5.193	9EL 860 743-001	6.48-6.50	9EL 964 116-121	1.188
9EL 148 180-111	1.166	9EL 340 002-011	5.99, 5.203	9EL 860 743-011	6.48, 6.50	9EL 964 289-001	5.123
9EL 148 180-131	1.166	9EL 340 201-001	5.183	9EL 860 743-021	6.48, 6.50	9EL 964 290-001	5.123
9EL 148 274-001	5.96	9EL 340 203-001	5.189	9EL 861 498-001	6.31, 6.33	9EL 964 291-001	5.123
9EL 148 345-011	1.48, 1.67	9EL 340 203-011	5.189	9EL 861 498-011	6.31, 6.33	9EL 964 479-011	1.62
9EL 148 345-021	1.48, 1.67	9EL 340 208-001	5.182	9EL 861 498-021	6.31, 6.33	9EL 964 480-011	1.62
9EL 148 673-021	5.123	9EL 340 208-021	5.182	9EL 861 597-001	6.48-6.50	9EL 964 483-011	1.62
9EL 149 957-121	1.204	9EL 340 829-001	5.184-5.186	9EL 861 597-011	6.48, 6.50	9EL 964 484-011	1.62
9EL 149 958-121	1.204	9EL 340 829-011	5.184-5.186	9EL 861 912-001	6.30-6.32	9EL 964 501-011	1.122, 1.190
9EL 150 867-001	1.73	9EL 340 829-021	5.184-5.186	9EL 861 912-021	6.30-6.31	9EL 964 502-011	1.122, 1.190
9EL 150 868-001	1.73	9EL 340 829-031	5.184-5.186	9EL 861 912-041	6.33	9EL 964 526-001	5.68
9EL 150 965-001	5.12	9EL 340 829-051	5.187	9EL 861 912-051	6.33	9EL 964 527-001	5.68
9EL 150 966-001	5.12	9EL 340 829-061	5.187	9EL 861 913-001	6.30-6.32	9EL 964 527-011	5.66
9EL 150 987-001	1.73	9EL 341 325-311	1.204	9EL 861 913-021	6.30-6.31	9EL 964 529-001	3.31, 5.69
9EL 150 988-001	1.73	9EL 341 325-321	1.204	9EL 861 913-041	6.33	9EL 964 529-011	5.66
9EL 151 127-001	2.113	9EL 341 326-311	1.204	9EL 861 913-051	6.33	9EL 964 530-001	5.69
9EL 151 128-001	2.113	9EL 341 326-321	1.204	9EL 862 140-001	6.07	9EL 964 531-001	5.69
9EL 151 494-001	5.50	9EL 343 142-001	5.18-5.19	9EL 862 140-021	6.12	9EL 964 532-001	5.67
9EL 151 829-011	1.181	9EL 343 143-001	5.18-5.19	9EL 862 140-031	6.12	9EL 964 533-001	5.69
9EL 151 830-011	1.181	9EL 343 143-011	5.19	9EL 862 141-001	6.07-6.08	9EL 964 534-001	5.68
9EL 151 875-021	1.165	9EL 343 273-001	5.202	9EL 862 141-011	6.08	9EL 964 535-001	5.67
9EL 151 876-021	1.165	9EL 354 050-011	1.44	9EL 862 141-021	6.07-6.08	9EL 964 536-001	3.30, 5.67
9EL 152 051-011	1.107, 1.147	9EL 354 050-021	1.44	9EL 862 171-001	6.09	9EL 964 541-021	1.190
9EL 152 052-011	1.107, 1.147	9EL 354 054-011	1.52	9EL 862 172-001	6.09	9EL 964 542-021	1.190
9EL 152 884-001	2.114-2.115, 2.117-2.118, 2.120-2.121, 5.09	9EL 354 054-021	1.52	9EL 862 267-001	6.11	9EL 964 599-001	1.131
9EL 152 889-001	1.197, 2.05, 2.07-2.14, 2.29, 2.32-2.33, 2.44, 2.46, 2.110-2.111, 2.113, 5.06-5.07	9EL 354 055-011	1.51	9EL 862 267-031	6.06	9EL 964 800-011	5.66
9EL 152 891-001	1.96, 2.51, 2.71, 5.08	9EL 354 055-021	1.51	9EL 862 678-001	6.10, 6.12	9EL 964 949-001	1.125
9EL 153 567-061	1.34	9EL 354 056-001	1.55	9EL 863 100-001	6.04	9EL 964 950-001	1.125
9EL 153 567-101	1.34	9EL 354 057-011	1.56	9EL 863 100-031	6.10	9EL 982 000-051	1.128
9EL 153 568-101	1.34	9EL 354 057-021	1.56	9EL 863 100-041	6.04	9EL 982 000-061	1.128
9EL 153 923-021	1.08	9EL 354 058-001	1.55	9EL 863 100-051	6.10	9EL 982 001-111	1.128
9EL 153 924-021	1.08	9EL 354 059-011	1.55	9EL 863 117-001	6.53-6.54	9EL 982 001-121	1.128
9EL 154 637-001	5.106	9EL 354 059-021	1.55	9EL 863 117-011	6.51-6.52	9EL 990 034-041	5.84
9EL 156 099-801	1.122, 1.124, 1.128, 1.131, 1.150, 1.165, 1.181, 1.188, 1.190	9EL 354 060-011	1.55	9EL 863 117-071	6.24-6.27	9EL 990 034-051	5.84
9EL 158 251-061	1.39	9EL 354 060-021	1.55	9EL 863 117-131	6.55	9EL 990 068-001	5.139
9EL 158 251-071	1.39	9EL 354 061-011	1.55	9EL 863 136-001	6.37	9EL 990 071-001	5.49
9EL 158 251-101	1.39	9EL 354 061-021	1.55	9EL 863 136-011	6.37	9EL 990 122-001	5.84
9EL 158 252-061	1.39	9EL 354 065-011	1.60	9EL 863 137-001	6.37	9EL 990 142-001	3.08, 3.110, 5.44
9EL 158 252-071	1.39	9EL 354 065-021	1.60	9EL 863 137-011	6.37	9EL 990 186-001	3.39, 4.63-4.64
9EL 158 252-101	1.39	9EL 354 066-011	1.60	9EL 863 943-061	6.14	9EL 990 186-101	3.39
9EL 158 254-011	1.08	9EL 354 066-021	1.60	9EL 863 943-071	6.14	9EL 990 632-001	5.36
9EL 158 254-021	1.08	9EL 354 067-011	1.59	9EL 907 325-001	1.122	9EL 990 632-011	5.37
9EL 158 993-001	5.13	9EL 354 067-021	1.59	9EL 907 326-001	1.122	9EL 990 633-011	5.38
9EL 160 467-011	1.102, 1.143	9EL 354 070-011	1.61	9EL 919 370-111	1.49	9EL 990 633-021	5.38
9EL 160 468-011	1.102, 1.143	9EL 354 070-021	1.61	9EL 919 370-121	1.49	9EL 990 633-031	5.39
9EL 161 421-011	1.103, 1.143	9EL 354 071-011	1.64	9EL 950 315-001	5.122	9EL 990 633-041	5.39
9EL 161 422-011	1.103, 1.143	9EL 354 071-021	1.64	9EL 950 315-031	5.122, 5.191	9EL 997 310-001	5.40
9EL 171 556-031	1.56	9EL 354 072-011	1.68	9EL 950 315-061	5.122, 5.191	9EL 997 313-001	5.42
9EL 171 556-041	1.56	9EL 354 072-021	1.68	9EL 961 255-011	1.50	9EL 997 315-001	5.44
9EL 171 558-011	1.64	9EL 354 073-011	1.103, 1.143	9EL 961 256-011	1.50	9EL 997 318-001	5.44
9EL 171 558-021	1.64	9EL 354 073-021	1.103, 1.143	9EL 961 831-011	1.125	9EL 997 320-001	5.44
9EL 171 558-031	1.64	9EL 354 074-011	1.136	9EL 961 832-021	1.125	9EL 997 332-001	5.47
9EL 171 558-041	1.64	9EL 354 074-021	1.136	9EL 962 025-011	1.130	9EL 997 387-001	5.93
9EL 171 558-051	1.64	9EL 354 075-011	1.136	9EL 962 025-031	1.130	9EL 997 388-001	5.93
9EL 171 558-061	1.64	9EL 354 075-021	1.136	9EL 962 026-011	1.130	9EL 997 451-001	5.42
9EL 171 968-011	1.70	9EL 354 076-011	1.137	9EL 962 026-031	1.130	9EL 997 452-001	5.42
9EL 171 968-021	1.70	9EL 354 076-021	1.137	9EL 962 027-011	1.130	9EL 997 453-001	5.34
9EL 171 974-011	1.133	9EL 354 077-011	1.138	9EL 962 028-011	1.130	9EL 997 459-001	3.40, 5.43
9EL 171 974-021	1.133	9EL 354 077-021	1.138	9EL 962 541-041	1.186	9EL 997 469-001	5.43
9EL 171 975-011	1.133	9EL 354 078-011	1.138	9EL 962 542-051	1.186	9EL 998 001-031	5.40
9EL 171 975-021	1.133	9EL 354 078-021	1.138	9EL 962 542-071	1.187	9EL 998 001-041	5.40
9EL 171 976-011	1.132	9EL 354 079-011	1.138	9EL 962 585-041	1.190	9EL 998 002-031	5.49
9EL 171 976-021	1.132	9EL 354 079-021	1.138	9EL 962 585-051	1.62		
9EL 171 977-011	1.133	9EL 354 080-011	1.123	9EL 962 586-041	1.190	9EM...	
9EL 176 574-011	1.66	9EL 354 080-021	1.123	9EL 962 586-051	1.62	9EM 127 010-061	1.157
9EL 176 574-021	1.66	9EL 354 081-011	1.123	9EL 962 839-021	1.186	9EM 128 229-001	2.64, 5.77
9EL 176 575-011	1.66	9EL 354 082-021	1.123	9EL 962 839-031	1.185	9EM 128 229-011	2.23, 5.77
9EL 176 575-021	1.66	9EL 852 061-001	6.18	9EL 962 840-021	1.186	9EM 128 229-031	2.64
9EL 176 575-021	1.66	9EL 852 061-021	6.18	9EL 962 840-031	1.185	9EM 128 230-001	2.23, 5.77
9EL 176 576-011	1.67	9EL 852 820-001	6.18	9EL 963 111-011	1.07	9EM 128 244-001	5.77
9EL 176 576-021	1.67	9EL 854 912-001	6.18	9EL 963 112-011	1.07	9EM 131 613-021	1.19
9EL 176 577-011	1.67	9EL 855 097-001	6.18	9EL 963 261-011	1.129	9EM 131 614-021	1.19
9EL 176 577-021	1.67	9EL 856 010-001	5.161	9EL 963 262-011	1.129	9EM 133 319-031	1.177
9EL 176 577-021	1.67	9EL 856 415-001	6.17	9EL 963 335-021	1.130	9EM 133 320-031	1.177
9EL 176 577-021	1.67	9EL 856 416-001	6.17-6.18	9EL 963 336-021	1.130	9EM 137 820-021	1.48-1.49
9EL 176 577-021	1.67	9EL 856 416-011	6.18	9EL 963 561-801	1.151		
9EL 176 577-021	1.67	9EL 856 417-001	6.17	9EL 963 561-811	1.151	9ES...	
9EL 176 577-021	1.67	9EL 856 418-001	6.17-6.18	9EL 963 669-081	1.150	9ES 012 060-011	3.09, 3.23, 3.28, 3.31, 3.36, 3.64
9EL 176 577-021	1.67	9EL 856 418-011	6.18	9EL 963 669-091	1.151	9ES 015 675-001	3.101, 4.51
9EL 176 577-021	1.67	9EL 856 418-011	6.18	9EL 963 670-081	1.150	9ES 069 831-001	3.72, 3.79, 3.111
9EL 176 577-021	1.67	9EL 856 989-001	6.36	9EL 963 670-091	1.151	9ES 082 333-031	5.131
9EL 236 217-011	1.70	9EL 857 576-021	6.36	9EL 963 701-011	1.131	9ES 084 374-001	2.57
9EL 236 218-011							



List of Part Numbers

Part number	Page	Part number	Page	Part number	Page	Part number	Page
9ES...		9GD...		9GS...		9MN...	
9ES 106 588-001	5.70	9GD 024 183-001	3.47, 3.53, 3.101, 4.48, 4.51	9GS 146 999-727	4.41	9MN 854 290-001	6.08, 6.18
9ES 113 918-001	2.77, 2.83			9GS 340 051-001	5.194, 5.197-5.199, 5.203-5.204, 5.215	9MN 857 622-001	6.17-6.18
9ES 113 919-001	2.77, 2.83	9GD 052 710-021	2.57			9MN 857 622-011	6.17-6.18
9ES 118 402-001	2.78, 2.84	9GD 082 716-001	2.108-2.109	9GT...		9MN 857 622-101	6.36, 6.48, 6.50
9ES 118 403-001	2.78, 2.84	9GD 087 883-355	2.18, 2.20, 2.24-2.25, 2.27, 2.59, 2.61, 2.68, 2.75, 2.81, 2.100, 2.103-2.104, 3.26-3.27, 3.62, 5.23	9GT 005 166-001	1.196, 2.22, 3.26, 3.122, 5.120, 5.123	9MN 857 622-111	6.36
9ES 120 723-001	1.97, 2.54, 2.60, 2.65, 3.14			9GT 067 751-001	4.49	9MN 858 114-001	6.03
9ES 120 725-001	1.97, 2.54, 2.60, 2.65, 3.14	9GD 100 140-001	2.108-2.109	9GT 074 132-001	2.18, 2.20, 2.22-2.23, 2.32, 2.35, 2.59, 2.61, 2.63, 2.70, 2.80, 2.88, 2.112, 2.122, 3.118-3.120, 3.122-3.123, 5.10, 5.16-5.17	9MN 858 114-011	6.03
9ES 120 726-001	1.97, 2.54, 2.60, 2.65, 3.14	9GD 100 711-021	3.11, 3.43-3.44			9MN 858 616-001	6.17
9ES 122 221-007	2.14, 2.17, 2.19, 2.24-2.25, 2.27, 2.34, 2.37, 2.40, 4.49	9GD 102 484-001	2.112, 2.122, 3.13, 3.49-3.50, 3.118-3.120, 3.122-3.123, 5.16, 5.20-5.21	9GT 134 130-001	3.62	9MN 858 616-011	6.17
				9GT 134 655-007	2.89, 2.96, 2.106, 5.88	9MN 859 116-101	6.48, 6.50
9ES 133 383-005	1.121	9GD 113 431-005	2.77-2.78, 2.83-2.84	9GT 141 941-001	1.98, 2.49, 2.51-2.52, 2.71, 2.73, 5.12	9MN 860 677-001	6.05
9ES 133 384-005	1.121	9GD 117 451-006	1.92			9MN 860 677-011	6.05
9ES 133 571-005	2.10	9GD 118 983-021	2.68, 2.100, 2.103-2.104, 5.23	9GT 143 133-007	2.89, 2.96, 2.106, 3.09, 5.88	9MN 860 677-021	6.05, 6.30-6.31
9ES 133 572-005	2.10					9MN 862 741-001	6.03, 6.07, 6.09
9ES 134 049-005	1.121	9GD 120 670-001	2.63, 3.97, 4.105			9NM...	
9ES 137 169-015	1.22	9GD 128 553-007	2.63, 2.68, 2.92	9GT 146 757-007	5.133-5.134	9NM 863 332-001	4.109, 6.04, 6.07, 6.10, 6.12, 6.16
9ES 137 170-015	1.22	9GD 142 757-031	1.26	9GT 341 438-007	5.66-5.67, 5.69		
9ES 140 721-015	2.08	9GD 157 876-007	5.100-5.101, 5.190, 5.201	9GT 343 367-002	5.102-5.103	9NS...	
9ES 140 722-015	2.08			9GT 963 129-001	2.93, 2.100, 2.102, 2.104, 2.107, 5.91	9NS 114 014-106	4.47
9ES 143 775-011	1.94	9GD 159 740-007	5.86			9NS 119 463-005	4.47
9ES 143 776-011	1.94	9GD 341 063-007	5.95	9GT 990 338-001	3.92	9NS 124 485-001	4.47
9ES 144 433-031	2.114	9GD 746 185-002	5.113-5.115			9NS 140 045-005	4.46
9ES 144 434-031	2.114	9GD 854 019-001	6.18	9HB...		9NS 140 046-005	4.46
9ES 145 251-005	1.26	9GD 856 466-001	6.13, 6.19	9HB 006 948-031	1.178		
9ES 145 252-005	1.26	9GD 856 562-001	6.17-6.18	9HB 006 948-041	1.178	9NU...	
9ES 145 599-001	1.10	9GD 856 863-001	6.13, 6.17, 6.19	9HB 126 601-001	5.15	9NU 858 004-001	6.05
9ES 145 600-001	1.10	9GD 858 013-001	6.17-6.18	9HB 152 021-007	5.134		
9ES 147 313-011	2.08-2.09	9GD 858 086-001	6.17	9HB 152 421-007	5.134	9SG...	
9ES 147 314-011	2.08-2.09	9GD 859 037-001	6.17	9HB 161 122-007	5.62	9SG 703 965-007	6.39
9ES 147 315-015	2.11	9GD 859 037-011	6.09	9HB 161 122-012	5.62	9SG 855 454-011	7.02-7.05
9ES 147 316-015	2.11	9GD 860 396-001	6.16	9HB 162 205-001	1.150	9SG 855 498-001	7.02-7.05
9ES 152 179-001	1.31-1.32	9GD 860 772-001	6.16	9HB 162 206-001	1.150	9SG 998 005-002	4.112
9ES 152 179-801	1.32	9GD 860 936-001	6.39, 6.41	9HB 163 085-001	5.58		
9ES 152 180-001	1.31-1.32	9GD 861 470-001	6.41	9HB 163 085-012	5.58	9ST...	
9ES 247 753-001	2.53	9GD 861 531-001	6.39, 6.41	9HB 164 168-002	5.62	9ST 855 447-001	7.05
9ES 247 754-001	2.53	9GD 861 810-001	6.39, 6.41	9HB 164 168-002	5.62	9ST 861 074-001	7.02-7.04
9ES 861 711-001	6.20	9GD 862 086-001	6.30	9HB 164 168-002	5.62	9ST 861 241-001	7.03
9ES 862 011-001	6.21	9GD 862 086-001	6.07-6.08, 6.12, 6.16	9HB 164 168-002	5.62		
		9GD 862 164-001	6.09	9HB 164 168-002	5.62	9SX...	
9EV...		9GD 862 178-001	6.09	9HB 164 168-002	5.62	9SX 007 609-001	6.41
9EV 113 436-005	2.77-2.78, 2.83-2.84	9GD 862 679-001	6.12	9HB 164 168-002	5.62	9SX 007 609-011	6.41
9EV 855 455-001	7.05	9GD 862 734-001	6.09	9HB 164 168-002	5.62	9SX 007 609-021	6.41
9EV 857 067-011	7.05	9GD 862 868-001	6.48-6.50	9HB 164 168-002	5.62	9SX 007 609-031	6.41
9EV 859 051-011	7.05	9GD 863 033-001	6.16	9HB 164 168-002	5.62	9SX 007 609-041	6.41
9EV 861 038-001	7.02-7.04	9GD 863 122-001	6.29, 6.60	9HB 164 168-002	5.62	9SX 007 609-051	6.41
		9GD 864 285-001	6.29, 6.60	9HB 164 168-002	5.62	9SX 008 902-001	6.59
9FF...		9GD 864 286-001	6.29, 6.60	9HB 164 168-002	5.62	9SX 008 902-021	6.38, 6.61
9FF 042 509-001	8.23	9GD 864 286-011	6.29, 6.60	9HB 164 168-002	5.62	9SX 008 902-001	6.38, 6.61
9FF 071 116-001	8.23	9GD 864 286-021	6.29, 6.60	9HB 164 168-002	5.62	9SX 861 562-001	6.42
9FF 078 830-001	8.23	9GD 882 080-001	6.34	9HB 164 168-002	5.62	9SX 861 562-011	6.42
9FF 085 081-001	8.23	9GD 882 081-001	6.34	9HB 164 168-002	5.62	9SX 863 114-001	6.38, 6.59, 6.61-6.62
9FF 085 642-001	1.90, 2.57	9GD 882 085-001	6.34	9HB 164 168-002	5.62		
9FF 090 500-001	3.09, 3.23, 3.28, 3.31, 3.36, 3.53, 3.64, 3.101, 4.48, 4.51	9GD 963 281-001	2.93, 2.100, 2.102, 2.104, 2.107, 5.91	9HB 164 168-002	5.62	9XB...	
				9HB 164 168-002	5.62	9XB 010 081-001	6.37, 6.39
9FF 111 606-021	3.54-3.55, 3.57, 3.59-3.63, 3.65, 3.101, 4.49	9GH...		9HB 164 168-002	5.62	9XB 136 202-005	5.162
		9GH 096 532-001	4.109, 6.15-6.16	9HB 164 168-002	5.62	9XB 161 749-007	5.56
9FF 121 000-001	2.90, 2.97, 2.106	9GH 116 966-011	1.84-1.85, 1.111-1.112, 1.152, 1.155-1.156, 1.189, 1.195, 1.198, 2.30, 2.47, 2.70, 3.29, 3.56, 3.58-3.59, 3.62-3.63, 3.65-3.66, 3.82-3.85	9HB 164 168-002	5.62	9XB 167 882-001	6.61
9FF 126 444-001	1.84-1.85, 1.111-1.112, 1.152, 1.155-1.156, 1.195, 1.198, 2.30, 2.47, 2.70, 3.116			9HB 164 168-002	5.62		
		9GH 126 647-011	3.16, 3.58, 3.60-3.61, 3.65, 3.116, 4.43	9HB 164 168-002	5.62	9XD...	
9FF 133 025-007	8.23	9GH 136 698-007	5.26	9HB 164 168-002	5.62	9XD 127 264-007	5.81
9FF 135 906-021	8.23	9GH 145 943-001	2.89, 2.96, 2.105, 4.40	9HB 164 168-002	5.62	9XD 130 261-001	2.31, 2.37, 2.41, 2.47, 3.06, 3.12, 3.18, 3.42, 3.53, 3.67, 3.85, 3.87, 3.92, 3.107-3.108, 3.116, 3.124, 4.54, 4.75, 4.78, 4.103-4.104, 4.111, 5.205
9FF 137 580-005	1.77, 1.93	9GH 147 009-007	3.18, 4.03-4.04, 4.31-4.32, 4.97	9HB 164 168-002	5.62		
9FF 138 324-001	8.23			9HB 164 168-002	5.62	9XD 132 749-005	3.37-3.38, 3.55, 3.59, 3.61, 3.66, 5.41
		9GH 152 654-007	4.34-4.35	9HB 164 168-002	5.62		
9FH...		9GH 156 191-001	2.53	9HB 164 168-002	5.62	9XD 160 867-007	5.110
9FH 113 447-011	2.54, 2.60, 2.65, 3.14	9GH 158 051-007	4.39	9HB 164 168-002	5.62	9XD 161 119-007	5.62
		9GH 990 316-031	4.64	9HB 164 168-002	5.62	9XD 161 119-017	5.58
9FT...		9GH 990 334-011	4.61	9HB 164 168-002	5.62	9XD 247 755-001	2.53
9FT 087 771-001	3.99	9GH 993 984-001	3.05, 3.14, 3.17-3.18, 3.32, 3.42, 3.67, 3.86-3.89, 3.92, 3.94, 3.97, 3.101, 3.104, 3.106-3.108, 3.111, 3.113-3.114, 3.123, 4.55-4.59, 4.78-4.79, 4.81-4.85, 4.89, 4.91, 4.95, 5.130	9HB 164 168-002	5.62	9XD 247 756-001	2.53
9FT 088 047-001	3.09-3.10, 3.21-3.24, 3.26, 3.28-3.29, 3.34, 3.36, 3.47, 3.65, 3.80-3.81, 3.98-3.99, 3.120, 5.78-5.79			9HB 164 168-002	5.62	9XD 857 445-801	6.35
		9GH 993 988-007	4.64-4.65	9HB 164 168-002	5.62	9XD 857 579-001	7.05
9FT 117 109-007	2.15, 2.17, 2.19, 2.21, 5.137			9HB 164 168-002	5.62	9XD 857 744-001	7.02-7.05
		9GP...		9HB 164 168-002	5.62	9XD 861 990-001	6.35
9FT 129 176-001	1.89, 1.93	9GP 003 995-801	2.31, 2.35-2.36, 2.38, 2.43, 2.48, 5.14-5.15, 5.23	9HB 164 168-002	5.62	9XD 861 990-011	6.35
9FT 861 790-001	6.34			9HB 164 168-002	5.62	9XD 861 990-021	6.35
9FT 861 790-011	6.34	9GP 859 115-001	6.03	9HB 164 168-002	5.62	9XD 861 995-801	6.35
9FT 861 790-021	6.29			9HB 164 168-002	5.62	9XD 863 403-801	6.39, 6.41
9FT 861 790-031	6.29			9HB 164 168-002	5.62	9XD 863 521-001	6.39, 6.41
9FT 998 007-011	5.50			9HB 164 168-002	5.62	9XD 863 533-001	6.22
		9MM...		9HB 164 168-002	5.62	9XD 863 828-001	6.22
9GD...		9MM 853 518-001	6.43	9HB 164 168-002	5.62	9XD 863 958-001	5.167
9GD 023 639-001	3.09, 3.23, 3.28, 3.31, 3.36, 3.64, 3.89, 3.98-3.100, 4.51			9MM 853 518-021	6.43	9XD 990 284-001	4.109, 6.16
				9MM 859 358-801	6.38, 6.42, 6.60, 6.62		
				9MM 860 814-801	6.42		
				9MM 862 206-011	6.43		
				9MM 862 358-801	6.38, 6.60, 6.62		
				9MM 863 164-001	6.55		
				9MM 863 164-011	6.37, 6.51-6.55, 6.61		
				9MM 863 165-001	6.37, 6.51-6.55		
				9MN...			

List of Part Numbers



Part number	Page	Part number	Page	Part number	Page	Part number	Page
9XD...							
9XD 990 298-001	3.05, 3.08-3.09, 3.87-3.88, 3.94, 3.96, 3.103, 3.105-3.106, 3.108, 3.113-3.115, 3.123, 4.61, 4.67, 4.69-4.70, 4.72-4.73, 4.84-4.85, 4.95, 4.99, 4.101, 4.111						
9XD 997 909-801	5.50, 5.70						
9XR...							
9XR 854 840-001	6.03, 6.06-6.07, 6.09, 6.17-6.18						
9XR 855 975-001	6.04, 6.24, 6.36-6.37, 6.48, 6.50-6.51						
9XS...							
9XS 027 639-001	4.107-4.108						
9XS 118 079-005	4.47						
9XS 854 769-001	7.05						
9XS 855 646-001	7.05						
9XS 857 585-001	7.05						
9XS 857 588-001	7.05						
9XS 861 127-051	7.03-7.04						
9XS 861 736-001	7.04						
9XS 862 004-001	7.02-7.04						
9XX...							
9XX 161 115-001	1.100, 1.141						
9XX 166 909-001	1.54						
9XX 340 173-801	5.184-5.186						
9XX 340 220-001	5.191, 5.193-5.194, 5.197-5.199, 5.203-5.204						
9XX 340 220-011	5.95, 5.204						
9XX 340 220-801	5.204						
9XX 340 222-001	5.183, 5.197, 5.206						
9XX 340 223-001	5.196, 5.199-5.200						
9XX 340 870-007	5.213						
9XX 340 871-007	5.213						
9XX 340 872-007	5.213						
9XX 340 876-007	5.213						
9XX 340 877-007	5.213						
9XX 340 878-007	5.213						
9XX 340 879-001	5.213						
9XX 340 880-001	5.213						
9XX 340 881-001	5.213						
9XX 340 882-001	5.213						
9XX 340 883-001	5.213						
9XX 340 884-001	5.213						



Manufacturer's no. / Hella no. Cross-Reference

Agria	Hella	Audi	Hella	Audi	Hella	Audi	Hella
1065 6	9EL 074 484-011	893 945 225 B	9EM 131 613-021	KDWHLO9210	8GM 002 091-121	KDWHLO9628	2XD 007 854-801
1140 226 15	2BA 001 227-201	893 945 226 A	9EL 131 614-031	KDWHLO9214	8GH 002 857-121	KDWHLO9638	9SX 007 609-041
1140 476 85	2KA 001 389-101	893 945 226 B	9EM 131 614-021	KDWHLO9216	2BA 003 236-021	KDWHLO9639	2VA 006 040-291
1140 618 75	2XS 955 031-001	893 953 049	9EL 135 007-001	KDWHLO9216	2BA 003 236-027	KDWHLO9639	2VA 006 040-297
2295 6	8JB 001 943-001	893 953 050	9EL 135 008-001	KDWHLO9217	8JA 001 915-001	KDWHLO9640	2VP 006 040-301
3148 5	2PF 001 634-101	895 941 699	1NL 005 150-051	KDWHLO9223	2AA 001 200-131	KDWHLO9640	2VP 006 040-307
4508 411 14-0	2SW 003 014-131	895 941 700	1NL 005 150-061	KDWHLO9224	2AA 001 200-151	KDWHLO9645	2RM 007 200-191
53344	9EL 115 003-011	8A0 945 217	9EL 140 347-021	KDWHLO9225	2AA 003 257-041	KDWHLO9654	2RL 007 337-011
5629 4	1TA 003 570-101	8A0 945 217 B	9EL 140 347-021	KDWHLO9225	2AA 003 257-042	KDWHLO9659	2JA 001 357-011
5629 4A1 14-0	1TA 003 570-101	8A0 945 217 C	9EL 140 347-021	KDWHLO9230	2AA 001 204-001	KDWHLO9661	8KB 007 895-821
60145	9GH 096 532-001	8A0 945 218	9EL 140 348-021	KDWHLO9233	8JA 001 921-102	KDWHLO9667	8JA 001 925-001
61940	1TA 122 718-001	8A0 945 218 B	9EL 140 348-021	KDWHLO9234	8RL 002 009-001	KDWHLO9668	2RL 007 900-551
6339 9	2XS 950 071-031	8A0 945 218 C	9EL 140 348-021	KDWHLO9236	8GM 002 092-121	KDWHLO9674	2BA 002 324-011
66699	9EL 854 912-001	8A0 953 049 A	9EL 141 605-011	KDWHLO9246	6ED 004 778-001	KDWHLO9675	2BA 002 324-021
		8A0 953 050 A	9EL 141 606-011	KDWHLO9252	2BA 001 275-011	KDWHLO9677	2JA 005 590-157
		8D0 953 049	9EL 158 254-011	KDWHLO9253	8GM 002 094-121	KDWHLO9681	2JA 001 331-011
		8D0 953 049 A	9EL 158 254-011	KDWHLO9262	2SE 002 844-011	KDWHLO9683	2RL 008 364-021
		8D0 953 050	9EL 158 254-021	KDWHLO9263	9GD 856 863-001	KDWHLO9684	2RL 008 366-031
		8D0 953 050 A	9EL 158 254-021	KDWHLO9305	9MK 854 066-001	KDWHLO9689	2RM 007 200-261
		8E0 941 699 C	1NO 010 380-011	KDWHLO9309	9XR 855 975-001	KDWHLO9690	9MM 862 358-801
		8E0 941 700 C	1NO 010 380-021	KDWHLO9310	8GH 002 089-133	KDWHLO9690	9MM 859 358-801
		8E5 945 095	2VP 965 037-051	KDWHLO9320	9EL 856 010-001	KDWHLO9690	8KB 261 213-001
		8E5 945 096	2VP 965 037-061	KDWHLO9327	2JA 004 531-001	KDWHLO9691	2RL 008 183-001
		8E5 945 217	9EL 153 923-021	KDWHLO9329	2AB 004 532-021	KDWHLO9691	8HG 006 294-011
		8E5 945 218	9EL 153 924-021	KDWHLO9332	1F7 004 700-391	KDWHLO9691	8HG 006 294-021
		8L0 941 003 AH	1LL 008 306-151	KDWHLO9402	4RA 003 510-081	N0177612	8GH 002 089-133
		8L0 941 004 AH	1LL 008 306-161	KDWHLO9412	2XM 004 444-001	N10256401	8GA 006 841-121
		8L0 941 295 A	6NM 007 878-541	KDWHLO9418	5AB 005 944-001	N10320101	8GA 007 157-121
		8L0 941 295 B	6NM 007 878-541	KDWHLO9426	2SA 003 014-051	N10320102	8GH 007 157-121
		8L0 953 049	9EL 963 111-011	KDWHLO9427	2BA 003 014-011	N10529601	8GH 008 357-001
		8L0 953 050	9EL 963 112-011	KDWHLO9430	1G4 003 470-031		
		8P0 941 003 AK	1LJ 009 648-031	KDWHLO9458	2XS 005 020-001		
		8P0 941 004 AK	1LJ 009 648-041	KDWHLO9458	2XS 005 020-002		
		911 652 127 00	8JA 001 921-102	KDWHLO9458	2XS 005 020-003		
		KDWHLO9033	2BA 003 022-021	KDWHLO9460	8HG 006 294-031		
		KDWHLO9074	2AB 004 532-001	KDWHLO9461	2XW 002 897-051		
		KDWHLO9086	2BA 003 022-001	KDWHLO9466	8RA 004 412-041		
		KDWHLO9206	2JA 004 192-001	KDWHLO9475	8GP 002 095-241		
		KDWHLO9246	6ED 004 778-001	KDWHLO9482	2RL 008 366-021		
		KDWHLO9421	2XW 003 146-001	KDWHLO9487	2RL 007 337-121		
		KDWHLO9493	2AB 004 532-011	KDWHLO9488	1G3 005 760-041		
		KDWHLO9007	9EL 854 912-001	KDWHLO9489	8HG 004 806-001		
		KDWHLO9008	2RM 007 200-271	KDWHLO9496	8GJ 002 525-941		
		KDWHLO9012	8GP 002 068-121	KDWHLO9500	8GA 002 071-251		
		KDWHLO9027	8HG 002 365-001	KDWHLO9503	9XD 857 445-801		
		KDWHLO9028	2BA 001 277-021	KDWHLO9507	2NE 006 609-001		
		KDWHLO9029	2BA 001 277-011	KDWHLO9507	2NE 006 609-007		
		KDWHLO9031	9EL 852 061-001	KDWHLO9508	2NE 006 609-011		
		KDWHLO9033	2BA 003 022-021	KDWHLO9508	2NE 006 609-017		
		KDWHLO9044	8GP 002 068-241	KDWHLO9510	2RL 007 337-101		
		KDWHLO9045	6ZE 001 759-071	KDWHLO9511	2XW 007 146-001		
		KDWHLO9050	6ED 004 778-011	KDWHLO9514	9MK 860 255-001		
		KDWHLO9053	2RL 007 900-001	KDWHLO9517	9GD 859 037-001		
		KDWHLO9054	9XD 861 995-801	KDWHLO9521	2SD 001 688-171		
		KDWHLO9057	2RL 007 900-201	KDWHLO9522	2SD 001 688-141		
		KDWHLO9061	3AG 003 399-081	KDWHLO9524	8GA 002 071-131		
		KDWHLO9064	2AB 001 208-001	KDWHLO9526	2AA 003 257-031		
		KDWHLO9066	2AA 001 204-011	KDWHLO9527	1G4 003 470-147		
		KDWHLO9068	2JA 001 364-001	KDWHLO9529	2JA 004 531-011		
		KDWHLO9071	1G5 003 241-021	KDWHLO9533	9MN 857 622-101		
		KDWHLO9073	2JA 003 231-001	KDWHLO9535	9DX 859 626-001		
		KDWHLO9074	2AB 004 532-001	KDWHLO9537	9EL 852 820-001		
		KDWHLO9078	8GA 002 074-121	KDWHLO9540	2VP 006 040-111		
		KDWHLO9083	8GM 002 091-131	KDWHLO9540	2VP 006 040-117		
		KDWHLO9086	2BA 003 022-001	KDWHLO9541	2VP 006 040-121		
		KDWHLO9097	2JA 003 354-001	KDWHLO9541	2VP 006 040-127		
		KDWHLO9098	9AR 120 266-001	KDWHLO9543	2XD 860 618-011		
		KDWHLO9099	8GA 002 083-131	KDWHLO9552	2RL 006 846-101		
		KDWHLO9102	2AA 001 201-011	KDWHLO9555	2AA 003 257-001		
		KDWHLO9111	8RL 002 009-011	KDWHLO9557	8GD 856 466-001		
		KDWHLO9115	2RL 008 061-001	KDWHLO9558	8KB 861 596-001		
		KDWHLO9116	8HG 854 516-001	KDWHLO9560	8KB 007 896-801		
		KDWHLO9124	9SX 007 609-051	KDWHLO9561	8KB 007 895-801		
		KDWHLO9129	2AA 001 200-041	KDWHLO9562	9GD 860 936-001		
		KDWHLO9129	2AA 001 200-042	KDWHLO9573	2RM 007 200-041		
		KDWHLO9131	8JB 004 777-001	KDWHLO9575	2RM 007 200-071		
		KDWHLO9131	8JB 004 777-002	KDWHLO9579	2RL 860 880-001		
		KDWHLO9132	1GA 007 506-011	KDWHLO9580	2RM 007 200-011		
		KDWHLO9133	8KB 990 299-001	KDWHLO9583	2RM 007 200-091		
		KDWHLO9134	8GH 002 090-133	KDWHLO9586	2XD 860 618-001		
		KDWHLO9136	2SD 001 679-001	KDWHLO9589	8GA 002 073-121		
		KDWHLO9139	2DA 003 014-031	KDWHLO9590	8GA 002 073-241		
		KDWHLO9139	2DA 003 014-037	KDWHLO9591	8GH 002 089-251		
		KDWHLO9151	2XW 003 146-001	KDWHLO9591	8GH 002 089-253		
		KDWHLO9157	2PS 962 964-031	KDWHLO9594	8KB 861 213-011		
		KDWHLO9157	2PS 962 964-037	KDWHLO9596	9AB 860 796-001		
		KDWHLO9161	9EL 855 097-001	KDWHLO9597	9AB 860 796-021		
		KDWHLO9172	1GA 996 142-041	KDWHLO9599	9EL 860 743-011		
		KDWHLO9200	8HG 116 741-801	KDWHLO9600	9GD 861 470-001		
		KDWHLO9201	2XS 950 071-001	KDWHLO9601	9GD 861 531-001		
		KDWHLO9202	2XS 003 168-131	KDWHLO9603	9MM 860 814-801		
		KDWHLO9204	1G8 002 340-011	KDWHLO9608	9SX 861 562-011		
		KDWHLO9205	8XT 002 120-001	KDWHLO9611	8GH 002 473-132		
		KDWHLO9206	2JA 004 192-001	KDWHLO9618	8KB 007 895-811		
		KDWHLO9209	2BA 001 227-201	KDWHLO9623	2RM 007 200-121		



Manufacturer's no. / Hella no.

Cross-Reference



Becker Group	Hella	BMW	Hella	BMW	Hella	BMW	Hella
570B965	2SA 001 638-021	2 146 162-01	2RM 007 200-111	63 12 6 910 959	1LG 009 059-031	65 73 2 137 977	95X 007 609-001
570D013	2BA 001 275-011	2 146 163	2RM 007 200-141	63 12 6 910 960	1LG 009 059-041	6 900 209	2VP 008 272-231
570D014	2BA 001 275-021	2 146 163-01	2RM 007 200-141	63 12 6 917 125	1LL 158 085-011	6 900 210	2VP 008 272-241
570E121	9EL 110 737-001	2 146 164	2RM 007 200-151	63 12 6 917 126	1LL 158 086-011	6 900 797	9ES 862 011-001
5790002	8JA 001 909-011	2 146 164-01	2RM 007 200-151	63 12 7 044 673	1ZS 169 009-131	6 902 221	2RM 007 200-131
BMW	Hella	2 146 202	9MM 859 358-801	63 12 7 044 674	1ZS 169 009-141	6 902 221-02	2RM 007 200-131
1 126 427	8HG 854 516-001	2 146 209	8KB 861 213-001	63 12 7 045 693	1ZS 169 009-131	6 902 519	1LL 008 053-591
1 243 841	9GH 096 532-001	2 183 995	2KA 001 378-001	63 12 7 045 694	1ZS 169 009-141	6 902 520	1LL 008 053-601
1 243 857	9EL 852 061-021	2 230 248	2AA 003 257-031	63 12 7 160 195	1LL 163 081-001	6 902 523	1LL 008 052-591
1 243 975	9EL 852 061-001	2 230 249	2AA 003 257-021	63 12 7 160 196	1LL 163 082-001	6 902 524	1LL 008 052-601
1 243 977	9EL 852 061-021	2 230 250	2AA 003 257-011	63 12 7 165 453	1LL 158 085-011	6 902 765	2BA 008 404-011
1 351 317	4RA 003 510-081	2 305 637	2RL 006 846-101	63 12 7 165 563	1LF 008 673-091	6 902 766	2BA 008 404-021
1 352 685	9KS 075 139-001	2 305 638	9EL 859 020-101	63 12 7 165 564	1LF 008 673-101	6 902 769	2BA 008 404-031
1 353 721	2NE 003 030-151	2 305 640	9EL 859 020-001	63 12 7 165 565	1LL 160 695-001	6 902 770	2BA 008 404-041
1 353 789	4RA 003 510-081	2 772 800	9EL 085 408-001	63 12 7 165 566	1LL 160 696-001	6 903 371	2RM 007 200-201
1 354 665	2KA 004 331-031	2 776 500	2BA 001 236-001	63 12 7 177 729	1LL 009 449-031	6 903 371-01	2RM 007 200-201
1 356 409	1K3 114 155-001	2 913 900	9AG 084 320-005	63 12 7 177 730	1LL 009 449-041	6 904 048	9DX 153 746-011
1 356 415	1M3 114 178-001	2 982 203	9FF 085 642-001	63 12 7 177 753	1LL 164 909-001	6 904 353	1LL 008 420-331
1 359 777	9NS 114 014-106	31 11 1 126 427	8HG 854 516-001	63 12 7 177 754	1LL 164 910-001	6 904 354	1LL 008 420-341
1 363 234	2JA 003 388-001	32 64 0 308 01	8JB 004 777-001	63 12 8 353 545	1LJ 007 143-051	6 907 488	5DV 008 290-004
1 366 361	2KA 004 331-031	32 64 0 308 01	8JB 004 777-002	63 12 8 353 546	1LJ 007 143-061	6 907 489	5DD 008 319-501
1 366 769	2VP 003 685-071	3 381 900	8JA 001 909-001	63 12 8 359 493	9AG 144 019-005	6 910 767	2VP 008 679-111
1 366 770	2VP 003 685-081	3 434 957	9EL 854 912-001	63 12 8 361 007	8GS 007 949-101	6 910 768	2VP 008 679-121
1 367 041	1NB 123 581-001	3 436 336	8GA 002 073-121	63 12 8 361 009	9ES 145 251-005	6 910 779	1LF 008 673-091
1 367 042	1NB 123 582-001	3 864 672	2DA 003 014-031	63 12 8 361 100	9ES 145 252-005	6 910 779.9	1LF 008 673-091
1 367 353	2JA 003 388-001	3 864 672	2DA 003 014-037	63 12 8 361 103	9GD 142 757-031	6 910 780	1LF 008 673-101
1 369 842	1K3 126 046-001	4 002 911	8RA 003 326-001	63 12 8 361 939	1LL 007 250-011	6 910 780.9	1LF 008 673-101
1 370 904	1K3 126 680-001	4 002 911	8RA 003 326-002	63 12 8 361 940	1LL 007 250-021	6 910 791	1N0 010 345-011
1 371 208	2BA 003 022-021	0 414 700	9EL 008 679-841	63 12 8 387 114	5DV 007 760-651	6 910 792	1N0 010 345-021
1 372 765	2KA 004 331-031	4 181 919	1ND 003 590-001	63 13 1 381 747	2BA 007 275-011	6 910 959	1LG 009 059-031
1 373 511	1K3 126 046-001	4 184 716	9FF 071 116-001	63 13 1 381 748	2BA 007 275-021	6 910 960	1LG 009 059-041
1 373 512	1K3 126 680-001	4 184 717	9FF 078 830-001	63 13 1 386 011	9EL 146 607-001	6 911 419	9SX 007 609-031
1 373 529	9AG 126 547-005	4 190 562	1KB 003 177-061	63 13 6 902 765	2BA 008 404-011	6 911 419-01	9SX 007 609-031
1 375 067	1NB 123 581-001	4 193 968	9EL 852 820-001	63 13 6 902 766	2BA 008 404-021	6 916 775	2DA 003 236-331
1 375 068	1NB 123 582-001	4 257 704	2RL 007 337-101	63 13 6 902 769	2BA 008 404-031	6 917 125	1LL 158 085-011
1 376 329	2JA 004 192-001	4 257 705	9GD 860 396-001	63 13 6 902 770	2BA 008 404-041	6 917 126	1LL 158 086-011
1 378 325	9AH 131 741-011	61 13 1 243 841	9GH 096 532-001	63 17 1 243 975	9EL 852 061-001	6 917 751	9SX 007 609-051
1 378 326	9AH 131 740-011	61 31 1 351 317	4RA 003 510-081	63 17 1 243 977	9EL 852 061-021	6 933 189	1LL 160 695-001
1 378 337	1K3 132 253-011	61 31 1 390 388	9SG 703 965-007	63 17 1 352 685	9KS 075 139-001	6 933 190	1LL 160 696-001
1 378 338	1K3 132 266-011	62 10 7 740 038	2AA 003 257-001	63 17 1 375 067	1NB 123 581-001	6 952 586	2XD 008 997-001
1 379 103	1NL 005 230-051	62 14 2 230 248	2AA 003 257-031	63 17 1 375 068	1NB 123 582-001	7 044 673	1ZS 169 009-131
1 379 104	1NL 005 230-061	62 14 2 230 249	2AA 003 257-021	63 17 1 379 103	1NL 005 230-051	7 044 674	1ZS 169 009-141
1 379 104	1NL 005 230-121	62 14 2 230 250	2AA 003 257-011	63 17 1 379 104	1NL 005 230-061	7 045 693	1ZS 169 009-131
1 379 823	9BG 136 027-011	62 14 8 680 130	9FF 085 642-001	63 17 1 379 104	1NL 005 230-121	7 045 694	1ZS 169 009-141
1 379 824	9BG 136 028-011	63 11 6 933 189	1LL 160 695-001	63 17 1 381 198	2RL 007 337-121	07 11 9 978 227	8GA 002 071-121
1 381 198	2RL 007 337-121	63 11 6 933 190	1LL 160 696-001	63 17 1 387 091	1NB 006 270-051	07 11 9 978 311	8GM 002 091-121
1 381 747	2BA 007 275-011	63 12 1 356 409	1K3 114 155-001	63 17 1 387 092	1NB 006 270-061	07 11 9 978 372	8GP 003 594-141
1 381 748	2BA 007 275-021	63 12 1 356 415	1M3 114 178-001	63 17 1 390 879	1NL 005 230-111	07 11 9 978 373	8GP 003 594-121
1 382 495	8GH 005 635-121	63 12 1 359 777	9NS 114 014-106	63 17 1 390 880	1NL 005 230-121	07 11 9 978 391	8GH 002 090-133
1 382 496	8GH 005 636-121	63 12 1 369 842	1K3 126 046-001	63 17 2 305 637	2RL 006 846-101	07 11 9 978 396	8GD 002 088-131
1 384 009	2VA 005 553-111	63 12 1 370 904	1K3 126 680-001	63 17 2 305 638	9EL 859 020-101	7 160 195	1LL 163 081-001
1 384 010	2VA 005 553-121	63 12 1 373 511	1K3 126 046-001	63 17 2 305 640	9EL 859 020-001	7 160 196	1LL 163 082-001
1 384 011	2NR 005 554-111	63 12 1 373 512	1K3 126 680-001	63 17 4 257 704	2RL 007 337-101	7 165 453	1LL 158 085-011
1 384 012	2NR 005 554-121	63 12 1 373 529	9AG 126 547-005	63 17 4 257 705	9GD 860 396-001	7 165 563	1LF 008 673-091
1 385 461	1K3 134 855-011	63 12 1 378 325	9AH 131 741-011	63 17 6 910 791	1N0 010 345-011	7 165 563-03	1LF 008 673-091
1 385 462	1K3 134 856-011	63 12 1 378 326	9AH 131 740-011	63 17 6 910 792	1N0 010 345-021	7 165 564	1LF 008 673-101
1 385 605	1DL 005 630-011	63 12 1 378 337	1K3 132 253-011	63 17 8 352 023	1NA 007 039-011	7 165 564-03	1LF 008 673-101
1 385 606	1DL 005 630-021	63 12 1 378 338	1K3 132 266-011	63 17 8 352 024	1NA 007 039-021	7 165 565	1LL 160 695-001
1 385 634	9BG 134 888-011	63 12 1 379 823	9BG 136 027-011	63 17 8 357 385	1NB 006 270-051	7 165 566	1LL 160 696-001
1 385 767	1DL 005 630-011	63 12 1 379 824	9BG 136 028-011	63 17 8 357 386	1NB 006 270-061	7 177 281	2VP 009 425-111
1 385 768	1DL 005 630-021	63 12 1 382 495	8GH 005 635-121	63 17 8 357 387	1NB 006 270-051	7 177 282	2VP 009 425-121
1 386 011	9EL 146 607-001	63 12 1 382 496	8GH 005 636-121	63 17 8 357 390	1NB 006 270-061	7 177 693	2VA 009 426-111
1 386 403	1K3 134 855-011	63 12 1 385 461	1K3 134 855-011	63 17 8 360 575	1NA 009 026-011	7 177 694	2VA 009 426-121
1 386 404	1K3 134 856-011	63 12 1 385 462	1K3 134 856-011	63 17 8 360 576	1NA 009 026-021	7 177 697	2TZ 009 427-111
1 386 407	1K3 134 855-011	63 12 1 385 605	1DL 005 630-011	63 17 8 361 951	1ND 007 646-011	7 177 698	2TZ 009 427-121
1 386 408	1K3 134 856-011	63 12 1 385 606	1DL 005 630-021	63 17 8 361 952	1ND 007 646-021	7 177 729	1LL 009 449-031
1 386 636	9BG 134 888-011	63 12 1 385 634	9BG 134 888-011	63 17 8 361 957	1NA 009 026-011	7 177 729-01	1LL 009 449-031
1 386 715	9BG 135 941-011	63 12 1 385 767	1DL 005 630-011	63 17 8 381 978	1NA 009 026-021	7 177 729-02	1LL 009 449-031
1 386 716	9BG 135 942-011	63 12 1 385 768	1DL 005 630-021	63 21 1 366 769	2VP 003 685-071	7 177 729-03	1LL 009 449-031
1 386 805	1DL 005 930-371	63 12 1 386 403	1K3 134 855-011	63 21 1 366 770	2VP 003 685-081	7 177 729-04	1LL 009 449-031
1 386 806	1DL 005 930-381	63 12 1 386 404	1K3 134 856-011	63 21 1 384 009	2VA 005 553-111	7 177 729-05	1LL 009 449-031
1 387 091	1NB 006 270-061	63 12 1 386 407	1K3 134 855-011	63 21 1 384 010	2VA 005 553-121	7 177 729-08	1LL 009 449-031
1 387 092	1NB 006 270-051	63 12 1 386 408	1K3 134 856-011	63 21 1 384 011	2NR 005 554-111	7 177 730	1LL 009 449-041
1 390 270	9DR 136 958-021	63 12 1 386 636	9BG 134 888-011	63 21 1 384 012	2NR 005 554-121	7 177 730-01	1LL 009 449-041
1 390 275	9BG 135 927-011	63 12 1 386 715	9BG 135 941-011	63 21 6 900 209	2VP 008 272-231	7 177 730-02	1LL 009 449-041
1 390 276	9BG 135 928-011	63 12 1 386 716	9BG 135 942-011	63 21 6 900 210	2VP 008 272-241	7 177 730-03	1LL 009 449-041
1 390 301	9DR 135 926-015	63 12 1 386 805	1DL 005 930-371	63 21 6 910 767	2VP 008 679-111	7 177 730-04	1LL 009 44



Manufacturer's no. / Hella no. Cross-Reference

BMW	Hella	Bosch	Hella	Bosch	Hella	Bosch	Hella
8 360 576	1NA 009 026-021	1 315 106 919	9EL 158 254-021	1 987 305 011 000 59	9EL 145 833-021	0 311 424 008	2SD 001 685-211
8 361 007	8GS 007 949-101	1 315 610 907	9EL 110 928-001	1 987 305 012	9EL 145 834-021	0 311 424 008	2SD 001 685-218
8 361 099	9ES 145 251-005	1 315 620 909	9EL 092 435-011	1 987 305 012 000 59	9EL 145 834-021	0 311 424 008	2SD 001 685-231
8 361 100	9ES 145 252-005	1 315 620 956	9EL 112 763-001	1 987 305 013	9ES 145 599-001	0 311 424 008	2SD 001 685-232
8 361 103	9GD 142 757-031	1 315 620 957	9EL 109 139-001	1 987 305 013 000 59	9ES 145 599-001	0 311 424 009	2SE 001 686-142
8 361 939	1LL 007 250-011	1 315 620 960	9EL 107 368-001	1 987 305 014	9ES 145 600-001	0 311 424 010	2SD 001 686-101
8 361 940	1LL 007 250-021	1 315 620 960	9EL 111 647-001	1 987 305 014 000 59	9ES 145 600-001	0 311 425 001	2SE 003 167-031
8 361 951	1ND 007 646-011	1 682 329 061	9XS 861 736-001	1 987 305 017	9HB 006 948-031	0 311 425 002	2SD 003 167-021
8 361 952	1ND 007 646-021	1 987 301 010	9EL 002 525-801	1 987 305 017 000 59	9HB 006 948-031	0 311 425 003	2SD 001 687-011
8 363 557	9EL 146 293-031	1 987 301 024	8GA 006 841-801	1 987 305 018	9HB 006 948-041	0 312 201 002	2DA 003 734-011
8 363 558	9EL 146 294-031	1 987 301 042	8GH 007 157-471	1 987 305 018 000 59	9HB 006 948-041	0 313 050 005	2SA 003 734-121
8 374 235	2BA 003 236-321	1 987 301 071	8GH 002 089-801	1 987 305 019	9EL 963 111-011	0 313 104 001	2NE 002 589-001
8 374 235-02	2BA 003 236-321	1 987 302 015	8GH 002 089-141	1 987 305 019 850 59	9EL 963 111-011	0 313 110 002	2NE 003 734-091
8 374 238	9SX 007 609-021	1 987 302 022	8GH 002 089-121	1 987 305 020	9EL 963 112-011	0 314 107 002	2ZR 003 734-041
8 374 238-02	9SX 007 609-021	1 987 302 023	8GD 002 088-131	1 987 305 020 850 59	9EL 963 112-011	0 315 104 027	2PF 003 734-031
8 376 311	9GD 860 936-001	1 987 302 031	8GH 002 090-133	2 301 014 107	9GD 113 431-005	0 318 214 203	2BA 006 749-071
8 376 311-01	9GD 860 936-001	1 987 302 035	8GH 002 090-371	2 305 320 919	9DE 116 734-007	0 318 214 204	2BA 006 749-081
8 379 538	2RM 007 200-071	1 987 302 041	8GJ 002 525-131	2 305 610 301	9EV 113 436-005	0 318 348 103	9EL 151 875-021
8 379 538-02	2RM 007 200-071	1 987 302 041	8GJ 002 525-133	0 300 383 001	1S3 001 117-041	0 318 348 104	9EL 151 876-021
8 379 539	2RM 007 200-061	1 987 302 043	8GJ 002 525-341	0 301 017 616	1LG 003 434-187	0 318 408 013	1NA 009 026-011
8 381 977	1NA 009 026-011	1 987 302 045	8GJ 002 525-361	0 301 019 601	1LE 003 427-041	0 318 408 014	1NA 009 026-021
8 381 978	1NA 009 026-021	1 987 302 071	8GH 007 157-121	0 301 036 405	1LJ 008 040-071	0 332 014 409	4RA 003 510-081
8 387 114	5DV 007 760-651	1 987 302 075	8GH 007 157-181	0 301 036 406	1LJ 008 040-081	0 335 411 015	5AB 005 944-001
8 680 130	9FF 085 642-001	1 987 302 081	8GH 008 356-121	0 301 036 407	1LJ 008 040-071	0 335 411 016	5AB 005 944-011
9 063 573	8GA 002 071-121	1 987 302 082	8GH 008 357-001	0 301 036 408	1LJ 008 040-081	0 341 201 006	6ZE 001 759-051
9 400 198	2AB 004 532-021	1 987 302 084	8GH 008 358-121	0 301 049 403	1LJ 008 041-031	0 341 500 801	6EG 001 567-041
9 822 034	9FF 085 642-001	1 987 302 152	8GH 005 635-121	0 301 049 403	1LJ 008 041-041	0 352 070 009	8JB 001 943-001
9 978 227	8GA 002 071-121	1 987 302 153	8GH 005 636-121	0 301 049 404	1LJ 008 041-031	0 352 070 012	8JB 001 943-001
9 978 311	8GM 002 091-121	1 987 302 201	8GA 002 073-121	0 301 049 404	1LJ 008 041-041	0 352 170 003	8JA 001 930-001
9 978 372	8GP 003 594-141	1 987 302 202	8GD 002 078-121	0 301 057 503	1LH 002 658-451	0 352 170 005	8JA 001 930-001
9 978 373	8GP 003 594-121	1 987 302 203	8GA 002 071-131	0 301 057 504	1LH 002 658-461	0 352 320 001	8JA 001 925-001
9 978 391	8GH 002 090-133	1 987 302 204	8GA 002 071-121	0 301 073 713	1LJ 007 219-371	0 366 206 004	4AZ 003 787-001
9 978 396	8GD 002 088-131	1 987 302 206	8GP 003 594-121	0 301 073 714	1LJ 007 219-381	7 781 999 002	8XT 002 117-001
		1 987 302 207	8GP 002 067-121	0 301 173 505	1LE 009 058-031	7 781 999 300	8XT 002 121-001
Bosch	Hella	1 987 302 208	8GP 002 095-121	0 301 173 506	1LE 009 058-041	7 781 999 305	9XS 027 639-001
1 300 312 025	9GT 067 751-001	1 987 302 209	8GD 002 084-131	0 301 173 705	1LE 009 058-071	7 782 322 009	2RL 007 550-001
1 300 508 024	9GH 116 966-011	1 987 302 210	8GM 002 091-131	0 301 173 706	1LE 009 058-081	7 782 322 011	2RL 008 061-101
1 300 508 034	9HD 121 297-001	1 987 302 211	8GM 002 092-121	0 301 177 601	1LG 009 059-031	7 782 322 207	2RL 008 061-001
1 300 508 034	9HD 121 297-035	1 987 302 212	8GP 002 068-121	0 301 177 602	1LG 009 059-041	7 782 324 009	2RL 007 550-011
1 300 630 034	9FF 085 642-001	1 987 302 213	8GA 006 841-121	0 301 303 028	1K3 114 155-001	7 782 324 011	2RL 008 061-111
1 300 636 071	9FT 129 176-001	1 987 302 214	8GA 002 072-121	0 301 303 032	1K3 114 155-001	7 782 324 207	2RL 008 061-011
1 300 636 140	9FF 126 444-001	1 987 302 215	8GD 004 772-121	0 301 303 034	1K3 114 155-001	7 782 332 008	2RL 007 551-001
1 304 485 004	8JA 001 909-001	1 987 302 217	8GP 003 594-141	0 301 383 001	1DL 005 630-011	7 782 332 009	2RL 007 553-001
1 304 485 900	8JA 001 909-001	1 987 302 219	8GA 007 997-031	0 301 383 002	1DL 005 630-021	7 782 332 011	2RL 008 060-101
1 305 210 901	9BG 134 888-011	1 987 302 220	8GA 007 997-041	0 301 385 001	1DL 005 930-371	7 782 332 209	2RL 008 060-001
1 305 211 900	9BG 136 027-011	1 987 302 221	8GA 007 997-081	0 301 385 002	1DL 005 930-381	7 782 334 007	2RL 007 551-011
1 305 211 901	9BG 136 028-011	1 987 302 224	8GP 002 066-121	0 301 385 202	1DL 005 930-371	7 782 334 008	2RL 007 553-011
1 305 219 004	9HD 121 297-001	1 987 302 226	8GM 002 094-121	0 301 385 202	1DL 005 930-381	7 782 334 009	2RL 008 060-111
1 305 230 904	9EL 129 161-011	1 987 302 229	8GM 002 091-121	0 301 608 519	1L8 003 060-561	7 782 334 207	2RL 008 060-011
1 305 230 905	9EL 129 162-011	1 987 302 230	8GM 002 091-181	0 301 608 611	1L8 003 060-691	7 782 362 008	2RL 008 065-101
1 305 230 906	9EL 135 007-001	1 987 302 231	8GH 002 473-151	0 301 608 613	1L8 004 190-111	7 782 362 008	2RL 008 065-107
1 305 230 907	9EL 135 008-001	1 987 302 232	8GH 007 643-121	0 301 709 001	1KB 003 177-061	7 782 362 207	2RL 008 065-001
1 305 230 916	9EL 141 605-011	1 987 302 233	8GH 007 643-171	0 301 709 000	1LB 003 177-081	7 782 364 007	2RL 008 065-111
1 305 230 917	9EL 141 606-011	1 987 302 238	8GM 002 091-141	0 305 063 003	1N0 009 594-011	7 782 364 207	2RL 008 065-011
1 305 231 028	2BA 006 091-011	1 987 302 240	8GP 938 026-001	0 305 063 004	1N0 009 594-021	7 782 372 003	2RL 007 552-001
1 305 231 029	2BA 006 091-021	1 987 302 241	8GP 003 594-541	0 305 406 901	1ND 005 700-841	7 782 372 004	2RL 008 062-101
1 305 232 905	9EL 127 689-001	1 987 302 244	8GA 007 997-001	0 305 603 001	1N4 005 750-001	7 782 372 204	2RL 008 062-001
1 305 232 912	9EL 127 688-001	1 987 302 245	8GH 002 473-132	0 305 603 901	1N4 005 750-801	7 782 374 005	2RL 007 552-011
1 305 232 921	9EL 150 987-001	1 987 302 411	8GH 002 089-251	0 306 407 001	1FD 005 700-051	7 782 374 006	2RL 008 062-111
1 305 232 922	9EL 150 988-001	1 987 302 411	8GH 002 089-253	0 306 407 901	1FD 005 700-851	7 782 374 203	2RL 008 062-011
1 305 232 923	9EL 150 867-001	1 987 302 421	8GD 002 088-251	0 306 480 001	1G5 003 241-021	7 782 430 030	1G9 001 523-021
1 305 232 924	9EL 150 868-001	1 987 302 422	8GH 002 085-241	0 306 606 901	1F4 005 750-811	7 782 430 000	9GH 096 532-001
1 305 233 051	2BA 003 110-011	1 987 302 431	8GH 002 090-251	0 307 106 001	2ZR 002 589-011	8 782 113 024	9NU 858 004-001
1 305 233 052	2BA 003 110-021	1 987 302 433	8GH 002 090-253	0 307 851 327	6NM 004 375-311	8 785 510 065	9EL 856 418-011
1 305 233 106	9EL 129 615-011	1 987 302 441	8GJ 002 525-281	0 307 851 347	6NM 007 282-211	8 785 510 071	9EL 852 820-001
1 305 233 916	9EL 120 651-001	1 987 302 442	8GJ 002 525-251	0 307 852 309	6NM 004 375-311	8 785 510 073	9EL 855 097-001
1 305 233 917	9EL 120 652-001	1 987 302 442	8GJ 002 525-253	0 310 152 006	2AA 003 257-041	8 785 510 098	9EL 854 912-001
1 305 233 928	9EL 129 615-011	1 987 302 471	8GH 007 157-241	0 310 152 006	2AA 003 257-042	8 787 022 001	8HG 002 365-001
1 305 301 918	1G4 129 089-011	1 987 302 501	8GA 002 073-241	0 310 153 002	2AA 001 204-001	8 787 022 013	8HG 006 294-051
1 305 311 050	9DR 060 567-001	1 987 302 503	8GA 002 073-251	0 310 153 004	2AA 001 204-031	8 787 022 016	8HG 006 294-011
1 305 313 935	1G8 132 233-011	1 987 302 504	8GP 002 095-241	0 310 153 010	2AA 001 204-011	8 787 220 627	9MN 860 677-001
1 305 320 816	9DF 112 246-001	1 987 302 505	8GA 002 071-251	0 311 109 001	2ST 001 673-011	8 787 510 023	8GH 002 089-251
1 305 320 818	9DF 112 247-001	1 987 302 507	8GM 002 092-241	0 311 109 002	2SB 001 673-002	8 787 510 023	8GH 002 089-253
1 305 331 903	1K3 126 046-001	1 987 302 508	8GP 002 068-241	0 311 113 007	2SE 001 680-291	8 787 540 003	8GM 002 092-121
1 305 331 904	1K3 126 690-001	1 987 302 510	8GA 002 071-241	0 311 113 007	2SE 002 582-071	8 797 022 002	2JA 003 231-001
1 305 331 909	1K3 134 855-011	1 987 302 511	8GA 002 071-261	0 311 113 008	2SD 001 680-281	8 797 337 026	2AA 001 200-131
1 305 331 910	1K3 134 856-011	1 987 302 512	8GP 002 067-241	0 311 113 009	2SD 003 184-031	0 986 310 093	2AA 003 257-041
1 305 363 958	9DE 129 975-021	1 987 302 514	8GA 007 997-071	0 311 113 009	2SD 003 184-037	0 986 310 093	2AA 003 257-042
1 305 363 959	9DE 129 974-021	1 987 302 517	8GP 003 594-241	0 311 118 001	2SE 001 699-071	0 986 310 205	1L9 007 095-111
1 305 365 915	9DE 131 520-017	1 987 302 518	8GP 003 594-251	0 311 118 002	2SD 001 699-061	0 986 310 205 000 59	1L9 007 095-111
1 305 5							

Manufacturer's no. / Hella no.

Cross-Reference



Bremi	Hella	Case IH	Hella	Citroën	Hella	Claas	Hella
11155A	8JA 001 909-011	0 605098 64	2SE 002 578-701	6350.77	2NE 354 053-011	031 802 20	2BN 964 169-051
11575/15SB	8JS 711 687-821	0 605098 64	2SE 002 578-707	6350.78	9EL 354 050-011	031 802 20	2BN 964 169-057
Case IH	Hella	0 605191 34	2PF 001 259-631	6350.79	2XX 354 033-011	031 802 30	2BA 964 169-041
1 07484C 1	8RA 002 016-111	0 605191 42	2SA 001 259-751	6350.V1	2ZR 354 052-011	031 802 30	2BA 964 169-047
1 07484O 1	8RA 002 016-111	0 605191 42	2SA 001 259-757	6350.Y0	2VP 354 030-031	031 802 40	2TA 964 169-061
1 089208 R91	1G4 003 470-031	0 605193 43	1DL 007 872-037	6351.AA	2NR 982 008-121	031 802 40	2TA 964 169-067
0 111950 1	1GA 006 991-021	0 605193 51	2BA 004 119-017	6351.AC	2SK 009 466-141	031 806 20	2KA 003 389-061
1 328046 C1	1G4 004 480-001	0 605193 76	1DL 007 872-047	6351.S7	2VP 354 030-021	031 806 20	2KA 003 389-062
1 328113 C1	9EL 115 662-021	0 605245 33	2JA 001 346-011	6351.T6	2SK 354 032-021	031 806 20	2KA 003 389-068
1 333292 C2	1VB 005 444-037	0 605257 76	2BM 002 847-021	6351.T7	2NE 354 053-021	031 832 20	2BN 964 169-051
1 333 295 C1	1LB 003 177-081	0 605257 84	2BM 002 847-011	6351.T8	9EL 354 050-021	031 832 20	2BN 964 169-057
1 34 672 4001	1GA 996 020-001	0 605315 16	1GA 007 506-001	6351.T9	2XX 354 033-021	031 832 30	2BA 964 169-041
1-34-701-505	2BE 003 014-251	0 605329 10	2BE 003 014-251	6351.V0	2NE 354 051-021	031 832 30	2BA 964 169-047
1-34-701-505	2BE 003 014-257	0 605329 10	2BE 003 014-257	6351.Y0	2VP 354 030-041	031 832 40	2TA 964 169-061
1 347760 10	9EL 118 614-011	0 605338 72	2JA 004 192-001	KN.210.03	2NE 003 030-151	031 832 40	2TA 964 169-067
1-40-172-000	1GB 996 080-021	679 850 R91	2AA 001 200-011	KN.213 .01	2ZR 003 030-171	041 592 10	9EL 854 912-001
1 40 172 0111	1GB 996 080-021	679 850 R91	2AA 001 200-012	KN.215.04	2DA 007 428-001	043 087 91	2JA 001 357-002
1-40-172-0121	1GA 996 083-011	679 873 R91	2AA 001 200-021	KN.215.04	2DA 007 428-007	434 011 8	2JA 003 231-001
1 40 172 0141	1GA 996 083-021	679 873 R91	2AA 001 200-023	Claas	Hella	4-41002030250	2JA 002 661-001
1 40 172 0151	1GA 996 083-021	0 700501 0	2BA 002 652-121	100 221 45	8GH 007 157-241	4-41004190120	2RL 008 061-111
1-40-172-0161	1GA 996 083-011	0 700501 0	2BA 002 652-127	100 221 46	2BA 008 221-001	4-41004190324	8JA 001 909-001
1 40 179 0021	1GA 998 522-011	0 700502 7	2BA 002 652-111	100 221 46	2BA 008 221-007	4-41005031095	2JA 006 487-261
1 40 179 0031	1GA 998 522-011	0 700502 7	2BA 002 652-117	100 221 46	2BA 008 221-007	4-41008190050	2JA 003 354-001
1 40 572 0011	1GA 996 083-011	0 706770 6	2SD 002 776-241	100 222 55	8GA 006 841-241	4-48000000230	2RL 008 061-101
1 40 572 0021	1GA 996 083-011	0 706770 6	2SD 002 776-247	001 005 70	2SA 003 236-041	4-48000001240	2JA 003 354-031
1 407722 12	1GA 998 525-001	0 706771 4	2SD 002 776-231	001 005 70	2SA 003 236-047	4-48000001250	2AB 001 208-001
1 89124A 2	2PS 003 748-121	0 706771 4	2SD 002 776-237	001 005 70	2SA 003 236-048	4-48000001260	2JA 343 660-101
1 89124A 2	2PS 003 748-127	0 706774 7	2KA 003 389-061	102 205 78	2PF 008 221-011	4-48000001260	2JA 343 660-107
1 987 491 C2	1GA 998 522-011	0 706774 7	2KA 003 389-062	102 933 55	2PF 008 221-017	4-48000001270	2JA 343 570-051
0 211950 2	2VP 006 040-117	0 707370 4	2KA 003 389-068	102 933 55	1K0 008 191-041	4-48000001280	2JA 343 700-271
0 211950 3	2VP 006 040-127	0 707374 5	2XS 950 071-031	101 069 90	1K0 008 191-047	4-500 106 990	2JA 001 357-002
0 211950 3	2VP 006 040-127	0 707383 3	8HG 006 294-051	101 069 90	2JA 001 357-002	4-50077.521.0	8JB 850 434-011
3 051599 R91	2BE 001 259-061	0 707383 3	2VA 006 040-077	110 539 20	2SD 343 130-167	4-500775220	9GH 096 532-001
3 051600 R91	2SB 001 259-261	0 707384 1	2VP 006 040-121	110 539 30	2SD 343 130-157	4-50625.586.0	2JA 006 447-041
3 051602 R91	8HG 002 247-001	0 707384 1	2VP 006 040-127	111 885 0	2JA 001 335-011	4-60002270000	2JA 003 231-001
3 053400 R92	2KA 001 389-147	0 707481 8	2RL 006 846-001	001 214 40	1G3 005 760-041	049 714 00	1GA 005 060-001
3 053497 R91	9EL 088 538-001	0 707481 8	8JA 001 909-001	001 252 70	2SB 003 014-151	501 003 2	2BE 343 130-081
3 053 586 R91	9EL 088 525-001	0 707657 1	1AB 007 145-001	001 310 70	6BM 005 633-001	057 097 51	2JA 004 531-001
3 059695 R91	2AA 001 201-011	0 707658 8	1GB 007 145-101	001 311 10	2BM 003 647-021	058 294 90	1G4 003 470-051
3 118 665 R2	2BA 001 227-201	0 707658 8	1GB 007 145-107	001311111	2BM 003 647-067	058 368 20	2BE 010 102-001
3 118 665 R2	8RA 002 014-031	0 708108 7	2XS 005 020-077	131 734 30	2VP 340 830-111	058 368 30	1LA 993 975-047
3 121089 R91	8RA 002 014-032	0 709088 3	8JB 004 777-001	013 712 10	2VP 340 830-101	058 489 90	2KA 003 738-057
3 121089 R91	2BE 003 014-251	0 709088 3	8JB 004 777-002	013 712 20	2SE 002 514-171	059 157 10	2BA 003 014-111
3 121 171 R91	2BE 003 014-257	7 13860R 1	9GD 100 711-021	013 712 20	2SD 002 514-161	059 157 20	2SD 003 182-051
3 121 171 R91	2AA 001 200-031	7 16160R 1	9ES 012 060-011	013 712 30	9EL 119 614-031	059 157 30	2SD 003 182-061
3 131223 R91	2AA 001 200-032	7 16161R 1	9GD 023 639-001	001 373 10	9GH 993 984-001	059 157 30	2SD 003 182-067
3 139251 R91	2BA 002 324-011	82 994 C91	9KS 075 139-001	013 733 0	1GB 996 080-021	059 157 40	2SD 003 182-067
3 145942 R91	2BA 002 324-021	8 422050 03	2SD 002 844-131	001 373 50	1GA 007 506-001	059 157 40	8RA 003 326-001
3 145942 R91	2SD 002 582-011	8 422050 03	2BA 002 652-121	001 375 90	1GA 007 506-061	059 197 00	8RA 003 326-002
3 145943 R91	2SD 002 582-017	8 481 446 8	1GB 006 213-111	001 378 70	1LA 996 127-017	059 197 20	9ES 069 831-001
3 145943 R91	2SD 002 582-021	8 481 446 8	1GB 006 213-117	00143290	1NA 008 283-001	059 197 20	9DE 077 356-021
3 148492 R91	2SD 002 582-027	9 25305C 92	2SD 001 680-281	001 452 90	1LB 007 145-047	059 197 30	9EL 110 536-001
3 148501 R1	2SW 003 014-131	9 25306C 92	2SE 001 680-291	001 478 90	2XS 955 232-001	059 197 40	9EL 118 614-011
3 149526 R1	9EL 115 003-055	9 28044C 1	8JA 001 909-011	001 478 91	2XS 955 232-017	059 510 10	2KA 001 386-231
3 217309 R92	9KS 075 307-001	9 802909 6	1G3 005 760-221	001 488 00	8GS 009 028-001	059 538 50	8JA 001 909-001
3 220360 R1	1G3 005 760-001	9 802909 6	1G3 005 760-227	001 488 10	5DV 008 855-001	059 771 30	1LB 996 157-201
3 220360 R1	2DA 003 014-031	9 803274 1	1GD 003 690-287	001 488 10	5DV 008 855-007	059 846 10	2ZR 964 169-031
3 221209 R92	2DA 003 014-037	9 803936 9	2TJ 001 633-211	001 488 60	2BA 008 221-001	059 879 90	1LB 996 157-201
3 221209 R92	2SE 002 844-051	9 804137 1	2SB 003 014-151	001 488 60	2BA 008 221-007	05988090	1GA 998 534-221
3 221210 R92	2SE 002 844-057	9 804245 9	2KA 001 386-281	001 488 60	2BA 008 221-107	060 405 30	2BM 002 652-031
3 221210 R92	2SD 002 844-061	9 804591 0	2RL 007 551-001	001 488 70	2PF 008 221-011	060 605 30	2BM 002 652-031
3 221211 R91	2SD 002 844-067	9 804617 1	1GB 006 213-101	001 488 70	2PF 008 221-017	062 228 60	2JA 006 447-041
3 223263 R91	2BE 002 582-031	9 804617 1	1GB 006 213-107	001 488 70	2PF 008 221-177	062 289 70	9AL 132 293-027
3 223263 R91	2SD 002 776-231	9 804669 8	9EL 136 825-011	001 489 80	2SD 964 169-111	062 289 80	2BE 003 347-001
3 223264 R91	2SD 002 776-237	9 804669 9	9EL 136 825-001	001 489 80	2SD 964 169-117	062 289 80	2SA 001 259-751
3 223264 R91	2SD 002 776-241	9 804750 6	9EL 860 627-001	001 615 30	2SD 344 169-037	062 438 72	2SA 001 259-757
3 224286 R1	2SD 002 776-247	9 961 9A1	9DX 859 626-001	001 634 60	4DN 009 492-101	062 455 90	2BE 001 259-061
3 224287 R1	9EL 115 662-011	E46821	1GA 998 522-011	001 664 50	1G0 996 176-131	062 456 00	2SB 001 259-261
3 229393 R1	2PF 003 014-071	G841783	1GA 998 522-011	001 684 50	9GT 134 655-007	062 558 60	2JA 006 447-041
3 229394 R1	2SA 003 014-051	K 303 720	2JA 002 931-031	001 757 20	1GA 998 534-001	062 571 90	1GB 006 213-111
3 369718 R91	1G4 003 470-051	K 965 604	2SD 001 693-011	017 715 90	9EL 859 020-001	062 571 90	1GB 006 213-117
3 512768 M91	1GA 005 060-337	Caterpillar	Hella	017 775 90	9EL 859 020-001	062 591 40	1GB 006 213-101
0 402274 6	8RA 002 020-001	120-6776	1G4 003 470-051	017 797 50	9GD 023 639-001	062 591 40	1GB 006 213-107
0 402274 6	8RA 002 020-002	120-6776	1GB 006 213-101	017 800 20	9EL 088 538-001	6-27906100020	8GA 002 071-251
0 402274 6	8RA 002 020-003	120-6776	1GB 006 213-107	017 802 10	9EL 119 397-001	064 398 00	2XS 005 020-021
47056352	1GA 996 083-011	00137330	1GA 007 506-001	017 802 20	9EL 118 633-001	065 817 60	2BE 003 185-051
470563520	1GA 996 083-011	00137350	1GA 007 506-001	021 174 80	8RA 002 014-101	065 817 70	2SW 003 185-047
47056353	1GA 996 083-011	199-3137	1GA 998 522-011	021 362 50	9EL 856 418-001	065 818 60	2BE 003 185-051
470563530	1GA 996 083-011	199-3139	1GA 007 506-491	021 362 70	9DX 859 560-001	065 828 40	1S0 001 430-011
470563540	1GA 996 083-021	5W-2681	1G4 003 470-051	021 400 50	9EL 147 747-001	065 829 50	1G3 005 760-001
470563550	1GA 996 083-021	L04002	1GA 006 875-001	021 400 50			



Manufacturer's no. / Hella no. Cross-Reference

Claas	Hella	DAF	Hella	DAF	Hella	DAF	Hella
007 463 20	1GA 998 522-011	130 2727	2PS 006 717-037	135 8789	9EL 150 966-001	152 3987	1F3 009 094-031
075 107 10	2SD 003 167-011	130 2728	2PS 006 717-061	135 8790	2KA 007 929-001	152 4085	9EL 147 097-001
075 107 30	2SD 003 167-021	130 2728	2PS 006 717-061	135 8790	2KA 007 929-007	152 4090	2VD 005 300-551
007 752 00	2RL 006 846-001	130 2729	9EL 141 135-031	135 8791	2XS 955 260-001	152 4091	2VD 005 300-581
007 752 10	8JB 850 434-011	130 4073	2ZR 003 315-041	135 8791	2XS 955 260-007	152 4093	9EL 145 103-011
007 752 20	9GH 096 532-001	130 4095	9EL 132 404-001	135 9738	8GP 003 594-251	152 4094	9EL 145 104-011
007 776 20	2TM 006 717-047	130 4096	9EL 132 403-001	135 9951	8GA 002 073-251	152 4097	2SB 009 362-011
07946400	2KA 003 389-061	130 4788	2VP 008 204-161	135 9952	9EL 122 772-001	152 4100	2BA 009 001-107
07946400	2KA 003 389-062	130 4789	2VD 008 204-171	135 9953	2SK 003 567-321	152 4102	2SA 008 405-011
07946400	2KA 003 389-068	131 1220	2XW 007 146-011	135 9954	2SK 003 567-331	152 4102	2SA 008 405-017
817 623 8	2JA 001 364-001	131 8143	9ES 147 313-011	135 9956	2XW 007 146-001	152 4391	1F1 009 390-021
081 969 81	8RW 341 235-007	131 8145	9ES 147 314-011	135 9959	1GA 005 060-001	152 4392	2BA 008 221-001
083 529 40	2PF 003 563-177	131 8151	9ES 147 315-015	135 9960	2SA 962 964-091	152 4392	2BA 008 221-007
836 254 0	2BA 003 014-011	131 8152	9ES 147 316-015	135 9961	2PG 962 964-051	152 4393	2ZR 008 221-051
084 625 10	8RA 002 014-101	132 1023	1NE 006 300-071	135 9961	2PG 962 964-057	152 4393	2ZR 008 221-057
875 059 030353	2SD 002 582-011	132 8860	9BG 147 497-002	135 9962	2SA 006 717-001	152 4394	2XA 008 221-021
875 059 030353	2SD 002 582-017	132 8861	9BG 147 498-002	135 9962	2SA 006 717-007	152 4394	2XA 008 221-027
875 059 030354	2SD 002 582-021	133 5901	1GA 007 506-011	135 9963	9EL 141 135-001	152 4396	1FA 008 284-011
875 059 030354	2SD 002 582-027	133 6853	2RL 007 550-011	135 9964	2PF 006 717-011	152 4399	8HG 160 409-002
908 430 301	2JA 003 232-001	134 1734	1G4 003 470-031	135 9965	9EL 141 135-011	152 4400	2PS 008 645-601
091 730 10	1G5 003 241-071	134 4984	2PF 001 259-631	135 9966	2PG 006 717-021	152 4400	2PS 008 645-607
092 959 20	8JA 001 914-011	134 6293	8HG 006 294-011	135 9966	2PG 006 717-022	152 4401	1GM 996 134-171
940 350 0	9EL 950 315-001	135 0426	2PS 007 943-011	135 9966	2PG 006 717-027	152 4403	2NE 008 221-031
940 351 0	9EL 950 315-031	135 0426	2PS 007 943-017	135 9967	9EL 141 135-021	152 4403	2NE 008 221-037
094 079 70	9EL 136 833-001	135 0427	2PS 007 943-021	135 9970	2BA 002 939-171	152 4404	2XA 008 221-021
094 576 20	2PF 001 634-101	135 0427	2PS 007 943-027	136 0045	1F8 147 077-011	152 4404	2XA 008 221-027
094 576 40	2SD 002 776-241	135 0428	2PS 963 639-011	136 0046	9AG 141 819-001	152 4405	8KA 152 134-007
094 576 40	2SD 002 776-247	135 0428	2PS 963 639-017	136 0086	1F8 007 560-051	152 4430	2PT 009 496-801
094 576 60	2SE 002 776-211	135 0429	2PS 963 639-071	136 0087	1F8 148 131-011	152 4431	2PT 009 599-801
094 576 60	2SE 002 776-217	135 0429	2PS 963 639-071	136 0088	9AG 147 939-021	152 4432	8XU 009 362-111
096 341 40	2SD 003 409-201	135 3664	8JB 850 434-011	136 7166	9GH 096 532-001	152 4433	8XU 009 362-101
096 341 40	2SD 003 409-207	135 3665	9GH 096 532-001	137 5936	2PF 007 205-001	152 4434	9HB 163 085-012
096 341 60	2SE 003 409-191	135 4854	8GP 003 594-121	137 5936	2PF 007 205-007	152 4435	9HB 161 122-012
096 341 60	2SE 003 409-197	135 4855	8GP 002 095-241	137 8137	2PS 962 964-012	152 4449	9XD 161 119-007
968 997 0	2SE 004 623-001	135 4856	8GM 002 091-121	137 8137	2PS 962 964-018	152 4450	8JD 156 150-807
968 997 0	2SE 004 623-007	135 4857	8GM 002 091-241	138 2999	2KA 001 386-231	152 4452	1F8 161 326-011
096 899 80	2SD 004 623-028	135 4858	8GH 002 089-133	138 3020	1NE 006 300-051	152 4639	1GA 996 083-021
096 978 50	2XS 950 071-031	135 4860	8GH 002 857-241	138 4518	9EL 116 771-031	152 4694	2VP 340 830-111
096 981 50	9EL 121 260-061	135 4861	8GP 003 594-141	139 1259	2SA 001 259-751	152 4695	2VP 340 830-101
096 981 60	9EL 121 260-051	135 4862	8GM 002 092-121	139 1259	2SA 001 259-757	152 4704	2RL 008 183-111
096 989 70	2SE 004 623-001	135 4863	8GM 002 092-241	139 9200	2NE 003 315-011	152 4705	2XD 009 052-011
096 989 70	2SE 004 623-007	135 4864	8GM 002 091-131	139 9392	9EL 119 977-001	152 4725	2RL 008 181-111
097 025 50	2SD 006 040-161	135 4865	8GA 002 071-121	139 9393	2ZR 003 315-041	152 4735	1F8 009 797-021
097 025 50	2SD 006 040-167	135 4866	8GA 002 071-241	142 7048	2PF 003 057-041	152 4736	1F8 009 797-031
097 025 60	2SE 006 040-011	135 4867	8GP 002 068-121	142 7049	2SA 003 057-021	152 4795	9EL 152 884-001
DAF	Hella	135 4868	8GP 002 066-121	142 7050	2PF 001 648-161	152 4886	2SE 997 005-011
135 8785	8KA 950 073-001	135 4869	8GP 002 066-241	142 7051	2BA 003 014-111	152 5015	2VP 340 830-001
011 9033	8GA 002 071-241	135 4870	8GP 002 095-121	142 7052	1F8 006 800-221	152 5016	9EL 340 829-001
121 2109	1FD 005 700-051	135 4871	8GA 002 073-121	142 7053	2SD 001 699-061	152 5168	8GA 002 073-271
121 2111	1ND 005 700-061	135 4872	8GA 002 073-241	142 7054	2SD 001 699-511	152 5177	9EL 152 889-001
121 2113	1FD 135 198-011	135 4873	8GP 003 594-241	142 7058	2KA 997 011-021	152 5203	2VP 340 931-101
121 2127	2TJ 001 633-211	135 4874	8GD 002 088-131	142 7059	9EL 109 139-001	152 5204	2VP 340 931-111
121 3926	1LG 005 480-075	135 4875	8GP 002 067-121	142 7061	9EL 117 330-001	152 5205	2VP 008 789-021
121 3928	1LG 005 480-031	135 4876	8GD 002 088-251	142 7062	9EL 108 435-001	152 5206	2VD 008 789-011
121 3929	1LG 005 480-041	135 4877	8GP 002 067-241	142 7063	9EL 135 266-001	152 5296	2RL 007 337-011
123 0972	2PF 001 647-031	135 4878	8GD 002 078-121	142 7064	9EL 109 208-011	152 5749	1FB 007 892-071
123 0972	2PF 001 647-037	135 4879	8GD 002 078-241	143 5116	2KA 001 386-281	152 5750	1FB 007 892-131
125 0158	8GA 002 083-251	135 4880	8GP 002 068-241	143 5134	9EL 122 689-021	152 5751	1F4 007 893-191
125 2218	9XB 136 202-005	135 4881	8GM 002 091-251	143 5318	8JB 001 933-031	152 5753	2PS 008 645-611
126 2815	9ES 140 721-015	135 4882	8GH 002 090-133	143 5321	9XD 857 445-801	152 5753	2PS 008 645-617
126 2816	9ES 140 722-015	135 4883	8GH 002 090-251	143 5322	2PS 963 639-041	152 5754	2PS 008 645-621
127 2653	9EL 152 889-001	135 4883	8GH 002 090-253	143 5322	2PS 963 639-047	152 5754	2PS 008 645-627
128 0716	2KA 003 389-061	135 4884	8GA 002 071-131	143 5323	2PS 963 639-021	152 5774	2XD 009 386-021
128 0716	2KA 003 389-062	135 4885	8GA 002 071-251	143 5323	2PS 963 639-027	152 5785	2TM 008 645-651
128 0716	2KA 003 389-068	135 4886	8GA 002 072-241	143 5324	2PS 963 639-081	152 5800	1NL 007 186-061
128 3167	2SD 001 685-231	135 4887	8GH 002 089-251	143 5325	2PS 963 639-001	152 5800	1NL 007 186-067
128 3167	2SD 001 685-232	135 4887	8GH 002 089-253	143 5325	2PS 963 639-007	152 6004	2BE 003 185-031
128 3168	2SE 001 685-221	135 4888	8GJ 002 525-131	143 5326	8HG 006 294-051	152 6142	2RL 007 900-211
128 3169	9EL 113 324-001	135 4888	8GJ 002 525-133	143 5327	9GT 963 129-001	152 6158	9EL 136 825-001
128 3241	9EL 113 324-007	135 4889	8GJ 002 525-251	143 8797	2JA 002 931-031	152 6159	9EL 136 825-011
128 3241	1LG 005 480-075	135 4889	8GJ 002 525-253	144 1064	1G3 996 001-271	152 6255	9MN 857 622-011
128 3243	1LG 005 480-031	135 4890	8GM 002 094-241	144 3100	1F8 007 560-041	152 6361	8GS 859 634-001
128 3244	1LG 005 480-041	135 4893	8GJ 002 525-281	144 4311	1F8 007 560-561	152 6377	2VA 343 640-071
128 9261	2XW 002 897-041	135 4894	8GA 002 071-271	144 4312	1F8 007 560-571	152 6377	2VA 343 640-077
129 1216	2VD 008 204-051	135 4895	8GA 002 071-261	145 0612	2JA 007 373-071	152 6378	2VP 343 640-021
129 3364	1LG 007 660-111	135 4896	8GP 002 067-261	145 1777	9GD 858 086-001	152 6378	2VP 343 640-027
129 3365	1LG 007 660-121	135 7075	2VD 008 204-251	148 7290	2SK 003 567-661	152 7838	2XS 008 479-051
129 3370	1LG 007 660-031	135 7076	2VP 008 204-241	148 7291	2SK 003 567-651	152 7838	2XS 008 479-057
129 3371	1LG 007 660-041	135 7426	2BA 007 135-011	148 7327	9EL 860 627-001	161 6169	2RL 008 061-101
129 9751	1F8 006 800-191	135 8193	2XS 955 232-001	148 7446	2BE 003 184-061	161 6257	2PG 008 645-041
129 9752	1N8 006 800-001	135 8201	8KA 962 886-001	148 9041	2BE 003 184-051	161 6257	2PG 008 645-047
130 0835	8HG 116 741-801	135 8320	8HG 006 294-041	148 9286	2KA 004 525-001	162 2273	1F8 007 560-131
130 1368	2BA 005 481-011	135 8321	8HG 006 294-021	148 9727	2PG 964 295-111	162 2671	2SL 003 567-311
130 1758	8JB 001 943-001	135 8779	2RL 006 846-001	148 9727	2PG 964 295-117	162 3563	1FE 002 537-191
130 1760	8JA 001 930-001	135 8780	2RL 006 846-011	148 9728	1ND 005 700-841	162 3564	2ZR 001 193-011
130 2721	2PS 004 361-001	135 8781	9EL 859 020-001	151 7076	1F1 009 094-051	162 4964	2KA 006 896-001
130 2721	2PS 004 361-007	135 8782	9EL 950 315-061	152 1141	2VP 006 040-301	162 4964	2KA 006 896-007
130 2722	2PG 004 361-011	135 8783	9EL 950 315-001	152 1141	2VP 006 040-307	162 5985	2VD 008 204-251
130 2722	2PG 004 361-017	135 8784	9EL 950 315-031	152 2232	2VP 008 204-181	162 5986	2VP 008 204-241
130 2723	2TM 004 361-021	135 8785	8KA 950 073-001	152 2278	2VD 008 204-191	163 6919	5DV 008 856-001
130 2724	9EL 114 401-001	135 8786	2VP 007 907-031	152 2301	2VD 008 204-151	163 6919	

Manufacturer's no. / Hella no.

Cross-Reference



DAF	Hella	DAF	Hella	DAF	Hella	DAF	Hella
165 984	9EL 102 240-031	086 5792	2BA 001 259-618	086 7504	2XS 005 020-001	087 8986	2XS 004 237-311
166 0613	9GD 863 033-001	086 5814	9EL 088 150-001	086 7504	2XS 005 020-002	087 8995	2SA 003 734-121
166 5750	9GH 156 191-001	086 6404	2VP 340 831-011	086 7504	2XS 005 020-003	087 8998	1F8 006 800-311
166 5752	5DD 008 319-501	086 6405	9EL 340 829-001	086 7505	2XS 008 078-001	087 8999	2PT 008 935-811
167 8624	2XM 001 974-151	086 6409	9EL 340 829-011	086 7505	2XS 008 078-007	087 9047	9EL 136 819-031
168 3694	1GA 007 506-021	086 6416	1FE 008 773-061	086 7506	2XS 955 031-001	087 9082	2SE 997 008-001
168 3695	1F8 006 800-401	086 6417	1FE 008 773-041	086 7507	2ZR 002 589-011	087 9085	9EL 997 332-001
168 4027	8JD 008 151-011	086 7068	2RL 007 900-611	086 7513	4RA 003 510-081	087 9100	2ZR 005 860-151
168 9949	1F8 007 560-201	086 7142	2KA 001 378-001	086 7520	6ED 004 778-001	087 9101	2ZR 997 506-391
169 9302	1LJ 247 046-051	086 7428	1FB 005 860-031	086 7526	8GH 002 089-361	087 9102	2ZR 005 700-191
169 9303	1LJ 247 046-061	086 7429	1FE 006 300-261	086 7527	8HG 006 294-021	087 9122	1F8 007 560-311
169 9305	1LJ 247 046-071	086 7430	1FE 138 520-011	086 7528	8JA 001 909-011	087 9123	1F8 007 560-301
169 9306	1LJ 247 046-081	086 7431	1NB 005 860-001	086 7534	8JA 008 658-011	087 9124	1F8 007 560-321
169 9435	9EL 862 141-001	086 7432	1NE 006 300-071	086 7534	8JA 008 658-017	087 9125	1F8 006 800-321
170 1119	2PS 008 645-031	086 7433	2AB 004 532-001	086 7539	8JE 340 060-011	087 9143	9EL 134 296-051
1725270	1PE 965 410-111	086 7434	2AB 004 532-011	086 7548	8RA 002 014-091	087 9144	9EL 134 296-041
1725271	1PE 965 410-121	086 7435	2XM 001 974-131	086 7549	8RA 002 016-121	087 9147	9EL 119 614-031
173 1959	2PS 008 645-001	086 7439	8XT 863 316-001	086 7550	8RA 003 326-031	087 9156	1FE 006 300-001
173 1959	2PS 008 645-007	086 7440	9DF 112 246-001	086 7551	8RA 003 326-051	087 9183	2VA 004 887-031
173 5534	8GS 861 955-021	086 7444	1G3 003 710-021	086 7553	8RA 964 292-001	088 0195	2VP 007 500-421
017 3732	2PF 001 647-031	086 7445	1G4 003 470-051	086 7556	9BG 119 721-001	088 0196	2VD 007 500-411
017 3732	2PF 001 647-037	086 7446	1GA 006 876-001	086 7557	9BG 121 587-031	088 0215	2XA 959 560-401
017 6043	8GA 002 073-241	086 7447	1GA 006 991-021	086 7557	9BG 121 587-037	088 0215	2XA 959 560-407
027 3336	1G4 003 470-031	086 7448	1GA 006 991-041	086 7558	9EL 107 368-001	088 0216	2XA 959 790-401
028 8326	4AZ 003 787-021	086 7449	1GA 006 991-091	086 7559	9EL 111 647-001	088 0216	2XA 959 790-407
029 9634	2BA 001 416-011	086 7450	1GA 007 506-001	086 7560	9EL 117 334-001	088 1373	2ZR 003 734-041
029 9635	2BA 001 416-021	086 7451	1GA 998 525-001	086 7561	9EL 118 700-001	088 1374	2DA 003 734-011
343 640071	2VA 343 640-071	086 7452	1S3 001 117-041	086 7562	9EL 118 701-001	088 1375	2BA 003 734-001
343 640071	2VA 343 640-077	086 7454	2BA 007 135-001	086 7563	9EL 119 544-021	088 2004	2VD 007 500-201
038 4985	1LG 005 480-031	086 7455	2BM 006 692-021	086 7568	9EL 137 241-001	088 2009	8GS 007 949-101
038 4986	1LG 005 480-041	086 7455	2BM 006 692-027	086 7569	9EL 146 491-001	088 2011	2SE 003 167-031
038 4988	2BA 005 481-001	086 7456	2BM 009 320-807	086 7570	9EL 146 838-001	088 2012	2SD 003 167-021
038 4990	2PF 002 452-017	086 7457	2JA 004 531-011	086 7571	9EL 147 747-001	088 2013	2JA 003 354-051
038 5313	1F6 003 939-031	086 7459	2KA 001 389-101	086 7571	9EL 147 747-007	088 2062	2VP 340 400-121
038 5317	2BA 005 407-001	086 7460	2KA 002 445-111	086 7572	9EL 147 910-001	088 2063	2VP 340 400-131
046 7569	9EL 146 491-001	086 7461	2KA 003 389-001	086 7573	9EL 148 274-001	088 2064	9EL 117 330-011
053 2655	2SE 001 688-151	086 7462	2KA 003 389-211	086 7574	9EL 340 201-001	088 2065	9EL 117 334-021
053 4597	8GA 002 071-251	086 7462	2KA 003 389-217	086 7575	9EL 340 208-001	088 2083	8RA 004 412-001
055 2953	8HG 002 365-001	086 7463	2KA 340 118-001	086 7576	9EL 963 984-001	088 2084	8RA 004 412-011
055 7060	2BA 003 014-111	086 7464	2NE 003 236-001	086 7577	9EL 964 289-001	088 2085	8RA 004 412-021
055 7096	2KA 001 378-041	086 7464	2NE 003 236-008	086 7578	9EL 964 290-001	088 2235	2BA 008 260-001
056 0333	2PF 001 259-631	086 7465	2PF 959 570-401	086 7579	9EL 990 034-051	088 2235	2BA 008 260-007
056 3047	2SE 001 685-201	086 7465	2PF 959 570-407	086 7584	9GD 963 281-001	088 2236	1NE 008 773-031
056 3048	2SD 001 685-211	086 7466	2PF 959 590-401	086 7585	9XD 997 909-801	088 2331	2VD 003 567-377
056 3048	2SD 001 685-218	086 7466	2PF 959 590-407	086 7588	1G4 997 033-011	088 7342	9XD 863 828-001
057 4235	2PF 001 648-171	086 7467	2PF 959 590-411	086 7589	1GA 006 991-051	088 7343	2RL 007 017-071
0614367	2ZR 001 423-001	086 7467	2PF 959 590-417	086 7590	1GA 998 532-011	088 7349	2VP 340 400-141
062 1969	8JA 001 915-001	086 7468	2PG 003 057-011	086 7591	2KA 001 386-291	088 7349	2VP 340 400-147
627 236	2NE 001 423-011	086 7469	2PG 003 748-151	086 7592	2PG 008 645-041	088 7400	2PF 959 590-411
063 3400	9GH 096 532-001	086 7470	2PG 962 964-041	086 7592	2PG 008 645-047	088 7400	2PF 959 590-417
064 1806	2JA 003 231-001	086 7471	2PG 963 639-401	086 7593	2PG 008 645-631	088 7639	1F8 009 797-121
006 6613	9DS 121 707-001	086 7472	2PS 003 748-121	086 7594	2SD 997 005-021	088 7640	1F8 006 800-341
006 6614	6ED 708 919-001	086 7472	2PS 003 748-127	086 7595	2TM 006 717-047	088 7685	2BA 964 169-501
006 6691	9HD 121 297-001	086 7473	2PS 003 748-161	086 7597	9BG 101 230-001	088 7685	2BA 964 169-507
006 6698	2BA 005 481-001	086 7473	2PS 003 748-167	086 7598	9EL 118 613-001	088 8487	9EL 862 141-021
006 6732	9ES 133 571-005	086 7474	2PS 006 717-061	086 7599	9EL 134 658-001	088 8498	2VP 340 930-011
006 6733	9ES 133 572-005	086 7474	2PS 006 717-067	086 7600	9EL 134 739-001	088 8499	2VP 340 930-001
006 6734	9DE 133 697-015	086 7475	2PS 007 972-011	086 7601	9DX 859 626-001	088 8500	9EL 340 829-031
006 6735	9DE 133 698-015	086 7475	2PS 007 972-017	086 7671	2ZR 002 985-261	088 8501	9EL 340 829-021
006 7392	2XS 950 071-031	086 7476	2PS 008 382-001	086 7735	2VP 340 450-031	088 8540	1GM 996 136-131
067 6003	2JA 003 354-001	086 7476	2PS 008 382-007	086 7735	2VP 340 450-037	088 8541	1FE 006 300-041
006 7735	9DE 133 698-015	086 7477	2PS 008 382-811	086 8179	9EL 147 096-001	088 8549	1FE 008 773-081
069 2279	9EL 101 353-001	086 7477	2PS 008 382-817	086 8182	2PS 963 639-111	088 8550	2PF 009 001-521
069 2421	2XW 003 146-001	086 7478	2PS 008 616-001	086 8182	2PS 963 639-117	088 8552	2BA 009 001-511
069 2705	9ES 106 588-001	086 7479	2PS 008 643-031	086 8217	9EL 152 891-001	904 1381	2XS 950 071-031
069 4231	1G5 003 241-081	086 7479	2PS 008 643-037	086 8227	1LG 007 150-121	009 3609	1N7 004 700-281
069 6363	9EL 120 240-011	086 7480	2PS 963 639-157	086 8229	2VD 008 204-111	X54 565	2BA 003 022-021
069 8807	9EL 110 737-001	086 7481	2RL 007 337-001	086 8230	2VP 008 204-101	X94 684	2KA 003 168-021
069 8808	9EL 110 736-001	086 7482	2RL 008 060-111	086 8291	2VP 007 323-101		
070 2462	2SD 001 688-141	086 7483	2SB 003 014-151	086 8292	2PS 008 643-011	Deere, John	Hella
073 2617	8RA 002 014-051	086 7484	2SD 001 680-271	086 8292	2PS 008 643-017	10 13 44	2KA 004 525-001
073 2617	8RA 002 014-052	086 7485	2SD 001 680-281	086 8293	2ZR 964 169-511	10 13 52	8RA 004 412-001
075 5355	2AB 004 532-051	086 7486	2SD 003 184-031	086 8293	2ZR 964 169-517	10 13 53	1ND 003 590-001
075 5355	2AB 004 532-057	086 7486	2SD 003 184-037	086 8296	2NE 964 169-021	10 14 11	9GT 005 166-001
0813700	2KA 001 386-301	086 7487	2SD 003 184-041	086 8296	2NE 964 169-027	10 16 97	2ZR 003 014-091
832 096	1G5 120 510-001	086 7487	2SD 003 184-047	087 1191	2PS 003 057-051	10 17 26	2ZR 003 236-051
083 5792	2BA 001 259-611	086 7488	2SE 001 685-221	087 1191	2PS 003 057-052	10 17 26	2ZR 003 236-057
083 5792	2BA 001 259-618	086 7488	2SE 001 685-227	087 1191	2PS 003 057-057	10 17 43	2JA 003 354-001
083 7034	9EL 110 536-011	086 7489	2SE 002 578-701	087 1201	1GA 007 506-081	10 17 45	8RA 003 326-041
083 7036	8GS 002 296-111	086 7489	2SE 002 578-707	087 1215	2RL 007 900-001	10 17 45	8RA 003 326-047
837 057	9GD 120 670-001	086 7490	2SE 007 547-041	087 1567	2PS 340 001-011	10 46 1023	2KA 003 389-061
083 7227	9GD 856 863-001	086 7491	2SK 340 101-001	087 1569	9XX 340 220-011	10 46 1023	2KA 003 389-062
083 7230	2SA 001 259-751	086 7492	2SK 340 101-011	087 1659	9EL 115 830-001	10 46 1023	2KA 003 389-068
083 7230	2SA 001 259-757	086 7493	2TM 003 748-011	087 4783	1LG 006 898-051	10 50 28	2BA 003 014-011
083 7246	9EL 856 418-001	086 7494	2TM 008 645-061	087 4784	1LG 006 898-091	10 50 66	2NE 003 236-001
083 7247	9EL 856 416-001	086 7494	2TM 008 645-067	087 4785	1LG 007 150-111	10 50 66	2NE 003 236-008
008 3764	2AB 004 532-051	086 7495	2TM 008 645-071	087 4883	9EL 145 103-011	10 50 79	2KA 001 610-001
008 3764	2AB 004 532-057	086 7495	2TM 008 645-077	087 4884	9EL 145 104-011	10 51 27	8RA 003 326-001
084 1885	8RA 002 010-011	086 7496	2TM 963 639-317	087 8908	9EL 147 096-031	10 51 27	8RA 003 326-002
084 1981	1G4 003 470-001	086 7498	2VB 007 547-171	087 8909	9EL 147 096-021	10 51 35	2XS 005 020-001
084 1981	1G4 003 470-011	086 7499	2VD 008 205-011	087 8982	2PS 008 616-011	10 51 35	2XS 005 020-003
084 4501	2XW 002 897-051	086 7500	2VD 008 205-021	087 8982	2PS 008 616-		



Manufacturer's no. / Hella no.

Cross-Reference

Deere, John	Hella	Deere, John	Hella	Deere, John	Hella	Deere, John	Hella
10 61 98	8RA 003 326-041	50 51 96	2SD 006 040-147	AL 25 537	2BA 002 652-101	AZ 61 159	2XS 950 071-031
10 61 98	8RA 003 326-047	50 61 51	2JA 003 354-001	AL 25 537	2BA 002 652-107	AZ Y1 0001	1VB 005 444-037
10 66 69	2XS 004 237-291	50 61 53	9EL 120 240-011	AL 25 645	2SE 002 582-071	AZ Y7 5217	2JA 003 115-001
10 66 70	2XS 004 237-301	50 65 69	8JA 001 921-102	AL 25 877	2PF 003 014-071	AZ Y7 53658	1GB 006 213-111
10 73 65	2SW 003 014-131	50 66 34	2AB 004 532-001	AL 25 879	2SD 001 693-011	AZ Y7 53658	1GB 006 213-117
11 03 24	2JA 002 661-001	53 50 50	2SE 002 578-701	AL 26 674	8RA 002 014-051	AZ Y7 5365A	1GB 006 213-101
11 03 38	2SK 003 567-331	53 50 50	2SE 002 578-707	AL 26 674	8RA 002 014-052	AZ Y7 5365A	1GB 006 213-107
11 03 39	2SK 003 567-321	53 53 08	2SD 003 182-061	AL 27 007	9EL 112 743-001	CE 14 020	9FF 078 830-001
11 05 44	2XS 005 020-081	53 53 08	2XS 003 182-067	AL 27 008	9EL 112 741-001	DD 11 491	2KA 001 389-101
11 23 84	8JA 001 925-001	53 53 09	2SD 003 182-051	AL 27 012	9EL 110 542-001	DD 12 056	2KA 001 386-281
11 79 52	9GD 082 716-001	53 53 09	2SD 003 182-057	AL 27 013	9EL 115 003-055	FO 05 273	8GA 002 071-251
11 91 47	2SL 003 567-311	55 02 4	3AG 003 399-081	AL 27 014	9EL 116 844-001	FO 11 328	8GA 008 901-241
12 21 70	2SA 003 057-021	55 02 8	3AG 003 399-101	AL 27 016	9EL 110 736-001	FO 24 690	2JA 003 236-357
01 22 36	2BA 002 324-001	55 31 5	8HG 854 516-001	AL 27 017	9EL 110 737-001	FO 246 93	2PS 006 717-031
12 51 5	2ZR 004 542-001	56 00 5	9EL 852 820-001	AL 27 978	2SA 003 014-051	FO 246 93	2PS 006 717-032
01 31 72	9EL 854 912-001	56 00 6	5AB 005 944-001	AL 28 296	1S3 001 117-041	FO 246 93	2PS 006 717-037
00 13 34	2SA 003 057-021	56 01 1	9GD 856 863-001	AL 29 614	1G5 119 738-001	L1 39 57	9GD 023 639-001
00 13 35	2PF 003 057-041	56 20 9	1G4 003 470-001	AL 30 794	8RA 002 014-101	L1 39 58	9FF 090 500-001
14 08 9023	2SD 001 680-281	56 21 0	1G5 003 241-021	AL 31 621	2SB 003 014-151	L1 50 689	8GS 007 949-101
14 09 4022	2SK 003 567-331	56 40 6	2SA 001 638-021	AL 32 067	8RA 123 251-005	L1 76 73	9ES 012 060-011
14 12 9023	2ZR 003 236-051	56 40 7	9GD 082 716-001	AL 32 071	2SE 003 184-011	L1 76 74	9KS 075 139-001
14 12 9023	2ZR 003 236-057	56 41 7	2BA 002 652-111	AL 32 071	2SE 003 184-017	L1 87 03	9GD 024 183-001
14 13 0022	2SD 001 699-511	56 41 7	2BA 002 652-117	AL 33 161	2KA 003 389-061	L1 87 04	9ES 015 675-001
14 15 9068	9EL 118 445-001	56 41 8	2BA 002 652-121	AL 33 161	2KA 003 389-062	L1 87 05	9KS 075 307-001
14 58 3023	2SA 003 057-021	56 41 8	2BA 002 652-127	AL 33 161	2KA 003 389-068	L2 57 40	8GA 008 901-241
14 72 3022	2NE 003 236-001	56 42 9	2BA 003 022-021	AL 35 176	2SD 003 184-031	L3 34 63	9GD 120 670-001
14 72 3022	2NE 003 236-008	56 62 1	2JA 001 357-012	AL 35 176	2SD 003 184-037	L3 38 99	9GD 120 670-001
01 52 04	2AB 004 532-021	56 63 7	2AB 004 532-001	AL 37 714	8JA 001 909-001	L5 69 06	9XD 132 749-005
01 52 10	1G5 003 241-021	56 63 8	2AB 004 532-051	AL 58 729	2BE 003 014-251	L6 35 06	9EL 137 308-001
15 93 4032	8RA 002 010-011	56 63 8	2AB 004 532-057	AL 58 729	2BE 003 014-257	L6 35 08	9EL 137 308-001
16 51 4023	2SD 001 685-211	56 64 4	2NE 002 589-001	AL 58 739	2BE 003 014-251	LY 46 759A	8JA 001 909-001
16 51 4023	2SD 001 685-218	56 66 5	2ZR 004 542-001	AL 58 739	2BE 003 014-257	R4 96 46	9EL 126 294-001
16 51 6022	2SD 001 699-061	56 66 7	2ZR 002 589-011	AL 59 724	2KA 001 389-101	XA H1 34124	2BA 002 652-111
16 51 7023	2SD 003 167-011	56 95 2	9FF 085 081-001	AL 60 127	2BE 003 182-091	XA H1 34124	2BA 002 652-117
16 51 8023	2SE 001 685-201	57 05 0	6ZE 001 759-071	AL 60 128	2BE 003 182-101	XA H1 34125	2BA 002 652-121
16 51 9022	2SE 001 699-071	57 05 2	6ED 004 778-011	AL 64 593	2KA 003 738-057	XA H1 34125	2BA 002 652-127
16 52 0022	2SE 003 167-031	05 72 1352	2PF 003 014-071	AL 67 206	2SD 002 776-241	Z 21 973	2AA 001 200-011
16 52 1023	2SD 003 167-021	05 72 2006	9EL 115 003-001	AL 67 207	2SD 002 776-247	Z 21 973	2AA 001 200-012
01 70 51	2SB 001 673-002	05 72 2007	2BE 003 185-031	AL 67 207	2SE 002 776-211	Z 21 974	2AA 001 200-021
01 70 52	1TA 003 570-101	05 72 6806	9EL 119 397-001	AL 67 208	2SE 002 776-217	Z 21 974	2AA 001 200-023
01 71 39	8RA 002 015-031	05 72 6807	2BA 003 014-011	AL 67 208	2SD 002 776-231	Z 21 975	2AA 001 200-002
00 17 70	8RA 002 014-051	05 72 6807	9EL 110 536-011	AL 67 208	2SD 002 776-237	Z 21 975	2AA 001 200-001
00 17 70	8RA 002 014-052	05 72 7078	8RA 002 015-031	AL 75 393	1GA 005 060-001	Z 21 975	2AA 001 200-002
00 17 80	8RA 003 326-011	57 M6 274	8GM 002 092-121	AL 78 501	9NS 140 045-005	Z 27 83	9KS 075 307-001
00 17 80	8RA 003 326-017	57 M6 844	8GD 002 088-131	AL 78 502	9NS 140 046-005	Z 35 14	9EL 854 912-001
18 06 7023	2XS 005 020-021	57 M7 011	8GD 002 078-121	AL Y4 3450A	1GD 003 590-701	Z 35 716	9DX 852 902-001
18 06 9023	2XS 005 020-001	57 M7 013	8GA 002 071-131	AT130 104	8GH 002 090-133	Z 49 15	9EL 120 201-001
18 06 9023	2XS 005 020-002	57 M7 014	8GA 002 073-121	AT 24 692	2AA 008 594-031	Z 48 80	9GH 126 647-011
18 06 9023	2XS 005 020-003	57 M7 019	8GS 002 089-133	AT 27 371	2AA 008 594-021	Z 5 19 82	9GH 096 532-001
19 80 8019	6ZE 001 759-051	57 M7 086	8GM 002 092-121	AT 27 535	2KA 001 389-147	Z 75 467	9EL 990 186-001
19 81 2023	2XS 005 020-011	57 M7 504	8GM 002 091-131	AT 32 246	2SE 001 679-051	Z 75 468	9EL 860 627-001
19 81 2023	2XS 005 020-017	57 M9 328	8GH 008 358-121	AT 32 247	2SD 001 679-001	Z 75 88	8GH 007 157-121
19 82 6067	3AG 003 399-081	79 69 723	8HG 002 365-001	AZ 100 331	1GB 996 147-101	ZZ 10 006	1GA 005 060-001
21 29 4	2BA 003 022-001	79 92 285	8XS 002 500-011	AZ 10 3535	2AA 008 594-021		
21 56 4108	9XS 027 639-001	80 79 003	2JA 003 354-001	AZ 10 4309	2BM 003 563-111	001 544 92 90	9EL 119 544-111
22 66 0068	9EL 122 772-001	80 80 055	8RA 003 326-051	AZ 10 792	2BA 001 227-201	001 544 94 90	9EL 119 544-001
24 22 6019	8JB 004 777-001	80 80 082	9FF 078 830-001	AZ 13 377	2PF 001 634-101	001 545 04 26	8JB 001 933-031
24 22 6019	8JB 004 777-002	80 80 255	8RA 003 326-041	AZ 23 618	2BA 003 014-111	001 820 05 01	2AB 004 532-051
24 23 0067	2JA 004 531-001	80 80 255	8RA 003 326-047	AZ 28 085	8JA 001 914-011	001 820 05 01	2AB 004 532-057
24 95 4999	9GD 087 883-355	87 50 249	9ES 082 333-031	AZ 30 044	2SA 001 259-751	001 820 25 21	2BA 003 236-541
00 36 11	2BA 003 014-011	87 52 297	9GH 096 532-001	AZ 30 044	2SA 001 259-757	001 820 39 21	2BM 006 692-011
00 45 40	2ZR 003 030-171	AH 13 4125	2BA 002 652-121	AZ 31 113	1GD 003 590-701	001 820 39 21	2BM 006 692-017
46 07 0947	2SB 003 018-031	AH 13 4125	2BA 002 652-127	AZ 34 621	8JB 850 434-011	001 820 40 21	2BM 006 692-021
46 07 1425	9EL 089 114-001	AH 20 6185	9BG 990 297-001	AZ 35 474	2SA 003 236-041	001 820 40 21	2BM 006 692-027
00 49 02	2JA 004 531-011	AL 11 0365	2JA 001 357-002	AZ 35 474	2SA 003 236-047	001 820 67 21	2BA 001 423-087
50 50 83	9EL 052 476-001	AL 112 011	2VA 006 356-081	AZ 35 474	2SA 003 236-048	001 820 68 56	2SA 001 647-041
50 50 95	9EL 112 743-001	AL 11 2474	9EL 147 992-001	AZ 39 131	2XS 005 020-001	001 820 77 01	2JA 006 447-251
50 50 96	9EL 112 741-001	AL 11 2964	2VA 006 356-101	AZ 39 131	2XS 005 020-002	001 820 83 01	2PF 006 717-011
50 51 05	2PF 001 650-001	AL 11 7065	1GA 998 525-001	AZ 39 131	2XS 005 020-003	001 820 89 21	2BA 008 221-007
50 51 09	8RA 002 016-101	AL 117 740	1GA 998 534-061	AZ 41 570	1GB 006 213-107	001 820 89 21	2BA 008 221-217
50 51 12	2PF 003 057-001	AL 13 659	2BE 001 259-061	AZ 41 571	1GB 006 213-117	001 820 96 56	2PF 002 860-031
50 51 12	2PF 003 057-002	AL 14 203	9DR 090 206-001	AZ 42 982	2BE 003 347-001	001 820 97 56	2SA 002 860-041
50 51 15	2KA 001 622-001	AL 15 005	9DR 060 567-001	AZ 44 705	2RL 006 846-001	001 822 28 20	2BA 001 240-301
50 51 21	9EL 118 700-001	AL 15 006	9AG 017 970-001	AZ 46 922	9EL 859 020-001	001 822 34 20	2BA 002 324-011
50 51 22	9EL 118 701-001	AL 15 2459	1GA 998 525-011	AZ 46 924	9GP 859 115-001	002 544 01 90	9EL 119 544-021
50 51 23	2XS 005 020-001	AL 15 2460	8KB 990 299-101	AZ 50 258	1AB 007 145-001	002 820 05 01	2AB 001 208-001
50 51 23	2XS 005 020-002	AL 154 988	2KA 998 523-117	AZ 50 274	2BA 002 324-001	002 820 44 61	1K0 008 192-027
50 51 23	2XS 005 020-003	AL 158 141	2XT 959 510-467	AZ 51 917	2SB 003 014-151	002 820 47 56	2PF 006 679-007
50 51 63	2SD 002 582-011	AL 161 607	2KA 998 523-117	AZ 55 251	4RA 003 510-361	002 820 57 56	2XS 003 168-071
50 51 63	2SD 002 582-017	AL 16 2349	2TJ 001 633-211	AZ 55 466	1GB 996 080-021	370 820 00 50	1GB 996 080-011
50 51 64	2SD 002 582-021	AL 16 6982	2BA 008 221-001	AZ 55 467	1GA 007 506-001	370 821 00 65	8JA 002 263-031
50 51 64	2SD 002 582-027	AL 16 6982	2BA 008 221-007	AZ 55 467	1GA 007 506-651	372 826 00 31	9XD 127 264-007
50 51 69	2SD 003 184-031	AL 16 6982	2BA 008 221-107	AZ 55 633	2RL 007 552-001	372 826 00 47	2PF 004 081-007
50 51 69	2SD 003 184-037	AL 16 6982	2BA 008 221-147	AZ 55 633A	2RL 007 552-001	372 826 00 47	2PF 004 081-007
50 51 70	2SD 003 184-041	AL167631	2AA 008 594-031	AZ 56 237	1LA 993 975-117	003 820 01 56	2DA 959 071-237
50 51 70	2SD 003 184-047	AL23015	2AA 003 257-021	AZ 56 280	1GB 996 147-101	003 820 01 56	2DA 959 071-737
50 51 83	2DA 003 014-031	AL 24 042	6ED 708 919-001	AZ 56 322	2RL 007 552-001	003 820 13 15	2XS 005 020-001
50 51 83	2DA 003 014-037	AL 24 544	2SD 002 582-011	AZ 56 492	1LB 007 145-047	003 820 13 15	2XS 005 020-002
50 51 84	2BA 003 014-011	AL 24 544	2SD 002 582-017	AZ 56 595	2JA 001 330-031	003 820 13 15	2XS 005 020-003
50 51 85	2SA 003 014-051	AL 24 545	2SD 002 582-021	AZ 57 444	8RA 003 326-031	003 820 13 56	

Manufacturer's no. / Hella no.

Cross-Reference



Evobus	Hella	Evobus	Hella	Faun	Hella	Faun	Hella
003 820 15 56	2KA 005 049-017	000 820 18 60	2KA 001 388-051	5240-499	2NE 003 236-307	99700760569	2ZR 003 014-091
003 820 16 56	2XS 005 020-001	000 820 19 66	9ES 143 776-011	5240-514	2SA 961 167-011	99700971531	1G5 003 241-021
003 820 16 56	2XS 005 020-002	000 820 25 68	2DA 001 240-341	5240-536	2NE 003 236-001	99700987118	8HG 002 655-001
003 820 16 56	2XS 005 020-003	000 820 37 21	2BA 004 119-001	5240-536	2NE 003 236-008	9970-1438216	9EL 134 659-001
003 820 20 56	2PF 959 590-401	000 820 41 64	2SB 001 423-097	5240-928	2RL 006 846-011	99701438217	9EL 134 660-001
003 820 20 56	2PF 959 590-407	000 820 59 56	2NE 001 423-011	5240 929	8HG 006 294-051	9970 5467158	9XR 854 840-001
003 820 20 56	2PF 959 590-457	000 820 63 01	2JA 003 115-001	5241-058	2VP 007 323-091	9970-7000448	1N4 005 750-001
003 820 21 56	2NE 008 221-031	000 820 90 56	2KA 003 389-061	5241-059	2VP 007 323-101	9970-7000939	2PS 006 717-031
003 820 21 56	2NE 008 221-037	000 820 90 56	2KA 003 389-062	5241-288	2ZR 004 542-001	9970-7000939	2PS 006 717-032
003 820 21 56	2NE 008 221-137	000 820 90 56	2KA 003 389-068	5241-379	8GP 003 594-241	9970-7000939	2PS 006 717-037
003 820 26 56	1KO 008 191-212	000 820 95 56	2TJ 003 168-151	5241-380	2PS 006 717-031	9970-7004770	2SA 001 259-751
003 826 63 90	9EL 139 898-005	000 821 09 66	9ES 143 776-011	5241-380	2PS 006 717-032	9970-7004770	2SA 001 259-757
000 544 11 04	2NE 003 236-001	000 825 01 03	2PF 002 452-017	5241-380	2PS 006 717-037	9970-7005086	1G3 005 760-001
000 544 11 04	2NE 003 236-008	000 825 02 03	2KA 001 389-101	5241-401	2RL 007 551-011	9970-7006297	2BM 006 692-011
000 544 18 04	2NE 003 236-301	000 825 06 03	2PF 004 081-001	5241-472	9EL 119 544-021	9970-7006297	2BM 006 692-017
000 544 18 04	2NE 003 236-307	000 825 06 03	2PF 004 081-007	5241-473	9EL 119 544-031	9970-7006298	2BM 006 692-021
000 544 20 34	2KA 003 010-007	000 826 09 40	8RL 002 009-001	5241-474	9EL 120 201-001	9970-7006298	2BM 006 692-027
000 544 24 07	2ZR 003 236-051	000 826 10 40	8RA 003 660-007	5242-372	2NE 003 236-301	99707006623	2SD 002 776-231
000 544 24 07	2ZR 003 236-057	000 826 11 91	9GD 118 983-021	5242-372	2NE 003 236-307	99707006623	2SD 002 776-237
000 544 33 07	2ZR 003 236-311	000 826 14 41	2PS 002 727-001	5242-372	2RL 007 337-011	99707006624	2SD 002 776-241
000 544 37 34	2KA 003 168-021	000 826 14 41	2PS 002 727-007	5243-536	1GA 007 506-011	99707006624	2SD 002 776-247
000 544 40 11	2XS 007 841-021	000 826 18 40	8RA 003 326-031	5243-537	2ZR 003 315-041	99707006701	5KG 007 629-011
000 544 48 11	2PS 963 639-117	000 826 26 10	9EL 116 380-045	5243-538	2NE 003 315-011	9970-7009052	2XD 007 854-811
000 544 77 02	9BG 121 740-001	000 826 27 10	9EL 116 380-035	5246-248	2RL 007 337-011	9970-7010742	2PS 008 645-001
000 545 82 26	8JB 850 434-011	000 826 28 97	9GD 128 553-007	5246524	1GM 996 135-051	9970-7010742	2PS 008 645-007
000 585 11 03	8XH 002 975-017	000 826 30 47	2SA 001 259-751	5246-736	2VD 007 547-181	99707010743	2PS 008 645-021
612 820 00 56	2KA 005 049-008	000 826 30 47	2SA 001 259-757	5246-762	2NE 002 985-001	9970-7011463	2RL 008 660-011
612 820 00 56	2KA 005 049-011	000 826 42 47	2PF 001 259-631	5246-777	8GD 002 078-241	99707011950	2RL 007 900-511
612 820 00 56	2KA 005 049-017	000 997 32 86	9GH 096 532-001	5246789	2PS 008 382-811	9970-7013043	9EL 862 141-001
612 820 01 20	2BM 008 355-001	HXB 373 820 17 64	2SA 003 236-041	5246789	2PS 008 382-817	99707013878	2RL 008 183-011
612 820 01 20	2BM 008 355-007	HXB 373 820 17 64	2SA 003 236-047	5246-845	2ZR 002 985-261	99707014602	2VD 007 323-131
613 826 02 41	2PS 962 964-031	HXB 373 820 17 64	2SA 003 236-048	5246 911	2VP 007 323-091	99707014603	2VP 007 323-111
613 826 02 41	2PS 962 964-037	HXB 373 820 18 64	2DA 003 236-031	5246-950	8RA 003 326-041	99707014709	2RL 007 551-011
627 820 00 20	2BA 996 027-001	HXB 373 820 18 64	2DA 003 236-037	5246-950	8RA 003 326-047	99707015359	9EL 110 542-001
628-08.50.359-10.4	2PT 009 496-801	HXB 373 826 15 10	9EL 119 544-031	5247-61	2RL 008 181-111	9970-7015510	9GH 993 984-001
628 820 04 56	2PT 009 496-007	N 000000 003884	8GP 008 285-001	5247 258	1ND 005 700-061	9970 7015528	1GA 996 142-151
628 892 00 456	2PT 009 496-007	N072601024900	8GP 002 067-241	5247 259	8GH 002 090-251	99707015845	1GA 998 525-001
6 290 010 089 1 14	2PF 004 081-001			5247 259	8GH 002 090-253	99707016350	8GS 007 949-101
6 290 010 089 1 14	2PF 004 081-007			5247 605	1GD 005 700-501	9970 7016499	1GA 007 506-431
6 290 001 0089 1 24	9XD 127 264-007			5247 653	2SE 007 547-041	99707016583	9BG 990 353-001
629-00.40.500-10.4	2PT 008 935-801			5247 667	2RL 007 017-071	9970 7016602	9EL 146 887-001
666 820 03 56	2PF 003 563-151			5247 757	2ZR 997 506-391	99707016603	9EL 146 838-001
671 820 04 56	2KA 006 896-001			5247-915	2VA 343 640-117	99707017009	2TM 008 645-061
671 820 04 56	2KA 006 896-007			5247-916	2VA 343 640-207	9970 7017009	2TM 008 645-067
7.312.018.000.0	6ED 004 778-001			524951	2KA 003 389-061	99707017363	2VD 007 323-141
7 512 129 012 0	1VB 005 444-037			524951	2KA 003 389-062	99707017364	2VP 007 323-111
7 513 114 000 0	1NB 003 367-137			524951	2KA 003 389-068	99707017939	2TM 008 645-071
7 515 115 000 0	2ZR 002 694-001			0552-315	2BA 002 652-111	99707017939	2TM 008 645-077
7 515 115 000 0	2ZR 002 694-002			0552-315	2BA 002 652-117	99707018060	2RL 008 183-111
7.515.115.004.0	9EL 113 928-001			5641 110	9EL 146 887-001	9970 7018848	2ZR 997 506-391
7.515.116.000.0	2ZR 001 240-351			0576-427	2BA 002 652-101	9970 7021893	2SA 962 964-091
7 521 123 000 0	2BA 001 277-021			0576-427	2BA 002 652-107	9970 7021899	9GT 963 129-001
7 521 138 000 0	9EL 115 830-001			6254 93	2XS 955 031-001	99707030021	2KA 001 378-001
7 521 145 000 0	2BA 003 236-021			7000-939	2PS 006 717-031	9970-7300981	9EL 856 416-001
7 521 145 000 0	2BA 003 236-027			7000-939	2PS 006 717-032	9970-7301861	9EL 122 689-021
7 521 146 000 0	2BA 001 240-301			7000-939	2PS 006 717-037	99707302238	1G3 135 211-011
7 521 148 000 0	2BM 002 847-011			7004-770	2SA 001 259-751	99707305610	9EL 120 240-011
7.521.149.000.0	2BM 002 847-021			7004-770	2SA 001 259-757	9970 7307671	9EL 950 315-001
7.534.113.000.0	2PF 001 638-011			7005-086	1G3 005 760-001	9970 7308166	9EL 950 315-031
7 534 113 004 0	9EL 107 443-011			7300-981	9EL 856 416-001	99707723462	1VB 005 444-037
7 534 113 017 0	9GD 100 140-001			7482 62	1GA 007 506-001	99707723582	2XS 005 020-001
7 534 114 004 0	9EL 107 443-061			7723-461	1KB 003 177-061	99707723582	2XS 005 020-002
7 534 114 017 0	9GD 082 716-001			7730-968	8HG 006 294-041	99707723582	2XS 005 020-003
7.534.118.104.0	9EL 114 401-001			7751-492	2PF 006 679-007	99707723582	2XS 005 020-077
7.534.155.003.0	9DX 119 545-011			8412-667	2SD 001 699-061	99707723637	2XS 005 020-081
7 534 160 000 0	2XS 005 020-011			8412-695	2BE 003 014-251	99707723802	2VP 003 567-111
7 534 160 000 0	2XS 005 020-017			8412-695	2BE 003 014-257	99707723803	2VP 003 567-121
7 534 165 000 0	2NE 003 236-001			8413-122	2JA 003 231-001	99707723803	2VP 003 567-127
7 534 165 000 0	2NE 003 236-008			8464-239	2PS 004 361-001	99707730123	1LB 003 177-081
7 534 171 000 0	2SA 001 638-021			8464-239	2PS 004 361-007	99707730539	2BA 996 027-001
7 534 177 000 0	2ZR 003 236-051			8464-953	2AB 004 532-051	9970-7751204	9XD 130 261-001
7 534 177 000 0	2ZR 003 236-057			8464-953	2AB 004 532-057	9970-7751228	1G3 005 760-011
7 534 183 000 0	2XS 005 020-001			8467-024	9EL 110 542-001	9970-7751280	8HG 006 294-021
7 534 183 000 0	2XS 005 020-002			8475-135	2SE 001 685-201	9970-7751492	2PF 006 679-007
7 534 183 000 0	2XS 005 020-003			8475-319	1N4 002 608-021	9970-7751917	2SE 001 685-201
7 534 191 004 0	9EL 141 135-031			0090-251	2JA 001 330-001	9970-7758097	2XS 950 071-031
7 542 108 000 0	2SB 003 014-151			0090-251	2JA 001 330-007	9970-784767	2XW 007 146-001
7 544 103 000 0	2KA 001 389-101			9970028918	8GA 002 083-251	99708007784	8GJ 002 525-251
7 544 111 000 0	2KA 003 389-001			9970030228	8GM 002 091-241	99708007784	8GJ 002 525-253
7 544 114 000 0	2KA 001 386-281			9970 0303229	8GP 002 067-241	99708102799	8GH 002 857-241
7 544 119 000 0	2KA 003 389-061			99700090251	2JA 001 330-001	99708412667	2SD 001 699-061
7 544 119 000 0	2KA 003 389-062			99700090251	2JA 001 330-007	99708412674	2BA 003 022-001
7 544 119 000 0	2KA 003 389-068			9970-0095025	8JA 001 909-001	99708412675	2SE 001 699-071
7 552 026 000 0	2ZR 002 589-011			9970-0095025	8JA 001 909-011	99708412692	2BA 003 734-061
7 552 026 004 0	9EL 112 858-011			99700118663	8GM 002 091-251	9970 8412748	1G3 005 241-071
7 552 030 000 0	2JA 001 331-011			99700339959	8GM 002 094-241	99708413122	2JA 003 231-001</



Manufacturer's no. / Hella no. Cross-Reference

Faun	Hella	Fendt	Hella	Fendt	Hella	Fendt	Hella
9970-8467024	9EL 110 542-001	F 716 900 020 030	9GH 126 647-011	X 830 180 033 000	2PF 001 648-161	X 830 180 206	2XS 008 479-017
9970-8467134	9EL 116 907-001	F 716 900 020 040	9EL 113 324-001	X 830 180 034	2BE 003 014-251	X 830 180 207	2DA 007 858-037
9970-8475136	2BA 003 014-011	F930.900.020.120	8JA 990 065-001	X 830 180 034	2BE 003 014-257	X830180207	2DA 007 858-037
9970-8476344	2XS 955 031-001	F930.900.111.010	1GA 990 305-001	X 830 180 035	2PF 001 648-161	X830180207	2DA 343 800-001
99708519965	2SA 003 057-021	F930.900.111.020	5DV 990 264-001	X 830 180 035 010	2PF 001 648-161	X830180207	2DA 343 800-007
99708520062	2PF 003 057-041	F931.901.020.020	9GD 159 740-007	X 830 180 036	2BE 002 776-251	X 830 180 208	8KA 146 751-007
9970-8520690	9EL 117 330-001	F931.901.111.010	5DV 008 855-001	X 830 180 036	2BE 002 776-257	X830180209	2DA 343 800-057
9970-8520691	9EL 117 330-011	F931.901.111.010	5DV 008 855-001	X 830 180 036 000	2BE 002 776-251	X 830 180 250	2ZR 003 236-051
		F931.901.111.020	8KB 990 299-241	X 830 180 036 000	2BE 002 776-257	X 830 180 250	2ZR 003 236-057
		G 210.902.140.020	2RL 007 551-001	X 830 180 037	2BE 002 776-261	X 830 180 250	2ZR 005 200-051
		G 246 900 020 050	1LB 006 213-057	X 830 180 037	2BE 002 776-267	X 830 180 250 000	2ZR 003 236-051
		G 260 900 020 020	1AL 009 998-001	X 830 180 037 000	2BE 002 776-261	X 830 180 250 000	2ZR 003 236-057
		G 294 900 110 010	1GB 006 213-111	X 830 180 037 000	2BE 002 776-267	X83018209	2DA 343 800-057
		G 294 900 110 010	1GB 006 213-117	X 830 180 038	2SD 002 776-231	X 830 190 050	8RL 002 009-021
		G 294 900 110 010	1GD 996 018-541	X 830 180 038	2SD 002 776-237	X 830 190 052 000	8RA 002 014-101
		G 312 900 110 010	1GA 007 506-081	X 830 180 039	2SD 002 776-241	X830.190.055	8RA 002 023-001
		G 312 900 111 030	1GA 006 991-051	X 830 180 039	2SD 002 776-247	X830.190.055.000	8RA 002 023-001
		G 312 900 113 020	1GB 996 080-011	X 830 180 040	2KA 001 389-101	X 830 230 554 000	8JA 990 065-001
		G 312 901 110 020	1GA 007 506-081	X 830 180 040 000	2KA 001 389-101	X 830 250 024 000	4RA 003 510-361
		G 334 900 111 010	1GO 996 176-021	X 830 180 041 000	2KA 003 168-021	Y 252 702 0	2BA 003 022-021
		G334.900.111.020	1GO 996 176-061	X 830 180 042 000	2PF 003 014-071	Y 252 702 4	2SD 003 184-031
		G 380 902 110 010	1GA 998 522-011	X 830 180 043	2KA 003 389-061	Y 252 702 4	2SD 003 184-037
		G 380.902.110.020	1GA 998 522-011	X 830 180 043	2KA 003 389-062	Y 252 702 7	2SD 003 184-041
		G 524 900 115 020	1GA 007 506-081	X 830 180 043	2KA 003 389-068	Y 252 700 1	2SD 003 184-047
		G 716 900 020 090	2SD 001 685-317	X 830 180 046	2SD 003 184-041	Y 650 000 2	2SD 003 184-047
		G718.970.010.090	8HG 004 806-001	X 830 180 046	2SD 003 184-047		2SD 003 184-047
		G 737 900 020 050	2BA 009 001-001	X 830 180 046 000	2SD 003 184-047		2SD 003 184-047
		G 737 900 020 050	2BA 009 001-007	X 830 180 046 000	2SD 003 184-047		2SD 003 184-047
		G 737 900 020 060	2SB 009 001-061	X 830 180 046 010	9EL 118 701-001		2SD 003 184-031
		G 737 900 020 060	2SB 009 001-067	X 830 180 047	2SD 003 184-031		2SD 003 184-037
		G 916 901 020 010	1GA 996 020-001	X 830 180 047	2SD 003 184-037		2SD 003 184-037
		G 916 901 210 010	2TJ 003 168-151	X 830 180 047 000	2SD 003 184-031		2SD 003 184-031
		G 930.900.111.010	1GA 996 142-021	X 830 180 047 000	2SD 003 184-037		2SD 003 184-037
		G930.900.111.020	1GA 996 261-511	X 830 180 047 010	9EL 118 700-001		9EL 118 700-001
		G930.900.112.020	1GA 996 261-521	X 830 180 048	2SE 003 184-011		2SE 003 184-011
		G930.900.113.010	1GB 996 147-101	X 830 180 048	2SE 003 184-017		2SE 003 184-017
		G931900020120	2BA 008 221-107	X 830 180 048 000	2SE 003 184-011		2SE 003 184-011
		G931900020120	2PF 008 221-177	X 830 180 048 000	2SE 003 184-017		2SE 003 184-017
		G931900020130	2BA 008 221-177	X 830 180 048 010	9EL 118 697-001		9EL 118 697-001
		G931900020130	2PF 008 221-177	X830.180.063.010	8GH 002 089-133		8GH 002 089-133
		G931.900.020.150	1K0 008 191-011	X 830 180 063 020	9EL 856 416-001		9EL 856 416-001
		G931.900.020.150	1K0 008 191-017	X 830 180 080	2PS 002 727-001		2PS 002 727-001
		G931.900.220.030	2KA 004 331-031	X 830 180 080	2PS 002 727-007		2PS 002 727-007
		G931.901.020.120	2PF 008 221-177	X 830 180 080	2PS 004 361-001		2PS 004 361-001
		G931.901.020.130	2BA 008 221-107	X 830 180 080	2PS 004 361-007		2PS 004 361-007
		G931.901.020.210	2SB 008 982-207	X 830 180 085	2NE 002 985-001		2NE 002 985-001
		G931.901.020.220	2BA 008 982-217	X 830 180 095	2BE 003 347-001		2BE 003 347-001
		H 737 900 020 010	8RA 009 001-031	X 830 180 095 000	2BE 003 347-001		2BE 003 347-001
		H 737 900 020 010	8RA 009 001-037	X 830 180 095 010	9EL 120 224-001		9EL 120 224-001
		H 816 810 200 010	2JA 002 931-031	X830180122	2PF 964 295-257		2PF 964 295-257
		H922.500.410.020	8RW 341 235-007	X830.180.147.000	2XS 005 020-001		2XS 005 020-001
		H931.901.020.080	5DS 009 602-011	X830.180.147.000	2XS 005 020-002		2XS 005 020-002
		X671.306.000.000	8GM 002 092-121	X830.180.147.000	2XS 005 020-003		2XS 005 020-003
		X671.306.500.000	8GA 002 071-131	X 830 180 152	2PS 002 727-001		2PS 002 727-001
		X825.107.041.000	8GD 002 078-221	X 830 180 152	2PS 002 727-007		2PS 002 727-007
		X825.107.043.000	8GA 006 841-121	X 830 180 152 000	2PS 002 727-001		2PS 002 727-001
		X 825.107.044.000	8GH 008 357-001	X 830 180 152 000	2PS 002 727-007		2PS 002 727-007
		X825.107.045.000	8GH 007 157-121	X 830 180 162	2PS 964 295-001		2PS 964 295-001
		X 825 282 160	2BA 001 259-611	X 830 180 162	2PS 964 295-007		2PS 964 295-007
		X 825 282 160	2BA 001 259-618	X 830 180 165	2PS 962 964-031		2PS 962 964-031
		X 825 282 160 000	2BA 001 259-611	X 830 180 165	2PS 962 964-037		2PS 962 964-037
		X 825 282 160 000	2BA 001 259-618	X 830 180 172	2KA 004 331-061		2KA 004 331-061
		X 825 282 160 010	9EL 088 150-001	X 830 180 172	2KA 004 331-067		2KA 004 331-067
		X825.283.214.000	8GS 007 949-101	X 830 180 180	2SD 004 460-011		2SD 004 460-011
		X825.283.215.000	8GS 009 028-001	X 830 180 180	2SD 004 460-017		2SD 004 460-017
		X 825.283.248.000	8GJ 002 525-131	X 830 180 180 000	2SD 004 460-011		2SD 004 460-011
		X 825.283.248.000	8GJ 002 525-133	X 830 180 180 000	2SD 004 460-017		2SD 004 460-017
		X825.283.253.000	8GP 002 067-121	X 830 180 181	2SD 004 460-001		2SD 004 460-001
		X825.283.254.000	8GP 002 067-121	X 830 180 181	2SD 004 460-007		2SD 004 460-007
		X825283262	8GA 006 841-121	X 830 180 181 000	2SD 004 460-001		2SD 004 460-001
		X825.283.277.000	8GD 002 078-121	X 830 180 182	2SK 004 460-041		2SK 004 460-041
		X825.283.286.000	8GA 006 841-121	X 830 180 182	2SK 004 460-041		2SK 004 460-041
		X825.283.291.000	8GH 002 090-133	X 830 180 183	2SK 004 460-031		2SK 004 460-031
		X825.283.299.000	8GM 002 091-131	X 830 180 183	2SK 004 460-037		2SK 004 460-037
		X 830 108 003 5010	8GA 002 073-121	X 830 180 190	2DA 007 421-001		2DA 007 421-001
		X 830 108 035 010	9EL 108 435-001	X 830 180 190	2DA 007 421-007		2DA 007 421-007
		X 830 160 100	9EL 108 435-001	X 830 180 190	2DA 007 541-001		2DA 007 541-001
		X 830 160 100 000	1GD 003 690-287	X 830 180 193	8KA 146 751-007		8KA 146 751-007
		X 830 180 001	2BA 002 324-011	X 830 180 195	2VA 007 502-011		2VA 007 502-011
		X 830 180 001 010	9EL 110 918-001	X 830 180 195	2VA 007 502-017		2VA 007 502-017
		X 830 180 002	2BA 002 324-021	X 830 180 195 000	2VA 007 502-011		2VA 007 502-011
		X 830 180 002 010	9EL 110 918-011	X 830 180 196	2VP 007 502-047		2VP 007 502-047
		X 830 180 015 010	9EL 118 633-001	X 830 180 196	2VP 007 502-047		2VP 007 502-047
		X 830 180 020	2XW 003 146-001	X 830 180 196 000	2VP 007 502-041		2VP 007 502-041
		X 830 180 030	2JA 001 330-001	X 830 180 196 000	2VP 007 502-047		2VP 007 502-047
		X 830 180 030	2JA 001 330-007	X 830 180 197	2VA 007 502-111		2VA 007 502-111
		X 830 180 030 000	2JA 001 330-001	X 830 180 197	2VA 007 502-117		2VA 007 502-117
		X 830 180 030 000	2JA 001 330-007	X 830 180 198	2VP 007 502-121		2VP 007 502-121
		X 830 180 032	2BE 003 014-251	X 830 180 198	2VP 007 502-127		2VP 007 502-127
		X 830 180 032 000	2BE 003 014-257	X 830 180 200	2DA 008 136-007		2DA 008 136-007
		X 830 180 032 000	2BE 003 014-251	X830180202	8KA 144 707-007		8KA 144 707-007
		X 830 180 032 000	2BE 003 014-257	X 830 180 205	2XS 008 479-001		2XS 008 479-001
		X 830 180 032 010	9EL 115 003-055	X 830 180 205	2XS 008 479-007		2XS 008 479-007
		X 830 180 033	2PF 001 648-161	X 830 180 206	2XS 008 479-011		2XS 008 479-011

Manufacturer's no. / Hella no.

Cross-Reference



Fiat	Hella	Ford	Hella	Ford	Hella	Ford	Hella
42304486	2DA 003 236-037	1 002 720	9EL 962 585-051	1 104 277	9EL 354 059-011	1 152 468	1LE 010 198-061
42304487	2NE 003 236-001	1 012 036	1LG 354 023-041	1 106 724	2ZR 354 063-011	1 152 471	1LE 010 198-051
42304487	2NE 003 236-008	1 012 037	1LG 354 023-031	1 106 914	1LE 009 058-081	1 198 222	1LF 010 197-041
42304488	2ZR 003 236-051	1 012 694	1LG 354 023-081	1 106 917	1LE 009 058-041	1 198 226	1LF 010 197-031
42304488	2ZR 003 236-057	1 012 696	1LG 354 023-071	1 106 937	1LE 009 058-071	1 202 148	2BA 010 231-021
42317738	2ZR 003 236-051	1 024 952	1NL 007 594-031	1 106 938	1LE 009 058-031	1 202 217	2BA 010 232-011
42317738	2ZR 003 236-057	1 024 953	1NL 007 594-041	1 107 390	2NE 354 062-021	1 202 218	2BA 010 232-021
42331327	8RA 003 660-007	1 031 155	1LJ 008 041-041	1 108 923	9EL 964 480-011	1 202 349	1NA 010 205-011
42340069	2JA 001 357-002	1 031 169	1LJ 008 041-031	1 108 924	9EL 964 479-011	1 202 351	1NA 010 205-021
42460351	9EL 110 536-001	1 043 152	1LJ 008 041-041	1 113 574	2VP 354 037-021	1 202 717	1LF 010 197-041
42486466	9EL 118 445-001	1 043 153	1LJ 008 041-031	1 113 577	2VP 354 037-011	1 202 721	1LF 010 197-031
42487086	9EL 113 324-001	1 044 103	2VP 354 034-021	1 114 878	2BA 010 231-021	1 203 328	2BA 010 231-011
42530460	9EL 146 491-001	1 044 104	2VP 354 034-011	1 114 880	2BA 010 231-011	1 203 538	1NA 010 205-011
42531998	9EL 115 830-001	1 044 158	9EL 354 072-011	1 114 893	1LG 354 023-081	1 203 540	1NA 010 205-021
445502	2KA 003 168-021	1 044 159	9EL 354 072-021	1 114 895	1LG 354 023-041	1 204 323	1NA 010 205-021
44902454	2KA 001 389-101	1 052 426	9EM 137 820-021	1 114 897	1LG 354 023-071	1 204 324	1NA 010 205-011
44906471	2BE 003 014-251	1 052 432	9EL 137 819-031	1 114 899	1LG 354 023-031	1 204 733	1LE 010 198-101
44906471	2BE 003 014-257	1 054 240	9EL 354 072-021	1 114 970	9EL 171 558-021	1 204 734	1LE 010 198-091
46429203	1LF 006 826-261	1 054 241	9EL 354 072-011	1 114 971	9EL 354 071-021	1 205 193	1LG 354 024-081
46429204	1LF 006 826-251	1 063 533	9EL 354 072-021	1 114 972	9EL 171 558-011	1 205 195	1LG 354 024-061
46512541	2BA 270 016-041	1 063 534	9EL 354 072-011	1 114 973	9EL 354 071-011	1 205 197	1LG 354 024-071
46512542	2BA 270 016-031	1 063 817	1LE 010 199-041	1 115 367	9EL 354 071-021	1 205 199	1LG 354 024-051
4833768	2SA 001 259-751	1 063 821	1LE 010 199-031	1 115 368	9EL 354 071-011	1 205 546	2BA 010 232-021
4833768	2SA 001 259-757	1 063 837	9EL 354 059-021	1 115 481	9EM 137 820-021	1 205 547	2BA 010 232-011
4961371	2SD 001 680-281	1 063 838	9EL 354 059-011	1 115 487	9EL 137 819-031	1 205 701	2VP 354 037-021
4961372	2SE 001 680-291	1 063 869	9EL 171 556-031	1 116 259	1LE 010 199-041	1 205 706	2VP 354 037-011
593628	2SD 001 693-011	1 063 874	9EL 171 556-041	1 116 267	1LE 010 199-031	1 207 958	2ZR 354 063-011
60657892	2DA 007 421-027	1 063 878	2NE 354 062-021	1 116 629	2VP 354 037-021	1 212 358	1LF 010 197-041
638230	2PS 002 727-001	1 063 886	2ZR 354 063-011	1 116 630	2VP 354 037-011	1 212 362	1LF 010 197-031
638230	2PS 002 727-007	1 065 778	9EL 354 061-021	1 119 440	9EL 354 057-021	1 214 223	9EL 354 061-011
71130013	2KA 001 389-101	1 065 780	9EL 354 061-011	1 119 442	9EL 354 057-011	1 214 226	9EL 354 061-021
71130027	2AA 001 200-001	1 065 782	9EL 354 057-021	1 120 246	9EL 171 556-041	1 215 917	9EL 354 059-021
71130027	2AA 001 200-002	1 065 783	9EL 354 057-011	1 120 248	9EL 171 556-031	1 216 868	1LE 010 198-061
71130034	8HG 002 240-021	1 065 786	9EL 171 556-041	1 120 616	9EL 354 061-021	1 216 912	1LE 010 198-051
71130046	2BA 001 259-611	1 065 787	9EL 171 556-031	1 120 617	9EL 354 061-011	1 218 226	1LE 010 198-101
71130046	2BA 001 259-618	1 067 265	2NE 354 062-021	1 121 317	9EL 354 071-021	1 218 242	1LE 010 198-091
71130101	8HG 002 240-031	1 067 267	9EL 354 059-021	1 121 318	9EL 171 558-011	1 219 836	9EL 354 059-011
7130027	2AA 001 200-001	1 067 268	9EL 354 059-011	1 121 319	9EL 354 071-011	1 227 684	9EL 171 558-011
7130027	2AA 001 200-002	1 068 441	9EL 171 556-041	1 124 434	2NE 354 062-021	1 227 685	9EL 171 558-021
71403699	8XS 113 389-001	1 068 444	9EL 171 556-031	1 125 614	9EL 964 484-011	1 232 640	1LG 354 024-141
71701052	2AB 004 532-001	1 069 266	2ZR 354 063-011	1 125 615	9EL 964 483-011	1 232 641	1LG 354 024-081
71904420	2BE 003 014-251	1 069 982	9EL 354 061-021	1 126 641	9EL 354 071-021	1 232 642	1LG 354 024-061
71904420	2BE 003 014-257	1 069 984	9EL 354 061-011	1 126 642	9EL 354 071-011	1 232 648	1LG 354 024-131
79069588	2BA 002 652-111	1 070 140	1LE 010 199-041	1 126 643	9EL 171 558-021	1 232 649	1LG 354 024-071
79069588	2BA 002 652-117	1 070 142	1LE 010 199-031	1 126 644	9EL 171 558-011	1 232 650	1LG 354 024-051
79069589	2BA 002 652-121	1 070 679	1LE 010 199-041	1 127 638	9EL 354 071-021	1 233 324	9EL 171 558-021
79069589	2BA 002 652-127	1 070 681	1LE 010 199-031	1 127 639	9EL 354 071-011	1 233 325	9EL 171 556-041
8119043	2KA 004 525-001	1 070 832	9EL 354 057-021	1 127 644	9EL 354 071-021	1 255 214	9EL 171 558-021
81812945	9EL 135 266-001	1 070 835	9EL 171 556-041	1 127 645	9EL 354 071-011	1 306 252	1NA 010 205-021
81813545	8RA 002 016-121	1 070 837	9EL 354 057-011	1 127 893	1LE 009 058-041	1 306 253	1NA 010 205-011
81815335	9EL 043 137-001	1 070 839	9EL 171 556-031	1 127 894	1LE 009 058-031	1 309 162	9EL 354 060-021
81817350	8JA 001 930-001	1 071 974	1LE 010 199-041	1 127 896	1LE 009 058-081	1 309 164	9EL 354 060-011
81838694	8RA 002 023-001	1 071 976	1LE 010 199-031	1 127 898	1LE 009 058-071	1 319 871	9EL 171 558-061
83926045	8RA 002 015-001	1 072 423	2VP 354 034-021	1 128 752	9EL 171 558-021	1 319 873	9EL 171 558-021
83931521	8GH 002 089-133	1 072 424	2VP 354 034-011	1 128 753	9EL 171 558-011	1 319 874	9EL 171 558-011
83952724	8GA 002 071-131	1 074 084	9EL 354 061-021	1 128 754	9EL 171 558-021	1 320 350	1LF 010 197-031
83959697	1L3 005 649-017	1 074 085	9EL 354 061-011	1 128 755	9EL 354 071-021	1 320 351	1LF 010 197-041
83961516	2BE 002 582-031	1 074 880	1LE 010 199-041	1 128 757	9EL 354 071-011	1 324 249	1LL 010 201-041
83985986	8GD 002 078-121	1 074 884	1LE 010 199-031	1 130 104	9EL 354 071-021	1 324 253	1LL 010 201-121
83989283	9EL 112 741-001	1 075 073	1LE 010 199-031	1 130 105	9EL 354 071-011	1 324 255	1LL 010 201-201
83989315	9EL 112 743-001	1 075 075	1LE 010 199-041	1 130 110	9EL 354 071-021	1 324 257	1LL 010 201-031
84037090	2SE 002 578-701	1 076 373	9EL 354 061-021	1 130 111	9EL 354 071-011	1 324 261	1LL 010 201-111
84037090	2SE 002 578-707	1 076 374	9EL 354 061-011	1 130 814	2ZR 354 063-011	1 324 263	1LL 010 201-191
88700084	2BA 001 248-001	1 084 891	1LE 010 199-041	1 134 215	1LE 010 199-031	1 327 649	9EL 354 071-021
88700087	2SB 003 018-031	1 084 892	1LE 010 199-031	1 134 219	1LE 010 199-041	1 327 650	9EL 354 071-011
88900167	9EL 089 527-001	1 085 526	9EL 354 061-021	1 136 537	9EL 171 558-021	1 329 408	1LL 010 201-081
88900168	9EL 111 647-001	1 085 655	9EL 171 556-041	1 136 538	9EL 171 558-011	1 329 412	1LL 010 201-241
88900169	9EL 107 368-001	1 085 665	9EL 171 556-031	1 137 928	9EL 354 060-021	1 329 414	1LL 010 201-071
93191714	9EL 119 544-021	1 088 971	1LE 010 199-041	1 137 929	9EL 354 060-011	1 329 418	1LL 010 201-231
93191715	9EL 119 544-001	1 088 974	1LE 010 199-031	1 138 143	2ZR 354 063-011	1 329 635	9EL 354 067-021
93191716	9EL 119 544-031	1 091 952	9EL 171 556-041	1 138 144	2NE 354 062-021	1 329 637	9EL 354 067-011
93191717	9EL 120 201-001	1 091 978	9EL 171 556-031	1 140 063	1LG 354 024-141	1 331 600	9EL 354 071-021
93191718	9EL 119 544-111	1 092 586	9EL 354 061-021	1 140 073	1LG 354 024-131	1 331 601	9EL 354 071-011
9638230	2PS 002 727-001	1 092 589	9EL 354 061-011	1 140 076	9EL 171 558-021	1 333 744	9EL 354 065-021
9638230	2PS 002 727-007	1 095 311	9EL 354 057-021	1 140 077	9EL 171 558-011	1 333 746	9EL 354 065-011
9651052	2PF 001 648-161	1 095 312	9EL 354 057-011	1 142 871	1LF 010 197-041	1 333 832	9EL 354 066-021
98434335	1ND 003 590-001	1 096 628	1LE 010 199-031	1 142 875	1LF 010 197-031	1 333 834	9EL 354 066-011
9843435	1ND 003 590-001	1 097 794	1LG 354 023-081	1 143 163	1LE 010 198-061	1 343 652	1LE 010 198-061
98455658	9GT 134 130-001	1 097 797	1LG 354 023-041	1 143 168	1LE 010 198-051	1 343 656	1LE 010 198-051
98466409	1ND 003 590-001	1 097 799	1LG 354 023-071	1 143 437	9EL 354 061-021	1 345 971	1LE 010 198-101
99446124	2SE 001 685-221	1 097 803	1LG 354 023-031	1 143 438	9EL 354 061-011	1 345 973	1LE 010 198-091
99446124	2SE 001 685-227	1 097 878	1LE 010 199-041	1 145 718	1LE 010 198-061	1 347 460	1LE 270 600-201
99446124	2XS 950 071-031	1 098 043	9EL 354 057-021	1 145 721	1LE 010 198-051	1 347 462	1LE 270 600-191
99446125	2SD 001 685-231	1 098 064	9EL 171 556-041	1 148 290	9EL 171 556-041	1 353 952	1LG 354 024-141
99446125	2SD 001 685-232	1 098 086	9EL 354 057-011	1 148 292	9EL 171 556-031	1 353 953	1LG 354 024-081
99446126	2XS 950 071-031	1 098 788	9EL 171 556-031	1 149 113	1NA 010 205-011	1 353 956	1LG 354 024-061
9946766	2BA 007 042-041	1 101 815	2BA 010 231-021	1 149 114	1NA 010 205-021	1 353 992	1LG 354 024-131
9946767	2BA 007 042-031	1 101 816	2BA 010 231-011	1 150 021	9EL 354 057-021	1 353 993	1LG 354 024-071
9947665	6NM 007 282-661	1 102 006	9EM 137 820-021	1 150 022	9EL 354 057-011	1 353 994	1LG 354 024-051
Fibron	Hella	1 102 007	9EL 137 819-031	1 151 625	9EL 171 558-021	1 36	



Manufacturer's no. / Hella no.

Cross-Reference

Ford	Hella	Ford	Hella	Ford	Hella	Ford	Hella
1 371 855	9EL 171 558-041	1M51 13A603 AA	9EL 354 061-011	2M5V 13W029 FA	1LE 010 198-161	4C16 13008 HA	1LG 354 024-141
1 371 857	9EL 171 558-031	1M51 13A603 AB	9EL 354 061-011	2M5V 13W030 FA	1LE 010 198-151	4C16 13008 KA	1LG 354 024-081
1 371 859	9EL 171 558-051	1M51 13A603 BA	9EL 354 057-011	2M5Z13C170AA	5DV 008 290-004	4C16 13008 MA	1LG 354 024-061
1 371 861	9EL 171 558-011	1M51 13A603 FA	9EL 171 556-031	2N1H 13W029 DF	1LD 246 044-241	4C16 13008 UA	1LG 354 024-141
1 380 503	9EL 354 055-021	1M51 13A603 FB	9EL 171 556-031	2N1H 13W030 DF	1LD 246 044-231	4C16 13008 VA	1LG 354 024-081
1 380 505	9EL 354 055-011	1M51 15512 AA	2ZR 354 063-011	2S6X 13W029 DA	1LF 010 197-041	4C16 13008 ZA	1LG 354 024-061
1 383 603	9EL 354 070-021	1M51 15512 AB	2ZR 354 063-011	2S6X 13W029 DB	1LF 010 197-041	4C16 13035 HA	1LG 354 024-131
1 383 636	9EL 354 054-021	1M51 15512 AC	2ZR 354 063-011	2S6X 13W029 DC	1LF 010 197-041	4C16 13035 KA	1LG 354 024-071
1 383 638	9EL 354 070-011	1M50 13100 AA	1LE 010 198-101	2S6X 13W029 DD	1LF 010 197-041	4C16 13035 MA	1LG 354 024-051
1 383 641	9EL 354 054-011	1M50 13100 AB	1LE 010 198-101	2S6X 13W029 DE	1LF 010 197-041	4C16 13035 UA	1LG 354 024-131
1 386 531	2NE 354 062-021	1M50 13100 AC	1LE 010 198-101	2S6X 13W030 DA	1LF 010 197-031	4C16 13035 VA	1LG 354 024-071
1 406 676	2NR 010 229-021	1M50 13101 AA	1LE 010 198-091	1M50 13100 DB	1LF 010 197-031	4C16 13035 ZA	1LG 354 024-051
1 406 677	2NR 010 229-011	1M50 13101 AB	1LE 010 198-091	2S6X 13W030 DC	1LF 010 197-031	4M51 13099 BA	1LL 010 201-041
1 406 679	2SD 010 230-021	1M50 13101 AC	1LE 010 198-091	2S6X 13W030 DD	1LF 010 197-031	4M51 13099 FA	1LL 010 201-121
1 406 680	2SD 010 230-011	1MVO 13368 BA	9EL 354 060-021	2S6X 13W030 DE	1LF 010 197-031	4M51 13099 HA	1LL 010 201-201
1 416 560	2ZR 354 063-011	1MVO 13368 BB	9EL 354 060-021	30 884 017	2RL 008 064-101	4M51 13099 KA	1LL 010 201-081
1 419 079	2NE 354 068-021	1MVO 13369 BA	9EL 354 060-011	32 009 011	8GH 002 090-251	4M51 13099 PA	1LL 010 201-161
1 419 084	2ZR 354 069-011	1MVO 13369 BB	9EL 354 060-011	32 009 011	8GH 002 090-253	4M51 13099 SA	1LL 010 201-241
1 420 450	9EL 354 067-021	1S71 13404 AF	9EL 171 558-021	32 010 159	8GA 002 073-121	4M51 13101 BA	1LL 010 201-031
1 420 451	9EL 354 067-011	1S71 13404 AH	9EL 171 558-021	32 230 100	2XW 003 146-001	4M51 13101 FA	1LL 010 201-111
1 420 467	9EL 354 065-021	1S71 13404 AL	9EL 171 558-021	3 227 655 0	2SD 001 305-021	4M51 13101 HA	1LL 010 201-191
1 420 470	9EL 354 065-011	1S71 13404 AM	9EL 171 558-021	3 227 655 0	2SD 003 184-041	4M51 13101 KA	1LL 010 201-071
1 432 269	9EL 354 055-021	1S71 13404 CD	9EL 354 071-021	3 227 655 0	2SD 003 184-047	4M51 13101 PA	1LL 010 201-151
1 432 274	9EL 354 055-011	1S71 13404 CE	9EL 354 071-021	32 276 583	2SB 003 018-031	4M51 13101 SA	1LL 010 201-231
1 435 880	9EL 171 968-021	1S71 13404 CF	9EL 354 071-021	32 276 630	8RA 002 015-031	4M51 13A602 AA	9EL 354 067-021
1 435 881	9EL 171 968-011	1S71 13404 CG	9EL 354 071-021	32 276 652	1S3 001 117-041	4M51 13A602 AB	9EL 354 067-021
1 437 625	9EL 354 054-021	1S71 13404 CH	9EL 354 071-021	32 280 228	1G5 003 241-021	4M51 13A602 FA	9EL 354 065-021
1 437 626	9EL 354 054-011	1S71 13404 CJ	9EL 354 071-021	3 959 697	1L3 005 649-017	4M51 13A603 AA	9EL 354 067-011
1 438 497	1LJ 009 250-781	1S71 13405 AF	9EL 171 558-011	3 961 516	2BE 002 582-031	4M51 13A603 AB	9EL 354 067-011
1 438 504	1LJ 009 250-771	1S71 13405 AG	9EL 171 558-011	3 989 283	9EL 112 743-001	4M51 13A603 FA	9EL 354 065-011
1 464 086	9EL 171 558-041	1S71 13405 AL	9EL 171 558-011	3 989 315	9EL 112 741-001	5 026 651	2KA 004 525-001
1 464 087	9EL 171 558-031	1S71 13405 AM	9EL 171 558-011	3 991 017	9EL 112 744-001	0 547 172	2KA 001 386-231
1 480 980	1LL 010 201-041	1S71 13405 CD	9EL 354 071-011	3C1115K201AA	1NE 007 517-051	5C46 13N429 AA	1G4 003 470-031
1 480 982	1LL 010 201-121	1S71 13405 CE	9EL 354 071-011	3C1115K201BA	1NE 007 517-061	5C46 13N429 AA	8GH 002 090-251
1 480 984	1LL 010 201-201	1S71 13405 CF	9EL 354 071-011	3C4613005BA	1K0 008 191-021	5C46 13N429 AA	8GH 002 090-253
1 480 986	1LL 010 201-081	1S71 13405 CG	9EL 354 071-011	3C4613005BA	1K0 008 191-027	5M51 13A602 AA	9EL 354 066-021
1 480 988	1LL 010 201-161	1S71 13405 CH	9EL 354 071-011	3C4613368AA	2BA 008 221-001	5M51 13A602 BA	2NE 354 068-021
1 480 991	1LL 010 201-031	1S71 13405 CJ	9EL 354 071-011	3C4613368AA	2BA 008 221-007	5M51 13A603 AA	9EL 354 066-011
1 480 993	1LL 010 201-111	1S71 13A602 CA	9EL 354 071-021	3C4613B390AA	2BA 008 221-001	5M51 15512 AA	2ZR 354 069-011
1 480 995	1LL 010 201-191	1S71 13A602 CB	9EL 354 071-021	3C4613B390AA	2BA 008 221-007	5NN13N302A	9EL 043 137-001
1 480 997	1LL 010 201-071	1S71 13A602 CC	9EL 354 071-021	3C4613D138AA	6NM 007 231-037	5NN13N365A	9EL 088 538-001
1 480 999	1LL 010 201-151	1S71 13A602 CD	9EL 354 071-021	3C4613D140AA	8GH 007 157-241	5NN13N366A	9EL 088 525-001
1 481 001	1LL 010 201-231	1S71 13A602 CE	9EL 354 071-021	3C4613D141AA	8GP 002 067-241	5NN13N370A	2BE 001 259-061
1 481 005	1N0 354 016-021	1S71 13A602 EA	9EL 171 558-021	3C46 13D144 AA	8JD 156 150-807	6 044 355	2PF 001 648-171
1 481 007	1N0 354 016-011	1S71 13A602 EB	9EL 171 558-021	3C4613D146BA	1K0 008 191-021	6 048 873	9GH 116 966-011
1 483 061	1LL 010 201-241	1S71 13A602 EC	9EL 171 558-021	3C4613D146BA	1K0 008 191-027	6 050 578	4RA 003 510-081
1 486 766	9EL 176 576-021	1S71 13A602 ED	9EL 171 558-021	3C4613K046AA	9GH 152 654-007	6 059 235	4RA 003 510-081
1 486 771	9EL 176 576-011	1S71 13A602 EE	9EL 171 558-021	3C4613N361AA	8GA 006 841-241	6 069 827	2KA 001 389-101
1 486 778	9EL 176 577-021	1S71 13A602 EF	9EL 171 558-021	3C4615B212AA	9GH 158 051-007	6 117 712	9HD 121 297-001
1 486 783	9EL 176 577-011	1S71 13A603 CA	9EL 354 071-011	3C4615B224AA	1N0 008 582-011	6 134 866	2PF 001 648-171
1 505 147	2KA 001 622-001	1S71 13A603 CB	9EL 354 071-011	3C4615B224AA	1N0 008 582-017	6 158 263	2VP 354 034-021
1 512 695	1ZL 010 541-081	1S71 13A603 CC	9EL 354 071-011	3C4615K201AA	1N0 008 582-011	6 158 264	2VP 354 034-011
1 512 697	1ZL 010 541-071	1S71 13A603 CD	9EL 354 071-011	3C4615K201AA	1N0 008 582-017	6 161 440	9EL 919 370-111
1 512 699	1LF 010 541-041	1S71 13A603 CE	9EL 354 071-011	3M51 13100 BA	1LE 270 600-201	6 161 441	9EL 919 370-121
1 512 700	1LF 010 541-031	1S71 13A603 EA	9EL 171 558-011	3M51 13101 BA	1LE 270 600-191	6 161 978	2VP 354 034-021
1 516 578	2SD 001 688-171	1S71 13A603 EB	9EL 171 558-011	3M51 15K201 AA	1N0 354 016-011	6 161 979	2VP 354 034-011
1 516 579	2SD 001 688-141	1S71 13A603 EC	9EL 171 558-011	3M51 15K202 AA	1N0 354 016-021	6 188 647	2VP 354 034-021
1 517 206	1LL 010 541-121	1S71 13A603 ED	9EL 171 558-011	3S5115B504AA	2ZR 008 221-157	6 188 648	2VP 354 034-011
1 517 209	1LL 010 541-111	1S71 13A603 EE	9EL 171 558-011	3S71 13A602 EA	9EL 171 558-061	6 197 982	9EL 354 072-021
1 523 730	9EL 176 575-021	1S71 13A603 EF	9EL 171 558-011	3S71 13A602 EB	9EL 171 558-061	6 197 983	9EL 354 072-011
1 523 732	9EL 176 574-021	22 7658	2SB 003 018-031	3S71 13A602 EC	9EL 171 558-061	6 200 194	2VP 354 034-021
1 523 733	9EL 176 574-011	2 967 157	9GT 074 132-001	4 041 626	2VP 354 037-021	6 200 195	2VP 354 034-011
1 523 738	9EL 176 575-011	2C14 13404 AA	2VP 354 037-021	4 041 627	2VP 354 037-011	6 695 705	2VP 354 034-021
1 524 466	1LJ 009 587-641	2M5112K072AA	5DV 008 290-004	42 048 298	8RA 002 014-051	6 695 706	2VP 354 034-011
1 524 468	1LJ 009 587-631	2M51 13100 AA	1LE 010 198-061	42 048 298	8RA 002 014-052	6 777 877	2BA 919 370-051
1 530 665	6ED 004 778-011	2M51 13100 AB	1LE 010 198-061	42 073 886	8RA 002 014-101	6 777 878	2BA 919 370-061
1 542 747	1LJ 009 696-741	2M51 13100 AC	1LE 010 198-061	4 345 805	1LE 010 198-151	6 955 366	9EL 354 072-021
1 542 754	1LJ 009 696-731	2M51 13100 AD	1LE 010 198-061	4 345 820	1LE 010 198-161	6 955 367	9EL 354 072-011
1 568 199	2SA 001 259-751	2M51 13101 AA	1LE 010 198-051	4 355 478	9EL 354 058-001	6C1113450AA	9EL 171 968-011
1 568 199	2SA 001 259-757	2M51 13101 AB	1LE 010 198-051	4 364 357	9EL 354 056-001	6C1113451AA	9EL 171 968-021
1 582 913	2AA 001 200-151	2M51 13101 AC	1LE 010 198-051	4 371 157	1LE 010 198-161	6ED 004.778-011	6ED 004 778-011
1 583 532	6ZE 001 759-051	2M51 13101 AD	1LE 010 198-051	4 371 173	1LE 010 198-151	6N11 13A602 AB	9EL 354 070-021
1 583 542	9MK 854 066-001	2M51 13K198AA	6NM 007 878-041	4 372 304	1LE 010 198-161	6N11 13A603 AB	9EL 354 070-011
1 631 498	2VP 354 034-021	2M51 13W029 FA	1LE 010 198-061	4 372 307	1LE 010 198-151	6S61 13A602 AE	9EL 354 055-021
1 631 499	2VP 354 034-011	2M51 13W029 FB	1LE 010 198-061	4 388 591	2VP 354 037-021	6S61 13A602 BD	9EL 354 055-021
1 641 671	2VP 354 034-021	2M51 13W030 FA	1LE 010 198-051	4 433 923	1LE 010 198-161	6S61 13A603 AE	9EL 354 054-011
1 641 672	2VP 354 034-011	2M51 13W030 FB	1LE 010 198-051	4 433 950	1LE 010 198-151	6S61 13A603 BD	9EL 354 055-011
1 641 702	2VP 354 034-021	2M51 15201 AD	1NA 010 205-011	4 505 431	2VP 354 034-021	6S71 13A602 EA	9EL 171 558-041
1 641 703	2VP 354 034-011	2M51 15201 AE	1NA 010 205-011	4 505 432	2VP 354 034-011	6S71 13A603 EA	9EL 171 558-031
1 657 858	6ZE 001 759-071	2M51 15201 AF	1NA 010 205-011	4 516 738	1NE 007 517-051	7 334 711	



Manufacturer's no. / Hella no. Cross-Reference

Hako	Hella	Hako	Hella	Hanomag-Henschel	Hella	Hanomag-Henschel	Hella
90-04638-4	2RL 008 060-101	90 51989 3	2BA 009 001-167	3081 528 M1	8RA 002 016-121	B 969 071 282 009	2SD 003 184-047
90-04942-0	6EG 001 567-041	90 51990 1	2BA 009 001-001	3082 018 M1	9EL 146 491-001	B 969 071 282 010	2AA 001 200-131
90051673	9ES 069 831-001	90 51991 0	2BA 009 001-007	308 3483 M91	2AA 001 200-001	B 969 071 282 011	8RA 003 503-001
90-06799-2	8JA 001 909-011	90 51992 7	2BA 009 001-107	308 3483 M91	2AA 001 200-002	B 969 171 324 212	2SD 001 305-021
90-09329-5	2BA 003 014-111	90 53966 9	2PF 003 563-187	308 6298 M91	2KA 003 389-061	B 969 171 346 205	8HG 854 516-001
90108358	2KA 001 378-001	90 53966 9	2BE 003 014-251	308 6298 M91	2KA 003 389-062	B 969 171 346 206	6ZE 001 759-071
90-11697-1	2SW 003 014-131	90-71340-5	2BE 003 014-257	308 6298 M91	2KA 003 389-068	B 969 271 409 210	2SD 002 776-231
90-12655-8	4RA 003 510-081	90-71340-5	2SE 002 578-701	309 3000 M91	2BE 001 259-061	B 969 271 409 211	2SD 002 776-241
90-13831-4	2PF 001 648-161	90-73843-6	2SE 002 578-707	3093 002 M1	8GM 002 094-241	B 969 271 409 211	2SD 002 776-247
90-14181-3	8JB 004 777-001	90-74099-4	8HG 006 294-031	32309340	6ED 708 919-001	B 969 271 456 001	1GA 005 060-041
90-14181-3	8JB 004 777-002	90-74237-0	1GB 006 213-101	32483940	8RA 003 660-007	B 969 271 456 004	8RA 003 503-001
90-15188-7	1TA 003 570-101	90-74566-2	1GB 006 213-107	32484040	1G4 003 470-031	B 969 271 456 007	2SD 001 305-021
90154444	2SY 003 014-121	90-75158-7	9BG 993 345-001	395 9358 13	8GH 002 090-251	X 842 070 990 001	2SE 001 685-201
90-17773-4	2BA 001 277-011	90 75300 5	2BE 001 259-061	2RL 002 551-011	8GH 002 090-253	X 842 070 990 002	2SD 001 685-211
90-17774-2	2BA 001 277-021	90-79421-5	2KA 003 168-021	8HG 006 294-041	2JA 001 360-001	X 842 070 990 002	2SD 001 685-218
90178062	2KA 003 168-021	90-79422-3	2ZR 003 014-091	2RL 006 846-011	2SA 001 259-751	X 842 070 990 013	2TJ 001 633-211
90-17808-6	2SD 003 184-041	90-79921-4	2R 006 846-011	4061 82M 1	2SA 001 259-757	X 842 070 990 017	2BA 001 634-121
90-17808-6	2SD 003 184-047	90-79933-9	2R 006 846-011	416Z 811 240	8JA 001 914-011	X 860 001 085 890	2SA 001 277-011
90-17809-6	2SD 003 184-041	90-80105-1	2R 006 846-011	4180 6K1 910	8HG 002 240-021	X 860 001 085 891	2BA 001 277-021
90-17809-6	2SD 003 184-047	90-80106-9	2R 006 846-011	4180 6K2 250	8RA 002 016-111	X 860 046 098 000	2BA 001 389-101
90191594	2SD 003 182-051	90801077	2R 006 846-011	4189 57H 110	9EL 113 324-001	X 860 046 235 000	2KA 001 389-101
90191594	2SD 003 182-057	97-70652-7	2R 006 846-011	41L0 6H3 020	2RL 008 062-111	X 860 395 935 814	2PF 001 648-171
90-19160-2	2SE 003 182-021	Hanomag-Henschel	9EL 135 266-001	4201 273 M1	1AB 007 145-001	X 860 395 935 815	2JA 003 232-011
90-19160-2	2SE 003 182-027	1730 232 M1	8GJ 002 525-913	4210 6H3 080	8JA 001 909-001	X 860 400 050 250	2JA 001 335-011
90-19161-0	2SD 003 182-061	2895 819 M91	Hella	42106H3160	1GD 003 590-701	X 860 400 050 250	2SD 001 685-211
90-19161-0	2SD 003 182-067	2949 826 M1	8GA 002 072-121	4210 6H7 100	8JA 001 909-001	X 860 400 050 480	2SD 001 685-218
90-19162-8	2SE 003 182-011	2949 827 M1	1G5 003 241-021	4210 6H7 100	2KA 003 389-061	X 860 400 050 550	8HG 002 365-001
90-19162-8	2SE 003 182-017	2949 833 M91	9EL 110 918-001	4215 6H2 430	2KA 003 389-062	X 860 400 050 550	2JA 001 330-001
90-19447-3	1G4 003 470-031	2949 834 M91	9EL 110 918-011	4220 512 M91	2KA 003 389-068	X 860 533 935 209	2JA 001 348-001
90-19456-4	8GH 002 090-251	2949 835 M91	2BA 002 324-011	4220 6H2 140	2JA 002 661-001	X 860 535 935 719	2BA 002 324-011
90-19456-4	8GH 002 090-253	2949 835 M91	2BA 002 324-021	4240 147 M91	1GA 005 060-001	X 860 540 186 047	2BA 002 324-021
90197500	2TJ 001 633-211	2954 497 M91	2BA 002 324-001	4240 149 M91	1GA 005 060-001	X 860 541 936 701	8JA 001 909-001
90-22708-3	2BE 003 014-251	3061 358 M8	8JA 001 909-011	4241 079 M91	2ZR 003 315-041	X 861 019 405 550	2KA 001 386-231
90-22708-3	2BE 003 014-257	3061 399 M8	2BA 002 324-001	4241 079 M91	1GB 006 213-101	X 861 019 405 550	2KA 001 386-231
90-23160-6	8RA 004 412-021	3065 113 M8	2BA 002 324-001	4241 080 M91	1GB 006 213-107	X 860 582 935 811	9GT 074 132-001
90-24388-2	2SE 002 578-701	3086 298 M91	9EL 089 475-001	4241 080 M91	2BA 002 652-121	X 860 582 935 869	2KA 001 610-001
90-24388-2	2SE 002 578-707	3086 298 M91	2BE 003 018-011	4241 079 M91	2BA 002 652-127	X 860 975 270 301	8RA 002 016-111
90-24826-1	2BA 002 652-111	3093 002 M1	2SB 003 018-031	4241 080 M91	2BA 002 652-111	X 860 975 910 001	2PF 001 634-101
90-24826-1	2BA 002 652-117	3101 698 M1	2KA 003 389-061	4241 080 M91	2BA 002 652-117	X 861 019 405 550	2JA 001 330-001
90-24827-9	2BA 002 652-101	159 9334 0	2KA 003 389-068	4241 080 M91	8HG 006 294-051	X 861 019 405 550	2JA 001 330-007
90-24827-9	2BA 002 652-107	000 1821 351	8GM 002 094-241	4241 657 M91	2RL 006 846-001	X 862 171 151 431	2BA 001 227-211
90-24827-9	2BA 002 652-121	20E-06-H9150	1G5 120 510-001	4246 417 M91	2RL 006 846-011	X 880 000 920 623	8RA 002 016-111
90-24827-9	2BA 002 652-127	20G 0631 160	2AA 001 200-131	4246 418 M91	8HG 006 294-021	X 880 000 920 644	2AA 001 200-001
90-29104-8	2XS 950 071-031	20G 0631 260	8JA 001 909-011	4246 418 M94	8HG 006 294-021	X 880 000 920 644	2AA 001 200-002
90-31507-8	8RA 002 014-031	20G46K1681	3AG 003 399-101	42T09H0380	2XW 003 146-001	X 880 000 920 645	2BA 001 240-301
90-31507-8	8RA 002 014-032	20G 47K1 690	1LA 996 074-197	42U0619120	8HG 006 294-051	X 880 000 920 649	2SA 001 240-331
90-31520-1	8RA 002 014-051	20G 47K1 690	1LA 996 074-207	42U0 619 140	2RL 006 846-001	X 880 000 920 651	2AA 001 200-021
90-31520-1	8RA 002 014-052	20K4631820	8RA 002 014-031	42U9 571 110	2RL 006 846-001	X 880 000 920 651	2AA 001 200-023
90-32191-0	2XS 005 020-011	21FO 614 410	8RA 002 014-032	42W 0633 160	8HG 006 294-011	X 880 000 921 222	2AA 001 200-011
90-32191-0	2XS 005 020-017	289 5819 M91	8RA 002 014-032	42Y0 6H3 050	1LA 993 975-117	X 880 000 921 222	2AA 001 200-012
90321928	1GA 005 060-001	289 7205 M91	8RA 004 412-021	42Y0 6H3 190	8RA 004 412-001	X 880 000 921 223	2AA 001 200-031
90-33707-2	8JA 001 909-001	290 4951 M91	2PF 001 650-001	42Y0 6H3 200	2VP 006 040-111	X 880 000 921 223	2AA 001 200-032
90-34013-1	8GJ 002 525-133	290 4951 M91	1G5 003 241-021	42Y0 6H3 200	2VP 006 040-117	X 880 000 922 244	2AA 001 200-032
90-34013-1	8GJ 002 525-133	290 4951 M91	2AB 001 208-001	42Y0 6H3 200	2VP 006 040-121	X 880 000 922 244	2SD 001 685-211
90-34014-6	2SD 002 582-011	290 4951 M91	2JA 001 360-001	42Y0 6H3 200	2VP 006 040-127	X 880 000 922 245	2SD 001 685-218
90-34014-6	2SD 002 582-017	292 4326 M91	2JA 001 360-001	42Y06H3200	9GD 102 484-001	X 880 000 922 245	2SE 001 685-201
90-34014-7	2SD 002 582-021	292 4326 M91	2AA 001 200-011	4600 186 M1	9EL 136 825-011	X 880 000 922 258	8RA 002 016-111
90-34014-7	2SD 002 582-027	292 4328 M91	2AA 001 200-012	4603 153 M1	8HG 002 240-021	X 880 000 922 258	8RA 002 016-121
90-34015-4	2KA 004 525-001	292 4332 M91	2AA 001 200-031	4603 153 M1	8RA 003 326-011	X 880 000 922 260	2BA 001 259-631
90-34015-4	2JA 001 330-001	292 4332 M91	2AA 001 200-032	4603 561 M1	8RA 003 326-017	X 880 000 922 262	2PF 001 259-631
90-34015-4	2JA 001 330-007	292 4342 M91	2AA 001 200-021	4603 644 091	8XS 113 389-001	X 880 000 922 269	8JA 001 914-011
90-34017-1	8JA 001 909-001	292 4332 M91	2AA 001 200-012	4603 644 M91	1LB 003 177-081	X 880 000 956 474	2BA 001 227-201
90-34058-1	8HG 006 294-031	292 4342 M91	2AA 001 200-021	4901 618 M1	1LB 003 177-081	X 880 001 085 063	2KA 001 386-291
90-34334-4	2BM 004 965-801	292 8260 M1	2AA 001 200-023	4901 618 M1	2BA 002 652-107	X 880 001 085 313	9GD 082 716-001
90-34396-3	2RL 006 846-001	292 8454 M1	2ZR 001 240-351	4917 453 M1	2BA 002 652-107	X 880 001 085 890	2BA 001 277-011
90-34397-1	8HG 006 294-051	293 2480 M1	1S3 001 117-041	4917 455 M1	9EL 134 659-001	X 880 001 085 891	2BA 001 277-021
90-34526-5	2BA 002 324-001	293 3967 M91	2BA 001 248-001	50102640	9EL 134 660-001	X 885 957 660 390	2JA 003 232-011
90-34526-5	2BA 002 324-011	293 3967 M91	9FF 090 500-001	50134398	2JA 003 232-001	Y252 702 0	2BA 003 022-021
90-34530-7	9FF 126 444-001	293 967 M91	2JA 001 364-001	516 2459 8	8GP 002 095-241	Y252 702 4	2SD 003 184-037
90-34602-8	2KA 006 896-001	293 7744 M91	2KA 001 386-231	05726740	8GM 002 091-251	Y252 702 7	2SD 003 184-041
90-34602-8	2KA 006 896-007	294 2064 M1	9ES 012 060-011	57622340	8HG 002 365-001	Y252 702 7	2SD 003 184-047
90-35055-9	2ZR 003 315-041	294 2095 M1	9GD 023 639-001	058 2504 0	1S5 003 178-431	Y650 000 1	2SD 003 184-041
90-37266-5	1LB 006 213-047	294 2097 M1	9DR 090 206-001	05838040	8GD 002 084-251	Y650 000 2	9EL 118 701-001
90-37956-1	4AZ 003 787-021	2942 098 M1	9KS 075 139-001	751 8700 07	2JA 003 232-011	Hercules	Hella
90-37970-2	8HG 003 799-001	2949 833 M91	2BA 002 324-011	76629173	2AA 001 200-151	927 340 18 01	2BA 001 263-001
90-37970-2	8HG 003 799-007	2949 834 M91	2BA 002 324-021	76629173	8GH 002 089-251	927 340 18 02	2BA 001 236-001
90-37973-6	2RL 006 846-011	294 9835 M91	8JA 001 909-011	769 6167 3	8GH 002 089-253	P00927 340 1802000	2BA 001 236-001
90-39206-9	2NE 003 315-011	294 9835 M91	8JA 001 909-011				

Manufacturer's no. / Hella no.

Cross-Reference



Holder	Hella	Ikarus	Hella	Iveco	Hella	Iveco	Hella
021163	2KA 001 389-101	70004-93170	2NE 005 603-071	250 6753KZ5025-80	2BA 001 240-301	4120 0761	1N8 007 560-021
021164	2KA 003 168-021	70004-93170	2NE 005 603-077	250 6755KZ5026-80	2SB 001 240-311	4120 0762	2RL 008 063-111
022369	9EL 854 912-001	70004-93209	2DA 005 603-031	250 6757KZ5026-80	2DA 001 240-341	4120 0763	8HG 006 294-021
023683	1GA 007 506-001	70004-93209	2DA 005 603-037	0250 6759	2SA 001 240-331	4157 2338	2BA 003 022-021
024290	8JA 001 909-001	70004-93210	2BA 005 603-011	2506 759KZ5027-80	2SA 001 240-331	4157 6613	2DA 003 014-031
027178	9GH 116 966-011	70004-93210	2BA 005 603-017	2525 487	6EG 001 567-041	4157 6613	2DA 003 014-037
027887	2SE 004 623-001	70004-93260	2BM 006 692-011	2525 995	2KA 001 386-231	4157 6613	2SW 003 014-131
027887	2SE 004 623-007	70004-93260	2BM 006 692-017	0253 4403	2KA 001 389-101	4160 184	2BA 003 236-541
027888	2RL 006 846-001	70004-93261	2BM 006 692-021	0253 4404	2KA 001 389-101	4162 2525	2ZR 003 014-091
027889	2VP 006 040-121	70004-93261	2BM 006 692-027	0256 3885	2PF 001 648-171	4162 2525EE6927-13	2ZR 003 014-091
027889	2VP 006 040-127	70004-93293	1GA 007 506-001	2593 626	2KA 001 386-291	4162 2580	2JA 007 373-107
027890	2VB 006 040-051			0259 3628	2SD 001 693-011	4162 3679	2KA 001 389-101
027952	9EL 859 020-001			259 3628KZ5762-76	2SD 001 693-011	4162 3679	2KA 003 389-061
028143	9EL 129 519-001			260 0655KZ5508-76	2BA 003 022-021	4162 3679	2KA 003 389-062
029990	2VP 006 040-111			0260 0659	9EL 116 907-001	4162 3679	2KA 003 389-068
029990	2VP 006 040-117			260 0659EZ5508-76	9EL 116 907-001	4162 3979	2JA 007 372-001
030074	8GH 002 090-133			2628 233	2BA 003 022-001	4162 4870	6ZE 001 759-071
030819	9GH 993 984-001			0262 8233 KZ5508-76	2BA 003 022-001	4162 4924	2NE 006 609-001
030941	9GH 152 654-007			2633 999	2BA 003 022-001	4162 4924	2NE 006 609-007
030941	9GH 158 051-007			263 3999KZ5508-76	2BA 003 022-001	4162 4928	1ND 003 590-001
52341800179	8HG 002 365-001			2751 193	1G9 001 523-021	4162 4928	2ZR 006 609-081
791606	8JB 850 434-011			2780 621	9EL 852 061-001	4162 4928	2ZR 006 609-087
792049	9EL 115 003-055			2780 811	9EL 852 820-001	4162 5266	1GB 006 213-111
792051	9ES 069 831-001			0278 0812	9EL 855 097-001	4162 5266	1GB 006 213-117
792056	9GH 096 532-001			0278 0816	9EL 854 912-001	4162 8725	2SD 003 167-011
792977	9KS 075 307-001			2781 601	2BA 003 014-011	4162 8726	2SD 003 167-021
797012	2BA 997 027-031			2914 462K1125-49	2SB 001 301-021	4162 8727	2ZR 003 236-051
797144	9EL 136 825-001			2960 217	9ES 084 374-001	4162 8727	2ZR 003 236-057
				2960 218	9DE 089 102-011	4162 8728	2BA 003 236-021
				2967 157	9GT 074 132-001	4162 8728	2BA 003 236-027
				296 7157EE5107-80	9GT 074 132-001	4162 8729	2NE 003 236-001
				2967 457	9GT 074 132-001	4162 8729	2NE 003 236-008
				0296 8264	9EL 109 139-001	4162 9261	8HG 006 294-011
				0296 8264EY5026-80	9EL 109 139-001	41629815	2XS 005 020-011
				0296 9513	9DF 112 246-001	41629815	2KS 005 020-017
				296 9513EY5023-80	9DF 112 246-001	4163 2525	2ZR 003 014-091
				0296 9580	9EL 110 737-001	4163 4740	2BA 002 652-111
				296 9580EY5762-80	9EL 110 737-001	4163 4740	2BA 002 652-117
				0296 9581	9EL 110 736-001	4163 4740EZ6927-04	2BA 002 652-111
				0296 9581EY5762-80	9EL 110 736-001	4163 4740EZ6927-04	2BA 002 652-117
				0296 9614	9GD 052 710-021	4163 4741	2BA 002 652-121
				2984 106	2SD 001 686-101	4163 4741	2BA 002 652-127
				2984 107	2SE 001 686-142	4163 4741EZ6927-04	2BA 002 652-121
				2984 108	2BA 002 324-011	4163 4741EZ6927-04	2BA 002 652-127
				298 4108KY8751-80	2BA 002 324-011	4163 4742	2DA 003 014-031
				2984 109	2BA 002 324-021	4163 4742	2DA 003 014-037
				298 4109KY8751-80	2BA 002 324-021	4163 5108	1G3 005 760-221
				2984 397	9DR 060 567-001	4163 5108	1G3 005 760-227
				2984 403	9EL 102 240-031	4163 5108	1GA 005 060-001
				2984 405	9EL 110 918-001	4163 7408	8HG 854 516-001
				298 4405EY8751-80	9EL 110 918-001	4164 0184	2BA 003 236-541
				2984 406	9EL 110 918-011	4168 0786	2SA 006 717-001
				298 4406EY8751-80	9EL 110 918-011	4168 0786	2SA 006 717-007
				0320 5388	9GH 993 988-007	41730324	1GA 006 991-051
				03351866KZ8976-47	8RA 002 016-121	4173 0537	4AZ 003 787-021
				3385 820M01A	2JA 001 357-002	4173 0589	4RA 003 510-651
				0338 6485	2AA 001 200-011	4182 2954	2KA 003 389-061
				0338 6485	2AA 001 200-012	4182 2954	2KA 003 389-062
				0338 8059	2KA 001 389-101	4182 2954	2KA 003 389-068
				0341 6454	2SD 001 686-101	4182 3094	2KA 003 389-061
				3416 605	8JA 001 909-011	418 22954EC5026-80	2KA 003 389-062
				3416 605	8JA 001 914-011	418 22954EC5026-80	2KA 003 389-068
				0341 6605 EE5041-80	8JA 001 909-011	4182 3094	1N4 005 750-001
				0341 6680	2PF 001 648-171	4182 3454	2ZR 001 193-011
				0341 6722	2SD 001 685-211	4191 4894	1GA 007 506-021
				0341 6722	2SD 001 685-218	4193 3709	2ZR 003 030-171
				341 6727KZ5026-80	2SD 001 688-141	419 33709KZ6927-13	2ZR 003 030-171
				3440 754	9GD 100 140-001	4195 2452	2XW 003 146-001
				345 1057KZ5736-78	2ZR 001 240-351	4199 1420	2KA 001 386-281
				3464 801	8HG 002 365-001	4199 4651	1G9 001 523-021
				3466 213	2KA 001 386-301	4199 6531	2BA 001 416-011
				0347 4671	2KA 001 389-101	4199 65316729-80	2BA 001 416-011
				0347 4671EY0909-12	2KA 001 389-101	4199 6532	2BA 001 416-021
				0347 4671EY0919-12	2KA 001 389-101	4199 6532EZ6727-80	2BA 001 416-021
				3476 687	2AA 001 200-001	4199 7529	9EL 852 061-021
				3476 687	2AA 001 200-002	4199 7529	9EL 852 061-011
				3476 688	2AA 001 200-011	4199 7529EZ6700-80	9EL 856 416-011
				3476 688	2AA 001 200-012	4201 3057	2SE 003 167-031
				3476 689	2AA 001 200-021	4201 3058	2SD 003 167-021
				3476 689	2AA 001 200-023	4201 3059	2SD 003 167-011
				3478 683	9FF 085 642-001	4201 3060	2SE 003 167-041
				0347 9142	2JA 001 346-011	420 24860EZ5027-80	8RA 003 326-011
				3505 853	2AA 001 200-031	420 24860EZ5027-80	8RA 003 326-017
				3505 853	2AA 001 200-032	4202 4986	2AA 001 685-201
				3517 928	2RL 007 017-071	4202 4987	2SD 001 685-211
				3522 674	2AB 001 208-001	4202 4987	2SD 001 685-218
				3540 288	1G3 996 001-331	4202 5923	2SE 002 578-701
				3814 569	9GD 856 863-001	4202 5923	2SE 002 578-707
				4105 4985	2PS 003 748-121	4204 5986EZ5018-65	8RA 002 014-051
				4105 4985	2PS 003 748-127	4204 5986EZ5018-65	8RA 002 014-052
				4120 0525	2SE 001 685-201	4204 6397	8RA 003 326-011
				4120 0526	2SD 001 685-211	4204 6397	8RA 003 326-017
				4120 0526	2SD 001 685-218	4204 7226	2BA 003 236-321
				4120 0761	1G3 005 760-021	4204 7226	2SA 003 236-341

Manufacturer's no. / Hella no.

Cross-Reference



Jungheinrich	Hella	Jungheinrich	Hella	Karmann	Hella	Kässbohrer	Hella
025416	1G4 003 470-031	50152680	8RA 002 023-001	803655	6EH 004 406-032	7.521.169.000.0	2BA 965 039-147
002587	1G3 005 760-001	50152682	2JA 001 330-001	803864	2KA 001 378-127	7.521.408.025.0	9XR 854 840-001
26903023	2BA 002 652-101	50152682	2JA 001 330-001	804280	2DA 008 136-017	7.521.420.000.0	2RL 007 337-011
26903023	2BA 002 652-107	50153283	1G4 003 470-031	804281	8KA 146 751-007	7.521.420.000.0	2RL 007 337-011
26903025	2KA 001 389-101	50155346	8RA 002 010-011	808088	8RA 004 412-001	7.521.420.004.0	9EL 859 020-001
26906440	8GA 002 083-251	50160849	9EL 112 858-011	808413	2ZR 003 236-051	7.521.420.004.0	9EL 859 020-001
28300060	8GP 002 068-241	50195185	2KA 004 525-001	808413	2ZR 003 236-057	7.521.421.000.0	2RL 007 337-001
28300130	8GD 002 084-131	50198056	8GJ 002 525-251	821 954	2AA 003 257-041	7.521.423.000.0	2RL 007 337-041
28300160	8GM 002 092-121	50198056	8GJ 002 525-253	821 954	2AA 003 257-042	7.521.425.000.0	2RL 006 846-001
2830071	8GA 002 074-121	502040141	2SD 003 184-031	822 051	2JA 003 232-011	7.522.004.000.0	2SW 003 014-131
28300880	2RL 008 061-111	502040141	2SD 003 184-037	824 301	2JA 001 364-001	7.522.010.000.0	2BA 003 236-541
28301140	9FF 090 500-001	50204141	2SD 003 184-031	824 306	8RA 003 326-001	7.525.123.000.0	2SD 003 184-041
28301690	8GM 002 091-121	50204142	2SD 003 184-037	824 306	8RA 003 326-002	7.525.123.000.0	2SD 003 184-047
28303350	2BA 003 014-011	50204142	2SD 003 184-041	824 418	2KA 003 389-001	7.526.009.000.0	2SE 006 040-011
28303540	8GA 002 083-131	50204142	2SD 003 184-047	824 418	2KA 003 389-061	7.526.009.001.0	9GD 102 484-001
28304140	8GA 002 073-241	50212531	2BE 003 014-251	824 418	2KA 003 389-062	7.526.010.000.0	2SD 006 040-041
28304390	8GP 002 067-241	50212531	2BE 003 014-257	824 418	2KA 003 389-068	7.526.010.000.0	2SD 006 040-041
28304760	2JA 004 531-011	50236485	9EL 856 010-001	827 092	2PF 003 057-001	7 526 111 000	2NE 002 589-001
28304810	2AB 004 532-001	50260000	9GH 993 984-001	827 092	2PF 003 057-002	7 526 111 004	9EL 112 763-001
28304900	8GA 002 074-241	50298227	2SD 001 679-001	828 500	2SA 003 236-041	7.526.122.000.0	2SD 003 184-031
28304910	8GH 002 090-251	50308042	9EL 112 743-001	828 500	2SA 003 236-047	7.526.122.000.0	2SD 003 184-037
28304910	8GH 002 090-253	05035227	1GA 007 506-001	828 500	2SA 003 236-048	7 526 122 004	9EL 118 700-001
28304940	8GA 002 071-271	50409964	8GA 002 073-241	828 621	8RA 002 020-001	7.526.122.004.0	9EL 118 700-001
28304950	2SD 003 184-031	50422871	2DA 996 012-041	828 621	8RA 002 020-002	7 526 123 000	2SD 003 184-041
28304950	2SD 003 184-037	50423347	2SD 997 131-051	828 621	8RA 002 020-003	7 526 123 000	2SD 003 184-047
28305120	8GA 002 071-241	50423369	2ZR 002 985-261	828 629	8HG 002 247-001	7.526.123.000.0	2SD 003 184-041
28305250	2BA 003 022-021	50423370	8GD 002 078-241			7.526.123.000.0	2SD 003 184-047
28305560	2PF 003 389-037	50436549	2JA 007 372-011			7 526 123 004	9EL 118 701-001
28305710	8GP 002 095-241	50451992	8GD 002 078-221			7.526.123.004.0	9EL 118 701-001
28305750	9EL 854 912-001	50453770	8GD 002 088-131			7.526.134.004.0	9EL 118 697-001
28306140	2ZR 003 014-091	50468122	2SW 003 014-131			7.526.319.000.0	2SK 003 567-331
28306400	8GH 002 473-151	50468123	8GM 002 092-241			7.526.319.004	9EL 122 772-001
28306430	8RA 002 014-081	510026218	8GS 002 296-101			7.526.325.000.0	2XL 004 762-001
28306510	2DA 003 014-031	51004920	4AZ 003 787-021			7.526.325.000.0	2XL 004 762-001
28306510	2DA 003 014-037	51006218	8GS 002 296-101			7.526.325.004.0	9EL 136 833-001
28306630	8GM 002 092-241	51016318	2SD 343 130-397			7.526.325.012.0	2SE 004 623-001
28306740	8HG 003 799-001	51016328	2SD 343 130-227			7.526.325.012.0	2SE 004 623-007
28306740	8HG 003 799-007	51017428	1GA 996 361-421			7.526.325.204.0	9EL 129 519-001
28306750	1TA 003 570-101	51017429	1GA 996 361-431			7.526.326.000.0	2SW 964 169-081
28306760	2SA 003 057-021	51026926	2RL 006 846-001			7.526.326.000.0	2SW 964 169-087
421-440051419	2BA 003 014-111	51061360	1GO 996 176-021			7.526.327.000.0	2NE 964 169-021
440050164	2SB 003 014-151	51079581	2BA 002 652-111			7.526.327.000.0	2NE 964 169-027
440054642	8RA 002 014-031	51079581	2BA 002 652-117			7.526.328.000.0	2SD 964 169-111
440054642	8RA 002 014-032	51079584	2BA 002 652-121			7.526.328.000.0	2SD 964 169-117
440056314	2KA 001 389-101	51079584	2BA 002 652-127			7.526.329.000.0	2SA 964 169-091
440072055	2SD 001 305-021	5108516	1GM 996 135-001			7.526.329.000.0	2SA 964 169-097
440073217	2ZR 003 014-091	51094600	2PT 009 599-011			7.526.332.000.0	2BE 343 130-777
440074545	4AZ 003 787-001	51094601	2PT 009 599-021			7.526.333.000.0	2BE 343 130-787
440075253	8GH 002 090-133	51097232	8GH 002 089-361			7.526.336.000.0	2SA 001 259-751
440075509	8GM 002 091-241	51111521	2PT 965 039-171			7.526.336.000.0	2SA 001 259-757
440075513	4AZ 003 787-021	51111521	2PT 965 039-177			7.526.336.004.0	9EL 135 266-001
44057072	2DA 003 014-031	51113392	4DM 009 492-001			7.534.101.000.0	2PF 001 648-171
44057072	2DA 003 014-037	51114681	2ZR 003 014-091			7.534.114.017	9GD 082 716-001
449090012	8GM 002 092-121	51116444	2RL 008 060-111			7 534 116 000	2PF 001 650-001
449090042	8GP 002 067-121	05112186	2SD 001 679-001			7 534 116 004	9EL 084 110-001
449090067	8GP 002 067-241	52021959	2JA 006 447-041			7 534 118 000	2PS 002 727-001
449090074	8GA 002 083-251	52030617	2AB 004 532-031			7 534 118 000	2PS 002 727-007
449090076	8GP 002 095-121	52030665	8GP 002 067-241			7 534 118 000	2PS 004 361-001
449090084	8GM 002 091-121	083.0029	2KA 001 386-281			7 534 118 000	2PS 004 361-007
449090087	8GA 002 073-121	0830071	8GA 002 074-121			7.534.128.000.0	2PF 001 259-631
449090088	8GA 002 073-241	0830141	8GP 002 067-121			7 534 134 000	2XS 005 020-001
4565385	8GH 002 089-251	083.0159	8GM 002 091-241			7 534 134 000	2XS 005 020-002
4565385	8GH 002 089-253	083.0471	8GP 002 066-241			7 534 134 000	2XS 005 020-003
04991783	8RA 002 014-081	0830494	8GA 002 071-251			7.534.135.000.0	2SA 001 240-331
50011267	2SE 002 578-701	0830495	2SD 003 184-031			7 534 138 000	2SA 001 634-121
50011267	2SE 002 578-707	0830495	2SD 003 184-037			7.534.140.000.0	2PG 003 057-011
50011268	2ZR 003 030-171	0830496	2SD 003 184-041			7.534.153.000.0	2ZR 003 236-051
50011360	8GA 002 071-251	0830496	2SD 003 184-047			7.534.153.000.0	2ZR 003 236-057
50012742	8GA 002 074-241					7.534.160.000.0	2XS 005 020-011
50015918	2SE 004 623-001					7.534.160.000.0	2XS 005 020-017
50015918	2SE 004 623-007					7.534.191.000.0	2PS 006 717-051
50035528	2SB 003 014-151					7.534.191.000.0	2PS 006 717-057
50035531	8GA 002 073-121					7.534.204.000.0	2PS 964 295-051
50035540	8GP 002 095-121					7.534.204.000.0	2PS 964 295-057
50035558	2SD 003 182-051					7.534.205.000.0	2PT 965 039-171
50035558	2SD 003 182-057					7.534.205.000.0	2PT 965 039-177
50035559	2SD 003 182-061					7.542.110.000.0	2DA 001 240-341
50035559	2SD 003 182-067					7.544.111.000.0	2KA 003 389-001
50037209	2BA 001 277-021					7.544.120.000.0	2KA 004 331-061
50038755	8GA 002 071-131					7.544.120.000.0	2KA 004 331-067
50042037	8GH 002 089-251					7.544.305.000.0	2KA 001 378-001
50042037	8GH 002 089-253					7.544.306.000.0	2KA 998 523-001
50051471	1GA 007 506-001					7.544.306.000.0	2KA 998 523-007
50051822	8GD 002 078-241					7.551.060.000.0	2JA 003 231-001
50051823	8GD 002 088-251					7.551.063.000.0	2JA 006 487-261
50052657	8JB 004 777-001					7.552.015.000.0	2JA 003 232-001
50052657	8JB 004 777-002					7.552.015.000.0	2JA 003 232-011
50052710	2BE 003 014-251					7.552.028.000.0	2JA 996 038-001
50052710	2BE 003 014-257					7.552.036.000.0	2JA 006 447-251
50052710	2SA 003 014-051					7.552.038.000.0	2JA 001 357-002
50058125	1G3 996 001-131					7.571.300.000.0	1GB 996 080-011
50142522	8RA 002 014-831					7.581.174.000.0	8GA 006 841-241
50142522	8RA 002 014-832					7.581.175.000.0	8GP 003 594-121
50150570	2XW 003 146-001					7.581.178.000.0	8GH 007 157-241
50152223	1TA 003 570-001					7.582.010.000.0	8GS 007 949-101



Manufacturer's no. / Hella no.

Cross-Reference

Kässbohrer	Hella	Kramer	Hella	Kramer	Hella	Krone	Hella
8.689.018.000	8RA 002 016-121	0003326115	2VB 006 040-051	56465	8HG 002 365-001	5800809/0	9GP 003 995-801
8.689.025.000.0	8RA 002 010-011	0004330068	2XW 007 146-001	56473	2KA 001 386-281	5801411/0	2KA 001 378-001
8.689.032.000	8RA 002 020-001	000 443 00 68	2XW 003 146-001	56474	9EL 118 700-001	5801411/0	2KA 001 378-001
8.689.032.000	8RA 002 020-002	56013	2AA 001 200-011	56479	2TJ 003 168-151	5801434	2SL 003 567-311
8.689.032.000	8RA 002 020-003	56013	2AA 001 200-012	56481	8HG 006 294-021	5801434/0	2SL 003 567-311
8.689.040.000	8RA 002 014-051	56014	2AA 001 200-141	56482	1NE 002 537-301	5802071	2SD 001 685-211
8.689.040.000	8RA 002 014-052	56017	2AA 003 257-001	56486	9EL 856 416-001	5802071	2SD 001 685-218
8.933.741.011	2BA 001 275-021	56019	2AA 003 257-021	56497	2VA 006 040-071	5802071/0	2SD 001 685-211
8.933.741.015.0	2BM 004 965-801	56020	2AA 003 257-031	56497	2VA 006 040-077	5802071/0	2SD 001 685-218
8.933.741.100	2JA 001 335-011	56038	2PG 003 748-151	56499	9EL 136 819-031	5802072/0	2KA 001 386-281
8.933.741.104	2PS 006 717-031	56040	2KA 001 389-101	56508	8HG 006 294-011	5803616/0	2PS 004 361-001
8.933.741.104	2PS 006 717-032	56041	2KA 001 388-021	56511	8GP 003 594-121	5803616/0	2PS 004 361-007
8.933.741.104	2PS 006 717-037	56042	2KA 003 389-061	56513	1GA 005 060-001	5803625/0	2PF 001 259-631
8.933.741.204	2SK 003 567-651	56042	2KA 003 389-062	56513	1GA 006 876-001	5803642/0	2SE 001 685-201
8.933.741.204	2SK 003 567-661	56042	2KA 003 389-068	56514	2JA 005 590-001	5804155/0	1G4 003 470-031
98 354 006	2ZR 002 589-011	56047	2NE 003 236-001	56516	9GD 858 086-001	5805106/1	2RL 008 060-111
		56047	2NE 003 236-008	56518	1GA 006 875-001	5805461/0	2KA 003 389-001
		56052	2TJ 001 633-211	56560	2PF 001 259-631	5806987/0	1GA 005 060-001
		56054	2PF 001 647-031	56591	9EL 136 825-011	5806987/0	1GB 006 213-111
		56054	2PF 001 647-037	58141	2XS 955 260-001	5806987/0	1GB 006 213-117
		56067	2SD 001 679-001	58141	2XS 955 260-007	5806987/1	1GB 996 102-101
		56069	2SD 001 680-281	58454	1GA 006 876-001	5807524/0	2PF 001 259-677
		56072	2SD 001 693-011	58458	2PS 003 748-121	5808491/0	2SK 005 883-011
		56075	2SD 002 582-011	58458	2PS 003 748-127	5808492/0	2SK 005 883-021
		56076	2SD 002 582-017	063 332 02 40	8HG 006 294-021	5808673/0	2PS 006 717-031
		56076	2SD 002 582-021	000 992 43 04	9KS 075 307-001	5808673/0	2PS 006 717-032
		56076	2SD 002 582-027			5808673/0	2PS 006 717-037
		56077	2SD 003 167-011	Kreidler	Hella	5809357/0	8RA 003 326-001
		56078	2SD 003 167-021	58 50 49 3	8JA 001 909-001	5809357/0	8RA 003 326-002
		56080	2ZR 005 200-051			5809598/0	1NE 006 300-051
		56081	2SE 001 679-051	Krone	Hella	5809608/0	2PG 003 057-011
		56087	2SE 002 578-701	110033	9AG 017 970-001	5809949	2JA 001 330-001
		56087	2SE 002 578-707	110034	9ES 015 675-001	5809949	2JA 001 330-007
		56090	2SE 003 167-031	110036	2PF 001 648-161	5810252/0	2PG 004 361-011
		56091	2SK 003 567-321	14405006	8GM 002 092-241	5810252/0	2PG 004 361-017
		56092	2SK 003 567-331	14405007	2SD 001 693-011	5810617/0	8HG 006 294-021
		56093	2SL 003 567-311	14405015	8GA 002 071-241	5810631/0	2PS 962 964-012
		56095	2TF 001 259-761	200807590	9EL 115 003-011	5810631/0	2PS 962 964-018
		56096	2XS 005 020-001	200807600	9EL 115 003-035	5810631/0	9GD 963 281-001
		56096	2XS 005 020-002	200807620	9EL 122 772-001	5811455/0	2SA 006 717-001
		56096	2XS 005 020-003	200807630	9EL 859 020-001	5811455/0	2SA 006 717-007
		56097	2XS 005 020-011	200807640	9EL 950 315-031	5811907/0	2PG 003 748-151
		56097	2XS 005 020-017	200807650	9EL 950 315-061	5811908/0	2PS 003 748-121
		56098	2XS 005 020-021	200807660	8GH 002 089-133	5811908/0	2PS 003 748-127
		56100	2XS 003 168-071	200808100	9EL 859 020-101	5811909/0	2PS 003 748-161
		56103	2XS 950 071-031	270000940	8RA 003 326-001	5811909/0	2PS 003 748-167
		56104	2XS 955 031-001	270000940	8RA 003 326-002	5811910/0	2KA 003 389-211
		56112	2ZR 003 236-051	0301853/0	2SB 001 259-261	5811910/0	2KA 003 389-217
		56112	2ZR 003 236-057	0301854/0	8GM 002 091-131	5812980/0	2PS 003 748-177
		56115	2PS 006 717-031	0301854/0	8GM 002 091-131	5814052/0	2XS 008 078-001
		56115	2PS 006 717-032	0302217/0	4RA 003 510-081	5814052/0	2XS 008 078-007
		56115	2PS 006 717-037	0302534/0	2SK 003 567-331	5814082/0	1GA 006 876-001
		56118	2PF 006 679-007	0302535/0	2SK 003 567-321	5814098/0	2VP 007 907-031
		56188	8JA 001 925-001	0302642/0	8HG 006 294-021	5814098/0	2VP 007 907-037
		56201	2SA 006 717-001	0302657/0	8KW 701 235-033	5814099/0	2VP 007 907-041
		56201	2SA 006 717-007	0302658/0	9GP 003 995-801	5814099/0	2VP 007 907-047
		56249	8KW 701 235-033	0302677/0	2SW 003 014-131	5814248/0	2PS 008 382-001
		56263	8RA 003 326-001	0302680/0	2TM 003 057-031	5814248/0	2PS 008 382-007
		56263	8RA 003 326-002	0302702/0	2KA 001 386-281	5814249/0	9EL 154 637-001
		56266	8RL 002 009-021	0302921/0	2SB 003 014-151	5814415/0	2PG 008 434-001
		56273	9BG 101 230-001	0303601/0	8GP 938 026-001	5815081/0	1ND 005 700-061
		56297	9EL 109 139-001	0303858/0	8GP 938 026-001	5815338/0	2VP 340 400-151
		56305	9EL 112 741-001	0303864/0	8GP 003 594-121	5815338/0	2VP 340 400-157
		56310	9EL 113 324-001	4501.7054	2PG 008 645-041	5815339/0	2VP 340 400-147
		56313	9EL 118 445-001	4501.7054	2PG 008 645-047	5815339/0	2VP 340 400-147
		56314	9EL 118 701-001	5327089/0	2SD 001 685-232	5815436/0	1GA 007 506-001
		56316	2BM 006 692-011	5327094/0	2NE 003 236-008	5816277/0	9GD 157 876-007
		56316	2BM 006 692-017	5327094/0	2ZR 003 236-051	5816704/0	8RA 003 326-011
		56316	9EL 122 772-001	5327095/0	2ZR 003 236-057	5816704/0	8RA 003 326-017
		56317	2BM 006 692-021	5327095/0	2KA 998 523-007	5819070/0	2VP 340 931-111
		56317	2BM 006 692-027	5327096/0	2SD 001 685-232	5819071/0	2VP 340 931-110
		56319	9EL 950 315-001	5327282/0	2SD 001 685-232	5819086/0	2PS 008 645-311
		56320	9EL 950 315-031	5327283/0	2KA 998 523-001	5819087/0	2PG 008 645-331
		56338	2KA 001 386-231	5327284/0	2KA 998 523-007	5820316/0	2PS 008 645-377
		56354	9EL 101 353-001	5327284/0	2SD 001 685-232	5821789/0	2KA 959 640-661
		56361	2SD 001 685-231	5327355/0	2VB 004 887-011	5821814/0	2XS 340 418-091
		56361	2SD 001 685-232	5336608/0	2SD 001 685-231	5821815/0	2XS 340 418-081
		56362	2AA 001 200-031	5336610/0	2SD 001 685-232	5821816/0	2XS 340 447-061
		56362	2AA 001 200-032	5336610/0	2XS 008 078-007	5821817/0	2XS 340 447-071
		56366	2ZR 002 694-001	5357550/0	2XS 008 078-007	5870268/0	9EL 340 208-001
		56366	2ZR 002 694-002	5357551-0	2XS 008 078-007	6000000/0	9EL 340 208-001
		56369	8RA 002 020-001	5358168/0	2VP 340 450-037	6200749/0	8RA 002 014-091
		56369	8RA 002 020-002	5358169/0	2VP 340 450-027	6200891/0	9EL 131 420-011
		56369	8RA 002 020-003	5358170/0	2VP 340 450-031	6200892/0	9EL 131 420-001
		56401	2KA 003 389-001	5358170/0	2VP 340 450-037	6200894/0	9EL 119 544-001
		56402	9EL 119 544-111	5358171/0	2VP 340 450-021	0924502/0	2XS 005 020-011
		56428	2AA 001 204-001	5358171/0	2VP 340 450-027	0924502/0	2XS 005 020-017
		56429	2AA 001 204-011	5385170/0	2VP 340 450-031	0924522/0	2ZR 001 423-001
		56430	9EL 150 965-001	5385171/0	2VP 340 450-037	0924533/0	8RA 002 010-011
		56431	9EL 150 966-001	5385171/0	2VP 340 450-021	0924533/0	8RA 002 010-011
		56437	9ES 106 588-001	5800123	2VP 340 450-027	0924578/0	8HG 002 365-001
		56450	2TM 003 748-011	5800123	2SE 001 685-221	0924580/0	8JB 001 933-001
		56454	2PS 004 361-001	5800123	2SE 001 685-227	0924581/0	8JA 001 925-001
		56454	2PS 004 361-007	5800123/0	2SE 001 685-221	0924603/0	2SE 003 167-031
		56464	9GP 003 995-801	5800123/0	2SE 001 685-227	0924635/0	1GA 007 506-001

Manufacturer's no. / Hella no.

Cross-Reference



Krone	Hella	Lada	Hella	Liebherr	Hella	Liebherr	Hella
0924635/0	1GA 007 506-011	2900-545-1	2KA 001 378-127	1 001 442 0	2SD 964 169-111	1 095 31	1TA 003 570-101
0924635/1	1GA 007 506-001	00 004 943 105 500	2KA 005 049-008	1 001 442 0	2SD 964 169-117	1 259 651	2PS 003 057-051
0924636/0	2BE 003 347-001	9402-71	2DA 007 428-001	1 001 442 3	1GA 007 506-011	1 259 651	2PS 003 057-052
0924636/1	2BE 003 347-001	9402-71	2DA 007 428-007	1 001 509 6	1GA 998 525-001	1 259 651	2PS 003 057-057
0924638/0	2RL 006 846-001			1 001 510 5	9GH 993 984-001	4 015 987 09013	9XR 854 840-001
0924639/0	2KA 001 386-231	Land Rover	Hella	1 001 518 9	8HG 006 294-011	4 050 650	2AB 004 532-031
0924639/0	2KA 998 523-001	LR001559	1LF 354 025-121	1 001 550 2	9GH 990 316-031	4 530 00	9EL 146 491-001
0924639/0	2KA 998 523-007	LR001563	1LL 354 025-081	1 001 775 3	8JD 156 151-807	0 456 104 2	1G3 005 760-221
0924669/0	2KA 003 389-061	LR001568	1LL 354 025-041	1 001 892 5	1G4 003 470-001	0 456 104 2	1G3 005 760-227
0924669/0	2KA 003 389-062	LR001572	1LF 354 025-111	1 001 913 2	2ZR 964 169-351	5 701 898 08	9EL 122 772-001
0924669/0	2KA 003 389-068	LR001576	1LL 354 025-071	1 001 913 3	2NE 964 169-341	5 701 899 08	9EL 122 772-051
0924672/0	2SK 003 567-331	LR001579	1LL 354 025-031	1 001 916 3	1GA 998 525-011	5 704 507 08	9EL 856 416-001
0924673/0	2SK 003 567-321	STC4286	8JB 001 943-001	1 002 051 4	1GA 996 142-311	5 704 507 77	9EL 856 416-001
0924688/0	8GH 002 090-133	XFB500020	2SK 354 035-021	1 002 119 6	2RL 008 183-111	5 706 012 08	9EL 857 801-001
0924690/0	8GA 002 073-241	XFB500030	2SK 354 035-011	1 002 214 2	1K0 008 191-021	5 710 680 08	9MN 858 616-011
0924691/0	8GA 002 071-251	XFF 1000070	8RA 342 014-157	1 002 214 2	1K0 008 191-027	5 710 680 77	9MN 858 616-011
0924692/0	8GA 002 071-131	XFF100071	8RA 342 014-157	1 002 214 6	8GH 007 157-241	5 711 167 08	9EL 119 544-001
0924693/0	8GA 002 073-121			1 002 214 6	2BA 008 221-001	5 714 139 77	9XR 854 840-001
0924709/0	8GM 002 092-121	Leart	Hella	1 002 214 6	2BA 008 221-007	5 714 381 08	9EL 950 315-031
0924710/0	9BG 993 345-001	34.500.800	9BG 147 498-002	1 002 225 5	8GA 006 841-241	5 714 381 77	9EL 950 315-031
0924714/0	8GJ 002 525-131	34.501.800	9BG 147 497-002	1 002 253 4	2BA 964 169-011	5 714 382 77	9EL 950 315-001
0924714/0	8GJ 002 525-133	34.506.800	1PE 965 410-121	1 002 253 4	2BA 964 169-017	5 716 571 08	9EL 859 020-001
0924723/0	8HG 006 294-051	37.108.028	2VP 008 204-181	1 002 253 5	2TA 964 169-061	5 717 426 08	9EL 146 838-001
0924742/0	2XL 005 194-021	37.109.000	2VP 008 204-181	1 002 253 5	2TA 964 169-067	5 799 507 08	9EL 859 020-101
0924743/0	2XL 005 194-011	37.111.000	2VD 008 204-191	1 002 516 2	2RL 008 181-111	5 799 676 08	9EL 859 020-101
0924744	1GB 006 213-101	37.170.000	2SK 008 208-061	1 002 935 1	9EL 859 020-101	5 799 943 08	9GD 113 431-005
0924744/0	1GB 006 213-107	37.170.135	2SK 008 208-061	1 003 248 1	8JD 156 150-807	6 000 116	2RL 006 846-011
0924744/0	1GB 006 213-101	37.171.000	2SK 008 208-051	1 003 525 1	2XS 007 841-011	6 000 117	8GM 002 091-131
0924745/0	1GB 006 213-107	37.171.135	2SK 008 208-051	1 003 525 1	2XS 007 841-017	6 000 167	8GM 002 091-251
0924745/0	1GB 006 213-111	37.414.000	2SD 001 685-211	1 003 576 8	2PF 959 590-401	6 000 312	1G8 002 340-001
0924745/0	1GB 006 213-117	37.415.000	2SE 001 685-201	1 003 576 8	2PF 959 590-407	6 000 316	8KW 701 235-033
0924746/0	1AB 007 145-001	37.420.000	2SD 003 167-011	1 003 576 8	2PF 959 590-411	6 000 322	2JA 003 231-001
0924748/0	1G3 005 760-021	37.420.026	2SD 003 167-021	1 003 576 8	2PF 959 590-417	6 000 332	2JA 003 231-001
0924749/0	2RL 006 846-101	37.420.026	9EL 118 445-001	1 003 694 5	8RA 002 023-001	6 000 766	2XW 003 146-001
0924766/0	8GH 002 473-151	37.421.000	2SE 003 167-031	1 003 812 3	1GM 996 134-081	6 000 766	2XW 007 146-001
9247670	8GH 008 357-001	37.421.000	2SE 003 167-041	1 004 031 3	9GH 993 988-007	6 000 776	1G4 003 470-051
0924788/0	8HG 006 294-031	37.440.000	2VP 003 567-121	1 004 074 1	2SD 964 169-111	6 000 780	2XS 005 020-011
0924789/0	8HG 006 294-041	37.443.000	2VP 003 567-111	1 004 074 1	2SD 964 169-117	6 000 780	2XS 005 020-017
9305004	2SD 001 699-061	37.446.128	2VP 354 037-021	1 004 074 3	2ZR 964 169-031	6 000 804	1GA 005 060-001
9305220	8GM 002 092-121	37.447.128	2VP 354 037-011	1 004 074 3	2ZR 964 169-037	6 000 804	1GA 998 522-011
0942729/0	8RA 003 326-011	37.476.000	9EL 270 198-011	1 004 074 7	2XS 005 020-077	6 000 865	8GH 002 089-133
0942729/0	8RA 003 326-011	37.477.000	9EL 270 197-011	1 004 189 1	8GS 859 634-001	6 000 907	8RL 002 009-021
944 005	2TJ 001 633-211	37.502.000	2VP 008 204-061	1 004 320 9	2PS 963 639-137	6 001 131	2XS 005 020-001
0944005/0	2TJ 001 633-211	37.503.000	2VP 008 204-061	1 004 321 0	2BA 996 027-001	6 001 131	2XS 005 020-002
0944006/0	2SA 001 634-121	37.505.000	2VD 008 204-071	1 004 383 6	1ND 003 590-401	6 001 131	2XS 005 020-003
0944008/0	2TF 001 259-761	37.516.000	2VP 008 204-161	1 004 461 3	8GH 007 157-121	6 001 131 08	2XS 005 020-001
0944009/0	2BA 001 259-611	37.516.028	9EL 152 889-001	1 009 749 9	8GD 002 078-121	6 001 131 08	2XS 005 020-002
0944009/0	2BA 001 259-618	37.517.000	2VP 008 204-161	1 009 770 5	1GA 998 534-231	6 001 131 08	2XS 005 020-003
0944011/0	2XS 005 020-021	37.519.000	2VD 008 204-171	1 009 770 5	1GA 998 534-271	6 001 152	2BM 001 318-001
0944012/0	2XS 950 071-031	37.526.000	2VP 008 204-101	1 009 773 1	2SD 997 131-051	6 001 202	1G3 005 760-001
0944013/0	2NE 003 236-001	37.526.028	9EL 152 891-001	1 011 284 2	2RL 008 063-111	6 001 202	1G3 005 760-201
0944013/0	2NE 003 236-008	37.529.000	2VD 008 204-111	1 021 893 1	8GH 002 857-241	6 001 202	1G3 005 760-207
0944014/0	2ZR 004 542-001	37.534.000	2VP 008 204-081	1 022 057 8	2PF 008 221-011	6 001 424	2BA 003 014-111
0944015/0	2ZR 003 236-051	37.537.000	2VD 008 204-091	1 022 057 8	2PF 008 221-017	6 001 424	2BA 996 012-061
0944015/0	2ZR 003 236-057	37.570.000	2VD 008 204-141	1 022 427 2	9XD 990 298-001	6 001 499	2BE 003 014-251
0944016/0	2SE 001 699-071	37.571.000	2VD 008 204-151	1 028 519 4	8HG 006 294-031	6 001 499	2BE 003 014-257
0944017/0	2SD 001 699-511	37.590.000	2VP 008 205-031	1 028 664 4	1GA 998 525-001	6 001 539	2NE 001 423-011
0944018/0	2SD 001 699-061	37.591.000	2VP 008 205-041	1 028 886 0	5DV 008 856-001	6 001 546	1GB 006 213-101
0944019/0	2SD 001 693-011	37.592.000	2VD 008 205-041	1 028 886 0	5DV 008 856-007	6 001 546	1GB 006 213-107
0944039/0	9GT 005 166-001	37.593.000	2VD 008 205-051	1 029 199 6	1GA 996 161-131	6 001 670	2SB 003 014-151
0944040/0	9GT 074 132-001	37.600.028	9EL 152 884-001	1 029 335 5	1K0 008 191-041	6 001 722	8HG 006 294-051
0944046/0	8HG 002 240-001	37.602.000	2VD 008 205-021	1 029 335 5	1K0 008 191-047	6 001 963	8JB 004 777-001
0944047/0	8HG 002 240-011	37.603.000	2VD 008 205-011	1 029 721 4	1GA 996 161-581	6 001 963	8JB 004 777-002
0944062/0	8GM 002 092-241	37.798.000	2VP 008 789-021	1 029 727 8	2RL 007 017-061	6 002 161	8JA 001 909-001
0944065/0	8GP 002 068-241	37.799.000	2VP 008 789-051	1 029 727 9	8HG 005 436-011	6 003 035	2SA 003 057-021
0944067/0	8GH 002 090-251	37.801.000	2VD 008 789-011	1 030 071 4	1GA 007 506-651	6 003 073	8JB 004 777-001
0944067/0	8GH 002 090-253	37.802.000	2VP 008 789-041	1 030 136 4	8GA 006 841-121	6 003 073	8JB 004 777-002
0944068/0	8GH 002 090-133	37.803.000	2VP 008 789-071	1 030 311 5	2BA 344 169-027	6 003 252	9EL 120 240-011
0944069/0	8GA 002 071-121	38.440.000	2SK 003 567-321	1 030 311 6	2TA 964 169-257	6 003 311	8JA 001 915-001
0944074/0	8GA 002 071-241	38.441.000	2SL 003 567-311	1 033 046 1	1GA 998 534-541	6 004 186	1AB 007 145-001
0944090/0	9EL 109 208-011	38.443.000	2SK 003 567-331	1 033 079 0	9GD 102 484-001	6 004 187	2BA 003 014-111
0944095/0	9EL 122 689-021	Leyland DAF	Hella	1 033 080 7	2VP 006 040-397	6 004 350	8RA 004 412-021
0944095/0	9EL 122 772-051	1293370	1LG 007 660-031	1 033 080 8	2VP 006 040-407	6 004 448	2ZR 964 169-031
0944096/0	9EL 147 747-001	1293371	1LG 007 660-041	1 033 150 4	8GS 009 028-001	6 004 448	2ZR 964 169-037
0944096/0	9EL 147 747-007	1299751	1F8 006 800-191	1 033 571 9	2JA 007 372-051	6 004 449	2SB 964 169-301
0944100/0	9EL 950 315-001	1301368	2BA 005 481-011	1 035 205 2	2XD 009 386-021	6 004 449	2SB 964 169-307
0944101/0	9EL 950 315-031	1318143	9ES 147 313-011	1 035 205 2	2XD 009 386-421	6 004 450	2BE 964 169-071
0944104/0	8RA 003 326-031	1318145	9ES 147 314-011	1 035 633 7	1GA 007 506-091	6 004 450	2BE 964 169-077
0944105/0	8RA 003 326-041	1328860	9BG 147 497-002	1 041 154 8	8HG 003 799-001	6 004 451	2XS 950 071-031
0944105/0	8RA 003 326-047	1328861	9BG 147 498-002	1 041 154 8	8HG 003 799-007	6 004 452	2PS 008 382-811
0944106/0	8RA 003 326-051	1444658	8RA 003 326-011	1 041 233 9	2RL 007 017-071	6 004 452	2PS 008 382-817
0944107/0	8RA 002 014-041	1444658	8RA 003 326-017	1 042 447 1	8HG 006 2		



Manufacturer's no. / Hella no. Cross-Reference

Liebherr	Hella	Liebherr	Hella	Liebherr	Hella	Liebherr	Hella
6 050 059 08	8JA 001 909-011	6 071 137 08	2BE 002 582-031	6 071 374 77	2XS 950 071-031	6 071 496 08	2BM 008 355-007
6 050 059 14	8JA 001 909-001	6 071 141	2SB 001 240-011	6 071 381 01	2PS 006 717-031	6 071 497 08	2TM 003 057-031
6 050 083	8JA 001 925-001	6 071 142 08	1G4 003 470-051	6 071 381 01	2PS 006 717-032	6 071 498 08	2BA 003 236-177
6 050 083 14	8JA 001 925-001	6 071 143	2RL 006 846-011	6 071 381 01	2PS 006 717-037	6 071 499 08	2BE 964 169-071
6 052 030 08	8JB 001 933-031	6 071 143 08	2RL 006 846-011	6 071 383 01	2SB 003 014-151	6 071 499 08	2BE 964 169-077
6 052 039 08	8JB 004 777-001	6 071 154 08	1G8 002 340-011	6 071 384 01	2PG 006 717-021	6 071 500 08	2XL 004 762-001
6 052 039 08	8JB 004 777-002	6 071 154 14	1G8 002 340-011	6 071 384 01	2PG 006 717-022	6 071 502 08	2XD 007 854-811
6 056 239 01	8KW 701 235-033	6 071 165 05	2PS 006 717-067	6 071 384 01	2PG 006 717-027	6 071 502 08	2XD 008 135-811
6 070 033 08	8GP 003 594-251	6 071 165 05	2PS 006 717-067	6 071 387 01	2ZR 003 014-091	6 071 503 08	1GA 007 506-111
6 070 045	8GD 002 084-131	6 071 198 01	2RL 006 846-011	6 071 388 01	2SD 002 582-011	6 071 505 08	1GA 006 991-021
6 070 047	8GM 002 091-121	6 071 202	8RA 002 016-111	6 071 388 01	2SD 002 582-017	6 071 506 08	2VD 007 323-141
6 070 062 05	2AA 001 200-141	6 071 213 08	2XS 003 168-081	6 071 389 01	2SD 002 582-011	6 071 507 08	2VD 007 323-131
6 070 140	8GP 002 068-121	6 071 237 08	2BA 003 014-011	6 071 389 01	2SD 002 582-017	6 071 508 08	2VP 007 323-121
6 070 141	8GP 002 067-121	6 071 238	2NE 003 236-001	6 071 389 01	2SD 002 582-021	6 071 509 08	1GA 007 506-081
6 070 142	8GA 002 071-121	6 071 238	2NE 003 236-008	6 071 389 01	2SD 002 582-027	6 071 511 08	1GA 007 506-121
6 070 146	8GD 002 088-131	6 071 239 08	1NE 006 300-011	6 071 389 08	2RL 006 846-011	6 071 512 08	1GA 996 142-141
6 070 196 01	2JA 007 372-011	6 071 243 08	2BA 001 227-201	607139108	2XS 005 020-001	6 071 513 08	1GA 996 142-151
6 070 203 08	8GP 002 067-241	6 071 251 08	1FE 002 537-191	607139108	2XS 005 020-002	6 071 578 14	2SA 961 167-011
6 070 206 08	8GA 002 072-241	6 071 251 08	1FE 006 300-001	607139108	2XS 005 020-003	6 071 580 14	1GB 996 080-001
6 070 214 08	8GA 002 071-241	6 071 252 01	2XS 950 071-031	607139208	1G3 005 760-011	6 071 600 01	2SL 003 567-311
6 070 216 08	8GP 002 066-241	6 071 257 14	2KA 003 389-001	607139301	2SK 003 567-331	6 071 605 01	2SA 006 717-001
6 070 216 14	8GP 002 066-241	6 071 262 01	8RA 002 014-051	607139401	2SK 003 567-321	6 071 605 01	2SA 006 717-007
6 070 217 14	8GA 002 073-241	6 071 262 01	8RA 002 014-052	607139408	2XS 005 020-121	6 071 610 01	2XS 955 260-001
6 070 220	8GM 002 092-121	6 071 263 01	8RA 002 023-021	607139601	2SD 006 040-031	6 071 610 01	2XS 955 260-007
6 070 222 08	8GP 002 068-121	6 071 266 01	8RA 003 326-011	607139601	2SD 006 040-037	607200908	8HG 002 240-021
6 070 232 08	8GA 002 071-251	6 071 266 01	8RA 003 326-017	6 071 397 01	2SE 002 578-701	6 072 009 14	8HG 002 240-021
6 070 234	8GJ 002 525-251	6 071 267 08	2SA 003 014-051	6 071 397 01	2SE 002 578-707	6072010	8HG 002 240-001
6 070 234	8GJ 002 525-253	6 071 269 08	2PS 003 057-051	607139708	2DA 003 014-031	6 072 012 08	8HG 002 365-001
6 070 234 08	8GJ 002 525-251	6 071 269 08	2PS 003 057-052	607139708	2DA 003 014-037	6 072 012 08	8HG 006 294-101
6 070 234 08	8GJ 002 525-253	6 071 269 08	2PS 003 057-057	607139801	2SD 006 040-161	6 072 012 14	8HG 002 365-001
6 070 237 08	8GH 002 089-251	6 071 269 14	2PS 003 057-051	607139801	2SD 006 040-167	607203508	9EL 092 435-011
6 070 237 08	8GH 002 089-253	6 071 269 14	2PS 003 057-052	6 071 401 08	2VD 005 300-551	607203814	9EL 110 736-001
6 070 240 14	8GH 002 089-133	6 071 269 14	2PS 003 057-057	607140408	2PF 003 389-037	607204208	9EL 110 910-001
6 071 000	2BA 001 227-201	6 071 279 01	2XS 950 071-031	6 071 405 08	1LH 002 658-511	6 072 055 14	9XS 027 639-001
6 071 010 08	2AA 001 200-131	6 071 283 01	2KA 001 386-281	6 071 406 08	1LH 002 658-521	607206008	9EL 110 918-001
6 071 011 08	2AA 001 200-141	6 071 292 08	2BM 002 652-031	6 071 408 08	2VD 005 300-581	6 072 060 14	9EL 110 918-001
6 071 040	2XM 004 444-011	6 071 293	2ZR 003 236-051	607140908	2XS 003 168-071	607206108	9EL 110 918-011
6 071 040 08	2XM 004 444-011	6 071 293	2ZR 003 236-057	607141708	2SA 006 679-027	6 072 061 14	9EL 110 918-011
6 071 043	2PF 001 648-161	6 071 295 08	2SA 003 236-041	607141908	1G9 001 523-021	607206408	9EL 112 744-001
6 071 043 08	2PF 001 648-161	6 071 295 08	2SA 003 236-047	6 071 420 01	2SD 002 582-011	6072078	9DR 060 567-001
6 071 043 77	2PF 001 648-161	6 071 295 08	2SA 003 236-048	6 071 420 01	2SD 002 582-017	6 072 104 08	9EL 112 858-011
6 071 058 08	2SD 001 688-141	6 071 296 08	2SA 003 236-041	607142008	2ZR 003 014-091	6 072 105 08	9EL 147 747-001
6 071 059	2BA 001 259-611	6 071 296 08	2SA 003 236-047	6 071 421 01	2SD 002 582-021	6 072 105 08	9EL 147 747-007
6 071 059	2BA 001 259-618	6 071 296 08	2SA 003 236-048	6 071 421 01	2SD 002 582-027	6 072 111 08	9EL 852 061-001
6 071 060 8	2XW 003 146-001	6 071 297 08	2SA 001 259-751	6 071 425 08	1G3 005 760-021	6 072 112 08	9DX 852 902-001
6 071 062 08	2XW 003 146-001	6 071 297 08	2SA 001 259-757	6 071 427 08	2PS 006 717-031	607212108	9GD 102 484-001
6 071 062 08	2XW 007 146-001	6 071 298 08	2TM 003 057-031	6 071 427 08	2PS 006 717-032	607212608	9EL 115 003-035
6 071 065 01	2SD 001 685-211	6 071 300	2JA 001 330-001	6 071 427 08	2PS 006 717-037	6 072 135 01	8HG 006 294-011
6 071 065 01	2SD 001 685-218	6 071 300	2JA 001 330-007	6 071 439 08	1FE 006 300-001	6 072 138 008	9EL 119 544-111
6 071 066 01	2SE 001 685-201	6 071 300 08	2JA 001 330-001	6 071 441 08	2VD 007 323-031	6 072 138 08	9EL 119 544-111
6 071 069	8RA 003 503-001	6 071 300 08	2JA 001 330-007	6 071 442 08	2VP 007 323-021	6 072 164 08	9EL 096 532-001
6 071 069 01	8RA 002 010-011	6 071 305 08	1G8 002 340-001	6 071 443 08	8RA 002 016-111	6 072 166 08	8HG 002 240-011
6 071 076	2KA 003 168-021	6 071 306 08	2ZR 001 193-011	6 071 444 08	2RL 006 846-011	6 072 213 08	9ES 082 333-031
6 071 076 08	2KA 003 168-021	6 071 314 08	2SD 001 685-231	6 071 445 08	1GA 006 876-001	607221508	1G5 119 738-001
6 071 078	2KA 003 389-061	6 071 314 08	2SD 001 685-232	6 071 451 08	2VD 007 323-041	6 072 216 08	9GD 120 670-001
6 071 078	2KA 003 389-062	6 071 316	2XS 005 020-021	6 071 457 08	2RL 006 846-111	607221708	6ED 708 919-001
6 071 078	2KA 003 389-068	6 071 316 0	2XS 005 020-021	6 071 458 08	1DL 005 600-097	607221908	9EL 088 150-001
6 071 078 0	2KA 003 389-061	6 071 318 08	1G3 996 001-001	6 071 459 08	1DL 005 600-107	607225708	9GD 082 716-001
6 071 078 0	2KA 003 389-062	6 071 325 14	2AB 004 532-051	6 071 460 01	8RA 002 016-101	6 072 260 08	9EL 110 013-001
6 071 078 0	2KA 003 389-068	6 071 325 14	2AB 004 532-057	6 071 460 08	2BA 004 119-001	6 072 261 08	9EL 110 014-001
6 071 079 08	2AB 004 532-051	6 071 334 08	2SD 001 679-001	6 071 461 08	1G3 005 760-021	6 072 266 08	9EL 146 887-001
6 071 079 08	2AB 004 532-057	6 071 335	2PS 004 361-001	6 071 466 08	2VP 007 323-011	6 072 268 08	8HG 006 294-051
6 071 080	2PF 001 648-161	6 071 335	2PS 004 361-007	6 071 469 08	2PS 962 964-012	6 072 268 08	8HG 006 294-091
6 071 082 08	8RA 002 014-101	6 071 335 01	2PS 962 964-012	6 071 469 08	2PS 962 964-018	6 072 274 08	9GH 145 943-001
6 071 087	8RA 003 326-001	6 071 335 01	2PS 962 964-018	6 071 471 08	2BM 002 847-011	6 072 275 08	9GT 134 655-007
6 071 087	8RA 003 326-002	6 071 335 01	2PS 962 964-031	6 071 472 08	2BM 002 847-021	6 072 276 08	9GT 143 133-007
6 071 087 08	8RA 003 326-001	6 071 335 01	2PS 962 964-037	6 071 474 08	2PF 006 679-007	6 072 277 08	9GH 993 988-007
6 071 087 08	8RA 003 326-002	6 071 335 08	2PS 004 361-001	6 071 476 14	2KA 003 389-061	6 072 283 08	9GT 990 338-001
6 071 088 08	8RA 003 326-011	6 071 335 08	2PS 004 361-007	6 071 476 14	2KA 003 389-062	6 072 284 08	9GD 113 431-005
6 071 088 08	8RA 003 326-017	6 071 340 08	2SA 003 057-021	6 071 476 14	2KA 003 389-068	6 072 300 14	9EL 856 416-011
6 071 097 08	2NE 001 423-011	6 071 341 08	2PF 003 057-001	6071477	2TJ 001 633-211	614001208	3AG 003 399-101
6 071 111	2JA 001 330-031	6 071 341 08	2PF 003 057-002	607147714	2TJ 001 633-211	6 140 013 08	5AB 005 944-011
6 071 111 08	2JA 001 330-031	6071343	2BA 001 221-031	6071478	2PF 003 057-001	6 140 018 08	6ZE 001 759-051
6 071 111 77	2JA 001 330-031	6071344	2BA 001 221-041	6071478	2PF 003 057-002	614006701	2RL 008 064-001
6 071 113 08	2AA 001 200-031	607134608	2SK 003 567-321	6 071 478 08	2PF 961 167-021	6 140 461 14	3AG 003 399-101
6 071 113 08	2AA 001 200-032	607134708	2SK 003 567-331	6071483	2AB 004 532-051	6200003	8JB 001 933-031
6 071 122	2ZR 003 236-051	6071349	2PF 001 647-031	6071483	2AB 004 532-057	6200011	8GA 002 074-241
6 071 122	2ZR 003 236-057	6071349	2PF 001 647-037	6 071 483 14	2AB 004 532-051	6200014	8GM 002 091-241
6 071 122 08	2ZR 003 236-051	6 071 349 08	2PF 001 647-031	6 071 483 14	2AB 004 532-057	6200029	8GD 002 084-251
6 071 122 08	2ZR 003 236-057	6 071 349 08	2PF 001 647-037	6 071 484 08	2BE 004 119-021	6200618	2BA 002 652-101
6 071 123 08	2BA 002 324-011	6 071 349 77	2PF 001 647-031	6 071 484 14	2JA 007 372-011	6200618	2BA 002 652-107
6 071 123 14	2BA 002 324-011	6 071 349 77	2PF 001 647-037	6 071 485 08	1KL 007 834-027	6 200 655	8GH 002 090-133
6 071 124	2BA 002 324-021	6071351	2XS 005 020-011	6 071 486 08	1NL 007 834-017	6200821	1G8 002 340-011
6 071 124 08	2BA 002 324-021	6071351	2XS 005 020-017	6 071 487 08	1BL 007 834-007	6200860	2BA 0

Manufacturer's no. / Hella no.

Cross-Reference



Liebherr	Hella	Liebherr	Hella	MAN	Hella	MAN	Hella
6201459	2SD 001 699-061	9 605 207	8RA 003 326-001	81 25225 6097	2SE 001 680-291	36.25260-6013	2PS 964 295-001
6201940	2NE 003 315-011	9 605 207	8RA 003 326-002	81 25225 6182	2KA 003 389-081	36.25260-6013	2PS 964 295-007
6 202 683	1GA 006 875-001			81 25229 0035	9EL 110 737-001	36.25320.6000	2BA 008 221-001
6 203 044	1GA 996 082-001			81 25229 0036	9EL 110 736-001	36.25320.6000	2BA 008 221-007
6 203 865	2JA 007 372-011			81 25320 6058	2BA 003 022-021	36.25320.6001	2BA 008 221-041
6 204 593	3AG 003 399-101			88 25225 6012	2BA 001 221-031	36.25320.6001	2BA 008 221-047
6 204 631	8RA 003 734-101			88 25229 0005	9EL 110 013-001	36.25320.6002	2BM 008 355-001
6 204 631 03	8RA 003 734-101			1.25103.6008	2ZR 001 193-011	36.25320.6002	2BM 008 355-007
6 205 347	1GD 996 018-541			1.25103.6016	2ZR 002 589-011	36.25320-6004	2BE 004 119-021
6505033	2BA 002 652-121			1.25103.6036	2ZR 003 236-051	36.25320-6005	2BA 005 603-117
6505033	2BA 002 652-127			1.25103.6036	2ZR 003 236-057	36.25320.6006	2BM 008 355-017
6 905 001	2SD 004 623-028			1.25103.6039	2NE 003 236-001	36.25323.0000	8XU 008 405-031
6 905 028	2XS 005 020-011			1.25103.6039	2NE 003 236-008	36.25323.0000	8XU 008 405-037
6 905 028	2XS 005 020-017			1.25103.6041	2ZR 004 542-001	36.25323.0001	8RA 008 405-001
6 905 032	2BA 002 652-111			1.25110.6005	9EL 101 353-001	36.25323.0001	8RA 008 405-007
6 905 032	2BA 002 652-117			1.25225.6042	2SD 001 693-011	36.25402.6000	8KA 152 134-007
6 905 033	2BA 002 652-121			1.25225.6092	2SD 001 680-281	36.96001-0001	9GH 145 943-001
6 905 033	2BA 002 652-127			1.25225.6097	2SE 001 680-291	4.25103.6006	2BA 003 236-311
6905204	2SD 002 582-117			1.25225.6182	2KA 003 389-081	4.25225.6028	2ZR 003 236-321
6905205	2SD 002 582-127			1.25225.6409	9EM 128 229-001	45 01500	2PF 001 634-101
6 905 206	8RA 003 326-011			1.25225.6410	9EM 128 244-001	50.25225-6002	2SD 001 693-011
6 905 206	8RA 003 326-017			1.25225.6411	9EM 128 229-011	70.08350.6636	2KA 001 386-291
6 905 207	8RA 003 326-001			1.25225.6423	2ZR 001 240-351	74.00360.6651	2AB 001 208-001
6 905 207	8RA 003 326-002			1.25225.6424	2DA 001 240-341	07.92008-1295	8GP 008 285-001
6 905 284	2KA 998 523-001			1.25225.6425	2SA 001 240-331	07.92008-1805	8GS 007 439-101
6 905 284	2KA 998 523-007			1.25225.6426	2BA 001 240-301	81.25101.0019	8XT 002 121-001
6 905 324	8GA 002 073-121			1.25228.6002	9BG 121 587-031	81.25101.6024	1S3 001 117-041
6 905 325	8GA 002 071-131			1.25228.6002	9BG 121 587-037	81.25101.6121	1S5 003 178-431
6 905 351	2RL 006 846-001			1.25229.0035	9EL 110 737-001	81.25101.6192	1G5 119 738-001
6 905 359	2RL 006 846-001			1.25229.0036	9EL 110 736-001	81.25101.6225	1LG 003 434-237
6 905 359	2RL 006 846-011			1.25229.0622	9EL 114 401-031	81.25101.6264	1FE 005 478-021
6 905 508	2SA 997 027-001			1.25229.0623	9EL 114 401-041	81.25101.6265	1FE 005 478-011
6 905 621	2BE 003 014-251			1.25320.6049	2BA 002 324-011	81.25101-6447	1L8 003 060-561
6 905 621	2BE 003 014-257			1.25320.6050	2BA 002 324-021	81.25101.7045	8JA 001 909-011
6 905 653	8GD 002 078-241			1525754	2BA 003 022-021	81.25102.6031	2NE 001 423-011
6 905 676	1GB 996 080-021			1525754	2PS 008 645-621	81 25102 6037	2NE 003 030-151
6 905 738	1GA 006 991-041			1525785	2PS 008 645-627	81.25102-6078	1NB 003 367-137
6 905 739	1GB 996 080-011			16 10072 0014	2TM 008 645-651	81.25102.6084	1NE 006 300-231
6 905 828	2JA 006 447-041			1.66804.6012	2JA 002 661-001	81.25102.6087	1ND 003 590-001
6 905 839	2JA 006 447-041			1.96001.0407	2XW 003 146-001	81.25102.6088	1NE 006 300-051
6 905 854	2VP 006 040-397			28 12510 3603 9	9GT 134 130-001	81.25102.6096	1NB 004 691-147
6 905 855	2VP 006 040-407			28 12510 3603 9	2ZR 003 236-051	81.25103.6008	2ZR 001 193-011
6 908 028 08	2XS 005 020-011			28 12510 3603 9	2ZR 003 236-057	81.25103.6011	2ZR 001 240-351
6 908 028 08	2XS 005 020-017			28 125207 6066	2RL 008 060-011	81.25103.6012	2ZR 001 423-001
6 930 298 14	2NE 001 423-011			28 12522 9085 9	9EL 147 747-001	81.25103 6016	2ZR 002 589-011
6 931 489 14	2SD 001 685-231			28 12522 9085 9	9EL 147 747-007	81.25103.6027	1G8 002 340-011
6 931 489 14	2SD 001 685-232			28 12526 0604 71	2XS 005 020-011	81.25103.6033	1G4 003 470-031
693149014	2ZR 001 423-001			28 12526 0604 71	2XS 005 020-017	81.25103.6039	2ZR 003 236-051
693149214	8GA 006 841-241			28.12526.0605.61	2XS 950 071-031	81.25103.6039	2ZR 003 236-057
6 931 650 14	9GH 993 984-001			28 22520 76036	2RL 008 060-111	81.25103.6041	2ZR 004 542-001
693173514	2XM 004 444-011			28.22526.060201	2XS 955 031-001	81.25103.6042	1G4 004 480-001
6 931 939 14	9EL 128 922-011			33.25225.6001	2BM 008 355-001	81.25103.6051	1G3 005 760-031
7 005 278	8RA 002 014-051			33.25225.6001	2BM 008 355-007	81.25103.6052	1FD 005 700-051
7 005 278	8RA 002 014-052			33.25225-6002	2PS 003 057-051	81.25103.6060	1GA 007 506-081
7 014 383	9EL 118 614-021			33.25225-6002	2PS 003 057-052	81.25103.7003	2ZR 001 240-351
7 014 433	2JA 001 357-002			33.25225-6002	2PS 003 057-057	81.25108.0013	1G4 129 089-011
7 016 076	1G3 135 211-011			36.25101.6000	1K0 008 191-041	81.25108.0015	1G3 135 211-011
7 018 158	8HG 006 294-021			36.25101.6000	1K0 008 191-047	81.25108.0016	9DF 112 247-001
7 021 344	9GH 096 532-001			36.25101-6002	1BL 007 834-007	81.25108.0020	1GA 998 525-001
7 026 567	2SD 998 531-067			36.25101-6003	1KL 007 834-027	81.25110.0066	9ES 122 221-007
7 026 568	2SD 998 531-057			36.25102.6000	1N0 008 582-011	81.25113.0030	1G8 132 233-001
7 026 604	1GA 998 534-011			36.25102.6000	1N0 008 582-017	81.25113.6011	9DF 112 246-001
7 026 898	9EL 998 001-041			36.25103.6000	2ZR 008 221-051	81.25113.6016	1NE 138 555-011
7 026 899	9EL 998 001-031			36.25103.6000	2ZR 008 221-057	81.25113.6017	1NE 138 575-011
7 026 907	8GS 007 949-101			36.25201-6010	2JA 004 531-011	81.25114.0065	9AG 120 516-005
7 026 908	5DV 990 264-011			36.25201-6012	2JA 005 590-001	81.25115.0019	9AL 120 514-001
7 027 205	1GA 007 506-391			36.25201-6013	2JA 003 231-001	81.25115.0020	9AL 120 515-002
7 029 805	1GM 996 134-091			36.25202-6003	2AB 004 532-051	81.25120.0014	9GH 152 654-007
0 713 880 1	2SD 002 582-021			36.25202-6003	2AB 004 532-057	81.25140.0097	9XD 130 261-001
0 713 880 1	2SD 002 582-027			36.25209.0002	9XB 161 749-007	81.25201.6075	2JA 003 232-011
7 209 013	9KS 075 307-001			36.25225.6000	2XA 008 221-021	81.25201.6086	2JA 003 231-011
7 365 734	2SD 001 699-061			36.25225.6000	2XA 008 221-027	81.25201.6087	2JA 001 346-011
7 365 734	9EL 109 139-001			36.25225.6001	2NE 008 221-031	81.25201.6132	2JA 001 357-002
7 367 680	9EL 856 416-001			36.25225.6001	2NE 008 221-037	81.25201.6192	2JA 003 354-001
7 372 932	9EL 859 020-001			36.25225.6002	2DA 959 071-737	81.25201.7006	2AB 001 208-001
7 403 320	2NE 996 012-021			36.25225-6006	2DA 005 603-031	81.25203.6016	2ZR 006 609-081
7 406 908	9EL 854 912-001			36.25225-6006	2DA 005 603-037	81.25203.6016	2ZR 006 609-087
7 408 151	8JA 001 921-102			36.25225-6007	2SA 005 603-027	81.25203.7003	2KA 001 386-291
7 412 253	1GA 007 506-011			36.25225-6008	2SD 003 184-037	81.25205-6008	2JB 996 012-121
7 412 253 03	1GA 007 506-011			36.25225-6009	2SD 003 184-047	81.25207.6003	8HG 002 365-001
7 615 832	8HG 002 240-021			36.25225-6015	2PS 009 226-017	81.25207.6066	2RL 008 060-011
7 617 452	9EL 856 416-001			36.25240.6000	2KA 005 049-011	81.25210.0014	2AA 001 200-011
7 618 722	8RA 002 014-031			36.25240.6000	2KA 005 049-017	81.25210.0014	2AA 001 200-012
7 618 722	8RA 002 014-032			36.25260.6000	2PF 008 221-011	81.25210.0015	2AA 001 200-021
7 621 243	8RW 341 421-001			36.25260.6000	2PF 008 221-017	81.25210.0015	2AA 001 200-023
7 622 572	8RA 003 326-031			36.25260.6001	2SA 008 405-011	81.25210.0026	2AA 001 200-041
7 622 573	8RA 003 326-041			36.25260.6001	2SA 008 405-017	81.25210.0026	2AA 001 200-042
7 622 573	8RA 003 326-047			36.25260.6002	2PF 003 563-151	81.25210.0027	2AA 001 200-141
7 623 693	2XW 007 146-001			36.25260.6004	2XS 008 479-051	81252100029	2AA 001 200-151
7 623 848	9EL 136 825-001			36.25260.6004	2XS 008 479-057	81.25210.0089	2AA 001 200-011
7 623 849	9EL 136 825-011			36.25260.6005	2XS 008 479-041	81.25210.0089	2AA 001 200-012
7 623 851	8HG 006 294-111			36.25260.6005	2XS 008 479-047	81.25225.6042	2SD 001 693-011
8 125 6	1GA 998 522-011			36.25260.6009	2PF 003 563-187	81.25225.6045	2SA 001 240-331
9 200 919	2SD 002 582-011						



Manufacturer's no. / Hella no.

Cross-Reference

MAN	Hella	MAN	Hella	MAN	Hella	MAN	Hella
81.25225.6049	2KA 001 386-241	81.25238.6009	9MN 858 616-011	82.25310.0001	4AZ 003 787-021	90.81615.9144	2SD 001 680-281
81.25225.6061	2SE 001 699-071	81.25250.7003	2SA 001 240-331	8.25225.6004	2BA 001 416-011	90.81615.9149	2PF 001 648-171
81.25225.6062	2SD 001 699-061	81.25260.6001	2PF 001 648-171	8.25225.6005	2BA 001 416-021	90.81615.9168	2JA 001 346-011
81.25225.6083	2BA 001 227-201	81.25260.6014	2XS 005 020-001	8.25225.6008	2BA 001 221-041	90.81615.9176	2KA 001 386-291
81.25225.6092	2SD 001 680-281	81.25260.6014	2XS 005 020-002	8.25225.6012	2BA 001 221-031	90.81615.9192	2BA 001 227-201
81.25225.6097	2SE 001 680-291	81.25260.6014	2XS 005 020-003	8.25229.0004	9EL 110 014-001	90.81615.9196	2AB 001 208-001
81.25225.6100	2KA 001 389-101	81.25260.6015	2PF 001 647-031	8.25229.0005	9EL 110 013-001	90.81615.9213	2AA 001 200-131
81.25225.6103	2SE 003 167-031	81.25260.6015	2PF 001 647-031	8.25232.0003	9GD 082 716-001	90.81615.9223	2AA 001 200-001
81.25225.6107	2BM 002 847-011	81.25260.6020	2SA 001 638-021	83.25101.6014	1KB 003 177-061	90.81615.9223	2AA 001 200-002
81.25225.6108	2BM 002 847-021	81.25260.6023	2SA 001 647-041	83.25114.0002	9AG 120 516-005	90.81615.9249	2BA 001 240-301
81.25225.6109	2KA 001 622-001	81.25260.6029	2TJ 001 633-211	83.25115.0001	9AL 120 514-001	90.81615.9251	2BA 001 240-301
81.25225.6111	2KA 001 378-041	81.25260.6047	2XS 005 020-011	83.25115.0002	9AL 120 515-001	90.81615.9285	2JA 001 335-011
81.25225.6119	2KA 001 389-101	81.25260.6047	2XS 005 020-017	83.25150.0001	9XS 118 079-005	90.81615.9297	2NE 003 030-151
81.25225.6121	2KA 003 010-007	81.25260.6056	2XS 950 071-031	83.25150.6002	9NS 124 485-001	90.81615.9298	2SA 001 240-331
81.25225.6141	2VP 003 567-111	81.25260.6058	2PF 001 259-631	83.25205.6501	2JA 001 364-001	90.81615.9299	2BA 001 240-301
81.25225.6151	2SL 003 567-311	81.25260.6062	2XS 005 020-041	83.25240.6001	2KA 001 378-041	90.89110.5336	8RA 002 016-111
81.25225.6162	2SA 003 567-021	81.25260.6062	2SA 005 020-047	83.25260.6504	2PF 959 570-401	90.89110.5357	8RA 002 023-011
81.25225.6172	2SL 003 567-311	81.25260.7009	2PF 001 638-011	83.25260.6504	2PF 959 570-407	90.89110.5358	8RA 002 023-021
81.25225.6182	2KA 003 389-081	81.2531.0030	9GD 120 670-001	84.00000.2595	2PF 001 638-011	E 50 25225 6002	2SD 001 693-011
81.25225.6198	2VP 003 567-121	81.25320.6049	2BA 002 324-011	84.25102.6002	2NE 002 589-001	E81.25103-6060	1GA 007 506-081
81.25225.6198	2VP 003 567-127	81.25320.6050	2BA 002 324-021	84.25102.6008	2NE 003 236-001	N1.01102-5087	2NE 005 603-077
81.25225.6233	2KA 001 386-301	81.25320.6058	2BA 003 022-021	84.25102.6008	2NE 003 236-008	N1.01102-5092	2SK 003 567-651
81.25225.6259	2SD 003 167-531	81.25320.6068	2BA 007 840-001	84.25102.6010	1FD 005 700-051	N1.01102-5159	9EL 116 771-031
81.25225.6260	2SD 003 167-541	81.25320.6071	2BA 003 236-021	84.25103.6006	2ZR 003 236-311	N1.01102-5161	9EL 123 631-001
81.25225.6402	2SD 001 685-231	81.25320.6071	2BA 003 236-027	84.25103.6008	1GD 003 590-701	N1.01102-5195	2BA 005 603-017
81.25225.6402	2SD 001 685-232	81.25320.6073	2BA 007 839-001	84.25202.0001	2AB 001 208-001	N1.01102-5196	9FF 121 000-001
81.25225.6403	2SE 001 685-221	81.25320.6076	2BA 003 014-011	84.25215.0005	8RA 002 023-011	N1.01102-5201	2BA 001 259-611
81.25225.6403	2SE 001 685-227	81.25321.0022	9EL 116 907-001	84.25215.0006	8RA 002 020-001	N1.01102-5244	2PS 962 964-018
81.25225.6404	2TF 001 259-761	81.25321.0028	9EL 990 186-001	84.25215.0006	8RA 002 020-002	N1.01102-5245	9GT 963 129-001
81.25225.6409	9EM 128 229-001	81.25326.7016	9EL 990 186-001	84.25215.0006	8RA 002 020-003	N1.01102-5246	9GD 963 281-001
81.25225.6413	2NE 003 236-301	81.25407.6139	8KA 950 073-001	84.25225.6015	2SB 001 240-311	N1.01102-5258	2SB 005 603-137
81.25225.6413	2NE 003 236-307	81.25432.0139	8JB 850 434-011	84.25225.6017	2DA 003 236-031	N1.01102-5268	2SD 003 184-041
81.25225.6423	2ZR 001 240-351	81.25435.0007	8JA 001 909-011	84.25225.6017	2DA 003 236-037	N1.01102-5268	2SD 003 184-047
81.25225.6424	2DA 001 240-341	81.25435.0040	8JA 001 915-001	84.25225.6018	2SA 003 236-041	N1.01102-5270	2SD 003 184-031
81.25225.6425	2SA 001 240-331	81.25435-007	8JA 001 909-011	84.25225.6018	2SA 003 236-047	N1.01102-5272	2SB 003 236-537
81.25225.6426	2BA 001 240-301	81.25435.0084	8JA 001 909-001	84.25225.6018	2SA 003 236-048	N1.01102-5279	2SD 002 582-117
81.25225.6438	2BA 002 652-101	81.25435.0088	8JA 001 914-011	84.25225.6028	2BA 003 236-321	N1.01102-5280	2SD 002 582-127
81.25225.6438	2BA 002 652-107	81.25505.0501	6ED 708 919-001	84.25225.6061	2KA 004 525-001	N1.01102-5301	8XU 007 167-021
81.25225.6449	2BA 005 603-001	81.25901.0008	8GP 002 067-241	84.25229-0078	9EL 119 544-031	N1.01102-5302	8XU 007 842-027
81.25225.6449	2BA 005 603-007	81.25901.0029	8GP 002 096-061	84.66804-6005	2XM 004 444-011	N1.01102-5316	9HD 155 239-001
81.25225.6451	2DA 003 734-011	81.25901.0043	8GP 002 095-241	85.20001-1848	2SK 003 567-321	N1.01102-5322	1NL 007 834-017
81.25225.6452	2KA 001 388-051	81.25901.0109	8GS 007 001-121	85.20001-1849	9GP 003 995-801	N1.01102-5329	1NL 007 186-047
81.25225.6459	2BM 006 692-011	81.25901.7052	8GA 002 072-241	85.20001-2511	2SE 003 167-511	N1.01102-5337	2SE 997 111-011
81.25225.6459	2BM 006 692-017	81.25901.7069	8GD 002 088-251	85.20001-2512	2SD 003 167-521	N1.01102-5344	2TM 003 748-011
81.25225.6460	2BM 006 692-021	81.25908.0036	9MK 854 066-001	85.25103.6001	1GA 006 876-001	N1.01102-5346	2ZR 005 603-067
81.25225.6460	2BM 006 692-027	81.25935.6540	5AB 005 944-011	85.25103-6012	1G3 996 001-331	N1.01102-5464	2PF 961 167-021
81.25225.6481	2SB 003 014-151	81.25940-0315	8HG 151 866-001	85.96001.0005	9GT 074 132-001	N1.01102-5491	2XS 005 020-002
81.25225.6482	2DA 003 014-031	81.25943-6017	5DV 007 810-171	88.25101.6007	1K0 008 191-021	N1.01102-5546	9EL 120 240-011
81.25225.6482	2DA 003 014-037	81.25943-6019	5DV 008 856-001	88.25101.6007	1K0 008 191-027	N1.01400-6813	2PF 002 860-031
81.25225.6523	2VP 008 204-241	81.25943-6019	5DV 008 856-007	88.25101-6008	1NL 008 090-117	N1.01401-4174	8JD 156 150-807
81.25225.6524	2VD 008 204-251	81.42950.0008	8RA 002 016-121	88.25120.0001	9GH 152 654-007		
81.25228.0015	9HB 126 601-001	81.42950.0012	8RA 002 023-011	88.25120.0002	9GH 158 051-007		
81.25228.6002	9BG 121 587-031	81.42950.0013	8RA 002 023-021	88.25201.6033	2JA 001 331-011		
81.25228.6002	9BG 121 587-037	81.42950.0028	8RL 002 009-021	88.25201.6064	2PF 001 259-677		
81.25228.6019	9BG 130 945-001	81.42950.0038	8RA 003 326-041	88.25210-6014	2PF 001 259-677		
81.25228.6020	9BG 130 946-001	81.42950.0038	8RA 003 326-047	88.25215.0001	8RA 008 405-001		
81.25229.0035	9EL 110 737-001	81.42950.0043	8RA 003 660-007	88.25215.0001	8RA 008 405-007		
81.25229.0036	9EL 110 736-001	81.42950.0050	8RA 002 016-121	88.252229-0004	9EL 110 014-001		
81.25229.0063	9EL 109 139-001	81.42950.0063	8RA 003 326-041	88.25225.6004	2BA 001 416-011		
81.25229.0066	9EL 854 912-001	81.42950.0063	8RA 003 326-047	88.25225.6005	2BA 001 416-021		
81.25229.0123	9EL 115 830-001	81.42950.0065	8RA 003 326-001	88.25225.6008	2BA 001 221-041		
81.25229.0124	9EL 108 651-001	81.42950.0065	8RA 003 326-002	88.25225.6012	2BA 001 221-031		
81.25229.0125	9EL 107 443-011	81.42950.0066	8RA 003 326-041	88.25225.6015	2KA 001 622-001		
81.25229.0158	9EL 116 607-005	81.66804 6012	2XW 003 146-001	88.25260.6023	2BA 003 236-541		
81.25229.0244	9EL 122 772-001	81.66804.6017	2XW 002 897-051	88.25225.6026	2BA 008 221-001		
81.25229.0269	9EL 118 445-001	81.66804.6026	2XW 003 146-001	88.25225.6026	2BA 008 221-007		
81.25229.0561	9EL 950 315-001	81.96001.0290	9GT 074 132-001	88.25225-6033	2SB 008 805-021		
81.25229.0561	9EL 950 315-061	81.96001.0311	9GT 067 751-001	88.25225-6033	2SB 008 805-027		
81.25229.0562	9EL 950 315-003	81.96001.0407	9GT 134 130-001	88.25225-6034	2KA 959 640-607		
81.25229.0602	9EL 132 404-001	81.96002.0196	9GH 096 532-001	88.25229.0004	9EL 110 014-001		
81.25229.6033	9EL 122 689-021	81.96101-0802	9GD 159 740-007	88.25229.0005	9EL 110 013-001		
81.25229.0617	9EL 132 215-011	81.96410.0355	9HD 121 297-001	88.25260.6003	2SA 001 638-021		
81.25229.0618	9EL 132 215-001	81.96410.0355	9HD 121 297-035	88.25260.6009	2XS 003 168-071		
81.25229.0623	9EL 114 401-041	81.96410.0601	9GH 126 647-011	88.25260.6010	2SA 006 679-027		
81.25229.0713	9EL 856 416-001	81.96820.0027	9XR 854 840-001	88.25260.6012	2PS 006 717-031		
81.25229.0784	9EL 119 544-111	82.00004.5492	2SE 001 685-201	88.25260.6012	2PS 006 717-032		
81.25229.0785	9EL 119 544-001	82.25101.6027	1FE 006 300-121	88.25260.6012	2PS 006 717-037		
81.25229.0786	9EL 119 544-021	82.25101-6036	2PF 002 985-291	88.25260.6014	2XS 005 020-001		
81.25229.0859	9EL 147 747-001	82.25103.6025	2ZR 003 315-041	88.25260.6014	2XS 005 020-002		
81.25229.0859	9EL 147 747-007	82.25103-6047	1G3 005 760-221	88.25260.6014	2XS 005 020-003		
81.25229.0962	9EL 862 141-001</						



Manufacturer's no. / Hella no. Cross-Reference

Mercedes-Benz Hella	
A 001 544 77 90	9EL 107 368-001
A 001 544 78 90	9EL 111 647-001
A 001 544 80 03	2SE 003 167-031
A 001 544 81 03	2SD 003 167-021
A 001 544 82 03	2SD 003 167-011
A 001 544 83 03	2SE 003 167-041
A 001 544 83 90	9EL 118 445-001
A 001 544 83 90	9EL 147 747-001
A 001 544 83 90	9EL 147 747-007
A 001 544 85 90	9EL 112 763-001
A 001 544 91 44	8GA 006 841-121
A 001 544 91 94	8GA 006 841-121
A 001 544 92 90	9EL 119 544-111
A 001 544 94 90	9EL 119 544-001
A 001 545 04 26	8JB 001 933-031
A 001 545 58 11	6ZE 001 759-071
A 001 545 89 32	1KL 007 834-027
A 001 820 00 56	2TJ 001 633-211
A 001 820 04 56	2XS 004 237-301
A 001 820 05 01	2AB 004 532-051
A 001 820 05 01	2AB 004 532-057
A 001 820 11 01	2AB 004 532-001
A 001 820 11 01	9EL 122 268-001
A 001 820 11 56	2XS 004 237-321
A 001 820 14 56	2KA 001 378-041
A 001 820 25 21	2BA 003 236-541
A 001 820 34 35	9MM 859 358-801
A 001 820 37 21	2BE 003 014-251
A 001 820 37 21	2BE 003 014-257
A 001 820 38 21	2BA 002 652-101
A 001 820 38 21	2BA 002 652-107
A 001 820 39 21	2BM 006 692-011
A 001 820 39 21	2BM 006 692-017
A 001 820 40 21	2BM 006 692-021
A 001 820 40 21	2BM 006 692-027
A 001 820 43 56	2XS 004 237-311
A 001 820 44 56	2XS 004 237-321
A 001 820 54 01	2JA 003 354-051
A 001 820 54 61	1L8 004 148-017
A 001 820 59 56	1NE 002 537-301
A 001 820 67 01	2JA 007 372-001
A 001 820 67 21	2BA 001 423-087
A 001 820 68 56	2SA 001 647-041
A 001 820 72 41	9XS 027 639-001
A 001 820 77 01	2JA 006 447-251
A 001 820 78 97	9SX 007 609-041
A 001 820 83 01	2PF 006 717-011
A 001 820 89 21	2BA 008 221-001
A 001 820 89 21	2BA 008 221-007
A 001 820 96 56	2PF 002 860-031
A 001 820 97 56	2SA 002 860-041
A 001 822 00 10	9EL 852 820-001
A 001 822 21 10	9EL 855 097-001
A 001 822 24 10	9EL 852 061-001
A 001 822 25 20	2BA 001 240-301
A 001 822 26 20	2BA 001 234-251
A 001 822 27 20	2BA 001 234-261
A 001 822 28 20	2BA 001 240-301
A 001 822 34 20	2BA 002 324-011
A 001 822 35 20	2BA 002 324-021
A 001 822 40 20	2BA 001 234-251
A 001 822 41 20	2BA 001 234-261
A 001 822 48 20	2BM 002 847-011
A 001 822 49 20	2BM 002 847-021
A 001 822 50 20	2BM 002 847-021
A 001 822 51 20	2BM 002 847-011
A 001 822 65 10	9EL 856 418-001
A 001 822 66 10	9EL 856 417-001
A 001 822 66 20	2BA 001 227-211
A 001 822 67 20	2BA 003 197-011
A 001 822 68 20	2BA 003 197-021
A 001 822 72 20	2BA 002 652-111
A 001 822 72 20	2BA 002 652-117
A 001 822 73 20	2BA 002 652-121
A 001 822 73 20	2BA 002 652-127
A 001 822 78 10	9EL 856 415-001
A 001 822 79 10	9EL 856 416-001
A 001 822 80 20	2BA 003 014-011
A 001 822 81 20	2BA 003 014-111
A 001 826 01 82	9FF 137 580-005
A 001 826 02 80	9GD 113 431-005
A 001 826 02 81	9DF 117 504-007
A 001 826 04 81	9DE 118 423-001
A 001 826 05 81	9DE 118 424-001
A 001 826 44 90	9EL 110 928-001
A 001 826 47 90	9EL 101 353-001
A 001 826 74 78	9DE 129 975-021
A 001 826 75 78	9DE 129 974-021
A 001 826 77 90	9EL 108 435-001
A 001 826 82 78	9DE 129 975-021
A 001 826 83 78	9DE 129 974-021
A 002 544 00 94	8GH 007 157-121
A 002 544 02 03	2SE 003 167-031
A 002 544 06 90	9EL 131 420-001
A 002 544 07 03	2VB 004 887-011

Mercedes-Benz Hella	
A 002 544 07 03	00102VB 004 887-011
A 002 544 07 03	10 2VB 004 887-011
A 002 544 07 90	9EL 131 420-011
A 002 544 08 03	2VP 004 887-021
A 002 544 08 03	00102VP 004 887-021
A 002 544 08 03	10 2VP 004 887-021
A 002 544 09 03	2VA 004 887-031
A 002 544 12 90	9EL 134 296-041
A 002 544 13 03	2SD 001 680-271
A 002 544 14 03	2SD 001 680-281
A 002 544 15 03	2SE 001 680-291
A 002 544 16 03	2SE 001 680-301
A 002 544 16 90	9EL 134 296-051
A 002 544 19 90	9EL 122 772-051
A 002 544 20 90	9EL 122 772-001
A 002 544 21 90	9EL 134 301-001
A 002 544 26 03	2VD 005 300-551
A 002 544 31 03	2SL 003 567-311
A 002 544 31 94	8GH 007 643-121
A 002 544 32 94	8GS 007 001-121
A 002 544 40 03	2VD 005 300-581
A 002 544 42 03	2VD 005 300-551
A 002 544 47 90	9EL 152 891-001
A 002 544 54 03	2VP 008 204-101
A 002 544 55 03	2VD 008 204-111
A 002 544 57 03	2SD 003 167-531
A 002 544 58 03	2SD 003 167-541
A 002 544 62 90	9EL 136 833-011
A 002 544 63 90	9EL 136 825-011
A 002 820 23 26	5DV 008 290-004
A 002 820 34 56	2PS 006 717-071
A 002 820 37 56	1NE 006 300-201
A 002 820 39 56	1FE 006 300-191
A 002 820 47 56	2PF 006 679-007
A 002 820 57 56	2XS 003 168-071
A 002 820 69 25	5DD 008 319-501
A 002 820 69 26	5DD 008 319-501
A 002 820 90 56	2DA 007 421-001
A 002 820 90 56	2DA 007 421-007
A 002 822 17 10	9EL 861 597-011
A 002 826 03 90	9EV 113 436-005
A 002 826 04 90	9ES 113 919-001
A 002 826 05 90	9ES 113 918-001
A 002 826 10 90	9ES 113 919-001
A 002 826 11 90	9ES 113 918-001
A 002 826 14 90	9EL 107 443-061
A 002 826 19 90	9EV 113 436-005
A 002 826 26 90	9ES 082 333-031
A 002 826 34 90	9ES 118 403-001
A 002 826 35 90	9ES 118 402-001
A 002 826 36 90	9EL 119 874-001
A 002 826 46 90	9ES 120 723-001
A 002 826 60 90	9EL 122 268-001
A 002 826 63 90	9EL 074 484-031
A 002 826 64 90	9ES 120 725-001
A 002 826 65 90	9ES 120 726-001
A 002 826 70 90	9ES 120 723-001
A 002 826 72 90	9EL 110 544-001
A 003 540 22 70	2VD 007 500-221
A 003 542 44 20	3AG 003 399-081
A 003 542 45 20	3AG 003 399-101
A 003 542 78 20	3AG 003 399-081
A 003 544 56 03	2VD 008 204-091
A 003 544 57 03	2VP 008 204-081
A 003 820 01 56	2DA 959 071-237
A 003 820 13 56	2XS 005 020-001
A 003 820 13 56	2XS 005 020-002
A 003 820 13 56	2XS 005 020-003
A 003 820 14 56	2XS 005 020-077
A 003 820 26 26	5DD 008 319-501
A 003 820 26 56	1K0 008 191-021
A 003 820 26 56	1K0 008 191-027
A 003 820 27 56	1N0 008 582-011
A 003 820 27 56	1N0 008 582-017
A 003 826 03 90	9EL 127 855-001
A 003 826 04 90	9EL 127 856-001
A 004 820 00 42	9MN 858 616-001
A 004 820 01 42	9MN 858 616-011
A 004 820 69 15	8KB 861 213-001
A 005 545 21 14	6ED 708 919-001
A 007 997 13 92	9XR 854 840-001
A 009 997 87 81	9GT 146 757-007
A 012 545 64 28	8JA 001 915-001
A 100 820 00 01	2JA 001 331-011
A 123 820 00 62	2KA 003 102-011
A 123 820 01 62	2KA 003 102-011
A 123 820 07 64	2VP 003 069-011
A 123 820 08 64	2VP 003 069-021
A 123 820 30 66	9EL 118 060-001
A 123 820 33 66	9EL 118 059-001
A 123 820 37 64	2VP 003 069-011
A 123 820 38 64	2VP 003 069-021
A 123 820 49 64	2VP 003 069-011
A 124 820 01 64	2VP 004 686-111
A 124 820 01 66	9EL 129 763-001

Mercedes-Benz Hella	
A 124 820 02 56	2KA 004 983-011
A 124 820 02 64	2VP 004 686-121
A 124 820 04 64	2VP 004 686-141
A 124 820 04 66	9EL 129 762-001
A 124 820 05 57	1LJ 007 219-371
A 124 820 06 57	1LJ 007 219-381
A 124 820 07 66	9EL 129 763-001
A 124 820 07 66	9EL 129 763-021
A 124 820 10 66	9EL 129 762-001
A 124 820 10 66	9EL 129 762-031
A 124 820 13 64	2VP 004 686-111
A 124 820 14 64	2VP 004 686-121
A 124 820 16 64	2VP 004 686-141
A 124 820 17 21	2BA 004 693-031
A 124 820 18 21	2BA 004 693-041
A 124 820 33 66	9EL 129 763-021
A 124 820 36 66	9EL 129 762-031
A 124 820 37 66	9EL 129 763-021
A 124 820 40 66	9EL 129 762-031
A 124 820 59 66	9AH 144 863-021
A 124 820 60 66	9AH 144 864-021
A 124 820 61 64	2VP 004 686-151
A 124 820 64 64	2VP 004 686-181
A 124 820 65 64	2VP 004 686-151
A 124 820 68 64	2VP 004 686-181
A 124 826 00 43	9EL 129 615-011
A 124 826 01 43	9EL 129 614-011
A 124 826 04 43	9EL 129 615-011
A 124 826 05 43	9EL 129 614-011
A 124 826 09 43	9EL 129 615-021
A 126 820 10 01	2JA 004 252-031
A 140 000 18 33	2PF 961 167-021
A 140 000 32 62	2BM 006 692-011
A 140 000 32 62	2BM 006 692-017
A 140 000 34 20	1DL 007 872-087
A 140 000 34 21	1DL 007 872-077
A 140 000 60 00	2JA 006 447-041
A 163 820 47 61	1LL 223 151-031
A 163 820 48 61	1LL 223 151-041
A 163 820 53 61	1LL 223 151-091
A 163 820 54 61	1LL 223 151-101
A 163 890 00 97	8RW 341 421-001
A 170 820 01 56	1NB 007 555-031
A 170 820 02 56	1NB 007 555-041
A 171 820 01 64	2VP 008 427-091
A 171 820 02 64	2VP 008 427-101
A 19 6 263698 02	2NE 002 589-001
A 19 6 263698 03	2ZR 002 589-011
A 201 826 00 43	9EL 127 689-001
A 201 826 01 43	9EL 127 688-001
A 201 826 04 43	9EL 127 689-001
A 201 826 05 43	9EL 127 688-001
A 202 820 19 61	1LJ 008 040-071
A 202 820 20 61	1LJ 008 040-081
A 202 826 01 43	9EL 150 987-001
A 202 826 02 43	9EL 150 988-001
A 202 826 05 43	9EL 150 987-001
A 202 826 06 43	9EL 150 988-001
A 202 826 07 43	9EL 150 867-001
A 202 826 08 43	9EL 150 868-001
A 202 826 10 43	9EL 150 867-001
A 202 826 13 43	9EL 150 868-001
A 202 826 14 43	9EL 150 867-001
A 203 820 04 09	2RM 007 200-261
A 203 820 05 64	2VP 008 031-051
A 203 820 06 64	2VP 008 031-061
A 203 820 11 56	1NA 007 976-111
A 203 820 11 64	2VP 008 048-051
A 203 820 12 56	1NA 007 976-121
A 203 820 12 64	2VP 008 048-061
A 203 820 17 56	1NA 007 976-231
A 203 820 18 56	1NA 007 976-241
A 203 820 49 15	9SX 861 562-001
A 208 820 09 26	5DV 007 760-651
A 209 820 01 64	2VP 008 326-051
A 209 820 02 64	2VP 008 326-061
A 209 820 07 56	1N0 009 295-031
A 209 820 07 56	1N0 009 295-037
A 209 820 08 56	1N0 009 295-041
A 209 820 08 56	1N0 009 295-047
A 210 820 00 09	2RM 007 200-131
A 210 820 01 09	2RM 007 200-141
A 210 820 02 09	2RM 007 200-151
A 210 820 05 66	9AH 144 231-041
A 210 820 06 66	9AH 144 232-041
A 210 820 08 09	2RM 007 200-261
A 210 820 11 61	1L9 007 095-111
A 210 820 12 61	1L9 007 095-121
A 210 820 35 61	1L9 378 158-001
A 210 820 36 61	1L9 378 159-001
A 210 82	

Manufacturer's no. / Hella no.

Cross-Reference



Mercedes-Benz Hella		Mercedes-Benz Hella		Mercedes-Benz Hella		Mercedes-Benz Hella	
A 755 601 20 02 0	2AB 004 532-057	124 826 05 43	9EL 129 614-011	001 820 38 21	2BA 002 652-101	210 820 00 09	2RM 007 200-131
A 84 2070 9900-31	2BA 002 324-001	124 826 09 43	9EL 129 615-021	001 820 38 21	2BA 002 652-107	210 820 01 09	2RM 007 200-141
A 84.2070.9900-31	2BA 002 324-001	012 545 64 28	8JA 001 915-001	001 820 39 21	2BM 006 692-011	210 820 02 09	2RM 007 200-151
A 86 0533 9352-09	2BA 001 248-001	126 820 10 01	2JA 004 252-031	001 820 39 21	2BM 006 692-017	210 820 05 66	9AH 144 231-041
A 86 0535 9351-03	9EL 110 918-001	140 000 18 33	2PF 961 167-021	001 820 40 21	2BM 006 692-021	210 820 06 66	9AH 144 232-041
A 86 0535 9351-04	9EL 110 918-011	140 000 32 62	2BM 006 692-011	001 820 40 21	2BM 006 692-027	210 820 08 09	2RM 007 200-261
A 86 0535 9357-19	2BA 002 324-011	140 000 32 62	2BM 006 692-017	001 820 43 56	2XS 004 237-311	210 820 11 61	1L9 007 095-111
A 86 0535 9357-20	2BA 002 324-021	140 000 34 20	1DL 007 872-087	001 820 44 56	2XS 004 237-321	210 820 12 61	1L9 007 095-121
A 86 1019 4054-90	2SD 001 679-001	140 000 34 21	1DL 007 872-077	001 820 54 01	2JA 003 354-051	210 820 35 61	1L9 378 158-001
A 86 1041 0603-60	2SB 003 018-031	140 000 60 00	2JA 006 447-041	001 820 54 61	1L8 004 148-017	210 820 36 61	1L9 378 159-001
A 86.0533.9352-09	2BA 001 248-001	001 540 13 70	2VD 007 500-091	001 820 59 56	1NE 002 537-301	210 820 39 66	9AH 378 392-001
A 86.0535.9351-03	9EL 110 918-001	001 540 16 70	2VD 007 500-201	001 820 67 01	2JA 007 372-001	210 820 40 66	9AH 378 393-001
A 86.0535.9351-04	9EL 110 918-011	001 540 17 70	2VD 007 500-111	001 820 67 21	2BA 001 423-087	210 820 59 26	9SX 007 609-001
A 86.0535.9357-19	2BA 002 324-011	001 540 20 70	2VD 007 500-221	001 820 68 56	2SA 001 647-041	210 820 60 26	9SX 007 609-021
A 86.0535.9357-20	2BA 002 324-021	001 540 22 70	2VD 007 500-111	001 820 72 41	9XS 027 639-001	210 820 98 26	9SX 007 609-041
A 86.1019.4054-90	2SD 001 679-001	001 540 25 70	2VD 007 500-111	001 820 77 01	2JA 006 447-251	210 822 00 97	9GD 860 936-001
A 86.1041.0603-60	2SB 003 018-031	001 540 26 70	2VD 007 500-201	001 820 78 97	9SX 007 609-041	210 822 02 97	9GD 861 810-001
A 88 0001 1067-32	9EL 110 910-001	001 540 29 70	2VD 007 500-091	001 820 83 01	2PF 006 717-011	211 820 05 56	1NB 008 275-031
A 88.0001.1067-32	9EL 110 910-001	001 540 57 70	2VD 007 500-411	001 820 89 21	2BA 008 221-001	211 820 05 61	1LL 008 369-171
A 9 19 6 263698 02	2NE 002 589-001	001 540 58 70	2VP 007 500-421	001 820 89 21	2BA 008 221-007	211 820 06 56	1NB 008 275-041
A 9 19 6 263698 03	2ZR 002 589-011	001 540 62 70	2VD 007 500-411	001 820 96 56	2PF 002 860-031	211 820 06 61	1LL 008 369-181
A 901 820 01 21	2BA 007 016-031	001 540 63 70	2VP 007 500-421	001 820 97 56	2SA 002 860-041	211 820 07 85	9SX 007 609-031
A 901 820 02 21	2BA 007 016-041	001 542 14 27	2AA 003 257-031	001 822 00 10	9EL 852 820-001	211 820 11 56	1NB 008 275-071
A 901 820 02 56	2NE 003 315-011	001 544 04 03	2SE 001 699-071	001 822 21 10	9EL 855 097-001	211 820 12 56	1NB 008 275-081
A 901 820 02 56 X	2NE 003 315-011	001 544 05 03	2SD 001 699-511	001 822 24 10	9EL 852 061-001	211 820 15 61	1LL 008 369-271
A 901 820 03 56	2ZR 003 315-041	001 544 06 03	2SA 001 634-121	001 822 25 20	2BA 001 240-301	211 820 16 61	1LL 008 369-281
A 901 820 03 61	1LH 006 900-031	001 544 08 03	2SE 001 680-291	001 822 26 20	2BA 001 234-251	211 820 21 61	1LS 008 369-491
A 901 820 04 61	1LH 006 900-041	001 544 09 03	2SD 001 680-281	001 822 27 20	2BA 001 234-261	211 820 22 61	1LS 008 369-501
A 901 820 12 61	1LH 008 010-031	001 544 10 03	2SE 001 686-142	001 822 28 20	2BA 001 240-301	211 820 31 61	1LL 009 260-091
A 901 820 13 61	1LH 008 010-041	001 544 11 03	2SD 001 686-101	001 822 34 20	2BA 002 324-011	211 820 32 61	1LL 009 260-101
A 901 820 28 61	1LH 246 047-031	001 544 12 01	1LA 004 109-217	001 822 35 20	2BA 002 324-021	211 870 55 85	5DC 009 060-011
A 901 820 29 61	1LH 246 047-041	001 544 12 03	2SE 001 680-291	001 822 40 20	2BA 001 234-251	211 870 80 26	5DC 009 060-011
A 901 820 30 61	1LH 246 047-071	001 544 13 03	2SE 001 680-301	001 822 41 20	2BA 001 234-261	211 870 88 26	5DC 009 060-011
A 901 820 31 61	1LH 246 047-081	001 544 14 03	2SD 001 680-281	001 822 48 20	2BM 002 847-011	211 870 90 26	5DC 009 060-011
A 906 820 03 61	1LB 247 012-031	001 544 15 03	2SD 001 680-271	001 822 49 20	2BM 002 847-021	215 820 05 56	1NA 007 976-071
A 906 820 04 61	1LB 247 012-041	001 544 19 03	2SE 001 688-161	001 822 50 20	2BM 002 847-021	215 820 06 56	1NA 007 976-081
A 906 820 07 61	1LB 247 012-071	001 544 20 03	2SD 001 688-171	001 822 51 20	2BM 002 847-011	219 820 11 61	1LS 008 821-331
A 906 820 08 61	1LB 247 012-081	001 544 21 94	8GH 002 473-132	001 822 65 10	9EL 856 418-001	219 820 12 61	1LS 008 821-341
A 939 723 10 93 01	2XS 950 071-031	001 544 36 90	9ES 093 815-001	001 822 66 10	9EL 856 417-001	221 820 04 56	2DA 007 592-101
A 940 820 03 21	2BA 247 015-031	001 544 37 90	9EL 102 240-031	001 822 66 20	2BA 001 227-211	230 820 05 56	1NO 008 582-001
A 940 820 04 21	2BA 247 015-041	001 544 40 03	2SE 001 699-071	001 822 67 20	2BA 003 197-011	230 820 05 56	1NO 008 582-007
A 940 820 05 61	1LB 247 011-051	001 544 41 03	2SD 001 699-061	001 822 68 20	2BA 003 197-021	0002481V002L044	8GH 003 594-121
A 940 820 06 61	1LB 247 011-061	001 544 45 03	2SE 001 699-071	001 822 72 20	2BA 002 652-111	002 544 00 94	8GP 007 157-121
A 943 820 18 61	1LH 009 513-051	001 544 46 01	1LB 006 213-047	001 822 72 20	2BA 002 652-117	002 544 02 03	2SE 003 167-031
A 943 820 19 61	1LH 009 513-061	001 544 46 03	2SD 001 699-061	001 822 73 20	2BA 002 652-121	002 544 06 90	9EL 131 420-001
A 943 820 20 61	1LH 009 513-071	001 544 55 90	9EL 109 139-001	001 822 73 20	2BA 002 652-127	002 544 07 03	2VB 004 887-011
A 943 820 21 61	1LH 009 513-081	001 544 63 03	2SD 001 685-211	001 822 78 10	9EL 856 415-001	002 544 07 03	2VB 004 887-011
A 957 540 04 40	8HG 153 152-001	001 544 63 03	2SD 001 685-218	001 822 79 10	9EL 856 416-001	002 544 07 03	2VB 004 887-011
A 957 820 00 01	2JA 006 447-041	001 544 64 03	2SE 001 685-201	001 822 80 20	2BA 003 014-011	002 544 07 90	9EL 131 420-011
A 957 820 02 61	1DL 007 872-077	001 544 68 03	2SD 003 167-011	001 822 81 20	2BA 003 014-111	002 544 08 03	2VP 004 887-021
A 957 820 03 61	1DL 007 872-087	001 544 68 03	2SD 003 167-021	001 822 81 82	9FF 137 580-005	002 544 08 03	2VP 004 887-021
A 957 826 00 59	9AH 149 259-015	001 544 68 90	9EL 092 435-011	001 826 02 80	9GD 113 431-005	002 544 08 03	2VP 004 887-021
A 957 826 01 59	9AH 149 260-015	001 544 69 03	2SE 003 167-031	001 826 02 81	9DF 117 504-007	002 544 09 03	2VA 004 887-031
A 973 820 05 21	2BA 247 016-031	001 544 69 03	2SE 003 167-041	001 826 04 81	9DE 118 423-001	002 544 12 90	9EL 134 296-041
A 973 820 06 21	2BA 247 016-041	001 544 75 03	2SD 001 680-281	001 826 05 81	9DE 118 424-001	002 544 13 03	2SD 001 680-271
100 820 00 01	2JA 001 331-011	001 544 76 03	2SE 001 680-291	001 826 44 90	9EL 110 928-001	002 544 14 03	2SD 001 680-281
123 820 00 62	2KA 003 102-011	001 544 77 90	9EL 107 368-001	001 826 47 90	9EL 101 353-001	002 544 15 03	2SE 001 680-291
123 820 01 62	2KA 003 102-011	001 544 78 90	9EL 111 647-001	001 826 74 78	9DE 129 975-021	002 544 16 03	2SE 001 680-301
123 820 07 64	2VP 003 069-011	001 544 80 03	2SE 003 167-031	001 826 75 78	9DE 129 974-021	002 544 16 90	9EL 134 296-051
123 820 08 64	2VP 003 069-021	001 544 81 03	2SD 003 167-021	001 826 77 90	9EL 108 435-001	002 544 19 90	9EL 122 772-051
123 820 30 66	9EL 118 060-001	001 544 82 03	2SD 003 167-011	001 826 82 78	9DE 129 975-021	002 544 20 90	9EL 122 772-001
123 820 33 66	9EL 118 059-001	001 544 83 03	2SE 003 167-041	001 826 83 78	9DE 129 974-021	002 544 21 90	9EL 134 301-001
123 820 37 64	2VP 003 069-011	001 544 83 90	9EL 118 445-001	19 6 263698 02	2NE 002 589-001	002 544 26 03	2VD 005 300-551
123 820 38 64	2VP 003 069-021	001 544 83 90	9EL 147 747-001	19 6 263698 03	2ZR 002 589-011	002 544 31 03	2SL 003 567-311
123 820 49 64	2VP 003 069-011	001 544 83 90	9EL 147 747-007	201 826 00 43	9EL 127 689-001	002 544 31 94	8GH 007 643-121
124 820 01 64	2VP 004 686-111	001 544 85 90	9EL 112 763-001	201 826 01 43	9EL 127 688-001	002 544 32 94	8GS 007 001-121
124 820 01 66	9EL 129 763-001	001 544 91 44	8GA 006 841-121	201 826 04 43	9EL 127 689-001	002 544 40 03	2VD 005 300-581
124 820 02 56	2KA 004 983-011	001 544 91 94	8GA 006 841-121	201 826 05 43	9EL 127 688-001	002 544 42 03	2VD 005 300-551
124 820 02 64	2VP 004 686-121	001 544 92 90	9EL 119 544-111	202 820 19 61	1LJ 008 040-071	002 544 47 90	9EL 152 891-001
124 820 04 64	2VP 004 686-141	001 544 94 90	9EL 119 544-001	202 820 20 61	1LJ 008 040-081	002 544 54 03	2VP 008 204-101
124 820 04 66	9EL 129 762-001	001 545 04 26	8JB 001 933-031	202 826 01 43	9EL 150 987-001	002 544 55 03	2VD 008 204-111
124 820 05 57	1LJ 007 219-371	001 545 58 11	6ZE 001 759-071	202 826 02 43	9EL 150 988-001	002 544 57 03	2SD 003 167-531
124 820 06 57	1LJ 007 219-381	001 545 89 32	1KL 007 834-027	202 826 05 43	9EL 150 987-001	002 544 58 03	2SD 003 167-541
124 820 07 66	9EL 129 763-001	163 820 47 61	1LL 223 151-031	202 826 06 43	9EL 150 988-001	002	



Manufacturer's no. / Hella no. Cross-Reference

Mercedes-Benz Hella		Mercedes-Benz Hella		Mercedes-Benz Hella		Mercedes-Benz Hella	
002 826 35 90	9ES 118 402-001	000 544 20 34	2KA 003 010-007	000 000 68 28	2PF 001 647-037	000 822 50 10	9EL 101 900-001
002 826 36 90	9EL 119 874-001	000 544 24 07	2ZR 003 236-051	000 000 68 85	2NE 003 236-301	000 822 74 10	9EL 052 476-001
002 826 46 90	9ES 120 723-001	000 544 24 07	2ZR 003 236-057	000 000 68 85	2NE 003 236-307	000 822 75 10	9EL 110 737-001
002 826 60 90	9EL 122 268-001	000 544 26 18	1G8 132 233-011	000 000 68 86	2ZR 003 236-311	000 822 76 10	9EL 110 736-001
002 826 63 90	9EL 074 484-031	000 544 27 93	9FF 090 500-001	699 544 03 03	2SK 003 567-331	000 822 77 10	9EL 109 440-002
002 826 64 90	9ES 120 725-001	000 544 28 34	2KA 001 386-281	699 544 04 03	2SK 003 567-321	000 822 80 20	2BA 001 275-011
002 826 65 90	9ES 120 726-001	000 544 29 05	8RL 002 009-021	755 601 20 02 0	2AB 004 532-051	000 822 81 20	2BA 001 275-021
002 826 70 90	9ES 120 723-001	000 544 30 05	8RA 002 014-031	755 601 20 02 0	2AB 004 532-057	000 822 86 10	9EL 110 918-001
002 826 72 90	9EL 110 544-001	000 544 30 05	8RA 002 014-032	007 997 13 92	9XR 854 840-001	000 822 87 10	9EL 110 918-011
301 826 00 96	9GD 128 553-007	000 544 30 34	2KA 001 386-231	000 820 00 50	2JA 003 354-001	000 822 98 10	9EL 115 830-001
301 826 01 96	9GD 128 553-007	000 544 32 05	8RL 002 009-021	000 820 00 52	2AB 001 208-001	000 825 00 03	2ZR 002 589-011
302 820 02 68	2SD 001 305-021	000 544 32 07	2BA 003 186-177	000 820 02 21	2BA 003 110-011	000 825 00 14	9XB 136 202-005
340 453 80 01	2SB 001 673-002	000 544 32 34	2KA 001 386-281	000 820 03 21	2BA 003 110-021	000 825 01 03	2PF 002 452-017
350 009 00 04	9EL 856 010-001	000 544 33 07	2ZR 003 236-311	000 820 04 21	9EL 120 651-001	000 825 02 03	2KA 001 389-101
350 090 90 03	2AA 001 204-001	000 544 34 91	9KS 075 307-001	000 820 04 57	2DA 959 071-737	000 825 05 01	2JA 001 357-002
350 090 90 04	2AA 001 204-011	000 544 35 05	8RA 002 014-051	000 820 05 21	9EL 120 652-001	000 825 06 03	2PF 004 081-001
350 090 90 10	2ST 003 018-061	000 544 35 05	8RA 002 014-052	000 820 06 21	2BA 003 411-001	000 825 06 03	2PF 004 081-007
350 090 90 18	2SD 001 679-001	000 544 37 34	2KA 003 168-021	000 820 08 64	2SA 001 240-331	000 825 07 01	2JA 001 357-002
350 090 90 19	2SB 001 259-261	000 544 37 90	9ES 015 675-001	000 820 09 09	9BG 121 587-031	000 825 08 01	2JA 001 357-012
350 693 90 01	8RA 002 010-011	000 544 39 05	8RA 002 014-051	000 820 09 09	9BG 121 587-037	000 825 30 10	9EL 116 607-005
350 923 90 15	9EL 088 150-001	000 544 39 05	8RA 002 014-052	000 820 12 60	2KA 001 378-041	000 825 36 10	9EL 112 858-011
350 923 90 20	9EL 088 525-001	000 544 39 11	2XS 007 841-011	000 820 12 64	2SA 001 240-331	000 825 54 10	9EL 120 240-011
003 540 22 70	2VD 007 500-221	000 544 39 11	2XS 007 841-017	000 820 14 64	2SA 001 638-021	000 825 60 01	2PT 008 935-001
003 542 44 20	3AG 003 399-081	000 544 40 11	2XS 007 841-021	000 820 14 67	2ZR 001 240-351	000 826 00 26	8JB 850 434-011
003 542 45 20	3AG 003 399-101	000 544 40 11	2XS 007 841-027	000 820 15 67	2ZR 001 193-011	000 826 04 44	2SE 001 680-301
003 542 78 20	3AG 003 399-081	000 544 41 05	8RA 002 016-111	000 820 16 21	2BA 003 110-011	000 826 04 47	2PF 001 647-031
003 544 56 03	2VD 008 204-091	000 544 41 91	9AH 131 494-015	000 820 17 21	2BA 003 110-021	000 826 04 47	2PF 001 647-037
003 544 57 03	2VP 008 204-081	000 544 42 05	8RA 003 326-001	000 820 17 68	2BA 001 240-301	000 826 04 56	9EL 950 315-001
371 820 07 56	1NE 006 300-071	000 544 42 05	8RA 003 326-002	000 820 18 60	2KA 001 388-051	000 826 05 56	9EL 950 315-031
373 820 07 56	2SA 961 167-011	000 544 43 90	9EL 141 612-001	000 820 18 66	9ES 143 775-011	000 826 07 14	9XD 247 756-001
373 820 17 64	2SA 003 236-041	000 544 44 03	2SB 001 673-002	000 820 19 60	2KA 001 389-101	000 826 08 14	9XD 247 756-001
373 820 17 64	2SA 003 236-047	000 544 44 05	8RA 004 412-021	000 820 19 66	9ES 143 776-011	000 826 09 40	8RL 002 009-001
373 820 17 64	2SA 003 236-048	000 544 45 05	8RA 002 016-111	000 820 20 56	2NE 001 423-011	000 826 09 97	9GD 100 140-001
373 820 18 64	2DA 003 236-031	000 544 48 11	2PS 963 639-011	000 820 22 67	2ZR 001 240-351	000 826 10 40	8RA 003 660-001
373 820 18 64	2DA 003 236-037	000 544 48 11	2PS 963 639-017	000 820 24 56	2ZR 004 542-001	000 826 10 44	2SD 001 693-011
381 820 31 61	1LH 002 658-451	000 544 48 11	2PS 963 639-111	000 820 24 68	2SB 001 673-002	000 826 10 97	9GD 082 716-001
381 820 32 61	1LH 002 658-461	000 544 48 11	2PS 963 639-117	000 820 25 68	2DA 001 240-341	000 826 11 40	8RA 002 014-041
381 820 33 61	1LH 002 658-511	000 544 56 03	2SD 001 686-101	000 820 27 21	2BA 003 975-031	000 826 11 40	8RA 002 014-042
381 820 34 61	1LH 002 658-521	000 544 56 30	2BA 003 236-021	000 820 28 21	2BA 003 975-041	000 826 11 80	9GD 024 183-001
381 820 41 61	1LH 002 658-451	000 544 56 30	2BA 003 236-027	000 820 34 21	2BA 003 411-001	000 826 11 91	9GD 118 983-021
381 820 42 61	1LH 002 658-461	000 544 59 30	2BA 002 939-251	000 820 37 21	2BA 004 119-001	000 826 12 24	9HD 121 297-001
003 820 01 56	2DA 959 071-237	000 544 65 03	2ST 001 673-011	000 820 41 64	2SB 001 423-097	000 826 13 41	8RL 002 009-011
003 820 13 56	2XS 005 020-001	000 544 65 92	9DR 060 567-001	000 820 52 21	2BM 004 312-051	000 826 14 40	8RA 003 326-021
003 820 13 56	2XS 005 020-002	000 544 65 93	9FF 111 606-021	000 820 52 61	1S5 003 178-431	000 826 14 41	2PS 002 727-001
003 820 13 56	2XS 005 020-003	000 544 70 03	2SE 001 699-071	000 820 53 08	9MN 857 622-101	000 826 14 41	2PS 002 727-007
003 820 14 56	2XS 005 020-077	000 544 76 03	2SD 001 686-101	000 820 53 21	2BM 004 312-061	000 826 14 41	2PS 004 361-001
003 820 26 26	5DD 008 319-501	000 544 77 02	9BG 121 740-001	000 820 55 01	2JA 001 364-001	000 826 14 41	2PS 004 361-007
003 820 26 56	1KO 008 191-021	000 544 77 03	2SD 001 699-061	000 820 59 26	5AB 005 944-001	000 826 16 40	8RA 003 326-041
003 820 26 56	1KO 008 191-027	000 544 77 80	9GD 102 484-001	000 820 59 56	2NE 001 423-011	000 826 16 40	8RA 003 326-047
003 820 27 56	1NO 008 582-011	000 544 78 03	2SE 001 699-071	000 820 60 56	1NE 002 537-301	000 826 17 41	8RA 003 326-011
003 820 27 56	1NO 008 582-017	000 544 78 06	1NL 008 090-117	000 820 61 21	2BM 002 652-051	000 826 17 41	8RA 003 326-017
003 826 03 90	9EL 127 855-001	000 544 79 80	9GD 102 484-001	000 820 62 21	2BA 003 975-031	000 826 18 40	2DA 003 236-031
003 826 04 90	9EL 127 856-001	000 544 85 80	9GD 087 883-355	000 820 63 01	2JA 003 115-001	000 826 18 40	2DA 003 236-037
400 453 86 08	2BA 001 227-201	000 544 87 80	9GD 120 670-001	000 820 63 21	2BA 003 975-041	000 826 18 40	8RA 003 326-031
400 809 00 00 07	8GH 007 157-121	000 544 93 03	2SE 002 582-071	000 820 63 56	2ZR 003 030-171	000 826 19 40	8RA 003 326-041
405 544 01 01	1DL 007 872-011	000 544 99 03	2SD 001 699-061	000 820 64 21	2BA 004 499-001	000 826 19 40	8RA 003 326-047
405 544 02 01	1DL 007 872-027	000 545 07 81	9SG 703 965-007	000 820 68 21	9EL 129 615-011	000 826 21 10	9EL 110 536-001
414 820 00 64	2VP 008 406-031	000 545 13 47	1GA 998 522-011	000 820 69 21	9EL 129 614-011	000 826 26 10	9EL 116 380-045
414 820 01 64	2VP 008 406-041	000 545 21 15	2AA 001 200-011	000 820 71 10	6ZE 001 759-051	000 826 27 10	9EL 116 380-035
421 540 00 54	9ES 082 333-031	000 545 21 15	2AA 001 200-012	000 820 72 56	2NE 003 030-151	000 826 27 40	8RA 004 412-001
461 820 00 26	9SX 007 609-021	005 545 21 14	6ED 708 919-001	000 820 73 21	9EL 120 651-001	000 826 28 40	8RA 003 326-041
461 820 00 35	9MM 860 814-801	000 580 01 97	2XM 004 444-001	000 820 74 21	9EL 120 652-001	000 826 28 40	8RA 003 326-047
461 820 44 15	8KB 007 896-801	000 583 09 53	2XW 003 146-001	000 820 77 21	9EL 127 689-001	000 826 28 97	9GD 128 553-007
461 820 45 15	8KB 861 213-011	000 583 29 53	2XW 002 897-041	000 820 78 21	9EL 127 688-001	000 826 29 47	2PF 001 648-161
461 822 00 97	9GD 860 936-001	000 585 11 03	8XH 002 975-017	000 820 79 21	2BM 002 652-071	000 826 30 10	9EL 115 003-055
004 820 00 42	9MN 858 616-001	608 926 00 56	9EL 126 294-001	000 820 80 21	2BM 002 652-081	000 826 30 47	2SA 001 259-751
004 820 01 42	9MN 858 616-011	000 600 61 27	9EL 118 445-001	000 820 81 21	9EL 129 615-011	000 826 30 47	2SA 001 259-757
004 820 69 15	8KB 861 213-001	612 820 00 56	2KA 005 049-011	000 820 82 21	9EL 129 614-011	000 826 31 10	9EL 110 536-011
500 076 70 01	2AA 001 200-011	612 820 00 56	2KA 005 049-017	000 820 87 01	2JA 001 330-001	000 826 34 81	9DR 080 706-015
500 076 70 01	2AA 001 200-012	612 820 01 20	2BM 008 355-001	000 820 87 01	2JA 001 330-007	000 826 34 82	9FF 085 642-001
500 090 90 10	2ST 003 018-061	612 820 01 20	2BM 008 355-007	000 820 87 56	2ZR 003 030-171	000 826 35 10	9EL 137 241-001
500 090 90 18	2SD 001 679-001	613 826 02 41	2PS 962 964-012	000 820 89 20	2BA 001 227-211	000 826 36 47	2PF 001 650-001
500 090 90 19	2SB 001 259-261	613 826 02 41	2PS 962 964-018	000 820 90 56	2KA 003 389-061	000 826 42 10	9ES 247 753-001
500 923 86 05	9EL 074 484-011	613 826 02 41	2PS 962 964-031	000 820 90 56	2KA 003 389-062	000 826 42 47	2PF 001 259-631
500 923 90 15	9EL 088 150-001	613 826 02 41	2PS 962 964-037	000 820 90 56	2KA 003 389-068	000 826 43 10	9ES 247 754-001
500 923 90 20	9EL 088 525-001	639 820 00 56	2DA 959 071-537	000 820 93 56	2XS 005 020-001	000 826 43 47	2BA 001 259-611
000 544 00 34	2KA 001 386-231	639 820 01 64	2SK 964 596-011	000 820 93 56	2XS 005 020-002	000 826 44 81	2BA 001 259-618
000 544 00 75	9EL 134 301-011	639 820 02 64	2SK 964 596-021	000 820 93 56	2XS 005 020-003	000 826 44 81	9DE 089 102-011
000 544 01 29	2PF 003 057-001	639 820 03 61	1LG 246 041-031	000 820 94 56	2TJ 001 633-211	000 826 54 90	9ES 091 489-001
000 544 01 29	2PF 003 057-002	639 820 04 61	1LG 246 041-041	000 820 95			

Manufacturer's no. / Hella no.

Cross-Reference



Mercedes-Benz Hella		Mitsubishi Hella		NATO Hella		NATO Hella	
84 2070 9900-31	2BA 002 324-001	SMME31640S6	1K0 008 191-001	6220-12-166-5053	2ZR 003 014-091	6220-12-304-6242	9DX 852 902-001
86 0533 9352-09	2BA 001 248-001	SMME31640S6	1K0 008 191-007	6220-12-166-5689	2JA 001 360-001	6220-12-311-5348	2XS 005 020-067
86 0535 9351-03	9EL 110 918-001	SMME31640S7	2BA 009 001-201	6220-12-166-9225	2JA 001 330-001	6220-99-777-3508	9XR 854 840-001
86 0535 9351-04	9EL 110 918-011	SMME31640S9	1LL 008 193-117	6220-12-166-9225	2JA 001 330-007	6220-99-803-2658	2AA 001 200-011
86 0535 9357-19	2BA 002 324-011	SMZ313636	1G3 005 760-011	6220-12-167-2085	2BA 003 022-001	6220-99-803-2658	2AA 001 200-012
86 0535 9357-20	2BA 002 324-021	SMZ313637	1F3 009 094-071	6220-12-167-3594	9EL 116 907-001	6220-99-806-1919	2BA 001 236-001
86 1019 4054-90	2SD 001 679-001	Z0412314	2XW 003 146-001	6220-12-168-9882	9ES 012 060-011	6230-12-182-5826	2XW 003 146-001
86 1041 0603-60	2SB 003 018-031	Z0430103	8GS 007 949-101	6220-12-170-8422	9ES 082 333-031	6240-12-120-7948	8GM 002 092-241
88 0001 1067-32	9EL 110 910-001	Z0430122	8GP 002 066-121	6220-12-171-1301	2JA 001 364-001	6240-12-120-7950	8GA 002 071-241
901 820 01 21	2BA 007 016-031	Z12190111	2XS 005 020-011	6220-12-171-1304	9ES 093 815-001	6240-12-120-7952	8GP 002 068-241
901 820 02 21	2BA 007 016-041	Z12190111	2XS 005 020-017	6220-12-172-0589	2JA 001 335-001	6240-12-120-7956	8GM 002 092-121
901 820 02 56	2NE 003 315-011	Z1219068	2PS 006 717-061	6220-12-172-9248	2KA 001 386-231	6240-12-120-7996	8GD 002 068-121
901 820 02 56 X	2NE 003 315-011	Z1219068	2PS 006 717-067	6220-12-172-9251	2ZR 001 193-011	6240-12-120-7998	8GA 002 071-121
901 820 03 56	2ZR 003 315-041	Z1219161	2PS 003 748-161	6220-12-173-2259	2KA 001 386-281	6240-12-120-8025	8GA 002 072-241
901 820 03 61	1LH 006 900-031	Z1219161	2PS 003 748-167	6220-12-174-0100	2PF 001 634-101	6240-12-121-2685	8GM 002 094-121
901 820 04 61	1LH 006 900-041	Z1219241	8GP 003 594-241	6220-12-174-2805	2KA 001 389-101	6240-12-121-2728	8GP 002 066-241
901 820 12 61	1LH 008 010-031	Z1519800	4RA 003 510-361	6220-12-176-0704	2JA 003 231-001	6240-12-121-2732	8GD 002 084-251
901 820 13 61	1LH 008 010-041	Z1719041	1FE 006 300-041	6220-12-176-4379	2SD 001 685-231	6240-12-124-4671	8GP 002 067-241
901 820 28 61	1LH 246 047-031	Z1719051	1NE 006 300-051	6220-12-176-4379	2SD 001 685-232	6240-12-124-9644	8GA 002 083-251
901 820 29 61	1LH 246 047-041	Z1719089	8GH 002 089-133	6220-12-178-2125	2BA 002 324-011	6240-12-127-4953	8GM 002 091-131
901 820 30 61	1LH 246 047-071	Z1719090	8GH 002 090-133	6220-12-178-3324	2BA 001 221-041	6240-12-127-4954	8GA 002 083-131
901 820 31 61	1LH 246 047-081	Z1719121	8GP 002 054-121	6220-12-178-3325	2BA 001 221-031	6240-12-129-3450	8GP 002 067-121
906 820 03 61	1LB 247 012-031	Z1719191	1FE 002 537-191	6220-12-178-3348	2BA 002 324-021	6240-12-129-4540	8GP 002 096-061
906 820 04 61	1LB 247 012-041	Z1719201	1NE 002 537-201	6220-12-178-3349	2BA 002 324-001	6240-12-129-4845	8GM 002 091-241
906 820 07 61	1LB 247 012-071	Z1719309	8KA 002 309-811	6220-12-178-3722	9EL 116 607-005	6240-12-129-4850	8GM 002 091-251
906 820 08 61	1LB 247 012-081	Z1719311	8KA 148 541-001	6220-12-178-3921	9EL 110 014-001	6240-12-129-6155	8GD 002 088-131
9 19 6 263698 02	2NE 002 589-001	Z1719531	1F8 007 560-561	6220-12-178-3922	9EL 110 013-001	6240-12-129-6156	8GD 002 088-251
9 19 6 263698 03	2ZR 002 589-011	Z1719621	1N8 007 560-021	6220-12-178-4344	2JA 002 661-001	6240-12-129-6157	8GD 002 084-131
939 723 10 93 01	2XS 950 071-031	Z1719631	1N8 007 560-031	6220-12-178-4670	9EL 118 445-001	6240-12-136-1126	8GA 002 074-241
940 820 03 21	2BA 247 015-031	Z1719641	1F8 007 560-041	6220-12-178-4672	2BM 002 847-021	6240-12-137-2181	8GA 002 074-121
940 820 04 21	2BA 247 015-041	Z1719651	1F8 007 560-051	6220-12-178-4673	9EL 115 830-001	6240-12-140-5265	8GA 002 072-121
940 820 05 61	1LB 247 011-051	Z2219609	2ZR 006 609-081	6220-12-179-5062	9EL 116 771-031	6240-12-147-2831	8GM 002 091-121
940 820 06 61	1LB 247 011-061	Z2219609	2ZR 006 609-087	6220-12-179-5622	2SE 001 699-071	6240-12-150-4410	8GA 002 073-241
943 820 18 61	1LH 009 513-051	Z2219660	2NE 006 609-001	6220-12-180-4221	8KA 002 309-811	6240-12-151-9661	8GH 002 089-251
943 820 19 61	1LH 009 513-061	Z2219660	2NE 006 609-007	6220-12-180-9533	2BA 001 275-011	6240-12-151-9661	8GH 002 089-253
943 820 20 61	1LH 009 513-071	Nagares S/A Hella		6220-12-180-9539	9EL 109 139-001	6240-12-159-7268	8GA 002 073-121
943 820 21 61	1LH 009 513-081	RLPA/4-12	4RA 003 510-081	6220-12-180-9767	2JA 001 357-012	6240-12-165-3331	8GJ 002 525-251
957 540 04 60	8HG 153 152-001	NATO Hella		6220-12-181-0915	2BM 002 847-011	6240-12-165-3331	8GJ 002 525-253
957 820 00 01	2JA 006 447-041	2510-12-192-0042	8HG 002 240-021	6220-12-181-1890	9EV 113 436-005	6240-12-165-6793	8GH 002 090-251
957 820 02 61	1DL 007 872-077	2590-12-196-0842	3AG 003 399-081	6220-12-181-6666	2ZR 003 030-171	6240-12-165-6793	8GH 002 090-253
957 820 03 61	1DL 007 872-087	5325-12-153-1910	9GT 005 166-001	6220-12-181-7671	2BA 003 014-011	6240-12-166-0983	8GM 002 090-133
957 826 00 59	9AH 149 259-015	5325-12-191-1793	9GT 074 132-001	6220-12-181-8961	9EL 101 900-001	6240-12-171-6626	8GP 002 095-121
957 826 01 59	9AH 149 260-015	5330-12-127-3814	9GD 024 183-001	6220-12-181-8962	9EL 101 899-001	6240-12-173-3418	8GP 002 095-241
973 820 05 21	2BA 247 016-031	5330-12-166-9819	9GD 052 710-021	6220-12-181-8963	2BA 001 275-021	6240-12-173-4825	8GA 002 071-251
973 820 06 21	2BA 247 016-041	5330-12-179-0308	9GD 023 639-001	6220-12-182-6686	2NE 001 423-011	6240-12-179-9642	8GJ 002 525-131
000 993 00 98	9XR 855 975-001	5330-12-181-2502	9GD 113 431-005	6220-12-183-8555	2SD 001 699-061	6240-12-179-9642	8GJ 002 525-133
000 997 32 86	9GH 096 532-001	5330-12-181-4797	9GD 120 670-001	6220-12-183-9749	9EL 088 150-001	6250-12-122-4544	9FF 078 830-001
000 997 80 81	9GT 074 132-001	5330-12-183-1675	9GD 100 140-001	6220-12-184-8508	9EL 852 820-001	6250-12-179-0634	9FF 078 830-001
000 997 80 91	9GT 074 132-001	5330-12-302-4690	9GD 087 883-355	6220-12-185-0513	9EL 113 065-001	6250-12-179-0634	9FF 085 642-001
000 997 95 81	9GT 067 751-001	5340-12-121-7999	9KS 071 571-001	6220-12-186-4524	2BA 001 277-011	6250-12-185-3302	9FF 071 116-001
009 997 87 81	9GT 146 757-007	5340-12-181-4796	9GH 096 532-001	6220-12-191-2085	2ZR 001 423-001	6250-12-300-5036	9FH 113 447-011
HKV 300 000 00 02	1NL 007 186-061	5340-12-185-0512	9GH 116 966-011	6220-12-191-3487	2SD 003 167-021	9390-12-169-3186	9GD 023 639-001
HKV 300 000 00 02	1NL 007 186-067	5355-12-179-4110	9SG 703 965-007	6220-12-191-3488	2SE 003 167-031	9905-12-127-4384	8RA 002 010-011
HKV 300 000 00 03	2BA 002 939-251	5360-12-151-8828	9KS 075 139-001	6220-12-192-3516	2JA 003 232-011	9905-12-129-1636	8RA 002 015-031
HKW 210 820 M0 16	9SX 007 609-031	5930-12-178-7323	6ZE 001 759-051	6220-12-192-6271	2SD 002 582-011	9905-12-139-8150	8RA 002 016-121
HXB 373 826 15	9EL 119 544-031	5935-12-127-9479	8JA 001 915-001	6220-12-192-6271	2SD 002 582-017	9905-12-162-7570	8RA 002 016-101
000010		5935-12-133-3200	8JA 001 925-001	6220-12-192-6272	2SD 002 582-021	9905-12-172-5334	8RA 002 016-111
N 910 139 000 000	8GS 007 001-121	5935-12-145-4256	9GH 096 532-001	6220-12-192-6272	2KA 002 582-027	9905-12-175-7514	8RA 002 023-011
Q078002A331	1X0 001 515-021	5935-12-168-6918	8JA 001 914-011	6220-12-192-7485	2JA 001 386-291	9905-12-181-7721	8RA 002 015-001
Q 10600 15150 21	8RA 002 014-081	5935-12-177-1842	8JA 001 930-001	6220-12-193-8425	2JA 001 335-011	9905-12-188-3859	8RA 002 014-051
Q 10600 20140 81	2XS 005 020-011	5935-12-177-1844	8JB 001 943-001	6220-12-194-3370	2KA 003 168-021	9905-12-188-3859	8RA 002 014-052
Q 10600 50200 11	2XS 005 020-011	5935-12-186-9559	8JA 001 909-011	6220-12-194-3370	2BE 003 184-051	9905-12-191-1123	8RA 003 326-001
Q 10600 50200 11	1ND 005 700-061	5935-12-186-9560	8JA 001 909-001	6220-12-196-0266	2BM 001 318-001	9905-12-191-1123	8RA 003 326-001
Q1ND005700061	2RL 860 880-001	5935-12-306-2247	8JB 850 434-011	6220-12-196-2592	1X0 001 515-021	9905-12-300-2792	8RA 002 023-017
Q2RL860880001	2XD 860 910-001	5945-12-300-4469	4AZ 003 787-021	6220-12-196-2754	2PF 001 648-161	9905-12-304-8722	8HG 002 240-011
Q2XD860910001	9EL 860 743-011	5975-12-183-5777	9GT 067 751-001	6220-12-197-0647	2NE 002 985-001	9905-12-306-9555	8HG 002 240-001
Q9EL860743011	9EL 860 743-021	6105-99-777-3507	9MK 854 066-001	6220-12-197-1856	2SD 003 184-031		
Q9EL860743021	2RL 007 337-021	6210-12-147-4230	2AB 001 208-001	6220-12-197-1856	2SD 003 184-037	0010 762	2JB 996 012-121
QEV111ABVGOX	1GA 007 506-001	6210-12-172-7941	2AA 001 204-001	6220-12-197-3499	2SE 001 685-201	1102.508.7	2NE 005 603-077
QEV111ACACKM	1GA 007 506-081	6210-12-172-7944	2AA 001 204-011	6220-12-197-5071	9EL 852 061-001	1102.508.8	2NE 005 603-077
QEV111ACACKM	2RL 007 337-121	6210-12-174-4347	2AA 001 204-031	6220-12-197-6875	1G4 003 470-051	1102.508.9	2SK 003 567-661
QKW 07 80 40 A056		6210-12-307-9614	2AA 001 200-141	6220-12-198-3109	1G8 002 340-011	1102.509.2	2SK 003 567-651
Merit, Malta Hella		6210-99-816-7109	2AA 001 200-031	6220-12-198-8343	1G5 003 241-081	1102.515.5	9GH 145 943-001
113301							



Manufacturer's no. / Hella no. Cross-Reference

Neoplan	Hella	Neoplan	Hella	Neoplan	Hella	Neoplan	Hella
1102.523.2	2BM 006 692-017	1102.556.6	2JA 001 364-001	1503.013.00	2BA 003 236-027	1503.408.00	2KA 005 049-017
1102.523.4	2BM 006 692-021	1102.558.3	2AB 004 532-051	1503.013.02	9EL 119 544-021	1503.511.10	1F8 007 560-041
1102.523.4	2BM 006 692-027	1102.558.3	2AB 004 532-057	1503.015.00	2BA 003 236-177	1503.513.00	1FD 003 590-411
1102.524.0	2SA 006 679-027	1102.558.5	9XB 136 202-005	1503.016.00	2BA 003 734-061	1503.527.00	1GD 003 590-701
1102.524.4	2PS 962 964-012	1102.776.1	9GT 143 133-007	1503.043.00	2BA 005 603-011	1503.541.20	2XS 005 020-041
1102.524.4	2PS 962 964-018	1102.871.2	8GA 002 071-251	1503.043.00	2BA 005 603-017	1503.541.20	2XS 005 020-047
1102.524.5	9GT 963 129-001	1102.872.3	8GJ 002 525-251	1503.052.00	2BA 001 259-611	1503.700.00	8RA 003 326-011
1102.524.6	9GD 963 281-001	1102.872.3	8GJ 002 525-253	1503.052.00	2BA 001 259-618	1503.700.00	8RA 003 326-017
1102.524.7	2PS 962 964-012	1102.872.4	8GH 002 089-251	1503.065.00	2KA 003 389-001	1503.700.10	8RA 003 326-041
1102.524.7	2PS 962 964-018	1102.872.4	8GH 002 089-253	1503.079.00	2ZR 002 589-011	1503.700.10	8RA 003 326-047
1102.525.1	2PF 006 679-007	1102.872.9	8GS 007 949-101	1503.081.00	2ZR 003 236-051	1503.700.50	8RA 003 326-021
1102.525.7	2PF 003 563-151	1102.877.1	8GM 002 092-241	1503.081.00	2ZR 003 236-057	1503.701.00	8RA 003 660-007
1102.525.8	2SB 005 603-137	1102.890.0	9EL 119 544-111	1503.082.00	8RA 003 326-011	1503.702.00	8RL 002 009-021
1102.526.0	1GA 006 876-001	1102.912.5	8KW 701 235-033	1503.082.00	8RA 003 326-017	1503.703.00	8RL 002 009-011
1102.526.4	2NE 003 236-001	1105.237.9	2XW 007 146-001	1503.101.00	2DA 003 236-331	1503.704.00	8RL 002 009-021
1102.526.4	2NE 003 236-008	1105.238.6	2XW 007 146-001	1503.102.00	2DA 003 236-031	1503.743.00	8RB 004 713-001
1102.526.5	9EL 119 544-001	1106.074.0	9GD 100 140-001	1503.102.00	2DA 003 236-037	1503.746.00	2XS 955 031-001
1102.527.0	2SD 003 184-031	1106.173.5	8JB 004 777-001	1503.102.01	9EL 120 201-001	1503.801.00	2PF 001 647-031
1102.527.0	2SD 003 184-037	1106.173.5	8JB 004 777-002	1503.103.00	2ZR 003 236-051	1503.801.00	2PF 001 647-037
1102.527.2	2SB 003 236-537	1106.390.1	2BM 008 355-001	1503.103.00	2ZR 003 236-057	1503.802.00	2PF 961 167-021
1102.527.3	2SA 003 236-341	1106.390.1	2BM 008 355-007	1503.105.00	9EL 110 014-001	1503.804.00	2SA 003 014-051
1102.527.8	2SA 005 603-021	1106.848.3	2NE 008 221-031	1503.108.00	2DA 005 603-031	1503.805.00	2PF 003 014-071
1102.527.8	2SA 005 603-027	1106.848.3	2NE 008 221-037	1503.108.00	2DA 005 603-037	1503.806.00	2PF 002 860-031
1102.527.9	2SD 002 582-117	1106.848.4	8RA 008 405-001	1503.114.00	9GD 100 140-001	1503.806.02	9GD 128 553-007
1102.528.0	2SD 002 582-127	1106.848.4	8RA 008 405-007	1503.116.00	9EL 107 443-011	1503.811.00	2JA 005 590-001
1102.528.5	9EL 122 772-001	1107.081.0	2XS 008 479-041	1503.141.00	2ZR 003 014-091	1503.817.00	2PF 004 081-001
1102.528.6	2SK 003 567-331	1107.081.0	2XS 008 479-047	1503.142.00	2BM 006 692-011	1503.817.00	2PF 004 081-007
1102.529.4	2BA 003 236-541	1107.081.1	2XS 008 479-051	1503.142.00	2BM 006 692-017	1503.900.01	9EL 118 445-001
1102.529.8	2ZR 001 240-377	1107.081.1	2XS 008 479-057	1503.143.00	2BM 006 692-021	1503.905.00	2SA 001 638-021
1102.530.1	8XU 007 842-017	1107.376.4	1K0 008 191-021	1503.143.00	2BM 006 692-027	1503.906.00	2PF 001 638-011
1102.530.2	8XU 007 842-027	1107.376.4	1K0 008 191-027	1503.145.00	2SA 006 679-027	1503.907.00	2XS 005 020-001
1102.531.1	1NL 007 186-027	1107.376.7	1N0 008 582-011	1503.148.00	2PS 962 964-012	1503.907.00	2XS 005 020-002
1102.531.2	9GH 147 009-007	1107.376.7	1N0 008 582-017	1503.148.00	2PS 962 964-018	1503.907.00	2XS 005 020-003
1102.531.4	1BL 007 834-007	1107.376.9	9GH 152 654-007	1503.148.10	9GT 963 129-001	1503.907.01	9EL 132 215-001
1102.531.6	9HD 155 239-001	1107.377.0	2DA 959 071-737	1503.148.20	9GD 963 281-001	1503.907.10	2XS 007 841-011
1102.532.0	1KL 007 834-027	1107.378.7	2BA 008 221-041	1503.160.00	2BA 003 734-061	1503.907.10	2XS 007 841-017
1102.532.2	1NL 007 834-017	1107.378.7	2BA 008 221-047	1503.203.00	2NE 003 236-001	1503.907.20	2XS 007 841-021
1102.532.3	2BA 005 603-117	1107.378.9	8RA 002 016-111	1503.203.00	2NE 003 236-008	1503.907.20	2XS 007 841-027
1102.532.4	8RA 002 016-121	1107.379.0	2SA 008 405-011	1503.203.02	9EL 119 544-001	1504.012.00	2JA 003 236-357
1102.532.6	2BE 004 119-021	1107.379.0	2SA 008 405-017	1503.205.02	9EL 119 544-001	1504.016.00	2JA 004 531-011
1102.532.7	9GT 134 655-007	1107.388.1	8KA 152 134-007	1503.207.00	2SD 001 693-011	1504.016.01	9EL 856 010-001
1102.532.8	9GT 143 133-007	1107.496.6	1K0 008 191-041	1503.208.00	2SD 003 184-041	1504.019.00	2SA 001 259-751
1102.533.7	2SE 997 111-011	1107.496.6	1K0 008 191-047	1503.208.00	2SD 003 184-047	1504.019.00	2SA 001 259-757
1102.533.8	2SE 997 111-021	1107.535.0	2BA 008 221-001	1503.209.00	2SD 003 184-031	1504.026.00	2JA 001 335-001
1102.534.2	2ZR 002 694-001	1107.535.0	2BA 008 221-007	1503.209.00	2SD 003 184-037	1504.027.00	2JA 001 335-011
1102.534.2	2ZR 002 694-002	1107.839.3	2PF 959 570-401	1503.210.00	2SB 003 236-537	1504.032.00	2JA 003 231-001
1102.534.3	2ZR 003 236-311	1107.839.3	2PF 959 570-407	1503.211.00	2SA 003 236-341	1504.033.00	2JA 002 661-001
1102.534.4	2TM 003 748-011	1107.941.2	8XU 008 405-031	1503.212.00	2SA 003 236-041	1504.037.10	9EL 120 240-011
1102.534.5	9EL 119 544-111	1107.941.2	8XU 008 405-037	1503.212.00	2SA 003 236-047	1504.039.00	2JA 001 331-011
1102.534.6	2ZR 005 603-061	1108.046.8	2PF 008 221-011	1503.212.00	2SA 003 236-048	1504.041.00	9EL 855 097-001
1102.534.6	2ZR 005 603-067	1108.046.8	2PF 008 221-017	1503.212.01	9EL 119 544-031	1504.106.00	2JA 001 364-001
1102.534.8	2KA 001 378-041	1108.046.9	2XA 008 221-021	1503.216.00	2SA 005 603-021	1504.207.00	2AB 004 532-051
1102.534.9	2KA 005 049-011	1108.046.9	2XA 008 221-027	1503.216.00	2SA 005 603-027	1504.207.00	2AB 004 532-057
1102.535.0	2KA 005 049-017	1108.047.0	2ZR 008 221-051	1503.217.00	2SD 002 582-117	1504.207.05	9XB 136 202-005
1102.535.0	2KA 003 389-061	1108.047.0	2ZR 008 221-057	1503.218.00	2SD 002 582-127	1504.637.10	9EL 120 240-011
1102.535.0	2KA 003 389-062	1108.047.1	8RA 008 405-001	1503.222.00	2SK 003 567-321	1508.021.00	8JA 001 909-001
1102.535.0	2KA 003 389-068	1108.047.1	8RA 008 405-007	1503.222.02	9EL 122 772-001	1508.148.00	2PS 962 964-012
1102.535.1	2KA 001 622-001	1108.060.8	8WT 008 549-601	1503.223.00	2ZR 001 240-377	1508.148.00	2PS 962 964-018
1102.535.6	2KA 005 049-011	1108.061.0	8WT 008 549-701	1503.226.00	2BA 003 236-541	1511.946.00	8KW 701 235-033
1102.535.6	2KA 005 049-017	1108.067.9	2JB 996 012-121	1503.23	2SD 003 167-011	1512.100.00	3AG 003 399-101
1102.542.1	2SK 003 567-321	1108.253.3	8KA 152 134-007	1503.230.00	2ZR 001 240-377	2602.042.00	2XM 004 444-001
1102.544.2	8RA 003 326-041	1111.389.8	2JA 001 346-011	1503.232.00	2SD 003 184-041	2602.105.00	2XW 003 146-001
1102.544.2	8RA 003 326-047	1111.461.6	2PF 959 590-401	1503.232.00	2SD 003 184-047	2602.119.00	2XW 003 149-001
1102.544.6	8RA 003 326-001	1111.461.6	2PF 959 590-407	1503.233.00	8XU 007 842-017	36.25100-6027	2PT 009 556-031
1102.544.6	8RA 003 326-002	1112.835.8	2PS 009 226-017	1503.234.00	8XU 007 842-027	36.25101-6000	1K0 008 191-041
1102.544.7	8RL 002 009-011	111.283.60	2BM 008 355-001	1503.239.00	1NL 007 186-047	36.25101-6000	1K0 008 191-047
1102.544.8	8RL 002 009-021	111.283.60	2BM 008 355-007	1503.241.00	2BA 004 119-001	36.25101-6002	1BL 007 834-007
1102.545.4	8RB 004 713-001	111.283.60	2BM 008 355-017	1503.242.00	2BA 005 603-011	36.25101-6003	1KL 007 834-027
1102.546.2	2SA 001 647-041	1113.245.2	2SA 009 001-137	1503.242.00	2BA 005 603-017	36.25101-6008	1NL 008 090-117
1102.546.4	2PF 961 167-021	1113.245.3	2BA 009 001-107	1503.244.00	1KL 007 834-027	36.25101-6030	2PT 009 599-041
1102.546.9	2PF 002 860-031	1114.574.3	2PF 003 563-187	1503.245.00	1NL 007 834-017	36.25102-0000	9HD 149 253-007
1102.547.0	9GD 128 553-007	1200.613.0	2PF 959 570-401	1503.250.01	9GT 134 655-007	36.25102-6000	1N0 008 582-011
1102.547.3	2SA 002 860-041	1200.613.0	2PF 959 570-407	1503.250.02	9GT 143 133-007	36.25102-6000	1N0 008 582-017
1102.547.5	1NL 007 186-027	1400.681.3	2PF 002 860-031	1503.253.00	2SD 003 184-031	36.25102-6004	1NL 008 090-327
1102.547.5	2JA 005 590-001	1401.191.4	2PS 963 639-011	1503.253.00	2SD 003 184-037	36.25103-6000	2ZR 008 221-051
1102.548.8	2SA 001 638-021	1401.191.4	2PS 963 639-017	1503.28	2SD 003 167-021	36.25103-6000	2ZR 008 221-057
1102.548.9	2PF 001 638-011	1401.502.7	8JD 156 151-807	1503.300.00	2ZR 002 694-001	36.25103-6003	2ZR 001 240-377
1102.549.1	2XS 005 020-001	1502.204.00	2NE 005 603-071	1503.300.00	2ZR 002 694-002	36.25109-0000	9HD 149 253-007
1102.549.1	2XS 005 020-002	1502.204.00	2NE 005 603-077	1503.301.00	2ZR 001 193-011	36.25115-0000	9AH 161 786-017
1102.549.1	2XS 005 020-003	1502.205.00	2SK 003 567-661	1503.302.00	2ZR 003 236-311	36.25201-6010	2JA 004 531-011
1102.549.3	2XS 007 841-011	1502.206.00	2SK 003 567-651	1503.303.00	2TM 003 748-011	36.25201-6012	2JA 005 590-001
1102.549.3	2XS 007 841-017	1502.207.00	9HB 126 601-001	1503.303.01	9EL 119 544-111	36.25201-6013	2JA 003 231-001
1102.549.4	2XS 007 841-021	1503.000.00	9GH 145 943-001	1503.307.00	2ZR 005 603-061	36.25202-6003	2AB 004 532-057
1102.549.4	2XS 007 841-027	1503.003.01	2BA 002 939-171	1503.307.00	2BA 005 603-067	36.25205-6000	2JB 996 012-121
1102.549.9	8GA 002 074-241	1503.003.02	9EL 116 771-031	1503.35	9EL 107 443-061	36.25225-	



Manufacturer's no. / Hella no. Cross-Reference

O & K	Hella	O & K	Hella	Opel	Hella	Opel	Hella
3004752	2BN 964 169-057	8110485	1GB 006 213-101	12 16 413	1LL 006 110-351	35438	8KB 007 895-811
3004753	2TA 964 169-061	8110485	1GB 006 213-107	12 16 499	1LG 006 920-231	36207	9GD 861 470-001
3004753	2TA 964 169-067	8110503	9EL 118 614-011	12 16 500	1LG 006 920-241	36209	2RM 007 200-141
3005654	2BA 996 012-147	81305004160	8PA 007 732-013	12 16 563	1LL 008 700-331	36831	8KB 007 897-801
30234	2SD 001 679-001	81344400160	9EV 857 067-011	12 16 564	1LL 008 700-341	37345	2RM 007 200-231
0033272	2BA 001 259-611	8200961	2SD 002 582-021	12 16 657	1LG 270 370-631	37730	9SX 007 609-031
0033272	2BA 001 259-618	8200961	2SD 002 582-027	12 16 658	1LG 270 370-641	37869	2RM 007 200-131
33766	8RA 002 016-111	8200962	2SD 002 582-011	12 17 273	9GH 116 966-011	39 00 017	2BA 003 236-021
0339992	2BA 002 324-001	8200962	2SD 002 582-017	12 17 276	9GH 116 966-011	39 00 017	2BA 003 236-027
0034464	2SB 001 259-261	8200963	9EL 112 743-001	12 20 610	1X0 001 515-021	40828	2RM 007 200-001
0034774	2BA 001 248-001	8200964	9EL 112 741-001	12 22 111	9EL 160 467-011	41 50 200	9EL 052 476-001
0035157	2AA 001 200-031	8202756	2SA 001 240-331	12 22 112	9EL 160 468-011	41 59 800	2SD 001 305-021
0035157	2AA 001 200-032	8202849	2SD 001 305-021	1 222 355	9EL 354 073-011	43093	1GA 996 142-041
0036652	2ZR 001 421-101	8412648	2SB 003 018-031	1 222 356	9EL 354 073-021	43846	9XB 167 882-001
0038280	9KS 075 139-001	8412656	2SD 001 693-011	12 22 600	8RA 007 051-041	43848	9MM 863 164-011
4158653	2JA 001 330-001	8412667	2SD 001 699-061	12 22 601	8RA 007 051-031	44001600	9EL 052 476-001
4158653	2JA 001 330-007	8412672	2SD 001 699-511	12 23 182	9EL 152 052-011	44012200	2SD 001 305-021
4158831	2SD 001 685-211	8412674	2BA 003 022-001	12 23 185	9EL 152 051-011	06-0288	2SY 003 014-121
4158831	2SD 001 685-218	8412675	2SE 001 699-071	12 24 120	2KA 001 622-001	06 35 200	2SA 003 014-051
4158831	2SD 001 685-231	8412692	2BA 003 734-061	12 24 124	2KA 001 386-281	62 07 044	6NM 007 878-351
4158831	2SD 001 685-232	8412695	2BE 003 014-251	12 24 136	2KA 003 485-021	62 23 151	9EL 143 579-021
4158904	9EL 109 139-001	8412695	2BE 003 014-257	12 24 137	2KA 004 434-031	62 23 152	9EL 143 580-021
4158974	9ES 093 815-001	8412748	1GS 003 241-071	12 24 139	2KA 003 485-021	62 35 086	5DD 008 319-501
4158975	9EL 113 324-001	8413050	2PF 001 648-161	12 26 048	2BA 006 091-011	62 35 149	5DV 008 290-004
4200838	9ES 069 831-001	8413122	2JA 003 231-001	12 26 049	2BA 006 091-021	67 10 010	1NA 009 029-011
0042488	2SD 001 679-001	8413692	9EL 110 918-011	12 26 050	2BA 006 091-011	67 10 011	1NA 009 033-011
0430879100	2JA 001 357-002	8413704	9EL 110 910-001	12 26 051	2BA 006 091-021	67 10 012	1NA 009 029-021
0043309	9KS 075 307-001	8413715	6ED 708 919-001	12 26 054	2BA 006 091-021	67 10 014	1NA 009 033-021
0434011800	2JA 003 231-001	8413762	9EL 854 912-001	12 26 055	2BA 006 091-011	67 10 020	1NA 009 032-011
0043497	9EL 088 150-001	8436822	9GT 074 132-001	12 26 056	2BA 007 249-021	89 83 807	2KA 001 622-001
0045911	9GD 024 183-001	8436830	9EL 115 003-055	12 26 057	2BA 007 249-011	90009587	2AA 003 257-041
0045912	9AG 017 970-001	8464232	2SA 001 634-121	12 26 058	4RA 003 510-361	90009587	2AA 003 257-042
0045913	9DR 060 567-001	8464263	2BE 003 182-101	13239286	1LG 270 370-631	90016718	2NE 002 985-001
4619240	2ZR 003 236-051	8464299	2XS 950 071-031	13239287	1LG 270 370-641	90017882	2KA 001 386-281
4619240	2ZR 003 236-057	8464300	2XS 005 020-001	17 10 039	1NA 009 031-011	90019231	2JA 001 346-011
0048139	9ES 069 831-001	8464300	2XS 005 020-002	17 10 040	1NA 009 031-021	90019235	3AG 003 399-081
0490772	8XS 113 389-001	8464300	2XS 005 020-003	17 10 164	1ND 003 590-001	90019236	5AB 005 944-001
0490775	2AA 001 200-131	8464301	2XS 005 020-011	17 12 292	2NE 002 985-001	90019237	6ZM 001 759-051
0490776	2AA 001 200-141	8464301	2XS 005 020-017	17 12 551	9EL 117 094-001	90033942	2JA 001 330-031
049775	2AA 001 200-131	8464788	2PF 003 389-037	17 13 402	2BM 003 563-111	90053687	9GH 116 966-011
0505650	1G8 002 340-001	8464953	2AB 004 532-051	17 44 302	2JA 001 330-031	090093441	9EL 117 094-001
0511591	2BA 002 324-011	8464953	2AB 004 532-057	17 44 305	2AB 004 532-021	90140910	1ND 003 590-001
0511592	2BA 002 324-021	8467019	9EL 110 544-001	17 76 027	6ZE 001 759-071	090141523	2BA 003 022-021
0524903	2BA 001 221-031	8467037	1GS 120 510-001	17 76 063	2BA 003 022-021	90141524	2AA 003 257-031
0524904	2BA 001 221-041	8467158	9XR 854 840-001	17 76 066	2AA 003 257-031	90186655	2BA 001 227-211
524951	2KA 003 389-061	8475319	1N4 002 608-021	17 76 204	2BA 001 227-211	90188724	6ED 004 778-001
524951	2KA 003 389-062	8476344	2XS 955 031-001	17 76 212	6ED 004 778-001	90271592	2AB 004 532-011
524951	2KA 003 389-068	8482092	9EL 146 491-001	17 76 325	2AA 003 257-041	90271592	2AB 004 532-001
0552314	2BA 002 652-121	8482692	9EL 855 097-001	17 76 325	2AA 003 257-042	90295524	2AB 004 532-001
0552314	2BA 002 652-127	8485655	9EL 856 418-001	17 76 633	8HG 002 365-001	90349849	2JA 001 364-001
0552315	2BA 002 652-111	8488471	2RL 008 060-111	17 76 856	6ZE 001 759-051	90369131	8HG 854 516-001
0552315	2BA 002 652-117	8488472	2RL 008 061-111	20 98 002	8GD 002 088-131	90392574	1LL 006 110-351
0559299	8GH 002 090-133	8519965	2SA 003 057-021	20 98 003	8GD 002 088-131	90392575	1LL 006 110-361
0576126	2PF 001 650-001	8520062	2PF 003 057-041	20 98 102	8GA 002 071-131	90457812	6NM 007 282-641
0576426	2SE 002 578-701	8520691	9EL 117 330-011	20 98 103	8GA 002 071-121	90485075	9GD 856 863-001
0576426	2SE 002 578-707	0090251	2JA 001 330-001	20 98 126	8GP 002 068-121	90487570	1LG 006 920-231
576427	2BA 002 652-101	0090251	2JA 001 330-007	20 98 129	8GP 002 067-121	90487572	1LG 006 920-241
576427	2BA 002 652-107	0915573	9ES 093 815-001	20 98 150	8GP 002 066-121	90487918	9GD 858 086-001
0590880	2BA 003 014-111	0933387	2JA 004 531-011	20 98 175	8GM 002 094-121	90492832	6NM 007 282-641
0591342	2SB 003 014-151	0933953	1G8 002 340-011	20 98 176	8GM 002 091-131	90544283	2JA 001 364-001
0591900	2ZR 001 193-011	937501	2BA 001 423-087	20 98 178	8GM 002 091-121	90565932	5DV 007 760-651
0597009	2SD 002 776-231	937501	2SB 001 423-097	20 98 201	8GM 002 092-121	90590665	6NM 007 878-351
0597009	2SD 002 776-237	0944197	9GT 067 751-001	20 98 251	8GA 002 072-121	91 18 758	1LL 008 020-281
0597064	2SD 002 776-241	0944198	1S5 003 178-431	20 98 252	8GA 002 073-121	91 18 761	1LL 008 020-271
0597064	2SD 002 776-247	0945429	2AA 001 200-041	20 98 326	8GH 002 090-133	91 20 067	2XW 007 146-001
598034	2SA 003 014-051	0945429	2AA 001 200-042	20 98 401	8GD 002 078-121	91 59 282	2BA 002 324-011
0598671	2SW 003 014-131	0095025	8JA 001 909-011	20 98 914	8GA 002 071-121	91 59 283	2BA 002 324-021
6914613	9EL 964 536-001	970097	2PF 001 259-631	20 98 939	8GA 007 997-171	91 59 284	8GA 002 073-121
7000-448	1N4 005 750-001	0971531	1GS 003 241-021	20 98 946	8GS 007 949-101	91 93 413	1LL 009 020-231
0718942	2SD 001 685-211	0971532	2KA 003 389-061	223335666	2SD 002 582-021	91 93 414	1LL 009 020-241
0718942	2SD 001 685-218	0971532	2KA 003 389-062	223335666	2SD 002 582-027	92 93 179	8HG 002 365-001
0726334	8RL 002 009-021	0971532	2KA 003 389-068	244065669	5DV 008 290-004	93171645	5DD 008 319-501
0726357	1G8 132 233-011	0987118	8HG 002 365-001	24417111	5DV 008 290-004	93172955	1LL 008 320-331
7300981	9EL 856 416-001	0987253	2XW 003 146-001	24451030	1LG 270 370-331	93172956	1LL 008 320-341
0760569	2ZR 003 014-091	BER511592	2BA 002 324-021	24451031	1LG 270 370-341	93175325	1LG 007 640-631
0763043	9ES 106 588-001			24 60505	2SB 003 018-031	93175326	1LG 007 640-641
7723-462	1VB 005 444-037			24 60 506	9ES 082 333-031	93175370	1LG 007 640-331
7751280	8HG 006 294-021			24 60 507	9EL 126 294-001	93175371	1LG 007 640-341
7803855	2AB 001 208-001			24 60 515	9EL 089 114-001	93175725	1LG 007 640-631
8000013	8GM 002 091-261			24610120	2SD 001 305-021	93175726	1LG 007 640-641
8002612	9EL 092 435-011			24610130	9EL 052 476-001	93177645	5DD 008 319-501
8003720	2BE 002 582-031			26 60 078	2SD 001 680-271	93178633	1LG 270 370-331
8003833	2KA 001 386-231			26 60 079	2SD 001 680-281	93178634	1LG 270 370-341
8003954	2SD 001 686-101			26600800	9EL 107 368-001	93178771	9EL 160 467-011
8005804	9EL 112 744-001			26600810	9EL 111 647-001	93178772	9EL 160 468-011
8006504	9EL 102 240-031			28 61030	2BA 003 022-021	93183055	9EL 161 421-011
8011905	8RA 003 326-011			29700301	2XS 005 020-021	93183056	9EL 161 422-011
8011905	8RA 003 326-011			33211	9GD 860 936-001	93190067	1LG 270 370-631
8011905	8RA 003 326-041			33214	8KB 007 896-801	93190068	1LG 270 370-641
8011905	8RA 003 326-047			33215	9SX 861 562-001	93190306	9EL 354 073-011
8063931	2BA 001 248-001			34308	9MM 860 814-801	93190307	9EL 354 073-021
8110307	2SD 003 182-051			34309	8KB 861 213-011	E-X0531306AA	6ED 004 778-001
8110307	2SD 003 182-057			34 59 065	9FF 085 642-001	J03040078	2DA 003 014-031
8110330	2SD 003 182-061			34 78 011	2AA 001 200-001	J03040078	2DA 003 014-037
8110330	2SD 003 182-067			34 78 011	2AA 001 200-002	J03040080	2PF 001 650-001

Manufacturer's no. / Hella no.

Cross-Reference



Opel	Hella	Osram	Hella	Osram	Hella	Philips	Hella
J03040091	2SA 003 014-051	2840	8GA 008 901-241	7528	8GD 002 078-121	12821LL	8GA 002 071-351
PR0531060	2ZR 003 315-041	2841	8GP 003 594-241	7528L	8GD 002 078-221	12829	8GP 002 066-121
PR0531975	2KA 003 389-061	2845	8GP 003 594-251	7535	8GA 002 072-241	12844	8GM 002 092-121
PR0531975	2KA 003 389-062	3724	8GP 002 096-061	7537	8GD 002 078-241	12844LL	8GM 002 092-171
PR0531975	2KA 003 389-068	3796	8GP 002 068-121	7569	8GA 002 074-121	12850	8GM 002 091-141
PR0532202	2SD 003 182-051	3797	8GP 002 068-241	7669	8GA 002 074-241	12866	8GM 002 091-131
PR0532202	2SD 003 182-057	3886X	8GP 007 676-121	7950	8GD 002 088-071	12910	8GP 002 068-131
PRA003110	8RA 002 016-121	3892	8GP 002 067-061	7951	8GD 002 088-131	12913	8GP 002 068-121
PRF866679	2XW 003 146-001	3893	8GP 002 067-121	7952	8GD 002 088-251	12929	8GP 002 067-121
PRK000489	2KA 005 049-011	3893CB	8GP 002 067-011	9005	8GH 005 635-121	12929BV	8GP 002 067-011
PRK000489	2KA 005 049-011	3894	8GP 002 068-131	9005L	8GH 005 635-181	12961	8GP 003 594-121
PRK000489	8RA 004 412-001	3898	8GP 002 066-121	9006	8GH 005 636-121	12961BV	8GP 003 594-261
PRK000588	2XW 003 146-001	3899	8GP 002 066-241	9006XS	8GH 005 636-201	12972	8GH 007 157-121
PRK000607	2AA 003 257-041	3930	8GP 002 067-241	921	8GA 008 246-001	12972BV	8GH 007 157-181
PRK000607	2AA 003 257-042	4050300170237	8GP 003 594-002	94193	8GJ 002 525-301	12972LL	8GH 007 157-201
PRK000607	2BA 002 324-001	5007	8GA 002 071-121	94196	8GJ 002 525-281	12972XP	8GH 007 157-531
PRK000607	2SD 001 699-061	5007L	8GA 002 071-351	9511	8GA 006 841-241	13227	8GA 002 083-251
PRK000607	2SD 001 699-511	5008	8GA 002 071-131	9627	8GA 002 073-251	13256	8GP 003 594-241
PRK000612	1ND 003 590-001	5008L	8GA 002 071-341	9637	8GA 002 071-261	13258	8GH 002 089-251
PRX002669	1TA 003 570-001	5627	8GA 002 071-241	9637	8GA 002 071-271	13258HD	8GH 002 089-361
PRX002669	1TA 003 570-101	5637	8GA 002 071-251	9930	8GP 002 067-261	13311	8GH 002 857-241
V01049500	2SB 003 018-031	6411	8GM 002 091-131	L8/29	8GS 002 296-101	13336	8GH 002 090-251
V03015300	1G5 003 241-081	64111	8GH 002 473-151	L8/33	8GS 002 296-111	133.42	8GJ 002 525-251
V04027900	2AA 001 200-031	64115	8GH 002 473-132	Peugeot	Hella	13342HD	8GJ 002 525-281
V04027900	2AA 001 200-032	64122MF	8GA 007 997-101	0024.78	8GP 002 066-121	13445	8GA 002 072-241
V04029400	2AA 001 200-011	64124MF	8GA 007 997-111	0026.18	1NB 005 860-001	13498	8GA 002 073-241
V04029400	2AA 001 200-012	64132	8GH 007 643-121	6204.ZC	1LG 010 196-031	134.98HD	8GA 002 073-251
V04159800	2SD 001 305-021	64132L	8GH 007 643-171	6204.ZF	1LG 010 196-031	13499	8GD 002 078-011
V04221200	1X0 001 515-021	64150	8GH 002 089-133	6205.ZC	1LG 010 196-041	13499	8GD 002 078-241
V04226800	2SD 001 679-001	64150CB	8GH 002 089-141	6205.ZF	1LG 010 196-041	13516	8GP 002 095-241
V06028800	2SW 003 014-131	64150CB-01B	8GH 002 089-141	6206.A9	1LF 009 237-031	13521	8GA 007 997-021
V06035200	2SA 003 014-051	64150L	8GH 002 089-351	6206.A9	1LF 009 237-041	13597	8GA 007 997-071
V06056500	2ZR 003 315-041	64150SVS	8GH 002 089-471	6208.A9	1LF 009 237-031	13620	8GD 002 088-251
V07000200	8RA 002 010-011	64151	8GH 002 090-133	6350.CE	2VP 354 039-011	13748	8GD 002 084-251
V07008700	2KA 001 386-231	64151CB	8GH 002 090-371	6350.Y7	2VP 354 038-011	13807	8GM 002 091-241
V08092200	1TA 003 570-101	64155	8GH 002 089-251	6351.CE	2VP 354 039-021	13814	8GA 002 071-251
V23660340	2SW 003 014-131	64155LTS	8GH 002 089-491	6351.Y7	2VP 354 038-021	13814 HD	8GA 002 071-271
V24605130	1G5 003 241-021	64156	8GH 002 090-251	9653563780	1LF 009 237-041	13818	8GM 002 094-241
V24610120	2SD 001 305-021	64156LTS	8GH 002 090-471	9653563880	1LF 009 237-031	13821	8GA 002 071-241
V26600200	8RA 002 015-021	64173	8GH 002 857-121	9941.68	8PA 007 732-103	13821HD	8GA 002 071-261
V26600610	1X0 001 515-021	64175	8GH 002 857-241	9941.69	8PA 007 732-093	13822	8GA 002 071-361
V26600780	2SD 001 680-271	6418	8GM 002 092-121	9941.70	8PA 007 732-083	13829	8GP 002 066-241
V26600790	2SD 001 680-281	6418D	8GM 002 092-171	Philips	Hella	13844	8GM 002 092-241
V26600810	9EL 111 647-001	6418L	8GM 002 092-171	12008	8GA 008 899-121	13850	8GM 002 091-261
V26600820	2BA 003 014-011	64193	8GJ 002 525-131	120.23	8GH 002 473-151	13866	8GM 002 091-251
V27600050	2SD 001 685-211	64193	8GJ 002 525-133	12025	8GH 002 473-132	13913	8GP 002 068-241
V27600050	2SD 001 685-218	64193ALS	8GJ 002 525-341	12036	8GH 007 643-121	13929	8GP 002 067-241
V27605030	2KA 001 386-281	64193CB	8GJ 002 525-361	12036LL	8GH 007 643-171	13929 HD	8GP 002 067-261
V28605420	2SK 003 567-321	64193D	8GJ 002 525-481	12052	8GH 007 676-121	13961	8GP 003 594-251
V28610250	2BA 001 227-201	64193NBR	8GJ 002 525-531	12061	8GP 938 026-001	13972	8GH 007 157-241
V28610300	2BA 003 022-021	64193SVS	8GJ 002 525-471	12067	8GA 008 246-001	020.0300	8GD 002 088-071
V29615040	8RA 002 016-121	64196	8GJ 002 525-251	12227	8GA 002 083-131	020.1050	8GD 002 084-131
V29700300	8RA 002 014-101	64196LTS	8GJ 002 525-511	12256	8GP 003 594-141	020.1300	8GD 002 088-131
V29700301	2XS 005 020-021	64210	8GH 007 157-121	12258BV	8GH 002 089-141	020.2010	8GD 002 084-251
V44012200	2SD 001 305-021	64210CB	8GH 007 157-181	12258LL	8GH 002 089-351	020.2300	8GD 002 088-251
V44022500	2SE 002 578-701	64210D-01B	8GH 007 157-201	12311	8GH 002 083-131	020.4030	8GA 002 083-131
V44022500	2SE 002 578-707	64210L	8GH 007 157-201	12336	8GH 002 090-133	020.4550	8GH 005 635-121
V44029700	2BA 001 227-201	64210NBR	8GH 007 157-531	12336BV	8GH 002 090-371	020.4551	8GH 005 636-121
V46019400	1X0 001 515-021	64210SVS	8GH 007 157-471	12342	8GJ 002 525-131	020.4910	8GH 002 090-133
V46021300	2SW 003 014-131	64211	8GH 008 358-121	12342AW	8GJ 002 525-133	020.4920	8GH 007 157-121
V46059200	2BA 003 014-011	64212	8GH 008 356-121	12342BV	8GJ 002 525-341	020.4930	8GH 002 857-121
V46061300	2BA 003 014-111	64213	8GH 008 357-001	12342ZB	8GJ 002 525-361	020.4978	8GH 002 073-241
V46063500	2ZR 003 014-019	64215	8GH 007 157-241	123.42HD	8GJ 002 525-301	020.5000	8GA 002 083-251
V47001800	8RA 002 015-031	64215LTS	8GH 007 157-231	12342LL	8GJ 002 525-481	020.5903	8GH 002 089-251
V47001900	8RA 003 503-001	64216LTS	8GH 008 358-251	12342VP	8GJ 002 525-471	020.5903	8GH 007 157-241
V99082800	8GS 859 634-001	6423	8GM 002 092-241	12342XP	8GJ 002 525-531	020.5910	8GH 002 090-251
V99120130	2AA 001 200-001	6428	8GM 002 094-121	12356LL	8GH 008 417-001	020.5930	8GH 002 857-241
V99120130	2AA 001 200-002	6429	8GM 002 091-251	12360	8GH 008 356-121	021.0205	8GA 006 841-121
V99120290	8HG 002 365-001	6430	8GM 002 094-241	12361	8GH 008 357-001	021.0206	8GA 002 073-121
V99120380	2AA 001 200-011	6451	8GM 002 091-141	12362	8GH 008 357-151	021.0207	8GD 002 078-121
V99120380	2AA 001 200-012	6453	8GM 002 091-261	12362	8GH 008 358-121	021.0209	8GD 004 772-121
Osram	Hella	6475	8GM 002 091-121	12362	8GH 008 358-121	021.0217	8GA 002 072-121
2322MFX	8GA 007 997-151	6476	8GM 002 091-181	12362	8GH 008 358-151	021.0306	8GA 002 073-241
2351MFX6	8GA 007 997-121	6480	8GM 002 091-241	12366	8GP 003 594-541	021.0307	8GD 002 078-241
2352MFX6	8GS 006 677-121	66142	8GS 009 028-001	12445	8GA 002 072-121	021.0316	8GA 002 073-251
2431MFX6	8GA 007 997-131	66240	8GS 007 949-101	124.96	8GA 006 841-121	021.0317	8GA 002 072-241
2452MFX6	8GA 007 997-141	66250	8GS 007 001-121	12498	8GA 002 073-121	021.1203	8GA 002 071-121
2473MFX6	8GA 007 997-171	7130	8GA 008 899-061	12498LL	8GA 002 073-271	021.1206	8GA 002 071-131
2707	8GP 938 026-001	7135	8GA 008 899-121	12499	8GD 002 078-121	021.1303	8GA 002 071-241
2721	8GA 007 997-011	7225	8GD 004 772-121	12499LL	8GD 002 078-221	021.1306	8GA 002 071-251
2721	8GP 002 095-121	7309	8GA 002 083-131	12516	8GA 007 997-011	021.1313	8GA 002 071-261
2721MF	8GA 007 997-031	7323	8GD 008 897-061	12516	8GP 002 095-121	021.1316	8GA 002 071-271
2721MF8	8GA 007 997-041	7324	8GD 008 898-061	125.94	8GD 004 772-121	021.2114	8GP 002 067-061
2721MF8W	8GA 007 997-051	7326	8GD 008 897-121	12597	8GA 007 997-031	021.2208	8GP 002 068-121
2722MF8	8GA 007 997-001	7327	8GD 002 084-131	12600	8GA 007 997-081	021.2210	8GP 002 066-121
2722MF8W	8GA 007 997-091	7360	8GD 002 084-251	12620	8GD 002 088-131	021.2214	8GP 002 067-121
2722MFX	8GA 007 997-081	7409	8GA 002 083-251	12718	8GD 008 897-121	021.2308	8GP 002 068-241
2741	8GP 002 095-241	7504	8GP 009 021-002	12728	8GD 002 084-131	021.2310	8GP 002 066-241
2741MF	8GA 007 997-071	7506	8GA 002 073-121	12748	8GD 002 084-151	021.2314	8GP 002 067-241
2741MF8	8GA 007 997-061	7506L	8GA 002 073-271	128.03	8GM 002 091-181	021.2324	8GP 002 067-261
2752MF	8GA 007 997-161	7507	8GA 006 841-121	12807	8GM 002 091-121	021.3201	8GM 002 094-121
2821	8GP 003 594-141	7507LDA	8GA 006 841-801	12814	8GA 002 071-131	021.3203	8GM 002 092-121
2825	8GP 003 594-121	7511	8GA 002 073-241	12814LL	8GA 002 071-341	021.3205	8GM 002 091-131
2825CB	8GP 003 594-261	7511HD	8GA 002 073-251	12818	8GM 002 094-121	021.3209	8GM 002 091-141
2827	8GP 003 594-541	7527	8GA 002 072-121	12821	8GA 002 071-121	021.3211	8GM 002 091-121



Manufacturer's no. / Hella no.

Cross-Reference

Philips	Hella	Renault	Hella	Rubbolite	Hella	Same	Hella
021.3301	8GM 002 094-241	50 01 835 292	9EL 119 544-021	360SPS/01/00	2VP 008 204-041	Deutz-Fahr	Hella
021.3303	8GM 002 092-241	50 01 842 626	9XB 136 202-005	360SPS/02/00	2VD 008 204-051	013 00962	9EL 090 411-001
021.3305	8GM 002 091-251	50 01 847 586	2VD 008 204-231	360SPS/07/00	2VP 008 204-061	130 0962EY0000-00	9EL 090 411-001
021.3311	8GM 002 091-241	50 01 847 587	2VP 008 204-221	360SPS/07/20	2VP 008 204-081	013 00971	9ES 015 675-001
021.4205	8GH 002 473-151	50 10 043 471	2AB 004 532-051	360SPS/08/01	2VD 008 204-071	130 0971EY0000-00	9ES 015 675-001
021.6202	8GP 003 594-141	50 10 043 471	2AB 004 532-057	360SPS/08/31	2VD 008 204-091	160 05189	2SD 006 040-141
021.6212	8GP 002 095-121	50 10 057 423	2XW 003 146-001	461SC/08/30	2VD 008 205-021	160 05189	2SD 006 040-147
021.6252	8GP 003 594-121	50 10 168 934	8RA 003 326-041	461SC/08/31	2VD 008 205-011	160 05190	2SD 006 040-331
021.6302	8GP 003 594-241	50 10 168 934	8RA 003 326-047	6311 A	9EL 152 889-001	160 05190	2SD 006 040-337
021.6312	8GP 002 095-241	50 10 174 173	2AB 004 532-051	80857 A	9EL 152 891-001	160 06018	2XS 005 020-001
021.6352	8GP 003 594-251	50 10 174 173	2AB 004 532-057	80873 A	9EL 152 884-001	160 06018	2XS 005 020-002
021.7362	8GH 007 643-121	50 10 256 873	2XW 007 146-011	Saab	Hella	160 06018	2XS 005 020-003
24362MD	8GH 008 358-251	50 10 578 448	1LL 247 010-311	10 663	2ZR 001 193-011	160 13869	9GD 102 484-001
24362ML	8GH 008 358-241	50 10 578 460	1LL 247 010-331	12 79 0580	9GH 156 191-001	160 19075	6ED 004 778-011
6064	8GD 004 772-151	50 10 578 472	1LL 247 010-321	12 79 0587	5DD 008 319-501	160 23487	9EL 856 416-001
6620	8GD 002 088-071	50 10 578 484	1LL 247 010-341	12 79 0592	5DV 008 290-004	160 29758	1AB 007 145-001
6718	8GD 008 897-061	54 30 064 863	2XS 950 071-031	14 129	2ZR 002 694-001	160 37017	1GA 007 506-061
6728	8GD 008 898-061	77 00 066 388	1K0 008 191-011	14 129	2ZR 002 694-002	160 46038	1GA 007 506-001
6929	8GP 002 067-061	77 00 066 388	1K0 008 191-017	15 09 319	2SD 001 688-141	160 46082	2BA 002 652-111
7008	8GA 008 899-061	77 00 067 781	9GH 152 654-007	19 888	2XD 003 022-061	160 46082	2BA 002 652-117
7212.032.59681	8JA 001 914-011	77 00 415 343	6NM 007 878-501	17 247	9GD 102 484-001	160 46084	2BA 002 652-111
85122	8GS 007 949-101	77 00 420 736	6NM 007 878-501	19 888	2KA 003 389-061	160 46084	2BA 002 652-117
85126	8GS 007 001-121	77 00 420 737	6NM 007 878-501	19 888	2KA 003 389-062	160 46084	2BA 002 652-121
85410	8GS 009 028-001	77 00 428 320	2VP 008 101-031	19 888	2KA 003 389-068	160 46084	2BA 002 652-127
9005	8GH 005 635-121	77 00 428 321	2VP 008 101-041	25 552	2ZR 001 423-001	160 49688	2KA 003 389-001
9006	8GH 005 636-121	77 00 840 141	6NM 007 878-501	27 751	8XS 113 389-001	160 50113	1GA 007 506-021
9008	8GJ 008 837-121	77 01 036 013	9EL 144 131-001	286 017	2JA 003 231-001	160 50113	1GA 007 506-101
Porsche	Hella	77 01 036 014	9EL 144 132-001	286 557	2JA 003 231-001	160 50119	1LB 006 213-057
111.947.111.E	2JA 002 532-011	77 01 036 112	6NM 007 878-501	286 577	2JA 003 231-001	160 50281	2RL 007 337-001
7L5.094.631.01.E	8RA 003 326-031	77 01 039 174	8GP 938 026-001	32000384	9EL 133 785-005	160 50287	9GD 860 396-001
7L5.094.631.02.E	2SD 002 514-161	77 01 045 171	1LE 007 350-111	33 203	2PS 002 727-001	160 58800	2JA 006 447-041
900.631.115.90	8GA 002 071-131	77 01 045 172	1LE 007 350-121	33 203	2PS 002 727-007	023 05218	9GD 024 183-001
900.631.127.90	8GA 002 071-121	77 01 045 176	1LL 007 510-071	33 408	2ZR 001 240-351	230 5218E1053-49	9GD 024 183-001
900.631.134.90	8GP 002 095-241	77 01 045 177	1LL 007 510-081	38 915	9ES 082 333-031	023 06631	2SD 001 306-061
911.799.613.44	2ZR 003 030-171	77 01 051 776	9GH 156 191-001	39 096	9EL 113 928-001	023 06632	2SE 001 306-051
914.613.419.11	6ED 004 778-001	77 01 057 655	1LB 008 461-551	40 354	8RA 003 734-101	023 21228	9AG 011 970-001
944.631.905.00	2PF 003 057-041	77 01 057 655	1LB 008 461-751	04 06 961	2SA 003 057-021	232 1228EY1125-49	9AG 011 970-001
955.628.181.00	9GS 146 999-727	77 01 057 659	1LB 008 461-561	04 14 129	2ZR 002 694-001	023 32189	9GD 100 711-021
959.631.619.00	2KA 004 331-031	77 01 064 002	1LB 008 461-761	04 14 129	2ZR 002 694-002	233 2189EY1001-49	9GD 100 711-021
962.631.031.40	8GS 007 949-101	77 01 064 003	1L7 271 510-341	04 15 320	2KA 001 610-001	023 32194	9EL 104 571-041
962.631.041.40	1K3 114 155-001	77 01 064 004	1L7 271 510-331	04 15 761	2XD 003 022-061	233 2194EY1001-49	9EL 104 571-041
980.094.631.01.EAS00	2VA 998 531-031	77 01 064 004	1L7 271 510-381	04 19 888	2KA 003 389-061	023 32197	9EL 104 571-031
980.631.038.00.AS00	2PS 006 717-051	77 01 064 004	1L7 271 510-371	04 19 888	2KA 003 389-062	233 2197E1001-49	9EL 104 571-031
980.631.038.00.AS00	2PS 006 717-057	77 01 363 204	2XW 007 146-001	04 19 888	2KA 003 389-068	233 2197EY1001-49	9EL 104 571-031
980.631.081.00	2ZR 008 221-051	77 01 363 210	2XW 002 897-051	04 27 753	2BA 001 275-011	023 62524/10	2SD 002 776-231
980.631.081.00	2ZR 008 221-057	77 01 366 010	2BE 003 184-061	04 27 754	2BA 001 275-021	023 62524/10	2SD 002 776-237
980.631.081.00.AS00	2ZR 008 221-051	77 01 366 012	2BE 003 184-051	43 219	2SE 001 688-151	023 70585	9DR 113 199-005
980.631.081.00.AS00	2ZR 008 221-057	77 01 366 012	2SE 002 578-701	43 220	2SE 001 688-161	237 0585EY100149	9DR 113 199-005
980.631.082.00.AS00	2ZR 008 221-051	77 01 366 014	2SE 002 578-707	04 33 408	2ZR 001 240-351	023 72742	2BE 001 259-061
980.631.082.00.AS00	2ZR 008 221-057	77 01 366 014	2ZR 002 694-001	43 81 448	9FF 085 642-001	023 72744	2JA 001 364-001
980.631.085.00	2NE 008 221-031	77 03 097 178	2ZR 002 694-002	04 51 756	2SA 003 734-121	023 77137	2SD 002 776-241
980.631.085.00	2NE 008 221-037	77 11 130 005	8GA 006 841-121	04 51 757	2DA 003 734-011	023 77137	2SD 002 776-247
980.631.085.00.AS00	2NE 008 221-031	77 11 130 005	9EL 144 132-001	04 53 090	8XS 113 389-001	237 7137KZ	2SD 002 776-241
980.631.085.00.AS00	2NE 008 221-037	77 11 130 006	9EL 144 131-001	49 111	9ES 106 588-001	237 7137KZ	2SD 002 776-247
980.631.091.00.AS00	8RA 008 405-001	77 11 130 007	9BG 142 247-021	509 319	2SD 001 688-141	023 77139	2SE 002 776-211
980.631.091.00.AS00	8RA 008 405-007	77 11 130 023	9BG 142 248-021	57 947	2BA 003 022-021	023 77139	2SE 002 776-211
980.631.500.00.AS00	2DA 959 380-511	77 11 130 024	9EL 144 132-001	61 225	2PG 002 727-021	237 7139KZ	2SE 002 776-211
996.631.046.9B	2BA 997 027-031	82 00 127 702	9EL 144 131-001	61 226	9EL 114 400-015	237 7139KZ	2SE 002 776-217
996.631.980.00	2DA 007 421-017	82 00 127 704	2SK 008 659-101	63 047	9GD 100 140-001	023 77448	2BE 002 776-251
997.094.631.22	2BA 002 939-251	82 00 142 687	2SK 008 659-091	66 33 415	8JA 001 909-001	023 77448	2BE 002 776-257
923.999.011.024	8PA 007 732-013	82 00 142 688	2VP 008 736-111	656 187	8RA 002 023-021	237 7448KZ	2BE 002 776-251
Renault	Hella	82 00 142 687	2VP 008 736-111	06 961	2SA 003 057-021	237 7448KZ	2BE 002 776-257
11244110	1K0 247 043-011	82 00 417 349	2VP 982 006-011	70 693	2PS 004 361-001	023 77450	2BE 002 776-261
11244110	1K0 247 043-017	82 00 417 351	2VP 982 006-021	70 693	2PS 004 361-007	023 77450	2BE 002 776-261
11244120	9AH 254 228-012	82 00 474 327	2SK 009 467-121	75 069	2SB 001 240-311	237 7450KZ	2BE 002 776-267
11244120	9AH 254 228-017	82 00 474 328	2SK 009 467-111	90019236	5AB 005 944-001	237 7450KZ	2BE 002 776-267
20 10 174 173	2AB 004 532-051	82 00 493 374	2SK 008 659-111	91 23 076	9EL 133 785-005	023 81366	9ES 093 815-001
20 10 174 173	2AB 004 532-057	82 00 493 375	2SK 008 659-121	91 23 084	9EL 133 786-005	238 1368EY1202-49	9KS 071 571-001
45 30 064 863	2XS 950 071-031	82 00 629 471	1L7 271 510-331	95 58 032	9ES 133 383-005	238 1368EY1202-49	9KS 071 571-001
50 00 242 198	2SE 001 699-071	82 00 629 472	1L7 271 510-341	95 58 040	9ES 133 384-005	023 81669	9EL 109 208-011
50 00 242 302	2SD 001 699-061	82 00 629 487	1L7 271 510-371	97 819	9EL 092 435-011	238 1669EZ1210-49	9EL 109 208-011
50 00 243 871	9EL 109 139-001	00 09 333 869	9GD 082 716-001	Same	Hella	023 81675	9EL 109 208-011
50 00 504 807	2JA 003 354-001	00 09 333 870	2PF 001 638-011	2.8039.160.3	1GA 007 506-121	238 1678EZ1210-49	9EL 088 538-001
50 00 589 612	2BA 001 240-301	00 09 333 871	2SA 001 638-021	011 01600	8JA 001 915-001	268 935167	9GT 005 166-001
50 00 786 223	8RA 002 014-051	Renault V.I.	Hella	011 03089	8HG 002 365-001	2.8039.110.0/01	9ES 069 831-001
50 00 786 223	8RA 002 014-052	50 01 847 584	2VD 008 204-251	110 3089EY8876-81	8HG 002 365-001	280 39160.3	1GA 007 506-111
50 00 786 922	8HG 002 365-001	50 01 865 642	1F8 006 800-191	011 35950	8GD 002 078-121	2.8210.004.0	1GA 007 506-121
50 00 807 391	9EL 854 912-001	50 01 865 643	1F8 006 800-221	011 45200	2BM 002 652-031	029 14462	8GA 002 083-131
50 00 820 133	8RL 002 009-021	50 10 168 934	8RA 003 326-041	011 6006018	2XS 005 020-001	306 1399M8	2SB 001 301-021
50 00 821 805	2SA 003 236-041	50 10 168 934	8RA 003 3				

Manufacturer's no. / Hella no.

Cross-Reference



Same	Hella	Same	Hella	SAW	Hella	SAW	Hella
Deutz-Fahr		Deutz-Fahr					
043 24753	2KA 001 389-101	062 17218	2BE 003 347-001	10.184-101	1GA 006 875-001	21.037-001	25T 001 673-011
043 24891	1G3 996 001-271	062 57809	2JA 001 330-001	10.185-021	1GA 006 876-001	21.037-021	25B 001 673-002
043 36132	9GD 120 670-001	062 57809	2JA 001 330-007	10.185-051	1GA 006 876-001	21.038-041	25B 001 301-021
433 6132EY1030-49	9GD 120 670-001	626 2009	2BA 003 022-021	10.186-011	1GA 005 060-001	21.044-001	25E 001 679-051
043 37596	9FF 090 500-001	626 2011	2SA 003 057-021	10.190-001	1GA 007 506-001	21.044-011	25D 001 679-001
433 7596EY1030-49	9FF 090 500-001	626 2012	1TA 003 570-101	10.190-011	1GA 007 506-011	21.086-021	25E 003 167-031
043 40118	2JA 003 231-001	626 2032	2ZR 002 589-011	10.190-031	1GA 007 506-001	21.086-031	25D 003 167-021
434 0118EC1024-49	2JA 003 231-001	626 9006	9EL 117 330-011	10.190-041	1GA 007 506-021	21.086-041	25E 003 167-041
043 49205/10	2SE 003 184-011	626 9007	1TA 122 718-001	10.190-061	1GA 007 506-021	21.088-051	25D 003 167-011
043 49205/10	2SE 003 184-011	626 9018	9EL 074 484-031	10.190-071	1GA 007 506-021	21.088-001	25E 997 088-001
043 49207/10	2SD 003 184-041	626 9018	2PF 003 014-071	10.200-001	1GA 998 532-011	21.111-001	25D 003 184-031
043 49207/10	2SD 003 184-047	062 77521	2SA 003 014-051	14.1145-101	2NE 003 236-001	21.111-001	25E 997 111-011
043 65082	2BE 003 014-251	062 77522	2SA 003 014-051	14.1145-201	2ZR 003 236-051	21.111-011	25E 997 111-021
043 65082	2BE 003 014-257	065 15208	2PG 003 057-011	14.1153-000	2SE 004 623-001	21.113-061	2VA 997 113-001
436 5082KZ1212-49	2BE 003 014-251	065 15208	2SA 003 057-021	14.1253-011	9EL 129 519-001	21.131-001	25D 997 131-051
436 5082KZ1212-49	2BE 003 014-257	065 26511	2ZR 003 014-091	20.013-001	2BA 001 277-011	21.147-001	2SK 003 567-331
043 65083	9EL 115 003-055	065 27091	2SB 003 014-151	20.013-011	2BA 001 277-021	21.147-001	25K 003 567-651
436 5083EY1212-49	9EL 115 003-055	065 32698	9EL 119 544-111	20.014-001	2BA 001 221-031	21.147-011	2SK 003 567-321
043 70259	9EL 118 701-001	065 38036	2KA 001 386-231	20.014-011	2BA 001 221-041	21.147-011	2SL 003 567-661
437 0259EY1075-49	9EL 118 701-001	680 966	9EL 087 769-001	20.015-001	2BA 003 022-021	21.147-021	2SK 003 567-311
043 70260	9EL 118 700-001	710 1621301	8JA 001 909-001	20.017-001	2PF 003 057-041	21.147-061	2VP 003 567-111
437 0260EY1075-49	9EL 118 700-001	000 9739002	9EX 043 137-001	20.017-011	2PF 003 057-001	21.147-071	2VP 003 567-121
043 74361	9ES 069 831-001	000 9739003	8XS 113 389-001	20.017-041	2SA 003 057-021	21.167-001	2SE 007 547-011
437 4361EY1078-49	9ES 069 831-001	000 9740211	2SW 003 014-131	20.017-161	2TM 003 057-031	21.167-001	2SE 007 547-011
043 74364	9DE 077 356-021	000 9740212	2SD 003 182-061	20.017-171	2PG 003 057-067	21.167-011	2SE 007 547-021
437 4364EY1078-49	9DE 077 356-021	000 9740212	2SD 003 182-067	20.017-181	2PS 003 057-051	21.167-011	2SE 007 547-027
043 84138	9GH 126 647-011	000 9740213	2SD 003 182-051	20.018-001	2SA 001 634-121	21.167-031	2SE 007 547-041
438 4138EY1101-49	9GH 126 647-011	000 9740213	2SD 003 182-057	20.019-001	2PF 001 648-161	21.167-051	2SL 007 547-061
043 85089	2KA 003 389-061	000 9740400	1S0 001 430-011	20.019-031	2PF 001 648-161	21.167-051	2SL 007 547-067
043 85089	2KA 003 389-062	000 9740600	2SB 003 018-031	20.022-001	2SA 997 022-001	21.176-001	2SL 005 883-031
043 85089	2KA 003 389-068	000 9741013	2BE 001 278-011	20.022-011	2PF 997 022-011	21.176-011	2SK 005 883-021
438 5089KZ	2KA 003 389-061	000 9741022	2BA 002 652-111	20.023-011	2PF 001 650-001	21.176-021	2SK 005 883-011
438 5089KZ	2KA 003 389-062	000 9741022	2BA 002 652-117	20.024-001	2PF 001 638-011	21.176-031	2SL 005 883-041
438 5089KZ	2KA 003 389-068	000 9741023	2BA 002 652-121	20.024-021	2SA 001 638-021	21.197-001	2VP 007 323-011
438 5089KZ	2KA 003 389-068	000 9741023	2BA 002 652-127	20.026-001	2SA 001 259-751	21.197-011	2VP 007 323-021
438 5089KZ1101-49	2KA 003 389-061	000 9741028	2BA 003 014-111	20.026-021	2PF 001 259-631	21.197-021	2VD 007 323-031
438 5089KZ1101-49	2KA 003 389-062	000 9741104	2TJ 001 633-211	20.026-041	2BA 001 259-611	21.197-031	2VD 007 323-041
438 5089KZ1101-49	2KA 003 389-068	000 9741500	2AA 001 200-021	20.026-201	2BA 001 259-611	21.197-101	2VP 007 323-111
043 89584	2BE 002 776-251	000 9741500	2AA 001 200-023	20.026-281	2PF 001 259-677	21.197-111	2VP 007 323-121
043 89584	2BE 002 776-257	000 9741700	2XW 003 146-001	20.027-201	2SA 997 027-001	21.197-121	2VD 007 323-131
438 9584KZ1065-49	2BE 002 776-251	000 9746015	9EL 087 769-001	20.027-211	2PF 997 027-011	21.197-131	2VD 007 323-141
438 9584KZ1065-49	2BE 002 776-257	000 9746024	9EL 052 476-001	20.027-221	2DA 997 027-021	22.003-021	2BE 002 582-031
043 89586	2BE 002 776-261	000 9746031	9EL 088 525-001	20.027-231	2BA 997 027-031	22.006-181	2BE 997 006-101
043 89586	2BE 002 776-267	000 9746034	9EL 110 540-001	20.028-001	2SA 003 014-051	22.007-101	2BE 003 182-091
438 9586KZ1065-49	2BE 002 776-261	000 9746035	9EL 115 003-011	20.028-011	2PF 003 014-071	22.007-111	2BE 003 182-101
438 9586KZ1065-49	2BE 002 776-267	000 9746036	9EL 118 614-011	20.028-021	2DA 003 014-031	22.026-171	2BE 001 259-061
043 89588	2SE 002 776-211	000 9746038	9EL 110 536-011	20.028-031	2BA 003 014-111	22.028-091	2BE 003 014-251
043 89588	2SE 002 776-217	000 9747905	9FF 090 500-001	20.028-041	2BA 003 014-011	22.111-001	2BE 003 184-051
438 9588KZ1065-49	2SE 002 776-211	000 9748101	9ES 015 675-001	20.029-001	2SA 001 240-331	22.111-011	2BE 003 184-061
438 9588KZ1065-49	2SE 002 776-217	000 9748110	9ES 069 831-001	20.029-011	2DA 001 240-341	22.131-011	2BE 997 131-081
043 89594	2SD 002 776-241	000 9748201	9DR 090 206-001	20.029-021	2BA 001 240-301	23.030-051	2NE 003 315-011
043 89594	2SD 002 776-247	000 9748202	9DR 090 206-001	20.029-031	2SA 001 240-331	23.033-001	2NE 001 423-011
438 9594KZ1065-49	2SD 002 776-241	000 9748203	9DR 066 847-001	20.196-001	2PS 006 717-031	23.056-011	2NE 002 985-001
438 9594KZ1065-49	2SD 002 776-247	000 9748303	9GD 023 639-001	20.196-011	2PS 006 717-051	24.027-201	2ZR 002 694-001
043 90876	9EL 134 739-001	000 9748305	9GD 024 183-001	20.196-011	2PS 006 717-057	24.028-001	2ZR 003 014-091
043 90876EY1065-49	9EL 134 739-001	000 9748315	9GD 120 670-001	20.196-021	2PS 006 717-061	24.029-001	2ZR 001 240-351
043 90877	9EL 134 741-021	000 9748403	9KS 075 139-001	20.196-031	2TM 006 717-047	24.030-051	2ZR 003 315-041
043 90877EY1065-49	9EL 134 741-021	000 9748405	9KS 075 307-001	20.196-041	2PG 006 717-021	24.033-001	2ZR 001 423-001
043 90878	9EL 137 308-001	000 9940112	8RA 002 015-021	21.001-021	2SE 001 699-071	24.033-031	1G4 997 033-011
043 90878EY1065-49	9EL 137 308-001	AH7 651	2AB 001 208-001	21.001-031	2SD 001 699-061	24.056-001	2ZR 002 985-081
043 90879	9EL 134 742-021	CC6 262010	2PF 003 057-041	21.001-071	2SD 001 699-511	24.056-011	2ZR 002 985-261
439 0879EY	9EL 134 742-021	CC6 262011	2SA 003 057-021	21.002-011	2SE 001 688-151	25.011-001	2KA 001 389-101
043 90879EY1065-49	9EL 134 742-021	CC6 269004	9EL 116 907-001	21.002-031	2SD 001 688-141	25.011-001	2KA 997 011-001
043 91462	1GA 006 991-021	CC6 269005	9EL 117 330-011	21.002-051	2SE 001 688-161	25.011-011	2KA 997 011-001
043 91462	1GA 998 522-011	CC6 269006	9EL 117 330-011	21.002-071	2SD 001 688-171	25.011-011	2KA 997 011-011
043 96049	2KA 001 378-041	D04 413298	8RA 004 412-021	21.003-001	2SE 002 582-071	25.011-021	2KA 001 389-101
044 03158	2SD 002 776-241	D11 25492720	2BE 003 018-011	21.003-011	2SD 002 582-021	25.011-021	2KA 997 011-021
044 03158	2SD 002 776-247	D11 55492210	2SB 003 018-031	21.003-051	2SD 002 582-011	25.012-001	2KA 001 386-291
044 03159	2SE 002 776-211			21.005-021	2SE 997 005-011	25.012-011	2KA 001 386-281
044 03159	2SE 002 776-217	Saturnus	Hella	21.005-031	2SD 997 005-021	25.012-041	2KA 001 386-291
044 03161	9EL 137 308-001	12952	9EL 139 138-061	21.006-001	2SE 997 006-011	25.012-051	2KA 001 386-281
044 03162	9EL 137 307-001	12953	9EL 139 137-061	21.006-011	2SD 997 006-021	25.012-061	2KA 001 386-241
044 11937.4	1GA 007 506-001	17136	2BM 002 847-011	21.006-221	2SD 997 006-031	25.012-071	2KA 001 386-231
044 13298	8RA 004 412-001	17137	2BM 002 847-021	21.007-001	2SE 002 776-211	25.087-001	2KA 003 389-061
044 13298	8RA 004 412-021	17235	2JA 003 388-001	21.007-011	2SD 002 776-231	25.087-161	2KA 998 523-001
044 13298EY2005-49	8RA 004 412-021	4500001200	6NM 007 878-041	21.007-081	2SE 003 182-011	25.122-001	2KA 997 122-001
044 13298X	8RA 004 412-001	00787804	6NM 007 878-041	21.007-091	2SD 003 182-061	26.027-091	2JA 997 027-051
044 14773	2RL 006 846-001	00831950	5DD 008 319-501	21.007-121	2SE 002 776-221	80.085-001	8HG 002 240-001
044 19284.4	9XD 990 284-001			21.007-131	2SD 002 776-231	80.085-011	8HG 002 240-011
044 24195.4	1GA 007 506-001	SAW	Hella	21.007-141	2SE 003 182		



Manufacturer's no. / Hella no.

Cross-Reference

SAW	Hella	Scania	Hella	Scania	Hella	Scania	Hella
80.143-011	8RA 002 023-011	1 379 384	2KA 003 389-062	20 223 840	2PS 006 717-031	286 577	2JA 003 231-001
80.143-021	8RA 002 023-021	1 379 384	2KA 003 389-068	20 223 840	2PS 006 717-032	289 927	2BE 003 649-011
90.001-011	9EL 109 139-001	1 380 819	9EL 152 884-001	20 223 840	2PS 006 717-037	289 928	2BE 003 649-021
90.002-011	9EL 092 435-011	138 5406	9DE 145 675-011	20 223 841	9EL 141 135-031	303 223	2KA 001 386-281
90.003-001	9EL 116 844-001	138 5407	9DE 145 676-011	20 223 842	9EL 114 401-001	313 659	9EL 123 209-005
90.003-011	9EL 112 741-001	1 385 410	9EL 145 103-011	20 223 848	8KW 701 235-033	313 660	9EL 123 210-005
90.003-021	9EL 112 744-001	1 386 271	2VD 008 204-141	20 223 851	2XS 005 020-001	339 729	2SA 003 014-051
90.003-051	9EL 112 743-001	1 386 272	2VD 008 204-151	20 223 851	2XS 005 020-002	356 823	2JA 002 661-001
90.003-061	9EL 997 310-001	1 387 155	9EL 145 104-011	20 223 851	2XS 005 020-003	356 824	9EL 116 607-005
90.005-001	9EL 997 313-001	1 387 877	2VD 008 205-011	20 223 852	2KA 001 386-231	357 947	2BA 003 022-021
90.006-091	9EL 997 315-001	1 387 878	2VD 008 205-021	20 223 853	2XS 005 020-021	370 693	2PS 004 361-001
90.006-101	9EL 997 318-001	1 391 144	2VD 008 205-011	20 223 854	9EL 109 139-001	370 693	2PS 004 361-007
90.006-151	9EL 997 320-001	1 391 144	2PS 007 972-017	20 223 856	2SK 003 567-331	370 694	2PG 004 361-011
90.007-001	9EL 134 739-001	1 414 366	2VD 008 205-011	20 223 857	1F8 148 131-011	370 694	2PG 004 361-017
90.007-011	9EL 137 308-001	1 414 367	2VD 008 205-021	20 223 858	2RL 008 060-111	405 235	2KA 001 622-001
90.007-081	9EL 118 613-001	1 414 368	2VD 008 205-011	20 223 859	9EL 146 491-001	406 961	2SA 003 057-021
90.007-091	9EL 118 614-011	1 414 369	2VD 008 205-021	20 223 860	9EL 147 096-031	410 663	2ZR 001 193-011
90.007-101	9EL 118 614-021	1 436 867	2VD 008 205-011	20 223 861	2SE 007 547-021	414 129	2ZR 002 694-001
90.007-111	9EL 137 307-001	1 436 868	2VD 008 205-021	20 223 861	2SE 007 547-027	414 129	2ZR 002 694-002
90.007-121	9EL 134 740-001	1 450 245	1NL 007 186-047	20 223 862	2KA 003 389-001	415 320	2KA 001 610-001
90.008-061	9EL 997 332-001	1 450 642	2XW 007 146-001	20 223 863	2PF 001 259-631	415 761	2XD 003 022-061
90.008-101	9EL 146 491-001	1 455 634	2DA 959 071-737	20 223 864	2PF 003 057-001	419 888	2KA 003 389-061
90.010-051	9EL 113 324-001	1 472 724	2PF 964 295-021	20 223 864	2PF 003 057-002	419 888	2KA 003 389-062
90.012-021	9BG 101 230-011	1 472 724	2PF 964 295-027	20 223 865	2SA 001 259-751	419 888	2KA 003 389-068
90.012-031	9BG 101 230-001	1 479 891	2BA 008 221-041	20 223 865	2SA 001 259-757	427 753	8XS 113 389-001
90.014-021	9EL 110 013-001	1 479 891	2BA 008 221-047	20 223 869	8JD 008 151-041	427 753	2BA 001 275-011
90.014-031	9EL 110 014-001	1 483 010	1NL 008 090-031	20 223 878	2SD 001 686-101	427 754	2BA 001 275-021
90.015-001	9EL 116 907-001	1 483 010	1NL 008 090-037	20 223 879	2ZR 001 423-001	433 408	2ZR 001 240-351
90.015-011	9EL 116 907-001	1 509 319	2SD 001 688-141	20 223 880	9EL 862 141-001	433 565	9EL 101 899-001
90.017-001	9EL 117 330-001	0 173 546	8GP 002 067-241	20 223 881	2DA 001 423-077	433 566	9EL 101 900-001
90.017-021	9EL 117 330-011	177 942	8JA 001 914-011	20 223 882	1GA 996 083-011	440 354	8RA 003 734-101
90.017-081	9EL 117 334-001	182 777	9ES 084 374-001	20 223 883	1GA 006 991-031	451 756	2SA 003 734-121
90.017-091	9EL 117 334-021	183 202	9DE 089 102-011	20 223 884	1GA 007 506-011	451 757	2DA 003 734-011
90.019-041	9EL 108 435-001	197 819	9EL 092 435-011	20 223 885	2PF 959 590-411	453 090	8XS 113 389-001
90.023-011	9EL 084 110-001	20 011 000	2XW 003 146-001	20 223 885	2PF 959 590-417	467 493	8RL 002 009-011
90.026-001	9EL 135 266-001	20 011 000	2XW 007 146-001	20 223 886	1GA 007 506-081	474 408	2BA 005 603-011
90.026-021	9EL 109 208-011	20 011 005	2XW 002 897-051	20 223 887	8GJ 002 525-131	474 408	2BA 005 603-017
90.026-041	9EL 088 150-001	20 044 850	2ZR 003 236-051	20 223 887	8GJ 002 525-133	474 409	2DA 005 603-031
90.026-091	9EL 088 538-001	20 044 850	2ZR 003 236-057	20 223 889	2XA 959 790-411	474 409	2DA 005 603-037
90.027-201	9EL 997 387-001	20 044 855	2NE 003 236-001	20 223 891	2BA 008 260-001	474 410	2SA 005 603-021
90.027-211	9EL 997 388-001	20 044 855	2NE 003 236-008	20 223 891	2BA 008 260-007	474 410	2SA 005 603-027
90.027-291	9EL 113 928-001	20 044 864	2PS 006 717-031	20 223 893	2BA 002 324-001	474 411	2ZR 005 603-061
90.028-111	9EL 110 540-001	20 044 864	2PS 006 717-032	20 223 896	2KA 003 389-211	474 411	2ZR 005 603-067
90.028-121	9EL 110 542-001	20 044 864	2PS 006 717-037	20 223 896	2KA 003 389-217	478 342	2PF 001 259-631
90.028-141	9EL 110 536-011	20 223 450	2ZR 005 860-151	20 223 897	1F8 007 560-211	0 478 343	2NE 005 603-071
90.028-151	9EL 110 536-001	20 223 500	2ZR 997 506-391	20 223 898	2PS 963 639-207	0 478 343	2NE 005 603-077
90.028-171	9EL 115 003-011	20 223 550	2ZR 005 700-191	20 223 899	2TM 963 639-317	478 344	2KA 001 378-041
90.028-181	9EL 115 003-035	20 223 576	2VD 008 789-011	20 223 906	9FT 861 790-011	478 345	8RA 002 014-081
90.028-201	9EL 115 003-055	20 223 577	2VP 008 789-021	20 223 907	2RL 007 900-211	478 346	2SA 001 259-751
90.028-211	9EL 110 544-001	20 223 582	2VP 340 940-101	20 223 908	9EL 950 315-031	478 346	2SA 001 259-757
90.030-061	9EL 119 977-001	20 223 583	2VP 340 940-111	20 223 909	2VP 008 789-051	478 349	2PG 962 964-051
90.044-011	9EL 126 294-001	20 223 603	2PG 003 748-151	20 223 911	2PG 962 964-041	478 349	2PG 962 964-057
90.086-021	9EL 118 445-001	20 223 604	2VD 008 204-071	20 223 913	2PS 003 748-161	478 349	2PS 962 964-012
90.087-001	9BG 121 587-031	20 223 610	2SA 006 717-001	20 223 913	2PS 003 748-167	478 349	2PS 962 964-018
90.111-001	9EL 118 700-001	20 223 610	2SA 006 717-007	20 223 915	2PS 008 616-011	484 769	2SA 962 964-091
90.111-001	9EL 997 451-001	20 223 791	2NE 001 423-011	20 223 915	2PS 008 616-017	484 770	2PF 962 964-071
90.111-011	9EL 997 452-001	20 223 792	2XS 007 841-021	20 223 918	2RL 008 061-111	484 771	2BA 001 221-031
90.111-021	9EL 118 703-001	20 223 792	2XS 007 841-027	20 223 920	1F8 007 560-311	484 772	2BA 001 221-041
90.111-031	9EL 118 705-001	20 223 793	2BM 008 355-001	20 223 923	2BA 007 135-001	487 70	2PF 962 964-071
90.113-001	9EL 997 453-001	20 223 793	2BM 008 355-007	20 223 925	2BA 007 135-011	488 421	9GT 963 129-001
90.131-001	9EL 997 459-001	20 223 797	2SK 003 567-321	20 223 926	2PS 340 001-011	490 896	9GD 963 281-001
90.131-081	9EL 997 469-001	20 223 798	9EL 150 966-001	20 223 929	9XX 340 220-011	492 205	2KA 001 378-041
90.147-001	9EL 122 772-001	20 223 799	1F8 007 560-321	20 223 933	2SL 003 567-311	561 225	2PG 002 727-021
90.147-021	9EL 122 689-021	20 223 801	9GH 152 654-007	20 223 938	9XX 340 220-001	561 226	9EL 114 400-015
90.167-001	9EL 147 096-001	20 223 807	8JD 008 151-011	20 223 943	2SK 003 567-651	583 086	2JA 004 531-011
90.167-011	9EL 147 097-001	20 223 810	2XS 008 479-051	20 223 950	1F8 006 800-221	618 260	2ZR 001 240-351
90.176-001	9EL 135 548-001	20 223 810	2XS 008 479-057	20 223 951	1F8 006 800-321	619 841	2KA 001 386-241
90.196-001	9EL 141 135-031	20 223 811	9MN 857 622-101	20 223 970	2SK 003 567-661	619 241	2KA 001 386-281
90.196-011	9EL 141 135-021	20 223 812	9XR 855 975-001	20 223 971	2RL 008 181-111	619 241	2KA 001 386-291
90.197-001	9EL 146 887-001	20223813	2PS 008 643-031	20 223 974	2SD 003 167-021	629 515	2SA 001 240-331
92.147-001	9BG 130 945-001	20223813	2PS 008 643-037	2 022 397 7	2RL 009 279-131	633 415	8JA 001 909-001
92.147-011	9BG 130 946-001	20 223 814	2RL 007 337-031	20223979	2RL 007 900-611	638 915	9ES 082 333-031
93.115-111	1GA 998 524-001	20 223 815	1G4 003 470-031	2 022 398 0	9XD 857 445-801	639 096	9EL 113 928-001
93.115-121	1GA 998 524-011	20 223 824	2SD 001 685-211	20 223 981	2PS 008 643-021	639 267	9EL 108 651-001
93.190-001	1GA 998 525-001	20 223 824	2SD 001 685-218	20 223 981	2PS 008 643-027	656 187	8RA 002 023-021
		20 223 825	1F8 007 560-051	2 022 398 2	1FE 006 300-001	663 046	2SA 001 638-021
		20 223 827	1F8 007 560-131	20 223 985	9EL 134 296-041	675 069	2SB 001 240-311
		20 223 828	9GD 856 863-001	20 223 991	8GS 007 949-101	692 470	2JA 001 330-001
		20 223 829	2PS 963 639-071	20 223 992	1K0 008 191-041	692 470	2JA 001 330-007
		20 223 829	2PS 963 639-077	20 223 992	1K0 008 191-047	715 725	9FF 042 509-001
		20 223 830	2RL 007 337-011	20 223 993	8GH 007 157-241		
		20 223 831	2XS 950 071-031	20 223 993	8XX 008 614-101		
		20 223 832	2XS 955 232-001	20 223 997	5DV 007 810-171		
		20 223 833	2XS 005 020-011	217 247	9GD 102 484-001		
		20 223 833	2XS 005 020-017	218 412	2AB 001 208-001		
		20 223 834	9EL 950 315-001	225 552	2ZR 001 423-001		
		20 223 835	2KA 003 389-061	233 203	2PS 002 727-001		
		20 223 835	2KA 003 389-062	233 203	2PS 002 727-007		
		20 223 835	2KA 003 389-068	241 227	2SE 001 685-221		
		20 223 836	2KA 001 386-281	241 227	2SE 001 685-227		
		20 223 837	2PS 004 361-001	243 219	2SE 001 688-151		
		20 223 837	2PS 004 361-007	243 220	2SE 001 688-161		
		20 223 838	2PS 003 748-121	245 593	9EL 113 324-001		
		20 223 838	2PS 003 748-127	249 111	9ES 106 588-001		
		20 223 839	9EL 122 772-001	257 933	2KA 001 378-041		

Manufacturer's no. / Hella no.

Cross-Reference



Schmitz Cargobull	Hella	Schmitz Cargobull	Hella	Schmitz Cargobull	Hella	Schmitz Cargobull	Hella
1044	2NE 003 236-001	1-FZELEK0501	8GA 002 073-241	060947	8HG 002 365-001	062462	2SD 004 431-011
1044276	2VA 004 887-031	1-INBEMA0009	8HG 002 365-001	060960	2XL 004 762-001	062672	2AA 003 257-041
1044279	2VP 004 887-021	2011	8GP 002 066-121	060973	2SD 003 184-031	062672	8GP 002 066-241
1056	8GA 002 071-121	2309	2AA 001 204-011	060973	2SD 003 184-037	062761	2VP 007 907-031
1057	8GA 002 071-131	2502	8GA 002 071-241	060974	2SD 003 184-041	062762	2VP 007 907-041
1058	3AG 003 399-101	3252	2PS 963 639-071	060976	2PF 006 717-011	062769	8JE 340 060-011
1059	5AB 005 944-011	3253	8GP 003 594-251	060977	2PS 006 717-031	062772	2XS 340 108-011
1072234	2ZR 997 506-391	3990	9EL 856 010-001	060977	2PS 006 717-037	062773	2XS 340 108-001
1072235	8KB 990 299-001	000-40.061	2SK 340 101-011	060978	2SA 006 717-001	062774	2SK 340 101-001
1076	8GA 002 073-241	000-40.070	2SK 340 101-031	060982	2PG 006 717-021	062916	2XS 340 109-011
1076211	8RA 004 412-021	000-40.073	2SK 340 101-021	060983	2PG 006 717-021	062917	2XS 340 109-001
1077	8GA 002 071-251	424753	2XW 003 146-001	060984	2BM 006 692-011	062984	1GA 340 110-001
1078	8GP 002 095-241	424753	2XW 007 146-001	060984	2BM 006 692-017	063001	2JA 001 335-011
1086	8HG 002 365-001	444736	1G9 001 523-021	061137	8KW 701 235-033	063002	2JA 003 232-001
1087	8GM 002 091-131	444737	8XT 002 120-001	061160	8GD 002 078-241	063020	2PS 340 000-011
1091	2BE 003 184-051	444739	1GA 007 506-021	061182	2BM 006 692-021	063029	9EL 950 315-031
1091030	2VP 340 400-141	447682	9XS 027 639-001	061182	2BM 006 692-027	063030	9EL 950 315-061
1091031	2VP 340 400-151	5111	1GB 006 213-111	061224	8HG 006 294-051	063033	2PS 340 001-001
1092	2BE 003 184-061	5112	9BG 993 345-001	612791	1GA 005 060-001	063047	9EL 340 201-001
1093	2SD 003 184-031	511591	2BA 002 324-011	612792	9XD 130 261-001	063049	9XX 340 220-001
1094	2SD 003 184-041	5370	8GP 002 095-121	061297	8GP 002 067-241	063050	9XX 340 222-001
1100	2PF 003 014-071	5529	8GP 002 067-241	061301	8GP 002 067-241	063051	9XX 340 223-001
1102	2VP 340 400-151	598777	1G4 004 480-011	061307	8GM 002 092-121	063052	2KA 340 118-001
1103	2VP 340 400-141	060001	1GD 003 590-701	061308	8GM 002 091-131	063083	2PS 340 001-011
1115	2BA 003 022-021	060050	2JA 004 531-001	061309	8GM 002 091-141	063102	8JB 001 933-031
1128	2ZR 003 236-051	060050	2JA 004 531-011	061312	8GM 002 091-251	063104	9EL 101 353-001
1128	2ZR 003 236-057	060050	2JA 007 372-011	061317	8GD 002 088-131	063106	9EL 150 966-001
1149	8GM 002 091-251	060056	2SD 001 693-011	061323	8GP 002 068-241	063107	9EL 150 965-001
1150	8JA 001 925-001	060071	2RL 008 060-111	061325	8GP 002 066-121	063113	1GD 005 700-501
1156	2JA 001 364-001	060075	2SK 003 567-651	061326	8GP 002 068-121	063118	1GD 005 700-501
116060	2JA 004 531-011	060133	8JB 001 933-031	061329	8GP 002 095-121	063392	2SK 340 101-011
116062	2JA 004 531-001	060182	2XS 005 020-011	061330	8GP 002 095-241	063587	2XS 340 108-011
116070	1GA 005 060-041	060182	2XS 005 020-017	061341	8GA 002 071-121	063588	2XS 340 108-001
116072	1G8 002 340-001	060453	8HG 002 240-021	061343	8GA 002 071-131	063602	2XS 008 078-001
116443	2RM 007 200-191	060503	2SE 003 167-031	061348	8GA 002 072-121	063602	2XS 008 078-007
116641	9GD 861 531-001	060515	2SE 001 685-201	061359	8GP 002 066-241	063635	8GA 002 071-131
116935	9MM 860 814-801	060515	2SE 001 685-221	061360	8GA 002 072-241	063637	8GM 002 091-131
116936	8KB 861 213-011	060515	2SE 001 685-227	061360	8GP 002 068-241	063686	9EL 340 201-001
118485	2XD 008 135-831	060516	2SD 001 685-211	061361	8GA 002 071-241	063728	8JE 340 060-001
1196	9EL 852 820-001	060516	2SD 001 685-231	061361	8GA 002 071-261	063748	2XS 955 031-001
1203	8GP 002 066-241	060516	2SD 001 685-232	061366	8GM 002 091-241	063834	8GA 002 071-121
121168	9XX 340 222-001	060520	2SD 001 699-061	061368	8GA 002 073-241	063854	2PF 959 590-411
121245	9XX 340 223-001	060521	2SE 001 699-071	061368	8GA 002 073-251	063854	2PF 959 590-417
121251	8JE 340 060-011	060522	9EL 107 368-001	061374	8GA 002 083-251	063857	8JE 340 060-011
121511	2VP 340 930-001	060523	9EL 111 647-001	061375	8GD 002 088-251	063889	2PF 959 590-437
121512	2VP 340 930-011	060524	9EL 109 139-001	061376	8GA 002 071-271	063947	2PF 959 590-401
1381	2XS 005 020-011	060526	9EL 147 747-001	061378	8GA 002 071-251	063947	2PF 959 590-407
1464	8HG 006 294-021	060528	9EL 102 240-031	061381	8GJ 002 525-251	063955	1NB 007 360-021
147478	9GD 859 037-001	060531	9ES 106 588-001	614299	1GA 007 506-081	063973	2VA 997 113-001
147490	8HG 005 436-011	060532	9EL 119 544-111	061458	2SD 001 688-141	064006	9EL 340 208-001
1501	9GD 856 863-001	060538	9EL 122 772-001	061469	9EL 118 445-001	064043	2DA 959 071-737
16062	2JA 004 531-001	060549	2SD 003 167-371	061470	9EL 113 324-001	064050	2XS 340 107-001
16070	1GA 005 060-041	060550	2SD 004 431-011	061471	8GA 002 071-251	064051	2XS 340 107-011
16071	1G5 003 241-081	060552	2SD 003 167-011	061591	2XW 002 897-041	64143	1G3 996 001-131
1619	2AB 004 532-051	060553	2SD 003 167-021	061591	2XW 002 897-051	064168	8KL 340 055-021
1748	2KA 001 389-101	060558	2NE 003 236-001	061601	2PF 003 389-037	064180	2VD 007 323-031
1748	2KA 006 896-001	060558	2NE 003 236-008	061611	2PF 003 014-071	064 370	2PS 008 616-011
1748	2KA 006 896-007	060561	2SK 003 567-321	061625	2XS 005 020-011	064 370	2PS 008 616-017
1751	2KA 998 523-001	060562	2SK 003 567-331	061639	2VD 005 300-551	064 372	8JA 008 658-011
182991	8RA 003 326-011	06 05 63	2SD 001 699-511	061651	8GP 003 594-251	064 372	8JA 008 658-011
183100	9EL 132 215-001	060565	2SD 003 167-011	061662	2SK 005 883-021	064541	9EL 146 838-001
188003	2BM 006 692-021	060566	2SD 003 167-021	061663	2SK 005 883-011	000646	2BA 003 022-021
188007	2BM 006 692-011	060576	2SD 001 688-141	061694	2VP 003 567-111	064726	2NE 003 315-011
188033	2XS 005 020-067	060576	2SE 001 688-161	061695	2VP 003 567-121	064815	2PG 340 000-121
193430	2XD 007 854-801	060577	2SD 001 688-171	061717	2PS 004 361-001	064816	2PS 340 000-051
193431	2XD 007 854-811	060577	2SE 001 688-151	061717	2PS 004 361-007	065081	2TM 963 639-317
19343101	2XD 007 854-831	060578	2SL 003 567-311	061723	2KA 001 386-281	065121	1G4 997 033-011
199019	2RM 007 200-001	060585	1ND 003 590-001	061724	2PG 004 361-011	066404	2NE 001 423-011
199021	9GD 860 936-001	060594	2SD 001 680-271	061724	2PG 004 361-017	066414	2ZR 001 423-001
199022	9SX 007 609-021	060595	2SD 001 680-281	061727	2SE 003 167-031	066416	2ZR 004 542-001
199023	9MM 859 358-801	060704	8RA 002 020-051	061803	8HG 002 240-031	066417	2ZR 003 236-051
199024	8KB 861 213-001	060707	8RA 002 016-101	061805	8HG 002 240-001	066602	2TJ 001 633-211
199025	8KB 007 896-811	060708	8RA 002 014-051	061806	8RA 004 412-011	066603	2PF 001 648-161
199026	9SX 861 562-001	060708	8RA 002 014-052	061807	8RA 003 326-041	066608	2PF 001 648-161
199026	9SX 861 562-011	060709	8RA 003 326-001	061817	2PS 006 717-061	066611	2TF 001 259-761
199028	8KB 007 895-811	060710	8RA 002 014-041	061817	2PS 006 717-067	066612	2PF 001 259-631
199440	6ZE 001 759-071	060712	8RA 003 326-041	061853	2NE 002 589-001	066612	2SA 001 259-751
1-FZELEK0069	2XS 005 020-011	060712	8RA 003 326-047	061866	8GM 002 091-241	066616	2XS 950 071-031
1-FZELEK0073	2JA 003 231-001	060718	2PS 002 727-007	618834	2PS 340 001-011	066622	2XS 003 168-081
1-FZELEK0081	2SL 003 567-311	060718	2PS 002 727-007	062091	2PS 003 748-161	066627	2TM 003 748-011
1-FZELEK0087	8RA 003 326-041	060729	8HG 002 240-001	062091	2PS 003 748-167	066634	2PG 003 057-011
1-FZELEK0100	8GA 002 071-251	060729	8HG 002 240-011	062117	2VP 007 323-011	066713	2KA 001 386-231
1-FZELEK0120	2PF 003 389-037	060731	8RA 002 014-051	062118	2VP 007 323-021	066713	2KA 001 386-281
1-FZELEK0124	8GM 002 091-241	060767	2SE 003 167-041	062164	2VP 007 323-011	000674	8RA 002 016-111
1-FZELEK0200	1G3 005 760-001	060827	2KA 003 389-061	062165	2VP 007 323-021	0674541	9EL 146 838-001
1-FZELEK0366	1GB 006 213-101	060827	2KA 003 389-068	062191	1NE 002 537-201	000687	9EL 092 435-011
1-FZELEK0366	1GB 006 213-107	060870	8RA 004 412-001	062244	2PS 962 964-012	7128	5KG 007 629-011
1-FZELEK0423	2XS 005 020-067	060896	2XS 005 020-077	062276	2VD 007 500-111	7129	5KG 007 629-001
1-FZELEK0432	2PS 003 748-161	060932	9GP 003 995-801	062286	2VB 004 887-011	7190	8RA 002 010-011
1-FZELEK0432	2PS 003 748-167	060935	2BA 003 014-111	062287	2VP 004 887-021	7226	2AB 004 532-001
1-FZELEK0481	1FD 005 700-051	060939	8GP 002 067-241	062374	2SK 003 567-331	7385	9MK 860 255-001
1-FZELEK0496	1GD 003 590-701	060940	2XS 005 020-021	062374	2SK 003 567-651	740021	2SD 001 685-232
1-FZELEK0497	2SD 003 167-021	060941	9GT 005 166-001	062375	2SK 003 567-661	740022	2NE 001 423-011
1-FZELEK0498	2SD 003 167-011	060946	1NE 002 537-301	062447	9EL 340 201-001	740305	2XS 950 071-031



Manufacturer's no. / Hella no.

Cross-Reference

Schmitz	Hella	Seat	Hella	Sisu	Hella	Skoda	Hella
Cargobull							
740599	2KA 003 389-061	1L0 953 050	9EL 144 444-001	187-130-0461	1K0 158 059-061	380 941 295 B	6NM 007 878-531
740599	2KA 003 389-068	1L0 953 050 C	9EL 963 262-011	187-181-0440	9GH 152 654-007	3U5945111	9EL 354 078-011
740724	2ZR 001 423-001	1M 594 010 701 C	9EL 964 599-001	187-181-5820	9GT 143 133-007	3U5 945 111 A	9EL 354 079-011
75 06 05	9GT 074 132-001	1M 594 511 101 C	9EL 963 701-011	187-191-0000	8JA 001 909-001	3U5945112	9EL 354 078-021
7711	2AA 001 204-001	1M 594 511 201 C	9EL 963 702-011	187-191-0000	8JA 001 909-011	3U5 945 112 A	9EL 354 079-021
8-0313852	8HG 006 294-021	1P0 945 107 A	9EL 982 001-111	187-201-0615	2BA 001 221-041	480 941 295	6NM 007 878-531
8482092	9EL 146 491-001	1P0 945 108 A	9EL 982 001-121	187-201-0616	2BA 001 221-031	480 941 295 A	6NM 007 878-531
887237	2PS 008 645-001	1P0 945 111 A	9EL 982 000-051	187-201-0647	2BA 002 652-101	5J0 941 701	1N0 354 018-011
910898	9XX 340 220-001	1P0 945 112 A	9EL 982 000-061	187-201-0647	2BA 002 652-107	5J0 941 702	1N0 354 018-021
965242	8KL 340 055-021	021 934 006 C	9EL 961 832-021	187-201-1427	2BE 003 014-251	5J7 945 111	9EL 354 077-011
980042	4RA 003 510-081	5P0 941 699 A	1N0 271 022-051	187-201-1427	2BE 003 014-257	5J7 945 112	9EL 354 077-021
980400	2SE 002 582-071	5P0 941 700 A	1N0 271 022-061	187-201-1617	2PF 001 648-161	6H0 941 699	1N0 270 204-051
980400	2TJ 001 633-211	5P8 945 107 A	9EL 354 081-011	187-201-2127	2BM 002 847-021	6H0 941 700	1N0 270 204-061
980400	8GH 002 857-241	5P8 945 108 A	9EL 354 082-021	187-201-2137	2BM 002 847-011	6U0 963 041 A	9EL 246 151-021
980400	9EL 109 139-001	5P8 945 111	9EL 354 080-011	187-201-2337	2PS 004 361-001	6Y6 945 111 B	9EL 171 976-011
980400	9EL 114 401-031	5P8 945 112	9EL 354 080-021	187-201-2337	2PS 004 361-007	6Y6 945 111 C	9EL 171 974-011
980400	9EL 118 445-001	6H0 941 699	1N0 270 204-051	187-201-2637	2XS 955 031-001	6Y6 945 112 B	9EL 171 976-021
980400	9EL 134 659-001	6H0 941 700	1N0 270 204-061	187-201-2557	2PF 961 167-021	6Y6 945 112 C	9EL 171 974-021
980400	9EL 134 660-001	6K0 941 701 A	1NA 907 312-111	187-201-2597	2TM 004 361-021	6Y9 945 111 B	9EL 171 977-011
980400X	9EL 114 401-031	6K0 941 701 A	1NA 961 557-751	187-201-2611	2PF 008 221-011	6Y9 945 111 D	9EL 171 975-011
980776	1GA 005 060-041	6K0 941 702 A	1NA 907 312-121	187-201-2611	2PF 008 221-017	6Y9 945 112 B	9EL 171 977-021
980776	1NL 005 566-051	6K0 941 702 A	1NA 961 557-761	187-201-2627	2BA 008 805-051	6Y9 945 112 D	9EL 171 975-021
980776	1NL 005 566-061	6K0 941 703	1NA 963 965-051	187-201-2627	2BA 008 805-057	098 788 185 A	9EL 246 151-021
980777	9XD 130 261-001	6K0 941 704	1NA 963 965-061	187-201-2637	2PG 964 295-111	098 788 186 A	9EL 246 152-021
980902	8GP 002 095-241	6K6 945 107	9EL 964 055-011	187-201-2637	2PG 964 295-117	098 788 189 A	9EL 246 151-011
980904	2SE 004 623-001	6K6 945 107 B	9EL 964 055-011	187-201-2657	2BA 008 221-001	098 788 189 B	9EL 246 201-011
980909	2NE 003 315-011	6K6 945 107 C	9EL 964 055-011	187-201-2657	2BA 008 221-007	098 788 190 A	9EL 246 202-011
980910	2ZR 003 315-041	6K6 945 108 B	9EL 964 056-011	187-205-0217	2BA 003 022-057	098 788 190 B	9EL 246 202-011
980924	2JA 003 354-001	6K6 945 108 C	9EL 964 056-011	187-206-0072	2RL 008 061-111	098 788 213 A	9EL 246 151-021
980950	2JA 001 330-001	6K6 945 111 G	9EL 964 023-011	187-206-0156	2BA 003 022-021	098 788 214 A	9EL 246 152-021
980967	8JA 001 915-001	6K6 945 112 A	9EL 962 542-051	187-206-0221	2RL 008 181-111	098 788 219	2DA 007 428-001
BS11194240001	1ND 005 700-061	6K6 945 112 C	9EL 962 542-071	187-207-0011	2XW 003 146-001	098 788 219	2DA 007 428-007
BS11982330001	1GA 006 991-031	6K6 945 112 G	9EL 964 024-011	187-251-0910	9EL 110 014-001		
EL0005-0020	8HG 006 294-051	6L0 941 703	1N0 009 617-011	187-251-0911	9EL 110 013-001	Smart (MCC)	Hella
EL0005-0045	8JS 711 687-821	6L5 945 111	9EL 964 949-001	187-251-1210	9EL 115 003-055	209 820 07 56	1N0 009 295-031
EL0006-0026	8HG 006 294-021	6L5 945 112	9EL 964 950-001	187-251-1300	9EL 108 435-001	209 820 07 56	1N0 009 295-037
EL0013-0002	8GA 002 071-131	6L6 945 105	8RA 354 036-011	187-251-1510	9EL 115 830-001	209 820 08 56	1N0 009 295-041
EL0013-0003	8GA 002 071-121	6L6 945 106	8RA 354 036-021	187-251-1900	9EL 856 418-001	209 820 08 56	1N0 009 295-047
EL0007-0001	2PS 340 000-011	6N0 941 699	1NA 962 530-011	187-251-2250	9EL 862 141-001		
EL0007-0004	2SK 340 101-011	6N0 941 699 A	1NA 962 490-011	187-281-0310	9GD 856 863-001	Starlite	Hella
EL0007-0016	9EL 340 201-001	6N0 941 700	1NA 962 530-021	187-301-0187	2SD 001 685-231	10002029	8KA 340 040-001
EL0007-0023	2KA 340 118-001	6N0 941 700 A	1NA 962 490-021	187-301-0187	2SD 001 685-232	110 20 29	8KA 340 040-001
EL0007-0038	2XS 340 107-011	6N2 941 015	1LF 962 489-171	187-301-0277	2SE 001 685-221	110 20 99	2PS 340 001-001
EL0007-0039	2XS 340 107-001	6N2 941 016	1LF 962 489-151	187-301-0277	2SE 001 685-227	110 28 29	2PS 340 001-011
EL0007-0046	9EL 146 838-001	6N2 941 016 A	1LF 962 489-181	187-301-0287	2SD 001 685-231	110 28 99	2PS 340 001-011
EL0007-0057	1G3 005 760-211	6N2 941 017	1LF 962 489-171	187-301-0287	2SD 001 685-232	1162029	2XS 340 109-011
EL0007-0057	9XD 130 261-001	6N2 941 017 A	1LF 962 489-151	187-301-0537	2KA 003 389-211	1162129	2XS 340 109-001
EL0007-0062	9XD 130 261-001	6N2 941 018	1LF 962 489-181	187-301-0537	2KA 003 389-217	1162199	2XS 340 109-001
EL0007-0063	2PF 959 590-401	6N2 941 018 A	1LF 962 489-161	187-301-0917	2PF 001 647-031	154 8000 29	1GA 340 110-001
EL0007-0067	2KA 340 828-001	7M0 945 095 F	9EL 907 325-001	187-301-0917	2VP 007 323-121	154 8000 99	1GA 340 110-001
EL0007-0071	2PS 008 616-001	7M0 945 096 F	9EL 907 326-001	187-305-0357	2SA 961 167-011	2202029L	2XS 340 108-011
EL0007-0075	1G3 005 760-241	7M3 945 095 F	9EL 964 501-011	187-351-1110	9EL 122 689-021	2202099LI	2XS 340 108-011
EL0007-0084	2VP 340 450-451	7M3 945 095 G	9EL 964 501-011	187-401-0117	2JA 001 330-001	2202129RE	2XS 340 108-001
EL0007-0085	2VP 340 450-441	7M3 945 096 F	9EL 964 502-011	187-401-0117	2JA 001 330-007	2202199RE	2XS 340 108-001
EL0007-0090	2VD 340 450-491	7M3 945 096 G	9EL 964 502-011	187-401-0851	2JA 007 372-011	384 14 29	2JA 340 111-001
EL0007-0092	2SK 340 103-131	7M3 945 096 J	9EL 964 502-011	187-408-0017	2AB 001 208-001	384 14 99	2JA 340 111-001
EL0007-0093	2SK 340 103-121			187-408-0021	2AB 004 532-051	444 50 25	9EL 340 201-001
EL0007-0111	2VP 340 450-021	Seima	Hella	187-408-0021	2AB 004 532-057	444 50 95	9EL 340 201-001
EL0007-0112	2VP 340 450-031	25.23.17.01	9EL 144 131-001	187-408-0031	2JA 004 192-001	444 52 26	2SK 340 101-011
EL0009-0001	9XX 340 220-001	25.23.18.01	9EL 144 132-001	187-801-1661	2AA 001 200-151	444 52 29	2SK 340 101-001
EL0009-0038	8JE 340 165-001	29.51.17.01	9EL 140 347-021	187-801-1671	2AA 001 200-041	444 52 96	2SK 340 101-011
EL0009-0041	9XX 340 880-001	29.51.18.01	9EL 140 348-021	187-801-1671	2AA 001 200-042	444 52 99	2SK 340 101-001
EL0009-0042	9XX 340 870-007	29.62.17.01	9EM 131 613-021			444 55 26	2SK 340 101-031
EL0009-0043	9XX 340 871-007	29.62.18.03	9EL 131 614-031	Skoda	Hella	444 55 29	2SK 340 101-021
EL0009-0045	9XX 340 884-001	29.63.17.01	9EL 131 651-031	1J0 941 295 B	6NM 007 878-041	6661529	8JE 340 060-011
EL0009-0046	9XX 340 881-001	29.63.18.01	9EL 131 652-031	1J0 941 295 C	6NM 007 878-041	6662410	9XX 340 220-001
EL0010-0016	8KL 340 050-001	29.78.17.01	9EL 129 149-021	1U0 953 155	9EL 246 175-011	6662420	9XX 340 222-001
EL0012-0002	8KA 340 040-001	29.78.18.01	9EL 129 150-021	1U0 953 155 C	9EL 354 075-011	6662430	9XX 340 223-001
EL0012-0014	8KA 340 031-001	34.89.07.03	2BM 003 933-031	1U0 953 156 A	9EL 354 075-011	6665029	8JE 340 060-001
EL0012-0077	8KA 340 815-001	34.89.08.03	2BM 003 933-041	1U0 953 156 B	9EL 246 176-011	9020	8KL 340 050-001
EL0012-0083	8KA 340 819-001			1U0 953 156 C	9EL 354 075-021	9022	8KL 340 050-001
EL0012-0088	8KA 340 822-001	Sisu	Hella	1U0 953 156 D	9EL 354 075-021	A3504529	8KA 340 031-001
EL0013-0006	8GD 002 078-241	181-030-1211	6NM 007 282-221	1U2 941 017 C	1LJ 010 202-051	A3504599	8KA 340 031-001
EL0014-0049	8JE 340 847-001	183-520-0151	5DV 007 810-171	1U2 941 017 D	1LL 010 202-071	S92 11 08	2PG 340 000-121
R 060 198	2PS 340 001-011	186-510-0781	8KA 152 134-007	1U2 941 017 E	1LL 010 202-111	S92 20 08	9EL 340 002-011
S060561	2SK 003 567-321	186-510-0791	8JD 156 150-807	1U2 941 017 F	1LL 010 202-051	S92 21 08	2PS 340 000-001
S060562	2SK 003 567-331	186-510-0801	8JD 156 151-807	1U2 941 017 G	1LL 010 202-071	S92 23 18	2PS 340 000-011
S060827	2KA 003 389-061	186-520-0013	8JB 004 777-001	1U2 941 017 H	1LL 010 202-111	S92 23 38	2PS 340 000-021
S060870	8RA 004 412-001	186-520-0013	8JB 004 777-002	1U2 941 017 I	1LL 010 202-061	S92 23 48	2PS 340 000-171
S061361	8GA 002 071-241	187-009-0331	8GS 859 634-001	1U2 941 017 J	1LL 010 202-081	S92 23 68	2PS 340 000-041
S061806	8RA 004 412-011	187-009-0381	8GS 007 949-101	1U2 941 018 A	1LL 010 202-		

Manufacturer's no. / Hella no.

Cross-Reference



Steinbock	Hella	Steyr	Hella	Steyr	Hella	Still	Hella
022 505	1TA 003 570-001	160.00.72.0721	9ES 106 588-001	6.805.80.119	6ED 004 778-011	1019001	8GJ 002 525-253
023 902	2BA 002 652-101	160.00.72.0727	9EL 110 014-001	692.00.72.0701	9EL 854 912-001	011437	8GA 002 071-241
023 902	2BA 002 652-107	160.00.72.0728	9EL 110 013-001	692.00.72.0740	9EL 856 418-001	012236	2BA 002 324-001
002 50761	9EL 854 912-001	160.00.72.0730	9EL 101 353-001	69200770123	9GT 074 132-001	013147	9EL 088 150-001
002 50985	9EL 112 858-011	1.610.47.200.11	2TJ 001 633-211	6.920.08.100.03	2SL 003 567-311	013150	8GM 002 091-251
000 26747	1TA 003 570-101	161.25.72.0701	9EL 855 097-001	69200810004	2SK 003 567-321	013159	2BA 001 259-611
026 821	2SE 002 578-701	161.25.72.0705	9MN 857 622-011	69200810005	9GP 003 995-801	013159	2BA 001 259-618
026 821	2SE 002 578-707	001 820 79 97	9SX 007 609-031	692.00.81.0701	9EL 122 772-001	013161	8GA 002 074-241
000 29338	2BE 003 014-251	189.73.0029	2BE 003 185-031	7.004.85.004.0	2BA 002 324-001	013165	2AA 001 200-011
000 29338	2BE 003 014-257	1.91S.76.003.3	2KA 001 389-101	700.4.85.800.1	9EL 110 910-001	013165	2AA 001 200-012
032 588	2SD 002 776-241	2.243.72.808.9	2KA 003 389-081	7.111.85.013.0	2SD 001 686-101	013170	8GP 002 068-241
032 588	2SD 002 776-247	002 544 20 90	9EL 122 772-001	7.111.85.565.0	9EL 852 061-001	013172	9EL 854 912-001
000 32851	1GA 005 060-001	2.812.51.036.01.2	2ZR 001 423-001	7.121.93.507.0	2BA 003 014-011	013175	8GP 002 095-241
032 869	2NE 003 300-151	2.812.52.606.06.2	1NE 006 300-231	7.121.93.524.1	8GS 859 634-001	013177	8GA 002 083-251
000 36554	2JA 004 531-011	2904 951 M91	2JA 001 360-001	7.121.93.529.0	2KA 004 525-001	013184	8GM 002 091-241
040 865	2BA 001 227-201	2924 342 M91	2ZR 001 240-351	7.141.85.225.9	2JA 004 531-011	013196	2AA 001 200-141
040 881	2KA 001 386-281	2928 454 M1	2BA 001 248-001	7.161.85.505.0	2KA 001 610-001	001334	2SA 003 057-021
044 50800	9EL 856 010-001	2949 826 M1	9EL 110 918-001	7162850230	2SK 003 567-331	001335	2PF 003 057-041
447 4976	1GA 004 480-001	2949 827 M1	9EL 110 918-011	716 285 02 40	2SK 003 567-321	139424	9EL 126 294-001
045 44058	8RA 003 326-001	2949 833 M91	2BA 002 324-011	7162855110	9EL 122 772-001	014376	8KW 701 235-033
045 44058	8RA 003 326-002	2949 834 M91	2BA 002 324-021	7.171.93.552.0	3AG 003 399-101	015204	2AB 004 532-021
454 4066	2ZR 003 014-091	2951 380 M91	2PF 001 634-101	7.211.85.539.1	8HG 096 531-007	015206	2AB 001 208-001
045 44074	2SE 004 623-001	2954 497 M91	2BA 002 324-001	7.534.11.600.40	9EL 084 110-001	015210	1G5 003 241-021
045 44074	2SE 004 623-007	3061 358 M8	9EL 089 475-001	7.534.18.300.00	2XS 005 020-001	015214	1G3 005 760-001
047 39236	2RL 006 846-011	3061 399 M8	2BE 003 018-011	7.534.18.300.00	2XS 005 020-002	158039	8JA 001 921-102
047 39244	8HG 006 294-021	3062 196 M8	9EL 087 769-001	7.534.18.300.00	2XS 005 020-003	161606	8GA 006 841-241
047 77427	2KA 004 525-001	3062 228 M8	2BE 001 278-011	7.581.85.001.0	1GA 007 506-011	170031	8GH 007 157-241
00004920	9FF 090 500-001	3062 229 M8	2BE 001 278-021	7.581.85.003.0	2BA 002 652-101	017051	2SB 001 673-002
049 74019	8JB 004 777-001	3065 113 M8	2SB 003 018-031	7.581.85.003.0	2BA 002 652-107	017052	1TA 003 570-101
049 74019	8JB 004 777-002	3075 726 M91	2SA 001 634-121	7.587.85.003.0	2BA 002 652-101	017139	8RA 002 015-031
049 91783	8RA 002 014-081	3093000M91	2BE 001 259-061	7.587.85.003.0	2BA 002 652-107	001770	8RA 002 014-051
500 35558	2SD 003 182-051	34-172-010	1GA 003 470-011	777 935 703	2PF 001 634-101	001770	8RA 002 014-052
500 35558	2SD 003 182-057	34-173-010	2SD 003 182-101	8.227.20.007	8JA 001 914-011	001771	8RA 002 014-041
500 35559	2SD 003 182-061	34-173-011	2BE 003 182-091	791.00.72.0036	8HG 002 365-001	001771	8RA 002 014-042
500 35559	2SD 003 182-067	34-176-060	2SD 003 182-061	7.910.08.100.13.0	2NE 003 236-001	001780	8GA 003 326-011
050 06227	2SB 003 014-151	34-176-060	2SD 003 182-067	7.910.08.100.13.0	2NE 003 236-008	001780	8RA 003 326-017
050 16229	2SD 001 305-021	34-176-061	2SD 003 182-051	7.910.08.100.14	2ZR 003 236-051	002804	4AZ 003 787-021
050 33598	2SA 003 057-021	34-176-061	2SD 003 182-057	7.910.08.100.14	2ZR 003 236-057	003193	2PF 001 259-631
050 35227	1GA 007 506-001	3.450.19.4	8HG 006 294-041	7.910.08.100.45	2SE 003 167-511	003611	2BA 003 014-011
510 16328	2SD 343 130-227	391.76.0022	2SE 001 679-051	7.910.08.100.46	2SD 003 167-521	400518	2SD 001 693-011
510 17429	1GA 996 361-431	395 935 813	2JA 001 360-001	791.00.81.0701	9EL 118 445-001	400519	9EL 950 315-031
51078719	2SD 343 910-017	461 820 00 97	8KB 007 896-801	791.00.81.0702	9GD 087 883-355	401307	8GP 002 067-241
51078719	2SD 343 910-027	470563520	1GA 996 083-011	791.00.81.0703	9EL 119 544-001	401454	2BA 004 532-051
510 94600	2PT 009 599-011	470563530	1GA 996 083-011	791.00.81.0704	9EL 119 544-111	401454	2AB 004 532-057
510 94601	2PT 009 599-021	470563540	1GA 996 083-021	804.13.29.701	9EL 090 411-001	402128	1GA 001 277-011
511 13392	4DM 009 492-001	470563550	1GA 996 083-021	8.042.21.200.01.0	8RA 002 010-011	406107	2BA 003 470-001
051 12186	2SD 001 679-001	470563560	1GA 996 083-011	8.125.10.260.84.1	1NE 006 300-231	406140	2BA 004 532-011
520 21959	2JA 006 447-041	470563570	1GA 996 083-011	8.125.10.260.88	1NE 006 300-051	040865	2BA 001 227-201
520 30617	2AB 004 532-031	484 820 00 01	2JA 007 373-061	8.125160.801.5	2PF 001 647-031	040873	2BE 003 118-011
520 30665	8GP 002 067-241	484 820 01 01	2ZR 003 315-041	81.25160.801.5	2PF 001 647-037	040881	2KA 001 386-281
524 112	2ZR 002 985-261	5.207.80.212.00.0	8JA 001 909-011	8.125.22.561.82	2KA 003 389-081	040882	2BA 001 259-618
525 535	2VP 006 040-111	5.323.84.175.29.0	2RL 008 062-111	8.125.26.060.15	2PF 001 647-031	040882	2BA 001 259-618
525 535	2VP 006 040-117	5.323.84.175.31.0	2ZR 003 030-171	8.125.26.060.15	2PF 001 647-037	040904	8GM 002 091-131
525 536	2VP 006 040-121	5.360.80.152.00.0	2AA 001 200-031	8.125.26.060.62	2XS 005 020-011	040906	8GP 002 067-121
525 536	2VP 006 040-127	5.360.80.152.00.0	2AA 001 200-032	8.125.26.060.62	2XS 005 020-017	041258	2SB 001 673-002
525 681	2VP 006 040-351	5.360.80.152.A0.0	2AA 001 200-021	8.125.26.060.62	2XS 005 020-041	040275	8GM 002 092-241
525 681	2VP 006 040-357	5.360.80.152.A0.0	2AA 001 200-023	8.125.26.060.62	2XS 005 020-047	428041	2SB 003 014-151
525 682	2VP 006 040-301	5.360.80.152.B0.0	2AA 001 200-001	8.166.80.460.12	2XW 003 146-001	004540	2ZR 003 030-171
525 682	2VP 006 040-307	5.360.80.152.B0.0	2AA 001 200-002	8.166.80.460.17	2XW 002 897-051	040896	2SA 001 259-751
077 61215	1LB 003 177-637	5.360.80.152.C0.0	2AA 001 200-011	8.525.10.360.01	1GA 006 876-001	040896	2SA 001 259-757
079 39863	1GA 005 060-001	5.360.80.152.C0.0	2AA 001 200-012	8.542.95.101.02	8HG 002 240-031	004902	2JA 004 531-011
850 06026	8RL 002 009-021	5.373.80.247.01.0	8HG 002 365-001	0.861.11.01	2BA 001 259-611	004902	2JA 001 372-011
088 82927	1GA 132 459-011	5.373.80.248.01.0	1G8 002 340-011	0.861.11.01	2BA 001 259-618	500146	8GP 002 066-121
089 28332	9EL 856 010-001	5.806.91.012.00.0	8RA 002 023-011	93.72.0701	2ZR 002 985-081	500155	2KA 001 389-101
987 4533	2SD 003 182-051	000 585 11 03	8XH 002 975-017	990.00.72.0706	9ES 069 831-001	500160	2SD 001 679-001
987 4533	2SD 003 182-057	5.899.91.000.06.0	2ZR 003 014-091	HKW210820M016	9DF 112 246-001	500166	8JB 001 943-001
988 3755	2VP 003 567-111	5.899.91.000.18.0	2ZR 003 236-051	HKW210820M050	9SX 007 609-031	502647	2BA 001 248-001
		5.899.91.000.18.0	2ZR 003 236-057	HKW21820M050	8KB 007 895-801	504185	8GM 002 091-241
		5.899.91.004.03.0	2BE 002 582-031	SFT 7161855050	8KB 007 895-801	507501	8GA 002 083-131
		5.899.91.004.08.0	2BA 003 236-021	X 842 070 990 013	2KA 001 610-001	507504	1X0 001 155-021
		5.899.91.004.08.0	2BA 003 236-027	X 842 070 990 017	2TJ 001 633-211	510694	8GA 002 083-251
		5.899.91.006.03.0	9GD 082 716-001	X 842 070 990 031	2SA 001 634-121	511466	2KA 001 388-051
		5.899.91.008.02.0	2KA 001 378-001	X 860 533 935 209	2BA 002 324-001	511505	2SA 001 634-121
		5.899.91.008.04.0	2KA 001 622-001	X 860 535 935 103	2BA 001 248-001	516597	9FF 090 500-001
		5.899.91.010.02.0	2SD 002 582-011	X 860 535 935 104	9EL 110 918-001	518289	8GA 002 071-251
		5.899.91.010.02.0	2SD 002 582-017	X 860 535 935 719	9EL 110 918-011	518819	8HG 002 240-001
		5.899.91.010.03.0	2SD 002 582-021	X 860 535 935 720	2BA 002 324-011	519565	2SY 003 014-121
		5.899.91.010.03.0	2SD 002 582-027	X 860 582 935 311	2BA 002 324-021	519566	2BA 003 014-011
		5.899.91.010.04.0	2SA 003 014-051	X 860 975 910 001	9GT 074 132-001	519699	8GH 002 089-133
		5.899.91.010.08.0	2SA 003 236-041	X 861 019 404 701	2PF 001 634-101	519845	2SA 003 014-051
		5.899.91.010.08.0	2SA 003 236-047	X 861 019 405 490	9EL 126 294-001	520208	2SW 003 014-131
		5.899.91.010.08.0	2SA 003 236-048	X 861 041 060 350	2SD 001 679-001		



Manufacturer's no. / Hella no.

Cross-Reference

Still	Hella	Still	Hella	Trifa	Hella	Tungsram	Hella
522981	8GH 002 090-251	999025	6ED 708 919-001	21661	8GJ 002 525-301	2661	8GP 002 067-241
522981	8GH 002 090-253	999038	1GA 007 506-061	21662	8GJ 002 525-281	2662	8GP 002 067-121
523034	8RA 002 023-021	999038	9EL 110 918-001	221	8GM 002 091-131	2663	8GP 002 068-241
523541	2BE 003 014-251	999039	1GA 007 506-011	2706	8GA 007 997-011	2692	8GP 002 066-241
523541	2BE 003 014-257	999040	2BA 002 652-101	2714	8GA 007 997-021	2696	8GP 002 066-121
523626	4AZ 003 787-021	999040	2BA 002 652-107	02715	8GA 007 997-121	2765	8GP 002 096-061
523778	2BA 003 014-111	999042	8XS 113 389-001	02716	8GA 007 997-131	50320	8GH 002 089-251
523895	8GP 002 067-241	999129	9EL 118 701-001	02718	8GA 007 997-171	50350	8GH 002 090-251
523926	2ST 003 014-141	999159	1GM 996 136-111	2719	8GA 007 997-041	50410	8GH 002 857-121
523940	2BA 002 652-111			2720	8GA 007 997-061	50420	8GH 002 857-241
523940	2BA 002 652-117	SWF	Hella	2721	8GA 007 997-001	5300	8GP 002 095-121
523941	2BA 002 652-121	300 588	2SD 001 699-061	02722	8GA 007 997-141	5301	8GP 002 095-241
523941	2BA 002 652-127	300 589	2SE 001 699-071	02723	8GA 007 997-151	5304	8GP 003 594-141
523942	2XS 950 071-031	394 267	9EL 139 137-061	2724	8GA 007 997-031	5305	8GP 003 594-241
523946	2SB 003 014-151	394 268	9EL 139 138-051	2725	8GA 007 997-071	5307	8GP 003 594-121
524112	2ZR 002 985-261	397 472	9EL 113 065-001	2726	8GA 007 997-081	7546	8GM 002 092-121
524976	1TA 003 570-101	611 004	4RA 003 510-081	02728	8GA 007 997-161	7552	8GM 002 092-241
525016	1GA 005 060-001	Toyota	Hella	2730	8GA 007 997-051	7576	8GM 002 091-131
525016	1GA 998 522-011	19883	1NO 008 582-001	2732	8GA 007 997-091	7580	8GM 002 091-251
525302-	2SE 002 578-701	19883	1NO 008 582-007	02733	8GA 007 997-211	7593	8GM 002 091-121
525302-	2SE 002 578-707	300242	9GH 158 051-007	02734	8GA 007 997-221	7595	8GM 002 091-241
525535	2VP 006 040-111	TD400-19883-0000P	1NO 008 582-001	02735	8GA 007 997-231		
525535	2VP 006 040-117	TD400-19883-0000P	1NO 008 582-007	02736	8GA 007 997-241	Ulo	Hella
525536	2VP 006 040-121	TD400-80242-0000P	9GH 158 051-007	02737	8GA 007 997-251	148 00 71	8RA 002 016-111
525536	2VP 006 040-127			02740	8GA 007 997-261	148 01 71	8RA 002 016-101
525681	2VP 006 040-351	Trifa	Hella	2749	8GA 007 997-272	148 50 71	8RA 002 016-121
525681	2VP 006 040-357	107	8GP 002 066-121	02750	8GA 007 997-191	2620 03	9EL 146 373-001
525682	2VP 006 040-301	109	8GP 002 066-241	02751	8GA 007 997-201	2798 05	9EL 146 372-001
525682	2VP 006 040-307	1102	8GP 002 068-241	304	8GA 002 071-121	2798 06	9EL 146 371-001
526077	2SE 004 623-001	112	8GP 002 068-131	306	8GA 002 071-131	2836-12	9EL 122 378-011
526077	2SE 004 623-007	1122	8GP 002 067-241	3381	8GD 002 078-121	2836-13	9EL 122 377-011
526078	2ZR 003 315-041	117	8GP 002 068-121	3382	8GD 002 078-241	2898-01	8RA 002 014-031
526 208	1TA 003 570-001	120	8GP 002 067-061	3391	8GD 004 772-121	2898-03	8RA 002 014-041
526282	1G3 005 760-001	1202	8GM 002 094-241	371	8GA 002 072-121	2898-04	8RA 002 014-051
526363	2SD 003 184-031	1204	8GM 002 092-241	381	8GA 002 072-121	308 02 29	9EL 146 373-001
526363	2SD 003 184-037	121	8GP 002 067-121	391	8GA 002 073-121	3135-01	2SD 001 693-011
526364	2SD 003 184-041	1215	8GM 002 091-251	00401	8GA 002 074-121	3135-13	2SD 001 699-511
526364	2SD 003 184-047	1221	8GM 002 091-141	00410	8GA 008 899-061	3135-17	2SE 001 699-071
526365	2ZR 006 609-081	1222	8GM 002 091-261	41607	8GH 007 157-201	3231 01	9EL 146 607-001
526365	2ZR 006 609-087	1223	8GM 002 091-251	41642	8GH 007 643-171	3233-02	2SE 002 514-171
526366	8RA 002 014-081	1231	8GM 002 091-121	41661	8GJ 002 525-481	3247-01	2SD 002 582-011
526668	2SD 002 582-011	1232	8GM 002 091-241	421	8GA 002 083-131	3248-01	2SD 002 582-021
526668	2SD 002 582-017	1241	8GA 002 071-241	500	8GD 002 088-071	3265 01	9EL 950 315-001
526669	2SD 002 582-021	1305	8GA 002 071-251	501	8GD 002 088-131	3265 01	9EL 950 315-061
526669	2SD 002 582-027	1354	8GA 002 072-241	503	8GD 002 088-251	3266 01	9EL 950 315-031
526786	8RA 004 412-021	1381	8GA 002 073-241	51607	8GH 007 157-471	3268-01	2XS 955 232-001
526868	2SK 003 567-321	1391	8GA 002 074-241	51650	8GH 002 089-471	328 01 70	2BM 003 647-021
526869	2SK 003 567-331	1425	8GA 002 083-251	51660	8GJ 002 525-471	331 45 71	2SD 001 680-281
527169	1G3 005 760-201	150	8GP 002 096-061	00520	8GD 008 897-061	332 02 25	9EL 116 771-031
527169	1G3 005 760-207	1526	8GD 002 084-251	52008	8GH 008 356-151	332 03 71	2BA 002 939-171
527367	8RA 003 326-931	01600	8GA 007 997-101	52009	8GH 008 357-151	336 01 25	9EL 115 830-001
527446	2JA 003 354-001	01602	8GA 007 997-111	52011	8GH 008 358-151	336 01 70	2BM 002 847-021
527885	1GA 007 506-001	1607	8GH 007 157-121	00521	8GD 008 898-061	336 11 70	2BM 002 847-011
527975	9GH 993 984-001	01607-86	8GH 007 157-921	523	8GD 002 084-131	3413-01	8RA 004 412-021
529489	2SE 998 530-061	01607-87	8GH 007 157-951	528	8GD 002 084-151	3453-02	2BM 003 647-021
529489	2SE 998 530-067	1617	8GH 007 157-241	00529	8GD 008 897-121	3464-01	8RA 002 020-001
529762	2NE 003 315-011	01617-51	8GH 007 157-931	6-1607	8GH 007 157-181	348 01 28	9EL 122 378-011
531429	8XS 113 389-001	1621	8GH 005 636-121	6-1655	8GH 002 089-141	348 11 28	9EL 122 377-011
532456	8GD 002 078-121	1623	8GH 005 635-121	6-1658	8GH 002 090-371	351 55 71	2SE 001 680-291
532472	8GH 007 157-121	1639	8GH 002 473-151	6-1661	8GJ 002 525-361	352 00 51	2SD 001 686-101
534115	2SE 003 184-101	1641	8GH 002 473-132	62008	8GH 008 356-181	352 10 51	2NE 001 423-011
534454	2SD 343 130-157	1642	8GH 007 643-121	62011	8GH 008 358-181	352 40 51	2SD 001 685-231
534455	2SD 343 130-167	1644	8GH 008 417-012	81381	8GA 006 841-241	352 55 51	2ZR 001 423-001
005519	2XS 950 071-031	1645	8GH 002 857-121	81388	8GA 006 841-251	353 00 51	2SE 001 686-142
634743	1GA 007 506-431	1646	8GH 002 857-241	81781	8GP 009 021-002	3531-01	1G4 004 480-001
007454	8GA 002 073-241	01655-50	8GH 002 089-921	8381	8GA 006 841-121	3532-01	1G4 004 480-011
8007454	8GA 002 073-241	1656	8GH 002 089-251	00091	8GA 007 997-901	353 40 51	2SE 001 685-221
8011488	8GA 002 072-241	01656-51	8GH 002 089-931	91661	8GJ 002 525-341	354 00 71	2SD 001 679-001
8013147	9EL 088 150-001	1659	8GH 002 090-251	00092	8GA 007 997-911	355 00 71	2SE 001 679-051
8013148	8GH 002 090-251	1702	8GA 007 997-011	00093	8GA 007 997-921	358 65 51	2SD 001 693-011
8013148	8GH 002 090-253	1702	8GP 002 095-121			358 85 51	2SD 001 699-061
8013159	2BA 001 259-611	1703	8GP 938 026-001	Tungsram	Hella	358 85 51	2SD 001 699-511
8013159	2BA 001 259-618	1704	8GP 002 095-241	1057	8GA 002 073-121	358 95 51	2SE 001 699-071
8013165	2AA 001 200-011	1704	8GP 002 095-241	1059	8GA 002 072-121	3672-01	2BA 002 652-121
8013165	2AA 001 200-012	01705	8GA 007 997-181	1060	8GA 002 073-241	3674-01	2BA 002 652-111
8013175	8GP 002 095-241	1712	8GP 003 594-141	1060HD	8GA 002 073-251	3676-01	2BA 002 652-101
8013175	8GM 002 091-241	1714	8GP 003 594-002	1077	8GD 002 078-121	3679-01	2KA 003 389-061
8017052	1TA 003 570-101	1724	8GP 003 594-241	1078	8GD 002 078-241	368 25 29	9EL 122 150-011
8402128	2BA 001 277-011	01725	8GA 008 901-241	1113	8GA 002 074-121	368 35 29	9EL 122 149-011
916232	2BA 001 277-011	1732	8GP 003 594-121	1117	8GA 002 072-241	3695-04	2BA 002 939-171
916650	1G4 003 470-001	1734	8GP 003 594-251	1120	8GA 002 074-241	3721-01	9EL 116 771-031
923025	2JA 007 372-011	1781	8GA 008 892-002	1122	8GD 004 772-121	3756-05	2BM 002 847-021
924394	2BA 001 259-611	1791	8GD 008 893-002	1130	8GA 002 083-251	3756-06	2BM 002 847-011
924394	2BA 001 259-618	02002	8GS 007 949-101	1215	8GA 002 083-131	376 01 70	2SD 002 514-161
924396	2AA 001 200-011	02002-11-19-5001	8GS 007 949-101	1526	8GD 002 084-131	376 11 70	2SE 002 514-171
924396	2AA 001 200-012	02004	8GS 007 001-121	1735	8GD 002 084-251	376 32 25	9EL 129 519-001
924399	8GP 002 068-241	02004-11-19-5001	8GS 007 001-121	1931	8GD 002 088-131	376 32 70	2SE 004 623-001
951923	2AB 004 532-011	02008	8GH 008 356-121	1937	8GD 002 088-251	376 32 70	2SE 004 623-007
954445	8GP 002 067-241	02009	8GH 008 357-001	2619	8GA 002 071-121	3765-01	9EL 115 830-001
000 974 04 12	1GA 005 060-001	02011	8GH 008 358-121	2627	8GA 002 071-241	3766-01	8RA 002 016-111
000 974 04 12	1GA 998 522-011	202	8GM 002 094-121	2627HD	8GA 002 071-261	3766-02	8RA 002 016-101
000 974 04 26	1G3 005 760-011	204	8GM 002 092-121	2641	8GA 002 071-131	3766-05	8RA 002 016-121
000 974 04 49	1GA 007 506-001	21122	8GP 002 067-261	2643	8GA 002 071-251	377 21 25	9EL 122 772-001
000 974 10 00	2BA 002 652-101	21304	8GA 002 071-261	2643HD	8GA 002 071-271	377 21 51	2SK 003 567-321
000 974 10 00	2BA 002 652-107	21305	8GA 002 071-271	2659	8GP 002 067-061	378 21 25	9EL 122 689-021
		21381	8GA 002 073-251	2660	8GP 002 068-121	3819-02	9EL 122 689-021

Manufacturer's no. / Hella no.

Cross-Reference



Ulo	Hella	Valeo	Hella	Vignal	Hella	Visteon	Hella
3821-02	9EL 122 772-001	085294	9EL 150 987-001	688621	2SE 003 167-031	20-210-01015	9EL 354 071-011
3825-05	2SK 003 567-321	085295	9EL 150 988-001	688631	2SD 003 167-021	20-210-01016	2VP 354 037-011
3825-06	2SL 003 567-311	085296	9EL 150 867-001			20-210-01019	9EL 354 076-021
3825-08	2SK 003 567-331	085297	9EL 150 868-001	Visteon	Hella	20-210-01020	2VP 354 030-021
388 02 29	9EL 146 372-001	085387	2BA 002 939-171	20-200-01001	1LE 010 199-031	20-210-01021	2VP 354 043-021
388 12 29	9EL 146 371-001	085388	9EL 116 771-031	20-200-01004	1LG 354 023-041	20-210-01022	2VP 354 042-021
3908-01	2XW 002 897-041	085390	9EL 141 701-001	20-200-01006	1LG 354 023-081	20-210-01023	9EL 354 066-021
3908-02	2XW 002 897-051	085391	9EL 141 702-001	20-200-01014	1LF 010 197-041	20-210-01024	9EL 354 065-021
393 15 72	2SD 002 582-021	085392	9EL 144 425-001	20-200-01016	1LJ 010 202-061	20-210-01026	9EL 354 067-021
393 16 72	2SD 002 582-011	085393	9EL 144 426-001	20-200-01018	1LL 010 202-081	20-210-01027	9EL 354 050-021
396 01 02	9EL 950 315-031	085394	8XU 144 427-001	20-200-01020	1LL 010 202-121	20-210-01028	2SK 354 032-021
396 30 50	2TJ 001 633-211	085395	8XU 144 428-001	20-200-01021	1LE 010 198-101	20-210-01029	9EL 171 558-061
399 00 50	2BA 001 259-611	085396	9EL 144 425-011	20-200-01023	1LE 010 198-061	20-210-01030	2VP 354 030-041
4092-01	8RA 003 503-001	085397	9EL 144 426-011	20-200-01026	1LE 010 198-161	20-210-01031	9EL 354 070-021
4651-04	8RA 003 326-001	085398	8XU 144 429-001	20-200-01030	1LG 354 024-081	20-210-01032	9EL 354 054-021
4651-05	8RA 003 326-021	085399	8XU 144 430-001	20-200-01032	1LG 354 024-061	20-210-01033	9EL 354 055-021
4651-06	8RA 003 326-011	085400	9EL 142 425-011	20-200-01035	1LG 354 024-141	20-210-01034	9EL 171 968-021
4651-07	8RA 003 326-031	085405	9EL 142 460-011	20-200-01037	1LG 010 196-041	20-210-01035	9EL 171 558-041
4651-08	8RA 003 326-051	085502	9HB 006 948-031	20-200-01042	1LL 354 027-061	20-210-01036	2VP 354 038-021
4651-09	8RA 003 326-041	085503	9HB 006 948-041	20-200-01044	1LL 354 027-101	20-210-01037	2VP 354 039-021
4886-01	8RL 002 009-021	085522	9BG 142 247-021	20-200-01046	1LL 010 203-041	20-210-01039	9EL 171 974-021
4886-02	8RL 002 009-011	085523	9BG 142 248-021	20-200-01048	1LL 010 201-041	20-210-01040	9EL 171 975-021
4886-03	8RL 002 009-011	085733	9EL 158 254-011	20-200-01050	1LL 010 201-081	20-210-01041	9EL 354 079-021
5030-01	8RA 002 014-081	085734	9EL 158 254-021	20-200-01053	1LL 010 201-121	20-210-01042	9EL 354 077-021
5105-01	8RA 002 023-001	085769	8KA 146 152-001	20-200-01054	1LL 010 201-161	20-210-01043	2NR 010 229-021
5105-02	8RA 002 023-011	085972	9EL 144 131-001	20-200-01056	1LL 010 201-201	20-210-01044	2SD 010 230-021
5105-03	8RA 002 023-021	085973	9EL 144 132-001	20-200-01058	1LL 010 201-241	20-210-01045	2SK 354 035-021
511 25 71	8RA 004 412-021	086754	9EL 151 875-021	20-200-01060	1LL 354 025-041	20-210-01046	9EL 354 080-021
520 00 70	8RL 002 009-021	086755	9EL 151 876-021	20-200-01062	1LL 354 025-081	20-210-01049	9EL 354 073-021
520 01 70	8RL 002 009-011	086845	9BG 142 248-021	20-200-01064	1LF 354 025-121	20-210-01051	9EL 176 577-021
520 02 70	8RL 002 009-011	086846	9BG 142 247-021	20-200-01066	1ZL 010 541-081	20-210-01052	9EL 176 576-021
521 00 70	8RA 003 326-001	086866	9EL 144 425-011	20-200-01068	1LL 010 541-121	20-210-01053	9EL 176 574-021
521 01 70	8RA 003 326-021	086867	9EL 144 425-001	20-200-01070	1LF 010 541-041	20-210-01054	9EL 176 575-021
521 02 70	8RA 003 326-011	086868	9EL 144 426-011	20-201-01002	1LE 010 199-041	20-210-01057	9EL 354 082-021
521 60 71	8RA 003 326-031	086869	9EL 144 426-001	20-201-01004	1LG 354 023-031	20-211-01001	9EL 354 061-011
521 61 71	8RA 003 326-051	086979	1LE 007 350-111	20-201-01006	1LG 354 023-071	20-211-01002	9EL 354 057-011
521 62 71	8RA 003 326-041	086980	1LE 007 350-121	20-201-01014	1LF 010 197-031	20-211-01004	9EL 171 556-041
528 00 71	8RA 003 503-001	087299	6NM 007 878-041	20-201-01016	1LJ 010 202-051	20-211-01005	2VP 354 034-021
537 00 70	8RA 002 020-001	088911	2SD 964 961-011	20-201-01018	1LL 010 202-071	20-211-01007	9EL 354 078-021
5521-02	8HG 002 240-001	088912	2SD 964 961-021	20-201-01020	1LL 010 202-111	20-211-01009	9EL 171 976-021
5521-04	8HG 002 240-011			20-201-01021	1LE 010 198-091	20-211-01011	9EL 354 074-021
5521-06	8HG 002 240-021	Vauxhall	Hella	20-201-01023	1LE 010 198-051	20-211-01013	9EL 171 977-021
5521-08	8HG 002 240-031	1 222 355	9EL 354 073-011	20-201-01026	1LE 010 198-151	20-211-01014	9EL 171 558-021
5694-01	9EL 129 763-001	1 222 356	9EL 354 073-021	20-201-01030	1LG 354 024-071	20-211-01015	9EL 354 071-021
5694-02	9EL 129 762-001	24406569	5DV 008 290-004	20-201-01032	1LG 354 024-051	20-211-01016	2VP 354 037-021
5695-01	9EL 129 763-021	24417111	5DV 008 290-004	20-201-01035	1LG 354 024-131	20-211-01019	9EL 354 076-011
5695-04	9EL 129 762-031	24451030	1LG 270 370-331	20-201-01037	1LG 010 196-031	20-211-01020	2VP 354 030-011
5702-01	2VP 003 069-011	90016718	2NE 002 985-001	20-201-01042	1LL 354 027-051	20-211-01021	2VP 354 043-011
5702-06	2VP 003 069-021	90019236	5AB 005 944-001	20-201-01044	1LL 354 027-091	20-211-01022	2VP 354 042-011
5703-01	9EL 118 059-001	90392574	1LL 006 110-351	20-201-01046	1LL 010 203-031	20-211-01023	9EL 354 066-011
5703-02	9EL 118 060-001	90392575	1LL 006 110-361	20-201-01048	1LL 010 201-031	20-211-01024	9EL 354 065-011
5720-06	2VP 004 686-121	90487570	1LG 006 920-231	20-201-01050	1LL 010 201-071	20-211-01026	9EL 354 067-011
5721-09	2VP 004 686-151	90487572	1LG 006 920-241	20-201-01053	1LL 010 201-111	20-211-01027	9EL 354 050-011
5721-12	2VP 004 686-181	9118758	1LL 008 020-281	20-201-01054	1LL 010 201-151	20-211-01028	2SK 354 032-011
5724 05	2VD 007 500-111	9118761	1LL 008 020-271	20-201-01056	1LL 010 201-191	20-211-01029	9EL 171 558-051
5724 12	2VD 007 500-221	9120067	2XW 007 146-001	20-201-01058	1LL 010 201-231	20-211-01030	2VP 354 030-031
5724-13	2VD 007 500-411	9193413	1LL 009 020-231	20-201-01060	1LL 354 025-031	20-211-01031	9EL 354 070-011
5724-14	2VP 007 500-421	9193414	1LL 009 020-241	20-201-01062	1LL 354 025-071	20-211-01032	9EL 354 054-011
5725 01	2VD 005 300-551	93175325	1LG 007 640-631	20-201-01064	1LF 354 025-111	20-211-01033	9EL 354 055-011
5865-01	2SE 003 167-031	93175325	1LG 007 640-641	20-201-01066	1ZL 010 541-071	20-211-01034	9EL 171 968-011
605 44 70	8RA 002 023-001	93175725	1LG 007 640-631	20-201-01068	1LL 010 541-111	20-211-01035	9EL 171 558-031
605 45 70	8RA 002 023-011	93175725	1LG 007 640-641	20-201-01070	1LF 010 541-031	20-211-01036	2VP 354 038-011
605 46 70	8RA 002 023-021	93177645	5DD 008 319-501	20-202-01002	1NA 010 205-011	20-211-01037	2VP 354 039-011
673 50 50	1G4 004 480-001	93178633	1LG 270 370-331	20-202-01003	1NO 354 017-021	20-211-01039	9EL 171 974-011
673 60 50	1G4 004 480-011	93178634	1LG 270 370-341	20-202-01004	1NO 354 016-021	20-211-01040	9EL 171 975-011
758 50 70	2BA 002 652-121	93178637	1LL 008 700-331	20-202-01005	1NO 354 013-021	20-211-01041	9EL 354 079-011
758 55 70	2BA 002 652-111	93178638	1LL 008 700-341	20-202-01006	1NO 354 018-021	20-211-01042	9EL 354 077-011
758 60 70	2BA 002 652-101	93190306	9EL 354 073-011	20-203-01002	1NA 010 205-021	20-211-01043	2NR 010 229-011
759 01 70	2KA 003 389-061	93190307	9EL 354 073-021	20-203-01003	1NO 354 017-011	20-211-01044	2SD 010 230-011
759 05 70	2KA 003 389-061			20-203-01004	1NO 354 016-011	20-211-01045	2SK 354 035-011
762 44 50	2XW 002 897-051	Vignal	Hella	20-203-01005	1NO 354 013-011	20-211-01046	9EL 354 080-011
906 20 81	8HG 002 240-001	167700	2VP 008 204-041	20-203-01006	1NO 354 018-011	20-211-01049	9EL 354 073-011
906 25 81	8HG 002 240-011	167770	2VD 008 204-051	20-204-01001	9EL 354 059-011	20-211-01051	9EL 176 577-011
906 30 81	8HG 002 240-021	168010	2VP 008 204-161	20-204-01002	9EL 354 072-011	20-211-01052	9EL 176 576-011
906 40 81	8HG 002 240-031	168020	2VD 008 204-171	20-204-01003	9EL 354 075-011	20-211-01053	9EL 176 574-011
		168090	2VP 008 204-061	20-204-01004	9EL 354 060-011	20-211-01054	9EL 176 575-011
		168100	2VD 008 204-071	20-204-01005	2BA 010 231-011	20-211-01056	9EL 354 081-011
		168270	2VP 008 204-201	20-204-01006	2BA 010 232-011	20-230-01001	2ZR 354 063-011
		168340	2VD 008 204-211	20-205-01001	9EL 354 059-021	20-230-01002	2ZR 354 052-011
		168350	2VD 008 204-151	20-205-01002	9EL 354 072-021	20-230-01003	2ZR 354 069-011
		168360	2VD 008 204-141	20-205-01003	9EL 354 075-021	20-240-01003	2NE 354 053-011
		169021	2VD 008 204-231	20-205-01004	9EL 354 060-021	20-240-01004	2NE 354 068-021
		169031	2VP 008 204-221	20-205-01005	9EL 354 060-021	20-241-01001	2NE 354 062-021
		169160	2VD 008 204-251	20-205-01006			



Manufacturer's no. / Hella no.

Cross-Reference

Volkswagen	Hella	Volkswagen	Hella	Volkswagen	Hella	Volkswagen	Hella
111 947 111 E	2JA 002 532-011	170 945 095 N	2SK 009 477-051	3B7 941 699 A	1NL 009 034-011	5M2 941 005 A	1LE 247 013-071
112 941 039 M	1L8 003 060-561	170 945 096 C	2VP 008 759-061	3B7 941 700	1NL 009 034-021	5M2 941 006 A	1LE 247 013-081
113 941 133	9XS 118 079-005	170 945 096 J	2SK 009 477-061	3B7 941 700 A	1NL 009 034-021	5N0 945 095 D	2SD 009 691-091
114 941 753 H	1L8 003 060-691	170 945 096 N	2SK 009 477-061	3C0 941 005 K	1LL 247 014-031	5N0 945 096 D	2SD 009 691-101
147 943 021	2KA 001 389-101	200 953 157	9EL 088 538-001	3C0 941 006 K	1LL 247 014-041	5N2 941 031 G	1LD 247 038-231
161 949 101	2BM 003 647-021	211 945 245 AD	9EL 113 065-001	3C0 941 699 B	1N0 271 296-031	5N2 941 032 G	1LD 247 038-241
161 953 081	9EL 123 323-011	211 951 297	9SG 703 965-007	3C0 941 700 B	1N0 271 296-041	600 857 520	9GT 005 166-001
161 953 082	9EL 123 324-011	211 953 061 B	2BA 001 227-201	3C0 953 041	2BA 010 118-011	600 857 524	9GT 074 132-001
171 943 021 B	2KA 002 445-111	251 945 111 D	9EL 122 149-011	3C0 953 041 C	2BA 010 118-011	600 860 285	2XW 003 146-001
171 953 055	2BA 002 939-171	251 945 111 H	9EL 122 149-011	3C0 953 041 E	2BA 010 118-031	600 945 103 C	8RA 002 016-121
171 953 055 D	2BA 002 939-171	251 945 112 D	9EL 122 150-011	3C0 953 041 F	2BA 010 118-011	600 945 241 B	9EL 122 772-001
171 953 141	9EL 116 771-031	251 945 112 H	9EL 122 150-011	3C0 953 041 H	2BA 010 118-031	600 945 341	2PF 003 389-041
181 941 425	9GH 096 532-001	251 953 141	9EL 122 377-011	3C0 953 042 C	2BA 010 118-021	612 170 620 1	2AA 001 200-011
181 945 701 A	2NE 003 300-151	251 953 142	9EL 122 378-011	3C0 953 042 C	2BA 010 118-021	612 170 620 2	2AA 001 200-012
181 947 303	2AB 001 208-001	271 941 091 G	9EL 852 820-001	3C0 953 042 E	2BA 010 118-041	690 945 105	8RA 002 014-051
183 941 101	9XR 854 840-001	281 941 091	9EL 855 097-001	3C0 953 042 F	2BA 010 118-021	690 945 105	8RA 002 014-052
183 941 219	9MK 854 066-001	281 945 105	8RA 002 014-031	3C0 953 042 H	2BA 010 118-041	690 945 105	5AB 005 944-011
183 945 095 A	2SD 002 582-011	281 945 105	8RA 002 014-032	411 941 047	9AG 084 320-005	6H0 941 699	1N0 270 204-051
183 945 095 A	2SD 002 582-017	281 945 729	9EL 146 373-001	411 941 669	9FF 085 642-001	6H0 941 699 A	1N0 270 204-051
183 945 096	2SD 002 582-021	281 947 103	2JA 003 354-001	431 941 159 B	9HD 121 297-001	6H0 941 699 B	1N0 271 247-051
183 945 096	2SD 002 582-027	281 953 357	9EL 116 907-001	438 941 663	1LB 003 177-511	6H0 941 700	1N0 270 204-061
183 945 227 A	9EL 112 743-001	283 943 111	9EL 121 230-001	443 945 217	9EL 126 339-021	6H0 941 700 A	1N0 270 204-061
183 945 228	9EL 112 741-001	283 943 111 A	9BG 121 587-031	443 945 218	9EL 126 340-021	6H0 941 700 B	1N0 271 247-061
191 941 699 D	1NL 006 315-051	283 943 111 A	9BG 121 587-037	445 945 217	9EL 129 149-021	6N0 941 641	5DV 007 760-651
191 941 700 D	1NL 006 315-061	283 945 069	2PF 001 648-161	445 945 218	9EL 129 150-021	6N0 941 699	1NA 962 530-011
191 953 155 C	9EL 141 701-001	283 945 095 C	2VP 003 567-111	481 919 209	2AA 001 200-141	6N0 941 699 A	1NA 962 490-011
191 953 156	9EL 141 702-001	283 945 096 C	2VP 003 567-121	4A0 035 787	6ED 004 778-001	6N0 941 699 E	1NA 963 981-031
191 998 101	2BM 003 647-801	283 945 096 C	2VP 003 567-127	4A0 941 115 A	9ES 137 169-015	6N0 941 700	1NA 962 530-021
191 998 101 B	2BA 006 728-801	283 945 341	2SA 001 259-751	4A0 941 115 J	9ES 145 599-001	6N0 941 700 A	1NA 962 490-021
192 941 703	1L8 004 190-111	283 945 341	2SA 001 259-757	4A0 941 116 A	9ES 137 170-015	6N0 941 700 E	1NA 963 981-041
192 941 753 A	1L8 004 190-111	283 945 341 A	2PF 003 389-041	4A0 941 116 J	9ES 145 600-001	6N0 945 096 J	9EL 964 116-121
1H0 941 091	9EL 856 415-001	2D0 941 091	9EL 856 418-001	4A0 941 295	6NM 007 282-211	6N0 945 111 A	9EL 962 541-041
1H0 941 099	9MN 857 622-001	2D0 941 091 A	9EL 856 417-001	4A0 941 699	1NL 006 150-071	6N0 945 112 A	9EL 962 542-051
1H0 941 211	9DX 859 560-001	2D0 941 219 A	9GD 856 562-001	4A0 941 700	1NL 006 150-081	6N0 945 112 C	9EL 962 542-071
1H0 941 295 C	6NM 007 282-211	2D0 945 095	9EL 270 197-011	4A0 945 223 A	9EL 138 463-031	6N0 953 041 N	9EL 964 005-021
1H0 941 295 E	6NM 007 282-211	2D0 945 095 A	2VD 008 204-131	4A0 945 223 D	9EL 145 997-021	6N0 953 042 N	9EL 964 006-021
1H0 941 777	8XU 144 427-001	2D0 945 096 D	2VP 008 204-121	4A0 945 224 A	9EL 138 464-031	6N0 953 049	9EL 962 839-031
1H0 941 777 A	8XU 144 427-001	2D0 945 105	8RA 003 326-001	4A0 945 224 D	9EL 145 998-021	6N0 953 049 A	9EL 962 839-021
1H0 941 778	8XU 144 428-001	2D0 945 105	8RA 003 326-002	4A0 949 101	2BM 003 647-021	6N0 953 050	9EL 962 840-031
1H0 941 778 A	8XU 144 428-001	2D0 945 111 C	9EL 270 197-011	4A0 953 049	9EL 139 383-031	6N0 953 050 A	9EL 962 840-021
1H0 941 779	8XU 144 429-001	2D0 945 112 C	9EL 270 198-011	4A0 953 049 D	9EL 145 833-021	6N2 941 017	1LF 962 489-171
1H0 941 780	8XU 144 430-001	2E0 947 105 AC	2JA 007 372-001	4A0 953 050	9EL 139 384-031	6N2 941 017 A	1LF 962 489-151
1H0 949 117	9EL 144 431-001	2E0 947 107 A	8GS 002 296-111	4A0 953 050 D	9EL 145 834-021	6N2 941 017 N	1LF 963 709-071
1H0 953 155	9EL 144 425-001	2E2 941 015	1LR 247 017-071	4A5 945 217	9EL 138 567-031	6N2 941 018	1LF 962 489-181
1H0 953 155 A	9EL 144 425-001	2E2 941 016	1LR 247 017-081	4A5 945 217 B	9EL 138 567-061	6N2 941 018 A	1LF 962 489-161
1H0 953 156	9EL 144 426-011	2K0 941 006 C	1LL 010 203-031	4A5 945 218	9EL 138 568-031	6N2 941 018 N	1LF 963 709-081
1H0 953 156 A	9EL 144 426-011	2K0 941 006 C	1LL 010 203-041	4A5 945 218 B	9EL 138 568-061	6Q0 941 699	1N0 270 255-051
1H0 971 671	8KA 146 152-001	2K0 945 095 F	2VP 354 043-011	4A9 945 217	9EL 140 063-021	6Q0 941 700	1N0 270 255-061
1H5 941 017 J	1LH 006 546-611	2K0 945 095 G	2VP 354 042-011	4A9 945 218	9EL 140 064-021	6Q2 941 007 J	1LE 247 019-191
1H5 941 018 J	1LH 006 546-621	2K0 945 096 F	2VP 354 043-021	4B0 941 029 L	1LL 007 821-291	6Q2 941 008 J	1LE 247 019-201
1H6 941 017 AG	1LJ 006 360-671	2L0 945 096 G	2VP 354 042-021	4B0 941 030 L	1LL 007 821-301	701 925 071	8JB 004 777-001
1H6 941 017 AK	1LJ 007 235-251	003 102 051	9EL 111 647-001	4B0 941 473	8GS 007 949-101	701 925 071	8JB 004 777-002
1H6 941 018 AG	1LJ 006 360-681	321 941 141 D	9NS 119 463-005	4B0 941 699 C	1N0 246 039-011	701 941 699 J	1NB 008 122-011
1H6 941 018 AK	1LJ 007 235-261	322 941 039 G	1L8 003 060-561	4B0 941 700 C	1N0 246 039-021	701 941 700 J	1NB 008 122-021
1H6 945 111	9EL 139 137-061	357 953 049	9EL 133 713-011	4B0 949 127	9EL 270 107-011	701 945 095 01C	9EL 146 371-001
1H6 945 111 A	9EL 139 137-051	357 953 049 A	9EL 133 719-011	4B5 945 095 B	2VP 008 468-051	701 945 096 01C	9EL 146 372-001
1H6 945 111 B	9EL 139 137-081	357 953 050	9EL 133 714-011	4B5 945 096 B	2VP 008 468-061	701 945 111	9EL 146 371-001
1H6 945 111 C	9EL 139 137-071	357 953 050 A	9EL 133 720-011	4B5 945 217	9EL 148 141-021	701 945 112	9EL 146 372-001
1H6 945 112	9EL 139 138-051	358 941 017	1LH 005 454-311	4B5 945 218	9EL 148 142-021	701 945 729	9EL 146 373-001
1H6 945 112 A	9EL 139 138-061	358 941 018	1LH 005 454-321	4E0 907 476	5DV 008 290-004	701 947 125	9EL 856 010-001
1H6 945 112 B	9EL 139 138-071	3A0 941 017 B	1LH 006 840-271	4E0 941 029 BP	1EL 009 236-611	701 953 049	9EL 136 401-011
1H6 945 112 C	9EL 139 138-081	3A0 941 018 B	1LH 006 840-281	4E0 941 029 P	1EL 008 540-551	701 953 050	9EL 136 402-011
1H9 945 111	9EL 142 825-021	3A0 941 067	9HB 006 948-031	4E0 941 030 BP	1EL 009 236-621	702 941 017	1LJ 006 051-191
1H9 945 111 A	9EL 142 825-031	3A0 941 068	9HB 006 948-041	4E0 941 030 P	1EL 008 540-561	702 941 018	1LJ 006 051-201
1H9 945 112	9EL 142 826-021	3A0 941 777	8XU 006 946-031	4E0 941 471	5DD 008 319-501	7D0 951 275	6ZE 001 759-071
1H9 945 112 A	9EL 142 826-031	3A0 941 778	8XU 006 946-041	4E0 945 030 P	1EL 008 540-561	7D0 951 275 A	6ZE 001 759-051
1J0 941 295 B	6NM 007 878-041	3A0 941 779	8XU 006 945-031	4F0 941 003 BK	1LJ 009 925-031	7E0 941 699	1N0 270 481-051
1J0 941 295 C	6NM 007 878-041	3A0 941 780	8XU 006 945-041	4F0 941 004 BK	1LJ 009 925-041	7E0 941 700	1N0 270 481-061
1J0 955 964 F	9GS 146 999-721	3A0 949 117	9EL 147 073-001	4F0 941 029 AL	1LL 008 881-431	7E0 945 095	2SK 008 579-091
1J5 945 111 M	9EL 963 669-081	3A0 953 155 A	9EL 142 459-011	4F0 941 030 AL	1LL 008 881-441	7E0 945 095 D	2SK 008 579-111
1J5 945 111 P	9EL 963 669-091	3A0 953 156 A	9EL 142 460-011	533 941 669	9FF 126 444-001	7E0 945 096	2SK 008 579-101
1J5 945 112 M	9EL 963 670-081	3A0 998 139	1NA 006 790-811	5M0 945 093 F	2ZR 964 962-031	7E0 945 096 D	2SK 008 579-121
1J5 945 112 P	9EL 963 670-091	3A5 945 107	9EL 141 907-071	5M0 945 093 K	2ZR 964 962-031	7H0 941 087	2RL 008 065-001
1J6 945 095 Q	9EL 151 875-021	3A5 945 108 A	9EL 141 908-071	5M0 945 093 L	2ZR 964 962-031	7H0 941 087 A	2RL 008 065-101
1J6 945 096 R	9EL 151 876-021	3A5 945 111	9EL 141 889-031	5M0 945 094 F	2NE 964 962-041	7H0 941 091	9EL 862 171-001
1J6 945 111 Q	9EL 151 875-021	3A5 945 111 B	9EL 141 889-041	5M0 945 094 K	2NE 964 962-041	7H0 941 091 A	9EL 862 172-001
1J6 945 112 Q	9EL 151 876-021	3A5 945 112	9EL 141 890-041	5M0 945 094 L	2SD 964 961-011	7H0 941 241	9GD 862 734-001
1K0 941 69							

Manufacturer's no. / Hella no.

Cross-Reference



Volkswagen	Hella	Volkswagen	Hella	Volkswagen	Hella	Volkswagen	Hella
7H5 945 095 D	2SK 008 579-131	KDWHLO9053	2RL 007 900-001	KDWHLO9510	2RL 007 337-101	KSP 953 353 A	2BA 964 169-501
7H5 945 095 F	2SK 008 579-131	KDWHLO9054	9XD 861 995-801	KDWHLO9511	2XW 007 146-001	KSP 953 353 A	2BA 964 169-507
7H5 945 095 H	2SK 008 579-131	KDWHLO9057	2RL 007 900-201	KDWHLO9514	9MK 860 255-001	N0177173	8GP 002 067-241
7H5 945 095 K	2SK 008 579-151	KDWHLO9061	3AG 003 399-081	KDWHLO9517	9GD 859 037-001	N0177175	8GP 002 067-241
7H5 945 096	2SK 008 579-141	KDWHLO9064	2AB 001 208-001	KDWHLO9521	2SD 001 688-171	N 017 738 2	8GD 002 078-121
7H5 945 096 D	2SK 008 579-141	KDWHLO9066	2AA 001 204-011	KDWHLO9522	2SD 001 688-141	N 102 564 01	8GA 006 841-121
7H5 945 096 F	2SK 008 579-141	KDWHLO9068	2JA 001 364-001	KDWHLO9524	8GA 002 071-131	N 10320101	8GH 007 157-121
7H5 945 096 H	2SK 008 579-141	KDWHLO9071	1G5 003 241-021	KDWHLO9526	2AA 003 257-031	N10 445 701	8GS 007 949-101
7H5 945 096 K	2SK 008 579-161	KDWHLO9073	2JA 003 231-001	KDWHLO9527	1G4 003 470-147	N 105 296 01	8GH 008 357-001
7H8 947 105	2AB 004 532-021	KDWHLO9074	2AB 004 532-001	KDWHLO9529	2JA 004 531-011	N 185 002	8RA 002 015-021
7M0 945 111	9EL 962 585-041	KDWHLO9078	8GA 002 074-121	KDWHLO9533	9MM 857 622-101	N47 82 00 525	2ZR 001 193-011
7M0 945 112	9EL 962 586-041	KDWHLO9083	8GM 002 091-131	KDWHLO9534	9MM 859 358-801	N77 82 00 518	2BM 001 313-001
7M3 945 093 C	9EL 964 541-021	KDWHLO9086	2BA 003 022-001	KDWHLO9535	9DX 859 626-001	N77 82 00 518	2BM 001 313-002
7M3 945 095 F	9EL 964 501-011	KDWHLO9097	2JA 003 354-001	KDWHLO9536	2RL 007 337-021	N 903 605 01	8GP 938 026-001
7M3 945 095 H	2VA 964 957-011	KDWHLO9098	9AR 120 266-001	KDWHLO9537	9EL 852 820-001	Z052010	9EL 007 720-851
7M3 945 096 F	9EL 964 502-011	KDWHLO9099	8GA 002 083-131	KDWHLO9540	2VP 006 040-111	Z052551007	2PS 008 138-821
7M3 945 096 H	2VA 964 957-021	KDWHLO9102	2AA 001 201-011	KDWHLO9540	2VP 006 040-117	Z052551018	2PS 008 138-801
7M3 945 096 J	9EL 964 502-011	KDWHLO9111	8RL 002 009-011	KDWHLO9541	2VP 006 040-121	Z052551041	2PS 008 138-811
7M3 945 255 H	8XU 964 435-021	KDWHLO9115	2RL 008 061-001	KDWHLO9541	2VP 006 040-127	Z 052 553	1NL 008 383-861
7M3 945 255 MGRU	8XU 964 981-001	KDWHLO9116	8HG 854 516-001	KDWHLO9543	2XD 860 618-011	Z052639	1NA 007 133-801
7M4 945 094 C	9EL 964 542-021	KDWHLO9124	9SX 007 609-051	KDWHLO9552	2RL 006 846-101	Z052799	1NL 008 383-821
811 953 049 D	9EL 129 161-011	KDWHLO9129	2AA 001 200-041	KDWHLO9555	2AA 003 257-001	Z052802 007	9EL 008 980-801
811 953 049 F	9EL 129 161-011	KDWHLO9129	2AA 001 200-042	KDWHLO9557	9GD 856 466-001	Z052802 041	9EL 008 980-811
811 953 050 D	9EL 129 162-011	KDWHLO9131	8JB 004 777-001	KDWHLO9558	8KB 861 596-001	Z 401 559 WE	8PA 007 732-013
811 953 050 F	9EL 129 162-011	KDWHLO9131	8JB 004 777-002	KDWHLO9560	8KB 007 896-801	Z 401 560 WE	8PA 007 732-003
813 941 047	9AG 120 516-005	KDWHLO9132	1GA 007 506-011	KDWHLO9561	8KB 007 895-801		
817 947 105 B	2JA 002 931-031	KDWHLO9133	8KB 990 299-001	KDWHLO9562	9GD 860 936-001		
823 941 653	1K3 114 155-001	KDWHLO9134	8GH 002 090-133	KDWHLO9563	9SX 007 609-001		
823 947 105 B	2JA 002 931-031	KDWHLO9136	2SD 001 679-001	KDWHLO9564	2XD 860 910-021		
867 941 701 B	1NL 006 280-051	KDWHLO9139	2DA 003 014-031	KDWHLO9565	2XD 860 910-011		
867 941 702	1NL 006 280-061	KDWHLO9139	2DA 003 014-037	KDWHLO9567	2RM 007 200-061		
867 943 021	2KA 002 445-171	KDWHLO9151	2XW 003 146-001	KDWHLO9568	9SX 007 609-021		
867 953 049	9EL 137 839-011	KDWHLO9153	9GD 862 868-001	KDWHLO9572	2RM 007 200-001		
867 953 050	9EL 137 840-011	KDWHLO9157	2PS 962 964-031	KDWHLO9573	2RM 007 200-041		
873 945 111 A	9EL 125 909-031	KDWHLO9157	2PS 962 964-037	KDWHLO9574	2RM 007 200-111		
873 945 112 A	9EL 125 910-041	KDWHLO9161	9EL 855 097-001	KDWHLO9575	2RM 007 200-071		
893 941 091	9EL 852 061-001	KDWHLO9172	1GA 996 142-041	KDWHLO9579	2RL 860 880-001		
893 945 217	9EL 131 651-031	KDWHLO9200	8HG 116 741-801	KDWHLO9580	2RM 007 200-011		
893 945 218	9EL 131 652-031	KDWHLO9201	2XS 950 071-031	KDWHLO9583	2RM 007 200-091		
893 945 225 A	9EL 131 613-031	KDWHLO9202	2XS 003 168-131	KDWHLO9586	2XD 860 618-001		
893 945 225 B	9EM 131 613-021	KDWHLO9204	1G8 002 340-011	KDWHLO9587	2XD 860 910-001		
893 945 226 A	9EL 131 614-031	KDWHLO9205	8XT 002 120-001	KDWHLO9588	2XD 860 910-031		
893 945 226 B	9EM 131 614-021	KDWHLO9206	2JA 004 192-001	KDWHLO9590	8GA 002 073-241		
893 953 049	9EL 135 007-001	KDWHLO9209	2BA 001 227-201	KDWHLO9591	8GH 002 089-251		
893 953 050	9EL 135 008-001	KDWHLO9210	8GM 002 091-121	KDWHLO9591	8GH 002 089-253		
895 941 699	1NL 005 150-051	KDWHLO9214	8GH 002 857-121	KDWHLO9594	8KB 861 213-011		
895 941 700	1NL 005 150-061	KDWHLO9216	2BA 003 236-021	KDWHLO9596	9AB 860 796-001		
8A0 945 217	9EL 140 347-021	KDWHLO9216	2BA 003 236-027	KDWHLO9597	9AB 860 796-021		
8A0 945 217 B	9EL 140 347-021	KDWHLO9217	8JA 001 915-001	KDWHLO9598	9EL 860 743-001		
8A0 945 217 C	9EL 140 347-021	KDWHLO9223	2AA 001 200-131	KDWHLO9599	9EL 860 743-011		
8A0 945 218	9EL 140 348-021	KDWHLO9224	2AA 001 200-151	KDWHLO9600	9GD 861 470-001		
8A0 945 218 B	9EL 140 348-021	KDWHLO9225	2AA 003 257-041	KDWHLO9601	9GD 861 531-001		
8A0 945 218 C	9EL 140 348-021	KDWHLO9225	2AA 003 257-042	KDWHLO9603	9MM 860 814-801		
8A0 953 049 A	9EL 141 605-011	KDWHLO9230	2AA 001 204-001	KDWHLO9607	9SX 861 562-001		
8A0 953 050 A	9EL 141 606-011	KDWHLO9233	8JA 001 921-102	KDWHLO9608	9SX 861 562-011		
8D0 953 049	9EL 158 254-011	KDWHLO9234	8RL 002 009-001	KDWHLO9611	8GH 002 473-132		
8D0 953 049 A	9EL 158 254-011	KDWHLO9236	8GM 002 092-121	KDWHLO9618	8KB 007 895-811		
8D0 953 050	9EL 158 254-021	KDWHLO9246	6ED 004 778-001	KDWHLO9623	2RM 007 200-121		
8D0 953 050 A	9EL 158 254-021	KDWHLO9252	2BA 001 275-011	KDWHLO9626	8KB 007 897-801		
8E0 941 699 B	1N0 009 594-011	KDWHLO9253	8GM 002 094-121	KDWHLO9628	2XD 007 854-801		
8E0 941 699 C	1N0 010 380-011	KDWHLO9262	2SE 002 844-011	KDWHLO9638	9SX 007 609-041		
8E0 941 700 B	1N0 009 594-021	KDWHLO9263	9GD 856 863-001	KDWHLO9639	2VA 006 040-291		
8E0 941 700 C	1N0 010 380-021	KDWHLO9305	9MK 854 066-001	KDWHLO9639	2VA 006 040-297		
8E5 945 217	9EL 153 923-021	KDWHLO9309	9XR 855 975-001	KDWHLO9640	2VP 006 040-301		
8E5 945 218	9EL 153 924-021	KDWHLO9310	8GH 002 089-133	KDWHLO9640	2VP 006 040-307		
8L0 941 003 AH	1LL 008 306-151	KDWHLO9320	9EL 856 010-001	KDWHLO9645	2RM 007 200-191		
8L0 941 004 AH	1LL 008 306-161	KDWHLO9327	2JA 004 531-001	KDWHLO9649	9GD 861 810-001		
8L0 953 049	9EL 963 111-011	KDWHLO9329	2AB 004 532-021	KDWHLO9654	2RL 007 337-011		
8L0 953 050	9EL 963 112-011	KDWHLO9332	1F7 004 700-391	KDWHLO9657	2RM 007 200-131		
8P0 941 003 AK	1LJ 009 648-031	KDWHLO9402	4RA 003 510-081	KDWHLO9659	2JA 001 357-002		
8P0 941 004 AK	1LJ 009 648-041	KDWHLO9412	2XM 004 444-001	KDWHLO9661	8KB 007 895-821		
8P0 941 699 A	1N0 247 003-011	KDWHLO9418	5AB 005 944-001	KDWHLO9662	8KB 007 897-811		
8P0 941 700 A	1N0 247 003-021	KDWHLO9426	2SA 003 014-051	KDWHLO9666	2RM 007 200-221		
ASE 401 559 00	8PA 007 732-013	KDWHLO9427	2BA 003 014-011	KDWHLO9667	8JA 001 925-001		
ASE 401 560 00	8PA 007 732-003	KDWHLO9430	1G4 003 470-031	KDWHLO9668	2RL 007 900-551		
ASE 401 563 00	9XS 861 736-001	KDWHLO9447	1TA 003 570-101	KDWHLO9669	9AB 860 796-011		
KDNHLO9543	2XD 860 618-011	KDWHLO9458	2XS 005 020-001	KDWHLO9670	9SX 007 609-031		
KDNHLO9563	9SX 007 609-001	KDWHLO9458	2XS 005 020-002	KDWHLO9674	2BA 002 324-011		
KDW 9H 1066	2AA 001 204-011	KDWHLO9458	2XS 005 020-003	KDWHLO9675	2BA 002 324-021		
KDWHLO9493	2AB 004 532-011	KDWHLO9460	8HG 006 294-031	KDWHLO9677	2JA 005 590-157		
KDW HLO 952 7	1G4 003 470-147	KDWHLO9461	2XW 002 897-051	KDWHLO9681	2JA 001 331-011		
KDWHLO929	2BA 001 277-011	KDWHLO9466	8RA 004 412-041	KDWHLO9683	2RL 008 364-021		
KDWHLO9007	9EL 854 912-001	KDWHLO9475	8GP 002 095-241	KDWHLO9684	2RL 008 366-031		
KDWHLO9008	2RM 007 200-217	KDWHLO9482	2RL 008 366-021	KDWHLO9689	2RM 007 200-261		
KDWHLO9012	8GP 002 068-121	KDWHLO9487	2RL 007 337-121	KDWHLO9690	9MM 862 358-801		
KDWHLO9027	8HG 002 365-001	KDWHLO9488	1G3 005 760-041	KSP 941 675	9GH 152 654-007		
KDWHLO9028	2BA 001 277-021	KDWHLO9489	8HG 004 806-001	KSP 941 781	1K0 008 192-011		
KDWHLO9029	2BA 001 277-011	KDWHLO9493	2AB 004 532-011	KSP 941 781	1K0 008 192-017		
KDWHLO9031	9EL 852 061-001	KDWHLO9496	8GJ 002 525-941	KSP 941 781 A	1K0 008 191-001		
KDWHLO9033	2BA 003 022-021	KDWHLO9500	8GA 002 071-251	KSP 941 781 A	1K0 008 191-007		
KDWHLO9040	4AZ 003 787-001	KDWHLO9503	8XD 857 445-801	KSP 945 227 A	2SB 964 169-531		
KDWHLO9044	8GP 002 068-241	KDWHLO9507	2NE 006 609-001	KSP 945 227 A	2SB 964 169-537		
KDWHLO9045	6ZE 001 759-071	KDWHLO9507	2NE 006 609-007	KSP 945 351	2PF 003 563-151		
KDWHLO9046	6ZE 001 759-051	KDWHLO9508	2NE 006 609-011	KSP 947 101	2XM 004 444-001		
KDWHLO9050	6ED 004 778-011	KDWHLO9508	2NE 006 609-017	KSP 953 351	2BM 003 563-111		



Manufacturer's no. / Hella no.

Cross-Reference

Volvo	Hella	Volvo	Hella	Volvo	Hella	Volvo	Hella
1 437 293 7	8RA 002 014-041	20005174007	8JA 001 909-011	030005050038	8GJ 002 525-133	43 743 170	8RA 002 023-001
1 437 293 7	8RA 002 014-042	20005230616	8GP 002 095-241	30005130035	4AZ 003 787-001	4 374 366	2SE 002 578-701
14 373 199	1LB 006 213-047	20005230620	8GH 002 089-251	30005170031	2ZR 002 694-001	4 374 366	2SE 002 578-707
14 375 286	2VA 006 040-457	20005230620	8GH 002 089-253	30005170031	2ZR 002 694-002	4 374 369	8HG 006 294-021
14 375 286	2VP 006 040-467	20005239651	1G4 003 470-051	030005170050	2VP 006 040-121	460 059	2KA 001 389-101
14 375 287	2VP 006 040-467	20007050631	8GP 002 067-241	030005170050	2VP 006 040-127	4 726 212	2SB 001 301-021
1 437 530 2	8HG 006 294-031	20007050638	8GA 002 071-251	030005170052	8RA 002 014-031	4 780 959	8RA 002 023-021
1 437 864 0	2BA 002 652-101	2 023 560	2KA 001 386-281	030005170052	8RA 002 014-032	4 780 964	2PS 002 727-001
1 437 864 0	2BA 002 652-107	20 379 338	9XB 136 202-005	30005170061	2SD 003 182-061	4 780 964	2PS 002 727-007
1 437 891 1	9GH 993 988-007	20 453 682	1FB 007 892-011	30005170061	2SD 003 182-067	4 780 974	8RA 002 014-051
14 379 469	8RA 003 660-007	20 453 766	1NB 007 892-001	030005170062	2SD 003 182-051	4 780 974	8RA 002 014-052
1 437 964 0	2BA 002 652-101	2 048 861 4	2AB 004 532-031	030005170062	2SD 003 182-057	4 785 120	2BE 002 582-031
1 437 964 0	2BA 002 652-107	2 050 343 5	2BM 002 847-011	30 855 747	1LG 007 302-191	4 785 121	2SD 002 582-011
1 438 529 1	2VA 343 640-117	2 050 485 8	1NA 008 284-001	30 855 748	1LG 007 302-201	4 785 121	2SD 002 582-017
1 438 529 2	2VP 343 640-081	2 052 079	8JB 001 943-001	30 859 761	6NM 007 878-551	4 785 122	2SD 002 582-021
1 438 529 2	2VP 343 640-087	2 052 079 4	8JB 001 943-001	30 862 523	2BA 007 924-071	4 785 122	2SD 002 582-027
1 438 796 5	2VP 343 640-091	2 052 551 0	8WT 008 549-701	3 086 252 4	2BA 007 924-081	4 785 537	2PF 001 648-161
1 438 796 5	2VP 343 640-097	2 054 372 5	8JD 156 151-807	30 864 592	6NM 007 878-551	4 803 218	2SD 001 685-231
1 438 796 7	2VA 343 640-207	2 054 732 5	8JD 156 151-807	30 899 684	1LG 007 861-451	4 803 218	2SD 001 685-232
1 443 210 0	8JB 004 777-001	2 055 172 0	8JB 004 777-001	30 899 685	1LG 007 861-461	4 803 622	2BA 002 652-111
1 443 210 0	8JB 004 777-002	2 055 172 0	2BA 008 221-047	3 093 003	4AZ 003 787-021	4 803 622	2BA 002 652-117
1 452 913 7	8HG 006 294-031	2 055 172 7	2DA 959 071-237	3 098 195	9AL 120 515-001	4 803 623	2BA 002 652-121
1 455 469 4	8HG 990 368-001	2 055 689 0	2SA 008 805-001	3 098 196	9AL 120 514-001	4 803 623	2BA 002 652-127
1 455 469 4	8HG 990 368-007	2 055 689 0	2SA 008 805-007	3 098 237	9EL 133 719-011	4 831 317	2JA 001 330-001
1 500 714	9EL 110 013-001	2 055 716 7	2ZR 008 805-007	3 098 238	9EL 133 720-011	4 831 317	2JA 001 330-007
1500714 VSE	9EL 110 013-001	2 055 716 7	2ZR 008 805-047	3 098 408	1DL 005 600-097	4 864 417	8HG 002 240-021
1 500 715	9EL 110 014-001	2 055 717 2	2NE 008 221-031	3 098 408	1DL 005 600-107	4 864 457	8RA 002 326-011
1500715 VSE	9EL 110 014-001	2 055 717 2	2NE 008 221-037	309 840 9	1DL 005 600-097	4 864 457	8RA 003 326-017
1 500 754	9EL 092 435-011	2 055 717 5	2DA 008 805-011	3 101 340	2SB 001 259-261	4 941 836	2KA 003 168-021
1 500 755	9GD 102 484-001	2 055 717 5	2DA 008 805-017	3 107 139	2KA 001 386-231	505 001 1	8GH 002 089-133
1 501 357	2JA 001 360-001	2 055 717 7	2BA 008 805-051	3 122 246	9NS 114 014-106	5 050 032	8GA 002 073-121
1 507 094	2BA 002 324-011	2 055 717 7	2BA 008 805-057	3 126 106	2XW 003 146-001	5 050 038	8GJ 002 525-131
1 507 095	2BA 002 324-021	2 072 821 0	2XW 003 146-001	3 343 851	9FF 085 642-001	5 050 038	8GJ 002 525-133
1 507 127 2	2PF 008 405-051	2 073 358 6	2PG 963 639-401	3 345 133	8GA 006 841-121	5 130 035	4AZ 003 787-001
1 507 127 2	2PF 008 405-057	2 073 752 4	2JA 003 231-001	3 345 721	6NM 007 282-651	517 003 1	2ZR 002 694-001
1 507 127 7	2BA 008 221-001	2 074 424 9	1LL 008 194-051	337 377	2SE 001 686-142	517 003 1	2ZR 002 694-002
1 507 127 7	2BA 008 221-007	2 076 848 9	2XS 005 020-017	337 378	2SD 001 686-101	517 004 5	2SD 003 184-031
1 507 128 0	9XB 161 749-007	2 084 700 2	8JB 004 777-001	3 402 018	2KA 005 049-008	517 004 5	2SD 003 184-037
1 507 128 9	1KO 008 191-001	2 084 700 2	8JB 004 777-002	3 402 626	2JA 003 354-001	5 170 050	2VP 006 040-121
1 507 128 9	1KO 008 191-007	2 087 712 9	9GD 159 740-007	3 402 650	8GJ 002 525-251	5 170 050	2VP 006 040-127
1 509 316	2SE 001 688-151	2 088 426 7	1NO 008 582-011	3 402 650	8GJ 002 525-253	5 170 052	8RA 002 014-031
1 509 317	2SD 001 688-141	2 088 426 7	1NO 008 582-017	3 430 003	8GD 004 772-121	5 170 052	8RA 002 014-032
1 509 319	2SE 001 688-161	2 089 175 2	2SA 008 405-011	345 133	8GA 006 841-121	517 006 1	2SD 003 182-061
1 517 025	9EL 110 918-001	2 089 175 2	2SA 008 405-017	348 750	2SE 001 685-221	517 006 1	2SD 003 182-067
1 517 026	9EL 110 918-011	2 090 489 5	2PF 959 590-401	348 750	2SE 001 685-227	5 170 062	2SD 003 182-051
1 518 676	9EL 852 061-021	2 090 489 5	2PF 959 590-407	3 528 793	9EL 138 650-031	5 170 062	2SD 003 182-057
1 566 887	2ZR 001 423-001	2 091 489 0	2PS 963 639-011	3 534 085	9EL 138 601-031	5 174 001	8RA 002 016-121
1 566 888	9ES 106 588-001	2 091 489 0	2PS 963 639-017	3 534 086	9EL 138 602-031	5 174 002	8RA 002 014-051
1 576 963	2NE 001 423-011	2 093 964 5	2SA 008 405-011	3 538 340	9EL 138 649-031	5 174 002	8RA 002 014-052
1 577 794	2KA 001 386-281	2 093 964 5	2SA 008 405-017	355 700	2ZR 001 423-001	5 174 005	2BA 003 014-111
1 587 794	2KA 001 386-281	2 097 021 0	2JA 003 354-001	356 720	2KA 001 389-101	5 174 007	8JA 001 909-011
1 594 161	1LG 004 679-051	2 107 112 1	9FF 121 000-001	362 540	2BA 001 221-031	5 230 616	8GP 002 095-241
1 620 476	2SL 005 883-031	2 107 131 4	5DV 007 810-171	362 541	2BA 001 221-041	5 230 620	8GH 002 089-251
1 620 477	2SK 005 883-021	2 116 600 9	2XA 959 790-401	363 716	2SE 001 685-201	5 230 620	8GH 002 089-253
1 620 478	2SK 005 883-011	2 116 600 9	2XA 959 790-407	3 930 194	1FE 006 300-121	5 232 297 1	9EL 146 491-001
1 620 479	2SL 005 883-041	2 128 602 7	2JA 343 720-121	3 930 861	2AA 001 200-001	5 232 298	9EL 110 536-011
1 620 480	9EL 135 548-001	2 146 470	2SW 003 014-131	3 930 862	2AA 001 200-002	5 239 651	1G4 003 470-051
182 025	8GP 002 067-261	2 174 120	2RL 008 060-111	3 930 862	2AA 001 200-131	5 239 666	2JA 001 346-011
182 032	8GD 002 084-251	2 174 760	1S5 003 178-431	3 930 863	2AA 001 200-001	5 403 000 1	2SA 005 200-331
20002023560	2KA 001 386-281	2 193 480	9EL 118 633-001	3 930 863	2AA 001 200-002	544 218	2SB 001 259-261
20002174120	2RL 008 060-111	2 230 900	9EL 115 003-011	3 930 863	2AA 001 200-011	547 337	8RA 002 014-051
20002174760	1S5 003 178-431	2 263 770	2JA 001 330-001	3 930 863	2AA 001 200-012	547 337	8RA 002 014-052
20002193480	9EL 118 633-001	2 263 770	2JA 001 330-007	3 950 305	1DL 005 600-097	6 211 443	9EL 113 324-001
20002230900	9EL 115 003-011	2 281 010	9GH 096 532-001	3 950 306	1DL 005 600-107	6 212 166	9EL 854 912-001
20002801241	2JA 006 447-251	2 284 699	9EL 110 918-001	398 1455	2VD 008 205-051	6 229 297	2BE 001 278-021
20002804478	2VP 006 040-117	2 284 700	9EL 110 918-011	398 1456	2VP 008 205-031	6 229 299	2BE 001 278-001
20002804478	2VP 006 040-111	2 289 665	9EL 146 491-001	398 1458	2VD 008 205-041	6 233 508	2JA 001 360-001
20002804479	2VP 006 040-121	240 413	8RA 002 014-051	398 1459	2VP 008 205-031	6 234 659	9EL 087 769-001
20002804479	2VP 006 040-127	240 413	8RA 002 014-052	3 981 593	1LG 006 898-091	6 235 604	2BA 002 652-101
20002813699	4RA 003 510-651	2 800 822	2SD 002 776-231	4 038 323	2AA 001 200-031	6 235 604	2BA 002 652-107
20002903490	9EL 137 307-001	2 800 822	2SD 002 776-237	4 038 323	2AA 001 200-032	6 612 583	2KA 001 389-101
20002903491	9EL 137 308-001	2 800 823	2SD 002 776-241	4 372 937	8RA 002 014-041	662 109	2JA 001 346-011
20002903856	9EL 136 825-001	2 800 823	2SD 002 776-247	4 372 937	8RA 002 014-042	6 627 514	8RA 002 020-001
20002903858	9EL 136 825-011	2 801 241	2JA 006 447-251	4 373 252	5AB 005 944-011	6 627 514	8RA 002 020-002
20002907237	9EL 990 186-001	2 801 243	1GA 006 876-001	4 373 253	6ZE 001 759-071	6 627 514	8RA 002 020-003
20003402650	8GJ 002 525-251	28 012 453	2RL 006 846-001	4 374 231	2KA 003 389-061	6 637 603	9ES 069 831-001
20003402650	8GJ 002 525-253	2 804 477	2JA 006 487-261	4 374 231	2KA 003 389-062	6 637 606	9DE 077 356-021
020004373252	5AB 005 944-011	2 804 478	2VP 006 040-111	4 374 231	2KA 003 389-068	6 644 168	9EL 090 411-001
20004373253	6ZE 001 759-071	2 804 478	2VP 006 040-117	4 374 248	2BA 002 324-011	6 644 374	9EL 112 744-001
20004374274	2SD 002 776-231	2 804 479	2VP 006 040-121	4 374 249	2BA 002 324-021	6 644 375	9EL 112 743-001
20004374274	2SD 002 776-237	2 804 479	2VP 006 040-127	4 374 261	1GD 003 590-701	6 644 376	9EL 112 741-001
020004374275	2SD 002 776-241	2 80					

Manufacturer's no. / Hella no.

Cross-Reference



Volvo	Hella	Volvo	Hella	Volvo Trucks	Hella	ZKW	Hella
7 030 531 6	2SA 006 679-027	8003331900005	8KA 152 134-007	2 076 848 9	2XS 005 020-017	425.01.000.00	2BA 002 939-171
7 030 531 8	2BE 004 119-021	8 140 055	1FE 006 300-251	2 087 712 9	9GD 159 740-007	425.02.000.00	9EL 141 701-001
7 030 532 0	1NL 007 186-047	8 144 285	1LG 006 898-051	2 088 426 7	1NO 008 582-011	425.02.000.01	9EL 141 702-001
7 030 532 2	2BA 003 236-021	8 144 693	1FE 006 300-251	2 088 426 7	1NO 008 582-017	425.03.000.02	9EL 144 425-001
7 030 532 4	2BA 003 236-027	8 156 751	2XW 002 897-051	2 097 021 0	2JA 003 354-001	425.03.000.03	9EL 144 426-001
7 030 532 4	2DA 003 236-031	8202331900001	8WS 008 549-501	2 105 935 1	2XT 959 510-427	425.13.000.00	9EL 144 425-011
7 030 532 4	2DA 003 236-037	85 104 436	2RL 008 060-111	2 801 243	1GA 006 876-001	425.13.000.01	9EL 144 426-011
7 030 532 6	2KA 005 049-011	85 104 437	2RL 008 061-111	2 804 482	1GA 007 506-011	441.03.000.00	2XW 007 146-001
7 030 532 6	2KA 005 049-017	85 104 765	9EL 862 141-001	290 349 0	9EL 137 307-001	456.01.000.00	9EL 122 689-021
7 030 533 0	2BM 006 692-011	8 510 479 6	2PF 003 563-151	363 716	2SE 001 685-201	469.01.000.00	2SL 003 567-311
7 030 533 0	2BM 006 692-017	8 510 479 9	2PS 962 964-012	4 785 120	2BE 002 582-031	469.01.200.00	9EL 122 772-001
7 030 533 1	2BM 006 692-021	8 510 479 9	2PS 962 964-018	662 109	2JA 001 346-011	469.01.200.01	9EL 122 689-021
7 030 533 1	2BM 006 692-027	8 511 107 1	9EL 860 627-001	6 774 450	8RA 003 326-041	469.02.000.00	2SK 003 567-321
7 030 535 45	2PS 963 639-011	864 417	8HG 002 240-021	6 774 450	8RA 003 326-047	469.02.000.00	25K 005 567-331
7 030 535 45	2PS 963 639-017	9 126 960	9EL 138 601-041	7 030 529 3	9GT 134 655-007	470.03.000.00	2BA 003 411-001
7 032 441 3	2NE 003 030-151	9 126 961	9EL 138 602-041	7 030 529 4	9GT 143 133-007	470.12.000.01	2BA 007 840-001
7 032 441 5	8RA 003 326-031	9 133 741	9EL 138 649-041	7 030 531 3	1KL 007 834-067	470.15.000.00	2BA 007 839-001
7 032 441 7	2DA 959 071-737	9 133 742	9EL 138 650-041	7 030 531 8	2BE 004 119-021	484.20.000.00	2BM 006 692-011
7 032 442 1	2BM 008 355-001	9 151 629	9EL 341 325-311	7 030 532 0	1NL 007 186-047	484.21.000.00	2BM 006 692-021
7 032 442 1	2BM 008 355-007	9 151 630	9EL 341 325-321	7 030 532 6	2KA 005 049-011	491.01.200.01	1NB 123 581-001
7 032 442 3	2BA 008 221-001	9 151 633	9EL 341 326-311	7 030 532 6	2KA 005 049-017	491.01.201.01	1NB 123 582-001
7 032 442 3	2BA 008 221-007	9 151 636	9EL 341 326-321	7 030 534 5	2PS 963 639-001	493.03.000.00	2BA 003 975-031
7 032 442 7	1KO 008 191-021	9 187 922	9EL 149 957-121	7 030 534 5	2PS 963 639-007	493.04.000.00	2BA 003 975-041
7 032 442 7	1KO 008 191-027	9 187 925	9EL 149 958-121	7 030 534 5	2PS 963 639-011	498.02.000.00	2SA 001 647-041
7 032 442 9	2BA 003 236-541	9 483 182	9EL 147 723-071	7 030 534 5	2PS 963 639-017	503.01.200.00	9EL 146 607-001
7 032 443 1	2PF 961 167-021	9 483 183	9EL 147 724-071	7 030 534 5	2PS 963 639-177	515.72.000.02	1NA 009 032-011
7 032 443 1	8JB 004 777-001	954 851	8HG 002 240-031	7 032 441 7	2DA 959 071-737	515.81.000.02	1NA 009 029-011
7 032 443 1	8JB 004 777-002	958 902	8GM 002 091-131	7 032 442 1	2BM 008 355-001	515.81.000.03	1NA 009 029-021
7 032 716 8	2PS 006 717-051	965 830	8GP 002 067-121	7 032 442 1	2BM 008 355-007	515.91.000.02	1NA 009 033-011
7 032 716 8	2PS 006 717-057	966 327	8GP 002 095-241	7 032 442 3	2BA 008 221-001	515.91.000.03	1NA 009 033-011
7 033 103 2	8RA 002 014-031	981 465	8GH 007 157-121	7 032 442 3	2BA 008 221-007	518.01.000.02	1NB 006 270-051
7 033 103 2	8RA 002 014-032	VOE11147756	2KA 003 389-061	7 032 442 7	1KO 008 191-021	518.01.000.03	1NB 006 270-061
7 033 103 4	1NL 007 834-057	VOE11147756	2KA 003 389-062	7 032 442 7	1KO 008 191-027	532.01.000.01	1BL 007 834-007
7 033 103 5	2SB 005 603-137	VOE11147756	2KA 003 389-068	7 032 443 1	2PF 961 167-021	564.01.000.02	1NA 009 026-011
7 034 746	9HD 155 239-001	VOE11370511	8GH 002 089-251	7 032 469 5	8JB 004 777-001	564.01.000.03	1NA 009 026-021
7 034 747	9GH 145 943-001	VOE11370511	8GH 002 089-253	7 032 469 5	8JB 004 777-002	575.01.000.00	1NA 009 031-011
7 034 553	1KO 008 191-041	VOE11713095	9EL 860 627-011	7 033 103 5	2SB 005 603-137	575.01.000.01	1NA 009 031-021
7 034 553	1KO 008 191-047	VOE11998512	9EL 859 020-001	7 034 374 6	9HD 155 239-001	597.01.000.00	1NL 009 034-011
7 034 592 4	2XS 005 020-001	VOE 143 794 69	8RA 003 660-007	7 034 374 7	9GH 145 943-001	597.01.000.01	1NL 009 034-021
7 034 592 4	2XS 005 020-002	VOE14385291	2VA 343 640-117	7 034 569 0	2AB 004 532-051		
7 034 592 4	2XS 005 020-003	VOE14385292	2VP 343 640-081	7 034 569 0	2AB 004 532-057		
7 034 770 0	2NE 005 603-071	VOE14385292	2VP 343 640-087	7 034 592 4	2XS 005 020-001		
7 034 770 0	2NE 005 603-077	VOE14387965	2VP 343 640-091	7 034 592 4	2XS 005 020-002		
7 034 770 1	2DA 005 603-031	VOE14387965	2VP 343 640-097	7 034 592 4	2XS 005 020-003		
7 034 770 1	2DA 005 603-037	VOE14387967	2VA 343 640-207	7 034 770 3	2SA 005 603-027		
7 034 770 2	2BA 005 603-117	VOE3570654	2BA 003 014-011	7 034 771 7	2PS 963 639-011		
7 034 770 3	2SA 005 603-021	VOE4785122	2SD 002 582-021	7 034 771 7	2PS 963 639-017		
7 034 770 3	2SA 005 603-027	VOE4785122	2SD 002 582-027	7 034 868 3	8HG 116 741-801		
7 034 770 4	2ZR 008 221-051			7 035 395 9	9GD 341 063-007		
7 034 770 4	2ZR 008 221-057			7 036 637 6	8RA 003 326-011		
7 034 770 5	8RA 008 405-001			7 036 637 6	8RA 003 326-017		
7 034 770 5	8RA 008 405-007			7 036 862 6	2ZR 002 985-261		
7 034 770 7	2SP 959 060-601			7 037 154 7	2DA 959 071-737		
7 034 770 8	2KA 005 049-011			7 037 481 3	2SB 008 805-021		
7 034 770 8	2KA 005 049-017			7 037 481 3	2SB 008 805-027		
7 034 770 9	2BA 008 221-001			8001331900022	2ZR 008 805-041		
7 034 770 9	2BA 008 221-007			8001331900022	2ZR 008 805-047		
7 034 771 1	1KO 008 191-021			8001331900025	9GH 158 051-007		
7 034 771 1	1KO 008 191-027			8003001900004	8GA 002 074-241		
7 034 771 3	1NL 007 186-047			8 156 751	2XW 002 897-051		
7 034 771 4	9GH 152 654-007			8 207 666 8	1F3 161 825-011		
7 034 771 5	8KA 152 134-007			8216271900001	2ZR 003 030-171		
7 034 771 6	2TM 963 639-317			8 510 443 6	2RL 008 060-111		
7 034 771 7	2PS 963 639-177			8 510 443 7	2RL 008 061-111		
7 034 771 8	2BM 008 355-001			8 510 476 5	9EL 862 141-001		
7 034 771 8	2BM 008 355-007			967711	8GP 002 067-261		
7 034 791 5	9GD 341 063-007			VOE14592565	2SB 009 001-157		
7 035 395 9	9GD 341 063-007			VOE14592566	2BA 009 001-107		
7 035 426 1	9GT 963 129-001			VOE14592567	2ZR 009 001-117		
7 035 764 8	9FF 138 324-001			VOE4785120	2BE 002 582-031		
7 036 051 4	1KO 008 192-027			VOE70324423	2BA 008 221-001		
7 036 054 6	2XS 008 078-001			VOE70324423	2BA 008 221-007		
7 036 054 6	2XS 008 078-007			ZM 2903490	9EL 137 307-001		
7 036 512	2BA 005 603-011						
7 036 512	2BA 005 603-017			Wegu	Hella		
7 036 512 0	2BA 005 603-011			420 013	8RA 002 020-001		
7 036 512 0	2BA 005 603-017			420 106	8RA 002 016-121		
7 036 512 1	2BA 005 603-061			420 108	8RA 002 016-111		
7 036 512 1	2ZR 005 603-067			420 116	8RA 002 016-101		
7 036 512 3	2DA 003 734-011			420 401	8HG 002 240-001		
7 050 631	8GP 002 067-241			420 402	8HG 002 240-011		
7 050 638	8GA 002 071-251			420 403	8HG 002 240-021		
7 349 573	9EL 126 294-001			420 405	8HG 002 240-031		
7 352 959	2PF 001 648-161						
7 353 869	2BE 001 259-061			Yale / Nacco	Hella		
7 356 266	9EL 052 476-001			1356335	1GA 006 876-001		
784 423	2BA 001 227-211			1356350	1GA 006 991-031		
784 593	8JA 001 909-001						
8 001 010 34	2SA 961 167-011			Yorka	Hella		
8001331900003	9GH 152 654-007			0 12 900 0048	2BA 004 257-011		
8001331900008	2SA 005 603-021			0 12 901 0047	2BA 004 257-021		
8001331900008	2SA 005 603-027			1 62 133 0065	9EL 131 651-031		
8001331900007	2DA 005 603-031			1 62 134 0064	9EL 131 652-031		
8001331900007	2DA 005 603-037			1 62 135 0063	9EM 131 613-021		
8003331900003	2BA 005 603-117			1 62 136 0062	9EL 131 614-031		
				ZKW	Hella		
				316.52.000.00	2SD 001 686-101		