

REFRIGERATION SOLUTIONS



SIGMA ENGINEERING LLC

Sigma Engineering LLC is proud to be recognized by our loyal customers as the “go-to” company for specialty Refrigeration and Chiller replacement parts. We have added items to our catalog that help the Supermarket customers with both repair and leak reduction in their systems. Sigma Engineering is the #1 supplier in the industry for Service Valve Caps thanks to the handy **CapMaster Chart!**

It's about the WHY! SERVICE • QUALITY • COMMUNICATION

Why should customers buy from us? The answer is simple; It's the level of service we provide. Our service covers every single step in our process—from always answering the phone, to providing knowledgeable information, to shipping on time and stocking sufficient inventory. Our overall communication and interaction with our customers is our highest priority.

The Sigma Engineering Catalog Cover by Annerly Dixon

A decision was made to do something very different but special for our catalog cover page. While the standard route is some glamour shots of company product we mixed it up with a one-of-a-kind artist rendering of our product. A local friend's daughter is a talented artist which makes this special for us. Sigma owner, Joe Shukys, tasked the young artist to create an abstract race car using Sigma products as the actual race car! Look closely and you will see all of your favorite Refrigeration Parts on this hot-rod. Artist, Annerly Dixon, stunned us all with this piece of art and we hope you love it too!

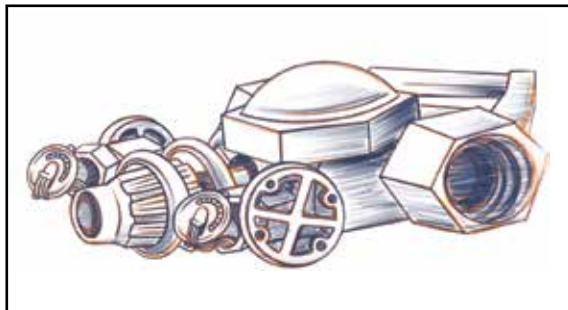
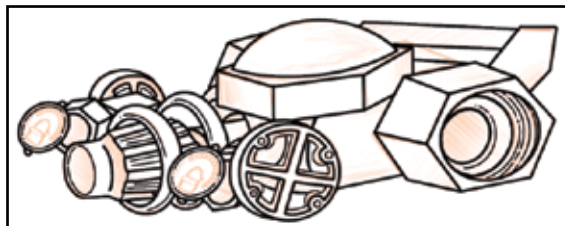
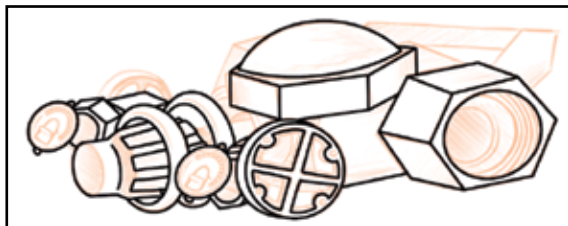

TABLE OF CONTENTS

- FLARELOK®** 4-5
- LIQUID LEVEL INDICATORS & ALARMS** 6-7
- VERTICAL LL INDICATORS** 8
- REPLACEMENT DIALS** 9
- SIGHT GLASSES** 10
- PRESSURE RELIEF PRODUCTS** 11
- ADAPTERS** 12-13
- ROTOLOCK & FLANGE SERVICE VALVES.** . 14-19

- COPELAND X-REF SERVICE VALVES** 20-21
- SERVICE VALVE ACCESSORIES & CAPS** . . 22-23
- CB45 & DRAINMATE** 24
- ZINC PLATES & BRACKETS.** 25
- GLASS DOOR PARTS** 26-27
- CHILLER BARREL & CONDENSER
GASKETS & ENDPLATES** 28-35

LL Indicators & Dials



Sigma is the **ONLY** choice for your replacement Liquid Level needs. All items in **STOCK** all of the time.

For more info check out pages 6-9

Service Valve Bottom Caps



Supermarkets rely on Sigma's large selection of replacement caps to address the issue of refrigerant leaks.

EVERY VALVE • EVERY CAP • IN STOCK

For more info check out pages 22-23

FlareLok®

LOCK THAT LEAK



FLARELOK® DELIVERS A CONFIDENT, LEAK-FREE FLARE!

CHANGING THE HVAC/R INDUSTRY

The FlareLok® was developed specifically for the HVAC/R industry. The seal protects against the primary area of flare leaks on the sealing surface. FlareLok® fits all common SAE flare connections for the industry. It not only provides a long term leak-free connection on new installations or products, but it also can be used to stop weeping connections in existing systems.

There is a general industry push toward leak-free systems and the elimination of leaks on existing equipment. Currently, the weak links in the system are the flare connections ... *but no more!*

The flare connection is preferred for components for ease of service but has slowly gone the way of sweat connections due to the leak issues and liability associated with loss of refrigerant.

The Multi-Ring-Seal by FlareLok® allows the best of both worlds in a flare connection. It allows for servicing components while maintaining a permanent leak-free connection. FlareLok® can even be used to repair a small existing leak!

ENDLESS APPLICATIONS!

- Mini-Split & VRF Systems
- Supermarket Rack Pilot Lines
- Expansion Valves
- Supermarket Rack Oil Lines
- Supermarket Rack Oil Filters
- Pressure Regulators
- Filter Driers
- Many, Many, More!

Why FlareLok®?

- Creates a confident leak-free flare connection
- Reduces annual cost of refrigerant
- Lowers cost to operate systems due to leak reductions
- Meets local codes or regulations
- Protects against weeping on new and existing equipment
- Allows for serviceable components to be installed
- Minimizes service calls due to refrigerant leaks
- Saves the environment
- Improves integrity of every flare connection

PROPRIETARY COATING IS COMPATIBLE WITH FULL RANGE OF REFRIGERANTS AND OILS, INCLUDING POE AND PVE OILS!

HOW TO INSTALL

STEP 1:

Open the fitting and snap the FlareLok® onto the male end of the flare. The mounting tabs will hold the seal in place during installation.

STEP 2:

For best results, add a drop of oil to the threaded area and a drop of oil to the FlareLok® prior to assembly.

STEP 3:

Tighten the fitting to suggested torque setting.

Once assembled, the FlareLok® becomes the best long term leak-free flare connection in the industry.

FlareLok®



BAG PACK

PART NO.	DESCRIPTION	QTY	BARCODE	SEALS/PACK
SEFT-BP-04	Sigma FlareLok - 1/4"	6	812181030000	6
SEFT-BP-06	Sigma FlareLok - 3/8"		812181030017	
SEFT-BP-08	Sigma FlareLok - 1/2"		812181030024	
SEFT-BP-10	Sigma FlareLok - 5/8"		812181030031	
SEFT-BP-12	Sigma FlareLok - 3/4"		812181030048	
SEFT-BPM	Sigma FlareLok - 1/4" thru 5/8"	2 each	812181030116	8

MINI-SPLIT KIT BAG PACK

PART NO.	DESCRIPTION	QTY	BARCODE	SEALS/PACK
SEFT-KIT-2X3	Sigma FlareLok Kit - 1/4" x 3/8"	2 each	812181030055	4
SEFT-KIT-2X4	Sigma FlareLok Kit - 1/4" x 1/2"		812181030062	
SEFT-KIT-2X5	Sigma FlareLok Kit - 1/4" x 5/8"		812181030079	
SEFT-KIT-3X4	Sigma FlareLok Kit - 3/8" x 1/2"		812181030086	
SEFT-KIT-3X5	Sigma FlareLok Kit - 3/8" x 5/8"		812181030093	
SEFT-KIT-4X5	Sigma FlareLok Kit - 1/2" x 5/8"		812181030109	

KEEPER KIT

PART NO.	DESCRIPTION	BARCODE	SEALS/PACK
SEFT-KIT-60PC	FlareLok Keeper Kit 60 pc: 20 pcs each: 1/4 & 3/8" and 10 pcs each: 1/2" & 5/8" In plastic container.	812181030178	60

MAXIMUM TORQUE SETTINGS

PIPE	APPROX. TORQUE
Ø 1/4"	10-13 ft-lbs
Ø 3/8"	22-30 ft-lbs
Ø 1/2"	36-39 ft-lbs
Ø 5/8"	45-55 ft-lbs

BOX/BULK PACK

PART NO.	DESCRIPTION	QTY	BARCODE	SEALS/PACK
SEFT-BX-04	Sigma FlareLok - 1/4"	100	812181030123	100
SEFT-BX-06	Sigma FlareLok - 3/8"		812181030130	
SEFT-BX-08	Sigma FlareLok - 1/2"		812181030147	
SEFT-BX-10	Sigma FlareLok - 5/8"		812181030154	
SEFT-BX-12	Sigma FlareLok - 3/4"		812181030161	

LIQUID LEVEL INDICATORS – HORIZONTAL



MECHANICAL GAUGE

Dial Action	Magnetic
Output Voltage	N/A
Output Current	N/A

This style also available in high-pressure model.

LIQUID LEVEL INDICATOR

Magnetic liquid level indicators are used for accurate gauging of refrigerant levels in a horizontal receiver. The dial reads percent of pump down capacity of the receiver: when the pointer indicates 100%, the receiver is 80% full of liquid.

Float, Gasket, Screws, and Assembly Dial are included.

DIAMETER	PART NUMBER
6-5/8"	INDIC283A
8-5/8"	INDIC111A
10-3/4"	INDIC76A
12-3/4"	INDIC85A
14"	INDIC94A
16"	INDIC102A
18"	INDIC483A
20"	INDIC490A
24"	INDIC497A



INDIC58A-**

AC Voltage	240 VAC Only
Current	1.0 Amp Inductive
Max Watts	75 Watts

LIQUID LEVEL ALARM

A liquid-level indicator is a single pole, single throw switch on which contacts close upon the decrease of the liquid level at 20% pumpdown. The indicator pointer, or switch contacts, are on the outer side and are operated by a small magnet which follows the position of the inner magnet. There is no connection, except the magnetic field, between the inside and outside. Internal gears and bearings are stainless steel. In case of external damage, the indicator dial or switch cartridge may be replaced from outside—the refrigerant charge is not disturbed.

DIAMETER	PART NO.
6-5/8"	INDIC58A-658
8-5/8"	INDIC58A-858
10-3/4"	INDIC58A-1034
12-3/4"	INDIC58A-1234
14"	INDIC58A-14
16"	INDIC58A-16
18"	INDIC58A-18
20"	INDIC58A-20
24"	INDIC58A-24



INDIC210A-**

Input Voltage	110 or 220 V
Resistance	15 Ohms
Output	Step 24VDC Max

LIQUID LEVEL INDICATOR WITH ALARM

This indicator-alarm with selectable low-level point provides a relay circuit that closes at one of five user selectable levels from 10–50%. The relay circuit can be used to drive a variety of applications from alarms to pumps. Each indicator-alarm uses highly reliable and accurate, three wire, voltage divider technology to send the level signal to the level alarm, relay circuitry. The connector built into the indicator-alarm mates with a standard Packard automotive type, rubber sealed connector for easy installation.

DIAMETER	PART NO.
6-5/8"	INDIC210A-658
8-5/8"	INDIC210A-858
10-3/4"	INDIC210A-1034
12-3/4"	INDIC210A-1234
14"	INDIC210A-14
16"	INDIC210A-16
18"	INDIC210A-18
20"	INDIC210A-20
24"	INDIC210A-24



LIQUID LEVEL INDICATOR WITH ALARM

This indicator-alarm is equipped with proportional voltage output with ranges of either 1-2 Volts or 1-6 Volts. They interface with various microprocessor based controllers typically used in supermarkets for accurate levels and rates of loss.

	INDIC82412A-**	INDIC82416A-**
<i>Input Voltage</i>	8-24 VDC	8-24 VDC
Output Voltage	1-2 V	1-6 V
<i>Output Current</i>	+/- 10ma	+/- 10ma
DIAMETER	ASSEMBLY PART NO.	ASSEMBLY PART NO.
6-5/8"	INDIC82412A-658	INDIC82416A-658
8-5/8"	INDIC82412A-858	INDIC82416A-858
10-3/4"	INDIC82412A-1034	INDIC82416A-1034
12-3/4"	INDIC82412A-1234	INDIC82416A-1234
14"	INDIC82412A-14	INDIC82416A-14
16"	INDIC82412A-16	INDIC82416A-16
18"	INDIC82412A-18	INDIC82416A-18
20"	INDIC82412A-20	INDIC82416A-20
24"	INDIC82412A-24	INDIC82416A-24



LIQUID LEVEL INDICATOR WITH ALARM

This indicator-alarm is equipped with proportional voltage output with ranges of 0.5-4.5 Volts. They interface with various microprocessor based controllers typically used in supermarkets for accurate levels and rates of loss.

	INDIC824545A-**	INDIC832545A-**
<i>Input Voltage</i>	8-24 VDC	8-32 VDC
Output Voltage	0.5-4.5 V	0.5-4.5 V
<i>Output Current</i>	+/- 1ma	+/- 1ma
DIAMETER	ASSEMBLY PART NO.	ASSEMBLY PART NO.
6-5/8"	INDIC824545A-658	INDIC832545A-658
8-5/8"	INDIC824545A-858	INDIC832545A-858
10-3/4"	INDIC824545A-1034	INDIC832545A-1034
12-3/4"	INDIC824545A-1234	INDIC832545A-1234
14"	INDIC824545A-14	INDIC832545A-14
16"	INDIC824545A-16	INDIC832545A-16
18"	INDIC824545A-18	INDIC832545A-18
20"	INDIC824545A-20	INDIC832545A-20
24"	INDIC824545A-24	INDIC832545A-24

LIQUID LEVEL INDICATORS – VERTICAL



NOMENCLATURE FOR ORDERING

SP1 -60 PS D12 R404A

PREFIXES:

SPO = 0v-5v output
 SP1 = 1v-6v output

FITTING STYLE:

PS = 3/4" NPT Stand-alone
 RS = Roto-Lok Stand-alone

REFRIGERANT/OIL:

R12 POE
 R22 MIN = Mineral
 R134A AKL = Alkybenzene
 R236FA
 R404A
 R407A
 R407C
 R407F
 R410A
 R422D
 R502
 R507 same as R507A
 R744 same as CO2

ACTIVE PROBE LENGTH:

= Inches

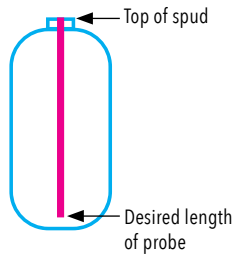

OPTIONS:

D = Display Only
 N = No Display

OPTIONS:

= With Cable
 (Length of cable in feet.
 Standards lengths 12,
 33 feet.)

NOTES

- All units are shipped with metal cover and gasket unless equipped with display.
- All units are shipped with DIN connector and cable.
- Probes are delivered calibrated to the Refrigerant/Oil called out on purchase order.
- Probe lengths are measured from the top of the spud on the receiver to within 1/2" of the bottom of the receiver. NPT threads models take into account 3/4" thread engagement into the receiver. Lengths to be to the lower whole number.

HORIZONTAL LL INDICATOR REPLACEMENT & SERVICE PARTS

PART NO.	DESCRIPTION	PKG QTY
SE-995-02	Gasket 995, Gasket for Liquid Level Indicators & Alarms – 2 pack	2 pcs/pack
SE-995-05	Gasket 995, Gasket for Liquid Level Indicators & Alarms – 5 pack	5 pcs/pack
SE-995-10	Gasket 995, Gasket for Liquid Level Indicators & Alarms – 10 pack	10 pcs/pack
SE-995-KIT	Gasket 995, Gasket and Bolts Kit for Indicators & Alarms	1 gasket + 4 bolts
SE-995-KIT-E	Gasket 995, Gasket and Bolts Kit for Electronic Indicators & Alarms	1 gasket + 4 bolts
SE-995-BULK	Gasket 995, Gasket for Liquid Level Indicators & Alarms – Bulk	Any

NOTE
 The Stainless Steel Hex Head Cap Bolts are designed for the Indicator to meet the overall Pressure Rating of the assembly. Extreme caution must be used if replacing with other style bolts.



SE-995-02



SE-995-05



SE-995-10



SE-995-KIT

DIAL MASTER CHART – REPLACEMENT DIALS

In stock and ready to ship. Please pay attention to wire colors and wire order on base.



INDIC21A

Dial Action	Magnetic
Output Voltage	N/A
Output Current	N/A
Dial Increments	0 to 100%
Operating Temp	-40°F to +158°F
Approx Wire Lead	N/A
X-Ref Number	5-527 or LL-1

INDIC49A

AC Voltage	240 VAC Only
Current	1.0 Amp Inductive
Max Watts	75 Watts
SPST Switch	Low Amp Triac
Operating Temp	-40°F to +158°F
Approx Wire Lead	N/A
X-Ref Number	M6253

INDIC238A

AC Voltage	110 or 220V
Nom Resistance	15 Ohms +/-5%
Wattage	1/4 Watt
Output	Step Output 24 VDC
Operating Temp	-40°F to +158°F
Approx Wire Lead	6 Inches
X-Ref Number	5AUNS03024P

INDIC245A

Blank-Off Plate

The INDIC245A is a simple blank-off plate. It is often used when service is required but the system needs to stay running, or when LL control is removed. The unit is supplied with correct mounting bolts and 995 gasket.



INDIC824-102A

Input Voltage	8-24 VDC
Output Voltage	1-2 V
Output Current	+/- 10ma
Dial Increments	0 to 100%
Operating Temp	-40°F to +175°F
Wire Order L-R	Black, Blue, Red
Approx Wire Lead	15 Inches
X-Ref Number	5ANBS03024

INDIC824-106A

Input Voltage	8-24 VDC
Output Voltage	1-6 V
Output Current	+/- 10ma
Dial Increments	0 to 100%
Operating Temp	-40°F to +175°F
Wire Order L-R	Black, Blue, Red
Approx Wire Lead	15 Inches
X-Ref Number	5ANCS03024

INDIC824-545A

Input Voltage	8-24 VDC
Output Voltage	0.5-4.5 V
Output Current	+/- 1ma
Dial Increments	0 to 100%
Operating Temp	-40°F to +175°F
Wire Order B-T	Red, Blue, Black
Approx Wire Lead	12 Inches
X-Ref Number	5AAKS03023

INDIC832-545A

Input Voltage	8-32 VDC
Output Voltage	0.5-4.5 V
Output Current	+/- 1ma
Dial Increments	E, 1/4, 1/2, 3/4, F
Operating Temp	-40°F to +175°F
Wire Order B-T	Red, Green, Black
Approx Wire Lead	12 Inches
X-Ref Number	5AAKS02770

SIGHT GLASSES

A SIGHT GLASS INDICATES THE LIQUID LEVEL INSIDE THE RECEIVER BY WAY OF A VIEW PORT.



Features Include:

- Nickel plated steel body
- Hermetically sealed viewing lens
- American standard tapered pipe thread
- Maximum working pressure of 500 PSI
- Maximum temperature of 300°F (148°C)
- Suitable for most standard refrigerants
- Usable with most industrial fluids that are non-corrosive to glass + steel



DIMENSIONS IN INCHES REFERENCE

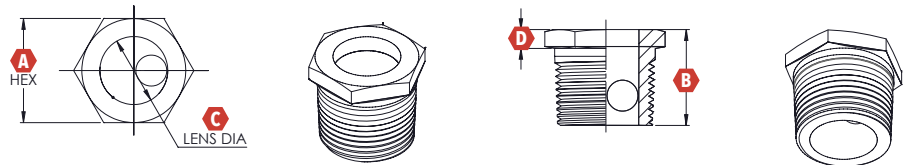

SIGHT GLASSES

SIGMA PART NO.	THREAD SIZE	DIMENSIONS IN INCHES			
		A	B	C	D
SG04	1/2" MPT	.938	.958	.563	.219
SG06	3/4" MPT	1.125	1.063	.750	.310
SG08	1" MPT	1.375	1.324	.938	.380
SG10	1-1/4" MPT	1.750	1.378	1.188	.410
SG16	2" MPT	2.50	1.423	1.630	.406
SG12	1-1/4"-12 Female ROTOLock Connection	1.375	N/A	.750	.625

* SG12 w/ Rotolock Connection comes with Teflon Seal-SE-24592



FUSIBLE PLUGS & FUSIBLE UNIONS

Our Fusible Plugs and Fusible Unions are the highest quality in the HVAC/R market. They are available in Bulk Pack quantities, but also available in single hanging packs which are popular with our Wholesale/Distributor customers.



FUSIBLE PLUGS

PART NO.	THREAD SIZE	MELTING TEMP	PKG QTY
PLUG-110	1/8 MPT	168°F	Single
PLUG-148	1/8 MPT	210°F	
PLUG-153	1/4 MPT	210°F	
PLUG-175	3/8 MPT	210°F	
PLUG-166	1/8 MPT	283°F	
PLUG-421	1/4 MPT	283°F	
PLUG-337	3/8 MPT	283°F	



FUSIBLE UNIONS

PART NO.	CONNECTIONS		MELTING TEMP	PKG QTY
UNION-154	1/4 SAE	1/4 MPT	210°F	Single
UNION-184	3/8 SAE	3/8 MPT	210°F	
UNION-58	3/8 SAE	1/2 MPT	210°F	
UNION-319	3/8 SAE	5/8-18 UNF	210°F	
UNION-44	1/4 SAE	1/4 MPT	283°F	
UNION-76	3/8 SAE	3/8 MPT	283°F	

RELIEF VALVES

PART NO.	CONNECTIONS		PRESSURE SETTING	BODY STYLE
VALVE-58	3/8 MPT	3/8 SAE	350 PSI	Angle
VALVE-67	3/8 MPT	3/8 SAE	400 PSI	
VALVE-771	3/8 MPT	3/8 SAE	450 PSI	
VALVE-5026	3/8 MPT	3/8 SAE	600 PSI	
VALVE-5033	3/8 MPT	3/8 SAE	675 PSA	
VALVE-94	1/2 MPT	5/8 SAE	350 PSI	Angle
VALVE-102	1/2 MPT	5/8 SAE	400 PSI	
VALVE-764	1/2 MPT	5/8 SAE	450 PSI	
VALVE-5057	1/2 MPT	5/8 SAE	675 PSI	
VALVE-5064	3/4 MPT	3/4 FPT	600 PSI	Angle
VALVE-5071	3/4 MPT	3/4 FPT	675 PSI	
VALVE-5040	1/2 MPT	5/8 SAE	600 PSI	Straight



PROTECTION NOTES

- Relief valves are installed in a refrigeration system primarily to protect the vessel in the event of fire or other emergency high pressure condition.
- Fusible unions and plugs protect only in the event of fire.
- The 5/8"-18UNF union or plug seats in a special 3/8" coupling with a copper zinc coated flare gasket, exactly as an SAE flare fitting. A conventional 3/8" mpt pipe threaded union, plug, or safety valve will also seal on the dryseal pipe thread of the coupling if ever necessary. All systems must have a relief valve or fuse plug installed in order to comply with the ANSI B9.1 code.

SIGMA ENGINEERING ADAPTERS

The Sigma Engineering Adapters are of the highest quality and Made in the USA. They are supplied to both OEM and Wholesale customers around the world.

Our units are direct replacements for your Copeland or Tecumseh items, and our service and inventory are second to none.

FOR THE WHOLESALE/DISTRIBUTOR:

Each unit is individually boxed in high quality packaging and labeled for ease of identifying. Each label contains cross reference information to aid the sales people and customers alike. All units are shipped WITH a Teflon Seal.

FOR THE OEM CUSTOMER:

Each unit is shipped in production/bulk-pack style, to minimize production floor waste. Teflon Seals are included for each unit. Individually packaged units available at no additional cost upon request.

ROTOLOCK BRASS STUB ADAPTERS

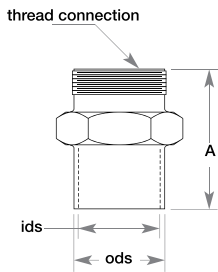

SIGMA PART NO.	CONNECTIONS			DIMENSION "A"	TEFLON SEAL PART NO.	COPELAND X-REF
	IDS	ODS	THREAD			
BA03X06A	3/8	1/2	3/4"-16	1-5/16	SE-24590	
BA03X08A	3/8	1/2	1"-14	1-5/16	SE-24591	998-0034-14
BA04X08A	1/2	5/8	1"-14	1-5/16	SE-24591	998-0034-15
BA05X08A	5/8	7/8	1"-14	1-5/16	SE-24591	998-0034-16
BA05X10A	5/8	7/8	1-1/4"-12	1-9/16	SE-24592	
BA06X10A	5/8	3/4	1-1/4"-12	1-9/16	SE-24592	998-0034-01
BA07X10A	7/8	1-1/8	1-1/4"-12	1-9/16	SE-24592	998-0034-02
BA09X10A	1-1/8	1-3/8	1-1/4"-12	1-9/16	SE-24592	
BA09X14A	1-1/8	1-3/8	1-3/4"-12	1-11/16	SE-24593	998-0034-03
BA11X14A	1-3/8	1-5/8	1-3/4"-12	1-11/16	SE-24593	998-0034-04
BA13X18A	1-5/8	1-7/8	2-1/4"-12	1-7/8	SE-24594	998-0034-06

ROTOLOCK STRAIGHT SWIVEL ADAPTERS

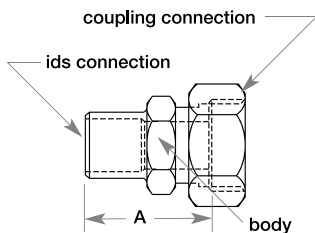

SIGMA PART NO.	CONNECTIONS		DIMENSION "A"	TEFLON SEAL PART NO.	COPELAND X-REF
	IDS	COUPLING			
SA03A	3/8	3/4"-16	1-9/32	SE-24590	
SA04A	1/2	1"-14	1-7/32	SE-24591	998-0034-18
SA05A	5/8	1"-14	1-9/32	SE-24591	998-0034-17
SA06A	3/4	1-1/4"-12	1-23/32	SE-24592	998-0034-07
SA07A	7/8	1-1/4"-12	1-23/32	SE-24592	998-0034-08
SA09A	1-1/8	1-1/4"-12	1-31/32	SE-24592	998-0034-09
SA09X14A	1-1/8	1-3/4"-12	2-7/16	SE-24593	998-0034-10
SA11A	1-3/8	1-3/4"-12	2-7/16	SE-24593	998-0034-13
SA11X18A	1-3/8	2-1/4"-12	2-7/16	SE-24594	998-0034-11
SA13X18A	1-5/8	2-1/4"-12	2-7/16	SE-24594	998-0034-12



ROTOLOCK ANGLE SWIVEL ADAPTERS

The Sigma Engineering Angle Adapters are of the highest quality and Made in the USA. They are supplied to both OEM and Wholesale customers around the world.

- This type of Adapter is commonly used in Tandem Compressor piping kits. They can also be used in general refrigeration piping to allow quick removal of components.
- For the Wholesale/Distributor; each unit is individually boxed in high quality packaging and labeled for ease of identifying. Each label contains cross reference information to aid the sales people and customers alike. All units are shipped WITH a Teflon Seal.
- For the OEM customer; each unit is shipped in production/bulk-pack style, to minimize production floor waste. Teflon Seals are included for each unit. Individually packaged units available at no additional cost upon request.

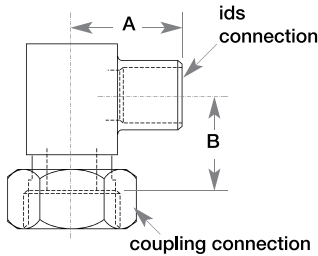

SIGMA PART NO.	CONNECTIONS		DIMENSION "A"	DIMENSION "B"	TEFLON SEAL PART NO.
	IDS	COUPLING			
AA03A	3/8	3/4"-16	1-5/16	1/2	SE-24590
AA04A	1/2	1"-14	1-3/32	17/32	SE-24591
AA05A	5/8	1"-14	1-3/32	19/32	SE-24591
AA07A	7/8	1-1/4"-12	1-9/16	5/8	SE-24592
AA09A	1-1/8	1-1/4"-12	1-13/16	1	SE-24592
AA11A	1-3/8	1-3/4"-12	2-3/16	1	SE-24593
AA13A	1-5/8	1-3/4"-12	2-1/8	1-3/4	SE-24593

COMPRESSOR ADAPTERS

These adapters bolt to a semi-hermetic compressor body and then allow use of a RotoLock style service valve. Included with the Adapter are Bolts, Gasket, and Teflon Seal.



SIGMA PART NO.	THREAD	BOLT CENTER	TEFLON SEAL	GASKET PART NO.	COPELAND PART NO.
FA13BCX10A	1-1/4"-12	2-Bolt 1-5/8" BC	SE-24592	GASKE-2158-00	998-0036-02
FA22BCX14A	1-3/4"-12	2-Bolt 2-3/4" BC	SE-24593	GASKE-2234-00	998-0036-00

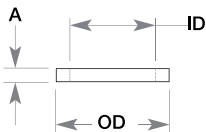

TEFLON SEALS

Teflon seals are provided with each valve. The Teflon Seal should be installed only after all soldering is completed. Teflon Seals can be ordered separately. Convenient kits are pictured below, but they can also be bulk/single pack ordered.



SIGMA PART NO.	DIMENSIONS (INCHES)				PKG QTY	COPELAND PART NO.
	ID	OD	A	THREAD USE		
SE-24590-06	7/16	9/16	1/16	3/4"-16 ROTOLOCK	6	020-0028-01
SE-24591-06	5/8	3/4	1/16	1"-14 ROTOLOCK	6	020-0028-00
SE-24592-06	7/8	1	1/16	1-1/4"-12 ROTOLOCK	6	020-0028-02
SE-24593-06	1-3/8	1-1/2	1/16	1-3/4"-12 ROTOLOCK	6	020-0028-03
SE-24594-04	1-7/8	2	1/16	2-1/4"-12 ROTOLOCK	4	020-0941-00
SE-TS-KIT	Multi-Pack Kit, Contains 3 of each 24590, 24591, 24592, 23593				12	

ROTOLOCK VALVES

Rotolock Valves, sometimes spelled "Rotalock" are service valves typically used in refrigeration systems. The actual Rotolock connection is a threaded connection that incorporates a Teflon Seal which is the main seal in preventing leaks in the connection. The primary uses of the valve include the ability to access the refrigeration system for charging and evacuation procedures. The valves are also very handy as they provide ease of removing equipment such as a compressor due to the threaded connection.

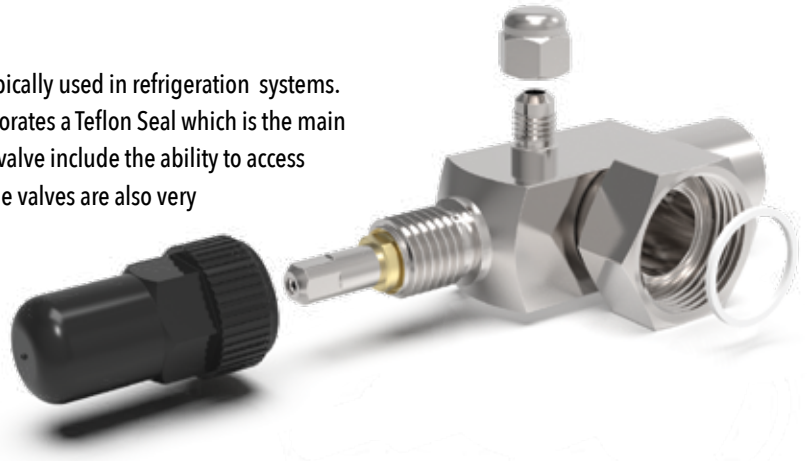

ROTOLOCK IDENTIFICATION PROCEDURE

STEP 1: BODY TYPE

Rotolock Valves are classified as Horizontal Rotolocks (Fig 1) or as Vertical Rotolocks (Fig 2). The primary difference is the location of the threaded Rotolock connection on the valve itself. The Horizontal Rotolock is typically mounted on a compressor, or vertical receiver or accumulator. The typical use for a Vertical Rotolock is on a horizontal receiver.



Fig 1 - Horizontal



Fig 2 - Vertical

STEP 2: IDENTIFY CONNECTIONS

Rotolock connections are available in multiple sizes and are determined by the inside diameter of the connection for refrigerant flow. When replacing a Rotolock Valve, it is important to replace with the exact ROTOLOCK thread size of the old valve to properly fit the threaded adapter fitting. The second connection on the valve is typically a flare (SAE) connection or a solder (IDS) connections.



STEP 3: SERVICE PORTS

All valves are supplied with at least one 1/4" SAE gauge port. This single port is primarily used for charging and evacuation and its location can vary. (Fig T, Fig L, & Fig R.)

Many Rotolock Valves are supplied with a secondary 1/4" SAE gauge port and the configuration most commonly seen is in the Fig D below. This gauge port is most commonly connected via a copper line or flexible hose to pressure control device.

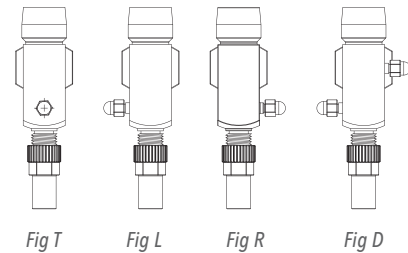

FIELD REPLACEMENT

Replacing a valve in the field is not always easy due to lack of access. Use this simple chart to help identify your Rotolock connection size and give to your local Refrigeration Wholesaler.

DIMENSION A	ROTOLOCK SIZE
7/8"	3/4"-16
1-1/8"	1"-14
1-3/8"	1-1/4"-12
2"	1-3/4"-12
2-1/2"	2-1/4"-12

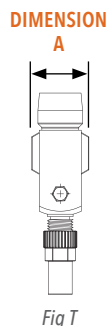

Fig T

SIGMA ROTOLOCK NOMENCLATURE

H05X10SDA

ROTOLOCK FITTING:

- H = Horizontal Rotolock Configuration
- V = Vertical Rotolock Configuration

FITTING SIZE:

- 03 = 3/8"
- 04 = 1/2"
- 05 = 5/8"
- 06 = 3/4"
- 07 = 7/8"
- 09 = 1-1/8"
- 11 = 1-3/8"
- 13 = 1-5/8"
- 17 = 2-1/8"
- 21 = 2-5/8"
- 25 = 3-1/8"

CHECK DIGIT

- ROTOLOCK/ THREAD SIZE:
- 06 = 3/4"-16
 - 08 = 1"-14
 - 10 = 1-1/4"-12
 - 14 = 1-3/4"-12
 - 18 = 2-1/4"-12

CONNECTION TYPE:

- F = SAE Flare
- S = Solder

SERVICE PORT(S):

- T = Top
- L = Left
- R = Right
- D = Dual

ASSEMBLY:

- A = Includes Teflon Seal & Packaging

HORIZONTAL ROTOLOCK VALVES



TOP PORT



- Aluminum or Brass Service Port Caps; Aluminum is standard.
- Plastic Stem Caps are standard. Steel Stem Caps with copper seal are available as separate item.
- All valves include a 1/4" SAE service port. Secondary ports or Gauge ports are available. This port is typically used on a pressure control.
- The secondary gauge ports are supplied with a standard small diameter vent hole but can be supplied with a Schrader valve.

SIGMA PART NO.	CONN SIZE	ROTOLOCK CONNECTION	TEFLON SEAL PART NO.	BOTTOM CAP PART NO.	COPELAND X-REF	TECUMSEH X-REF
H03FTA	3/8 SAE	3/4"-16	SE-24590	SE-RCAP-01P		31547-1
H04FTA	1/2 SAE	1"-14	SE-24591	SE-RCAP-01P		31546
H05FTA	5/8 SAE	1"-14	SE-24591	SE-RCAP-01P		31071-2
H03STA	3/8 IDS	3/4"-16	SE-24590	SE-RCAP-01P		31555-1
H04STA	1/2 IDS	1"-14	SE-24591	SE-RCAP-01P		
H05STA	5/8 IDS	1"-14	SE-24591	SE-RCAP-01P		
H06STA	3/4 IDS	1-1/4"-12	SE-24592	SE-RCAP-02P		31530-1
H07STA	7/8 IDS	1-1/4"-12	SE-24592	SE-RCAP-02P		
H09STA	1-1/8 IDS	1-1/4"-12	SE-24592	SE-RCAP-02P		31524-1
H11STA	1-3/8 IDS	1-3/4"-12	SE-24593	SE-RCAP-03P	998-0510-46	
H13STA	1-5/8 IDS	1-3/4"-12	SE-24593	SE-RCAP-03P	998-0510-66	
H13X18STA	1-5/8 IDS	2-1/4"-12	SE-24594	SE-RCAP-04P	998-0510-68	
H17STA	2-1/8 IDS	2-1/4"-12	SE-24594	SE-RCAP-03P		

LEFT PORT

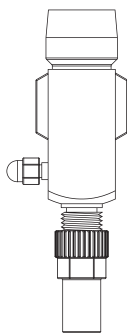

SIGMA PART NO.	CONN SIZE	ROTOLOCK CONNECTION	TEFLON SEAL PART NO.	BOTTOM CAP PART NO.	COPELAND X-REF	TECUMSEH X-REF
H03FLA	3/8 SAE	3/4"-16	SE-24590	SE-RCAP-01P		31547-6
H04FLA	1/2 SAE	1"-14	SE-24591	SE-RCAP-01P	998-0510-58	
H05FLA	5/8 SAE	1"-14	SE-24591	SE-RCAP-01P		
H03SLA	3/8 IDS	3/4"-16	SE-24590	SE-RCAP-01P		
H04SLA	1/2 IDS	1"-14	SE-24591	SE-RCAP-01P		31527-2
H05SLA	5/8 IDS	1"-14	SE-24591	SE-RCAP-01P		31523-1
H06SLA	3/4 IDS	1-1/4"-12	SE-24592	SE-RCAP-02P	998-0510-38	
H07SLA	7/8 IDS	1-1/4"-12	SE-24592	SE-RCAP-02P	998-0510-39	
H09SLA	1-1/8 IDS	1-1/4"-12	SE-24592	SE-RCAP-02P	998-0510-47	
H11SLA	1-3/8 IDS	1-3/4"-12	SE-24593	SE-RCAP-03P		

HORIZONTAL ROTOLOCK VALVES (CONTINUED)



RIGHT PORT

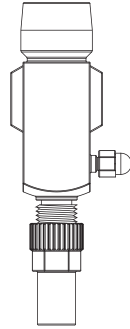

SIGMA PART NO.	CONN SIZE	ROTOLOCK CONNECTION	TEFLON SEAL PART NO.	BOTTOM CAP PART NO.	COPELAND X-REF	TECUMSEH X-REF
H03FRA	3/8 SAE	3/4"-16	SE-24590	SE-RCAP-01P		
H04FRA	1/2 SAE	1"-14	SE-24591	SE-RCAP-01P		
H05FRA	5/8 SAE	1"-14	SE-24591	SE-RCAP-01P	998-0510-56	31552-3
H03SRA	3/8 IDS	3/4"-16	SE-24590	SE-RCAP-01P		
H04SRA	1/2 IDS	1"-14	SE-24591	SE-RCAP-01P		
H05SRA	5/8 IDS	1"-14	SE-24591	SE-RCAP-01P		
H05X10SRA	5/8 IDS	1-1/4"-12	SE-24592	SE-RCAP-02P	998-0510-93	31531-1
H07SRA	7/8 IDS	1-1/4"-12	SE-24592	SE-RCAP-02P	998-0510-94	31529-1
H07X14SRA	7/8 IDS	1-3/4"-12	SE-24593	SE-RCAP-03P	998-0510-37	
H09SRA	1-1/8 IDS	1-1/4"-12	SE-24592	SE-RCAP-02P		
H09X14SRA	1-1/8 IDS	1-3/4"-12	SE-24593	SE-RCAP-03P	998-0510-02	31524-1
H11SRA	1-3/8 IDS	1-3/4"-12	SE-24593	SE-RCAP-03P	998-0510-46	
H11X18SRA	1-3/8 IDS	2-1/4"-12	SE-24594	SE-RCAP-03P	998-0510-67	

- Aluminum or Brass Service Port Caps; Aluminum is standard.
- Plastic Stem Caps are standard. Steel Stem Caps with copper seal are available as separate item.
- All valves include a 1/4" SAE service port. Secondary ports or Gauge ports are available. This port is typically used on a pressure control.
- The secondary gauge ports are supplied with a standard small diameter vent hole but can be supplied with a Schrader valve.
- Steel Stem Caps are standard on Dual Port Valves.

DUAL PORT

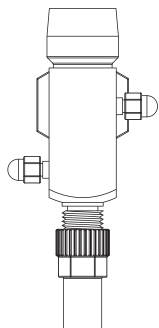

SIGMA PART NO.	CONN SIZE	ROTOLOCK CONNECTION	TEFLON SEAL PART NO.	BOTTOM CAP PART NO.	COPELAND X-REF	TECUMSEH X-REF
H03FDA	3/8 SAE	1"-14	SE-24591	SE-RCAP-01P	998-0510-42	31578-1
H04FDA	1/2 SAE	1"-14	SE-24591	SE-RCAP-01P	998-0510-40	31585
H05FDA	5/8 SAE	1"-14	SE-24591	SE-RCAP-01P	998-0510-41	31522-4
H03SDA	3/8 IDS	1"-14	SE-24591	SE-RCAP-01P	998-0510-97	31593
H04SDA	1/2 IDS	1"-14	SE-24591	SE-RCAP-01P	998-0510-98	31592
H05SDA	5/8 IDS	1"-14	SE-24591	SE-RCAP-01P	998-0511-00	31590
H05X10SDA	5/8 IDS	1-1/4"-12	SE-24592	SE-RCAP-02P	998-0510-69	
H06X08SDA	3/4 IDS	1"-14	SE-24591	SE-RCAP-01P	998-0511-02	
H06SDA	3/4 IDS	1-1/4"-12	SE-24592	SE-RCAP-02P		
H07X08SDA	7/8 IDS	1"-14	SE-24591	SE-RCAP-01P	998-0510-89	
H07SDA	7/8 IDS	1-1/4"-12	SE-24592	SE-RCAP-02P	998-0510-90	
H09SDA	1-1/8 IDS	1-1/4"-12	SE-24592	SE-RCAP-02P	998-0510-99	

VERTICAL ROTOLOCK VALVES



- Aluminum or Brass Service Port Caps; Aluminum is standard.
- Plastic Stem Caps are standard. Steel Stem Caps with copper seal are available as separate item.
- All valves include a 1/4" SAE service port. Secondary ports or Gauge ports are available. This port is typically used on a pressure control.
- The secondary gauge ports are supplied with a standard small diameter vent hole but can be supplied with a Schrader valve.

TOP PORT

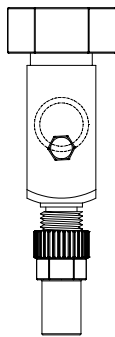

SIGMA PART NO.	CONN SIZE	ROTOLOCK CONNECTION	BODY SIZE	TEFLON SEAL PART NO.	BOTTOM CAP PART NO.	BEST MATCH BRASS ADAPTER
V03FTA	3/8 SAE	3/4"-16	3/4 hex	SE-24590	SE-RCAP-01P	BA03X06A
V04FTA	1/2 SAE	1"-14	7/8 sq	SE-24591	SE-RCAP-01P	BA04X08A
V05FTA	5/8 SAE	1"-14	7/8 sq	SE-24591	SE-RCAP-01P	BA05X08A
V03STA	3/8 IDS	3/4"-16	3/4 hex	SE-24590	SE-RCAP-01P	BA03X06A
V04STA	1/2 IDS	1"-14	7/8 sq	SE-24591	SE-RCAP-01P	BA04X08A
V05STA	5/8 IDS	1"-14	7/8 sq	SE-24591	SE-RCAP-01P	BA05X08A
V06STA	3/4 IDS	1-1/4"-12	7/8 sq	SE-24592	SE-RCAP-02P	BA06X10A
V07STA	7/8 IDS	1-1/4"-12	1-1/8 sq	SE-24592	SE-RCAP-02P	998-0510-49
V09STA	1-1/8 IDS	1-1/4"-12	1-1/8 sq	SE-24592	SE-RCAP-02P	BA09X10A
V11STA	1-3/8 IDS	1-3/4"-12	1-3/8 sq	SE-24593	SE-RCAP-03P	BA11X14A

LEFT PORT

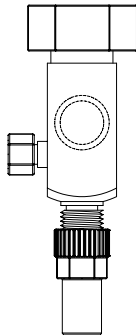

SIGMA PART NO.	CONN SIZE	ROTOLOCK CONNECTION	BODY SIZE	TEFLON SEAL PART NO.	BOTTOM CAP PART NO.	BEST MATCH BRASS ADAPTER
V03FLA	3/8 SAE	3/4"-16	3/4 hex	SE-24590	SE-RCAP-01P	BA03X06A
V04FLA	1/2 SAE	1"-14	7/8 sq	SE-24591	SE-RCAP-01P	BA04X08A
V05FLA	5/8 SAE	1"-14	7/8 sq	SE-24591	SE-RCAP-01P	BA05X08A
V03SLA	3/8 IDS	3/4"-16	3/4 hex	SE-24590	SE-RCAP-01P	BA03X06A
V04SLA	1/2 IDS	1"-14	7/8 sq	SE-24591	SE-RCAP-01P	BA04X08A
V05SLA	5/8 IDS	1"-14	7/8 sq	SE-24591	SE-RCAP-01P	BA05X08A
V06SLA	3/4 IDS	1-1/4"-12	7/8 sq	SE-24592	SE-RCAP-02P	BA06X10A
V07SLA	7/8 IDS	1-1/4"-12	1-1/8 sq	SE-24592	SE-RCAP-02P	998-0510-49
V09SLA	1-1/8 IDS	1-1/4"-12	1-1/8 sq	SE-24592	SE-RCAP-02P	BA09X10A
V11SLA	1-3/8 IDS	1-3/4"-12	1-3/8 sq	SE-24593	SE-RCAP-03P	BA11X14A

RIGHT PORT

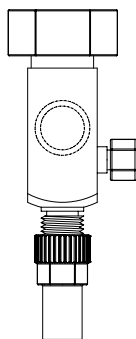

SIGMA PART NO.	CONN SIZE	ROTOLOCK CONNECTION	BODY SIZE	TEFLON SEAL PART NO.	BOTTOM CAP PART NO.	BEST MATCH BRASS ADAPTER
V03FRA	3/8 SAE	3/4"-16	3/4 hex	SE-24590	SE-RCAP-01P	BA03X06A
V04FRA	1/2 SAE	1"-14	7/8 sq	SE-24591	SE-RCAP-01P	BA04X08A
V05FRA	5/8 SAE	1"-14	7/8 sq	SE-24591	SE-RCAP-01P	BA05X08A
V03SRA	3/8 IDS	3/4"-16	3/4 hex	SE-24590	SE-RCAP-01P	BA03X06A
V04SRA	1/2 IDS	1"-14	7/8 sq	SE-24591	SE-RCAP-01P	BA04X08A
V05SRA	5/8 IDS	1"-14	7/8 sq	SE-24591	SE-RCAP-01P	BA05X08A
V06SRA	3/4 IDS	1-1/4"-12	7/8 sq	SE-24592	SE-RCAP-02P	BA06X10A
V07SRA	7/8 IDS	1-1/4"-12	1-1/8 sq	SE-24592	SE-RCAP-02P	998-0510-49
V09SRA	1-1/8 IDS	1-1/4"-12	1-1/8 sq	SE-24592	SE-RCAP-02P	BA09X10A
V11SRA	1-3/8 IDS	1-3/4"-12	1-3/8 sq	SE-24593	SE-RCAP-03P	BA11X14A

All items on this page can be ordered individually or by case quantity.

SERVICE VALVES FLANGE STYLE



SIGMA PART NO.	CONN SIZE	FLANGE SIZE BOLT CENTER	BODY SIZE	ACCESS PORTS QTY/POS	GASKET NUMBER	BOTTOM CAP PART NO.	COPELAND X-REF
2F03FLA-SB	3/8 SAE	2 Bolt 1-5/8	Steel 3/4 Hex	1 - Left	GASKE-2158-01R	SE-RCAP-01P	998-0510-26
2F03FRA-SB	3/8 SAE	2 Bolt 1-5/8	Steel 3/4 Hex	1 - Right	GASKE-2158-01R	SE-RCAP-01P	
2F04FLA-SB	1/2 SAE	2 Bolt 1-5/8	Steel 7/8 Sq	1 - Left	GASKE-2158-01R	SE-RCAP-01P	998-0510-22
2F04FRA-SB	1/2 SAE	2 Bolt 1-5/8	Steel 7/8 Sq	1 - Right	GASKE-2158-01R	SE-RCAP-01P	998-0510-24
2F05FLA-SB	5/8 SAE	2 Bolt 1-5/8	Steel 7/8 Sq	1 - Left	GASKE-2158-01R	SE-RCAP-01P	998-0510-23
2F05FRA-SB	5/8 SAE	2 Bolt 1-5/8	Steel 7/8 Sq	1 - Right	GASKE-2158-01R	SE-RCAP-01P	998-0510-25
2F03SLA-SB	3/8 IDS	2 Bolt 1-5/8	Steel 3/4 Hex	1 - Left	GASKE-2158-01R	SE-RCAP-01P	998-0510-36
2F03SRA-SB	3/8 IDS	2 Bolt 1-5/8	Steel 3/4 Hex	1 - Right	GASKE-2158-01R	SE-RCAP-01P	998-0510-35
2F04SLA-SB	1/2 IDS	2 Bolt 1-5/8	Steel 7/8 Sq	1 - Left	GASKE-2158-01R	SE-RCAP-01P	998-0510-34
2F04SRA-SB	1/2 IDS	2 Bolt 1-5/8	Steel 7/8 Sq	1 - Right	GASKE-2158-01R	SE-RCAP-01P	998-0510-32
2F05SLA-SB	5/8 IDS	2 Bolt 1-5/8	Steel 7/8 Sq	1 - Left	GASKE-2158-01R	SE-RCAP-01P	998-0510-31
2F05SRA-SB	5/8 IDS	2 Bolt 1-5/8	Steel 7/8 Sq	1 - Right	GASKE-2158-01R	SE-RCAP-01P	998-0510-33



SIGMA PART NO.	CONN SIZE	FLANGE SIZE BOLT CENTER	BODY TYPE	ACCESS PORTS QTY/POS	GASKET NUMBER	BOTTOM CAP PART NO.	COPELAND X-REF
2F03FDA-BB	3/8 SAE	2 Bolt 1-5/8	Cast Brass	Left & Right	GASKE-2158-01G	SE-RCAP-01B	998-0510-15
2F04FDA-BB	1/2 SAE	2 Bolt 1-5/8	Cast Brass	Left & Right	GASKE-2158-01G	SE-RCAP-01B	998-0510-16
2F05FDA-BB	5/8 SAE	2 Bolt 1-5/8	Cast Brass	Left & Right	GASKE-2158-01G	SE-RCAP-01B	998-0510-17
2F03SDA-BB	3/8 IDS	2 Bolt 1-5/8	Cast Brass	Left & Right	GASKE-2158-01G	SE-RCAP-01B	998-0510-04
2F04SDA-BB	1/2 IDS	2 Bolt 1-5/8	Cast Brass	Left & Right	GASKE-2158-01G	SE-RCAP-01B	998-0510-05
2F05SDA-BB	5/8 IDS	2 Bolt 1-5/8	Cast Brass	Left & Right	GASKE-2158-01G	SE-RCAP-01B	998-0510-06



SIGMA PART NO.	CONN SIZE	FLANGE SIZE BOLT CENTER	BODY TYPE	ACCESS PORTS QTY/POS	GASKET NUMBER	BOTTOM CAP PART NO.	COPELAND X-REF
2F06STA-BB	3/4 IDS	2 Bolt 1-5/8	Brass Solder	1 - Top	GASKE-2158-00G	SE-RCAP-04P	998-0510-14
2F07STA-BB	7/8 IDS	2 Bolt 1-5/8	Brass Solder	1 - Top	GASKE-2158-00G	SE-RCAP-04P	998-0510-12
2F09STA-BB	1-1/8 IDS	2 Bolt 1-5/8	Brass Solder	1 - Top	GASKE-2158-00G	SE-RCAP-04P	998-0510-13

SERVICE VALVES FLANGE STYLE



SIGMA PART NO.	CONN SIZE	FLANGE SIZE BOLT CENTER	BODYTYPE	ACCESS PORTS QTY/POS	GASKET NUMBER	BOTTOM CAP PART NO.	COPELAND X-REF
2F07STA-FU	7/8 IDS	2 Bolt 2-3/4	Brass Flange Union	1 - Top	GASKE-2234-00G	SE-RCAP-04P	998-0510-10
2F09STA-FU	1-1/8 IDS	2 Bolt 2-3/4	Brass Flange Union	1 - Top	GASKE-2234-00G	SE-RCAP-04P	998-0510-09
2F11STA-FU	1-3/8 IDS	2 Bolt 2-3/4	Brass Flange Union	1 - Top	GASKE-2234-00G	SE-RCAP-04P	998-0510-11

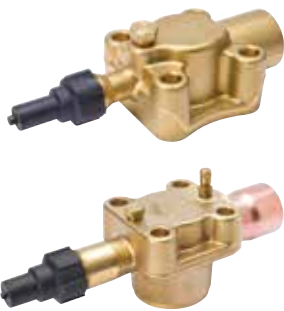

SIGMA PART NO.	CONN SIZE	FLANGE SIZE BOLT CENTER	BODYTYPE	ACCESS PORTS QTY/POS	GASKET NUMBER	BOTTOM CAP PART NO.	COPELAND X-REF
4F09STA-BB	1-1/8 IDS	4 Bolt 2-1/2	Brass Solder	1 - Top	GASKE04250G	SE-RCAP-04P	
4F11STA-BB	1-3/8 IDS	4 Bolt 2-1/2	Brass Solder	1 - Top	GASKE04250G	SE-RCAP-04P	998-0510-08
4F13STA-BB	1-5/8 IDS	4 Bolt 2-1/2	Brass Solder	1 - Top	GASKE04250G	SE-RCAP-04P	998-0510-21
4F17SDA-BB	2-1/8 IDS	4 Bolt 3-1/16	Brass Solder	2 - Top	GASKE002672	SE-RCAP-04P	998-0510-01



SIGMA PART NO.	CONN SIZE	FLANGE SIZE BOLT CENTER	BODYTYPE	ACCESS PORTS QTY/POS	GASKET NUMBER	BOTTOM CAP PART NO.	COPELAND X-REF
4F13STA-CIA	1-5/8 IDS	4 Bolt 2-1/2	Brass	1 - Top	GASKE001831 GASKE04250G	SE-RCAP-04P	998-0510-07

This item is a lower cost option of the Cast Iron Valve 4F13STA-CI, which is Copeland PN **998-0510-07**.



SIGMA PART NO.	CONN SIZE	FLANGE SIZE BOLT CENTER	BODYTYPE	ACCESS PORTS QTY/POS	GASKET NUMBER	BOTTOM CAP PART NO.	COPELAND X-REF
4F13STA-CI	1-5/8 IDS	4 Bolt 2-1/2	Cast Iron	1 - Top	GASKE001831	SE-RCAP-53P*	998-0510-07
4F17STA-CI	2-1/8 IDS	4 Bolt 3-1/16	Cast Iron	1 - Top	GASKE002672	SE-RCAP-54P*	998-0510-20
4F21STA-CI	2-5/8 IDS	4 Bolt 3-7/8	Cast Iron	1 - Top	GASKE000637	SE-RCAP-54P*	998-0510-19
4F25STA-CI	3-1/8 IDS	4 Bolt 3-7/8	Cast Iron	1 - Top	GASKE000637	SE-RCAP-54PL*	998-0510-18

* See **CAP MASTER** Chart for cross reference to ensure correct replacement. Cast Iron Caps are obsolete.

Note about Metric Caps: The newer cast iron valves will have a Metric thread for the bottom cap. The old caps will not fit the new valves and the new caps will not fit the old valves. Sigma has inventory of both items so please refer to the **CAP MASTER** sheet to identify your needs.

CROSS REFERENCE ROTOLOCK VALVES

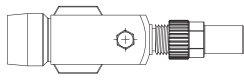

STYLE 1

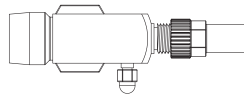

STYLE 2

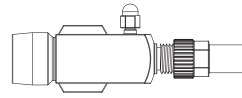

STYLE 3

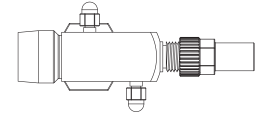

STYLE 4

COPELAND KIT NO.	SIGMA PART NO.	ALTERNATE SIGMA PART NO.	BODY STYLE	TEFLON SEAL PART NO.	BOTTOM CAP PLASTIC	BOTTOM CAP STEEL	BEST MATCH BRASS ADAPTER
998-0510-02	H09X14SRA		Style 3	SE-24593	SE-RCAP-03P	SE-RCAP-03S	BA09X14A
998-0510-37	H07X14SRA		Style 3	SE-24593	SE-RCAP-03P	SE-RCAP-03S	BA09X14A
998-0510-38	H06SLA		Style 2	SE-24592	SE-RCAP-02P	SE-RCAP-02S	BA07X10A
998-0510-39	H07SLA	H07STA or H07SRA	Style 2	SE-24592	SE-RCAP-02P	SE-RCAP-02S	BA07X10A
998-0510-40	H04FDA		Style 4	SE-24591	SE-RCAP-01P	SE-RCAP-01S	BA04X08A
998-0510-41	H05FDA		Style 4	SE-24591	SE-RCAP-01P	SE-RCAP-01S	BA05X08A
998-0510-42	H03FDA		Style 4	SE-24591	SE-RCAP-01P	SE-RCAP-01S	BA03X08A
998-0510-43	H03SDA		Style 4	SE-24591	SE-RCAP-01P	SE-RCAP-01S	BA03X08A
998-0510-44	H04SDA		Style 4	SE-24591	SE-RCAP-01P	SE-RCAP-01S	BA04X08A
998-0510-45	H05SDA		Style 4	SE-24591	SE-RCAP-01P	SE-RCAP-01S	BA05X08A
998-0510-46	H11SRA	H11STA or H11SLA	Style 3	SE-24593	SE-RCAP-03P	SE-RCAP-03S	BA11X14A
998-0510-47	H09SLA		Style 2	SE-24592	SE-RCAP-02P	SE-RCAP-02S	BA09X10A
998-0510-49	V07STA	V07SRA or V07SLA	Style 1	SE-24592	SE-RCAP-02P	SE-RCAP-02S	BA07X10A
998-0510-51	H09SDA		Style 4	SE-24592	SE-RCAP-02P	SE-RCAP-02S	BA09X10A
998-0510-52	H07X08SDA		Style 4	SE-24591	SE-RCAP-01P	SE-RCAP-01S	BA05X08A
998-0510-56	H05FRA	H05FTA or H05FLA	Style 3	SE-24591	SE-RCAP-01P	SE-RCAP-01S	BA05X08A
998-0510-58	H03X08FLA	H04FLA	Style 2	SE-24591	SE-RCAP-01P	SE-RCAP-01S	BA03X08A
998-0510-66	H13STA		Style 1	SE-24593	SE-RCAP-03P	SE-RCAP-03S	BA11X14A
998-0510-67	H11X18SRA		Style 3	SE-24594	SE-RCAP-03P	SE-RCAP-03S	BA13X18A
998-0510-68	H13X18STA		Style 1	SE-24594	SE-RCAP-04P	SE-RCAP-04B	BA13X18A
998-0510-69	H05X10SDA		Style 4	SE-24592	SE-RCAP-01P	SE-RCAP-01S	BA05X10A
998-0510-89	H07X08SDA		Style 4	SE-24591	SE-RCAP-01P	SE-RCAP-01S	BA05X08A
998-0510-90	H07SDA		Style 4	SE-24592	SE-RCAP-02P	SE-RCAP-02S	BA07X10A
998-0510-93	H05X10SRA		Style 3	SE-24592	SE-RCAP-01P	SE-RCAP-01S	BA05X10A
998-0510-94	H07SRA	H07STA or H07SLA	Style 3	SE-24592	SE-RCAP-02P	SE-RCAP-02S	BA07X10A
998-0510-97	H03SDA		Style 4	SE-24591	SE-RCAP-01P	SE-RCAP-01S	BA03X08A
998-0510-98	H04SDA		Style 4	SE-24591	SE-RCAP-01P	SE-RCAP-01S	BA04X08A
998-0510-99	H09SDA		Style 4	SE-24592	SE-RCAP-02P	SE-RCAP-02S	BA09X10A
998-0511-00	H05SDA		Style 4	SE-24591	SE-RCAP-01P	SE-RCAP-01S	BA05X08A
998-0511-02	H06X08SDA		Style 4	SE-24591	SE-RCAP-01P	SE-RCAP-01S	BA05X08A

CROSS REFERENCE SERVICE VALVES (FLANGE STYLE)



COPELAND KIT NO.	SIGMA PART NO.	BODY STYLE	SERVICE PORT	GASKET PART NO.	BOTTOM CAP PLASTIC	STEEL CAP (S) BRASS CAP (B) ALUM CAP (A)
998-0510-04	2F03SDA-BB	Brass Body	Dual	GASKE-2158-01G	SE-RCAP-01P	SE-RCAP-01B
998-0510-05	2F04SDA-BB	Brass Body	Dual	GASKE-2158-01G	SE-RCAP-01P	SE-RCAP-01B
998-0510-06	2F05SDA-BB	Brass Body	Dual	GASKE-2158-01G	SE-RCAP-01P	SE-RCAP-01B
998-0510-07	4F13STA-CI	Cast Iron	Top	GASKE001831	SE-RCAP-53P	SE-RCAP-53A
998-0510-08	4F11STA-BB	Brass Body	Top	GASKE04250G	SE-RCAP-04P	SE-RCAP-04B
998-0510-09	2F09STA-FU	Brass Body	Top	GASKE-2234-00G	SE-RCAP-04P	SE-RCAP-04B
998-0510-10	2F07STA-FU	Brass Body	Top	GASKE-2234-00G	SE-RCAP-04P	SE-RCAP-04B
998-0510-11	2F11STA-FU	Brass Body	Top	GASKE-2234-00G	SE-RCAP-04P	SE-RCAP-04B
998-0510-12	2F07STA-BB	Brass Body	Top	GASKE-2158-00G/R	SE-RCAP-04P	SE-RCAP-04B
998-0510-13	2F09STA-BB	Brass Body	Top	GASKE-2158-00G/R	SE-RCAP-04P	SE-RCAP-04B
998-0510-14	2F06STA-BB	Brass Body	Top	GASKE-2158-00G/R	SE-RCAP-04P	SE-RCAP-04B
998-0510-15	2F03FDA-BB	Brass Body	Dual	GASKE-2158-01G	SE-RCAP-01P	SE-RCAP-01B
998-0510-16	2F04FDA-BB	Brass Body	Dual	GASKE-2158-01G	SE-RCAP-01P	SE-RCAP-01B
998-0510-17	2F05FDA-BB	Brass Body	Dual	GASKE-2158-01G	SE-RCAP-01P	SE-RCAP-01B
998-0510-18	4F25STA-CI	Brass Body	Top	GASKE000637	SE-RCAP-54PL	SE-RCAP-54AL
998-0510-19	4F21STA-CI	Cast Iron	Top	GASKE000637	SE-RCAP-54P	SE-RCAP-54A
998-0510-20	4F17STA-CI	Cast Iron	Top	GASKE002672	SE-RCAP-54P	SE-RCAP-54A
998-0510-21	4F13STA-BB	Brass Body	Top	GASKE04250G	SE-RCAP-04P	SE-RCAP-04B
998-0510-22	2F04FLA-SB	Steel Body	Left	GASKE-2158-01R	SE-RCAP-01P	SE-RCAP-01S
998-0510-23	2F05FLA-SB	Steel Body	Left	GASKE-2158-01R	SE-RCAP-01P	SE-RCAP-01S
998-0510-24	2F04FRA-SB	Steel Body	Right	GASKE-2158-01R	SE-RCAP-01P	SE-RCAP-01S
998-0510-25	2F05FRA-SB	Steel Body	Right	GASKE-2158-01R	SE-RCAP-01P	SE-RCAP-01S
998-0510-26	2F03FLA-SB	Steel Body	Left	GASKE-2158-01R	SE-RCAP-01P	SE-RCAP-01S
998-0510-31	2F05SLA-SB	Steel Body	Left	GASKE-2158-01R	SE-RCAP-01P	SE-RCAP-01S
998-0510-31	2F05SRA-SB	Steel Body	Right	GASKE-2158-01R	SE-RCAP-01P	SE-RCAP-01S
998-0510-32	2F04SRA-SB	Steel Body	Right	GASKE-2158-01R	SE-RCAP-01P	SE-RCAP-01S
998-0510-33	2F05SLA-SB	Steel Body	Left	GASKE-2158-01R	SE-RCAP-01P	SE-RCAP-01S
998-0510-34	2F04SLA-SB	Steel Body	Left	GASKE-2158-01R	SE-RCAP-01P	SE-RCAP-01S
998-0510-35	2F03SRA-SB	Steel Body	Right	GASKE-2158-01R	SE-RCAP-01P	SE-RCAP-01S
998-0510-36	2F03SLA-SB	Steel Body	Left	GASKE-2158-01R	SE-RCAP-01P	SE-RCAP-01S
998-0511-01	4F17STA-BB	Brass Body	Dual Top	GASKE001831	SE-RCAP-04P	SE-RCAP-04B

CAP MASTER CHART

Caps shown actual size • Match your cap and place your order • In stock and ready to ship



SE-SCAP-CB45-**
Material: Brass/Cu Bonnet
THIS CAP ONLY - NOT ACTUAL SIZE
Thread: 1/4" SAE



SE-RCAP-20B
Material: Brass
Height: 1-1/2"
Thread: 11/16"-20



SE-RCAP-01B
Material: Brass
Height: 1-3/8"
Thread: 3/4"-16
505-0431-00



SE-RCAP-01S
Material: Steel*
Height: 1-3/8"
Thread: 3/4"-16
005-0601-00



SE-RCAP-01P
Material: Plastic
Height: 1-7/16"
Thread: 3/4"-16



SE-RCAP-02S
Material: Steel*
Height: 1-7/8"
Thread: 3/4"-16



SE-RCAP-02P
Material: Plastic
Height: 1-7/8"
Thread: 3/4"-16
005-0585-00



SE-RCAP-03S
Material: Steel*
Height: 2-1/4"
Thread: 1"-14
505-0438-00



SE-RCAP-03P
Material: Plastic
Height: 2-3/8"
Thread: 1"-14
505-0435-00



SE-RCAP-04P
Material: Valox
Height: 2-3/16"
Thread: 1-1/16"-18
505-0280-00



SE-RCAP-04B
Material: Brass
Height: 2-5/16"
Thread: 1-1/16"-18
505-0374-00



SE-RCAP-06P
Material: CFIP*
Height: 2-3/16"
Thread: 1-3/8"-12
005-0663-00



SE-RCAP-08P
Material: Valox
Height: 3-1/8"
Thread: 1-5/8"-12
005-0664-00



SE-RCAP-53P
Material: Valox
Height: 2-3/16"
Thread: M27 x 2
005-0953-00



SE-RCAP-54P
Material: Valox
Height: 2-5/8"
Thread: M36 x 1.5
005-0954-00

* Steel Caps finish may vary between Black and Silver. CFIP= Carbon Fiber Infused Polycarbonate

CAP MASTER CHART

Caps shown actual size • Match your cap and place your order • In stock and ready to ship



SE-RCAP-10S
Material: Steel
Height: 1-1/2"
Thread: 7/8"-18



SE-RCAP-22P
Material: Valox
Height: 2-1/32"
Thread: M22 x 1.5



SE-RCAP-24P
Material: Valox
Height: 2-5/16"
Thread: M24 x 2



SE-RCAP-53A
Material: Alum
Height: 2-3/4"
Thread: M27 x 2
005-0953-00



SE-RCAP-54A
Material: Alum
Height: 2-5/8"
Thread: M36 x 1.5
005-0954-00

REPLACEMENT CAPS FOR ROTOLock & SERVICE VALVES

SINGLE PACK	10 PACK	DESCRIPTION	COPELAND PART NO.
SE-RCAP-01B	SE-RCAP-01BB	Rotolock Stem Cap BRASS, Short, 3/4"-16 Thread x 1-3/8" Tall	505-0431-00
SE-RCAP-01P	SE-RCAP-01PB	Rotolock Stem Cap PLASTIC, Short, 3/4"-16 Thread x 1-7/16" Tall	N/A
SE-RCAP-01S	SE-RCAP-01SB	Rotolock Stem Cap STEEL, Short, 3/4"-16 Thread x 1-3/8" Tall	005-0601-00
SE-RCAP-02P	SE-RCAP-02PB	Rotolock Stem Cap PLASTIC, Medium, 3/4"-16 Thread x 1-7/8" Tall	005-0585-00
SE-RCAP-02S	SE-RCAP-02SB	Rotolock Stem Cap STEEL, Medium, 3/4"-16 Thread x 1-7/8" Tall	N/A
SE-RCAP-03P	SE-RCAP-03PB	Rotolock Stem Cap PLASTIC, Large, 1"-14 Thread x 2-3/8" Tall	505-0435-00
SE-RCAP-03S	SE-RCAP-03SB	Rotolock Stem Cap STEEL, Large, 1"-14 Thread x 2-1/4" Tall	505-0438-00
SE-RCAP-04B	SE-RCAP-04BB	Service Valve Cap BRASS, 1-1/16"-18 Thread x 2-5/16" Tall	505-0374-00
SE-RCAP-04P	SE-RCAP-04PB	Service Valve Cap VALOX, 1-1/16"-18 Thread x 2-3/16" Tall	505-0280-00
SE-RCAP-06P	SE-RCAP-06PB	Service Valve Cap CFIP*, 1-3/8"-12 Thread x 2-3/16" Tall	005-0663-00
SE-RCAP-08P	SE-RCAP-08PB	Service Valve Cap VALOX, 1-5/8"-12 Thread x 3-1/8" Tall	005-0664-00
SE-RCAP-10S	SE-RCAP-10SB	Service Valve Cap STEEL, 7/8"-18 Thread x 1-1/2" Tall	N/A
SE-RCAP-12P	SE-RCAP-12PB	Rotolock Stem Cap VALOX, Medium, 3/4"-16 Thread w/ O-RING	005-0585-00
SE-RCAP-20B	SE-RCAP-20BB	Service Valve Cap BRASS, 11/16"-20 Thread x 1-1/2" Tall	N/A
SE-RCAP-22P	SE-RCAP-22PB	Service Valve Cap Valox, M22 x 1.5 Thread x 1-7/8" Tall	NEW!
SE-RCAP-24P	SE-RCAP-24PB	Service Valve Cap Valox, M24 x 2.0 Thread x 2-1/4" Tall	NEW!
SE-RCAP-53P	SE-RCAP-53PB	Service Valve Cap Valox, M27 x 2.0 Thread x 2-3/16" Tall	005-0953-00
SE-RCAP-54P	SE-RCAP-54PB	Service Valve Cap Valox, M36 x 1.5 Thread x 2-5/8" Tall	005-0954-00
SE-RCAP-53A	SE-RCAP-53AB	Service Valve Cap ALUMINUM, M27 x 2.0 Thread x 2-3/16" Tall	005-0953-00
SE-RCAP-54A	SE-RCAP-54AB	Service Valve Cap ALUMINUM, M36 x 1.5 Thread x 2-5/8" Tall	005-0954-00

* CFIP - Sigma Engineering exclusive Carbon Fiber Infused Polycarbonate design.

POPULAR ADDITIONS TO THE SIGMA ENGINEERING PRODUCT OFFERING

The seasoned Technician will remember this product. It combines the "Acorn" nut with a Copper Crush Bonnet in a **1/4" SAE 45 Flare Cap!** This used to be standard issue stuff until the cost police eliminated it; but refrigerant loss is too expensive to ignore making it a no brainer for the Service Company that is responsible for refrigerant loss! This does not have a rubber seal that often grabs and damages the Shrader causing additional problems.

**CB45 CAP
SUPERMARKET
LEAK STOPPER**

BENEFITS

- Copper crush bonnet
- Hex flats to tighten
- No shrader damage
- Re-useable
- Reliable

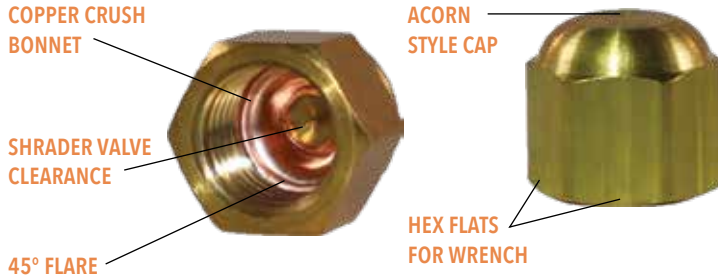

PART NO.	DESCRIPTION
SE-SCAP-CB45-6	6 pcs CB45 CAP
SE-SCAP-CB45-10	10 pcs CB45 CAP
SE-SCAP-CB45-25	25 pcs CB45 CAP
SE-SCAP-CB45-100	100 pcs CB45 CAP

DRAIN MATE RTUv

SE-DM15

The P-Trap that you have been waiting for is finally here! Introducing the Drain Mate RTUv. It is designed for Rooftop Packaged HVAC units and it addresses problems that are common to this application! No more snapping the trap when a service technician brushes against it—as they are usually brittle. No more freezing and bursting PVC—as the flexible design nearly eliminates the ability to crack under freezing conditions. No more UV problems—as the material incorporates aggressive UV inhibitors to extend product life in harsh sunny environments.

**DM15
THE BEST CONDENSATE
TRAP EVER!**

FEATURES

- Flexible material resists breakage
- Multiple mounting positions
- UV inhibitors greatly extend product life
- Soft composition resists bursting under freezing conditions
- No Spring callbacks for cracked pipes

APPLICATION

- 3/4" PVC Coupling Pipe will fit Drain Mate RTUv ID
- 1" PVC will fit Drain Mate RTUv OD
- Multiple mounting methods



ACCESSORY SERVICE ITEMS FOR CONDENSERS & RECEIVERS

PART NO.	DESCRIPTION	APPLICATION	DIMENSIONS
ZN 60	Zinc Plate Anode	6-5/8" Dia. Condenser	6" OD x .250"
ZN 65		6-5/8" Dia. Condenser	6-5/8" OD x .250"
ZN 85		8-5/8" Dia. Condenser	8-5/8" OD x .250"
ZN 105		10-3/4" Dia. Condenser	10-3/4" OD x .250"
ZN 122	Zinc PLUG Anode	3/4"-10 UNC Plug Thread	1/2" Dia x 2-3/8" Long
ZN 3332		3/8" NPT Plug Thread	3/8" Dia x 1" Long



ZN PLATE ANODE



ZN 122 PLUG ANODE



ZN 3332 PLUG ANODE

UNIVERSAL

PART NO.	DIMENSIONS (INCHES)					
	A	B	C	D	E	F
5A	5	5-1/2	7	2-9/16		
6A	6	5-1/2	7	2-9/16		
6B	6-5/8	5-1/2	7	2-9/16	7/16	1-1/16
8B	8-5/8	8	9	2-7/8		
10B	10-3/4	10	11	3-5/16		
12B	12-3/4	11-5/8	13	4-1/8		
14B	14	13 1/4	14-1/2	4-1/8	9/16	1-1/2
16B	16	15-3/4	17	4-1/8		

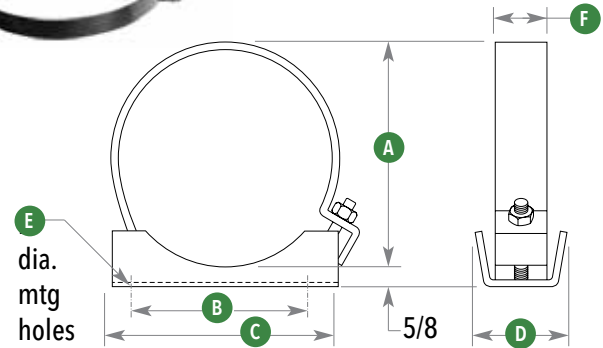

COMPRESSOR/CONDENSER

PART NO.	DIMENSIONS (INCHES)	
	A	B
BR1	6	14
BR3	6-5/8	
BR5	8-5/8	
BR7	10-3/4	
BR9	12-3/4	24
BR10	14	
BR11	16	
BR12	18	
BR13	20	

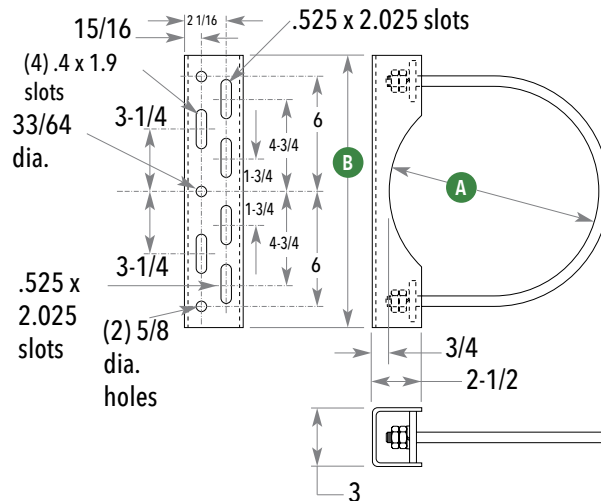

DOOR REPAIR PARTS FOR ANTHONY, GEMTRON & HUSSMANN DOORS

ELECTRICAL REPLACEMENT ITEMS



SE-HP-L-SLV

Hinge Pin with Leads: **Silver**
Anthony PN: **60-10847-0003**



SE-HP-L-BLK

Hinge Pin with Leads: **Black**
Anthony PN: **60-10847-0004**



SE-HP-NL-SLV

Hinge Pin NO Leads: **Silver**
Anthony PN: **60-10848-0001**



SE-HP-NL-BLK

Hinge Pin NO Leads: **Black**
Anthony PN: **60-10848-0002**



SE-EHPR-3-SGL

Hinge Pin Receptacle L/R: **3-Wire**
Anthony PN: **60-12376-0001/0002**



SE-EHPR-6-DBL

Hinge Pin Receptacle L/R: **6-Wire**
Anthony PN: **60-12377-0001**

SIGMA PART NO.	DESCRIPTION	ANTHONY CROSS PART NO.
SE-HP-L-SLV	Anthony Hinge Pin with Leads - Silver	60-10847-0003
SE-HP-L-BLK	Anthony Hinge Pin with Leads - Black	60-10847-0004
SE-HP-NL-SLV	Anthony Hinge Pin with NO Leads - Silver	60-10848-0001
SE-HP-NL-BLK	Anthony Hinge Pin with NO Leads - Black	60-10848-0002
SE-EHPR-3-SGL	Electrical Hinge Pin Single Receptacle L/R - 3-Wire	60-12376-0001/0002
SE-EHPR-6-DBL	Electrical Hinge Pin Double Receptacle - 6-Wire	60-12377-0001

DOOR REPAIR

MECHANICAL REPLACEMENT ITEMS



SE-TMR-SLV (SINGLE PACK)
SE-TMR-SLV-6 (6 PACK)

Reversible Torque Master: **Silver**
 Anthony PN: **02-10568-00**



SE-TMR-BLK (SINGLE PACK)
SE-TMR-BLK-6 (6 PACK)

Reversible Torque Master: **Black**
 Anthony PN: **02-10568-03**



SE-TR-29-HEX (SINGLE PACK)
SE-TR-29-HEX10 (10 PACK)

29" Torque Rod with Hex Base
 Anthony PN: **02-10308-0007**



SE-DHO-ASSY

Door Hold Open Assembly with Hardware
 Anthony PN: **02-14649-0001**



SE-DHO-OS-ASSY (KIT WITH OVERSIZED HARDWARE)
SE-DHO-OS-HDW (OVERSIZED HARDWARE ONLY)

Oversized Hold Open Hardware and Kit
 Anthony PN: **02-14649-01 Oversize**

SIGMA PART NO.	DESCRIPTION	ANTHONY CROSS PART NO.
SE-TMR-SLV	Silver Torque Master Reversible for Anthony Door - 1 pack	02-10568-0001
SE-TMR-SLV-6	Silver Torque Master Reversible for Anthony Door - 6 pack	02-10568-0001
SE-TMR-BLK	Black Torque Master Reversible for Anthony Door - 1 pack	02-10568-0003
SE-TMR-BLK-6	Black Torque Master Reversible for Anthony Door - 6 pack	02-10568-0003
SE-TR-29-HEX	29" Torque Rod with Hex Base for Anthony Door	02-10308-0007
SE-TR-29-HEX10	29" Torque Rod with Hex Base for Anthony Door - 10 pack	02-10308-0007
SE-DHO-ASSY	Anthony Hold Open Assy with Hardware	02-14649-0001
SE-DHO-OS-ASSY	Anthony Hold Open Assy with Oversize Hardware	02-14649-0001 OVERSIZE
SE-DHO-OS-HDW	Anthony Hold Open Oversize Hardware Only	

HUSSMANN DOOR PARTS (NOT PICTURED)

SE-TR-33LH-HUSS

Hussmann Torque Rod LH Only
 Hussmann PN: **0428627**

SE-BASEP-HUSS

Hussmann Base Plate Only L & R
 Hussmann PN: **0428586**

CHILLER BARREL & CONDENSER GASKETS & ENDPLATES

We are the official source for all of the Gaskets, Heads, and Parts for the Standard Refrigeration line of heat exchangers. This includes current products, as well as legacy products. The Gaskets on the following pages are still manufactured by Sigma Engineering and are readily available. Our technical support team can assist you in selecting the proper item and we can also assist with installation instructions and torque recommendations.



EVAPORATORS - GASKET CROSS REFERENCE

MODELS	FRONT (GASKET)	REAR (GASKET)	SINGLE CIRCUIT	DUAL CIRCUIT	QUAD CIRCUIT
TX2	2865	2865	Fig. A	NA	NA
TX3	2865	2865	Fig. A	NA	
TX5	2872	2872	Fig. A	NA	
TX6	2872	2872	Fig. A	NA	
TX7.5	2872	2872	Fig. A	NA	
TX10	2872	2872	Fig. A	Fig. C	
TX12	2889	2889	Fig. A	Fig. C	
TX15	2889	2889	Fig. A	Fig. C	
TX20	2889	2889	Fig. A	Fig. C	
TX25	2889	2889	Fig. A	Fig. C	
TXC30	2218	2218	Fig. B	Fig. D	
TXC40	2227	2227	Fig. B	Fig. D	
TXC50	2227	2227	Fig. B	Fig. D	
TXC60	2227	2227	Fig. B	Fig. D	
TXC75	2227	2227	Fig. B	Fig. D	
TXC100	4892	4804	Fig. A	Fig. C	
TXC120	4892	4804	Fig. A	Fig. C	
TXC150	3549	3549	NA	Fig. C	
TXC175	5169	5169	NA	Fig. D	
TXC200	5169	5169	NA	Fig. D	
TXC250	3675	3675	NA	Fig. C	
TXC300	3637	3637	NA	Fig. C	
TXC400	3637	4878	NA	Fig. C	
TXC500	3532	3532	NA	Fig. D	

FIGURE A SINGLE CIRCUIT DUAL PASS

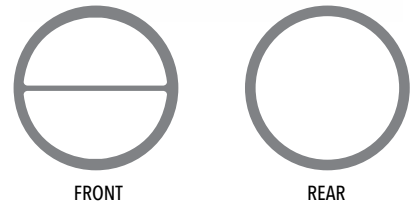

FIGURE B SINGLE CIRCUIT FOUR PASS

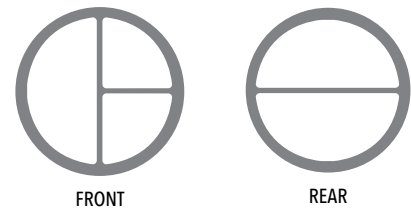

FIGURE C DUAL CIRCUIT DUAL PASS

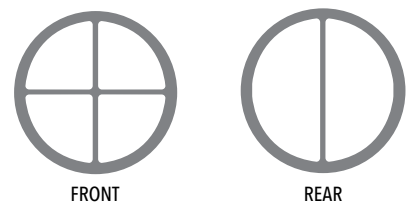
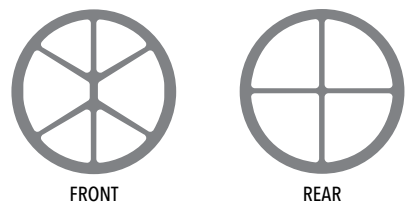

FIGURE D DUAL CIRCUIT FOUR PASS



SST – GASKET AND ENDPLATES CROSS REFERENCE

MODELS	FRONT GASKET	REAR GASKET	FRONT ENDPLATE	REAR ENDPLATE
SST 75A	3156	346	4304	30
SST 75	337	346	49	30
SST 100A	3163	3149	5040	5026
SST 100	175	184	67	58
SST 150	175	184	67	58
SST 200A	3101	3170	5819	76
SST 200	193	201	85	76
SST 300A	3101	3170	5819	76
SST 300	193	201	85	76
SST 500A	3118	2584	5938	4047
SST 500	210	229	120	21
SST 750A	3118	2584	5938	4047
SST 750	210	229	12	21
SST 755A	3118	2584	5938	4047
SST 755	238	247	12	21
SST 1000A	1723	2953	6605	4047
SST 1000	238	247	12	21
SST 1500A	1723	2953	5576	4047
SST 1501	2977	2584	175	4047
SST 1555A	2591	2984	5907	4180
SST 1555	256	265	193	184
SST 2005A	2591	2984	5914	4180
SST 2005	256	265	148	184
SST 2026A	2591	2984	5914	4180
SST 2026	256	265	148	184
SST 2505A	2591	2984	6205	4180
SST 2505	256	265	148	184
SST 2527A	2591	2984	6205	4180
SST 2527	256	265	148	184
SST 3005A	2591	2984	6205	4180
SST 3005	256	265	148	184
SST 3028A	2591	2984	6205	4180

MODELS	FRONT GASKET	REAR GASKET	FRONT ENDPLATE	REAR ENDPLATE
SST 3028	256	265	148	184
SST 30-460M	166	111	166	157
SST 3505A	2591	2984	6205	4180
SST 35-520M	166	111	201	157
SST 4005A	111	120	210	238
SST 40-610M	111	120	210	238
SST 4505A	111	120	210	238
SST 45-680M	111	120	210	238
SST 5005A	111	120	247	238
SST 50-760M	111	120	210	238
SST 5505A	111	120	247	238
SST 55-850M	111	120	210	238
SST 6005A	111	120	247	238
SST 60-940M	111	120	247	238
SST 7005A	111	120	247	238
SST 70-1060M	111	120	247	238
SST 8005A	111	120	247	238
SST 80-1200M	111	120	247	238
SST 100-1408A	120	120	2245	2245
SST 100-1500M	111	120	247	238
SST 120-1408A	120	120	2245	2245
SST 126-1905M	120	120	3994	3994
SST 150-1410A	120	120	2245	2245
SST 150-2250M	2254	2254	1039	1039
SST 200-1412A	120	120	4335	4335
SST 200-3000M	2263	2263	1048	1048
SST 250-3750M	1679	1679	1057	1057
SST 300-4500M	1688	1688	1066	1066
SST 350-5250M	1688	1688	1066	1066
SST 400-6000M	2290	2290	1921	1921
SST 500-7500M	2290	2290	1921	1921

This chart is to be used for reference purposes only.
For replacement parts contact customer service with your condenser model and serial numbers.

HSE/HP/CA/MSE – GASKET AND ENDPLATES CROSS REFERENCE

MODELS	FRONT GASKET	REAR GASKET	FRONT ENDPLATE	REAR ENDPLATE
HSE 2	337	346	6412	30
HSE 3	175	184	6717	5026
HSE 5	3718	3170	6229	76
HSE 7	3718	3170	5552	76
HSE 10	3718	3170	5552	76
HSE 15	445	247	5495	21
HSE 20A	2953	2584	5707	4047
HSE 20	1723	1732	2227	21
HSE 25A	2953	2584	5707	4047
HSE 25	1723	1732	2227	21
HSE 30A	1741	2984	5583	4180
HSE 30	1741	1750	2236	4180
HSE 40A	1741	2984	6900	4180
HSE 40	1741	1750	2236	4180
HSE 50A	1741	2984	6900	4180
HSE 50	1741	1750	2236	4180
HSE 60	111	120	247	238
HSE 70	111	120	247	238
HSE 80	111	120	247	238
HSE 100	120	120	2245	2245
HSE 125	120	120	2245	2245
HSE 150	2254	2254	1039	1039
HSE 200	2263	2263	1048	1048
HSE 250	1679	1679	1057	1057
HSE 300	1688	1688	1066	1066
HSE 350	1688	1688	1066	1066
HSE 400	2290	2290	1921	1921
HSE 450	2290	2290	1921	1921
HSE 500	2290	2290	1921	1921

This chart is to be used for reference purposes only. For replacement parts contact customer service with your condenser model and serial numbers.

MODELS	FRONT GASKET	REAR GASKET	FRONT ENDPLATE	REAR ENDPLATE
HP 10	Call/Contact Customer Service			
HP 15				
HP 20				
HP 30				
HP 40				
HP 50				
HP 60				
HP 80				

MODELS	FRONT GASKET	REAR GASKET	FRONT ENDPLATE	REAR ENDPLATE
CA 050	355	364	2876	2885
CA 075	238	247	2911	2902
CA 100	238	247	2911	2902
CA 150	256	265	2920	2948
CA 200	445	247	2894	2902
CA 300	373	265	2939	2948

MODELS	FRONT GASKET	REAR GASKET	FRONT ENDPLATE	REAR ENDPLATE
MSE 100	3163	3149	6436	300
MSE 200	3163	3149	6436	300
MSE 300	355	364	6386	337
MSE 500	355	364	6386	337
MSE 750	436	364	6281	4461
MSE 1005	436	364	6281	4461
MSE 1500	445	2584	5752	4104
MSE 2005	1723	2953	5752	4104
MSE 2505	1723	2953	5752	4104
MSE 3006	1723	2953	6467	4104
MSE 3305	1741	2984	6481	5114
MSE 4005	1741	2984	6481	5114
MSE 4505	1741	2984	6481	5114
MSE 5005	1741	2984	6481	5114
MSE 6505	111	120	2542	5233
MSE 7505	111	120	2542	5233
MSE 100Hp	4092	4092	120	120
MSE 120Hp	4092	4092	120	120

This chart is to be used for reference purposes only. For replacement parts contact customer service with your condenser model and serial numbers. MSE models with zinc anode may require a special rear endplate. Please Call/Contact Customer Service.



ELT/KHX - GASKET AND ENDPLATES CROSS REFERENCE

MODELS	FRONT GASKET	REAR GASKET	FRONT ENDPLATE	REAR ENDPLATE
ELT 100A	5057	5064	3055	3073
ELT 150A	5057	5064	3055	3073
ELT 200A	5057	5057	3055	3154
ELT 300A	2191	2209	3253	3280
ELT 500A	2191	2209	3253	3280
ELT 800A	2461	2470	3451	3482
ELT 1000A	2461	2470	3451	3482
ELT 50	2092	2100	3046	3064
ELT 75	2092	2100	3046	3064
ELT 100	2092	2100	3046	3064
ELT 150	2092	2100	3046	3064
ELT 200	2092	2092	3424	3424
ELT 300	2191	2209	3262	3280
ELT 500	2191	2209	3262	3280
ELT 800	2461	2470	3475	3482
ELT 1000	2461	2470	3475	3482

MODELS	FRONT GASKET	REAR GASKET	FRONT ENDPLATE	REAR ENDPLATE
KH 11/2X	698A	698B	1840	1796
KH 2X	698A	698B	1840	1796
KH 3X	698A	698B	1840	1796
KH 5X	706A	706B	1859	1813
KH 71/2X	724A	724B	1868	1831
KH 10X	724A	724B	1868	1831

This chart is to be used for reference purposes only.
 For replacement parts contact customer service with your condenser model and serial numbers.

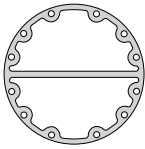
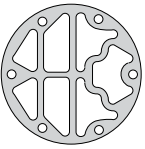
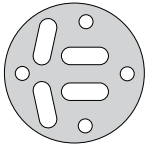
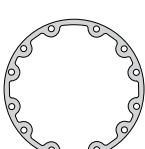
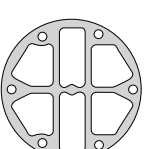
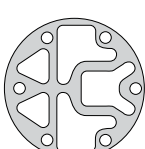
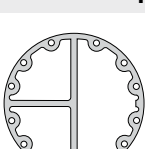
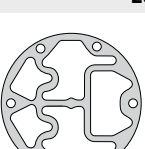
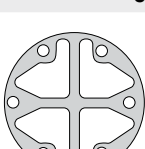
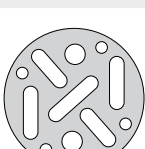
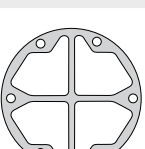
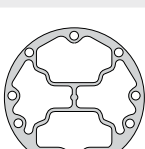
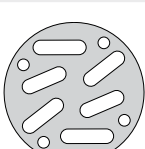
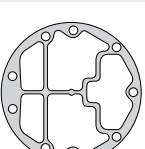
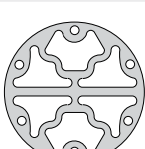
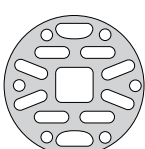
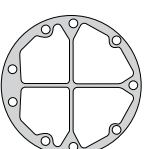
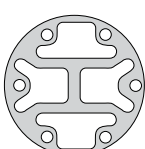
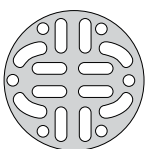
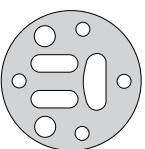
GASKETS ID

<p>111</p> <p>12-3/4" Dia. 12 Studs</p>		<p>210</p> <p>8-5/8" Dia. 6 Studs</p>		<p>346</p> <p>5" Dia. 4 Studs</p>	
<p>120</p> <p>12-3/4" Dia. 12 Studs</p>		<p>229</p> <p>8-5/8" Dia. 6 Studs</p>		<p>355</p> <p>6-5/8" Dia. 12 Studs</p>	
<p>166</p> <p>12-3/4" Dia. 12 Studs</p>		<p>238</p> <p>8-5/8" Dia. 6 Studs</p>		<p>364</p> <p>6-5/8" Dia. 6 Studs</p>	
<p>175</p> <p>6" Dia. 4 Studs</p>		<p>247</p> <p>8-5/8" Dia. 6 Studs</p>		<p>373</p> <p>10-3/4" Dia. 9 Studs</p>	
<p>184</p> <p>6" Dia. 4 Studs</p>		<p>256</p> <p>10-3/4" Dia. 9 Studs</p>		<p>382</p> <p>6-5/8" Dia. 6 Studs</p>	
<p>193</p> <p>6-5/8" Dia. 6 Studs</p>		<p>265</p> <p>10-3/4" Dia. 9 Studs</p>		<p>436</p> <p>6-5/8" Dia. 6 Studs</p>	
<p>201</p> <p>6-5/8" Dia. 6 Studs</p>		<p>337</p> <p>5" Dia. 4 Studs</p>		<p>445</p> <p>8-5/8" Dia. 12 Studs</p>	

GASKETS ID

689A

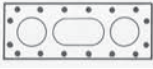

689B



706A



706B



724A



724B



1057

6-5/8" Dia.
6 Studs

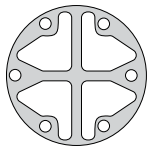

1066

6-5/8" Dia.
6 Studs

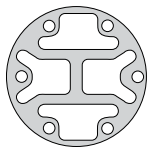

1462

10-3/4" Dia.
12 Studs

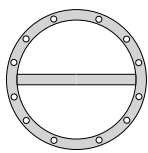

1471

8-5/8" Dia.
12 Studs

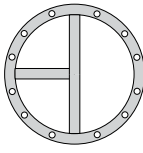

1480

12-3/4" Dia.
12 Studs

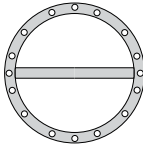

1499

14" Dia.
12 Studs

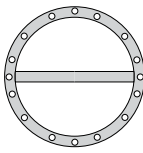

1679

19-11/16" Dia.

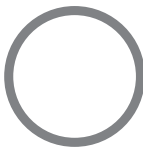

1688

21-11/16" Dia.



1723

8-5/8" Dia.
6 Studs

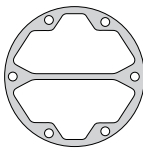

1732

8-5/8" Dia.
6 Studs

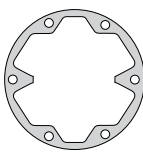

1741

10-3/4" Dia.
9 Studs

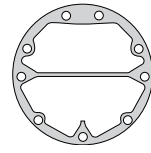

1750

10-3/4" Dia.
9 Studs

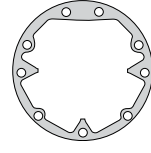

2074

Tube-in-tube gasket
No picture available

2083

Tube-in-tube gasket
No picture available

2092

1-3/16" x 9-1/16"



2100

1-3/16" x 6-5/16"



2191

2-9/16" x 15-3/4"

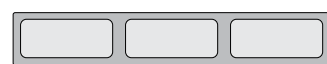

2209

2-9/16" x 15-3/4"



2254

14-11/16" Dia.

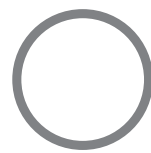

GASKETS ID

2263

16-11/16"
Dia.



2977

8-5/8" Dia.
6 Studs

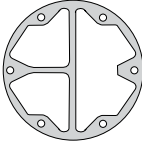

3170

6-5/8" Dia.
6 Studs

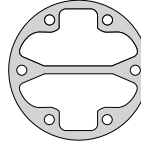

2290

25" Dia.



2984

10-3/4" Dia.
9 Studs

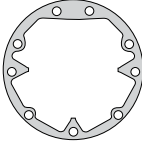

3718

6-5/8" Dia.
6 Studs

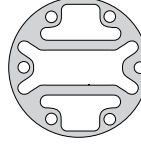

2461

3-1/4" x 20-1/4"

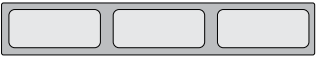

3101

6-5/8" Dia.
6 Studs

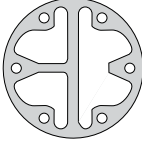

5057

1-3/16" x 9-1/16"

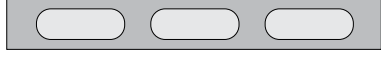

2470

3-1/4" x 13-1/2"



3118

8-5/8" Dia.
6 Studs

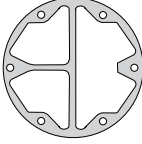

2584

8-5/8" Dia.
6 Studs



3149

6" Dia.
4 Studs



2591

8-5/8" Dia.
6 Studs

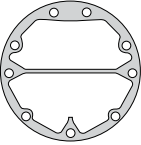

3156

5" Dia.
4 Studs

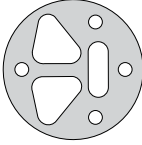

2953

8-5/8" Dia.
6 Studs

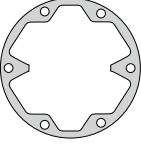

3163

6" Dia.
4 Studs

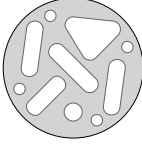

ENDPLATE REPLACEMENT

We still offer EndPlates for all Stan-Ref Chiller Barrels and Water Cooled Condensers. Simply provide us with your model and serial number and we will identify for you.

Or you can visit our website and find all of the Line Drawings of the EndPlates for easy identification.

www.sigmaengineeringllc.com

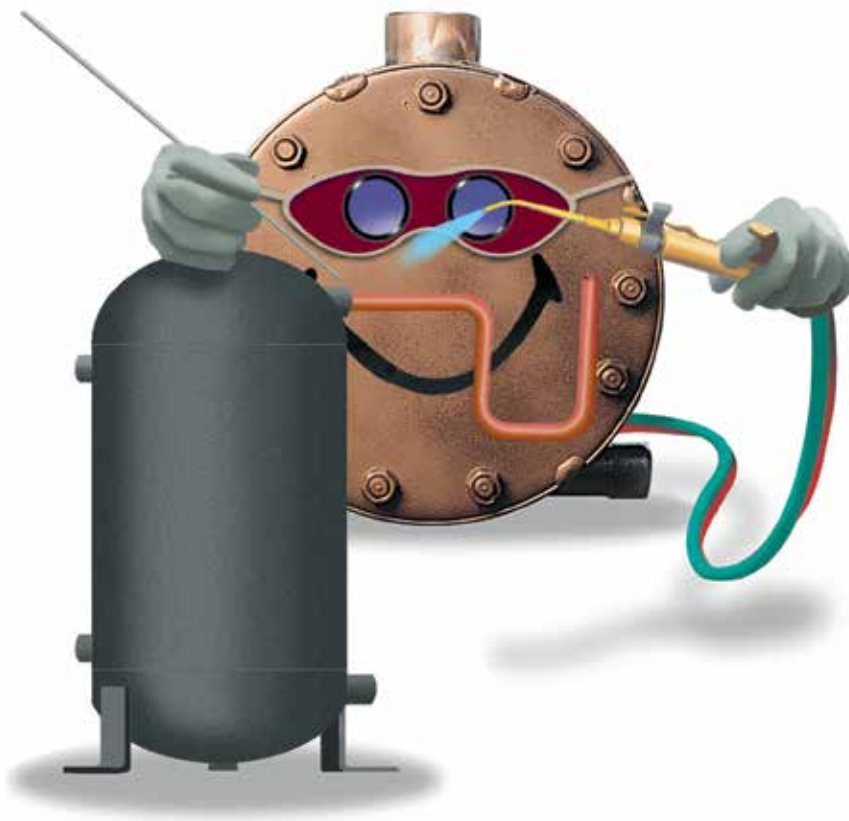



Refrigeration Solutions

**2166 14th Circle North,
St. Petersburg, FL 33713**

sales@sigmaengineeringllc.com

SigmaEngineeringLLC.com

(888) 744-6211