

# Price List

## Architectural Hardware

United States | PL36 | January 2024



# What's New

This price book PL36 dated January 2024 contains new products and pricing. All changes are listed below and take effect immediately.

## Architectural Hardware

- Prices increased by average 4.5%

Page blank intentionally

# Table of Contents

<b>Introduction</b>	Terms of Sale	
	Finishes Cross Reference	
<b>Locks</b>	Locks Product Guide	1
	M9000 Grade 1 Mortise Series	3
	D900 Grade 1 Mortise Dead Bolt Series	17
	T900 Tubular Series	20
	C100 Grade 1 Cylindrical Series	26
	DB100 Grade 1 Dead Bolt Series	34
	C200 Grade 2 Cylindrical Series	39
	C500 Grade 2 Cylindrical Series	46
	DB600 Grade 2 Dead Bolt Series	50
	C300 Grade 2 Cylindrical Series	54
	J300 Grade 2 Interconnected Series	56
	<b>Cylinders, Keys, and Keying</b>	Cylinders, Keys, and Keying Product Guide
Master Keying/DORMA SKC Policy		59
Mortise Cylinders		60
Rim Cylinders		65
Key-in-Knob/Lever Cylinders		67
Hotel Cylinders		68
Small Format Interchangeable Cores		70
Large Format Interchangeable Cores		71
Retrofit Cylinder Housings		72
Tailpieces		73
Keys and Key Blanks		74
SFIC Padlocks		76
Service Parts		77
Labeling and Cylinder Marking		79
<b>Exit Devices</b>	Exit Devices Guide	80
	9000 Series	82
	9000 Series Wide Stile Exits	83
	9000 Series Wide Stile Trim	94
	9000 Series Narrow Stile Exits	111
	9000 Series Narrow Stile Trim	120
	8000 Series	130
	8000 Series Exits	131
	8000 Series Trim	137
Mullions	146	
<b>Electronic Access Control Components</b>	DKPS Power Supply Series	147

After careful consideration, beginning July 2023, all electric strike and electromagnetic lock products will be available via dormakaba RCI. Contact your BEST dormakaba sales representative for further details or to inquire about sales enablement.	ES Series (See RCI Electronic Locking Hardware)	
	EML Series (See RCI Electronic Locking Hardware)	
	EMLSG Series (See RCI Electronic Locking Hardware)	150
	EMSL Series (Contact dormakaba for options)	
	EMDE Series (See RCI Electronic Locking Hardware)	
	AC Series	152
	PB Series	154
	39 Series	158
	KS Series	160
	Accessories	163
<b>Low Energy Operators</b>	ED900 Series	166
	ED50/ED100	170
<b>Surface Closers</b>	Surface Closers Product Guide	172
	TS93 Series	174
	8900 Series	177
	8600 Series	183
	7400 Series	187
	7300 Series	191
	STA Series	195
	GSR Series	197
	Closer Bodies	199
<b>Fire/Life Safety</b>	Fire/Life Safety Product Guide	201
	EMR/EMF Series	203
	1800 Series	207
	EM Series	211
<b>Concealed Closers/Pivots</b>	Concealed Door Closers Product Guide	213
	BTS80 Series	215
	BTS80 EMB Series	221
	BTS75V Series	227
	ITS96 Series	233
	RTS88 Series	235
	LM Series Heavy-Duty Pivots	241
	LM Series Extra Heavy-Duty Pivots	245
<b>Stops/holders</b>	900/700 Series	249
<b>Architectural Pulls and Handles</b>	Finishes Cross Reference	253
	TG 138 Locking and Non-Locking Ladder Pulls	255
	TG 9387 Non-Locking Ladder Pulls	257
	MANET Non-Locking Ladder Pulls	260
	TG Decorative Pulls	263
	ARCOS Decorative Pulls	264
	Pull Handles for Commercial Doors	265

## General information

### Terms and conditions of sale

**Acceptance.** The following Terms and Conditions of sale are applicable to all Quotations, Contract, Purchase Orders, Order Acknowledgement Forms, and sales of Seller's services and products, and are the only applicable terms and conditions thereto, except for terms establishing prices, quantities, delivery schedules, terms of payment, invoicing, shipping instructions, and the identification of the products associated with each transaction. If any conflict exists between the Terms and Conditions and a Quotation, Purchase Order, Order Acknowledgment form, or sale, these Terms and Conditions shall prevail BY REQUESTING A QUOTATION OF ORDERING ANY PRODUCTS OR SERVICES FROM SELLER, BUYER AGREES TO ALL THE FOLLOWING TERMS AND CONDITIONS. If a written contract signed by both parties is in existence covering the sale of the goods and services, the terms and conditions of the contract shall control to the extent they are inconsistent with these Terms and Conditions.

**1. Order Procedure.** Buyer may or may not request the preparation of a Quotation prior to ordering any products or services from Seller. Buyer then shall place a Purchase Order with Seller. By placing a Purchase Order, Buyer makes an offer to purchase products or services from Seller pursuant to these Terms and Conditions. Seller, in its discretion, may accept or reject the Purchase Order. If Seller accepts the Purchase Order, Seller shall issue an Order Acknowledgement Form confirming Buyer's order. No Purchase Order is binding on Seller unless accepted by Seller as provided in these Terms and Conditions.

**2. Quotations.** All Quotations by Seller are subject to change or withdrawal without prior notice to Buyer unless otherwise specifically stated in the Quotation. Quotation prices are valid on Purchase Orders placed within 90 days of the quote being issued, unless otherwise specifically stated in the quotation. If no order is placed within the stated time frame, prices may be adjusted to reflect the then-current published prices, surcharges, escalators, or other pricing adjustment due to, among other things, costs of materials, labor, transportation, taxes, duties, and other cost increases to Seller. All resulting Purchase Orders become effective only if and when approved and accepted in writing by Seller by the issuance of its Order Acknowledgement Form. Seller reserves the right to discontinue manufacture of any products or change products materials, design, or specifications without notice.

Quotation prices are valid on Purchase Orders placed within 90 days of the quote being issued, unless otherwise specifically stated in this quotation. If no order is placed within the stated time frame, prices may be adjusted to reflect the then-current published prices, surcharges, escalators, or other pricing adjustment due to, among other things, costs of materials, labor, transportation, taxes, duties, and other cost increases to Seller. All resulting Purchase Orders become effective only if and when approved and accepted in writing by Seller by the issuance of its Order Acknowledgement Form. All Quotations and resulting orders are subject to Seller's Terms and Conditions set forth in the price book

#### 3. Site Requirements.

a. The Quotation is contingent upon all work being performed during normal business hours unless otherwise negotiated and a mutually agreeable schedule. The Quotation is calculated on one continuous installation engagement based on acceptable site conditions where other dependent scopes have completed preparation for proposed materials (i.e. electrical work, floor work, adjacent construction). When Buyer has given authorization for work to begin, no other scopes may impede Seller's ability to complete installation in agreed upon area. Seller reserves the right to invoice for costs that are incurred due to unacceptable site conditions or delays by others resulting in additional installation visits.

b. Signed acceptance by Buyer of shop drawings and/or submittals shall be interpreted as acceptance that proposed scope is the correct interpretation of construction documents. Any field verification and/or work required by others as detailed in the submittal will be provided and coordinated by Buyer. Work shall not begin nor shall orders be placed for any projects until all shop drawings and submittals have been approved in writing by Buyer.

**4. Warranty.** Seller warrants only that all products sold pursuant to a Quotation or Purchase Order will conform to the description in the Price Book and will be free from defects in workmanship and materials. The duration of each product warranty is dependent on the particular product. Refer to EAD & DHW warranty statement. Extended warranties may be available for an additional cost. Seller is not responsible for defects or damages caused by wear and tear, consumable materials, vandalism, fires, storms, floods, acts of God, misuse, abuse or alteration by any company other than Seller. Seller further warrants that Buyer will receive good and valid title to the products. Any claim on account of nonconforming or defective products or for any other cause whatsoever shall conclusively be deemed waived by Buyer unless written notice thereof is given to Seller promptly after discovery but no later than sixty (60) days from date of shipment. Seller shall have the right either to replace or repair any nonconforming or defective products, to refund the purchase price upon return of the products, or to grant a reasonable allowance on account of such nonconformance or defect Seller's liability and Buyer's exclusive remedy for nonconforming or defective products shall be limited solely to replacement, repair, refund, or allowance as Seller may elect. Seller shall be given reasonable opportunity to investigate all claims and no materials shall be returned to Seller until after inspection and approval by Seller and receipt by Buyer of written shipping instructions from Seller. Buyer acknowledges and agrees that the remedies set forth in this paragraph are Buyer's exclusive remedies for the delivery of nonconforming or defective products.

#### Additional Warranties

- a) No credit will be provided for any work completed by others during warranty term.
- b) Warranty work will be performed during normal business hours with our standard response times. Any warranty work taking place beyond normal business hours or with expedited response time may be billable.
- c) Products repaired or replaced under the warranty are warranted only through the remainder of the original warranty period.

**Disclaimer of Further Warranties.** Except as set forth above, there is no warranty, representation, or condition of any kind, express or implied (including no warranty of merchantability or fitness of the products for any use contemplated by Buyer) concerning Seller's products or services and none shall be implied by law.

**5. Limitation of Liability and Remedies.** Seller shall not be liable, and Buyer waives all claims against Seller for any incidental, consequential, or special damages, including without limitation, lost revenues and profits even if Seller has been advised of the possibility of such damages. Buyer's exclusive remedy for any cause of action under these Terms and Conditions is a claim for damages and in no event will damages or any other recovery of any kind against Seller exceed the purchase price of the specific products or services as to which the claim is made. Seller will not be liable to Buyer for any loss, damage, or injury to persons or property resulting from the handling, storage, transportation, resale, or use of the products in manufacturing processes, or in combination with other substances, or otherwise.

**6. Intellectual Property Indemnification.** (a) Seller agrees to defend, indemnify and hold Buyer harmless against any claims,

## General information

### Terms and conditions of sale (con't)

costs, damages, liability and expenses resulting from actual or alleged patent, trademark, or copyright infringement, misappropriation of confidential information, or violation of any other intellectual property right, domestic or foreign, in the selling or use of any part or product that is owned by Seller and that pertains to the subject matter of a Quotation, Purchase Order, or sale of products or services (provided that the product is not modified in anyway by Buyer or any other party, and that the product is used in the manner intended by Seller). If a suit or claim results in any injunction or any other order that would prevent Seller from supplying any product falling under a Quotation, Purchase Order, or sale, or if the result of such a suit or claim would, in the reasonable opinion of Seller, otherwise cause Seller to be unable to supply such products, Seller shall have the right, at its option, if it so chooses, to do one or more of the following: (i) secure an appropriate license to permit Seller to continue supplying the products to Buyer; (ii) modify the relevant product so that it becomes non-infringing, provided that any modification does not cause any material change to the operation or performance of the product; or (iii) replace the relevant product with a non-infringing but practically equivalent product. (b) Buyer agrees to defend, indemnify, and hold Seller harmless against any claims, costs, damages, liability and expenses resulting from actual or alleged patent, trademark, or copyright infringement, misappropriation of confidential information, or violation of any other intellectual property right, domestic or foreign, in the making, using or selling of any product or using any process that is owned by Buyer or is designed or specified by Buyer and that pertains to the subject matter of a Quotation, Purchase Order, or sale.

**7. Ownership of Inventions.** All drawings, know-how, designs, confidential information, and the like disclosed to Buyer by Seller and all rights therein will remain the property of Seller. Buyer shall have no claim to, ownership interest in, no license to, or no rights to any information provided or communicated by Seller.

**8. Lead Times.** If applicable, lead times are based on standard requirements by factory to provide materials proposed. Ship dates will be provided as estimate only once order is placed with the factory. Adequate packaging will be provided for any normal shipping circumstance such that materials will be protected and labeled as required. Special packaging may be provided for an additional expense. Shipping will be cost effective unless expedited fees are accepted by Buyer. If materials are to be provided to job site or Buyer location, dormakaba will make an informed decision as to the best instruction to provide the shipping company. If materials are not required to have direct delivery, materials will be brought to branch for pickup by Buyer. All freight terms shall be FOB. Any claims for damage in transit or lost freight, receiving, and inspection of materials is the responsibility of Buyer. It is a requirement of Buyer to inspect and review all materials prior to accepting shipment.

**9. Title/Risk of Loss.** All products shall be shipped FOB Seller's manufacturing facility to Buyer's designated delivery location. Unless otherwise agreed by the parties, Seller shall select the method of and carrier for the products. Seller reserves the right to ship items in a single or in multiple shipments. Title and risk of loss to products ordered passes to Buyer upon delivery of the products to the freight carrier. Unless mutually agreed upon in writing, shipping dates are approximate and are based upon prompt receipt of all necessary information.

**10. Prices.** Quoted price is valid for 90 days. Seller reserve the right to revise quotations after the 90 days. All accepted Purchase Orders are subject to Seller's price in effect at time of shipment. Buyer shall be responsible for any increase in freight rates or transportation charges occurring after Seller prepared the Order Acknowledgment Form. on the Order Acknowledgment Form. Buyer shall pay to Seller in addition to the purchase price the amount of all fees, duties, licenses, and all sales, use, privilege, occupation, excise, or other taxes, federal, state, local, or foreign which Seller is required to pay or collect in connection

with products or services sold to Buyer.

**11. Payments.** Unless otherwise agreed in writing between the parties, all Seller's invoices are payable within thirty (30) days of their date. Time is of the essence. Interest on past due amounts will be assessed at the rate of 2% per month (24% per annum), or the maximum allowable by law.

Seller reserves the right to full payment upon completion of work unless credit is pre-established. For any work requiring materials purchase or scheduling, a 50% deposit is due at time of proposal acceptance. Twenty percent (20%) of the Quotation, Purchase Order value may be billed after job award. Joint check agreements may be requested at the discretion of Seller. If payment is outstanding for any one account, work may be stopped and outstanding orders cancelled until account is restored. Should Seller require the use of collection, attorney's fees, or fees for insufficient funds, Buyer agrees that these funds will be repaid to Seller. Seller retains the right to file a lien against all or part of the property being improved. Seller reserves the right to add a 2.5% charge if invoice becomes delinquent beyond terms.

**12. Cancellation.** In the event a Buyer's Purchase Order and the issuance of an Order Acceptance Form is cancelled, it will be subject to standard 35% restocking fees, cancellation fees, engineering fees, materials & freight costs incurred, and administrative fees. Standard cancellation is 20% of order as long as no materials have been ordered. Should Buyer release material orders, Buyer will be liable for that portion of the job and 20% of the remaining amount of work unperformed/unordered.

**13. Storage.** If applicable, Seller reserves the right to implement a storage fee if delivery is delayed after agreed upon date. Should project timeline require storage of materials, Seller reserves the right to bill for those materials at the time they have been received at a Seller location, Buyer location, or at job site. Certificate of insurance for stored materials can be provided to Buyer upon request. Signed acceptance by Buyer of shop drawings and/or submittals shall be interpreted as acceptance that proposed scope is the correct interpretation of construction documents. Any field verification and/or work required by others as detailed in the submittal will be provided and coordinated by Buyer.

**14. Insolvency.** Seller may, at any time or times, suspend performance of any order or require payment in cash, security, or other adequate assurance satisfactory to Seller when, in Seller's opinion, the financial condition of Buyer or other grounds for insecurity, including the filing of a petition for bankruptcy, warrant such action.

**15. Force Majeure.** Seller shall not be liable for any delay in fulfilling any order due to (a) fires, floods, strikes, or other labor disputes, accidents to machinery, acts of sabotage, riots, precedence or priorities granted at the request or for the benefit, directly or indirectly, of the federal or any state government or any subdivision or agency thereof, delays in transportation or lack of transportation facilities, restrictions imposed by federal or state legislation or rules of regulations thereunder; or (b) any cause beyond the control of Seller.

**16. Ownership of Equipment.** Unless otherwise agreed in a writing, all material, equipment, facilities, and special tooling, which term includes but is not limited to jigs, dies, fixtures, molds, patterns, special taps, special gauges, special test equipment, and manufacturing aids and replacements thereof, used in the manufacture of the products covered by any order shall remain the property of Seller. Any material, tooling, and equipment furnished to Seller by Buyer shall be and remain the personal property of Buyer with the title to and right of possession remaining in Buyer.

**17. Confidential Information.** All information furnished or made available by Seller to Buyer in connection with a transaction shall be held in confidence by Buyer. Buyer agrees not to use such information

## General information

### Terms and conditions of sale (con't)

or disclose such information to others without Seller's prior written consent. The obligations of this paragraph does not apply to any information which (a) at the time of disclosure was, or thereafter becomes, generally available to the public by publication or otherwise through no breach by Buyer of any obligation herein, (b) Buyer can show by written records was in Buyer's possession prior to disclosure by the disclosing party, (c) is legally made available to Buyer by or through a third party having no direct or indirect confidentiality obligation to Seller with respect to such information, (d) was independently developed by Buyer without use of any of Seller's confidential information, or (e) is required to be disclosed pursuant to applicable law.

**18. Waiver.** No waiver by Seller of any of these Terms and Conditions shall be effective unless explicitly set forth in writing and signed by Seller. No failure to exercise, or delay in exercising, any rights, remedy, power, or privilege arising from these Terms and Conditions shall operate or be construed as a waiver thereof, nor shall any single or partial exercise of any right, remedy, power, or privilege hereunder preclude any other or further exercise thereof or the exercise of any other right, remedy, power or privilege.

**19. Assignment.** No assignment of any right or interest or delegation of any obligation or performance of Buyer under this order may be made without the prior written consent of Seller. Any attempted assignment or delegation will be wholly void and totally ineffective for all purposes.

**20. Choice of Law.** All sales, agreements for sale, offers to sell, proposals, acknowledgments and contracts of sale, including, but not limited to, Purchase Orders accepted by Seller, shall be considered a contract under the laws of the State of Delaware, and the rights and duties of all persons, and the construction and effect of all provisions hereof, shall be governed by and construed according to the laws of the State of Delaware.

**21. Integration Clause.** These Terms and Conditions constitute the entirety of terms and conditions, except as set forth in paragraph one, governing the sale and purchase of products and services sold by Seller. No modification of these Terms and Conditions shall be of any force or effect unless in writing and signed Seller and Buyer. Buyer may desire to utilize its own form of acknowledgment or acceptance of these Terms and Conditions. However, the use of any such form shall be for convenience only. No modification of these Terms and Conditions shall be affected by the acknowledgment or acceptance of purchase orders, shipping instruction forms, bills of lading or any other document containing terms or conditions at variance with or in addition to those set forth herein, all such varying or additional terms being hereby objected to and rejected by Seller and deemed to be waived by Buyer.

**22. Installation Projects. Communication:** Buyer shall communicate all of these installation terms to any end-user receiving installation services from dormakaba. **Work Execution:** Any installation quote is prepared with the understanding that openings within the scope of work ("Work") have doors and frames in good working order. dormakaba will perform the Work in the order set forth in a field survey conducted by an end-user, an end-user consultant, or Buyer prior to beginning the installation. Work shall occur weekdays during normal business hours (M-F, 8am – 5pm, local time). Work performed outside of normal business hours is available at a rate of 135% of the normal base rate. Any Work requested to be performed outside of normal business hours will require start and stop time confirmation with installation site, such start and stop time to be obtained by the Buyer or the end-user. Installation Projects are performed as one continuous installation event, from commencement until the completion of the installation. Unless specifically noted otherwise in writing, there will be additional charges for delays or additional trips not caused by dormakaba. Commencement of installation is conditioned on acceptable site conditions, including the completion of dependent scopes of work (e.g., electrical work, keying meetings, distribution of credentials). When Buyer or end-user has given authorization for work to begin, Buyer or end-user shall ensure no other scopes may impede dormakaba's ability to complete installation in agreed upon area. dormakaba reserves the right to assess a fee for

costs incurred due to unacceptable site conditions or delays by others resulting in additional installation visits. Union labor, prevailing wage, and certified payroll are excluded from the installation quote unless otherwise set forth in writing. Insurance certificates will be provided upon request. Coverage is limited to the types and amounts set forth on the insurance certificate. Includes execution of materials only as detailed within proposal. **Additional Charges:** Additional charges may be assessed for delays or additional install time to correct any deficiencies or discrepancies between scope of work and actual jobsite. Any dormakaba materials delivered to Buyer but missing from installation site will be reordered at customer's expense. Any hardware changes or change orders shall be quoted on a separate proposal and timeline. **Storage:** dormakaba reserves the right to assess a storage fee if Buyer or end-user causes delivery to be delayed after the agreed upon delivery date. Should project timeline require storage of materials after delivery to Buyer or end-user, through no act or omission of dormakaba, dormakaba reserves the right to assess a storage fee, Buyer location, or at job site. Certificate of insurance for stored materials can be provided to Buyer upon request. **Exclusions:** Unless explicitly included in the installation quote, these are excluded: Distribution to staff of any form of keys, fobs or cards or credentials; any temporary security, barricades, or signage; all carpentry work outside of this specification including drywall, paint, framing, patching of existing holes, etc.; union labor, prevailing wage & certified payroll unless noted otherwise; permits are the responsibility of the end-user; Any special consideration for asbestos and lead paint hazards; any bonds; disposal of material and packaging; damage from negligence, vandalism or Force Majeure; cleaning of site beyond broom clean; cost for special insurance requirements; consumable materials (e.g., batteries); any electrical work including 120v connections and low voltage wiring pulls; and other similar categories of labor and materials not included in the installation quote.

**23. Installation Warranty** dormakaba will provide one (1) year warranty on materials to be free from manufacturer defects and on installation labor performed. Extended warranties are available for an additional cost. dormakaba is not responsible for defects or damages caused by wear and tear, consumable materials (e.g., batteries), vandalism, fires, storms, floods, acts of God, misuse, abuse, or alteration on by any company other than dormakaba. No credit will be provided for any work completed by others during warranty term. dormakaba reserves the right to withhold the performance of warranty work if Buyer payments have become past due. Warranty work will be performed during normal business hours with our standard response times. Any warranty work taking place beyond normal business hours or with expedited response time may be billable. In the event that Buyer, its agents, employees, successors, and/or assigns tampers with, misuses, removes any parts, or adds any parts or equipment, Buyer agrees to indemnify, save and hold harmless dormakaba, its agents, employees, successors, and/or assigns, from any and all liability, damages, or losses, including reasonable attorney's fees, arising out of, or incidental to, the aforementioned conduct. dormakaba warrants that all goods manufactured by dormakaba and all services provided by dormakaba hereunder will be free from defects in workmanship and materials for twelve (12) months from the date of final project invoice to the carrier, unless sold as "With All Faults", "Shop", "As Is", "As They Stand" or other similar designation. Products repaired or replaced under the warranty are warranted only through the remainder of the original warranty period.

April 2023



## General information

### Finishes Cross Reference

Finish Description	Finish Appearance	dormakaba/BHMA Code	Nearest U.S. Equivalent
Brass	Bright	605	US3
	Satin	606	US4
Bronze	Polished	611	US9
	Satin	612	US10
	Oil Rubbed/Dark Satin	613	US10B
Nickel	Bright	618	US14
	Satin	619	US15
Chrome	Bright	625	US26
	Satin	626	US26D
Stainless	Bright	629	US32
	Satin	630	US32D
Aluminum	Satin Anodized	628	US28
Dark Oxidized Bronze	Satin Anodized	710	US10B
Flat Black	Anodized	711	US19
Aluminum	Painted or Powder Coated	689	US28
Dark (Statuary) Bronze	Painted or Powder Coated	690	US20
Light (Dull) Bronze	Painted or Powder Coated	691	US10
Black	Painted or Powder Coated	693	Black Anodized
Dark (Duronodic) Bronze	Painted or Powder Coated	695	Dark Bronze Anodized
Satin Brass (Gold)	Painted or Powder Coated	696	US4
Primed	Painted or Powder Coated	600	USP
Custom	Painted or Powder Coated	Custom	RAL Pallet
Designer	Painted	Designer	Sample Match

\* Excluding Mechanical Locks, Architectural Pulls & Handles, and Sliding Systems. See appropriate product section for available finishes.

Reference: ANSI A156.18 American National Standard for Materials and Finishes

600 Series Plated Finishes designate the appearance of the finish, regardless of the base material. For example, 605 defines a polished brass material, but 605 can be any base material, like steel or stainless, that is finished to provide the appearance of polished brass.

Standard sprayed finishes are shown above.

For a **Custom Color**, refer to the Custom Color Pallet. For Door Controls, a \$110.00 net setup fee per purchase order, per color will be charged. For exits and trim, a \$120.00 net setup fee per purchase order, per color will be charged. For a copy of the Custom Color Pallet, please contact your Representative or our Customer Service Department. Locks are NOT included in the Custom Color program.

For a **Designer Color**, custom matched to a supplied sample, three (3) each 2" x 3" color chip samples are required. For Door Controls, a non-refundable fee of \$270.00 net is required per color match request, per order prior to processing. For exits and trim, non-refundable \$430.00 net fee is required per color match request, per order prior to processing. Allow six (6) weeks for designer color development. If a match can not be made to the customer's satisfaction after three (3) attempts, dormakaba reserves the right to decline the order. Metallic colors are difficult to duplicate and may be rejected. Locks are NOT included in the Designer Color program.

Please contact our Sales Service Department, or your local sales representative for further information.

# Locks

## How to Determine Hand of Door

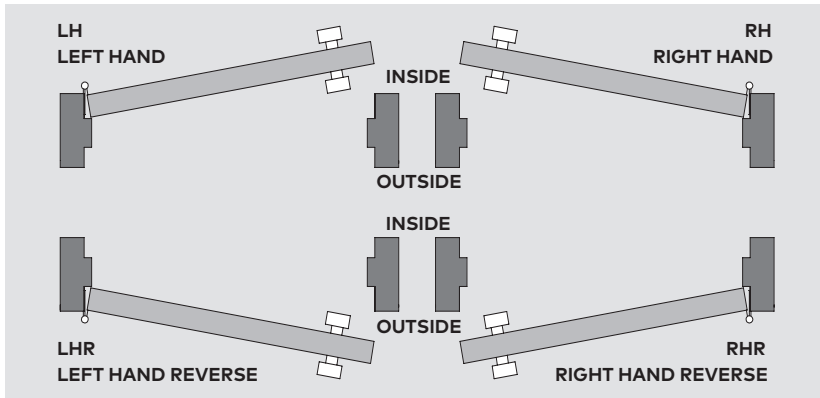

## How to Determine Handed Levers

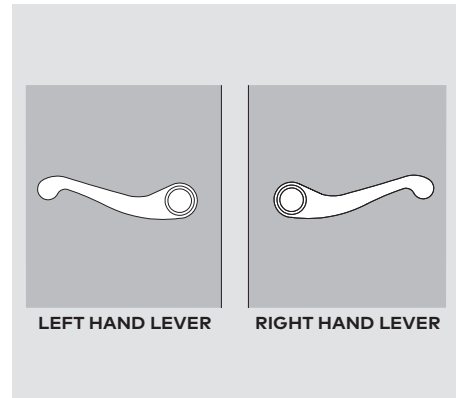

## Product Guide

	Description	ANSI BHMA	Fire Rated	Standard Cylinder	SFIC	Schlage Style/LFIC
<b>M9000 Lock</b>	GR1 Mortise Lock	Yes	Yes	Yes	Yes	Yes
<b>T900 Lock</b>	GR2 Decorative Tubular Lock (M9000 Trim)	No	Option	N/A	N/A	N/A
<b>D900 Dead Bolt</b>	GR1 Small Case Mortise Dead Bolt	Yes	Yes	Yes	Yes	Yes
<b>C100 Lever Lock</b>	GR1 Cylindrical Lever Lock	Yes	Yes	Yes	Yes	No
<b>DB100 Dead Bolt</b>	GR1 Tubular Dead Bolt	Yes	Yes	Yes	Yes	No
<b>C200 Lever Lock</b>	GR1 Tubular Dead Bolt	Yes	Yes	Yes	Yes	No
<b>DB600 Dead Bolt</b>	GR2 Tubular Dead Bolt	Yes	Yes	Yes	Yes	No
<b>C500 Lever Lock</b>	GR2 Cylindrical Lever Lock	Yes	Yes	Yes	Yes	No
<b>C300 Lever Lock</b>	GR2 Cylindrical Lever Lock	Yes	Option	Yes	No	No
<b>J300 Interconnected Lock</b>	GR2 Interconnected Lock	Yes	Yes	Yes	Yes	No



# M9000 Series Ordering Guide

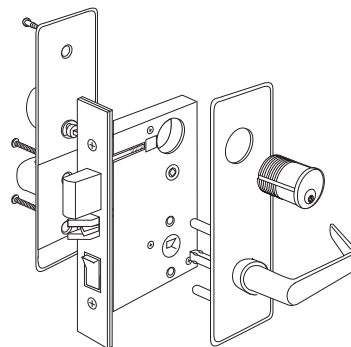

	Function <sup>2</sup>
Privacy w/DB & Indicator	996
Faculty Restroom/Hotel w/DB & Indicator	986
Storeroom w/DB Single Cylinder	980
Classroom Intruder w/DB	974
Dormitory w/DB (F21)	973
Intruder Dead Bolt (F33)	968
Intruder Dead Bolt (F34)	967
Storeroom w/DB (F14)	966
Storeroom w/DB (F35)	958
Dormitory w/DB (F11)	957
Corridor w/DB (F13)	956
Entry w/DB (F20)	953
Privacy w/DB (F19)	940
Institution (F30)	082
Electrically Unlocked/Locked w/Double Locking	082EU/EL
Electrically Unlocked/Locked	080EU/EL
Storeroom (F07)	080
Classroom Intruder Latch Bolt with Indicator	072
Classroom Intruder Latch Bolt (F32) <sup>1</sup>	071
Classroom (F05)	070
Apartment (F09)	060
Office/Entry (Alt F04)	053
Office/Entry (F04)	050
Privacy w/Indicator	046
Privacy w/Coin Turn	042
Privacy, Bedroom or Bath (F22)	040
Exit/Communicating Passage (F31)	025
Passage/Closet (F01)	010
Dummy Trim Two Sides	002
Dummy Trim One Side	001

- Indicator cannot be added to M9071 function. For intruder function with indicator, order M9072.
- Additional functions available. Detailed function descriptions available in M9000 Series brochure.
- KB knob priced same as Premium lever.
- D Rose not available in 625 or 626.
- Available in 626 and 630 finishes only. Not available on 630 H escutcheon.
- Security Screws only available with 619, 625, 626 and 630 finishes.
- Standard door thickness is 1-3/4" (44 mm). Requirements for doors 1-13/16" (46 mm) and thicker can vary by trim and function. See page 14
- Example shows default values. Refer to Configuration Options section for full details

Lever Design		Finish
Premium Lever	PREMIUM	630 — Satin Stainless
Knob <sup>3</sup>	KB	626 — Satin Chrome
Lever	LT	625 — Bright Chrome
Lever	LR	622 PVD — Satin Black
Lever	LN	619 PVD — Satin Nickel
Lever	LG	613 PVD — Dark Oxidized Satin Bronze
Lever	LD	612 PVD — Satin Bronze
Lever	LC	606 PVD — Satin Brass
		605 PVD — Bright Brass

**Product Family**

M9	953	D	LR	A	626			RH	134	5006	114	XXXX
----	-----	---	----	---	-----	--	--	----	-----	------	-----	------

**Cylinder Type**

Temporary SFIC	T
SFIC (Less Core)	J
SFIC (With Core)	C
Less Cylinder	L
Conventional Cylinder	D
Temporary Schlage FSIC	G
Schlage FSIC (Less Core)	R
Schlage FSIC	F

**Rose/Escutcheon Design**

A	2-1/4" Dia. Rose
B	2-9/16" Dia. Rose
H	2-1/8" x 8-9/16" Escutcheon
M	2-1/2" x 8" Escutcheon
D	2-9/16" Dia. Decorative Rose <sup>4</sup>

**Door Hand**

RH	Right Hand
RHR	Right Hand Reverse
LH	Left Hand
LHR	Left Hand Reverse

**Security Screws<sup>6</sup>**

AM	Antimicrobial Coating <sup>5</sup>
TX	Security Screws <sup>6</sup>

**Door Thickness<sup>7</sup>**

**Strike Options<sup>8</sup>**

**Lip Length<sup>8</sup>**

**Keying Options Field**

# Trim Options

## Lever Options – Standard

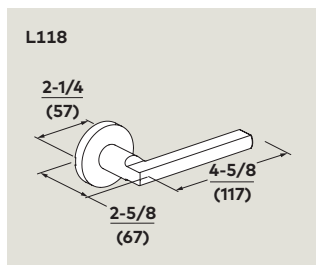
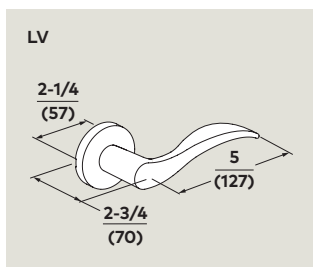
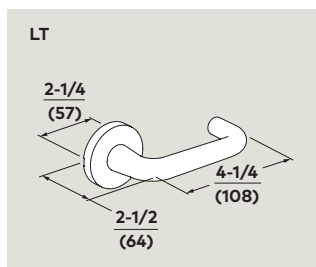
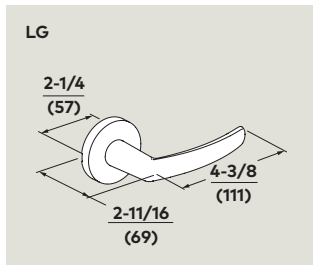
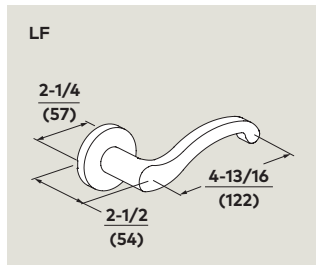
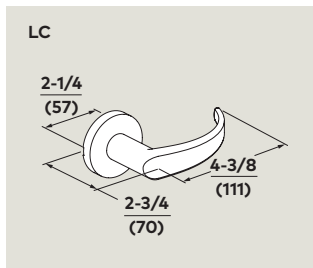
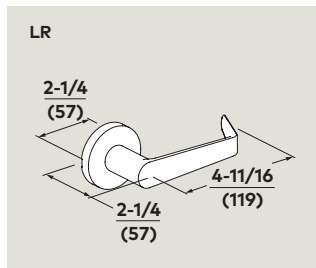

## Lever Options – Premium

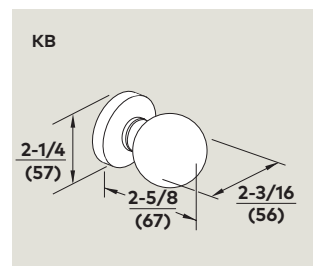
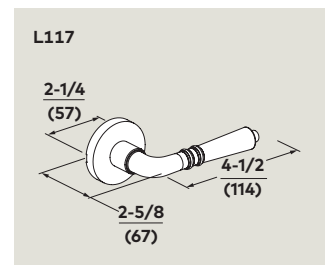
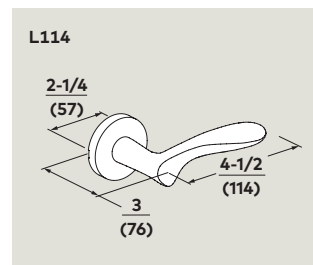
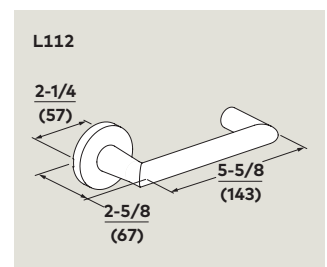
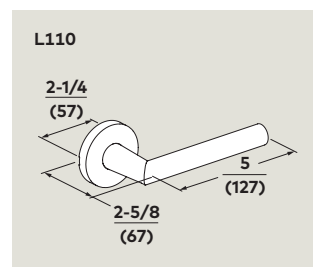
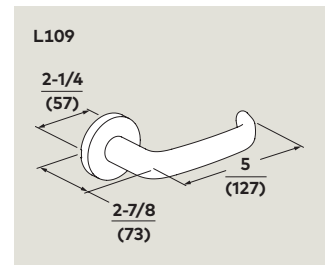
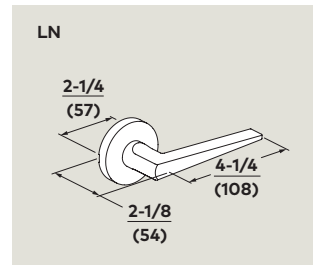
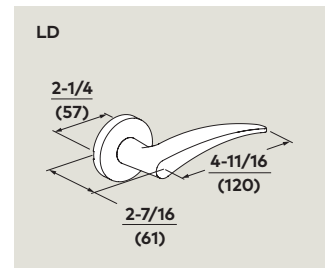
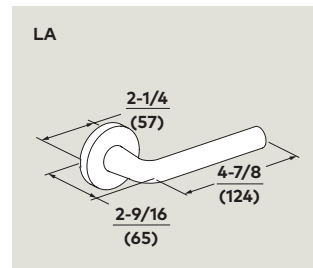

**Trim Styles**

All Finishes

**Wrought Roses**

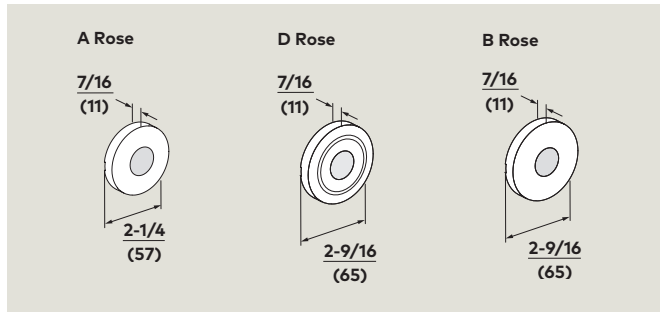

**Escutcheons**

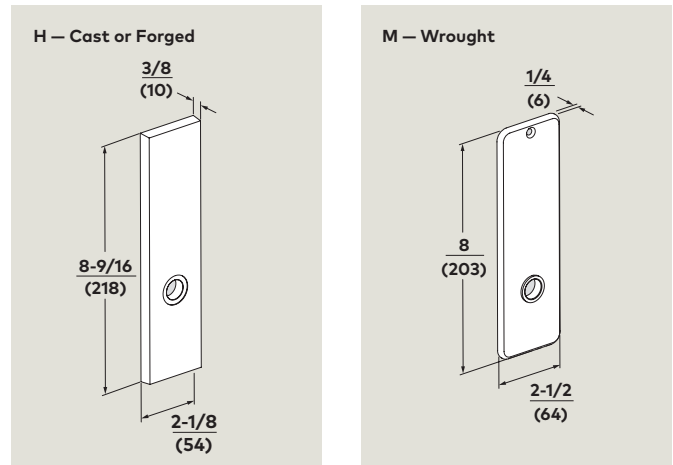

**NOTE:** H Escutcheon Trim cannot be rehanded in the field.

**Finish Availability Chart**

	605	606	612	613	619	622	625	626	630
<b>Standard Levers</b>									
LR	•	•	•	•	•	•	•	•	•
LC	•	•	•	•	•	•	•	•	•
LG	•	•	•	•	•	•	•	•	•
LF	•	•	•	•	•	•	•	•	•
LT	•	•	•	•	•	•	•	•	•
LV	•	•	•	•	•	•	•	•	•
L118		•	•	•	•	•			•
<b>Premium Levers</b>									
LA	•	•	•	•	•	•	•	•	•
LD	•	•	•	•	•	•	•	•	•
LN	•	•	•	•	•	•	•	•	•
L109		•	•	•	•	•			•
L110	•	•	•	•	•	•	•	•	•
L112		•	•	•	•	•			•
L114	•	•	•	•	•	•	•	•	
L117	•	•	•	•	•	•			•
<b>Knob</b>									
KB		•	•	•	•	•			•

**NOTE:** See next 4 pages for mortise lock pricing arranged by Trim Style.

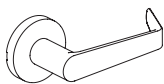

Standard levers with Rose trim

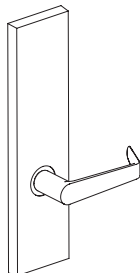

Standard levers with Escutcheon trim

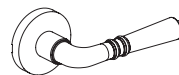

Premium levers with Rose trim

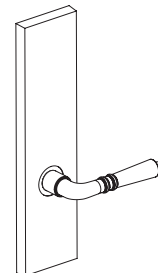

Premium levers with Escutcheon trim

# Standard Lever – Rose Styles

Levers: LR, LC, LF, LG, LT, LV, L118

Roses: A, B, D

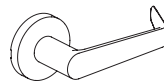

L118 not available in 605, 625, or 626 finish.  
 LF and LV not available in 630 finish.  
 See Lever Finish Availability Chart, page 5.  
 D rose not available in 625 or 626 finish.

A,B,D Rose

626

605, 606,  
 612, 613,  
 619, 622,  
 625, 630

ANSI #	Function	Description	List \$	
<b>Non-Keyed</b>				
—	M9001 (w/out lock case)	Single dummy	304.00	348.00
—	M9002 (w/out lock case)	Double dummy	647.00	696.00
—	M9003 (w/lock case)	Single dummy	478.00	504.00
—	M9004 (w/lock case)	Double dummy	786.00	833.00
F01	M9010 <sup>2</sup>	Passage/closet	845.00	940.00
F31	M9025 <sup>1</sup>	Exit/communicating passage	973.00	1072.00
F22	M9040	Privacy, bedroom or bath	973.00	1072.00
—	M9042	Privacy w/coin turn	1040.00	1141.00
—	M9046	Privacy w/indicator	1171.00	1223.00
F19	M9940	Privacy w/dead bolt	1171.00	1223.00
—	M9942	Privacy w/dead bolt and coin turn	1243.00	1292.00
<b>Keyed, Single Cylinder</b>				
F04	M9050 <sup>1</sup>	Office/Entry	1083.00	1188.00
F04	M9053 <sup>2</sup>	Office/Entry	1083.00	1188.00
—	M9056	Office/Entry w/automatic unlocking	1179.00	1286.00
F05	M9070 <sup>2</sup>	Classroom	1083.00	1188.00
F06	M9076	Holdback	1083.00	1188.00
F07	M9080 <sup>1</sup>	Storeroom	1083.00	1188.00
—	M9080EL <sup>1</sup>	Electrically locked (Fail Safe; 24 V)	1631.00	1679.00
—	M9080EU <sup>1</sup>	Electrically unlocked (Fail Secure; 24 V)	1631.00	1679.00
F20	M9953	Entry w/dead bolt	1115.00	1223.00
—	M9954	Security entrance w/dead bolt	1115.00	1223.00
F13	M9956	Corridor w/dead bolt	1115.00	1223.00
F12	M9959	Dormitory/Exit w/dead bolt	1115.00	1223.00
F21	M9973	Dormitory w/dead bolt	1115.00	1223.00
—	M9980	Storeroom w/dead bolt	1115.00	1223.00
F15	M9985	Faculty restroom/hotel w/dead bolt	1179.00	1286.00
—	M9986	Faculty restroom/hotel w/dead bolt/indicator	1270.00	1387.00
—	M9996	Privacy w/dead bolt/indicator	1270.00	1387.00
<b>Keyed, Double Cylinder</b>				
F09	M9060	Apartment	1188.00	1300.00
F32	M9071 <sup>2</sup>	Intruder latch bolt	1188.00	1300.00
—	M9072	Intruder latch bolt with indicator	1295.00	1403.00
—	M9077	Holdback double cylinder	1188.00	1300.00
F30	M9082 <sup>2</sup>	Institution lock	1188.00	1300.00
—	M9082EL <sup>3</sup>	Electrically locked (Fail Safe) w/double locking (24 V)	1723.00	1770.00
—	M9082EU <sup>3</sup>	Electrically unlocked (Fail Secure) w/double locking (24 V)	1723.00	1770.00
F11	M9957	Dormitory w/dead bolt	1247.00	1300.00
F35	M9958	Storeroom w/dead bolt	1247.00	1300.00
F14	M9966	Storeroom w/dead bolt	1247.00	1300.00
F34	M9967	Intruder w/dead bolt	1247.00	1300.00
—	M9974	Classroom intruder w/dead bolt	1247.00	1300.00
<b>Deadbolt Only</b>				
F17	M9960	Deadbolt Only – Cylinder x Turn <b>(No Trim)</b>	563.00	586.00
F18	M9961	Deadbolt Only – Cylinder x Blank <b>(No Trim)</b>	463.00	491.00
F16	M9962	Deadbolt Only – Cylinder x Cylinder <b>(No Trim)</b>	680.00	706.00
F29	M9963	Deadbolt Only – Classroom <b>(No Trim)</b>	680.00	706.00

**NOTES:**

1. Available with Request to Exit (RX), Latch Monitoring (LM) or both
  2. Available with Latch Monitoring (LM) only
  3. Available with Request to Exit (RX) or Latch Monitoring
- See page 13 for RX and LM Pricing

# Standard Lever – Escutcheon Styles

Levers: LR, LC, LF, LG, LT, LV, L118

Escutcheons: H, M

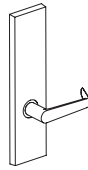

L118 not available in 605, 625, or 626 finish.  
 LF and LV not available in 630 finish.  
 See Lever Finish Availability Chart, page 5.

NOTE: H Escutcheon Trim cannot be rehanded in the field.

H Escutcheon		M Escutcheon	
626	605, 606, 612, 613, 619, 622, 625, 630	626, 630	605, 606, 612, 613, 619, 622, 625

ANSI #	Function	Description	List \$			
<b>Non-Keyed</b>						
–	M9001 (w/out lock case)	Single dummy	356.00	378.00	292.00	333.00
–	M9002 (w/out lock case)	Double dummy	709.00	699.00	620.00	663.00
–	M9003 (w/lock case)	Single dummy	523.00	518.00	455.00	489.00
–	M9004 (w/lock case)	Double dummy	852.00	836.00	750.00	797.00
F01	M9010 <sup>2</sup>	Passage/closet	956.00	930.00	806.00	894.00
F31	M9025 <sup>1</sup>	Exit/communicating passage	–	–	923.00	1020.00
F22	M9040	Privacy, bedroom or bath	1089.00	1055.00	923.00	1020.00
–	M9042	Privacy w/coin turn	1158.00	1120.00	985.00	1084.00
–	M9046	Privacy w/indicator	–	–	–	–
F19	M9940	Privacy w/dead bolt	1241.00	1192.00	1113.00	1160.00
–	M9942	Privacy w/dead bolt and coin turn	1308.00	1258.00	1175.00	1223.00
<b>Keyed, Single Cylinder</b>						
F04	M9050 <sup>1</sup>	Office/Entry	1204.00	1161.00	1025.00	1126.00
F04	M9053 <sup>2</sup>	Office/Entry	1204.00	1161.00	1025.00	1126.00
–	M9056	Office/Entry w/automatic unlocking	1306.00	1211.00	1117.00	1221.00
F05	M9070 <sup>2</sup>	Classroom	1204.00	1161.00	1025.00	1126.00
F06	M9076	Holdback	1204.00	1161.00	1025.00	1126.00
F07	M9080 <sup>1</sup>	Storeroom	1204.00	1161.00	1025.00	1126.00
–	M9080EL <sup>1</sup>	Electrically locked (Fail Safe; 24 V)	1697.00	1627.00	1540.00	1586.00
–	M9080EU <sup>1</sup>	Electrically unlocked (Fail Secure; 24 V)	1697.00	1627.00	1540.00	1586.00
F20	M9953	Entry w/dead bolt	1239.00	1194.00	1055.00	1157.00
–	M9954	Security entrance w/dead bolt	1239.00	1194.00	1055.00	1157.00
F13	M9956	Corridor w/dead bolt	1239.00	1194.00	1055.00	1157.00
F12	M9959	Dormitory/Exit w/dead bolt	1239.00	1194.00	1055.00	1157.00
F21	M9973	Dormitory w/dead bolt	1239.00	1194.00	1055.00	1157.00
–	M9980	Storeroom w/dead bolt	1239.00	1194.00	1055.00	1157.00
F15	M9985	Faculty restroom/hotel w/dead bolt	1306.00	1241.00	1117.00	1221.00
–	M9986	Faculty restroom/hotel w/dead bolt/indicator	–	–	–	–
–	M9996	Privacy w/dead bolt/indicator	–	–	–	–
<b>Keyed, Double Cylinder</b>						
F09	M9060	Apartment	1314.00	1265.00	1126.00	1229.00
F32	M9071 <sup>2</sup>	Intruder latch bolt	1314.00	1265.00	1126.00	1229.00
–	M9077	Holdback double cylinder	1314.00	1265.00	1126.00	1229.00
F30	M9082 <sup>2</sup>	Institution lock	1314.00	1265.00	1126.00	1229.00
–	M9082EL <sup>3</sup>	Electrically locked (Fail Safe) w/double locking (24 V)	1789.00	1708.00	1625.00	1673.00
–	M9082EU <sup>3</sup>	Electrically unlocked (Fail Secure) w/double locking (24 V)	1789.00	1708.00	1625.00	1673.00
F11	M9957	Dormitory w/dead bolt	1314.00	1265.00	1182.00	1229.00
F35	M9958	Storeroom w/dead bolt	1314.00	1265.00	1182.00	1229.00
F14	M9966	Storeroom w/dead bolt	1314.00	1265.00	1182.00	1229.00
F34	M9967	Intruder w/dead bolt	1314.00	1265.00	1182.00	1229.00
–	M9974	Classroom intruder w/dead bolt	1314.00	1265.00	1182.00	1229.00
<b>Deadbolt Only</b>						
F17	M9960	Deadbolt Only – Cylinder x Turn <b>(No Trim)</b>	–	586.00	–	–
F18	M9961	Deadbolt Only – Cylinder x Blank <b>(No Trim)</b>	–	491.00	–	–
F16	M9962	Deadbolt Only – Cylinder x Cylinder <b>(No Trim)</b>	–	706.00	–	–
F29	M9963	Deadbolt Only – Classroom <b>(No Trim)</b>	–	706.00	–	–

**NOTES:**

- 1. Available with Request to Exit (RX), Latch Monitoring (LM) or both
  - 2. Available with Latch Monitoring (LM) only
  - 3. Available with Request to Exit (RX) or Latch Monitoring
- See page 13 for RX and LM Pricing



# Premium Lever – Rose Styles

Levers: LA, LD, LN, L109, L110, L112, L114, L117, KB

Roses: A, B, D



L109, L112, and L117 not available in 625 or 626 finishes.  
LD, LN, and L114 not available in 630 finish.  
See Lever Finish Availability Chart, page 5.  
D rose not available in 625 or 626 finish.

A, B, D Rose

626

605, 606,  
612, 613, 619,  
622, 625,  
630

ANSI #	Function	Description	List \$	
<b>Non-Keyed</b>				
–	M9001 (w/out lock case)	Single dummy	299.00	343.00
–	M9002 (w/out lock case)	Double dummy	638.00	683.00
–	M9003 (w/lock case)	Single dummy	466.00	493.00
–	M9004 (w/lock case)	Double dummy	771.00	820.00
F01	M9010 <sup>2</sup>	Passage/closet	831.00	920.00
F31	M9025 <sup>1</sup>	Exit/communicating passage	953.00	1050.00
F22	M9040	Privacy, bedroom or bath	953.00	1050.00
–	M9042	Privacy w/coin turn	1014.00	1122.00
–	M9046	Privacy w/indicator	1144.00	1193.00
F19	M9940	Privacy w/dead bolt	1144.00	1193.00
–	M9942	Privacy w/dead bolt and coin turn	1215.00	1259.00
<b>Keyed, Single Cylinder</b>				
F04	M9050 <sup>1</sup>	Office/Entry	1055.00	1157.00
F04	M9053 <sup>2</sup>	Office/Entry	1055.00	1157.00
–	M9056	Office/Entry w/automatic unlocking	1150.00	1256.00
F05	M9070 <sup>2</sup>	Classroom	1055.00	1157.00
F06	M9076	Holdback	1055.00	1157.00
F07	M9080 <sup>1</sup>	Storeroom	1055.00	1157.00
–	M9080EL <sup>1</sup>	Electrically locked (Fail Safe; 24 V)	1586.00	1632.00
–	M9080EU <sup>1</sup>	Electrically unlocked (Fail Secure; 24 V)	1586.00	1632.00
F20	M9953	Entry w/dead bolt	1087.00	1192.00
–	M9954	Security entrance w/dead bolt	1087.00	1192.00
F13	M9956	Corridor w/dead bolt	1087.00	1192.00
F12	M9959	Dormitory/Exit w/dead bolt	1087.00	1192.00
F21	M9973	Dormitory w/dead bolt	1087.00	1192.00
–	M9980	Storeroom w/dead bolt	1087.00	1192.00
F15	M9985	Faculty restroom/hotel w/dead bolt	1150.00	1256.00
–	M9986	Faculty restroom/hotel w/dead bolt/indicator	1237.00	1353.00
–	M9996	Privacy w/dead bolt/indicator	1237.00	1353.00
<b>Keyed, Double Cylinder</b>				
F09	M9060	Apartment	1157.00	1266.00
F32	M9071 <sup>2</sup>	Intruder latch bolt	1157.00	1266.00
–	M9072	Intruder latch bolt with indicator	1256.00	1365.00
–	M9077	Holdback double cylinder	1157.00	1266.00
F30	M9082 <sup>2</sup>	Institution lock	1157.00	1266.00
–	M9082EL <sup>3</sup>	Electrically locked (Fail Safe) w/double locking (24 V)	1673.00	1722.00
–	M9082EU <sup>3</sup>	Electrically unlocked (Fail Secure) w/double locking (24 V)	1673.00	1722.00
F11	M9957	Dormitory w/dead bolt	1220.00	1266.00
F35	M9958	Storeroom w/dead bolt	1220.00	1266.00
F14	M9966	Storeroom w/dead bolt	1220.00	1266.00
F34	M9967	Intruder w/dead bolt	1220.00	1266.00
–	M9974	Classroom intruder w/dead bolt	1220.00	1266.00
<b>Deadbolt Only</b>				
F17	M9960	Deadbolt Only – Cylinder x Turn <b>(No Trim)</b>	563.00	586.00
F18	M9961	Deadbolt Only – Cylinder x Blank <b>(No Trim)</b>	463.00	491.00
F16	M9962	Deadbolt Only – Cylinder x Cylinder <b>(No Trim)</b>	680.00	706.00
F29	M9963	Deadbolt Only – Classroom <b>(No Trim)</b>	680.00	706.00

**NOTES:**

1. Available with Request to Exit (RX), Latch Monitoring (LM) or both
  2. Available with Latch Monitoring (LM) only
  3. Available with Request to Exit (RX) or Latch Monitoring
- See page 13 for RX and LM Pricing

## Premium Lever – Escutcheon Styles

Levers: LA, LD, LN, L109, L110, L112, L114, L117, KB

Escutcheons: H, M

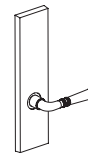

**NOTE:** H Escutcheon Trim cannot be rehanded in the field.  
**L109, L112, and L117 not available in 625 or 626 finishes.**  
**LD, LN, and L114 not available in 630 finish.**  
 See Lever Finish Availability Chart, page 5.

H Escutcheon		M Escutcheon	
626	605, 606, 612, 613, 619, 622, 625, 630	626, 630	605, 606, 612, 613, 619, 622, 625

ANSI #	Function	Description	List \$			
<b>Non-Keyed</b>						
—	M9001 (w/out lock case)	Single dummy	376.00	398.00	308.00	351.00
—	M9002 (w/out lock case)	Double dummy	752.00	736.00	653.00	702.00
—	M9003 (w/lock case)	Single dummy	544.00	542.00	477.00	510.00
—	M9004 (w/lock case)	Double dummy	894.00	781.00	786.00	836.00
F01	M9010 <sup>1</sup>	Passage/closet	1005.00	976.00	847.00	938.00
F31	M9025 <sup>1</sup>	Exit/communicating passage	—	—	969.00	1064.00
F22	M9040	Privacy, bedroom or bath	1138.00	1106.00	969.00	1064.00
—	M9042	Privacy w/coin turn	1210.00	1168.00	1030.00	1131.00
—	M9046	Privacy w/indicator	—	—	—	—
F19	M9940	Privacy w/dead bolt	1295.00	1242.00	1161.00	1210.00
—	M9942	Privacy w/dead bolt and coin turn	1361.00	1311.00	1227.00	1273.00
<b>Keyed, Single Cylinder</b>						
F04	M9050 <sup>1</sup>	Office/Entry	1254.00	1214.00	1072.00	1172.00
F04	M9053 <sup>2</sup>	Office/Entry	1254.00	1214.00	1072.00	1172.00
—	M9056	Office/Entry w/automatic unlocking	1359.00	1263.00	1165.00	1271.00
F05	M9070 <sup>2</sup>	Classroom	1254.00	1214.00	1072.00	1172.00
F06	M9076	Holdback	1254.00	1214.00	1072.00	1172.00
F07	M9080 <sup>1</sup>	Storeroom	1254.00	1214.00	1072.00	1172.00
—	M9080EL <sup>1</sup>	Electrically locked (Fail Safe; 24 V)	1763.00	1689.00	1600.00	1648.00
—	M9080EU <sup>1</sup>	Electrically unlocked (Fail Secure; 24 V)	1763.00	1689.00	1600.00	1648.00
F20	M9953	Entry w/dead bolt	1295.00	1245.00	1106.00	1210.00
—	M9954	Security entrance w/dead bolt	1295.00	1245.00	1106.00	1210.00
F13	M9956	Corridor w/dead bolt	1295.00	1245.00	1106.00	1210.00
F12	M9959	Dormitory/Exit w/dead bolt	1295.00	1245.00	1106.00	1210.00
F21	M9973	Dormitory w/dead bolt	1295.00	1245.00	1106.00	1210.00
—	M9980	Storeroom w/dead bolt	1295.00	1245.00	1106.00	1210.00
F15	M9985	Faculty restroom/hotel w/dead bolt	1359.00	1293.00	1165.00	1271.00
—	M9986	Faculty restroom/hotel w/dead bolt/indicator	—	—	—	—
—	M9996	Privacy w/dead bolt/indicator	—	—	—	—
<b>Keyed, Double Cylinder</b>						
F09	M9060	Apartment	1370.00	1333.00	1172.00	1281.00
F32	M9071 <sup>2</sup>	Intruder latch bolt	1370.00	1333.00	1172.00	1281.00
—	M9077	Holdback double cylinder	1370.00	1333.00	1172.00	1281.00
F30	M9082 <sup>2</sup>	Institution lock	1370.00	1333.00	1172.00	1281.00
—	M9082EL <sup>3</sup>	Electrically locked (Fail Safe) w/double locking (24 V)	1856.00	1788.00	1688.00	1736.00
—	M9082EU <sup>3</sup>	Electrically unlocked (Fail Secure) w/double locking (24 V)	1856.00	1788.00	1688.00	1736.00
F11	M9957	Dormitory w/dead bolt	1370.00	1333.00	1231.00	1281.00
F35	M9958	Storeroom w/dead bolt	1370.00	1333.00	1231.00	1281.00
F14	M9966	Storeroom w/dead bolt	1370.00	1333.00	1231.00	1281.00
F34	M9967	Intruder w/dead bolt	1370.00	1333.00	1231.00	1281.00
—	M9974	Classroom intruder w/dead bolt	1370.00	1333.00	1231.00	1281.00
<b>Deadbolt Only</b>						
F17	M9960	Deadbolt Only – Cylinder x Turn <b>(No Trim)</b>	—	586.00	—	—
F18	M9961	Deadbolt Only – Cylinder x Blank <b>(No Trim)</b>	—	491.00	—	—
F16	M9962	Deadbolt Only – Cylinder x Cylinder <b>(No Trim)</b>	—	706.00	—	—
F29	M9963	Deadbolt Only – Classroom <b>(No Trim)</b>	—	706.00	—	—

### NOTES:

1. Available with Request to Exit (RX), Latch Monitoring (LM) or both
  2. Available with Latch Monitoring (LM) only
  3. Available with Request to Exit (RX) or Latch Monitoring
- See page 13 for RX and LM Pricing

## Cylinder Types, Keying Options, and Keyways

Cylinder	Option	Description	List Add/Deduct \$
<b>Conventional Cylinders (non-interchangeable core)</b>			
D		Conventional cylinder	Example: M9070D
	<b>KD</b>	<b>Keyed differently to a random combination; SC keyway with 2 keys (default)</b>	<b>N/C</b>
	KA2	Keyed alike in pairs to a random combination; SC keyway with 2 keys	N/C
	NSK	Keyed alike, sets of three or more; SC keyway with 2 keys	18.00
	NS2	Keyed alike double cylinder locks; SC keyway with 2 keys	34.00
	1-Bit	Operated by 1-bit cut key; SC, SE keyway with 2 key blanks (order 1-bit key separately)	N/C
	0-Bit	Operated by 0-bit key; D100 keyway — <b>Keys sold separately</b>	N/C
	0-Bit	Operated by 0-bit cut key; AA, CA, CB, CC, CD, CE, RA, RB, GA, SF, YA, YG keyways with 2 key blanks	18.00
	MKD	Master keyed; SC, SE, or D100 keyway — <b>Keys sold separately</b>	23.00
	MK2	Master keyed double cylinder lock; SC, SE, or D100 keyway — <b>Keys sold separately</b>	45.00
	CMK	Construction master keyed single cylinder locks — <b>Keys sold separately</b>	25.00
	CM2	Construction master keyed double cylinder locks — <b>Keys sold separately</b>	49.00
L		Lock less conventional cylinder and cylinder ring	Example: M9070L Deduct 30.00
<b>Interchangeable Core Cylinders</b>			
T		SFIC — Housing with keyed temporary SFIC construction core (Core may be returned for a full refund) — <b>Keys sold separately</b>	Example: M9070T 54.00
J		SFIC — Housing with disposable plastic SFIC plug	Example: M9070J 54.00
C		SFIC — Housing with combined SFIC core installed at the factory; BA (default), BB, BC, BD, BE, BF, BG, BH, BJ, BK, BL, BM, BQ, D100 keyway — <b>Keys sold separately</b>	Example: M9070C 62.00
G		Schlage LFIC — Housing with keyed temporary Schlage LFIC construction core (Core may be returned for full refund) — <b>Keys sold separately</b>	Example: M9070G 65.00
R		Schlage LFIC — Housing less core	Example: M9070R 12.00
F		Schlage LFIC — Housing with combined Schlage LFIC installed at the factory (SC keyway) — <b>Keys sold separately</b>	Example: M9070F 62.00

1. For uncombined cores, UNC, cores must be ordered separately, see Cylinders, Keys & Keying.

Locks will be supplied w/plastic construction core, Option J.

⊗ Denotes keys must be ordered separately.

### Cut Keys Ordered Separately

Part #	Description	List \$
45101	SFIC Cut key— Change key, master key, construction master key, or control key; BA, BB, BC, BD, BE, BF BG, BH, BJ, BK, BL, BM, BQ, SC, SE keyways	10.00
45401	SFIC Cut key— Change key, master key, or control key; SKC keyways — D100 etc.	16.00
45103	SFIC Cut key— Emergency key for M9985C or M9986C; BA keyways	28.00
45403	SFIC Cut key— Emergency key for M9985C or M9986C; SKC keyways — D100 etc.	28.00
45404	CONV/LFIC Cut key— 1-bit key for operating 1-bit cylinders — SC, SE keyways	8.00
45405	LFIC Cut key — 1-bit control key (to install/remove "1-bit" LFIC cores) — SC keyway	8.00
44101SC	CONV/LFIC Key blank — SC keyway	5.00
44104SC	LFIC Key blank — Control key (to install/ remove LFIC Cores) — SC keyway	7.00

**NOTES:**

- M9985D and M9986D are available MKD, CMK, or 1-bit only.
- Emergency keys for M9985D and M9986D are 45101 or 45401.
- Distribution of DORMA SKC keys (listed as D100) is restricted. See Cylinders, Keys & Keying section for DORMA SKC policies.
- 1-bit cylinder comes with (2) uncut keys and will require a 1-bit cut key, sold separately, to operate cylinder. SC and SE keyways only.
- See Keys and Key Blanks section for complete list.

## Configuration Options

Description: <b>Grade 1 Mortise Locks Less Components (Use LRA trim design and specified finish for base list price.)</b>	List Deduct \$
Less outside lever and rose Example: M9953D <b>LLL</b> × LRA 626 RH 134 5006 114; includes mortise less trim kit 76007272	Deduct 36.00
Less inside lever and rose Example: M9953D LRA × <b>LLL</b> 626 RH 134 5006 114; includes mortise less trim kit 76007272	Deduct 36.00
Less strike Example: M9953D LRA 626 RH 134 <b>LLL</b>	Deduct 36.00

**NOTES:**

- For other configurations, consult factory.
- Mortise locks not available less trim both sides.

### Strikes

Part #	Description	List Add \$
<b>5006 – ANSI Strike for Mortise Lock (*see below for usage)</b>		
<b>5006-114</b>	<b>1-1/4" × 4-7/8", 1-1/4" lip length, square corner, curved lip</b>	N/C
5006-078	1-1/4" × 4-7/8", 7/8" lip length, square corner, straight lip	26.00
5006-112	1-1/4" × 4-7/8", 1-1/2" lip length, square corner, curved lip	26.00
5006-134	1-1/4" × 4-7/8", 1-3/4" lip length, square corner, curved lip	26.00
5006-200	1-1/4" × 4-7/8", 2" lip length, square corner, curved lip	26.00
5006-214	1-1/4" × 4-7/8", 2-1/4" lip length, square corner, curved lip	35.00

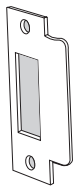

\* Default length strike shown in bold for all M9000 functions. Lip length is distance from center of mounting holes to edge of strike.

Part #	Description	List Add \$
<b>5007 – ANSI Strike for Mortise Lock (*see below for usage)</b>		
5007-114	1-1/4" × 4-7/8", 1-1/4" lip length, square corner (specify hand)	17.00

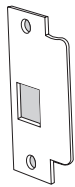

\* Optional handed strike available for M9000 functions without dead bolts. Only available in 1-1/4" lip length. Specify hand.

### Antimicrobial Coating

Description of Components Coated	List Add \$
<b>Available on 626 and 630 finishes only. Not available with 630 H escutcheon. Specify AM. Example: 626AM or 630AM</b>	
Rose Trim A, B, or D	Inside: lever, rose, and thumbturn Outside: Lever and rose 97.00
Escutcheon Trim H* or M	Inside: lever, escutcheon, and thumbturn Outside: Lever and escutcheon 112.00

**NOTES:**





- Extended leadtime, consult factory.
- \*AM option on 630 H escutcheon, consult factory.

## Special Application Options

### Lead Lined Lock Case

Part #	Description	List Add \$
660001	Lead lining plate for M9000 Series Mortise Locks	294.00

### Occupancy Indicators

	Part #	Description	List Add \$
	79019	Occupancy indicator for rose trim used w/cylinder, reading OCCUPIED/VACANT or SECURED/UNSECURED. Both readings supplied. Specify finish.	123.00
		Optional RG — Solid red/green indicator inserts. Specify 79019 630 RG.	11.00
		M9072 indicator inserts (LOCKED/UNLOCKED with red/green background). Specify 79019 630 M9072.	11.00
	79020	Occupancy indicator for rose trim used without cylinder, emergency access, reading OCCUPIED/VACANT. Specify finish.	123.00
	79021	Occupancy indicator for rose trim used without cylinder, reading SECURED/UNSECURED. No emergency access. Used on inside of door with 79019 on outside.	123.00
	79022	Occupancy indicator w/cointurn for rose trim used without cylinder, reading OCCUPIED/VACANT. Specify finish.	123.00

**NOTES:**

- 1-3/4"–2-1/8" thick doors.
- Specify finish. Example: 79019 626.
- Indicators will work on the following functions but may have unexpected operation on lock sets that remain locked when the dead bolt is retracted: M9046, 9056, 9072, 9940, 9942, 9953, 9956, 9957, 9959, 9960, 9961, 9962, 9966, 9967, 9968, 9973, 9974, 9980, 9985, 9986, 9996

### Tactile Markings

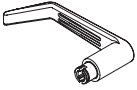
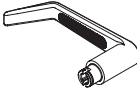
	Part #	Description	List Add \$
	660002	Knurled or grooved lever (LR, LT, and LG designs only)	85.00
	660003	Abrasive coated lever or knob (all designs)	61.00

**NOTE:** Tactile marking is applied to outside knob or lever only, unless otherwise specified. Prices shown per single lever or knob.

**Request to Exit/Latch Monitoring**

Suffix	Description	List Add \$
RX	Request to exit, M9025/ 9050/ 9080 / 9080EU/ 9080EL/ 9082EU/ 9082EL. Specify RX. Example: M9010RX.	221.00
LM	Latch Monitoring, M9010/ 9025/ 9050/ 9053/ 9070/ 9071/ 9080/ 9080EL/ 9080EU/ 9082/ 9082EL/ 9082EU. Specify LM. Example: M9080EULM.	221.00
RXLM	Request to Exit & Latch Monitoring, M9025/ 9050/ 9080/ 9080EL/ 9080EU. Specify RXLM. Example: M9050RXLM.	436.00

**Security Screws**

Specify	Description	List Add \$
TX A/B/D	Security screws for all exposed fasteners (sectional trim and dead bolts only).	24.00
TX H	Security screws for all exposed fasteners (H escutcheon only).	26.00
TX M	Security screws for all exposed fasteners (M escutcheon only).	26.00

**NOTE:** Only available for use with 619, 625, 626, and 630 finish locksets.

**Special Strikes (Non-Standard Lip Lengths)**

Part #	Description	626,	605, 606,
		630	612, 613, 622
		List Add \$	
5006-XXX	1-1/4" x 4-7/8", special lip length (greater than 2-1/4"). Specify lip length.	113.00	140.00

**Example:** 5006-312 630 for a 2-1/2" lip length strike in 630 finish.

**NOTE:** Non-standard items are considered to be special request items and have an extended lead time. Consult factory for more information.

**Non-Standard Door Thickness**

Charges include special strike and cylinder requirements. Extended lead time may be required, check with factory. For functions requiring an indicator, add \$75.

Description	Type	List Add \$
<b>Functions without a Cylinder</b>		
Doors >1-3/4" to 2-1/2"	EE, EI, EO, ED	N/C
Doors >2-1/2" to 4"	EE, EI, EO, ED	111.00
<b>Single Cylinder Functions</b>		
Doors >1-3/4" to 2-1/2"	EE, EI, EO, ED	N/C
Doors >2-1/2" to 4"	EI	111.00
Doors >2-1/2" to 4"	EE, EO, ED	301.00
<b>Double Cylinder Functions</b>		
Doors >1-3/4" to 2-1/2"	EE, EI, EO, ED	N/C
Doors >2-1/2" to 4"	EI	111.00
Doors >2-1/2" to 4"	EE, EO, ED	524.00

**NOTES:**

- EE – Door thickness extended equally (lock is centered)
- EI – Door thickness extended inside only
- EO – Door thickness extended outside only
- ED – Door thickness extended differently inside and outside

**Required Information – For Non-Standard Door Thickness**

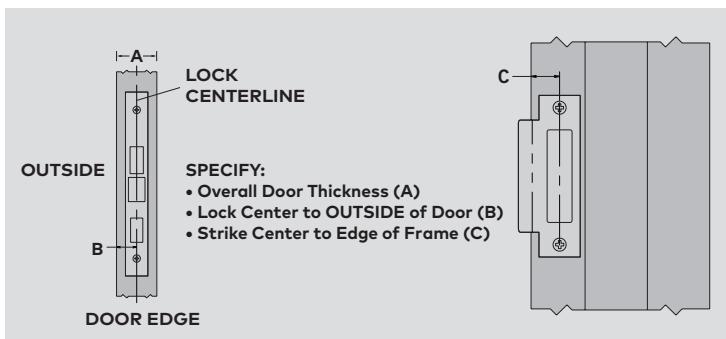

**Special Requests:**  
 Customized products may be available to solve unusual functions or applications.  
 Contact Technical Services for assistance.







# D900 Series

## Ordering Guide

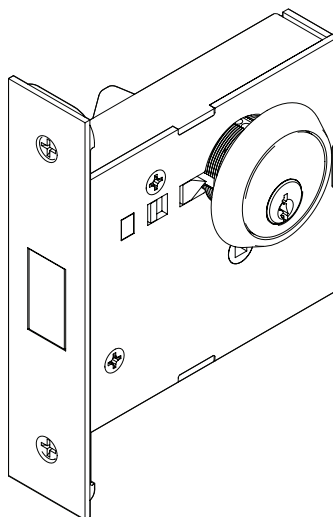

Function		Antimicrobial Coating		Security Screws		Strike Options		Keying Options Field		
Turn Only	81	AM	TX							
Indicator x Turn	71									
Cylinder x Classroom	63*									
Cylinder x Cylinder	62									
Cylinder x Blank	61									
Cylinder x Turn	60									
<b>Product Family</b>	<b>D9</b>	<b>60</b>	<b>626</b>			<b>RH</b>	<b>134</b>	<b>5301</b>	<b>D</b>	<b>XXXX</b>
Grade 1 Small Case Mortise Dead Bolt	Satin Stainless	630	Right Hand/ Right Hand Reverse	RH	134	1-3/4" - 2-1/4"	T	Temporary SFIC		
	Satin Chrome	626	Left Hand/ Left Hand Reverse	LH		<b>Door Thickness</b>	J	SFIC (Less Core)		
	Bright Chrome	625					C	SFIC		
	Satin Black	622 PVD					L	Less Cylinder		
	Satin Nickel	619 PVD					D	Conventional Cylinder		
	Dark Oxidized	613 PVD					G	Temporary Schlage LFIC		
	Satin Bronze	612 PVD					R	Schlage LFIC (Less Core)		
	Satin Bronze	612 PVD					F	Schlage LFIC		
	Satin Brass	606 PVD								
	Bright Brass	605 PVD								

**Handing (D963 only)**

**Cylinder Type**

\* D963 function available in 613, 619, 626, and 630 finish only.

ANSI #	Function	Description	List \$	
E06071	D960	Cylinder x Turn	436.00	463.00
E06061	D962	Cylinder x Cylinder	500.00	526.00
E06091	D963	Cylinder x Classroom	500.00	526.00
E06081	D961	Cylinder x Blank	413.00	438.00
—	D971	Cylinder Indicator x Turn	500.00	532.00
E06181	D981	Turn Only	327.00	343.00

## Cylinder Types, Keying Options, and Keyways

Cylinder	Option	Description	List Add/Deduct \$
<b>Conventional Cylinders (non-interchangeable core)</b>			
<b>D</b>		Conventional cylinder	Example: D960D
	<b>KD</b>	<b>Keyed differently to a random combination; SC keyway with 2 keys (default)</b>	<b>N/C</b>
	KA2	Keyed alike in pairs to a random combination; SC keyway with 2 keys	N/C
	NSK	Keyed alike, sets of three or more; SC keyway with 2 keys	18.00
	NS2	Keyed alike double cylinder locks; SC keyway with 2 keys	34.00
	1-Bit	Operated by 1-bit cut key; SC, SE keyway with 2 key blanks (order 1-bit key separately)	N/C
	1-Bit	Operated by 1-bit cut key; D100 keyway — <b>⊗ Keys sold separately</b>	N/C
	0-Bit	Operated by 0-bit cut key; AA, CA, CB, CC, CD, CE, RA, RB, GA, SF, YA, YG keyways with 2 key blanks	18.00
	MKD	Master keyed; SC, SE, or D100 keyway — <b>⊗ Keys sold separately</b>	23.00
	MK2	Master keyed double cylinder lock; SC, SE, or D100 keyway — <b>⊗ Keys sold separately</b>	45.00
	CMK	Construction master keyed single cylinder locks — <b>⊗ Keys sold separately</b>	25.00
	CM2	Construction master keyed double cylinder locks — <b>⊗ Keys sold separately</b>	49.00
<b>L</b>		Lock less conventional cylinder and collar	Example: D960L Deduct 30.00
<b>Interchangeable Core Cylinders</b>			
<b>T</b>		SFIC — Housing with keyed temporary SFIC construction core (Core may be returned for a full refund) — <b>⊗ Keys sold separately</b>	Example: D960T 54.00
<b>J</b>		SFIC — Housing with disposable plastic SFIC plug	Example: D960J 54.00
<b>C</b>		SFIC — Housing with combined SFIC core installed at the factory; BA (default), BB, BC, BD, BE, BF, BG, BH, BJ, BK, BL, BM, BQ, D100 keyway — <b>⊗ Keys sold separately</b>	Example: D960C 62.00
<b>G</b>		Schlage LFIC — Housing with keyed temporary Schlage LFIC construction core (Core may be returned for full refund) — <b>⊗ Keys sold separately</b>	Example: D960G 54.00
<b>R</b>		Schlage LFIC — Housing less core	Example: D960R 12.00
<b>F</b>		Schlage LFIC — Housing with combined Schlage LFIC installed at the factory (SC keyway) — <b>⊗ Keys sold separately</b>	Example: D960F 62.00

1. For uncombined cores, UNC, cores must be ordered separately, see Cylinders, Keys & Keying.  
Locks will be supplied w/plastic construction core, Option J.

⊗ Denotes keys must be ordered separately.

### Cut Keys Ordered Separately

Part #	Description	List \$
45101	SFIC Cut key — Change key, master key, construction master key, or control key; BA, BB, BC, BD, BE, BF BG, BH, BJ, BK, BL, BM, BQ, SC, SE keyways	10.00
45401	SFIC Cut key — Change key, master key, or control key; SKC keyways — D100 etc.	16.00
45404	CONV/LFIC Cut key — 1-bit key for operating 1-bit cylinders — SC, SE keyways	8.00
45405	LFIC Cut key — 1-bit control key (to install/remove "1-bit" LFIC cores) — SC keyway	8.00
44101SC	CONV/LFIC Key blank — SC keyway	5.00
44104SC	LFIC Key blank — Control key (to install/ remove LFIC Cores) — SC keyway	7.00

#### NOTES:

- Distribution of DORMA SKC keys (listed as D100) is restricted. See Cylinders, Keys & Keying section for DORMA SKC policies.
- 1 bit cylinder comes with (2) uncut keys and will require a 1 bit cut key, sold separately, to operate cylinder. SC and SE keyways only.
- See Keys and Key Blanks section for complete list.

## D900 Accessories

### Antimicrobial Coating

Description of Components Coated		List \$
<b>Available on 626 and 630 finished. Specify AM. Example 626AM or 630AM.</b>		
Inside	Thumb Turn and Rose if applicable to function	47.00

**NOTE:** AM Coating not available on Cylinders (AM Coating not available on outside). Extended lead time required, consult factory.

### Security Screws

Specify	Description	List \$
TX	Security Screws for Strike, Armor Plate, Thumb Turn	24.00

**NOTE:** Only available for use with 619, 625, 626, and 630 finish locksets.

# T900 Series

## Ordering Guide

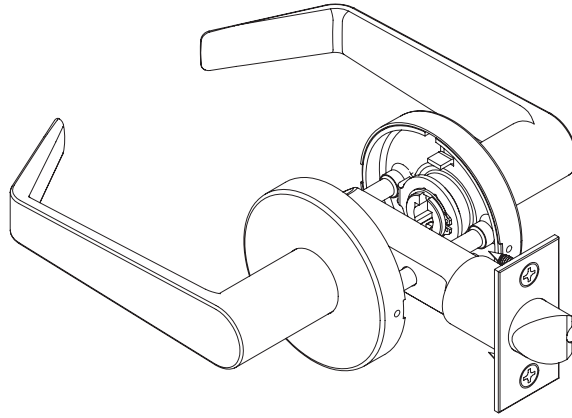

Function		Rose Design		Finish <sup>3</sup>		Fire-Rated <sup>5</sup>		Latch Bolt <sup>6</sup>		Strike Options <sup>6</sup>		Lip Length <sup>6</sup>	
Privacy, Bedroom or Bath	40	2-9/16" Dia. <sup>1</sup>	D	630	— Satin Stainless								
Exit/Communicating Passage	25	Decorative		626	— Satin Chrome								
Passage/Closet	10			625	— Bright Chrome								
Double Dummy	02			622 PVD	— Satin Black								
Single Dummy, Through-Bolted	01	2-9/16" Dia.	B	619 PVD	— Satin Nickel								
				613 PVD	— Dark Oxidized Satin Bronze								
				612 PVD	— Satin Bronze								
				606 PVD	— Satin Brass								
				605 PVD	— Bright Brass								
						F							
<b>T9</b>	<b>10</b>	<b>LR</b>	<b>B</b>	<b>626</b>		<b>RH</b>		<b>90202</b>	<b>134</b>	<b>5101</b>	<b>118</b>		
<b>Product Family</b> Grade 2 Tubular Lockset		<b>LC</b>	— Lever	<b>AM</b>	<b>Antimicrobial Coating<sup>4</sup></b>	<b>RH</b>	— Right Hand		<b>134</b>	— 1-3/8" - 1-3/4"			
		<b>LD</b>	— Lever, Handed			<b>LH</b>	— Left Hand						
		<b>LG</b>	— Lever										
		<b>LN</b>	— Lever										
		<b>LR</b>	— Lever										
		<b>LT</b>	— Lever										
		<b>PREMIUM</b>	— Premium Lever										
		<b>Lever Design<sup>2</sup></b>											

1. D rose not available in 625 or 626.
2. See Finish Availability chart, page 21.
3. For split finishes, consult factory. Specify in-swing or out-swing.
4. Available on 626/630 finishes only.
5. Fire rated latch available on T925 (standard) and T910 (optional). Not available on T
6. Example shows default values. Refer to Configuration Options section for full detail
7. Standard door thickness is 1-3/8"-1-3/4". Contact factory for other thicknesses.

# Trim Options

## Lever Options

### Standard

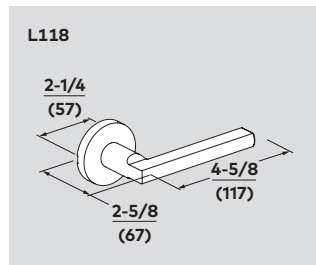
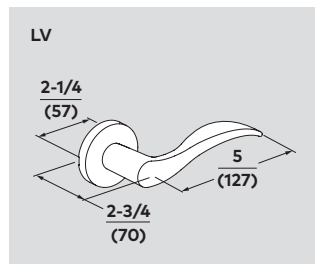
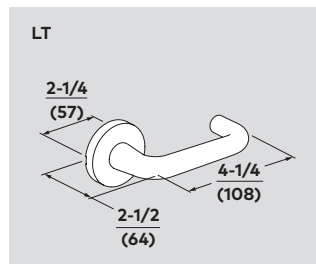
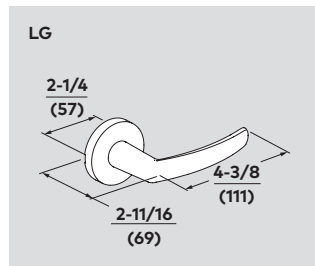
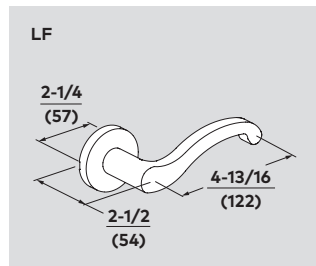
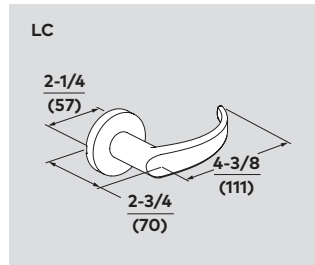
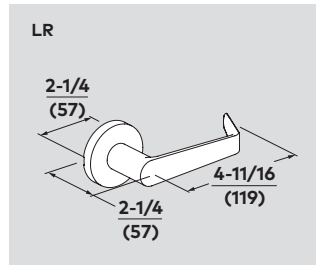

### Premium

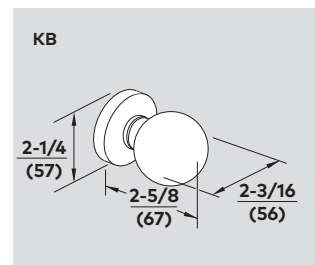
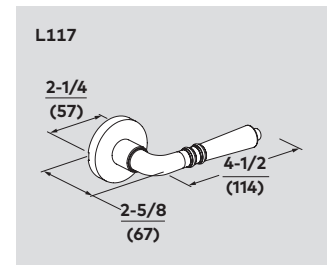
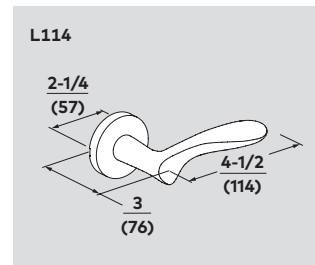
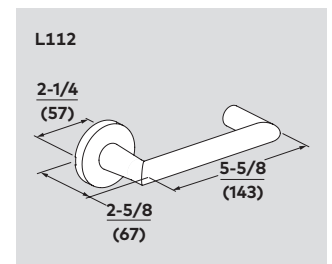
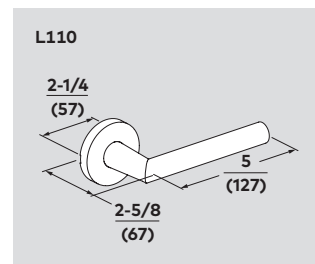
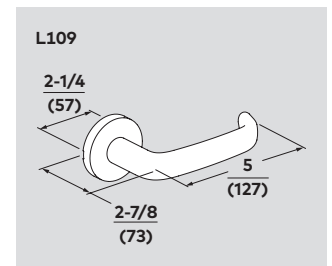
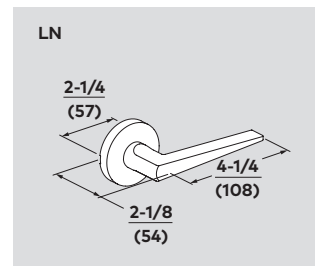
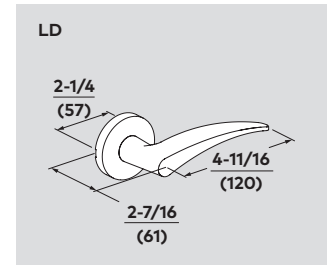
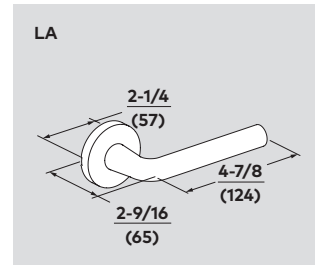

Wrought Roses

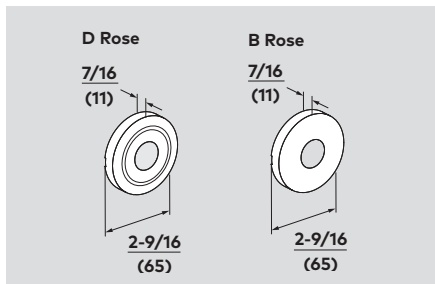

Finish Availability Chart									
	605	606	612	613	619	622	625	626	630
<b>Standard Levers</b>									
LR	•	•	•	•	•	•	•	•	•
LC	•	•	•	•	•	•	•	•	•
LG	•	•	•	•	•	•	•	•	•
LF	•	•	•	•	•	•	•	•	
LT	•	•	•	•	•	•	•	•	•
LV	•	•	•	•	•	•	•	•	
L118		•	•	•	•	•			•
<b>Premium Levers</b>									
LA	•	•	•	•	•	•	•	•	•
LD	•	•	•	•	•	•	•	•	
LN	•	•	•	•	•	•	•	•	
L109		•	•	•	•	•			•
L110	•	•	•	•	•	•	•	•	•
L112		•	•	•	•	•			•
L114	•	•	•	•	•	•	•	•	
L117	•	•	•	•	•	•			•
<b>Knob</b>									
KB		•	•	•	•	•			•

# T900 Series

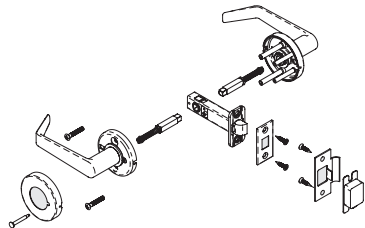

## Standard Levers

L118 not available in 605, 625, or 626 finish.  
 LF and LV not available in 630 finish.  
 See Lever Finish Availability Chart, page 21.  
 D rose not available in 625 or 626.

626	605, 606, 612, 619, 622, 625, 613, 630
-----	---

ANSI #	Function	Description	List \$	
<b>Keyless</b>				
—	T901	Single dummy, surface mounted	201.00	212.00
—	T902	Double dummy	274.00	293.00
F75	T910	Passage/closet	329.00	350.00
F111	T925	Exit/communicating	329.00	350.00
F76	T940	Privacy, bedroom or bath	352.00	370.00

**NOTE:** Split finishes will be priced at the higher finish list price.

## Premium Levers

L109, L112, and L117 not available in 625 or 626 finishes.  
 LD, LN, and L114 not available in 630 finish.  
 See Lever Finish Availability Chart, page 21.  
 D rose not available in 625 or 626.

626	605, 606, 612, 619, 622, 625, 613, 630
-----	---

ANSI #	Function	Description	List \$	
<b>Keyless</b>				
—	T901	Single dummy, surface mounted	218.00	230.00
—	T902	Double dummy	305.00	324.00
F75	T910	Passage/closet	364.00	383.00
F111	T925	Exit/communicating	364.00	383.00
F76	T940	Privacy, bedroom or bath	384.00	405.00

**NOTE:** Split finishes will be priced at the higher finish list price.



## Configuration Options

### Non-Fire Latch Bolts

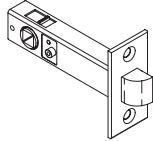

Part #	Backset	Description	List Add \$
90202	2-3/4"	1-1/8" faceplate, passage, square corner, non-fire, T910 only	N/C
90200	2-3/4"	1" faceplate, passage, square corner, non-fire, T910 only	N/C
90100	2-3/8"	1" faceplate, passage, square corner, non-fire, T910 only	N/C
90101	2-3/8"	1" faceplate, passage, 1/4" radius corner, non-fire, T910 only	N/C
90232	2-3/4"	1-1/8" faceplate, privacy, square corner, non-fire, T940 only	N/C
90230	2-3/4"	1" faceplate, privacy, square corner, non-fire, T940 only	N/C
90130	2-3/8"	1" faceplate, privacy, square corner, non-fire, T940 only	N/C
90131	2-3/8"	1" faceplate, privacy, 1/4" radius corner, non-fire, T940 only	N/C

### Fire-Rated Latch Bolts

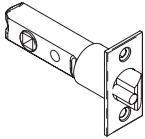

Part #	Backset	Description	List Add \$
91202	2-3/4"	1-1/8" faceplate, passage, square corner, 90 min fire-rated, T910	20.00
91200	2-3/4"	1" faceplate, passage, square corner, 90 min fire-rated, T910	20.00
91100	2-3/8"	1" faceplate, passage, square corner, 90 min fire-rated, T910	20.00
91101	2-3/8"	1" faceplate, passage, 1/4" radius corner, 90 min fire-rated, T910	20.00

**NOTE:** List add for fire-rated latch with T910 only. Fire-rated latch standard for T925 – no list add. Not available on T940.

### Strikes

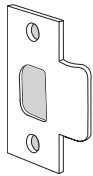

Part #	Description	List Add \$
<b>5101 – T Strike with Dust Box</b>		
<b>5101-118</b>	<b>1-1/8" x 2-3/4", 1-1/8" lip length, square corner</b>	N/C
5101-112	1-1/8" x 2-3/4", 1-1/2" lip length, square corner	28.00
5102-118	1-1/8" x 2-3/4", 1-1/8" lip length, radius corner	N/C

**NOTE:** Default strike shown in bold.

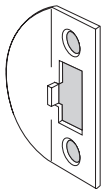

Part #	Description	List Add \$
<b>5201, 5202 – Full Lip Strike</b>		
5201-118	1-5/8" x 2-1/4", 1-1/8" lip length, square corner	N/C
5202-118	1-5/8" x 2-1/4", 1-1/8" lip length, 1/4" radius corner	N/C

Strikes Continued

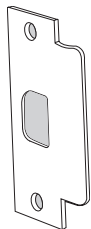

Part #	Description	List Add \$
<b>5001 – ANSI Strike, includes Dust Box</b>		
5001-1316	1-1/4" x 4-7/8", 1-3/16 lip length, square corner	N/C
5001-112	1-1/4" x 4-7/8", 1-1/2 lip length, square corner	28.00
5001-078	1-1/4" x 4-7/8", 7/8 lip length	28.00

## Special Application Options

### Antimicrobial Coating

Available on 626 and 630 finish. Specify AM. Example: 626AM

Description of Components Coated	List Add \$
Lever trim Inside: Lever and rose Outside: lever and rose	62.00

**NOTE:** Extended leadtime, consult factory.

### Tactile Markings

Part #	Description	List Add \$
660002	Knurled or grooved lever (LR, LT, and LG designs only)	85.00
660003	Abrasive coated lever or knob (all designs)	61.00

**NOTE:** Tactile marking is applied to outside knob or lever only, unless otherwise specified. Prices shown per single lever or knob.

### Special Strikes (Non-Standard Lip Lengths)

Part #	Description	List Add \$
<b>5001 – ANSI Strike with Tubular Lock Cutout, includes Dust Box</b>		
5001-XXX	1-1/4" x 4-7/8", special lip length (longer than 1-1/2"). Specify length and finish.	116.00

**Example:** 5001-200 630 for a 2" lip length in 630 finish.

**NOTE:** Non-standard items are considered to be special request items and have an extended lead time. Consult factory for more information.

# C100 Series

## Ordering Guide

**Function**

F93 – Faculty Restroom/Hotel <sup>1</sup>	85
F87 – Asylum	82
Electrically Unlocked (Fail Secure)	80EU
Electrically Locked (Fail Safe)	80EL
F86 – Storeroom	80
F110 – Classroom Intruder	77
F90 – Corridor/Dormitory	73
F80 – Communicating	72
F84 – Classroom	70
F91 – Store Door	66
F113 – Exit/Communicating Classroom	65
F88 – Apartment	60
F92 – Service Station	55
F109 – Entry	53
F82 – Entry/Office	50
F112 – Exit/Communicating Storeroom	48
Hospital Privacy	44
F76A – Privacy, Bedroom or Bath	40
F77A – Patio	30
F111 – Exit/Communicating Passage	25
F89 – Exit	12
F75 – Passage/Closet	10
Double Dummy	02
Single Dummy	01

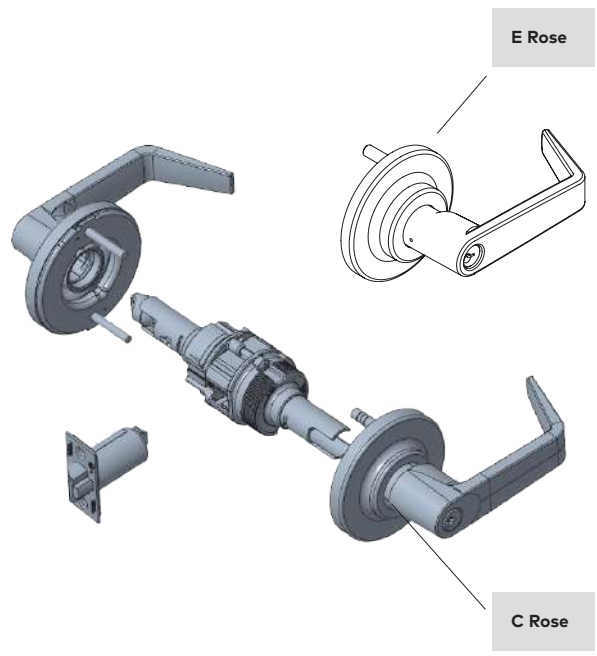

**Finish**

626	– Satin Chrome
625	– Bright Chrome
622	– Satin Black
619	– Satin Nickel
613	– Dark Oxidized Satin Bronze
612	– Satin Bronze
606	– Satin Brass
605	– Bright Brass

**Cylinder Type<sup>3</sup>**

D	– Conventional Cylinder
L	– Less Conventional Cylinder
J	– SFIC (Less Core)
T	– Temporary SFIC

<b>C1</b>	<b>53</b>		<b>D</b>	<b>LR</b>	<b>C</b>	<b>626</b>			<b>RH</b>	<b>10252</b>	<b>134</b>	<b>5001</b>	<b>1316</b>	<b>XXXX</b>
-----------	-----------	--	----------	-----------	----------	------------	--	--	-----------	--------------	------------	-------------	-------------	-------------

Request to Exit<sup>2</sup>

<b>RX</b>	Lever	<b>LR</b>
	Lever	<b>LC</b>
	Lever	<b>LG</b>

**Lever Design**

<b>C</b>	– 3-1/2" Dia. stamped, LOCK
<b>D</b>	– 3-1/2" Dia. stamped, LOCK
<b>E</b>	– 3-1/2" Dia. stepped rose
<b>F</b>	– 3-1/2" Dia. stepped rose stamped, LOCK

**Rose Design**

**AM**

**TX**

**Security Screws**

**Antimicrobial Coating<sup>4</sup>**

**Latch Bolt**

**Strike Options**

**Lip Length**

**134** – 1-3/4" – 2-1/4"

**138** – 1-3/8" – 1-5/8"

**Door Thickness<sup>5</sup>**

**Keying Options Field**

**Product Family**  
Heavy-Duty Grade 1 Cylindrical Lockset

1. Faculty restroom/hotel function available only in SFIC.
2. Request to exit option only available on lever lock. Available with C110, C150, C153, C170, C180, C180EL & C180EU functions only.
3. Consult factory for other cylinder options
4. Antimicrobial coating available on lever trim, 626 finish only. Consult factory for other finishes.
5. Door thickness range: Lever locks 1-3/4" – 2-1/4" without spacers; 1-3/8" – 1-5/8" with spacers.

Lever Designs

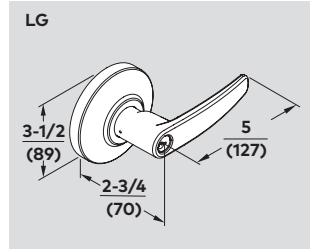
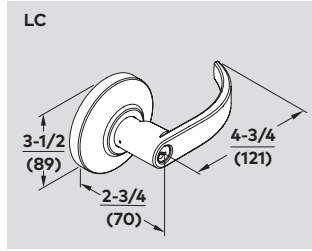
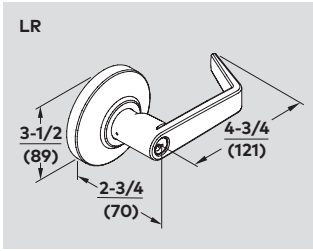

Rose Designs

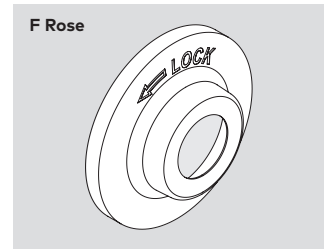
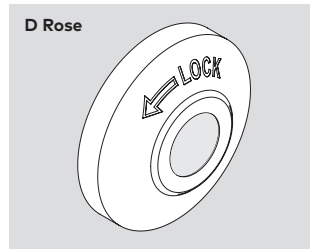
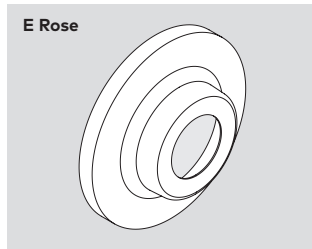
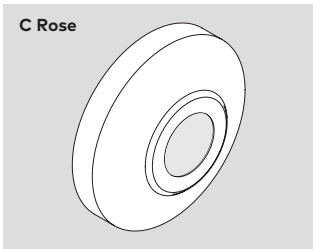

# Lever Locks

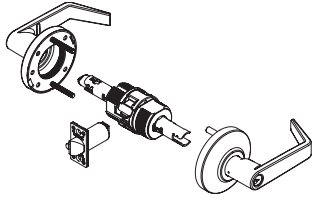

Lever Locks







626

605, 606,  
612, 619,  
625, 613,  
622

ANSI #	Function	Description	List \$	
<b>Keyless</b>				
F75	C110	Passage/closet	582.00	627.00
F89	C112	Exit	582.00	627.00
F111	C125	Exit/communicating passage	582.00	627.00
F77A	C130	Patio	688.00	737.00
F76A	C140	Privacy, bedroom or bath	666.00	714.00
—	C144	Hospital privacy	666.00	714.00
—	C101	Single dummy	251.00	274.00
—	C102	Double dummy	480.00	529.00
<b>Keyed, Single Cylinder</b>				
F112	C148	Exit/communicating storeroom	774.00	835.00
F82	C150	Entry/office	774.00	835.00
F109	C153	Entry	774.00	835.00
F84	C170	Classroom	774.00	835.00
F92	C155	Service station	774.00	835.00
F113	C165	Exit/communicating classroom	774.00	835.00
F86	C180	Storeroom	774.00	835.00
F90	C173	Corridor/dormitory	798.00	845.00
F93	C185 <sup>1</sup>	Faculty restroom/hotel	904.00	951.00
—	C180EL	Electrically locked (fail safe)	1,054.00	1,104.00
—	C180EU	Electrically unlocked (fail secure)	1,054.00	1,104.00
<b>Keyed, Double Cylinder</b>				
F80	C172	Communicating	936.00	986.00
F87	C182	Asylum	936.00	986.00
F88	C160	Apartment	936.00	986.00
F91	C166	Store door	936.00	986.00
F110	C177	Classroom intruder (includes <b>LOCK</b> rose on inside)	936.00	986.00

**NOTE: 1.** Faculty restroom/hotel function available only in SFIC.

## Cylinder Types, Keying Options, and Keyways

Cylinder	Option	Description	List Add/Deduct \$
<b>Conventional Cylinders (non-interchangeable core)</b>			
<b>D</b>		Conventional cylinder	Example: C153D
	<b>KD</b>	<b>Keyed differently to a random combination; SC keyway with 2 keys (default)</b>	N/C
	KA2	Keyed alike in pairs to a random combination; SC keyway with 2 keys	N/C
	NSK	Keyed alike, sets of three or more; SC keyway with 2 keys	18.00
	NS2	Keyed alike double cylinder locks; SC keyway with 2 keys	34.00
	1-Bit	Operated by 1-bit cut key; SC, SE keyway with 2 key blanks (order 1-bit key separately)	N/C
	0-Bit	Operated by 0-bit key; D100 keyway —  <b>Keys sold separately</b>	N/C
	0-Bit	Operated by 0-bit cut key; AA, CA, CB, CC, CD, CE, RA, RB, GA, SF, YA, YG keyways with 2 key blanks	18.00
	MKD	Master keyed; SC, SE, or D100 keyway —  <b>Keys sold separately</b>	23.00
	MK2	Master keyed double cylinder lock; SC, SE, or D100 keyway —  <b>Keys sold separately</b>	45.00
	CMK	Construction master keyed single cylinder locks —  <b>Keys sold separately</b>	25.00
	CM2	Construction master keyed double cylinder locks —  <b>Keys sold separately</b>	49.00
<b>L</b>		Lock less conventional cylinder	Example: C153L Deduct 30.00
<b>Interchangeable Core Cylinders</b>			
<b>T</b>		SFIC — Housing with keyed temporary SFIC construction core (Core may be returned for a full refund) —  <b>Keys sold separately</b>	Example: C170T 54.00
<b>J</b>		SFIC — Housing with disposable plastic SFIC plug	Example: C170J 54.00

1. For uncombined cores, UNC, cores must be ordered separately, see Cylinders, Keys & Keying.

 Denotes keys must be ordered separately.

**Cut Keys Ordered Separately**

Part #	Description	List \$
45101	SFIC Cut key – Change key, master key, construction master key, or control key; BA, BB, BC, BD, BE, BF, BG, BH, BJ, BK, BL, BM, BQ, SC, SE keyways	10.00
45401	SFIC Cut key – Change key, master key, or control key; SKC keyways – D100 etc.	16.00
45404	CONV Cut key – 1-bit key for operating 1 bit cylinders – SC, SE keyways	8.00
44101SC	CONV Key blank – SC keyway	5.00

**NOTES:**

Distribution of DORMA SKC keys (listed as D100) is restricted. See Cylinders, Keys & Keying section for DORMA SKC policies. 1-bit cylinder comes with (2) uncut keys and will require a 1-bit cut key, sold separately, to operate cylinder. See Keys and Key Blanks section for complete list.

## Configuration Options

**Latch Bolts**

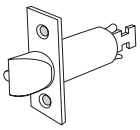

**9/16" Throw, 2-3/4" Backset**

Part #	Description	List Add \$
For 110, 140, 144 Functions		
10202	1-1/8" x 2-3/4" front, 1" diameter, square corner, spring latch	N/C
For All Other Functions		
10252	1-1/8" x 2-3/4" front, 1" diameter, square corner, deadlocking latch	N/C

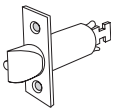

**9/16" Throw, 3-3/4" Backset**

Part #	Description	List Add \$
For 110, 140, 144 Functions		
10302	1-1/8" x 2-1/4" front, 1" diameter, square corner, spring latch	30.00
For All Other Functions		
10352	1-1/8" x 2-1/4" front, 1" diameter, square corner, deadlocking latch	30.00

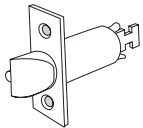

**9/16" Throw, 5" Backset**

Part #	Description	List Add \$
For 110, 140, 144 Functions		
10502	1-1/8" x 2-1/4" front, 1" diameter, square corner, spring latch	30.00
For All Other Functions		
10552	1-1/8" x 2-1/4" front, 1" diameter, square corner, deadlocking latch	30.00

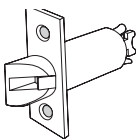

**3/4" Throw, 2-3/4" Backset**

Part #	Description	List Add \$
<b>100 Locks</b>		
18262	1-1/8" x 2-1/4" front, 1" diameter, square corner. Available in 605/ 606, 612, 613, 622, 626.	135.00

Strikes

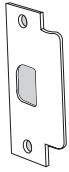

Part #	Description	List Add \$
<b>5001 – ANSI Strike Includes Dust Box</b>		
<b>5001-1316</b>	<b>1-1/4" x 4-7/8", 1-3/16" lip length, square corner</b>	N/C
5003-078	ANSI 7/8" Flat lip strike	26.00

**NOTE:** Default strike shown in bold.

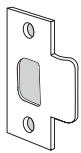

Part #	Description	List Add \$
<b>5101 – T Strike with Dust Box</b>		
5101-118	1-1/8" x 2-3/4", 1-1/8" lip length, square corner	N/C
5105-112	1-1/8" x 2-3/4", 1-1/2" lip length, square corner	26.00

**Antimicrobial Coating**

Available on 626 finish. Specify AM. Example: 626AM

Description of Components Coated	List Add \$
Lever trim      Inside: Lever and rose Outside: lever and rose	58.00

**NOTE:** Extended leadtime, consult factory.



## Special Application Options

### Knurled Levers (Tactile Markings)

Part #	Description	List Add \$
660003	Abrasive adhesion	61.00

**NOTE:** Tactile marking is applied to outside knob or lever only, unless otherwise specified. Prices shown are for one lever only.

### Spacers for 1-3/8" Doors, C100 Series

Part #	Description	605, 606, 612, 613, 622, 625, 626 List Add \$
660005	Spacers for thin door, 1 pair (2 spacers) 1-3/8" door – Specify finish.	58.00

**NOTE:** Spacers are included if 1-3/8" door thickness is specified.

### Security Screws

Part #	Description	List Add \$
TX	Security screws for latch and strike.	21.00

**NOTE:** Specify finish 625/626, 605/606, 611/612, 613

### Special Strikes (Non-Standard Lip Lengths)



Part #	Description	List Add \$
5001-XXX	1-1/4" x 4-7/8", special lip length (longer than 1-1/2"). Specify length.	109.00

**NOTE:** Non-standard items are considered to be special request items and have an extended lead time. Consult factory for more information.  
Lip length is distance from center of mounting holes to edge of strike.

### Request to Exit

Specify	Description	List Add \$
RX	Request to exit, available on C100 lever models: C110, C150, C153, C170, C180, C180EL, C180EU	198.00

### Indicator Rose

Specify	Description	List Add \$
	D Rose* Stamped <b>LOCK</b> on inside rose (specify finish)	N/C
	F Rose* Stepped, stamped <b>LOCK</b> on inside rose (specify finish)	N/C

\* Optional on inside of C160 Apartment function; Standard on inside of C177 Intruder function.



# DB100 Series

## Ordering Guide

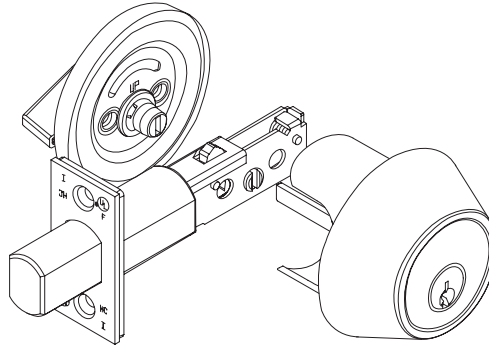

Function		Cylinder Type <sup>1</sup>		Latch Bolt <sup>3</sup>											
Turn x Turn —	<b>82</b>	<table border="1"> <tr> <td><b>D</b></td> <td>— Conventional Cylinder</td> </tr> <tr> <td><b>J</b></td> <td>— SFIC (Less Core)</td> </tr> <tr> <td><b>T</b></td> <td>— Temporary SFIC</td> </tr> </table>	<b>D</b>	— Conventional Cylinder	<b>J</b>	— SFIC (Less Core)	<b>T</b>	— Temporary SFIC	<table border="1"> <tr> <td><b>28752</b></td> <td><b>5103</b></td> </tr> </table>	<b>28752</b>	<b>5103</b>	<table border="1"> <tr> <td colspan="2"><b>XXXX</b></td> </tr> </table>		<b>XXXX</b>	
<b>D</b>	— Conventional Cylinder														
<b>J</b>	— SFIC (Less Core)														
<b>T</b>	— Temporary SFIC														
<b>28752</b>	<b>5103</b>														
<b>XXXX</b>															
Turn only —	<b>81</b>														
Turn x Blank Plate —	<b>80</b>														
Turn x Occupancy Indicator —	<b>71</b>														
Cylinder x Classroom —	<b>63</b>														
Cylinder x Cylinder —	<b>62</b>														
Cylinder x Blank Plate —	<b>61</b>														
Cylinder x Turn —	<b>60</b>														

<b>DB</b>	<b>1</b>	<b>60</b>	<b>D</b>	<b>626</b>	<b>AM</b>	<b>28752</b>	<b>5103</b>	<b>XXXX</b>
-----------	----------	-----------	----------	------------	-----------	--------------	-------------	-------------

  

<b>Product Type</b>  Heavy-Duty Grade 1 Tubular Dead Bolt  <b>Product Family</b>	Dead Bolt —	<b>D</b>
	Bright Brass —	<b>605</b>
	Satin Brass —	<b>606</b>
	Satin Bronze <sup>4</sup> —	<b>612</b>
	Dark Oxidized Satin Bronze —	<b>613</b>
	Satin Nickel <sup>4</sup> —	<b>619</b>
	Matte Black <sup>4</sup> —	<b>622</b>
	Bright Chrome <sup>4</sup> —	<b>625</b>
	Satin Chrome —	<b>626</b>

**Finish**

1. The Less Conventional Cylinder option is not available for the DB100 Series.  
 2. Example shows default values. Refer to Configuration Options section for full details.  
 3. Available on 626 finish only. Consult factory for other finishes.  
 4. Special Order Finish — May require additional lead time.

## DB100 Series

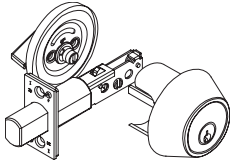

<b>626</b>	<b>605, 606, 612, 619, 625, 613, 622</b>
------------	--

ANSI #	Function	Description	List \$	
<b>Keyless</b>				
E21111	DB180	Thumb turn x blank plate	222.00	246.00
E2191	DB181	Thumb turn only	213.00	237.00
—	DB182	Thumb turn x thumb turn (windstorm)	264.00	291.00
—	DB171	Thumb turn x occupancy indicator w/coin turn	217.00	242.00
<b>Keyed, Single Cylinder</b>				
E2151	DB160	Cylinder x turn	264.00	291.00
E2161	DB161	Cylinder x blank	245.00	270.00
E2171	DB163	Cylinder x classroom turn	277.00	303.00
<b>Keyed, Double Cylinder**</b>				
E2141	DB162	Cylinder x cylinder	339.00	364.00

**\*\* CAUTION:** Double cylinder locks used on residences and any door in a structure which is used for egress are a life safety hazard in times of emergency and their use is not recommended. Installation should be in accordance with existing codes only.

**NOTE:** List prices for keyed locks include standard DORMA (D) cylinder, keyed different (KD) with two (2) nickel silver keys.

## Cylinder Types, Keying Options, and Keyways

Cylinder	Option	Description	List Add/Deduct \$
<b>Conventional Cylinders (non-interchangeable core)</b>			
<b>D</b>		Conventional cylinder	Example: DB160D
	<b>KD</b>	<b>Keyed differently to a random combination; SC keyway with 2 keys (default)</b>	N/C
	KA2	Keyed alike in pairs to a random combination; SC keyway with 2 keys	N/C
	NSK	Keyed alike, sets of three or more; SC keyway with 2 keys	18.00
	NS2	Keyed Alike double cylinder locks; SC keyway with 2 keys	34.00
	1-Bit	Operated by 1-bit cut key; SC, SE keyway with 2 key blanks (order 1-bit key separately)	N/C
	0-Bit	Operated by 0-bit key; D100 keyway — <b>Keys sold separately</b>	N/C
	0-Bit	Operated by 0-bit cut key; AA, CA, CB, CC, CD, CE, RA, RB, GA, SF, YA, YG keyways with 2 key blanks	18.00
	MKD	Master keyed; SC, SE, or D100 keyway — <b>Keys sold separately</b>	23.00
	MK2	Master keyed double cylinder lock; SC, SE, or D100 keyway — <b>Keys sold separately</b>	45.00
	CMK	Construction master keyed single cylinder locks — <b>Keys sold separately</b>	25.00
	CM2	Construction master keyed double cylinder locks — <b>Keys sold separately</b>	49.00
<b>Interchangeable Core Cylinders</b>			
<b>T</b>		Lock with keyed temporary SFIC construction core (cores may be returned for a full refund) — <b>Keys sold separately</b>	Example: DB160T 54.00
<b>J</b>		Lock with disposable plastic SFIC plug	Example: DB160J 54.00

\* The Less Cylinder option is not available for the D800 Series.

1. For uncombined cores, UNC, cores must be ordered separately, see Cylinders, Keys & Keying. Locks will be supplied w/plastic construction core, Option J.

☒ Denotes keys must be ordered separately.

### Cut Keys Ordered Separately

Part #	Description	List \$
45101	SFIC Cut key — Change key, master key, construction master key, or control key; BA, BB, BC, BD, BE, BF BG, BH, BJ, BK, BL, BM, BQ, SC, SE keyways	10.00
45401	SFIC Cut key — Change key, master key, or control key; SKC keyways — D100 etc.	16.00
45404	CONV Cut key — 1-bit key for operating 1-bit cylinders — SC, SE keyways	8.00
44101SC	CONV Key blank — SC keyway	5.00

#### NOTES:

- Distribution of DORMA SKC keys (listed as D100) is restricted. See Cylinders, Keys & Keying section for DORMA SKC policies.
- 1-bit cylinder comes with (2) uncut keys and will require a 1-bit cut key, sold separately, to operate
- See Keys and Key Blanks section for complete list.

# Configuration Options

## Dead Bolts

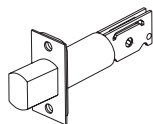

**1" Throw**

Part #	Description	List Add \$
<b>28752</b>	<b>1-1/8" x 2-1/4" faceplate, 2-3/4" backset, square corner</b>	N/C
28652	1-1/8" x 2-1/4" faceplate, 2-3/8" backset, square corner	N/C

**NOTE:** Default configuration shown above in bold.

## Strikes

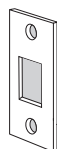

Part #	Description	List Add \$
<b>5103</b>	<b>Standard Strike for Dead Bolt</b>	
<b>5103</b>	<b>1-1/8" x 2-3/4", no lip, square corner</b>	N/C

**NOTE:** Default strike shown above in bold.

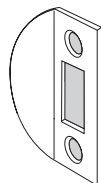

Part #	Description	List Add \$
<b>5203</b>	<b>Full Lip Strike with Dead Bolt Cutout</b>	
5203-118	1-5/8" x 2-1/4", 1-1/8" lip length, square corner	N/C
5204-118	1-5/8" x 2-1/4", 1-1/8" lip length, 1/4" radius corner	N/C



Part #	Description	List Add \$
<b>5004</b>	<b>ANSI Strike with Dead Bolt Cutout (specify finish)</b>	
5004	1-1/4" x 4-7/8" no lip, square corner	11.00

## Antimicrobial Coating

Description of Components Coated	List Add \$
<b>Available on 626 finish. Specify AM. Example: 626AM</b>	
Inside: thumbturn, rose, or same as outside for double cylinder	62.00
Outside: trim ring and cylinder faceplate	

**NOTE:** Extended leadtime, consult factory.



# C200 Series

## Ordering Guide

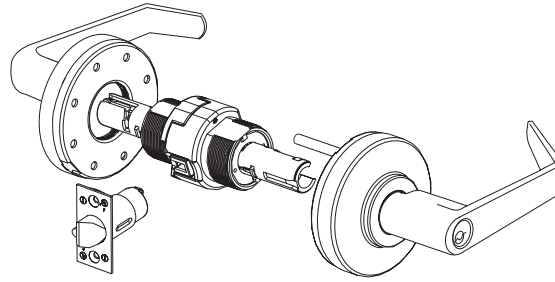

Function		Cylinder Type		Finish		Door Thickness		Lip Length		Strike Options <sup>1</sup>		Keying Options Field	
Storeroom	80	D	Conventional Cylinder	626	Satin Chrome	134	1-3/8" - 1-3/4"	2001	1316	XXXX	134	1-3/8" - 1-3/4"	
Classroom	70			625	Bright Chrome								
Entry	53	L	Less Cylinder	613	Dark Oxidized Satin Bronze	134	1-3/8" - 1-3/4"	2001	1316	XXXX	134	1-3/8" - 1-3/4"	
Entry/Office	50			612	Satin Bronze								
Privacy, Bedroom or Bath	40	J	SFIC (Less Core)	606	Satin Brass	134	1-3/8" - 1-3/4"	2001	1316	XXXX	134	1-3/8" - 1-3/4"	
Patio	30			605	Bright Brass								
Exit/Communicating Passage	25	T	Construction Core SFIC			134	1-3/8" - 1-3/4"	2001	1316	XXXX	134	1-3/8" - 1-3/4"	
Exit	12												
Passage/Closet	10					134	1-3/8" - 1-3/4"	2001	1316	XXXX	134	1-3/8" - 1-3/4"	
Dummy Trim One Side	01												
Lever Trim	C	2	53	D	LR	E	626	TX	17252	134	2001	1316	XXXX
<b>Product Type</b>	Grade 2 Cylindrical Lockset		<b>Product Family</b>		<b>Lever Design</b>		<b>Security Screws</b>		<b>Latch Bolt<sup>1</sup></b>		<b>Keying Options Field</b>		
			Lever - LR	Lever - LC	Lever - LG	E - 3-7/16" Dia. Rose	TX						

1. Example shows default values. Refer to Lock Options section or price book for full details.

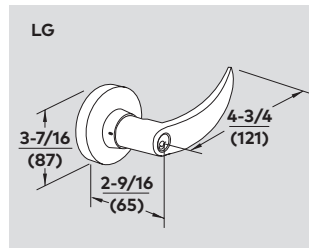
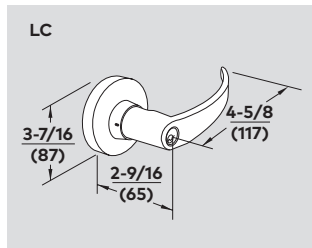
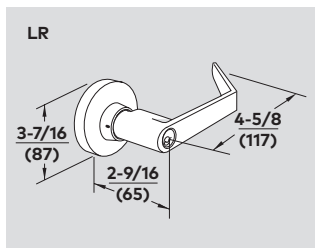



# Lever Locks

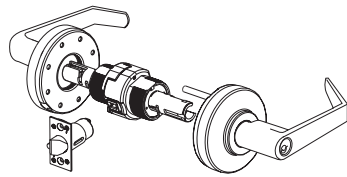

**Lever Locks**

626

605, 606, 612,  
625, 613

ANSI #	Function	Description	List \$	
<b>Keyless</b>				
F75	C210	Passage/closet	263.00	303.00
F89	C212	Exit	291.00	331.00
F111	C225	Exit/communicating passage	291.00	331.00
F77A	C230	Patio	299.00	338.00
F76A	C240	Privacy, bedroom or bath	299.00	338.00
—	C201	Single dummy	151.00	173.00
<b>Keyed, Single Cylinder</b>				
F82	C250	Entry/office	383.00	422.00
F109	C253	Entry	383.00	422.00
F84	C270	Classroom	383.00	422.00
F86	C280	Storeroom	383.00	422.00

**NOTES:**

- Split trim not available.

## Cylinder Types, Keying Options, and Keyways

Cylinder	Option	Description	List Add/Deduct \$
<b>Conventional Cylinders (non-interchangeable core)</b>			
<b>D</b>		Conventional cylinder	Example: C253D
	<b>KD</b>	<b>Keyed differently to a random combination; SC keyway with 2 keys (default)</b>	N/C
	KA2	Keyed alike in pairs to a random combination; SC keyway with 2 keys	N/C
	NSK	Keyed alike, sets of three or more; SC keyway with 2 keys	18.00
	NS2	Keyed alike double cylinder locks; SC keyway with 2 keys	34.00
	1-Bit	Operated by 1-bit cut key; SC, SE keyway with 2 key blanks (order 1-bit key separately)	N/C
	0-Bit	Operated by 0-bit key; D100 keyway — <b>⊗ Keys sold separately</b>	N/C
	0-Bit	Operated by 0-bit cut key; AA, CA, CB, CC, CD, CE, RA, RB, GA, SF, YA, YG keyways with 2 key blanks	18.00
	MKD	Master keyed; SC, SE, or D100 keyway — <b>⊗ Keys sold separately</b>	23.00
	MK2	Master keyed double cylinder lock; SC, SE, or D100 keyway — <b>⊗ Keys sold separately</b>	45.00
	CMK	Construction master keyed single cylinder locks — <b>⊗ Keys sold separately</b>	25.00
	CM2	Construction master keyed double cylinder locks — <b>⊗ Keys sold separately</b>	49.00
<b>L</b>		Lock less conventional cylinder	Example: C253L Deduct 30.00
<b>Small Format Interchangeable Core Cylinders</b>			
<b>T</b>		Lock with keyed temporary SFIC construction core (cores may be returned for a full refund) — <b>⊗ Keys sold separately</b>	Example: C253T 54.00
<b>J</b>		Lock with disposable plastic SFIC plug	Example: C253J 54.00

1. For uncombined cores, UNC, cores must be ordered separately, see Cylinders, Keys & Keying.

Locks will be supplied w/plastic construction core, Option J.

⊗ Denotes keys must be ordered separately.

### Cut Keys Ordered Separately

Part #	Description	List \$
45101	SFIC Cut key — Change key, master key, construction master key, or control key; BA, BB, BC, BD, BE, BF BG, BH, BJ, BK, BL, BM, BQ, SC, SE keyways	10.00
45401	SFIC Cut key — Change key, master key, or control key; SKC keyways — D100 etc.	16.00
45404	CONV Cut key — 1-bit key for operating 1-bit cylinders — SC, SE keyways	8.00

#### NOTES:

- Distribution of DORMA SKC keys (listed as D100) is restricted. See Cylinders, Keys & Keying section for DORMA SKC policies.
- 1-bit cylinder comes with (2) uncut keys and will require a 1-bit cut key, sold separately, to operate cylinder.
- See Keys and Key Blanks section for complete list.

# Configuration Options

## Latch Bolts

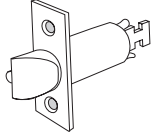

**1/2" Throw, 2-3/8" Backset**

Part #	Description	List Add \$
<b>For 210, 212, 225, 250, 253, 270, or 280 Functions</b>		
17150	1" x 2-1/4" front, 7/8" diameter, square corner	N/C
17151	1" x 2-1/4" front, 7/8" diameter, 1/4" radius corner	N/C
17152	1-1/8" x 2-1/4" front, 1" diameter, square corner	N/C
<b>For 230 &amp; 240 Function</b>		
17180	1" x 2-1/4" front, 7/8" diameter, square corner	N/C
17181	1" x 2-1/4" front, 7/8" diameter, 1/4" radius corner	N/C
17182	1-1/8" x 2-1/4" front, 1" diameter, square corner	N/C

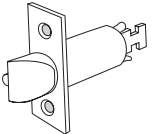

**1/2" Throw, 2-3/4" Backset**

Part #	Description	List Add \$
<b>For 210, 212, 225, 250, 253, 270, or 280 Functions</b>		
17250	1" x 2-1/4" front, 7/8" diameter, square corner	N/C
17251	1" x 2-1/4" front, 7/8" diameter, 1/4" radius corner	N/C
<b>17252</b>	<b>1-1/8" x 2-1/4" front, 1" diameter, square corner</b>	N/C
<b>For 230 &amp; 240 Function</b>		
17280	1" x 2-1/4" front, 7/8" diameter, square corner	N/C
17281	1" x 2-1/4" front, 7/8" diameter, 1/4" radius corner	N/C
<b>17282</b>	<b>1-1/8" x 2-1/4" front, 1" diameter, square corner</b>	N/C

**NOTE:** Default configurations for C200 shown above in bold.

## Latch Bolts (continued)

<b>1/2" Throw, 3-3/4" Backset</b>		
<b>Part #</b>	<b>Description</b>	<b>List Add \$</b>
<b>For 210, 212, 225, 250, 253, 270, or 280 Functions</b>		
17350	1" x 2-1/4" front, 7/8" diameter, square corner	27.00
17351	1" x 2-1/4" front, 7/8" diameter, 1/4" radius corner	27.00
17352	1-1/8" x 2-1/4" front, 1" diameter, square corner	27.00
<b>For 230 &amp; 240 Function</b>		
17380	1" x 2-1/4" front, 7/8" diameter, square corner	27.00
17381	1" x 2-1/4" front, 7/8" diameter, 1/4" radius corner	27.00
17382	1-1/8" x 2-1/4" front, 1" diameter, square corner	27.00

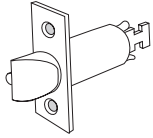

<b>1/2" Throw, 5" Backset</b>		
<b>Part #</b>	<b>Description</b>	<b>List Add \$</b>
<b>For 210, 212, 225, 250, 253, 270, or 280 Functions</b>		
17550	1" x 2-1/4" front, 7/8" diameter, square corner	27.00
17551	1" x 2-1/4" front, 7/8" diameter, 1/4" radius corner	27.00
17552	1-1/8" x 2-1/4" front, 1" diameter, square corner	27.00
<b>For 230 &amp; 240 Function</b>		
17580	1" x 2-1/4" front, 7/8" diameter, square corner	27.00
17581	1" x 2-1/4" front, 7/8" diameter, 1/4" radius corner	27.00
17582	1-1/8" x 2-1/4" front, 1" diameter, square corner	27.00

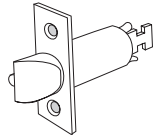

Strikes

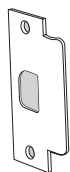

Part #	Description	List Add \$
<b>2001 – ANSI Strike with Cylindrical Lock Cutout</b>		
<b>2001-1316</b>	<b>1-1/4" x 4-7/8", 1-3/16" lip length, square corner</b>	N/C

**NOTE:** Default strike for C200 lock shown above in bold.

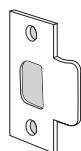

Part #	Description	List Add \$
<b>2101 – T Strike with Dust Box</b>		
2101-118	1-1/8" x 2-3/4", 1-1/8" lip length, square corner	N/C
2102-118	1-1/8" x 2-3/4", 1-1/8" lip length, radius corner. Available only in 630 for use with 626 and 619.	N/C

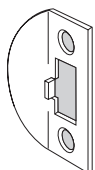

Part #	Description	List Add \$
<b>2201, 2202 – Full Lip Strike</b>		
2201-118	1-5/8" x 2-1/4", 1-1/8" lip length, square corner	N/C
2202-118	1-5/8" x 2-1/4", 1-1/8" lip length, 1/4" radius corner	N/C

## Special Application Options

### Security Screws

Specify	Description	List Add \$
TX	Security screws for latch and strike. 626 Finish Only	21.00

**NOTE:** Only available for use with 619, 625, 626, and 630 finish locksets.



# C500 Series

## Finish Availability Chart

	613	619	626	605	606	625
LR	•	•	•	•	•	•
LC	•	•	•	•	•	•
LG	•	•	•	—	—	—

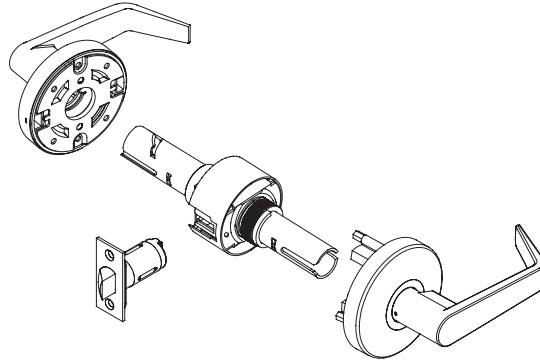

<b>Function</b>		<b>Cylinder Type<sup>1</sup></b>		<b>Finish<sup>2</sup></b>		<b>Keying Options Field</b>	
Storeroom —	<b>80</b>	D — Conventional Cylinder	C — SFIC (With Core)	626 — Satin Chrome	<b>15250</b> Latch Bolt <sup>3</sup>	<b>134</b> Door Thickness — 1-3/8" — 1-3/4"	<b>XXXX</b> Keying Options Field
Classroom —	<b>70</b>						
Entry —	<b>53</b>						
Office/Entry —	<b>50</b>						
Privacy, Bedroom or Bath —	<b>40</b>						
Patio —	<b>30</b>						
Exit/Communicating Passage —	<b>25</b>						
Passage/Closet —	<b>10</b>						
Dummy Trim One Side —	<b>01</b>						
		T — Temporary SFIC		619 — Satin Nickel			
				625 — Bright Chrome			
				613 — Dark Oxidized Satin Bronze			
				606 — Satin Brass			
				605 — Bright Brass			

  

<b>C5</b>	<b>53</b>	<b>D</b>	<b>LR</b>	<b>C</b>	<b>626</b>	<b>15250</b>	<b>134</b>	<b>5001</b>	<b>XXXX</b>
-----------	-----------	----------	-----------	----------	------------	--------------	------------	-------------	-------------

Grade 2 Cylindrical Lockset (C5)  
 Lever Design (53)  
 Rose Design (LR)  
 Latch Bolt<sup>3</sup> (15250)

- The C500 is not available less conventional cylinder. All keyed functions are available with or without SFIC cores.
- For split finishes, consult factory. Specify in-swing or out-swing.
- Example shows default values. Refer to Configuration Options section for full details.

**NOTE:** SFIC available on LR and LC lever designs only, not available on LG lever.

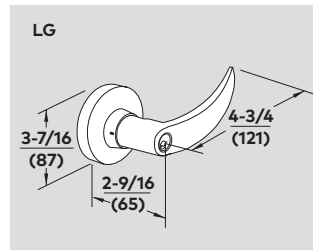
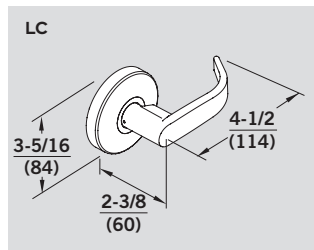
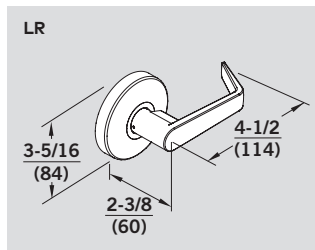

## Lever Locks

			Lever Locks	
			626	605, 606, 613, 619, 625
ANSI #	Function	Description	List \$	
<b>Keyless</b>				
F75	C510	Passage/closet	170.00	188.00
F111	C525	Exit/Communicating passage	170.00	188.00
F77A	C530	Patio	174.00	191.00
F76A	C540	Privacy, bedroom or bath	174.00	191.00
—	C501	Single dummy	101.00	109.00
<b>Keyed, Single Cylinder</b>				
F82A	C550	Entry/Office	185.00	204.00
F109	C553	Entry	185.00	204.00
F84	C570	Classroom	185.00	204.00
F86	C580	Storeroom	185.00	204.00

**NOTE:** Split finishes will be priced at the higher finish list price.

### Cylinder Types, Keying Options & Keyways

Cylinder	Option	Description	List Add/Deduct \$
<b>Conventional Cylinders (non-interchangeable core)</b>			
<b>D</b>	Conventional cylinder	Example: C553D	
	<b>KD</b>	<b>Keyed differently to a random combination; SC keyway with 2 keys (default)</b>	N/C
	KA2	Keyed alike in pairs to a random combination; SC keyway with 2 keys	N/C
	NSK	Keyed alike, sets of three or more; SC keyway with 2 keys	18.00
	1-Bit	Operated by 1-bit cut key; D100 keyway — <b>Keys sold separately</b>	N/C
	0-Bit	Operated by 0-bit key; SC, SE keyway with 2 key blanks (order 1-bit key separately)	N/C
	0-Bit	Operated by 0-bit cut key; SC, SE, AA, CA, CB, CC, CD, CE, RA, RB, GA, SF, YA, YG keyways with 2 key blanks	18.00
	MKD	Master keyed; SC, SE, or D100 keyway — <b>Keys sold separately</b>	23.00
	CMK	Construction master keyed single cylinder locks — <b>Keys sold separately</b>	25.00
<b>Small Format Interchangeable Core Cylinders</b>			
<b>T</b>	Temporary SFIC construction core (Cores may be returned for a full refund) — <b>Keys sold separately</b>	Example: C553T	54.00
<b>J</b>	SFIC core sold separately (see Cylinders & Keying)	Example: C553J	54.00
<b>C</b>	Lock with combined SFIC core installed at the factory <sup>1</sup> ; BA (default), BB, BC, BD, BE, BF, BG, BH, BJ, BK, BL, BM, BQ, D100 keyway — <b>Keys sold separately</b>	Example: C553C	65.00

\*The Less Cylinder option is not available for the C500 Series

**1.** For uncombined cores, UNC, cores must be ordered separately, see Cylinders, Keys & Keying.

☉ Denotes keys must be ordered separately.

### Cut Keys Ordered Separately

Part #	Description	List \$
45101	SFIC Cut key — Change key, master key, construction master key, or control key; BA, BB, BC, BD, BE, BF, BG, BH, BJ, BK, BL, BM, BQ, SC, SE keyways	10.00
45401	SFIC Cut key — Change key, master key, or control key; SKC keyways — D100 etc.	16.00
45404	CONV/LFIC Cut key — 1-bit key for operating 1-bit cylinders — SC, SE keyways	8.00

### NOTES:

- Distribution of DORMA SKC keys (listed as D100) is restricted. See Cylinders, Keys & Keying section for DORMA SKC policies.
- 1-bit cylinder comes with (2) uncut keys and will require a 1-bit cut key, sold separately, to operate cylinder.
- See Keys and Key Blanks section for complete list.



# Configuration Options

## Latch Bolts

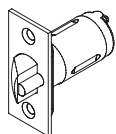

**1/2" Throw, 2-3/8" Backset**

Part #	Description	Add List \$
<b>For 510 or 540 Functions</b>		
15130	1" x 2-1/4" front, 7/8" diameter, square corner	N/C
15131	1" x 2-1/4" front, 7/8" diameter, 1/4" radius corner	N/C
<b>For 525, 550, 553, 570, or 580 Functions</b>		
15150	1" x 2-1/4" front, 7/8" diameter, square corner	N/C
15151	1" x 2-1/4" front, 7/8" diameter, 1/4" radius corner	N/C
<b>For 530 Function</b>		
15180	1" x 2-1/4" front, 7/8" diameter, square corner	N/C
15181	1" x 2-1/4" front, 7/8" diameter, 1/4" radius corner	N/C

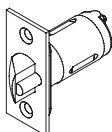

**1/2" Throw, 2-3/4" Backset**

Part #	Description	List Add \$
<b>For 510 or 540 Functions</b>		
<b>15230</b>	<b>1" x 2-1/4" front, 7/8" diameter, square corner</b>	N/C
15231	1" x 2-1/4" front, 7/8" diameter, 1/4" radius corner	N/C
15232	1-1/8" x 2-1/4" front, 7/8" diameter, square corner	N/C
<b>For 525, 550, 553, 570, or 580 Functions</b>		
<b>15250</b>	<b>1" x 2-1/4" front, 7/8" diameter, square corner</b>	N/C
15251	1" x 2-1/4" front, 7/8" diameter, 1/4" radius corner	N/C
15252	1-1/8" x 2-1/4" front, 7/8" diameter, square corner	N/C
<b>For 530 Function</b>		
<b>15280</b>	<b>1" x 2-1/4" front, 7/8" diameter, square corner</b>	N/C
15281	1" x 2-1/4" front, 7/8" diameter, 1/4" radius corner	N/C
15282	1-1/8" x 2-1/4" front, 7/8" diameter, square corner	N/C

**NOTE:** Default configurations for C500 shown above in bold.

## Special Application Options

### Drilling Jig

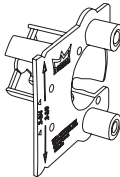
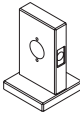
	Part #	Description	List \$
	76004795	Drilling jig for C800, CL700, and C500 locksets	19.00
	640003	Mount, C800 lever, CL700, and C500 Series — 1-1/8" x 2-1/4" faceplate	137.00

### Strikes

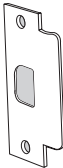
	Part #	Description	List Add \$
	<b>5001 — ANSI Strike with Cylindrical Lock Cutout</b>		
	<b>5001-1316</b>	<b>1-1/4" x 4-7/8", 1-3/16" lip length, square corner</b>	N/C
	5001-112	1-1/4" x 4-7/8", 1-1/2" lip length, square corner	28.00

**NOTE:** Default strike for C500 lock shown above in bold.

	Part #	Description	List Add \$
	<b>5101, 5102 — "T" Strike with Dust Box</b>		
	5101-118	1-1/8" x 2-3/4", 1-1/8" lip length, square corner	N/C
	5101-112	1-1/8" x 2-3/4", 1-1/2" lip length, square corner	28.00
	5102-118	1-1/8" x 2-3/4", 1-1/8" lip length, 1/4" radius corner	N/C
	5102-112	1-1/8" x 2-3/4", 1-1/2" lip length, 1/4" radius corner	28.00

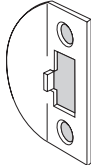
	Part #	Description	List Add \$
	<b>5201, 5202 — Full Lip Strike</b>		
	5201-118	1-5/8" x 2-1/4", 1-1/8" lip length, square corner	N/C
	5202-118	1-5/8" x 2-1/4", 1-1/8" lip length, 1/4" radius corner	N/C

### Abrasive Coated Levers (Tactile Markings)

Part #	Description	List Add \$
660003	Abrasive coated lever (all designs)	61.00

**NOTE:** Tactile marking is applied to outside lever only, unless otherwise specified.

# DB600 Series

## Ordering Guide

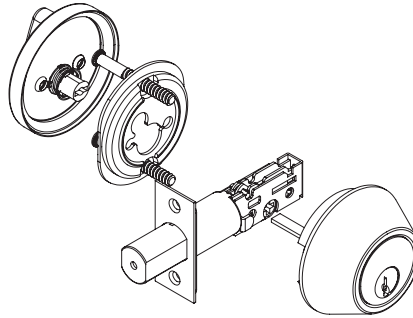

		<b>Cylinder Type<sup>5</sup></b>				<b>Door Thickness<sup>6</sup></b>		<b>Keying Options Field</b>		
		<b>Function</b>	<b>D</b> – Conventional Cylinder							
Cylinder x Blank <sup>1</sup> –		<b>80</b>	<b>C</b> – SFIC (With Core)							
Cylinder x Cylinder –		<b>62</b>	<b>J</b> – SFIC (Less Core)							
Cylinder x Turn –		<b>60</b>	<b>T</b> – Temporary SFIC			<b>134</b> – 1-3/8" – 1-3/4"				
		<b>DB</b>	<b>6</b>	<b>60</b>	<b>D</b>	<b>630</b>	<b>26170</b>	<b>134</b>	<b>5103</b>	<b>XXXX</b>
Dead Bolt – <b>DB</b>		Bright Brass – <b>605</b>		<b>26173</b> – Adj, Drive-In						
<b>Product Type</b>		Dark Oxidized Satin Bronze – <b>613</b>		<b>26171</b> – Adj, 1" RC						<b>Strike Options<sup>6</sup></b>
		Satin Nickel <sup>2</sup> – <b>619</b>		<b>26170</b> – Adj, 1" SQ with Filler						
		Satin Chrome – <b>626</b>		<b>Latch Bolt<sup>6</sup></b>						
Grade 2 Tubular Dead Bolt		Bright Stainless <sup>3</sup> – <b>629</b>								
<b>Product Family</b>		Satin Stainless – <b>630</b>								
		<b>Finish<sup>4</sup></b>								

1. DB680 not available in 605 finish.
2. 619 finish available standard cylinder only.
3. 629 finish only available for DB660 (standard and SFIC)
4. For split finishes, consult factory. Specify in-swing or out-swing.
5. The Less Conventional Cylinder option is not available for the DB600 Series.
6. Example shows default values. Refer to Configuration Options section for full details.

# DB600 Series

ANSI #	Function	Description	List \$	
			626, 630	605, 613, 619* 629**
E2152	DB660	Cylinder x turn	128.00	137.00
E2142	DB662	Cylinder x cylinder	161.00	174.00
	DB680	Turn x blank	96.00	105.00

\*619 finish available standard cylinder only.  
 \*\*629 finish only available for DB660 – standard and SFIC

**NOTES:**

- List prices for keyed locks include standard DORMA (D) cylinder, keyed different (KD) with two (2) nickel silver keys.
- Split finishes will be priced at the higher finish list price.

### Cylinder Types, Keying Options & Keyways

Cylinder	Option	Description	List Add/Deduct \$
<b>Conventional Cylinders (non-interchangeable core)</b>			
<b>D</b>		Conventional cylinder	Example: DB660D
	<b>KD</b>	<b>Keyed differently to a random combination; SC keyway with 2 keys (default)</b>	N/C
	KA2	Keyed alike in pairs to a random combination; SC keyway with 2 keys	N/C
	NSK	Keyed alike, sets of three or more; SC keyway with 2 keys	18.00
	NS2	Keyed alike double cylinder locks; SC keyway with 2 keys	34.00
	1-Bit	Operated by 1-bit cut key; SC, SE keyway with 2 key blanks (order 1-bit key separately)	N/C
	0-Bit	Operated by 0-bit key; D100 keyway – <b>⊗ Keys sold separately</b>	N/C
	0-Bit	Operated by 0-bit cut key; AA, CA, CB, CC, CD, CE, RA, RB, GA, SF, YA, YG keyways with 2 key blanks	18.00
	MKD	Master keyed; SC, SE, or D100 keyway – <b>⊗ Keys sold separately</b>	23.00
	MK2	Master keyed double cylinder lock; SC, SE, or D100 keyway – <b>⊗ Keys sold separately</b>	45.00
	CMK	Construction master keyed single cylinder locks – <b>⊗ Keys sold separately</b>	25.00
	CM2	Construction master keyed double cylinder locks – <b>⊗ Keys sold separately</b>	49.00
<b>Small Format Interchangeable Core Cylinders</b>			
<b>T</b>		Locks with keyed temporary SFIC construction cores (Cores may be returned for a full refund) – <b>⊗ Keys sold separately</b>	Example: DB660T 54.00
<b>J</b>		SFIC core sold separately	Example: DB660J 54.00
<b>C</b>		Lock with combined SFIC core installed at the factory <sup>1</sup> ; BA (default), BB, BC, BD, BE, BF, BG, BH, BJ, BK, BL, BM, BQ, D100 keyway – <b>⊗ Keys sold separately</b>	Example: DB660C 65.00

\* The Less Cylinder option is not available for the DB600 Series.  
 1. For uncombined cores, UNC, cores must be ordered separately, see Cylinders, Keys & Keying.  
 ⊗ Denotes keys must be ordered separately.

### Cut Keys Ordered Separately

Part #	Description	List \$
45101	SFIC Cut key – Change key, master key, construction master key, or control key; BA, BB, BC, BD, BE, BF BG, BH, BJ, BK, BL, BM, BQ, SC, SE keyways	10.00
45401	SFIC Cut key – Change key, master key, or control key; SKC keyways – D100 etc.	16.00
45404	CONV/LFIC Cut key – 1-bit key for operating 1-bit cylinders – SC, SE keyways	8.00

**NOTES:**

- Distribution of DORMA SKC keys (listed as D100) is restricted. See Cylinders, Keys & Keying section for DORMA SKC policies.
- 1-bit cylinder comes with (2) uncut keys and will require a 1-bit cut key, sold separately, to operate cylinder.
- See Keys and Key Blanks section for complete list.

## Configuration Options

### Dead Bolts

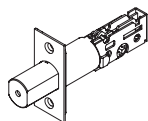

**1" Throw, 2-3/8" – 2-3/4" Adjustable Backset**

Part #	Description	List Add \$
<b>26170</b>	<b>1" × 2-1/4" faceplate, square corner (1-1/8" wide w/filler)</b>	N/C
26171	1" × 2-1/4" Faceplate, Radius Corner	N/C
26173	1" diameter, drive in (626 Finish only)	N/C

**NOTE:** Default configuration shown above in bold.

### Strikes



Part #	Description	List Add \$
<b>5103</b>	<b>Standard Strike for Dead Bolt</b>	
<b>5103</b>	<b>1-1/8" × 2-3/4", no lip, square corner</b>	N/C

**NOTE:** Default strike shown above in bold.

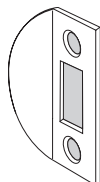

Part #	Description	List Add \$
<b>5203</b>	<b>Full Lip Strike with Dead Bolt Cutout</b>	
5203-118	1-5/8" × 2-1/4", 1-1/8" lip length, square corner	N/C
5204-118	1-5/8" × 2-1/4", 1-1/8" lip length, 1/4" radius corner	N/C

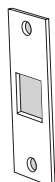

Part #	Description	List Add \$
<b>5004</b>	<b>ANSI Strike with Dead Bolt Cutout</b>	
5004	1-1/4" × 4-7/8", no lip, square corner	9.00



# C300 Series

## Finish Availability Chart

	626	613	619	605
LR	•	•		
LC	•	•		•
LG	•	•	•	
LS		•	•	•
L118	•	•	•	

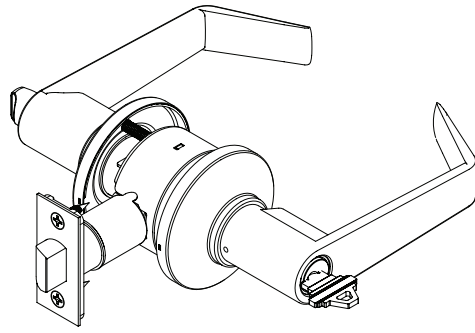

Product Family	Lever				Backset				Strike				Cylinder Type		Keying	
	Grade 2 Cylindrical Lockset	L118	2-3/8" Fire	238F	ANSI Strike, Square Corner	5001	2-3/4" Fire	234F	T Strike, Square Corner	5101	2-3/8" Non-Fire*	238N	Full Lip, Square Corner	5201		D
<b>C3</b>	<b>53</b>	<b>LRB</b>	<b>626</b>											<b>RH</b>	<b>D</b>	<b>SCKD</b>
Single Dummy	01		626	Satin Chrome	100S	1" Square	RH		SC	SC Keyway						
Passage	10		613	Dark Bronze	118S	1-1/8" Square	LH		D100	DORMA SKC D100 Keyway						
Patio	30		619	Satin Nickel	100R	1" Radius										
Privacy	40		605	Bright Brass	DRIV	Drive-In 238N Only										
Entry	53															
				<b>Finish</b>										<b>Handing</b>		<b>Keyway</b>

\*C353 and C330 only available with fire rated latch.

## Levers

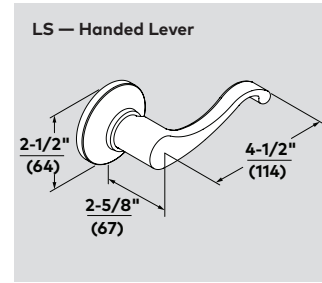
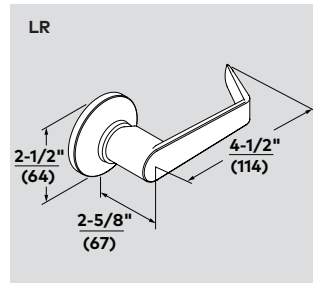
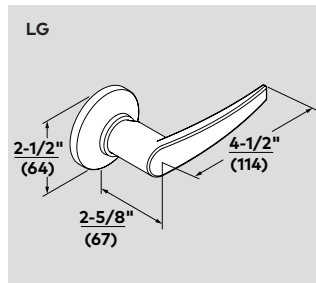
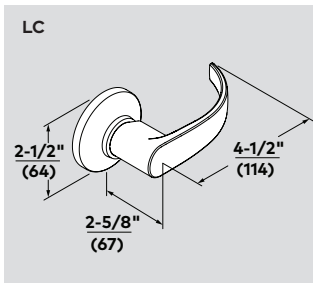

## Strikes

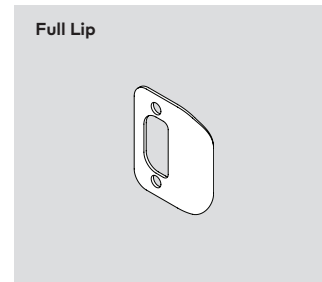
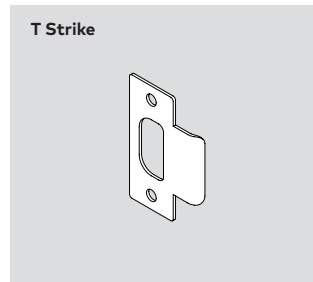
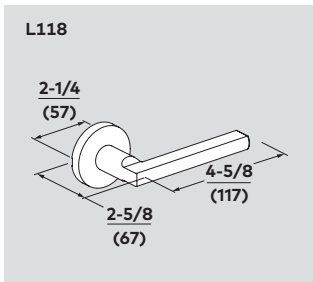

ANSI #	Function	Description	626	605, 613, 619
			List \$	
—	C301	Single dummy	51.00	53.00
F75	C310	Passage/closet	98.00	100.00
F77A	C330	Patio	110.00	113.00
F76A	C340	Privacy, bedroom, or bath	102.00	104.00
F109	C353	Entry	126.00	129.00

**Strikes**

Option	Description	List \$
5202	<b>Full lip strike, radius corner — default</b>	N/C
5001	ANSI strike	13.00
5101	T strike, square corner	N/C
5102	T strike, radius corner	N/C
5201	Full lip strike, square corner	N/C

**Latches**

Option	Description	List \$
<b>C310/C340 Latches</b>		
234N	2-3/4" Backset non-fire	N/C
238N	2-3/8" Backset non-fire	N/C
234F	2-3/4" Backset fire rated	14.00
238F	2-3/8" Backset fire rated	14.00
<b>C330/C353 Latches</b>		
234F	2-3/4" Backset fire rated	N/C
238F	2-3/8" Backset fire rated	N/C

**Abrasive Coated Levers (Tactile Markings)**

Part #	Description	List \$
660003	Abrasive coated lever (all designs)	61.00

**NOTE:** Tactile marking is applied to outside lever only, unless otherwise specified.

**Keying**

Option	Description	List \$
<b>KD</b>	<b>Keyed differently to a random combination; SC keyway with 2 keys (default)</b>	N/C
KA2	Keyed alike in pairs to a random combination; SC keyway with 2 keys	19.00
NSK	Keyed alike, sets of three or more; SC keyway with 2 keys	18.00
1-Bit	Operated by 1-bit cut key, SC, SE keyway with 2 key blanks (order 1-bit key separately)	19.00
0-Bit	Operated by 0-bit key, D100 keyway — <b>Keys sold separately</b>	19.00
0-Bit	Operated by 0-bit cut key; AA, CA, CB, CC, CD, CE, RA, RB, GA, SF, YA, YG keyways with 2 key blanks	18.00
MKD	Master keyed; SC, SE, or D100 keyway — <b>Keys sold separately</b>	23.00
CMK	Construction master keyed single cylinder locks — <b>Keys sold separately</b>	25.00

**NOTE:** Less Cylinder option is not available on the C300 series.  Denotes keys must be ordered separately.

**Keys**

Part #	Description	List \$
45101	SFIC Cut key — Change key, master key, construction master key, or control key; BA, BB, BC, BD, BE, BF BG, BH, BJ, BK, BL, BM, BQ, SC, SE keyways	10.00
45401	SFIC Cut key — Change key, master key, or control key; SKC keyways — D100 etc.	16.00
45404	CONV/LFIC Cut key — 1-bit key for operating 1-bit cylinders — SC, SE keyways	8.00

**NOTES:**

- Distribution of DORMA SKC keys (listed as D100) is restricted. See Cylinders, Keys & Keying section for DORMA SKC policies.
- 1-bit cylinder comes with (2) uncut keys and will require a 1-bit cut key, sold separately, to operate cylinder.
- See Keys and Key Blanks section for complete list.



J300 Series

Finish Availability Chart

	626	613	619	605 <sup>1</sup>
LR	•	•		
LC	•	•		•
LG	•	•	•	
LS		•	•	•
L118	•	•	•	

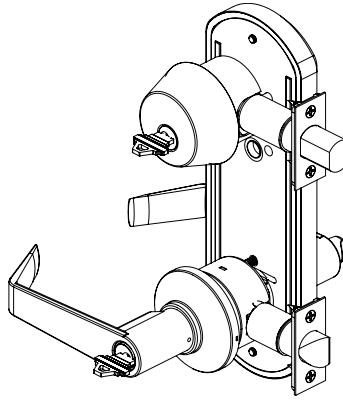

Product Family	Grade 2 Interconnected Lockset	Lever				Backset	Handing	Cylinder Type		Keying			
		Lever	Lever (Handed)	Lever	Lever			T	C		J	D	
J3	10	L118	LSB	LGB	LCB	2-3/8" Fire	238F	LH	RH	T	C	J	D
					LRB	2-3/4" Fire	234F						
Entry - Single Cylinder	10	Satin Chrome	626	1" Square	100S	5701	- (1) T Strike Square, (1) No Lip Square						
Privacy with Indicator <sup>1</sup>	46	Dark Bronze	613	1-1/8" Square	118S	5703	- (1) Full Lip Square, (1) No Lip Square						
Entry - Double Cylinder <sup>2</sup>	53	Satin Nickel	619	1" Radiused	100R	5704	- (1) Full Lip Radiused, (1) No Lip Radiused						
		Bright Brass	605			5705	- (1) Full Lip Square, (1) Full Lip Square						
						5706	- (1) Full Lip Radiused, (1) Full Lip Radiused						

1. J346 not available in 605.  
 2. SFIC core on C353 function available with LR lever only.

Levers

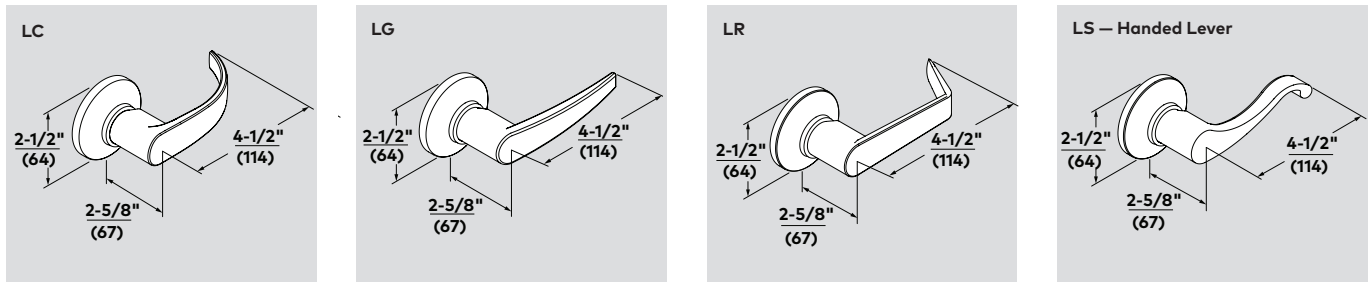

Strikes

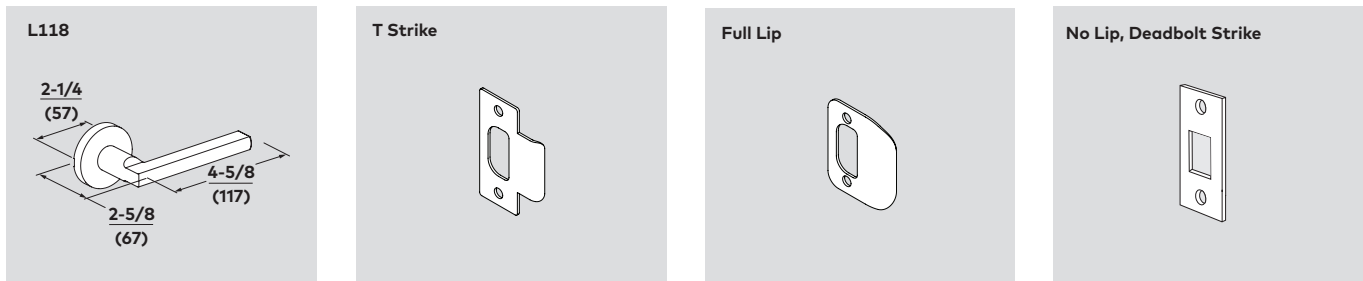

## All Levers — Per Chart

ANSI #	Function	Description	All Levers — Per Chart	
			626	605, 613, 619
F95	J310	Entrance, Single Locking	505.00	524.00
—	J346	Privacy with Indicator	505.00	524.00
F97	J353	Entrance, Double Locking	632.00	647.00

## Strikes

Option	Description	List Add \$
<b>5701</b>	<b>Lock — T strike square/Deadbolt — no lip square (default)</b>	N/C
5703	Lock — full lip square/Deadbolt — no lip square	N/C
5704	Lock — full lip radiused/Deadbolt — no lip radiused	N/C
5705	Lock — full lip square/Deadbolt — full lip square	N/C
5706	Lock — full lip radiused/Deadbolt — full lip radiused	N/C
<b>Description</b>		
	Split Finish	45.00

## Cylinder Types, Keying Options and Keyways

Cylinder	Option	Description	List Add/Deduct \$
<b>Conventional Cylinders (non-interchangeable core)</b>			
<b>D</b>		Conventional cylinder	
	<b>KD</b>	<b>Keyed differently to a random combination; SC keyway with 2 keys (default)</b>	N/C
	KA2	Keyed alike in pairs to a random combination; SC keyway with 2 keys	19.00
	NSK	Keyed alike, sets of three or more; SC keyway with 2 keys	18.00
	1-Bit	Operated by 1-bit cut key; SC, SE keyway with 2 key blanks (order 1-bit key separately)	19.00
	0-Bit	Operated by 0-bit key; D100 keyway — <b>⊗ Keys sold separately</b>	19.00
	0-Bit	Operated by 0-bit cut key; AA, CA, CB, CC, CD, CE, RA, RB, GA, SF, YA, YG keyways with 2 key blanks	18.00
	MKD	Master keyed; SC, SE, or D100 keyway — <b>⊗ Keys sold separately</b>	23.00
	MK2	Master keyed double cylinder lock; SC, SE, or D100 keyway — <b>⊗ Keys sold separately</b>	45.00
	CMK	Construction master keyed single cylinder locks — <b>⊗ Keys sold separately</b>	25.00
	CM2	Construction master keyed double cylinder locks — <b>⊗ Keys sold separately</b>	49.00
<b>L</b>		Lock less conventional cylinder, per cylinder	Example: J310L Deduct 30.00

## Small Format Interchangeable Core Cylinders

<b>T</b>	Lock with keyed temporary SFIC construction core, per cylinder (cores may be returned for a full refund) — <b>⊗ Keys sold separately</b>	Example: J310T	54.00
<b>J</b>	Lock with disposable plastic SFIC construction core	Example: J353J	54.00
<b>C</b>	Lock with combined SFIC core installed at the factory; BA (default), BB, BC, BD, BE, BF, BG, BH, BJ, BK, BL, BM, BQ, D100 keyway — <b>⊗ Keys sold separately</b>	Example: J310C	65.00

**NOTE:** The Less Cylinder option is not available on the C500 Series.

⊗ Denotes keys must be ordered separately.

## Cut Keys Ordered Separately

Part #	Description	List \$
45101	SEIC Cut key — Change key, master key, construction master key, or control key; BA, BB, BC, BD, BE, BF, BG, BH, BJ, BK, BL, BM, BQ, SC, SE keyways	10.00
45401	SFIC Cut key — Change key, master key, or control key; SKC keyways — D100 etc.	16.00
45404	CONV/LFIC Cut key — 1-bit key for operating 1-bit cylinders — SC, SE keyways	8.00

## NOTES:

- 1-bit cylinder comes with (2) uncut keys and will require a 1-bit cut key, sold separately, to operate cylinder. SC and SE keyways only.
- See Keys and Key Blanks section for complete list.

# Cylinders, Keys, and Keying

## Product Guide

CYLINDER AVAILABILITY	Conventional	Interchangeable Core 6-Pin	Interchangeable Core 7-Pin	Conventional Hotel	Interchangeable Core Hotel
Mortise Cylinder	90	96	97	—	98
Rim Cylinder	80	86	87	—	—
KIL Cylinder	70	—	—	75	—
KIK Cylinder	71	—	—	—	—
Small Format Interchangeable Core	—	76	77	—	—

KEYWAY AVAILABILITY	SC Keyway	SE Keyway	Retrofit Keyways AA, CA, CB, CC, CD, CE, RA, RB, GA, SF, WA, YA, YG	SFIC Keyways BA, BB, BC, BD, BE, BF, BG, BH, BJ, BK, BL, BM, BQ	DORMA SKC Keyways D100
<b>KD</b> Keyed different to a random combination	Yes	No	No	No	No
<b>KA2</b> Keyed alike in pairs to a random combination	Yes	No	No	No	No
<b>NSK</b> Keyed alike in sets of 3 or more	Yes	No	No	No	No
<b>MKD</b> Master keyed or keyed to a specific combination	Yes	Yes	No	Yes	Yes
<b>CMK</b> Construction master keyed	Yes	Yes	No	No	Yes (Not available SFIC)

## Master Keying

Master keying charges do not include keys. Always order and price keys as a separate line item.

A completed Key System Specification Form is required for every new master key system ordered. Orders and keying schedules must use BHMA/ANSI Standard Key Coding Symbols. See ANSI 156.28 for reference.

Keying capacity varies greatly with product and system architecture. Check keying requirements prior to selecting product. Expressions like "Plan for maximum expansion" have no meaning. The table below is a very general guide and can be misinterpreted. For more information, please contact Customer Service.

Cylinder/Core Mechanism	Theoretical Number of Changes Under the Top Master Key	System Capacity	Example of Theoretical Keying Capacity in Three Levels of Keying (Grand Master, Master and Changes)
SC Keyway with Construction Keying	$4^4 = 1,024$	Smaller Projects	GMK and 16 Masters of 64 Changes Each
SC Keyway without Construction Keying	$4^5 = 4,096$	Medium Projects	GMK and 16 Masters of 256 Changes Each
77BA, BB etc. SFIC only	$4^6 = 16,384$	Larger Projects	GMK and 64 Masters of 256 Changes Each
DORMA SKC with Construction keying	$6 \times 4^5 = 24,576$	Very Large Projects	GMK and 96 Masters of 256 Changes Each
DORMA SKC without Construction Keying	$6 \times 4^6 = 98,304$	Extremely Large Projects	GMK and 384 Masters of 256 Changes Each

### DORMA SKC

Distribution of DORMA SKC (Shown in the price list as D100 keyway) is restricted. Possession of a price list does not constitute authorization to purchase DORMA SKC. Contact your local representative for information about authorization to purchase DORMA SKC.

DORMA SKC may only be used in the USA and Canada.

# Conventional (Non-IC) Mortise Cylinders

## Ordering Guide

**Cylinder Type**

Conventional Mortise — **90** **X**

**Cylinder Ring (List Add)**

**90** **X** **10** **SC** **118** **626** **KD**

Adams Rite & dormakaba 134OKR Key Removable Mullion — **01**

Adams Rite 4070 — **02**

dormakaba 9600, 9700 & 9800 Exit Z Trim w/09 or 12 Functions — **09**

dormakaba M9050, 9080 & 9082 (2) Mortise Locks; dormakaba 9100, 9300, 9400 & 9500 Exit Y Trim/Options & Other Straight Cam Applications — **10**

dormakaba M9056, 9080EL/EU, 9080ELRX/EURX 9082EL/EU & M9900 Mortise Locks w/Dead Bolts — **11**

dormakaba M9053, 9070, 9071 (2), 9076, 9077 (2) & 9060 Insider Cylinder Mortise Locks — **12**

dormakaba M9060 Outside Cylinder Mortise Locks; dormakaba 9600, 9700 & 9800 Exit Z Trim w/08 or 11 Functions — **13**

Schlage Style Clover (L) — **15**

dormakaba 5000 Series Exit J Trim, Sargent & Yale Narrow — **16**

Best & CorbinRusswin Style Clover — **19**

Falcon Dead Bolt Style Clover — **30**

CorbinRusswin DL4000 Style — **31**

D900 — **32**

**Length**

**300** — 3"

**234** — 2-3/4"

**212** — 2-1/2"

**214** — 2-1/4"

**200** — 2"

**134** — 1-3/4"

**158** — 1-5/8"

**112** — 1-1/2"

**138** — 1-3/8"

**114** — 1-1/4"

**118** — 1-1/8"

**Keying**

**OBIT** — SC & D100 provided in 1-bit - 1-bit key sold separately; other keyways provided in 0-bit

**CMK** — Construction Master Keyed

**MKD** — Master Keyed

**NSK** — Keyed Alike, sets of 3 or More

**KA2** — Keyed Alike, Sets of 2

**KD** — Keyed Different

**Keyway**

**SC** — Schlage C

**SE** — Schlage E

**D100** — DORMA SKC

**AA** — Arrow A

**CA** — Corbin 60

**CB** — Corbin 67

**CC** — Corbin 77

**CD** — Corbin 59A1

**CE** — CorbinRusswin L4

**RA** — Russwin 981

**RB** — Russwin D1

**GA** — Sargent LA

**SF** — Schlage F

**YA** — Yale 8

**YG** — Yale GA

**Keyway** Retrofit Keyways Available 0-Bitted Only

**Finish**

**605** — Bright Brass

**606** — Satin Brass

**612** — Satin Bronze

**613** — Dark Oxidized Satin Bronze

**625** — Bright Chrome

**626** — Satin Chrome

**630** — Satin Stainless (also for use with 619)

**NOTE:** For Cylinder Rings, refer to page 67.

**NOTE:** Not all keyways available in all cylinder lengths. Consult factory.

Length Includes Cam

Mortise Cylinder

Option	Keyway	Example	Keys	All Finishes \$
KD (standard)/KA2	SC	90X10 SC 118 626 KD	2 keys ea.	94.00
NSK (keyed alike, sets of 3 or more)	SC	90X10 SC 118 626 NSK KA31	2 keys ea.	Add 33.00
Master keyed	SC, SE, D100	90X10 SC 118 626 MKD	⊗ <b>Keys sold separately</b>	Add 33.00
Construction master keyed	SC, SE, D100	90X10 SC 118 626 CMK	⊗ <b>Keys sold separately</b>	Add 40.00
0-Bit	SC, SE	90X10 SC 118 626 OBIT	2 key blanks provided (1-bit key needed to operate).	94.00
0-Bit	D100	90X10 D100 118 626 OBIT	⊗ <b>Keys sold separately</b>	94.00
0-Bit	Retro	90X10 RB 118 626 OBIT	2 key blanks	94.00
138, 112, 158, 134, or 200 length		90X10 SC 112 626 KD		Add 79.00
214, 212, 234, or 300 length		90B10 SC 200 626 KD		Add 58.00

⊗ Denotes keys must be ordered separately.

### Keys Ordered Separately for MKD, CMK, and SKC

Part #	Description	List \$
45101	Cut key — change key, master key, construction key; SC, SE keyways	10.00
45401	Cut key — change key, master key, construction key; SKC keyways — D100 etc.	16.00
45404	CONV Cut key — 1-bit key for operating 1-bit cylinders; SC, SE keyways only	8.00

### NOTES:

- D100 keyway cylinders must be ordered 0-bitted or MKD; keys sold separately.
- Other restrictions apply. See Cylinders, Keys & Keying section for DORMA SKC policies.
- 1-bit cylinder comes with (2) uncut keys and will require a 1-bit cut key, sold separately, to operate cylinder. SC and SE keyways only.
- See Keys and Key Blanks section for complete list.

# Small Format Interchangeable Core Mortise Housings

## Ordering Guide

**Cylinder Type**

For 7 Pin Core — **97**

For 6 Pin Core — **96**    **X**

**Cylinder Ring  
(List Add)**

**10**    **138**    **626**

**Length**

**300** — 3"

**212** — 2-1/2"

**214** — 2-1/4"

**200** — 2"

**134** — 1-3/4"

**138** — 1-3/8"

  

<p>Adams Rite &amp; dormakaba 134OKR Key Removable Mullion — <b>01</b></p> <p>Adams Rite 4070 — <b>02</b></p> <p>dormakaba 9600, 9700 &amp; 9800 Exit Z Trim w/09 or 12 Functions — <b>09</b></p> <p>dormakaba M9050, 9080 &amp; 9082 (2) Mortise Locks; dormakaba 9100, 9300, 9400 &amp; 9500 Exit Y Trim/Options &amp; Other Straight Cam Applications — <b>10</b></p> <p>dormakaba M9056, 9080EL/EU, 9080ELRX/EURX 9082EL/EU &amp; M9900 Mortise Locks w/Dead Bolts — <b>11</b></p> <p>dormakaba M9053, 9070, 9071 (2), 9076, 9077 (2) &amp; 9060 Inside Cylinder Mortise Locks — <b>12</b></p> <p>dormakaba M9060 Outside Cylinder Mortise Locks; dormakaba 9600, 9700 &amp; 9800 Exit Z Trim w/08 or 11 Functions — <b>13</b></p> <p>D900, Schlage Style Clover (L) — <b>15</b></p> <p>dormakaba 5000 Series Exit J Trim, Sargent &amp; Yale Narrow — <b>16</b></p> <p>Best &amp; CorbinRusswin Style Clover — <b>19</b></p> <p>Falcon Dead Bolt Style Clover — <b>30</b></p> <p>CorbinRusswin DL4000 Style — <b>31</b></p>	<p><b>01</b></p> <p><b>02</b></p> <p><b>09</b></p> <p><b>10</b></p> <p><b>11</b></p> <p><b>12</b></p> <p><b>13</b></p> <p><b>15</b></p> <p><b>16</b></p> <p><b>19</b></p> <p><b>30</b></p> <p><b>31</b></p>	<p><b>605</b> — Bright Brass</p> <p><b>606</b> — Satin Brass</p> <p><b>612</b> — Satin Bronze</p> <p><b>613</b> — Dark Oxidized Satin Bronze</p> <p><b>625</b> — Bright Chrome</p> <p><b>626</b> — Satin Chrome</p> <p><b>630</b> — Satin Stainless (also for use with 619)</p>	<p><b>605</b></p> <p><b>606</b></p> <p><b>612</b></p> <p><b>613</b></p> <p><b>625</b></p> <p><b>626</b></p> <p><b>630</b></p>
--	---	---	---

**Finish**

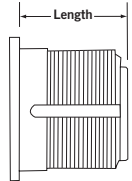

Length Includes Cam

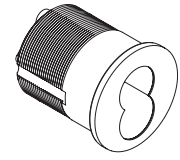

SFIC Mortise Housing

**NOTES:**

- For Cylinder Rings, refer to page 67.
- To order cores, refer to page 73.

Description	Example	All Finishes \$
Housing less core	97X10 00 138 626	86.00
Housing less core — 200 or 214 length (extended leadtime)	97X10 00 200 626	ADD 298.00
Housing less core — 212 or 300 length (extended leadtime)	97X10 00 212 626	ADD 375.00

# Dummy and Thumbturn Cylinders

## Ordering Guides

**Cylinder Ring (List Add)**

**Cylinder Type**

Dummy — 91 X

**91 X 118 626**

1-1/8" — 118

1-1/4" — 114

**Length**

**Finish**

- 605 — Bright Brass
- 606 — Satin Brass
- 612 — Satin Bronze
- 613 — Dark Oxidized Satin Bronze
- 625 — Bright Chrome
- 626 — Satin Chrome

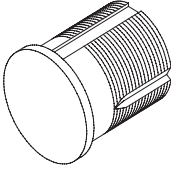

**Dummy Cylinder**

**NOTE:** For Cylinder Rings, refer to page 67.

**Cylinder Ring (List Add)**

**Cylinder Type**

Thumbturn — 92 X

**92 X 10 118 626**

Adams Rite & dormakaba 1340KR Key Removable Mullion — 01

Adams Rite 4070 — 02

dormakaba M9050, 9080 & 9082 (2) Mortise Locks; DORMA 9100, 9300, 9400 & 9500 Exit Y Trim/Options & Other Straight Cam Applications — 10

dormakaba M9056, 9080EL/EU, 9080ELRX/EURX 9082EL/EU & M9900 Mortise Locks w/Dead Bolts — 11

dormakaba M9053, 9070, 9071 (2), 9076, 9077 (2) & 9060 Insider Cylinder Mortise Locks — 12

Best & CorbinRusswin Style Clover — 19

**Cam**

**Finish**

- 626 — Satin Chrome
- 625 — Bright Chrome
- 613 — Dark Oxidized Satin Bronze
- 612 — Satin Bronze
- 606 — Satin Brass
- 605 — Bright Brass

**Length**

- 100 — 1"
- 114 — 1-1/4"
- 118 — 1-1/8"

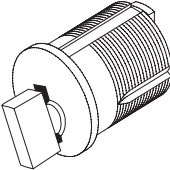

**Thumbturn Cylinder**

**NOTE:** For Cylinder Rings, refer to page 67.

**NOTE:** For special arm applications, consult Technical Services.

Description	Example	All Finishes \$
91 Series dummy cylinder	91X 118 626	69.00
92 Series thumbturn cylinder	92X 10 118 626	94.00

**NOTE:** For cylinders over 1-1/4" long, contact the factory.

# Mortise Cylinder Cams for DORMA Products

## Ordering Guide

Product Type	Pattern
Mortise Cylinder Cam — <b>63</b>	<b>C</b> — dormakaba SFIC Screw-On dormakaba 93R Housing for Schlage FSIC
	<b>D</b> — dormakaba Conventional
<b>63 10 D</b>	
dormakaba Key Removable Mullion & Adams Rite	<b>01</b>
Adams Rite 4070 & Amarlite; Baldwin Mortise Locks; Miscellaneous Non-dormakaba Straight Cam Applications	<b>02</b> (Not available in SFIC)
dormakaba 9600, 9700 & 9800 Exit Z Trim w/09 or 12 Functions	<b>09</b>
dormakaba M9050, 9080 & 9082 (2) Mortise Locks; dormakaba 9100, 9300, 9400 & 9500 (prior to 11/2014) Exit Y Trim/Options & Other Straight Cam Applications	<b>10</b>
dormakaba M9056, 9080EL/EU, 9080ELRX/EURX 9082EL/EU & M9900 Mortise Locks w/Dead Bolts'	<b>11</b>
dormakaba M9053, 9070, 9071 (2), 9076, 9077 (2) & 9060 Insider Cylinder Mortise Locks;	<b>12</b>
dormakaba 9500 05 and 08 Functions (11/2014 or later)	<b>13</b>
dormakaba M9060 Outside Cylinder Mortise Locks; dormakaba 9500 05 and 08 Functions (11/2014 or later), 9600, 9700 & 9800 Exit Z Trim w/08 or 11 Functions	<b>15</b>
D900 C Only; Schlage Style Clover (L)	<b>16</b>
dormakaba 5000 Series Exit J Trim, Sargent & Yale Narrow	<b>19</b>
Best & CorbinRusswin Style Clover	<b>22</b>
Vingcard	<b>32</b>
D900 D Only	

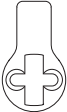

**6310D**



**6310C**

**Conventional Cams (Suffix D) have mounting holes at 3 and 9 o'clock.**

**SFIC/LFIC Cams (Suffix C) have mounting screw holes at 12 and 6 o'clock.**

**Cam**

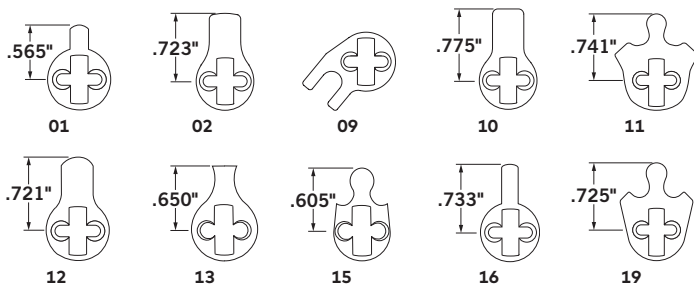

Description	U/M	List \$
Cams — 6301D, 6302D, 6309D, 6310D, 6311D, 6312D, 6313D, 6315D, 6316D, 6319D, 6332D	ea.	11.00
Cams — 6301C, 6309C, 6310C, 6311C, 6312C, 6313C, 6315C, 6316C	ea.	11.00



Part#	Description	U/M	List \$
76007125	Cam screws, DORMA I/C mortise housing (used with "C" suffix cams) – pack of 20	pack	32.00
76019185	Cam screws, DORMA standard mortise cylinder (used with "D" suffix cams) – pack of 20	pack	32.00



## Retrofit Mortise Cylinder Cams

Ordering Guide for other manufacturers' cylinders when used in M9000 Series Locks

		<b>Pattern</b>	
		SG	— Arrow and Sargent Conventional Cylinders
		CR	— CorbinRusswin Conventional Cylinders
<b>Product Type</b>	63	11	CR
Mortise Cylinder Cam —	63	11	CR
dormakaba 9600, 9700 & 9800 Exit Z Trim w/09 or 12 Functions		09 <sup>1</sup>	
dormakaba M9056, 9080EL/EU, 9080ELRX/EURX 9082EL/EU & M9900 Mortise Locks w/Dead Bolts		11	
dormakaba M9053, 9070, 9071 (2), 9076, 9077 (2) & 9060 Insider Cylinder Mortise Locks		12	
dormakaba M9060 Outside Cylinder Mortise Locks; dormakaba 9600, 9700 & 9800 Exit Z Trim w/08 or 11 Functions		13	
		<b>Cam</b>	

**6311SG**      **6311CR**

**Retrofit cams are configured to fit non-dormakaba cylinders. Use of incorrect cams can cause lockouts.**

1. 09 cam required for dormakaba Z09 & Z12 exit trim. For this, or any other application not shown, contact Technical Services.

Description	List \$
Cams — 6311CR, 6312CR, 6313CR	13.00
Cams — 6311SG, 6312SG, 6313SG	13.00

## Mortise Cylinder Rings

Ordering Guide

		<b>Cylinder Ring</b>	
		H	— 13/16" Tapered Ring raises cylinder 5/8" off door
		G	— 11/16" Tapered Ring raises cylinder 1/2" off door
		K	— 17/32" Tapered Ring raises cylinder 7/16" off door
		J	— 7/16" Tapered Ring raises cylinder 1/4" off door
		A	— 9/32" Tapered Ring raises cylinder 3/32" off door
		D	— 1/4" Blocking Ring
		C	— 1/8" Blocking Ring
<b>Product Type</b>	64	J	626
Mortise Cylinder Ring —	64	J	626
		605	— Bright Brass
		606	— Satin Brass
		612	— Satin Bronze
		613	— Dark Oxidized Satin Bronze
		622	— Satin Black
		625	— Bright Chrome
		626	— Satin Chrome
		630	— Satin Stainless (also for use with 619)
		<b>Finish</b>	

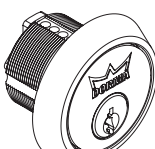
**Cylinder with Blocking Ring**      **Cylinder with Tapered Ring**

	<b>626</b>	<b>605, 606, 612, 619, 625, 630</b>
--	------------	-------------------------------------

Description	List \$	
Blocking rings — 64C, 64D	11.00	13.00
Tapered rings — 64A, 64J, 64K (includes wave washer)	30.00	33.00
Tapered rings — 64G, 64H (includes wave washer)	32.00	34.00
Wave washer (sold in multiples of 25 only)	25 pack	25 pack

**Example:** 64J 626

# Conventional (Non-IC) Rim Cylinders

## Ordering Guide

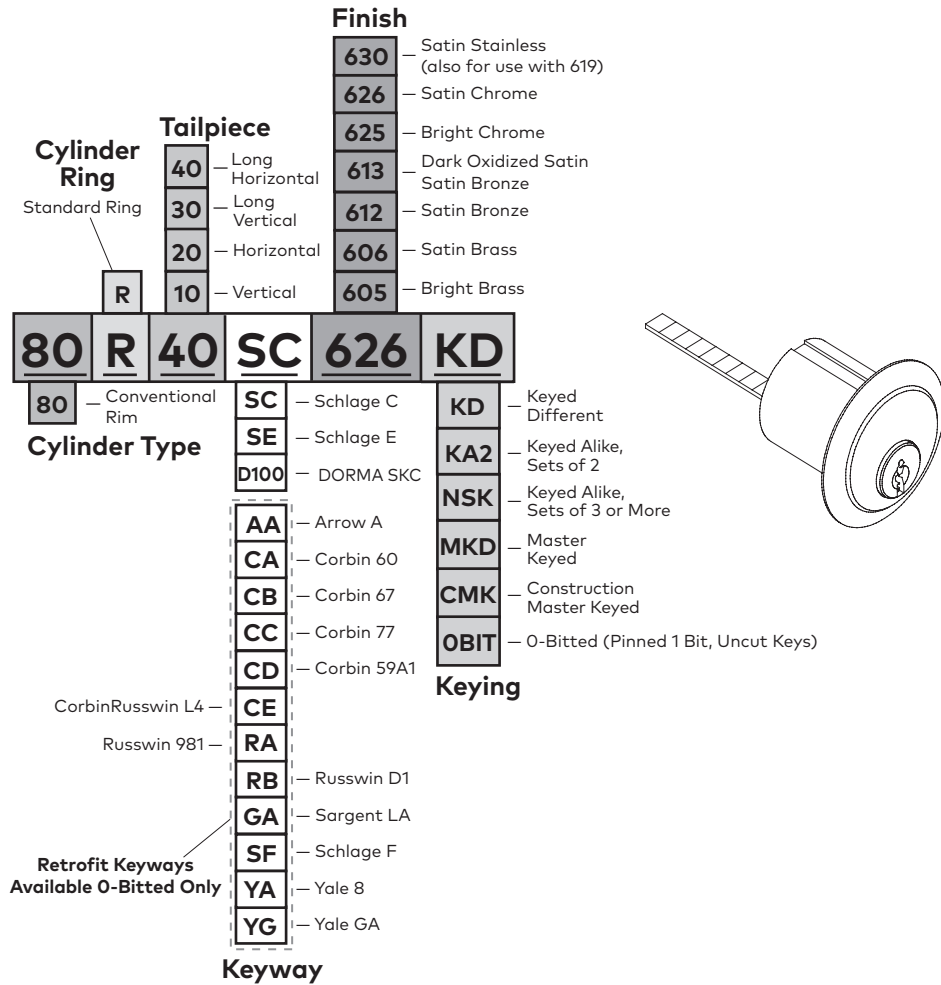

Option	Keyway	Example	Keys	All Finishes \$
KD (standard)/KA2/KA4	SC	80R40 SC 626 KD	2 keys ea.	65.00
NSK (KA other than KA2/KA4)	SC	80R40 SC 626 NSK KA31	2 keys ea.	Add 30.00
Master keyed	SC, SE, D100	80R40 SC 626 MKD	⊗ Keys sold separately	Add 30.00
Construction master keyed	SC, SE, D100	80R40 SC 626 CMK	⊗ Keys sold separately	Add 37.00
O-Bit	SC, SE	80R40 SC 626 OBIT	2 keys ea.	65.00
O-Bit	D100	80R40 D100 626 OBIT	⊗ Keys sold separately	65.00
O-Bit	Retro	80R40 RB 626 OBIT	2 keys ea.	65.00

⊗ Denotes keys must be ordered separately.

### Keys Ordered Separately for MKD, CMK, and SKC

Part #	Description	List \$
45101	Cut key — change key, master key, construction key; SC, SE keyways	10.00
45401	Cut key — change key, master key, construction key; SKC keyways — D100 etc.	16.00
45404	CONV Cut key — 1-bit key for operating 1-bit cylinders; SC, SE keyways only	8.00

#### NOTES:

- D100 keyway cylinders must be ordered O-bitted or MKD; keys sold separately.
- Other restrictions apply. See Cylinders, Keys & Keying section for DORMA SKC policies.
- 1-bit cylinder comes with (2) uncut keys and will require a 1-bit cut key, sold separately, to operate cylinder. SC and SE keyways only.
- See Keys and Key Blanks section for complete list.

# Small Format Interchangeable Core Rim Housings

## Ordering Guide

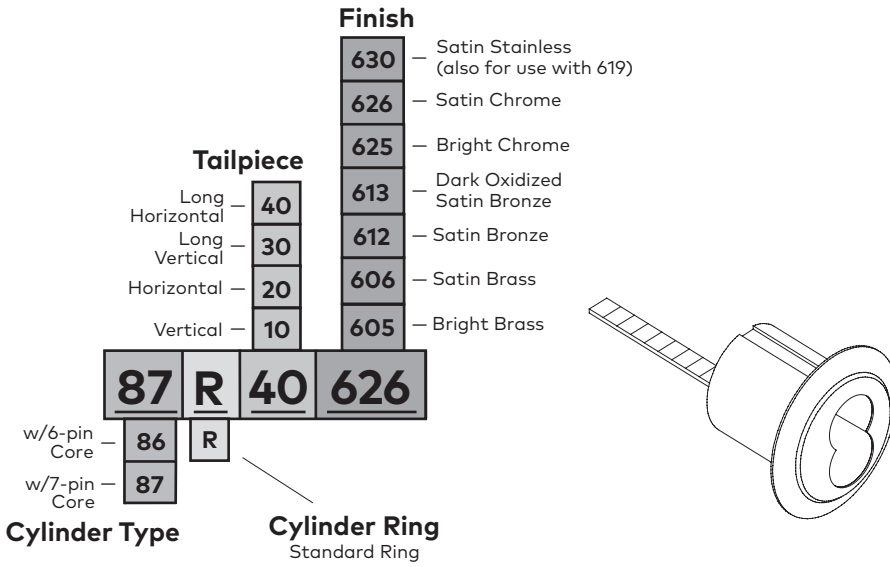

**NOTES:** • To order cores, refer to page 73.

Description	Example	All Finishes \$
Housing less core	87R40 00 626	62.00

# Conventional (Non-IC) Key-in-Knob/Lever Cylinders

## Ordering Guide (Except Hotel Function)

Tailpiece		Keyway		Keying	
J300 Upper Cylinder	33	YG	Yale GA	OBIT	0-Bitted (SC keyway only 1-bitted, Uncut Keys)
C353 & J353 Lower Cylinder	32	YA	Yale 8	CMK	Construction Master Keyed
D880	30	SF	Schlage F	MKD	Master Keyed
C873 Lever Only	28	GA	Sargent LA	NSK	Keyed Alike, Sets of 3 or More
All C800 Levers except C873 & 885	27	RB	Russwin D1	KA2	Keyed Alike, Sets of 2
D860 & 863 1-13/16"-3" Door	26	RA	Russwin 981	KD	Keyed Different
C570	25	CE	CorbinRusswin L4		
C550, 553, 555, 580	24	CD	Corbin 59A1		
D862 1-13/16"-2" Door	21	CC	Corbin 77		
D862 1-3/8"-1-3/4" Door	20	CB	Corbin 67		
D860 & 863 1-3/8"-2" Door	19	CA	Corbin 60		
D861	18	AA	Arrow A		
DB662	17	D100	DORMA SKC		
DB660	16	SE	Schlage E		
R08 Trim CL700 Levers	13	SC	Schlage C		
CK700 Knobs	12				

Lock Type	Finish
Lever Designs — 70	Satin Brass — 606
Knob Designs — 71	Satin Chrome — 626

**NOTE:** To order tailpiece only, refer to page 76.

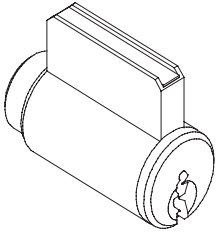

Option	Keyway	Example	Keys	All Finishes \$
KD (standard)/KA2	SC	7010 SC 626 KD2 keys ea.	2 keys ea.	59.00
NSK (keyed alike, sets of 3 or more)	SC	7010 SC 626 NSK KA31	2 keys ea.	Add 30.00
Master keyed	SC, SE, D100	7010 SC 626 MKD	⊗ Keys sold separately	Add 30.00
Construction master keyed	SC, SE, D100	7010 SC 626 CMK	⊗ Keys sold separately	Add 37.00
0-Bit	SC, SE	7010 SC 626 OBIT	2 keys ea.	59.00
0-Bit	D100	7010 D100 626 OBIT	⊗ Keys sold separately	59.00
0-Bit	Retro	7010 RB 626 OBIT	2 keys ea.	59.00

NOTE: For locksets in 619, 625, 626, 629, and 630 finish, order cylinders in 626. For locksets in 605, 606, 612, and 613, order in 606.  
 ⊗ Denotes keys must be ordered separately.

### Keys Ordered Separately for MKD, CMK, and SKC

Part #	Description	List \$
45101	Cut key — change key, master key, construction key; SC, SE keyways	10.00
45401	Cut key — change key, master key, construction key; SKC keyways — D100 etc.	16.00
45404	CONV Cut key — 1-bit cut key for operating 1-bit cylinders; SC, SE keyways only	8.00

**NOTES:**

- D100 keyway cylinders must be ordered 0-bitted or MKD; keys sold separately.
- Other restrictions apply. See Cylinders, Keys & Keying section for DORMA SKC policies.
- 1-bit cylinder comes with (2) uncut keys and will require a 1-bit cut key, sold separately, to operate cylinder. SC and SE keyways only.
- See Keys and Key Blanks section for complete list.

# Conventional (Non-IC) Hotel Cylinders

## Ordering Guide

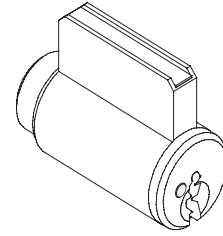
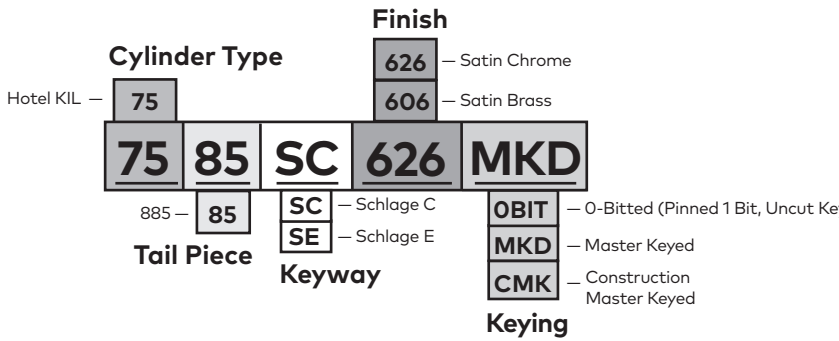

Description	Example	All Finishes \$
<b>Key-in-Lever Cylinders</b>		
Key-in-lever hotel cylinder	7585 SC 626 OBIT	95.00
Key-in-lever master keyed cylinder — <b>⊗ Keys sold separately</b>	7585 SC 626 MKD	Add 30.00
Key-in-lever construction keyed cylinder — <b>⊗ Keys sold separately</b>	7585 SC 626 CMK	Add 37.00

- NOTES:**
- For key-in-lever locksets in 619, 625, and 626 finish, order cylinders in 626. For key-in-lever locksets in 605, 606, 612, and 613, order in 606.
  - Key-in-lever hotel cylinders are not available in D100 keyway.
  - **⊗** Denotes keys must be ordered separately.

### Keys Ordered Separately for MKD and CMK cylinders

Part #	Description	List \$
45101	Cut key — change key, master key, construction key; SC, SE keyways	10.00
45401	Cut key — change key, master key, construction key; SKC keyways — D100 etc.	16.00
45102	Cut key — emergency key 75CYL; SC, SE keyways	27.00

- NOTES:**
- D100 keyway cylinders must be ordered 0-bitted or MKD; keys sold separately.
  - Other restrictions apply. See Cylinders, Keys & Keying section for DORMA SKC policies.
  - See Keys and Key Blanks section for complete list.

# Small Format Interchangeable Core Hotel Cylinder

## Ordering Guide

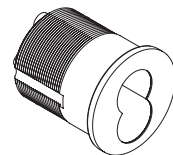
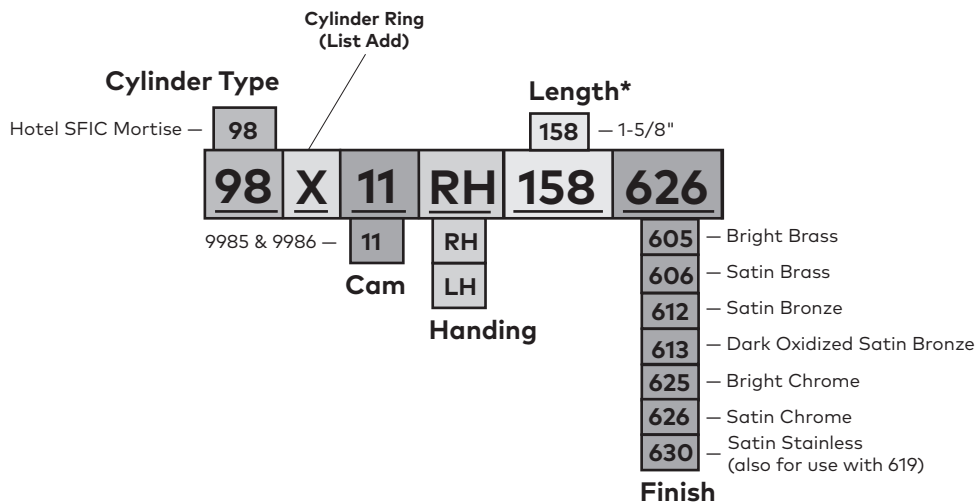

Cylinder without Ring

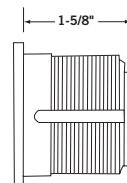

Length Includes Cam

\* Extended length cylinders not available.

**NOTES:** • To order cores, refer to page 73.

Description	Example	All Finishes \$
Housing less core	98H11 00 158 626	83.00

1. For uncombined cores, UNC, cores must be ordered separately.

# Small Format Interchangeable Cores

## Ordering Guide

**Core Length**

7-Pin Core — **77**

6-Pin Core — **76**

**Finish**

**626** — Satin Chrome

**606** — Satin Brass

**77 BA 606 MKD**

**Keyway**

- BA** — Best A
- BB** — Best B
- BC** — Best C
- BD** — Best D
- BE** — Best E
- BF** — Best F
- BG** — Best G
- BH** — Best H
- BJ** — Best J
- BK** — Best K
- BL** — Best L
- BM** — Best M
- TB** — Best TB
- BQ** — Best Q
- D100** — DORMA SKC (supplied standard with DORMA logo - 7-pin Core only)
- BLK** — Black Construction Core
- BLU** — Blue Construction Core
- GRN** — Green Construction Core

**Specify Color If Required to Match Existing Project**

**Keying**

- MKD** — Combined (Master Keyed)
- UNC** — Uncombined
- TMP** — Temporary Construction Core

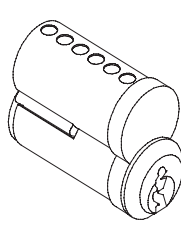

**NOTE:** To order tailpiece only, refer to page 76.

Description	Example	All Finishes \$
Uncombined core — <b>Keys sold separately</b>	77 BA 606 UNC	44.00
76 or 77 Series core, combined — <b>Keys sold separately</b>	77 BA 606 MKD	Add 30.00
Temporary construction core — <b>Keys sold separately</b>	77 XX 606 TMP	58.00

Cores may be returned for a full refund (Quantities limited; contact Customer Service for details)

**NOTES:**

- For locksets in 619, 625, 626, 629, and 630 finish, order cores in 626. For locksets in 605, 606, 612, and 613, order cores in 606.
- SFIC cores are not available O-Bitted.
- Denotes keys must be ordered separately.

**Keys Ordered Separately**

Part #	Description	List \$
45101	Cut key — change key, master key, control key; "B" keyways	10.00
45401	Cut key — change key, master key, control key; SKC keyways — D100 etc.	16.00
45103	Cut key — emergency key for M9985C "B" keyways	28.00
45403	Cut key — emergency key for M9985C D100 keyway	28.00

**NOTES:**

- D100 keyway cylinders must be ordered UNC or MKD; keys sold separately.
- Other restrictions apply. See Cylinders, Keys & Keying section for DORMA SKC policies.
- See Keys and Key Blanks section for complete list.

**Service Items**

Part #	Description	List \$
860051	Plastic construction core	9.00

# Large Format Interchangeable Core

## Ordering Guide

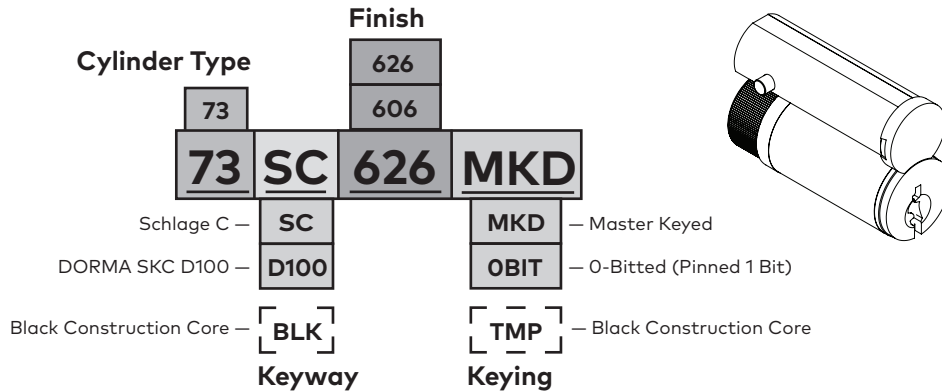

### Large Format Interchangeable Cores

Keyway	Option	Example	Keys	All Finishes \$
SC	0-BIT	73 SC 626 0-BIT	2 Keys Ea. (Control Key Sold Separately)	64.00
SC	MKD	73 SC 626 MKD	Keys Sold Separately	94.00
D100	0-BIT	73 D100 626 0-BIT	Keys Sold Separately	64.00
D100	MKD	73 D100 626 MKD	Keys Sold Separately	94.00
SC	Temp Construction Core	73 BLK 626 TMP	Keys Sold Separately	81.00

**NOTES:**

- "0-bitted" SC cores come with (2) uncut keys, a 1-bit cut key is required to operate cylinder and must be ordered separately. Control key for removing and installing core must be ordered separately.
- "0-bitted" D100 cores do not come with keys. Keys must be ordered separately (pages 77–78).
- Distribution of DORMA SKC keys (listed as D100) is restricted. See Cylinders, Keys & Keying section for DORMA SKC policies.

### Keys

Part #	Description	List \$
45101	Cut key – change key, master key, construction key – SC keyway	10.00
45401	Cut key – change key, master key, construction key – D100 keyway	16.00
45404	Cut key – 1-bit change key (to operate "1-bit" cores) – SC keyway	8.00
45405	Cut key – 1-bit control key (to install/remove "1-bit" LFIC cores) – SC keyway	8.00
44101SC	Key blank – SC keyway	5.00
44104SC	Key blank – Control key (to install/remove LFIC Cores) – SC keyway	7.00
44404D100	Key blank – control key – D100 76014824	21.00
45404D100	Cut key – control key – D100	27.00



# Retrofit Interchangeable Core Cylinder Housings

## Ordering Guides

**Cylinder Type**  
Rim Cylinder Housing — **83**

**Cylinder Ring**  
Standard Ring — **R**

**Tailpiece**  
40 — Long Horizontal  
30 — Long Vertical

**Retrofit Type**  
Sargent XC 11-P-7300B  
Arrow Choice Plus CP7S  
Arrow Choice Flex C7FS  
Arrow Choice Base C7S — **X7**  
Less Core<sup>1</sup> — **00**  
Arrow Choice Plus CP6S  
Arrow Choice Flex C6FS  
Arrow Choice Base C6S — **X6**  
Schlage FSIC — **R**

**Interchangeable Core Housing** — **93**

**Cylinder Type**  
Arrow Choice Plus CP6S  
Arrow Choice Flex C6FS  
Arrow Choice Base C6S — **93**

**Retrofit Type**  
Sargent XC 11-P-7300B  
Arrow Choice Plus CP7S  
Arrow Choice Flex C7FS  
Arrow Choice Base C7S — **R**  
Schlage FSIC — **R**

**Cylinder Ring (List Add)**  
**X6**  
**X7**

**Finish**  
605 — Bright Brass  
606 — Satin Brass  
612 — Satin Bronze  
613 — Dark Oxidized Satin Bronze  
625 — Bright Chrome  
626 — Satin Chrome  
630 — Satin Stainless (also for use with 619)

**Length**  
112 — 1-1/2" (R only)  
134 — 1-3/4" (X7, X6 only)  
138 — 1-3/8" (X7, X6 only)

**Cam**  
01 — Adams Rite & dormakaba 1340KR Key Removable Mullion  
02 — Adams Rite 4070  
09 — dormakaba 9600, 9700 & 9800 Exit Z Trim w/09 or 12 Functions  
10 — dormakaba M9050, 9080 & 9082 (2) Mortise Locks; dormakaba 9100, 9300, 9400 & 9500 Exit Y Trim/Options & Other Straight Cam Applications  
11 — dormakaba M9056, 9080EL/EU, 9080ELRX/EURX 9082EL/EU & M9900 Mortise Locks w/Dead Bolts  
12 — dormakaba M9053, 9070, 9071 (2), 9076, 9077 (2) & 9060 Inside Cylinder Mortise Locks  
13 — dormakaba M9060 Outside Cylinder Mortise Locks; dormakaba 9600, 9700 & 9800 Exit Z Trim w/08 or 11 Functions  
15 — Schlage Style Clover (L)  
16 — dormakaba 5000 Series Exit J Trim, Sargent & Yale Narrow  
19 — Best & CorbinRusswin Style Clover  
30 — Falcon Dead Bolt Style Clover  
31 — CorbinRusswin DL4000 Style

**83 R R 40 00 626**

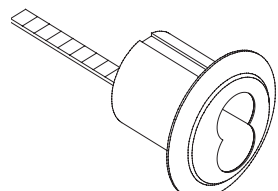

**93 R X 10 00 112 626**

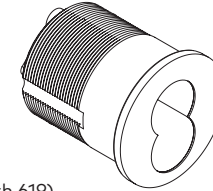

**1. Interchangeable cores only available in R option (Schlage C) for these rim cylinder housings.**

**1. Interchangeable cores only available in R option (Schlage C) for these mortise cylinder housings.**

Retrofit	Description	Example	All Finishes \$
<b>Full Size Interchangeable Core Housing — Less Core</b>			
R	Housing prepared for Schlage FSIC	83 R R 40 00 626 or 93 R G 10 00 112 626	75.00
<b>Small Format Interchangeable Core Housings — Less Core</b>			
X7 <sup>1</sup>	Housing prepared for Sargent XC 7P and Arrow Choice 7P	83 X7 R 40 00 626 or 93 X7 G 10 00 112 626	75.00
X6 <sup>1</sup>	Housing prepared for Arrow Choice 6P	83 X6 R 40 00 626 or 93 X6 G 10 00 112 626	75.00

**NOTE:** If temporary construction cores are required, consult technical services. SFIC housings X6 require 6-pin temporary cores; X7 require 7-pin temporary cores.

## Tailpieces

<b>C800 Lever</b>	<b>Tailpiece</b>	<b>Cylinder Type</b>	<b>Application</b>	<b>List \$</b>
	6727D	Standard	All functions except C873, C885	10.00
	6728D	Standard	C873 function only	10.00
	6785D	Standard	C885 function only (hotel)	10.00
	6727C	SFIC	All functions except C873, C885	10.00
	6728C	SFIC	C873 function only	10.00
	6727R	R (Schlage FSIC)	All functions except C873	10.00
	6728R	R (Schlage FSIC)	C873 function only	10.00
	6727A	A (Corbin FSIC)	All functions except C873	10.00
	6728A	A (Corbin FSIC)	C873 function only	10.00
	6727M	M (Medeco 32 FSIC)	All functions except C873	10.00
	6728M	M (Medeco 32 FSIC)	C873 function only	10.00
	6727E	E (Corbin 2000 KIL)	All functions except C873	10.00
	6728E	E (Corbin 2000 KIL)	C873 function only	10.00
	6727N	N (Sargent 6300 FSIC)	All functions except C873	10.00
	6728N	N (Sargent 6300 FSIC)	C873 function only	10.00
	6727S	S (Sargent 10 Line KIL)	All functions except C873	10.00
	6728S	S (Sargent 10 Line KIL)	C873 function only	10.00
	6727Y	Y (Yale 1210/Medeco 31 FSIC)	All functions except C873	10.00
	6728Y	Y (Yale 1210/Medeco 31 FSIC)	C873 function only	10.00
<b>C800 Knob</b>				
	6727D	Standard	All functions except C873	10.00
	6728D	Standard	C873 function only	10.00
	6712C	SFIC	All functions except C873	10.00
	6729C	SFIC	C873 function only	10.00
<b>CL700 Lever</b>				
	6713D	Standard	All functions	10.00
	6713C	SFIC	All functions	10.00
<b>CK700 Knob</b>				
	6712D	Standard	All functions	10.00
	6712C	SFIC	All functions	10.00
<b>C500 Tailpieces</b>				
	6724D	Standard	All functions except C570	10.00
	6725D	Standard	C570 function only	10.00
	6724C	SFIC	All functions except C570	10.00
	6725C	SFIC	C570 function only	10.00
<b>J300 Tailpieces</b>				
	6732D	Standard	J353 (lever)	10.00
	6733D	Standard	All functions (deadbolt)	10.00
	6733C	SFIC	All functions (deadbolt)	10.00
	6732C	SFIC	J353 (lever)	10.00
<b>C300 Tailpieces</b>				
	6732D	Standard	C353	10.00

**NOTE:** 6727C & 6728C tailpieces for C800C accommodate both 6 & 7-pin cores.

<b>D800 Tailpieces</b>	<b>Tailpiece</b>	<b>Cylinder Type</b>	<b>Application</b>	<b>List \$</b>
	6718C	SFIC	D861	10.00
	6718D	Standard	D861	10.00
	6719C	SFIC	D860/D863	10.00
	6719D	Standard	D860/D863	10.00
	6720C	SFIC	D862	10.00
	6720D	Standard	D862	10.00
	6721C	SFIC	D862	10.00
	6721D	Standard	D862	10.00
	6726C	SFIC	D860/D863 long (4.5" door)	10.00
	6726D	Standard	D860/D863 (1-3/4"-2" door)	10.00
<b>DB600 Tailpieces</b>				
	6716D	Standard	D660	10.00
	6717D	Standard	D662	10.00
	6716C	SFIC	D660	10.00
	6717C	SFIC	D662	10.00

## Miscellaneous Tailpieces/Parts

<b>Part #</b>	<b>Description</b>	<b>List \$</b>
76008829	Tailpiece, Rim cylinder	10.00
76009468	SFIC tailpiece spacer for use with 6-pin cores (except C800C Series)	6.00

## Keys and Key Blanks

### Key Blanks

<b>Part #</b>	<b>Description</b>	<b>List \$</b>
44101SC	SC section 6-pin (order in multiples of 50), w/DORMA logo	5.00
44101SE	SE section 6-pin (order in multiples of 50), w/DORMA logo	5.00
44101BA	BA section 7-pin (order in multiples of 50), w/DORMA logo and stamped DO NOT DUPLICATE	5.00
44401D100	D100 section 7-pin (order in multiples of 50), w/DORMA logo and stamped DO NOT DUPLICATE	8.00
44102SC	SC section emergency blank for C885D	23.00
44102SE	SE section emergency blank for C885D	23.00
44103BA	BA section emergency blank for M9985C and M9986C	27.00
44104SC	Key Blank – Control key (to install/remove LFIC Cores) SC keyway.	7.00
44403D100	D100 section emergency blank for M9985C and M9986C	27.00
44404D100	Key blank – control key – (to install/remove LFIC cores) D100 keyway	21.00
44303D400	D400 Emergency key blank for M9985 and M9986C	29.00

**NOTE:** Distribution of DORMA SKC keys (listed as D100) is restricted. See Cylinders, Keys & Keying section for DORMA SKC policies.

**Cut Keys****Use cut key for master keys, change keys, control keys, construction keys, and emergency key for M9985 and M9986**

<b>Part #</b>	<b>Description</b>	<b>List \$</b>
45101	Cut key SC, SE, or B sections	10.00
45401D100	Cut key D100 section	16.00
45102SC	SC section emergency key for C885D	27.00
45102SE	SE section emergency key for C885D	27.00
45103	Emergency keys for SFIC, M9985C, and M9986C (specify B keyway)	28.00
45403D100	D100 section emergency key for M9985C and M9986C	28.00
45404D100	Cut key - control key (to install/remove LFIC cores) D100 keyway	28.00

**NOTE:** Distribution of DORMA SKC keys (listed as D100) is restricted. See Cylinders, Keys & Keying section for DORMA SKC policies.

**Key Stamping**

<b>Part #</b>	<b>Description</b>	<b>List Add \$</b>
—	Alpha-numeric non-standard key symbols, up to 6 characters	9.00
—	Do not duplicate or US Property Do Not Duplicate	9.00

**NOTE:** BB through BQ section key stamped DUPLICATION PROHIBITED

# SFIC Padlocks

## Ordering Guides

**Cylinder Type**

<b>Shackle Length</b>	<b>T</b> – SFIC, Temporary Core	<b>Keying</b>
2" Shackle – <b>20</b>	<b>C</b> – SFIC, with Core	<b>TMP</b> – Temporary Construction Core
1" Shackle – <b>10</b>	<b>J</b> – SFIC, Less Core	<b>MKD</b> – Combined (Master Keyed)

SFIC Heavy Duty Padlock – **P1 10 J 626 BA MKD**

Satin Chrome – **626**

**Finish**

- BA** – Best A
- BB** – Best B
- BC** – Best C
- BD** – Best D
- BE** – Best E
- BF** – Best F
- BG** – Best G
- BH** – Best H
- BJ** – Best J
- BK** – Best K
- BL** – Best L
- BM** – Best M
- BQ** – Best Q
- TB** – Best TB
- D100** – DORMA SKC 7-Pin Only

Black Construction Core – **BLK**

Blue Construction Core – **BLU**

Green Construction Core – **GRN**

**Keyway**

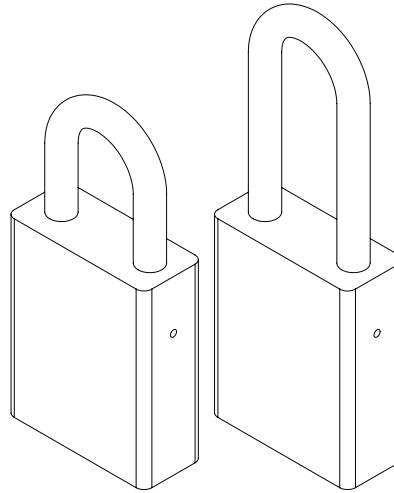

Description	List \$
P110 J 626 — SFIC Padlock with 1" shackle, less core	65.00
P120 J 626 — SFIC Padlock with 2" shackle, less core	77.00

Small Format Interchangeable Cores	List Add \$
T Temporary construction core — Cores may be returned for a full refund	52.00
J SFIC Core sold separately	54.00
C Padlock with combined SFIC core; BA (default). Shipped separately BB, BC, BD, BE, BF, BG, BH, BJ, BK, BL, BM, BQ, D100 Keyway — Keys sold separately	59.00

**Cut Keys Ordered Separately**

Part #	Description	List \$
45101	Change key, master key, construction master key or control key; BA, BB, BC, BD, BE, BF, BG, BH, BJ, BK, BL, BM, BQ, SC, SE keyways	10.00
45401	Change key, master key or control key; SKC keyways — D100 etc.	16.00

## Service Parts

**Pin Kits**

Part #	Description	List \$
76006942	Pin kit for SC and SE keyway conventional cylinders (0.015 dia. pins)	190.00
76006943	Pin kit for dormakaba small format IC (BA, BB, etc., A2 system; 0.108 dia. pins)	190.00
76007399	Pin kit for DORMA SKC (D100) SFIC and conventional cylinders (A2 system)	445.00

**NOTE:** 7-pin kit for DORMA SKC also pins B keyway SFIC.

**Key Machine**

Part #	Description	List \$
76007932	Code key machine for originating DORMA SKC keys, 120 VAC 60 Hz. 4 week lead time.	5,816.00
76007934	Code key machine for originating DORMA SKC keys, 220 VAC 60 Hz. 4 week lead time.	6,104.00
76007936	Replacement cutter for dormakaba key machines	556.00
76007938	Replacement belt for dormakaba key machines	90.00
76010077	DORMA SKC code card for HPC1200/Ilco Universal code machines	35.00

**IC Capping Equipment**

Part #	Description	List \$
76007939	Capsaver press for D100	2,291.00
76010091	Manual capping set for D100 and B keyways (capping block and capping tool)	252.00
76010076	SFIC decombining block and ejector tool (for B keyways only)	224.00
76010074	Capping tool for manual capping	60.00
76010075	Ejector tool for decombining	35.00
76010068	Capping strips (pack of 50)	86.00
76010069	Individual caps for manual capping (pack of 500)	27.00

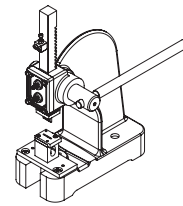

**Capsaver Press**

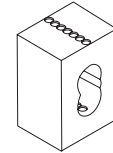

**Capping Block**



**Capping Tool**



**Ejector Tool**

**Tools and Service Items**

Part #	Description	List \$
76010070	Small format IC housing installation wrench	119.00
76010071	Pin tumbler tweezers	50.00
76010072	Cylinder shims (pack of 25; for servicing conventional cylinders)	20.00
76007846	Follower (for servicing all dormakaba conventional cylinders)	17.00
76010246	DORMA SKC sample set	173.00
76010534	BA sample set, 626	86.00
76010535	BA sample set, 606	86.00

**Replacement Pins, A2 System**

Part #	Description (Order in multiples of 100) — Price is per pin	List \$
76007952	SKC Spring	0.14
76007953	SKC full size 0 bottom pin .185"	0.30
76007954	SKC full size 1 bottom pin .1975"	0.30
76007955	SKC full size 2 bottom pin .210"	0.30
76007956	SKC full size 3 bottom pin .2225"	0.30
76007957	SKC full size 4 bottom pin .235"	0.30
76007958	SKC full size 5 bottom pin .2475"	0.30
76007959	SKC full size 6 bottom pin .260"	0.30
76007960	SKC full size 7 bottom pin .2725"	0.30
76007961	SKC full size 8 bottom pin .285"	0.30
76007962	SKC full size 9 bottom pin .2975"	0.30
76007963	SKC full size A top pin .200"	0.30
76007964	SKC full size B top pin .235"	0.30
76007965	SKC full size C top pin .285"	0.30
76007966	SKC full size D top pin .2975"	0.30
76010031	SFIC/SKC size 2 top .025"	0.17
76010032	SFIC/SKC size 3 top .0375"	0.17
76010033	SFIC/SKC size 4 top .050"	0.17
76010034	SFIC/SKC size 5 top .0625"	0.17
76010035	SFIC/SKC size 6 top .075"	0.17
76010036	SFIC/SKC size 7 top .0875"	0.17
76010037	SFIC/SKC size 8 top .100"	0.17

Part #	Description (Order in multiples of 100) — Price is Per Pin	List \$
76010038	SFIC/SKC size 9 top .1125"	0.17
76010039	SFIC/SKC size 10 top .125"	0.17
76010040	SFIC/SKC size 11 top .1375"	0.17
76010041	SFIC/SKC size 12 top .150"	0.17
76010042	SFIC/SKC size 13 top .1625"	0.17
76010043	SFIC/SKC size 14 top .175"	0.17
76010044	SFIC/SKC size 15 top .1875"	0.17
76010045	SFIC/SKC size 16 top .200"	0.17
76010046	SFIC/SKC size 17 top .2125"	0.17
76010047	SFIC/SKC size 18 top .225"	0.17
76010048	SFIC/SKC size 19 top .2375"	0.17
76010049	SFIC/SKC size 0 bottom pin .110"	0.17
76010050	SFIC/SKC size 1 bottom pin .1225"	0.17
76010051	SFIC/SKC size 2 bottom pin .135"	0.17
76010052	SFIC/SKC size 3 bottom pin .1475"	0.17
76010053	SFIC/SKC size 4 bottom pin .160"	0.17
76010054	SFIC/SKC size 5 bottom pin .1725"	0.17
76010055	SFIC/SKC size 6 bottom pin .185"	0.17
76010056	SFIC/SKC size 7 bottom pin .1975"	0.17
76010057	SFIC/SKC size 8 bottom pin .210"	0.17
76010058	SFIC/SKC size 9 bottom pin .2225"	0.17

## Labeling and Cylinder Marking

Each product on a contract order is automatically labeled with door number, keying information, and hardware set information. This information is placed on a special secondary label. **There is no extra charge for this service.**

In addition to the secondary label, we mark our cylinders with our key symbol in a concealed location using a water-resistant marker. If the cylinder needs to be rekeyed, the marking can be rubbed off without damaging the cylinder.

Visible Cylinder Marking Locations

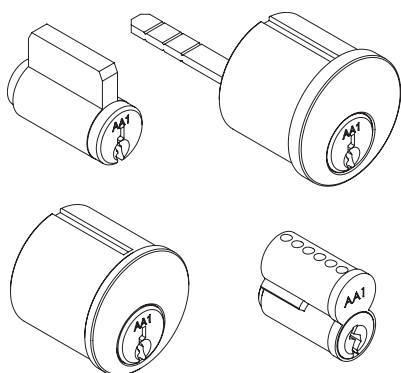

Concealed Cylinder Marking Locations

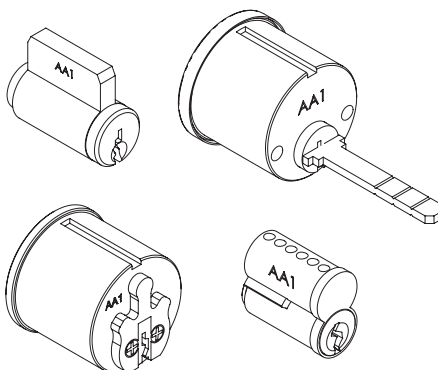



# Exit Devices

Product Guide (1 of 2)

GRADE 1 EXIT DEVICES	Concealed Vertical Rod	Rim	Surface Vertical Rod	Mortise
<b>Architectural Wide Stile</b> <b>9000 Series</b> <b>Panic and Fire Rated</b>	9100	9300	9400	9500
<b>Architectural Narrow Stile</b> <b>9000 Series</b> <b>Panic and Fire Rated</b>	9600	9700	9800	—
<b>Wide Stile</b> <b>8000 Series</b> <b>Panic and Fire Rated</b>	—	8300	8400	—

<b>Architectural Mullions</b> <b>1300 Series</b> <b>Panic/Fire Rated</b>	Aluminum 1-5/8" x 2-5/8" 1310 Panic Rated	Steel 1-1/2" x 2-1/2" 1330 Panic Rated	Steel 2" x 3" 1300 Panic/Fire Rated	Steel 2" x 3" HC1300 Hurricane Rated	Steel 2" x 3" 1340 Key Removable Panic/Fire Rated
--	--	---	--	---	---

# Exit Devices

Product Guide (1 of 2)

Yes <input type="radio"/> No	A156.3 Grade1	EN1125 Grade1	5 Mil Extended Cycle Test	Latch Bolt Load Rated	Hurricane Rated	Plated Finishes	PowderCoat Finishes	Fire Rated	Panic Rated	Escutcheon Trim	Sectional Trim	Plate and Pull Trim	Electric Latch Retraction	Delayed Egress
8300 Rim Wide Stile	Yes	<input type="radio"/>	<input type="radio"/>	<input type="radio"/>	Yes	<input type="radio"/>	Yes	Yes	Yes	Yes	Yes	Yes	Yes	<input type="radio"/>
8400 SVR Wide Stile	Yes	<input type="radio"/>	<input type="radio"/>	<input type="radio"/>	Yes	<input type="radio"/>	Yes	Yes	Yes	Yes	Yes	Yes	Yes	<input type="radio"/>
9300 Rim Wide Stile	Yes	<input type="radio"/>	Yes	Yes	Yes	Yes	Yes	Yes	Yes	Yes	Yes	Yes	Yes	Yes
9100 CVR Wide Stile	Yes	<input type="radio"/>	Yes	<input type="radio"/>	<input type="radio"/>	Yes	Yes	Yes	Yes	Yes	Yes	Yes	Yes	Yes
9400 SVR Wide Stile	Yes	<input type="radio"/>	Yes	<input type="radio"/>	Yes	Yes	Yes	Yes	Yes	Yes	Yes	Yes	Yes	<input type="radio"/>
9500 Mortise Wide Stile	Yes	<input type="radio"/>	Yes	<input type="radio"/>	Yes	Yes	Yes	Yes	Yes	Yes	<input type="radio"/>	Yes	<input type="radio"/>	Yes
9700 Rim Narrow Stile	Yes	Yes	Yes	Yes	<input type="radio"/>	Yes	Yes	Yes	Yes	Yes	Yes	Yes	Yes	Yes
9600 CVR Narrow Stile	Yes	Yes	Yes	<input type="radio"/>	<input type="radio"/>	Yes	Yes	Yes	Yes	Yes	Yes	Yes	Yes	Yes
9800 SVR Narrow Stile	Yes	Yes	Yes	<input type="radio"/>	<input type="radio"/>	Yes	Yes	Yes	Yes	Yes	Yes	Yes	Yes	<input type="radio"/>

### Barrier-free (BF) Model Availability

ANSI Exit Device Type	dormakaba Exit Device Model	Functions	Electric Options	Device Lengths	Ratings
Type 1 – Rim	<b>8300BF</b>	01, 02, 03, 05, 08, 23	BA, B4	36" & 48"	Panic & Fire
	<b>9300BF</b>				
Type 3 – Mortise	<b>9500 BF</b>				
Type 4 – Narrow Rim	<b>9700BF</b>				

### Handing

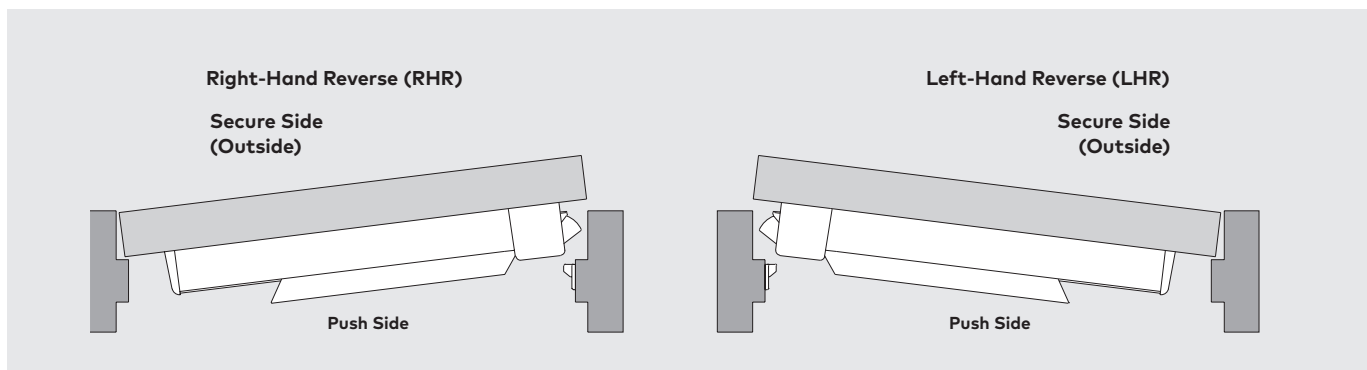

# 9000 Series Exit Devices

## How to Order

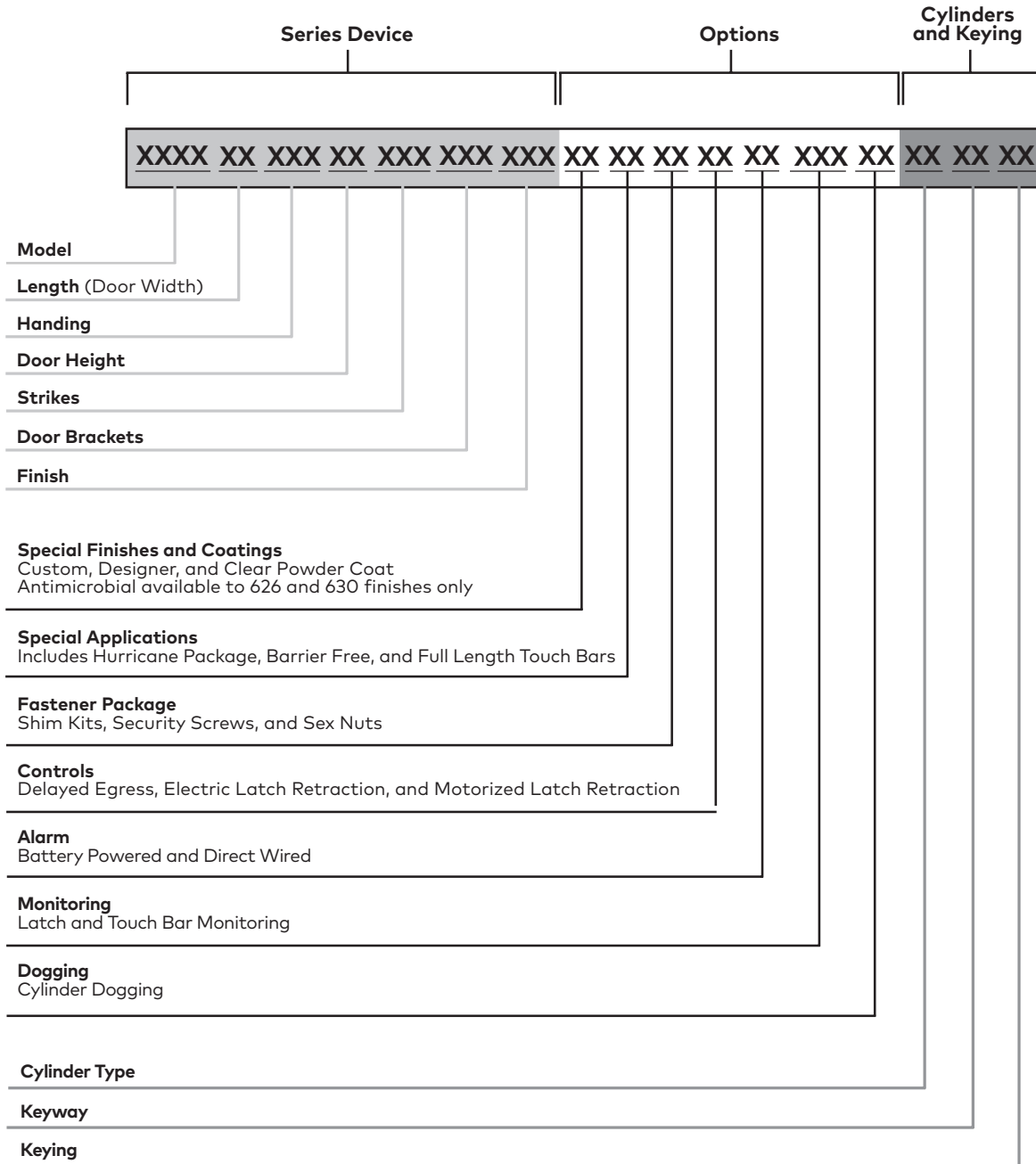

# 9100 Series

## Wide Stile Concealed Vertical Rod Exit Device

9100 Series Device								Options (Specify)							Cylinders and Keying			
Device	Length	Touchbar	Handing	Door Height	Top Strike	Bottom Strike	Finish	Special Finish Coating	Bottom Latch	Alum Door Latch Brackets	Fastener Package	Control	Alarm	Monitoring	Dogging	Cylinder Type	Keyway	Keying
<b>9100</b>	<b>B</b>		<b>RHR</b>	<b>7</b>	<b>418</b>	<b>439</b>	<b>630</b>									<b>D</b>	<b>SC</b>	<b>KD</b>
F9100	A	FL	RHR	7	418	340	605	*AM	LB	ALD	SK	DE	BPA	LM	CD	T	CA	KD
9100	B		LHR	8	419	431	606	**PC	PB		SNB	DE30	BPAR	MS	LD	J	CD	KA2
	C			9		439	611		SB		TX	ES	DWA	LMMS		C	CE	KA4
	SPCL			10			612				SKTX	DECBC		LMMSBP		L	<b>D100</b>	NSK
				SPCL			613				SKSNB	MLR				D	GA	MKD
							619				TXSNB					G	RA	CMK
							625				SKTXSNB					R	RB	SKD
							626									F	SC	OBit
							628								X6		SE	
							629								X7		SF	
							<b>630</b>										YA	
							689										YG	
							691											
							693											
							695											
							696											
							Custom											
							Designer											

 - Default

 - Supplied with Standard KD Cylinder

**\*Patented Key Control**  
**D100** is the keyway for our patented **SKC** serialized key control system. **SKC** is internet based and provides added layers of security. For more information, contact your local sales representative or Technical Service at 800-387-4938.

### 9000 Series – Wide Stile Applications

Device Length	All Device Options (except BA, DA, or DE)		BA or DA Device Options	DE Device Option
	Maximum Door Width <sup>1</sup>	Minimum Door Width <sup>2</sup>	Minimum Door Width <sup>2</sup>	Minimum Door Width <sup>2</sup>
<b>A</b>	48" (1220 mm)	34" (864 mm)	39" (991 mm)	41" (1042 mm)
<b>B</b>	36" (915 mm)	28" (712 mm)	33" (839 mm)	35" (889 mm)
<b>C</b>	30" (762 mm)	25" (635 mm)	30" (762 mm)	N/A

- As delivered from factory, device will fit doors of this width. For other widths, consult Technical Services.
- Touch bar and rail assembly can be shortened at time of installation to fit doors down to this width.

\*Antimicrobial available to 626 and 630 finishes only  
 \*\*PC - Clear Powder Coat available over 630 - Stainless Steel

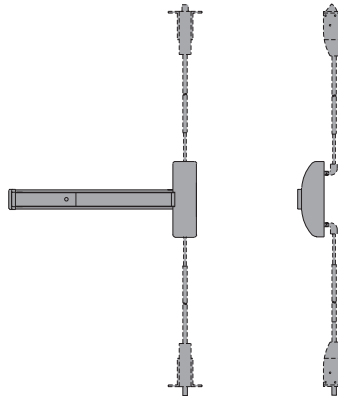

Available Finishes \$

Function	Description	Device, Exit Only	689, 691, 693, 695, 696	630	606, 612, 613, 619	605, 611, 625, 626, 629**
01	Panic	9100 Concealed vertical rod	2,571.00	3,034.00	3,064.00	3,260.00
01	Fire	F9100 Concealed vertical rod	2,855.00	3,307.00	3,339.00	3,526.00

Typical Options

Item	Description	List Add \$
ALD	Wide Stile aluminum door bracket (9100 Series)	N/C
CD	Cylinder dogging (Includes cylinder)	126.00
LD	Less dogging (Standard with fire rated device)	N/C
AM	Antimicrobial coating Note: Antimicrobial available to 626 and 630 finishes only	111.00
SNB	Sex nuts (Included with F and HC Options)	25.00
TX	Security screws	49.00
FL	Full length touchbar (Not Available DE)	N/C
LB	Less bottom rod	N/C
PB	Pullman bottom latch	77.00
SB	Slide bolt (Default)	N/C
Up to 8'	7' to 8' Adjustable	N/C
Up to 10'	Door Heights over 8' to 10'	— 152.00 — —

\*\* For 629 finish, please allow 4 week lead time.

NOTES:

- Prices shown apply to A, B, or C length devices.
- Specify door width and handing. If not specified, Size B, RHR is the standard default.
- List price includes default strikes. For optional strikes, specify strike number and adjust list price accordingly.
- List price for the device does not include trim.
- Devices include wood and machine screws standard.
- Fire and hurricane rated devices include SNB sex nuts standard.
- For options requiring a cylinder, the option list price includes the default cylinder.
- Device includes precut and drilled rods for 7' to 8' doors.  
For 9' doors, device includes precut and drilled rods for a 7' door and a 2' rod extension for the top rod. Specify 9' on order. For 10' doors, device includes precut and drilled rods for an 8' door and a 2' rod extension for the top rod. Specify 10' on order.
- See Device Options for pricing information.
- For special lengths and/or door heights over 10', consult Technical Service.
- All standard devices and trim are designed for 1-3/4"-2-1/4" thick doors. For door thickness greater than 2-1/4", consult Technical Service.
- **ALD** for Wide and Narrow Stile aluminum.

# 9300 Series

## Wide Stile Rim Exit Device

9300 Series Device					Options (Specify)							Cylinders and Keying		
Device	Length	Touchbar	Strike	Finish	Special Finish Coating	Special Application Package	Fastener Package	Control	Alarm	Monitoring	Dogging	Cylinder Type	Keyway	Keying
<b>9300</b>	<b>B</b>		<b>463</b>	<b>630</b>								<b>D</b>	<b>SC</b>	<b>KD</b>
F9300	A	FL	320	605	*AM	HC	SK	DE	BPA	LM	CD	T	CA	KD
9300	B		430	606	**PC	**BF	SNB	DE30	BPAR	MS	LD	J	CD	KA2
	C		463	611			TX	ES	DWA	LMMS		C	CE	KA4
	SPCL		486	612			SKTX	DECBC		LMMSBP		L	<b>*D100</b>	NSK
				613			SKSNB	MLR				D	GA	MKD
				619			TXSNB					G	RA	CMK
				625			SKTXSNB					R	RB	SKD
				626								F	SC	OBIt
				629								X6	SE	
				630								X7	SF	
				689									YA	
				691									YG	
				693										
				695										
				696										
				Custom										
				Designer										

 - Default

 - Supplied with Standard KD Cylinder

**\*Patented Key Control**  
**D100** is the keyway for our patented **SKC** serialized key control system. **SKC** is internet based and provides added layers of security. For more information, contact your local sales representative or Technical Service at 800-387-4938.

**\*\* Barrier Free option availability:**

Exit Device	Functions	Electric Options	Device Lengths	Ratings
9300BF	01, 02, 03, 05, 08, 23	ES, BA, B4, LM, MS, LM/MS, LM/MS/BP	36" & 48"	Panic & Fire

**9000 Series – Wide Stile Applications**

Device Length	All Device Options (except BA, DA, or DE)		BA or DA Device Options	DE Device Option
	Maximum Door Width <sup>1</sup>	Minimum Door Width <sup>2</sup>	Minimum Door Width <sup>2</sup>	Minimum Door Width <sup>2</sup>
<b>A</b>	48" (1220 mm)	34" (864 mm)	39" (991 mm)	41" (1042 mm)
<b>B</b>	36" (915 mm)	28" (712 mm)	33" (839 mm)	35" (889 mm)
<b>C</b>	30" (762 mm)	25" (635 mm)	30" (762 mm)	N/A

1. As delivered from factory, device will fit doors of this width. For other widths, consult Technical Services.  
 2. Touch bar and rail assembly can be shortened at time of installation to fit doors down to this width.

\*Antimicrobial available to 626 and 630 finishes only  
 \*\*PC - Clear Powder Coat available over 630 - Stainless Steel

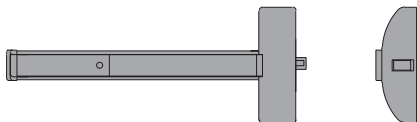

Function	Description	Device, Exit Only	Available Finishes \$			
			689, 691, 693, 695, 696	630	606, 612, 613, 619	605, 611, 625, 626, 629**
01	Panic	9300 Rim	1,257.00	1,949.00	1,968.00	2,119.00
01	Fire	F9300 Rim	1,506.00	2,189.00	2,211.00	2,351.00

### Typical Options

Item	Description	List Add \$
CD	Cylinder dogging (Includes cylinder)	126.00
LD	Less dogging (Standard with fire rated device)	N/C
AM	Antimicrobial coating Note: Antimicrobial available to 626 and 630 finishes only	111.00
SNB	Sex nuts (Included with F and HC Options)	25.00
TX	Security screws	49.00
HC	Hurricane (Includes SNB)	232.00
BF	Barrier free exit device, meets California Building Code (Section 11B-309.4) requirements for maximum 5 lb operating force.	68.00
FL	Full length touchbar (Not Available DE)	N/C

**\*\* For 629 finish, please allow 4 week lead time.**



#### NOTES:

- Prices shown apply to A, B, or C length devices.
- Specify door width. If not specified, Size B is the standard default.
- List price includes default strikes. For optional strikes, specify strike number and adjust list price accordingly.
- List price for the device does not include trim.
- Devices include wood and machine screws standard.
- Fire and hurricane rated devices include 463 rim strike and SNB sex nuts standard.
- For options requiring a cylinder, the option list price includes the default cylinder.
- For special lengths, consult Technical Service.
- All standard devices and trim are designed for 1-3/4" -2-1/4" thick doors. For door thickness greater than 2-1/4", consult Technical Service.

# 9400 Series

## Wide Stile Surface Vertical Rod Exit Device

9400 Series Device							Options (Specify)							Cylinders and Keying				
Device	Length	Touchbar Handling	Door Height	Top Strike	Bottom Strike	Finish	Special Finish Coating	Bottom Latch	Special Application Package	Fastener Package	Control	Alarm	Monitoring	Dogging	Cylinder Type	Keyway	Keying	
<b>9400</b>	<b>B</b>		<b>RHR</b>	<b>7</b>	<b>426</b>	<b>439</b>	<b>630</b>								<b>D</b>	<b>SC</b>	<b>KD</b>	
F9400	A	FL	RHR	7	426	340	605	*AM	LB	HC	SK	ES	BPA	LM	CD	T	CA	KD
9400	B		LHR	8	426A	416V	606	**PC	PB		SNB	MLR	BPAR	MS	LD	J	CD	KA2
	C			9		431	611		SB		TX		DWA	LMMS		C	CE	KA4
	SPCL			10		439	612				SKTX			LMMSBP		L	<b>D100</b>	NSK
			SPCL				613				SXSNB					D	GA	MKD
							619				TXSNB					G	RA	CMK
							625				SKTXSNB					R	RB	SKD
							626									F	<b>SC</b>	OBIt
							629									X6	SE	
							<b>630</b>									X7	SF	
							689										YA	
							691										YG	
							693											
							695											
							696											
							Custom											
							Designer											

 - Default  
 - Supplied with Standard KD Cylinder

**\*Patented Key Control**  
**D100** is the keyway for our patented **SKC** serialized key control system. **SKC** is internet based and provides added layers of security. For more information, contact your local sales representative or Technical Service at 800-387-4938.

### 9000 Series – Wide Stile Applications

Device Length	All Device Options (except BA or DA)		BA or DA Device Options
	Maximum Door Width <sup>1</sup>	Minimum Door Width <sup>2</sup>	Minimum Door Width <sup>2</sup>
<b>A</b>	48" (1220 mm)	34" (864 mm)	39" (991 mm)
<b>B</b>	36" (915 mm)	28" (712 mm)	33" (839 mm)
<b>C</b>	30" (762 mm)	25" (635 mm)	30" (762 mm)

- As delivered from factory, device will fit doors of this width. For other widths, consult Technical Services.
- Touch bar and rail assembly can be shortened at time of installation to fit doors down to this width.

\*Antimicrobial available to 626 and 630 finishes only  
 \*\*PC - Clear Powder Coat available over 630 - Stainless Steel



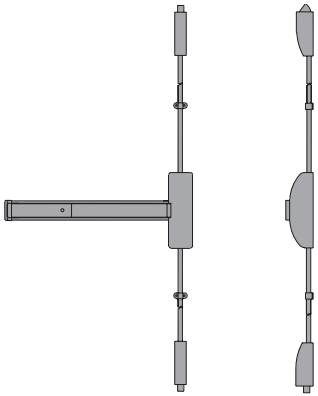

Available Finishes \$

			689, 691, 693, 695, 696	630	606, 612, 613, 619	605, 611, 625, 626, 629**
Function	Description	Device, Exit Only				
01	Panic	9400 Surface vertical rod	2,512.00	2,840.00	2,867.00	3,093.00
01	Fire	F9400 Surface vertical rod	2,798.00	3,115.00	3,145.00	3,358.00

Typical Options

Item	Description	List Add \$
CD	Cylinder dogging (Includes Cylinder)	126.00
LD	Less dogging (Standard with fire rated device)	N/C
AM	Antimicrobial coating Note: Antimicrobial available to 626 and 630 finishes only	111.00
SNB	Sex nuts (included with F and HC options)	25.00
TX	Security screws	49.00
HC	Hurricane (Includes SNB)	232.00
FL	Full length touchbar (Not Available DE)	N/C
LB	Less bottom rod	N/C
PB	Pullman bottom latch	77.00
SB	Slide bolt (Default)	N/C
Up to 8'	7' Default	N/C
Up to 10'	Door Heights over 8' to 10'	78.00 152.00 152.00 152.00

\*\* For 629 finish, please allow 4 week lead time.

NOTES:

- Prices shown apply to A, B, or C length devices.
- Specify door width and handing. If not specified, Size B, RHR is the standard default.
- List price includes default strikes. For optional strikes, specify strike number and adjust list price accordingly.
- List price for the device does not include trim.
- Devices include wood and machine screws standard.
- Fire and hurricane rated devices include SNB sex nuts standard.
- For options requiring a cylinder, the option list price includes the default cylinder.
- Device includes precut and drilled rods for 7' or 8' doors as specified on order.  
For 9' doors, device includes precut and drilled rods for a 7' door and a 2' rod extension for the top rod.  
For 10' doors, device includes precut and drilled rods for an 8' door and a 2' rod extension for the top rod.  
See Device Options for pricing information.
- For special lengths and/or door heights over 10', consult Technical Service.
- All standard devices and trim are designed for 1-3/4"-2-1/4" thick doors. For door thickness greater than 2-1/4", consult Technical Service.

# 9500 Series

## Wide Stile Mortise Exit Device

9500 Series Device							Options (Specify)							Cylinders and Keying			
Device	Length	Touchbar Function	Handing	Strike	Finish	Special Finish Coating	Special Application Package	Fastener Package	Electric Locking	Control	Alarm	Monitoring	Dogging	Cylinder Type	Keyway	Keying	
<b>9500</b>	<b>B</b>	<b>08</b>	<b>RHR</b>	<b>465</b>	<b>630</b>									<b>D</b>	<b>SCKD</b>		
F9500	A	FL	01	RHR	465	605	*AM	HC	SK	LFSC	DE	BPA	LM	CD	T	CA	KD
9500	B		03	LHR	565	606	**PC	**BF	SNB	LFSF	DE30	BPAR	MS	LD	J	CD	KA2
	C		05			611			TX		DECBC	DWA	LMMS		C	CE	KA4
	SPCL		08			612			SKTX		MLR		LMMSBP		L	<b>D100</b>	NSK
			22			613			SKSNB						D	GA	MKD
						619			TXSNB						G	RA	CMK
						625			SKTXSNB						R	RB	SKD
						626									F	SC	OBit
						629								X6	SE		
						<b>630</b>								X7	SF		
						689									YA		
						691									YG		
						693											
						695											
						696											
						Custom											
						Designer											

 - Default

 - Supplied with Standard KD Cylinder

**\*Patented Key Control**  
**D100** is the keyway for our patented **SKC** serialized key control system. **SKC** is internet based and provides added layers of security. For more information, contact your local sales representative or Technical Service at 800-387-4938.

**\*\* Barrier Free option availability:**

Exit Device	Functions	Electric Options	Device Lengths	Ratings
9500BF	01, 02, 03, 05, 08, 23	ES, BA, B4, LM, MS, LM/MS, LM/MS/BP	36" & 48"	Panic & Fire

**9000 Series – Wide Stile Applications**

Device Length	All Device Options (except BA, DA, or DE)		BA or DA Device Options	DE Device Option
	Maximum Door Width <sup>1</sup>	Minimum Door Width <sup>2</sup>	Minimum Door Width <sup>2</sup>	Minimum Door Width <sup>2</sup>
<b>A</b>	48" (1220 mm)	34" (864 mm)	39" (991 mm)	41" (1042 mm)
<b>B</b>	36" (915 mm)	28" (712 mm)	33" (839 mm)	35" (889 mm)
<b>C</b>	30" (762 mm)	25" (635 mm)	30" (762 mm)	N/A

1. As delivered from factory, device will fit doors of this width. For other widths, consult Technical Services.  
 2. Touch bar and rail assembly can be shortened at time of installation to fit doors down to this width.

\*Antimicrobial available to 626 and 630 finishes only  
 \*\*PC - Clear Powder Coat available over 630 - Stainless Steel

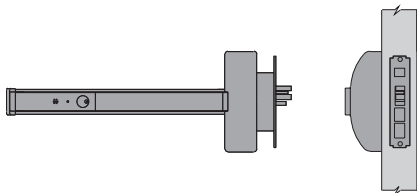

			Available Finishes \$			
			689, 691, 693, 695, 696	630	606, 612, 613, 619	605, 611, 625, 626, 629**
Function	Description	Device, Exit Only				
01	Panic	9500 Mortise	2,246.00	2,729.00	2,756.00	2,881.00
01	Fire	F9500 Mortise	2,494.00	2,969.00	2,999.00	3,114.00

**Typical Options**

Item	Description	List Add \$
CD	Cylinder dogging (Includes Cylinder)	126.00
LD	Less dogging (Standard with fire rated device)	N/C
AM	Antimicrobial coating Note: Antimicrobial available to 626 and 630 finishes only	111.00
SNB	Sex nuts (Included with F and HC options)	25.00
TX	Security screws	49.00
HC	Hurricane (Includes SNB)	232.00
FL	Full length touchbar (Not Available DE)	N/C
BF	Barrier free exit device, meets California Building Code (Section 11B-309.4) requirements for maximum 5 lb operating force.	68.00
LFSF	Fail safe, electric locking of mortise lock (requires DKPS-2A power supply and ES105 power transfer)	1,353.00
LFSC	Fail secure, electric unlocking of mortise lock (requires DKPS-2A power supply and ES105 power transfer)	1,353.00

**\*\* For 629 finish, please allow 4 week lead time.**

**NOTES:**

- Prices shown apply to A, B, or C length devices.
- Specify door width and handing. If not specified, Size B, RHR is the standard default.
- List price includes default strikes. For optional strikes, specify strike number and adjust list price accordingly.
- List price for the device does not include trim.
- Devices include wood and machine screws standard.
- Fire and hurricane rated devices include SNB sex nuts standard.
- For options requiring a cylinder, the option list price includes the default cylinder.
- For special lengths, consult Technical Service.
- All standard devices and trim are designed for 1-3/4" -2-1/4" thick doors. For door thickness greater than 2-1/4", consult Technical Service.

## Wide Stile Dummy Bars

		Available Finishes \$			
		689, 691, 693, 695, 696	630	606, 612, 613, 619	605, 611, 625, 626, 629**
Item	Description				
<b>Dummy Touchbars</b>					
9030	Rigid dummy touchbar	802.00	1,156.00	1,196.00	1,196.00
9030MS	Dummy touchbar w/ microswitch	1,187.00	1,478.00	1,495.00	1,495.00
9035	Rigid touchbar	802.00	1,156.00	1,196.00	1,196.00
9036	Moveable touchbar	802.00	1,156.00	1,196.00	1,196.00
9036MS	Moveable touchbar w/ microswitch	1,187.00	1,478.00	1,495.00	1,495.00

**\*\* For 629 finish, please allow 4 week lead time.**

**NOTE:** Dummy touchbars available in all rail sizes: A, B or C

## Wide Stile Options

Option Code	Description	List Add \$
<b>Strikes</b>		
<b>9100, 9400 Concealed and Surface Vertical Rods</b>		
340	Flat slide bolt bottom strike (9100 and 9400 Series)	N/C
416V	Surface bottom strike for pullman latch (9400)	N/C
418	Standard top strike (9100 Series)	N/C
419	Wood frame top strike (9100 Series)	25.00
426	Standard top strike (9400 Series)	N/C
426A	Top strike w/angle (9400 Series)	40.00
431	Recessed bottom strike for pullman latch (9100 and 9400 Series)	40.00
439	Standard slide bolt bottom strike (9100 and 9400 Series)	N/C
<b>9300 Rim Devices</b>		
320	Overlap strike	40.00
430	Rim box strike	63.00
463	Standard rim strike (default/no charge for 9300/F9300)	N/A
486	Roller strike	25.00
<b>9500 Mortise</b>		
465	Standard mortise strike	N/C
565	Open back strike	40.00
<b>Special Finishes and Coatings</b>		
AM	Antimicrobial protected coating Note: Antimicrobial available to 626 and 630 finishes only	111.00
PC	Clear Powder Coat available over 630 – Stainless Steel	111.00
Custom Color	Custom painted finish selected from RAL color pallet book. For details, see <b>Finishes Cross Reference</b> , page viii.	
	Per order, setup charge ( <b>Net</b> )	177.00
	per exit device only, list add	98.00
	per trim only, list add	98.00
Designer Color	Designer painted color matched to supplied samples. Three (3) each 2" x 3" color chip samples required. For details, see <b>Finishes Cross Reference</b> , page viii.	
	per order, non-refundable development/setup charge ( <b>Net</b> )	624.00
	per exit device only, list add	98.00
	per trim only, list add	98.00
<b>Bottom Latches for 9100 Concealed Vertical Rods &amp; 9400 Surface Vertical Rods</b>		
LB	Less bottom rod	N/C
PB	Pullman bottom latch	77.00
SB	Slide bolt (Default)	N/C
<b>Door Height Designation</b>		
<b>9100 Concealed Vertical Rods</b>		
7 or 8	Door heights from 7' to 8' adjustable	N/C
9 or 10	Door heights over 8', up to 10'	78.00
Over 10'	Contact DORMA Technical Service for assistance	
<b>9400 Surface Vertical Rods</b>		
7 or 8	Door heights from 7' to 8' (7' Default)	N/C
9 or 10	Door heights over 8', up to 10'	
	For 689, 691, 693, 695, 696 finishes	78.00
	For 605, 606, 611, 612, 613, 619, 625, 626, 630 finishes	152.00

**Wide Stile Options (continued)**

Option Code	Description	List Add \$
Over 10'	Consult DORMA Technical Service	
<b>Special Application Packages</b>		
HC	Hurricane (9300, 9400, and 9500 Series only) Includes SNB	232.00
FL	Full length touchbar (Not Available DE)	N/C
BF	Barrier free exit device, meets California Building Code (Section 11B-309.4) requirements for maximum 5 lb operating force.	68.00
<b>Fastener Package</b>		
SK	Shim kit	125.00
SNB	Sex nuts	25.00
TX	Security screws	49.00
SKTX	Shim kit and security screws	193.00
SXSNB	Shim kit and sex nuts	145.00
TXSNB	Security screws and sex nuts	97.00
SKTXSNB	Shim kit, security screws, and sex nuts	217.00
<b>Electronic Controls</b>		
DE*	Delayed egress (requires ES100 power supply and ES105 power transfer)	2,284.00
DE30*	Delayed egress, 30 second (requires special approval from authority having jurisdiction)	2,825.00
DECBC*	Delayed egress, CBC compliant	2,825.00
MLR	Motorized Latch Retraction/dogging (use DKPS-2A or DKPS-2A power supply—2 MLR's)	1,281.00
ES	Electric latch retraction (requires PS501 power supply and ES105 power transfer)	1,209.00
<b>Alarm</b>		
BA*	Battery powered alarm	838.00
B4*	Battery powered alarm, 4 minute reset	894.00
DA*	Direct wired alarm	838.00
<b>Monitoring</b>		
LM	Latch bolt monitoring	332.00
MS	Monitor switch in touchbar	332.00
LMMS	Latch bolt and touchbar monitor	659.00
LMMSBP*	Latch bolt and touchbar monitor with bypass	659.00
<b>Dogging</b>		
CD*	Cylinder dogging (panic devices only)	126.00
LD	Less dogging (panic devices only)	N/C
<b>Power Supplies, Power Transfers, Power Modules</b>		
AD100	Export power supply for up to 2 ES or LFSF/LFSC or 1 DE device 220 V.	1,006.00
ES101	Delay module	188.00
ES103	Relay module	119.00
ES100	Power supply for DE devices and LFSC/LFSF trims. Powers 1 DE device or 2 trims.	856.00
ES105	Power transfer (recommended for ES, DE & MLR options)	288.00
PS501	Power supply for ES9000 devices. Powers up to 2 devices.	1,006.00
PS501220	Export power supply, 220 VAC. Powers up to 2 ES9000 devices.	1,006.00
ES2	Power supply card for PS501. Powers an additional 2 devices.	548.00
DKPS-2A	Power supply for 9500 LFSC/LFSF, or MLR. Powers 1 device.	764.00
DKPS-2A	Power supply for 9500 LFSC/LFSF powers 2 devices (will also power 1 MLR device).	764.00
DKPS-2A	Power supply for MLR. Powers 2 devices.	764.00
PS406BB	Power supply with battery back-up for solenoid electric latch retraction option.	1,435.00

\* List price includes default cylinder.

# 9000 Series Exit Trim

## How to Order

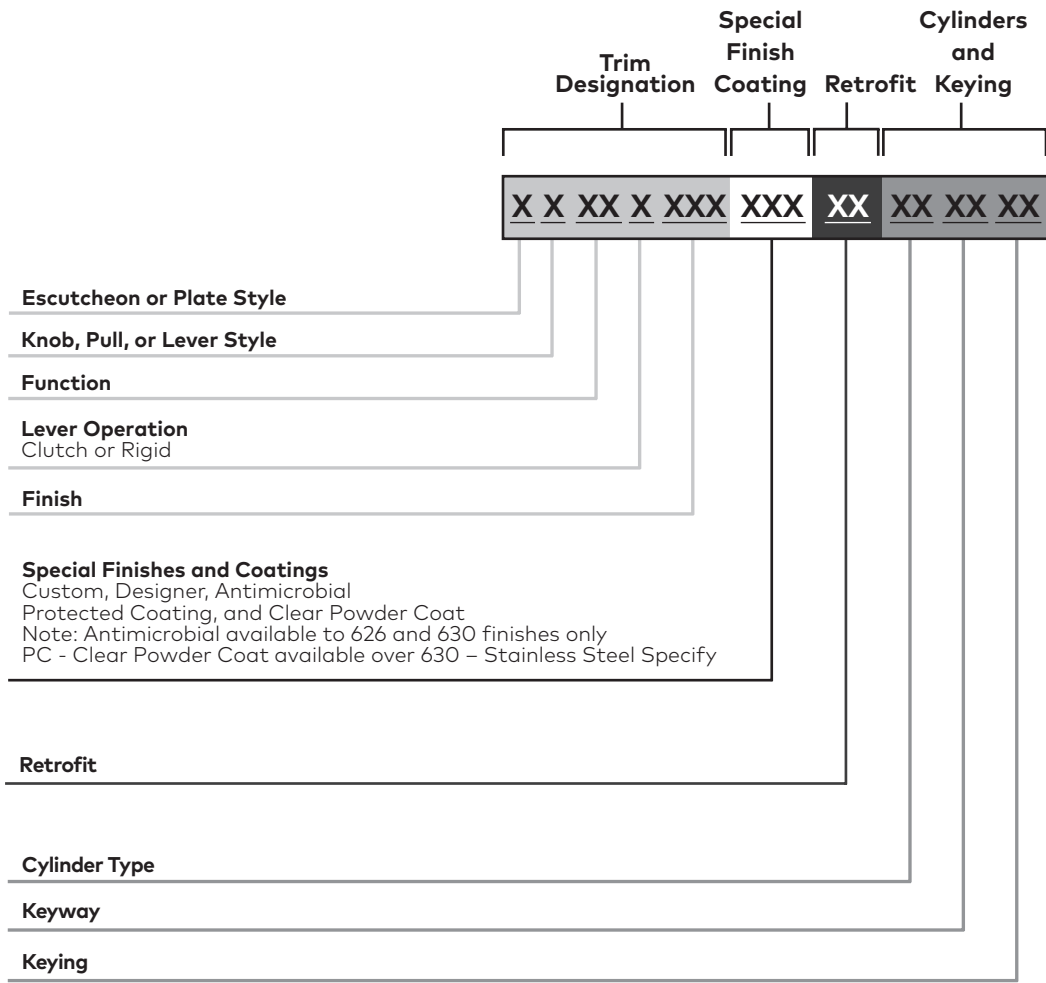

# Lever and Knob Styles

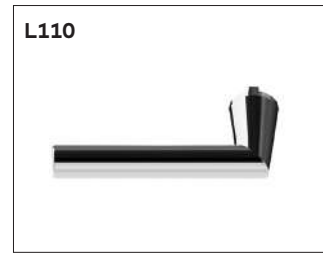
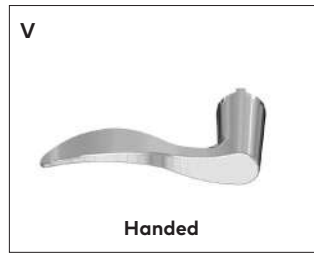
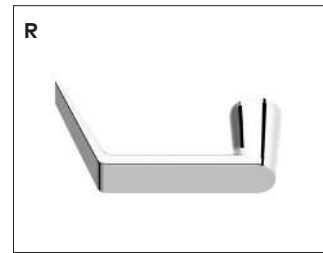
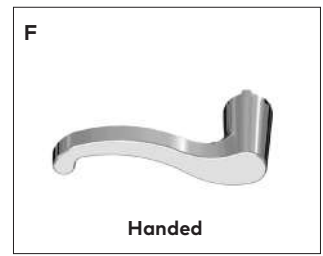
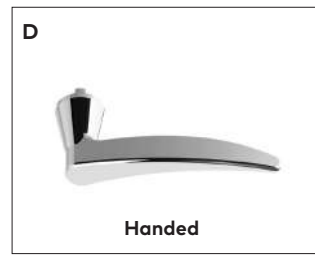
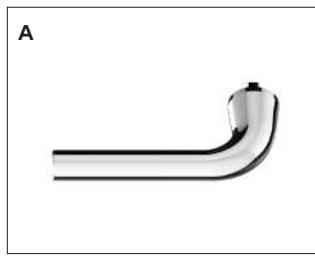



ANSI Function	Description	Y Series Raised Escutcheon 2-3/4" W x 8-1/2" H x 15/16" D	Sectional Trim 3-3/8" Diameter Rose	Plate 2" W x 16" H	Plate 3" W x 16" H	Pulls	Cylinder Only Pull by Others
DT	Dummy trim						
02	Entrance by trim when touchbar is dogged						
03	Entrance by trim when latch bolt is retracted by key. Key removable only when trim is locked.						
05	Entrance by thumbpiece. Key locks or unlocks thumbpiece.						
06	Entrance by thumbpiece only when released by key. Key removable only when locked.						
08	Entrance by lever or knob. Key locks or unlocks lever or knob.						
08C w/ clutch (Handed)	Entrance by lever with clutch option. Key locks or unlocks lever.						
0808 Double Cylinder	Entrance by knob or lever. Outside or inside key locks or unlocks knob or lever. (9300 only)						
09	Entrance by lever or knob only when unlocked by key. Key removable only when locked.						
09C w/ clutch (Handed)	Entrance by lever with clutch option trim unlocked by key. Key removable only when locked.						
11	Entrance by thumbturn and pull. Key locks or unlocks thumbturn.						
12	Entrance by thumbturn and pull only when released by key. Key removable only when locked.						
22	Entrance by thumbpiece (no cylinder). Thumbpiece always active.						
23	Entrance by lever or knob (no cylinder). Lever or knob always active.						
25	Entrance by thumbturn and pull (no cylinder). Thumbturn always active.						

# 9000 Series Wide Stile Y Escutcheon Trim

Y Series Trim (Specify)					Door Thickness	Special Finish Coating	Retrofit	Cylinders and Keying	
Escutcheon Knob, Pull, or Lever	Function	Handing	Electric Locking <sup>2</sup>	Finish				Cylinder Type Keyway Keying	
				<b>630</b>				<b>D S C K D</b>	
Y	A	DT	RHR	LFSC	605	Ext3	*AM	R1 <sup>3</sup>	T CA KD
	C	O2R	LHR	LFSF	606	Ext4	**PC		J CD KA2
Handed -	D	O3			611				C CE KA4
Handed -	K	O3R			612				L <b>D100</b> NSK
	F	O3MR			613				D GA MKD
	G	O8			619				G RA CMK
	R	O8M			625				R RB SKD
	T	O8C - Handed			626				F SC OBit
	O	O8MC - Handed			629 <sup>1</sup>				X6 SE
	P	O8O8 - Double Cylinder (Specific handing)			630				X7 SF
Handed -	N	O9			689				YA
	V	O9C - Handed			691				YG
	L109	23			693				
	L110				695				
Handed -	L112	Suffix <b>M</b> required for 9500 mortise			696				
	L114	Suffix <b>C</b> and <b>LHR/RHR</b> required for clutch			Custom				
	L117	Suffix <b>R</b> required for rigid lever			Designer				
	L118								



YK



YC



YP

**\*Patented Key Control**  
**D100** is the keyway for our patented **SKC** serialized key control system. **SKC** is internet based and provides added layers of security. For more information, contact your local sales representative or Technical Service at 800-387-4938.

- 1. For 629 finish, please allow 4 week lead time.
- 2. LFSC/LFSF only on 09/09C Functions
- 3. R1 available for 9300 series devices only.

\*Antimicrobial available to 626 and 630 finishes only  
 \*\*PC - Clear Powder Coat available over 630 - Stainless Steel

		Concealed Vertical Rod	Rim	Surface Vertical Rod	Mortise	Available Finishes \$		
		9100 F9100	9300 F9300	9400 F9400	9500 F9500	689, 691, 693, 695, 696	630	605, 606, 611, 612, 613, 619, 625, 626, 629**
ANSI Function	Description							
DT	Dummy trim	YODT				185.00	266.00	306.00
02	Entrance by trim when touchbar is dogged.	YP02, YK02R, Yx02R				391.00	567.00	624.00
03	Entrance by trim when latch bolt is retracted by key. Key removable only when trim is locked.	YO03*			YO03M*	289.00	385.00	408.00
		YP03, YK03R, Yx03R			YP03M YK03R Yx3MR	514.00	666.00	726.00
08	Entrance by lever or knob. Key locks or unlocks lever or knob.	YK08, Yx08			YK08M Yx08M	675.00	779.00	897.00
08 w/clutch	Entrance by lever with clutch option. Key locks or unlocks lever. (Handed)	Yx08C			Yx08MC	957.00	1,108.00	1,168.00
0808 (9300)	Entrance by lever. Outside or inside key locks or unlocks lever.	—	Yx0808	—	—	1,181.00	1,339.00	1,389.00
09	Entrance by lever or knob only when unlocked by key. Key removable only when locked.	YK09, Yx09			—	675.00	779.00	897.00
09 w/clutch	Entrance by lever with clutch option trim unlocked by key. Key removable only when locked. (Handed)	Yx09C			—	957.00	1,108.00	1,168.00
11	Entrance by thumbturn. Key locks or unlocks thumbturn.	YP11			—	637.00	764.00	789.00
12	Entrance by thumbturn when unlocked by key. Key removable only when locked.	YP12			—	637.00	764.00	789.00
11	Entrance by thumbturn. Key locks or unlocks thumbturn.	Y011			—	556.00	715.00	737.00
12	Entrance by thumbturn when unlocked by key. Key removable only when locked.	Y012			—	556.00	715.00	737.00
23	Entrance by lever or knob (no cylinder). Lever or knob always active.	YK23, Yx23			YK23M Yx23M	447.00	652.00	666.00

\* Requires Pull by Others

\*\* For 629 finish, please allow 4 week lead time.

**NOTES:**

- Where x appears above, x = lever styles A, C, D, F, G, N, R, T, V, L109, L110, L112, L114, L117 or L118. (Handed Levers — D, F, V, L114)
- List price includes the default cylinder.

# 9000 Series Wide Stile Sectional Trim

Sectional Trim (Specify)			Special Finish Coating	Cylinders and Keying		
Knob or Lever	Function	Finish		Cylinder Type	Keyway	Keying
		<b>626</b>		<b>D</b>	<b>SC</b>	<b>KD</b>
9C	02	605	*AM	C	CA	KD
9G	03	606	**PC	D	CD	KA2
9K	08	611		J	CE	KA4
9R	23	612		L	<b>D100</b>	NSK
		613		T	GA	MKD
		619			RA	CMK
		625			RB	SKD
		626			SC	OBit
		630			SE	
		689			SF	
		691			YA	
		693			YG	
		695				
		696				
		Custom				
		Designer				



9R



9K

 - Default

**\*Patented Key Control**  
**D100** is the keyway for our patented **SKC** serialized key control system. **SKC** is internet based and provides added layers of security. For more information, contact your local sales representative or Technical Service at 800-387-4938.

\*Antimicrobial available to 626 and 630 finishes only  
 \*\*PC - Clear Powder Coat available over 630 - Stainless Steel

		Concealed Vertical Rod	Rim	Surface Vertical Rod	Mortise	Available Finishes \$		
		9100 F9100	9300 F9300	9400 F9400	9500 F9500	689, 691, 693, 695, 696	605, 606, 611, 612, 613, 619, 625, 626	
ANSI Function	Description							
02	Entrance by trim when touchbar is dogged.		9C02R 9G02R 9K02R 9R02R		—	431.00	—	486.00
03	Entrance by trim when latch bolt is retracted by key. Key removable only when trim is locked.		9C03 9G03 9K03 9R03		—	528.00	—	587.00
08	Entrance by lever or knob. Key locks or unlocks lever or knob.		9C08 9G08 9K08 9R08		—	528.00	—	587.00
23	Entrance by lever or knob (no cylinder). Lever or knob always active.		9C23 9G23 9K23 9R23		—	431.00	—	486.00

**NOTE:** List price includes the default cylinder.

# 9000 Series Wide Stile 3" Plate Trim

Plate Trim (Specify)		Special Finish Coating	Retrofit	Cylinders and Keying			
Plate Type	Function	Finish		Cylinder Type	Keyway	Keying	
		<b>630</b>		<b>D</b>	<b>SC</b>	<b>KD</b>	
HRT	DT	630	*AM	R1 <sup>1</sup>	T	CA	KD
HTT	DTCV	689	**PC		J	CD	KA2
NPT	02	691			C	CE	KA4
PRT	02CV	693			L	<b>*D100</b>	NSK
PTT	03	695			D	GA	MKD
80	03CV	696			G	RA	CMK
	03M	696			R	RB	SKD
	05	Custom			F	SC	OBit
	05CV	Designer			X6	SE	
	05M				X7	SF	
	06					YA	
	06CV					YG	
	22						
	22CV						
	22M						

 - Default

Suffix **CV** required for 9100 CVR  
 Suffix **M** required for 9500 mortise

**\*Patented Key Control**  
**D100** is the keyway for our patented **SKC** serialized key control system. **SKC** is internet based and provides added layers of security. For more information, contact your local sales representative or Technical Service at 800-387-4938.



HTT



PRT

1. R1 available for 9300 series devices only.

		Concealed Vertical Rod	Rim	Surface Vertical Rod	Mortise	Available Finishes \$		
		9100 F9100	9300 F9300	9400 F9400	9500 F9500	689, 691, 693, 695, 696	630	605, 606, 611, 612, 613, 619, 625, 626
ANSI Function	Description							
DT	Dummy Trim	NPTDTCV	NPTDT			173.00	235.00	257.00
02	Entrance by trim when touchbar is dogged.	PRT02CV PTT02CV	PRT02 PTT02	PRT02M PTT02M		192.00	276.00	319.00
03	Entrance by trim when latch bolt is retracted by key. Key removable only when trim is locked.	NPT03CV* PRT03CV PTT03CV	NPT03* PRT03 PTT03	NPT03M* PRT03M PTT03M		299.00	402.00	424.00
05	Entrance by thumbpiece. Key locks or unlocks thumbpiece.	HRT05CV HTT05CV	HRT05 HTT05	HRT05M HTT05M		341.00	424.00	461.00
06	Entrance by thumbpiece only when released by key. Key removable only when locked.	HRT06CV HTT06CV	HRT06 HTT06	—		341.00	424.00	461.00
22	Entrance by thumbpiece (no cylinder). Thumb-piece always active.	HRT22CV HTT22CV	HRT22 HTT22	HRT22M HTT22M		341.00	337.00	382.00

\* Requires Pull by Others

**NOTE:** List price includes the default cylinder.

# 9000 Series Wide Stile 2" Plate Trim

Plate Trim (Specify)		Special Finish Coating	Retrofit	Cylinders and Keying			
Plate Type	Function	Finish		Cylinder Type	Keyway	Keying	
		<b>630</b>		<b>D</b>	<b>SC</b>	<b>KD</b>	
VO	DT	605	*AM	R1 <sup>1</sup>	T	CA	KD
V1	DTCV	606	**PC		J	CD	KA2
V3	02	611			C	CE	KA4
	02CV	612			L	<b>D100</b>	NSK
	03	613			D	GA	MKD
	03CV	619			G	RA	CMK
	03M	625			R	RB	SKD
		626			F	SC	OBit
		<b>630</b>			X6	SE	
		689			X7	SF	
		691				YA	
		693				YG	
		695					
		696					
		Custom					
		Designer					

Suffix CV required for 9100 CVR  
 Suffix M required for 9500 mortise

 - Default

**\*Patented Key Control**  
**D100** is the keyway for our patented **SKC** serialized key control system. **SKC** is internet based and provides added layers of security. For more information, contact your local sales representative or Technical Service at 800-387-4938.

1. R1 available for 9300 series devices only.

\*Antimicrobial available to 626 and 630 finishes only  
 \*\*PC - Clear Powder Coat available over 630 - Stainless Steel





		Concealed Vertical Rod	Rim	Surface Vertical Rod	Mortise	Available Finishes \$		
		9100 F9100	9300 F9300	9400 F9400	9500 F9500	689, 691, 693 695, 696	630	605, 606, 611, 612, 613, 619, 625, 626
ANSI Function	Description							
DT	Dummy Trim	VODTCV		VODT	—	173.00	191.00	257.00
02	Entrance by trim when touchbar is dogged.	V102CV V302CV		V102 V302	—	192.00	257.00	319.00
03	Entrance by trim when latch bolt is retracted by key. Key removable only when trim is locked.	VO03CV* V103CV V303CV		VO03* V103 V303	VO03M* V103M V303M	299.00	358.00	424.00

\* Requires Pull by Others

**NOTE:** List price includes the default cylinder.

# 9000 Series Wide Stile Pull Trim

Pulls (Specify)			Special Finish Coating	Cylinders and Keying		
Pull Type	Function	Handing	Finish		Cylinder Type	Keyway Keying
			<b>630</b>		<b>D SC KD</b>	
OP	02	RHR	605	*AM	T CA	KD
POF	03HDA	LHR	606	**PC	J CD	KA2
VRF	02SPM		611		C CE	KA4
9PBO <sup>1</sup>	03SPM		612		L <b>D100</b>	NSK
	03		613		D GA	MKD
			619		G RA	CMK
			625		R RB	SKD
			626		F SC	OBit
			630		X6 SE	
			689		X7 SF	
			691		YA	
			693		YG	
			695			
			696			
			Custom			
			Designer			

□ - Default

**\*Patented Key Control**  
 D100 is the keyway for our patented SKC serialized key control system. SKC is internet based and provides added layers of security. For more information, contact your local sales representative or Technical Service at 800-387-4938.

<sup>1</sup> 9PBO not applicable on 9500 Device. 03 Function only. Not available in 693 finish.

\*Antimicrobial available to 626 and 630 finishes only  
 \*\*PC - Clear Powder Coat available over 630 - Stainless Steel



VRF



OP



POF



9PBO

ANSI Function	Description	Concealed Vertical Rod	Rim	Surface Vertical Rod	Mortise	Available Finishes \$			
		9100 F9100	9300 F9300	9400 F9400	9500 F9500	689, 691, 693, 695, 696	630	605, 606, 611, 612, 613, 619 625, 626	
02	Entrance by trim when touchbar is dogged.	OP02				173.00	214.00	251.00	
		—	VRF02SPM	—	—	—	862.00	—	
03	Entrance by trim when latch bolt is retracted by key. Key removable only when trim is locked.	—	POF03HDA	—	—	—	1217.00	—	
		9PBO03				—	193.00	192.00	192.00
		—	VRF03SPM	—	—	—	—	862.00	—

**NOTES:**

- List price includes the default cylinder.
- 9PBO03 trim not recommended for wood doors. For hollow metal and aluminum door applications. Not applicable on 9500 devices. Not available in 693 finish.

## Trim Options

Option Code	Description	List Add \$
<b>Special Finishes and Coatings</b>		
AM	Antimicrobial protected coating Note: Antimicrobial available to 626 and 630 finishes only	111.00
PC	Clear Powder Coat available over 630 – Stainless Steel	111.00
Custom Color	Custom painted finish selected from RAL color pallet book. For details, see <b>Finishes Cross Reference</b> , page viii.	
	Per order, setup charge <b>(Net)</b>	177.00
	per exit device only, list add	98.00
	per trim only, list add	98.00
Designer Color	Designer painted color matched to supplied samples. Three (3) each 2" x 3" color chip samples required. For details, see <b>Finishes Cross Reference</b> , page viii.	
	per order, non-refundable development/setup charge <b>(Net)</b>	624.00
	per exit device only, list add	98.00
	per trim only, list add	98.00
<b>Electric Locking Trim for 9100 Concealed Vertical Rods, 9300 Rim &amp; 9400 Surface Vertical Rods</b>		
LFSC	Fail secure (requires DORMA ES100 power supply)	774.00
LFSF	Fail safe (requires DORMA ES100 power supply)	774.00
<b>Retrofit</b>		
R1	Von Duprin® retrofit. For Y series and wide stile plate trims (9300 Series devices only)	N/C
<b>Door Thickness (includes extended spindle and fasteners)</b>		
Ext3	Door thickness from 2-1/4" –3-1/4" (57 mm to 83 mm)	116.00
Ext4	Door thickness from 3-1/4" –4-1/4" (83 mm to 108 mm)	116.00

# Cylinders

## Rim Cylinders

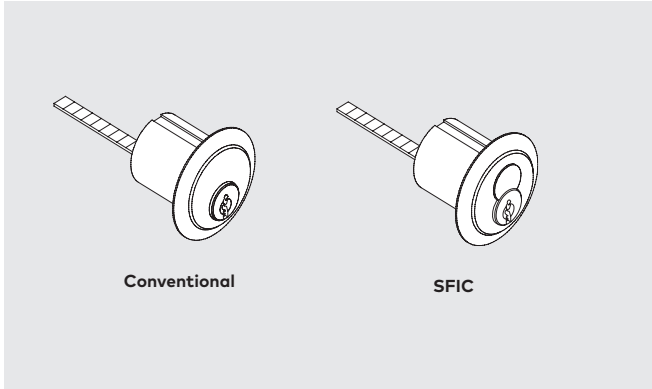

## Mortise Cylinders

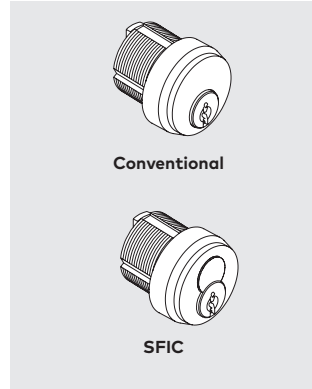

## Key-in-Lever Cylinders

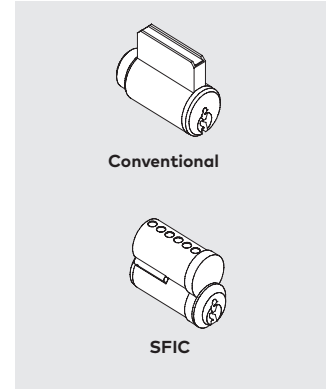

## Wide Stile

Application	ANSI Function	Cylinder Type	Conventional (Default)	Cam	SFIC 7-Pin
<b>Cylinders for 9100/F9100 Concealed Vertical Rod, 9300/F9300 Rim, and 9400/F9400 Surface Vertical Rod Wide Stile Devices</b>					
Sectional Trim (Key-in-Lever)	03, 08	Key-in-lever	7013SC	NA	77BA
Wide Plate Trim	03	Rim	80R40SC	NA	87R40BA
Wide Plate Trim	05, 06	Mortise	90A10BA118	#10	97A10BA138
Narrow Plate Trim	03	Rim	80R40SC	NA	87R40BA
Y Escutcheon Trim	03	Rim	80R40SC	NA	87R40BA
Y Escutcheon Trim	08	Mortise	90X10SC118	#10	97D10BA138
Y Escutcheon Trim	09	Mortise	90X09SC118	#9	97D09BA138
<b>Cylinders for 9500/F9500 Mortise Devices shipped prior to 11/2014</b>					
Wide Plate Trim	03, 05	Mortise	90A10SC118	#10	97B10BA138
Wide Plate Trim	03	Mortise	90A10SC118	#10	97B10BA138
Y Escutcheon Trim	03, 08	Mortise	90X10SC158	#10	97D10BA134
<b>Cylinders for 9500/F9500 Mortise Devices shipped 11/2014 or after</b>					
Wide Plate Trim	03	Mortise	90A13SC118	#13	97B13BA138
Wide Plate Trim	05	Mortise	90A12SC118	#12	97B12BA138
Narrow Plate Trim	03	Mortise	90A13SC118	#13	97B13BA138
Y Escutcheon Trim	03	Mortise	90X13SC118	#13	97C13BA138
Y Escutcheon Trim	05, 08	Mortise	90X12SC118	#12	97C12BA138
<b>Cylinders for Device Options</b>					
CD, BA, B4, DE, DE30, DECBC, DA, LMMSBP	—	Mortise	90X10SC118	#10	97D10BA138

# Cylinder Types, Keying Options and Keyways for Removable Mullions and Exit Devices

Cylinder	Option	Description	List Add/Deduct \$
<b>Conventional Cylinders (non-interchangeable core)</b>			
<b>D</b>		Keying for exit device or removable mullions with conventional cylinder (default)	
	<b>KD</b>	<b>Keyed differently to a random combination; SC keyway with 2 keys (default)</b>	N/C
	KA2	Keyed alike in pairs to a random combination; SC keyway with 2 keys	N/C
	NSK	Keyed alike, sets of three or more; SC keyway with 2 keys	20.00
	1-Bit	Operated by a 1-bit key (sold separately); SC, SE keyway with 2 key blanks	N/C
	1-Bit	Operated by a 1-bit key (sold separately); D100 keyway – <b>⊗ Keys sold separately</b>	N/C
	0-Bit	Operated by a key blank; CA, CD, CE, RA, RB, GA, SF, YA, YG keyways with 2 key blanks	20.00
	MKD	Master keyed; SC, SE, or D100 keyway – <b>⊗ Keys sold separately</b>	25.00
	CMK	Construction master keyed single cylinder locks – <b>⊗ Keys sold separately</b>	27.00
<b>L</b>		Keying for exit device or removable mullions less conventional cylinder	Deduct 30.00
<b>Interchangeable Core Cylinders</b>			
<b>T</b>		Keying for exit device or removable mullions with keyed temporary SFIC construction core Keying for exit trim with keyed temporary SFIC construction core (cores may be returned for a full refund) – <b>⊗ Keys sold separately</b>	58.00
<b>J</b>		Keying for exit device or removable mullions with disposable plastic SFIC construction core	N/C
<b>C</b>		Keying for exit device or removable mullions with combined SFIC core installed at factory <sup>1</sup> Keying for exit trim with combined core installed at factory; BA (default), BB, BC, BD, BE, BF, BG, BH, BJ, BK, BL, BM, BQ, D100 keyway – <b>⊗ Keys sold separately</b>	65.00
<b>G</b>		Schlage LFIC – Housing with keyed temporary Schlage LFIC construction core (Core may be returned for full refund) – <b>⊗ Keys sold separately</b>	58.00
<b>F</b>		Schlage LFIC – Housing with combined Schlage LFIC installed at the factory (SC keyway) – <b>⊗ Keys sold separately</b>	65.00
<b>Cylinder Housings Less Cores</b>			
<b>R</b>		Housing prepared for Schlage LFIC	13.00
<b>X7</b>		Housing prepared for Sargent XC 7P and Arrow Choice 7P SFIC	13.00
<b>X6</b>		Housing prepared for Arrow Choice 6P SFIC	13.00

1. For uncombined cores, **UNC**, cores must be ordered separately, see **Cylinders, Keys & Keying**. Exits/trim will be supplied w/ plastic construction core, Option J.  
 ⊗ Denotes keys must be ordered separately.

<b>Cut Keys Ordered Separately</b>		
Part #	Description	List \$
45101	SFIC Cut key – Change key, master key, construction master key, or control key; BA, BB, BC, BD, BE, BF BG, BH, BJ, BK, BL, BM, BQ, SC, SE keyways	11.00
45401	SFIC Cut key – Change key, master key, or control key; D100 keyways – D100 etc.	17.00
45404	CONV/LFIC Cut key – 1 bit key for operating 1 bit cylinders – SC, SE keyways	9.00
45405	LFIC Cut key – 1 bit control key (to install/remove "0-bit" LFIC cores) – SC keyway	9.00
44101SC	CONV/LFIC Key blank – SC keyway	6.00
44104SC	LFIC Key blank – Control key (to install/remove LFIC Cores) – SC keyway	8.00

**NOTES:**

- Distribution of DORMA SKC keys (listed as D100) is restricted. See Cylinders, Keys & Keying section for DORMA SKC policies.
- For additional information, please refer to Cylinders, Keys, and Keying
- See Keys and Key Blanks section for complete list.

## Mullions

Item	Description	List \$
<b>Aluminum Mullions x 628 (clear anodized), 1-5/8" x 2-5/8"</b>		
1310-8	8'	1,303.00
1310-8 x 443	8', recessed strike	1,519.00
WS1310-8	8', weatherstrip	1,387.00
WS1310-8 x 443	8', weatherstrip and recessed strike	1,534.00
1310-10	10'	1,387.00
1310-10 x 443	10', recessed strike	1,665.00
WS1310-10	10', weatherstrip	1,519.00
WS1310-10 x 443	10', weatherstrip and recessed strike	1,759.00
<b>Aluminum Mullions x 695 (painted), 1-5/8" x 2-5/8"</b>		
1310-8	8'	1,582.00
1310-8 x 443	8', recessed strike	1,792.00
WS1310-8	8', weatherstrip	1,665.00
WS1310-8 x 443	8', weatherstrip and recessed strike	1,893.00
1310-10	10'	1,712.00
1310-10 x 443	10', recessed strike	1,940.00
WS1310-10	10', weatherstrip	1,826.00
WS1310-10 x 443	10', weatherstrip and recessed strike	1,842.00
<b>Steel Mullions x 600 (primed for paint), 1-1/2" x 2-1/2"</b>		
1330-8	8'	655.00
1330-10	10'	687.00
<b>Steel Mullions x 600 (primed for paint), 2" x 3"</b>		
1300-8	8'	849.00
F1300-8	8', fire-rated	1,094.00
F1300-10	10', fire-rated	1,459.00
1340KR-8	8', key removable (includes standard cylinder using 01 cam)	1,435.00
F1340KR-8	8', fire-rated mullion, key removable (includes standard cylinder using 01 cam)	1,681.00
F1340KR-10	10', fire-rated mullion, key removable (includes standard cylinder using 01 cam)	1,968.00
1300-10	10'	979.00
1340KR-EL	8', key removable, electrified mullion	1,665.00
1340KR-10	10', key removable (includes standard cylinder using 01 cam)	1,519.00
1340KR-EL-10	10', key removable, electrified mullion	1,746.00
HC1300-8	8', design pressure rated 80PSF for openings up to 8' x 8' with HC9300 device.	1,582.00
<b>Mullion Storage Kit</b>		
1340SK	Storage kit for 1340/F1340 Series key removable mullion.	427.00

### Cylinders for 1340KR/F1340KR Mullions and 1340SK Storage Kit

Type	Standard	7-pin IC	Cam
Mortise	90X01SC118	97D01BA138	01 (AR)

# 9600 Series

## Narrow Stile Concealed Vertical Rod Exit Device

9600 Series Device									Options (Specify)							Cylinders and Keying		
Device	Length	Touchbar	Handing	Door Height	Top Strike	Bottom Strike	Door Latch Brackets	Finish	Special Finish Coating	Bottom Latch	Fastener Package	Control	Alarm	Monitoring	Dogging	Cylinder Type	Keyway	Keying
<b>9600</b>	<b>BB</b>		<b>RHR</b>	<b>7</b>	<b>418</b>	<b>439</b>	<b>NS</b>	<b>630</b>								<b>D</b>	<b>SC</b>	<b>KD</b>
F9600	AA	FL	RHR	7	418	340	NS	605	*AM	LB	SK	DE	BPA	LM	CD	T	CA	KD
9600	BB		LHR	8	419	431	ALD	606	**PC	PB	SNB	DE30	BPAR	MS	LD	J	CD	KA2
	CC			9		439	WD	611		SB	TX	ES	DWA	LMMS		C	CE	KA4
	SPCL			10				612			SKTX	DECBC		LMMSBP		L	<b>D100</b>	NSK
				SPCL				613			SKSNB	MLR				D	GA	MKD
								619			TXSNB					G	RA	CMK
								625			SKTXSNB					R	RB	SKD
								626			METRIC					F	SC	OBIt
								629								X6	SE	
								<b>630</b>								X7	SF	
								689									YA	
								691									YG	
								693										
								695										
								696										
								Custom										
								Designer										

— Default

— Supplied with Standard KD Cylinder

**\*Patented Key Control**

**D100** is the keyway for our patented **SKC** serialized key control system. **SKC** is internet based and provides added layers of security. For more information, contact your local sales representative or Technical Service at 800-387-4938.

### 9000 Series – Narrow Stile Applications: Standard Glass AL Doors

Device Length	All Device Options (except BA, DA, or DE)		BA or DA Device Options	DE Device Option
	Maximum Door Width <sup>1</sup>	Minimum Door Width <sup>2</sup>	Minimum Door Width <sup>2</sup>	Minimum Door Width <sup>2</sup>
<b>AA</b>	48" (1220 mm)	32-1/2" (826 mm)	37.5" (952.5 mm)	40" (1016 mm)
<b>BB</b>	36" (915 mm)	27" (686 mm)	31.5" (800.1 mm)	32" (812.8 mm)
<b>CC</b>	36" (915 mm)	23-1/2" (597 mm)	28.5" (723.9 mm)	N/A

### 9000 Series – Narrow Stile with Full Length Touchbar Applications

Device Length	All Device Options (except BA, DA, or DE)		BA or DA Device Options	DE Option
	Maximum Door Width <sup>1</sup>	Minimum Door Width <sup>2</sup>	Minimum Door Width <sup>2</sup>	N/A on FL Touchbar
<b>AA</b>	48" (1220 mm)	33" (839 mm)	34" (837 mm)	—
<b>BB</b>	36" (915 mm)	27" (686 mm)	28" (711 mm)	—
<b>CC</b>	36" (915 mm)	24" (610 mm)	25" (635 mm)	—

- As delivered from factory, device will fit doors of this width. For other widths, consult Technical Services.
- Touch bar and rail assembly can be shortened at time of installation to fit doors down to this width. Varies by installations.

\*Antimicrobial available to 626 and 630 finishes only  
 \*\*PC - Clear Powder Coat available over 630 - Stainless Steel



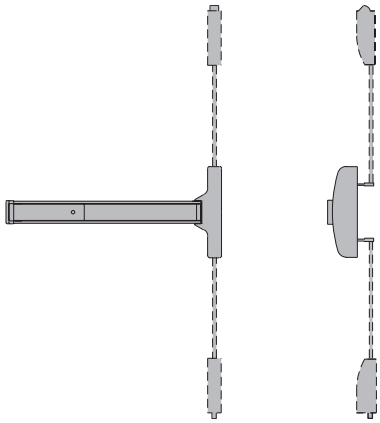

			Available Finishes \$			
			689, 691, 693, 695, 696	630	606, 612, 613, 619	605, 611, 625, 626, 629**
Function	Description	Device, Exit Only				
01	Panic	9600 Concealed vertical rod	2,837.00	3,319.00	3,194.00	3,374.00
01	Fire	F9600 Concealed vertical rod	2,971.00	3,595.00	3,459.00	3,628.00
Typical Options						
Item	Description					List Add \$
ALD	Wide Stile aluminum door bracket (9600 Series)					N/C
NS	2-1/8" narrow stile aluminum door bracket (default, 9600 Series only)					N/C
WD	Narrow stile wood or hollow steel door bracket (9600 Series only)					N/C
CD	Cylinder dogging (includes cylinder)					126.00
LD	Less dogging (Standard with fire rated device)					N/C
AM	Antimicrobial coating Note: Antimicrobial available to 626 and 630 finishes only					111.00
SNB	Sex nuts (Included with F and HC options)					25.00
TX	Security screws					49.00
FL	Full length touchbar (Not Available DE)					N/C
LB	Less bottom rod					N/C
PB	Pullman bottom latch					77.00
SB	Slide Bolt (Default)					N/C
Up to 8'	7' to 8' adjustable					N/C
Up to 10'	Door heights over 8' to 10'		—	152.00	—	—

\*\* For 629 finish, please allow 4 week lead time.

**Notes:**

- Prices shown apply to AA, BB, or CC length devices.
- Specify door width and handing. If not specified, Size BB, RHR is the standard default.
- List price includes default strikes. For optional strikes, specify strike number and adjust list price accordingly.
- List price for the device does not include trim.
- Devices include wood and machine screws standard.
- Specify door latch brackets: **NS** (default) for 2-1/8" narrow stile aluminum, **ALD** for Wide Stile aluminum, or **WD** for wood or hollow steel.
- Fire rated devices include SNB sex nuts standard.
- For options requiring a cylinder, the option list price includes the default cylinder.
- Device includes precut and drilled rods for 7' to 8' doors as specified on order  
For 9' doors, device includes precut and drilled rods for a 7' door and a 2' rod extension for the top rod. Specify 9' on order.  
For 10' doors, device includes precut and drilled rods for an 8' door and a 2' rod extension for the top rod. Specify 10' on order.  
See Device Options for pricing information.
- For special lengths and/or door heights over 10', consult Technical Service.
- All standard devices and trim are designed for 1-3/4"-2-1/4" thick doors. For door thickness greater than 2-1/4", consult Technical Service.
- FL (full length touchbar) and **METRIC** (metric installation fasteners) must be specified when ordered and included in the model number.  
**Example:** 9600 BB FL RHR 430 630 METRIC
- Full length touchbar not available with DE. CD option on FL devices supplied with U.S. mortise cylinder.
- ALD wide stile aluminum door bracket (9100 and 9600 Series) N/C
- NS 2-1/8" narrow stile aluminum door bracket (9600 Series only) N/C
- WD narrow stile wood or hollow steel door bracket (9600 Series only) N/C

# 9700 Series

## Narrow Stile Rim Exit Device

9700 Series Device					Options (Specify)							Cylinders and Keying		
Device	Length	Touch Bar	Strike	Finish	Special Finish Coating	Special Applications Package	Fastener Package	Control	Alarm	Monitoring	Dogging	Cylinder Type	Keyway	Keying
<b>9700</b>	<b>BB</b>		<b>430</b>	<b>630</b>								<b>D</b>	<b>SC</b>	<b>KD</b>
F9700	AA	FL	320	605	*AM	HC	SK	DE	BPA	LM	CD	T	CA	KD
9700	BB		430	606	**PC	**BF	SNB	DE30	BPAR	MS	LD	J	CD	KA2
	CC		463	611			TX	ES	DWA	LMMS		C	CE	KA4
	SPCL		486	612			SKTX	DECBC		LMMSBP		L	<b>D100</b>	NSK
				613			SKSNB	MLR				D	GA	MKD
				619			TXSNB					G	RA	CMK
				625			SKTXSNB					R	RB	SKD
				626			METRIC					F	SC	OBit
				629								X6	SE	
				630								X7	SF	
				689									YA	
				691									YG	
				693										
				695										
				696										
				Custom										
				Designer										

– Default

– Supplied with Standard KD Cylinder

**\*Patented Key Control**  
**D100** is the keyway for our patented **SKC** serialized key control system. **SKC** is internet based and provides added layers of security. For more information, contact your local sales representative or Technical Service at 800-387-4938.

**\*\* Barrier Free option availability:**

Exit Device	Functions	Electric Options	Device Lengths	Ratings
9700BF	01, 02, 03, 05, 08, 23	ES, BA, B4, LM, MS, LM/MS, LM/MS/BP	36" & 48"	Panic & Fire

### 9000 Series – Narrow Stile Applications: Standard Glass AL Doors

Device Length	All Device Options (except BA, DA, or DE)		BA or DA Device Options	DE Device Options
	Maximum Door Width <sup>1</sup>	Minimum Door Width <sup>2</sup>	Minimum Door Width <sup>2</sup>	Minimum Door Width <sup>2</sup>
<b>AA</b>	48" (1220 mm)	32-1/2" (826 mm)	37.5" (952.5 mm)	40" (1016 mm)
<b>BB</b>	36" (915 mm)	27" (686 mm)	31.5" (800.1 mm)	32" (812.88 mm)
<b>CC</b>	36" (915 mm)	23-1/2" (597 mm)	28.5" (723.9 mm)	N/A

### 9000 Series – Narrow Stile with Full Length Touchbar Applications

Device Length	All Device Options (except BA, DA, or DE)		BA or DA Device Options	DE Device Option
	Maximum Door Width <sup>1</sup>	Minimum Door Width <sup>2</sup>	Minimum Door Width <sup>2</sup>	N/A on FL touchbar
<b>AA</b>	48" (1220 mm)	33" (839 mm)	34" (837 mm)	–
<b>BB</b>	36" (915 mm)	27" (686 mm)	28" (711 mm)	–
<b>CC</b>	36" (915 mm)	24" (610 mm)	25" (635 mm)	–

1. As delivered from factory, device will fit doors of this width. For other widths, consult Technical Services.

2. Touch bar and rail assembly can be shortened at time of installation to fit doors down to this width.

\*Antimicrobial available to 626 and 630 finishes only

\*\*PC - Clear Powder Coat available over 630 - Stainless Steel

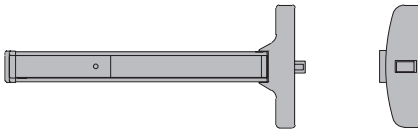

Function	Description	Device, Exit Only	Available Finishes \$			
			689, 691, 693, 695, 696	630	606, 612, 613, 619	605, 611, 625, 626, 629**
01	Panic	9700 Rim	1,524.00	2,379.00	2,286.00	2,678.00
01	Fire	F9700 Rim	1,687.00	2,618.00	2,521.00	2,901.00

### Typical Options

Item	Description	List Add \$
CD	Cylinder dogging (Includes cylinder)	113.00
LD	Less dogging (Standard with fire rated device)	N/C
AM	Antimicrobial coating Note: Antimicrobial available to 626 and 630 finishes only	111.00
SNB	Sex nuts (Included with F and HC options)	25.00
TX	Security screws	49.00
HC	Hurricane (Includes SNB)	232.00
BF	Barrier free exit device, meets California Building Code (Section 11B-309.4) requirements for maximum 5 lb operating force.	68.00
FL	Full length touchbar (Not Available DE)	N/C

\*\* For 629 finish, please allow 4 week lead time.

#### NOTES:

- Prices shown apply to AA, BB, or CC length devices.
- Specify door width. If not specified, Size BB is the standard default.
- List price includes default strikes. For optional strikes, specify strike number and adjust list price accordingly.
- List price for the device does not include trim.
- Devices include wood and machine screws standard.
- Fire and hurricane rated devices include 463 rim strike and SNB sex nuts standard.
- For options requiring a cylinder, the option list price includes the default cylinder.
- All standard devices and trim are designed for 1-3/4"-2-1/4" thick doors. For door thickness greater than 2-1/4", consult Technical Service.
- **FL** (full length touchbar) and **METRIC** (metric installation fasteners) must be specified when ordered and included in the model number.  
**Example:** 9700 BB FL RHR 430 630 METRIC
- For special lengths, consult Technical Service.
- Full length touchbar not available with DE. CD option on FL devices supplied with U.S. mortise cylinder.

# 9800 Series

## Narrow Stile Surface Vertical Rod Exit Device

9800 Series Device								Options (Specify)								Cylinders and Keying		
Device	Length	Touch Bar	Handing	Door Height	Top Strike	Bottom Strike	Finish	Special Finish Coating	Special Applications Package	Bottom Latch	Fastener Package	Control	Alarm	Monitoring	Dogging	Cylinder Type	Keyway	Keying
<b>9800</b>	<b>BB</b>		<b>RHR</b>	<b>7</b>	<b>426</b>	<b>439</b>	<b>630</b>									<b>D</b>	<b>SC</b>	<b>KD</b>
F9800	AA	FL	RHR	7	426	340	605	*AM	HC	LB	SK	ES	BPA	LM	CD	T	CA	KD
9800	BB		LHR	8	426A	416V	606	**PC	TGD	PB	SNB	MLR	BPAR	MS	LD	J	CD	KA2
	CC			9		431	611			SB	TX		DWA	LMMS		C	CE	KA4
	SPCL			10		439	612				SKTX		LMMSSBP			L	<b>*D100</b>	NSK
				SPCL			613				SKSNB					D	GA	MKD
							619				TXSNB					G	RA	CMK
							625				SKTXSNB					R	RB	SKD
							626				METRIC					F	SC	OBIt
							629									X6	SE	
							<b>630</b>									X7	SF	
							689										YA	
							691										YG	
							693											
							695											
							696											
							Custom											
							Designer											

 - Default

 - Supplied with Standard KD Cylinder

**\*Patented Key Control**  
**D100** is the keyway for our patented **SKC** serialized key control system. **SKC** is internet based and provides added layers of security. For more information, contact your local sales representative or Technical Service at 800-387-4938.

### 9000 Series – Narrow Stile Applications: Standard Glass AL Doors

Device Length	All Device Options (except BA or DA)		BA or DA Device Options
	Maximum Door Width <sup>1</sup>	Minimum Door Width <sup>2</sup>	Minimum Door Width <sup>2</sup>
AA	48" (1220 mm)	32-1/2" (826 mm)	37.5" (952.5 mm)
BB	36" (915 mm)	27" (686 mm)	31.5" (800.1 mm)
CC	36" (915 mm)	23-1/2" (597 mm)	28.5" (723.9 mm)

### 9000 Series – Narrow Stile with Full Length Touchbar Applications

Device Length	All Device Options (except BA or DA)		BA or DA Device Options
	Maximum Door Width <sup>1</sup>	Minimum Door Width <sup>2</sup>	Minimum Door Width <sup>2</sup>
AA	48" (1220 mm)	33" (839 mm)	34" (837 mm)
BB	36" (915 mm)	27" (686 mm)	28" (711 mm)
CC	36" (915 mm)	24" (610 mm)	25" (635 mm)

- As delivered from factory, device will fit doors of this width. For other widths, consult Technical Services.
- Touch bar and rail assembly can be shortened at time of installation to fit doors down to this width. Varies by installation.

\*Antimicrobial available to 626 and 630 finishes only  
 \*\*PC - Clear Powder Coat available over 630 - Stainless Steel

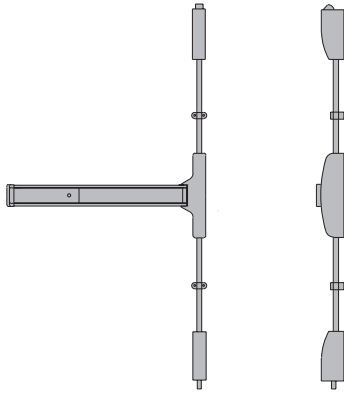

Available Finishes \$

			689, 691, 693, 695, 696	630	606, 612, 613, 619	605, 611, 625, 626, 629**
Function	Description	Device, Exit Only				
01	Panic	9800 Surface vertical rod	2,777.00	3,127.00	3,006.00	3,214.00
01	Fire	F9800 Surface vertical rod	2,917.00	3,402.00	3,273.00	3,469.00

Typical Options

Item	Description	List Add \$			
CD	Cylinder dogging (Includes Cylinder)				126.00
LD	Less dogging (Standard with fire rated device)				N/C
AM	Antimicrobial coating Note: Antimicrobial available to 626 and 630 finishes only				111.00
SNB	Sex nuts (Included with F and HC options)				25.00
TX	Security screws				49.00
HC	Hurricane (Includes SNB)				232.00
FL	Full length touchbar (Not available DE)				N/C
LB	Less bottom rod				N/C
PB	Pullman bottom latch				77.00
SB	Slide bolt (Default)				N/C
TGD	Tempered glass doors—9800 only	—	875.00	—	—
Up to 8'	7' Default				N/C
Up to 10'	Door Heights over 8' to 10'	78.00	152.00	152.00	152.00

\*\* For 629 finish, please allow 4 week lead time.

NOTES:

- Prices shown apply to AA, BB, or CC length devices.
- Specify door width and handing. If not specified, Size BB, RHR is the standard default.
- List price includes default strikes. For optional strikes, specify strike number and adjust list price accordingly.
- List price for the device does not include trim.
- Devices include wood and machine screws standard.
- Fire and hurricane rated devices include SNB sex nuts standard.
- For options requiring a cylinder, the option list price includes the default cylinder.
- Device includes precut and drilled rods for 7' or 8' doors as specified on order.  
For 9' doors, device includes precut and drilled rods for a 7' door and a 2' rod extension for the top rod.  
For 10' doors, device includes precut and drilled rods for an 8' door and a 2' rod extension for the top rod.  
See Device Options for pricing information.
- For special lengths and/or door heights over 10', consult Technical Service.
- All standard devices and trim are designed for 1-3/4"-2-1/4" thick doors. For door thickness greater than 2-1/4", consult Technical Service.
- **FL** (full length touchbar) and **METRIC** (metric installation fasteners) must be specified when ordered and included in the model number.  
**Example:** 9800 BB FL RHR 430 630 METRIC
- Full length touchbar not available with DE. CD option on FL devices supplied with U.S. mortise cylinder.

## Narrow Stile Dummy Bars

Item	Description	Available Finishes \$			
		689, 691, 693, 695, 696	630	606, 612, 613, 619	605, 611, 625, 626, 629**
<b>Dummy Touchbars</b>					
9230	Rigid dummy touchbar	802.00	1,156.00	1,196.00	1,196.00
9230MS	Dummy touchbar with microswitch	1,187.00	1,478.00	1,495.00	1,495.00
9235	Rigid touchbar	802.00	1,156.00	1,196.00	1,196.00
9236	Moveable touchbar	802.00	1,156.00	1,196.00	1,196.00
9236MS	Moveable touchbar with microswitch	1,187.00	1,478.00	1,495.00	1,495.00

**\*\* For 629 finish, please allow 4 week lead time.**

**NOTE:** Dummy touchbars available in all rail sizes: AA, BB or CC

## Narrow Stile Options

Option Code	Description	List Add \$
<b>Strikes</b>		
<b>9600, and 9800 Concealed and Surface Vertical Rods</b>		
340	Flat slide bolt bottom strike (9600, and 9800 Series)	N/C
416V	Surface bottom strike for pullman latch (9800 Series)	N/C
418	Standard top strike (9600 Series)	N/C
419	Wood frame top strike (9600 Series)	25.00
426	Standard top strike (9800 Series)	N/C
426A	Top strike w/angle (9800 Series)	40.00
431	Recessed bottom strike for pullman latch (9600, and 9800 Series)	40.00
439	Standard slide bolt bottom strike (9600, and 9800 Series)	N/C
<b>9700 Rim Devices</b>		
320	Overlap strike	40.00
430	Rim box strike (default/no charge for 9700 Series panic devices)	63.00
463	Standard rim strike (default/no charge for F9700 devices)	101.00
486	Roller strike	25.00
<b>Special Finishes and Coatings</b>		
AM	Antimicrobial protected coating Note: Antimicrobial available to 626 and 630 finishes only	111.00
PC	Clear Powder Coat available over 630 – Stainless Steel	111.00
Custom Color	Custom painted finish selected from RAL color pallet book. For details, see <b>Finishes Cross Reference</b> , page viii.	
	Per order, setup charge ( <b>Net</b> )	177.00
	per exit device only, list add	98.00
	per trim only, list add	98.00
Designer Color	Designer painted color matched to supplied samples. Three (3) each 2" x 3" color chip samples required. For details, see <b>Finishes Cross Reference</b> , page viii.	
	per order, non-refundable development/setup charge ( <b>Net</b> )	624.00
	per exit device only, list add	98.00
	per trim only, list add	98.00
<b>Bottom Latches for 9600 Concealed Vertical Rods &amp; 9800 Surface Vertical Rods</b>		
LB	Less bottom rod	N/C
PB	Pullman bottom latch	77.00
SB	Slide bolt (Default)	N/C
<b>Door Height Designation</b>		
<b>9600 Concealed Vertical Rods</b>		
7 or 8	Door heights from 7' to 8' adjustable	N/C
9 or 10	Door heights over 8', up to 10'	78.00
Over 10'	Contact Technical Service for assistance	
<b>9800 Surface Vertical Rods</b>		
7 or 8	Door heights from 7' to 8' (7' Default)	N/C
9 or 10	Door heights over 8', up to 10'	
	For 689, 691, 693, 695, 696 finishes	78.00
	For 605, 606, 611, 612, 613, 619, 625, 626, 630 finishes	152.00
Over 10'	Consult Technical Service	

**Narrow Stile Options (continued)**

Option Code	Description	List Add \$
Over 10'	Consult Technical Service	
<b>Special Application Packages</b>		
HC	Hurricane (9700, 9800) Includes SNB	232.00
BF	Barrier free exit device (9700), meets California Building Code (Section 11B-309.4) requirements for maximum 5 lb operating force.	68.00
FL	Full length touchbar (Not Available DE)	N/C
<b>Fastener Package</b>		
SK	Shim kit	125.00
SNB	Sex nuts	25.00
TX	Security screws	49.00
SKTX	Shim kit and security screws	193.00
SKSNB	Shim kit and sex nuts	145.00
TXSNB	Security screws and sex nuts	97.00
SKTXSNB	Shim kit, security screws, and sex nuts	217.00
METRIC	Metric installation fasteners (9600, 9700, and 9800 Series only)	N/C
<b>Tempered Glass Door Applications (9800 Series Only)</b>		
TGD	Tempered glass doors in 630 finish	963.00
<b>Electronic Controls</b>		
DE*	Delayed egress (requires ES100 power supply and ES105 power transfer)	2,284.00
DE30*	Delayed egress, 30 second (requires special approval from authority having jurisdiction)	2,825.00
DECBC*	Delayed egress, CBC compliant	2,825.00
MLR	Motorized Latch Retraction/dogging (use DKPS-2A or DKPS-2A power supply—2 MLR's)	1,281.00
ES	Electric latch retraction (requires PS501 power supply and ES105 power transfer)	1,209.00
<b>Alarm</b>		
BA*	Battery powered alarm	838.00
B4*	Battery powered alarm, 4 minute reset	894.00
DA*	Direct wired alarm	838.00
<b>Monitoring</b>		
LM	Latch bolt monitoring	332.00
MS	Monitor switch in touchbar	332.00
LMMS	Latch bolt and touchbar monitor	659.00
LMMSBP*	Latch bolt and touchbar monitor with bypass	659.00
<b>Dogging</b>		
CD*	Cylinder dogging (panic devices only)	126.00
LD	Less dogging (panic devices only)	N/C
<b>Power Supplies, Power Transfers, Power Modules</b>		
AD100	Export power supply for up to 2 ES or 1 DE device 220 V.	1,006.00
ES101	Delay module	188.00
ES103	Relay module	119.00
ES100	Power supply for DE devices. Powers 1 DE device.	856.00
ES105	Power transfer (recommended for ES, DE & MLR options)	288.00
PS501	Power supply for ES9000 devices. Powers up to 2 devices.	1,006.00
PS501220	Export power supply, 220 VAC. Powers up to 2 ES9000 devices.	1,006.00
ES2	Power supply card for PS501. Powers an additional 2 devices.	548.00
DKPS-2A	Power supply for MLR. Powers 1 device.	764.00
DKPS-2A	Power supply for Powers 2 devices (will also power 1 MLR device).	764.00
DKPS-2A	Power supply for MLR. Powers 2 devices.	764.00
PS406BB	Power supply with battery back-up for solenoid electric latch retraction option.	1,435.00



# 9000 Series Exit Trim



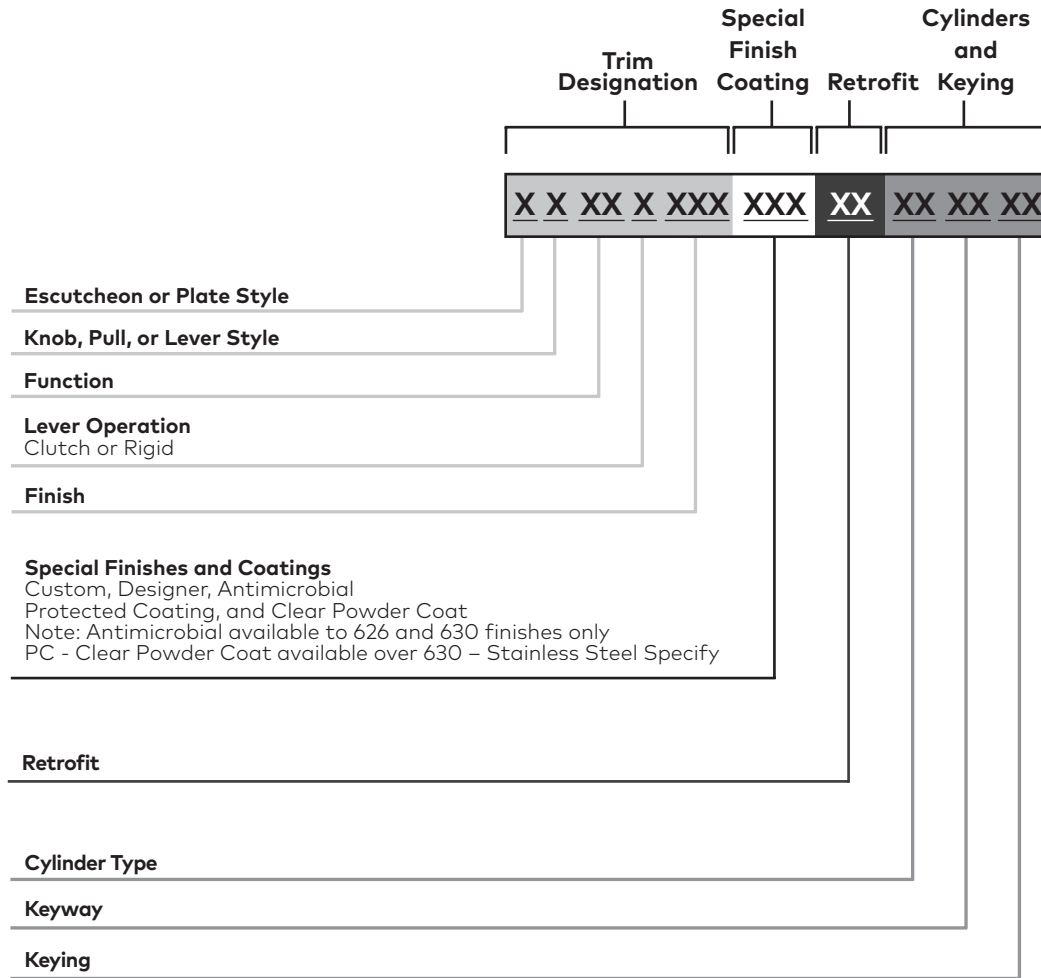





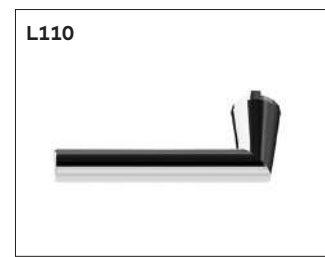
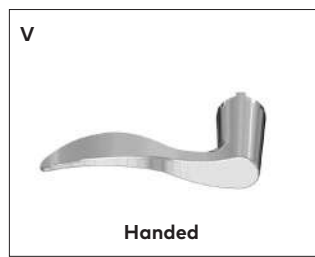
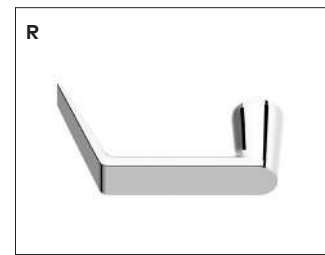
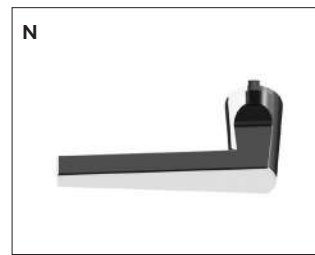
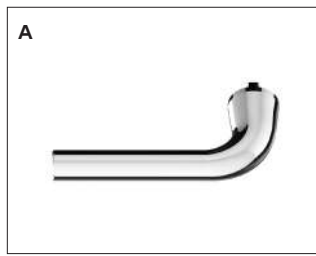

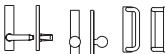
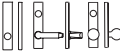
## How to Order



\*Antimicrobial available to 626 and 630 finishes only  
 \*\*PC - Clear Powder Coat available over 630 - Stainless Steel

# Lever and Knob Styles



ANSI Function	Description	Z Series Raised Escutcheon 1-5/8" W x 8-1/2" H x 15/16" D	Cylinder Only Pull by Others
DT	Dummy trim		
02	Entrance by trim when touchbar is dogged		
03	Entrance by trim when latch bolt is retracted by key. Key removable only when trim is locked.		
08	Entrance by lever or knob. Key locks or unlocks lever or knob.		
08C w/ clutch (Handed)	Entrance by lever with clutch option. Key locks or unlocks lever.		
09	Entrance by lever or knob only when unlocked by key. Key removable only when locked.		
09C w/ clutch (Handed)	Entrance by lever with clutch option trim unlocked by key. Key removable only when locked.		
11	Entrance by thumbturn and pull. Key locks or unlocks thumbturn.		
12	Entrance by thumbturn and pull only when released by key. Key removable only when locked.		
23	Entrance by lever or knob (no cylinder). Lever or knob always active.		
25	Entrance by thumbturn and pull (no cylinder). Thumbturn always active.		

# 9000 Series Narrow Stile Z Trim

Z Series Trim (Specify)				Special Finish Coating			Special Application Package			
Escutcheon Knob, Pull, or Lever				Door Thickness			Cylinders and Keying			
Escutcheon	Knob, Pull, or Lever	Function	Handing	Finish	Door Thickness	Special Finish Coating	Cylinder Type	Keyway	Keying	
				<b>630</b>			<b>D</b>	<b>SC</b>	<b>KD</b>	
Z	A	DT	RHR	605	Ext3	*AM	TGD	T	CA	KD
	C	O2	LHR	606	Ext4	**PC		J	CD	KA2
Handed -	D	O2R		611				C	CE	KA4
Handed -	K	O3		612				L	<b>D100</b>	NSK
	F	O3R		613				<b>D</b>	GA	MKD
	G	O8		619				G	RA	CMK
	R	O8C	- Handed	625				R	RB	SKD
	T	O9		626				F	<b>SC</b>	OBit
	O	O9C	- Handed	629				X6	SE	
	P	11		<b>630</b>				X7	SF	
Handed -	N	12		689					YA	
	V	23		691					YG	
	L109	25		693						
	L110			693						
	L112			695						
Handed -	L114			696						
	L117			Custom						
	L118			Designer						

Suffix **C** and **LH/RH** required for clutch  
 Suffix **R** required for rigid lever

 - Default

**\*Patented Key Control**  
**D100** is the keyway for our patented **SKC** serialized key control system. **SKC** is internet based and provides added layers of security. For more information, contact your local sales representative or Technical Service at 800-387-4938.



ZP



ZK



ZC

\*Antimicrobial available to 626 and 630 finishes only  
 \*\*PC - Clear Powder Coat available over 630 - Stainless Steel

		Concealed Vertical Rod	Rim	Surface Vertical Rod	Available Finishes \$		
		9600 F9600	9700 F9700	9800 F9800	689, 691, 693 695, 696	630	605, 606, 611, 612, 613, 619, 625, 626, 629**
ANSI Function	Description						
DT	Dummy trim	ZODT			185.00	266.00	306.00
02	Entrance by trim when touchbar is dogged.	ZPO2			347.00	463.00	526.00
		ZK02R, Zx02R			261.00	417.00	509.00
03	Entrance by trim when latch bolt is retracted by key. Key removable only when trim is locked.	ZO03			289.00	385.00	408.00
		ZP03, ZK03R, Zx03R			514.00	666.00	726.00
08	Entrance by lever or knob. Key locks or unlocks lever or knob.	ZK08, Zx08			675.00	779.00	897.00
08 w/ clutch (Handed)	Entrance by lever with clutch option. Key locks or unlocks lever.	Zx08C			957.00	1,108.00	1,168.00
09	Entrance by lever or knob only when unlocked by key. Key removable only when locked.	ZK09, Zx09			675.00	779.00	897.00
09 w/ clutch (Handed)	Entrance by lever with clutch option trim unlocked by key. Key removable only when locked.	Zx09C			957.00	1,108.00	1,168.00
11	Entrance by thumbturn. Key locks or unlocks thumbturn	Z011			556.00	715.00	737.00
12	Entrance by thumbturn when unlocked by key. Key removable only when locked.	Z012			556.00	715.00	737.00
11	Entrance by thumbturn. Key locks or unlocks thumbturn	ZP11			637.00	764.00	789.00
12	Entrance by thumbturn when unlocked by key. Key removable only when locked.	ZP12			637.00	764.00	789.00
23	Entrance by lever or knob (no cylinder). Lever or knob always active.	ZK23, Zx23			447.00	624.00	666.00
25	Entrance by thumbturn and pull (no cylinder). Thumbturn always active.	ZP25			553.00	675.00	822.00

**\*\* For 629 finish, please allow 4 week lead time.**

**NOTES:**

- Where x appears above, x = lever styles A, C, D, F, G, N, R, T, V, L109, L110, L112, L114, L117 or L118. (Handed – D, F, V, L114)
- List price includes the default cylinder.

# 9000 Series Narrow Stile Pull Trim

Pull (Specify)		Special Finish Coating
Pull Type	Function	Finish
		<b>630</b>
OP	02	605 *AM
9BPO <sup>1</sup>	03	606 **PC
		611
		612
		613 <input type="checkbox"/> - Default
		619
		625
		626
		<b>630</b>
		689
		691
		693
		695
		696
		Custom
		Designer



OP



9PBO

1. 9PBO not applicable on 9500 Device. 03 Function only. Not available in 693 finish

Concealed Vertical Rod	Rim	Surface Vertical Rod	Available Finishes \$		
9600 F9600	9700 F9700	9800 F9800	689, 691, 693, 695, 696	630	605, 606, 611, 612, 613, 619, 625, 626

ANSI Function	Description				
02	Entrance by trim when touchbar is dogged.	OP02	173.00	214.00	251.00
03	Entrance by trim when latch bolt is retracted by key. Key removable only when trim is locked.	9PBO03	193.00	192.00	192.00

**NOTES:**

- List price includes the default cylinder.
- 9PBO03 trim not recommended for wood doors. For hollow metal and aluminum door applications. Not available in 693 finish.

\*Antimicrobial available to 626 and 630 finishes only

\*\*PC - Clear Powder Coat available over 630 - Stainless Steel

## Trim Options

Option Code	Description	List Add \$
<b>Special Finishes and Coatings</b>		
AM	Antimicrobial protected coating Note: Antimicrobial available to 626 and 630 finishes only	111.00
PC	Clear Powder Coat available over 630 – Stainless Steel	111.00
Custom Color	Custom painted finish selected from RAL color pallet book. For details, see <b>Finishes Cross Reference</b> , page viii.	
	Per order, setup charge ( <b>Net</b> )	177.00
	per exit device only, list add	98.00
	per trim only, list add	98.00
Designer Color	Designer painted color matched to supplied samples. Three (3) each 2" x 3" color chip samples required. For details, see <b>Finishes Cross Reference</b> , page viii.	
	per order, non-refundable development/setup charge ( <b>Net</b> )	624.00
	per exit device only, list add	98.00
	per trim only, list add	98.00
<b>Tempered Glass Door Applications</b>		
TGD	Tempered glass doors (Z series trim only), available in 630 finish only	58.00
<b>Door Thickness (includes extended spindle and fasteners)</b>		
Ext3	Door thickness from 2-1/4"-3-1/4" (57 mm to 83 mm)	116.00
Ext4	Door thickness from 3-1/4"-4-1/4" (83 mm to 108 mm)	116.00

## Cylinders

### Rim Cylinders

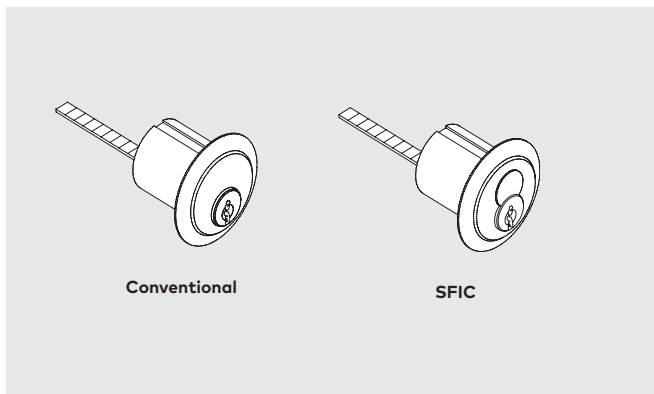

### Mortise Cylinders

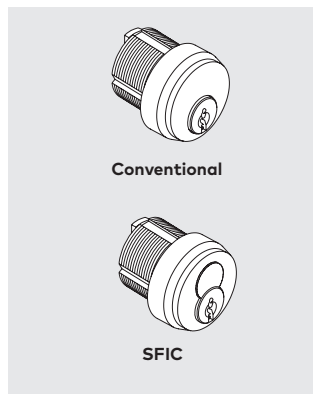

### Key-in-Lever Cylinders

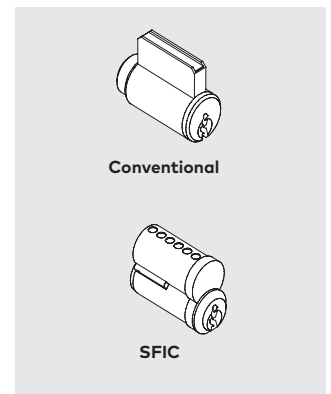







### Narrow Stile

Application	ANSI Function	Cylinder Type	Conventional (Default)	Cam	SFIC 7-Pin
<b>Cylinders for 9600/F9600 Concealed Vertical Rod, 9700/F9700 Rim, and 9800/F9800 Surface Vertical Rod Narrow Stile Devices</b>					
Z Escutcheon Trim	03	Rim	80R40SC	NA	87R40BA
Z Escutcheon Trim	08, 11	Mortise	90x13SC118	#13	97C13BA138
Z Escutcheon Trim	09, 12	Mortise	90x09SC118	#9	97C09BA138
<b>Cylinders for Device Options</b>					
CD, BA, B4, DE, DE30, DECBC, DA, LMMSBP	—	Mortise	90x10SC118	#10	97D10BA138

**NOTE:** For additional information, please refer to Cylinders, Keys & Keying.

## Cylinder Types, Keying Options and Keyways for Removable Mullions and Exit Devices

Cylinder	Option	Description	List Add/Deduct \$
<b>Conventional Cylinders (non-interchangeable core)</b>			
D		Keying for exit device or removable mullions with conventional cylinder (default)	
	<b>KD</b>	<b>Keyed differently to a random combination; SC keyway with 2 keys (default)</b>	N/C
	KA2	Keyed alike in pairs to a random combination; SC keyway with 2 keys	N/C
	NSK	Keyed alike, sets of three or more; SC keyway with 2 keys	20.00
	1-Bit	1-bit key (sold separately); SC, SE keyway with 2 key blanks	N/C
	1-Bit	1-bit key (sold separately); D100 keyway —  <b>Keys sold separately</b>	N/C
	0-Bit	Operated by a key blank; CA, CD, CE, RA, RB, GA, SF, YA, YG keyways with 2 key blanks	20.00
	MKD	Master keyed; SC, SE, or D100 keyway —  <b>Keys sold separately</b>	25.00
	CMK	Construction master keyed single cylinder locks —  <b>Keys sold separately</b>	27.00
L		Keying for exit device or removable mullions less conventional cylinder	Deduct 30.00
<b>Interchangeable Core Cylinders</b>			
T		Keying for exit device or removable mullions with keyed temporary SFIC construction core Keying for exit trim with keyed temporary SFIC construction core (cores may be returned for a full refund) —  <b>Keys sold separately</b>	58.00
J		Keying for exit device or removable mullions with disposable plastic SFIC construction core	N/C
C		Keying for exit device or removable mullions with combined SFIC core installed at factory <sup>1</sup> Keying for exit trim with combined core installed at factory; BA (default), BB, BC, BD, BE, BF, BG, BH, BJ, BK, BL, BM, BQ, D100 keyway —  <b>Keys sold separately</b>	65.00
G		Schlage LFIC — Housing with keyed temporary Schlage LFIC construction core (Core may be returned for full refund) —  <b>Keys sold separately</b>	58.00
F		Schlage LFIC — Housing with combined Schlage LFIC installed at the factory (SC keyway) —  <b>Keys sold separately</b>	65.00
<b>Cylinder Housings Less Cores</b>			
EP		Euro profile half cylinder housing	N/C
R		Housing prepared for Schlage LFIC	13.00
X7		Housing prepared for Sargent XC 7P and Arrow Choice 7P SFIC	13.00
X6		Housing prepared for Arrow Choice 6P SFIC	13.00

1. For uncombined cores, **UNC** cores must be ordered separately, see **Cylinders, Keys & Keying**. Exits/trim will be supplied w/ plastic construction core, Option J.

 Denotes keys must be ordered separately.

### Cut Keys Ordered Separately

Part #	Description	List \$
45101	SFIC Cut key — Change key, master key, construction master key, or control key; BA, BB, BC, BD, BE, BF, BG, BH, BJ, BK, BL, BM, BQ, SC, SE keyways	11.00
45401	SFIC Cut key — Change key, master key, or control key; D100 keyways — D100 etc.	17.00
45404	CONV/LFIC Cut key — 1 bit key for operating 1 bit cylinders — SC, SE keyways	9.00
45405	LFIC Cut key — 1 bit control key (to install/remove "0-bit" LFIC cores) — SC keyway	9.00
44101SC	CONV/LFIC Key blank — SC keyway	6.00
44104SC	LFIC Key blank — Control key (to install/remove LFIC Cores) — SC keyway	8.00

#### NOTES:

- Distribution of DORMA SKC keys (listed as D100) is restricted. See Cylinders, Keys & Keying section for DORMA SKC policies.
- For additional information, please refer to Cylinders, Keys, and Keying
- See Keys and Key Blanks section for complete list.



## Mullions

Item	Description	List \$
<b>Aluminum Mullions x 628 (clear anodized), 1-5/8" x 2-5/8"</b>		
1310-8	8'	1,303.00
1310-8 x 443	8', recessed strike	1,519.00
WS1310-8	8', weatherstrip	1,387.00
WS1310-8 x 443	8', weatherstrip and recessed strike	1,534.00
1310-10	10'	1,387.00
1310-10 x 443	10', recessed strike	1,665.00
WS1310-10	10', weatherstrip	1,519.00
WS1310-10 x 443	10', weatherstrip and recessed strike	1,759.00
<b>Aluminum Mullions x 695 (painted), 1-5/8" x 2-5/8"</b>		
1310-8	8'	1,582.00
1310-8 x 443	8', recessed strike	1,792.00
WS1310-8	8', weatherstrip	1,665.00
WS1310-8 x 443	8', weatherstrip and recessed strike	1,893.00
1310-10	10'	1,712.00
1310-10 x 443	10', recessed strike	1,940.00
WS1310-10	10', weatherstrip	1,826.00
WS1310-10 x 443	10', weatherstrip and recessed strike	1,842.00
<b>Steel Mullions x 600 (primed for paint), 1-1/2" x 2-1/2"</b>		
1330-8	8'	655.00
1330-10	10'	687.00
<b>Steel Mullions x 600 (primed for paint), 2" x 3"</b>		
1300-8	8'	849.00
F1300-8	8', fire-rated	1,094.00
F1300-10	10', fire-rated	1,459.00
1340KR-8	8', key removable (includes standard cylinder using 01 cam)	1,435.00
F1340KR-8	8', fire-rated mullion, key removable (includes standard cylinder using 01 cam)	1,681.00
F1340KR-10	10', fire-rated mullion, key removable (includes standard cylinder using 01 cam)	1,968.00
1300-10	10', fire-rated	979.00
1340KR-EL	8', key removable, electrified mullion	1,665.00
1340KR-10	10', key removable (includes standard cylinder using 01 cam)	1,519.00
1340KR-EL-10	10', key removable, electrified mullion	1,746.00
HC1300-8	8', design pressure rated 80PSF for openings up to 8' x 8' with HC9300 device.	1,582.00
<b>Mullion Storage Kit</b>		
1340SK	Storage kit for 1340/F1340 Series key removable mullion.	427.00

### Cylinders for 1340KR/F1340KR Mullions and 1340SK Storage Kit

Type	Standard	7-pin IC	Cam
Mortise	90X01SC118	97D01BA138	01 (AR)



# 8000 Series Exit Devices

## How to Order

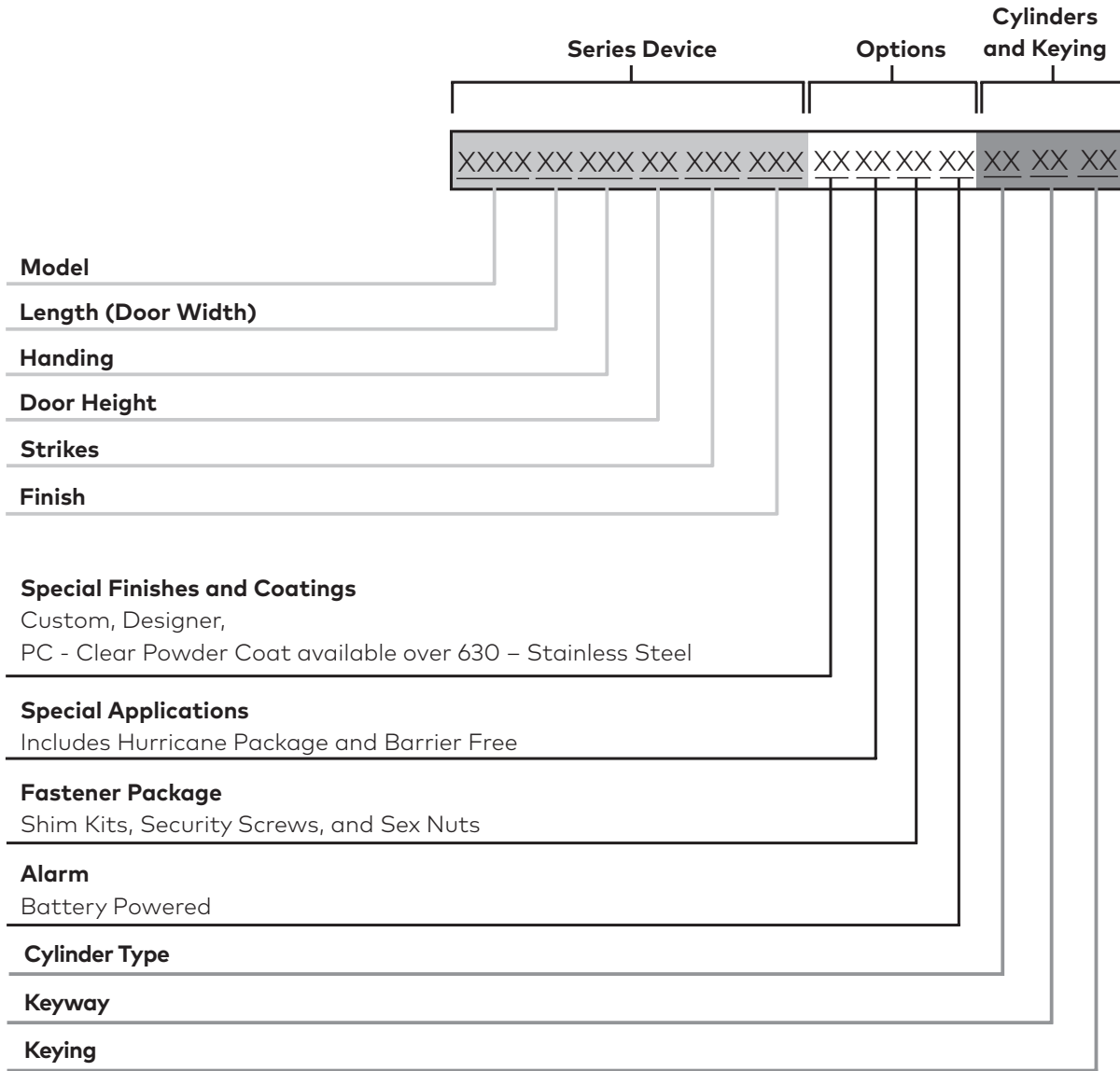

# 8300 Series

## Rim Exit Device

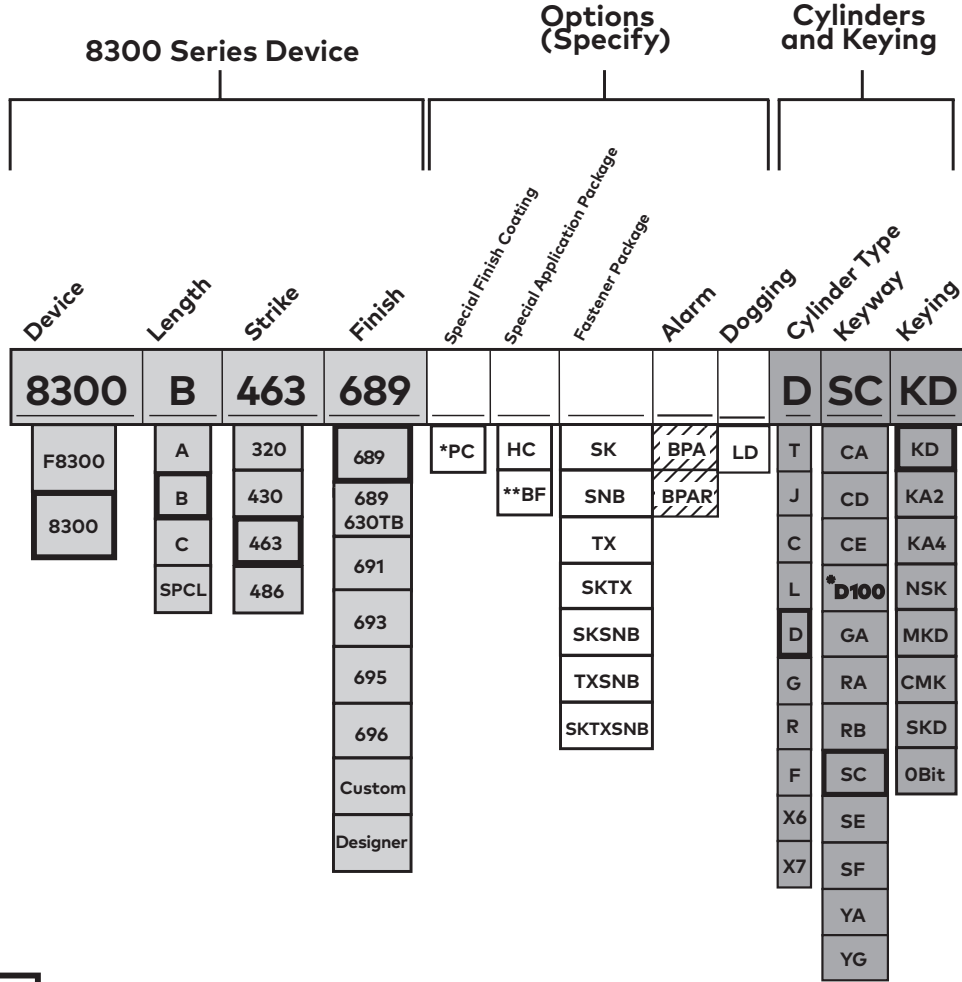

 – Default

 – Supplied with Standard KD Cylinder

**\*Patented Key Control**  
**D100** is the keyway for our patented **SKC** serialized key control system. **SKC** is internet based and provides added layers of security. For more information, contact your local sales representative or Technical Service at 800-387-4938.

**\*\* Barrier Free option availability:**

Exit Device	Functions	Device Lengths	Ratings
8300BF	01, 02, 03, 05, 08, 23	36" & 48"	Panic & Fire

**8000 Series – Wide Stile Applications**

Device Length	All Device Options (except BA or DA)		BA or DA Device Options
	Maximum Door Width <sup>1</sup>	Minimum Door Width <sup>2</sup>	Minimum Door Width <sup>2</sup>
A	48" (1220 mm)	34" (864 mm)	39" (991 mm)
B	36" (915 mm)	28" (712 mm)	33" (839 mm)
C	36" (915 mm)	22" (559 mm)	22" (559 mm)

1. As delivered from factory, device will fit doors of this width. For other widths, consult Technical Services.  
 2. Touch bar and rail assembly can be shortened at time of installation to fit doors down to this width.

\*PC - Clear Powder Coat available over 630 – Stainless Steel



## Available Finishes \$

Function	Description	Device, Exit Only	Available Finishes \$	
			689, 691, 693, 695, 696	689 w/ 630 TB
01	Panic	8300 Rim	704.00	1,059.00
01	Fire	F8300 Rim	963.00	1,322.00

## Typical Options

Item	Description	List Add \$
LD	Less dogging (Standard with fire rated device)	N/C
SNB	Sex nuts (Included with F and H options)	25.00
TX	Security screws	49.00
HC	Hurricane (includes SNB)	232.00
BF	Barrier free exit device, meets California Building Code (Section 11B-309.4) requirements for maximum 5 lb operating force.	68.00
320	Overlap strike	40.00
430	Rim box strike	63.00
463	Standard rim strike	N/C
486	Roller strike	25.00

## NOTES:

- Prices shown apply to A, B, or C length devices.
- Specify door width. If not specified, Size B is the standard default.
- List price includes default strikes. For optional strikes, specify strike number and adjust list price accordingly.
- List price for the device does not include trim.
- Devices include wood and machine screws standard.
- Fire and hurricane rated devices include SNB sex nuts standard.
- For options requiring a cylinder, the option list price includes the default cylinder.
- For special lengths, consult Technical Service.
- All standard devices and trim are designed for 1-3/4"-2-1/4" thick doors. For door thickness greater than 2-1/4", consult Technical Service.

# 8400 Series

## Surface Vertical Rod Exit Device

8400 Series Device							Options (Specify)						Cylinders and Keying		
Device	Length	Handing	Door Height	Top Strike	Bottom Strike	Finish	Special Finish Coating	Bottom Latch	Special Application Package	Fastener Package	Alarm	Dogging	Cylinder Type	Keyway	Keying
<b>8400</b>	<b>B</b>	<b>RHR</b>	<b>7</b>	<b>426</b>	<b>439</b>	<b>689</b>							<b>D</b>	<b>SC</b>	<b>KD</b>
F8400	A	RHR	7	426	340	689	*PC	LB	HC	SK	BPA	LD	T	CA	KD
8400	B	LHR	8	426A	416V	689		PB		SNB	BPAR		J	CD	KA2
	C		9		431	630TB		SB		TX			C	CE	KA4
	SPCL		10		439	691				SKTX			L	<b>D100</b>	NSK
			SPCH			693				SKSNB			D	GA	MKD
						695				TXSNB			G	RA	CMK
						696				SKTXSNB			R	RB	SKD
						Custom							F	SC	OBit
						Designer							X6	SE	
													X7	SF	
														YA	
														YG	

 – Default

 – Supplied with Standard KD Cylinder

### 8000 Series – Wide Stile Applications

Device Length	All Device Options (except BA or DA)		BA or DA Device Options
	Maximum Door Width <sup>1</sup>	Minimum Door Width <sup>2</sup>	Minimum Door Width <sup>2</sup>
<b>A</b>	48" (1220 mm)	34" (864 mm)	39" (991 mm)
<b>B</b>	36" (915 mm)	28" (712 mm)	33" (839 mm)
<b>C</b>	36" (915 mm)	22" (559 mm)	22" (559 mm)

1. As delivered from factory, device will fit doors of this width. For other widths, consult Technical Services.  
 2. Touch bar and rail assembly can be shortened at time of installation to fit doors down to this width.

\*PC - Clear Powder Coat available over 630 – Stainless Steel

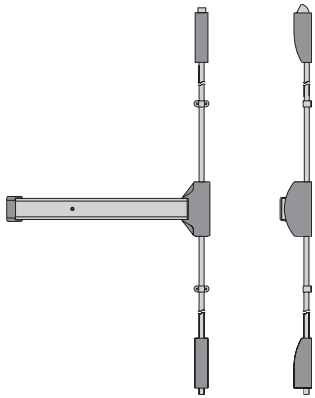

Function	Description	Device, Exit Only	Available Finishes \$	
			689, 691, 693, 695, 696	689 w/ 630 TB
01	Panic	8400 Surface vertical rod	1,198.00	1,583.00
01	Fire	F8400 Surface vertical rod	1,523.00	1,904.00

### Typical Options

Item	Description	List Add \$
LD	Less dogging (Standard with fire rated device)	N/C
SNB	Sex nuts (Included with F and HC options)	25.00
TX	Security screws	49.00
HC	Hurricane (Includes SNB)	232.00
LB	Less bottom rod	N/C
PB	Pullman bottom latch	77.00
SB	Slide bolt (Default)	N/C
Up to 8'	7' default	N/C
Up to 10'	Door heights over 8' to 10' (over 10', call Technical Service)	73.00
340	Flat slide bolt bottom strike	N/C
416V	Surface bottom strike for pullman latch	N/C
426	Standard top strike	N/C
426A	Top strike with angle	40.00
431	Recessed bottom strike for pullman latch	40.00
439	Standard slide bolt bottom strike	N/C

### NOTES:

- Prices shown apply to A, B, or C length devices.
- Specify door width and handing. If not specified, Size B, RHR is the standard default.
- List price includes default strikes. For optional strikes, specify strike number and adjust list price accordingly.
- List price for the device does not include trim.
- Devices include wood and machine screws standard.
- Fire and hurricane rated devices include SNB sex nuts standard.
- For options requiring a cylinder, the option list price includes the default cylinder.
- Device includes precut and drilled rods for 7' or 8' doors as specified on order.  
For 9' doors, device includes precut and drilled rods for a 7' door and a 2' rod extension for the top rod.  
For 10' doors, device includes precut and drilled rods for an 8' door and a 2' rod extension for the top rod.  
See Device Options for pricing information.
- For special lengths and/or door heights over 10', consult Technical Service.
- All standard devices and trim are designed for 1-3/4"-2-1/4" thick doors. For door thickness greater than 2-1/4", consult Technical Service.

## Options

Option Code	Description	List Add \$
<b>Special Finishes and Coatings</b>		
PC	Powder Coat available over 630 – Stainless Steel	111.00
Custom Color	Custom painted finish selected from RAL color pallet book.	162.00
	For details, see <b>Finishes Cross Reference</b>	
	Per order, setup charge <b>(Net)</b>	89.00
	per exit device only, list add	89.00
	per trim only, list add	572.00
Designer Color	Designer painted color matched to supplied samples. Three (3) each 2" x 3" color chip samples required. For details, see <b>Finishes Cross Reference</b> per order, non-refundable development/setup charge <b>(Net)</b>	89.00
	per exit device only, list add	89.00
	per trim only, list add	86.00
<b>Fastener Package</b>		
SK	Shim kit	125.00
SNB	Sex nuts	25.00
TX	Security screws	49.00
SKTX	Shim kit and security screws	193.00
SXSNB	Shim kit and sex nuts	145.00
TXSNB	Security screws and sex nuts	97.00
SKTXSNB	Shim kit, security screws, and sex nuts	217.00
<b>Special Application Packages</b>		
HC	Hurricane. Includes SNB	232.00
BF	Barrier free exit device (8300), meets California Building Code (Section 11B-309.4) requirements for maximum 5 lb operating force.	68.00
<b>Alarm</b>		
BA*	Battery Power Alarm	838.00
B4*	Battery Power Alarm, 4 minute reset	894.00
DA*	Direct wired alarm	838.00
<b>Power Supplies, Power Transfers, Power Modules</b>		
ES101	Delay module	188.00
ES103	Relay module	119.00
ES100	Power supply. Powers (2) 8000 ES devices.	856.00
ES105	Power transfer for ES devices	288.00









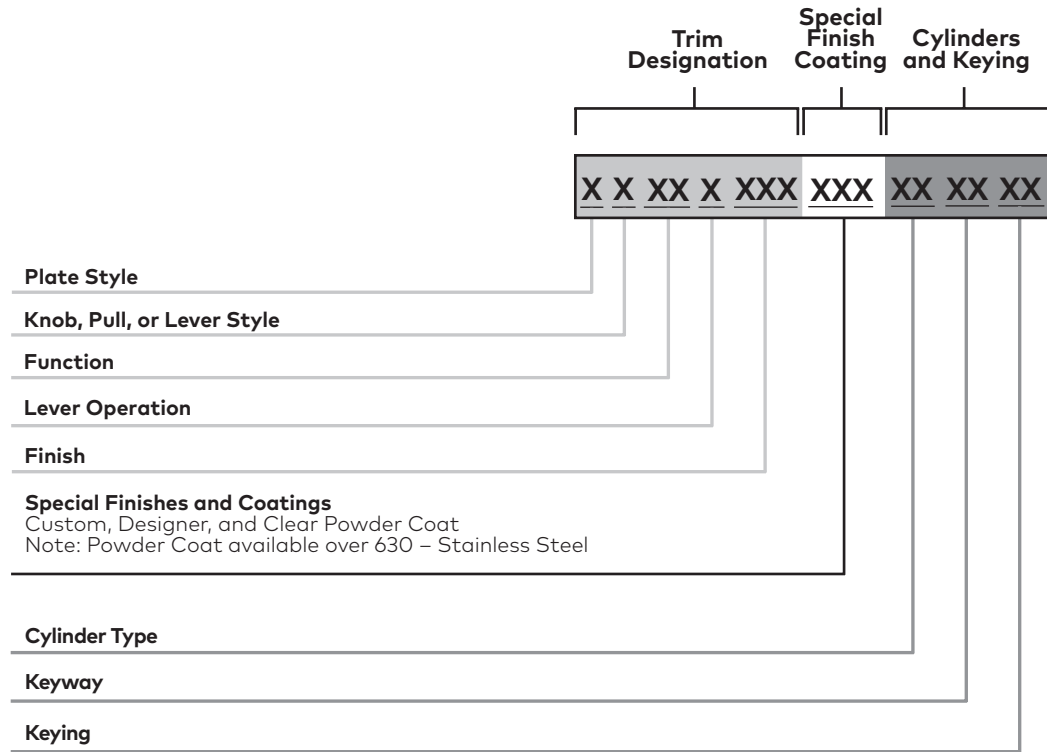















# 8000 Series Exit Trim

## How to Order



## Lever and Knob Styles



ANSI Function	Description	Escutcheon	Sectional 3-3/8" Diameter Rose	Wide Plate 3" W x 16" H	Pulls	Cylinder Only Pull by Others
DT	Dummy trim					
02	Entrance by trim when touchbar is dogged					
03	Entrance by trim when latch bolt is retracted by key. Key removable only when trim is locked.					
05	Entrance by thumbpiece. Key locks or unlocks thumbpiece.					
06	Entrance by thumbpiece only when released by key. Key removable only when locked.					
08	Entrance by lever or knob. Key locks or unlocks lever or knob.					
09	Entrance by lever or knob when unlocked by key. Key removable only when locked.					
22	Entrance by thumbpiece (no cylinder). Thumbpiece always active.					
23	Entrance by lever or knob (no cylinder). Lever or knob always active.					

# 8000 Series Escutcheon Trim

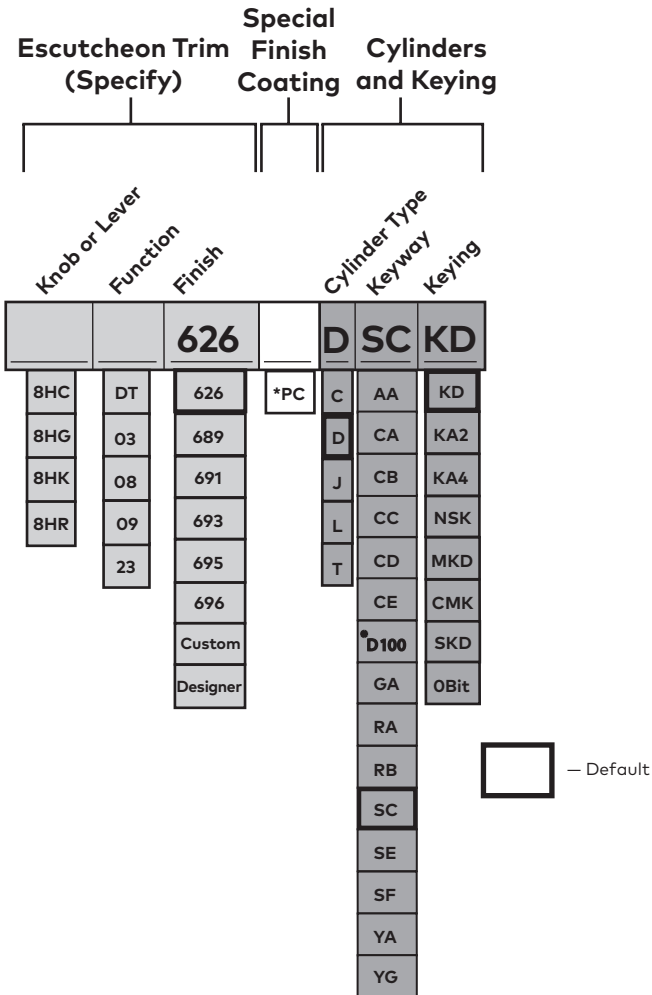

8HR



8HK

**\*Patented Key Control**  
**D100** is the keyway for our patented **SKC** serialized key control system. **SKC** is internet based and provides added layers of security. For more information, contact your local sales representative or Technical Service at 800-387-4938.

Rim	Surface Vertical Rod	Available Finishes \$	
<b>8300</b> F8300	<b>8400</b> F8400	<b>689, 691, 693</b> <b>695, 696</b>	<b>626</b>

ANSI Function	Description			
DT	Dummy trim	8HDT	371.00	346.00
03	Entrance by trim when latch bolt is retracted by key. Key removable only when trim is locked.	8Hx03 8HK03	501.00	460.00
08	Entrance by lever or knob. Key locks or unlocks lever or knob.	8Hx08 8HKx08	501.00	460.00
09	Entrance by lever or knob when unlocked by key. Key removable only when locked.	8Hx09 8HK09	501.00	460.00
23	Entrance by lever or knob (no cylinder). Lever or knob always active.	8Hx23 8HK23	416.00	365.00

- NOTES:**
- List price includes the default cylinder.
  - Where x appears above, x = lever style. See page 142 for details.

\*PC - Clear Powder Coat available over 630 – Stainless Steel

# 8000 Series Sectional Trim

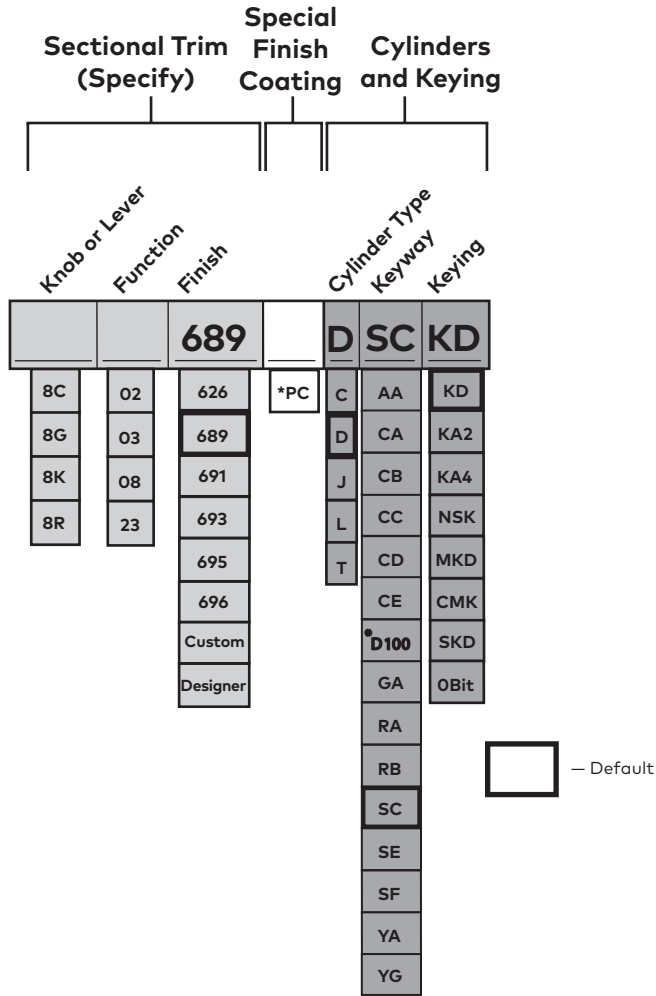

8R



8K

**\*Patented Key Control**  
**D100** is the keyway for our patented **SKC** serialized key control system. **SKC** is internet based and provides added layers of security. For more information, contact your local sales representative or Technical Service at 800-387-4938.

Rim	Surface Vertical Rod	Available Finishes \$	
8300 F8300	8400 F8400	689, 691, 693 695, 696	626

ANSI Function	Description			
02	Entrance by trim when touchbar is dogged.	8x02R 8K02R	365.00	416.00
03	Entrance by trim when latch bolt is retracted by key. Key removable only when trim is locked.	8x03 8K03	448.00	371.00
08	Entrance by lever or knob. Key locks or unlocks lever or knob.	8x08 8K08	448.00	501.00
23	Entrance by lever or knob (no cylinder). Lever or knob always active.	8x23 8K23	365.00	416.00

**Notes:**

- List price includes the default cylinder.
- Where x appears above, x = lever style. See page 142 for details.

\*PC - Clear Powder Coat available over 630 - Stainless Steel

# 8000 Series Wide Plate Trim

Wide Plate Trim (Specify)			Special Finish Coating	Cylinders and Keying		
Plate Type	Function	Finish		Cylinder Type	Keyway	Keying
		<b>630</b>		<b>D</b>	<b>SC</b>	<b>KD</b>
HRS	DT	630	*PC	T	AA	KD
HTS	02	689		J	CA	KA2
NPS	03	691		C	CB	KA4
PRS	05	693		L	CC	NSK
PTS	06	695		D	CD	MKD
80	08	696		G	CE	CMK
	22	Custom		R	<b>D100</b>	SKD
		Designer		F	GA	OBit
				X6	RA	
				X7	RB	
					SC	
					SE	
					SF	
					YA	
					YG	



PRS



HTS

**\*Patented Key Control**  
**D100** is the keyway for our patented **SKC** serialized key control system. **SKC** is internet based and provides added layers of security. For more information, contact your local sales representative or Technical Service at 800-387-4938.



\*PC - Clear Powder Coat available over 630 - Stainless Steel

		Rim	Surface Vertical Rod	Available Finishes \$	
		8300 F8300	8400 F8400	689, 691, 693 695, 696	630
ANSI Function	Description				
DT	Dummy trim	NPSDT		164.00	229.00
		80DT		101.00	—
02	Entrance by trim when touchbar is dogged.	PRS02 PTS02		229.00	285.00
03	Entrance by trim when latch bolt is retracted by key. Key removable only when trim is locked.	NPS03		229.00	305.00
		PRS03 PTS03		285.00	365.00
05	Entrance by thumbpiece. Key locks or unlocks thumbpiece.	HRS05 HTS05		324.00	425.00
06	Entrance by thumbpiece only when released by key. Key removable only when locked.	HRS06 HTS06		324.00	425.00
22	Entrance by thumbpiece (no cylinder). Thumbpiece always active.	HRS22 HTS22		266.00	324.00

**NOTE:**

- List price includes the default cylinder.

# 8000 Series Pull Trim

Pulls (Specify)			Special Finish Coating	Cylinders and Keying		
Pull Type	Function	Finish		Cylinder Type	Keyway	Keying
		<b>689</b>		<b>D</b>	<b>SC</b>	<b>KD</b>
80 <sup>1</sup>	DTP	689	*PC	T	AA	KD
8P	O2	691		J	CA	KA2
8PBO <sup>2</sup>	O3	693		C	CB	KA4
	O3P	695		L	CC	NSK
		696		D	CD	MKD
		Custom		G	CE	CMK
		Designer		R	<b>*D100</b>	SKD
				F	GA	OBit
				X6	RA	
				X7	RB	
					SC	
					SE	
					SF	
					YA	
					YG	

– Default

**\*Patented Key Control**  
**D100** is the keyway for our patented **SKC** serialized key control system. **SKC** is internet based and provides added layers of security. For more information, contact your local sales representative or Technical Service at 800-387-4938.



80



8PBO



8P

1. Specify hand.
2. 8PBO available for O3 Function only. Not available in 693 finish.

Rim	Surface Vertical Rod	Available Finishes \$
8300 F8300	8400 F8400	689, 691, 693 695, 696

ANSI Function	Description		
02	Entrance by trim when touchbar is dogged.	8P02	324.00
		80DTP	227.00
		8PDT	125.00
03	Entrance by trim when latch bolt is retracted by key. Key removable only when trim is locked.	8003P	305.00
		8003	164.00
		8P03	204.00
		8PBO03	183.00

- NOTES:**
- List price includes the default cylinder.
  - 8PBO03 trim not recommended for wood doors. Hollow metal and aluminum door applications.

\*PC - Clear Powder Coat available over 630 - Stainless Steel



# Trim Options

Option Code	Description	List Add \$
<b>Special Finishes and Coatings</b>		
P	Clear powder coat	110.00
Custom Color	Custom painted finish selected from RAL color pallet book. For details, see <b>Finishes Cross Reference</b> , page viii.	
	Per order, setup charge ( <b>Net</b> )	175.00
	per exit device only, list add	96.00
	per trim only, list add	96.00
Designer Color	Designer painted color matched to supplied samples. Three (3) each 2" x 3" color chip samples required. For details, see <b>Finishes Cross Reference</b> , page viii.	
	per order, non-refundable development/setup charge ( <b>Net</b> )	615.00
	per exit device only, list add	96.00
	per trim only, list add	96.00

## Cylinders

### Rim Cylinders

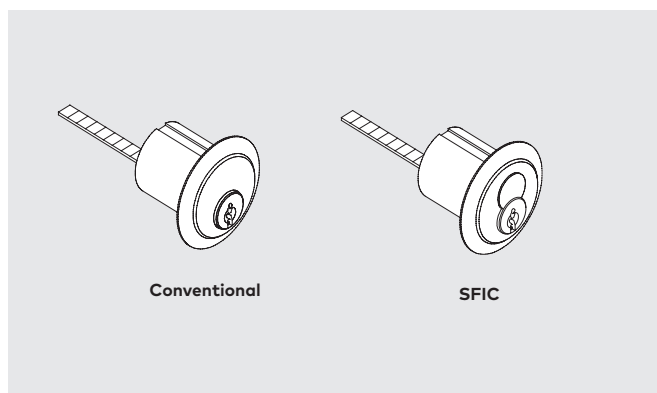

### Mortise Cylinders

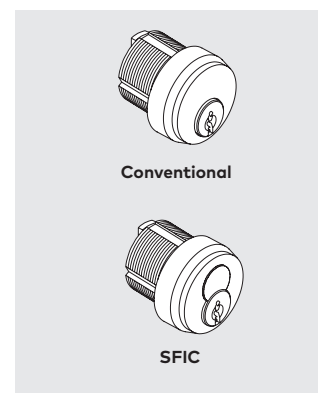

### Key-in-Lever Cylinders

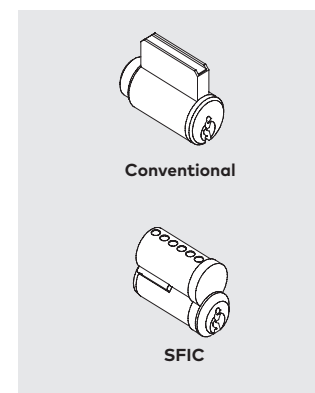

Application	ANSI Function	Cylinder Type	Conventional (Default)	SFIC 7-Pin
<b>Trim</b>				
Sectional Trim (Key-in-Lever)	03, 08	Key-in-lever	70135C	77
3" Wide Plate Trim	03	Rim	80R40SC	87A40
3" Wide Plate Trim	05, 06	Mortise	90X10SC118	97C10138
Pulls	03	Rim	80R40SC	87A40
<b>Device Options</b>				
CD, BA, B4,		Mortise	90X10SC118	97D10138

**NOTE:**

- For additional information, please refer to Cylinders, Keys, and Keying.

# Cylinder Types, Keying Options and Keyways for Removable Mullions and Exit Devices

Cylinder	Option	Description	List Add/Deduct \$
<b>Conventional Cylinders (non-interchangeable core)</b>			
<b>D</b>		Keying for exit device or removable mullions with conventional cylinder (default)	
	<b>KD</b>	<b>Keyed differently to a random combination; SC keyway with 2 keys (default)</b>	N/C
	KA2	Keyed alike in pairs to a random combination; SC keyway with 2 keys	N/C
	1-Bit	1-bit key (sold separately); SC, SE keyway with 2 key blanks	N/C
	1-Bit	1-bit key (sold separately); D100 keyway — <b>⊗ Keys sold separately</b>	N/C
	0-Bit	Operated by a key blank; CA, CD, CE, RA, RB, GA, SF, YA, YG keyways with 2 key blanks	20.00
	NSK	Keyed alike, sets of three or more; SC keyway with 2 keys	20.00
	MKD	Master keyed; SC, SE, or D100 keyway — <b>⊗ Keys sold separately</b>	25.00
	CMK	Construction master keyed single cylinder locks — <b>⊗ Keys sold separately</b>	27.00
<b>L</b>		Keying for exit device or removable mullions less conventional cylinder	Deduct 30.00
<b>Interchangeable Core Cylinders</b>			
<b>T</b>		Keying for exit device or removable mullions with keyed temporary SFIC construction core Keying for exit trim with keyed temporary SFIC construction core (cores may be returned for a full refund) — <b>⊗ Keys sold separately</b>	58.00
<b>J</b>		Keying for exit device or removable mullions with disposable plastic SFIC construction core	N/C
<b>C</b>		Keying for exit device or removable mullions with combined SFIC core installed at factory <sup>1</sup> Keying for exit trim with combined core installed at factory; BA (default), BB, BC, BD, BE, BF, BG, BH, BJ, BK, BL, BM, BQ, D100 keyway — <b>⊗ Keys sold separately</b>	65.00
<b>G</b>		Schlage LFIC — Housing with keyed temporary Schlage LFIC construction core (Core may be returned for full refund) — <b>⊗ Keys sold separately</b>	58.00
<b>F</b>		Schlage LFIC — Housing with combined Schlage LFIC installed at the factory (SC keyway) — <b>⊗ Keys sold separately</b>	65.00
<b>Cylinder Housings Less Cores</b>			
<b>R</b>		Housing prepared for Schlage FSIC	13.00
<b>X7</b>		Housing prepared for Sargent XC 7P and Arrow Choice 7P SFIC	13.00
<b>X6</b>		Housing prepared for Arrow Choice 6P SFIC	13.00

1. For uncombined cores, **UNC** cores must be ordered separately, see **Cylinders, Keys & Keying**. Exits/trim will be supplied w/ plastic construction core, Option J.

⊗ Denotes keys must be ordered separately.

### Cut Keys Ordered Separately

Part #	Description	List \$
45101	SFIC Cut key — Change key, master key, construction master key, or control key; BA, BB, BC, BD, BE, BF, BG, BH, BJ, BK, BL, BM, BQ, SC, SE keyways	11.00
45401	SFIC Cut key — Change key, master key, or control key; D100 keyways — D100 etc.	17.00
45404	CONV/LFIC Cut key — 1 bit key for operating 1 bit cylinders — SC, SE keyways	9.00
45405	LFIC Cut key — 1 bit control key (to install/remove "0-bit" LFIC cores) — SC keyway	9.00
44101SC	CONV/LFIC Key blank — SC keyway	6.00
44104SC	LFIC Key blank — Control key (to install/remove LFIC Cores) — SC keyway	8.00

**NOTES:**

- Distribution of DORMA SKC keys (listed as D100) is restricted. See Cylinders, Keys & Keying section for DORMA SKC policies.
- For additional information, please refer to Cylinders, Keys, and Keying
- See Keys and Key Blanks section for complete list.

## Mullions

Item	Description	List \$
<b>Aluminum Mullions × 628 (clear anodized), 1-5/8" × 2-5/8"</b>		
1310-8	8'	1,303.00
1310-8 × 443	8', recessed strike	1,519.00
WS1310-8	8', weatherstrip	1,387.00
WS1310-8 × 443	8', weatherstrip and recessed strike	1,534.00
1310-10	10'	1,387.00
1310-10 × 443	10', recessed strike	1,665.00
WS1310-10	10', weatherstrip	1,519.00
WS1310-10 × 443	10', weatherstrip and recessed strike	1,759.00
<b>Aluminum Mullions × 695 (painted), 1-5/8" × 2-5/8"</b>		
1310-8	8'	1,582.00
1310-8 × 443	8', recessed strike	1,792.00
WS1310-8	8', weatherstrip	1,665.00
WS1310-8 × 443	8', weatherstrip and recessed strike	1,893.00
1310-10	10'	1,712.00
1310-10 × 443	10', recessed strike	1,940.00
WS1310-10	10', weatherstrip	1,826.00
WS1310-10 × 443	10', weatherstrip and recessed strike	1,842.00
<b>Steel Mullions × 600 (primed for paint), 1-1/2" × 2-1/2"</b>		
1330-8	8'	655.00
1330-10	10'	687.00
<b>Steel Mullions × 600 (primed for paint), 2" × 3"</b>		
1300-8	8'	849.00
F1300-8	8', fire-rated	1,094.00
F1300-10	10', fire-rated	1,459.00
1340KR-8	8', key removable (includes standard cylinder using 01 cam)	1,435.00
F1340KR-8	8', fire-rated mullion, key removable (includes standard cylinder using 01 cam)	1,681.00
F1340KR-10	10', fire-rated mullion, key removable (includes standard cylinder using 01 cam)	1,968.00
1300-10	10', fire-rated	979.00
1340KR-EL	8', key removable, electrified mullion	1,665.00
1340KR-10	10', key removable (includes standard cylinder using 01 cam)	1,519.00
1340KR-EL-10	10', key removable, electrified mullion	1,746.00
HC1300-8	8', design pressure rated 80PSF for openings up to 8' × 8' with HC9300 device.	1,582.00
<b>Mullion Storage Kit</b>		
1340SK	Storage kit for 1340/F1340 Series key removable mullion.	427.00

### Cylinders for 1340KR/F1340KR Mullions and 1340SK Storage Kit

Type	Standard	7-pin IC	Cam
Mortise	90X01SC118	97D01BA138	01 (AR)

# DKPS Power Supply Series

## Ordering Guide



### DKPS Power Supply Series

Item	Description	List \$
DKPS-2A	110 V/2.0 A @ 24 VDC filter/reg, class 2 selectable output	764.00
DKPS-4A	110 V/4.0 A @ 24 VDC filter/reg, class 2 selectable output, (2) 2.0 A or (1) 4.0 A	1,386.00
DKPS-6A	110 V/6.0 A @ 24 VDC filter/reg, class 2 selectable output, (3) 2.0 A or (1) 6.0 A	1,668.00
PS502RF-220	220V/1.0 A @ 24 VDC filter/reg, class 2 selectable output	761.00

### DKPS Series Specifications

Features	DKPS-2A	DKPS-4A	DKPS-6A
Enclosure dimensions	Metric 338mm X 448mm X 110mm, Standard 13-5/16" X 17-41/64" X 4-21/64"		
UL294, CAN/ULC -60839-11-1	Y	Y	Y
CAN/ULC-S533, CE, FCC	Y	Y	Y
Input Requirements	100-240VAC, 50-60Hz. 2.4A Max draw	100-240VAC, 50-60Hz. 1.8A Max draw	100-240VAC, 50-60Hz. 2.5A Max draw
Output Performance	2.5 Amps continuous supply current at Nominal 12/24 VDC	4 Amps continuous supply current at Nominal PF 0.6 at nominal 12/24 VDC	6 Amps continuous supply current at Nominal PF 0.6 at nominal 12/24 VDC
Battery Back-Up Charger (ordered separately)	Standard	Standard	Standard
Keyed Cabinet	Standard (Keyed alike)	Standard (Keyed alike)	Standard (Keyed alike)
LED Power Status Indicator	Standard	Standard	Standard
Fire Alarm Termination	Standard	Standard	Standard
Power Distribution Board	4 Outputs	8 Outputs	8 Outputs
Warranty	Limited Lifetime		

## DKPS Power Supply Series

### Ordering Guide

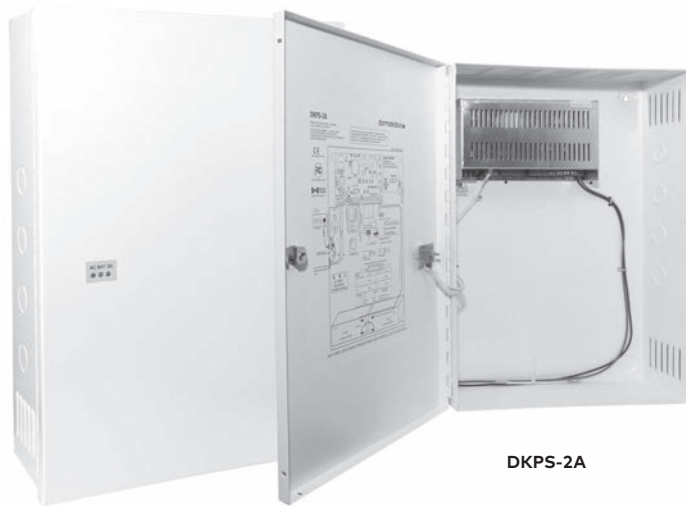

DKPS-2A

#### Options

Item	Description	List \$
BB12-4	4.5 Ahr battery backup for 12 V	71.00
BB12-7	7 Ahr battery backup for 12 V	110.00
BB24-4	4.5 Ahr battery backup for 24 V	142.00
BB24-7	7 Ahr battery backup for 24 V	216.00

**Power Supplies for Use with Exit Devices**

Item	Description	List \$
ES100	110 V/24 VDC, 6 A surge, 0.65 A continuous per zone. Use with delayed egress (DE) exit device or LFSC/LFSF electrified exit device trim.	856.00
PS501	110 V/36 VDC, 14-18 A surge, 2 A continuous per zone. Use with solenoid latch retraction (ES) exit devices (UL requirement)	1006.00
AD100	220 V/24 VDC, 6 A surge, 0.65 A continuous per zone. Use with solenoid latch retraction (ES) exit devices (UL requirement)	1006.00
PS406BB*	Power supply with battery backup solenoid latch retraction	1,435.00

**Note:** PS406BB can only be used with latch retraction option

**Power Supply Options for Use with Exit Devices**

Item	Description	List \$
ES101	Delay module (ES100 only)	188.00
ES103	Relay module (ES100 only)	119.00
ES105	Power transfer (recommended for ES and DE option)	288.00
ES2	Power card (PS501 only), powers an additional 2 devices (4 total)	548.00

## Electric Strikes, Electromagnetic Locks & Shear Locks

**After careful consideration, beginning July 2023, all electric strike and electromagnetic lock products will be available via dormakaba RCI Electronic Locking Hardware.**

**This change will provide customers with access to electronic controls such as electric strikes and electromagnetic locks but also a robust product offering including power supplies, switches, specialty locks, readers and credentials found within the dormakaba RCI product line.**

**Contact your dormakaba sales representative for further details or to inquire about sales enablement.**





# AC Series

**Available Items**

**AC200 Keypads**

Item	Description	List \$
AC217 630	Keypad, Indoor 120 user code, satin stainless face plate	609.00
AC217 605	Keypad, Indoor 120 user code, bright brass face plate	778.00
AC225 630	Keypad, Outdoor, 480 user code, satin stainless face plate	886.00



AC217



AC225



## Red Mushroom Push Buttons

### Available Items

Item	Color	Label	Diameter	Faceplate	Switch	Faceplate Finish	List \$
PB RE2 MA 628	Red	Exit	1-9/16"	Narrow	Maintained	Brushed Aluminum	218.00
PB RE2 MO 628	Red	Exit	1-9/16"	Narrow	Momentary	Brushed Aluminum	218.00
PB RE2 MA 710	Red	Exit	1-9/16"	Narrow	Maintained	Dark Bronze	218.00
PB RE2 MO 710	Red	Exit	1-9/16"	Narrow	Momentary	Dark Bronze	218.00
PB EP0 PA 630	Red	Push to exit	1-5/8"	Narrow	Momentary with pneumatic time delay	Satin Stainless	650.00
PB RE3 MA 628	Red	Exit	1-9/16"	Single Gang	Maintained	Brushed Aluminum	218.00
PB RE3 MO 628	Red	Exit	1-9/16"	Single Gang	Momentary	Brushed Aluminum	218.00
PB RE3 MA 710	Red	Exit	1-9/16"	Single Gang	Maintained	Dark Bronze	218.00
PB RE3 MO 710	Red	Exit	1-9/16"	Single Gang	Momentary	Dark Bronze	218.00
PB E03 MA 628	Red	Exit	2-3/8"	Single Gang	Maintained	Brushed Aluminum	253.00
PB E03 MO 628	Red	Exit	2-3/8"	Single Gang	Momentary	Brushed Aluminum	253.00
PB E03 MA 710	Red	Exit	2-3/8"	Single Gang	Maintained	Dark Bronze	253.00
PB E03 MO 710	Red	Exit	2-3/8"	Single Gang	Momentary	Dark Bronze	253.00
PB EP3 PA 630	Red	Push to exit	1-5/8"	Single Gang	Momentary with pneumatic time delay	Satin Stainless	600.00

### Accessories

Item	Description	List \$
TD-ADJ	Field Selectable Timer — 0-30 seconds — wire inline	128.00
TD-FIX	Fixed Timer — 30 seconds — wire inline	128.00
SBX	Surface mounting box, single gang — PBBH2 MO 630 SBX	87.00

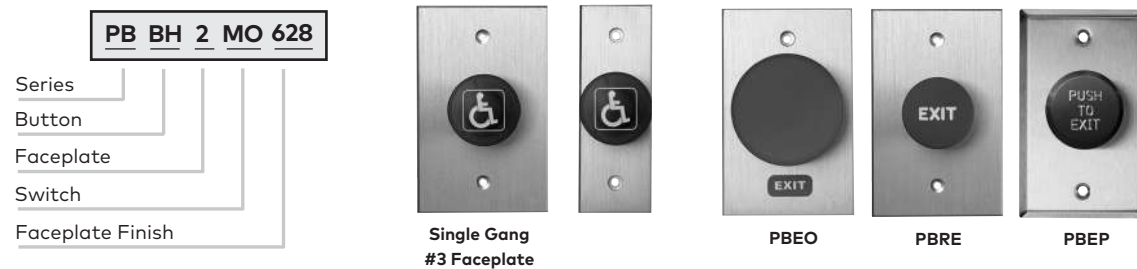

# Blue Mushroom Push Buttons

### Available Items

Item	Color	Label	Diameter	Faceplate	Switch	Faceplate Finish	List \$
PB BH2 MA 628	Blue	Handicap	1-9/16"	Narrow	Maintained	Brushed Aluminum	218.00
PB BH2 MO 628	Blue	Handicap	1-9/16"	Narrow	Momentary	Brushed Aluminum	218.00
PB BH2 MA 710	Blue	Handicap	1-9/16"	Narrow	Maintained	Dark Bronze	218.00
PB BH2 MO 710	Blue	Handicap	1-9/16"	Narrow	Momentary	Dark Bronze	218.00
PB HP2 PA 630	Blue	Handicap	1-5/8"	Narrow	Momentary with pneumatic time delay	Satin Stainless	650.00
PB BH3 MA 628	Blue	Handicap	1-9/16"	Single Gang	Maintained	Brushed Aluminum	218.00
PB BH3 MO 628	Blue	Handicap	1-9/16"	Single Gang	Momentary	Brushed Aluminum	218.00
PB BH3 MA 710	Blue	Handicap	1-9/16"	Single Gang	Maintained	Dark Bronze	218.00
PB BH3 MO 710	Blue	Handicap	1-9/16"	Single Gang	Momentary	Dark Bronze	218.00
PB HO3 MA 628	Blue	Handicap	2-3/8"	Single Gang	Maintained	Brushed Aluminum	253.00
PB HO3 MO 628	Blue	Handicap	2-3/8"	Single Gang	Momentary	Brushed Aluminum	253.00
PB HO3 MA 710	Blue	Handicap	2-3/8"	Single Gang	Maintained	Dark Bronze	253.00
PB HO3 MO 710	Blue	Handicap	2-3/8"	Single Gang	Momentary	Dark Bronze	253.00
PB HP3 PA 630	Blue	Handicap	1-5/8"	Single Gang	Momentary with pneumatic time delay	Satin Stainless	600.00

### Accessories

Item	Description	List \$
TD-ADJ	Field Selectable Timer — 0–30 seconds — wire inline	128.00
TD-FIX	Fixed Timer — 30 seconds — wire inline	128.00
SBX	Surface mounting box, single gang — PBBH2 MO 630 SBX	87.00

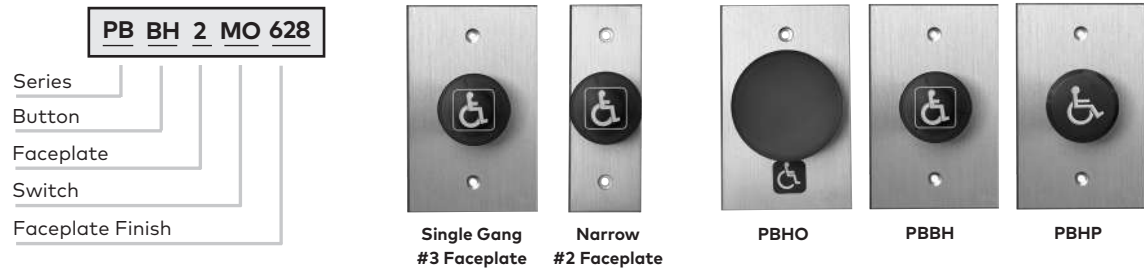

# Illuminated Push Buttons

## Available Items

Item	Button	Faceplate	Switch	Faceplate Finish	List \$
PB 731 MO 630	2" x 2" LED	Single Gang	Momentary	Brushed Stainless	83.00
PB 752 MO 628	1" x 1" LED	Narrow	Momentary	Brushed Aluminum	268.00
PB 752 MO 710	1" x 1" LED	Narrow	Momentary	Dark Bronze	268.00

## Accessories

Item	Description	List \$
TD-ADJ	Field Selectable Timer — 0-30 seconds — wire inline	128.00
TD-FIX	Fixed Timer — 30 seconds — wire inline	128.00
SBX	Surface mounting box, single gang — PB731 MO 630 SBX	87.00

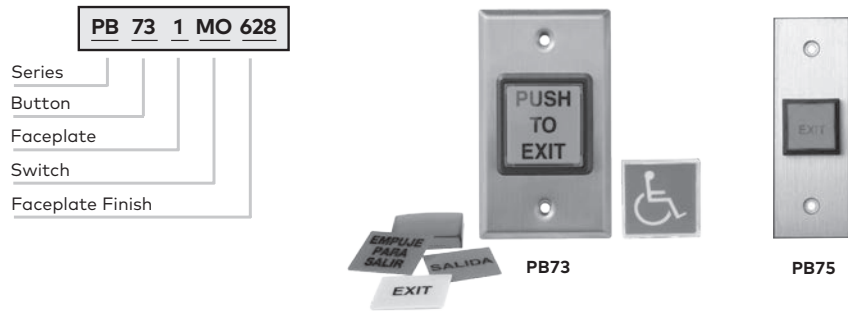

# Rotary/Key Release Switches

## Ordering Guide

**Faceplate Option**

**Style**

Red Key Release, 1-9/16" Dia — **KR<sup>1</sup>** — Aluminum, 628 or 710

Red Rotary, 1-3/4" Dia — **RR** — Stainless Steel, 630

**Mounting Box**

**SBX** — Surface Mount, Single Gang

**PB** **MA** **630**

Push-Button/Switch Actuator — **PB** Maintained — **MA**

**Series** **Switch Function** **Finish**

**628** — Clear Anodized Aluminum (PBRR only)

**630** — Satin Stainless (PBKR only)

**710** — Satin Anodized Dark Oxidized Bronze (PBRR only)



PBRR



PBKR

1. PBKR Key Switch uses a disc tumbler style cylinder. This style cylinder can NOT be configured into the building master key system.

Item	Description	630 Finish \$	628 Finish \$	710 Finish \$
<b>Red Rotary/Key Release Switches, 12/24 VDC</b>				
PBRR	1-3/4" Dia MA, 2A SPDT, rotary release, single gang aluminum	—	273.00	248.00
PBKR	1-9/16" Dia MA, 2A SPDT, key release, single gang stainless steel	273.00	—	—

## Mounting Box Options for PB Series

Item	Description	List \$
SBX	Surface Mount	87.00

# 39 Series Sounders

## Ordering Guide

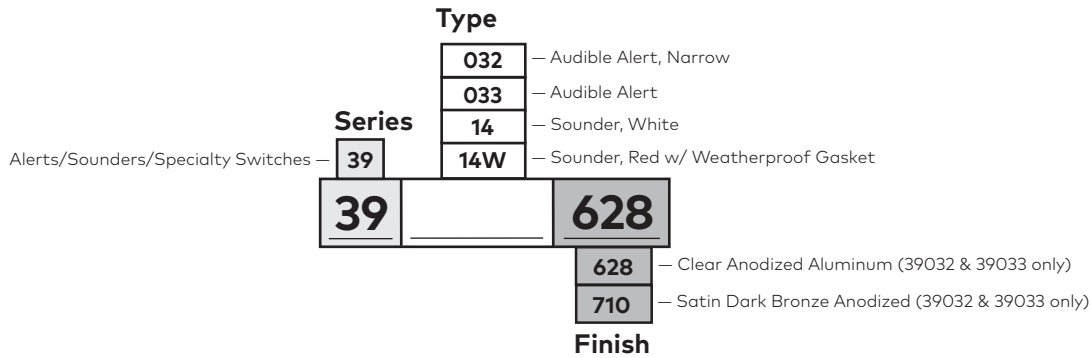

39032



39033



3914/3914W

## 39 Series Alerts/Sounders/Specialty Switches

Item	Description	630 Finish \$	628 Finish \$	710 Finish \$
<b>Alerts</b>				
39032	Audible alert, narrow	—	231.00	241.00
39033	Audible alert	—	231.00	241.00
<b>Sounders</b>				
3914	Sounder, red w/ weatherproof gasket	167.00	—	—
3914W	Sounder, white	167.00	—	—





# KS Series

## Ordering Guide

<b>Series</b>		<b>Timer Options<sup>2</sup></b>		<b>Key Switch Options</b>		<b>Mounting Box</b>	
Key Switch Actuator — <b>KS</b>		30 Sec Adjustable — <b>EA</b>	<b>L2</b> — 2 Bicolor LEDs (Red/Green)			<b>SBX</b> — Surface Mount, Single Gang	
		30 Sec Fixed — <b>EF</b>	<b>L1</b> — Bicolor LED (Red/Green)				
<b>KS</b>				<b>628</b>		<b>D XXXX</b>	
Narrow Aluminum <sup>1</sup> — <b>5</b>	<b>01</b> — MA SPDT			<b>628</b> — Clear Anodized Aluminum			<b>T</b> — Temporary SFIC
Single Gang Aluminum — <b>8</b>	<b>02</b> — MO SPDT			<b>710</b> — Satin Dark Bronze Aluminum			<b>J</b> — SFIC (Less Core)
<b>Faceplate Options</b>				<b>Finish</b>			
		<b>03</b> — MA DPDT					<b>C</b> — SFIC (With Core)
		<b>04</b> — MO DPDT					<b>L</b> — Less Cylinder
		<b>07</b> — 2 MO SPDT					<b>D</b> — Conventional Cylinder
		<b>08</b> — 1 MO SPDT/ 1 MA SPDT					<b>G</b> — Temporary Schlage LFIC
		<b>17</b> — 2 MO SPDT Reset/Bypass					<b>R</b> — Schlage LFIC (less core)
		<b>Switch Function</b>					
						<b>F</b> — Schlage LFIC	
						<b>X6</b> — Arrow Choice 6P SFIC (Less Core)	
						<b>X7</b> — Sargent XC 7P and Arrow Choice 7P SFIC (Less Core)	

**See Brochure  
for Keying  
Options**

1. Faceplate option 5 only available with switch functions **01** and **02**.
2. Timer options only available with switch function **02**.
3. List price includes default conventional cylinder.



**KS8 Single Gang Aluminum**



**KS5 Narrow Aluminum**

# KS Series Key Switches

Item	Description	List \$
<b>KS800 Series Single Gang Aluminum</b>		
KS801	MA SPDT	247.00
KS802	MO SPDT	247.00
KS 802 EA	MO SPDT, electronic timer, 1–30 sec adjustable	379.00
KS 802 EF	MO SPDT, electronic timer, 30 sec fixed	379.00
KS 803	MA DPDT	247.00
KS 804	MO DPDT	247.00
KS 503	MA DPDT	247.00
KS 504	MA DPDT	247.00
KS807	MO (2) SPDT	311.00
KS808	MO SPDT/MA SPDT	311.00
KS817	MO (2) SPDT, labeled Reset/Bypass	311.00
<b>KS500 Series Narrow Aluminum</b>		
KS501	MA SPDT	247.00
KS502	MO SPDT	247.00
KS502 EA	MO SPDT, electronic timer, 1–30 sec adjustable	379.00
KS502 EF	MO SPDT, electronic timer, 30 sec fixed	379.00
KS 502 PA	(2) SPDT, pneumatic timer, 2–60 sec adjustable	668.00

## Options

Item	Description	List Add \$
<b>Key Switch Options</b>		
L1	One (1) bicolor (red/green) LED added to faceplate	33.00
<b>Mounting Box Options</b>		
SBX	Surface mount, single gang	87.00

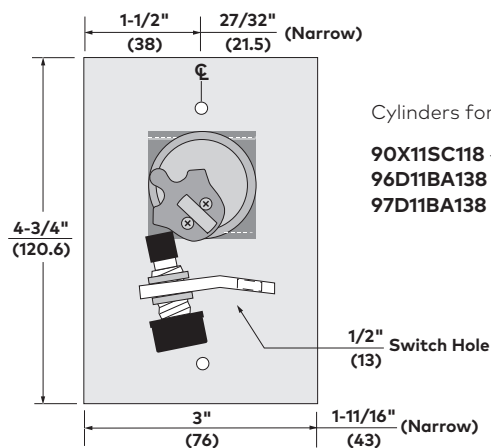

Cylinders for use with all single key switches:

- 90X11SC118** – 6-pin mortise
- 96D11BA138** – 6-pin SFIC mortise
- 97D11BA138** – 7-pin SFIC mortise

## Cylinder, Keying, and Keyway Options for KS Series

Cylinder	Option	Description	Examples	List Add/Deduct \$
<b>Conventional Cylinders (non-interchangeable core)</b>				
		Keying with conventional cylinder (default)	KS02628	
	<b>KD</b>	<b>Keyed differently to a random combination; SC keyway with 2 keys (default)</b>		N/C
	KA2	Keyed alike in pairs to a random combination; SC keyway with 2 keys		N/C
	NSK	Keyed alike, sets of three or more; SC keyway with 2 keys		21.00
	NS2	Keyed alike double cylinder locks; SC keyway with 2 keys		38.00
	1-Bit	Operated by 1-bit cut key; SC, SE keyway with 2 key blanks (order 1-bit key separately)		21.00
	0-Bit	Operated by 0-bit key; D100 keyway — <b>⊗ Keys sold separately</b>		21.00
	0-Bit	Operated by 0-bit cut key; AA, CA, CB, CC, CD, CE, RA, RB, GA, SF, YA, YG keyways with 2 key blanks		21.00
	MKD	Master keyed; SC, SE, or D100 keyway — <b>⊗ Keys sold separately</b>		26.00
	MK2	Master keyed double cylinder lock; SC, SE, or D100 keyway — <b>⊗ Keys sold separately</b>		50.00
	CMK	Construction master keyed single cylinder locks — <b>⊗ Keys sold separately</b>		28.00
	CM2	Construction master keyed double cylinder locks — <b>⊗ Keys sold separately</b>		55.00
<b>L</b>		Keying less conventional cylinder	KS02628L	Deduct 32.00
<b>Interchangeable Core Cylinders</b>				
<b>T</b>		SFIC — Housing with keyed temporary SFIC construction core (Core may be returned for a full refund) — <b>⊗ Keys sold separately</b>		62.00
<b>J</b>		SFIC — Housing with disposable plastic SFIC plug		N/C
<b>C</b>		SFIC — Housing with combined SFIC core installed at the factory <sup>1</sup> ; BA (default), BB, BC, BD, BE, BF, BG, BH, BJ, BK, BL, BM, BQ, D100 keyway — <b>⊗ Keys sold separately</b>		67.00
<b>G</b>		Schlage LFIC — Housing with keyed temporary Schlage LFIC construction core (Core may be returned for full refund) — <b>⊗ Keys sold separately</b>		62.00
<b>R</b>		<b>Schlage LFIC — Housing less core</b>		—
<b>F</b>		Schlage LFIC — Housing with combined Schlage LFIC installed at the factory (SC keyway) — <b>⊗ Keys sold separately</b>		67.00
<b>Cylinder Housings Less Cores</b>				
<b>R</b>		Housing prepared for Schlage LFIC		14.00
<b>X7</b>		Housing prepared for Sargent XC 7P and Arrow Choice 7P SFIC		14.00
<b>X6</b>		Housing prepared for Arrow Choice 6P SFIC		14.00

1. For uncombined cores, **UNC**, cores must be ordered separately.

⊗ Denotes keys must be ordered separately

### Cut Keys Ordered Separately

Item	Description	List \$
45101	SFIC Cut key — Change key, master key, construction master key, or control key; BA, BB, BC, BD, BE, BF, BG, BH, BJ, BK, BL, BM, BQ, SC, SE keyways	12.00
45401	SFIC Cut key — Change key, master key, or control key; D100 keyways — D100 etc.	18.00
45404	CONV/LFIC Cut key — 1-bit key for operating 1-bit cylinders — SC, SE keyways	10.00
45405	LFIC Cut key — 1-bit control key (to install/remove "1-bit" LFIC cores) — SC keyway	10.00
44101SC	CONV/LFIC Key blank — SC keyway	7.00
44104SC	LFIC Key blank — Control key (to install/remove LFIC Cores) — SC keyway	9.00

#### NOTES:

- Distribution of DORMA SKC keys (listed as D100) is restricted. See Cylinders, Keys & Keying section for DORMA SKC policies
- See Keys and Key Blanks section for complete list.

## Accessories

### Available Items

Item	Description	List \$
<b>Power Transfer</b>		
ES105	Power transfer conduit — satin chrome finish	287.00
<b>Flex Loops</b>		
3118 628	Loop, 18", surface mount flex, satin aluminum finish	57.00
3118 695	Loop, 18" flex, surface mount, less wires, dark bronze painted	83.00
3118 714	Loop, 18" flex, surface mount, less wires, white painted	83.00
3218 630	Loop, 18" flex, heavy duty, less wires, satin stainless	107.00
<b>Wired Hinges</b>		
		<b>STD</b> <b>DPS</b>
PTH4 626 / PTH4 DPS 626	Hinge, 4 wire power transfer, 4-1/2" x 4-1/2", satin chrome finish	407.00    538.00
PTH4 613 / PTH4 DPS 613	Hinge, 4 wire power transfer, 4-1/2" x 4-1/2", dark bronze finish	407.00    538.00
PTH4 605 / PTH4 DPS 605	Hinge, 4 wire power transfer, 4-1/2" x 4-1/2", bright brass finish	407.00    538.00
PTH6 626 / PTH6 DPS 626	Hinge, 6 wire power transfer, 4-1/2" x 4-1/2", satin chrome finish	639.00    605.00
PTH6 613 / PTH6 DPS 613	Hinge, 6 wire power transfer, 4-1/2" x 4-1/2", dark bronze finish	639.00    605.00
PTH6 605 / PTH6 DPS 605	Hinge, 6 wire power transfer, 4-1/2" x 4-1/2", bright brass finish	639.00    605.00
PTH10 626 / PTH10 DPS 626	Hinge, 10 wire power transfer, 4-1/2" x 4-1/2", satin chrome finish	659.00    675.00
PTH10 613 / PTH10 DPS 613	Hinge, 10 wire power transfer, 4-1/2" x 4-1/2", dark bronze finish	659.00    675.00
PTH10 605 / PTH10 DPS 605	Hinge, 10 wire power transfer, 4-1/2" x 4-1/2", bright brass finish	659.00    675.00
<b>Wired Pivots</b>		
75200 626 (standard)	Pivot, 3/4" offset intermediate, electrified, 8 wire, satin chrome finish	815.00
75200 605	Pivot, 3/4" offset intermediate, electrified, 8 wire, bright brass finish	815.00
75200 606	Pivot, 3/4" offset intermediate, electrified, 8 wire, satin brass finish	815.00
75200 611	Pivot, 3/4" offset intermediate, electrified, 8 wire, bright bronze finish	815.00
75200 612	Pivot, 3/4" offset intermediate, electrified, 8 wire, satin bronze finish	815.00
75200 613	Pivot, 3/4" offset intermediate, electrified, 8 wire, dark bronze finish	815.00
75200 619	Pivot, 3/4" offset intermediate, electrified, 8 wire, satin nickel finish	815.00
75200 625	Pivot, 3/4" offset intermediate, electrified, 8 wire, bright chrome finish	815.00
E80622 630 (Standard)	Pivot, center hung top, electrified, 2 wire, satin chrome finish	889.00
E80622 605	Pivot, center hung top, electrified, 2 wire, bright brass finish	889.00
E80622 606	Pivot, center hung top, electrified, 2 wire, satin brass finish	889.00
E80622 611	Pivot, center hung top, electrified, 2 wire, bright bronze finish	889.00
E80622 612	Pivot, center hung top, electrified, 2 wire, satin bronze finish	889.00
E80622 613	Pivot, center hung top, electrified, 2 wire, dark bronze finish	889.00
E80622 619	Pivot, center hung top, electrified, 2 wire, satin nickel finish	889.00
E80622 629	Pivot, center hung top, electrified, 2 wire, bright stainless finish	889.00
E80622 689	Pivot, center hung top, electrified, 2 wire, aluminum painted finish	889.00
E80622 695	Pivot, center hung top, electrified, 2 wire, dark bronze painted finish	889.00
E80624 630 (Standard)	Pivot, center hung top, electrified, 4 wire, satin chrome finish	889.00
E80624 605	Pivot, center hung top, electrified, 4 wire, bright brass finish	889.00
E80624 606	Pivot, center hung top, electrified, 4 wire, satin brass finish	889.00
E80624 611	Pivot, center hung top, electrified, 4 wire, bright bronze finish	889.00
E80624 612	Pivot, center hung top, electrified, 4 wire, satin bronze finish	889.00
E80624 613	Pivot, center hung top, electrified, 4 wire, dark bronze finish	889.00
E80624 619	Pivot, center hung top, electrified, 4 wire, satin nickel finish	889.00
E80624 629	Pivot, center hung top, electrified, 4 wire, bright stainless finish	889.00
E80624 689	Pivot, center hung top, electrified, 4 wire, aluminum painted finish	889.00
E80624 695	Pivot, center hung top, electrified, 4 wire, dark bronze painted finish	889.00

**Request to Exit Touch Bars (No latch assembly)**

Item	Description	628, 711	605, 629, 630
		Standard Finish \$	Plated Finish \$
MSD550	Exit touch bar with mechanical switch (power transfer required), 628 or 711 finish standard, optional plated finishes 605, 629, 630	553.00	881.00

**Timers/Relays**

Item	Description	List \$
14-2	7-day programmable timer with memory and battery back-up. Specify 12 or 24 V	580.00
TD-ADJ	0-30 second adjustable timer	129.00
TD-FIX	30 second fixed timer	129.00
TDM	Time delay module sequencer relay	353.00

**Desk Switches**

Item	Description	List \$
PD15-1	MA SPDT	262.00
PD15-2	MO SPDT	180.00
PD15-3	MA SPDT (Toggle)	313.00

**Desk Top Models for One or Two Doors**

Item	Description	List \$
CC401DTM	One Momentary (MO) switch and one LED	527.00
CC402DTM	Two Momentary (MO) switches and two LEDs	655.00
CC403DTM	One Momentary (MO) and one Maintained (MA) switch and two LEDs	787.00
CC402DTMA	Two Maintained (MA) switches and two LEDs	655.00

**Specialty Switches**

Item	Description	List \$
3909S MA	Rocker switch, maintained	98.00
3909S MO	Rocker switch, momentary	98.00
39043B	Emergency pull station, blue with red pull	269.00
39043Y	Emergency pull station, yellow with red pull	304.00

**Desk Top Models for One or Two Doors**

Item	Description	List \$
DPS11	Adjustable ball type SPDT, 5 amp	108.00
DPS112	Adjustable ball type 2 SPDT, 5 amp	162.00
MC4	Recessed magnetic	66.00
MC4M	Recessed magnetic mounted on plate	207.00
MC7	Biased high security recessed magnetic	162.00

**Passive Infrared Egress Control**

Item	Description	List \$
MS1RV1	Motion sensor (Requires PS1 RMT)	537.00
PS1RMT	Remote control for motion sensor	94.00
MD31DOW	Motion sensor with time delay — off white	537.00
MD31DB	Motion sensor with time delay — black	537.00

**Monitor Strikes**

Item	Description	List \$
MS12	Cylindrical latch monitor, 2-3/4" SPDT	295.00
MS12D	Cylindrical latch monitor, 2-3/4" DPDT	379.00
MS14	Cylindrical latch monitor, 4-7/8" SPDT	295.00
MS14D	Cylindrical latch monitor, 4-7/8" DPDT	379.00
MS16	Mortise lock latch monitor SPDT	295.00
MS16D	Mortise lock latch monitor DPDT	379.00
MS18	Mortise lock dead bolt monitor SPDT	295.00
MS18D	Mortise lock dead bolt monitor DPDT	405.00
MS20	Mortise lock latch and bolt monitor SPDT	379.00
MS20D	Mortise lock latch and bolt monitor DPDT	501.00

# ED900 Series Ordering Guide

**Mount/Arm**

	<b>T</b>	— Pull Side Track Mount, 0"-1" Reveal	
	<b>T275</b>	— Pull Side Track Mount, 1" - 2-3/4" Reveal	
	<b>J8</b>	— Push Side Top Jab Mount, 0-8" Reveal	<b>Options</b>
	<b>J12</b>	— Push Side Top Jamb Mount, 8-12" Reveal	<b>PC</b> — Power Cord
			<b>CB</b> — Conduit Box

  

Low Energy Swing Door Operator — <b>900</b>	<b>Model</b>		<b>Function</b>			
	<b>ED 900</b>	<b>PR</b>	<b>CMP</b>	<b>SW</b>	<b>689</b>	
Power Door Operator — <b>ED</b>	<b>Series</b>	<b>Application</b>	<b>Options</b>	<b>Cover</b>	<b>Painted Finish</b>	
	Pair of Doors 2 ED900s	Companion (Not Powered)	— Standard Width	<b>600</b> — Primed	<b>689</b> — Aluminum	Remote Key switch (628 finish) less cylinder
			<b>FWS</b> — Full Width, Sgl. Door, Seamless Cover	<b>689</b>	<b>690</b> — Statuary Bronze	
			<b>FW2</b> — Full Width, Sgl. Doors 2 piece cover	<b>691</b> — Dull Bronze	<b>693</b> — Black	
			<b>FWPRS</b> — Full Width, Pair of Doors, Seamless Cover	<b>693</b>	<b>695</b> — Dark Duranodic Bronze	
			<b>FWPR3</b> — Full Width, Pair of Doors, 3-Piece	<b>695</b>	<b>696</b> — Gold	
				<b>696</b>	<b>Custom</b> — Custom Painted Finish	
					<b>Designer</b> — Designer Painted Finish	

SW  
Standard Width 27"; Single Door

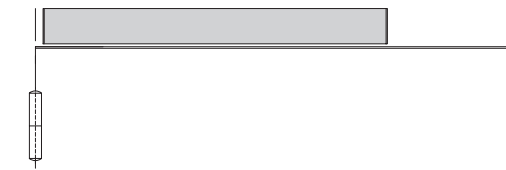

FWS  
Seamless Full Width Cover, Single Door, From 29" (737 mm) to 48" (1219 mm)

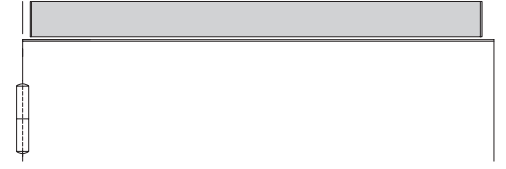

FW2  
Full Width Cover, 2-Pieces, Includes 27" SW Cover and extension cover up to 21" (533 mm).

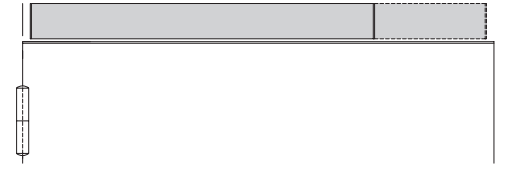

FWPRS  
Seamless Full Width Cover for Pair of Doors, From 56" (1422 mm) to 96" (2438 mm)

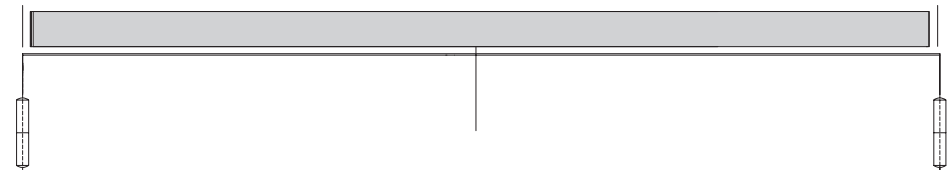

FWPR3  
Full Width Pair of Doors, includes two 27" Standard Width Covers, and extension cover to fill remaining opening, up to 35" (889 mm).

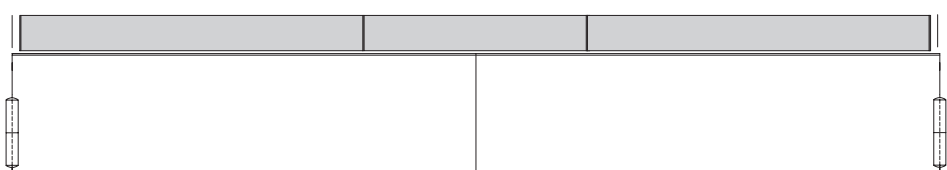

## ED900 Series Low Energy Operators

### Single Door Applications

Model	Arm	Mounting	List Add Painted \$
ED900	T	Pull-side, regular mount, track arm, 0"–1" reveal	8,236.00
ED900	T275	Pull-side, regular mount, track arm, 1"–2-3/4" reveal	8,459.00
ED900	J8	Push-side, top jamb mount, 0"–8" reveal, mechanical arm stop	8,236.00
ED900	J12	Push-side, top jamb mount, 8"–12" reveal, mechanical arm stop	8,459.00
<b>Covers</b>			
SW		Standard width cover, 27", included with ED900	N/C
FWS		Full width cover for single door (door widths from 29"–48"), double mode switch and cable included.	354.00
FW2		A 27" standard cover, with field cut cover and mounting plate, (door width up to 48"), seam concealer, double mode switch and cable included.	354.00

### Pair of Door Applications (Includes two ED900 Operators)

Model	Arm	Mounting	List Add Painted \$
ED900PR	T	Two ED900 operators, pull-side mount with track arms, 0"–1" reveal for pairs of doors	16,466.00
ED900PR	T275	Two ED900 operators, pull-side mount with track arms, 1"–2-3/4" reveal, for pairs of doors	16,928.00
ED900PR	J8	Two ED900 operators, push-side, top jamb mount arms, 0"–8" reveal, for pairs of doors	16,466.00
ED900PR	J12	Two ED900 operators, push-side, top jamb mount arms, 8"–12" reveal, for pairs of doors	16,928.00
ED900PRCMP	T	ED900 operator with manual door closer for second door, single full length cover, pull-side mount with track arms, 0"–1" reveal for pairs of doors	13,253.00
ED900PRCMP	T275	ED900 operator with manual door closer for second door, single full length cover, pull-side mount with track arms, 1"–2-3/4" reveal for pairs of doors	13,253.00
ED900PRCMP	J8	ED900 operator with manual door closer for second door, single full length cover, push-side, top jamb mount arms, 0"–8" reveal for pairs of doors	13,253.00
ED900PRCMP	J12	ED900 operator with manual door closer for second door, single full length cover, push-side, top jamb mount arms, 8"–12" reveal for pairs of doors	13,253.00
<b>Covers</b>			
SW		Two standard width covers, 27", for two ED900 operators	N/C
FWPRS		Seamless full width cover for pair of doors (door widths from 56"–96"), includes center mounting plate, control switch wiring harness, synchronizing cable, mode switch with cable, and power harness jumper.	728.00
FWPR3		Two 27" standard covers with field cut cover and mounting plate (door widths from 56"–96"), with seam concealers, control switch wiring harness, synchronizing cable, mode switch with cable, and power harness jumper.	728.00

**NOTE:** ED900 T, J8, J12 and ED900PR T, J8, J12 models include all axle extension 5/16" (9mm), 3/4" (20mm), 1-1/8" (30mm), and 2-3/8" (60mm).



## Options

Item	Description	List Add \$
<b>Special Finishes</b>		
Custom Color	Custom painted finish selected from DORMA RAL color pal book. For details, see DORMA Finishes Cross Reference, page viii.	
	Per operator, set-up charge <b>(Net)</b>	98.00
	Per operator, list add	90.00
Designer Color	Designer painted color matched to supplied samples. Three (3) each, 2" x 2" color chip samples required. For details, see DORMA Finishes Cross Reference, page viii.	
	Per operator, non-refundable development/set-up charge <b>(Net)</b>	348.00
	Per operator, list add	125.00
<b>Electrical Connection Options</b>		
CB	Conduit box (only)	94.00
PC	Power cord (includes conduit box and power cord)	178.00

## Accessories

Item	Description	List \$
<b>Hard Wired Switches and Accessories</b>		
WS1	Wall Switch — 6" square	422.00
WS 1 LOGO	Wall switch — with wheelchair logo only, 6" square	422.00
WS 1 SQ4	Wall switch, 4-1/2" square	467.00
WS 1 RND4	Wall switch, 4-1/2" round	467.00
WSTLS	Wall switch, touch-less sensor (available in white, gray, black)	717.00
FS 1	Frame switch, 1-3/4" x 4-1/2"	289.00
FS 1 LOGO	Frame switch with wheelchair logo only, 1-3/4" x 4-1/2"	289.00
UMB	Universal mounting box, for surface mounting WS-1, where no junction box is supplied	185.00
UMBFR	Universal mounting box flush mount ring, dress ring for WS-1	125.00
UMBRFT	Universal mounting box only, for 6" square WS/RFT 1 type switches (includes circuit board)	429.00

Item	Description	List \$
<b>RF Switches and Accessories</b>		
WSRFT 1	Wall switch – RF 300 MHz, 6" square	688.00
WSRFT 1 LOGO	Wall switch – RF 300 MHz, 6" square, with wheelchair logo only	688.00
WSRFT 1 433	Wall switch – RF 433 MHz, 6" square	673.00
WSRFT 1 433 SQ4	Wall switch – RF 433 MHz, 4-1/2" square	673.00
WSRFT 1 433 RND4	Wall switch – RF 433 MHz, 4-1/2" round	673.00
RFR	RF receiver, 300 MHz, 12 or 24 AC/DC (can be powered from ED900)	476.00
RFR 433	RF receiver, 433 MHz, 12 or 24 VAC/DC, 24AC (can be powered from ED900)	339.00
HHRFT 1 433	Hand held transmitter, 433 MHz	206.00
HHRFT 2 433	Hand held dual transmitter, 433 MHz	283.00
HHRFT 4 433	Hand held four button transmitter, 433 MHz	355.00
KCRFT 2 433	Key chain dual transmitter, 433 MHz	185.00
<b>Miscellaneous Accessories</b>		
SP1	Axle adaptor, zero extension	100.00
SP2	Axle adaptor, 3/4" (20mm) extension	100.00
SP3	Axle adaptor, 1-1/8" (30mm) extension	100.00
SP6	Axle adaptor, 2-3/8" (60mm) extension	116.00
SCRPK, ED900 Track	ED900 track arm, screwpack	21.00
970	Angle bracket	382.00
SCRPK900970	ED900 970 bracket, screwpack	21.00
930	Drop plate for arm shoe	101.00
SCRPK900930	930 drop plate, screwpack	21.00
BSTP25	Bumper/stop (1/4" thick plate)	108.00
BSTP50	Bumper/stop (1/2" thick plate)	108.00
BSTPSHM25	Bumper/stop shim, 1/4" thick	108.00
BSTPSHM50	Bumper/stop shim, 1/2" thick	108.00
BUMPER BLK	Bumper only	39.00
HEXKEY T	Hex key, 5mm, T-handle	28.00
DECAL ED900	Decal, ED900 door set	73.00
PRCONKIT96	Pair connection kit up to 96" opening width	270.00
TERMCONBD	Terminal Connection Board	123.00
T	Pull side track mount arm, 0"–1" reveal	389.00
T275	Pull side deep reveal track mount arm, 1"–2-3/4" reveal	607.00
J8	Push side top jamb mount arm, 0"–8" reveal	389.00
J12	Push side top jamb deep reveal mount arm, 8"–12" reveal	607.00
CAPSCOV5	Plastic endcaps/pinion cover	38.00

**ED50LE**

The ED50LE low energy swing door operator is easy to install and is the perfect solution for touch-free access applications, offering a true manual door closer experience.

This medium-duty swing door operator can automate new or existing manual swing doors with a wave plate (RCI 946T, 950T Series; 910TC Series or 912 Series), or other "knowing act" device. The ED50LE combines advanced automatic power assist, minimal push forces (as low as ANSI size 1) and reliable closing. Outswing or inswing doors can be adapted for touch-free access with push or pull arms suited to a wide variety of door usage options.

Item	Description	Finish	List \$
<b>ED50LE</b>			
7266003	34" Single Operator, PULL ARM	CL - Clear anodized	4,069.00
7266004	34" Single Operator, PULL ARM	DB - Dark bronze anodized	4,069.00
7266005	34" Single Operator, PUSH ARM	CL - Clear anodized	4,069.00
7266006	34" Single Operator, PUSH ARM	DB - Dark bronze anodized	4,069.00

**ED100LE**

The ED100LE low energy swing door operator is the perfect solution for touch free access applications, a versatile operator ideal for ADA-compliant applications.

This medium or heavy-duty swing door operator can automate new or existing manual swing doors with a wave plate (RCI 946T, 950T Series; 910TC Series or 912 Series) or other "knowing act" device. The ED100LE combines advanced power assist, reliable closing, and special firmware capabilities to help manage the combination of wind and building pressure. With a multitude of adjustable features, you have the flexibility to fine tune the operator to meet opening requirements.

Item	Description	Finish	List \$
<b>ED100LE</b>			
7265853	34" Single Operator, PULL ARM	CL - Clear anodized	7,100.00
7265854	34" Single Operator, PULL ARM	DB - Dark bronze anodized	7,100.00
7265855	34" Single Operator, PUSH ARM	CL - Clear anodized	7,100.00
7265856	34" Single Operator, PUSH ARM	DB - Dark bronze anodized	7,100.00

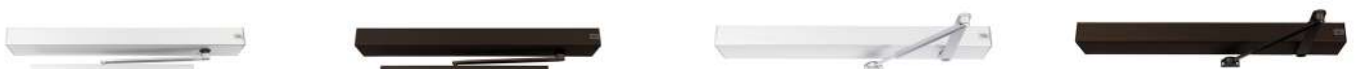



# Surface Closers

Product Guide (1 of 2)

SURFACE MOUNTED CLOSERS	Full Cover	Slimline Cover	No Cover
Grade 1 – Cam Action Fully Adjustable (Power) Size	TS93	—	—
Grade 1 – Heavy Duty Fully Adjustable (Power) Size	8900	—	—
	STA8900	—	—
Grade 1 – Fully Adjustable (Power) Size	8600 × FC/FMC/FCSL	8600 × COV	—
	STA8600 × FC/FMC/FCSL	STA8600 × COV	—
Grade 1 – Adjustable (Power) Size	7400 × FC/FCSL	7400 × COV	7400
	STA7400 × FC/FCSL	STA7400 × COV	STA7400
Grade 1 – Sized (Power) per Application	—	7300 × COV	7300

# Surface Closers

Product Guide (2 of 2)

<input type="radio"/> No	A156.4 Grade1	UL10C	Advanced Cam and Roller Design	Rack and Pinion Design	Stainless	Plated or Decorative Finishes	Standard Painted Finishes	Custom Painted Finishes	Adjustable Power	Fixed Power
TS93	Yes	Yes	Yes	<input type="radio"/>	<input type="radio"/>	Yes	Yes	Yes	Yes	<input type="radio"/>
8900	Yes	Yes	<input type="radio"/>	Yes	<input type="radio"/>	Yes	Yes	Yes	Yes	<input type="radio"/>
STA8900	Yes	Yes	<input type="radio"/>	Yes	Yes	Yes	Yes	Yes	Yes	<input type="radio"/>
8600	Yes	Yes	<input type="radio"/>	Yes	<input type="radio"/>	Yes	Yes	Yes	Yes	<input type="radio"/>
STA8600	Yes	Yes	<input type="radio"/>	Yes	Yes	Yes	Yes	Yes	Yes	<input type="radio"/>
7400	Yes	Yes	<input type="radio"/>	Yes	<input type="radio"/>	Yes	Yes	Yes	Yes	<input type="radio"/>
U1500	Yes	Yes	<input type="radio"/>	Yes	<input type="radio"/>	<input type="radio"/>	Yes*	<input type="radio"/>	Yes	<input type="radio"/>
7300	Yes	Yes	<input type="radio"/>	Yes	<input type="radio"/>	<input type="radio"/>	Yes	Yes	<input type="radio"/>	Yes
GSR	Yes	Yes	Yes	<input type="radio"/>	<input type="radio"/>	Yes	Yes	Yes	Yes	<input type="radio"/>

\* 689 and 695 only.

# TS93 Series Ordering Guide

Arm Type		Fastener Pack		Painted	
171°-180° Pocket Mount left handed	TPKT180L	SN3	Sex Nuts for 1-3/8" Door	PNT	Special Sprayed Finish (must specify)
171°-180° Pocket Mount right handed	TPKT180R	SN4	Sex Nuts for 1-3/4" Door	696	Gold
120°-170° Pocket Mount left handed	TPKT170L			695	Dark Duranodic Bronze
120°-170° Pocket Mount right handed	TPKT170R			693	Black
90°-119° Pocket Mount	TPKT119			691	Dull Bronze
90° Pocket Mount	TPKT90			690	Statuary Bronze
Track hold open, pull side frame mounted heavy-duty spring cushion	STH			689	Aluminum
Track hold open, push side soffit mounted	PTH			600	Primed
Track hold open, pull side frame mounted	TH				
Track, push side soffit mounted heavy-duty spring cushion	SPT				
Track, pull side frame mounted heavy-duty spring cushion	ST				
Track, push side soffit mounted	PT				
Track, pull side frame mounted	T				

<b>TS93</b>	<b>15</b>	<b>T</b>	<b>SN3</b>	<b>CS*</b>	<b>689</b>
Model	Spring Size			Cushion Stop	Architectural Finish
	56 - Size 5-6				605 - Bright Brass
					630 - Satin Stainless

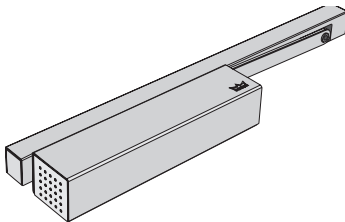

\* Available for use with T, TH, PT, PTH arms only.

**NOTES:**

- All combinations of features and options are not available for all models.
- Please refer to TS93 Series product brochure for details.

Body	Arm	Mounting	Painted Finish \$	605/630 \$
<b>Slide Track Non-Hold Open</b>				
TS9315, TS9356	T	Door mounted (pull side)	818.00	1,355.00
	PT	Soffit mounted (push side)	818.00	1,355.00
<b>Slide Track Hold Open</b>				
TS9315, TS9356	TH	Door mounted (pull side)	858.00	1,397.00
	PTH	Soffit mounted (push side)	858.00	1,397.00
<b>Slide Track Non-Hold Open w/Spring Cushion</b>				
TS9315, TS9356	ST	Door mounted w/ stop (pull side)	1,177.00	1,776.00
	SPT	Soffit mounted w/ stop (push side)	1,177.00	1,776.00
<b>Slide Track Hold Open w/Spring Cushion</b>				
TS9315, TS9356	STH	Door mounted w/ stop (pull side)	1,221.00	1,820.00

**NOTE:** S-track (stop) units ordered in 630 finish are furnished as a combination of 619 and 630 finish components.

Body	Arm	Mounting	Painted Finish \$
<b>90° Slide Track/Pocket Pivot Applications</b>			
TS9356	TPKT90	90° track application less pocket pivots For nonfire-rated applications, order (3 ea.) plated finish 75520 pocket pivots, separately For 3-hour fire-rated applications, order (3 ea.) plated finish 75523 pocket pivots, separately	878.00
<b>90°-180° Slide Track/Pocket Pivot Applications</b>			
TS9356	TPKT119	90° to 119°, offset pivots or hinges, closer on door, track in pocket. Order EM504 electromagnet separately.	1,059.00
	TPKT170	120° to 170°, closer on wall in pocket, track on door, right handed. Order EM504 electromagnet separately.	1,120.00
	TPKT180L	171° to 180°, closer on wall in pocket, track on door, left handed. Order EM504 electromagnet separately.	1,174.00
	TPKT180R	171° to 180°, closer on wall in pocket, track on door, right handed. Order EM504 electromagnet separately.	1,174.00



## Options

(List Price 'add' when ordered with complete closer)

Item	Description	List Add/Deduct \$
CS	Cushion stop/bumper to help slow door in normal opening cycle (for T, TH, PT, PTH arms only)	57.00
SN4	(4) each 10-32 aluminum sex nuts for 1-3/8" door	N/C
LSN	Less sex nuts (less SN3 pack)	Deduct 5.00
Custom Color	Custom painted finish selected from RAL color pallet book. For details, see <b>Finishes Cross Reference</b> , page viii.	
	per order, setup charge <b>(Net)</b>	165.00
	per closer, list add	55.00
Designer Color	Designer painted color matched to supplied samples. Three (3) each 2" x 3" color chip samples required. For details, see <b>Finishes Cross Reference</b> , page viii.	
	per order, non-refundable development/ setup charge <b>(Net)</b>	398.00
	per closer, list add	55.00

### NOTES:

- Painted finish price includes full metal cover with plastic end caps.
- Specify closer and arm designation and finish when ordering
- TS93 packaged (2) units per master carton.
- SN3 sex nuts and (DA) delayed action is standard with all TS93 closers.

# 8900 Series

## Ordering Guide

Spring Size		Body Cover		Accessory Plates		Other Accessories		
Adjustable 1-6	16		Full Plastic	FC	Drop Plate	DP89	AB89 - Angle Bracket	
Fixed Size 7	07	TANDEM	Full Plastic Slotted	FCSL	Back Plate	BP89	NFHD - Narrow Frame Bracket, Heavy Duty	
Adjustable 5-6	56	DA	Full Metal Cover	FMC**			FTHD - Flush Transom Bracket, Heavy Duty	
							BS - Blade Stop Spacer	
							BSDH - Blade Stop Heavy Duty	
<b>Series</b>	<b>8900</b>	<b>89</b>	<b>16</b>	<b>AF89</b>	<b>FC</b>	<b>SN1</b>	<b>689</b>	
	Flat Form Non-Hold Open, Tri-Pack	AF89P	PFT	PA Transom	SN2	TX89	605	Polished Brass
	Flat Form Non-Hold Open, TJ 4"-8" Reveal	AF89J	PD	Drop Bracket	SN1	SNDPK	606	Satin Brass
	Flat Form Non-Hold Open, Reg./TJ 0"-4" Reveal	AF89	MJ*	Mortise Jamb	Fastener Pack Sex Nuts 1-3/8" Sex Nuts 1-3/4"		611	Polished Bronze
	Flat Form Non-Hold Open With Mortise Jamb Bracket	AF8MJ	PA Bracket		DPK89	Self-Drilling	612	Satin Bronze
	Flat Form Non-Hold Open, Rigid Regular Mount	RRA			SNTPK	Std. and Self-Tapping	613	Oxidized Satin Oil Rubbed Bronze
	Friction Hold Open, Tri-Pack	FHP			TPK89	Self-Tapping	618	Polished Nickel
	Friction Hold Open, TJ 4"-8" Reveal	FHJ			Arm Fastener Pack		619	Satin Nickel
	Friction Hold Open, Reg./TJ 0"-4" Reveal	FH			Plated		625	Polished Chrome
	Plunger Hold Open, Parallel Arm (TJ 1-1/2"-3-1/2" Reveal)	PHP			Painted		626	Satin Chrome
	Plunger Hold Open, Reg./TJ 0"-1-1/2" Reveal	PH					600	Primed
	Heavy-duty Door Saver Cushion, Parallel	DS					689	Aluminum
	Heavy-duty Door Saver Cushion Thumb Turn Hold Open, Parallel	DST					690	Statuary Bronze
	Extra Heavy-duty Door Saver Spring Cushion, Parallel	SDS					691	Dull Bronze
	Heavy-duty Cushion, Reg./TJ 0"-3-1/2" Reveal	SDST					693	Black
	Extra Heavy-duty Spring Cushion Reg./TJ 0"-3-1/2" Reveal	IS					695	Dark Duranodic Bronze
	Extra Heavy-duty Spring Cushion Reg./TJ 0"-3-1/2" Reveal	ISH					696	Gold
	Heavy-duty Cushion, Top Jamb 3-1/2"-6-1/2" Reveal	SIS*					PNT	Special sprayed finish (must specify)***
	Heavy-duty Cushion, Top Jamb 3-1/2"-6-1/2" Reveal	SISH						
	Extra Heavy-duty Spring Cushion, Top Jamb 3-1/2"-6-1/2" Reveal	ISJ						
	Super Parallel Arm	ISJH						
	Super Parallel Arm Thumb Turn Hold Open	SISJ*						
	Track, Pull Side Door Mounted	SISJH						
	Jamb Track, Pull Side Frame Face Mounted	SPA						
	Push Track, Push Side Soffit Mounted	SPAT						
	Track Double Egress, Pull Side Transom Mounted	SPAS6						
	Track Hold Open, Pull Side Door Mounted	T						
	Push Track Hold Open, Push Side Soffit Mounted	JT						
	Flush Track Hold Open, Pull Side Frame Face Mounted	PT						
	Track Application, 90° Pocket Door (8956 only)	TDE						
	Double Lever Flat Form Arm, 90° Pocket Door (8907 only)	FT						
		FTH						
		TPKT90						
		AFPKT90						
		AFPKT180						
		<b>Arm Type</b>						

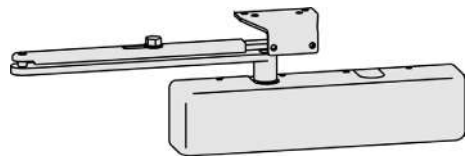

- NOTES:**
- All combinations of features and options are not available for all models. Please refer to 8900 product brochure for details.
  - Non-fire rated, 90TPK (90° pocket) applications require (3 ea.) 75520 pocket pivots, ordered separately.
  - Fire rated, 90 TPK (90° pocket) applications require (3 ea.) 75523 pocket pivots, ordered separately.

\*When used with flat form non-hold open arms, the MJ bracket must be used with a special length arm. Specify AF8MJ.  
 \*\*Optional 630 stainless satin finish with stainless base material only available for SIS/SISJ arms or FMC.  
 \*\*\*For optional dormakaba custom color or designer Color Finishes, contact Customer Service.  
 \*\*\*\* Only in combination with SPA arm and FMC.

Body	Arm	Mounting	Painted Finish \$	Plated Finish \$
<b>Non-Hold Open</b>				
8916, 8956	<b>AF89P</b>	<b>PA, REG &amp; TJ fpr reveals to 4" (flat)</b>	648.00	1,084.00
	AF89J	TJ for reveals 4" to 8" (flat)	643.00	1,009.00
	AF89	REG or TJ for reveals to 4" (flat)	637.00	1,002.00
	AF8MJ	REG with mortise jamb bracket (flat)	671.00	—
	RRA	REG, rigid regular mount arm (flat)	714.00	—
<b>Bumper or Spring Cushion</b>				
8916, 8956	DS	Heavy-duty door saver cushion parallel arm	720.00	1,163.00
	DST	w/thumb turn hold open	782.00	1,215.00
	SDS	Extra heavy-duty door saver spring cushion parallel arm	908.00	1,458.00
	SDST	w/thumb turn hold open	967.00	1,521.00
	IS	Heavy-duty cushion arm, REG and TJ for 0" to 3-1/2" reveal	894.00	1,304.00
	ISH	Heavy-duty cushion arm, w/ hold open REG and TJ for 0" to 3-1/2" reveal (not available on 8956)	959.00	—
	SIS	Extra heavy-duty spring cushion arm, REG and TJ for 0" to 3-1/2" reveal	959.00	1,481.00
	SISH	w/hold open, REG and TJ for 0" to 3-1/2" reveal (not available on 8956)	1,060.00	—
	ISJ	Heavy-duty cushion arm, TJ for 3-1/2" to 6-1/2" reveal	926.00	1,329.00
	ISJH	Heavy-duty cushion arm w/hold open, TJ for 3-1/2" to 6-1/2" reveal (not available on 8956)	989.00	—
	SISJ	Extra heavy-duty spring cushion arm, TJ for 3-1/2" to 6-1/2" reveal	1,029.00	1,512.00
	SISJH	w/hold open, TJ for 3-1/2" to 6-1/2" reveal (not available on 8956)	1,087.00	—
<b>Heavy Duty PA</b>				
8916, 8956	SPA	Super parallel arm	674.00	1,110.00
	SPAT	w/thumb turn hold open	736.00	1,163.00
	SPAS6	Super parallel arm w/ drop spacer	682.00	—
<b>Hold Open</b>				
8916, 8956	FHP	Friction PA, REG & TJ for reveals to 4"	695.00	—
	FHJ	TJ for reveals 4" to 8"	690.00	—
	FH	REG or TJ for reveals to 4"	686.00	—
	PHP	Plunger PA & TJ for reveals 1-1/4" to 3-1/4"	800.00	1,230.00
	PH	REG or TJ for reveals 0" to 1-1/4"	796.00	1,145.00

\* Available in 630 finish only and not intended for corrosive environments.

**NOTE:** Standard arm configuration is indicated in **bold**.

Body	Arm	Mounting	Painted Finish \$	Plated Finish \$
<b>Slide Track</b>				
8916, 8956	T	Door mounted (pull side)	690.00	1,110.00
	JT	Frame mounted (pull side)	690.00	1,110.00
	FT	Flush transom mounted (push side)	690.00	1,110.00
	PT	Soffit mounted (push side)	690.00	1,110.00
	TDE	Frame mounted double egress frame (pull side), specify hand	769.00	1,185.00
<b>Track Hold Open</b>				
8916, 8956	TH	Door mounted (pull side)	723.00	1,141.00
	JTH	Frame mounted (pull side)	723.00	1,141.00
	FTH	Flush transom mounted (push side)	723.00	1,141.00
	PTH	Soffit mounted (push side)	723.00	1,141.00
	TDEH	Frame mounted double egress frame (pull side), specify hand	799.00	1,222.00
<b>Pocket Applications</b>				
8956	TPKT90	Track application, 90 degree pocket door	690.00	1,110.00
8907	AFPKT90	Double lever flat form arm, 90 degree pocket door	690.00	1,125.00
	AFPKT180	Double lever flat form arm, 180 degree pocket door	690.00	1,178.00



# Options

Item	Description	List Add/Deduct \$
DA	Adjustable delayed action (suffix to model)	47.00
FCSL	Full plastic slotted cover (low ceiling conditions)	N/C
FMC	Full metal cover (handed for TJ or T [FMCL/FMCR])	12.00
FMCLL	Full metal cover, lead lined. Handed & non-handed.	145.00
SN2	(4) each 1/4-20 aluminum sex nuts for 1-3/8" thick door	N/C
LSN	Less sex nuts (less SN1 pack)	Deduct 5.00
DPK89	All fasteners to be self-drilling (in lieu of standard fasteners)	N/C
SNDPK	Standard fasteners and DPK89	17.00
TPK89	All fasteners to be self-tapping (in lieu of standard fasteners)	N/C
SNTPK	Standard fasteners and TPK89	17.00
TX89	All exposed fasteners to be Torx security fasteners (n/a with track applications)	38.00
TANDEM	Dual closer body system for extra heavy or wide doors or doors with difficult air handling conditions 8916 or 8956 (select one). SPA, FMC.	744.00
TANDEM	Dual closer body system for extra heavy or wide doors or doors with difficult air handling conditions. 8907, SPA, FMC.	778.00
Custom Color	Custom painted finish selected from RAL color pallet book. For details, see <b>Finishes Cross Reference</b> , page viii.	
	per order, setup charge (Net)	142.00
	per closer, list add	47.00
Designer Color	Designer painted color matched to supplied samples. Three (3) each 2" x 3" color chip samples required. For details, see <b>Finishes Cross Reference</b> , page viii.	
	per order, non-refundable development/setup charge (Net)	342.00
	per closer, list add	47.00

**NOTES:**

- All painted components w/plated line item will be painted complementary finish.  
**Example:** For a line item ordered w/plated 626 FMC only, all other components will be 689.
- Painted finish price includes full plastic cover.
- Plated finish price includes optional full metal cover.
- Specify closer and arm designation, hand (when required), finish, and options when ordering.  
 All spring cushion, heavy-duty PA, tracks, and top jamb (J) configurations packaged (4) units per master carton.
- All others are packaged (6) units per master carton.
- FMC is only cover available in plated finishes.
- Sex nuts for 1-3/4" door (SN1) furnished standard with all 8900 and included in price. Specify (SN2) for 1-3/8" door.

## Accessories

Item	Description	List \$
BP89	Backplate for top jamb with frame < 2-7/8" wide	44.00
DP89	Drop plate for PA where top rail is < 5-3/4"	44.00
AB89	Angle bracket for closer with full plastic cover	79.00
PFT	Parallel flush transom bracket	34.00
PD	Parallel drop bracket, non-hold open arms (AF89 only)	44.00
MJ  	Mortised jamb bracket, non-hold open arms (AF89 only)	32.00
BS	Blade stop spacer (P89, PHB, and PD)	32.00
BSHD	Blade stop spacer for use with heavy duty door saver and super parallel arms	35.00
NFHD	Narrow frame bracket for use with heavy duty door saver and super parallel arms	35.00
FTHD	Flush transom bracket for use with heavy duty door saver and super parallel arms	61.00

  When used with flat form non-hold open arms, the MJ bracket must be used with a special length arm. Specify AF8MJ for 8600 or 8900 Series closers.



# 8600 Series

## Ordering Guide

Series	Spring Size			Cover	Fastener Pack	Arm Fastener Pack	Finish
	8600	16	Delay - DA				
<b>86</b>	<b>16</b>		<b>AF86P</b>	<b>COV</b>	<b>SNB1</b>		<b>689</b>
Flat Form Non-Hold Open, Tri-Pack			<b>AF86P</b>	<b>COV</b> Slim Cover	<b>SNB1</b> Sex Nuts & Machine Screws, 1-3/4"	<b>AWS</b> All Wood Screws	
Flat Form Non-Hold Open, TJ 4"-8" Reveal			<b>AF86J</b>	<b>FC</b> Full Plastic	<b>SNB2</b> Sex Nuts & Machine Screws, 1-3/8"	<b>TX86</b> Torx Security Pack	
Flat Form Non-Hold Open With Mortise Jamb Bracket			<b>AF8MJ</b>	<b>FCSL</b> Full Plastic Slotted	<b>LSN</b> Less Sex Nuts	<b>SNTPK</b> Std. and Self-Tapping	
Flat Form Non-Hold Open, Reg./TJ 0"-4" Reveal			<b>AF86</b>	<b>FMC**</b> Full Metal Cover		<b>TPK86</b> Self-Tapping	
Round Arm Non-Hold Open, Tri-Pack			<b>ARP</b>			<b>SNDPK</b> Std. and Self-Drilling	
Round Arm Non-Hold Open, Narrow Profile, Reg./TJ 0"-4" Reveal			<b>ARNP</b>			<b>DPK86</b> Self-Drilling	
Round Arm Non-Hold Open, Reg. 4"-8" Reveal, Narrow Profile			<b>ARNPJ</b>			<b>COMBO</b> Wood/Machine Screw Combination	
Round Arm Non-Hold Open, Tri-pack, Narrow Profile			<b>ARNPP</b>				
Round Arm Non-Hold Open, TJ 4"-8" Reveal			<b>ARJ</b>				
Round Arm Non-Hold Open, TJ 0"-4" Reveal			<b>AR</b>				
Round Arm Secure Non-Hold Open, Tri-Pack			<b>AO8P</b>				
Round Arm Secure Non-Hold Open, Reg./TJ 0"-4" Reveal			<b>AO8</b>				
Friction Hold Open, Tri-Pack			<b>FHP</b>				
Friction Hold Open, TJ 4"-8" Reveal			<b>FHJ</b>				
Friction Hold Open, Reg./TJ 0"-4" Reveal			<b>FH</b>				
Plunger Hold Open, Parallel and TJ (1-1/2"-3-1/2" Reveal)			<b>PHP</b>				
Plunger Hold Open, Reg./TJ 0"-1-1/2" Reveal			<b>PH</b>				
Heavy-duty Door Saver Cushion Thumb Turn Hold Open, Parallel			<b>DS</b>				
			<b>DST</b>	<b>PFT</b> PA Flush Transom Bracket		<b>NFHD</b> Narrow Frame Bracket, Heavy Duty	<b>605</b> Polished Brass
			<b>SDS</b>	<b>PD</b> Drop Bracket		<b>FTHD</b> Flush Transom Bracket, Heavy Duty	<b>606</b> Satin Brass
Extra Heavy-duty Door Saver Spring Cushion Thumb Turn Hold Open, Parallel			<b>SDST</b>	<b>MJ*</b> Mortise Jamb		<b>BP86C</b> Conversion Plate	<b>611</b> Polished Bronze
Heavy-duty Cushion, Reg./TJ 0"-3-1/2" Reveal			<b>IS</b>	<b>Accessory Brackets</b>			<b>612</b> Satin Bronze
			<b>ISH</b>				<b>613</b> Oxidized Satin Oil Rubbed Bronze
Extra Heavy-duty Spring Cushion Reg./TJ 0"-3-1/2" Reveal			<b>SIS*</b>				<b>618</b> Polished Nickel
			<b>SISH</b>				<b>619</b> Satin Nickel
Heavy-duty Cushion, Top Jamb 3-1/2"-6-1/2" Reveal			<b>ISJ</b>				<b>625</b> Polished Chrome
			<b>ISJH</b>				<b>626</b> Satin Chrome
Extra Heavy-duty Spring Cushion, Top Jamb 3-1/2"-6-1/2" Reveal			<b>SISJ*</b>				
			<b>SISJH</b>				
Super Parallel Arm			<b>SPA</b>				
Super Parallel Arm Thumb Turn Hold Open			<b>SPAT</b>				
			<b>SPAS6</b>				
Track, Pull Side Door Mounted			<b>T</b>				
Jamb Track, Pull Side Frame Face Mounted			<b>JT</b>				
Push Track, Push Side Soffit Mounted			<b>PT</b>				
Track Double Egress, Pull Side Transom Mounted			<b>TDE</b>				
Flush Track, Push Side Transom Mounted			<b>FT</b>				
Track Hold Open, Pull Side Door Mounted			<b>TH</b>				
			<b>JTH</b>				
Push Track Hold Open, Push Side Soffit Mounted			<b>PTH</b>				
			<b>TDEH</b>				
Flush Track Hold Open, Push Side Transom Mount			<b>FTH</b>				

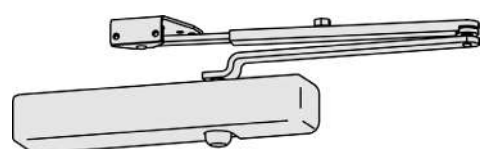

\*When used with flat form non-hold open arms, the MJ bracket must be used with a special length arm. Specify AF8MJ.  
 \*\* Optional 630 stainless satin finish with stainless base material only available for SIS/SISJ arms or FMC.

**NOTES:**

- All combinations of features and options are not available for all models. Please refer to 8600 Series product brochure for details.
- To simplify initial installation, a range of back plates (BPxx), drop plates (DPxx), brackets, and spacers are listed under 8600 Accessories in this section. Refer to 8600 Series product brochure for details.



Body	Arm	Mounting	Painted Finish \$	Plated Finish \$
<b>Non-Hold Open</b>				
8616	<b>AF86P</b>	<b>PA, REG and TJ for reveals to 4" (flat)</b>	515.00	1,002.00
	AF86J	TJ for reveals 4" to 8" (flat)	499.00	909.00
	AF86	REG or TJ for reveals to 4" (flat)	494.00	894.00
	AF8MJ	REG with mortise jamb bracket (flat)	525.00	—
	ARP	PA, REG and TJ for reveals to 4" (round)	497.00	950.00
	ARNP	Narrow profile, REG or TJ for reveals to 4" (round)	477.00	862.00
	ARNPJ	Narrow profile for reveals 4" to 8" (round)	448.00	806.00
	ARNPP	Narrow profile, PA, REG, TJ (round)	461.00	884.00
	ARJ	TJ for reveals 4" to 8" (round)	482.00	867.00
	AR	REG or TJ for reveals to 4" (round)	477.00	862.00
	AO8P	PA, REG and TJ secured elbow for reveals to 4" (round)	497.00	—
	AO8	REG or TJ secured elbow for reveals to 4" (round)	491.00	—
<b>Bumper or Spring Cushion</b>				
8616	DS	Heavy-duty door saver cushion parallel arm	601.00	1,065.00
	DST	w/ thumb turn hold open	671.00	1,131.00
	SDS	Extra heavy-duty door saver spring cushion parallel arm	787.00	1,391.00
	SDST	w/ thumb turn hold open	856.00	1,458.00
	IS	Heavy-duty cushion arm, REG and TJ for 0" to 3-1/2" reveal	778.00	1,205.00
	ISH	Heavy-duty cushion arm w/hold open, REG and TJ for 0" to 3-1/2" reveal	845.00	—
	SIS	Extra heavy-duty spring cushion arm, REG and TJ for 0" to 3-1/2" reveal	886.00	1,410.00
	SISH	w/ hold open, REG and TJ for 0" to 3-1/2" reveal	948.00	—
	ISJ	Heavy-duty cushion arm, TJ for 3-1/2" to 6-1/2" reveal	809.00	1,249.00
	ISJH	Heavy-duty cushion arm w/hold open, TJ for 3-1/2" to 6-1/2" reveal	878.00	—
	SISJ	Extra heavy-duty spring cushion arm, TJ for 3-1/2" to 6-1/2" reveal	918.00	1,447.00
	S-ISJH	w/ hold open, TJ for 3-1/2" to 6-1/2" reveal	982.00	—
<b>Heavy Duty PA</b>				
8616	SPA	Super parallel arm	540.00	1,018.00
	SPAT	w/ thumb turn hold open	608.00	1,086.00
	SPAS6	Super parallel arm w/ drop spacer	502.00	—
<b>Hold Open</b>				
8616	FHP	Friction PA, REG and TJ for reveals to 4"	579.00	—
	FHJ	TJ for reveals 4" to 8"	557.00	—
	FH	REG or TJ for reveals to 4"	551.00	—
	PHP	Plunger PA and TJ for reveals 1-1/2" to 3-1/2"	678.00	1,151.00
	PH	REG or TJ for reveals 0" to 1-1/2"	670.00	1,077.00
<b>Slide Track</b>				
8616	T	Door mounted (pull side)	557.00	1,004.00
	JT	Frame mounted (pull side)	557.00	1,004.00
	FT	Flush transom mounted (push side)	557.00	1,004.00
	PT	Soffit mounted (push side)	557.00	1,004.00
	TDE	Frame mounted double egress frame (pull side), specify hand	641.00	1,091.00

\* Available in 630 finish only and not intended for corrosive environments.

\* FMC is the only cover available in 630 finish

**NOTE:** Standard arm configuration is indicated in **bold**

Body	Arm	Mounting	Painted Finish \$	Plated Finish \$
<b>Track Hold Open</b>				
8616	TH	Door mounted (pull side)	592.00	1,126.00
	JTH	Frame mounted (pull side)	592.00	1,126.00
	FTH	Flush transom mounted (push side)	592.00	1,126.00
	PTH	Soffit mounted (push side)	592.00	1,126.00
	TDEH	Frame mounted double egress frame (pull side), specify hand	675.00	1,084.00

## Options

(List Price 'add' when ordered with complete closer)

Item	Description	List Add/Deduct \$
DA	Adjustable delayed action (suffix to model)	52.00
LCOV	Less slim plastic cover, Deduct	Deduct 15.00
FC	Full plastic cover	12.00
FCSL	Full plastic slotted cover (low ceiling conditions)	12.00
FMC	Full metal cover (handed for TJ or JT [FMCL/FMCR])	18.00
FMCLL	Full metal cover, lead lined. Handed & non-handed.	170.00
SNB2	(4) each 1/4-20 aluminum sex nuts and bolts for 1-3/8" door	N/C
LSN	Less sex nuts (less SN1 pack)	Deduct 5.00
AWS	All wood screws	15.00
DPK86	All fasteners to be self-drilling (in lieu of standard fasteners)	N/C
SNDPK	Standard fasteners and DPK86	18.00
TPK86	All fasteners to be self-tapping (in lieu of standard fasteners)	N/C
SNTPK	Standard fasteners and TPK86,	18.00
TX86	All exposed fasteners to be Torx security fasteners (n/a with track applications)	41.00

Item	Description	List Add/Deduct \$
Custom Color	Custom painted finish selected from RAL color pallet book. For details, see <b>Finishes Cross Reference</b> , page viii.	
	per order, setup charge (Net)	159.00
	per closer, list add	52.00
Designer Color	Designer painted color matched to supplied samples. Three (3) each 2" x 3" color chip samples required. For details, see <b>Finishes Cross Reference</b> , page viii.	
	per order, non-refundable development/setup charge ( <b>Net</b> )	379.00
	per closer, list add	52.00

**NOTES:**

- All painted components w/plated line item will be painted complementary finish. Example: For a line item ordered w/plated 626 FMC only, all other components will be 689.
- Painted finish price includes slim plastic cover.
- Plated finish price includes optional full metal cover.
- Specify closer and arm designation, hand (when required), and finish when ordering.
- All spring cushion, heavy-duty PA, tracks, and top jamb (J) configurations packaged (4) units per master carton.
- All others are packaged (6) units per master carton.
- FMC is only cover available in plated finishes.
- All 8600 closers standard with SNB1.
- T, TH, FT, FTH include backplate standard.
- 8600 Series closer prepared standard to accept COV, FC, FCSL, or FMC.

## Accessories

Item	Description	List \$
BP86	Backplate for closer with slim cover	48.00
BP86FC	Backplate for closer with full cover	48.00
BP86T	Backplate for slide track closer with slim cover	48.00
BP86TFC	Backplate for slide track closer with full cover	48.00
BP86FTFC	Backplate for flush transom slide track closer w/wo/cover or full cover	48.00
DP86	Drop plate for closer with slim cover	48.00
DP86FC	Drop plate for closer with full cover	48.00
BP86C	Backplate for conversion of 7600 Series to 8600 Series	48.00
AB86	Angle bracket for closer with slim cover	83.00
PFT	Parallel flush transom bracket	39.00
PD	Parallel drop bracket, non-hold open arms (AF86, AR, AO8 only)	50.00
MJ 	Mortised jamb bracket, non-hold open arms (AF86 only)	35.00
BS	Blade stop spacer (P86, PHB, and PD)	35.00
BSHD	Blade stop spacer for use with heavy duty door saver and super parallel arms	40.00
NFHD	Narrow frame bracket for use with heavy duty door saver and super parallel arms	40.00
FTHD	Flush transom bracket for use with heavy duty door saver and super parallel arms	67.00

 When used with flat form non-hold open arms, the MJ bracket must be used with a special length arm. Specify AF8MJ for 8600 or 8900 Series closers.

# 7400 Series

## Ordering Guide

Series	Spring Size		Delay - DA	Cover		Accessory Plates		Other Accessories				
	7400	14		COV	FC	DPXX	BPXX	ABXX	XXHD	PD	BS	BSHD
	74	14		ARP		COMBO						689
				ARP	SNB2	COMBO		600				
				ARJ	SNB1	DPK86		689				
				AR		CMBDPK		690				
				AO8P		TPK86		691				
				AO8		CMBTPK		693				
				FHP		TX86		695				
				FHJ		AWS		696				
				FH				PNT				
				DS								
				DST								
				SDS								
				SDST								
				IS								
				ISH								
				SIS								
				SISH								
				ISJ								
				ISJH								
				SISJ								
				SISJH								
				SPA								
				SPAT								
				T								
				JT								
				PT								
				TDE								
				FT								
				TH								
				JTH								
				PTH								
				TDEH								
				FTH								

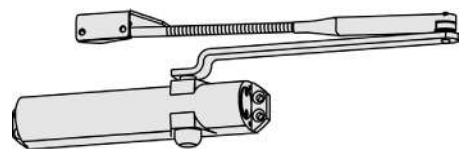

**NOTES:**

- All combinations of features and options are not available for all models. Please refer to 7400 Series product brochure for details.
- To simplify initial installation, a range of back plates (BPxx), drop plates (DPxx), brackets, and spacers are listed under 7400 Accessories in this section. Refer to 7400 Series product brochure for details.

Body	Arm	Mounting	Painted Finish \$
<b>Non-Hold Open</b>			
7414, 7436	<b>ARP</b>	<b>PA, REG &amp; TJ for reveals to 4" (round)</b>	347.00
	ARJ	TJ for reveals 4" to 8" (round)	339.00
	AR	REG or TJ for reveals to 4" (round)	334.00
	AO8P	PA, REG & TJ secured elbow for reveals to 4" (round)	348.00
	AO8	REG or TJ secured elbow for reveals to 4" (round)	334.00
<b>Bumper or Spring Cushion</b>			
7414, 7436	DS	Heavy-duty door saver cushion parallel arm	447.00
	DST	w/thumb turn hold open	516.00
	SDS	Extra heavy-duty door saver spring cushion parallel arm	652.00
	SDST	w/thumb turn hold open	717.00
	IS	Heavy-duty cushion arm, REG and TJ for 0" to 3-1/2" reveal	640.00
	ISH	Heavy-duty cushion arm w/hold open, REG and TJ for 0" to 3-1/2" reveal	707.00
	SIS	Extra heavy-duty spring cushion arm, REG and TJ for 0" to 3-1/2" reveal	747.00
	SISH	w/hold open, REG and TJ for 0" to 3-1/2" reveal	816.00
	ISJ	Heavy-duty cushion arm, TJ for 3-1/2" to 6-1/2" reveal	671.00
	ISJH	Heavy-duty cushion arm w/hold open, TJ for 3-1/2" to 6-1/2" reveal	741.00
	SISJ	Extra heavy-duty spring cushion arm, TJ for 3-1/2" to 6-1/2" reveal	782.00
	SISJH	w/hold open, TJ for 3-1/2" to 6-1/2" reveal	851.00
<b>Heavy Duty PA</b>			
7436	SPA	Super parallel arm	399.00
	SPAT	w/thumb turn hold open	467.00
<b>Friction Hold Open</b>			
7414, 7436	FHP	PA, REG & TJ for reveals to 4"	434.00
	FHJ	TJ for reveals 4" to 8"	417.00
	FH	REG or TJ for reveals to 4"	411.00
<b>Slide Track</b>			
7436	T	Door mounted (pull side)	417.00
	JT	Frame mounted (pull side)	417.00
	FT	Flush transom mounted (push side)	417.00
	PT	Soffit mounted (push side)	417.00
	TDE	Frame mounted double egress frame (pull side), specify hand	463.00
<b>Track Hold Open</b>			
7436	TH	Door mounted (pull side)	452.00
	JTH	Frame mounted (pull side)	452.00
	FTH	Flush transom mounted (push side)	452.00
	PTH	Soffit mounted (push side)	452.00
	TDEH	Frame mounted double egress frame (pull side), specify hand	498.00

**NOTE:** Standard arm configuration is indicated in **bold**.

## Options

(List Price 'add' when ordered with complete closer)

Item	Description	List Add \$
DA	Adjustable delayed action (suffix to model number)	52.00
COV	Slim plastic cover	28.00
FC	Full plastic cover	35.00
FCSL	Full plastic slotted cover (low ceiling conditions)	35.00
SNB1	(4) each 1/4-20 sex nuts and machine screws for 1-3/4" door	13.00
SNB2	(4) each 1/4-20 sex nuts and machine screws for 1-3/8" door	13.00
AWS	All wood screws	15.00
DPK86	All fasteners to be self-drilling fasteners (In lieu of combo screws)	N/C
CMBDPK	Standard and DPK86 fasteners	18.00
TPK86	All fasteners to be self-tapping fasteners (In lieu of combo screws)	N/C
CMBTPK	Standard and TPK86 fasteners	18.00
TX86	All exposed fasteners to be Torx security fasteners (n/a with track applications)	41.00
Custom Color	Custom painted finish selected from RAL color pallet book. For details, see <b>Finishes Cross Reference</b> , page viii.	
	per order, setup charge ( <b>Net</b> )	159.00
	per closer, list add	52.00
Designer Color	Designer painted color matched to supplied samples. Three (3) each 2" x 3" colorchip samples required. For details, see <b>Finishes Cross Reference</b> , page viii.	
	per order, non-refundable development/setup charge ( <b>Net</b> )	382.00
	per closer, list add	52.00

### NOTES:

- Standard price does not include cover.
- Specify closer and arm designation, hand (when required), and finish when ordering.
- All dead stop, heavy-duty PA, tracks, and top jamb (J) configurations packaged (4) units per master carton.
- All others are packaged (6) units per master carton.
- T, TH, FT, FTH include backplate standard.
- 7400 closers are not furnished to accept FC or FCSL unless specified at time of order.
- Sex nuts and bolts standard with cushion or dead stop arms and included in list price.

## Accessories

Item	Description	List \$
BP74	Backplate for 7400	48.00
BP74T	Backplate for 7400 slide track closer without cover	48.00
BP640C	Back plate to retrofit 9 1/16" hole spacing with 7400. Examples: DORMA 640, Norton 1600 or Yale 50.	11.00
BP86	Backplate for closer with slim cover	48.00
BP86T	Backplate for 7400 slide track closer with slim cover	48.00
BP86FC	Backplate for closer with full cover	48.00
DP74	Drop plate for 7400	48.00
DP86	Drop plate for closer with slim cover	48.00
DP86FC	Drop plate for closer with full cover	48.00
AB74	Angle bracket for 7400 without cover	83.00
AB86	Angle bracket for 7400 with slim cover	83.00
PFT	Parallel flush transom bracket	39.00
PD	Parallel drop bracket, non-hold open arms (AR, AO8 only)	50.00
BS	Blade stop spacer (P86, PHB, and PD)	35.00
BSHD	Blade stop spacer for use with heavy duty door saver and super parallel arms	40.00
NFHD	Narrow frame bracket for use with heavy duty door saver and super parallel arms	40.00
FTHD	Flush transom bracket for use with heavy duty door saver and super parallel arms	67.00

# 7300 Series

## Ordering Guide

Series	Spring Size			Cover		Finish	
	7300	05 — ANSI Size 5	04 — ANSI Size 4	COV	— Slim Cover	PNT	— Special Sprayed Finish (must specify)
		03 — ANSI Size 3			— No Cover	696	— Gold
						695	— Dark Duranodic Bronze
						693	— Black
						691	— Dull Bronze
						690	— Statuary Bronze
						689	— Aluminum
						600	— Primed
	<b>73</b>	<b>04</b>	<b>AR</b>			<b>COMBO</b>	<b>689</b>
Round Arm Non-Hold Open, Tri-Pack			<b>ARP</b>		<b>SNB2</b>	<b>COMBO</b>	— Default Fastener Pack
Round Arm Non-Hold Open, TJ 4"-8" Reveal			<b>ARJ</b>			<b>DPK86</b>	— Self-Drilling
Round Arm Non-Hold Open, Reg./TJ 0"-4" Reveal			<b>AR</b>		<b>SNB1</b>	<b>CMBDPK</b>	— Std. and Self-Drilling
Round Arm Secure Non-Hold Open, Tri-Pack			<b>AO8P</b>			<b>TPK86</b>	— Self-Tapping
Round Arm Secure Non-Hold Open, Reg./TJ 0"-4" Reveal			<b>AO8</b>			<b>CMBTPK</b>	— Std. and Self-Tapping
Friction Hold Open, Tri-Pack			<b>FHP</b>			<b>TX86</b>	— Torx Security Pack
Friction Hold Open, TJ 4"-8" Reveal			<b>FHJ</b>			<b>AWS</b>	— All Wood Screws
Friction Hold Open, Reg./TJ 0"-4" Reveal			<b>FH</b>				
Heavy-duty Door Saver Cushion, Parallel			<b>DS</b>				
Heavy-duty Door Saver Cushion Thumb Turn Hold Open, Parallel			<b>DST</b>				
Extra Heavy-duty Door Saver Spring Cushion, Parallel			<b>SDS</b>				
Extra Heavy-duty Door Saver Spring Cushion Thumb Turn Hold Open, Parallel			<b>SDST</b>				
Heavy-duty Cushion, Reg./TJ 0"-3-1/2" Reveal			<b>IS</b>				
			<b>ISH</b>				— Heavy-duty Cushion Hold Open, Reg./TJ 0"-3-1/2" Reveal
Extra Heavy-duty Spring Cushion, Reg./TJ 0"-3-1/2" Reveal			<b>SIS</b>				
			<b>SISH</b>				— Extra Heavy-duty Spring Cushion Hold Open, Reg./TJ 0"-3-1/2" Reveal
Heavy-duty Cushion, Top Jamb 3-1/2"-6-1/2" Reveal			<b>ISJ</b>				
			<b>ISJH</b>				— Heavy-duty Cushion Hold Open, Top Jamb 3-1/2"-6-1/2" Reveal
Extra Heavy-duty Spring Cushion, Top Jamb 3-1/2"-6-1/2" Reveal			<b>SISJ</b>				
			<b>SISJH</b>				— Extra Heavy-duty Spring Cushion Hold Open, Top Jamb 3-1/2"-6-1/2" Reveal
Super Parallel			<b>SPA</b>				
Super Parallel Thumb Turn Hold Open			<b>SPAT</b>				
Track, Pull Side Door Mounted			<b>T</b>				
Jamb Track, Pull Side Frame Face Mounted			<b>JT</b>				
Push Track, Push Side Soffit Mounted			<b>PT</b>				
Flush Track, Push Side Transom Mounted			<b>FT</b>				
Track Hold Open, Pull Side Door Mounted			<b>TH</b>				
			<b>JTH</b>				— Jamb Track Hold Open, Pull Side Frame Face Mounted
Push Track Hold Open, Push Side Soffit Mounted			<b>PTH</b>				
			<b>FTH</b>				— Flush Track Hold Open, Pull Side Frame Face Mounted

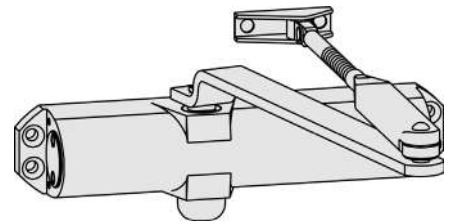

**NOTES:**

- All combinations of features and options are not available for all models. Please refer to 7300 Series product brochure for details.
- To simplify initial installation, a range of back plates (BPxx), drop plates (DPxx), brackets, and spacers are listed under 7300 Accessories in this section. Refer to 7300 Series product brochure for details.



Body	Arm	Mounting	Painted Finish \$
<b>Non-Hold Open</b>			
7303, 7304,	ARP	PA, REG and TJ for reveals to 4" (round)	368.00
7305	ARJ	TJ for reveals 4" to 8" (round)	359.00
	AR	REG or TJ for reveals to 4" (round)	353.00
	AO8P	PA, REG and TJ secured elbow for reveals to 4" (round)	368.00
	AO8	REG or TJ secured elbow for reveals to 4" (round)	353.00
<b>Bumper or Spring Cushion</b>			
7303, 7304,	DS	Heavy-duty door saver cushion parallel arm (size 5)	475.00
7305	DST	w/ thumb turn hold open (size 5)	547.00
	SDS	Extra heavy-duty door saver spring cushion parallel arm (size 5)	689.00
	SDST	w/ thumb turn hold open (size 5)	760.00
	IS	Heavy-duty cushion arm, REG and TJ for 0" to 3-1/2" reveal	678.00
	ISH	Heavy-duty cushion arm w/ hold open, REG and TJ for 0" to 3-1/2" reveal	747.00
	SIS	Extra heavy-duty spring cushion arm, REG and TJ for 0" to 3-1/2" reveal	788.00
	SISH	w/ hold open, REG and TJ for 0" to 3-1/2" reveal	862.00
	ISJ	Heavy-duty cushion arm, TJ for 3-1/2" to 6-1/2" reveal	712.00
	ISJH	Heavy-duty cushion arm w/ hold open, TJ for 3-1/2" to 6-1/2" reveal	783.00
	SISJ	Extra heavy-duty spring cushion arm, TJ for 3-1/2" to 6-1/2" reveal	827.00
	SISJH	w/ hold open, TJ for 3-1/2" to 6-1/2" reveal	899.00
<b>Heavy Duty PA</b>			
7305	SPA	Super parallel arm	422.00
	SPAT	w/ thumb turn hold open	493.00
<b>Friction Hold Open</b>			
7303, 7304,	FHP	PA, REG and TJ for reveals to 4"	447.00
7305	FHJ	TJ for reveals 4" to 8"	441.00
	FH	REG or TJ for reveals to 4"	434.00
<b>Track Units</b>			
7305	T	Door mounted (pull side)	441.00
	JT	Frame mounted (pull side)	441.00
	FT	Flush transom mounted (push side)	441.00
	PT	Soffit mounted (push side)	441.00
	TH	Door mounted (pull side)	477.00
	JTH	Frame mounted (pull side)	477.00
	FTH	Flush transom mounted (push side)	477.00
	PTH	Soffit mounted (push side)	477.00

**NOTE:** Standard arm configuration is indicated in **bold**.

## Options

(List Price 'add' when ordered with complete closer)

Item	Description	List Add \$
COV	Slim plastic cover	28.00
SNB1	(4) each 1/4-20 sex nuts and machine screws for 1-3/4" door	13.00
SNB2	(4) each 1/4-20 sex nuts and machine screws for 1-3/8" door	13.00
AWS	All wood screws	15.00
DPK86	All fasteners to be self-drilling fasteners (In lieu of combo screws)	N/C
CMBDPK	Standard and DPK86 fasteners	18.00
TPK86	All fasteners to be self-tapping fasteners (In lieu of combo screws)	N/C
CMBTPK	Standard and TPK86 fasteners	18.00
TX86	All exposed fasteners to be Torx security fasteners (n/a with track applications)	41.00
Custom Color	Custom painted finish selected from RAL color pallet book. For details, see <b>Finishes Cross Reference</b> , page viii.	
	per order, setup charge ( <b>Net</b> )	159.00
	per closer, list add	52.00
Designer Color	Designer painted color matched to supplied samples. Three (3) each 2" x 3" color chip samples required. For details, see <b>Finishes Cross Reference</b> , page viii.	
	per order, non-refundable development/setup charge ( <b>Net</b> )	382.00
	per closer, list add	52.00

### NOTES:

- Standard price does not include cover.
- Specify closer and arm designation, hand (when required), and finish when ordering.
- All spring cushion, heavy-duty PA, tracks, and top jamb (J) configurations packaged (4) units per master carton.
- All others are packaged (6) units per master carton.

## Accessories

Item	Description	List \$
BP73	Backplate for 7300	48.00
BP73T	Backplate for 7300 slide track closer without cover	48.00
BP86	Backplate for closer with slim cover	48.00
BP86T	Backplate for 7300 slide track closer with slim cover	48.00
DP73	Drop plate for 7300	48.00
DP86	Drop plate for closer with slim cover	48.00
AB73	Angle bracket for 7300 without cover	83.00
AB86	Angle bracket for 7300 with slim cover	83.00
PFT	Parallel flush transom bracket	39.00
PD	Parallel drop bracket, non-hold open arms (AR, AO8 only)	50.00
BS	Blade stop spacer (P86, PHB, and PD)	35.00
BSHD	Blade stop spacer for use with heavy duty door saver and super parallel arms	40.00
NFHD	Narrow frame bracket for use with heavy duty door saver and super parallel arms	40.00
FTHD	Flush transom bracket for use with heavy duty door saver and super parallel arms	67.00

# STA Series

## Ordering Guide

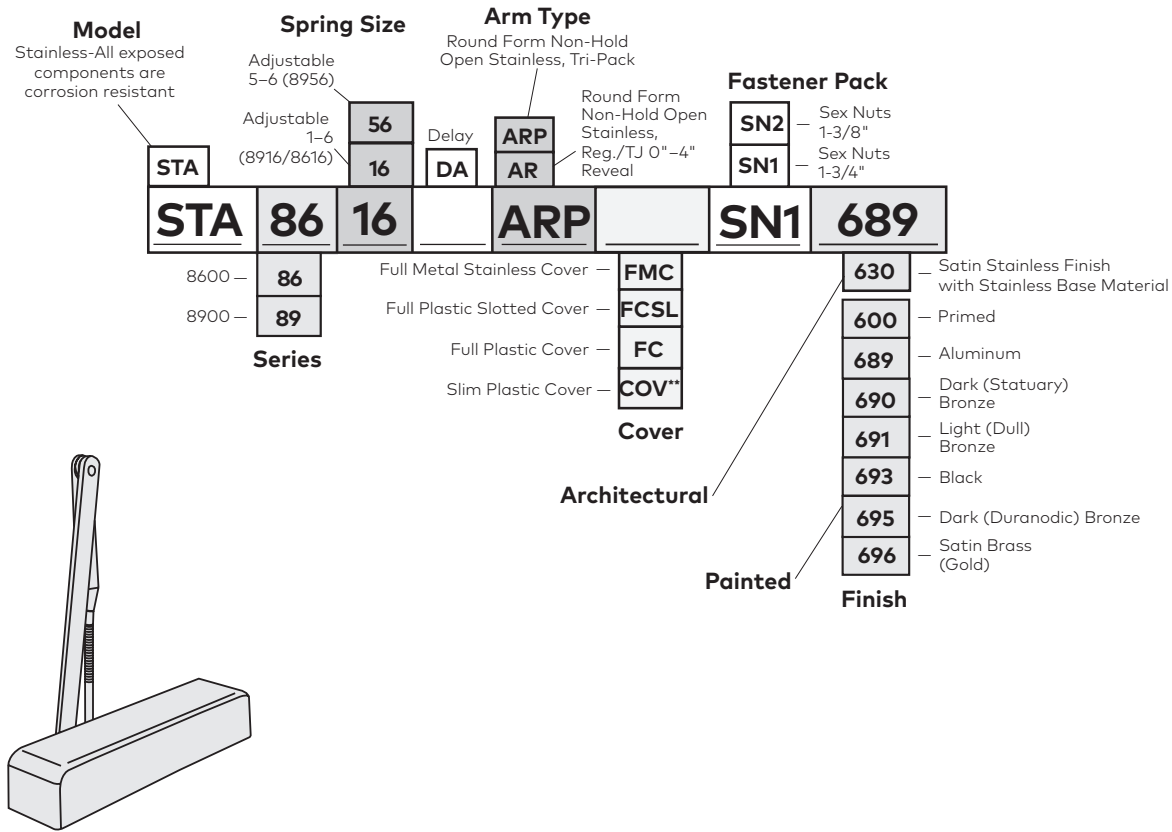

**NOTE:** Because STA is specified in the beginning of the model description, it does not need to be specified at the component level.

Example: **STA8616 ARP FC SN1 689**

\* Delay Action is a standard feature for spring size 1-6 version and not available for 5-6 version

\*\* Slim plastic cover only available for 8600 series

Body	Arm	Mounting	Painted Finish \$	630 \$
<b>STA 8900</b>				
STA 8916/8956	ARP	PA, REG & TJ for reveals to 4" (painted price w/FC)	1,193.00	1,702.00
	AR	REG or TJ for reveals to 4" (painted price w/FC)	1,112.00	1,580.00
<b>STA 8600</b>				
STA 8616	ARP	PA, REG & TJ for reveals to 4" (painted price w/COV)	1,142.00	1,795.00
	AR	REG or TJ for reveals to 4" (painted price w/COV)	1,049.00	1,652.00

## Options

(List Price 'add' when ordered with complete closer)

Item	Model	Description	List Add/Deduct \$
DA	8000	Adjustable delayed action (suffix to model number) (Only for 8616 and 8916)	47.00
LSN	8000	Less sex nuts (less SN1 pack)	Deduct 5.00
SN2	8000	(4) each 1/4-20 aluminum sex nuts for 1-3/8" door	N/C
LCOV	8600	Less slim plastic cover for 8600	Deduct 11.00
FC or FC SL	8600	Full plastic cover for 8600(FC standard w/8900)	12.00
FC SL	8900	Full plastic slotted cover for 8900	N/C
FMC	8600/8900	Full metal cover for 8600 and 8900	16.00
Custom Color		Custom painted finish selected from RAL color pallet book. For details, see <b>Finishes Cross Reference</b> , page viii.	
		per order, setup charge ( <b>Net</b> )	142.00
		per closer, list add	47.00
Designer Color		Designer painted color matched to supplied samples. Three (3) each 2" x 3" color chip samples required. For details, see <b>Finishes Cross Reference</b> , page viii.	
		per order, non-refundable development/setup charge ( <b>Net</b> )	342.00
		per closer, list add	47.00

**NOTES:**

- Architectural finish price (630) includes optional full stainless metal cover.
- Specify closer and arm designation and finish when ordering.
- All STA Series closers are packaged (6) units per master.
- STA full metal cover (FMC) is the only cover available in architectural finish 630.
- STA closers are supplied standard with SN1. Specify LSN for less SN1 deduct.
- STA 8900 standard with FC, 8600 standard with COV.

# GSR Series

## Ordering Guide

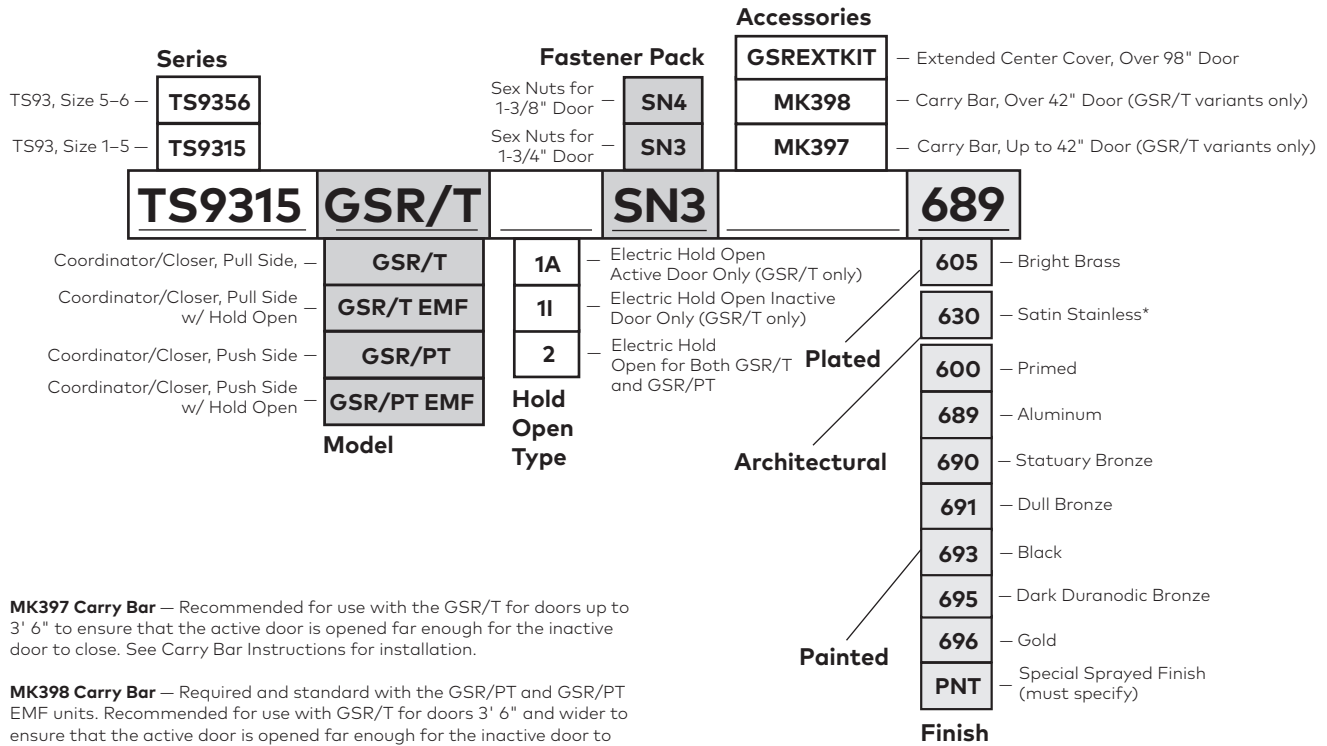

**MK397 Carry Bar** — Recommended for use with the GSR/T for doors up to 3' 6" to ensure that the active door is opened far enough for the inactive door to close. See Carry Bar Instructions for installation.

**MK398 Carry Bar** — Required and standard with the GSR/PT and GSR/PT EMF units. Recommended for use with GSR/T for doors 3' 6" and wider to ensure that the active door is opened far enough for the inactive door to close. See Carry Bar Instructions for installation.

\* Stainless steel base material with Satin Finish

**NOTES:**

- All combinations and options are not available for all models.
- Please refer to EMR/EMF Series Product Brochure for details.
- EMR/EMF accepts 24 VAC/DC.
- Transformer must be purchased if power source is 120 VAC.

Body	Arm	Mounting	Painted Finish \$	605/630
<b>TS93 Coordinators</b>				
TS9315, TS9356	GSR/T	Door closer/coordinator system only (pull side)	2,133.00	3,520.00
TS9315, TS9356	GSR/PT	Door closer/coordinator system only (push side)	2,845.00	4,745.00
	GSR/T EMF/1A	Electromagnetic holder/release device (active door) closer/coordinator system (pull)	3,106.00	4,359.00
	GSR/T EMF/1I	Electromagnetic holder/release device (inactive door) with door closer/coordinator system (pull)	3,106.00	4,359.00
	GSR/T EMF/2	Electromagnetic holder/release device (both doors) with door closer/coordinator system (pull)	3,988.00	5,234.00
	GSR/PT EMF/2	Electromagnetic holder/release device (both doors) with door closer/coordinator system (push)	5,254.00	6,984.00

**NOTE:** Standard GSR is packaged for installation on openings 53" to 98" wide. For narrower or wider openings, contact the factory. Opening size is derived from measuring centerline of hinge on one door to centerline of hinge on second door.

## Options

(List Price 'add' when ordered with complete closer)

Item	Description	Painted Finish \$
SN4	(4) each 10-32 sex nuts for 1-3/8" door	N/C
LSN	Less sex nuts (less SN3 pack)	Deduct 3.00
MK397	Carry bar — up to 3' 6" wide doors (included with GSR/PT variants option for GRS/PT variants)	66.00
MK398	Carry bar — 3' 6" and wider doors (included with GSR/PT variants option for GRS/PT variants)	73.00
Custom Color	Custom painted finish selected from RAL color pallet book. For details, see <b>Finishes Cross Reference</b> , page viii.	
	per order, setup charge ( <b>Net</b> )	165.00
	per closer, list add	55.00
Designer Color	Designer painted color matched to supplied samples. Three (3) Color each 2" x 3" colorchip samples required. For details, see <b>Finishes Cross Reference</b> , page viii.	
	per order, non-refundable development/setup charge ( <b>Net</b> )	398.00
	per closer, list add	55.00

**NOTES:**

- Specify body and arm designation, centerline to centerline of hinge or hanging means (indicate type), hand of active door, and finish, when ordering.
- Closer cover and/or track main arm only are electroplated when specified. Frame unit cover and closer cover caps are furnished primed or in complementing color.
- MK carry bars will be painted complementary color when ordered for plated units.

# 8900/8600/7400

## Closer Bodies

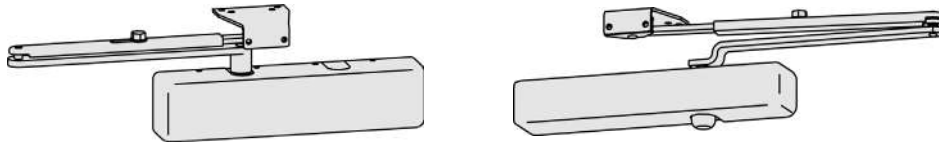

Item	Description	Painted Finish \$
MOD, 8916 FCXX	Closer body x full plastic cover and mounting screws	497.00
MOD, 8916 FCSL	Closer body x slotted full plastic cover and mounting screws	497.00
MOD, 8916 FMC	Closer body x full metal cover and mounting screws	506.00
MOD, 8916DA FC	Delay closer body x full plastic cover and mounting screws	544.00
MOD, 8916DA FCSL	Delay closer body x slotted full plastic cover and mounting screws	544.00
MOD, 8916DA FMC	Delay closer body x full metal cover and mounting screws	553.00
MOD, 8956 FC	Closer body x full plastic cover and mounting screws	497.00
MOD, 8956 FCSL	Closer body x slotted full plastic cover and mounting screws	497.00
MOD, 8956 FMC	Closer body x full metal cover and mounting screws	506.00
MOD, 8956DA FC	Delay closer body x full plastic cover and mounting screws	544.00
MOD, 8956DA FCSL	Delay closer body x slotted full plastic cover and mounting screws	544.00
MOD, 8956DA FMC	Delay closer body x full metal cover and mounting screws	553.00
MOD, 8616 COV	Closer body x slim plastic cover and mounting screws	354.00
MOD, 8616 FC	Closer body x full plastic cover and mounting screws	360.00
MOD, 8616 FCSL	Closer body x slotted full plastic cover and mounting screws	360.00
MOD, 8616 FMC	Closer body x full metal cover and mounting screws	366.00
MOD, 8616DA COV	Delay closer body x slim plastic cover and mounting screws	405.00
MOD, 8616DA FC	Delay closer body x full plastic cover and mounting screws	414.00
MOD, 8616DA FCSL	Delay closer body x slotted full plastic cover and mounting screws	414.00
MOD, 8616 DA FMC	Delay closer body x full metal cover and mounting screws	425.00
MOD, 7414	Closer body and mounting screws	207.00
MOD, 7414 COV	Closer body x slim plastic cover and mounting screws	237.00
MOD, 7414 FC	Closer body x full plastic cover and mounting screws	244.00
MOD, 7414 FCSL	Closer body x slotted full plastic cover and mounting screws	244.00
MOD, 7414DA	Delay closer body and mounting screws	260.00
MOD, 7414DA COV	Delay closer body x slim plastic cover and mounting screws	288.00
MOD, 7414DA FC	Delay closer body x full plastic cover and mounting screws	295.00
MOD, 7414DA FCSL	Delay closer body x slotted full plastic cover and mounting screws	295.00
MOD, 7436	Closer body and mounting screws	207.00
MOD, 7436 COV	Closer body x slim plastic cover and mounting screws	237.00
MOD, 7436 FC	Closer body x full plastic cover and mounting screws	244.00
MOD, 7436 FCSL	Closer body x slotted full plastic cover and mounting screws	244.00
MOD, 7436DA	Delay closer body and mounting screws	260.00
MOD, 7436DA COV	Delay closer body x slim plastic cover and mounting screws	288.00
MOD, 7436DA FC	Delay closer body x full plastic cover and mounting screws	295.00
MOD, 7436DA FCSL	Delay closer body x slotted full plastic cover and mounting screws	295.00



**Arms (All arms include "all" mounting screws and installation instructions)**

Item	Description	Painted Finish \$
MOD, AF89P (8900 only)	Arm, flat tri-pack NHO w/P89 bracket	143.00
MOD, AF89J (8900 only)	Arm, flat NHO TJ 4" to 8" reveal	137.00
MOD, AF89 (8900 only)	Arm, flat NHO Reg./TJ 0" to 4" reveal	132.00
MOD, AF86P (8600 only)	Arm, flat tri-pack NHO w/P86 bracket	146.00
MOD, AF86J (8600 only)	Arm, flat NHO TJ 4" to 8" reveal	142.00
MOD, AF86 (8600 only)	Arm, flat NHO Reg./TJ 0" to 4" reveal	133.00
MOD, ARP (8600/7400)	Arm, round tri-pack NHO w/P86 bracket	131.00
MOD, ARJ (8600/7400)	Arm, round NHO TJ 4" to 8" reveal	125.00
MOD, AR (8600/7400)	Arm, round NHO Reg./TJ 0" to 4" reveal	115.00
MOD, AO8P (8600/7400)	Arm, round secure tri-pack NHO w/P86 bracket	137.00
MOD, AO8 (8600/7400)	Arm, round secure Reg./TJ 0" to 4" reveal	132.00
MOD, DS	Arm, heavy-duty door saver cushion parallel	199.00
MOD, DST	Arm, heavy-duty door saver cushion parallel with thumb turn hold open	256.00
MOD, SDS	Arm, extra heavy-duty door saver spring cushion parallel	364.00
MOD, SDST	Arm, extra heavy-duty door saver spring cushion parallel with thumb turn hold open	423.00
MOD, FHP	Arm, friction hold open w/PHB bracket (0" to 4" reveal)	181.00
MOD, FHJ	Arm, friction hold open TJ 4" to 8" reveal	175.00
MOD, FH	Arm, friction hold open Reg./TJ 0" to 4" reveal	169.00
MOD, IS	Arm, heavy-duty cushion, Reg./TJ 0" to 3-1/2" reveal	357.00
MOD, ISH	Arm, heavy-duty cushion with hold open, Reg./TJ 0" to 3-1/2" reveal	409.00
MOD, SIS	Arm, extra heavy-duty spring cushion	445.00
MOD, SISH	Arm, extra heavy-duty spring cushion with hold open	502.00
MOD, ISJ	Arm, heavy-duty cushion, TJ 3-1/2" to 6-1/2" reveal	386.00
MOD, ISJH	Arm, heavy-duty cushion with hold open, TJ 3-1/2" to 6-1/2" reveal	438.00
MOD, SISJ	Arm, extra heavy-duty spring cushion, top jamb and mount for 3-1/2" to 6-1/2" reveal	474.00
MOD, SISJH	Arm, extra heavy-duty spring cushion with hold open, top jamb and mount for 3-1/2" to 6-1/2" reveal	528.00
MOD, PHP	Arm, plunger hold open w/ P89 bracket 1-1/2" to 3-1/2"	272.00
MOD, PH	Arm, plunger hold open Reg. 0" to 1-1/2" reveal	267.00
MOD, SPA	Arm, parallel heavy duty (Super Parallel Arm)	159.00
MOD, SPAT	Arm, parallel heavy duty thumb turn hold open (Super Parallel Arm)	216.00
MOD, T	Arm, track (T, JT and FT)	175.00
MOD, TH	Arm, track hold open (TH, JTH and FTH)	201.00
MOD, TDE	Arm, track double egress	243.00
MOD, TDEH	Arm, track double egress hold open	271.00

**NOTES:**

- MOD, 8600 Series includes SNB1 standard. Deduct \$6.00 list when ordering MOD, 8600 Series less SNB1.
- Modular packaging is designed to save you, our valued stocking distributor up to 15% on your inventory dollars. Instead of stocking all door closer requirements in complete units in various arm types, dormakaba produces a packaging option to allow a mixed stock of closer body combinations and arm types in separate packaging that easily combine later in the stocking distributor warehouse.
- Determine the arm type required to be packaged with a particular closer body, place the closer body package inside the arm pack, mark the appropriate check list on the carton label and deliver the product. It's that simple.
- dormakaba recommends that the 80% usage items such as 8916 AF89P FC SN1 689 and 8616 AF86P COV 689 be packaged complete and the remainder of inventory be packaged in modular packaged items. This allows the 20% mixed variations to be handled with much less inventory. Arm mix inventory can be cut in half since the majority of arms can be used with the 8900, 8600, or 7400 Series closer.

# Fire/Life Safety

## Product Guide (1 of 2)

<b>FIRE/LIFE SAFETY CLOSER/HOLDERS</b>	<b>Surface Mount</b>	<b>Floor-Mount</b>	<b>Wall-Mount</b>
<b>Closer/Holder Only</b>	TS93 EMF	—	
	8900 EMF	—	
	8600 EMF	—	
<b>Closer/Holder with Integral Smoke Detector</b>	TS93 EMR	—	
	8900 EMR	—	
	8600 EMR	—	
	1800 Series	—	
<b>Electromagnetic Door Holders</b>	—	EM501	EM504
	—	EM502	EM505
	—	—	EM508
	—	—	EM509

# Fire/Life Safety

Product Guide (2 of 2)

<input type="radio"/> No	A156.15	UL10C	Includes Smoke Detector	No Smoke Detector	Advanced Cam & Roller Design	Rack & Pinion Design	Plated Finishes	Custom Painted Finishes	Adjustable Power
TS93 EMF	Yes	Yes	<input type="radio"/>	Yes	Yes	<input type="radio"/>	Yes	Yes	Yes
8900 EMF	Yes	Yes	<input type="radio"/>	Yes	<input type="radio"/>	Yes	Yes	Yes	Yes
8600 EMF	Yes	Yes	<input type="radio"/>	Yes	<input type="radio"/>	Yes	Yes	Yes	Yes
TS93 EMR	Yes	Yes	Yes	<input type="radio"/>	Yes	<input type="radio"/>	Yes	Yes	Yes
8900 EMR	Yes	Yes	Yes	<input type="radio"/>	<input type="radio"/>	Yes	Yes	Yes	Yes
8600 EMR	Yes	Yes	Yes	<input type="radio"/>	<input type="radio"/>	Yes	Yes	Yes	Yes
1800 SD	Yes	Yes	Yes	<input type="radio"/>	<input type="radio"/>	Yes	Yes	Yes	Yes
1800	Yes	Yes	<input type="radio"/>	Yes	<input type="radio"/>	Yes	Yes	Yes	Yes

# EMR/EMF Series

## Ordering Guide

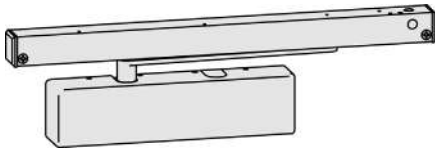
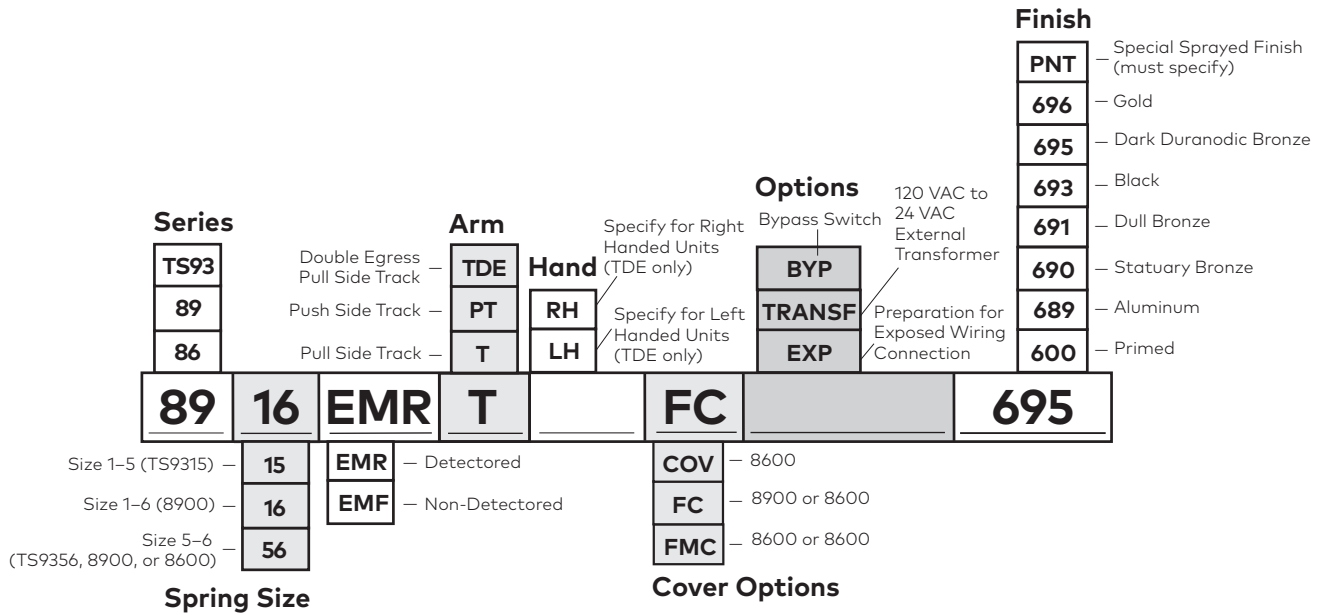

**NOTES:**

- All combinations of features and options are not available for all models.
- Please refer to EMR/EMF Series product brochure for details.

**EMR Series (with Detector)**

Body	Arm	Mounting	Painted Finish \$
<b>Premium Electromagnetic Slide Track Holder/Closing Device with Detector – 24 VAC/DC</b>			
TS9315, TS9356	EMR/T	Frame mounted (pull side)	3,073.00
	EMR/PT	Soffit mounted (push side)	3,073.00
	EMR/TDE	Frame mounted (pull side; double egress), handed	3,160.00
<b>Heavy-Duty Electromagnetic Slide Track Holder/Closing Device with Detector – 24 VAC/DC</b>			
8916, 8956	EMR/T	Frame mounted (pull side)	3,000.00
	EMR/PT	Soffit mounted (push side)	3,000.00
	EMR/TDE	Frame mounted (pull side; double egress), handed	3,085.00
<b>Electromagnetic Slide Track Holder/Closing Device with Detector – 24 VAC/DC</b>			
8656	EMR/T	Frame mounted (pull side)	2,803.00
	EMR/PT	Soffit mounted (push side)	2,803.00
	EMR/TDE	Frame mounted (pull side; double egress), handed	2,889.00

**EMF Series (No Detector)**

Body	Arm	Mounting	Painted Finish \$
<b>Premium Electromagnetic Slide Track Holder/Closing Device – 24 VAC/DC. Transformer required if power source is 120 VAC.</b>			
TS9315, TS9356	EMF/T	Frame mounted, (pull side)	1,372.00
	EMF/PT	Soffit mounted (push side)	1,372.00
	EMF/TDE	Frame mounted (pull side; double egress), handed	1,459.00
<b>Heavy-Duty Electromagnetic Slide Track Holder/Closing Device – 24 VAC/DC. Transformer required if power source is 120 VAC.</b>			
8916, 8956	EMF/T	Frame mounted, (pull side)	1,315.00
	EMF/PT	Soffit mounted (push side)	1,315.00
	EMF/TDE	Frame mounted (pull side; double egress), handed	1,403.00
<b>Electromagnetic Slide Track Holder/Closing Device – 24 VAC/DC. Transformer required if power source is 120 VAC.</b>			
8656	EMF/T	Frame mounted (pull side)	1,122.00
	EMF/PT	Soffit mounted (push side)	1,122.00
	EMF/TDE	Frame mounted (pull side; double egress), handed	1,209.00

## Options

(List Price 'add' when ordered with complete closer)

Item	Description	List Add \$
FC	Full plastic closer body cover, 8600	13.00
FMC	Full metal closer body cover (Handed), used w/8900	13.00
FMC	Full metal closer body cover (Handed), used w/8600	21.00
BYP	Concealed switch to bypass hold open function	81.00
TRANSF	120 VAC to 24 VAC transformer (installed separately)	92.00
EXP	Exposed wiring preparation	40.00
Custom Color	Custom painted finish selected from RAL color pallet book. For details, see <b>Finishes Cross Reference</b> , page viii.	
	per order, setup charge ( <b>Net</b> )	159.00
	per closer, list add	52.00
Designer Color	Designer painted color matched to supplied samples. Three (3) each 2" x 3" colorchip samples required. For details, see <b>Finishes Cross Reference</b> , page viii.	
	per order, non-refundable development/setup charge (Net)	382.00
	per closer, list add	52.00

### NOTES:

- Specify body and arm designation, voltage, hand (when required), and finish when ordering.
- EMF/EMR powered from 120 VAC power source requires optional "external" 120 VAC to 24 VAC transformer (TRANSF).
- MF Series unit must be ordered 24 V when used as a companion to an EMR Series unit.

## Accessories

Item	Series	Applicable Description	List \$
COV	8600	Slim plastic closer body cover	28.00
FC	8900/8600	Full plastic closer body cover	35.00
FMC	8900/8600	Full metal closer body cover (specify hand)	43.00
SN1	8900	(4) each 1/4-20 sex nuts for 1-3/4" door	13.00
SN3	TS93	(4) each 10-32 sex nuts for 1-3/4" door	13.00
SNB1	8600	(4) each 1/4-20 sex nuts and machine screws for 1-3/4" door	13.00
SD2	EMR	Replacement detector module	688.00
RFR	All	Radio frequency receiver for wireless release of hold open 272	446.00
HHRFT1	All	Hand held transmitter for wireless release of hold open	222.00
TRANSF	All	120 VAC to 24 VAC Transformer (External)	92.00
SCRPKEMRDET	EMR	Standoff for SD-2 Detector Replacement (EMR)	11.00



# 1800 Series

## Ordering Guide

<b>Series</b>		<b>Arm</b>		<b>Hand</b>		<b>Finish</b>	
18	16	AR	J	RH	SD	689	PNT
Size 1-6 (AR or J Options Only)	Size 5-6 (T Options Only)	Push Side Top Jamb Mount, 0"-4" Reveal	Push Side Top Jamb Mount, 4"-8" Reveal	Specify for Right Handed Units	Specify for Left Handed Units	Special Sprayed Finish (must specify)	Gold
16	56	H	SF	24 V AC/DC Less Transformer (Deduct)	24V	BYP	Dark Duranodic Bronze
Size 1-6 (AR or J Options Only)	Size 5-6 (T Options Only)	Hold Open	Swing Free	Includes Transformer in Unit	120V	EXP	Black
<b>Spring Size</b>		<b>Arm</b>		<b>Options</b>			
				Smoke Detector Includes Transformer		Primed	

**Electrical Specifications**

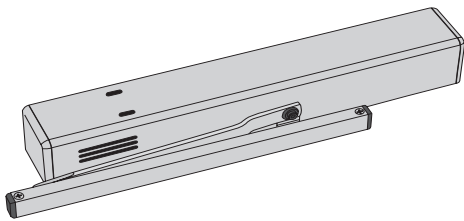

**NOTES:**

- All combinations of features and options are not available for all models.
- Please refer to 1800 Series product brochure for details.



**1800 SD Series (with Detector)**

Body	Arm	Mounting	Painted Finish \$
<b>Electromagnetic Holder/Closing Device with Integral Smoke Detector – 24 VAC/DC and 120 VAC</b>			
1856	HT SD	Frame mounted slide track (pull side)	3,500.00
1816	HJ SD	Frame mounted top jamb (push side)	3,500.00
<b>Electromagnetic Swing Free/Closing Device with Integral Smoke Detector – 24 VAC/DC and 120 VAC</b>			
1856	SFT SD	Frame mounted slide track (pull side)	3,571.00
1816	SFJ SD	Frame mounted top jamb (push side)	3,571.00

**1800 Series (No Detector)**

Body	Arm	Mounting	Painted Finish \$
<b>Electromagnetic Holder/Closing Device – 24VAC/DC and 120VAC</b>			
1856	HT	Frame mounted slide track (pull side)	1,768.00
1816	HJ	Frame mounted top jamb (push side)	1,768.00
<b>Electromagnetic Swing Free/Closing Device – 24VAC/DC and 120VAC</b>			
1856	SFT	Frame mounted slide track (pull side)	1,841.00
1816	SFJ	Frame mounted top jamb (push side)	1,841.00

**NOTES:**

- Specify body, arm, hand, and finish for all units.
- Specify if less than 2" frame face for (T) track mounted units. Specify **<2"** (no additional charge).
- Specify **DROP** for top jamb drop applications (no additional charge if noted at time of order).
- 1800 Series can be used as a companion to the 1800 SD Series, bypass 120 VAC transformer when making wiring connections or order less transformer for deduct.

## Options

(List Price 'add' when ordered with complete closer)

Item	Description	List Add/Deduct \$
LTRANSF	1800 Less 120 VAC transformer (deduct)	Deduct 29.00
<2"	T mount <2" frame face	N/C
DROP	Top jamb drop applications (configure at factory)	N/C
BYP	Concealed switch to bypass hold open function	81.00
EXP	Exposed wiring preparation	40.00
AR	Complete arm for top jamb 0" -4" reveal	Deduct 3.00
Custom Color	Custom painted finish selected from RAL color pallet book. For details, see <b>Finishes Cross Reference</b> , page viii.	
	per order, setup charge ( <b>Net</b> )	160.00
	per closer, list add	52.00
Designer Color	Designer painted color matched to supplied samples. Three (3) each 2" x 3" color chip samples required. For details, see <b>Finishes Cross Reference</b> , page viii.	
	per order, non-refundable development/setup charge ( <b>Net</b> )	383.00
	per closer, list add	52.00

## Accessories

Item	Applicable Description	List \$
SN1	(4) each 1/4-20 sex nuts for 1-3/4" door	13.00
SNB1	(4) each 1/4-20 sex nuts and machine screws for 1-3/4" door	13.00
EXPKIT	Exposed wiring bracket	51.00
SFKIT	Swing free kit	69.00
SOL1800	1800 replacement solenoid 24 VAC/DC	468.00
SD2	Replacement detector module	688.00
RFR	Radio frequency receiver for wireless release of hold open	447.00
HHRFT1	Hand held transmitter for wireless release of hold open	222.00
CAMDRIVE	Replacement Hold Open Cam/Cam Drive	33.00
TRANSF	120 VAC to 24 VAC Transformer	92.00



# EM SERIES

## Ordering Guide

Series		Options (Packaged Separately)		Finish	
EM		2-5/8" Catch Plate –	CP LONG	696	– Satin Brass Painted
		2" Catch Plate –	CP SHORT	695	– Dark Duranodic Bronze Powder Coated
		8-3/8" to 12" Adjustable Extension –	ER 12	689	– Aluminum Powder Coated
		6-3/8" to 8" Adjustable Extension –	ER 7		
		2" Extension –	ER 2.0		
		1-1/2" Extension –	ER 1.5		
<b>EM</b>	<b>504</b>	<b>24120</b>		<b>689</b>	
Single Floor –	501	24120			– Dual Voltage 24 VDC, 120 VAC
Double Floor –	502				
Semi-Flush, Long Catch –	504				
Semi-Flush, Short Catch –	505				
Surface –	508				
Completely Flush –	509				

**Electrical Specification**

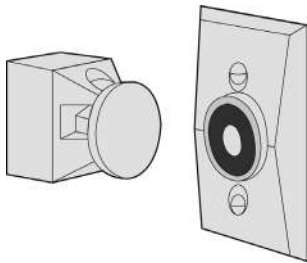

**NOTES:**

- All combinations of features and options are not available for all models.
- Please refer to EM Series product brochure for details.

Body	Mounting	689/695 Finish \$	696 Finish \$
<b>Electromagnetic Floor Mounted Holder – 24 VDC, 24 VAC, or 120 VAC</b>			
EM 501-24120	Floor mount, single unit	1,071.00	1,137.00
EM 502-24120	Floor mount, double unit	1,331.00	1,403.00
<b>Electromagnetic Wall Mounted Holder – 24 VDC, 24 VAC, or 120 VAC</b>			
EM 504-24120	Semi-flush mount, (recessed) long catch plate	578.00	644.00
EM 505-24120	Semi-flush mount, (recessed) short catch plate	578.00	644.00
EM 508-24120	Surface mount	613.00	680.00
EM 509-24120*	Completely flush mount	613.00	680.00

\* The EM509 is shipped with a 630 faceplate when ordered in 689 finish.

## Options

Item	Description	689 Finish \$
ER1.5	1-1/2" extension rod	97.00
ER2.0	2" extension rod	108.00
ER7	6-3/8" – 8" adjustable extension rod	120.00
ER12	8-3/8" – 12" adjustable extension rod	132.00

## Accessories

Item	Description	689/695 Finish \$	696 Finish \$
CPSHORT	2" projection catch plate (door portion)	137.00	159.00
CPLONG	2-5/8" projection catch plate (door portion)	156.00	179.00
EMDPPK**	Door plate pack, (plate, bracket and fasteners)	53.00	—
EMSCRPK**	Universal fastener pack for all EM models	38.00	—
EMSURFPK**	Surface mount box and fastener pack for EM 509	122.00	—
EMFACEPLTPK**	Brackets and fastener pack for all EM face plates	35.00	—

\*\* Available in 689 finish only.

# Concealed Door Closers

Product Guide (1 of 2)

CONCEALED DOOR CLOSERS	CONCEALED IN THE FLOOR	CONCEALED IN THE FRAME	CONCEALED IN THE DOOR
<p><b>Grade 1 Heavy-Duty Sized (Power) per Application</b></p>	<p>BTS80</p>	<p>—</p>	<p>—</p>
<p><b>Grade 1 Heavy-Duty Sized (Power) per Application Hold Open</b></p>	<p>BTS80 EMB</p>	<p>—</p>	<p>—</p>
<p><b>Grade 1 Commercial Adjustable (Power) Size</b></p>	<p>BTS75V</p>	<p>ITS96</p>	<p>ITS96</p>
<p><b>Commercial Sized (Power) per Application</b></p>	<p>—</p>	<p>RTS88</p>	<p>—</p>

# Concealed Door Closers

Product Guide (2 of 2)

<input type="radio"/> No	A156.4 Grade 1	A156.4 Grade 3	UL10C UBC7-2	Advanced Cam & Roller Design	Plated Finishes	Standard Painted Finishes	Custom Painted Finishes	Adjustable Power	Fixed Power
BTS75V	Yes	<input type="radio"/>	Yes	Yes	Yes	Yes	Yes	Yes	<input type="radio"/>
BTS80	Yes	<input type="radio"/>	Yes	Yes	Yes	Yes	Yes	<input type="radio"/>	Yes
BTS80 EMB	Yes	<input type="radio"/>	Yes	Yes	Yes	Yes	Yes	<input type="radio"/>	Yes
ITS96	<input type="radio"/>	Yes	Yes	Yes	Yes	Yes	Yes	Yes	<input type="radio"/>
RTS88	<input type="radio"/>	<input type="radio"/>	<input type="radio"/>	Yes	Yes	Yes	Yes	<input type="radio"/>	Yes

# BTS80 SERIES

## Ordering Guide

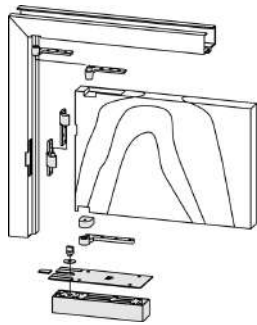

### Spindle

1-1/2" Pre-Loaded Spindle	80030
1-5/16" Pre-Loaded Spindle	80025
1-1/8" Pre-Loaded Spindle	80020
7/8" Pre-Loaded Spindle	80015
3/4" Pre-Loaded Spindle	80010
1/2" Pre-Loaded Spindle	80005
5/16" Pre-Loaded Spindle	80003
2-5/16" Spindle	74050
2-1/16" Spindle	74045
1-7/8" Spindle	74040
1-11/16" Spindle	74035
1-1/2" Spindle	74030
1-5/16" Spindle	74025
1-1/8" Spindle	74020
7/8" Spindle	74015
13/16" Spindle	74012
3/4" Spindle	74010
5/8" Spindle	74007
1/2" Spindle	74005
5/16" Spindle	74003

### Optional Accessories

<b>E80624</b>	Through Wire CH Top Pivot (4 wire)
<b>E80622</b>	Through Wire CH Top Pivot (2 wire)
<b>HD8062</b>	Heavy Duty CH Top Pivot
<b>75200</b>	Through Wire Intermediate Pivot for 3/4" Offset
<b>15233</b>	3 h Intermediate Pivot for 1-1/2" Offset
<b>15222</b>	20 min Intermediate Pivot for 1-1/2" Offset
<b>15220</b>	Through Wire Intermediate Pivot for 1-1/2" Offset
<b>75243</b>	3 h Intermediate Pivot for Lead Lined 3/4" Offset (see note*)
<b>75242</b>	20 min Intermediate Pivot for Lead Lined 3/4" Offset (see note*)
<b>75240</b>	Intermediate Pivot for Lead Lined 3/4" Offset (see note*)
<b>75233</b>	3 h Intermediate Pivot for 3/4" Offset
<b>75222</b>	20 min Intermediate Pivot for 3/4" Offset
<b>75220</b>	Intermediate Pivot for 3/4" Offset
<b>SC2</b>	Sealing Compound
<b>TP80 CH</b>	Terrazo Pan CH and 1-1/2" Offset
<b>TP80</b>	Terrazo Pan for 3/4" Offset

Hand	
<b>LH</b>	Specify for Left Handed Units
<b>RH</b>	Specify for Right Handed Units

Deducts	
<b>LBX</b>	Less Cement Box
<b>LFP</b>	Less Floor Plate
<b>LTP</b>	Less Top Pivot

Series
<b>BTS80</b>

<b>BTS80</b>	<b>D</b>	<b>74010</b>	<b>RH</b>	<b>AMS</b>		<b>626</b>
--------------	----------	--------------	-----------	------------	--	------------

CH Double Acting, Aluminum Door and Frame	<b>A</b>
CH Double Acting, Wood or Steel Door and Frame	<b>B</b>
1-1/2" Offset, Handed	<b>C-E</b>
1-1/2" Offset, 20 min Rated Handed	<b>C-F</b>
1-1/2" Offset, 3 h Rated Handed	<b>D</b>
CH Single Acting, Aluminum Door and Frame	<b>E</b>
CH Single Acting, Wood or Steel Door and Frame	<b>F</b>
Independent Hung, Non-Handed	<b>G</b>
Independent Hung, Up to 3 h Rated, Non-Handed	<b>H</b>
3/4" Offset Lead Lined, Handed*	<b>I</b>
3/4" Offset Lead Lined, 20 min Rated Handed*	<b>IF</b>
3/4" Offset Lead Lined, 3 h Rated Handed*	<b>L</b>
Independent Hung On Pocket Pivots, Non-Handed	<b>L-E</b>
Independent Hung On Pocket Pivots, Up to 3 h Rated, Non-Handed	<b>L-F</b>
	<b>P</b>
	<b>PF</b>

Spring Size
<b>3</b> - Size 3, Light Opening Force, No Backcheck
<b>4</b> - Size 4, No Need to Specify
<b>5</b> - Size 5, for use w/Fire Pkgs, No Delay, No Hold Open
<b>6</b> - Size 6, Strong

Offset
<b>F</b> - 3/4" Offset, Handed
<b>G</b> - 3/4" Offset, 20 min Rated Handed
<b>H</b> - 3/4" Offset, 3 h Rated Handed

Fastener Packs
<b>AMS</b> - All Metal Screws
<b>W2</b> - All Wood Screws
<b>W1</b> - 1/2 Wood Screws
<b>AMSAWS</b> - All Metal Screws All Wood Screws

Painted
<b>600</b> - Primed
<b>689</b> - Aluminum
<b>690</b> - Statuary Bronze
<b>691</b> - Dull Bronze
<b>693</b> - Black
<b>695</b> - Dark Duranodic Bronze
<b>696</b> - Gold
<b>PNT</b> - Special Sprayed Finish (must specify)

**\* "L" Package Door Thickness Note:**  
The standard door thickness is 1-3/4", and is the default unless otherwise specified.

Other alternative sizes are { -2, -2-1/4, -2-1/2, -3

Examples: L-E-2-1/2....75242-2-1/2

Example above 20 min. lead lined package for 2-1/2" thick door.

Plated
Bright Brass - <b>605</b>
Satin Brass - <b>606</b>
Bright Bronze - <b>611</b>
Satin Bronze - <b>612</b>
Oxidized Satin Oil Rubbed - <b>613</b>
Bright Nickel - <b>618</b>
Satin Nickel - <b>619</b>
Bright Chrome - <b>625</b>
Satin Chrome - <b>626</b>

### Package

### Finish

- NOTES:**
- All combinations of features and options are not available for all models.
  - Please refer to BTS80 Series product brochure for details.
  - When replacing standard package hardware with optional hardware, adjust list price accordingly.



Package	Description	Painted Finish \$	Plated Finish \$
<b>Center Hung, Double Acting, Aluminum Door and Frame (Non-Handed)</b>			
<b>BTS80A</b>	<b>Complete package</b> BTS80-4, 74010, 7410, 7422, 8062	—	<b>2,286.00</b>
BTS80/A LFP	Complete package, less floor plate		Deduct 153.00
<b>Center Hung, Double Acting, Wood or Steel Door and Frame (Non-Handed)</b>			
<b>BTS80B</b>	<b>Complete package</b> BTS80-4, 74010, 7410, 7421, 8062	—	<b>2,240.00</b>
BTS80/B LFP	Complete package, less floor plate		Deduct 153.00
<b>1-1/2" Offset, Single Acting, Wood, Steel or Aluminum Door and Frame (Specify Hand)</b>			
<b>BTS80C</b>	<b>Complete package</b> BTS80-4, 74010, 7410, 15323, 15120	—	<b>2,783.00</b>
BTS80C LFP	Complete package, less floor plate		Deduct 153.00
<b>1-1/2" Offset, Single Acting, 20 Minute Rated Fire Door and Frame (Specify Hand)</b>			
<b>BTS80CE</b>	<b>Complete package</b> BTS80 F-5, 74010, 7410, 15323, 15122	<b>2,872.00</b>	<b>2,872.00</b>
BTS80CE LFP	Complete package, less floor plate		Deduct 153.00
<b>1-1/2" Offset, Single Acting, 3 Hour Rated Fire Door and Frame (Specify Hand)</b>			
<b>BTS80CF</b>	<b>Complete package</b> BTS80 F-5, 74010, 7410, 15323, 15133	<b>2,916.00</b>	<b>3,370.00</b>
BTS80CF LFP	Complete package, less floor plate		Deduct 153.00
<b>3/4" Offset, Single Acting, Wood, Steel or Aluminum Door and Frame (Specify Hand)</b>			
<b>BTS80D</b>	<b>Complete package</b> BTS80-4, 74010, 7410, 75323, 75120	—	<b>2,366.00</b>
BTS80D LFP	Complete package, less floor plate		Deduct 153.00
<b>3/4" Offset, Single Acting, 20 Minute Rated Fire Door and Frame (Specify Hand)</b>			
<b>BTS80E</b>	<b>Complete Package</b> BTS80 F-5, 74010, 7410, 75323, 75122	<b>2,435.00</b>	<b>2,435.00</b>
BTS80E LFP	Complete package, less floor plate		Deduct 153.00
<b>3/4" Offset, Single Acting, 3 Hour Rated Fire Door and Frame (Specify Hand)</b>			
<b>BTS80F</b>	<b>Complete package</b> BTS80 F-5, 74010, 7410, 75323, 75133	<b>2,496.00</b>	<b>2,826.00</b>
BTS80F LFP	Complete package, less floor plate		Deduct 153.00
<b>Center Hung, Single Acting, Aluminum Door and Frame (Specify Hand)</b>			
<b>BTS80G</b>	<b>Complete package</b> BTS80-4, 80010, 7410, 7422, 8062	—	<b>2,286.00</b>
BTS80G LFP	Complete package, less floor plate		Deduct 153.00
<b>Center Hung, Single Acting, Wood or Steel Door and Frame (Specify Hand)</b>			
<b>BTS80H</b>	<b>Complete package</b> BTS80-4, 80010, 7410, 7421, 8062	—	<b>2,240.00</b>
BTS80H LFP	Complete package, less floor plate		Deduct 153.00

**NOTE:** See BTS80 Accessories for intermediate pivots and individual component list prices.

Package	Description	Painted Finish \$	Plated Finish \$
<b>Independent Hung, on Hinges, etc. (Non-Handed)</b>			
<b>BTS80I</b>	<b>Complete package</b> BTS80-4, 74003, 7410, 7451N-A**	<b>2,242.00</b>	<b>2,417.00</b>
BTS80I LFP	Complete package, less floor plate		Deduct 153.00
<b>Independent Hung, 3 Hour Rated Steel, 1-1/2 hour Rated Wood Fire Doors Hung on Hinges, etc. (Specify Hand)</b>			
<b>BTS80IF</b>	<b>Complete package</b> BTS80 F-5, 74003, 7410, 7451N	<b>2,280.00</b>	<b>2,616.00</b>
BTS80IF LFP	Complete package, less floor plate		Deduct 153.00
<b>3/4" Offset, Single Acting, Wood or Steel Lead Lined Door and Frame, for 1-3/4" thick door (Specify Hand)</b>			
<b>BTS80L</b>	<b>Complete package</b> BTS80-4, 74010, 7410, 75343, 75140	—	<b>2,989.00</b>
BTS80L LFP	Complete package, less floor plate		Deduct 153.00
<b>3/4" Offset, Single Acting, Lead Lined 20 Minute Rated Fire Door and Frame, for 1-3/4" thick door (Specify Hand)</b>			
<b>BTS80LE</b>	<b>Complete package</b> BTS80 F-5, 74010, 7410, 75343, 75142	<b>3,061.00</b>	<b>3,061.00</b>
BTS80LE LFP	Complete package, less floor plate		Deduct 153.00
<b>3/4" Offset, Single Acting, Lead Lined 3 Hour Rated Fire Door and Frame, for 1-3/4" thick door (Specify Hand)</b>			
<b>BTS80LF</b>	<b>Complete package</b> BTS80 F-5, 74010, 7410, 75343, 75143	<b>3,137.00</b>	<b>3,373.00</b>
BTS80LF LFP	Complete package, less floor plate		Deduct 153.00
<b>Independent Hung, on Pocket Pivots (Non-Handed)</b>			
<b>BTS80P</b>	<b>Complete package (priced w/ 3 pivots)</b> BTS80-4, 74003, 7410, 7451N-A, 75520	<b>4,168.00</b>	<b>4,725.00</b>
<b>BTS80P LFP</b>	<b>Complete package, less floor plate</b> (priced w/ 3 pivots)		Deduct 153.00
<b>Independent Hung, 3 Hour Rated Steel, 1-1/2 Hour Rated Wood Fire Doors Hung on Pocket Pivots (Specify Hand)</b>			
<b>BTS80PF</b>	<b>Complete package (priced w/ 3 pivots)</b> BTS80 F-5, 74003, 7410, 7451N, 75523	<b>4,336.00</b>	<b>5,057.00</b>
<b>BTS80PF LFP</b>	<b>Complete package, less floor plate</b> (priced w/ 3 pivots)		Deduct 153.00

\* Floor closer is painted black only. Cement case is galvanized steel.  
 Spindle is available in zinc plated finish only.  
 Center hung bottom arms are available in zinc plated finish only (7421/7422).  
 Floor plate is only available in plated finishes.

\*\* Bottom arm for painted finish would be 7451N.  
 See BTS80 Accessories for intermediate pivots. See BTS Accessories for individual component list prices.  
 See **Options** for Less **Cement Box**.

# Options

(List Price 'add' when ordered with complete closer)

Item	Description	Painted Add \$	Plated Add \$
3	ANSI size 3, light opening force, non-fire rated doors (previously BFE)	N/C	—
6	ANSI size 6, spring for up to 4'0" exterior or 4'6" interior non-fire rated doors (previously Sz 3)	N/C	—
AMS	All metal screws	N/C	—
AMSAWS	All metal screws, all wood screws	17.00	23.00
W1	Half wood screws	10.00	11.00
W2	All wood screws	12.00	14.00
74003, 74005, 74007, 74010	5/16", 1/2", 5/8", or 3/4" clearance spindle	N/C	—
74012, 74015, 74020	13/16", 7/8", or 1-1/8" clearance spindle	37.00	—
74025, 74030, 74035	1-5/16", 1-1/2", or 1-11/16" clearance spindle	37.00	—
74040, 74045, 74050	1-7/8", 2-1/16", or 2-5/16" clearance spindle	37.00	—
TP80	▲ Terrazo pan for BTS 80, 80 F, 80 EMB — 3/4" offset (handed)	—	777.00
TP80CH	▲ Terrazo pan for BTS 80, 80 F, 80 EMB — Center hung or 1-1/2" offset	—	708.00
SC2	Sealing compound	109.00	—
LBX	Less cement box	Deduct 24.00	—
Custom Color	Custom painted finish selected from RAL color pallet book. For details, see <b>Finishes Cross Reference</b> , page viii.		
	per order, setup charge <b>(Net)</b>	155.00	—
	per closer, list add	96.00	—
Designer Color	Designer painted color matched to supplied samples. Three (3) each 2" x 3" colorchip samples required. For details, see <b>Finishes Cross Reference</b> , page viii.		
	per order, non-refundable development/ setup charge <b>(Net)</b>	373.00	—
	per closer, list add	96.00	—

## Spindle Inserts for Center Hung Single Acting Packages

Item	Description	Painted Add \$	Plated Add \$
80003, 80005, 80010	5/16", 1/2" or 3/4" clearance spindle (specify hand)	N/C	—
80015, 80020, 80025, 80030	7/8", 1-1/8", 1-5/16" or 1-1/2" clearance spindle (specify hand)	37.00	—

▲ Terrazo pans are available stainless steel only.

## Accessories

### Pivots

Item	Description	Painted Finish \$	Plated Finish \$
<b>3/4" Offset Hung Intermediate Pivots**</b>			
75220	Full mortise standard intermediate pivot	427.00	427.00
75222	Full mortise intermediate pivot — 20 minute rated fire door	455.00	455.00
75233	Full mortise intermediate pivot — 3 hour rated fire door	478.00	922.00
75240	Full mortise intermediate pivot — 1-3/4" lead lined doors	639.00	639.00
75242	Full mortise intermediate pivot — 20 minute rated, 1-3/4" lead-lined doors	675.00	675.00
75243	Full mortise intermediate pivot — 3 hour rated, 1-3/4" lead-lined doors	692.00	1,291.00
<b>1-1/2" Offset Hung Intermediate Pivots**</b>			
15220	Full mortise standard intermediate pivot	639.00	639.00
15222	Full mortise intermediate pivot — 20 minute rated fire door	692.00	692.00
15233	Full mortise intermediate pivot — 3 hour rated fire door	710.00	1,241.00
<b>Power Transfer Pivots</b>			
75200	Through-wire 3/4" offset intermediate pivot — 8 wire**	793.00	793.00
E80622	Through-wire center hung top pivot (2 wire)	864.00	864.00
E80624	Through-wire center hung top pivot (4 wire)	864.00	864.00

\*\* All intermediate pivots are handed.

#### NOTES:

- Only packages with an "E" or "F" designation in the package description are available in painted finishes.
- Specify package designation, hand (when required), finish, and options or accessories when ordering.
- Complete package prices are indicated in bold.
- When ordering a package "less components," deduct the list price for the component removed.
- Cover plate not available in painted finish. Cover plate will be plated to match when ordering with painted finishes.
- All packages furnished with all machine screws standard (AMS).
- Lead-lined packages shown are for 1-3/4" thick doors. For lead-lined doors from 2" up to 3" thick, add \$107.00 list to the package price. Example, specify: BTS80L-3 for a 3" thick door.
- Lead-lined packages are designed for doors with lead in center of door thickness.
- Package price for P or PF packages includes 3 pocket pivots.



# BTS80 EMB Series

## Ordering Guide

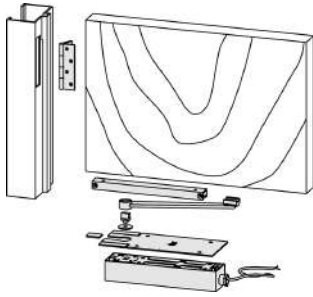

### Spindle

<b>80030</b>	— 1-1/2" Pre-Loaded Spindle
<b>80025</b>	— 1-5/16" Pre-Loaded Spindle
<b>80020</b>	— 1-1/8" Pre-Loaded Spindle
<b>80015</b>	— 7/8" Pre-Loaded Spindle
<b>80010</b>	— 3/4" Pre-Loaded Spindle
<b>80005</b>	— 1/2" Pre-Loaded Spindle
<b>80003</b>	— 5/16" Pre-Loaded Spindle
<b>74050</b>	— 2-5/16" Spindle
<b>74045</b>	— 2-1/16" Spindle
<b>74040</b>	— 1-7/8" Spindle
<b>74035</b>	— 1-11/16" Spindle
<b>74030</b>	— 1-1/2" Spindle
<b>74025</b>	— 1-5/16" Spindle
<b>74020</b>	— 1-1/8" Spindle
<b>74015</b>	— 7/8" Spindle
<b>74012</b>	— 13/16" Spindle
<b>74010</b>	— 3/4" Spindle
<b>74007</b>	— 5/8" Spindle
<b>74005</b>	— 1/2" Spindle
<b>74003</b>	— 5/16" Spindle

### Hand

<b>LH</b>	— Specify for Left Handed Units
<b>RH</b>	— Specify for Right Handed Units

### Optional Accessories

<b>E80624</b>	— Through Wire CH Top Pivot (4 wire)
<b>E80622</b>	— Through Wire CH Top Pivot (2 wire)
<b>HD8062</b>	— Heavy Duty CH Top Pivot
<b>75200</b>	— Through Wire Intermediate Pivot for 3/4" Offset
<b>15233</b>	— 3 h Intermediate Pivot for 1-1/2" Offset
<b>15222</b>	— 20 min Intermediate Pivot for 1-1/2" Offset
<b>15220</b>	— Intermediate Pivot for 1-1/2" Offset
<b>75243</b>	— 3 h Intermediate Pivot for Lead Lined 3/4" Offset (see note*)
<b>75242</b>	— 20 min Intermediate Pivot for Lead Lined 3/4" Offset (see note*)
<b>75240</b>	— Intermediate Pivot for Lead Lined 3/4" Offset (see note*)
<b>75233</b>	— 3 h Intermediate Pivot for 3/4" Offset
<b>75222</b>	— 20 min Intermediate Pivot for 3/4" Offset
<b>75220</b>	— Intermediate Pivot for 3/4" Offset
<b>SC2</b>	— Sealing Compound
<b>TP80 CH</b>	— Terrazo Pan CH and 1-1/2" Offset
<b>TP80</b>	— Terrazo Pan for 3/4" Offset

### Deducts

<b>LFP</b>	— Less Floor Plate
<b>LTP</b>	— Less Top Pivot

### Series

**BTS80EMB**

<b>BTS80EMB</b>	<b>D</b>	<b>5</b>	<b>74010</b>	<b>RH</b>	<b>AMS</b>		<b>626</b>	
-----------------	----------	----------	--------------	-----------	------------	--	------------	--

1-1/2" Offset, Handed	<b>C</b>
1-1/2" Offset, 20 min Rated Handed	<b>C-E</b>
1-1/2" Offset, 3 h Rated Handed	<b>C-F</b>
3/4" Offset, Handed	<b>D</b>
3/4" Offset, 20 min Rated Handed	<b>E</b>
3/4" Offset, 3 h Rated Handed	<b>F</b>
CH Single Acting, Aluminum Door and Frame	<b>G</b>
CH Single Acting, Wood or Steel Door and Frame	<b>H</b>
Independent Hung, Non-Handed	<b>I</b>
Independent Hung, Up to 3 h Rated, Non-Handed	<b>IF</b>
3/4" Offset Lead Lined, Handed*	<b>L</b>
3/4" Offset Lead Lined, 20 min Rated Handed*	<b>L-E</b>
3/4" Offset Lead Lined, 3 h Rated Handed*	<b>L-F</b>

### Package

**5** — ANSI Size 5  
**Spring Size**

<b>AMS</b>	— All Metal Screws
<b>W2</b>	— All Wood Screws
<b>W1</b>	— 1/2 Wood Screws
<b>AMSAWS</b>	— All Metal Screws All Wood Screws

### Fastener Packs

<b>600</b>	— Primed
<b>689</b>	— Aluminum
<b>690</b>	— Statuary Bronze
<b>691</b>	— Dull Bronze
<b>693</b>	— Black
<b>695</b>	— Dark Duranodic Bronze
<b>696</b>	— Gold
<b>PNT</b>	— Special Sprayed Finish (must specify)
<b>605</b>	— Bright Brass
<b>606</b>	— Satin Brass
<b>611</b>	— Bright Bronze
<b>612</b>	— Satin Bronze
<b>613</b>	— Oxidized Satin Oil Rubbed
<b>618</b>	— Bright Nickel
<b>619</b>	— Satin Nickel
<b>625</b>	— Bright Chrome
<b>626</b>	— Satin Chrome

### Painted

### Plated

**\* "L" Package Door Thickness Note:**  
The standard door thickness is 1-3/4", and is the default unless otherwise specified.

Other alternative sizes are

- 2
- 2-1/4
- 2-1/2
- 3

Examples: L-E-2-1/2...75242-2-1/2

Example above 20 min. lead lined package for 2-1/2" thick door.

### NOTES:

- All combinations of features and options are not available for all models.
- Please refer to BTS80 EMB Series product brochure for details.

Package	Description	Painted Finish \$	Plated Finish \$
<b>1-1/2" Offset, Single Acting, Wood, Steel or Aluminum Door and Frame (Specify Hand)</b>			
<b>BTS80 EMBC</b>	<b>Complete package</b> 80 EMB-5, 74010, 7410, 15323, 15120	—	<b>5,348.00</b>
BTS80 EMBC LFP	Complete package, less floor plate		Deduct 153.00
<b>1-1/2" Offset, Single Acting, 20 Minute Rated Fire Door and Frame (Specify Hand)</b>			
<b>BTS80 EMBCE</b>	<b>Complete package</b> 80 EMB-5, 74010, 7410, 15323, 15122	<b>5,403.00</b>	<b>5,403.00</b>
BTS80 EMBCE LFP	Complete package, less floor plate		Deduct 153.00
<b>1-1/2" Offset, Single Acting, 3 Hour Rated Fire Door and Frame (Specify Hand)</b>			
<b>BTS80 EMBCF</b>	<b>Complete package</b> 80 EMB-5, 74010, 7410, 15323, 15133	<b>5,445.00</b>	<b>5,897.00</b>
BTS80 EMBCF LFP	Complete package, less floor plate		Deduct 153.00
<b>3/4" Offset, Single Acting, Wood, Steel or Aluminum Door and Frame (Specify Hand)</b>			
<b>BTS80 EMBD</b>	<b>Complete package</b> 80 EMB-5, 74010, 7410, 75323, 75120	—	<b>4,932.00</b>
BTS80 EMBD LFP	Complete package, less floor plate	—	Deduct 153.00
<b>3/4" Offset, Single Acting, 20 Minute Rated Fire Door and Frame (Specify Hand)</b>			
<b>BTS80 EMBE</b>	<b>Complete package</b> 80 EMB-5, 74010, 7410, 75323, 75122	<b>4,964.00</b>	<b>4,964.00</b>
BTS80 EMBE LFP	Complete package, less floor plate		Deduct 153.00
<b>3/4" Offset, Single Acting, 3 Hour Rated Fire Door and Frame (Specify Hand)</b>			
<b>BTS80 EMBF</b>	<b>Complete package</b> 80 EMB-5, 74010, 7410, 75323, 75133	<b>5,026.00</b>	<b>5,305.00</b>
BTS80 EMBF LFP	Complete package, less floor plate		Deduct 153.00
<b>Center Hung, Single Acting, Aluminum Door and Frame (Specify Hand)</b>			
<b>BTS80 EMBG</b>	<b>Complete package</b> 80 EMB-5, 80010, 7410, 7422, 8062	—	<b>4,847.00</b>
BTS80 EMBG LFP	Complete package, less floor plate	—	Deduct 153.00
<b>Center Hung, Single Acting, Wood or Steel Door and Frame (Specify Hand)</b>			
<b>BTS80 EMBH</b>	<b>Complete package</b> 80 EMB-5, 80010, 7410, 7421, 8062	—	<b>4,803.00</b>
BTS80 EMBH LFP	Complete package, less floor plate	—	Deduct 153.00
<b>Independent Hung, on Hinges, etc. (Specify Hand)</b>			
<b>BTS80 EMBI</b>	<b>Complete package</b> 80 EMB-5, 74003, 7410, 7451N-A	<b>4,809.00</b>	<b>4,980.00</b>
BTS80 EMBI LFP	Complete package, less floor plate		Deduct 153.00
<b>Independent Hung, 3 Hour Rated Steel, 1-1/2 Hour Rated Wood Fire Door Hung on Hinges, etc. (Specify Hand)</b>			
<b>BTS80 EMBIF</b>	<b>Complete package</b> 80 EMB-5, 74003, 7410, 7451N**	<b>4,809.00</b>	<b>5,144.00</b>
BTS80 EMBIF LFP	Complete package, less floor plate		Deduct 153.00

**NOTE:** See BTS80 EMB Accessories for intermediate pivots. See BTS Accessories for individual component list prices.

Package	Description	Painted Finish \$	Plated Finish \$
<b>3/4" Offset, Single Acting, Lead Lined, Wood, or Steel Door and Frame, for 1-3/4" thick door (Specify Hand)</b>			
<b>BTS80 EMBL</b>	<b>Complete package</b> 80 EMB-5, 74010, 7410, 75343, 75140	—	<b>5,553.00</b>
BTS80 EMBL LFP	Complete package, less floor plate		Deduct 153.00
<b>3/4" Offset, Single Acting, Lead Lined 20 Minute Rated Fire Door and Frame, for 1-3/4" thick door (Specify Hand)</b>			
<b>BTS80 EMBL-E</b>	<b>Complete package</b> 80 EMB-5, 74010, 7410, 75343, 75142	<b>5,586.00</b>	<b>5,586.00</b>
BTS80 EMBLE LFP	Complete package, less floor plate		Deduct 153.00
<b>3/4" Offset, Single Acting, Lead Lined 3 Hour Rated Fire Door and Frame, for 1-3/4" thick door (Specify Hand)</b>			
<b>BTS80 EMBL-F</b>	<b>Complete package</b> 80 EMB-5, 74010, 7410, 75343,75143	<b>5,662.00</b>	<b>5,898.00</b>
BTS80 EMBLF LFP	Complete package, less floor plate		Deduct 153.00

\* Floor closer is painted black only. Cement case is galvanized steel.  
 Spindle is available in zinc plated finish only.  
 Center hung bottom arms are available in zinc plated finish only (7421/7422).  
 Floor plate is only available in plated finishes.

\*\* Bottom arm for painted finish would be 7451N.  
 See BTS80 EMB Accessories for intermediate pivots. See BTS Accessories for individual component list prices.  
 See Options for Less Cement Box.



# Options

(List Price 'add' when ordered with complete closer)

Item	Description	Painted Add \$	Plated Add \$
AMS	All metal screws	N/C	0.00
AMSAWS	All metal screws, all wood screws	17.00	23.00
W1	Half wood screws	10.00	11.00
W2	All wood screws	12.00	14.00
74003, 74005, 74007, 74010	5/16", 1/2", 5/8", or 3/4" clearance spindle	N/C	—
74012, 74015, 74020	13/16", 7/8", or 1-1/8" clearance spindle	37.00	—
74025, 74030, 74035	1-5/16", 1-1/2", or 1-11/16" clearance spindle	37.00	—
74040, 74045, 74050	1-7/8", 2-1/16", or 2-5/16" clearance spindle	37.00	—
TP80	▲ Terrazo pan for BTS 80, 80 F, 80 EMB - 3/4" offset (handed)	—	777.00
TP80 CH	▲ Terrazo pan for BTS 80, 80 F, 80 EMB - Center hung or 1-1/2" offset	—	708.00
SC2	Sealing compound	109.00	—
Custom Color	Custom painted finish selected from RAL color pallet book. For details, see <b>Finishes Cross Reference</b> , page viii.		
	per order, setup charge <b>(Net)</b>	155.00	—
	per closer, list add	96.00	—
Designer Color	Designer painted color matched to supplied samples. Three (3) each 2" x 3" colorchip samples required. For details, see <b>Finishes Cross Reference</b> , page viii.		
	per order, non-refundable development/ setup charge <b>(Net)</b>	373.00	—
	per closer, list add	96.00	—

## Spindle Inserts for Center Hung Single Acting Packages

Item	Description	Painted Add \$	Plated Add \$
80003, 80005, 80010	5/16", 1/2" or 3/4" clearance spindle (specify hand)	N/C	—
80015, 80020, 80025, 80030	7/8", 1-1/8", 1-5/16" or 1-1/2" clearance spindle (specify hand)	37.00	—

▲ Terrazo pans are available stainless steel only.

## Accessories

### Pivots

Item	Description	Painted Finish \$	Plated Finish \$
<b>3/4" Offset Hung Intermediate Pivots**</b>			
75220	Full mortise standard intermediate pivot	427.00	427.00
75222	Full mortise intermediate pivot – 20 minute rated fire door	455.00	455.00
75233	Full mortise intermediate pivot – 3 hour rated fire door	478.00	922.00
75240	Full mortise intermediate pivot – 1-3/4" lead-lined doors	639.00	639.00
75242	Full mortise intermediate pivot – 20 minute rated, 1-3/4" lead-lined doors	675.00	675.00
<b>1-1/2" Offset Hung Intermediate Pivots**</b>			
15220	Full mortise standard intermediate pivot	639.00	639.00
15222	Full mortise intermediate pivot – 20 minute rated fire door	692.00	692.00
15233	Full mortise intermediate pivot – 3 hour rated fire door	710.00	1,241.00
<b>Power Transfer Pivots</b>			
75200	Through-wire 3/4" offset intermediate pivot – 8 wire**	793.00	793.00
E80622	Through-wire center hung top pivot (2 wire)	864.00	864.00
E80624	Through-wire center hung top pivot (4 wire)	864.00	864.00

\*\* All intermediate pivots are handed.

### Miscellaneous

Item	Description	List \$
TP80	▲ Terrazo pan for BTS 80, 80 F, 80 EMB – 3/4" offset (Handed)	777.00
TP80CH	Terrazo pan for BTS 80, 80 F, 80 EMB – Center hung or 1-1/2" offset	708.00
SC2	Sealing compound	109.00

▲ Terrazo pans are available stainless steel only.

### NOTES:

- Only packages with an "E" or "F" designation in the package description are available in painted finishes.
- Specify package designation, hand (when required), finish, and options or accessories when ordering.
- Complete package prices are indicated in bold.
- When ordering a package "less components," deduct the list price for the component removed.
- Cover plate not available in painted finish. Cover plate will be plated to match when ordering with painted finishes.
- All packages furnished with all machine screws standard (AMS).
- Lead-lined packages shown are for 1-3/4" thick doors. For lead-lined doors from 2" up to 3" thick, add \$107.00 list to the package price. Example, specify: BTS80/L-3 for a 3" door.



# BTS75V SERIES

## Ordering Guide

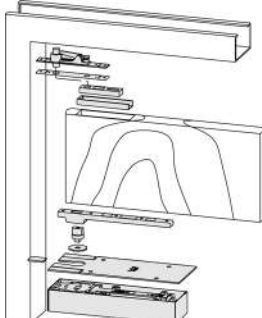

**Series**  
**BTS75V**

**Spindle**

1-1/2" Pre-Loaded Spindle	80030
1-5/16" Pre-Loaded Spindle	80025
1-1/8" Pre-Loaded Spindle	80020
7/8" Pre-Loaded Spindle	80015
3/4" Pre-Loaded Spindle	80010
1/2" Pre-Loaded Spindle	80005
5/16" Pre-Loaded Spindle	80003
2-5/16" Spindle	74050
2-1/16" Spindle	74045
1-7/8" Spindle	74040
1-11/16" Spindle	74035
1-1/2" Spindle	74030
1-5/16" Spindle	74025
1-1/8" Spindle	74020
7/8" Spindle	74015
13/16" Spindle	74012
3/4" Spindle	74010
5/8" Spindle	74007
1/2" Spindle	74005
5/16" Spindle	74003

**Hold Open**

150° Hold Open (BF Not Available)	105
90° Hold Open	90
Non-Hold Open	NHO

**Optional Accessories**  
(multiple options can be ordered)

E80624	Through Wire CH Top Pivot (4 wire)
E80622	Through Wire CH Top Pivot (2 wire)
HD8062	Heavy Duty CH Top Pivot
75200	Through Wire Intermediate Pivot for 3/4" Offset
15233	3h Intermediate Pivot for 1-1/2" Offset
15222	20 min Intermediate Pivot for 1-1/2" Offset
15220	Through Wire Intermediate Pivot for 1-1/2" Offset
75233	3 h Intermediate Pivot for 3/4" Offset
75222	20 min Intermediate Pivot for 3/4" Offset
75220	Intermediate Pivot for 3/4" Offset
SC2	Sealing Compound
TP75 CH	Terrazo Pan CH and 1-1/2" Offset
TP75	Terrazo Pan for 3/4" Offset

**Deducts**

LBX	Less Cement Box
LFP	Less Floor Plate
LTP	Less Top Pivot

<b>BTS75V</b>	<b>D</b>		<b>NHO</b>	<b>74010</b>	<b>RH</b>	<b>AMS</b>		<b>626</b>	
---------------	----------	--	------------	--------------	-----------	------------	--	------------	--

**Package**

<b>A</b>	CH Double Acting, Aluminum Door and Frame
<b>B</b>	CH Double Acting, Wood or Steel Door and Frame
<b>C</b>	CH Double Acting, Wood or Steel Door and Frame
<b>C-E</b>	1-1/2" Offset, Handed
<b>C-F</b>	1-1/2" Offset, 20 min Rated Handed
<b>D</b>	1-1/2" Offset, 3 h Rated Handed
<b>E</b>	3/4" Offset, Handed
<b>F</b>	3/4" Offset, 20 min Rated Handed
<b>G</b>	3/4" Offset, 3 h Rated Handed
<b>H</b>	CH Single Acting, Aluminum Door and Frame
<b>I</b>	CH Single Acting, Wood or Steel Door and Frame
<b>J</b>	Independent Hung, Non-Handed
<b>IF</b>	Independent Hung, Up to 3 h Rated, Non-Handed
<b>P</b>	Independent Hung On Pocket Pivots, Non-Handed
<b>PF</b>	Independent Hung On Pocket Pivots, Up to 3 h Rated, Non-Handed

**Spring Size**

<b>Std.</b>	No Need to Specify Size 1-4, No Delay
<b>BF</b>	Size 1-4, No Backcheck

**Hand**

<b>LH</b>	Specify for Left Handed Units
<b>RH</b>	Specify for Right Handed Units

**Fastener Packs**

<b>AMS</b>	All Metal Screws
<b>W2</b>	All Wood Screws
<b>W1</b>	1/2 Wood Screws
<b>AMSAWS</b>	All Metal Screws All Wood Screws

**Painted**

<b>600</b>	Primed
<b>689</b>	Aluminum
<b>690</b>	Statuary Bronze
<b>691</b>	Dull Bronze
<b>693</b>	Black
<b>695</b>	Dark Duranodic Bronze
<b>696</b>	Gold Special Sprayed Finish (must specify)
<b>PNT</b>	
<b>605</b>	Bright Brass
<b>606</b>	Satin Brass
<b>611</b>	Bright Bronze
<b>612</b>	Satin Bronze
<b>613</b>	Oxidized Satin Oil Rubbed
<b>618</b>	Bright Nickel
<b>619</b>	Satin Nickel
<b>625</b>	Bright Chrome
<b>626</b>	Satin Chrome

**Plated**

**NOTES:**

- All combinations of features and options are not available for all models.
- Please refer to BTS75V Series product brochure for details.

Package	Description	Painted Finish \$	Plated Finish \$
<b>Center Hung, Double Acting, Aluminum Door and Frame (Non-Handed)</b>			
<b>BTS75VA</b>	<b>Complete package</b> BTS75V NHO, 74010, 7510, 7422, 8062	—	<b>2,149.00</b>
BTS75VA LFP	Complete package, less floor plate		Deduct 153.00
<b>Center Hung, Double Acting, Wood or Steel Door and Frame (Non-handed)</b>			
<b>BTS75VB</b>	<b>Complete Package</b> BTS75V NHO, 74010, 7510, 7421, 8062	—	<b>2,104.00</b>
BTS75VB LFP	Complete package, less floor plate		Deduct 153.00
<b>1-1/2" Offset, Single Acting, Wood, Steel, or Aluminum Door and Frame (Specify Hand)</b>			
<b>BTS75VC</b>	<b>Complete package</b> BTS75V NHO, 74010, 7510, 15323, 15120	—	<b>2,647.00</b>
BTS75VC LFP	Complete package, less floor plate		Deduct 153.00
<b>1-1/2" Offset, Single Acting, 20 Minute Rated Fire Door and Frame (Specify Hand)</b>			
<b>BTS75VCE</b>	<b>Complete package</b> BTS75V NHO, 74010, 7510, 15323, 15122	<b>2,699.00</b>	<b>2,699.00</b>
BTS75VCE LFP	Complete package, less floor plate		Deduct 153.00
<b>1-1/2" Offset, Single Acting, 3 Hour Rated Fire Door and Frame (Specify Hand)</b>			
<b>BTS75VCF</b>	<b>Complete package</b> BTS75V NHO, 74010, 7510, 15323, 15133	<b>2,744.00</b>	<b>3,195.00</b>
BTS75VCF LFP	Complete package, less floor plate		Deduct 153.00
<b>3/4" Offset, Single Acting, Wood, Steel, or Aluminum Door and Frame (Specify Hand)</b>			
<b>BTS75VD</b>	<b>Complete Package</b> BTS75V NHO, 74010, 7510, 75323, 75120	—	<b>2,228.00</b>
BTS75VD LFP	Complete package, less floor plate		Deduct 153.00
<b>3/4" Offset, Single Acting, 20 Minute Rated Fire Door and Frame (Specify Hand)</b>			
<b>BTS75VE</b>	<b>Complete package</b> BTS75V NHO, 74010, 7510, 75323, 75122	<b>2,262.00</b>	<b>2,262.00</b>
BTS75VE LFP	Complete package, less floor plate		Deduct 153.00
<b>3/4" Offset, Single Acting, 3 Hour Rated Fire Door and Frame (Specify Hand)</b>			
<b>BTS75VF</b>	<b>Complete package</b> BTS75V NHO, 74010, 7510, 75323, 75133	<b>2,324.00</b>	<b>2,605.00</b>
BTS75VF LFP	Complete package, less floor plate		Deduct 153.00
<b>Center Hung, Single Acting, Aluminum Door and Frame (Specify Hand)</b>			
<b>BTS75VG</b>	<b>Complete package</b> BTS75V NHO, 80010, 7510, 7422, 8062	—	<b>2,148.00</b>
BTS75VG LFP	Complete package, less floor plate		Deduct 153.00
<b>Center Hung, Single Acting, Wood or Steel Door and Frame (Specify Hand)</b>			
<b>BTS75VH</b>	<b>Complete package</b> BTS75V NHO, 80010, 7510, 7421, 8062	—	<b>2,104.00</b>
BTS75VH LFP	Complete package, less floor plate		Deduct 153.00

**NOTES:**

- See BTS75V Accessories for intermediate pivots. See BTS Accessories for individual component list prices.

Package	Description	Painted Finish \$	Plated Finish \$
<b>Independent Hung, on Hinges, etc. (Non-Handed)</b>			
<b>BTS75VI</b>	<b>Complete package</b> BTS75V NHO, 74003, 7510, 7451N-A**	<b>2,105.00</b>	<b>2,280.00</b>
BTS75VI LFP	Complete package, less floor plate		Deduct 153.00
<b>Independent Hung, 3 Hour Rated Steel and 1-1/2 Hour Rated Wood Fire Doors Hung on Hinges, etc. (Non-Handed)</b>			
<b>BTS75VIF</b>	<b>Complete package</b> BTS75V NHO, 74003, 7510, 7451N	<b>2,105.00</b>	<b>2,442.00</b>
BTS75VIF LFP	Complete package, less floor plate		Deduct 153.00
<b>Independent Hung, on Pocket Pivots (Non-Handed)</b>			
<b>BTS 75VP</b>	<b>Complete package (priced w/ 3 pivots)</b> BTS75V NHO, 74003, 7510, 7451N-A, 75520	<b>4,027.00</b>	<b>4,589.00</b>
BTS75VP LFP	Complete package, less floor plate		Deduct 153.00
<b>Independent Hung, 3 Hour Rated Steel and 1-1/2 Hour Rated Wood Fire Doors Hung on Pocket Pivots (Specify Hand)</b>			
<b>BTS75VPF</b>	<b>Complete package (priced w/ 3 pivots)</b> BTS75V NHO, 74003, 7510, 7451N, 75523	<b>4,129.00</b>	<b>4,883.00</b>
BTS75VPF LFP	Complete package, less floor plate		Deduct 153.00

\* Floor closer is painted black only. Cement case is galvanized steel.  
 Spindle is available in zinc plated finish only.  
 Center hung bottom arms are available in zinc plated finish only (7421/7422).  
 Floor plate is only available in plated finishes.

\*\* Bottom arm for painted finish would be 7451N.  
 See BTS Accessories for individual component list prices.  
 See Options for Less Cement Box.

# Options

(List Price 'add' when ordered with complete closer)

Item	Description	Painted Add \$	Plated Add \$
90	90° hold open	87.00	—
105	105° hold open	87.00	—
BF, BF 90	Barrier free for non-fire doors only	N/C	—
AMS	All metal screws	N/C	—
AMSAWS	All metal screws, all wood screws	17.00	23.00
W1	Half wood screws	10.00	11.00
W2	All wood screws	12.00	14.00
74003, 74005, 74007, 74010	5/16", 1/2", 5/8", or 3/4" clearance spindle	N/C	—
74012, 74015, 74020	13/16", 7/8", or 1-1/8" clearance spindle	37.00	—
74025, 74030, 74035	1-5/16", 1-1/2", or 1-11/16" clearance spindle	37.00	—
74040, 74045, 74050	1-7/8", 2-1/16", or 2-5/16" clearance spindle	37.00	—
TP75	▲ Terrazo pan for BTS 75V — 3/4" offset (Handed)	—	741.00
TP75CH	▲ Terrazo pan for BTS 75V — Center hung or 1-1/2" offset	—	673.00
SC2	Sealing compound	109.00	0.00
LBX	Less cement box	Deduct 24.00	
Custom Color	Custom painted finish selected from RAL color pallet book. For details, see <b>Finishes Cross Reference</b> , page viii.		
	per order, setup charge ( <b>Net</b> )	155.00	—
	per closer, list add	96.00	—
Designer Color	Designer painted color matched to supplied samples. Three (3) each 2" x 3" colorchip samples required. For details, see <b>Finishes Cross Reference</b> , page viii.		
	per order, non-refundable development/ setup charge ( <b>Net</b> )	373.00	—
	per closer, list add	96.00	—

▲ Terrazo pans are available stainless steel only.

## Spindle Inserts for Center Hung Single Acting Packages

Item	Description	Painted Add \$	Plated Add \$
80003, 80005, 80010	5/16", 1/2", or 3/4" clearance spindle (specify hand)	N/C	—
80015, 80020, 80025, 80030	7/8", 1-1/8", 1-5/16", or 1-1/2" clearance spindle (specify hand)	37.00	—

## Accessories

### Pivots

Item	Description	Painted Finish \$	Plated Finish \$
<b>3/4" Offset Hung Intermediate Pivots**</b>			
75220	Full mortise standard intermediate pivot	427.00	427.00
75222	Full mortise intermediate pivot — 20 minute rated fire door	455.00	455.00
75233	Full mortise intermediate pivot — 3 hour rated fire door	478.00	922.00
<b>1-1/2" Offset Hung Intermediate Pivots**</b>			
15220	Full mortise standard intermediate pivot	639.00	639.00
15222	Full mortise intermediate pivot — 20 minute rated fire door	692.00	692.00
15233	Full mortise intermediate pivot — 3 hour rated fire door	710.00	1,241.00
<b>Power Transfer Pivots</b>			
75200	Through-wire 3/4" offset intermediate pivot — 8 wire**	793.00	793.00
E80622	Through-wire center hung top pivot (2 wire)	864.00	864.00
E80624	Through-wire center hung top pivot (4 wire)	864.00	864.00

\*\* All intermediate pivots are handed.

#### NOTES:

- Only packages with an "E" or "F" designation in the package description are available in painted finishes.
- Specify package designation, hand (when required), finish, and options or accessories when ordering.
- Complete package prices are indicated in bold.
- When ordering a package "less components," deduct the list price of the removed component.
- Cover plate not available in painted finish. Cover plate will be plated to match when ordering with painted finishes.
- All packages furnished with all machine screws standard (AMS).
- Package price for P or PF packages includes 3 pocket pivots.
- When BTS75D Package is ordered through Select Service, the BF closer is supplied as the default, unless specified otherwise.





# ITS96 Series

## Ordering Guide

						<b>Painted Finish</b>																	
						<table border="1"> <tr><td><b>PNT</b></td><td>— Special Sprayed Finish (must specify)</td></tr> <tr><td><b>696</b></td><td>— Gold</td></tr> <tr><td><b>695</b></td><td>— Dark Duranodic Bronze</td></tr> <tr><td><b>693</b></td><td>— Black</td></tr> <tr><td><b>691</b></td><td>— Dull Bronze</td></tr> <tr><td><b>690</b></td><td>— Statuary Bronze</td></tr> <tr><td><b>689</b></td><td>— Aluminum</td></tr> <tr><td><b>600</b></td><td>— Primed</td></tr> </table>		<b>PNT</b>	— Special Sprayed Finish (must specify)	<b>696</b>	— Gold	<b>695</b>	— Dark Duranodic Bronze	<b>693</b>	— Black	<b>691</b>	— Dull Bronze	<b>690</b>	— Statuary Bronze	<b>689</b>	— Aluminum	<b>600</b>	— Primed
<b>PNT</b>	— Special Sprayed Finish (must specify)																						
<b>696</b>	— Gold																						
<b>695</b>	— Dark Duranodic Bronze																						
<b>693</b>	— Black																						
<b>691</b>	— Dull Bronze																						
<b>690</b>	— Statuary Bronze																						
<b>689</b>	— Aluminum																						
<b>600</b>	— Primed																						
				<b>Mounting Kit Options</b>																			
				Steel Frame Mounting Kit — <b>BRKTMD</b>																			
				Wood Frame Mount Kit — <b>BRKTWD</b>																			
<b>Application</b>																							
Inverted (closer in frame) — <b>INV</b>																							
Standard —																							
<b>ITS96</b>		<b>13</b>	<b>NHO</b>			<b>689</b>																	
<b>ITS96</b>	Size 1-3 — <b>13</b>		<b>HO</b> — Hold Open			<b>605</b>	— Bright Brass																
<b>Series</b>	Size 2-5 — <b>25</b>		<b>NHO</b> — Non-Hold Open			<b>606</b>	— Satin Brass																
	<b>Spring Size</b>		<b>Hold Open</b>			<b>611</b>	— Bright Bronze																
						<b>612</b>	— Satin Bronze																
						<b>613</b>	— Oxidized Satin Oil Rubbed Bronze																
						<b>618</b>	— Bright Nickel																
						<b>619</b>	— Satin Nickel																
						<b>625</b>	— Bright Chrome																
						<b>626</b>	— Satin Chrome																
						<b>Plated Finish</b>																	

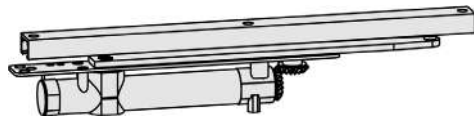

- NOTES:**
- All combinations of features and options are not available for all models.
  - Please refer to ITS96 Series product brochure for details.

Body	Mounting	Painted Finish \$	Plated Finish \$
<b>Non-Hold Open</b>			
ITS9613	Concealed in door (size 1-3)	699.00	868.00
ITS9625	Concealed in door (size 2-5)	833.00	1,039.00
<b>Hold Open</b>			
ITS9613 HO	Concealed in door w/hold open (size 1-3)	794.00	963.00
ITS9625 HO	Concealed in door w/hold open (size 2-5)	931.00	1,131.00

## Options

(List Price 'add' when ordered with complete closer)

Item	Description	Painted Add \$	Plated Add \$
INV	Inverted ITS96 (closer in header)	28.00	52.00
BRKT ITS WOOD	Wood frame mounting kit	45.00	—
BRKT ITS METAL	Steel frame mounting kit	45.00	—
Custom Color	Custom painted finish selected from RAL color pallet book. For details, see <b>Finishes Cross Reference</b> , page viii.		
	per order, setup charge ( <b>Net</b> )	155.00	—
	per closer, list add	51.00	—
Designer Color	Designer painted color matched to supplied samples. Three (3) each 2" x 3" color chip samples required. For details, see <b>Finishes Cross Reference</b> , page viii.		
	per order, non-refundable development/setup charge ( <b>Net</b> )	373.00	—
	per closer, list add	51.00	—

### NOTES:

- Standard configuration is painted arm with track channel to match (shown in bold); closer and closer mounting plate are one finish only.
- Plated finish price includes arm plated and track sprayed with complementary finish.
- Minimum door thickness for ITS9625 is 2" when concealed in the door.  
For 1-3/4" thick doors, install ITS9625 in the header (i.e. ITS9625 INV).

# RTS88 Series

## Ordering Guide

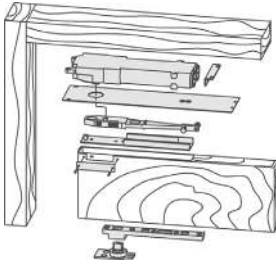

Series	Non-Hold Open	Hold Open	Fastener Packs	Accessories	Adds or Deducts	
<b>RTS</b>	Non-Hold Open — <b>NHO</b>	Hold Open — <b>HO</b>	All Metal Screws — <b>AMSAWS</b> All Wood Screws — <b>W1</b> 1/2 Wood Screws — <b>W2</b> All Wood Screws — <b>AMS</b>	<b>8836S</b> — Closer Arm for 7/8" Top Rail Glass Shoe <b>8820J</b> — Conversion Bracket for Jackson OHC <b>8521E</b> — 1-5/16" Spindle Extension	<b>LBA</b> — Less Bottom Arm <b>LTA</b> — Less Top Arm <b>LBP</b> — Less Bottom Pivot <b>5MM</b> — W/ 5mm Extended Spindle <b>LMC</b> — Less Mounting Channel <b>8563</b> — Cover Plate for Aluminum Frame Application	
<b>RTS</b>	<b>03</b>	<b>105</b>	<b>NHO</b>	<b>Sz3</b>	<b>AMS</b>	<b>626</b>
CH Side, Aluminum — <b>01</b>	<b>105</b> — 105° Cushion	<b>Sz2</b> — Light Opening Force	<b>600</b> — Primed			
CH Side, Aluminum — <b>02</b>	<b>90</b> — 90° Cushion	<b>Sz3</b> — Standard Closing Force	<b>689</b> — Aluminum			
CH Side, Steel — <b>03</b>	<b>Cushion</b>	<b>Sz4</b> — Strongest Closing Force	<b>690</b> — Statuary Bronze			
CH Side, Wood Door, Steel Frame — <b>04</b>		<b>BFE</b> — Light Opening Force for Exterior Doors	<b>691</b> — Dull Bronze			
CH Side, Wood Door, Aluminum Frame — <b>05</b>	— CH Side, Wood	<b>BFI</b> — Lightest Opening Force for Interior	<b>693</b> — Black			
<b>06</b>		<b>Spring Size</b>	<b>695</b> — Dark Duranodic Bronze			
<b>07</b>	— CH End, Aluminum		<b>696</b> — Gold			
<b>08</b>	— CH End, Aluminum		<b>PNT</b> — Special Sprayed Finish (must specify)			
<b>09</b>	— CH End, Aluminum		<b>Painted</b>			
<b>10</b>	— CH End, Aluminum		Bright Brass — <b>605</b>			
<b>11</b>	— CH End, Aluminum		Satin Brass — <b>606</b>			
<b>12</b>	— CH End, Aluminum		Bright Bronze — <b>611</b>			
<b>13</b>	— CH End, Aluminum		Satin Bronze — <b>612</b>			
<b>14</b>	— CH End, Aluminum		Oxidized Satin Oil Rubbed — <b>613</b>			
<b>15</b>	— CH End, Aluminum		Bright Nickel — <b>618</b>			
<b>16</b>	— CH End, Aluminum		Satin Nickel — <b>619</b>			
<b>17</b>	— CH End, Aluminum		Bright Chrome — <b>625</b>			
<b>18</b>	— CH End, Aluminum		Satin Chrome — <b>626</b>			
<b>19</b>	— CH End, Aluminum		<b>Plated</b>			
<b>20</b>	— CH End, Aluminum		<b>Finish</b>			
<b>21</b>	— CH End, Aluminum					
<b>22</b>	— CH End, Aluminum					
<b>25</b>	— Hinge Hung, Aluminum					
<b>26</b>	— 3/4" Offset, Aluminum					
<b>27</b>	— Hinge or 3/4" Offset, Steel					
<b>28</b>	— Hinge or 3/4" Offset, Wood Door, Steel Frame					
<b>29</b>	— Hinge or 3/4" Offset, Wood					
<b>30</b>	— Hinge, Wood Door, Aluminum Frame					
<b>31</b>	— 3/4" Offset, Wood Door, Aluminum Frame					

**Package**

**NOTES:**

- All combinations of features and options are not available for all models.
- Please refer to RTS88 Series product brochure for details.

Package	Description	Painted Finish \$	Plated Finish \$
<b>Center Hung Side Load, Double or Single Acting, Aluminum Door and Frame (Non-Handed)</b>			
<b>RTS01</b>	<b>Complete package</b> RTS88, 8831, 8572	<b>896.00</b>	<b>—</b>
RTS01 × 8563	Complete package, including 8563 frame cover plate	997.00	—
<b>Center Hung Side Load, Double or Single Acting, Aluminum Door and Frame (Non-Handed)</b>			
<b>RTS02</b>	<b>Complete package</b> RTS88, 8831, 8570	<b>933.00</b>	<b>—</b>
RTS02 × 8563	Complete package, including 8563 frame cover plate	1,034.00	—
<b>Center Hung Side Load, Double or Single Acting, Steel Door and Frame (Non-Handed)</b>			
<b>RTS03</b>	<b>Complete package</b> RTS88, 8831, 7471K, 7421, 8575, 8532**	<b>1,293.00</b>	<b>1,437.00</b>
RTS03 LMC	Complete package, less mounting channel	1,206.00	1,352.00
<b>Center Hung Side Load, Double or Single Acting, Wood Door and Steel Frame (Non-Handed)</b>			
<b>RTS04</b>	<b>Complete package</b> RTS88, 8832, 7471K, 7421, 8575, 8532**, W1	<b>1,414.00</b>	<b>1,561.00</b>
RTS04 LMC	Complete package, less mounting channel	1,330.00	1,475.00
<b>Center Hung Side Load, Double or Single Acting, Wood Door and Frame (Non-Handed)</b>			
<b>RTS05</b>	<b>Complete package</b> RTS88, 8832, 7471K, 7421, 8561, W2	<b>1,322.00</b>	<b>1,475.00</b>
<b>Center Hung Side Load, Double or Single Acting, Wood Door and Aluminum Frame (Non-Handed)</b>			
<b>RTS06</b>	<b>Complete package</b> RTS88, 8832, 7471K, 7421, W1	<b>1,216.00</b>	<b>1,363.00</b>
RTS06 × 8563	Complete package, including 8563 frame cover plate	1,315.00	1,465.00
<b>Center Hung End Load, Double or Single Acting, Aluminum Door and Frame (Non-Handed)</b>			
<b>RTS07</b>	<b>Complete package</b> RTS88, 8835, 8857	<b>1,077.00</b>	<b>—</b>
RTS07 × 8563	Complete package, including 8563 frame cover plate	1,179.00	—
<b>Center Hung End Load, Double or Single Acting, Aluminum Door and Frame (Non-Handed)</b>			
<b>RTS08</b>	<b>Complete package</b> RTS88, 8835, 8853	<b>914.00</b>	<b>—</b>
RTS08 × 8563	Complete package, including 8563 frame cover plate	1,015.00	—
<b>Center Hung End Load, Double or Single Acting, Aluminum Door and Frame (Non-Handed)</b>			
<b>RTS09</b>	<b>Complete package</b> RTS88, 8835, 8855	<b>914.00</b>	<b>—</b>
RTS09 × 8563	Complete package, including 8563 frame cover plate	1,015.00	—
<b>Center Hung End Load, Double or Single Acting, Aluminum Door and Frame (Non-Handed)</b>			
<b>RTS10</b>	<b>Complete package</b> RTS88, 8835, 8852	<b>914.00</b>	<b>—</b>
RTS10 × 8563	Complete package, including 8563 frame cover plate	1,015.00	—

**NOTES:**

- See RTS88 Accessories for individual component list prices.

Package	Description	Painted Finish \$	Plated Finish \$
<b>Center Hung End Load, Double or Single Acting, Aluminum Door and Frame (Non-Handed)</b>			
<b>RTS11</b>	<b>Complete package</b> RTS88, 8836, 8857	<b>914.00</b>	—
RTS11 × 8563	Complete package, including 8563 frame cover plate	1,015.00	—
<b>Center Hung End Load, Double or Single Acting, Aluminum Door and Frame (Non-Handed)</b>			
<b>RTS12</b>	<b>Complete package</b> RTS88, 8836, 8853	<b>914.00</b>	—
RTS12 × 8563	Complete package, including 8563 frame cover plate	1,015.00	—
<b>Center Hung End Load, Double or Single Acting, Aluminum Door and Frame (Non-Handed)</b>			
<b>RTS13</b>	<b>Complete package</b> RTS88, 8836, 8855	<b>914.00</b>	—
RTS13 × 8563	Complete package, including 8563 frame cover plate	1,015.00	—
<b>Center Hung End Load, Double or Single Acting, Aluminum Door and Frame (Non-Handed)</b>			
<b>RTS14</b>	<b>Complete package</b> RTS88, 8836, 8852	<b>914.00</b>	—
RTS14 × 8563	Complete package, including 8563 frame cover plate	1,015.00	—
<b>Center Hung End Load, Double or Single Acting, Aluminum Door and Frame (Non-Handed)</b>			
<b>RTS15</b>	<b>Complete package</b> RTS88, 8838, 8857	<b>914.00</b>	—
RTS15 × 8563	Complete package, including 8563 frame cover plate	1,015.00	—
<b>Center Hung End Load, Double or Single Acting, Aluminum Door and Frame (Non-Handed)</b>			
<b>RTS16</b>	<b>Complete package</b> RTS88, 8838, 8853	<b>914.00</b>	—
RTS16 × 8563	Complete package, including 8563 frame cover plate	1,015.00	—
<b>Center Hung End Load, Double or Single Acting, Aluminum Door and Frame (Non-Handed)</b>			
<b>RTS17</b>	<b>Complete package</b> RTS88, 8838, 8855	<b>914.00</b>	—
RTS17 × 8563	Complete package, including 8563 frame cover plate	1,015.00	—
<b>Center Hung End Load, Double or Single Acting, Aluminum Door and Frame (Non-Handed)</b>			
<b>RTS18</b>	<b>Complete package</b> RTS88, 8838, 8852	<b>914.00</b>	—
RTS18 × 8563	Complete package, including 8563 frame cover plate	1,015.00	—
<b>Center Hung End Load, Double or Single Acting, Aluminum Door and Frame (Non-Handed)</b>			
<b>RTS19</b>	<b>Complete package</b> RTS88, 8837, 8857	<b>914.00</b>	—
RTS19 × 8563	Complete package, including 8563 frame cover plate	1,015.00	—
<b>Center Hung End Load, Double or Single Acting, Aluminum Door and Frame (Non-Handed)</b>			
<b>RTS20</b>	<b>Complete package</b> RTS88, 8837, 8853	<b>914.00</b>	—
RTS20 × 8563	Complete package, including 8563 frame cover plate	1,015.00	—

**NOTE:** See RTS88 Accessories for individual component list prices.

Package	Description	Painted Finish \$	Plated Finish \$
<b>Center Hung End Load, Double or Single Acting, Aluminum Door and Frame (Non-Handed)</b>			
<b>RTS21</b>	<b>Complete package</b> RTS88, 8837, 8855	<b>914.00</b>	—
RTS21 × 8563	Complete package, including 8563 frame cover plate	1,015.00	—
<b>Center Hung End Load, Double or Single Acting, Aluminum Door and Frame (Non-Handed)</b>			
<b>RTS22</b>	<b>Complete package</b> RTS88, 8837, 8852	<b>914.00</b>	—
RTS22 × 8563	Complete package, including 8563 frame cover plate	1,015.00	—
<b>Hinge Hung, Single Acting, Aluminum Door and Frame (Non-Handed)</b>			
<b>RTS25</b>	<b>Complete package</b> RTS88, 8812	<b>914.00</b>	—
RTS25 × 8563	Complete package, including 8563 frame cover plate	1,015.00	—
<b>3/4" Offset Pivot Hung, Single Acting, Aluminum Door and Frame (Non-Handed)</b>			
<b>RTS26</b>	<b>Complete package</b> RTS88, 8812	<b>914.00</b>	—
RTS26 × 8563	Complete package, including 8563 frame cover plate	1,015.00	—
<b>Hinge or 3/4" Offset Pivot Hung, Single Acting, Steel Door and Frame (Non-Handed)</b>			
<b>RTS27</b>	<b>Complete package</b> RTS88, 8812, 8575, 8532**	<b>1,077.00</b>	<b>1,224.00</b>
RTS27 LMC	Complete package, less mounting channel	992.00	1,139.00
<b>Hinge or 3/4" offset Pivot Hung, Single Acting, Wood Door and Steel Frame (Non-Handed)</b>			
<b>RTS28</b>	<b>Complete package</b> RTS88, 8812, 8575, 8532**, W1	<b>1,079.00</b>	<b>1,228.00</b>
RTS28 LMC	Complete package, less mounting channel	996.00	1,145.00
<b>Hinge or 3/4" Offset Pivot Hung, Single Acting, Wood Door and Frame (Non-Handed)</b>			
<b>RTS29</b>	<b>Complete package</b> RTS88, 8812, 8561, W2	<b>992.00</b>	<b>1,146.00</b>
<b>Hinge Hung, Single Acting, Wood Door and Aluminum Frame (Non-Handed)</b>			
<b>RTS30</b>	<b>Complete package</b> RTS88, 8812, W1	<b>884.00</b>	<b>1,146.00</b>
RTS30 × 8563	Complete package, including 8563 frame cover plate	984.00	—
<b>3/4" Offset Pivot Hung, Single Acting, Wood Door and Aluminum Frame (Non-Handed)</b>			
<b>RTS31</b>	<b>Complete package</b> RTS88, 8812, W1	<b>884.00</b>	—
RTS31 × 8563	Complete package, including 8563 frame cover plate	984.00	—

**NOTES:**

- See RTS88 Accessories for individual component list prices.
- RTS closer body is always painted aluminum.
- Bottom arm and closer arm are always zinc plated finish. Frame mounting channel is always unfinished. 8563 cover plate is available painted only.

\*\* No. 8532 steel header mounting channel is specifically designed to install the RTS closer into open-throat steel header sections. Typical practice would be to install the mounting channel in the header prior to shipment to the job site.

## Options

(List Price 'add' when ordered with complete closer)

Item	Description	Painted Add \$	Plated Add \$
AMS	All metal screws	N/C	—
AMSAWS	All metal screws, all wood screws	17.00	23.00
W1	Half wood screws	10.00	11.00
W2	All wood screws	12.00	14.00
105° NHO Sz 3, 4, BFI, BFE	Closer with 105° bumper without hold open	N/C	—
105° HO Sz 3, 4, BFI, BFE	Closer with 105° bumper and 105° hold open	N/C	—
90° NHO Sz 2, 3, or 4	Closer with 90° bumper without hold open	N/C	—
90° HO Sz 2, 3 or 4	Closer with 90° bumper and 90° hold open	N/C	—
5 mm EXT	3/16" (5 mm) extended spindle (integral part of pinion)	N/C	—
Custom Color	Custom painted finish selected from RAL color pallet book. For details, see <b>Finishes Cross Reference</b> , page viii.		
	per order, setup charge ( <b>Net</b> )	155.00	—
	per closer, list add	96.00	—
Designer Color	Designer painted color matched to supplied samples. Three (3) each 2" x 3" color chip samples required. For details, see <b>Finishes Cross Reference</b> , page viii.		
	per order, non-refundable development/ setup charge ( <b>Net</b> )	373.00	—
	per closer, list add	96.00	—

### NOTES:

- Specify package designation, hand (when required), finish, and options or accessories when ordering.
- RTS packages furnished standard with 105° NHO, size 3 closer.
- Complete package prices are indicated in bold.
- When ordering a package "less components," deduct the list price of the component removed.
- Auxiliary limiting stop required for all RTS88 installations, especially those doors experiencing unusual conditions, e.g. excessive wind pressure or abuse.

## Accessories

Item	Description	List \$
8836S	Closer arm, 7/8" top rail glass door shoe (zinc plated finish only)	284.00
8511	Slide arm, (8812) cover/applied stop (specify hand and finish)	386.00
8521E	Add-on 1-5/16" spindle extension (finish not required)	90.00
8532	Steel header closer mounting channel (finish not required)	89.00
8820J	Conversion bracket kit to replace Jackson OH closer with RTS88 (Finish not required)	28.00





# LM Series, Heavy-Duty Ordering Guide

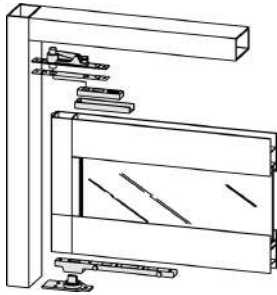

### Spindle Extensions

50mm	— 50 mm Extended Spindle
45mm	— 45 mm Extended Spindle
40mm	— 40 mm Extended Spindle
35mm	— 35 mm Extended Spindle
30mm	— 30 mm Extended Spindle
25mm	— 25 mm Extended Spindle
20mm	— 20 mm Extended Spindle
15mm	— 15 mm Extended Spindle
10mm	— 10 mm Extended Spindle
5mm	— 5 mm Extended Spindle

### Fastener Packs

All Metal Screws	AMSAWS
All Wood Screws	
1/2 Wood Screws	W1
All Wood Screws	W2
All Metal Screws	AMS

### Deducts

LCP	— Less Cover Plate
LA	— Less Arm
LBP	— Less Bottom Pivot
LTP	— Less Top Pivot

<b>Series</b>	Specify for Right Handed Units	<b>Hand</b>	Specify for Left Handed Units
Center Pivot — CP		RH	
Offset Pivot — OP		LH	

<b>OP</b>	<b>440</b>	<b>RH</b>	<b>AMS</b>			<b>626</b>	
-----------	------------	-----------	------------	--	--	------------	--

Up to 440 lb, CH Aluminum —	<b>A440</b>	Intermediate Pivot for 3/4" Offset —	<b>75220</b>	<b>605</b>	— Bright Brass
Up to 440 lb, CH or 3/4" Offset —	<b>440</b>	20 min Intermediate Pivot for 3/4" Offset —	<b>75222</b>	<b>606</b>	— Satin Brass
Up to 440 lb, 20 min Fire Door, 3/4" Offset —	<b>440E</b>	3 h Intermediate Pivot for 3/4" Offset —	<b>75233</b>	<b>611</b>	— Bright Bronze
Up to 440 lb, Up to 3 h Fire Door, 3/4" Offset —	<b>440F</b>	Intermediate Pivot for Lead Lined 3/4" Offset (see note*) —	<b>75240</b>	<b>612</b>	— Satin Bronze
Up to 350 lb, Jamb Mount, 3/4" Offset —	<b>J350</b>	20 min Intermediate Pivot for Lead Lined 3/4" Offset (see note*) —	<b>75242</b>	<b>613</b>	— Oxidized Satin Oil Rubbed Bronze
Up to 440 lb, Lead Lined 3/4" Offset (see note*) —	<b>L440</b>	3 h Intermediate Pivot for Lead Lined 3/4" Offset (see note*) —	<b>75243</b>	<b>618</b>	— Bright Nickel
Up to 440 lb, 20 min Fire Door, Lead Lined 3/4" Offset (see note*) —	<b>L440E</b>	Intermediate Pivot for 1-1/2" Offset —	<b>15220</b>	<b>619</b>	— Satin Nickel
Up to 440 lb, 3 h Fire Door, Lead Lined 3/4" Offset (see note*) —	<b>L440F</b>	20 min Intermediate Pivot for 1-1/2" Offset —	<b>15222</b>	<b>625</b>	— Bright Chrome
Up to 200 lb, 1-1/2" Offset —	<b>15200</b>	3 h Intermediate Pivot for 3/4" Offset —	<b>15233</b>	<b>626</b>	— Satin Chrome
Up to 200 lb, 20 min Fire Door, 1-1/2" Offset —	<b>15200E</b>	Through Wire Intermediate Pivot for 3/4" Offset —	<b>75200</b>	<b>600</b>	— Primed
Up to 200 lb, 3 h Fire Door, 1-1/2" Offset —	<b>15200F</b>	Through Wire CH Top Pivot (2 wire) —	<b>E80622</b>	<b>689</b>	— Aluminum
		Through Wire CH Top Pivot (4 wire) —	<b>E80624</b>	<b>690</b>	— Statuary Bronze
				<b>691</b>	— Dull Bronze
				<b>693</b>	— Black
				<b>695</b>	— Dark Duranodic Bronze
				<b>696</b>	— Gold
				<b>PNT</b>	— Special Sprayed Finish (must specify)

**Package**

**Pivot Accessories**

**Finish**

Plated

Painted

**\* "L" Package Door Thickness Note:**

The standard door thickness is 1-3/4", and is the default unless otherwise specified.

Other alternative sizes are  $\left\{ \begin{array}{l} -2 \\ -2-1/4 \\ -2-1/2 \\ -3 \end{array} \right.$

Examples: L-E-2-1/2...75242-2-1/2

Example above 20 min. lead lined package for 2-1/2" thick door.

**NOTES:**

- All combinations of features and options are not available for all models.
- Please refer to LM Heavy-Duty Series product brochure for details.

## Packages for Doors Weighing up to 440 lb

### Center Hung Packages

Package	Description	Painted Finish \$	Plated Finish \$
<b>Double or Single Acting, Aluminum Door and Frame (Non-handed)</b>			
<b>CPA440</b>	<b>Complete package</b> 7471K, 7422, 8062	<b>549.00</b>	<b>549.00</b>
<b>Double or Single Acting, Wood or Steel Door and Frame (Non-handed)</b>			
<b>CP440</b>	<b>Complete package</b> 7471K, 7421, 8062	<b>503.00</b>	<b>503.00</b>

**NOTE:** Bottom arms are available in zinc plated finish only.

### 3/4" Offset Packages

Package	Description	Painted Finish \$	Plated Finish \$
<b>Single Acting, Wood, Steel, or Aluminum Door and Frame (Specify Hand)</b>			
<b>OP440</b>	<b>Complete package</b> 7471K, 75323, 75120	<b>630.00</b>	<b>630.00</b>
<b>Single Acting, 20 Minute Rated Fire Door and Frame (Specify Hand)</b>			
<b>OP440E</b>	<b>Complete package</b> 7471K, 75323, 75122	<b>659.00</b>	<b>659.00</b>
<b>Single Acting, 3 Hour Rated Fire Door and Frame (Specify Hand)</b>			
<b>OP440F</b>	<b>Complete package</b> 7471K, 75323, 75133	<b>724.00</b>	<b>1,007.00</b>
<b>Single Acting, Wood or Steel Door and Frame (Specify Hand)</b>			
<b>OPJ350</b>	<b>Complete package</b> 75320, 75120	<b>863.00</b>	<b>863.00</b>
<b>Single Acting, Lead-Lined Door and Frame, 1-3/4" Thick Door (Specify Hand)</b>			
<b>OPL440</b>	<b>Complete package</b> 7471K, 75343, 75140	<b>1,256.00</b>	<b>1,256.00</b>
<b>Single Acting, Lead-Lined, 20 Minute Rated Fire Door and Frame, 1-3/4" Thick Door (Specify Hand)</b>			
<b>OPL440E</b>	<b>Complete package</b> 7471K, 75343, 75142	<b>1,291.00</b>	<b>1,291.00</b>
<b>Single Acting, Lead-Lined, 3 Hour Rated Fire Door and Frame, 1-3/4" Thick Door (Specify Hand)</b>			
<b>OPL440F</b>	<b>Complete package</b> 7471K, 75343, 75143	<b>1,362.00</b>	<b>1,295.00</b>

**NOTE:** See LM Heavy Duty Accessories for intermediate pivots. See LM Accessories for individual component list prices.

**1-1/2" Offset Packages**

Package	Description	Painted Finish \$	Plated Finish \$
<b>Single Acting, Wood, Steel, or Aluminum Door and Frame (Specify Hand)</b>			
<b>OP15200</b>	<b>Complete package</b> 7471K, 15323, 15120	<b>1,047.00</b>	<b>1,047.00</b>
<b>Single Acting, 20 Minute Rated Fire Door and Frame (Specify Hand)</b>			
<b>OP15200E</b>	<b>Complete package</b> 7471K, 15323, 15122	<b>1,101.00</b>	<b>1,101.00</b>
<b>Single Acting, 3 Hour Rated Fire Door and Frame (Specify Hand)</b>			
<b>OP15200F</b>	<b>Complete package</b> 7471K, 15323, 15133	<b>1,146.00</b>	<b>1,597.00</b>

**NOTE:** See LM Heavy Duty Accessories for intermediate pivots. See LM Accessories for individual component list prices.

## Options

(List Price 'add' when ordered with complete closer)

Item	Description	Painted Finish \$	Plated Finish \$
AMS	All metal screws	N/C	—
AMSAWS	All wood screws, all metal screws	17.00	23.00
W1	Half wood screws	10.00	11.00
W2	All wood screws	12.00	14.00
EXT	Extended spindles available in 5 mm increments from 5 mm–45 mm in height (specify height)	63.00	0.00

## Accessories

(Center Hung Pivot)

Item	Description	Painted Finish \$	Plated Finish \$
HD8062	Heavy-duty complete top pivot	621.00	643.00
E80622	Through-wire center hung top pivot (2 wire) fire door	864.00	864.00
E80624	Through-wire center hung top pivot (4 wire)	864.00	864.00

**3/4" Offset Hung Intermediate Pivots\*\***

Item	Description	Painted Finish \$	Plated Finish \$
75220	Full mortise standard intermediate pivot	427.00	427.00
75222	Full mortise intermediate pivot – 20 minute rated fire door	455.00	455.00
75233	Full mortise intermediate pivot – 3 hour rated fire door	478.00	922.00
75240	Full mortise intermediate pivot – 1-3/4" lead-lined doors	639.00	639.00
75242	Full mortise intermediate pivot – 20 minute rated 1-3/4" lead-lined doors	675.00	675.00
75243	Full mortise intermediate pivot – 3 hour rated 1-3/4" lead-lined doors	692.00	1,291.00
75200	Through-wire 3/4" offset intermediate pivot – 8 wire**	793.00	793.00

\*\* All intermediate pivots are handed.

**1/2" Offset Hung Intermediate Pivots\*\***

Item	Description	Painted Finish \$	Plated Finish \$
15220	Full mortise standard intermediate pivot	639.00	639.00
15222	Full mortise intermediate pivot – 20 minute rated fire door	692.00	692.00
15233	Full mortise intermediate pivot – 3 hour rated fire door	710.00	1,241.00

\*\* All intermediate pivots are handed.

**NOTES:**

- Specify package designation, hand (when required), finish, and options or accessories when ordering.
- Complete package prices are indicated in bold.
- When ordering a package "less components," deduct the list price of the component removed.
- Lead-lined packages shown are for 1-3/4" thick non-fire rated doors. For lead-lined doors up to 3" thick, add \$107.00 list to the package price. Example: OPL800 - 2-1/2. Others available are 2", 2-1/4", and 3".
- Consult factory for quotes on lead-lined, fire-rated packages for various door thicknesses.
- All pivots furnished with all machine screws standard (AMS).

# LM Series, Extra Heavy-Duty

## Ordering Guide

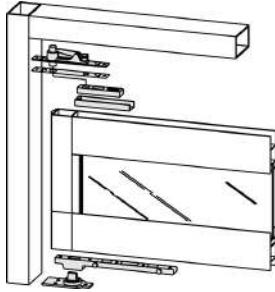

Series	Hand	Fastener Packs	Spindle	Deducts
Center Pivot — <b>CP</b> Specify for Right Handed Units	<b>RH</b> All Wood Screws	All Metal Screws — <b>AMSAWS</b> All Wood Screws	<b>74030</b> — 1-3/4" Spindle	<b>LCP</b> — Less Cover Plate
Offset Pivot — <b>OP</b> Specify for Left Handed Units	<b>LH</b> All Wood Screws	1/2 Wood Screws — <b>W1</b> All Wood Screws — <b>W2</b> All Metal Screws — <b>AMS</b>	<b>74025</b> — 1-9/16" Spindle <b>74020</b> — 1-3/8" Spindle <b>74015</b> — 1-1/8" Spindle <b>74012</b> — 1-1/16" Spindle <b>74010</b> — 1" Spindle <b>74007</b> — 7/8" Spindle <b>74005</b> — 3/4" Spindle <b>74003</b> — 9/16" Spindle	<b>LA</b> — Less Arm <b>LBP</b> — Less Bottom Pivot <b>LTP</b> — Less Top Pivot
<b>OP</b>	<b>H750</b>	<b>RH</b>	<b>AMS</b>	<b>74005</b>
				<b>626</b>
Up to 660 lb, CH —	<b>660</b>	Intermediate Pivot for 3/4" Offset —	<b>75220</b>	<b>605</b> — Bright Brass
Up to 1000 lb, CH —	<b>1000</b>	20 min Intermediate Pivot for 3/4" Offset —	<b>75222</b>	<b>606</b> — Satin Brass
Up to 750 lb, 3/4" Offset —	<b>H750</b>	3 h Intermediate Pivot for 3/4" Offset —	<b>75233</b>	<b>611</b> — Bright Bronze
Up to 750 lb, 20 min Fire Door, 3/4" Offset —	<b>H750E</b>	Intermediate Pivot for Lead Lined 3/4" Offset (see note*) —	<b>75240</b>	<b>612</b> — Satin Bronze
Up to 750 lb, Up to 3 h Fire Door, 3/4" Offset —	<b>H750F</b>	20 min Intermediate Pivot for Lead Lined 3/4" Offset (see note*) —	<b>75242</b>	<b>613</b> — Oxidized Satin Oil Rubbed Bronze
Up to 800 lb, Lead Lined 3/4" Offset (see note*) —	<b>L800</b>	3 h Intermediate Pivot for Lead Lined 3/4" Offset (see note*) —	<b>75243</b>	<b>618</b> — Bright Nickel
Up to 800 lb, 20 min Fire Door, Lead Lined 3/4" Offset (see note*) —	<b>L800E</b>	Intermediate Pivot for 1-1/2" Offset —	<b>15220</b>	<b>619</b> — Satin Nickel
Up to 800 lb, 3 h Fire Door, Lead Lined 3/4" Offset (see note*) —	<b>L800F</b>	20 min Intermediate Pivot for 1-1/2" Offset —	<b>15222</b>	<b>625</b> — Bright Chrome
Up to 500 lb, 1-1/2" Offset —	<b>15500</b>	3 h Intermediate Pivot for 3/4" Offset —	<b>15233</b>	<b>626</b> — Satin Chrome
Up to 500 lb, 20 min Fire Door, 1-1/2" Offset —	<b>15500E</b>	Through Wire Intermediate Pivot for 3/4" Offset —	<b>75200</b>	<b>600</b> — Primed
Up to 500 lb, 3 h Fire Door, 1-1/2" Offset —	<b>15500F</b>	Through Wire CH Top Pivot (2 wire) —	<b>E80622</b>	<b>689</b> — Aluminum
		Through Wire CH Top Pivot (4 wire) —	<b>E80624</b>	<b>690</b> — Statuary Bronze
				<b>691</b> — Dull Bronze
				<b>693</b> — Black
				<b>695</b> — Dark Duranodic Bronze
				<b>696</b> — Gold
				<b>PNT</b> — Special Sprayed Finish (must specify)

**Package**

**Pivot Accessories**

**Finish**

Plated

Painted

**\* "L" Package Door Thickness Note:**  
The standard door thickness is 1-3/4", and is the default unless otherwise specified.

Other alternative sizes are { -2, -2-1/4, -2-1/2, -3 }

Examples: L-E-2-1/2...75242-2-1/2

Example above 20 min. lead lined package for 2-1/2" thick door.

**NOTES:**

- All combinations of features and options are not available for all models.
- Please refer to LM Heavy-Duty Series product brochure for details.

## Packages for Doors Weighing 440 lb.

### Center Hung Packages

Package	Description	Painted Finish \$	Plated Finish \$
<b>Double or Single Acting, Wood or Steel Door and Frame (Non-handed)</b>			
CP660	Complete package 7471HD/74005, 7421, 8062	1,219.00	1,219.00
<b>Double or Single Acting, Wood or Steel Door and Frame (Non-handed)</b>			
CP1000	Complete package 7471HD/74005, 7421, HD8062	1,656.00	1,656.00

### 3/4" Offset Packages

Package	Description	Painted Finish \$	Plated Finish \$
<b>Single Acting, Wood, Steel, or Aluminum Door and Frame (Specify Hand)</b>			
OPH750	Complete package 7471HD/74005, 75323, 75120	1,348.00	1,348.00
<b>Single Acting, 20 Minute Rated Fire Door and Frame (Specify Hand)</b>			
OPH750E	Complete package 7471HD/74005, 75323, 75122	1,378.00	1,378.00
<b>Single Acting, 3 Hour Rated Fire Door and Frame (Specify Hand)</b>			
OPH750F	Complete package 7471HD/74005, 75323, 75133	1,441.00	1,722.00
<b>Single Acting, Lead-Lined Door and Frame, 1-3/4" Thick Door (Specify Hand)</b>			
OPL800	Complete package 7471HD/74005, 75343, 75140	1,971.00	1,971.00
<b>Single Acting, Lead-Lined, 20 Minute Rated Fire Door and Frame, 1-3/4" Thick Door (Specify Hand)</b>			
OPL800E	Complete package 7471HD/74005, 75343, 75142	2,005.00	2,005.00
<b>Single Acting, Lead-Lined, 3 Hour Rated Fire Door and Frame, 1-3/4" Thick Door (Specify Hand)</b>			
OPL800F	Complete package 7471HD/74005, 75343, 75143	2,078.00	2,317.00

**1-1/2" Offset Packages**

Package	Description	Painted Finish \$	Plated Finish \$
<b>Single Acting, Wood, Steel, or Aluminum Door and Frame (Specify Hand)</b>			
<b>OP15500</b>	<b>Complete package</b> 7471HD/74005, 15323, 15120	<b>1,763.00</b>	<b>1,763.00</b>
<b>Single Acting, 20 Minute Rated Fire Door and Frame (Specify Hand)</b>			
<b>OP15500E</b>	<b>Complete package</b> 7471HD/74005, 15323, 15122	<b>1,818.00</b>	<b>1,818.00</b>
<b>Single Acting, 3 Hour Rated Fire Door and Frame (Specify Hand)</b>			
<b>OP15500F</b>	<b>Complete package</b> 7471HD/74005, 15323, 15133	<b>1,862.00</b>	<b>2,314.00</b>

**NOTES:**

- See LM Extra-Heavy Duty Accessories for intermediate pivots. See LM Accessories for individual component list prices.
- Center hung bottom arms are available in zinc plated finish only.
- 7471HD floor bearings not available in painted finish. 7471HD is plated to match when ordering with painted finishes.
- See LM Extra Heavy-Duty Accessories for intermediate pivots. See LM Accessories for individual component list prices.

## Options

**(List Price 'add' when ordered with complete set)**

Item	Description	Painted Add \$	Plated Add \$
AMS	All metal screws	N/C	—
AMSAWS	All metal screws, all wood screws	17.00	23.00
W1	Half wood screws	10.00	11.00
W2	All wood screws	12.00	14.00
74003	9/16" clearance spindle (when used w/7471HD)	N/C	—
74007	7/8" clearance spindle (when used w/7471HD)	N/C	—
74010	1" clearance spindle (when used w/7471HD)	N/C	—
74012	1-1/16" clearance spindle (when used w/7471HD)	37.00	—
74015	1-1/8" clearance spindle (when used w/7471HD)	37.00	—
74020	1-3/8" clearance spindle (when used w/7471HD)	37.00	—
74025	1-9/16" clearance spindle (when used w/7471HD)	37.00	—
74030	1-3/4" clearance spindle (when used w/7471HD)	37.00	—



## Accessories

### (Center Hung Pivot)

Item	Description	Painted Finish \$	Plated Finish \$
HD8062	Heavy-duty complete top pivot	621.00	643.00
E80622	Through-wire center hung top pivot (2 wire) fire door	864.00	864.00
E80624	Through-wire center hung top pivot (4 wire)	864.00	864.00

### 3/4" Offset Hung Intermediate Pivots\*\*

Item	Description	Painted Finish \$	Plated Finish \$
75220	Full mortise standard intermediate pivot	427.00	427.00
75222	Full mortise intermediate pivot — 20 minute rated fire door	455.00	455.00
75233	Full mortise intermediate pivot — 3 hour rated fire door	478.00	922.00
75240	Full mortise intermediate pivot — 1-3/4" lead lined doors	639.00	639.00
75242	Full mortise intermediate pivot — 20 minute rated 1-3/4" lead-lined doors	675.00	675.00
75243	Full mortise intermediate pivot — 3 hour rated 1-3/4" lead-lined doors	692.00	1,291.00
75200	Through-wire 3/4" offset intermediate pivot — 8 wire**	793.00	793.00

\*\* All intermediate pivots are handed.

### 1-1/2" Offset Hung Intermediate Pivots\*\*

Item	Description	Painted Finish \$	Plated Finish \$
15220	Full mortise standard intermediate pivot	639.00	633.00
15222	Full mortise intermediate pivot — 20 minute rated fire door	692.00	692.00
15233	Full mortise intermediate pivot — 3 hour rated fire door	710.00	1,241.00

\*\* All intermediate pivots are handed.

### 90° Pocket Pivots

Item	Description	Painted Finish \$	Plated Finish \$
75520	Standard pocket pivot	641.00	775.00
75523	3 hour rated pocket pivot	677.00	817.00

#### NOTES:

- Specify package designation, hand (when required), finish, and options or accessories when ordering.
- Complete package prices are indicated in bold.
- When ordering a package "less components," deduct the list price of the component removed.
- Lead-lined packages shown are for 1-3/4" thick non-fire rated doors. For lead-lined doors up to 3" thick, add \$107.00 list to the package price. Example: OPL800 - 2-1/2. Others available are 2", 2-1/4", and 3".
- Consult factory for quotes on lead-lined, fire-rated packages for various door thicknesses.
- All pivots furnished with all machine screws standard (AMS).

# 900/700 Series

## Ordering Guide

### Optional Brackets Painted Finish

(Use with RTS Closers)

			Push Side Mounting Bracket Used w/903 & RTS Offset Hung	<b>903RTSOFF</b>	<b>PNT</b>	– Special Sprayed Finish (must specify)
			Push Side Mounting Bracket Used w/902 & RTS Offset Hung	<b>902RTSOFF</b>	<b>696</b>	– Gold
			Push Side Mounting Bracket Used w/RTS Center Hung	<b>900RTSCH</b>	<b>695</b>	– Dark Duranodic Bronze
Heavy Duty Surface –	<b>90</b>		Pull Side Mounting Bracket	<b>7090</b>	<b>693</b>	– Black
Heavy Duty Concealed –	<b>91</b>				<b>691</b>	– Dull Bronze
Standard Surface –	<b>70</b>				<b>690</b>	– Statuary Bronze
Standard Concealed –	<b>71</b>				<b>689</b>	– Aluminum
	<b>90</b>	<b>2</b>			<b>600</b>	– Primed
		<b>1</b>	<b>S</b>	– Stop Only	<b>605</b>	– Bright Brass
		<b>2</b>	<b>H</b>	– Stop/Hold	<b>606</b>	– Satin Brass
		<b>3</b>	<b>F</b>	– Friction Stop (700 only)	<b>611</b>	– Bright Bronze
					<b>612</b>	– Satin Bronze
					<b>613</b>	– Oxidized Satin Oil Rubbed Bronze
					<b>618</b>	– Bright Nickel
					<b>619</b>	– Satin Nickel
					<b>625</b>	– Bright Chrome
					<b>626</b>	– Satin Chrome

### Door Size

Refer to 700/900 Series Brochure; varies by Model and Mount.

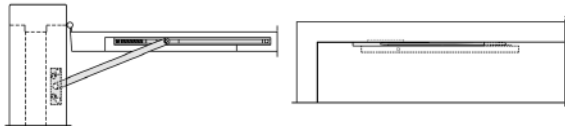

### Plated Finish

#### NOTES:

- All combinations of features and options are not available for all models.
- Please refer to 700/900 Series product brochure for details.

## 700 Series

### Standard Duty Surface

Item	Description	Painted Finish \$	Plated Finish \$
701S	Stop only	182.00	359.00
702S	Stop only	182.00	359.00
703S	Stop only	182.00	359.00
701F	Friction stop	182.00	359.00
702F	Friction stop	182.00	359.00
703F	Friction stop	182.00	359.00
701H	Stop/hold	182.00	359.00
702H	Stop/hold	182.00	359.00
703H	Stop/hold	182.00	359.00

### Standard Duty Concealed

Item	Description	Painted Finish \$	Plated Finish \$
711S	Stop only	177.00	321.00
712S	Stop only	177.00	321.00
713S	Stop only	177.00	321.00
711F	Friction stop	177.00	321.00
712F	Friction stop	177.00	321.00
713F	Friction stop	177.00	321.00
711H	Stop/hold	177.00	321.00
712H	Stop/hold	177.00	321.00
713H	Stop/hold	177.00	321.00

## 900 Series

### Heavy Duty Surface

Item	Description	Painted Finish \$	Plated Finish \$
901S	Stop only	360.00	613.00
902S	Stop only	360.00	613.00
903S	Stop only	360.00	613.00
901H	Stop/hold	360.00	613.00
902H	Stop/hold	360.00	613.00
903H	Stop/hold	360.00	613.00

### Heavy Duty Concealed

Item	Description	Painted Finish \$	Plated Finish \$
911S	Stop only	441.00	572.00
912S	Stop only	441.00	572.00
913S	Stop only	441.00	572.00
911H	Stop/hold	441.00	572.00
912H	Stop/hold	441.00	572.00
913H	Stop/hold	441.00	572.00

## Options

(List Price 'add')

Item	Description	Painted Finish \$	Plated Finish \$
7090	Pull side mounting bracket (900/700)	78.00	155.00
900RTSCH	Push side mounting bracket for use with RTS center hung closer. Provides mount for surface applied stop mount plate to prevent screws from damaging RTS closer body.	78.00	155.00
902RTSOFF	Push side mounting bracket for 902 stop/holder, used with offset pivots when RTS closer is installed in the header.	78.00	155.00
903RTSOFF	Push side mounting bracket for 903 stop/holder, used with offset pivots and an RTS closer installed in the header.	78.00	155.00
Custom Color	Custom painted finish selected from RAL color pallet book. For details, see <b>Finishes Cross Reference</b> , page viii.		
	per order, setup charge <b>(Net)</b>	155.00	—
	per closer, list add	51.00	—
Designer Color	Designer painted color matched to supplied samples. Three (3) Color each 2" x 3" colorchip samples required. For details, see <b>Finishes Cross Reference</b> , page viii.		
	per order, non-refundable development/setup charge <b>(Net)</b>	374.00	—
	per closer, list add	51.00	—

**NOTE:** Standard screw pack includes wood and machine screws for the soffit bracket, and sex nuts for the door, as required.



# Pull Finishes Cross Reference

	DORMA GMBH Finish #	Closest BHMA Equivalent
<b>Anodized Aluminum Parts</b>		
Clear	101	628
Similar to Stainless Steel	107	670
Dark Bronze	108	710
Black	109	711
Aluminum Color	114	718
<b>Brass</b>		
Polished Brass without Lacquer	503	—
Satin Brass without Lacquer	599	728
<b>Steel or Stainless Steel</b>		
Satin Stainless Steel	700	630
Polished Stainless Steel	701	629
<b>Bronze</b>		
Satin Bronze without Lacquer	600	612
Polished Bronze without Lacquer	601	611
<b>Custom Finish*</b>		
	999	—

\*All Custom Finishes will incur a \$200 net setup fee per purchase order, per color.

## TG 138 Ladder Pulls

### Ordering Guide

Function		Door Thickness		Screwpack Options		Keying Options Field		
Locking — <b>L</b>				<b>SNUT</b> — Sex Nut, up to 3-5/16"				
Non-Locking — <b>NL</b>		<b>134</b> — Wood Door Screw Pack		<b>BLIND</b> — 1-3/4" wood door, not through door				
				<b>B2B80</b> — Back-to-back up to 3-5/16" thick door				
				<b>B2B44</b> — Back-to-back 1-3/4" wood				
<b>TG 138</b>	<b>NL</b>	<b>B2B</b>	<b>134</b>	<b>49</b>	<b>B2B12</b>	<b>700</b>	<b>C6</b>	<b>XXXX</b>
<b>Model</b>	Back-To-Back — <b>B2B</b>	49" Length — <b>49</b>		Satin Stainless — <b>700</b>		<b>T</b> — Temporary SFIC		
	Single Sided — <b>SNG</b>	60" Length — <b>60</b>		Custom Polished finish — <b>701</b>		<b>J</b> — SFIC (Less Core)		
	<b>Pull Type</b>	72" Length — <b>72</b>		Custom Paint or Powder — <b>999</b>	<b>Finish</b>	<b>C</b> — 7-Pin SFIC (With Core)		
		84" Length — <b>84</b>				<b>C6</b> — 6-Pin SFIC (With Core)		
		XX" (Specify) Length — <b>Custom</b>				<b>L</b> — Less Cylinder		
		<b>(L) Length</b>				<b>D</b> — Conventional Cylinder		
						<b>R</b> — Schlage LFIC (Less Core)		
						<b>THB</b> — Thumbturn Single Pull Handle		
						<b>Cylinder Type</b>		

# TG 138 Locking and Non-Locking Ladder Pulls

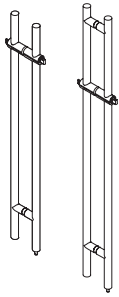
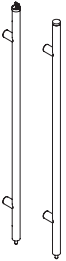
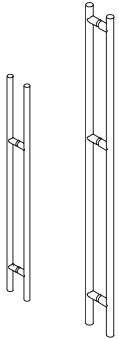
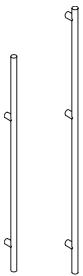
Locking Ladder Pull Configurations Single and Back-To-Back Locking and Non-Locking Pulls					Standard Finish \$		Custom Finish \$	
Model	Ref. #	U/M	No. Of Fixing Posts	Description	700	701	999	
<b>Back-to-Back Locking Ladder Pull with T Small Format Interchangeable Core (SFIC) Cylinder, BA Core MKD (KD)</b>					3	SO	SO	
	926.933	Set	3F	L B2B STD 84" 700	2,185.00	2,820.00	—	
	926.932	Set	3F	L B2B STD 72" 700	2,129.00	2,746.00	—	
	926.936	Set	3F	L B2B STD 60" 700	2,079.00	2,680.00	—	
	926.930	Set	2F	L B2B STD 49" 700	1,995.00	2,572.00	—	
<b>Single Sided Locking Ladder Pull with T Cylinder (SFIC), BA Core MKD (KD), or Thumb-Turn (TT)</b>								
	926.934	Ea.	2F	L SNG STD 49" CYL 700	1,137.00	1,459.00	—	
	926.935	Ea.	2F	L SNG STD 49" TT 700	1,137.00	1,459.00	—	
<b>NOTE:</b> Cylinder or Thumb-Turn are Top Mounted								
<b>Back-to-Back Non-Locking Ladder Pull</b>					3	SO	SO	
	926.923	2 Ea.	3F	NL B2B STD 84" 700	926.00	1,204.00	1,223.00	
	926.922	2 Ea.	3F	NL B2B STD 72" 700	876.00	1,135.00	1,173.00	
	926.924	2 Ea.	3F	NL B2B STD 60" 700	821.00	1,066.00	1,119.00	
	926.920	2 Ea.	2F	NL B2B STD 49" 700	738.00	958.00	1,036.00	
<b>NOTE:</b> Specify 2 Ea. for a back-to-back set,								
<b>Single Sided Non-Locking Ladder Pull</b>								
	926.923	Ea.	3F	NL SNG STD 84" 700	538.00	700.00	717.00	
	926.922	Ea.	3F	NL SNG STD 72" 700	509.00	659.00	686.00	
	926.924	Ea.	3F	NL SNG STD 60" 700	477.00	620.00	656.00	
	926.920	Ea.	2F	NL SNG STD 49" 700	429.00	554.00	606.00	
<b>NOTE:</b> Customer must specify Fixing Pack and adjust List Price accordingly for Non-Locking Single Ladder Pulls and all door panel thicknesses greater than 1/2".								



**NOTES:**

- Default fastener pack addresses 3/8"–3/4" thick glass, except locking ladder pulls, 3/8"–5/8". 3/4" glass for locking pulls requires special 926.911 locking assembly at List \$212.
- Default cylinder for TG 138 L pulls uses SFIC C Cylinder BA Core.
- Other cylinder and keying options available, see **Cylinder Types, Keying Options & Keyways**.
- 999 Finish is Custom Paint and Powder only, not available on locking pulls.

SO Special Fabricated/Finish or Special Order; lead time up to 9 weeks.

3 Standard or Non-Standard Fabricated; lead time up to 3 business days.

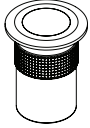
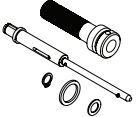
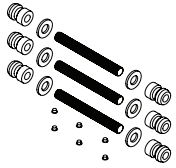
## TG 138 Locking and Non-Locking Ladder Pulls Accessories

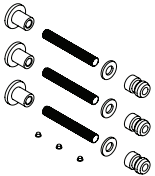
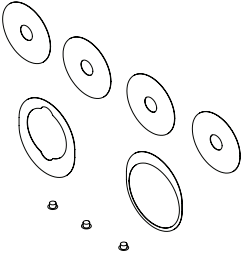
Mounting	Ref. #	Description	Door Thickness	List \$
	926.937	Strike, Dustproof, Standard 1-1/8" (29 mm)		58.00
	926.890	Locking Post Mounting Pack, Back-to-back, (Non-Locking Post Fasteners not included)	1-3/4" (44 mm)	303.00
	926.909	Mounting Pack, Back-to-back Non-Locking Post	1-3/8" (34 mm) – 1-3/4" (44 mm)	81.00
	926.910	Mounting Pack, SNG Blind, 3 each in pack (Will not project through door)	min. 1-3/4" (44 mm)	40.00
	926.908	Mounting Pack, Single Non-Locking x Sex Nut	3/4" (19 mm) – 3-1/8" (80 mm)	85.00
	926.939	Washer Pack	–	23.00

**NOTE:** Default cylinder for Locking Ladder pulls uses SFIC T cylinder with temporary construction core in 626 Satin. Other cylinder and keying options available, see next page.

(SO) Special Fabricated/Finish or Special Order; lead time up to 9 weeks.



# TG 138 Cylinder Types, Keying Options, and Keyways

Cylinder	Option	Description	Deduct \$
L		Lock less cylinder and cylinder ring	Deduct 75.00
<b>Interchangeable Core Cylinders</b>			
C		<b>SFIC – Housing with combined SFIC construction core installed at the factory; BA (default), BB, BC, BD, BE, BF, BG, BH, BJ, BK, BL, BM, BQ, D100 keyway – ☒ Keys sold separately</b>	N/C
	MKD	Master keyed, Keyed Different (Keyed different to a random combination) or Keyed Alike; BA Core with 1 control key and 2 change keys; Up to 20 days additional lead time for Keyed Alike.	N/C
T		SFIC – Housing with keyed temporary SFIC construction core (Core may be returned for a full refund) – ☒ <b>Keys sold separately</b>	Deduct 5.00
J		SFIC – Housing with disposable plastic SFIC plug	Deduct 45.00
R		Schlage LFIC - Housing less core	Deduct 37.00
<b>Conventional Cylinders (non-interchangeable core)</b>			
D		Conventional cylinder	Deduct 45.00
	KD	Keyed differently to a random combination; SC keyway with 2 keys (default)	Deduct 45.00
	KA2	Keyed alike in pairs to a random combination; SC keyway with 2 keys	Deduct 45.00
	NSK	Keyed alike (or Keyed to Order - KTO) sets of 3 or more; SC keyway with 2 keys	Deduct 33.00
	1-Bit SC	Operated by 1-bit key (sold separately); SC, SE keyway with 2 key blanks	Deduct 45.00
	0-Bit D-100	Operated by 0-bit key (sold separately); D100 keyway – ☒ <b>Keys sold separately</b>	Deduct 45.00
	0-Bit	Operated by a key blank; AA, CA, CB, CC, CD, CE, RA, RB, GA, SF, WA, YA, YG keyways with 2 keys	Deduct 33.00
	MKD	Master keyed; SC, SE, or D100 keyway – ☒ <b>Keys sold separately</b>	Deduct 29.00
	CMK	Construction master keyed single cylinder locks – ☒ <b>Keys sold separately</b>	Deduct 27.00

Ladder Pulls will be supplied with SFIC C cylinder, Option BA MKD (KD).

☒ Denotes keys must be ordered separately.

## Cut Keys Ordered Separately

Part #	Description	List \$
45101	SFIC Cut Key – Change key, master key, construction master key, or control key; BA, BB, BC, BD, BE, BF BG, BH, BJ, BK, BL, BM, BQ, SC, SE keyways	11.00
45401	SFIC Cut Key – Change key, master key, or control key; SKC keyways – D100 etc.	17.00
45404	CONV/LFIC Cut Key – 1-Bit key for operating 1-bit cylinders – SC, SE keyways	9.00

**NOTES:**

- Distribution of DORMA SKC keys (listed as D100) is restricted. Call customer service for dormakaba SKC policies.
- See Keys and Key Blanks section for complete list.

# TG 9387 Ladder Pulls

## Ordering Guide



				<b>SNG Mounting Type</b>	
		<b>Door Thickness</b>		<b>ROSE</b>	— Screw-on-Rose
		<b>134</b>	— Wood Door Screw Pack	<b>BLIND</b>	— Concealed
<b>S-TG 9387</b>	<b>SNG</b>	<b>134</b>	<b>18</b>	<b>BLIND</b>	<b>700</b>
<b>S-TG 9387</b>	Single Sided — <b>SNG</b>	12" Length —	<b>12</b>	DORMA 700/ BHMA 630 —	<b>700</b>
<b>Model</b>	Back-To-Back — <b>B2B</b>	18" Length —	<b>18</b>		
<b>Pull Type</b>		36" Length —	<b>36</b>		
		42" Length —	<b>42</b>		
		60" Length —	<b>60</b>		
		<b>(L) Length</b>			
				<b>Finish</b>	

# Stock TG 9387 Standard Size Non-Locking Ladder Pulls, with Straight Fixing Posts

Stock Pull Handles for Commercial Doors						Finish \$
Model	Ref. #	U/M	No. Of Fixing Posts	Description		700
<b>Back-to-Back 1-1/4" (32 mm) Diameter</b>						<b>3</b>
	B2B.905.370	Set	3F	L = 60"	CTC = 37-1/2"	366.00
	B2B.905.371	Set	2F	L = 42"	CTC = 26-1/4"	251.00
	B2B.905.372	Set	2F	L = 36"	CTC = 22-1/2"	230.00
	B2B.905.373	Set	2F	L = 18"	CTC = 11-1/4"	184.00
	B2B.905.374	Set	2F	L = 12"	CTC = 7-1/2"	172.00
<b>Single Sided 1-1/4" (32 mm) Diameter</b>						<b>3</b>
	SNG.905.370	Ea.	3F	L = 60"	CTC = 37-1/2"	189.00
	SNG.905.371	Ea.	2F	L = 42"	CTC = 26-1/4"	129.00
	SNG.905.372	Ea.	2F	L = 36"	CTC = 22-1/2"	116.00
	SNG.905.373	Ea.	2F	L = 18"	CTC = 11-1/4"	95.00
	SNG.905.374	Ea.	2F	L = 12"	CTC = 7-1/2"	89.00
						<b>List \$</b>
<b>POWDER</b> All Custom powder coated orders will include a net charge per purchase order.						299.00

**NOTES:**

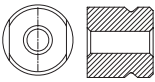
- Prefix Ref. # with (SNG) single or (B2B) back-to-back. Specify part number, pull height, door material, and door thickness. For single pull on wood door, specify roses or blind fasteners.
- Inserts and mounting hardware included in stock pull TG 9387, list price as shown.
- Mounting hardware also available as multi-pack service packs and priced separately following pulls.

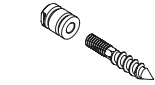
Model Accessories	Ref. #	U/M	Description	List \$
	905.390	Set	Service inserts, reduces post thread from 8 mm–6 mm, used for every mounting post. Bulk pack of 6. Used as service item.	12.00
	905.388	Set	Service mounting pack with finished mounting ROSE used for SNG WOOD mount 1-3/8"–2" (40 mm–51 mm). Bulk pack of 6. Used as service item.	51.00
	905.386	Set	Service mounting pack used for BACK-TO-BACK WOOD mount 1-3/8"–2" (40 mm–51 mm). Bulk pack of 6. Used as service item.	27.00
	905.389	Set	Service mounting pack with BLIND (concealed) fasteners. Used for SNG WOOD mount ≥ 1-3/8" (40 mm). Bulk pack of 6. Used as service item.	27.00

<b>øG</b>	1-1/4" (32)				
<b>øS</b>	1" (25)				
<b>H</b>	3-3/8" (85)				
<b>3 fixings required</b>	60" (1,524)				
<b>(CTC) Center-to-Center</b>	37-1/2" (953)	26-1/4" (667)	22-1/2" (571)	11-1/4" (286)	7-1/2" (191)
<b>L (Length)</b>	60" (1,524)	42" (1,067)	36" (914)	18" (457)	12" (305)

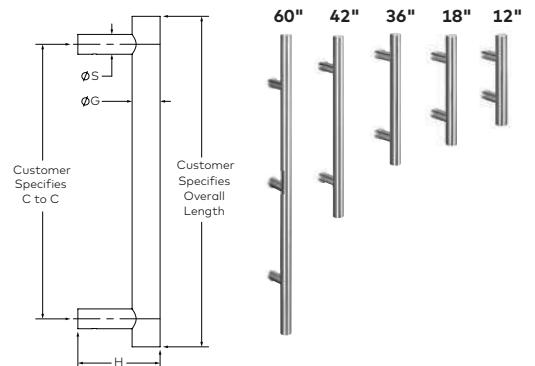

# TG 9387 Custom Size Non-Locking Ladder Pulls, with Straight Fixing Posts

Pull Handles for Commercial Doors					Standard Finish \$		Custom Finish \$
Model	Ref. #	U/M	No. Of Fixing Posts	Description	700	701	999
<b>Back-to-Back 1-1/4" (32 mm) Diameter</b>					(SO)	(SO)	(SO)
	905.568	Ea.	3F	L = 94-1/2" through 110-3/16"	1,622.00	1,784.00	2,215.00
	905.567	Ea.	3F	L = 74-13/16" through 94-7/16"	1,404.00	1,543.00	1,996.00
	905.566	Ea.	2F	L = 59-1/16" through 74-3/4"	1,187.00	1,303.00	1,780.00
	905.565	Ea.	2F	L = 43-5/16" through 59"	968.00	1,065.00	1,413.00
	905.564	Ea.	2F	L = 27-9/16" through 43-1/4"	748.00	824.00	1,194.00
	905.563	Ea.	2F	L = 11-13/16" through 27-1/2"	529.00	582.00	975.00
<b>Single Sided 1-1/4" (32 mm) Diameter</b>					(SO)	(SO)	(SO)
	905.368	Ea.	3F	L = 94-1/2" through 110-3/16"	961.00	1,056.00	1,257.00
	905.367	Ea.	3F	L = 74-13/16" through 94-7/16"	843.00	926.00	1,137.00
	905.366	Ea.	2F	L = 59-1/16" through 74-3/4"	723.00	794.00	1,018.00
	905.365	Ea.	2F	L = 43-5/16" through 59"	603.00	665.00	827.00
	905.364	Ea.	2F	L = 27-9/16" through 43-1/4"	485.00	534.00	708.00
	905.363	Ea.	2F	L = 11-13/16" through 27-1/2"	365.00	401.00	589.00
<b>Back-to-Back 1" (25 mm) Diameter</b>					(SO)	(SO)	(SO)
	905.527	Ea.	3F	L = 94-1/2" through 110-3/16"	1,413.00	1,553.00	2,006.00
	905.526	Ea.	3F	L = 74-13/16" through 94-7/16"	1,257.00	1,383.00	1,850.00
	905.525	Ea.	3F	L = 59-1/16" through 74-3/4"	1,102.00	1,211.00	1,695.00
	905.524	Ea.	2F	L = 43-5/16" through 59"	944.00	1,040.00	1,388.00
	905.523	Ea.	2F	L = 27-9/16" through 43-1/4"	789.00	868.00	1,235.00
	905.522	Ea.	2F	L = 11-13/16" through 27-1/2"	634.00	699.00	1,078.00
<b>Single Sided 1" (25 mm) Diameter</b>					(SO)	(SO)	(SO)
	905.327	Ea.	3F	L = 94-1/2" through 110-3/16"	917.00	1,009.00	1,213.00
	905.326	Ea.	3F	L = 74-13/16" through 94-7/16"	817.00	898.00	1,114.00
	905.325	Ea.	3F	L = 59-1/16" through 74-3/4"	718.00	789.00	1,015.00
	905.324	Ea.	2F	L = 43-5/16" through 59"	619.00	682.00	843.00
	905.323	Ea.	2F	L = 27-9/16" through 43-1/4"	519.00	572.00	741.00
	905.322	Ea.	2F	L = 11-13/16" through 27-1/2"	417.00	460.00	640.00

**Net Add \$**

**POWDER** All Custom powder coated orders will include a net charge per purchase order.

299.00

**NOTE:** Specify door thickness to acquire appropriate mounting screwpack.

<b>øG</b>	1" (25)	1-1/4" (32)
<b>øS</b>	11/16" (18)	1" (25)
<b>H</b>	2-15/16" (75)	3-3/8" (85)
<b>3 fixings required</b>	59-1/16" (1,500)	59-1/16" (1,500)

**NOTES:**

- When required, 3rd fixing post is centered on L dimension unless otherwise requested. Center distance can be specifically tailored to your requirements.
- Specify door thickness and desired screwpack.
- Top and bottom post location is preset at factory unless specified custom by customer.

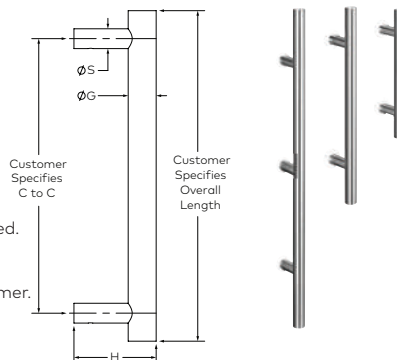

(SO) Special Fabricated/Finish or Special Order; lead time up to 5 weeks.

# MANET Non-Locking Ladder Pulls, with straight fixing posts and MANET clamping disks

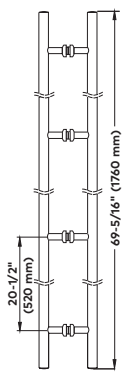
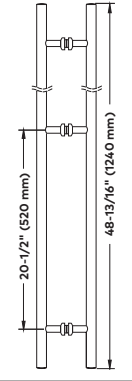
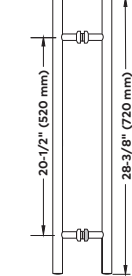
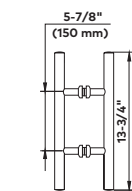
Pull Handles for Commercial Doors, Back-to-Back (B2B) or Single Sided					Standard Finish \$	Custom Finish \$
Model	Ref. #	U/M	No. Of Fixing Posts	Description	700	999
<b>Back-to-Back</b>					①	SO
	821.276	Ea.	4F	20-1/2" (520 mm) Center-to-Center Length 69-5/16" (1760 mm)	903.00	1,728.00
	821.273	Ea.	3F	20-1/2" (520 mm) Center-to-Center Length 48-13/16" (1240 mm)	752.00	1,590.00
	821.270	Ea.	2F	20-1/2" (520 mm) Center-to-Center Length 28-3/8" (720 mm)	602.00	1,071.00
	821.267	Ea.	2F	5-7/8" (150 mm) Center-to-Center Length 13-3/4" (350 mm)	440.00	884.00

**Net Add \$**

**POWDER** All Custom powder coated orders will include a net charge per purchase order.

299.00

**NOTES:**

- Specify door thickness and either wood or glass door material.
- Specify Ref. # 829.991 for 1-3/4" (44 mm) wood door fasteners, no additional charge.

① Non-Fabricated item, ships in 1 business day.

SO Special Fabricated/Finish or Special Order; lead time up to 5 weeks.

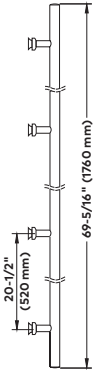
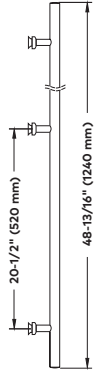
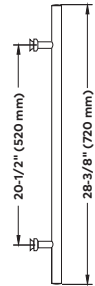
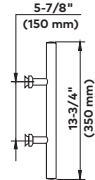
Pull Handles for Commercial Doors					Standard Finish \$	Custom Finish \$
Model	Ref. #	U/M	No. Of Fixing Posts	Description	700	999
<b>Single Sided</b>					(SO)	(SO)
	821.243	Ea.	4F	20-1/2" (520 mm) Center-to-Center Length 69-5/16" (1760 mm)	707.00	1,003.00
	821.242	Ea.	3F	20-1/2" (520 mm) Center-to-Center Length 48-13/16" (1240 mm)	574.00	871.00
	821.241	Ea.	2F	20-1/2" (520 mm) Center-to-Center Length 28-3/8" (720 mm)	400.00	621.00
	821.240	Ea.	2F	5-7/8" (150 mm) Center-to-Center Length 13-3/4" (350 mm)	327.00	550.00
<b>Net Add \$</b>						
<b>POWDER</b>	All Custom powder coated orders will include a net charge per purchase order.					299.00

**NOTES:**

- Specify door thickness and either wood or glass door material.
- Specify Ref. # 829.991 for 1-3/4" (44 mm) wood door fasteners, no additional charge.

(SO) Special Fabricated/Finish or Special Order; lead time up to 5 weeks.

# TG 9335 Decorative Pulls, Straight Pull with Mitered Corners/Posts

Pull Handles for Commercial Doors					Standard Finish \$		Custom Finish \$
Model	Ref. #	U/M	No. Of Fixing Posts	Description	700	701	999
<b>Back-to-Back 1-1/4" (32 mm) Diameter</b>					(SO)	(SO)	(SO)
	905.545	Ea.	3F	CTC = 94-1/2" through 110-3/16"	1,490.00	1,637.00	2,082.00
	905.544	Ea.	3F	CTC = 74-13/16" through 94-7/16"	1,282.00	1,408.00	1,875.00
	905.543	Ea.	3F	CTC = 59-1/16" through 74-3/4"	1,075.00	1,181.00	1,669.00
	905.542	Ea.	2F	CTC = 43-5/16" through 59"	867.00	952.00	1,313.00
	905.541	Ea.	2F	CTC = 27-9/16" through 43-1/4"	658.00	724.00	1,104.00
	905.540	Ea.	2F	CTC = 7-7/8" through 27-1/2"	450.00	495.00	896.00
<b>Single Sided 1-1/4" (32 mm) Diameter</b>					(SO)	(SO)	(SO)
	905.345	Ea.	3F	CTC = 94-1/2" through 110-3/16"	895.00	984.00	1,191.00
	905.344	Ea.	3F	CTC = 74-13/16" through 94-7/16"	781.00	857.00	1,077.00
	905.343	Ea.	3F	CTC = 59-1/16" through 74-3/4"	666.00	733.00	963.00
	905.342	Ea.	2F	CTC = 43-5/16" through 59"	551.00	606.00	774.00
	905.341	Ea.	2F	CTC = 27-9/16" through 43-1/4"	438.00	482.00	659.00
	905.340	Ea.	2F	CTC = 7-7/8" through 27-1/2"	325.00	358.00	549.00
<b>Back-to-Back 1" (25 mm) Diameter</b>					(SO)	(SO)	(SO)
	905.506	Ea.	3F	CTC = 94-1/2" through 110-3/16"	1,880.00	2,068.00	2,476.00
	905.505	Ea.	3F	CTC = 74-13/16" through 94-7/16"	1,663.00	1,831.00	2,258.00
	905.504	Ea.	3F	CTC = 59-1/16" through 74-3/4"	1,450.00	1,595.00	2,043.00
	905.503	Ea.	2F	CTC = 43-5/16" through 59"	1,235.00	1,357.00	1,680.00
	905.502	Ea.	2F	CTC = 27-9/16" through 43-1/4"	1,018.00	1,122.00	1,465.00
	905.501	Ea.	2F	CTC = 8-1/4" through 27-1/2"	804.00	884.00	1,249.00
<b>Single Sided 1" (25 mm) Diameter</b>					(SO)	(SO)	(SO)
	905.306	Ea.	3F	CTC = 94-1/2" through 110-3/16"	1,104.00	1,213.00	1,401.00
	905.305	Ea.	3F	CTC = 74-13/16" through 94-7/16"	984.00	1,082.00	1,281.00
	905.304	Ea.	3F	CTC = 59-1/16" through 74-3/4"	865.00	950.00	1,160.00
	905.303	Ea.	2F	CTC = 43-5/16" through 59"	743.00	817.00	965.00
	905.302	Ea.	2F	CTC = 27-9/16" through 43-1/4"	622.00	685.00	846.00
	905.301	Ea.	2F	CTC = 8-1/4" through 27-1/2"	503.00	552.00	726.00

**Net Add \$**

**POWDER** All Custom powder coated orders will include a net charge per purchase order.

299.00

**NOTES:**

- When required, 3rd fixing post is centered on **CTC** dimension unless otherwise requested.
- CTC=Center to center of mounting posts.
- Specify door thickness and desired screwpack. See following page for options.

(SO) Special Fabricated/Finish or Special Order; lead time up to 5 weeks.



# TG Decorative Pulls

Pull Handles for Commercial Doors				Standard Finish \$		Custom Finish \$
Model	Ref. #	U/M	Description	700	701	999
<b>TG 9830 Bowed Pull, 13-3/4" (349 mm) Center-to-Center</b>				(SO)	(SO)	(SO)
	905.530	Set	Back-to-Back	889.00	979.00	1,187.00
	905.330	Ea.	Single Sided	547.00	601.00	769.00
<b>TG 9304 Curved Pull, Radius Standoff, 1-1/4" (32 mm) Diameter, 13-3/4" (349 mm) Center-to-Center</b>				(SO)	(SO)	(SO)
	905.569	Set	Back-to-Back	450.00	495.00	747.00
	905.369	Ea.	Single Sided	295.00	324.00	517.00
			Ø 1-1/4" (32 mm)			
			R 1-3/4" (44 mm)			
			R1 6-7/8" (175 mm)			
			B 8-11/16" (220 mm)			
			H 3-3/8" (85 mm)			
			CTC 13-3/4" (350 mm)			
<b>TG 9306 Curved Pull, Sharp/Straight Standoff, 1-9/16" (40 mm) Diameter, 13-3/4" (349 mm) Center-to-Center</b>				(SO)	(SO)	(SO)
	905.611	Set	Back-to-Back	996.00	1,096.00	1,293.00
	905.411	Ea.	Single Sided	598.00	657.00	821.00
			ØGØS 1-9/16" (40 mm)			
			R 6-7/8" (175 mm)			
			B 8-3/16" (205 mm)			
			H 3-15/16" (100 mm)			
			M 1" (24 mm)			
<b>NOTE:</b> Specify door thickness and desired screwpack.						
<b>Fixings for TG Handles to Glass Doors 1-3/8" (35 mm)–3-15/16" (100 mm) Thick</b>				<b>700/701</b>		<b>999</b>
				(SO)	(SO)	
	905.901	Ea.	Back-to-Back – M6	39.00	41.00	
	905.903	Ea.	Back-to-Back – M8	39.00	41.00	
	905.907	Ea.	Single Sided – M6	65.00	72.00	
	905.906	Ea.	Single Sided – M8	65.00	72.00	
<b>Rose Options for TG Pulls</b>						
	905.971	Ea.	1-9/16" (40 mm) Rose – M6	18.00	21.00	
	905.972	Ea.	1-3/4" (44 mm) Rose – M8	18.00	21.00	
<b>Net Add \$</b>						
<b>POWDER</b>	All Custom powder coated orders will include a net charge per purchase order.					299.00

(SO) Special Fabricated/Finish or Special Order; lead time up to 5 weeks.



# ARCOS Decorative Pulls

Pulls for Commercial Doors					Standard Finish \$	Custom Finish \$
Model	Ref. #	U/M	No. Of Fixing Posts	Description	114	999
<b>ARCOS 15-11/16" (398 mm) Length</b>					(SO)	(SO)
	826.500	Set	2F	13-3/4" (350 mm) Center-to-Center	508.00	804.00
<b>ARCOS 32-1/16" (824 mm) Length</b>					(SO)	(SO)
	826.510	Set	2F	29-1/2" (750 mm) Center-to-Center	598.00	1,191.00

**NOTE:** Specify door thickness and either wood or glass door material.

(SO) Special Fabricated/Finish or Special Order; lead time up to 5 weeks.

## Solid and Tubular Pull Handles for Commercial doors

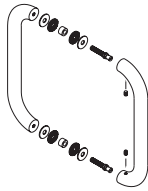
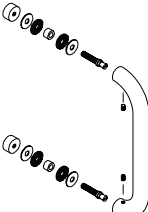
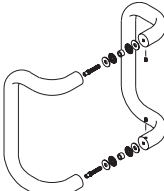
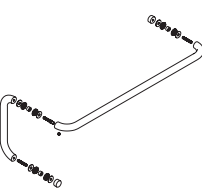
				Finishes \$						
Model	Ref. #	U/M	Description	101	108	109	503/599	600/601	700	701
<b>Solid and Tubular, Back-to-Back, 10" and 12" (Center-to-Center) Handles</b>				①	①	SO	SO	SO	①	SO
	926.001	Set	10" (254 mm) Solid	89.00	94.00	94.00	—	375.00	199.00	199.00
	926.601	Set	10" (254 mm) Tubular	—	—	—	159.00	—	107.00	107.00
	926.004	Set	12" (305 mm) Solid	94.00	100.00	100.00	269.00	671.00	219.00	219.00
	926.604	Set	12" (305 mm) Tubular	—	—	—	169.00	—	111.00	111.00
<b>Solid and Tubular, Single Sided, 10" and 12" (Center-to-Center) Handles</b>				SO	SO	SO	SO	SO	SO	SO
	926.012	Ea.	10" (254 mm) Solid	53.00	63.00	63.00	—	—	0.00	0.00
	926.612	Ea.	10" (254 mm) Tubular	—	—	—	—	—	67.00	67.00
	926.016	Ea.	12" (305 mm) Solid	69.00	74.00	74.00	—	—	—	—
	926.616	Ea.	12" (305 mm) Tubular	—	—	—	—	—	74.00	74.00
<b>Solid and Tubular, Back-to-Back Offset, 10" and 12" (Center-to-Center) Handles</b>				SO	SO	SO	SO	SO	SO	SO
	926.622	Set	10" (254 mm) Tubular	—	—	—	—	—	132.00	132.00
	926.009	Set	12" (305 mm) Solid	107.00	116.00	116.00	—	—	—	—
	926.609	Set	12" (305 mm) Tubular	—	—	—	216.00	—	145.00	145.00
<b>Solid and Tubular, Back-to-Back, 10" and 12" (Center-to-Center) x 27-3/4" Handles</b>				SO	SO	SO	SO	SO	SO	SO
	926.002	Set	10" x 27-3/4" (254 x 705 mm) Solid	123.00	135.00	135.00	—	—	—	—
	926.602	Set	10" x 27-3/4" (254 x 705 mm) Tubular	—	—	—	—	—	171.00	171.00
	926.005	Set	12" x 27-3/4" (305 x 705 mm) Solid	116.00	130.00	130.00	—	—	369.00	369.00
	926.605	Set	12" x 27-3/4" (305 x 705 mm) Tubular	—	—	—	230.00	—	182.00	182.00

**NOTES:**

- Tubular handles include a 1-1/4" (32 mm) washer.
- Specify door thickness and either wood or glass door material.
- Call Customer Service for wood door thickness 1-3/8"–2-1/2" fastener information and ordering guidance.

- ① Non-Fabricated item, 2-day lead time.
- SO Special Fabricated/Finish or Special Order; lead time up to 5 weeks.



Door  
Hardware



Electronic  
Access & Data



Mechanical  
Key Systems



Lodging  
Systems



Entrance  
Systems



Safe  
Locks



Service

## Our Sustainability Commitment

We are committed to fostering a sustainable development along our entire value chain in line with our economic, environmental and social responsibilities toward current and future generations.

dormakaba USA  
6161 E. 75th Street  
Indianapolis, IN 46250

T: 1 800-523-8483

[dormakaba.us](https://www.dormakaba.us)

[dahorders.us@dormakaba.com](mailto:dahorders.us@dormakaba.com)

