

Price List 2023

Architectural Hardware

Canada | April 2023 R3



What's New

This price book dated April 2023 R3 contains new and revised products. All changes are listed below and take effect immediately. No Price Changes.

Architectural Hardware

After careful consideration, beginning July 2023, all electric strike and electromagnetic lock products will be available via dormakaba RCI. Contact your dormakaba sales representative for further details or to inquire about sales enablement.

Table of Contents

Introduction	Terms of Sale	
	Finishes Cross Reference	
Locks	Locks Product Guide	1
	M9000 Grade 1 Mortise Series	3
	D900 Grade 1 Mortise Dead Bolt Series	15
	T900 Tubular Series	19
	C100 Grade 1 Cylindrical Series	25
	DB100 Grade 1 Dead Bolt Series	35
	C200 Grade 2 Cylindrical Series	41
	C500 Grade 2 Cylindrical Series	49
	DB600 Grade 2 Dead Bolt Series	53
	C300 Grade 2 Cylindrical Series	57
	J300 Grade 2 Interconnected Series	59
Cylinders, Keys, and Keying	Cylinders, Keys, and Keying Product Guide	61
	Master Keying/SKC Policy	62
	Mortise Cylinders	63
	Rim Cylinders	68
	Key-in-Knob/Lever Cylinders	70
	Hotel Cylinders	71
	Small Format Interchangeable Cores	73
	Large Format Interchangeable Cores	74
	Retrofit Cylinder Housings	75
	Tailpieces	76
	Keys and Key Blanks	77
	SFIC Padlocks	79
	Service Parts	80
	Labeling and Cylinder Marking	82
Exit Devices	Exit Device Product Guide	83
	9000 Series	85
	9000 Series Wide Stile Exits	85
	9000 Series Wide Stile Trim	97
	9000 Series Narrow Stile Exits	114
	9000 Series Narrow Stile Trim	123
	8000 Series	133
	8000 Series Exits	134
8000 Series Trim	140	
Electronic Access Control Components	DKPS Series Power Supplies	150

<p>After careful consideration, effective July 2023, all electric strike and electromagnetic lock products will be available via dormakaba RCI. Contact your sales representative for further details or to inquire about sales enablement.</p>	ES Series (See RCI options)	153
	EML Series (See RCI options)	157
	EMLSG Series (See RCI options)	165
	EMSL Series (Contact dormakaba for options)	167
	EMDE Series (See RCI options)	169
	AC Series	171
	PB Series	173
	39 Series	177
	KS Series	179
	Accessories	182
Low Energy Operators	ED900 Series	185
	ED50LE	189
	ED100LE	189
Surface Closers	Surface Closers Product Guide	191
	TS93 Series	193
	8900 Series	197
	8600 Series	203
	7400 Series	207
	7300 Series	211
	STA Series	215
	GSR Series	217
	Modular Packaging	219
Fire/Life Safety	Fire/Life Safety Product Guide	221
	EMR/EMF Series	223
	1800 Series	227
	EM Series	231
Concealed Closers/Pivots	Concealed Door Closers Product Guide	233
	BTS80 Series	235
	BTS80 EMB Series	241
	BTS75V Series	247
	ITS96 Series	253
	RTS88 Series	255
	LM Series Heavy-Duty Pivots	261
	LM Series Extra Heavy-Duty Pivots	265
Stops/holders	900/700 Series	269
Architectural Pulls and Handles	Finishes Cross Reference	273
	TG 138 Locking and Non-Locking Ladder Pulls	274
	TG 9387 Non-Locking Ladder Pulls	277
	MANET Non-Locking Ladder Pulls	280
	TG Decorative Pulls	283
	ARCOS and Beyond Decorative Pulls	284
	Pull Handles for Commercial Doors	285

General information

Terms and conditions of sale

Acceptance. The following Terms and Conditions of sale are applicable to all Quotations, Contract, Purchase Orders, Order Acknowledgement Forms, and sales of Seller's services and products, and are the only applicable terms and conditions thereto, except for terms establishing prices, quantities, delivery schedules, terms of payment, invoicing, shipping instructions, and the identification of the products associated with each transaction. If any conflict exists between the Terms and Conditions and a Quotation, Purchase Order, Order Acknowledgement form, or sale, these Terms and Conditions shall prevail BY REQUESTING A QUOTATION OF ORDERING ANY PRODUCTS OR SERVICES FROM SELLER, BUYER AGREES TO ALL THE FOLLOWING TERMS AND CONDITIONS. If a written contract signed by both parties is in existence covering the sale of the goods and services, the terms and conditions of the contract shall control to the extent they are inconsistent with these Terms and Conditions.

1. Order Procedure. Buyer may or may not request the preparation of a Quotation prior to ordering any products or services from Seller. Buyer then shall place a Purchase Order with Seller. By placing a Purchase Order, Buyer makes an offer to purchase products or services from Seller pursuant to these Terms and Conditions. Seller, in its discretion, may accept or reject the Purchase Order. If Seller accepts the Purchase Order, Seller shall issue an Order Acknowledgement Form confirming Buyer's order. No Purchase Order is binding on Seller unless accepted by Seller as provided in these Terms and Conditions.

2. Quotations. All Quotations by Seller are subject to change or withdrawal without prior notice to Buyer unless otherwise specifically stated in the Quotation. Quotation prices are valid on Purchase Orders placed within 90 days of the quote being issued, unless otherwise specifically stated in the quotation. If no order is placed within the stated time frame, prices may be adjusted to reflect the then-current published prices, surcharges, escalators, or other pricing adjustment due to, among other things, costs of materials, labor, transportation, taxes, duties, and other cost increases to Seller. All resulting Purchase Orders become effective only if and when approved and accepted in writing by Seller by the issuance of its Order Acknowledgement Form. Seller reserves the right to discontinue manufacture of any products or change products materials, design, or specifications without notice.

Quotation prices are valid on Purchase Orders placed within 90 days of the quote being issued, unless otherwise specifically stated in this quotation. If no order is placed within the stated time frame, prices may be adjusted to reflect the then-current published prices, surcharges, escalators, or other pricing adjustment due to, among other things, costs of materials, labor, transportation, taxes, duties, and other cost increases to Seller. All resulting Purchase Orders become effective only if and when approved and accepted in writing by Seller by the issuance of its Order Acknowledgement Form. All Quotations and resulting orders are subject to Seller's Terms and Conditions set forth in the price book

3. Site Requirements.

- a. The Quotation is contingent upon all work being performed during normal business hours unless otherwise negotiated and a mutually agreeable schedule. The Quotation is calculated on one continuous installation engagement based on acceptable site conditions where other dependent scopes have completed preparation for proposed materials (i.e. electrical work, floor work, adjacent construction). When Buyer has given authorization for work to begin, no other scopes may impede Seller's ability to complete installation in agreed upon area. Seller reserves the right to invoice for costs that are incurred due to unacceptable site conditions or delays by others resulting in additional installation visits.
- b. Signed acceptance by Buyer of shop drawings and/or submittals shall be interpreted as acceptance that proposed scope is the correct interpretation of construction documents. Any field verification and/or work required by others as detailed in the submittal will be provided and coordinated by Buyer. Work shall

not begin nor shall orders be placed for any projects until all shop drawings and submittals have been approved in writing by Buyer.

4. Warranty. Seller warrants only that all products sold pursuant to a Quotation or Purchase Order will conform to the description in the Price Book and will be free from defects in workmanship and materials. The duration of each product warranty is dependent on the particular product. Refer to EAD & DHW warranty statement. Extended warranties may be available for an additional cost. Seller is not responsible for defects or damages caused by wear and tear, consumable materials, vandalism, fires, storms, floods, acts of God, misuse, abuse or alteration by any company other than Seller. Seller further warrants that Buyer will receive good and valid title to the products. Any claim on account of nonconforming or defective products or for any other cause whatsoever shall conclusively be deemed waived by Buyer unless written notice thereof is given to Seller promptly after discovery but no later than sixty (60) days from date of shipment. Seller shall have the right either to replace or repair any nonconforming or defective products, to refund the purchase price upon return of the products, or to grant a reasonable allowance on account of such nonconformance or defect Seller's liability and Buyer's exclusive remedy for nonconforming or defective products shall be limited solely to replacement, repair, refund, or allowance as Seller may elect. Seller shall be given reasonable opportunity to investigate all claims and no materials shall be returned to Seller until after inspection and approval by Seller and receipt by Buyer of written shipping instructions from Seller. Buyer acknowledges and agrees that the remedies set forth in this paragraph are Buyer's exclusive remedies for the delivery of nonconforming or defective products.

Additional Warranties

- a) No credit will be provided for any work completed by others during warranty term.
- b) Warranty work will be performed during normal business hours with our standard response times. Any warranty work taking place beyond normal business hours or with expedited response time may be billable.
- c) Products repaired or replaced under the warranty are warranted only through the remainder of the original warranty period.

Disclaimer of Further Warranties. Except as set forth above, there is no warranty, representation, or condition of any kind, express or implied (including no warranty of merchantability or fitness of the products for any use contemplated by Buyer) concerning Seller's products or services and none shall be implied by law.

5. Limitation of Liability and Remedies. Seller shall not be liable, and Buyer waives all claims against Seller for any incidental, consequential, or special damages, including without limitation, lost revenues and profits even if Seller has been advised of the possibility of such damages. Buyer's exclusive remedy for any cause of action under these Terms and Conditions is a claim for damages and in no event will damages or any other recovery of any kind against Seller exceed the purchase price of the specific products or services as to which the claim is made. Seller will not be liable to Buyer for any loss, damage, or injury to persons or property resulting from the handling, storage, transportation, resale, or use of the products in manufacturing processes, or in combination with other substances, or otherwise.

6. Intellectual Property Indemnification. (a) Seller agrees to defend, indemnify and hold Buyer harmless against any claims, costs, damages, liability and expenses resulting from actual or alleged patent, trademark, or copyright infringement, misappropriation of confidential information, or violation of any other intellectual property right, domestic or foreign, in the selling or use of any part or product that is owned by Seller and that pertains to the subject matter of a Quotation, Purchase Order, or sale of products or services (provided that the product is not modified in anyway by Buyer or any other party, and that the product is used in the manner intended by Seller). If a suit or claim results in any injunction or any other order that would prevent Seller

General information

Terms and conditions of sale

from supplying any product falling under a Quotation, Purchase Order, or sale, or if the result of such a suit or claim would, in the reasonable opinion of Seller, otherwise cause Seller to be unable to supply such products, Seller shall have the right, at its option, if it so chooses, to do one or more of the following: (i) secure an appropriate license to permit Seller to continue supplying the products to Buyer; (ii) modify the relevant product so that it becomes non-infringing, provided that any modification does not cause any material change to the operation or performance of the product; or (iii) replace the relevant product with a non-infringing but practically equivalent product. (b) Buyer agrees to defend, indemnify, and hold Seller harmless against any claims, costs, damages, liability and expenses resulting from actual or alleged patent, trademark, or copyright infringement, misappropriation of confidential information, or violation of any other intellectual property right, domestic or foreign, in the making, using or selling of any product or using any process that is owned by Buyer or is designed or specified by Buyer and that pertains to the subject matter of a Quotation, Purchase Order, or sale.

7. Ownership of Inventions. All drawings, know-how, designs, confidential information, and the like disclosed to Buyer by Seller and all rights therein will remain the property of Seller. Buyer shall have no claim to, ownership interest in, no license to, or no rights to any information provided or communicated by Seller.

8. Lead Times. If applicable, lead times are based on standard requirements by factory to provide materials proposed. Ship dates will be provided as estimate only once order is placed with the factory. Adequate packaging will be provided for any normal shipping circumstance such that materials will be protected and labeled as required. Special packaging may be provided for an additional expense. Shipping will be cost effective unless expedited fees are accepted by Buyer. If materials are to be provided to job site or Buyer location, dormakaba will make an informed decision as to the best instruction to provide the shipping company. If materials are not required to have direct delivery, materials will be brought to branch for pickup by Buyer. All freight terms shall be FOB. Any claims for damage in transit or lost freight, receiving, and inspection of materials is the responsibility of Buyer. It is a requirement of Buyer to inspect and review all materials prior to accepting shipment.

9. Title/Risk of Loss. All products shall be shipped FOB Seller's manufacturing facility to Buyer's designated delivery location. Unless otherwise agreed by the parties, Seller shall select the method of and carrier for the products. Seller reserves the right to ship items in a single or in multiple shipments. Title and risk of loss to products ordered passes to Buyer upon delivery of the products to the freight carrier. Unless mutually agreed upon in writing, shipping dates are approximate and are based upon prompt receipt of all necessary information.

10. Prices. Quoted price is valid for 90 days. Seller reserve the right to revise quotations after the 90 days. All accepted Purchase Orders are subject to Seller's price in effect at time of shipment. Buyer shall be responsible for any increase in freight rates or transportation charges occurring after Seller prepared the Order Acknowledgment Form. on the Order Acknowledgment Form. Buyer shall pay to Seller in addition to the purchase price the amount of all fees, duties, licenses, and all sales, use, privilege, occupation, excise, or other taxes, federal, state, local, or foreign which Seller is required to pay or collect in connection with products or services sold to Buyer.

11. Payments. Unless otherwise agreed in writing between the parties, all Seller's invoices are payable within thirty (30) days of their date. Time is of the essence. Interest on past due amounts will be assessed at the rate of 2% per month (24% per annum), or the maximum allowable by law.

Seller reserves the right to full payment upon completion of work unless credit is pre-established. For any work requiring materials purchase or scheduling, a 50% deposit is due at

time of proposal acceptance. Twenty percent (20%) of the Quotation, Purchase Order value may be billed after job award. Joint check agreements may be requested at the discretion of Seller. If payment is outstanding for any one account, work may be stopped and outstanding orders cancelled until account is restored. Should Seller require the use of collection, attorney's fees, or fees for insufficient funds, Buyer agrees that these funds will be repaid to Seller. Seller retains the right to file a lien against all or part of the property being improved. Seller reserves the right to add a 2.5% charge if invoice becomes delinquent beyond terms.

12. Cancellation. In the event a Buyer's Purchase Order and the issuance of an Order Acceptance Form is cancelled, it will be subject to standard 35% restocking fees, cancellation fees, engineering fees, materials & freight costs incurred, and administrative fees. Standard cancellation is 20% of order as long as no materials have been ordered. Should Buyer release material orders, Buyer will be liable for that portion of the job and 20% of the remaining amount of work unperformed/unordered.

13. Storage. If applicable, Seller reserves the right to implement a storage fee if delivery is delayed after agreed upon date. Should project timeline require storage of materials, Seller reserves the right to bill for those materials at the time they have been received at a Seller location, Buyer location, or at job site. Certificate of insurance for stored materials can be provided to Buyer upon request. Signed acceptance by Buyer of shop drawings and/or submittals shall be interpreted as acceptance that proposed scope is the correct interpretation of construction documents. Any field verification and/or work required by others as detailed in the submittal will be provided and coordinated by Buyer.

14. Insolvency. Seller may, at any time or times, suspend performance of any order or require payment in cash, security, or other adequate assurance satisfactory to Seller when, in Seller's opinion, the financial condition of Buyer or other grounds for insecurity, including the filing of a petition for bankruptcy, warrant such action.

15. Force Majeure. Seller shall not be liable for any delay in fulfilling any order due to (a) fires, floods, strikes, or other labor disputes, accidents to machinery, acts of sabotage, riots, precedence or priorities granted at the request or for the benefit, directly or indirectly, of the federal or any state government or any subdivision or agency thereof, delays in transportation or lack of transportation facilities, restrictions imposed by federal or state legislation or rules of regulations thereunder; or (b) any cause beyond the control of Seller.

16. Ownership of Equipment. Unless otherwise agreed in a writing, all material, equipment, facilities, and special tooling, which term includes but is not limited to jigs, dies, fixtures, molds, patterns, special taps, special gauges, special test equipment, and manufacturing aids and replacements thereof, used in the manufacture of the products covered by any order shall remain the property of Seller. Any material, tooling, and equipment furnished to Seller by Buyer shall be and remain the personal property of Buyer with the title to and right of possession remaining in Buyer.

17. Confidential Information. All information furnished or made available by Seller to Buyer in connection with a transaction shall be held in confidence by Buyer. Buyer agrees not to use such information or disclose such information to others without Seller's prior written consent. The obligations of this paragraph does not apply to any information which (a) at the time of disclosure was, or thereafter becomes, generally available to the public by publication or otherwise through no breach by Buyer of any obligation herein, (b) Buyer can show by written records was in Buyer's possession prior to disclosure by the disclosing party, (c) is legally made available to Buyer by or through a third party having no direct or indirect confidentiality obligation to Seller

General information

Terms and conditions of sale

with respect to such information, (d) was independently developed by Buyer without use of any of Seller's confidential information, or (e) is required to be disclosed pursuant to applicable law.

18. Waiver. No waiver by Seller of any of these Terms and Conditions shall be effective unless explicitly set forth in writing and signed by Seller. No failure to exercise, or delay in exercising, any rights, remedy, power, or privilege arising from these Terms and Conditions shall operate or be construed as a waiver thereof, nor shall any single or partial exercise of any right, remedy, power, or privilege hereunder preclude any other or further exercise thereof or the exercise of any other right, remedy, power or privilege.

19. Assignment. No assignment of any right or interest or delegation of any obligation or performance of Buyer under this order may be made without the prior written consent of Seller. Any attempted assignment or delegation will be wholly void and totally ineffective for all purposes.

20. Choice of Law. All sales, agreements for sale, offers to sell, proposals, acknowledgments and contracts of sale, including, but not limited to, Purchase Orders accepted by Seller, shall be considered a contract under the laws of the State of Delaware, and the rights and duties of all persons, and the construction and effect of all provisions hereof, shall be governed by and construed according to the laws of the State of Delaware.

21. Integration Clause. These Terms and Conditions constitute the entirety of terms and conditions, except as set forth in paragraph one, governing the sale and purchase of products and services sold by Seller. No modification of these Terms and Conditions shall be of any force or effect unless in writing and signed Seller and Buyer. Buyer may desire to utilize its own form of acknowledgment or acceptance of these Terms and Conditions. However, the use of any such form shall be for convenience only. No modification of these Terms and Conditions shall be affected by the acknowledgment or acceptance of purchase orders, shipping instruction forms, bills of lading or any other document containing terms or conditions at variance with or in addition to those set forth herein, all such varying or additional terms being hereby objected to and rejected by Seller and deemed to be waived by Buyer.

22. Installation Projects. Communication: Buyer shall communicate all of these installation terms to any end-user receiving installation services from dormakaba. **Work Execution:** Any installation quote is prepared with the understanding that openings within the scope of work ("Work") have doors and frames in good working order. dormakaba will perform the Work in the order set forth in a field survey conducted by an end-user, an end-user consultant, or Buyer prior to beginning the installation. Work shall occur weekdays during normal business hours (M-F, 8am – 5pm, local time). Work performed outside of normal business hours is available at a rate of 135% of the normal base rate. Any Work requested to be performed outside of normal business hours will require start and stop time confirmation with installation site, such start and stop time to be obtained by the Buyer or the end-user. Installation Projects are performed as one continuous installation event, from commencement until the completion of the installation. Unless specifically noted otherwise in writing, there will be additional charges for delays or additional trips not caused by dormakaba. Commencement of installation is conditioned on acceptable site conditions, including the completion of dependent scopes of work (e.g., electrical work, keying meetings, distribution of credentials). When Buyer or end-user has given authorization for work to begin, Buyer or end-user shall ensure no other scopes may impede dormakaba's ability to complete installation in agreed upon area. dormakaba reserves the right to assess a fee for costs incurred due to unacceptable site conditions or delays by others resulting in additional installation visits. Union labor, prevailing wage, and certified payroll are excluded from the installation quote unless otherwise set forth in writing. Insurance certificates will be provided upon request. Coverage is limited to the types and amounts set forth on the insurance certificate. Includes execution of materials only as detailed within proposal. **Additional Charges:** Additional charges may be assessed for delays or additional install time to correct any deficiencies or discrepancies between scope of work and actual

jobsite. Any dormakaba materials delivered to Buyer but missing from installation site will be reordered at customer's expense. Any hardware changes or change orders shall be quoted on a separate proposal and timeline. **Storage:** dormakaba reserves the right to assess a storage fee if Buyer or end-user causes delivery to be delayed after the agreed upon delivery date. Should project timeline require storage of materials after delivery to Buyer or end-user, through no act or omission of dormakaba, dormakaba reserves the right to assess a storage fee, Buyer location, or at job site. Certificate of insurance for stored materials can be provided to Buyer upon request. **Exclusions:** Unless explicitly included in the installation quote, these are excluded: Distribution to staff of any form of keys, fobs or cards or credentials; any temporary security, barricades, or signage; all carpentry work outside of this specification including drywall, paint, framing, patching of existing holes, etc.; union labor, prevailing wage & certified payroll unless noted otherwise; permits are the responsibility of the end-user; Any special consideration for asbestos and lead paint hazards; any bonds; disposal of material and packaging; damage from negligence, vandalism or Force Majeure; cleaning of site beyond broom clean; cost for special insurance requirements; consumable materials (e.g., batteries); any electrical work including 120v connections and low voltage wiring pulls; and other similar categories of labor and materials not included in the installation quote.

23. Installation Warranty dormakaba will provide one (1) year warranty on materials to be free from manufacturer defects and on installation labor performed. Extended warranties are available for an additional cost. dormakaba is not responsible for defects or damages caused by wear and tear, consumable materials (e.g., batteries), vandalism, fires, storms, floods, acts of God, misuse, abuse, or alteration on by any company other than dormakaba. No credit will be provided for any work completed by others during warranty term. dormakaba reserves the right to withhold the performance of warranty work if Buyer payments have become past due. Warranty work will be performed during normal business hours with our standard response times. Any warranty work taking place beyond normal business hours or with expedited response time may be billable. In the event that Buyer, its agents, employees, successors, and/or assigns tampers with, misuses, removes any parts, or adds any parts or equipment, Buyer agrees to indemnify, save and hold harmless dormakaba, its agents, employees, successors, and/or assigns, from any and all liability, damages, or losses, including reasonable attorney's fees, arising out of, or incidental to, the aforementioned conduct. dormakaba warrants that all goods manufactured by dormakaba and all services provided by dormakaba hereunder will be free from defects in workmanship and materials for twelve (12) months from the date of final project invoice to the carrier, unless sold as "With All Faults", "Shop", "As Is", "As They Stand" or other similar designation. Products repaired or replaced under the warranty are warranted only through the remainder of the original warranty period.

April 2023

General information

Finishes Cross Reference

Finish Description	Finish Appearance	dormakaba/BHMA Code	Nearest U.S. Equivalent
Brass	Bright	605	US3
	Satin	606	US4
Bronze	Polished	611	US9
	Satin	612	US10
	Oil Rubbed/Dark Satin	613	US10B
Nickel	Bright	618	US14
	Satin	619	US15
Chrome	Bright	625	US26
	Satin	626	US26D
Stainless	Bright	629	US32
	Satin	630	US32D
Aluminum	Satin Anodized	628	US28
Dark Oxidized Bronze	Satin Anodized	710	US10B
Flat Black	Anodized	711	US19
Aluminum	Painted or Powder Coated	689	US28
Dark (Statuary) Bronze	Painted or Powder Coated	690	US20
Light (Dull) Bronze	Painted or Powder Coated	691	US10
Black	Painted or Powder Coated	693	Black Anodized
Dark (Duronodic) Bronze	Painted or Powder Coated	695	Dark Bronze Anodized
Satin Brass (Gold)	Painted or Powder Coated	696	US4
Primed	Painted or Powder Coated	600	USP
Custom	Painted or Powder Coated	Custom	RAL Pallet
Designer	Painted	Designer	Sample Match

* Excluding Mechanical Locks, Architectural Pulls & Handles. See appropriate product section for available finishes.

Reference: ANSI A156.18 American National Standard for Materials and Finishes

600 Series Plated Finishes designate the appearance of the finish, regardless of the base material. For example, 605 defines a polished brass material, but 605 can be any base material, like steel or stainless, that is finished to provide the appearance of polished brass.

Standard sprayed finishes are shown above.

For a **Custom Color**, refer to the Custom Color Pallet. For Door Controls, a \$110.00 net setup fee per purchase order, per color will be charged. For exits and trim, a \$121.00 net setup fee per purchase order, per color will be charged. For a copy of the Custom Color Pallet, please contact your Representative or our Customer Service Department. Locks are NOT included in the Custom Color program.

For a **Designer Color**, custom matched to a supplied sample, three (3) each 2" x 3" color chip samples are required. For Door Controls, a non-refundable fee of \$276.00 net is required per color match request, per order prior to processing. For exits and trim, non-refundable \$441.00 net fee is required per color match request, per order prior to processing. Allow six (6) weeks for designer color development. If a match can not be made to the customer's satisfaction after three (3) attempts, dormakaba reserves the right to decline the order. Metallic colors are difficult to duplicate and may be rejected. Locks are NOT included in the Designer Color program.

Please contact our Sales Service Department, or your local sales representative for further information.

Locks

How to Determine Hand of Door

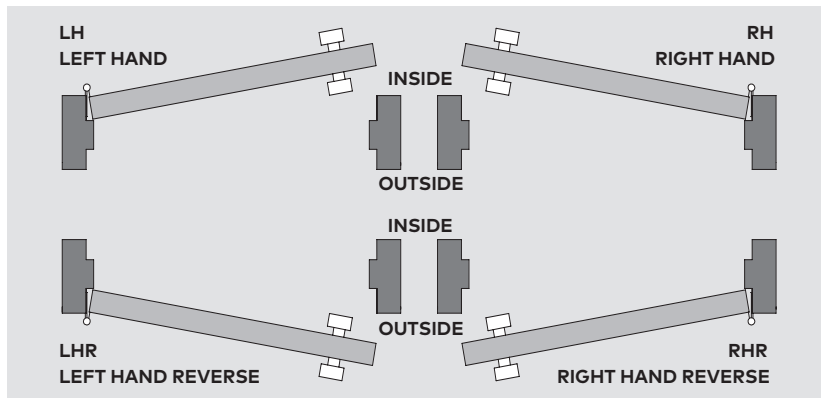

How to Determine Handed Levers

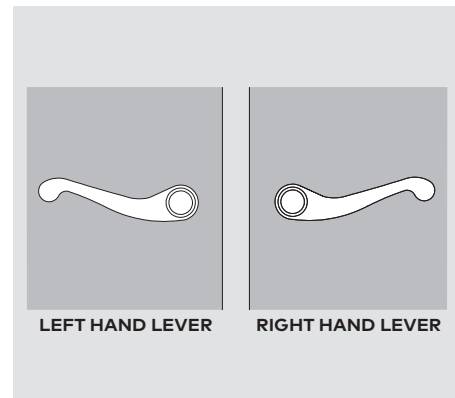

Product Guide

	Description	ANSI BHMA	Fire Rated	Standard Cylinder	SFIC	Schlage Style/LFIC
M9000 Lock (available only while supplies last)	GR1 Mortise Lock	Yes	Yes	Yes	Yes	Yes
T900 Lock	GR2 Decorative Tubular Lock (M9000 Trim)	No	Option	N/A	N/A	N/A
D900 Dead Bolt (available only while supplies last)	GR1 Small Case Mortise Dead Bolt	Yes	Yes	Yes	Yes	Yes
C100 Lever Lock	GR1 Cylindrical Lever Lock	Yes	Yes	Yes	Yes	Yes
DB100 Dead Bolt	GR1 Tubular Dead Bolt	Yes	Yes	Yes	Yes	Yes
D800 Dead Bolt (available only while supplies last)	GR1 Tubular Dead Bolt	Yes	Yes	Yes	Yes	Yes
C200 Lever Lock	GR1 Tubular Dead Bolt	Yes	Yes	Yes	Yes	Yes
DB600 Dead Bolt	GR2 Tubular Dead Bolt	Yes	Yes	Yes	Yes	No
C500 Lever Lock	GR2 Cylindrical Lever Lock	Yes	Yes	Yes	Yes	No
C300 Lever Lock	GR2 Cylindrical Lever Lock	Yes	Option	Yes	No	No
J300 Interconnected Lock	GR2 Interconnected Lock	Yes	Yes	Yes	Yes	No

M9000 Series

Ordering Guide

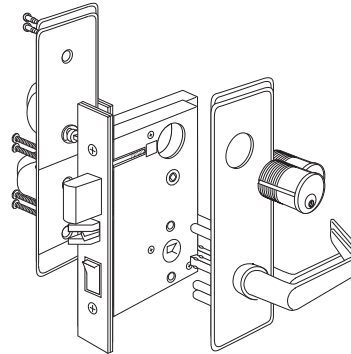

	Function ²
Privacy w/DB & Indicator	996
Faculty Restroom/Hotel w/DB & Indicator	986
Storeroom w/DB Single Cylinder	980
Classroom Intruder w/DB	974
Dormitory w/DB (F21)	973
Intruder Dead Bolt (F33)	968
Intruder Dead Bolt (F34)	967
Storeroom w/DB (F14)	966
Storeroom w/DB (F35)	958
Dormitory w/DB (F11)	957
Corridor w/DB (F13)	956
Entry w/DB (F20)	953
Privacy w/DB (F19)	940
Institution (F30)	082
Electrically Unlocked/Locked w/Double Locking	082EU/EL
Electrically Unlocked/Locked	080EU/EL
Storeroom (F07)	080
Classroom Intruder Latch Bolt with Indicator	072
Classroom Intruder Latch Bolt (F32)*	071
Classroom (F05)	070
Apartment (F09)	060
Office/Entry (Alt F04)	053
Office/Entry (F04)	050
Privacy w/Indicator	046
Privacy w/Coin Turn	042
Privacy, Bedroom or Bath (F22)	040
Exit/Communicating Passage (F31)	025
Passage/Closet (F01)	010
Dummy Trim Two Sides	002
Dummy Trim One Side	001

- Indicator cannot be added to M9071 function. For intruder function with indicator, order M9072.
- Additional functions available. Detailed function descriptions available in M9000 Series brochure.
- KB knob priced same as Premium lever.
- D Rose not available in 625 or 626.
- Available in 626 and 630 finishes only. Not available on 630 H escutcheon.
- Security Screws only available with 619, 625, 626 and 630 finishes.
- Standard door thickness is 1-3/4" (44 mm). Requirements for doors 1-13/16" (46 mm) and thicker can vary by trim and function. See page 14
- Example shows default values. Refer to Configuration Options section for full details.

		Lever Design		Finish		Door Hand		Door Thickness ⁷		Strike Options ⁸		Lip Length ⁸	
		Premium Lever	PREMIUM	630	Satin Stainless								
		Knob ³	KB	626	Satin Chrome								
		Lever	LT	625	Bright Chrome								
		Lever	LR	622 PVD	Satin Black								
		Lever	LN	619 PVD	Satin Nickel								
		Lever	LG	613 PVD	Dark Oxidized Satin Bronze								
		Lever	LD	612 PVD	Satin Bronze								
		Lever	LC	606 PVD	Satin Brass								
				605 PVD	Bright Brass								
M9	953		D	LR	A	626			RH	134	5006	114	XXXX
Product Family	Temporary SFIC		T		A	2-1/4" Dia. Rose	AM	TX	RH	Right Hand			Keying Options Field
	SFIC (Less Core)		J		B	2-9/16" Dia. Rose			RHR	Right Hand Reverse			
Heavy Duty Grade 1 Mortise Lockset	SFIC (With Core)		C		H	2-1/8" x 8-9/16" Escutcheon			LH	Left Hand			
	Less Cylinder		L		M	2-1/2" x 8" Escutcheon			LHR	Left Hand Reverse			
	Conventional Cylinder		D		D	2-9/16" Dia. Decorative Rose ⁴							
	Temporary Schlage LFIC		G										
	Schlage LFIC (Less Core)		R										
	Schlage LFIC		F										

Trim Options

Lever Options – Standard

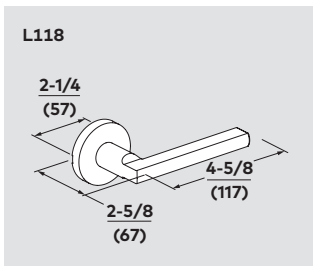
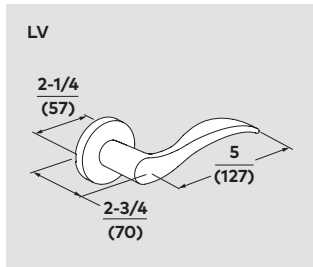
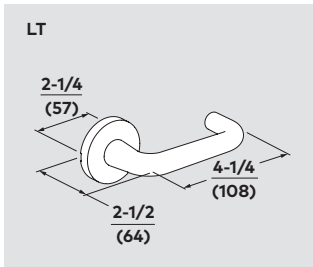
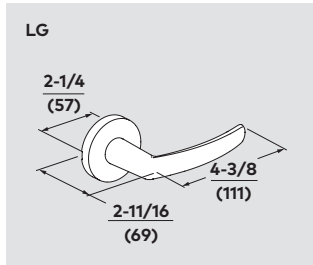
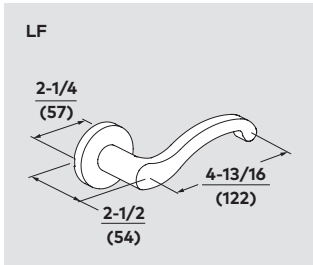
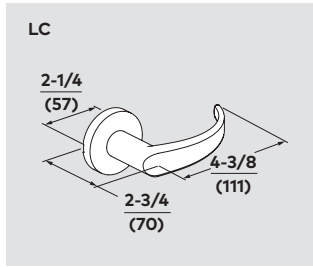
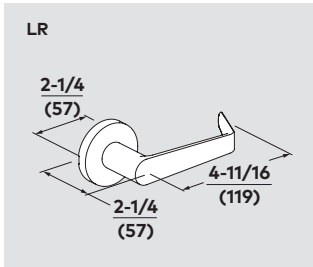

Lever Options – Premium

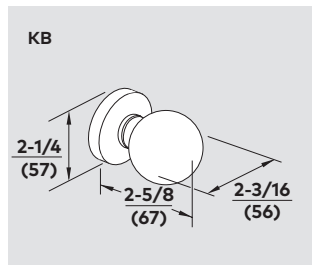
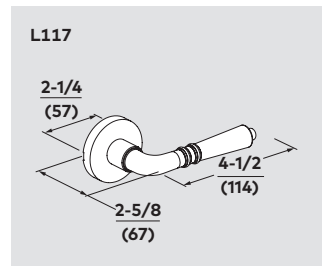
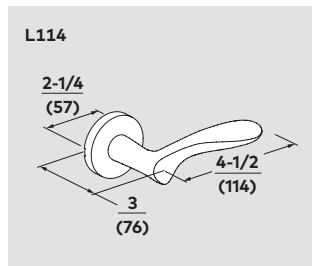
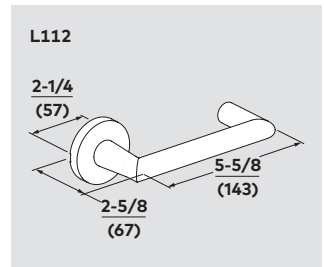
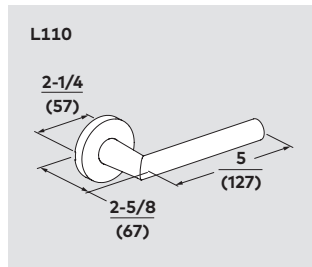
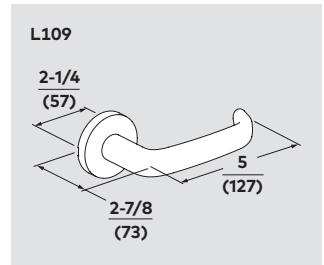
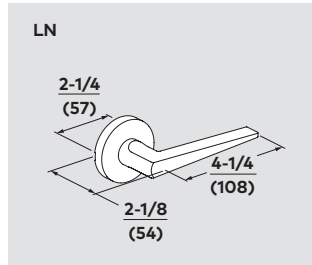
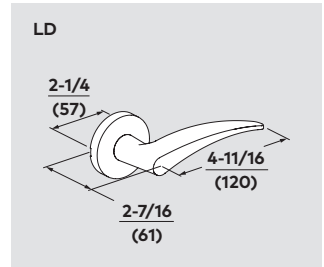
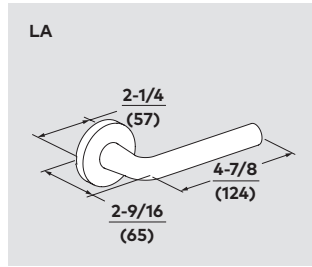

Trim Styles

All Finishes

Wrought Roses

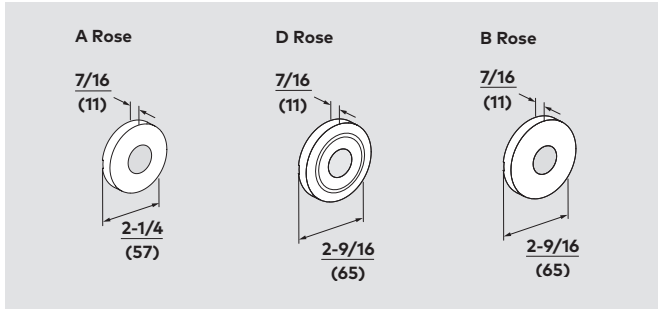

Escutcheons

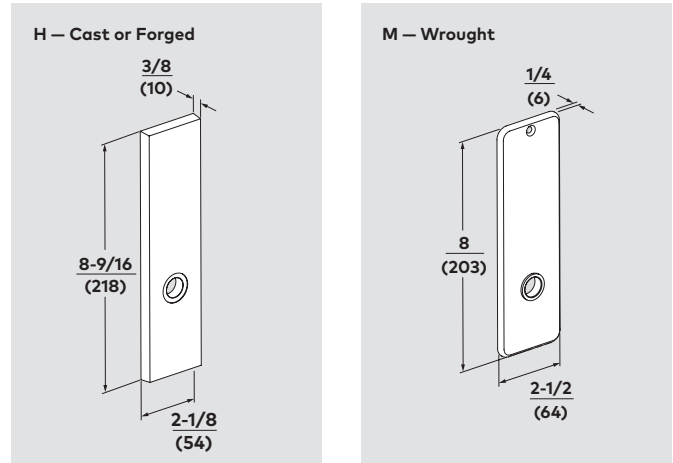

NOTE: H Escutcheon Trim cannot be rehanded in the field.

Finish Availability Chart

	605	606	612	613	619	622	625	626	630
Standard Levers									
LR	•	•	•	•	•	•	•	•	•
LC	•	•	•	•	•	•	•	•	•
LG	•	•	•	•	•	•	•	•	•
LF	•	•	•	•	•	•	•	•	•
LT	•	•	•	•	•	•	•	•	•
LV	•	•	•	•	•	•	•	•	•
L118		•	•	•	•	•			•
Premium Levers									
LA	•	•	•	•	•	•	•	•	•
LD	•	•	•	•	•	•	•	•	•
LN	•	•	•	•	•	•	•	•	
L109		•	•	•	•	•			•
L110	•	•	•	•	•	•	•	•	•
L112		•	•	•	•	•			•
L114	•	•	•	•	•	•	•	•	
L117	•	•	•	•	•	•			•
Knob									
KB		•	•	•	•	•			•

NOTE: See next 4 pages for mortise lock pricing arranged by Trim Style.

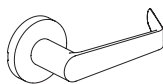

Standard levers with Rose trim

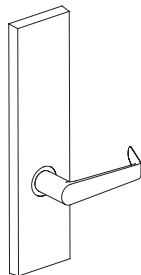

Standard levers with Escutcheon trim

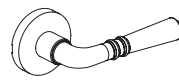

Premium levers with Rose trim

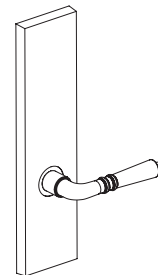

Premium levers with Escutcheon trim

Standard Lever – Rose Styles

Levers: LR, LC, LF, LG, LT, LV, L118

Roses: A, B, D

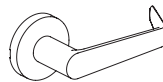

L118 not available in 605, 625, or 626 finish.
 LF and LV not available in 630 finish.
 See Lever Finish Availability Chart, page 5.
 D rose not available in 625 or 626 finish.

A,B,D Rose

626

605, 606,
612, 613,
619, 622,
625, 630

ANSI #	Function	Description	List \$	
Non-Keyed				
—	M9001 (w/out lock case)	Single dummy	297.00	338.00
—	M9002 (w/out lock case)	Double dummy	634.00	683.00
—	M9003 (w/lock case)	Single dummy	467.00	494.00
—	M9004 (w/lock case)	Double dummy	771.00	817.00
F01	M9010 ¹	Passage/closet	829.00	922.00
F31	M9025 ¹	Exit/communicating passage	956.00	1052.00
F22	M9040	Privacy, bedroom or bath	956.00	1052.00
—	M9042	Privacy w/coin turn	1021.00	1122.00
—	M9046	Privacy w/indicator	1150.00	1198.00
F19	M9940	Privacy w/dead bolt	1150.00	1198.00
—	M9942	Privacy w/dead bolt and coin turn	1221.00	1267.00
Keyed, Single Cylinder				
F04	M9050 ¹	Office/Entry	1062.00	1165.00
F04	M9053 ²	Office/Entry	1062.00	1165.00
—	M9056	Office/Entry w/automatic unlocking	1157.00	1263.00
F05	M9070 ²	Classroom	1062.00	1165.00
F06	M9076	Holdback	1062.00	1165.00
F07	M9080 ¹	Storeroom	1062.00	1165.00
—	M9080EL ¹	Electrically locked (Fail Safe; 24 V)	1601.00	1648.00
—	M9080EU ¹	Electrically unlocked (Fail Secure; 24 V)	1601.00	1648.00
F20	M9953	Entry w/dead bolt	1094.00	1198.00
—	M9954	Security entrance w/dead bolt	1094.00	1198.00
F13	M9956	Corridor w/dead bolt	1094.00	1198.00
F12	M9959	Dormitory/Exit w/dead bolt	1094.00	1198.00
F21	M9973	Dormitory w/dead bolt	1094.00	1198.00
—	M9980	Storeroom w/dead bolt	1094.00	1198.00
F15	M9985	Faculty restroom/hotel w/dead bolt	1157.00	1263.00
—	M9986	Faculty restroom/hotel w/dead bolt/indicator	1246.00	1361.00
—	M9996	Privacy w/dead bolt/indicator	1246.00	1361.00
Keyed, Double Cylinder				
F09	M9060	Apartment	1165.00	1275.00
F32	M9071 ²	Intruder latch bolt	1165.00	1275.00
—	M9072	Intruder latch bolt with indicator	1268.00	1378.00
—	M9077	Holdback double cylinder	1165.00	1275.00
F30	M9082 ²	Institution lock	1165.00	1275.00
—	M9082EL ³	Electrically locked (Fail Safe) w/double locking (24 V)	1690.00	1738.00
—	M9082EU ³	Electrically unlocked (Fail Secure) w/double locking (24 V)	1690.00	1738.00
F11	M9957	Dormitory w/dead bolt	1226.00	1275.00
F35	M9958	Storeroom w/dead bolt	1226.00	1275.00
F14	M9966	Storeroom w/dead bolt	1226.00	1275.00
F34	M9967	Intruder w/dead bolt	1226.00	1275.00
—	M9974	Classroom intruder w/dead bolt	1226.00	1275.00
Deadbolt Only				
F17	M9960	Deadbolt Only – Cylinder x Turn (No Trim)	552.00	576.00
F18	M9961	Deadbolt Only – Cylinder x Blank (No Trim)	453.00	481.00
F16	M9962	Deadbolt Only – Cylinder x Cylinder (No Trim)	667.00	693.00
F29	M9963	Deadbolt Only – Classroom (No Trim)	667.00	693.00

NOTES:

1. Available with Request to Exit (RX), Latch Monitoring (LM) or both
 2. Available with Latch Monitoring (LM) only
 3. Available with Request to Exit (RX) or Latch Monitoring
- See page 13 for RX and LM Pricing

Standard Lever – Escutcheon Styles

Levers: LR, LC, LF, LG, LT, LV, L118

Escutcheons: H, M

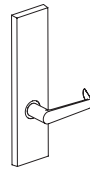

L118 not available in 605, 625, or 626 finish.
LF and LV not available in 630 finish.
See Lever Finish Availability Chart, page 5.

NOTE: H Escutcheon Trim cannot be rehanded in the field.

H Escutcheon		M Escutcheon	
626	605, 606, 612, 613, 619, 622, 625, 630	626, 630	605, 606, 612, 613, 619, 622, 625

ANSI #	Function	Description	List \$			
Non-Keyed						
—	M9001 (w/out lock case)	Single dummy	346.00	371.00	347.00	371.00
—	M9002 (w/out lock case)	Double dummy	641.00	685.00	640.00	686.00
—	M9003 (w/lock case)	Single dummy	486.00	510.00	487.00	508.00
—	M9004 (w/lock case)	Double dummy	773.00	819.00	772.00	820.00
F01	M9010 ¹	Passage/closet	868.00	914.00	868.00	912.00
F31	M9025 ¹	Exit/communicating passage	—	—	868.00	912.00
F22	M9040	Privacy, bedroom or bath	993.00	1037.00	993.00	1036.00
—	M9042	Privacy w/coin turn	1054.00	1099.00	1054.00	1098.00
—	M9046	Privacy w/indicator	—	—	—	—
F19	M9940	Privacy w/dead bolt	1127.00	1169.00	1126.00	1169.00
—	M9942	Privacy w/dead bolt and coin turn	1193.00	1234.00	1193.00	1235.00
Keyed, Single Cylinder						
F04	M9050 ¹	Office/Entry	1092.00	1139.00	1093.00	1139.00
F04	M9053 ²	Office/Entry	1092.00	1139.00	1093.00	1139.00
—	M9056	Office/Entry w/automatic unlocking	1143.00	1187.00	1142.00	1188.00
F05	M9070 ²	Classroom	1092.00	1139.00	1093.00	1139.00
F06	M9076	Holdback	1092.00	1139.00	1093.00	1139.00
F07	M9080 ¹	Storeroom	1092.00	1139.00	1093.00	1139.00
—	M9080EL ¹	Electrically locked (Fail Safe; 24 V)	1554.00	1596.00	1553.00	1596.00
—	M9080EU ¹	Electrically unlocked (Fail Secure; 24 V)	1554.00	1596.00	1553.00	1596.00
F20	M9953	Entry w/dead bolt	1126.00	1172.00	1125.00	1171.00
—	M9954	Security entrance w/dead bolt	1126.00	1172.00	1125.00	1171.00
F13	M9956	Corridor w/dead bolt	1126.00	1172.00	1125.00	1171.00
F12	M9959	Dormitory/Exit w/dead bolt	1126.00	1172.00	1125.00	1171.00
F21	M9973	Dormitory w/dead bolt	1126.00	1172.00	1125.00	1171.00
—	M9980	Storeroom w/dead bolt	1126.00	1172.00	1125.00	1171.00
F15	M9985	Faculty restroom/hotel w/dead bolt	1172.00	1217.00	1171.00	1217.00
—	M9986	Faculty restroom/hotel w/dead bolt/indicator	—	—	—	—
—	M9996	Privacy w/dead bolt/indicator	—	—	—	—
Keyed, Double Cylinder						
F09	M9060	Apartment	1195.00	1241.00	1195.00	1240.00
F32	M9071 ²	Intruder latch bolt	1195.00	1241.00	1195.00	1240.00
—	M9077	Holdback double cylinder	1195.00	1241.00	1195.00	1240.00
F30	M9082 ²	Institution lock	1195.00	1241.00	1195.00	1240.00
—	M9082EL ³	Electrically locked (Fail Safe) w/double locking (24 V)	1629.00	1675.00	1628.00	1674.00
—	M9082EU ³	Electrically unlocked (Fail Secure) w/double locking (24 V)	1629.00	1675.00	1628.00	1674.00
F11	M9957	Dormitory w/dead bolt	1195.00	1241.00	1195.00	1240.00
F35	M9958	Storeroom w/dead bolt	1195.00	1241.00	1195.00	1240.00
F14	M9966	Storeroom w/dead bolt	1195.00	1241.00	1195.00	1240.00
F34	M9967	Intruder w/dead bolt	1195.00	1241.00	1195.00	1240.00
—	M9974	Classroom intruder w/dead bolt	1195.00	1241.00	1195.00	1240.00
Deadbolt Only						
F17	M9960	Deadbolt Only — Cylinder x Turn (No Trim)	552.00	576.00	552.00	576.00
F18	M9961	Deadbolt Only — Cylinder x Blank (No Trim)	453.00	481.00	453.00	481.00
F16	M9962	Deadbolt Only — Cylinder x Cylinder (No Trim)	667.00	693.00	667.00	693.00
F29	M9963	Deadbolt Only — Classroom (No Trim)	667.00	693.00	667.00	693.00

NOTES:

1. Available with Request to Exit (RX), Latch Monitoring (LM) or both
 2. Available with Latch Monitoring (LM) only
 3. Available with Request to Exit (RX) or Latch Monitoring
- See page 13 for RX and LM Pricing

Premium Lever – Rose Styles

Levers: LA, LD, LN, L109, L110, L112, L114, L117, KB



Roses: A, B, D

L109, L112, and L117 not available in 625 or 626 finishes.
LD, LN, and L114 not available in 630 finish.
See Lever Finish Availability Chart, page 5.
D rose not available in 625 or 626 finish.

A, B, D Rose

626

605, 606,
612, 613, 619,
622, 625,
630

ANSI #	Function	Description	List \$	
Non-Keyed				
–	M9001 (w/out lock case)	Single dummy	294.00	337.00
–	M9002 (w/out lock case)	Double dummy	627.00	671.00
–	M9003 (w/lock case)	Single dummy	457.00	484.00
–	M9004 (w/lock case)	Double dummy	755.00	805.00
F01	M9010 ¹	Passage/closet	815.00	902.00
F31	M9025 ¹	Exit/communicating passage	934.00	1031.00
F22	M9040	Privacy, bedroom or bath	934.00	1031.00
–	M9042	Privacy w/coin turn	995.00	1100.00
–	M9046	Privacy w/indicator	1123.00	1170.00
F19	M9940	Privacy w/dead bolt	1123.00	1170.00
–	M9942	Privacy w/dead bolt and coin turn	1192.00	1235.00
Keyed, Single Cylinder				
F04	M9050 ¹	Office/Entry	1037.00	1137.00
F04	M9053 ²	Office/Entry	1037.00	1137.00
–	M9056	Office/Entry w/automatic unlocking	1128.00	1232.00
F05	M9070 ²	Classroom	1037.00	1137.00
F06	M9076	Holdback	1037.00	1137.00
F07	M9080 ¹	Storeroom	1037.00	1137.00
–	M9080EL ¹	Electrically locked (Fail Safe; 24 V)	1557.00	1601.00
–	M9080EU ¹	Electrically unlocked (Fail Secure; 24 V)	1557.00	1601.00
F20	M9953	Entry w/dead bolt	1066.00	1169.00
–	M9954	Security entrance w/dead bolt	1066.00	1169.00
F13	M9956	Corridor w/dead bolt	1066.00	1169.00
F12	M9959	Dormitory/Exit w/dead bolt	1066.00	1169.00
F21	M9973	Dormitory w/dead bolt	1066.00	1169.00
–	M9980	Storeroom w/dead bolt	1066.00	1169.00
F15	M9985	Faculty restroom/hotel w/dead bolt	1128.00	1232.00
–	M9986	Faculty restroom/hotel w/dead bolt/indicator	1214.00	1327.00
–	M9996	Privacy w/dead bolt/indicator	1214.00	1327.00
Keyed, Double Cylinder				
F09	M9060	Apartment	1137.00	1242.00
F32	M9071 ²	Intruder latch bolt	1137.00	1242.00
–	M9072	Intruder latch bolt with indicator	1232.00	1339.00
–	M9077	Holdback double cylinder	1137.00	1242.00
F30	M9082 ²	Institution lock	1137.00	1242.00
–	M9082EL ³	Electrically locked (Fail Safe) w/double locking (24 V)	1643.00	1689.00
–	M9082EU ³	Electrically unlocked (Fail Secure) w/double locking (24 V)	1643.00	1689.00
F11	M9957	Dormitory w/dead bolt	1196.00	1242.00
F35	M9958	Storeroom w/dead bolt	1196.00	1242.00
F14	M9966	Storeroom w/dead bolt	1196.00	1242.00
F34	M9967	Intruder w/dead bolt	1196.00	1242.00
–	M9974	Classroom intruder w/dead bolt	1196.00	1242.00
Deadbolt Only				
F17	M9960	Deadbolt Only – Cylinder x Turn (No Trim)	552.00	576.00
F18	M9961	Deadbolt Only – Cylinder x Blank (No Trim)	453.00	481.00
F16	M9962	Deadbolt Only – Cylinder x Cylinder (No Trim)	667.00	693.00
F29	M9963	Deadbolt Only – Classroom (No Trim)	667.00	693.00

NOTES:

1. Available with Request to Exit (RX), Latch Monitoring (LM) or both
 2. Available with Latch Monitoring (LM) only
 3. Available with Request to Exit (RX) or Latch Monitoring
- See page 13 for RX and LM Pricing

Premium Lever – Escutcheon Styles

Levers: LA, LD, LN, L109, L110, L112, L114, L117, KB

Escutcheons: H, M

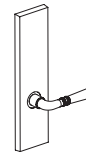

L109, L112, and L117 not available in 625 or 626 finishes.
LD, LN, and L114 not available in 630 finish.
See Lever Finish Availability Chart, page 5.

NOTE: H Escutcheon Trim cannot be rehanded in the field.

H Escutcheon		M Escutcheon	
626	605, 606, 612, 613, 619, 622, 625, 630	626, 630	605, 606, 612, 613, 619, 622, 625

ANSI #	Function	Description	List \$			
Non-Keyed						
–	M9001 (w/out lock case)	Single dummy	363.00	390.00	363.00	391.00
–	M9002 (w/out lock case)	Double dummy	680.00	722.00	680.00	722.00
–	M9003 (w/lock case)	Single dummy	507.00	533.00	507.00	532.00
–	M9004 (w/lock case)	Double dummy	811.00	767.00	810.00	766.00
F01	M9010 ¹	Passage/closet	908.00	957.00	907.00	957.00
F31	M9025 ¹	Exit/communicating passage	–	–	907.00	957.00
F22	M9040	Privacy, bedroom or bath	1038.00	1085.00	1037.00	1085.00
–	M9042	Privacy w/coin turn	1099.00	1148.00	1098.00	1145.00
–	M9046	Privacy w/indicator	–	–	–	–
F19	M9940	Privacy w/dead bolt	1177.00	1218.00	1174.00	1218.00
–	M9942	Privacy w/dead bolt and coin turn	1242.00	1287.00	1241.00	1286.00
Keyed, Single Cylinder						
F04	M9050 ¹	Office/Entry	1141.00	1191.00	1140.00	1191.00
F04	M9053 ²	Office/Entry	1141.00	1191.00	1140.00	1191.00
–	M9056	Office/Entry w/automatic unlocking	1194.00	1240.00	1194.00	1239.00
F05	M9070 ²	Classroom	1141.00	1191.00	1140.00	1191.00
F06	M9076	Holdback	1141.00	1191.00	1140.00	1191.00
F07	M9080 ¹	Storeroom	1141.00	1191.00	1140.00	1191.00
–	M9080EL ¹	Electrically locked (Fail Safe; 24 V)	1612.00	1659.00	1611.00	1657.00
–	M9080EU ¹	Electrically unlocked (Fail Secure; 24 V)	1612.00	1659.00	1611.00	1657.00
F20	M9953	Entry w/dead bolt	1175.00	1222.00	1173.00	1222.00
–	M9954	Security entrance w/dead bolt	1175.00	1222.00	1173.00	1222.00
F13	M9956	Corridor w/dead bolt	1175.00	1222.00	1173.00	1222.00
F12	M9959	Dormitory/Exit w/dead bolt	1175.00	1222.00	1173.00	1222.00
F21	M9973	Dormitory w/dead bolt	1175.00	1222.00	1173.00	1222.00
–	M9980	Storeroom w/dead bolt	1175.00	1222.00	1173.00	1222.00
F15	M9985	Faculty restroom/hotel w/dead bolt	1222.00	1269.00	1222.00	1268.00
–	M9986	Faculty restroom/hotel w/dead bolt/indicator	–	–	–	–
–	M9996	Privacy w/dead bolt/indicator	–	–	–	–
Keyed, Double Cylinder						
F09	M9060	Apartment	1259.00	1308.00	1259.00	1308.00
F32	M9071 ²	Intruder latch bolt	1259.00	1308.00	1259.00	1308.00
–	M9077	Holdback double cylinder	1259.00	1308.00	1259.00	1308.00
F30	M9082 ²	Institution lock	1259.00	1308.00	1259.00	1308.00
–	M9082EL ³	Electrically locked (Fail Safe) w/double locking (24 V)	1569.00	1755.00	1568.00	1754.00
–	M9082EU ³	Electrically unlocked (Fail Secure) w/double locking (24 V)	1569.00	1755.00	1568.00	1754.00
F11	M9957	Dormitory w/dead bolt	1259.00	1308.00	1259.00	1308.00
F35	M9958	Storeroom w/dead bolt	1259.00	1308.00	1259.00	1308.00
F14	M9966	Storeroom w/dead bolt	1259.00	1308.00	1259.00	1308.00
F34	M9967	Intruder w/dead bolt	1259.00	1308.00	1259.00	1308.00
–	M9974	Classroom intruder w/dead bolt	1259.00	1308.00	1259.00	1308.00
Deadbolt Only						
F17	M9960	Deadbolt Only – Cylinder x Turn (No Trim)	552.00	576.00	552.00	576.00
F18	M9961	Deadbolt Only – Cylinder x Blank (No Trim)	453.00	481.00	453.00	481.00
F16	M9962	Deadbolt Only – Cylinder x Cylinder (No Trim)	667.00	693.00	667.00	693.00
F29	M9963	Deadbolt Only – Classroom (No Trim)	667.00	693.00	667.00	693.00

NOTES:

1. Available with Request to Exit (RX), Latch Monitoring (LM) or both
 2. Available with Latch Monitoring (LM) only
 3. Available with Request to Exit (RX) or Latch Monitoring
- See page 13 for RX and LM Pricing

Cylinder Types, Keying Options, and Keyways

Cylinder	Option	Description	List Add/Deduct \$
Conventional Cylinders (non-interchangeable core)			
D		Conventional cylinder	Example: M9070D
	KD	Keyed differently to a random combination; SC keyway with 2 keys (default)	N/C
	KA2	Keyed alike in pairs to a random combination; SC keyway with 2 keys	N/C
	NSK	Keyed alike, sets of three or more; SC keyway with 2 keys	21.00
	NS2	Keyed alike double cylinder locks; SC keyway with 2 keys	38.00
	1-Bit	Operated by 1-bit cut key; SC, SE keyway with 2 key blanks (order 1-bit key separately)	N/C
	0-Bit	Operated by 0-bit key; D100 keyway — ⊗ Keys sold separately	N/C
	0-Bit	Operated by 0-bit cut key; AA, CA, CB, CC, CD, CE, RA, RB, GA, SF, YA, YG keyways with 2 key blanks	21.00
	MKD	Master keyed; SC, SE, or D100 keyway — ⊗ Keys sold separately	26.00
	MK2	Master keyed double cylinder lock; SC, SE, or D100 keyway — ⊗ Keys sold separately	49.00
	CMK	Construction master keyed single cylinder locks — ⊗ Keys sold separately	23.00
	CM2	Construction master keyed double cylinder locks — ⊗ Keys sold separately	41.00
L		Lock less conventional cylinder and cylinder ring	Example: M9070L Deduct 33.00
Interchangeable Core Cylinders			
T		SFIC — Housing with keyed temporary SFIC construction core (Core may be returned for a full refund) — ⊗ Keys sold separately	Example: M9070T 62.00
J		SFIC — Housing with disposable plastic SFIC plug	Example: M9070J N/C
C		SFIC — Housing with combined SFIC core installed at the factory ¹ ; BA (default), BB, BC, BD, BE, BF, BG, BH, BJ, BK, BL, BM, BQ, D100 keyway — ⊗ Keys sold separately	Example: M9070C 68.00
G		Schlage LFIC — Housing with keyed temporary Schlage LFIC construction core (Core may be returned for full refund) — ⊗ Keys sold separately	Example: M9070G 62.00
R		Schlage LFIC — Housing less core	Example: M9070R 12.00
F		Schlage LFIC — Housing with combined Schlage LFIC installed at the factory (SC keyway) — ⊗ Keys sold separately	Example: M9070F 68.00

1. For uncombined cores, UNC, cores must be ordered separately, see Cylinders, Keys & Keying. Locks will be supplied w/plastic construction core, Option J.

⊗ Denotes keys must be ordered separately.

Cut Keys Ordered Separately

Part #	Description	List \$
45101	SFIC Cut key — Change key, master key, construction master key, or control key; BA, BB, BC, BD, BE, BF BG, BH, BJ, BK, BL, BM, BQ, SC, SE keyways	10.00
45401	SFIC Cut key — Change key, master key, or control key; SKC keyways — D100 etc.	16.00
45103	SFIC Cut key — Emergency key for M9985C or M9986C; BA keyways	32.00
45403	SFIC Cut key — Emergency key for M9985C or M9986C; SKC keyways — D100 etc.	32.00
45404	CONV/LFIC Cut key — 1-bit key for operating 1-bit cylinders — SC, SE keyways	8.00
45405	LFIC Cut key — 1-bit control key (to install/remove "1-bit" LFIC cores) — SC keyway	8.00
44101SC	CONV/LFIC Key blank — SC keyway	6.00
44104SC	LFIC Key blank — Control key (to install/remove LFIC Cores) — SC keyway	7.00

NOTES:

- M9985D and M9986D are available MKD, CMK, or 1-bit only.
- Emergency keys for M9985D and M9986D are 45101 or 45401.
- Distribution of DORMA SKC keys (listed as D100) is restricted. See Cylinders, Keys & Keying section for DORMA SKC policies.
- 1-bit cylinder comes with (2) uncut keys and will require a 1-bit cut key, sold separately, to operate cylinder. SC and SE keyways only.
- See Keys and Key Blanks section for complete list.

Configuration Options

Description: Grade 1 Mortise Locks Less Components (Use LRA trim design and specified finish for base list price.)	List Deduct \$
Less outside lever and rose Example: M9953D LLL × LRA 626 RH 134 5006 114; includes mortise less trim kit 76007272	Deduct 40.00
Less inside lever and rose Example: M9953D LRA × LLL 626 RH 134 5006 114; includes mortise less trim kit 76007272	Deduct 40.00
Less strike Example: M9953D LRA 626 RH 134 LLL	Deduct 40.00

NOTES:

- For other configurations, consult factory.
- Mortise locks not available less trim both sides.

Strikes

Part #	Description	List Add \$
5006 – ANSI Strike for Mortise Lock (*see below for usage)		
5006-114	1-1/4" × 4-7/8", 1-1/4" lip length, square corner, curved lip	N/C
5006-078	1-1/4" × 4-7/8", 7/8" lip length, square corner, straight lip	30.00
5006-112	1-1/4" × 4-7/8", 1-1/2" lip length, square corner, curved lip	30.00
5006-134	1-1/4" × 4-7/8", 1-3/4" lip length, square corner, curved lip	30.00
5006-200	1-1/4" × 4-7/8", 2" lip length, square corner, curved lip	30.00
5006-214	1-1/4" × 4-7/8", 2-1/4" lip length, square corner, curved lip	38.00

* Default length strike shown in bold for all M9000 functions. Lip length is distance from center of mounting holes to edge of strike.

Part #	Description	List Add \$
5007 – ANSI Strike for Mortise Lock (*see below for usage)		
5007-114	1-1/4" × 4-7/8", 1-1/4" lip length, square corner (specify hand)	17.00

* Optional handed strike available for M9000 functions without dead bolts. Only available in 1-1/4" lip length. Specify hand.

Antimicrobial Coating

Description of Components Coated	List Add \$
Available on 626 and 630 finishes only. Not available with 630 H escutcheon. Specify AM. Example: 626AM or 630AM	
Rose Trim A, B, or D	Inside: lever, rose, and thumbturn Outside: Lever and rose
Escutcheon Trim H* or M	Inside: lever, escutcheon, and thumbturn Outside: Lever and escutcheon
	64.00
	64.00

NOTES:





- Extended leadtime, consult factory.
- *AM option on 630 H escutcheon, consult factory.

Special Application Options

Lead Lined Lock Case

Part #	Description	List Add \$
660001	Lead lining plate for M9000 Series Mortise Locks	303.00



Occupancy Indicators

	Part #	Description	List Add \$
	79019	Occupancy indicator for rose trim used w/cylinder, reading OCCUPIED/VACANT or SECURED/UNSECURED. Both readings supplied. Specify finish.	116.00
		Optional RG – Solid red/green indicator inserts. Specify 79019 630 RG.	9.00
		M9072 indicator inserts (LOCKED/UNLOCKED with red/green background). Specify 79019 630 M9072.	9.00
	79020	Occupancy indicator for rose trim used without cylinder, emergency access, reading OCCUPIED/VACANT. Specify finish.	116.00
	79021	Occupancy indicator for rose trim used without cylinder, reading SECURED/UNSECURED. No emergency access. Used on inside of door with 79019 on outside.	116.00
	79022	Occupancy indicator w/cointurn for rose trim used without cylinder, reading OCCUPIED/VACANT. Specify finish.	116.00

NOTES:

- 1-3/4"-2-1/8" thick doors.
- Specify finish. Example: 79019 626.
- Indicators will work on the following functions but may have unexpected operation on lock sets that remain locked when the dead bolt is retracted:
M9046, 9056, 9072, 9940, 9942, 9953, 9956, 9957, 9959, 9960, 9961, 9962, 9966, 9967, 9968, 9973, 9974, 9980, 9985, 9986, 9996

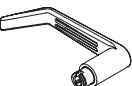
Tactile Markings

	Part #	Description	List Add \$
	660002	Knurled or grooved lever (LR, LT, and LG designs only)	78.00
	660003	Abrasive coated lever or knob (all designs)	62.00

NOTE: Tactile marking is applied to outside knob or lever only, unless otherwise specified. Prices shown per single lever or knob.

Request to Exit/Latch Monitoring

Suffix	Description	List Add \$
RX	Request to exit, M9010/ 9025/ 9050/ 9080 / 9080EU/ 9080EL/ 9082EU/ 9082EL. Specify RX. Example: M9010RX.	227.00
LM	Latch Monitoring, M9010/ 9025/ 9050/ 9053/ 9070/ 9071/ 9080/ 9080EL/ 9080EU/ 9082/ 9082EL/ 9082EU. Specify LM. Example: M9080EULM.	227.00
RXLM	Request to Exit & Latch Monitoring, M9010/ 9025/ 9050/ 9080/ 9080EL/ 9080EU. Specify RXLM. Example: M9010RXLM.	450.00

Security Screws

Specify	Description	List Add \$
TX A/B/D	Security screws for all exposed fasteners (sectional trim and dead bolts only).	26.00
TX H	Security screws for all exposed fasteners (H escutcheon only).	30.00
TX M	Security screws for all exposed fasteners (M escutcheon only).	30.00

NOTE: Only available for use with 619, 625, 626, and 630 finish locksets.

Special Strikes (Non-Standard Lip Lengths)

Part #	Description	626, 630	605, 606, 612, 613, 622	List Add \$
5006-XXX	1-1/4" × 4-7/8", special lip length (greater than 2-1/4"). Specify lip length.	122.00	151.00	

Example: 5006-312 630 for a 2-1/2" lip length strike in 630 finish.

NOTE: Non-standard items are considered to be special request items and have an extended lead time. Consult factory for more information.

Non-Standard Door Thickness

Charges include special strike and cylinder requirements. Extended lead time may be required, check with factory. For functions requiring an indicator, add \$75.

Description	Type	List Add \$
Functions without a Cylinder		
Doors >1-3/4" to 2-1/2"	EE, EI, EO, ED	N/C
Doors >2-1/2" to 4"	EE, EI, EO, ED	111.00
Single Cylinder Functions		
Doors >1-3/4" to 2-1/2"	EE, EI, EO, ED	N/C
Doors >2-1/2" to 4"	EI	111.00
Doors >2-1/2" to 4"	EE, EO, ED	301.00
Double Cylinder Functions		
Doors >1-3/4" to 2-1/2"	EE, EI, EO, ED	N/C
Doors >2-1/2" to 4"	EI	111.00
Doors >2-1/2" to 4"	EE, EO, ED	524.00

NOTES:

- EE – Door thickness extended equally (lock is centered)
- EI – Door thickness extended inside only
- EO – Door thickness extended outside only
- ED – Door thickness extended differently inside and outside

Required Information – For Non-Standard Door Thickness

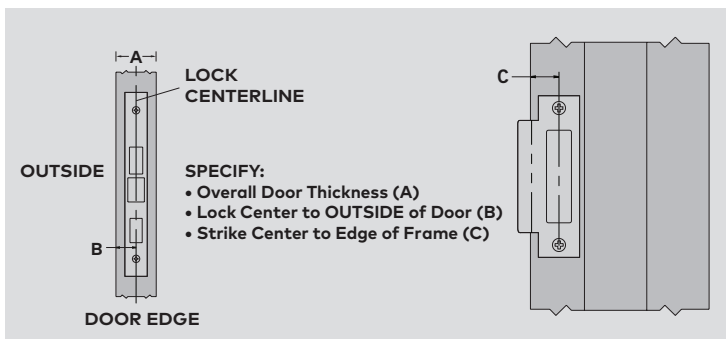

Special Requests:

Customized products may be available to solve unusual functions or applications.

Contact Technical Services for assistance.

Cylinder Types, Keying Options, and Keyways

Cylinder	Option	Description	List Add/Deduct \$
Conventional Cylinders (non-interchangeable core)			
D		Conventional cylinder	Example: D960D
	KD	Keyed differently to a random combination; SC keyway with 2 keys (default)	N/C
	KA2	Keyed alike in pairs to a random combination; SC keyway with 2 keys	N/C
	NSK	Keyed alike, sets of three or more; SC keyway with 2 keys	21.00
	NS2	Keyed alike double cylinder locks; SC keyway with 2 keys	38.00
	1-Bit	Operated by 1-bit cut key; SC, SE keyway with 2 key blanks (order 1-bit key separately)	N/C
	1-Bit	Operated by 1-bit cut key; D100 keyway — ⊗ Keys sold separately	N/C
	0-Bit	Operated by 0-bit cut key; AA, CA, CB, CC, CD, CE, RA, RB, GA, SF, YA, YG keyways with 2 key blanks	21.00
	MKD	Master keyed; SC, SE, or D100 keyway — ⊗ Keys sold separately	26.00
	MK2	Master keyed double cylinder lock; SC, SE, or D100 keyway — ⊗ Keys sold separately	49.00
	CMK	Construction master keyed single cylinder locks — ⊗ Keys sold separately	23.00
	CM2	Construction master keyed double cylinder locks — ⊗ Keys sold separately	41.00
L		Lock less conventional cylinder and collar	Example: D960L Deduct 30.00
Interchangeable Core Cylinders			
T		SFIC — Housing with keyed temporary SFIC construction core (Core may be returned for a full refund) — ⊗ Keys sold separately	Example: D960T 62.00
J		SFIC — Housing with disposable plastic SFIC plug	Example: D960J N/C
C		SFIC — Housing with combined SFIC core installed at the factory ¹ ; BA (default), BB, BC, BD, BE, BF, BG, BH, BJ, BK, BL, BM, BQ, D100 keyway — ⊗ Keys sold separately	Example: D960C 68.00
G		Schlage LFIC — Housing with keyed temporary Schlage LFIC construction core (Core may be returned for full refund) — ⊗ Keys sold separately	Example: D960G 62.00
R		Schlage LFIC — Housing less core	Example: D960R 12.00
F		Schlage LFIC — Housing with combined Schlage LFIC installed at the factory (SC keyway) — ⊗ Keys sold separately	Example: D960F 68.00

1. For uncombined cores, UNC, cores must be ordered separately, see Cylinders, Keys & Keying. Locks will be supplied w/plastic construction core, Option J.

⊗ Denotes keys must be ordered separately.

Cut Keys Ordered Separately

Part #	Description	List \$
45101	SFIC Cut key— Change key, master key, construction master key, or control key; BA, BB, BC, BD, BE, BF BG, BH, BJ, BK, BL, BM, BQ, SC, SE keyways	9.00
45401	SFIC Cut key— Change key, master key, or control key; SKC keyways — D100 etc.	13.00
45404	CONV/LFIC Cut key—1-bit key for operating 1-bit cylinders — SC, SE keyways	7.00
45405	LFIC Cut key — 1-bit control key (to install/remove "1-bit" LFIC cores) — SC keyway	7.00
44101SC	CONV/LFIC Key blank — SC keyway	5.00
44104SC	LFIC Key blank — Control key (to install/ remove LFIC Cores) — SC keyway	6.00

NOTES:

- Distribution of DORMA SKC keys (listed as D100) is restricted. See Cylinders, Keys & Keying section for DORMA SKC policies.
- 1 bit cylinder comes with (2) uncut keys and will require a 1 bit cut key, sold separately, to operate cylinder. SC and SE keyways only.
- See Keys and Key Blanks section for complete list.

D900 Accessories

Antimicrobial Coating

Description of Components Coated		List \$
Available on 626 and 630 finished. Specify AM. Example 626AM or 630AM.		
Inside	Thumb Turn and Rose if applicable to function	46.00

NOTE: AM Coating not available on Cylinders (AM Coating not available on outside). Extended lead time required, consult factory.

Security Screws

Specify	Description	List \$
TX	Security Screws for Strike, Armor Plate, Thumb Turn	24.00

NOTE: Only available for use with 619, 625, 626, and 630 finish locksets.

Trim Options

Lever Options

Standard

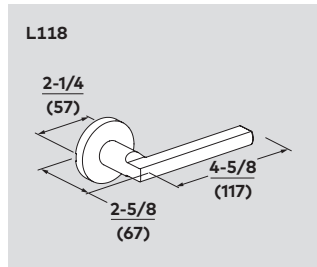
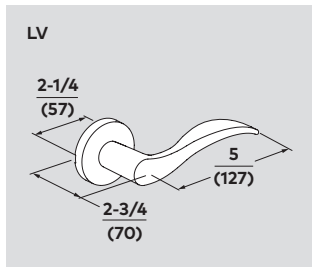
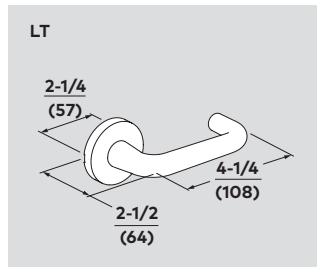
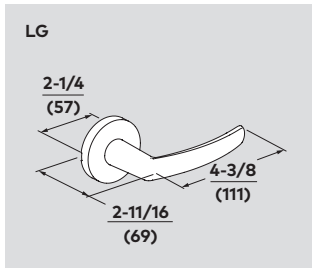
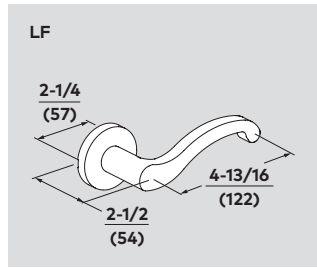
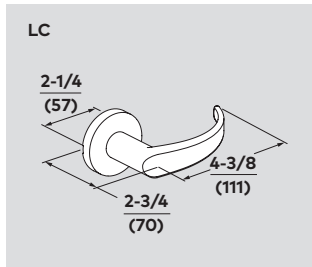
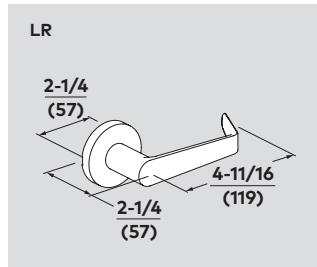

Premium

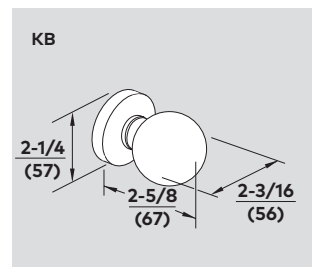
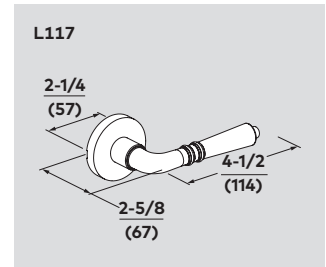
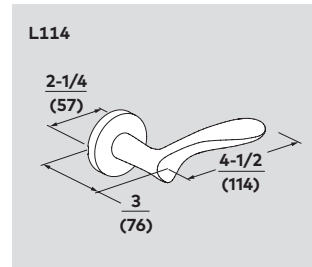
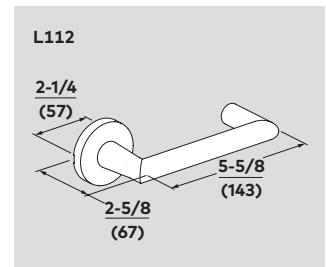
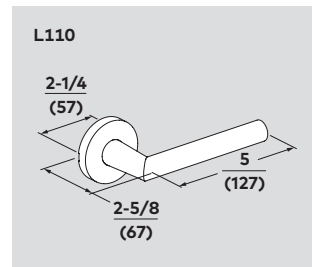
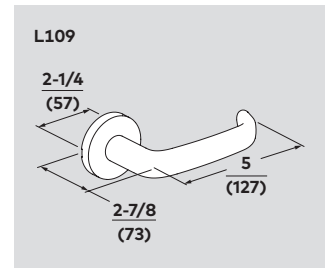
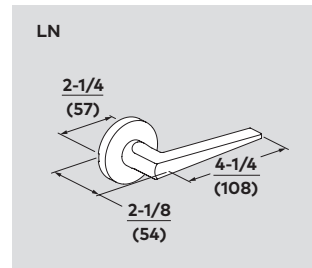
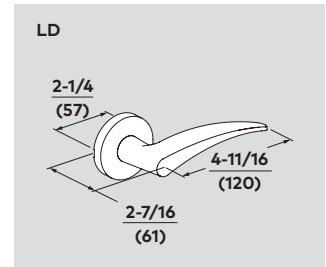
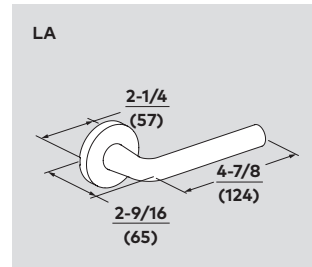

Wrought Roses

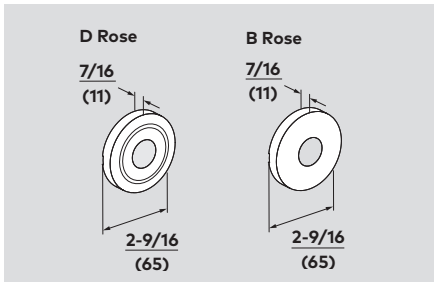

Finish Availability Chart

	605	606	612	613	619	622	625	626	630
Standard Levers									
LR	•	•	•	•	•	•	•	•	•
LC	•	•	•	•	•	•	•	•	•
LG	•	•	•	•	•	•	•	•	•
LF	•	•	•	•	•	•	•	•	
LT	•	•	•	•	•	•	•	•	•
LV	•	•	•	•	•	•	•	•	
L118		•	•	•	•	•			•
Premium Levers									
LA	•	•	•	•	•	•	•	•	•
LD	•	•	•	•	•	•	•	•	
LN	•	•	•	•	•	•	•	•	
L109		•	•	•	•	•			•
L110	•	•	•	•	•	•	•	•	•
L112		•	•	•	•	•			•
L114	•	•	•	•	•	•	•	•	
L117	•	•	•	•	•	•			•
Knob									
KB		•	•	•	•	•			•

T900 Series

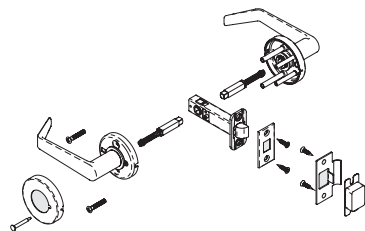

Standard Levers

L118 not available in 605, 625, or 626 finish.
 LF and LV not available in 630 finish.
 See Lever Finish Availability Chart, page 21.
 D rose not available in 625 or 626.

626	605, 606, 612, 619, 622, 625, 613, 630
-----	---

ANSI #	Function	Description	List \$	
Keyless				
—	T901	Single dummy, surface mounted	189.00	198.00
—	T902	Double dummy	260.00	278.00
F75	T910	Passage/closet	312.00	331.00
F111	T925	Exit/communicating	312.00	331.00
F76	T940	Privacy, bedroom or bath	332.00	351.00

NOTE: Split finishes will be priced at the higher finish list price.

Premium Levers

L109, L112, and L117 not available in 625 or 626 finishes.
 LD, LN, and L114 not available in 630 finish.
 See Lever Finish Availability Chart, page 21.
 D rose not available in 625 or 626.

626	605, 606, 612, 619, 622, 625, 613, 630
-----	---

ANSI #	Function	Description	List \$	
Keyless				
—	T901	Single dummy, surface mounted	207.00	215.00
—	T902	Double dummy	288.00	307.00
F75	T910	Passage/closet	344.00	363.00
F111	T925	Exit/communicating	344.00	363.00
F76	T940	Privacy, bedroom or bath	365.00	384.00

NOTE: Split finishes will be priced at the higher finish list price.

Configuration Options

Non-Fire Latch Bolts

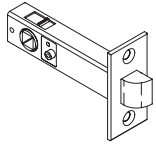

Part #	Backset	Description	List Add \$
90202	2-3/4"	1-1/8" faceplate, passage, square corner, non-fire, T910 only	N/C
90200	2-3/4"	1" faceplate, passage, square corner, non-fire, T910 only	N/C
90100	2-3/8"	1" faceplate, passage, square corner, non-fire, T910 only	N/C
90101	2-3/8"	1" faceplate, passage, 1/4" radius corner, non-fire, T910 only	N/C
90232	2-3/4"	1-1/8" faceplate, privacy, square corner, non-fire, T940 only	N/C
90230	2-3/4"	1" faceplate, privacy, square corner, non-fire, T940 only	N/C
90130	2-3/8"	1" faceplate, privacy, square corner, non-fire, T940 only	N/C
90131	2-3/8"	1" faceplate, privacy, 1/4" radius corner, non-fire, T940 only	N/C

Fire-Rated Latch Bolts

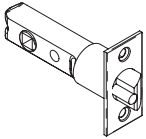

Part #	Backset	Description	List Add \$
91202	2-3/4"	1-1/8" faceplate, passage, square corner, 90 min fire-rated, T910	21.00
91200	2-3/4"	1" faceplate, passage, square corner, 90 min fire-rated, T910	21.00
91100	2-3/8"	1" faceplate, passage, square corner, 90 min fire-rated, T910	21.00
91101	2-3/8"	1" faceplate, passage, 1/4" radius corner, 90 min fire-rated, T910	21.00

NOTE: List add for fire-rated latch with T910 only. Fire-rated latch standard for T925 – no list add. Not available on T940.

Strikes

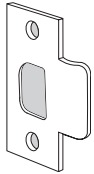

Part #	Description	List Add \$
5101 – T Strike with Dust Box		
5101-118	1-1/8" x 2-3/4", 1-1/8" lip length, square corner	N/C
5101-112	1-1/8" x 2-3/4", 1-1/2" lip length, square corner	28.00
5102-118	1-1/8" x 2-3/4", 1-1/8" lip length, radius corner	N/C

NOTE: Default strike shown in bold.

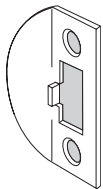

Part #	Description	List Add \$
5201, 5202 – Full Lip Strike		
5201-118	1-5/8" x 2-1/4", 1-1/8" lip length, square corner	N/C
5202-118	1-5/8" x 2-1/4", 1-1/8" lip length, 1/4" radius corner	N/C

Strikes Continued

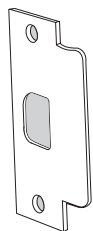

Part #	Description	List Add \$
5001 – ANSI Strike, includes Dust Box		
5001-1316	1-1/4" x 4-7/8", 1-3/16 lip length, square corner	N/C
5001-112	1-1/4" x 4-7/8", 1-1/2 lip length, square corner	28.00
5001-078	1-1/4" x 4-7/8", 7/8 lip length	28.00

Special Application Options

Antimicrobial Coating

Available on 626 and 630 finish. Specify AM. Example: 626AM

Description of Components Coated	List Add \$
Lever trim Inside: Lever and rose Outside: lever and rose	42.00

NOTE: Extended leadtime, consult factory.

Tactile Markings

Part #	Description	List Add \$
660002	Knurled or grooved lever (LR, LT, and LG designs only)	78.00
660003	Abrasive coated lever or knob (all designs)	62.00

NOTE: Tactile marking is applied to outside knob or lever only, unless otherwise specified. Prices shown per single lever or knob.

Special Strikes (Non-Standard Lip Lengths)

Part #	Description	List Add \$
5001 – ANSI Strike with Tubular Lock Cutout, includes Dust Box		
5001-XXX	1-1/4" x 4-7/8", special lip length (longer than 1-1/2"). Specify length and finish.	121.00

Example: 5001-200 630 for a 2" lip length in 630 finish.

NOTE: Non-standard items are considered to be special request items and have an extended lead time. Consult factory for more information.

Lever Designs

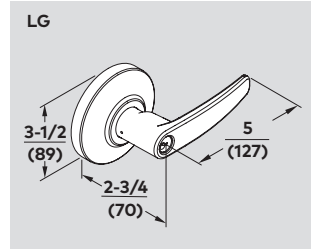
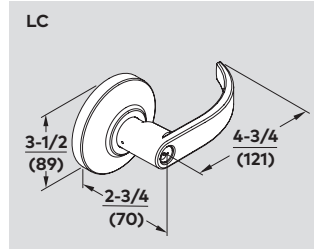
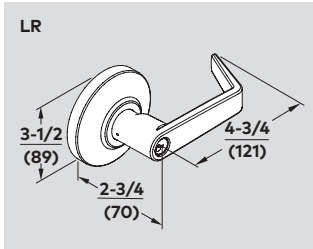

Rose Designs

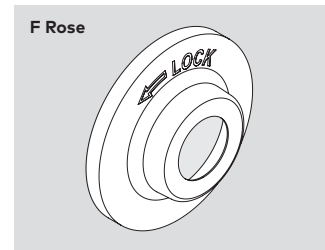
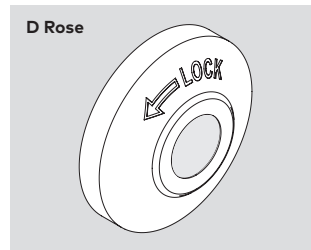
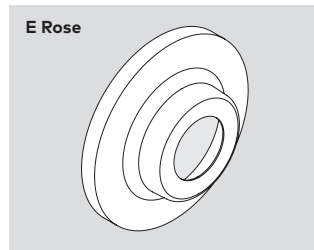
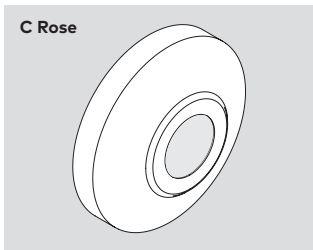

Lever Locks

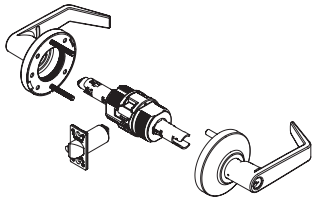

Lever Locks







626

605, 606,
612, 619,
625, 613,
622

ANSI #	Function	Description	List \$	
Keyless				
F75	C110	Passage/closet	524.00	565.00
F89	C112	Exit	524.00	565.00
F111	C125	Exit/communicating passage	524.00	565.00
F77A	C130	Patio	620.00	665.00
F76A	C140	Privacy, bedroom or bath	601.00	644.00
—	C144	Hospital privacy	601.00	644.00
—	C101	Single dummy	227.00	247.00
—	C102	Double dummy	432.00	478.00
Keyed, Single Cylinder				
F112	C148	Exit/communicating storeroom	697.00	753.00
F82	C150	Entry/office	697.00	753.00
F109	C153	Entry	697.00	753.00
F84	C170	Classroom	697.00	753.00
F92	C155	Service station	697.00	753.00
F113	C165	Exit/communicating classroom	697.00	753.00
F86	C180	Storeroom	697.00	753.00
F90	C173	Corridor/dormitory	718.00	763.00
F93	C185 ¹	Faculty restroom/hotel	814.00	857.00
—	C180EL	Electrically locked (fail safe)	950.00	995.00
—	C180EU	Electrically unlocked (fail secure)	950.00	995.00
Keyed, Double Cylinder				
F80	C172	Communicating	843.00	889.00
F87	C182	Asylum	843.00	889.00
F88	C160	Apartment	843.00	889.00
F91	C166	Store door	843.00	889.00
F110	C177	Classroom intruder (includes LOCK rose on inside)	843.00	889.00

NOTE: 1. Faculty restroom/hotel function available only in SFIC.

Cylinder Types, Keying Options, and Keyways

Cylinder	Option	Description	List Add/Deduct \$
Conventional Cylinders (non-interchangeable core)			
D		Conventional cylinder	Example: C153D
	KD	Keyed differently to a random combination; SC keyway with 2 keys (default)	N/C
	KA2	Keyed alike in pairs to a random combination; SC keyway with 2 keys	N/C
	NSK	Keyed alike, sets of three or more; SC keyway with 2 keys	17.00
	NS2	Keyed alike double cylinder locks; SC keyway with 2 keys	32.00
	1-Bit	Operated by 1-bit cut key; SC, SE keyway with 2 key blanks (order 1-bit key separately)	N/C
	0-Bit	Operated by 0-bit key; D100 keyway —  Keys sold separately	N/C
	0-Bit	Operated by 0-bit cut key; AA, CA, CB, CC, CD, CE, RA, RB, GA, SF, YA, YG keyways with 2 key blanks	17.00
	MKD	Master keyed; SC, SE, or D100 keyway —  Keys sold separately	22.00
	MK2	Master keyed double cylinder lock; SC, SE, or D100 keyway —  Keys sold separately	41.00
	CMK	Construction master keyed single cylinder locks —  Keys sold separately	19.00
	CM2	Construction master keyed double cylinder locks —  Keys sold separately	34.00
L		Lock less conventional cylinder	Example: C153L Deduct 33.00
Interchangeable Core Cylinders			
T		SFIC — Housing with keyed temporary SFIC construction core (Core may be returned for a full refund) —  Keys sold separately	Example: C170T 52.00
J		SFIC — Housing with disposable plastic SFIC plug	Example: C170J 197.00

1. For uncombined cores, UNC, cores must be ordered separately, see Cylinders, Keys & Keying.

 Denotes keys must be ordered separately.

Cut Keys Ordered Separately

Part #	Description	List \$
45101	SFIC Cut key — Change key, master key, construction master key, or control key; BA, BB, BC, BD, BE, BF, BG, BH, BJ, BK, BL, BM, BQ, SC, SE keyways	9.00
45401	SFIC Cut key — Change key, master key, or control key; SKC keyways — D100 etc.	14.00
45404	CONV Cut key — 1-bit key for operating 1 bit cylinders — SC, SE keyways	7.00
44101SC	CONV Key blank — SC keyway	5.00

NOTES:

- Distribution of DORMA SKC keys (listed as D100) is restricted. See Cylinders, Keys & Keying section for DORMA SKC policies.
- 1-bit cylinder comes with (2) uncut keys and will require a 1-bit cut key, sold separately, to operate cylinder.
- See Keys and Key Blanks section for complete list.

Configuration Options

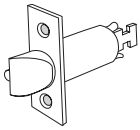
Latch Bolts**9/16" Throw, 2-3/4" Backset**

Part #	Description	List Add \$
10252	1-1/8" x 2-7/4" front, 1" diameter, square corner	N/C

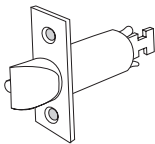
**9/16" Throw, 3-3/4" Backset**

Part #	Description	List Add \$
10352	1-1/8" x 2-1/4" front, 1" diameter, square corner	19.00

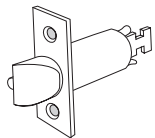
**9/16" Throw, 5" Backset**

Part #	Description	List Add \$
10552	1-1/8" x 2-1/4" front, 1" diameter, square corner	26.00

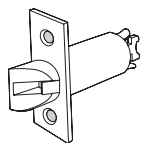
**3/4" Throw, 2-3/4" Backset**

Part #	Description	List Add \$
100 Locks		
18262	1-1/8" x 2-1/4" front, 1" diameter, square corner. Available in 605/ 606, 612, 613, 622, 626.	133.00

Strikes

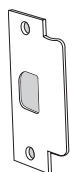

Part #	Description	List Add \$
5001	ANSI Strike Includes Dust Box	
5001-1316	1-1/4" x 4-7/8", 1-3/16" lip length, square corner	N/C
5003-078	ANSI 7/8" Flat lip strike	27.00

NOTE: Default strike shown in bold.

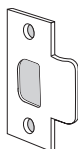

Part #	Description	List Add \$
5101	T Strike with Dust Box	
5101-118	1-1/8" x 2-3/4", 1-1/8" lip length, square corner	N/C
5105-112	1-1/8" x 2-3/4", 1-1/2" lip length, square corner	27.00

Antimicrobial Coating

Available on 626 finish. Specify AM. Example: 626AM

Description of Components Coated	List Add \$
Lever trim Inside: Lever and rose Outside: lever and rose	40.00

NOTE: Extended leadtime, consult factory.

Special Application Options

Knurled Levers (Tactile Markings)

Part #	Description	List Add \$
660003	Abrasive adhesive	57.00

NOTE: Tactile marking is applied to outside knob or lever only, unless otherwise specified. Prices shown are for one lever only.

Spacers for 1-3/8" Doors, C100 Series

Part #	Description	605, 606, 612, 613, 622, 625, 626 List Add \$
660005	Spacers for thin door, 1 pair (2 spacers) 1-3/8" door – Specify finish.	56.00

NOTE: Spacers are included if 1-3/8" door thickness is specified.

Security Screws

Part #	Description	List Add \$
TX	Security screws for latch and strike.	22.00

NOTE: Specify finish 625/626, 605/606, 611/612, 613

Special Strikes (Non-Standard Lip Lengths)



Part #	Description	List Add \$
5001-XXX	1-1/4" x 4-7/8", special lip length (longer than 1-1/2"). Specify length.	113.00

NOTE: Non-standard items are considered to be special request items and have an extended lead time. Consult factory for more information.
Lip length is distance from center of mounting holes to edge of strike.

Request to Exit

Specify	Description	List Add \$
RX	Request to exit, available on C100 lever models: C110, C150, C153, C170, C180, C180EL, C180EU	196.00

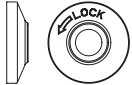
Indicator Rose

	Specify	Description	List Add \$
	D Rose*	Stamped LOCK on inside rose (specify finish)	N/C
	F Rose*	Stepped, stamped LOCK on inside rose (specify finish)	N/C

* Optional on inside of C860 Apartment function; Standard on inside of C877 Intruder function.

DB100 Series Ordering Guide

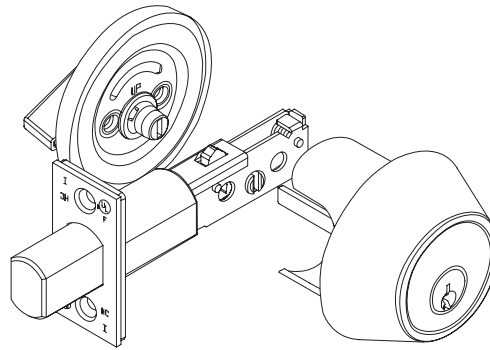

Function		Cylinder Type ¹		Latch Bolt ³	
Turn x Turn —	82				
Turn only —	81				
Turn x Blank Plate —	80				
Turn x Occupancy Indicator —	71				
Cylinder x Classroom —	63	D	— Conventional Cylinder		
Cylinder x Cylinder —	62	J	— SFIC (Less Core)		
Cylinder x Blank Plate —	61				
Cylinder x Turn —	60	T	— Temporary SFIC		

Product Type	Product Family	Finish	Antimicrobial Coating ³	Strike Options ²	Keying Options Field
D	1	60	D	626	AM
Dead Bolt —	Heavy-Duty Grade 1 Tubular Dead Bolt	Bright Brass — 605			
		Satin Brass — 606			
		Satin Bronze ⁴ — 612			
		Dark Oxidized Satin Bronze — 613			
		Satin Nickel ⁴ — 619			
		Matte Black ⁴ — 622			
		Bright Chrome ⁴ — 625			
		Satin Chrome — 626			

- 1. The Less Conventional Cylinder option is not available for the DB100 Series.
- 2. Example shows default values. Refer to Configuration Options section for full details.
- 3. Available on 626 finish only. Consult factory for other finishes.
- 4. Special Order Finish — May require additional lead time.

DB100 Series

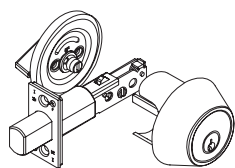

ANSI #	Function	Description	List \$	
			626	605, 606, 612, 619, 625, 613, 622
Keyless				
E21111	DB180	Thumb turn x blank plate	212.00	235.00
E2191	DB181	Thumb turn only	203.00	226.00
—	DB182	Thumb turn x thumb turn (windstorm)	252.00	278.00
—	DB171	Thumb turn x occupancy indicator w/coin turn	207.00	231.00
Keyed, Single Cylinder				
E2151	DB160	Cylinder x turn	252.00	278.00
E2161	DB161	Cylinder x blank	252.00	278.00
E2171	DB163	Cylinder x classroom turn	265.00	289.00
Keyed, Double Cylinder**				
E2141	DB162	Cylinder x cylinder	324.00	348.00

**** CAUTION:** Double cylinder locks used on residences and any door in a structure which is used for egress are a life safety hazard in times of emergency and their use is not recommended. Installation should be in accordance with existing codes only.

NOTE: List prices for keyed locks include standard DORMA (D) cylinder, keyed different (KD) with two (2) nickel silver keys.

Cylinder Types, Keying Options, and Keyways

Cylinder	Option	Description	List Add/Deduct \$
Conventional Cylinders (non-interchangeable core)			
D		Conventional cylinder	Example: DB160D
	KD	Keyed differently to a random combination; SC keyway with 2 keys (default)	N/C
	KA2	Keyed alike in pairs to a random combination; SC keyway with 2 keys	N/C
	NSK	Keyed alike, sets of three or more; SC keyway with 2 keys	18.00
	NS2	Keyed Alike double cylinder locks; SC keyway with 2 keys	34.00
	1-Bit	Operated by 1-bit cut key; SC, SE keyway with 2 key blanks (order 1-bit key separately)	N/C
	0-Bit	Operated by 0-bit key; D100 keyway — Keys sold separately	N/C
	0-Bit	Operated by 0-bit cut key; AA, CA, CB, CC, CD, CE, RA, RB, GA, SF, YA, YG keyways with 2 key blanks	18.00
	MKD	Master keyed; SC, SE, or D100 keyway — Keys sold separately	26.00
	MK2	Master keyed double cylinder lock; SC, SE, or D100 keyway — Keys sold separately	45.00
	CMK	Construction master keyed single cylinder locks — Keys sold separately	25.00
	CM2	Construction master keyed double cylinder locks — Keys sold separately	49.00
Interchangeable Core Cylinders			
T		Lock with keyed temporary SFIC construction core (cores may be returned for a full refund) — Keys sold separately	Example: DB160T 62.00
J		Lock with disposable plastic SFIC plug	Example: DB160J N/C

* The Less Cylinder option is not available for the D800 Series.

1. For uncombined cores, UNC, cores must be ordered separately, see Cylinders, Keys & Keying. Locks will be supplied w/plastic construction core, Option J.

⊗ Denotes keys must be ordered separately.

Cut Keys Ordered Separately

Part #	Description	List \$
45101	SFIC Cut key — Change key, master key, construction master key, or control key; BA, BB, BC, BD, BE, BF BG, BH, BJ, BK, BL, BM, BQ, SC, SE keyways	10.00
45401	SFIC Cut key — Change key, master key, or control key; SKC keyways — D100 etc.	6.00
45404	CONV Cut key — 1-bit key for operating 1-bit cylinders — SC, SE keyways	8.00
44101SC	CONV Key blank — SC keyway	5.00

NOTES:

- Distribution of DORMA SKC keys (listed as D100) is restricted. See Cylinders, Keys & Keying section for DORMA SKC policies.
- 1-bit cylinder comes with (2) uncut keys and will require a 1-bit cut key, sold separately, to operate
- See Keys and Key Blanks section for complete list.

Configuration Options

Dead Bolts

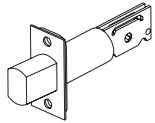

1" Throw

Part #	Description	List Add \$
28752	1-1/8" x 2-1/4" faceplate, 2-3/4" backset, square corner	N/C
28652	1-1/8" x 2-1/4" faceplate, 2-3/8" backset, square corner	N/C

NOTE: Default configuration shown above in bold.

Strikes

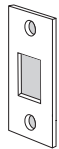

Part #	Description	List Add \$
5103 – Standard Strike for Dead Bolt		
5103	1-1/8" x 2-3/4", no lip, square corner	N/C

NOTE: Default strike shown above in bold.

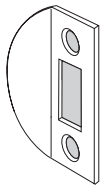

Part #	Description	List Add \$
5203 – Full Lip Strike with Dead Bolt Cutout		
5203-118	1-5/8" x 2-1/4", 1-1/8" lip length, square corner	N/C
5204-118	1-5/8" x 2-1/4", 1-1/8" lip length, 1/4" radius corner	N/C

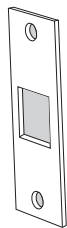

Part #	Description	List Add \$
5004 – ANSI Strike with Dead Bolt Cutout (specify finish)		
5004	1-1/4" x 4-7/8" no lip, square corner	10.00

Antimicrobial Coating

Description of Components Coated	List Add \$
Available on 626 finish. Specify AM. Example: 626AM	
Inside: thumbturn, rose, or same as outside for double cylinder	59.00
Outside: trim ring and cylinder faceplate	

NOTE: Extended leadtime, consult factory.

C200 Series

Ordering Guide

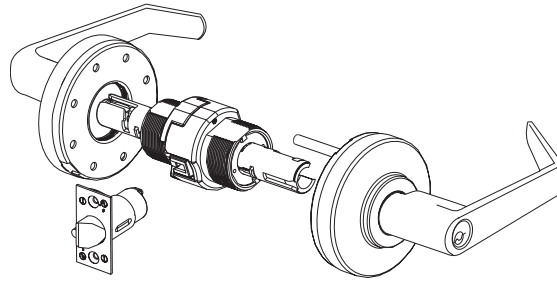

Function		Cylinder Type		Finish		Door Thickness		Lip Length		Strike Options ¹		Keying Options Field	
Storeroom	80			626	Satin Chrome								
Classroom	70			625	Bright Chrome								
Entry	53			613	Dark Oxidized Satin Bronze								
Entry/Office	50			612	Satin Bronze								
Privacy, Bedroom or Bath	40			606	Satin Brass								
Patio	30	D	Conventional Cylinder	605	Bright Brass								
Exit/Communicating Passage	25	L	Less Cylinder										
Exit	12	J	SFIC (Less Core)										
Passage/Closet	10	T	Construction Core SFIC										
Dummy Trim One Side	01												
Lever Trim	C	2	53	D	LR	E	626		17252	134	2001	1316	XXXX
Product Type	Grade 2 Cylindrical Lockset		Product Family	Lever Design	Rose Design	Security Screws	Latch Bolt ¹						
				LR	E	3-7/16" Dia. Rose	TX			134	1-3/8" - 1-3/4"		
				LC									
				LG									

1. Example shows default values. Refer to Lock Options section or price book for full details.

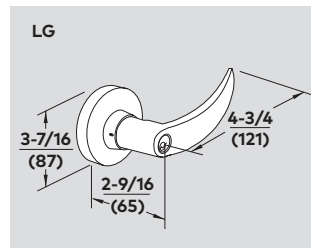
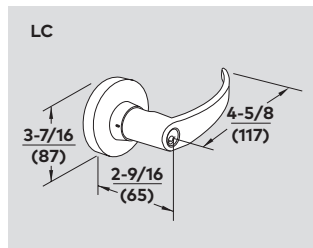
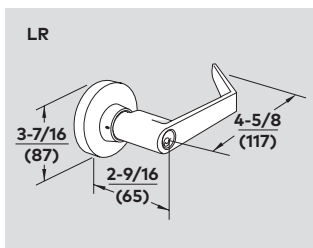

Lever Locks

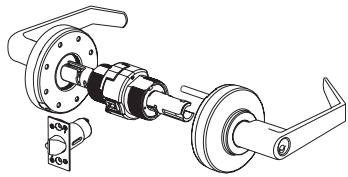

Lever Locks

626

605, 606, 612,
625, 613

ANSI #	Function	Description	List \$	
Keyless				
F75	C210	Passage/closet	236.00	273.00
F89	C212	Exit	262.00	297.00
F111	C225	Exit/communicating passage	262.00	297.00
F77A	C230	Patio	270.00	304.00
F76A	C240	Privacy, bedroom or bath	270.00	304.00
—	C201	Single dummy	137.00	156.00
Keyed, Single Cylinder				
F82	C250	Entry/office	345.00	358.00
F109	C253	Entry	345.00	358.00
F84	C270	Classroom	345.00	358.00
F86	C280	Storeroom	345.00	358.00

NOTES:

- Split trim not available.

Cylinder Types, Keying Options, and Keyways

Cylinder	Option	Description	List Add/Deduct \$
Conventional Cylinders (non-interchangeable core)			
D		Conventional cylinder	Example: C253D
	KD	Keyed differently to a random combination; SC keyway with 2 keys (default)	N/C
	KA2	Keyed alike in pairs to a random combination; SC keyway with 2 keys	N/C
	NSK	Keyed alike, sets of three or more; SC keyway with 2 keys	19.00
	NS2	Keyed alike double cylinder locks; SC keyway with 2 keys	35.00
	1-Bit	Operated by 1-bit cut key; SC, SE keyway with 2 key blanks (order 1-bit key separately)	N/C
	0-Bit	Operated by 0-bit key; D100 keyway — ⊗ Keys sold separately	N/C
	0-Bit	Operated by 0-bit cut key; AA, CA, CB, CC, CD, CE, RA, RB, GA, SF, YA, YG keyways with 2 key blanks	19.00
	MKD	Master keyed; SC, SE, or D100 keyway — ⊗ Keys sold separately	24.00
	MK2	Master keyed double cylinder lock; SC, SE, or D100 keyway — ⊗ Keys sold separately	45.00
	CMK	Construction master keyed single cylinder locks — ⊗ Keys sold separately	21.00
	CM2	Construction master keyed double cylinder locks — ⊗ Keys sold separately	38.00
L		Lock less conventional cylinder	Example: C253L Deduct 33.00
Small Format Interchangeable Core Cylinders			
T		Lock with keyed temporary SFIC construction core (cores may be returned for a full refund) — ⊗ Keys sold separately	Example: C253T 57.00
J		Lock with disposable plastic SFIC plug	Example: C253J 78.00

1. For uncombined cores, UNC, cores must be ordered separately, see Cylinders, Keys & Keying. Locks will be supplied w/plastic construction core, Option J.

⊗ Denotes keys must be ordered separately.

Cut Keys Ordered Separately

Part #	Description	List \$
45101	SFIC Cut key — Change key, master key, construction master key, or control key; BA, BB, BC, BD, BE, BF BG, BH, BJ, BK, BL, BM, BQ, SC, SE keyways	9.00
45401	SFIC Cut key — Change key, master key, or control key; SKC keyways — D100 etc.	14.00
45404	CONV Cut key — 1-bit key for operating 1-bit cylinders — SC, SE keyways	7.00

NOTES:

- Distribution of DORMA SKC keys (listed as D100) is restricted. See Cylinders, Keys & Keying section for DORMA SKC policies.
- 1-bit cylinder comes with (2) uncut keys and will require a 1-bit cut key, sold separately, to operate cylinder.
- See Keys and Key Blanks section for complete list.

Configuration Options

Latch Bolts

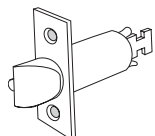

1/2" Throw, 2-3/8" Backset

Part #	Description	List Add \$
For 710, 712, 725, 750, 753, 770, or 780 Functions		
17150	1" x 2-1/4" front, 7/8" diameter, square corner	N/C
17151	1" x 2-1/4" front, 7/8" diameter, 1/4" radius corner	N/C
17152	1-1/8" x 2-1/4" front, 1" diameter, square corner	N/C
For 730 & 740 Function		
17180	1" x 2-1/4" front, 7/8" diameter, square corner	N/C
17181	1" x 2-1/4" front, 7/8" diameter, 1/4" radius corner	N/C
17182	1-1/8" x 2-1/4" front, 1" diameter, square corner	N/C

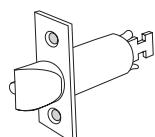

1/2" Throw, 2-3/4" Backset

Part #	Description	List Add \$
For 710, 712, 725, 750, 753, 770, or 780 Functions		
17250	1" x 2-1/4" front, 7/8" diameter, square corner	N/C
17251	1" x 2-1/4" front, 7/8" diameter, 1/4" radius corner	N/C
17252	1-1/8" x 2-1/4" front, 1" diameter, square corner	N/C
For 730 & 740 Function		
17280	1" x 2-1/4" front, 7/8" diameter, square corner	N/C
17281	1" x 2-1/4" front, 7/8" diameter, 1/4" radius corner	N/C
17282	1-1/8" x 2-1/4" front, 1" diameter, square corner	N/C

NOTE: Default configurations for CL700 shown above in bold.

Latch Bolts (continued)

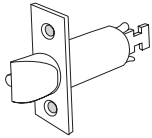
**1/2" Throw, 3-3/4" Backset**

Part #	Description	List Add \$
For 710, 712, 725, 750, 753, 770, or 780 Functions		
17350	1" x 2-1/4" front, 7/8" diameter, square corner	25.00
17351	1" x 2-1/4" front, 7/8" diameter, 1/4" radius corner	25.00
17352	1-1/8" x 2-1/4" front, 1" diameter, square corner	25.00
For 730 & 740 Function		
17380	1" x 2-1/4" front, 7/8" diameter, square corner	25.00
17381	1" x 2-1/4" front, 7/8" diameter, 1/4" radius corner	25.00
17382	1-1/8" x 2-1/4" front, 1" diameter, square corner	25.00

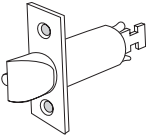
**1/2" Throw, 5" Backset**

Part #	Description	List Add \$
For 710, 712, 725, 750, 753, 770, or 780 Functions		
17550	1" x 2-1/4" front, 7/8" diameter, square corner	23.00
17551	1" x 2-1/4" front, 7/8" diameter, 1/4" radius corner	23.00
17552	1-1/8" x 2-1/4" front, 1" diameter, square corner	23.00
For 730 & 740 Function		
17580	1" x 2-1/4" front, 7/8" diameter, square corner	23.00
17581	1" x 2-1/4" front, 7/8" diameter, 1/4" radius corner	23.00
17582	1-1/8" x 2-1/4" front, 1" diameter, square corner	23.00

Strikes

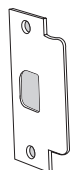

Part #	Description	List Add \$
2001 – ANSI Strike with Cylindrical Lock Cutout		
2001-1316	1-1/4" x 4-7/8", 1-3/16" lip length, square corner	N/C

NOTE: Default strike for C200 lock shown above in bold.

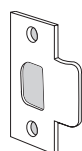

Part #	Description	List Add \$
2101 – T Strike with Dust Box		
2101-118	1-1/8" x 2-3/4", 1-1/8" lip length, square corner	N/C
2102-118	1-1/8" x 2-3/4", 1-1/8" lip length, radius corner. Available only in 630 for use with 626 and 619.	N/C

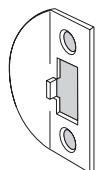

Part #	Description	List Add \$
2201, 2202 – Full Lip Strike		
2201-118	1-5/8" x 2-1/4", 1-1/8" lip length, square corner	N/C
2202-118	1-5/8" x 2-1/4", 1-1/8" lip length, 1/4" radius corner	N/C

Special Application Options

Security Screws

Specify	Description	List Add \$
TX	Security screws for latch and strike. 626 Finish Only	22.00

NOTE: Only available for use with 619, 625, 626, and 630 finish locksets.

C500 Series

Finish Availability Chart

	613	619	626	605	606	625
LR	•	•	•	•	•	•
LC	•	•	•	•	•	•
LG	•	•	•	—	—	—

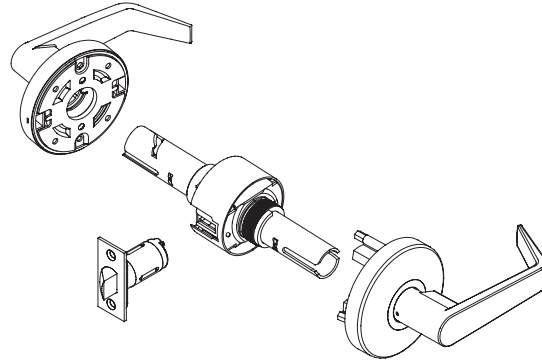

Function

Storeroom	80
Classroom	70
Entry	53
Office/Entry	50
Privacy, Bedroom or Bath	40
Patio	30
Exit/Communicating Passage	25
Passage/Closet	10
Dummy Trim One Side	01

Cylinder Type¹

D	Conventional Cylinder
C	SFIC (With Core)
J	SFIC (Less Core)
T	Temporary SFIC

Finish²

626	Satin Chrome
625	Bright Chrome
619	Satin Nickel
613	Dark Oxidized Satin Bronze
606	Satin Brass
605	Bright Brass

Keying Options Field

Strike Options³

Door Thickness

Product Family

Lever Design

Rose Design

Latch Bolt³

Example Configuration: C5 53 D LR C 626 15250 134 5001 XXXX

134 — 1-3/8" - 1-3/4"

- The C500 is not available less conventional cylinder. All keyed functions are available with or without SFIC cores.
- For split finishes, consult factory. Specify in-swing or out-swing.
- Example shows default values. Refer to Configuration Options section for full details.

NOTE: SFIC available on LR and LC lever designs only, not available on LG lever.

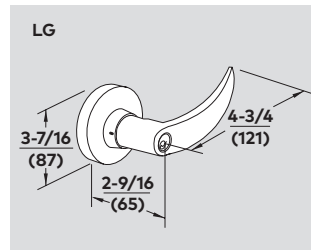
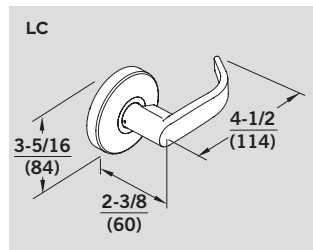
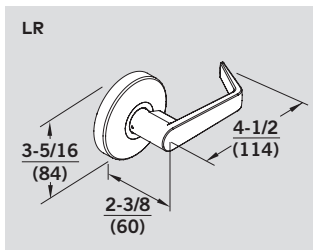

Lever Locks

ANSI #	Function	Description	Lever Locks	
			626	605, 606, 613, 619, 625
Keyless			List \$	
F75	C510	Passage/closet	159.00	178.00
F111	C525	Exit/Communicating passage	159.00	178.00
F77A	C530	Patio	163.00	180.00
F76A	C540	Privacy, bedroom or bath	163.00	180.00
—	C501	Single dummy	95.00	102.00
Keyed, Single Cylinder				
F82A	C550	Entry/Office	175.00	193.00
F109	C553	Entry	175.00	193.00
F84	C570	Classroom	175.00	193.00
F86	C580	Storeroom	175.00	193.00

NOTE: Split finishes will be priced at the higher finish list price.

Cylinder Types, Keying Options & Keyways

Cylinder	Option	Description	List Add/Deduct \$
Conventional Cylinders (non-interchangeable core)			
D		Conventional cylinder Example: C553D	
	KD	Keyed differently to a random combination; SC keyway with 2 keys (default)	N/C
	KA2	Keyed alike in pairs to a random combination; SC keyway with 2 keys	N/C
	NSK	Keyed alike, sets of three or more; SC keyway with 2 keys	21.00
	1-Bit	Operated by 1-bit cut key; D100 keyway — ⊗ Keys sold separately	N/C
	0-Bit	Operated by 0-bit key; SC, SE keyway with 2 key blanks (order 1-bit key separately)	N/C
	0-Bit	Operated by 0-bit cut key; SC, SE, AA, CA, CB, CC, CD, CE, RA, RB, GA, SF, YA, YG keyways with 2 key blanks	17.00
	MKD	Master keyed; SC, SE, or D100 keyway — ⊗ Keys sold separately	26.00
	CMK	Construction master keyed single cylinder locks — ⊗ Keys sold separately	23.00
Small Format Interchangeable Core Cylinders			
T		Temporary SFIC construction core (Cores may be returned for a full refund) — ⊗ Keys sold separately Example: C553T	62.00
J		SFIC core sold separately (see Cylinders & Keying) Example: C553J	N/C
C		Lock with combined SFIC core installed at the factory ¹ ; BA (default), BB, BC, BD, BE, BF, BG, BH, BJ, BK, BL, BM, BQ, D100 keyway — ⊗ Keys sold separately Example: C553C	67.00

¹The Less Cylinder option is not available for the C500 Series

1. For uncombined cores, UNC, cores must be ordered separately, see Cylinders, Keys & Keying.

⊗ Denotes keys must be ordered separately.

Cut Keys Ordered Separately

Part #	Description	List \$
45101	SFIC Cut key — Change key, master key, construction master key, or control key; BA, BB, BC, BD, BE, BF, BG, BH, BJ, BK, BL, BM, BQ, SC, SE keyways	10.00
45401	SFIC Cut key — Change key, master key, or control key; SKC keyways — D100 etc.	16.00
45404	CONV/LFIC Cut key — 1-bit key for operating 1-bit cylinders — SC, SE keyways	8.00

NOTES:

- Distribution of DORMA SKC keys (listed as D100) is restricted. See Cylinders, Keys & Keying section for DORMA SKC policies.
- 1-bit cylinder comes with (2) uncut keys and will require a 1-bit cut key, sold separately, to operate cylinder.
- See Keys and Key Blanks section for complete list.

Configuration Options

Latch Bolts

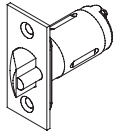

1/2" Throw, 2-3/8" Backset

Part #	Description	Add List \$
For 510 or 540 Functions		
15130	1" x 2-1/4" front, 7/8" diameter, square corner	N/C
15131	1" x 2-1/4" front, 7/8" diameter, 1/4" radius corner	N/C
For 525, 550, 553, 570, or 580 Functions		
15150	1" x 2-1/4" front, 7/8" diameter, square corner	N/C
15151	1" x 2-1/4" front, 7/8" diameter, 1/4" radius corner	N/C
For 530 Function		
15180	1" x 2-1/4" front, 7/8" diameter, square corner	N/C
15181	1" x 2-1/4" front, 7/8" diameter, 1/4" radius corner	N/C

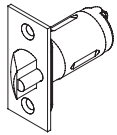

1/2" Throw, 2-3/4" Backset

Part #	Description	List Add \$
For 510 or 540 Functions		
15230	1" x 2-1/4" front, 7/8" diameter, square corner	N/C
15231	1" x 2-1/4" front, 7/8" diameter, 1/4" radius corner	N/C
15232	1-1/8" x 2-1/4" front, 7/8" diameter, square corner	N/C
For 525, 550, 553, 570, or 580 Functions		
15250	1" x 2-1/4" front, 7/8" diameter, square corner	N/C
15251	1" x 2-1/4" front, 7/8" diameter, 1/4" radius corner	N/C
15252	1-1/8" x 2-1/4" front, 7/8" diameter, square corner	N/C
For 530 Function		
15280	1" x 2-1/4" front, 7/8" diameter, square corner	N/C
15281	1" x 2-1/4" front, 7/8" diameter, 1/4" radius corner	N/C
15282	1-1/8" x 2-1/4" front, 7/8" diameter, square corner	N/C

NOTE: Default configurations for C500 shown above in bold.

Special Application Options

Drilling Jig

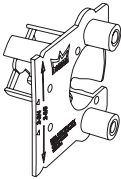
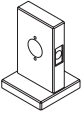
	Part #	Description	List \$
	76004795	Drilling jig for C800, CL700, and C500 locksets	18.00
	640003	Mount, C800 lever, CL700, and C500 Series — 1-1/8" × 2-1/4" faceplate	136.00

Strikes

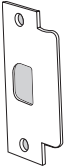
	Part #	Description	List Add \$
	5001 — ANSI Strike with Cylindrical Lock Cutout		
	5001-1316	1-1/4" × 4-7/8", 1-3/16" lip length, square corner	N/C
	5001-112	1-1/4" × 4-7/8", 1-1/2" lip length, square corner	28.00

NOTE: Default strike for C500 lock shown above in bold.

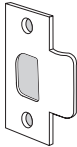
	Part #	Description	List Add \$
	5101, 5102 — "T" Strike with Dust Box		
	5101-118	1-1/8" × 2-3/4", 1-1/8" lip length, square corner	N/C
	5101-112	1-1/8" × 2-3/4", 1-1/2" lip length, square corner	28.00
	5102-118	1-1/8" × 2-3/4", 1-1/8" lip length, 1/4" radius corner	N/C
	5102-112	1-1/8" × 2-3/4", 1-1/2" lip length, 1/4" radius corner	28.00

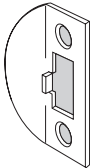
	Part #	Description	List Add \$
	5201, 5202 — Full Lip Strike		
	5201-118	1-5/8" × 2-1/4", 1-1/8" lip length, square corner	N/C
	5202-118	1-5/8" × 2-1/4", 1-1/8" lip length, 1/4" radius corner	N/C

Abrasive Coated Levers (Tactile Markings)

Part #	Description	List Add \$
660003	Abrasive coated lever (all designs)	62.00

NOTE: Tactile marking is applied to outside lever only, unless otherwise specified.

DB600 Series

Ordering Guide

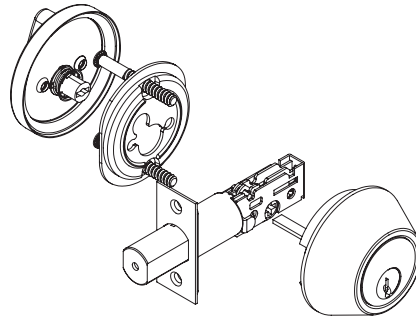

		Cylinder Type⁵						
		Function	D	Conventional Cylinder				
Cylinder x Blank ¹	80	C	SFIC (With Core)					
Cylinder x Cylinder	62	J	SFIC (Less Core)					
Cylinder x Turn	60	T	Temporary SFIC					
				Door Thickness⁶	Keying Options Field			
				134	1-3/8"	1-3/4"		
DB	6	60	D	630	26170	134	5103	XXXX
Product Type	Dead Bolt – DB	Grade 2 Tubular Dead Bolt		Latch Bolt⁶		Strike Options⁶		
Product Family	Bright Brass – 605	Dark Oxidized Satin Bronze – 613	Satin Nickel ² – 619	Satin Chrome – 626	Bright Stainless ³ – 629	Satin Stainless – 630	26173 – Adj, Drive-In	26171 – Adj, 1" RC
							26170 – Adj, 1" SQ with Filler	

1. DB680 not available in 605 finish.
2. 619 finish available standard cylinder only.
3. 629 finish only available for DB660 (standard and SFIC)
4. For split finishes, consult factory. Specify in-swing or out-swing.
5. The Less Conventional Cylinder option is not available for the DB600 Series.
6. Example shows default values. Refer to Configuration Options section for full details.

DB600 Series

ANSI #	Function	Description	626, 630	605, 613, 619* 629**
			List \$	
E2152	DB660	Cylinder x turn	116.00	125.00
E2142	DB662	Cylinder x cylinder	149.00	160.00
	DB680	Turn x blank	88.00	97.00

* 619 finish available standard cylinder only.

**629 finish only available for DB660 – standard and SFIC

NOTES:

- List prices for keyed locks include standard DORMA (D) cylinder, keyed different (KD) with two (2) nickel silver keys.
- Split finishes will be priced at the higher finish list price.

Cylinder Types, Keying Options & Keyways

Cylinder	Option	Description	List Add/Deduct \$
Conventional Cylinders (non-interchangeable core)			
D		Conventional cylinder	Example: DB660D
	KD	Keyed differently to a random combination; SC keyway with 2 keys (default)	N/C
	KA2	Keyed alike in pairs to a random combination; SC keyway with 2 keys	N/C
	NSK	Keyed alike, sets of three or more; SC keyway with 2 keys	21.00
	NS2	Keyed alike double cylinder locks; SC keyway with 2 keys	38.00
	1-Bit	Operated by 1-bit cut key; SC, SE keyway with 2 key blanks (order 1-bit key separately)	N/C
	0-Bit	Operated by 0-bit key; D100 keyway – Keys sold separately	N/C
	0-Bit	Operated by 0-bit cut key; AA, CA, CB, CC, CD, CE, RA, RB, GA, SF, YA, YG keyways with 2 key blanks	21.00
	MKD	Master keyed; SC, SE, or D100 keyway – Keys sold separately	26.00
	MK2	Master keyed double cylinder lock; SC, SE, or D100 keyway – Keys sold separately	49.00
	CMK	Construction master keyed single cylinder locks – Keys sold separately	23.00
	CM2	Construction master keyed double cylinder locks – Keys sold separately	41.00
Small Format Interchangeable Core Cylinders			
T		Locks with keyed temporary SFIC construction cores (Cores may be returned for a full refund) – Keys sold separately	Example: DB660T 62.00
J		SFIC core sold separately	Example: DB660J N/C
C		Lock with combined SFIC core installed at the factory ¹ ; BA (default), BB, BC, BD, BE, BF, BG, BH, BJ, BK, BL, BM, BQ, D100 keyway – Keys sold separately	Example: DB660C 68.00

* The Less Cylinder option is not available for the DB600 Series.

¹ For uncombined cores, UNC, cores must be ordered separately, see Cylinders, Keys & Keying.

⊗ Denotes keys must be ordered separately.

Cut Keys Ordered Separately

Part #	Description	List \$
45101	SFIC Cut key – Change key, master key, construction master key, or control key; BA, BB, BC, BD, BE, BF BG, BH, BJ, BK, BL, BM, BQ, SC, SE keyways	10.00
45401	SFIC Cut key – Change key, master key, or control key; SKC keyways – D100 etc.	16.00
45404	CONV/LFIC Cut key – 1-bit key for operating 1-bit cylinders – SC, SE keyways	8.00

NOTES:

- Distribution of DORMA SKC keys (listed as D100) is restricted. See Cylinders, Keys & Keying section for DORMA SKC policies.
- 1-bit cylinder comes with (2) uncut keys and will require a 1-bit cut key, sold separately, to operate cylinder.
- See Keys and Key Blanks section for complete list.

Configuration Options

Dead Bolts

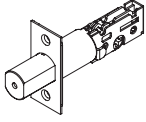

1" Throw, 2-3/8" – 2-3/4" Adjustable Backset

Part #	Description	List Add \$
26170	1" x 2-1/4" faceplate, square corner (1-1/8" wide w/filler)	N/C
26171	1" x 2-1/4" Faceplate, Radius Corner	N/C
26173	1" diameter, drive in (626 Finish only)	N/C

NOTE: Default configuration shown above in bold.

Strikes

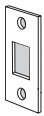

Part #	Description	List Add \$
5103	Standard Strike for Dead Bolt	
5103	1-1/8" x 2-3/4", no lip, square corner	N/C

NOTE: Default strike shown above in bold.

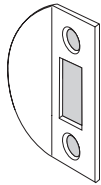

Part #	Description	List Add \$
5203	Full Lip Strike with Dead Bolt Cutout	
5203-118	1-5/8" x 2-1/4", 1-1/8" lip length, square corner	N/C
5204-118	1-5/8" x 2-1/4", 1-1/8" lip length, 1/4" radius corner	N/C

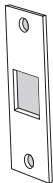

Part #	Description	List Add \$
5004	ANSI Strike with Dead Bolt Cutout	
5004	1-1/4" x 4-7/8", no lip, square corner	9.00

C300 Series

Finish Availability Chart

	626	613	619	605
LR	•	•		
LC	•	•		•
LG	•	•	•	
LS		•	•	•
L118	•	•	•	

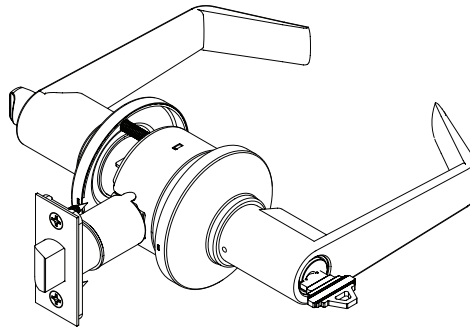

Product Family	Lever				Backset				Strike				Cylinder Type		Keying		
	L118	LSB	LGB	LCB	LRB	2-3/8" Fire	2-3/4" Fire	2-3/8" Non-Fire*	2-3/4" Non-Fire*	ANSI Strike, Square Corner	T Strike, Square Corner	Full Lip, Square Corner	Full Lip, Radius Corner	D		Standard Cylinder	
C3	53	LRB	626											RH	D	SCKD	
Single Dummy	01		626	Satin Chrome						100S	1" Square			RH		SC	SC Keyway
Passage	10		613	Dark Bronze						118S	1-1/8" Square			LH		D100	DORMA SKC D100 Keyway
Patio	30		619	Satin Nickel						100R	1" Radius			Handing			
Privacy	40		605	Bright Brass						DRIV	Drive-In 238N Only						
Entry	53																
Function		Finish				Faceplate				Keyway							

*C353 and C330 only available with fire rated latch.

Levers

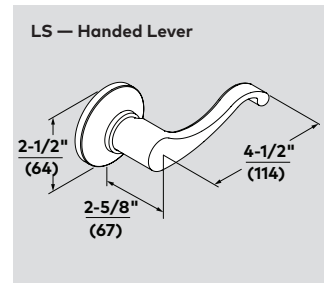
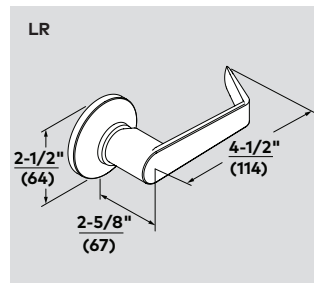
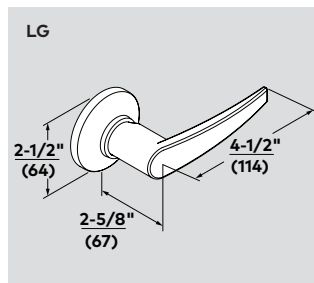
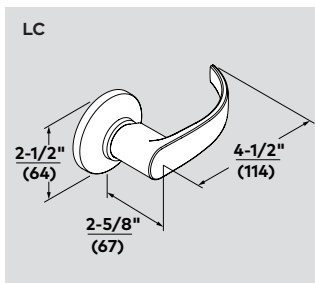

Strikes

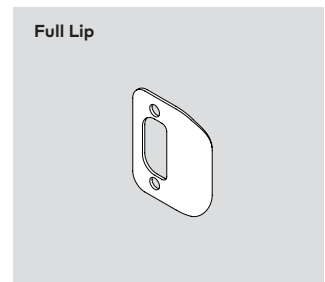
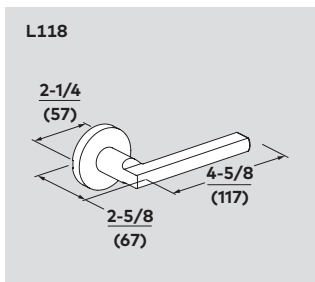

ANSI #	Function	Description	List \$	
			626	605, 613, 619
—	C301	Single dummy	48.00	50.00
F75	C310	Passage/closet	91.00	94.00
F77A	C330	Patio	105.00	108.00
F76A	C340	Privacy, bedroom, or bath	96.00	98.00
F109	C353	Entry	119.00	123.00

Strikes

Option	Description	List \$
5202	Full lip strike, radius corner — default	N/C
5001	ANSI strike	11.00
5101	T strike, square corner	N/C
5102	T strike, radius corner	N/C
5201	Full lip strike, square corner	N/C

Latches

Option	Description	List \$
C310/C340 Latches		
234N	2-3/4" Backset non-fire	N/C
238N	2-3/8" Backset non-fire	N/C
234F	2-3/4" Backset fire rated	12.00
238F	2-3/8" Backset fire rated	12.00
C330/C353 Latches		
234F	2-3/4" Backset fire rated	N/C
238F	2-3/8" Backset fire rated	N/C

Abrasive Coated Levers (Tactile Markings)

Part #	Description	List \$
660003	Abrasive coated lever (all designs)	62.00

NOTE: Tactile marking is applied to outside lever only, unless otherwise specified.

Keying

Option	Description	List \$
KD	Keyed differently to a random combination; SC keyway with 2 keys (default)	N/C
KA2	Keyed alike in pairs to a random combination; SC keyway with 2 keys	21.00
NSK	Keyed alike, sets of three or more; SC keyway with 2 keys	21.00
1-Bit	Operated by 1-bit cut key, SC, SE keyway with 2 key blanks (order 1-bit key separately)	21.00
0-Bit	Operated by 0-bit key, D100 keyway — ⊗ Keys sold separately	21.00
0-Bit	Operated by 0-bit cut key; AA, CA, CB, CC, CD, CE, RA, RB, GA, SF, YA, YG keyways with 2 key blanks	21.00
MKD	Master keyed; SC, SE, or D100 keyway — ⊗ Keys sold separately	26.00
CMK	Construction master keyed single cylinder locks — ⊗ Keys sold separately	23.00

NOTE: Less Cylinder option is not available on the C300 series. ⊗ Denotes keys must be ordered separately.

Keys

Part #	Description	List \$
45101	SFIC Cut key — Change key, master key, construction master key, or control key; BA, BB, BC, BD, BE, BF BG, BH, BJ, BK, BL, BM, BQ, SC, SE keyways	10.00
45401	SFIC Cut key — Change key, master key, or control key; SKC keyways — D100 etc.	16.00
45404	CONV/LFIC Cut key — 1-bit key for operating 1-bit cylinders — SC, SE keyways	8.00

NOTES:

- Distribution of DORMA SKC keys (listed as D100) is restricted. See Cylinders, Keys & Keying section for DORMA SKC policies.
- 1-bit cylinder comes with (2) uncut keys and will require a 1-bit cut key, sold separately, to operate cylinder.
- See Keys and Key Blanks section for complete list.

J300 Series

Finish Availability Chart

	626	613	619	605
LR	•	•		
LC	•	•		•
LG	•	•	•	
LS		•	•	•
L118	•	•	•	

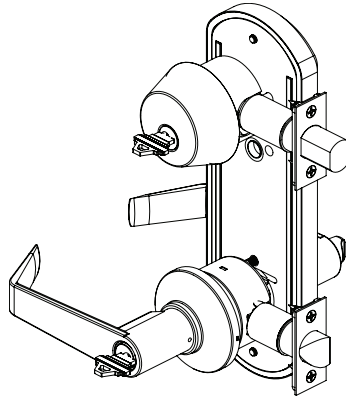

Product Family	Function	Lever	Finish	Backset	Faceplate	Strike	Handing	Keying
J3	10	LRB	626	238F	100S	5701	LH	T
Entry – Single Cylinder –	10	Satin Chrome –	626	1" Square –	100S	5701	RH	C
Privacy with Indicator ¹ –	46	Dark Bronze –	613	1-1/8" Square –	118S	5703		J
Entry – Double Cylinder ² –	53	Satin Nickel –	619	1" Radiused –	100R	5704		D
		Bright Brass –	605			5705		
						5706		

(1) T Strike Square, (1) No Lip Square
 (1) Full Lip Square, (1) No Lip Square
 (1) Full Lip Radiused, (1) No Lip Radiused
 (1) Full Lip Square, (1) Full Lip Square
 (1) Full Lip Radiused, (1) Full Lip Radiused

1. J346 not available in 605.
 2. SFIC core on C353 function available with LR lever only.

Levers

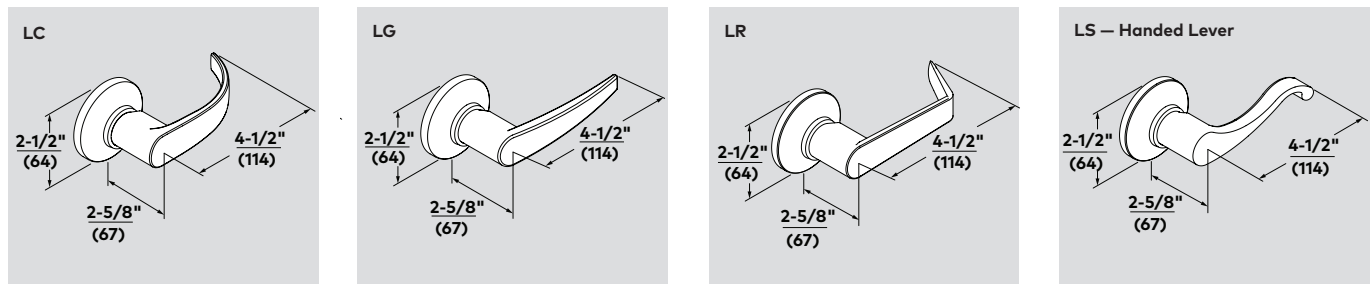

Strikes

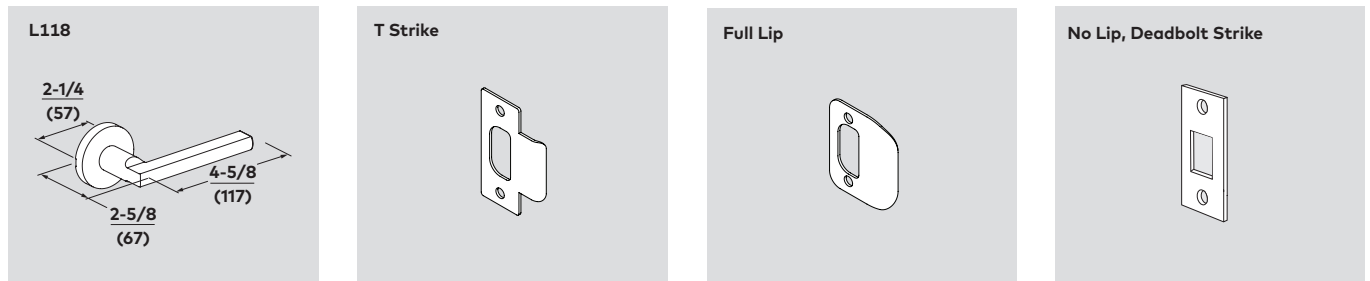

ANSI #	Function	Description	All Levers — Per Chart	
			626	605, 613, 619
F95	J310	Entrance, Single Locking	464.00	482.00
—	J346	Privacy with Indicator	464.00	482.00
F97	J353	Entrance, Double Locking	580.00	597.00

Strikes

Option	Description	List Add \$
5701	Lock — T strike square/Deadbolt — no lip square (default)	N/C
5703	Lock — full lip square/Deadbolt — no lip square	N/C
5704	Lock — full lip radiused/Deadbolt — no lip radiused	N/C
5705	Lock — full lip square/Deadbolt — full lip square	N/C
5706	Lock — full lip radiused/Deadbolt — full lip radiused	N/C

Description

Split Finish	42.00
--------------	-------

Cylinder Types, Keying Options and Keyways

Cylinder	Option	Description	List Add/Deduct \$
Conventional Cylinders (non-interchangeable core)			
D		Conventional cylinder	
	KD	Keyed differently to a random combination; SC keyway with 2 keys (default)	N/C
	KA2	Keyed alike in pairs to a random combination; SC keyway with 2 keys	21.00
	NSK	Keyed alike, sets of three or more; SC keyway with 2 keys	21.00
	1-Bit	Operated by 1-bit cut key; SC, SE keyway with 2 key blanks (order 1-bit key separately)	21.00
	0-Bit	Operated by 0-bit key; D100 keyway — ⊗ Keys sold separately	21.00
	0-Bit	Operated by 0-bit cut key; AA, CA, CB, CC, CD, CE, RA, RB, GA, SF, YA, YG keyways with 2 key blanks	21.00
	MKD	Master keyed; SC, SE, or D100 keyway — ⊗ Keys sold separately	26.00
	MK2	Master keyed double cylinder lock; SC, SE, or D100 keyway — ⊗ Keys sold separately	49.00
	CMK	Construction master keyed single cylinder locks — ⊗ Keys sold separately	23.00
	CM2	Construction master keyed double cylinder locks — ⊗ Keys sold separately	40.00
L		Lock less conventional cylinder, per cylinder	Example: J310L Deduct 33.00
Small Format Interchangeable Core Cylinders			
T		Lock with keyed temporary SFIC construction core, per cylinder (cores may be returned for a full refund) — ⊗ Keys sold separately	Example: J310T 62.00
J		Lock with disposable plastic SFIC construction core	Example: J353J N/C
C		Lock with combined SFIC core installed at the factory ¹ ; BA (default), BB, BC, BD, BE, BF, BG, BH, BJ, BK, BL, BM, BQ, D100 keyway — ⊗ Keys sold separately	Example: J310C 67.00

NOTE: The Less Cylinder option is not available on the C500 Series.

⊗ Denotes keys must be ordered separately.

Cut Keys Ordered Separately

Part #	Description	List \$
45101	SEIC Cut key — Change key, master key, construction master key, or control key; BA, BB, BC, BD, BE, BF, BG, BH, BJ, BK, BL, BM, BQ, SC, SE keyways	10.00
45401	SFIC Cut key — Change key, master key, or control key; SKC keyways — D100 etc.	16.00
45404	CONV/LFIC Cut key — 1-bit key for operating 1-bit cylinders — SC, SE keyways	8.00

NOTES:

- 1-bit cylinder comes with (2) uncut keys and will require a 1-bit cut key, sold separately, to operate cylinder. SC and SE keyways only.
- See Keys and Key Blanks section for complete list.

Cylinders, Keys, and Keying

Product Guide

CYLINDER AVAILABILITY	Conventional	Interchangeable Core 6-Pin	Interchangeable Core 7-Pin	Conventional Hotel	Interchangeable Core Hotel
Mortise Cylinder	90	96	97	—	98
Rim Cylinder	80	86	87	—	—
KIL Cylinder	70	—	—	75	—
KIK Cylinder	71	—	—	—	—
Small Format Interchangeable Core	—	76	77	—	—

KEYWAY AVAILABILITY ● Yes ○ No	SC Keyway	SE Keyway	Retrofit Keyways AA, CA, CB, CC, CD, CE, RA, RB, GA, SF, WA, YA, YG	SFIC Keyways BA, BB, BC, BD, BE, BF, BG, BH, BJ, BK, BL, BM, BQ	DORMA SKC Keyways D100
KD Keyed different to a random combination	●	○	○	○	○
KA2 Keyed alike in pairs to a random combination	●	○	○	○	○
NSK Keyed alike in sets of 3 or more	●	○	○	○	○
MKD Master keyed or keyed to a specific combination	●	●	○	●	●
CMK Construction master keyed	●	●	○	○	● (Not available SFIC)

Master Keying

Master keying charges do not include keys. Always order and price keys as a separate line item.

A completed Key System Specification Form is required for every new master key system ordered. Orders and keying schedules must use BHMA/ANSI Standard Key Coding Symbols. See ANSI 156.28 for reference.

Keying capacity varies greatly with product and system architecture. Check keying requirements prior to selecting product. Expressions like "Plan for maximum expansion" have no meaning. The table below is a very general guide and can be misinterpreted. For more information, please contact Customer Service.

Cylinder/Core Mechanism	Theoretical Number of Changes Under the Top Master Key	System Capacity	Example of Theoretical Keying Capacity in Three Levels of Keying (Grand Master, Master and Changes)
SC Keyway with Construction Keying	$4^5 = 1,024$	Smaller Projects	GMK and 16 Masters of 64 Changes Each
SC Keyway without Construction Keying	$4^6 = 4,096$	Medium Projects	GMK and 16 Masters of 256 Changes Each
77BA, BB etc. SFIC only	$4^7 = 16,384$	Larger Projects	GMK and 64 Masters of 256 Changes Each
DORMA SKC with Construction keying	$6 \times 4^6 = 24,576$	Very Large Projects	GMK and 96 Masters of 256 Changes Each
DORMA SKC without Construction Keying	$6 \times 4^7 = 98,304$	Extremely Large Projects	GMK and 384 Masters of 256 Changes Each

DORMA SKC

Distribution of DORMA SKC (Shown in the price list as D100 keyway) is restricted. Possession of a price list does not constitute authorization to purchase DORMA SKC. Contact your local representative for information about authorization to purchase DORMA SKC.

DORMA SKC may only be used in the USA and Canada.

Conventional (Non-IC) Mortise Cylinders

Ordering Guide

Cylinder Type

Conventional Mortise — **90** **X**

Cylinder Ring (List Add)

90 **X** **10** **SC** **118** **626** **KD**

Adams Rite & dormakaba 1340KR Key Removable Mullion — **01**

Adams Rite 4070 — **02**

dormakaba 9600, 9700 & 9800 Exit Z Trim w/09 or 12 Functions — **09**

dormakaba M9050, 9080 & 9082 (2) Mortise Locks; dormakaba 9100, 9300, 9400 & 9500 Exit Y Trim/Options & Other Straight Cam Applications — **10**

dormakaba M9056, 9080EL/EU, 9080ELRX/EURX 9082EL/EU & M9900 Mortise Locks w/Dead Bolts' — **11**

dormakaba M9053, 9070, 9071 (2), 9076, 9077 (2) & 9060 Insider Cylinder Mortise Locks — **12**

dormakaba M9060 Outside Cylinder Mortise Locks; dormakaba 9600, 9700 & 9800 Exit Z Trim w/08 or 11 Functions — **13**

Schlage Style Clover (L) — **15**

dormakaba 5000 Series Exit J Trim, Sargent & Yale Narrow — **16**

Best & CorbinRusswin Style Clover — **19**

Falcon Dead Bolt Style Clover — **30**

CorbinRusswin DL4000 Style — **31**

D900 — **32**

Cam

Length

300 — 3"

234 — 2-3/4"

212 — 2-1/2"

214 — 2-1/4"

200 — 2"

134 — 1-3/4"

158 — 1-5/8"

112 — 1-1/2"

138 — 1-3/8"

114 — 1-1/4"

118 — 1-1/8"

Keying

OBIT — SC & D100 provided in 1-bit - 1-bit key sold separately; other keyways provided in 0-bit

CMK — Construction Master Keyed

MKD — Master Keyed

NSK — Keyed Alike, sets of 3 or More

KA2 — Keyed Alike, Sets of 2

KD — Keyed Different

Finish

605 — Bright Brass

606 — Satin Brass

612 — Satin Bronze

613 — Dark Oxidized Satin Bronze

625 — Bright Chrome

626 — Satin Chrome

630 — Satin Stainless (also for use with 619)

NOTE: For Cylinder Rings, refer to page 67.

NOTE: Not all keyways available in all cylinder lengths. Consult factory.

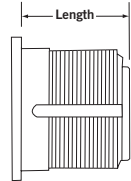
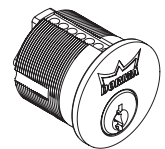
Length Includes Cam **Mortise Cylinder**

Option	Keyway	Example	Keys	All Finishes \$
KD (standard)/KA2	SC	90X10 SC 118 626 KD	2 keys ea.	90.00
NSK (keyed alike, sets of 3 or more)	SC	90X10 SC 118 626 NSK KA31	2 keys ea.	Add 31
Master keyed	SC, SE, D100	90X10 SC 118 626 MKD	⊗ Keys sold separately	Add 31
Construction master keyed	SC, SE, D100	90X10 SC 118 626 CMK	⊗ Keys sold separately	Add 39
0-Bit	SC, SE	90X10 SC 118 626 OBIT	2 key blanks provided (1-bit key needed to operate).	90.00
0-Bit	D100	90X10 D100 118 626 OBIT	⊗ Keys sold separately	90.00
0-Bit	Retro	90X10 RB 118 626 OBIT	2 key blanks	90.00
138, 112, 158, 134, or 200 length		90X10 SC 112 626 KD		Add 76.00
214, 212, 234, or 300 length		90B10 SC 200 626 KD		Add 64.00

⊗ Denotes keys must be ordered separately.

Keys Ordered Separately for MKD, CMK, and SKC

Part #	Description	List \$
45101	Cut key — change key, master key, construction key; SC, SE keyways	10.00
45401	Cut key — change key, master key, construction key; SKC keyways — D100 etc.	16.00
45404	CONV Cut key — 1-bit key for operating 1-bit cylinders; SC, SE keyways only	8.00

NOTES:

- D100 keyway cylinders must be ordered 0-bitted or MKD; keys sold separately.
 - Other restrictions apply. See Cylinders, Keys & Keying section for DORMA SKC policies.
 - 1-bit cylinder comes with (2) uncut keys and will require a 1-bit cut key, sold separately, to operate cylinder. SC and SE keyways only.
 - See Keys and Key Blanks section for complete list.
- Architectural Hardware Canada Price List - PL32

Small Format Interchangeable Core Mortise Housings

Ordering Guide

Cylinder Type		Length	
For 7 Pin Core —	97	300 — 3"	
For 6 Pin Core —	96	212 — 2-1/2"	
	X	214 — 2-1/4"	
		200 — 2"	
		134 — 1-3/4"	
		138 — 1-3/8"	
	97	10	626
	X		
	10		
	138		
	626		
Adams Rite & dormakaba 134OKR Key Removable Mullion	01		605 — Bright Brass
Adams Rite 4070	02		606 — Satin Brass
dormakaba 9600, 9700 & 9800 Exit Z Trim w/09 or 12 Functions	09		612 — Satin Bronze
dormakaba M9050, 9080 & 9082 (2) Mortise Locks; dormakaba 9100, 9300, 9400 & 9500 Exit Y Trim/Options & Other Straight Cam Applications	10		613 — Dark Oxidized Satin Bronze
dormakaba M9056, 9080EL/EU, 9080ELRX/EURX 9082EL/EU & M9900 Mortise Locks w/Dead Bolts	11		625 — Bright Chrome
dormakaba M9053, 9070, 9071 (2), 9076, 9077 (2) & 9060 Inside Cylinder Mortise Locks	12		626 — Satin Chrome
dormakaba M9060 Outside Cylinder Mortise Locks; dormakaba 9600, 9700 & 9800 Exit Z Trim w/08 or 11 Functions	13		630 — Satin Stainless (also for use with 619)
D900, Schlage Style Clover (L)	15		
dormakaba 5000 Series Exit J Trim, Sargent & Yale Narrow	16		
Best & CorbinRusswin Style Clover	19		
Falcon Dead Bolt Style Clover	30		
CorbinRusswin DL4000 Style	31		

Finish

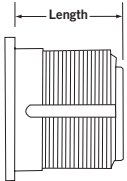

Length Includes Cam

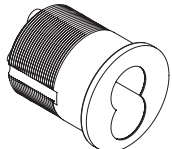

SFIC Mortise Housing

NOTES:

- For Cylinder Rings, refer to page 67.
- To order cores, refer to page 73.

Description	Example	All Finishes \$
Housing less core	97X10 00 138 626	81.00
Housing less core — 200 or 214 length (extended leadtime)	97X10 00 200 626	ADD 294.00
Housing less core — 212 or 300 length (extended leadtime)	97X10 00 212 626	ADD 369.00

Dummy and Thumbturn Cylinders

Ordering Guides

Cylinder Ring (List Add)

Cylinder Type

Dummy — **91** **X**

91 **X** **118** **626**

1-1/8" — **118** **605** — Bright Brass

1-1/4" — **114** **606** — Satin Brass

Length **612** — Satin Bronze

613 — Dark Oxidized Satin Bronze

625 — Bright Chrome

626 — Satin Chrome

Finish

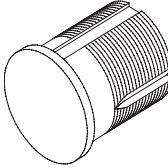

Dummy Cylinder

NOTE: For Cylinder Rings, refer to page 67.

Cylinder Ring (List Add)

Cylinder Type

Thumbturn — **92** **X**

92 **X** **10** **118** **626**

Adams Rite & dormakaba 134OKR Key Removable Mullion — **01** **100** — 1"

Adams Rite 4070 — **02** **114** — 1-1/4"

dormakaba M9050, 9080 & 9082 (2) Mortise Locks; DORMA 9100, 9300, 9400 & 9500 Exit Y Trim/Options & Other Straight Cam Applications — **10** **118** — 1-1/8"

dormakaba M9056, 9080EL/EU, 9080ELRX/EURX 9082EL/EU & M9900 Mortise Locks w/Dead Bolts — **11**

dormakaba M9053, 9070, 9071 (2), 9076, 9077 (2) & 9060 Insider Cylinder Mortise Locks — **12**

Best & CorbinRusswin Style Clover — **19**

Length

Finish

626 — Satin Chrome

625 — Bright Chrome

613 — Dark Oxidized Satin Bronze

612 — Satin Bronze

606 — Satin Brass

605 — Bright Brass

Cam

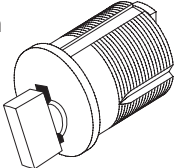

Thumbturn Cylinder

NOTE: For Cylinder Rings, refer to page 67.

NOTE: For special arm applications, consult Technical Services.

Description	Example	All Finishes \$
91 Series dummy cylinder	91X 118 626	68.00
92 Series thumbturn cylinder	92X 10 118 626	90.00

NOTE: For cylinders over 1-1/4" long, contact the factory.

Mortise Cylinder Cams for DORMA Products

Ordering Guide

Product Type



Mortise Cylinder Cam — **63**

63 10 D

Pattern

C — dormakaba SFIC Screw-On
dormakaba 93R Housing for Schlage FSIC

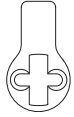
D — dormakaba Conventional

dormakaba Key Removable Mullion & Adams Rite	01	
Adams Rite 4070 & Amarlite; Baldwin Mortise Locks; Miscellaneous Non-dormakaba Straight Cam Applications	02	(Not available in SFIC)
dormakaba 9600, 9700 & 9800 Exit Z Trim w/09 or 12 Functions	09	
dormakaba M9050, 9080 & 9082 (2) Mortise Locks; dormakaba 9100, 9300, 9400 & 9500 (prior to 11/2014) Exit Y Trim/Options & Other Straight Cam Applications	10	
dormakaba M9056, 9080EL/EU, 9080ELRX/EURX 9082EL/EU & M9900 Mortise Locks w/Dead Bolts'	11	
dormakaba M9053, 9070, 9071 (2), 9076, 9077 (2) & 9060 Insider Cylinder Mortise Locks; dormakaba 9500 05 and 08 Functions (11/2014 or later)	12	 6310D
dormakaba M9060 Outside Cylinder Mortise Locks; dormakaba 9500 05 and 08 Functions (11/2014 or later), 9600, 9700 & 9800 Exit Z Trim w/08 or 11 Functions	13	
D900 C Only; Schlage Style Clover (L)	15	 6310C
dormakaba 5000 Series Exit J Trim, Sargent & Yale Narrow	16	
Best & CorbinRusswin Style Clover	19	<p>Conventional Cams (Suffix D) have mounting holes at 3 and 9 o'clock.</p> <p>SFIC/LFIC Cams (Suffix C) have mounting screw holes at 12 and 6 o'clock.</p>
Vingcard	22	
D900 D Only	32	

Cam

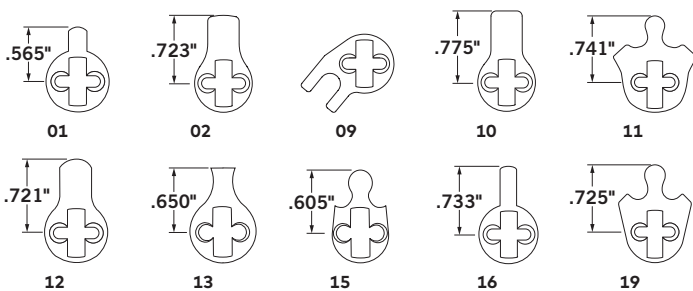

Description	U/M	List \$
Cams — 6301D, 6302D, 6309D, 6310D, 6311D, 6312D, 6313D, 6315D, 6316D, 6319D, 6332D	ea.	9.00
Cams — 6301C, 6309C, 6310C, 6311C, 6312C, 6313C, 6315C, 6316C	ea.	9.00



Part#	Description	U/M	List \$
76007125	Cam screws, DORMA I/C mortise housing (used with "C" suffix cams) – pack of 20	pack	28.00
76019185	Cam screws, DORMA standard mortise cylinder (used with "D" suffix cams) – pack of 20	pack	28.00

Retrofit Mortise Cylinder Cams

Ordering Guide for other manufacturers' cylinders when used in M9000 Series Locks

Product Type		Pattern	
Mortise Cylinder Cam —	63	SG — Arrow and Sargent Conventional Cylinders	
		CR — CorbinRusswin Conventional Cylinders	
	63	11	CR
dormakaba 9600, 9700 & 9800 Exit Z Trim w/09 or 12 Functions		09¹	
dormakaba M9056, 9080EL/EU, 9080ELRX/EURX 9082EL/EU & M9900 Mortise Locks w/Dead Bolts		11	
dormakaba M9053, 9070, 9071 (2), 9076, 9077 (2) & 9060 Insider Cylinder Mortise Locks		12	
dormakaba M9060 Outside Cylinder Mortise Locks; dormakaba 9600, 9700 & 9800 Exit Z Trim w/08 or 11 Functions		13	
			Cam

1. 09 cam required for dormakaba Z09 & Z12 exit trim. For this, or any other application not shown, contact Technical Services.

6311SG **6311CR**



Retrofit cams are configured to fit non-dormakaba cylinders. Use of incorrect cams can cause lockouts.

Description	List \$
Cams — 6311CR, 6312CR, 6313CR	11.00
Cams — 6311SG, 6312SG, 6313SG	11.00

Mortise Cylinder Rings

Ordering Guide

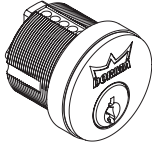
Product Type		Cylinder Ring	
Mortise Cylinder Ring —	64	H — 13/16" Tapered Ring raises cylinder 5/8" off door	
		G — 11/16" Tapered Ring raises cylinder 1/2" off door	
		K — 17/32" Tapered Ring raises cylinder 7/16" off door	
		J — 7/16" Tapered Ring raises cylinder 1/4" off door	
		A — 9/32" Tapered Ring raises cylinder 3/32" off door	
		D — 1/4" Blocking Ring	
		C — 1/8" Blocking Ring	
	64	J	626
		605 — Bright Brass	
		606 — Satin Brass	
		612 — Satin Bronze	
		613 — Dark Oxidized Satin Bronze	
		622 — Satin Black	
		625 — Bright Chrome	
		626 — Satin Chrome	
		630 — Satin Stainless (also for use with 619)	
			Finish

Cylinder with Blocking Ring **Cylinder with Tapered Ring**

626	605, 606, 612, 619, 625, 630
------------	-------------------------------------

Description	List \$	
Blocking rings — 64C, 64D	9.00	11.00
Tapered rings — 64A, 64J, 64K (includes wave washer)	12.00	19.00
Tapered rings — 64G, 64H (includes wave washer)	16.00	20.00
Wave washer (sold in multiples of 25 only)	25 (pack)	25 (pack)

Example: 64J 626

Conventional (Non-IC) Rim Cylinders

Ordering Guide

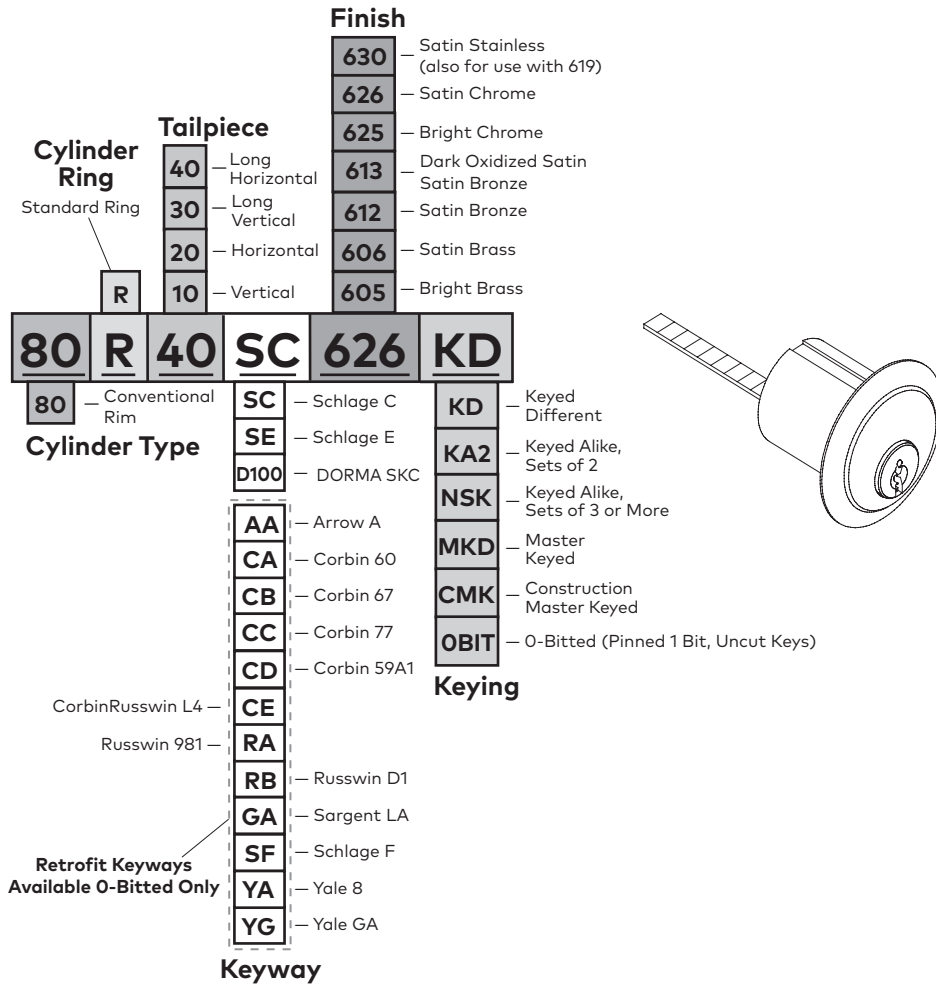

Option	Keyway	Example	Keys	All Finishes \$
KD (standard)/KA2/KA4	SC	80R40 SC 626 KD	2 keys ea.	63.00
NSK (KA other than KA2/KA4)	SC	80R40 SC 626 NSK KA31	2 keys ea.	Add 28.00
Master keyed	SC, SE, D100	80R40 SC 626 MKD	⊗ Keys sold separately	Add 28.00
Construction master keyed	SC, SE, D100	80R40 SC 626 CMK	⊗ Keys sold separately	Add 35.00
0-Bit	SC, SE	80R40 SC 626 OBIT	2 keys ea.	63.00
0-Bit	D100	80R40 D100 626 OBIT	⊗ Keys sold separately	63.00
0-Bit	Retro	80R40 RB 626 OBIT	2 keys ea.	63.00

⊗ Denotes keys must be ordered separately.

Keys Ordered Separately for MKD, CMK, and SKC

Part #	Description	List \$
45101	Cut key — change key, master key, construction key; SC, SE keyways	9.00
45401	Cut key — change key, master key, construction key; SKC keyways — D100 etc.	16.00
45404	CONV Cut key — 1-bit key for operating 1-bit cylinders; SC, SE keyways only	7.00

NOTES:

- D100 keyway cylinders must be ordered 0-bitted or MKD; keys sold separately.
- Other restrictions apply. See Cylinders, Keys & Keying section for DORMA SKC policies.
- 1-bit cylinder comes with (2) uncut keys and will require a 1-bit cut key, sold separately, to operate cylinder. SC and SE keyways only.
- See Keys and Key Blanks section for complete list.

Small Format Interchangeable Core Rim Housings

Ordering Guide

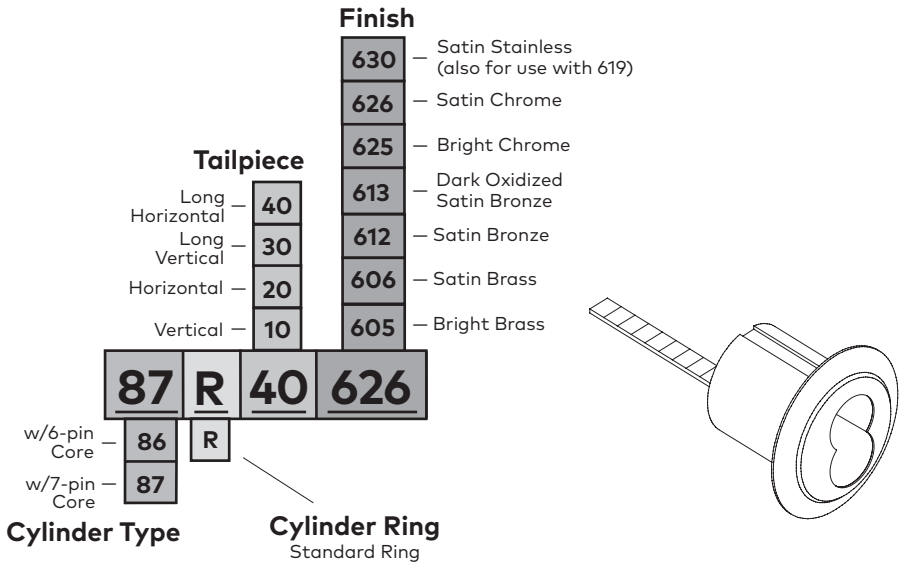

NOTES: • To order cores, refer to page 73.

Description	Example	All Finishes \$
Housing less core	87R40 00 626	60.00

Conventional (Non-IC) Key-in-Knob/Lever Cylinders

Ordering Guide (Except Hotel Function)

Tailpiece

J300 Upper Cylinder	33
C353 & J353 Lower Cylinder	32
D880	30
C873 Lever Only	28
All C800 Levers except C873 & 885	27
D860 & 863 1-13/16" -3" Door	26
C570	25
C550, 553, 555, 580	24
D862 1-13/16" -2" Door	21
D862 1-3/8" -1-3/4" Door	20
D860 & 863 1-3/8" -2" Door	19
D861	18
DB662	17
DB660	16
RO8 Trim CL700 Levers	13
CK700 Knobs	12

Keyway

YG	Yale GA
YA	Yale 8
SF	Schlage F
GA	Sargent LA
RB	Russwin D1
RA	Russwin 981
CE	CorbinRusswin L4
CD	Corbin 59A1
CC	Corbin 77
CB	Corbin 67
CA	Corbin 60
AA	Arrow A
D100	DORMA SKC
SE	Schlage E
SC	Schlage C

Keying

OBIT	0-Bitted (SC keyway only 1-bitted, Uncut Keys)
CMK	Construction Master Keyed
MKD	Master Keyed
NSK	Keyed Alike, Sets of 3 or More
KA2	Keyed Alike, Sets of 2
KD	Keyed Different

Lock Type

Lever Designs	70
Knob Designs	71

Finish

Satin Brass	606
Satin Chrome	626

Keyway Available 0-Bitted Only

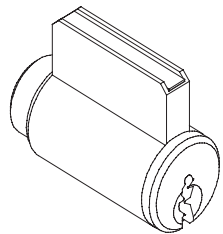

NOTE: To order tailpiece only, refer to page 76.

Option	Keyway	Example	Keys	All Finishes \$
KD (standard)/KA2	SC	7010 SC 626 KD2 keys ea.	2 keys ea.	57.00
NSK (keyed alike, sets of 3 or more)	SC	7010 SC 626 NSK KA31	2 keys ea.	Add 28.00
Master keyed	SC, SE, D100	7010 SC 626 MKD	⊗ Keys sold separately	Add 28.00
Construction master keyed	SC, SE, D100	7010 SC 626 CMK	⊗ Keys sold separately	Add 36.00
0-Bit	SC, SE	7010 SC 626 OBIT	2 keys ea.	57.00
0-Bit	D100	7010 D100 626 OBIT	⊗ Keys sold separately	57.00
0-Bit	Retro	7010 RB 626 OBIT	2 keys ea.	57.00

NOTE: For locksets in 619, 625, 626, 629, and 630 finish, order cylinders in 626. For locksets in 605, 606, 612, and 613, order in 606.

⊗ Denotes keys must be ordered separately.

Keys Ordered Separately for MKD, CMK, and SKC

Part #	Description	List \$
45101	Cut key — change key, master key, construction key; SC, SE keyways	9.00
45401	Cut key — change key, master key, construction key; SKC keyways — D100 etc.	16.00
45404	CONV Cut key — 1-bit cut key for operating 1-bit cylinders; SC, SE keyways only	7.00

NOTES:

- D100 keyway cylinders must be ordered 0-bitted or MKD; keys sold separately.
- Other restrictions apply. See Cylinders, Keys & Keying section for DORMA SKC policies.
- 1-bit cylinder comes with (2) uncut keys and will require a 1-bit cut key, sold separately, to operate cylinder. SC and SE keyways only.
- See Keys and Key Blanks section for complete list.

Conventional (Non-IC) Hotel Cylinders

Ordering Guide

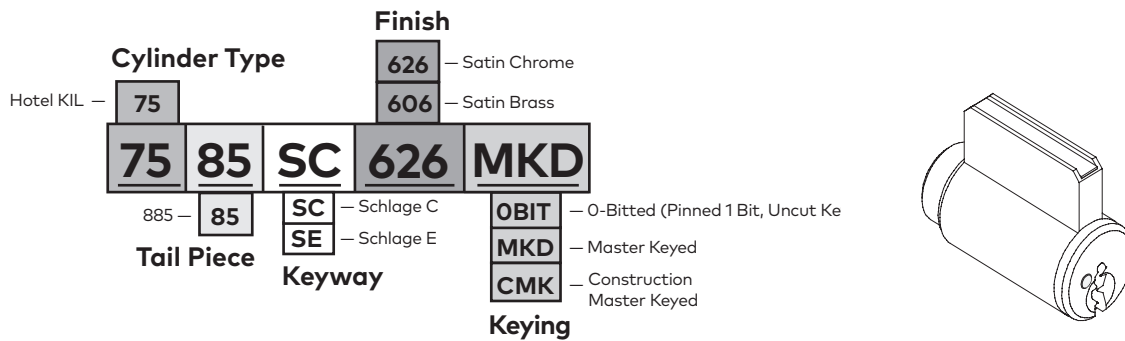

Description	Example	All Finishes \$
Key-in-Lever Cylinders		
Key-in-lever hotel cylinder	7585 SC 626 OBIT	91.00
Key-in-lever master keyed cylinder — Keys sold separately	7585 SC 626 MKD	Add 28.00
Key-in-lever construction keyed cylinder — Keys sold separately	7585 SC 626 CMK	Add 36.00

NOTES:

- For key-in-lever locksets in 619, 625, and 626 finish, order cylinders in 626. For key-in-lever locksets in 605, 606, 612, and 613, order in 606.
- Key-in-lever hotel cylinders are not available in D100 keyway.

Denotes keys must be ordered separately.

Keys Ordered Separately for MKD and CMK cylinders

Part #	Description	List \$
45101	Cut key — change key, master key, construction key; SC, SE keyways	9.00
45401	Cut key — change key, master key, construction key; SKC keyways — D100 etc.	16.00
45102	Cut key — emergency key 75CYL; SC, SE keyways	28.00

NOTES:

- D100 keyway cylinders must be ordered 0-bitted or MKD; keys sold separately.
- Other restrictions apply. See Cylinders, Keys & Keying section for DORMA SKC policies.
- See Keys and Key Blanks section for complete list.

Small Format Interchangeable Core Hotel Cylinder

Ordering Guide

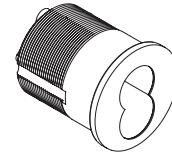
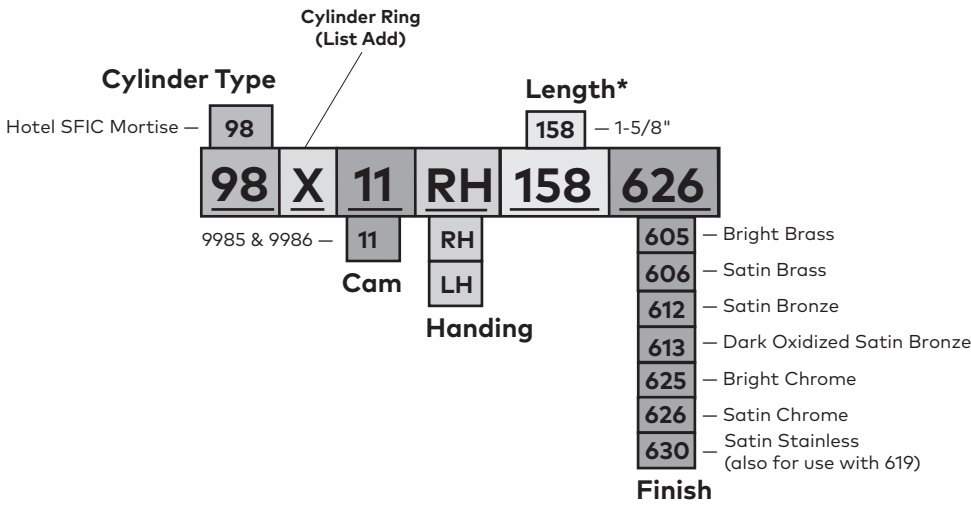

Cylinder without Ring

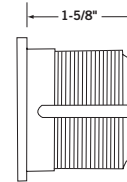

Length Includes Cam

* Extended length cylinders not available.

NOTES: • To order cores, refer to page 73.

Description	Example	All Finishes \$
Housing less core	98H11 00 158 626	80.00

1. For uncombined cores, UNC, cores must be ordered separately.

Small Format Interchangeable Cores

Ordering Guide

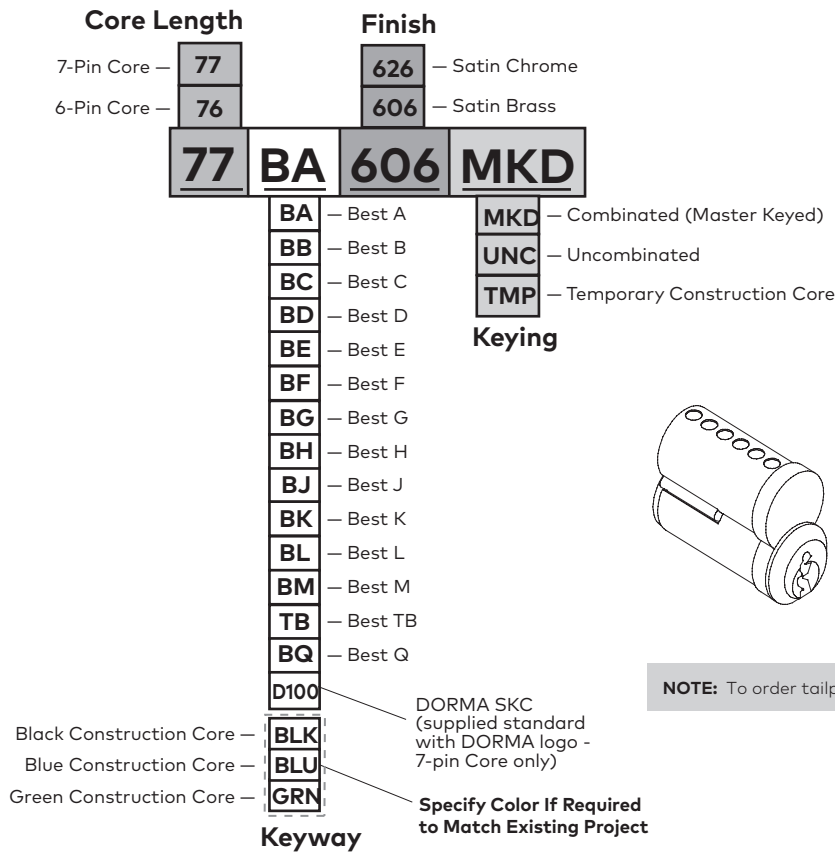

Description	Example	All Finishes \$
Uncombined core — Keys sold separately	77 BA 606 UNC	43.00
76 or 77 Series core, combined — Keys sold separately	77 BA 606 MKD	Add 28.00
Temporary construction core — Keys sold separately	77 XX 606 TMP	56.00

Cores may be returned for a full refund (Quantities limited; contact Customer Service for details)

- NOTES:**
- For locksets in 619, 625, 626, 629, and 630 finish, order cores in 626. For locksets in 605, 606, 612, and 613, order cores in 606.
 - SFIC cores are not available O-Bitted.
 - Denotes keys must be ordered separately.

Keys Ordered Separately

Part #	Description	List \$
45101	Cut key — change key, master key, control key; "B" keyways	9.00
45401	Cut key — change key, master key, control key; SKC keyways — D100 etc.	16.00
45103	Cut key — emergency key for M9985C "B" keyways	27.00
45403	Cut key — emergency key for M9985C D100 keyway	27.00

- NOTES:**
- D100 keyway cylinders must be ordered UNC or MKD; keys sold separately.
 - Other restrictions apply. See Cylinders, Keys & Keying section for DORMA SKC policies.
 - See Keys and Key Blanks section for complete list.

Service Items

Part #	Description	List \$
860051	Plastic construction core	7.00

Large Format Interchangeable Core

Ordering Guide

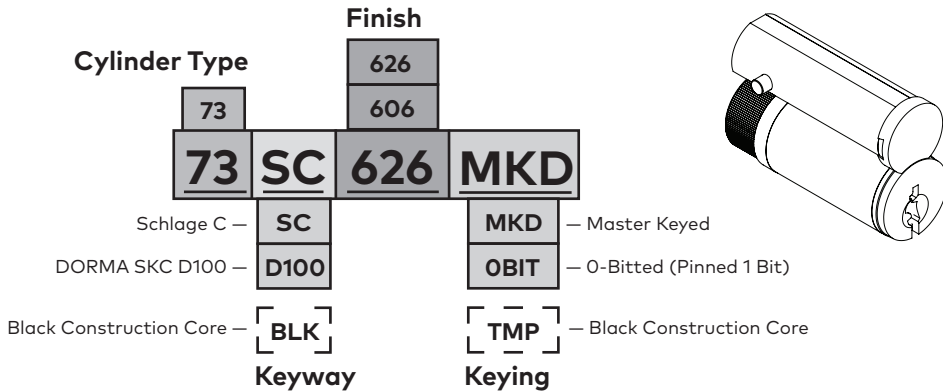

Large Format Interchangeable Cores

Keyway	Option	Example	Keys	All Finishes \$
SC	0-BIT	73 SC 626 0-BIT	2 Keys Ea. (Control Key Sold Separately)	62.00
SC	MKD	73 SC 626 MKD	Keys Sold Separately	90.00
D100	0-BIT	73 D100 626 0-BIT	Keys Sold Separately	62.00
D100	MKD	73 D100 626 MKD	Keys Sold Separately	90.00
SC	Temp Construction Core	73 BLK 626 TMP	Keys Sold Separately	76.00

NOTES:

- "O-bitted" SC cores come with (2) uncut keys, a 1-bit cut key is required to operate cylinder and must be ordered separately. Control key for removing and installing core must be ordered separately.
- "O-bitted" D100 cores do not come with keys. Keys must be ordered separately (pages 77–78).
- Distribution of DORMA SKC keys (listed as D100) is restricted. See Cylinders, Keys & Keying section for DORMA SKC policies.

Keys

Part #	Description	List \$
45101	Cut key — change key, master key, construction key — SC keyway	9.00
45401	Cut key — change key, master key, construction key — D100 keyway	16.00
45404	Cut key — 1-bit change key (to operate "1-bit" cores) — SC keyway	7.00
45405	Cut key — 1-bit control key (to install/remove "1-bit" LFIC cores) — SC keyway	7.00
44101SC	Key blank — SC keyway	5.00
44104SC	Key blank — Control key (to install/remove LFIC Cores) — SC keyway	6.00
44404D100	Key blank — control key — D100 76014824	21.00
45404D100	Cut key — control key — D100	27.00

Retrofit Interchangeable Core Cylinder Housings

Ordering Guides

Cylinder Type
Rim Cylinder Housing — 83

Cylinder Ring
Standard Ring — R

Tailpiece
40 — Long Horizontal
30 — Long Vertical

Retrofit Type
X7 — Sargent XC 11-P-7300B
Arrow Choice Plus CP7S
Arrow Choice Flex C7FS
Arrow Choice Base C7S
X6 — Arrow Choice Plus CP6S
Arrow Choice Flex C6FS
Arrow Choice Base C6S
R — Schlage FSIC

Finish
605 — Bright Brass
606 — Satin Brass
612 — Satin Bronze
613 — Dark Oxidized Satin Bronze
625 — Bright Chrome
626 — Satin Chrome
630 — Satin Stainless (also for use with 619)

Example Code: 83 R R 40 00 626

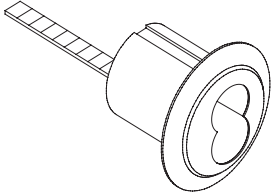

1. Interchangeable cores only available in R option (Schlage C) for these rim cylinder housings.

Cylinder Type
Interchangeable Core Housing — 93

Retrofit Type
R — Schlage FSIC
X6 — Arrow Choice Plus CP6S
Arrow Choice Flex C6FS
Arrow Choice Base C6S
X7 — Sargent XC 11-P-7300B
Arrow Choice Plus CP7S
Arrow Choice Flex C7FS
Arrow Choice Base C7S

Cylinder Ring (List Add)
X

Length
112 — 1-1/2" (R only)
134 — 1-3/4" (X7, X6 only)
138 — 1-3/8" (X7, X6 only)

Cam
01 — Adams Rite & dormakaba 134OKR Key Removable Mullion
02 — Adams Rite 4070
09 — dormakaba 9600, 9700 & 9800 Exit Z Trim w/09 or 12 Functions
10 — dormakaba M9050, 9080 & 9082 (2) Mortise Locks; dormakaba 9100, 9300, 9400 & 9500 Exit Y Trim/Options & Other Straight Cam Applications
11 — dormakaba M9056, 9080EL/EU, 9080ELRX/EURX 9082EL/EU & M9900 Mortise Locks w/Dead Bolts
12 — dormakaba M9053, 9070, 9071 (2), 9076, 9077 (2) & 9060 Inside Cylinder Mortise Locks
13 — dormakaba M9060 Outside Cylinder Mortise Locks; dormakaba 9600, 9700 & 9800 Exit Z Trim w/08 or 11 Functions
15 — Schlage Style Clover (L)
16 — dormakaba 5000 Series Exit J Trim, Sargent & Yale Narrow
19 — Best & CorbinRusswin Style Clover
30 — Falcon Dead Bolt Style Clover
31 — CorbinRusswin DL4000 Style

Finish
605 — Bright Brass
606 — Satin Brass
612 — Satin Bronze
613 — Dark Oxidized Satin Bronze
625 — Bright Chrome
626 — Satin Chrome
630 — Satin Stainless (also for use with 619)

Example Code: 93 R X 10 00 112 626

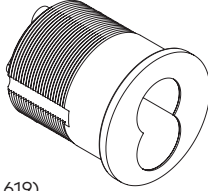

1. Interchangeable cores only available in R option (Schlage C) for these mortise cylinder housings.

Retrofit	Description	Example	All Finishes \$
Full Size Interchangeable Core Housing — Less Core			
R	Housing prepared for Schlage FSIC	83 R R 40 00 626 or 93 R G 10 00 112 626	71.00
Small Format Interchangeable Core Housings — Less Core			
X7 ¹	Housing prepared for Sargent XC 7P and Arrow Choice 7P	83 X7 R 40 00 626 or 93 X7 G 10 00 112 626	71.00
X6 ¹	Housing prepared for Arrow Choice 6P	83 X6 R 40 00 626 or 93 X6 G 10 00 112 626	71.00

NOTE: If temporary construction cores are required, consult technical services. FSIC housings X6 require 6-pin temporary cores; X7 require 7-pin temporary cores.

Tailpieces

C800 Lever	Tailpiece	Cylinder Type	Application	List \$
	6727D	Standard	All functions except C873, C885	8.00
	6728D	Standard	C873 function only	8.00
	6785D	Standard	C885 function only (hotel)	8.00
	6727C	SFIC	All functions except C873, C885	8.00
	6728C	SFIC	C873 function only	8.00
	6727R	R (Schlage FSIC)	All functions except C873	8.00
	6728R	R (Schlage FSIC)	C873 function only	8.00
	6727A	A (Corbin FSIC)	All functions except C873	8.00
	6728A	A (Corbin FSIC)	C873 function only	8.00
	6727M	M (Medeco 32 FSIC)	All functions except C873	8.00
	6728M	M (Medeco 32 FSIC)	C873 function only	8.00
	6727E	E (Corbin 2000 KIL)	All functions except C873	8.00
	6728E	E (Corbin 2000 KIL)	C873 function only	8.00
	6727N	N (Sargent 6300 FSIC)	All functions except C873	8.00
	6728N	N (Sargent 6300 FSIC)	C873 function only	8.00
	6727S	S (Sargent 10 Line KIL)	All functions except C873	8.00
	6728S	S (Sargent 10 Line KIL)	C873 function only	8.00
	6727Y	Y (Yale 1210/Medeco 31 FSIC)	All functions except C873	8.00
	6728Y	Y (Yale 1210/Medeco 31 FSIC)	C873 function only	8.00
C800 Knob				
	6727D	Standard	All functions except C873	8.00
	6728D	Standard	C873 function only	8.00
	6712C	SFIC	All functions except C873	8.00
	6729C	SFIC	C873 function only	8.00
CL700 Lever				
	6713D	Standard	All functions	8.00
	6713C	SFIC	All functions	8.00
CK700 Knob				
	6712D	Standard	All functions	8.00
	6712C	SFIC	All functions	8.00
C500 Tailpieces				
	6724D	Standard	All functions except C570	8.00
	6725D	Standard	C570 function only	8.00
	6724C	SFIC	All functions except C570	8.00
	6725C	SFIC	C570 function only	8.00
J300 Tailpieces				
	6732D	Standard	J353 (lever)	8.00
	6733D	Standard	All functions (deadbolt)	8.00
	6733C	SFIC	All functions (deadbolt)	8.00
	6732C	SFIC	J353 (lever)	8.00
C300 Tailpieces				
	6732D	Standard	C353	8.00

NOTE: 6727C & 6728C tailpieces for C800C accommodate both 6 & 7-pin cores.

D800 Tailpieces	Tailpiece	Cylinder Type	Application	List \$
	6718C	SFIC	D861	8.00
	6718D	Standard	D861	8.00
	6719C	SFIC	D860/D863	8.00
	6719D	Standard	D860/D863	8.00
	6720C	SFIC	D862	8.00
	6720D	Standard	D862	8.00
	6721C	SFIC	D862	8.00
	6721D	Standard	D862	8.00
	6726C	SFIC	D860/D863 long (4.5" door)	8.00
	6726D	Standard	D860/D863 (1-3/4"-2" door)	8.00
DB600 Tailpieces				
	6716D	Standard	D660	8.00
	6717D	Standard	D662	8.00
	6716C	SFIC	D660	8.00
	6717C	SFIC	D662	8.00

Miscellaneous Tailpieces/Parts

Part #	Description	List \$
76008829	Tailpiece, Rim cylinder	8.00
76009468	SFIC tailpiece spacer for use with 6-pin cores (except C800C Series)	4.00

Keys and Key Blanks

Key Blanks

Part #	Description	List \$
44101SC	SC section 6-pin (order in multiples of 50), w/DORMA logo	5.00
44101SE	SE section 6-pin (order in multiples of 50), w/DORMA logo	5.00
44101BA	BA section 7-pin (order in multiples of 50), w/DORMA logo and stamped DO NOT DUPLICATE	5.00
44401D100	D100 section 7-pin (order in multiples of 50), w/DORMA logo and stamped DO NOT DUPLICATE	7.00
44102SC	SC section emergency blank for C885D	25.00
44102SE	SE section emergency blank for C885D	25.00
44103BA	BA section emergency blank for M9985C and M9986C	27.00
44104SC	Key Blank – Control key (to install/remove LFIC Cores) SC keyway.	6.00
44403D100	D100 section emergency blank for M9985C and M9986C	28.00
44404D100	Key blank – control key – (to install/remove LFIC cores) D100 keyway	21.00
44303D400	D400 Emergency key blank for M9985 and M9986C	28.00

NOTE: Distribution of DORMA SKC keys (listed as D100) is restricted. See Cylinders, Keys & Keying section for DORMA SKC policies.

Cut Keys**Use cut key for master keys, change keys, control keys, construction keys, and emergency key for M9985 and M9986**

Part #	Description	List \$
45101	Cut key SC, SE, or B sections	9.00
45401D100	Cut key D100 section	16.00
45102SC	SC section emergency key for C885D	28.00
45102SE	SE section emergency key for C885D	28.00
45103	Emergency keys for SFIC, M9985C, and M9986C (specify B keyway)	28.00
45403D100	D100 section emergency key for M9985C and M9986C	28.00
45404D100	Cut key - control key (to install/remove LFIC cores) D100 keyway	28.00

NOTE: Distribution of DORMA SKC keys (listed as D100) is restricted. See Cylinders, Keys & Keying section for DORMA SKC policies.

Key Stamping

Part #	Description	List Add \$
—	Alpha-numeric non-standard key symbols, up to 6 characters	7.00
—	Do not duplicate or US Property Do Not Duplicate	7.00

NOTE: BB through BQ section key stamped DUPLICATION PROHIBITED

SFIC Padlocks

Ordering Guides

Cylinder Type

Shackle Length	T – SFIC, Temporary Core	Keying
	C – SFIC, with Core	
	J – SFIC, Less Core	

2" Shackle – 20	TMP – Temporary Construction Core
1" Shackle – 10	MKD – Combined (Master Keyed)

SFIC Heavy Duty Padlock – **P1 10 J 626 BA MKD**

Satin Chrome – **626**

Finish

BA – Best A
BB – Best B
BC – Best C
BD – Best D
BE – Best E
BF – Best F
BG – Best G
BH – Best H
BJ – Best J
BK – Best K
BL – Best L
BM – Best M
BQ – Best Q
TB – Best TB
D100 – DORMA SKC 7-Pin Only

Black Construction Core – **BLK**

Blue Construction Core – **BLU**

Green Construction Core – **GRN**

Keyway

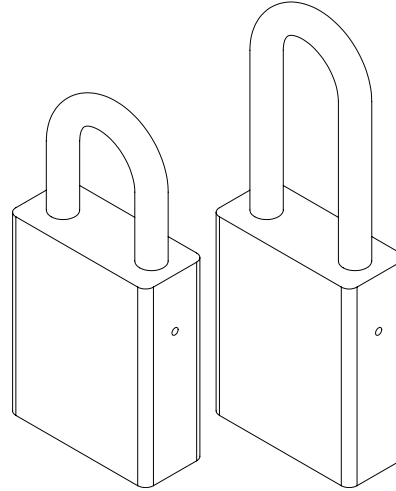

Description	List \$
P110 J 626 — SFIC Padlock with 1" shackle, less core	63.00
P120 J 626 — SFIC Padlock with 2" shackle, less core	73.00

Small Format Interchangeable Cores	List Add \$
T Temporary construction core — Cores may be returned for a full refund	56.00
J SFIC Core sold seperately	N/C
C Padlock with combinated SFIC core; BA (default). Shipped seperately BB, BC, BD, BE, BF, BG, BH, BJ, BK, BL, BM, BQ, D100 Keyway — Keys sold seperately	62.00

Cut Keys Ordered Seperately

Part #	Description	List \$
45101	Change key, master key, construction master key or control key; BA, BB, BC, BD, BE, BF, BG, BH, BJ, BK, BL, BM, BQ, SC, SE keyways	9.00
45401	Change key, master key or control key; SKC keyways — D100 etc.	16.00

Service Parts

Pin Kits

Part #	Description	List \$
76006942	Pin kit for SC and SE keyway conventional cylinders (0.015 dia. pins)	186.00
76006943	Pin kit for dormakaba small format IC (BA, BB, etc., A2 system; 0.108 dia. pins)	186.00
76007399	Pin kit for DORMA SKC (D100) SFIC and conventional cylinders (A2 system)	438.00

NOTE: 7-pin kit for DORMA SKC also pins B keyway SFIC.

Key Machine

Part #	Description	List \$
76007932	Code key machine for originating DORMA SKC keys, 120 VAC 60 Hz. 4 week lead time.	5745.00
76007934	Code key machine for originating DORMA SKC keys, 220 VAC 60 Hz. 4 week lead time.	6023.00
76007936	Replacement cutter for dormakaba key machines	549.00
76007938	Replacement belt for dormakaba key machines	88.00
76010077	DORMA SKC code card for HPC1200/Ilco Universal code machines	36.00

IC Capping Equipment

Part #	Description	List \$
76007939	Capsaver press for D100	2260.00
76010091	Manual capping set for D100 and B keyways (capping block and capping tool)	247.00
76010076	SFIC decombining block and ejector tool (for B keyways only)	221.00
76010074	Capping tool for manual capping	59.00
76010075	Ejector tool for decombining	35.00
76010068	Capping strips (pack of 50)	83.00
76010069	Individual caps for manual capping (pack of 500)	26.00

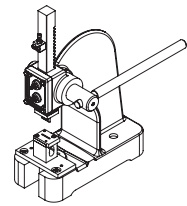

Capsaver Press

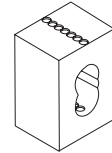

Capping Block



Capping Tool



Ejector Tool

Tools and Service Items

Part #	Description	List \$
76010070	Small format IC housing installation wrench	116.00
76010071	Pin tumbler tweezers	47.00
76010072	Cylinder shims (pack of 25; for servicing conventional cylinders)	19.00
76007846	Follower (for servicing all dormakaba conventional cylinders)	14.00
76010246	DORMA SKC sample set	170.00
76010534	BA sample set, 626	83.00
76010535	BA sample set, 606	83.00

Replacement Pins, A2 System

Part #	Description (Order in multiples of 100) — Price is per pin	List \$
76007952	SKC Spring	0.13
76007953	SKC full size 0 bottom pin .185"	0.28
76007954	SKC full size 1 bottom pin .1975"	0.28
76007955	SKC full size 2 bottom pin .210"	0.28
76007956	SKC full size 3 bottom pin .2225"	0.28
76007957	SKC full size 4 bottom pin .235"	0.28
76007958	SKC full size 5 bottom pin .2475"	0.28
76007959	SKC full size 6 bottom pin .260"	0.28
76007960	SKC full size 7 bottom pin .2725"	0.28
76007961	SKC full size 8 bottom pin .285"	0.28
76007962	SKC full size 9 bottom pin .2975"	0.28
76007963	SKC full size A top pin .200"	0.28
76007964	SKC full size B top pin .235"	0.28
76007965	SKC full size C top pin .285"	0.28
76007966	SKC full size D top pin .2975"	0.28
76010031	SFIC/SKC size 2 top .025"	0.16
76010032	SFIC/SKC size 3 top .0375"	0.16
76010033	SFIC/SKC size 4 top .050"	0.16
76010034	SFIC/SKC size 5 top .0625"	0.16
76010035	SFIC/SKC size 6 top .075"	0.16
76010036	SFIC/SKC size 7 top .0875"	0.16
76010037	SFIC/SKC size 8 top .100"	0.16

Part #	Description (Order in multiples of 100) — Price is Per Pin	List \$
76010038	SFIC/SKC size 9 top .1125"	0.16
76010039	SFIC/SKC size 10 top .125"	0.16
76010040	SFIC/SKC size 11 top .1375"	0.16
76010041	SFIC/SKC size 12 top .150"	0.16
76010042	SFIC/SKC size 13 top .1625"	0.16
76010043	SFIC/SKC size 14 top .175"	0.16
76010044	SFIC/SKC size 15 top .1875"	0.16
76010045	SFIC/SKC size 16 top .200"	0.16
76010046	SFIC/SKC size 17 top .2125"	0.16
76010047	SFIC/SKC size 18 top .225"	0.16
76010048	SFIC/SKC size 19 top .2375"	0.16
76010049	SFIC/SKC size 0 bottom pin .110"	0.16
76010050	SFIC/SKC size 1 bottom pin .1225"	0.16
76010051	SFIC/SKC size 2 bottom pin .135"	0.16
76010052	SFIC/SKC size 3 bottom pin .1475"	0.16
76010053	SFIC/SKC size 4 bottom pin .160"	0.16
76010054	SFIC/SKC size 5 bottom pin .1725"	0.16
76010055	SFIC/SKC size 6 bottom pin .185"	0.16
76010056	SFIC/SKC size 7 bottom pin .1975"	0.16
76010057	SFIC/SKC size 8 bottom pin .210"	0.16
76010058	SFIC/SKC size 9 bottom pin .2225"	0.16

Labeling and Cylinder Marking

Each product on a contract order is automatically labeled with door number, keying information, and hardware set information. This information is placed on a special secondary label. **There is no extra charge for this service.**

In addition to the secondary label, we mark our cylinders with our key symbol in a concealed location using a water-resistant marker. If the cylinder needs to be rekeyed, the marking can be rubbed off without damaging the cylinder.

We do not recommend permanent marking for cylinders, but if required, we can mark the cylinder in a concealed location with up to six characters, or in a visible location (plug or core face) with up to four characters.

Permanent marking voids the warranty with regards to finish and adds \$5 list to the price of each cylinder.

Visible Cylinder Marking Locations

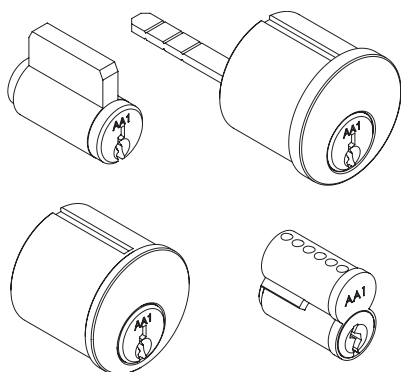

Concealed Cylinder Marking Locations

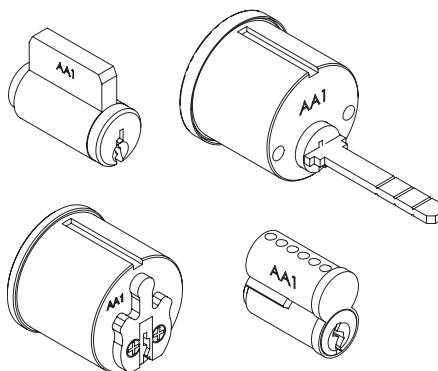

Exit Devices

Product Guide (1 of 2)

GRADE 1 EXIT DEVICES	Concealed Vertical Rod	Rim	Surface Vertical Rod	Mortise
Architectural Wide Stile 9000 Series Panic and Fire Rated	9100	9300	9400	9500
Architectural Narrow Stile 9000 Series Panic and Fire Rated	9600	9700	9800	—
Wide Stile 8000 Series Panic and Fire Rated	—	8300	8400	—

Architectural Mullions 1300 Series Panic/Fire Rated	Aluminum 1-5/8" x 2-5/8" 1310 Panic Rated	Steel 1-1/2" x 2-1/2" 1330 Panic Rated	Steel 2" x 3" 1300 Panic/Fire Rated	Steel 2" x 3" HC1300 Hurricane Rated	Steel 2" x 3" 1340 Key Removable Panic/Fire Rated
--	--	---	--	---	---

Exit Devices

Product Guide (1 of 2)

<input checked="" type="radio"/> Yes <input type="radio"/> No	A156.3 Grade 1	EN1125 Grade 1	5 Mil Extended Cycle Test	Latch Bolt Load Rated	Hurricane Rated	Plated Finishes	Powder Coat Finishes	Fire Rated	Panic Rated	Escutcheon Trim	Sectional Trim	Plate and Pull Trim	Electric Latch Retraction	Delayed Egress
8300 Rim Wide Stile	<input checked="" type="radio"/>	<input type="radio"/>	<input type="radio"/>	<input type="radio"/>	<input checked="" type="radio"/>	<input type="radio"/>	<input checked="" type="radio"/>	<input checked="" type="radio"/>	<input checked="" type="radio"/>	<input checked="" type="radio"/>	<input checked="" type="radio"/>	<input checked="" type="radio"/>	<input checked="" type="radio"/>	<input type="radio"/>
8400 SVR Wide Stile	<input checked="" type="radio"/>	<input type="radio"/>	<input type="radio"/>	<input type="radio"/>	<input checked="" type="radio"/>	<input type="radio"/>	<input checked="" type="radio"/>	<input checked="" type="radio"/>	<input checked="" type="radio"/>	<input checked="" type="radio"/>	<input checked="" type="radio"/>	<input checked="" type="radio"/>	<input checked="" type="radio"/>	<input type="radio"/>
9300 Rim Wide Stile	<input checked="" type="radio"/>	<input type="radio"/>	<input checked="" type="radio"/>	<input checked="" type="radio"/>	<input checked="" type="radio"/>	<input checked="" type="radio"/>	<input checked="" type="radio"/>	<input checked="" type="radio"/>	<input checked="" type="radio"/>	<input checked="" type="radio"/>	<input checked="" type="radio"/>	<input checked="" type="radio"/>	<input checked="" type="radio"/>	<input checked="" type="radio"/>
9100 CVR Wide Stile	<input checked="" type="radio"/>	<input type="radio"/>	<input checked="" type="radio"/>	<input type="radio"/>	<input type="radio"/>	<input checked="" type="radio"/>	<input checked="" type="radio"/>	<input checked="" type="radio"/>	<input checked="" type="radio"/>	<input checked="" type="radio"/>	<input checked="" type="radio"/>	<input checked="" type="radio"/>	<input checked="" type="radio"/>	<input checked="" type="radio"/>
9400 SVR Wide Stile	<input checked="" type="radio"/>	<input type="radio"/>	<input checked="" type="radio"/>	<input type="radio"/>	<input checked="" type="radio"/>	<input checked="" type="radio"/>	<input checked="" type="radio"/>	<input checked="" type="radio"/>	<input checked="" type="radio"/>	<input checked="" type="radio"/>	<input checked="" type="radio"/>	<input checked="" type="radio"/>	<input checked="" type="radio"/>	<input type="radio"/>
9500 Mortise Wide Stile	<input checked="" type="radio"/>	<input type="radio"/>	<input checked="" type="radio"/>	<input type="radio"/>	<input checked="" type="radio"/>	<input checked="" type="radio"/>	<input checked="" type="radio"/>	<input checked="" type="radio"/>	<input checked="" type="radio"/>	<input checked="" type="radio"/>	<input type="radio"/>	<input checked="" type="radio"/>	<input type="radio"/>	<input checked="" type="radio"/>
9700 Rim Narrow Stile	<input checked="" type="radio"/>	<input checked="" type="radio"/>	<input checked="" type="radio"/>	<input checked="" type="radio"/>	<input type="radio"/>	<input checked="" type="radio"/>	<input checked="" type="radio"/>	<input checked="" type="radio"/>	<input checked="" type="radio"/>	<input checked="" type="radio"/>	<input checked="" type="radio"/>	<input checked="" type="radio"/>	<input checked="" type="radio"/>	<input checked="" type="radio"/>
9600 CVR Narrow Stile	<input checked="" type="radio"/>	<input checked="" type="radio"/>	<input checked="" type="radio"/>	<input type="radio"/>	<input type="radio"/>	<input checked="" type="radio"/>	<input checked="" type="radio"/>	<input checked="" type="radio"/>	<input checked="" type="radio"/>	<input checked="" type="radio"/>	<input checked="" type="radio"/>	<input checked="" type="radio"/>	<input checked="" type="radio"/>	<input checked="" type="radio"/>
9800 SVR Narrow Stile	<input checked="" type="radio"/>	<input checked="" type="radio"/>	<input checked="" type="radio"/>	<input type="radio"/>	<input type="radio"/>	<input checked="" type="radio"/>	<input checked="" type="radio"/>	<input checked="" type="radio"/>	<input checked="" type="radio"/>	<input checked="" type="radio"/>	<input checked="" type="radio"/>	<input checked="" type="radio"/>	<input checked="" type="radio"/>	<input type="radio"/>

Handing

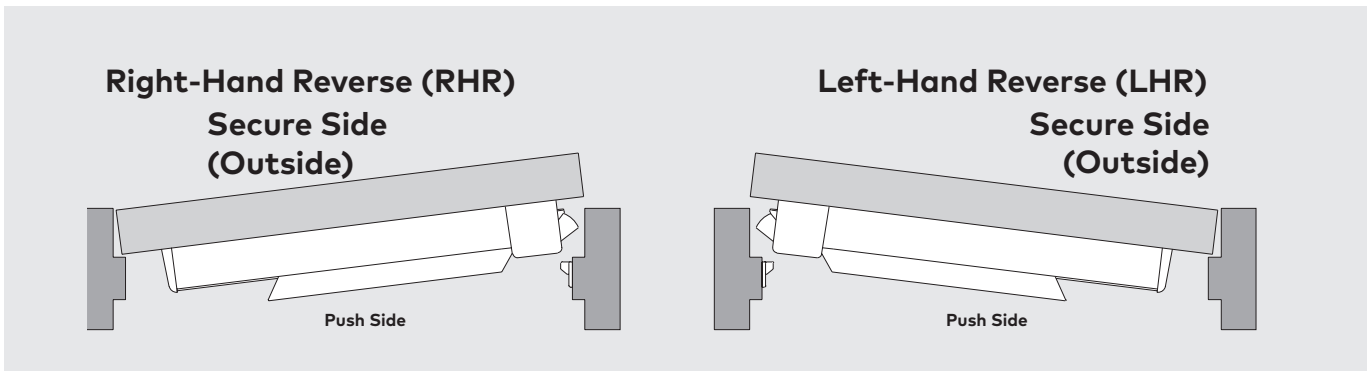

9000 Series Exit Devices

How to Order

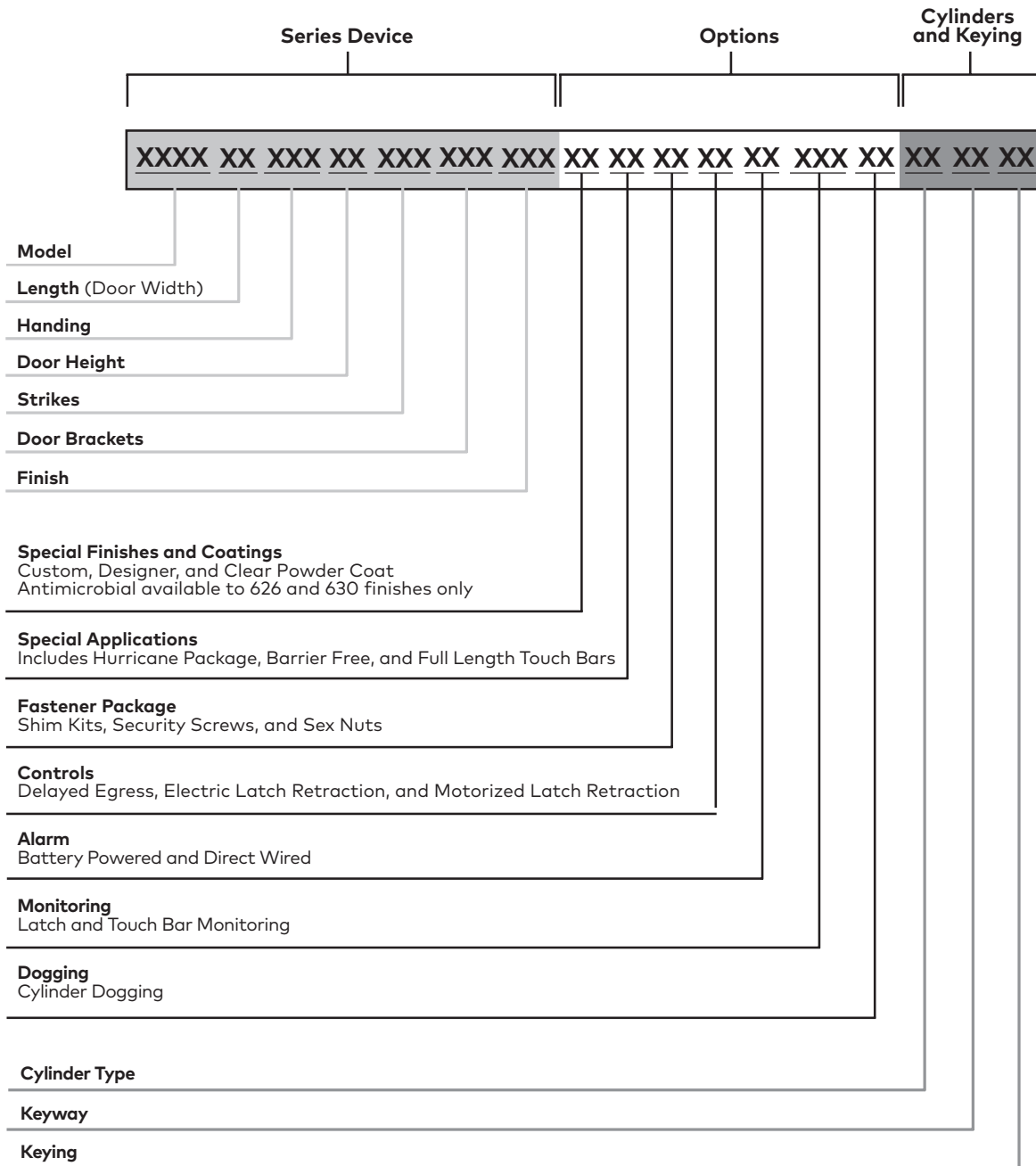

9100 Series

Wide Stile Concealed Vertical Rod Exit Device

9100 Series Device								Options (Specify)							Cylinders and Keying			
Device	Length	Touchbar	Handing	Door Height	Top Strike	Bottom Strike	Finish	Special Finish Coating	Bottom Latch	Alum Door Latch	Fastener Package	Control	Alarm	Monitoring	Dogging	Cylinder Type	Keyway	Keying
9100	B		RHR	7	418	439	630									D	SC	KD
F9100	A	FL	RHR	7	418	340	605	*AM	LB	ALD	SK	DE	BPA	LM	CD	T	CA	KD
9100	B		LHR	8	419	431	606	**PC	PB		SNB	DE30	BPAR	MS	LD	J	CD	KA2
	C			9		439	611		SB		TX	ES	DWA	LMMS		C	CE	KA4
	SPCL			10			612				SKTX	DECBC		LMMSBP		L	*D100	NSK
				SPCL			613				SKSNB	MLR				D	GA	MKD
							619				TXSNB					G	RA	CMK
							625				SKTXSNB					R	RB	SKD
							626									F	SC	OBit
							628								X6		SE	
							629								X7		SF	
							630										YA	
							689										YG	
							691											
							693											
							695											
							696											
							Custom											
							Designer											

— Default

— Supplied with Standard KD Cylinder

***Patented Key Control**
D100 is the keyway for our patented **SKC** serialized key control system. **SKC** is internet based and provides added layers of security. For more information, contact your local sales representative or Technical Service at 800-387-4938.

9000 Series – Wide Stile Applications

Device Length	All Device Options (except BA, DA, or DE)		BA or DA Device Options	DE Device Option
	Maximum Door Width ¹	Minimum Door Width ²	Minimum Door Width ²	Minimum Door Width ²
A	48" (1220 mm)	34" (864 mm)	39" (991 mm)	41" (1042 mm)
B	36" (915 mm)	28" (712 mm)	33" (839 mm)	35" (889 mm)
C	30" (762 mm)	25" (635 mm)	30" (762 mm)	N/A

- As delivered from factory, device will fit doors of this width. For other widths, consult Technical Services.
- Touch bar and rail assembly can be shortened at time of installation to fit doors down to this width.

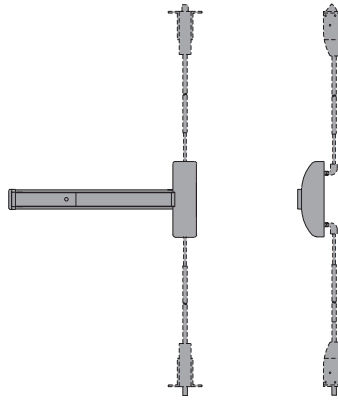

			Available Finishes \$			
			689, 691, 693, 695, 696	630	606, 612, 613, 619	605, 611, 625, 626, 629**
Function	Description	Device, Exit Only				
01	Panic	9100 Concealed vertical rod	2414.00	2876.00	2905.00	3089.00
01	Fire	F9100 Concealed vertical rod	2682.00	3135.00	3166.00	3344.00

Typical Options

Item	Description	List Add \$
ALD	Wide Stile aluminum door bracket (9100 Series)	N/C
CD	Cylinder dogging (Includes cylinder)	123.00
LD	Less dogging (Standard with fire rated device)	N/C
AM	Antimicrobial coating	110.00
SNB	Sex nuts (Included with F and HC Options)	24.00
TX	Security screws	49.00
FL	Full length touchbar (Not Available DE)	N/C
LB	Less bottom rod	N/C
PB	Pullman bottom latch	74.00
SB	Slide bolt (Default)	N/C
Up to 8'	7' to 8' Adjustable	N/C
Up to 10'	Door Heights over 8' to 10'	— 149.00 — —

** For 629 finish, please allow 4 week lead time.

NOTES:

- Prices shown apply to A, B, or C length devices.
- Specify door width and handing. If not specified, Size B, RHR is the standard default.
- List price includes default strikes. For optional strikes, specify strike number and adjust list price accordingly.
- List price for the device does not include trim.
- Devices include wood and machine screws standard.
- Fire and hurricane rated devices include SNB sex nuts standard.
- For options requiring a cylinder, the option list price includes the default cylinder.
- Device includes precut and drilled rods for 7' to 8' doors.
For 9' doors, device includes precut and drilled rods for a 7' door and a 2' rod extension for the top rod. Specify 9' on order. For 10' doors, device includes precut and drilled rods for an 8' door and a 2' rod extension for the top rod. Specify 10' on order.
See Device Options for pricing information.
- For special lengths and/or door heights over 10', consult Technical Service.
- All standard devices and trim are designed for 1-3/4"-2-1/4" thick doors. For door thickness greater than 2-1/4", consult Technical Service.
- **ALD** for Wide and Narrow Stile aluminum.

9300 Series

Wide Stile Rim Exit Device

9300 Series Device					Options (Specify)							Cylinders and Keying		
Device	Length	Touchbar	Strike	Finish	Special Finish Coating	Special Application Package	Fastener Package	Control	Alarm	Monitoring	Dogging	Cylinder Type	Keyway	Keying
9300	B		463	630								D	SC	KD
F9300	A	FL	320	605	*AM	HC	SK	DE	BPA	LM	CD	T	CA	KD
9300	B		430	606	**PC	**BF	SNB	DE30	BPAR	MS	LD	J	CD	KA2
	C		463	611			TX	ES	DWA	LMMS		C	CE	KA4
	SPCL		486	612			SKTX	DECBC		LMMSBP		L	*D100	NSK
				613			SKSNB	MLR				D	GA	MKD
				619			TXSNB					G	RA	CMK
				625			SKTXSNB					R	RB	SKD
				626								F	SC	OBIt
				629								X6	SE	
				630								X7	SF	
				689								YA		
				691								YG		
				693										
				695										
				696										
Custom					** Barrier Free option availability:									
Designer					Exit Device	Functions	Electric Options	Device Lengths	Ratings					
					9300BF	01, 02, 03, 05, 08, 23	ES, BA, B4, LM, MS, LM/MS, LM/MS/BP	36" & 48"	Panic & Fire					

 - Default

 - Supplied with Standard KD Cylinder

***Patented Key Control**
D100 is the keyway for our patented **SKC** serialized key control system. **SKC** is internet based and provides added layers of security. For more information, contact your local sales representative or Technical Service at 800-387-4938.

9000 Series – Wide Stile Applications

Device Length	All Device Options (except BA, DA, or DE)		BA or DA Device Options	DE Device Option
	Maximum Door Width ¹	Minimum Door Width ²	Minimum Door Width ²	Minimum Door Width ²
A	48" (1220 mm)	34" (864 mm)	39" (991 mm)	41" (1042 mm)
B	36" (915 mm)	28" (712 mm)	33" (839 mm)	35" (889 mm)
C	30" (762 mm)	25" (635 mm)	30" (762 mm)	N/A

1. As delivered from factory, device will fit doors of this width. For other widths, consult Technical Services.

2. Touch bar and rail assembly can be shortened at time of installation to fit doors down to this width.

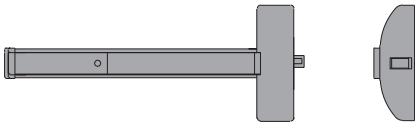

			Available Finishes \$			
			689, 691, 693, 695, 696	630	606, 612, 613, 619	605, 611, 625, 626, 629**
Function	Description	Device, Exit Only				
01	Panic	9300 Rim	1180.00	1848.00	1865.00	2006.00
01	Fire	F9300 Rim	1415.00	2076.00	2095.00	2229.00

Typical Options

Item	Description	List Add \$
CD	Cylinder dogging (Includes cylinder)	120.00
LD	Less dogging (Standard with fire rated device)	N/C
AM	Antimicrobial coating	106.00
SNB	Sex nuts (Included with F and HC Options)	23.00
TX	Security screws	46.00
HC	Hurricane (Includes SNB)	222.00
BF	Barrier free exit device, meets California Building Code (Section 11B-309.4) requirements for maximum 5 lb operating force. "	65.00
FL	Full length touchbar (Not Available DE)	N/C

**** For 629 finish, please allow 4 week lead time.**



NOTES:

- Prices shown apply to A, B, or C length devices.
- Specify door width. If not specified, Size B is the standard default.
- List price includes default strikes. For optional strikes, specify strike number and adjust list price accordingly.
- List price for the device does not include trim.
- Devices include wood and machine screws standard.
- Fire and hurricane rated devices include 463 rim strike and SNB sex nuts standard.
- For options requiring a cylinder, the option list price includes the default cylinder.
- For special lengths, consult Technical Service.
- All standard devices and trim are designed for 1-3/4" -2-1/4" thick doors. For door thickness greater than 2-1/4", consult Technical Service.

9400 Series

Wide Stile Surface Vertical Rod Exit Device

9400 Series Device							Options (Specify)							Cylinders and Keying				
Device	Length	Touchbar Handling	Door Height	Top Strike	Bottom Strike	Finish	Special Finish Coating	Bottom Latch	Special Application Package	Fastener Package	Control	Alarm	Monitoring	Dogging	Cylinder Type	Keyway	Keying	
9400	B		RHR	7	426	439	630								D	SC	KD	
F9400	A	FL	RHR	7	426	340	605	*AM	LB	HC	SK	ES	BPA	LM	CD	T	CA	KD
9400	B		LHR	8	426A	416V	606	**PC	PB		SNB	MLR	BPAR	MS	LD	J	CD	KA2
	C			9		431	611		SB		TX		DWA	LMMS		C	CE	KA4
	SPCL			10		439	612				SKTX			LMMSBP		L	*D100	NSK
			SPCL				613				SXSNB					D	GA	MKD
							619				TXSNB					G	RA	CMK
							625				SKTXSNB					R	RB	SKD
							626									F	SC	OBIt
							629								X6		SE	
							630								X7		SF	
							689										YA	
							691										YG	
							693											
							695											
							696											
							Custom											
							Designer											

 — Default
 — Supplied with Standard KD Cylinder

***Patented Key Control**
 D100 is the keyway for our patented SKC serialized key control system. SKC is internet based and provides added layers of security. For more information, contact your local sales representative or Technical Service at 800-387-4938.

9000 Series – Wide Stile Applications

Device Length	All Device Options (except BA or DA)		BA or DA Device Options
	Maximum Door Width ¹	Minimum Door Width ²	Minimum Door Width ²
A	48" (1220 mm)	34" (864 mm)	39" (991 mm)
B	36" (915 mm)	28" (712 mm)	33" (839 mm)
C	30" (762 mm)	25" (635 mm)	30" (762 mm)

- As delivered from factory, device will fit doors of this width. For other widths, consult Technical Services.
- Touch bar and rail assembly can be shortened at time of installation to fit doors down to this width.

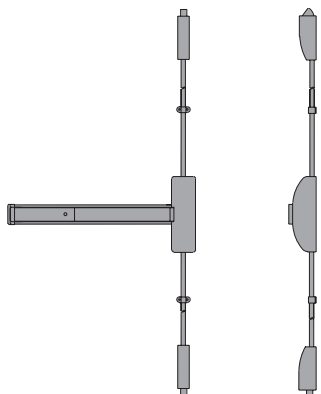

Available Finishes \$

			689, 691, 693, 695, 696	630	606, 612, 613, 619	605, 611, 625, 626, 629**
Function	Description	Device, Exit Only				
01	Panic	9400 Surface vertical rod	2360.00	2692.00	2719.00	2933.00
01	Fire	F9400 Surface vertical rod	2627.00	2954.00	2981.00	3185.00

Typical Options

Item	Description	List Add \$
CD	Cylinder dogging (Includes Cylinder)	123.00
LD	Less dogging (Standard with fire rated device)	N/C
AM	Antimicrobial coating	110.00
SNB	Sex nuts (included with F and HC options)	24.00
TX	Security screws	49.00
HC	Hurricane (Includes SNB)	229.00
FL	Full length touchbar (Not Available DE)	N/C
LB	Less bottom rod	N/C
PB	Pullman bottom latch	74.00
SB	Slide bolt (Default)	N/C
Up to 8'	7' Default	N/C
Up to 10'	Door Heights over 8' to 10'	75.00 149.00 149.00 149.00

** For 629 finish, please allow 4 week lead time.

NOTES:

- Prices shown apply to A, B, or C length devices.
- Specify door width and handing. If not specified, Size B, RHR is the standard default.
- List price includes default strikes. For optional strikes, specify strike number and adjust list price accordingly.
- List price for the device does not include trim.
- Devices include wood and machine screws standard.
- Fire and hurricane rated devices include SNB sex nuts standard.
- For options requiring a cylinder, the option list price includes the default cylinder.
- Device includes precut and drilled rods for 7' or 8' doors as specified on order.
- For 9' doors, device includes precut and drilled rods for a 7' door and a 2' rod extension for the top rod.
- For 10' doors, device includes precut and drilled rods for an 8' door and a 2' rod extension for the top rod.
- See Device Options for pricing information.
- For special lengths and/or door heights over 10', consult Technical Service.
- All standard devices and trim are designed for 1-3/4"-2-1/4" thick doors. For door thickness greater than 2-1/4", consult Technical Service.

9500 Series

Wide Stile Mortise Exit Device

9500 Series Device							Options (Specify)							Cylinders and Keying			
Device	Length	Touchbar	Function	Handing	Strike	Finish	Special Finish Coating	Special Application Package	Fastener Package	Electric Locking	Control	Alarm	Monitoring	Dogging	Cylinder Type	Keyway	Keying
9500	B		08	RHR	465	630									D	SCKD	
F9500	A	FL	01	RHR	465	605	*AM	HC	SK	LFSC	DE	BPA	LM	CD	T	CA	KD
9500	B		03	LHR	565	606	**PC	**BF	SNB	LFSF	DE30	BPAR	MS	LD	J	CD	KA2
	C		05			611			TX		DECBC	DWA	LMMS		C	CE	KA4
	SPCL		08			612			SKTX		MLR		LMMSBP		L	D100	NSK
			22			613			SXSNB						D	GA	MKD
						619			TXSNB						G	RA	CMK
						625			SKTXSNB						R	RB	SKD
						626									F	SC	OBit
						629								X6	SE		
						630								X7	SF		
						689									YA		
						691									YG		
						693											
						695											
						696											
						Custom											
						Designer											

– Default

– Supplied with Standard KD Cylinder

***Patented Key Control**
D100 is the keyway for our patented **SKC** serialized key control system. **SKC** is internet based and provides added layers of security. For more information, contact your local sales representative or Technical Service at 800-387-4938.

**** Barrier Free option availability:**

Exit Device	Functions	Electric Options	Device Lengths	Ratings
9500BF	01, 02, 03, 05, 08, 23	ES, BA, B4, LM, MS, LM/MS, LM/MS/BP	36" & 48"	Panic & Fire

9000 Series – Wide Stile Applications

Device Length	All Device Options (except BA, DA, or DE)		BA or DA Device Options	DE Device Option
	Maximum Door Width ¹	Minimum Door Width ²	Minimum Door Width ²	Minimum Door Width ²
A	48" (1220 mm)	34" (864 mm)	39" (991 mm)	41" (1042 mm)
B	36" (915 mm)	28" (712 mm)	33" (839 mm)	35" (889 mm)
C	30" (762 mm)	25" (635 mm)	30" (762 mm)	N/A

1. As delivered from factory, device will fit doors of this width. For other widths, consult Technical Services.
 2. Touch bar and rail assembly can be shortened at time of installation to fit doors down to this width.

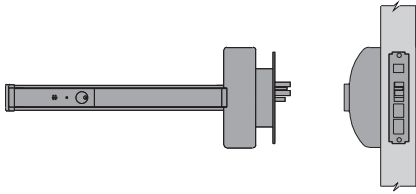

Function	Description	Device, Exit Only	Available Finishes \$			
			689, 691, 693, 695, 696	630	606, 612, 613, 619	605, 611, 625, 626, 629**
01	Panic	9500 Mortise	2109.00	2587.00	2613.00	2732.00
01	Fire	F9500 Mortise	2344.00	2814.00	2842.00	2950.00

Typical Options

Item	Description	List Add \$
CD	Cylinder dogging (Includes Cylinder)	120.00
LD	Less dogging (Standard with fire rated device)	N/C
AM	Antimicrobial coating	106.00
SNB	Sex nuts (Included with F and HC options)	23.00
TX	Security screws	46.00
HC	Hurricane (Includes SNB)	222.00
FL	Full length touchbar (Not Available DE)	N/C
BF	Barrier free exit device, meets California Building Code (Section 11B-309.4) requirements for maximum 5 lb operating force. "	65.00
LF5F	Fail safe, electric locking of mortise lock (requires DKPS-2A power supply and ES105 power transfer)	1294.00
LF5C	Fail secure, electric unlocking of mortise lock (requires DKPS-2A power supply and ES105 power transfer)	1294.00

** For 629 finish, please allow 4 week lead time.

NOTES:

- Prices shown apply to A, B, or C length devices.
- Specify door width and handing. If not specified, Size B, RHR is the standard default.
- List price includes default strikes. For optional strikes, specify strike number and adjust list price accordingly.
- List price for the device does not include trim.
- Devices include wood and machine screws standard.
- Fire and hurricane rated devices include SNB sex nuts standard.
- For options requiring a cylinder, the option list price includes the default cylinder.
- For special lengths, consult Technical Service.
- All standard devices and trim are designed for 1-3/4"–2-1/4" thick doors. For door thickness greater than 2-1/4", consult Technical Service.

Wide Stile Dummy Bars

Available Finishes \$

Item	Description	Available Finishes \$			
		689, 691, 693, 695, 696	630	606, 612, 613, 619	605, 611, 625, 626, 629**
Dummy Touchbars					
9030	Rigid dummy touchbar	751.00	1094.00	1132.00	1132.00
9030MS	Dummy touchbar w/ microswitch	1113.00	1401.00	1417.00	1417.00
9035	Rigid touchbar	751.00	1132.00	1132.00	1132.00
9036	Moveable touchbar	751.00	1132.00	1132.00	1132.00
9036MS	Moveable touchbar w/ microswitch	1113.00	1401.00	1417.00	1417.00

**** For 629 finish, please allow 4 week lead time.**

NOTE: Dummy touchbars available in all rail sizes: A, B or C

Wide Stile Options

Option Code	Description	List Add \$
Strikes		
9100, 9400 Concealed and Surface Vertical Rods		
340	Flat slide bolt bottom strike (9100 and 9400 Series)	N/C
416V	Surface bottom strike for pullman latch (9400)	N/C
418	Standard top strike (9100 Series)	N/C
419	Wood frame top strike (9100 Series)	24.00
426	Standard top strike (9400 Series)	N/C
426A	Top strike w/angle (9400 Series)	39.00
431	Recessed bottom strike for pullman latch (9100 and 9400 Series)	39.00
439	Standard slide bolt bottom strike (9100 and 9400 Series)	N/C
9300 Rim Devices		
320	Overlap strike	39.00
430	Rim box strike	61.00
463	Standard rim strike (default/no charge for 9300/F9300)	N/A
486	Roller strike	24.00
9500 Mortise		
465	Standard mortise strike	N/C
565	Open back strike	39.00
Special Finishes and Coatings		
AM	Antimicrobial protected coating	110.00
P	Clear powder coat	110.00
Custom Color	Custom painted finish selected from RAL color pallet book. For details, see Finishes Cross Reference , page viii.	
	Per order, setup charge (Net)	168.00
	per exit device only, list add	85.00
	per trim only, list add	85.00
Designer Color	Designer painted color matched to supplied samples. Three (3) each 2" x 3" color chip samples required. For details, see Finishes Cross Reference , page viii.	
	per order, non-refundable development/setup charge (Net)	608.00
	per exit device only, list add	85.00
	per trim only, list add	85.00
Bottom Latches for 9100 Concealed Vertical Rods & 9400 Surface Vertical Rods		
LB	Less bottom rod	N/C
PB	Pullman bottom latch	74.00
SB	Slide bolt (Default)	N/C
Door Height Designation		
9100 Concealed Vertical Rods		
7 or 8	Door heights from 7' to 8' adjustable	N/C
9 or 10	Door heights over 8', up to 10'	75.00
Over 10'	Contact DORMA Technical Service for assistance	
9400 Surface Vertical Rods		
7 or 8	Door heights from 7' to 8' (7' Default)	N/C
9 or 10	Door heights over 8', up to 10'	
	For 689, 691, 693, 695, 696 finishes	75.00
	For 605, 606, 611, 612, 613, 619, 625, 626, 630 finishes	149.00
Over 10'	Consult DORMA Technical Service	

Wide Stile Options (continued)

Option Code	Description	List Add \$
Special Application Packages		
HC	Hurricane (9300, 9400, and 9500 Series only) Includes SNB	229.00
BF	Barrier free, meets CBC (Section 11B-309.4) requirements for max. 5 lb operating force (9300, 9500)	64.00
FL	Full length touchbar (Not Available DE)	N/C
Fastener Package		
SK	Shim kit	121.00
SNB	Sex nuts	24.00
TX	Security screws	49.00
SKTX	Shim kit and security screws	192.00
SKSNB	Shim kit and sex nuts	145.00
TXSNB	Security screws and sex nuts	95.00
SKTXSNB	Shim kit, security screws, and sex nuts	213.00
Electronic Controls		
DE*	Delayed egress (requires ES100 power supply and ES105 power transfer)	2272.00
DE30*	Delayed egress, 30 second (requires special approval from authority having jurisdiction)	2812.00
DECBC*	Delayed egress, CBC compliant	2812.00
MLR	Motorized Latch Retraction/dogging (use DKPS-2A power supply—2 MLR's)	1272.00
ES	Electric latch retraction (requires PS501 power supply and ES105 power transfer)	1204.00
Alarm		
BA*	Battery powered alarm	835.00
B4*	Battery powered alarm, 4 minute reset	890.00
DA*	Direct wired alarm	835.00
Monitoring		
LM	Latch bolt monitoring	329.00
MS	Monitor switch in touchbar	329.00
LMMS	Latch bolt and touchbar monitor	656.00
LMMSBP*	Latch bolt and touchbar monitor with bypass	656.00
Dogging		
CD*	Cylinder dogging (panic devices only)	123.00
LD	Less dogging (panic devices only)	N/C
MD	Electric dogging (requires DKPS-2A power supply)	1099.00
Power Supplies, Power Transfers, Power Modules		
AD100	Export power supply for up to 2 ES or LFSF/LFSC or 1 DE device 220 V.	971.00
ES101	Delay module	181.00
ES103	Relay module	114.00
ES100	Power supply for DE devices and LFSC/LFSF trims. Powers 1 DE device or 2 trims.	825.00
ES105	Power transfer (recommended for ES, DE & MLR options)	275.00
PS501	Power supply for ES9000 devices. Powers up to 2 devices.	971.00
PS501220	Export power supply, 220 VAC. Powers up to 2 ES9000 devices.	971.00
ES2	Power supply card for PS501. Powers an additional 2 devices.	529.00
DKPS-2A	Power supply for MD, 9500 LFSC/LFSF, or MLR. Powers 1 device.	726.00
DKPS-2A	Power supply for MD, 9500 LFSC/LFSF powers 2 devices (will also power 1 MLR device).	726.00
DKPS-2A	Power supply for MLR. Powers 2 devices.	726.00
PS406BB	Power supply with battery back-up for solenoid electric latch retraction option.	1386.00
IMPORTANT NOTE: PS406BB can only be used with electric latch retraction option		

* List price includes default cylinder.

9000 Series Exit Trim

How to Order

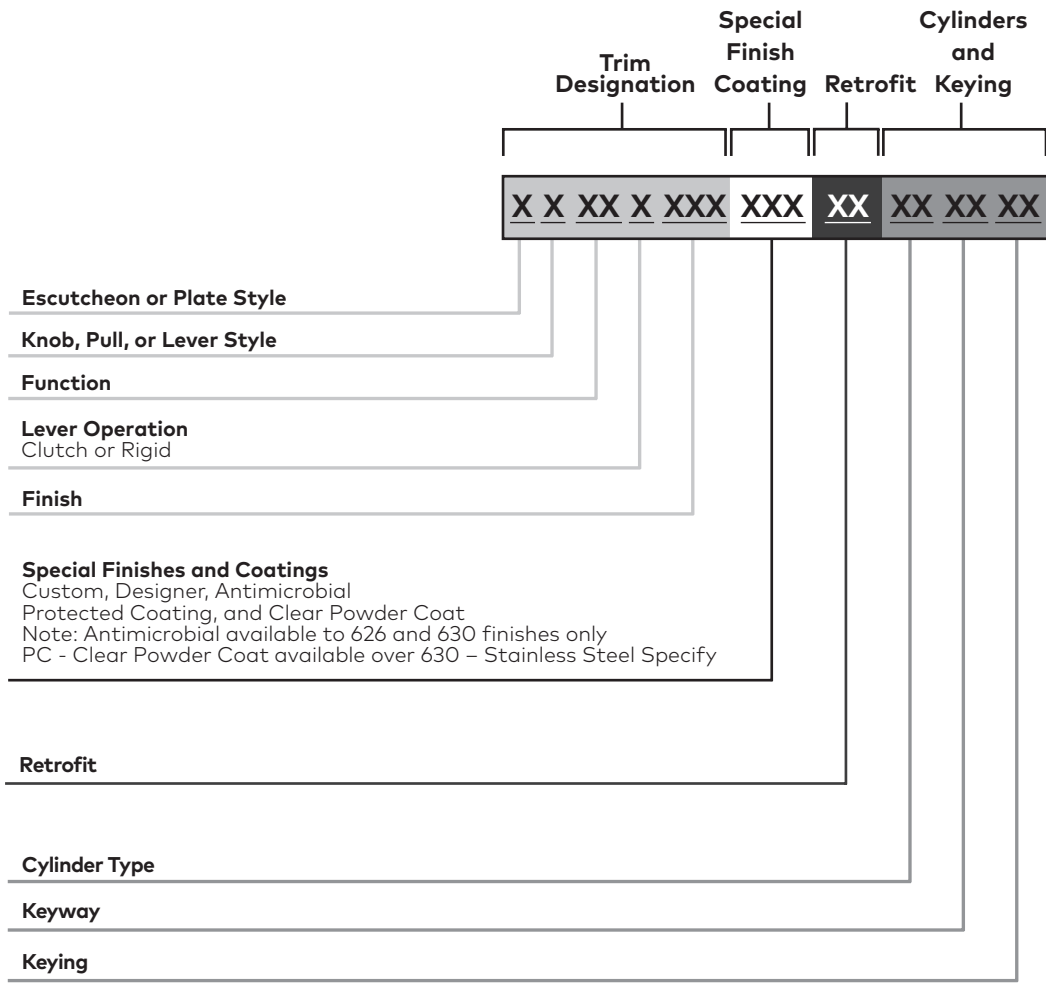

Lever and Knob Styles

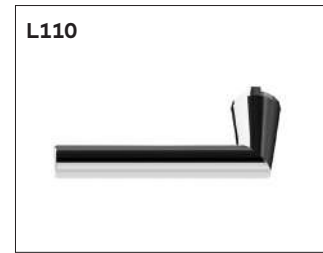
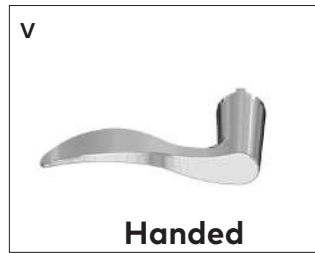
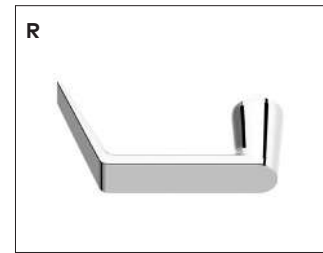
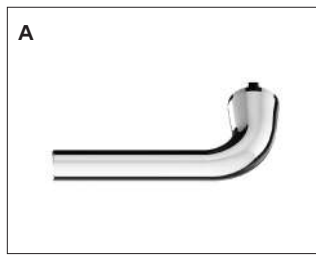

ANSI Function	Description	Y Series Raised Escutcheon 2-3/4" W x 8-1/2" H x 15/16" D	Sectional Trim 3-3/8" Diameter Rose	Plate 2" W x 16" H	Plate 3" W x 16"H	Pulls	Cylinder Only Pull by Others
DT	Dummy trim						
02	Entrance by trim when touchbar is dogged						
03	Entrance by trim when latch bolt is retracted by key. Key removable only when trim is locked.						
05	Entrance by thumbpiece. Key locks or unlocks thumbpiece.						
06	Entrance by thumbpiece only when released by key. Key removable only when locked.						
08	Entrance by lever or knob. Key locks or unlocks lever or knob.						
08C w/ clutch (Handed)	Entrance by lever with clutch option. Key locks or unlocks lever.						
0808 Double Cylinder	Entrance by knob or lever. Outside or inside key locks or unlocks knob or lever. (9300 only)						
09	Entrance by lever or knob only when unlocked by key. Key removable only when locked.						
09C w/ clutch (Handed)	Entrance by lever with clutch option trim unlocked by key. Key removable only when locked.						
11	Entrance by thumbturn and pull. Key locks or unlocks thumbturn.						
12	Entrance by thumbturn and pull only when released by key. Key removable only when locked.						
22	Entrance by thumbpiece (no cylinder). Thumbpiece always active.						
23	Entrance by lever or knob (no cylinder). Lever or knob always active.						
25	Entrance by thumbturn and pull (no cylinder). Thumbturn always active.						

9000 Series Wide Stile Y Escutcheon Trim

Y Series Trim (Specify)					Door Thickness	Special Finish Coating	Retrofit	Cylinders and Keying				
Escutcheon	Knob, Pull, or Lever	Function	Handing	Electric Locking ²	Finish			Cylinder Type	Keyway	Keying		
					630			D	S	C	K	D
Y	A	DT	RHR	LFSC	605	Ext3	*AM	R1 ³	T	CA	KD	
	C	O2R	LHR	LFSF	606	Ext4	**PC		J	CD	KA2	
Handed -	D	O3			611				C	CE	KA4	
Handed -	K	O3R			612				L	D100	NSK	
	F	O3MR			613				D	GA	MKD	
	G	O8			619				G	RA	CMK	
	R	O8M			625				R	RB	SKD	
	T	O8C - Handed			626				F	SC	OBIt	
	O	O8MC - Handed			629 ¹				X6	SE		
	P	O8O8 - Double Cylinder (Specific handing)			630				X7	SF		
Handed -	N	O9			689					YA		
	V	O9C - Handed			691					YG		
	L109	23			693							
	L110				695							
Handed -	L112	Suffix M required for 9500 mortise			696							
	L114	Suffix C and LHR/RHR required for clutch			Custom							
	L117	Suffix R required for rigid lever			Designer							
	L118											



YK



YC



YP

□ - Default

***Patented Key Control**
D100 is the keyway for our patented **SKC** serialized key control system. **SKC** is internet based and provides added layers of security. For more information, contact your local sales representative or Technical Service at 800-387-4938.

- 1. For 629 finish, please allow 4 week lead time.
- 2. LFSC/LFSF only on 09/09C Functions
- 3. R1 available for 9300 series devices only.

		Concealed Vertical Rod	Rim	Surface Vertical Rod	Mortise	Available Finishes \$		
		9100 F9100	9300 F9300	9400 F9400	9500 F9500	689, 691, 693, 695, 696	630	605, 606, 611, 612, 613, 619, 625, 626, 629**
ANSI Function	Description							
DT	Dummy trim	YODT				182.00	265.00	304.00
02	Entrance by trim when touchbar is dogged.	YP02, YK02R, Yx02R				384.00	563.00	623.00
03	Entrance by trim when latch bolt is retracted by key. Key removable only when trim is locked.	YO03*			YO03M*	283.00	384.00	404.00
		YP03, YK03R, Yx03R			YP03M YK03R Yx3MR	504.00	665.00	722.00
08	Entrance by lever or knob. Key locks or unlocks lever or knob.	YK08, Yx08			YK08M Yx08M	665.00	779.00	890.00
08 w/clutch	Entrance by lever with clutch option. Key locks or unlocks lever. (Handed)	Yx08C			Yx08MC	940.00	1102.00	1163.00
0808 (9300)	Entrance by lever. Outside or inside key locks or unlocks lever.	—	Yx0808	—	—	1164.00	1332.00	1383.00
09	Entrance by lever or knob only when unlocked by key. Key removable only when locked.	YK09, Yx09			—	665.00	779.00	890.00
09 w/clutch	Entrance by lever with clutch option trim unlocked by key. Key removable only when locked. (Handed)	Yx09C			—	940.00	1102.00	1163.00
11	Entrance by thumbturn. Key locks or unlocks thumbturn.	YP11			—	627.00	761.00	784.00
12	Entrance by thumbturn when unlocked by key. Key removable only when locked.	YP12			—	627.00	761.00	784.00
11	Entrance by thumbturn. Key locks or unlocks thumbturn.	Y011			—	547.00	709.00	733.00
12	Entrance by thumbturn when unlocked by key. Key removable only when locked.	Y012			—	547.00	709.00	733.00
23	Entrance by lever or knob (no cylinder). Lever or knob always active.	YK23, Yx23			YK23M Yx23M	441.00	623.00	665.00

* Requires Pull by Others

** For 629 finish, please allow 4 week lead time.

NOTES:

- Where x appears above, x = lever styles A, C, D, F, G, N, R, T, V, L109, L110, L112, L114, L117 or L118. (Handed Levers — D, F, V, L114)
- List price includes the default cylinder.

9000 Series Wide Stile Sectional Trim

Sectional Trim (Specify)			Special Finish Coating	Cylinders and Keying		
Knob or Lever	Function	Finish		Cylinder Type	Keyway	Keying
		626		D	SC	KD
9C	02	605	*AM	C	CA	KD
9G	03	606	**PC	D	CD	KA2
9K	08	611		J	CE	KA4
9R	23	612		L	D100	NSK
		613		T	GA	MKD
		619			RA	CMK
		625			RB	SKD
		626			SC	OBit
		630			SE	
		689			SF	
		691			YA	
		693			YG	
		695				
		696				
		Custom				
		Designer				



9R



9K

 - Default

***Patented Key Control**
D100 is the keyway for our patented **SKC** serialized key control system. **SKC** is internet based and provides added layers of security. For more information, contact your local sales representative or Technical Service at 800-387-4938.

		Concealed Vertical Rod	Rim	Surface Vertical Rod	Mortise	Available Finishes \$	
		9100 F9100	9300 F9300	9400 F9400	9500 F9500	689, 691, 693, 695, 696	630 605, 606, 611, 612, 613, 619, 625, 626
ANSI Function	Description						
02	Entrance by trim when touchbar is dogged.		9C02R 9G02R 9K02R 9R02R		—	424.00	— 481.00
03	Entrance by trim when latch bolt is retracted by key. Key removable only when trim is locked.		9C03 9G03 9K03 9R03		—	520.00	— 583.00
08	Entrance by lever or knob. Key locks or unlocks lever or knob.		9C08 9G08 9K08 9R08		—	520.00	— 583.00
23	Entrance by lever or knob (no cylinder). Lever or knob always active.		9C23 9G23 9K23 9R23		—	424.00	— 481.00

NOTE: List price includes the default cylinder.

9000 Series Wide Stile 3" Plate Trim

Plate Trim (Specify)		Special Finish Coating	Retrofit	Cylinders and Keying			
Plate Type	Function	Finish		Cylinder Type	Keyway	Keying	
		630		D	SC	KD	
HRT	DT	630	*AM	R1 ¹	T	CA	KD
HTT	DTCV	689	**PC		J	CD	KA2
NPT	02	691			C	CE	KA4
PRT	02CV	693			L	*D100	NSK
PTT	03	695			D	GA	MKD
80	03CV	696			G	RA	CMK
	03M	696			R	RB	SKD
	05	Custom			F	SC	OBit
	05CV	Designer			X6	SE	
	05M				X7	SF	
	06					YA	
	06CV					YG	
	22						
	22CV						
	22M						

 - Default



HTT



PRT

Suffix **CV** required for 9100 CVR
 Suffix **M** required for 9500 mortise

***Patented Key Control**
D100 is the keyway for our patented **SKC** serialized key control system. **SKC** is internet based and provides added layers of security. For more information, contact your local sales representative or Technical Service at 800-387-4938.

1. R1 available for 9300 series devices only.

		Concealed Vertical Rod	Rim	Surface Vertical Rod	Mortise	Available Finishes \$		
		9100 F9100	9300 F9300	9400 F9400	9500 F9500	689, 691, 693, 695, 696	630	605, 606, 611, 612, 613, 619, 625, 626
ANSI Function	Description							
DT	Dummy Trim	NPTDTCV	NPTDT			169.00	234.00	251.00
02	Entrance by trim when touchbar is dogged.	PRT02CV PTT02CV	PRT02 PTT02	PRT02M PTT02M		189.00	274.00	317.00
03	Entrance by trim when latch bolt is retracted by key. Key removable only when trim is locked.	NPT03CV* PRT03CV PTT03CV	NPT03* PRT03 PTT03	NPT03M* PRT03M PTT03M		296.00	398.00	420.00
05	Entrance by thumbpiece. Key locks or unlocks thumbpiece.	HRT05CV HTT05CV	HRT05 HTT05	HRT05M HTT05M		335.00	420.00	457.00
06	Entrance by thumbpiece only when released by key. Key removable only when locked.	HRT06CV HTT06CV	HRT06 HTT06	—		335.00	420.00	457.00
22	Entrance by thumbpiece (no cylinder). Thumb-piece always active.	HRT22CV HTT22CV	HRT22 HTT22	HRT22M HTT22M		274.00	335.00	378.00

* Requires Pull by Others

NOTE: List price includes the default cylinder.

9000 Series Wide Stile 2" Plate Trim

Plate Trim (Specify)		Special Finish Coating	Retrofit	Cylinders and Keying			
Plate Type	Function	Finish		Cylinder Type	Keyway	Keying	
		630		D	SC	KD	
VO	DT	605	*AM	R1 ¹	T	CA	KD
V1	DTCV	606	**PC		J	CD	KA2
V3	02	611			C	CE	KA4
	02CV	612			L	D100	NSK
	03	613			D	GA	MKD
	03CV	619			G	RA	CMK
	03M	625			R	RB	SKD
		626			F	SC	OBit
		630			X6	SE	
		689			X7	SF	
		691				YA	
		693				YG	
		695					
		696					
		Custom					
		Designer					

Suffix CV required for 9100 CVR
 Suffix M required for 9500 mortise

 - Default

***Patented Key Control**
D100 is the keyway for our patented **SKC** serialized key control system. **SKC** is internet based and provides added layers of security. For more information, contact your local sales representative or Technical Service at 800-387-4938.

1. R1 available for 9300 series devices only.



V3



V1

		Concealed Vertical Rod	Rim	Surface Vertical Rod	Mortise	Available Finishes \$		
		9100 F9100	9300 F9300	9400 F9400	9500 F9500	689, 691, 693 695, 696	630	605, 606, 611, 612, 613, 619, 625, 626
ANSI Function	Description							
DT	Dummy Trim	VODTCV		VODT	—	168.00	189.00	251.00
02	Entrance by trim when touchbar is dogged.	V102CV V302CV		V102 V302	—	189.00	251.00	317.00
03	Entrance by trim when latch bolt is retracted by key. Key removable only when trim is locked.	VO03CV* V103CV V303CV		VO03* V103 V303	VO03M* V103M V303M	296.00	356.00	415.00

* Requires Pull by Others

NOTE: List price includes the default cylinder.

9000 Series Wide Stile Pull Trim

Pulls (Specify)			Special Finish Coating	Cylinders and Keying		
Pull Type	Function	Handing	Finish		Cylinder Type	Keyway Keying
			630		D SC KD	
OP	02	RHR	605	*AM	T CA	KD
POF	03HDA	LHR	606	**PC	J CD	KA2
VRF	02SPM		611		C CE	KA4
9PBO ¹	03SPM		612		L D100	NSK
	03		613		D GA	MKD
			619		G RA	CMK
			625		R RB	SKD
			626		F SC	OBit
			630		X6 SE	
			689		X7 SF	
			691		YA	
			693		YG	
			695			
			696			
			Custom			
			Designer			

 - Default

***Patented Key Control**
 D100 is the keyway for our patented **SKC** serialized key control system. **SKC** is internet based and provides added layers of security. For more information, contact your local sales representative or Technical Service at 800-387-4938.

¹ 9PBO not applicable on 9500 Device. 03 Function only. Not available in 693 finish.



VRF



OP



POF



9PBO

ANSI Function	Description	Concealed Vertical Rod	Rim	Surface Vertical Rod	Mortise	Available Finishes \$			
		9100 F9100	9300 F9300	9400 F9400	9500 F9500	689, 691, 693, 695, 696	630	605, 606, 611, 612, 613, 619 625, 626	
02	Entrance by trim when touchbar is dogged.	OPO2				168.00	211.00	249.00	
		—	VRF02SPM	—	—	—	856.00	—	
03	Entrance by trim when latch bolt is retracted by key. Key removable only when trim is locked.	—	POF03HDA	—	—	—	1211.00	—	
		9PBO03				—	190.00	190.00	190.00
		—	VRF03SPM	—	—	—	856.00	—	

NOTES:

- List price includes the default cylinder.
- 9PBO03 trim not recommended for wood doors. For hollow metal and aluminum door applications. Not applicable on 9500 devices. Not available in 693 finish.

Trim Options

Option Code	Description	List Add \$
Special Finishes and Coatings		
AM	Antimicrobial protected coating	110.00
P	Clear powder coat	110.00
Custom Color	Custom painted finish selected from RAL color pallet book. For details, see Finishes Cross Reference , page viii.	
	Per order, setup charge (Net)	168.00
	per exit device only, list add	85.00
	per trim only, list add	85.00
Designer Color	Designer painted color matched to supplied samples. Three (3) each 2" x 3" color chip samples required. For details, see Finishes Cross Reference , page viii.	
	per order, non-refundable development/setup charge (Net)	608.00
	per exit device only, list add	85.00
	per trim only, list add	85.00
Electric Locking Trim for 9100 Concealed Vertical Rods, 9300 Rim & 9400 Surface Vertical Rods		
LFSC	Fail secure (requires DORMA ES100 power supply)	799.00
LFSF	Fail safe (requires DORMA ES100 power supply)	799.00
Retrofit		
R1	Von Duprin® retrofit. For Y series and wide stile plate trims (9300 Series devices only)	N/C
Door Thickness (includes extended spindle and fasteners)		
Ext3	Door thickness from 2-1/4"–3-1/4" (57 mm to 83 mm)	114.00
Ext4	Door thickness from 3-1/4"–4-1/4" (83 mm to 108 mm)	114.00

Cylinders

Rim Cylinders

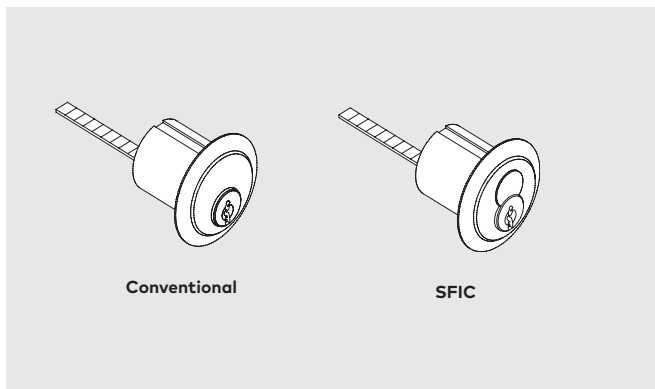

Mortise Cylinders

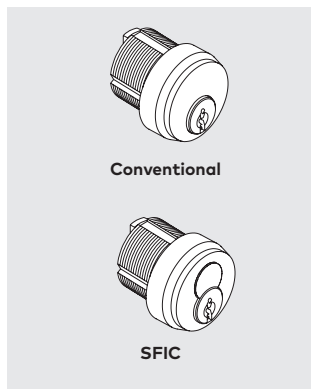

Key-in-Lever Cylinders

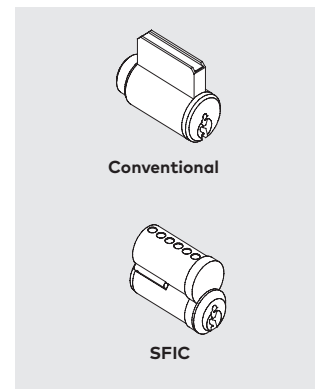

Wide Stile

Application	ANSI Function	Cylinder Type	Conventional (Default)	Cam	SFIC 7-Pin
Cylinders for 9100/F9100 Concealed Vertical Rod, 9300/F9300 Rim, and 9400/F9400 Surface Vertical Rod Wide Stile Devices					
Sectional Trim (Key-in-Lever)	03, 08	Key-in-lever	7013SC	NA	77BA
Wide Plate Trim	03	Rim	80R40SC	NA	87R40BA
Wide Plate Trim	05, 06	Mortise	90A10BA118	#10	97A10BA138
Narrow Plate Trim	03	Rim	80R40SC	NA	87R40BA
Y Escutcheon Trim	03	Rim	80R40SC	NA	87R40BA
Y Escutcheon Trim	08	Mortise	90X10SC118	#10	97D10BA138
Y Escutcheon Trim	09	Mortise	90X09SC118	#9	97D09BA138
Cylinders for 9500/F9500 Mortise Devices shipped prior to 11/2014					
Wide Plate Trim	03, 05	Mortise	90A10SC118	#10	97B10BA138
Wide Plate Trim	03	Mortise	90A10SC118	#10	97B10BA138
Y Escutcheon Trim	03, 08	Mortise	90X10SC158	#10	97D10BA134
Cylinders for 9500/F9500 Mortise Devices shipped 11/2014 or after					
Wide Plate Trim	03	Mortise	90A13SC118	#13	97B13BA138
Wide Plate Trim	05	Mortise	90A12SC118	#12	97B12BA138
Narrow Plate Trim	03	Mortise	90A13SC118	#13	97B13BA138
Y Escutcheon Trim	03	Mortise	90X13SC118	#13	97C13BA138
Y Escutcheon Trim	05, 08	Mortise	90X12SC118	#12	97C12BA138
Cylinders for Device Options					
CD, BA, B4, DE, DE30, DECBC, DA, LMMSBP	—	Mortise	90X10SC118	#10	97D10BA138

Cylinder Types, Keying Options and Keyways for Removable Mullions and Exit Devices

Cylinder	Option	Description	List Add/Deduct \$
Conventional Cylinders (non-interchangeable core)			
	D	Keying for exit device or removable mullions with conventional cylinder (default)	
	KD	Keyed differently to a random combination; SC keyway with 2 keys (default)	N/C
	KA2	Keyed alike in pairs to a random combination; SC keyway with 2 keys	N/C
	NSK	Keyed alike, sets of three or more; SC keyway with 2 keys	21.00
	1-Bit	Operated by a 1-bit key (sold separately); SC, SE keyway with 2 key blanks	N/C
	1-Bit	Operated by a 1-bit key (sold separately); D100 keyway – ⊗ Keys sold separately	N/C
	0-Bit	Operated by a key blank; CA, CD, CE, RA, RB, GA, SF, YA, YG keyways with 2 key blanks	21.00
	MKD	Master keyed; SC, SE, or D100 keyway – ⊗ Keys sold separately	25.00
	CMK	Construction master keyed single cylinder locks – ⊗ Keys sold separately	26.00
L		Keying for exit device or removable mullions less conventional cylinder	Deduct 33.00
Interchangeable Core Cylinders			
T		Keying for exit device or removable mullions with keyed temporary SFIC construction core Keying for exit trim with keyed temporary SFIC construction core (cores may be returned for a full refund) – ⊗ Keys sold separately	62.00
J		Keying for exit device or removable mullions with disposable plastic SFIC construction core	N/C
C		Keying for exit device or removable mullions with combined SFIC core installed at factory ¹ Keying for exit trim with combined core installed at factory; BA (default), BB, BC, BD, BE, BF, BG, BH, BJ, BK, BL, BM, BQ, D100 keyway – ⊗ Keys sold separately	69.00
G		Schlage LFIC – Housing with keyed temporary Schlage LFIC construction core (Core may be returned for full refund) – ⊗ Keys sold separately	62.00
F		Schlage LFIC – Housing with combined Schlage LFIC installed at the factory (SC keyway) – ⊗ Keys sold separately	69.00
Cylinder Housings Less Cores			
R		Housing prepared for Schlage LFIC	12.00
X7		Housing prepared for Sargent XC 7P and Arrow Choice 7P SFIC	12.00
X6		Housing prepared for Arrow Choice 6P SFIC	12.00

1. For uncombined cores, **UNC**, cores must be ordered separately, see **Cylinders, Keys & Keying**. Exits/trim will be supplied w/ plastic construction core, Option J.

⊗ Denotes keys must be ordered separately.

Cut Keys Ordered Separately		
Part #	Description	List \$
45101	SFIC Cut key – Change key, master key, construction master key, or control key; BA, BB, BC, BD, BE, BF, BG, BH, BJ, BK, BL, BM, BQ, SC, SE keyways	10.00
45401	SFIC Cut key – Change key, master key, or control key; D100 keyways – D100 etc.	16.00
45404	CONV/LFIC Cut key – 1 bit key for operating 1 bit cylinders – SC, SE keyways	8.00
45405	LFIC Cut key – 1 bit control key (to install/remove "0-bit" LFIC cores) – SC keyway	8.00
44101SC	CONV/LFIC Key blank – SC keyway	6.00
44104SC	LFIC Key blank – Control key (to install/remove LFIC Cores) – SC keyway	7.00

NOTES:

- Distribution of DORMA SKC keys (listed as D100) is restricted. See Cylinders, Keys & Keying section for DORMA SKC policies.
- For additional information, please refer to Cylinders, Keys, and Keying
- See Keys and Key Blanks section for complete list.

Mullions

Item	Description	List \$
Aluminum Mullions x 628 (clear anodized), 1-5/8" x 2-5/8"		
1310-8	8'	1298.00
1310-8 x 443	8', recessed strike	1509.00
WS1310-8	8', weatherstrip	1380.00
WS1310-8 x 443	8', weatherstrip and recessed strike	1523.00
1310-10	10'	1380.00
1310-10 x 443	10', recessed strike	1656.00
WS1310-10	10', weatherstrip	1509.00
WS1310-10 x 443	10', weatherstrip and recessed strike	1751.00
Aluminum Mullions x 695 (painted), 1-5/8" x 2-5/8"		
1310-8	8'	1572.00
1310-8 x 443	8', recessed strike	1783.00
WS1310-8	8', weatherstrip	1656.00
WS1310-8 x 443	8', weatherstrip and recessed strike	1883.00
1310-10	10'	1703.00
1310-10 x 443	10', recessed strike	1931.00
WS1310-10	10', weatherstrip	1816.00
WS1310-10 x 443	10', weatherstrip and recessed strike	1833.00
Steel Mullions x 600 (primed for paint), 1-1/2" x 2-1/2"		
1330-8	8'	648.00
1330-10	10'	683.00
Steel Mullions x 600 (primed for paint), 2" x 3"		
1300-8	8'	845.00
F1300-8	8', fire-rated	1087.00
F1300-10	10', fire-rated	1453.00
1340KR-8	8', key removable (includes standard cylinder using 01 cam)	1428.00
F1340KR-8	8', fire-rated mullion, key removable (includes standard cylinder using 01 cam)	1672.00
F1340KR-10	10', fire-rated mullion, key removable (includes standard cylinder using 01 cam)	1956.00
1300-10	10'	973.00
1340KR-EL	8', key removable, electrified mullion	1656.00
1340KR-10	10', key removable (includes standard cylinder using 01 cam)	1509.00
1340KR-EL-10	10', key removable, electrified mullion	1737.00
HC1300-8	8', design pressure rated 80PSF for openings up to 8' x 8' with HC9300 device.	1572.00
Mullion Storage Kit		
1340SK	Storage kit for 1340/F1340 Series key removable mullion.	424.00

Cylinders for 1340KR/F1340KR Mullions and 1340SK Storage Kit

Type	Standard	7-pin IC	Cam
Mortise	90X01SC118	97D01BA138	01 (AR)

9600 Series

Narrow Stile Concealed Vertical Rod Exit Device

9600 Series Device									Options (Specify)							Cylinders and Keying		
Device	Length	Touchbar	Handing	Door Height	Top Strike	Bottom Strike	Door Latch Brackets	Finish	Special Finish Coating	Bottom Latch	Fastener Package	Control	Alarm	Monitoring	Dogging	Cylinder Type	Keyway	Keying
9600	BB		RHR	7	418	439	NS	630								D	SC	KD
F9600	AA	FL	RHR	7	418	340	NS	605	*AM	LB	SK	DE	BPA	LM	CD	T	CA	KD
9600	BB		LHR	8	419	431	ALD	606	**PC	PB	SNB	DE30	BPAR	MS	LD	J	CD	KA2
	CC			9		439	WD	611		SB	TX	ES	DWA	LMMS		C	CE	KA4
	SPCL			10				612			SKTX	DECBC		LMMSBP		L	D100	NSK
				SPCL				613			SKSNB	MLR				D	GA	MKD
								619			TXSNB					G	RA	CMK
								625			SKTXSNB					R	RB	SKD
								626			METRIC					F	SC	OBIt
								629								X6	SE	
								630								X7	SF	
								689									YA	
								691									YG	
								693										
								695										
								696										
								Custom										
								Designer										

— Default

— Supplied with Standard KD Cylinder

***Patented Key Control**

D100 is the keyway for our patented **SKC** serialized key control system. **SKC** is internet based and provides added layers of security. For more information, contact your local sales representative or Technical Service at 800-387-4938.

9000 Series – Narrow Stile Applications: Standard Glass AL Doors

Device Length	All Device Options (except BA, DA, or DE)		BA or DA Device Options	DE Device Option
	Maximum Door Width ¹	Minimum Door Width ²	Minimum Door Width ²	Minimum Door Width ²
AA	48" (1220 mm)	32-1/2" (826 mm)	37.5" (952.5 mm)	40" (1016 mm)
BB	36" (915 mm)	27" (686 mm)	31.5" (800.1 mm)	32" (812.8 mm)
CC	36" (915 mm)	23-1/2" (597 mm)	28.5" (723.9 mm)	N/A

9000 Series – Narrow Stile with Full Length Touchbar Applications

Device Length	All Device Options (except BA, DA, or DE)		BA or DA Device Options	DE Option
	Maximum Door Width ¹	Minimum Door Width ²	Minimum Door Width ²	N/A on FL Touchbar
AA	48" (1220 mm)	33" (839 mm)	34" (837 mm)	—
BB	36" (915 mm)	27" (686 mm)	28" (711 mm)	—
CC	36" (915 mm)	24" (610 mm)	25" (635 mm)	—

1. As delivered from factory, device will fit doors of this width. For other widths, consult Technical Services.
 2. Touch bar and rail assembly can be shortened at time of installation to fit doors down to this width. Varies by installations.

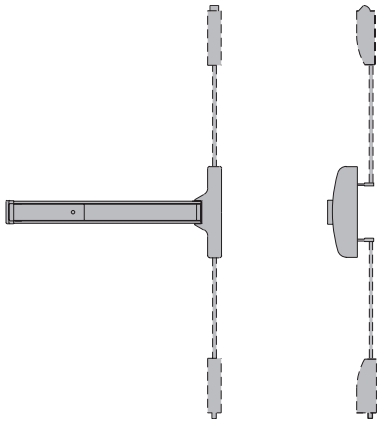

Available Finishes \$

689, 691, 693, 695, 696	630	606, 612, 613, 619	605, 611, 625, 626, 629**
-------------------------	-----	--------------------	---------------------------

Function	Description	Device, Exit Only	689, 691, 693, 695, 696	630	606, 612, 613, 619	605, 611, 625, 626, 629**
01	Panic	9600 Concealed vertical rod	2663.00	3149.00	3029.00	3200.00
01	Fire	F9600 Concealed vertical rod	2791.00	3411.00	3278.00	3442.00

Typical Options

Item	Description	689, 691, 693, 695, 696	630	606, 612, 613, 619	605, 611, 625, 626, 629**	List Add \$
ALD	Wide Stile aluminum door bracket (9600 Series)	—	—	—	—	N/C
NS	2-1/8" narrow stile aluminum door bracket (default, 9600 Series only)	—	—	—	—	N/C
WD	Narrow stile wood or hollow steel door bracket (9600 Series only)	—	—	—	—	N/C
CD	Cylinder dogging (includes cylinder)	—	—	—	—	123.00
LD	Less dogging (Standard with fire rated device)	—	—	—	—	N/C
AM	Antimicrobial coating	—	—	—	—	110.00
SNB	Sex nuts (Included with F and HC options)	—	—	—	—	24.00
TX	Security screws	—	—	—	—	49.00
FL	Full length touchbar (Not Available DE)	—	—	—	—	N/C
LB	Less bottom rod	—	—	—	—	N/C
PB	Pullman bottom latch	—	—	—	—	74.00
SB	Slide Bolt (Default)	—	—	—	—	N/C
Up to 8'	7' to 8' adjustable	—	—	—	—	N/C
Up to 10'	Door heights over 8' to 10'	—	149.00	—	—	—

** For 629 finish, please allow 4 week lead time.

Notes:

- Prices shown apply to AA, BB, or CC length devices.
- Specify door width and handing. If not specified, Size BB, RHR is the standard default.
- List price includes default strikes. For optional strikes, specify strike number and adjust list price accordingly.
- List price for the device does not include trim.
- Devices include wood and machine screws standard.
- Specify door latch brackets: **NS** (default) for 2-1/8" narrow stile aluminum, **ALD** for Wide Stile aluminum, or **WD** for wood or hollow steel.
- Fire rated devices include SNB sex nuts standard.
- For options requiring a cylinder, the option list price includes the default cylinder.
- Device includes precut and drilled rods for 7' to 8' doors as specified on order
 For 9' doors, device includes precut and drilled rods for a 7' door and a 2' rod extension for the top rod. Specify 9' on order.
 For 10' doors, device includes precut and drilled rods for an 8' door and a 2' rod extension for the top rod. Specify 10' on order.
 See Device Options for pricing information.
- For special lengths and/or door heights over 10', consult Technical Service.
- All standard devices and trim are designed for 1-3/4"-2-1/4" thick doors. For door thickness greater than 2-1/4", consult Technical Service.
- FL (full length touchbar) and **METRIC** (metric installation fasteners) must be specified when ordered and included in the model number.
Example: 9600 BB FL RHR 430 630 METRIC
- Full length touchbar not available with DE. CD option on FL devices supplied with U.S. mortise cylinder.
- ALD wide stile aluminum door bracket (9100 and 9600 Series) N/C
- NS 2-1/8" narrow stile aluminum door bracket (9600 Series only) N/C
- WD narrow stile wood or hollow steel door bracket (9600 Series only) N/C

9700 Series

Narrow Stile Rim Exit Device

9700 Series Device					Options (Specify)							Cylinders and Keying		
Device	Length	Touch Bar	Strike	Finish	Special Finish Coating	Special Applications Package	Fastener Package	Control	Alarm	Monitoring	Dogging	Cylinder Type	Keyway	Keying
9700	BB		430	630								D	SC	KD
F9700	AA	FL	320	605	*AM	HC	SK	DE	BPA	LM	CD	T	CA	KD
9700	BB		430	606	**PC	**BF	SNB	DE30	BPAR	MS	LD	J	CD	KA2
	CC		463	611			TX	ES	DWA	LMMS		C	CE	KA4
	SPCL		486	612			SKTX	DECBC		LMMSBP		L	D100	NSK
				613			SKSNB	MLR				D	GA	MKD
				619			TXSNB					G	RA	CMK
				625			SKTXSNB					R	RB	SKD
				626			METRIC					F	SC	OBit
				629								X6	SE	
				630								X7	SF	
				689									YA	
				691									YG	
				693										
				695										
				696										
				Custom										
				Designer										

– Default

– Supplied with Standard KD Cylinder

***Patented Key Control**
D100 is the keyway for our patented **SKC** serialized key control system. **SKC** is internet based and provides added layers of security. For more information, contact your local sales representative or Technical Service at 800-387-4938.

**** Barrier Free option availability:**

Exit Device	Functions	Electric Options	Device Lengths	Ratings
9700BF	01, 02, 03, 05, 08, 23	ES, BA, B4, LM, MS, LM/MS, LM/MS/BP	36" & 48"	Panic & Fire

9000 Series – Narrow Stile Applications: Standard Glass AL Doors

Device Length	All Device Options (except BA, DA, or DE)		BA or DA Device Options	DE Device Options
	Maximum Door Width ¹	Minimum Door Width ²	Minimum Door Width ²	Minimum Door Width ²
AA	48" (1220 mm)	32-1/2" (826 mm)	37.5" (952.5 mm)	40" (1016 mm)
BB	36" (915 mm)	27" (686 mm)	31.5" (800.1 mm)	32" (812.88 mm)
CC	36" (915 mm)	23-1/2" (597 mm)	28.5" (723.9 mm)	N/A

9000 Series – Narrow Stile with Full Length Touchbar Applications

Device Length	All Device Options (except BA, DA, or DE)		BA or DA Device Options	DE Device Option
	Maximum Door Width ¹	Minimum Door Width ²	Minimum Door Width ²	N/A on FL touchbar
AA	48" (1220 mm)	33" (839 mm)	34" (837 mm)	–
BB	36" (915 mm)	27" (686 mm)	28" (711 mm)	–
CC	36" (915 mm)	24" (610 mm)	25" (635 mm)	–

1. As delivered from factory, device will fit doors of this width. For other widths, consult Technical Services.
 2. Touch bar and rail assembly can be shortened at time of installation to fit doors down to this width.

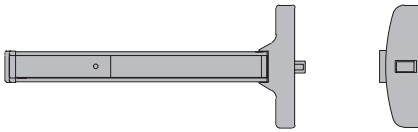

			Available Finishes \$			
			689, 691, 693, 695, 696	630	606, 612, 613, 619	605, 611, 625, 626, 629**
Function	Description	Device, Exit Only				
01	Panic	9700 Rim	1431.00	2256.00	2170.00	2539.00
01	Fire	F9700 Rim	1584.00	2485.00	2390.00	2751.00

Typical Options

Item	Description	List Add \$
CD	Cylinder dogging (Includes cylinder)	123.00
LD	Less dogging (Standard with fire rated device)	N/C
AM	Antimicrobial coating	110.00
SNB	Sex nuts (Included with F and HC options)	24.00
TX	Security screws	49.00
HC	Hurricane (Includes SNB)	229.00
BF	Barrier free exit device, meets California Building Code (Section 11B-309.4) requirements for maximum 5 lb operating force. See page 86 for compatible functions/options."	65.00
FL	Full length touchbar (Not Available DE)	N/C

**** For 629 finish, please allow 4 week lead time.**

NOTES:

- Prices shown apply to AA, BB, or CC length devices.
- Specify door width. If not specified, Size BB is the standard default.
- List price includes default strikes. For optional strikes, specify strike number and adjust list price accordingly.
- List price for the device does not include trim.
- Devices include wood and machine screws standard.
- Fire and hurricane rated devices include 463 rim strike and SNB sex nuts standard.
- For options requiring a cylinder, the option list price includes the default cylinder.
- All standard devices and trim are designed for 1-3/4"-2-1/4" thick doors. For door thickness greater than 2-1/4", consult Technical Service.
- **FL** (full length touchbar) and **METRIC** (metric installation fasteners) must be specified when ordered and included in the model number.
Example: 9700 BB FL RHR 430 630 METRIC
- For special lengths, consult Technical Service.
- Full length touchbar not available with DE. CD option on FL devices supplied with U.S. mortise cylinder.

9800 Series

Narrow Stile Surface Vertical Rod Exit Device

9800 Series Device								Options (Specify)								Cylinders and Keying		
Device	Length	Touch Bar	Handing	Door Height	Top Strike	Bottom Strike	Finish	Special Finish Coating	Special Applications Package	Bottom Latch	Fastener Package	Control	Alarm	Monitoring	Dogging	Cylinder Type	Keyway	Keying
9800	BB		RHR	7	426	439	630									D	SC	KD
F9800	AA	FL	RHR	7	426	340	605	*AM	HC	LB	SK	ES	BPA	LM	CD	T	CA	KD
9800	BB		LHR	8	426A	416V	606	**PC	TGD	PB	SNB	MLR	BPAR	MS	LD	J	CD	KA2
	CC			9		431	611			SB	TX		DWA	LMMS		C	CE	KA4
	SPCL			10		439	612				SKTX		LMMSBP			L	*D100	NSK
				SPCL			613				SKSNB					D	GA	MKD
							619				TXSNB					G	RA	CMK
							625				SKTXSNB					R	RB	SKD
							626				METRIC					F	SC	OBIt
							629									X6	SE	
							630									X7	SF	
							689										YA	
							691										YG	
							693											
							695											
							696											
							Custom											
							Designer											

 – Default

 – Supplied with Standard KD Cylinder

***Patented Key Control**
D100 is the keyway for our patented **SKC** serialized key control system. **SKC** is internet based and provides added layers of security. For more information, contact your local sales representative or Technical Service at 800-387-4938.

9000 Series – Narrow Stile Applications: Standard Glass AL Doors

Device Length	All Device Options (except BA or DA)		BA or DA Device Options
	Maximum Door Width ¹	Minimum Door Width ²	Minimum Door Width ²
AA	48" (1220 mm)	32-1/2" (826 mm)	37.5" (952.5 mm)
BB	36" (915 mm)	27" (686 mm)	31.5" (800.1 mm)
CC	36" (915 mm)	23-1/2" (597 mm)	28.5" (723.9 mm)

9000 Series – Narrow Stile with Full Length Touchbar Applications

Device Length	All Device Options (except BA or DA)		BA or DA Device Options
	Maximum Door Width ¹	Minimum Door Width ²	Minimum Door Width ²
AA	48" (1220 mm)	33" (839 mm)	34" (837 mm)
BB	36" (915 mm)	27" (686 mm)	28" (711 mm)
CC	36" (915 mm)	24" (610 mm)	25" (635 mm)

- As delivered from factory, device will fit doors of this width. For other widths, consult Technical Services.
- Touch bar and rail assembly can be shortened at time of installation to fit doors down to this width. Varies by installation.

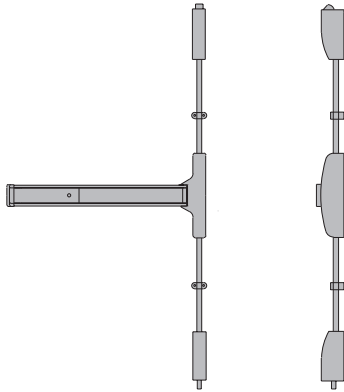

Available Finishes \$

			689, 691, 693, 695, 696	630	606, 612, 613, 619	605, 611, 625, 626, 629**
Function	Description	Device, Exit Only				
01	Panic	9800 Surface vertical rod	2610.00	2963.00	2848.00	3047.00
01	Fire	F9800 Surface vertical rod	2740.00	3225.00	3101.00	3290.00

Typical Options

Item	Description	List Add \$
CD	Cylinder dogging (Includes Cylinder)	123.00
LD	Less dogging (Standard with fire rated device)	N/C
AM	Antimicrobial coating	110.00
SNB	Sex nuts (Included with F and HC options)	24.00
TX	Security screws	49.00
HC	Hurricane (Includes SNB)	229.00
FL	Full length touchbar (Not available DE)	N/C
LB	Less bottom rod	N/C
PB	Pullman bottom latch	74.00
SB	Slide bolt (Default)	N/C
TGD	Tempered glass doors—9800 only	778.00
Up to 8'	7' Default	N/C
Up to 10'	Door Heights over 8' to 10'	149.00

** For 629 finish, please allow 4 week lead time.

NOTES:

- Prices shown apply to AA, BB, or CC length devices.
- Specify door width and handing. If not specified, Size BB, RHR is the standard default.
- List price includes default strikes. For optional strikes, specify strike number and adjust list price accordingly.
- List price for the device does not include trim.
- Devices include wood and machine screws standard.
- Fire and hurricane rated devices include SNB sex nuts standard.
- For options requiring a cylinder, the option list price includes the default cylinder.
- Device includes precut and drilled rods for 7' or 8' doors as specified on order.
 For 9' doors, device includes precut and drilled rods for a 7' door and a 2' rod extension for the top rod.
 For 10' doors, device includes precut and drilled rods for an 8' door and a 2' rod extension for the top rod.
 See Device Options for pricing information.
- For special lengths and/or door heights over 10', consult Technical Service.
- All standard devices and trim are designed for 1-3/4"-2-1/4" thick doors. For door thickness greater than 2-1/4", consult Technical Service.
- **FL** (full length touchbar) and **METRIC** (metric installation fasteners) must be specified when ordered and included in the model number.
Example: 9800 BB FL RHR 430 630 METRIC
- Full length touchbar not available with DE. CD option on FL devices supplied with U.S. mortise cylinder.

Narrow Stile Dummy Bars

Available Finishes \$

Item	Description	Available Finishes \$			
		689, 691, 693, 695, 696	630	606, 612, 613, 619	605, 611, 625, 626, 629**
Dummy Touchbars					
9230	Rigid dummy touchbar	751.00	1094.00	1132.00	1132.00
9230MS	Dummy touchbar with microswitch	1113.00	1401.00	1417.00	1417.00
9235	Rigid touchbar	751.00	1094.00	1132.00	1132.00
9236	Moveable touchbar	751.00	1094.00	1132.00	1132.00
9236MS	Moveable touchbar with microswitch	1113.00	1401.00	1417.00	1417.00

**** For 629 finish, please allow 4 week lead time.**

NOTE: Dummy touchbars available in all rail sizes: AA, BB or CC

Narrow Stile Options

Option Code	Description	List Add \$
Strikes		
9600, and 9800 Concealed and Surface Vertical Rods		
340	Flat slide bolt bottom strike (9600, and 9800 Series)	N/C
416V	Surface bottom strike for pullman latch (9800 Series)	N/C
418	Standard top strike (9600 Series)	N/C
419	Wood frame top strike (9600 Series)	24.00
426	Standard top strike (9800 Series)	N/C
426A	Top strike w/angle (9800 Series)	39.00
431	Recessed bottom strike for pullman latch (9600, and 9800 Series)	39.00
439	Standard slide bolt bottom strike (9600, and 9800 Series)	N/C
9700 Rim Devices		
320	Overlap strike	39.00
430	Rim box strike (default/no charge for 9700 Series panic devices)	61.00
463	Standard rim strike (default/no charge for F9700 devices)	97.00
486	Roller strike	24.00
Special Finishes and Coatings		
AM	Antimicrobial protected coating	110.00
P	Clear powder coat	110.00
Custom Color	Custom painted finish selected from RAL color pallet book. For details, see Finishes Cross Reference , page viii.	
	Per order, setup charge (Net)	168.00
	per exit device only, list add	85.00
	per trim only, list add	85.00
Designer Color	Designer painted color matched to supplied samples. Thr Electric dogging (requires DKPS-2A power supply) ee (3) each 2" x 3" color chip samples required. For details, see Finishes Cross Reference , page viii.	
	per order, non-refundable development/setup charge (Net)	608.00
	per exit device only, list add	85.00
	per trim only, list add	85.00
Bottom Latches for 9600 Concealed Vertical Rods & 9800 Surface Vertical Rods		
LB	Less bottom rod	N/C
PB	Pullman bottom latch	74.00
SB	Slide bolt (Default)	N/C
Door Height Designation		
9600 Concealed Vertical Rods		
7 or 8	Door heights from 7' to 8' adjustable	N/C
9 or 10	Door heights over 8', up to 10'	75.00
Over 10'	Contact DORMA Technical Service for assistance	
9800 Surface Vertical Rods		
7 or 8	Door heights from 7' to 8' (7' Default)	N/C
9 or 10	Door heights over 8', up to 10'	
	For 689, 691, 693, 695, 696 finishes	75.00
	For 605, 606, 611, 612, 613, 619, 625, 626, 630 finishes	149.00
Over 10'	Consult Technical Service	

Narrow Stile Options (continued)

Option Code	Description	List Add \$
Special Application Packages		
HC	Hurricane (9700, 9800 Series only) Includes SNB	229.00
BF	Barrier free, meets CBC (Section 11B-309.4) requirements for max. 5 lb operating force (9700)	64.00
FL	Full length touchbar (Not Available DE)	N/C
Fastener Package		
SK	Shim kit	121.00
SNB	Sex nuts	24.00
TX	Security screws	49.00
SKTX	Shim kit and security screws	192.00
SKSNB	Shim kit and sex nuts	145.00
TXSNB	Security screws and sex nuts	95.00
SKTXSNB	Shim kit, security screws, and sex nuts	213.00
METRIC	Metric installation fasteners (9600, 9700, and 9800 Series only)	N/C
Tempered Glass Door Applications (9800 Series Only)		
TGD	Tempered glass doors in 630 finish	958.00
Electronic Controls		
DE*	Delayed egress (requires ES100 power supply and ES105 power transfer)	2231.00
DE30*	Delayed egress, 30 second (requires special approval from authority having jurisdiction)	2762.00
DECBC*	Delayed egress, CBC compliant	2762.00
MLR	Motorized Latch Retraction/dogging (use DKPS-2A power supply—2 MLR's)	1251.00
ES	Electric latch retraction (requires PS501 power supply and ES105 power transfer)	1204.00
Alarm		
BA*	Battery powered alarm	835.00
B4*	Battery powered alarm, 4 minute reset	890.00
DA*	Direct wired alarm	835.00
Monitoring		
LM	Latch bolt monitoring	329.00
MS	Monitor switch in touchbar	329.00
LMMS	Latch bolt and touchbar monitor	656.00
LMMSBP*	Latch bolt and touchbar monitor with bypass	656.00
Dogging		
CD*	Cylinder dogging (panic devices only)	123.00
LD	Less dogging (panic devices only)	N/C
MD	Electric dogging (requires DKPS-2A power supply)	1099.00
Power Supplies, Power Transfers, Power Modules		
AD100	Export power supply for up to 2 ES or 1 DE device 220 V.	971.00
ES101	Delay module	181.00
ES103	Relay module	114.00
ES100	Power supply for DE devices. Powers 1 DE device.	825.00
ES105	Power transfer (recommended for ES, DE & MLR options)	275.00
PS501	Power supply for ES9000 devices. Powers up to 2 devices.	971.00
PS501220	Export power supply, 220 VAC. Powers up to 2 ES9000 devices.	971.00
ES2	Power supply card for PS501. Powers an additional 2 devices.	529.00
DKPS-2A	Power supply for MD or MLR. Powers 1 device.	726.00
DKPS-2A	Power supply for MD. Powers 2 devices (will also power 1 MLR device).	726.00
DKPS-2A	Power supply for MLR. Powers 2 devices.	726.00
PS406BB	Power supply with battery back-up for solenoid electric latch retraction option.	1386.00
IMPORTANT NOTE: PS406BB can only be used with electric latch retraction option		

* List price includes default cylinder.





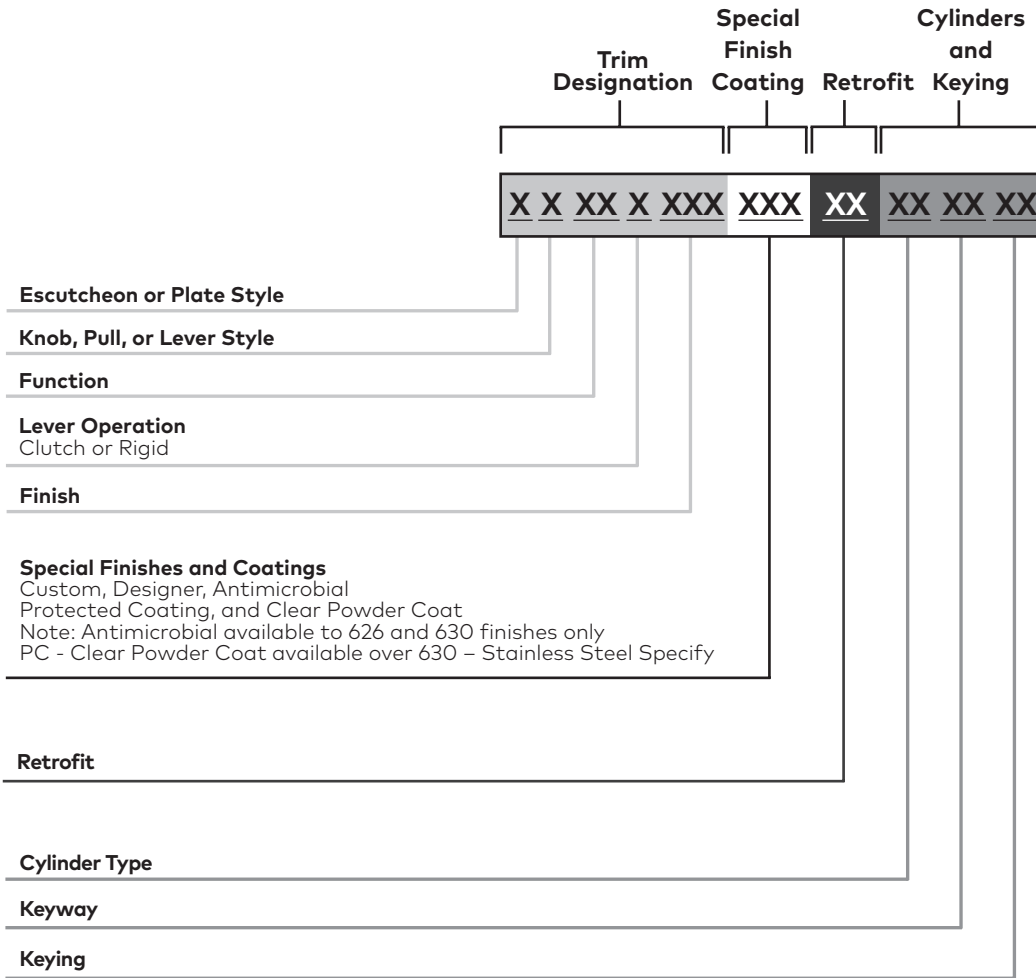

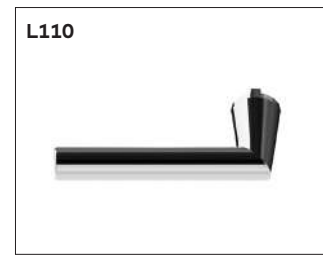
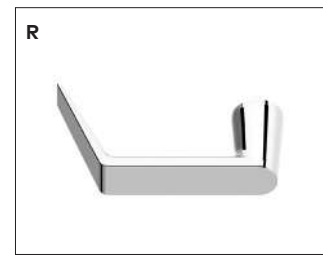
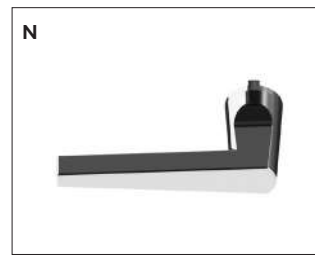
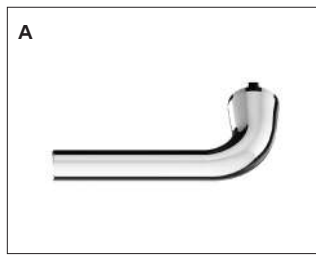

9000 Series Exit Trim

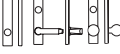
How to Order

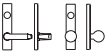

Lever and Knob Styles



ANSI Function	Description	Z Series Raised Escutcheon 1-5/8" W x 8-1/2" H x 15/16" D	Cylinder Only Pull by Others
DT	Dummy trim		
02	Entrance by trim when touchbar is dogged		
03	Entrance by trim when latch bolt is retracted by key. Key removable only when trim is locked.		
08	Entrance by lever or knob. Key locks or unlocks lever or knob.		
08C w/ clutch (Handed)	Entrance by lever with clutch option. Key locks or unlocks lever.		
09	Entrance by lever or knob only when unlocked by key. Key removable only when locked.		
09C w/ clutch (Handed)	Entrance by lever with clutch option trim unlocked by key. Key removable only when locked.		
11	Entrance by thumbturn and pull. Key locks or unlocks thumbturn.		
12	Entrance by thumbturn and pull only when released by key. Key removable only when locked.		
23	Entrance by lever or knob (no cylinder). Lever or knob always active.		
25	Entrance by thumbturn and pull (no cylinder). Thumbturn always active.		

9000 Series Narrow Stile Z Trim

Z Series Trim (Specify)				Special Finish Coating			Special Application Package		
Z Series Trim (Specify)				Door Thickness			Cylinders and Keying		
Escutcheon	Knob, Pull, or Lever	Function	Handing	Finish	Special Finish Coating	Special Application Package	Cylinder Type	Keyway	Keying
Z	A	DT	RHR	630	Ext3	*AM	T	CA	KD
	C	O2	LHR	606	Ext4	**PC	J	CD	KA2
Handed -	D	O2R		611			C	CE	KA4
Handed -	K	O3		612			L	D100	NSK
	F	O3R		613			D	GA	MKD
	G	O8		619			G	RA	CMK
	R	O8C	- Handed	625			R	RB	SKD
	T	O9		626			F	SC	OBit
	O	O9C	- Handed	629			X6	SE	
	P	11		630			X7	SF	
Handed -	N	12		689				YA	
	V	23		691				YG	
	L109	25		693					
	L110			695					
Handed -	L112			696					
	L114			Custom					
	L117			Designer					
	L118								

Suffix **C** and **LH/RH** required for clutch
 Suffix **R** required for rigid lever

 - Default



ZP



ZK



ZC

***Patented Key Control**
D100 is the keyway for our patented **SKC** serialized key control system. **SKC** is internet based and provides added layers of security. For more information, contact your local sales representative or Technical Service at 800-387-4938.

		Concealed Vertical Rod	Rim	Surface Vertical Rod	Available Finishes \$		
		9600 F9600	9700 F9700	9800 F9800	689, 691, 693 695, 696	630	605, 606, 611, 612, 613, 619, 625, 626, 629**
ANSI Function	Description						
DT	Dummy trim	ZODT			182.00	265.00	304.00
02	Entrance by trim when touchbar is dogged.	ZPO2			342.00	462.00	521.00
		ZK02R, Zx02R			253.00	415.00	506.00
03	Entrance by trim when latch bolt is retracted by key. Key removable only when trim is locked.	ZO03			283.00	384.00	404.00
		ZP03, ZK03R, Zx03R			504.00	665.00	722.00
08	Entrance by lever or knob. Key locks or unlocks lever or knob.	ZK08, Zx08			665.00	779.00	891.00
08 w/ clutch (Handed)	Entrance by lever with clutch option. Key locks or unlocks lever.	Zx08C			940.00	1102.00	1163.00
09	Entrance by lever or knob only when unlocked by key. Key removable only when locked.	ZK09, Zx09			665.00	779.00	891.00
09 w/ clutch (Handed)	Entrance by lever with clutch option trim unlocked by key. Key removable only when locked.	Zx09C			940.00	1102.00	1163.00
11	Entrance by thumbturn. Key locks or unlocks thumbturn	Z011			547.00	709.00	733.00
12	Entrance by thumbturn when unlocked by key. Key removable only when locked.	Z012			547.00	709.00	733.00
11	Entrance by thumbturn. Key locks or unlocks thumbturn	ZP11			627.00	761.00	784.00
12	Entrance by thumbturn when unlocked by key. Key removable only when locked.	ZP12			627.00	761.00	784.00
23	Entrance by lever or knob (no cylinder). Lever or knob always active.	ZK23, Zx23			441.00	615.00	665.00
25	Entrance by thumbturn and pull (no cylinder). Thumbturn always active.	ZP25			543.00	669.00	819.00

**** For 629 finish, please allow 4 week lead time.**

NOTES:

- Where x appears above, x = lever styles A, C, D, F, G, N, R, T, V, L109, L110, L112, L114, L117 or L118. (Handed — D, F, V, L114)
- List price includes the default cylinder.

9000 Series Narrow Stile Pull Trim

Pull (Specify)		Special Finish Coating
Pull Type	Function	Finish
		630
OP	02	605 *AM
9BPO ¹	03	606 **PC
		611
		612
		613 <input type="checkbox"/> - Default
		619
		625
		626
		630
		689
		691
		693
		695
		696
		Custom
		Designer



OP



9PBO

1. 9PBO not applicable on 9500 Device. 03 Function only. Not available in 693 finish

Concealed Vertical Rod	Rim	Surface Vertical Rod	Available Finishes \$		
9600 F9600	9700 F9700	9800 F9800	689, 691, 693, 695, 696	630	605, 606, 611, 612, 613, 619, 625, 626

ANSI Function	Description				
02	Entrance by trim when touchbar is dogged.	OP02	169.00	211.00	249.00
03	Entrance by trim when latch bolt is retracted by key. Key removable only when trim is locked.	9PBO03	190.00	190.00	190.00

- NOTES:**
- List price includes the default cylinder.
 - 9PBO03 trim not recommended for wood doors. For hollow metal and aluminum door applications. Not available in 693 finish.

Trim Options

Option Code	Description	List Add \$
Special Finishes and Coatings		
AM	Antimicrobial protected coating	110.00
P	Clear powder coat	110.00
Custom Color	Custom painted finish selected from RAL color pallet book. For details, see Finishes Cross Reference , page viii.	
	Per order, setup charge (Net)	169.00
	per exit device only, list add	85.00
	per trim only, list add	85.00
Designer Color	Designer painted color matched to supplied samples. Three (3) each 2" x 3" color chip samples required. For details, see Finishes Cross Reference , page viii.	
	per order, non-refundable development/setup charge (Net)	608.00
	per exit device only, list add	85.00
	per trim only, list add	85.00
Tempered Glass Door Applications		
TGD	Tempered glass doors (Z series trim only), available in 630 finish only	59.00
Door Thickness (includes extended spindle and fasteners)		
Ext3	Door thickness from 2-1/4"-3-1/4" (57 mm to 83 mm)	114.00
Ext4	Door thickness from 3-1/4"-4-1/4" (83 mm to 108 mm)	114.00

Cylinders

Rim Cylinders

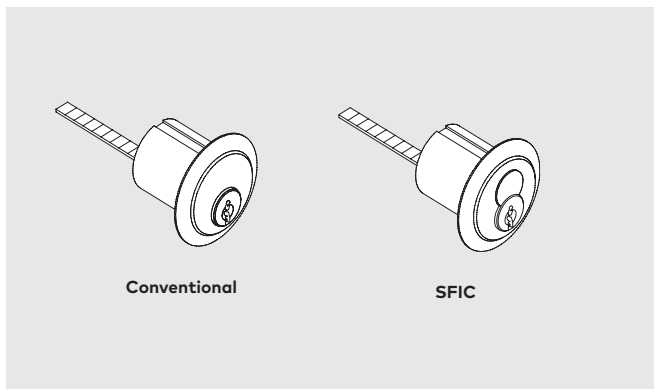

Mortise Cylinders

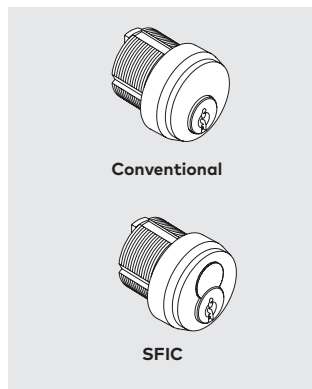

Key-in-Lever Cylinders

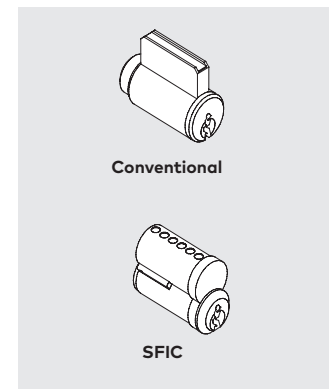

Narrow Stile

Application	ANSI Function	Cylinder Type	Conventional (Default)	Cam	SFIC 7-Pin
Cylinders for 9600/F9600 Concealed Vertical Rod, 9700/F9700 Rim, and 9800/F9800 Surface Vertical Rod Narrow Stile Devices					
Z Escutcheon Trim	03	Rim	80R40SC	NA	87R40BA
Z Escutcheon Trim	08, 11	Mortise	90x13SC118	#13	97C13BA138
Z Escutcheon Trim	09, 12	Mortise	90x09SC118	#9	97C09BA138
Cylinders for Device Options					
CD, BA, B4, DE, DE30, DECBC, DA, LMMSBP	—	Mortise	90x10SC118	#10	97D10BA138

NOTE: For additional information, please refer to Cylinders, Keys & Keying.

Cylinder Types, Keying Options and Keyways for Removable Mullions and Exit Devices

Cylinder	Option	Description	List Add/Deduct \$
Conventional Cylinders (non-interchangeable core)			
D		Keying for exit device or removable mullions with conventional cylinder (default)	
	KD	Keyed differently to a random combination; SC keyway with 2 keys (default)	N/C
	KA2	Keyed alike in pairs to a random combination; SC keyway with 2 keys	N/C
	NSK	Keyed alike, sets of three or more; SC keyway with 2 keys	21.00
	1-Bit	1-bit key (sold separately); SC, SE keyway with 2 key blanks	N/C
	1-Bit	1-bit key (sold separately); D100 keyway — Keys sold separately	N/C
	0-Bit	Operated by a key blank; CA, CD, CE, RA, RB, GA, SF, YA, YG keyways with 2 key blanks	21.00
	MKD	Master keyed; SC, SE, or D100 keyway — Keys sold separately	25.00
	CMK	Construction master keyed single cylinder locks — Keys sold separately	26.00
L		Keying for exit device or removable mullions less conventional cylinder	Deduct 30.00
Interchangeable Core Cylinders			
T		Keying for exit device or removable mullions with keyed temporary SFIC construction core Keying for exit trim with keyed temporary SFIC construction core (cores may be returned for a full refund) — Keys sold separately	62.00
J		Keying for exit device or removable mullions with disposable plastic SFIC construction core	N/C
C		Keying for exit device or removable mullions with combined SFIC core installed at factory ¹ Keying for exit trim with combined core installed at factory; BA (default), BB, BC, BD, BE, BF, BG, BH, BJ, BK, BL, BM, BQ, D100 keyway — Keys sold separately	69.00
G		Schlage LFIC — Housing with keyed temporary Schlage LFIC construction core (Core may be returned for full refund) — Keys sold separately	62.00
F		Schlage LFIC — Housing with combined Schlage LFIC installed at the factory (SC keyway) — Keys sold separately	69.00
Cylinder Housings Less Cores			
EP		Euro profile half cylinder housing	N/C
R		Housing prepared for Schlage LFIC	12.00
X7		Housing prepared for Sargent XC 7P and Arrow Choice 7P SFIC	12.00
X6		Housing prepared for Arrow Choice 6P SFIC	12.00

1. For uncombined cores, **UNC** cores must be ordered separately, see **Cylinders, Keys & Keying**. Exits/trim will be supplied w/ plastic construction core, Option J.

⊗ Denotes keys must be ordered separately.

Cut Keys Ordered Separately

Part #	Description	List \$
45101	SFIC Cut key — Change key, master key, construction master key, or control key; BA, BB, BC, BD, BE, BF, BG, BH, BJ, BK, BL, BM, BQ, SC, SE keyways	10.00
45401	SFIC Cut key — Change key, master key, or control key; D100 keyways — D100 etc.	16.00
45404	CONV/LFIC Cut key — 1 bit key for operating 1 bit cylinders — SC, SE keyways	8.00
45405	LFIC Cut key — 1 bit control key (to install/remove "0-bit" LFIC cores) — SC keyway	8.00
44101SC	CONV/LFIC Key blank — SC keyway	6.00
44104SC	LFIC Key blank — Control key (to install/remove LFIC Cores) — SC keyway	7.00

NOTES:

- Distribution of DORMA SKC keys (listed as D100) is restricted. See Cylinders, Keys & Keying section for DORMA SKC policies.
- For additional information, please refer to Cylinders, Keys, and Keying
- See Keys and Key Blanks section for complete list.

Mullions

Item	Description	List \$
Aluminum Mullions x 628 (clear anodized), 1-5/8" x 2-5/8"		
1310-8	8'	1298.00
1310-8 x 443	8', recessed strike	1509.00
WS1310-8	8', weatherstrip	1380.00
WS1310-8 x 443	8', weatherstrip and recessed strike	1523.00
1310-10	10'	1380.00
1310-10 x 443	10', recessed strike	1656.00
WS1310-10	10', weatherstrip	1509.00
WS1310-10 x 443	10', weatherstrip and recessed strike	1751.00
Aluminum Mullions x 695 (painted), 1-5/8" x 2-5/8"		
1310-8	8'	1572.00
1310-8 x 443	8', recessed strike	1783.00
WS1310-8	8', weatherstrip	1656.00
WS1310-8 x 443	8', weatherstrip and recessed strike	1883.00
1310-10	10'	1703.00
1310-10 x 443	10', recessed strike	1931.00
WS1310-10	10', weatherstrip	1816.00
WS1310-10 x 443	10', weatherstrip and recessed strike	1833.00
Steel Mullions x 600 (primed for paint), 1-1/2" x 2-1/2"		
1330-8	8'	648.00
1330-10	10'	683.00
Steel Mullions x 600 (primed for paint), 2" x 3"		
1300-8	8'	845.00
F1300-8	8', fire-rated	1087.00
F1300-10	10', fire-rated	1453.00
1340KR-8	8', key removable (includes standard cylinder using 01 cam)	1428.00
F1340KR-8	8', fire-rated mullion, key removable (includes standard cylinder using 01 cam)	1672.00
F1340KR-10	10', fire-rated mullion, key removable (includes standard cylinder using 01 cam)	1956.00
1300-10	10'	973.00
1340KR-EL	8', key removable, electrified mullion	1656.00
1340KR-10	10', key removable (includes standard cylinder using 01 cam)	1509.00
1340KR-EL-10	10', key removable, electrified mullion	1737.00
HC1300-8	8', design pressure rated 80PSF for openings up to 8' x 8' with HC9300 device.	1572.00
Mullion Storage Kit		
1340SK	Storage kit for 1340/F1340 Series key removable mullion.	424.00

Cylinders for 1340KR/F1340KR Mullions and 1340SK Storage Kit

Type	Standard	7-pin IC	Cam
Mortise	90X01SC118	97D01BA138	01 (AR)

8000 Series Exit Devices

How to Order

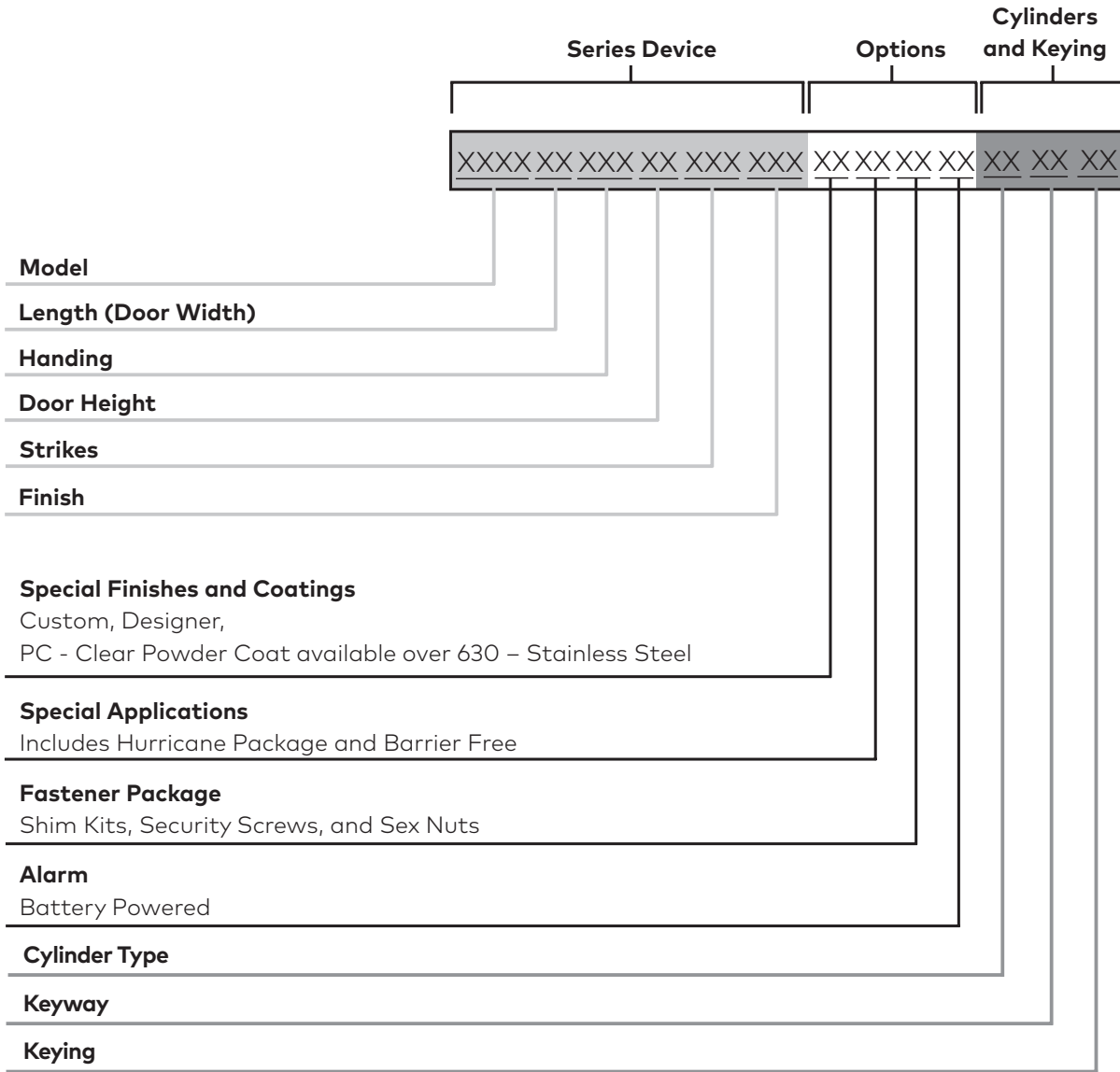

8300 Series

Rim Exit Device

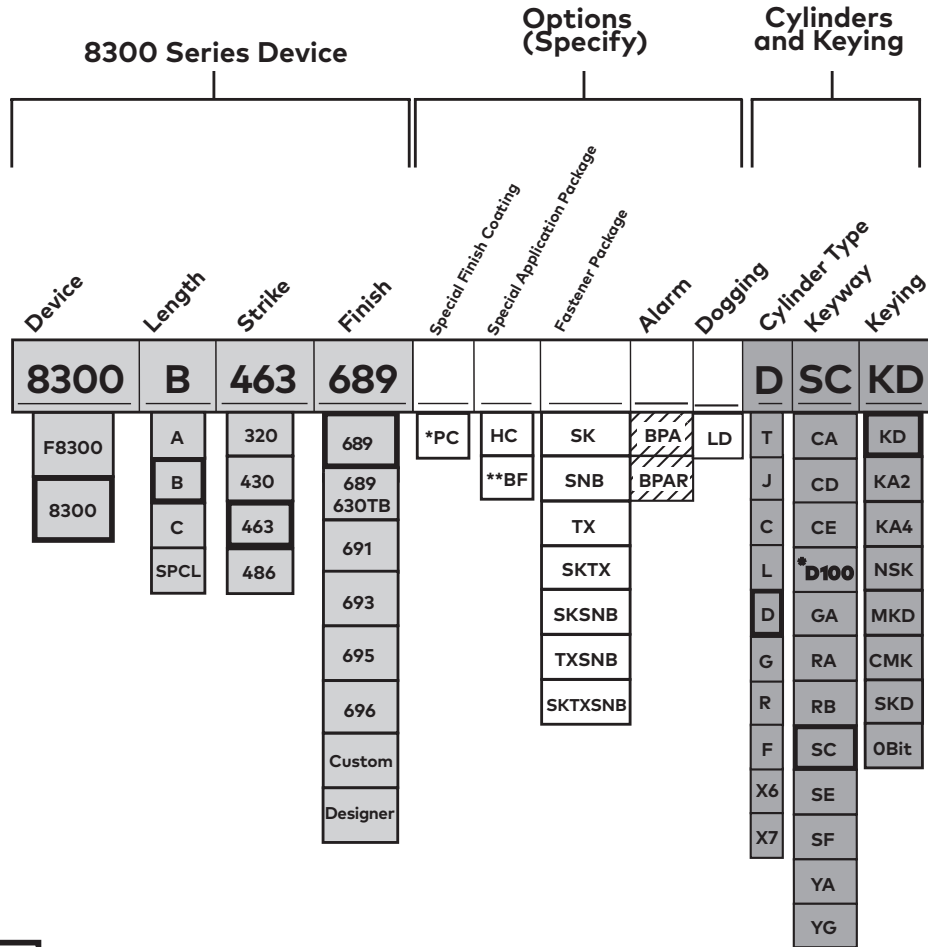

 – Default

 – Supplied with Standard KD Cylinder

***Patented Key Control**

D100 is the keyway for our patented **SKC** serialized key control system. **SKC** is internet based and provides added layers of security. For more information, contact your local sales representative or Technical Service at 800-387-4938.

**** Barrier Free option availability:**

Exit Device	Functions	Electric Options	Device Lengths	Ratings
8300BF	01, 02, 03, 05, 08, 23	ES, BA, B4, LM, MS, LM/MS	36" & 48"	Panic & Fire

8000 Series – Wide Stile Applications

Device Length	All Device Options (except BA or DA)		BA or DA Device Options
	Maximum Door Width ¹	Minimum Door Width ²	Minimum Door Width ²
A	48" (1220 mm)	34" (864 mm)	39" (991 mm)
B	36" (915 mm)	28" (712 mm)	33" (839 mm)
C	36" (915 mm)	22" (559 mm)	22" (559 mm)

1. As delivered from factory, device will fit doors of this width. For other widths, consult Technical Services.
 2. Touch bar and rail assembly can be shortened at time of installation to fit doors down to this width.



Available Finishes \$

Function	Description	Device, Exit Only	Available Finishes \$	
			689, 691, 693, 695, 696	689 w/ 630 TB
01	Panic	8300 Rim	702.00	1059.00
01	Fire	F8300 Rim	962.00	1322.00

Typical Options

Item	Description	List Add \$
ES	Electric latch retraction (requires ES100 power supply and ES105 power transfer)	1204.00
CD	Cylinder dogging (includes cylinder)	123.00
LD	Less dogging (Standard with fire rated device)	N/C
SNB	Sex nuts (Included with F and H options)	24.00
TX	Security screws	49.00
HC	Hurricane (includes SNB)	229.00
BF	Barrier free exit device, meets California Building Code (Section 11B-309.4) requirements for maximum 5 lb operating force. See page 86 for compatible functions/options."	40.00
320	Overlap strike	39.00
430	Rim box strike	61.00
463	Standard rim strike	N/C
486	Roller strike	24.00

NOTES:

- Prices shown apply to A, B, or C length devices.
- Specify door width. If not specified, Size B is the standard default.
- List price includes default strikes. For optional strikes, specify strike number and adjust list price accordingly.
- List price for the device does not include trim.
- Devices include wood and machine screws standard.
- Fire and hurricane rated devices include SNB sex nuts standard.
- For options requiring a cylinder, the option list price includes the default cylinder.
- For special lengths, consult Technical Service.
- All standard devices and trim are designed for 1-3/4" - 2-1/4" thick doors. For door thickness greater than 2-1/4", consult Technical Service.

8400 Series

Surface Vertical Rod Exit Device

8400 Series Device							Options (Specify)					Cylinders and Keying			
Device	Length	Handing	Door Height	Top Strike	Bottom Strike	Finish	Special Finish Coating	Bottom Latch	Special Application Package	Fastener Package	Alarm	Dogging	Cylinder Type	Keyway	Keying
8400	B	RHR	7	426	439	689							D	SC	KD
F8400	A	RHR	7	426	340	689	*PC	LB	HC	SK	BPA	LD	T	CA	KD
8400	B	LHR	8	426A	416V	689		PB		SNB	BPAR		J	CD	KA2
	C		9		431	630TB		SB		TX			C	CE	KA4
	SPCL		10		439	691				SKTX			L	CE	NSK
			SPCH			693				SKSNB			D	GA	MKD
						695				TXSNB			G	RA	CMK
						696				SKTXSNB			R	RB	SKD
						Custom							F	SC	OBit
						Designer							X6	SE	
													X7	SF	
														YA	
														YG	

 – Default

 – Supplied with Standard KD Cylinder

8000 Series – Wide Stile Applications

Device Length	All Device Options (except BA or DA)		BA or DA Device Options
	Maximum Door Width ¹	Minimum Door Width ²	Minimum Door Width ²
A	48" (1220 mm)	34" (864 mm)	39" (991 mm)
B	36" (915 mm)	28" (712 mm)	33" (839 mm)
C	36" (915 mm)	22" (559 mm)	22" (559 mm)

1. As delivered from factory, device will fit doors of this width. For other widths, consult Technical Services.

2. Touch bar and rail assembly can be shortened at time of installation to fit doors down to this width.

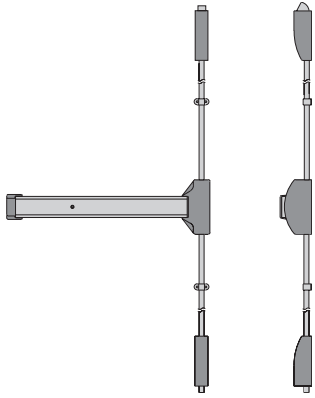

Available Finishes \$

689, 691, 693, 695, 696	689 w/ 630 TB
----------------------------	---------------

Function	Description	Device, Exit Only		
01	Panic	8400 Surface vertical rod	1163.00	1536.00
01	Fire	F8400 Surface vertical rod	1478.00	1848.00

Typical Options

Item	Description	List Add \$
ES	Electric latch retraction (requires ES100 power supply and ES105 power transfer)	1204.00
CD	Cylinder dogging (Includes cylinder)	123.00
LD	Less dogging (Standard with fire rated device)	N/C
SNB	Sex nuts (Included with F and HC options)	24.00
TX	Security screws	49.00
HC	Hurricane (Includes SNB)	229.00
LB	Less bottom rod	N/C
PB	Pullman bottom latch	74.00
SB	Slide bolt (Default)	N/C
Up to 8'	7' default	N/C
Up to 10'	Door heights over 8' to 10' (over 10', call Technical Service)	73.00
340	Flat slide bolt bottom strike	N/C
416V	Surface bottom strike for pullman latch	N/C
426	Standard top strike	N/C
426A	Top strike with angle	39.00
431	Recessed bottom strike for pullman latch	39.00
439	Standard slide bolt bottom strike	N/C

NOTES:

- Prices shown apply to A, B, or C length devices.
- Specify door width and handing. If not specified, Size B, RHR is the standard default.
- List price includes default strikes. For optional strikes, specify strike number and adjust list price accordingly.
- List price for the device does not include trim.
- Devices include wood and machine screws standard.
- Fire and hurricane rated devices include SNB sex nuts standard.
- For options requiring a cylinder, the option list price includes the default cylinder.
- Device includes precut and drilled rods for 7' or 8' doors as specified on order.
For 9' doors, device includes precut and drilled rods for a 7' door and a 2' rod extension for the top rod.
For 10' doors, device includes precut and drilled rods for an 8' door and a 2' rod extension for the top rod.
See Device Options for pricing information.
- For special lengths and/or door heights over 10', consult Technical Service.
- All standard devices and trim are designed for 1-3/4"-2-1/4" thick doors. For door thickness greater than 2-1/4", consult Technical Service.

Options

Option Code	Description	List Add \$
Special Finishes and Coatings		
P	Clear powder coat	102.00
Custom Color	Custom painted finish selected from RAL color pallet book. For details, see Finishes Cross Reference	
	Per order, setup charge (Net)	156.00
	per exit device only, list add	79.00
	per trim only, list add	79.00
Designer Color	Designer painted color matched to supplied samples. Three (3) each 2" x 3" color chip samples required. For details, see Finishes Cross Reference , page viii.	
	per order, non-refundable development/setup charge (Net)	565.00
	per exit device only, list add	79.00
	per trim only, list add	79.00
Fastener Package		
SK	Shim kit	112.00
SNB	Sex nuts	22.00
TX	Security screws	45.00
SKTX	Shim kit and security screws	178.00
SКСNB	Shim kit and sex nuts	134.00
TXSNB	Security screws and sex nuts	88.00
SKTXSNB	Shim kit, security screws, and sex nuts	198.00
Special Application Packages		
HC	Hurricane, Includes SNB	200.00
BF	Barrier free, meets CBC (Section 11B-309.4) requirements for max. 5 lb operating force (8300)	27.00
Alarm		
BA*	Battery powered alarm	776.00
B4*	Battery powered alarm, 4 minute reset	827.00
DA*	Direct wired alarm	776.00
Monitoring		
LM	Latch bolt monitoring	306.00
MS	Monitor switch in touchbar	306.00
LMMS	Latch bolt and touchbar monitor	610.00
Power Supplies, Power Transfers, Power Modules		
ES101	Delay module	168.00
ES103	Relay module	106.00
ES100	Power supply. Powers (2) 8000 ES devices.	767.00
ES105	Power transfer for ES devices	255.00





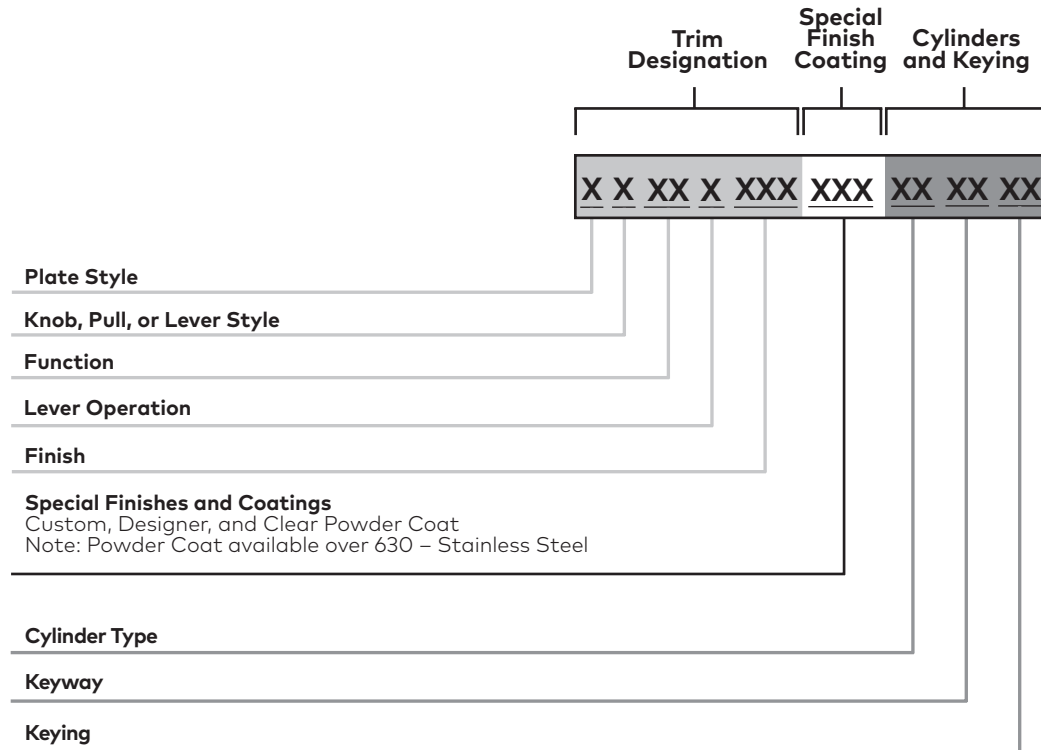



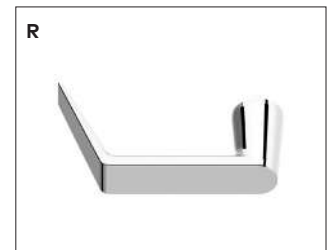













8000 Series Exit Trim

How to Order



Lever and Knob Styles



ANSI Function	Description	Escutcheon	Sectional 3-3/8" Diameter Rose	Wide Plate 3" W x 16" H	Pulls	Cylinder Only Pull by Others
DT	Dummy trim					
02	Entrance by trim when touchbar is dogged					
03	Entrance by trim when latch bolt is retracted by key. Key removable only when trim is locked.					
05	Entrance by thumbpiece. Key locks or unlocks thumbpiece.					
06	Entrance by thumbpiece only when released by key. Key removable only when locked.					
08	Entrance by lever or knob. Key locks or unlocks lever or knob.					
09	Entrance by lever or knob when unlocked by key. Key removable only when locked.					
22	Entrance by thumbpiece (no cylinder). Thumbpiece always active.					
23	Entrance by lever or knob (no cylinder). Lever or knob always active.					

8000 Series Escutcheon Trim

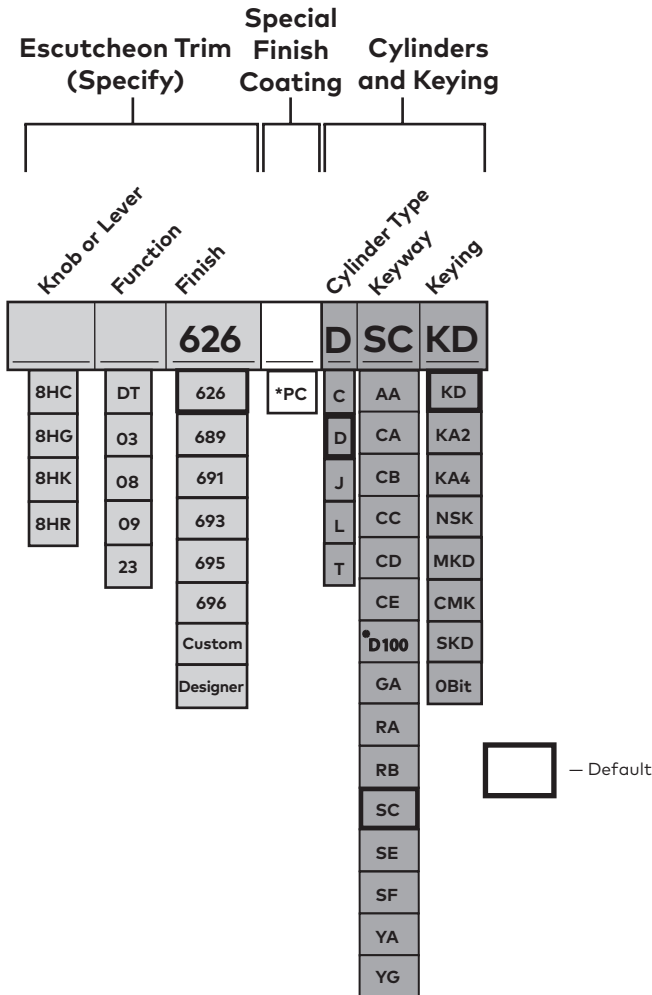

8HR



8HK

***Patented Key Control**
D100 is the keyway for our patented **SKC** serialized key control system. **SKC** is internet based and provides added layers of security. For more information, contact your local sales representative or Technical Service at 800-387-4938.

Rim	Surface Vertical Rod	Available Finishes \$	
8300 F8300	8400 F8400	689, 691, 693 695, 696	626

ANSI Function	Description			
DT	Dummy trim	8HDT	387.00	362.00
03	Entrance by trim when latch bolt is retracted by key. Key removable only when trim is locked.	8Hx03 8HK03	524.00	482.00
08	Entrance by lever or knob. Key locks or unlocks lever or knob.	8Hx08 8HKx08	524.00	482.00
09	Entrance by lever or knob when unlocked by key. Key removable only when locked.	8Hx09 8HK09	524.00	482.00
23	Entrance by lever or knob (no cylinder). Lever or knob always active.	8Hx23 8HK23	436.00	382.00

NOTES:

- List price includes the default cylinder.
- Where x appears above, x = lever style. See page 142 for details.

8000 Series Sectional Trim

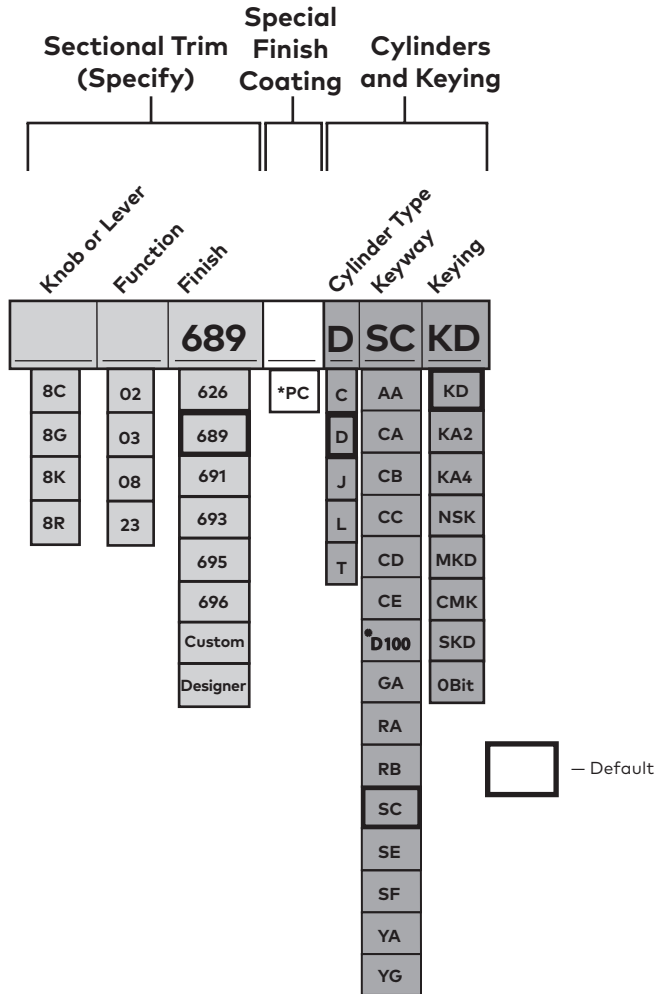

8R



8K

***Patented Key Control**
D100 is the keyway for our patented **SKC** serialized key control system. **SKC** is internet based and provides added layers of security. For more information, contact your local sales representative or Technical Service at 800-387-4938.

Rim	Surface Vertical Rod	Available Finishes \$	
8300 F8300	8400 F8400	689, 691, 693 695, 696	626

ANSI Function	Description			
02	Entrance by trim when touchbar is dogged.	8x02R 8K02R	382.00	436.00
03	Entrance by trim when latch bolt is retracted by key. Key removable only when trim is locked.	8x03 8K03	468.00	524.00
08	Entrance by lever or knob. Key locks or unlocks lever or knob.	8x08 8K08	468.00	524.00
23	Entrance by lever or knob (no cylinder). Lever or knob always active.	8x23 8K23	382.00	436.00

Notes:

- List price includes the default cylinder.
- Where x appears above, x = lever style. See page 142 for details.

8000 Series Wide Plate Trim

Wide Plate Trim (Specify)			Special Finish Coating	Cylinders and Keying		
Plate Type	Function	Finish		Cylinder Type	Keyway	Keying
		630		D	SC	KD
HRS	DT	630	*PC	T	AA	KD
HTS	02	689		J	CA	KA2
NPS	03	691		C	CB	KA4
PRS	05	693		L	CC	NSK
PTS	06	695		D	CD	MKD
80	08	696		G	CE	CMK
	22	Custom		R	D100	SKD
		Designer		F	GA	OBit
				X6	RA	
				X7	RB	
					SC	
					SE	
					SF	
					YA	
					YG	



PRS



HTS

 - Default

***Patented Key Control**
D100 is the keyway for our patented **SKC** serialized key control system. **SKC** is internet based and provides added layers of security. For more information, contact your local sales representative or Technical Service at 800-387-4938.

		Rim	Surface Vertical Rod	Available Finishes \$	
		8300 F8300	8400 F8400	689, 691, 693 695, 696	630
ANSI Function	Description				
DT	Dummy trim	NPSDT		169.00	238.00
		80DT		103.00	—
02	Entrance by trim when touchbar is dogged.	PRS02 PTS02		238.00	298.00
03	Entrance by trim when latch bolt is retracted by key. Key removable only when trim is locked.	NPS03		238.00	321.00
		PRS03 PTS03		298.00	382.00
05	Entrance by thumbpiece. Key locks or unlocks thumbpiece.	HRS05 HTS05		338.00	444.00
06	Entrance by thumbpiece only when released by key. Key removable only when locked.	HRS06 HTS06		338.00	444.00
22	Entrance by thumbpiece (no cylinder). Thumbpiece always active.	HRS22 HTS22		278.00	338.00

NOTE:

- List price includes the default cylinder.

8000 Series Pull Trim

Pulls (Specify)			Special Finish Coating	Cylinders and Keying		
Pull Type	Function	Finish		Cylinder Type	Keyway	Keying
		689		D	SC	KD
80 ¹	DTP	689	*PC	T	AA	KD
8P	O2	691		J	CA	KA2
8PBO ²	O3	693		C	CB	KA4
	O3P	695		L	CC	NSK
		696		D	CD	MKD
		Custom		G	CE	CMK
		Designer		R	*D100	SKD
				F	GA	OBit
				X6	RA	
				X7	RB	
					SC	
					SE	
					SF	
					YA	
					YG	

– Default

***Patented Key Control**
D100 is the keyway for our patented **SKC** serialized key control system. **SKC** is internet based and provides added layers of security. For more information, contact your local sales representative or Technical Service at 800-387-4938.



80



8PBO



8P

- 1. Specify hand.
- 2. 8PBO available for O3 Function only. Not available in 693 finish.

Rim	Surface Vertical Rod	Available Finishes \$
8300 F8300	8400 F8400	689, 691, 693 695, 696

ANSI Function	Description		
02	Entrance by trim when touchbar is dogged.	8P02	338.00
		80DTP	236.00
		8PDT	128.00
03	Entrance by trim when latch bolt is retracted by key. Key removable only when trim is locked.	8003P	321.00
		8003	169.00
		8P03	213.00
		8PBO03	190.00

- NOTES:**
- List price includes the default cylinder.
 - 8PBO03 trim not recommended for wood doors. Hollow metal and aluminum door applications.

Trim Options

Option Code	Description	List Add \$
Special Finishes and Coatings		
P	Clear powder coat	110.00
Custom Color	Custom painted finish selected from RAL color pallet book. For details, see Finishes Cross Reference , page viii.	
	Per order, setup charge (Net)	168.00
	per exit device only, list add	85.00
	per trim only, list add	85.00
Designer Color	Designer painted color matched to supplied samples. Three (3) each 2" x 3" color chip samples required. For details, see Finishes Cross Reference , page viii.	
	per order, non-refundable development/setup charge (Net)	608.00
	per exit device only, list add	85.00
	per trim only, list add	85.00

Cylinders

Rim Cylinders

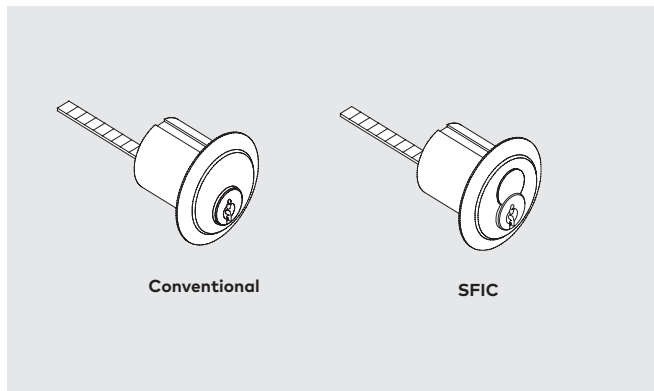

Mortise Cylinders

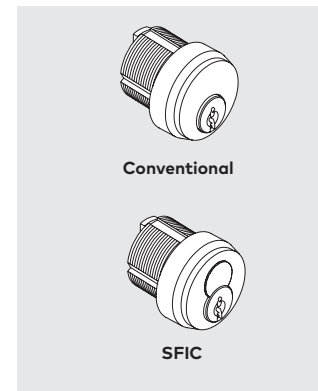

Key-in-Lever Cylinders

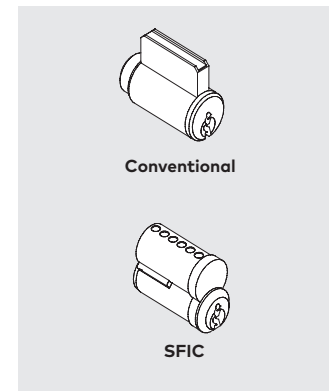

Application	ANSI Function	Cylinder Type	Conventional (Default)	SFIC 7-Pin
Trim				
Sectional Trim (Key-in-Lever)	03, 08	Key-in-lever	70135C	77
3" Wide Plate Trim	03	Rim	80R40SC	87A40
3" Wide Plate Trim	05, 06	Mortise	90X10SC118	97C10138
Pulls	03	Rim	80R40SC	87A40
Device Options				
CD, BA, B4,		Mortise	90X10SC118	97D10138

NOTE:

- For additional information, please refer to Cylinders, Keys, and Keying.

Cylinder Types, Keying Options and Keyways for Removable Mullions and Exit Devices

Cylinder	Option	Description	List Add/Deduct \$
Conventional Cylinders (non-interchangeable core)			
D		Keying for exit device or removable mullions with conventional cylinder (default)	
	KD	Keyed differently to a random combination; SC keyway with 2 keys (default)	N/C
	KA2	Keyed alike in pairs to a random combination; SC keyway with 2 keys	N/C
	1-Bit	1-bit key (sold separately); SC, SE keyway with 2 key blanks	N/C
	1-Bit	1-bit key (sold separately); D100 keyway — Keys sold separately	N/C
	0-Bit	Operated by a key blank; CA, CD, CE, RA, RB, GA, SF, YA, YG keyways with 2 key blanks	21.00
	NSK	Keyed alike, sets of three or more; SC keyway with 2 keys	21.00
	MKD	Master keyed; SC, SE, or D100 keyway — Keys sold separately	26.00
	CMK	Construction master keyed single cylinder locks — Keys sold separately	22.00
L		Keying for exit device or removable mullions less conventional cylinder	Deduct 33.00
Interchangeable Core Cylinders			
T		Keying for exit device or removable mullions with keyed temporary SFIC construction core Keying for exit trim with keyed temporary SFIC construction core (cores may be returned for a full refund) — Keys sold separately	62.00
J		Keying for exit device or removable mullions with disposable plastic SFIC construction core	N/C
C		Keying for exit device or removable mullions with combined SFIC core installed at factory ¹ Keying for exit trim with combined core installed at factory; BA (default), BB, BC, BD, BE, BF, BG, BH, BJ, BK, BL, BM, BQ, D100 keyway — Keys sold separately	69.00
G		Schlage LFIC — Housing with keyed temporary Schlage LFIC construction core (Core may be returned for full refund) — Keys sold separately	62.00
F		Schlage LFIC — Housing with combined Schlage LFIC installed at the factory (SC keyway) — Keys sold separately	69.00
Cylinder Housings Less Cores			
R		Housing prepared for Schlage FSIC	12.00
X7		Housing prepared for Sargent XC 7P and Arrow Choice 7P SFIC	12.00
X6		Housing prepared for Arrow Choice 6P SFIC	12.00

1. For uncombined cores, **UNC** cores must be ordered separately, see **Cylinders, Keys & Keying**. Exits/trim will be supplied w/ plastic construction core, Option J.

⊗ Denotes keys must be ordered separately.

Cut Keys Ordered Separately

Part #	Description	List \$
45101	SFIC Cut key — Change key, master key, construction master key, or control key; BA, BB, BC, BD, BE, BF, BG, BH, BJ, BK, BL, BM, BQ, SC, SE keyways	10.00
45401	SFIC Cut key — Change key, master key, or control key; D100 keyways — D100 etc.	16.00
45404	CONV/LFIC Cut key — 1 bit key for operating 1 bit cylinders — SC, SE keyways	8.00
45405	LFIC Cut key — 1 bit control key (to install/remove "0-bit" LFIC cores) — SC keyway	8.00
44101SC	CONV/LFIC Key blank — SC keyway	6.00
44104SC	LFIC Key blank — Control key (to install/remove LFIC Cores) — SC keyway	7.00

NOTES:

- Distribution of DORMA SKC keys (listed as D100) is restricted. See Cylinders, Keys & Keying section for DORMA SKC policies.
- For additional information, please refer to Cylinders, Keys, and Keying
- See Keys and Key Blanks section for complete list.

Mullions

Item	Description	List \$
Aluminum Mullions x 628 (clear anodized), 1-5/8" x 2-5/8"		
1310-8	8'	1298.00
1310-8 x 443	8', recessed strike	1509.00
WS1310-8	8', weatherstrip	1380.00
WS1310-8 x 443	8', weatherstrip and recessed strike	1523.00
1310-10	10'	1380.00
1310-10 x 443	10', recessed strike	1656.00
WS1310-10	10', weatherstrip	1509.00
WS1310-10 x 443	10', weatherstrip and recessed strike	1751.00
Aluminum Mullions x 695 (painted), 1-5/8" x 2-5/8"		
1310-8	8'	1572.00
1310-8 x 443	8', recessed strike	1783.00
WS1310-8	8', weatherstrip	1656.00
WS1310-8 x 443	8', weatherstrip and recessed strike	1883.00
1310-10	10'	1703.00
1310-10 x 443	10', recessed strike	1931.00
WS1310-10	10', weatherstrip	1816.00
WS1310-10 x 443	10', weatherstrip and recessed strike	1833.00
Steel Mullions x 600 (primed for paint), 1-1/2" x 2-1/2"		
1330-8	8'	648.00
1330-10	10'	683.00
Steel Mullions x 600 (primed for paint), 2" x 3"		
1300-8	8'	845.00
F1300-8	8', fire-rated	1087.00
F1300-10	10', fire-rated	1453.00
1340KR-8	8', key removable (includes standard cylinder using 01 cam)	1428.00
F1340KR-8	8', fire-rated mullion, key removable (includes standard cylinder using 01 cam)	1672.00
F1340KR-10	10', fire-rated mullion, key removable (includes standard cylinder using 01 cam)	1956.00
1300-10	10'	973.00
1340KR-EL	8', key removable, electrified mullion	1656.00
1340KR-10	10', key removable (includes standard cylinder using 01 cam)	1509.00
1340KR-EL-10	10', key removable, electrified mullion	1737.00
HC1300-8	8', design pressure rated 80PSF for openings up to 8' x 8' with HC9300 device.	1572.00
Mullion Storage Kit		
1340SK	Storage kit for 1340/F1340 Series key removable mullion	424.00

Cylinders for 1340KR/F1340KR Mullions and 1340SK Storage Kit

Type	Standard	7-pin IC	Cam
Mortise	90X01SC118	97D01BA138	01 (AR)

DKPS Power Supply Series

Ordering Guide



DKPS-4A

DKPS Power Supply Series

Item	Description	List \$
DKPS-2A	110 V/2.0 A @ 24 VDC filter/reg, class 2 selectable output	726.00
DKPS-4A	110 V/4.0 A @ 24 VDC filter/reg, class 2 selectable output, (2) 2.0 A or (1) 4.0 A	1340.00
DKPS-6A	110 V/6.0 A @ 24 VDC filter/reg, class 2 selectable output, (3) 2.0 A or (1) 6.0 A	1,613.00
PS502RF-220	220V/1.0 A @ 24 VDC filter/reg, class 2 selectable output	742.00

DKPS Series Specifications

Features	DKPS-2A	DKPS-4A	DKPS-6A
Enclosure dimensions	Metric 338mm X 448mm X 110mm, Standard 13-5/16" X 17-41/64" X 4-21/64"		
UL294, CAN/ULC -60839-11-1	Y	Y	Y
CAN/ULC-S533, CE, FCC	Y	Y	Y
Input Requirements	100-240VAC, 50-60Hz. 2.4A Max draw	100-240VAC, 50-60Hz. 1.8A Max draw	100-240VAC, 50-60Hz. 2.5A Max draw
Output Performance	2.5 Amps continuous supply current at Nominal 12/24 VDC	4 Amps continuous supply current at Nominal PF 0.6 at nominal 12/24 VDC	6 Amps continuous supply current at Nominal PF 0.6 at nominal 12/24 VDC
Battery Back-Up Charger (ordered separately)	Standard	Standard	Standard
Keyed Cabinet	Standard (Keyed alike)	Standard (Keyed alike)	Standard (Keyed alike)
LED Power Status Indicator	Standard	Standard	Standard
Fire Alarm Termination	Standard	Standard	Standard
Power Distribution Board	4 Outputs	8 Outputs	8 Outputs
Warranty	Limited Lifetime		

DKPS Power Supply Series

Ordering Guide

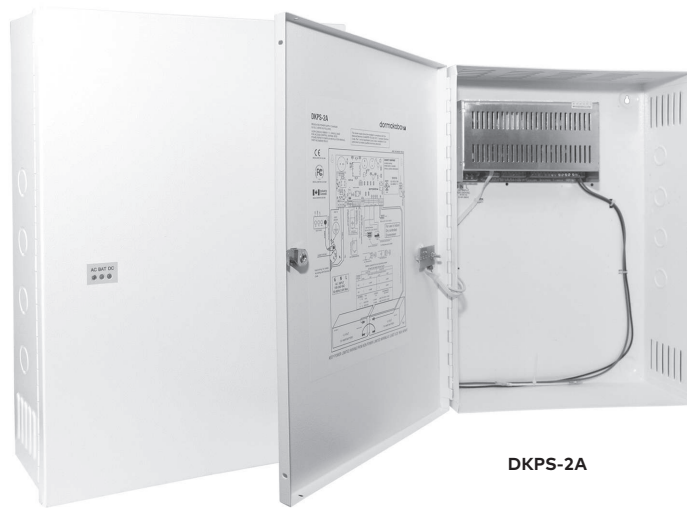

DKPS-2A

Options

Item	Description	List \$
BB12-4	4.5 Ahr battery backup for 12 V	75.00
BB12-7	7 Ahr battery backup for 12 V	114.00
BB24-4	4.5 Ahr battery backup for 24 V	149.00
BB24-7	7 Ahr battery backup for 24 V	227.00

Power Supplies for Use with Exit Devices

Item	Description	List \$
ES100	110 V/24 VDC, 6 A surge, 0.65 A continuous per zone. Use with delayed egress (DE) exit device or LFSC/LFSF electrified exit device trim.	821.00
PS501	110 V/36 VDC, 14-18 A surge, 2 A continuous per zone. Use with solenoid latch retraction (ES) exit devices (UL requirement)	966.00
AD100	220 V/24 VDC, 6 A surge, 0.65 A continuous per zone. Use with solenoid latch retraction (ES) exit devices (UL requirement)	966.00
PS406BB*	Power supply with battery backup for solenoid latch retraction	1379.00

Note: PS406BB can only be used with latch retraction option

Power Supply Options for Use with Exit Devices

Item	Description	List \$
ES101	Delay module (ES100 only)	180.00
ES103	Relay module (ES100 only)	113.00
ES105	Power transfer (recommended for ES and DE option)	274.00
ES2	Power card (PS501 only), powers an additional 2 devices (4 total)	526.00

Electric Strikes

After careful consideration, beginning July 2023, all electric strike and electromagnetic lock products will be available via dormakaba RCI. This change will provide customers with access to electronic controls such as electric strikes and electromagnetic locks but also a robust product offering including power supplies, switches, specialty locks, readers and credentials found within the dormakaba RCI product line. Contact your dormakaba sales representative for further details or to inquire about sales enablement.

ES62 (See RCI 0162)

Application – Rim Exit Device

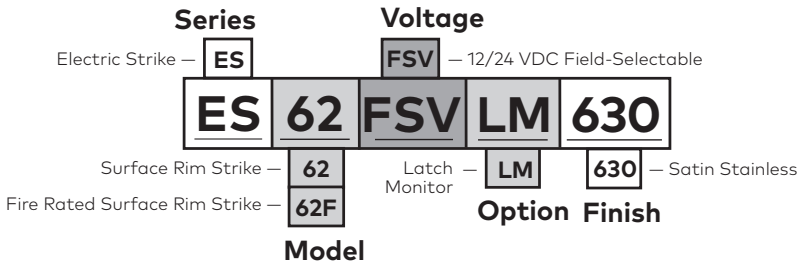

ES62

NOTE: Fail secure only.

ES62 Electric Strikes

Item	Description
ES62 FSV 630	Surface mount rim exit strike, UL 1034 (CVXY), 12/24 V
ES62F FSV 630	3 Hour fire rated surface mount rim exit strike, UL 1034 (CVXY), 12/24 V
ES62 FSV LM 630	Surface mount rim exit strike with Latch Monitor switch, UL 1034 (CVXY), 12/24 V
ES62F FSV LM 630	Fire rated surface mount rim exit strike with Latch Monitor switch, UL 1034 (CVXY), 12/24 V

ES62 Accessories

DPH62	Door pair housing, ES62, 628 finish only
MSK62	Shim mounting kit, ES62

After careful consideration, beginning July 2023, all electric strike and electromagnetic lock products will be available via dormakaba RCI. This change will provide customers with access to electronic controls such as electric strikes and electromagnetic locks but also a robust product offering including power supplies, switches, specialty locks, readers and credentials found within the dormakaba RCI product line. Contact your dormakaba sales representative for further details or to inquire about sales enablement.

ES96F (See RCI F2164/2364)

Application – Mortise Lock / Cylindrical Lock

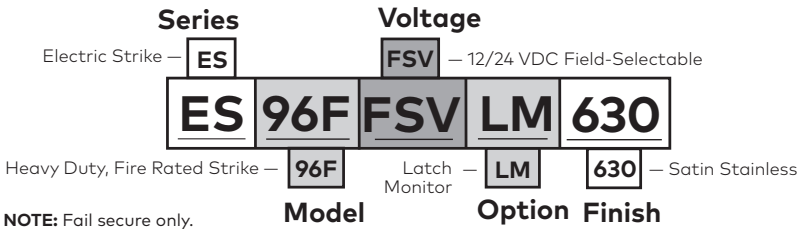

ES96F

ES96F Electric Strikes

Item	Description
ES96F FSV 630	Heavy duty, fire rated mortise strike, 12/24 V, 3 hr
ES96F FSV LM 630	Heavy duty, fire rated mortise strike with Latch Monitor switch, 12/24 V, 3 hr

ES96F Accessories

96LM	Latch monitor switch, ES96F
------	-----------------------------

ES72F (See RCI F4114)

Application – Fire Rated Cylindrical Lock

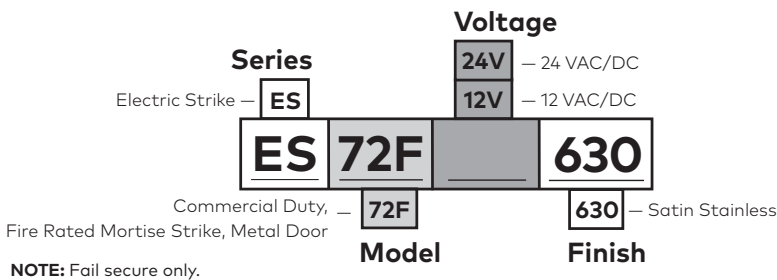

ES72F

ES72F Electric Strikes

Item	Description
ES72F 12V 630	Commercial duty, fire rated cylindrical strike, 12 V, 90 minute fire rated
ES72F 24V 630	Commercial duty, fire rated cylindrical strike, 24 V, 90 minute fire rated

After careful consideration, beginning July 2023, all electric strike and electromagnetic lock products will be available via dormakaba RCI. This change will provide customers with access to electronic controls such as electric strikes and electromagnetic locks but also a robust product offering including power supplies, switches, specialty locks, readers and credentials found within the dormakaba RCI product line. Contact your dormakaba sales representative for further details or to inquire about sales enablement.

ES84/86 (See RCI S6504 / L 6504 or S6514 / L6514)

Application — Non-Fire Rated Cylindrical Lock

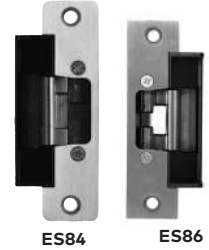
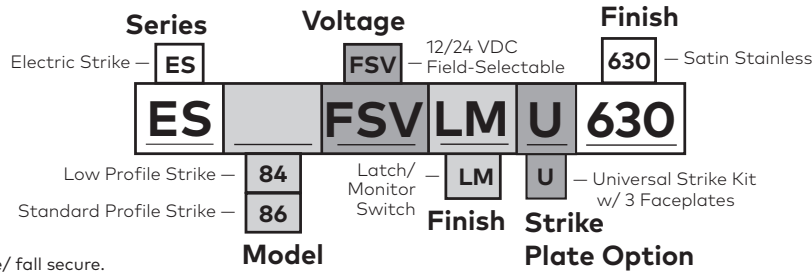

NOTE: Field Selectable. Fail safe/ fall secure.

ES84/86 Electric Strikes

Item	Description
ES84 FSV U 630	Low profile, commercial duty cylindrical strike, 12/24 V
ES84 FSV LM U 630	Low profile, commercial duty cylindrical strike with Latch Monitor switch, 12/24 V
ES86 FSV U 630	Standard profile, commercial duty cylindrical strike, 12/24 V
ES86 FSV LM U 630	Standard profile, commercial duty cylindrical strike with Latch Monitor strike, 12/24 V

Strike Plate Options (ES84/86, 630 finish)

U	Universal strike kit standard with ES84/86 electric strikes includes (3) face plates S4, S4S, and S7
S4*	1-1/4" x 4-7/8" with radius corners
S4S*	1-1/4" x 4-7/8" with square corners
S5	1-1/8" x 5-7/8" with radius corners
S6	1-1/4" x 6-7/8" with radius corners
S7*	1-7/16" x 7-15/16" with radius corners

* Included with "U" kit

After careful consideration, beginning July 2023, all electric strike and electromagnetic lock products will be available via dormakaba RCI. This change will provide customers with access to electronic controls such as electric strikes and electromagnetic locks but also a robust product offering including power supplies, switches, specialty locks, readers and credentials found within the dormakaba RCI product line. Contact your dormakaba sales representative for further details or to inquire about sales enablement.

ES84/86 Accessories

Item	Description
84LE1	1" Lip extension, ES84
84LE2	2" Lip extension, ES84
84LE3	3" Lip extension, ES84
86LE1	1" Lip extension, ES86
86LE2	2" Lip extension, ES86
86LE3	3" Lip extension, ES86
84JIG	Frame prep jig, ES84
86JIG	Frame prep jig, ES86
84TP5	Trim plate, ES84
86TP5	Trim plate, ES86
86LG	Latch guard, ES84/86
84/86HK	Mounting hardware kit, ES84/86
84S4DD	Face plate kit – 1-1/4" x 4-7/8" with radius corners, bullnose for double door, low profile (ES84)
86S4DD	Face plate kit – 1-1/4" x 4-7/8" with radius corners, bullnose for double door, standard profile (ES86)

ES74F (See RCI F4114)

Application – Heavy Duty Fire Rated Cylindrical Lock – BHMA Listed

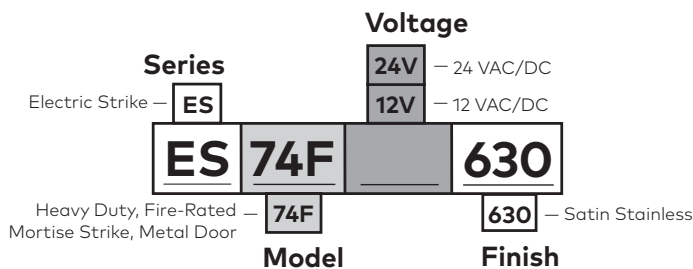

ES74F Electric Strikes

Item	Description
ES74F 12V 630	Heavy duty, fire rated cylindrical strike, 12 V, 90 minute fire rated
ES74F 24V 630	Heavy duty, fire rated cylindrical strike, 24 V, 90 minute fire rated

After careful consideration, beginning July 2023, all electric strike and electromagnetic lock products will be available via dormakaba RCI. This change will provide customers with access to electronic controls such as electric strikes and electromagnetic locks but also a robust product offering including power supplies, switches, specialty locks, readers and credentials found within the dormakaba RCI product line. Contact your dormakaba sales representative for further details or to inquire about sales enablement.

Electromagnetic Locks

EML310/320 (See RCI 8315 / 8325)

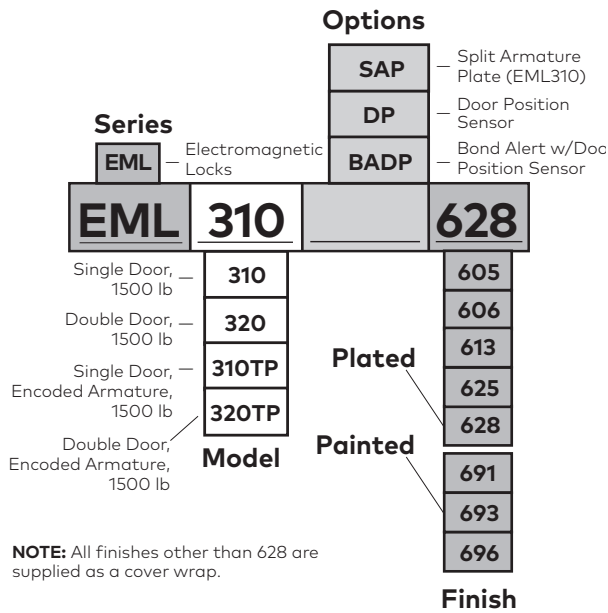

EML310



EML320

After careful consideration, beginning July 2023, all electric strike and electromagnetic lock products will be available via dormakaba RCI. This change will provide customers with access to electronic controls such as electric strikes and electromagnetic locks but also a robust product offering including power supplies, switches, specialty locks, readers and credentials found within the dormakaba RCI product line. Contact your dormakaba sales representative for further details or to inquire about sales enablement.

EML310/320 Electromagnetic Locks

Item	Description
EML310 Series Single Door, 1500 lb Holding Force	
EML310	Single lock
EML310 DP	Single lock w/ DP sensor
EML310 BA DP	Single lock w/ BA sensor, DP sensor
EML310TP Series Single Door, 1500 lb Holding Force	
EML310TP	Single lock w/ encoded armature
EML320 Series Double Door, 1500 lb Holding Force	
EML320	Double lock
EML320 DP	Double lock w/ DP sensor
EML320 BA DP	Double lock w/ BA sensor, DP sensor
EML320TP Series Double Door, 1500 lb Holding Force	
EML320TP	Double lock w/ encoded armature

EML310/320 Options

Item	Description
Angle Brackets	
AB11	1"H x 1"W x 10-1/2"L, EML310
AB12	1-1/2"H x 1"W x 10-1/2"L, EML310
AB13	1-1/2"H x 1-1/4"W x 10-1/2"L, EML310
AB20	1"H x 1"W x 21"L, EML320
AB21	1-1/2"H x 1"W x 21"L, EML320
AB22	1-1/2"H x 1-1/2"W x 21"L, EML320
L Brackets	
LB10	2-1/2"H x 2"W x 10-1/2"L, EML310
LB20	2-1/2"H x 2"W x 21"L, EML320
Filler Bars	
FB11	1/8"H x 3/4"W x 10-1/2"L, EML310
FB12	1/4"H x 3/4"W x 10-1/2"L, EML310
FB14N	1/2"H x 5/8"W x 10-1/2"L, EML310
FB14	1/2"H x 3/4"W x 10-1/2"L, EML310
FB15	5/8"H x 3/4"W x 10-1/2"L, EML310
FB21	1/8"H x 3/4"W x 21"L, EML320
FB22	1/4"H x 3/4"W x 21"L, EML320
FB24N	1/2"H x 5/8"W x 21"L, EML320
FB24	1/2"H x 3/4"W x 21"L, EML320
FB25	5/8"H x 3/4"W x 21"L, EML320
Blade Stop Spacers	
BSS14	1/2"H x 1-1/2"W x 10-1/2"L, EML310
BSS15	5/8"H x 1-1/2"W x 10-1/2"L, EML310
BSS24	1/2"H x 1-1/2"W x 10-1/2"L, EML320
BSS25	5/8"H x 1-1/2"W x 10-1/2"L, EML320

After careful consideration, beginning July 2023, all electric strike and electromagnetic lock products will be available via dormakaba RCI. This change will provide customers with access to electronic controls such as electric strikes and electromagnetic locks but also a robust product offering including power supplies, switches, specialty locks, readers and credentials found within the dormakaba RCI product line. Contact your dormakaba sales representative for further details or to inquire about sales enablement.

Item	Description
Top Jam Brackets	
TJ10	Top jamb bracket, EML310
TJ20	Top jamb bracket, EML320
Conduit Mounting Bracket	
CMB10	1"H x 2-1/4"W x 10-9/16"L, EML310
Armature Plates	
AP02	5/8" (15.9 mm) thick, EML310/EML311
AP21	5/8" (9.5 mm) thick, EML310/EML311
Armature Plate Holders	
APH10	Armature plate holder, EML310
APH15	Armature plate holder, EML310 with DP function
APH20	Armature plate holder, EML320
APH25	Armature plate holder, EML320 with DP function
Armature Mounting Bolts	
AMB225	Extended length for doors 1-3/4" to 2-1/4" thick
AMB275	Extended length for doors 2-1/4" to 2-3/4" thick
AMB300	Extended length for doors 2-3/4" to 3" thick

Glass Door Brackets

Item	Description
GDB14	1/2" thick glass, EML310
GDB16	3/4" thick glass, EML310
GDB24	1/2" thick glass, EML320
GDB26	3/4" thick glass, EML320

Split Armature Plate

Item	Description
SAP	Split armature plate, EML310

EML310/320 Accessories

Item	Description
MCW310	Cover wrap for EML310
MCW320	Cover wrap for EML320
MCW310TP	Cover wrap for EML310TP

After careful consideration, beginning July 2023, all electric strike and electromagnetic lock products will be available via dormakaba RCI. This change will provide customers with access to electronic controls such as electric strikes and electromagnetic locks but also a robust product offering including power supplies, switches, specialty locks, readers and credentials found within the dormakaba RCI product line. Contact your dormakaba sales representative for further details or to inquire about sales enablement.

EML371/372 (See RCI 8371/8372)

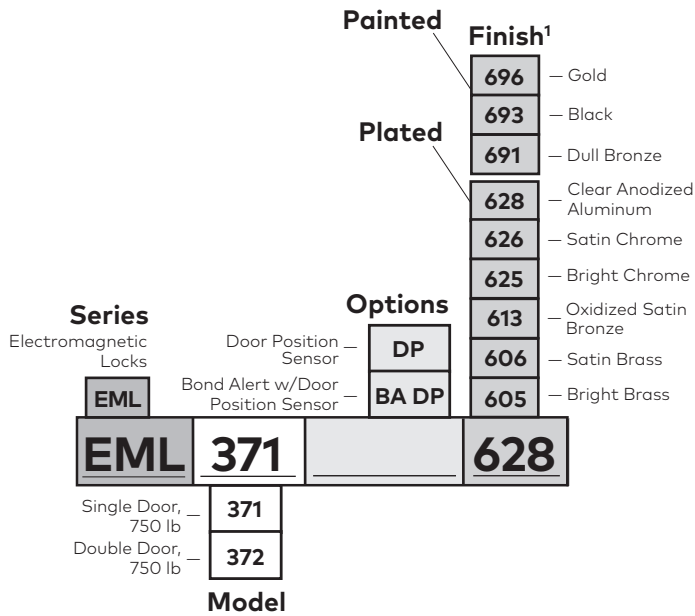

1. Lock body supplied in 628. All other finishes supplied as a cover.
2. Specify 628 or 695 finish, except BSS752 available in 628 only.

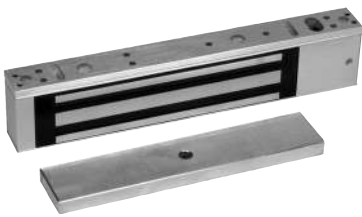

EML371

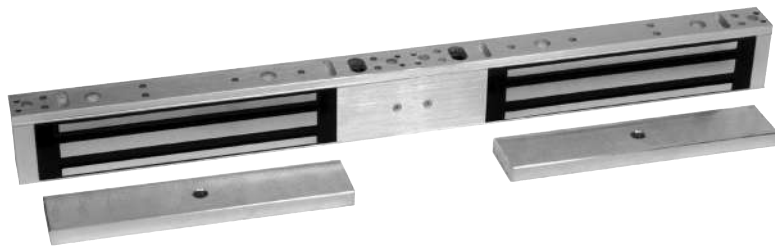

EML372

After careful consideration, beginning July 2023, all electric strike and electromagnetic lock products will be available via dormakaba RCI. This change will provide customers with access to electronic controls such as electric strikes and electromagnetic locks but also a robust product offering including power supplies, switches, specialty locks, readers and credentials found within the dormakaba RCI product line. Contact your dormakaba sales representative for further details or to inquire about sales enablement.

EML371/372 Electromagnetic Locks

Item	Description
EML371 Single Door, 750 lb Holding Force	
EML371	Single lock
EML371 DP	Single lock w/ DP sensor
EML371 BA DP	Single lock w/ BA sensor, DP sensor
EML372 Double Door, 750 lb Holding Force	
EML372	Single lock
EML372 DP	Single lock w/ DP sensor
EML372 BA DP	Single lock w/ BA sensor, DP sensor

EML371/372 Options

Item	Description
Angle Brackets	
AB710	1"H x 1"W x 9-3/8"L, EML371
AB711	1-1/2"H x 1"W x 9-3/8"L, EML371
AB712	1-1/2"H x 1-1/2"W x 9-3/8"L, EML371
AB713	1-1/2"H x 2"W x 9-3/8"L, EML371
AB720	1"H x 1"W x 18-3/4"L, EML372
AB721	1-1/2"H x 1"W x 18-3/4"L, EML372
AB722	1-1/2"H x 1-1/2"W x 18-3/4"L, EML372
AB723	1-1/2"H x 2"W x 18-3/4"L, EML372
Filler Bars	
FB712	1/4"H x 3/4"W x 9"L, EML371
FB713	3/8"H x 3/4"W x 9"L, EML371
FB714	1/2"H x 3/4"W x 9"L, EML371
FB715	5/8"H x 3/4"W x 9"L, EML371
FB722	1/4"H x 3/4"W x 18-3/4"L, EML372
FB724	1/2"H x 3/4"W x 18-3/4"L, EML372
FB725	5/8"H x 3/4"W x 18-3/4"L, EML372
Blade Stop Spacers	
BSS714	1/2"H x 1"W x 9-3/8"L, EML371
BSS715	5/8"H x 1"W x 9-3/8"L, EML371
BSS724	1/2"H x 1"W x 18-3/4"L, EML372
BSS725	5/8"H x 1"W x 18-3/4"L, EML372
Top Jam Brackets	
TJ71	Top jamb bracket, EML371
TJ72	Top jamb bracket, EML372

After careful consideration, beginning July 2023, all electric strike and electromagnetic lock products will be available via dormakaba RCI. This change will provide customers with access to electronic controls such as electric strikes and electromagnetic locks but also a robust product offering including power supplies, switches, specialty locks, readers and credentials found within the dormakaba RCI product line. Contact your dormakaba sales representative for further details or to inquire about sales enablement.

Item	Description
------	-------------

Armature Plate

AP03	3/8" (9.5 mm) thick, EML371/EML372
------	------------------------------------

Armature Plate Holders

APH71	Armature plate holder, EML371
-------	-------------------------------

Armature Mounting Bolts

AMB225	Extended length for doors 1-3/4" to 2-1/4" thick
AMB275	Extended length for doors 2-1/4" to 2-3/4" thick
AMB300	Extended length for doors 2-3/4" to 3" thick
APH72	Armature plate holder, EML372

Glass Door Brackets

Item	Description
------	-------------

GDB714	1/2" thick glass, EML371
GDB716	3/4" thick glass, EML371
GDB724	1/2" thick glass, EML372
GDB726	3/4" thick glass, EML372

EML371/372 Accessories

Item	Description
------	-------------

MCW371	Cover wrap for EML371
MCW372	Cover wrap for EML372

EML375 (See RCI 8375)

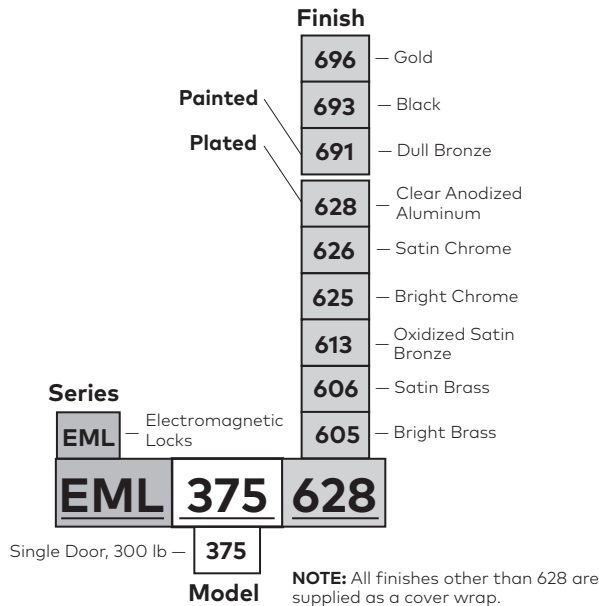

EML375

After careful consideration, beginning July 2023, all electric strike and electromagnetic lock products will be available via dormakaba RCI. This change will provide customers with access to electronic controls such as electric strikes and electromagnetic locks but also a robust product offering including power supplies, switches, specialty locks, readers and credentials found within the dormakaba RCI product line. Contact your dormakaba sales representative for further details or to inquire about sales enablement.

EML375 Electromagnetic Locks

Item	Description
EML375 Single Door, 300 lb Holding Force	
EML375	Single lock

EML375 Options

Item	Description
Blade Stop Spacers	
BSS752	1/4"H x 13/16"W x 6-9/16"L, EML375
Top Jam Brackets	
TJ75	Top jamb bracket, EML375
Armature Plate	
AP04	5/16" (7.9 mm) thick, EML375
Armature Plate Holders	
APH75	Armature plate holder, EML375
Armature Mounting Bolts	
AMB225	Extended length for doors 1-3/4" to 2-1/4" thick
AMB275	Extended length for doors 2-1/4" to 2-3/4" thick
AMB300	Extended length for doors 2-3/4" to 3" thick

Glass Door Brackets

Item	Description
GDB754	1/2" thick glass, EML375
GDB756	3/4" thick glass, EML375

EML375 Accessories

Item	Description
MCW375	Cover wrap for EML375

Specialized Electromagnetic Locks

After careful consideration, beginning July 2023, all electric strike and electromagnetic lock products will be available via dormakaba RCI. This change will provide customers with access to electronic controls such as electric strikes and electromagnetic locks but also a robust product offering including power supplies, switches, specialty locks, readers and credentials found within the dormakaba RCI product line. Contact your dormakaba sales representative for further details or to inquire about sales enablement.

EMLSG360/365 (See RCI 8360/8365)



EMLSG360



EMLSG365

EMLSG380 (See RCI 8380)

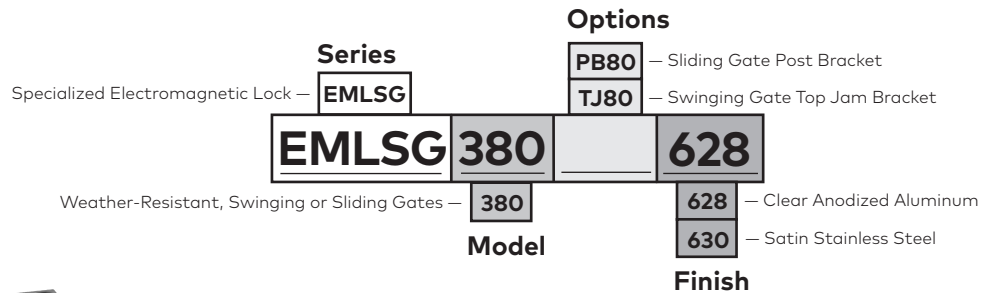

After careful consideration, beginning July 2023, all electric strike and electromagnetic lock products will be available via dormakaba RCI. This change will provide customers with access to electronic controls such as electric strikes and electromagnetic locks but also a robust product offering including power supplies, switches, specialty locks, readers and credentials found within the dormakaba RCI product line. Contact your dormakaba sales representative for further details or to inquire about sales enablement.

EMLSG Series Specialized Electromagnetic Locks

Item	Description
EMLSG360	Mortise lock for sliding doors, 750 lb
EMLSG365	Mortise lock for sliding drawers, 300 lb
EMLSG380	Weather-resistant gate lock with stainless steel housing

EMLSG Option

Item	Description
TJ80	Top jamb bracket, EMLSG380
PB80	Post bracket, EMLSG380
AP03	3/8" (9.5 mm) thick, EMLSG360
AP04	5/16" (7.9 mm) thick, EMLSG365

After careful consideration, beginning July 2023, all electric strike and electromagnetic lock products will be available via dormakaba RCI. This change will provide customers with access to electronic controls such as electric strikes and electromagnetic locks but also a robust product offering including power supplies, switches, specialty locks, readers and credentials found within the dormakaba RCI product line. Contact your dormakaba sales representative for further details or to inquire about sales enablement.

EMSL Series Micro Shear Locks (2,000 lb Holding Force)

Item	Description
EMSL2000-61	Concealed mount with integral time delay. 1-5/8" projection (fits 1-3/4"-2" frame).
EMSL2000-61S	Surface mount push side of door
EMSL2000-61TJ	Surface mount pull side of door
EMSL2000-62	Concealed mount with external time delay. 1-1/4" projection (fits 1-1/4"-1-3/4" frame).
EMSL2000-62SC	Semi-concealed push side of door. Lock is mortised.
EMSL2000-62SCGDB-KT1/2	Semi-concealed w/glass door bracket, 1/2" glass. Lock is mortise
EMSL2000-62SCGDB-KT3/4	Semi-concealed w/glass door bracket, 3/4" glass. Lock is mortised

* Specify mounting kit for all locks (see options below).

EMSL Series High Shear Locks (2,700 lb Holding Force)

Item	Description
EMSL2700-65	Built-in auto re-lock and time delay to ensure alignment before re-locking. 1-5/8" projection (fits 1-3/4"-2" frame).
EMSL2700-66	Built-in auto re-lock and external time delay. 1-1/4" projection (fits 1-1/4"-1-1/2" frame).

* Specify mounting kit for all locks (see options below).

EMSL Series Options

Item	Description
*AHC	Standard mounting armature kit for aluminum and hollow metal doors w/ 7/8" to 1-1/8" deep top channels, wood doors, and factory prepared hollow metal flush edge doors
*FC	Mounting kit for field prepared horizontal mounting in hollow metal doors w/flush edge
*AC	Mounting kit for aluminum doors with 1-15/16" web (1 pack of two 1" shims)

Must specify one of the above options for every shear lock ordered. Add Suffix "M" for Micro Shear Lock Armatures: i.e. AHCM

ATR	Aluminum top rail armature bracket for leading edge adjustments
BA	Bond sensor (Not available on 2062 or 2766)
DPS	Door position switch
L3	External LED. Mounted separately through the frame 
WDRBM	Wood door reinforcement box (Micro-shear)
WDRB	Wood door reinforcement box (High-shear)

 L3 option may use one, two, or three colors.

After careful consideration, beginning July 2023, all electric strike and electromagnetic lock products will be available via dormakaba RCI. This change will provide customers with access to electronic controls such as electric strikes and electromagnetic locks but also a robust product offering including power supplies, switches, specialty locks, readers and credentials found within the dormakaba RCI product line. Contact your dormakaba sales representative for further details or to inquire about sales enablement.

Delayed Egress Electromagnetic locks EMDE (See RCI DE8310 Delayed Egress)

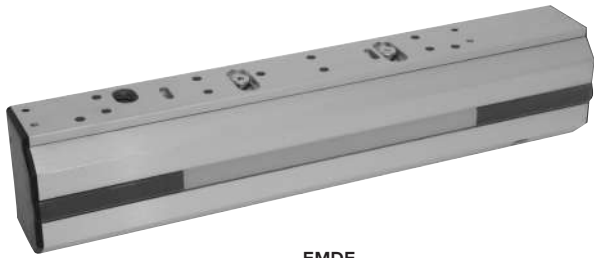
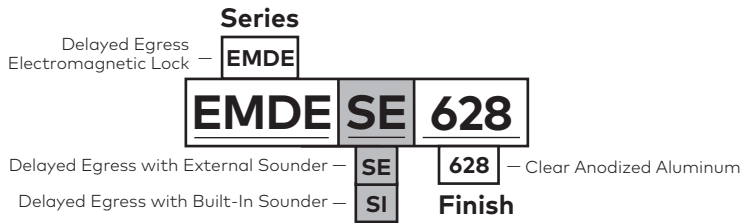

EMDE

Item	Description
EMDE SE	Lock with external sounder, 1200 lb
EMDE SI	Lock with integral sounder, 1200 lb

AC Series

Available Items

AC200 Keypads

Item	Description	List \$
AC217 630	Keypad, Indoor 120 user code, satin stainless face plate	590.00
AC217 605	Keypad, Indoor 120 user code, bright brass face plate	753.00
AC225 630	Keypad, Outdoor, 480 user code, satin stainless face plate	854.00
AC228 626	Keypad, Indoor, 480 user code, satin chrome face plate	430.00



AC217



AC225



AC228

Red Mushroom Push Buttons

Available Items

Item	Color	Label	Diameter	Faceplate	Switch	Faceplate Finish	List \$
PB RE2 MA 628	Red	Exit	1-9/16"	Narrow	Maintained	Brushed Aluminum	206.00
PB RE2 MO 628	Red	Exit	1-9/16"	Narrow	Momentary	Brushed Aluminum	206.00
PB RE2 MA 710	Red	Exit	1-9/16"	Narrow	Maintained	Dark Bronze	206.00
PB RE2 MO 710	Red	Exit	1-9/16"	Narrow	Momentary	Dark Bronze	206.00
PB EP0 PA 630	Red	Push to exit	1-5/8"	Narrow	Momentary with pneumatic time delay	Satin Stainless	612.00
PB RE3 MA 628	Red	Exit	1-9/16"	Single Gang	Maintained	Brushed Aluminum	206.00
PB RE3 MO 628	Red	Exit	1-9/16"	Single Gang	Momentary	Brushed Aluminum	206.00
PB RE3 MA 710	Red	Exit	1-9/16"	Single Gang	Maintained	Dark Bronze	206.00
PB RE3 MO 710	Red	Exit	1-9/16"	Single Gang	Momentary	Dark Bronze	206.00
PB E03 MA 628	Red	Exit	2-3/8"	Single Gang	Maintained	Brushed Aluminum	237.00
PB E03 MO 628	Red	Exit	2-3/8"	Single Gang	Momentary	Brushed Aluminum	237.00
PB E03 MA 710	Red	Exit	2-3/8"	Single Gang	Maintained	Dark Bronze	237.00
PB E03 MO 710	Red	Exit	2-3/8"	Single Gang	Momentary	Dark Bronze	237.00
PB EP3 PA 630	Red	Push to exit	1-5/8"	Single Gang	Momentary with pneumatic time delay	Satin Stainless	564.00

Accessories

Item	Description	List \$
TD-ADJ	Field Selectable Timer — 0-30 seconds — wire inline	123.00
TD-FIX	Fixed Timer — 30 seconds — wire inline	123.00
SBX	Surface mounting box, single gang — PBBH2 MO 630 SBX	81.00

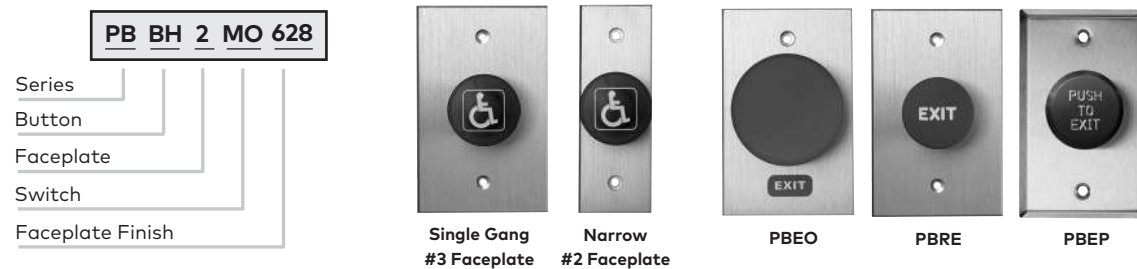

Blue Mushroom Push Buttons

Available Items

Item	Color	Label	Diameter	Faceplate	Switch	Faceplate Finish	List \$
PB BH2 MA 628	Blue	Handicap	1-9/16"	Narrow	Maintained	Brushed Aluminum	206.00
PB BH2 MO 628	Blue	Handicap	1-9/16"	Narrow	Momentary	Brushed Aluminum	206.00
PB BH2 MA 710	Blue	Handicap	1-9/16"	Narrow	Maintained	Dark Bronze	206.00
PB BH2 MO 710	Blue	Handicap	1-9/16"	Narrow	Momentary	Dark Bronze	206.00
PB HP2 PA 630	Blue	Handicap	1-5/8"	Narrow	Momentary with pneumatic time delay	Satin Stainless	612.00
PB BH3 MA 628	Blue	Handicap	1-9/16"	Single Gang	Maintained	Brushed Aluminum	206.00
PB BH3 MO 628	Blue	Handicap	1-9/16"	Single Gang	Momentary	Brushed Aluminum	206.00
PB BH3 MA 710	Blue	Handicap	1-9/16"	Single Gang	Maintained	Dark Bronze	206.00
PB BH3 MO 710	Blue	Handicap	1-9/16"	Single Gang	Momentary	Dark Bronze	206.00
PB HO3 MA 628	Blue	Handicap	2-3/8"	Single Gang	Maintained	Brushed Aluminum	237.00
PB HO3 MO 628	Blue	Handicap	2-3/8"	Single Gang	Momentary	Brushed Aluminum	237.00
PB HO3 MA 710	Blue	Handicap	2-3/8"	Single Gang	Maintained	Dark Bronze	237.00
PB HO3 MO 710	Blue	Handicap	2-3/8"	Single Gang	Momentary	Dark Bronze	237.00
PB HP3 PA 630	Blue	Handicap	1-5/8"	Single Gang	Momentary with pneumatic time delay	Satin Stainless	564.00

Accessories

Item	Description	List \$
TD-ADJ	Field Selectable Timer — 0–30 seconds — wire inline	123.00
TD-FIX	Fixed Timer — 30 seconds — wire inline	123.00
SBX	Surface mounting box, single gang — PBBH2 MO 630 SBX	81.00

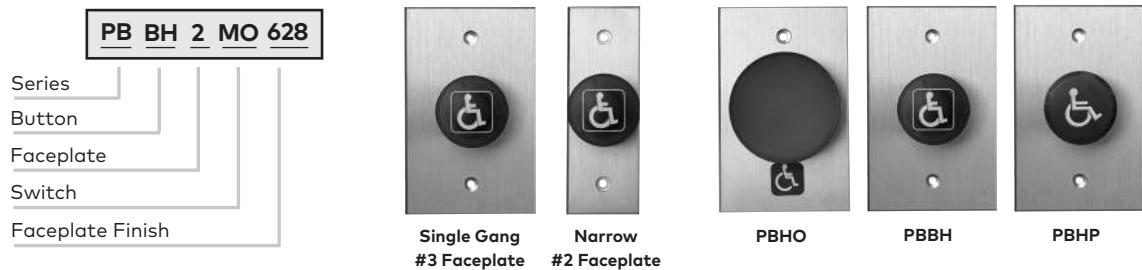

Illuminated Push Buttons

Available Items

Item	Button	Faceplate	Switch	Faceplate Finish	List \$
PB 731 MO 630	2" x 2" LED	Single Gang	Momentary	Brushed Stainless	159.00
PB 752 MO 628	1" x 1" LED	Narrow	Momentary	Brushed Aluminum	250.00
PB 752 MO 710	1" x 1" LED	Narrow	Momentary	Dark Bronze	250.00

Accessories	
Item	Description
TD-ADJ	Field Selectable Timer — 0–30 seconds — wire inline
TD-FIX	Fixed Timer — 30 seconds — wire inline
SBX	Surface mounting box, single gang — PB731 MO 630 SBX

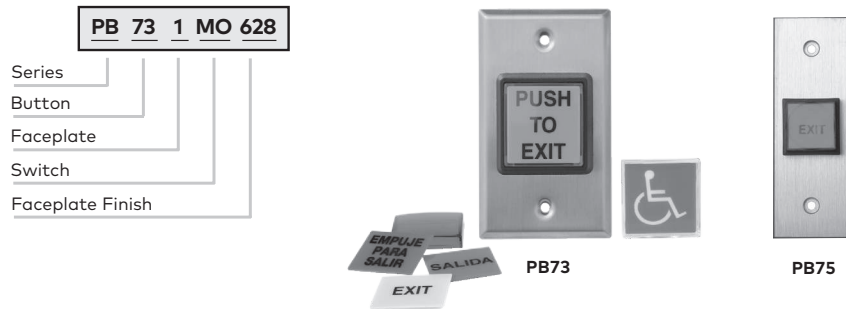

Rotary/Key Release Switches

Ordering Guide

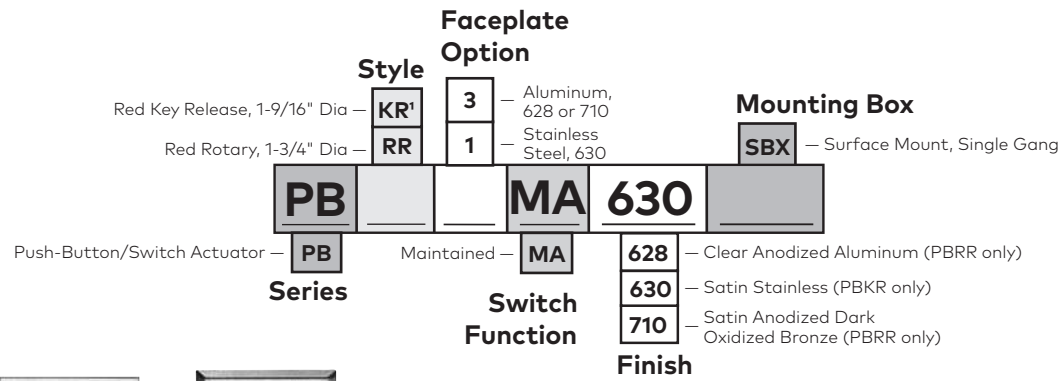

PBRR



PBKR

1. PBKR Key Switch uses a disc tumbler style cylinder. This style cylinder can NOT be configured into the building master key system.

Item	Description	630 Finish \$	628 Finish \$	710 Finish \$
Red Rotary/Key Release Switches, 12/24 VDC				
PBRR	1-3/4" Dia MA, 2A SPDT, rotary release, single gang aluminum	—	262.00	238.00

Mounting Box Options for PB Series

Item	Description	List \$
SBX	Surface Mount	75.00

39 Series Sounders

Ordering Guide

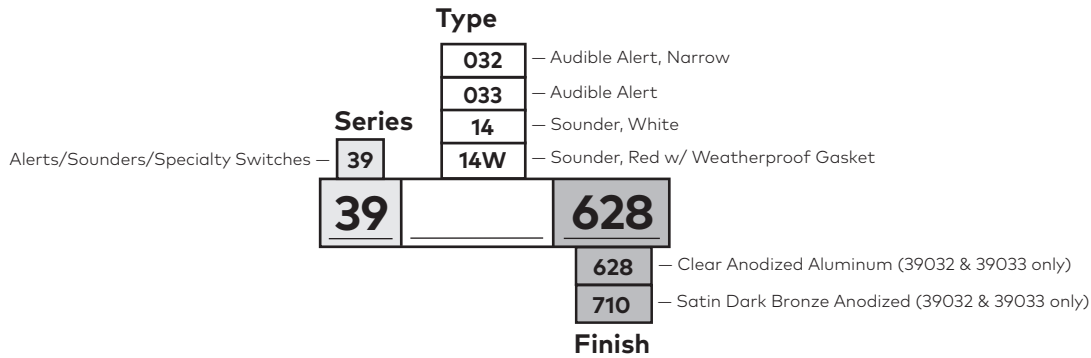

39032



39033



3914/3914W

39 Series Alerts/Sounders/Specialty Switches

Item	Description	List \$	628 Finish \$	710 Finish \$
Alerts				
39032	Audible alert, narrow	—	222.00	222.00
39033	Audible alert	—	222.00	222.00
Sounders				
3914	Sounder, red w/ weatherproof gasket	142.00	—	—
3914W	Sounder, white	199.00	—	—

KS Series

Ordering Guide

Timer Options ²		Key Switch Options		Mounting Box	
Key Switch Actuator — KS	30 Sec Adjustable — EA	L2 — 2 Bicolor LEDs (Red/Green)	L1 — Bicolor LED (Red/Green)	SBX — Surface Mount, Single Gang	
	30 Sec Fixed — EF				
KS			628	D	XXXX
Narrow Aluminum ¹ — 5	01 — MA SPDT	628 — Clear Anodized Aluminum	710 — Satin Dark Bronze Aluminum	T — Temporary SFIC	See Brochure for Keying Options
Single Gang Aluminum — 8	02 — MO SPDT	Finish		J — SFIC (Less Core)	
Faceplate Options	03 — MA DPDT			C — SFIC (With Core)	
	04 — MO DPDT			L — Less Cylinder	
	07 — 2 MO SPDT			D — Conventional Cylinder	
	08 — 1 MO SPDT/ 1 MA SPDT			G — Temporary Schlage LFIC	
	17 — 2 MO SPDT Reset/Bypass			R — Schlage LFIC (less core)	
Switch Function				F — Schlage LFIC	
				X6 — Arrow Choice 6P SFIC (Less Core)	
				X7 — Sargent XC 7P and Arrow Choice 7P SFIC (Less Core)	

1. Faceplate option 5 only available with switch functions **01** and **02**.
2. Timer options only available with switch function **02**.
3. List price includes default conventional cylinder.



KS8 Single Gang Aluminum



KS5 Narrow Aluminum

KS Series Key Switches

Item	Description	List \$
KS800 Series Single Gang Aluminum		
KS801	MA SPDT	231.00
KS802	MO SPDT	231.00
KS 802 EA	MO SPDT, electronic timer, 1-30 sec adjustable	354.00
KS 802 EF	MO SPDT, electronic timer, 30 sec fixed	354.00
KS 803	MA DPDT	231.00
KS 804	MO DPDT	231.00
KS 503	MA DPDT	231.00
KS 504	MA DPDT	231.00
KS807	MO (2) SPDT	291.00
KS808	MO SPDT/MA SPDT	291.00
KS817	MO (2) SPDT, labeled Reset/Bypass	291.00
KS500 Series Narrow Aluminum		
KS501	MA SPDT	231.00
KS502	MO SPDT	231.00
KS502 EA	MO SPDT, electronic timer, 1-30 sec adjustable	354.00
KS502 EF	MO SPDT, electronic timer, 30 sec fixed	354.00
KS 502 PA	(2) SPDT, pneumatic timer, 2-60 sec adjustable	627.00

Options

Item	Description	List Add \$
Key Switch Options		
L1	One (1) bicolor (red/green) LED added to faceplate	30.00
Mounting Box Options		
SBX	Surface mount, single gang	81.00

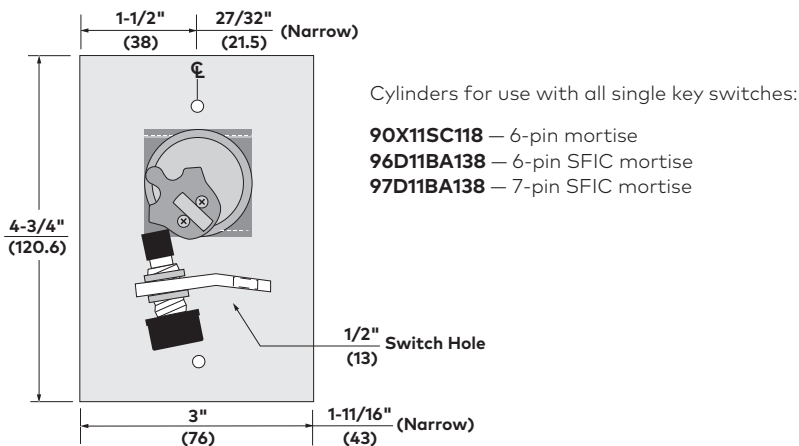

Cylinder, Keying, and Keyway Options for KS Series

Cylinder	Option	Description	Examples	List Add/Deduct \$
Conventional Cylinders (non-interchangeable core)				
		Keying with conventional cylinder (default)	KS02628	
	KD	Keyed differently to a random combination; SC keyway with 2 keys (default)		N/C
	KA2	Keyed alike in pairs to a random combination; SC keyway with 2 keys		N/C
	NSK	Keyed alike, sets of three or more; SC keyway with 2 keys		21.00
	NS2	Keyed alike double cylinder locks; SC keyway with 2 keys		38.00
	1-Bit	Operated by 1-bit cut key; SC, SE keyway with 2 key blanks (order 1-bit key separately)		21.00
	0-Bit	Operated by 0-bit key; D100 keyway — Keys sold separately		21.00
	0-Bit	Operated by 0-bit cut key; AA, CA, CB, CC, CD, CE, RA, RB, GA, SF, YA, YG keyways with 2 key blanks		21.00
	MDK	Master keyed; SC, SE, or D100 keyway — Keys sold separately		26.00
	MK2	Master keyed double cylinder lock; SC, SE, or D100 keyway — Keys sold separately		49.00
	CMK	Construction master keyed single cylinder locks — Keys sold separately		23.00
	CM2	Construction master keyed double cylinder locks — Keys sold separately		41.00
L		Keying less conventional cylinder	KS02628L	Deduct 33.00
Interchangeable Core Cylinders				
T		SFIC — Housing with keyed temporary SFIC construction core (Core may be returned for a full refund) — Keys sold separately	Example: M9070T	62.00
J		SFIC — Housing with disposable plastic SFIC plug	Example: M9070J	N/C
C		SFIC — Housing with combined SFIC core installed at the factory ¹ ; BA (default), BB, BC, BD, BE, BF, BG, BH, BJ, BK, BL, BM, BQ, D100 keyway — Keys sold separately	Example: M9070C	69.00
G		Schlage LFIC — Housing with keyed temporary Schlage LFIC construction core (Core may be returned for full refund) — Keys sold separately	Example: M9070G	62.00
R		Schlage LFIC — Housing less core	Example: M9070R	12.00
F		Schlage LFIC — Housing with combined Schlage LFIC installed at the factory (SC keyway) — Keys sold separately	Example: M9070F	69.00

1. For uncombined cores, **UNC**, cores must be ordered separately.

☞ Denotes keys must be ordered separately

Cut Keys Ordered Separately

Item	Description	List \$
45101	SFIC Cut key — Change key, master key, construction master key, or control key; BA, BB, BC, BD, BE, BF, BG, BH, BJ, BK, BL, BM, BQ, SC, SE keyways	6.00
45401	SFIC Cut key — Change key, master key, or control key; D100 keyways — D100 etc.	16.00
45404	CONV/LFIC Cut key — 1-bit key for operating 1-bit cylinders — SC, SE keyways	8.00
45405	LFIC Cut key — 1-bit control key (to install/remove "1-bit" LFIC cores) — SC keyway	8.00
44101SC	CONV/LFIC Key blank — SC keyway	6.00
44104SC	LFIC Key blank — Control key (to install/remove LFIC Cores) — SC keyway	7.00

NOTES:

- Distribution of DORMA SKC keys (listed as D100) is restricted. See Cylinders, Keys & Keying section for DORMA SKC policies
- See Keys and Key Blanks section for complete list.

Accessories

Available Items

Item	Description	List \$	
Power Transfer			
ES105	Power transfer conduit – satin chrome finish	274.00	
Flex Loops			
3118 628	Loop, 18", surface mount flex, satin aluminum finish	50.00	
3118 695	Loop, 18" flex, surface mount, less wires, dark bronze painted	75.00	
3118 714	Loop, 18" flex, surface mount, less wires, white painted	75.00	
3218 630	Loop, 18" flex, heavy duty, less wires, satin stainless	98.00	
Wired Hinges			
		STD	DPS
PTH4 626 / PTH4 DPS 626	Hinge, 4 wire power transfer, 4-1/2" x 4-1/2", satin chrome finish	380.00	505.00
PTH4 613 / PTH4 DPS 613	Hinge, 4 wire power transfer, 4-1/2" x 4-1/2", dark bronze finish	380.00	505.00
PTH4 605 / PTH4 DPS 605	Hinge, 4 wire power transfer, 4-1/2" x 4-1/2", bright brass finish	380.00	505.00
PTH6 626 / PTH6 DPS 626	Hinge, 6 wire power transfer, 4-1/2" x 4-1/2", satin chrome finish	598.00	568.00
PTH6 613 / PTH6 DPS 613	Hinge, 6 wire power transfer, 4-1/2" x 4-1/2", dark bronze finish	598.00	568.00
PTH6 605 / PTH6 DPS 605	Hinge, 6 wire power transfer, 4-1/2" x 4-1/2", bright brass finish	598.00	568.00
PTH10 626 / PTH10 DPS 626	Hinge, 10 wire power transfer, 4-1/2" x 4-1/2", satin chrome finish	505.00	630.00
PTH10 613 / PTH10 DPS 613	Hinge, 10 wire power transfer, 4-1/2" x 4-1/2", dark bronze finish	505.00	630.00
PTH10 605 / PTH10 DPS 605	Hinge, 10 wire power transfer, 4-1/2" x 4-1/2", bright brass finish	505.00	630.00
Wired Pivots			
75200 626 (standard)	Pivot, 3/4" offset intermediate, electrified, 8 wire, satin chrome finish	699.00	
75200 605	Pivot, 3/4" offset intermediate, electrified, 8 wire, bright brass finish	699.00	
75200 606	Pivot, 3/4" offset intermediate, electrified, 8 wire, satin brass finish	699.00	
75200 611	Pivot, 3/4" offset intermediate, electrified, 8 wire, bright bronze finish	699.00	
75200 612	Pivot, 3/4" offset intermediate, electrified, 8 wire, satin bronze finish	699.00	
75200 613	Pivot, 3/4" offset intermediate, electrified, 8 wire, dark bronze finish	699.00	
75200 619	Pivot, 3/4" offset intermediate, electrified, 8 wire, satin nickel finish	699.00	
75200 625	Pivot, 3/4" offset intermediate, electrified, 8 wire, bright chrome finish	699.00	
E80622 630 (Standard)	Pivot, center hung top, electrified, 2 wire, satin chrome finish	819.00	
E80622 605	Pivot, center hung top, electrified, 2 wire, bright brass finish	819.00	
E80622 606	Pivot, center hung top, electrified, 2 wire, satin brass finish	819.00	
E80622 611	Pivot, center hung top, electrified, 2 wire, bright bronze finish	819.00	
E80622 612	Pivot, center hung top, electrified, 2 wire, satin bronze finish	819.00	
E80622 613	Pivot, center hung top, electrified, 2 wire, dark bronze finish	819.00	
E80622 619	Pivot, center hung top, electrified, 2 wire, satin nickel finish	819.00	
E80622 629	Pivot, center hung top, electrified, 2 wire, bright stainless finish	819.00	
E80622 689	Pivot, center hung top, electrified, 2 wire, aluminum painted finish	819.00	
E80622 695	Pivot, center hung top, electrified, 2 wire, dark bronze painted finish	819.00	
E80624 630 (Standard)	Pivot, center hung top, electrified, 4 wire, satin chrome finish	819.00	
E80624 605	Pivot, center hung top, electrified, 4 wire, bright brass finish	819.00	
E80624 606	Pivot, center hung top, electrified, 4 wire, satin brass finish	819.00	
E80624 611	Pivot, center hung top, electrified, 4 wire, bright bronze finish	819.00	
E80624 612	Pivot, center hung top, electrified, 4 wire, satin bronze finish	819.00	
E80624 613	Pivot, center hung top, electrified, 4 wire, dark bronze finish	819.00	
E80624 619	Pivot, center hung top, electrified, 4 wire, satin nickel finish	819.00	
E80624 629	Pivot, center hung top, electrified, 4 wire, bright stainless finish	819.00	
E80624 689	Pivot, center hung top, electrified, 4 wire, aluminum painted finish	819.00	
E80624 695	Pivot, center hung top, electrified, 4 wire, dark bronze painted finish	819.00	

Request to Exit Touch Bars (No latch assembly)

		628, 711	605, 629, 630
Item	Description	Standard Finish \$	Plated Finish \$
MSD550	Exit touch bar with mechanical switch (power transfer required), 628 or 711 finish standard, optional plated finishes 605, 629, 630	520.00	827.00

Timers/Relays

Item	Description	List \$
14-2	7-day programmable timer with memory and battery back-up. Specify 12 or 24 V	543.00
TD-ADJ	0-30 second adjustable timer	123.00
TD-FIX	30 second fixed timer	123.00
TDM	Time delay module sequencer relay	329.00

Desk Switches

Item	Description	List \$
PD15-1	MA SPDT	246.00
PD15-2	MO SPDT	168.00
PD15-3	MA SPDT (Toggle)	295.00

Desk Top Models for One or Two Doors

Item	Description	List \$
CC401DTM	One Momentary (MO) switch and one LED	492.00
CC402DTM	Two Momentary (MO) switches and two LEDs	613.00
CC403DTM	One Momentary (MO) and one Maintained (MA) switch and two LEDs	735.00
CC402DTMA	Two Maintained (MA) switches and two LEDs	613.00

Specialty Switches

Item	Description	List \$
3909S MA	Rocker switch, maintained	90.00
3909S MO	Rocker switch, momentary	90.00
39043B	Emergency pull station, blue with red pull	250.00
39043Y	Emergency pull station, yellow with red pull	282.00

Door Position Sensors (SPDT)

Item	Description	List \$
DPS11	Adjustable ball type SPDT, 5 amp	99.00
DPS112	Adjustable ball type 2 SPDT, 5 amp	150.00
MC4	Recessed magnetic	62.00
MC4M	Recessed magnetic mounted on plate	193.00
MC7	Biased high security recessed magnetic	150.00

Passive Infrared Egress Control

Item	Description	List \$
MS1RV1	Motion sensor (Requires PS1 RMT)	504.00
PS1RMT	Remote control for motion sensor	85.00
MD31DOW	Motion sensor with time delay – off white	504.00
MD31DB	Motion sensor with time delay – black	504.00

Monitor Strikes

Item	Description	List \$
MS12	Cylindrical latch monitor, 2-3/4" SPDT	277.00
MS12D	Cylindrical latch monitor, 2-3/4" DPDT	354.00
MS14	Cylindrical latch monitor, 4-7/8" SPDT	277.00
MS14D	Cylindrical latch monitor, 4-7/8" DPDT	354.00
MS16	Mortise lock latch monitor SPDT	277.00
MS16D	Mortise lock latch monitor DPDT	354.00
MS18	Mortise lock dead bolt monitor SPDT	277.00
MS18D	Mortise lock dead bolt monitor DPDT	379.00
MS20	Mortise lock latch and bolt monitor SPDT	354.00
MS20D	Mortise lock latch and bolt monitor DPDT	472.00

ED900 Series Ordering Guide

		Mount/Arm			
		T	— Pull Side Track Mount, 0"-1" Reveal		
		T275	— Pull Side Track Mount, 1" - 2-3/4" Reveal		
		J8	— Push Side Top Jab Mount, 0-8" Reveal	Options	
		J12	— Push Side Top Jamb Mount, 8-12" Reveal	PC	— Power Cord
				CB	— Conduit Box
Low Energy Swing Door Operator —	Model	900	Function	CMP	Companion (Not Powered)
Power Door Operator —	ED	900			
	Series	Application	SW		689
		Pair of Doors 2 ED900s — PR			
			SW	— Standard Width	600 — Primed
			FWS	— Full Width, Sgl. Door, Seamless Cover	689 — Aluminum
			FW2	— Full Width, Sgl. Doors 2 piece cover	690 — Statuary Bronze
			FWPRS	— Full Width, Pair of Doors, Seamless Cover	691 — Dull Bronze
			FWPR3	— Full Width, Pair of Doors, 3-Piece	693 — Black
					695 — Dark Duranodic Bronze
					696 — Gold
					Custom — Custom Painted Finish
					Designer — Designer Painted Finish

Remote Key switch (628 finish) less cylinder

SW
Standard Width 27"; Single Door

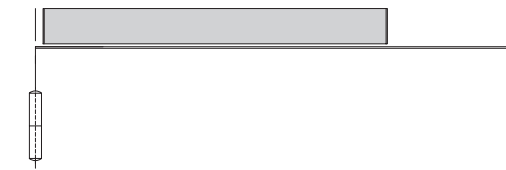

FWS
Seamless Full Width Cover, Single Door, From 29" (737 mm) to 48" (1219 mm)

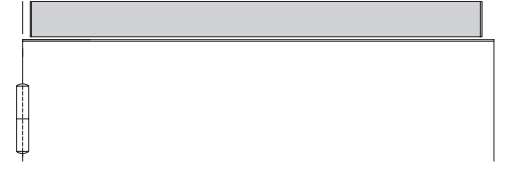

FW2
Full Width Cover, 2-Pieces, Includes 27" SW Cover and extension cover up to 21" (533 mm).

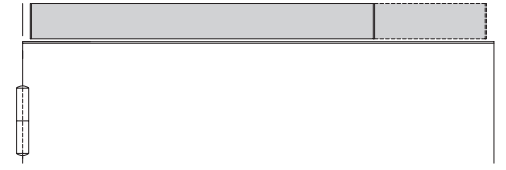

FWPRS
Seamless Full Width Cover for Pair of Doors, From 56" (1422 mm) to 96" (2438 mm)

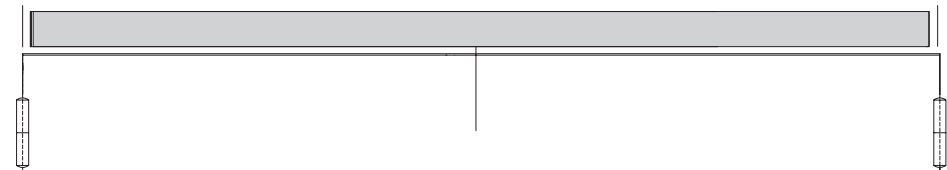

FWPR3
Full Width Pair of Doors, includes two 27" Standard Width Covers, and extension cover to fill remaining opening, up to 35" (889 mm).

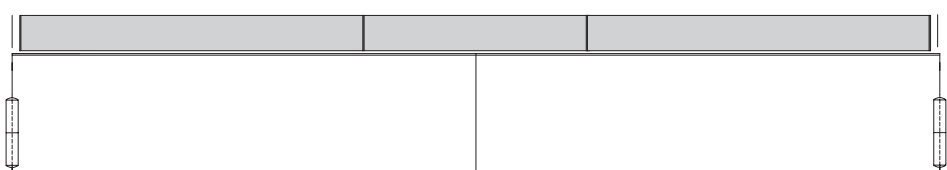

Painted Finish

ED900 Series Low Energy Operators

Single Door Applications

Model	Arm	Mounting	List Add Painted \$
ED900	T	Pull-side, regular mount, track arm, 0"–1" reveal	7660.00
ED900	T275	Pull-side, regular mount, track arm, 1"–2-3/4" reveal	7868.00
ED900	J8	Push-side, top jamb mount, 0"–8" reveal, mechanical arm stop	7660.00
ED900	J12	Push-side, top jamb mount, 8"–12" reveal, mechanical arm stop	7868.00
Covers			
SW		Standard width cover, 27", included with ED900	N/C
FWS		Full width cover for single door (door widths from 29"–48"), double mode switch and cable included.	357.00
FW2		A 27" standard cover, with field cut cover and mounting plate, (door width up to 48"), seam concealer, double mode switch and cable included.	357.00

Pair of Door Applications (Includes two ED900 Operators)

Model	Arm	Mounting	List Add Painted \$
ED900PR	T	Two ED900 operators, pull-side mount with track arms, 0"–1" reveal for pairs of doors	15318.00
ED900PR	T275	Two ED900 operators, pull-side mount with track arms, 1"–2-3/4" reveal, for pairs of doors	15746.00
ED900PR	J8	Two ED900 operators, push-side, top jamb mount arms, 0"–8" reveal, for pairs of doors	15318.00
ED900PR	J12	Two ED900 operators, push-side, top jamb mount arms, 8"–12" reveal, for pairs of doors	15746.00
ED900PRCMP	T	ED900 operator with manual door closer for second door, single full length cover, pull-side mount with track arms, 0"–1" reveal for pairs of doors	12095.00
ED900PRCMP	T275	ED900 operator with manual door closer for second door, single full length cover, pull-side mount with track arms, 1"–2-3/4" reveal for pairs of doors	12095.00
ED900PRCMP	J8	ED900 operator with manual door closer for second door, single full length cover, push-side, top jamb mount arms, 0"–8" reveal for pairs of doors	12095.00
ED900PRCMP	J12	ED900 operator with manual door closer for second door, single full length cover, push-side, top jamb mount arms, 8"–12" reveal for pairs of doors	12095.00
Covers			
SW		Two standard width covers, 27", for two ED900 operators	N/C
FWPRS		Seamless full width cover for pair of doors (door widths from 56"–96"), includes center mounting plate, control switch wiring harness, synchronizing cable, mode switch with cable, and power harness jumper.	711.00
FWPR3		Two 27" standard covers with field cut cover and mounting plate (door widths from 56"–96"), with seam concealers, control switch wiring harness, synchronizing cable, mode switch with cable, and power harness jumper.	711.00

NOTE: ED900 T, J8, J12 and ED900PR T, J8, J12 models include all axle extension 5/16" (9mm), 3/4" (20mm), 1-1/8" (30mm), and 2-3/8" (60mm).

Options

Item	Description	List Add \$
Special Finishes		
Custom Color	Custom painted finish selected from DORMA RAL color pal book. For details, see DORMA Finishes Cross Reference, page viii.	
	Per operator, set-up charge (Net)	86.00
	Per operator, list add	82.00
Designer Color	Designer painted color matched to supplied samples. Three (3) each, 2" x 2" color chip samples required. For details, see DORMA Finishes Cross Reference, page viii.	
	Per operator, non-refundable development/set-up charge (Net)	333.00
	Per operator, list add	102.00
Electrical Connection Options		
CB	Conduit box (only)	89.00
PC	Power cord (includes conduit box and power cord)	169.00

Accessories

Item	Description	List \$
Hard Wired Switches and Accessories		
WS1	Wall Switch – 6" square	390.00
WS 1 LOGO	Wall switch – with wheelchair logo only, 6" square	390.00
WS 1 SQ4	Wall switch, 4-1/2" square	433.00
WS 1 RND4	Wall switch, 4-1/2" round	433.00
WSTLS	Wall switch, touch-less sensor (available in white, gray, black)	665.00
FS 1	Frame switch, 1-3/4" x 4-1/2"	266.00
FS 1 LOGO	Frame switch with wheelchair logo only, 1-3/4" x 4-1/2"	266.00
UMB	Universal mounting box, for surface mounting WS-1, where no junction box is supplied	172.00
UMBFR	Universal mounting box flush mount ring, dress ring for WS-1	113.00
UMBRFT	Universal mounting box only, for 6" square WS/RFT 1 type switches (includes circuit board)	398.00

Item	Description	List \$
RF Switches and Accessories		
WSRFT 1	Wall switch – RF 300 MHz, 6" square	640.00
WSRFT 1 LOGO	Wall switch – RF 300 MHz, 6" square, with wheelchair logo only	640.00
WSRFT 1 433	Wall switch – RF 433 MHz, 6" square	626.00
WSRFT 1 433 SQ4	Wall switch – RF 433 MHz, 4-1/2" square	626.00
WSRFT 1 433 RND4	Wall switch – RF 433 MHz, 4-1/2" round	626.00
RFR	RF receiver, 300 MHz, 12 or 24 AC/DC (can be powered from ED900)	440.00
RFR 433	RF receiver, 433 MHz, 12 or 24 VAC/DC, 24AC (can be powered from ED900)	312.00
HHRFT 1 433	Hand held transmitter, 433 MHz	191.00
HHRFT 2 433	Hand held dual transmitter, 433 MHz	262.00
HHRFT 4 433	Hand held four button transmitter, 433 MHz	328.00
KCRFT 2 433	Key chain dual transmitter, 433 MHz	172.00
Miscellaneous Accessories		
SP1	Axle adaptor, zero extension	92.00
SP2	Axle adaptor, 3/4" (20mm) extension	92.00
SP3	Axle adaptor, 1-1/8" (30mm) extension	92.00
SP6	Axle adaptor, 2-3/8" (60mm) extension	108.00
SCRPK, ED900 Track	ED900 track arm, screwpack	19.00
970	Angle bracket	355.00
SCRPK900970	ED900 970 bracket, screwpack	19.00
930	Drop plate for arm shoe	93.00
SCRPK900930	930 drop plate, screwpack	19.00
BSTP25	Bumper/stop (1/4" thick plate)	98.00
BSTP50	Bumper/stop (1/2" thick plate)	98.00
BSTPSHM25	Bumper/stop shim, 1/4" thick	98.00
BSTPSHM50	Bumper/stop shim, 1/2" thick	98.00
BUMPER BLK	Bumper only	35.00
HEXKEY T	Hex key, 5mm, T-handle	25.00
DECAL ED900	Decal, ED900 door set	66.00
PRCONKIT96	Pair connection kit up to 96" opening width	249.00
TERMCONBD	Terminal Connection Board	111.00
T	Pull side track mount arm, 0" – 1" reveal	363.00
T275	Pull side deep reveal track mount arm, 1" – 2-3/4" reveal	564.00
J8	Push side top jamb mount arm, 0" – 8" reveal	363.00
J12	Push side top jamb deep reveal mount arm, 8" – 12" reveal	564.00
CAPSCOVS	Plastic endcaps/pinion cover	33.00

NOTE: Safety and motion sensors available for use with the ED900. Please contact customer service for ordering support.

ED50LE

The ED50LE low energy swing door operator is easy to install and is the perfect solution for touch-free access applications, offering a true manual door closer experience.

This medium-duty swing door operator can automate new or existing manual swing doors with a wave plate (RCI 946T, 950T Series; 910TC Series or 912 Series), or other "knowing act" device. The ED50LE combines advanced automatic power assist, minimal push forces (as low as ANSI size 1) and reliable closing. Outswing or inswing doors can be adapted for touch-free access with push or pull arms suited to a wide variety of door usage options.

Item	Description	Finish	List \$
ED50LE			
7266003	34" Single Operator, PULL ARM	CL - Clear anodized	4,643.00
7266004	34" Single Operator, PULL ARM	DB - Dark bronze anodized	4,643.00
7266005	34" Single Operator, PUSH ARM	CL - Clear anodized	4,643.00
7266006	34" Single Operator, PUSH ARM	DB - Dark bronze anodized	4,643.00



ED100LE

The ED100LE low energy swing door operator is the perfect solution for touch free access applications, a versatile operator ideal for ADA-compliant applications.

This medium or heavy-duty swing door operator can automate new or existing manual swing doors with a wave plate (RCI 946T, 950T Series; 910TC Series or 912 Series) or other "knowing act" device. The ED100LE combines advanced power assist, reliable closing, and special firmware capabilities to help manage the combination of wind and building pressure. With a multitude of adjustable features, you have the flexibility to fine tune the operator to meet opening requirements.

Item	Description	Finish	List \$
ED100LE			
7265853	34" Single Operator, PULL ARM	CL - Clear anodized	8,102.00
7265854	34" Single Operator, PULL ARM	DB - Dark bronze anodized	8,102.00
7265855	34" Single Operator, PUSH ARM	CL - Clear anodized	8,102.00
7265856	34" Single Operator, PUSH ARM	DB - Dark bronze anodized	8,102.00



Surface Closers

Product Guide (1 of 2)

SURFACE MOUNTED CLOSERS	Full Cover	Slimline Cover	No Cover
Grade 1 – Cam Action Fully Adjustable (Power) Size	TS93	–	–
Grade 1 – Heavy Duty Fully Adjustable (Power) Size	8900	–	–
	STA8900	–	–
Grade 1 – Fully Adjustable (Power) Size	8600 × FC/FMC/FCSL	8600 × COV	–
	STA8600 × FC/FMC/FCSL	STA8600 × COV	–
Grade 1 – Adjustable (Power) Size	7400 × FC/FCSL	7400 × COV	7400
	STA7400 × FC/FCSL	STA7400 × COV	STA7400
Grade 1 – Sized (Power) per Application	–	7300 × COV	7300

Surface Closers

Product Guide (2 of 2)

<input checked="" type="radio"/> Yes <input type="radio"/> No	A156.4 Grade1	UL10C	Advanced Cam and Roller Design	Rack and Pinion Design	Stainless	Plated or Decorative Finishes	Standard Painted Finishes	Custom Painted Finishes	Adjustable Power	Fixed Power
TS93	<input checked="" type="radio"/>	<input checked="" type="radio"/>	<input checked="" type="radio"/>	<input type="radio"/>	<input type="radio"/>	<input checked="" type="radio"/>	<input checked="" type="radio"/>	<input checked="" type="radio"/>	<input checked="" type="radio"/>	<input type="radio"/>
8900	<input checked="" type="radio"/>	<input checked="" type="radio"/>	<input type="radio"/>	<input checked="" type="radio"/>	<input type="radio"/>	<input checked="" type="radio"/>	<input checked="" type="radio"/>	<input checked="" type="radio"/>	<input checked="" type="radio"/>	<input type="radio"/>
STA8900	<input checked="" type="radio"/>	<input checked="" type="radio"/>	<input type="radio"/>	<input checked="" type="radio"/>	<input checked="" type="radio"/>	<input checked="" type="radio"/>	<input checked="" type="radio"/>	<input checked="" type="radio"/>	<input checked="" type="radio"/>	<input type="radio"/>
8600	<input checked="" type="radio"/>	<input checked="" type="radio"/>	<input type="radio"/>	<input checked="" type="radio"/>	<input type="radio"/>	<input checked="" type="radio"/>	<input checked="" type="radio"/>	<input checked="" type="radio"/>	<input checked="" type="radio"/>	<input type="radio"/>
STA8600	<input checked="" type="radio"/>	<input checked="" type="radio"/>	<input type="radio"/>	<input checked="" type="radio"/>	<input checked="" type="radio"/>	<input checked="" type="radio"/>	<input checked="" type="radio"/>	<input checked="" type="radio"/>	<input checked="" type="radio"/>	<input type="radio"/>
7400	<input checked="" type="radio"/>	<input checked="" type="radio"/>	<input type="radio"/>	<input checked="" type="radio"/>	<input type="radio"/>	<input checked="" type="radio"/>	<input checked="" type="radio"/>	<input checked="" type="radio"/>	<input checked="" type="radio"/>	<input type="radio"/>
U1500	<input checked="" type="radio"/>	<input checked="" type="radio"/>	<input type="radio"/>	<input checked="" type="radio"/>	<input type="radio"/>	<input type="radio"/>	<input checked="" type="radio"/> *	<input type="radio"/>	<input checked="" type="radio"/>	<input type="radio"/>
7300	<input checked="" type="radio"/>	<input checked="" type="radio"/>	<input type="radio"/>	<input checked="" type="radio"/>	<input type="radio"/>	<input type="radio"/>	<input checked="" type="radio"/>	<input checked="" type="radio"/>	<input type="radio"/>	<input checked="" type="radio"/>
GSR	<input checked="" type="radio"/>	<input checked="" type="radio"/>	<input checked="" type="radio"/>	<input type="radio"/>	<input type="radio"/>	<input checked="" type="radio"/>	<input checked="" type="radio"/>	<input checked="" type="radio"/>	<input checked="" type="radio"/>	<input type="radio"/>

* 689 and 695 only.

TS93 Series Ordering Guide

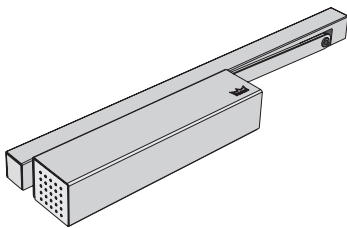
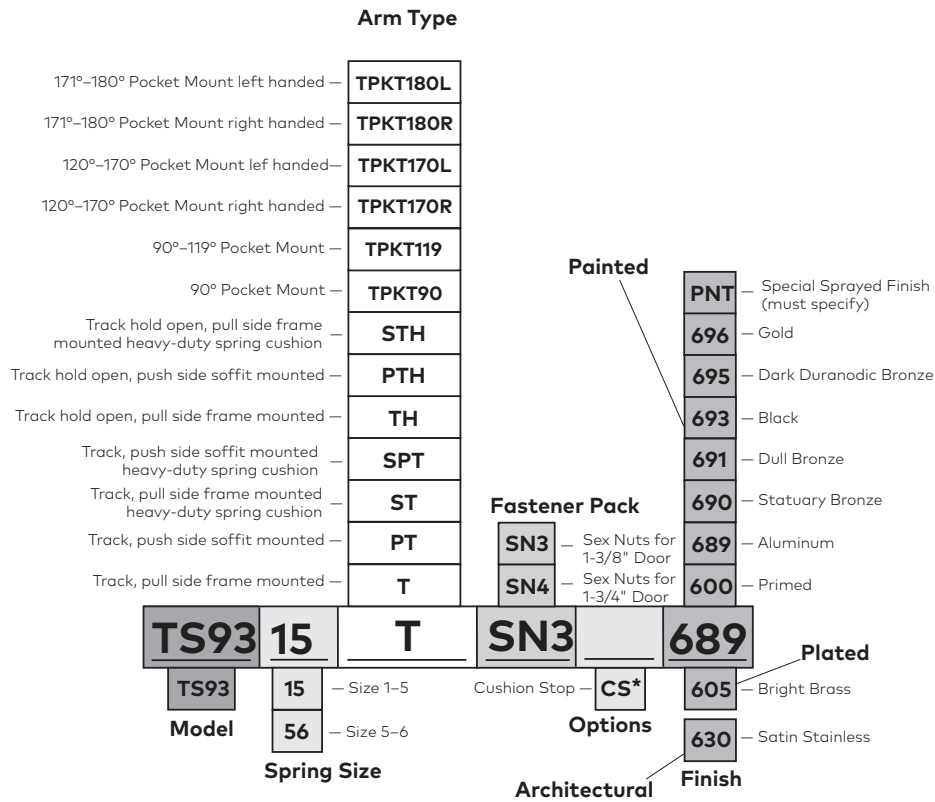

* Available for use with T, TH, PT, PTH arms only.

NOTES:

- All combinations of features and options are not available for all models.
- Please refer to TS93 Series product brochure for details.

Body	Arm	Mounting	Painted Finish \$	605/630 \$
Slide Track Non-Hold Open				
TS9315, TS9356	T	Door mounted (pull side)	754.00	1247.00
	PT	Soffit mounted (push side)	754.00	1247.00
Slide Track Hold Open				
TS9315, TS9356	TH	Door mounted (pull side)	791.00	1285.00
	PTH	Soffit mounted (push side)	791.00	1285.00
Slide Track Non-Hold Open w/Spring Cushion				
TS9315, TS9356	ST	Door mounted w/ stop (pull side)	1086.00	1636.00
	SPT	Soffit mounted w/ stop (push side)	1086.00	1636.00
Slide Track Hold Open w/Spring Cushion				
TS9315, TS9356	STH	Door mounted w/ stop (pull side)	1123.00	1676.00

NOTE: S-track (stop) units ordered in 630 finish are furnished as a combination of 619 and 630 finish components.

Body	Arm	Mounting	Painted Finish \$
90° Slide Track/Pocket Pivot Applications			
TS9356	TPKT90	90° track application less pocket pivots For nonfire-rated applications, order (3 ea.) plated finish 75520 pocket pivots, separately For 3-hour fire-rated applications, order (3 ea.) plated finish 75523 pocket pivots, separately	808.00
90°-180° Slide Track/Pocket Pivot Applications			
TS9356	TPKT119	90° to 119°, offset pivots or hinges, closer on door, track in pocket. Order EM504 electromagnet separately.	974.00
	TPKT170	120° to 170°, closer on wall in pocket, track on door, left handed. Order EM504 electromagnet separately.	1030.00
	TPKT180L	171° to 180°, closer on wall in pocket, track on door, left handed. Order EM504 electromagnet separately	1081.00
	TPKT180R	171° to 180°, closer on wall in pocket, track on door, right handed. Order EM504 electromagnet separately.	1081.00

Options

(List Price 'add' when ordered with complete closer)

Item	Description	List Add/Deduct \$
CS	Cushion stop/bumper to help slow door in normal opening cycle (for T, TH, PT, PTH arms only)	50.00
SN4	(4) each 10-32 aluminum sex nuts for 1-3/8" door	N/C
LSN	Less sex nuts (less SN3 pack)	Deduct 5.00
Custom Color	Custom painted finish selected from RAL color pallet book. For details, see Finishes Cross Reference , page viii.	
	per order, setup charge (Net)	155.00
	per closer, list add	43.00
Designer Color	Designer painted color matched to supplied samples. Three (3) each 2" x 3" color chip samples required. For details, see Finishes Cross Reference , page viii.	
	per order, non-refundable development/ setup charge (Net)	386.00
	per closer, list add	49.00

NOTES:

- Painted finish price includes full metal cover with plastic end caps.
- Specify closer and arm designation and finish when ordering
- TS93 packaged (2) units per master carton.
- SN3 sex nuts and (DA) delayed action is standard with all TS93 closers.

8900 Series

Ordering Guide

Spring Size		Body Cover		Accessory Plates		Other Accessories			
Adjustable 1-6	16	Full Plastic	FC	Drop Plate	DP89	AB89	Angle Bracket		
Fixed Size 7	07	Full Plastic Slotted	FCSL	Back Plate	BP89	NFHD	Narrow Frame Bracket, Heavy Duty		
Adjustable 5-6	56	Full Metal Cover	FMC**			FTHD	Flush Transom Bracket, Heavy Duty		
	TANDEM					BS	Blade Stop Spacer		
	DA					BSDH	Blade Stop Heavy Duty		
Series	89	16	AF89	FC	SN1		689		
Flat Form Non-Hold Open, Tri-Pack			AF89P	PFT	SN2	TX89	605	Polished Brass	
Flat Form Non-Hold Open, TJ 4"-8" Reveal			AF89J	PD	SN1	SNDPK	606	Satin Brass	
Flat Form Non-Hold Open, Reg./TJ 0"-4" Reveal			AF89	MJ*	Fastener Pack		611	Polished Bronze	
Flat Form Non-Hold Open With Mortise Jamb Bracket			AF8MJ	PA Bracket		DPK89	612	Satin Bronze	
Flat Form Non-Hold Open, Rigid Regular Mount			RRA	Sex Nuts 1-3/8"		SNTPK	613	Oxidized Satin Oil Rubbed Bronze	
Friction Hold Open, Tri-Pack			FHP	Sex Nuts 1-3/4"		TPK89	618	Polished Nickel	
Friction Hold Open, TJ 4"-8" Reveal			FHJ			Arm Fastener Pack		619	Satin Nickel
Friction Hold Open, Reg./TJ 0"-4" Reveal			FH			Plated		625	Polished Chrome
Plunger Hold Open, Parallel Arm (TJ 1-1/2"-3-1/2" Reveal)			PHP			Architectural		626	Satin Chrome
Plunger Hold Open, Reg./TJ 0"-1-1/2" Reveal			PH			Painted		630**	Stainless Satin Finish with Stainless Base Material
Heavy-duty Door Saver Cushion, Parallel			DS					600	Primed
Heavy-duty Door Saver Cushion Thumb Turn Hold Open, Parallel			DST					689	Aluminum
Extra Heavy-duty Door Saver Spring Cushion, Parallel			SDS					690	Statuary Bronze
Heavy-duty Cushion, Reg./TJ 0"-3-1/2" Reveal			SDST					691	Dull Bronze
Extra Heavy-duty Spring Cushion Reg./TJ 0"-3-1/2" Reveal			IS					693	Black
Heavy-duty Cushion, Top Jamb 3-1/2"-6-1/2" Reveal			ISH					695	Dark Duranodic Bronze
Extra Heavy-duty Spring Cushion, Reg./TJ 0"-3-1/2" Reveal			SIS*					696	Gold
Heavy-duty Cushion, Top Jamb 3-1/2"-6-1/2" Reveal			SISH					PNT	Special sprayed finish (must specify)***
Extra Heavy-duty Spring Cushion, Top Jamb 3-1/2"-6-1/2" Reveal			ISJ						
Heavy-duty Cushion Hold Open, Top Jamb 3-1/2"-6-1/2" Reveal			ISJH						
Extra Heavy-duty Spring Cushion, Top Jamb 3-1/2"-6-1/2" Reveal			SISJ*						
Super Parallel Arm			SISJH						
Super Parallel Arm Thumb Turn Hold Open			SPA						
Track, Pull Side Door Mounted			SPAT						
Jamb Track, Pull Side Frame Face Mounted			SPAS6						
Push Track, Push Side Soffit Mounted			T						
Track Double Egress, Pull Side Transom Mounted			JT						
Track Hold Open, Pull Side Door Mounted			PT						
Track Hold Open, Pull Side Door Mounted			TDE						
Push Track Hold Open, Push Side Soffit Mounted			FT						
Flush Track Hold Open, Pull Side Frame Face Mounted			TH						
Double Lever Flat Form Arm, 90° Pocket Door (8907 only)			JTH						
			PTH						
			TDEH						
			FTH						
			TPKT90						
			AFPKT90						
			AFPKT180						

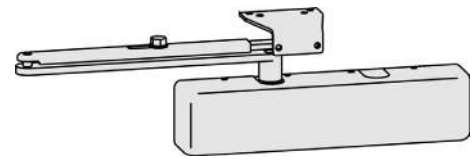

NOTES:

- All combinations of features and options are not available for all models. Please refer to 8900 product brochure for details.
- Non-fire rated, 90°TPK (90° pocket) applications require (3 ea.) 75520 pocket pivots, ordered separately.
- Fire rated, 90° TPK (90° pocket) applications require (3 ea.) 75523 pocket pivots, ordered separately.

*When used with flat form non-hold open arms, the MJ bracket must be used with a special length arm. Specify AF8MJ.

**Optional 630 stainless satin finish with stainless base material only available for SIS/SISJ arms or FMC.

***For optional dormakaba custom color or designer Color Finishes, contact Customer Service.

**** Only in combination with SPA arm and FMC

Body	Arm	Mounting	Painted Finish \$	Plated Finish \$
Non-Hold Open				
8916, 8956	AF89P	PA, REG & TJ for reveals to 4" (flat)	620.00	1038.00
	AF89J	TJ for reveals 4" to 8" (flat)	615.00	965.00
	AF89	REG or TJ for reveals to 4" (flat)	608.00	957.00
	AF8MJ	REG with mortise jamb bracket (flat)	641.00	—
	RRA	REG, rigid regular mount arm (flat)	683.00	—
Bumper or Spring Cushion				
8916, 8956	DS	Heavy-duty door saver cushion parallel arm	690.00	1110.00
	DST	w/thumb turn hold open	745.00	1163.00
	SDS	Extra heavy-duty door saver spring cushion parallel arm	867.00	1396.00
	SDST	w/thumb turn hold open	925.00	1455.00
	IS	Heavy-duty cushion arm, REG and TJ for 0" to 3-1/2" reveal	854.00	1246.00
	ISH	Heavy-duty cushion arm, w/ hold open REG and TJ for 0" to 3-1/2" reveal (not available on 8956)	915.00	—
	SIS	Extra heavy-duty spring cushion arm, REG and TJ for 0" to 3-1/2" reveal	915.00	1417.00
	SISH	w/hold open, REG and TJ for 0" to 3-1/2" reveal (not available on 8956)	1013.00	0.00
	ISJ	Heavy-duty cushion arm, TJ for 3-1/2" to 6-1/2" reveal	885.00	1271.00
	ISJH	Heavy-duty cushion arm w/hold open, TJ for 3-1/2" to 6-1/2" reveal (not available on 8956)	945.00	—
	SISJ	Extra heavy-duty spring cushion arm, TJ for 3-1/2" to 6-1/2" reveal	983.00	1447.00
	SISJH	w/hold open, TJ for 3-1/2" to 6-1/2" reveal (not available on 8956)	1042.00	—
Heavy Duty PA				
8916, 8956	SPA	Super parallel arm	644.00	1059.00
	SPAT	w/thumb turn hold open	702.00	1110.00
	SPAS6	Super parallel arm w/ drop spacer	697.00	—
Hold Open				
8916, 8956	FHP	Friction PA, REG & TJ for reveals to 4"	666.00	—
	FHJ	TJ for reveals 4" to 8"	661.00	—
	FH	REG or TJ for reveals to 4"	653.00	—
	PHP	Plunger PA & TJ for reveals 1-1/4" to 3-1/4"	765.00	1179.00
	PH	REG or TJ for reveals 0" to 1-1/4"	759.00	1097.00

* Available in 630 finish only and not intended for corrosive environments.

NOTE: Standard arm configuration is indicated in **bold**.

Body	Arm	Mounting	Painted Finish \$	Plated Finish \$
Slide Track				
8916, 8956	T	Door mounted (pull side)	661.00	1059.00
	JT	Frame mounted (pull side)	661.00	1059.00
	FT	Flush transom mounted (push side)	661.00	1059.00
	PT	Soffit mounted (push side)	661.00	1059.00
	TDE	Frame mounted double egress frame (pull side), specify hand	735.00	1136.00
Track Hold Open				
8916, 8956	TH	Door mounted (pull side)	691.00	1093.00
	JTH	Frame mounted (pull side)	691.00	1093.00
	FTH	Flush transom mounted (push side)	691.00	1093.00
	PTH	Soffit mounted (push side)	691.00	1093.00
	TDEH	Frame mounted double egress frame (pull side), specify hand	763.00	1168.00
Pocket Applications				
8956	TPKT90	Track application, 90 degree pocket door	661.00	1059.00
8907	AFPKT90	Double lever flat form arm, 90 degree pocket door	661.00	1077.00
	AFPKT180	Double lever flat form arm, 180 degree pocket door	661.00	1127.00

Options

Item	Description	List Add/Deduct \$
DA	Adjustable delayed action (suffix to model)	45.00
FCSL	Full plastic slotted cover (low ceiling conditions)	N/C
FMC	Full metal cover (handed for TJ or T [FMCL/FMCR])	10.00
FMCLL	Full metal cover, lead lined. Handed & non-handed.	147.00
SN2	(4) each 1/4-20 aluminum sex nuts for 1-3/8" thick door	N/C
LSN	Less sex nuts (less SN1 pack)	Deduct 5.00
DPK89	All fasteners to be self-drilling (in lieu of standard fasteners)	N/C
SNDPK	Standard fasteners and DPK89	14.00
TPK89	All fasteners to be self-tapping (in lieu of standard fasteners)	N/C
SNTPK	Standard fasteners and TPK89	14.00
TX89	All exposed fasteners to be Torx security fasteners (n/a with track applications)	36.00
TANDEM	Dual closer body system for extra heavy or wide doors or doors with difficult air handling conditions 8916 or 8956 (select one). SPA, FMC.	710.00
TANDEM	Dual closer body system for extra heavy or wide doors or doors with difficult air handling conditions. 8907, SPA, FMC.	744.00
Custom Color	Custom painted finish selected from RAL color pallet book. For details, see Finishes Cross Reference , page viii.	
	per order, setup charge (Net)	135.00
	per closer, list add	38.00
Designer Color	Designer painted color matched to supplied samples. Three (3) each 2" x 3" color chip samples required. For details, see Finishes Cross Reference , page viii.	
	per order, non-refundable development/setup charge (Net)	338.00
	per closer, list add	42.00

NOTES:

- All painted components w/plated line item will be painted complementary finish.
- Example:** For a line item ordered w/plated 626 FMC only, all other components will be 689.
- Painted finish price includes full plastic cover.
- Plated finish price includes optional full metal cover.
- Specify closer and arm designation, hand (when required), finish, and options when ordering.
- All spring cushion, heavy-duty PA, tracks, and top jamb (J) configurations packaged (4) units per master carton.
- All others are packaged (6) units per master carton.
- FMC is only cover available in plated finishes.
- Sex nuts for 1-3/4" door (SN1) furnished standard with all 8900 and included in price. Specify (SN2) for 1-3/8" door.

Accessories

Item	Description	List \$
BP89	Backplate for top jamb with frame < 2-7/8" wide	42.00
DP89	Drop plate for PA where top rail is < 5-3/4"	42.00
AB89	Angle bracket for closer with full plastic cover	76.00
PFT	Parallel flush transom bracket	34.00
PD	Parallel drop bracket, non-hold open arms (AF89 only)	43.00
MJ 	Mortised jamb bracket, non-hold open arms (AF89 only)	31.00
BS	Blade stop spacer (P89, PHB, and PD)	31.00
BSHD	Blade stop spacer for use with heavy duty door saver and super parallel arms	35.00
NFHD	Narrow frame bracket for use with heavy duty door saver and super parallel arms	35.00
FTHD	Flush transom bracket for use with heavy duty door saver and super parallel arms	62.00

 When used with flat form non-hold open arms, the MJ bracket must be used with a special length arm. Specify AF8MJ for 8600 or 8900 Series closers.

8600 Series

Ordering Guide

Series	8600	16	Delay	DA	Spring Size	Adjustable 1-6	Fastener Pack	Arm Fastener Pack	Finish
	86	16			AF86P		SNB1		689
	Flat Form Non-Hold Open, Tri-Pack				AF86P				605 - Polished Brass
	Flat Form Non-Hold Open, TJ 4"-8" Reveal				AF86J				606 - Satin Brass
	Flat Form Non-Hold Open With Mortise Jamb Bracket				AF8MJ				611 - Polished Bronze
	Flat Form Non-Hold Open, Reg./TJ 0"-4" Reveal				AF86				612 - Satin Bronze
	Round Arm Non-Hold Open, Tri-Pack				ARP				613 - Oxidized Satin Oil Rubbed Bronze
	Round Arm Non-Hold Open, Narrow Profile, Reg./TJ 0"-4" Reveal				ARNP				618 - Polished Nickel
	Round Arm Non-Hold Open, Reg. 4"-8" Reveal, Narrow Profile				ARNPJ				619 - Satin Nickel
	Round Arm Non-Hold Open, Tri-pack, Narrow Profile				ARNPP				625 - Polished Chrome
	Round Arm Non-Hold Open, TJ 4"-8" Reveal				ARJ				626 - Satin Chrome
	Round Arm Non-Hold Open, TJ 0"-4" Reveal				AR				630** - Satin Stainless Finish with Stainless Base Material
	Round Arm Secure Non-Hold Open, Tri-Pack				AO8P				600 - Primed
	Round Arm Secure Non-Hold Open, Reg./TJ 0"-4" Reveal				AO8				689 - Aluminum
	Friction Hold Open, Tri-Pack				FHP				690 - Statuary Bronze
	Friction Hold Open, TJ 4"-8" Reveal				FHJ				691 - Dull Bronze
	Friction Hold Open, Reg./TJ 0"-4" Reveal				FH				693 - Black
	Plunger Hold Open, Parallel and TJ (1-1/2"-3-1/2" Reveal)				PHP				695 - Dark Duranodic Bronze
	Plunger Hold Open, Reg./TJ 0"-1-1/2" Reveal				PH				696 - Gold
	Heavy-duty Door Saver Cushion Thumb Turn Hold Open, Parallel				DS				PNT - Special Sprayed Finish (must specify)
	Extra Heavy-duty Door Saver Spring Cushion Thumb Turn Hold Open, Parallel				SDS				
	Heavy-duty Cushion, Reg./TJ 0"-3-1/2" Reveal				IS				
	Extra Heavy-duty Spring Cushion Reg./TJ 0"-3-1/2" Reveal				ISH				
	Heavy-duty Cushion, Top Jamb 3-1/2"-6-1/2" Reveal				ISJ				
	Extra Heavy-duty Spring Cushion, Top Jamb 3-1/2"-6-1/2" Reveal				SISJ*				
	Super Parallel Arm				SPA				
	Super Parallel Arm Thumb Turn Hold Open				SPAT				
	Track, Pull Side Door Mounted				SPAS6				
	Jamb Track, Pull Side Frame Face Mounted				T				
	Push Track, Push Side Soffit Mounted				JT				
	Track Double Egress, Pull Side Transom Mounted				PT				
	Flush Track, Push Side Transom Mounted				TDE				
	Track Hold Open, Pull Side Door Mounted				FT				
	Push Track Hold Open, Push Side Soffit Mounted				TH				
	Flush Track Hold Open, Push Side Transom Mount				JTH				
					PTH				
					TDEH				
					FTH				

Cover

Slim Cover	COV
Full Plastic	FC
Full Plastic Slotted	FCSL
Full Metal Cover	FMC**

Fastener Pack

Less Sex Nuts	LSN
Sex Nuts & Machine Screws, 1-3/8"	SNB2
Sex Nuts & Machine Screws, 1-3/4"	SNB1

Arm Fastener Pack

AWS	All Wood Screws
TX86	Torx Security Pack
SNTPK	Std. and Self-Tapping
TPK86	Self-Tapping
SNDPK	Std. and Self-Drilling
DPK86	Self-Drilling
COMBO	Wood/Machine Screw Combination

Accessory Brackets

PFT	PA Flush Transom Bracket
PD	Drop Bracket
MJ*	Mortise Jamb

Other Accessories

NFHD	Narrow Frame Bracket, Heavy Duty
FTHD	Flush Transom Bracket, Heavy Duty
BP86C	Conversion Plate

Plated

Architectural

Painted

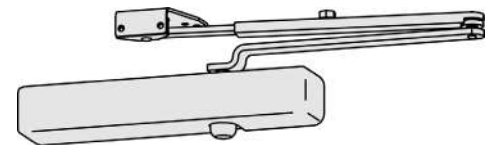

*When used with flat form non-hold open arms, the MJ bracket must be used with a special length arm. Specify AF8MJ.

** Optional 630 stainless satin finish with stainless base material only available for SIS/SISJ arms or FMC.

NOTES:

- All combinations of features and options are not available for all models. Please refer to 8600 Series product brochure for details.
- To simplify initial installation, a range of back plates (BPxx), drop plates (DPxx), brackets, and spacers are listed under 8600 Accessories in this section. Refer to 8600 Series product brochure for details.

Body	Arm	Mounting	Painted Finish \$	Plated Finish \$
Non-Hold Open				
8616	AF86P	PA, REG and TJ for reveals to 4" (flat)	492.00	958.00
	AF86J	TJ for reveals 4" to 8" (flat)	476.00	868.00
	AF86	REG or TJ for reveals to 4" (flat)	471.00	856.00
	AF8MJ	REG with mortise jamb bracket (flat)	501.00	—
	ARP	PA, REG and TJ for reveals to 4" (round)	476.00	910.00
	ARNP	Narrow profile, REG or TJ for reveals to 4" (round)	455.00	826.00
	ARNPJ	Narrow profile for reveals 4" to 8" (round)	457.00	824.00
	ARNPP	Narrow profile, PA, REG, TJ (round)	471.00	903.00
	ARJ	TJ for reveals 4" to 8" (round)	460.00	830.00
	AR	REG or TJ for reveals to 4" (round)	455.00	826.00
	AO8P	PA, REG and TJ secured elbow for reveals to 4" (round)	476.00	—
	AO8	REG or TJ secured elbow for reveals to 4" (round)	469.00	—
Bumper or Spring Cushion				
8616	DS	Heavy-duty door saver cushion parallel arm	575.00	1021.00
	DST	w/ thumb turn hold open	642.00	1082.00
	SDS	Extra heavy-duty door saver spring cushion parallel arm	754.00	1331.00
	SDST	w/ thumb turn hold open	819.00	1396.00
	IS	Heavy-duty cushion arm, REG and TJ for 0" to 3-1/2" reveal	742.00	1154.00
	ISH	Heavy-duty cushion arm w/hold open, REG and TJ for 0" to 3-1/2" reveal	807.00	—
	SIS	Extra heavy-duty spring cushion arm, REG and TJ for 0" to 3-1/2" reveal	847.00	1349.00
	SISH	w/ hold open, REG and TJ for 0" to 3-1/2" reveal	909.00	—
	ISJ	Heavy-duty cushion arm, TJ for 3-1/2" to 6-1/2" reveal	774.00	1196.00
	ISJH	Heavy-duty cushion arm w/hold open, TJ for 3-1/2" to 6-1/2" reveal	839.00	—
	SISJ	Extra heavy-duty spring cushion arm, TJ for 3-1/2" to 6-1/2" reveal	878.00	1384.00
	S-ISJH	w/ hold open, TJ for 3-1/2" to 6-1/2" reveal	939.00	—
Heavy Duty PA				
8616	SPA	Super parallel arm	515.00	976.00
	SPAT	w/ thumb turn hold open	580.00	1041.00
	SPAS6	Super parallel arm w/ drop spacer	513.00	-
Hold Open				
8616	FHP	Friction PA, REG and TJ for reveals to 4"	552.00	—
	FHJ	TJ for reveals 4" to 8"	533.00	—
	FH	REG or TJ for reveals to 4"	526.00	—
	PHP	Plunger PA and TJ for reveals 1-1/2" to 3-1/2"	648.00	1099.00
	PH	REG or TJ for reveals 0" to 1-1/2"	641.00	1030.00
Slide Track				
8616	T	Door mounted (pull side)	533.00	962.00
	JT	Frame mounted (pull side)	533.00	962.00
	FT	Flush transom mounted (push side)	533.00	962.00
	PT	Soffit mounted (push side)	533.00	962.00
	TDE	Frame mounted double egress frame (pull side), specify hand	612.00	1043.00

* Available in 630 finish only and not intended for corrosive environments.

* FMC is the only cover available in 630 finish

NOTE: Standard arm configuration is indicated in **bold**

Body	Arm	Mounting	Painted Finish \$	Plated Finish \$
Track Hold Open				
8616	TH	Door mounted (pull side)	566.00	974.00
	JTH	Frame mounted (pull side)	566.00	974.00
	FTH	Flush transom mounted (push side)	566.00	974.00
	PTH	Soffit mounted (push side)	566.00	974.00
	TDEH	Frame mounted double egress frame (pull side), specify hand	633.00	1057.00

Options

(List Price 'add' when ordered with complete closer)

Item	Description	List Add/Deduct \$
DA	Adjustable delayed action (suffix to model)	49.00
LCOV	Less slim plastic cover, Deduct	Deduct 15.00
FC	Full plastic cover	11.00
FCSL	Full plastic slotted cover (low ceiling conditions)	11.00
FMC	Full metal cover (handed for TJ or JT [FMCL/FMCR])	17.00
FMCLL	Full metal cover, lead lined. Handed & non-handed.	157.00
SNB2	(4) each 1/4-20 aluminum sex nuts and bolts for 1-3/8" door	N/C
LSN	Less sex nuts (less SN1 pack)	Deduct 5.00
AWS	All wood screws	13.00
DPK86	All fasteners to be self-drilling (in lieu of standard fasteners)	N/C
SNDPK	Standard fasteners and DPK86	16.00
TPK86	All fasteners to be self-tapping (in lieu of standard fasteners)	N/C
SNTPK	Standard fasteners and TPK86,	16.00
TX86	All exposed fasteners to be Torx security fasteners (n/a with track applications)	40.00

Item	Description	List Add/Deduct \$
Custom Color	Custom painted finish selected from RAL color pallet book. For details, see Finishes Cross Reference , page viii.	
	per order, setup charge (Net)	148.00
	per closer, list add	42.00
Designer Color	Designer painted color matched to supplied samples. Three (3) each 2" x 3" color chip samples required. For details, see Finishes Cross Reference , page viii.	
	per order, non-refundable development/setup charge (Net)	371.00
	per closer, list add	47.00

NOTES:

- All painted components w/plated line item will be painted complementary finish.
Example: For a line item ordered w/plated 626 FMC only, all other components will be 689.
- Painted finish price includes slim plastic cover.
- Plated finish price includes optional full metal cover.
- Specify closer and arm designation, hand (when required), and finish when ordering.
- All spring cushion, heavy-duty PA, tracks, and top jamb (J) configurations packaged (4) units per master carton.
- All others are packaged (6) units per master carton.
- FMC is only cover available in plated finishes.
- All 8600 closers standard with SNB1.
- T, TH, FT, FTH include backplate standard.
- 8600 Series closer prepared standard to accept COV, FC, FCSL, or FMC.

Accessories

Item	Description	List \$
BP86	Backplate for closer with slim cover	46.00
BP86FC	Backplate for closer with full cover	46.00
BP86T	Backplate for slide track closer with slim cover	46.00
BP86TFC	Backplate for slide track closer with full cover	46.00
BP86FTFC	Backplate for flush transom slide track closer w/wo/cover or full cover	46.00
DP86	Drop plate for closer with slim cover	46.00
DP86FC	Drop plate for closer with full cover	46.00
BP86C	Backplate for conversion of 7600 Series to 8600 Series	46.00
AB86	Angle bracket for closer with slim cover	81.00
PFT	Parallel flush transom bracket	38.00
PD	Parallel drop bracket, non-hold open arms (AF86, AR, AO8 only)	48.00
MJ 	Mortised jamb bracket, non-hold open arms (AF86 only)	33.00
BS	Blade stop spacer (P86, PHB, and PD)	33.00
BSHD	Blade stop spacer for use with heavy duty door saver and super parallel arms	39.00
NFHD	Narrow frame bracket for use with heavy duty door saver and super parallel arms	39.00
FTHD	Flush transom bracket for use with heavy duty door saver and super parallel arms	69.00

 When used with flat form non-hold open arms, the MJ bracket must be used with a special length arm. Specify AF8MJ for 8600 or 8900 Series closers.

Body	Arm	Mounting	Painted Finish \$
Non-Hold Open			
7414, 7436	ARP	PA, REG & TJ for reveals to 4" (round)	329.00
	ARJ	TJ for reveals 4" to 8" (round)	323.00
	AR	REG or TJ for reveals to 4" (round)	315.00
	AO8P	PA, REG & TJ secured elbow for reveals to 4" (round)	332.00
	AO8	REG or TJ secured elbow for reveals to 4" (round)	315.00
Bumper or Spring Cushion			
7414, 7436	DS	Heavy-duty door saver cushion parallel arm	427.00
	DST	w/thumb turn hold open	493.00
	SDS	Extra heavy-duty door saver spring cushion parallel arm	624.00
	SDST	w/thumb turn hold open	687.00
	IS	Heavy-duty cushion arm, REG and TJ for 0" to 3-1/2" reveal	612.00
	ISH	Heavy-duty cushion arm w/hold open, REG and TJ for 0" to 3-1/2" reveal	678.00
	SIS	Extra heavy-duty spring cushion arm, REG and TJ for 0" to 3-1/2" reveal	714.00
	SISH	w/hold open, REG and TJ for 0" to 3-1/2" reveal	780.00
	ISJ	Heavy-duty cushion arm, TJ for 3-1/2" to 6-1/2" reveal	642.00
	ISJH	Heavy-duty cushion arm w/hold open, TJ for 3-1/2" to 6-1/2" reveal	709.00
	SISJ	Extra heavy-duty spring cushion arm, TJ for 3-1/2" to 6-1/2" reveal	748.00
	SISJH	w/hold open, TJ for 3-1/2" to 6-1/2" reveal	813.00
Heavy Duty PA			
7436	SPA	Super parallel arm	379.00
	SPAT	w/thumb turn hold open	444.00
Friction Hold Open			
7414, 7436	FHP	PA, REG & TJ for reveals to 4"	414.00
	FHJ	TJ for reveals 4" to 8"	398.00
	FH	REG or TJ for reveals to 4"	393.00
Slide Track			
7436	T	Door mounted (pull side)	391.00
	JT	Frame mounted (pull side)	391.00
	FT	Flush transom mounted (push side)	391.00
	PT	Soffit mounted (push side)	391.00
	TDE	Frame mounted double egress frame (pull side), specify hand	469.00
Track Hold Open			
7436	TH	Door mounted (pull side)	432.00
	JTH	Frame mounted (pull side)	432.00
	FTH	Flush transom mounted (push side)	432.00
	PTH	Soffit mounted (push side)	432.00
	TDEH	Frame mounted double egress frame (pull side), specify hand	509.00

NOTE: Standard arm configuration is indicated in **bold**.

Options

(List Price 'add' when ordered with complete closer)

Item	Description	List Add \$
DA	Adjustable delayed action (suffix to model number)	49.00
COV	Slim plastic cover	27.00
FC	Full plastic cover	33.00
FCSL	Full plastic slotted cover (low ceiling conditions)	33.00
SNB1	(4) each 1/4-20 sex nuts and machine screws for 1-3/4" door	12.00
SNB2	(4) each 1/4-20 sex nuts and machine screws for 1-3/8" door	12.00
AWS	All wood screws	13.00
DPK86	All fasteners to be self-drilling fasteners (In lieu of combo screws)	N/C
CMBDPK	Standard and DPK86 fasteners	17.00
TPK86	All fasteners to be self-tapping fasteners (In lieu of combo screws)	N/C
CMBTPK	Standard and TPK86 fasteners	17.00
TX86	All exposed fasteners to be Torx security fasteners (n/a with track applications)	40.00
Custom Color	Custom painted finish selected from RAL color pallet book. For details, see Finishes Cross Reference , page viii.	
	per order, setup charge (Net)	148.00
	per closer, list add	42.00
Designer Color	Designer painted color matched to supplied samples. Three (3) each 2" x 3" colorchip samples required. For details, see Finishes Cross Reference , page viii.	
	per order, non-refundable development/setup charge (Net)	371.00
	per closer, list add	47.00

NOTES:

- Standard price does not include cover.
- Specify closer and arm designation, hand (when required), and finish when ordering.
- All dead stop, heavy-duty PA, tracks, and top jamb (J) configurations packaged (4) units per master carton.
- All others are packaged (6) units per master carton.
- T, TH, FT, FTH include backplate standard.
- 7400 closers are not furnished to accept FC or FCSL unless specified at time of order.
- Sex nuts and bolts standard with cushion or dead stop arms and included in list price.

Accessories

Item	Description	List \$
BP74	Backplate for 7400	46.00
BP74T	Backplate for 7400 slide track closer without cover	46.00
BP640C	Back plate to retrofit 9 1/16" hole spacing with 7400. Examples: DORMA 640, Norton 1600 or Yale 50.	9.00
BP86	Backplate for closer with slim cover	46.00
BP86T	Backplate for 7400 slide track closer with slim cover	46.00
BP86FC	Backplate for closer with full cover	46.00
DP74	Drop plate for 7400	46.00
DP86	Drop plate for closer with slim cover	46.00
DP86FC	Drop plate for closer with full cover	46.00
AB74	Angle bracket for 7400 without cover	81.00
AB86	Angle bracket for 7400 with slim cover	81.00
PFT	Parallel flush transom bracket	38.00
PD	Parallel drop bracket, non-hold open arms (AR, AOB only)	48.00
BS	Blade stop spacer (P86, PHB, and PD)	33.00
BSHD	Blade stop spacer for use with heavy duty door saver and super parallel arms	39.00
NFHD	Narrow frame bracket for use with heavy duty door saver and super parallel arms	39.00
FTHD	Flush transom bracket for use with heavy duty door saver and super parallel arms	69.00

7300 Series

Ordering Guide

		Spring Size		Cover		Finish	
Series	7300	05 - ANSI Size 5	04 - ANSI Size 4	03 - ANSI Size 3	COV - Slim Cover		
							PNT - Special Sprayed Finish (must specify) 696 - Gold 695 - Dark Duranodic Bronze 693 - Black 691 - Dull Bronze 690 - Statuary Bronze 689 - Aluminum 600 - Primed
	73	04	AR			COMBO	689
Round Arm Non-Hold Open, Tri-Pack			ARP			COMBO	- Default Fastener Pack
Round Arm Non-Hold Open, TJ 4"-8" Reveal			ARJ		SNB2	DPK86	- Self-Drilling
Round Arm Non-Hold Open, Reg./TJ 0"-4" Reveal			AR		SNB1	CMBDPK	- Std. and Self-Drilling
Round Arm Secure Non-Hold Open, Tri-Pack			AO8P			TPK86	- Self-Tapping
Round Arm Secure Non-Hold Open, Reg./TJ 0"-4" Reveal			AO8			CMBTPK	- Std. and Self-Tapping
Friction Hold Open, Tri-Pack			FHP			TX86	- Torx Security Pack
Friction Hold Open, TJ 4"-8" Reveal			FHJ			AWS	- All Wood Screws
Friction Hold Open, Reg./TJ 0"-4" Reveal			FH				
Heavy-duty Door Saver Cushion, Parallel			DS				
Heavy-duty Door Saver Cushion Thumb Turn Hold Open, Parallel			DST				
Extra Heavy-duty Door Saver Spring Cushion, Parallel			SDS				
Extra Heavy-duty Door Saver Spring Cushion Thumb Turn Hold Open, Parallel			SDST				
Heavy-duty Cushion, Reg./TJ 0"-3-1/2" Reveal			IS				
			ISH				- Heavy-duty Cushion Hold Open, Reg./TJ 0"-3-1/2" Reveal
Extra Heavy-duty Spring Cushion Reg./TJ 0"-3-1/2" Reveal			SIS				
			SISH				- Extra Heavy-duty Spring Cushion Hold Open, Reg./TJ 0"-3-1/2" Reveal
Heavy-duty Cushion, Top Jamb 3-1/2"-6-1/2" Reveal			ISJ				
			ISJH				- Heavy-duty Cushion Hold Open, Top Jamb 3-1/2"-6-1/2" Reveal
Extra Heavy-duty Spring Cushion, Top Jamb 3-1/2"-6-1/2" Reveal			SISJ				
			SISJH				- Extra Heavy-duty Spring Cushion Hold Open, Top Jamb 3-1/2"-6-1/2" Reveal
Super Parallel			SPA				
Super Parallel Thumb Turn Hold Open			SPAT				
Track, Pull Side Door Mounted			T				
Jamb Track, Pull Side Frame Face Mounted			JT				
Push Track, Push Side Soffit Mounted			PT				
Flush Track, Push Side Transom Mounted			FT				
Track Hold Open, Pull Side Door Mounted			TH				
			JTH				- Jamb Track Hold Open, Pull Side Frame Face Mounted
Push Track Hold Open, Push Side Soffit Mounted			PTH				
			FTH				- Flush Track Hold Open, Pull Side Frame Face Mounted

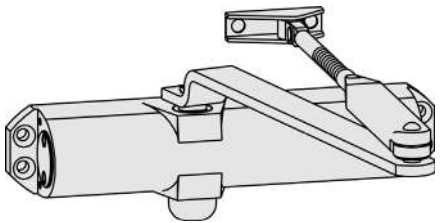

NOTES:

- All combinations of features and options are not available for all models. Please refer to 7300 Series product brochure for details.
- To simplify initial installation, a range of back plates (BPxx), drop plates (DPxx), brackets, and spacers are listed under 7300 Accessories in this section. Refer to 7300 Series product brochure for details.

Body	Arm	Mounting	Painted Finish \$
Non-Hold Open			
7303, 7304,	ARP	PA, REG and TJ for reveals to 4" (round)	336.00
7305	ARJ	TJ for reveals 4" to 8" (round)	325.00
	AR	REG or TJ for reveals to 4" (round)	321.00
	AO8P	PA, REG and TJ secured elbow for reveals to 4" (round)	336.00
	AO8	REG or TJ secured elbow for reveals to 4" (round)	321.00
Bumper or Spring Cushion			
7303, 7304,	DS	Heavy-duty door saver cushion parallel arm (size 5)	432.00
7305	DST	w/ thumb turn hold open (size 5)	497.00
	SDS	Extra heavy-duty door saver spring cushion parallel arm (size 5)	629.00
	SDST	w/ thumb turn hold open (size 5)	693.00
	IS	Heavy-duty cushion arm, REG and TJ for 0" to 3-1/2" reveal	619.00
	ISH	Heavy-duty cushion arm w/ hold open, REG and TJ for 0" to 3-1/2" reveal	682.00
	SIS	Extra heavy-duty spring cushion arm, REG and TJ for 0" to 3-1/2" reveal	721.00
	SISH	w/ hold open, REG and TJ for 0" to 3-1/2" reveal	788.00
	ISJ	Heavy-duty cushion arm, TJ for 3-1/2" to 6-1/2" reveal	649.00
	ISJH	Heavy-duty cushion arm w/ hold open, TJ for 3-1/2" to 6-1/2" reveal	714.00
	SISJ	Extra heavy-duty spring cushion arm, TJ for 3-1/2" to 6-1/2" reveal	755.00
	SISJH	w/ hold open, TJ for 3-1/2" to 6-1/2" reveal	822.00
Heavy Duty PA			
7305	SPA	Super parallel arm	382.00
	SPAT	w/ thumb turn hold open	449.00
Friction Hold Open			
7303, 7304,	FHP	PA, REG and TJ for reveals to 4"	408.00
7305	FHJ	TJ for reveals 4" to 8"	401.00
	FH	REG or TJ for reveals to 4"	395.00
Track Units			
7305	T	Door mounted (pull side)	401.00
	JT	Frame mounted (pull side)	401.00
	FT	Flush transom mounted (push side)	401.00
	PT	Soffit mounted (push side)	401.00
	TH	Door mounted (pull side)	435.00
	JTH	Frame mounted (pull side)	435.00
	FTH	Flush transom mounted (push side)	435.00
	PTH	Soffit mounted (push side)	435.00

NOTE: Standard arm configuration is indicated in **bold**.

Options

(List Price 'add' when ordered with complete closer)

Item	Description	List Add \$
COV	Slim plastic cover	27.00
SNB1	(4) each 1/4-20 sex nuts and machine screws for 1-3/4" door	12.00
SNB2	(4) each 1/4-20 sex nuts and machine screws for 1-3/8" door	12.00
AWS	All wood screws	13.00
DPK86	All fasteners to be self-drilling fasteners (In lieu of combo screws)	N/C
CMBDPK	Standard and DPK86 fasteners	17.00
TPK86	All fasteners to be self-tapping fasteners (In lieu of combo screws)	N/C
CMBTPK	Standard and TPK86 fasteners	17.00
TX86	All exposed fasteners to be Torx security fasteners (n/a with track applications)	40.00
Custom Color	Custom painted finish selected from RAL color pallet book. For details, see Finishes Cross Reference , page viii.	
	per order, setup charge (Net)	148.00
	per closer, list add	42.00
Designer Color	Designer painted color matched to supplied samples. Three (3) each 2" x 3" color chip samples required. For details, see Finishes Cross Reference , page viii.	
	per order, non-refundable development/setup charge (Net)	371.00
	per closer, list add	47.00

NOTES:

- Standard price does not include cover.
- Specify closer and arm designation, hand (when required), and finish when ordering.
- All spring cushion, heavy-duty PA, tracks, and top jamb (J) configurations packaged (4) units per master carton.
- All others are packaged (6) units per master carton.

Accessories

Item	Description	List \$
BP73	Backplate for 7300	46.00
BP73T	Backplate for 7300 slide track closer without cover	46.00
BP86	Backplate for closer with slim cover	46.00
BP86T	Backplate for 7300 slide track closer with slim cover	46.00
DP73	Drop plate for 7300	46.00
DP86	Drop plate for closer with slim cover	46.00
AB73	Angle bracket for 7300 without cover	81.00
AB86	Angle bracket for 7300 with slim cover	81.00
PFT	Parallel flush transom bracket	38.00
PD	Parallel drop bracket, non-hold open arms (AR, AO8 only)	48.00
BS	Blade stop spacer (P86, PHB, and PD)	33.00
BSHD	Blade stop spacer for use with heavy duty door saver and super parallel arms	39.00
NFHD	Narrow frame bracket for use with heavy duty door saver and super parallel arms	39.00
FTHD	Flush transom bracket for use with heavy duty door saver and super parallel arms	69.00

STA Series

Ordering Guide

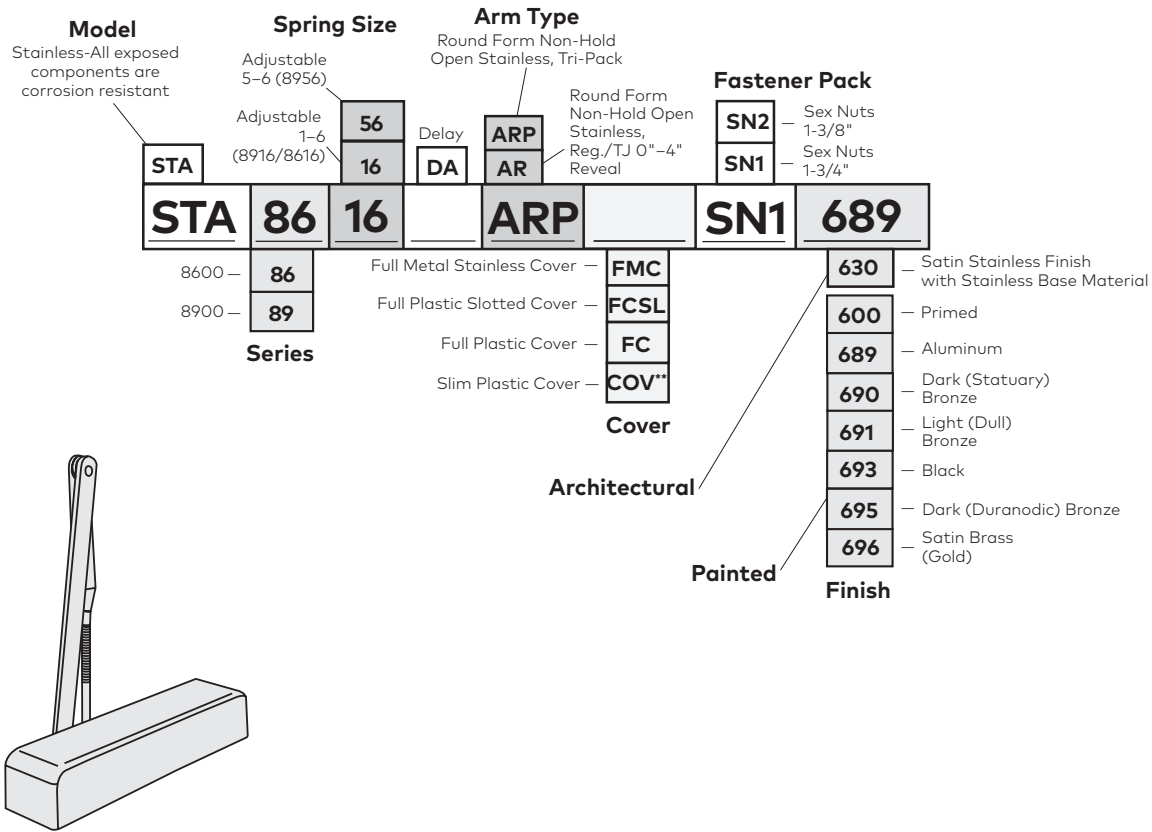

NOTE: Because STA is specified in the beginning of the model description, it does not need to be specified at the component level.

Example: **STA8616 ARP FC SN1 689**

* Delay Action is a standard feature for spring size 1-6 version and not available for 5-6 version

** Slim plastic cover only available for 8600 series

Body	Arm	Mounting	Painted Finish \$	630 \$
STA 8900				
STA 8916/8956	ARP	PA, REG & TJ for reveals to 4" (painted price w/FC)	1120.00	1598.00
	AR	REG or TJ for reveals to 4" (painted price w/FC)	1044.00	1482.00
STA 8600				
STA 8616	ARP	PA, REG & TJ for reveals to 4" (painted price w/COV)	1050.00	1647.00
	AR	REG or TJ for reveals to 4" (painted price w/COV)	965.00	1523.00

Options

(List Price 'add' when ordered with complete closer)

Item	Model	Description	List Add/Deduct \$
DA	8000	Adjustable delayed action (suffix to model number) (Only for 8616 and 8916)	45.00
LSN	8000	Less sex nuts (less SN1 pack)	Deduct 5.00
SN2	8000	(4) each 1/4-20 aluminum sex nuts for 1-3/8" door	N/C
LCOV	8600	Less slim plastic cover for 8600	Deduct 11.00
FC or FC SL	8600	Full plastic cover for 8600(FC standard w/8900)	10.00
FC SL	8900	Full plastic slotted cover for 8900	N/C
FMC	8600/8900	Full metal cover for 8600 and 8900	17.00
Custom Color		Custom painted finish selected from RAL color pallet book. For details, see Finishes Cross Reference , page viii.	
		per order, setup charge (Net)	135.00
		per closer, list add	38.00
Designer Color		Designer painted color matched to supplied samples. Three (3) each 2" x 3" color chip samples required. For details, see Finishes Cross Reference , page viii.	
		per order, non-refundable development/setup charge (Net)	338.00
		per closer, list add	42.00

NOTES:

- Architectural finish price (630) includes optional full stainless metal cover.
- Specify closer and arm designation and finish when ordering.
- All STA Series closers are packaged (6) units per master.
- STA full metal cover (FMC) is the only cover available in architectural finish 630.
- STA closers are supplied standard with SN1. Specify LSN for less SN1 deduct.
- STA 8900 standard with FC, 8600 standard with COV.

GSR Series

Ordering Guide

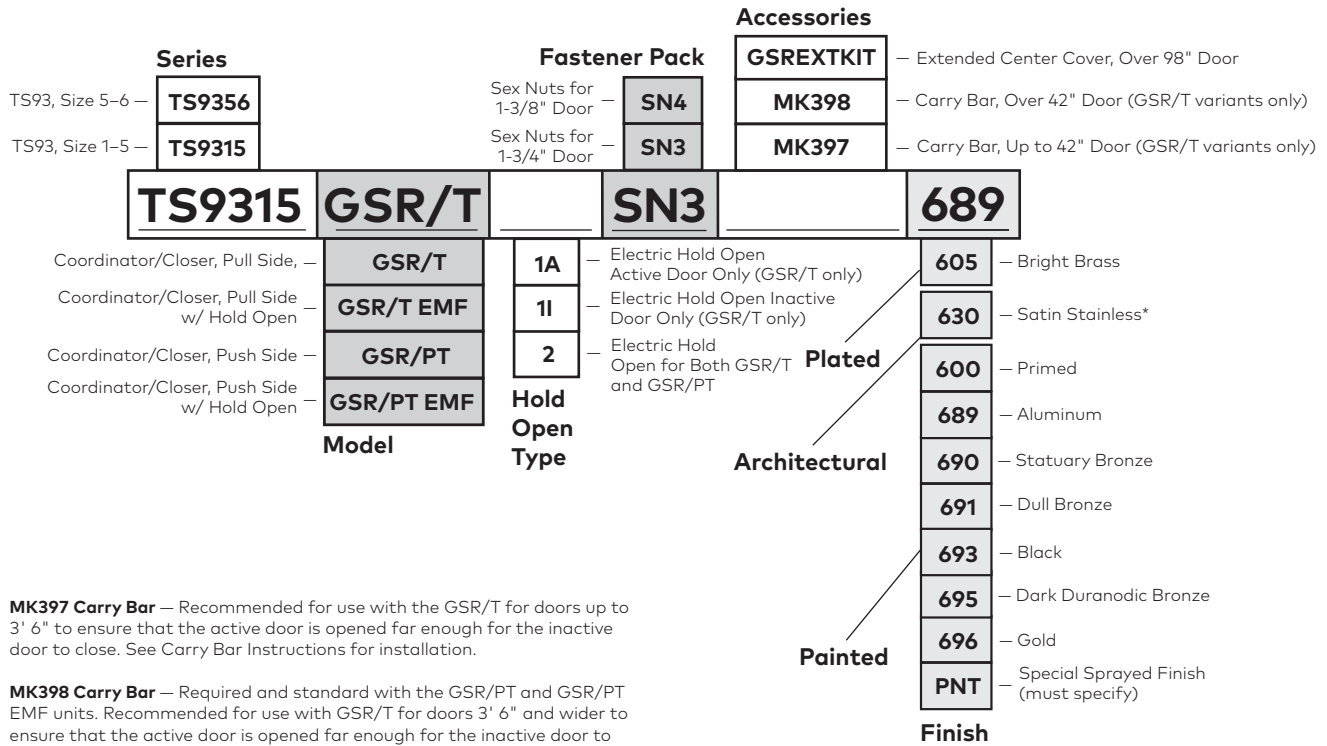

MK397 Carry Bar — Recommended for use with the GSR/T for doors up to 3' 6" to ensure that the active door is opened far enough for the inactive door to close. See Carry Bar Instructions for installation.

MK398 Carry Bar — Required and standard with the GSR/PT and GSR/PT EMF units. Recommended for use with GSR/T for doors 3' 6" and wider to ensure that the active door is opened far enough for the inactive door to close. See Carry Bar Instructions for installation.

* Stainless steel base material with Satin Finish

NOTES:

- All combinations and options are not available for all models.
- Please refer to EMR/EMF Series Product Brochure for details.
- EMR/EMF accepts 24 VAC/DC.
- Transformer must be purchased if power source is 120 VAC.

Body	Arm	Mounting	Painted Finish \$	605/630
TS93 Coordinators				
TS9315, TS9356	GSR/T	Door closer/coordinator system only (pull side)	1963.00	3245.00
TS9315, TS9356	GSR/PT	Door closer/coordinator system only (push side)	2622.00	4371.00
	GSR/T EMF/1A	Electromagnetic holder/release device (active door) closer/coordinator system (pull)	2861.00	4013.00
	GSR/T EMF/1I	Electromagnetic holder/release device (inactive door) with door closer/coordinator system (pull)	2861.00	4013.00
	GSR/T EMF/2	Electromagnetic holder/release device (both doors) with door closer/coordinator system (pull)	3673.00	4822.00
	GSR/PT EMF/2	Electromagnetic holder/release device (both doors) with door closer/coordinator system (push)	4840.00	6434.00

NOTE: Standard GSR is packaged for installation on openings 53" to 98" wide. For narrower or wider openings, contact the factory. Opening size is derived from measuring centerline of hinge on one door to centerline of hinge on second door.

Options

(List Price 'add' when ordered with complete closer)

Item	Description	Painted Finish \$	605/630
SN4	(4) each 10-32 sex nuts for 1-3/8" door	N/C	—
LSN	Less sex nuts (less SN3 pack)	Deduct 3.00	—
MK397	Carry bar — up to 3' 6" wide doors (included with GSR/PT variants option for GRS/PT variants)	61.00	122.00
MK398	Carry bar — 3' 6" and wider doors (included with GSR/PT variants option for GRS/PT variants)	65.00	143.00
Custom Color	Custom painted finish selected from RAL color pallet book. For details, see Finishes Cross Reference , page viii.		
	per order, setup charge (Net)	155.00	—
	per closer, list add	43.00	—
Designer Color	Designer painted color matched to supplied samples. Three (3) Color each 2" x 3" colorchip samples required. For details, see Finishes Cross Reference , page viii.		
	per order, non-refundable development/setup charge (Net)	386.00	—
	per closer, list add	49.00	—

NOTES:

- Specify body and arm designation, centerline to centerline of hinge or hanging means (indicate type), hand of active door, and finish, when ordering.
- Closer cover and/or track main arm only are electroplated when specified. Frame unit cover and closer cover caps are furnished primed or in complementing color.

8900/8600/7400

Closer Bodies

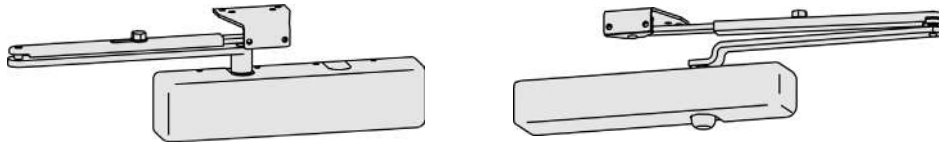

Item	Description	Painted Finish \$
MOD, 8916 FCXX	Closer body x full plastic cover and mounting screws	475.00
MOD, 8916 FCSL	Closer body x slotted full plastic cover and mounting screws	475.00
MOD, 8916 FMC	Closer body x full metal cover and mounting screws	481.00
MOD, 8916DA FC	Delay closer body x full plastic cover and mounting screws	522.00
MOD, 8916DA FCSL	Delay closer body x slotted full plastic cover and mounting screws	522.00
MOD, 8916DA FMC	Delay closer body x full metal cover and mounting screws	529.00
MOD, 8956 FC	Closer body x full plastic cover and mounting screws	475.00
MOD, 8956 FCSL	Closer body x slotted full plastic cover and mounting screws	475.00
MOD, 8956 FMC	Closer body x full metal cover and mounting screws	481.00
MOD, 8956DA FC	Delay closer body x full plastic cover and mounting screws	522.00
MOD, 8956DA FCSL	Delay closer body x slotted full plastic cover and mounting screws	522.00
MOD, 8956DA FMC	Delay closer body x full metal cover and mounting screws	529.00
MOD, 8616 COV	Closer body x slim plastic cover and mounting screws	347.00
MOD, 8616 FC	Closer body x full plastic cover and mounting screws	355.00
MOD, 8616 FCSL	Closer body x slotted full plastic cover and mounting screws	355.00
MOD, 8616 FMC	Closer body x full metal cover and mounting screws	358.00
MOD, 8616DA COV	Delay closer body x slim plastic cover and mounting screws	399.00
MOD, 8616DA FC	Delay closer body x full plastic cover and mounting screws	408.00
MOD, 8616DA FCSL	Delay closer body x slotted full plastic cover and mounting screws	408.00
MOD, 8616 DA FMC	Delay closer body x full metal cover and mounting screws	415.00
MOD, 7414	Closer body and mounting screws	206.00
MOD, 7414 COV	Closer body x slim plastic cover and mounting screws	231.00
MOD, 7414 FC	Closer body x full plastic cover and mounting screws	239.00
MOD, 7414 FCSL	Closer body x slotted full plastic cover and mounting screws	239.00
MOD, 7414DA	Delay closer body and mounting screws	257.00
MOD, 7414DA COV	Delay closer body x slim plastic cover and mounting screws	282.00
MOD, 7414DA FC	Delay closer body x full plastic cover and mounting screws	291.00
MOD, 7414DA FCSL	Delay closer body x slotted full plastic cover and mounting screws	291.00
MOD, 7436	Closer body and mounting screws	206.00
MOD, 7436 COV	Closer body x slim plastic cover and mounting screws	231.00
MOD, 7436 FC	Closer body x full plastic cover and mounting screws	239.00
MOD, 7436 FCSL	Closer body x slotted full plastic cover and mounting screws	239.00
MOD, 7436DA	Delay closer body and mounting screws	257.00
MOD, 7436DA COV	Delay closer body x slim plastic cover and mounting screws	282.00
MOD, 7436DA FC	Delay closer body x full plastic cover and mounting screws	291.00
MOD, 7436DA FCSL	Delay closer body x slotted full plastic cover and mounting screws	291.00

Arms (All arms include "all" mounting screws and installation instructions)

Item	Description	Painted Finish \$
MOD, AF89P (8900 only)	Arm, flat tri-pack NHO w/P89 bracket	140.00
MOD, AF89J (8900 only)	Arm, flat NHO TJ 4" to 8" reveal	134.00
MOD, AF89 (8900 only)	Arm, flat NHO Reg./TJ 0" to 4" reveal	129.00
MOD, AF86P (8600 only)	Arm, flat tri-pack NHO w/P86 bracket	146.00
MOD, AF86J (8600 only)	Arm, flat NHO TJ 4" to 8" reveal	141.00
MOD, AF86 (8600 only)	Arm, flat NHO Reg./TJ 0" to 4" reveal	135.00
MOD, ARP (8600/7400)	Arm, round tri-pack NHO w/P86 bracket	129.00
MOD, ARJ (8600/7400)	Arm, round NHO TJ 4" to 8" reveal	124.00
MOD, AR (8600/7400)	Arm, round NHO Reg./TJ 0" to 4" reveal	116.00
MOD, AO8P (8600/7400)	Arm, round secure tri-pack NHO w/P86 bracket	140.00
MOD, AO8 (8600/7400)	Arm, round secure Reg./TJ 0" to 4" reveal	131.00
MOD, DS	Arm, heavy-duty door saver cushion parallel	206.00
MOD, DST	Arm, heavy-duty door saver cushion parallel with thumb turn hold open	264.00
MOD, SDS	Arm, extra heavy-duty door saver spring cushion parallel	377.00
MOD, SDST	Arm, extra heavy-duty door saver spring cushion parallel with thumb turn hold open	436.00
MOD, FHP	Arm, friction hold open w/PHB bracket (0" to 4" reveal)	186.00
MOD, FHJ	Arm, friction hold open TJ 4" to 8" reveal	179.00
MOD, FH	Arm, friction hold open Reg./TJ 0" to 4" reveal	172.00
MOD, IS	Arm, heavy-duty cushion, Reg./TJ 0" to 3-1/2" reveal	369.00
MOD, ISH	Arm, heavy-duty cushion with hold open, Reg./TJ 0" to 3-1/2" reveal	424.00
MOD, SIS	Arm, extra heavy-duty spring cushion	461.00
MOD, SISH	Arm, extra heavy-duty spring cushion with hold open	516.00
MOD, ISJ	Arm, heavy-duty cushion, TJ 3-1/2" to 6-1/2" reveal	397.00
MOD, ISJH	Arm, heavy-duty cushion with hold open, TJ 3-1/2" to 6-1/2" reveal	454.00
MOD, SISJ	Arm, extra heavy-duty spring cushion, top jamb and mount for 3-1/2" to 6-1/2" reveal	489.00
MOD, SISJH	Arm, extra heavy-duty spring cushion with hold open, top jamb and mount for 3-1/2" to 6-1/2" reveal	547.00
MOD, PHP	Arm, plunger hold open w/ P89 bracket 1-1/2" to 3-1/2"	281.00
MOD, PH	Arm, plunger hold open Reg. 0" to 1-1/2" reveal	275.00
MOD, SPA	Arm, parallel heavy duty (Super Parallel Arm)	164.00
MOD, SPAT	Arm, parallel heavy duty thumb turn hold open (Super Parallel Arm)	221.00
MOD, T	Arm, track (T, JT and FT)	179.00
MOD, TH	Arm, track hold open (TH, JTH and FTH)	208.00
MOD, TDE	Arm, track double egress	249.00
MOD, TDEH	Arm, track double egress hold open	279.00

NOTES:

- MOD, 8600 Series includes SNB1 standard. Deduct \$7.00 list when ordering MOD, 8600 Series less SNB1.
- Modular packaging is designed to save you, our valued stocking distributor up to 15% on your inventory dollars. Instead of stocking all door closer requirements in complete units in various arm types, dormakaba produces a packaging option to allow a mixed stock of closer body combinations and arm types in separate packaging that easily combine later in the stocking distributor warehouse.
- Determine the arm type required to be packaged with a particular closer body, place the closer body package inside the arm pack, mark the appropriate check list on the carton label and deliver the product. It's that simple.
- dormakaba recommends that the 80% usage items such as 8916 AF89P FC SN1 689 and 8616 AF86P COV 689 be packaged complete and the remainder of inventory be packaged in modular packaged items. This allows the 20% mixed variations to be handled with much less inventory. Arm mix inventory can be cut in half since the majority of arms can be used with the 8900, 8600, or 7400 Series closer.

Fire/Life Safety

Product Guide (1 of 2)

FIRE/LIFE SAFETY CLOSER/HOLDERS	Surface Mount	Floor-Mount	Wall-Mount
Closer/Holder Only	TS93 EMF	—	
	8900 EMF	—	
	8600 EMF	—	
Closer/Holder with Integral Smoke Detector	TS93 EMR	—	
	8900 EMR	—	
	8600 EMR	—	
	1800 Series	—	
Electromagnetic Door Holders	—	EM501	EM504
	—	EM502	EM505
	—	—	EM508
	—	—	EM509

Fire/Life Safety

Product Guide (2 of 2)

<input checked="" type="radio"/> Yes <input type="radio"/> No	A156.15	UL10C	Includes Smoke Detector	No Smoke Detector	Advanced Cam & Roller Design	Rack & Pinion Design	Plated Finishes	Custom Painted Finishes	Adjustable Power
TS93 EMF	<input checked="" type="radio"/>	<input checked="" type="radio"/>	<input type="radio"/>	<input checked="" type="radio"/>	<input checked="" type="radio"/>	<input type="radio"/>	<input checked="" type="radio"/>	<input checked="" type="radio"/>	<input checked="" type="radio"/>
8900 EMF	<input checked="" type="radio"/>	<input checked="" type="radio"/>	<input type="radio"/>	<input checked="" type="radio"/>	<input type="radio"/>	<input checked="" type="radio"/>	<input checked="" type="radio"/>	<input checked="" type="radio"/>	<input checked="" type="radio"/>
8600 EMF	<input checked="" type="radio"/>	<input checked="" type="radio"/>	<input type="radio"/>	<input checked="" type="radio"/>	<input type="radio"/>	<input checked="" type="radio"/>	<input checked="" type="radio"/>	<input checked="" type="radio"/>	<input checked="" type="radio"/>
TS93 EMR	<input checked="" type="radio"/>	<input checked="" type="radio"/>	<input checked="" type="radio"/>	<input type="radio"/>	<input checked="" type="radio"/>	<input type="radio"/>	<input checked="" type="radio"/>	<input checked="" type="radio"/>	<input checked="" type="radio"/>
8900 EMR	<input checked="" type="radio"/>	<input checked="" type="radio"/>	<input checked="" type="radio"/>	<input type="radio"/>	<input type="radio"/>	<input checked="" type="radio"/>	<input checked="" type="radio"/>	<input checked="" type="radio"/>	<input checked="" type="radio"/>
8600 EMR	<input checked="" type="radio"/>	<input checked="" type="radio"/>	<input checked="" type="radio"/>	<input type="radio"/>	<input type="radio"/>	<input checked="" type="radio"/>	<input checked="" type="radio"/>	<input checked="" type="radio"/>	<input checked="" type="radio"/>
1800 SD	<input checked="" type="radio"/>	<input checked="" type="radio"/>	<input checked="" type="radio"/>	<input type="radio"/>	<input type="radio"/>	<input checked="" type="radio"/>	<input checked="" type="radio"/>	<input checked="" type="radio"/>	<input checked="" type="radio"/>
1800	<input checked="" type="radio"/>	<input checked="" type="radio"/>	<input type="radio"/>	<input checked="" type="radio"/>	<input type="radio"/>	<input checked="" type="radio"/>	<input checked="" type="radio"/>	<input checked="" type="radio"/>	<input checked="" type="radio"/>

EMR Series (with Detector)

Body	Arm	Mounting	Painted Finish \$
Premium Electromagnetic Slide Track Holder/Closing Device with Detector – 24 VAC/DC			
TS9315, TS9356	EMR/T	Frame mounted (pull side)	2829.00
	EMR/PT	Soffit mounted (push side)	2829.00
	EMR/TDE	Frame mounted (pull side; double egress), handed	2911.00
Heavy-Duty Electromagnetic Slide Track Holder/Closing Device with Detector – 24 VAC/DC			
8916, 8956	EMR/T	Frame mounted (pull side)	2789.00
	EMR/PT	Soffit mounted (push side)	2789.00
	EMR/TDE	Frame mounted (pull side; double egress), handed	2871.00
Electromagnetic Slide Track Holder/Closing Device with Detector – 24 VAC/DC			
8656	EMR/T	Frame mounted (pull side)	2608.00
	EMR/PT	Soffit mounted (push side)	2608.00
	EMR/TDE	Frame mounted (pull side; double egress), handed	2686.00

EMF Series (No Detector)

Body	Arm	Mounting	Painted Finish \$
Premium Electromagnetic Slide Track Holder/Closing Device – 24 VAC/DC. Transformer required if power source is 120 VAC.			
TS9315, TS9356	EMF/T	Frame mounted, (pull side)	1263.00
	EMF/PT	Soffit mounted (push side)	1263.00
	EMF/TDE	Frame mounted (pull side; double egress), handed	1345.00
Heavy-Duty Electromagnetic Slide Track Holder/Closing Device – 24 VAC/DC. Transformer required if power source is 120 VAC.			
8916, 8956	EMF/T	Frame mounted, (pull side)	1222.00
	EMF/PT	Soffit mounted (push side)	1222.00
	EMF/TDE	Frame mounted (pull side; double egress), handed	1302.00
Electromagnetic Slide Track Holder/Closing Device – 24 VAC/DC. Transformer required if power source is 120 VAC.			
8656	EMF/T	Frame mounted (pull side)	1042.00
	EMF/PT	Soffit mounted (push side)	1042.00
	EMF/TDE	Frame mounted (pull side; double egress), handed	1124.00

Options

(List Price 'add' when ordered with complete closer)

Item	Description	List Add \$
FC	Full plastic closer body cover, 8600	11.00
FMC	Full metal closer body cover (Handed), used w/8900	11.00
FMC	Full metal closer body cover (Handed), used w/8600	17.00
BYP	Concealed switch to bypass hold open function	74.00
TRANSF	120 VAC to 24 VAC transformer (installed separately)	82.00
EXP	Exposed wiring preparation	36.00
Custom Color	Custom painted finish selected from RAL color pallet book. For details, see Finishes Cross Reference , page viii.	
	per order, setup charge (Net)	148.00
	per closer, list add	42.00
Designer Color	Designer painted color matched to supplied samples. Three (3) each 2" x 3" colorchip samples required. For details, see Finishes Cross Reference , page viii.	
	per order, non-refundable development/setup charge (Net)	371.00
	per closer, list add	47.00

NOTES:

- Specify body and arm designation, voltage, hand (when required), and finish when ordering.
- EMF/EMR powered from 120 VAC power source requires optional "external" 120 VAC to 24 VAC transformer (TRANSF).
- MF Series unit must be ordered 24 V when used as a companion to an EMR Series unit.

Accessories

Item	Series	Applicable Description	List \$
COV	8600	Slim plastic closer body cover	27.00
FC	8900/8600	Full plastic closer body cover	33.00
FMC	8900/8600	Full metal closer body cover (specify hand)	41.00
SN1	8900	(4) each 1/4-20 sex nuts for 1-3/4" door	10.00
SN3	TS93	(4) each 10-32 sex nuts for 1-3/4" door	10.00
SNB1	8600	(4) each 1/4-20 sex nuts and machine screws for 1-3/4" door	12.00
SD2	EMR	Replacement detector module	640.00
RFR	All	Radio frequency receiver for wireless release of hold open 272	414.00
HHRFT1	All	Hand held transmitter for wireless release of hold open	207.00
TRANSF	All	120 VAC to 24 VAC Transformer (External)	82.00
SCRPKEMRDET	EMR	Standoff for SD-2 Detector Replacement (EMR)	8.00

1800 SD Series (with Detector)

Body	Arm	Mounting	Painted Finish \$
Electromagnetic Holder/Closing Device with Integral Smoke Detector – 24 VAC/DC and 120 VAC			
1856	HT SD	Frame mounted slide track (pull side)	3245.00
1816	HJ SD	Frame mounted top jamb (push side)	3245.00
Electromagnetic Swing Free/Closing Device with Integral Smoke Detector – 24 VAC/DC and 120 VAC			
1856	SFT SD	Frame mounted slide track (pull side)	3311.00
1816	SFJ SD	Frame mounted top jamb (push side)	3311.00

1800 Series (No Detector)

Body	Arm	Mounting	Painted Finish \$
Electromagnetic Holder/Closing Device – 24VAC/DC and 120VAC			
1856	HT	Frame mounted slide track (pull side)	1641.00
1816	HJ	Frame mounted top jamb (push side)	1641.00
Electromagnetic Swing Free/Closing Device – 24VAC/DC and 120VAC			
1856	SFT	Frame mounted slide track (pull side)	1705.00
1816	SFJ	Frame mounted top jamb (push side)	1705.00

NOTES:

- Specify body, arm, hand, and finish for all units.
- Specify if less than 2" frame face for (T) track mounted units. Specify **<2"** (no additional charge).
- Specify **DROP** for top jamb drop applications (no additional charge if noted at time of order).
- 1800 Series can be used as a companion to the 1800 SD Series, bypass 120 VAC transformer when making wiring connections or order less transformer for deduct.

Options

(List Price 'add' when ordered with complete closer)

Item	Description	List Add/Deduct \$
LTRANSF	1800 Less 120 VAC transformer (deduct)	Deduct 31
<2"	T mount <2" frame face	N/C
DROP	Top jamb drop applications (configure at factory)	N/C
BYP	Concealed switch to bypass hold open function	74.00
EXP	Exposed wiring preparation	36.00
AR	Complete arm for top jamb 0"-4" reveal	Deduct 3.00
Custom Color	Custom painted finish selected from RAL color pallet book. For details, see Finishes Cross Reference , page viii.	
	per order, setup charge (Net)	148.00
	per closer, list add	42.00
Designer Color	Designer painted color matched to supplied samples. Three (3) each 2" x 3" color chip samples required. For details, see Finishes Cross Reference , page viii.	
	per order, non-refundable development/setup charge (Net)	371.00
	per closer, list add	47.00

Accessories

Item	Applicable Description	List \$
SN1	(4) each 1/4-20 sex nuts for 1-3/4" door	10.00
SNB1	(4) each 1/4-20 sex nuts and machine screws for 1-3/4" door	12.00
EXPKIT	Exposed wiring bracket	47.00
SFKIT	Swing free kit	63.00
SOL1800	1800 replacement solenoid 24 VAC/DC	432.00
SD2	Replacement detector module	639.00
RFR	Radio frequency receiver for wireless release of hold open	414.00
HHRFT1	Hand held transmitter for wireless release of hold open	207.00
CAMDRIVE	Replacement Hold Open Cam/Cam Drive	28.00
TRANSF	120 VAC to 24 VAC Transformer	82.00

EM SERIES

Ordering Guide

Series		Options (Packaged Separately)			Finish	
EM		2-5/8" Catch Plate –	CP LONG		696	– Satin Brass Painted
		2" Catch Plate –	CP SHORT		695	– Dark Duranodic Bronze Powder Coated
		8-3/8" to 12" Adjustable Extension –	ER 12		689	– Aluminum Powder Coated
		6-3/8" to 8" Adjustable Extension –	ER 7			
		2" Extension –	ER 2.0			
		1-1/2" Extension –	ER 1.5			
EM	504	24120			689	
Single Floor –	501	24120				– Dual Voltage 24 VDC, 120 VAC
Double Floor –	502					
Semi-Flush, Long Catch –	504					
Semi-Flush, Short Catch –	505					
Surface –	508					
Completely Flush –	509					

Electrical Specification

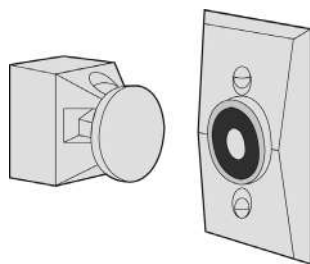

- NOTES:**
- All combinations of features and options are not available for all models.
 - Please refer to EM Series product brochure for details.

Body	Mounting	689/695 Finish \$	696 Finish \$
Electromagnetic Floor Mounted Holder – 24 VDC, 24 VAC, or 120 VAC			
EM 501-24120	Floor mount, single unit	994.00	1058.00
EM 502-24120	Floor mount, double unit	1240.00	1302.00
Electromagnetic Wall Mounted Holder – 24 VDC, 24 VAC, or 120 VAC			
EM 504-24120	Semi-flush mount, (recessed) long catch plate	535.00	598.00
EM 505-24120	Semi-flush mount, (recessed) short catch plate	535.00	598.00
EM 508-24120	Surface mount	566.00	650.00
EM 509-24120*	Completely flush mount	566.00	650.00

* The EM509 is shipped with a 630 faceplate when ordered in 689 finish.

Options

Item	Description	689 Finish \$
ER1.5	1-1/2" extension rod	89.00
ER2.0	2" extension rod	97.00
ER7	6-3/8" – 8" adjustable extension rod	111.00
ER12	8-3/8" – 12" adjustable extension rod	123.00

Accessories

Item	Description	689/695 Finish \$	696 Finish \$
CPSHORT	2" projection catch plate (door portion)	126.00	146.00
CPLONG	2-5/8" projection catch plate (door portion)	145.00	165.00
EMDPPK**	Door plate pack, (plate, bracket and fasteners)	48.00	—
EMSCRPK**	Universal fastener pack for all EM models	32.00	—
EMSURFPK**	Surface mount box and fastener pack for EM 509	112.00	—
EMFACEPLTPK**	Brackets and fastener pack for all EM face plates	31.00	—

** Available in 689 finish only.

Concealed Door Closers

Product Guide (1 of 2)

CONCEALED DOOR CLOSERS	CONCEALED IN THE FLOOR	CONCEALED IN THE FRAME	CONCEALED IN THE DOOR
<p>Grade 1 Heavy-Duty Sized (Power) per Application</p>	<p>BTS80</p>	<p>—</p>	<p>—</p>
<p>Grade 1 Heavy-Duty Sized (Power) per Application Hold Open</p>	<p>BTS80 EMB</p>	<p>—</p>	<p>—</p>
<p>Grade 1 Commercial Adjustable (Power) Size</p>	<p>BTS75V</p>	<p>ITS96</p>	<p>ITS96</p>
<p>Commercial Sized (Power) per Application</p>	<p>—</p>	<p>RTS88</p>	<p>—</p>

Concealed Door Closers

Product Guide (2 of 2)

<input checked="" type="radio"/> Yes <input type="radio"/> No	A156.4 Grade 1	A156.4 Grade 3	UL10C UBC7-2	Advanced Cam & Roller Design	Plated Finishes	Standard Painted Finishes	Custom Painted Finishes	Adjustable Power	Fixed Power
BTS75V	<input checked="" type="radio"/>	<input type="radio"/>	<input checked="" type="radio"/>	<input checked="" type="radio"/>	<input checked="" type="radio"/>	<input checked="" type="radio"/>	<input checked="" type="radio"/>	<input checked="" type="radio"/>	<input type="radio"/>
BTS80	<input checked="" type="radio"/>	<input type="radio"/>	<input checked="" type="radio"/>	<input checked="" type="radio"/>	<input checked="" type="radio"/>	<input checked="" type="radio"/>	<input checked="" type="radio"/>	<input type="radio"/>	<input checked="" type="radio"/>
BTS80 EMB	<input checked="" type="radio"/>	<input type="radio"/>	<input checked="" type="radio"/>	<input checked="" type="radio"/>	<input checked="" type="radio"/>	<input checked="" type="radio"/>	<input checked="" type="radio"/>	<input type="radio"/>	<input checked="" type="radio"/>
ITS96	<input type="radio"/>	<input checked="" type="radio"/>	<input checked="" type="radio"/>	<input checked="" type="radio"/>	<input checked="" type="radio"/>	<input checked="" type="radio"/>	<input checked="" type="radio"/>	<input checked="" type="radio"/>	<input type="radio"/>
RTS88	<input type="radio"/>	<input type="radio"/>	<input type="radio"/>	<input checked="" type="radio"/>	<input checked="" type="radio"/>	<input checked="" type="radio"/>	<input checked="" type="radio"/>	<input type="radio"/>	<input checked="" type="radio"/>

BTS80 SERIES

Ordering Guide

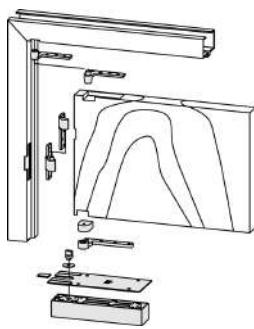

Spindle	
1-1/2" Pre-Loaded Spindle	80030
1-5/16" Pre-Loaded Spindle	80025
1-1/8" Pre-Loaded Spindle	80020
7/8" Pre-Loaded Spindle	80015
3/4" Pre-Loaded Spindle	80010
1/2" Pre-Loaded Spindle	80005
5/16" Pre-Loaded Spindle	80003
2-5/16" Spindle	74050
2-1/16" Spindle	74045
1-7/8" Spindle	74040
1-11/16" Spindle	74035
1-1/2" Spindle	74030
1-5/16" Spindle	74025
1-1/8" Spindle	74020
7/8" Spindle	74015
13/16" Spindle	74012
3/4" Spindle	74010
5/8" Spindle	74007
1/2" Spindle	74005
5/16" Spindle	74003

Hand	
LH	Specify for Left Handed Units
RH	Specify for Right Handed Units

Optional Accessories	
E80624	Through Wire CH Top Pivot (4 wire)
E80622	Through Wire CH Top Pivot (2 wire)
HD8062	Heavy Duty CH Top Pivot
75200	Through Wire Intermediate Pivot for 3/4" Offset
15233	3 h Intermediate Pivot for 1-1/2" Offset
15222	20 min Intermediate Pivot for 1-1/2" Offset
15220	Through Wire Intermediate Pivot for 1-1/2" Offset
75243	3 h Intermediate Pivot for Lead Lined 3/4" Offset (see note*)
75242	20 min Intermediate Pivot for Lead Lined 3/4" Offset (see note*)
75240	Intermediate Pivot for Lead Lined 3/4" Offset (see note*)
75233	3 h Intermediate Pivot for 3/4" Offset
75222	20 min Intermediate Pivot for 3/4" Offset
75220	Intermediate Pivot for 3/4" Offset
SC2	Sealing Compound
TP80 CH	Terrazo Pan CH and 1-1/2" Offset
TP80	Terrazo Pan for 3/4" Offset

Deducts	
LBX	Less Cement Box
LFP	Less Floor Plate
LTP	Less Top Pivot

Series
BTS80

Package	
A	CH Double Acting, Aluminum Door and Frame
B	CH Double Acting, Wood or Steel Door and Frame
C	1-1/2" Offset, Handed
C-E	1-1/2" Offset, 20 min Rated Handed
C-F	1-1/2" Offset, 3 h Rated Handed
D	CH Single Acting, Aluminum Door and Frame
E	CH Single Acting, Wood or Steel Door and Frame
F	Independent Hung, Non-Handed
G	Independent Hung, Up to 3 h Rated, Non-Handed
H	3/4" Offset Lead Lined, Handed*
I	3/4" Offset Lead Lined, 20 min Rated Handed*
IF	3/4" Offset Lead Lined, 3 h Rated Handed*
L	Independent Hung On Pocket Pivots, Non-Handed
L-E	Independent Hung On Pocket Pivots, Up to 3 h Rated, Non-Handed
L-F	
P	
PF	

Spring Size	Fastener Packs	Finish
3	AMS - All Metal Screws	600 - Primed
4	W2 - All Wood Screws	689 - Aluminum
5	W1 - 1/2 Wood Screws	690 - Statuary Bronze
6	AMSAWS - All Metal Screws All Wood Screws	691 - Dull Bronze
		693 - Black
		695 - Dark Duranodic Bronze
		696 - Gold
		PNT - Special Sprayed Finish (must specify)
		605 - Bright Brass
		606 - Satin Brass
		611 - Bright Bronze
		612 - Satin Bronze
		613 - Oxidized Satin Oil Rubbed
		618 - Bright Nickel
		619 - Satin Nickel
		625 - Bright Chrome
		626 - Satin Chrome

Series	Hand	Spring Size	Fastener Packs	Finish
BTS80	RH	74010	AMS	626

*** "L" Package Door Thickness Note:**
 The standard door thickness is 1-3/4", and is the default unless otherwise specified.

Other alternative sizes are

-2
-2-1/4
-2-1/2
-3

Examples: L-E-2-1/2....75242-2-1/2

Example above 20 min. lead lined package for 2-1/2" thick door.

- NOTES:**
- All combinations of features and options are not available for all models.
 - Please refer to BTS80 Series product brochure for details.
 - When replacing standard package hardware with optional hardware, adjust list price accordingly.

Package	Description	Painted Finish \$	Plated Finish \$
Center Hung, Double Acting, Aluminum Door and Frame (Non-Handed)			
BTS80A	Complete package BTS80-4, 74010, 7410, 7422, 8062	—	2104.00
BTS80/A LFP	Complete package, less floor plate	—	Deduct \$153
Center Hung, Double Acting, Wood or Steel Door and Frame (Non-Handed)			
BTS80B	Complete package BTS80-4, 74010, 7410, 7421, 8062	—	2063.00
BTS80/B LFP	Complete package, less floor plate	—	Deduct \$153
1-1/2" Offset, Single Acting, Wood, Steel or Aluminum Door and Frame (Specify Hand)			
BTS80C	Complete package BTS80-4, 74010, 7410, 15323, 15120	—	2564.00
BTS80C LFP	Complete package, less floor plate	—	Deduct \$153
1-1/2" Offset, Single Acting, 20 Minute Rated Fire Door and Frame (Specify Hand)			
BTS80CE	Complete package BTS80 F-5, 74010, 7410, 15323, 15122	2645.00	2645.00
BTS80CE LFP	Complete package, less floor plate		Deduct \$153
1-1/2" Offset, Single Acting, 3 Hour Rated Fire Door and Frame (Specify Hand)			
BTS80CF	Complete package BTS80 F-5, 74010, 7410, 15323, 15133	2687.00	3103.00
BTS80CF LFP	Complete package, less floor plate		Deduct \$153
3/4" Offset, Single Acting, Wood, Steel or Aluminum Door and Frame (Specify Hand)			
BTS80D	Complete package BTS80-4, 74010, 7410, 75323, 75120	—	2181.00
BTS80D LFP	Complete package, less floor plate	—	Deduct \$153
3/4" Offset, Single Acting, 20 Minute Rated Fire Door and Frame (Specify Hand)			
BTS80E	Complete Package BTS80 F-5, 74010, 7410, 75323, 75122	2242.00	2242.00
BTS80E LFP	Complete package, less floor plate		Deduct \$153
3/4" Offset, Single Acting, 3 Hour Rated Fire Door and Frame (Specify Hand)			
BTS80F	Complete package BTS80 F-5, 74010, 7410, 75323, 75133	2298.00	2604.00
BTS80F LFP	Complete package, less floor plate		Deduct \$153
Center Hung, Single Acting, Aluminum Door and Frame (Specify Hand)			
BTS80G	Complete package BTS80-4, 80010, 7410, 7422, 8062	—	2104.00
BTS80G LFP	Complete package, less floor plate	—	Deduct \$153
Center Hung, Single Acting, Wood or Steel Door and Frame (Specify Hand)			
BTS80H	Complete package BTS80-4, 80010, 7410, 7421, 8062	—	2063.00
BTS80H LFP	Complete package, less floor plate	—	Deduct \$153

NOTE: See BTS80 Accessories for intermediate pivots and individual component list prices.

Package	Description	Painted Finish \$	Plated Finish \$
Independent Hung, on Hinges, etc. (Non-Handed)			
BTS80I	Complete package BTS80-4, 74003, 7410, 7451N-A**	2064.00	2225.00
BTS80I LFP	Complete package, less floor plate		Deduct \$153
Independent Hung, 3 Hour Rated Steel, 1-1/2 hour Rated Wood Fire Doors Hung on Hinges, etc. (Specify Hand)			
BTS80IF	Complete package BTS80 F-5, 74003, 7410, 7451N	2099.00	2407.00
BTS80IF LFP	Complete package, less floor plate		Deduct \$153
3/4" Offset, Single Acting, Wood or Steel Lead Lined Door and Frame, for 1-3/4" thick door (Specify Hand)			
BTS80L	Complete package BTS80-4, 74010, 7410, 75343, 75140	—	2754.00
BTS80L LFP	Complete package, less floor plate	—	Deduct \$153
3/4" Offset, Single Acting, Lead Lined 20 Minute Rated Fire Door and Frame, for 1-3/4" thick door (Specify Hand)			
BTS80LE	Complete package BTS80 F-5, 74010, 7410, 75343, 75142	2820.00	2820.00
BTS80LE LFP	Complete package, less floor plate		Deduct \$153
3/4" Offset, Single Acting, Lead Lined 3 Hour Rated Fire Door and Frame, for 1-3/4" thick door (Specify Hand)			
BTS80LF	Complete package BTS80 F-5, 74010, 7410, 75343, 75143	2888.00	3105.00
BTS80LF LFP	Complete package, less floor plate		Deduct \$153
Independent Hung, on Pocket Pivots (Non-Handed)			
BTS80P	Complete package (priced w/ 3 pivots) BTS80-4, 74003, 7410, 7451N-A, 75520	3838.00	4354.00
BTS80P LFP	Complete package, less floor plate (priced w/ 3 pivots)		Deduct \$153
Independent Hung, 3 Hour Rated Steel, 1-1/2 Hour Rated Wood Fire Doors Hung on Pocket Pivots (Specify Hand)			
BTS80PF	Complete package (priced w/ 3 pivots) BTS80 F-5, 74003, 7410, 7451N, 75523	3994.00	4660.00
BTS80PF LFP	Complete package, less floor plate (priced w/ 3 pivots)		Deduct \$153

* Floor closer is painted black only. Cement case is galvanized steel.
 Spindle is available in zinc plated finish only.
 Center hung bottom arms are available in zinc plated finish only (7421/7422).
 Floor plate is only available in plated finishes.

** Bottom arm for painted finish would be 7451N.
 See BTS80 Accessories for intermediate pivots. See BTS Accessories for individual component list prices.
 See **Options** for Less **Cement Box**.

Options

(List Price 'add' when ordered with complete closer)

Item	Description	Painted Add \$	Plated Add \$
3	ANSI size 3, light opening force, non-fire rated doors (previously BFE)	N/C	—
6	ANSI size 6, spring for up to 4'0" exterior or 4'6" interior non-fire rated doors (previously Sz 3)	N/C	—
AMS	All metal screws	N/C	—
AMSAWS	All metal screws, all wood screws	14.00	22.00
W1	Half wood screws	8.00	9.00
W2	All wood screws	10.00	12.00
74003, 74005, 74007, 74010	5/16", 1/2", 5/8", or 3/4" clearance spindle	N/C	—
74012, 74015, 74020	13/16", 7/8", or 1-1/8" clearance spindle	32.00	—
74025, 74030, 74035	1-5/16", 1-1/2", or 1-11/16" clearance spindle	32.00	—
74040, 74045, 74050	1-7/8", 2-1/16", or 2-5/16" clearance spindle	32.00	0.00
TP80	▲ Terrazo pan for BTS 80, 80 F, 80 EMB — 3/4" offset (handed)	—	714.00
TP80CH	▲ Terrazo pan for BTS 80, 80 F, 80 EMB — Center hung or 1-1/2" offset	—	650.00
SC2	Sealing compound	98.00	—
LBX	Less cement box	Deduct 26.00	—
Custom Color	Custom painted finish selected from RAL color pallet book. For details, see Finishes Cross Reference , page viii.		
	per order, setup charge (Net)	145.00	—
	per closer, list add	81.00	—
Designer Color	Designer painted color matched to supplied samples. Three (3) each 2" x 3" colorchip samples required. For details, see Finishes Cross Reference , page viii.		
	per order, non-refundable development/ setup charge (Net)	362.00	—
	per closer, list add	93.00	—

Spindle Inserts for Center Hung Single Acting Packages

Item	Description	Painted Add \$	Plated Add \$
80003, 80005, 80010	5/16", 1/2" or 3/4" clearance spindle (specify hand)	N/C	—
80015, 80020, 80025, 80030	7/8", 1-1/8", 1-5/16" or 1-1/2" clearance spindle (specify hand)	32.00	—

▲ Terrazo pans are available stainless steel only.

Accessories

Pivots

Item	Description	Painted Finish \$	Plated Finish \$
3/4" Offset Hung Intermediate Pivots**			
75220	Full mortise standard intermediate pivot	392.00	392.00
75222	Full mortise intermediate pivot — 20 minute rated fire door	419.00	419.00
75233	Full mortise intermediate pivot — 3 hour rated fire door	440.00	848.00
75240	Full mortise intermediate pivot — 1-3/4" lead lined doors	589.00	589.00
75242	Full mortise intermediate pivot — 20 minute rated, 1-3/4" lead-lined doors	622.00	622.00
75243	Full mortise intermediate pivot — 3 hour rated, 1-3/4" lead-lined doors	639.00	1235.00
1-1/2" Offset Hung Intermediate Pivots**			
15220	Full mortise standard intermediate pivot	589.00	589.00
15222	Full mortise intermediate pivot — 20 minute rated fire door	639.00	639.00
15233	Full mortise intermediate pivot — 3 hour rated fire door	654.00	1144.00
Power Transfer Pivots			
75200	Through-wire 3/4" offset intermediate pivot — 8 wire**	728.00	728.00
E80622	Through-wire center hung top pivot (2 wire)	797.00	797.00
E80624	Through-wire center hung top pivot (4 wire)	797.00	797.00

** All intermediate pivots are handed.

NOTES:

- Only packages with an "E" or "F" designation in the package description are available in painted finishes.
- Specify package designation, hand (when required), finish, and options or accessories when ordering.
- Complete package prices are indicated in bold.
- When ordering a package "less components," deduct the list price for the component removed.
- Cover plate not available in painted finish. Cover plate will be plated to match when ordering with painted finishes.
- All packages furnished with all machine screws standard (AMS).
- Lead-lined packages shown are for 1-3/4" thick doors. For lead-lined doors from 2" up to 3" thick, add \$92.00 list to the package price. Example, specify: BTS80L-3 for a 3" thick door.
- Lead-lined packages are designed for doors with lead in center of door thickness.
- Package price for P or PF packages includes 3 pocket pivots.

BTS80 EMB Series

Ordering Guide

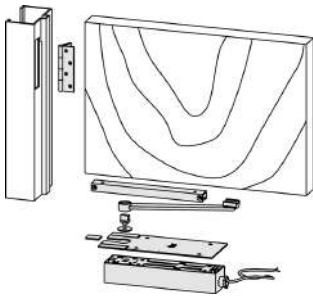

- 1/2" Pre-Loaded Spindle –
- 5/16" Pre-Loaded Spindle –
- 2-5/16" Spindle –
- 2-1/16" Spindle –
- 1-7/8" Spindle –
- 1-11/16" Spindle –
- 1-1/2" Spindle –
- 1-5/16" Spindle –
- 1-1/8" Spindle –
- 7/8" Spindle –
- 13/16" Spindle –
- 3/4" Spindle –
- 5/8" Spindle –
- 1/2" Spindle –
- 5/16" Spindle –

Spindle

80030	– 1-1/2" Pre-Loaded Spindle
80025	– 1-5/16" Pre-Loaded Spindle
80020	– 1-1/8" Pre-Loaded Spindle
80015	– 7/8" Pre-Loaded Spindle
80010	– 3/4" Pre-Loaded Spindle
80005	
80003	
74050	
74045	
74040	
74035	
74030	
74025	
74020	
74015	
74012	
74010	
74007	
74005	
74003	

Hand

LH	– Specify for Left Handed Units
RH	– Specify for Right Handed Units

Optional Accessories

E80624	– Through Wire CH Top Pivot (4 wire)
E80622	– Through Wire CH Top Pivot (2 wire)
HD8062	– Heavy Duty CH Top Pivot
75200	– Through Wire Intermediate Pivot for 3/4" Offset
15233	– 3 h Intermediate Pivot for 1-1/2" Offset
15222	– 20 min Intermediate Pivot for 1-1/2" Offset
15220	– Intermediate Pivot for 1-1/2" Offset
75243	– 3 h Intermediate Pivot for Lead Lined 3/4" Offset (see note*)
75242	– 20 min Intermediate Pivot for Lead Lined 3/4" Offset (see note*)
75240	– Intermediate Pivot for Lead Lined 3/4" Offset (see note*)
75233	– 3 h Intermediate Pivot for 3/4" Offset
75222	– 20 min Intermediate Pivot for 3/4" Offset
75220	– Intermediate Pivot for 3/4" Offset
SC2	– Sealing Compound
TP80 CH	– Terrazo Pan CH and 1-1/2" Offset
TP80	– Terrazo Pan for 3/4" Offset

Deducts

LFP	– Less Floor Plate
LTP	– Less Top Pivot

Series

BTS80EMB

BTS80EMB	D	5	74010	RH	AMS		626	
-----------------	----------	----------	--------------	-----------	------------	--	------------	--

1-1/2" Offset, Handed	C
1-1/2" Offset, 20 min Rated Handed	C-E
1-1/2" Offset, 3 h Rated Handed	C-F
3/4" Offset, Handed	D
3/4" Offset, 20 min Rated Handed	E
3/4" Offset, 3 h Rated Handed	F
CH Single Acting, Aluminum Door and Frame	G
CH Single Acting, Wood or Steel Door and Frame	H
Independent Hung, Non-Handed	I
Independent Hung, Up to 3 h Rated, Non-Handed	IF
3/4" Offset Lead Lined, Handed*	L
3/4" Offset Lead Lined, 20 min Rated Handed*	L-E
3/4" Offset Lead Lined, 3 h Rated Handed*	L-F

Package

5 – ANSI Size 5
Spring Size

AMS	– All Metal Screws
W2	– All Wood Screws
W1	– 1/2 Wood Screws
AMSAWS	– All Metal Screws All Wood Screws

Fastener Packs

600	– Primed
689	– Aluminum
690	– Statuary Bronze
691	– Dull Bronze
693	– Black
695	– Dark Duranodic Bronze
696	– Gold
PNT	– Special Sprayed Finish (must specify)

Painted

Bright Brass	605
Satin Brass	606
Bright Bronze	611
Satin Bronze	612
Oxidized Satin	613
Oil Rubbed	613
Bright Nickel	618
Satin Nickel	619
Bright Chrome	625
Satin Chrome	626

Plated

Finish

*** "L" Package Door Thickness Note:**
The standard door thickness is 1-3/4", and is the default unless otherwise specified.

Other alternative sizes are

- 2
- 2-1/4
- 2-1/2
- 3

Examples: L-E-2-1/2...75242-2-1/2

Example above 20 min. lead lined package for 2-1/2" thick door.

- NOTES:**
- All combinations of features and options are not available for all models.
 - Please refer to BTS80 EMB Series product brochure for details.

Package	Description	Painted Finish \$	Plated Finish \$
1-1/2" Offset, Single Acting, Wood, Steel or Aluminum Door and Frame (Specify Hand)			
BTS80 EMBC	Complete package 80 EMB-5, 74010, 7410, 15323, 15120	—	4925.00
BTS80 EMBC LFP	Complete package, less floor plate	—	Deduct \$153
1-1/2" Offset, Single Acting, 20 Minute Rated Fire Door and Frame (Specify Hand)			
BTS80 EMBCE	Complete package 80 EMB-5, 74010, 7410, 15323, 15122	4977.00	4977.00
BTS80 EMBCE LFP	Complete package, less floor plate		Deduct \$153
1-1/2" Offset, Single Acting, 3 Hour Rated Fire Door and Frame (Specify Hand)			
BTS80 EMBCF	Complete package 80 EMB-5, 74010, 7410, 15323, 15133	5018.00	5435.00
BTS80 EMBCF LFP	Complete package, less floor plate		Deduct \$153
3/4" Offset, Single Acting, Wood, Steel or Aluminum Door and Frame (Specify Hand)			
BTS80 EMBD	Complete package 80 EMB-5, 74010, 7410, 75323, 75120	—	4541.00
BTS80 EMBD LFP	Complete package, less floor plate	—	Deduct \$153
3/4" Offset, Single Acting, 20 Minute Rated Fire Door and Frame (Specify Hand)			
BTS80 EMBE	Complete package 80 EMB-5, 74010, 7410, 75323, 75122	4571.00	4571.00
BTS80 EMBE LFP	Complete package, less floor plate		Deduct \$153
3/4" Offset, Single Acting, 3 Hour Rated Fire Door and Frame (Specify Hand)			
BTS80 EMBF	Complete package 80 EMB-5, 74010, 7410, 75323, 75133	4629.00	4889.00
BTS80 EMBF LFP	Complete package, less floor plate		Deduct \$153
Center Hung, Single Acting, Aluminum Door and Frame (Specify Hand)			
BTS80 EMBG	Complete package 80 EMB-5, 80010, 7410, 7422, 8062	—	4466.00
BTS80 EMBG LFP	Complete package, less floor plate	—	Deduct \$153
Center Hung, Single Acting, Wood or Steel Door and Frame (Specify Hand)			
BTS80 EMBH	Complete package 80 EMB-5, 80010, 7410, 7421, 8062	—	4425.00
BTS80 EMBH LFP	Complete package, less floor plate	—	Deduct \$153
Independent Hung, on Hinges, etc. (Specify Hand)			
BTS80 EMBI	Complete package 80 EMB-5, 74003, 7410, 7451N-A	4426.00	4589.00
BTS80 EMBI LFP	Complete package, less floor plate		Deduct \$153
Independent Hung, 3 Hour Rated Steel, 1-1/2 Hour Rated Wood Fire Door Hung on Hinges, etc. (Specify Hand)			
BTS80 EMBIF	Complete package 80 EMB-5, 74003, 7410, 7451N**	4426.00	4738.00
BTS80 EMBIF LFP	Complete package, less floor plate		Deduct \$153

NOTE: See BTS80 EMB Accessories for intermediate pivots. See BTS Accessories for individual component list prices.

Package	Description	Painted Finish \$	Plated Finish \$
3/4" Offset, Single Acting, Lead Lined, Wood, or Steel Door and Frame, for 1-3/4" thick door (Specify Hand)			
BTS80 EMBL	Complete package 80 EMB-5, 74010, 7410, 75343, 75140	—	5117.00
BTS80 EMBL LFP	Complete package, less floor plate	—	Deduct \$153
3/4" Offset, Single Acting, Lead Lined 20 Minute Rated Fire Door and Frame, for 1-3/4" thick door (Specify Hand)			
BTS80 EMBL-E	Complete package 80 EMB-5, 74010, 7410, 75343, 75142	5147.00	5147.00
BTS80 EMBLE LFP	Complete package, less floor plate		Deduct \$153
3/4" Offset, Single Acting, Lead Lined 3 Hour Rated Fire Door and Frame, for 1-3/4" thick door (Specify Hand)			
BTS80 EMBL-F	Complete package 80 EMB-5, 74010, 7410, 75343, 75143	5217.00	5436.00
BTS80 EMBLF LFP	Complete package, less floor plate		Deduct \$153

* Floor closer is painted black only. Cement case is galvanized steel.
 Spindle is available in zinc plated finish only.
 Center hung bottom arms are available in zinc plated finish only (7421/7422).
 Floor plate is only available in plated finishes.

** Bottom arm for painted finish would be 7451N.
 See BTS80 EMB Accessories for intermediate pivots. See BTS Accessories for individual component list prices.
 See Options for Less Cement Box.

Options

(List Price 'add' when ordered with complete closer)

Item	Description	Painted Add \$	Plated Add \$
AMS	All metal screws	N/C	—
AMSAWS	All metal screws, all wood screws	14.00	22.00
W1	Half wood screws	8.00	9.00
W2	All wood screws	9.00	12.00
74003, 74005, 74007, 74010	5/16", 1/2", 5/8", or 3/4" clearance spindle	N/C	N/C
74012, 74015, 74020	13/16", 7/8", or 1-1/8" clearance spindle	32.00	—
74025, 74030, 74035	1-5/16", 1-1/2", or 1-11/16" clearance spindle	32.00	—
74040, 74045, 74050	1-7/8", 2-1/16", or 2-5/16" clearance spindle	32.00	—
TP80	▲ Terrazo pan for BTS 80, 80 F, 80 EMB - 3/4" offset (handed)	—	714.00
TP80 CH	▲ Terrazo pan for BTS 80, 80 F, 80 EMB - Center hung or 1-1/2" offset	—	650.00
SC2	Sealing compound	98.00	—
Custom Color	Custom painted finish selected from RAL color pallet book. For details, see Finishes Cross Reference , page viii.		
	per order, setup charge (Net)	145.00	—
	per closer, list add	81.00	—
Designer Color	Designer painted color matched to supplied samples. Three (3) each 2" x 3" colorchip samples required. For details, see Finishes Cross Reference , page viii.		
	per order, non-refundable development/ setup charge (Net)	362.00	—
	per closer, list add	93.00	—

Spindle Inserts for Center Hung Single Acting Packages

Item	Description	Painted Add \$	Plated Add \$
80003, 80005, 80010	5/16", 1/2" or 3/4" clearance spindle (specify hand)	N/C	—
80015, 80020, 80025, 80030	7/8", 1-1/8", 1-5/16" or 1-1/2" clearance spindle (specify hand)	32.00	—

▲ Terrazo pans are available stainless steel only.

Accessories

Pivots

Item	Description	Painted Finish \$	Plated Finish \$
3/4" Offset Hung Intermediate Pivots**			
75220	Full mortise standard intermediate pivot	392.00	392.00
75222	Full mortise intermediate pivot — 20 minute rated fire door	419.00	419.00
75233	Full mortise intermediate pivot — 3 hour rated fire door	440.00	848.00
75240	Full mortise intermediate pivot — 1-3/4" lead-lined doors	589.00	589.00
75242	Full mortise intermediate pivot — 20 minute rated, 1-3/4" lead-lined doors	622.00	622.00
1-1/2" Offset Hung Intermediate Pivots**			
15220	Full mortise standard intermediate pivot	589.00	589.00
15222	Full mortise intermediate pivot — 20 minute rated fire door	639.00	639.00
15233	Full mortise intermediate pivot — 3 hour rated fire door	654.00	1144.00
Power Transfer Pivots			
75200	Through-wire 3/4" offset intermediate pivot — 8 wire**	728.00	728.00
E80622	Through-wire center hung top pivot (2 wire)	797.00	797.00
E80624	Through-wire center hung top pivot (4 wire)	797.00	797.00

** All intermediate pivots are handed.

Miscellaneous

Item	Description	List \$
TP80	▲ Terrazo pan for BTS 80, 80 F, 80 EMB — 3/4" offset (Handed)	714.00
TP80CH	Terrazo pan for BTS 80, 80 F, 80 EMB — Center hung or 1-1/2" offset	650.00
SC2	Sealing compound	98.00

▲ Terrazo pans are available stainless steel only.

NOTES:

- Only packages with an "E" or "F" designation in the package description are available in painted finishes.
- Specify package designation, hand (when required), finish, and options or accessories when ordering.
- Complete package prices are indicated in bold.
- When ordering a package "less components," deduct the list price for the component removed.
- Cover plate not available in painted finish. Cover plate will be plated to match when ordering with painted finishes.
- All packages furnished with all machine screws standard (AMS).
- Lead-lined packages shown are for 1-3/4" thick doors. For lead-lined doors from 2" up to 3" thick, add \$92.00 list to the package price. Example, specify: BTS80/L-3 for a 3" door.

BTS75V SERIES

Ordering Guide

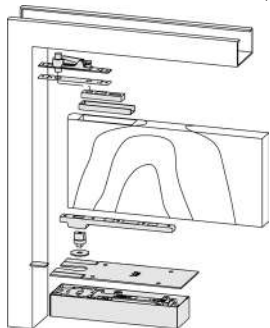

Spindle

1-1/2" Pre-Loaded Spindle	80030
1-5/16" Pre-Loaded Spindle	80025
1-1/8" Pre-Loaded Spindle	80020
7/8" Pre-Loaded Spindle	80015
3/4" Pre-Loaded Spindle	80010
1/2" Pre-Loaded Spindle	80005
5/16" Pre-Loaded Spindle	80003
2-5/16" Spindle	74050
2-1/16" Spindle	74045
1-7/8" Spindle	74040
1-11/16" Spindle	74035
1-1/2" Spindle	74030
1-5/16" Spindle	74025
1-1/8" Spindle	74020

Hold Open

150° Hold Open (BF Not Available)	105
90° Hold Open	90
Non-Hold Open	NHO

Optional Accessories
(multiple options can be ordered)

E80624	Through Wire CH Top Pivot (4 wire)
E80622	Through Wire CH Top Pivot (2 wire)
HD8062	Heavy Duty CH Top Pivot
75200	Through Wire Intermediate Pivot for 3/4" Offset
15233	3h Intermediate Pivot for 1-1/2" Offset
15222	20 min Intermediate Pivot for 1-1/2" Offset
15220	Through Wire Intermediate Pivot for 1-1/2" Offset
75233	3 h Intermediate Pivot for 3/4" Offset
75222	20 min Intermediate Pivot for 3/4" Offset
75220	Intermediate Pivot for 3/4" Offset

Deducts

LBX	Less Cement Box
LFP	Less Floor Plate
LTP	Less Top Pivot

Series
BTS75V

BTS75V	D	NHO	74010	RH	AMS	626
---------------	----------	------------	--------------	-----------	------------	------------

CH Double Acting, Aluminum Door and Frame

CH Double Acting, Wood or Steel Door and Frame

1-1/2" Offset, Handed

1-1/2" Offset, 20 min Rated Handed

1-1/2" Offset, 3 h Rated Handed

Spring Size

— 3/4" Offset, Handed

— 3/4" Offset, 20 min Rated Handed

— 3/4" Offset, 3 h Rated Handed

— CH Single Acting, Aluminum Door and Frame

— CH Single Acting, Wood or Steel Door and Frame

— Independent Hung, Non-Handed

— Independent Hung, Up to 3 h Rated, Non-Handed

— Independent Hung On Pocket Pivots, Non-Handed

— Independent Hung On Pocket Pivots, Up to 3 h Rated, Non-Handed

Hand

Specify for Left Handed Units

Specify for Right Handed Units

Fastener Packs

— All Metal Screws

— All Wood Screws

— 1/2 Wood Screws

— All Metal Screws All Wood Screws

Painted

Bright Brass

Satin Brass

Bright Bronze

Satin Bronze

Oxidized Satin Oil Rubbed

Bright Nickel

Satin Nickel

Bright Chrome

Satin Chrome

Plated

— Primed

— Aluminum

— Statuary Bronze

— Dull Bronze

— Black

— Dark Duranodic Bronze

— Gold

— Special Sprayed Finish (must specify)

Package

NOTES:

- All combinations of features and options are not available for all models.
- Please refer to BTS75V Series product brochure for details.

Package	Description	Painted Finish \$	Plated Finish \$
Center Hung, Double Acting, Aluminum Door and Frame (Non-Handed)			
BTS75VA	Complete package BTS75V NHO, 74010, 7510, 7422, 8062	—	1980.00
BTS75VA LFP	Complete package, less floor plate	—	Deduct \$153
Center Hung, Double Acting, Wood or Steel Door and Frame (Non-handed)			
BTS75VB	Complete Package BTS75V NHO, 74010, 7510, 7421, 8062	—	1938.00
BTS75VB LFP	Complete package, less floor plate	—	Deduct \$153
1-1/2" Offset, Single Acting, Wood, Steel, or Aluminum Door and Frame (Specify Hand)			
BTS75VC	Complete package BTS75V NHO, 74010, 7510, 15323, 15120	—	2438.00
BTS75VC LFP	Complete package, less floor plate	—	Deduct \$153
1-1/2" Offset, Single Acting, 20 Minute Rated Fire Door and Frame (Specify Hand)			
BTS75VCE	Complete package BTS75V NHO, 74010, 7510, 15323, 15122	2487.00	2487.00
BTS75VCE LFP	Complete package, less floor plate	Deduct \$153	
1-1/2" Offset, Single Acting, 3 Hour Rated Fire Door and Frame (Specify Hand)			
BTS75VCF	Complete package BTS75V NHO, 74010, 7510, 15323, 15133	2525.00	2943.00
BTS75VCF LFP	Complete package, less floor plate	Deduct \$153	
3/4" Offset, Single Acting, Wood, Steel, or Aluminum Door and Frame (Specify Hand)			
BTS75VD	Complete Package BTS75V NHO, 74010, 7510, 75323, 75120	—	2053.00
BTS75VD LFP	Complete package, less floor plate	—	Deduct \$153
3/4" Offset, Single Acting, 20 Minute Rated Fire Door and Frame (Specify Hand)			
BTS75VE	Complete package BTS75V NHO, 74010, 7510, 75323, 75122	2084.00	2084.00
BTS75VE LFP	Complete package, less floor plate	Deduct \$153	
3/4" Offset, Single Acting, 3 Hour Rated Fire Door and Frame (Specify Hand)			
BTS75VF	Complete package BTS75V NHO, 74010, 7510, 75323, 75133	2139.00	2401.00
BTS75VF LFP	Complete package, less floor plate	Deduct \$153	
Center Hung, Single Acting, Aluminum Door and Frame (Specify Hand)			
BTS75VG	Complete package BTS75V NHO, 80010, 7510, 7422, 8062	—	1980.00
BTS75VG LFP	Complete package, less floor plate	—	Deduct \$153
Center Hung, Single Acting, Wood or Steel Door and Frame (Specify Hand)			
BTS75VH	Complete package BTS75V NHO, 80010, 7510, 7421, 8062	—	1938.00
BTS75VH LFP	Complete package, less floor plate	—	Deduct \$153

NOTES:

- See BTS75V Accessories for intermediate pivots. See BTS Accessories for individual component list prices.

Package	Description	Painted Finish \$	Plated Finish \$
Independent Hung, on Hinges, etc. (Non-Handed)			
BTS75VI	Complete package BTS75V NHO, 74003, 7510, 7451N-A**	1939.00	2099.00
BTS75VI LFP	Complete package, less floor plate		Deduct \$153
Independent Hung, 3 Hour Rated Steel and 1-1/2 Hour Rated Wood Fire Doors Hung on Hinges, etc. (Non-Handed)			
BTS75VIF	Complete package BTS75V NHO, 74003, 7510, 7451N	1939.00	2248.00
BTS75VIF LFP	Complete package, less floor plate		Deduct \$153
Independent Hung, on Pocket Pivots (Non-Handed)			
BTS 75VP	Complete package (priced w/ 3 pivots) BTS75V NHO, 74003, 7510, 7451N-A, 75520	3710.00	4226.00
BTS75VP LFP	Complete package, less floor plate		Deduct \$153
Independent Hung, 3 Hour Rated Steel and 1-1/2 Hour Rated Wood Fire Doors Hung on Pocket Pivots (Specify Hand)			
BTS75VPF	Complete package (priced w/ 3 pivots) BTS75V NHO, 74003, 7510, 7451N, 75523	3805.00	4500.00
BTS75VPF LFP	Complete package, less floor plate		Deduct \$153

* Floor closer is painted black only. Cement case is galvanized steel.
Spindle is available in zinc plated finish only.
Center hung bottom arms are available in zinc plated finish only (7421/7422).
Floor plate is only available in plated finishes.

** Bottom arm for painted finish would be 7451N.
See BTS Accessories for individual component list prices.
See Options for Less Cement Box.

Options

(List Price 'add' when ordered with complete closer)

Item	Description	Painted Add \$	Plated Add \$
90	90° hold open	78.00	—
105	105° hold open	78.00	—
BF, BF 90	Barrier free for non-fire doors only	N/C	—
AMS	All metal screws	N/C	—
AMSAWS	All metal screws, all wood screws	14.00	22.00
W1	Half wood screws	8.00	9.00
W2	All wood screws	7.00	10.00
74003, 74005, 74007, 74010	5/16", 1/2", 5/8", or 3/4" clearance spindle	N/C	—
74012, 74015, 74020	13/16", 7/8", or 1-1/8" clearance spindle	32.00	—
74025, 74030, 74035	1-5/16", 1-1/2", or 1-11/16" clearance spindle	32.00	—
74040, 74045, 74050	1-7/8", 2-1/16", or 2-5/16" clearance spindle	32.00	—
TP75	▲ Terrazo pan for BTS 75V — 3/4" offset (Handed)	—	680.00
TP75CH	▲ Terrazo pan for BTS 75V — Center hung or 1-1/2" offset	—	621.00
SC2	Sealing compound	98.00	—
LBX	Less cement box	Deduct 26.00	
Custom Color	Custom painted finish selected from RAL color pallet book. For details, see Finishes Cross Reference , page viii.		
	per order, setup charge (Net)	145.00	—
	per closer, list add	81.00	—
Designer Color	Designer painted color matched to supplied samples. Three (3) each 2" x 3" colorchip samples required. For details, see Finishes Cross Reference , page viii.		
	per order, non-refundable development/ setup charge (Net)	362.00	—
	per closer, list add	93.00	—

▲ Terrazo pans are available stainless steel only.

Spindle Inserts for Center Hung Single Acting Packages

Item	Description	Painted Add \$	Plated Add \$
80003, 80005, 80010	5/16", 1/2", or 3/4" clearance spindle (specify hand)	N/C	—
80015, 80020, 80025, 80030	7/8", 1-1/8", 1-5/16", or 1-1/2" clearance spindle (specify hand)	32.00	—

Accessories

Pivots

Item	Description	Painted Finish \$	Plated Finish \$
3/4" Offset Hung Intermediate Pivots**			
75220	Full mortise standard intermediate pivot	392.00	392.00
75222	Full mortise intermediate pivot — 20 minute rated fire door	419.00	419.00
75233	Full mortise intermediate pivot — 3 hour rated fire door	440.00	848.00
1-1/2" Offset Hung Intermediate Pivots**			
15220	Full mortise standard intermediate pivot	589.00	589.00
15222	Full mortise intermediate pivot — 20 minute rated fire door	639.00	639.00
15233	Full mortise intermediate pivot — 3 hour rated fire door	654.00	1144.00
Power Transfer Pivots			
75200	Through-wire 3/4" offset intermediate pivot — 8 wire**	728.00	728.00
E80622	Through-wire center hung top pivot (2 wire)	797.00	797.00
E80624	Through-wire center hung top pivot (4 wire)	797.00	797.00

** All intermediate pivots are handed.

NOTES:

- Only packages with an "E" or "F" designation in the package description are available in painted finishes.
- Specify package designation, hand (when required), finish, and options or accessories when ordering.
- Complete package prices are indicated in bold.
- When ordering a package "less components," deduct the list price of the removed component.
- Cover plate not available in painted finish. Cover plate will be plated to match when ordering with painted finishes.
- All packages furnished with all machine screws standard (AMS).
- Package price for P or PF packages includes 3 pocket pivots.
- When BTS75D Package is ordered through Select Service, the BF closer is supplied as the default, unless specified otherwise.

Body	Mounting	Painted Finish \$	Plated Finish \$
Non-Hold Open			
ITS9613	Concealed in door (size 1-3)	665.00	825.00
ITS9625	Concealed in door (size 2-5)	794.00	989.00
Hold Open			
ITS9613 HO	Concealed in door w/hold open (size 1-3)	756.00	913.00
ITS9625 HO	Concealed in door w/hold open (size 2-5)	885.00	1078.00

Options

(List Price 'add' when ordered with complete closer)

Item	Description	Painted Add \$	Plated Add \$
INV	Inverted ITS96 (closer in header)	25.00	47.00
BRKT ITS WOOD	Wood frame mounting kit	41.00	—
BRKT ITS METAL	Steel frame mounting kit	41.00	—
Custom Color	Custom painted finish selected from RAL color pallet book. For details, see Finishes Cross Reference , page viii.		
	per order, setup charge (Net)	145.00	—
	per closer, list add	41.00	—
Designer Color	Designer painted color matched to supplied samples. Three (3) each 2" x 3" color chip samples required. For details, see Finishes Cross Reference , page viii.		
	per order, non-refundable development/setup charge (Net)	362.00	—
	per closer, list add	46.00	—

NOTES:

- Standard configuration is painted arm with track channel to match (shown in bold); closer and closer mounting plate are one finish only.
- Plated finish price includes arm plated and track sprayed with complementary finish.
- Minimum door thickness for ITS9625 is 2" when concealed in the door.
For 1-3/4" thick doors, install ITS9625 in the header (i.e. ITS9625 INV).

RTS88 Series

Ordering Guide

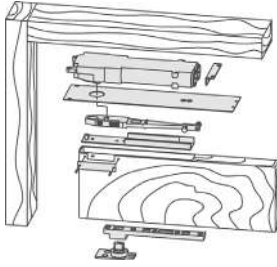

Series		Hold Open		Fastener Packs		Accessories		Adds or Deducts	
RTS	Non-Hold Open — NHO	All Metal Screws —	AMS	AMS	8836S	8836S	— Closer Arm for 7/8" Top Rail Glass Shoe	LBA	— Less Bottom Arm
	Hold Open — HO	All Wood Screws —	W1	W2	8820J	8820J	— Conversion Bracket for Jackson OHC	LTA	— Less Top Arm
		1/2 Wood Screws —	AMS	AMS	8521E	8521E	— 1-5/16" Spindle Extension	LBP	— Less Bottom Pivot
		All Metal Screws —						5MM	— W/ 5mm Extended Spindle
		All Wood Screws —						LMC	— Less Mounting Channel
								8563	— Cover Plate for Aluminum Frame Application
RTS	03	105	NHO	Sz3	AMS		626		
CH Side, Aluminum —	01	105 — 105° Cushion		Sz2 — Light Opening Force			600 — Primed		
CH Side, Aluminum —	02	90 — 90° Cushion		Sz3 — Standard Closing Force			689 — Aluminum		
CH Side, Steel —	03	Cushion		Sz4 — Strongest Closing Force			690 — Statuary Bronze		
CH Side, Wood Door, Steel Frame —	04			BFE — Light Opening Force for Exterior Doors			691 — Dull Bronze		
CH Side, Wood Door, Aluminum Frame —	05	— CH Side, Wood		BFI — Lightest Opening Force for Interior			693 — Black		
	06			Spring Size			695 — Dark Duranodic Bronze		
	07	— CH End, Aluminum					696 — Gold		
	08	— CH End, Aluminum					PNT — Special Sprayed Finish (must specify)		
	09	— CH End, Aluminum							
	10	— CH End, Aluminum							
	11	— CH End, Aluminum							
	12	— CH End, Aluminum							
	13	— CH End, Aluminum							
	14	— CH End, Aluminum							
	15	— CH End, Aluminum							
	16	— CH End, Aluminum							
	17	— CH End, Aluminum							
	18	— CH End, Aluminum							
	19	— CH End, Aluminum							
	20	— CH End, Aluminum							
	21	— CH End, Aluminum							
	22	— CH End, Aluminum							
	25	— Hinge Hung, Aluminum							
	26	— 3/4" Offset, Aluminum							
	27	— Hinge or 3/4" Offset, Steel							
	28	— Hinge or 3/4" Offset, Wood Door, Steel Frame							
	29	— Hinge or 3/4" Offset, Wood							
	30	— Hinge, Wood Door, Aluminum Frame							
	31	— 3/4" Offset, Wood Door, Aluminum Frame							

Package

- NOTES:**
- All combinations of features and options are not available for all models.
 - Please refer to RTS88 Series product brochure for details.

Package	Description	Painted Finish \$	Plated Finish \$
Center Hung Side Load, Double or Single Acting, Aluminum Door and Frame (Non-Handed)			
RTS01	Complete package RTS88, 8831, 8572	802.00	—
RTS01 × 8563	Complete package, including 8563 frame cover plate	901.00	—
Center Hung Side Load, Double or Single Acting, Aluminum Door and Frame (Non-Handed)			
RTS02	Complete package RTS88, 8831, 8570	835.00	—
RTS02 × 8563	Complete package, including 8563 frame cover plate	930.00	—
Center Hung Side Load, Double or Single Acting, Steel Door and Frame (Non-Handed)			
RTS03	Complete package RTS88, 8831, 7471K, 7421, 8575, 8532**	1155.00	1288.00
RTS03 LMC	Complete package, less mounting channel	1075.00	1207.00
Center Hung Side Load, Double or Single Acting, Wood Door and Steel Frame (Non-Handed)			
RTS04	Complete package RTS88, 8832, 7471K, 7421, 8575, 8532**, W1	1265.00	1398.00
RTS04 LMC	Complete package, less mounting channel	1185.00	1317.00
Center Hung Side Load, Double or Single Acting, Wood Door and Frame (Non-Handed)			
RTS05	Complete package RTS88, 8832, 7471K, 7421, 8561, W2	1185.00	1322.00
Center Hung Side Load, Double or Single Acting, Wood Door and Aluminum Frame (Non-Handed)			
RTS06	Complete package RTS88, 8832, 7471K, 7421, W1	1088.00	1221.00
RTS06 × 8563	Complete package, including 8563 frame cover plate	1185.00	1317.00
Center Hung End Load, Double or Single Acting, Aluminum Door and Frame (Non-Handed)			
RTS07	Complete package RTS88, 8835, 8857	963.00	—
RTS07 × 8563	Complete package, including 8563 frame cover plate	912.00	—
Center Hung End Load, Double or Single Acting, Aluminum Door and Frame (Non-Handed)			
RTS08	Complete package RTS88, 8835, 8853	819.00	—
RTS08 × 8563	Complete package, including 8563 frame cover plate	912.00	—
Center Hung End Load, Double or Single Acting, Aluminum Door and Frame (Non-Handed)			
RTS09	Complete package RTS88, 8835, 8855	819.00	—
RTS09 × 8563	Complete package, including 8563 frame cover plate	912.00	—
Center Hung End Load, Double or Single Acting, Aluminum Door and Frame (Non-Handed)			
RTS10	Complete package RTS88, 8835, 8852	819.00	—
RTS10 × 8563	Complete package, including 8563 frame cover plate	912.00	—

NOTES:

- See RTS88 Accessories for individual component list prices.

Package	Description	Painted Finish \$	Plated Finish \$
Center Hung End Load, Double or Single Acting, Aluminum Door and Frame (Non-Handed)			
RTS11	Complete package RTS88, 8836, 8857	819.00	—
RTS11 × 8563	Complete package, including 8563 frame cover plate	912.00	—
Center Hung End Load, Double or Single Acting, Aluminum Door and Frame (Non-Handed)			
RTS12	Complete package RTS88, 8836, 8853	819.00	—
RTS12 × 8563	Complete package, including 8563 frame cover plate	912.00	—
Center Hung End Load, Double or Single Acting, Aluminum Door and Frame (Non-Handed)			
RTS13	Complete package RTS88, 8836, 8855	819.00	—
RTS13 × 8563	Complete package, including 8563 frame cover plate	912.00	—
Center Hung End Load, Double or Single Acting, Aluminum Door and Frame (Non-Handed)			
RTS14	Complete package RTS88, 8836, 8852	819.00	—
RTS14 × 8563	Complete package, including 8563 frame cover plate	912.00	—
Center Hung End Load, Double or Single Acting, Aluminum Door and Frame (Non-Handed)			
RTS15	Complete package RTS88, 8838, 8857	819.00	—
RTS15 × 8563	Complete package, including 8563 frame cover plate	912.00	—
Center Hung End Load, Double or Single Acting, Aluminum Door and Frame (Non-Handed)			
RTS16	Complete package RTS88, 8838, 8853	819.00	—
RTS16 × 8563	Complete package, including 8563 frame cover plate	912.00	—
Center Hung End Load, Double or Single Acting, Aluminum Door and Frame (Non-Handed)			
RTS17	Complete package RTS88, 8838, 8855	819.00	—
RTS17 × 8563	Complete package, including 8563 frame cover plate	912.00	—
Center Hung End Load, Double or Single Acting, Aluminum Door and Frame (Non-Handed)			
RTS18	Complete package RTS88, 8838, 8852	819.00	—
RTS18 × 8563	Complete package, including 8563 frame cover plate	912.00	—
Center Hung End Load, Double or Single Acting, Aluminum Door and Frame (Non-Handed)			
RTS19	Complete package RTS88, 8837, 8857	819.00	—
RTS19 × 8563	Complete package, including 8563 frame cover plate	912.00	—
Center Hung End Load, Double or Single Acting, Aluminum Door and Frame (Non-Handed)			
RTS20	Complete package RTS88, 8837, 8853	819.00	—
RTS20 × 8563	Complete package, including 8563 frame cover plate	912.00	—

NOTE: See RTS88 Accessories for individual component list prices.

Package	Description	Painted Finish \$	Plated Finish \$
Center Hung End Load, Double or Single Acting, Aluminum Door and Frame (Non-Handed)			
RTS21	Complete package RTS88, 8837, 8855	819.00	—
RTS21 × 8563	Complete package, including 8563 frame cover plate	912.00	—
Center Hung End Load, Double or Single Acting, Aluminum Door and Frame (Non-Handed)			
RTS22	Complete package RTS88, 8837, 8852	819.00	—
RTS22 × 8563	Complete package, including 8563 frame cover plate	912.00	—
Hinge Hung, Single Acting, Aluminum Door and Frame (Non-Handed)			
RTS25	Complete package RTS88, 8812	819.00	—
RTS25 × 8563	Complete package, including 8563 frame cover plate	912.00	—
3/4" Offset Pivot Hung, Single Acting, Aluminum Door and Frame (Non-Handed)			
RTS26	Complete package RTS88, 8812	819.00	—
RTS26 × 8563	Complete package, including 8563 frame cover plate	912.00	—
Hinge or 3/4" Offset Pivot Hung, Single Acting, Steel Door and Frame (Non-Handed)			
RTS27	Complete package RTS88, 8812, 8575, 8532**	963.00	1095.00
RTS27 LMC	Complete package, less mounting channel	883.00	1015.00
Hinge or 3/4" offset Pivot Hung, Single Acting, Wood Door and Steel Frame (Non-Handed)			
RTS28	Complete package RTS88, 8812, 8575, 8532**, W1	966.00	1101.00
RTS28 LMC	Complete package, less mounting channel	883.00	1015.00
Hinge or 3/4" Offset Pivot Hung, Single Acting, Wood Door and Frame (Non-Handed)			
RTS29	Complete package RTS88, 8812, 8561, W2	888.00	1025.00
Hinge Hung, Single Acting, Wood Door and Aluminum Frame (Non-Handed)			
RTS30	Complete package RTS88, 8812, W1	790.00	—
RTS30 × 8563	Complete package, including 8563 frame cover plate	886.00	—
3/4" Offset Pivot Hung, Single Acting, Wood Door and Aluminum Frame (Non-Handed)			
RTS31	Complete package RTS88, 8812, W1	790.00	—
RTS31 × 8563	Complete package, including 8563 frame cover plate	886.00	—

NOTES:

- See RTS88 Accessories for individual component list prices.
- RTS closer body is always painted aluminum.
- Bottom arm and closer arm are always zinc plated finish.
Frame mounting channel is always unfinished.
8563 cover plate is available painted only.

** No. 8532 steel header mounting channel is specifically designed to install the RTS closer into open-throat steel header sections.
Typical practice would be to install the mounting channel in the header prior to shipment to the job site.

Options

(List Price 'add' when ordered with complete closer)

Item	Description	Painted Add \$	Plated Add \$
AMS	All metal screws	N/C	—
AMSAWS	All metal screws, all wood screws	14.00	22.00
W1	Half wood screws	8.00	9.00
W2	All wood screws	10.00	12.00
105° NHO Sz 3, 4, BFI, BFE	Closer with 105° bumper without hold open	N/C	—
105° HO Sz 3, 4, BFI, BFE	Closer with 105° bumper and 105° hold open	N/C	—
90° NHO Sz 2, 3, or 4	Closer with 90° bumper without hold open	N/C	—
90° HO Sz 2, 3 or 4	Closer with 90° bumper and 90° hold open	N/C	—
5 mm EXT	3/16" (5 mm) extended spindle (integral part of pinion)	N/C	—
Custom Color	Custom painted finish selected from RAL color pallet book. For details, see Finishes Cross Reference , page viii.		
	per order, setup charge (Net)	145.00	—
	per closer, list add	81.00	—
Designer Color	Designer painted color matched to supplied samples. Three (3) each 2" x 3" color chip samples required. For details, see Finishes Cross Reference , page viii.		
	per order, non-refundable development/ setup charge (Net)	362.00	—
	per closer, list add	93.00	—

NOTES:

- Specify package designation, hand (when required), finish, and options or accessories when ordering.
- RTS packages furnished standard with 105° NHO, size 3 closer.
- Complete package prices are indicated in bold.
- When ordering a package "less components," deduct the list price of the component removed.
- Auxiliary limiting stop required for all RTS88 installations, especially those doors experiencing unusual conditions, e.g. excessive wind pressure or abuse.

Accessories

Item	Description	List \$
8836S	Closer arm, 7/8" top rail glass door shoe (zinc plated finish only)	247.00
8511	Slide arm, (8812) cover/applied stop (specify hand and finish)	342.00
8521E	Add-on 1-5/16" spindle extension (finish not required)	79.00
8532	Steel header closer mounting channel (finish not required)	79.00
8820J	Conversion bracket kit to replace Jackson OH closer with RTS88 (Finish not required)	26.00

LM Series, Heavy-Duty

Ordering Guide

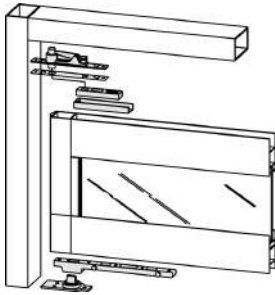

Spindle Extensions

50mm	— 50 mm Extended Spindle
45mm	— 45 mm Extended Spindle
40mm	— 40 mm Extended Spindle
35mm	— 35 mm Extended Spindle
30mm	— 30 mm Extended Spindle
25mm	— 25 mm Extended Spindle
20mm	— 20 mm Extended Spindle
15mm	— 15 mm Extended Spindle
10mm	— 10 mm Extended Spindle
5mm	— 5 mm Extended Spindle

Fastener Packs

All Metal Screws	—	AMSAWS
All Wood Screws	—	W1
1/2 Wood Screws	—	W2
All Wood Screws	—	AMS
All Metal Screws	—	

Deducts

LCP	— Less Cover Plate
LA	— Less Arm
LBP	— Less Bottom Pivot
LTP	— Less Top Pivot

Series	Specify for Right Handed Units
Center Pivot — CP	
Offset Pivot — OP	Specify for Left Handed Units

Hand	
RH	— Right Handed
LH	— Left Handed

OP	440	RH	AMS			626	
-----------	------------	-----------	------------	--	--	------------	--

Up to 440 lb, CH Aluminum	A440	Intermediate Pivot for 3/4" Offset	75220	605	— Bright Brass
Up to 440 lb, CH or 3/4" Offset	440	20 min Intermediate Pivot for 3/4" Offset	75222	606	— Satin Brass
Up to 440 lb, 20 min Fire Door, 3/4" Offset	440E	3 h Intermediate Pivot for 3/4" Offset	75233	611	— Bright Bronze
Up to 440 lb, Up to 3 h Fire Door, 3/4" Offset	440F	Intermediate Pivot for Lead Lined 3/4" Offset (see note*)	75240	612	— Satin Bronze
Up to 350 lb, Jamb Mount, 3/4" Offset	J350	20 min Intermediate Pivot for Lead Lined 3/4" Offset (see note*)	75242	613	— Oxidized Satin Oil Rubbed Bronze
Up to 440 lb, Lead Lined 3/4" Offset (see note*)	L440	3 h Intermediate Pivot for Lead Lined 3/4" Offset (see note*)	75243	618	— Bright Nickel
Up to 440 lb, 20 min Fire Door, Lead Lined 3/4" Offset (see note*)	L440E	Intermediate Pivot for 1-1/2" Offset	15220	619	— Satin Nickel
Up to 440 lb, 3 h Fire Door, Lead Lined 3/4" Offset (see note*)	L440F	20 min Intermediate Pivot for 1-1/2" Offset	15222	625	— Bright Chrome
Up to 200 lb, 1-1/2" Offset	15200	3 h Intermediate Pivot for 3/4" Offset	15233	626	— Satin Chrome
Up to 200 lb, 20 min Fire Door, 1-1/2" Offset	15200E	Through Wire Intermediate Pivot for 3/4" Offset	75200	600	— Primed
Up to 200 lb, 3 h Fire Door, 1-1/2" Offset	15200F	Through Wire CH Top Pivot (2 wire)	E80622	689	— Aluminum
		Through Wire CH Top Pivot (4 wire)	E80624	690	— Statuary Bronze
				691	— Dull Bronze
				693	— Black
				695	— Dark Duranodic Bronze
				696	— Gold
				PNT	— Special Sprayed Finish (must specify)

Package

Pivot Accessories

Finish

Plated

Painted

*** "L" Package Door Thickness Note:**
The standard door thickness is 1-3/4", and is the default unless otherwise specified.

Other alternative sizes are

- 2
- 2-1/4
- 2-1/2
- 3

Examples: L-E-2-1/2...75242-2-1/2

Example above 20 min. lead lined package for 2-1/2" thick door.

NOTES:

- All combinations of features and options are not available for all models.
- Please refer to LM Heavy-Duty Series product brochure for details.

Packages for Doors Weighing up to 440 lb

Center Hung Packages

Package	Description	Painted Finish \$	Plated Finish \$
Double or Single Acting, Aluminum Door and Frame (Non-handed)			
CPA440	Complete package 7471K, 7422, 8062	505.00	505.00
Double or Single Acting, Wood or Steel Door and Frame (Non-handed)			
CP440	Complete package 7471K, 7421, 8062	463.00	463.00

NOTE: Bottom arms are available in zinc plated finish only.

3/4" Offset Packages

Package	Description	Painted Finish \$	Plated Finish \$
Single Acting, Wood, Steel, or Aluminum Door and Frame (Specify Hand)			
OP440	Complete package 7471K, 75323, 75120	578.00	578.00
Single Acting, 20 Minute Rated Fire Door and Frame (Specify Hand)			
OP440E	Complete package 7471K, 75323, 75122	608.00	608.00
Single Acting, 3 Hour Rated Fire Door and Frame (Specify Hand)			
OP440F	Complete package 7471K, 75323, 75133	665.00	926.00
Single Acting, Wood or Steel Door and Frame (Specify Hand)			
OPJ350	Complete package 75320, 75120	795.00	795.00
Single Acting, Lead-Lined Door and Frame, 1-3/4" Thick Door (Specify Hand)			
OPL440	Complete package 7471K, 75343, 75140	1153.00	1153.00
Single Acting, Lead-Lined, 20 Minute Rated Fire Door and Frame, 1-3/4" Thick Door (Specify Hand)			
OPL440E	Complete package 7471K, 75343, 75142	1186.00	1186.00
Single Acting, Lead-Lined, 3 Hour Rated Fire Door and Frame, 1-3/4" Thick Door (Specify Hand)			
OPL440F	Complete package 7471K, 75343, 75143	1255.00	1192.00

NOTE: See LM Heavy Duty Accessories for intermediate pivots. See LM Accessories for individual component list prices.

1-1/2" Offset Packages

Package	Description	Painted Finish \$	Plated Finish \$
Single Acting, Wood, Steel, or Aluminum Door and Frame (Specify Hand)			
OP15200	Complete package 7471K, 15323, 15120	962.00	962.00
Single Acting, 20 Minute Rated Fire Door and Frame (Specify Hand)			
OP15200E	Complete package 7471K, 15323, 15122	1012.00	1012.00
Single Acting, 3 Hour Rated Fire Door and Frame (Specify Hand)			
OP15200F	Complete package 7471K, 15323, 15133	1053.00	1470.00

NOTE: See LM Heavy Duty Accessories for intermediate pivots. See LM Accessories for individual component list prices.

Options

(List Price 'add' when ordered with complete closer)

Item	Description	Painted Finish \$	Plated Finish \$
AMS	All metal screws	N/C	—
AMSAWS	All wood screws, all metal screws	14.00	22.00
W1	Half wood screws	8.00	9.00
W2	All wood screws	10.00	12.00
EXT	Extended spindles available in 5 mm increments from 5 mm–50 mm in height (specify height)	56.00	—

Accessories

(Center Hung Pivot)

Item	Description	Painted Finish \$	Plated Finish \$
HD8062	Heavy-duty complete top pivot	593.00	593.00
E80622	Through-wire center hung top pivot (2 wire) fire door	797.00	797.00
E80624	Through-wire center hung top pivot (4 wire)	797.00	797.00

3/4" Offset Hung Intermediate Pivots**

Item	Description	Painted Finish \$	Plated Finish \$
75220	Full mortise standard intermediate pivot	392.00	392.00
75222	Full mortise intermediate pivot — 20 minute rated fire door	419.00	419.00
75233	Full mortise intermediate pivot — 3 hour rated fire door	440.00	848.00
75240	Full mortise intermediate pivot — 1-3/4" lead-lined doors	589.00	589.00
75242	Full mortise intermediate pivot — 20 minute rated 1-3/4" lead-lined doors	622.00	622.00
75243	Full mortise intermediate pivot — 3 hour rated 1-3/4" lead-lined doors	639.00	1235.00
75200	Through-wire 3/4" offset intermediate pivot — 8 wire**	728.00	728.00

** All intermediate pivots are handed.

1/2" Offset Hung Intermediate Pivots**

Item	Description	Painted Finish \$	Plated Finish \$
15220	Full mortise standard intermediate pivot	589.00	589.00
15222	Full mortise intermediate pivot — 20 minute rated fire door	639.00	639.00
15233	Full mortise intermediate pivot — 3 hour rated fire door	654.00	1144.00

** All intermediate pivots are handed.

NOTES:

- Specify package designation, hand (when required), finish, and options or accessories when ordering.
- Complete package prices are indicated in bold.
- When ordering a package "less components," deduct the list price of the component removed.
- Lead-lined packages shown are for 1-3/4" thick non-fire rated doors. For lead-lined doors up to 3" thick, add \$92.00 list to the package price. Example: OPL800 - 2-1/2. Others available are 2", 2-1/4", and 3".
- Consult factory for quotes on lead-lined, fire-rated packages for various door thicknesses.
- All pivots furnished with all machine screws standard (AMS).

LM Series, Extra Heavy-Duty

Ordering Guide

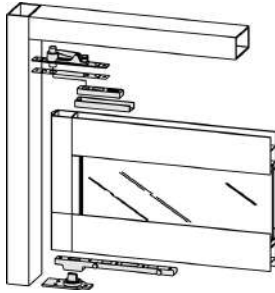

Series		Hand		Fastener Packs			Spindle		Deducts	
Center Pivot	CP	Specify for Right Handed Units	RH	All Metal Screws	AMSAWS	1/2 Wood Screws	74030	1-3/4" Spindle	LCP	Less Cover Plate
Offset Pivot	OP	Specify for Left Handed Units	LH	All Wood Screws			W1	74025	1-9/16" Spindle	LA
				All Wood Screws	W2	All Metal Screws	74020	1-3/8" Spindle	LBP	Less Bottom Pivot
				All Metal Screws	AMS		74015	1-1/8" Spindle	LTP	Less Top Pivot
							74012	1-1/16" Spindle		
							74010	1" Spindle		
							74007	7/8" Spindle		
							74005	3/4" Spindle		
							74003	9/16" Spindle		
	OP	H750	RH	AMS	74005		626			
Up to 660 lb, CH		660		Intermediate Pivot for 3/4" Offset		75220	605	Bright Brass		
Up to 1000 lb, CH		1000		20 min Intermediate Pivot for 3/4" Offset		75222	606	Satin Brass		
Up to 750 lb, 3/4" Offset		H750		3 h Intermediate Pivot for 3/4" Offset		75233	611	Bright Bronze		
Up to 750 lb, 20 min Fire Door, 3/4" Offset		H750E		Intermediate Pivot for Lead Lined 3/4" Offset (see note*)		75240	612	Satin Bronze		
Up to 750 lb, Up to 3 h Fire Door, 3/4" Offset		H750F		20 min Intermediate Pivot for Lead Lined 3/4" Offset (see note*)		75242	613	Oxidized Satin Oil Rubbed Bronze		
Up to 800 lb, Lead Lined 3/4" Offset (see note*)		L800		3 h Intermediate Pivot for Lead Lined 3/4" Offset (see note*)		75243	618	Bright Nickel		
Up to 800 lb, 20 min Fire Door, Lead Lined 3/4" Offset (see note*)		L800E		Intermediate Pivot for 1-1/2" Offset		15220	619	Satin Nickel		
Up to 800 lb, 3 h Fire Door, Lead Lined 3/4" Offset (see note*)		L800F		20 min Intermediate Pivot for 1-1/2" Offset		15222	625	Bright Chrome		
Up to 500 lb, 1-1/2" Offset		15500		3 h Intermediate Pivot for 3/4" Offset		15233	626	Satin Chrome		
Up to 500 lb, 20 min Fire Door, 1-1/2" Offset		15500E		Through Wire Intermediate Pivot for 3/4" Offset		75200	600	Primed		
Up to 500 lb, 3 h Fire Door, 1-1/2" Offset		15500F		Through Wire CH Top Pivot (2 wire)		E80622	689	Aluminum		
				Through Wire CH Top Pivot (4 wire)		E80624	690	Statuary Bronze		
							691	Dull Bronze		
							693	Black		
							695	Dark Duranodic Bronze		
							696	Gold		
							PNT	Special Sprayed Finish (must specify)		

*** "L" Package Door Thickness Note:**
The standard door thickness is 1-3/4", and is the default unless otherwise specified.

Other alternative sizes are $\left. \begin{matrix} -2 \\ -2-1/4 \\ -2-1/2 \\ -3 \end{matrix} \right\}$

Examples: L-E-2-1/2...75242-2-1/2

Example above 20 min. lead lined package for 2-1/2" thick door.

NOTES:

- All combinations of features and options are not available for all models.
- Please refer to LM Heavy-Duty Series product brochure for details.

Plated

Painted

Packages for Doors Weighing 440 lb.

Center Hung Packages

Package	Description	Painted Finish \$	Plated Finish \$
Double or Single Acting, Wood or Steel Door and Frame (Non-handed)			
CP660	Complete package 7471HD/74005, 7421, 8062	1122.00	1122.00
Double or Single Acting, Wood or Steel Door and Frame (Non-handed)			
CP1000	Complete package 7471HD/74005, 7421, HD8062	1523.00	1523.00

3/4" Offset Packages

Package	Description	Painted Finish \$	Plated Finish \$
Single Acting, Wood, Steel, or Aluminum Door and Frame (Specify Hand)			
OPH750	Complete package 7471HD/74005, 75323, 75120	1240.00	1240.00
Single Acting, 20 Minute Rated Fire Door and Frame (Specify Hand)			
OPH750E	Complete package 7471HD/74005, 75323, 75122	1269.00	1269.00
Single Acting, 3 Hour Rated Fire Door and Frame (Specify Hand)			
OPH750F	Complete package 7471HD/74005, 75323, 75133	1325.00	1586.00
Single Acting, Lead-Lined Door and Frame, 1-3/4" Thick Door (Specify Hand)			
OPL800	Complete package 7471HD/74005, 75343, 75140	1815.00	1815.00
Single Acting, Lead-Lined, 20 Minute Rated Fire Door and Frame, 1-3/4" Thick Door (Specify Hand)			
OPL800E	Complete package 7471HD/74005, 75343, 75142	1845.00	1845.00
Single Acting, Lead-Lined, 3 Hour Rated Fire Door and Frame, 1-3/4" Thick Door (Specify Hand)			
OPL800F	Complete package 7471HD/74005, 75343, 75143	1913.00	2132.00

1-1/2" Offset Packages

Package	Description	Painted Finish \$	Plated Finish \$
Single Acting, Wood, Steel, or Aluminum Door and Frame (Specify Hand)			
OP15500	Complete package 7471HD/74005, 15323, 15120	1624.00	1624.00
Single Acting, 20 Minute Rated Fire Door and Frame (Specify Hand)			
OP15500E	Complete package 7471HD/74005, 15323, 15122	1674.00	1674.00
Single Acting, 3 Hour Rated Fire Door and Frame (Specify Hand)			
OP15500F	Complete package 7471HD/74005, 15323, 15133	1715.00	2131.00

NOTES:

- See LM Extra-Heavy Duty Accessories for intermediate pivots. See LM Accessories for individual component list prices.
- Center hung bottom arms are available in zinc plated finish only.
- 7471HD floor bearings not available in painted finish. 7471HD is plated to match when ordering with painted finishes.
- See LM Extra Heavy-Duty Accessories for intermediate pivots. See LM Accessories for individual component list prices.

Options

(List Price 'add' when ordered with complete set)

Item	Description	Painted Add \$	Plated Add \$
AMS	All metal screws	N/C	—
AMSAWS	All metal screws, all wood screws	14.00	22.00
W1	Half wood screws	8.00	9.00
W2	All wood screws	10.00	12.00
74003	9/16" clearance spindle (when used w/7471HD)	N/C	—
74007	7/8" clearance spindle (when used w/7471HD)	N/C	—
74010	1" clearance spindle (when used w/7471HD)	N/C	—
74012	1-1/16" clearance spindle (when used w/7471HD)	32.00	—
74015	1-1/8" clearance spindle (when used w/7471HD)	32.00	—
74020	1-3/8" clearance spindle (when used w/7471HD)	32.00	—
74025	1-9/16" clearance spindle (when used w/7471HD)	32.00	—
74030	1-3/4" clearance spindle (when used w/7471HD)	32.00	—

Accessories

(Center Hung Pivot)

Item	Description	Painted Finish \$	Plated Finish \$
HD8062	Heavy-duty complete top pivot	593.00	593.00
E80622	Through-wire center hung top pivot (2 wire) fire door	797.00	797.00
E80624	Through-wire center hung top pivot (4 wire)	797.00	797.00

3/4" Offset Hung Intermediate Pivots**

Item	Description	Painted Finish \$	Plated Finish \$
75220	Full mortise standard intermediate pivot	392.00	392.00
75222	Full mortise intermediate pivot – 20 minute rated fire door	419.00	419.00
75233	Full mortise intermediate pivot – 3 hour rated fire door	440.00	848.00
75240	Full mortise intermediate pivot – 1-3/4" lead lined doors	589.00	589.00
75242	Full mortise intermediate pivot – 20 minute rated 1-3/4" lead-lined doors	622.00	622.00
75243	Full mortise intermediate pivot – 3 hour rated 1-3/4" lead-lined doors	639.00	1235.00
75200	Through-wire 3/4" offset intermediate pivot – 8 wire**	728.00	728.00

** All intermediate pivots are handed.

1-1/2" Offset Hung Intermediate Pivots**

Item	Description	Painted Finish \$	Plated Finish \$
15220	Full mortise standard intermediate pivot	589.00	711.00
15222	Full mortise intermediate pivot – 20 minute rated fire door	639.00	639.00
15233	Full mortise intermediate pivot – 3 hour rated fire door	654.00	1144.00

** All intermediate pivots are handed.

90° Pocket Pivots

Item	Description	Painted Finish \$	Plated Finish \$
75520	Standard pocket pivot	591.00	711.00
75523	3 hour rated pocket pivot	623.00	753.00

NOTES:

- Specify package designation, hand (when required), finish, and options or accessories when ordering.
- Complete package prices are indicated in bold.
- When ordering a package "less components," deduct the list price of the component removed.
- Lead-lined packages shown are for 1-3/4" thick non-fire rated doors. For lead-lined doors up to 3" thick, add \$92.00 list to the package price. Example: OPL800 - 2-1/2. Others available are 2", 2-1/4", and 3".
- Consult factory for quotes on lead-lined, fire-rated packages for various door thicknesses.
- All pivots furnished with all machine screws standard (AMS).

900/700 Series

Ordering Guide

Optional Brackets Painted Finish

(Use with RTS Closers)

			Push Side Mounting Bracket Used w/903 & RTS Offset Hung	903RTSOFF	PNT – Special Sprayed Finish (must specify)
			Push Side Mounting Bracket Used w/902 & RTS Offset Hung	902RTSOFF	696 – Gold
			Push Side Mounting Bracket Used w/RTS Center Hung	900RTSCH	695 – Dark Duranodic Bronze
Heavy Duty Surface	90		Pull Side Mounting Bracket	7090	693 – Black
Heavy Duty Concealed	91				691 – Dull Bronze
Standard Surface	70				690 – Statuary Bronze
Standard Concealed	71				689 – Aluminum
					600 – Primed
	90	2	S		626
		1	S	– Stop Only	605 – Bright Brass
		2	H	– Stop/Hold	606 – Satin Brass
		3	F	– Friction Stop (700 only)	611 – Bright Bronze
			Function		612 – Satin Bronze
			Door Size		613 – Oxidized Satin Oil Rubbed Bronze
			Refer to 700/900 Series Brochure; varies by Model and Mount.		618 – Bright Nickel
					619 – Satin Nickel
					625 – Bright Chrome
					626 – Satin Chrome

Plated Finish

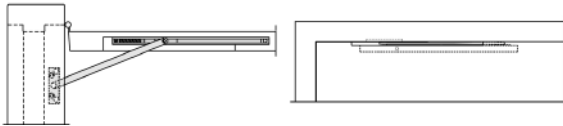

NOTES:

- All combinations of features and options are not available for all models.
- Please refer to 700/900 Series product brochure for details.

700 Series

Standard Duty Surface

Item	Description	Painted Finish \$	Plated Finish \$
701S	Stop only	169.00	329.00
702S	Stop only	169.00	329.00
703S	Stop only	169.00	329.00
701F	Friction stop	169.00	329.00
702F	Friction stop	169.00	329.00
703F	Friction stop	169.00	329.00
701H	Stop/hold	169.00	329.00
702H	Stop/hold	169.00	329.00
703H	Stop/hold	169.00	329.00

Standard Duty Concealed

Item	Description	Painted Finish \$	Plated Finish \$
711S	Stop only	162.00	297.00
712S	Stop only	162.00	297.00
713S	Stop only	162.00	297.00
711F	Friction stop	162.00	297.00
712F	Friction stop	162.00	297.00
713F	Friction stop	162.00	297.00
711H	Stop/hold	162.00	297.00
712H	Stop/hold	162.00	297.00
713H	Stop/hold	162.00	297.00

900 Series

Heavy Duty Surface

Item	Description	Painted Finish \$	Plated Finish \$
901S	Stop only	328.00	563.00
902S	Stop only	328.00	563.00
903S	Stop only	328.00	563.00
901H	Stop/hold	328.00	563.00
902H	Stop/hold	328.00	563.00
903H	Stop/hold	328.00	563.00

Heavy Duty Concealed

Item	Description	Painted Finish \$	Plated Finish \$
911S	Stop only	406.00	527.00
912S	Stop only	406.00	527.00
913S	Stop only	406.00	527.00
911H	Stop/hold	406.00	527.00
912H	Stop/hold	406.00	527.00
913H	Stop/hold	406.00	527.00

Options

(List Price 'add')

Item	Description	Painted Finish \$	Plated Finish \$
7090	Pull side mounting bracket (900/700)	71.00	149.00
900RTSCH	Push side mounting bracket for use with RTS center hung closer. Provides mount for surface applied stop mount plate to prevent screws from damaging RTS closer body.	71.00	149.00
902RTSOFF	Push side mounting bracket for 902 stop/holder, used with offset pivots when RTS closer is installed in the header.	71.00	149.00
903RTSOFF	Push side mounting bracket for 903 stop/holder, used with offset pivots and an RTS closer installed in the header.	71.00	149.00
Custom Color	Custom painted finish selected from RAL color pallet book. For details, see Finishes Cross Reference , page viii.		
	per order, setup charge (Net)	145.00	—
	per closer, list add	41.00	—
Designer Color	Designer painted color matched to supplied samples. Three (3) Color each 2" x 3" colorchip samples required. For details, see Finishes Cross Reference , page viii.		
	per order, non-refundable development/setup charge (Net)	363.00	—
	per closer, list add	46.00	—

NOTE: Standard screw pack includes wood and machine screws for the soffit bracket, and sex nuts for the door, as required.

Pull Finishes Cross Reference



	DORMA GMBH Finish #	Closest BHMA Equivalent
Anodized Aluminum Parts		
Clear	101	628
Similar to Stainless Steel	107	670
Dark Bronze	108	710
Black	109	711
Aluminum Color	114	718
Brass		
Polished Brass without Lacquer	503	—
Satin Brass without Lacquer	599	728
Steel or Stainless Steel		
Satin Stainless Steel	700	630
Polished Stainless Steel	701	629
Bronze		
Satin Bronze without Lacquer	600	612
Polished Bronze without Lacquer	601	611
Custom Finish*		
	999	—

*All Custom Finishes will incur a \$200 net setup fee per purchase order, per color.

TG 138 Ladder Pulls Ordering Guide

Function		Door Thickness		Screwpack Options		Keying Options Field		
Locking — L				SNUT — Sex Nut, up to 3-5/16"				
Non-Locking — NL		134 — Wood Door Screw Pack		BLIND — 1-3/4" wood door, not through door				
				B2B80 — Back-to-back up to 3-5/16" thick door				
				B2B44 — Back-to-back 1-3/4" wood				
TG 138	NL	B2B	134	49	B2B12	700	C6	XXXX
Model	Back-To-Back — B2B	49" Length — 49		Satin Stainless — 700		T — Temporary SFIC		
	Single Sided — SNG	60" Length — 60		Custom Polished finish — 701		J — SFIC (Less Core)		
	Pull Type	72" Length — 72		Custom Paint or Powder — 999	Finish	C — 7-Pin SFIC (With Core)		
		84" Length — 84				C6 — 6-Pin SFIC (With Core)		
		XX" (Specify) Length — Custom				L — Less Cylinder		
		(L) Length				D — Conventional Cylinder		
						R — Schlage LFIC (Less Core)		
						THB — Thumbturn Single Pull Handle		
						Cylinder Type		

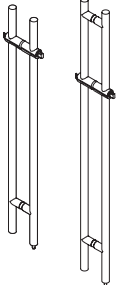
TG 138 Locking and Non-Locking Ladder Pulls

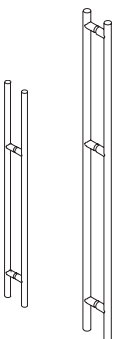
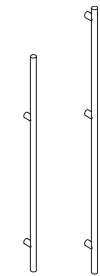
Locking Ladder Pull Configurations Single and Back-To-Back Locking and Non-Locking Pulls					Standard Finish \$		Custom Finish \$	
Model	Ref. #	U/M	No. Of Fixing Posts	Description	700	701	999	
Back-to-Back Locking Ladder Pull with T Small Format Interchangeable Core (SFIC) Cylinder, BA Core MKD (KD)					3	(SO)	(SO)	
	926.933	Set	3F	L B2B STD 84" 700	2009.00	2592.00	—	
	926.932	Set	3F	L B2B STD 72" 700	1958.00	2526.00	—	
	926.936	Set	3F	L B2B STD 60" 700	1912.00	2467.00	—	
	926.930	Set	2F	L B2B STD 49" 700	1837.00	2368.00	—	
Single Sided Locking Ladder Pull with T Cylinder (SFIC), BA Core MKD (KD), or Thumb-Turn (TT)								
	926.934	Ea.	2F	L SNG STD 49" CYL 700	1046.00	1341.00	—	
	926.935	Ea.	2F	L SNG STD 49" TT 700	1046.00	1341.00	—	
NOTE: Cylinder or Thumb-Turn are Top Mounted								
Back-to-Back Non-Locking Ladder Pull					3	(SO)	(SO)	
	926.923	2 Ea.	3F	NL B2B STD 84" 700	852.00	1107.00	1124.00	
	926.922	2 Ea.	3F	NL B2B STD 72" 700	806.00	1045.00	1079.00	
	926.924	2 Ea.	3F	NL B2B STD 60" 700	755.00	980.00	1028.00	
	926.920	2 Ea.	2F	NL B2B STD 49" 700	678.00	881.00	952.00	
NOTE: Specify 2 Ea. for a back-to-back set,								
Single Sided Non-Locking Ladder Pull								
	926.923	Ea.	3F	NL SNG STD 84" 700	494.00	642.00	658.00	
	926.922	Ea.	3F	NL SNG STD 72" 700	468.00	607.00	630.00	
	926.924	Ea.	3F	NL SNG STD 60" 700	439.00	570.00	604.00	
	926.920	Ea.	2F	NL SNG STD 49" 700	393.00	511.00	557.00	
NOTE: Customer must specify Fixing Pack and adjust List Price accordingly for Non-Locking Single Ladder Pulls and all door panel thicknesses greater than 1/2".								

NOTES:

- Default fastener pack addresses 3/8"–3/4" thick glass, except locking ladder pulls, 3/8"–5/8" 3/4" glass for locking pulls requires special 926.911 locking assembly at List \$212.
- Default cylinder for TG 138 L pulls uses SFIC C Cylinder BA Core.
- Other cylinder and keying options available, see **Cylinder Types, Keying Options & Keyways.**
- 999 Finish is Custom Paint and Powder only, not available on locking pulls.

(SO) Special Fabricated/Finish or Special Order; lead time up to 9 weeks.

3 Standard or Non-Standard Fabricated; lead time up to 3 business days.

TG 138 Locking and Non-Locking Ladder Pulls Accessories

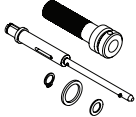
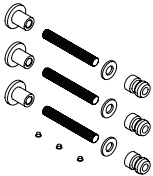
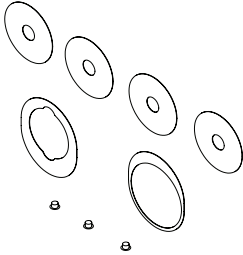
Mounting	Ref. #	Description	Door Thickness	List \$
	926.937	Strike, Dustproof, Standard 1-1/8" (29 mm)		52.00
	926.890	Locking Post Mounting Pack, Back-to-back, (Non-Locking Post Fasteners not included)	1-3/4" (44 mm)	278.00
	926.909	Mounting Pack, Back-to-back Non-Locking Post	1-3/8" (34 mm) – 1-3/4" (44 mm)	75.00
	926.910	Mounting Pack, SNG Blind, 3 each in pack (Will not project through door)	min. 1-3/4" (44 mm)	36.00
	926.908	Mounting Pack, Single Non-Locking x Sex Nut	3/4" (19 mm) – 3-1/8" (80 mm)	79.00
	926.939	Washer Pack	—	22.00

NOTE: Default cylinder for Locking Ladder pulls uses SFIC T cylinder with temporary construction core in 626 Satin. Other cylinder and keying options available, see next page.

(SO) Special Fabricated/Finish or Special Order; lead time up to 9 weeks.

TG 138 Cylinder Types, Keying Options, and Keyways

Cylinder	Option	Description	Deduct \$
L		Lock less cylinder and cylinder ring	Deduct 75.00
Interchangeable Core Cylinders			
C		SFIC – Housing with combined SFIC construction core installed at the factory; BA (default), BB, BC, BD, BE, BF, BG, BH, BJ, BK, BL, BM, BQ, D100 keyway – ☒ Keys sold separately	N/C
	MKD	Master keyed, Keyed Different (Keyed different to a random combination) or Keyed Alike; BA Core with 1 control key and 2 change keys; Up to 20 days additional lead time for Keyed Alike.	N/C
T		SFIC – Housing with keyed temporary SFIC construction core (Core may be returned for a full refund) – ☒ Keys sold separately	Deduct 5.00
J		SFIC – Housing with disposable plastic SFIC plug	Deduct 45.00
R		Schlage LFIC - Housing less core	Deduct 37.00
Conventional Cylinders (non-interchangeable core)			
D		Conventional cylinder	Deduct 45.00
	KD	Keyed differently to a random combination; SC keyway with 2 keys (default)	Deduct 45.00
	KA2	Keyed alike in pairs to a random combination; SC keyway with 2 keys	Deduct 45.00
	NSK	Keyed alike (or Keyed to Order - KTO) sets of 3 or more; SC keyway with 2 keys	Deduct 33.00
	1-Bit SC	Operated by 1-bit key (sold separately); SC, SE keyway with 2 key blanks	Deduct 45.00
	0-Bit D-100	Operated by 0-bit key (sold separately); D100 keyway – ☒ Keys sold separately	Deduct 45.00
	0-Bit	Operated by a key blank; AA, CA, CB, CC, CD, CE, RA, RB, GA, SF, WA, YA, YG keyways with 2 keys	Deduct 33.00
	MKD	Master keyed; SC, SE, or D100 keyway – ☒ Keys sold separately	Deduct 29.00
	CMK	Construction master keyed single cylinder locks – ☒ Keys sold separately	Deduct 27.00

Ladder Pulls will be supplied with SFIC C cylinder, Option BA MKD (KD).
 ☒ Denotes keys must be ordered separately.

Cut Keys Ordered Separately

Part #	Description	List \$
45101	SFIC Cut Key – Change key, master key, construction master key, or control key; BA, BB, BC, BD, BE, BF BG, BH, BJ, BK, BL, BM, BQ, SC, SE keyways	10.00
45401	SFIC Cut Key – Change key, master key, or control key; SKC keyways – D100 etc.	16.00
45404	CONV/LFIC Cut Key – 1-Bit key for operating 1-bit cylinders – SC, SE keyways	8.00

NOTES:

- Distribution of DORMA SKC keys (listed as D100) is restricted. Call customer service for dormakaba SKC policies.
- See Keys and Key Blanks section for complete list.

TG 9387 Ladder Pulls

Ordering Guide



				SNG Mounting Type	
		Door Thickness		ROSE	— Screw-on-Rose
		134	— Wood Door Screw Pack	BLIND	— Concealed
S-TG 9387	SNG	134	18	BLIND	700
S-TG 9387	Single Sided — SNG	12" Length — 12	DORMA 700/ BHMA 630		700
Model	Back-To-Back — B2B	18" Length — 18			
		Pull Type	36" Length — 36	Finish	
			42" Length — 42		
			60" Length — 60		
		(L) Length			

Stock TG 9387 Standard Size Non-Locking Ladder Pulls, with Straight Fixing Posts

Stock Pull Handles for Commercial Doors						Finish \$
Model	Ref. #	U/M	No. Of Fixing Posts	Description		700
Back-to-Back 1-1/4" (32 mm) Diameter						3
	B2B.905.370	Set	3F	L = 60" CTC = 37-1/2"		337.00
	B2B.905.371	Set	2F	L = 42" CTC = 26-1/4"		232.00
	B2B.905.372	Set	2F	L = 36" CTC = 22-1/2"		210.00
	B2B.905.373	Set	2F	L = 18" CTC = 11-1/4"		169.00
	B2B.905.374	Set	2F	L = 12" CTC = 7-1/2"		159.00
Single Sided 1-1/4" (32 mm) Diameter						3
	SNG.905.370	Ea.	3F	L = 60" CTC = 37-1/2"		172.00
	SNG.905.371	Ea.	2F	L = 42" CTC = 26-1/4"		119.00
	SNG.905.372	Ea.	2F	L = 36" CTC = 22-1/2"		108.00
	SNG.905.373	Ea.	2F	L = 18" CTC = 11-1/4"		86.00
	SNG.905.374	Ea.	2F	L = 12" CTC = 7-1/2"		81.00
						List \$
POWDER All Custom powder coated orders will include a net charge per purchase order.						275.00

NOTES:

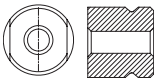
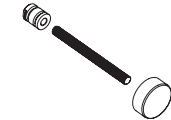
- Prefix Ref. # with (SNG) single or (B2B) back-to-back. Specify part number, pull height, door material, and door thickness.
For single pull on wood door, specify roses or blind fasteners.
- Inserts and mounting hardware included in stock pull TG 9387, list price as shown.
- Mounting hardware also available as multi-pack service packs and priced separately following pulls.

Model Accessories	Ref. #	U/M	Description	List \$
	905.390	Set	Service inserts, reduces post thread from 8 mm–6 mm, used for every mounting post. Bulk pack of 6. Used as service item.	11.00
	905.388	Set	Service mounting pack with finished mounting ROSE used for SNG WOOD mount 1-3/8"–2" (40 mm–51 mm). Bulk pack of 6. Used as service item.	47.00
	905.386	Set	Service mounting pack used for BACK-TO-BACK WOOD mount 1-3/8"–2" (40 mm–51 mm). Bulk pack of 6. Used as service item.	25.00
	905.389	Set	Service mounting pack with BLIND (concealed) fasteners. Used for SNG WOOD mount ≥ 1-3/8" (40 mm). Bulk pack of 6. Used as service item.	25.00

øG	1-1/4" (32)				
øS	1" (25)				
H	3-3/8" (85)				
3 fixings required	60" (1,524)				
(CTC) Center-to-Center	37-1/2" (953)	26-1/4" (667)	22-1/2" (571)	11-1/4" (286)	7-1/2" (191)
L (Length)	60" (1,524)	42" (1,067)	36" (914)	18" (457)	12" (305)

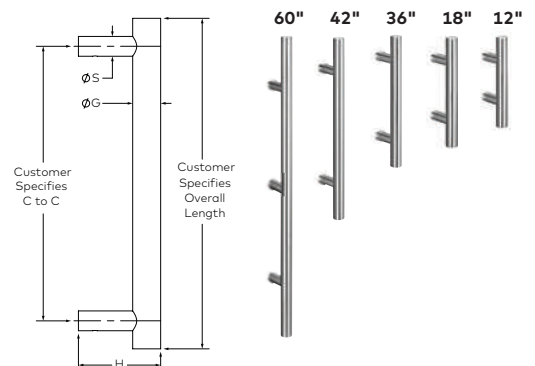

TG 9387 Custom Size Non-Locking Ladder Pulls, with Straight Fixing Posts

Pull Handles for Commercial Doors					Standard Finish \$		Custom Finish \$
Model	Ref. #	U/M	No. Of Fixing Posts	Description	700	701	999
Back-to-Back 1-1/4" (32 mm) Diameter					(SO)	(SO)	(SO)
	905.568	Ea.	3F	L = 94-1/2" through 110-3/16"	1492.00	1640.00	2039.00
	905.567	Ea.	3F	L = 74-13/16" through 94-7/16"	1290.00	1421.00	1838.00
	905.566	Ea.	2F	L = 59-1/16" through 74-3/4"	1091.00	1199.00	1637.00
	905.565	Ea.	2F	L = 43-5/16" through 59"	890.00	979.00	1298.00
	905.564	Ea.	2F	L = 27-9/16" through 43-1/4"	690.00	757.00	1098.00
	905.563	Ea.	2F	L = 11-13/16" through 27-1/2"	487.00	537.00	896.00
Single Sided 1-1/4" (32 mm) Diameter					(SO)	(SO)	(SO)
	905.368	Ea.	3F	L = 94-1/2" through 110-3/16"	882.00	971.00	1156.00
	905.367	Ea.	3F	L = 74-13/16" through 94-7/16"	774.00	852.00	1046.00
	905.366	Ea.	2F	L = 59-1/16" through 74-3/4"	664.00	730.00	937.00
	905.365	Ea.	2F	L = 43-5/16" through 59"	555.00	611.00	759.00
	905.364	Ea.	2F	L = 27-9/16" through 43-1/4"	446.00	491.00	650.00
	905.363	Ea.	2F	L = 11-13/16" through 27-1/2"	336.00	368.00	540.00
Back-to-Back 1" (25 mm) Diameter					(SO)	(SO)	(SO)
	905.527	Ea.	3F	L = 94-1/2" through 110-3/16"	1298.00	1428.00	1844.00
	905.526	Ea.	3F	L = 74-13/16" through 94-7/16"	1156.00	1272.00	1702.00
	905.525	Ea.	3F	L = 59-1/16" through 74-3/4"	1012.00	1113.00	1559.00
	905.524	Ea.	2F	L = 43-5/16" through 59"	869.00	956.00	1278.00
	905.523	Ea.	2F	L = 27-9/16" through 43-1/4"	726.00	797.00	1136.00
	905.522	Ea.	2F	L = 11-13/16" through 27-1/2"	582.00	641.00	992.00
Single Sided 1" (25 mm) Diameter					(SO)	(SO)	(SO)
	905.327	Ea.	3F	L = 94-1/2" through 110-3/16"	843.00	928.00	1116.00
	905.326	Ea.	3F	L = 74-13/16" through 94-7/16"	752.00	827.00	1024.00
	905.325	Ea.	3F	L = 59-1/16" through 74-3/4"	661.00	726.00	933.00
	905.324	Ea.	2F	L = 43-5/16" through 59"	569.00	626.00	774.00
	905.323	Ea.	2F	L = 27-9/16" through 43-1/4"	477.00	525.00	681.00
	905.322	Ea.	2F	L = 11-13/16" through 27-1/2"	385.00	423.00	590.00

Net Add \$

POWDER All Custom powder coated orders will include a net charge per purchase order.

275.00

NOTE: Specify door thickness to acquire appropriate mounting screwpack.

øG	1" (25)	1-1/4" (32)
øS	11/16" (18)	1" (25)
H	2-15/16" (75)	3-3/8" (85)
3 fixings required	59-1/16" (1,500)	59-1/16" (1,500)

NOTES:

- When required, 3rd fixing post is centered on L dimension unless otherwise requested. Center distance can be specifically tailored to your requirements.
- Specify door thickness and desired screwpack.
- Top and bottom post location is preset at factory unless specified custom by customer.

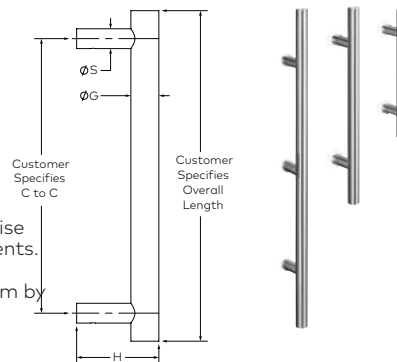

(SO) Special Fabricated/Finish or Special Order; lead time up to 5 weeks.

MANET Non-Locking Ladder Pulls, with straight fixing posts and MANET clamping disks

Pull Handles for Commercial Doors, Back-to-Back (B2B) or Single Sided **Standard Finish \$** **Custom Finish \$**

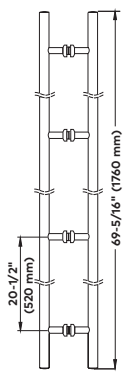
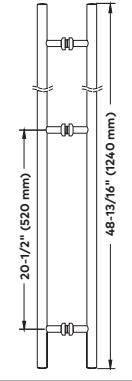
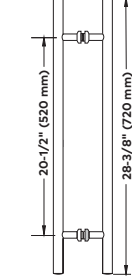
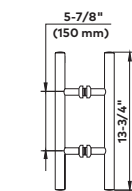
Model	Ref. #	U/M	No. Of Fixing Posts	Description	700	999
Back-to-Back					①	SO
	821.276	Ea.	4F	20-1/2" (520 mm) Center-to-Center Length 69-5/16" (1760 mm)	830.00	1588.00
	821.273	Ea.	3F	20-1/2" (520 mm) Center-to-Center Length 48-13/16" (1240 mm)	692.00	1460.00
	821.270	Ea.	2F	20-1/2" (520 mm) Center-to-Center Length 28-3/8" (720 mm)	554.00	985.00
	821.267	Ea.	2F	5-7/8" (150 mm) Center-to-Center Length 13-3/4" (350 mm)	404.00	813.00

Net Add \$

POWDER All Custom powder coated orders will include a net charge per purchase order. 275.00

NOTES:

- Specify door thickness and either wood or glass door material.
- Specify Ref. # 829.991 for 1-3/4" (44 mm) wood door fasteners, no additional charge.

- ① Non-Fabricated item, ships in 1 business day.
- SO Special Fabricated/Finish or Special Order; lead time up to 5 weeks.

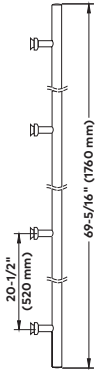
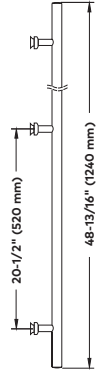
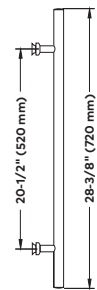
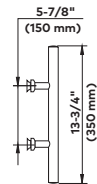
Pull Handles for Commercial Doors					Standard Finish \$	Custom Finish \$
Model	Ref. #	U/M	No. Of Fixing Posts	Description	700	999
Single Sided					(SO)	(SO)
	821.243	Ea.	4F	20-1/2" (520 mm) Center-to-Center Length 69-5/16" (1760 mm)	649.00	922.00
	821.242	Ea.	3F	20-1/2" (520 mm) Center-to-Center Length 48-13/16" (1240 mm)	527.00	801.00
	821.241	Ea.	2F	20-1/2" (520 mm) Center-to-Center Length 28-3/8" (720 mm)	366.00	572.00
	821.240	Ea.	2F	5-7/8" (150 mm) Center-to-Center Length 13-3/4" (350 mm)	301.00	506.00
Net Add \$						
POWDER	All Custom powder coated orders will include a net charge per purchase order.					275.00

NOTES:

- Specify door thickness and either wood or glass door material.
- Specify Ref. # 829.991 for 1-3/4" (44 mm) wood door fasteners, no additional charge.

(SO) Special Fabricated/Finish or Special Order; lead time up to 5 weeks.

TG 9335 Decorative Pulls, Straight Pull with Mitered Corners/Posts

Pull Handles for Commercial Doors					Standard Finish \$		Custom Finish \$
Model	Ref. #	U/M	No. Of Fixing Posts	Description	700	701	999
Back-to-Back 1-1/4" (32 mm) Diameter					(SO)	(SO)	(SO)
	905.545	Ea.	3F	CTC = 94-1/2" through 110-3/16"	1371.00	1508.00	1917.00
	905.544	Ea.	3F	CTC = 74-13/16" through 94-7/16"	1179.00	1296.00	1725.00
	905.543	Ea.	3F	CTC = 59-1/16" through 74-3/4"	987.00	1086.00	1535.00
	905.542	Ea.	2F	CTC = 43-5/16" through 59"	796.00	877.00	1207.00
	905.541	Ea.	2F	CTC = 27-9/16" through 43-1/4"	606.00	665.00	1015.00
	905.540	Ea.	2F	CTC = 7-7/8" through 27-1/2"	414.00	455.00	825.00
Single Sided 1-1/4" (32 mm) Diameter					(SO)	(SO)	(SO)
	905.345	Ea.	3F	CTC = 94-1/2" through 110-3/16"	823.00	905.00	1096.00
	905.344	Ea.	3F	CTC = 74-13/16" through 94-7/16"	716.00	790.00	991.00
	905.343	Ea.	3F	CTC = 59-1/16" through 74-3/4"	612.00	675.00	885.00
	905.342	Ea.	2F	CTC = 43-5/16" through 59"	507.00	557.00	712.00
	905.341	Ea.	2F	CTC = 27-9/16" through 43-1/4"	403.00	441.00	607.00
	905.340	Ea.	2F	CTC = 7-7/8" through 27-1/2"	299.00	329.00	505.00
Back-to-Back 1" (25 mm) Diameter					(SO)	(SO)	(SO)
	905.506	Ea.	3F	CTC = 94-1/2" through 110-3/16"	1729.00	1903.00	2275.00
	905.505	Ea.	3F	CTC = 74-13/16" through 94-7/16"	1530.00	1685.00	2077.00
	905.504	Ea.	3F	CTC = 59-1/16" through 74-3/4"	1332.00	1466.00	1879.00
	905.503	Ea.	2F	CTC = 43-5/16" through 59"	1136.00	1249.00	1545.00
	905.502	Ea.	2F	CTC = 27-9/16" through 43-1/4"	937.00	1031.00	1346.00
	905.501	Ea.	2F	CTC = 8-1/4" through 27-1/2"	740.00	813.00	1149.00
Single Sided 1" (25 mm) Diameter					(SO)	(SO)	(SO)
	905.306	Ea.	3F	CTC = 94-1/2" through 110-3/16"	1015.00	1116.00	1288.00
	905.305	Ea.	3F	CTC = 74-13/16" through 94-7/16"	905.00	995.00	1177.00
	905.304	Ea.	3F	CTC = 59-1/16" through 74-3/4"	794.00	873.00	1068.00
	905.303	Ea.	2F	CTC = 43-5/16" through 59"	682.00	752.00	888.00
	905.302	Ea.	2F	CTC = 27-9/16" through 43-1/4"	573.00	629.00	778.00
	905.301	Ea.	2F	CTC = 8-1/4" through 27-1/2"	462.00	509.00	666.00

Net Add \$

POWDER All Custom powder coated orders will include a net charge per purchase order.

275.00

NOTES:



- When required, 3rd fixing post is centered on **CTC** dimension unless otherwise requested.
- CTC=Center to center of mounting posts.
- Specify door thickness and desired screwpack. See following page for options.

(SO) Special Fabricated/Finish or Special Order; lead time up to 5 weeks.

TG Decorative Pulls

Pull Handles for Commercial Doors				Standard Finish \$		Custom Finish \$
Model	Ref. #	U/M	Description	700	701	999
TG 9830 Bowed Pull, 13-3/4" (349 mm) Center-to-Center				(SO)	(SO)	(SO)
	905.530	Set	Back-to-Back	816.00	898.00	1091.00
	905.330	Ea.	Single Sided	503.00	553.00	707.00
TG 9304 Curved Pull, Radius Standoff, 1-1/4" (32 mm) Diameter, 13-3/4" (349 mm) Center-to-Center				(SO)	(SO)	(SO)
	905.569	Set	Back-to-Back	414.00	455.00	688.00
	905.369	Ea.	Single Sided	271.00	298.00	476.00
			Ø 1-1/4" (32 mm)			
			R 1-3/4" (44 mm)			
			R1 6-7/8" (175 mm)			
			B 8-11/16" (220 mm)			
			H 3-3/8" (85 mm)			
			CTC 13-3/4" (350 mm)			
TG 9306 Curved Pull, Sharp/Straight Standoff, 1-9/16" (40 mm) Diameter, 13-3/4" (349 mm) Center-to-Center				(SO)	(SO)	(SO)
	905.611	Set	Back-to-Back	915.00	1007.00	1188.00
	905.411	Ea.	Single Sided	550.00	605.00	755.00
			ØGØS 1-9/16" (40 mm)			
			R 6-7/8" (175 mm)			
			B 8-3/16" (205 mm)			
			H 3-15/16" (100 mm)			
			M 1" (24 mm)			
NOTE: Specify door thickness and desired screwpack.						
Fixings for TG Handles to Glass Doors 1-3/8" (35 mm)–3-15/16" (100 mm) Thick				700/701		999
				(SO)	(SO)	
	905.901	Ea.	Back-to-Back – M6	35.00	38.00	
	905.903	Ea.	Back-to-Back – M8	35.00	38.00	
	905.907	Ea.	Single Sided – M6	60.00	64.00	
	905.906	Ea.	Single Sided – M8	60.00	64.00	
Rose Options for TG Pulls						
	905.971	Ea.	1-9/16" (40 mm) Rose – M6	16.00	19.00	
	905.972	Ea.	1-3/4" (44 mm) Rose – M8	16.00	19.00	
						Net Add \$
POWDER	All Custom powder coated orders will include a net charge per purchase order.					275.00
(SO) Special Fabricated/Finish or Special Order; lead time up to 5 weeks.						

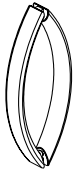
ARCOS and BEYOND Decorative Pulls

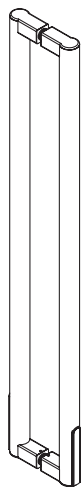
Pulls for Commercial Doors					Standard Finish \$	Custom Finish \$	
Model	Ref. #	U/M	No. Of Fixing Posts	Description	114	999	
ARCOS 15-11/16" (398 mm) Length					(SO)	(SO)	
	826.500	Set	2F	13-3/4" (350 mm) Center-to-Center	466.00	740.00	
ARCOS 32-1/16" (824 mm) Length					(SO)	(SO)	
	826.510	Set	2F	29-1/2" (750 mm) Center-to-Center	550.00	1096.00	
					107	999	
BEYOND, Specify Door Thickness					(SO)	(SO)	
	830.300	Set	2F	17-3/4" (450 mm) Center-to-Center 3/8" (10 mm) or 1/2" (12 mm)	1115.00	1388.00	
	830.305	Set	2F	23-5/8" (600 mm) Center-to-Center 3/8" (10 mm) or 1/2" (12 mm)	1293.00	1565.00	
	830.310	Set	2F	35-7/16" (900 mm) Center-to-Center 3/8" (10 mm) or 1/2" (12 mm)	1542.00	2089.00	
					Net Add \$		
POWDER	All Custom powder coated orders will include a net charge per purchase order.					275.00	

NOTE: Specify door thickness and either wood or glass door material.

(SO) Special Fabricated/Finish or Special Order; lead time up to 5 weeks.

Solid and Tubular Pull Handles for Commercial doors

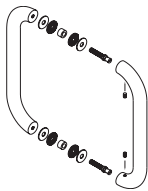
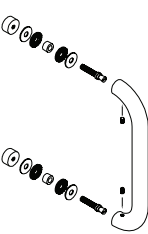
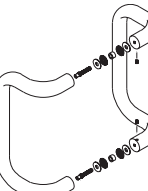
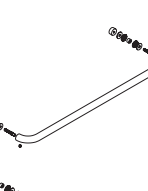
Model	Ref. #	U/M	Description	Finishes \$						
				101	108	109	503/599	600/601	700	701
Solid and Tubular, Back-to-Back, 10" and 12" (Center-to-Center) Handles				①	①	SO	SO	SO	①	SO
	926.001	Set	10" (254 mm) Solid	81.00	85.00	85.00	0.00	342.00	182.00	182.00
	926.601	Set	10" (254 mm) Tubular	—	—	—	147.00	—	97.00	97.00
	926.004	Set	12" (305 mm) Solid	85.00	92.00	92.00	247.00	616.00	202.00	202.00
	926.604	Set	12" (305 mm) Tubular	—	—	—	155.00	—	102.00	102.00
Solid and Tubular, Single Sided, 10" and 12" (Center-to-Center) Handles				SO	SO	SO	SO	SO	SO	SO
	926.012	Ea.	10" (254 mm) Solid	49.00	57.00	57.00	—	—	—	—
	926.612	Ea.	10" (254 mm) Tubular	—	—	—	—	—	62.00	62.00
	926.016	Ea.	12" (305 mm) Solid	63.00	68.00	68.00	—	—	—	—
	926.616	Ea.	12" (305 mm) Tubular	—	—	—	—	—	68.00	68.00
Solid and Tubular, Back-to-Back Offset, 10" and 12" (Center-to-Center) Handles				SO	SO	SO	SO	SO	SO	SO
	926.622	Set	10" (254 mm) Tubular	—	—	—	—	—	123.00	123.00
	926.009	Set	12" (305 mm) Solid	97.00	108.00	108.00	—	—	—	—
	926.609	Set	12" (305 mm) Tubular	—	—	—	197.00	—	132.00	132.00
Solid and Tubular, Back-to-Back, 10" and 12" (Center-to-Center) x 27-3/4" Handles				SO	SO	SO	SO	SO	SO	SO
	926.002	Set	10" x 27-3/4" (254 x 705 mm) Solid	111.00	125.00	125.00	—	—	—	—
	926.602	Set	10" x 27-3/4" (254 x 705 mm) Tubular	—	—	—	—	—	157.00	157.00
	926.005	Set	12" x 27-3/4" (305 x 705 mm) Solid	108.00	120.00	120.00	0.00	0.00	339.00	339.00
	926.605	Set	12" x 27-3/4" (305 x 705 mm) Tubular	—	—	—	210.00	0.00	168.00	168.00

NOTES:

- Tubular handles include a 1-1/4" (32 mm) washer.
- Specify door thickness and either wood or glass door material.
- Call Customer Service for wood door thickness 1-3/8"-2-1/2" fastener information and ordering guidance.

① Non-Fabricated item, 2-day lead time.

SO Special Fabricated/Finish or Special Order; lead time up to 5 weeks.



Door
Hardware



Electronic
Access & Data



Mechanical
Key Systems



Lodging
Systems



Entrance
Systems



Safe
Locks



Service

Our Sustainability Commitment

We are committed to fostering a sustainable development along our entire value chain in line with our economic, environmental and social responsibilities toward current and future generations.

