

textiles (asia pacific)

program guide

12.18.2023



teknion

update summary

Please be advised that information has been updated within the Textiles Program Guide (Asia Pacific). To highlight these updates a summary has been created for your reference.

new

The following new fabrics have been added:

- Architectural
 - Intraweb (Gr.3)
 - Milieu (Gr.3)

- Upholstery
 - Intraweb (Gr.3)
 - Milieu (Gr.3)
 - Contrast Slub (Gr.7)

Please note, first orders for new products will be accepted on December 18, 2023. All software will also be updated by December 18, 2023. If you have any questions regarding the information enclosed, please contact your Teknion Customer Service Representative.





PANEL FABRICS	7
UPHOLSTERY FABRICS	21
GENERAL INFORMATION	83
ZONES TEXTILES	93

panel fabrics

APPLICATION MATRICES

STANDARD PANEL FABRICS	8
ARCHITECTURAL FABRICS	9

LISTINGS MATRICES

STANDARD PANEL FABRICS

GRADE A	
BEELINE	10
BITSTREAM	10
EGYPT	10
NITTY GRITTY	10
TANGLE	10
WALES	10
WIRED UP	10
GRADE 1	
BANDEAU	10
BRAZIL	10
EMIT	10
ESSENTIALS	10
FLICKER	10
HEATHER TECH	10
INDIA	11
LINEN WEAVE	11
LUSTRADO	11
MAKAH	11
PERU	11
PRESSE	11
RATIONALE	11
TOPOLOGY	11
WARP SPEED	11
GRADE 2	
ACTUATE	11
BOUCLE GRID	11
COMPLEMENT	11
DIGI TWEED	11
GRAVITON	12
MEGACHECK	12
PERCEPT	12
STRATIFORM	12
TWINING	12

GRADE 3	
ARTOPIA	12
CROSS DYE	12
ARCHITECTURAL FABRICS	
GRADE 1	
RATIONALE	13
GRADE 2	
ACTUATE	13
ARTOPIA	13
BANDEAU	13
BOUCLE GRID	13
COMPLEMENT	13
CROSSGRAIN	13
DIGI TWEED	13
EMIT	13
GRAVITON	14
HEATHER TECH	14
INTONE	14
LUSTRADO	14
MEGACHECK	14
PERCEPT	14
PRESSE	14
STRATIFORM	14
STRIO	14
TWINING	14
GRADE 3	
ECOTONE	14
GRID STATE	15
 INTRAWEB	15
 MILIEU	15
TWISTED TWEED	15



application matrices

STANDARD PANEL FABRICS

	complement (metric)	district	expansion casegood	expansion citybench	expansion cityline	filing & storage	height-adjustable-bench	interpret international	seating	social & collaborative	tables & collaborative	tek vue	tek n	world wide complements	pod
Grade A															
Beeline	Available	Available		Available	Available		Available	Available						Available	
Bitstream					Available									Available	
Egypt	Available	Available		Available			Available	Available						Available	
Nitty Gritty	Available	Available		Available			Available	Available						Available	
Tangle	Available	Available		Available			Available	Available						Available	
Wales	Available	Available		Available			Available	Available						Available	
Wired Up	Available	Available		Available			Available	Available						Available	
Grade 1															
Bandeau	Available	Available		Available	Available		Available	Available						Available	
Brazil	Available	Available		Available	Available		Available	Available						Available	
Emit	Available	Available		Available	Available		Available	Available						Available	
Essentials	Available	Available		Available	Available		Available	Available						Available	
Heather Tech	Available	Available		Available	Available		Available	Available						Available	
Flicker	Available	Available		Available	Available		Available	Available						Available	
India	Available	Available		Available	Available		Available	Available						Available	
Linen Weave	Available	Available		Available	Available		Available	Available						Available	
Lustrado	Available	Available		Available	Available		Available	Available						Available	
Makah	Available	Available		Available	Available		Available	Available						Available	
Peru	Available	Available		Available	Available		Available	Available						Available	
Presse	Available	Available		Available	Available		Available	Available						Available	
Rationale	Available	Available		Available	Available		Available	Available						Available	
Topology	Available	Available		Available	Available		Available	Available						Available	
Warp Speed	Available	Available		Available	Available		Available	Available						Available	
Grade 2															
Actuate				Available	Available									Available	
Boucle Grid				Available	Available		Available							Available	
Complect					Available									Available	
Complement				Available	Available									Available	
Crossgrain					Available									Available	
Digi Tweed				Available	Available		Available							Available	
Graviton				Available	Available		Available							Available	
Megacheck					Available									Available	
Percept					Available									Available	
Stratiform					Available									Available	
Twining					Available									Available	
Grade 3															
Artopia	Available	Available			Available		Available	Available						Available	
Cross Dye	Available	Available			Available		Available	Available						Available	

application matrices

ARCHITECTURAL FABRICS

	complement (metric)	district	expansion casegood	expansion city/bench	expansion city/line	filing & storage	height-adjustable- bench	interpret international	seating	social & collaborative	tables & collaborative	tek vue	tek n	world wide complements	pod
Grade 1															
Rationale															
Grade 2															
Actuate															
Artopia															
Bandeau															
Bitsream															
Boucle Grid															
Complect															
Complement															
Crossgrain															
Digi Tweed															
Emit															
Graviton															
Heather Tech															
Intone															
Lustrado															
Megacheck															
Percept															
Presse															
Stratiform															
Strio															
Twining															
Grade 3															
Ecotone															
Grid State															
Intraweb 															
Milieu 															
Twisted Tweed															

listings matrices

STANDARD PANEL FABRICS

GRADE A

Beeline

Plumb	B631
String	B632
Strand	B633
Thread	B634

Bitstream

Blue Team	R591
Firewire	R592
Flash Drive	R593
Grey Code	R586
Hardware	R583
Lithium	R585
Silicone	R587
Tablet	R582
Trackback	R584
Wavelet	R590
White Noise	R588
Xenon	R589

Egypt

Cairo	E301
Edfu	E356
Giza	E302
Idku	E355
Jirja	E354
Mallawi	E352
Port Said	E304
Suez	E305

Nitty Gritty

Block	N122
Detail	N123
Factor	N134
Gist	N133
Specific	N135
Think	N130

Tangle

Crook	T538
Entwine	T540
Interweave	T533
Kinks	T535
Knot	T532
Muddle	T539
Ravel	T534
Snarl	T531
Spangle	T536
Tousle	T537

GRADE A (continued)

Wales

Bangor	W417
Corwen	W416
Goodwick	W421
Kidwelly	W420
Newbridge	W418
Newport	W404
Pembroke	W419
Swansea	W402
Teifi	W403
Wrexham	W414

Wired Up

Caged	W731
Circuit	W744
Drawplate	W742
Intermingle	W739
Linkage	W741
Mesh	W740
Nichrome	W743

GRADE 1

Bandeau

Farran	B128
Grosgrain	B126
Palla	B127
Washi	B124

Brazil

Betim	B220
Campo Grande	B260
Canela	B204
Jacarei	B217
Laguna	B233
Manaus	B203
Olinda	B231
Serra	B261
Timbo	B208

Emit

Dazzle	T730
Hertz	T728
Joule	T729
Particle	T732
Surge	T731
Watt	T727

GRADE 1 (continued)

Essentials

Atlantic	E413
Banner	E391
Basil	E412
Brier	E383
Dove	E382
Gris	E380
Light Grey	E384
Mist	E410
Pebble	E415
Slate	E385
Snowdrift	E409
Tropic	E416

Flicker

Beam	F532
Flash	F534
Gleam	F537
Glint	F535
Glitter	F531
Glow	F538
Luster	F539
Sheen	F536
Sparkle	F533
Twinkle	F540

Heather Tech

Basalt Tech	R247
Beetroot Tech	R255
Clear Tech	R258
Crag Tech	R246
Dust Tech	R240
Flax Tech	R243
Lav Tech	R257
Loam Tech	R245
Loch Tech	R259
Loden Tech	R248
Madder Tech	R254
Meadow Tech	R250
North Sea Tech	R261
Oat Tech	R242
Obsidian Tech	R263
Ocean Tech	R260
Onyx Tech	R262
Raspite Tech	R253
Rose Tech	R252
Sagebrush Tech	R249
Silt Tech	R244
Sundew Tech	R251
Thistle Tech	R256
Topaz Tech	R241

listings matrices

STANDARD PANEL FABRICS (continued)

GRADE 1 (continued)

India

Agra	D404
Bombay	D402
Chennai	D422
Gwalior	D405
Haora	D408
Kashmir	D417
Kerala	D419
Manali	D425
Mumbai	D424
Munnar	D420
Nanital	D421
Pune	D423
Pushkar	D418
Surat	D409
Varanasi	D407

Linen Weave

Bast	L328
Coir	L327
Dusty Grey	L329
Gate	L308
Linseed	L331
Mineral	L330
Sesame	L309

Lustrado

Acetate	L364
Alloy	L366
Brilliance	L365
Gallium	L367
Glassine	L363
Incandescent	L368
Resin	L369
Sterling	L370
Varnish	L372
Vitreous	L373

Makah

Arundo	M417
Flitch	M419
Luminous	M416
Shaker	M415
Solano	M418
Splint	M420

Peru

Callao	P409
Casma	P404
Cuzco	P406
Lima	P403
Nazca	P402
Puerto	P412
Puno	P405
Tacna	P401
Tingo Maria	P407
Tumbes	P411

GRADE 1 (continued)

Presse

Gravure	P105
Halo Effect	P100
Masked	P102
Overlay	P101
Plaited	P104
Relief	P103

Rationale

Abstract	R384
Classical	R380
Drift	R381
Firma	R382
Infinite	R386
Lucid	R383
Mind's Eye	R385
Transcend	R387

Topology

Ceramic	T100
Cooling	T103
Natural	T102
Open Space	T101
Shadow	T104

Warp Speed

Earth Orbit	W116
Headwind	W110
Reed Arrow	W113
Jet	W114
Strobe	W112
Steel Racer	W115
White Space	W111

GRADE 2

Actuate

Aqueous	T740
Spectral	T741
Aether	T742
Facet	T743
Syntax	T744
Vanish	T745
Suffuse	T746
Mordant	T747
Lambent	T748
Conscious	T749
Fortify	T750
Favrile	T751
Prelude	T752
Meridian	T753
Thermal	T754
Induction	T755

GRADE 2 (continued)

Boucle Grid

Ardoise	B121
Bis	B120
Craie	B119
Fauve	B122
Nuage	B123

Complement

Amarillo	C284
Arancia	C285
Carnelian	C286
Dusk	C280
Fresh Air	C289
Garnet	C287
Grey Wolf	C281
Nightfall	C279
Peacock	C290
Roan	C283
Sea Salt	C282

Digi Tweed

Basalt Tweed	B137
Beetroot Tweed	B145
Clear Tweed	B148
Crag Tweed	B136
Dust Tweed	B130
Flax Tweed	B133
Lav Tweed	B147
Loam Tweed	B135
Loch Tweed	B149
Loden Tweed	B138
Madder Tweed	B144
Meadow Tweed	B140
North Sea Tweed	B151
Oat Tweed	B132
Obsidian Tweed	B153
Ocean Tweed	B150
Onyx Tweed	B152
Raspite Tweed	B143
Rose Tweed	B142
Sagebrush Tweed	B139
Silt Tweed	B134
Sundew Tweed	B141
Thistle Tweed	B146
Topaz Tweed	B131

listings matrices

STANDARD PANEL FABRICS (continued)

GRADE 2 (continued)

Graviton

Dark Matter	R351
Chain Reaction	R352
Echo	R353
Cloud Chamber	R354
Albedo	R355
Half Life	R356
Luminous Flux	R357
Fission	R358
Kelvin	R359
Boiling Point	R360
Quantum	R361
Condensation	R362
Centigrade	R363
Ampere	R364
Cold Fusion	R365
Hydrostatic	R366

Megacheck

Liminal	R654
Convex	R655
Concave	R656
Drop Shadow	R657
Litmus	R658
Gradient	R659
Distort	R660
Resolution	R661
Glitch	R662
Flashbulb	R663
Visage	R664
Magnitude	R665

Percept

Amplitude	C823
Cardinality	C825
Constant	C835
Context	C818
Devotion	C831
Epiphany	C821
Essence	C819
Fringe	C840
Harmonic	C829
Ignite	C828
Intrinsic	C815
Jubilant	C827
Nebula	C826
Peak	C830
Placid	C838
Pristine	C814
Propagate	C837
Pulse	C834
Radiant	C836
Reason	C824
Render	C833
Schema	C813

GRADE 2 (continued)

Percept (continued)

Singular	C839
Sublime	C817
Tenet	C820
Transmit	C832
Verve	C822

Stratiform

Calcify	R600
Limestone	R601
Sandhill	R602
Moraine	R603
Glacial	R604
Bedrock	R605
Flint	R606

Twining

Ivory Vine	W117
Pale Straw	W118
Abaca	W119
Sisal	W120
Quill	W121
Silvery Strand	W122
Bulrush	W123

GRADE 3

Artopia

Amerlith	R180
Aquatint	R182
Cadmium	R181
Kinetic	R177
Magenta	R179
Primer	R176
Stencil	R178
Vivid Blue	R183

Cross Dye

Ace Grey	R155
Almond	R153
Artichoke	R161
Azure	R164
Carmine	R159
Carotene	R157
Cool Ash	R156
Crimson	R158
Earl Grey	R150
Light Birch	R152
Linen	R151
Logwood	R165
Plum	R162
Soft Shadow	R154
Tea Tree	R160
Watercolor	R163

listings matrices

ARCHITECTURAL FABRICS

GRADE 1

Rationale

Abstract	B384
Classical	B380
Drift	B381
Firma	B382
Infinite	B386
Lucid	B383
Mind's Eye	B385
Transcend	B387

GRADE 2

Actuate

Aether	A211
Aqueous	A209
Conscious	A218
Facet	A212
Favrile	A220
Fortify	A219
Induction	A224
Lambent	A217
Meridian	A222
Mordant	A216
Prelude	A221
Spectral	A210
Suffuse	A215
Syntax	A213
Thermal	A223
Vanish	A214

Artopia

Amerlith	R234
Aquatint	R236
Cadmium	R235
Kinetic	R231
Magenta	R233
Primer	R230
Stencil	R232
Vivid Blue	R237

Bandeau

Farran	D115
Grosgrain	D113
Palla	D114
Washi	D111

GRADE 2 (continued)

Bitstream

Tablet	B582
Hardware	B583
Trackback	B584
Lithium	B585
Grey Code	B586
Silicone	B587
White Noise	B588
Xenon	B589
Wavelet	B590
Blue Team	B591
Firewire	B592
Flash Drive	B593

Boucle Grid

Ardoise	C113
Bis	C112
Craie	C111
Fauve	C114
Nuage	C115

Complect

Melanite	C293
Quarry	C294
Silverleaf	C295
Jute	C296
Cumulus	C297
Yolk	C298
Apricot	C299
Highlighter Pink	C300
Deep Crimson	C301
Autumn	C302
Opaline	C303
Reservoir	C304
Gentian	C305
Blue Ice	C306
Winter	C307
Boreal	C308
Turquoise	C309
Okra	C310
Agave	C311

Complement

Amarillo	T153
Arancia	T154
Carnelian	T155
Dusk	T149
Fresh Air	T158
Garnet	T156
Grey Wolf	T150
Nightfall	T148
Peacock	T159
Roan	T152
Sea Salt	T151

GRADE 2 (continued)

Crossgrain

Underbrush	C157
Dado	C158
Blackwood	C159
Cove	C160
Xylem	C161
Tenon	C162
Amaranth	C163
Red Oak	C164
Tuliptree	C165
Iroko	C166
Ginkgo	C167
Burl	C168
Cypress	C169
Springwood	C170
Driftwood	C171

Digi Tweed

Basalt Tweed	D317
Beetroot Tweed	D325
Clear Tweed	D328
Crag Tweed	D316
Dust Tweed	D310
Flax Tweed	D313
Lav Tweed	D327
Loam Tweed	D315
Loch Tweed	D329
Loden Tweed	D318
Madder Tweed	D324
Meadow Tweed	D320
North Sea Tweed	D331
Oat Tweed	D312
Obsidian Tweed	D333
Ocean Tweed	D330
Onyx Tweed	D332
Raspite Tweed	D323
Rose Tweed	D322
Sagebrush Tweed	D319
Silt Tweed	D314
Sundew Tweed	D321
Thistle Tweed	D326
Topaz Tweed	D311

Emit

Watt	E314
Hertz	E315
Joule	E316
Dazzle	E317
Surge	E318
Particle	E319

listings matrices

ARCHITECTURAL FABRICS (continued)

GRADE 2 (continued)

Graviton

Dark Matter	G222
Chain Reaction	G223
Echo	G224
Cloud Chamber	G225
Albedo	G226
Half Life	G227
Luminous Flux	G228
Fission	G229
Kelvin	G230
Boiling Point	G231
Quantum	G232
Condensation	G233
Centigrade	G234
Ampere	G235
Cold Fusion	G236
Hydrostatic	G237

Heather Tech

Basalt Tech	T169
Beetroot Tech	T177
Clear Tech	T180
Crag Tech	T168
Dust Tech	T162
Flax Tech	T165
Lav Tech	T179
Loam Tech	T167
Loch Tech	T181
Loden Tech	T170
Madder Tech	T176
Meadow Tech	T172
North Sea Tech	T183
Oat Tech	T164
Obsidian Tech	T185
Ocean Tech	T182
Onyx Tech	T184
Raspite Tech	T175
Rose Tech	T174
Sagebrush Tech	T171
Silt Tech	T166
Sundew Tech	T173
Thistle Tech	T178
Topaz Tech	T163

Intone

Ash	LM12
Caraway	LM16
Cinder	LM18
Creme	LM13
Eclipse	LM21
Harbor	LM14
Lute	LM19
Oxide	LM17
Pome	LM20
Quicksilver	LM15

GRADE 2 (continued)

Lustrado

Acetate	D101
Alloy	D103
Brilliance	D102
Gallium	D104
Glassine	D100
Incandescent	D105
Resin	D106
Sterling	D107
Varnish	D109
Vitreous	D110

Megacheck

Liminal	M328
Convex	M329
Concave	M330
Drop Shadow	M331
Litmus	M332
Gradient	M333
Distort	M334
Resolution	M335
Glitch	M336
Flashbulb	M337
Visage	M338
Magnitude	M339

Percept

Amplitude	P116
Cardinality	P118
Constant	P128
Context	P111
Devotion	P124
Epiphany	P114
Essence	P112
Fringe	P133
Harmonic	P122
Ignite	P121
Intrinsic	P108
Jubilant	P120
Nebula	P119
Peak	P123
Placid	P131
Pristine	P107
Propagate	P130
Pulse	P127
Radiant	P129
Reason	P117
Render	P126
Schema	P106
Singular	P132
Sublime	P110
Tenet	P113
Transmit	P125
Verve	P115

GRADE 2 (continued)

Presse

Gravure	R191
Halo Effect	R186
Masked	R188
Overlay	R187
Plaited	R190
Relief	R189

Stratiform

Calcify	B590
Limestone	B591
Sandhill	B592
Moraine	B593
Glacial	B594
Bedrock	B595
Flint	B596

Strio

Calcite	S239
Dolomite	S237
Feldspar	S242
Lithic	S238
Mineral	S236
Sandstone	S243
Silica	S240
Tor	S244

Twining

Ivory Vine	T141
Pale Straw	T142
Abaca	T143
Sisal	T144
Quill	T145
Silvery Strand	T146
Bulrush	T147

GRADE 3

Ecotone

Abyss	E136
Ravine	E137
Rocky Shore	E138
Permafrost	E139
Tundra	E140
Arid	E141
Savanna	E142
Desert Bloom	E143
Badlands	E144
Caldera	E145
Freshwater	E146
Intertidal	E147
Rain Shadow	E148
Lichen	E149
Mangrove	E150
Treeline	E151

listings matrices

ARCHITECTURAL FABRICS (continued)

GRADE 3 (continued)

Grid State

Arc Flash	G132
Open Circuit	G133
Volt Switch	G134
Hydropower	G135
Switchboard	G136
Megawatt	G137
Circuit Break	G138
Electrode	G139
Live Wire	G140
Turbine	G141
Neon Bulb	G142
Wolfram	G143

Intraweb

Raster	T397
Dual Trace	T398
Polytope	T397
Superposition	T400
Coaxial	T401
Origin	T402
Slope	T403
Polarity	T404
Isosurface	T405

Milieu

Kettle	M570
Thunder	M571
Memory	M572
Steam	M573
Wing	M574
Nest	M575
Leap	M576
Troupe	M577
Peregrine	M578
Hedge	M579
Prickle	M580
Spring	M581
Muster	M582
Herd	M583
Parcel	M584
Bloom	M585
Fling	M586
Flamboyance	M587
Bazaar	M588
Rabble	M589
Zeal	M590
Bevy	M591
Loft	M592
Float	M593
Paddling	M594
Shoal	M595
Fleet	M596

GRADE 3 (continued)

Twisted Tweed

Wrought Iron	T278
Rock Garden	T279
Shady Patch	T280
Moongate	T281
Plaster	T282
Stucco	T283
Thatch	T284
Arbor	T285
Daylight	T286
Sundial	T287
Koi Pond	T288
Brickwork	T289
Annual	T290
Perennial	T291
Rain Chain	T292
Open Air	T293
Water Feature	T294
Terrace	T295
Veranda	T296

environmental data

STANDARD PANEL FABRICS

Pattern	Composition	Recycled Polyester	
		Post Consumer	Pre Consumer
Grade A			
Beeline	100% Recycled Polyester	39%	61%
Bitsream	100% Recycled Polyester	58%	42%
Egypt	100% Recycled Polyester		100%
Nitty Gritty	100% Recycled Polyester		100%
Tangle	80% Recycled Polyester 20% Polyester		80%
Wales	93% Recycled Polyester 7% Polyester		93%
Wired Up	100% Recycled Polyester	45%	55%
Grade 1			
Bandeau	100% Recycled Polyester		100%
Brazil	50% Recycled Polyester 50% Polyester		50%
Emit	44% Recycled Polyester 56% Polyester	29%	15%
Essentials	100% Recycled Polyester	35%	65%
Flicker	100% Recycled Polyester	46%	54%
Heather Tech	67% Recycled Polyester 33% Polyester	100%	
India	78% Recycled Polyester 22% Polyester	78%	
Linen Weave	100% Recycled Polyester		100%
Lustrado	75% Recycled Polyester 25% Polypropylene		75%
Makah	100% Recycled Polyester	54%	46%
Peru	100% Recycled Polyester	34%	66%
Presse	100% Recycled Polyester		100%

environmental data

STANDARD PANEL FABRICS (continued)

Pattern	Composition	Recycled Polyester	
		Post Consumer	Pre Consumer
Grade 1 (continued)			
Rationale	80% Recycled Polyester 20% Polyester	80%	
Topology	53% Recycled Polyester 47% Polyester		53%
Warp Speed	67% Recycled Polyester 33% Polyester		67%
Grade 2			
Actuate	40% Recycled Polyester 60% Polyester	40%	
Boucle Grid	100% Recycled Polyester		100%
Complect			
Complements	100% Polyester		
Crossgrain			
Digi Tweed	55% Recycled Polyester 45% Polyester	100%	
Graviton	100% Recycled Polyester	100%	
Megacheck	100% Recycled Polyester		
Percept	81% Recycled Polyester 19% Polyester	81%	
Stratiform	52% Recycled Polyester 48% Polypropylene	43%	9%
Twining	100% Recycled Polyester		100%
Grade 3			
Artopia	100% Polyester		
Cross Dye	66% Recycled Polyester 34% Polyester	61%	5%



environmental data

ARCHITECTURAL FABRICS

Pattern	Composition	Recycled Polyester	
		Post Consumer	Pre Consumer
Grade 1			
Rationale	80% Recycled Polyester 20% Polyester	80%	
Grade 2			
Actuate	40% Recycled Polyester 60% Polyester	40%	
Artopia	100% Polyester		
Bandeau	100% Recycled Polyester		100%
Bitstream	100% Recycled Polyester	58%	42%
Boucle Grid	100% Recycled Polyester		100%
Complect	100% Recycled Polyester	100%	
Complement	100% Polyester		
Crossgrain	100% Polyester		
Digi Tweed	55% Recycled Polyester 45% Polyester	55%	
Emit	44% Recycled Polyester 56% Polyester	29%	15%
Graviton	100% Recycled Polyester	100%	
Heather Tech	67% Recycled Polyester 33% Polyester	67%	
Intone	53% Recycled Polyester 47% Polyester	34.4%	18.6%
Lustrado	75% Recycled Polyester 25% Polypropylene		75%
Megacheck	100% Recycled Polyester		

environmental data

ARCHITECTURAL FABRICS (continued)

Pattern	Composition	Recycled Polyester	
		Post Consumer	Pre Consumer
Grade 2 (continued)			
Percept	81% Recycled Polyester 19% Polyester	81%	
Presse	100% Recycled Polyester		100%
Stratiform	52% Recycled Polyester 48% Polypropylene	43%	9%
Strio	100% Polyester		
Twining	100% Recycled Polyester		100%
Grade 3			
Ecotone	100% Recycled Biodegradable** Polyester		
Grid State	BIODEGRADABLE CLEAN IMPACT TEXTILES™ - 100% Post-Consumer Recycled Biodegradable Polyester**	100%	
Intraweb 	100% Recycled Biodegradable* Polyester		
Milieu 	90% Recycled Polyester, 10% Polyester		
Twisted Tweed	100% Recycled Polyester	100%	

upholstery fabrics

upholstery fabrics

APPLICATION MATRICES

UPHOLSTERY FABRICS	26
LEATHER	29
ASIA PACIFIC	30

LISTING MATRICES

UPHOLSTERY

COM

GRAVITY	34
MAIN LINE FLAX	34
SELECTE	34



GRADE 1

BITSTREAM	34
FUNDAMENTALS	34
HEATHER TECH	35
MAGNIFY	35
STIMULI	35

GRADE 2

ACTUATE	35
COMPECT	35
COMPLEMENT	35
CROSS DYE	35
CROSSGRAIN	35
DECOY	35
DIGI TWEED	36
GRAVITON	36
INTONE	36
MEGACHECK	36
PERCEPT	36
ULTRA DURABLE	36

GRADE 3

AMPLE	37
DOYENNE	37
ECOTONE	37
FINE GRAIN	37
FOCUS	37
FOCUS MELANGE	37
 INTRAWEB	37
MARL CLOTH	37
 MILIEU	38
SITU	38
SUPERSPUN	38
TWISTED TWEED	38

GRADE 4

ELASTIC WOOL	38
FORMWORK	38
GRID STATE	38
INTERSTICE	38
META TEXTURE	38
MODULUS	39
VELVET UNDERGROUND	39

GRADE 5

ADAGE	39
CULT CLASSIC	39
MONOTEX	39
PARTICULATE	39
SYNAPTIC	39

GRADE 6

AMALGAM	39
DUO CHROME	40
HAPTIC	39
OUTPRESS	40
PERILUNE	40
PHOTOGRAM	40
VECTOR	40

GRADE 7

 CONTRAST SLUB	40
EPHEMERA	40
FLEX WOOL	40
OEUVRE	40
OX	40
PEBBLE MELANGE	40
STRUCTURED STRIPE	40
TILT SHIFT REDUX	40
WOOL FLECK	41

upholstery fabrics (continued)

LISTING MATRICES (continued)

UPHOLSTERY (continued)

GRADE 8

CONSTRUCT	41
FULL WOOL	41
GEOGLYPH	41
HOMAGE	41
WAVEFIELD	41
WELDED	41

GRADE 9

EQUILUX	41
GRAPH SPECK	41
HEATHER FELT	41
MELANGE CHECK	41
TOP COAT	42

GRADE 10

COLOR FUSE	42
FLEECE	42

LEATHER

LEATHER - LA	42
LEATHER - LB	42
LEATHER - LC	42
LEATHER - LD	42

ASIA PACIFIC STANDARD

UPHOLSTERY OFFERING

PHILOMINA	42
---------------------	----

INDIA STANDARD

UPHOLSTERY OFFERING

ELEGANT	42
NEPTUNE	42
MARS	43

upholstery fabrics

TEKNION STANDARD UPHOLSTERY FABRIC PROGRAM

All fabrics are developed to enhance Teknion systems products incorporating technology in fiber development. They are designed to coordinate with the other finishes in Teknion system and seating programs. The fabrics are offered in a range of low intensity colors with some stronger hues and a variety of solids, patterns and textures. All Teknion fabrics are developed to exceed technical standards.

Teknion has a full program of standard fabrics, vinyl and leather appropriate for most seating lines. All fabrics are covered by Teknion standard warranty and meet all standards for CAL 116 and 117 and exceed industry durability requirements. All upholstery coverings may not be approved for use on all chair families. Please refer to the **Listing & Application Matrices** within this section for fabric applications.

Fabrics meet or exceed performance standards by ACT (Association for Contract Textiles).



Please note, leathers and faux-leathers may show natural blemishes, scars and wrinkles which are inherent material characteristics and as such deemed acceptable by Teknion. Variation of color, grain and texture found in wood and leather are also natural. Teknion is not responsible for reverse crocking of dyes from clothing onto our seating upholstery and finishes.

FABRIC PATTERN DIRECTIONAL GUIDELINES

Directional specifications are not required for any of Teknion Standard Upholstery to Teknion products. All Standard Upholstery Fabrics will be run off-the-bolt, as shown on the sample card. See the **Fabric Pattern Directional Guidelines** in the General Information section at the back of the book for more details.

application matrices

UPHOLSTERY FABRICS

	complement (metric)	district	expansion casegood	expansion citybench	expansion cityline	fling & storage	height-adjustable-bench	interpret international	seating	social & collaborative	tables & collaborative	tek vue	tek n	world wide complements	pod
COM															
Gravity										**					
Selecte										*					
Main Line Flax										*					
Grade 1															
Bitstream		Available				Available			Available	Available			Available	Available	
Fundamentals		Available				Available			Available	Available			Available	Available	
Heather Tech		Available				Available			Available	Available			Available	Available	
Magnify		Available				Available			Available	Available			Available	Available	
Stimuli		Available				Available			Available	Available			Available	Available	
Grade 2															
Actuate		Available				Available			Available	Available			Available	Available	
Complect		Not Available				Not Available			Available	Available			Available	Available	
Complement		Available				Available			Available	Available			Available	Available	
Cross Dye		Available				Available			Available	Available			Available	Available	
Crossgrain		Available				Available			Available	Available			Available	Available	
Decoy		Available				Available			Available	Available			Available	Available	
Digi Tweed		Available				Available			Available	Available			Available	Available	
Graviton		Not Available				Not Available			Available	Available			Available	Available	
Intone		Not Available				Not Available			Available	Available			Available	Available	
Megacheck		Not Available				Not Available			Not Available	Available			Available	Available	
Percept		Available				Available			Available	Available			Available	Available	
Ultra Durable		Available				Available			Available	Available			Available	Available	
Grade 3															
Ample		Not Available				Not Available			Available	Available			Available	Available	
Doyenne		Not Available				Not Available			Available	Available			Available	Available	
Ecotone		Not Available				Not Available			Available	Available			Available	Available	
Fine Grain		Available				Available			Available	Available			Available	Available	
Focus		Not Available				Not Available			Not Available	**			Not Available	Not Available	
Focus Melange		Not Available				Not Available			Not Available	**			Not Available	Not Available	
Intraweb 		Not Available				Not Available			Available	Available			Available	Available	
Marl Cloth		Available				Available			Available	Available			Available	Available	
Milieu 		Not Available				Not Available			Available	Available			Available	Available	
Situ		Not Available				Not Available			Available	Available			Available	Available	
Superspun		Not Available				Not Available			Available	Available			Available	Available	
Twisted Tweed		Not Available				Not Available			Not Available	Available			Available	Available	

note

- * Social & Collaborative: Applicable for Artifort collections
- ** Social & Collaborative: Applicable for True Design collections
- Applicable on single upholstery. On dual upholstery, applicable for seat only.
- District: Applies to rolling pedestal with seat (MUPR) and seat cushion (MUWLC)

application matrices

UPHOLSTERY FABRICS (continued)

	complement (metric)	district	expansion casegood	expansion citybench	expansion cityline	filing & storage	height-adjustable-bench	interpret international	seating	social & collaborative	tables & collaborative	tek vue	tek n	world wide complements	pod
Grade 4															
Elastic Wool									Available	Available					
Formwork									Available	Available					
Grid State									Available	Available					
Interstice									Available	Available					
Meta Texture									Available	Available					
Modulus									Available	Available					
Velvet Underground									Available	Available					
Grade 5															
Adage									Available	Available					
Cult Classic									Available	Available					
Monotex									Available	Available					
Particulate									Available	Available					
Synaptic									Available	Available					
Grade 6															
Amalgam									Available	Available					
Duo Chrome									Available	Available					
Haptic									Available	Available					
Outpress									Available	Available					
Perilune									Available	Available					
Photogram									Available	Available					
Vector									Available	Available					
Grade 7															
Contrast Slub									Available	Available					
Ephemera									Available	Available		Available	Available		
Flex Wool									Available	Available		Available	Available		
Oeuvre									Available	Available		Available	Available		
Ox									Available	Available *		Available	Available		
Pebble Melange									Available	Available		Available	Available		
Structured Stripe									Available	Available		Available	Available		
Tilt Shift Redux									Available	Available		Available	Available		
Wool Fleck									Available	Available		Available	Available		
Grade 8															
Construct									Available	Available					
Full Wool									Available •	Available					
Geoglyph									Available	Available					
Homage									Available	Available					
Wavefield									Available	Available					
Welded									Available	Available					

note

- * Social & Collaborative: Applicable for Artifort collections
- ** Social & Collaborative: Applicable for True Design collections
- Applicable on single upholstery. On dual upholstery, applicable for seat only.
- District: Applies to rolling pedestal with seat (MUPR) and seat cushion (MUWLC)

application matrices

UPHOLSTERY FABRICS (continued)

	complement (metric)	district	expansion casegood	expansion citybench	expansion cityline	fling & storage	height-adjustable-bench	interpret international	seating	social & collaborative	tables & collaborative	tek vue	tek n	world wide complements	pod 
Grade 9															
Equilux															
Graph Speck															
Heather Felt															
Melange Check															
Top Coat															
Grade 10															
Color Fuse															
Fleece															

note * Social & Collaborative: Applicable for Artifort collections
 ** Social & Collaborative: Applicable for True Design collections
 • Applicable on single upholstery. On dual upholstery, applicable for seat only.
 District: Applies to rolling pedestal with seat (MUPR) and seat cushion (MUWLC)

application matrices

LEATHER

	complement (metric)	district	expansion casegood	expansion citybench	expansion cityline	filing & storage	height-adjustable-bench	interpret international	seating	social & collaborative	tables & collaborative	tek vue	tek n	world wide complements	pod 
Leather - LA															
Base Grade Leather									•						
Leather - LB															
Merus															
Leather - LC															
Pela															
Leather - LD															
Fortis															

- note**
- * Social & Collaborative: Applicable for Artifort collections
 - ** Social & Collaborative: Applicable for True Design collections
 - Applicable on single upholstery. On dual upholstery, applicable for seat only.
 - District: Applies to rolling pedestal with seat (MUPR) and seat cushion (MUWLC)

ASIA PACIFIC STANDARD UPHOLSTERY OFFERING

<div style="display: flex; align-items: center;"> <div style="width: 15px; height: 10px; background-color: #0070C0; margin-right: 5px;"></div> Available </div> <div style="display: flex; align-items: center; margin-top: 5px;"> <div style="width: 15px; height: 10px; border: 1px solid black; margin-right: 5px;"></div> Not Available </div>		complement (metric)	district	expansion casegood	expansion citybench	expansion cityline	filing & storage	height-adjustable-bench	interpret international	seating	social & collaborative	tables & collaborative	tek vue	tek n	world wide complements	pod
Grade AA																
Philomina									•							

note Applicable to Mina and Seño back only.

application matrices

INDIA STANDARD UPHOLSTERY OFFERING

	complement (metric)	district	expansion casegood	expansion city/bench	expansion city/line	filing & storage	height-adjustable-bench	interpret international	seating	social & collaborative	tables & collaborative	tek vue	tek n	world wide complements	pod
Grade A															
Elegant															
Cloud															
Wild Mushroom															
Duomo															
Acid															
Dark Roast															
Droplet															
Roasted Beans															
Greysto															
EG09															
Ocean Force															
Villa De-Sole															
Roman Green															
Burnt Orange															
Oriel															
Turchino															
Beacon															
Dark Forest															
Coffee															
Neptune															
Cream Blue															
Natural Fawn															
Beige Pacific Blue															
Cream Fawn															
Beige Green															
Grey Blue															
Beige Marble															
Gray Lilac															
Beige Brown															
Natural Stone															
Gray Gargoyle															
Cement Yellow															
Gold Blue															
Wine Blue															
Blue															

application matrices

INDIA STANDARD UPHOLSTERY OFFERING (continued)

	complement (metric)	district	expansion casegood	expansion citybench	expansion cityline	filing & storage	height-adjustable-bench	interpret international	seating	social & collaborative	tables & collaborative	tek vue	tek n	world wide complements	pod
Grade A															
Mars															
Baby Blue															
Dolphin															
Electric															
Amalfi															
Med Blue															
Corn Flower															
China Sea															
Waterfall															
Vesuvius															
Turchino															
Lilac															
Blush															
Fuscia															
Pink															
Lavender															
Amethyst															
Flame															
Aattenzione															
Fresco															
Burnt Orange															
Cinnamon															
Warm Glow															
Villa DeSole															
Salmon															
Dago Orange															
Lemon															
Frengia															
Nuetro															
Cream															
Peach Cream															
Peach															
Latte															
Indian Coffee															
Caramel															
Acron															
Dark Forest															
Relection															
Olive															

listings matrices

UPHOLSTERY FABRICS

COM

Gravity

Petal	CPC01
Lavender	CPC02
Berry	CPC03
Brook	CPC04
Dewdrop	CPC05
Botanic	CPC06
Gooseberry	CPC07
Evergreen	CPC08
Lake	CPC09
Almond	CPC10
Tigerlily	CPC11
Nutmeg	CPC12
Rose	CPC13
Mustard	CPC14
Ice	CPC15
Slate	CPC16
Dove	CPC17
Sunni	CPC20
Wheat	CPC21
Fresh	CPC23
Tulip	CPC25
Military	CPC26
Frozen	CPC27
Aqua	CPC28
Lagoon	CPC29
Navy Blue	CPC30
Black	CPC31
Frost	CPC32

Main Line Flax

Watford	MLF
Aldgate	MLF01
Archway	MLF02
Barbican	MLF03
Holborn	MLF05
Kilburn	MLF06
Kensington	MLF07
Lambeth	MLF08
Monument	MLF09
Newbury	MLF10
Morden	MLF12
Leyton	MLF13
Parsons	MLF14
Stockwell	MLF15
Temple	MLF16
Tooting	MLF17
Tuffnell	MLF18
Victoria	MLF19
Upminster	MLF20
Waterloo	MLF21
Westminster	MLF22
Bank	MLF23

COM (continued)

Main Line Flax (continued)

Bayswater	MLF24
Bethnal	MLF25
Camden	MLF26
Edgware	MLF28
Farringdon	MLF29
Goldhawk	MLF31
Greenford	MLF32
Pimlico	MLF34
Brompton	MLF35
Tower	MLF36
Stanmore	MLF37
Northfields	MLF40
Alpertown	MLF43
Balham	MLF44
Barking	MLF45
Blackwall	MLF46
Brixton	MLF47
Chigwell	MLF48
Clapham	MLF49
Embankment	MLF50
Epping	MLF51
Greenwich	MLF52
Hampstead	MLF53
Harrow	MLF54
Hornchurch	MLF55
Kentish	MLF56
Moorgate	MLF57
Perivale	MLF59
Pinner	MLF60
Redbridge	MLF61
Richmond	MLF62
Shadwell	MLF63
Stratford	MLF64
Whitechapel	MLF66
Woodford	MLF67

Selecte

Light Grey	130
Charcoal	180
Taupe	220
Tweed Grey	260
Chocolate	280
Mustard Yellow	480
Salmon	520
Sweet Red	580
Burgundy	680
Denim Blue	720
Azure Blue	760
Deep Blue	780
Sky Blue	820
Deep Green	980

GRADE 1

Bitstream

Blue Team	B169
Firewire	B170
Flash Drive	B171
Grey code	B164
Hardware	B161
Lithium	B163
Silicone	B165
Tablet	B160
Trackback	B162
Wavelet	B168
White Noise	B166
Xenon	B167

Fundamentals

Aqua	E529
Armory	E521
Azure	E530
Banner	E505
Black	E523
Brier	E518
Dove	E532
Lapis	E538
Latte	E535
Light Grey	E522
Malachite	E539
Marble	E536
Moonstone	E537
Nickel	E533
Parakeet	E516
Salsa	E504
Slate	E534
Sudan	E519
Tangelo	E526
Verde	E528
Wendigo	E520

listings matrices

UPHOLSTERY FABRICS (continued)

GRADE 1 (continued)

Heather Tech

Basalt Tech	T169
Beetroot Tech	T177
Clear Tech	T180
Crag Tech	T168
Dust Tech	T162
Flax Tech	T165
Lav Tech	T179
Loam Tech	T167
Loch Tech	T181
Loden Tech	T170
Madder Tech	T176
Meadow Tech	T172
North Sea Tech	T183
Oat Tech	T164
Obsidian Tech	T185
Ocean Tech	T182
Onyx Tech	T184
Raspite Tech	T175
Rose Tech	T174
Sagebrush Tech	T171
Silt Tech	T166
Sundew Tech	T173
Thistle Tech	T178
Topaz Tech	T163

Magnify

Deep Water	M146
Flare Up	M148
Force Field	M144
Infrared	M151
Light Beam	M147
Long Wave	M145
Polished Mirror	M141
Reflection	M142
Telescope	M140
Viewfinder	M149
Zoom Lens	M143

Stimuli

Black Tea	S155
Catalyst	S154
Daredevil	S150
Euphoria	S151
Rush	S147
Sensitive	S145
Tactile	S149
Thrill	S153
Turbinado	S146
Vigor	S152
Zest	S148

GRADE 2

Actuate

Aqueous	A209
Spectral	A210
Aether	A211
Facet	A212
Syntax	A213
Vanish	A214
Suffuse	A215
Mordant	A216
Lambent	A217
Conscious	A218
Fortify	A219
Favrite	A220
Prelude	A221
Meridian	A222
Thermal	A223
Induction	A224

Complete

Agave	C311
Apricot	C299
Autumn	C302
Blue Ice	C306
Boreal	C308
Cumulus	C297
Deep Crimson	C301
Gentian	C305
Highlighter Pink	C300
Jute	C296
Melanite	C293
Okra	C310
Opaline	C303
Quarry	C294
Reservoir	C304
Silverleaf	C295
Turquoise	C309
Winter	C307
Yolk	C298

GRADE 2 (continued)

Complement

Amarillo	T153
Arancia	T154
Carnelian	T155
Dusk	T149
Fresh Air	T158
Garnet	T156
Grey Wolf	T150
Nightfall	T148
Peacock	T159
Roan	T152
Sea Salt	T151

Cross Dye

Ace Grey	C125
Almond	C123
Artichoke	C131
Azure	C134
Carmine	C129
Carotene	C127
Cool Ash	C126
Crimson	C128
Earl Grey	C120
Light Birch	C122
Linen	C121
Logwood	C135
Plum	C132
Soft Shadow	C124
Tea Tree	C130
Watercolor	C133

Crossgrain

Underbrush	C163
Dado	C164
Blackwood	C165
Cove	C166
Xylem	C167
Tenon	C168
Amaranth	C169
Red Oak	C170
Tuliptree	C171
Iroko	C172
Ginkgo	C173
Burl	C174
Cypress	C175
Springwood	C176
Driftwood	C177

listings matrices

UPHOLSTERY FABRICS (continued)

GRADE 2 (continued)

Decoy

Alias	D186
Atlantis	D162
Cahoots	D172
Clandestine	D171
Cloak	D166
Copycat	D157
Crocodyle Tears	D187
Ditto	D153
Double Bluff	D150
Eavesdrop	D178
Encore	D181
Façade	D155
Feign	D161
Figment	D168
Fool's Gold	D184
Incognito	D158
Lark	D179
Lookalike	D177
Lure	D165
Masquerade	D176
Mimic	D174
Mirage	D163
Monkey Business	D185
Mystify	D167
Pipe Dream	D159
Pretense	D183
Proxy	D154
Red Handed	D170
Retort	D175
Reverie	D164
Rook	D156
Ruse	D169
Sheep's Clothing	D151
Stand In	D180
Sweet Talk	D182
Synonym	D173
Trick Mirror	D152
Trip Wire	D160
Emulate	D192
Espionage	D191
Face Value	D189
Garden Path	D190
Mare's Nest	D195
Parallel	D194
Parrot	D188
Replay	D193

GRADE 2 (continued)

Digi Tweed

Basalt Tweed	D317
Beetroot Tweed	D325
Clear Tweed	D328
Crag Tweed	D316
Dust Tweed	D310
Flax Tweed	D313
Lav Tweed	D327
Loam Tweed	D315
Loch Tweed	D329
Loden Tweed	D318
Madder Tweed	D324
Meadow Tweed	D320
North Sea Tweed	D331
Oat Tweed	D312
Obsidian Tweed	D333
Ocean Tweed	D330
Onyx Tweed	D332
Raspite Tweed	D323
Rose Tweed	D322
Sagebrush Tweed	D319
Silt Tweed	D314
Sundew Tweed	D321
Thistle Tweed	D326
Topaz Tweed	D311

Graviton

Albedo	G226
Ampere	G235
Boiling Point	G231
Centigrade	G234
Chain Reaction	G223
Cloud Chamber	G225
Cold Fusion	G236
Condensation	G233
Dark Matter	G222
Echo	G224
Fission	G229
Half Life	G227
Hydrostatic	G237
Kelvin	G230
Luminous Flux	G228
Quantum	G232

Intone

Ash	LM12
Caraway	LM16
Cinder	LM18
Creme	LM13
Eclipse	LM21
Harbor	LM14
Lute	LM19
Oxide	LM17
Pome	LM20
Quicksilver	LM15

GRADE 2 (continued)

Megacheck

Liminal	M328
Convex	M329
Concave	M330
Drop Shadow	M331
Litmus	M332
Gradient	M333
Distort	M334
Resolution	M335
Glitch	M336
Flashbulb	M337
Visage	M338
Magnitude	M339

Percept

Amplitude	P116
Cardinality	P118
Constant	P128
Context	P111
Devotion	P124
Epiphany	P114
Essence	P112
Fringe	P133
Harmonic	P122
Ignite	P121
Intrinsic	P108
Jubilant	P120
Nebula	P119
Peak	P123
Placid	P131
Pristine	P107
Propagate	P130
Pulse	P127
Radiant	P129
Reason	P117
Render	P126
Schema	P106
Singular	P132
Sublime	P110
Tenet	P113
Transmit	P125
Verve	P115

Ultra Durable

Black Velvet	V187
Fig	V503
Iced Coffee	V182
Mohair	V180
Morning Glory	V497
Neptune	V500
Silver Age	V493
Tungsten	V184
Wet Clay	V490

listings matrices

UPHOLSTERY FABRICS (continued)

GRADE 3

Ample

Blue Comet	T239
Cosmic	T229
Neutron	T242
Quark	T220
Radioactive	T224
Reaction	T227
Sunburst	T222
Tempered	T243
Voltage	T221
Vortex	T241

Doyenne

Alizarin	Y111
Aquamedia	Y104
Copperplate	Y109
Grisailles	Y103
Intaglio	Y102
Phthalo	Y107
Sepia Tone	Y101
Sienna	Y110
Terre Verte	Y108
Verdigris	Y106
Watermark	Y105
Woodblock	Y100

Ecotone

Abyss	E136
Ravine	E137
Rocky Shore	E138
Permafrost	E139
Tundra	E140
Arid	E141
Savanna	E142
Desert Bloom	E143
Badlands	E144
Caldera	E145
Freshwater	E146
Intertidal	E147
Rain Shadow	E148
Lichen	E149
Mangrove	E150
Treeline	E151

GRADE 3 (continued)

Fine Grain

Carbon Neutral	F409
Deep Indigo	F411
Fathom Blue	F412
French Beige	F415
Frosted Zephyr	F410
Garnet Sand	F419
Ginger Snap	F416
Iron Oxide	F420
Lunar Regolith	F406
Madder Root	F418
Martian Soil	F417
Matcha Leaves	F414
Metallic Swarf	F407
Peat Moss	F421
Putty Paste	F404
River One	F402
Saw Dust	F403
Sea Weed	F413
Volcanic Ash	F408
Warm Earth	F401
White Out	F405

Focus

Color 60200	60200
Color 60209	60209
Color 60210	60210
Color 60211	60211
Color 60212	60212
Color 60999	60999
Color 61035	61035
Color 61036	61036
Color 61037	61037
Color 61039	61039
Color 61244	61244
Color 61248	61248
Color 62018	62018
Color 63133	63133
Color 64041	64041

Focus Melange

Color 60099	60099
Color 60308	60308
Color 60309	60309
Color 60310	60310
Color 60311	60311
Color 60312	60312
Color 60900	60900
Color 61235	61235
Color 61236	61236
Color 61237	61237
Color 61238	61238
Color 61239	61239
Color 61241	61241
Color 61242	61242
Color 62117	62117

GRADE 3 (continued)

Focus Melange (continued)

Color 62118	62118
Color 63112	63112
Color 64241	64241
Color 64242	64242
Color 64243	64243
Color 64244	64244
Color 64245	64245
Color 65132	65132
Color 65133	65133
Color 66209	66209
Color 66210	66210
Color 66211	66211
Color 66219	66219
Color 66220	66220
Color 66221	66221
Color 66222	66222
Color 66223	66223
Color 66224	66224
Color 68244	68244
Color 68245	68245
Color 68247	68247

Intraweb

Raster	T397
Dual Trace	T398
Polytope	T397
Superposition	T400
Coaxial	T401
Origin	T402
Slope	T403
Polarity	T404
Isosurface	T405

Marl Cloth

Berry	F320
Blacksmith	F321
Camp Fire	F317
Dreamscape	F324
Dry Stone	F318
Guy Rope	F315
Landmark	F325
Sea Nomad	F322
Tree Bark	F326
Wild Fruit	F323
Yurt	F314

UPHOLSTERY FABRICS (continued)

Milieu 

Kettle	M570
Thunder	M571
Memory	M572
Steam	M573
Wing	M574
Nest	M575
Leap	M576
Troupe	M577
Peregrine	M578
Hedge	M579
Prickle	M580
Spring	M581
Muster	M582
Herd	M583
Parcel	M584
Bloom	M585
Fling	M586
Flamboyance	M587
Bazaar	M588
Rabble	M589
Zeal	M590
Bevy	M591
Loft	M592
Float	M593
Paddling	M594
Shoal	M595
Fleet	M596

Situ

Amphora	F117
Archeology	F115
Flamante	F122
Hydro	F123
Mar	F126
Phosphor	F121
Pozzolana	F116
Statue	F118
Terrena	F125
Tunnel	F120
Wind Tower	F119

GRADE 3 (continued)

Superspun

Bluing	S453
Creel	S457
Denier	S443
Drawdown	S442
Harness	S448
Pirn	S456
Red Cast	S450
Roving	S445
Selvedge	S451
Sett	S455
Skein	S452
Spindle	S447
Staple	S446
Tensile	S444
Tenter	S449
Treadle	S454

Twisted Tweed

Wrought Iron	T278
Rock Garden	T279
Shady Patch	T280
Moongate	T281
Plaster	T282
Stucco	T283
Thatch	T284
Arbor	T285
Daylight	T286
Sundial	T287
Koi Pond	T288
Brickwork	T289
Annual	T290
Perennial	T291
Rain Chain	T292
Open Air	T293
Water Feature	T294
Terrace	T295
Veranda	T296

GRADE 4

Elastic Wool

Aegean	E133
Ceylon	E128
Clean	E123
Dart	E135
Delphi	E134
Elm	E131
Fantom	E121
Fortress	E120
Jovial	E130
Lovelace	E129
Mercury	E122
Python	E132
Ruby	E127
Rust	E126
Seed	E124
Tea	E125

GRADE 4 (continued)

Formwork

Azurite	F144
Candela	F141
Distill	F143
Elixir	F146
Kiln	F142
Lead	F137
Metallurgy	F136
Opal	F139
Pearl Ash	F140
Precipitant	F147
Selenite	F138
Verditer	F145

Grid State

Arc Flash	G132
Circuit Break	G138
Electrode	G139
Hydropower	G135
Live Wire	G140
Megawatt	G137
Neon Bulb	G142
Open Circuit	G133
Switchboard	G136
Turbine	G141
Volt Switch	G134
Wolfram	G143

Interstice

Atom	R313
Caesura	R318
Fragment	R312
Inkling	R307
Interval	R317
Lacuna	R309
Respite	R315
Scintilla	R311
Trace	R314
Vestige	R316
Whit	R310

Meta Texture

Blue Skies	M233
Deep Dive	M232
Deep Space	M224
Grassroots	M230
Grey Matter	M225
Heat Wave	M235
Hive Mind	M228
Jaded	M231
Neutral Ground	M229
Pale Shadow	M226
Punchline	M236
Rosy Outlook	M234
Silver Lining	M227

listings matrices

UPHOLSTERY FABRICS (continued)

GRADE 4 (continued)

Modulus

Form	M178
Landscape	M173
Masonry	M174
Monument	M183
Plinth	M172
Rebar	M180
Shadow Play	M179
Site	M177
Skylight	M176
Spatial	M181
Superstructure	M175
Threshold	M182

Velvet Underground

Blacktop	V318
Blue Denim	V315
Brass Section	V319
Dark Current	V322
Dark Moon	V317
Flame Desire	V313
Full Phase	V321
Garden Level	V328
Green Room	V327
Metal Machine	V310
New Wave	V329
Purple Rain	V326
Shock Wave	V320
Smoke Screen	V323
Ultraviolet	V325
Wallflower	V324

GRADE 5

Adage

Anthracite	A146
Carbon Fiber	A147
Chromite	A149
Halite	A152
Quartzite	A153
Script	A166
Singularity	A150
Splice	A148
Valence	A151
Amythyst	A164
Canopy	A160
Diffraction	A163
Halogen	A159
Holograph	A157
Orchil	A156
Pascal	A165
Petrol	A162
Photon	A158
Raw Jade	A161
Rubelite	A154
Thremite	A155

GRADE 5 (continued)

Cult Classic

Blue Velvet	C246
Black Lagoon	C247
Metropolis	C248
Grey Gardens	C249
White Heat	C250
Ziggy Stardust	C251
Pink Flamingos	C252
Purple Noon	C253
Blue Sunshine	C254
Xanadu	C255
Emerald City	C256
Forrest Gump	C257

Monotex

Annatto	G117
Bark Cloth	G112
Burlap	G113
Ferrous	G111
Grey Flannel	G108
Grey Marl	G109
Jean	G118
Kingfisher	G119
Oxalis	G120
Redroot	G115
Sharkskin	G107
Silver Lane	G106
Sulfur	G121
Sumac	G114
Tarpaper	G110
Tyrian	G116

Particulate

Molecule	P212
Light Speed	P213
Granule	P214
Allotrope	P215
Current	P216
Corrosion	P217
Inertia	P218
Swell	P219
Oxidation	P220
Proton	P221
Irrigation	P222
Isotope	P223
Electrostatic	P224
Quasar	P225
Smolder	P226

Synaptic

Axon	S144
Conduit	S138
Contact	S135
Phase	S136
Receptor	S140
Sensory	S139
Transmission	S142
Traverse	S141

GRADE 6

Amalgam

Aura	K106
Fluid	K109
Fuse	K114
Jolt	K111
Magma	K113
Medallion	K108
Nitro	K112
Pyrite	K107
Ultraviolet	K110

Duo Chrome

Aquamarine	D141
Black Pepper	D132
Boysenberry	D144
Canvas	D134
Charcoal	D131
Citron	D137
Copper	D135
Dusty Plum	D146
Ebony	D130
Emerald	D138
Evergreen	D140
Goldenrod	D136
Hydrangea	D145
Iris	D143
Navy	D142
Oxblood	D147
Persimmon	D149
Platinum	D133
Red Oxide	D148
Silver Elm	D139

Haptic

Cliffline	H616
Gravel	H617
Alluvium	H618
Sediment	H619
Pink Salt	H620
Montane	H621
Butte	H622
Arroyo	H623
Superbloom	H624
Mantle	H625
Geode	H626
Flood Plain	H627
Isthmus	H628
Aquifer	H629
Delta	H630
Fjord	H631

listings matrices

UPHOLSTERY FABRICS (continued)

GRADE 6 (continued)

Outpress

Ashen	C237
Caribbean	C244
Denim	C245
Monarch	C243
Pepper	C242
Raven	C241
Sand	C238
Soot	C240
Stone	C239

Photogram

Mitre	P160
Toner	P161
Silver Salts	P162
Light Meter	P163
Sunprint	P164
Heliograph	P165
Safelight	P166
Cyanotype	P167
Mezzotint	P168
Darkroom	P169

Perilune

Asteroid	M161
Blue Moon	M166
Gravity	M164
Hot Crater	M171
Pulsar	M169
Red Shift	M165
Satellite	M163
Solar	M170
Space Age	M167
Stellar	M162
Terrene	M160
Verdant	M168

Vector

Dovetail	V221
Horizon Line	V222
Hypercube	V227
Latitude	V224
Parallax	V229
Radial	V226
Scalar	V228
Tessera	V223
Vertex	V225

GRADE 7

Contrast Slub

Charred Seed	F428
Silver Thyme	F429
Cotton Blossom	F430
Tumbleweed	F431
Bramble	F432
Manzanita	F433
Cactus Flower	F434
Scarlet Sage	F435
Anemone	F436
Crepe Myrtle	F437
Wild Indigo	F438
Jacaranda	F439
Cenote	F440
Oleander	F441
Eucalyptus	F442
Lemongrass	F443

Ephemera

Afterglow	E109
Ashfall	E117
Blue Shift	E116
Gamma Burst	E114
Green Flash	E115
Halcyon	E111
Ice Cloud	E110
Lucent	E108
Nightglow	E118
Penumbra	E119
Phosphene	E112
Solar Flare	E113

Flex Wool

Agile	F487
Arena	F486
Blur	F491
Buoyant	F488
Dynamo	F482
Raceway	F490
Rebound	F480
Spark	F484
Tempo	F481
Thrive	F485
Torque	F489
Vim	F483

Oeuvre

Blithe	V520
Salient	V521
Austere	V522
Earnest	V523
Ardent	V524
Fervor	V525
Finesse	V526
Mettle	V527
Flourish	V528
Charm	V529
Deft	V530
Crest	V531

GRADE 7 (continued)

Ox

Pure White	5000
Cognac	5080
Hazelnut	5100
Camel	5110
Passion	5200
Elephant	5290
Black	5300
Storm	5310
Sahara	5320
Atlantic	5431
Warm White	5518
Stone	552

Pebble Melange

Esker	P186
Earthen	P187
Pewter	P188
Tectonic	P189
Geyser	P190
Palustrine	P191
Forest Marble	P192
Everglade	P193
Estuary	P194
Meteor	P195
Barkhan	P196
Lava	P197

Structured Stripe

Shadow Weave	S335
Silver Lap	S336
Countermarche	S337
Double Beam	S338
Block Draw	S339
Box Motion	S340
Overshot	S341
Punch Card	S342

Tilt Shift Redux

Alpha	T445
Baseline	T442
Beta	T443
Elevation	T440
Fluctuate	T444
Plexus	T441
Amplifier	T446
Bandwidth	T448
Modulate	T451
Sensor	T447
Sonar	T450
Synapse	T449

listings matrices

UPHOLSTERY FABRICS (continued)

GRADE 8

Wool Fleck

Boulder	W128
Packstone	W129
Zinc	W130
Micrite	W131
Coquina	W132
Beachrock	W133
Tawny	W134
Corten	W135
Pink Nacre	W136
Birchbark	W137
Firesand	W138
Chamotte	W139
Blackberry	W140
Mussel Dust	W141
Gitti	W142
Iolite	W143
Storm Petrel	W144
Bittercress	W145
Oat Grass	W146
Aloe	W147
Wild Mustard	W148

Construct

Argent	C530
Auburn	C517
Beryl	C526
Brandy	C513
Cadmium Orange	C515
Canary	C523
Celadon	C522
Clay	C512
Cornflower	C520
Fawn	C511
Fir	C528
Gunmetal	C531
Midnight	C529
Noir	C532
Ochre	C525
Pacific	C521
Turmeric	C524
Ultramarine	C519
Vermilion	C514
Viridian	C527
Wisteria	C518
Zinnia	C516

GRADE 8 (continued)

Full Wool

Blanc	F207
Deep Orchid	F223
Fresh Water	F215
Hot Stone	F209
Ink	F212
Lagoon	F221
Macchiato	F211
Neptune	F218
Oak Room	F222
Safari	F219
Serpent	F216
Tigerlily	F214
Vintage Red	F220
Éclair	F210

Geoglyph

Drifting Sediment	G270
Polar Lights	G271
Moonlit Mountain	G272
Organic Compound	G273
Dappled Sunlight	G274
Painted Desert	G275

Homage

Authority	H1041
Dashing	H103
Esteem	H102
Respect	H100
Winsome	H101

Wavefield

Tideline	W480
Groundwater	W481
Red Tide	W482
Aspen Reflection	W483
Rivulet	W484
Cascade	W485
Sea Level	W486
Brackish	W487
Wake Zone	W488

Welded

Alliance	W209
Bond	W211
Brass Alloy	W214
Charcoal Flux	W210
Copper Foil	W216
Mingle	W217
Palladium	W213
Rose Torch	W215
Soda Ash	W212
Synergy	W218
Synthesis	W219

GRADE 9

Equilux

Eventide	E100
Diamond Dust	E101
Solstice	E102
Moonbow	E103
Corona	E104
Blue Hour	E105
Kindle	E106
Sunspot	E107

Graph Speck

Cavern	G250
Steel Frame	G251
Stonework	G252
Gypsum	G253
Earthworks	G254
Cob	G255
Breccia	G256
Hearth	G257
Fired Clay	G258
Ionic Order	G259
Waterwheel	G260
Trellis	G261
Limecrete	G262
Plate Glass	G263
Riverfront	G264
Structure	G265

Heather Felt

Noil	H510
Alumina	H511
Bone Ash	H512
Pinon Tree	H513
Indian Ocean	H516
Mustard Seed	H517
Saffron	H518
Acai	H519
Armor	H520
Marina	H522
Grove	H523
Scarlet	H525

Melange Check

Cobblestone	M534
Bisque	M535
Soda Fired	M536
Goldspeck	M537
Pink Kaolin	M538
Brick Dust	M539
Alkaline	M540
Vapor Glaze	M541
Faience Blue	M542
Greenware	M543

listings matrices

UPHOLSTERY FABRICS (continued)

GRADE 9 (continued)

Top Coat

Shell	T418
Glaze	T419
Chromate	T420
Stoneware	T421
Aniline	T422
Braze	T423
Conduct	T424
Heat Set	T425
Claycast	T426
Toast	T427
Polish	T428
Frit	T429
Shellac	T430
Dip	T431
Indigo Ink	T432
Seal	T433
Weld	T434
Black Oxide	T435

GRADE 10

Color Fuse

Wax	C154
Emulsion	C155
Jell	C156
Enamel	C157
Liquefy	C158
Freeze	C159
Molten	C160
Solvent	C161
Plasma	C162

Fleece

Alum	M191
Aer	M192
Linseed	M193
Rubedo	M194
Ignis	M195
Cypher	M196
Balsam	M197
Glyph	M198
Nero	M199

Leather - LA

Base Grade Leather

White	L215
Shale	L101
Chocolate	L204
Chime	L205
Fossil	L206
Buttercup	L214
Poppy	L210
Parlor	L211
Marine	L212
Black	L104
Sand	L200

Leather - LB

Merus

Teak	L110
White Birch	L111
Beechwood	L112
Almond Shell	L114
Smoke	L117
Hopi	L118
Crushed Bark	L119
Black Truffle	L123

Leather - LC

Pela

Clove	L216
White Clay	L217
Chamois	L218
Buckwheat	L220
Hemlock	L221
Fern	L222
Cerulean	L226
Marigold	L227
Pomegranate	L228
Cordon	L229
Black Cherry	L230
Nightshade	L232
Morel	L233
Russet	L234
Carbon	L235
Pitch	L236

Leather - LD

Fortis

Canyon	L310
Bone	L311
Terra	L313
Nugget	L314
Black Rock	L316

Grade AA

Philomina (Applicable to Mina and Sejo only.)

Black	SP01
Red	SP02
Sapphire	SP06
Pearl Grey	SP16

Grade A

Elegant

Cloud (EG01)	IA01
Wild Mushroom (EG02)	IA02
Duomo (EG03)	IA03
Acid (EG04)	IA04
Dark Roast (EG05)	IA05
Droplet (EG06)	IA06
Roasted Beans (EG07)	IA07
Greysto (EG08)	IA08
EG09 (EG09)	IA09
Ocean Force (EG010)	IA10
Villa De-Sole (EG011)	IA11
Roman Green (EG012)	IA12
Burnt Orange (EG013)	IA13
Oriel (EG014)	IA14
Turchino (EG015)	IA15
Beacon (EG016)	IA16
Dark Forest (EG017)	IA17
Coffee (EG018)	IA18

Neptune

Cream Blue (NE801)	IC01
Natural Fawn (NE802)	IC02
Beige Pacific Bluen (NE803)	IC03
Cream Fawn (NE804)	IC04
Beige Green (NE805)	IC05
Grey Blue (NE806)	IC06
Beige Marble (NE807)	IC07
Gray Lilac (NE809)	IC08
Beige Brown (NE810)	IC09
Natural Stone (NE811)	IC10
Gray Gargoyle (NE814)	IC11
Cement Yellow (NE817)	IC12
Gold Blue (NE821)	IC13
Wine Blue (NE822)	IC14
Blue (NE824)	IC15

listings matrices

UPHOLSTERY FABRICS (continued)

Grade A (continued)

Mars

Baby Blue (MS401).....	IB01
Dolphin (MS402).....	IB02
Electric (MS403).....	IB03
Amalfi (MS404).....	IB04
Med Blue (MS405).....	IB05
Corn Flower (MS406).....	IB06
China Sea (MS407).....	IB07
Waterfall (MS409).....	IB08
Vesuvius (MS410).....	IB09
Turchino (MS411).....	IB10
Lilac (MS412).....	IB11
Blush (MS413).....	IB12
Fuscia (MS414).....	IB13
Pink (MS415).....	IB14
Lavender (MS416).....	IB15
Amethyst (MS417).....	IB16
Flame (MS418).....	IB17
Aattenzione (MS419).....	IB18
Fresco (MS420).....	IB19
Burnt Orange (MS421).....	IB20
Cinnamon (MS422).....	IB21
Warm Glow (MS423).....	IB22
Villa DeSole (MS424).....	IB23
Salmon (MS425).....	IB24
Dago Orange (MS426).....	IB25
Lemon (MS427).....	IB26
Frengia (MS428).....	IB27
Nuetro (MS429).....	IB28
Cream (MS430).....	IB29
Peach Cream (MS431).....	IB30
Peach (MS432).....	IB31
Latte (MS433).....	IB32
Indian Coffee (MS434).....	IB33
Caramel (MS435).....	IB34
Acron (MS436).....	IB35
Dark Forest (MS437).....	IB36
Relection (MS438).....	IB37
Olive (MS439).....	IB38
Roman Green (MS440).....	IB39
Azazon (MS441).....	IB40
Verde (MS442).....	IB41
Duomo (MS443).....	IB42
Verona (MS444).....	IB43
Bramble (MS445).....	IB44
Cloud (MS446).....	IB45
Arno (MS447).....	IB46
Greysto (MS448).....	IB47
Mink (MS449).....	IB48
Acid (MS450).....	IB49
Gargoyle (MS451).....	IB50
Granada (MS452).....	IB51
Black (MS453).....	IB52



environmental data

STANDARD UPHOLSTERY FABRICS

Pattern	Composition	Recycled Polyester	
		Post Consumer	Pre Consumer
COM			
Gravity	76% Polyester, 24% Recycled Polyester		
Selecte	90% Wool		
Main Line Flax	75% Virgin Wool, 25% Flax		
Grade 1			
Bitstream	100% Recycled Polyester	58%	42%
Fundamentals	100% Recycled Polyester	80%	20%
Heather Tech	67% Recycled Polyester 33% Polyester	67%	
Magnify	54% Recycled Polyester 46% Polyester	54%	
Stimuli	100% Recycled Polyester	75%	25%
Grade 2			
Actuate	40% Recycled Polyester 60% Polyester	40%	
Complect	100% Recycled Polyester	100%	
Complement	100% Polyester		
Cross Dye	66% Recycled Polyester 34% Polyester	61%	5%
Crossgrain	39% Recycled Polyester 61% Polyester	39%	

environmental data

STANDARD UPHOLSTERY FABRICS (continued)

Pattern	Composition	Recycled Polyester	
		Post Consumer	Pre Consumer
Grade 2 (continued)			
Decoy	Face: 100% PVC Back: 100% Polyester Knit		
Digi Tweed	55% Recycled Polyester 45% Polyester	55%	
Graviton	100% Recycled Polyester	100%	
Intone	53% Recycled Polyester 47% Polyester	18.6%	34.4%
Megacheck	100% Recycled Polyester		
Percept	81% Recycled Polyester 19% Polyester	81%	
Ultra Durable	Anti-Bacterial, Anti-Microbial Treated Vinyl		
Grade 3			
Ample	77% Polyester, 17% Cotton 6% Acrylic		
Doyenne	38.5% Recycled Polyester 61.5% Polyester	38.5%	
Ecotone	100% Recycled Biodegradable** Polyester		
Fine Grain	100% Polyurethane Face 100% Polyester Backing		
Focus	100% Recyclable Wool		
Focus Melange	100% Recyclable Wool		
Intraweb 	100% Recycled Biodegradable* Polyester (Postconsumer)		
Marl Cloth	57% Recycled Polyester 42% Polyester, 1% Nylon	30%	27%
Milieu 	90% Recycled Polyester (Postconsumer), 10% Polyester		

environmental data

STANDARD UPHOLSTERY FABRICS (continued)

Pattern	Composition	Recycled Polyester	
		Post Consumer	Pre Consumer
Grade 3 (continued)			
Situ	55% Recycled Polyester 45% Polyester		55%
Superspun	55% Recycled Polyester 45% Polyester	55%	
Twisted Tweed	100% Recycled Polyester	100%	
Grade 4			
Elastic Wool	50% Wool, 27% Polyester 21% Nylon, 2% Elastane		
Formwork	51% Recycled Polyester 49% Polyester	51%	
Grid State	BIODEGRADABLE CLEAN IMPACT TEXTILES™ - 100% Post- Consumer Recycled Biodegradable Polyester**		
Interstice	85% Polyester 12% Cotton, 3% Acrylic		
Meta Texture	95% Polycarbonate Polyurethane 5% Silicon Back: Polyester Knit		
Modulus	75% Recycled Polyester 25% Polyester	52%	23%
Velvet Underground	100% Recycled Polyester		
Grade 5			
Adage	82% Polyester 14% Cotton, 4% Acrylic		
Cult Classic	100% Polyester		
Monotex	100% Polyurethane Face 100% Polyester Knit Backing		
Particulate	65% Recycled Polyester 35% Polyester	65%	

environmental data

STANDARD UPHOLSTERY FABRICS (continued)

Pattern	Composition	Recycled Polyester	
		Post Consumer	Pre Consumer
Synaptic	100% Polyurethane Face 100% Polyester Knit Backing		
Grade 6			
Amalgam	100% Recycled Polyester		
Duo Chrome	100% Polyester		
Haptic	68% Acrylic 32% Polyester		
Outpress	82.7% Polyester 17.33% Nylon		
Perilune	Face: 100% Polyurethane Back: 100% Polyester Knit		
Photogram	55% Polyester 45% Recycled Polyester		
Vector	78% Recycled Polyester 22% Nylon	78%	
Grade 7			
Contrast Slub 	62% Cotton, 17% Polyester, 14% Viscose, 7% Linen		
Ephemera	57% Polyester 43% Acrylic		
Flex Wool	41% Wool, 41% Polyester 17% Nylon, 1% Elastane		
Oeuvre	30% Wool, 22% Polyester 18% Nylon, 18% Cotton, 12% Silk		
Ox	Pigmented leather (Aniline leather)		
Pebble Melange	98% Polypropylene, 2% Polyester		
Structured Stripe	100% Polyester		
Tilted Shift Redux	82% Recycled Polyester 18% Nylon	82%	
Wool Fleck	51% Recycled Wool, 39% Recycled Acrylic, 10% Recycled Polyester		

environmental data

STANDARD UPHOLSTERY FABRICS (continued)

Pattern	Composition	Recycled Polyester	
		Post Consumer	Pre Consumer
Grade 8			
Construct	80% Wool, 20% Nylon		
Full Wool	100% Wool		
Geoglyph	98% Polypropylene, 2% Polyester		
Homage	40% Wool, 24% Nylon 20% Polyester, 16% Silk		
Wavefield	68% Polyester 32% Recycled Polyester	32%	
Welded	Coating: 100% Tekloom TPE Base Cloth: 100% Polyester Woven		
Grade 9			
Equilux	54% Rayon 43% Wool, 3% Nylon		
Graph Speck	51% Recycled Wool, 39% Recycled Acrylic, 10% Recycled Polyester		
Heather Felt	100% Wool		
Melange Check	51% Recycled Wool, 39% Recycled Acrylic, 10% Recycled Polyester		
Top Coat	100% Silicone		
Grade 10			
Color Fuse	Coating: 100% Polycarbonate Polyurethane Base Cloth: 100% Cotton Woven		
Fleece	60% Wool, 24% Polyester, 16% Cotton		

environmental data

STANDARD UPHOLSTERY FABRICS (continued)

Pattern	Composition	Recycled Polyester	
		Post Consumer	Pre Consumer
Leather LA			
Base Grade Leather			
Leather LB			
Merus	European Top Grain Semi-Aniline Dyed Cowhide		
Leather LC			
Pela	European Top Grain Semi-Aniline Dyed Cowhide		
Leather LD			
Fortis	European Top Grain Semi-Aniline Dyed Cowhide		

ASIA PACIFIC STANDARD UPHOLSTERY OFFERING

Pattern	Composition	Recycled Polyester	
		Post Consumer	Pre Consumer
Grade AA			
Philomina	100% Polyester		

textile listings by pattern number

FABRIC PATTERN	COLOR CODE	TEKNION COLOR CODE	PATTERN NAME	COLOR NAME	APPLICATION GRADE
1001	02	E354	Egypt	Jirja	Panel - A
1001	03	E355	Egypt	Idku	Panel - A
1001	05	E352	Egypt	Mallawi	Panel - A
1001	06	E301	Egypt	Cairo	Panel - A
1001	07	E302	Egypt	Giza	Panel - A
1001	10	E304	Egypt	Port Said	Panel - A
1001	11	E356	Egypt	Edfu	Panel - A
1001	13	E305	Egypt	Suez	Panel - A
<hr/>					
1002	01	W417	Wales	Bangor	Panel - A
1002	02	W403	Wales	Teifi	Panel - A
1002	03	W404	Wales	Newport	Panel - A
1002	04	W402	Wales	Swansea	Panel - A
1002	05	W416	Wales	Corwen	Panel - A
1002	06	W414	Wales	Wrexham	Panel - A
1002	07	W419	Wales	Pembroke	Panel - A
1002	08	W420	Wales	Kidwelly	Panel - A
1002	09	W418	Wales	Newbridge	Panel - A
1002	10	W421	Wales	Goodwick	Panel - A
<hr/>					
1003	01	D418	India	Pushkar	Panel - 1
1003	02	D405	India	Gwalior	Panel - 1
1003	03	D404	India	Agra	Panel - 1
1003	04	D419	India	Kerala	Panel - 1
1003	05	D402	India	Bombay	Panel - 1
1003	06	D425	India	Manali	Panel - 1
1003	07	D408	India	Haora	Panel - 1
1003	08	D417	India	Kashmir	Panel - 1
1003	09	D423	India	Pune	Panel - 1
1003	10	D424	India	Mumbai	Panel - 1
1003	11	D407	India	Varanasi	Panel - 1
1003	12	D420	India	Munnar	Panel - 1
1003	13	D422	India	Chennai	Panel - 1
1003	14	D409	India	Surat	Panel - 1
1003	15	D421	India	Nanital	Panel - 1
<hr/>					
1004	01	B260	Brazil	Campo Grande	Panel - 1
1004	02	B220	Brazil	Betim	Panel - 1
1004	03	B208	Brazil	Timbo	Panel - 1
1004	04	B204	Brazil	Canela	Panel - 1
1004	05	B203	Brazil	Manaus	Panel - 1
1004	06	B261	Brazil	Serra	Panel - 1
1004	08	B217	Brazil	Jacarei	Panel - 1
1004	09	B231	Brazil	Olinda	Panel - 1
1004	10	B233	Brazil	Laguna	Panel - 1

textile listings by pattern number (continued)

FABRIC PATTERN	COLOR CODE	TEKNION COLOR CODE	PATTERN NAME	COLOR NAME	APPLICATION GRADE
1006	01	E380	Essentials	Gris	Panel - 1
1006	03	E382	Essentials	Dove	Panel - 1
1006	04	E383	Essentials	Brier	Panel - 1
1006	05	E384	Essentials	Light Grey	Panel - 1
1006	06	E385	Essentials	Slate	Panel - 1
1006	12	E391	Essentials	Banner	Panel - 1
1006	13	E409	Essentials	Snowdrift	Panel - 1
1006	14	E410	Essentials	Mist	Panel - 1
1006	16	E412	Essentials	Basil	Panel - 1
1006	17	E413	Essentials	Atlantic	Panel - 1
1006	18	E414	Essentials	Desert	Panel - 1
1006	19	E415	Essentials	Pebble	Panel - 1
1006	20	E416	Essentials	Tropic	Panel - 1
<hr/>					
1007	01	W110	Warp Speed	Headwind	Panel - 1
1007	02	W111	Warp Speed	White Space	Panel - 1
1007	03	W112	Warp Speed	Strobe	Panel - 1
1007	04	W113	Warp Speed	Reed Arrow	Panel - 1
1007	05	W114	Warp Speed	Jet	Panel - 1
1007	06	W115	Warp Speed	Steel Racer	Panel - 1
1007	07	W116	Warp Speed	Earth Orbit	Panel - 1
<hr/>					
1008	01	F537	Flicker	Gleam	Panel - 1
1008	02	F531	Flicker	Glitter	Panel - 1
1008	03	F532	Flicker	Beam	Panel - 1
1008	04	F535	Flicker	Glint	Panel - 1
1008	05	F533	Flicker	Sparkle	Panel - 1
1008	06	F534	Flicker	Flash	Panel - 1
1008	07	F536	Flicker	Sheen	Panel - 1
1008	08	F539	Flicker	Luster	Panel - 1
1008	09	F538	Flicker	Glow	Panel - 1
1008	10	F540	Flicker	Twinkle	Panel - 1
<hr/>					
1009	01	T531	Tangle	Snarl	Panel - A
1009	02	T533	Tangle	Interweave	Panel - A
1009	03	T532	Tangle	Knot	Panel - A
1009	04	T540	Tangle	Entwine	Panel - A
1009	05	T534	Tangle	Ravel	Panel - A
1009	06	T535	Tangle	Kinks	Panel - A
1009	07	T538	Tangle	Crook	Panel - A
1009	08	T536	Tangle	Spangle	Panel - A
1009	09	T537	Tangle	Tousle	Panel - A
1009	10	T539	Tangle	Muddle	Panel - A

textile listings by pattern number (continued)

FABRIC PATTERN	COLOR CODE	TEKNION COLOR CODE	PATTERN NAME	COLOR NAME	APPLICATION GRADE
1010	01	P401	Peru	Tacna	Panel - 1
1010	02	P402	Peru	Nazca	Panel - 1
1010	03	P407	Peru	Tingo Maria	Panel - 1
1010	04	P404	Peru	Casma	Panel - 1
1010	05	P403	Peru	Lima	Panel - 1
1010	06	P409	Peru	Callao	Panel - 1
1010	07	P406	Peru	Cuzco	Panel - 1
1010	08	P412	Peru	Puerto	Panel - 1
1010	09	P411	Peru	Tumbes	Panel - 1
1010	10	P405	Peru	Puno	Panel - 1
1011	01	T100	Topology	Ceramic	Panel - 1
1011	02	T101	Topology	Open Space	Panel - 1
1011	03	T102	Topology	Natural	Panel - 1
1011	04	T103	Topology	Cooling	Panel - 1
1011	05	T104	Topology	Shadow	Panel - 1
1012	01	M415	Makah	Shaker	Panel - 1
1012	02	M416	Makah	Luminous	Panel - 1
1012	03	M417	Makah	Arundo	Panel - 1
1012	04	M418	Makah	Solano	Panel - 1
1012	05	M419	Makah	Flitch	Panel - 1
1012	06	M420	Makah	Splint	Panel - 1
1015	01	B639	Beeline	Band	Panel - A
1015	02	B631	Beeline	Plumb	Panel - A
1015	03	B633	Beeline	Strand	Panel - A
1015	04	B634	Beeline	Thread	Panel - A
1015	05	B632	Beeline	String	Panel - A
1015	06	B640	Beeline	Dash	Panel - A
1016	01	N122	Nitty Gritty	Block	Panel - A
1016	02	N133	Nitty Gritty	Gist	Panel - A
1016	03	N123	Nitty Gritty	Detail	Panel - A
1016	04	N134	Nitty Gritty	Factor	Panel - A
1016	05	N130	Nitty Gritty	Think	Panel - A
1016	06	N135	Nitty Gritty	Specific	Panel - A
1017	01	W741	Wired Up	Linkage	Panel - A
1017	02	W742	Wired Up	Drawplate	Panel - A
1017	03	W743	Wired Up	Nichrome	Panel - A
1017	04	W739	Wired Up	Intermingle	Panel - A
1017	05	W731	Wired Up	Caged	Panel - A
1017	06	W744	Wired Up	Circuit	Panel - A
1017	07	W740	Wired Up	Mesh	Panel - A
1018	01	L327	Linen Weave	Coir	Panel - 1
1018	02	L328	Linen Weave	Bast	Panel - 1
1018	03	L329	Linen Weave	Dusty Grey	Panel - 1
1018	04	L330	Linen Weave	Mineral	Panel - 1
1018	05	L331	Linen Weave	Linseed	Panel - 1
1018	06	L308	Linen Weave	Gate	Panel - 1
1018	07	L309	Linen Weave	Sesame	Panel - 1

Teknion Color Code Identifier (P) - Panel (U) - Upholstery (A) - Architectural

textile listings by pattern number (continued)

FABRIC PATTERN	COLOR CODE	TEKNION COLOR CODE	PATTERN NAME	COLOR NAME	APPLICATION GRADE
1019	01	C111 (A) - B119 (P)	Boucle Grid	Craie	Panel - 2, Architectural - 2
1019	02	C112 (A) - B120 (P)	Boucle Grid	Bis	Panel - 2, Architectural - 2
1019	03	C113 (A) - B121 (P)	Boucle Grid	Ardoise	Panel - 2, Architectural - 2
1019	04	C114 (A) - B122 (P)	Boucle Grid	Fauve	Panel - 2, Architectural - 2
1019	05	C115 (A) - B123 (P)	Boucle Grid	Nuage	Panel - 2, Architectural - 2
1020	01	D100 (A) - L363 (P)	Lustrado	Glassine	Panel - 1, Architectural - 2
1020	02	D101 (A) - L364 (P)	Lustrado	Acetate	Panel - 1, Architectural - 2
1020	03	D102 (A) - L365 (P)	Lustrado	Brilliance	Panel - 1, Architectural - 2
1020	04	D103 (A) - L366 (P)	Lustrado	Alloy	Panel - 1, Architectural - 2
1020	05	D104 (A) - L367 (P)	Lustrado	Gallium	Panel - 1, Architectural - 2
1020	06	D105 (A) - L368 (P)	Lustrado	Incandescent	Panel - 1, Architectural - 2
1020	07	D106 (A) - L369 (P)	Lustrado	Resin	Panel - 1, Architectural - 2
1020	08	D107 (A) - L370 (P)	Lustrado	Sterling	Panel - 1, Architectural - 2
1020	10	D109 (A) - L372 (P)	Lustrado	Varnish	Panel - 1, Architectural - 2
1020	11	D110 (A) - L373 (P)	Lustrado	Vitreous	Panel - 1, Architectural - 2
1021	01	R186 (A) - P100 (P)	Presse	Halo Effect	Panel - 1, Architectural - 2
1021	02	R187 (A) - P101 (P)	Presse	Overlay	Panel - 1, Architectural - 2
1021	03	R188 (A) - P102 (P)	Presse	Masked	Panel - 1, Architectural - 2
1021	04	R189 (A) - P103 (P)	Presse	Relief	Panel - 1, Architectural - 2
1021	05	R190 (A) - P104 (P)	Presse	Plaited	Panel - 1, Architectural - 2
1021	06	R191 (A) - P105 (P)	Presse	Gravure	Panel - 1, Architectural - 2
1022	01	D111 (A) - B124 (P)	Bandeau	Washi	Panel - 1, Architectural - 2
1022	03	D113 (A) - B126 (P)	Bandeau	Grosgrain	Panel - 1, Architectural - 2
1022	04	D114 (A) - B127 (P)	Bandeau	Palla	Panel - 1, Architectural - 2
1022	05	D115 (A) - B128 (P)	Bandeau	Farran	Panel - 1, Architectural - 2
1023	01	R230 (A) - R176 (P)	Artopia	Primer	Panel - 3, Architectural - 2
1023	02	R231 (A) - R177 (P)	Artopia	Kinetic	Panel - 3, Architectural - 2
1023	03	R232 (A) - R178 (P)	Artopia	Stencil	Panel - 3, Architectural - 2
1023	04	R233 (A) - R179 (P)	Artopia	Magenta	Panel - 3, Architectural - 2
1023	05	R234 (A) - R180 (P)	Artopia	Amberlith	Panel - 3, Architectural - 2
1023	06	R235 (A) - R181 (P)	Artopia	Cadmium	Panel - 3, Architectural - 2
1023	07	R236 (A) - R182 (P)	Artopia	Aquatint	Panel - 3, Architectural - 2
1023	08	R237 (A) - R183 (P)	Artopia	Vivid Blue	Panel - 3, Architectural - 2
1025	01	E314 (A) - T727 (P)	Emit	Watt	Panel - 1, Architectural 2
1025	02	E315 (A) - T728 (P)	Emit	Hertz	Panel - 1, Architectural 2
1025	03	E316 (A) - T729 (P)	Emit	Joule	Panel - 1, Architectural 2
1025	04	E317 (A) - T730 (P)	Emit	Dazzle	Panel - 1, Architectural 2
1025	05	E318 (A) - T731 (P)	Emit	Surge	Panel - 1, Architectural 2
1025	06	E319 (A) - T732 (P)	Emit	Particle	Panel - 1, Architectural 2
1030	01	R600 (P) - 8590 (A)	Stratiform	Calcify	Panel - 2, Architectural - 2
1030	02	R601 (P) - 8591 (A)	Stratiform	Limestone	Panel - 2, Architectural - 2
1030	03	R602 (P) - 8592 (A)	Stratiform	Sandhill	Panel - 2, Architectural - 2
1030	04	R603 (P) - 8593 (A)	Stratiform	Moraine	Panel - 2, Architectural - 2
1030	05	R604 (P) - 8594 (A)	Stratiform	Glacial	Panel - 2, Architectural - 2
1030	06	R605 (P) - 8595 (A)	Stratiform	Bedrock	Panel - 2, Architectural - 2
1030	07	R606 (P) - 8596 (A)	Stratiform	Flint	Panel - 2, Architectural - 2

Teknion Color Code Identifier (P) - Panel (U) - Upholstery (A) - Architectural

textile listings by pattern number (continued)

FABRIC PATTERN	COLOR CODE	TEKNION COLOR CODE	PATTERN NAME	COLOR NAME	APPLICATION GRADE
1032	01	C293 (U/A) - P800 (P)	Complect	Melanite	Upholstery - 2, Panel - 2, Architectural - 2
1032	02	C294 (U/A) - P801 (P)	Complect	Quarry	Upholstery - 2, Panel - 2, Architectural - 2
1032	03	C295 (U/A) - P802 (P)	Complect	Silverleaf	Upholstery - 2, Panel - 2, Architectural - 2
1032	04	C296 (U/A) - P803 (P)	Complect	Jute	Upholstery - 2, Panel - 2, Architectural - 2
1032	05	C297 (U/A) - P804 (P)	Complect	Cumulus	Upholstery - 2, Panel - 2, Architectural - 2
1032	06	C298 (U/A) - P805 (P)	Complect	Yolk	Upholstery - 2, Panel - 2, Architectural - 2
1032	07	C299 (U/A) - P806 (P)	Complect	Apricot	Upholstery - 2, Panel - 2, Architectural - 2
1032	08	C300 (U/A) - P807 (P)	Complect	Highlighter Pink	Upholstery - 2, Panel - 2, Architectural - 2
1032	09	C301 (U/A) - P808 (P)	Complect	Deep Crimson	Upholstery - 2, Panel - 2, Architectural - 2
1032	10	C302 (U/A) - P809 (P)	Complect	Autumn	Upholstery - 2, Panel - 2, Architectural - 2
1032	11	C303 (U/A) - P810 (P)	Complect	Opaline	Upholstery - 2, Panel - 2, Architectural - 2
1032	12	C304 (U/A) - P811 (P)	Complect	Reservoir	Upholstery - 2, Panel - 2, Architectural - 2
1032	13	C305 (U/A) - P812 (P)	Complect	Gentian	Upholstery - 2, Panel - 2, Architectural - 2
1032	14	C306 (U/A) - P813 (P)	Complect	Blue Ice	Upholstery - 2, Panel - 2, Architectural - 2
1032	15	C307 (U/A) - P814 (P)	Complect	Winter	Upholstery - 2, Panel - 2, Architectural - 2
1032	16	C308 (U/A) - P815 (P)	Complect	Boreal	Upholstery - 2, Panel - 2, Architectural - 2
1032	17	C309 (U/A) - P816 (P)	Complect	Turquoise	Upholstery - 2, Panel - 2, Architectural - 2
1032	18	C310 (U/A) - P817 (P)	Complect	Okra	Upholstery - 2, Panel - 2, Architectural - 2
1032	19	C311 (U/A) - P818 (P)	Complect	Agave	Upholstery - 2, Panel - 2, Architectural - 2
1034	01	G222	Graviton	Dark Matter	Upholstery - 2
1034	02	G223	Graviton	Chain Reaction	Upholstery - 2
1034	03	G224	Graviton	Echo	Upholstery - 2
1034	04	G225	Graviton	Cloud Chamber	Upholstery - 2
1034	05	G226	Graviton	Albedo	Upholstery - 2
1034	06	G227	Graviton	Half Life	Upholstery - 2
1034	07	G228	Graviton	Luminous Flux	Upholstery - 2
1034	08	G229	Graviton	Fission	Upholstery - 2
1034	09	G230	Graviton	Kelvin	Upholstery - 2
1034	10	G231	Graviton	Boiling Point	Upholstery - 2
1034	11	G232	Graviton	Quantum	Upholstery - 2
1034	12	G233	Graviton	Condensation	Upholstery - 2
1034	13	G234	Graviton	Centigrade	Upholstery - 2
1034	14	G235	Graviton	Ampere	Upholstery - 2
1034	15	G236	Graviton	Cold Fusion	Upholstery - 2
1034	16	G237	Graviton	Hydrostatic	Upholstery - 2

textile listings by pattern number (continued)

FABRIC PATTERN	COLOR CODE	TEKNION COLOR CODE	PATTERN NAME	COLOR NAME	APPLICATION GRADE
2001	01	L165 (P) - M570 (U/A)	Milieu	Kettle	Panel - 4, Upholstery - 3, Architectural - 3
2001	02	L166 (P) - M571 (U/A)	Milieu	Thunder	Panel - 4, Upholstery - 3, Architectural - 3
2001	03	L167 (P) - M572 (U/A)	Milieu	Memory	Panel - 4, Upholstery - 3, Architectural - 3
2001	04	L168 (P) - M573 (U/A)	Milieu	Steam	Panel - 4, Upholstery - 3, Architectural - 3
2001	05	L169 (P) - M574 (U/A)	Milieu	Wing	Panel - 4, Upholstery - 3, Architectural - 3
2001	06	L170 (P) - M575 (U/A)	Milieu	Nest	Panel - 4, Upholstery - 3, Architectural - 3
2001	07	L171 (P) - M576 (U/A)	Milieu	Leap	Panel - 4, Upholstery - 3, Architectural - 3
2001	08	L172 (P) - M577 (U/A)	Milieu	Troupe	Panel - 4, Upholstery - 3, Architectural - 3
2001	09	L173 (P) - M578 (U/A)	Milieu	Peregrine	Panel - 4, Upholstery - 3, Architectural - 3
2001	10	L174 (P) - M579 (U/A)	Milieu	Hedge	Panel - 4, Upholstery - 3, Architectural - 3
2001	11	L175 (P) - M580 (U/A)	Milieu	Prickle	Panel - 4, Upholstery - 3, Architectural - 3
2001	12	L176 (P) - M581 (U/A)	Milieu	Spring	Panel - 4, Upholstery - 3, Architectural - 3
2001	13	L177 (P) - M582 (U/A)	Milieu	Mustar	Panel - 4, Upholstery - 3, Architectural - 3
2001	14	L178 (P) - M583 (U/A)	Milieu	Herd	Panel - 4, Upholstery - 3, Architectural - 3
2001	15	L179 (P) - M584 (U/A)	Milieu	Parcel	Panel - 4, Upholstery - 3, Architectural - 3
2001	16	L180 (P) - M585 (U/A)	Milieu	Bloom	Panel - 4, Upholstery - 3, Architectural - 3
2001	17	L181 (P) - M586 (U/A)	Milieu	Fling	Panel - 4, Upholstery - 3, Architectural - 3
2001	18	L182 (P) - M587 (U/A)	Milieu	Flamboyance	Panel - 4, Upholstery - 3, Architectural - 3
2001	19	L183 (P) - M588 (U/A)	Milieu	Bazaar	Panel - 4, Upholstery - 3, Architectural - 3
2001	20	L184 (P) - M589 (U/A)	Milieu	Rabble	Panel - 4, Upholstery - 3, Architectural - 3
2001	21	L185 (P) - M590 (U/A)	Milieu	Zeal	Panel - 4, Upholstery - 3, Architectural - 3
2001	22	L186 (P) - M591 (U/A)	Milieu	Bevy	Panel - 4, Upholstery - 3, Architectural - 3
2001	23	L187 (P) - M592 (U/A)	Milieu	Loft	Panel - 4, Upholstery - 3, Architectural - 3
2001	24	L188 (P) - M593 (U/A)	Milieu	Float	Panel - 4, Upholstery - 3, Architectural - 3
2001	25	L189 (P) - M594 (U/A)	Milieu	Paddling	Panel - 4, Upholstery - 3, Architectural - 3
2001	26	L190 (P) - M595 (U/A)	Milieu	Shoal	Panel - 4, Upholstery - 3, Architectural - 3
2001	27	L191 (P) - M596 (U/A)	Milieu	Fleet	Panel - 4, Upholstery - 3, Architectural - 3
2002	01	W235 (P) - T397 (U/A)	Intraweb	Raster	Panel - 4, Upholstery - 3, Architectural - 3
2002	02	W236 (P) - T398 (U/A)	Intraweb	Dual Trace	Panel - 4, Upholstery - 3, Architectural - 3
2002	03	W237 (P) - T399 (U/A)	Intraweb	Polytope	Panel - 4, Upholstery - 3, Architectural - 3
2002	04	W238 (P) - T400 (U/A)	Intraweb	Superposition	Panel - 4, Upholstery - 3, Architectural - 3
2002	05	W239 (P) - T401 (U/A)	Intraweb	Coaxial	Panel - 4, Upholstery - 3, Architectural - 3
2002	06	W240 (P) - T402 (U/A)	Intraweb	Origin	Panel - 4, Upholstery - 3, Architectural - 3
2002	07	W241 (P) - T403 (U/A)	Intraweb	Slope	Panel - 4, Upholstery - 3, Architectural - 3
2002	08	W242 (P) - T404 (U/A)	Intraweb	Polarity	Panel - 4, Upholstery - 3, Architectural - 3
2002	09	W243 (P) - T405 (U/A)	Intraweb	Isosurface	Panel - 4, Upholstery - 3, Architectural - 3

textile listings by pattern number (continued)

FABRIC PATTERN	COLOR CODE	TEKNION COLOR CODE	PATTERN NAME	COLOR NAME	APPLICATION GRADE
4001	01	E505	Fundamentals	Banner	Upholstery - 1
4001	03	E535	Fundamentals	Latte	Upholstery - 1
4001	04	E518	Fundamentals	Brier	Upholstery - 1
4001	05	E532	Fundamentals	Dove	Upholstery - 1
4001	06	E522	Fundamentals	Light Grey	Upholstery - 1
4001	07	E519	Fundamentals	Sudan	Upholstery - 1
4001	09	E528	Fundamentals	Verde	Upholstery - 1
4001	10	E533	Fundamentals	Nickel	Upholstery - 1
4001	12	E516	Fundamentals	Parakeet	Upholstery - 1
4001	13	E534	Fundamentals	Slate	Upholstery - 1
4001	14	E526	Fundamentals	Tangelo	Upholstery - 1
4001	15	E529	Fundamentals	Aqua	Upholstery - 1
4001	16	E521	Fundamentals	Armory	Upholstery - 1
4001	17	E504	Fundamentals	Salsa	Upholstery - 1
4001	18	E530	Fundamentals	Azure	Upholstery - 1
4001	19	E523	Fundamentals	Black	Upholstery - 1
4001	21	E520	Fundamentals	Wendigo	Upholstery - 1
4001	22	E536	Fundamentals	Marble	Upholstery - 1
4001	23	E537	Fundamentals	Moonstone	Upholstery - 1
4001	24	E538	Fundamentals	Lapis	Upholstery - 1
4001	25	E539	Fundamentals	Malachite	Upholstery - 1
<hr/>					
4007	01	H510	Heather Felt	Noil	Upholstery - 9
4007	02	H511	Heather Felt	Alumina	Upholstery - 9
4007	03	H512	Heather Felt	Bone Ash	Upholstery - 9
4007	04	H513	Heather Felt	Pinon Tree	Upholstery - 9
4007	06	H515	Heather Felt	Saddle	Upholstery - 9
4007	07	H516	Heather Felt	Indian Ocean	Upholstery - 9
4007	08	H517	Heather Felt	Mustard Seed	Upholstery - 9
4007	09	H518	Heather Felt	Saffron	Upholstery - 9
4007	10	H519	Heather Felt	Acai	Upholstery - 9
4007	11	H520	Heather Felt	Armor	Upholstery - 9
4007	13	H522	Heather Felt	Marina	Upholstery - 9
4007	14	H523	Heather Felt	Grove	Upholstery - 9
4007	16	H525	Heather Felt	Scarlet	Upholstery - 9

textile listings by pattern number (continued)

FABRIC PATTERN	COLOR CODE	TEKNION COLOR CODE	PATTERN NAME	COLOR NAME	APPLICATION GRADE
4008	02	F207	Full Wool	Blanc	Upholstery - 8
4008	04	F209	Full Wool	Hot Stone	Upholstery - 8
4008	05	F210	Full Wool	Éclair	Upholstery - 8
4008	06	F211	Full Wool	Macchiato	Upholstery - 8
4008	07	F212	Full Wool	Ink	Upholstery - 8
4008	09	F214	Full Wool	Tigerlily	Upholstery - 8
4008	10	F215	Full Wool	Fresh Water	Upholstery - 8
4008	11	F216	Full Wool	Serpent	Upholstery - 8
4008	13	F218	Full Wool	Neptune	Upholstery - 8
4008	14	F219	Full Wool	Safari	Upholstery - 8
4008	15	F220	Full Wool	Vintage Red	Upholstery - 8
4008	16	F221	Full Wool	Lagoon	Upholstery - 8
4008	17	F222	Full Wool	Oak Room	Upholstery - 8
4008	18	F223	Full Wool	Deep Orchid	Upholstery - 8
<hr/>					
4009	01	C120 (U) - R150 (P)	Cross Dye	Earl Grey	Upholstery - 2, Panel - 3
4009	02	C121 (U) - R151 (P)	Cross Dye	Linen	Upholstery - 2, Panel - 3
4009	03	C122 (U) - R152 (P)	Cross Dye	Light Birch	Upholstery - 2, Panel - 3
4009	04	C123 (U) - R153 (P)	Cross Dye	Almond	Upholstery - 2, Panel - 3
4009	05	C124 (U) - R154 (P)	Cross Dye	Soft Shadow	Upholstery - 2, Panel - 3
4009	06	C125 (U) - R155 (P)	Cross Dye	Ace Grey	Upholstery - 2, Panel - 3
4009	07	C126 (U) - R156 (P)	Cross Dye	Cool Ash	Upholstery - 2, Panel - 3
4009	08	C127 (U) - R157 (P)	Cross Dye	Carotene	Upholstery - 2, Panel - 3
4009	09	C128 (U) - R158 (P)	Cross Dye	Crimson	Upholstery - 2, Panel - 3
4009	10	C129 (U) - R159 (P)	Cross Dye	Carmine	Upholstery - 2, Panel - 3
4009	11	C130 (U) - R160 (P)	Cross Dye	Tea Tree	Upholstery - 2, Panel - 3
4009	12	C131 (U) - R161 (P)	Cross Dye	Artichoke	Upholstery - 2, Panel - 3
4009	13	C132 (U) - R162 (P)	Cross Dye	Plum	Upholstery - 2, Panel - 3
4009	14	C133 (U) - R163 (P)	Cross Dye	Watercolor	Upholstery - 2, Panel - 3
4009	15	C134 (U) - R164 (P)	Cross Dye	Azure	Upholstery - 2, Panel - 3
4009	16	C135 (U) - R165 (P)	Cross Dye	Logwood	Upholstery - 2, Panel - 3
<hr/>					
4010	01	F314 (U) - R166 (P)	Marl Cloth	Yurt	Upholstery - 3, Panel - 3
4010	02	F315 (U) - R167 (P)	Marl Cloth	Guy Rope	Upholstery - 3, Panel - 3
4010	04	F317 (U) - R169 (P)	Marl Cloth	Camp Fire	Upholstery - 3, Panel - 3
4010	05	F318 (U) - R170 (P)	Marl Cloth	Dry Stone	Upholstery - 3, Panel - 3
4010	07	F320 (U) - R172 (P)	Marl Cloth	Berry	Upholstery - 3, Panel - 3
4010	08	F321 (U) - R173 (P)	Marl Cloth	Blacksmith	Upholstery - 3, Panel - 3
4010	09	F322 (U) - R174 (P)	Marl Cloth	Sea Nomad	Upholstery - 3, Panel - 3
4010	10	F323 (U) - R175 (P)	Marl Cloth	Wild Fruit	Upholstery - 3, Panel - 3
4010	11	F324 (U) - R195 (P)	Marl Cloth	Dreamscape	Upholstery - 3, Panel - 3
4010	12	F325 (U) - R196 (P)	Marl Cloth	Landmark	Upholstery - 3, Panel - 3
4010	13	F326 (U) - R197 (P)	Marl Cloth	Tree Bark	Upholstery - 3, Panel - 3

textile listings by pattern number (continued)

FABRIC PATTERN	COLOR CODE	TEKNION COLOR CODE	PATTERN NAME	COLOR NAME	APPLICATION GRADE
4015	01	V310	Velvet Underground	Metal Machine	Upholstery - 4
4015	04	V313	Velvet Underground	Flame Desire	Upholstery - 4
4015	06	V315	Velvet Underground	Blue Denim	Upholstery - 4
4015	08	V317	Velvet Underground	Dark Moon	Upholstery - 4
4015	09	V318	Velvet Underground	Blacktop	Upholstery - 4
4015	11	V319	Velvet Underground	Brass Section	Upholstery - 4
4015	13	V320	Velvet Underground	Shock Wave	Upholstery - 4
4015	19	V321	Velvet Underground	Full Phase	Upholstery - 4
4015	20	V322	Velvet Underground	Dark Current	Upholstery - 4
4015	10	V323	Velvet Underground	Smoke Screen	Upholstery - 4
4015	12	V324	Velvet Underground	Wallflower	Upholstery - 4
4015	14	V325	Velvet Underground	Ultraviolet	Upholstery - 4
4015	15	V326	Velvet Underground	Purple Rain	Upholstery - 4
4015	16	V327	Velvet Underground	Green Room	Upholstery - 4
4015	17	V328	Velvet Underground	Garden Level	Upholstery - 4
4015	18	V329	Velvet Underground	New Wave	Upholstery - 4
<hr/>					
4019	01	M140	Magnify	Telescope	Upholstery - 1
4019	02	M141	Magnify	Polished Mirror	Upholstery - 1
4019	03	M142	Magnify	Reflection	Upholstery - 1
4019	04	M143	Magnify	Zoom Lens	Upholstery - 1
4019	05	M144	Magnify	Force Field	Upholstery - 1
4019	06	M145	Magnify	Long Wave	Upholstery - 1
4019	07	M146	Magnify	Deep Water	Upholstery - 1
4019	08	M147	Magnify	Light Beam	Upholstery - 1
4019	09	M148	Magnify	Flare Up	Upholstery - 1
4019	10	M149	Magnify	Viewfinder	Upholstery - 1
4019	12	M151	Magnify	Infrared	Upholstery - 1
<hr/>					
4021	01	V490	Ultra Durable	Wet Clay	Upholstery - 2
4021	02	V180	Ultra Durable	Mohair	Upholstery - 2
4021	03	V182	Ultra Durable	Iced Coffee	Upholstery - 2
4021	04	V493	Ultra Durable	Silver Age	Upholstery - 2
4021	08	V497	Ultra Durable	Morning Glory	Upholstery - 2
4021	11	V500	Ultra Durable	Neptune	Upholstery - 2
4021	12	V184	Ultra Durable	Tungsten	Upholstery - 2
4021	14	V503	Ultra Durable	Fig	Upholstery - 2
4021	15	V187	Ultra Durable	Black Velvet	Upholstery - 2

textile listings by pattern number (continued)

FABRIC PATTERN	COLOR CODE	TEKNION COLOR CODE	PATTERN NAME	COLOR NAME	APPLICATION GRADE
4023	01	L110	Merus	Teak	Leather - LB
4023	02	L111	Merus	White Birch	Leather - LB
4023	03	L112	Merus	Beechwood	Leather - LB
4023	05	L114	Merus	Almond Shell	Leather - LB
4023	08	L117	Merus	Smoke	Leather - LB
4023	09	L118	Merus	Hopi	Leather - LB
4023	10	L119	Merus	Crushed Bark	Leather - LB
4023	14	L123	Merus	Black Truffle	Leather - LB
4024	01	L216	Pela	Clove	Leather - LC
4024	02	L217	Pela	White Clay	Leather - LC
4024	03	L218	Pela	Chamois	Leather - LC
4024	05	L220	Pela	Buckwheat	Leather - LC
4024	06	L221	Pela	Hemlock	Leather - LC
4024	07	L222	Pela	Fern	Leather - LC
4024	11	L226	Pela	Cerulean	Leather - LC
4024	12	L227	Pela	Marigold	Leather - LC
4024	13	L228	Pela	Pomegranate	Leather - LC
4024	14	L229	Pela	Cordon	Leather - LC
4024	15	L230	Pela	Black Cherry	Leather - LC
4024	17	L232	Pela	Nightshade	Leather - LC
4024	18	L233	Pela	Morel	Leather - LC
4024	19	L234	Pela	Russet	Leather - LC
4024	20	L235	Pela	Carbon	Leather - LC
4024	21	L236	Pela	Pitch	Leather - LC
4025	01	L310	Fortis	Canyon	Leather - LD
4025	02	L311	Fortis	Bone	Leather - LD
4025	04	L313	Fortis	Terra	Leather - LD
4025	05	L314	Fortis	Nugget	Leather - LD
4025	07	L316	Fortis	Black Rock	Leather - LD
4029	01	F115	Situ	Archeology	Upholstery - 3
4029	02	F116	Situ	Pozzolana	Upholstery - 3
4029	03	F117	Situ	Amphora	Upholstery - 3
4029	04	F118	Situ	Statue	Upholstery - 3
4029	05	F119	Situ	Wind Tower	Upholstery - 3
4029	06	F120	Situ	Tunnel	Upholstery - 3
4029	07	F121	Situ	Phosphor	Upholstery - 3
4029	08	F122	Situ	Flamante	Upholstery - 3
4029	09	F123	Situ	Hydro	Upholstery - 3
4029	11	F125	Situ	Terrena	Upholstery - 3
4029	12	F126	Situ	Mar	Upholstery - 3

textile listings by pattern number (continued)

FABRIC PATTERN	COLOR CODE	TEKNION COLOR CODE	PATTERN NAME	COLOR NAME	APPLICATION GRADE
4030	01	S135	Synaptic	Contact	Upholstery - 5
4030	02	S136	Synaptic	Phase	Upholstery - 5
4030	04	S138	Synaptic	Conduit	Upholstery - 5
4030	05	S139	Synaptic	Sensory	Upholstery - 5
4030	06	S140	Synaptic	Receptor	Upholstery - 5
4030	07	S141	Synaptic	Traverse	Upholstery - 5
4030	08	S142	Synaptic	Transmission	Upholstery - 5
4030	10	S144	Synaptic	Axon	Upholstery - 5
4033	01	S145	Stimuli	Sensitive	Upholstery - 1
4033	02	S146	Stimuli	Turbinado	Upholstery - 1
4033	03	S147	Stimuli	Rush	Upholstery - 1
4033	04	S148	Stimuli	Zest	Upholstery - 1
4033	05	S149	Stimuli	Tactile	Upholstery - 1
4033	06	S150	Stimuli	Daredevil	Upholstery - 1
4033	07	S151	Stimuli	Euphoria	Upholstery - 1
4033	08	S152	Stimuli	Vigor	Upholstery - 1
4033	09	S153	Stimuli	Thrill	Upholstery - 1
4033	10	S154	Stimuli	Catalyst	Upholstery - 1
4033	11	S155	Stimuli	Black Tea	Upholstery - 1
4034	01	T220	Ample	Quark	Upholstery - 3
4034	02	T221	Ample	Voltage	Upholstery - 3
4034	03	T222	Ample	Sunburst	Upholstery - 3
4034	05	T224	Ample	Radioactive	Upholstery - 3
4034	08	T227	Ample	Reaction	Upholstery - 3
4034	10	T229	Ample	Cosmic	Upholstery - 3
4034	11	T239	Ample	Blue Comet	Upholstery - 3
4034	13	T241	Ample	Vortex	Upholstery - 3
4034	14	T242	Ample	Neutron	Upholstery - 3
4034	15	T243	Ample	Tempered	Upholstery - 3
4035	01	H100	Homage	Respect	Upholstery - 8
4035	02	H102	Homage	Winsome	Upholstery - 8
4035	03	H105	Homage	Esteem	Upholstery - 8
4035	04	H103	Homage	Dashing	Upholstery - 8
4035	05	H104	Homage	Authority	Upholstery - 8
4035	07	H106	Homage	Soigné	Upholstery - 8
4035	08	H107	Homage	Valor	Upholstery - 8
4035	09	H108	Homage	Sanguine	Upholstery - 8
4035	10	H109	Homage	Vivant	Upholstery - 8
4035	11	H110	Homage	Guild	Upholstery - 8
4035	12	H111	Homage	Pinnacle	Upholstery - 8
4035	13	H112	Homage	Noble	Upholstery - 8

textile listings by pattern number (continued)

FABRIC PATTERN	COLOR CODE	TEKNION COLOR CODE	PATTERN NAME	COLOR NAME	APPLICATION GRADE
4040	01	P107 (U/A) - C814 (P)	Percept	Pristine	Upholstery - 2, Panel - 2, Architectural - 2
4040	02	P110 (U/A) - C817 (P)	Percept	Sublime	Upholstery - 2, Panel - 2, Architectural - 2
4040	03	P111 (U/A) - C818 (P)	Percept	Context	Upholstery - 2, Panel - 2, Architectural - 2
4040	04	P112 (U/A) - C819 (P)	Percept	Essence	Upholstery - 2, Panel - 2, Architectural - 2
4040	06	P108 (U/A) - C815 (P)	Percept	Intrinsic	Upholstery - 2, Panel - 2, Architectural - 2
4040	07	P106 (U/A) - C813 (P)	Percept	Schema	Upholstery - 2, Panel - 2, Architectural - 2
4040	08	P114 (U/A) - C821 (P)	Percept	Epiphany	Upholstery - 2, Panel - 2, Architectural - 2
4040	09	P117 (U/A) - C824 (P)	Percept	Reason	Upholstery - 2, Panel - 2, Architectural - 2
4040	10	P120 (U/A) - C827 (P)	Percept	Jubilant	Upholstery - 2, Panel - 2, Architectural - 2
4040	11	P113 (U/A) - C820 (P)	Percept	Tenet	Upholstery - 2, Panel - 2, Architectural - 2
4040	12	P123 (U/A) - C830 (P)	Percept	Peak	Upholstery - 2, Panel - 2, Architectural - 2
4040	13	P116 (U/A) - C823 (P)	Percept	Amplitude	Upholstery - 2, Panel - 2, Architectural - 2
4040	14	P122 (U/A) - C829 (P)	Percept	Harmonic	Upholstery - 2, Panel - 2, Architectural - 2
4040	15	P119 (U/A) - C826 (P)	Percept	Nebula	Upholstery - 2, Panel - 2, Architectural - 2
4040	16	P124 (U/A) - C831 (P)	Percept	Devotion	Upholstery - 2, Panel - 2, Architectural - 2
4040	17	P118 (U/A) - C825 (P)	Percept	Cardinality	Upholstery - 2, Panel - 2, Architectural - 2
4040	18	P121 (U/A) - C828 (P)	Percept	Ignite	Upholstery - 2, Panel - 2, Architectural - 2
4040	19	P115 (U/A) - C822 (P)	Percept	Verve	Upholstery - 2, Panel - 2, Architectural - 2
4040	20	P125 (U/A) - C832 (P)	Percept	Transmit	Upholstery - 2, Panel - 2, Architectural - 2
4040	21	P126 (U/A) - C833 (P)	Percept	Render	Upholstery - 2, Panel - 2, Architectural - 2
4040	22	P127 (U/A) - C834 (P)	Percept	Pulse	Upholstery - 2, Panel - 2, Architectural - 2
4040	23	P128 (U/A) - C835 (P)	Percept	Constant	Upholstery - 2, Panel - 2, Architectural - 2
4040	24	P129 (U/A) - C836 (P)	Percept	Radiant	Upholstery - 2, Panel - 2, Architectural - 2
4040	25	P130 (U/A) - C837 (P)	Percept	Propagate	Upholstery - 2, Panel - 2, Architectural - 2
4040	26	P131 (U/A) - C838 (P)	Percept	Placid	Upholstery - 2, Panel - 2, Architectural - 2
4040	27	P132 (U/A) - C839 (P)	Percept	Singular	Upholstery - 2, Panel - 2, Architectural - 2
4040	28	P133 (U/A) - C840 (P)	Percept	Fringe	Upholstery - 2, Panel - 2, Architectural - 2
<hr/>					
4041	01	M160	Perilune	Terrene	Upholstery - 6
4041	02	M161	Perilune	Asteroid	Upholstery - 6
4041	03	M162	Perilune	Stellar	Upholstery - 6
4041	04	M163	Perilune	Satellite	Upholstery - 6
4041	05	M164	Perilune	Gravity	Upholstery - 6
4041	06	M165	Perilune	Red Shift	Upholstery - 6
4041	07	M166	Perilune	Blue Moon	Upholstery - 6
4041	08	M167	Perilune	Space Age	Upholstery - 6
4041	09	M168	Perilune	Verdant	Upholstery - 6
4041	10	M169	Perilune	Pulsar	Upholstery - 6
4041	11	M170	Perilune	Solar	Upholstery - 6
4041	12	M171	Perilune	Hot Crater	Upholstery - 6
<hr/>					
4042	01	T148 (U/A) - C279 (P)	Complement	Nightfall	Panel - 2, Upholstery 2, Architectural - 2
4042	02	T149 (U/A) - C280 (P)	Complement	Dusk	Panel - 2, Upholstery 2, Architectural - 2
4042	03	T150 (U/A) - C281 (P)	Complement	Grey Wolf	Panel - 2, Upholstery 2, Architectural - 2
4042	04	T151 (U/A) - C282 (P)	Complement	Sea Salt	Panel - 2, Upholstery 2, Architectural - 2
4042	05	T152 (U/A) - C283 (P)	Complement	Roan	Panel - 2, Upholstery 2, Architectural - 2
4042	06	T153 (U/A) - C284 (P)	Complement	Amarillo	Panel - 2, Upholstery 2, Architectural - 2
4042	07	T154 (U/A) - C285 (P)	Complement	Arancia	Panel - 2, Upholstery 2, Architectural - 2
4042	08	T155 (U/A) - C286 (P)	Complement	Carnelian	Panel - 2, Upholstery 2, Architectural - 2
4042	09	T156 (U/A) - C287 (P)	Complement	Garnet	Panel - 2, Upholstery 2, Architectural - 2
4042	11	T158 (U/A) - C289 (P)	Complement	Fresh Air	Panel - 2, Upholstery 2, Architectural - 2
4042	12	T159 (U/A) - C290 (P)	Complement	Peacock	Panel - 2, Upholstery 2, Architectural - 2

Teknion Color Code Identifier (P) - Panel (U) - Upholstery (A) - Architectural

textile listings by pattern number (continued)

FABRIC PATTERN	COLOR CODE	TEKNION COLOR CODE	PATTERN NAME	COLOR NAME	APPLICATION GRADE
4046	01	F401	Fine Grain	Warm Earth	Upholstery - 3
4046	02	F402	Fine Grain	River Ore	Upholstery - 3
4046	03	F403	Fine Grain	Saw Dust	Upholstery - 3
4046	04	F404	Fine Grain	Putty Paste	Upholstery - 3
4046	05	F405	Fine Grain	White Out	Upholstery - 3
4046	06	F406	Fine Grain	Lunar Regolith	Upholstery - 3
4046	07	F407	Fine Grain	Metallic Swarf	Upholstery - 3
4046	08	F408	Fine Grain	Volcanic Ash	Upholstery - 3
4046	09	F409	Fine Grain	Carbon Neutral	Upholstery - 3
4046	10	F410	Fine Grain	Frosted Zephyr	Upholstery - 3
4046	11	F411	Fine Grain	Deep Indigo	Upholstery - 3
4046	12	F412	Fine Grain	Fathom Blue	Upholstery - 3
4046	13	F413	Fine Grain	Sea Weed	Upholstery - 3
4046	14	F414	Fine Grain	Matcha Leaves	Upholstery - 3
4046	15	F415	Fine Grain	French Beige	Upholstery - 3
4046	16	F416	Fine Grain	Ginger Snap	Upholstery - 3
4046	17	F417	Fine Grain	Martian Soil	Upholstery - 3
4046	18	F418	Fine Grain	Madder Root	Upholstery - 3
4046	19	F419	Fine Grain	Garnet Sand	Upholstery - 3
4046	20	F420	Fine Grain	Iron Oxide	Upholstery - 3
4046	21	F421	Fine Grain	Peat Moss	Upholstery - 3
<hr/>					
4048	01	LP11 (P) - LM12 (A/U)	Intone	Ash	Panel - 3, Architectural 2, Upholstery 2
4048	02	LP12 (P) - LM13 (A/U)	Intone	Creme	Panel - 3, Architectural 2, Upholstery 2
4048	03	LP13 (P) - LM14 (A/U)	Intone	Harbor	Panel - 3, Architectural 2, Upholstery 2
4048	04	LP14 (P) - LM15 (A/U)	Intone	Quicksilver	Panel - 3, Architectural 2, Upholstery 2
4048	05	LP15 (P) - LM16 (A/U)	Intone	Caraway	Panel - 3, Architectural 2, Upholstery 2
4048	06	LP16 (P) - LM17 (A/U)	Intone	Oxide	Panel - 3, Architectural 2, Upholstery 2
4048	07	LP17 (P) - LM18 (A/U)	Intone	Cinder	Panel - 3, Architectural 2, Upholstery 2
4048	08	LP18 (P) - LM19 (A/U)	Intone	Lute	Panel - 3, Architectural 2, Upholstery 2
4048	09	LP19 (P) - LM20 (A/U)	Intone	Pome	Panel - 3, Architectural 2, Upholstery 2
4048	10	LP20 (P) - LM21 (A/U)	Intone	Eclipse	Panel - 3, Architectural 2, Upholstery 2
<hr/>					
4049	01	C237	Outpress	Ashen	Upholstery - 6
4049	02	C238	Outpress	Sand	Upholstery - 6
4049	03	C239	Outpress	Stone	Upholstery - 6
4049	04	C240	Outpress	Soot	Upholstery - 6
4049	05	C241	Outpress	Raven	Upholstery - 6
4049	06	C242	Outpress	Pepper	Upholstery - 6
4049	07	C243	Outpress	Monarch	Upholstery - 6
4049	08	C244	Outpress	Caribbean	Upholstery - 6
4049	09	C245	Outpress	Denim	Upholstery - 6
<hr/>					
4051	01	K106	Amalgam	Aura	Upholstery - 6
4051	02	K107	Amalgam	Pyrite	Upholstery - 6
4051	03	K108	Amalgam	Medallion	Upholstery - 6
4051	04	K109	Amalgam	Fluid	Upholstery - 6
4051	05	K110	Amalgam	Ultraviolet	Upholstery - 6
4051	06	K111	Amalgam	Jolt	Upholstery - 6
4051	07	K112	Amalgam	Nitro	Upholstery - 6
4051	08	K113	Amalgam	Magma	Upholstery - 6
4051	09	K114	Amalgam	Fuse	Upholstery - 6

Teknion Color Code Identifier (P) - Panel (U) - Upholstery (A) - Architectural

textile listings by pattern number (continued)

FABRIC PATTERN	COLOR CODE	TEKNION COLOR CODE	PATTERN NAME	COLOR NAME	APPLICATION GRADE
4053	01	G106	Monotex	Silver Lane	Upholstery - 5
4053	02	G107	Monotex	Sharkskin	Upholstery - 5
4053	03	G108	Monotex	Grey Flannel	Upholstery - 5
4053	04	G109	Monotex	Grey Marl	Upholstery - 5
4053	05	G110	Monotex	Tarpaper	Upholstery - 5
4053	06	G111	Monotex	Ferrous	Upholstery - 5
4053	07	G112	Monotex	Bark Cloth	Upholstery - 5
4053	08	G113	Monotex	Burlap	Upholstery - 5
4053	09	G114	Monotex	Sumac	Upholstery - 5
4053	10	G115	Monotex	Redroot	Upholstery - 5
4053	11	G116	Monotex	Tyrian	Upholstery - 5
4053	12	G117	Monotex	Anatto	Upholstery - 5
4053	13	G118	Monotex	Jean	Upholstery - 5
4053	14	G119	Monotex	Kingfisher	Upholstery - 5
4053	15	G120	Monotex	Oxalis	Upholstery - 5
4053	16	G121	Monotex	Sulfur	Upholstery - 5
<hr/>					
4057	01	M172	Modulus	Plinth	Upholstery - 4
4057	02	M173	Modulus	Landscape	Upholstery - 4
4057	03	M174	Modulus	Masonry	Upholstery - 4
4057	04	M175	Modulus	Superstructure	Upholstery - 4
4057	05	M176	Modulus	Skylight	Upholstery - 4
4057	06	M177	Modulus	Site	Upholstery - 4
4057	07	M178	Modulus	Form	Upholstery - 4
4057	08	M179	Modulus	Shadow Play	Upholstery - 4
4057	09	M180	Modulus	Rebar	Upholstery - 4
4057	10	M181	Modulus	Spatial	Upholstery - 4
4057	11	M182	Modulus	Threshold	Upholstery - 4
4057	12	M183	Modulus	Monument	Upholstery - 4
<hr/>					
4058	01	D310 (U/A) - B130 (P)	Digi Tweed	Dust Tweed	Upholstery - 2, Panel - 2, Architectural - 2
4058	02	D311 (U/A) - B131 (P)	Digi Tweed	Topaz Tweed	Upholstery - 2, Panel - 2, Architectural - 2
4058	03	D312 (U/A) - B132 (P)	Digi Tweed	Oat Tweed	Upholstery - 2, Panel - 2, Architectural - 2
4058	04	D313 (U/A) - B133 (P)	Digi Tweed	Flax Tweed	Upholstery - 2, Panel - 2, Architectural - 2
4058	05	D314 (U/A) - B134 (P)	Digi Tweed	Silt Tweed	Upholstery - 2, Panel - 2, Architectural - 2
4058	06	D315 (U/A) - B135 (P)	Digi Tweed	Loam Tweed	Upholstery - 2, Panel - 2, Architectural - 2
4058	07	D316 (U/A) - B136 (P)	Digi Tweed	Crag Tweed	Upholstery - 2, Panel - 2, Architectural - 2
4058	08	D317 (U/A) - B137 (P)	Digi Tweed	Basalt Tweed	Upholstery - 2, Panel - 2, Architectural - 2
4058	09	D318 (U/A) - B138 (P)	Digi Tweed	Loden Tweed	Upholstery - 2, Panel - 2, Architectural - 2
4058	10	D319 (U/A) - B139 (P)	Digi Tweed	Sagebrush Tweed	Upholstery - 2, Panel - 2, Architectural - 2
4058	11	D320 (U/A) - B140 (P)	Digi Tweed	Meadow Tweed	Upholstery - 2, Panel - 2, Architectural - 2
4058	12	D321 (U/A) - B141 (P)	Digi Tweed	Sundew Tweed	Upholstery - 2, Panel - 2, Architectural - 2
4058	13	D322 (U/A) - B142 (P)	Digi Tweed	Rose Tweed	Upholstery - 2, Panel - 2, Architectural - 2
4058	14	D323 (U/A) - B143 (P)	Digi Tweed	Raspite Tweed	Upholstery - 2, Panel - 2, Architectural - 2
4058	15	D324 (U/A) - B144 (P)	Digi Tweed	Madder Tweed	Upholstery - 2, Panel - 2, Architectural - 2
4058	16	D325 (U/A) - B145 (P)	Digi Tweed	Beetroot Tweed	Upholstery - 2, Panel - 2, Architectural - 2
4058	17	D326 (U/A) - B146 (P)	Digi Tweed	Thistle Tweed	Upholstery - 2, Panel - 2, Architectural - 2
4058	18	D327 (U/A) - B147 (P)	Digi Tweed	Lav Tweed	Upholstery - 2, Panel - 2, Architectural - 2
4058	19	D328 (U/A) - B148 (P)	Digi Tweed	Clear Tweed	Upholstery - 2, Panel - 2, Architectural - 2
4058	20	D329 (U/A) - B149 (P)	Digi Tweed	Loch Tweed	Upholstery - 2, Panel - 2, Architectural - 2
4058	21	D330 (U/A) - B150 (P)	Digi Tweed	Ocean Tweed	Upholstery - 2, Panel - 2, Architectural - 2
4058	22	D331 (U/A) - B151 (P)	Digi Tweed	North Sea Tweed	Upholstery - 2, Panel - 2, Architectural - 2
4058	23	D332 (U/A) - B152 (P)	Digi Tweed	Onyx Tweed	Upholstery - 2, Panel - 2, Architectural - 2
4058	24	D333 (U/A) - B153 (P)	Digi Tweed	Obsidian Tweed	Upholstery - 2, Panel - 2, Architectural - 2

Teknion Color Code Identifier (P) - Panel (U) - Upholstery (A) - Architectural

textile listings by pattern number (continued)

FABRIC PATTERN	COLOR CODE	TEKNION COLOR CODE	PATTERN NAME	COLOR NAME	APPLICATION GRADE
4059	01	T162 (U/A) - R240 (P)	Heather Tech	Dust Tech	Upholstery - 1, Panel - 1, Architectural - 2
4059	02	T163 (U/A) - R241 (P)	Heather Tech	Topaz Tech	Upholstery - 1, Panel - 1, Architectural - 2
4059	03	T164 (U/A) - R242 (P)	Heather Tech	Oat Tech	Upholstery - 1, Panel - 1, Architectural - 2
4059	04	T165 (U/A) - R243 (P)	Heather Tech	Flax Tech	Upholstery - 1, Panel - 1, Architectural - 2
4059	05	T166 (U/A) - R244 (P)	Heather Tech	Silt Tweed	Upholstery - 1, Panel - 1, Architectural - 2
4059	06	T167 (U/A) - R245 (P)	Heather Tech	Loam Tweed	Upholstery - 1, Panel - 1, Architectural - 2
4059	07	T168 (U/A) - R246 (P)	Heather Tech	Crag Tech	Upholstery - 1, Panel - 1, Architectural - 2
4059	08	T169 (U/A) - R247 (P)	Heather Tech	Basalt Tech	Upholstery - 1, Panel - 1, Architectural - 2
4059	09	T170 (U/A) - R248 (P)	Heather Tech	Loden Tech	Upholstery - 1, Panel - 1, Architectural - 2
4059	10	T171 (U/A) - R249 (P)	Heather Tech	Sagebrush Tech	Upholstery - 1, Panel - 1, Architectural - 2
4059	11	T172 (U/A) - R250 (P)	Heather Tech	Meadow Tech	Upholstery - 1, Panel - 1, Architectural - 2
4059	12	T173 (U/A) - R251 (P)	Heather Tech	Sundew Tech	Upholstery - 1, Panel - 1, Architectural - 2
4059	13	T174 (U/A) - R252 (P)	Heather Tech	Rose Tech	Upholstery - 1, Panel - 1, Architectural - 2
4059	14	T175 (U/A) - R253 (P)	Heather Tech	Raspite Tech	Upholstery - 1, Panel - 1, Architectural - 2
4059	15	T176 (U/A) - R254 (P)	Heather Tech	Madder Tech	Upholstery - 1, Panel - 1, Architectural - 2
4059	16	T177 (U/A) - R255 (P)	Heather Tech	Beetroot Tech	Upholstery - 1, Panel - 1, Architectural - 2
4059	17	T178 (U/A) - R256 (P)	Heather Tech	Thistle Tech	Upholstery - 1, Panel - 1, Architectural - 2
4059	18	T179 (U/A) - R257 (P)	Heather Tech	Lav Tech	Upholstery - 1, Panel - 1, Architectural - 2
4059	19	T180 (U/A) - R258 (P)	Heather Tech	Clear Tech	Upholstery - 1, Panel - 1, Architectural - 2
4059	20	T181 (U/A) - R259 (P)	Heather Tech	Loch Tech	Upholstery - 1, Panel - 1, Architectural - 2
4059	21	T182 (U/A) - R260 (P)	Heather Tech	Ocean Tech	Upholstery - 1, Panel - 1, Architectural - 2
4059	22	T183 (U/A) - R261 (P)	Heather Tech	North Sea Tech	Upholstery - 1, Panel - 1, Architectural - 2
4059	23	T184 (U/A) - R262 (P)	Heather Tech	Onyx Tech	Upholstery - 1, Panel - 1, Architectural - 2
4059	24	T185 (U/A) - R263 (P)	Heather Tech	Obsidian Tech	Upholstery - 1, Panel - 1, Architectural - 2
<hr/>					
4060	01	E100	Equilux	Eventide	Upholstery - 9
4060	02	E101	Equilux	Diamond Dust	Upholstery - 9
4060	03	E102	Equilux	Solstice	Upholstery - 9
4060	04	E103	Equilux	Moonbow	Upholstery - 9
4060	05	E104	Equilux	Corona	Upholstery - 9
4060	06	E105	Equilux	Blue Hour	Upholstery - 9
4060	07	E106	Equilux	Kindle	Upholstery - 9
4060	08	E107	Equilux	Sunspot	Upholstery - 9
<hr/>					
4061	01	R307	Interstice	Inkling	Upholstery - 4
4061	03	R309	Interstice	Lacuna	Upholstery - 4
4061	04	R310	Interstice	Whit	Upholstery - 4
4061	05	R311	Interstice	Scintilla	Upholstery - 4
4061	06	R312	Interstice	Fragment	Upholstery - 4
4061	07	R313	Interstice	Atom	Upholstery - 4
4061	08	R314	Interstice	Trace	Upholstery - 4
4061	09	R315	Interstice	Respite	Upholstery - 4
4061	10	R316	Interstice	Vestige	Upholstery - 4
4061	11	R317	Interstice	Interval	Upholstery - 4
4061	12	R318	Interstice	Caesura	Upholstery - 4

textile listings by pattern number (continued)

FABRIC PATTERN	COLOR CODE	TEKNION COLOR CODE	PATTERN NAME	COLOR NAME	APPLICATION GRADE
4063	01	M224	Meta Texture	Deep Space	Upholstery - 4
4063	02	M225	Meta Texture	Grey Matter	Upholstery - 4
4063	03	M226	Meta Texture	Pale Shadow	Upholstery - 4
4063	04	M227	Meta Texture	Silver Lining	Upholstery - 4
4063	05	M228	Meta Texture	Hive Mind	Upholstery - 4
4063	06	M229	Meta Texture	Neutral Ground	Upholstery - 4
4063	07	M230	Meta Texture	Grassroots	Upholstery - 4
4063	08	M231	Meta Texture	Jaded	Upholstery - 4
4063	09	M232	Meta Texture	Deep Dive	Upholstery - 4
4063	10	M233	Meta Texture	Blue Skies	Upholstery - 4
4063	11	M234	Meta Texture	Rosy Outlook	Upholstery - 4
4063	12	M235	Meta Texture	Heat Wave	Upholstery - 4
4063	13	M236	Meta Texture	Punchline	Upholstery - 4
<hr/>					
4064	01	S442	Superspun	Drawdown	Upholstery - 3
4064	02	S443	Superspun	Denier	Upholstery - 3
4064	03	S444	Superspun	Tensile	Upholstery - 3
4064	04	S445	Superspun	Roving	Upholstery - 3
4064	05	S446	Superspun	Staple	Upholstery - 3
4064	06	S447	Superspun	Spindle	Upholstery - 3
4064	07	S448	Superspun	Harness	Upholstery - 3
4064	08	S449	Superspun	Tenter	Upholstery - 3
4064	09	S450	Superspun	Red Cast	Upholstery - 3
4064	10	S451	Superspun	Selvedge	Upholstery - 3
4064	11	S452	Superspun	Skein	Upholstery - 3
4064	12	S453	Superspun	Bluing	Upholstery - 3
4064	13	S454	Superspun	Treadle	Upholstery - 3
4064	14	S455	Superspun	Sett	Upholstery - 3
4064	15	S456	Superspun	Pirn	Upholstery - 3
4064	16	S457	Superspun	Creel	Upholstery - 3
<hr/>					
4065	01	E108	Ephemera	Lucent	Upholstery - 7
4065	02	E109	Ephemera	Afterglow	Upholstery - 7
4065	03	E110	Ephemera	Ice Cloud	Upholstery - 7
4065	04	E111	Ephemera	Halcyon	Upholstery - 7
4065	05	E112	Ephemera	Phosphene	Upholstery - 7
4065	06	E113	Ephemera	Solar Flare	Upholstery - 7
4065	07	E114	Ephemera	Gamma Burst	Upholstery - 7
4065	08	E115	Ephemera	Green Flash	Upholstery - 7
4065	09	E116	Ephemera	Blue Shift	Upholstery - 7
4065	10	E117	Ephemera	Ashfall	Upholstery - 7
4065	11	E118	Ephemera	Nightglow	Upholstery - 7
4065	12	E119	Ephemera	Penumbra	Upholstery - 7

textile listings by pattern number (continued)

FABRIC PATTERN	COLOR CODE	TEKNION COLOR CODE	PATTERN NAME	COLOR NAME	APPLICATION GRADE
4066	01	B160 (U) - R582 (P)	Bitstream	Tablet	Panel - A, Upholstery - 1
4066	02	B161 (U) - R583 (P)	Bitstream	Hardware	Panel - A, Upholstery - 1
4066	03	B162 (U) - R584 (P)	Bitstream	Trackback	Panel - A, Upholstery - 1
4066	04	B163 (U) - R585 (P)	Bitstream	Lithium	Panel - A, Upholstery - 1
4066	05	B164 (U) - R586 (P)	Bitstream	Grey Code	Panel - A, Upholstery - 1
4066	06	B165 (U) - R587 (P)	Bitstream	Silicone	Panel - A, Upholstery - 1
4066	07	B166 (U) - R588 (P)	Bitstream	White Noise	Panel - A, Upholstery - 1
4066	08	B167 (U) - R589 (P)	Bitstream	Xenon	Panel - A, Upholstery - 1
4066	09	B168 (U) - R590 (P)	Bitstream	Wavelet	Panel - A, Upholstery - 1
4066	10	B169 (U) - R591 (P)	Bitstream	Blue Team	Panel - A, Upholstery - 1
4066	11	B170 (U) - R592 (P)	Bitstream	Firewire	Panel - A, Upholstery - 1
4066	12	B171 (U) - R593 (P)	Bitstream	Flash Drive	Panel - A, Upholstery - 1
4067	01	E120	Elastic Wool	Fortress	Upholstery - 4
4067	02	E121	Elastic Wool	Fantom	Upholstery - 4
4067	03	E122	Elastic Wool	Mercury	Upholstery - 4
4067	04	E123	Elastic Wool	Clean	Upholstery - 4
4067	05	E124	Elastic Wool	Seed	Upholstery - 4
4067	06	E125	Elastic Wool	Tea	Upholstery - 4
4067	07	E126	Elastic Wool	Rust	Upholstery - 4
4067	08	E127	Elastic Wool	Ruby	Upholstery - 4
4067	09	E128	Elastic Wool	Ceylon	Upholstery - 4
4067	10	E129	Elastic Wool	Lovelace	Upholstery - 4
4067	11	E130	Elastic Wool	Jovial	Upholstery - 4
4067	12	E131	Elastic Wool	Elm	Upholstery - 4
4067	13	E132	Elastic Wool	Python	Upholstery - 4
4067	14	E133	Elastic Wool	Aegean	Upholstery - 4
4067	15	E134	Elastic Wool	Delphi	Upholstery - 4
4067	16	E135	Elastic Wool	Dart	Upholstery - 4
4069	01	A166	Adage	Script	Upholstery - 5
4069	02	A146	Adage	Anthracite	Upholstery - 5
4069	03	A147	Adage	Carbon Fiber	Upholstery - 5
4069	04	A148	Adage	Splice	Upholstery - 5
4069	05	A149	Adage	Chromite	Upholstery - 5
4069	06	A150	Adage	Singularity	Upholstery - 5
4069	07	A151	Adage	Valence	Upholstery - 5
4069	08	A152	Adage	Halite	Upholstery - 5
4069	09	A153	Adage	Quartzite	Upholstery - 5
4069	10	A154	Adage	Rubelite	Upholstery - 5
4069	11	A155	Adage	Thremite	Upholstery - 5
4069	12	A156	Adage	Orchil	Upholstery - 5
4069	13	A157	Adage	Holograph	Upholstery - 5
4069	14	A158	Adage	Photon	Upholstery - 5
4069	15	A159	Adage	Halogen	Upholstery - 5
4069	16	A160	Adage	Canopy	Upholstery - 5
4069	17	A161	Adage	Raw Jade	Upholstery - 5
4069	18	A162	Adage	Petrol	Upholstery - 5
4069	19	A163	Adage	Diffraction	Upholstery - 5
4069	20	A164	Adage	Amethyst	Upholstery - 5
4069	21	A165	Adage	Pascal	Upholstery - 5

textile listings by pattern number (continued)

FABRIC PATTERN	COLOR CODE	TEKNION COLOR CODE	PATTERN NAME	COLOR NAME	APPLICATION GRADE
4070	01	C154	Color Fuse	Wax	Upholstery - 10
4070	02	C155	Color Fuse	Emulsion	Upholstery - 10
4070	03	C156	Color Fuse	Jell	Upholstery - 10
4070	04	C157	Color Fuse	Enamel	Upholstery - 10
4070	05	C158	Color Fuse	Liquefy	Upholstery - 10
4070	06	C159	Color Fuse	Freeze	Upholstery - 10
4070	07	C160	Color Fuse	Molten	Upholstery - 10
4070	08	C161	Color Fuse	Solvent	Upholstery - 10
4070	09	C162	Color Fuse	Plasma	Upholstery - 10
<hr/>					
4073	01	A209 (U/A) - T740 (P)	Actuate	Aqueous	Upholstery - 2, Panel - 2, Architectural - 2
4073	02	A210 (U/A) - T741 (P)	Actuate	Spectral	Upholstery - 2, Panel - 2, Architectural - 2
4073	03	A211 (U/A) - T742 (P)	Actuate	Aether	Upholstery - 2, Panel - 2, Architectural - 2
4073	04	A212 (U/A) - T743 (P)	Actuate	Facet	Upholstery - 2, Panel - 2, Architectural - 2
4073	05	A213 (U/A) - T744 (P)	Actuate	Syntax	Upholstery - 2, Panel - 2, Architectural - 2
4073	06	A214 (U/A) - T745 (P)	Actuate	Vanish	Upholstery - 2, Panel - 2, Architectural - 2
4073	07	A215 (U/A) - T746 (P)	Actuate	Suffuse	Upholstery - 2, Panel - 2, Architectural - 2
4073	08	A216 (U/A) - T747 (P)	Actuate	Mordant	Upholstery - 2, Panel - 2, Architectural - 2
4073	09	A217 (U/A) - T748 (P)	Actuate	Lambent	Upholstery - 2, Panel - 2, Architectural - 2
4073	10	A218 (U/A) - T749 (P)	Actuate	Conscious	Upholstery - 2, Panel - 2, Architectural - 2
4073	11	A219 (U/A) - T750 (P)	Actuate	Fortify	Upholstery - 2, Panel - 2, Architectural - 2
4073	12	A220 (U/A) - T751 (P)	Actuate	Favrite	Upholstery - 2, Panel - 2, Architectural - 2
4073	13	A221 (U/A) - T752 (P)	Actuate	Prelude	Upholstery - 2, Panel - 2, Architectural - 2
4073	14	A222 (U/A) - T753 (P)	Actuate	Meridian	Upholstery - 2, Panel - 2, Architectural - 2
4073	15	A223 (U/A) - T754 (P)	Actuate	Thermal	Upholstery - 2, Panel - 2, Architectural - 2
4073	16	A224 (U/A) - T755 (P)	Actuate	Induction	Upholstery - 2, Panel - 2, Architectural - 2
<hr/>					
4075	01	S335	Structured Stripe	Shadow Weave	Upholstery - 7
4075	01	S336	Structured Stripe	Silver Lap	Upholstery - 7
4075	01	S337	Structured Stripe	Countermarche	Upholstery - 7
4075	01	S338	Structured Stripe	Double Beam	Upholstery - 7
4075	01	S339	Structured Stripe	Block Draw	Upholstery - 7
4075	01	S340	Structured Stripe	Box Motion	Upholstery - 7
4075	01	S341	Structured Stripe	Overshot	Upholstery - 7
4075	01	S342	Structured Stripe	Punch Card	Upholstery - 7

textile listings by pattern number (continued)

FABRIC PATTERN	COLOR CODE	TEKNION COLOR CODE	PATTERN NAME	COLOR NAME	APPLICATION GRADE
4076	01	D130	Duo Chrome	Ebony	Upholstery - 6
4076	02	D131	Duo Chrome	Charcoal	Upholstery - 6
4076	03	D132	Duo Chrome	Black Pepper	Upholstery - 6
4076	04	D133	Duo Chrome	Platinum	Upholstery - 6
4076	05	D134	Duo Chrome	Canvas	Upholstery - 6
4076	06	D135	Duo Chrome	Copper	Upholstery - 6
4076	07	D136	Duo Chrome	Goldenrod	Upholstery - 6
4076	08	D137	Duo Chrome	Citron	Upholstery - 6
4076	09	D138	Duo Chrome	Emerald	Upholstery - 6
4076	10	D139	Duo Chrome	Silver Elm	Upholstery - 6
4076	11	D140	Duo Chrome	Evergreen	Upholstery - 6
4076	12	D141	Duo Chrome	Aquamarine	Upholstery - 6
4076	13	D142	Duo Chrome	Navy	Upholstery - 6
4076	14	D143	Duo Chrome	Iris	Upholstery - 6
4076	15	D144	Duo Chrome	Boysenberry	Upholstery - 6
4076	16	D145	Duo Chrome	Hydrangea	Upholstery - 6
4076	17	D146	Duo Chrome	Dusty Plum	Upholstery - 6
4076	18	D147	Duo Chrome	Oxblood	Upholstery - 6
4076	19	D148	Duo Chrome	Red Oxide	Upholstery - 6
4076	20	D149	Duo Chrome	Persimmon	Upholstery - 6
<hr/>					
4077	01	V520	Oeuvre	Blithe	Upholstery - 7
4077	02	V521	Oeuvre	Salient	Upholstery - 7
4077	03	V522	Oeuvre	Austere	Upholstery - 7
4077	04	V523	Oeuvre	Earnest	Upholstery - 7
4077	05	V524	Oeuvre	Ardent	Upholstery - 7
4077	06	V525	Oeuvre	Fervor	Upholstery - 7
4077	07	V526	Oeuvre	Finesse	Upholstery - 7
4077	08	V527	Oeuvre	Mettle	Upholstery - 7
4077	09	V528	Oeuvre	Flourish	Upholstery - 7
4077	10	V529	Oeuvre	Charm	Upholstery - 7
4077	11	V530	Oeuvre	Deft	Upholstery - 7
4077	12	V531	Oeuvre	Crest	Upholstery - 7
<hr/>					
4078	01	Y100	Doyenne	Woodbrick	Upholstery - 3
4078	02	Y101	Doyenne	Sepia Tone	Upholstery - 3
4078	03	Y102	Doyenne	Intaglio	Upholstery - 3
4078	04	Y103	Doyenne	Grisailles	Upholstery - 3
4078	05	Y104	Doyenne	Aquamedia	Upholstery - 3
4078	06	Y105	Doyenne	Watermark	Upholstery - 3
4078	07	Y106	Doyenne	Verdigris	Upholstery - 3
4078	08	Y107	Doyenne	Phthalo	Upholstery - 3
4078	09	Y108	Doyenne	Terre Verte	Upholstery - 3
4078	10	Y109	Doyenne	Copperplate	Upholstery - 3
4078	11	Y110	Doyenne	Sienna	Upholstery - 3
4078	12	Y111	Doyenne	Alizarin	Upholstery - 3

textile listings by pattern number (continued)

FABRIC PATTERN	COLOR CODE	TEKNION COLOR CODE	PATTERN NAME	COLOR NAME	APPLICATION GRADE
4079	01	C511	Construct	Fawn	Upholstery - 8
4079	02	C512	Construct	Clay	Upholstery - 8
4079	03	C513	Construct	Brandy	Upholstery - 8
4079	04	C514	Construct	Vermilion	Upholstery - 8
4079	05	C515	Construct	Cadmium Orange	Upholstery - 8
4079	06	C516	Construct	Zinnia	Upholstery - 8
4079	07	C517	Construct	Auburn	Upholstery - 8
4079	08	C518	Construct	Wisteria	Upholstery - 8
4079	09	C519	Construct	Ultramarine	Upholstery - 8
4079	10	C520	Construct	Cornflower	Upholstery - 8
4079	11	C521	Construct	Pacific	Upholstery - 8
4079	12	C522	Construct	Celadon	Upholstery - 8
4079	13	C523	Construct	Canary	Upholstery - 8
4079	14	C524	Construct	Turmeric	Upholstery - 8
4079	15	C525	Construct	Ochre	Upholstery - 8
4079	16	C526	Construct	Beryl	Upholstery - 8
4079	17	C527	Construct	Viridian	Upholstery - 8
4079	18	C528	Construct	Fir	Upholstery - 8
4079	19	C529	Construct	Midnight	Upholstery - 8
4079	20	C530	Construct	Argent	Upholstery - 8
4079	21	C531	Construct	Gunmetal	Upholstery - 8
4079	22	C532	Construct	Noir	Upholstery - 8
<hr/>					
4081	01	F480	Flex Wool	Rebound	Upholstery - 7
4081	02	F481	Flex Wool	Tempo	Upholstery - 7
4081	03	F482	Flex Wool	Dynamo	Upholstery - 7
4081	04	F483	Flex Wool	Vim	Upholstery - 7
4081	05	F484	Flex Wool	Spark	Upholstery - 7
4081	06	F485	Flex Wool	Thrive	Upholstery - 7
4081	07	F486	Flex Wool	Arena	Upholstery - 7
4081	08	F487	Flex Wool	Agile	Upholstery - 7
4081	09	F488	Flex Wool	Buoyant	Upholstery - 7
4081	10	F489	Flex Wool	Torque	Upholstery - 7
4081	11	F490	Flex Wool	Raceway	Upholstery - 7
4081	12	F491	Flex Wool	Blur	Upholstery - 7
<hr/>					
4082	01	V221	Vector	Dovetail	Upholstery - 6
4082	02	V222	Vector	Horizon Line	Upholstery - 6
4082	03	V223	Vector	Tessera	Upholstery - 6
4082	04	V224	Vector	Latitude	Upholstery - 6
4082	05	V225	Vector	Vertex	Upholstery - 6
4082	06	V226	Vector	Radial	Upholstery - 6
4082	07	V227	Vector	Hypercube	Upholstery - 6
4082	08	V228	Vector	Scalar	Upholstery - 6
4082	09	V229	Vector	Parallax	Upholstery - 6

textile listings by pattern number (continued)

FABRIC PATTERN	COLOR CODE	TEKNION COLOR CODE	PATTERN NAME	COLOR NAME	APPLICATION GRADE
4083	01	T418	Top Coat	Shell	Upholstery - 9
4083	02	T419	Top Coat	Glaze	Upholstery - 9
4083	03	T420	Top Coat	Chromate	Upholstery - 9
4083	04	T421	Top Coat	Stoneware	Upholstery - 9
4083	05	T422	Top Coat	Aniline	Upholstery - 9
4083	06	T423	Top Coat	Braze	Upholstery - 9
4083	07	T424	Top Coat	Conduct	Upholstery - 9
4083	08	T425	Top Coat	Heat Set	Upholstery - 9
4083	09	T426	Top Coat	Claycast	Upholstery - 9
4083	10	T427	Top Coat	Toast	Upholstery - 9
4083	11	T428	Top Coat	Polish	Upholstery - 9
4083	12	T429	Top Coat	Frit	Upholstery - 9
4083	13	T430	Top Coat	Shellac	Upholstery - 9
4083	14	T431	Top Coat	Dip	Upholstery - 9
4083	15	T432	Top Coat	Indigo Ink	Upholstery - 9
4083	16	T433	Top Coat	Seal	Upholstery - 9
4083	17	T434	Top Coat	Weld	Upholstery - 9
4083	18	T435	Top Coat	Black Oxide	Upholstery - 9
4084	01	M191	Fleece	Alum	Upholstery - 10
4084	02	M192	Fleece	Aer	Upholstery - 10
4084	03	M193	Fleece	Linseed	Upholstery - 10
4084	04	M194	Fleece	Rubedo	Upholstery - 10
4084	05	M195	Fleece	Ignis	Upholstery - 10
4084	06	M196	Fleece	Cypher	Upholstery - 10
4084	07	M197	Fleece	Balsam	Upholstery - 10
4084	08	M198	Fleece	Glyph	Upholstery - 10
4084	09	M199	Fleece	Nero	Upholstery - 10

textile listings by pattern number (continued)

FABRIC PATTERN	COLOR CODE	TEKNION COLOR CODE	PATTERN NAME	COLOR NAME	APPLICATION GRADE
4087	01	D150	Decoy	Double Bluff	Upholstery - 2
4087	02	D151	Decoy	Sheep's Clothing	Upholstery - 2
4087	03	D152	Decoy	Trick Mirror	Upholstery - 2
4087	04	D153	Decoy	Ditto	Upholstery - 2
4087	05	D154	Decoy	Proxy	Upholstery - 2
4087	06	D155	Decoy	Façade	Upholstery - 2
4087	07	D156	Decoy	Rook	Upholstery - 2
4087	08	D157	Decoy	Copycat	Upholstery - 2
4087	09	D158	Decoy	Incognito	Upholstery - 2
4087	10	D159	Decoy	Pipe Dream	Upholstery - 2
4087	11	D160	Decoy	Trip Wire	Upholstery - 2
4087	12	D161	Decoy	Feign	Upholstery - 2
4087	13	D162	Decoy	Atlantis	Upholstery - 2
4087	14	D163	Decoy	Mirage	Upholstery - 2
4087	15	D164	Decoy	Reverie	Upholstery - 2
4087	16	D165	Decoy	Lure	Upholstery - 2
4087	17	D166	Decoy	Cloak	Upholstery - 2
4087	18	D167	Decoy	Mystify	Upholstery - 2
4087	19	D168	Decoy	Figment	Upholstery - 2
4087	20	D169	Decoy	Ruse	Upholstery - 2
4087	21	D170	Decoy	Red Handed	Upholstery - 2
4087	22	D171	Decoy	Clandestine	Upholstery - 2
4087	23	D172	Decoy	Cahoots	Upholstery - 2
4087	24	D173	Decoy	Synonym	Upholstery - 2
4087	25	D174	Decoy	Mimic	Upholstery - 2
4087	26	D175	Decoy	Retort	Upholstery - 2
4087	27	D176	Decoy	Masquerade	Upholstery - 2
4087	28	D177	Decoy	Lookalike	Upholstery - 2
4087	29	D178	Decoy	Eavesdrop	Upholstery - 2
4087	30	D179	Decoy	Lark	Upholstery - 2
4087	31	D180	Decoy	Stand In	Upholstery - 2
4087	32	D181	Decoy	Encore	Upholstery - 2
4087	33	D182	Decoy	Sweet Talk	Upholstery - 2
4087	34	D183	Decoy	Pretense	Upholstery - 2
4087	35	D184	Decoy	Fool's Gold	Upholstery - 2
4087	36	D185	Decoy	Monkey Business	Upholstery - 2
4087	37	D186	Decoy	Alias	Upholstery - 2
4087	38	D187	Decoy	Crocodile Tears	Upholstery - 2
4087	39	D188	Decoy	Parrot	Upholstery - 2
4087	40	D189	Decoy	Face Value	Upholstery - 2
4087	41	D190	Decoy	Garden Path	Upholstery - 2
4087	42	D191	Decoy	Espionage	Upholstery - 2
4087	43	D192	Decoy	Emulate	Upholstery - 2
4087	44	D193	Decoy	Replay	Upholstery - 2
4087	45	D194	Decoy	Parallel	Upholstery - 2
4087	46	D195	Decoy	Mare's Nest	Upholstery - 2

textile listings by pattern number (continued)

FABRIC PATTERN	COLOR CODE	TEKNION COLOR CODE	PATTERN NAME	COLOR NAME	APPLICATION GRADE
4089	01	C163	Crossgrain	Underbrush	Panel - 2, Upholstery - 2
4089	02	C164	Crossgrain	Dado	Panel - 2, Upholstery - 2
4089	03	C165	Crossgrain	Blackwood	Panel - 2, Upholstery - 2
4089	04	C166	Crossgrain	Cove	Panel - 2, Upholstery - 2
4089	05	C167	Crossgrain	Xylem	Panel - 2, Upholstery - 2
4089	06	C168	Crossgrain	Tenon	Panel - 2, Upholstery - 2
4089	07	C169	Crossgrain	Amaranth	Panel - 2, Upholstery - 2
4089	08	C170	Crossgrain	Red Oak	Panel - 2, Upholstery - 2
4089	09	C171	Crossgrain	Tuliptree	Panel - 2, Upholstery - 2
4089	10	C172	Crossgrain	Iroko	Panel - 2, Upholstery - 2
4089	11	C173	Crossgrain	Ginkgo	Panel - 2, Upholstery - 2
4089	12	C174	Crossgrain	Burl	Panel - 2, Upholstery - 2
4089	13	C175	Crossgrain	Cypress	Panel - 2, Upholstery - 2
4089	14	C176	Crossgrain	Springwood	Panel - 2, Upholstery - 2
4089	15	C177	Crossgrain	Driftwood	Panel - 2, Upholstery - 2
<hr/>					
4090	01	4090	Grid State	Arc Flash	Upholstery - 4, Architectural - 3
4090	02	4090	Grid State	Open Circuit	Upholstery - 4, Architectural - 3
4090	03	4090	Grid State	Volt Switch	Upholstery - 4, Architectural - 3
4090	04	4090	Grid State	Hydropower	Upholstery - 4, Architectural - 3
4090	05	4090	Grid State	Switchboard	Upholstery - 4, Architectural - 3
4090	06	4090	Grid State	Megawatt	Upholstery - 4, Architectural - 3
4090	07	4090	Grid State	Circuit Break	Upholstery - 4, Architectural - 3
4090	08	4090	Grid State	Electrode	Upholstery - 4, Architectural - 3
4090	09	4090	Grid State	Live Wire	Upholstery - 4, Architectural - 3
4090	10	4090	Grid State	Turbine	Upholstery - 4, Architectural - 3
4090	11	4090	Grid State	Neon Bulb	Upholstery - 4, Architectural - 3
4090	12	4090	Grid State	Wolfram	Upholstery - 4, Architectural - 3
<hr/>					
4092	01	E136 (U/A) - R285 (P)	Ecotone	Abyss	Upholstery - 3, Panel - 5, Architectural - 5
4092	02	E137 (U/A) - R286 (P)	Ecotone	Ravine	Upholstery - 3, Panel - 5, Architectural - 5
4092	03	E138 (U/A) - R287 (P)	Ecotone	Rocky Shore	Upholstery - 3, Panel - 5, Architectural - 5
4092	04	E139 (U/A) - R288 (P)	Ecotone	Permafrost	Upholstery - 3, Panel - 5, Architectural - 5
4092	05	E140 (U/A) - R289 (P)	Ecotone	Tundra	Upholstery - 3, Panel - 5, Architectural - 5
4092	06	E141 (U/A) - R290 (P)	Ecotone	Arid	Upholstery - 3, Panel - 5, Architectural - 5
4092	07	E142 (U/A) - R291 (P)	Ecotone	Savanna	Upholstery - 3, Panel - 5, Architectural - 5
4092	08	E143 (U/A) - R292 (P)	Ecotone	Desert Bloom	Upholstery - 3, Panel - 5, Architectural - 5
4092	09	E144 (U/A) - R293 (P)	Ecotone	Badlands	Upholstery - 3, Panel - 5, Architectural - 5
4092	10	E145 (U/A) - R294 (P)	Ecotone	Caldera	Upholstery - 3, Panel - 5, Architectural - 5
4092	11	E146 (U/A) - R295 (P)	Ecotone	Freshwater	Upholstery - 3, Panel - 5, Architectural - 5
4092	12	E147 (U/A) - R296 (P)	Ecotone	Intertidal	Upholstery - 3, Panel - 5, Architectural - 5
4092	13	E148 (U/A) - R297 (P)	Ecotone	Rain Shadow	Upholstery - 3, Panel - 5, Architectural - 5
4092	14	E149 (U/A) - R298 (P)	Ecotone	Lichen	Upholstery - 3, Panel - 5, Architectural - 5
4092	15	E150 (U/A) - R299 (P)	Ecotone	Mangrove	Upholstery - 3, Panel - 5, Architectural - 5
4092	16	E151 (U/A) - R300 (P)	Ecotone	Treeline	Upholstery - 3, Panel - 5, Architectural - 5

textile listings by pattern number (continued)

FABRIC PATTERN	COLOR CODE	TEKNION COLOR CODE	PATTERN NAME	COLOR NAME	APPLICATION GRADE
4102	01	F136	Formwork	Metallurgy	Upholstery - 4
4102	02	F137	Formwork	Lead	Upholstery - 4
4102	03	F138	Formwork	Selenite	Upholstery - 4
4102	04	F139	Formwork	Opal	Upholstery - 4
4102	05	F140	Formwork	Pearl Ash	Upholstery - 4
4102	06	F141	Formwork	Candela	Upholstery - 4
4102	07	F142	Formwork	Kiln	Upholstery - 4
4102	08	F143	Formwork	Distill	Upholstery - 4
4102	09	F144	Formwork	Azurite	Upholstery - 4
4102	10	F145	Formwork	Verditer	Upholstery - 4
4102	11	F146	Formwork	Elixir	Upholstery - 4
4102	12	F147	Formwork	Precipitant	Upholstery - 4
<hr/>					
7003	01	B380 (A) - R380 (P)	Rationale	Classical	Panel - 1, Architectural - 1
7003	02	B381 (A) - R381 (P)	Rationale	Drift	Panel - 1, Architectural - 1
7003	03	B382 (A) - R382 (P)	Rationale	Firma	Panel - 1, Architectural - 1
7003	04	B383 (A) - R383 (P)	Rationale	Lucid	Panel - 1, Architectural - 1
7003	05	B384 (A) - R384 (P)	Rationale	Abstract	Panel - 1, Architectural - 1
7003	06	B385 (A) - R385 (P)	Rationale	Mind's Eye	Panel - 1, Architectural - 1
7003	07	B386 (A) - R386 (P)	Rationale	Infinite	Panel - 1, Architectural - 1
7003	08	B387 (A) - R387 (P)	Rationale	Transcend	Panel - 1, Architectural - 1
<hr/>					
7007	01	S236	Strio	Mineral	Architectural - 2
7007	02	S237	Strio	Dolomite	Architectural - 2
7007	03	S238	Strio	Lithic	Architectural - 2
7007	04	S239	Strio	Calcite	Architectural - 2
7007	05	S240	Strio	Silica	Architectural - 2
7007	07	S242	Strio	Feldspar	Architectural - 2
7007	08	S243	Strio	Sandstone	Architectural - 2
7007	09	S244	Strio	Tor	Architectural - 2
<hr/>					
7012	01	W117 (P) - T141 (A)	Twining	Ivory Vine	Panel - 2, Architectural - 2
7012	02	W121 (P) - T145 (A)	Twining	Quill	Panel - 2, Architectural - 2
7012	03	W122 (P) - T146 (A)	Twining	Silvery Strand	Panel - 2, Architectural - 2
7012	04	W123 (P) - T147 (A)	Twining	Bulrush	Panel - 2, Architectural - 2
7012	05	W120 (P) - T144 (A)	Twining	Sisal	Panel - 2, Architectural - 2
7012	06	W119 (P) - T143 (A)	Twining	Abaca	Panel - 2, Architectural - 2
7012	07	W118 (P) - T142 (A)	Twining	Pale Straw	Panel - 2, Architectural - 2

textile listings by pattern number (continued)

FABRIC PATTERN	COLOR CODE	TEKNION COLOR CODE	PATTERN NAME	COLOR NAME	APPLICATION GRADE
4096	01	T278 (A) - R325 (P)	Twisted Tweed	Wrought Iron	Upholstery - 3, Panel - 4, Architectural - 3
4096	02	T279 (A) - R326 (P)	Twisted Tweed	Rock Garden	Upholstery - 3, Panel - 4, Architectural - 3
4096	03	T280 (A) - R327 (P)	Twisted Tweed	Shady Patch	Upholstery - 3, Panel - 4, Architectural - 3
4096	04	T281 (A) - R328 (P)	Twisted Tweed	Moongate	Upholstery - 3, Panel - 4, Architectural - 3
4096	05	T282 (A) - R329 (P)	Twisted Tweed	Plaster	Upholstery - 3, Panel - 4, Architectural - 3
4096	06	T283 (A) - R330 (P)	Twisted Tweed	Stucco	Upholstery - 3, Panel - 4, Architectural - 3
4096	07	T284 (A) - R331 (P)	Twisted Tweed	Thatch	Upholstery - 3, Panel - 4, Architectural - 3
4096	08	T285 (A) - R332 (P)	Twisted Tweed	Arbor	Upholstery - 3, Panel - 4, Architectural - 3
4096	09	T286 (A) - R333 (P)	Twisted Tweed	Daylight	Upholstery - 3, Panel - 4, Architectural - 3
4096	10	T287 (A) - R334 (P)	Twisted Tweed	Sundial	Upholstery - 3, Panel - 4, Architectural - 3
4096	11	T288 (A) - R335 (P)	Twisted Tweed	Koi Pond	Upholstery - 3, Panel - 4, Architectural - 3
4096	12	T289 (A) - R336 (P)	Twisted Tweed	Brickwork	Upholstery - 3, Panel - 4, Architectural - 3
4096	13	T290 (A) - R337 (P)	Twisted Tweed	Annual	Upholstery - 3, Panel - 4, Architectural - 3
4096	14	T291 (A) - R338 (P)	Twisted Tweed	Perennial	Upholstery - 3, Panel - 4, Architectural - 3
4096	15	T292 (A) - R339 (P)	Twisted Tweed	Rain Chain	Upholstery - 3, Panel - 4, Architectural - 3
4096	16	T293 (A) - R340 (P)	Twisted Tweed	Open Air	Upholstery - 3, Panel - 4, Architectural - 3
4096	17	T294 (A) - R341 (P)	Twisted Tweed	Water Feature	Upholstery - 3, Panel - 4, Architectural - 3
4096	18	T295 (A) - R342 (P)	Twisted Tweed	Terrace	Upholstery - 3, Panel - 4, Architectural - 3
4096	19	T296 (A) - R343 (P)	Twisted Tweed	Veranda	Upholstery - 3, Panel - 4, Architectural - 3
<hr/>					
4093	01	H616	Haptic	Cliffline	Upholstery - 6
4093	02	H617	Haptic	Gravel	Upholstery - 6
4093	03	H618	Haptic	Alluvium	Upholstery - 6
4093	04	H619	Haptic	Sediment	Upholstery - 6
4093	05	H620	Haptic	Pink Salt	Upholstery - 6
4093	06	H621	Haptic	Montane	Upholstery - 6
4093	07	H622	Haptic	Butte	Upholstery - 6
4093	08	H623	Haptic	Arroyo	Upholstery - 6
4093	09	H624	Haptic	Superbloom	Upholstery - 6
4093	10	H625	Haptic	Mantle	Upholstery - 6
4093	11	H626	Haptic	Geode	Upholstery - 6
4093	12	H627	Haptic	Flood Plain	Upholstery - 6
4093	13	H628	Haptic	Isthmus	Upholstery - 6
4093	14	H629	Haptic	Aquifer	Upholstery - 6
4093	15	H630	Haptic	Delta	Upholstery - 6
4093	16	H631	Haptic	Fjord	Upholstery - 6
<hr/>					
4094	01	P160	Photogram	Shadowgraph	Upholstery - 6
4094	02	P161	Photogram	Toner	Upholstery - 6
4094	03	P162	Photogram	Silver Salts	Upholstery - 6
4094	04	P163	Photogram	Light Meter	Upholstery - 6
4094	05	P164	Photogram	Sunprint	Upholstery - 6
4094	06	P165	Photogram	Heliograph	Upholstery - 6
4094	07	P166	Photogram	Safelight	Upholstery - 6
4094	08	P167	Photogram	Cyanotype	Upholstery - 6
4094	09	P168	Photogram	Mezzotint	Upholstery - 6
4094	10	P169	Photogram	Darkroom	Upholstery - 6

textile listings by pattern number (continued)

FABRIC PATTERN	COLOR CODE	TEKNION COLOR CODE	PATTERN NAME	COLOR NAME	APPLICATION GRADE
1031	01	C246	Cult Classic	Blue Velvet	Upholstery - 5
1031	02	C247	Cult Classic	Black Lagoon	Upholstery - 5
1031	03	C248	Cult Classic	Metropolis	Upholstery - 5
1031	04	C249	Cult Classic	Grey Gardens	Upholstery - 5
1031	05	C250	Cult Classic	White Heat	Upholstery - 5
1031	06	C251	Cult Classic	Ziggy Stardust	Upholstery - 5
1031	07	C252	Cult Classic	Pink Flamingos	Upholstery - 5
1031	08	C253	Cult Classic	Purple Noon	Upholstery - 5
1031	09	C254	Cult Classic	Blue Sunshine	Upholstery - 5
1031	10	C255	Cult Classic	Xanadu	Upholstery - 5
1031	11	C256	Cult Classic	Emerald City	Upholstery - 5
1031	12	C257	Cult Classic	Forrest Gump	Upholstery - 5
4098	01	T440	Tilt Shift Redux	Elevation	Upholstery - 7
4098	02	T441	Tilt Shift Redux	Plexus	Upholstery - 7
4098	03	T442	Tilt Shift Redux	Baseline	Upholstery - 7
4098	04	T443	Tilt Shift Redux	Beta	Upholstery - 7
4098	05	T444	Tilt Shift Redux	Fluctuate	Upholstery - 7
4098	06	T445	Tilt Shift Redux	Alpha	Upholstery - 7
4098	07	T446	Tilt Shift Redux	Amplifier	Upholstery - 7
4098	08	T447	Tilt Shift Redux	Sensor	Upholstery - 7
4098	09	T448	Tilt Shift Redux	Bandwidth	Upholstery - 7
4098	10	T449	Tilt Shift Redux	Synapse	Upholstery - 7
4098	11	T450	Tilt Shift Redux	Sonar	Upholstery - 7
4098	12	T451	Tilt Shift Redux	Modulate	Upholstery - 7
4099	01	W128	Wool Fleck	Boulder	Upholstery - 7
4099	02	W129	Wool Fleck	Packstone	Upholstery - 7
4099	03	W130	Wool Fleck	Zinc	Upholstery - 7
4099	04	W131	Wool Fleck	Micrite	Upholstery - 7
4099	05	W132	Wool Fleck	Coquina	Upholstery - 7
4099	06	W133	Wool Fleck	Beachrock	Upholstery - 7
4099	07	W134	Wool Fleck	Tawny	Upholstery - 7
4099	08	W135	Wool Fleck	Corten	Upholstery - 7
4099	09	W136	Wool Fleck	Pink Nacre	Upholstery - 7
4099	10	W137	Wool Fleck	Birchbark	Upholstery - 7
4099	11	W138	Wool Fleck	Firesand	Upholstery - 7
4099	12	W139	Wool Fleck	Chamotte	Upholstery - 7
4099	13	W140	Wool Fleck	Blackberry	Upholstery - 7
4099	14	W141	Wool Fleck	Mussel Dust	Upholstery - 7
4099	15	W142	Wool Fleck	Gitti	Upholstery - 7
4099	16	W143	Wool Fleck	Iolite	Upholstery - 7
4099	17	W144	Wool Fleck	Storm Petrel	Upholstery - 7
4099	18	W145	Wool Fleck	Bittercress	Upholstery - 7
4099	19	W146	Wool Fleck	Oat Grass	Upholstery - 7
4099	20	W147	Wool Fleck	Aloe	Upholstery - 7
4099	21	W148	Wool Fleck	Wild Mustard	Upholstery - 7

textile listings by pattern number (continued)

FABRIC PATTERN	COLOR CODE	TEKNION COLOR CODE	PATTERN NAME	COLOR NAME	APPLICATION GRADE
4091	01	W480	Wavefield	Tideline	Upholstery - 8
4091	02	W481	Wavefield	Groundwater	Upholstery - 8
4091	03	W482	Wavefield	Red Tide	Upholstery - 8
4091	04	W483	Wavefield	Aspen Reflection	Upholstery - 8
4091	05	W484	Wavefield	Rivulet	Upholstery - 8
4091	06	W485	Wavefield	Cascade	Upholstery - 8
4091	07	W486	Wavefield	Sea Level	Upholstery - 8
4091	08	W487	Wavefield	Brackish	Upholstery - 8
4091	09	W488	Wavefield	Wake Zone	Upholstery - 8
4095	01	W209	Welded	Alliance	Upholstery - 8
4095	02	W210	Welded	Charcoal Flux	Upholstery - 8
4095	03	W211	Welded	Bond	Upholstery - 8
4095	04	W212	Welded	Soda Ash	Upholstery - 8
4095	05	W213	Welded	Palladium	Upholstery - 8
4095	06	W214	Welded	Brass Alloy	Upholstery - 8
4095	07	W215	Welded	Rose Torch	Upholstery - 8
4095	08	W216	Welded	Copper Foil	Upholstery - 8
4095	09	W217	Welded	Mingle	Upholstery - 8
4095	10	W218	Welded	Synergy	Upholstery - 8
4095	11	W219	Welded	Synthesis	Upholstery - 8
4100	01	M534	Melange Check	Cobblestone	Upholstery - 9
4100	02	M535	Melange Check	Bisque	Upholstery - 9
4100	03	M536	Melange Check	Soda Fired	Upholstery - 9
4100	04	M537	Melange Check	Goldspeck	Upholstery - 9
4100	05	M538	Melange Check	Pink Kaolin	Upholstery - 9
4100	06	M539	Melange Check	Brick Dust	Upholstery - 9
4100	07	M540	Melange Check	Alkaline	Upholstery - 9
4100	08	M541	Melange Check	Vapor Glaze	Upholstery - 9
4100	09	M542	Melange Check	Faience Blue	Upholstery - 9
4100	10	M543	Melange Check	Greenware	Upholstery - 9
4106	01	G250	Graphic Speck	Cavern	Upholstery - 9
4106	02	G251	Graphic Speck	Steel Frame	Upholstery - 9
4106	03	G252	Graphic Speck	Stonework	Upholstery - 9
4106	04	G253	Graphic Speck	Gypsum	Upholstery - 9
4106	05	G254	Graphic Speck	Earthworks	Upholstery - 9
4106	06	G255	Graphic Speck	Cob	Upholstery - 9
4106	07	G256	Graphic Speck	Breccia	Upholstery - 9
4106	08	G257	Graphic Speck	Hearth	Upholstery - 9
4106	09	G258	Graphic Speck	Fired Clay	Upholstery - 9
4106	10	G259	Graphic Speck	Ionic Order	Upholstery - 9
4106	11	G260	Graphic Speck	Waterwheel	Upholstery - 9
4106	12	G261	Graphic Speck	Trellis	Upholstery - 9
4106	13	G262	Graphic Speck	Limecrete	Upholstery - 9
4106	14	G263	Graphic Speck	Plate Glass	Upholstery - 9
4106	15	G264	Graphic Speck	Riverfront	Upholstery - 9
4106	16	G265	Graphic Speck	Structure	Upholstery - 9

textile listings by pattern number (continued)

FABRIC PATTERN	COLOR CODE	TEKNION COLOR CODE	PATTERN NAME	COLOR NAME	APPLICATION GRADE
4107	01	G270	Geoglyph	Drifting Sediment	Upholstery - 8
4107	02	G271	Geoglyph	Polar Lights	Upholstery - 8
4107	03	G272	Geoglyph	Moonlit Mountain	Upholstery - 8
4107	04	G273	Geoglyph	Organic Compound	Upholstery - 8
4107	05	G274	Geoglyph	Dappled Sunlight	Upholstery - 8
4107	06	G275	Geoglyph	Painted Desert	Upholstery - 8
4108	01	P186	Pebble Melange	Esker	Upholstery - 7
4108	02	P187	Pebble Melange	Earthen	Upholstery - 7
4108	03	P188	Pebble Melange	Pewter	Upholstery - 7
4108	04	P189	Pebble Melange	Tectonic	Upholstery - 7
4108	05	P190	Pebble Melange	Geyser	Upholstery - 7
4108	06	P191	Pebble Melange	Palustrine	Upholstery - 7
4108	07	P192	Pebble Melange	Forest Marble	Upholstery - 7
4108	08	P193	Pebble Melange	Everglade	Upholstery - 7
4108	09	P194	Pebble Melange	Estuary	Upholstery - 7
4108	10	P195	Pebble Melange	Meteor	Upholstery - 7
4108	11	P196	Pebble Melange	Barkhan	Upholstery - 7
4108	12	P197	Pebble Melange	Lava	Upholstery - 7
4109	01	P212	Particulate	Molecule	Upholstery - 5
4109	02	P213	Particulate	Light Speed	Upholstery - 5
4109	03	P214	Particulate	Granule	Upholstery - 5
4109	04	P215	Particulate	Allotrope	Upholstery - 5
4109	05	P216	Particulate	Current	Upholstery - 5
4109	06	P217	Particulate	Corrosion	Upholstery - 5
4109	07	P218	Particulate	Inertia	Upholstery - 5
4109	08	P219	Particulate	Swell	Upholstery - 5
4109	09	P220	Particulate	Oxidation	Upholstery - 5
4109	10	P221	Particulate	Proton	Upholstery - 5
4109	11	P222	Particulate	Irrigation	Upholstery - 5
4109	12	P223	Particulate	Isotope	Upholstery - 5
4109	13	P224	Particulate	Electrostatic	Upholstery - 5
4109	14	P225	Particulate	Quasar	Upholstery - 5
4109	15	P226	Particulate	Smolder	Upholstery - 5

textile listings by pattern number (continued)

FABRIC PATTERN	COLOR CODE	TEKNION COLOR CODE	PATTERN NAME	COLOR NAME	APPLICATION GRADE
4115	01	F428	Contrast Slub	Charred Seed	Upholstery - 7
4115	02	F429	Contrast Slub	Silver Thyme	Upholstery - 7
4115	03	F430	Contrast Slub	Cotton Blossom	Upholstery - 7
4115	04	F431	Contrast Slub	Tumbleweed	Upholstery - 7
4115	05	F432	Contrast Slub	Bramble	Upholstery - 7
4115	06	F433	Contrast Slub	Manzanita	Upholstery - 7
4115	07	F434	Contrast Slub	Cactus Flower	Upholstery - 7
4115	08	F435	Contrast Slub	Scarlet Sage	Upholstery - 7
4115	09	F436	Contrast Slub	Anemone	Upholstery - 7
4115	10	F437	Contrast Slub	Crepe Myrtle	Upholstery - 7
4115	11	F438	Contrast Slub	Wild Indigo	Upholstery - 7
4115	12	F439	Contrast Slub	Jacaranda	Upholstery - 7
4115	13	F440	Contrast Slub	Cenote	Upholstery - 7
4115	14	F441	Contrast Slub	Oleander	Upholstery - 7
4115	15	F442	Contrast Slub	Eucalyptus	Upholstery - 7
4115	16	F443	Contrast Slub	Lemongrass	Upholstery - 7
	01	SP01	Philomina	Black	Upholstery - AA
	02	SP02	Philomina	Red	Upholstery - AA
	03	SP06	Philomina	Sapphire	Upholstery - AA
	04	SP16	Philomina	Pearl Grey	Upholstery - AA
	01	CPC01	Gravity	Petal	COM
	02	CPC02	Gravity	Lavender	COM
	03	CPC03	Gravity	Berry	COM
	04	CPC04	Gravity	Brook	COM
	05	CPC05	Gravity	Dewdrop	COM
	06	CPC06	Gravity	Botanic.	COM
	07	CPC07	Gravity	Gooseberry	COM
	08	CPC08	Gravity	Evergreen	COM
	09	CPC09	Gravity	Lake	COM
	10	CPC10	Gravity	Almond	COM
	11	CPC11	Gravity	Tigerlily	COM
	12	CPC12	Gravity	Nutmeg	COM
	13	CPC13	Gravity	Rose	COM
	14	CPC14	Gravity	Mustard	COM
	15	CPC15	Gravity	Ice	COM
	16	CPC16	Gravity	Slate	COM
	17	CPC17	Gravity	Dove	COM
	20	CPC20	Gravity	Sunni	COM
	21	CPC21	Gravity	Wheat	COM
	23	CPC23	Gravity	Fresh	COM
	25	CPC25	Gravity	Tulip	COM
	26	CPC26	Gravity	Military	COM
	27	CPC27	Gravity	Frozen	COM
	28	CPC28	Gravity	Aqua	COM
	29	CPC29	Gravity	Lagoon	COM
	30	CPC30	Gravity	Navy Blue	COM
	31	CPC31	Gravity	Black	COM
	32	CPC32	Gravity	Frost	COM

textile listings by pattern number (continued)

FABRIC PATTERN	COLOR CODE	TEKNION COLOR CODE	PATTERN NAME	COLOR NAME	APPLICATION GRADE
	01	MLF	Main Line Flax	Watford	COM
	02	MLF01	Main Line Flax	Aldgate	COM
	03	MLF02	Main Line Flax	Archway	COM
	04	MLF03	Main Line Flax	Barbican	COM
	05	MLF05	Main Line Flax	Holborn	COM
	06	MLF06	Main Line Flax	Kilburn	COM
	07	MLF07	Main Line Flax	Kensington	COM
	08	MLF08	Main Line Flax	Lambeth	COM
	09	MLF09	Main Line Flax	Monument	COM
	10	MLF10	Main Line Flax	Newbury	COM
	11	MLF12	Main Line Flax	Morden	COM
	12	MLF13	Main Line Flax	Leyton	COM
	13	MLF14	Main Line Flax	Parsons	COM
	14	MLF15	Main Line Flax	Stockwell	COM
	15	MLF16	Main Line Flax	Temple	COM
	16	MLF17	Main Line Flax	Tooting	COM
	17	MLF18	Main Line Flax	Tuffnell	COM
	18	MLF19	Main Line Flax	Victoria	COM
	19	MLF20	Main Line Flax	Upminster	COM
	20	MLF21	Main Line Flax	Waterloo	COM
	21	MLF22	Main Line Flax	Westminster	COM
	22	MLF23	Main Line Flax	Bank	COM
	01	130	Selecte	Light Grey	COM
	02	180	Selecte	Charcoal	COM
	03	220	Selecte	Taupe	COM
	04	260	Selecte	Tweed Grey	COM
	05	280	Selecte	Chocolate	COM
	06	480	Selecte	Mustard Yellow	COM
	07	520	Selecte	Salmon	COM
	08	580	Selecte	Sweet Red	COM
	09	680	Selecte	Burgundy	COM
	10	720	Selecte	Denim Blue	COM
	11	760	Selecte	Azure Blue	COM
	12	780	Selecte	Deep Blue	COM
	13	820	Selecte	Sky Blue	COM
	14	980	Selecte	Deep Green	COM
	01	60200	Focus	Color 60200	Upholstery - 3
	02	60209	Focus	Color 60209	Upholstery - 3
	03	60210	Focus	Color 60210	Upholstery - 3
	04	60211	Focus	Color 60211	Upholstery - 3
	05	60212	Focus	Color 60212	Upholstery - 3
	06	60999	Focus	Color 60999	Upholstery - 3
	07	61035	Focus	Color 61035	Upholstery - 3
	08	61036	Focus	Color 61036	Upholstery - 3
	09	61037	Focus	Color 61037	Upholstery - 3
	10	61039	Focus	Color 61039	Upholstery - 3
	11	61244	Focus	Color 61244	Upholstery - 3
	12	61248	Focus	Color 61248	Upholstery - 3
	13	62018	Focus	Color 62018	Upholstery - 3
	14	63133	Focus	Color 63133	Upholstery - 3
	15	64041	Focus	Color 64041	Upholstery - 3

textile listings by pattern number (continued)

FABRIC PATTERN	COLOR CODE	TEKNION COLOR CODE	PATTERN NAME	COLOR NAME	APPLICATION GRADE
	01	60099	Focus Melange	Color 60099	Upholstery - 3
	02	60308	Focus Melange	Color 60308	Upholstery - 3
	03	60309	Focus Melange	Color 60309	Upholstery - 3
	04	60310	Focus Melange	Color 60310	Upholstery - 3
	05	60311	Focus Melange	Color 60311	Upholstery - 3
	06	60312	Focus Melange	Color 60312	Upholstery - 3
	07	60900	Focus Melange	Color 60900	Upholstery - 3
	08	61235	Focus Melange	Color 61235	Upholstery - 3
	09	61236	Focus Melange	Color 61236	Upholstery - 3
	10	61237	Focus Melange	Color 61237	Upholstery - 3
	11	61238	Focus Melange	Color 61238	Upholstery - 3
	12	61239	Focus Melange	Color 61239	Upholstery - 3
	13	61241	Focus Melange	Color 61241	Upholstery - 3
	14	61242	Focus Melange	Color 61242	Upholstery - 3
	15	62117	Focus Melange	Color 62117	Upholstery - 3
	16	62118	Focus Melange	Color 62118	Upholstery - 3
	17	63112	Focus Melange	Color 63112	Upholstery - 3
	18	64241	Focus Melange	Color 64241	Upholstery - 3
	19	64242	Focus Melange	Color 64242	Upholstery - 3
	20	64243	Focus Melange	Color 64243	Upholstery - 3
	21	64244	Focus Melange	Color 64244	Upholstery - 3
	22	64245	Focus Melange	Color 64245	Upholstery - 3
	23	65132	Focus Melange	Color 65132	Upholstery - 3
	24	65133	Focus Melange	Color 65133	Upholstery - 3
	25	66209	Focus Melange	Color 66209	Upholstery - 3
	26	66210	Focus Melange	Color 66210	Upholstery - 3
	27	66211	Focus Melange	Color 66211	Upholstery - 3
	28	66219	Focus Melange	Color 66219	Upholstery - 3
	29	66220	Focus Melange	Color 66220	Upholstery - 3
	30	66221	Focus Melange	Color 66221	Upholstery - 3
	31	66222	Focus Melange	Color 66222	Upholstery - 3
	32	66223	Focus Melange	Color 66223	Upholstery - 3
	33	66224	Focus Melange	Color 66224	Upholstery - 3
	34	68244	Focus Melange	Color 68244	Upholstery - 3
	35	68245	Focus Melange	Color 68245	Upholstery - 3
	36	68247	Focus Melange	Color 68247	Upholstery - 3
	01	5000	Ox	Pure White	Upholstery - 7
	02	5080	Ox	Cognac	Upholstery - 7
	03	5100	Ox	Hazelnut	Upholstery - 7
	04	5110	Ox	Camel	Upholstery - 7
	05	5200	Ox	Passion	Upholstery - 7
	06	5290	Ox	Elephant	Upholstery - 7
	07	5300	Ox	Black	Upholstery - 7
	08	5310	Ox	Storm	Upholstery - 7
	09	5320	Ox	Sahara	Upholstery - 7
	10	5431	Ox	Atlantic	Upholstery - 7
	11	5518	Ox	Warm White	Upholstery - 7
	12	5522	Ox	Stone	Upholstery - 7

general information

general information

TEKNIPAINT & TEKNISTAIN	85
FABRIC DIRECTIONAL GUIDELINES	86
CUSTOMER'S OWN MATERIAL (COM)	88
CARE & MAINTENANCE	89
TOUCH-UP-KITS	90

teknipaint & teknistain

TekniPaint

A TekniPaint form is required if the customer requires a custom paint color.

The color matching procedures will take a minimum of 10 working days.

Standard lead times apply once customer approved sample is received by Teknion Customer Service Representative.

Using the TekniPaint

Prior to placing the order, Dealer submits the color match sample (minimum size 2" x 2") to Teknion Customer Service Representative in conjunction with a completed TekniPaint form.

After the color match process is completed, two (2) samples are returned to the Customer Service Representative who forwards them to the Dealer with a sign-off sticker, attached to the back of the sample, for approval by the customer.

Customer formally signs-off on the color samples by signing the attached sticker.

Dealer returns one (1) of the customer approved samples to a Customer Service Representative or a fax of the signed off sample to Teknion.

Dealer submits the order, quoting the paint name and paint number as indicated on the customer sign-off sticker.

Teknion products included in this program:

- Panels and Supports
- Providers, Overheads & Active Storage Products
- Electrical Products
- Pedestals, Lateral files & Storage Cabinets.

TekniPaint forms and information on how to use these forms can be found at www.teknion.com/products for your printing convenience.

TekniStain

A TekniStain form is required if a Teknion Wood product is needed in colors outside our standard offering.

To order a Custom Wood Stain, follow these instructions:

If specifying a custom color for Seating, please use code NOCWS.

If specifying a custom color for District, Interpret, Leverage, Marketplace, TOS, Transit, Expansion Casegoods or Expansion Wood, please use code ZOCWS.

If specifying a custom color for Dossier, Cana, Westcoast, Solitär, Grayson, Agenda, Gemini, Table&Conferencing and Executive Casegoods, please use code ZCCWS.

Please forward a TekniStain form to your Customer Service Representative along with two color samples. Allow two (2) weeks for the TekniStain approval process. The Custom Wood Stain sample must be signed off prior to placing product order. The total lead time will begin once final approval samples have been received from customer to Teknion.

Using the TekniStain

Teknion requires dealer or client to supply one (1) TekniStain form for each color being custom matched.

Include three (3) for U.S./two (2) for Canada minimum 3 x 3 color samples for each color being submitted for Custom Wood Stain

Teknion will provide customer with two color samples for each TekniStain submitted. The customer must sign the back of the approved sample. The second sample to be kept for customer reference.

TekniStain forms and information on how to use these forms can be found at www.teknion.com/products for your printing convenience.

fabric directional guidelines

Railroaded and Off-the-Bolt are terms that describe the orientation the fabric is applied to furniture.

Railroaded

All Teknion Standard panel fabrics are applied Railroaded.

Panel fabrics are typically 66" wide and are applied Railroaded regardless of a pattern orientation on the fabric. The fabric width equals the height of the element. For panel elements or screens greater than 60" in height, fabric direction is applied Off-the-Bolt, as the height of the product is greater than the width of the fabric.

The combination of panel heights up to 60" with higher panels will result in opposite pattern directions. Non-directional fabrics are recommended for these installations.

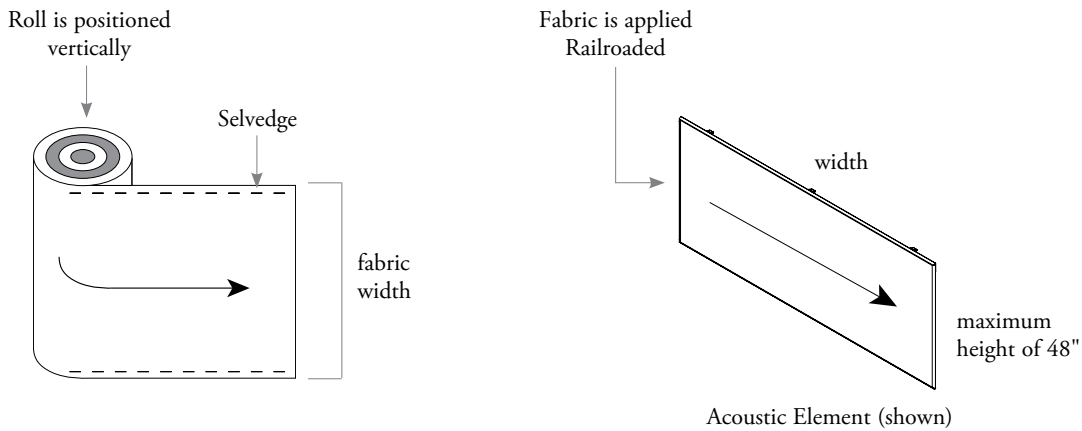

Off-the-Bolt

All Teknion Standard Architectural and Upholstery fabrics are applied Off-the-Bolt. Most upholstery fabrics are 54" wide.

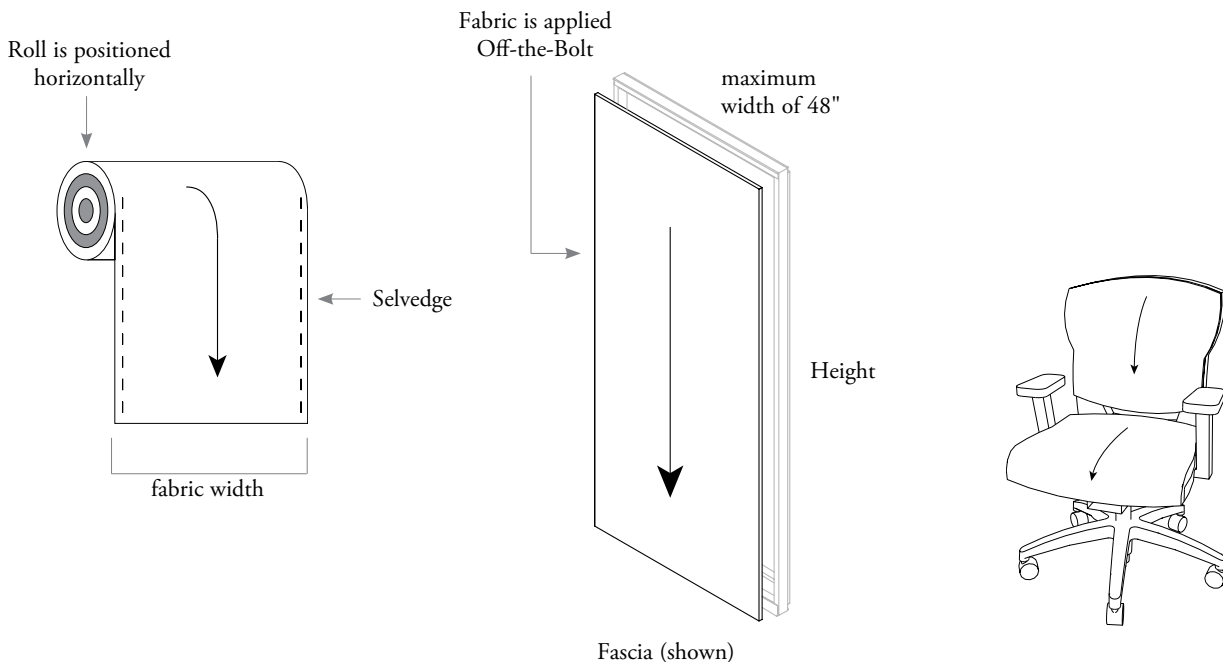

fabric directional guidelines (continued)

Pedestal & Credenza Cushions

Cushions on Teknion Pedestals and Credenzas are also applied Off-the-Bolt as illustrated below. The combination of storage cushions and the orientation of these products within an environment will result in fabric patterns appearing in opposite directions. If there is a need to change the orientation of the pattern on the cushion, a CR/Special is required.

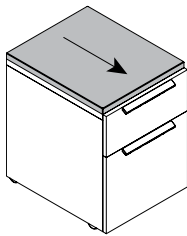

Pedestal

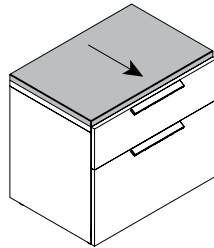

Stretch Pedestal

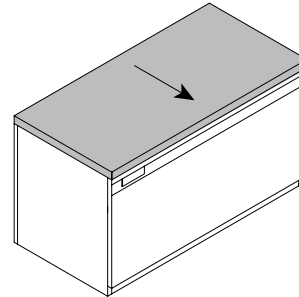

Extra Large Stretch Pedestal

Pattern Directions

The placement of storage within the workstation can result in the fabric pattern running in the opposite direction. Please see example below.

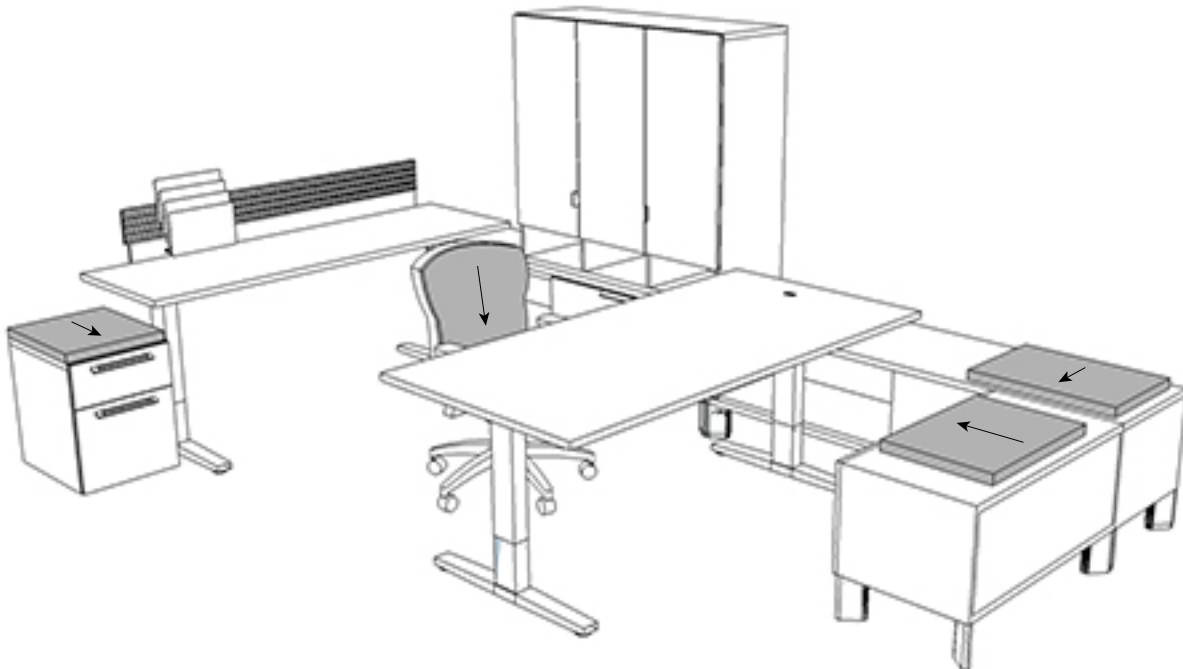

customer's own material (COM)

Customers Own Material or Leather (COM / COL)

A COM form is required if a Teknion product is needed in a textile outside our Standard or Graded-In Programs. For any COM/COL requests, please check with Teknion Customer Service for a record of the test results. If the fabric/leather has been approved, a serial number for the fabric and a cutting direction will be supplied by Teknion. This number must be shown on the order. Please note, for various reasons, certain fabrics/leathers may not be approved for use. The required COM/COL yardages given on the price pages are for orders up to 100 chairs. This number is approximate and can vary depending on the pattern repeat.

The COM process will take a minimum of 5 working days once the test yardage has been received by Teknion.

COM forms and information on how to use these forms can be found at www.teknion.com/products for your printing convenience.

COM Pattern Directional Guidelines for Seating

Usually, seating fabrics are patterned to run Off-the-Bolt. At the request of the customer, upholstery can be applied railroaded but yardage requirements may vary.

To avoid unnecessary confusion, you must always specify Off-the-Bolt or railroaded when using a COM fabric.

Estimated Material Requirement

More yardage may be required depending upon the upholstery pattern, repeat, directionality and pattern matching. Leather yield varies from 60-80% and may be affected by the quality of the COL including location and quantity of blemishes, size and shape of hide. The size of the sewing pattern and the number of units ordered may also impact yield. Always round-up to the next hide.

Teknion dna™

When selecting a COM fabric on Teknion dna, please note fabrics containing the following characteristics may result in poor application and therefore may be rejected :

- Lack of elasticity & recovery from an extension (below 3% threshold)
- Higher percentage of fiber content, (i.e. Cotton, Viscose rayon & polyolefin fibers)
- Very tight fabric construction
- Special finishes (Crypton, GreenShield, stain resistant, etc.)

Fabric Direction

All Standard Panel Fabrics are applied railroaded.

Railroaded application (RR)

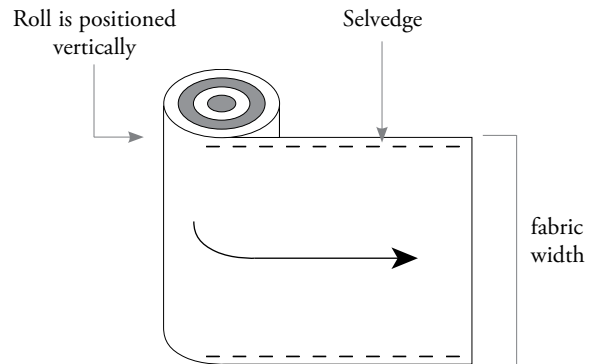

All Standard Seating and Architectural Fabrics are applied Off-the-Bolt.

Off-the-Bolt application (OB)

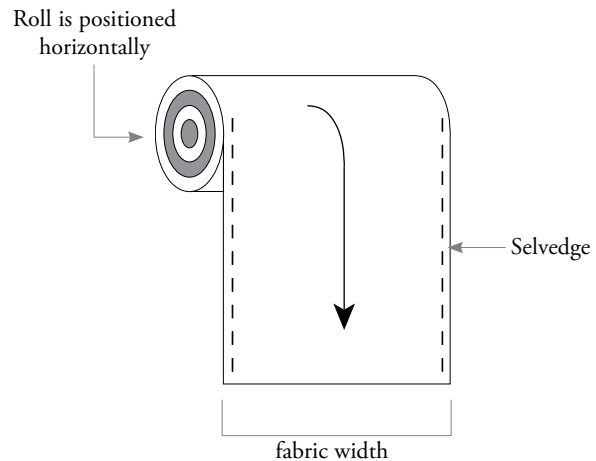

care & maintenance

Regular cleaning of your furniture system will maintain the appearance and optimize the long term return on investment.

Fabric

Panel and Seating fabrics are comprised of a variety of fiber construction. They are colorfast to standard wet and dry cleaning procedures. Avoid excessive brushing or rubbing during cleaning to prevent fuzzing of the fabric surface. Due to the low absorption properties, soiling will tend to remain on the fiber surface. To prevent overall soiling, frequent vacuuming or light brushing to remove dust and grime is recommended.

Oil or grease-type spots will respond to mild solvents or dry cleaning agents. When spot cleaning with a mild solvent or dry cleaning agent, follow instructions carefully and clean only in a well ventilated room. Avoid any product which contains carbon tetrachloride or other toxic materials. The blotting technique, without rubbing, should be sufficient to remove most spots.

To remove general dirt or grime spots, sponge with the foam from a mild detergent or upholstery shampoo. Rinse well with a clean sponge to remove traces of the water-based cleaning agent.

When spot cleaning with either the water-base or solvent-base type cleaning agents, test a small inconspicuous area before proceeding to spot clean the fabric any further. If an overall soiled condition has been reached, contact a professional furniture cleaning service.

Leather

Clean leather with a damp cloth and mild soap using light, circular motions. Repeat the process with a clean moist cloth and allow the leather to dry. A soft, dry cloth can then be used to polish the leather. Do not clean leather with detergents.

Vinyl Durable

Should be periodically cleaned to maintain its appearance and prevent build-up of dirt and contaminants. Any stain, spill or soiling should be cleaned up promptly to prevent the possibility of permanent staining. When cleaning, always rub gently.

Dried on Dirt

Remove with a soft cloth dampened with water. Wipe with soft cloth dampened with water. Allow to air dry.

Liquid Spills

Wipe immediately with a clean absorbent cloth. Rinse with clean water.

Stubborn Dirt

Wash with a soft cloth moistened with a mild soap and water. Rinse with clean water. Stubborn Spots and Stains: Spray with either *Formula 409*®, or *Tannery Car Care Cleaner*® and rub with a soft cloth. Rinse with clean water. Powdered abrasives, abrasive cleaners, and steel wool damage vinyl, as do strong solvents, lacquer solvents and inks. Lotions, waxes and polishes, etc., contain oils and dyes that can cause stiffening and staining of vinyls.

Ultra Durable

Cleaning Ultra Durable vinyl for most stains is achieved by prompt, energetic washing using a sponge and warm, soapy water, clear water rinses or a mild, non-abrasive cleaner. Moderate scrubbing with a medium bristle brush will help to loosen soiling materials from the depressions of embossed surfaces but have not penetrated the vinyl surface.

Advanced Cleaning Methods

Use the following commercially available mild detergents in accordance with the manufacturer's instructions, *Formula 409*®, *Fantastik*®, or *Mr. Clean*®. When opening a new container, please test the cleaner in an inconspicuous area as cleaner manufacturers may change formula without notice.

Full strength rubbing alcohol or mineral spirits may be tried with caution if the commercially available cleaners do not work. Indiscriminate use of strong solvents can severely damage or discolor Ultra Durable vinyl.

Ultra Durable offers enhanced resistance to most of the common chemicals used for sterilization and cleaning in medical environments. Ultra Durable will resist, without serious discoloration, the repeated action of normal dilutions of chlorine bleaches, ammonia based cleaners, excluding Quaternary Ammonium Compounds and Phenolics, as well as many common oxidizing and reducing chemicals.

Bleach can be diluted up to 9:1 ratio (10%). Liberally apply diluted disinfectant using a sponge, rinse with cold water several times, and then wipe dry. Repeat if necessary. Federal regulation requires that guidelines on the bleach label need to be followed for antiseptic or antimicrobial purposes.

touch-up kits

Teknion offers two types of Touch-Up Kits; a bottle with brush (paint) or a crayon, depending on which finish the product is applied.

KT100 – Bottle with brush is available for:

Foundation
Mica
Accent
Filling & Storage Paint Colors
Seamless Color (not available for Group 2 colors)

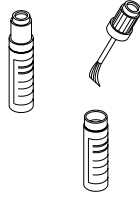

KT401 – Crayon is available for:

Fascia Laminate
Flintwood
Natural Veneer
Seamless Color (available for Group 1 colors)

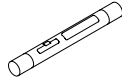

KT402 – Marker is available for:

Flintwood
Natural Veneer
Seamless Color (available for Group 1 colors)

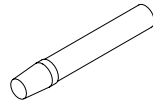

Ordering Touch-Up Kits:

Touch-Up Kits can be ordered through the Leverage product line specification software.

Touch-Up Kit Directions

Before You Begin

Make sure the surface is clean, dry and free of grease and oil. If needed, use a mild solvent and a clean cloth to wipe down surface. NOTE: Touch-Up should be used on small nicks and scratches only. It is not meant for large areas or deep gouges.

How to Use the Small Brush (KT100)

Always shake the bottle for at least one minute after the mixing balls begin to rattle. If the product is not adequately mixed, the color of the paint will not be correct. (Do not try to get all of the residue on the bottom of the bottle; it will never totally blend). Make sure that the product is capped tightly before shaking.

Dip brush into the bottle as far as it will go.

Slowly remove the brush from the bottle. The brush wiper which is mounted in the bottle opening reduces the opening diameter and helps to wipe excess paint from the brush. This eliminates dripping paint from the brush after removing it from the bottle.

Brush paint on with smooth strokes. Use very slight pressure when touching the brush to the substrate. Avoid retouching the wet paint film with the brush after it is applied. Do not try to retouch applied paint after paint has set up for more than 2 minutes.

When finished, recap the bottle.

How to Use the Crayon (KT401)

Apply by simply rubbing the semi-hard compound into the defect or damaged substrate or finish in a variety of directions.

Once applied, and slightly overfilled, the excess filler is removed by carefully leveling off using a semi-flexible plastic leveling card. An old bank card works sufficiently for this step. To finish off the task, use a soft lint free cloth for wiping off any further excess material from the area being worked on. Paper towel can also be substituted for a lint free cloth and this purpose.

How to Use the Marker (KT402)

Shake marker thoroughly to get full color strength. Depress the nib to begin material flow. Do not overload the nib with material. With light strokes, slowly apply color to the damaged area being careful not to “puddle” the material. Gently feather the applied material with a finger to blend the color in with the surrounding area.

zones textiles

zones textiles

ZONES PANEL FABRICS 95

ZONES UPHOLSTERY FABRICS 103

ZONES GENERAL INFORMATION 117

zones panel fabrics

zones panel fabrics

PANEL FABRICS APPLICATION MATRICES	97
--	----

PANEL FABRICS LISTING MATRICES

GRADE A

BEELINE	98
BITSTREAM	98
EGYPT	98
NITTY GRITTY	98
TANGLE	98
WALES	98
WIRED UP	98

GRADE 1

BANDEAU	98
BRAZIL	98
EMIT	98
ESSENTIALS	98
FLICKER	98
INDIA	98
LINEN WEAVE	98
LUSTRADO	99
MAKAH	99
PERU	99
PRESSE	99
RATIONALE	99
TOPOLOGY	99
VISTA	99
WARP SPEED	99

GRADE 2





























































































ACTUATE	99
BOUCLE GRID	99
COMPLEMENT	99
PERCEPT	99
TWINING	100

GRADE 3

ARTOPIA	100
CROSS DYE	100
MARL CLOTH	100

panel fabrics application matrices

The following charts outlines panel fabrics that are available for use on Zones Easel and Fabric Buffer.

	easel	buffers	
		flat	quilted
 Available			
 Not Available			
Grade A			
Beeline			
Bitstream			
Egypt			
Nitty Gritty			
Tangle			
Wales			
Wired Up			
Grade 1			
Bandeau			
Brazil			
Emit			
Essentials			
Flicker			
India			
Linen Weave			
Lustrado			
Makah			
Peru			
Presse			
Rationale			
Topology			
Vista			
Warp Speed			
Grade 2			
Actuate			
Boucle Grid			
Complement			
Percept			
Twining			
Grade 3			
Artopia			
Cross Dye			
Marl Cloth			

panel fabrics listings matrices

PANEL FABRICS

GRADE A

Beeline

Plumb.....	B631
String.....	B632
Strand.....	B633
Thread.....	B634
Band.....	B639
Dash.....	B640

Bitstream

Tablet.....	R582
Hardware.....	R583
Trackback.....	R584
Lithium.....	R585
Grey Code.....	R586
Silicone.....	R587
White Noise.....	R588
Xenon.....	R589
Wavelet.....	R590
Blue Team.....	R591
Firewire.....	R592
Flash Drive.....	R593

Egypt

Cairo.....	E301
Giza.....	E302
Port Said.....	E304
Suez.....	E305
Mallawi.....	E352
Jirja.....	E354
Idku.....	E355
Edfu.....	E356

Nitty Gritty

Block.....	N122
Detail.....	N123
Think.....	N130
Gist.....	N133
Factor.....	N134
Specific.....	N135

Tangle

Snarl.....	T531
Knot.....	T532
Interweave.....	T533
Ravel.....	T534
Kinks.....	T535
Spangle.....	T536
Tousle.....	T537
Crook.....	T538
Muddle.....	T539
Entwine.....	T540

GRADE A (Continued)

Wales

Swansea.....	W402
Teifi.....	W403
Newport.....	W404
Wrexham.....	W414
Corwen.....	W416
Bangor.....	W417
Newbridge.....	W418
Pembroke.....	W419
Kidwelly.....	W420
Goodwick.....	W421

Wired Up

Caged.....	W731
Intermingle.....	W739
Mesh.....	W740
Linkage.....	W741
Drawplate.....	W742
Nichrome.....	W743
Circuit.....	W744

GRADE 1

Bandeau

Washi.....	B124
Grosgrain.....	B126
Palla.....	B127
Farran.....	B128

Brazil

Betim.....	B220
Canela.....	B204
Olinda.....	B231
Timbo.....	B208
Manaus.....	B203
Jacarei.....	B217
Laguna.....	B233
Campo Grande.....	B260
Serra.....	B261

Emit

Watt.....	T727
Hertz.....	T728
Joule.....	T729
Dazzle.....	T730
Surge.....	T731
Particle.....	T732

GRADE 1 (Continued)

Essentials

Gris.....	E380
Dove.....	E382
Brier.....	E383
Light Grey.....	E384
Slate.....	E385
Banner.....	E391
Snowdrift.....	E409
Mist.....	E410
Basil.....	E412
Atlantic.....	E413
Desert.....	E414
Pebble.....	E415
Tropic.....	E416

Flicker

Glitter.....	F531
Beam.....	F532
Sparkle.....	F533
Flash.....	F534
Glint.....	F535
Sheen.....	F536
Gleam.....	F537
Glow.....	F538
Luster.....	F539
Twinkle.....	F540

India

Bombay.....	D402
Agra.....	D404
Gwalior.....	D405
Varanasi.....	D407
Haora.....	D408
Surat.....	D409
Manali.....	D425
Kashmir.....	D417
Pushkar.....	D418
Kerala.....	D419
Chennai.....	D422
Mumbai.....	D424
Pune.....	D423
Munnar.....	D420
Nanital.....	D421

Linen Weave

Gate.....	L308
Sesame.....	L309
Coir.....	L327
Bast.....	L328
Dusty Grey.....	L329
Mineral.....	L330
Linseed.....	L331

panel fabrics listings matrices

PANEL FABRICS

GRADE 1 (Continued)

Lustrado

Glassine	L363
Acetate	L364
Brilliance	L365
Alloy	L366
Gallium	L367
Incandescent	L368
Resin	L369
Sterling	L370
Varnish	L372
Vitreous	L373

Makah

Shaker	M415
Luminous	M416
Arundo	M417
Solano	M418
Flitch	M419
Splint	M420

Peru

Tacna	P401
Nazca	P402
Lima	P403
Casma	P404
Puno	P405
Cuzco	P406
Tingo Maria	P407
Callao	P409
Tumbes	P411
Puerto	P412

Presse

Halo Effect	P100
Overlay	P101
Masked	P102
Relief	P103
Plaited	P104
Gravure	P105

Rationale

Classical	R380
Drift	R381
Firma	R382
Lucid	R383
Abstract	R384
Mind's Eye	R385
Infinite	R386
Transcend	R387

GRADE 1 (Continued)

Topology

Ceramic	T100
Open Space	T101
Natural	T102
Cooling	T103
Shadow	T104

Vista

Panorama	V201
Glimpse	V202
Scene	V204
Valley	V205
Horizon	V206

Warp Speed

Headwind	W110
White Space	W111
Stroke	W112
Reed Arrow	W113
Jet	W114
Steel Racer	W115
Earth Orbit	W116

GRADE 2

Actuate

Aqueous	A209
Spectral	A210
Aether	A211
Facet	A212
Syntax	A213
Vanish	A214
Suffuse	A215
Mordant	A216
Lambent	A217
Conscious	A218
Fortify	A219
Favrile	A220
Prelude	A221
Meridian	A222
Thermal	A223
Induction	A224

Boucle Grid

Craie	B119
Bis	B120
Ardoise	B121
Fauve	B122
Nuage	B123

GRADE 2 (Continued)

Complement

Nightfall	C279
Dusk	C280
Grey Wolf	C281
Sea Salt	C282
Roan	C283
Amarillo	C284
Arancia	C285
Carnelian	C286
Garnet	C287
Fresh Air	C289
Peacock	C290

Percept

Schema	C813
Pristine	C814
Intrinsic	C815
Sublime	C817
Context	C818
Essence	C819
Tenet	C820
Epiphany	C821
Verve	C822
Amplitude	C823
Reason	C824
Cardinality	C825
Nebula	C826
Jubilant	C827
Ignite	C828
Harmonic	C829
Peak	C830
Devotion	C831

PANEL FABRICS

GRADE 2 (Continued)

Twining

Ivory Vine.....	W117
Pale Straw.....	W118
Abaca.....	W119
Sisal.....	W120
Quill.....	W121
Silvery Strand.....	W122
Bulrush.....	W123

GRADE 3

Artopia

Primer.....	R176
Kinetic.....	R177
Stencil.....	R178
Magenta.....	R179
Amerlith.....	R180
Cadmium.....	R181
Aquatint.....	R182
Vivid Blue.....	R183

Cross Dye

Earl Grey.....	R150
Linen.....	R151
Light Birch.....	R152
Almond.....	R153
Soft Shadow.....	R154
Ace Grey.....	R155
Cool Ash.....	R156
Carotene.....	R157
Crimson.....	R158
Carmine.....	R159
Tea Tree.....	R160
Artichoke.....	R161
Plum.....	R162
Watercolor.....	R163
Azure.....	R164
Logwood.....	R165

Marl Cloth

Yurt.....	R166
Guy Rope.....	R167
Camp Fire.....	R169
Dry Stone.....	R170
Wilderness.....	R171
Berry.....	R172
Blacksmith.....	R173
Sea Nomad.....	R174
Wild Fruit.....	R175
Dreamscape.....	R195
Landmark.....	R196
Tree Bark.....	R197

zones upholstery
fabrics

zones upholstery fabrics

UPHOLSTERY FABRICS OVERVIEW 105

UPHOLSTERY FABRICS APPLICATION MATRICES 106

UPHOLSTERY FABRICS APPLICATION LISTINGS



GRADE 1

BITSTREAM108
FUNDAMENTALS108
HEATHER TECH.108
MAGNIFY108
STIMULI108

GRADE 2

ACTUATE108
COMPLEMENT108
CROSS DYE108
CROSGRAIN109
DECOY109
DIGI TWEED109
MIAMI109
PERCEPT109
ULTRA DURABLE109
INTONE109

GRADE 3

AMPLE110
DOYENNE110
ECOTONE110
SITU110
SUPERSPUN110
FINE GRAIN.110
MARL CLOTH110
BEADED STRIPE110
 INTRAWEB110
 MILIEU110

GRADE 4

INTERSTICE111
MODULUS.111
VELVET UNDERGROUND . .111
META TEXTURE111
ELASTIC WOOL111

GRADE 5

ADAGE111
MONOTEX.111
SUBSTANCE111
SYNAPTIC111

GRADE 6

AMALGAM112
HAPTIC112
PERILUNE112
PHOTOGRAM112
VECTOR112
DUO CHROME112
OUTPRESS112

GRADE 7

 CONTRAST SLUB112
FLEX WOOL.112
OEUVRE112
STRUCTURED STRIPE. . .113
EPHEMERA113

GRADE 8

CONSTRUCT113
HOMAGE113
FULL WOOL113

GRADE 9

TOP COAT.113
HEATHER FELT113
EQUILUX113

GRADE 10

COLOR FUSE.113
FLEECE113

LEATHER

LEATHER - LA113
LEATHER - LB113
LEATHER - LC114
LEATHER - LD114

upholstery fabrics overview

teknon standard upholstery fabric program

All fabrics are developed to enhance Teknion systems products incorporating technology in fiber development. They are designed to coordinate with the other finishes in Teknion system and seating programs. The fabrics are offered in a range of low intensity colors with some stronger hues and a variety of solids, patterns and textures. All Teknion fabrics are developed to exceed technical standards.

Teknion has a full program of standard fabrics, vinyl and leather appropriate for most seating lines. All fabrics are covered by Teknion standard warranty and meet all standards for CAL 116 and 117 and exceed industry durability requirements. All upholstery coverings may not be approved for use on all chair families. Please refer to the **Listing & Application Matrices** within this section for fabric applications.

Fabrics meet or exceed performance standards by ACT (Association for Contract Textiles).

Please note, leathers and faux-leathers may show natural blemishes, scars and wrinkles which are inherent material characteristics and as such deemed acceptable by Teknion. Variation of color, grain and texture found in wood and leather are also natural. Teknion is not responsible for reverse crocking of dyes from clothing onto our seating upholstery and finishes.

fabric pattern directional guidelines

Directional specifications are not required for any of Teknion Standard Upholstery to Teknion products. All Standard Upholstery Fabrics will be run Off-the-Bolt, as shown on the sample card. See the Fabric Pattern Directional Guidelines in the General Information section at the back of the book for more details.

upholstery fabrics application matrices

The following charts outlines upholstery fabrics that are available for use on Zones Seating and Vertical Surfaces.

	vertical surfaces				seating									
	desk edge screens	easels	buffers		club	multi-use					sofa	soft		
			flat	quilted	club chairs	arm chairs	side chairs	benches	side stools	backless stools	sofas	solo lounge chairs	sled lounge chairs	sled lounge ottomans
Grade 1														
Bitstream	Available	Available	Available	Available	Available	Available	Available	Available	Available	Available	Available	Available	Available	Available
Fundamentals	Available	Not Available	Available	k	Available	Available	Available	Available	Available	Available	Available	Available	Available	Available
Heather Tech	Available	Available	Available	Available	Available	Available	Available	Available	Available	Available	Available	Available	Available	Available
Magnify	Available	Available	Available	Available	Available	Available	Available	Available	Available	Available	Available	Available	Available	Available
Stimuli	Available	Available	Available	Available	Available	Available	Available	Available	Available	Available	Available	Available	Available	Available
Grade 2														
Actuate	Available	Available	Available	Available	Available	Available	Available	Available	Available	Available	Available	Available	Available	Available
Complement	Available	Available	Available	Available	Available	Available	Available	Available	Available	Available	Available	Available	Available	Available
Cross Dye	Available	Available	Available	Available	Available	Available	Available	Available	Available	Available	Available	Available	Available	Available
Crossgrain	Available	Available	Available	Available	Available	Available	Available	Available	Available	Available	Available	Available	Available	Available
Decoy	Available	Available	Available	Available	Available	Available	Available	Available	Available	Available	Available	Available	Available	Available
Digi Tweed	Available	Available	Available	Available	Available	Available	Available	Available	Available	Available	Available	Available	Available	Available
Miami	Available	Available	Available	Available	Available	Available	Available	Available	Available	Available	Available	Available	Available	Available
Percept	Available	Available	Available	k	Available	Available	Available	Available	Available	Available	Available	Available	Available	Available
Ultra Durable	Available	Available	Available	Available	Available	Available	Available	Available	Available	Available	Available	Available	Available	Available
Intone	Available	Available	Available	Available	Available	Available	Available	Available	Available	Available	Available	Available	Available	Available
Grade 3														
Ample	Available	Available	Available	k	Available	Available	Available	Available	Available	Available	Available	Available	Available	Available
Doyenne	Available	Available	Available	Available	Available	Available	Available	Available	Available	Available	Available	Available	Available	Available
Ecotone	Available	Available	Available	Available	Available	Available	Available	Available	Available	Available	Available	Available	Available	Available
Situ	Available	Available	Available	Available	Available	Available	Available	Available	Available	Available	Available	Available	Available	Available
Superspun	Available	Available	Available	Available	Available	Available	Available	Available	Available	Available	Available	Available	Available	Available
Fine Grain	Available	Available	Available	Available	Available	Available	Available	Available	Available	Available	Available	Available	Available	Available
Marl Cloth	Available	Available	Available	Available	Available	Available	Available	Available	Available	Available	Available	Available	Available	Available
Beaded Stripe	Available	Available	Available	Available	Available	Available	Available	Available	Available	Available	Available	Available	Available	Available
Intraweb	Available	Available	Available	Available	Available	Available	Available	Available	Available	Available	Available	Available	Available	Available
Milieu	Available	Available	Available	Available	Available	Available	Available	Available	Available	Available	Available	Available	Available	Available
Grade 4														
Interstice	Available	Available	Available	Available	Available	Available	Available	Available	Available	Available	Available	Available	Available	Available
Modulus	Available	Available	Available	Available	Available	Available	Available	Available	Available	Available	Available	Available	Available	Available
Velvet Underground	Available	Available	Available	Available	Available	Available	Available	Available	Available	Available	Available	Available	Available	Available
Meta Texture	Available	Available	Available	Available	Available	Available	Available	Available	Available	Available	Available	Available	Available	Available
Elastic Wool	Available	Available	Available	Available	Available	Available	Available	Available	Available	Available	Available	Available	Available	Available
Grade 5														
Adage	Available	Available	Available	Available	Available	Available	Available	Available	Available	Available	Available	Available	Available	Available
Monotex	Available	Available	Available	Available	Available	Available	Available	Available	Available	Available	Available	Available	Available	Available
Substance	Available	Available	Available	Available	Available	Available	Available	Available	Available	Available	Available	Available	Available	Available
Synaptic	Available	Available	Available	Available	Available	Available	Available	Available	Available	Available	Available	Available	Available	Available

k Not all colorways are approved.

upholstery fabrics application matrices

The following charts outlines upholstery fabrics that are available for use on Zones Seating and Vertical Surfaces.

	vertical surfaces				seating								
	desk edge screens	easels	buffers		club	multi-use				sofa	soft		
			flat	quilted	club chairs	arm chairs	side chairs	benches	side stools	backless stools	sofas	solo lounge chairs	sled lounge chairs
Grade 6													
Amalgam													
Haptic													
Perilune													
Photogram													
Vector													
Duo Chrome													
Outpress													
Grade 7													
Contrast Slub 													
Flex Wool													
Oeuvre													
Structured Stripe													
Ephemera													
Grade 8													
Contract													
Homage													
Full Wool													
Grade 9													
Top Coat													
Heather Felt													
Equilux													
Grade 10													
Color Fuse													
Fleece													
Leather - LA													
Base Grade Leather													
Leather - LB													
Merus													
Leather - LC													
Pela													
Leather - LD													
Fortis													

k Not all colorways are approved.

upholstery fabrics listings matrices

UPHOLSTERY FABRICS

GRADE 1

Bitstream

Tablet	B160
Hardware	B161
Trackback	B162
Lithium	B163
Grey code	B164
Silicone	B165
White Noise	B166
Xenon	B167
Wavelet	B168
Blue Team	B169
Firewire	B170
Flash Drive	B171

Fundamentals

* Salsa	E504
* Banner	E505
* Parakeet	E516
* Brier	E518
* Sudan	E519
* Wendigo	E520
* Armory	E521
* Light Grey	E522
* Black	E523
* Tangelo	E526
* Verde	E528
* Aqua	E529
* Azure	E530
* Dove	E532
* Nickel	E533
* Slate	E534
* Latte	E535
* Marble	E536
* Moonstone	E537
* Lapis	E538
* Malachite	E539

GRADE 1 (Continued)

Heather Tech

Dust Tech	T162
Topaz Tech	T163
Oat Tech	T164
Flax Tech	T165
Silt Tech	T166
Loam Tech	T167
Crag Tech	T168
Basalt Tech	T169
Loden Tech	T170
Sagebrush Tech	T171
Meadow Tech	T172
Sundew Tech	T173
Rose Tech	T174
Raspite Tech	T175
Madder Tech	T176
Beetroot Tech	T177
Thistle Tech	T178
Lav Tech	T179
Clear Tech	T180
Loch Tech	T181
Ocean Tech	T182
North Sea Tech	T183
Onyx Tech	T184
Obsidian Tech	T185

Magnify

Telescope	M140
Polished Mirror	M141
Reflection	M142
Zoom Lens	M143
Force Field	M144
Long Wave	M145
Deep Water	M146
Light Beam	M147
Flare Up	M148
Viewfinder	M149
Infrared	M151

Stimuli

Sensitive	S145
Turbinado	S146
Rush	S147
Zest	S148
Tactile	S149
Daredevil	S150
Euphoria	S151
Vigor	S152
Thrill	S153
Catalyst	S154
Black Tea	S155

GRADE 2

Actuate

Aqueous	A209
Spectral	A210
Aether	A211
Facet	A212
Syntax	A213
Vanish	A214
Suffuse	A215
Mordant	A216
Lambent	A217
Conscious	A218
Fortify	A219
Favrite	A220
Prelude	A221
Meridian	A222
Thermal	A223
Induction	A224

Complement

Nightfall	T148
Dusk	T149
Grey Wolf	T150
Sea Salt	T151
Roan	T152
Amarillo	T153
Arancia	T154
Carnelian	T155
Garnet	T156
Fresh Air	T158
Peacock	T159

Cross Dye

Earl Grey	C120
Linen	C121
Light Birch	C122
Almond	C123
Soft Shadow	C124
Ace Grey	C125
Cool Ash	C126
Carotene	C127
Crimson	C128
Carmine	C129
Tea Tree	C130
Artichoke	C131
Plum	C132
Watercolor	C133
Azure	C134
Logwood	C135

upholstery fabrics listings matrices

UPHOLSTERY FABRICS (continued)

GRADE 2 (Continued)

Crossgrain

Underbrush	C163
Dado	C164
Blackwood	C165
Cove	C166
Xylem	C167
Tenon	C168
Amaranth	C169
Red Oak	C170
Tuliptree	C171
Iroko	C172
Ginkgo	C173
Burl	C174
Cypress	C175
Springwood	C176
Driftwood	C177

Decoy

Double Bluff	D150
Sheep's Clothing	D151
Trick Mirror	D152
Ditto	D153
Proxy	D154
Façade	D155
Rook	D156
Copycat	D157
Incognito	D158
Pipe Dream	D159
Trip Wire	D160
Feign	D161
Atlantis	D162
Mirage	D163
Reverie	D164
Lure	D165
Cloak	D166
Mystify	D167
Figment	D168
Ruse	D169
Red Handed	D170
Clandestine	D171
Cahoots	D172
Synonym	D173
Mimic	D174
Retort	D175
Masquerade	D176
Lookalike	D177
Eavesdrop	D178
Lark	D179
Stand In	D180
Encore	D181
Sweet Talk	D182
Pretense	D183
Fool's Gold	D184
Monkey Business	D185
Alias	D186

GRADE 2 (Continued)

Decoy (continued)

Crocodile Tears	D187
Parrot	D188
Face Value	D189
Garden Path	D190
Espionage	D191
Emulate	D192
Replay	D193
Parallel	D194
Mare's Nest	D195

Digi Tweed

Dust Tweed	D310
Topaz Tweed	D311
Oat Tweed	D312
Flax Tweed	D313
Silt Tweed	D314
Loam Tweed	D315
Crag Tweed	D316
Basalt Tweed	D317
Loden Tweed	D318
Sagebrush Tweed	D319
Meadow Tweed	D320
Sundew Tweed	D321
Rose Tweed	D322
Raspite Tweed	D323
Madder Tweed	D324
Beetroot Tweed	D325
Thistle Tweed	D326
Lav Tweed	D327
Clear Tweed	D328
Loch Tweed	D329
Ocean Tweed	D330
North Sea Tweed	D331
Onyx Tweed	D332
Obsidian Tweed	D333

Miami

Collins Avenue	M507
Wynwood	M522
Homestead	M523
Dade	M524
Liberty City	M526
Coral Gables	M528
South Beach	M529
Pincrest	M530
Boardwalk	M531
Downtown	M532

GRADE 2 (Continued)

Percept

* Schema	P106
* Pristine	P107
Intrinsic	P108
* Sublime	P110
* Context	P111
* Essence	P112
* Tenet	P113
Epiphany	P114
Verve	P115
* Amplitude	P116
Reason	P117
* Cardinality	P118
Nebula	P119
* Jubilant	P120
Ignite	P121
* Harmonic	P122
Peak	P123
* Devotion	P124

Ultra Durable

Mohair	V180
Iced Coffee	V182
Tungsten	V184
Black Velvet	V187
Wet Clay	V490
Silver Age	V493
Morning Glory	V497
Neptune	V500
Fig	V503

Intone

Ash	LM12
Creme	LM13
Harbor	LM14
Quicksilver	LM15
Caraway	LM16
Oxide	LM17
Cinder	LM18
Lute	LM19
Pome	LM20
Eclipse	LM21

* Colorway approved for Quilted Fabric Buffer.

upholstery fabrics listings matrices

UPHOLSTERY FABRICS (continued)

GRADE 3

Ample

* Quark	T220
Voltage	T221
Sunburst	T222
Radioactive	T224
Reaction	T227
* Cosmic	T229
Blue Comet	T239
* Vortex	T241
* Neutron	T242
* Tempered	T243
Charge	T270
Equilibrium	T271
Magnetic Field	T272
Convection	T273
Radar	T274
Conductor	T275
Evaporate	T276
Halide	T277

Doyenne

Woodblock	Y100
Sepia Tone	Y101
Intaglio	Y102
Grisailles	Y103
Aquamedia	Y104
Watermark	Y105
Verdigris	Y106
Phthalo	Y107
Terre Verte	Y108
Copperplate	Y109
Sienna	Y110
Alizarin	Y111

Ecotone

Abyss	E136
Ravine	E137
Rocky Shore	E138
Permafrost	E139
Tundra	E140
Arid	E141
Savanna	E142
Desert Bloom	E143
Badlands	E144
Caldera	E145
Freshwater	E146
Intertidal	E147
Rain Shadow	E148
Lichen	E149
Mangrove	E150
Treeline	E151

GRADE 3 (Continued)

Situ

Archeology	F115
Pozzolana	F116
Amphora	F117
Statue	F118
Wind Tower	F119
Tunnel	F120
Phosphor	F121
Flamante	F122
Hydro	F123
Terrena	F125
Mar	F126

Superspun

Drawdown	S442
Denier	S443
Tensile	S444
Roving	S445
Staple	S446
Spindle	S447
Harness	S448
Tenter	S449
Red Cast	S450
Selvedge	S451
Skein	S452
Bluing	S453
Treadle	S454
Sett	S455
Pirn	S456
Creel	S457

Fine Grain

Warm Earth	F401
River Ore	F402
Saw Dust	F403
Putty Paste	F404
White Out	F405
Lunar Regolith	F406
Metallic Swarf	F407
Volcanic Ash	F408
Carbon Neutral	F409
Frosted Zephyr	F410
Deep Indigo	F411
Fathom Blue	F412
Sea Weed	F413
Matcha Leaves	F414
French Beige	F415
Ginger Snap	F416
Martian Soil	F417
Madder Root	F418
Garnet Sand	F419
Iron Oxide	F420
Peat Moss	F421

GRADE 3 (Continued)

Marl Cloth

Yurt	F314
Guy Rope	F315
Camp Fire	F317
Dry Stone	F318
Wilderness	F319
Berry	F320
Blacksmith	F321
Sea Nomad	F322
Wild Fruit	F323
Dreamscape	F324
Landmark	F325
Tree Bark	F326

Beaded Stripe

Venetian	P497
Crystal	P498
Amulet	P499
Gemstone	P500
Lazuli	P501
Cinnabar	P502

Intraweb 

Raster	T397
Dual Trace	T398
Polytope	T397
Superposition	T400
Coaxial	T401
Origin	T402
Slope	T403
Polarity	T404
Isosurface	T405

Milieu 

Kettle	M570
Thunder	M571
Memory	M572
Steam	M573
Wing	M574
Nest	M575
Leap	M576
Troupe	M577
Peregrine	M578
Hedge	M579
Prickle	M580
Spring	M581
Muster	M582
Herd	M583
Parcel	M584
Bloom	M585
Fling	M586
Flamboyance	M587
Bazaar	M588
Rabble	M589
Zeal	M590
Bevy	M591
Loft	M592
Float	M593
Paddling	M594
Shoal	M595
Fleet	M596

* Colorway approved for Quilted Fabric Buffer.

upholstery fabrics listings matrices

UPHOLSTERY FABRICS (continued)

GRADE 4

Interstice

Inkling	R307
Pinpoint	R308
Lacuna	R309
Whit	R310
Scintilla	R311
Fragment	R312
Atom	R313
Trace	R314
Respite	R315
Vestige	R316
Interval	R317
Caesura	R318

Modulus

Plinth	M172
Landscape	M173
Masonry	M174
Superstructure	M175
Skylight	M176
Site	M177
Form	M178
Shadow Play	M179
Rebar	M180
Spatial	M181
Threshold	M182
Monument	M183

Velvet Underground

Metal Machine	V310
Flame Desire	V313
Blue Denim	V315
Dark Moon	V317
Blacktop	V318
Brass Section	V319
Shock Wave	V320
Full Phase	V321
Dark Current	V322
Smoke Screen	V323
Wallflower	V324
Ultraviolet	V325
Purple Rain	V326
Green Room	V327
Garden Level	V328
New Wave	V329

GRADE 4 (Continued)

Meta Texture

Deep Space	M224
Grey Matter	M225
Pale Shadow	M226
Silver Lining	M227
Hive Mind	M228
Neutral Ground	M229
Grassroots	M230
Jaded	M231
Deep Dive	M232
Blue Skies	M233
Rosy Outlook	M234
Heat Wave	M235
Punchline	M236

Elastic Wool

Fortress	E120
Fantom	E121
Mercury	E122
Clean	E123
Seed	E124
Tea	E125
Rust	E126
Ruby	E127
Ceylon	E128
Lovelace	E129
Jovial	E130
Elm	E131
Python	E132
Aegean	E133
Delphi	E134
Dart	E135

Adage

Script	a166
Anthracite	a146
Carbon Fiber	a147
Splice	a148
Chromite	a149
Singularity	a150
Valence	a151
Halite	a152
Quartzite	a153
Rubelite	a154
Thremite	a155
Orchil	a156
Holograph	a157
Photon	a158
Halogen	a159
Canopy	a160
Raw Jade	a161
Petrol	a162
Diffraction	a163
Amythyst	a164
Pascal	a165

GRADE 5

Substance

Quartz	S172
Terrain	S173
Adobe	S174
Lodestone	S175
Bluestone	S176
Green Beryl	S177
Chert	S178
Foundation	S179
Forge	S180

Synaptic

Contact	S135
Phase	S136
Conduit	S138
Sensory	S139
Receptor	S140
Traverse	S141
Transmission	S142
Axon	S144

Monotex

Silver Lane	G106
Sharkskin	G107
Grey Flannel	G108
Grey Marl	G109
Tarpaper	G110
Ferrous	G111
Bark Cloth	G112
Burlap	G113
Sumac	G114
Redroot	G115
Tyrian	G116
Annatto	G117
Jean	G118
Kingfisher	G119
Oxalis	G120
Sulfur	G121

* Colorway approved for Quilted Fabric Buffer.

upholstery fabrics listings matrices

UPHOLSTERY FABRICS (continued)

GRADE 6

Amalgam

Aura	K106
Pyrite	K107
Medallion	K108
Fluid	K109
Ultraviolet	K110
Joit	K111
Nitro	K112
Magma	K113
Fuse	K114

Haptic

Cliffline	H616
Gravel	H617
Alluvium	H618
Sediment	H619
Pink Salt	H620
Montane	H621
Butte	H622
Arroyo	H623
Superbloom	H624
Mantle	H625
Geode	H626
Flood Plain	H627
Isthmus	H628
Aquifer	H629
Delta	H630
Fjord	H631

Perilune

Terrene	M160
Asteroid	M161
Stellar	M162
Satellite	M163
Gravity	M164
Red Shift	M165
Blue Moon	M166
Space Age	M167
Verdant	M168
Pulsar	M169
Solar	M170
Hot Crater	M171

Photogram

Mitere	P160
Toner	P161
Silver Salts	P162
Light Meter	P163
Sunprint	P164
Heliograph	P165
Safelight	P166
Cyanotype	P167
Mezzotint	P168
Darkroom	P169

GRADE 6 (Continued)

Vector

Dovetail	V221
Horizon Line	V222
Tessera	V223
Latitude	V224
Vertex	V225
Radial	V226
Hypercube	V227
Scalar	V228
Parallax	V229

Duo Chrome

Ebony	D130
Charcoal	D131
Black Pepper	D132
Platinum	D133
Canvas	D134
Copper	D135
Goldenrod	D136
Citron	D137
Emerald	D138
Silver Elm	D139
Evergreen	D140
Aquamarine	D141
Navy	D142
Iris	D143
Boysenberry	D144
Hydrangea	D145
Dusty Plum	D146
Oxblood	D147
Red Oxide	D148
Persimmon	D149

Outpress

Ashen	C237
Sand	C238
Stone	C239
Soot	C240
Raven	C241
Pepper	C242
Monarch	C243
Caribbean	C244
Denim	C245

GRADE 7

Contrast Slub 

Charred Seed	F428
Silver Thyme	F429
Cotton Blossom	F430
Tumbleweed	F431
Bramble	F432
Manzanita	F433
Cactus Flower	F434
Scarlet Sage	F435
Anemone	F436
Crepe Myrtle	F437
Wild Indigo	F438
Jacaranda	F439
Cenote	F440
Oleander	F441
Eucalyptus	F442
Lemongrass	F443

Flex Wool

Rebound	F480
Tempo	F481
Dynamo	F482
Vim	F483
Spark	F484
Thrive	F485
Arena	F486
Agile	F487
Buoyant	F488
Torque	F489
Raceway	F490
Blur	F491

Oeuvre

Blithe	V520
Salient	V521
Austere	V522
Earnest	V523
Ardent	V524
Fervor	V525
Finesse	V526
Mettle	V527
Flourish	V528
Charm	V529
Deft	V530
Crest	V531

Structured Stripe

Shadow Weave	S335
Silver Lap	S336
Countermarche	S337
Double Beam	S338
Block Draw	S339
Box Motion	S340
Overshot	S341
Punch Card	S342

* Colorway approved for Quilted Fabric Buffer.

upholstery fabrics listings matrices

UPHOLSTERY FABRICS (continued)

GRADE 7 (Continued)

Ephemera

Lucent	E108
Afterglow	E109
Ice Cloud	E110
Halcyon	E111
Phosphene	E112
Solar Flare	E113
Gamma Burst	E114
Green Flash	E115
Blue Shift	E116
Ashfall	E117
Nightglow	E118
Penumbra	E119

GRADE 8

Construct

Fawn	C511
Clay	C512
Brandy	C513
Vermilion	C514
Cadmium Orange	C515
Zinnia	C516
Auburn	C517
Wisteria	C518
Ultramarine	C519
Cornflower	C520
Pacific	C521
Celadon	C522
Canary	C523
Turmeric	C524
Ochre	C525
Beryl	C526
Viridian	C527
Fir	C528
Midnight	C529
Argent	C530
Gunmetal	C531
Noir	C532

Homage

* Respect	H100
* Winsome	H101
* Esteem	H102
* Dashing	H103
* Authority	H104
Soigné	H106
Valor	H107
Sanguine	H108
Vivant	H109
Guild	H110
Pinnacle	H111
Noble	H112

GRADE 8 (Continued)

Full Wool

Blanc	F207
Hot Stone	F209
* Éclair	F210
Macchiato	F211
Ink	F212
* Tigerlily	F214
Fresh Water	F215
* Serpent	F216
Neptune	F218
* Safari	F219
Vintage Red	F220
* Lagoon	F221
* Oak Room	F222
Deep Orchid	F223

GRADE 9

Top Coat

Shell	T418
Glaze	T419
Chromate	T420
Stoneware	T421
Aniline	T422
Braze	T423
Conduct	T424
Heat Set	T425
Claycast	T426
Toast	T427
Polish	T428
Frit	T429
Shellac	T430
Dip	T431
Indigo Ink	T432
Seal	T433
Weld	T434
Black Oxide	T435

Heather Felt

* Noil	H510
Alumina	H511
* Bone Ash	H512
* Pinon Tree	H513
Saddle	H515
* Indian Ocean	H516
* Mustard Seed	H517
* Saffron	H518
Acai	H519

Equilux

Eventide	E100
Diamond Dust	E101
Solstice	E102
Moonbow	E103
Corona	E104
Blue Hour	E105
Kindle	E106
Sunspot	E107

GRADE 10

Color Fuse

Wax	C154
Emulsion	C155
Jell	C156
Enamel	C157
Liquefy	C158
Freeze	C159
Molten	C160
Solvent	C161
Plasma	C162

Fleece

Alum	M191
Aer	M192
Linseed	M193
Rubedo	M194
Ignis	M195
Cypher	M196
Balsam	M197
Glyph	M198
Nero	M199

LEATHER - LA

Base Grade Leather

Shale	L101
Black	L104
Sand	L200
Chocolate	L204
Chime	L205
Fossil	L206
Poppy	L210
Parlor	L211
Marine	L212
Buttercup	L214
White	L215

LEATHER - LB

Merus

Teak	L110
White Birch	L111
Beechwood	L112
Almond Shell	L114
Smoke	L117
Hopi	L118
Crushed Bark	L119
Black Truffle	L123

* Colorway approved for Quilted Fabric Buffer.

upholstery fabrics listings matrices

UPHOLSTERY FABRICS (continued)

LEATHER - LC

Pela

Clove	L216
White Clay	L217
Chamois	L218
Buckwheat	L220
Hemlock	L221
Fern	L222
Cerulean	L226
Marigold	L227
Pomegranate	L228
Cordon	L229
Black Cherry	L230
Nightshade	L232
Morel	L233
Russet	L234
Carbon	L235
Pitch	L236

LEATHER - LD

Fortis

Canyon	L310
Bone	L311
Terra	L313
Nugget	L314
Black Rock	L316

zones general
information

zones general information

FABRIC CARE & MAINTENANCE	118
TEKNIPAIN & TEKNISTAIN	119
FABRIC PATTERN DIRECTIONAL GUIDELINES	120
FABRIC PATTERN SEAM GUIDELINES	123
CUSTOMER'S OWN MATERIAL (COM)	124

fabric care & maintenance

Regular cleaning of your furniture system will maintain the appearance and optimize the long term return on investment.

Fabric

Panel and Seating fabrics are comprised of a variety of fiber construction. They are colorfast to standard wet and dry cleaning procedures. Avoid excessive brushing or rubbing during cleaning to prevent fuzzing of the fabric surface. Due to the low absorption properties, soiling will tend to remain on the fiber surface. To prevent overall soiling, frequent vacuuming or light brushing to remove dust and grime is recommended.

Oil or grease-type spots will respond to mild solvents or dry cleaning agents. When spot cleaning with a mild solvent or dry cleaning agent, follow instructions carefully and clean only in a well ventilated room. Avoid any product which contains carbon tetrachloride or other toxic materials. The blotting technique, without rubbing, should be sufficient to remove most spots.

To remove general dirt or grime spots, sponge with the foam from a mild detergent or upholstery shampoo. Rinse well with a clean sponge to remove traces of the water-based cleaning agent.

When spot cleaning with either the water-base or solvent-base type cleaning agents, test a small inconspicuous area before proceeding to spot clean the fabric any further. If an overall soiled condition has been reached, contact a professional furniture cleaning service.

Leather

Clean leather with a damp cloth and mild soap using light, circular motions. Repeat the process with a clean moist cloth and allow the leather to dry. A soft, dry cloth can then be used to polish the leather. Do not clean leather with detergents.

Ultra Durable

Cleaning Ultra Durable vinyl for most stains is achieved by prompt, energetic washing using a sponge and warm, soapy water, clear water rinses or a mild, non-abrasive cleaner. Moderate scrubbing with a medium bristle brush will help to loosen soiling materials from the depressions of embossed surfaces but have not penetrated the vinyl surface.

Advanced Cleaning Methods

Use the following commercially available mild detergents in accordance with the manufacturer's instructions, *Formula 409*®, *Fantastik*®, or *Mr. Clean*®. When opening a new container, please test the cleaner in an inconspicuous area as cleaner manufacturers may change formula without notice.

Full strength rubbing alcohol or mineral spirits may be tried with caution if the commercially available cleaners do not work. Indiscriminate use of strong solvents can severely damage or discolor Ultra Durable vinyl.

Ultra Durable offers enhanced resistance to most of the common chemicals used for sterilization and cleaning in medical environments. Ultra Durable will resist, without serious discoloration, the repeated action of normal dilutions of chlorine bleaches, ammonia based cleaners, excluding Quaternary Ammonium Compounds and Phenolics, as well as many common oxidizing and reducing chemicals.

Bleach can be diluted up to 9:1 ratio (10%). Liberally apply diluted disinfectant using a sponge, rinse with cold water several times, and then wipe dry. Repeat if necessary. Federal regulation requires that guidelines on the bleach label need to be followed for antiseptic or antimicrobial purposes.

teknipaint & teknistain

TekniPaint

A TekniPaint form is required if the customer requires a custom paint color. Custom paint is applicable to metal and seamless product.

The color matching procedures will take a minimum of 10 working days.

Standard lead times apply once customer approved sample is received by Teknion Customer Service Representative.

Using the TekniPaint

Prior to placing the order, Dealer submits the color match sample (minimum size 2" x 2") to Teknion Customer Service Representative in conjunction with a completed TekniPaint form.

After the color match process is completed, two (2) samples are returned to the Paint and Stain Coordinator who forwards them to the Dealer with a sign-off sticker, attached to the back of the sample, for approval by the customer.

Customer formally signs-off on the color samples by signing the attached sticker.

Dealer returns one (1) of the customer approved samples to a Customer Service Representative or a fax of the signed off sample to Teknion.

Dealer submits the order, quoting the paint name and paint number as indicated on the customer sign-off sticker.

TekniPaint forms and information on how to use these forms can be found on My Teknion, Order & Specification, Order Services, PreOrder, Order & Specification Prep, Custom Paint, Stain & Laminate for your printing convenience.

TekniStain

A TekniStain form is required if a wood product is needed in colors outside our standard offering.

Teknion requires dealer or client to supply one (1) TekniStain form for each color being custom matched.

Include three (3) for U.S./two (2) for Canada minimum 3 x 3 color samples for each color being submitted for Custom Wood Stain

Teknion will provide customer with two color samples for each TekniStain submitted. The customer must sign the back of the approved sample. The second sample to be kept for customer reference.

To order a Custom Wood Stain, follow these instructions:

If specifying a custom color for Seating, please use code NOCWS.

If specifying a custom color for District, Interpret, Leverage, Marketplace, TOS, Transit, Expansion Casegoods or Expansion Wood, please use code ZOCWS.

If specifying a custom color for Dossier, Cana, Westcoast, Table&Conferencing and Executive Casegoods, please use code ZCCWS.

Please forward a TekniStain form to your Customer Service Representative along with two color samples. Allow two (2) weeks for the TekniStain approval process. The Custom Wood Stain sample must be signed off prior to placing product order. The total lead time will begin once final approval samples have been received from customer to Teknion.

Using the TekniStain

TekniPaint forms and information on how to use these forms can be found on My Teknion, Order & Specification, Order Services, PreOrder, Order & Specification Prep, Custom Paint, Stain & Laminate for your printing convenience.

fabric pattern directional guidelines

Railroaded and Off-the-Bolt are terms that describe the orientation the fabric is applied to furniture.

Railroaded

- Panel fabrics are typically 66" wide
- Upholstery fabrics are typically 54" wide

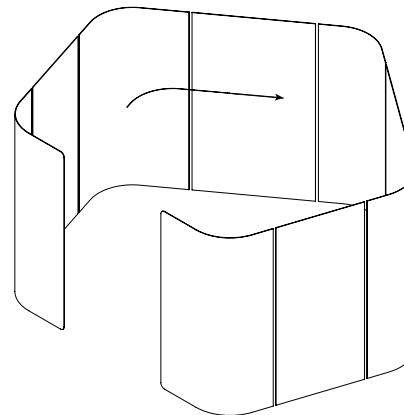
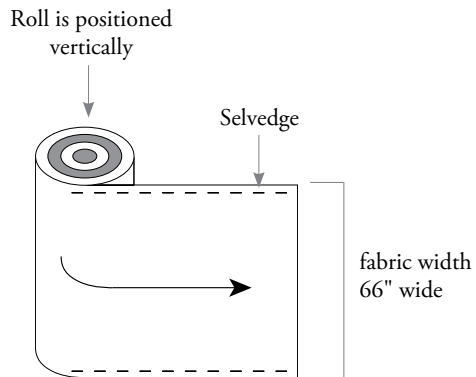

55" high Enclosure (shown)

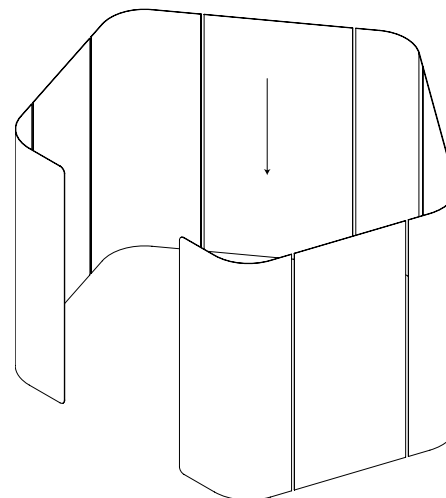
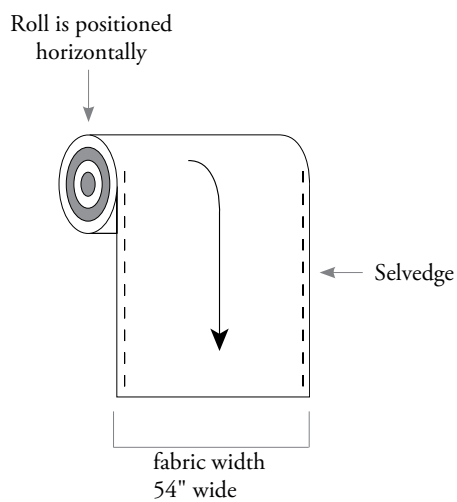

Off-the-Bolt



72" high Enclosure (shown)

fabric pattern directional guidelines (continued)

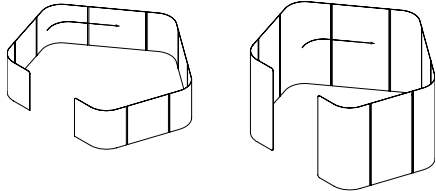
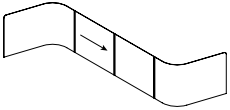
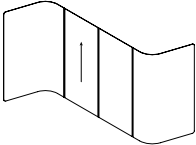
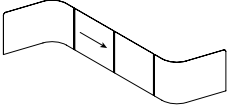
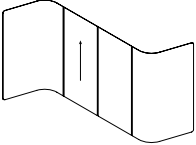
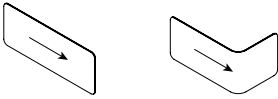
The following should be considered when planning with Enclosures, Screens, Easels and Seating.

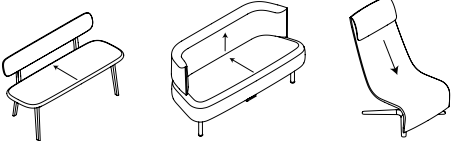
	Railroaded	Off-the-Bolt
Zones Enclosures – 55" high (Panel and Upholstery Fabric)	 <p>with partial buffer with full buffer</p>	
Zones Screens – 55" high (Panel and Upholstery Fabric)	 <p>with partial buffer</p>	 <p>with full buffer</p>
Zones Screens – 72" high (Panel and Upholstery Fabric)	 <p>with partial buffer</p>	 <p>with full buffer</p>
Zones Desk Edge Screens (Panel and Upholstery Fabric)		
Zones Easels (Panel and Upholstery Fabric)		
Zones Seating (Upholstery Fabric) Note: Panel Fabric not available on Seating		 <p>All Zones Seating</p>

fabric pattern directional guidelines (continued)

Fabric Direction

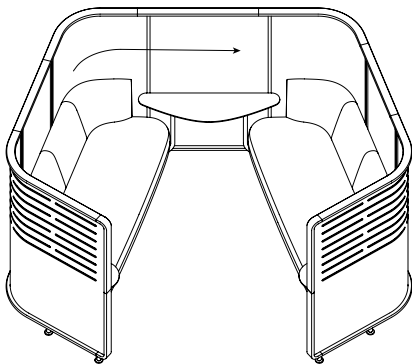

55" High Enclosure

When applying a Panel or Upholstery Fabric to Fabric Buffers, the fabric direction will run Railroaded on the Fabric Buffer.

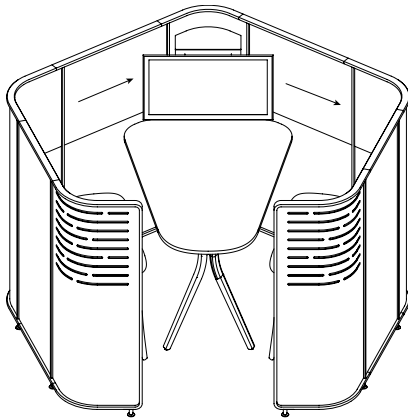

72" High Enclosure, Interior

When applying a Panel or Upholstery Fabric to partial Fabric Buffers, the fabric direction will run Railroaded on the Fabric Buffer.

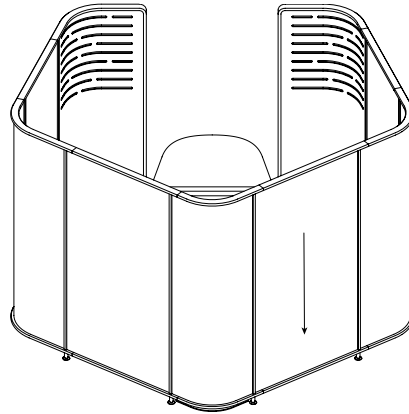

72" High Enclosure, Exterior

When applying a Panel or Upholstery Fabric to full Fabric Buffers, the fabric direction will run Off-the-Bolt on the Fabric Buffer.

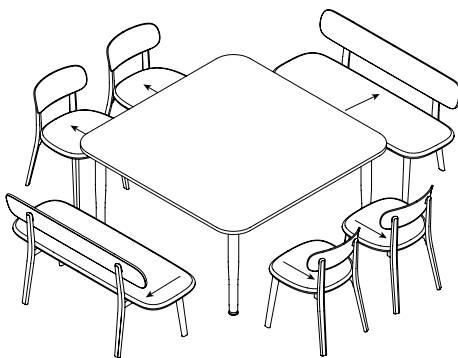

Zones Seating

When applying Upholstery Fabric to all Zones seating, the fabric direction will run Off-the-Bolt.

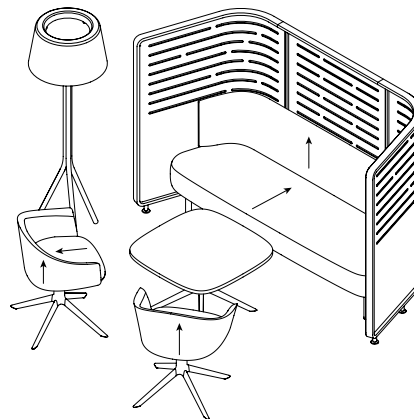

fabric pattern seam guidelines

All fabrics for Zones Modular Seating are applied Off-the-bolt (front to back). Patterned upholstery is not recommended due to the curved form and manner in which the upholstery is applied.

COMs will follow the same fabric orientation and pattern seams.

Seams are required in the center-line of 3-seater straight upholstered benches and curved concave units as indicated below. Seams are applied to the back side and front face of the bench backs.

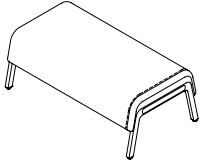
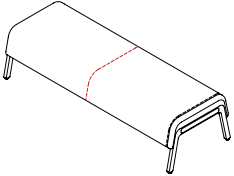
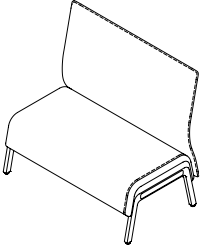
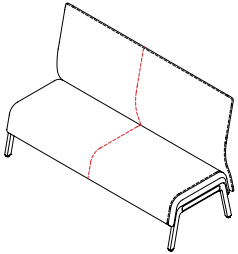
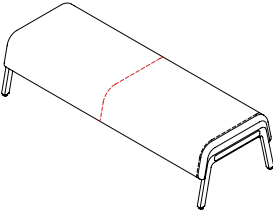
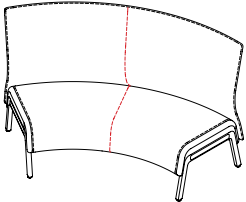
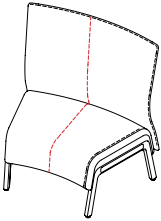
Model	Fabric Pattern Seams	Model	Fabric Pattern Seams
<p>Zones Modular Seating – Straight Upholstered Bench – No Back 2-Seater</p>		<p>Zones Modular Seating – Straight Upholstered Bench – No Back 3-Seater</p>	
<p>Zones Modular Seating Straight Upholstered Bench Low and High Back 2-Seater</p>		<p>Zones Modular Seating Straight Upholstered Bench Low and High Back 3-Seater</p>	
<p>Zones Modular Seating 30° concave Upholstered Bench Low and High Back</p>		<p>Zones Modular Seating 60° concave Upholstered Bench Low and High Back</p>	
<p>Zones Modular Seating 90° concave Upholstered Bench Low and High Back</p>			

customer's own material (COM)

Customers Own Material or Leather (COM / COL)

A COM form is required if a Teknion product is needed in a textile outside our Standard or Graded-In Programs. For any COM/COL requests, please check with Teknion Customer Service for a record of the test results. If the fabric/leather has been approved, a serial number for the fabric and a cutting direction will be supplied by Teknion. This number must be shown on the order. Please note, for various reasons, certain fabrics/leathers may not be approved for use. The required COM/COL yardages given on the price pages are for orders up to 100 chairs. This number is approximate and can vary depending on the pattern repeat.

The COM process will take a minimum of 5 working days once the test yardage has been received by Teknion.

COM forms and information on how to use these forms can be found on My Teknion, Order & Specification, Order Services, PreOrder, Customize, COM, for your printing convenience.

NOTE: Applying the fabric pattern to a rendering may **not** accurately represent the actual product.

COM Pattern Directional Guidelines for Seating

Usually, seating fabrics are patterned to run Off-the-Bolt. At the request of the customer, upholstery can be applied railroaded but yardage requirements may vary.

To avoid unnecessary confusion, you must always specify Off-the-Bolt or railroaded when using a COM fabric.

Due to Zones Modular Seating part geometry and compound surfaces of curved units, fabric patterns with vertical lines will **not** always appear truly vertical and may also show lines converging/diverging on seams at certain points.

It must be noted that the vertical pattern repeat on the fabric may not match exactly from unit to unit, due to the fabric pattern repeat size and also the need for seams on the adjacent units.

See Fabric Pattern Seam Guidelines earlier in this section for more information.

Estimated Material Requirement

COM yardage shown on each products COM/COL Material Requirement Chart is based on unpatterned (plain) fabrics only.

More yardage may be required depending upon the upholstery pattern, repeat, directionality and pattern matching. Leather yield varies from 60-80% and may be affected by the quality of the COL including location and quantity of blemishes, size and shape of hide. The size of the sewing pattern and the number of units ordered may also impact yield. Always round-up to the next yard or hide for each unit that is specified prior to calculating. For larger unit quantities, additional hides may be required.

COL Hide Calculation

When calculating the number of hides required, one must first understand the hide square footage from the chosen COL supplier as the size of leather hides vary by region and by line.

It is not possible to achieve 100% yield optimum due to the nature of hides having various configurations, blemishes and scars, as well as the individual chairs part sizes and part dimensions. Customer order size may also impact yield. Hide calculation requires use of the smallest hide size and applying a yield factor of 70% utilization in order to estimate the usable square footage.

As an example, a supplier of hides from a particular region may advise that their hides vary in size from 55-60 square feet. Hide calculation is required to use the smallest hide size (55 square feet in this case) and apply a yield factor of 70% utilization.

When the square footage required for each chair is **less than the usable square footage of (1X) hide:**

SAMPLE CASE A:

26 chairs are to be ordered and the COL Material Requirement Chart indicates 16.5 square feet COL is required per chair. The smallest hide size identified by the supplier is 55 square feet.

$55 \text{ square feet} \times 70\% \text{ yield} = 38.5 \text{ square feet usable hide size}$

$38.5 \text{ square feet usable hide size} \div 16.5 \text{ square feet required per chair} = 2.33 \text{ chairs per hide}$

Round down the number of chairs produced from a hide = 2 chairs per hide

For 26 units, divide by 2 chairs per hide = 13 hides

A total of 13 hides are estimated to complete the order.

When the square footage required for each chair is **greater than the usable square footage of (1X) hide:**

SAMPLE CASE B:

2 sofas are to be ordered and the COL Material Requirement Chart indicates 88 square feet COL is required per sofa. The smallest hide size identified by the supplier is 55 square feet.

$55 \text{ square feet} \times 70\% = 38.5 \text{ square feet usable hide size}$

$38.5 \text{ square feet usable hide size} \div 88 \text{ square feet required per sofa} = 0.44 \text{ sofas per hide}$

For 1 unit $\div 0.44 \text{ chairs per hide} = 2.27 \text{ hides to create (1x) sofa}$

Round up to 3 hides per sofa

To calculate for (2x) units, multiply by 2

A total of 6 hides are estimated to complete the order.

customer's own material (COM) (continued)

Fabric Direction

All Standard Panel Fabrics are applied railroaded.

Railroaded application (RR)

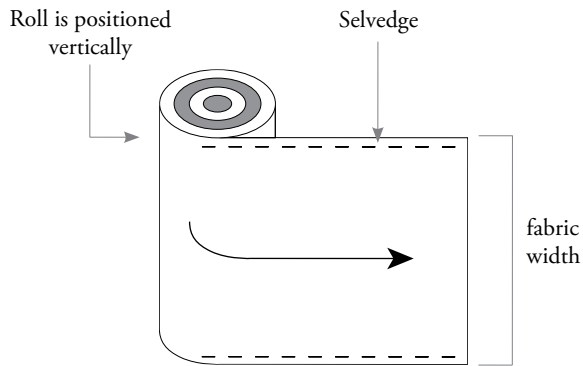

Regular cleaning of your furniture system will maintain the appearance and optimize the long term return on investment.

Zones Seating

Due to the unique shape and size of Zones Seating and the inherent properties of some fabrics, mild creasing or puckering may result and is not considered a quality issue by Teknion. In most cases, the fabric can be smoothed-over by hand to improve the appearance.

All Standard Seating and Architectural Fabrics are applied Off-the-Bolt.

Off-the-Bolt application (OB)

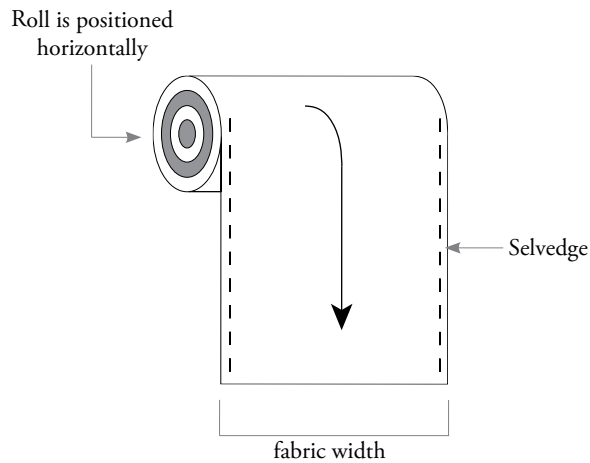

teknion

www.teknion.com

teknion asia hq:
Lot 761 Jalan Haji Sirat
Off Jalan Meru,
42100 Klang, Selangor
Malaysia
Tel 603-3342-4345

in canada:
1150 Flint Road
Toronto, Ontario
M3J 2J5 Canada
Tel 866.teknion
866.835.6466

in the usa:
350 Fellowship Road
Mt Laurel, New Jersey
08054 usa
Tel 877.teknion
877.835.6466

other offices located in:
Europe, South and Central America
Middle East and Russia
For regional contact information
go to www.teknion.com

my 12
©Teknion 2023

®, ™ trade marks of Teknion
Corporation and/or its subsidiaries or
licensed to it. Patents may be pending.

Some products may not be available
in all markets. Contact your
local Teknion Representative for
availability.