

Bulletin 700-HA

- 10 A Contact Rating
- DPDT, 3PDT
- Pin Style Terminals
- Standard ON/OFF Flag Indicator
- Clear Cover for Easy Visual Inspection
- Optional Push-to-test and Manual Override
- Optional LED
- Optional Socket Mounted Surge Suppressor Module
- Optional Multi-Function Timing Module
- Type HAB—Bifurcated Contacts
- Type HAX—Gold Bifurcated Contacts

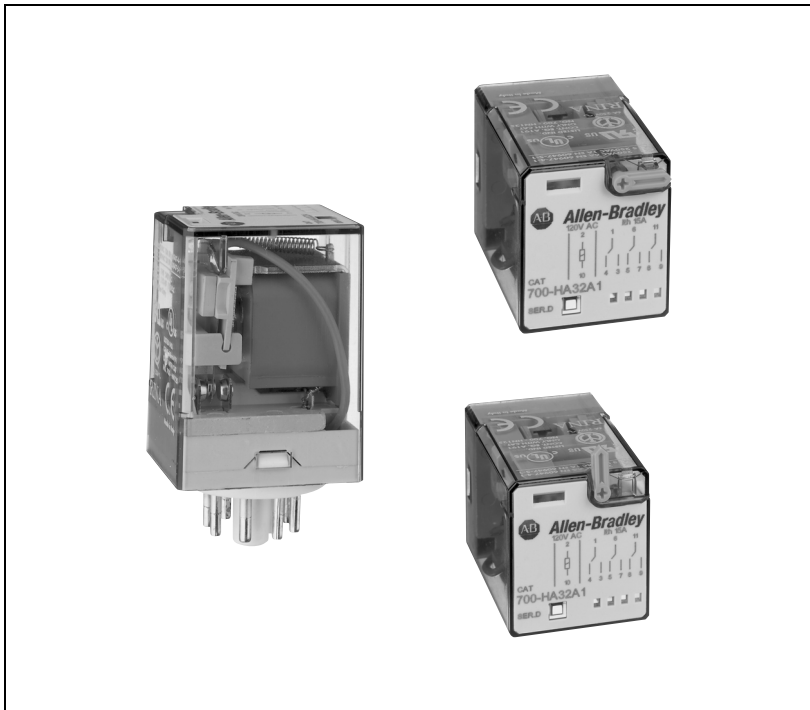

TABLE OF CONTENTS

Description	Page	Description	Page
Product Selection	43	Timing Charts.....	51
Accessories	46	Approximate Dimensions	52
Specifications	49		

Description

The Bulletin 700-HA General Purpose Relays have pin-style terminals and are available in 2-pole (DPDT) or 3-pole (3PDT). They feature a standard ON/OFF flag indicator, and can be ordered with an optional push-to-test operator, a LED, and bifurcated or gold bifurcated contacts. Coils are available in a wide range of AC and DC voltages. Contacts are rated up to 10 A.

Conformity to Standards:

EN 60947-4-1
 EN 60947-5-1
 IEC 947
 CSA 22.2
 UL 508
 NEMA/EE MAC compliant
 ICS-2 compliant

Approvals:

cURus Recognized, File E3125
 Guide NLDX 2
 cULus Listed, with Allen-Bradley socket
 CE Marked (per EU Low Voltage
 Directive 73/23 EEC 93/68 EEC)
 ABS (American Bureau of Shipping),
 File 00-GE195140-PDA
 RINA listed

Your order must include:

- Cat. No. of the plug-in relay plus suffixes of selection options.
- Cat. No. of socket required.
- If required, Cat. No. of any accessories.

Third Party Approval:

IMQ listed

Bulletin 700-HA Tube Base Relay with PIN Terminals (Single Contact) —
Mechanical ON/OFF Indicator included ❶

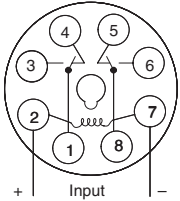
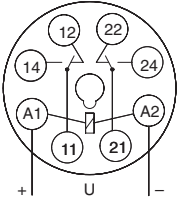
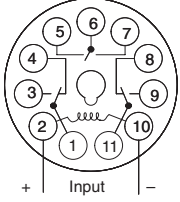
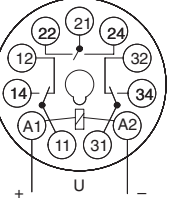
	Description	Contact Rating	Wiring Diagrams		Coil Voltage	Cat. No. ❷❸❹	Factory-Stocked Item					
			U.S./Canada	International			❺	❻				
	DPDT 2-Pole 2 Form C Single AgNi Contact	10 A B300			6V AC	700-HA32A06						
					12V AC	700-HA32A12	✓					
					24V AC	700-HA32A24 ❺	✓					
					120V AC	700-HA32A1 ❺	✓	✓				
					240V AC	700-HA32A2 ❺	✓					
					277V AC	700-HA32A27❻	✓					
					6V DC	700-HA32Z06						
					12V DC	700-HA32Z12 ❺	✓					
					24V DC	700-HA32Z24 ❺	✓					
					36V DC	700-HA32Z36						
					48V DC	700-HA32Z48	✓					
					110V DC	700-HA32Z1	✓					
					125V DC	700-HA32Z01	✓					
					140V DC	700-HA32Z3						
Sockets		700-HN125	700-HN100 700-HN202									
	3PDT 3-Pole 3 Form C Single AgNi Contact	10 A B300			6V AC	700-HA33A06						
					12V AC	700-HA33A12						
					24V AC	700-HA33A24 ❺	✓					
					120V AC	700-HA33A1 ❺	✓	✓				
					240V AC	700-HA33A2	✓					
					6V DC	700-HA33Z06						
					12V DC	700-HA33Z12	✓					
					24V DC	700-HA33Z24 ❺	✓					
					48V DC	700-HA33Z48						
					110V DC	700-HA33Z1						
					125V DC	700-HA33Z01	✓					
					140V DC	700-HA33Z3						
					Sockets		700-HN126	700-HN101 700-HN203				

- ❶ For Time Module and Surge Suppressor Module, see page 47.
- ❷ LED Option: Add suffix (-4) to the selected Bulletin 700-HA Relay Cat. No., except for the 240V AC Units, add (-4L).
- ❸ Push-to-test, Manual Override, and LED Option: Add suffix (-3-4) to the selected Bulletin 700-HA Relay Cat. No., except for the 240V AC units, add (-3-4L).
- ❹ Push-to-test and Manual Override option: Add suffix (-3) to the selected Bulletin 700-HA relay.
- ❺ Bulk Package Option: Relay can be purchased at discounted prices in bulk quantities of 10. Add suffix (-99) to the selected relay catalog number.
- ❻ LED not available.
- ❼ Single pack
- ❽ Bulk pack

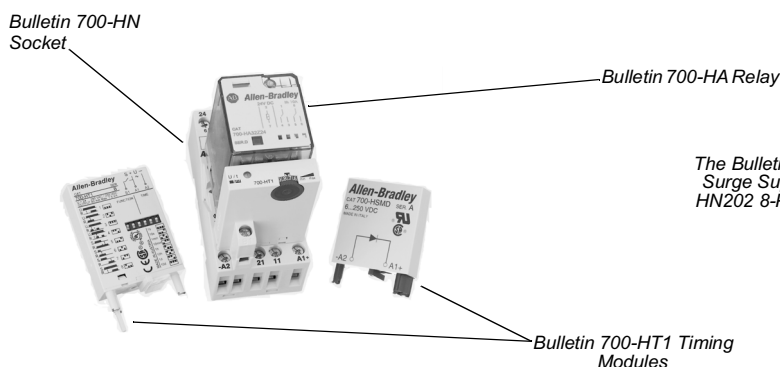

General Purpose Relays

Product Selection, Continued

Bulletin 700-HAB Tube Base Relay with PIN Terminals (Bifurcated Contacts) —

Mechanical ON/OFF Indicator included ❶

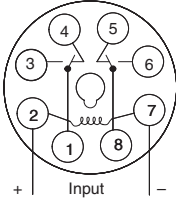
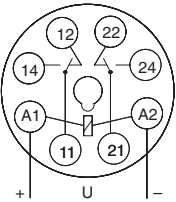
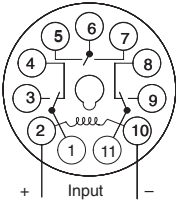
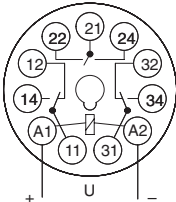
	Description	Contact Rating	Wiring Diagrams		Coil Voltage	Cat. No. ❷❸❹	Factory-stocked Item ❺				
			U.S./Canada	International							
	DPDT 2-Pole 2 Form C Bifurcated AgNi Contacts	4 A			6V AC	700-HAB2A06					
					12V AC	700-HAB2A12					
					24V AC	700-HAB2A24					
					120V AC	700-HAB2A1	✓				
					240V AC	700-HAB2A2					
					277V AC	700-HAB2A27 ❻					
					6V DC	700-HAB2Z06					
					12V DC	700-HAB2Z12					
					24V DC	700-HAB2Z24	✓				
					36V DC	700-HAB2Z36					
					48V DC	700-HAB2Z48					
					110V DC	700-HAB2Z1					
					125V DC	700-HAB2Z01					
					140V DC	700-HAB2Z3					
Sockets		700-HN125	700-HN100 700-HN202								
	3PDT 3-Pole 3 Form C Bifurcated AgNi Contacts	4 A			6V AC	700-HAB3A06					
					12V AC	700-HAB3A12					
					24V AC	700-HAB3A24					
					120V AC	700-HAB3A1	✓				
					240V AC	700-HAB3A2					
					6V DC	700-HAB3Z06					
					12V DC	700-HAB3Z12					
					24V DC	700-HAB3Z24	✓				
					48V DC	700-HAB3Z48					
					110V DC	700-HAB3Z1					
					125V DC	700-HAB3Z01					
					140V DC	700-HAB3Z3					
					Sockets		700-HN126	700-HN101 700-HN203			

❶ For Time Module and Surge Suppressor Module, see page 47.

❷ LED Option: Add suffix (-4) to the selected Bulletin 700-HAB Relay Cat. No., except for the 240V AC Units, add (-4L).

❸ Push-to-test, Manual Override & Pilot Light Option: Add suffix (-3 -4) to the selected Bulletin 700-HAB Relay Cat. No., except for the 240V AC units, add (-3 -4L).

❹ Push-to-test and Manual Override option: Add suffix (-3) to the selected Bulletin 700-HA relay.





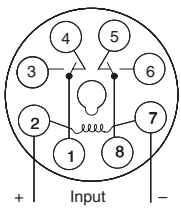
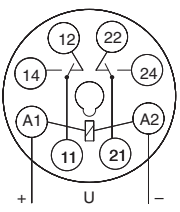
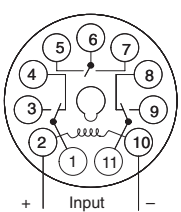
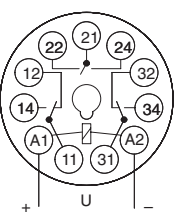

❺ Single Pack



❻ LED not available.

**Bulletin 700-HAX Tube Base Relay with PIN Terminals (Bifurcated Contacts with Gold Overlay) —
 Mechanical ON/OFF Indicator Included ❶**

	Description	Contact Rating	Wiring Diagrams		Coil Voltage	Cat. No. ❷❸❹	Factory-stocked Item ❺				
			U.S./Canada	International							
	DPDT 2-Pole 2 Form C Bifurcated AgNi Contacts with Gold Overlay Sockets	4 A			6V AC	700-HAX2A06					
					12V AC	700-HAX2A12					
					24V AC	700-HAX2A24					
					120V AC	700-HAX2A1	✓				
					240V AC	700-HAX2A2					
					277V AC	700-HAX2A27❻					
					6V DC	700-HAX2Z06					
					12V DC	700-HAX2Z12					
					24V DC	700-HAX2Z24	✓				
					36V DC	700-HAX2Z36					
					48V DC	700-HAX2Z48					
					110V DC	700-HAX2Z1					
					125V DC	700-HAX2Z01					
					140V DC	700-HAX2Z3					
Sockets		700-HN125	700-HN100 700-HN202								
	3PDT 3-Pole 3 Form C Bifurcated AgNi Contacts with Gold Overlay	4 A			6V AC	700-HAX3A06					
					12V AC	700-HAX3A12					
					24V AC	700-HAX3A24					
					120V AC	700-HAX3A1	✓				
					240V AC	700-HAX3A2					
					6V DC	700-HAX3Z06					
					12V DC	700-HAX3Z12					
					24V DC	700-HAX3Z24	✓				
					48V DC	700-HAX3Z48					
					110V DC	700-HAX3Z1					
					125V DC	700-HAX3Z01					
					140V DC	700-HAX3Z3					
					Sockets		700-HN126	700-HN101 700-HN203			

- ❶ For Time Module and Surge Suppressor Module, see page 47.
- ❷ LED Option: Add suffix (-4) to the selected Bulletin 700-HAX Relay Cat. No., except for the 240V AC Units, add (-4L).
- ❸ Push-to-test and LED Option: Add suffix (-3-4) to the selected Bulletin 700-HAX Relay Cat. No., except for the 240V AC units, add (-3-4L).
- ❹ Push-to-test and Manual Override option: Add suffix (-3) to the selected Bulletin 700-HA relay.
- ❺ LED not available.
- ❻ Single pack

	Description	Pkg. Qty.	Cat. No.	Factory-stocked Item
 <p>Cat. No. 700-HN100</p>	<p>Screw Terminal Tube Base Sockets – Panel or DIN Rail Mounting. Guarded Terminal Construction 8-pin for use with DPDT Bulletin 700-HA relays, -HX digital timing relays, -HT (ON-Delay) and -HRM, -HRC and -HV (Repeat Cycle) timing relays. Order must be for 10 sockets or multiples of 10.</p>	10	700-HN100	✓
 <p>Cat. No. 700-HN125</p>	<p>Screw Terminal Tube Base Sockets – Panel or DIN Rail Mounting Open Style Construction 8-pin for use with DPDT Bulletin 700-HA relays, -HT (ON-Delay) and -HRM, -HRC and -HV (Repeat Cycle) timing relays. Order must be for 10 sockets or multiples of 10. No retainer clip required.</p>	10	700-HN125	✓
 <p>Cat. No. 700-HN101</p>	<p>Screw Terminal Tube Base Sockets – Panel or DIN Rail Mounting. Guarded Terminal Construction 11-pin for use with 3PDT Bulletin 700-HA relays, -HR and -HT (OFF-Delay) timing relays. Order must be for 10 sockets or multiples of 10.</p>	10	700-HN101	✓
 <p>Cat. No. 700-HN126</p>	<p>Screw Terminal Tube Base Sockets – Panel or DIN Rail Mounting. Guarded Terminal Construction 11-pin for use with 3PDT Bulletin 700-HA relays, -HR and -HT (OFF-Delay) timing relays. Order must be for 10 sockets or multiples of 10.</p>	10	700-HN126	✓
 <p>Cat. No. 700-HN203</p>	<p>8-Pin Socket – Can Be Used With or Without Timing Attachment or Surge Suppressor Screw Terminal Tube Base Sockets – panel or DIN Rail mounting. Guarded terminal construction. Used with DPDT Bulletin 700-HA relays. Order must be for 10 sockets or multiples of 10.</p>	10	700-HN202	✓
	<p>11-Pin Socket – Can Be Used With or Without Timing Attachment or Surge Suppressor Screw Terminal Tube Base Sockets – panel or DIN Rail mounting. Guarded terminal construction. Used with 3PDT Bulletin 700-HA relays. Order must be for 10 sockets or multiples of 10.</p>	10	700-HN203	✓
 <p>Cat. No. 199-DR1</p>	<p>DIN Rail Mounting Pack Standard 35 x 7.5 mm DIN Rail, 1 meter long, 10 rails per package. Order must be for 10 rails or multiples of 10.</p>	10	199-DR1	✓

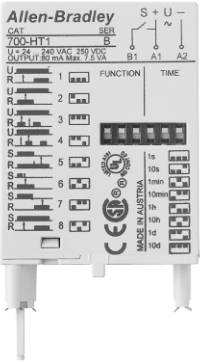
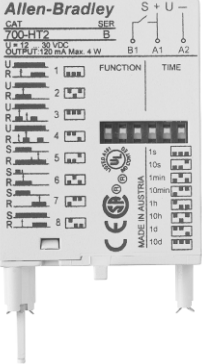
	Description	Pkg. Qty.	Cat. No.	Factory-stocked Item
 <p>Cat. No. 700-HSV1</p>	<p>MOV Suppressor Module ① Voltage Range: 24V AC 24...30V DC Order must be for 20 modules or multiples of 20.</p> <p>MOV Suppressor Module ① Voltage Range: 220...240V AC 220...300V DC Order must be for 20 modules or multiples of 20.</p> <p>MOV Suppressor Module ① Voltage Range: 110...120V AC 110...150V DC Order must be for 20 modules or multiples of 20.</p>	20	700-HSV1	✓
 <p>Cat. No. 700-HSMD</p>	<p>Diode Surge Suppressor ① Voltage Range: 6...250V DC Order must be for 20 modules or multiples of 20.</p>	20	700-HSMD	✓
 <p>Cat. No. 700-HT1</p>	<p>Multi-Function Multi-Range Time Module ① Voltage range 24...240V AC 50/60 Hz and 24...250V DC, with a voltage variation of 85...110%. Repeat accuracy of <0.5%. Reset time 150 ms. Refer to page 50 for Specifications.</p> <p>Eight (8) Timing Modes</p> <p>Eight (8) Timing Ranges:</p> <ol style="list-style-type: none"> 1. 1 s 2. 10 s 3. 1 min. 4. 10 min. 5. 1 hour 6. 10 hours 7. 1 day (24 hours) 8. 10 days (240 hours) <p>LED Indicator:</p> <ol style="list-style-type: none"> 1. Steady Green (G) for power on, flashing during timing. 	1	700-HT1	✓
 <p>Cat. No. 700-HT2</p>	<p>Multi-Function Multi-Range Time Module ① Voltage range 12...30V DC, with a voltage variation of 90...110%. Repeat accuracy of <0.5%. Reset time 150 ms. Refer to page 50 for Specifications.</p> <p>Eight (8) Timing Modes (See page 51 for further details.)</p> <p>Eight (8) Timing Ranges:</p> <ol style="list-style-type: none"> 1. 1 s 2. 10 s 3. 1 min. 4. 10 min. 5. 1 hour 6. 10 hours 7. 1 day (24 hours) 8. 10 days (240 hours) <p>LED Indicator:</p> <ol style="list-style-type: none"> 1. Steady Green (G) for power on, flashing during timing 	1	700-HT2	

① Suppressors and Time Modules easily plug into sockets (Cat. Nos. 700-HN202 and 700-HN203). For use with Bulletin 700-HA relays.

ATTENTION: Cat. No. 700-HT1 Series A is wired with switch "S" connected to "A2", but 700-HT1 Series B is wired with switch "S" connected to "A1". The Time Modules must be wired correctly. Check the front of the Time Modules for the correct wiring diagrams.

Bulletin 700-HA
General Purpose Relays
Accessories, Continued

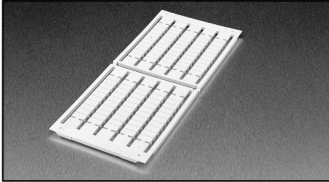
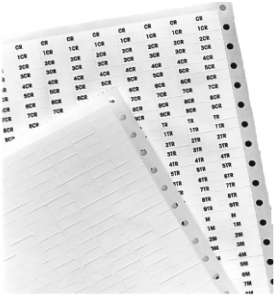
	Description	Pkg. Qty.	Cat. No.	Factory-stocked Item
 Sample Retainer Clips	Retainer Clip for Cat. Nos. 700-HN100, -HN101, -HN200, -HN201, -HN202, and -HN203 Sockets with Bulletin 700-HA Relays ❶ Secures relay in socket. Order must be for 10 clips or multiples of 10.	10	700-HN157	✓
 Snap-in markers	Relay Identification Snap-in Markers ❷ Snap-in markers fit on top of Bulletin 700-HA relay covers. The following are blank cards. Squares slip into molded slot on top of Bulletin 700-HA or 700-HB relay cover.	100	1492-SM5X12 1492-SM6X9 1492-SM6X12 1492-SM8X9 1492-SM8X12 1492-MP-Blank	●
	Pre-printed identification tags – contains 10 sheets of pre-printed and blank tags. Each sheet contains 13 sets of the markings CR...9CR, TR...9TR, M...9M, F, R, 1S, and 117 blank tags. Tags are peel-off with sticky backing for easy placement on relays.	10	700-N40	
	Blank identification tags – contains 10 sheets of blank identification tags for customer specialized printing. Each sheet contains 546 blank tags. Tags are peel-off with sticky backing for easy placement on relays.	10	700-N41	

❶ See Bulletin 700-HA Relay, Socket, and Retainer Clip Reference Chart

❷ Refer to terminal block marking systems within the Industrial Control Catalog, publication A114

❸ For pre-printed marker cards, turn to the following 1492 sections: 1492-SM5X12_, 1492-SM6X9_, 1492-SM8X9_, 1492-SM8X12_, 1492-MP_

Relay Type	Socket	Retainer Clip
700-HA32	700-HN100	700-HN157
700-HAB2	700-HN125	Not Required ❹
700-HAX2	700-HN202	700-HN157
	700-HN200	700-HN157
700-HA33	700-HN201	700-HN157
700-HAB3	700-HN101	700-HN157
700-HAX3	700-HN126	Not Required ❹
	700-HN203	700-HN157

❹ Design of these sockets holds the relays securely and does not require retainer clips.

		Cat. No. 700-HA...		
Electrical Ratings				
Pilot Duty Rating ②		NEMA B300		
Rated Thermal Current (I_{th})		HA = 10 A – 120V, 240V HAB/HAX = 6 A – 120V, 240V		
Rated Insulation Voltage (U_i)		250V IEC – 300V UL/CSA		
Contacts	Inductive	Make	Break	Hp
	120V AC	▶ ◀	◀ ▶	0.33
	240V AC	30 A	3 A	1
	DC	15 A	1.5 A	
		30V DC, 10 A		
Min. Low Energy Permissible Load		HA = 10V, 50 mA HAB= 6V, 30 mA HAX = 6V, 1 mA		
Permissible Coil Voltage Variation		85...110% of Nominal Voltage at 50 Hz 85...110% of Nominal Voltage at 60 Hz 80...110% of Nominal Voltage at DC		
Coil Consumption ±10%	AC Coils	50 Hz	60 Hz	
	Inrush	3.3 VA	2.85 VA	
	Sealed	2.2 VA	1.9 VA	
	DC Coils	1.3 W		
Max. Allowable Leakage		25% of VA		
		10% of W		
Design Specification/Test Requirements				
Electrical				
Dielectric Withstand Voltage				
Pole-to-Pole		2000V		
Contact to Coil		2000V		
Contact to Frame		2000V		
Electrical Life (Operating)		100,000 min.		
Mechanical				
Degree of Protection (Open Type) IEC 529		IP 40		
Mechanical Life Operations (AC/DC)		> 20 x 10 ⁶ / 50 x 10 ⁶		
Switching Frequency Operations		3600/HR		
Coil Voltages		See Product Selection		
Operating Time	Max. Pickup	10 ms		
	Max. Dropout	10 ms		
Maximum Operating Rate		4 Ops/s		
Vibration	Endurance	5 G		
	Operational	2.5 G		
Shock	Endurance	50 G		
	Operational	9 G		
Environmental				
Temperature	Operating	AC/DC	-40...+70°C	
	Storage	AC/DC	-40...+100°C	
Altitude		2000 m (6560 ft)		
Construction				
Insulating Material		Molded High Dielectric Material		
Enclosure		Transparent Dust Cover		
Contact Material		700-HA: 10 A– AgNi		
		700-HAB: 4 A–Bifurcated AgNi		
		700-HAX: 4 A–Bifurcated/Gold Plating AgNi		
Terminal Markings on Socket		In accordance with EN50 0005		
Sockets		8-Pin Socket — 700-HN100, -HN125, -HN202 11-Pin Socket — 700-HN101, -HN126, -HN203		
Certifications		CE, cULus listed, IMQ, RINA, ABS		

① Performance Data – See page Important-2, Industrial Controls Catalog.

② NEMA Rating Chart is on page 29.

Bulletin 700-HA
General Purpose Relays
Specifications, Continued ❶

700-HA Relay Performance Graphs

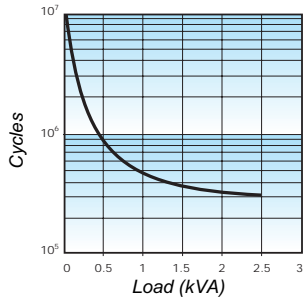

Contact life vs. AC1 load at 1,800 cycles/h

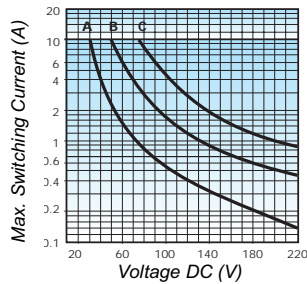

Breaking capacity for DC1 load at 1800 cycles/h
A= load applied to 1 contact
B= load applied to 2 contacts in series
C= load applied to three contacts in series

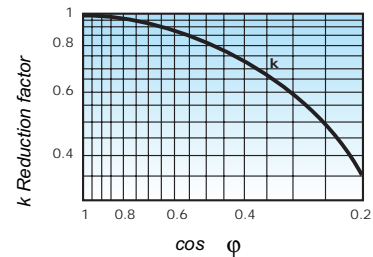

Load reduction factor vs. $\cos \phi$

		Time Module Cat. No. 700-HT1	Time Module Cat. No. 700-HT2
Electrical Ratings			
Operating Voltage Range		24...240V AC at 50/60 Hz 24...250V DC	12...30V DC
Power Consumption		24V AC/DC 70 mW 240V AC/DC 700 mW	12V DC 40 mW 30V DC 100 mW
Maximum Output Current		80 mA (2 W at 24V DC)	120 mA (2 W at 24V DC)
Maximum Output Voltage		265V AC, 275V DC	33V DC
Maximum Output Power		7.5 VA (30 mA at 240V AC)	4 W
Mechanical			
Degree of Protection of Input (B1) Terminal		IP 20 (Guarded Terminal)	
Input Terminal Wire Range		2 x 1.5 mm ² (2 # 16 AWG...1 # 20 AWG)	
Input Terminal Torque Range		0.45...0.8 Nm (4...7 lb-in.)	
LED Indicator		Steady when Power On and Flashing during Timing Period	
Repeat Accuracy ❷		<0.5% or 5 ms	
Timing Change	Voltage Effect Temp. Effect	≤0.001%/V ≤0.01%/°C	≤0.001%/V ≤0.01%/°C
Reset Time		Power Reset: 150 ms Signal Reset: 50 ms AC, 30 ms DC	Power Reset: 150 ms Signal Reset: 10 ms DC
Selectable Timing Ranges		3 DIP Switches, 8 Ranges (set from 10...100% of range): 1 s, 10 s, 1 min., 10 min., 1 hr., 10 hr., 24 hr., 240 hr.	
Selectable Timing Modes		3 DIP Switches, 8 Modes: Power ON–Delay Single Shot – Power On Repeat Cycle – Starting with OFF–Delay Repeat Cycle – Starting with ON–Delay Signal OFF–Delay Single Shot – Signal is a Pulse Single Shot – Signal Off Signal ON–Delay	
Thumbwheel Scale Accuracy		≤5% of Time Range	
Environmental			
Temperature	Operating Storage	–25...+55°C (–13...+131°F) –55...+85°C (–67...+185°F)	
Altitude		2000 m (6560 ft)	
Construction			
Enclosure		Gray Plastic Housing	
Mounting with Socket Only		8- or 11-Pin Socket with Module Plug	
Sockets		700-HN202 (8-Pin with Plug) 700-HN203 (11-Pin with Plug)	
Certifications		CE, UL listed, CSA	

❶ Performance Data - See page Important-2, publication A113.

❷ At constant voltage and temperature.

Timing Charts, Cat. Nos. 700-HT1 and 700-HT2 Multi-Function Time Module (t = Time Range 0.10 s...240 h)
Cat. Nos. 700-HT1 and -HT2 Timing Modes, Time Description, Timing Charts, and DIP Switch Selections

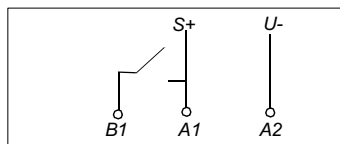

Terms:
U is Power Input (Steady Green LED)
R is Relay Output
S Control, **+A1** Socket, **B1** Timer
t is the resulting Time Delay (Flashing Green LED)

1. Power On-Delay

When the input voltage U is applied, the timing delay t begins. The relay contacts R change state after the time delay is complete. The contacts will return to their shelf state when the power U is removed. The terminal B1 is not used in this mode.

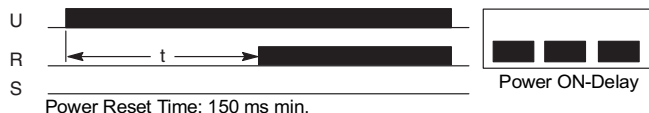

2. Single Shot — Power On

When the input voltage U is applied, the relay contacts R change state immediately and the timing cycle begins. When the time delay t is complete, the contacts return to shelf state. When the input voltage U is removed, the contacts return to their shelf state. The terminal B1 is not used in this mode.

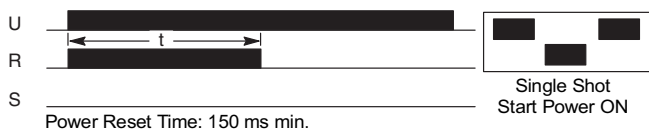

3. Repeat Cycle — Starting with Relay Energized

When the input voltage U is applied, the relay contacts R change state immediately and time delay t begins. When the time delay t is complete, the contacts return to their shelf state for time delay t. This cycle will repeat until the input voltage U is removed. The terminal B1 is not used in this mode.

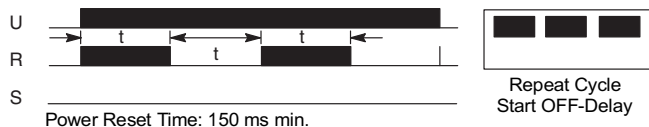

4. Repeat Cycle — Starting with On-Delay

When the input voltage U is applied, the time delay t begins. When the time delay t is complete, the relay contacts R change state for the time delay t. This cycle will repeat until the input voltage U is removed. The terminal B1 is not used in this mode.

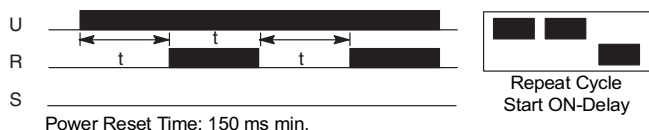

5. Signal Off-Delay

The input voltage U must be applied continuously. When the control S (wired at B1) is energized, the relay contacts R change state. When the control S is de-energized, the delay t begins. When delay t is complete, the contacts R return to their shelf state. If signal S is energized before the time delay t is complete, then the Time Module is reset, the delay begins again, and the relay contacts remain in their energized state. If the input voltage U is removed, the relay contacts R return to their shelf state.

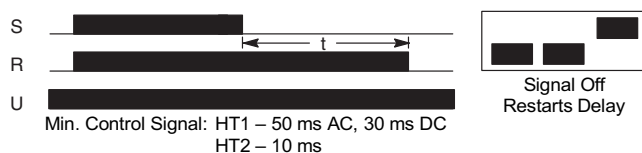

6. Single Shot — Signal Is a Pulse

The input U must be applied continuously. When the Control S (wired to B1 terminal) is energized, the relay contacts R change state and the time delay t begins. When the time delay t is completed, the contacts return to their shelf state. If signal S is de-energized before time t is completed, contacts R still stay in their changed state. The input signal S has control again when delay is completed or power reset. If the input voltage U is removed, the relay contacts R return to their shelf state.

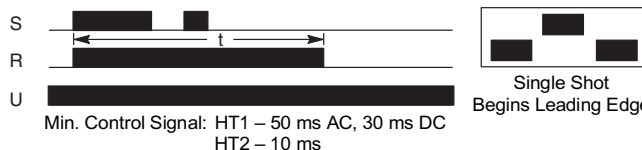

7. Single Shot — Signal Off

The input voltage U must be applied continuously. When the control S (wired at B1) is energized and then de-energized, the relay contacts R change state for the time delay t. If the control S is pulsed during the time period t, the relay contacts R will not be affected. If the input power is removed, the relay contacts R return to their shelf state.

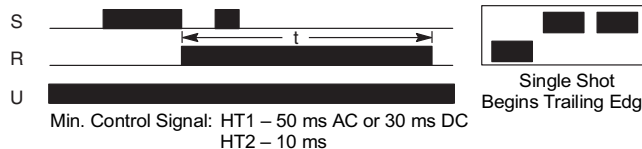

8. On Delay — Pulse Controlled

The input voltage U must be applied continuously. When the control S (wired at B1) is energized, the time delay t begins. When the time delay t is complete, the relay contacts R change state and remain energized until the control S is de-energized. If the input power U is removed the relay contacts R return to their shelf state.

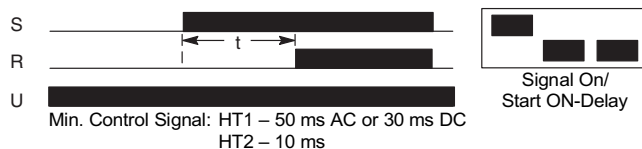

General Purpose Relays

Approximate Dimensions

Dimensions are shown in millimeters (inches). Dimensions are not intended to be used for manufacturing purposes.

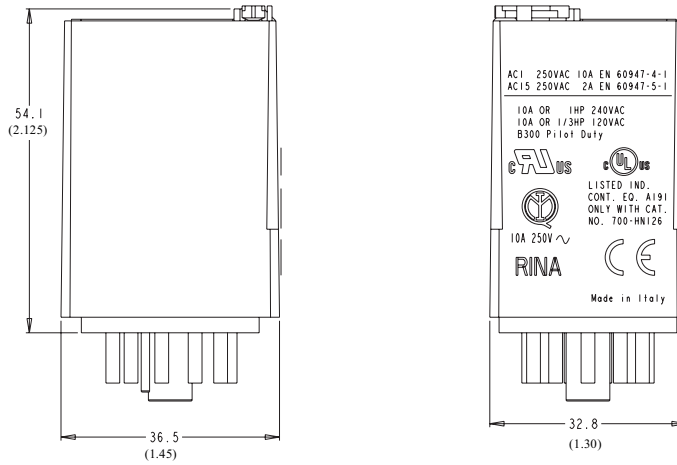

Bulletin 700-HA Relay

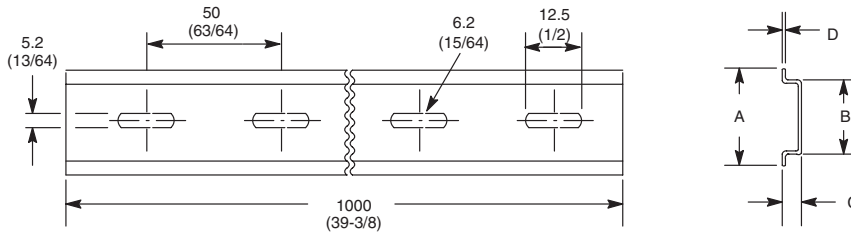

Cat. No. 199-DR1 DIN Mounting Rail Series B
 Cat. No. 199-DR4 DIN Mounting Rail Series B Has No Mounting Holes

Cat. No.	A	B	C	D	Approx. Shipping Wt.
199-DR1	35 (1-3/8)	27 (1-1/16)	7.5 (19/64)	1.02 (1/64)	1.85 kg (4.07 lbs.) (10/pkg)
199-DR4	35 (1-3/8)	27 (1-1/16)	15 (19/32)	2.3 (3/32)	3.68 kg (8 lbs.) (5/pkg)

Dimensions are shown in millimeters (inches). Dimensions are not intended to be used for manufacturing purposes.

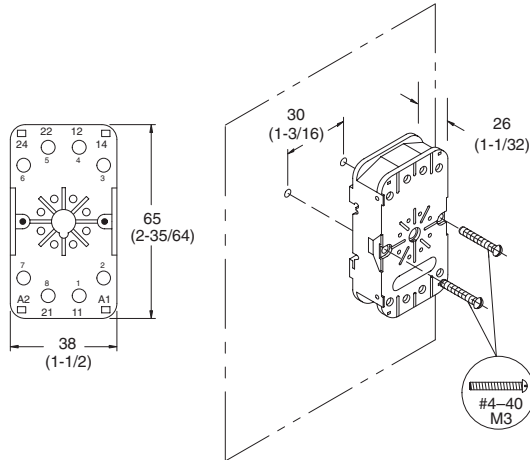

Cat. No. 700-HN100

Panel Mounting

Wire Size: $2 \times 2.5 \text{ mm}^2$
 Single Wire – Up to #12 AWG
 Double Wire – $2 \times 2.5 \text{ mm}^2$ (#2–14 AWG... #2–20 AWG)
 (Either Solid or Stranded)
 Strip Length: 9 mm (3/8") – Torque: 0.8 Nm (7 lb.-in.)

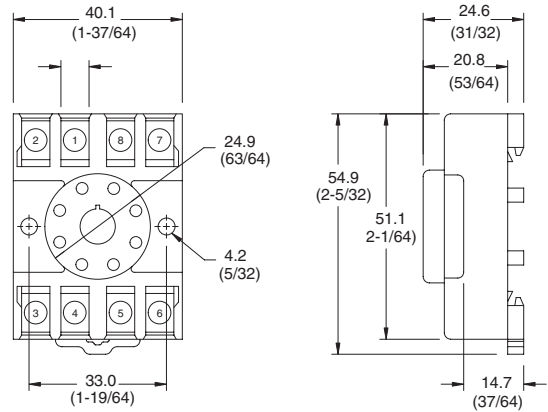

Cat. No. 700-HN125

Wire Size: $2 \times 2.5 \text{ mm}^2$
 Single Wire – Up to 12 AWG
 Double Wire – $2 \times 2.5 \text{ mm}^2$ (#2–#4 AWG... #2–20 AWG)
 (Either Solid or Stranded)
 Strip Length: 9 mm (3/8") – Torque: 0.8 Nm (7 lb.-in.)

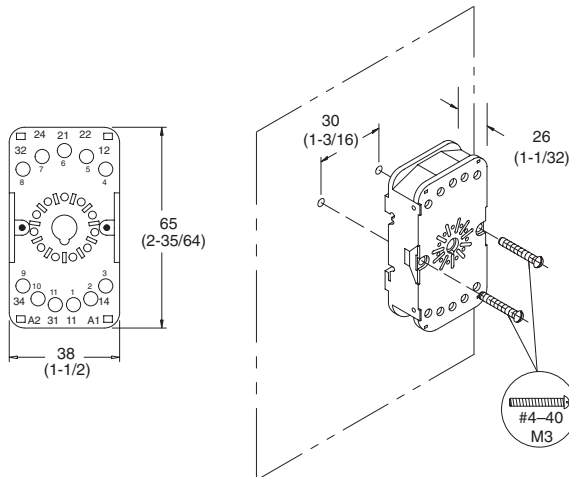

Cat. No. 700-HN101

Panel Mounting

Wire Size: $2 \times 2.5 \text{ mm}^2$
 Single Wire – Up to #12 AWG
 Double Wire – $2 \times 2.5 \text{ mm}^2$ (#2–14 AWG... #2–20 AWG)
 (Either Solid or Stranded)
 Strip Length: 9 mm (3/8 in.) – Torque: 0.8 Nm (7 lb.-in.)

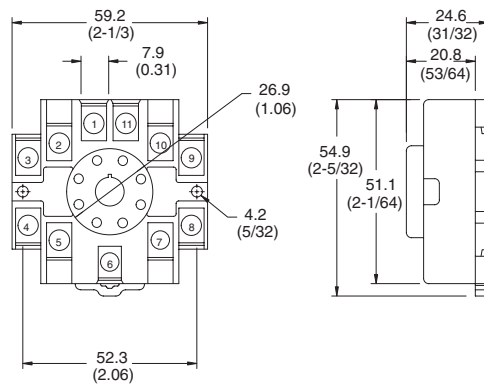

Cat. No. 700-HN126

Wire Size: $2 \times 2.5 \text{ mm}^2$
 Single Wire – Up to #12 AWG
 Double Wire – $2 \times 2.5 \text{ mm}^2$ (#2–#14 AWG... #2–20 AWG)
 (Either Solid or Stranded)
 Strip Length: 9 mm (3/8 in.) – Torque: 0.8 Nm (7 lb.-in.)

• Cat. No. 199-FSM Surge Suppressors fit on the coil terminals. See page 195.

General Purpose Relays

Approximate Dimensions, Continued

Dimensions are shown in millimeters (inches). Dimensions are not intended to be used for manufacturing purposes.

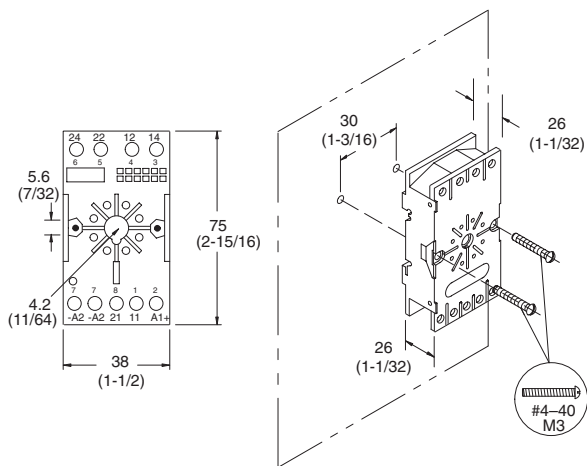

Cat. No. 700-HN202

Panel Mounting

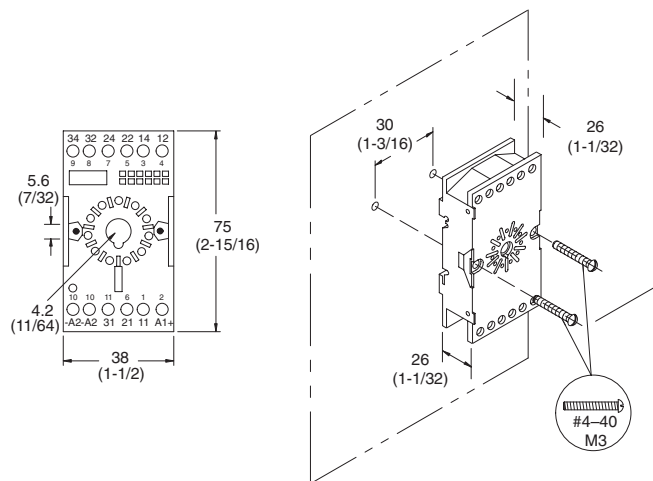

Cat. No. 700-HN203

Panel Mounting

Wire Size: 2 x 2.5 mm²
 Single Wire – Up to #12 AWG
 Double Wire – 2 x 2.5 mm² (#2–14 AWG... #2–20 AWG)
 (Either Solid or Stranded)
 Strip Length: 9 mm (3/8 in.) – Torque: 0.8 Nm (7 lb.-in.)

Wire Size: 2 x 2.5 mm²
 Single Wire – Up to #12 AWG
 Double Wire – 2 x 2.5 mm² (#2–14 AWG ... #2–20 AWG)
 (Either Solid or Stranded)
 Strip Length: 9 mm (3/8 in.) – Torque: 0.8 Nm (7 lb.-in.)

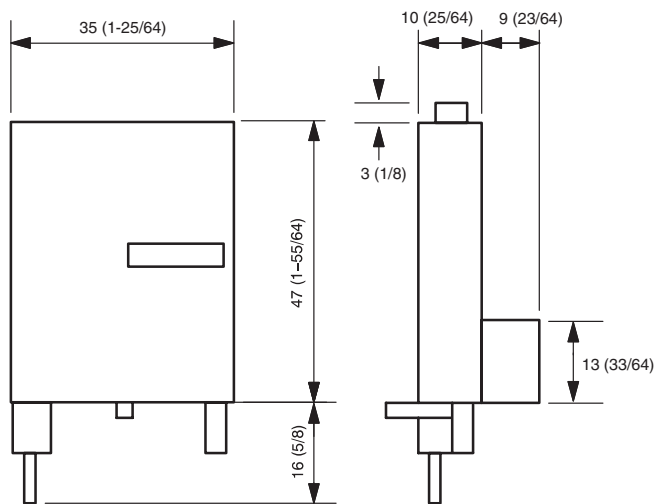

Cat. Nos. 700-HT1 and 700-HT2

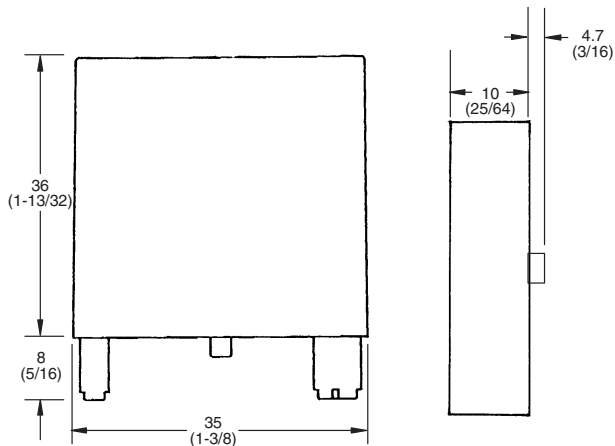

Cat. Nos. 700-HSV1, 700-HSV2, 700-HSV3, and 700-HSMD

Wire Size: 2 x 1.5 mm² (#2 – 16 AWG... #1–20 AWG)
 (Either Solid or Stranded)
 Strip Length: 9 mm (3/8 in.) – Torque: 0.8 Nm (7 lb.-in.)