

SHARP®

MODEL

MX-M260

MX-M310

DIGITAL MULTIFUNCTIONAL SYSTEM

OPERATION MANUAL

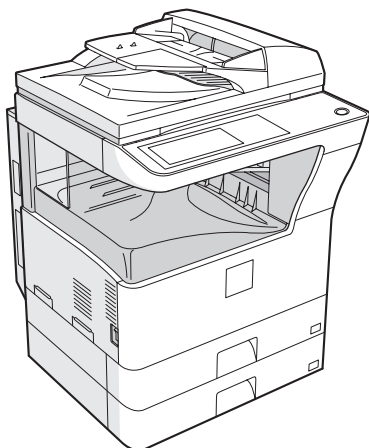

	Page
• BEFORE USING THE MACHINE	9
• COPY FUNCTIONS	22
• CONVENIENT COPY FUNCTIONS	36
• NETWORK SCANNER FUNCTION	54
• SYSTEM SETTINGS (GENERAL)	90
• SYSTEM SETTINGS (ADMINISTRATOR)	96
• TROUBLESHOOTING AND MAINTENANCE	116
• PERIPHERAL DEVICES AND SUPPLIES	139
• APPENDIX	143

Each instruction also covers the optional units used with these products.

Caution:
For complete electrical disconnection, pull out the main plug.
The socket-outlet shall be installed near the equipment and shall be easily accessible.

FOR YOUR RECORDS ...
To protect against loss or theft, record and retain for reference the copier's serial number located on the back of the unit.

Model Number _____
 Serial Number _____
 Date of Purchase _____
 Place of Purchase _____
 Authorized Sharp Copier _____
 Service Department Number _____

For users in the USA

This device complies with Part 15 of the FCC Rules. Operation is subject to the following two conditions: (1) This device may not cause harmful interference, and (2) this device must accept any interference received, including interference that may cause undesired operation.

WARNING:
FCC Regulations state that any unauthorized changes or modifications to this equipment not expressly approved by the manufacturer could void the user's authority to operate this equipment.

Note:
This equipment has been tested and found to comply with the limits for a Class A digital device, pursuant to Part 15 of the FCC Rules. These limits are designed to provide reasonable protection against harmful interference when the equipment is operated in a commercial environment. This equipment generates, uses, and can radiate radio frequency energy and, if not installed and used in accordance with the instruction manual, may cause harmful interference to radio communications. Operation of this equipment in a residential area is likely to cause harmful interference in which case the user will be required to correct the interference at his own expense.

Shielded interface cables must be used with this equipment to maintain compliance with EMC regulations.

Do not make copies of anything which is prohibited from copying by law. The following items are normally prohibited from copying by national law. Other items may be prohibited by local law.

- Money ● Stamps ● Bonds ● Stocks ● Bank drafts
- Checks ● Passports ● Driver's licenses

CONTENTS

CAUTIONS	4
● CAUTIONS ON USING THE MACHINE.....	4
● IMPORTANT POINTS WHEN SELECTING AN INSTALLATION SITE	4
● CAUTIONS ON HANDLING THE MACHINE.....	5
● LASER INFORMATION	5
● ENVIRONMENTAL INFORMATION.....	6
USING THE MANUAL	6
● ABOUT THE OPERATION MANUALS.....	6
● THE MEANING OF "R" IN ORIGINAL AND PAPER SIZE INDICATIONS	7
● CONVENTIONS USED IN THIS MANUAL.....	7
MAIN FEATURES	8

1 BEFORE USING THE MACHINE

PART NAMES AND FUNCTIONS	9
● OPERATION PANEL.....	11
● TOUCH PANEL	12
POWER ON AND OFF	14
● POWER ON.....	14
● POWER OFF	14
● INITIAL SETTINGS.....	15
● POWER SAVE MODES.....	15
LOADING PAPER	16
● PAPER.....	16
● LOADING PAPER.....	18
● CHANGING A TRAY'S PAPER TYPE AND PAPER SIZE SETTINGS.....	20

2 COPY FUNCTIONS

MAIN SCREEN OF COPY MODE	22
NORMAL COPYING	23
● COPYING FROM THE DOCUMENT GLASS	23
● COPYING FROM THE RSPF	24
● POINTS TO NOTE WHEN MAKING COPIES	25
● BYPASS FEED (special paper)	27
AUTOMATIC TWO-SIDED COPYING	28
● USING THE DOCUMENT GLASS.....	28
● USING THE RSPF.....	29
EXPOSURE ADJUSTMENT	30
● SELECTING THE ORIGINAL IMAGE TYPE AND MANUALLY ADJUSTING THE EXPOSURE.....	30
REDUCTION/ENLARGEMENT/ZOOM	31
● AUTOMATIC RATIO SELECTION	31
● MANUAL RATIO SELECTION.....	32
● SELECTING THE VERTICAL AND HORIZONTAL COPY RATIOS SEPARATELY (XY ZOOM copying).....	33
INTERRUPTING A COPY RUN	35

3 CONVENIENT COPY FUNCTIONS

COPY FINISHING FUNCTIONS	36
● SORT COPY.....	36
● GROUP COPY.....	36
● OFFSET FUNCTION (When the finisher is installed).....	36
● STAPLE SORT (when the finisher (MX-FN13) is installed)	38
● ORIENTATION OF THE ORIGINAL AND STAPLING POSITIONS.....	38
SPECIAL MODES	40
● GENERAL PROCEDURE FOR USING THE SPECIAL FUNCTIONS.....	41
● MARGIN SHIFT COPY	42
● ERASE COPY.....	43
● DUAL PAGE COPY	44
● PAMPHLET COPY	45
● JOB BUILD MODE.....	46
● MULTI SHOT COPY	47
● ORIGINAL SIZE.....	48
● COVER COPY	49
● B/W REVERSE COPY.....	51
● CARD SHOT.....	52

4 NETWORK SCANNER FUNCTION

INTRODUCTION	54
ABOUT THE NETWORK SCANNER FUNCTION	55
SETTINGS AND PROGRAMMING REQUIRED FOR THE NETWORK SCANNER FEATURE	56
● SETTINGS REQUIRED FOR THE NETWORK SCANNER FUNCTION.....	56
● ACCESSING WEB PAGES	56
● ABOUT THE WEB PAGE	57
● BASIC SETTINGS FOR NETWORK SCANNING	58

- SMTP SERVER AND DNS SERVER SETTINGS59
- CONFIGURING LDAP SERVER SETTINGS (WHEN USING AN LDAP SERVER)60
- PROGRAMMING CUSTOM INDEX NAMES61
- SETTING UP DESTINATION INFORMATION..62
- STORING THE SENDER INFORMATION (Scan to E-mail)67
- PROTECTING INFORMATION PROGRAMMED IN THE WEB PAGE ("Passwords")68
- RESTRICTING USE OF THE NETWORK SCANNER FUNCTION (USER AUTHENTICATION)69
- INITIAL SCREEN OF SCANNER MODE 70**
- SENDING AN IMAGE 72**
 - BASIC TRANSMISSION METHOD72
 - TRANSMISSION METHODS FOR SCAN TO E-MAIL.....74
 - SCANNING AND TRANSMITTING A TWO-SIDED ORIGINAL (when an RSPF is installed).....76
 - SCANNING A LARGE NUMBER OF ORIGINALS (when an RSPF is installed)77
- SCANNING SETTINGS (ORIGINAL SIZE, QUALITY, RESOLUTION, FILE FORMAT, AND SEND SETTING)..... 78**
 - MANUALLY SETTING THE SCANNING SIZE78
 - SELECTING THE QUALITY.....79
 - SELECTING THE RESOLUTION80
 - SELECTING THE FILE FORMAT81
 - CHANGING THE SEND SETTINGS82
- CANCELING AN E-MAIL/FTP TRANSMISSION 83**
- METADATA DELIVERY (DATA ENTRY)..... 84**
- PREPARATIONS FOR METADATA TRANSMISSION 85**
 - SETTINGS REQUIRED IN THE WEB PAGES85
 - METADATA TRANSMISSION FOR SCAN TO DESKTOP.....85
- TRANSMITTING METADATA 86**
 - METADATA FIELDS88
- CHECKING THE IP ADDRESS 89**

5 SYSTEM SETTINGS (GENERAL)

- SYSTEM SETTINGS..... 90**
 - GENERAL PROCEDURE FOR SYSTEM SETTINGS 54
 - SETTINGS 92
- JOB PROGRAM MEMORY 93**
 - STORING A JOB PROGRAM..... 93
 - EXECUTING A JOB PROGRAM 94
 - DELETING A STORED JOB PROGRAM 94
- AUDITING MODE 95**
 - COPYING WHEN AUDITING MODE IS ENABLED 95

6 SYSTEM SETTINGS (ADMINISTRATOR)

- PURPOSE OF THE ADMINISTRATOR SETTINGS 96**
- PROGRAMMING A ADMINISTRATOR PASSWORD 96**
- USING THE ADMINISTRATOR SETTINGS.... 97**
- ADMINISTRATOR SETTING LIST 99**
 - ADMINISTRATOR SETTING MENU 101
- GENERAL PROGRAMS..... 103**
 - ACCOUNT CONTROL..... 103
 - ENERGY SAVE 105
 - OPERATION SETTINGS..... 106
 - DEVICE CONTROL 107
 - CHANGE ADMINISTRATOR PASSWORD. 109
 - PRODUCT KEY 109
- PROGRAMS FOR COPY MODE..... 110**
 - COPY SETTINGS..... 110
- PROGRAMS FOR PRINT MODE 111**
 - PRINT SETTINGS 111
- PROGRAMS FOR NETWORK SCANNER MODE..... 115**
 - SCANNER SETTINGS 115

7**TROUBLESHOOTING AND MAINTENANCE**

DISPLAY MESSAGES.....	117
TROUBLESHOOTING.....	119
PROBLEMS WHEN THE NETWORK SCANNER FUNCTION IS USED.....	123
● DISPLAY MESSAGES.....	125
● IF YOUR E-MAIL IS RETURNED	126
● IMPORTANT POINTS WHEN USING SCAN TO E-MAIL	126
MISFEED REMOVAL.....	127
● MISFEED REMOVAL GUIDANCE	127
● MISFEED IN THE RSPF.....	128
● MISFEED IN THE BYPASS TRAY	129
● MISFEED IN THE MACHINE.....	129
● MISFEED IN THE CENTER TRAY	131
● MISFEED IN THE UPPER PAPER TRAY ...	131
● MISFEED IN THE LOWER PAPER TRAY ...	132
● MISFEED IN THE RIGHT TRAY (when a right tray (MX-TE10) is installed)	132
● MISFEED IN THE UPPER EXIT AREA (when a job separator tray kit or finisher (MX-FN13) is installed).....	133
● MISFEED IN AN OUTPUT TRAY (when a finisher (MX-FN13) is installed).....	133
REPLACING THE TONER CARTRIDGE	134
STAPLE CARTRIDGE REPLACEMENT.....	135
CHECKING THE TONER QUANTITY AND TOTAL COUNT.....	137
CLEANING THE MACHINE.....	137
● DOCUMENT GLASS AND RSPF	137
● THE BYPASS TRAY PAPER FEED ROLLER.....	138

8**PERIPHERAL DEVICES AND SUPPLIES**

PERIPHERAL DEVICES.....	139
● FINISHER (MX-FN13)	140
● 500-SHEET PAPER FEED UNIT/ 2 x 500- SHEET PAPER FEED UNIT.....	141
STORAGE OF SUPPLIES	142
● PROPER STORAGE	142

9**APPENDIX**

SPECIFICATIONS	143
SPECIFICATIONS FOR NETWORK SCANNER ..	145
MATERIAL SAFETY DATA SHEET.....	146
INDEX	154
● INDEX BY PURPOSE.....	158
TO THE ADMINISTRATOR OF THE MACHINE...	162

CAUTIONS

Follow the cautions below when using this machine.

CAUTIONS ON USING THE MACHINE

⚠ Warning:

- The fusing area is hot. Exercise care in this area when removing misfed paper.
- Do not look directly at the light source. Doing so may damage your eyes.

⚠ Caution:

- Do not switch the machine rapidly on and off. After turning the machine off, wait 10 to 15 seconds before turning it back on.
- Machine power must be turned off before installing any supplies.
- Place the machine on a firm, level surface.
- Do not install the machine in a humid or dusty location.
- When the machine is not used for a long time, for example, during prolonged holidays, turn the power switch off and remove the power cord from the outlet.
- When moving the machine, be sure to turn the power switch off and remove the power cord from the outlet.
- Do not cover the machine with a dust cover, cloth or plastic film while the power is on. Doing so may prevent heat dissipation, damaging the machine.
- Use of controls or adjustments or performance of procedures other than those specified herein may result in hazardous laser radiation exposure.
- The socket-outlet should be installed near the machine and should be easily accessible.
- Do not throw the toner cartridge into a fire. Toner may fly and cause burns.
- Store toner cartridges out of the reach of small children.

IMPORTANT POINTS WHEN SELECTING AN INSTALLATION SITE

Improper installation may damage the machine. Please note the following during initial installation and whenever the machine is moved.



Caution If the machine is moved from a cool place to a warm place, condensation may form inside the machine. Operation in this condition will cause poor copy quality and malfunctions. Leave the machine at room temperature for at least 2 hours before use.

Do not install your machine in areas that are:

- damp, humid, or very dusty



- exposed to direct sunlight

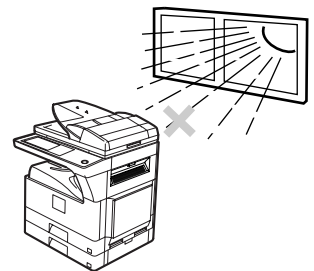

- poorly ventilated

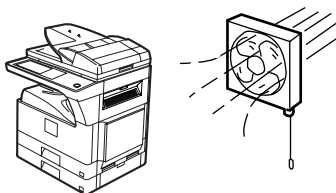

- subject to extreme temperature or humidity changes, e.g., near an air conditioner or heater.

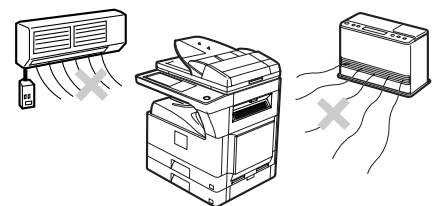

The machine should be installed near an accessible power outlet for easy connection and disconnection.

Be sure to connect the power cord only to a power outlet that meets the specified voltage and current requirements. Also make certain the outlet is properly grounded.



Connect the machine to a power outlet which is not used for other electric appliances. If a lighting fixture is connected to the same outlet, the light may flicker.

Be sure to allow the required space around the machine for servicing and proper ventilation.

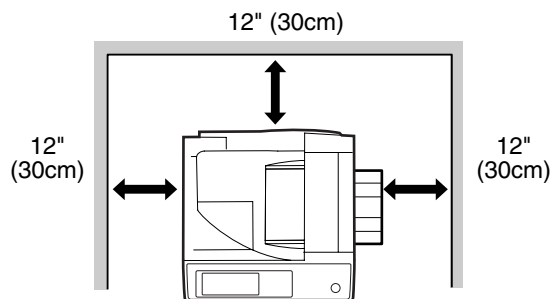

CAUTION:

Do not install the machine in a location with poor air circulation.

A small amount of ozone is created inside the machine during printing. The amount of ozone created is not sufficient to be harmful; however, an unpleasant odor may be noticed during large copy runs, and thus the machine should be installed in a room with a ventilation fan or windows that provide sufficient air circulation. (The odor may occasionally cause headaches.)

* Install the machine so that people are not directly exposed to exhaust from the machine. If installed near a window, ensure that the machine is not exposed to direct sunlight.

Note:

The present recommended long term exposure limit for ozone is 0.1 ppm (0.2 mg/m³) calculated as an 8 hr. time-weighted average concentration.

However, since the small amount that is emitted may have an objectionable odor, it is advisable to place the machine in a ventilated area.

CAUTIONS ON HANDLING THE MACHINE

Observe the following precautions when handling the machine to maintain top performance.

Do not drop the machine, subject it to shock or strike it against any object.

Store spare toner cartridges in a cool dry place without removing from the package before use.

- If they are exposed to direct sunlight or excessive heat, poor copies may result.

Do not touch the photoconductive drum (green portion).

- Scratches or smudges on the drum will cause dirty copies.

Safety precautions:

This Digital Copier is rated Class I and complies with 21 CFR 1040.10 and 1040.11 of the CDRH standards. This means that the machine does not produce hazardous laser radiation. For your safety, observe the precautions below.

- Do not remove the cabinet, operation panel or any other covers.
- The machine's exterior covers contain several safety interlock switches. Do not bypass any safety interlock by inserting wedges or other items into switch slots.

This product utilizes a CR coin Lithium battery which contains a Perchlorate material. Special handling for this material may apply, California residents, See www.dtsc.ca.gov/hazardouswaste/perchlorate/ Others, consult local environmental officers.

LASER INFORMATION

Wave length	785 nm +10 nm -15 nm
Pulse times	North America: 26 cpm model: (6.213 μs)/7 mm 31 cpm model: (7.385 μs)/7 mm Europe: 26 cpm model: (6.213 μs)/7 mm 31 cpm model: (7.385 μs)/7 mm
Output power	Max. 0.9 mW

ENVIRONMENTAL INFORMATION



Products that have earned the ENERGY STAR® are designed to protect the environment through superior energy efficiency.



The Environmental Choice Program guidelines are applied to the products only in Canada. The products that meet the Environmental Choice Program guidelines carry the logo shown to the left. The products without the logo may not meet the Environmental Choice Program guidelines.

"BATTERY DISPOSAL"

THIS PRODUCT CONTAINS A LITHIUM PRIMARY MEMORY BACK-UP BATTERY THAT MUST BE DISPOSED OF PROPERLY. PLEASE CONTACT YOUR LOCAL SHARP DEALER OR AUTHORIZED SERVICE REPRESENTATIVE FOR ASSISTANCE IN DISPOSING OF THIS BATTERY.

This product utilizes tin-lead solder, and fluorescent lamp containing a small amount of mercury. Disposal of these materials may be regulated due to environmental consideration. For disposal or recycling information, please contact your local authorities, the Electronics Industries Alliance: www.eiae.org, the lamp recycling organization: www.lamprecycle.org or Sharp at 1-800-BE-SHARP.
(For U.S.A. Only)

USING THE MANUAL

This machine has been designed to provide convenient copying features in a minimum amount of office space and with maximum operational ease. To get full use of all machine features, be sure to familiarize yourself with this manual and the machine. For quick reference during machine use, keep this manual in a handy location.

ABOUT THE OPERATION MANUALS

The operation manuals for the machine are as follows:

Operation Manual (this manual)

This manual contains explanations of the product and procedures for using the machine as a copier or network scanner.

This also explains administrator settings for machine management and copier related functions. Administrator settings for the fax functions are explained in the operation manual for facsimile.

Online manual (for printer)

This manual is on the CD-ROM, and explains the procedures for using the machine as a printer, network printer, and network scanner.

Software setup guide (for printer)

This manual contains instructions for installing the software that allows the machine to be used with your computer and procedures for establishing initial printer settings.

THE MEANING OF "R" IN ORIGINAL AND PAPER SIZE INDICATIONS

An "R" appearing at the end of an original or paper size (5-1/2" x 8-1/2"R, 8-1/2" x 11"R, etc.) indicates that the original or paper is oriented horizontally as shown below.

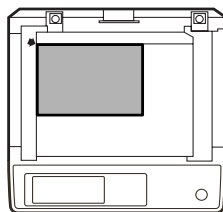

<Horizontal (Landscape) orientation>

Sizes that can be placed only in the horizontal (landscape) orientation (8-1/2" x 14", 11" x 17"), do not contain the "R" in their size indication.

CONVENTIONS USED IN THIS MANUAL



Warning Warns that injury may result if the contents of the warning are not properly followed.



Caution Cautions that damage to the machine or one of its components may result if the contents of the caution are not properly followed.



Note Notes provide useful information on the specifications, functions, performance, and operation of the machine.

Explanation of words and illustration

- This operation manual refers to the Reversing Single Pass Feeder as the "RSPF".
- The illustrations in this manual show the MX-M260/MX-M310 with the optional job separator tray kit (MX-TR11) installed.

The appearance of your machine may be different depending on the model and options installed, however, the basic operations are the same.

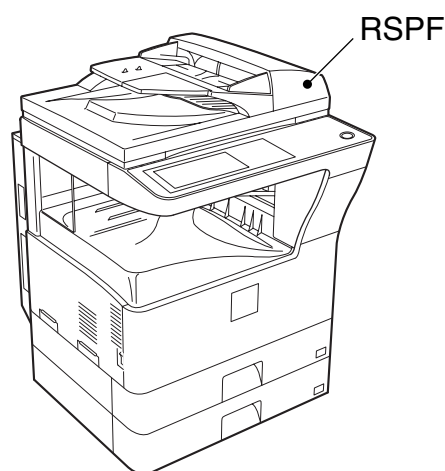

- For peripheral devices that can be installed, see "PERIPHERAL DEVICES" (p.139).
- The explanations in this manual assume that the person who will install the product and the users of the product have a working knowledge of Microsoft Windows.
- In this manual, American spellings are used.
- For information on the operating system, please refer to your operating system manual or the online Help function.
- The explanations of screens and procedures in this manual are for Windows Vista. The screens may vary depending on your Windows version and settings.

MAIN FEATURES

High-speed laser copying

- First-copy time* is only 4.8 seconds (MX-M260) or 4.5 seconds (MX-M310).
 - Copying speed is 26 copies/min. (MX-M260) or 31 copies/min. (MX-M310). This is ideal for business use and provides a big boost to workplace productivity.
- * First-Copy time may vary depending on the power-supply voltage, ambient temperature, and other operating conditions.

High-quality digital image

- In addition to automatic exposure adjustment, three original type modes are available: "TEXT mode" for text-only originals, "TEXT/PHOTO mode" for mixed text and photo originals, and "PHOTO mode" for photos. The exposure can be manually adjusted to 5 levels in each mode.

Enhanced copying features

- Zoom copies can be made from 25% to 400% in increments of 1%.
- Continuous copying of up to 999 copies is possible.
- Automatic two-sided copying can be performed.
- Useful special features such as erase, margin shift, 2 in 1 and 4 in 1, pamphlet copy, dual page copy and cover copy are available.

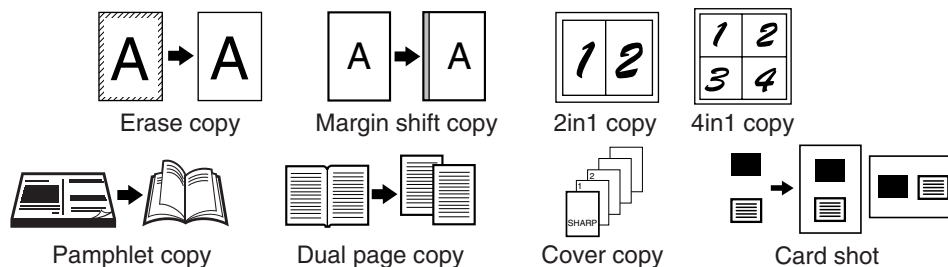

- Administrator settings allow the setting or modification of functions to meet your specific needs. The administrator settings can also be used to enable audit mode, which allows the machine administrator to control use of the machine.

Black and white LCD touch panel makes it easy to operate the machine

- Employing a backlit black and white LCD display, the touch panel provides step-by-step guidance for each function of the machine. The touch panel even provides instructions for removing paper misfeeds and other problems that occur.

Environment and people friendly design

- Preheat and auto power shut-off modes are provided to reduce power consumption when the machine is not in use.
- A universal design has been implemented in the product whereby the height of the operation panel and shape of the keys are designed to be usable by as many people as possible.

1

Chapter 1

BEFORE USING THE MACHINE

This chapter contains basic information that should be read before using the machine.

PART NAMES AND FUNCTIONS

Exterior

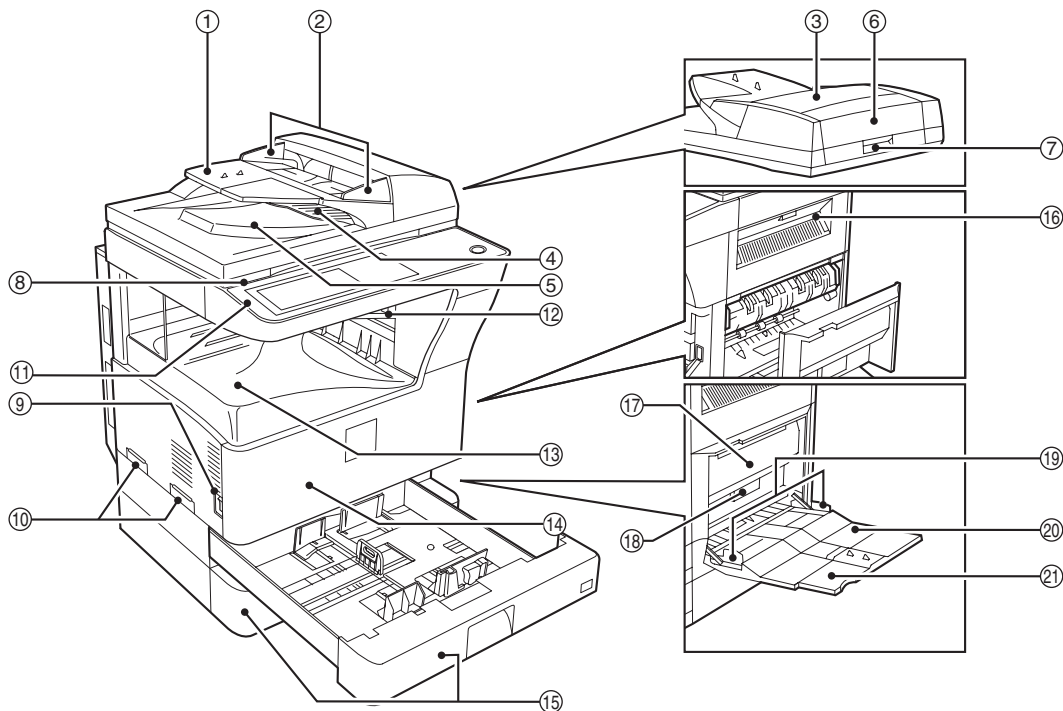

- ① **Document feeder tray**
Place the original(s) that you wish to scan face up here. (p.24)
- ② **Original guides**
Adjust to the size of the originals.
- ③ **Document feeder cover**
Open to remove misfed originals. (p.128)
- ④ **Reversing tray**
Pull out to remove misfed originals. (p.128)
- ⑤ **Exit area**
Originals exit the machine here after copying.
- ⑥ **Document transport cover**
Open to remove misfed originals. (p.128)
- ⑦ **Document transport cover knob**
Pull to open the document transport cover (p.128)
- ⑧ **Document glass**
Place an original that you wish to scan face down here. (p.23)
- ⑨ **Power switch**
Press to turn the machine power on and off. (p.14)
- ⑩ **Handles**
Use to move the machine.
- ⑪ **Operation panel**
Contains operation keys and the touch panel. (p.11)
- ⑫ **Job separator tray (Upper tray) (optional)**
Print jobs and received faxes are delivered to this tray.
- ⑬ **Center tray**
Finished copies are delivered to the center tray.
- ⑭ **Front cover**
Open to remove paper misfeeds and perform machine maintenance. (p.129)

Interior

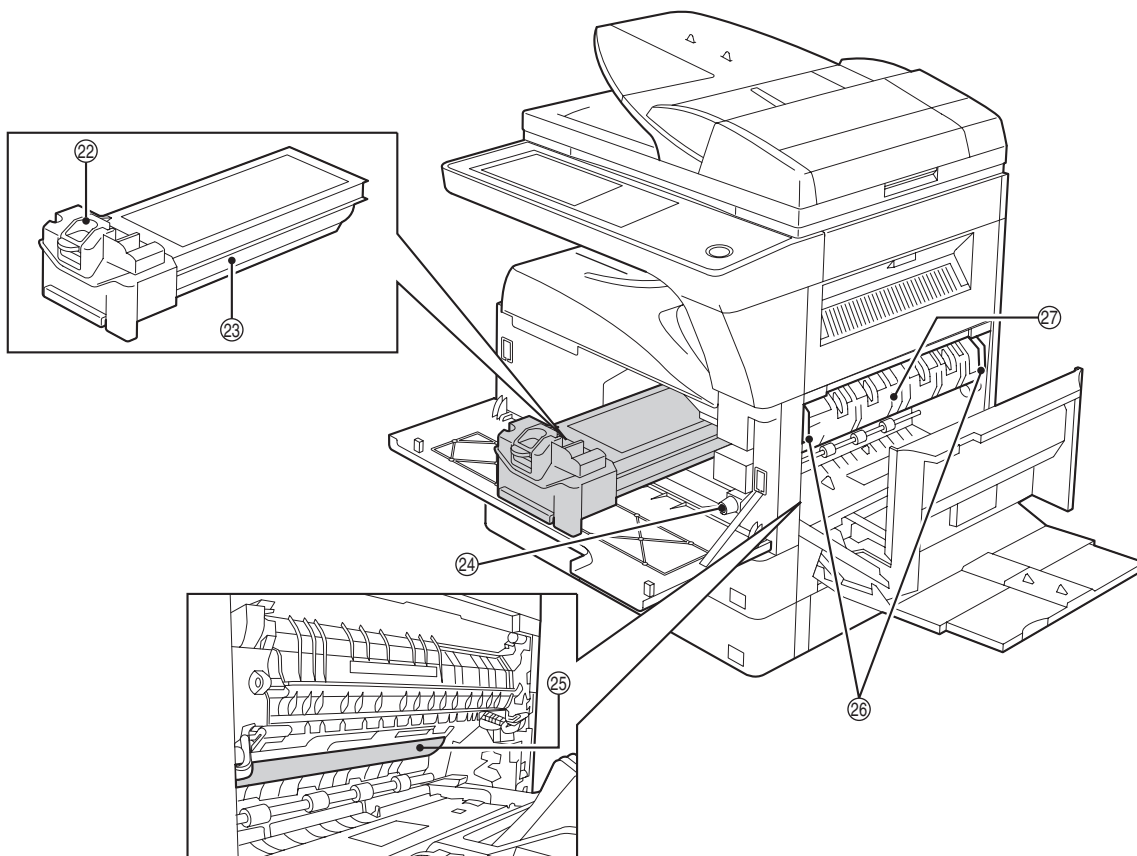

- ⑮ **Paper trays**
Each tray holds 500 sheets of copy paper. (p.16)
- ⑯ **Upper right side cover**
Open to remove misfeeds when an optional job separator tray kit or a optional finisher is installed. (p.133)
- ⑰ **Side cover**
Open to remove misfeeds. (p.129)
- ⑱ **Side cover handle**
Pull to open the side cover. (p.129)
- ⑲ **Bypass tray paper guides**
Adjust to the width of the paper. (p.19)
- ⑳ **Bypass tray**
Regular paper and special paper (such as transparency film) can be fed from the bypass tray. (p.19)
- ㉑ **Bypass tray extension**
Pull out the bypass tray extension before placing paper in the bypass tray. (p.19)
- ㉒ **Toner cartridge lock release lever**
Use to unlock the toner cartridge. (p.134)
- ㉓ **Toner cartridge**
Contains toner. (p.134)

- ㉔ **Roller rotating knob**
Turn to remove misfed paper. (p.129)
- ㉕ **Photoconductive drum**
Copy images are formed on the photoconductive drum.



Caution

Do not touch the photoconductive drum (green portion). Doing so may damage the drum and cause smudges on copies.

- ㉖ **Fusing unit release levers**
To remove a paper misfeed in the fusing unit, push up on these levers and remove the paper. (p.130)



Warning

The fusing unit is hot. Do not touch the fusing unit when removing misfed paper. Doing so may cause a burn or injury.

- ㉗ **Fusing unit paper guide**
Open to remove misfed paper. (p.130)



Note

The model name is on the front cover of the machine.

OPERATION PANEL

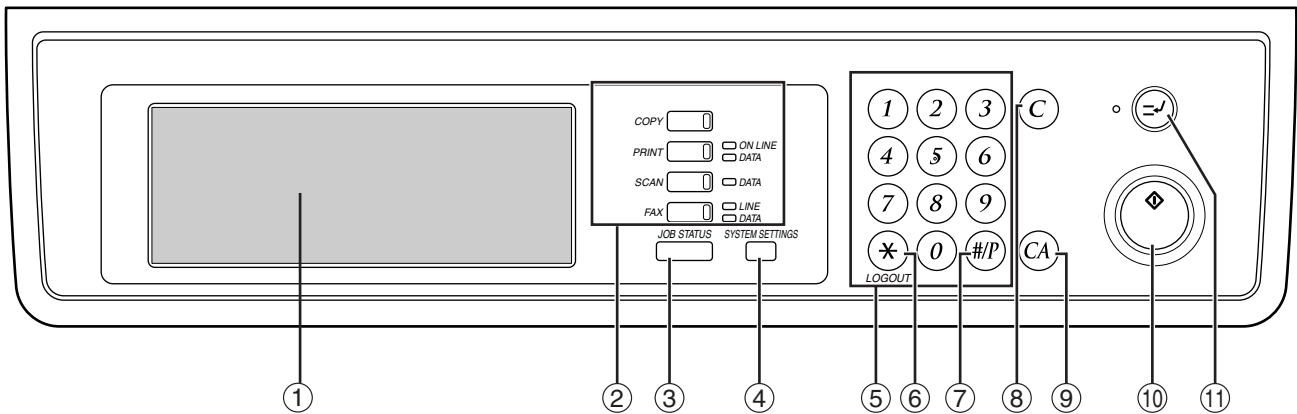

1

- ① **Touch panel**
The machine status, messages and touch keys are displayed on the panel. The display will show the status of printing, copying or network scanning according to the mode that is selected. For details see the next page.
- ② **Mode select keys and indicators**
Use to change modes and the corresponding display on the touch panel.
 - [COPY] key**
Press to select copy mode.
 - [PRINT] key/ONLINE indicator/ DATA indicator**
Press to select print mode.
 - **ONLINE indicator**
Print jobs can be received when this indicator is lit.
 - **DATA indicator**
A print job is in memory. The indicator lights steadily while the job is held in memory, and blinks while the job is printed.
 - [SCAN] key/DATA indicator (When the network scanner option is installed.)**
Press to select network scan mode when the network scanner option is installed.
 - **DATA indicator**
Lights steadily or blinks while a scanned image is being sent.
(See "4. NETWORK SCANNER FUNCTION".)
 - [FAX] key/LINE indicator/DATA indicator (When the fax option is installed.)**
Press to select fax mode when the fax option is installed.
 - **LINE indicator**
this lights up while faxes are being sent or received.
 - **DATA indicator**
Blinks when a fax has been received to memory and lights steadily when a fax is waiting in memory for transmission.
(See operation manual for facsimile.)
- ③ **[JOB STATUS] key**
Press to display the current job status. (p.13)
- ④ **[SYSTEM SETTINGS] key**
Use to adjust various settings of the machine including the contrast of the touch panel and administrator settings. (p.91)
- ⑤ **Numeric keys**
Use to enter numeric values for various settings.
- ⑥ **[LOGOUT] key (*)**
When auditing mode is enabled, press this key after finishing a job to return the machine to account number entry standby.
- ⑦ **[#/P] key (#/P)**
Use this key to execute a job program in copy mode.
The key is also used to dial in fax mode.
- ⑧ **[CLEAR] key (C)**
Press to clear a copy number setting or cancel a job.
- ⑨ **[CLEAR ALL] key (CA)**
Resets the settings to the initial settings.
- ⑩ **[START] key (⊙)**
Press in copy mode, scanner mode, or fax mode to begin copying, network scanning, or faxing.
This key blinks when auto power shut mode has activated. Press the key to return to normal operation.
- ⑪ **[INTERRUPT] key (⊖)**
Use to perform an interrupt copy job. (p.35)

TOUCH PANEL

Using the touch panel

[Example 1]

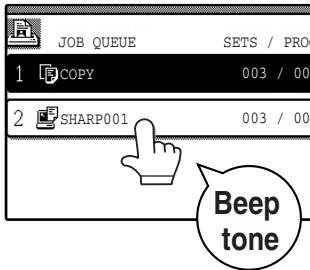

Items on the touch panel are selected by touching the key associated with the item. A beep will sound to confirm that the item was selected and the key will be highlighted.

* A double-beep is sounded when an invalid key is touched.

[Example 2]

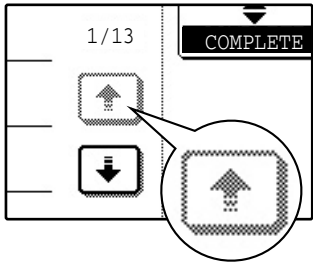

Keys which are grayed out cannot be selected.

The confirmation beeps can be disabled in the administrator settings. (See "6. SYSTEM SETTINGS (ADMINISTRATOR)".)

The touch panel screens shown in this manual are printed images and may differ from the actual screens.

Selecting a function

[Example 1]

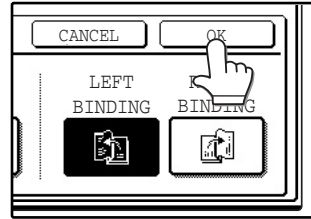

Items which are highlighted at the time a screen appears are already selected and will take effect when the [OK] key is touched.

[Example 2]

If you need to cancel a selection, simply press the key once again so that it is not highlighted.

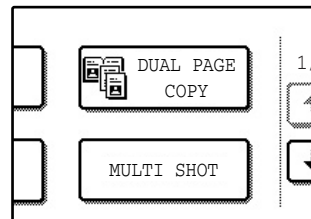
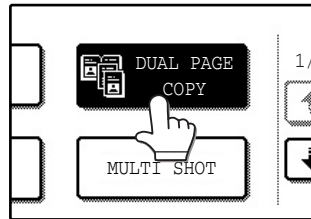

The key is no longer highlighted and the selection is canceled.

[Example 3]

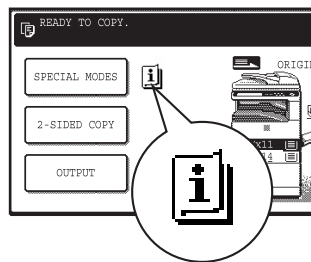

When the machine is used in copy mode or fax mode and a special mode is selected, a icon will appear on the touch panel.

Job status screen (common to copy, print, network scan and fax)

This screen appears when the [JOB STATUS] key on the operation panel is pressed.

A job list showing the current job and the stored jobs or a list showing completed jobs can be displayed.

The contents of jobs can be viewed and jobs can be deleted from the queue. The following screen shows the job queue for print jobs.

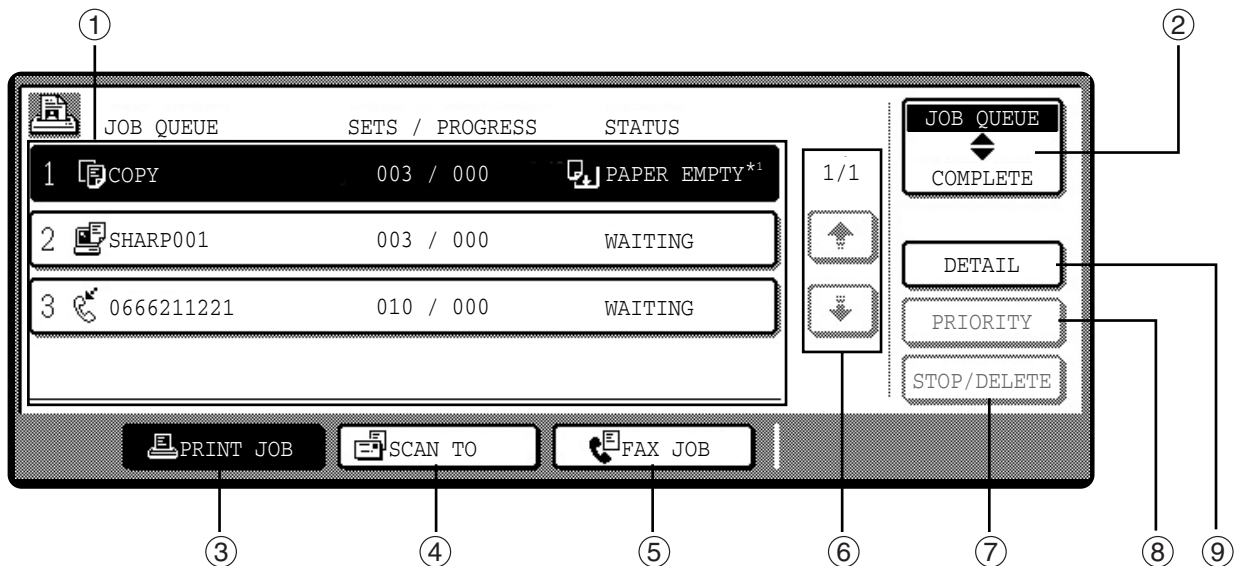

① Job list

Shows stored jobs and the job currently being executed. Touch one of keys ③ to ⑤ in the above illustration to select the type of job. The icon next to each job name indicates the mode of the job as follows:

	Copy mode		Printer mode
	Network scanner mode		
	Fax mode (Send jobs)		Fax mode (Receive jobs)

The jobs in the job list appear in the form of keys. To give priority to a job or pause or delete a job, touch the key of the job and then use the key described in ⑦ or ⑧.

*1: "PAPER EMPTY" in the job status display

"PAPER EMPTY" in the job status display indicates that the machine is out of the specified size of paper. Add the specified size of paper. If the specified size of paper is not available and you are in printer mode, another size of paper can be loaded in the bypass tray to allow printing to take place. (See the "Online manual".)

② Mode switching keys

Use to select the job list mode: "JOB QUEUE" (Stored/currently executing jobs) or "COMPLETE" (Finished jobs).

"JOB QUEUE":

Shows jobs that have been stored and the job that is currently being executed.

"COMPLETE":

Shows the jobs that have been finished. Note that copy jobs do not appear in this list.

If the power is turned off, or if auto power shut-off mode activates when there are no jobs, the jobs in the "COMPLETE" list will be erased.

③ [PRINT JOB] key

Use to view the list of output jobs for all modes (print, copy, and fax).

④ [SCAN TO] key

Displays a network scanner job (When the network scanner function is installed.).

⑤ [FAX JOB] key

This displays stored fax jobs and the fax job currently being executed (When the fax option is installed.).

⑥ Display switching keys

Use to change the page of the displayed job list.

⑦ [STOP/DELETE] key

Use to pause or delete a job currently being executed, or to delete a stored job. Copy jobs and received faxes cannot be paused or deleted with this key. Copy jobs can be canceled by pressing the [CLEAR] key (Ⓢ) or [CLEAR ALL] key (Ⓢ).

⑧ [PRIORITY] key

Touch this key after selecting a stored job in this [JOB QUEUE] list to print the job ahead of the other jobs.

⑨ [DETAIL] key

Shows information on the selected job. This cannot be used for a received fax.

POWER ON AND OFF

The power switch is located on the left side of the machine.



When the power switch is turned on, the machine starts up in the previously used mode. The following explanations assume that the previously used mode was copy mode.

POWER ON

Turn the power switch to the "ON" position.

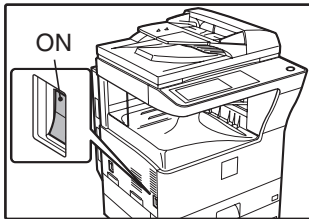

- When the power switch is turned to the "ON" position, the message "WARMING UP. A COPYING JOB CAN BE SET NOW." will appear in the message display and the machine will start warming up. When "READY TO COPY." appears, the machine is ready to copy. Copy settings can be selected during warm-up.
- If auditing mode is enabled, "ENTER YOUR ACCOUNT NUMBER." will appear. When a valid account number is entered, the account status will appear on the main screen for several seconds. Then copying can be performed. (See "6. SYSTEM SETTINGS (ADMINISTRATOR)".)

POWER OFF

When the machine is not used for a long time, be sure to turn it off.

Make sure that the machine is not in operation and then turn the power switch to the "OFF" position.

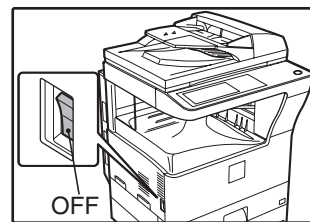

If the power switch is turned off while the machine is in operation, a misfeed may occur and the job that was in progress will be canceled.



If the fax option is installed, be sure to keep the power turned on. Faxes cannot be received when the power is turned off.

INITIAL SETTINGS

The machine reverts to the initial settings when it is first turned on, when the [CLEAR ALL] key (☺) is pressed, or the preset "auto clear time" elapses after the last copy is made in any mode. When the machine reverts to the initial settings, all settings and functions selected to that point are canceled. The auto clear time can be changed in the administrator settings. (See "6. SYSTEM SETTINGS (ADMINISTRATOR)".)

The initial settings that appear in the display are shown below.

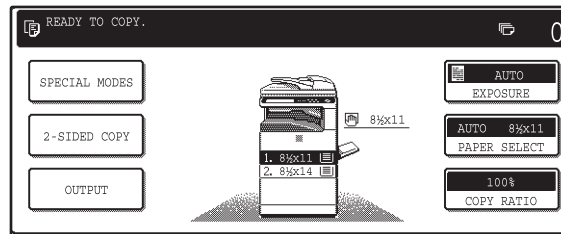

Functions and settings are explained based on the above screen as applicable.

Copy ratio: 100%, **Exposure:** Automatic, **Copy quantity:** 0, **Automatic two-sided:** One side to One side, **Auto paper selection:** On, **Paper tray:** Upper paper tray



The initial settings can be changed in the administrator settings. (See "6. SYSTEM SETTINGS (ADMINISTRATOR)".)
For the initial settings (initial screen) of printer, fax, and scanner modes, see the operation manuals of those modes.

POWER SAVE MODES

The machine has two power save modes to reduce overall power consumption and thereby reduce the cost of operation. These modes help conserve natural resources and reduce environmental pollution. The two power save modes are "Preheat mode" and "Auto power shut-off mode".

The time settings for each mode can be changed in the administrator settings. (See "6. SYSTEM SETTINGS (ADMINISTRATOR)".)

Preheat mode

When the set time elapses, the temperature of the fusing unit is automatically lowered to reduce power consumption while on standby. To return to normal operation, touch any key on the operation panel. To make a copy when the machine is in this mode, simply select the desired copy selections and then press the [START] key (☺).

Auto power shut-off mode

When the set time elapses, the power to the fusing unit automatically turns off to reduce power consumption. (This is based on the guidelines of the International Energy Star Program.) When the machine enters this mode, the touch panel screen turns off and only the [START] key (☺) blinks. To return to normal operation, press the [START] key (☺). To copy after warm-up starts, make desired copy selections and press the [START] key (☺). When the machine receives a fax or a print job, Auto power shut-off mode automatically deactivates and the machine returns to normal operation.

LOADING PAPER

When a tray runs out of paper, a message appears in the touch panel. Load paper in the tray.

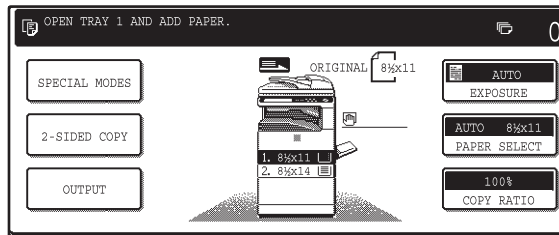

PAPER

The specifications for the types and sizes of paper that can be loaded in the paper trays are shown below. For best results, use only SHARP recommended paper.

Tray No.	Paper tray type	Paper type	Size	Weight	Capacity
1	Upper paper tray*1	Plain paper Letterhead paper Recycled paper Color paper	5-1/2" x 8-1/2" to 11" x 17" (A5 to A3)	15 lbs. to 28 lbs. (56 g/m ² to 105 g/m ²)	500 sheets*4
2	Lower paper tray*2				
3	500-sheet paper feed unit/ Upper paper tray of 2 x 500-sheet paper feed unit				
4	Lower paper tray of 2 x 500-sheet paper feed unit				
	Bypass tray	Plain paper Letterhead paper Recycled paper Color paper	5-1/2" x 8-1/2" to 11" x 17" (A6 to A3)	16 lbs. to 34.5 lbs. (60 g/m ² to 128 g/m ²) *3	100 sheets*4
		Thin paper		15 lbs. to 16 lbs. (56 g/m ² to 59 g/m ²)	100 sheets
		Heavy paper		Max. 54 lbs. (200 g/m ²)	30 sheets
		Labels			40 sheets
		Transparency film			40 sheets
		Envelope		International DL (110 x 220 mm) International C5 (162 x 229 mm) Commercial 10 (4-1/8" x 9-1/2")	

*1 5-1/2" x 8-1/2" (A5) size paper can only be loaded in tray 1 and the bypass tray.

*2 B5 size paper cannot be loaded in tray 2 (However, B5R paper can be loaded.).

*3 When loading paper larger than 8-1/2" x 11" (A4) size, do not use paper of weight greater than 28 lbs. (105 g/m²).

*4 When paper weight is 21 lbs. (80 g/m²). The number of sheets of paper which can be loaded varies depending on the weight of the paper.

Special papers

Follow these guidelines when using special papers.

Envelopes

Do not use the following envelopes (Misfeeds will occur.).

- Envelopes with metal tabs, clasps, strings, holes, or windows.
- Envelopes with rough fibers, carbon paper, or glossy surfaces.
- Envelopes with two or more flaps.
- Envelopes with tape, film, or paper attached to the flap.
- Envelopes with a fold in the flap.
- Envelopes with glue on the flap to be moistened for sealing.
- Envelopes with labels or stamps.
- Envelopes that are slightly inflated with air.
- Envelopes with glue protruding from the seal area.
- Envelopes with part of the seal area peeled off.

Letterhead paper

Letterhead paper is paper with information pre-printed at the top such as a company name and address.

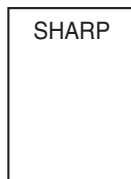

- Use SHARP recommended transparency film and label sheets. Using other than SHARP recommended paper may result in misfeeds or smudges on the output. If other than SHARP recommended media must be used, feed each sheet one at a time using the bypass tray (Do not attempt continuous copying or printing.).
- There are many varieties of special paper available on the market, and some cannot be used with this machine. Before using special paper, contact a SHARP service center.
- Before using other than SHARP recommended paper, make a test copy to see if the paper is suitable.

LOADING PAPER

Make sure that the machine is not copying, printing, or printing a received fax, and then follow these steps to load paper.

Loading the paper in the paper tray

1 Pull out the paper tray until it stops.

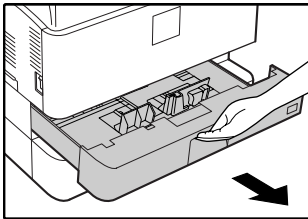

If you are loading the same size of paper as was loaded previously, go to step 4. If you are loading a different size of paper, continue with the following step.

2 Squeeze the lock lever of the front guide and slide the front guide to match the width of the paper.

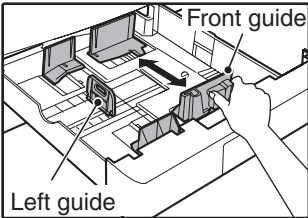

3 Move the left guide to the appropriate slot as marked on the tray.

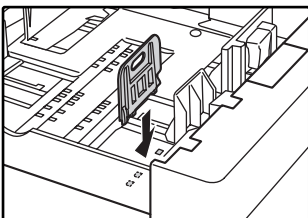

When using 11" x 17" copy paper, store the left front of the paper tray.

4 Fan the copy paper.

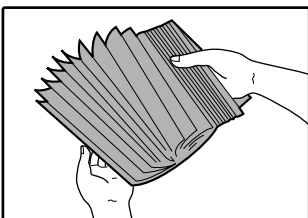

5 Load paper in the tray.

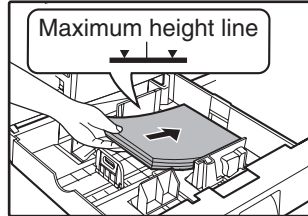

Note

- Load the paper with the print side facing up.
- Insert the paper along the guides.
- The tray holds up to 500 sheets of 21 lb. (80g/m²) bond paper.
- Do not load paper above the maximum height line.
- When adding paper, first remove any paper remaining in the tray, combine it with the paper to be added, and then reload as a single stack.

6 Push the paper tray firmly back into the machine.

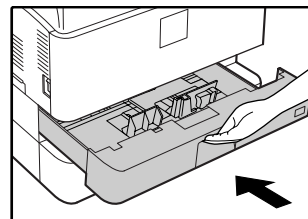

If you loaded a different size of paper that was loaded previously, place the appropriate paper size card in the front of the paper tray to indicate the new paper size.

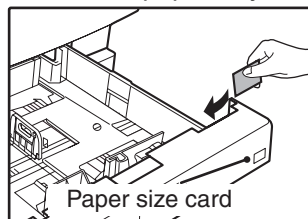

Note

If you loaded a different size of paper that was loaded previously, go to "CHANGING A TRAY'S PAPER TYPE AND PAPER SIZE SETTINGS" (p.20).

Loading paper in the bypass tray

1 Unfold the bypass tray.

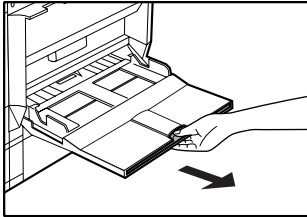
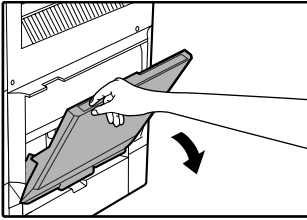

To enable correct detection of the paper size, be sure to pull out the bypass tray extension.

2 Set the paper guides to the copy paper width.

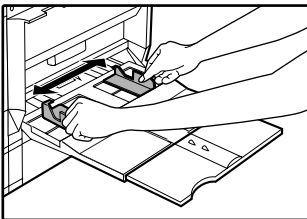

3 Insert the copy paper (print side down) all the way into the bypass tray.

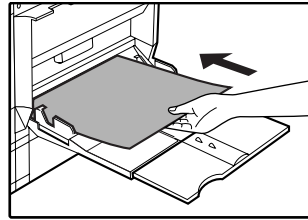

1

Important points when inserting paper in the bypass tray

- Be sure to place envelopes horizontally as shown in the following diagram.
- Load the paper with the print side facing down.

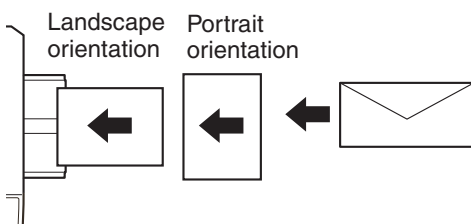

- When loading envelopes, make sure that they are straight and flat and do not have loosely glued construction flaps (not the closure flap).
- When adding paper, first remove any paper remaining in the bypass tray, combine it with the paper to be added, and then reload as a single stack. The paper to be added must be the same size and type as the paper already in the bypass tray.
- Do not use paper that is smaller than the original image. This may cause smudges or unclean images.
- Do not use paper that has already been printed on by a laser printer or plain paper fax machine. This may cause smudges or unclean images.

CHANGING A TRAY'S PAPER TYPE AND PAPER SIZE SETTINGS

When you change the paper in a tray, follow the steps below to change the tray's paper type and paper size settings. The settings cannot be changed when operation has stopped because the paper ran out or a misfeed occurred, or when an interrupt copy job is being performed.

Even in copy mode, the settings cannot be changed while a print job or received fax is being printed.



- 5-1/2" x 8-1/2" (A5) size paper can only be set for tray 1.
- B5 size paper cannot be set for tray 2 (However, B5R size paper can be set.).
- Tray settings for trays other than the bypass tray can be prohibited in the administrator settings. (See "6. SYSTEM SETTINGS (ADMINISTRATOR)".)

1 Load paper in the tray as explained in "Loading the paper in the paper tray" (p.18).

2 Press the [SYSTEM SETTINGS] key.

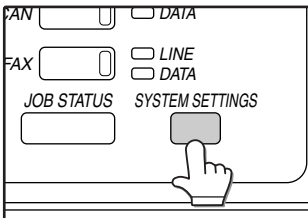

The system settings menu screen will appear.

3 Touch the [TRAY SETTINGS] key.

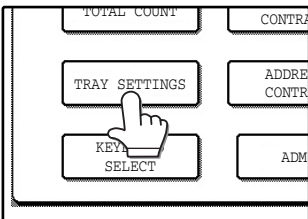

The tray settings screen will appear.

4 Select the tray in which you loaded paper.

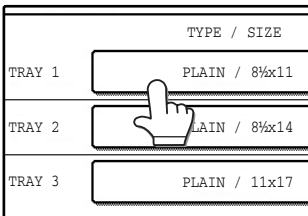

For the tray numbers, see "PAPER" (p.16). If the desired tray does not appear in the display, use the [↑] key or [↓] key to scroll until it appears.

5 Select the size and type of paper that is loaded in the tray.

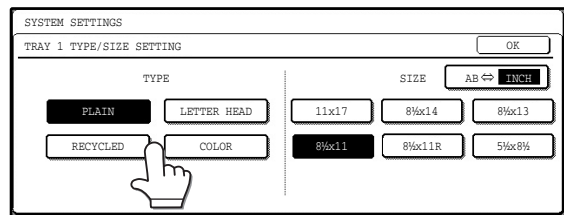

The currently selected paper type will be highlighted.

- To change the paper type selection, touch the appropriate type key.
- To change the paper size selection, touch the appropriate size key.
- To change the displayed size selections to AB sizes, touch [AB ↔ INCH].

6 Touch the [OK] key.

7 A message appears prompting you to check the paper in the tray. Check the paper and then touch the [OK] key.

You will return to the tray settings screen.

Setting the paper type in the bypass tray

Use either of the following two methods to set the bypass tray's paper type setting.

From the [SYSTEM SETTINGS] key

- 1 Load paper in the bypass tray as explained in "Loading paper in the bypass tray" (p.19).

- 2 Press the [SYSTEM SETTINGS] key.

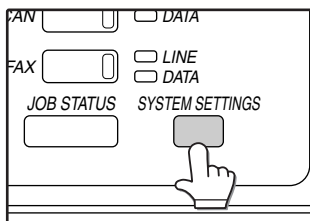

The system settings menu screen will appear.

- 3 Touch the [TRAY SETTINGS] key.

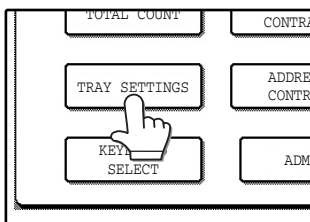

The tray settings screen will appear.

- 4 Touch the [BYPASS TRAY] key.

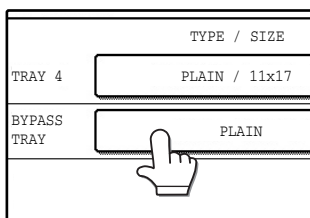

- 5 Select the type of paper that is loaded in the tray.

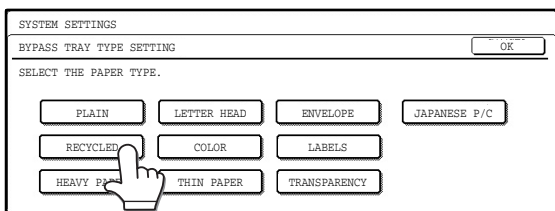

"JAPANESE P/C" refers to official postcards used in Japan.

- 6 Touch the [OK] key.

You will return to the tray settings screen.

From the [PAPER SELECT] key

- 1 Load paper in the bypass tray as explained in "Loading paper in the bypass tray" (p.19).

- 2 Touch the [PAPER SELECT] key.

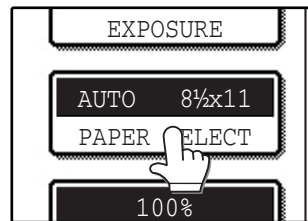

- 3 Touch the paper type selection key.

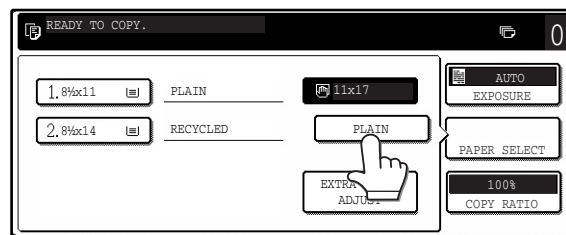

- 4 Select the paper type.

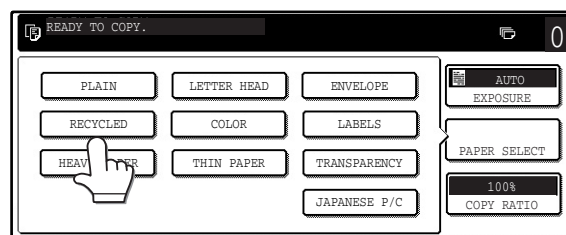

"JAPANESE P/C" refers to official postcards used in Japan.

- 5 Touch the [PAPER SELECT] key.

You will return to the main screen of copy mode.

This chapter explains basic copying functions such as normal copying, reduction or enlargement, and exposure adjustment.

MAIN SCREEN OF COPY MODE

The main screen of copy mode shows messages, keys, and settings that are used for copying. Touch a key to make a selection. The main screen of copy mode appears when the [COPY] key is pressed (Except when the system settings screen appears.).

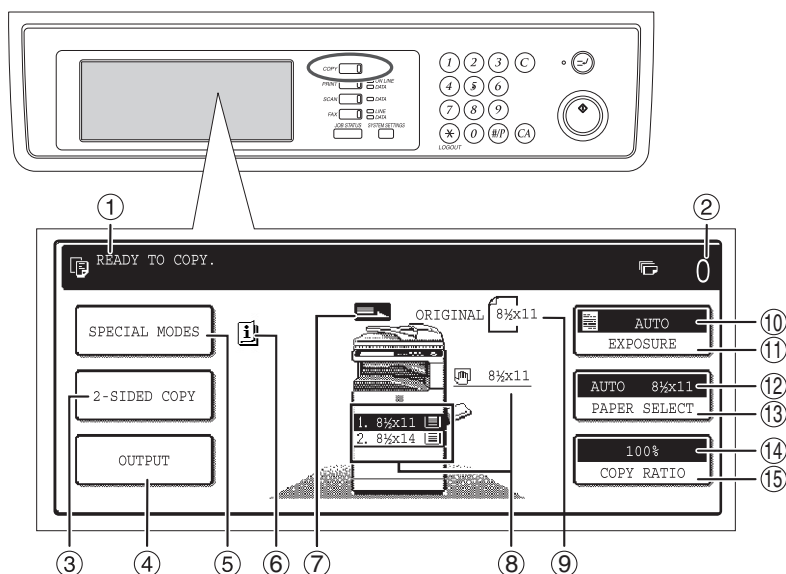

The screen will vary depending on the equipment installed.

- ① **Message display**
Status messages are displayed here.
- ② **Copy number display**
Displays the selected number of copies before the [START] key (⊙) is pressed or the number of remaining copies after the [START] key (⊙) is pressed. A single copy can be made when "0" is displayed.
- ③ **[2-SIDED COPY] key (p.28)**
Touch to open the duplex copy mode setting screen.
- ④ **[OUTPUT] key (p.36)**
Touch to select sort, group, staple sort, and other output settings.
- ⑤ **[SPECIAL MODES] key (p.40)**
Touch to open the special modes selection screen.
- ⑥ **[INFORMATION] icon**
The [INFORMATION] icon appears in the base screen when one or more special modes are selected.
- ⑦ **Original feed display**
This appears when an original is placed in the RSPF.
- ⑧ **Paper size display**
This shows the location of the paper trays, the size of the paper in the trays. "≡" indicates whether or not there is paper. A paper tray can be touched to change the paper tray selection.
- ⑨ **Original size display**
Displays the original size only when an original is placed for copying.
- ⑩ **Exposure display**
Displays the icon of the selected exposure type and the exposure scale.
- ⑪ **[EXPOSURE] key (p.30)**
Use this key to adjust the copy exposure.
- ⑫ **Paper select display**
Displays the selected paper size. When auto paper select mode is selected, "AUTO" appears when auto paper select mode is selected.
- ⑬ **[PAPER SELECT] key (p.23, p.27)**
Use this key to select the paper size.
- ⑭ **Copy ratio display**
Displays the selected copy ratio.
- ⑮ **[COPY RATIO] key (p.32)**
Use this key to select the copy ratio.

NORMAL COPYING

COPYING FROM THE DOCUMENT GLASS



If "AUDITING MODE" (p.95) has been enabled, enter your 5-digit account number.

1 Open the RSPF and place the original face down on the document glass.

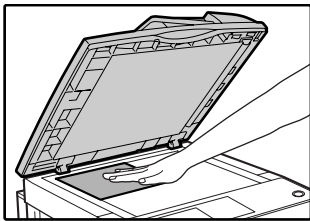

[How to place the original]

Align the corner or the original with the tip of the arrow (▲) at the left rear corner of the glass as shown in the illustration.

Original scale

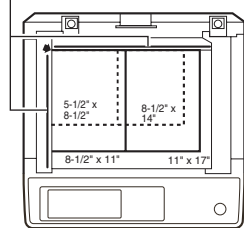

Original scale

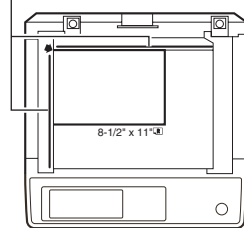

2 Close the RSPF.

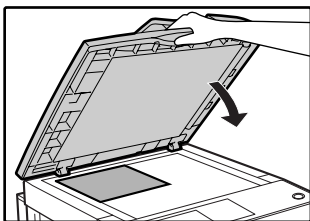

The original size appears in the touch panel. After placing the original, be sure to close the RSPF. If left open, parts outside of the original will be copied black, causing excessive use of toner.



If the original size is not automatically detected, manually set the original size. (p.48)

3 Make sure that the same size of paper as the original is automatically selected.

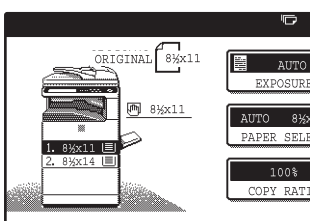

The selected tray is highlighted. If the tray contains a different size of paper than the original, "LOAD xxxx PAPER." will appear.

Even if the message above is displayed, copying can be performed using the selected paper tray.



- To load paper, see "LOADING PAPER" (p.16). If you change the paper size in the tray, you will also need to change the tray's paper size and paper type settings. (p.20)
- The paper types for the auto paper selection function can be selected, or the function disabled, in the administrator settings. (See "6. SYSTEM SETTINGS (ADMINISTRATOR)".)

Manually selecting the paper size (paper tray)

If auto paper selection is disabled in the administrator settings, or if you wish to use a different size of paper than the original, touch the [PAPER SELECT] key and select the paper tray with the desired paper size. (The selected paper will be highlighted and the paper selecting screen will close.)

To close the screen without selecting a paper size, touch the [PAPER SELECT] key again.

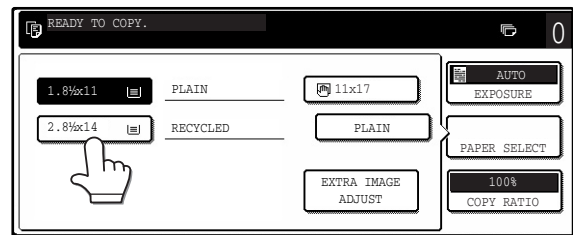

4 Select the number of copies and any other desired copy settings, and then press the [START] key (⊙).

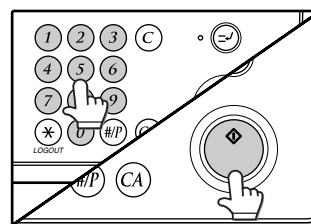

- The number in the copy quantity display will decrease by 1 each time a copy is made.
- If you are only making a single copy, the copy can be made with the copy number display showing "0".
- To clear a mistake, press the [CLEAR] key (⊙).



- Press the [CLEAR] key (⊙) to stop copying in the middle of a run.
- To repeat the same copy sequence for a different original, simply replace the original and press the [START] key (⊙).
- If copying stops because the tray has run out of paper, you can resume copying by touching the [PAPER SELECT] key and selecting the bypass tray or a paper tray that has the same size and type of paper loaded in the same orientation.

2

COPYING FROM THE RSPF



- If "AUDITING MODE" (p.95) is enabled, enter your 5-digit account number.
- If the RSPF is disabled in the administrator settings, the RSPF cannot be used. See "6. SYSTEM SETTINGS (ADMINISTRATOR)".

1 Make sure that an original has not been left on the document glass and then close the RSPF.

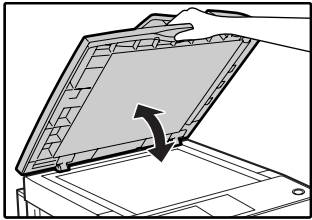

If an original remains on the document glass after a copy was made, "REMOVE THE ORIGINAL FROM THE DOCUMENT GLASS." will appear in the touch panel.

2 Adjust the original guides to the size of the original.

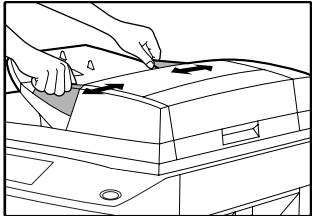

3 Place the originals face up in the document feeder tray.

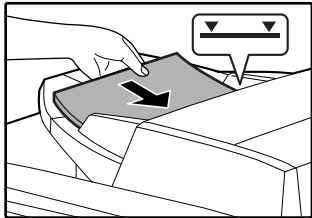

Insert the originals all the way into the feed slot. The original size appears in the touch panel.



- Up to 100 pages (24 lbs. (90 g/m²)) can be inserted at once. The stack of originals must not be higher than the indicator line on the tray.
- If the original size is not automatically detected, manually set the original size. (p.48)

4 Make sure that the same size of paper as the original is selected.

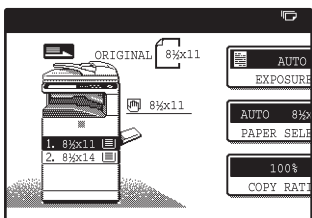

The selected tray is highlighted. If none of the trays have the same size of paper as the original, "LOAD xxxx PAPER." will appear.

Even if the message above is displayed, copying can be performed using the selected paper tray.



- To load paper, see "LOADING PAPER" (p.16). If you change the paper size in the tray, you will also need to change the tray's paper size and paper type settings. (p.20)
- If needed, manually select the paper tray that has the desired size of paper as explained on page 22.
- The paper types for the auto paper selection function can be selected, or the function disabled, in the administrator settings. (See "6. SYSTEM SETTINGS (ADMINISTRATOR)".)
- If the original size is larger than the paper size, the result of copying from the document glass may differ from the result of copying from the RSPF. (p.23)

5 Select the number of copies and any other desired copy settings, and then press the [START] key (⊙).

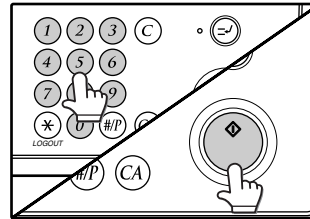

- The number in the copy quantity display will decrease by 1 each time a copy is made.
- If you are only making a single copy, the copy can be made with the copy number display showing "0".
- To clear a mistake, press the [CLEAR] key (⊙).



- Press the [CLEAR] key (⊙) to stop copying in the middle of a run.
- If copying stops because the tray has run out of paper, you can resume copying by touching the [PAPER SELECT] key and selecting the bypass tray or a paper tray that has the same size and type of paper loaded in the same orientation.

Stream feeding mode

If stream feeding mode is enabled in the administrator settings, "SET ORIGINALS FOR STREAM FEEDING." will appear in the touch panel for approximately 5 seconds after the originals are fed. Any new originals placed in the RSPF while this message appears will be fed and copied automatically.

Copying a large number of originals

Job Build mode is useful when you need to copy more originals that can be placed in the RSPF at once. For information on Job Build mode, see "JOB BUILD MODE" (p.46).

POINTS TO NOTE WHEN MAKING COPIES

Document glass and RSPF

- Paper in a different orientation from the original can be selected if the auto paper select or auto image function has been selected. In this case, the image of the original will be rotated.
- When copying a book or an original that has been folded or crumpled, press down gently on the RSPF. This will reduce shadow lines caused by uneven contact between the original and the document glass.
- When the center tray counter function is enabled, the number of pages that can be delivered to the output tray is limited to 500 (A4 and 8-1/2" x 14" sizes only; the limit for all other sizes is 300 pages.). When the offset function is used, the limit is approximately 300 pages. When the limit is reached, copying stops and the [START] key (⊙) light turns off. Remove the copies from the center tray and then press the [START] key (⊙) to resume copying. The center tray counter function can be disabled in the administrator settings. (See "6. SYSTEM SETTINGS (ADMINISTRATOR)".)

Originals that can be used in the RSPF

A maximum of 100 sheet originals of equal size (8-1/2" x 11", 24 lbs. (90g/m²)) can be placed in the RSPF. Originals of different length can be placed together in the RSPF as long the widths are equal; however, some copy functions may not operate correctly.

Acceptable originals

Originals of size 5-1/2" x 8-1/2" to 11" x 17" having a weight of 9 lbs. to 34 lbs. (35g/m² to 128g/m²) or 14 lbs. to 28 lbs. (52g/m² to 105g/m²) for two-sided originals can be used.

Other considerations

- Use originals that are within the specified size and weight ranges. Originals outside the specified ranges may cause misfeeds.
- Make sure that there are no paper clips or staples on the original.
- If an original has damp spots from correction fluid or ink, or glue from pasteups, be sure it has dried completely before using it to make a copy. Otherwise the interior of the RSPF or the document glass may become soiled.
- The following originals cannot be used. These may cause misfeeds, smudging, and unclear images.
 - Transparencies, tracing paper, other transparent or translucent paper, photographs
 - Carbon paper
 - Thermal paper
 - Originals that are creased, folded, or torn
 - Glued originals, cut-out originals
 - Originals with binder holes
 - Originals printed using an ink ribbon (thermal transfer printing), originals printed on thermal transfer paper

Copying originals of mixed length (Mixed feeding)

When using the RSPF, originals of mixed length can be fed together as long as the width of the originals is the same. To copy originals of mixed length, follow these steps:

1 Touch the [SPECIAL MODES] key.

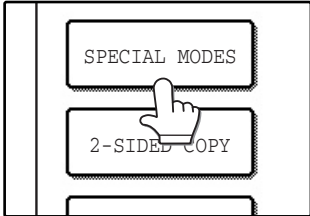

2 Touch the [↓] key and then the [ORIGINAL SIZE] key.

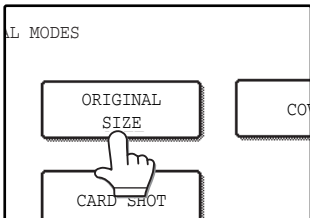

3 Select the "MIX SIZE ORIGINAL FEEDING MODE" checkbox.

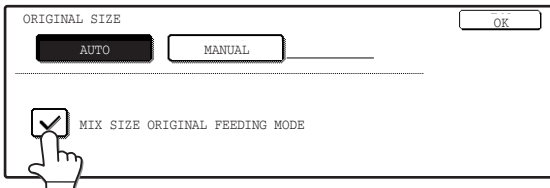

4 Touch the [OK] key.

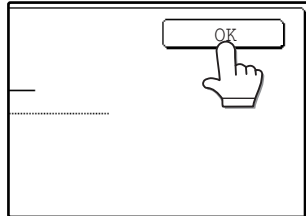

The setting is entered and you return to the main screen. The original size icon changes to (Mixed) to indicate that mixed feeding is selected.



Note When copying is started in mixed feeding mode, all originals are scanned before copying begins.

Automatic copy image rotation (Rotation copying)

If the originals are placed in a different orientation than the copy paper, the original image will be automatically rotated 90°. (When an image is rotated, a message will be displayed.) If a function is selected that is not suitable for rotation, such as enlarging the copy to greater than 8-1/2" x 11" (A4) size or margin shift copy, rotation will not be possible.

[Example]

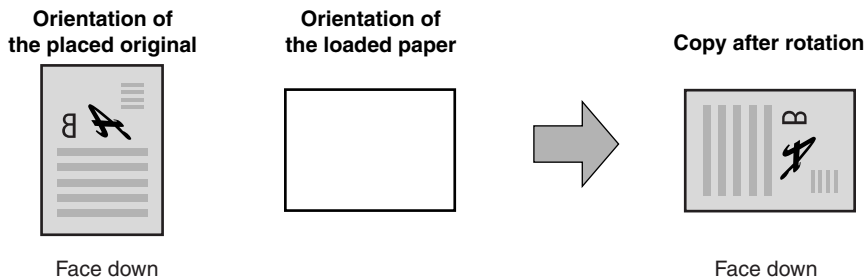

- This function operates in both the auto paper select and auto image modes. Rotation copying can be disabled in the administrator settings. (See "6. SYSTEM SETTINGS (ADMINISTRATOR)".)

BYPASS FEED (special paper)

The bypass tray must be used to feed special papers such as transparency film and labels. The bypass tray can also be used to feed standard copy paper.

1 Place the original(s). (p.23, p.24)

2 Insert the paper (print face down) all the way into the bypass tray.

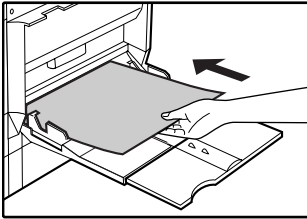

For paper that can be used in the bypass tray, see "PAPER" (p.16). To load paper, see "Loading paper in the bypass tray" (p.19).

3 Touch the [PAPER SELECT] key or the tray in the image of the machine in the touch panel, and select the bypass tray.

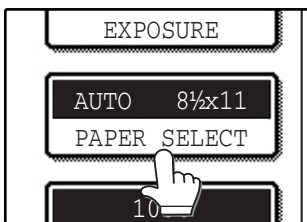

Set the type of paper that you loaded in the bypass tray. (p.21)

4 Select the number of copies and any other desired copy settings, and then press the [START] key (⊙).

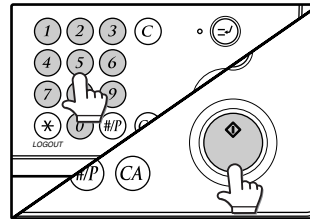

2

Shifting the starting position of copying

When copying on a special size of paper in the bypass tray, the starting position of printing can be shifted vertically for fine adjustment of the image position. To adjust the starting position of printing, follow the steps below. This function can only be used when feeding special sizes of paper from the bypass tray.

1 Touch the [PAPER SELECT] key and then touch the [EXTRA IMAGE ADJUST] key on the bypass tray.

2 Use the key or key to adjust the printing position, and then touch the [OK] key.

- The position can be adjusted from -0.5 inch to +0.5 inch in 0.02 inch increments.
- When a setting from -0.5 inch to -0.02 inch is selected, the starting position of printing is moved to front from the standard position. When a setting from +0.02 inch to +0.5 inch is selected, the starting position of printing is moved to rear.

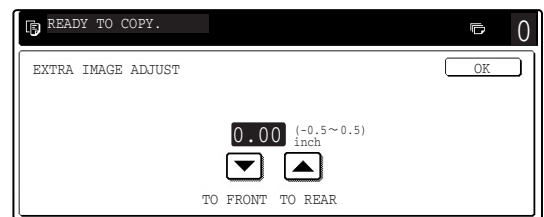

AUTOMATIC TWO-SIDED COPYING

Two originals can be automatically copied onto both sides of a single sheet of paper. When the RSPF is used, two-sided copies of two-sided originals can easily be made.

	Original → Paper		
Document glass	One-sided original → Two sides (1 _h →2)		
RSPF	One-sided original → Two sides (1 _h →2)	Two-sided original → Two sides (2→2)	Two-sided original → One side (2→1 _h)



- Paper sizes that can be used are 8-1/2" x 11", 8-1/2" x 11"R, 8-1/2" x 13", 8-1/2" x 14" and 11" x 17" (A5, B5, B5R, A4, A4R, B4, and A3).
- When making two-sided copies on letterhead paper, place the side with the letterhead face down if using a tray, or face up if using the bypass tray (This is the opposite of normal.).
- Automatic two-sided copying is not possible on thick paper, thin paper, labels, transparency film, envelopes, and other special types of paper.
- Automatic two-sided copying can be disabled in the administrator settings. (See "6. SYSTEM SETTINGS (ADMINISTRATOR)".)
- When dual page copy (p.44) is selected, two-sided original to two sides or two-sided original to one side cannot be used.

USING THE DOCUMENT GLASS

1 Place the original on the document glass. (p.23)

2 Touch the [2-SIDED COPY] key.

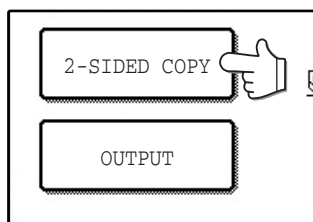

3 Touch the [One-sided to two-sided copy] key.

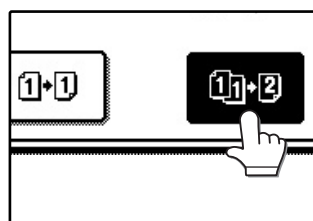

Touch the [BINDING CHANGE] key when making the tablet binding, or when making automatic two-sided copies of a one-sided 11" x 17" or 8-1/2" x 14" size portrait original, touch the [BINDING CHANGE] key.

Portrait-oriented original
(11" x 17" or 8-1/2" x 14" size)

Before [BINDING CHANGE] After [BINDING CHANGE]

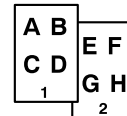
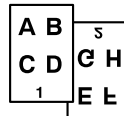

4 Touch the [OK] key.

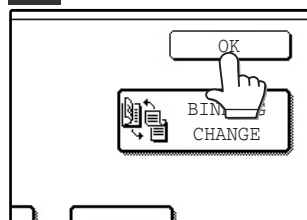

- 5** Make sure that a suitable paper size is automatically selected, or select another size using the [PAPER SELECT] key.

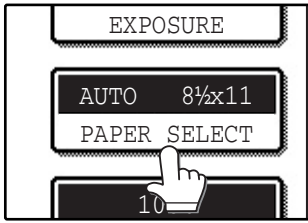

- 6** Select the number of copies and any other desired copy settings, and then press the [START] key (⊙).

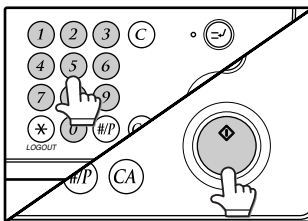

The original for the front side is scanned.

- 7** Remove the first original and then place the original for the back side on the document glass. Close the RSPF and then press the [START] key (⊙).

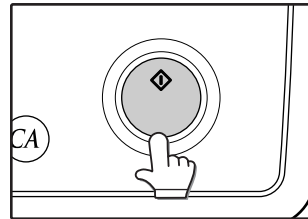

To cancel automatic two-sided copying, press the [CLEAR] key (⊙).



When making two-sided copies of an odd number of originals, touch the [READ-END] key after scanning the last original.

USING THE RSPF

- 1** Place the original(s) in the document feeder tray. (p.24)

- 2** Touch the [2-SIDED COPY] key.

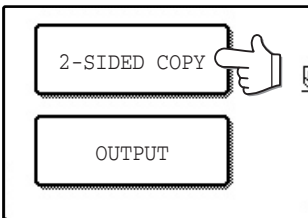

- 3** Touch the desired copy mode.

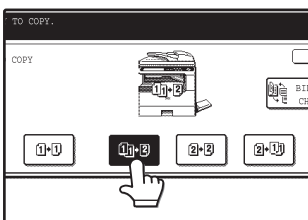

Touch the [BINDING CHANGE] key when making the tablet binding, or when making automatic two-sided copies of a one-sided 11" x 17" or 8-1/2" x 14" size portrait original, touch the [BINDING CHANGE] key.

Portrait-oriented original
(11" x 17" or 8-1/2" x 14" size)

Before [BINDING CHANGE] After [BINDING CHANGE]

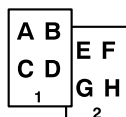
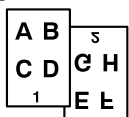

- 4** Touch the [OK] key.

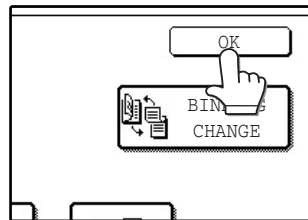

- 5** Make sure that a suitable paper size is automatically selected, or select another size using the [PAPER SELECT] key.

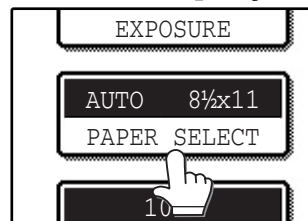

- 6** Select the number of copies and any other desired copy settings, and then press the [START] key (⊙).

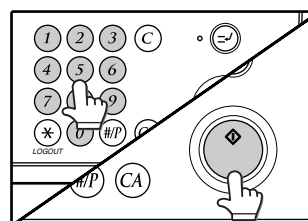

EXPOSURE ADJUSTMENT

SELECTING THE ORIGINAL IMAGE TYPE AND MANUALLY ADJUSTING THE EXPOSURE

[AUTO] is selected by default for automatic adjustment of the exposure according to the original. If you wish to specify the original image type or manually adjust the exposure, place the original in the RSPF or on the document glass, check the paper size, and then perform the following steps.

1 Touch the [EXPOSURE] key.

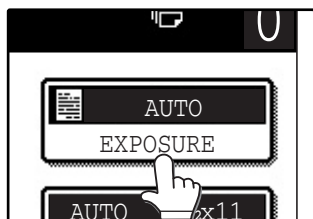

2 Select [TEXT], [TEXT/PHOTO], or [PHOTO] as appropriate for the original.

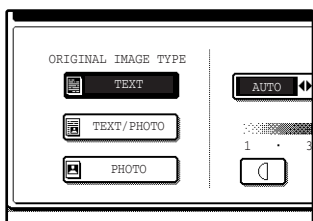

Selecting the original image type

- Three original image type selections are available.

TEXT	Use for regular text, blueprints, and light pencil writing.
TEXT/PHOTO	Use for mixed text/photo originals and printed photos.
PHOTO	Use for photos and when you desire clearer halftones.

- Automatic exposure adjustment can only be selected when [TEXT] is selected for the original image type.

3 Manually adjust the copy exposure.

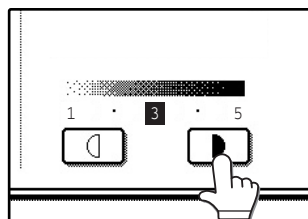

If [TEXT] was selected for the original image type, touch the [AUTO] key to select [MANUAL] and then adjust the copy exposure.

Touch the key to make darker copies.
Touch the key to make lighter copies.



Exposure value guidelines

- 1 - 2 Dark originals like newspapers
- 3 Normal originals
- 4 - 5 Light colored text or text written in pencil

To change back to automatic exposure adjustment, follow these steps:

- 1 Touch the [EXPOSURE] key.
- 2 Touch the [TEXT] key.
The [AUTO] key appears when [TEXT] is selected.
- 3 Touch the [AUTO] key so that [AUTO] is highlighted.
- 4 Touch the [OK] key.

4 Touch the [OK] key.

You will return to the main screen of copy mode.

- 5 Check the paper size, select the number of copies and any other desired copy settings, and then press the [START] key (⏻).

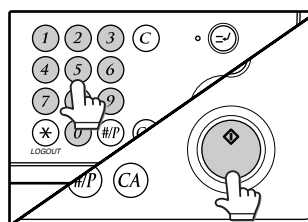

REDUCTION/ENLARGEMENT/ZOOM

There are three ways to enlarge and reduce copies:

- Automatic ratio selection according to the paper size AUTOMATIC RATIO SELECTION (below)
- Specifying a ratio with the reduce key, enlarge key, or zoom key MANUAL RATIO SELECTION (p.32)
- Separately selecting vertical and horizontal ratios XY ZOOM copying (p.33)

Ratios that can be selected vary depending on the following conditions:

Original position	Selectable ratios
Document glass	25 to 400%
RSPF	50 to 200%

AUTOMATIC RATIO SELECTION

The ratio is automatically selected based on the original size and paper size.

2

1 Place the original(s). (p.23, p.24)

The original size appears in the touch panel.



- If the original size does not appear in the touch panel, specify the original size manually. (p.48)
- Automatic ratio selection is not possible if the original or paper is a non-standard size.



- When automatic ratio selection is selected, the [AUTO IMAGE] key is highlighted in the main screen.
- If the original and paper are in different orientations, the image is automatically rotated to match the paper orientation (for paper sizes 8-1/2" x 11" (A4) or less).
- Rotation of the image can be disabled in the administrator settings. (See "6. SYSTEM SETTINGS (ADMINISTRATOR)".)
- If "IMAGE IS LARGER THAN THE COPY PAPER." appears in the touch panel, part of the image will be cut off in the copy.

2 Touch the [PAPER SELECT] key and then select the desired paper size.

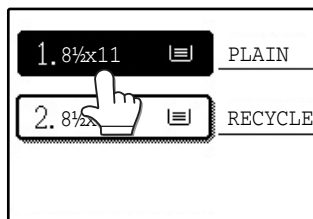

The selected key is highlighted and the paper selection screen closes.



If paper of the desired size is not loaded in any of the trays, load paper of the required size in a paper tray or in the bypass tray. (p.19)

4 Select the number of copies and any other desired settings, and then press the [START] key (⊙).

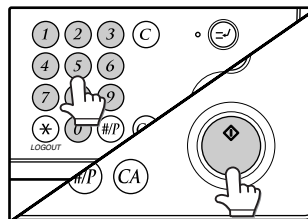

3 Touch the [AUTO IMAGE] key.

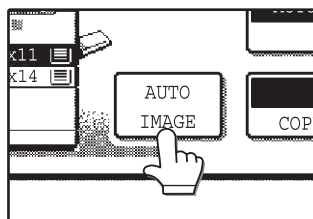



A suitable ratio is selected based on the original size and selected paper size. (The ratio appears in the touch panel.)



To cancel automatic ratio selection, touch the [AUTO IMAGE] key. Automatic ratio selection also turns off automatically when the enlargement key, the reduction key, or a [ZOOM] key (⏪/⏩) is touched to allow the ratio to be selected.

MANUAL RATIO SELECTION

There are four preset reduction ratios and four preset enlargement ratios.
In addition, the [ZOOM] keys (, ) can be pressed to select the ratio in increments of 1%.

1 Place the original(s). (p.23, p.24)

2 Touch the [COPY RATIO] key.

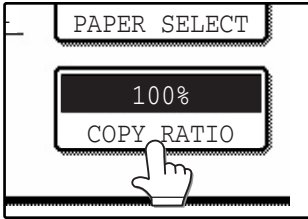

3 Use the [MENU] key to select menu [1] or menu [2] for copy ratio selection.

Menu 1

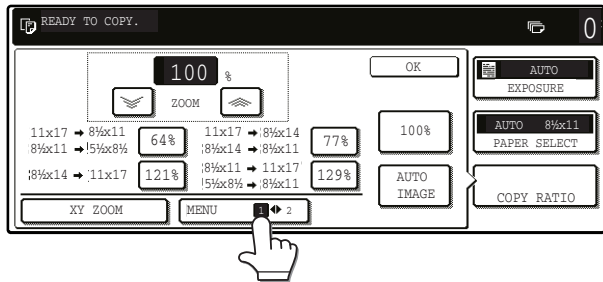

- Preset reduction keys : 64%, 77%
- Preset enlargement keys : 121%, 129%
- [100%] key 100%



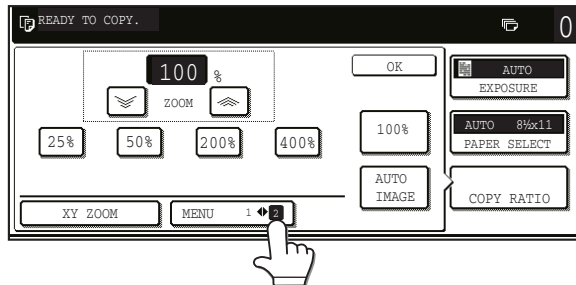



Menu 2

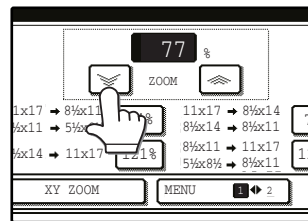
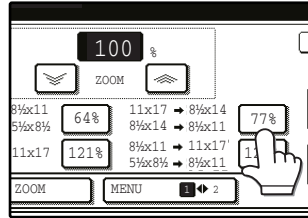



- Preset reduction keys : 25%, 50%
- Preset enlargement keys : 200%, 400%
- [100%] key 100%

4 Use the enlargement key or reduction key, or the [ZOOM] key (,) to set the desired copy ratio.



The [ZOOM] keys (, ) can be used to change the ratio in increments of 1%. Touch the  key to increase the ratio or the  key to decrease the ratio. Continuing to touch a [ZOOM] key (, ) makes the ratio change faster.



- Touch a reduction or enlargement key to set the approximate ratio, then touch the  key to decrease the ratio or the  key to increase the ratio.
- If "IMAGE IS LARGER THAN THE COPY PAPER." appears, the selected copy ratio is too large for the paper size. However, if you press the [START] key (), a copy will be made.

5 Touch the [OK] key.

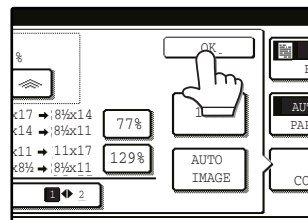

6 Make sure that a suitable paper size is automatically selected, or select another size using the [PAPER SELECT] key.

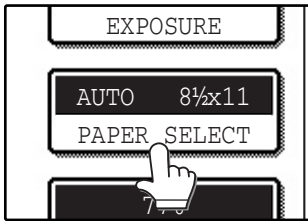

If AUTO PAPER SELECT is enabled, the appropriate copy paper size is automatically selected based on the original size and selected copy ratios.

7 Select the number of copies and any other desired copy settings, and then press the [START] key (⏻).

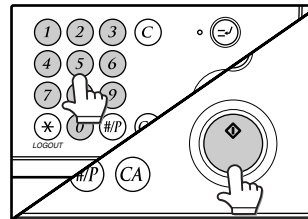

To return the ratio setting to 100%, touch the [COPY RATIO] key to display the ratio menu and then touch the [100%] key. (p.32, step 3)

2

SELECTING THE VERTICAL AND HORIZONTAL COPY RATIOS SEPARATELY (XY ZOOM copying)

The XY ZOOM feature allows the horizontal and vertical copy ratios to be changed independently.

Example: Vertical ratio set to 100% and horizontal ratio set to 50%.

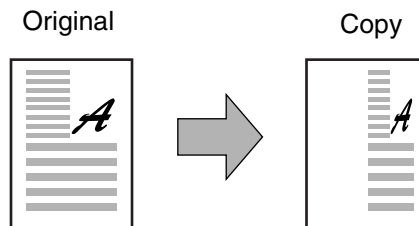

- The AUTO IMAGE/MULTI SHOT/PAMPHLET COPY feature cannot be used in combination with the XY ZOOM function.
- To use the XY ZOOM feature with the DUAL PAGE COPY feature (p.44), set the DUAL PAGE COPY feature first and then the XY ZOOM feature.

1 Place the original(s). (p.23, p.24)

2 Touch the [COPY RATIO] key.

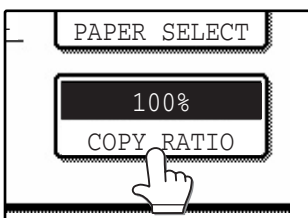

3 Touch the [XY ZOOM] key.

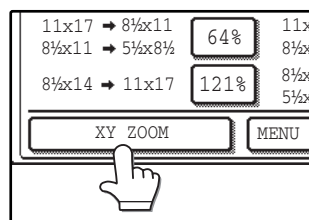

4 Touch the [X] key.

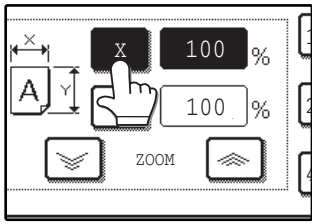

The [X] key is selected (highlighted) by default, so there is normally no need to perform this step (Go to step 5.). If the [X] key is not highlighted, perform this step.

5 Use the reduction, enlargement, and [ZOOM] keys ([] / []) to change the copy ratio in the horizontal (X) direction.

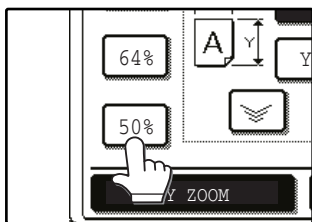

A fixed ratio key will not become highlighted when touched.

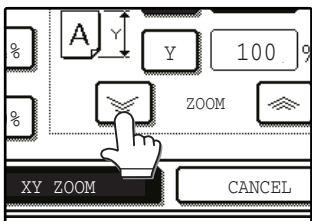

The [ZOOM] keys ([] / []) can be used to change the ratio in increments of 1%. Touch the [] key to increase the ratio, or the [] key to decrease the ratio. Continuing to touch a [ZOOM] key ([] / []) makes the ratio change faster.

Note Touch a reduction or enlargement key to set the approximate ratio, then touch the [] key to decrease the ratio or the [] key to increase the ratio.

6 Touch the [Y] key.

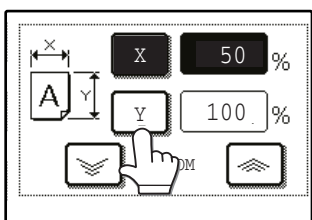

7 Use the reduction, enlargement, and [ZOOM] keys ([] / []) to change the copy ratio in the vertical (Y) direction.

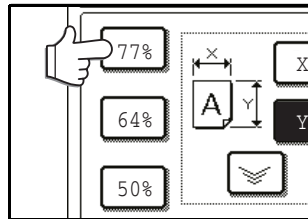

A fixed ratio key will not become highlighted when touched.

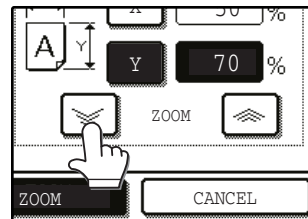

If you need to readjust the horizontal ratio, touch the [X] key again.

8 Touch the [OK] key.

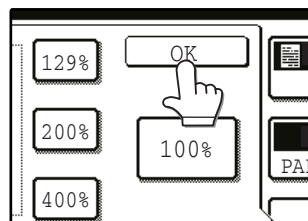

9 Make sure that a suitable paper size is automatically selected, or select another size using the [PAPER SELECT] key.

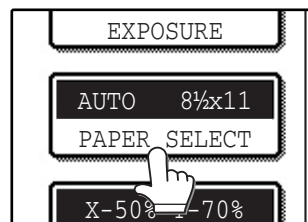

If AUTO PAPER SELECT is enabled, the appropriate copy paper size is automatically selected based on the original size and selected copy ratios.

10 Select the number of copies and any other desired copy settings, and then press the [START] key ([]).

Note To cancel this function, touch the [CANCEL] key in the XY ZOOM screen.

INTERRUPTING A COPY RUN

A copy run can be temporarily interrupted to allow another copy job to be performed. When the other job is finished, the copy run will resume using the original copy settings.



Automatic two-sided copying, sort/group copying, staple sort, pamphlet copy, job build, cover copy, job build, job programs, card shot, or multi shot copying cannot be used for interrupt copying.

1 Press the [INTERRUPT] key (⊖) to interrupt the copy run.

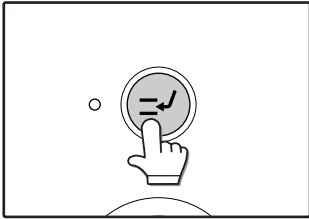

The [INTERRUPT] key (⊖) blinks until the machine is ready for the interrupt job, after which it lights steadily.

If you decide to cancel the interrupt job while selecting settings, press the [INTERRUPT] key (⊖).



- If audit mode is enabled, a message will appear prompting you to enter your account number. Enter your account number with the numeric keys. The copies that you make will be added to your account's count.
- If an original is being scanned when the [INTERRUPT] key (⊖) is pressed, the interrupt job will begin after the original is scanned. If a copy is being printed, the interrupt job will begin after the copy is printed.

2 Remove the previous original(s) and place the original(s) of the interrupt copy job. (p.23, p.24)

3 Select the number of copies and any other desired copy settings, and then press the [START] key (⊙).

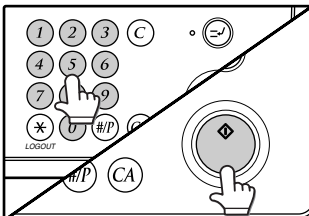

When the finisher is installed, the interrupt copies will be offset from the previous copies. (Offset function, p.36)

4 When the copy job is finished, press the [INTERRUPT] key (⊖) and remove the original(s).

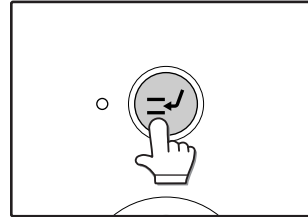

5 Replace the previous original(s) and press the [START] key (⊙) to resume copying.

Replace only the originals that have not yet been scanned.

This chapter explains special finishing functions and other convenient functions.

COPY FINISHING FUNCTIONS

This section explains the sort, group, and offset functions, as well as the staple sort function which is used to staple output collated with the sort function when a finisher is installed.

SORT COPY

This function is used to collate sets of copies. Copies can be output to the job separator tray, or the offset tray or right tray (output tray unit) of the peripheral finisher.

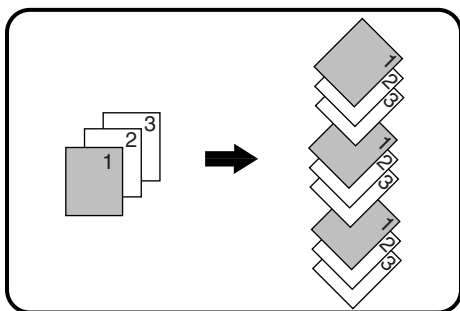

GROUP COPY

This function is used to group sets of copies by page. Copies can be output to the job separator tray, or the offset tray or right tray (output tray unit) of the peripheral finisher.

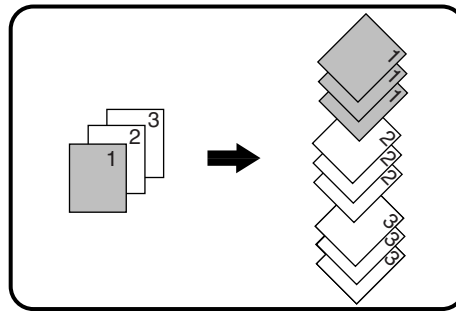

OFFSET FUNCTION (When the finisher is installed)

Each set of copies is offset from the previous set in the output tray, making it easy to distinguish one set from another.

Offset function "ON"

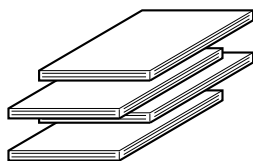

Offset function "OFF"

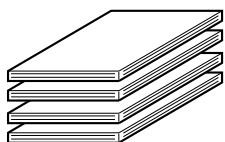

Enabling the offset function

The offset function operates when a checkmark appears in the [OFFSET] checkbox, which is displayed by touching the [OUTPUT] key. (If a checkmark does not appear, touch the checkbox.)

1 Place the originals in the RSPF or on the document glass. (p.23, p.24)

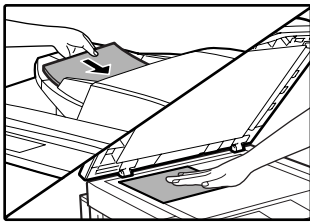

If originals are placed in the RSPF, the sort function is automatically selected. (To disable this function, see the "6. SYSTEM SETTINGS (ADMINISTRATOR)".)

Example: 5 sets of copies or 5 copies per page of 3 originals



2 Touch the [OUTPUT] key.

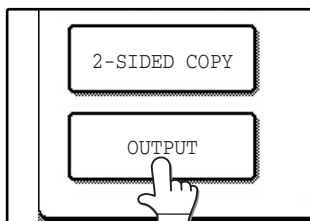

3 Touch the [SORT] or [GROUP] key.

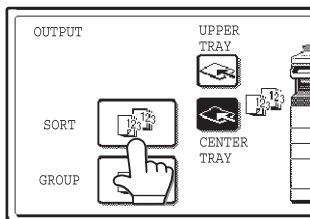

4 Touch the output tray that you wish to use.

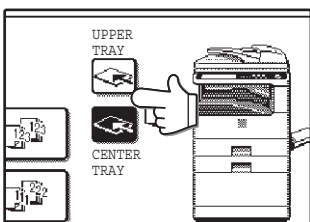

The output tray can only be selected when a job separator or finisher is installed.

Note

To enable the offset function (p.36), touch the [OFFSET] checkbox so that a checkmark appears. To disable the offset function, touch the [OFFSET] checkbox again to clear the checkmark.

5 Touch the [OK] key.

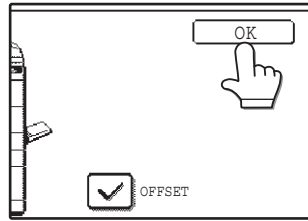

6 Select the number of copies and any other desired copy settings, and then press the [START] key (⊙).

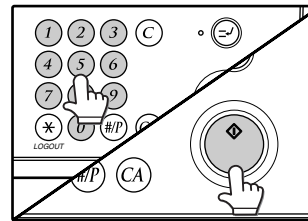

7 [When using the RSPF:]

Copying will start after all the originals are scanned.

[When using the document glass:]

Replace the original with the next original and press the [START] key (⊙). Repeat this step until all originals have been scanned, and then touch the [READ-END] key.

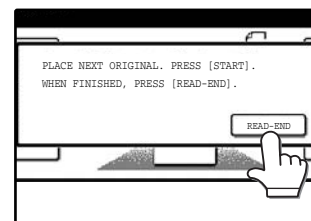

The copies are grouped as follows:

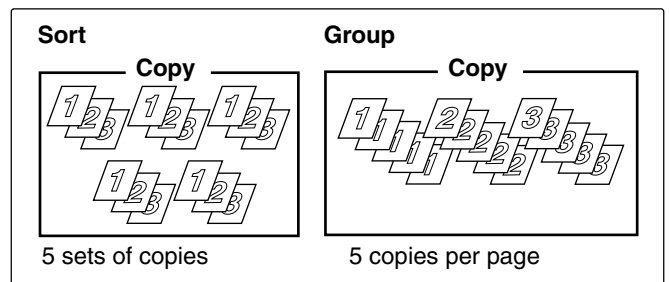

If the memory becomes full while scanning the originals, "MEMORY IS FULL. PRESS [START] TO BEGIN COPYING OR [CA] TO CANCEL." will appear. To copy only the originals that have been scanned, press the [START] key (⊙). To cancel the job, press the [CLEAR ALL] key (Ⓒ).

Note

The number of originals that can be scanned into memory can be increased by increasing the memory allocation in the administrator settings, or by installing more memory. (See "6. SYSTEM SETTINGS (ADMINISTRATOR)".)

STAPLE SORT (when the finisher (MX-FN13) is installed)

This function collates the copies, staples each set, and delivers the sets to the offset tray. The staple sort function can only be used when a finisher is installed.

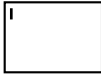
Stapling position	Portrait orientation		Landscape orientation	
Top left corner		Available paper sizes: 8-1/2" x 11" (A4, B5) Stapling capacity: For each size, up to 50 sheets can be stapled.		Available paper sizes: 11" x 17", 8-1/2" x 14", 8-1/2" x 13", 8-1/2" x 11" R (A3, B4, A4R, B5R) Stapling capacity: 11" x 17", 8-1/2" x 14", 8-1/2" x 13" (A3, B4) For each size, up to 30 sheets can be stapled. 8-1/2" x 11"R, (A4R, B5R) For each size, up to 50 sheets can be stapled.

ORIENTATION OF THE ORIGINAL AND STAPLING POSITIONS

Using the RSPF

Insert the originals face up.

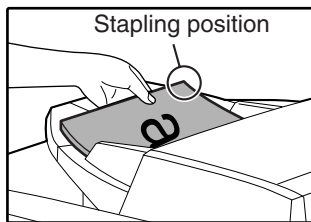

Using the document glass

Place each original face down.

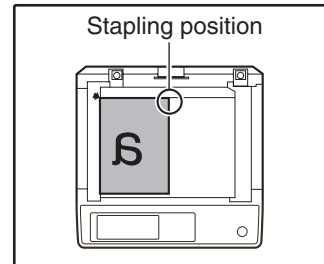

When copying 8-1/2" x 14" or 11" x 17" (B4 or A3) vertically oriented originals, the copies will be stapled at the position shown below.

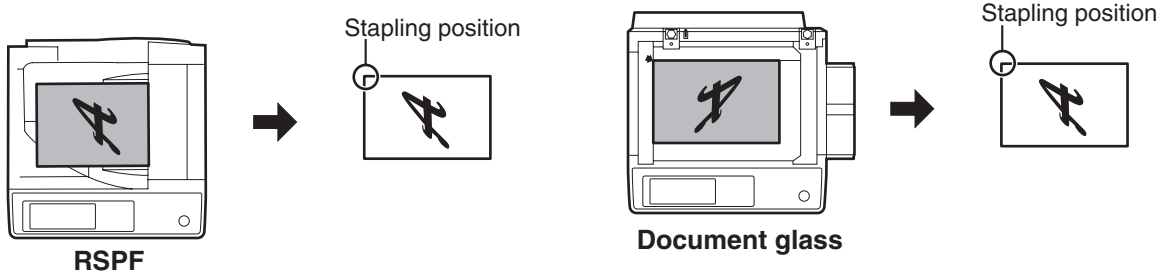

- When using letterhead paper in the staple sort, load the paper with the letterhead to the front or to the right as shown in the diagram.

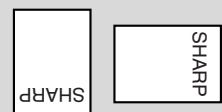

- When the staple sort is used, the automatic original image rotation function does not operate.
- Different sized originals cannot be copied on the corresponding sizes of paper.
- The staple sort function cannot be used if disabled in the administrator settings. (See "6. SYSTEM SETTINGS (ADMINISTRATOR).")
- The offset function (p.36) cannot be used.

1 Place the original(s). (p.23, p.24)

2 Touch the [OUTPUT] key.

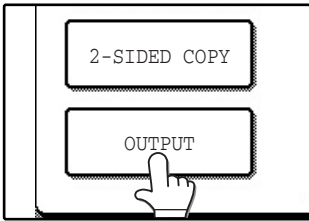

3 Touch the [STAPLE SORT] key.

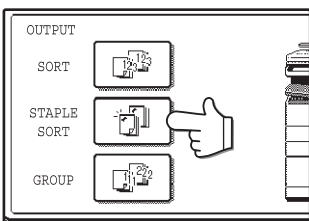

When the [STAPLE SORT] key is selected, the offset tray is automatically selected as the output tray. The top tray and center tray cannot be used.

4 Touch the [OK] key.

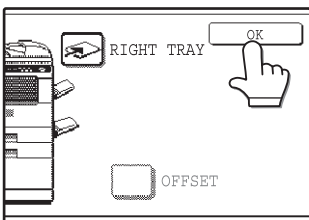

5 Select the number of copies and other copy settings, and then press the [START] key (⊙).

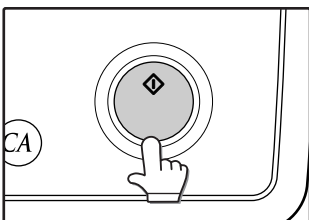

6 [When using the RSPF:]

Copying will start after all originals have been scanned.

[When using the document glass:]

Replace the original with the next original and press the [START] key (⊙). Repeat this step until all originals have been scanned, and then touch the [READ-END] key.

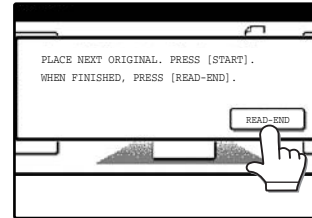

If the memory becomes full while scanning the originals, "MEMORY IS FULL. PRESS [START] TO BEGIN COPYING OR [CA] TO CANCEL." will appear. To copy only the originals that have been scanned, press the [START] key (⊙). To cancel the job, press the [CLEAR ALL] key (Ⓢ).



The number of originals that can be scanned into memory can be increased by increasing the memory allocation in the administrator settings, or by installing more memory. (See "6. SYSTEM SETTINGS (ADMINISTRATOR).")

3

SPECIAL MODES

When the [SPECIAL MODES] key in the main screen of copy mode is touched, the special modes screen will appear. This screen contains the following special function keys.

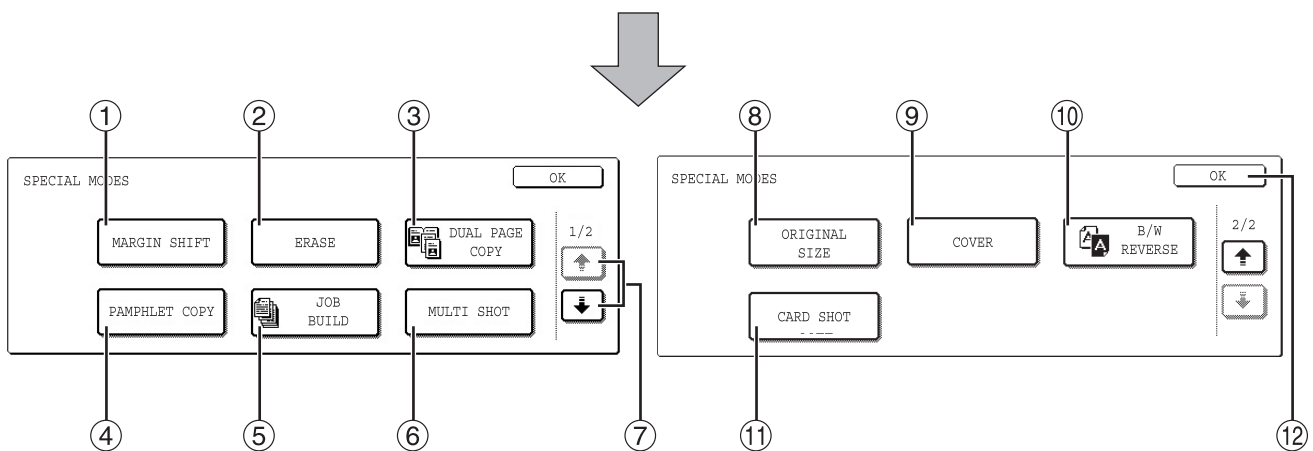
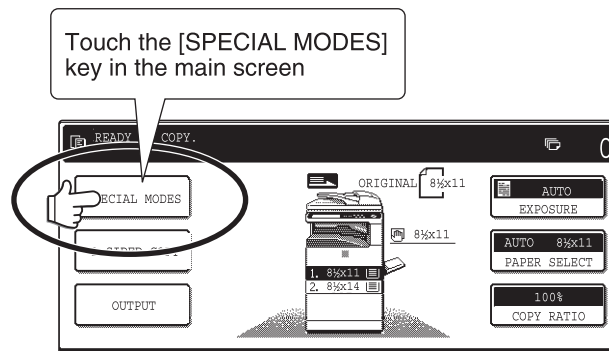

① **[MARGIN SHIFT] key (p.42)**

Use this to shift the image on the copy paper to create binding margins.

② **[ERASE] key (p.43)**

Use this to erase peripheral shadows that occur when making copies of books and other thick originals.

③ **[DUAL PAGE COPY] key (p.44)**

Use this to make separate copies of the left and right pages of bound documents.

④ **[PAMPHLET COPY] key (p.45)**

The pamphlet copy function is used to arrange copies in the proper order for center-stapling and folding into a booklet. Two original pages are copied onto each side of the paper, such that a total of four pages are copied onto one sheet.

⑤ **[JOB BUILD] key (p.46)**

Use this when you need to copy more originals than can be placed in the RSPF at once. This allows you to divide the originals into sets and scan them sequentially in the RSPF.

⑥ **[MULTI SHOT] key (p.47)**

The multi shot copy function is used to copy two or four originals onto one sheet of copy paper in any of four layout patterns.

⑦ **(↓) key, (↑) key**

Use these to change pages in the special functions screen.

⑧ **[ORIGINAL SIZE] key (p.48)**

Use to manually select the original size. When the original size is selected, the auto ratio select function will automatically select an appropriate ratio based on the paper size.

⑨ **[COVER] key (p.49)**

Press this to use a different type of paper for front and back covers (When the RSPF is used.).

⑩ **[B/W REVERSE] key (p.51)**

Use to reverse black and white areas.

⑪ **[CARD SHOT] key (p.52)**

The front and reverse sides of a card can be copied onto one sheet of paper.

⑫ **[OK] key**

Touch to return to the main screen of the copy mode.



Note Some functions cannot be used in combination with each other. If a prohibited combination of functions has been selected, a message will appear in the touch panel.

GENERAL PROCEDURE FOR USING THE SPECIAL FUNCTIONS

1 Touch the [SPECIAL MODES] key.

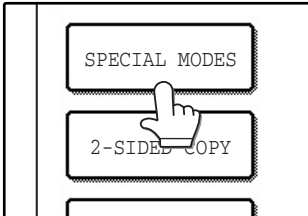

2 Touch the key of the desired special mode.

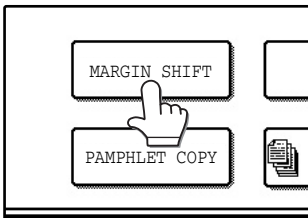

Example:
Selecting the margin shift function

3

Procedures for modes that require further settings are explained starting on the next page.

MARGIN SHIFT COPY

The margin shift function is used to automatically shift the text or image on the copy paper approximately 1/2" in its initial setting.

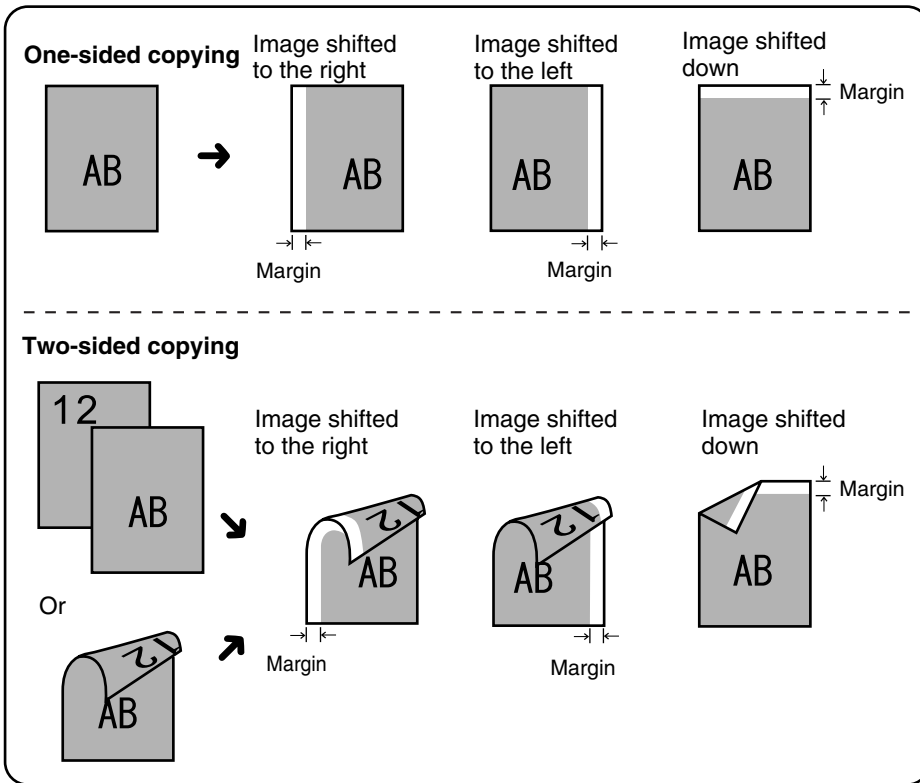

- Right, left or down can be selected for the shift direction as shown in the illustration.
- The shift width (margin) can be set from 0" to 1" in increments of 1/8".
- If [DOWN] key is selected, set the original(s) so that the margin to be increased is set to the rear side of the RSPF or the document glass.

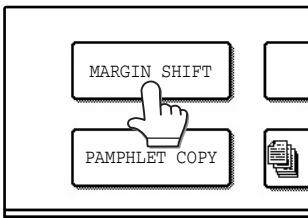

1 Touch the [MARGIN SHIFT] key in the special modes screen.

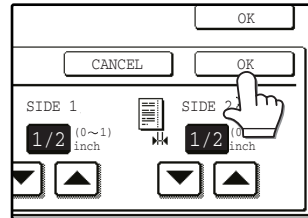

The margin shift setting screen will appear. The margin shift icon (, etc.) will also appear in the screen to indicate that the function is turned on.

3 Adjust the shift width as needed and touch the [OK] key.



Use the  and  keys to set the shift width. The shift amount can be set from 0" to 1" in increments of 1/8".

2 Select the shift direction.

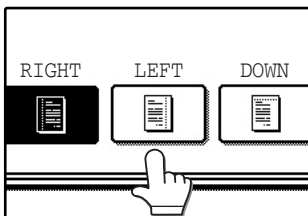

Touch the [RIGHT], [LEFT], or [DOWN] key. The selected key will be highlighted.

4 Touch the [OK] key in the special modes screen.

You will return to the main screen of copy mode.

About the steps that follow

If you are using the document glass, see page 23.
If you are using the RSPF, see page 24.



- When margin shift is selected, rotation copying will not function.
- This feature cannot be used with paper that is not a standard size.
- To cancel the margin shift function, touch the [CANCEL] key in the margin shift setting screen. (See the screen of step 3.)

ERASE COPY

The erase function is used to erase the shadow lines on copies that are produced when copying thick originals or books. The erase modes that can be selected are shown below. The erase width is initially set to 1/2".

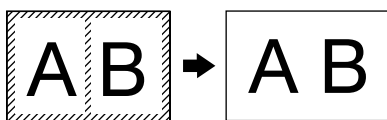
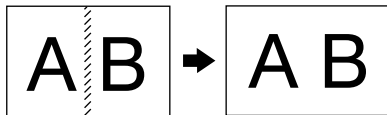
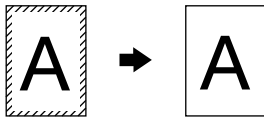

EDGE ERASE

Eliminates shadow lines around the edges of copies caused when heavy paper or a book is copied.

CENTER ERASE

Eliminates shadow lines produced by the bindings of bound documents.

EDGE + CENTER ERASE

Eliminates both the shadow lines around the edges of copies and the shadow at the center.

3

1 Touch the [ERASE] key in the special modes screen.

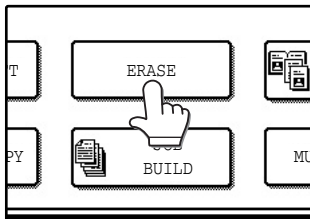

The erase setting screen will appear. The erase icon (, etc.) will also appear in the screen to indicate that the function is turned on.

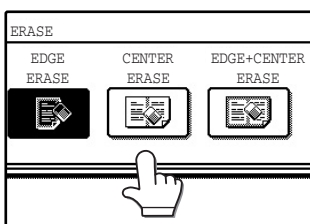

2 Select the desired erase mode.

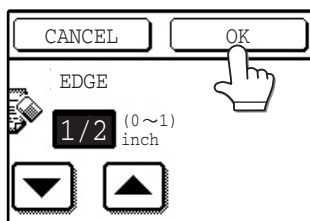

Select one of the three erase modes. The selected key will be highlighted.

3 Adjust the erase width as needed and touch the [OK] key.



Use the  and  keys to adjust the erase width. The erase width can be set from 0" to 1" in increments of 1/8".

4 Touch the [OK] key in the special modes screen.

You will return to the main screen of copy mode.

About the steps that follow

If the document glass is being used, see page 23.
If the RSPF is being used, see page 24.



- This feature cannot be used with non-standard size originals.
- This feature cannot be selected when mixed feeding (p.26) is used.
- To cancel the erase copy function, touch the [CANCEL] key in the erase setting screen. (See the screen of step 3.)

DUAL PAGE COPY

The dual page copy function produces separate copies of two adjoining pages on the document glass. It is especially useful when copying books and other bound documents.

[Example] Copying the right and left pages of a book

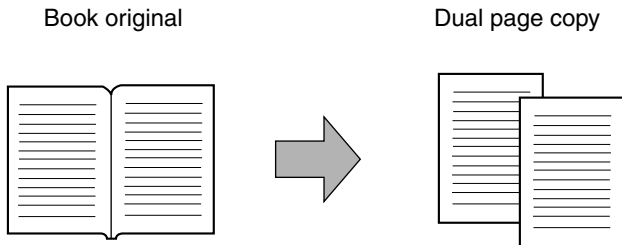

- A reduction setting can be selected when using the dual page copy function, however, an enlargement setting cannot be selected.
- The dual page copy function can only be used when copying from the document glass. The RSPF cannot be used.
- Only 8-1/2" x 11" paper can be used.

1 Touch the [DUAL PAGE COPY] key in the special modes screen.

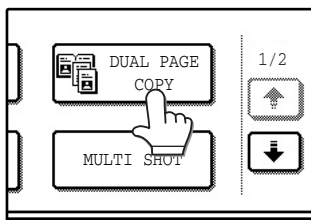

The [DUAL PAGE COPY] key is highlighted to indicate that the function is enabled, and the dual page copy icon (📄) will appear in the screen.

When copying book originals:

When copying a thick book, press down gently on the book to flatten it against the document glass.

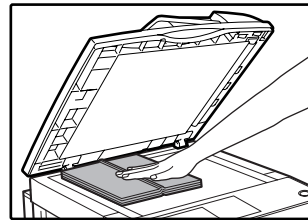

2 Touch the [OK] key in the special modes screen.

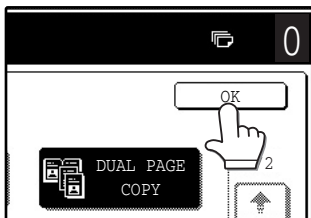

You will return to the main screen of copy mode.

4 Make sure that 8-1/2" x 11" size paper is selected.

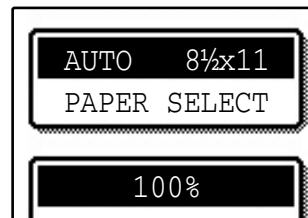

If 8-1/2" x 11" size paper is not selected, touch the [PAPER SELECT] key to select 8-1/2" x 11" paper.

3 Place the originals on the document glass. (p.23)

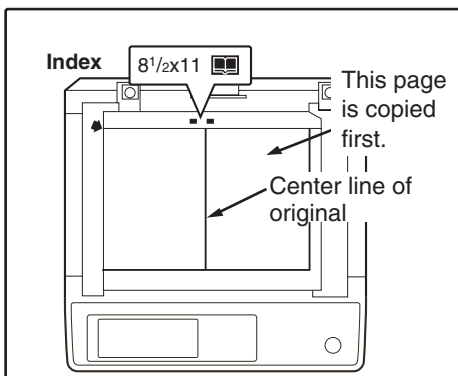

5 Select the number of copies and any other desired copy settings, and then press the [START] key (⏻).

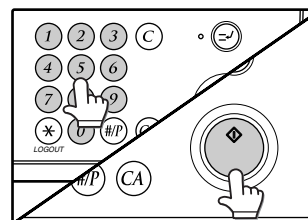

Note

- To cancel the dual page copy function, touch the [DUAL PAGE COPY] key in the special modes screen. (The key will no longer be highlighted.) (See the screen of step 1.)
- To erase shadows caused by the document binding, use the edge erase function (p.43). (Center Erase and Edge + Center Erase cannot be used with the dual page copy function.)

PAMPHLET COPY

The pamphlet copy function is used to arrange copies in the proper order for center-stapling and folding into a booklet. Two original pages are copied onto each side of the copy paper, such that a total of four pages are copied onto each sheet.

This function is convenient for arranging copies into an attractive booklet or pamphlet.

[Example]: Copying 8 originals with pamphlet copy

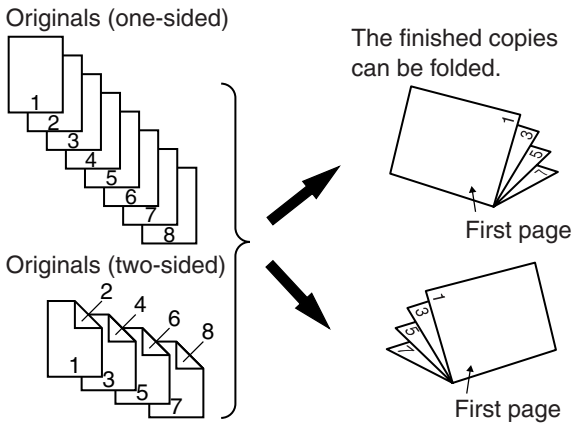

- Scan the originals in order from the first page to the last page. The order of copying will be automatically adjusted by the machine.
- Either left binding (opening from right to left) or right binding (opening from left to right) can be selected.
- Four originals will be copied onto one sheet. Blank pages may be automatically added at the end, depending on the number of the originals.

3

1 Touch the [PAMPHLET COPY] key in the special modes menu screen.

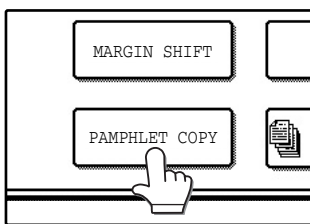

The pamphlet copy setting screen will appear. The pamphlet copy icon (📄, etc.) will also appear in the upper left corner of the screen to indicate that the function is enabled.

2 Specify whether 1-sided or 2-sided originals will be copied.

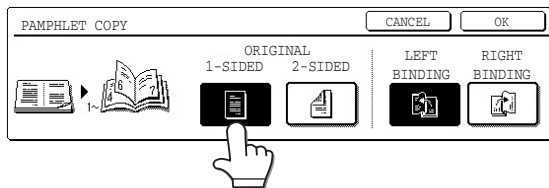

3 Select the binding position ([LEFT BINDING] or [RIGHT BINDING]) and then touch the [OK] key in the pamphlet copy setting screen.

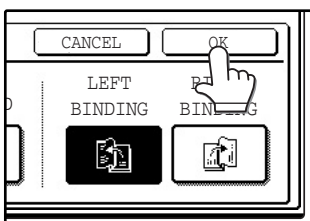

You will return to the special modes menu screen.

4 Touch the [OK] key in the special modes screen.

You will return to the main screen of copy mode.

5 Place the original(s). (p.23, p.24)

6 Make sure that a suitable paper size has been automatically selected.

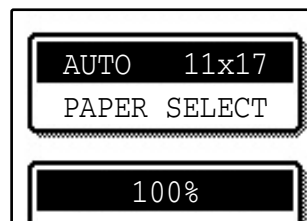

If the desired copy paper size is not selected, use the [PAPER SELECT] key to select the paper size. After the paper size is selected, touch the [AUTO IMAGE] key. A suitable ratio will be automatically selected.

7 Select the number of copies and any other desired copy settings, and then press the [START] key (⊙).

8 [When using the RSPF:]

Copying will start after all originals have been scanned.

[When using the document glass:]

Replace the original with the next original and press the [START] key (⊙). Repeat this step until all originals have been scanned, and then touch the [READ-END] key.

When the pamphlet copy function is selected, two-sided copying will be automatically enabled.



Note To cancel the pamphlet copy function, touch the [CANCEL] key in the pamphlet copy setting screen. (See the screen of step 2.)

JOB BUILD MODE

Use this function when you need to copy more originals than can be placed in the RSPF at once. (The maximum number of originals that can be placed in the RSPF at once is 100.)



- If the memory becomes full while scanning the originals, "MEMORY IS FULL. PRESS [START] TO BEGIN COPYING OR [CA] TO CANCEL." will appear. To copy only the originals that have been scanned, press the [START] key (☺). To cancel the job, press the [CLEAR ALL] key (☹).
- Depending on the content of the originals, the memory may become full before 100 originals have been scanned. In this case, press the [START] key (☺) to copy the originals that have been scanned, and then place the originals that weren't scanned in the RSPF once again and repeat the copy procedure.
- To increase the number of originals that can be scanned, install more memory or increase the memory allocation in the administrator settings. (See "6. SYSTEM SETTINGS (ADMINISTRATOR)".)

Example: Copying 130 sheets (8-1/2" x 11" size originals)

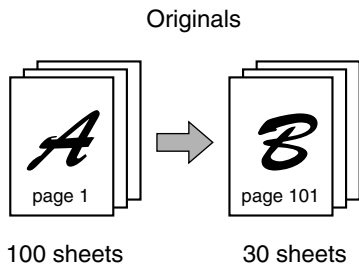

* Divide the originals into sets so that each set is no more than 100 pages. Scan the sets in order beginning from the first page of set A.

1 Touch the [JOB BUILD] key in the special modes menu screen.

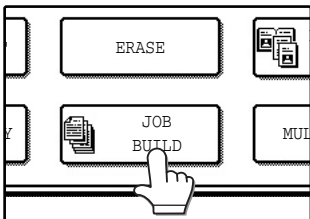

The [JOB BUILD] key is highlighted. The job build copy icon (☺) will also appear in the screen to indicate that the function is enabled.

2 Touch the [OK] key in the special modes screen.

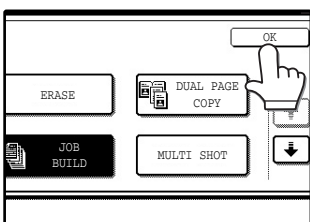

You will return to the main screen of copy mode.

3 Place the original(s) in the RSPF. (p.24)

4 Make sure that a suitable paper size is selected, select the number of copies and any other desired copy settings, and then press the [START] key (☺).

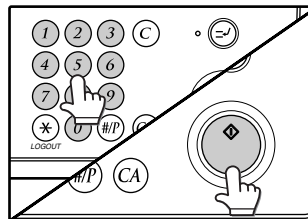

Scanning begins. When scanning of the first set of originals (A in the above example) is finished, insert the second set and press the [START] key (☺).

Repeat this step until all the remaining originals (B in the above example) have been scanned. Remove each scanned set of originals before inserting the next set.

5 Touch the [READ-END] key.

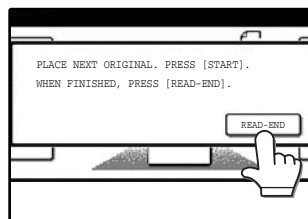

Copying begins.



To cancel the job build mode function, touch the [JOB BUILD] key in the special modes screen so that it is no longer highlighted. (See the screen of step 1.)

MULTI SHOT COPY

The multi shot copy function is used to copy two or four originals onto one sheet of copy paper in a specified order.

Example: Copying four originals onto one sheet of paper
(Page number: 4 in 1 (☐), layout: (1/2 3/4))

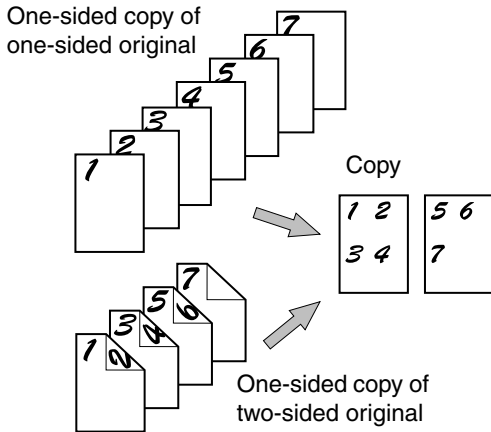

- When using the multi shot copy function, place the originals, select the desired paper size, and select the copy mode before selecting the multi shot copy function in the special modes screen.
- When using the multi shot copy function, the appropriate copy ratio will be automatically set based on the original size, paper size, and the number of originals to be copied onto one sheet. The minimum reduction ratio is 25%. (The minimum ratio is 50% when the RSPF is used.) Depending on the original size, paper size, and the number of originals to be copied onto one sheet, portions of original images may be cut off.

3

1 Touch the [MULTI SHOT] key in the SPECIAL MODES menu screen.

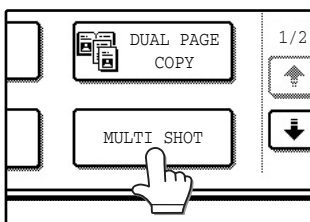

The multi shot copy setting screen will appear. The multi shot copy icon (☐, etc.) will also appear in the screen to indicate that the function is enabled.

2 Select the number of originals to be copied onto one sheet in the multi shot copy selection screen.

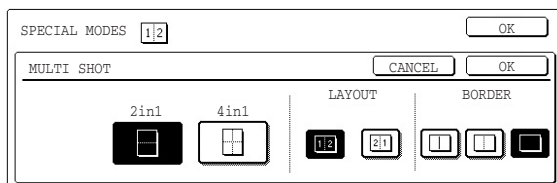

4 Select a borderline setting.

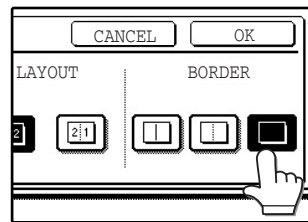

Select [☐], [☐], or [☐].

5 Touch the [OK] key in the multi shot setting screen.

You will return to the special modes menu screen.

6 Touch the [OK] key in the special modes menu screen.

You will return to the main screen of copy mode.

3 Select the layout.

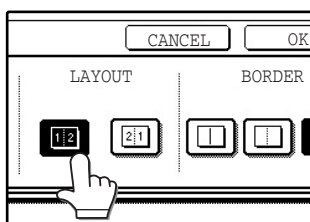

Select the order in which the originals will appear on the copy.

7 Select the number of copies and any other desired copy settings, and then press the [START] key (⊙).

8 [When using the RSPF:]

Copying will start after all originals have been scanned.

[When using the document glass:]

Replace the original with the next original and press the [START] key (⊙). Repeat this step until all originals have been scanned, and then touch the [READ-END] key if necessary.



- The images may be rotated depending on the number of originals and the orientation of the originals and copy paper.
- To cancel the multi shot copy function, touch the [CANCEL] key in the multi shot setting screen (the screen of step 2).

ORIGINAL SIZE

If you wish to use the paper other than the automatically selected original size, original size setting is specified by the special modes. The mix feeding setting (p.26) is also selected here.

1 Touch the **[+]** key and then touch the **[ORIGINAL SIZE]** key in the special modes menu screen.

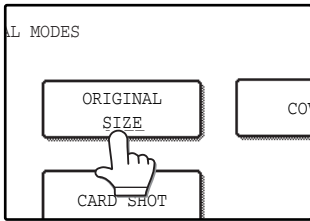

The original size setting screen will appear.

5 Touch the **[OK]** key in the special modes menu screen.

You will return to the main screen of the copy mode.



To select mixed feeding, select the "MIX SIZE ORIGINAL FEEDING MODE" checkbox. Mixed feeding is explained on page 26.

2 Touch the **[MANUAL]** key.

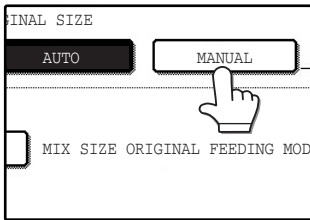

3 Select the original size.

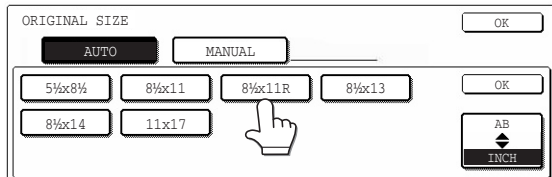

[MANUAL] key is highlighted and the selected paper size is displayed.



To select an AB size original, touch the [AB ◀ INCH] key. AB sizes will appear.

4 Touch the inside **[OK]** key.

You will return to the special modes menu screen.

COVER COPY

Cover copy mode is used to add a cover to the front or back, or both the front and back, of a multipage document. To use cover copy mode, the RSPF must be used.

Copying onto a cover

One-sided copies from one-sided or two-sided originals

One-sided originals → One-sided copies (copying onto a cover)

Two-sided originals → One-sided copies (copying onto a cover)

Two-sided copies from one-sided or two-sided originals

One-sided originals → Two-sided copies (copying onto a cover)

Two-sided originals → Two-sided copies (copying onto a cover)

- A front cover, back cover, or both a front and a back cover can be selected.
- You can specify whether or not the front cover is copied on.
- Copying is not possible on either side of a back cover.

Not copying onto a cover

One-sided copies from one-sided or two-sided originals

One-sided originals → One-sided copies (not copying onto a cover)

Two-sided originals → One-sided copies (not copying onto a cover)

Two-sided copies from one-sided or two-sided originals

One-sided originals → One-sided copies (not copying onto a cover)

Two-sided originals → Two-sided copies (not copying onto a cover)

- A front cover, back cover, or both a front and a back cover can be selected.

1 Touch the  key and then touch the [COVER] key in the special modes menu screen.

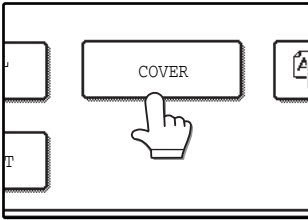

The cover setting screen will appear. The cover icon (, etc.) will also appear in the screen to indicate that the function is turned on.

2 Select the cover(s) that you wish to add.

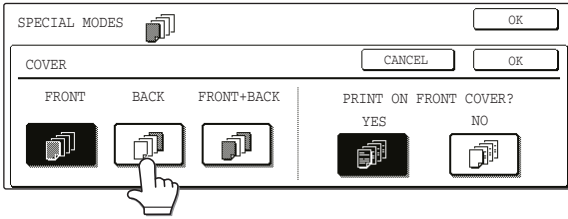

To add only a front cover, touch the [FRONT] key. To add only a back cover, touch the [BACK] key. To add both a front and back cover, touch the [FRONT+BACK] key.

3 Specify whether or not the front cover is to be copied on.

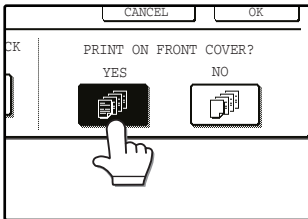

Select [YES] or [NO] in the touch panel. If [YES] is selected, the first page of the document will be copied onto the front cover sheet.

4 Touch the [OK] key in the cover setting screen.

Return to the special modes screen.

5 Touch the [OK] key in the special modes screen.

You will return to the main screen of copy mode.

6 Load the cover paper to be used into the bypass tray.

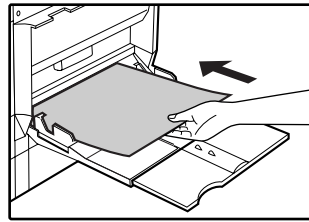

Load the same size of paper as the paper to be used for the copy job.

About the steps that follow
See page 24.

 **Note**

- It is not possible to copy on the inside of a front cover, nor on either side of a back cover.
- Be sure to place the originals in the RSPF. The document glass cannot be used for this function.
- During cover copying, stream feeding mode will not function even if enabled in the administrator settings. (See "6. SYSTEM SETTINGS (ADMINISTRATOR)".)
- To cancel the cover copy function, select the cover copy function again and touch the [CANCEL] key. (See the screen of step 2.)

B/W REVERSE COPY

The B/W REVERSE feature is used to reverse black and white in a copy to create a negative image.

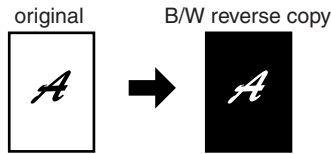

- When the B/W reverse function is selected, the exposure mode will be automatically set to TEXT mode. Other exposure modes cannot be selected. If B/W reverse is canceled, TEXT mode will not automatically be canceled.

1 Touch the  key and then touch the [B/W REVERSE] key in the special modes menu screen.

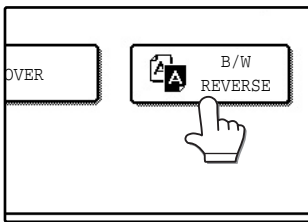

The [B/W REVERSE] key is highlighted. The B/W reverse icon () will also appear in the screen to indicate that the function is enabled.

2 Touch the [OK] key in the special modes screen.

You will return to the main screen of copy mode.

About the steps that follow

If the document glass is being used, see page 23.
If the RSPF is being used, see page 24.



To cancel the B/W reverse copy function, touch the [B/W REVERSE] key in the special modes screen. (The key will no longer be highlighted.) (See the screen of step 1.)

3

CARD SHOT

The front and back of a card can be copied onto one sheet of paper. This function is convenient for making copies for certification purposes and helps save paper.

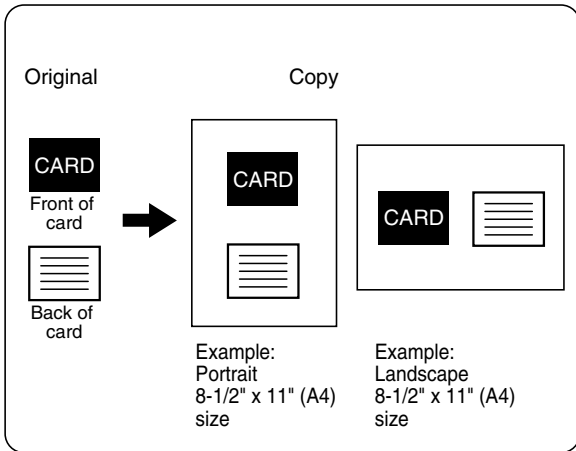

- Copying is only possible on standard size paper.
- The image cannot be rotated when using this function.

1 Make sure that a suitable paper size is selected, or select another size using the [PAPER SELECT] key.

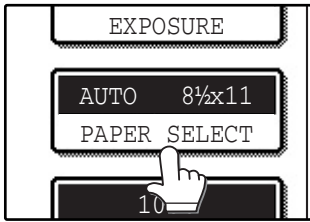

2 Touch the [] key and then touch the [CARD SHOT] key in the special modes screen.

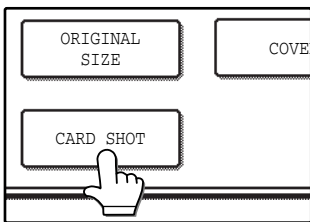

The CARD SHOT setting screen will appear. A card shot icon () will also appear in the upper left corner of the screen to indicate that the function is turned on.

3 Enter the X dimension (width) and Y dimension (length) of the original card with the [] [] keys.

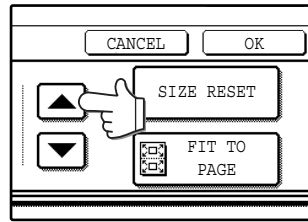

- X (width) is initially selected. Enter X dimension and then touch the Y () key to enter Y dimension.
- To change the X or Y value back to the default value, touch the [SIZE RESET] key. The default values can be changed in the administrator settings. (See "6. SYSTEM SETTINGS (ADMINISTRATOR).")
- To have the images enlarged or reduced by a suitable ratio based on the entered original size so that the front and back sides fit into the selected paper size, touch the [FIT TO PAGE] key.

4 Touch the outer [OK] key.

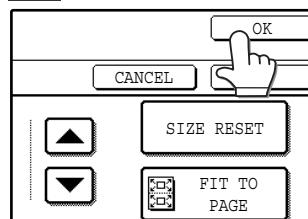

You will return to the main screen of copy mode.

5 Place the original on the document glass.

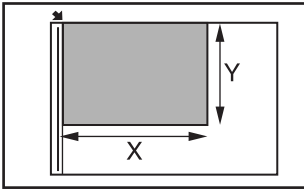

Place the front side of the original face down and close the document cover/RSPF.

6 Select the number of copies and any other desired copy settings, and then press the [START] key (⊙).

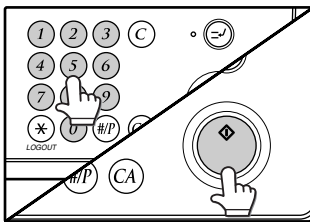

The front side of the card is scanned.

7 Place the back side of the original face down on the document glass.

8 Press the [START] key (⊙).

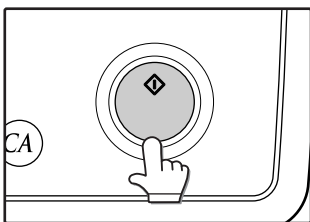

The back side of the card is scanned and copying begins.

Note

- The original must be placed on the document glass. The RSPF cannot be used.
- Even when [FIT TO PAGE] is selected, you can touch the [COPY RATIO] key in the main screen of copy mode to manually select the ratio.
- To cancel the card shot function, touch the [CANCEL] key in the card shot setting screen (the screen of step 4).

INTRODUCTION

The network scanner expansion Kit enables the machine to be used as a network scanner.

- To enable the network scanner function of this machine, a product key (password) must be entered using a administrator setting. This is only required once. Use the "PRODUCT KEY" program to enter the product key. If you do not know your product key, please ask your dealer. (For information on using administrator settings, refer to "6. SYSTEM SETTINGS (ADMINISTRATOR)".)
- The printer expansion kit (MX-PB12) and at least 128 MB of memory* are required to use the network scanner function.
- For the procedures for using the software programs, see the user's guides on the CD-ROM.

* Memory can be added by installing a commercially available 128 MB or 256 MB memory module (144-pin SDRAM SODIMM). For more information, consult your dealer.

ABOUT THE NETWORK SCANNER FUNCTION

When the network scanner function is added to the machine, a document or photo can be scanned into an image file and sent over a network or the Internet to a file server, e-mail destination, or your own computer. The scanned image can be sent to the following types of destinations:

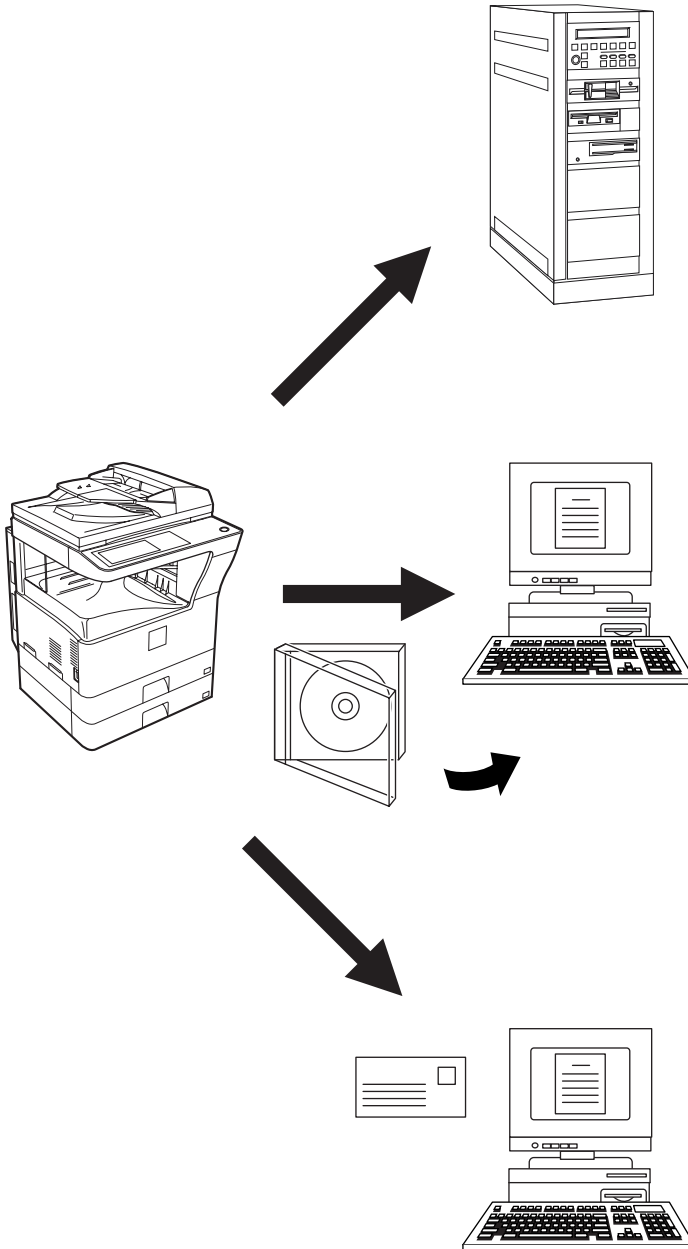

1. The scanned image can be sent to a memory storage device on a network (a designated directory on an FTP server). (This is called "**Scan to FTP**" in this manual.)

When sending scanned image to an FTP server, an e-mail message can also be sent to a preset e-mail address to inform the recipient of the location of the scanned image data. (This is called "**Scan to FTP (Hyperlink)**" in this manual.)

2. A scanned image can be sent to a computer connected to the same network as the machine. (This is called "**Scan to Desktop**" in this manual.)

* Before Scan to Desktop can be performed, the "Network Scanner Tool" software in the CD-ROM that accompanied the Network Scanner Expansion Kit (MX-NSX1) must be installed. For information on Scan to Desktop system requirements, installing the Network Scanner Tool, and storing the destination, see the Users Guide for the Network Scanner Tool on the CD-ROM that accompanies the network scanner expansion kit.

3. The scanned image can be sent to an e-mail recipient. (This is called "**Scan to E-mail**" in this manual.)

* A limit is set in the Web page for the size of image files that can be sent using Scan to E-mail (p.58).

SETTINGS AND PROGRAMMING REQUIRED FOR THE NETWORK SCANNER FEATURE

To use the Network Scanner feature, settings for the SMTP server, DNS server, and destination addresses must be established.

To establish the settings, use a computer that is connected to the same network as the machine to access the machine's Web page.

SETTINGS REQUIRED FOR THE NETWORK SCANNER FUNCTION

To use transmit images using the network scanner function, configure the settings in the Web pages as follows:

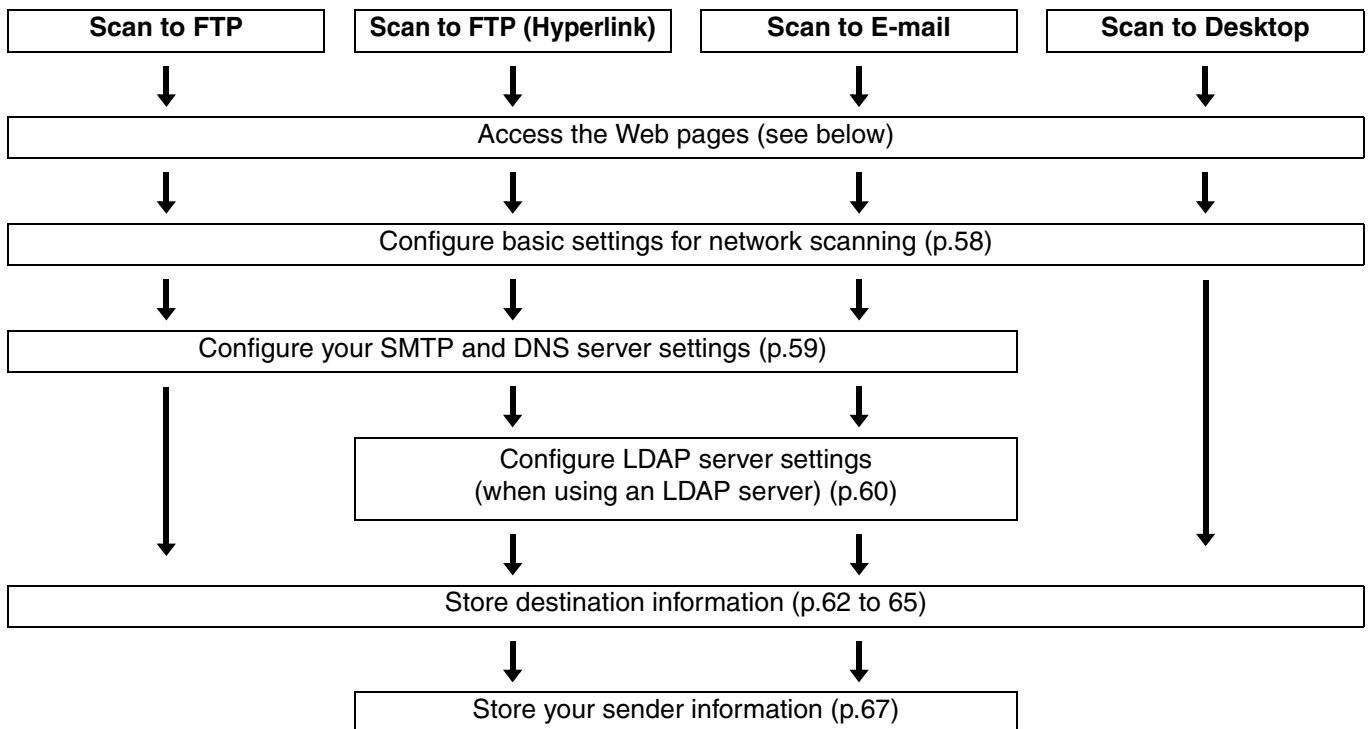

The following settings can also be configured to enable convenient use of the network scanner function:

- Programming custom index names. (p.61)
- Setting passwords. (p.68)

ACCESSING WEB PAGES

Use the following procedure to access the Web pages.

1 Open the Web browser on your computer.

Supported browsers:

- Internet Explorer: 6.0 or later (Windows®)
- Netscape Navigator: 9 or later (Windows®)
- Firefox: 2.0 or later (Windows®)
- Safari: 1.5 or later (Macintosh)

2 In the "Address" field of your Web browser, enter the IP address of the machine as a URL.

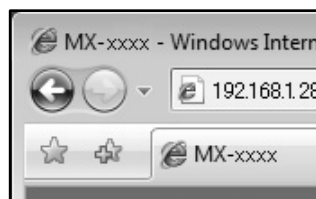

Enter the IP address that has been programmed in the machine.
If you do not know the IP address, see page 89.

When the connection is completed, the Web page will appear in your Web browser. (p.57)

ABOUT THE WEB PAGE

When you access the Web page in the machine, the following page will appear in your browser.

A menu frame appears on the left side of the page. When you click an item in the menu, a screen appears in the right frame that allows you to establish settings for that item.

For detailed explanations of the procedures for establishing settings, click "Help" in the menu frame.

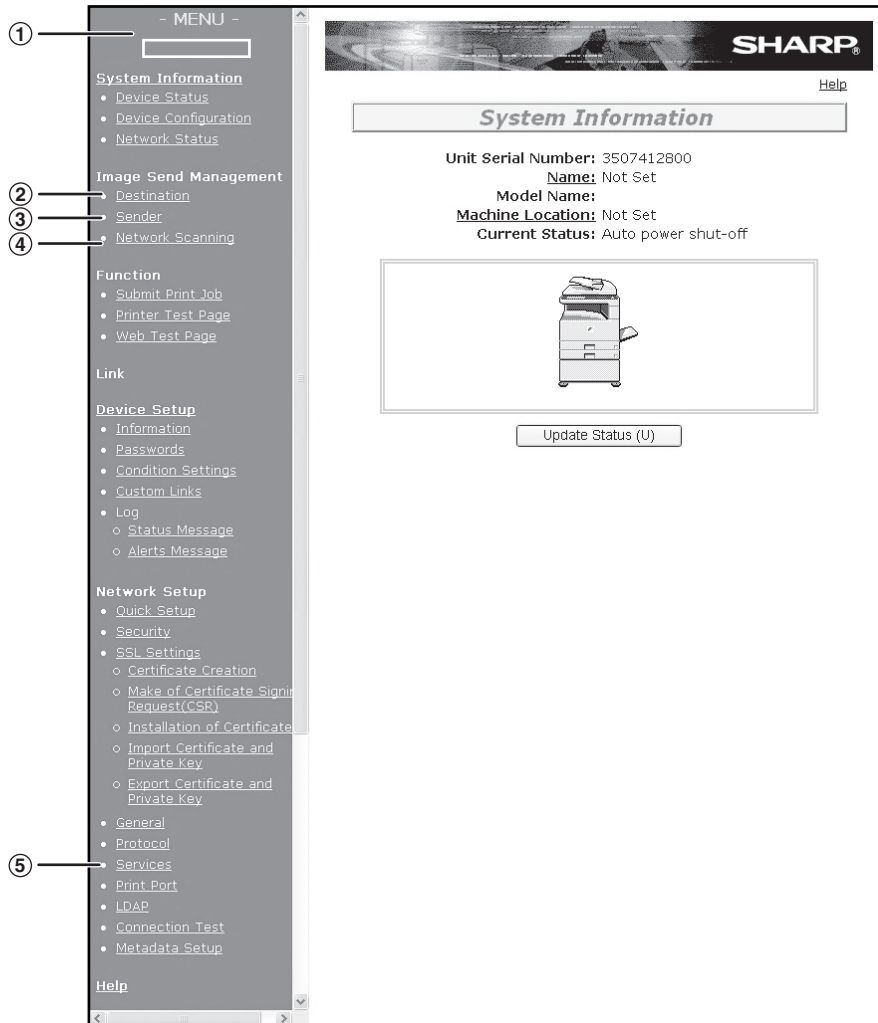

- ① **Menu frame**
Click the menu items displayed here to configure the corresponding settings.
- ② **Destination (p.62)**
Set up destinations for Scan to FTP, Scan to FTP (Hyperlink), Scan to Desktop, and Scan to E-mail. You can also edit or delete previously set destination information.
- ③ **Sender (p.67)**
Enter the sender's information that appears in the recipient's e-mail program (sender name and e-mail address) when you send an image using Scan to E-mail.
If user authentication is being used, enter the login name.
- ④ **Network Scanning (p.58)**
This lets you select transmission methods for the network scanner function, configure settings for Scan to E-mail, and program group indexes.
- ⑤ **Services (p.59)**
This lets you establish SMTP server settings, DNS server settings, and WINS server settings for Scan to E-mail and Scan to FTP (Hyperlink), and for entering a host name instead of an IP address when storing a transmission destination. Configure LDAP server settings if an LDAP server is used.

BASIC SETTINGS FOR NETWORK SCANNING

Click "Network Scanning" in the menu frame, and then establish the required settings. These settings should only be established by the network administrator.
 For detailed explanations of the procedures for establishing settings, click "Help" in the menu frame.

1 Click "Network Scanning" in the menu frame.

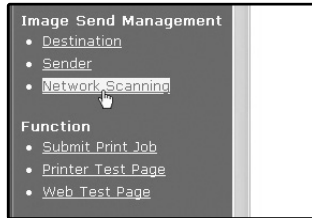

The Network Scanning Setup page appears.

2 Select the transmission methods that you wish to use.

Select the scanner delivery methods that you want to use. In the "Enable Scanner Delivery to:" field, click the checkbox next to each method that you want to use so that a checkmark appears in the checkbox.
 All transmission methods are initially selected (factory default settings).

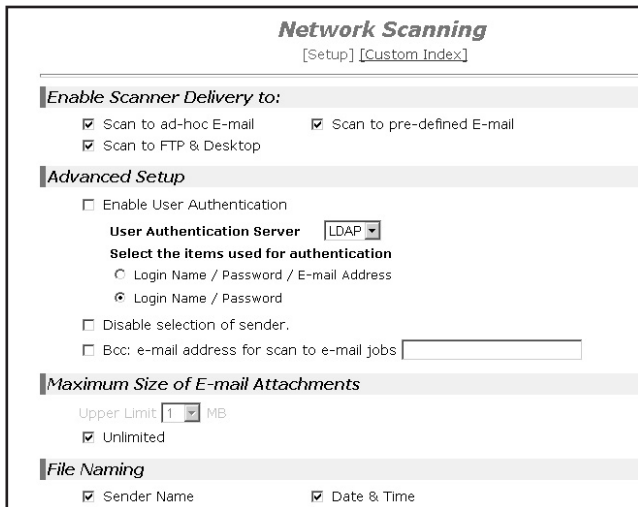

3 Configure the Advanced Setup settings.

Select advanced functions that can be used for Scan to E-mail.
 Select the checkboxes of the functions that you wish to use.

- The "Enable User Authentication" checkbox can be selected to restrict use of the network scanner function to authorized users. (p.69)
- To allow a sender to be selected when sending an image by Scan to E-mail, make sure that "Disable selection of sender from Sender List" is not selected. (p.82)
- If you wish to Bcc a copy of a Scan to E-mail transmission to an e-mail address, select the "Bcc:" checkbox and enter the e-mail address.

4 Set a limit for the size of image files.

A limit can be set for the size of image files sent by Scan to E-mail to prevent excessively large files from being sent.
 If the image file created from the scanned image is larger than the set limit, the image file is discarded. The limit can be set from 1 MB to 10 MB in increments of 1 MB.
 The factory default setting is "Unlimited". If you wish to set a limit, remove the checkmark from the "Unlimited" checkbox and enter the desired limit in "Upper Limit".

5 Select the method for assigning a file name to a scanned image.

Select the method for assigning a file name to a scanned image. In "File Naming", click the items that you wish to use in the file name. "Destination Name" and "Date & Time" are initially selected.



- If you are going to send images to the same recipient more than once, we recommend that you also select "Session Page Counter" or "Unique Identifier" to prevent sending multiple files with the same name, which would result in each successive file overwriting the previous file.
- If a file name is entered at the time of transmission, the file name entered here will be disregarded.

6 Selecting an e-mail subject (only used for Scan to E-mail).

The setting is used to enter the subject that appears in the recipient's e-mail program when you perform Scan to E-mail. (This setting is not necessary if you will not be using Scan to E-mail.)
 The subject can be up to 80 characters long. Only one subject can be entered. If nothing is entered, "Scanned image from <Device Name>" will appear.
 * The name that appears in <Device Name> is the name stored in "Name" in the screen that appears when you click "System Information" in the menu frame. If a name has not been stored, the product name will appear.



If a subject is entered at the time of transmission, the subject entered here will be disregarded.

7 Click "Submit".

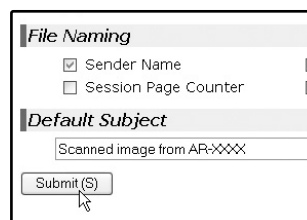

After entering the settings, be sure to click "Submit" to store them.

SMTP SERVER AND DNS SERVER SETTINGS

SMTP is used to transmit e-mail that is sent using Scan to E-mail or Scan to FTP (Hyperlink). To use these transmission methods, your SMTP server settings must be configured.

Configuring SMTP server settings

1 Click "Services" in the menu frame.



2 Click "SMTP".



3 Enter the required information in "SMTP Setup".

For detailed explanations of the procedures for establishing settings, click "Help" in the menu frame.

4 When you have completed all of the entries, click "Submit".

The entries will be stored.

4

Configuring DNS server settings

If you entered a host name in "Primary SMTP Server" or "Secondary SMTP Server" of "SMTP Setup", you must also configure your DNS server settings.

You will also need to configure your DNS server settings if host names will be entered in "Hostname or IP Address" when storing destinations for Scan to FTP (Scan to FTP (Hyperlink)) or Scan to Desktop.

1 Click "Services" in the menu frame.



2 Click "DNS".



3 Enter the required information in "DNS Setup".

For detailed explanations of the procedures for establishing settings, click "Help" in the menu frame.

4 When you have completed all of the entries, click "Submit".

The entries will be stored.

CONFIGURING LDAP SERVER SETTINGS (WHEN USING AN LDAP SERVER)

If mail addresses are managed on your network by an LDAP server, the e-mail addresses stored in the LDAP server can be used for Scan to E-mail.

In addition, user authentication can be enabled to restrict use of the network scanner function by means of user passwords stored in the LDAP server. (p.69)

To allow the machine to use the e-mail addresses in the LDAP server, the LDAP server settings must be configured in the Web page.

1 Click "LDAP" in the menu frame.



2 Select "Enable" in the "LDAP Setup" menu.



3 Click "Submit".

4 Configure the settings in "Global Address Books List".

For detailed explanations of the procedures for establishing settings, click "Help" in the menu frame.

5 When you have completed all of the entries, click "Submit".

The entries will be stored.

PROGRAMMING CUSTOM INDEX NAMES

Stored destinations appear as one-touch keys in the Address book screen of the touch panel (p.71). Each stored destination appears in the ABC (alphabetical) index, and can also be included in one of the six custom indexes (note that these are called "group indexes" in the touch panel). To program names for the custom indexes, follow the steps below.



- To change a previously programmed custom index name, simply overwrite the old name.
- To switch between the ABC index and the custom indexes in the Address book screen, see page 71.

1 Click "Network Scanning" in the menu frame.

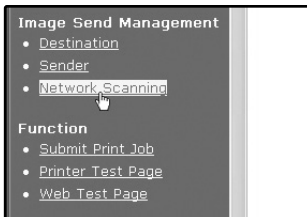

2 Click "Custom Index".



3 Enter names for groups 1 to 6.

Six group indexes are available, and a name up to six characters long can be assigned to each. The names "USER 1" to "USER 6" are initially entered. Change the names as needed.

The screenshot shows the 'Change Custom Index Name' screen. The title is 'Change Custom Index Name' and the subtitle is '[Setup] [Custom Index]'. There are six input fields, each containing 'USER 1' through 'USER 6'. Below the input fields is a 'Submit (S)' button.

4 When you have completed all of the entries, click "Submit".

The entries will be stored.

SETTING UP DESTINATION INFORMATION

To store the name and address of a destination in a one-touch key, click "Destination" in the Web page menu frame. "Destination" can also be used to edit or clear stored destinations. (p.66)

A total of 200 destinations can be stored, including E-mail, FTP, Desktop, and Group destinations. Stored destinations can be selected in the machine's touch panel when transmission is performed.

* Multiple e-mail addresses (up to 100) can be stored as a group. Note that this may reduce the maximum number of destinations (normally 200) that can be stored.

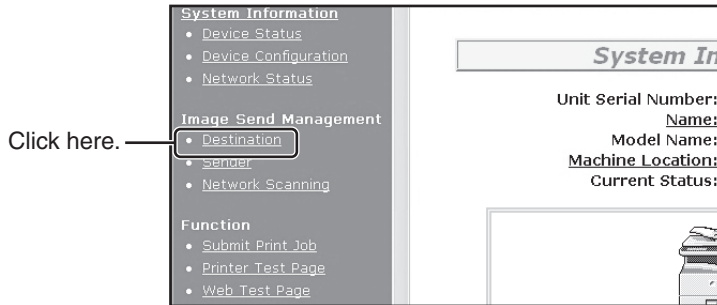

E-mail: See below
 FTP: Refer to page 63.
 Desktop: Refer to page 64.
 Group: Refer to page 65.



Note Make sure that the address book screen (p.71) does not appear in the machine's touch panel when you store, edit, or delete destinations. Destinations cannot be edited or deleted when the address book screen appears.

Storing destinations for Scan to E-mail

1 Click "Destination" in the menu frame.



2 Click "E-mail".



3 Enter the destination information.

For detailed explanations of the procedures for establishing settings, click "Help" in the menu frame.

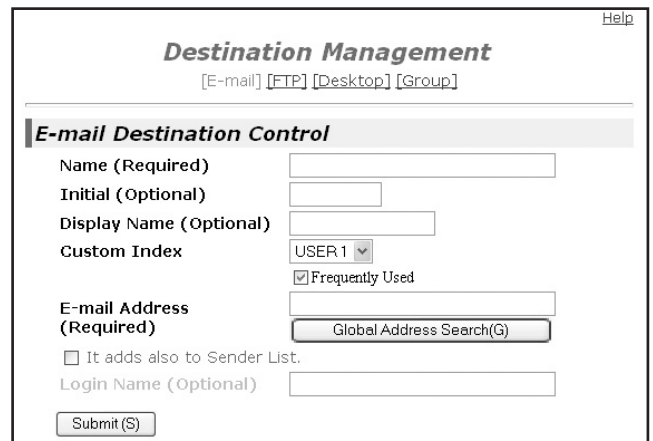

Note If user authentication is enabled and you wish to allow login using the above stored information, select the "It adds also to the Sender List." checkbox and enter the "Login Name" (maximum of 32 characters). The login name must be the same as the login name stored in the LDAP server.

4 When you have completed all of the entries, click "Submit".

The entries will be stored.



Note To perform Scan to E-mail, the SMTP server settings must first be established. Click "Application" in the Web page, click "SMTP" in the screen that appears, and then enter the settings under "SMTP Setup" (p.59).

Storing destinations for Scan to FTP

1 Click "Destination" in the menu frame.

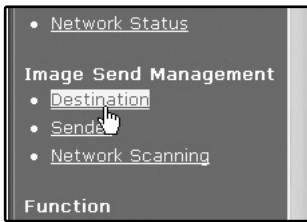

2 Click "FTP".



3 Enter the destination information.

For detailed explanations of the procedures for establishing settings, click "Help" in the menu frame.

A screenshot of the 'Destination Management' form. The form has a title bar with 'Help' and a subtitle '[E-mail] [FTP] [Desktop] [Group]'. The main section is titled 'FTP Destination Control' and contains several input fields: 'Name (Required)', 'Initial (Optional)', 'Display Name (Optional)', 'Custom Index' (with a dropdown menu set to 'USER 1' and a checked 'Frequently Used' checkbox), 'Hostname or IP Address (Required)', 'User Name (Optional)', 'Password (Optional)', and 'Directory (Optional)'. There is a checkbox for 'Enable Hyperlink to FTP server to be e-mailed'. Below these fields is an 'E-mail Destination' section with a 'Global Address Search(G)' button and a list of addresses: 'eee', 'bbb', 'ccc', 'ddd', 'eee'. A 'Submit (S)' button is at the bottom left.



If you select the "Enable Hyperlink to FTP server to be e-mailed" checkbox and select a previously stored recipient (p.62) from "E-mail Destination", an e-mail will be sent to the recipient informing them of the file format and location of the scanned image data. A hyperlink to the file server to which the scanned image data was sent appears in the e-mail, and the recipient can click the hyperlink to go directly to the location where the image data is stored.

4 When you have completed all of the entries, click "Submit".

The entries will be stored.



If you entered a host name in "Hostname or IP Address", you will need to enter the DNS server or WINS server settings. Click "Application" in the menu frame and then click "DNS" or "WINS" in the page that appears to configure the corresponding settings. To perform Scan to FTP (Hyperlink), you must also click "SMTP" and then enter the settings under "SMTP Setup" for the SMTP server (p.59).

Storing destinations for Scan to Desktop

The destination for Scan to Desktop is stored by the Sharp Network Scanner Tool Setup Wizard when "Network Scanner Tool" is installed in your computer. For this reason, there is no need to store the Scan to Desktop destination in the Web page. (The Network Scanner Tool is on the CD-ROM that accompanied the Network Scanner Expansion Kit .)

For information on Scan to Desktop system requirements, installing the Network Scanner Tool, and storing the destination, see the Users Guide for the Network Scanner Tool on the CD-ROM that accompanies the network scanner expansion kit.

Normally your computer is stored as the destination by the method indicated above.

The following page for storing Scan to Desktop destination information appears when "Destination" is selected in the menu frame, followed by "Desktop". This page is used by mainly by the system administrator in the following circumstance.

- When another machine with the network scanner function has been added to the same network, and you wish to perform Scan to Desktop from the added machine to a destination programmed in the previously existing machine. Refer to "Editing and deleting programmed transmission destinations" (p.66), and select the Scan to Desktop destination information that you wish to transfer to the new machine. Enter the displayed information in the same setting screen of the new machine. (When all information has been entered, click "Submit".)

If there are additional destinations that you want to transfer to the new machine, repeat this procedure for each destination.

The screenshot shows a web browser window with the SHARP logo at the top. Below the logo are links for "Link to SHARP Global Home Page" and "Help". The main heading is "Destination Management", with sub-links for "[E-mail] [FTP] [Desktop] [Group(E-mail)] [Fax] [Group(Fax)]". The "Desktop Destination Control" section contains the following fields:
Name (Required): [Text Input]
Initial (Optional): [Text Input]
Display Name (Optional): [Text Input]
Custom Index: [Dropdown Menu: USER 1] and Frequently Used
Hostname or IP Address (Required): [Text Input]
Port Number (Required): [Text Input: 21]
Process Directory (Optional): [Text Input]
User Name (Optional): [Text Input]
Password (Optional): [Text Input]
Submit (S) button

Note that if there are any discrepancies between the newly programmed information and the information in the host computer, transmission and reception may not be possible.



- For detailed explanations of the procedures for establishing settings, click "Help" in the menu frame.
- If you entered a host name in "Hostname or IP Address", you will need to enter the DNS server or WINS server settings. Click "Application" in the menu frame and then click "DNS" or "WINS" in the page that appears to configure the corresponding settings.

Storing Groups (Scan to E-mail)

If you are using Scan to E-mail, a scanned image can be sent to multiple destinations in a single operation.



Up to 100 destinations can be stored in one group.

1 Click "Destination" in the menu frame.

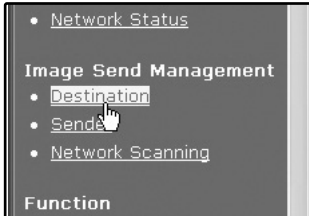

2 Click "Group".



3 Enter the destination information.

For detailed explanations of the procedures for establishing settings, click "Help" in the menu frame.

Destination Management Help
 [E-mail] [FTP] [Desktop] [Group]

Group Destination Control

Name (Required)

Initial (Optional)

Display Name (Optional)

Custom Index Frequently Used

Address(es) (Required)

E-mail

4 When you have completed all of the entries, click "Submit".

The entries will be stored.

Editing and deleting programmed transmission destinations

To edit or delete programmed destinations, click "Destination" in the menu frame of the Web page.

1 Click "Destination" in the menu frame of the Web page.

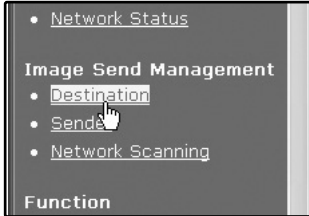

2 In the Destinations List, click the checkbox of the destination that you want to edit or delete.

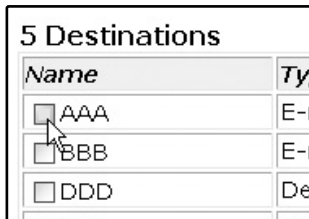

3 To edit the selected destination, click "Edit" under the Destinations List.

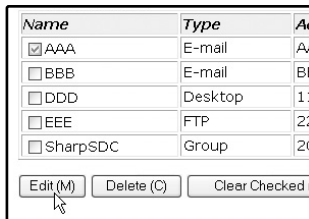

The programming screen of the destination selected in step 2 appears. Edit the information in the same way as you initially stored it.

When finished, be sure to click "Submit" to save your changes.

To delete the selected destination, click "Delete" under the Destinations List.

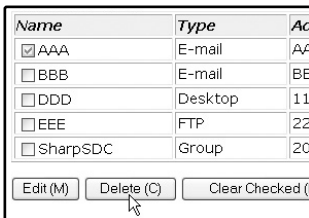

A message appears asking you to confirm the deletion. Click "Yes" to delete.



If you attempt to edit or delete a programmed destination in the following situations, a warning message will appear and editing/deletion will not be possible.

- The destination that you wish to edit or delete is currently being used for transmission.
- The destination is included in a group.

If the destination is being used for a current transmission, cancel the transmission or wait until it is completed and then edit or delete the destination. If the destination is included in a group, delete the destination from the group and then edit or delete the destination.

STORING THE SENDER INFORMATION (Scan to E-mail)

Use this procedure to store the sender information (sender name and e-mail address) that appears when you send an image by Scan to E-mail. Up to 200 senders can be stored (only one sender can be selected for a transmission). The sender name appears in the recipient's e-mail program.

1 Click "Sender" in the menu frame.



2 Click "Add".

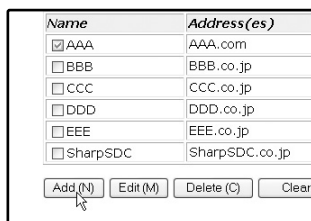

The sender programming screen appears.

3 Enter the sender information.

For detailed explanations of the procedures for establishing settings, click "Help" in the menu frame.

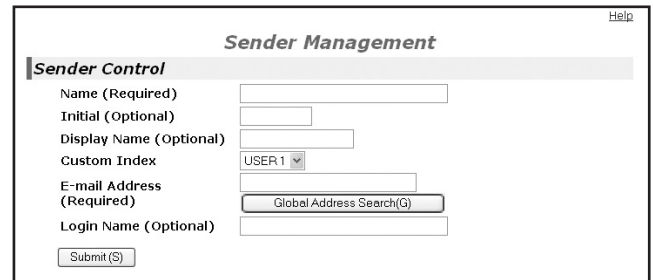

If user authentication is enabled and you wish to allow login using the above stored information, enter the login name for that information in "Login Name" (maximum of 32 characters). The login name must be the same as the login name stored in the LDAP server.

4 When you have completed all of the entries, click "Submit".

The entries will be stored.

4

Editing and deleting programmed sender's information

1 Click "Sender" in the menu frame.

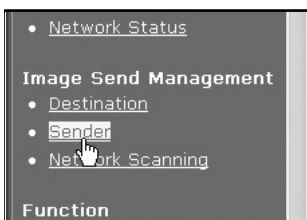

2 Click "Edit" or "Delete".

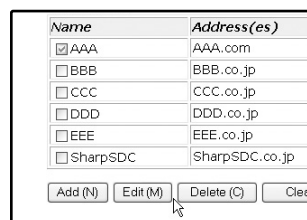

If you clicked "Edit", edit the information in the same way that you initially programmed it and then click "Add" to save your changes. If you clicked "Delete", a message will appear asking you to confirm the deletion. Click "Yes" to delete.

PROTECTING INFORMATION PROGRAMMED IN THE WEB PAGE ("Passwords")

Passwords can be established to protect the settings and information stored in the Web page. Note that it is not necessary to set passwords; the network scanner functionality can also be used without passwords. A password can be set for the administrator and a password can be set for users. When the Web page is accessed with the user password, the "Device Setup" and "Network Setup" settings cannot be configured.

1 Click "Passwords" in the menu frame.

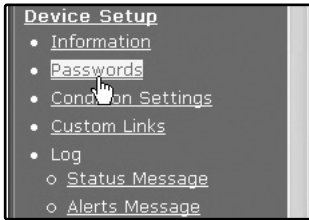

2 Select the "Enable Password Protection of this Web Site" checkbox.



3 Enter the current password in "Admin Password".

When establishing a password for the first time, enter "Sharp" in "Admin Password".



Be sure to enter "S" in upper case and "harp" in lower case (passwords are case sensitive).

4 Enter passwords in "User Password" and "Admin Password".

A maximum of 7 characters and/or numbers can be entered for each password (passwords are case sensitive).

Be sure to enter the same password in "New Password" as you did in "Confirm Password".

5 When you have completed all of the entries, click "Submit".

The entered password is stored. **After setting the password, turn the machine power off and then back on.**

When a password is set, you will be prompted for the password when you attempt to access a Web page with protected settings. For the "User name", enter "user" if you are accessing the page as a user, or "admin" if you are accessing the page as an administrator. For detailed information on setting passwords, refer to "Help".

RESTRICTING USE OF THE NETWORK SCANNER FUNCTION (USER AUTHENTICATION)

Use of the network scanner function can be restricted by means of user passwords stored in an LDAP server.

Settings required for user authentication

To implement user authentication, the following settings are required:

- Enable user authentication (step 3 on page 58)
- Configure LDAP server settings (p.60)
- Store login names (p.67)

Logging in when user authentication is enabled

To use the network scanner function when user authentication is enabled, you must first log in. Follow these steps:

1 Press the [SCAN] key on the operation panel.

The login screen will appear in the touch panel.

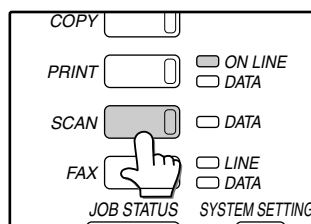

If you will use the [SELECT FROM SENDER LIST] key, go to step 3.

2 Touch the [LOGIN NAME] key, [E-MAIL ADDRESS] key.

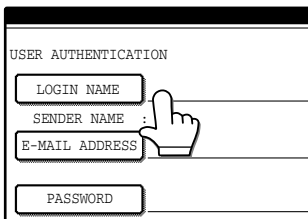

A text entry screen will appear when each key is touched. Enter the LOGIN NAME, SENDER NAME, and E-MAIL ADDRESS. (Go to step 4.)

3 Touch the [SELECT FROM SENDER LIST] key.

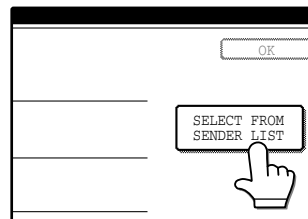

The sender list screen appears. When you select your login name, sender name and e-mail address are entered.

4 Enter the password.

For the password, enter the user password that is stored in the server.

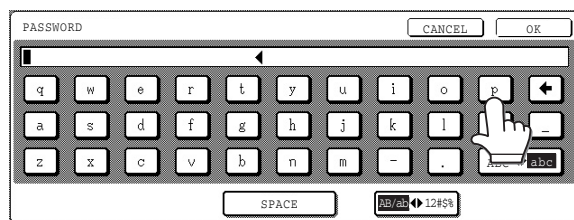

5 Touch the [OK] key.

If the login name and password are valid, the initial screen (p.70) of scanner mode appears.



- To logout, press the [LOGOUT] key(⊛). If audit mode is enabled, you will also log out of your account.
- To switch to a mode other than network scanner mode, you must log out.

INITIAL SCREEN OF SCANNER MODE

The condition setting screen of scanner mode is displayed by pressing the [SCAN] key (refer to the operation manual for copier) while the copy mode, print mode, fax mode, or job status screen appears in the touch panel. If user authentication is enabled, the initial screen will appear after authentication. (p.69)

In the explanations that follow, it is assumed that the initial screen that appears after pressing the [SCAN] key is the condition setting screen (shown below). If you have set the display to show the address book screen (following page) when the [SCAN] key is pressed, touch the [CONDITION SETTINGS] key in the address book screen to display the condition setting screen.



- The administrator setting "DEFAULT DISPLAY SETTINGS" can be used to set the display to show either the condition setting screen (shown below) or the address book screen (following page) when the [SCAN] key is pressed (refer to "6. SYSTEM SETTINGS (ADMINISTRATOR)").
- For information on the parts of the machine and the operation panel that are used for network scanning, refer to the operation manual for copier.

Condition settings screen

The display is initially set (factory setting) to show the following condition setting screen as the initial screen.

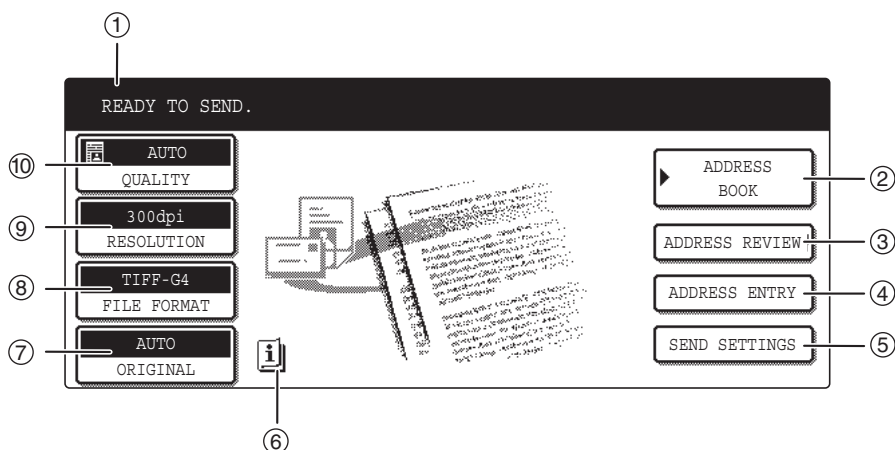

- ① Message display**
Messages appear here to indicate the current status of the machine.
- ② [ADDRESS BOOK] key (p.71)**
This displays the address book screen (next page). Touch this key when you wish to use a one-touch key that has a destination (or group) programmed in it.
- ③ [ADDRESS REVIEW] key (p.74)**
When performing Scan to E-mail broadcast transmission, touch this key to check your selected destinations. A list of the destinations will appear, and you can delete any incorrect destinations.
- ④ [ADDRESS ENTRY] key (p.74)**
When performing Scan to E-mail, touch this key if you wish to enter the e-mail address of the recipient manually instead of using a one-touch key.
- ⑤ [SEND SETTINGS] key (p.82)**
Touch this key to change the subject*, file name, or sender* when sending a scanned image.
* When using Scan to E-mail.
- ⑥ [INFORMATION] icon (p.79)**
The [INFORMATION] icon appears in the base screen when one or more special modes are selected.
- ⑦ Two-sided original and job build icon display (p.76, 77)**
Either icon appears when two-sided scanning or job build scanning (when an RSPF is installed) is selected after pressing the [ORIGINAL] key. The icon can be touched to open a function selection screen.
- ⑧ [ORIGINAL] key (p.76, 77, 78)**
Touch this key to set the original size manually, select two-sided scanning, or select job build (when an RSPF is installed).
- ⑨ [FILE FORMAT] key (p.81)**
Touch this key to change the format of the image file to be sent, or change the number of pages per file. The selected format is highlighted at the top of the key.
- ⑩ [RESOLUTION] key (p.80)**
Touch this key to change the resolution setting for the original to be scanned. The selected resolution setting will be highlighted above the key.
- ⑪ [QUALITY] key (p.79)**
Touch this key to change the image quality and density settings for scanning. The selected image quality and density are highlighted at the top of the key.

Address book screen

Touch the [ADDRESS BOOK] key in the condition setting screen (previous page) to display the screen shown below at right.

Destinations stored using the Web page are grouped in indexes (⑥) according to the letter entered in "Initial" for each destination, and the name entered in "Display Name" is displayed in the one-touch key (①).

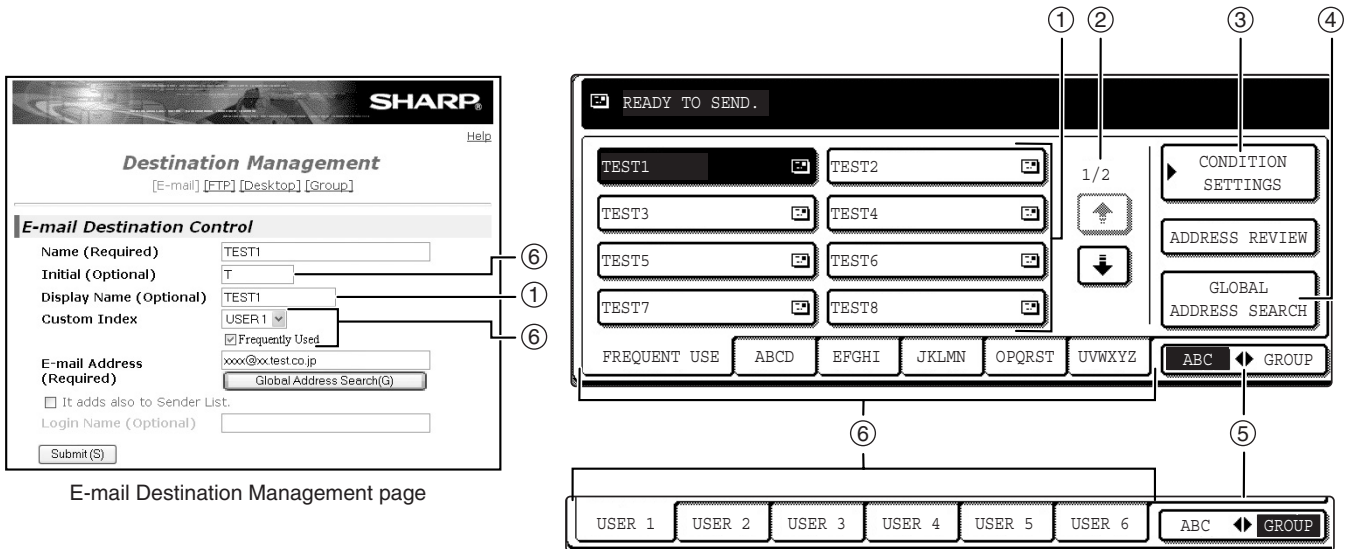

E-mail Destination Management page

① One-touch key display

This shows the one-touch keys that have been stored on the selected "index card". The key type is indicated by the icon at the right.

:Scan to E-mail

:Scan to FTP

:Scan to Desktop

The number of one-touch keys that appear in one screen can be changed to 6, 8, or 12 using "THE NUMBER OF DIRECT ADDRESS / SENDER KEYS DISPLAYED SETTING" in the administrator settings.

② Display switching keys

In cases where the one-touch keys cannot all be displayed on one screen, this shows how many screens are left. Touch the "" "" keys to move through the screens.

③ [CONDITION SETTINGS] key

This displays the condition setting screen (p.70), which is used to set various conditions.

④ [GLOBAL ADDRESS SEARCH] key (p.75)

If an LDAP server is used, touch this key to select a Scan to E-mail destination in the LDAP server. If an LDAP server is not used, the key is grayed out and cannot be selected.

⑤ [ABC <-> GROUP] key

Touch this key to switch between the alphabetical index and the group index. The selected index type is displayed.

⑥ Index keys

One-touch key destinations are stored on each of these index cards (alphabetical index or group index). Touch an index key to display the card. Group indexes make it possible to store one-touch keys by group with an assigned name for easy reference. This is done with the system settings (p.61). Frequently used one-touch key destinations can be stored on the [FREQUENT USE] card for convenient access.



- If the initial screen has been set to the address book screen in the administrator settings, the above screen will be the initial screen.
- If desired, you can use the administrator settings, "DEFAULT DISPLAY SETTINGS", to set the default screen to the group index. (See "6. SYSTEM SETTINGS (ADMINISTRATOR)".)

SENDING AN IMAGE

BASIC TRANSMISSION METHOD

1 Make sure the machine is in scanner mode.

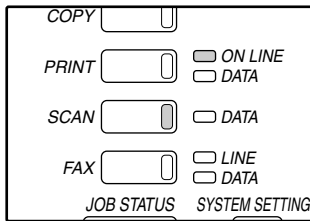

When the [SCAN] key light is on, the machine is in scanner mode. If the light is not on, press the [SCAN] key. If user authentication is enabled, you must log in. (p.69)

2 Load the original.

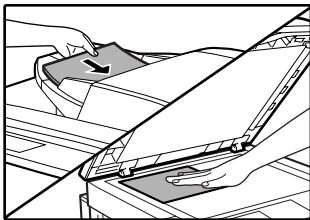

For detailed information on loading an original, refer to the operation manual for copier.



You cannot load documents in both the RSPF and on the document glass and send them in a single transmission. If documents are loaded in both the RSPF and on the document glass, only the document in the RSPF will be scanned and transmitted.

3 Check the original size that appears in the top half of the [ORIGINAL] key.

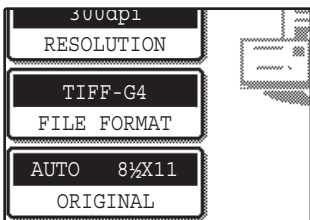

The original size is automatically detected. If you loaded a non-standard size document or wish to change the scanning size, touch the [ORIGINAL] key and set the document size. (Refer to page 78.)



- To scan a two-sided original (when an RSPF is installed), refer to page 76.
- If you are scanning a large number of originals (and the RSPF is installed), follow the procedure on page 77.
- To rotate the document image 90° before transmission, see page 78.

4 Adjust the quality setting. (p.79)

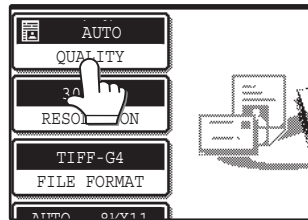

The factory default settings are:

- Image quality: TEXT/PHOTO
- Density: AUTO

5 Adjust the resolution setting. (p.80)

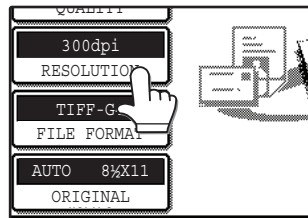

The factory default setting is "300dpi".

6 Select the file format. (p.81)

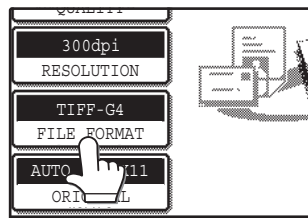

The factory default settings are:

- FILE TYPE: TIFF
- COMPRESSION MODE: MMR (G4)
- PAGES PER FILE: ALL

7 Touch the [ADDRESS BOOK] key.

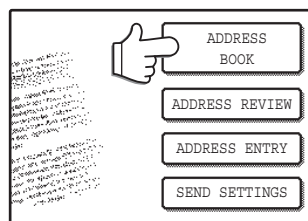

The address book screen appears.

8 Touch the one-touch key of the desired destination.

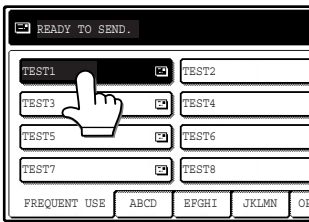

The key you touched is highlighted. If you touch the wrong key, touch the key again to cancel the selection. The key display will return to normal.

Note

- Refer to pages 62 to 65 for information on programming one-touch key destinations.
- When touching a one-touch key, corresponding information from the e-mail destination screen is shown in the message display.
- The destination e-mail address for Scan to E-mail can be entered manually, or you can search for a destination in an LDAP server on the network (p.74 to 75).
- Multiple destinations can be specified for a Scan to E-mail transmission (p.74).

9 Enter a file name for the scanned image. (p.82)

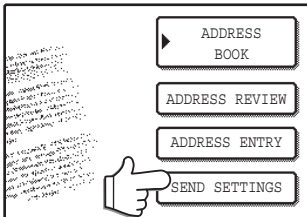

If the send settings are not changed, a file name is assigned based on the items specified in the Web page.

Note

When sending an image by Scan to E-mail, a subject and sender's name can be entered. Normally the subject and sender are automatically entered based on the information stored in "Reply E-mail Address" in "SMTP Setup" in the Web page. If user authentication is enabled, the e-mail address of the user who logged in is used as the sender.

Using the RSPF

10 Press the [START] key (⊙).

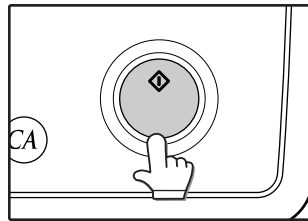

Scanning begins. When scanning is finished, "SENDING. PRESS [C] TO CANCEL." appears in the touch panel and transmission begins. When transmission is finished, "SENDING COMPLETED." appears in the touch panel.

Using the document glass

10 Press the [START] key (⊙).

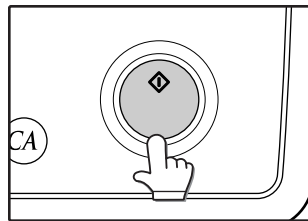

The original is scanned and the [READ-END] key appears.

11 If you have another page to scan, change pages and then press the [START] key (⊙).

Repeat this sequence until all pages have been scanned.

Note

If no action is taken for one minute, scanning automatically ends and transmission begins.

12 After the final page is scanned, touch the [READ-END] key.

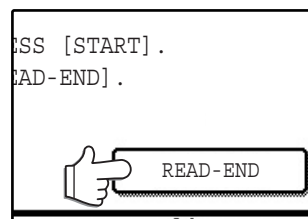

"SENDING. PRESS [C] TO CANCEL." appears in the touch panel and transmission begins. When transmission is finished, "SENDING COMPLETED." appears in the touch panel.

Note

- To cancel transmission while "SCANNING ORIGINAL." appears in the display or before the [READ-END] key is touched, press the [CLEAR] key (⊙) or the [CLEAR ALL] key (⊙). If you press the [CLEAR] key (⊙), the destination and scan settings are saved. To cancel a transmission, press the [JOB STATUS] key and cancel the job. (p.83)
- If you exceed the number of pages that can be scanned while scanning an original, "THE MEMORY BECOMES FULL." will appear in the touch panel. To send the data that has been scanned to that point, touch the [SEND] key. To cancel the transmission, touch the [CANCEL] key.
- If a misfeed occurs while an original is being scanned, remove the original according to the instructions in the touch panel. To resume scanning after removing the misfeed, press the [START] key (⊙).

TRANSMISSION METHODS FOR SCAN TO E-MAIL

The destination for a Scan to E-mail transmission can be selected from the address book or entered manually. You can also use an e-mail address stored on an LDAP server.

It is possible to select multiple destinations for a Scan to E-mail transmission using a combination of these methods. Use the following procedure when you wish to enter the e-mail address manually or use an e-mail address stored on an LDAP server.

Sending an image by entering an e-mail address manually

1 Perform steps 1 through 6 of "BASIC TRANSMISSION METHOD". (p.72)

2 Touch the [ADDRESS ENTRY] key.

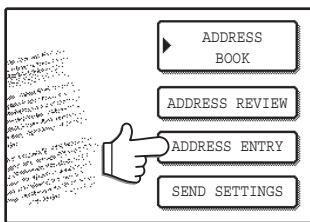

The e-mail address entry screen appears.

3 Touch the keys on the keyboard to enter the e-mail address.

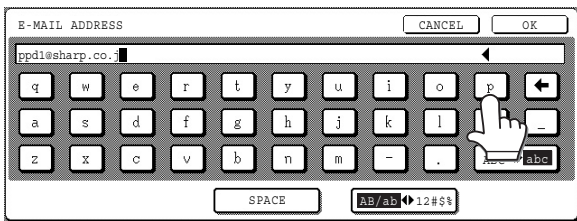

- If you make a mistake, touch the [←] key to move the cursor (■) back to the mistake and then enter the correct character.
- To enter a number, touch the [AB/ab ◀ 12#%] key. The screen will change to the number entry screen. To return to the text entry screen, touch the [AB/ab ▶ 12#%] key again.

4 Touch the [OK] key.

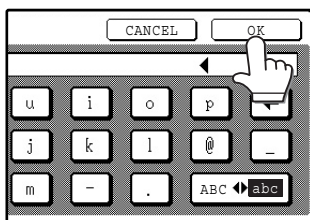

5 If you wish to enter another e-mail address, repeat steps 2 through 4.

If you wish to select an e-mail address from the address book screen, follow steps 7 and 8 of "BASIC TRANSMISSION METHOD" (p.72 to 73). If you wish to select an e-mail address in an LDAP server, follow the steps in "Sending an image by selecting an e-mail address in an LDAP server" (p.75).



Note If you frequently transmit to a fixed group of destinations, you can store the destinations as a group (p.65).

6 Touch the [ADDRESS REVIEW] key and check the destinations.

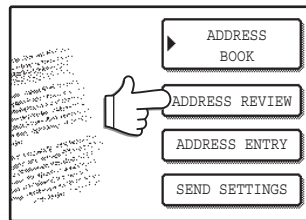

When the [ADDRESS REVIEW] key is touched, only the entered destinations are displayed. To delete a destination, touch the key of the destination that you wish to delete. Touch the [OK] key to return to the initial screen.



Note The entered or selected destinations appear in the address review screen as one touch keys. A maximum of 18 characters of the name or e-mail address can appear in each key.

7 Continue from step 9 of "BASIC TRANSMISSION METHOD" (p.73).



Note To cancel the operation when selecting destinations, press the [CLEAR ALL] key (Ⓢ).

⚠ Caution

- **Important points when using Scan to E-mail**
Be very careful not to send image data files that are too large. Your mail server's system administrator may have placed a limit on the amount of data that can be sent in one e-mail transmission. If this limit is exceeded, the e-mail will not be delivered to the recipient. Even if there is no limit and your e-mail is successfully delivered, a large data file may take a long time to be received and place a heavy burden on the recipient's network, depending on the recipient's network (Internet) connection environment. If large image data files are repeatedly sent, the resulting burden on the network may slow down the speed of other, unrelated data transmissions and in some cases, may even cause the mail server or network to go down. In cases where you need to send multiple documents, try such measures as lowering the resolution mode.
- A limit can be set for the size of image files sent by Scan to E-mail in "Maximum Size of File" (p.58) in the Web page.

Sending an image by selecting an e-mail address in an LDAP server

To use an LDAP server, the LDAP server settings must be configured in the Web page.

1 Perform steps 1 through 6 of "BASIC TRANSMISSION METHOD". (p.72)

2 Touch the [ADDRESS BOOK] key.

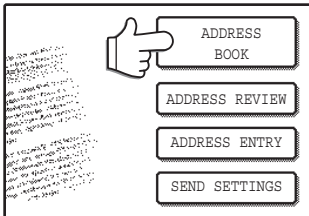

The address book screen appears.

3 Touch the [GLOBAL ADDRESS SEARCH] key.

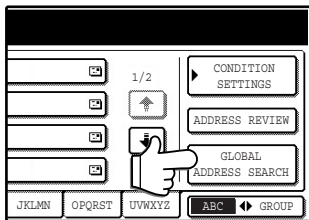

The global address search screen appears.



If multiple LDAP servers have been configured, the server select screen appears. Touch the key of the server that you wish to search and then touch the [OK] key.

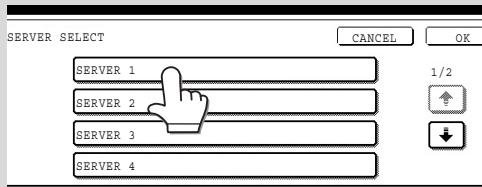

The selected server key is highlighted.

4 Touch the key of the server that you wish to search and then touch the [OK] key.

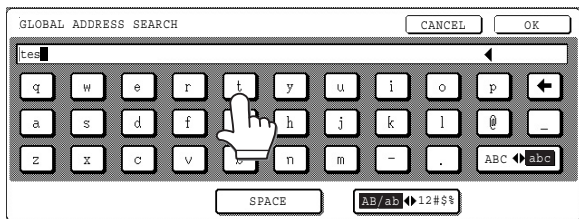

- If you make a mistake, touch the [←] key to move the cursor (■) back to the mistake and then enter the correct character.
- To enter a number, touch the [AB/ab ◀ 12#\$%] key. The screen will change to the number entry screen. To return to the text entry screen, touch the [AB/ab ▶ 12#\$%] key again.

5 Touch the [OK] key.

The server begins searching. When the search is finished, a list of the matching e-mail addresses appears.



If there are no matches, touch the [OK] key in the message screen that appears. Touch the [SEARCH AGAIN] key and repeat the procedure from step 4.

6 Touch the one-touch key of the desired destination.

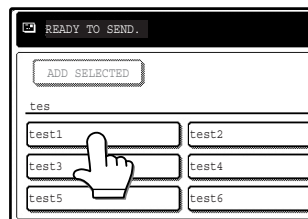

If you touch the wrong key, touch the correct key.

7 Touch the [ADD SELECTED] key.

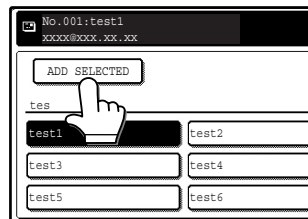

The destination selected in step 6 is entered as a destination of the transmission.

8 If you wish to enter another e-mail address, repeat steps 6 through 7.

If multiple LDAP servers have been configured and you wish to select a different server, touch the [ADDRESS BOOK] key and then touch the [GLOBAL ADDRESS SEARCH] key.

9 Touch the [ADDRESS REVIEW] key and check the destinations.

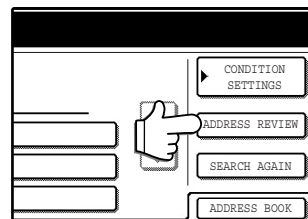

When the [ADDRESS REVIEW] key is touched, only the entered destinations are displayed. To delete a destination, touch the key of the destination that you wish to delete. Touch the [OK] key to return to the initial screen.

10 Continue from step 9 of "BASIC TRANSMISSION METHOD" (p.73).



To cancel the operation when selecting destinations, press the [CLEAR ALL] key (Ⓢ).

SCANNING AND TRANSMITTING A TWO-SIDED ORIGINAL (when an RSPF is installed)

Follow these steps to automatically scan a two-sided original.

1 Make sure the machine is in scanner mode and then load the document in the RSPF. (p.72)

2 Touch the [ORIGINAL] key.

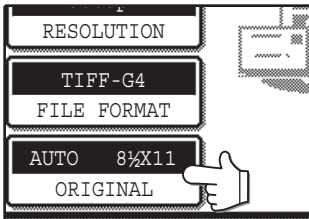

3 Touch the [2-SIDED BOOKLET] key or the [2-SIDED TABLET] key as appropriate for the original you loaded.

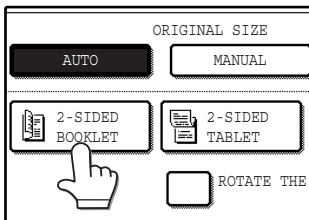

If you wish to rotate the original 90° when creating an image file, touch the [ROTATE THE IMAGE 90 DEGREES] checkbox (a checkmark should appear in the box).



Note If the correct original size does not appear in the screen of step 2, touch the [MANUAL] key and specify the correct original size (p.78).

4 Touch the [OK] key.

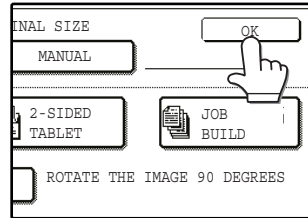

You will return to the initial screen.

5 Continue from step 4 of "BASIC TRANSMISSION METHOD" (p.72 to 73).



- Booklets and tablets
Two-sided originals that are bound at the side are booklets, and two-sided originals that are bound at the top are tablets.
- Two-sided scanning mode turns off after transmission is finished. Two-sided scanning mode can also be canceled by pressing the [CLEAR ALL] key (Ⓢ).

Booklet



Tablet

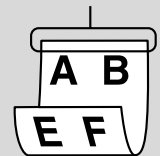

SCANNING A LARGE NUMBER OF ORIGINALS (when an RSPF is installed)

If you have a large number of originals, the originals can be scanned in batches using the RSPF.

1 Make sure the machine is in scanner mode and then load the document in the RSPF. (p.72)

2 Touch the [ORIGINAL] key.

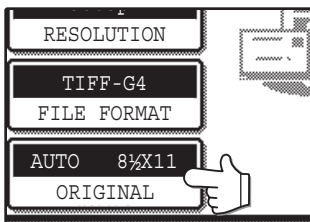

3 Touch the [JOB BUILD] key.

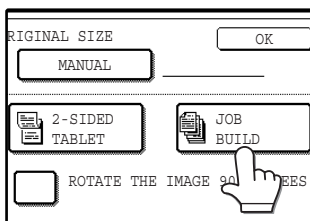

If you wish to rotate the original 90° when creating an image file, touch the [ROTATE THE IMAGE 90 DEGREES] checkbox (a checkmark should appear in the box).



If the correct original size does not appear in the screen of step 2, touch the [MANUAL] key and specify the correct original size (p.78).

4 Touch the [OK] key.

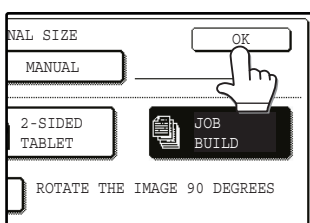

You will return to the initial screen.

5 Perform steps 4 through 9 of "BASIC TRANSMISSION METHOD". (p.72 to 73)

6 Press the [START] key (⊙).

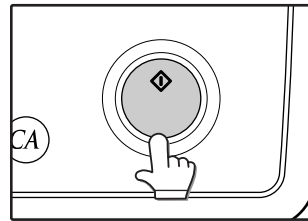

Scanning of the originals begins. A message appears in the touch panel.

7 When all of the originals in the RSPF have been scanned, load the next batch and press the [START] key (⊙). Repeat this sequence until all pages have been scanned.



If no action is taken for one minute, scanning automatically ends and transmission begins.

8 When all originals have been scanned, touch the [READ-END] key.

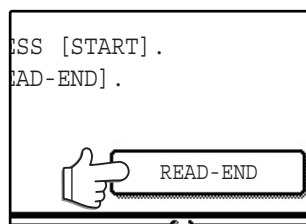

"SENDING. PRESS [C] TO CANCEL." appears in the touch panel and transmission begins. When transmission is finished, "SENDING COMPLETED." appears in the touch panel.



- Job build mode turns off after transmission is finished. Job build mode can also be canceled by pressing the [CLEAR ALL] key (⊙).
- When performing Scan to E-mail, see the notes on page 74.

SCANNING SETTINGS

(ORIGINAL SIZE, QUALITY, RESOLUTION, FILE FORMAT, AND SEND SETTING)

When sending an image, you can change the original scan size, quality, resolution, file format, and file name.

MANUALLY SETTING THE SCANNING SIZE

If you load an original that is not a standard size, or if you wish to change the scanning size, touch the [ORIGINAL] key and set the original size manually.

Perform the following steps after loading the document in the RSPF or on the document glass.



***Standard sizes:**

The following original sizes will be correctly detected:

- Countries/regions that use inch-based standard sizes: 11"x17", 8-1/2"x14", 8-1/2"x11", 8-1/2"x11"R, 5-1/2"x8-1/2", 5-1/2"x8-1/2"R*.
- Countries/regions that use AB standard sizes: A3, A4, A4R, A5, A5R*, B4, B5, B5R.

* These sizes can only be automatically detected when the RSPF is used.

If a non-standard size original is loaded (including special sizes), the closest standard size may be displayed, or the original size may not appear.

1 Touch the [ORIGINAL] key.

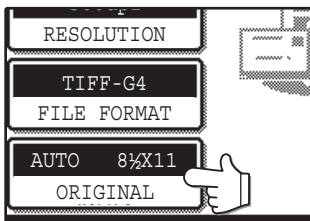

If you wish to select an AB size, touch the [AB \blacktriangle INCH] key and then touch the desired original size key.

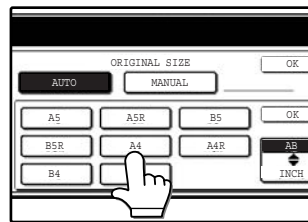

[AB] is highlighted and AB size keys are displayed. To return to the inch size, touch the [AB \blacktriangle INCH] key once again.

2 Touch the [MANUAL] key.

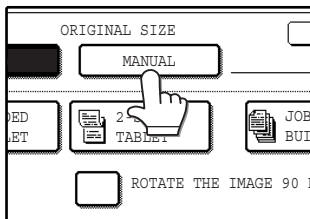

The sizes that can be selected are displayed.

4 Touch the outer [OK] key.

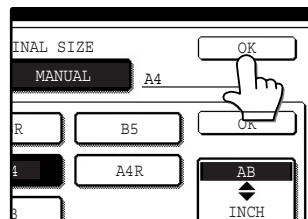

You will return to the initial screen. Touching the inner [OK] key in the step above returns you to step 2.



- If you wish to rotate the original 90° when creating an image file, touch the [ROTATE THE IMAGE 90 DEGREES] checkbox (a checkmark should appear in the box).
- The [2-SIDED] key and [JOB BUILD] key do not appear on models that do not have an RSPF installed.

3 Touch the desired original size key.

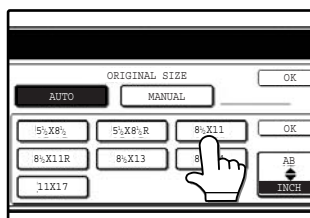

[AUTO] is no longer highlighted. [MANUAL] and the original size key you touched are highlighted.

5 The selected size appears in the top half of the [ORIGINAL] key.

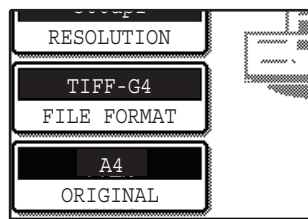

You can return to automatic detection by pressing the [CLEAR ALL] key (C^A).

SELECTING THE QUALITY

You can adjust the quality manually to match the type of original. After loading the original in scanner mode, follow the steps below. The factory default settings are "TEXT/PHOTO" for the image quality, and "AUTO" for the density.

1 Touch the [QUALITY] key.

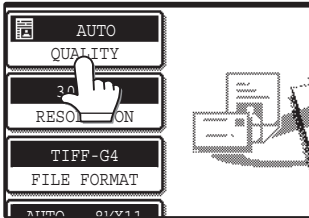

5 Touch the [OK] key.

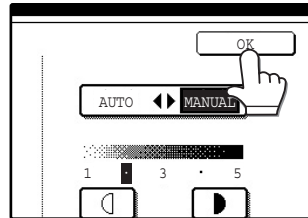

You will return to the initial screen.

2 Selecting the original type.

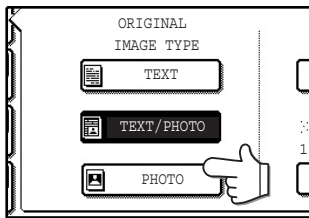

Touch the appropriate key for the type of original to be scanned. The image will be processed according to the selected type. You can select the original type from "TEXT", "TEXT/PHOTO" or "PHOTO".

- TEXT ([icon]) : Text original
- TEXT/PHOTO ([icon]) : Original with mixed text and photos.
- PHOTO ([icon]) : Photograph or illustration

3 Touch the [AUTO ◀▶ MANUAL] key.

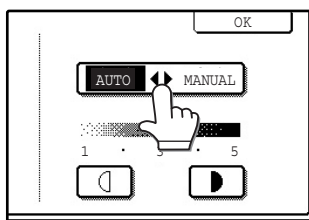

"MANUAL" is highlighted.

4 Adjust the density.

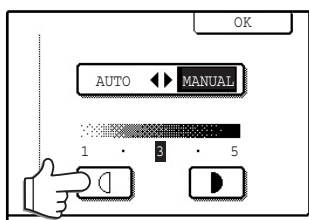

Touch the [right arrow] or [left arrow] key to adjust the scanning density. (Touch the [right arrow] key for a darker image or the [left arrow] key for a lighter image.)

SELECTING THE RESOLUTION

The resolution for scanning an original can be selected. Load the original in scanner mode and then follow the steps below. The factory default setting for the resolution is "300 dpi".

Change the resolution

1 Touch the [RESOLUTION] key.

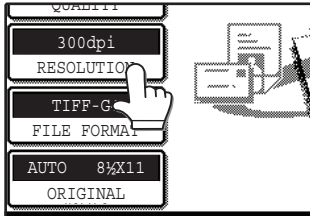

2 Touch the desired resolution key.

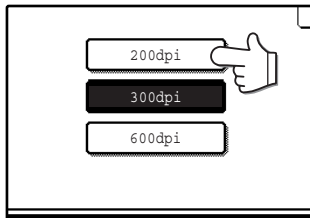

Touch the resolution key that is most suitable for the original. The selected key will be highlighted.

3 Touch the [OK] key.

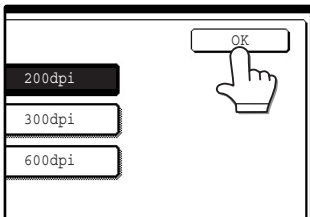

You will return to the initial screen.



- The resolution is initially set to 300 dpi (factory default setting). A resolution of 200 dpi or 300 dpi produces sufficiently clear image data for normal text originals. (200 dpi is equivalent to the "Fine" character mode used for facsimiles).
The 600 dpi setting should only be used in cases where high-clarity image reproduction is required, such as a photograph or an illustration. Note that a high resolution setting will result in a larger file size, and transmission may not be successful if there is insufficient disk capacity in the server to which the image is sent (or if the administrator of the server has restricted the file size). If transmission is not successful, you can try such measures as reducing the number of scanned pages in the file or reducing the scan size setting for the original ("MANUALLY SETTING THE SCANNING SIZE" (p.78)).
- The default resolution setting can be changed in the administrator settings. (See "INITIAL RESOLUTION SETTING" in "6. SYSTEM SETTINGS (ADMINISTRATOR)".)
- The resolution setting cannot be changed once scanning has begun.

SELECTING THE FILE FORMAT

You can select the format of the image file that will be created (file type, compression mode, and pages per file). The factory default settings are "TIFF" for the file type, "MMR (G4)" for the compression mode, and "ALL" for the pages per file.

1 Touch the [FILE FORMAT] key.

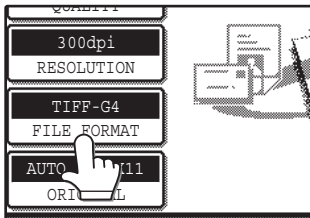

2 Select the file type and the compression mode.

Either [TIFF] or [PDF] can be selected for the file type of the image data to be created, and [NONE], [MH (G3)] or [MMR (G4)] can be selected for the compression format.

3 Set the number of pages per file.

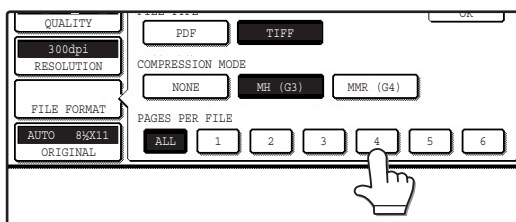

Touch the "ALL" key or one of keys [1] to [6].

- [ALL]: The scanned images are combined into a single file.
- [1] to [6]: Multiple image files are created, each with the selected number of pages per file.

4 Touch the [OK] key.

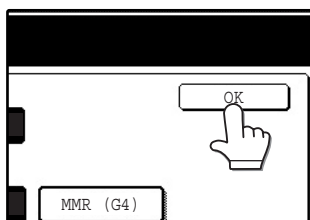

You will return to the initial screen.



- The factory default setting can be changed in the administrator settings. (See "INITIAL FILE FORMAT SETTING" in "6. SYSTEM SETTINGS (ADMINISTRATOR)".)
- To open the scanned image without using the software program in the CD-ROM that accompanies the network scanner expansion kit, the recipient must have a viewer program that can open the image format (file type) that was selected as explained above.
- The factory default setting for the image format produces the smallest file (TIFF G4). If the recipient cannot open the image, try sending the image in a different format.
- If the number of scanned originals is not divisible by the number set in "PAGES PER FILE", the last file will have less pages.

CHANGING THE SEND SETTINGS

The file name of the scanned image can be changed.

When performing Scan to E-mail, the subject and sender can also be changed.

If the send settings are not changed, these items are entered automatically using the information stored in the Web page.

1 Touch the [SEND SETTINGS] key.

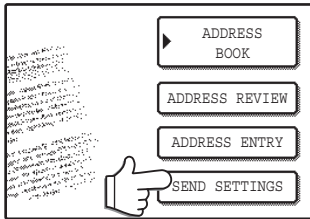

2 Touch the [SUBJECT], [FILE NAME], or [SENDER] key to change the corresponding entry.

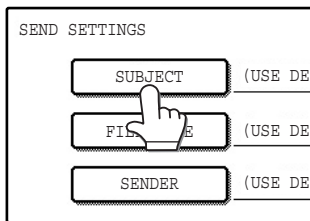

If the [Enable User Authentication] or [Disable selection of sender from Sender List] checkbox is selected in "Advanced Setup" in "Network Scanning" in the Web page, the [SENDER] key will be grayed out and cannot be selected (p.58).

3 If the [SUBJECT] key or [FILE NAME] key is touched, a keyboard will appear. Enter the desired text and then touch the [OK] key.

Up to 64 characters can be entered.

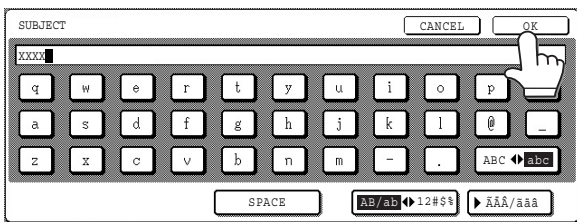

- A maximum of only 54 characters can be displayed in the send settings screen.
- When entering a file name, there is no need to enter a file extension. The file extension is added automatically based on the selected file format.
- The following symbols cannot be used when entering a file name or folder name.

\	?	/	"	;	:	,
<	>	!	*		&	#

Depending on the environment of use of the OS, it may not be possible to use spaces and the symbols indicated below. For example, hyperlinks will not operate correctly or nonsense characters may appear.
\$ % ' () + - . = @ [] ^ ` { } _

4 If [SENDER] is touched, a sender selection screen will appear. Touch the desired one-touch key and then touch the [OK] key.

The [GLOBAL ADDRESS SEARCH] key is used to select a user stored in a global address book as a sender. (p.75)

The [ADDRESS ENTRY] key is used to directly enter an e-mail address.

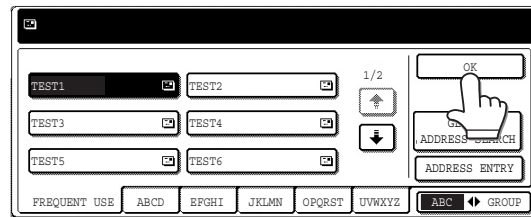

- The senders that have been stored in "Sender" in the Web page appear in the sender select screen. If the desired sender does not appear, you must first store it as a Scan to E-mail destination in "Sender" in the Web page. (p.67)
- When a checkmark appears in the [Disable selection of sender.] checkbox in the Web page, the [SENDER] key in the "SEND SETTING" screen is grayed out to prevent selection of senders and entry of e-mail addresses.
- If an LDAP server is not configured in the Web page, the [GLOBAL ADDRESS SEARCH] key will be grayed out and searching will not be possible.

5 Touch the [OK] key in the send settings screen.

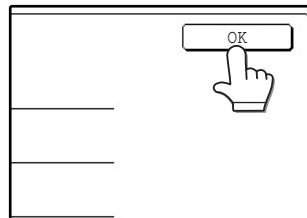

You will return to the initial screen.

CANCELING AN E-MAIL/FTP TRANSMISSION

You can cancel a transmission job that is in progress. Cancellation is done from the scanner job status screen.



You can cancel a transmission after scanning is finished by pressing the [CLEAR] key (Ⓢ) or the [CLEAR ALL] key (Ⓢ) while "SENDING. PRESS [C] TO CANCEL." appears in the touch key.

1 Press the [JOB STATUS] key.

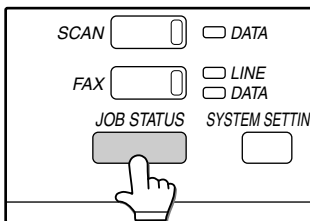

2 Touch the [SCAN TO] key.

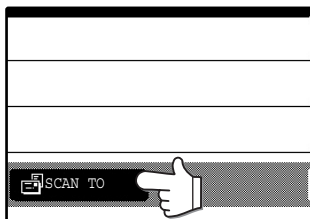

3 Touch the job key of the transmission job that you wish to cancel.

The touched key is highlighted.

4 Touch the [STOP/DELETE] key.

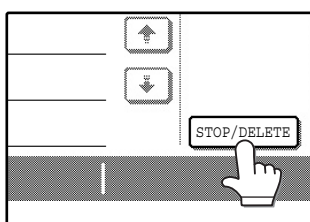

A message appears to confirm the cancellation. Touch the [YES] key to delete the selected job key and cancel the transmission.



If you do not wish to cancel the transmission, touch the [NO] key.

METADATA DELIVERY (DATA ENTRY)

When the application integration module is installed and an image file is generated for a scan send transmission, metadata (data indicating the attributes of the image file and how it is to be processed) can be generated based on pre-stored information and transmitted as a separate file. The metadata file is created in XML format. By linking the metadata with applications such as document management software, a workflow application, or an encryption server, a sophisticated document solution environment can be built.

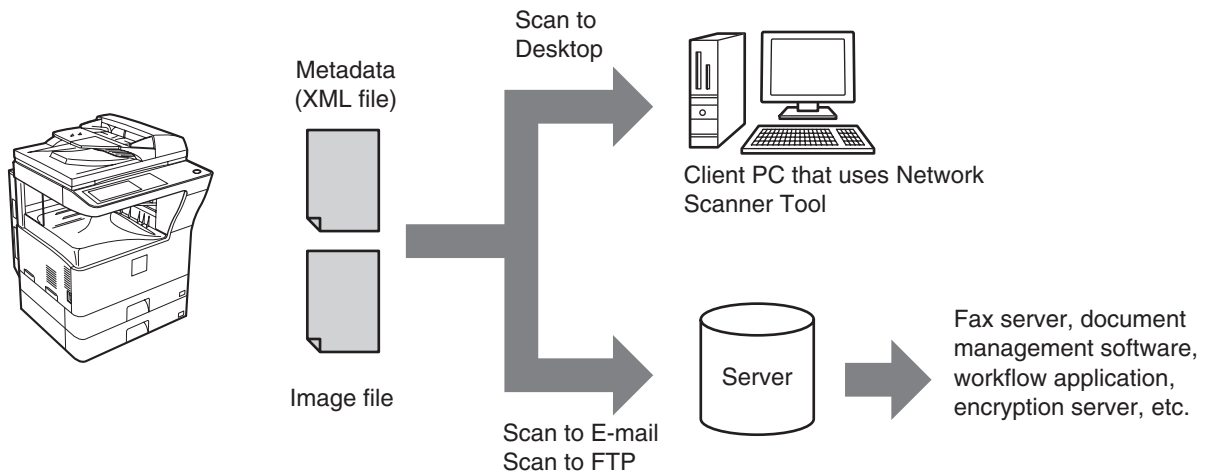

Using the application integration module, information on a generated image file can be entered at the touch panel and transmitted along with the image as an XML file.

PREPARATIONS FOR METADATA TRANSMISSION

SETTINGS REQUIRED IN THE WEB PAGES

All settings related to metadata are configured in the Web pages. (Administrator rights are required.) To configure metadata settings, click [Metadata Settings] in the Web page menu frame.

Storing Metadata Sets

Store the items (the metadata set) that are written to the XML file that is generated during scanning. Up to 10 metadata items can be configured in a metadata set. A stored metadata set can be selected at the time of transmission.



Addresses specified in "Require destination selection and include in metadata" when a metadata set is stored can be selected as transmission destinations at the time of transmission using one-touch keys, manual entry, and/or a global address book search. (Addresses for which metadata entry is not allowed cannot be specified as transmission destinations.)

METADATA TRANSMISSION FOR SCAN TO DESKTOP

When Network Scanner Tool is used in its factory default configuration, a file will be generated with a new file name on the computer. When Network Scanner Tool is used as a means of sending a metadata file to a third party software application, this setting must be disabled to allow cross referencing between the image file and XML file by means of the file name generated by the computer. (When setting the file name in [SEND SETTINGS], to ensure that a previously existing file on a computer is not overwritten by a transmitted file of the same name, be sure to configure the file name so that name duplication cannot occur; for example, by including a unique extension (the date, etc.) in the generated file name. If the file name setting is left blank, the machine will automatically generate a file name that is unique.)

4



- It is recommended that you use Network Scanner Tool to receive metadata. For more information, see the Network Scanner Tool User's Guide (PDF format) on the "Sharpdesk/Network Scanner Utilities" CD-ROM.
- For information on the license agreement and how to use the CD-ROM that accompanies the application integration module, see the separate "Sharpdesk license kit" manual.
- **Using third party software applications**
Various types of third party software applications exist. Some applications can start automatically from Network Scanner Tool and some cannot. When the auto-run function of an application is enabled, Network Scanner Tool will start the application with the ".exe" command using the file name as a parameter. Normally an application is started twice, once for the image file and once for the XML file. For example, when Network Scanner Tool is set to start the application "APP.EXE", the following commands are applied when the two files "IMG.TIF" and "IMG.XML" are received.
APP.EXE IMG.TIF
APPEXE IMG.XML

TRANSMITTING METADATA

Follow the steps below to select a metadata set, enter each item, and perform metadata transmission.

1 Touch the [DATA ENTRY] key.

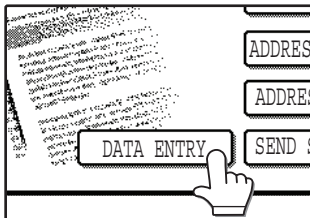

If no metadata sets have been stored, the [DATA ENTRY] key cannot be selected. Store a metadata set in the Web pages and then perform the transmission procedure.

2 Touch the key of the metadata that you wish to use.

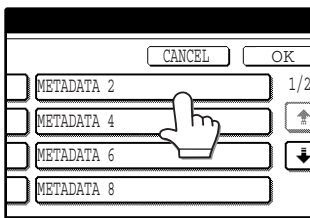

3 Touch the [OK] key.

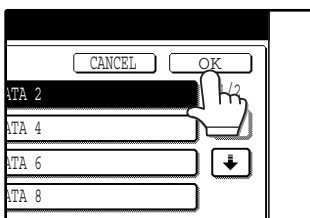

4 The keys of the items stored in the metadata set will appear. Touch the key of the item that you wish to enter.

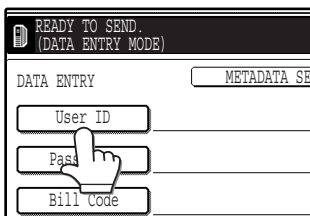

If you selected the wrong metadata set, touch the [METADATA SET] key and return to the screen of step 3. Metadata items entered to that point will not longer be effective.

5 Touch the key of the value that you wish to enter.

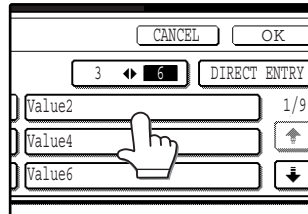

- If the entry values of the metadata item were stored in selection format, the selections will appear as keys. If a value is editable, the [DIRECT ENTRY] key can be touched to manually enter a value.
- If a metadata item requires the entry of text, a text entry screen will appear. Enter the required information.



- To change the number of items that appear at once, touch the display item number select key. Each time the key is touched, the number of items displayed switches between 3 and 6.

6 Touch the [OK] key.

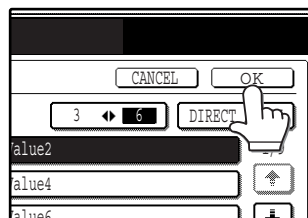

7 Enter all items.

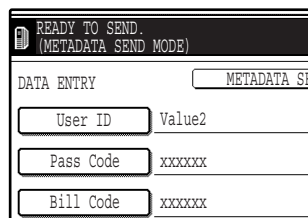

8 Touch the [OK] key.

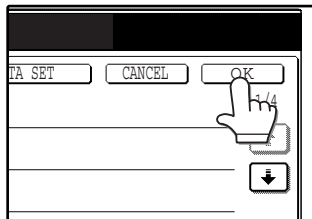

9 Select image settings and any other settings, and perform the scan send procedure.

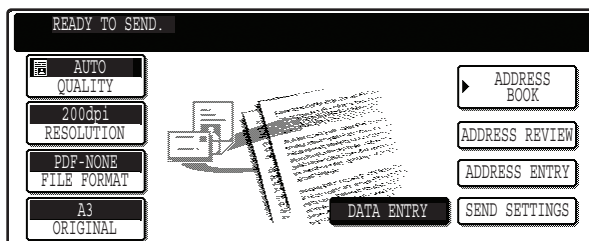

- The procedures for selecting settings and performing transmission are the same as for scan send.
- To change an entered value, touch the [DATA ENTRY] key again. The entry screen for the selected metadata set will appear.

4



- When metadata send settings are configured, the [DATA ENTRY] key is highlighted. If you do not wish to send metadata, cancel the metadata settings and then perform the transmission
- When a destination or metadata setting has been selected in data entry mode, it will not be possible to switch to another mode.

METADATA FIELDS

The following three types of metadata are included in the XML file that is transmitted.

- Data automatically generated by the machine: These data are always included in the XML file and are automatically stored on your computer.
- Previously defined fields: These fields are automatically recognized by the machine and assigned to appropriate XML tags. These fields are selectable, and can only be included in the XML file if enabled in the Web pages.
- User defined fields: Custom fields can be added to the XML file. These fields are selectable and can be defined in the Web pages.

If a defined metadata field is one of the following fields, a message will appear informing you that the field cannot be entered. Enter appropriate information in the related items of the send settings.

Name entered in metadata field	Description	Where entered
fromName	Name of the user who sent the job. If the name is not entered as metadata, the sender name determined by the usual rules for determining the sender name will be applied as metadata.	[SENDER NAME] (Sender name of selected sender)
senderName	E-mail address to which the transmission result will be sent.	[SENDER NAME] (E-mail address of selected sender)
documentSubject	Job name appearing in the e-mail "Subject" line, or job name on the fax cover sheet. When the user enters a [SUBJECT] in the send settings screen in the touch panel, the entered value is applied as metadata.	[SUBJECT] (Blank until a value is set in the send settings screen.)
fileName	Enter the file name of the image to be sent.	[FILE NAME] (Only when the [Allow Custom Filenames] checkbox is selected <input checked="" type="checkbox"/> in the metadata settings screen in the Web pages.) (Blank until a value is set in the send settings screen.)

CHECKING THE IP ADDRESS

To check the IP address of the machine, print out the settings list from the operation panel of the machine.

1 Press the [SYSTEM SETTINGS] key.

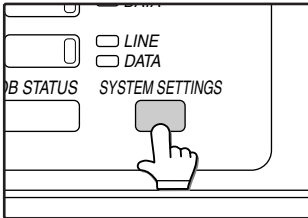

The system settings screen will appear.

2 Touch the [LIST PRINT] key.

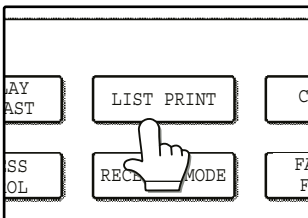

3 Touch the [PRINTER TEST PAGE] key.

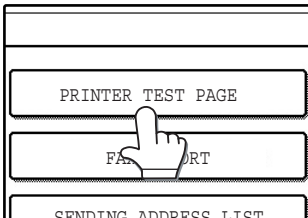

4 Touch the [PRINTER SETTINGS LIST] key.

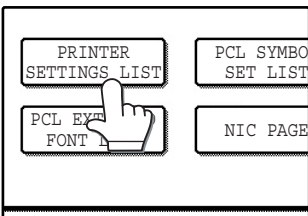

"PRINT JOB IN MEMORY. PLEASE WAIT UNTIL PRINT OUT." appears in the message screen and printing begins.

SYSTEM SETTINGS

The system settings let you adjust certain features of the machine to better suit your needs.

The system settings consist of settings that are used by general users, and settings that can only be configured by an administrator of the machine.

This chapter explains system settings (general) that can be configured by general users.

The system settings include the following settings:

- TOTAL COUNT This displays the number of pages output by the machine. (p.92)
- DISPLAY CONTRAST This is used to adjust the contrast of the touch panel. (p.92)
- LIST PRINT*¹ This is used to print a setting list or a font list. (p.92)
- CLOCK This is used to set the date and time of the machine's built-in clock. (p.92)
- TRAY SETTINGS This is used to configure the paper type and paper size settings for each tray, and select whether or not automatic switch over to another tray with the same size and type of paper will take place if the paper runs out during continuous printing. (p.92)

The following settings are explained in detail in the operation manual for facsimile.

- ADDRESS CONTROL*² If your machine has the fax option, this setting is used to store fax numbers for automatic dialing. Group keys and user indexes can also be programmed.
- RECEIVE MODE*² This is used to select the fax receive mode (automatic or manual).
- FAX DATA FORWARD*² This is used to forward faxes received in memory to another destination.

- KEYBOARD SELECT*³ When using the fax or network scanner function, use this setting to change the layout of the keyboard in the letter entry screen. (p.92)
- ADMINISTRATOR SETTINGS.... Settings for administrators of this machine) A key appears for these settings in the system settings menu screen. For explanations of the settings, see "6. SYSTEM SETTINGS (ADMINISTRATOR)". (For explanations of administrator settings for the fax option, see the operation manual for facsimile.)

*¹ The fax option or network printer function must be installed.

*² The fax option must be installed.

*³ The fax option or network scanner function must be installed.

GENERAL PROCEDURE FOR SYSTEM SETTINGS

1 Press the [SYSTEM SETTINGS] key.

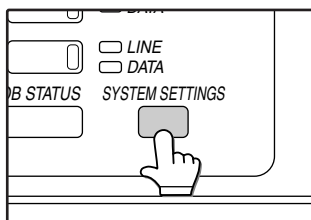

2 Touch the key of the desired setting. The setting screen will appear.

Each of the system settings is explained on the following pages.

The [TRAY SETTINGS] key is selected in the following example.

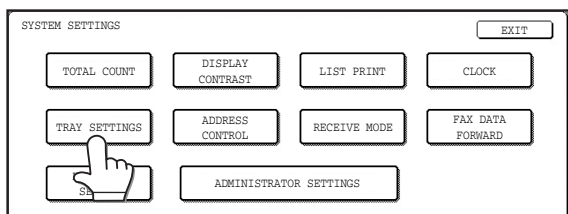

When the [TRAY SETTINGS] key is selected, the following screen appears.

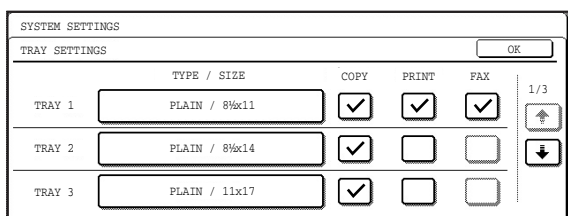

- When a checkbox appears next to an item in a screen, touch the checkbox () to select the item. A checkmark () will appear to indicate that the item is selected.

In the above settings, tray 1 can be used for printer, copy, and fax mode. Tray 2 and tray 3 can only be used for copy mode.

- For a detailed explanation of the trays, see "CHANGING A TRAY'S PAPER TYPE AND PAPER SIZE SETTINGS" (p.20).

3 Touch the [OK] key in the setting screen to close it.

4 When you are ready to exit the system settings, touch the [EXIT] key.

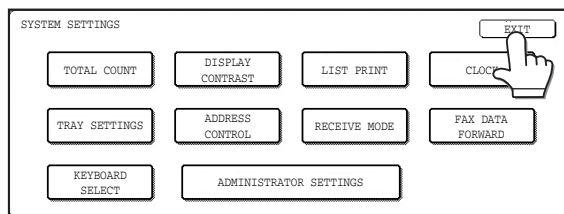

SETTINGS

Total count

The total page count display shows the following counts:

- The total count shows the combined output total of the copy, fax, and printer functions.
- Total number of copies and printed pages
- Number of pages fed through the RSPF
- Number of two-sided copies
- Number of times the stapler was used
- Number of pages sent using the network scanner function
- Number of sent and received fax pages

The counts that appear will vary depending on the peripheral equipment installed.

- Each sheet of paper that is 11" x 17" (A3) size is counted as two sheets.
- Each sheet of paper used for automatic two-sided copying is counted as two sheets (11" x 17" (A3) paper is counted as four sheets.).

Display contrast

Screen contrast adjustment is used to make the touch panel easier to view under various lighting conditions. Touch the [LIGHTER] key to make the screen lighter, or the [DARKER] key to make the screen darker.

List print

Use this to print the PRINTER TEST PAGE, the FAX REPORT, or the SENDING ADDRESS LIST.

Clock

Use this to set the date and time of the machine's built-in clock. The date and time are used for functions that require date and time information.

Tray settings

The paper type, paper size, and enabled modes can be set for each tray. Auto tray switching and disabling of two-sided printing on letterhead paper can also be set. See page 20 and 21 for details on setting the paper type and paper size.

- To select which trays can be used in each of copy, printer, and fax modes, select the checkboxes (☑) of the desired trays in each mode.
- When a tray runs out of paper in the middle of a job, the auto tray switching function automatically switches the paper source to another tray that has the same paper size and paper type settings. (The auto tray switching function cannot be set for the bypass tray.)

Keyboard select

When using the fax or network scanner function, you can change the layout of the keyboard that appears in the letter entry screen. Select the layout that you find easiest to use.

The following three keyboard configurations are available:

- Keyboard 1 (QWERTY configuration)*
- Keyboard 2 (AZERTY configuration)
- Keyboard 3 (ABCDEF configuration)

*The default setting is "Keyboard 1".

(Example: Letter entry screen when Keyboard 3 is selected.)

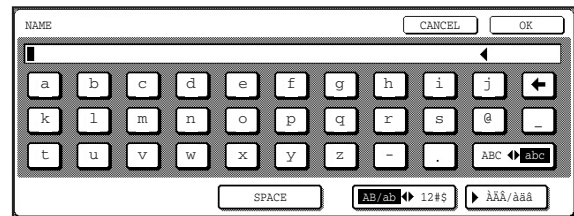

JOB PROGRAM MEMORY

If you frequently use the same settings for copy jobs, you can store in the settings in a job program. Up to 10 job programs can be stored, and the programs are retained even when the power is turned off. By storing frequently used copy settings in a program, you can eliminate the bother of selecting the settings each time you use them for a copy job.

- After a job program is stored, if any settings of the administrator settings related to the stored job program are prohibited, the related settings in the job program will not be recalled.
- If the overwriting of job programs is prohibited in the administrator settings, it will not be possible to overwrite or delete a job program.
- To exit job program memory mode, press the [CLEAR ALL] key (Ⓢ) on the operation panel or touch the [EXIT] key on the touch panel.

STORING A JOB PROGRAM

1 Press the [#/P] key (Ⓢ).

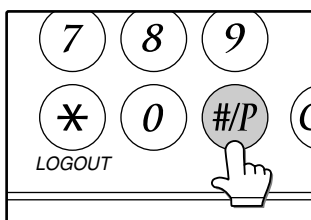

4 Select the copy settings that you wish to store in the program.

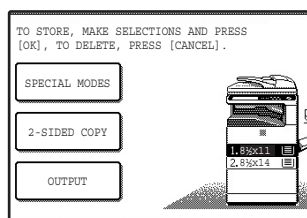

The number of copies cannot be stored.

2 Touch the [STORE/DELETE] key.

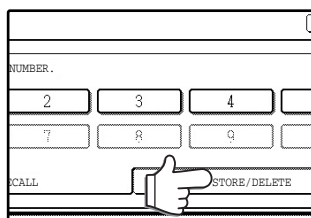

5 Touch the [OK] key.

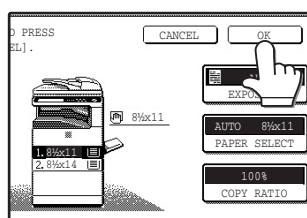

The selected settings will be stored under the program number selected in step 3.

3 Touch a program number from 1 to 10 in the storage register screen.

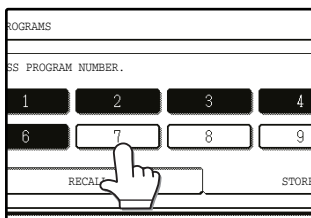

If a numeric key is selected that has already been programmed, a confirmation screen will appear. To replace the existing program with the new program, touch the [STORE] key and continue from step 4. If you do not wish to replace the existing program, touch the [CANCEL] key to return to the above screen and select a different numeric key.

5

EXECUTING A JOB PROGRAM

1 Press the [# / P] key (Ⓢ).

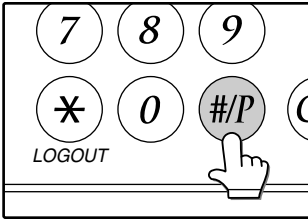

2 Touch the program number key of the desired program.

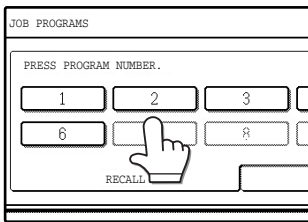

The job program will be executed. A number for which no job program has been stored cannot be selected.

3 Place the original, check the original size, and then set the number of copies and any other desired copy settings not stored in the program. When finished, press the [START] key (Ⓢ).

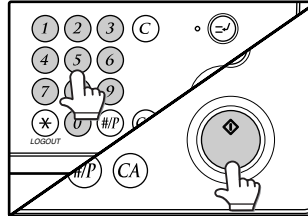

DELETING A STORED JOB PROGRAM

1 Press the [# / P] key (Ⓢ).

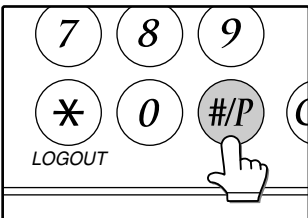

2 Touch the [STORE/DELETE] key.

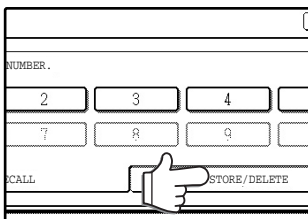

3 Select the program number of the program to be deleted.

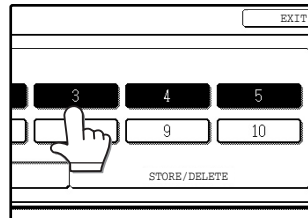

If a number key for which no job program has been stored is selected, the proceed to step 4 on the previous page (for storing a job program).

4 Touch the [DELETE] key.

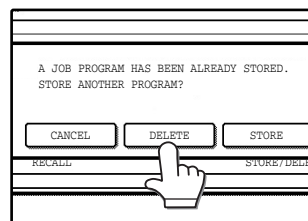

The selected program will be deleted and you will return to the screen of step 3. If the [CANCEL] key is touched, you will return to the screen of step 3 without deleting the program.

If you are finished deleting programs, touch the [EXIT] key in the screen of step 3 to exit.

AUDITING MODE

When auditing mode is enabled, a count is kept of the number of pages printed or copied by each account (maximum of 100 accounts). The counts can be viewed whenever necessary.



- Auditing mode can be enabled for all modes (copy mode, fax mode, network scanner mode, and printer mode) in the administrator settings. (See "6. SYSTEM SETTINGS (ADMINISTRATOR)".)
- To print in printer mode when auditing mode is enabled, enter your account number in the printer driver setup screen on your computer.

COPYING WHEN AUDITING MODE IS ENABLED

When auditing mode is enabled, the following account number entry screen appears.

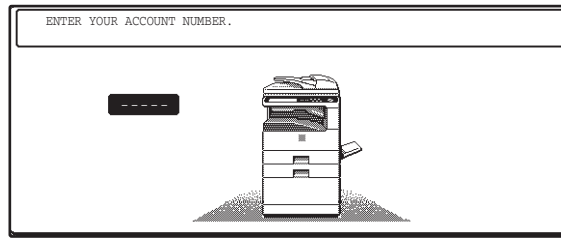

1 Enter your account number (5 digits) with the numeric keys.

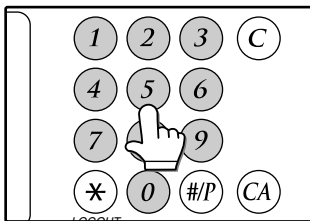

Each digit is indicated by an asterisk "*".

2 When the copy job is finished, press the [LOGOUT] key (*).

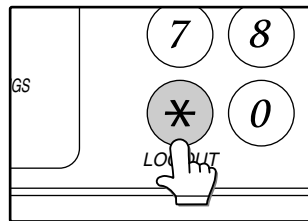

The screen reverts to the account number entry screen.

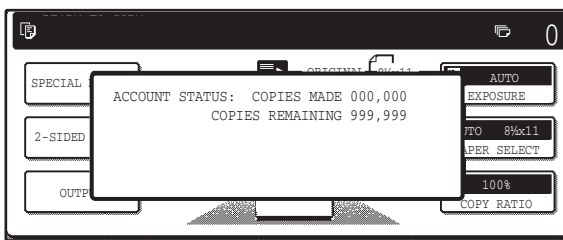

- When a valid account number is entered, the number of copies already made by that account appears for several seconds on the initial screen.
- If a limit has been set in the administrator settings for the number of copies that can be made by the account, the remaining number that can be made is displayed in the message display together with the number of copies already made. (See "6. SYSTEM SETTINGS (ADMINISTRATOR)".)



- To perform an interrupt job when auditing mode is enabled, press the [INTERRUPT] key (⊖). The account number entry screen will appear. Enter your account number. When the interrupt job is finished, be sure to press the [INTERRUPT] key (⊖) or the [CLEAR ALL] key (⊕) to end interrupt mode.
- If an invalid account number is entered in step 1, the account number entry screen reappears.
- When ACCOUNT NUMBER SECURITY in the administrator settings is enabled (See "6. SYSTEM SETTINGS (ADMINISTRATOR)".), the following message will appear and operation will not be permitted for 1 minute if an invalid account number is entered 3 times in a row.

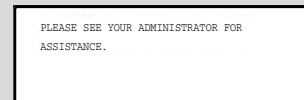

PURPOSE OF THE ADMINISTRATOR SETTINGS

The administrator settings in the system settings are used by the administrator of the machine to customize certain features of the machine to better meet the needs of users.

This chapter explains administrator settings that are common to all functions of the multifunction system (copy function, fax function, printer function, and network scanner function), as well as programs that are specific to the copy function, printer function, and network scanner function. Programs that are specific to the fax function are explained in the following manual:

- Fax function "AR-FX7 Operation manual" (Chapter 8)

In order to access the administrator settings, the administrator password must be entered.

PROGRAMMING A ADMINISTRATOR PASSWORD

The administrator password is a 5-digit number that must be entered in order to access the administrator settings. The administrator of the machine should change the default administrator password that was set at the factory to a new 5-digit number. Be sure to remember the new administrator password, as it must be entered each time the administrator settings are subsequently used. (Only one administrator password can be programmed.) To change the administrator password, see "USING THE ADMINISTRATOR SETTINGS" on the following page.

The administrator password is initially set to "00000" at the factory.

USING THE ADMINISTRATOR SETTINGS



When using the administrator settings for the first time, change the factory default administrator password to a new code. (Step 3 to step 5)

1 Press the [SYSTEM SETTINGS] key.

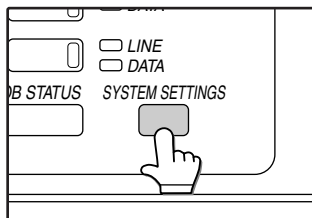

2 Touch the [ADMINISTRATOR SETTINGS] key.

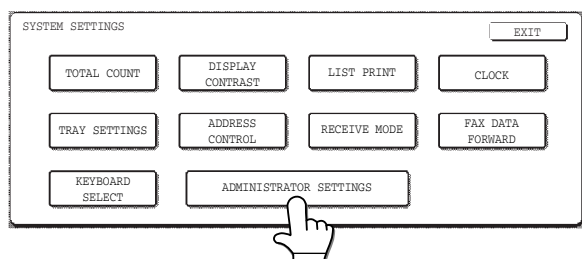

3 Use the numeric keys to enter the five-digit administrator password.



Each time a digit is entered, the dash (-) that indicates the digit will change to an asterisk (*). The factory default setting for the administrator password is 00000.

4 Touch a key to select the desired category of administrator settings.

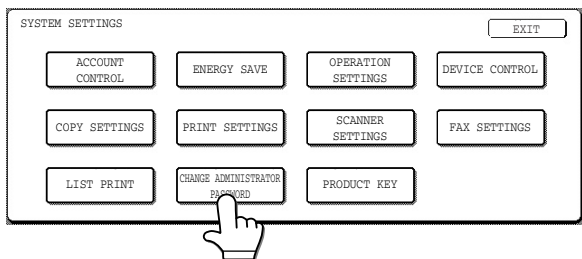

Example:

To change the administrator password, touch the [CHANGE ADMINISTRATOR PASSWORD] key.

- Each time you need to configure a program, use this procedure to select the program.
- In the following steps, the setting screen for the selected program appears. Refer to the explanation of the program to select the desired setting (the explanations of the programs begin on page 103).

5 Use the numeric keys to enter the new 5-digit administrator password.

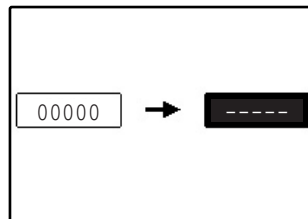

Use a number for the administrator password that has not been programmed as an account number for auditing mode (a number that has been programmed as an

account number cannot be used). The entered number will be the new administrator password. Be sure to remember this number.

6 Touch the [OK] key. You will return to the screen of step 4.

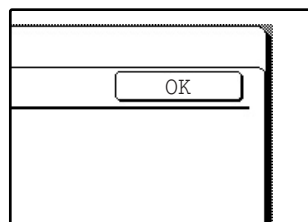

This completes the procedure for changing the administrator password. If you wish to configure another program, touch the key of the desired program in the screen of step 4.

7 Press the [CLEAR ALL] key (CA) to exit the setting.

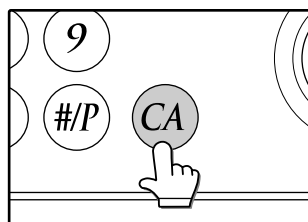

6

KEYS USED IN ADMINISTRATOR SETTINGS

Example: Auditing mode

The following keys appear in screens that require the entry of numerical values.

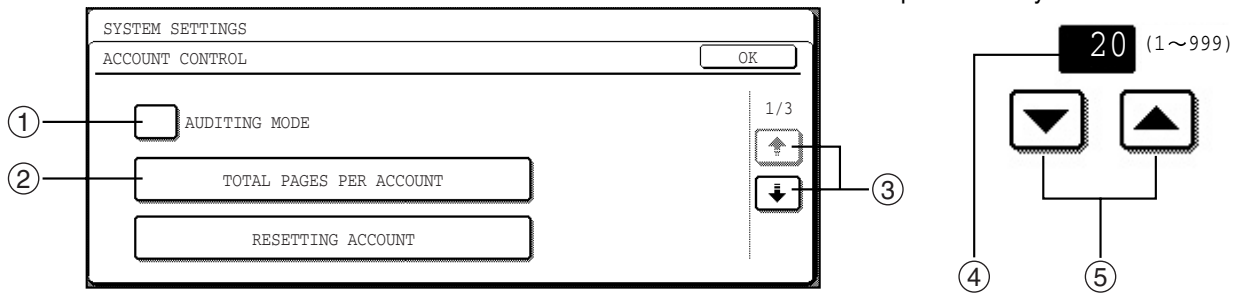

- ① When a checkbox () appears in front of a setting, a checkmark () will appear when the checkbox is touched. This indicates that the setting is enabled. If a checkbox with a checkmark () is touched, the checkmark is cleared () and the setting is disabled.
- ② When a key that appears in the form is touched, the setting screen of that key will appear.
- ③ If the settings continue on the following screen(s), touch the and keys to move back and forth through the screens. To return to the category selection screen, touch the [OK] key.
- ④ The currently set numerical value is displayed.
- ⑤ Numerical values can be set by touching the and keys.

ADMINISTRATOR SETTING LIST



The administrator settings that can be accessed depend on the optional equipment that is installed.

GENERAL PROGRAMS

Program name	Factory default settings	Page
ACCOUNT CONTROL		
AUDITING MODE	Disabled	103
TOTAL PAGES PER ACCOUNT	—	103
RESETTING ACCOUNT	—	103
ACCOUNT NUMBER CONTROL	—	104
ACCOUNT LIMIT SETTING	—	104
ACCOUNT NUMBER SECURITY	Disabled	104
CANCEL JOBS OF INVALID ACCOUNTS *4	Disabled	104
ENERGY SAVE		
AUTO POWER SHUT-OFF	Enabled	105
AUTO POWER SHUT-OFF TIMER	—	105
PREHEAT MODE SETTING	—	105
TONER SAVE MODE	Disabled	105
OPERATION SETTINGS		
AUTO CLEAR SETTING	60 (sec)	106
MESSAGE TIME SETTING	6 (sec)	106
KEYS TOUCH SOUND	• KEYS TOUCH SOUND: Short • KEYS TOUCH SOUND AT INITIAL POINT: Disabled	106
TOUCH KEY OPERATION SETTING	• Time to entry: 0.0 (sec) • DISABLE AUTO KEY REPEAT: Disabled	106
DISABLE INTERRUPT PRINT JOB	Disabled	106
STREAM FEEDING MODE	Disabled	107
DISPLAY LANGUAGE SETTING	AMERICAN ENGLISH	107
DISABLE DISPLAY TIMEOUT	Disabled	107
DISABLING OF TRAY SETTINGS	Disabled	107
DISABLING OF CLOCK ADJUSTMENT	Disabled	107

Program name	Factory default settings	Page
DEVICE CONTROL		
DISABLING OF DOCUMENT FEEDER	Disabled	107
DISABLING OF DUPLEX	Disabled	107
DISABLING OF STAPLER *2	Disabled	107
OUTPUT TRAYS *3	PATTERN 1	108
DISABLING OF OFFSET *2	Disabled	108
MEMORY FOR PRINTER	• 50% • MEMORY AREA FOR PRINT HOLD *4 : 30%	108
DISABLING OF CENTER TRAY COUNTING	Disabled	108
RETURN FROM COPY MODE TIMING	60 (sec)	108
MIX SIZE ORIGINAL FEEDING MODE	Disabled	108
SECURITY SETTINGS	—	108
CHANGE ADMINISTRATOR PASSWORD	00000	109
PRODUCT KEY *4		
PS3 EXPANSION KIT *4	—	109
NETWORK SCANNER EXPANSION KIT *5	—	109
E-MAIL ALERT AND STATUS *4	—	109
APPLICATION INTEGRATION MODULE *5	—	109
SERIAL NUMBER	—	109

PROGRAMS FOR COPY MODE

Program name	Factory default settings	Page
COPY SETTINGS		
INITIAL STATUS SETTINGS	—	110
ROTATION COPY SETTING	Enabled	110
EXPOSURE ADJUSTMENT	• Document glass: 3 • Document feeder: 3	110
AUTO PAPER SELECTION SETTING	PLAIN PAPER	110
SETTING A MAXIMUM NUMBER OF COPIES	999	110
SORT AUTO SELECT	Enabled	110
DISABLING DELETION OF JOB PROGRAMS	Disabled	110
CARD SHOT SETTINGS	—	110

PROGRAMS FOR PRINT MODE

Program name	Factory default settings	Page
PRINT SETTINGS		
DEFAULT SETTINGS		
PROHIBIT NOTICE PAGE PRINTING	Disabled	111
PRINT DENSITY LEVEL	3	111
PROHIBIT TEST PAGE PRINTING *4	Disabled	111
ROTATED PRINT	Enabled	111
FORCED OUTPUT OF PRINT	Disabled	111
EXCLUDE BYPASS-TRAY FROM ATS	Enabled	111
DISABLE DEFAULT SETTING CHANGES *4	Disabled	111
INTERFACE SETTINGS		
HEXADECIMAL DUMP MODE *4	Disabled	112
I/O TIMEOUT	180 (sec) 60 (sec) *4	112
USB PORT EMULATION SWITCHING *4	PCL	112
NETWORK PORT EMULATION SWITCHING *4	AUTO	112
PORT SWITCHING METHOD *4	SWITCH AT END OF JOB	113
ENABLE USB PORT *4	Enabled	113
ENABLE NETWORK PORT *4	Enabled	113
NETWORK SETTINGS *4		
IP ADDRESS SETTING	DHCP: Enabled	113
ENABLE TCP/IP	Enabled	113
ENABLE NetWare	Enabled	113
ENABLE EtherTalk	Enabled	114
ENABLE NetBEUI	Enabled	114
RESET THE NIC	—	114
INITIALIZE AND/OR STORE SETTINGS *4		
RESTORE FACTORY DEFAULTS	—	114
STORE CURRENT CONFIGURATION	—	114
RESTORE CONFIGURATION	—	114

PROGRAMS FOR NETWORK SCANNER MODE

Program name	Factory default settings	Page
SCANNER SETTINGS *1		
INITIAL FILE FORMAT SETTING	<ul style="list-style-type: none"> • File type: TIFF • Compression mode: G4 • Number of pages per file: All 	115
INITIAL QUALITY SETTING	<ul style="list-style-type: none"> • Original image type: Text/Photo • Exposure: Auto 	115
INITIAL RESOLUTION SETTING	300 dpi	115
DEFAULT DISPLAY SETTINGS	CONDITION SETTINGS	115
THE NUMBER OF DIRECT ADDRESS / SENDER KEYS DISPLAYED SETTING	8 (keys)	115

*1 Appears when the scanner function is enabled.
 *2 Appears when a FINISHER is installed.
 *3 Can be enabled when a JOB SEPARATOR TRAY KIT or FINISHER and Right tray are installed.
 *4 Appears when the PRINTER EXPANSION KIT is installed.
 *5 Appears when the PRINTER EXPANSION KIT and EXPANSION MEMORY are installed.

ADMINISTRATOR SETTING MENU

The administrator settings are arranged in the following menu.
 Refer to this menu when enabling or disabling the settings that are explained beginning on page 103.
 * Some programs contain an additional level of settings (setting screen).

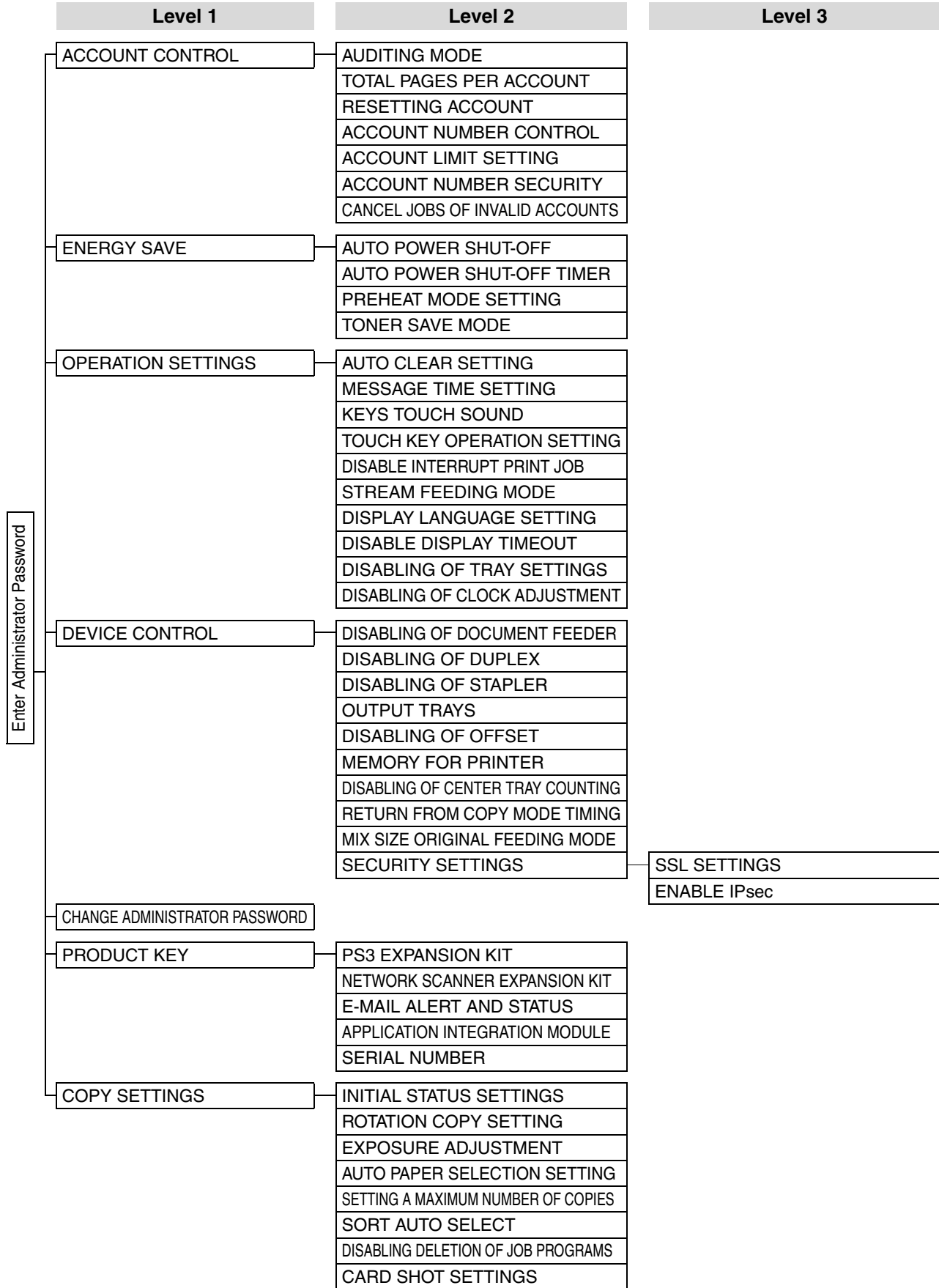

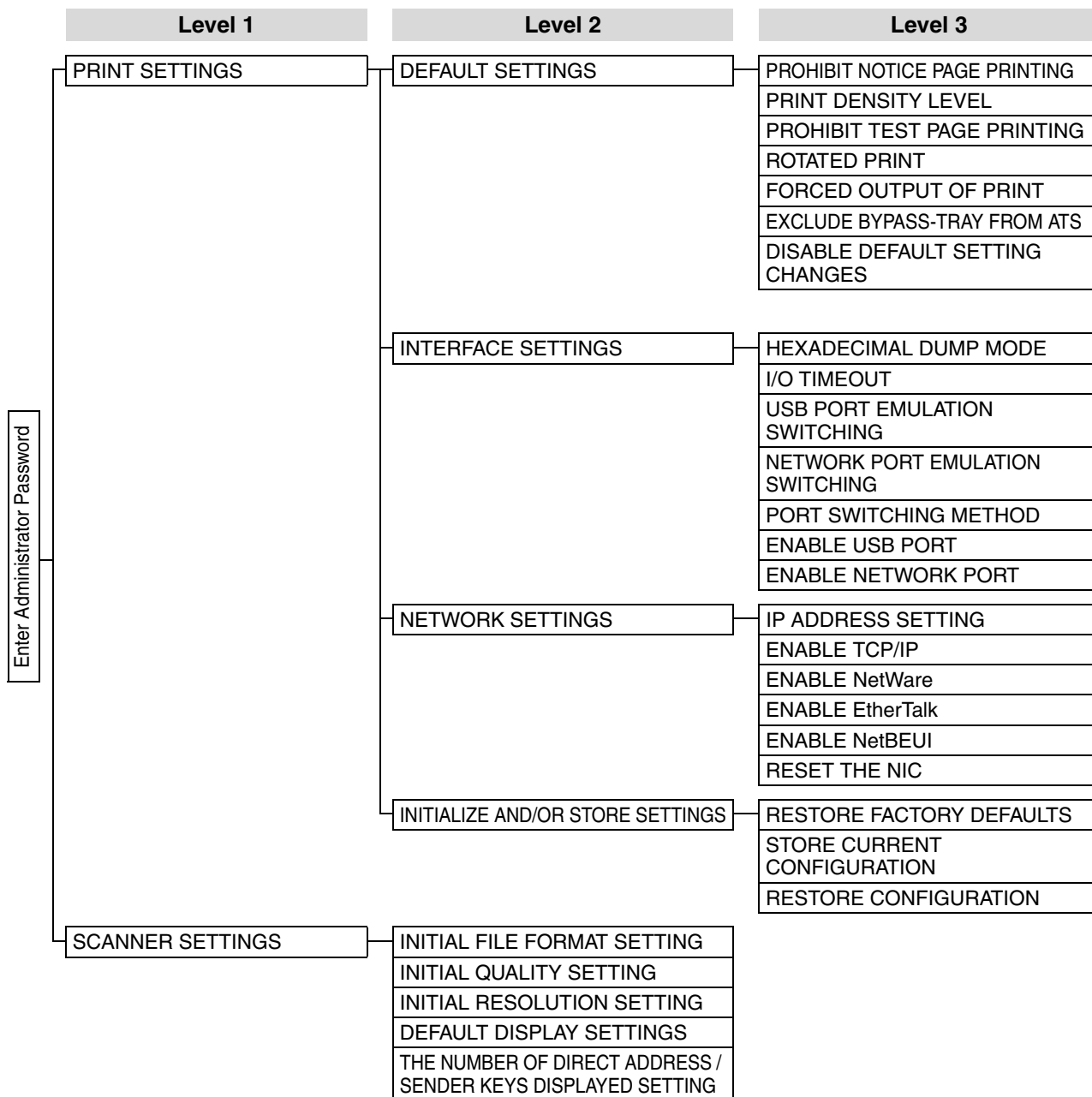

GENERAL PROGRAMS

This chapter explains administrator settings that are common to all functions of the multifunction system (copy function, fax function, printer function, and network scanner function).

ACCOUNT CONTROL

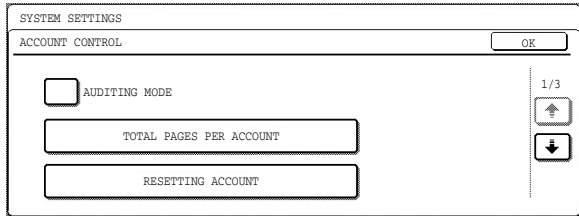

"ACCOUNT CONTROL" consists of the following programs.

- AUDITING MODE
 - TOTAL PAGES PER ACCOUNT
 - RESETTING ACCOUNT
 - ACCOUNT NUMBER CONTROL
 - ACCOUNT LIMIT SETTING
 - ACCOUNT NUMBER SECURITY
 - CANCEL JOBS OF INVALID ACCOUNTS *
- * Appears when the PRINTER EXPANSION KIT is installed.

AUDITING MODE

When AUDITING MODE is enabled, a count is kept of the pages printed by each account (up to 100 accounts can be established). The page counts can be viewed in the display. This program is initially disabled (factory default setting).



After enabling "AUDITING MODE", program account numbers using "ACCOUNT NUMBER CONTROL".

When using the copy function, fax function, or network scanner function, an account number must be entered to scan an original.

TOTAL PAGES PER ACCOUNT

This program is used to display the page counts of each account. Misfed pages are not included in the page counts. When the fax and network scanner functions are used, the fax and network scanner page counts show the number of pages transmitted.

Touch the [TOTAL PAGES PER ACCOUNT] key to display the page count screen.

ACCOUNT NUMBER	COPIES (LIMIT)	PRINTS	SCAN	FAX SEND	
11111	123,456 (150,000)	123,456	123,456	123,456	1/2
22222	123,456 (150,000)	123,456	123,456	123,456	↑
33333	123,456 (150,000)	123,456	123,456	123,456	↓
44444	123,456 (150,000)	123,456	123,456	123,456	

RESETTING ACCOUNT

This program is used to reset the page counts of each account to zero.

When the fax and network scanner functions are used, this program resets the fax and network scanner page counts to zero.

Touch the [RESETTING ACCOUNT] key to display the account reset screen.

ACCOUNT NUMBER	COPIES (LIMIT)	PRINTS	SCAN	FAX SEND	
11111	123,456 (150,000)	123,456	123,456	123,456	1/2
22222	123,456 (150,000)	123,456	123,456	123,456	↑
33333	123,456 (150,000)	123,456	123,456	123,456	↓
44444	123,456 (150,000)	123,456	123,456	123,456	

ALL ACCOUNTS
RESET

● Resetting a single account

Touch the key of the account that you wish to reset, and then select [YES] in the confirmation screen. If the account that you wish to reset does not appear, touch the ↑ key or ↓ key until the account appears. When finished, touch the [OK] key.

● Resetting all accounts

Touch the [RESET] key and then select [YES]. When finished, touch the [OK] key.

ACCOUNT NUMBER CONTROL

This program is used to store, delete, and change account numbers for AUDITING MODE. A maximum of 100 account numbers can be stored.

● Storing a new account number

To store a new account number, touch the [ENTER] key and then use the numeric keys to enter a 5-digit account number. Touch the [ENTER] key to store the number. After storing the account number, you can continue storing other account numbers.

Note that the same number as the administrator password cannot be stored.

● Deleting an account number

To delete an account number, touch the [DELETE] key and then select whether you wish to delete a single account number or all account numbers.

To delete a single account number, use the numeric keys to enter the account number that you wish to delete and then touch the [ENTER] key.

To delete all account numbers, touch the [DELETE] key and then touch [YES] in the screen that appears to confirm the deletion.

● Changing an account number

To change an account number, touch the [CHANGE] key and use the numeric keys to enter the account number that you wish to change. Enter the new account number and then touch the [ENTER] key. After changing the account number, you can continue changing other account numbers. If you make a mistake while entering the account number that you wish to change and enter a number that is not in use, an alarm will sound and the display will change to hyphens (-).

ACCOUNT LIMIT SETTING

A limit for the number of copies that can be made can be set for a single account or for all accounts at once. The maximum limit that can be entered is 999,999. Touch the [ACCOUNT LIMIT SETTING] key to display the account limit setting screen.

● Setting a limit for a single account

Use the numeric keys to enter the number of the account for which you wish to set a limit, and then enter the limit. When finished, touch the [ENTER] key.

If you enter an account number that already has a limit, the limit will appear in the display. To change the limit, press the [CLEAR] key (Ⓢ) (the display will change to hyphens (-)) and then enter the new limit. If you touch the [ENTER] key while the display shows hyphens (-) for the limit, the limit set for the account will be canceled. When you have finished setting a limit for one account, you can continue setting limits for other accounts.

When finished, touch the [OK] key to exit.

● Setting a limit for all accounts

Touch the [LIMIT] key. [ALL] will appear in the account number entry screen.

Enter a limit for all accounts in the same way as explained above for a single account.

When finished, touch the [OK] key to exit.

ACCOUNT NUMBER SECURITY

This program is used to display an alarm and prohibit entry of account numbers for one minute if an incorrect account number is entered three times in a row when "AUDITING MODE" is enabled. (This prevents unauthorized people from attempting to guess an account number.)

This program is initially disabled (factory default setting).

CANCEL JOBS OF INVALID ACCOUNTS

This program is used to control use of the printer function when "AUDITING MODE" is enabled. When this program is enabled, the machine will not print a print job if the operator enters an invalid account number at the computer or fails to enter an account number.

When the program is disabled, print jobs received without the entry of a valid account number will be printed and the number of pages will be included in the [OTHERS] count.

This program is initially disabled (factory default setting).

ENERGY SAVE

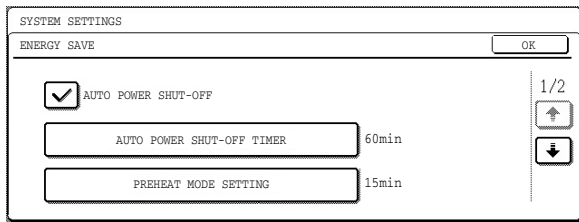

"ENERGY SAVE" provides the following four programs to reduce your power costs. From an environmental perspective, this also helps conserve natural resources and reduce pollution.

- AUTO POWER SHUT-OFF
- AUTO POWER SHUT-OFF TIMER
- PREHEAT MODE SETTING
- TONER SAVE MODE

AUTO POWER SHUT-OFF

If the machine is not used for the amount of time set in "AUTO POWER SHUT-OFF TIMER", AUTO POWER SHUT-OFF will activate and switch the machine to a standby state that conserves the maximum amount of energy. This program can be used to prevent AUTO POWER SHUT-OFF from operating. When this is done, the "AUTO POWER SHUT-OFF TIMER" setting is disabled. Use this program when circumstances require that AUTO POWER SHUT-OFF be disabled. This program is initially enabled (factory default setting).



Rather than disabling the auto power shut-off feature, we suggest that you first try lengthening the time set in "AUTO POWER SHUT-OFF TIMER" In most cases a suitable timer setting will allow work to proceed with minimal delay and still enable you to enjoy the benefits of power conservation.

AUTO POWER SHUT-OFF TIMER

This program is used to set the amount of time after which "AUTO POWER SHUT-OFF" activates when the machine is not used.

This function allows you to reduce power costs, and at the same time helps conserve natural resources and reduce pollution.

The time can be set to as long as 240 minutes in increments of one minute.



- Select a suitable time according to your pattern of use of the machine.
- If "AUTO POWER SHUT-OFF" is disabled, the time setting is also disabled.

PREHEAT MODE SETTING

If the printer is not used for the length of time set with this program after printing is finished, it will enter preheat mode. This function reduces your power costs, and at the same time helps conserve natural resources and reduce pollution.

Select the most suitable setting to match your pattern of use of the printer.

The time can be set to as long as 240 minutes in increments of one minute. (Preheat mode cannot be disabled.)

TONER SAVE MODE

The toner save mode will reduce toner consumption by approximately 10% in the automatic, text, and text/photo exposure modes. Copies will be lighter but still adequate for general use. Selection of this mode has no effect on the photo and super photo modes. This program is initially disabled (factory default setting).

OPERATION SETTINGS

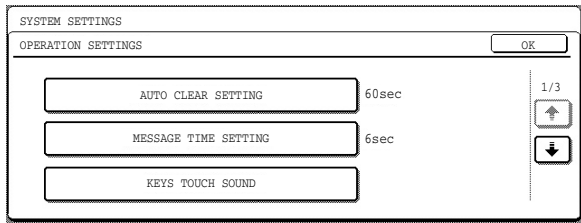

The "OPERATION SETTINGS" are related to basic operation of the machine and consist of the following programs:

- AUTO CLEAR SETTING
- MESSAGE TIME SETTING
- KEYS TOUCH SOUND
- TOUCH KEY OPERATION SETTING
- DISABLE INTERRUPT PRINT JOB
- STREAM FEEDING MODE
- DISPLAY LANGUAGE SETTING
- DISABLE DISPLAY TIMEOUT
- DISABLING OF TRAY SETTINGS
- DISABLING OF CLOCK ADJUSTMENT

AUTO CLEAR SETTING

If no action is taken for a certain length of time when viewing information on finished jobs, jobs in progress, or stored jobs, the auto clear function activates and returns the display to the initial screen of copy mode or the job status screen. AUTO CLEAR SETTING is used to set the amount of time that must elapse for the auto clear function to activate. The time can be set from 10 seconds to 240 seconds in increments of 10 seconds, or the auto clear function can be disabled. (This setting only operates in copy mode and network scanner mode.)

The factory default setting is "60" (sec.).

MESSAGE TIME SETTING

This program is used to set the length of time that messages appear in the display (this applies to messages that appear for a certain length of time and then automatically disappear.)

The time can be set to as long as 12 seconds in increments of one second.

The factory default setting is "6" (sec.).

KEYS TOUCH SOUND

This program is used to select whether or not a beep is sounded when a key is touched, and if sounded, what type of beep.

The program is also use to select whether or not a special key touch beep is sounded at the initial point of a setting.

The factory default settings are as follows:

- KEYS TOUCH SOUND: Short
- KEYS TOUCH SOUND AT INITIAL POINT: Disabled

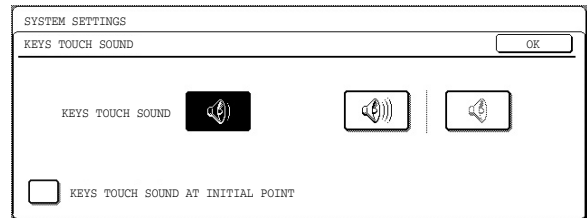

- key Touch this key to select a short beep volume. A single short beep indicates a valid key, and a double short beep indicates an invalid key.
- key Touch this key to select a long beep volume. A single long beep indicates a valid key, and a double long beep indicates an invalid key.
- key Touch this key to disable key touch beeps.

Select the [KEYS TOUCH SOUND AT INITIAL POINT] checkbox to have three long beeps sound (when the beep volume is set to long) or three short beeps sound (when the beep volume is set to short) when the initial point of a setting is reached while selecting basic settings. The initial point settings are as follows:

Mode	Initial point (set from initial screen)
Copy mode	Ratio: 100% Exposure: 3
Fax mode	Exposure: 3
Network scanner mode	Exposure setting: 3

TOUCH KEY OPERATION SETTING

These programs are used to set the length of time that must elapse until a setting is entered after a key is touched, and to disable key repeat.

The setting entry time can be set from 0.0 seconds to 2.0 seconds in increments of 0.5 seconds.

When [DISABLE AUTO KEY REPEAT] is enabled, only one touch is registered if key is touched continuously.

The factory default settings are as follows:

- Time to entry: 0.0 (sec.)
- DISABLE AUTO KEY REPEAT: Disabled

DISABLE INTERRUPT PRINT JOB (When the printer function is enabled)

Enable this program if you wish to prevent pausing of printing for interrupt copy jobs.

This program is initially disabled (factory default setting).

STREAM FEEDING MODE

Use this program to enable stream feeding mode. When this mode is enabled and originals are scanned from the RSPF, an original can be added to the RSPF within 5 seconds after the previous original is fed, and be automatically scanned using the settings of the previous original. This function can be used with the copy function and the scanner function. This program is initially disabled (factory default setting).

DISPLAY LANGUAGE SETTING

This program is used to change the language used in the display. The factory default setting is "AMERICAN ENGLISH".

DISABLE DISPLAY TIMEOUT

When this program is disabled, the display will close the screen that is currently open and return to the initial screen if no keys are touched for 60 seconds. When the program is enabled, the display will not close the screen that is currently open. This program is initially disabled (factory default setting).

DISABLING OF TRAY SETTINGS

This program can be enabled to prohibit changes to the paper tray settings in the system settings (general). Note that bypass tray settings will still be possible. This program is initially disabled (factory default setting).

DISABLING OF CLOCK ADJUSTMENT

This program can be enabled to prohibit adjustment of the "CLOCK" setting in the system settings. This program is initially disabled (factory default setting).

DEVICE CONTROL

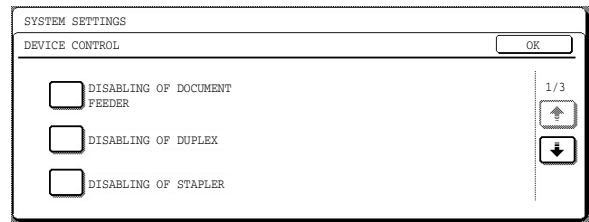

Use these programs when a peripheral device on the machine has failed or when you wish to temporarily disable a device. The programs can also be used to change the function setting of a device as required by your conditions of use.

"DEVICE CONTROL" consists of the following programs:

- DISABLING OF DOCUMENT FEEDER
- DISABLING OF DUPLEX
- DISABLING OF STAPLER
- OUTPUT TRAYS
- DISABLING OF OFFSET
- MEMORY FOR PRINTER
- DISABLING OF CENTER TRAY COUNTING
- RETURN FROM COPY MODE TIMING
- MIX SIZE ORIGINAL FEEDING MODE
- SECURITY SETTINGS

DISABLING OF DOCUMENT FEEDER

Use this program when the RSPF is not operational or you wish to disable the automatic feeding function. (Originals can still be scanned using the document glass.) This program is initially disabled (factory default setting).

DISABLING OF DUPLEX

Use this program when you wish to disable the two-sided printing function or the function has failed. When this program is enabled, only one-sided printing is possible. This program is initially disabled (factory default setting).

DISABLING OF STAPLER (When a FINISHER is installed)

Use this program to disable stapling. When this program is enabled, stapling does not take place. This program is initially disabled (factory default setting).

OUTPUT TRAYS

(When a JOB SEPARATOR TRAY KIT or FINISHER and Right tray are installed)

This program is used to select the respective output trays for the copy, printer, and fax functions. The factory default setting is "PATTERN 1".

Example: When a FINISHER and Right tray are installed

* Settings that can be selected vary depending on the options that are installed.

Settings	Description
PATTERN 1	Printer: Offset tray Fax: Right tray Copy: Offset tray
PATTERN 2	Printer: Right tray Fax: Right tray Copy: Offset tray
PATTERN 3 (When the fax function is enabled)	Printer: Offset tray Fax: Right tray Copy: Offset tray

DISABLING OF OFFSET

(When the FINISHER is installed)

This program is used to enable or disable the offset functions of the offset tray.

This program is initially disabled (factory default setting).

MEMORY FOR PRINTER

This program is used to set the amount of IMC memory that is allocated to the printer function. The amount of memory can be set from 30% to 70% in increments of 10%.

The factory default settings are as follows:

- 50 (%)
- THE MEMORY AREA FOR PRINT HOLD: 30 (%)

● Memory allocated to print hold (When the PRINTER EXPANSION KIT is installed)

To set the amount of memory allocated to print hold, touch the [THE MEMORY AREA FOR PRINT HOLD] key. The amount of memory can be set from 30% to 70% in increments of 10%. If 0% is selected, the print hold function cannot be used.

DISABLING OF CENTER TRAY COUNTING

This program is used to disable counting of pages delivered to the center tray.

When this program is enabled, center tray full detection does not take place.

This program is initially disabled (factory default setting).

RETURN FROM COPY MODE TIMING

(When the printer function or fax function is enabled)

This program is used to set the amount of time that must elapse after a copy job is finished before the printer or fax function resumes operation. The amount of time can be set from 1 second to 60 seconds in increments of 1 second.

The factory default setting is "60" (sec.).

MIX SIZE ORIGINAL FEEDING MODE

When this program is enabled, originals of mixed length (the widths must be the same) can be scanned in copy mode and each original copied onto the corresponding length of paper.

This program is initially disabled (factory default setting).

SECURITY SETTINGS

The following settings are related to security. Touch the [SECURITY SETTINGS] key to configure the settings.

When any of these settings are changed, you must exit the administrator settings, turn off the main switch, wait a brief interval, and then turn the main switch back on to make the new settings take effect.

● SSL SETTINGS

SSL can be used for data transmission over a network.

SSL is a protocol that enables the encryption of information communicated over a network.

Encrypting data makes it possible to transmit and receive sensitive information safely.

- HTTPS: Apply SSL encryption to HTTP communication.
- IPP-SSL: Apply SSL encryption to IPP communication.

● ENABLE IPsec

IPsec can be used for data transmission/reception on a network. When IPsec is used, data can be sent and received safely without the need to configure settings for IP packet encryption in a Web browser or other higher-level application.

This setting is only used to enable or disable IPsec; detailed IPsec settings are configured in the Web pages.

Some Web page settings may not allow connection to the machine, or the settings may not allow printing, scanning, or Web page display. In this case, deselect [ENABLE IPsec] in this screen and change the Web page settings.

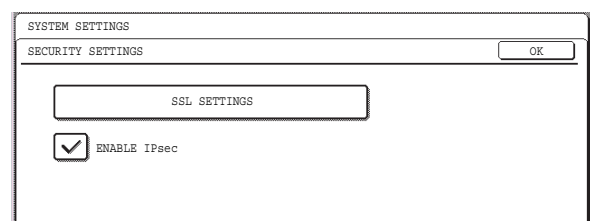

CHANGE ADMINISTRATOR PASSWORD

This program is used to change the administrator password that must be entered to configure the administrator settings. When the machine is first used, the administrator of the machine should change the administrator password that was set at the factory to the desired 5-digit code. (A number that has been programmed as an account number cannot be used.) Only one administrator password can be programmed. The factory default setting for the administrator password is **00000**.

PRODUCT KEY (When the PRINTER EXPANSION KIT is installed)

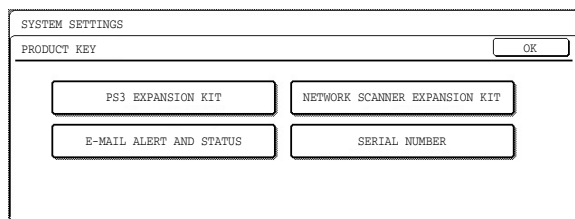

Use these programs to enter the product keys for the following options.

PS3 EXPANSION KIT (When the PRINTER EXPANSION KIT is installed)

This program is used to enter the product key that enables the machine to be used as a PostScript printer. Ask your dealer for the product key.

NETWORK SCANNER EXPANSION KIT (When the PRINTER EXPANSION KIT and EXPANSION MEMORY are installed)

This program is used to enter the product key for the network scanner function. Ask your dealer for the product key.

E-MAIL ALERT AND STATUS (When the PRINTER EXPANSION KIT is installed)

This program is used to enter the product key for E-MAIL ALERT AND STATUS, which enables customer product support via a network system. Ask your dealer for the product key.

APPLICATION INTEGRATION MODULE (When the PRINTER EXPANSION KIT and EXPANSION MEMORY are installed)

This setting is used to enter the product key that allows use of the metadata send function. Ask your dealer for the product key.

SERIAL NUMBER

Use this program to display the serial number of the machine. The serial number is required when obtaining product keys for PS3 EXPANSION KIT, NETWORK SCANNER EXPANSION KIT, APPLICATION INTEGRATION MODULE and the E-MAIL ALERT AND STATUS.

PROGRAMS FOR COPY MODE

This chapter explains the administrator settings that are used for copy mode.

COPY SETTINGS

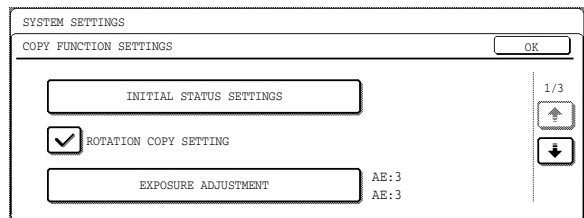

"COPY SETTINGS" consists of the following programs:

- INITIAL STATUS SETTINGS
- ROTATION COPY SETTING
- EXPOSURE ADJUSTMENT
- AUTO PAPER SELECTION SETTING
- SETTING A MAXIMUM NUMBER OF COPIES
- SORT AUTO SELECT
- DISABLING DELETION OF JOB PROGRAMS
- CARD SHOT SETTINGS

INITIAL STATUS SETTINGS

The copy settings revert to the default settings when the power switch is turned on, when the [CLEAR ALL] key (CA) is pressed, or when the auto clear time elapses. This program is used to change the default settings, or return changed default settings to the initial factory default settings.

Defaults for the following copy settings can be changed:

- Paper tray
- Exposure mode
- Copy ratio
- Duplex function
- Post-processing functions* (non-sort, sort, staple sort, and group)

*Settings for the post-processing functions vary depending on whether or not a FINISHER is installed.



If this program is used to change the default setting for the duplex function to other than "one-sided" → "one-sided" and the RSPF fails or is disabled, the setting will revert to "one-sided" → "one-sided".

- * DISABLING OF DOCUMENT FEEDER (p.107)
- DISABLING OF DUPLEX (p.107)

ROTATION COPY SETTING

When this program is enabled, the original image is automatically rotated 90 degrees in the event that the original and the paper are in different orientations. (Rotation can only take place when auto paper selection and automatic ratio selection are used.) This program is initially enabled (factory default setting).

EXPOSURE ADJUSTMENT

This program is used to adjust the exposure level when "Auto" is used for the copy exposure.

The auto exposure level can be set separately for the document glass and RSPF.

[1] is the lightest level and [5] is the darkest level.

The factory default settings are as follows:

- Document glass: 3
- Document feeder: 3

AUTO PAPER SELECTION SETTING

This program is used to select the paper type* that is used when the automatic paper selection function operates. "PLAIN PAPER" or "PLAIN AND RECYCLE PAPER" can be selected. Auto paper selection can also be disabled with this program.

The factory default setting is "PLAIN PAPER".

* The paper type set for each tray in the tray settings of the system settings (general). (See "5. SYSTEM SETTINGS (GENERAL)".)

SETTING A MAXIMUM NUMBER OF COPIES

This program is used to set the maximum number of copies that are allowed per original.

Any number from 1 to 999 can be set for the maximum.

The factory default setting is "999".

SORT AUTO SELECT

This program can be used to disable automatic selection of the sort function.

This program is initially enabled (factory default setting).

DISABLING DELETION OF JOB PROGRAMS

This program is used to prevent copy settings stored in job programs from being changed or deleted.

This program is initially disabled (factory default setting).

CARD SHOT SETTINGS

This program is used to set the initial original card size for the card shot function. Entry of the X dimension (width) is initially selected. Touch the keys to enter the Y dimension (length) in the same way. To have "FIT TO PAGE" be initially selected when the card shot screen is opened, touch the [FIT TO PAGE] key.

PROGRAMS FOR PRINT MODE

This chapter explains administrator settings that are used for the printer function. These programs can only be configured on models that have the printer function.

PRINT SETTINGS

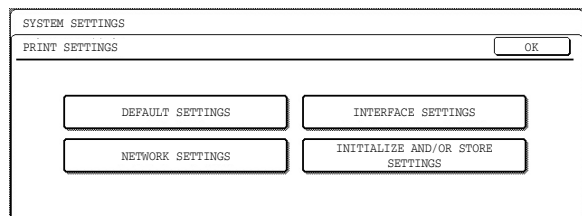

DEFAULT SETTINGS

These programs allow you to change certain default settings for the printer function.

The "DEFAULT SETTINGS" consist of the following programs:

- PROHIBIT NOTICE PAGE PRINTING
- PRINT DENSITY LEVEL
- PROHIBIT TEST PAGE PRINTING
- ROTATED PRINT
- FORCED OUTPUT OF PRINT
- EXCLUDE BYPASS-TRAY FROM ATS
- DISABLE DEFAULT SETTING CHANGES

PROHIBIT NOTICE PAGE PRINTING

This program is used to prohibit the printing of notice pages. For an explanation of notice pages, see "If a Notice Page is printed" in the online manual for printer. This program is initially disabled (factory default setting).

PRINT DENSITY LEVEL

The print density can be set to one of five different levels. [1] is the lightest level and [5] is the darkest level.

The factory default setting is "3".

PROHIBIT TEST PAGE PRINTING

(When the PRINTER EXPANSION KIT is installed)

This program is used to prohibit the printing of test pages.

When the program is enabled, a test page cannot be printed from the system settings (general).

This program is initially disabled (factory default setting).

ROTATED PRINT

This program is used to enable or disable rotation of the print image when an A4R, B5R, or 8-1/2 x 11R (Letter R) document is being printed but there is no paper loaded in that orientation.

This program is initially enabled (factory default setting).

FORCED OUTPUT OF PRINT

This program is used to enable or disable automatic printing on a different size of paper when no paper trays have the selected size of paper.

This program is initially disabled (factory default setting).

EXCLUDE BYPASS-TRAY FROM ATS

This program is used to exclude paper in the bypass tray when automatic paper selection is used.

This program is initially enabled (factory default setting).

DISABLE DEFAULT SETTING CHANGES

(When the PRINTER EXPANSION KIT is installed)

This program is used to prevent the configuration setting defaults from being changed.

This program is initially disabled (factory default setting).

INTERFACE SETTINGS

The "INTERFACE SETTINGS" are used to monitor and set limits for the data that is sent to the machine's USB port or network port. The settings consist of the following programs:

- HEXADECIMAL DUMP MODE
- I/O TIMEOUT
- USB PORT EMULATION SWITCHING
- NETWORK PORT EMULATION SWITCHING
- PORT SWITCHING METHOD
- ENABLE USB PORT
- ENABLE NETWORK PORT

HEXADECIMAL DUMP MODE

(When the PRINTER EXPANSION KIT is installed)

This program is used to print out the print data from the computer in hexadecimal and in the corresponding text characters (based on ASCII code). This allows you to check whether or not print data is being correctly sent from the computer.

This program is initially disabled (factory default setting).

Example of output in hexadecimal dump mode (A4 portrait)

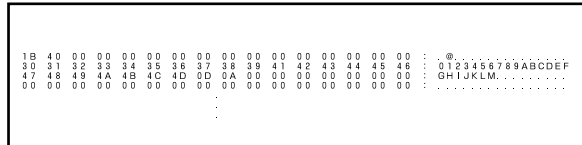

I/O TIMEOUT

This program is used to set the amount of time until I/O timeout when waiting for print data.

In the event that the set amount of time elapses without the port receiving any print data, the I/O timeout function temporarily breaks the port connection and initiates automatic port selection or makes the port begin waiting for the next set of print data.

The factory default settings are as follows:

- 180 (sec.)
- When the PRINTER EXPANSION KIT is installed: 60 (sec.)

USB PORT EMULATION SWITCHING

(When the PRINTER EXPANSION KIT is installed)

This program is used to set the printer language when the machine is connected using the USB port.

The factory default setting is "PCL*".

* When the PS3 expansion kit is installed, the setting is "AUTO".

Unless printing errors occur frequently, it is recommended that the setting be kept at "AUTO".

Selections	Description
AUTO	The printer language is automatically changed to match the data received from the computer.
PostScript (When the PS3 EXPANSION KIT is installed)	The data received from the computer is printed using PostScript.
PCL	The data received from the computer is printed using PCL.

NETWORK PORT EMULATION SWITCHING

(When the PRINTER EXPANSION KIT is installed)

This program is used to set the printer language when the machine is connected using the USB port. The selections are the same as for "USB PORT EMULATION SWITCHING".

The factory default setting is "AUTO".

Unless printing errors occur frequently, it is recommended that the setting be kept at "AUTO".

PORT SWITCHING METHOD

(When the PRINTER EXPANSION KIT is installed)

This program is used to set the method for switching printer ports.

The machine can use the following three printer ports:

- USB port
- Network port

The factory default setting is "SWITCH AT END OF JOB".

Selections	Description
SWITCH AT END OF JOB	Automatic printer port selection at the end of each print job.
SWITCH AFTER I/O TIMEOUT	Automatic printer port selection if the time set in "I/O TIMEOUT" elapses.

ENABLE USB PORT

(When the PRINTER EXPANSION KIT is installed)

This program is used to enable or disable printing via the USB port.

This program is initially enabled (factory default setting).

ENABLE NETWORK PORT

(When the PRINTER EXPANSION KIT is installed)

This program is used to enable or disable printing via the network port.

This program is initially enabled (factory default setting).

NETWORK SETTINGS

(When the PRINTER EXPANSION KIT is installed)

The NETWORK SETTINGS are used when the machine is used as a network printer. The "NETWORK SETTINGS" consist of the following programs:

- IP ADDRESS SETTING
- ENABLE TCP/IP
- ENABLE NetWare
- ENABLE EtherTalk
- ENABLE NetBEUI
- RESET THE NIC

 **Consult your network administrator before configuring the NETWORK SETTINGS.**

 **Note**

- After changing the settings, you must turn off the machine's power switch, wait briefly, and then turn the switch back on in order to make the changes take effect.
- Some programs in the following are marked by "**1". This indicates that a message will appear at the end of the setting procedure asking you to confirm execution of the new setting. If needed, you can cancel the new setting by touching the [NO] key.

IP ADDRESS SETTING

This program is used to set the IP address (IP address, Subnet Mask, and Gateway) of the machine when TCP/IP protocol is used on the network. When "DHCP" is selected, the machine will obtain an IP address automatically. This is the factory default setting. When the machine is used on a TCP/IP network, be sure to enable the "ENABLE TCP/IP" program.

 **When DHCP is used, the IP address assigned to the machine may automatically be changed on occasion. If this happens, printing will not be possible.**

 **Note**

This setting is only effective in a network environment that uses Ipv4 TCP/IP protocol. To set an IP address on a Ipv6 TCP/IP network, use the Web pages. In an IPv6 environment, the machine can use LPD or IPP protocol.

ENABLE TCP/IP

This program must be enabled to use the machine on a TCP/IP network. "IP ADDRESS SETTING" must also be configured.

This program is initially enabled (factory default setting).

ENABLE NetWare

This program must be enabled to use the machine on a network that uses NetWare protocol.

This program is initially enabled (factory default setting).

ENABLE EtherTalk

This program must be enabled to use the machine on a network that uses EtherTalk protocol.
This program is initially enabled (factory default setting).

ENABLE NetBEUI

This program must be enabled to use the machine on a network that uses NetBEUI protocol.
This program is initially enabled (factory default setting).

RESET THE NIC ^{*1}

This program is used to restore all network settings to the factory default settings.

INITIALIZE AND/OR STORE SETTINGS

(When the **PRINTER EXPANSION KIT** is installed)

These programs are used to return the configuration settings (See the online manual for network printer) and the "PRINT SETTINGS" (p.111) to the factory default settings. The programs are also used to store the current settings and to restore stored settings. "INITIALIZE AND/OR STORE SETTINGS" consists of the following programs:

- RESTORE FACTORY DEFAULTS
- STORE CURRENT CONFIGURATION
- RESTORE CONFIGURATION



Some programs in the following are marked by "^{*1}". This indicates that a message will appear at the end of the setting procedure asking you to confirm execution of the new setting. If needed, you can cancel the new setting by touching the [NO] key.

RESTORE FACTORY DEFAULTS ^{*1}

This program is used to return the configuration settings (see the online manual for network printer) and the "PRINT SETTINGS" (p.111) to the factory default settings. If you need a record of the current settings before restoring the factory defaults, use "Data list print" in the system settings (general) to print a list of the current settings. (See "4. SYSTEM SETTINGS (GENERAL)".)

STORE CURRENT CONFIGURATION ^{*1}

This program is used to store the current configuration settings (see online manual for network printer) and "PRINT SETTINGS" (p.111). The stored settings will not be erased even if the power is turned off. To restore the stored settings, use the "RESTORE CONFIGURATION" program.

RESTORE CONFIGURATION ^{*1}

This program is used to restore settings that were stored using the "STORE CURRENT CONFIGURATION" program.
The current settings will change to the restored settings.



If any of the "NETWORK SETTINGS" (p.113) were changed before execution of this program, you must turn off the machine's power switch, wait briefly, and then turn the switch back on in order to make the settings take effect.

PROGRAMS FOR NETWORK SCANNER MODE

This chapter explains administrator settings that are used for the network scanner function. These programs can only be configured on models that have the network scanner function.

SCANNER SETTINGS

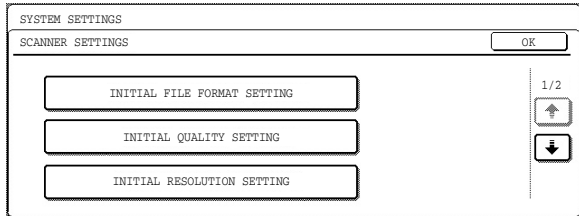

The "SCANNER SETTINGS" consist of the following programs:

- INITIAL FILE FORMAT SETTING
- INITIAL QUALITY SETTING
- INITIAL RESOLUTION SETTING
- DEFAULT DISPLAY SETTINGS
- THE NUMBER OF DIRECT ADDRESS / SENDER KEYS DISPLAYED SETTING

INITIAL FILE FORMAT SETTING

Use this program to change the default file format (file type, compression mode, and number of pages per file) that is used when sending an image by Scan to E-mail, Scan to Desktop, or Scan to FTP.

The factory default settings are as follows:

- File type: TIFF
- Compression mode: G4
- Number of pages per file: All

INITIAL QUALITY SETTING

This program is used to set the default original type and exposure level for network scanner mode.

For information on these settings, see "4. NETWORK SCANNER FUNCTION".

The factory default settings are as follows:

- Original image type: Text/Photo
- Exposure: Auto

INITIAL RESOLUTION SETTING

This program is used to set the default resolution for network scanner mode.

The factory default setting is "300" (dpi).

DEFAULT DISPLAY SETTINGS

Use this program to select the initial screen that appears when the [SCAN] key is pressed to switch to network scanner mode, or when the [CLEAR ALL] key (CA) is pressed in scanner mode.

Three selections are available for the initial screen:

- CONDITION SETTINGS
- ADDRESS BOOK (ABC)
- ADDRESS BOOK (GROUP)

The factory default setting is "CONDITION SETTINGS".

THE NUMBER OF DIRECT ADDRESS / SENDER KEYS DISPLAYED SETTING

This program is used to select the number of one-touch keys that are displayed in the address book screen and sender selection screen. Selections are [6], [8], and [12].

The factory default setting is "8" (keys).



Note

Each displayed one-touch key name can be up to 18 characters long when the number of displayed one-touch keys is 6 or 8. Each name can only be 10 characters long when the number of displayed one-touch keys is 12.

7

Chapter 7

TROUBLESHOOTING AND MAINTENANCE

This chapter describes troubleshooting and maintenance such as misfeed removal, replacing the toner cartridge and cleaning the machine.

DISPLAY MESSAGES..... 117
TROUBLESHOOTING 119

Trouble	Page	
Problems related to machine operation		
The machine does not operate.	119	
The power is on but copying is not possible.		
Two-sided copying is not possible.		
Wrong paper size is displayed for paper in the bypass tray.		
A copy job stops before it is finished.		
The contrast of the touch panel is too high or too low.		
Image cannot be rotated.		
Original size is not selected automatically, or copying does not take place on paper that matches the original size.	120	
Paper size for a paper tray cannot be set.		
Order of copies is incorrect.		
The job is canceled after the originals were being scanned.		
Not all pages are copied.		
The RSPF cannot be used.		
Lighting fixture flickers.	121	
Paper feeding problems		
When using paper fed from the bypass tray, the copied image is skewed.		
Paper from the bypass tray misfeeds.		
Paper misfeeds.		
Output does not collect neatly in the output tray of the finisher.		
Stapled output does not collect neatly.	122	
Image quality problems		
Copies are too dark or too light.		
Text is not clear in a copy.		
Part of the copied image is cut off.		
Blank copies.		
Paper is wrinkled or the copied image comes off when the paper surface is rubbed.		
Copies are smudged or dirty.		
White or black lines appear copies.		

MISFEED REMOVAL..... 127
REPLACING THE TONER CARTRIDGE 134
STAPLE CARTRIDGE REPLACEMENT..... 135
CHECKING THE TONER QUANTITY AND TOTAL COUNT..... 137
CLEANING THE MACHINE..... 137
 DOCUMENT GLASS AND RSPF 137
 THE BYPASS TRAY PAPER FEED ROLLER..... 138

DISPLAY MESSAGES

If one of the following messages appears in the display, take prompt action as instructed by the message.

Message	Cause and solution	Page
ENTER YOUR ACCOUNT NUMBER.	Auditing mode is enabled. Enter your account number.	95
A MISFEED HAS OCCURRED.	Remove the misfeed as explained in "MISFEED REMOVAL".	127
2-SIDED COPIES CANNOT BE MADE ON THIS PAPER TYPE.	This appears when you attempt to make two-sided copies on special paper that cannot be used for two-sided copying. Cancel two-sided copying or change the paper.	16, 28
REMOVE PAPER FROM THE <*>TRAY.	The indicated output tray is full. Remove the output from the tray. (<*> indicates the tray that is full.)	-
CLOSE THE <*> COVER.	The indicated cover is open. Close the cover. (<*> indicates the cover that is open.)	-
PLEASE EXTEND BYPASS-TRAY.	When copying from the bypass tray, be sure to pull out the bypass tray extension.	19
COVER SHEETS MUST BE THE SAME SIZE AS THE COPY PAPER USED.	When adding a cover, load paper in the bypass tray that is the same size as the paper in the tray selected for copying.	49
PREPARE A NEW ONE.	The toner cartridge must be prepared.	134
TONER SUPPLY IS LOW.	The toner cartridge must be replaced soon.	134
CHANGE THE TONER CARTRIDGE.	The toner cartridge is out of toner. Replace the toner cartridge.	134
CHECK THE TONER CARTRIDGE.	Make sure that the toner cartridge is installed correctly.	134
THE DOCUMENT FEEDER IS DISABLED.	The RSPF has been disabled in the administrator settings. Use the document glass.	23
SELECTED PAPER TRAY IS PROHIBITED. PLEASE SELECT ANOTHER PAPER TRAY.	This appears when a tray is selected that has been prohibited in "TRAY SETTINGS" in the system settings.	92
PLEASE CHECK THE PAPER SIZE OF TRAY <***>.	The tray's paper size setting is different from the actual paper size. Load the correct size of paper. The tray is indicated in <***>.	16
ADD STAPLES.	The finisher is out of staples. Replace the staple cartridge as explained in "STAPLE CARTRIDGE REPLACEMENT".	135
PLEASE REMOVE PAPER FROM THE STAPLER COMPILER.	Paper remains in the stapler compiler. Remove the paper.	133
MEMORY IS FULL. PRESS [START] TO BEGIN COPYING OR [CA] TO CANCEL.	The memory becomes full while scanning originals. Press the [START] key (Ⓢ) to copy only the originals that have been scanned, or press the [CLEAR ALL] key (Ⓢ) to cancel the job.	-

Message	Cause and solution	Page
SELECTED PAPER TRAY IS OUT OF SERVICE.	Contact your SHARP service center.	-
CHECK STAPLER POSITION OR STAPLE JAM.	Staples are jammed in the finisher or the staple case is not attached correctly. Check the staple case. If the message still appears after removing the jammed staples, disable the stapler using "DISABLING OF STAPLER" in the administrator settings (See "6. SYSTEM SETTINGS (ADMINISTRATOR)")., and contact your SHARP service center.	136
(CALL FOR SERVICE SOON.)	It will soon be time for regular maintenance. Contact your SHARP service center.	-
(MAINTENANCE REQUIRED.)	It is time for regular maintenance. Contact your SHARP service center.	-
CALL FOR SERVICE. CODE: **--**	Turn off the power and then turn it back on. If this does not clear the message, write down the 2-digit main code and 2-digit sub-code and promptly contact your SHARP service center.	-
PLEASE CHECK THE ORIGINAL SIZE. JOB IS CANCELED.	The original in the RSPF is longer than the size that was detected. Reinsert the original, make sure that the size indicated in the touch panel is the same as the actual size, and begin copying. You can also select mixed feeding to copy onto paper that matches each original size after all originals have been scanned.	-

TROUBLESHOOTING

If you experience difficulty using the machine, check the following troubleshooting guide before calling for service. Many problems can be easily resolved by the user. If you are unable to solve the problem using the troubleshooting guide, turn off the power switch, unplug the machine, and contact your SHARP service center. The following problems are related to the general operation of the machine and copying.

For problems related to the printer, fax, and network scanner functions, see the corresponding operation manuals.

Problems related to machine operation

Problem	Cause and solution	Page
The machine does not operate.	Power switch OFF. → Turn the power switch ON.	14
	The machine is warming up. → The machine requires about 23 seconds (MX-M260) or 25 seconds (MX-M310) to warm up after the power switch is turned on. While the machine is warming up, copy settings can be selected but copying is not possible. Wait until "READY TO COPY." appears.	14
	Out of paper. → Load paper.	18
	Out of toner. → Replace the toner cartridge.	134
	Misfeed occurs. → Remove the misfed paper.	127
The power is on but copying is not possible.	The machine is in auto power shut-off mode. → If only the [START] key (⊙) blinks, auto power shut-off mode has activated. Press the [START] key (⊙) to return the machine to normal operation.	15
	Copy mode is not selected. → Press the [COPY] key to select copy mode.	11
Two-sided copying is not possible.	Automatic two-sided copying was attempted on paper that is not suitable for automatic two-sided copying. → Two-sided copying is not possible on special paper. Use paper that is suitable for automatic two-sided copying.	28
	Two-sided copying is prohibited in the administrator settings. → Change the setting in the administrator settings to permit two-sided copying.	107
Wrong paper size is displayed for paper in the bypass tray.	The bypass tray extension is not pulled out. → To detect the paper size correctly, the bypass tray extension must be pulled out when the paper is loaded.	19
A copy job stops before it is finished.	Too many pages have accumulated in the output tray, causing the tray full sensor to activate. Further copying is not possible until the pages are removed. → Remove the pages from the output tray.	-
The contrast of the touch panel is too high or too low.	The display contrast has not been adjusted. → Adjust the contrast using "DISPLAY CONTRAST" in the system settings.	92
Image cannot be rotated.	Neither auto paper selection nor auto image mode are selected. → Rotation copy functions only if auto paper select mode or auto image mode is selected.	26, 31
	Rotation copy is prohibited in the administrator settings. → Change the setting in the administrator settings to permit rotation copying.	110

Problem	Cause and solution	Page
<p>Original size is not selected automatically, or copying does not take place on paper that matches the original size.</p>	<p>The RSPF was not opened completely when the original was placed on the document glass. → Open the RSPF completely, place the original on the document glass, and close the RSPF.</p>	-
	<p>The original contains large black solid areas. → If the original contains any large black solid areas, the original size may not be detected automatically. Use the [SPECIAL MODES] key to select the original size.</p>	48
	<p>The original is smaller than 5-1/2" x 8-1/2" size. → When the original is smaller than 5-1/2" x 8-1/2" size, the size cannot be detected. Use the [PAPER SELECT] key to select the desired paper size.</p>	23
	<p>The original is not a standard size. → When the original is not a standard size, the size cannot be detected. Manually select the closest standard original size, or use the [PAPER SELECT] key to select the desired paper size.</p>	23, 48
<p>Paper size for a paper tray cannot be set.</p>	<p>A copy, print job, or received fax is being printed. → Set the correct paper size after printing is finished.</p>	-
	<p>Operation has temporarily stopped because the tray is out of paper or a misfeed occurred. → Load paper or remove the misfeed, finish the copy job, and then set the paper size.</p>	20, 127
	<p>During an interrupt copy job. → Set the correct paper size after the interrupt copy job is finished.</p>	35
	<p>Misfeed occurs. → Remove the misfed paper.</p>	127
	<p>Paper tray settings are prohibited in the administrator settings. → Change the setting in the administrator settings to permit paper tray settings.</p>	107
<p>Order of copies is incorrect.</p>	<p>The originals were placed in the wrong order. → When using the document glass, scan the originals one sheet at a time beginning from the first page. When using the RSPF, insert the originals with the first page on top and facing up.</p>	24
<p>The job is canceled after the originals were being scanned.</p>	<p>The memory become full while the originals were being scanned. → When using a function such as pamphlet copy or multi shot copy where all original pages are scanned into memory before copying begins, scanning will stop and copying will not take place if the memory becomes full. The number of pages that can be scanned into memory can be increased by installing more memory.</p>	139
<p>Not all pages are copied.</p>	<p>The memory become full while the originals were being scanned. → When the memory becomes full while the originals are being scanned, you can select whether you want to continue the job and print only those originals that were scanned, or cancel the job. If you continue the job, copies will only be made of the originals that were scanned, and thus all originals cannot be copied at once.</p>	-
<p>The RSPF cannot be used.</p>	<p>Use of the RSPF has been prohibited in the administrator settings. → Enable use of the RSPF in the administrator settings.</p>	107
<p>Lighting fixture flickers.</p>	<p>The same power outlet is used for the lighting fixture and the machine. → Connect the machine to a power outlet which is not used for other electric appliances.</p>	5

Paper feeding problems

Problem	Cause and solution	Page
When using paper fed from the bypass tray, the copied image is skewed.	The number of sheets placed on the bypass tray exceeds the maximum number. → Do not place more than the maximum number of sheets.	16
	The bypass guide is not adjusted to the size of the loaded paper. → Adjust the bypass guide to the size of the loaded paper.	19
Paper from the bypass tray misfeeds.	The paper type setting is not correct. → When using a special paper, be sure to set the correct paper type.	21
	The number of sheets placed on the bypass tray exceeds the maximum number. → Do not place more than the maximum number of sheets.	16
	The bypass guide is not adjusted to the size of the loaded paper. → Adjust the bypass guide to the size of the loaded paper.	19
Paper misfeeds.	The paper is outside of the specified size and weight range. → Use copy paper within the specified range.	16
	Paper is curled or damp. → Do not use curled or crimped paper. Replace with dry copy paper. During periods when the machine is not used for a long time, remove the paper from the tray and store it in a dark place in a bag to prevent moisture absorption.	142
	Paper is not loaded properly. → Make sure the paper is properly loaded.	18
	Pieces of paper remain inside machine. → Remove all pieces of misfed paper.	127
	Sheets of paper stick together. → Fan the paper well before loading it.	18
	Output does not collect neatly in the output tray of the finisher.	The paper is curled. → It may help to turn the paper over in the paper tray.
Stapled output does not collect neatly.	The paper is curled. → It may help to turn the paper over in the paper tray.	-

Image quality problems

Problem	Cause and solution	Page
Copies are too dark or too light.	The image of the original is too light or too dark. → Select the correct original image type in the exposure setting and adjust the copying exposure.	30
	The copying exposure is set to "AUTO". → The "EXPOSURE ADJUSTMENT" system settings (administrator) can be used to adjust the exposure level used for "AUTO" exposure. Consult the administrator of the machine.	110
	The original type that is most suitable for the original has not been selected in the copy exposure setting screen. → Change the original image type selection to "AUTO", or manually select the most suitable original image type setting.	30
Text is not clear in a copy.	The correct original type has not been selected in the copy exposure setting screen. → Change the original image type setting to "TEXT".	30
Part of the copied image is cut off.	The original was placed in the wrong position. → Place the original in the correct position. When using the document glass, place the original against the far left side.	23, 24
	A suitable ratio for the original size and paper size has not been selected. → Use auto ratio selection to obtain the correct ratio for the copy.	31
	The tray's paper size setting was not changed when a different size of paper was loaded in the tray. → Be sure to change the tray's paper size setting when loading a different size of paper in the tray.	20
	An AB paper size is being used. → When using copy paper that is an AB size, set the original size manually.	48
Blank copies.	The original is not placed face up in the RSPF or face down on the document glass. → Place the original face up in the RSPF or face down on the document glass.	23, 24
Paper is wrinkled or the copied image comes off when the paper surface is rubbed.	The paper is outside of the specified size and weight range. → Use copy paper within the specified range.	16
	The paper type setting is not correct. → Set the correct paper type. To set the paper type for a tray, see "CHANGING A TRAY'S PAPER TYPE AND PAPER SIZE SETTINGS".	20, 21
	Paper is curled or damp. → Do not use curled or wrinkled paper. Replace with dry copy paper. During periods when the machine is not used for a long time, remove the paper from the tray and store it in a dark place in a bag to prevent moisture absorption.	142
Copies are smudged or dirty.	The document glass or the underside of the RSPF is dirty. → Clean regularly.	137
	The original is smudged or blotchy. → Use a clean original.	-
White or black lines appear copies.	The scanner glass for the RSPF is dirty. → Clean the long, narrow scanning glass.	137

PROBLEMS WHEN THE NETWORK SCANNER FUNCTION IS USED

If a problem or question arises, try to solve the situation using the following information before contacting your authorized SHARP dealer.

Problem	Cause and solution	Page
The image cannot be scanned.	The original is loaded upside down. → If you are using the document glass, the original must be placed face down. If you are using the RSPF, the original must be inserted face up.	72
A moiré (stripe pattern) appears on the scanned image.	A slight amount of moiré sometimes appears when printed matter is scanned. → Moiré can in some cases be reduced by changing the scanning resolution. If you are using the document glass, also try shifting the position and/or angle of the original on the document glass.	80
The scanned image is fuzzy or has smudges.	The document glass or the underside of the RSPF (or document cover) is dirty. → To clean the document glass and the underside of the document cover, see operation manual for copier.	—
The scanned image is clipped.	The set original scanning size is smaller than the actual original size. → Set the actual original size. If you intentionally selected a size setting smaller than the actual original size, take into consideration the part of the original that you wish to scan when placing the original. For example, if the actual size is 8-1/2" x 11" and you selected 5-1/2" x 8-1/2" for the size setting, place the original so that the part that you wish to scan is within the 5-1/2" x 8-1/2" area indicated by the guides on the far left side of the document glass.	78
The scanned image is upside down or on its side.	The original was not placed in the correct orientation. → Place the original in the correct orientation. (See operation manual for copier) To rotate the image 90 degrees, touch the [ORIGINAL] key in the initial screen and then touch the "ROTATE THE IMAGE 90 DEGREES" checkbox to make a checkmark appear.	78
The received image data cannot be opened.	The viewer program used by the recipient does not support the format of the received image data. → Try selecting a different file type (TIFF or PDF) and/or a different compression format (NONE, MH (G3), MMR (G4)) when sending the image data. Otherwise, have the recipient use Sharpdesk or a viewer program that supports the above combinations of file types and compression formats.	81
When the same file name is used for two successive Scan to FTP transmissions, the second file is not sent.	The first file may still remain in the cache of the file server client. Disable use of the cache in the client software.	—

Problem	Cause and solution	Page
<p>The recipient does not receive transmitted data.</p>	<p>An incorrect destination was selected. Otherwise, there is a mistake in the information stored for the destination (e-mail address or FTP server information). → Select the correct destination and make sure the correct information is stored for the destination. * If delivery by e-mail (Scan to E-mail) is unsuccessful, an error message such as "Undelivered Message" may be sent to the designated administrator's e-mail address. This information may help you determine the cause of the problem.</p>	<p>62 - 65</p>
<p>The recipient does not receive data sent by e-mail (Scan to E-mail).</p>	<p>Check the Web page to see if a limit has been set for the size of image files sent using Scan to E-mail (the factory default setting is "Unlimited"). A limit can be set from 1 MB to 10 MB. Consult the administrator of the Web page to select a suitable limit.</p>	<p>58</p>
	<p>The amount of data that can be sent in one e-mail transmission is sometimes limited by the administrator of the mail server. Even if the amount of data sent is within the limit setting explained above, if it exceeds the limit set by the administrator of the mail server, the data will not be delivered to the recipient. Decrease the amount of data sent in the e-mail transmission (reduce the number of pages scanned). (Ask your mail server administrator what the data limit is for one e-mail transmission.)</p>	<p>—</p>
<p>Transmission takes a long time.</p>	<p>When there is a large amount of image information, the data file is also large and transmission takes a long time.</p>	<p>—</p>



In order to select image quality and data compression settings that are suited to the purpose of transmission and create image data that is well-balanced in terms of image quality and file size, pay attention to the following points:

• **Image quality modes (TEXT, TEXT/PHOTO, PHOTO)**

The factory default setting is "TEXT/PHOTO". If the original does not contain photographs, illustrations, or other halftone images, "TEXT" mode will give you the most workable scanned image. "TEXT/PHOTO" should only be selected when the original includes a photograph and you wish to give priority to the quality of the photograph. (There is no advantage to scanning a text-only original in "TEXT/PHOTO" or "PHOTO" mode.) "PHOTO" mode should only be used to scan a photograph or illustration. Note that this will produce a larger file size than the other modes.

• **Resolution**

The factory default setting is "300 dpi". This is suitable for originals with mixed text and illustrations/photographs; however, it produces a slightly larger file size. For normal text originals, a resolution setting of 200 dpi produces an image that is sufficiently readable. (200 dpi is equivalent to the "Fine" resolution setting of fax machines.)

The 600 dpi setting should only be used in cases where high-clarity image reproduction is required, such as an original that includes photographs or illustrations. Note that a high-resolution setting will result in a larger file size and transmission may not be successful if there is insufficient disk capacity in the server to which the image is sent (or if the administrator of the server has restricted the file size). If transmission is not successful, you can try such measures as reducing the number of scanned pages in the file or reducing the scan size setting for the original.

DISPLAY MESSAGES

If one of the following messages appears in the display, promptly take action as instructed by the message.

Message	Solution	Page
THE DOCUMENT FEEDER IS DISABLED.	Use of the RSPF has been disabled in the administrator settings. Use the document glass.	—
YOUR FILENAME IS WRONG.	The characters ¥/;:*? "<> cannot be used in a file name. Select a name that does not use those characters.	—
NO MATCHING ADDRESS FOUND. PRESS [OK] THEN [SEARCH AGAIN].	There are no addresses in the LDAP server that match your search text. Select a different server or change the search text.	75
UNABLE TO ACCESS THE SERVER. CHECK SERVER ADDRESS ON DEVICE WEB PAGE.	The server settings are not configured correctly. Check the server settings.	59
THE ADDRESS LIMIT HAS BEEN REACHED. NO MORE ADDRESSES CAN BE ENTERED.	The maximum number of destinations that can be selected for a single Scan to E-mail transmission is 100. Do not select more than 100 destinations.	—
THE MEMORY BECOMES FULL. SCANNED DATA IS TRANSMITTED.	The memory became full while scanning the originals. If you wish to send just the originals that were scanned, touch the [SEND] key. If you wish to cancel the entire transmission, touch the [CANCEL] key.	—
NO RESPONSE FROM SERVER. COMMUNICATION TERMINATED DUE TO TIMEOUT.	The scanned image was not sent because the server was busy or there was too much traffic. Wait briefly and then try again.	—
NETWORK ERROR THE DIRECTORY NAME OF FTP SERVER IS INVALID.	The scanned image was not sent because the directory of the destination FTP server was not correct. Make sure that the correct FTP server information is configured in the Web page.	63
SERVER ACCESS DENIED. CHECK ACCOUNT INFORMATION ON DEVICE WEB PAGE.	The scanned image was not sent because a connection to the server could not be established. Make sure that the SMTP server settings or FTP server settings in the Web page are correct.	59
	Make sure that your login name and password are correct.	—
NETWORK ERROR. (**-**) CONSULT YOUR ADMINISTRATOR OR SYSTEM ADMIN. FOR SPECIFIC INFORMATION.	Turn off the power and turn it back on. Consult with your network administrator to make sure that no problems exist on the network or in the server. If the error is not cleared after turning the power off and on, write down the 2-digit main code and 2-digit sub-code, turn off the power, and contact your dealer.	—

Error codes

If a transmission error occurs when you send a scanned image, a message informing you of the error and an error code will appear in the touch panel on the machine.

Error Code Table

Error Code	Description of the Error
CE-01	An interface hardware error has occurred.
CE-03	The server was down during the scanning of the original.
CE-00	An error other than the above has occurred.

IF YOUR E-MAIL IS RETURNED

If a Scan to E-mail is not successfully transmitted, an e-mail informing you of this fact is sent to the sender selected at the time of transmission. If this happens, read the e-mail and determine the cause of the error, and then repeat the transmission.

IMPORTANT POINTS WHEN USING SCAN TO E-MAIL

Be very careful not to send image data files that are too large.

Your mail server's system administrator may have placed a limit on the amount of data that can be sent in one e-mail transmission. If this limit is exceeded, the e-mail will not be delivered to the recipient. Even if there is no limit and your e-mail is successfully delivered, a large data file may take a long time to be received and place a heavy burden on the recipient's network, depending on the recipient's network (Internet) connection environment.

If large image data files are repeatedly sent, the resulting burden on the network may slow down the speed of other, unrelated data transmissions and in some cases, may even cause the mail server or network to go down.

The images on the following page will produce the following file sizes when scanned as 8-1/2" x 11" or A4 size originals:

Resolution	File size of text original A when scanned in "TEXT" mode.	File size of photo original B when scanned in "TEXT/PHOTO" mode.
300dpi	Approx. 50 KB	Approx. 1400 KB
600dpi	Approx. 90 KB	Approx. 5000 KB

* If multiple images are scanned, the file size will be approximately (Size of each image as indicated above) x (Number of images scanned).

Although the actual limitation depends on your network environment, a general guideline for the maximum file size for Scan to E-mail is 2000 KB. In cases where you need to send multiple documents, try such measures as lowering the resolution mode.

Original image samples

The original images shown below are samples to help you understand the above explanations. Note that these images are smaller than the actual originals (the actual originals are 8-1/2" x 11" size).

Text original A

Photo original B

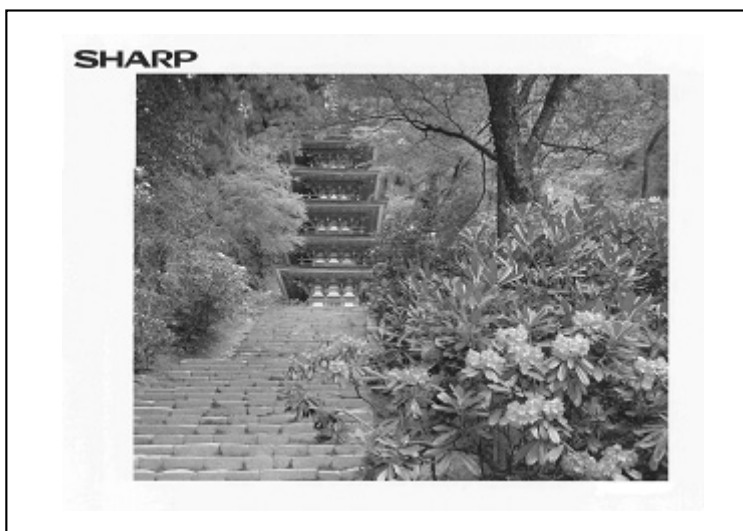
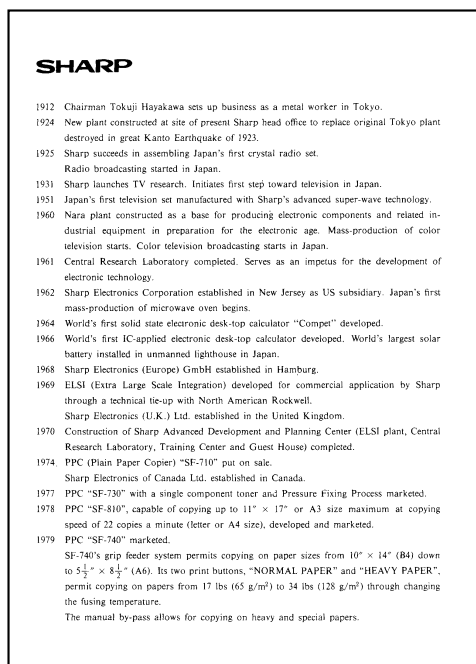

MISFEED REMOVAL

When a misfeed occurs during copying, the message "MISFEED HAS OCCURRED." will appear in the touch panel and printing will stop.

- If the misfed paper tears during removal, remove the torn pieces. Take care not to touch the photoconductive drum while removing the pieces. Nicks and scratches on the drum will cause dirty copies.

First, locate the misfeed

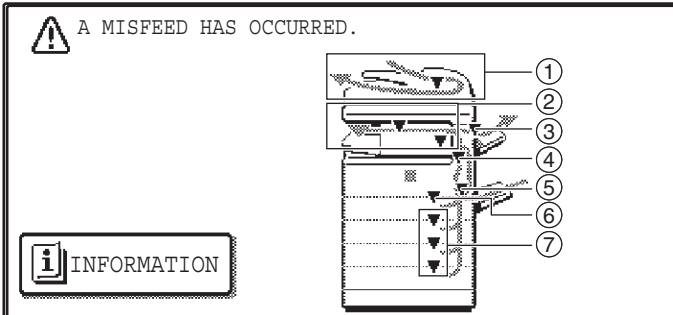

- ① Misfeed in the RSPF (p.128)
- ② Misfeed in the finisher (p.133)
- ③ Misfeed in the right tray (p.132)
- ④ Misfeed in the machine (p.129)
- ⑤ Misfeed in the bypass tray (p.129)
- ⑥ Misfeed in the upper paper tray (p.131)
- ⑦ Misfeed in the lower paper tray (p.132)



If the fax option is installed, all received faxes are stored in memory. The faxes are automatically printed after the misfeed is removed.

MISFEED REMOVAL GUIDANCE

Misfeed removal guidance can be displayed by touching the [INFORMATION] key on the touch panel after a misfeed has occurred.

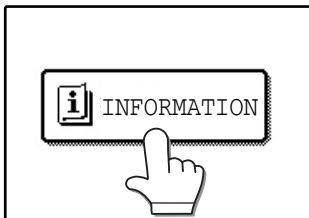

MISFEED IN THE RSPF

1 Remove the misfed original.

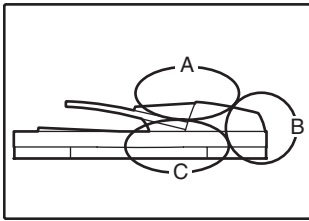

Check sections A, B, and C in the illustration at left and remove the misfed original.

Section A

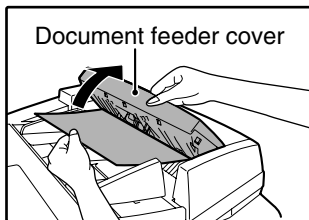

Open the document feeder cover and carefully remove the misfed original from the document feeder tray. Close the document feeder cover.

Section B

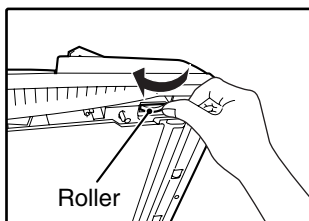

Open the RSPF and rotate the release roller in the direction of the arrow to feed the original out. Close the RSPF and then carefully remove the original.

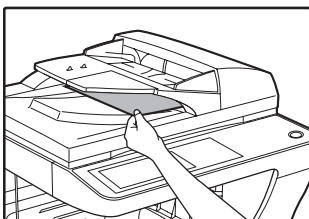

If the misfed original cannot be removed, open the document transport cover (below), and rotate the release roller again.

If a small original (5-1/2" x 8-1/2", etc.) is misfed, or if an original misfeed occurs in the reversing tray of the RSPF, lift the document transport cover knob, open the document transport cover, and remove the original.

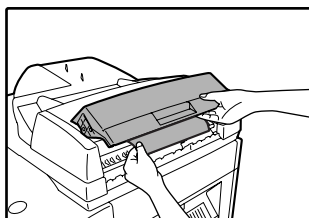
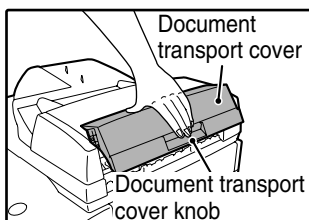

Section C

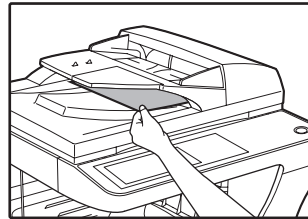

Carefully remove the misfed original from the exit area.

If the misfed original cannot be easily removed from the exit area, open the moveable part of the document feeder tray and remove the reversing tray, and then remove the original.

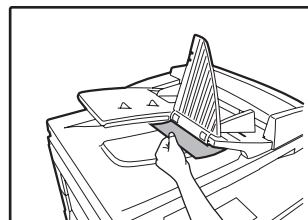
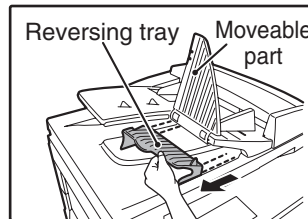

Note After removing a misfed original from the exit area, be sure to attach the reversing tray securely to the exit area (When the RSPF is installed.).

2 Open and close the RSPF to clear the misfeed message from the touch panel.

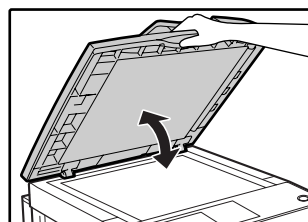

The message can also be cleared by opening and closing the document feeder cover or the document transport cover.

After the misfeed is removed and the misfeed message is cleared, a message will appear indicating the number of originals that must be reinserted in the RSPF.

3 Reinsert the originals that still must be scanned (Including the original that was being scanned when the misfeed occurred.), and press the [START] key (⏻).

Copying of the remaining originals will resume.

MISFEED IN THE BYPASS TRAY

- 1** Carefully pull the misfed paper out.

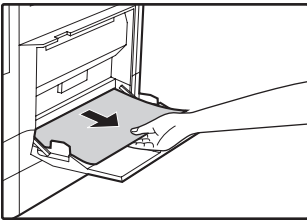

- 2** Open and close the side cover.

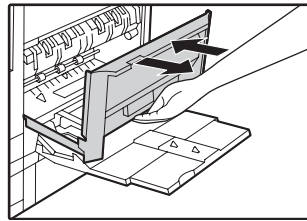

Make sure that the misfeed message is cleared.
The message can also be cleared by opening and closing the front cover.
If the message is not cleared, see "A. Misfeed in the paper feed area".

MISFEED IN THE MACHINE

Determine the location of the misfeed and remove it appropriately as indicated below.

If paper is misfed here, go to "A. Misfeed in the paper feed area" (below).

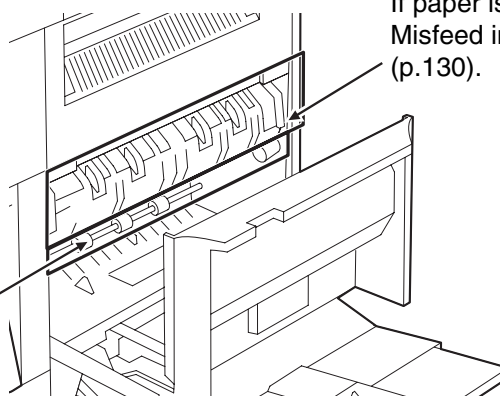

If paper is misfed, go to "B: Misfeed in the fusing area" (p.130).

A. Misfeed in the paper feed area

- 1** Open the bypass tray and the side cover.

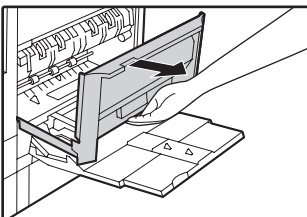

- 2** Press gently on both sides of the front cover and pull it open.

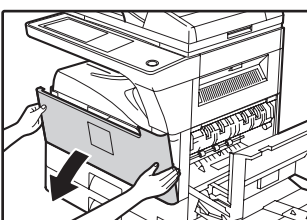

- 3** Carefully remove the misfed paper. Turn the roller rotating knob in the direction of the arrow to assist in removing it.

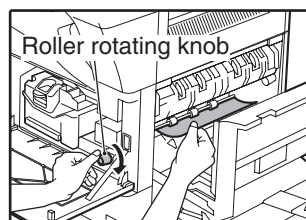

Be careful not to tear the misfed paper during removal.



Warning The fusing unit is hot. Do not touch the fusing unit when removing misfed paper. Doing so may cause a burn or injury.



Caution Do not touch the photoconductive drum (green portion) when removing the misfed paper. Doing so may damage the drum and cause smudges on copies.

4 Close the front cover and side cover.

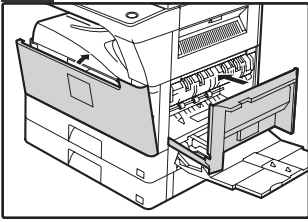

Make sure that the misfeed message is cleared.

B: Misfeed in the fusing area

1 Open the bypass tray and the side cover.

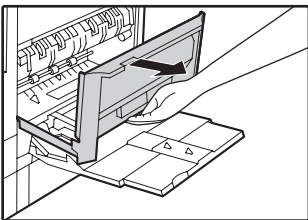

2 Press and pull it open gently on both sides of the front cover.

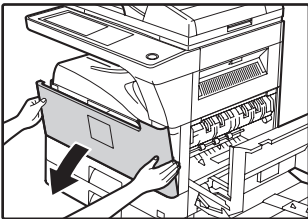

3 Turn the roller rotating knob in the direction of the arrow.

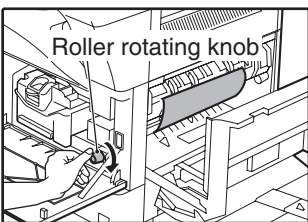

4 Lift the fusing unit release levers and carefully remove the misfed paper.

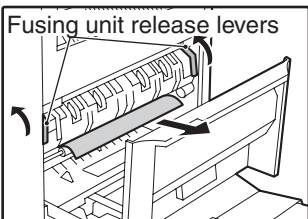

Warning The fusing unit is hot. Do not touch the fusing unit when removing misfed paper. Doing so may cause a burn or injury.

5 If you were unable to remove the misfeed in step 4, press down on the fusing unit paper guide knob to open the paper guide, and carefully remove the misfed paper.



Caution

- Do not touch the photoconductive drum (green portion) when removing the misfed paper. Doing so may damage the drum and cause smudges on copies.
- Take care not to let unfixed toner on the misfed paper soil your hands or clothes.

6 Close the fusing unit paper guide and press down on the fusing unit release levers.

7 Close the front cover and side cover.

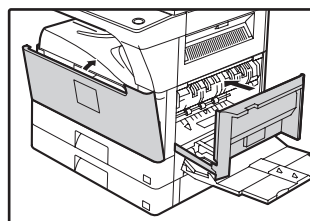

Make sure that the misfeed message is cleared.

MISFEED IN THE CENTER TRAY

Remove the paper by pulling it into the center tray.

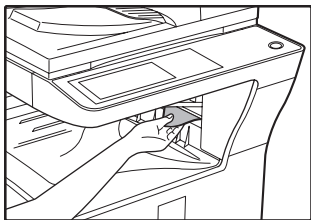

MISFEED IN THE UPPER PAPER TRAY

Make sure that there is no misfed paper in the machine before pulling the tray out. (p.129)

1 Lift and pull out the upper paper tray and then remove the misfed paper.

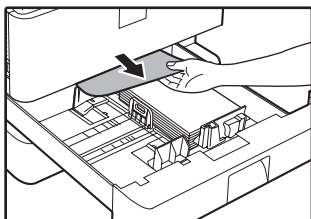

Be careful not to tear the misfed paper during removal.

2 Replace the upper paper tray.

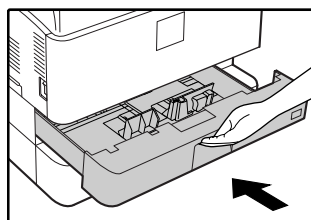

Push the upper paper tray in completely.

3 Open and close the side cover.

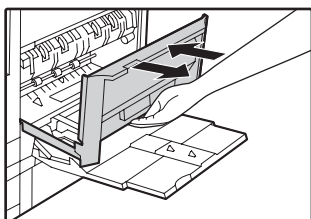

Make sure that the misfeed message is cleared.
The message can also be cleared by opening and closing the front cover.

MISFEED IN THE LOWER PAPER TRAY

- Make sure that there is no misfed paper in the machine before pulling the tray out. (p.129)
- Use the following procedure to remove misfeeds that occur in the 500-sheet paper feed unit or 2 x 500-sheet paper feed unit.

1 Open the lower side cover.

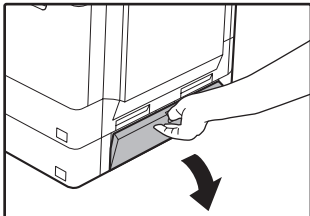

2 Remove the misfed paper.

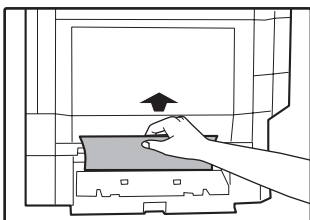

Be careful not to tear the misfed paper during removal.

3 If the misfed paper is not visible in step 2, lift and pull out the lower paper tray and remove the misfed paper.

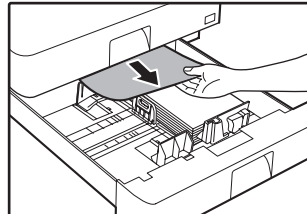

Be careful not to tear the misfed paper during removal.

4 Replace the lower paper tray.

Push the lower paper tray in completely.

5 Close the lower side cover.

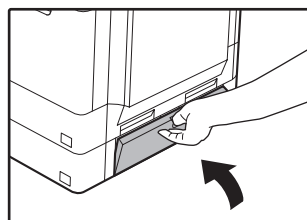

Make sure that the misfeed message is cleared.

MISFEED IN THE RIGHT TRAY (when a right tray (MX-TE10) is installed)

1 Gently open the right tray cover.

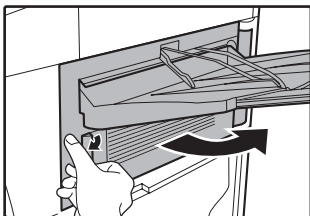

2 Remove the misfed paper.

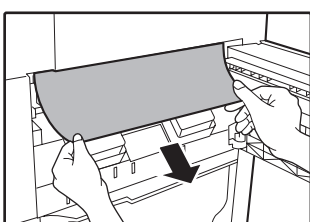

Be careful not to tear the misfed paper during removal.

3 Close the right tray cover.

Make sure that the misfeed message is cleared.

MISFEED IN THE UPPER EXIT AREA (when a job separator tray kit or finisher (MX-FN13) is installed)

If a job separator tray kit or a finisher is installed, a misfeed may occur in the upper exit area.

1 Open the upper right side cover.

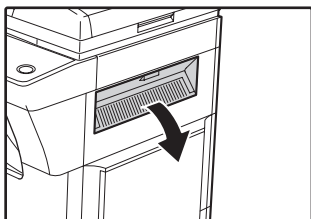

2 Gently pull the misfed paper out.



Be careful not to tear the misfed paper during removal.

3 Close the upper right side cover.

Make sure that the misfeed message is cleared.

MISFEED IN AN OUTPUT TRAY (when a finisher (MX-FN13) is installed)

1 Open the front cover.

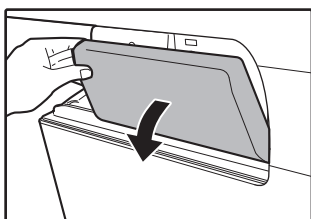

4 Slide the finisher back to the right.

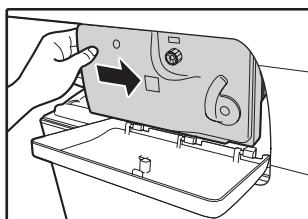

2 While pressing the lever over to the left, slide the finisher to the left until it stops.

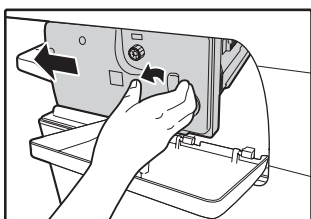

Gently slide the finisher until it stops.

5 Close the cover.

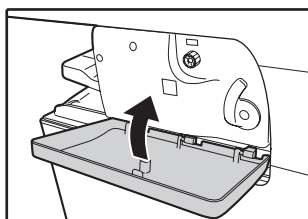

3 Turn roller rotating knob in the direction of the arrow to remove the misfed paper.

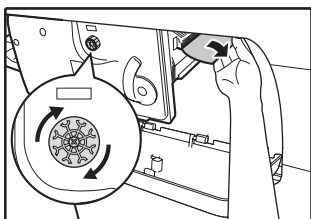

REPLACING THE TONER CARTRIDGE

To check how much toner remains in the toner cartridge (p.137), hold down the [COPY] key. The amount of toner remaining will appear in the display. When less than 25% of the toner remains, obtain a new toner cartridge as soon as possible. When "PREPARE A NEW ONE." appears in the display, the toner cartridge must be prepared. When "TONER SUPPLY IS LOW." appears in the display, be sure to have a new cartridge on hand for replacement at any time as little toner remains. When "CHANGE THE TONER CARTRIDGE." appears in the touch panel, the toner cartridge must be replaced. Follow these steps to replace the cartridge.

! Caution

- Do not throw the toner cartridge into a fire. Toner may fly and cause burns.
- Store toner cartridges out of the reach of small children.

Note

When running long copy jobs or copying originals with many areas of solid black, "TONER REPLENISHMENT IN PROGRESS." may appear in the touch panel and copying may stop even though the cartridge still has toner. When this occurs, the toner is being replenished. Replenishment will last about two minutes. When toner replenishment finishes, copying resumes.

1 Press gently on both sides of the front cover and pull it open.

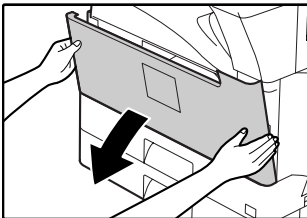

2 Pull the toner cartridge out while pressing the lock release lever.

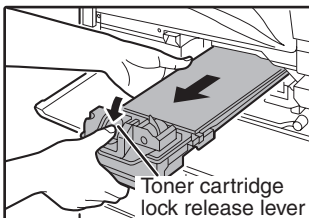

When pulling out the toner cartridge, place your other hand on the green part of the cartridge.

Note

- After removing the toner cartridge, do not shake it or tap it. Doing so may cause toner to leak from the cartridge.
- Dispose of the old toner cartridge in accordance with local regulations.

3 Remove the new toner cartridge from the bag. Grasp both ends of the cartridge and shake it horizontally about 4 or 5 times.

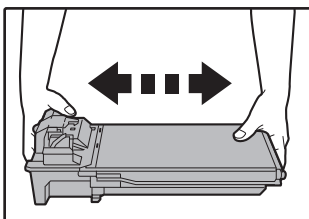

4 While holding down the lock release lever, insert along guides inside the machine until the cartridge locks into place.

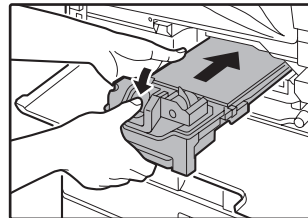

Note

If dirt or dust adheres to the toner cartridge, remove it before installing the cartridge.

5 Close the front cover.

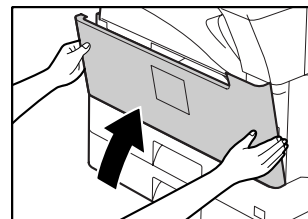

STAPLE CARTRIDGE REPLACEMENT

(when the finisher (MX-FN13) is installed)

When the staple cartridge runs out of staples, a message will appear in the operation panel. Follow the procedure below to replace the staple cartridge.

Replacing the staple cartridge

1 Open the cover.

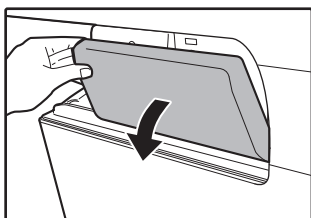

2 While pressing the lever over to the left, slide the finisher to the left until it stops.

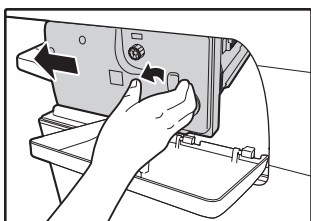

Gently slide the finisher until it stops.

3 Lower the staple case release lever and remove the staple case.

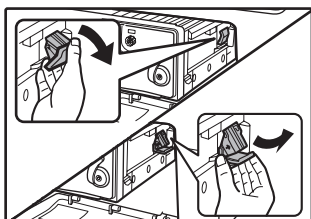

Pull the staple case out to the right.

4 Remove the empty staple cartridge from the staple case.

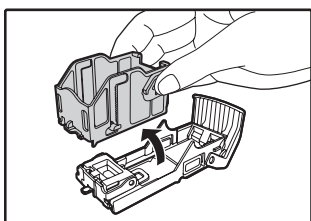

5 Insert a new staple cartridge into the staple case as shown.

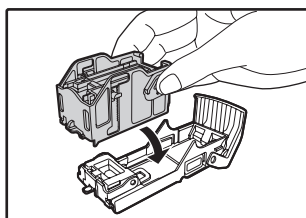

Push the staple cartridge in until it clicks into place.

6 Replace the staple case.

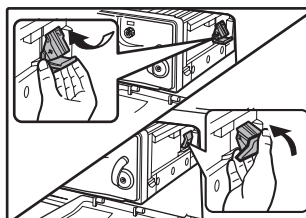

Push the staple case in until it clicks into place.

7 Slide the finisher back to the right.

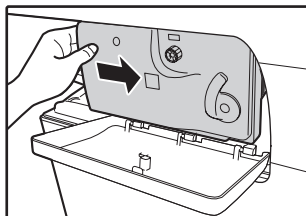

Gently slide the finisher back to the right until it locks into its original position.

8 Close the cover.

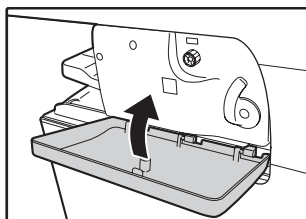

Gently slide the finisher back to the right until it locks into its original position.



Make a test print or copy in staple sort mode to verify that stapling takes place correctly.

Removing staple jams

Follow the steps below to remove a staple jam.

1 Open the cover.

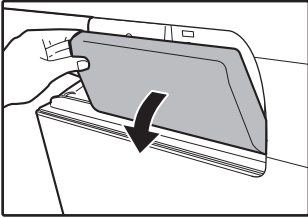

2 While pressing the lever over to the left, slide the finisher to the left until it stops.

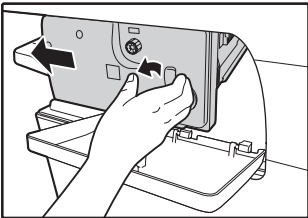

Gently slide the finisher until it stops.

3 Lower the staple case release lever and remove the staple case.

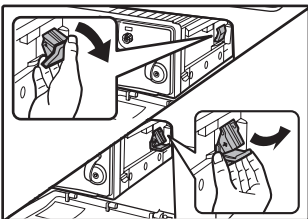

Pull the staple case out to the right.

4 Raise the lever at the front end of the staple case and remove the jammed staple.

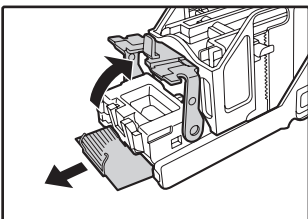

Remove the leading staple if it is bent. If bent staples remain, a staple jam will occur again.

5 Lower the lever at the front end of the staple case.

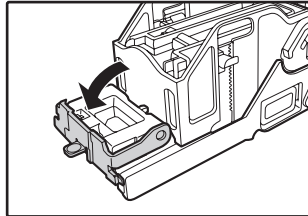

6 Replace the staple case.

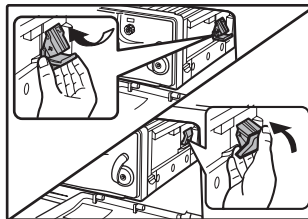

Push the staple case in until it clicks into place.

7 Slide the finisher back to the right.

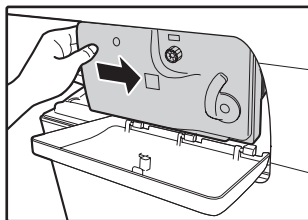

Gently slide the finisher back to the right until it locks into its original position.

8 Close the cover.

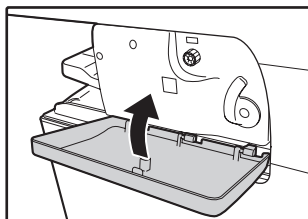

Gently slide the finisher back to the right until it locks into its original position.

Caution Take care that a bent staple does not hurt you.

CHECKING THE TONER QUANTITY AND TOTAL COUNT

The approximate quantity of toner remaining and the total count can be displayed as explained below.

- The total count shows the combined output total of the copy, fax, and printer functions.

Checking the total count and toner quantity

Hold down the [COPY] key. The total count and toner quantity appear while the key is held down.

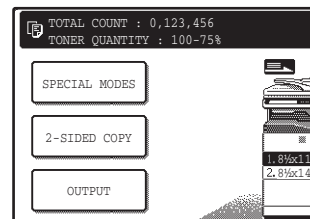
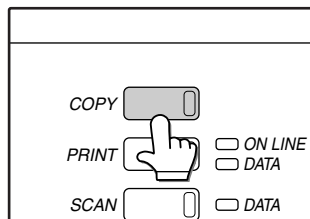

- Each 11" x 17" (A3) page is counted as two pages. Two-sided 8-1/2" x 11" (A4) size output is counted as two sheets
- The amount of toner consumed will vary depending on conditions of usage and the type of originals copied. The toner quantity display should only be used as an approximate guide.

CLEANING THE MACHINE

DOCUMENT GLASS AND RSPF

If the document glass, RSPF, or scanning glass for originals fed from the RSPF (the long narrow glass surface on the right side of the document glass) become dirty, the dirt may appear on copies. Always keep these parts clean. Stains or dirt on the document glass/RSPF will also be copied. Wipe the document glass, the RSPF and the scanning window on the document glass with a soft, clean cloth.

If necessary, dampen the cloth with water. Do not use thinner, benzene, or similar volatile cleaning agents.



Do not spray flammable cleaner gas. Gas from the spray may come in contact with the internal electrical components or high-temperature parts of the fusing unit, creating a risk of fire or electrical shock.

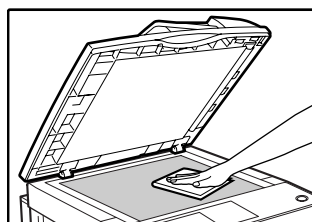

Surface of document glass

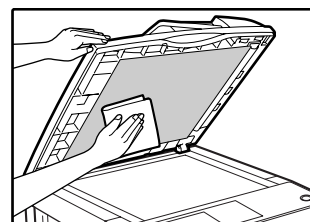

Underside of RSPF

Cleaning the scanning glass for RSPF

If white or black lines appear in copies made with using the RSPF, use the provided glass cleaner to clean the scanning glass for RSPF.

Example of dirty print image

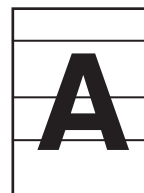

Black lines



White lines

1 Open the RSPF and take out the glass cleaner.

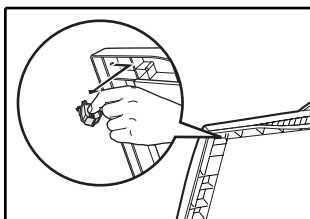

2 Clean the scanning glass with the glass cleaner.

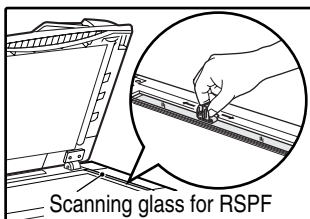

3 Return the glass cleaner to its original position.



Use a soft cloth to gently wipe off dirt from the area on the operation panel with a mirror-like finish (shown at right). If you use a stiff cloth or rub hard, the surface may be damaged.

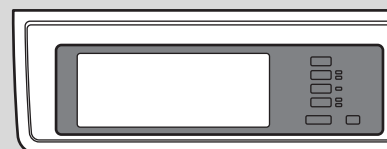

The area with a mirror-like finish is the area that is .

THE BYPASS TRAY PAPER FEED ROLLER

If misfeeds occur frequently when feeding envelopes or other thick paper from the bypass tray, wipe the paper feed roller at the feed slot of the bypass tray with a soft, clean cloth moistened with alcohol or water.

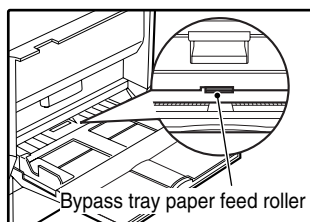

Optional equipments and supplies are explained in this chapter. To purchase optional equipment and supplies contact your SHARP service center.

PERIPHERAL DEVICES

FINISHER (MX-FN13) See page 140.
500-SHEET PAPER FEED UNIT (MX-DE10) See page 141.
2 x 500-SHEET PAPER FEED UNIT (MX-DE11) See page 141.
HIGH STAND (MX-DS11)
LOW STAND (MX-DS12)
RIGHT TRAY (MX-TE10) When a finisher (MX-FN13) is installed, an output tray can be added on the right side.
JOB SEPARATOR TRAY KIT (MX-TR11) This enables separation of output locations by mode (copy, printer, etc.).
PRINTER EXPANSION KIT (MX-PB12) This allows the machine to be used as a network printer.
APPLICATION INTEGRATION MODULE KIT (MX-AMX1)*1 The application integration module can be used in combination with the network scanner function to attach metadata to a scanned image file before it is transmitted.
MACRO FONT FLASH ROM KIT (AR-PF2) Fonts and forms can be downloaded and stored.
PS3 EXPANSION KIT (MX-PB12)*2 This kit offers PostScript 3 compatibility.
BARCODE FONT KIT (AR-PF1)*2 This font set adds barcode printing capability.
NETWORK SCANNER EXPANSION KIT (MX-NSX1)*3 This allows the machine to be used as a network scanner.
FACSIMILE EXPANSION KIT (AR-FX7) This allows the machine can be used as a facsimile machine.
8MB FAX MEMORY (AR-MM9) Image memory can be expanded by installing the optional fax expansion memory.
256MB EXPANSION MEMORY BOARD (AR-SM5) 512MB EXPANSION MEMORY BOARD (AR-SM6) Additional memory can be installed in the machine. There are two DIMM slots in this machine, and the memory can be expanded to a maximum of 1056 MB.

*1 Requires installation of the NETWORK SCANNER EXPANSION KIT (MX-NSX1).

*2 Requires installation of the PRINTER EXPANSION KIT (MX-PB12).

*3 Requires installation of the PRINTER EXPANSION KIT (MX-PB12), and 128MB or more of memory must be extended.



A commercial 64/128/256/512MB (the 168 pin SDRAM DIMM) memory module can be used to expand memory in this unit. For more information, consult your SHARP service center.

FINISHER (MX-FN13)

The finisher is equipped with the offset function, which offsets each set of output from the previous set. In addition, each set of sorted output can be stapled.

Part names

The following parts can be accessed when the finisher is open.

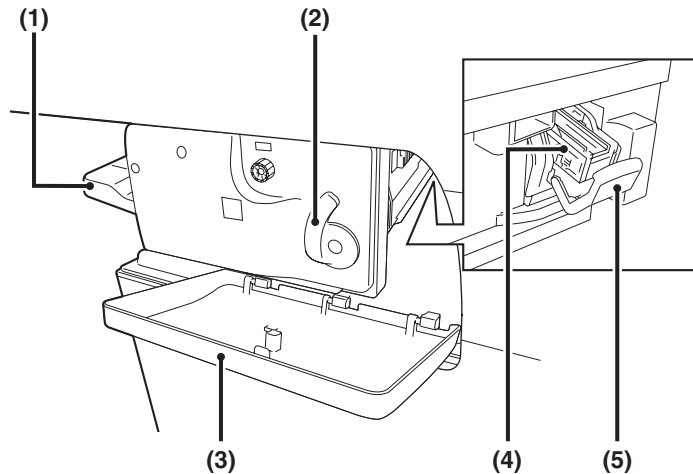

(1) Offset tray

Stapled and offset output is delivered to this tray. The tray is slidable. Extend the tray for large output (11" x 17", 8-1/2" x 14", 8-1/2" x 13", 8-1/2" x 11"R, 7-1/4" x 10-1/2"R, A3, A4R, B4 sizes).

(2) Lever

Use this to move the finisher in order to remove a paper misfeed, replace staples, or remove a staple jam.

(3) Front cover

Open this cover to remove a paper misfeed, replace staples, remove a staple jam, or remove the punch scrap case.

(4) Staple case

This holds the staple cartridge. Pull the case out to replace the staple cartridge or remove a staple jam.

(5) Staple case release lever

Use this to remove the staple case.

Specifications

	MX-FN13	
Tray capacity	500 sheets (250 sheets for sizes larger than 8-1/2" x 11"R (A4R))	
Paper size	Size	5-1/2" x 8-1/2" to 11" x 17" (A6R to A3)
	Weight	15 lbs. to 54 lbs. (56 g/m ² to 200 g/m ²)
Offset	1-3/16" (30 mm) (Offset Tray)	
Paper sizes that can be stapled	11" x 17", 8-1/2" x 14", 8-1/2" x 13", 8-1/2" x 11", 8-1/2" x 11"R (A3, B4, A4, A4R, B5, B5R)	
Stapling capacity	8-1/2" x 11", 8-1/2" x 11"R, A4, A4R, B5, B5R: 50 sheets (21 lbs. (80 g/m ²))	
	11" x 17", 8-1/2" x 14", 8-1/2" x 13", A3, B4: 30 sheets (21 lbs. (80 g/m ²))	
Power supply	Drawn from the machine	
Weight	Approx. 31.8 lbs. (14.4 kg)	
Dimensions	18-37/64" (W) x 18-5/32" (D) x 7-27/32" (H) (472 mm (W) x 461 mm (D) x 199 mm (H)) (Normal)	
	24-3/8" (W) x 18-5/32" (D) x 7-27/32" (H) (619 mm (W) x 461 mm (D) x 199 mm (H)) (Tray extended)	



- As a part of our policy of continuous improvement, SHARP reserves the right to make design and specification changes for product improvement without prior notice. The performance specification figures indicated are nominal values of production units and there may be some deviations from these values in individual units.
- Use caution when you turn on the power and when printing is taking place, as the offset tray may move up and down.

500-SHEET PAPER FEED UNIT/ 2 x 500-SHEET PAPER FEED UNIT

These paper feed units provide the convenience of increased paper capacity for the machine and a greater choice of paper sizes readily available for copying.

The MX-DE10 contains one 500-sheet paper tray and the MX-DE11 contains two 500-sheet paper trays.

Part names

500-SHEET PAPER FEED UNIT
(MX-DE10)

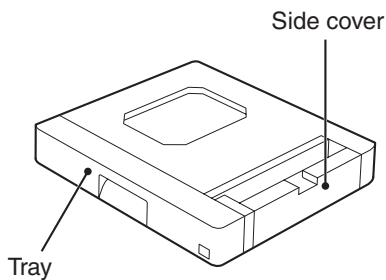

2x500-SHEET PAPER FEED UNIT
(MX-DE11)

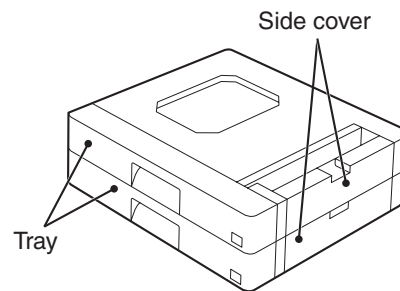

Specifications

		MX-DE10	MX-DE11
Paper	Size	8-1/2" x 11" to 11" x 17" (B5 to A3)	
	Weight	15 lbs. to 28 lbs. (56 g/m ² to 105 g/m ²)	
Paper capacity	Upper tray	500 sheets	500 sheets
	Lower tray	—	500 sheets
Weight		Approx. 15.5 lbs. (7.0 kg)	Approx. 29.2 lbs. (13.2 kg)
Dimensions		23-15/32" (W) x 19-39/64" (D) x 4-1/64" (H) (596 mm (W) x 498 mm (D) x 102 mm (H))	23-15/32" (W) x 19-39/64" (D) x 7-61/64" (H) (596 mm (W) x 498 mm (D) x 202 mm (H))
Power supply		Drawn from the machine	



As a part of our policy of continuous improvement, SHARP reserves the right to make design and specification changes for product improvement without prior notice. The performance specification figures indicated are nominal values of production units and there may be some deviations from these values in individual units.

STORAGE OF SUPPLIES

Standard supplies for this product that are to be replaced by the user are paper and the toner cartridge.

SHARP

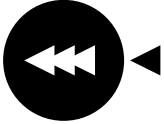

GENUINE SUPPLIES

For best copying results, be sure to use only SHARP Genuine Supplies which are designed, engineered and tested to maximize the life and performance of SHARP copiers. Look for the Genuine Supplies label on the toner package.

PROPER STORAGE

Store the supplies in a location that is:

- clean and dry,
- at a stable temperature,
- not exposed to direct sunlight.

Store paper in the wrapper and lying flat.

Paper stored out of the wrapper or in packages standing on end may curl or get damp, resulting in paper misfeeds.

Supply and Consumables

The supply of spare parts for a repair of the appliance is guaranteed for at least 7 years following the termination of production. Spare parts are those parts of the apparatus which may break down within the scope of the ordinary use of the product - whereas those parts which normally exceed the life of the product are not to be considered as spare parts. Consumables too, are available for 7 years following the termination of production.

SPECIFICATIONS

Model	MX-M260	MX-M310
Type	Digital Multifunction System, Desktop	
Photoconductive type	OPC drum	
Document glass type	Fixed	
Copy system	Dry, electrostatic transfer	
Originals	Sheets, bound documents	
Originals size	Max. 11" x 17" (A3)	
Copy size	Max. 11" x 17" (A3) Min. 5-1/2" x 8-1/2" (A6) Image loss: Max. 5/32" (4 mm) (leading and trailing edges) Max. 11/64" (6 mm) (along other edges in total)	
Copying speed (one-sided copying at 100% copy ratio)	14 copies/min. 11" x 17" 16 copies/min. 8-1/2" x 14" 18 copies/min. 8-1/2" x 11" 26 copies/min. 8-1/2" x 11" 26 copies/min. 5-1/2" x 8-1/2"	17 copies/min. 11" x 17" 20 copies/min. 8-1/2" x 14" 24 copies/min. 8-1/2" x 11" 31 copies/min. 8-1/2" x 11" 31 copies/min. 5-1/2" x 8-1/2"
Continuous copy	Max. 999 copies; subtractive counter	
First-copy time ^{*1}	Approx. 4.8 sec. (When 8-1/2" x 11" (A4) size paper is fed horizontally from tray1)	Approx. 4.5 sec. (When 8-1/2" x 11" (A4) size paper is fed horizontally from tray1)
Warm-up time ^{*2}	Approx. 23 sec.	Approx. 25 sec.
Copy ratio	Variable: 25% to 400%, in 1% increments (total 376 steps) Fixed preset: 25%, 50%, 64%, 77%, 100%, 121%, 129%, 200%, 400%	
Exposure system	Document glass: Moving optical source, slit exposure (stationary platen) with automatic exposure function RSPF: Moving original	
Paper feed	Two automatic feeding paper trays (500 sheets x 2) + bypass tray (100 sheets)	
Fusing system	Heat rollers	
Developer system	Magnetic brush development	
Light source	Xenon lamp	
Resolution	Scan: 400 x 600 dpi Output: 600 x 600 dpi	
Gradation	Scanning: 256 levels Printing: Equivalent to 256 levels	
Power supply	AC 120V±10%, 60 Hz, 12A	
Power consumption	Max. 1.45 kW	
Overall dimensions	42-3/4" (W) x 24-23/32" (D) (1086 mm (W) x 628 mm (D))	
Weight	Approx. 113.6 lbs. (51.5 kg) (Not includes toner cartridge)	

Dimensions	24-17/32" (W) x 24-23/32" (D) x 31-1/64" (H) (623 mm (W) x 628 mm (D) x 788 mm (H))
Operating conditions	Temperature: 59°F to 86°F (15°C to 30°C), Humidity: 20% to 85%
Noise level	<p>Sound Power Level L_{WA}(1B=10dB) Copying: 6.3[B] (MX-M260) Copying: 6.3[B] (MX-M310) Standby: 3.1[B] (MX-M260, MX-M310)</p> <p>Sound Pressure Level L_{pA} (bystander positions) Copying: 50[dB(A)] (MX-M260) Copying: 49[dB(A)] (MX-M310) Standby: 16[dB(A)] (MX-M260, MX-M310)</p> <p>Sound Pressure Level L_{pA} (operator position) Copying: 49[dB(A)] (MX-M260) Copying: 49[dB(A)] (MX-M310) Standby: 17[dB(A)] (MX-M260) Standby: 17[dB(A)] (MX-M310)</p> <p>Noise emission measurement in accordance with ISO 7779.</p>
Emission concentration (measured according to RAL-UZ62: Editon Jan. 2002)	<p>Ozone: 0.02 mg/m³ or less Dust: 0.075 mg/m³ or less Styrene: 0.07 mg/m³ or less</p>

*1 First copy time is measured with original on the document glass in full ready condition with fuser at operating temperature and mirror motor at operating speed, actual time may vary based on environment conditions.

*2 The warm-up time may vary depending on the power-supply voltage, ambient temperature, and other operating conditions.

Reversing single pass feeder (RSPF)

Acceptable original	Weight	9 lbs. to 34 lbs. (35 g/m ² to 128 g/m ²) (14 lbs. to 28 lbs. (52 g/m ² to 105 g/m ²) for two-sided original)
	Size	5-1/2" x 8-1/2" to 11" x 17"
	Capacity	Up to 100 sheets* (Thickness 33/64" (13 mm) and below)
Detectable original sizes	5-1/2" x 8-1/2", 5-1/2" x 8-1/2"R, 8-1/2" x 11", 8-1/2" x 11"R, 8-1/2" x 14", 11" x 17" (A4, A3)	
Weight	16.4 lbs. (7.4 kg)	
Dimensions	23-1/16" (W) x 19-31/64" (D) x 7-23/64" (H) (586 mm (W) x 495 mm (D) x 187 mm (H))	

* When paper weight is 24 lbs. (90 g/m²).



As a part of our policy of continuous improvement, SHARP reserves the right to make design and specification changes for product improvement without prior notice. The performance specification figures indicated are nominal values of production units. There may be some deviations from these values in individual units.

SPECIFICATIONS FOR NETWORK SCANNER

Maximum original size	11" x 17" or A3
Optical resolution	400dpi
Output resolution	200, 300, 600dpi
Output modes	1bit/pixel
Halftone processing	Error dispersion (200/300/600dpi)
File format	File type: TIFF/PDF Compression mode: MH (G3)/MMR (G4)/NONE
File creation method	One file for all pages/One file per each 1 to 6 pages
Two-sided originals	Possible (when an RSPF is installed)
Scan destinations	Scan to FTP, Scan to Desktop, Scan to E-mail
Web browser	Internet Explorer 6.0 or later (Windows), Netscape Navigator 7.0 or later, Safari 1.2 or later (Macintosh)
Management system	Uses built-in Web server
Network protocol	TCP/IP, SMTP, LDAP, FTP
Supported mail system	Mail servers supporting SMTP
LAN connectivity	10Base-T/100Base-TX
Number of destinations	200 maximum
Number of destinations for Scan To E-mail broadcast transmission	100 maximum*

* Multiple e-mail addresses (up to 100) can be stored as a group. Note that this may reduce the maximum number of destinations (normally 200) that can be stored.

Some discrepancies may exist in the illustrations and content due to improvements to the machine.

Scanning margins

When scanning an original, the area indicated in the following diagram cannot be scanned.

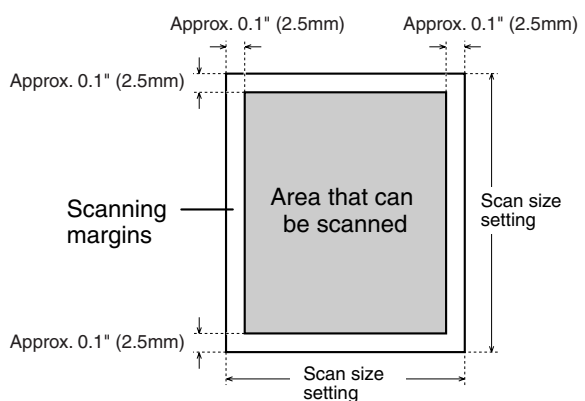

Date Issued : Jun. 1, 2009
 MSDS No. F-01791

1.PRODUCT AND COMPANY IDENTIFICATION

Product Name : MX-312NT / MX-312GT / MX-312AT / MX-312BT / MX-312FT / MX-312JT
 MX-313JT / MX-314JTK (Black Toner)

Supplier Identification : Sharp Corporation
 22-22 Nagaike-cho, Abeno-ku, Osaka, Japan

Local suppliers are listed below. Please contact the nearest supplier for additional information.

Area	(Country)	(Name and Telephone Number)
North America	U.S.A.	Sharp Electronics Corporation Sharp Plaza, Mahwah, NJ Telephone number for information : 1-800-237-4277 Emergency telephone number : 1-800-255-3924
	Canada	Sharp Electronics of Canada Ltd. Telephone number for information : 905-890-2100 Emergency telephone number : 1-800-255-3924
Oceania	Australia	Sharp Corporation of Australia PTY. Ltd. No1 Huntingwood Drive Huntingwood Blacktown N.S.W. Telephone number for information : 1300-13-50-22
Europe	Germany	Sharp Electronics (Europe) GMBH Sonninstrasse 3, 20097 Hamburg Telephone number to access MSDS : 040-2376-2185 For more information : 040-2376-2613
	United Kingdom	Sharp Electronics (U. K.) Ltd. Telephone number for information : 08705-274-277
	France	Sharp Electronics France S.A. Telephone number for information : 01-49-90-34-00
	Austria	Sharp Electronics GMBH Telephone number for information : 01-727-19-0
	Italy	Sharp Electronics (Italy) S.P.A. Telephone number for information : 02895951
	Spain	Sharp Electronics (Espana) S.A. Telephone number for information : 93-581-97-00
	Netherlands	Sharp Electronics Benelux B.V. Telephone number for information : 30-6359500
	Sweden	Sharp Electronics Nordic AB Telephone number for information : 08-634-36-00
Middle East	Switzerland	Sharp Electronics(Schweiz)AG Telephone number for information : 01-846-6111
	U.A.E.	Sharp Middle East FZE P.O.Box 17115 Jebel Ali, Dubai Telephone number for information : 04-815311

2.COMPOSITION / INFORMATION ON INGREDIENTS

Substance[] Ingredient	Preparation[X] CAS No.	Proportion	OSHA PEL	ACGIH TLV	MAK-TWA	NOHSC-TWA
Styrene-Acrylate copolymer	Confidential	80-90%	Not listed	Not listed	Not listed	Not listed
Carbon black	1333-86-4	5-10%	3.5mg/m ³	3.5mg/m ³	Not listed	3mg/m ³
Polyethylene	Confidential	1-5%	Not listed	Not listed	Not listed	Not listed
Polypropylene	Confidential	1-5%	Not listed	Not listed	Not listed	Not listed
Charge control agent	Confidential	0.1-1%	Not listed	Not listed	Not listed	Not listed
Amorphous silica	68611-44-9	0.1-1%	80 mg/m ³	2mg/m ³	Not listed	Not listed
Iron Oxide	1309-38-2	1-5%	Not listed	Not listed	Not listed	Not listed

Date Issued : Jun. 1, 2009
MSDS No. F-01791

3. HAZARDS IDENTIFICATION

Most Important Hazards and Effects of the Products

Human Health Effects : There are no anticipated carcinogenic effects from exposure based on animal tests performed using toner. When used as intended according to instructions, studies do not indicate any symptoms of fibrosis will occur.

Environmental Effects : Not toxic to aquatic organisms
[Estimated from the other product containing similar material]

Specific Hazards : Dust explosion (like most finely divided organic powders)

Directive 1999/45/EC(Europe) : Not classified as dangerous

4. FIRST-AID MEASURES

Route(s) of Entry : <u>Inhalation?</u>	<u>Skin?</u>	<u>Ingestion?</u>
Yes	No	Possible but very unusual.

Inhalation : Remove to fresh air. If symptoms occur, consult medical personnel.

Skin Contact : Wash with soap and water for 15 minutes or until particle is removed.
If irritation does occur, consult medical personnel.

Eye Contact : Flush eyes immediately with water for 15 minutes. If irritation does occur, consult medical personnel.

Ingestion : Rinse with water and drink several glasses of water. If irritation or discomfort does occur, consult medical personnel.

5. FIRE-FIGHTING MEASURES

Extinguishing Media : Water, CO₂, foam and dry chemicals

Special Fire Fighting Procedures : None

Fire and Explosion Hazards : Toner material, like most finely divided organic powders, may form an explosive mixture.

6. ACCIDENTAL RELEASE MEASURES

Personal Precautions : None

Environmental Precautions : None

Methods for Cleaning Up : Wipe off with paper or cloth. Do not use vacuum cleaner when a large amount is released. It, like most finely divided organic powders, is capable of creating a dust explosion.

7. HANDLING AND STORAGE

Handling

Technical Measures : None

Precautions : None

Safe Handling Advice : Use of a dust mask is recommended when handling a large quantity of toner or during long term exposure, as with any non-toxic dust. Try not to disperse the particles.

Storage

Technical Measures : None

Storage Conditions : Keep container closed and Store in a cool and dry place.
Keep out of the reach of children.

Incompatible Products : None

8. EXPOSURE CONTROLS / PERSONAL PROTECTION

Engineering Measures

Ventilation : Not required under intended use.

Exposure Limit Values

OSHA-PEL(USA) : 15mg/m³ (Total Dust), 5mg/m³ (Respirable Dust)

ACGIH-TLV(USA) : 10mg/m³ (Total Dust), 3mg/m³ (Respirable Dust)

Date Issued : Jun. 1, 2009
MSDS No. F-01791

Personal Protective Equipment

Respiratory Protection : Not required under intended use.
Hand Protection : Not required under intended use.
Eye Protection : Not required under intended use.
Skin Protection : Not required under intended use.
Other Protective Equipment : Use of a dust mask and goggles are recommended when handling a large quantity of toner or during long term exposure, as with any non-toxic dust.

9. PHYSICAL AND CHEMICAL PROPERTIES

Appearance

Physical State : Solid Form : Powder Color : Black Odor : odorless

Ph : Not applicable

Boiling / Melting Point : Not applicable

Softening Point(°C) : 100 - 130

Flash Point(°C) : Not applicable

Ignition Point(°C) : > 350

Explosion Properties : No data

Density(g/cm³) : 1.1 (bulk density : approx. 0.35)

Solubility in Water : Negligible

10. STABILITY AND REACTIVITY

Stability : Stable

Hazardous Reactions : Dust explosion, like most finely divided organic powders.

Conditions to Avoid : Electric discharge, throwing into fire.

Materials to Avoid : Oxidizing Materials

Hazardous Decomposition Products : CO, CO₂ and NO_x

Further Information : None Dermal

11. TOXICOLOGICAL INFORMATION

Acute Toxicity

Ingestion(oral) : LD₅₀ > 2000mg/kg (Rats) [Estimated from the other product containing similar material]

Inhalation : LC₅₀ > 5.0mg/L (Rats) [Estimated from the other product containing similar material]

Eye irritation : Not an irritant (Rabbits) [Estimated from the other product containing similar material]

Skin irritation : Not an irritant (Rabbits) [Estimated from the other product containing similar material]

Skin sensitizer : No sensitization[Estimated from the other product containing similar material]

Mutagenicity : Negative (Ames Test) [Estimated from the other product containing similar material]

Carcinogenicity : In 1996 the IARC reevaluated carbon black as a Group 2B carcinogen (possible human carcinogen). This classification is given to chemicals for which there is inadequate human evidence, but sufficient animal evidence on which to base an opinion of carcinogenicity. The classification is based upon the development of lung tumors in rats receiving chronic inhalation exposures to free carbon black at levels that induce particle overload of the lung. Studies performed in animal models other than rats did not show any association between carbon black and lung tumors. Moreover, a two-year cancer bioassay using a typical toner preparation, where carbon black is bound in a resin matrix, demonstrated no association between toner exposure and tumor development in rats.

Chronic Effect : In a study in rats of chronic inhalation exposure to a typical toner, a mild to moderate degree of lung fibrosis was observed in 92% of the rats in the high concentration (16mg/m³) exposure group, and a minimal to mild degree of fibrosis was noted in 22% of the animals in the middle (4mg/m³) exposure group, but no pulmonary change was reported in the lowest (1mg/m³) exposure group, the most relevant level to potential human exposures.

Date Issued : Jun. 1, 2009
MSDS No. F-01791

12.ECOLOGICAL INFORMATION

Ecotoxicity

On available data, toner is not harmful to aquatic organisms

13.DISPOSAL CONSIDERATIONS

Waste from Residues : Waste material may be dumped or incinerated under conditions which meet all federal, state and local environmental regulations.**Contaminated Packaging** : Waste may be disposed or incinerated under conditions which meet all federal, state and local environmental regulations.

14.TRANSPORT INFORMATION

UN Classification : None

Not classified as hazardous for transport.

15.REGULATORY INFORMATION

US Information

TSCA(Toxic Substances Control Act) :

All chemical substances in this product comply with all applicable rules or order under TSCA.

SARA(Superfund Amendments and Reauthorization Act) Title III

302 Extreme Hazardous Substance : None

311/312 Hazard Classification : None

EU Information

1999/45/EC and 67/548/EEC

Symbol & Indication : Not required

R-Phrase : Not required

76/769/EEC : All chemical substances in this product comply with all applicable rules or order under 76/769/EEC.

16.OTHER INFORMATION

NFPA Rating (USA) : Health=1 Flammability=1 Reactivity=0

WHMIS Legislation (Canada) : This product is not a controlled product.

References

IARC(1996) : IARC monographs on the Evaluation of the Carcinogenic Risk of Chemicals to Humans, Vol. 65, Printing Process And Printing Inks, Carbon Black and Some Nitro Compounds, Lyon, pp.149-261

H.Muhle, B.Bellmann, O.Creutzenberg, C.Dasenbrock, H.Ernst, R.Kilpper, J.C.MacKenzie, P.Morrow, U.Mohr, S.Takenaka, and R.Mermelstein(1991) Pulmonary Response to Toner upon Chronic Inhalation Exposure in Rats. Fundamental and Applied Toxicology 17, pp.280-299.

The information on this data sheet represents our current data and best opinion as to the proper use in handling of this product under normal conditions. However, all materials may present unknown hazards and should be used with caution. Although certain hazards are described herein, we do not guarantee that these are the only hazards which exist.

Date Issued : Jun. 1, 2009
MSDS No. F-31791

1.PRODUCT AND COMPANY IDENTIFICATION

Product Name : MX-312NV / MX-312GV / MX-312AV / MX-312FV / MX-312JV (Black Developer)

Supplier Identification : Sharp Corporation
22-22 Nagaike-cho, Abeno-ku, Osaka, Japan

Local suppliers are listed below. Please contact the nearest supplier for additional information.

Area	(Country)	(Name and Telephone Number)
North America	U.S.A.	Sharp Electronics Corporation Sharp Plaza, Mahwah, NJ Telephone number for information : 1-800-237-4277 Emergency telephone number : 1-800-255-3924
	Canada	Sharp Electronics of Canada Ltd. Telephone number for information : 905-890-2100 Emergency telephone number : 1-800-255-3924
Oceania	Australia	Sharp Corporation of Australia PTY. Ltd. No1 Huntingwood Drive Huntingwood Blacktown N.S.W. Telephone number for information : 1300-13-50-22
Europe	Germany	Sharp Electronics (Europe) GMBH Sonninstrasse 3, 20097 Hamburg Telephone number to access MSDS : 040-2376-2185 For more information : 040-2376-2613
	United Kingdom	Sharp Electronics (U. K.) Ltd. Telephone number for information : 08705-274-277
	France	Sharp Electronics France S.A. Telephone number for information : 01-49-90-34-00
	Austria	Sharp Electronics GMBH Telephone number for information : 01-727-19-0
	Italy	Sharp Electronics (Italy) S.P.A. Telephone number for information : 02895951
	Spain	Sharp Electronics (Espana) S.A. Telephone number for information : 93-581-97-00
	Netherlands	Sharp Electronics Benelux B.V. Telephone number for information : 30-6359500
	Sweden	Sharp Electronics Nordic AB Telephone number for information : 08-634-36-00
Middle East	Switzerland	Sharp Electronics(Schweiz)AG Telephone number for information : 01-846-6111
	U.A.E.	Sharp Middle East FZE P.O.Box 17115 Jebel Ali, Dubai Telephone number for information : 04-815311

2.COMPOSITION / INFORMATION ON INGREDIENTS

Substance[]	Preparation[X]					
<u>Ingredient</u>	<u>CAS No.</u>	<u>Proportion</u>	<u>OSHA PEL</u>	<u>ACGIH TLV</u>	<u>MAK-TWA</u>	<u>NOHSC-TWA</u>
Iron powder	7439-89-6	>90%	Not listed	Not listed	Not listed	Not listed
Silicone resin	Confidential	1-5%	Not listed	Not listed	Not listed	Not listed
Styrene-Acrylate copolymer	Confidential	5-10%	Not listed	Not listed	Not listed	Not listed
Carbon black	1333-86-4	0.1-1%	3.5mg/m ³	3.5mg/m ³	Not listed	3mg/m ³

Date Issued : Jun. 1, 2009
MSDS No. F-31791

3. HAZARDS IDENTIFICATION

Most Important Hazards and Effects of the Products

Human Health Effects : There are no anticipated carcinogenic effects from exposure based on animal tests performed using toner. When used as intended according to instructions, studies do not indicate any symptoms of fibrosis will occur.

Environmental Effects : No toxic to aquatic organisms.
[Estimated from the other product containing similar material]

Specific Hazards : Dust explosion (like most finely divided organic powders)

Directive 1999/45/EC(Europe) : Not classified as dangerous

4. FIRST-AID MEASURES

Route(s) of Entry : <u>Inhalation?</u>	<u>Skin?</u>	<u>Ingestion?</u>
No	No	Possible but very unusual.

Inhalation : Remove to fresh air. If symptoms occur, consult medical personnel.

Skin Contact : Wash with soap and water for 15 minutes or until particle is removed.
If irritation does occur, consult medical personnel.

Eye Contact : Flush eyes immediately with water for 15 minutes. If irritation does occur, consult medical personnel.

Ingestion : Rinse with water and drink several glasses of water. If irritation or discomfort does occur, consult medical personnel.

5. FIRE-FIGHTING MEASURES

Extinguishing Media : Water, CO₂, foam and dry chemicals

Special Fire Fighting Procedures : None

Fire and Explosion Hazards : Toner material, like most finely divided organic powders, may form an explosive mixture.

6. ACCIDENTAL RELEASE MEASURES

Personal Precautions : None

Environmental Precautions : None

Methods for Cleaning Up : Wipe off with paper or cloth. Do not use vacuum cleaner when a large amount is released. It, like most finely divided organic powders, is capable of creating a dust explosion.

7. HANDLING AND STORAGE

Handling

Technical Measures : None

Precautions : None

Safe Handling Advice : Use of a dust mask is recommended when handling a large quantity of toner or during long term exposure, as with any non-toxic dust. Try not to disperse the particles.

Storage

Technical Measures : None

Storage Conditions : Keep container closed and Store in a cool and dry place.
Keep out of the reach of children.

Incompatible Products : None

Date Issued : Jun. 1, 2009
MSDS No. F-31791

8.EXPOSURE CONTROLS / PERSONAL PROTECTION

Engineering Measures

Ventilation : Not required under intended use.

Exposure Limit Values

OSHA-PEL(USA) : 15mg/m³ (Total Dust) , 5mg/m³ (Respirable Dust)

ACGIH-TLV(USA) : 10mg/m³ (Total Dust) , 3mg/m³ (Respirable Dust)

Personal Protective Equipment

Respiratory Protection : Not required when used as intended in Sharp equipment.

Hand Protection : Not required when used as intended in Sharp equipment.

Eye Protection : Not required when used as intended in Sharp equipment.

Skin Protection : Not required when used as intended in Sharp equipment.

Other Protective Equipment : Use of a dust mask and goggles are recommended when handling a large quantity of toner or during long term exposure, as with any non-toxic dust.

9.PHYSICAL AND CHEMICAL PROPERTIES

Appearance

Physical State : Solid Form : Powder Color : Black Odor : odorless

Ph : Not applicable

Boiling / Melting Point : Not applicable

Flash Point(°C) : Not applicable

Ignition Point(°C) : No data

Explosion Properties : No data

Density(g/cm³) : Approx.5.0 (bulk density : Approx. 2.0)

Solubility in Water : Negligible

10.STABILITY AND REACTIVITY

Stability : Stable

Hazardous Reactions : Dust explosion, like most finely divided organic powders.

Conditions to Avoid : Electric discharge, throwing into fire.

Materials to Avoid : Oxidizing Materials

Hazardous Decomposition Products : CO, CO₂ and NO_x

Further Information : None

11.TOXICOLOGICAL INFORMATION

Acute Toxicity

Ingestion(oral) : LD₅₀ > 2000mg/kg (Rats) [Estimated from the other product containing similar material]

Inhalation : No Data

Eye irritation : No Data

Skin irritation : Not an irritant [Estimated from the other product containing similar material]

Skin sensitizer : No sensitization [Estimated from the other product containing similar material]

Mutagenicity : Negative (Ames Test) [Estimated from the other product containing similar material]

Carcinogenicity : In 1996 the IARC reevaluated carbon black as a Group 2B carcinogen (possible human carcinogen). This classification is given to chemicals for which there is inadequate human evidence, but sufficient animal evidence on which to base an opinion of carcinogenicity. The classification is based upon the development of lung tumors in rats receiving chronic inhalation exposures to free carbon black at levels that induce particle overload of the lung. Studies performed in animal models other than rats did not show any association between carbon black and lung tumors. Moreover, a two-year cancer bioassay using a typical toner preparation , where carbon black is bound in a resin matrix, demonstrated no association between toner exposure and tumor development in rats.

Date Issued : Jun. 1, 2009
MSDS No. F-31791

Chronic Effect : In a study in rats of chronic inhalation exposure to a typical toner, a mild to moderate degree of lung fibrosis was observed in 92% of the rats in the high concentration (16mg/m³) exposure group, and a minimal to mild degree of fibrosis was noted in 22% of the animals in the middle (4mg/m³) exposure group, but no pulmonary change was reported in the lowest (1mg/m³) exposure group, the most relevant level to potential human exposures.

12.ECOLOGICAL INFORMATION

Ecotoxicity

On available data, toner is not harmful to aquatic organisms.

13.DISPOSAL CONSIDERATIONS

Waste from Residues : Waste material may be dumped or incinerated under conditions which meet all federal, state and local environmental regulations.

Contaminated Packaging : Waste may be disposed or incinerated under conditions which meet all federal, state and local environmental regulations.

14.TRANSPORT INFORMATION

UN Classification : None

Not classified as hazardous for transport.

15.REGULATORY INFORMATION

US Information

TSCA(Toxic Substances Control Act) :

All chemical substances in this product comply with all applicable rules or order under TSCA.

SARA(Superfund Amendments and Reauthorization Act) Title III

302 Extreme Hazardous Substance : None

311/312 Hazard Classification : None

EU Information

1999/45/EC and 67/548/EEC

Symbol & Indication : Not required

R-Phrase : Not required

76/769/EEC : All chemical substances in this product comply with all applicable rules or order under 76/769/EEC.

16.OTHER INFORMATION

NFPA Rating (USA) : Health=1 Flammability=1 Reactivity=0

WHMIS Legislation (Canada) : This product is not a controlled product.

References

IARC(1996) : IARC monographs on the Evaluation of the Carcinogenic Risk of Chemicals to Humans, Vol. 65, Printing Process And Printing Inks, Carbon Black and Some Nitro Compounds, Lyon, pp.149-261
H.Muhle, B.Bellmann, O.Creutzenberg, C.Dasenbrock, H.Ernst, R.Kilpper, J.C.MacKenzie, P.Morrow, U.Mohr, S.Takenaka, and R.Mermelstein(1991) Pulmonary Response to Toner upon Chronic Inhalation Exposure in Rats. Fundamental and Applied Toxicology 17, pp.280-299.

The information on this data sheet represents our current data and best opinion as to the proper use in handling of this product under normal conditions. However, all materials may present unknown hazards and should be used with caution. Although certain hazards are described herein, we do not guarantee that these are the only hazards which exist.

INDEX

Symbols

[#/P] key 11, 93, 94

2 - 8

2 x 500-sheet paper feed unit 132, 139, 141
256MB expansion memory board 139
[2-SIDED COPY] key 22, 28, 29
500-sheet paper feed unit 132, 139, 141
512MB expansion memory board 139
8MB fax memory 39

A

ABCDEF configuration 92
About the web page 57
Accessing web pages 56
Account control 103
Account number 95
Address book screen 71
Adjusting the exposure 30
Administrator password 96, 109
Administrator setting list 99
Administrator settings 96

- Account control 103
- Change administrator password 109
- Copy settings 110
- Device control 107
- Energy save 105
- Operation settings 106
- Print settings 111
- Product key 109
- Scanner settings 115

Auditing mode 95
[AUTO IMAGE] key 31
Auto tray switching 92
Automatic ratio selection 31
Automatic two-sided copying

- Document glass 28
- RSPF 29

AZERTY configuration 92

B

B/W reverse copy 51
[B/W REVERSE] key 40, 51
Barcode font kit 139
Basic settings for network scanning 58
Basic transmission method 72
[BINDING CHANGE] key 28
Bypass feed 27
Bypass tray 10, 27, 129, 138
Bypass tray extension 10, 19
[BYPASS TRAY] key 21
Bypass tray paper feed roller 138
Bypass tray paper guides 10

C

Card shot 52
[CARD SHOT] key 40, 52
Canceling an e-mail/FTP transmission 83
Cautions on handling the machine 5
Cautions on using the machine 4

Center tray 9, 131
Center tray counter function 25
Change administrator password 109
Changing a tray's paper tray
and paper size settings 20
Changing the send settings 82
Checking the IP address 89
Checking the toner quantity 137
Cleaning the machine

- Bypass tray paper feed roller 138
- Document glass 137
- RSPF 137

[CLEAR ALL] key 11, 15
CLEAR key 11, 23, 24
Clock 90
Color paper 16
Configuring DNS server settings 59
Configuring LDAP server settings 60
Configuring SMTP server settings 59
Copy finishing functions

- Group copy 36
- Offset function 36
- Sort copy 36
- Staple sort 38

[COPY] key 22, 134, 137
Copy number display 22
Copy ratio display 22
[COPY RATIO] key 22, 32, 33
Copy settings 110
Cover copy 49
[COVER] key 40, 50

D

[DELETE] key 94
[DETAIL] key 13
Device control 107
Disabling of two-sided printing on
letterhead paper 92
Display contrast 90, 92
Display message 117
Display switching key 13
Document feeder cover 9, 128
Document feeder tray 9, 24, 128
Document glass 9
Document transport cover 9, 128
Document transport cover knob 9, 128
Dual page copy 44
[DUAL PAGE COPY] key 40, 44

E

Editing and deleting programmed transmission
destinations 66
Energy save 105
Enlargement key 32
Envelope 16, 17
Erase copy 43
[ERASE] key 40, 43

Erase mode		List print.....	90, 92
- Center erase	43	Loading paper	16
- Edge erase.....	43	Loading paper in the bypass tray	19
- Edge+center erase.....	43	Loading the paper in the paper tray	18
Erase width	43	[LOGOUT] key	11, 95
Error message.....	117	M	
Exit area	9, 128	Main screen of copy mode	22
Exposure adjustment	30	[MANUAL] key.....	48
Exposure display.....	22	Manual ratio selection	32
[EXPOSURE] key.....	22, 30	Margin shift copy	42
Exposure value guidelines	30	[MARGIN SHIFT] key.....	40, 42
Extra image adjust	27	[MENU] key	32
F		Message display	22
Facsimile expansion kit.....	139	Metadata delivery (data entry)	84, 85, 86
[FAX JOB] key.....	13	Metadata fields.....	88
[FAX] key		Misfed original.....	128
- DATA indicator.....	11	Misfeed in an output tray.....	133
- LINE indicator	11	Misfeed in the bypass tray	129
Finisher	38, 133, 135, 139	Misfeed in the center tray.....	131
Front cover	9, 129, 130, 134	Misfeed in the fusing area	130
Fusing unit paper guide.....	10, 130	Misfeed in the lower paper tray	132
Fusing unit release lever.....	10, 130	Misfeed in the machine	129
G		Misfeed in the paper feed area	129
Grayed out	12	Misfeed in the upper exit area.....	133
Group copy.....	36	Misfeed in the upper paper tray	131
[GROUP] key	37	Misfeed removal	
H		- Bypass tray	129
Handles	9	- Center tray	131
Heavy paper.....	16	- Lower paper tray	132
How to place the original		- Machine.....	129
- Document glass	23	- Output tray	133
- RSPF	24	- Right tray.....	132
I		- RSPF.....	128
Icon (Job status screen).....	13	- Upper exit tray.....	133
Important points when inserting paper		- Upper paper tray	131
in the bypass tray.....	19	Misfeed removal guidance	127
Important points when selecting an installation site...4		Mixed feeding.....	26
[INFORMATION] key	127	Mode select keys	11
Initial settings	15	Mode switching key.....	13
[INTERRUPT] key	11, 35	Multi shot copy	47
Interrupting copy	35	[MULTI SHOT] key.....	40, 47
J		N	
[JOB BUILD] key	40, 46	Network scanner expansion kit	139
Job build mode.....	24, 46	Normal copying	
Job list	13	- Document glass	23
Job program		- RSPF.....	24
- Deleting.....	94	Number of pages fed through the RSPF	92
- Executing	94	Number of pages sent using the network	
- Storing.....	92, 93	scanner function.....	92
Job separator tray	9, 139	Number of sent and received fax pages	92
[JOB STATUS] key	11, 13	Number of times the stapler was used.....	92
Job status screen	13	Number of two-sided copies.....	92
L		Numeric keys	11
Label	16	O	
Laser information	5	Offset function	36, 37
Layout	47	Offset tray.....	38, 108, 140
Letterhead paper.....	16, 17, 28	Operation panel.....	9
		Operation settings	106
		Optional equipment	139

Orientation of the original (Staple sort)	38
Original feed display	22
Original guides	9
Original image type	
- Photo	30
- Text	30
- Text/photo	30
Original size	23, 24, 25, 48
Original size display	22
[ORIGINAL SIZE] key	40, 48
Originals that can be used in the RSPF	25
[OUTPUT] key	22, 36, 37, 39
Output tray	133

P

Pamphlet copy	45
[PAMPHLET COPY] key	40, 45
Paper	16
Paper capacity	16
Paper misfeeds	121
Paper select display	22
[PAPER SELECT] key	21, 22, 23, 24, 27
Paper size	16, 20
Paper size card	18
Paper size display	22
Paper tray	10, 16, 18, 20, 131
Paper type	16, 20, 21
Paper weight	16
Part names and functions	
- Operation panel	11
Passwords	68
Peripheral devices	139
Photoconductive drum	10, 129
Plain paper	16
Points to note when making copies	25
Power off	14
Power on	14
Power outlet	4
Power save modes	
- Auto power shut-off mode	15
- Preheat mode	15
Power switch	9, 14
Preset enlargement ratios	32
[PRINT JOB] key	13
[PRINT] key	
- DATA indicator	11
- ONLINE indicator	11
Print settings	111
Printer expansion kit	139
[PRIORITY] key	13
Problems when the network scanner function is used	123
Product key	109
Programming custom index names	61
Protecting information programmed in the web page	68
PS3 expansion kit	139

Q

QWERTY configuration	92
----------------------------	----

R

[READ-END] key	37, 39, 46, 47
Recycled paper	16
Reduction key	32
Reduction/enlargement/zoom	31
Release roller	128
Replacing the toner cartridge	134
Restricting use of the network scanner function	69
Reversing tray	9, 128
Right tray	132, 139
Roller rotating knob	10, 129, 130
Rotation copying	26
RSPF	24, 25, 128, 144

S

[SCAN] key	
- DATA indicator	11, 72
[SCAN TO] key	13
Scanner settings	115
Scanning and transmitting a two-sided original	76
Scanning settings	78
Selecting the file format	81
Selecting the original image type	30
Selecting the quality	79
Selecting the resolution	80
Setting the paper type in the bypass tray	
- [PAPER SELECT] key	21
- [SYSTEM SETTINGS] key	21
Setting up destination information	62
Shift direction	42
Side cover	10, 130
Side cover handle	10
Sort copy	36
[SORT] key	37
Special modes	
- B/W reverse copy	51
- Card shot	52
- Cover copy	49
- Dual page copy	44
- Erase copy	43
- Job build mode	46
- Margin shift copy	42
- Multi shot copy	47
- Original size	48
- Pamphlet copy	45
[SPECIAL MODES] key	22, 40, 41
Special papers	26
- Envelope	17
- Letterhead paper	17
Specifications	143
Staple cartridge	135
Staple cartridge replacement	135
Staple case	135, 140
Staple jam removal	136
Staple sort	38
[STAPLE SORT] key	39
Stapling positions	38
[START] key	11, 23, 24
[STOP/DELETE] key	13
Storage of supplies	142
[STORE/DELETE] key	93, 94

Storing destinations for scan to desktop	64
Storing destinations for scan to e-mail	62
Storing destinations for scan to FTP	63
Storing groups (Scan to E-mail)	65
Storing the sender information (Scan to E-mail)	
Stream feeding mode	24
System settings	90, 96
[SYSTEM SETTINGS] key	11, 20, 21, 91

T

Thin paper	16
Toner cartridge	10, 134
Toner cartridge lock release lever	10, 134
Total count	90, 92, 137
Total number of copies and printed pages	92
Touch panel	11, 12
To the administrator of the machine	160
Transmission methods for scan to e-mail	74
Transparency film	16, 17, 28
Tray number	16, 20
Tray settings	20, 21, 90, 92
[TRAY SETTINGS] key	20, 21
Troubleshooting	119

U

Upper exit area	133
Upper right side cover	10, 133
User authentication	69
Using the touch panel	12

W

Warm-up	14
---------------	----

X

[X] key	34
XY ZOOM copying	33
[XY ZOOM] key	33

Y

[Y] key	34
---------------	----

INDEX BY PURPOSE

Preparations

Bypass tray, loading paper in	19
Initial settings, returning to	15
Paper size, changing	20
Paper type, changing	20
Paper, loading	18
Power, turning off	14
Power, turning on	14

Making copies

Auditing mode, copying when enabled	95
Automatic two-sided copying	
- Document glass	28
- RSPF	29
Bypass tray, copying from	27
Copy run, stopping	23, 24
Copying	
- Document glass	23
- RSPF	24
Document glass, copying from	23
Enlarging/reducing copies	
- Automatic ratio selection	31
- Manual ratio selection	32
- XY zoom copying	33
Exposure, adjusting	30
Exposure, selecting	30
Image orientation, changing	28, 29
Interrupt copying	35
Mixed feeding	26
Original image type, selecting	30
Paper size (tray), selecting manually	23
RSPF, copying from	24
Special paper, copying on	27
Stream feeding mode, using	24

Using convenient copy functions

Black and white reverse copying	51
Cover, adding to copies	49
Dual page copying	44
Erase copying	43
Group copying, using	36
Large number of originals, copying	46
Margin, creating	42
Multi shot copying	47
Offset function, using	36
Original size, specifying	48
Pamphlet copying	45
Selecting finishing functions	
- Group copying	36
- Offset function	36
- Sort copying	36
- Staple sort function	38
Sort copying, using	36

Special modes, using

- B/W reverse copy	51
- Card shot copy	52
- Cover copy	49
- Dual page copy	44
- Erase copy	43
- Job build mode	46
- Margin shift copy	42
- Multi shot copy	47
- Original size	48
- Pamphlet copy	45
Staple sort function, using	38

Using network scanner functions

Accessing web pages	56
Basic transmission method	72
Canceling an e-mail/FTP transmission	83
Changing the send settings	82
Checking the IP address	89
Configuring DNS server settings	59
Configuring LDAP server settings	60
Configuring SMTP server settings	59
Editing and deleting programmed transmission destinations	66
Programming custom index names	61
Protecting information programmed in the web page	68
Restricting use of the network scanner function	69
Scanning and transmitting a two-sided original	76
Scanning settings	78
Selecting the file format	81
Selecting the quality	79
Selecting the resolution	80
Setting up destination information	62
Storing destinations for scan to desktop	64
Storing destinations for scan to e-mail	62
Storing destinations for scan to FTP	63
Storing groups (Scan to E-mail)	65
Storing the sender information (Scan to E-mail)	67
Transmission methods for scan to e-mail	74
Transmitting metadata	86

Making the machine easier to use

Canceling a job	13
Canceling a job in progress	13
Date and time, setting	92
Deleting a job	13
Display contrast, adjusting	92
Job details, displaying	13
Job program, deleting	94
Job program, executing	94
Job program, storing	93
Keyboard, changing	92
Lists, printing	92
Priority, giving to a specified job	13
System settings, configuring	90, 96
Total count, displaying	92
Trays, configuring settings	92

Configuring the administrator settings	
Change administrator password	109
Copy settings	110
Device control	107
Energy save	105
Operation settings	106
Print settings	111
Product key	109
Scanner settings	115
Using the administrator settings	97

Troubleshooting and maintenance

Cleaning the machine	137
Misfeeds, removing	
- Bypass tray	129
- Center tray	131
- Lower paper tray	132
- Machine	129
- Output tray	133
- Right tray	132
- RSPF	128
- Upper exit area	133
- Upper paper tray	131
Staple cartridge, replacing	135
Staple jams, removing	136
Toner cartridge, replacing	134
Toner, checking	137
Total count, checking	137
Troubleshooting	116

Trademark acknowledgments

The following trademarks and registered trademarks are used in conjunction with the machine and its peripheral devices and accessories.

- Microsoft®, Windows®, Windows® 98, Windows® Me, Windows NT® 4.0, Windows® 2000, Windows® XP, Windows Server® 2003, Windows Vista®, Windows Server® 2008 and Internet Explorer® are registered trademarks or trademarks of Microsoft Corporation in the U.S.A. and other countries.
- PostScript is a registered trademark of Adobe Systems Incorporated.
- Macintosh, Mac OS, AppleTalk, EtherTalk and LaserWriter are trademarks of Apple Inc., registered in the U.S. and other countries.
- Netscape Navigator is a trademark of Netscape Communications Corporation.
- Adobe, the Adobe logo, Acrobat, the Adobe PDF logo, and Reader are registered trademarks or trademarks of Adobe Systems Incorporated in the United States and other countries.
- PCL is a registered trademark of the Hewlett-Packard Company.
- IBM, PC/AT, and PowerPC are trademarks of International Business Machines Corporation.
- Sharpdesk is a trademark of Sharp Corporation.
- All other trademarks and copyrights are the property of their respective owners.

Candid and Taffy are trademarks of Monotype Imaging, Inc. registered in the United States Patent and Trademark Office and may be registered in certain jurisdictions. CG Omega, CG Times, Garamond Antiqua, Garamond Halbfett, Garamond Kursiv, Garamond and Halbfett Kursiv are trademarks of Monotype Imaging, Inc. and may be registered in certain jurisdictions. Albertus, Arial, Coronet, Gill Sans, Joanna and Times New Roman are trademarks of The Monotype Corporation registered in the United States Patent and Trademark Office and may be registered in certain jurisdictions. Avant Garde, ITC Bookman, Lubalin Graph, Mona Lisa, Zapf Chancery and Zapf Dingbats are trademarks of International Typeface Corporation registered in the United States Patent and Trademark Office and may be registered in certain jurisdictions. Clarendon, Eurostile, Helvetica, Optima, Palatino, Stempel Garamond, Times and Univers are trademarks of Heidelberger Druckmaschinen AG, which may be registered in certain jurisdictions, exclusively licensed through Linotype Library GmbH, a wholly owned subsidiary of Heidelberger Druckmaschinen AG. Apple Chancery, Chicago, Geneva, Monaco and New York are trademarks of Apple Computer Inc. and may be registered in certain jurisdictions. HGGothicB, HGMinchoL, HGP GothicB and HGPMInchoL are trademarks of Ricoh Company, Ltd. and may be registered in some jurisdictions. Wingdings is a registered trademark of Microsoft Corporation in the United States and other countries. Marigold and Oxford are trademarks of Arthur Baker and may be registered in some jurisdictions. Antique Olive is a trademark of Marcel Olive and may be registered in certain jurisdictions. Hoefler Text is a trademark of Johnathan Hoefler and may be registered in some jurisdictions. ITC is a trademark of International Typeface Corporation registered in the United States Patent and Trademark Office and may be registered in certain jurisdictions. Agfa is a trademark of the Agfa-Gevaert Group and may be registered in certain jurisdictions. Intellifont, MicroType and UFST are trademarks of Monotype Imaging, Inc. registered in the United States Patent and Trademark Office and may be registered in certain jurisdictions. Macintosh and TrueType are trademarks of Apple Computer Inc. registered in the United States Patent and Trademark Office and other countries. PostScript is a trademark of Adobe Systems Incorporated and may be registered in some jurisdictions. HP, PCL, FontSmart and LaserJet are trademarks of Hewlett-Packard Company and may be registered in some jurisdictions. The Type 1 processor resident in Monotype Imaging's UFST product is under license from Electronics For Imaging, Inc. All other trademarks are the property of their respective owners.

Administrator

Name:

Contact at:



Information that the administrator of the machine requires is printed on the back of this page.

(Separate this page from the manual and keep it in a safe place. In addition, fill in the name of the administrator and the administrator's contact information in the left hand margin.)

TO THE ADMINISTRATOR OF THE MACHINE

(Separate this page from the manual and keep it in a safe place.)

Factory default passwords

When accessing the system settings, the administrator password is required to log in with administrator rights. The system settings can be configured in the Web pages as well as on the operation panel. To access the system settings using the Web pages, a password is also required.

Factory default administrator password

Factory default setting: 00000

Store a new administrator password as soon as the machine is installed. Once the administrator password has been changed, the new password is required to restore the factory default password. Take care to remember the new password.

Factory default passwords (Web pages)

There are two factory default accounts: "Administrator" and "User". A person who logs in as an "Administrator" can configure all settings in the Web pages. In addition, an administrator can restrict access to other settings by enabling "User" accounts. The factory default passwords are shown below.

	Factory default account	Factory default password
User	user	Sharp
Administrator	admin	Sharp

Memo

Connectors

Caution:

This connector is only intended for service purposes.
Any connection to this terminal may cause malfunctions
of the copy machine.

Instruction for service technician:

The cable length for the service terminal has to be less
than 10 feet (3 m).

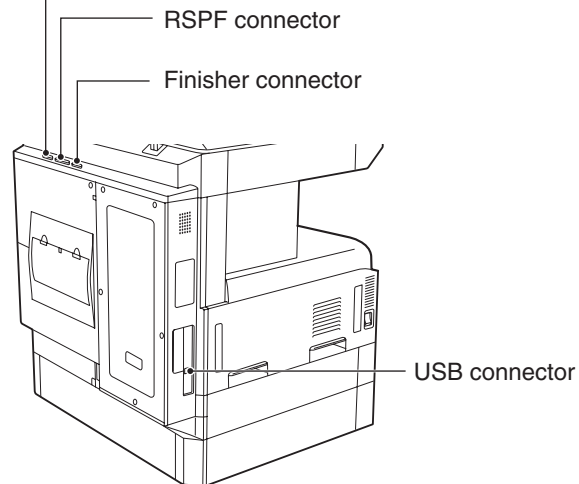

NOTICE for users in the USA

BE SURE TO ASK YOUR AUTHORIZED SHARP DEALER ABOUT THE WARRANTY THAT YOUR SELLING DEALER EXTENDS TO YOU. In order to assure you, the end-user, of warranty protection, Sharp extends a limited warranty to each of its authorized dealers and, in turn, requires each of its authorized dealers to extend its own warranty to you on terms that are no less favorable than those given to the dealer by Sharp. You should be aware, however, that Sharp does not itself extend any warranties, either express or implied, directly to you, the end-user, and no one is authorized to make any representations or warranties on behalf of Sharp. Specifically, SHARP DOES NOT EXTEND TO YOU, THE END-USER, ANY EXPRESS WARRANTY OR ANY IMPLIED WARRANTY OF MERCHANTABILITY, FITNESS FOR USE OR FITNESS FOR ANY PARTICULAR PURPOSE IN CONNECTION WITH THE HARDWARE, SOFTWARE OR FIRMWARE EMBODIED IN, OR USED IN CONJUNCTION WITH THIS PRODUCT. Sharp is not responsible for any damages or loss, either direct, incidental or consequential, which you, the end-user, may experience as a result of your purchase or use of the hardware, software or firmware embodied in or used in conjunction with this Product. Your sole remedy, in the event that you encounter any difficulties with this Product, is against the authorized dealer from which you purchased the Product.

MX-M260 Digital Multifunctional System

MX-M310 Digital Multifunctional System

In the event that this authorized dealer does not honor its warranty commitments, please contact the General Manager, Business Products Group, Sharp Electronics Corporation, 1 Sharp Plaza, Mahwah, NJ 07495-1163, so that Sharp can try to help assure complete satisfaction of all the warranty rights to which you are entitled from the authorized dealer.

SHARP®

SHARP ELECTRONICS CORPORATION

1 Sharp Plaza, Mahwah, New Jersey 07495-1163.

www.sharpusa.com

SHARP ELECTRONICS OF CANADA LTD.

335 Britannia Road East, Mississauga, Ontario, L4Z 1W9

SHARP CORPORATION

This manual has been printed using a vegetable-based soy oil ink to help protect the environment.



PRINTED IN CHINA
2009G KS1
TINSE2026QSZZ