

FusionServer 1288H V6 Server

Technical White Paper

Issue **04**
Date **2022-06-25**

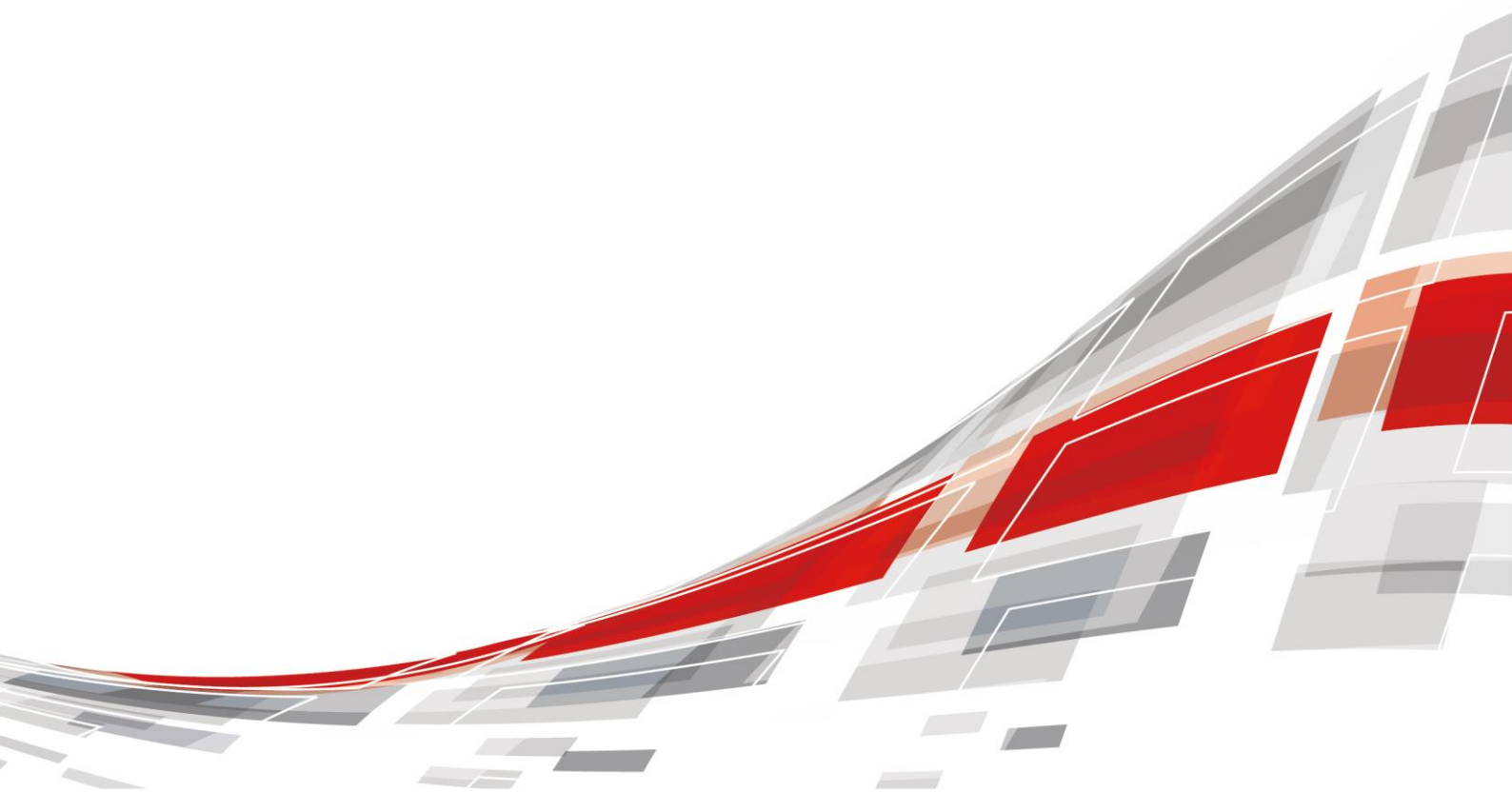

Copyrights © xFusion Digital Technologies Co., Ltd. 2022. All rights reserved.

No part of this document may be reproduced or transmitted in any form or by any means without prior written consent of xFusion Digital Technologies Co., Ltd.

Trademarks and Permissions

XFUSION and other xFusion trademarks are trademarks of xFusion Digital Technologies Co., Ltd.

All other trademarks and trade names mentioned in this document are the property of their respective holders.

Notice

In this document, "xFusion" is used to refer to "xFusion Digital Technologies Co., Ltd." for concise description and easy understanding, which does not mean that "xFusion" may have any other meaning. Any "xFusion" mentioned or described hereof may not be understood as any meaning other than "xFusion Digital Technologies Co., Ltd.", and xFusion Digital Technology Co., Ltd. shall not bear any liability resulting from the use of "xFusion".

The purchased products, services and features are stipulated by the contract made between xFusion and the customer. All or part of the products, services and features described in this document may not be within the purchase scope or the usage scope. Unless otherwise specified in the contract, all statements, information, and recommendations in this document are provided "AS IS" without warranties, guarantees or representations of any kind, either express or implied.

The information in this document is subject to change without notice. Every effort has been made in the preparation of this document to ensure accuracy of the contents, but all statements, information, and recommendations in this document do not constitute a warranty of any kind, express or implied.

xFusion Digital Technologies Co., Ltd.

Address: 9th Floor, Building 1, Zensun Boya Square, Longzihu Wisdom Island
Zhengdong New District 450046
Zhengzhou, Henan Province
People's Republic of China

Website: <https://www.xfusion.com>

Contents

About This Document	v
1 Overview	7
2 Features	8
3 Physical Structure	11
4 Logical Structure	13
5 Hardware Description	15
5.1 Front Panel.....	15
5.1.1 Appearance	15
5.1.2 Indicators and Buttons	16
5.1.3 Ports	19
5.2 Rear Panel.....	22
5.2.1 Appearance	22
5.2.2 Indicators and Buttons	22
5.2.3 Ports	24
5.3 Processors	25
5.4 Memory	26
5.4.1 DDR4 Memory	26
5.4.1.1 Memory ID	26
5.4.1.2 Memory Subsystem Architecture.....	27
5.4.1.3 Memory Compatibility	28
5.4.1.4 DIMM Installation Rules	30
5.4.1.5 Memory Installation Positions	31
5.4.1.6 Memory Protection Technologies	34
5.4.2 PMem.....	34
5.4.2.1 Memory Identifier.....	34
5.4.2.2 Memory Subsystem Architecture.....	35
5.4.2.3 Memory Compatibility	36
5.4.2.4 DIMM Installation Rules	37
5.4.2.5 Memory Installation Positions	38
5.4.2.6 Memory Protection Technologies	40
5.5 Storage	40

5.5.1 Drive Configurations	40
5.5.2 Drive Numbering	43
5.5.3 Drive Indicators	51
5.5.4 RAID Controller Card	53
5.6 Network	53
5.6.1 OCP 3.0 Network Adapter	53
5.7 I/O Expansion	54
5.7.1 PCIe Cards	54
5.7.2 PCIe Slots	54
5.7.3 PCIe Slot Description	55
5.8 PSUs	57
5.9 Fan Modules	57
5.10 Boards	59
5.10.1 Mainboard	59
5.10.2 Drive Backplane	61
6 Product Specifications	64
6.1 Technical Specifications	64
6.2 Environmental Specifications	68
6.3 Physical Specifications	69
7 Software and Hardware Compatibility	72
8 Safety Instructions	73
8.1 Security	73
8.2 Maintenance and Warranty	76
9 System Management	77
10 Certifications	79
A Appendix	81
B Glossary	98
C Acronyms and Abbreviations	101

About This Document

Purpose





This document describes the FusionServer 1288H V6 rack server in terms of features, structure, specifications, and component hardware and software compatibility.

Intended Audience

This document is intended for pre-sales engineers.

Symbol Conventions

The symbols that may be found in this document are defined as follows.

Symbol	Description
 DANGER	Indicates a hazard with a high level of risk which, if not avoided, will result in death or serious injury.
 WARNING	Indicates a hazard with a medium level of risk which, if not avoided, could result in death or serious injury.
 CAUTION	Indicates a hazard with a low level of risk which, if not avoided, could result in minor or moderate injury.
 NOTICE	Indicates a potentially hazardous situation which, if not avoided, could result in equipment damage, data loss, performance deterioration, or unanticipated results. NOTICE is used to address practices not related to personal injury.
 NOTE	Supplements the important information in the main text. NOTE is used to address information not related to personal injury, equipment damage, and environment deterioration.

Change History

Issue	Release Date	Change Description
04	2022-06-25	<ul style="list-style-type: none">• Added a figure that shows how to measure dimensions.• Upgrades the standards of CE, UKCA, and CCC certifications in the chapter 10 Certifications.• Added A.1 Chassis Label.• Updated A.3 Operating Temperature Limitations.
03	2022-05-18	Added support for 5.4.2 PMem.
02	2022-03-18	<ul style="list-style-type: none">• Updated 5.4.1.6 Memory Protection Technologies.• Updated 6.1 Technical Specifications and claimed support for U.2 drives.• Added 10 Certifications.
01	2021-12-24	This issue is the first official release.

1 Overview

FusionServer 1288H V6 (1288H V6) is a new-generation 1U 2-socket rack server designed for Internet, Internet Data Center (IDC), cloud computing, enterprise, and telecom applications.

The 1288H V6 is ideal for IT core services, cloud computing, virtualization, high-performance computing, distributed storage, big data processing, enterprise or telecom service applications, and other complex workloads.

The reliable 1288H V6 features low power consumption, high scalability, easy deployment, and simplified management.

 **NOTE**

For details about the 1288H V6 nameplate information, see A.4 Nameplate.

Figure 1-1 Physical structure of a 1288H V6 with 8 x 2.5" drives (example)



2 Features

Performance and Scalability

- Powered by the third-generation Intel® Xeon® Scalable Ice Lake processors, the server provides up to 40 cores, 3.6 GHz frequency, a 60 MB L3 cache, and up to three 11.2 GT/s UPI links between the processors, which deliver supreme processing performance.
 - It supports up to two processors with 80 cores and 160 threads to maximize the concurrent execution of multithreaded applications.
 - The L2 cache capacity is increased. Each core exclusively occupies 1.25 MB L2 cache, and at least 1.5 MB L3 cache.
 - Intel Turbo Boost Technology 2.0 allows processor cores to run faster than the frequency specified in the Thermal Design Power (TDP) configuration if they are operating below power, current, and temperature specification limits.
 - Intel Hyper-Threading Technology enables each processor core to run up to two threads, improving parallel computation capability.
 - The hardware-assisted Intel® Virtualization Technology (Intel® VT) allows operating system (OS) to better use hardware to address virtualization workloads.
 - Intel® Advanced Vector Extensions 512 (Intel AVX-512) significantly accelerates floating-point performance for computing-intensive applications.
 - Intel DL Boost (VNNI) is supported to improve the performance of deep learning applications.
 - The Intel® SGX and Intel® TME security features provide fine-grained data protection through application isolation in the memory, and defend against physical attacks through full memory encryption.
- The server supports a maximum of 32 memory modules in the following memory forms:
 - The server supports a maximum of 32 DDR4 ECC 3200 MT/s DIMMs. The DDR4 ECC DIMMs support registered DIMMs (RDIMM) and load-reduced DIMMs (LRDIMMs), which provide high speed and availability. A server supports a maximum memory capacity of 8192 GB and a maximum memory bandwidth of 400 GB/s in theory.
 - The server supports a maximum of 16 Intel® Optane™ Persistent Memory Module 200 series (PMem modules for short), which must be used with the DDR4 memory modules. When the DDR4 memory modules are used together, the server supports a maximum of 12 TB memory capacity (calculated based on a maximum of 256 GB capacity per DDR4 memory module and a maximum of 512 GB capacity per PMem module).

- Flexible drive configurations meet a variety of business requirements and ensure high elasticity and scalability of storage resources.
- The use of all solid-state drives (SSDs) is supported. An SSD supports up to 100 times more I/O operations per second (IOPS) than a typical hard disk drive (HDD). The use of all SSDs provides higher I/O performance than the use of all HDDs or a combination of HDDs and SSDs.
- The use of 12 Gbit/s SCSI (SAS) serial connection for internal storage provides 2x data transmission rate than the use of 6 Gbit/s SAS connection, maximizing the performance of I/O-intensive applications.
- With Intel integrated I/O, the third-generation Intel® Xeon® Scalable processors integrate the PCIe 4.0 controller to shorten I/O latency and improve overall system performance.
- The server supports a maximum of three PCIe 4.0 expansion slots
- The server supports two FlexIO cards (applicable to the OCP 3.0 network adapter) with flexible configuration of GE/10GE/25GE/100GE network adapters, which are hot swappable.

Availability and Serviceability

- Carrier-class components with process expertise ensure high system reliability and availability.
- The server supports hot-swappable SAS/SATA/NVMe drives. SAS/SATA drives support RAID 0, 1, 1E, 10, 5, 50, 6, and 60, depending on the RAID controller card used. It also uses a supercapacitor to protect the RAID cache data against power failures.
- SSDs offer better reliability than HDDs, prolonging system uptime.
- The server provides simplified O&M and efficient troubleshooting through the UID/HLY indicators on the front panel, fault diagnosis LED, and iBMC WebUI.
- The panel provides iBMC direct connect management ports to support local iBMC O&M, improving O&M efficiency.
- A server provides two hot-swappable PSUs in 1+1 redundancy mode and seven hot-swappable fan modules in N+1 redundancy mode, improving system availability.
- The built-in iBMC monitors system parameters in real time, triggers alarms, and performs recovery actions to minimize the system downtime.
- For details about the warranty policy, visit [Warranty](#).

Manageability and Security

- The built-in iBMC monitors server operating status and provides remote management.
- A password is required for accessing the BIOS, ensuring system boot and management security.
- The NC-SI feature allows a network port to serve as a management port and a service port. The NC-SI feature is disabled by default and can be enabled through the iBMC or BIOS.
- The integrated Unified Extensible Firmware Interface (UEFI) improves setup, configuration, and update efficiency and simplifies fault handling.
- The server chassis panel ensures security of local data.
- Chassis cover opening detection is supported to enhance security.
- Intel Execute Disable Bit (EDB) function prevents certain types of malicious buffer overflow attacks when working with a supported OS.

- The Intel Converged Boot Guard & Trusted Execution Technology (Intel CbT) prevents malicious software attacks based on hardware, prevents the firmware from being maliciously modified, and prevents the execution of unauthorized boot blocks. It also allows applications to run in their own independent space without being affected by other software running in the system, thereby enhancing security.
- The secure boot based on the chip RoT implements level-by-level firmware verification starting from the hardware RoT and builds a complete secure boot chain.
- The trusted platform module (TPM) and trusted cryptography module (TCM) provide advanced encryption functions, such as digital signatures and remote authentication.
- The following requirements in NIST SP 800-147B are met:
 - The BIOS firmware digital signature update mechanism is supported. During the upgrade, the digital signature is verified to prevent unauthorized BIOS firmware upgrade.
 - The flash security protection mechanism is supported to prevent unauthorized modification of the flash memory in the OS.

NOTE

The service port with NC-SI enabled supports the following configuration:

- Configuring any network port on the FlexIO card 1, FlexIO card 2, or PCIe NIC (with NC-SI enabled).
- Enabling, disabling, and setting a virtual local area network (VLAN) ID for this port. The VLAN ID is 0 and disabled by default.
- Configuring IPv4 addresses (IPv4 address, subnet mask, and gateway) and IPv6 addresses (IPv6 address, prefix length, and gateway) for this port.

Energy Efficiency

- The server supports 80 Plus Platinum/Titanium PSUs of different energy efficiency levels. The PSU efficiency reaches 96% at 50% load.
- Active/standby power supply and HVDC power supply are supported, improving the efficiency of the power supply system.
- Efficient voltage regulator-down (VRD) power supplies for boards minimize the energy loss from DC/DC power conversion.
- Area-based, Proportional-Integral-Derivative (PID) intelligent fan speed adjustment and intelligent CPU frequency scaling optimize heat dissipation and reduce overall system power consumption.
- The improved thermal design with energy-efficient fans ensures optimal heat dissipation and reduces system power consumption.
- The server is protected with power capping and power control measures.
- Staggered spin-up of drives reduces the server boot power consumption.

3 Physical Structure

Figure 3-1 Physical structure of a server with 8 x 2.5" drives (example)

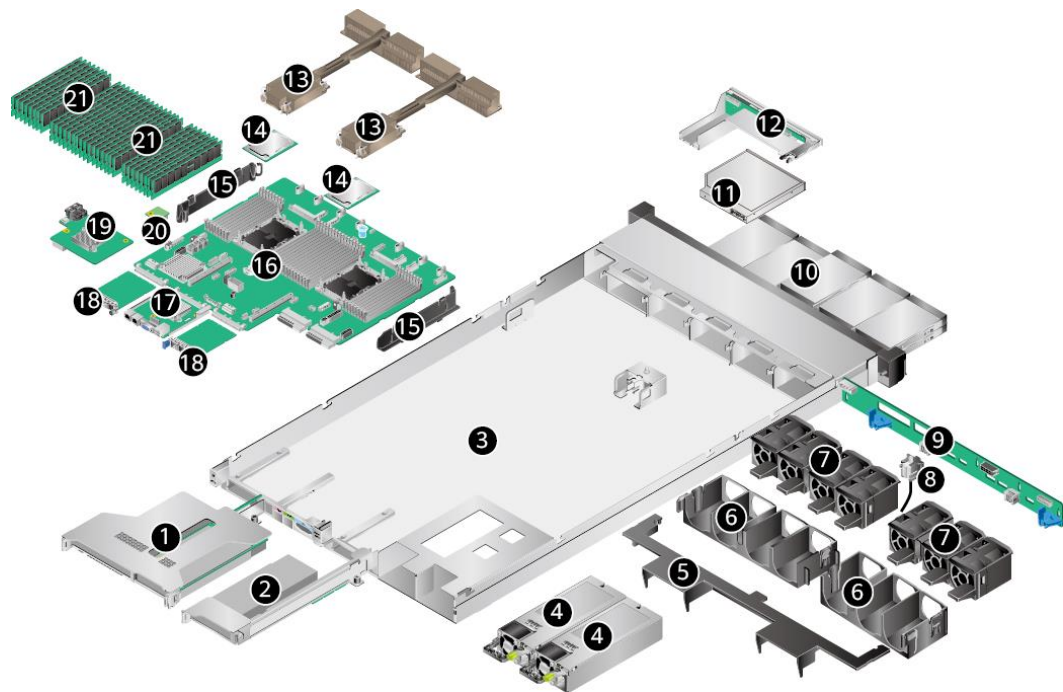

1	I/O module 1	2	I/O module 2
3	Chassis	4	PSUs
5	Air duct	6	Fan module brackets
7	Fan modules	8	Intrusion sensor
9	Front-drive backplane	10	Front drives
11	Built-in DVD drive	12	Indicator board
13	Processor heat sinks	14	Processors
15	Cable organizers	16	Mainboard

17	BMC card	18	OCP 3.0 network adapters
19	Screw-in RAID controller card	20	TPM/TCM
21	Memory modules	-	-

4 Logical Structure

Figure 4-1 Logical Structure

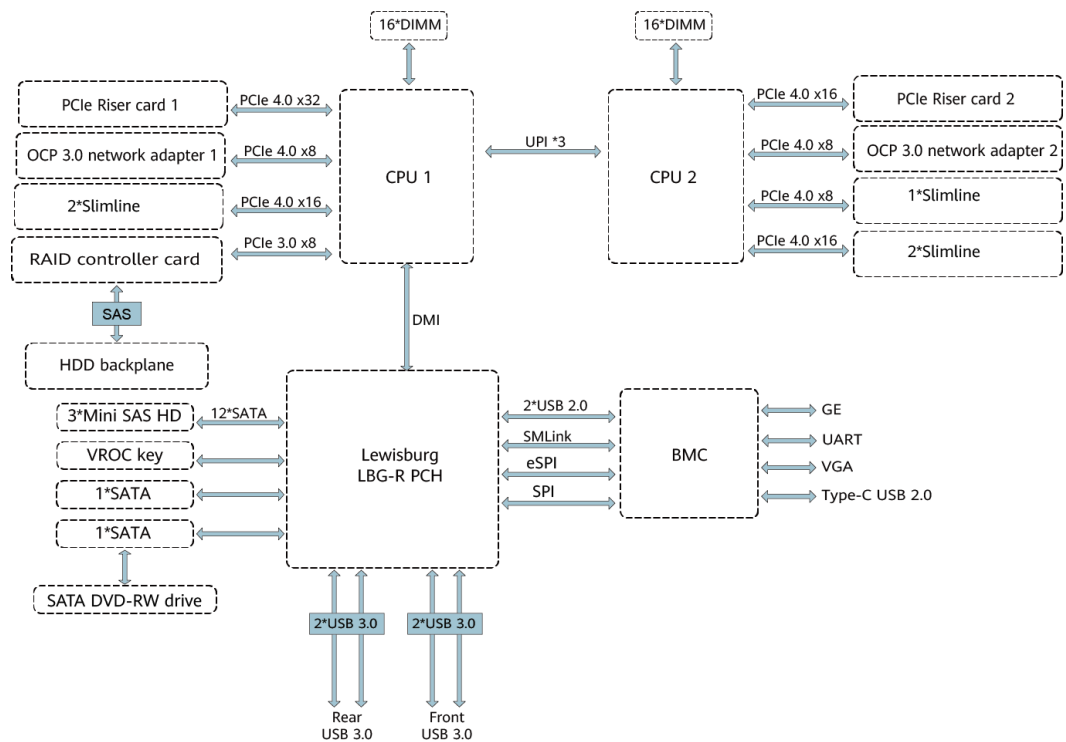

- The server supports one or two third-generation Intel® Xeon® Scalable Ice Lake processors.
- The server supports up to 32 memory modules.
- The CPUs (processors) interconnect with each other through three UPI links at a speed of up to 11.2 GT/s.
- The PCIe riser card connects to the processors through PCIe buses to provide ease of expandability and connection.
- CPU1 and CPU2 each support one OCP 3.0 network adapter.
- The screw-in RAID controller card on the mainboard connects to CPU 1 through PCIe buses, and connects to the drive backplane through SAS signal cables. A variety of drive backplanes are provided to support different local storage configurations.
- The LBG-R Platform Controller Hub (PCH) is integrated on the mainboard to support four USB 3.0 ports.

- The BMC management chip integrated on the mainboard supports a video graphic array (VGA) port, a management network port, and a serial port.

5 Hardware Description

- 5.1 Front Panel
- 5.2 Rear Panel
- 5.3 Processors
- 5.4 Memory
- 5.5 Storage
- 5.6 Network
- 5.7 I/O Expansion
- 5.8 PSUs
- 5.9 Fan Modules
- 5.10 Boards

5.1 Front Panel

5.1.1 Appearance

- 4 x 3.5" drive configuration

Figure 5-1 Front view



1	Drive	2	Slide-out label plate (with an SN label)
---	-------	---	--

- 8 x 2.5" Drive Configuration

Figure 5-2 Front view

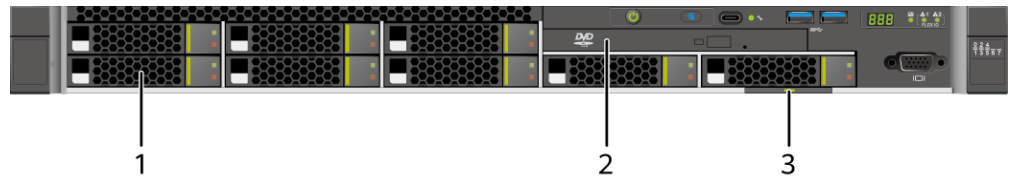

1	Drive	2	(Optional) Built-in DVD drive
3	Label with SN	-	-

- 10 x 2.5" drive configuration

Figure 5-3 Front view

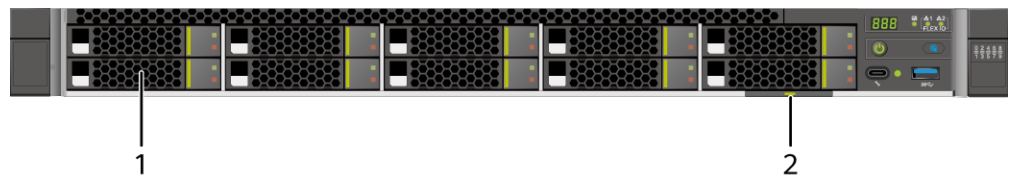

1	Drive	2	Slide-out label plate (with an SN label)
---	-------	---	--

5.1.2 Indicators and Buttons

Indicator and Button Positions

- 4 x 3.5" drive configuration

Figure 5-4 Indicators and buttons on the front panel

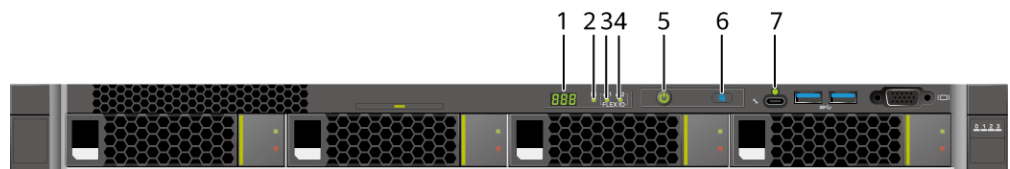

1	Fault diagnosis LED	2	Health status indicator
3	FlexIO card 1 presence	4	FlexIO card 2 presence

	indicator		indicator
5	Power button/indicator	6	UID button/indicator
7	iBMC direct connect management port indicator	-	-

- 8 x 2.5" drive configuration

Figure 5-5 Indicators and buttons on the front panel

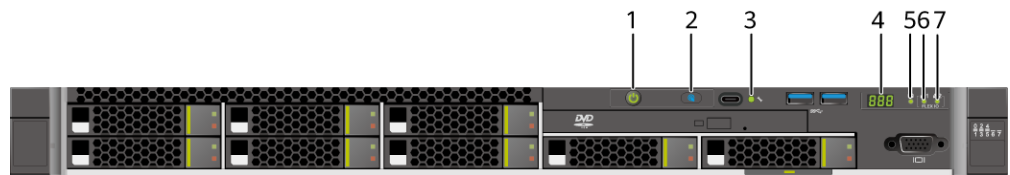

1	Power button/indicator	2	UID button/indicator
3	iBMC direct connect management port indicator	4	Fault diagnostic LED
5	Health status indicator	6	FlexIO card 1 presence indicator
7	FlexIO card 2 presence indicator	-	-

- 10 x 2.5" drive configuration



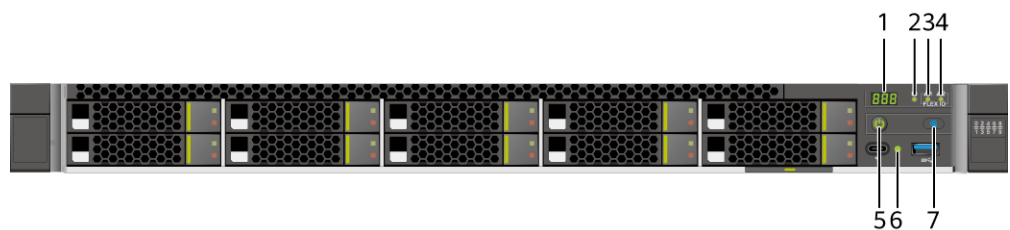

Figure 5-6 Indicators and buttons on the front panel





1	Fault diagnosis LED	2	Health status indicator
3	FlexIO card 1 presence indicator	4	FlexIO card 2 presence indicator
5	Power button/indicator	6	iBMC direct connect management port indicator
7	UID button/indicator	-	-

Indicator and Button Descriptions

Table 5-1 Description of indicators and buttons on the front panel

Silkscreen	Indicator and Button	Description
	Fault diagnosis LED	<ul style="list-style-type: none"> ---: The device is operating properly. Error code: A component is faulty. For details about error codes, see the FusionServer Rack Server iBMC Alarm Handling .
	Health status indicator	<ul style="list-style-type: none"> Off: The device is powered off or is faulty. Blinking red at 1 Hz: A major alarm has been generated on the system. Blinking red at 5 Hz: A critical alarm has been generated on the system. Steady green: The device is operating properly.
	FlexIO card presence indicator	Indicates whether the FlexIO card is detected. <ul style="list-style-type: none"> Off: The FlexIO card is not detected. Blinking green at 0.5 Hz: The FlexIO card is detected but is not powered on. Blinking green at 2 Hz: The FlexIO card is detected and has just been inserted. Steady green: The FlexIO card is detected and the power supply is normal.
	Power button/indicator	Power indicator: <ul style="list-style-type: none"> Off: The device is not powered on. Steady green: The device is powered on. Blinking yellow: The iBMC is starting. The power button is locked and cannot be pressed. The iBMC is started in about 1 minute, and then the power indicator is steady yellow. Steady yellow: The device is standby. Power button: <ul style="list-style-type: none"> When the device is powered on, you can press this button to gracefully shut down the OS. <p>NOTE For different OSs, you may need to shut down the OS as prompted.</p> <ul style="list-style-type: none"> When the device is powered on, you can hold down this button for 6 seconds to forcibly power off the device. When the power indicator is steady yellow, you can press this button to power on the device.

Silkscreen	Indicator and Button	Description
	UID button/indicator	The UID button/indicator helps identify and locate a device. UID indicator: <ul style="list-style-type: none"> • Off: The device is not being located. • Blinking or steady blue: The device is being located. UID button: <ul style="list-style-type: none"> • You can control the UID indicator status by pressing the UID button or using the iBMC. • You can press this button to turn on or off the UID indicator. • You can press and hold down this button for 4 to 6 seconds to reset the iBMC.
	iBMC direct connect management port indicator	Indicates the status when the iBMC direct connect management port connects to a terminal (local PC or Android mobile phone): <ul style="list-style-type: none"> • Off: No terminal is connected. • Blinking green at short intervals for 3 seconds and then off: The port is disabled. • Steady green: The terminal is connected. Indicates the status when the iBMC direct connect management port connects to a USB device: <ul style="list-style-type: none"> • Blinking red at long intervals: The job fails or an error is reported when the job is complete. • Blinking green at short intervals: The job is being executed. • Blinking green at short intervals for 3 seconds and then off: The port is disabled. • Steady green: The server configuration file is being copied from the USB device or the job is successfully completed.

5.1.3 Ports

Port Positions

- 4 x 3.5" drive configuration

Figure 5-7 Ports on the front panel



1	iBMC direct connect management port	2	USB 3.0 port
3	VGA port	-	-

- 8 x 2.5" drive configuration

Figure 5-8 Ports on the front panel



1	iBMC direct connect management port	2	USB 3.0 port
3	VGA port	-	-

- 10 x 2.5" drive configuration

Figure 5-9 Ports on the front panel

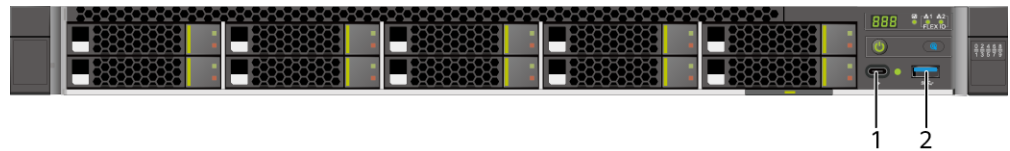

1	iBMC direct connect management port	2	USB 3.0 port
---	-------------------------------------	---	--------------

Port Description

Table 5-2 Ports on the front panel

Port	Type	Quantity ^{Note}	Description
VGA port	DB15	1	Used to connect a display terminal, such as a monitor or KVM.
iBMC direct connect management port	USB Type-C NOTE The USB 2.0 protocol is supported.	1	<p>Used to connect to a local PC through a USB Type-C cable to monitor and manage the system.</p> <p>NOTE Only local PCs running Windows 10 are supported.</p> <ul style="list-style-type: none"> To log in to the iBMC from the local PC, enter https://IP address of the iBMC management network port in the address box of the browser on the local PC. <p>Used to connect to a USB device.</p> <p>NOTICE</p> <ul style="list-style-type: none"> Before connecting an external USB device, ensure that the USB device functions properly. Otherwise, it may adversely impact the server. For details about how to connect a USB device to the iBMC management port, see FusionServer Rack Server iBMC User Guide.
USB port	USB 3.0	2	<p>Used to connect to a USB 3.0 device.</p> <p>NOTICE</p> <ul style="list-style-type: none"> Before connecting an external USB device, ensure that the USB device functions properly. Otherwise, it may adversely impact the server. The USB 3.0 port can be used to supply power to low-power peripherals. However, the USB 3.0 port must comply with the USB specifications. To run advanced peripherals, such as external CD/DVD drives, an external power supply is required.
<p>Note: The number of ports varies depending on server configuration. This table lists the maximum number of ports in different configurations.</p>			

5.2 Rear Panel

5.2.1 Appearance

Figure 5-10 Rear view

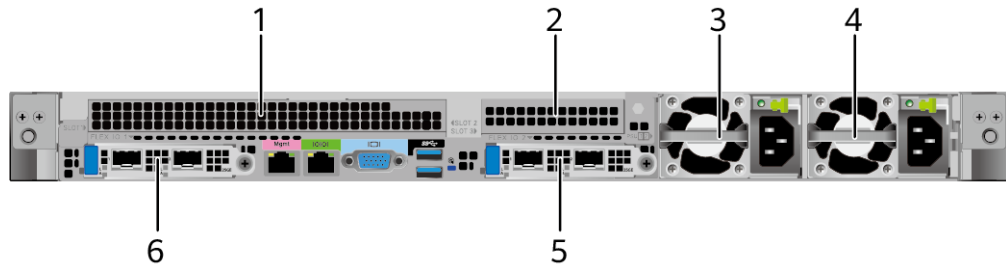

1	I/O module 1	2	I/O module 2
3	PSU 1	4	Power supply 2
5	(Optional) FlexIO card 2 NOTE The FlexIO card slot supports only OCP 3.0 network adapters.	6	(Optional) FlexIO card 1 NOTE The FlexIO card slot supports only OCP 3.0 network adapters.

NOTE

- I/O module 1 supports a PCIe riser module or rear drive module.
- I/O module 2 supports only the PCIe riser module.
- For details about the OCP 3.0 network adapter, see 5.6.1 OCP 3.0 Network Adapter .
- The figure is for reference only. The actual configuration may vary.

5.2.2 Indicators and Buttons

Indicator Positions

Figure 5-11 Indicators on the rear panel

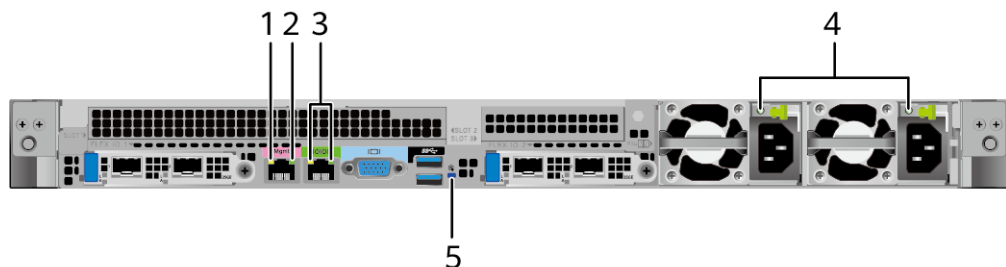

1	Data transmission status	2	Connection status indicator
---	--------------------------	---	-----------------------------

	indicator for the management network port		for the management network port
3	Serial port indicators NOTE Reserved and unavailable currently.	4	PSU indicators
5	UID indicator	-	-

Indicator Description

Table 5-3 Indicators on the rear panel

Silkscreen	Indicator	Description
-	Data transmission status indicator for the management network port	<ul style="list-style-type: none"> Off: No data is being transmitted. Blinking yellow: Data is being transmitted.
-	Connection status indicator for the management network port	<ul style="list-style-type: none"> Off: The network port is not connected. Steady green: The network port is connected properly.
-	PSU indicator	<ul style="list-style-type: none"> Off: No power is supplied. Blinking green at 1 Hz: <ul style="list-style-type: none"> The input is normal, and the server is standby. The input is overvoltage or undervoltage. The PSU is in deep hibernation mode. Blinking green at 4 Hz: The firmware is being upgraded online. Steady green: The power input and output are normal. Steady orange: The input is normal but there is no output. <p>NOTE The possible causes of no power output are as follows:</p> <ul style="list-style-type: none"> Power supply overtemperature protection Power output overcurrent or short-circuit Output overvoltage Short-circuit protection Device failure (excluding failure of all devices)

Silkscreen	Indicator	Description
	UID indicator	<p>The UID indicator helps identify and locate a device.</p> <ul style="list-style-type: none"> Off: The device is not being located. Blinking or steady blue: The device is being located. <p>NOTE You can control the UID indicator status by pressing the UID button or using the iBMC.</p>

5.2.3 Ports

Port Positions

Figure 5-12 Ports on the rear panel

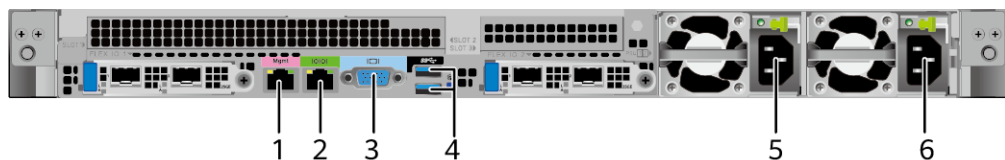

1	Management network port	2	Serial port
3	VGA port	4	USB 3.0 ports
5	Socket for PSU 1	6	Socket for PSU 2

Port Description

Table 5-4 Ports on the rear panel

Port	Type	Quantity	Description
Management network port	RJ45	1	<p>iBMC management network port, which is used to manage the server.</p> <p>NOTE The management network port is a GE port that supports 100 Mbit/s and 1000 Mbit/s auto-negotiation.</p>
Serial port	RJ45	1	<p>Default operating system serial port used for debugging. You can also set it as the iBMC serial port by using the iBMC command.</p>

Port	Type	Quantity	Description
			<p>NOTE</p> <p>The port uses 3-wire serial communication interface, and the default baud rate is 115,200 bit/s.</p>
VGA port	DB15	1	Used to connect a display terminal, such as a monitor or KVM.
USB port	USB 3.0	2	<p>Used to connect to a USB 3.0 device.</p> <p>NOTICE</p> <ul style="list-style-type: none"> • The maximum current is 1.3 A for an external USB device. • Before connecting an external USB device, ensure that the USB device functions properly. Otherwise, it may adversely impact the server. • The USB 3.0 port can be used to supply power to low-power peripherals. However, the USB 3.0 port must comply with the USB specifications. To run advanced peripherals, such as external CD/DVD drives, an external power supply is required.
PSU socket	-	2	<p>Used to connect to a power distribution unit (PDU) through a power cable. You can select the PSUs as required.</p> <p>NOTE</p> <p>When determining the PSUs, ensure that the rated power of the PSUs is greater than that of the server.</p>

5.3 Processors

- The server supports one or two processors.
- If only one processor is required, install it in socket CPU1.
- Processors of the same model must be used in a server.
- Contact your local sales representative or see "Search Parts" in the [Compatibility Checker](#) to determine the components to be used.

Figure 5-13 Processor positions

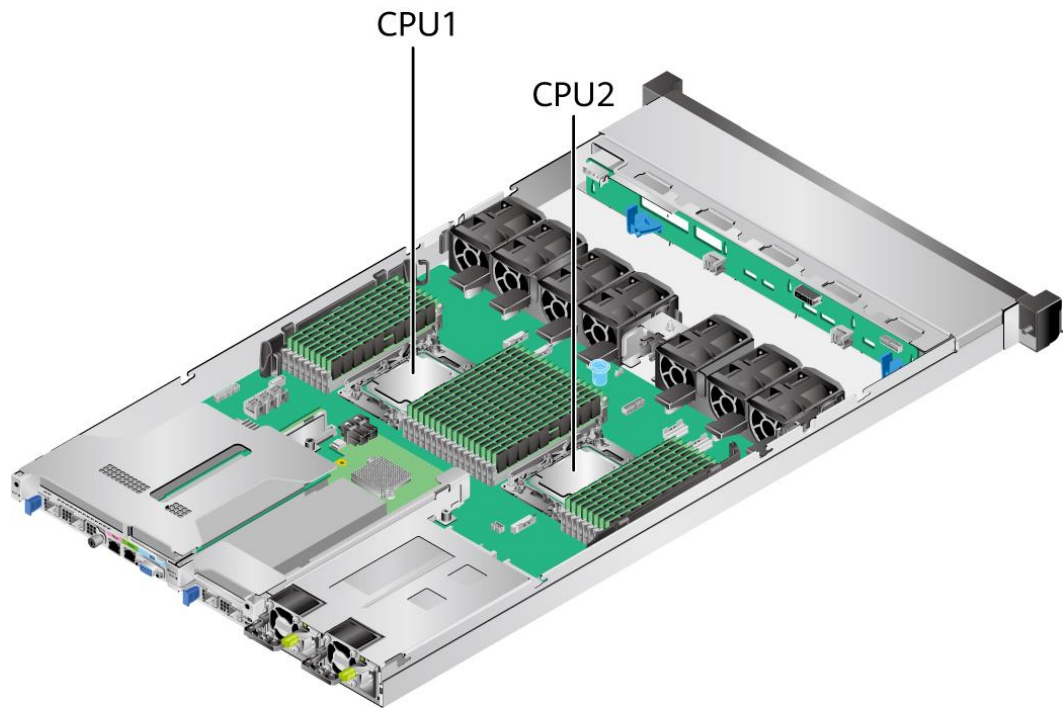

5.4 Memory

5.4.1 DDR4 Memory

5.4.1.1 Memory ID

You can determine the memory module properties based on the label attached to the memory module.

Figure 5-14 Memory identifier

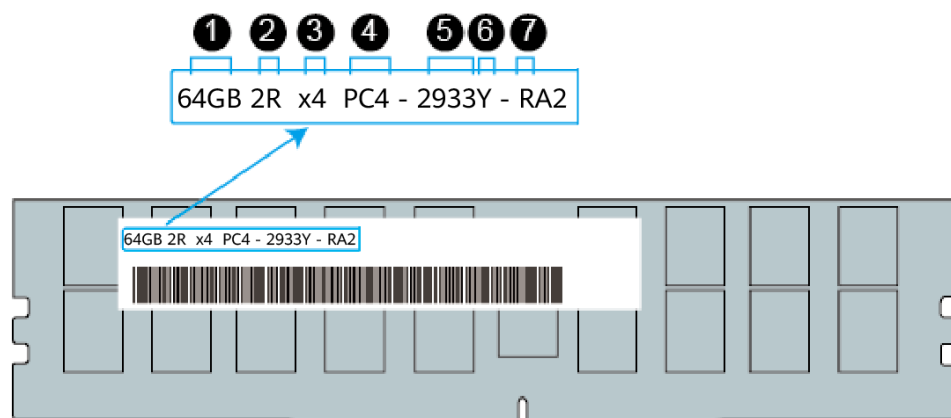

No.	Description	Example
1	Capacity	<ul style="list-style-type: none"> • 16 GB • 32 GB • 64 GB • 128 GB • 256 GB
2	Number of ranks	<ul style="list-style-type: none"> • 1R: single-rank • 2R: dual-rank • 4R: quad-rank • 8R: octal-rank
3	Data width on the DRAM	<ul style="list-style-type: none"> • x4: 4-bit • x8: 8-bit
4	Type of the memory interface	<ul style="list-style-type: none"> • PC4: DDR4
5	Maximum memory speed	<ul style="list-style-type: none"> • 2933 MT/s • 3200 MT/s
6	Memory latency parameters (CL-tRCD-tRP)	<ul style="list-style-type: none"> • W = 20-20-20 • Y = 21-21-21 • AA = 22-22-22
7	DIMM type	<ul style="list-style-type: none"> • R = RDIMM • L = LRDIMM

5.4.1.2 Memory Subsystem Architecture

A server provides 32 memory slots. Each processor integrates eight memory channels.

Install the memory modules in the primary memory channels first. If the primary memory channel is not populated, the memory modules in secondary memory channels cannot be used.

Table 5-5 Memory channels

CPU	Channel	Memory Slot
CPU 1	A (primary)	DIMM000(A)
	A	DIMM001(I)
	B (primary)	DIMM010(B)
	B	DIMM011(J)
	C (primary)	DIMM020(C)
	C	DIMM021(K)
	D (primary)	DIMM030(D)

CPU	Channel	Memory Slot
	D	DIMM031(L)
	E (primary)	DIMM040(E)
	E	DIMM041(M)
	F (primary)	DIMM050(F)
	F	DIMM051(N)
	G (primary)	DIMM060(G)
	G	DIMM061(O)
	H (primary)	DIMM070(H)
	H	DIMM071(P)
CPU2	A (primary)	DIMM100(A)
	A	DIMM101(I)
	B (primary)	DIMM110(B)
	B	DIMM111(J)
	C (primary)	DIMM120(C)
	C	DIMM121(K)
	D (primary)	DIMM130(D)
	D	DIMM131(L)
	E (primary)	DIMM140(E)
	E	DIMM141(M)
	F (primary)	DIMM150(F)
	F	DIMM151(N)
	G (primary)	DIMM160(G)
	G	DIMM161(O)
	H (primary)	DIMM170(H)
H	DIMM171(P)	

5.4.1.3 Memory Compatibility

Observe the following rules when configuring DDR4 memory modules:

NOTICE

- A server must use DDR4 memory modules of the same part number (P/N code), and the memory speed is the minimum value of the following items:
 - Memory speed supported by a CPU
 - Maximum operating speed of a memory module
 - The DDR4 DIMMs of different types (RDIMM and LRDIMM) and specifications (capacity, bit width, rank, and height) cannot be used together.
 - Contact your local sales representative or see "Search Parts" in the [Compatibility Checker](#) to determine the components to be used.
-
- The memory can be used with the third-generation Intel® Xeon® Scalable Ice Lake processors. The maximum memory capacity supported by all processor models is the same.
 - The total memory capacity is the sum of the capacity of all DDR4 DIMMs.

NOTICE

The total memory capacity refers to the capacity when DDR4 memory modules are fully configured. For details about the memory capacity when PMem modules are used together with DDR4 memory modules, see 5.4.2.3 Memory Compatibility.

- For details about the capacity type of a single memory module, see "Search Parts" in the [Compatibility Checker](#).
- The maximum number of memory modules supported depends on the memory type and rank quantity.

 **NOTE**

Each memory channel supports a maximum of 8 ranks. The number of memory modules supported by each channel varies depending on the number of ranks supported by each channel:

Number of memory modules supported by each channel ≤ Number of ranks supported by each memory channel / Number of ranks supported by each memory module

- A memory channel supports more than eight ranks for LRDIMMs.

 **NOTE**

A quad-rank LRDIMM generates the same electrical load as a single-rank RDIMM on a memory bus.

Table 5-6 DDR4 memory specifications

Parameter	Specifications				
Capacity per DDR4 memory module (GB)	16	32	64	128	256
Type	RDIMM	RDIMM	RDIMM	LRDIMM	RDIMM
Rated speed (MT/s)	3200	3200	3200	3200	2933
Operating voltage (V)	1.2	1.2	1.2	1.2	1.2
Maximum number of DDR4 DIMMs in a	32	32	32	32	32

Parameter		Specifications				
server ^a						
Maximum DDR4 memory capacity of the server (GB)		512	1024	2048	4096	8192
Actual rate (MT/s)	1DPC ^b	3200	3200	3200	3200	2933
	2DPC	3200	3200	3200	3200	2933
<ul style="list-style-type: none"> • a: The maximum number of DDR4 memory modules is based on dual-processor configuration. The value is halved for a server with only one processor. • b: DPC (DIMM per channel) indicates the number of memory modules per channel. • The information listed in this table is for reference only. For details, consult the local sales representative. 						

5.4.1.4 DIMM Installation Rules

 **NOTE**

This section applies to a server fully configured with DDR4 memory modules. If PMem modules are used together, see 5.4.2.4 DIMM Installation Rules.

Observe the following when configuring DDR4 memory modules:

- Install memory modules only when corresponding processors are installed.
- Do not install LRDIMMs and RDIMMs in the same server.
- Install filler memory modules in vacant slots.

Observe the following when configuring DDR4 memory modules in specific operating mode:

- Rank sparing mode
 - Comply with the general installation guidelines.
 - At least two ranks must be configured for each channel.
 - A maximum of two standby ranks can be configured for each channel.
 - The capacity of a standby rank must be greater than or equal to that of other ranks in the same channel.
- Memory mirroring mode
 - Comply with the general installation guidelines.
 - Each processor supports four integrated memory controllers (IMCs), and each IMC has two channels for installing memory modules. The installed memory modules must be identical in size and organization.
 - For a multi-processor configuration, each processor must have a valid memory mirroring configuration.
- Memory scrubbing mode
 - Comply with the general installation guidelines.

5.4.1.5 Memory Installation Positions

A server supports a maximum of 32 DDR4 memory modules. To maximize performance, balance the total memory capacity between the installed processors and to load the channels similarly whenever possible.

Observe the memory module installation rules when configuring memory modules. For details, see [Memory Configuration Assistant](#).

NOTICE

At least one DDR4 memory module must be installed in the primary memory channels corresponding to CPU 1.

Figure 5-15 Memory slots

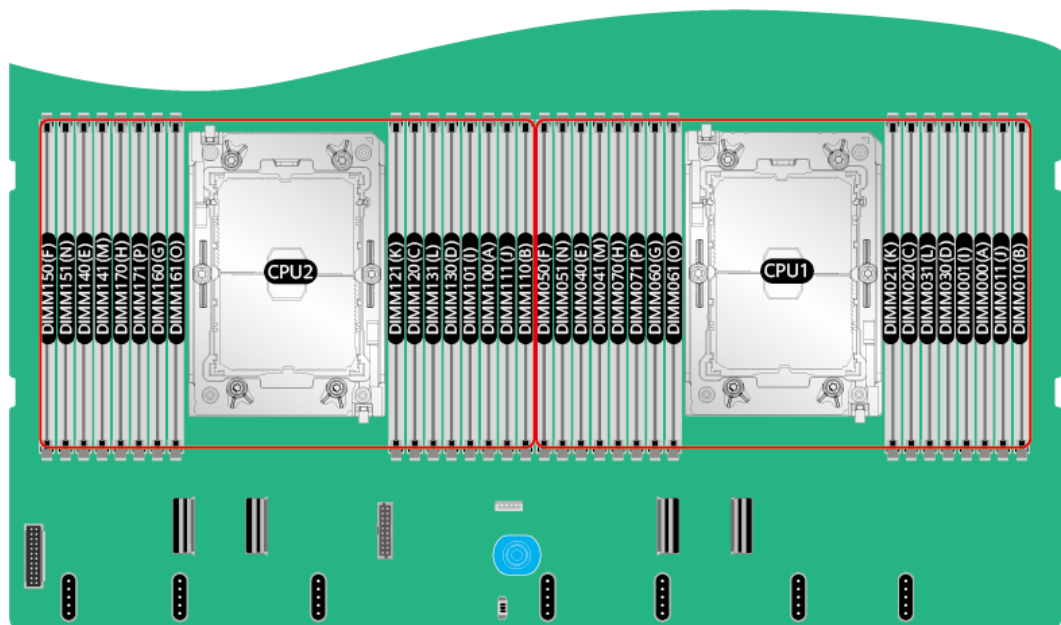

Figure 5-16 DDR4 memory module installation guidelines (1 processor)

CPU	Channel	DIMM Slot	Number of DIMMs (√: recommended ○: not recommended)								
			√	√	√	√	√	√	○	√	
			1	2	4	6	8	12	12	16	
CPU1	A	DIMM000(A)	●	●	●	●	●	●	●	●	●
		DIMM001(I)							●	●	●
	B	DIMM010(B)				●	●	●	●	●	●
		DIMM011(J)							●		●
	C	DIMM020(C)			●	●	●	●	●	●	●
		DIMM021(K)							●	●	●
	D	DIMM030(D)					●		●		●
		DIMM031(L)									●
	E	DIMM040(E)		●	●	●	●	●	●	●	●
		DIMM041(M)							●	●	●
	F	DIMM050(F)				●	●	●	●	●	●
		DIMM051(N)							●		●
	G	DIMM060(G)			●	●	●	●	●	●	●
		DIMM061(O)							●	●	●
	H	DIMM070(H)					●		●		●
		DIMM071(P)									●
Note	When 12 DIMMs are configured, the recommended installation (marked with √) achieves better performance than the installation that is not recommended (marked with ○). However, only the installation that is not recommended (marked with ○) supports SNC2, Hemi, SGX, and UMA X-skt.										

Figure 5-17 DDR4 memory module installation guidelines (2 processors)

CPU	Channel	DIMM Slot	Number of DIMMs (√: recommended ○: not recommended)								
			√	√	√	√	√	√	○	√	
			2	4	8	12	16	24	24	32	
CPU1	A	DIMM000(A)	●	●	●	●	●	●	●	●	●
		DIMM001(I)						●	●	●	
	B	DIMM010(B)				●	●	●	●	●	
		DIMM011(J)						●		●	
	C	DIMM020(C)			●	●	●	●	●	●	
		DIMM021(K)						●	●	●	
	D	DIMM030(D)					●		●	●	
		DIMM031(L)								●	
	E	DIMM040(E)		●	●	●	●	●	●	●	
		DIMM041(M)						●	●	●	
	F	DIMM050(F)				●	●	●	●	●	
		DIMM051(N)						●		●	
	G	DIMM060(G)			●	●	●	●	●	●	
		DIMM061(O)						●	●	●	
	H	DIMM070(H)					●		●	●	
		DIMM071(P)								●	
CPU2	A	DIMM100(A)	●	●	●	●	●	●	●	●	
		DIMM101(I)						●	●	●	
	B	DIMM110(B)				●	●	●	●	●	
		DIMM111(J)						●		●	
	C	DIMM120(C)			●	●	●	●	●	●	
		DIMM121(K)						●	●	●	
	D	DIMM130(D)					●		●	●	
		DIMM131(L)								●	
	E	DIMM140(E)		●	●	●	●	●	●	●	
		DIMM141(M)						●	●	●	
	F	DIMM150(F)				●	●	●	●	●	
		DIMM151(N)						●		●	
	G	DIMM160(G)			●	●	●	●	●	●	
		DIMM161(O)						●	●	●	
	H	DIMM170(H)					●		●	●	
		DIMM171(P)								●	
Note	When 24 DIMMs are configured, the recommended installation (marked with √) achieves better performance than the installation that is not recommended (marked with ○). However, only the installation that is not recommended (marked with ○) supports SNC2, Hemi, SGX, and UMA X-skt.										

5.4.1.6 Memory Protection Technologies

The following memory protection technologies are supported:

- ECC
- Memory Mirroring
- Memory Single Device Data Correction (SDDC)
- Failed DIMM Isolation
- Memory Thermal Throttling
- Command/Address Parity Check and Retry
- Memory Demand/Patrol Scrubbing
- Memory Data Scrambling
- Memory Multi Rank Sparing
- Post Package Repair (PPR)
- Write Data CRC Protection
- Adaptive Data Correction - Single Region (ADC-SR)
- Adaptive Double Device Data Correction - Multiple Region (ADDDC-MR)
- Partial Cache Line Sparing (PCLS)

5.4.2 PMem

5.4.2.1 Memory Identifier

Figure 5-18 Memory identifier

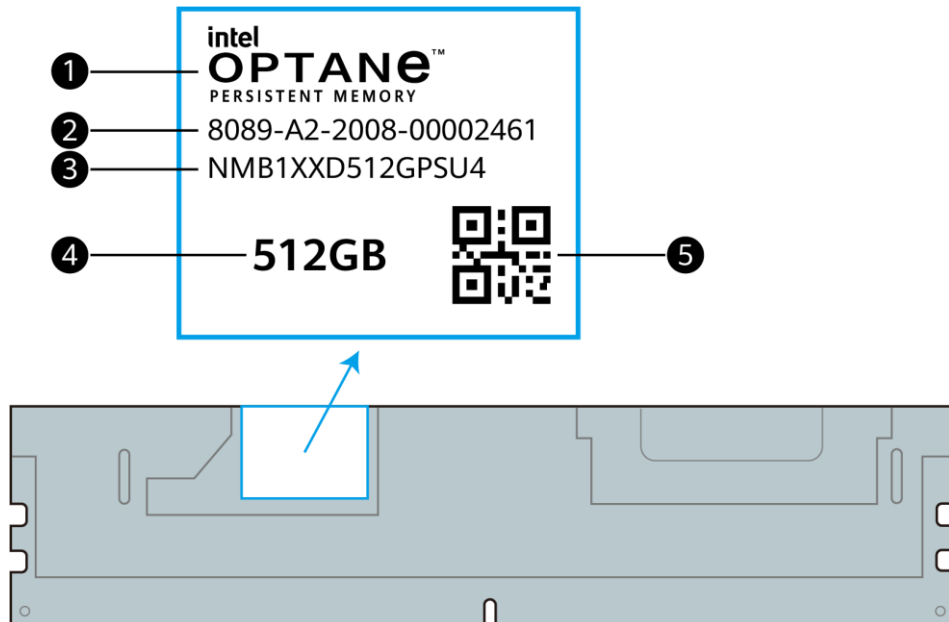

No.	Description	Example
-----	-------------	---------

No.	Description	Example
1	Component	Intel Optane™ Persistent Memory
2	SN	8089-A2-2008-00002461
3	Model	NMB1XXD512GPSU4
4	Capacity (GB)	<ul style="list-style-type: none"> • 128 • 256 • 512
5	SN QR code	8089-A2-2008-00002461

5.4.2.2 Memory Subsystem Architecture

The server provides 32 memory slots. Each processor integrates eight memory channels, and each memory channel supports only one PMem module.

PMem modules must be used with DDR4 memory modules.

Table 5-7 Memory channels

CPU	Channel	Memory Slot
CPU 1	A (primary)	DIMM000(A)
	A	DIMM001(I)
	B (primary)	DIMM010(B)
	B	DIMM011(J)
	C (primary)	DIMM020(C)
	C	DIMM021(K)
	D (primary)	DIMM030(D)
	D	DIMM031(L)
	E (primary)	DIMM040(E)
	E	DIMM041(M)
	F (primary)	DIMM050(F)
	F	DIMM051(N)
	G (primary)	DIMM060(G)
	G	DIMM061(O)
	H (primary)	DIMM070(H)
	H	DIMM071(P)
CPU2	A (primary)	DIMM100(A)

CPU	Channel	Memory Slot
	A	DIMM101(I)
	B (primary)	DIMM110(B)
	B	DIMM111(J)
	C (primary)	DIMM120(C)
	C	DIMM121(K)
	D (primary)	DIMM130(D)
	D	DIMM131(L)
	E (primary)	DIMM140(E)
	E	DIMM141(M)
	F (primary)	DIMM150(F)
	F	DIMM151(N)
	G (primary)	DIMM160(G)
	G	DIMM161(O)
	H (primary)	DIMM170(H)
	H	DIMM171(P)

5.4.2.3 Memory Compatibility

Observe the following rules when configuring PMem modules:

NOTICE

- The PMem modules must be used with the DDR4 memory modules. For details, see [FusionServer PMem 200 User Guide](#).
- Contact your local sales representative or see "Search Parts" in the [Compatibility Checker](#) to determine the components to be used.
- The memory must be used with the third-generation Intel® Xeon® Scalable Ice Lake processors. The maximum memory capacity supported by all processor models is the same.
- The PMem module can work only in App Direct Mode (AD) and Memory Mode (MM). The total supported memory capacity is calculated as follows:
 - PMem module in AD mode
 Total memory capacity = Total capacity of all PMem modules+ Total capacity of all DDR4 memory modules
 - PMem module in MM mode

Total memory capacity = Total capacity of all PMem modules (The DDR4 memory modules are used as the cache and therefore are not calculated as memory capacity.)

NOTICE

For details about the AD and MM modes, see *FusionServer PMem 200 User Guide*.

- For details about the capacity type of a single memory module, see "Search Parts" in the [Compatibility Checker](#).
- The maximum number of memory modules supported depends on the memory type and rank quantity.

 **NOTE**

Each memory channel supports a maximum of 8 ranks. The number of memory modules supported by each channel varies depending on the number of ranks supported by each channel:

Number of memory modules supported by each channel ≤ Number of ranks supported by each memory channel / Number of ranks supported by each memory module

Table 5-8 PMem specifications

Parameter	Specifications		
Capacity per PMem module (GB)	128	256	512
Rated speed (MT/s)	3200	3200	3200
Operating voltage (V)	1.2	1.2	1.2
Maximum number of PMem modules in a server ^a	16	16	16
Maximum PMem capacity of the server (GB) ^b	2048	4096	8192
Actual rate (MT/s)	3200	3200	3200
<ul style="list-style-type: none"> • a: The maximum number of PMem modules is based on dual-processor configuration. The value is halved for a server with only one processor. • b: The maximum PMem capacity varies depending on the PMem working mode. • The information listed in this table is for reference only. For details, consult the local sales representative. 			

5.4.2.4 DIMM Installation Rules

- Observe the following when configuring PMem modules:
 - The DDR4 memory modules used with the PMem modules include RDIMMs and LRDIMMs.
 - The PMem modules used in a server must have the same part number (P/N code).
 - The DDR4 memory modules used with the PMem modules in a server must have the same part number (P/N code).
- Observe the following when configuring PMem modules in MM mode:

On the same server, it is recommended that the ratio of the DDR4 memory capacity to the PMem capacity be 1:4 to 1:16.

5.4.2.5 Memory Installation Positions

A server supports a maximum of 16 PMem modules. The PMem modules must be used with the DDR4 memory modules.

Observe the memory module installation rules when configuring memory modules. For details, see [Memory Configuration Assistant](#).

Figure 5-19 Memory slots

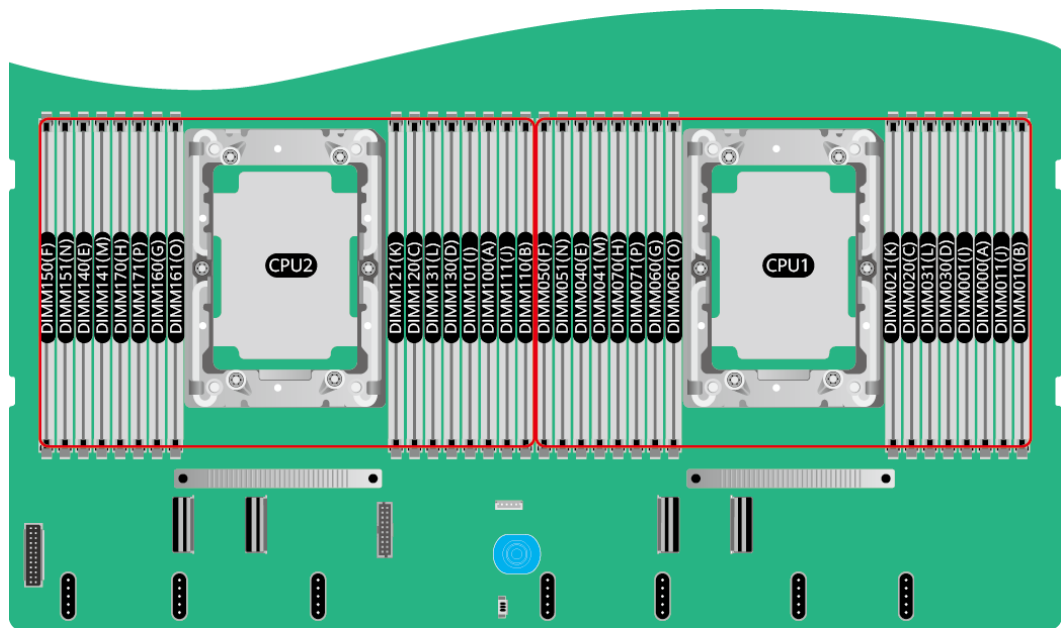

Figure 5-20 PMem module installation guidelines (1 processor)

CPU	Channel	DIMM Slot	Installation Guideline (●: DDR4 ○: PMem)								
			AD	MM	AD	AD	AD	MM	AD	MM	AD
			4+4		6+1	8+1	8+4	8+8	12+2		
CPU1	IMC0	A	DIMM000(A)	●	●	●	●	●	●	●	●
			DIMM001(I)			○	○	○	○	●	
		B	DIMM010(B)	○	●	●	●	●	●	○	
			DIMM011(J)						○		
	IMC1	C	DIMM020(C)	●	●	●	●	●	●	●	
			DIMM021(K)				○	○		●	
		D	DIMM030(D)	○	○	●	●	●	●	●	
			DIMM031(L)						○	●	
	IMC2	E	DIMM040(E)	●	●	●	●	●	●	●	
			DIMM041(M)				○	○		●	
		F	DIMM050(F)	○	●	●	●	●	●	○	
			DIMM051(N)						○		
	IMC3	G	DIMM060(G)	●	●	●	●	●	●	●	
			DIMM061(O)				○	○		●	
		H	DIMM070(H)	○		●	●	●	●	●	
			DIMM071(P)						○	●	

Figure 5-21 PMem module installation guidelines (2 processors)

CPU	Channel	DIMM Slot	Installation Guideline (●: DDR4 ○: PMem)								
			AD	MM	AD	AD	AD	MM	AD	MM	AD
			8+8		12+2	16+2	16+8	16+16	24+4		
CPU1	IMC0	A	DIMM000(A)	●	●	●	●	●	●	●	
			DIMM001(I)			○	○	○	●		
		B	DIMM010(B)	○	●	●	●	●	●	○	
			DIMM011(J)						○		
	IMC1	C	DIMM020(C)	●	●	●	●	●	●		
			DIMM021(K)				○	○	●		
		D	DIMM030(D)	○	○	●	●	●	●		
			DIMM031(L)						○	●	
	IMC2	E	DIMM040(E)	●	●	●	●	●	●		
			DIMM041(M)				○	○	●		
		F	DIMM050(F)	○	●	●	●	●	●	○	
			DIMM051(N)						○		
	IMC3	G	DIMM060(G)	●	●	●	●	●	●		
			DIMM061(O)				○	○	●		
		H	DIMM070(H)	○		●	●	●	●	●	
			DIMM071(P)						○	●	
CPU2	IMC0	A	DIMM000(A)	●	●	●	●	●	●		
			DIMM001(I)			○	○	○	●		
		B	DIMM010(B)	○	●	●	●	●	●	○	
			DIMM011(J)						○		
	IMC1	C	DIMM020(C)	●	●	●	●	●	●		
			DIMM021(K)				○	○	●		
		D	DIMM030(D)	○	○	●	●	●	●		
			DIMM031(L)						○	●	
	IMC2	E	DIMM040(E)	●	●	●	●	●	●		
			DIMM041(M)				○	○	●		
		F	DIMM050(F)	○	●	●	●	●	●	○	
			DIMM051(N)						○		
	IMC3	G	DIMM060(G)	●	●	●	●	●	●		
			DIMM061(O)				○	○	●		
		H	DIMM070(H)	○		●	●	●	●	●	
			DIMM071(P)						○	●	

5.4.2.6 Memory Protection Technologies

The following memory protection technologies are supported:

- PMem module Error Detection and Correction
- PMem module Device Failure Recovery (SDDC)
- PMem module Package Sparing (DDDC)
- PMem module Patrol Scrubbing
- PMem module Address Error Detection
- PMem module Data Poisoning (Corrupt Data Containment)
- PMem module Viral
- PMem module Address Range Scrub (ARS)
- PMem module Error Injection
- DDR-T Command and Address Parity Check and Retry
- DDR-T Read Write Data ECC Check and Retry
- PMem module Faulty DIMM Isolation
- PMem module Error Reporting

5.5 Storage

5.5.1 Drive Configurations

Table 5-9 Drive configuration

Configuration	Front Drive	Rear Drive	Drive Management Mode
4 x 3.5" drive pass-through configuration 1	<ul style="list-style-type: none"> • Front drive: 4 x 3.5 – Slots 0 to 3 support only SATA drives. 	-	<ul style="list-style-type: none"> • PCH
4 x 3.5" drive pass-through configuration 2	<ul style="list-style-type: none"> • Front drive: 4 x 3.5 – Slots 0 to 3 support only SAS/SATA drives. 	<ul style="list-style-type: none"> • I/O module 1: 2 x 2.5" – Slots 12 and 13 support only SAS/SATA drives. 	<ul style="list-style-type: none"> • 1 x screw-in RAID controller card
4 x 3.5" drive pass-through configuration 3	<ul style="list-style-type: none"> • Front drive: 4 x 3.5 – Slots 0 to 3 support only SAS/SATA drives. 	-	<ul style="list-style-type: none"> • 1 x PCIe RAID controller card

Configuration	Front Drive	Rear Drive	Drive Management Mode
8 x 2.5" drive pass-through configuration 1	<ul style="list-style-type: none"> • Front drive: 8 x 2.5" <ul style="list-style-type: none"> – Slots 0 to 7 support only SATA drives. 	-	<ul style="list-style-type: none"> • PCH
8 x 2.5" drive pass-through configuration 2	<ul style="list-style-type: none"> • Front drive: 8 x 2.5" <ul style="list-style-type: none"> – Slots 0 to 7 support only SAS/SATA drives. 	-	<ul style="list-style-type: none"> • 1 x screw-in RAID controller card
8 x 2.5" drive pass-through configuration 3	<ul style="list-style-type: none"> • Front drive: 8 x 2.5" <ul style="list-style-type: none"> – Slots 0 to 7 support only SAS/SATA drives. 	-	<ul style="list-style-type: none"> • 1 x PCIe RAID controller card
10 x 2.5" drive pass-through configuration 1	<ul style="list-style-type: none"> • Front drive: 10 x 2.5" <ul style="list-style-type: none"> – Slots 0 to 9 support only SAS/SATA drives. 	<ul style="list-style-type: none"> • I/O module 1: 2 x 2.5" <ul style="list-style-type: none"> – Slots 12 and 13 support only SAS/SATA drives. 	<ul style="list-style-type: none"> • 1 x screw-in RAID controller card
10 x 2.5" drive pass-through configuration 2	<ul style="list-style-type: none"> • Front drive: 10 x 2.5" <ul style="list-style-type: none"> – Slots 0 to 9 support only SAS/SATA drives. 	-	<ul style="list-style-type: none"> • 1 x PCIe RAID controller card
10 x 2.5" drive pass-through configuration 3	<ul style="list-style-type: none"> • Front drive: 10 x 2.5" <ul style="list-style-type: none"> – Slots 0 to 5 support only SATA drives. – Slots 6 and 7 support only SATA/NVMe drives. – Slots 8 to 9 support only NVMe drives. 	-	<ul style="list-style-type: none"> • SATA drive: PCH • NVMe drive: CPU

Configuration	Front Drive	Rear Drive	Drive Management Mode
10 x 2.5" drive pass-through configuration 4	<ul style="list-style-type: none"> • Front drive: 10 x 2.5" <ul style="list-style-type: none"> – Slots 0 to 5 support only SAS/SATA drives. – Slots 6 and 7 support SAS/SATA/NVMe drives. – Slots 8 and 9 support only NVMe drives. 	-	<ul style="list-style-type: none"> • SAS/SATA drive: 1 x screw-in RAID controller card • NVMe drive: CPU
10 x 2.5" drive pass-through configuration 5	<ul style="list-style-type: none"> • Front drive: 10 x 2.5" <ul style="list-style-type: none"> – Slots 0 to 5 support only SAS/SATA drives. – Slots 6 and 7 support SAS/SATA/NVMe drives. – Slots 8 and 9 support only NVMe drives. 	-	<ul style="list-style-type: none"> • SAS/SATA drive: 1 x PCIe RAID controller card • NVMe drive: CPU
10 x 2.5" drive NVMe configuration 1	<ul style="list-style-type: none"> • Front drive: 10 x 2.5" <ul style="list-style-type: none"> – Slots 0 to 3 support only SATA/NVMe drives. – Slots 4 to 9 support only NVMe drives. 	-	<ul style="list-style-type: none"> • SATA drive: PCH • NVMe drive: CPU
10 x 2.5" drive NVMe configuration 2	<ul style="list-style-type: none"> • Front drive: 10 x 2.5" <ul style="list-style-type: none"> – Slots 0 to 3 support SAS/SATA/NVMe drives. – Slots 4 to 9 	<ul style="list-style-type: none"> • I/O module 1: 2 x 2.5" <ul style="list-style-type: none"> – Slots 12 and 13 support only SAS/SATA drives. 	<ul style="list-style-type: none"> • SAS/SATA drive: 1 x screw-in RAID controller card • NVMe drive: CPU

Configuration	Front Drive	Rear Drive	Drive Management Mode
	support only NVMe drives.		
10 x 2.5" drive NVMe configuration 3	<ul style="list-style-type: none"> Front drive: 10 x 2.5" <ul style="list-style-type: none"> Slots 0 to 3 support SAS/SATA/NVMe drives. Slots 4 to 9 support only NVMe drives. 	<ul style="list-style-type: none"> I/O module 1: 2 x 2.5" <ul style="list-style-type: none"> Slots 12 and 13 support only SAS/SATA drives. 	<ul style="list-style-type: none"> SAS/SATA drive: 1 x PCIe RAID controller card NVMe drive: CPU
Note: Contact your local sales representative or see "Search Parts" in the Compatibility Checker to determine the components to be used.			

5.5.2 Drive Numbering

NOTICE

The drive numbers identified by the RAID controller card vary depending on the cabling of the RAID controller card. The drive numbers identified by the RAID controller card in this section are provided based on the default cabling described in "Internal Cabling" in *FusionServer 1288H V6 Server Maintenance and Service Guide*.

- 4 x 3.5" drive pass-through configuration
 Corresponds to 4 x 3.5" drive pass-through configuration 1 in 5.5.1 Drive Configurations .

Figure 5-22 Slot Numbers



Table 5-10 Slot numbers

Drive No.	Drive Number Identified by the iBMC
0	0
1	1
2	2

Drive No.	Drive Number Identified by the iBMC
3	3

- 4 x 3.5" drive pass-through configuration
 Corresponds to 4 x 3.5" drive pass-through configuration 2 in 5.5.1 Drive Configurations .

Figure 5-23 Slot Numbers

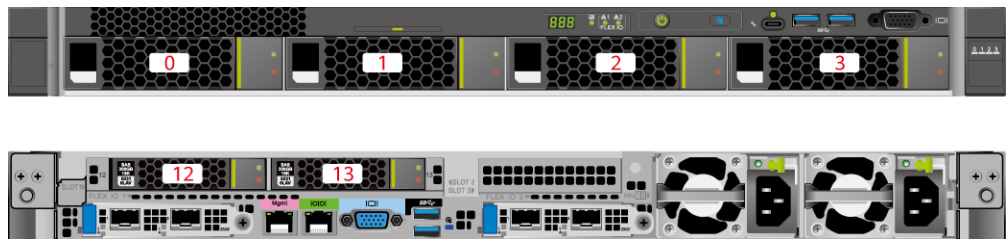

Table 5-11 Slot numbers

Drive No.	Drive Number Identified by the iBMC	Drive Number Identified by the RAID Controller
0	0	0
1	1	1
2	2	2
3	3	3
12	12	4
13	13	5

- 4 x 3.5" drive pass-through configuration
 Corresponds to 4 x 3.5" drive pass-through configuration 3 in 5.5.1 Drive Configurations .

Figure 5-24 Slot Numbers



Table 5-12 Slot numbers

Drive No.	Drive Number Identified by the iBMC	Drive Number Identified by the RAID Controller
-----------	-------------------------------------	--

Drive No.	Drive Number Identified by the iBMC	Drive Number Identified by the RAID Controller
0	0	0
1	1	1
2	2	2
3	3	3

- 8 x 2.5" drive pass-through configuration
 Corresponds to 8 x 2.5" drive pass-through configuration 1 in 5.5.1 Drive Configurations .

Figure 5-25 Slot numbers



Table 5-13 Slot numbers

Drive No.	Drive Number Identified by the iBMC
0	0
1	1
2	2
3	3
4	4
5	5
6	6
7	7

- 8 x 2.5" drive pass-through configuration
 Corresponds to 8 x 2.5" drive pass-through configuration 2 and 8 x 2.5" drive pass-through configuration 3 in 5.5.1 Drive Configurations .

Figure 5-26 Slot Numbers



Table 5-14 Slot numbers

Drive No.	Drive Number Identified by the iBMC	Drive Number Identified by the RAID Controller
0	0	0
1	1	1
2	2	2
3	3	3
4	4	4
5	5	5
6	6	6
7	7	7

- 10 x 2.5" drive pass-through configuration
 Corresponds to 10 x 2.5" drive pass-through configuration 1 in 5.5.1 Drive Configurations .

Figure 5-27 Slot numbers

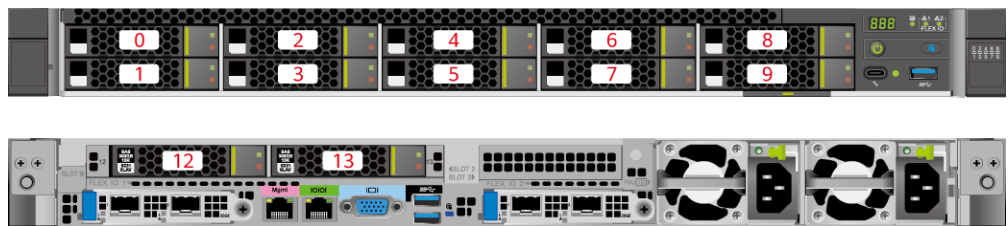

Table 5-15 Slot numbers

Drive No.	Drive Number Identified by the iBMC	Drive Number Identified by the RAID Controller
0	0	0
1	1	1
2	2	2
3	3	3
4	4	4
5	5	5
6	6	6
7	7	7

Drive No.	Drive Number Identified by the iBMC	Drive Number Identified by the RAID Controller
8	8	8
9	9	9
12	12	12
13	13	13

- 10 x 2.5" drive pass-through configuration
 Corresponds to 10 x 2.5" drive pass-through configuration 2 in 5.5.1 Drive Configurations .

Figure 5-28 Slot numbers



Table 5-16 Slot numbers

Drive No.	Drive Number Identified by the iBMC	Drive Number Identified by the RAID Controller
0	0	0
1	1	1
2	2	2
3	3	3
4	4	4
5	5	5
6	6	6
7	7	7
8	8	8
9	9	9

- 10 x 2.5" drive pass-through configuration
 Corresponds to 10 x 2.5" drive pass-through configuration 3 in 5.5.1 Drive Configurations .

Figure 5-29 Slot Numbers



Table 5-17 Slot numbers

Drive No.	Drive Number Identified by the iBMC
0	0
1	1
2	2
3	3
4	4
5	5
6	6
7	7
8	8
9	9

- 10 x 2.5" drive pass-through configuration
 Corresponds to 10 x 2.5" drive pass-through configuration 4 and 10 x 2.5" drive pass-through configuration 5 in 5.5.1 Drive Configurations .

Figure 5-30 Slot Numbers



Table 5-18 Slot numbers

Drive No.	Drive Number Identified by the iBMC	Drive Number Identified by the RAID Controller
0	0	0
1	1	1
2	2	2
3	3	3
4	4	4

Drive No.	Drive Number Identified by the iBMC	Drive Number Identified by the RAID Controller
5	5	5
6	6	6 ^{Note}
7	7	7 ^{Note}
8	8	-
9	9	-

Note: If the slot is configured with a SAS/SATA drive, the RAID controller card can manage the drive and allocate a number to the drive.

- 10 x 2.5" NVMe drive configuration
 Corresponds to 10 x 2.5" drive NVMe configuration 1 in 5.5.1 Drive Configurations .

Figure 5-31 Slot Numbers



Table 5-19 Slot numbers

Drive No.	Drive Number Identified by the iBMC
0	0
1	1
2	2
3	3
4	4
5	5
6	6
7	7
8	8
9	9

- 10 x 2.5" NVMe drive configuration
 Corresponds to 10 x 2.5" NVMe drive configuration 2 and 10 x 2.5" NVMe drive configuration 3 in 5.5.1 Drive Configurations .

Figure 5-32 Slot Numbers

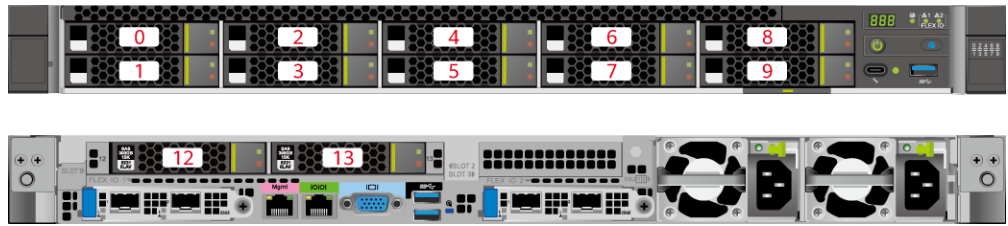

Table 5-20 Slot numbers

Drive No.	Drive Number Identified by the iBMC	Drive Number Identified by the RAID Controller
0	0	0 ^{Note}
1	1	1 ^{Note}
2	2	2 ^{Note}
3	3	3 ^{Note}
4	4	-
5	5	-
6	6	-
7	7	-
8	8	-
9	9	-
12	12	4
13	13	5
<p>Note: If the slot is configured with a SAS/SATA drive, the RAID controller card can manage the drive and allocate a number to the drive.</p>		

5.5.3 Drive Indicators

SAS/SATA Drive Indicators

Figure 5-33 SAS/SATA drive indicators

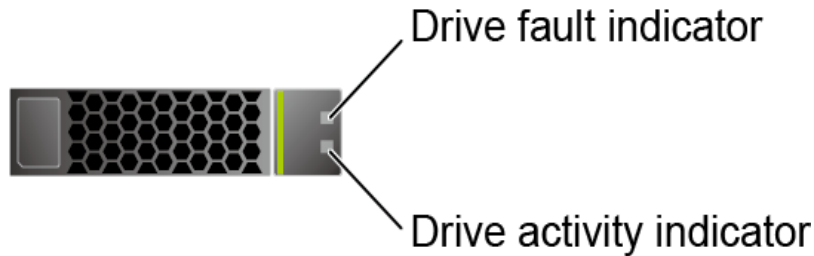
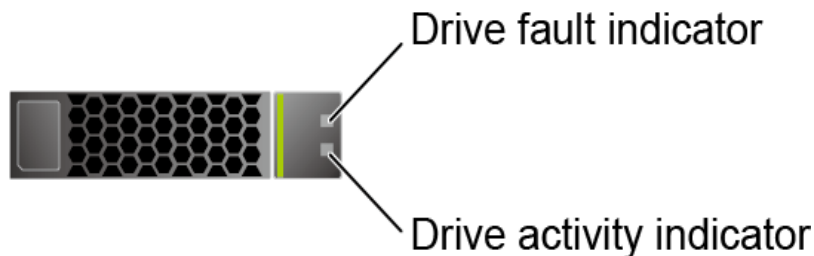

Table 5-21 SAS/SATA drive indicators

Activity Indicator (Green)	Fault Indicator (Yellow)	Description
Off	Off	The drive is not in position.
Steady on	Off	The drive is detected.
Blinking at 4 Hz	Off	Data is being read or written properly, or data on the primary drive is being rebuilt.
Steady on	Blinking at 1 Hz	The drive is being located.
Blinking at 1 Hz	Blinking at 1 Hz	Data on the secondary drive is being rebuilt.
Off	Steady on	A drive in a RAID array is removed.
Steady on	Steady on	The drive is faulty.

NVMe Drive Indicators

Figure 5-34 NVMe drive indicators



- If the VMD function is enabled and the latest VMD driver is installed, the NVMe drives support surprise hot swap.

Table 5-22 NVMe drive indicators (VMD enabled)

Activity Indicator (Green)	Fault Indicator (Yellow)	Description
Off	Off	The NVMe drive is not detected.
Steady on	Off	The NVMe drive is detected and operating properly.
Blinking at 2 Hz	Off	Data is being read from or written to the NVMe drive.
Off	Blinking at 2 Hz	The NVMe drive is being located.
Off	Blinking at 8 Hz	The data on the secondary NVMe drive is being rebuilt.
Steady on/Off	Steady on	The NVMe drive is faulty.

- If the VMD function is disabled, NVMe drives support only orderly hot swap.

Table 5-23 NVMe drive indicators (VMD disabled)

Activity Indicator (Green)	Fault Indicator (Yellow)	Description
Off	Off	The NVMe drive is not detected.
Steady on	Off	The NVMe drive is detected and operating properly.
Blinking at 2 Hz	Off	Data is being read from or written to the NVMe drive.
Off	Blinking at 2 Hz	The NVMe drive is being located or hot-swapped.
Off	Blinking at 0.5 Hz	The NVMe drive has completed the hot swap process and is removable.
Steady on/Off	Steady on	The NVMe drive is faulty.

M.2 FRU Indicators

The server supports the Avago SAS3004iMR RAID controller card, which supports two M.2 FRUs.

Figure 5-35 M.2 FRU indicators

M.2 FRU fault indicator M.2 FRU activity indicator



Table 5-24 M.2 FRU indicators

M.2 FRU Active Indicator (Green)	M.2 FRU Fault Indicator (Yellow)	Description
Off	Off	The M.2 FRU is not detected.
Steady on	Off	The M.2 FRU is inactive.
Blink	Off	The M.2 FRU is in the read/write or synchronization state.
Steady on	Blink	The M.2 FRU is being located.
Blink	Blink	The RAID array is being rebuilt.
Off	Steady on	The M.2 FRU cannot be detected or is faulty.
Steady on	Steady on	The M.2 FRU RAID status is abnormal.

5.5.4 RAID Controller Card

The RAID controller card supports RAID configuration, RAID level migration, and drive roaming.

- Contact your local sales representative or see "Search Parts" in the [Compatibility Checker](#) to determine the components to be used.
- For details about the RAID controller card, see [V6 Server RAID Controller Card User Guide](#).

5.6 Network

5.6.1 OCP 3.0 Network Adapter

OCP 3.0 network adapters provide network expansion capabilities.

- The FlexIO slot supports the OCP 3.0 network adapter, which can be configured as required.

- Contact your local sales representative or see "Search Parts" in the [Compatibility Checker](#) to determine the components to be used.
- For details about the OCP 3.0 network adapter, see the documents of each OCP 3.0 network adapter.

5.7 I/O Expansion

5.7.1 PCIe Cards

PCIe cards provide ease of expandability and connection.

- A maximum of three PCIe 4.0 slots are supported.
- Contact your local sales representative or see "Search Parts" in the [Compatibility Checker](#) to determine the components to be used.
- When IB cards are used to build an IB network, ensure that the IPoIB modes of the IB cards at both ends of the network are the same. For details, contact technical support.

5.7.2 PCIe Slots

PCIe Slots

Figure 5-36 PCIe slots



- I/O module 1 provides slots 1 and 2.
- I/O module 2 provides slot 3.

PCIe Riser Modules

- PCIe riser module 1
Provides PCIe slots 1 and 2 in I/O module 1.

Figure 5-37 PCIe riser module

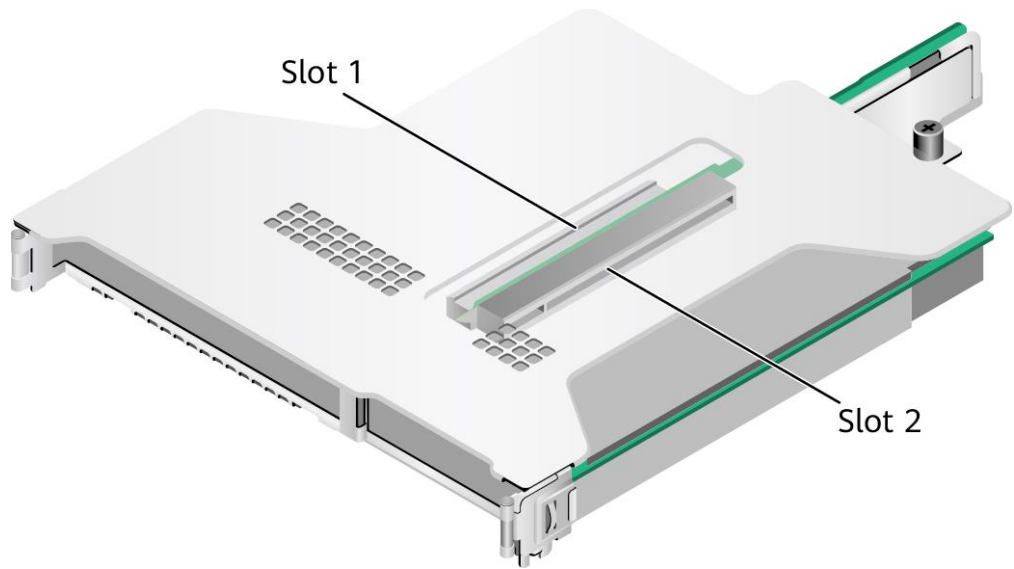

- PCIe riser module 2
Provides PCIe slot 3 in I/O module 2.

Figure 5-38 PCIe riser module

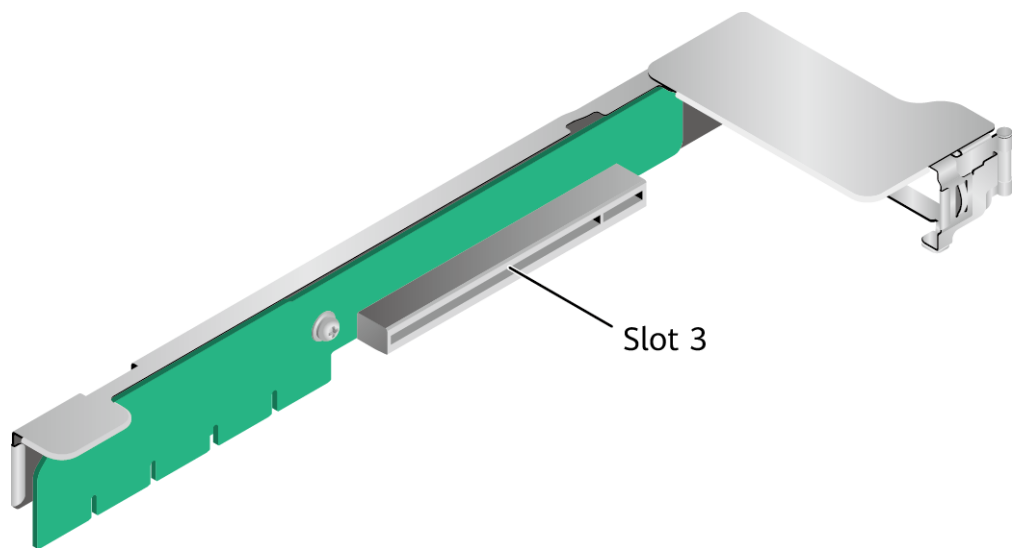

5.7.3 PCIe Slot Description

NOTE

The PCIe slots mapping to a vacant CPU socket are unavailable.

Table 5-25 PCIe slot description

PCIe Slot	CPU	PCIe Standards	Connector Width	Bus Width	Port No.	Root Port (B/D/F)	Device (B/D/F)	Slot Size
Screw-in RAID controller card	CPU1	PCIe 3.0	x8	x8	Port0A	16/02/0	17/00/0	-
FlexIO card 1	CPU1	PCIe 4.0	x16	x8 Expansion cables used by the mainboard: x8 + x8 ^a	Port0C	16/04/0	18/00/0	OCP 3.0 specifications
FlexIO card 2	CPU2	PCIe 4.0	x16	x8 Expansion cable used by the mainboard: x16	Port2A	C9/02/0	CA/00/0	OCP 3.0 specifications
Slot1	CPU1	PCIe 4.0	x16	x16	Port1A	30/02/0	31/00/0	FHHL
Slot2	CPU1	PCIe 4.0	x16	x16	Port2A	4A/02/0	4B/00/0	HHHL
Slot3	CPU2	PCIe 4.0	x16	x16	Port0A	97/02/0	98/00/0	HHHL

- a: When CPU1 and CPU2 use x8 signals, the socket-direct function is supported.
- The B/D/F (Bus/Device/Function Number) is the default value when the server is fully configured with PCIe cards. The value may differ if the server is not fully configured with PCIe cards or if a PCIe card with a PCI bridge is configured.
- Root Port (B/D/F) indicates the B/D/F of an internal PCIe root port of the processor.
- Device (B/D/F) indicates the B/D/F (bus address displayed on the OS) of an onboard or extended PCIe device.
- The PCIe x16 slots are compatible with PCIe x16, PCIe x8, PCIe x4, and PCIe x1 cards. The PCIe cards are not forward compatible. That is, the PCIe slot width cannot be smaller than the PCIe card link width.
- The full-height half-length (FHHL) PCIe slots are compatible with FHHL PCIe cards and half-height half-length (HHHL) PCIe cards.

PCIe Slot	CPU	PCIe Standards	Connector Width	Bus Width	Port No.	Root Port (B/D/F)	Device (B/D/F)	Slot Size
<ul style="list-style-type: none"> The maximum power supply of each PCIe slot is 75 W. 								

5.8 PSUs

- The server supports one or two PSUs.
- The server supports AC or DC PSUs.
- The PSUs are hot-swappable.
- The server supports two PSUs in 1+1 redundancy.
- PSUs of the same part number (P/N code) must be used in a server.
- The PSUs are protected against short circuit. Double-pole fuse is provided for the PSUs with dual input live wires.
- If the DC power supply is used, purchase the DC power supply that meets the requirements of the safety standards or the DC power supply that has passed the CCC certification.
- Contact your local sales representative or see "Search Parts" in the [Compatibility Checker](#) to determine the components to be used.

Figure 5-39 Positions of PSUs

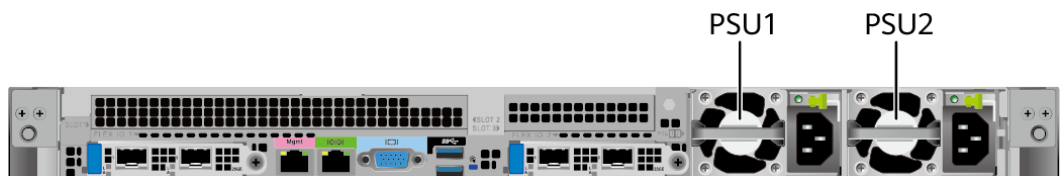

5.9 Fan Modules

- The server supports seven fan modules.
- The fan modules are hot-swappable.
- N+1 redundancy is supported. That is, the server can work properly when a single fan fails.
- The fan speed can be adjusted.
- Fan modules of the same part number (P/N code) must be used in a server.

Figure 5-40 Positions of fan modules

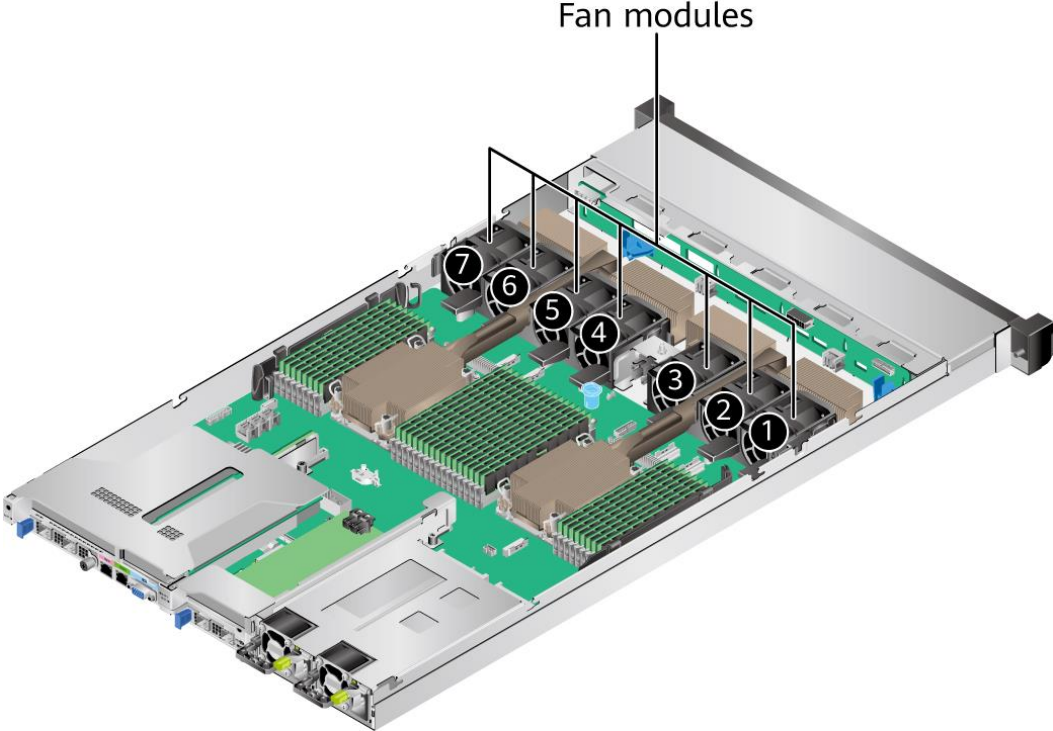

5.10 Boards

5.10.1 Mainboard

Figure 5-41 1288H V6 mainboard

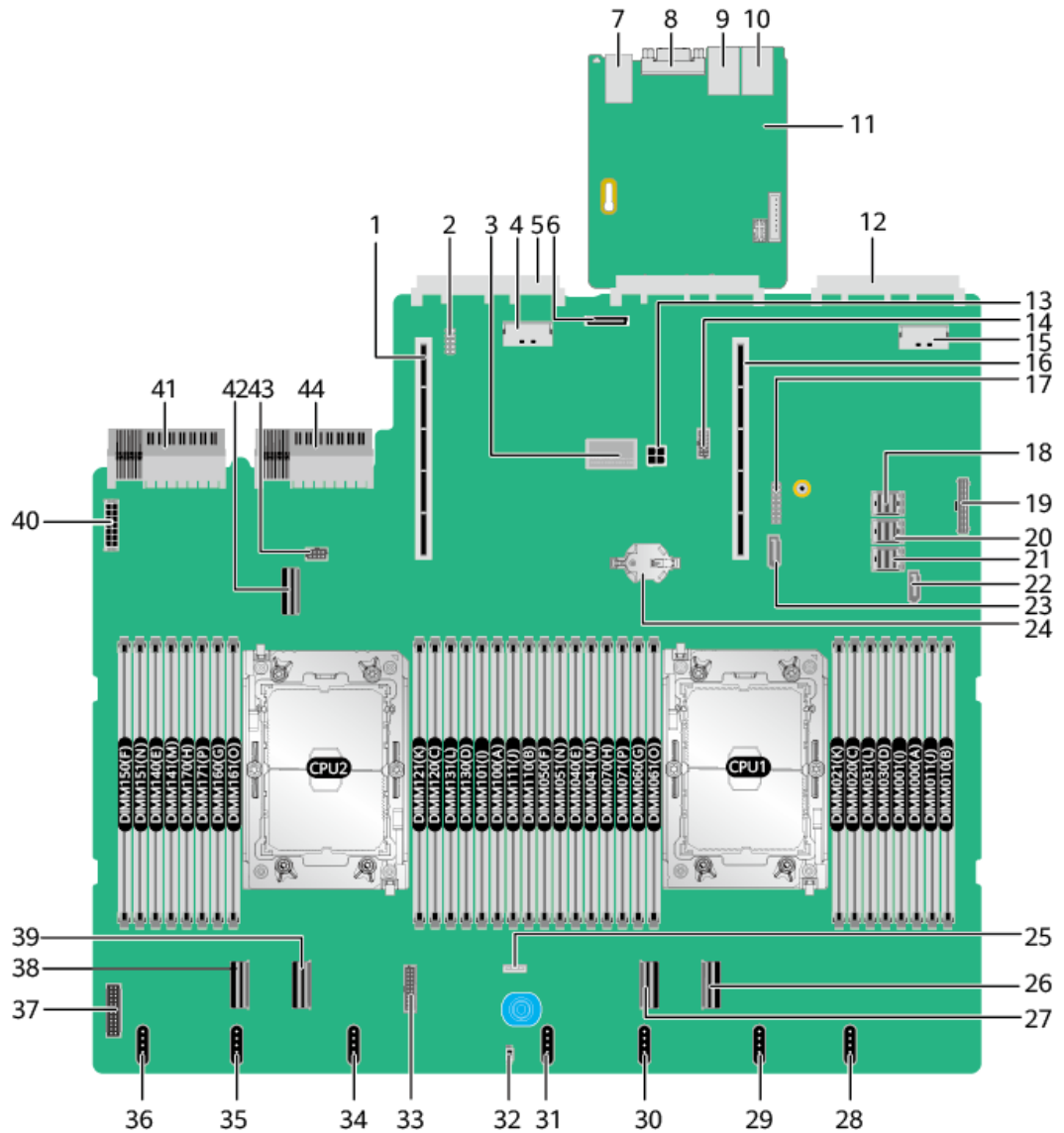

1	PCIe riser 2 slot (PCIE RISER2/J51)	2	Debugging pin (J103)
3	Screw-in RAID controller card connector (RAID CARD/J86)	4	LP slimline 7 connector for OCP 3.0 network adapter 2 (SLIMLINE7/J31)
5	OCP 3.0 network adapter 2 connector (OCP2 CONN/J109)	6	Built-in storage expansion port (SD CARD/J87)

7	2 x USB 3.0 ports (USB3.0 CONN/J88)	8	Rear VGA port (VGA CONN/J60)
9	Serial port (COM/J6020)	10	BMC management network port (BMC_GE /J6019)
11	BMC management board	12	OCP 3.0 network adapter 1 connector (OCP1 CONN/J108)
13	Rear 4-pin power connector 2 (REAR BP PWR2/J21)	14	NC-SI connector (NCSI CONN/J114)
15	LP slimline 6 connector for OCP 3.0 network adapter 1 (SLIMLINE6/J13)	16	PCIe riser 1 slot (PCIE RISER1/J50)
17	TPM/TCM connector (J10)	18	Mini-SAS HD connector C (MiniHD PORTC/J4)
19	Right mounting ear connector (RCIA BOARD/J113)	20	Mini-SAS HD connector B (MiniHD PORTB/J5)
21	Mini-SAS HD connector A (MiniHD PORTA/J6)	22	SATA 9-pin connector 1 (SATA1/J1)
23	SATA 9-pin connector 2 (SATA2/J2)	24	Cell battery holder (U9)
25	VROC key connector (Soft RAID KEY/J3) ^a	26	LP slimline 1 connector (SLIMLINE1/J11)
27	LP slimline 2 connector (SLIMLINE2/J84)	28	Fan module 7 connector (1U FAN7/J99)
29	Fan module 6 connector (1U FAN6/J98)	30	Fan module 5 connector (1U FAN5/J96)
31	Fan module 4 connector (1U FAN4/J94)	32	Intrusion sensor connector (INTRUDER CONN/S1)
33	Front low-speed signal connector (FRONT HDD BP/J75)	34	Fan module 3 connector (1U FAN3/J92)
35	Fan module 2 connector (1U FAN2/J101)	36	Fan module 1 connector (1U FAN1/J67)
37	Left mounting ear connector (LCIA BOARD/J106)	38	LP slimline 4 connector (SLIMLINE4/J12)
39	LP slimline 3 connector (SLIMLINE3/J85)	40	Front 14-pin power connector 1 (HDD BP PWR1/J26)
41	PSU 2 connector (PSU2/J56)	42	LP slimline 5 connector (SLIMLINE5/J30)
43	Built-in low-speed signal connector (INNER HDD	44	PSU 1 connector (PSU1/J28)

	BP/J27)		
a: Reserved and unavailable currently.			

5.10.2 Drive Backplane

Front Drive Backplane

- 4 x 3.5" drive pass-through backplane
 Configure this backplane in 4 x 3.5" drive pass-through configuration 1, 4 x 3.5" drive pass-through configuration 2, and 4 x 3.5" drive pass-through configuration 3 in 5.5.1 Drive Configurations .

Figure 5-42 4 x 3.5" drive pass-through backplane

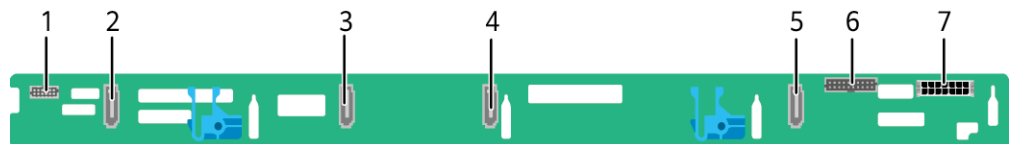

1	Backplane indicator signal cable connector (SGPIO/J6)	2	SAS3 signal connector (PORT3/J5)
3	SAS2 signal connector (PORT2/J4)	4	SAS1 signal connector (PORT1/J3)
5	SAS0 signal connector (PORT0/J2)	6	Backplane signal cable connector (HDD_BP/J1)
7	Backplane power connector (HDD POWER/J24)	-	-

- 8 x 2.5" drive pass-through backplane
 Configure this backplane in 8 x 2.5" drive pass-through configuration 1, 8 x 2.5" drive pass-through configuration 2, and 8 x 2.5" drive pass-through configuration 3 in 5.5.1 Drive Configurations .

Figure 5-43 8 x 2.5" drive pass-through backplane



1	Built-in DVD drive connector (DVD_POWER/J11)	2	Mini-SAS HD connector (PORT B/J29)
---	--	---	------------------------------------

3	Backplane power connector (HDD POWER/J24)	4	Mini-SAS HD connector (PORT A/J28)
5	Backplane signal cable connector (HDD_BP/J1)	-	-

- 10 x 2.5" drive pass-through backplane
 Configure this backplane in 10 x 2.5" drive pass-through configuration 1, 10 x 2.5" drive pass-through configuration 2, 10 x 2.5" drive pass-through configuration 3, 10 x 2.5" drive pass-through configuration 4, and 10 x 2.5" drive pass-through configuration 5 in 5.5.1 Drive Configurations .

Figure 5-44 10 x 2.5" drive pass-through backplane

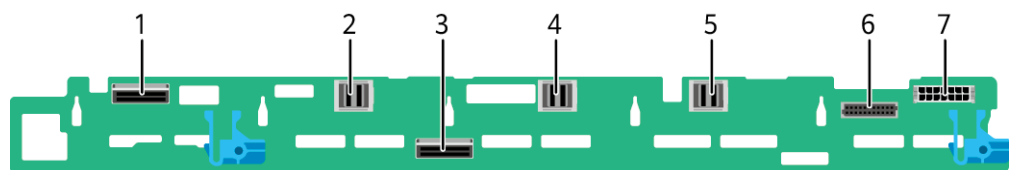

1	LP slimline 2 connector (SLIM A/SLIM2/J12)	2	Mini-SAS HD connector (PORT C/J15)
3	LP slimline 1 connector (SLIM B/SLIM1/J11)	4	Mini-SAS HD connector (PORT B/J14)
5	Mini-SAS HD connector (PORT A/J13)	6	Backplane signal cable connector (HDD BP/J1)
7	Backplane power connector (HDD POWER/J24)	-	-

- 10 x 2.5" drive NVMe backplane
 Configure this backplane in 10 x 2.5" NVMe drive configuration 1, 10 x 2.5" NVMe drive configuration 2, and 10 x 2.5" NVMe drive configuration 3 in 5.5.1 Drive Configurations .

Figure 5-45 10 x 2.5" drive NVMe backplane

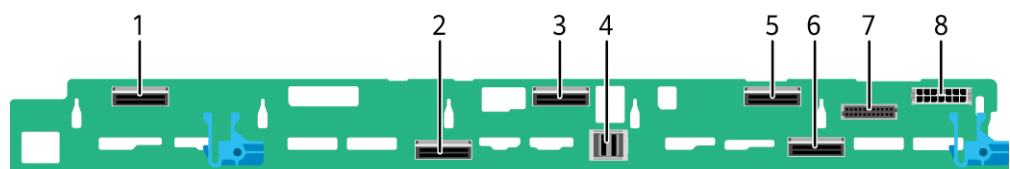

1	LP slimline 2 connector (SLIM A/ SLIM_2/ SLIM_5/J3)	2	LP slimline 1 connector (SLIM B/ SLIM_1/PORT_2B/J2)
---	---	---	---

3	LP slimline 4 connector (SLIM C/SLIM_4/PORT_2A/J5)	4	Mini-SAS HD connector (PORT A/J6)
5	LP slimline 3 connector (SLIM D/SLIM_3/PORT_1B/J4)	6	LP slimline 5 connector (SLIM E/SLIM_5/PORT_1A/J17)
7	Backplane low-speed signal connector (HDD BP/J1)	8	Backplane power connector (HDD POWER/J30)

Rear-drive backplane

- 2 x 2.5" drive backplane

Figure 5-46 2 x 2.5" drive backplane

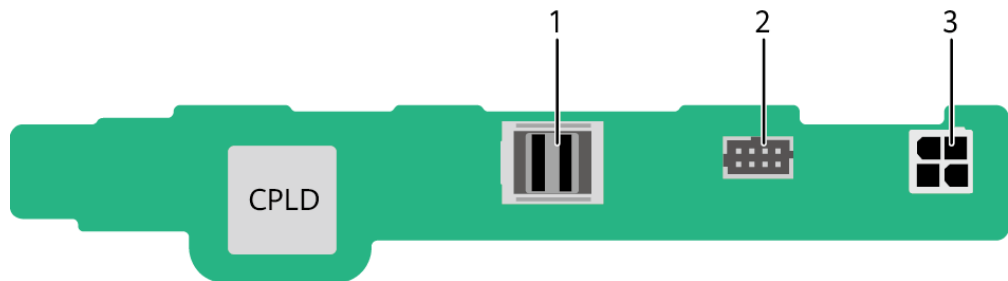

1	Mini-SAS HD connector (PORT/J3)	2	Low-speed signal connector (HDD_BP/J1)
3	Power connector (HDD_POWER/J2)	-	-

6 Product Specifications

- 6.1 [Technical Specifications](#)
- 6.2 [Environmental Specifications](#)
- 6.3 [Physical Specifications](#)

6.1 Technical Specifications

Table 6-1 Technical specifications

Component	Specifications
Form factor	1U rack server
Chipset	Intel® C621A
Processor	<p>Supports one or two processors.</p> <ul style="list-style-type: none"> • Third-generation Intel® Xeon® Scalable Ice Lake processors • Built-in memory controller and eight memory channels per processor • Built-in PCIe controller, supporting PCIe 4.0 and 64 lanes per processor • Three UPI buses between processors, providing up to 11.2 GT/s transmission per channel • Up to 40 cores • Max. 3.6 GHz • Min. 1.5 MB L3 cache per core • Max. 270 W TDP <p>NOTE The preceding information is for reference only. For details, see "Search Parts" in the Compatibility Checker.</p>
DIMM	<p>Supports 32 memory module slots.</p> <ul style="list-style-type: none"> • Up to 32 DDR4 memory modules

Component	Specifications
	<ul style="list-style-type: none"> - RDIMM and LRDIMM support - Max. 3200 MT/s memory speed - The DDR4 memory modules of different types (RDIMM and LRDIMM) and specifications (capacity, bit width, rank, and height) cannot be used together. - A server must use DDR4 memory modules of the same part number (P/N code). • Up to 16 PMem modules <ul style="list-style-type: none"> - The PMem modules must be used with the DDR4 memory modules, and only one PMem module can be installed in each memory channel. - The PMem modules support the AD or MM mode. - Max. 3200 MT/s memory speed - The PMem modules of different specifications (capacity and rank) cannot be used together. - For details about the PMem modules, see <i>FusionServer PMem 200 User Guide</i>. <p>NOTE The preceding information is for reference only. For details, see "Search Parts" in the Compatibility Checker.</p>
Storage	<p>Supports a variety of drive configurations. For details, see 5.5.1 Drive Configurations .</p> <ul style="list-style-type: none"> • Supports two M.2 SSDs. <ul style="list-style-type: none"> - M.2 SSDs are supported for RAID configuration when the server is configured with an Avago SAS3004iMR RAID controller card. <p>NOTE</p> <ul style="list-style-type: none"> • The M.2 SSD is used only as a boot device for installing the OS. Small-capacity (32 GB or 64 GB) M.2 SSDs do not support logging due to poor endurance. If a small-capacity M.2 SSD is used as the boot device, a dedicated log drive or log server is required for logging. For example, you can dump VMware logs in either of the following ways: <ul style="list-style-type: none"> • Redirect /scratch. For details, see https://kb.vmware.com/s/article/1033696. • Configure syslog. For details, see https://kb.vmware.com/s/article/2003322. • The M.2 SSD cannot be used to store data due to poor endurance. In write-intensive applications, the M.2 SSD will wear out in a short time. <p>If you want to use SSDs or HDDs as data storage devices, use enterprise-level SSDs or HDDs with high DDPD.</p> • The M.2 SSD is not recommended for write-intensive service software due to poor endurance. • Do not use M.2 SSDs for cache. <ul style="list-style-type: none"> • Supports hot swap of SAS/SATA/NVMe U.2 drives. <p>NOTE</p>

Component	Specifications
	<p>The NVMe drives support:</p> <ul style="list-style-type: none"> • Before using the VMD function, contact technical support engineers of the OS vendor to check whether the OS supports the VMD function. If yes, check whether the VMD driver needs to be manually installed and check the installation method. • Surprise hot swap if the VMD function is enabled and the latest Intel VMD driver is installed. • Orderly hot swap if the VMD function is disabled. <ul style="list-style-type: none"> • Supports a variety of RAID controller cards. For details, see "Search Parts" in the Compatibility Checker. <ul style="list-style-type: none"> – The RAID controller card supports RAID configuration, RAID level migration, and drive roaming. – The RAID controller card supports a supercapacitor for power-off protection to ensure user data security. – The PCIe RAID controller card occupies one PCIe slot. <p>For details about the RAID controller card, see V6 Server RAID Controller Card User Guide.</p> <p>NOTE If the BIOS is in legacy mode, the 4K drive cannot be used as the boot drive.</p>
Network	<p>Supports expansion capability of multiple types of networks.</p> <ul style="list-style-type: none"> • OCP 3.0 network adapter <ul style="list-style-type: none"> – The two FlexIO card slots support two OCP 3.0 network adapter respectively, which can be configured as required. – Supports orderly hot swap. <p>NOTE The OCP 3.0 network adapter supports orderly hot swap only when the VMD function is disabled.</p> <ul style="list-style-type: none"> – Supports a variety of OCP 3.0 network adapters. For details, see "Search Parts" in the Compatibility Checker.
I/O expansion	<p>Supports 6 PCIe slots.</p> <ul style="list-style-type: none"> • One PCIe slot dedicated for a screw-in RAID controller card, two FlexIO slots dedicated for OCP 3.0 network adapters, and three PCIe slots for standard PCIe cards. <p>For details, see 5.7.2 PCIe Slots and 5.7.3 PCIe Slot Description.</p> <ul style="list-style-type: none"> • Support GPU cards. <p>NOTE The preceding information is for reference only. For details, see "Search Parts" in the Compatibility Checker.</p>
Port	<p>Supports a variety of ports.</p> <ul style="list-style-type: none"> • Ports on the front panel: <ul style="list-style-type: none"> – One USB Type-C iBMC direct connect management port

Component	Specifications
	<ul style="list-style-type: none"> - Two USB 3.0 ports - One DB15 VGA port <p>NOTE The front panel of a server with 10 x 2.5" drives provides only one USB Type-C iBMC direct connect management port and one USB 3.0 port.</p> <ul style="list-style-type: none"> • Ports on the rear panel: <ul style="list-style-type: none"> - Two USB 3.0 ports - One DB15 VGA port - One RJ45 serial port - One RJ45 management network port • Built-in ports: <ul style="list-style-type: none"> - Two SATA ports <p>NOTE You are not advised to install the operating system on the USB storage media.</p>
Video card	<p>An SM750 video chip with 32 MB display memory is integrated on the mainboard. The maximum display resolution is 1920 x 1200 at 60 Hz with 16 M colors.</p> <p>NOTE</p> <ul style="list-style-type: none"> • The integrated video card can provide the maximum display resolution (1920 x 1200) only after the video card driver matching the operating system version is installed. Otherwise, only the default resolution supported by the operating system is provided. • If both the front and rear VGA ports are connected to monitors, only the monitor connected to the front VGA port displays information.
System management	<ul style="list-style-type: none"> • UEFI • iBMC • NC-SI • Integration with third-party management systems
Security feature	<ul style="list-style-type: none"> • Power-on password • Administrator password • TCM (only in China)/TPM • Secure boot • Front bezel (optional) • Chassis cover opening detection

6.2 Environmental Specifications

Table 6-2 Environmental specifications

Category	Specifications
Temperature	<ul style="list-style-type: none"> Operating temperature: 5°C to 45°C (41°F to 113°F) (ASHRAE Classes A1 to A4 compliant) Storage temperature (within three months): -30°C to +60°C (-22°F to 140°F) Storage temperature (within six months): -15°C to +45°C (5°F to 113°F) Storage temperature (within one year): -10°C to +35°C (14°F to 95°F) Maximum rate of temperature change: 20°C (36°F) per hour, 5°C (9°F) per 15 minutes <p>NOTE The highest operating temperature varies depending on the server configuration. For details, see A.3 Operating Temperature Limitations.</p>
Relative humidity (RH, non-condensing)	<ul style="list-style-type: none"> Operating humidity: 8% to 90% Storage humidity (within three months): 8% to 85% Storage humidity (within six months): 8% to 80% Storage humidity (within one year): 20% to 75% Maximum humidity change rate: 20%/h
Air volume	≥ 96 cubic feet per minute (CFM)
Operating altitude	≤ 3050 m (10006.44 ft) <ul style="list-style-type: none"> When the server configuration complies with ASHRAE Classes A1 and A2 and the altitude is above 900 m (2952.76 ft), the highest operating temperature decreases by 1°C (1.8°F) for every increase of 300 m (984.24 ft). When the server configuration complies with ASHRAE Class A3 and the altitude is above 900 m (2952.76 ft), the highest operating temperature decreases by 1°C (1.8°F) for every increase of 175 m (574.14 ft). When the server configuration complies with ASHRAE Class A4 and the altitude is above 900 m (2952.76 ft), the highest operating temperature decreases by 1°C (1.8°F) for every increase of 125 m (410.1 ft). HDDs cannot be used at an altitude of over 3050 m (10006.44 ft).
Corrosive gaseous contaminant	Maximum corrosion product thickness growth rate: <ul style="list-style-type: none"> Copper corrosion rate test: 300 Å/month (meeting level G1 requirements of the ANSI/ISA-71.04-2013 standard on gaseous corrosion) Silver corrosion rate test: 200 Å/month
Particle contaminant	<ul style="list-style-type: none"> The equipment room environment meets the requirements

Category	Specifications
	of ISO 14664-1 Class 8. <ul style="list-style-type: none"> There is no explosive, conductive, magnetic, or corrosive dust in the equipment room. <p>NOTE It is recommended that the particulate pollutants in the equipment room be monitored by a professional organization.</p>
Acoustic noise	The declared A-weighted sound power levels (LWAd) and declared average bystander position A-weighted sound pressure levels (LpAm) listed are measured at 23°C (73.4°F) in accordance with ISO 7779 (ECMA 74) and declared in accordance with ISO 9296 (ECMA 109). <ul style="list-style-type: none"> Idle: <ul style="list-style-type: none"> LWAd: 6.2 Bels LpAm: 45.3 dBA Operating: <ul style="list-style-type: none"> LWAd: 6.97 Bels LpAm: 52.6 dBA <p>NOTE Actual sound levels generated during server operation vary depending on server configuration, load, and ambient temperature.</p>

 **NOTE**

SSDs and HDDs (including NL-SAS, SAS, and SATA) cannot be preserved for a long time in the power-off state. Data may be lost or faults may occur if the preservation duration exceeds the specified maximum duration. When drives are preserved under the storage temperature and humidity specified in the preceding table, the following preservation time is recommended:

- Maximum preservation duration of SSDs:
 - 12 months in power-off state without data stored
 - 3 months in power-off state with data stored
- Maximum preservation duration of HDDs:
 - 6 months in unpacked/packed and powered-off state
- The maximum preservation duration is determined according to the preservation specifications provided by drive vendors. For details, see the manuals provided by drive vendors.

6.3 Physical Specifications

Table 6-3 Physical specifications

Item	Description
Dimensions (H x W x D)	<ul style="list-style-type: none"> 3.5" drive chassis: 43.5 mm x 447 mm x 790 mm (1.71 in. x 17.60 in. x 31.10 in.) 2.5" drive chassis: 43.5 mm x 447 mm x 790 mm (1.71 in. x 17.60 in. x 31.10 in.)

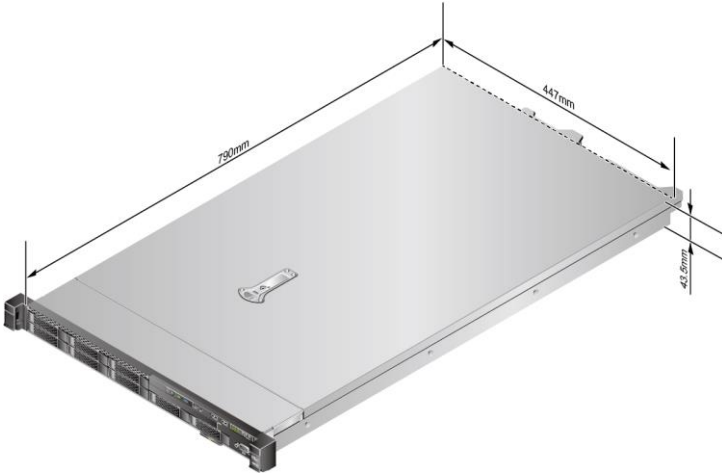
Item	Description
	<p>Figure 6-1 Physical dimensions (example: 2.5" drive chassis)</p>  <p>NOTE</p> <ul style="list-style-type: none"> • See Figure 6-1 for methods in measuring physical dimensions of the chassis. • Methods measuring 3.5" and 2.5" drive chassis are the same. The 2.5" drive chassis is used as an example.
<p>Installation dimension requirements</p>	<ul style="list-style-type: none"> • Requirements for cabinet installation: Cabinet compliant with the International Electrotechnical Commission (IEC) 297 standard <ul style="list-style-type: none"> - Cabinet width: 482.6 mm (19.00 in.) - Cabinet depth ≥ 1000 mm (39.37 in.) • Requirements for guide rail installation: <ul style="list-style-type: none"> - L-shaped guide rails: apply only to our company's cabinets. - Static rail kit: applies to cabinets with a distance of 610 mm to 950 mm (24.02 in. to 37.40 in.) between the front and rear mounting bars. - Ball bearing rail kit: applies to cabinets with a distance of 609 mm to 950 mm (23.98 in. to 37.40 in.) between the front and rear mounting bars.
<p>Fully equipped weight</p>	<ul style="list-style-type: none"> • Net weight <ul style="list-style-type: none"> - Maximum weight for server with 4 x 3.5" drives: 20.5 kg (45.19 lb) - Maximum weight for server with 8 x 2.5" drives: 18.0 kg (39.68 lb) - Maximum weight for server with 10 x 2.5" drives: 18.5 kg (40.79 lb) • Packaging materials: 5 kg (11.03 lb)

Item	Description
Energy consumption	The power consumption parameters vary with hardware configurations (including the configurations complying with EU ErP). Use the Power Calculator to obtain specific information.

7 Software and Hardware Compatibility

Use the [Compatibility Checker](#) to obtain information about the operating systems and hardware supported.

NOTICE

- If incompatible components are used, the device may be abnormal. This fault is beyond the scope of technical support and warranty.
 - The performance of servers is closely related to application software, basic middleware software, and hardware. The slight differences of the application software, middleware basic software, and hardware may cause performance inconsistency between the application layer and test software layer.
 - If the customer has requirements on the performance of specific application software, contact technical support to apply for POC tests in the pre-sales phase to determine detailed software and hardware configurations.
 - If the customer has requirements on hardware performance consistency, specify the specific configuration requirements (for example, specific drive models, RAID controller cards, or firmware versions) in the pre-sales phase.
-

8 Safety Instructions

[8.1 Security](#)

[8.2 Maintenance and Warranty](#)

8.1 Security

General Statement

- Comply with local laws and regulations when installing devices. These Safety Instructions are only a supplement.
- The "DANGER", "WARNING", and "CAUTION" information in this document does not represent all the safety instructions, but supplements to the safety instructions.
- Observe all safety instructions provided on the device labels when installing hardware. Follow them in conjunction with these Safety Instructions.
- Only qualified personnel are allowed to perform special tasks, such as performing high-voltage operations and driving a forklift.



If this device works in a residential environment, the wireless interference may be generated.

Personal Safety

- Only personnel certified or authorized are allowed to install equipment.
- Discontinue any dangerous operations and take protective measures. Report anything that could cause personal injury or device damage to a project supervisor.
- Do not move devices or install racks and power cables in hazardous weather conditions.
- Do not carry the weight that is over the maximum load per person allowed by local laws or regulations. Before moving or installing equipment, check the maximum equipment weight and arrange required personnel.
- Wear clean protective gloves, ESD clothing, a protective hat, and protective shoes, as shown in Figure 8-1.

Figure 8-1 Safety work wear

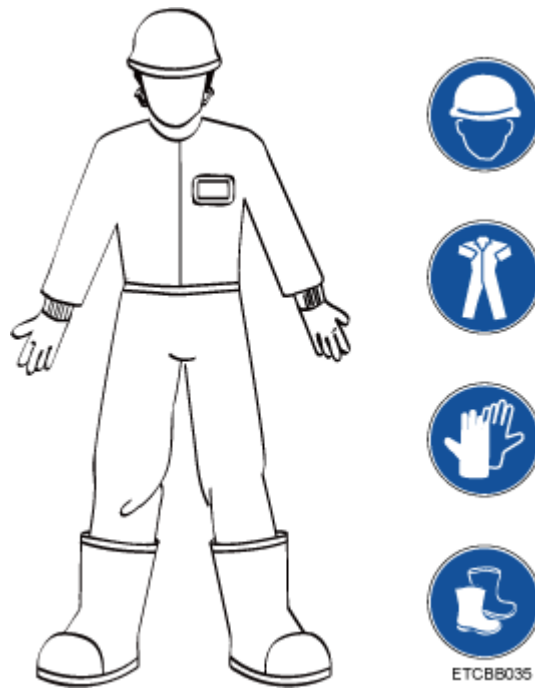

- Before touching a device, wear ESD clothing and gloves (or wrist strap), and remove any conductive objects (such as watches and jewelry). Figure 8-2 shows conductive objects that must be removed before you touch a device.

Figure 8-2 Removing conductive objects



Figure 8-3 shows how to wear an ESD wrist strap.

- Put your hands into the ESD wrist strap.
- Tighten the strap buckle and ensure that the ESD wrist strap is in contact with your skin.
- Insert the ground terminal attached to the ESD wrist strap into the jack on the grounded rack or chassis.

Figure 8-3 Wearing an ESD wrist strap

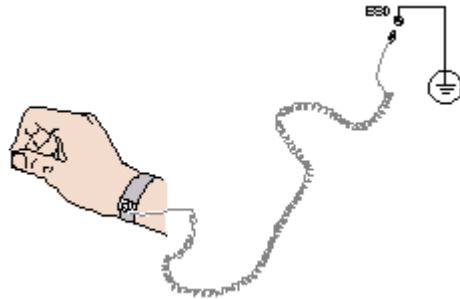

- Exercise caution when using tools.
- If the installation position of a device is higher than the shoulders of the installation personnel, use a vehicle such as a lift to facilitate installation. Prevent the device from falling down and causing personal injury or damage to the device.
- The equipment is powered by high-voltage power sources. Direct or indirect contact (especially through damp objects) with high-voltage power sources may result in serious injury or death.
- Ground the equipment before powering it on. Otherwise, personal injury may be caused by high electricity leakage.
- When a ladder is used, ensure that another person holds the ladder steady to prevent accidents.
- Do not look into optical ports without eye protection.

Device Security

- Use the recommended power cables at all times.
- Use power cables only for dedicated servers. Do not use them for other devices.
- Before operating equipment, wear ESD clothes and gloves to prevent electrostatic-sensitive devices from being damaged by ESD.
- When moving a device, hold the bottom of the device. Do not hold the handles of the installed modules, such as the PSUs, fan modules, drives, and the mainboard. Handle the equipment with care.
- Exercise caution when using tools.
- Connect the primary and secondary power cables to different power distribution units (PDUs) to ensure reliable system operation.
- Ground a device before powering it on. Otherwise, high leakage current may cause device damage.

Transportation Precautions

Improper transportation may damage equipment. Contact the manufacturer for precautions before attempting transportation.

Transportation precautions include but are not limited to:

- The logistics company engaged to transport the device must be reliable and comply with international standards for transporting electronics. Ensure that the equipment being transported is always kept upright. Take necessary precautions to prevent collisions, corrosion, package damage, damp conditions and pollution.

- Transport each device in its original packaging.
- If the original packaging is unavailable, package heavy, bulky parts (such as chassis and blades) and fragile parts (such as PCIe cards and optical modules) separately.

 **NOTE**

For details about the components supported by the server, see "Compatibility" in the [Compatibility Checker](#).

- Power off all devices before transportation.

Maximum Weight Carried by a Person

 **CAUTION**

Comply with local regulations for the maximum load per person.

Table 8-1 lists the maximum weight one person is permitted to carry as stipulated by a number of organizations.

Table 8-1 Maximum weight carried per person

Organization	Weight (kg/lb)
European Committee for Standardization (CEN)	25/55.13
International Organization for Standardization (ISO)	25/55.13
National Institute for Occupational Safety and Health (NIOSH)	23/50.72
Health and Safety Executive (HSE)	25/55.13

For more information about safety instructions, see [Server Safety Information](#).

8.2 Maintenance and Warranty

For details about the maintenance policy, visit [Customer Support Service](#).

For details about the warranty policy, visit [Warranty](#).

9 System Management

This product integrates the new-generation Intelligent Baseboard Management Controller (iBMC), which complies with Intelligent Platform Management Interface 2.0 (IPMI 2.0) specifications and provides reliable hardware monitoring and management.

The iBMC provides the following features:

- Various management interfaces
The iBMC provides the following standard interfaces to meet various system integration requirements:
 - DCMI 1.5 interface
 - IPMI 1.5/IPMI 2.0 interface
 - CLI
 - Redfish interface
 - HTTPS
 - SNMP
- Fault detection and alarm management
Faults can be detected and rectified in advance to ensure 24/7 stable running of the device.
 - The iBMC allows screenshots and videos to be created when the system breaks down, facilitating cause analysis of the system breakdown.
 - The iBMC offers screen snapshots and videos, simplifying routine preventive maintenance, recording, and auditing.
 - The FDM function supports component-based precise fault diagnosis, facilitating component fault locating and replacement.
 - The iBMC supports the reporting of alarms through syslog packets, trap packets, and emails, helping the upper-layer NMS to collect the fault information about the server.
- Security management
 - Software image backup improves system security. Even if the running software breaks down, the system can be started from the backup image.
 - Diversified user security control interfaces are provided to ensure user login security.
 - Multiple types of certificates can be imported and replaced to ensure data transmission security.

- System maintenance interface
 - The virtual KVM and virtual media functions facilitate remote maintenance.
 - The iBMC supports out-of-band RAID monitoring and configuration to improve RAID configuration efficiency and management capabilities.
 - Smart Provisioning provides a convenient operation interface for installing the OS, configuring RAID, and performing the upgrade without a CD-ROM.
- Various network protocols
 - The NTP synchronizes network time to optimize time configuration.
 - The iBMC supports domain name system (DNS) and Lightweight Directory Application Protocol (LDAP) to implement domain management and directory service.
- Intelligent power management
 - The power capping technology helps you easily improve deployment density.
 - The iBMC uses dynamic power saving to reduce operational expenditure (OPEX).
- License management

By managing licenses, you can use the features of the iBMC advanced edition in authorization mode.

Compared with the standard edition, the iBMC advanced edition provides more advanced features, such as:

 - Implements the OS deployment using Redfish.
 - Collect the original data of intelligent diagnosis using Redfish.

10 Certifications

Country/Region	Certification	Standards
Europe	WEEE	2012/19/EU
Europe	REACH	EC NO. 1907/2006
Europe	CE	Safety: EN 62368-1:2014+A11:2017 EMC: EN 55032:2015+A11:2020 CISPR 32:2015+A1:2019 EN IEC 61000-3-2:2019+A1:2021 EN 61000-3-3:2013+A1:2019 EN 55035:2017+A11:2020 CISPR 35:2016 EN 55024:2010+A1:2015 CISPR 24:2010+A1:2015 ETSI EN 300 386 V1.6.1:2012 ETSI EN 300 386 V2.1.1:2016 RoHS: EN IEC 63000:2018 ErP: Commission Regulation(EU) 424/2019
Russia	EAC&GOST	GOCT CISPR 32-2015 GOCT CISPR 24-2013 GOCT 30804 3.2-2013 GOCT 30804 3.3-2013 GOCT 15150-69
UK	UKCA	Safety: EN 62368-1:2014+A11:2017 EMC:

Country/Region	Certification	Standards
		EN 55032:2015+A11:2020 CISPR 32:2015+A1:2019 EN IEC 61000-3-2:2019+A1:2021 EN 61000-3-3:2013+A1:2019 EN 55035:2017+A11:2020 CISPR 35:2016 EN 55024:2010+A1:2015 CISPR 24:2010+A1:2015 ETSI EN 300 386 V1.6.1:2012 ETSI EN 300 386 V2.1.1:2016 RoHS: BS EN IEC 63000:2018 ErP: Commission Regulation(EU) 424/2019
China	CCC	GB 17625.1-2012 GB 4943.1-2011 GB/T 9254.1-2021
China	RoHS	SJ/T-11364 GB/T 26572
North America	NRTL	UL 62368-1:2014 CAN/CSA-C22.2 NO.62368-1-14
US	FCC	FCC PART 15
Canada	IC	ICES-003
Japan	VCCI	VCCI 32-1
Global	CB	IEC 62368-1:2014

A Appendix

A.1 Chassis Label

NOTE

The label information and location are for reference only. For details, see the actual product.

A.1.1 On the Front Top

Figure A-1 Chassis head label

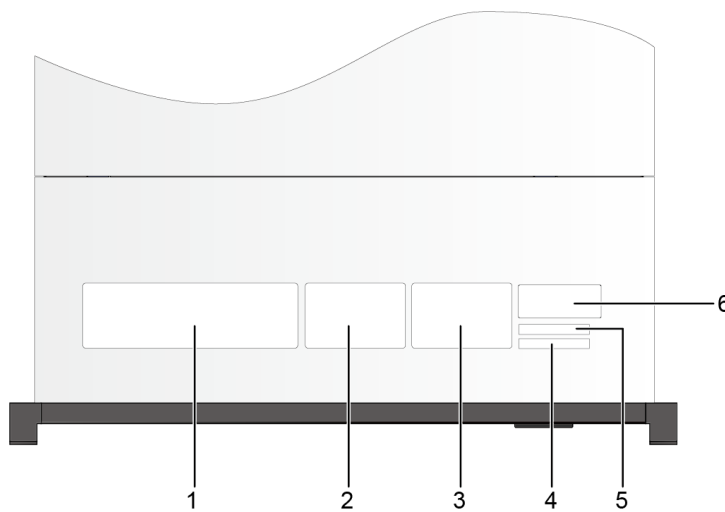

1	Nameplate	2	Certificate
3	Quick access tag	4	SN NOTE For details, see A.2 Product SN.
5	Reserved space for custom label	6	Pressure-proof label NOTE This label indicates that do not place any objects on top of a rack-mounted

			device.
--	--	--	---------

A.1.1.1 Nameplate

Figure A-2 Nameplate example

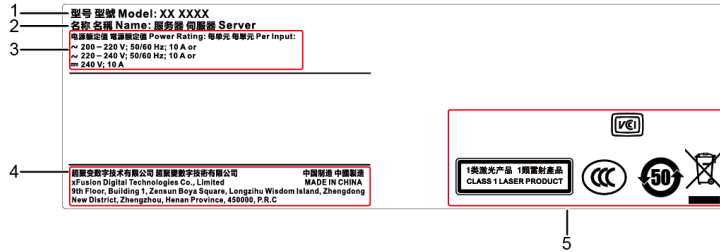

Table A-1 Nameplate description

No.	Description
1	Server Model For details, see A.4 Nameplate .
2	Device names
3	Power Supply Requirements
4	Vendor Information
5	Authentication ID

A.1.1.2 Certificate

Figure A-3 Sample certificate of conformity



Table A-2 Certificate of conformity description

No.	Description
1	Order
2	No. NOTE For details, see Figure A-4 and Table A-3.
3	QC inspector
4	Production date
5	No. Barcode

Figure A-4 Sample certificate number

PZY0224SL0B-00019

1 2 3 4 5 6 7 8 9 10

Table A-3 Certificate No. Description

No.	Description
1	"P", fixed
2	"Z", fixed
3	<ul style="list-style-type: none"> Y: Server B: Semi-finished product of the whole machine. N: Loose spare parts
4	"0", Reserved bit.
5	Year (2 digits).
6	Month (1 digit). <ul style="list-style-type: none"> Digits 1 to 9 indicate January to September, respectively. Letters A to C indicate October to December, respectively.
7	Day (1 digit). <ul style="list-style-type: none"> Digits 1 to 9 indicate the 1st to 9th Letters A to H indicate the 10th to 17th. Letters J to N indicate the 18th to 22nd. Letters P to Y indicate the 23rd to 31st
8	Hour (1 digit). <ul style="list-style-type: none"> Digits 0 to 9 indicate 0 to 9:00.

No.	Description
	<ul style="list-style-type: none"> • Letters A to H indicate 10 to 17:00. • Letters J to N indicate 18 to 22:00. • Letters P to Q indicate 23 to 24:00.
9	Serial number (2 digits)
10	Manufacturing serial number (5 digits).

A.1.1.3 Sample Quick Access Tags

Figure A-5 Sample quick access tags

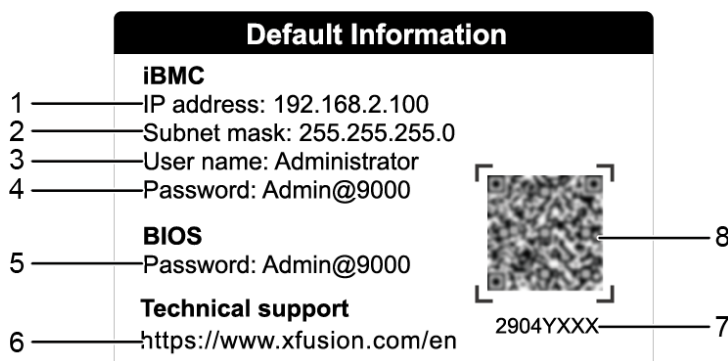
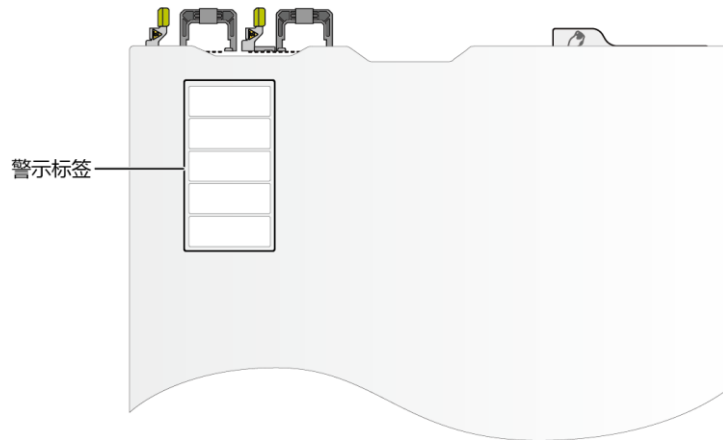

Table A-4 Quick access tab description

No.	Description
1	IP address of the iBMC management network port
2	Subnet mask of the iBMC management network port
3	Default iBMC user name
4	Default iBMC password
5	Default BIOS password
6	Technical support website
7	P/N Code
8	QR Code NOTE Scan the QR code to obtain technical support resources.

A.1.2 Chassis Tail Label

Figure A-6 Chassis tail label



NOTE

For details about the warning label, see [Server Security Information](#).

A.1.3 Chassis Internal Label

Figure A-7 Chassis internal label



NOTE

- The quick guide is located on the inside of the chassis cover. It describes how to remove the mainboard components, important components of the chassis, precautions, and QR codes of technical resources. The pictures are for reference only. For details, see the actual product.
- The quick guide is optional. For details, see the actual product.

A.2 Product SN

The serial number (SN) on the slide-out label plate uniquely identifies a device. The SN is required when you contact technical support.

Figure A-8 SN example



Table A-5 SN description

No.	Description
1	ESN ID (two characters), which can only be 21 .
2	Material ID (eight characters), that is, the processing code.
3	Vendor code (two characters), that is, the code of the processing place.
4	<p>Year and month (two characters).</p> <ul style="list-style-type: none"> The first character indicates the year. <ul style="list-style-type: none"> Digits 1 to 9 indicate years 2001 to 2009, respectively. Letters A to H indicate years 2010 to 2017, respectively. Letters J to N indicate years 2018 to 2022, respectively. Letters P to Y indicate years 2023 to 2032, respectively. <p>NOTE The years from 2010 are represented by upper-case letters excluding I, O, and Z because the three letters are similar to the digits 1, 0, and 2.</p> <ul style="list-style-type: none"> The second character indicates the month. <ul style="list-style-type: none"> Digits 1 to 9 indicate January to September, respectively. Letters A to C indicate October to December, respectively.
5	Serial number (six digits).
6	RoHS compliance (one character). Y indicates RoHS compliant.
7	Internal model, that is, product name.

A.3 Operating Temperature Limitations

Table A-6 Operating temperature limitations

Configuration	Maximum Operating Temperature 30°C (86°F)	Maximum Operating Temperature 35°C (95°F)	Maximum Operating Temperature 40°C (104°F)	Maximum Operating Temperature 45°C (113°F)
4 x 3.5-inch drive pass-through	<ul style="list-style-type: none"> 6334/6342/6346/6348/6354/8358P/83 	<ul style="list-style-type: none"> Rear drives (including HDD/SSD/ 	<ul style="list-style-type: none"> 5320/6312U/6326/6334/6336Y/6342 	<ul style="list-style-type: none"> Only 4309Y/4310/4310T/4314

Configuration	Maximum Operating Temperature 30°C (86°F)	Maximum Operating Temperature 35°C (95°F)	Maximum Operating Temperature 40°C (104°F)	Maximum Operating Temperature 45°C (113°F)
configuration	51N/8358/8360Y/8362/8368/8380 processors are not supported.	<p>M.2) are not supported.</p> <ul style="list-style-type: none"> 6334/6342/6346/6348/6354/8358P/8351N/8358/8360Y/8362/8368/8380 processors are not supported. PMem of 512 GB per module is not supported. 	<p>/6314U/6330/6330N/6338/6338N/6346/6348/6354/8351N/8352V/8352S/8352Y/8358/8358P/8360Y/8362/8368/8380 processors are not supported.</p> <ul style="list-style-type: none"> DDR4/PMem memory modules whose capacity is 256 GB per module or larger are not supported. Rear drives (including HDD/SSD/M.2) are not supported. GPU cards are not supported. IB cards are not supported. CX5/CX6 NICs are not supported. OCP 3.0 network adapters with 25Gbit/s rate or higher are not supported. 	<p>processors are supported.</p> <ul style="list-style-type: none"> DDR4/PMem memory modules whose capacity is 128 GB per module or larger are not supported. Rear drives (including HDD/SSD/M.2) are not supported. GPU cards are not supported. IB cards are not supported. CX5/CX6 NICs are not supported. OCP 3.0 network adapters are not supported. NICs whose rate is greater than 25 Gbit/s are not supported. 9460-16i RAID controller cards are not supported.
8 x 2.5-inch	<ul style="list-style-type: none"> All options 	<ul style="list-style-type: none"> Rear drives 	<ul style="list-style-type: none"> 5320/6312U 	<ul style="list-style-type: none"> Only

Configuration	Maximum Operating Temperature 30°C (86°F)	Maximum Operating Temperature 35°C (95°F)	Maximum Operating Temperature 40°C (104°F)	Maximum Operating Temperature 45°C (113°F)
drive pass-through configuration	supported.	(including HDD/SSD/M.2) are not supported. <ul style="list-style-type: none"> • PMem memory modules whose capacity is 512 GB per module or larger are not supported. 	/6326/6334/6336Y/6342/6314U/6330/6330N/638/6338N/6346/6348/6354/8351N/8352V/8352S/8352Y/8358/8358P/8360Y/8362/8368/8380 processors are not supported. <ul style="list-style-type: none"> • DDR4/PMem memory modules whose capacity is 256 GB per module or larger are not supported. • Rear drives (including HDD/SSD/M.2) are not supported. • GPU cards are not supported. • IB cards are not supported. • CX5/CX6 NICs are not supported. • OCP 3.0 network adapters with ports of 25 GE or higher rate are not supported. 	4309Y/4310/4310T/4314 processors are supported. <ul style="list-style-type: none"> • DDR4/PMem memory modules whose capacity is 128 GB per module or larger are not supported. • Rear drives (including HDD/SSD/M.2) are not supported. • GPU cards are not supported. • IB cards are not supported. • CX5/CX6 NICs are not supported. • OCP 3.0 network adapters are not supported. • NICs whose rate is greater than 25 Gbit/s are not supported. • 9460-16i RAID controller cards are not supported.

Configuration	Maximum Operating Temperature 30°C (86°F)	Maximum Operating Temperature 35°C (95°F)	Maximum Operating Temperature 40°C (104°F)	Maximum Operating Temperature 45°C (113°F)
10 x 2.5-inch drive pass-through configuration	<ul style="list-style-type: none"> All options supported. 	<ul style="list-style-type: none"> Rear drives (including HDD/SSD/M.2) are not supported. PMem memory modules whose capacity is 512 GB per module or larger are not supported. 	<ul style="list-style-type: none"> 5320/6312U /6326/6334/6336Y/6342 /6314U/6330/6338/6338N/6346/6348/6354/8351N/8352V/8352S/8352Y/8358/8358P/8360Y/8362/8368/8380 processors are not supported. DDR4/PMem memory modules whose capacity is 256 GB per module or larger are not supported. Rear drives (including HDD/SSD/M.2) are not supported. GPU cards are not supported. IB cards are not supported. CX5/CX6 NICs are not supported. OCP 3.0 network adapters with 25Gbit/s rate or higher are 	<ul style="list-style-type: none"> Only 4309Y/4310 /4310T/4314 processors are supported. DDR4/PMem memory modules whose capacity is 128 GB per module or larger are not supported. Rear drives (including HDD/SSD/M.2) are not supported. GPU cards are not supported. IB cards are not supported. CX5/CX6 NICs are not supported. OCP 3.0 network adapters are not supported. NICs whose rate is greater than 25 Gbit/s are not supported. 9460-16i RAID controller cards are not supported.

Configuration	Maximum Operating Temperature 30°C (86°F)	Maximum Operating Temperature 35°C (95°F)	Maximum Operating Temperature 40°C (104°F)	Maximum Operating Temperature 45°C (113°F)
			not supported.	
10 x 2.5-inch NVMe drive configuration	<ul style="list-style-type: none"> All options supported. 	<ul style="list-style-type: none"> 6334/6342/6348/6346/6354/8358P/8351N/8358/8360Y/8362/8368/8380 processors are not supported. Memory of 256 GB per module or larger DDR4/PMem are not supported. Rear drives (including HDD/SSD/M.2) are not supported. GPU cards are not supported. IB cards are not supported. CX5/CX6 NICs are not supported. OCP 3.0 network adapters with 25Gbit/s rate or higher are not supported. 	<ul style="list-style-type: none"> Not supported. 	<ul style="list-style-type: none"> Not supported.

 **NOTE**

- When a single fan is faulty, the highest operating temperature is 5°C (9°F) lower than the rated value.

- When a single fan is faulty, the system performance may be affected.
- When memory modules of 256 GB per module or larger or 6342/6348/6346/6354/8352V/8352S/8352Y/8358P/8351N/8358/8360Y/8368/8380 processors are configured, rear GPU cards, rear drives (including HDDs, SSDs, and M.2), IB cards, or OCP 3.0 network adapters with 25Gbit/s rate or higher are not supported.
- It is recommended that servers be deployed at an interval of 1 U to reduce server noise and improve server energy efficiency.
- The server does not support 8368Q 38c 270 W 2.6 GHz liquid-cooled processors.

A.4 Nameplate

Certified Model	Usage Restrictions
H12H-06	Global

A.5 RAS Features

The server supports a variety of Reliability, Availability, and Serviceability (RAS) features. You can configure these features for better performance.

For details about the RAS features, see *FusionServer Ice Lake Platform RAS Technical White Paper*.

A.6 Sensor List

Sensor	Description	Component
Inlet Temp	Air inlet temperature	Indicator board
Outlet Temp	Air outlet temperature	BMC card
PCH Temp	PCH bridge temperature	Mainboard
CPUN Core Rem	CPU core temperature	CPUN N indicates the CPU number. The value is 1 or 2 .
CPUN DTS	Difference between the real-time CPU temperature and the core CPU temperature threshold	CPUN N indicates the CPU number. The value is 1 or 2 .
CPUN Margin	Difference between the real-time CPU temperature and the CPU Tcontrol threshold	CPUN N indicates the CPU number. The value is 1 or 2 .
CPUN VDDQ Temp	CPU VDDQ temperature	Mainboard N indicates the CPU number. The value ranges from 1 to 2 .
CPUN VRD Temp	CPU VRD temperature	Mainboard

Sensor	Description	Component
		<i>N</i> indicates the CPU number. The value is 1 or 2 .
CPUN MEM Temp	CPU memory module temperature	Memory module corresponding to CPU <i>N</i> <i>N</i> indicates the CPU number. The value is 1 or 2 .
CPUN 12V	12 V voltage supplied by the mainboard to the CPU	Mainboard <i>N</i> indicates the CPU number. The value is 1 or 2 .
Riser 12V	12 V voltage supplied by the mainboard to the riser card	Mainboard
Disk BP 12V	12 V voltage supplied by the mainboard to the drive backplane	Mainboard
CPUN DDR VDDQ	1.2 V memory module voltage	Mainboard <i>N</i> indicates the CPU number. The value is 1 or 2 .
CPUN DDR VDDQ2	1.2 V memory module voltage	Mainboard <i>N</i> indicates the CPU number. The value is 1 or 2 .
CPUN VCCIN	CPU VCCIN voltage	Mainboard <i>N</i> indicates the CPU number. The value is 1 or 2 .
CPUN VSA	CPU VSA voltage	Mainboard <i>N</i> indicates the CPU number. The value is 1 or 2 .
CPUN P1V8	CPU P1V8 voltage	Mainboard <i>N</i> indicates the CPU number. The value is 1 or 2 .
CPUN VCCIO	CPU VCCIO voltage	Mainboard <i>N</i> indicates the CPU number. The value is 1 or 2 .
CPUN VCCANA	CPU VCCANA voltage	Mainboard <i>N</i> indicates the CPU number. The value is 1 or 2 .
FAN <i>N</i> F Speed	Fan speed	Fan module <i>N</i>
FAN <i>N</i> R Speed		<i>N</i> indicates the fan module number. The value ranges from 1 to 7 .
Power	Server input power	Power supply unit (PSU)

Sensor	Description	Component
PSN VIN	PSU <i>N</i> input voltage	PSU <i>N</i> <i>N</i> indicates the PSU number. The value is 1 or 2 .
Disks Temp	Maximum drive temperature	Drive
RAID Temp	Temperature of the RAID controller card	RAID controller card
Power <i>N</i>	PSU input power	PSU <i>N</i> <i>N</i> indicates the PSU number. The value is 1 or 2 .
PCH Status	PCH chip fault diagnosis health status	Mainboard
CPUN UPI Link	CPU UPI link fault diagnosis health status	Mainboard or CPU <i>N</i> <i>N</i> indicates the CPU number. The value is 1 or 2 .
CPUN Prochot	CPU Prochot	CPUN <i>N</i> indicates the CPU number. The value is 1 or 2 .
CPUN Status	CPU status	CPUN <i>N</i> indicates the CPU number. The value is 1 or 2 .
CPUN Memory	Status of the memory corresponding to the CPU	Memory module corresponding to CPU <i>N</i> <i>N</i> indicates the CPU number. The value is 1 or 2 .
FAN <i>N</i> F Status	Fan fault status	Fan module <i>N</i> <i>N</i> indicates the fan module number. The value ranges from 1 to 7 .
FAN <i>N</i> R Status		
DIMM <i>N</i>	DIMM status	DIMM <i>N</i> <i>N</i> indicates the DIMM slot number.
RTC Battery	RTC battery status. An alarm is generated when the voltage is lower than 1 V.	RTC battery on the mainboard
PCIE Status	PCIe status error	PCIe card
Power Button	Power button pressed	Mainboard and power button
Watchdog2	Watchdog	Mainboard
Mngmnt Health	Management subsystem	Management modules

Sensor	Description	Component
	health status	
UID Button	UID button status	Mainboard
PwrOk Sig. Drop	Voltage dip status	Mainboard
PwrOn TimeOut	Power-on timeout	Mainboard
PwrCap Status	Power capping status	Mainboard
HDD Backplane	Hardware presence	Drive backplane
HDD BP Status	Drive backplane health status	Drive Backplane
Riser <i>N</i> Card	Hardware presence	Riser card <i>N</i> <i>N</i> indicates the riser card slot number. The value is 1 or 2 .
FAN <i>N</i> Presence	Fan presence	Fan module <i>N</i> <i>N</i> indicates the fan module number. The value ranges from 1 to 7 .
RAID Presence	RAID presence	RAID Controller Card
PS Redundancy	Redundancy failure due to PSU removal	Power supply unit (PSU)
RAID Status	RAID controller card health status	RAID Controller Card
RAID PCIE ERR	Health status of the RAID controller card in fault diagnosis	RAID Controller Card
RAID Card BBU	LSI SAS3106 RAID controller card BBU	RAID Controller Card
PS <i>N</i> Status	PSU status	PSU <i>N</i> <i>N</i> indicates the PSU number. The value is 1 or 2 .
PS <i>N</i> Fan Status	PSU fan fault status	PSU <i>N</i> <i>N</i> indicates the PSU number. The value is 1 or 2 .
PS <i>N</i> Temp Status	PSU presence	PSU <i>N</i> <i>N</i> indicates the PSU number. The value is 1 or 2 .
DISK <i>N</i>	Disk status	Drive <i>N</i> <i>N</i> indicates the drive slot number. The value ranges from 0 to 9 .

Sensor	Description	Component
PCIe RAID\$ Temp	Temperature of the PCIe RAID controller card	PCIe RAID controller card
M2 Temp(PCIe\$)	Maximum temperature of all M.2 drives of the RAID controller card	PCIe RAID controller card
PCIe\$ OP Temp	PCIe card optical module temperature	PCIe card
PCIe NIC\$ Temp	PCIe card chip temperature	PCIe card
PCIe FC\$ Temp	PCIe card chip temperature	PCIe card
1711 Core Temp	Core temperature of the BMC management chip	BMC card
PS\$ IIn	PSU input current	Power supply unit (PSU)
PS\$ IOOut	PSU output current	Power supply unit (PSU)
PS\$ Pout	PSU output power	Power supply unit (PSU)
PS\$ Temp	Maximum internal temperature of the PSU	Power supply unit (PSU)
PS\$ Inlet Temp	PSU air inlet temperature	Power supply unit (PSU)
AreaIntrusion	Listening to the unpacking action	Mainboard
OCP\$ OP Temp	OCP card optical module temperature	OCP 3.0 Network Adapters
OCP\$ Temp	OCP card chip temperature	OCP 3.0 Network Adapters
CPU <i>N</i> PMem Temp	CPU PMem module temperature	PMem module corresponding to CPU <i>N</i> . <i>N</i> indicates the CPU number. The value is 1 or 2 .
Riser\$ Temp	Riser card temperature	Riser cards
Disk BP\$ Temp	Drive backplane temperature	Drive Backplanes
SSD Max Temp	Maximum SSD temperature	SSD
RAID BBU Temp	RAID controller card capacitor temperature	Supercapacitor of the RAID controller card
IB\$ Temp	IB NIC temperature	IB card
SAS Cable	Entity presence	SAS cable on the mainboard
LCD Status	LCD health status	LCD
LCD Presence	LCD presence	LCD

Sensor	Description	Component
PCIe\$ Temp	PCIe card chip temperature	PCIe card
PCIe\$ Card BBU	BBU status of the PCIe RAID controller card	PCIe RAID controller card
GPU\$ Power	GPU card power	GPU cards
GPU\$ Temp	GPU temperature	GPU cards
GPU\$ MINI Temp	Mini chip temperature of the GPU card	GPU cards
GPU\$ DDR Temp	DDR chip temperature of the GPU card	GPU cards
GPU\$ HBM Temp	HBM chip temperature of the GPU card	GPU cards
CPU Usage	CPU usage.	N/A
Memory Usage	Memory usage.	
ACPI State	ACPI status	
SysFWProgress	Software process and system startup errors	
System Notice	Hot restart reminder and fault diagnosis program information collection	
System Error	System suspension or restart. Check the background logs.	
SysRestart	Cause of system restart	
Boot Error	Boot error	
BMC Boot Up	BMC startup events	
BMC Time Hopping	Time hopping	
NTP Sync Failed	NTP synchronization failure and recovery events	
SEL Status	SEL full or clearing events	
Op. Log Full	Operation log full or clearing events	
Sec. Log Full	Security log full or clearing events	
Host Loss	System monitoring software (BMA) link loss detection	
OAMPort1_\$ Link	Network port OAM link status	

Sensor	Description	Component
OAMPort2_\$ Link	Network port OAM link status	

B Glossary

B.1 A-E

B

BMC	The baseboard management controller (BMC) complies with the Intelligent Platform Management Interface (IPMI). It collects, processes, and stores sensor signals, and monitors the operating status of components. The BMC provides the hardware status and alarm information about the managed objects to the upper-level management system, so that the management system can manage the objects.
------------	--

E

ejector lever	A part on the panel of a device used to facilitate installation or removal of the device.
Ethernet	A baseband local area network (LAN) architecture developed by Xerox Corporation by partnering with Intel and DEC. Ethernet uses the Carrier Sense Multiple Access/Collision Detection (CSMA/CD) access method and allows data transfer over various cables at 10 Mbit/s. The Ethernet specification is the basis for the IEEE 802.3 standard.

B.2 F-J

G

Gigabit Ethernet (GE)	An extension and enhancement of traditional shared media Ethernet standards. It is compatible with 10 Mbit/s and 100 Mbit/s Ethernet and complies with IEEE 802.3z standards.
------------------------------	---

H

hot swap	Replacing or adding components without stopping or shutting down the system.
-----------------	--

B.3 K-O

K

KVM	A hardware device that provides public video, keyboard and mouse (KVM).
------------	---

B.4 P-T

P

panel	An external component (including but not limited to ejector levers, indicators, and ports) on the front or rear of the server. It seals the front and rear of the chassis to ensure optimal ventilation and electromagnetic compatibility (EMC).
Peripheral Component Interconnect Express (PCIe)	A computer bus PCI, which uses the existing PCI programming concepts and communication standards, but builds a faster serial communication system. Intel is the main sponsor for PCIe. PCIe is used only for internal interconnection. A PCI system can be transformed to a PCIe system by modifying the physical layer instead of software. PCIe delivers a faster speed and can replace almost all AGP and PCI buses.

R

redundancy	A mechanism that allows a backup device to automatically take over services from a faulty device to ensure uninterrupted running of the system.
redundant array of independent disks (RAID)	A storage technology that combines multiple physical drives into a logical unit for the purposes of data redundancy and performance improvement.

S

server	A special computer that provides services for clients over a network.
---------------	---

system event log (SEL)	Event records stored in the system used for subsequent fault diagnosis and system recovery.
-------------------------------	---

B.5 U-Z

U

U	A unit defined in International Electrotechnical Commission (IEC) 60297-1 to measure the height of a cabinet, chassis, or subrack. 1 U = 44.45 mm
UltraPath Interconnect (UPI)	A point-to-point processor interconnect developed by Intel.

C Acronyms and Abbreviations

C.1 A-E

A

AC	alternating current
AES	Advanced Encryption Standard New Instruction Set
ARP	Address Resolution Protocol
AVX	Advanced Vector Extensions

B

BBU	backup battery unit
BIOS	Basic Input/Output System
BMC	baseboard management controller

C

CCC	China Compulsory Certification
CD	calendar day
CE	Conformite Europeenne
CIM	Common Information Model
CLI	command-line interface

D

DC	direct current
DDR4	Double Data Rate 4
DDDC	double device data correction
DEMT	Dynamic Energy Management Technology
DIMM	dual in-line memory module
DRAM	dynamic random-access memory
DVD	digital video disc

E

ECC	error checking and correcting
ECMA	European Computer Manufacturer Association
EDB	Execute Disable Bit
EN	European Efficiency
ERP	enterprise resource planning
ETS	European Telecommunication Standards

C.2 F-J

F

FB-DIMM	Fully Buffered DIMM
FC	Fiber Channel
FCC	Federal Communications Commission
FCoE	Fibre Channel over Ethernet
FTP	File Transfer Protocol

G

GE	Gigabit Ethernet
GPIO	General Purpose Input/Output
GPU	graphics processing unit

H

HA	high availability
HDD	hard disk drive
HPC	high-performance computing
HTTP	Hypertext Transfer Protocol
HTTPS	Hypertext Transfer Protocol Secure

I

iBMC	intelligent baseboard management controller
IC	Industry Canada
ICMP	Internet Control Message Protocol
IDC	Internet Data Center
IEC	International Electrotechnical Commission
IEEE	Institute of Electrical and Electronics Engineers
IGMP	Internet Group Message Protocol
IOPS	input/output operations per second
IP	Internet Protocol
IPC	Intelligent Power Capability
IPMB	Intelligent Platform Management Bus
IPMI	Intelligent Platform Management Interface

C.3 K-O

K

KVM	keyboard, video, and mouse
------------	----------------------------

L

LC	Lucent Connector
-----------	------------------

LRDIMM	load-reduced dual in-line memory module
LED	light emitting diode
LOM	LAN on motherboard

M

MAC	media access control
MMC	module management controller

N

NBD	next business day
NC-SI	Network Controller Sideband Interface

O

OCP	Open Compute Project
------------	----------------------

C.4 P-T

P

PCIe	Peripheral Component Interconnect Express
PDU	power distribution unit
PHY	physical layer
PMBUS	power management bus
POK	Power OK
PWM	pulse-width modulation
PXE	Preboot Execution Environment

R

RAID	redundant array of independent disks
-------------	--------------------------------------

RAS	reliability, availability and serviceability
RDIMM	registered dual in-line memory module
REACH	Registration Evaluation and Authorization of Chemicals
RJ45	registered jack 45
RoHS	Restriction of the Use of Certain Hazardous Substances in Electrical and Electronic Equipment

S

SAS	Serial Attached Small Computer System Interface
SATA	Serial Advanced Technology Attachment
SCM	supply chain management
SDDC	single device data correction
SERDES	serializer/deserializer
SGMII	serial gigabit media independent interface
SMI	serial management interface
SMTP	Simple Mail Transfer Protocol
SNMP	Simple Network Management Protocol
SOL	serial over LAN
SONCAP	Standards Organization of Nigeria-Conformity Assessment Program
SSD	solid-state drive
SSE	Streaming SIMD Extension

T

TACH	tachometer signal
TBT	Turbo Boost Technology
TCG	Trusted Computing Group
TCM	trusted cryptography module
TCO	total cost of ownership
TDP	thermal design power
TELNET	Telecommunication Network Protocol

TET	Trusted Execution Technology
TFM	TransFlash module
TFTP	Trivial File Transfer Protocol
TOE	TCP offload engine
TPM	trusted platform module

C.5 U-Z

U

UDIMM	unbuffered dual in-line memory module
UEFI	Unified Extensible Firmware Interface
UID	unit identification light
UL	Underwriter Laboratories Inc.
UPI	UltraPath Interconnect
USB	Universal Serial Bus

V

VCCI	Voluntary Control Council for Interference by Information Technology Equipment
VGA	Video Graphics Array
VLAN	virtual local area network
VRD	voltage regulator-down

W

WEEE	waste electrical and electronic equipment
WSMAN	Web Service Management