



AGI Industries

PUMPS  
HYDRAULICS  
PACKAGED SYSTEMS

PUMPS  
FOR  
INDUSTRY



HISTORY OF AGI INDUSTRIES

AGI Industries was founded in 1968 as Al George Inc., a fluid power service and repair company. The company expanded to include pump distribution, packaged pumps systems and the manufacture of high pressure triplex pumps and related components. The company formally became AGI Industries in 1998. Today AGI Industries consists of three divisions, AGI Industries, AGI Packaged Pump Systems and Hydroplex. AGI Industries is expanding in a controlled manner that allows us to recruit, train and retain the best employees in the industry. AGI Industries' corporate office is located in Lafayette, Louisiana with branches in Lake Charles, Marrero, Baton Rouge and Houston, Texas.

MARKETS SERVED

- Food and Beverage
  - Sugar and Syrup Mills
  - Canning and Processing
  - Bottling
- Process Industries
  - HPI – Hydrocarbon Processing Industries
  - CPI – Chemical Processing Industries
  - Bio Fuels
- Oil and Gas
  - Production
  - Transmission
  - Terminals
- Marine
- Pulp, Paper and Wood Products
- Industrial Manufacturing Plants
- Metals and Materials
- General Industrial

QUALITY PRODUCTS



CUSTOMER SERVICE



SERVICE & REPAIR



INVENTORY



TECHNICAL SUPPORT





CENTRIFUGAL PUMPS

- ANSI
- API 610
- General Industrial
- Multistage
- Submersible
- Sump
- Vertical Turbine

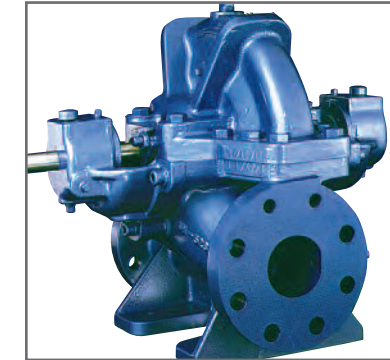

POSITIVE DISPLACEMENT PUMPS

- Diaphragm
- Peristaltic
- Piston
- Plunger
- Progressive Cavity
- Rotary Gear
- Two Screw
- Three Screw

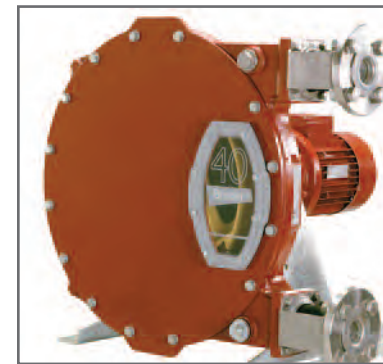
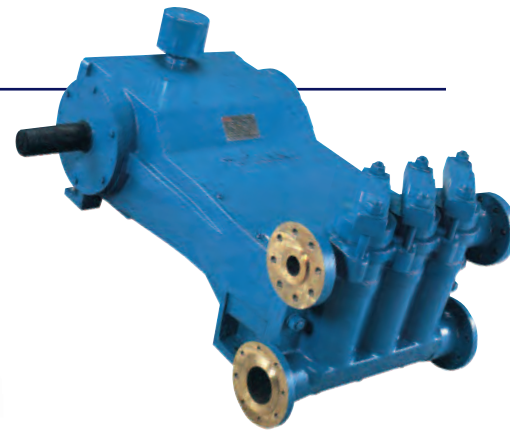

CHEMICAL METERING PUMPS

- Diaphragm
- Electric
- Plunger
- Pneumatic

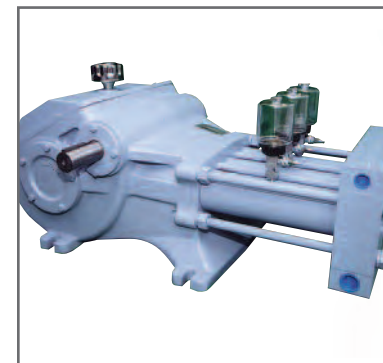
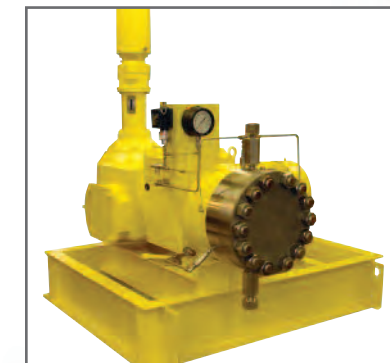
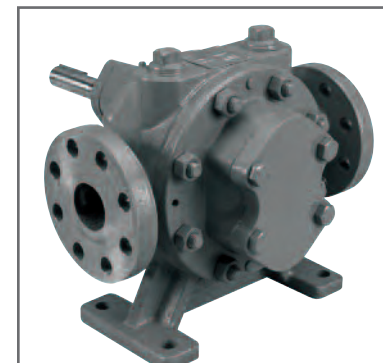
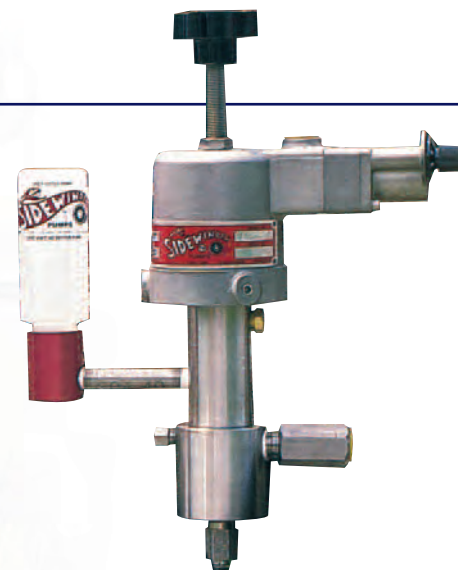



HYDRAULICS

- Coolers
- Cylinders
- Filters
- Fittings
- Hose
- Motors
- Power Units

- Pumps
- Valves

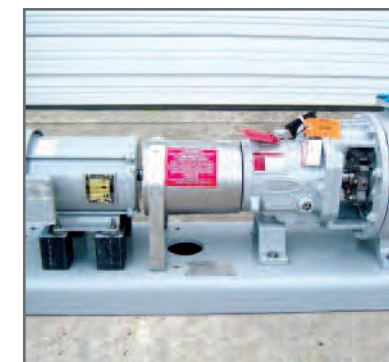
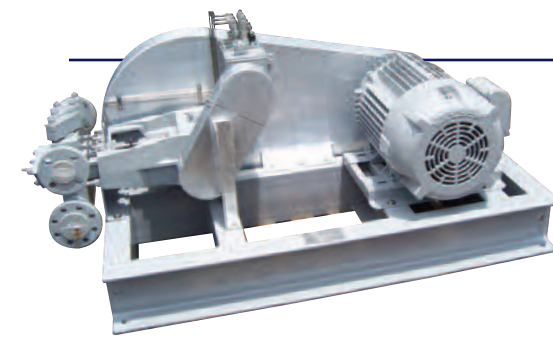
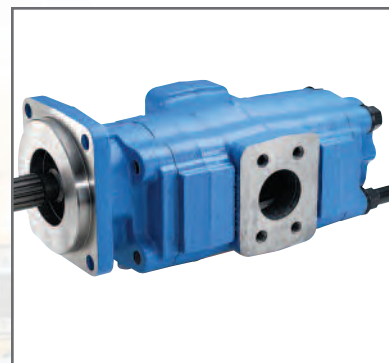
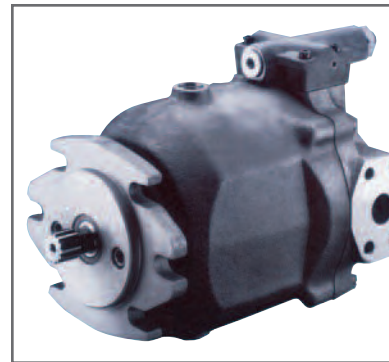
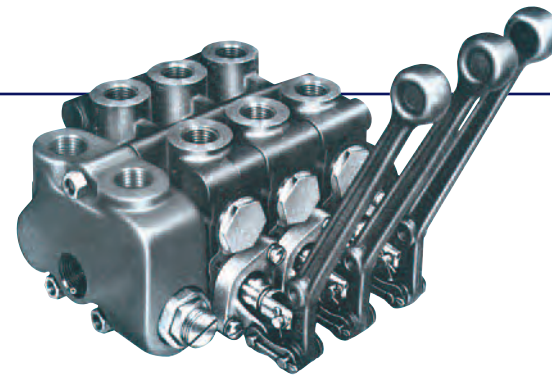

BASIC PUMP UNITS

- Centrifugal
- Reciprocating
- Machined Baseplate
- Retrofits
- Belt-Driven
- Engine Driven
- Gear-Box



PACKAGED PUMP SYSTEMS

- Methanol Injection
- Chemical Injection
- Fire Water
- Hydraulic Power Units
- Hydrostatic Test
- Pipe Handling
- Pipeline
- Potable Water
- Process Packages
- Salt Water Disposal
- Washdown



FABRICATION CAPABILITIES

- 3D CAD Drafting and Design
- 20,000 sq. ft. Manufacturing Facility
- 130,000 lbs. Lifting Capacity
- 45' x 20' Packages
- Certified Welders – Pipe and Structural
- Instrumentation and Tubing
- Engineering

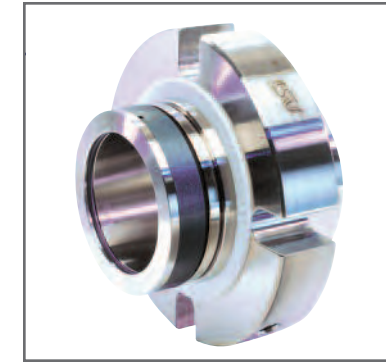

RELATED PRODUCTS

- Tank Mixers
- Static Mixers
- Chemical Injection Valves
- Chemical Gauging Equipment
- Lubrication Systems
- Mechanical Seals & Systems
- Suction & Pulsation Dampening/Surge Control





CAPABILITIES

Our repairs are done to factory, A.N.S.I. or A.P.I. standards and can be customized per customer's written request.

- Factory Authorized Repair Center
- Field Services – Offshore/Onshore/International
- Laser Alignment
- Clean Room for Final Assembly
- Quality Assurance Inspection with Documentation
- Hydro-Testing of Pump Rebuilds and Seal Installation with Test Results
- Pump Grouting and Installation
- Hydraulic Pump Repair and Systems Inspection
- Start-Up Services
- System Analysis
- Troubleshooting
- Root Cause Failure Analysis
- NPSH Analysis

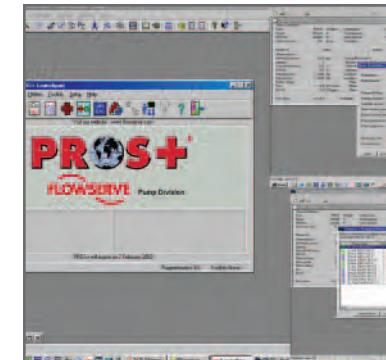
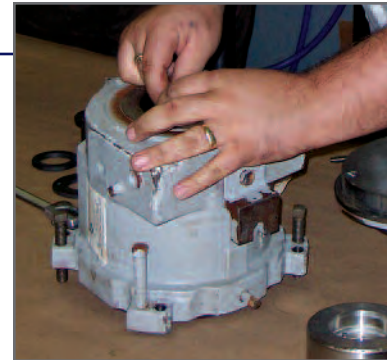

ENGINEERING SERVICE

- Field Flow Testing
- NPSH Evaluation
- Product Development
- Staff Professional Engineers
- System Analysis
- Training
- Structural Calculations
- Pump Sizing and Selection

TRAINED, SKILLED & EXPERIENCED CRAFTSMAN

Total customer satisfaction depends upon the performance of our people. AGI Industries has a wealth of experience backed by training and certifications (depending on the craft involved) ranging from the operation of machinery such as cranes and forklifts to water survival training to OSHA certifications to drug awareness and on-and-on.

The depth of training, range of experience and dedication to safety of AGI Industries employees are focused on providing you our customer, solutions to your problems.

## LOCATIONS

---

### BATON ROUGE

11559 Cloverland Avenue  
Baton Rouge, LA 70809  
225.236.3028 phone  
225.756.3135 fax

### LAFAYETTE

2110 S.W. Evangeline Thruway  
Lafayette, LA 70508  
337.233.0626 phone  
337.233.0828 fax

### NEW ORLEANS

4612 4th Street  
Marrero, LA 70072  
504.340.6905 phone  
504.348.2593 fax

### HOUSTON

8203 Willow Place South, Suite 330  
Houston, TX 77070  
713.463.7660 phone  
713.463.7023 fax

### LAKE CHARLES

106 Bayou Bend Road  
Sulphur, LA 70663  
337.626.PUMP phone  
337.626.0668 fax

### NORTH LOUISIANA

Coming Soon!

Visit us online at [www.agiindustries.com](http://www.agiindustries.com)



Through product and industry specialization, and intensive ongoing training, our employees are geared to make your experience with AGI Industries the most convenient and productive time you spend today.



AGI Industries

PUMPS  
HYDRAULICS  
PACKAGED SYSTEMS