



H61M-ITX

User Manual

Version 1.0

Published May 2012

Copyright©2012 ASRock INC. All rights reserved.

Copyright Notice:

No part of this manual may be reproduced, transcribed, transmitted, or translated in any language, in any form or by any means, except duplication of documentation by the purchaser for backup purpose, without written consent of ASRock Inc.

Products and corporate names appearing in this manual may or may not be registered trademarks or copyrights of their respective companies, and are used only for identification or explanation and to the owners' benefit, without intent to infringe.

Disclaimer:

Specifications and information contained in this manual are furnished for informational use only and subject to change without notice, and should not be constructed as a commitment by ASRock. ASRock assumes no responsibility for any errors or omissions that may appear in this manual.

With respect to the contents of this manual, ASRock does not provide warranty of any kind, either expressed or implied, including but not limited to the implied warranties or conditions of merchantability or fitness for a particular purpose.

In no event shall ASRock, its directors, officers, employees, or agents be liable for any indirect, special, incidental, or consequential damages (including damages for loss of profits, loss of business, loss of data, interruption of business and the like), even if ASRock has been advised of the possibility of such damages arising from any defect or error in the manual or product.



This device complies with Part 15 of the FCC Rules. Operation is subject to the following two conditions:

- (1) this device may not cause harmful interference, and
- (2) this device must accept any interference received, including interference that may cause undesired operation.

CALIFORNIA, USA ONLY

The Lithium battery adopted on this motherboard contains Perchlorate, a toxic substance controlled in Perchlorate Best Management Practices (BMP) regulations passed by the California Legislature. When you discard the Lithium battery in California, USA, please follow the related regulations in advance.

“Perchlorate Material-special handling may apply, see

www.dtsc.ca.gov/hazardouswaste/perchlorate”

The terms HDMI™ and HDMI High-Definition Multimedia Interface, and the HDMI logo are trademarks or registered trademarks of HDMI Licensing LLC in the United States and other countries.



Contents

1 Introduction	5
1.1 Package Contents	5
1.2 Specifications.....	6
1.3 Motherboard Layout.....	12
1.4 I/O Panel	13
2 Installation	14
2.1 Screw Holes.....	14
2.2 Pre-installation Precautions	14
2.3 CPU Installation	15
2.4 Installation of Heatsink and CPU fan	17
2.5 Installation of Memory Modules (DIMM).....	18
2.6 Expansion Slot (PCI Express Slot).....	19
2.7 Dual Monitor and Surround Display Features.....	20
2.8 ASRock Smart Remote Installation Guide	23
2.9 Jumpers Setup	24
2.10 Onboard Headers and Connectors	24
2.11 Serial ATA (SATA) / Serial ATAII (SATAII) Hard Disks Installation	28
2.12 Hot Plug Function for SATA / SATAII HDDs	28
2.13 SATA / SATAII HDD Hot Plug Feature and Operation Guide	29
2.14 Driver Installation Guide	31
2.15 Installing Windows® 7 / 7 64-bit / Vista™ / Vista™ 64-bit / XP / XP 64-bit Without RAID Functions	31
2.15.1 Installing Windows® XP / XP 64-bit Without RAID Functions.....	31
2.15.2 Installing Windows® 7 / 7 64-bit / Vista™ / Vista™ 64-bit Without RAID Functions.....	32

3 UEFI SETUP UTILITY	33
3.1 Introduction	33
3.1.1 UEFI Menu Bar	33
3.1.2 Navigation Keys	34
3.2 Main Screen.....	34
3.3 OC Tweaker Screen	35
3.4 Advanced Screen.....	40
3.4.1 CPU Configuration	41
3.4.2 North Bridge Configuration.....	42
3.4.3 South Bridge Configuration.....	43
3.4.4 Storage Configuration	44
3.4.5 Intel(R) Rapid Start Technology	45
3.4.6 Intel(R) Smart Connect Technology	46
3.4.7 Super IO Configuration	47
3.4.8 ACPI Configuration.....	48
3.4.9 USB Configuration	49
3.5 Hardware Health Event Monitoring Screen	50
3.6 Boot Screen.....	51
3.7 Security Screen	52
3.8 Exit Screen	53
4 Software Support.....	54
4.1 Install Operating System.....	54
4.2 Support CD Information	54
4.2.1 Running Support CD.....	54
4.2.2 Drivers Menu.....	54
4.2.3 Utilities Menu.....	54
4.2.4 Contact Information.....	54

Chapter 1: Introduction

Thank you for purchasing ASRock **H61M-ITX** motherboard, a reliable motherboard produced under ASRock's consistently stringent quality control. It delivers excellent performance with robust design conforming to ASRock's commitment to quality and endurance.

In this manual, chapter 1 and 2 contain introduction of the motherboard and step-by-step guide to the hardware installation. Chapter 3 and 4 contain the configuration guide to BIOS setup and information of the Support CD.



Because the motherboard specifications and the BIOS software might be updated, the content of this manual will be subject to change without notice. In case any modifications of this manual occur, the updated version will be available on ASRock website without further notice. You may find the latest VGA cards and CPU support lists on ASRock website as well. ASRock website <http://www.asrock.com>

If you require technical support related to this motherboard, please visit our website for specific information about the model you are using.

www.asrock.com/support/index.asp

1.1 Package Contents

ASRock **H61M-ITX** Motherboard

(Mini-ITX Form Factor: 6.7-in x 6.7-in, 17.0 cm x 17.0 cm)

ASRock **H61M-ITX** Quick Installation Guide

ASRock **H61M-ITX** Support CD

2 x Serial ATA (SATA) Data Cables (Optional)

1 x 3.5mm Audio Cable (Optional)

1 x I/O Panel Shield



ASRock Reminds You...

To get better performance in Windows® 7 / 7 64-bit / Vista™ / Vista™ 64-bit, it is recommended to set the BIOS option in Storage Configuration to AHCI mode. For the BIOS setup, please refer to the "User Manual" in our support CD for details.

1.2 Specifications

Platform	<ul style="list-style-type: none"> - Mini-ITX Form Factor: 6.7-in x 6.7-in, 17.0 cm x 17.0 cm - All Solid Capacitor design (100% Japan-made high-quality Conductive Polymer Capacitors)
CPU	<ul style="list-style-type: none"> - Supports 3rd and 2nd Generation Intel® Core™ i7 / i5 / i3 in LGA1155 Package - Supports Intel® Turbo Boost 2.0 Technology - Supports K-Series unlocked CPU - Supports Hyper-Threading Technology (see CAUTION 1)
Chipset	<ul style="list-style-type: none"> - Intel® H61 - Supports Intel® Rapid Start Technology and Smart Connect Technology
Memory	<ul style="list-style-type: none"> - Dual Channel DDR3 Memory Technology (see CAUTION 2) - 2 x DDR3 DIMM slots - Supports DDR3 1600/1333/1066 non-ECC, un-buffered memory (DDR3 1600 with Intel® Ivy Bridge CPU, DDR3 1333 with Intel® Sandy Bridge CPU) - Max. capacity of system memory: 16GB (see CAUTION 3) - Supports Intel® Extreme Memory Profile (XMP) 1.3 / 1.2 with Intel® Ivy Bridge CPU
Expansion Slot	<ul style="list-style-type: none"> - 1 x PCI Express 3.0 x16 slot (blue @ x16 mode) * PCIE 3.0 is only supported with Intel® Ivy Bridge CPU. With Intel® Sandy Bridge CPU, it only supports PCIE 2.0.
Graphics	<ul style="list-style-type: none"> * Intel® HD Graphics Built-in Visuals and the VGA outputs can be supported only with processors which are GPU integrated. - Supports Intel® HD Graphics Built-in Visuals: Intel® Quick Sync Video 2.0, Intel® InTru™ 3D, Intel® Clear Video HD Technology, Intel® Insider™, Intel® HD Graphics 2500/4000 with Intel® Ivy Bridge CPU - Supports Intel® HD Graphics Built-in Visuals: Intel® Quick Sync Video, Intel® InTru™ 3D, Intel® Clear Video HD Technology, Intel® HD Graphics 2000/3000, Intel® Advanced Vector Extensions (AVX) with Intel® Sandy Bridge CPU - Pixel Shader 5.0, DirectX 11 with Intel® Ivy Bridge CPU. Pixel Shader 4.1, DirectX 10.1 with Intel® Sandy Bridge CPU. - Max. shared memory 1760MB with Intel® Ivy Bridge CPU. Max. shared memory 1759MB with Intel® Sandy Bridge CPU. (see CAUTION 4)

	<ul style="list-style-type: none"> - Three VGA Output options: D-Sub, DVI-D and HDMI (see CAUTION 5) - Supports HDMI 1.4a Technology with max. resolution up to 1920x1200 @ 60Hz - Supports DVI with max. resolution up to 1920x1200 @ 60Hz - Supports D-Sub with max. resolution up to 2048x1536 @ 75Hz - Supports Auto Lip Sync, xvYCC and HBR (High Bit Rate Audio) with HDMI (Compliant HDMI monitor is required) (see CAUTION 6) - Supports HDCP function with DVI and HDMI ports - Supports Full HD 1080p Blu-ray (BD) / HD-DVD playback with DVI and HDMI ports
Audio	<ul style="list-style-type: none"> - 7.1 CH HD Audio (Realtek ALC887 Audio Codec) - Supports THX TruStudio™
LAN	<ul style="list-style-type: none"> - PCIE x1 Gigabit LAN 10/100/1000 Mb/s - Realtek RTL8111E - Supports Wake-On-LAN - Supports LAN Cable Detection - Supports Energy Efficient Ethernet 802.3az - Supports PXE
Rear Panel I/O	<p>I/O Panel</p> <ul style="list-style-type: none"> - 1 x PS/2 Keyboard Port - 1 x D-Sub Port - 1 x DVI-D Port - 1 x HDMI Port - 1 x Optical SPDIF Out Port - 4 x Ready-to-Use USB 2.0 Ports - 1 x eSATA2 Connector - 2 x Ready-to-Use USB 3.0 Ports - 1 x RJ-45 LAN Port with LED (ACT/LINK LED and SPEED LED) - HD Audio Jack: Rear Speaker/Central/Bass/Line in/Front Speaker/Microphone (see CAUTION 7)
USB 3.0	<ul style="list-style-type: none"> - 2 x USB 3.0 ports by ASMedia ASM1042, support USB 1.0/2.0/3.0 up to 5Gb/s
Connector	<ul style="list-style-type: none"> - 3 x SATA2 3.0 Gb/s connectors, support NCQ, AHCI and Hot Plug functions - 1 x CIR header - 1 x Power LED header

	<ul style="list-style-type: none"> - CPU/Chassis FAN connector - 24 pin ATX power connector - 4 pin 12V power connector - Front panel audio connector - 2 x USB 2.0 headers (support 4 USB 2.0 ports)
BIOS Feature	<ul style="list-style-type: none"> - 32Mb AMI BIOS - AMI UEFI Legal BIOS with GUI support - Supports "Plug and Play" - ACPI 1.1 Compliance Wake Up Events - Supports jumperfree - SMBIOS 2.3.1 Support
Support CD	<ul style="list-style-type: none"> - Drivers, Utilities, AntiVirus Software (Trial Version), CyberLink MediaEspresso 6.5 Trial, ASRock MAGIX Multimedia Suite - OEM
Unique Feature	<ul style="list-style-type: none"> - ASRock Extreme Tuning Utility (AXTU) (see CAUTION 8) - ASRock Instant Boot - ASRock Instant Flash (see CAUTION 9) - ASRock APP Charger (see CAUTION 10) - ASRock SmartView (see CAUTION 11) - ASRock XFast USB (see CAUTION 12) - ASRock XFast LAN (see CAUTION 13) - ASRock XFast RAM (see CAUTION 14) - ASRock On/Off Play Technology (see CAUTION 15) - Hybrid Booster: <ul style="list-style-type: none"> - ASRock U-COP (see CAUTION 16) - Boot Failure Guard (B.F.G.) - Good Night LED
Hardware Monitor	<ul style="list-style-type: none"> - CPU Temperature Sensing - Chassis Temperature Sensing - CPU/Chassis Fan Tachometer - CPU/Chassis Quiet Fan (Allow Chassis Fan Speed Auto-Adjust by CPU Temperature) - CPU/Chassis Fan Multi-Speed Control - Voltage Monitoring: +12V, +5V, +3.3V, CPU Vcore
OS	<ul style="list-style-type: none"> - Microsoft® Windows® 7 / 7 64-bit / Vista™ / Vista™ 64-bit / XP / XP 64-bit compliant
Certifications	<ul style="list-style-type: none"> - FCC, CE, WHQL - ErP/EuP Ready (ErP/EuP ready power supply is required) (see CAUTION 17)

* For detailed product information, please visit our website: <http://www.asrock.com>

WARNING

Please realize that there is a certain risk involved with overclocking, including adjusting the setting in the BIOS, applying Untied Overclocking Technology, or using the third-party overclocking tools. Overclocking may affect your system stability, or even cause damage to the components and devices of your system. It should be done at your own risk and expense. We are not responsible for possible damage caused by overclocking.

CAUTION!

1. About the setting of "Hyper Threading Technology", please check page 40.
2. This motherboard supports Dual Channel Memory Technology. Before you implement Dual Channel Memory Technology, make sure to read the installation guide of memory modules on page 18 for proper installation.
3. Due to the operating system limitation, the actual memory size may be less than 4GB for the reservation for system usage under Windows® 7 / Vista™ / XP. For Windows® OS with 64-bit CPU, there is no such limitation. You can use ASRock XFast RAM to utilize the memory that Windows® cannot use.
4. The maximum shared memory size is defined by the chipset vendor and is subject to change. Please check Intel® website for the latest information.
5. You can choose to use two of the four monitors only. D-Sub, DVI-D and HDMI monitors cannot be enabled at the same time. Besides, with the DVI-to-HDMI adapter, the DVI-D port can support the same features as HDMIport.
6. xvYCC is only supported under Windows® 7 64-bit / 7. HBR is supported under Windows® 7 64-bit / 7 / Vista™ 64-bit / Vista™.
7. For microphone input, this motherboard supports both stereo and mono modes. For audio output, this motherboard supports 2-channel, 4-channel, 6-channel, and 8-channel modes. Please check the table on page 13 for proper connection.
8. ASRock Extreme Tuning Utility (AXTU) is an all-in-one tool to fine-tune different system functions in a user-friendly interface, which is including Hardware Monitor, Fan Control, Overclocking, OC DNA and IES. In Hardware Monitor, it shows the major readings of your system. In Fan Control, it shows the fan speed and temperature for you to adjust. In Overclocking, you are allowed to overclock CPU frequency for optimal system performance. In OC DNA, you can save your OC settings as a profile and share with your friends. Your friends then can load the OC profile to their own system to get the same OC settings. In IES (Intelligent Energy Saver), the voltage regulator can reduce the number of output

phases to improve efficiency when the CPU cores are idle without sacrificing computing performance. Please visit our website for the operation procedures of ASRock Extreme Tuning Utility (AXTU).

ASRock website: <http://www.asrock.com>

9. ASRock Instant Flash is a BIOS flash utility embedded in Flash ROM. This convenient BIOS update tool allows you to update system BIOS without entering operating systems first like MS-DOS or Windows®. With this utility, you can press <F6> key during the POST or press <F2> key to BIOS setup menu to access ASRock Instant Flash. Just launch this tool and save the new BIOS file to your USB flash drive, floppy disk or hard drive, then you can update your BIOS only in a few clicks without preparing an additional floppy diskette or other complicated flash utility. Please be noted that the USB flash drive or hard drive must use FAT32/16/12 file system.
10. If you desire a faster, less restricted way of charging your Apple devices, such as iPhone/iPod/iPad Touch, ASRock has prepared a wonderful solution for you - ASRock APP Charger. Simply installing the APP Charger driver, it makes your iPhone charged much quickly from your computer and up to 40% faster than before. ASRock APP Charger allows you to quickly charge many Apple devices simultaneously and even supports continuous charging when your PC enters into Standby mode (S1), Suspend to RAM (S3), hibernation mode (S4) or power off (S5). With APP Charger driver installed, you can easily enjoy the marvelous charging experience than ever.
ASRock website: <http://www.asrock.com/Feature/AppCharger/index.asp>
11. SmartView, a new function of internet browser, is the smart start page for IE that combines your most visited web sites, your history, your Facebook friends and your real-time newsfeed into an enhanced view for a more personal Internet experience. ASRock motherboards are exclusively equipped with the SmartView utility that helps you keep in touch with friends on-the-go. To use SmartView feature, please make sure your OS version is Windows® 7 / 7 64 bit / Vista™ / Vista™ 64 bit, and your browser version is IE8. ASRock website: <http://www.asrock.com/Feature/SmartView/index.asp>
12. ASRock XFast USB can boost USB storage device performance. The performance may depend on the property of the device.
13. ASRock XFast LAN provides a faster internet access, which includes below benefits. LAN Application Prioritization: You can configure your application priority ideally and/or add new programs. Lower Latency in Game: After setting online game priority higher, it can lower the latency in game. Traffic Shaping: You can watch Youtube HD video and download files simultaneously. Real-Time Analysis of Your Data: With the status window, you can easily recognize which data streams you are currently transferring.

-
14. ASRock XFast RAM is a new function that is included into ASRock Extreme Tuning Utility (AXTU). It fully utilizes the memory space that cannot be used under Windows® OS 32-bit CPU. ASRock XFast RAM shortens the loading time of previously visited websites, making web surfing faster than ever. And it also boosts the speed of Adobe Photoshop 5 times faster. Another advantage of ASRock XFast RAM is that it reduces the frequency of accessing your SSDs or HDDs in order to extend their lifespan.
 15. ASRock On/Off Play Technology allows users to enjoy the great audio experience from the portable audio devices, such like MP3 player or mobile phone to your PC, even when the PC is turned off (or in ACPI S5 mode)! This motherboard also provides a free 3.5mm audio cable (optional) that ensures users the most convenient computing environment.
 16. While CPU overheat is detected, the system will automatically shutdown. Before you resume the system, please check if the CPU fan on the motherboard functions properly and unplug the power cord, then plug it back again. To improve heat dissipation, remember to spray thermal grease between the CPU and the heatsink when you install the PC system.
 17. EuP, stands for Energy Using Product, was a provision regulated by European Union to define the power consumption for the completed system. According to EuP, the total AC power of the completed system shall be under 1.00W in off mode condition. To meet EuP standard, an EuP ready motherboard and an EuP ready power supply are required. According to Intel's suggestion, the EuP ready power supply must meet the standard of 5v standby power efficiency is higher than 50% under 100 mA current consumption. For EuP ready power supply selection, we recommend you checking with the power supply manufacturer for more details.

1.3 Motherboard Layout

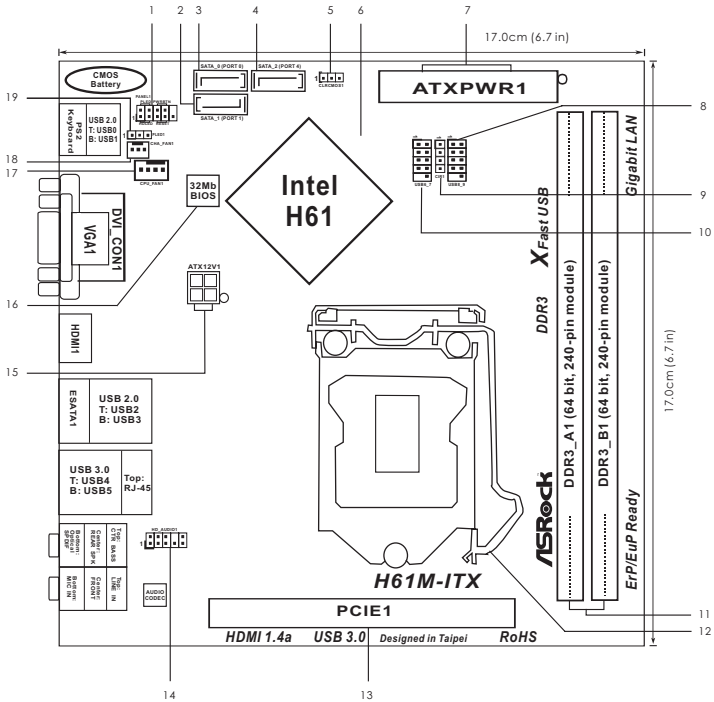

- | | | | |
|----|--|----|---|
| 1 | System Panel Header (PANEL1, White) | 12 | 1155-Pin CPU Socket |
| 2 | SATA2 Connector (SATA_1 (PORT 1), Blue) | 13 | PCI Express 2.0 x16 Slot (PCIE1, Blue) |
| 3 | SATA2 Connector (SATA_0 (PORT 0), Blue) | 14 | Front Panel Audio Header (HD_AUDIO1, White) |
| 4 | SATA2 Connector (SATA_2 (PORT 4), Blue) | 15 | ATX 12V Power Connector (ATX12V1) |
| 5 | Clear CMOS Jumper (CLRCMOS1) | 16 | 32Mb SPI Flash |
| 6 | Intel H61 Chipset | 17 | CPU Fan Connector (CPU_FAN1) |
| 7 | ATX Power Connector (ATXPWR1) | 18 | Chassis Fan Connector (CHA_FAN1) |
| 8 | USB 2.0 Header (USB8_9, Blue) | 19 | Power LED Header (PLED1) |
| 9 | Consumer Infrared Module Header (CIR1) | | |
| 10 | USB 2.0 Header (USB6_7, Blue) | | |
| 11 | 2 x 240-pin DDR3 DIMM Slots (Dual Channel: DDR3_A1, DDR3_B1, Blue) | | |

1.4 I/O Panel

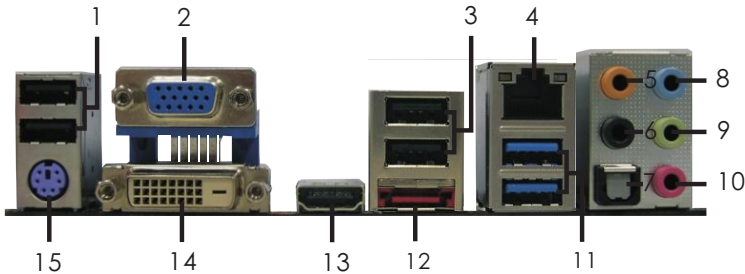

- | | | | |
|-----|-------------------------|------|-----------------------------|
| 1 | USB 2.0 Ports (USB01) | ** 9 | Front Speaker (Lime) |
| 2 | D-Sub Port | 10 | Microphone (Pink) |
| 3 | USB 2.0 Ports (USB23) | 11 | USB 3.0 Ports (USB45) |
| * 4 | LAN RJ-45 Port | 12 | eSATA2 Port |
| 5 | Central / Bass (Orange) | 13 | HDMI Port |
| 6 | Rear Speaker (Black) | 14 | DVI-D Port |
| 7 | Optical SPDIF Out Port | 15 | PS/2 Keyboard Port (Purple) |
| 8 | Line In (Light Blue) | | |

* There are two LED next to the LAN port. Please refer to the table below for the LAN port LED indications.

LAN Port LED Indications

Activity/Link LED	
Status	Description
Off	No Link
Blinking	Data Activity
On	Link

SPEED LED	
Status	Description
Off	10Mbps connection
Orange	100Mbps connection
Green	1Gbps connection

ACT/LINK LED SPEED LED

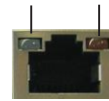

LAN Port

** If you use 2-channel speaker, please connect the speaker's plug into "Front Speaker Jack".
See the table below for connection details in accordance with the type of speaker you use.

TABLE for Audio Output Connection

Audio Output Channels	Front Speaker (No. 9)	Rear Speaker (No. 6)	Central / Bass (No. 5)	Line In or Side Speaker (No. 8)
2	V	--	--	--
4	V	V	--	--
6	V	V	V	--
8	V	V	V	V

To enable Multi-Streaming function, you need to connect a front panel audio cable to the front panel audio header. After restarting your computer, you will find "Mixer" tool on your system. Please select "Mixer ToolBox" , click "Enable playback multi-streaming", and click

"ok". Choose "2CH", "4CH", "6CH", or "8CH" and then you are allowed to select "Realtek HDA Primary output" to use Rear Speaker, Central/Bass, and Front Speaker, or select "Realtek HDA Audio 2nd output" to use front panel audio.

Chapter 2: Installation_

This is a Mini-ITX form factor (6.7" x 6.7", 17.0 x 17.0 cm) motherboard. Before you install the motherboard, study the configuration of your chassis to ensure that the motherboard fits into it.



Make sure to unplug the power cord before installing or removing the motherboard. Failure to do so may cause physical injuries to you and damages to motherboard components.

2.1 Screw Holes

Place screws into the holes indicated by circles to secure the motherboard to the chassis.



Do not over-tighten the screws! Doing so may damage the motherboard.

2.2 Pre-installation Precautions

Take note of the following precautions before you install motherboard components or change any motherboard settings.

1. Unplug the power cord from the wall socket before touching any component.
2. To avoid damaging the motherboard components due to static electricity, NEVER place your motherboard directly on the carpet or the like. Also remember to use a grounded wrist strap or touch a safety grounded object before you handle components.
3. Hold components by the edges and do not touch the ICs.
4. Whenever you uninstall any component, place it on a grounded antistatic pad or in the bag that comes with the component.



Before you install or remove any component, ensure that the power is switched off or the power cord is detached from the power supply. Failure to do so may cause severe damage to the motherboard, peripherals, and/or components.

2.3 CPU Installation

For the installation of Intel 1155-Pin CPU, please follow the steps below.

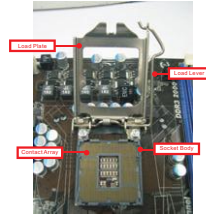

1155-Pin Socket Overview



Before you insert the 1155-Pin CPU into the socket, please check if the CPU surface is unclean or if there is any bent pin on the socket. Do not force to insert the CPU into the socket if above situation is found. Otherwise, the CPU will be seriously damaged.

Step 1. Open the socket:

Step 1-1. Disengaging the lever by depressing down and out on the hook to clear retention tab.



Step 1-2. Rotate the load lever to fully open position at approximately 135 degrees.

Step 1-3. Rotate the load plate to fully open position at approximately 100 degrees.



Step 2. Remove PnP Cap (Pick and Place Cap).

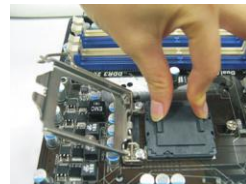

1. It is recommended to use the cap tab to handle and avoid kicking off the PnP cap.
2. This cap must be placed if returning the motherboard for after service.

Step 3. Insert the 1155-Pin CPU:

Step 3-1. Hold the CPU by the edge where is marked with black line.



Step 3-2. Orient the CPU with IHS (Integrated Heat Sink) up. Locate Pin1 and the two orientation key notches.

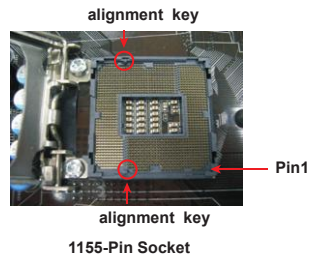
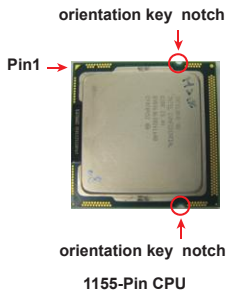

For proper inserting, please ensure to match the two orientation key notches of the CPU with the two alignment keys of the socket.

Step 3-3. Carefully place the CPU into the socket by using a purely vertical motion.



Step 3-4. Verify that the CPU is within the socket and properly mated to the orient keys.

Step 4. Close the socket:

Step 4-1. Rotate the load plate onto the IHS.

Step 4-2. While pressing down lightly on load plate, engage the load lever.



2.4 Installation of CPU Fan and Heatsink

This motherboard is equipped with 1155-Pin socket that supports Intel 1155-Pin CPU. Please adopt the type of heatsink and cooling fan compliant with Intel 1155-Pin CPU to dissipate heat. Before you installed the heatsink, you need to spray thermal interface material between the CPU and the heatsink to improve heat dissipation. Ensure that the CPU and the heatsink are securely fastened and in good contact with each other. Then connect the CPU fan to the CPU_FAN connector (CPU_FAN1, see page 12, No. 17).

For proper installation, please kindly refer to the instruction manuals of your CPU fan and heatsink.

Below is an example to illustrate the installation of the heatsink for 1155-Pin CPU.

Step 1. Apply thermal interface material onto center of IHS on the socket surface.



Step 2. Place the heatsink onto the socket. Ensure fan cables are oriented on side closest to the CPU fan connector on the motherboard (CPU_FAN1, see page 12, No. 17).

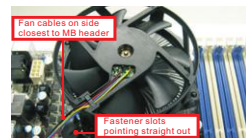

Step 3. Align fasteners with the motherboard through-holes.

Step 4. Rotate the fastener clockwise, then press down on fastener caps with thumb to install and lock. Repeat with remaining fasteners.



If you press down the fasteners without rotating them clockwise, the heatsink cannot be secured on the motherboard.

Step 5. Connect fan header with the CPU fan connector on the motherboard.
Step 6. Secure excess cable with tie-wrap to ensure cable does not interfere with fan operation or contact other components.

2.5 Installation of Memory Modules (DIMM)

This motherboard provides two 240-pin DDR3 (Double Data Rate 3) DIMM slots, and supports Dual Channel Memory Technology. For dual channel configuration, you always need to install two identical (the same brand, speed, size and chip-type) memory modules in the DDR3 DIMM slots to activate Dual Channel Memory Technology. Otherwise, it will operate at single channel mode.



1. It is not allowed to install a DDR or DDR2 memory module into DDR3 slot; otherwise, this motherboard and DIMM may be damaged.
2. If you install only one memory module or two non-identical memory modules, it is unable to activate the Dual Channel Memory Technology.
3. Some DDR3 1GB double-sided DIMMs with 16 chips may not work on this motherboard. It is not recommended to install them on this motherboard.

Installing a DIMM



Please make sure to disconnect power supply before adding or removing DIMMs or the system components.

- Step 1. Unlock a DIMM slot by pressing the retaining clips outward.
- Step 2. Align a DIMM on the slot such that the notch on the DIMM matches the break on the slot.

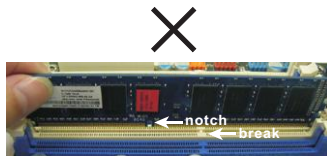
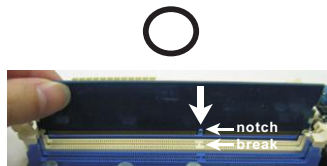

The DIMM only fits in one correct orientation. It will cause permanent damage to the motherboard and the DIMM if you force the DIMM into the slot at incorrect orientation.

- Step 3. Firmly insert the DIMM into the slot until the retaining clips at both ends fully snap back in place and the DIMM is properly seated.

2.6 Expansion Slot (PCI Express Slot)

There is 1 PCI Express slot on this motherboard.

PCIE slots:

PCIE1 (PCIE 3.0 x16 slot; Blue) is used for PCI Express x16 lane width graphics cards.



Only PCIE1 slot supports Gen 3 speed. To run the PCI Express in Gen 3 speed, please install an Ivy Bridge CPU. If you install a Sandy Bridge CPU, the PCI Express will run only at PCI Express Gen 2 speed.

Installing an expansion card

- Step 1. Before installing the expansion card, please make sure that the power supply is switched off or the power cord is unplugged. Please read the documentation of the expansion card and make necessary hardware settings for the card before you start the installation.
- Step 2. Remove the system unit cover (if your motherboard is already installed in a chassis).
- Step 3. Remove the bracket facing the slot that you intend to use. Keep the screws for later use.
- Step 4. Align the card connector with the slot and press firmly until the card is completely seated on the slot.
- Step 5. Fasten the card to the chassis with screws.
- Step 6. Replace the system cover.

2.7 Dual Monitor and Surround Display Features

Dual Monitor Feature

This motherboard supports dual monitor feature. With the internal VGA output support (DVI-D, D-Sub and HDMI), you can easily enjoy the benefits of dual monitor feature without installing any add-on VGA card to this motherboard. This motherboard also provides independent display controllers for DVI-D, D-Sub and HDMI to support dual VGA output so that DVI-D, D-sub and HDMI can drive same or different display contents.

To enable dual monitor feature, please follow the below steps:

1. Connect DVI-D monitor cable to DVI-D port on the I/O panel, connect D-Sub monitor cable to D-Sub port on the I/O panel, or connect HDMI monitor cable to HDMI port on the I/O panel.

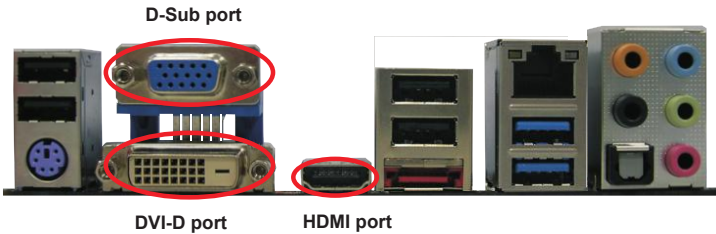

2. If you have installed onboard VGA driver from our support CD to your system already, you can freely enjoy the benefits of dual monitor function after your system boots. If you haven't installed onboard VGA driver yet, please install onboard VGA driver from our support CD to your system and restart your computer.



D-Sub, DVI-D and HDMI monitors cannot be enabled at the same time. You can only choose the combination: DVI-D + HDMI, DVI-D + D-Sub, or HDMI + D-Sub.

Surround Display Feature

This motherboard supports surround display upgrade. With the internal VGA output support (DVI-D, D-Sub and HDMI) and external add-on PCI Express VGA cards, you can easily enjoy the benefits of surround display feature.

Please refer to the following steps to set up a surround display environment:

1. Install the PCI Express VGA card on PCIE1 slot. Please refer to page 19 for proper expansion card installation procedures for details.
2. Connect DVI-D monitor cable to DVI-D port on the I/O panel, connect D-Sub monitor cable to D-Sub port on the I/O panel, or connect HDMI monitor cable to HDMI port on the I/O panel. Then connect other monitor cables to the corresponding connectors of the add-on PCI Express VGA card on PCIE1 slot.
3. Boot your system. Press <F2> or to enter UEFI setup. Enter "Share Memory" option to adjust the memory capability to [32MB], [64MB], [128MB], [256MB] or [512MB] to enable the function of D-sub. Please make sure that the value you select is less than the total capability of the system memory. If you do not adjust the UEFI setup, the default value of "Share Memory", [Auto], will disable D-Sub function when the add-on VGA card is inserted to this motherboard.
4. Install the onboard VGA driver and the add-on PCI Express VGA card driver to your system. If you have installed the drivers already, there is no need to install them again.
5. Set up a multi-monitor display.

For Windows® XP / XP 64-bit OS:

Right click the desktop, choose "Properties", and select the "Settings" tab so that you can adjust the parameters of the multi-monitor according to the steps below.

- A. Click the "Identify" button to display a large number on each monitor.
- B. Right-click the display icon in the Display Properties dialog that you wish to be your primary monitor, and then select "Primary". When you use multiple monitors with your card, one monitor will always be Primary, and all additional monitors will be designated as Secondary.
- C. Select the display icon identified by the number 2.
- D. Click "Extend my Windows desktop onto this monitor".
- E. Right-click the display icon and select "Attached", if necessary.
- F. Set the "Screen Resolution" and "Color Quality" as appropriate for the second monitor. Click "Apply" or "OK" to apply these new values.
- G. Repeat steps C through E for the diaplay icon identified by the number one, two, three and four.

For Windows® 7 / 7 64-bit / Vista™ / Vista™ 64-bit OS:

Right click the desktop, choose “Personalize”, and select the “Display Settings” tab so that you can adjust the parameters of the multi-monitor according to the steps below.

- A. Click the number “2” icon.
 - B. Click the items “This is my main monitor” and “Extend the desktop onto this monitor”.
 - C. Click “OK” to save your change.
 - D. Repeat steps A through C for the display icon identified by the number three and four.
6. Use Surround Display. Click and drag the display icons to positions representing the physical setup of your monitors that you would like to use. The placement of display icons determines how you move items from one monitor to another.



HDCP Function

HDCP function is supported on this motherboard. To use HDCP function with this motherboard, you need to adopt the monitor that supports HDCP function as well. Therefore, you can enjoy the superior display quality with high-definition HDCP encryption contents. Please refer to below instruction for more details about HDCP function.

What is HDCP?

HDCP stands for High-Bandwidth Digital Content Protection, a specification developed by Intel® for protecting digital entertainment content that uses the DVI interface. HDCP is a copy protection scheme to eliminate the possibility of intercepting digital data midstream between the video source, or transmitter - such as a computer, DVD player or set-top box - and the digital display, or receiver - such as a monitor, television or projector. In other words, HDCP specification is designed to protect the integrity of content as it is being transmitted.

Products compatible with the HDCP scheme such as DVD players, satellite and cable HDTV set-top-boxes, as well as few entertainment PCs requires a secure connection to a compliant display. Due to the increase in manufacturers employing HDCP in their equipment, it is highly recommended that the HDTV or LCD monitor you purchase is compatible.

2.8 ASRock Smart Remote Installation Guide

ASRock Smart Remote is only used for ASRock motherboard with CIR header. Please refer to below procedures for the quick installation and usage of ASRock Smart Remote.

Step1. Find the CIR header located next to the USB 2.0 header on ASRock motherboard.



Step2. Connect the front USB cable to the USB 2.0 header (as below, pin 1-5) and the CIR header. Please make sure the wire assignments and the pin assignments are matched correctly.

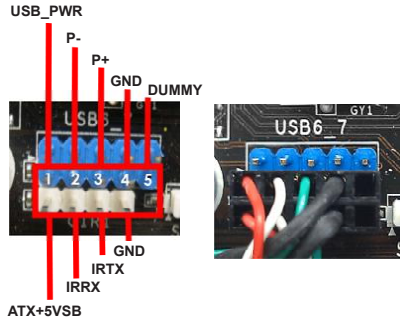

Step3. Install Multi-Angle CIR Receiver to the front USB port. If Multi-Angle CIR Receiver cannot successfully receive the infrared signals from MCE Remote Controller, please try to install it to the other front USB port.

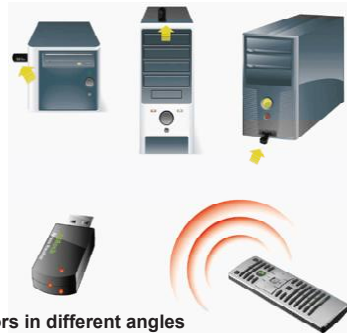

3 CIR sensors in different angles





1. Only one of the front USB port can support CIR function. When the CIR function is enabled, the other port will remain USB function.
2. Multi-Angle CIR Receiver is used for front USB only. Please do not use the rear USB bracket to connect it on the rear panel. Multi-Angle CIR Receiver can receive the multi-direction infrared signals (top, down and front), which is compatible with most of the chassis on the market.
3. The Multi-Angle CIR Receiver does not support Hot-Plug function. Please install it before you boot the system.

* ASRock Smart Remote is only supported by some of ASRock motherboards. Please refer to ASRock website for the motherboard support list: <http://www.asrock.com>

2.9 Jumpers Setup

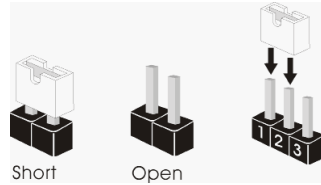
The illustration shows how jumpers are setup. When the jumper cap is placed on pins, the jumper is “Short”. If no jumper cap is placed on pins, the jumper is “Open”. The illustration shows a 3-pin jumper whose pin1 and pin2 are “Short” when jumper cap is placed on these 2 pins.



Jumper	Setting	Description
Clear CMOS Jumper (CLRCMOS1) (see p.12, No. 5)	<div style="display: flex; justify-content: space-around;"> <div style="text-align: center;"> <p>1_2</p>  <p>Default</p> </div> <div style="text-align: center;"> <p>2_3</p>  <p>Clear CMOS</p> </div> </div>	

Note: CLRCMOS1 allows you to clear the data in CMOS. To clear and reset the system parameters to default setup, please turn off the computer and unplug the power cord from the power supply. After waiting for 15 seconds, use a jumper cap to short pin2 and pin3 on CLRCMOS1 for 5 seconds. However, please do not clear the CMOS right after you update the BIOS. If you need to clear the CMOS when you just finish updating the BIOS, you must boot up the system first, and then shut it down before you do the clear-CMOS action. Please be noted that the password, date, time and user default profile will be cleared only if the CMOS battery is removed.

2.10 Onboard Headers and Connectors



Onboard headers and connectors are NOT jumpers. Do NOT place jumper caps over these headers and connectors. Placing jumper caps over the headers and connectors will cause permanent damage of the motherboard!

Serial ATAII Connectors

(SATA_0 (PORT 0):

see p.12, No. 3)

(SATA_1 (PORT 1):

see p.12, No. 2)

(SATA_2 (PORT 4):

see p.12, No. 4)

SATA_0 (PORT 0) SATA_2 (PORT 4)



SATA_1 (PORT 1)



These three Serial ATAII

(SATAII) connectors support SATA data cables for internal storage devices. The current SATAII interface allows up to 3.0 Gb/s data transfer rate.

Serial ATA (SATA)
Data Cable
(Optional)



Either end of the SATA data cable can be connected to the SATA / SATAII hard disk or the SATAII connector on this motherboard.

3.5mm Audio Cable
(Optional)



Either end of the 3.5mm audio cable can be connected to the portable audio devices, such as MP3 player and mobile phone or the Line-in port of your PC.

USB 2.0 Headers
(9-pin USB6_7)
(see p.12 No. 10)

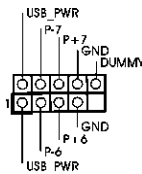

(9-pin USB8_9)
(see p.12 No. 8)

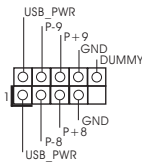

Besides four default USB 2.0 ports on the I/O panel, there are two USB 2.0 headers on this motherboard. Each USB 2.0 header can support two USB 2.0 ports.

Consumer Infrared Module Header
(4-pin CIR1)
(see p.12 No. 9)



This header can be used to connect the remote controller receiver.

Front Panel Audio Header
(9-pin HD_AUDIO1)
(see p.12 No. 14)

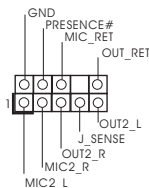

This is an interface for front panel audio cable that allows convenient connection and control of audio devices.



1. High Definition Audio supports Jack Sensing, but the panel wire on the chassis must support HDA to function correctly. Please follow the instruction in our manual and chassis manual to install your system.
2. If you use AC'97 audio panel, please install it to the front panel audio header as below:
 - A. Connect Mic_IN (MIC) to MIC2_L.
 - B. Connect Audio_R (RIN) to OUT2_R and Audio_L (LIN) to OUT2_L.
 - C. Connect Ground (GND) to Ground (GND).
 - D. MIC_RET and OUT_RET are for HD audio panel only. You don't need to connect them for AC'97 audio panel.
 - E. To activate the front mic.
For Windows® XP / XP 64-bit OS:
Select "Mixer". Select "Recorder". Then click "FrontMic".
For Windows® 7 / 7 64-bit / Vista™ / Vista™ 64-bit OS:
Go to the "FrontMic" Tab in the Realtek Control panel. Adjust "Recording Volume".

System Panel Header

(9-pin PANEL1)
(see p.12 No. 1)

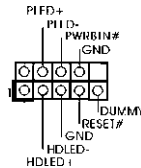

This header accommodates several system front panel functions.



Connect the power switch, reset switch and system status indicator on the chassis to this header according to the pin assignments below. Note the positive and negative pins before connecting the cables.

PWRBTN (Power Switch):

Connect to the power switch on the chassis front panel. You may configure the way to turn off your system using the power switch.

RESET (Reset Switch):

Connect to the reset switch on the chassis front panel. Press the reset switch to restart the computer if the computer freezes and fails to perform a normal restart.

PLED (System Power LED):

Connect to the power status indicator on the chassis front panel. The LED is on when the system is operating. The LED keeps blinking when the system is in S1 sleep state. The LED is off when the system is in S3/S4 sleep state or powered off (S5).

HDLED (Hard Drive Activity LED):

Connect to the hard drive activity LED on the chassis front panel. The LED is on when the hard drive is reading or writing data.

The front panel design may differ by chassis. A front panel module mainly consists of power switch, reset switch, power LED, hard drive activity LED, speaker and etc. When connecting your chassis front panel module to this header, make sure the wire assignments and the pin assignments are matched correctly.

Power LED Header

(3-pin PLED1)

(see p.12 No. 19)



Please connect the chassis power LED to this header to indicate system power status. The LED is on when the system is operating. The LED keeps blinking in S1 state. The LED is off in S3/S4 state or S5 state (power off).

Chassis Fan Connector

(3-pin CHA_FAN1)

(see p.12 No. 18)

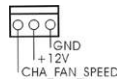

Please connect the fan cables to the fan connectors and match the black wire to the ground pin.

CPU Fan Connectors

(4-pin CPU_FAN1)

(see p.12 No. 17)

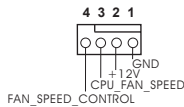

Please connect the CPU fan cable to the connector and match the black wire to the ground pin.



Though this motherboard provides 4-Pin CPU fan (Quiet Fan) support, the 3-Pin CPU fan still can work successfully even without the fan speed control function. If you plan to connect the 3-Pin CPU fan to the CPU fan connector on this motherboard, please connect it to Pin 1-3.

Pin 1-3 Connected



3-Pin Fan Installation

ATX Power Connector

(24-pin ATXPWR1)

(see p.12 No. 7)

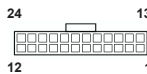

Please connect an ATX power supply to this connector.



Though this motherboard provides 24-pin ATX power connector, it can still work if you adopt a traditional 20-pin ATX power supply. To use the 20-pin ATX power supply, please plug your power supply along with Pin 1 and Pin 13.

20-Pin ATX Power Supply Installation

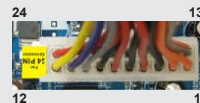

ATX 12V Power Connector

(4-pin ATX12V1)

(see p.12 No. 15)



Please connect an ATX 12V power supply to this connector.

2.11 Serial ATA (SATA) / Serial ATAII (SATAII) Hard Disks Installation

This motherboard adopts Intel® H61 chipset that supports Serial ATA (SATA) / Serial ATAII (SATAII) hard disks. You may install SATA / SATAII hard disks on this motherboard for internal storage devices. This section will guide you to install the SATA / SATAII hard disks.

STEP 1: Install the SATA / SATAII hard disks into the drive bays of your chassis.

STEP 2: Connect the SATA power cable to the SATA / SATAII hard disk.

STEP 3: Connect one end of the SATA data cable to the motherboard's SATAII connector.

STEP 4: Connect the other end of the SATA data cable to the SATA / SATAII hard disk.

2.12 Hot Plug Function for SATA / SATAII HDDs

This motherboard supports Hot Plug function for SATA / SATAII in AHCI mode.

Intel® H61 chipset provides hardware support for Advanced Host controller Interface (AHCI), a new programming interface for SATA host controllers developed thru a joint industry effort.



NOTE

What is Hot Plug Function?

If the SATA / SATAII HDDs are NOT set for RAID configuration, it is called "Hot Plug" for the action to insert and remove the SATA / SATAII HDDs while the system is still power-on and in working condition.

However, please note that it cannot perform Hot Plug if the OS has been installed into the SATA / SATAII HDD.

2.13 SATA / SATAII HDD Hot Plug Feature and Operation Guide

This motherboard supports Hot Plug feature for SATA / SATAII HDD in AHCI mode. Please read below operation guide of Hot Plug feature carefully. Before you process the SATA / SATAII HDD Hot Plug, please check below cable accessories from the motherboard gift box pack.

A. 7-pin SATA data cable

B. SATA power cable with SATA 15-pin power connector interface

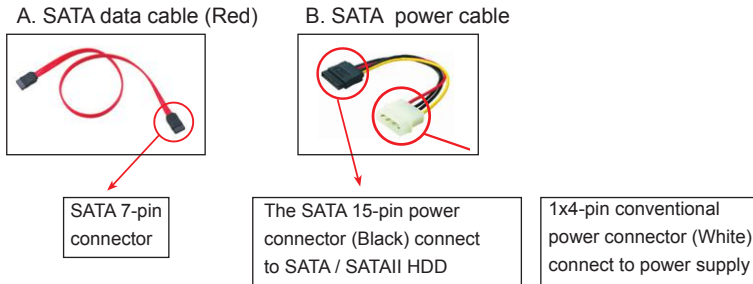

Caution

1. Without SATA 15-pin power connector interface, the SATA / SATAII Hot Plug cannot be processed.
2. Even some SATA / SATAII HDDs provide both SATA 15-pin power connector and IDE 1x4-pin conventional power connector interfaces, the IDE 1x4-pin conventional power connector interface is definitely not able to support Hot Plug and will cause the HDD damage and data loss.

Points of attention, before you process the Hot Plug:

1. Below operation procedure is designed only for our motherboard, which supports SATA / SATAII HDD Hot Plug.
 - * The SATA / SATAII Hot Plug feature might not be supported by the chipset because of its limitation, the SATA / SATAII Hot Plug support information of our motherboard is indicated in the product spec on our website: www.asrock.com
2. Make sure your SATA / SATAII HDD can support Hot Plug function from your dealer or HDD user manual. The SATA / SATAII HDD, which cannot support Hot Plug function, will be damaged under the Hot Plug operation.
3. Please make sure the SATA / SATAII driver is installed into system properly. The latest SATA / SATAII driver is available on our support website: www.asrock.com
4. Make sure to use the SATA power cable & data cable, which are from our motherboard package.
5. Please follow below instructions step by step to reduce the risk of HDD crash or data loss.

How to Hot Plug a SATA / SATAII HDD:

Points of attention, before you process the Hot Plug:

Please do follow below instruction sequence to process the Hot Plug, improper procedure will cause the SATA / SATAII HDD damage and data loss.

Step 1 Please connect SATA power cable 1x4-pin end (White) to the power supply 1x4-pin cable.

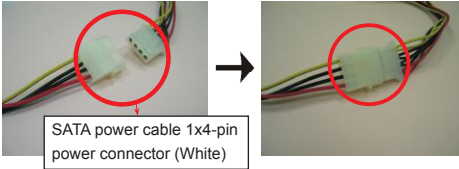

Step 2 Connect SATA data cable to the motherboard's SATAII connector.



Step 3 Connect SATA 15-pin power cable connector (Black) end to SATA / SATAII HDD.



Step 4 Connect SATA data cable to the SATA / SATAII HDD.



How to Hot Unplug a SATA / SATAII HDD:

Points of attention, before you process the Hot Unplug:

Please do follow below instruction sequence to process the Hot Unplug, improper procedure will cause the SATA / SATAII HDD damage and data loss.

Step 1 Unplug SATA data cable from SATA / SATAII HDD side.

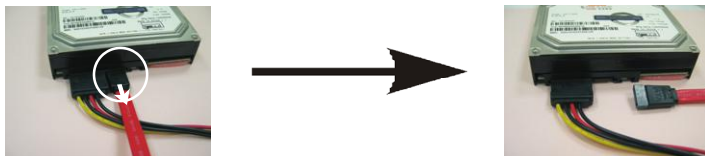

Step 2 Unplug SATA 15-pin power cable connector (Black) from SATA / SATAII HDD side.

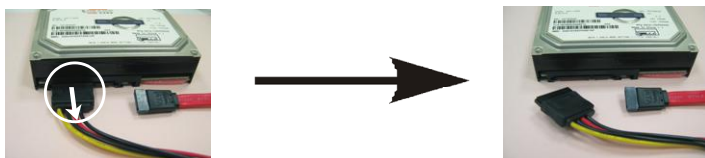

2.14 Driver Installation Guide

To install the drivers to your system, please insert the support CD to your optical drive first. Then, the drivers compatible to your system can be auto-detected and listed on the support CD driver page. Please follow the order from up to bottom side to install those required drivers. Therefore, the drivers you install can work properly.

2.15 Installing Windows® 7 / 7 64-bit / Vista™ / Vista™ 64-bit / XP / XP 64-bit Without RAID Functions

If you want to install Windows® 7 / 7 64-bit / Vista™ / Vista™ 64-bit / XP / XP 64-bit OS on your SATA / SATAII HDDs without RAID functions, please follow below procedures according to the OS you install.

2.15.1 Installing Windows® XP / XP 64-bit Without RAID Functions

If you want to install Windows® XP / XP 64-bit OS on your SATA / SATAII HDDs without RAID functions, please follow below steps.

Using SATA / SATAII HDDs with NCQ function

STEP 1: Set Up UEFI.

- A. Enter UEFI SETUP UTILITY → Advanced screen → SATA Configuration.
- B. Set the option “SATA Mode Selection” to [AHCI].

STEP 2: Make a SATA / SATAII driver diskette. (Please use USB floppy or floppy disk.)

- A. Insert the Support CD into your optical drive to boot your system.
- B. During POST at the beginning of system boot-up, press <F11> key, and then a window for boot devices selection appears. Please select CD-ROM as the boot device.
- C. When you see the message on the screen, “Do you want to generate Serial ATA driver diskette [YN]?”, press <Y>.
- D. Then you will see these messages,

Please insert a diskette into the floppy drive.

WARNING! Formatting the floppy diskette will lose ALL data in it!

Start to format and copy files [YN]?

Please insert a floppy diskette into the floppy drive, and press <Y>.

- E. The system will start to format the floppy diskette and copy SATA / SATAII drivers into the floppy diskette.

STEP 3: Install Windows® XP / XP 64-bit OS on your system.

After making a SATA / SATAII driver diskette, you can start to install Windows® XP / XP 64-bit on your system. At the beginning of Windows® setup, press F6 to install a third-party AHCI driver. When prompted, insert the SATA / SATAII driver diskette containing the Intel® AHCI driver. After reading the floppy disk, the driver will be presented. Select the driver to install according to the mode you choose and the OS you install.

Using SATA / SATAII HDDs without NCQ function

STEP 1: Set up UEFI.

- A. Enter UEFI SETUP UTILITY → Advanced screen → SATA Configuration.
- B. Set the option “SATA Mode Selection” to [IDE].

STEP 2: Install Windows® XP / XP 64-bit OS on your system.

2.15.2 Installing Windows® 7 / 7 64-bit / Vista™ / Vista™ 64-bit Without RAID Functions

If you want to install Windows® 7 / 7 64-bit / Vista™ / Vista™ 64-bit OS on your SATA / SATAII HDDs without RAID functions, please follow below steps.

Using SATA / SATAII HDDs with NCQ function

STEP 1: Set Up UEFI.

- A. Enter UEFI SETUP UTILITY → Advanced screen → SATA Configuration.
- B. Set the option “SATA Mode Selection” to [AHCI].

STEP 2: Install Windows® 7 / 7 64-bit / Vista™ / Vista™ 64-bit OS on your system.

Using SATA / SATAII HDDs without NCQ function

STEP 1: Set up UEFI.

- A. Enter UEFI SETUP UTILITY → Advanced screen → SATA Configuration.
- B. Set the option “SATA Mode Selection” to [IDE].

STEP 2: Install Windows® 7 / 7 64-bit / Vista™ / Vista™ 64-bit OS on your system.

Chapter 3: UEFI SETUP UTILITY

3.1 Introduction

This section explains how to use the UEFI SETUP UTILITY to configure your system. The UEFI chip on the motherboard stores the UEFI SETUP UTILITY. You may run the UEFI SETUP UTILITY when you start up the computer. Please press <F2> or during the Power-On-Self-Test (POST) to enter the UEFI SETUP UTILITY, otherwise, POST will continue with its test routines.

If you wish to enter the UEFI SETUP UTILITY after POST, restart the system by pressing <Ctl> + <Alt> + <Delete>, or by pressing the reset button on the system chassis. You may also restart by turning the system off and then back on.



Because the UEFI software is constantly being updated, the following UEFI setup screens and descriptions are for reference purpose only, and they may not exactly match what you see on your screen.

3.1.1 UEFI Menu Bar

The top of the screen has a menu bar with the following selections:

Main	To set up the system time/date information
OC Tweaker	To set up overclocking features
Advanced	To set up the advanced UEFI features
H/W Monitor	To display current hardware status
Boot	To set up the default system device to locate and load the Operating System
Security	To set up the security features
Exit	To exit the current screen or the UEFI SETUP UTILITY

Use <←> key or <→> key to choose among the selections on the menu bar, and then press <Enter> to get into the sub screen. You can also use the mouse to click your required item.

3.1.2 Navigation Keys

Please check the following table for the function description of each navigation key.

Navigation Key(s)	Function Description
← / →	Moves cursor left or right to select Screens
↑ / ↓	Moves cursor up or down to select items
+ / -	To change option for the selected items
<Tab>	Switch to next function
<Enter>	To bring up the selected screen
<PGUP>	Go to the previous page
<PGDN>	Go to the next page
<HOME>	Go to the top of the screen
<END>	Go to the bottom of the screen
<F1>	To display the General Help Screen
<F7>	Discard changes and exit the UEFI SETUP UTILITY
<F9>	Load optimal default values for all the settings
<F10>	Save changes and exit the UEFI SETUP UTILITY
<F12>	Print screen
<ESC>	Jump to the Exit Screen or exit the current screen

3.2 Main Screen

When you enter the UEFI SETUP UTILITY, the Main screen will appear and display the system overview.

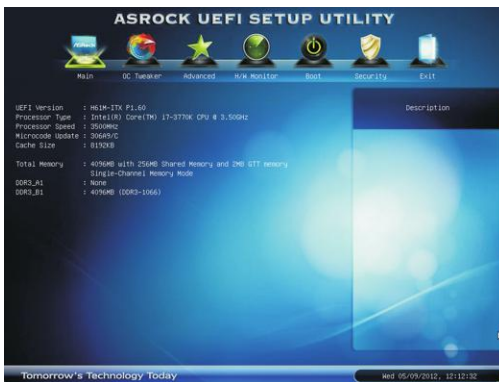

3.3 OC Tweaker Screen

In the OC Tweaker screen, you can set up overclocking features.



CPU Configuration

CPU Turbo Ratio

Use this item to change the ratio value of this motherboard.

Intel SpeedStep Technology

Intel SpeedStep technology is Intel's new power saving technology. Processors can switch between multiple frequencies and voltage points to enable power saving. The default value is [Enabled]. Configuration options: [Enabled] and [Disabled]. If you install Windows® Vista™ / 7 and want to enable this function, please set this item to [Enabled]. This item will be hidden if the current CPU does not support Intel SpeedStep technology.



Please note that enabling this function may reduce CPU voltage and lead to system stability or compatibility issues with some power supplies. Please set this item to [Disabled] if above issues occur.

Intel Turbo Boost Technology

Use this item to enable or disable Intel Turbo Boost Mode Technology. Turbo Boost Mode allows processor cores to run faster than marked frequency in specific conditions. The default value is [Enabled].

Long Duration Power Limit

Use this item to configure long duration power limit in watts. The default value is [Auto].

Long Duration Maintained

Use this item to configure time window which the long duration power is maintained. The default value is [Auto].

Short Duration Power Limit

Use this item to configure short duration power limit in watts. The default value is [Auto].

Primary Plane Current Limit

Use this item to configure the maximum instantaneous current allowed for the primary plane. The default value is [Auto].

Secondary Plane Current Limit

Use this item to configure the maximum instantaneous current allowed for the secondary plane. The default value is [Auto].

GT OverClocking Support

Use this item to enable or disable GT OverClocking Support. The default value is [Disabled].

DRAM Timing Configuration

Load XMP Setting

Use this to load XMP setting. Configuration options: [Auto], [Default], [Profile 1] and [Profile 2]. The default value is [Auto].

DRAM Frequency

If [Auto] is selected, the motherboard will detect the memory module(s) inserted and assign the appropriate frequency automatically.

DRAM Timing Control



DRAM tCL

Use this item to change CAS# Latency (tCL) Auto/Manual setting. The default is [Auto].

DRAM tRCD

Use this item to change RAS# to CAS# Delay (tRCD) Auto/Manual setting. The default is [Auto].

DRAM tRP

Use this item to change Row Precharge Time (tRP) Auto/Manual setting.
The default is [Auto].

DRAM tRAS

Use this item to change RAS# Active Time (tRAS) Auto/Manual setting.
The default is [Auto].

Command Rate (CR)

Use this item to change Command Rate (CR) Auto/Manual setting. The default is [Auto].

DRAM tWR

Use this item to change Write Recovery Time (tWR) Auto/Manual setting.
The default is [Auto].

DRAM tRFC

Use this item to change Refresh Cycle Time (tRFC) Auto/Manual setting.
The default is [Auto].

DRAM tRRD

Use this item to change RAS to RAS Delay (tRRD) Auto/Manual setting.
The default is [Auto].

DRAM tWTR

Use this item to change Write to Read Delay (tWTR) Auto/Manual setting.
The default is [Auto].

DRAM tRTP

Use this item to change Read to Precharge (tRTP) Auto/Manual setting.
The default is [Auto].

DRAM tFAW

Use this item to change Four Activate Window (tFAW) Auto/Manual setting. The default is [Auto].

DRAM tCWL

Use this item to change CAS# Write Latency (tCWL) Auto/Manual setting.
The default is [Auto].

ODT WR (CH A)

Use this item to change ODT WR (CH A) setting. The default is [Auto].

ODT WR (CH B)

Use this item to change ODT WR (CH B) setting. The default is [Auto].

ODT NOM (CH A)

Use this item to change ODT NOM (CH A) setting. The default is [Auto].

ODT NOM (CH B)

Use this item to change ODT NOM (CH B) setting. The default is [Auto].

MRC Fast Boot

Use this item to enable or disable MRC Fast Boot. The default is [Enabled].

Voltage Configuration

DRAM Voltage

Use this to select DRAM Voltage. The default value is [Auto].

User Defaults

In this option, you are allowed to load and save three user defaults according to your own requirements.

3.4 Advanced Screen

In this section, you may set the configurations for the following items: CPU Configuration, North Bridge Configuration, South Bridge Configuration, Storage Configuration, Intel(R) Rapid Start Technology, Intel(R) Smart Connect Technology, Super IO Configuration, ACPI Configuration and USB Configuration.



Setting wrong values in this section may cause the system to malfunction.

Instant Flash

Instant Flash is a UEFI flash utility embedded in Flash ROM. This convenient UEFI update tool allows you to update system UEFI without entering operating systems first like MS-DOS or Windows®. Just save the new UEFI file to your USB flash drive, floppy disk or hard drive and launch this tool, then you can update your UEFI only in a few clicks without preparing an additional floppy diskette or other complicated flash utility. Please be noted that the USB flash drive or hard drive must use FAT32/16/12 file system. If you execute Instant Flash utility, the utility will show the UEFI files and their respective information. Select the proper UEFI file to update your UEFI, and reboot your system after the UEFI update process is completed.

3.4.1 CPU Configuration



Intel Hyper Threading Technology

To enable this feature, a computer system with an Intel processor that supports Hyper-Threading technology and an operating system that includes optimization for this technology, such as Microsoft® Windows® XP / Vista™ / 7 is required. Set to [Enabled] if using Microsoft® Windows® XP, Vista™, 7, or Linux kernel version 2.4.18 or higher. This option will be hidden if the installed CPU does not support Hyper-Threading technology.

Active Processor Cores

Use this item to select the number of cores to enable in each processor package. The default value is [All].

Enhance Halt State (C1E)

All processors support the Halt State (C1). The C1 state is supported through the native processor instructions HLT and MWAIT and requires no hardware support from the chipset. In the C1 power state, the processor maintains the context of the system caches.

CPU C3 State Support

Use this to enable or disable CPU C3 (ACPI C2) report to OS.

CPU C6 State Support

Use this to enable or disable CPU C6 (ACPI C3) report to OS.

Package C State Support

Selected option will program into C State package limit register. The default value is [Auto].

CPU Thermal Throttling

You may select [Enabled] to enable CPU internal thermal control mechanism to keep the CPU from overheating.

No-Execute Memory Protection

No-Execution (NX) Memory Protection Technology is an enhancement

to the IA-32 Intel Architecture. An IA-32 processor with “No Execute (NX) Memory Protection” can prevent data pages from being used by malicious software to execute codes. This option will be hidden if the current CPU does not support No-Execute Memory Protection.

Intel Virtualization Technology

When this option is set to [Enabled], a VMM (Virtual Machine Architecture) can utilize the additional hardware capabilities provided by Vanderpool Technology. This option will be hidden if the installed CPU does not support Intel Virtualization Technology.

Hardware Prefetcher

Use this item to turn on/off the MLC streamer prefetcher.

Adjacent Cache Line Prefetch

Use this item to turn on/off prefetching of adjacent cache lines.

3.4.2 North Bridge Configuration



Primary Graphics Adapter

This allows you to select [Onboard] or [PCI Express] as the boot graphic adapter priority. The default value is [PCI Express].

VT-d

Use this to enable or disable Intel® VT-d technology (Intel® Virtualization Technology for Directed I/O). The default value of this feature is [Disabled].

Share Memory

This allows you to set onboard VGA share memory feature. The default value is [Auto].

IGPU Multi-Monitor

This allows you to enable or disable IGPU Multi-Monitor. The default value is [Enabled]. If you install the PCI Express card under Windows® XP / Vista™ OS, please disable this option.

Render Standby

Use this to enable or disable Render Standby by Internal Graphics Device. The default value is [Enabled].

Deep Render Standby

Use this to enable or disable Deep Render Standby by Internal Graphics Device. The default value is [Enabled].

3.4.3 South Bridge Configuration



Onboard HD Audio

Select [Auto], [Enabled] or [Disabled] for the onboard HD Audio feature. If you select [Auto], the onboard HD Audio will be disabled when PCI Sound Card is plugged.

Front Panel

Select [Auto] or [Disabled] for the onboard HD Audio Front Panel.

On/Off Play

Use this item to enable or disable On/Off Play Technology. The default value is [Enabled]. When On/Off Play is enabled, Deep Sleep will be disabled. If you want to enable Deep Sleep, please disable On/Off Play first.

Onboard HDMI HD Audio

This allows you to enable or disable the Onboard HDMI HD Audio feature.

Onboard LAN

This allows you to enable or disable the Onboard LAN feature.

Deep Sleep

Mobile platforms support Deep S4/S5 in DC only and desktop platforms support Deep S4/S5 in AC only. The default value is [Enabled in S5].

Restore on AC/Power Loss

This allows you to set the power state after an unexpected AC/power loss. If [Power Off] is selected, the AC/power remains off when the power recovers. If [Power On] is selected, the AC/power resumes and the system starts to boot up when the power recovers.

Good Night LED

Use this item to enable or disable Power LED and LAN LED.

3.4.4 Storage Configuration



SATA Controller(s)

Use this item to enable or disable the SATA Controller feature.

SATA Mode Selection

Use this to select SATA mode. Configuration options: [IDE Mode], [AHCI Mode] and [Disabled]. The default value is [AHCI Mode].



AHCI (Advanced Host Controller Interface) supports NCQ and other new features that will improve SATA disk performance but IDE mode does not have these advantages.

Aggressive Link Power Management

Use this item to configure Aggressive Link Power Management.

Hard Disk S.M.A.R.T.

Use this item to enable or disable the S.M.A.R.T. (Self-Monitoring, Analysis, and Reporting Technology) feature. Configuration options: [Disabled] and [Enabled].

3.4.5 Intel(R) Rapid Start Technology



Intel(R) Rapid Start Technology

Use this item to enable or disable Intel(R) Rapid Start Technology. Intel(R) Rapid Start Technology is a new zero power hibernation mode which allows users to resume in just 5-6 seconds. The default is [Enabled].

Entry After

Select a time to enable RTC wake timer at S3 entry. The default is [10 minutes].

Active Page Threshold Support

This allows you to enable or disable Active Page Threshold Support. The default is [Disabled].

3.4.6 Intel(R) Smart Connect Technology



Intel(R) Smart Connect Technology

Use this item to enable or disable Intel(R) Smart Connect Technology. Intel(R) Smart Connect Technology keeps your e-mail and social networks, such as Twitter, Facebook, etc. updated automatically while the computer is in sleep mode. The default is [Enabled].

3.4.7 Super IO Configuration



CIR Controller

Use this item to enable or disable CIR controller.

3.4.8 ACPI Configuration



Suspend to RAM

Use this item to select whether to auto-detect or disable the Suspend-to-RAM feature. Selecting [Auto] will enable this feature if the OS supports it.

Check Ready Bit

Use this item to enable or disable the feature Check Ready Bit.

ACPI HPET Table

Use this item to enable or disable ACPI HPET Table. The default value is [Enabled]. Please set this option to [Enabled] if you plan to use this motherboard to submit Windows® Vista™ certification.

PS/2 Keyboard Power On

Use this item to enable or disable PS/2 keyboard to turn on the system from the power-soft-off mode.

PCI Devices Power On

Use this item to enable or disable PCI devices to turn on the system from the power-soft-off mode.

Ring-In Power On

Use this item to enable or disable Ring-In signals to turn on the system from the power-soft-off mode.

RTC Alarm Power On

Use this item to enable or disable RTC (Real Time Clock) to power on the system.

USB Keyboard/Remote Power On

Use this item to enable or disable USB Keyboard/Remote to turn on the system from the power-soft-off mode.

USB Mouse Power On

Use this item to enable or disable USB Mouse to turn on the system from the power-soft-off mode.

3.4.9 USB Configuration



USB 2.0 Controller

Use this item to enable or disable the use of USB 2.0 controller.

USB 3.0 Controller

Use this item to enable or disable the use of USB 3.0 controller.

Legacy USB Support

Use this option to select legacy support for USB devices. There are four configuration options: [Enabled], [Auto], [Disabled] and [UEFI Setup Only]. The default value is [Enabled]. Please refer to below descriptions for the details of these four options:

[Enabled] - Enables support for legacy USB.

[Auto] - Enables legacy support if USB devices are connected.

[Disabled] - USB devices are not allowed to use under legacy OS and UEFI setup when [Disabled] is selected. If you have USB compatibility issue, it is recommended to select [Disabled] to enter OS.

[UEFI Setup Only] - USB devices are allowed to use only under UEFI setup and Windows / Linux OS.

Legacy USB 3.0 Support

Use this option to enable or disable legacy support for USB 3.0 devices. The default value is [Disabled].



To use Instant Flash, USB Keyboard/Remote Power On and USB Mouse Power On functions on USB 3.0 devices, please enable the item “Legacy USB 3.0 Support“.

3.5 Hardware Health Event Monitoring Screen

In this section, it allows you to monitor the status of the hardware on your system, including the parameters of the CPU temperature, motherboard temperature, CPU fan speed, chassis fan speed, and the critical voltage.



CPU Fan Setting

This allows you to set the CPU fan speed. Configuration options: [Full On] and [Automatic Mode]. The default is value [Full On].

Chassis Fan 1 Setting

This allows you to set the chassis fan 1 speed. Configuration options: [Full On] and [Automatic Mode]. The default is value [Full On].

3.6 Boot Screen

In this section, it will display the available devices on your system for you to configure the boot settings and the boot priority.



Setup Prompt Timeout

This shows the number of seconds to wait for setup activation key. 65535(0XFFFF) means indefinite waiting.

Bootup Num-Lock

If this item is set to [On], it will automatically activate the Numeric Lock function after boot-up.

PCI ROM Priority

Use this item to adjust PCI ROM Priority. The default value is [Legacy ROM].

Full Screen Logo

Use this item to enable or disable OEM Logo. The default value is [Enabled].

AddOn ROM Display

Use this option to adjust AddOn ROM Display. If you enable the option "Full Screen Logo" but you want to see the AddOn ROM information when the system boots, please select [Enabled]. Configuration options: [Enabled] and [Disabled]. The default value is [Enabled].

Boot From Onboard LAN

Use this item to enable or disable the Boot From Onboard LAN feature.

Boot Failure Guard

Enable or disable the feature of Boot Failure Guard.

Boot Failure Guard Count

Use this item to configure Boot Failure Guard Count.

3.7 Security Screen

In this section, you may set or change the supervisor/user password for the system. For the user password, you may also clear it.



3.8 Exit Screen



Save Changes and Exit

When you select this option, the following message “Save configuration changes and exit setup?” will pop-out. Select [Yes] to save the changes and exit the UEFI SETUP UTILITY.

Discard Changes and Exit

When you select this option, the following message “Discard changes and exit setup?” will pop-out. Select [Yes] to exit the UEFI SETUP UTILITY without saving any changes.

Discard Changes

When you select this option, the following message “Discard changes?” will pop-out. Select [Yes] to discard all changes.

Load UEFI Defaults

Load UEFI default values for all the setup questions. F9 key can be used for this operation.

Launch EFI Shell from filesystem device

Attempts to Launch EFI Shell application (Shell64.efi) from one of the available filesystem devices.

Chapter 4: Software Support

4.1 Install Operating System

This motherboard supports various Microsoft® Windows® operating systems: 7 / 7 64-bit / Vista™ / Vista™ 64-bit / XP / XP 64-bit. Because motherboard settings and hardware options vary, use the setup procedures in this chapter for general reference only. Refer to your OS documentation for more information.

4.2 Support CD Information

The Support CD that came with the motherboard contains necessary drivers and useful utilities that enhance the motherboard features.

4.2.1 Running The Support CD

To begin using the support CD, insert the CD into your CD-ROM drive. The CD automatically displays the Main Menu if “AUTORUN” is enabled in your computer. If the Main Menu did not appear automatically, locate and double click on the file “ASSETUP.EXE” from the BIN folder in the Support CD to display the menus.

4.2.2 Drivers Menu

The Drivers Menu shows the available devices drivers if the system detects installed devices. Please install the necessary drivers to activate the devices.

4.2.3 Utilities Menu

The Utilities Menu shows the applications software that the motherboard supports. Click on a specific item then follow the installation wizard to install it.

4.2.4 Contact Information

If you need to contact ASRock or want to know more about ASRock, welcome to visit ASRock’s website at <http://www.asrock.com>; or you may contact your dealer for further information.

Installing OS on a HDD Larger Than 2TB

This motherboard is adopting UEFI BIOS that allows Windows® OS to be installed on a large size HDD (>2TB). Please follow below procedure to install the operating system.

1. Please make sure to use **Windows® Vista™ 64-bit (with SP1 or above)** or **Windows® 7 64-bit**.
2. Press <F2> or <Delete> at system POST. Set **AHCI Mode** in UEFI Setup Utility > Advanced > Storage Configuration > SATA Mode.
3. Choose the item **“UEFI:xxx”** to boot in UEFI Setup Utility > Boot > Boot Option #1. (“xxx” is the device which contains your Windows® installation files. Normally it is an optical drive.) You can also press <F11> to launch boot menu at system POST and choose the item **“UEFI:xxx”** to boot.
4. Start Windows® installation.
5. If you install **Windows® 7 64-bit** OS, OS will be formatted by GPT (GUID Partition Table). Please install the hotfix file from Microsoft®:
<http://support.microsoft.com/kb/979903>