

GA-M68MT-D3P

GA-M68MT-S2P

User's Manual

Rev. 3101

12ME-M68MT2P-3101R

Declaration of Conformity

We, Manufacturer/Importer

G.B.T. Technology Trading GmbH

Bültenkoppl 16, 22047 Hamburg, Germany

declare that the product

GA-M68MT-D3P/GA-M68MT-S2P

(reference to the specification under which conformity is declared)
in accordance with the EMC Directive 2004/108/E

EN 55011 Limits and methods of measurement of radio disturbance characteristics of household appliances, systems and high frequency equipment

EN 61000-3-2 Disturbances in supply systems caused by household appliances and similar electrical equipment "Voltage fluctuations"

Disturbances in supply systems caused by household appliances and similar electrical equipment "Voltage fluctuations"

EN 55013 Limits and methods of measurement of radio disturbance characteristics of broadcast receivers and associated equipment

EN 55024 Information Technology equipment/Immunity characteristics/Limits and methods of measurement

Information Technology equipment/Immunity characteristics/Limits and methods of measurement

EN 55014-1 Limits and methods of measurement of radio disturbance characteristics of portable tools and similar electrical apparatus

EN 50082-1 Generic immunity standard Part 1: Residential, commercial and light industry

Generic immunity standard Part 1: Residential, commercial and light industry

EN 55015 Limits and methods of measurement of radio disturbance characteristics of fluorescent lamps and luminaires

EN 55014-2 Immunity requirements for household appliances tools and similar apparatus

Immunity requirements for household appliances tools and similar apparatus

EN 55020 Immunity from radio interference of broadcast receivers and associated equipment

EN 50091-2 EMC requirements for uninterruptible power systems (UPS)

EMC requirements for uninterruptible power systems (UPS)

EN 55022 Limits and methods of measurement of radio disturbance characteristics of information technology equipment

EN 55014-1-2 Immunity from radio interference of information technology equipment

Immunity from radio interference of information technology equipment

DIN VDE 0885 Colored distribution system for receiving and/or distribution from part 10
 part 11
 part 12
 part 13
 part 14
 part 15



(CE conformity marking)

CE marking

EN 60085-2 Safety requirements for mains operated electronic and related apparatus for household and similar general use

Safety requirements for mains operated electronic and related apparatus for household and similar general use

EN 60085 Safety requirements for mains operated electronic and related apparatus for household and similar general use

EN 60950 Safety for information technology equipment including electrical business equipment

Safety for information technology equipment including electrical business equipment

EN 60335 Safety of household and similar electrical appliances

EN 50091-1 General and Safety requirements for uninterruptible power systems (UPS)

General and Safety requirements for uninterruptible power systems (UPS)

Manufacturer/Importer

Signature: *Timmy Huang*

(Stamp)

Date: Dec. 31, 2010

Name: Timmy Huang

DECLARATION OF CONFORMITY

Per FCC Part 2 Section 2.1077(a)



Responsible Party Name: G.B.T. INC. (U.S.A)

Address: 17388 Railroad Street

City of Industry, CA 91748

Phone/Fax No: (818) 854-9338/ (818) 854-9339

hereby declares that the product

Product Name: **Motherboard**

Model Number: GA-M68MT-D3P
GA-M68MT-S2P

Conforms to the following specifications:

FCC Part 15, Subpart B, Section 15.107(a) and Section 15.109

(a), Class B Digital Device

Supplementary Information:

This device complies with part 15 of the FCC Rules. Operation is subject to the following two conditions: (1) This device may not cause harmful and (2) this device must accept any interference received, including that may cause undesired operation.

Representative Person's Name: ERIC LU

Signature: *Eric Lu*

Date: Dec. 31, 2010

Copyright

© 2011 GIGA-BYTE TECHNOLOGY CO., LTD. All rights reserved.

The trademarks mentioned in this manual are legally registered to their respective owners.

Disclaimer

Information in this manual is protected by copyright laws and is the property of GIGABYTE.

Changes to the specifications and features in this manual may be made by GIGABYTE without prior notice. No part of this manual may be reproduced, copied, translated, transmitted, or published in any form or by any means without GIGABYTE's prior written permission.

- In order to assist in the use of this product, carefully read the User's Manual.
- For product-related information, check on our website at: <http://www.gigabyte.com>

Identifying Your Motherboard Revision

The revision number on your motherboard looks like this: "REV: X.X." For example, "REV: 1.0" means the revision of the motherboard is 1.0. Check your motherboard revision before updating motherboard BIOS, drivers, or when looking for technical information.

Example:

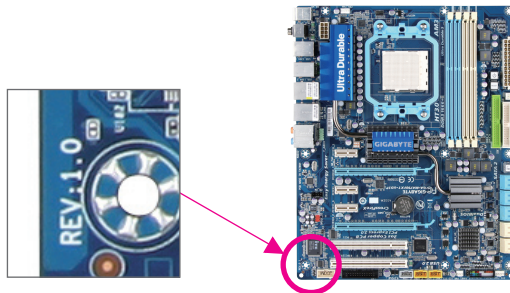
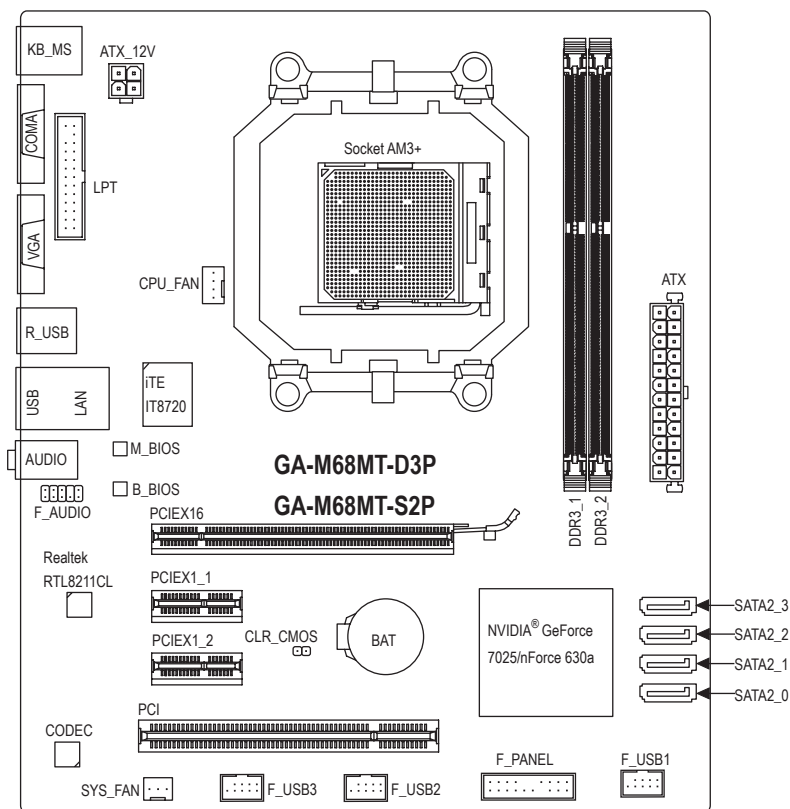

Table of Contents

GA-M68MT-D3P/GA-M68MT-S2P Motherboard Layout	5
GA-M68MT-D3P/GA-M68MT-S2P Motherboard Block Diagram	6
Chapter 1 Hardware Installation	7
1-1 Installation Precautions	7
1-2 Product Specifications	8
1-3 Installing the CPU and CPU Cooler	10
1-3-1 Installing the CPU	10
1-4 Installing the Memory	10
1-4-1 Dual Channel Memory Configuration	11
1-5 Installing an Expansion Card	11
1-6 Back Panel Connectors	11
1-7 Internal Connectors	13
Chapter 2 BIOS Setup	20
2-1 Startup Screen	20
2-2 The Main Menu	20
2-3 MB Intelligent Tweaker(M.I.T.)	21
2-4 Standard CMOS Features	23
2-5 Advanced BIOS Features	25
2-6 Integrated Peripherals	27
.....
27	
2-7 Power Management Setup	29
2-8 PnP/PCI Configurations	31
2-9 PC Health Status	31
2-10 Load Fail-Safe Defaults	32
2-11 Load Optimized Defaults	33
2-12 Set Supervisor/User Password	33
2-13 Save & Exit Setup	34
2-14 Exit Without Saving	34
Chapter 3 Drivers Installation	35
Installing Chipset Drivers	35
Chapter 4 Appendix	35
Configuring SATA Hard Drive(s)	35

GA-M68MT-D3P/GA-M68MT-S2P Motherboard Layout



Box Contents

- GA-M68MT-D3P or GA-M68MT-S2P motherboard
- Motherboard driver disk
- User's Manual
- I/O Shield
- Two SATA cables

The box contents above are for reference only and the actual items shall depend on the product package you obtain.
The box contents are subject to change without notice.

*** The GA-M68MT-D3P adopts All-Solid Capacitor design.

GA-M68MT-D3P/GA-M68MT-S2P Motherboard Block Diagram

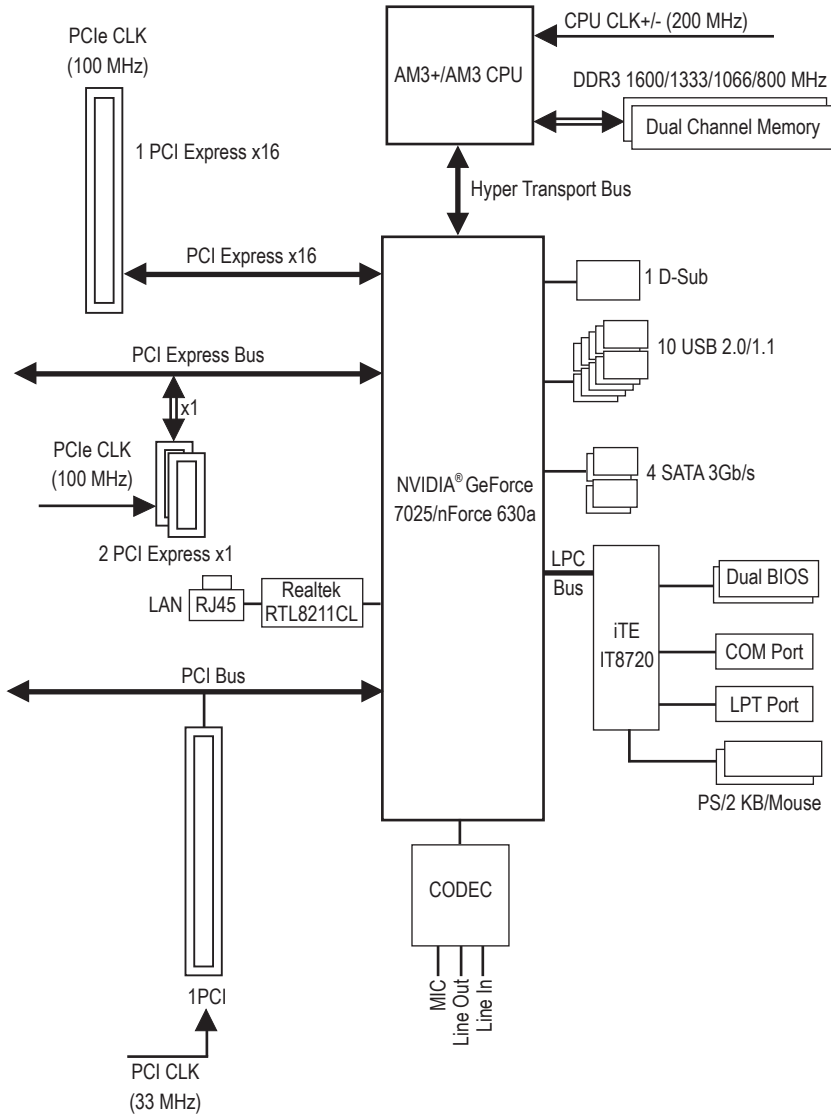











Chapter 1 Hardware Installation









1-1 Installation Precautions

The motherboard contains numerous delicate electronic circuits and components which can become damaged as a result of electrostatic discharge (ESD). Prior to installation, carefully read the user's manual and follow these procedures:

- Prior to installation, do not remove or break motherboard S/N (Serial Number) sticker or warranty sticker provided by your dealer. These stickers are required for warranty validation.
- Always remove the AC power by unplugging the power cord from the power outlet before installing or removing the motherboard or other hardware components.
- When connecting hardware components to the internal connectors on the motherboard, make sure they are connected tightly and securely.
- When handling the motherboard, avoid touching any metal leads or connectors.
- It is best to wear an electrostatic discharge (ESD) wrist strap when handling electronic components such as a motherboard, CPU or memory. If you do not have an ESD wrist strap, keep your hands dry and first touch a metal object to eliminate static electricity.
- Prior to installing the motherboard, please have it on top of an antistatic pad or within an electrostatic shielding container.
- Before unplugging the power supply cable from the motherboard, make sure the power supply has been turned off.
- Before turning on the power, make sure the power supply voltage has been set according to the local voltage standard.
- Before using the product, please verify that all cables and power connectors of your hardware components are connected.
- To prevent damage to the motherboard, do not allow screws to come in contact with the motherboard circuit or its components.
- Make sure there are no leftover screws or metal components placed on the motherboard or within the computer casing.
- Do not place the computer system on an uneven surface.
- Do not place the computer system in a high-temperature environment.
- Turning on the computer power during the installation process can lead to damage to system components as well as physical harm to the user.
- If you are uncertain about any installation steps or have a problem related to the use of the product, please consult a certified computer technician.

1-2 Product Specifications

	CPU	<ul style="list-style-type: none"> ◆ AM3+ Socket: <ul style="list-style-type: none"> - AMD AM3+ FX processors <ul style="list-style-type: none"> * You must install an external graphics card if you want to install Windows XP on your AM3+ CPU-based system. - AMD AM3 Phenom™ II processors/AMD Athlon™ II processors (Go to GIGABYTE's website for the latest CPU support list.)
	Hyper Transport Bus	<ul style="list-style-type: none"> ◆ 2000 MT/s
	Chipset	<ul style="list-style-type: none"> ◆ NVIDIA® GeForce 7025/nForce 630a
	Memory	<ul style="list-style-type: none"> ◆ 2 x 1.5V DDR3 DIMM sockets supporting up to 8 GB of system memory <ul style="list-style-type: none"> * Due to Windows 32-bit operating system limitation, when more than 4 GB of physical memory is installed, the actual memory size displayed will be less than 4 GB. ◆ Dual channel memory architecture ◆ Support for DDR3 1600/1333/1066/800 MHz memory modules (Go to GIGABYTE's website for the latest supported memory speeds and memory modules.)
	Onboard Graphics	<ul style="list-style-type: none"> ◆ Chipset: <ul style="list-style-type: none"> - 1 x D-Sub port
	Audio	<ul style="list-style-type: none"> ◆ Realtek ALC888B/889 codec ◆ High Definition Audio ◆ 2/4/5.1/7.1-channel <ul style="list-style-type: none"> * To configure 7.1-channel audio, you have to use an HD front panel audio module and enable the multi-channel audio feature through the audio driver.
	LAN	<ul style="list-style-type: none"> ◆ 1 x Realtek RTL8211CL chip (10/100/1000 Mbit)
	Expansion Slots	<ul style="list-style-type: none"> ◆ 1 x PCI Express x16 slot, running at x16 ◆ 2 x PCI Express x1 slots ◆ 1 x PCI slot
	Storage Interface	<ul style="list-style-type: none"> ◆ Chipset: <ul style="list-style-type: none"> - 4 x SATA 3Gb/s connectors supporting up to 4 SATA 3Gb/s devices - Support for RAID 0, RAID 1, RAID 5, RAID 10, and JBOD
	USB	<ul style="list-style-type: none"> ◆ Chipset: <ul style="list-style-type: none"> - Up to 10 USB 2.0/1.1 ports (4 ports on the back panel, 6 ports available through the internal USB headers)
	Internal Connectors	<ul style="list-style-type: none"> ◆ 1 x 24-pin ATX main power connector ◆ 1 x 4-pin ATX 12V power connector ◆ 4 x SATA 3Gb/s connectors ◆ 1 x CPU fan header ◆ 1 x system fan header ◆ 1 x front panel header ◆ 1 x front panel audio header ◆ 3 x USB 2.0/1.1 headers ◆ 1 x parallel port connector ◆ 1 x clearing CMOS jumper

	Back Panel Connectors	<ul style="list-style-type: none"> ◆ 1 x PS/2 keyboard port ◆ 1 x PS/2 mouse port ◆ 1 x D-Sub port ◆ 1 x serial port ◆ 4 x USB 2.0/1.1 ports ◆ 1 x RJ-45 port ◆ 3 x audio jacks (Line In/Line Out/Microphone)
	I/O Controller	<ul style="list-style-type: none"> ◆ iTE IT8720 chip
	Hardware Monitor	<ul style="list-style-type: none"> ◆ System voltage detection ◆ CPU/System temperature detection ◆ CPU/System fan speed detection ◆ CPU/System overheating warning ◆ CPU/System fan fail warning ◆ CPU fan speed control <p style="margin-left: 20px;">* Whether the CPU/system fan speed control function is supported will depend on the CPU/system cooler you install.</p>
	BIOS	<ul style="list-style-type: none"> ◆ 2 x 16 Mbit flash ◆ Use of licensed AWARD BIOS ◆ Support for DualBIOS™ ◆ PnP 1.0a, DMI 2.0, SM BIOS 2.4, ACPI 1.0b
	Unique Features	<ul style="list-style-type: none"> ◆ Support for @BIOS ◆ Support for Q-Flash ◆ Support for Xpress BIOS Rescue ◆ Support for Download Center ◆ Support for Xpress Install ◆ Support for Xpress Recovery2 ◆ Support for EasyTune <p style="margin-left: 20px;">* Available functions in EasyTune may differ by motherboard model.</p> <ul style="list-style-type: none"> ◆ Support for Auto Green ◆ Support for ON/OFF Charge
	Bundled Software	<ul style="list-style-type: none"> ◆ Norton Internet Security (OEM version)
	Operating System	<ul style="list-style-type: none"> ◆ Support for Microsoft® Windows 7/Vista/XP
	Form Factor	<ul style="list-style-type: none"> ◆ Micro ATX Form Factor; 24.4cm x 20.5cm

* GIGABYTE reserves the right to make any changes to the product specifications and product-related information without prior notice.

1-3 Installing the CPU and CPU Cooler



Read the following guidelines before you begin to install the CPU:

- Make sure that the motherboard supports the CPU.
(Go to GIGABYTE's website for the latest CPU support list.)
- Always turn off the computer and unplug the power cord from the power outlet before installing the CPU to prevent hardware damage.
- Locate the pin one of the CPU. The CPU cannot be inserted if oriented incorrectly. (Or you may locate the notches on both sides of the CPU and alignment keys on the CPU socket.)
- Apply an even and thin layer of thermal grease on the surface of the CPU.
- Do not turn on the computer if the CPU cooler is not installed, otherwise overheating and damage of the CPU may occur.
- Set the CPU host frequency in accordance with the CPU specifications. It is not recommended that the system bus frequency be set beyond hardware specifications since it does not meet the standard requirements for the peripherals. If you wish to set the frequency beyond the standard specifications, please do so according to your hardware specifications including the CPU, graphics card, memory, hard drive, etc.

1-3-1 Installing the CPU

Locate the pin one (denoted by a small triangle) of the CPU socket and the CPU.

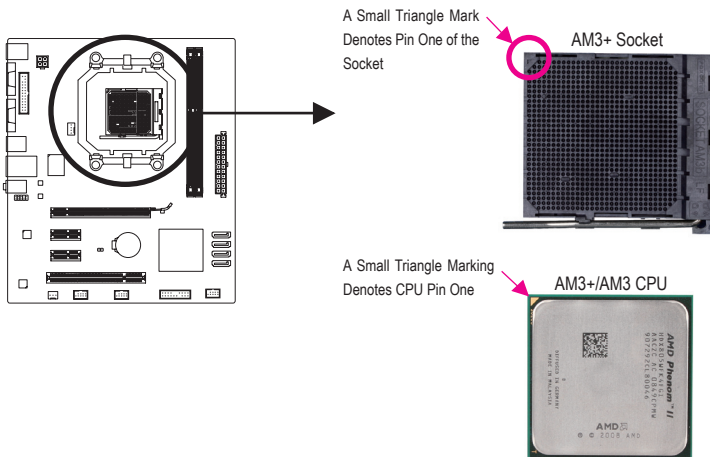

1-4 Installing the Memory



Read the following guidelines before you begin to install the memory:

- Make sure that the motherboard supports the memory. It is recommended that memory of the same capacity, brand, speed, and chips be used.
(Go to GIGABYTE's website for the latest supported memory speeds and memory modules.)
- Always turn off the computer and unplug the power cord from the power outlet before installing the memory to prevent hardware damage.
- Memory modules have a foolproof design. A memory module can be installed in only one direction. If you are unable to insert the memory, switch the direction.

1-4-1 Dual Channel Memory Configuration

This motherboard provides two DDR3 memory sockets and supports Dual Channel Technology.

The two DDR3 memory sockets are divided into two channels and each channel has two memory sockets as following:

- ▶▶ Channel 0: DDR3_1
- ▶▶ Channel 1: DDR3_2

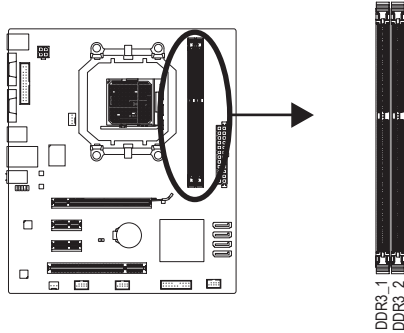

Due to CPU limitation, read the following guidelines before installing the memory in Dual Channel mode.

1. Dual Channel mode cannot be enabled if only one DDR3 memory module is installed.
2. When enabling Dual Channel mode with two memory modules, it is recommended that memory of the same capacity, brand, speed, and chips be used.

1-5 Installing an Expansion Card



Read the following guidelines before you begin to install an expansion card:

- Make sure the motherboard supports the expansion card. Carefully read the manual that came with your expansion card.
- Always turn off the computer and unplug the power cord from the power outlet before installing an expansion card to prevent hardware damage.

1-6 Back Panel Connectors

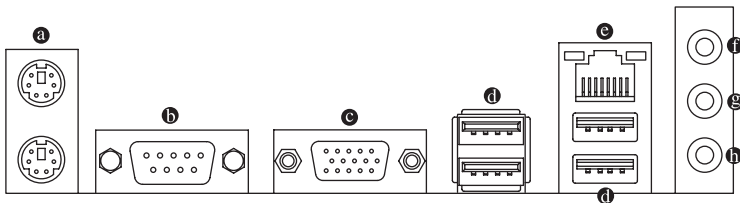

a PS/2 Keyboard and PS/2 Mouse Port

Use the upper port (green) to connect a PS/2 mouse and the lower port (purple) to connect a PS/2 keyboard.

b Serial Port

Use the serial port to connect devices such as a mouse, modem or other peripherals.

④ D-Sub Port

The D-Sub port supports a 15-pin D-Sub connector. Connect a monitor that supports D-Sub connection to this port.

⑤ USB 2.0/1.1 Port

The USB port supports the USB 2.0/1.1 specification. Use this port for USB devices such as a USB keyboard/mouse, USB printer, USB flash drive and etc.

⑥ RJ-45 LAN Port

The Gigabit Ethernet LAN port provides Internet connection at up to 1 Gbps data rate. The following describes the states of the LAN port LEDs.

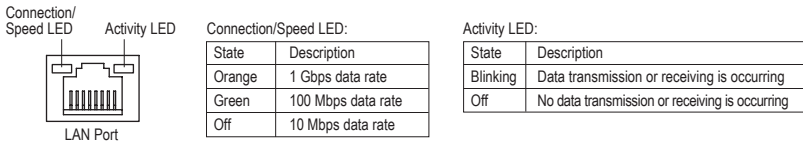

⑦ Line In Jack (Blue)

The default line in jack. Use this audio jack for line in devices such as an optical drive, walkman, etc.

⑧ Line Out Jack (Front Speaker Out, Green)

The default line out jack. Use this audio jack for a headphone or 2-channel speaker. This jack can be used to connect front speakers in a 4/5.1-channel audio configuration.

⑨ Mic In Jack (Pink)

The default Mic in jack. Microphones must be connected to this jack.



To configure 7.1-channel audio, you have to use an HD front panel audio module and enable the multi-channel audio feature through the audio driver.



- When removing the cable connected to a back panel connector, first remove the cable from your device and then remove it from the motherboard.
- When removing the cable, pull it straight out from the connector. Do not rock it side to side to prevent an electrical short inside the cable connector.

1-7 Internal Connectors

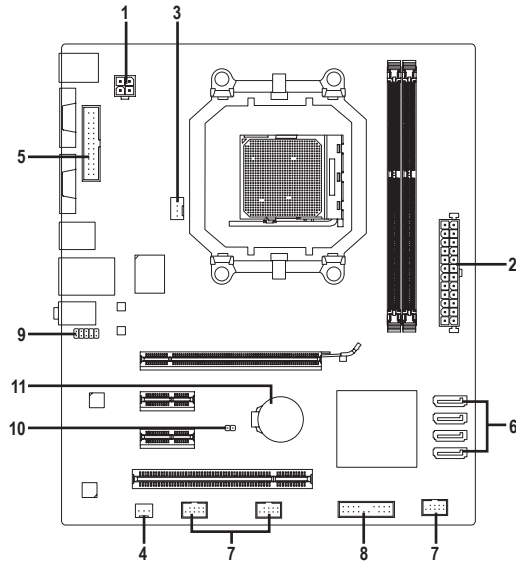

1) ATX_12V	7) F_USB1/F_USB2/F_USB3
2) ATX	8) F_PANEL
3) CPU_FAN	9) F_AUDIO
4) SYS_FAN	10) CLR_CMOS
5) LPT	11) BAT
6) SATA2_0/1/2/3	



Read the following guidelines before connecting external devices:

- First make sure your devices are compliant with the connectors you wish to connect.
- Before installing the devices, be sure to turn off the devices and your computer. Unplug the power cord from the power outlet to prevent damage to the devices.
- After installing the device and before turning on the computer, make sure the device cable has been securely attached to the connector on the motherboard.

1/2) ATX_12V/ATX (2x2 12V Power Connector and 2x12 Main Power Connector)

With the use of the power connector, the power supply can supply enough stable power to all the components on the motherboard. Before connecting the power connector, first make sure the power supply is turned off and all devices are properly installed. The power connector possesses a foolproof design. Connect the power supply cable to the power connector in the correct orientation. The 12V power connector mainly supplies power to the CPU. If the 12V power connector is not connected, the computer will not start.



To meet expansion requirements, it is recommended that a power supply that can withstand high power consumption be used (500W or greater). If a power supply is used that does not provide the required power, the result can lead to an unstable or unbootable system.

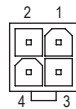
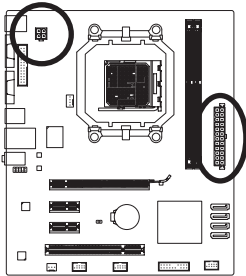

ATX_12V

ATX_12V:

Pin No.	Definition
1	GND
2	GND
3	+12V
4	+12V

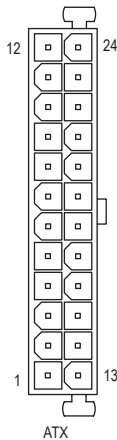

ATX:

Pin No.	Definition	Pin No.	Definition
1	3.3V	13	3.3V
2	3.3V	14	-12V
3	GND	15	GND
4	+5V	16	PS_ON (soft On/Off)
5	GND	17	GND
6	+5V	18	GND
7	GND	19	GND
8	Power Good	20	-5V
9	5VSB (stand by +5V)	21	+5V
10	+12V	22	+5V
11	+12V (Only for 2x12-pin ATX)	23	+5V (Only for 2x12-pin ATX)
12	3.3V (Only for 2x12-pin ATX)	24	GND (Only for 2x12-pin ATX)

3/4) CPU_FAN/SYS_FAN (Fan Headers)

The motherboard has a 4-pin CPU fan header (CPU_FAN) and a 3-pin (SYS_FAN) system fan headers. Most fan headers possess a foolproof insertion design. When connecting a fan cable, be sure to connect it in the correct orientation (the black connector wire is the ground wire). The motherboard supports CPU fan speed control, which requires the use of a CPU fan with fan speed control design. For optimum heat dissipation, it is recommended that a system fan be installed inside the chassis.

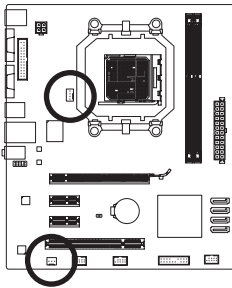

CPU_FAN:

Pin No.	Definition
1	GND
2	+12V / Speed Control
3	Sense
4	Speed Control

SYS_FAN:

Pin No.	Definition
1	GND
2	+12V
3	Sense



- Be sure to connect fan cables to the fan headers to prevent your CPU and system from overheating. Overheating may result in damage to the CPU or the system may hang.
- These fan headers are not configuration jumper blocks. Do not place a jumper cap on the headers.

5) LPT (Parallel Port Header)

The LPT header can provide one parallel port via an optional LPT port cable. For purchasing the optional LPT port cable, please contact the local dealer.

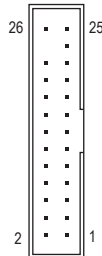
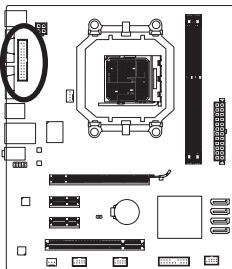

Pin No.	Definition	Pin No.	Definition
1	STB-	14	GND
2	AFD-	15	PD6
3	PD0	16	GND
4	ERR-	17	PD7
5	PD1	18	GND
6	INIT-	19	ACK-
7	PD2	20	GND
8	SLIN-	21	BUSY
9	PD3	22	GND
10	GND	23	PE
11	PD4	24	No Pin
12	GND	25	SLCT
13	PD5	26	GND

6) SATA2_0/1/2/3 (SATA 3Gb/s Connectors)

The SATA connectors conform to SATA 3Gb/s standard and are compatible with SATA 1.5Gb/s standard. Each SATA connector supports a single SATA device. The NVIDIA® GeForce 7025/nForce 630a chipset supports RAID 0, RAID 1, RAID 5, RAID 10, and JBOD. Refer to Chapter 4, "Configuring SATA Hard Drive(s)," for instructions on configuring a RAID array.

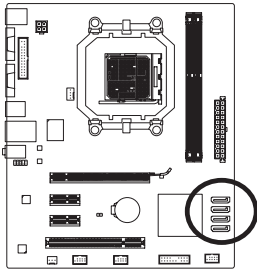

Pin No.	Definition
1	GND
2	TXP
3	TXN
4	GND
5	RXN
6	RXP
7	GND

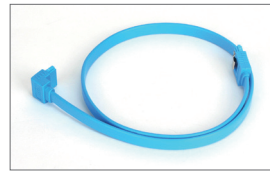

Please connect the L-shaped end of the SATA cable to your SATA hard drive.



- A RAID 0 or RAID 1 configuration requires at least two hard drives. If more than two hard drives are to be used, the total number of hard drives must be an even number.
- A RAID 5 configuration requires at least three hard drives. (The total number of hard drives does not have to be an even number.)
- A RAID 10 configuration requires four hard drives.

7) F_USB1/F_USB2/F_USB3 (USB Headers)

The headers conform to USB 2.0/1.1 specification. Each USB header can provide two USB ports via an optional USB bracket. For purchasing the optional USB bracket, please contact the local dealer.

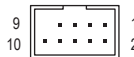
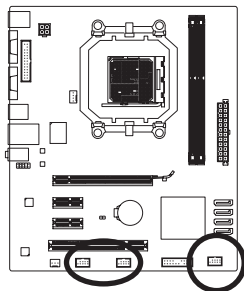

Pin No.	Definition
1	Power (5V)
2	Power (5V)
3	USB DX-
4	USB DY-
5	USB DX+
6	USB DY+
7	GND
8	GND
9	No Pin
10	NC



- Do not plug the IEEE 1394 bracket (2x5-pin) cable into the USB 2.0/1.1 header.
- Prior to installing the USB bracket, be sure to turn off your computer and unplug the power cord from the power outlet to prevent damage to the USB bracket.

8) F_PANEL (Front Panel Header)

Connect the power switch, reset switch, speaker, chassis intrusion switch/sensor and system status indicator on the chassis to this header according to the pin assignments below. Note the positive and negative pins before connecting the cables.

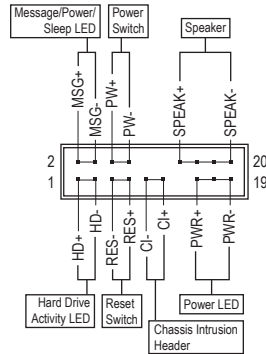
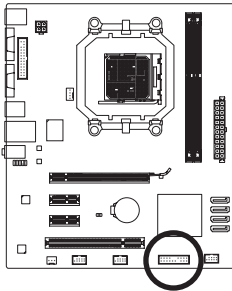

- **MSG/PWR** (Message/Power/Sleep LED, Yellow/Purple):

System Status	LED
S0	On
S1	Blinking
S3/S4/S5	Off

Connects to the power status indicator on the chassis front panel. The LED is on when the system is operating. The LED keeps blinking when the system is in S1 sleep state. The LED is off when the system is in S3/S4 sleep state or powered off (S5).

- **PW** (Power Switch, Red):

Connects to the power switch on the chassis front panel. You may configure the way to turn off your system using the power switch (refer to Chapter 2, "BIOS Setup," "Power Management Setup," for more information).

- **SPEAK** (Speaker, Orange):

Connects to the speaker on the chassis front panel. The system reports system startup status by issuing a beep code. One single short beep will be heard if no problem is detected at system startup. If a problem is detected, the BIOS may issue beeps in different patterns to indicate the problem.

- **HD** (Hard Drive Activity LED, Blue)

Connects to the hard drive activity LED on the chassis front panel. The LED is on when the hard drive is reading or writing data.

- **RES** (Reset Switch, Green):

Connects to the reset switch on the chassis front panel. Press the reset switch to restart the computer if the computer freezes and fails to perform a normal restart.

- **CI** (Chassis Intrusion Header, Gray):

Connects to the chassis intrusion switch/sensor on the chassis that can detect if the chassis cover has been removed. This function requires a chassis with a chassis intrusion switch/sensor.



The front panel design may differ by chassis. A front panel module mainly consists of power switch, reset switch, power LED, hard drive activity LED, speaker and etc. When connecting your chassis front panel module to this header, make sure the wire assignments and the pin assignments are matched correctly.

9) F_AUDIO (Front Panel Audio Header)

The front panel audio header supports Intel High Definition audio (HD) and AC'97 audio. You may connect your chassis front panel audio module to this header. Make sure the wire assignments of the module connector match the pin assignments of the motherboard header. Incorrect connection between the module connector and the motherboard header will make the device unable to work or even damage it.

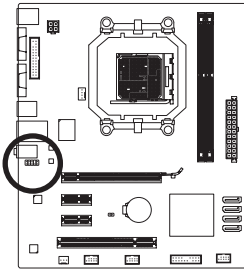

For HD Front Panel Audio:

Pin No.	Definition
1	MIC2_L
2	GND
3	MIC2_R
4	-ACZ_DET
5	LINE2_R
6	GND
7	FAUDIO_JD
8	No Pin
9	LINE2_L
10	GND

For AC'97 Front Panel Audio:

Pin No.	Definition
1	MIC
2	GND
3	MIC Power
4	NC
5	Line Out (R)
6	NC
7	NC
8	No Pin
9	Line Out (L)
10	NC



- The front panel audio header supports HD audio by default.
- Audio signals will be present on both of the front and back panel audio connections simultaneously.
- Some chassis provide a front panel audio module that has separated connectors on each wire instead of a single plug. For information about connecting the front panel audio module that has different wire assignments, please contact the chassis manufacturer.

10) CLR_CMOS (Clearing CMOS Jumper)

Use this jumper to clear the CMOS values (e.g. date information and BIOS configurations) and reset the CMOS values to factory defaults. To clear the CMOS values, place a jumper cap on the two pins to temporarily short the two pins or use a metal object like a screwdriver to touch the two pins for a few seconds.

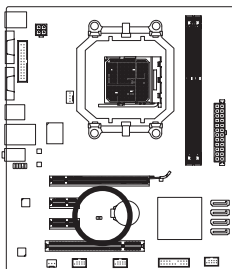

 Open: Normal

 Short: Clear CMOS Values



- Always turn off your computer and unplug the power cord from the power outlet before clearing the CMOS values.
- After clearing the CMOS values and before turning on your computer, be sure to remove the jumper cap from the jumper. Failure to do so may cause damage to the motherboard.
- After system restart, go to BIOS Setup to load factory defaults (select **Load Optimized Defaults**) or manually configure the BIOS settings (refer to Chapter 2, "BIOS Setup," for BIOS configurations).

11) BAT (Battery)

The battery provides power to keep the values (such as BIOS configurations, date, and time information) in the CMOS when the computer is turned off. Replace the battery when the battery voltage drops to a low level, or the CMOS values may not be accurate or may be lost.

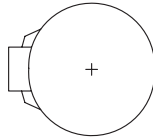
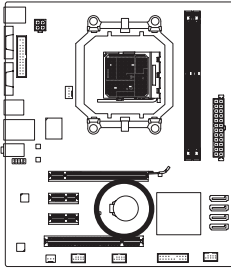

You may clear the CMOS values by removing the battery:

1. Turn off your computer and unplug the power cord.
2. Gently remove the battery from the battery holder and wait for one minute. (Or use a metal object like a screwdriver to touch the positive and negative terminals of the battery holder, making them short for 5 seconds.)
3. Replace the battery.
4. Plug in the power cord and restart your computer.



- Always turn off your computer and unplug the power cord before replacing the battery.
- Replace the battery with an equivalent one. Danger of explosion if the battery is replaced with an incorrect model.
- Contact the place of purchase or local dealer if you are not able to replace the battery by yourself or uncertain about the battery model.
- When installing the battery, note the orientation of the positive side (+) and the negative side (-) of the battery (the positive side should face up).
- Used batteries must be handled in accordance with local environmental regulations.

Chapter 2 BIOS Setup

To access the BIOS Setup program, press the <Delete> key during the POST when the power is turned on. To see more advanced BIOS Setup menu options, you can press <Ctrl> + <F1> in the main menu of the BIOS Setup program.

To upgrade the BIOS, use either the GIGABYTE Q-Flash or @BIOS utility.

- Q-Flash allows the user to quickly and easily upgrade or back up BIOS without entering the operating system.
- @BIOS is a Windows-based utility that searches and downloads the latest version of BIOS from the Internet and updates the BIOS.



- Because BIOS flashing is potentially risky, if you do not encounter problems using the current version of BIOS, it is recommended that you not flash the BIOS. To flash the BIOS, do it with caution. Inadequate BIOS flashing may result in system malfunction.
- It is recommended that you not alter the default settings (unless you need to) to prevent system instability or other unexpected results. Inadequately altering the settings may result in system's failure to boot. If this occurs, try to clear the CMOS values and reset the board to default values. (Refer to the "Load Optimized Defaults" section in this chapter or introductions of the battery/clearing CMOS jumper in Chapter 1 for how to clear the CMOS values.)

2-1 Startup Screen

The following screens may appear when the computer boots.

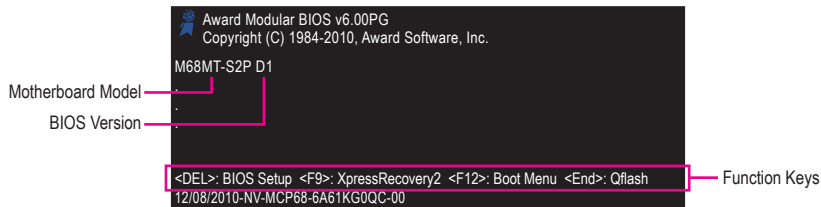

2-2 The Main Menu

Once you enter the BIOS Setup program, the Main Menu (as shown below) appears on the screen. Use arrow keys to move among the items and press <Enter> to accept or enter a sub-menu.

(Sample BIOS Version: GA-M68MT-S2P D1)

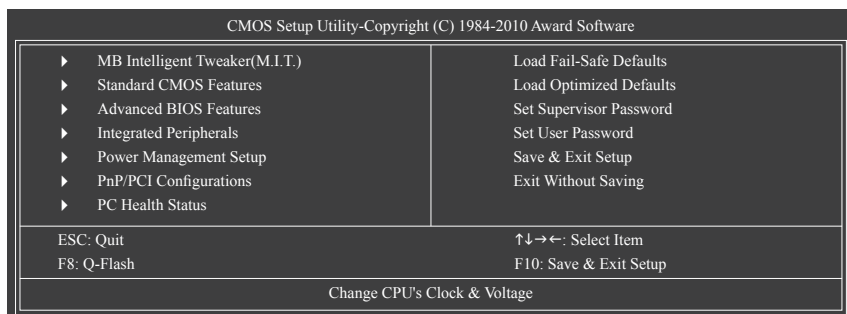



- If you do not find the settings you want in the Main Menu or a submenu, press <Ctrl>+<F1> to access more advanced options.
- When the system is not stable as usual, select the **Load Optimized Defaults** item to set your system to its defaults.
- The BIOS Setup menus described in this chapter are for reference only and may differ by BIOS version.

2-3 MB Intelligent Tweaker(M.I.T.)

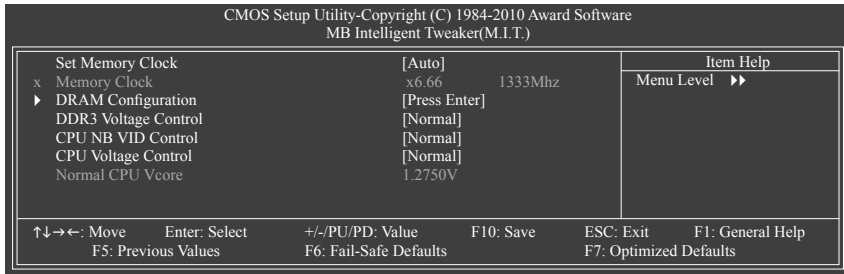

Whether the system will work stably with the overclock settings you made is dependent on your overall system configurations. Incorrectly doing overclock may result in damage to CPU, chipset, or memory and reduce the useful life of these components. This page is for advanced users only and we recommend you not to alter the default settings to prevent system instability or other unexpected results. (Inadequately altering the settings may result in system's failure to boot. If this occurs, clear the CMOS values and reset the board to default values.)

☞ Set Memory Clock

Determines whether to manually set the memory clock. **Auto** lets BIOS automatically set the memory clock as required. **Manual** allows the memory clock control item below to be configurable. (Default: Auto)

☞ Memory Clock

This option is configurable only when **Set Memory Clock** is set to **Manual**. The adjustable range is dependent on the CPU being installed.

☞ DRAM Configuration

CMOS Setup Utility-Copyright (C) 1984-2010 Award Software				
DRAM Configuration				
				Item Help
DCTs Mode		[Unganged]		Menu Level ▶▶
DDR3 Timing Items		[Auto]	SPD	Auto
x	CAS# latency	Auto	7T	7T
x	RAS to CAS R/W Delay	Auto	7T	7T
x	Row Precharge Time	Auto	7T	7T
x	Minimum RAS Active Time	Auto	20T	20T
x	1T/2T Command Timing	Auto	--	--
x	TwTr Command Delay	Auto	4T	4T
x	Trfc0 for DIMM1	Auto	110ns	110ns
x	Trfc1 for DIMM3	Auto	--	--
x	Write Recovery Time	Auto	8T	8T
x	Precharge Time	Auto	4T	4T
x	Row Cycle Time	Auto	27T	27T
x	RAS to RAS Delay	Auto	4T	4T
CKE Power Down Mode		[Disabled]		
CKE Power Down Control		[per Channel]		
↑↓→←: Move Enter: Select +/-/PU/PD: Value F10: Save ESC: Exit F1: General Help F5: Previous Values F6: Fail-Safe Defaults F7: Optimized Defaults				

☞ DCTs Mode

Allows you to set memory control mode.

- ▶▶ Ganged Sets memory control mode to single dual-channel.
- ▶▶ Unganged Sets memory control mode to two single-channel. (Default)

☞ DDR3 Timing Items

Manual allows all DDR3 Timing items below to be configurable.

Options are: Auto (default), Manual.

☞ CAS# latency

Options are: Auto (default), 4T~12T.

☞ RAS to CAS R/W Delay

Options are: Auto (default), 5T~12T.

☞ Row Precharge Time

Options are: Auto (default), 5T~12T.

☞ Minimum RAS Active Time

Options are: Auto (default), 15T~30T.

☞ 1T/2T Command Timing

Options are: Auto (default), 1T, 2T.

☞ TwTr Command Delay

Options are: Auto (default), 4T~7T.

☞ Trfc0 for DIMM1

Options are: Auto (default), 90ns, 110ns, 160ns, 300ns, 350ns.

☞ Trfc1 for DIMM3

Options are: Auto (default), 90ns, 110ns, 160ns, 300ns, 350ns.

☞ Write Recovery Time

Options are: Auto (default), 5T~12T.

☞ **Precharge Time**

Options are: Auto (default), 4T~7T.

☞ **Row Cycle Time**

Options are: Auto (default), 11T~42T.

☞ **RAS to RAS Delay**

Options are: Auto (default), 4T~7T.

☞ **CKE Power Down Mode**

Determines whether to set the memory to power down mode when the CKE pin is closed. (Default: Disabled)

☞ **CKE Power Down Control**

Allows you to select a CKE power down mode. Options are per Channel (Default), per CS.

☞ **DDR3 Voltage Control**

Allows you to set the memory voltage.

▶▶ Normal Supplies the memory voltage as required. (Default)

▶▶ +0.1V ~ +0.7V The adjustable range is from +0.1V to +0.7V.

Note: Increasing memory voltage may result in damage to the memory or reduce the useful life of the memory.

☞ **CPU NB VID Control**

Allows you to set the CPU Northbridge VID voltage. **Auto** sets the CPU Northbridge VID voltage as required. The adjustable range is dependent on the CPU being installed. (Default: Normal)

Note: Increasing CPU voltage may result in damage to your CPU or reduce the useful life of the CPU.

☞ **CPU Voltage Control**

Allows you to set the CPU voltage. **Auto** sets the CPU voltage as required. The adjustable range is dependent on the CPU being installed. (Default: Normal)

Note: Increasing CPU voltage may result in damage to your CPU or reduce the useful life of the CPU.

☞ **Normal CPU Vcore**

Displays the normal operating voltage of your CPU.

2-4 Standard CMOS Features

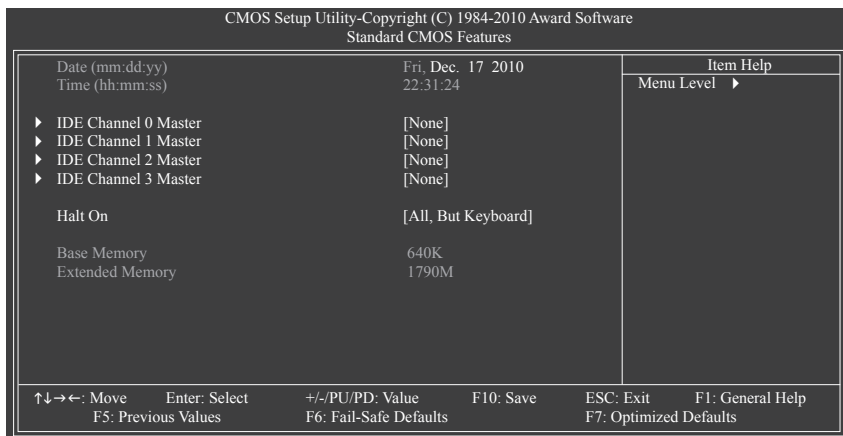

☞ **Date (mm:dd:yy)**

Sets the system date.

☞ **Time (hh:mm:ss)**

Sets the system time.

☞ **IDE Channel 0, 1, 2, 3 Master**

▶▶ IDE HDD Auto-Detection, IDE Auto-Detection

Press <Enter> to autodetect the parameters of the SATA device on this channel.

▶▶ IDE Channel 0, 1 Master, Extended IDE Drive

Configure your SATA devices by using one of the three methods below:

- Auto Lets the BIOS automatically detect SATA devices during the POST. (Default)
- None If no SATA devices are used, set this item to **None** so the system will skip the detection of the device during the POST for faster system startup.
- Manual Allows you to manually enter the specifications of the hard drive when the hard drive access mode is set to **CHS**. (For **IDE Channel 0, 1 Master** only.)

▶▶ Access Mode Sets the hard drive access mode. (Default: Auto)

The following fields display your hard drive specifications. If you wish to enter the parameters manually, refer to the information on the hard drive.

▶▶ Capacity Approximate capacity of the currently installed hard drive.

▶▶ Cylinder Number of cylinders.

▶▶ Head Number of heads.

▶▶ Precomp Write precompensation cylinder.

▶▶ Landing Zone Landing zone.

▶▶ Sector Number of sectors.

☞ **Halt On**

Allows you to determine whether the system will stop for an error during the POST.

Options are: "All Errors," "No Errors," "All, But Keyboard" (default), "All, But Diskette," "All, But Disk/Key."

☞ **Memory**

These fields are read-only and are determined by the BIOS POST.

2-5 Advanced BIOS Features

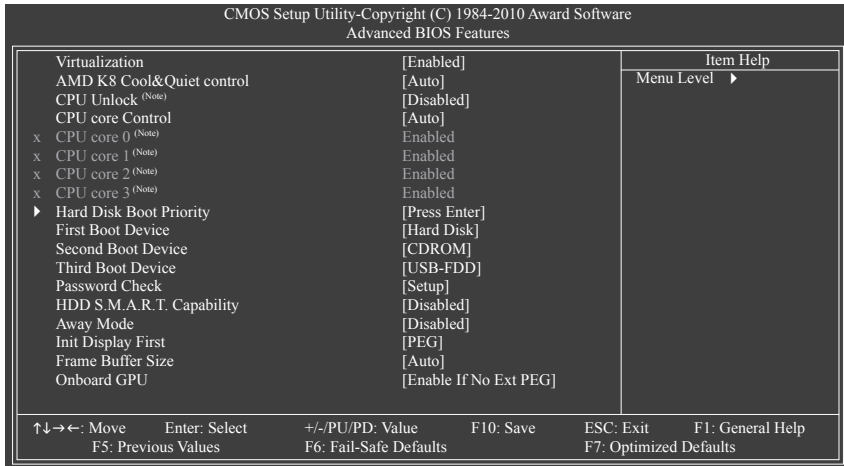

Virtualization

Virtualization allows a platform to run multiple operating systems and applications in independent partitions. With virtualization, one computer system can function as multiple virtual systems.

(Default: Enabled)

AMD K8 Cool&Quiet control

▶▶ Auto Lets the AMD Cool'n'Quiet driver dynamically adjust the CPU clock and VID to reduce heat output from your computer and its power consumption. (Default)

▶▶ Disabled Disables this function.

CPU Unlock (Note)

Allows you to determine whether to unlock hidden CPU cores. (Default: Disabled)

CPU core Control

Allows you to determine whether to manually enable/disable CPU Core 2 and Core 3. **Manual** allows the two items below to be configurable.

▶▶ Auto Lets the BIOS to enable all CPU cores (number of cores available depends on the CPU being used).

▶▶ Manual Allows you to individually enable/disable CPU Core 2 and Core 3.

CPU core 0 (Note)

Enables or disables CPU Core 0. (Default: Enabled)

CPU core 1 (Note)

Enables or disables CPU Core 1. (Default: Enabled)

CPU core 2 (Note)

Enables or disables CPU Core 2. (Default: Enabled)

CPU core 3 (Note)

Enables or disables CPU Core 3. (Default: Enabled)

Hard Disk Boot Priority

Specifies the sequence of loading the operating system from the installed hard drives.

(Note) This item appears only when you install a CPU that supports this feature.

☞ **First/Second/Third Boot Device**

Specifies the boot order from the available devices.

☞ **Password Check**

Specifies whether a password is required every time the system boots, or only when you enter BIOS Setup. After configuring this item, set the password(s) under the **Set Supervisor/User Password** item in the BIOS Main Menu.

- ▶▶ Setup A password is only required for entering the BIOS Setup program. (Default)
- ▶▶ System A password is required for booting the system and for entering the BIOS Setup program.

☞ **HDD S.M.A.R.T. Capability**

Enables or disables the S.M.A.R.T. (Self Monitoring and Reporting Technology) capability of your hard drive. This feature allows your system to report read/write errors of the hard drive and to issue warnings when a third party hardware monitor utility is installed. (Default: Enabled)

☞ **Away Mode**

Enables or disables Away Mode in Windows XP Media Center operating system. Away Mode allows the system to silently perform unattended tasks while in a low-power mode that appears off. (Default: Disabled)

☞ **Init Display First**

Specifies the first initiation of the monitor display from the installed PCI graphics card, PCI Express graphics card, or the onboard graphics.

- ▶▶ PCI Slot Sets the PCI graphics card as the first display.
- ▶▶ Onboard VGA Sets the onboard graphics as the first display.
- ▶▶ PEG Sets the PCI Express graphics card as the first display. (Default)

☞ **Frame Buffer Size**

Frame buffer size is the total amount of system memory allocated solely for the onboard graphics controller. MS-DOS, for example, will use only this memory for display. Options are: Auto (Default), Disabled, 32M, 64M, 128M, 256M.

☞ **Onboard GPU**

Enables or disables the onboard graphics function.

- ▶▶ Enable If No Ext PEG
Activates the onboard graphics only if no PCI Express graphics card is installed. (Default)
- ▶▶ Always Enable

Always activates the onboard graphics, whether or not a PCI Express card is installed. If you wish to set up a dual view configuration, set this item to **Always Enable**.

2-6 Integrated Peripherals

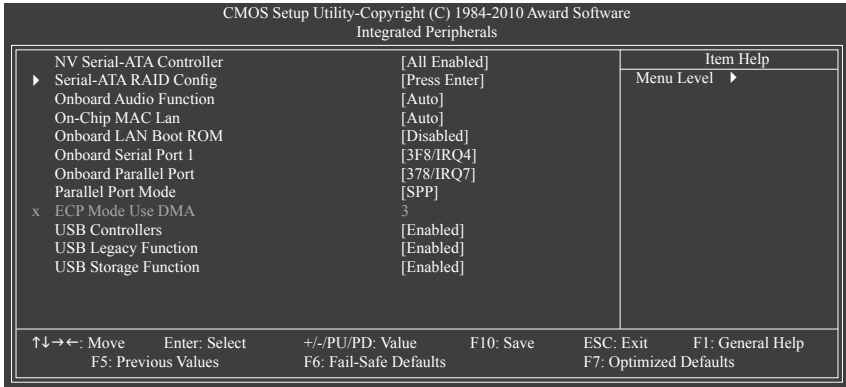

⌘ NV Serial-ATA Controller

Enables or disables the integrated SATA controller(s). You can select whether to enable all SATA controllers or only the first SATA controller. (Default: All Enabled)

⌘ Serial-ATA RAID Config

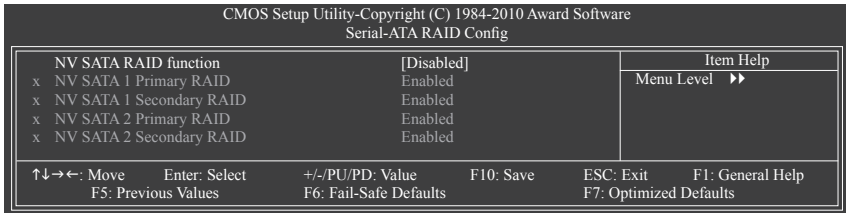

⌘ NV SATA RAID function

Enables or disables RAID for the integrated SATA 3Gb/s controllers. Enabled allows you to configure RAID for individual SATA channel. (Default: Disabled)

⌘ NV SATA 1 Primary RAID

Enables or disables RAID for the first channel of the first integrated SATA 3Gb/s controller. This item is configurable only when the **NV SATA RAID function** item is set to Enabled. (Default: Enabled)

⌘ NV SATA 1 Secondary RAID

Enables or disables RAID for the second channel of the first integrated SATA 3Gb/s controller. This item is configurable only when the **NV SATA RAID function** item is set to Enabled. (Default: Enabled)

⌘ NV SATA 2 Primary RAID

Enables or disables RAID for the first channel of the second integrated SATA 3Gb/s controller. This item is configurable only when the **NV SATA RAID function** item is set to Enabled. (Default: Enabled)

⌘ NV SATA 2 Secondary RAID

Enables or disables RAID for the second channel of the second integrated SATA 3Gb/s controller. This item is configurable only when the **NV SATA RAID function** item is set to Enabled. (Default: Enabled)

☞ **Onboard Audio Function**

Enables or disables the onboard audio function. (Default: Auto)

If you wish to install a 3rd party add-in audio card instead of using the onboard audio, set this item to **Disabled**.

☞ **On-Chip MAC Lan**

Enables or disables the onboard LAN function. (Default: Auto)

If you wish to install a 3rd party add-in network card instead of using the onboard LAN, set this item to **Disabled**.

☞ **Onboard LAN Boot ROM**

Allows you to decide whether to activate the boot ROM integrated with the onboard LAN chip.

(Default: Disabled)

☞ **Onboard Serial Port 1**

Enables or disables the first serial port and specifies its base I/O address and corresponding interrupt.

Options are: Auto, 2F8/IRQ3, 3F8/IRQ4(default), 3E8/IRQ4, 2E8/IRQ3, Disabled.

☞ **Onboard Parallel Port**

Enables or disables the onboard parallel port (LPT) and specifies its base I/O address and corresponding interrupt. Options are: 378/IRQ7 (default), 278/IRQ5, 3BC/IRQ7, Disabled.

☞ **Parallel Port Mode**

Selects an operating mode for the onboard parallel (LPT) port. Options are: SPP (Standard Parallel Port) (default), EPP (Enhanced Parallel Port), ECP (Extended Capabilities Port), ECP+EPP.

☞ **ECP Mode Use DMA**

Selects DMA channel for the LPT port in ErP mode. This item is configurable only when **Parallel Port Mode** is set to **ECP** or **ECP+EPP** mode. Options are: 3 (default), 1.

☞ **USB Controllers**

Enables or disables the integrated USB controllers. (Default: Enabled)

Disabled will turn off all of the USB functionalities below.

☞ **USB Legacy Function**

Allows USB keyboard to be used in MS-DOS. (Default: Enabled)

☞ **USB Storage Function**

Determines whether to detect USB storage devices, including USB flash drives and USB hard drives during the POST. (Default: Enabled)

2-7 Power Management Setup

CMOS Setup Utility-Copyright (C) 1984-2010 Award Software		
Power Management Setup		
		Item Help
ACPI Suspend Type	[S3(STR)]	Menu Level ▶
Soft-Off by Power button	[Instant-Off]	
PME Event Wake Up	[Enabled]	
Modem Ring On	[Enabled]	
USB Resume from Suspend	[Enabled]	
Power-On by Alarm	[Disabled]	
x Day of Month Alarm	Everyday	
x Time (hh:mm:ss) Alarm	0 : 0 : 0	
HPET Support ^(Note)	[Enabled]	
HPET Mode ^(Note)	[32-bit mode]	
Power On By Mouse	[Disabled]	
Power On By Keyboard	[Disabled]	
x KB Power ON Password	Enter	
AC Back Function	[Soft-Off]	
ErP Support	[Disabled]	

↑↓→←: Move Enter: Select +/-/PU/PD: Value F10: Save ESC: Exit F1: General Help
 F5: Previous Values F6: Fail-Safe Defaults F7: Optimized Defaults

☞ ACPI Suspend Type

Specifies the ACPI sleep state when the system enters suspend.

- ▶▶ S1(POS) Enables the system to enter the ACPI S1 (Power on Suspend) sleep state. In S1 sleep state, the system appears suspended and stays in a low power mode. The system can be resumed at any time.
- ▶▶ S3(STR) Enables the system to enter the ACPI S3 (Suspend to RAM) sleep state (default). In S3 sleep state, the system appears to be off and consumes less power than in the S1 state. When signaled by a wake-up device or event, the system resumes to its working state exactly where it was left off.

☞ Soft-Off by Power button

Configures the way to turn off the computer in MS-DOS mode using the power button.

- ▶▶ Instant-Off Press the power button and then the system will be turned off instantly. (Default)
- ▶▶ Delay 4 Sec. Press and hold the power button for 4 seconds to turn off the system. If the power button is pressed for less than 4 seconds, the system will enter suspend mode.

☞ PME Event Wake Up

Allows the system to be awakened from an ACPI sleep state by a wake-up signal from a PCI or PCIe device. Note: To use this function, you need an ATX power supply providing at least 1A on the +5VSB lead. (Default: Enabled)

☞ Modem Ring On

Allows the system to be awakened from an ACPI sleep state by a wake-up signal from a modem that supports wake-up function. (Default: Enabled)

☞ USB Resume from Suspend

Allows the system to be awakened from ACPI S3 sleep state by a wake-up signal from the installed USB device. (Default: Enabled)

(Note) Supported on Windows 7/Vista operating system only.

☞ **Power-On by Alarm**

Determines whether to power on the system at a desired time. (Default: Disabled)

If enabled, set the date and time as following:

▶▶ Day of Month Alarm: Turn on the system at a specific time on each day or on a specific day in a month.

▶▶ Time (hh: mm: ss) Alarm: Set the time at which the system will be powered on automatically.

Note: When using this function, avoid inadequate shutdown from the operating system or removal of the AC power, or the settings may not be effective.

☞ **HPET Support** ^(Note)

Enables or disables High Precision Event Timer (HPET) for Windows 7/Vista operating system.

(Default: Enabled)

☞ **HPET Mode** ^(Note)

Allows you to select the HPET mode for your Windows 7/Vista operating system. This item is configurable only when the **HPET Support** is set to **Enabled**. (Default: 32-bit mode)

☞ **Power On By Mouse**

Allows the system to be turned on by a PS/2 mouse wake-up event. (Default: Disabled)

Note: To use this function, you need an ATX power supply providing at least 1A on the +5VSB lead.

▶▶ Double Click Double click on left button on the PS/2 mouse to turn on the system.

☞ **Power On By Keyboard**

Allows the system to be turned on by a PS/2 keyboard wake-up event. (Default: Disabled)

Note: you need an ATX power supply providing at least 1A on the +5VSB lead.

▶▶ Password Set a password with 1~5 characters to turn on the system.

▶▶ Any KEY Press any key on the keyboard to turn on the system.

▶▶ Keyboard 98 Press POWER button on the Windows 98 keyboard to turn on the system.

☞ **KB Power ON Password**

Set the password when **Power On by Keyboard** is set to **Password**. Press <Enter> on this item and set a password with up to 5 characters and then press <Enter> to accept. To turn on the system, enter the password and press <Enter>.

Note: To cancel the password, press <Enter> on this item. When prompted for the password, press <Enter> again without entering the password to clear the password settings.

☞ **AC Back Function**

Determines the state of the system after the return of power from an AC power loss.

▶▶ Soft-Off The system stays off upon the return of the AC power. (Default)

▶▶ Full-On The system is turned on upon the return of the AC power.

☞ **ErP Support**

Determines whether to let the system consume less than 1W power in S5 (shutdown) state. (Default: Disabled)

Note: When this item is set to **Enabled**, the following four functions will become unavailable:

PME event wake up, power on by mouse, power on by keyboard, and wake on LAN.

(Note) Supported on Windows 7/Vista operating system only.

2-8 PnP/PCI Configurations

CMOS Setup Utility-Copyright (C) 1984-2010 Award Software					
PnP/PCI Configurations					
PCI1 IRQ Assignment	[Auto]			Item Help	
PCI2 IRQ Assignment	[Auto]			Menu Level ▶	
↑↓→←: Move	Enter: Select	+/-/PU/PD: Value	F10: Save	ESC: Exit	F1: General Help
F5: Previous Values		F6: Fail-Safe Defaults		F7: Optimized Defaults	

☞ PCI1/2 IRQ Assignment

- ▶▶ Auto BIOS auto-assigns IRQ to the first/second PCI slot. (Default)
- ▶▶ 3,4,5,7,9,10,11,12,14,15 Assigns IRQ 3,4,5,7,9,10,11,12,14,15 to the first/second PCI slot.

2-9 PC Health Status

CMOS Setup Utility-Copyright (C) 1984-2010 Award Software					
PC Health Status					
Reset Case Open Status	[Disabled]			Item Help	
Case Opened	No			Menu Level ▶	
Vcore	1.364V				
DDR3 1.5V	1.520V				
+3.3V	3.280V				
+12V	12.048V				
Current System Temperature	38°C				
Current CPU Temperature	36°C				
Current CPU FAN Speed	1962 RPM				
Current SYSTEM FAN Speed	0 RPM				
System Warning Temperature	[Disabled]				
CPU Warning Temperature	[Disabled]				
CPU FAN Fail Warning	[Disabled]				
SYSTEM FAN Fail Warning	[Disabled]				
CPU Smart FAN Control	[Enabled]				
CPU Smart FAN Mode	[Auto]				
↑↓→←: Move	Enter: Select	+/-/PU/PD: Value	F10: Save	ESC: Exit	F1: General Help
F5: Previous Values		F6: Fail-Safe Defaults		F7: Optimized Defaults	

☞ Reset Case Open Status

Keeps or clears the record of previous chassis intrusion status. **Enabled** clears the record of previous chassis intrusion status and the **Case Opened** field will show "No" at next boot. (Default: Disabled)

☞ Case Opened

Displays the detection status of the chassis intrusion detection device attached to the motherboard CI header. If the system chassis cover is removed, this field will show "Yes", otherwise it will show "No". To clear the chassis intrusion status record, set **Reset Case Open Status** to **Enabled**, save the settings to the CMOS, and then restart your system.

☞ Current Voltage(V) Vcore/DDR3 1.5V/+3.3V/+12V

Displays the current system voltages.

☞ Current System/CPU Temperature

Displays current system/CPU temperature.

☞ Current CPU/SYSTEM FAN Speed (RPM)

Displays current CPU/system fan speed.

☞ System/CPU Warning Temperature

Sets the warning threshold for system/CPU temperature. When system/CPU temperature exceeds the threshold, BIOS will emit warning sound. Options are: Disabled (default), 60°C/140°F, 70°C/158°F, 80°C/176°F, 90°C/194°F.

☞ CPU/SYSTEM FAN Fail Warning

Allows the system to emit warning sound if the CPU/system fan is not connected or fails. Check the fan condition or fan connection when this occurs. (Default: Disabled)

☞ CPU Smart FAN Control

Enables or disables the CPU fan speed control function. **Enabled** allows the CPU fan to run at different speed according to the CPU temperature. You can adjust the fan speed with EasyTune based on system requirements. If disabled, the CPU fan runs at full speed. (Default: Enabled)

☞ CPU Smart FAN Mode

Specifies how to control CPU fan speed. This item is configurable only when **CPU Smart FAN Control** is set to **Enabled**.

- ▶▶ Auto Lets the BIOS automatically detect the type of CPU fan installed and sets the optimal CPU fan control mode. (Default)
- ▶▶ Voltage Sets Voltage mode for a 3-pin CPU fan.
- ▶▶ PWM Sets PWM mode for a 4-pin CPU fan.

2-10 Load Fail-Safe Defaults

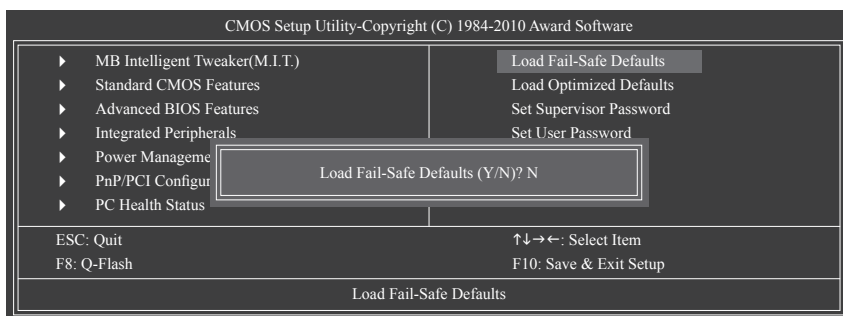

Press <Enter> on this item and then press the <Y> key to load the safest BIOS default settings.

In case system instability occurs, you may try to load Fail-Safe defaults, which are the safest and most stable BIOS settings for the motherboard.

2-11 Load Optimized Defaults

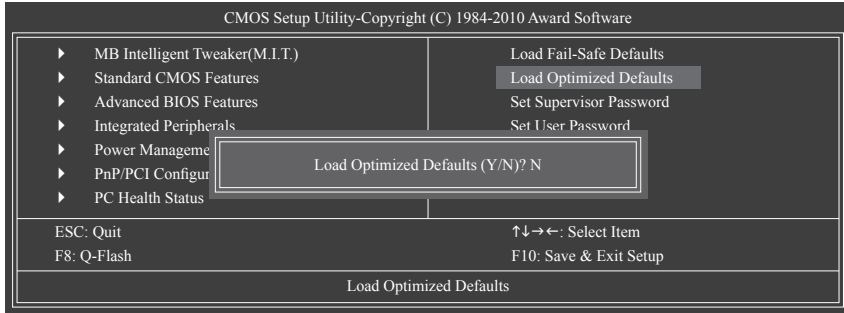

Press <Enter> on this item and then press the <Y> key to load the optimal BIOS default settings. The BIOS defaults settings help the system to operate in optimum state. Always load the Optimized defaults after updating the BIOS or after clearing the CMOS values.

2-12 Set Supervisor/User Password

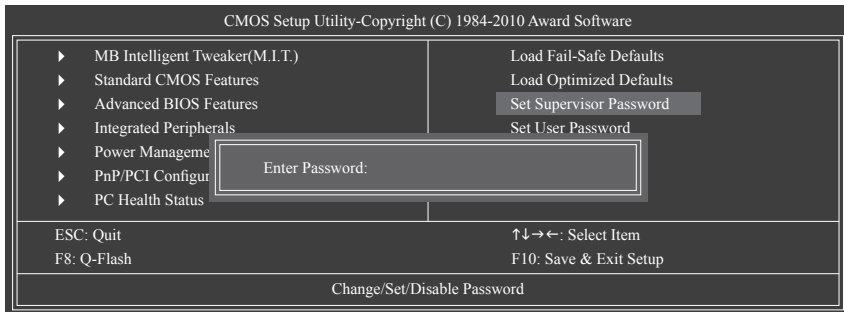

Press <Enter> on this item and type the password with up to 8 characters and then press <Enter>. You will be requested to confirm the password. Type the password again and press <Enter>.

The BIOS Setup program allows you to specify two separate passwords:

☞ Supervisor Password

When a system password is set and the **Password Check** item in **Advanced BIOS Features** is set to **Setup**, you must enter the supervisor password for entering BIOS Setup and making BIOS changes.

When the **Password Check** item is set to **System**, you must enter the supervisor password (or user password) at system startup and when entering BIOS Setup.

☞ User Password

When the **Password Check** item is set to **System**, you must enter the supervisor password (or user password) at system startup to continue system boot. In BIOS Setup, you must enter the supervisor password if you wish to make changes to BIOS settings. The user password only allows you to view the BIOS settings but not to make changes.

To clear the password, press <Enter> on the password item and when requested for the password, press <Enter> again. The message "PASSWORD DISABLED" will appear, indicating the password has been cancelled.

2-13 Save & Exit Setup

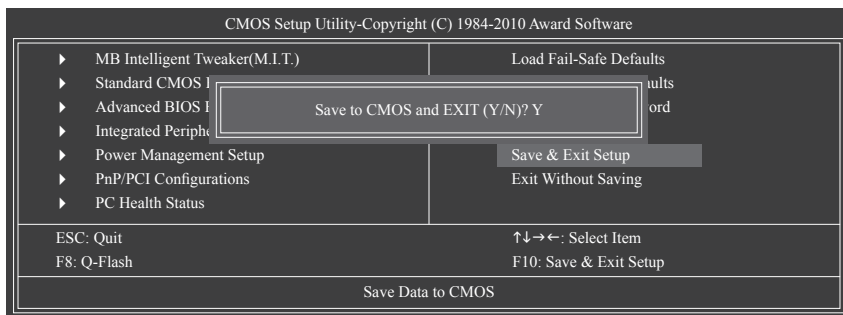

Press <Enter> on this item and press the <Y> key. This saves the changes to the CMOS and exits the BIOS Setup program. Press <N> or <Esc> to return to the BIOS Setup Main Menu.

2-14 Exit Without Saving

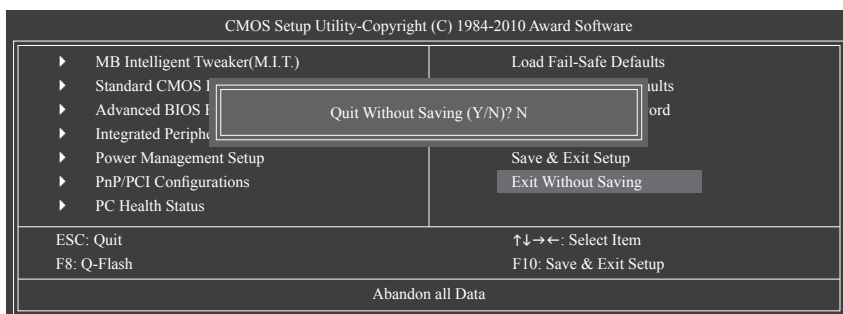

Press <Enter> on this item and press the <Y> key. This exits the BIOS Setup without saving the changes made in BIOS Setup to the CMOS. Press <N> or <Esc> to return to the BIOS Setup Main Menu.

Chapter 3 Drivers Installation



- Before installing the drivers, first install the operating system.
- After installing the operating system, insert the motherboard driver disk into your optical drive. The driver Autorun screen is automatically displayed which looks like that shown in the screen shot below. (If the driver Autorun screen does not appear automatically, go to My Computer, double-click the optical drive and execute the **Run.exe** program.)

Installing Chipset Drivers

After inserting the driver disk, "Xpress Install" will automatically scan your system and then list all the drivers that are recommended to install. You can click the **Install All** button and "Xpress Install" will install all the recommended drivers. Or click **Install Single Items** to manually select the drivers you wish to install.

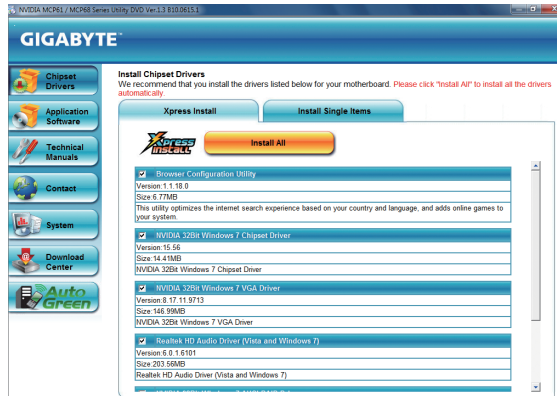

Chapter 4 Appendix

Configuring SATA Hard Drive(s)

Before you begin

Please prepare:

- At least two SATA hard drives (to ensure optimal performance, it is recommended that you use two hard drives with identical model and capacity). If you do not want to create RAID, you may prepare only one hard drive.
- An empty formatted floppy disk.
- Windows Vista/XP setup disk.
- Motherboard driver disk.

Configuring the Onboard SATA Controller

A. Installing SATA hard drive(s) in your computer

Attach one end of the SATA signal cable to the rear of the SATA hard drive and the other end to available SATA port on the motherboard. Then connect the power connector from your power supply to the hard drive.

B. Configuring SATA controller mode in BIOS Setup

Make sure to configure the SATA controller mode correctly in system BIOS Setup. For the BIOS Setup menus, refer to Chapter 2, "BIOS Setup," "Integrated Peripherals."

Steps:

1. Turn on your computer and press <Delete> to enter BIOS Setup during the POST (Power-On Self-Test). Under **Integrated Peripherals**, make sure **NV Serial-ATA Controller** is enabled. To enable RAID, go to the **Serial-ATA RAID Config** sub-menu.
2. Set **NV SATA RAID function** to **Enabled** to enable RAID control for each SATA connector. Then enable the SATA channels with hard drives that you want to use for RAID (for example, **NV SATA 1 Primary RAID** controls the SATA2_0 connector and **NV SATA 1 Secondary RAID** controls the SATA2_1 connector).
3. Save changes and exit BIOS Setup.



The BIOS Setup options described in this section may differ from the exact settings for your motherboard. The actual BIOS Setup options you will see shall depend on the motherboard you have and the BIOS version.

C. Configuring RAID set in RAID BIOS

Enter the RAID BIOS setup utility to configure a RAID array. After the POST memory test begins and before the operating system boot begins, look for a message which says "Press <F10> to enter RAID setup utility." Hit the <F10> key to enter the NVIDIA RAID setup utility.

Steps:

1. Press the <Tab> key to move from field to field until the appropriate field is highlighted.
2. In the **RAID Mode** field, use the up or down arrow key to select a RAID mode. The following procedure demonstrates how a RAID 0 array (Striping) is created.
3. In the **Striping Block** field, use the up or down arrow key to set the striping block size. The striping block size can be set from 4 KB to 128 KB.
4. Next, press <Tab> to move to the **Free Disks** block. Select the target hard drives using the up or down arrow key and use the right arrow key to add the hard drives to the **Array Disks** block.
5. Press <F7>. A message which says "Clear disk data?" appears. Press <Y> to confirm. (If the hard drives contain a previously created RAID array, you need to press <Y> to clear the data in the hard drives.) After that, the **Array List** screen appears, displaying the RAID array that you have created.
6. To exit the NVIDIA RAID setup utility, press <Esc> in the main menu or <Ctrl>+<X> in the **Array List** screen. Now, you can proceed to the installation of the SATA controller driver and operating system.

Making a SATA RAID Driver Diskette

Copy the driver for the SATA controller from the motherboard driver disk to a floppy disk (for Windows XP) or a USB flash drive (for Windows 7/Vista). For example, to copy the RAID driver for Windows XP 32-bit operating system, copy the driver from the following directory to your floppy disk: **BootDrv\UDA\WinXP\sataraid**

Installing the SATA RAID Driver and Operating System

A. Installing Windows XP

Restart your system to boot from the Windows XP setup disk and press <F6> as soon as you see the message "Press F6 if you need to install a 3rd party SCSI or RAID driver." Insert the floppy disk containing the SATA controller driver. Follow the on-screen instructions to install the two drivers displayed. When completed, proceed with the Windows XP installation.

B. Installing Windows 7/Vista

Restart your system to boot from the Windows 7/Vista setup disk and perform standard OS installation steps. Select **Load Driver**. Insert the floppy disk/USB flash drive (for users using a SATA optical drive) containing the driver or insert the motherboard driver disk. For Windows 7, browse to **BootDrv\UDA\Win7\sataraid** to load the driver and continue the OS installation. For Windows Vista, browse to **BootDrv\UDA\Win Vistat\sataraid** to load the driver and continue the OS installation.



Contact Us

GIGA-BYTE TECHNOLOGY CO., LTD.

Address: No.6, Bao Chiang Road, Hsin-Tien Dist., New Taipei City 231, Taiwan

TEL: +886-2-8912-4000, FAX: +886-2-8912-4003

Tech. and Non-Tech. Support (Sales/Marketing) : <http://ggts.gigabyte.com.tw>

WEB address (English): <http://www.gigabyte.com>

WEB address (Chinese): <http://www.gigabyte.tw>

You may go to the GIGABYTE website, select your language in the language list on the top right corner of the website.

- **GIGABYTE Global Service System**



To submit a technical or non-technical (Sales/Marketing) question, please link to:

<http://ggts.gigabyte.com.tw>

Then select your language to enter the system.