

CONTRINEX

NEW

INDUCTIVE SENSORS

- Full Inox Chip-Immune
- Full Inox Maritime DNV-GL Approved

PHOTOELECTRIC SENSORS

- TRU-C23 UV Transparent
- TRR-C23 Standard Transparent
- M18 Series
- C23 Distance Laser
- C55 Distance IO-Link
- Light Grids

SAFETY

- Slim Safety Light Curtains
- Magnetic and RFID Safety Sensors

RFID

- HF RWM with IO-Link
- UHT Tags
- Function Blocks

GENERAL CATALOG



INTRODUCTION

CONTRINEX

Contrinex is a leading manufacturer of sensors for factory automation. The Swiss company, headquartered in Corminboeuf near Fribourg (CH), has a unique and innovative range of products whose features far surpass those of standard sensors.

Since its foundation in 1972 by Peter Heimlicher, Dipl Ing ETH, Contrinex has grown from a one-man operation to a multinational group with over 580 employees worldwide. More than 13 subsidiaries cover the core markets in Europe, Asia, North and South America.

At a glance

- Technology leading manufacturer of inductive and photoelectric sensors as well as safety and RFID systems
- World market leader for miniature sensors, sensors with long operating distances and devices for particularly demanding operating conditions (all-metal, high-pressure and high-temperature resistant sensors)
- Represented in over 60 countries worldwide, headquarters in Switzerland
- 8000 products

Technology leader for sensor intelligence and industrial RFID

CONTRINEX - SENSE MORE, DO MORE

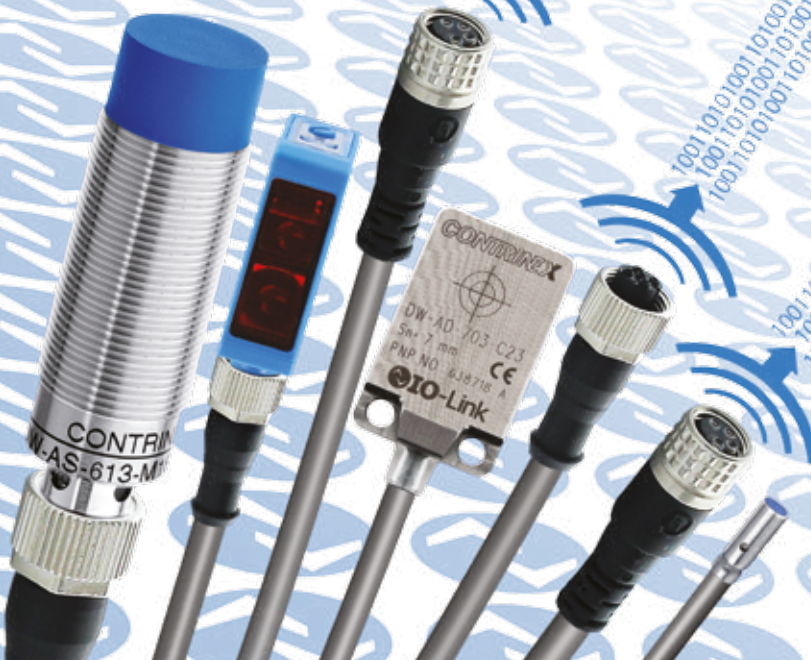

MARKET-LEADING INNOVATION

- 1979** Sensor business starts with self-contained subminiature inductive sensors: Ø4 mm (instead of M8 before)
- 1982** Launch of inductive sensor with Condist® technology – market leadership with operating distances 3x standard
- 1986** Launch of Ø3 mm inductive sensors, now market leader for subminiature inductive sensors
- 1996** Market launch of Ø4 mm subminiature photoelectric sensors
- 1999** Launch of world's first inductive sensor with full-metal housing – thanks to Condet® technology
- 2005** Integration of Contrinex's excellent performance for inductive sensors in CMOS-ASIC (Application-Specific Integrated Circuit), a proprietary development
- 2007** Launch of RFID products for closed loop industrial applications. First RFID product range with tags and readers in full-metal housing
- 2008** Launch of Safetinex®, the industrial safety product range
- 2009** The smart sensor is born. Launch of next generation ASIC, a “system on a chip”, including IO-Link interface
- 2011** Development starts on Contrinex's first ASIC for photoelectric sensors
- 2014** Launch of photoelectric sensor with new generation Contrinex ASIC and IO-Link
- 2017** Launch of photoelectric sensor with patented UV technology for transparent object detection

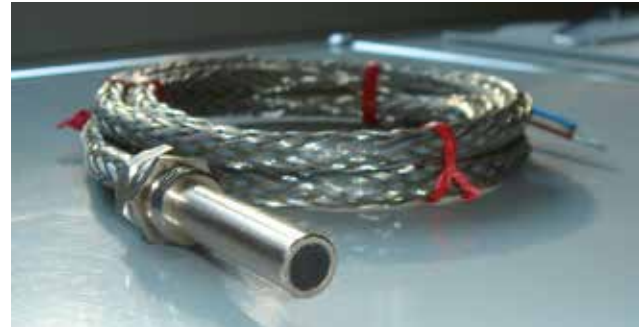

Early inductive sensor produced for own use in 1973 (special version for extreme conditions)

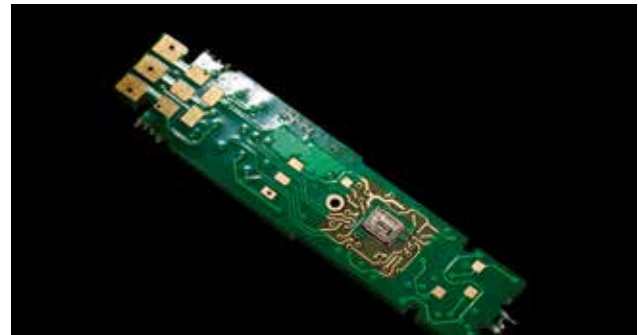

ASIC sensor technology



Safety product range



Subminiature photoelectric sensor



SENSORS

INDUCTIVE

- BASIC
- MINIATURE
- EXTREME
- ANALOG OUTPUT
- 2-WIRE
- EXTRA / HIGH PRESSURE
- EXTRA / HIGH TEMPERATURE
- WELD-IMMUNE
- CHIP-IMMUNE
- DOUBLE-SHEET
- MARITIME
- WASHDOWN

PHOTOELECTRIC

- STANDARD
- MINIATURE
- TRANSPARENT OBJECT
- FIBER OPTIC SENSORS AND FIBERS
- DISTANCE
- COLOR AND CONTRAST
- LIGHT GRIDS

SAFETY

LIGHT CURTAINS AND SENSORS

- FINGER PROTECTION TYPE 4
- HAND PROTECTION TYPE 4 AND TYPE 2
- ACCESS CONTROL TYPE 4
- MAGNETIC SENSORS
- RFID SENSORS
- ACCESSORIES

RFID

LOW AND HIGH FREQUENCY

- BASIC TAGS AND RWMS
- EXTREME TAGS AND RWMS
- HIGH TEMPERATURE TAGS
- WASHDOWN TAGS AND RWMS
- USB RWMS
- IO-LINK RWMS
- INTERFACES
- ACCESSORIES

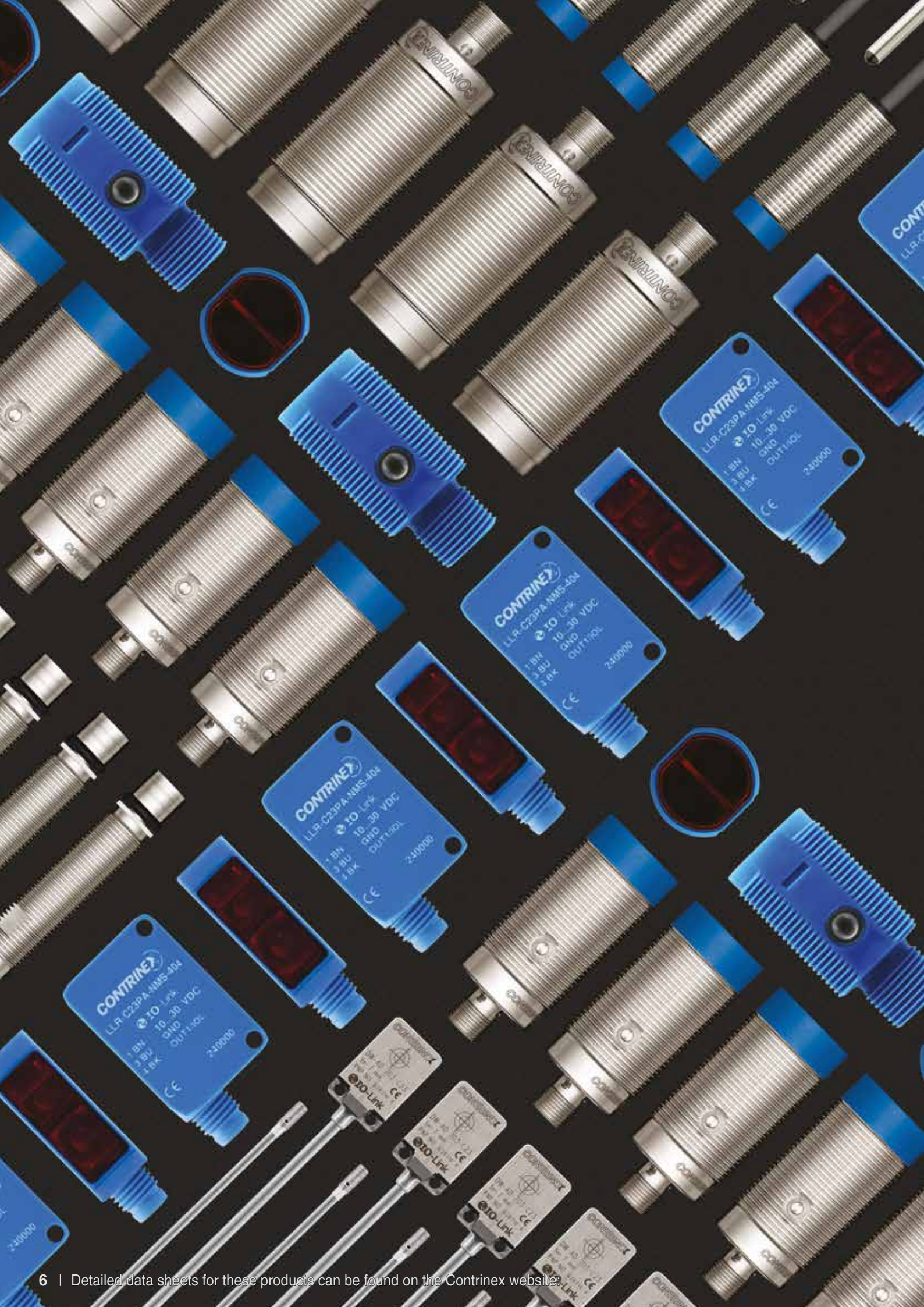

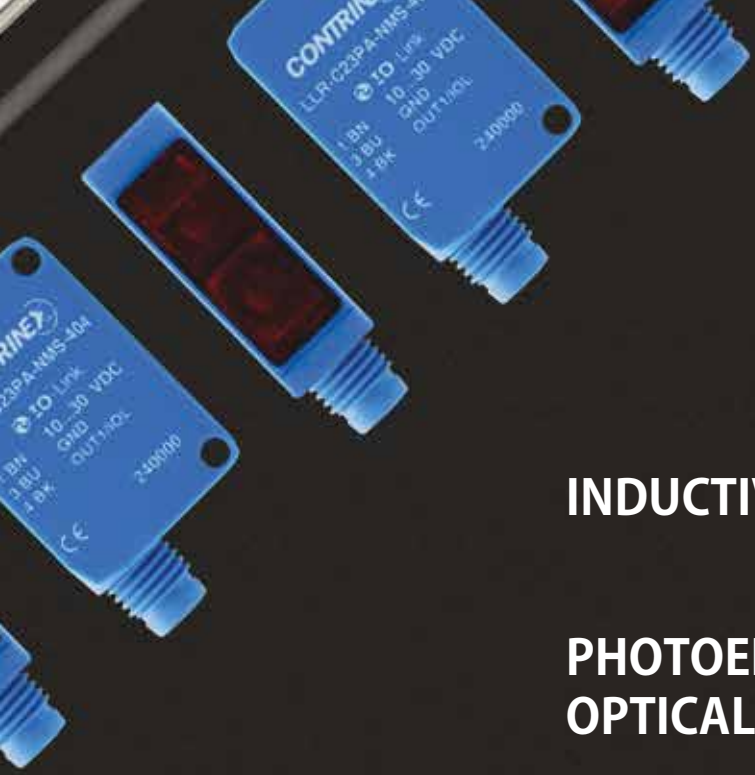

INDUCTIVE SENSORS 14-175

**PHOTOELECTRIC SENSORS /
OPTICAL FIBERS** 176-305

SAFETY 306-367

RFID 368-439

CONNECTIVITY 440-449

ACCESSORIES 450-455

GLOSSARY 456-477

INDEX 478-503



SENSOR SELECTOR

INDUCTIVE



SENSING DISTANCE

1 mm - 40 mm

TARGET MATERIAL

Metal only

SENSING SPEED

0.02 - 10 kHz

ENVIRONMENT

Versions for normal or harsh and dirty environments, with protection class up to IP 68 / IP 69K

PROGRAM OVERVIEW

P. 16 - 19

TASKS

- ✓ Presence detection of metal objects
- ✓ Position control of all kinds of metal targets
- ✓ Counting tasks
- ✓ Distance control on end positions
- ✓ Quality control

PHOTOELECTRIC

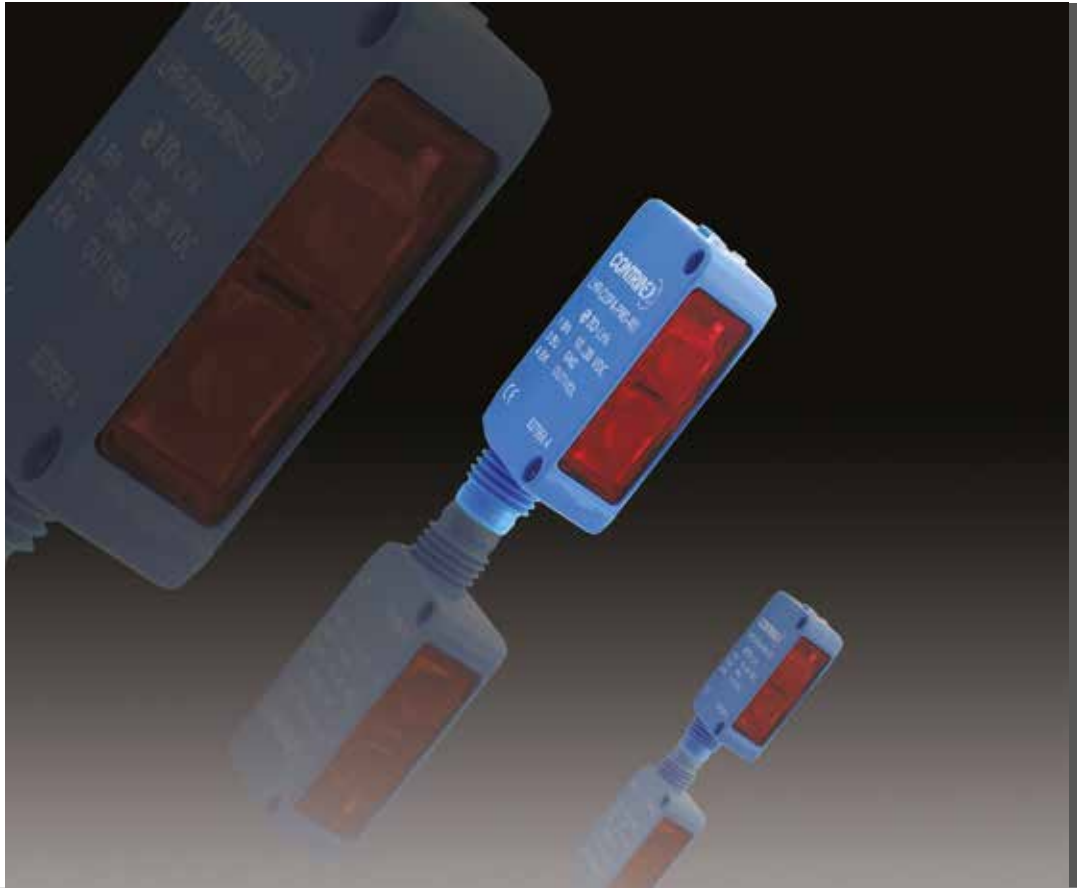

SENSING DISTANCE

1 mm - 50,000 mm

TARGET MATERIAL

Any material that reflects light

SENSING SPEED

1 - 5 kHz

ENVIRONMENT

For clean environments without dust or steam, with protection class up to IP 67

PROGRAM OVERVIEW

P. 178 - 181

TASKS

- ✓ Sensing of light reflective objects
- ✓ Position control of cartons and other objects on conveyors
- ✓ Detection of small objects over large distances

APPLICATIONS

AUTOMOTIVE MANUFACTURING INDUSTRY

Today, sensors of all types are common in automotive factories around the globe. Highly automated plants with demanding conformity requirements rely heavily on sensor technology to maintain world-class quality standards, particularly where harsh processes such as welding, metal finishing and high-temperature coating are required.

Manufacturing engineers working for automotive manufacturers and for first- and second-tier suppliers expect robust, reliable sensors that deliver accurate, repeatable results with minimal downtime.

Recommended product ranges:

- Inductive - Full Inox - Extreme
- Inductive - Classics - Basic
- Inductive - Full Inox - Weld-Immune
- Inductive - Extra Distance - Basic
- Inductive - Full Inox - Double-Sheet
- Inductive - Full Inox - Chip-Immune



PACKAGING MACHINES

On the journey from manufacturer to consumer, packaging protects all types of product, including foods, pharmaceuticals, white goods and cosmetics. Although packaging helps bring competitive products to target markets in the best possible condition, costs are often significant, and automation helps minimize the impact.

The packaging industry is highly innovative, using sensors to identify, select and position packaging of all types. Reducing manufacturing costs and ensuring environmental sustainability are key objectives, and sensors for packaging machines are chosen to maximize efficiency while ensuring reliable, repeatable operation.

Recommended product ranges:

- Photoelectric - Standard
- Photoelectric - Transparent Object
- Photoelectric - Fiber Optic
- Photoelectric - Color and Contrast
- Photoelectric - Light Grids



MACHINE TOOLS

Machine tools impose harsh operating conditions on the sensors needed to control cutting, forming and joining processes that run continuously in many metalworking factories. Common hazards include cutting fluid, cooling sprays, swarf particles and electromagnetic interference, making sensor selection particularly difficult where world-class performance is essential.

Size is another key factor, as modern tool-holders allow only limited space for the sensors needed to identify and position individual tools during rapid tool-changing. The right sensors contribute to efficient production, without interruption or error.

Recommended product ranges:

Inductive - Classics - Miniature
Inductive - Full Inox - Chip-Immune
Photoelectric - Miniature
Photoelectric - Fiber Optic
Inductive - Extra Distance - Basic



LOGISTICS

Whatever the logistics system, choosing the right sensors is crucial to achieving the six “rights” of logistics: ensuring that the right goods, in the right quantities, in the right condition, are delivered to the right place, at the right time, for the right cost.

From large-scale containerized shipping to everyday internal logistics, engineers select the right sensor technology for each container, conveyor, palletizer or robot, ensuring reliable, repeatable detection and identification, together with trouble-free operation.

Recommended product ranges:

Photoelectric - Standard
Photoelectric - Distance
Photoelectric - Light Grids



APPLICATIONS

TEXTILE

Machinery manufacturers supplying the textile, leather and clothing industries rely on sensors for efficiency, reliability and precision. World-class accuracy is essential for production of technical textiles and for making the carbon or chemical fibers used in modern, innovative products, often in highly automated factories.

The high-speed machinery used by textile manufacturers must operate continuously and safely, relying on top-quality sensors for all aspects of access and control. The environmental challenges include industrial cleaning routines that test every sensor to the limit of its capability.



Recommended product ranges:

Inductive - Classics - Basic

Inductive - Extra Distance - Basic

Photoelectric - Standard

Photoelectric - Color and Contrast



FILLING MACHINES

Filling machines are widespread in many industries, including solids handling, chemical, food, beverage and pharmaceutical, often operating continuously around the clock. Industrial sensors detect containers, lids, labels and caps, measure fill levels and more, and play a vital role in keeping automated filling equipment running reliably, accurately and with minimal downtime.

When handling bulk solids or aggressive chemicals, or working in environments that may operate harsh clean-in-place routines, choosing robust, high-quality sensors is essential to maximize operational efficiency and minimize total cost of ownership.



Recommended product ranges:

Photoelectric - Transparent Object

Photoelectric - Color and Contrast

Photoelectric - Standard



GREEN ENERGY AND ENVIRONMENT

The Green Economy relies heavily on technology for its continued advancement, and sensors are a major component of any eco-friendly strategy. Environmental initiatives include wind-, wave- and solar-power generation, industrial and domestic recycling, energy management and development of alternative fuels.

To deliver the green agenda, all of these sectors utilize sensors extensively for reliable detection and identification of materials, accurate measurement of operational parameters and consistent control of processes.

Recommended product ranges:

- Inductive - Full Inox - Washdown
- Inductive - Full Inox - Maritime
- Inductive - Classics - Basic
- Inductive - Extra Distance - Basic



MOBILE EQUIPMENT

Repairing and servicing equipment on site can be difficult and costly at best, and sometimes impossible. In these circumstances, robust, highly reliable sensors are vital for continuous operation in environments that may be challenging in the extreme. Exposure to dirt and dust, impact, vibration, seawater, corrosive chemicals and extremes of temperature and pressure are all part of a regular day's work.

Manufacturers of mobile and portable equipment, including forklifts, agricultural machines, construction plant, aircraft, vehicles and ships, expect exceptional reliability and life-expectancy when selecting fit-and-forget sensors for these demanding applications.

Recommended product ranges:

- Inductive - Extra Distance - High pressure
- Inductive - Full Inox - Extreme
- Inductive - Extra Distance - Basic



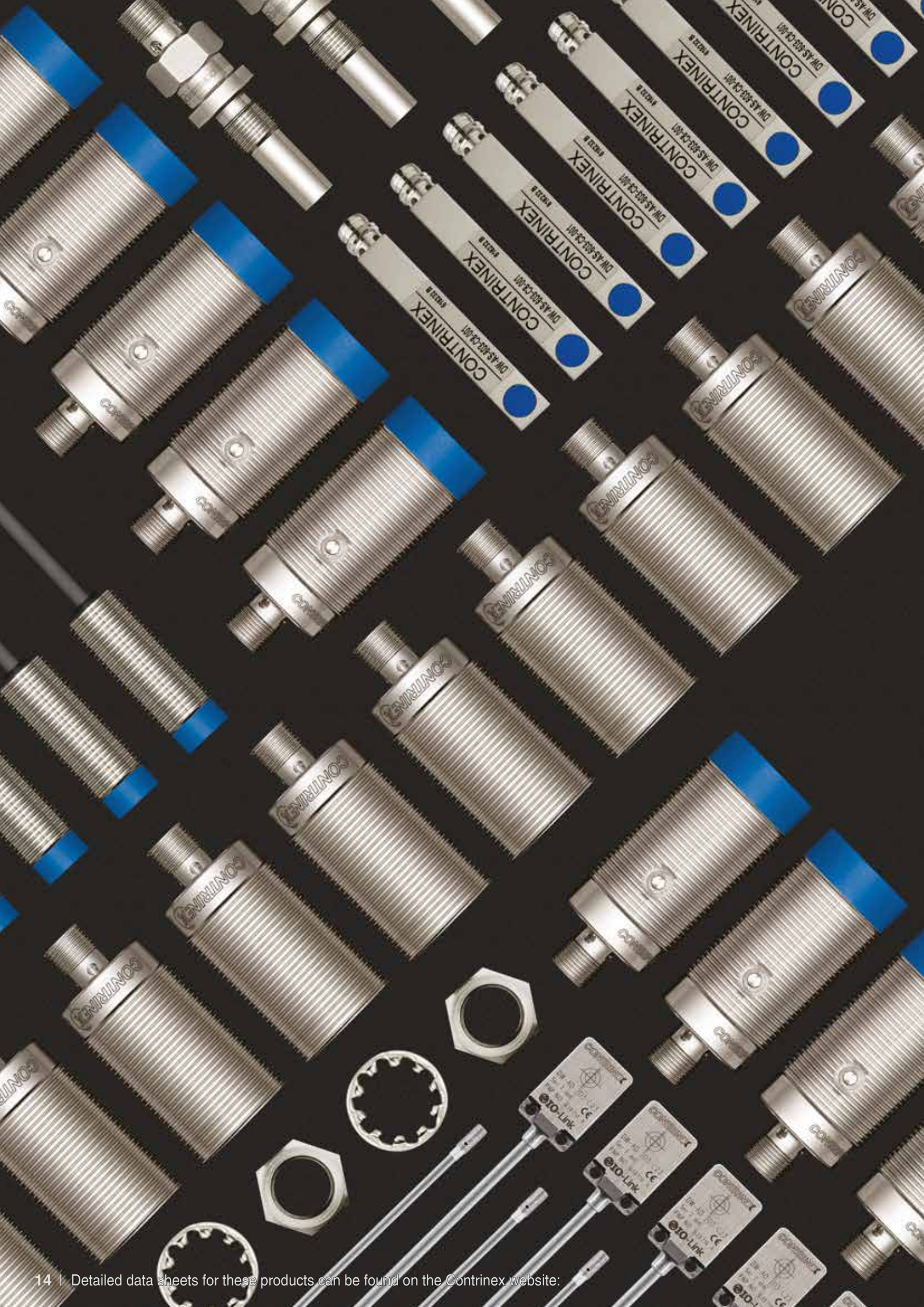

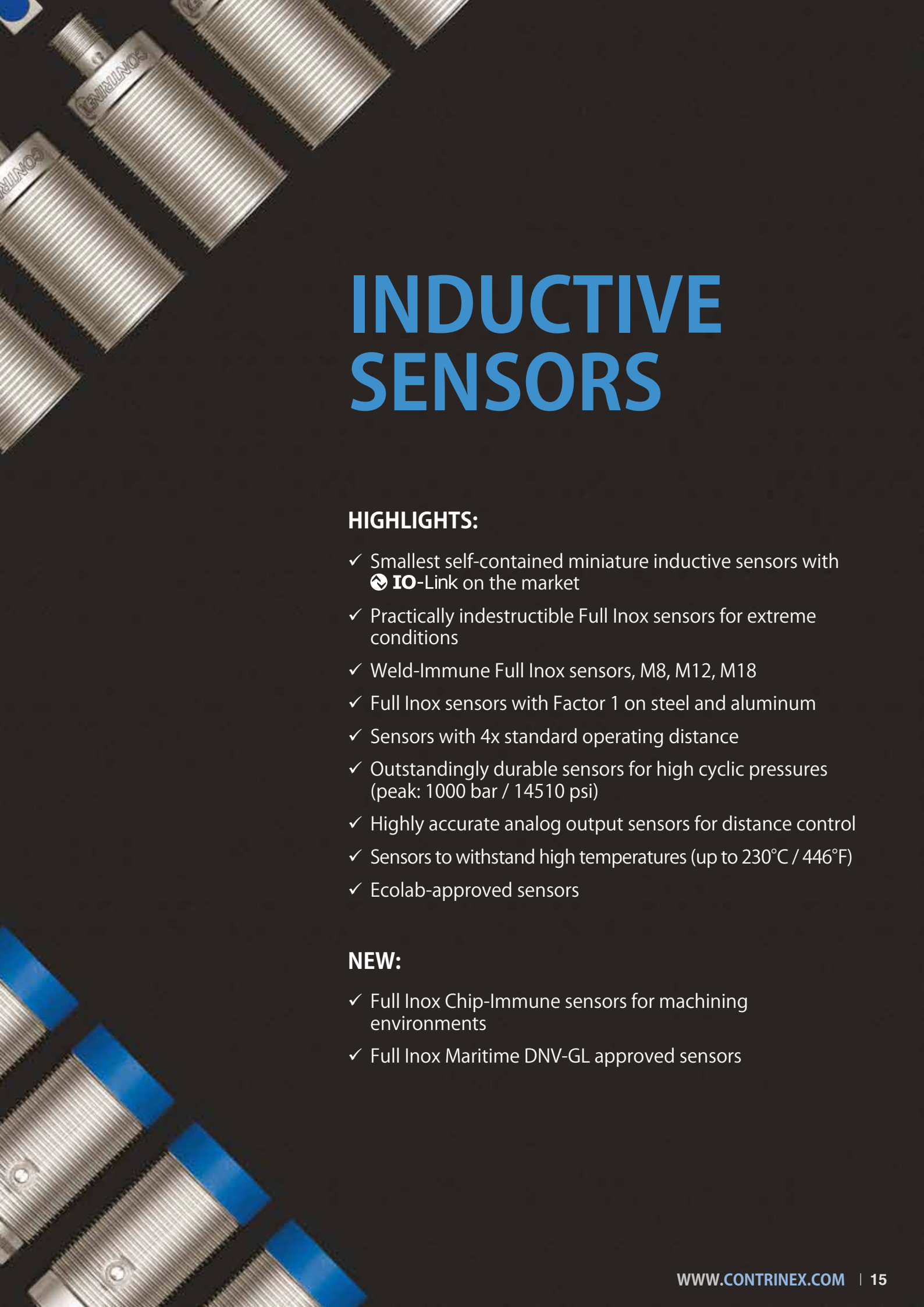

INDUCTIVE SENSORS



































HIGHLIGHTS:





















- ✓ Smallest self-contained miniature inductive sensors with  IO-Link on the market
- ✓ Practically indestructible Full Inox sensors for extreme conditions
- ✓ Weld-Immune Full Inox sensors, M8, M12, M18
- ✓ Full Inox sensors with Factor 1 on steel and aluminum
- ✓ Sensors with 4x standard operating distance
- ✓ Outstandingly durable sensors for high cyclic pressures (peak: 1000 bar / 14510 psi)
- ✓ Highly accurate analog output sensors for distance control
- ✓ Sensors to withstand high temperatures (up to 230°C / 446°F)
- ✓ Ecolab-approved sensors

NEW:

- ✓ Full Inox Chip-Immune sensors for machining environments
- ✓ Full Inox Maritime DNV-GL approved sensors

PROGRAM OVERVIEW

FAMILY	HOUSING SIZE	OPERATING DISTANCE	BASIC	MINIATURE	EXTREME	ANALOG OUTPUT
			 IO-Link	 IO-Link	 IO-Link	
CLASSICS Series 600 1 x S _n / 2 x S _n	∅ 3	0.6 ... 1 mm		 p. 71-72		
	M4	0.6 ... 1 mm		 p. 72-73		
	∅ 4	0.8 ... 1.5 mm		 p. 73-75		
	M5	0.8 ... 1.5 mm		 p. 76-77		
	C5	0.8 ... 1.5 mm		 p. 78-79		
	∅ 6.5	1.5 ... 2 mm	 p. 31-35			
	M8	1.5 ... 4 mm	 p. 35-41, 43-44			
	C8	1.5 ... 2 mm	 p. 45-46			
	M12	2 ... 8 mm	 p. 47-51			
	M18	5 ... 8 mm	 p. 54-57			
	M30	10 ... 25 mm	 p. 60-61, 64			
	M50	25 mm				
	40 x 40	15 ... 40 mm	 p. 66-67			
EXTRA DISTANCE Series 500 3 x S _n / 4 x S _n	∅ 4	2.5 mm		 p. 75		
	M5 / P5	1 ... 2.5 mm		 p. 77		
	∅ 6.5	2.5 ... 3 mm	 p. 35			
	M8 / P8	1.5 ... 6 mm	 p. 42-45			p. 95-96
	C8	2 ... 4 mm	 p. 46			p. 95
	M12 / P12	1.5 ... 10 mm	 p. 50-54			p. 96-97
	M18	12 ... 20 mm	 p. 57-59			p. 97-98
	M30	20 ... 40 mm	 p. 62-65			p. 98-99
	M14 / P20	3 mm				
FULL INOX Series 700 full-metal housing	∅ 4	3 mm		 p. 75		
	M5	3 mm		 p. 78		
	∅ 6.5					
	M8	2 ... 6 mm	 p. 41		 p. 83-84	
	M12 / P12	1.5 ... 15 mm	 p. 47-48		 p. 84-86	
	M18	5 ... 20 mm	 p. 55		 p. 87-88	
	M30	3 ... 40 mm	 p. 61		 p. 89-90	
	C23	7 mm			 p. 91	

	2-WIRE	EXTRA/HIGH PRESSURE up to 1000 bar peak  IO-Link	EXTRA TEMP. HIGH TEMP. -40 to +230°C  IO-Link	WELD-IMMUNE CHIP-IMMUNE DOUBLE-SHEET  IO-Link	MARITIME  IO-Link	WASHDOWN  IO-Link	Inductive
	p.103	 p.131					Photoelectric
	p. 103						
	p. 104	 p.131					
	p. 105	 p.131	 p.143				Safety
	p. 105						
	p. 106, 110						
	p. 107, 110-113		 p.143, 147				RFID
	p. 107, 114-119		 p.143, 147			 p.171	
	p. 108, 119-123		 p.143, 147-148				
	p. 109, 124-127		p. 148-149				Connectivity
			p.149				
		 p.135					Accessories
		 p.131					
		 p.135					
		 p.135-137					Glossary
							Index
		 p.137		p.153			
				 p.153, 157	 p.165	 p.171-172	
				 p.153, 157	 p.166	 p.172-173	
				 p.157, 161	 p.166-167	 p.173-174	
					 p.167		

PROGRAM OVERVIEW

MINIATURE + BASIC

HOUSING SIZE	OPERATING DISTANCE													PAGE
	5 mm	10 mm	15 mm	20 mm	25 mm	30 mm	35 mm	40 mm	45 mm	50 mm	55 mm	60 mm	65 mm	
∅ 3 mm / M4	0.6 mm													71 - 72
	1 mm													71 - 73
∅ 4 mm / M5	0.8 mm													73-74, 76
	1.5 mm													74 - 77
	2.5 mm													75, 77
	3 mm													75, 78
C5	0.8 mm													78
	1.5 mm													79
∅ 6.5 mm	1.5 mm													31 - 33
	2 mm													33 - 35
	3 mm													35
M8	1.5 mm													35 - 37
	2 mm													38 - 41
	2.5 mm													41
	3 mm													42
	4 mm													43 - 44
	6 mm													44 - 45
C8	1.5 mm													45
	2 mm													45 - 46
	3 mm													46
M12	2 mm													47
	3 ... 4 mm													47 - 50
	6 mm													50 - 51
	8 mm													51 - 53
	10 mm													53 - 54
M18	5 mm													54 - 55
	8 mm													55 - 57
	12 mm													57 - 58
	20 mm													59
M30	10 mm													60 - 61
	15 mm													61
	22 mm													62 - 63
	25 mm													64
	40 mm													64 - 65
C44	15 mm													66
	20 mm													66
	30 mm													67
	40 mm													67

OTHER RANGES

HOUSING SIZE	OPERATING DISTANCE													PAGE	Inductive
	5 mm	10 mm	15 mm	20 mm	25 mm	30 mm	35 mm	40 mm	45 mm	50 mm	55 mm	60 mm	65 mm		
EXTREME															
M8 / M12	2 ... 3 mm													83 - 84	Photoelectric
M8 / M12	6 mm													83 - 85	
M18 / C23	5 ... 7 mm													87, 91	
M12 / M18 / M30	10 mm													85 - 89	
M12	15 mm													86	
M18 / M30	20 mm													88 - 89	
M30	40 mm													90	
ANALOG OUTPUT															
C8 / M8	0 ... 4 mm													95 - 96	Safety
M12	0 ... 6 mm													96 - 97	
M18	0 ... 10 mm													97 - 98	
M18 / M30	0 ... 20 mm													98 - 99	
M30	0 ... 40 mm													99	
2-WIRE															
∅ 3 / ∅ 4 / M4 / M5 / C5	0.6 ... 0.8 mm													103 - 105	RFID
∅ 6.5	1.5 mm													106, 110	
M8	1.5 ... 2.5 mm													107, 110 - 113	
M12	2 ... 4 mm													107, 114 - 119	
M18	5 ... 8 mm													108, 119 - 123	
M30	10 ... 15 mm													109, 124 - 127	
EXTRA/HIGH PRESSURE															
∅ 3 / ∅ 4 / M5	0.6 ... 0.8 mm													131	Connectivity
∅ 6.5	2.5 mm													131	
M5 / P5	1 mm													135	
M8 / P8 / M12 / P12	1.5 ... 2.5 mm													135 - 137	
M14 / P20	3.0 mm													137 - 138	
EXTRA/HIGH TEMP.															
M5	0.8 mm													143	Accessories
M8	2 ... 4 mm													143, 147	
M12	2 ... 4 mm													143, 147	
M18	5 mm													143, 147-148	
M30	10 mm													148 - 149	
M50	25 mm													149	
WELD-IMMUNE CHIP-IMMUNE DOUBLE SHEET															
M8 / M12	3 ... 6 mm													153, 157	Glossary
M18	5 ... 10 mm													153, 157	
M30	12 mm													157	
M30	3 ... 5 mm													161	
MARITIME															
M12	1.5 mm													165	Index
M12	6 mm													165	
M18	10 mm													166	
M30	20 mm													166 - 167	
C23	7 mm													167	
WASHDOWN															
M12	2 mm													171	
M12	6 mm													171	
M12 / M18	10 mm													171 - 172	
M18 / M30	20 mm													173 - 174	
M30	40 mm													174	

INTRODUCTION

TECHNOLOGY

Contrinex inductive devices work according to one of **three different technologies**. All involve the generation of an alternating magnetic field that emerges at the sensing face. The presence of a conductive, generally metallic, object influences this field in a way that can be detected and evaluated by built-in electronics. All Contrinex ASIC sensors are IO-Link enabled in PNP NO versions.

TECHNOLOGY FAMILIES

CLASSICS FAMILY:

Conventional technology, engineered by Contrinex

The **Classics** family uses conventional inductive sensor technology, but with the benefit of a Contrinex ASIC (application specific integrated circuit). ASIC technology ensures reliability, stability and ease of commissioning, due to low variation. Sensors in this family achieve operating distances up to 2 x the industry standard. All ASIC sensors in the **Classics** family are IO-Link enabled in PNP NO versions.

Classics sensors have a conventional oscillator and coil generating a high-frequency magnetic field that emerges at the sensing face. Any metallic object found in this field absorbs some of the energy, which is in turn detected and evaluated by built-in electronics (Fig. 1).

Ferromagnetic metals (steel, nickel, cobalt) absorb the most energy. The achievable operating distances are therefore greatest with these metals. Non-ferromagnetic metals, such as aluminum, absorb less energy. As a result, operating distances are lower (approx. 25 ... 45% of those on steel).

The **Classics** technology family (series 600) includes devices from the ranges **Basic, Miniature, Extra Pressure, Extra Temperature, High Temperature, Wash-down** and **2-Wire**.

EXTRA DISTANCE FAMILY:

Increased stability for exceptionally long operating distance

The **Extra Distance** family is based on the Condist® oscillator developed by Contrinex. Sensors benefit from **up to 4x the standard** operating distance, keeping them out of harm's way in rugged, industrial environments. Sensor lifetime is therefore increased.

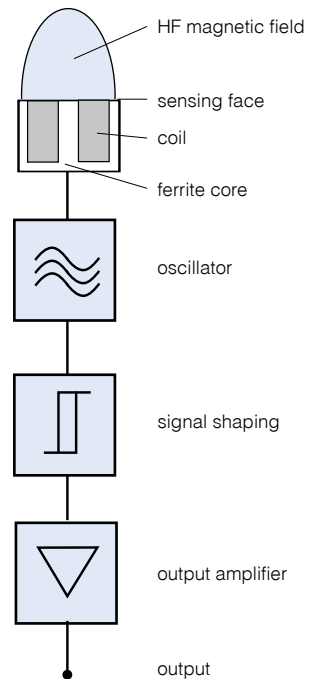

Fig. 1: Conventional inductive sensor technology, as used in the **Classics** family

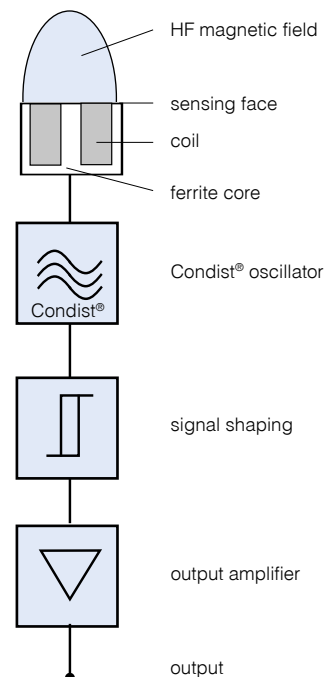

Fig. 2: Contrinex's Condist® inductive sensor technology, as used in the **Extra Distance** family

Like **Classics** family sensors, these also generate a high-frequency magnetic field that emerges at the sensing face (Fig. 2). Again, the resulting effect is that any metallic object entering the field absorbs energy from it.

However, the oscillator and the subsequent signal evaluation circuit are completely different, with the objective of achieving a significantly **better stability** with respect to environmental influences, in particular temperature. The most important contribution to this comes from the Contrinex Condist® oscillator.

Improved stability permits the switch point to be further away, leading to **long operating distances** on ferromagnetic metals (Fig. 3). Sensors with this technology also react particularly well to **narrow targets**, e.g. small screws, wires and foils.

Apart from the Condist® oscillator, all other assemblies are equivalent to the **Classics** family. Material dependencies and other properties are also the same as for **Classics** family sensors.

Special attention has been paid to **meet the relevant standards as much as possible**, so that easy **interchangeability** with conventional devices is guaranteed. Great emphasis has been placed on very good EMC resistance and on perfect sealing against liquid penetration.

The **Extra Distance** technology family includes devices from the **Basic, Miniature, Extra Pressure, High Pressure** and **Analog Output** ranges. This technology is used in series 500 devices.

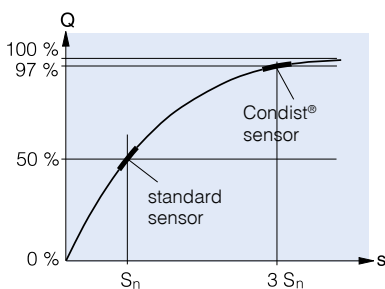

Fig. 3: **Extra Distance** family sensors have a longer operating distance, due to Condist® oscillator technology

FULL INOX FAMILY:

All-round stainless steel protection - practically indestructible

The **Full Inox** family is based on Contrinex's Condet® technology. These one-piece stainless steel sensors are not only the most durable on the market, they also offer long operating distances on any conductive metal.

Full Inox sensors also function according to inductive technology. However, the coil which generates the magnetic field is not part of the oscillator (Fig. 4). Instead, the field is generated by periodic, short **transmitter current pulses**, which flow through the coil (Fig. 5). This field induces a voltage in the target which, in turn, generates a current flow in it. When the transmitter current pulse is switched off, the current in the object dies away, causing a **voltage to be induced** in the transmitting coil (Fig. 6).

This voltage generates the signal required, and is in principle **independent of the field's energy loss**. Therein lies the fundamental advantage of this technology, since the field energy losses, which are evaluated in conventional sensors, are subject to a number of undesirable environmental and material influences.

Condet® technology allows the sensor, including its face, to be fully encapsulated in a protective, stainless steel housing, with the added security of long operating distances.

The coupling between the target and the coil is rather **like a transformer**, and is hence **temperature independent** and only **slightly influenced by the target's material**. Operating distances are therefore identical on steel and aluminum. Only metals which are non-ferromagnetic and also have poor electrical conductivity give a reduced usable signal.

The **Full Inox** family includes devices from the **Basic, Miniature, Extreme, High Pressure, Washdown, Weld-Immune, Chip-Immune, Maritime** and **Double-Sheet** ranges.

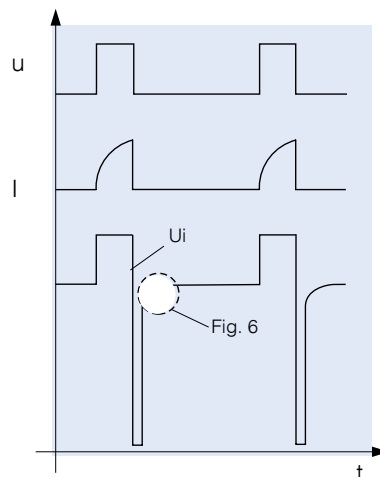

Fig. 5: Evolution of main signals

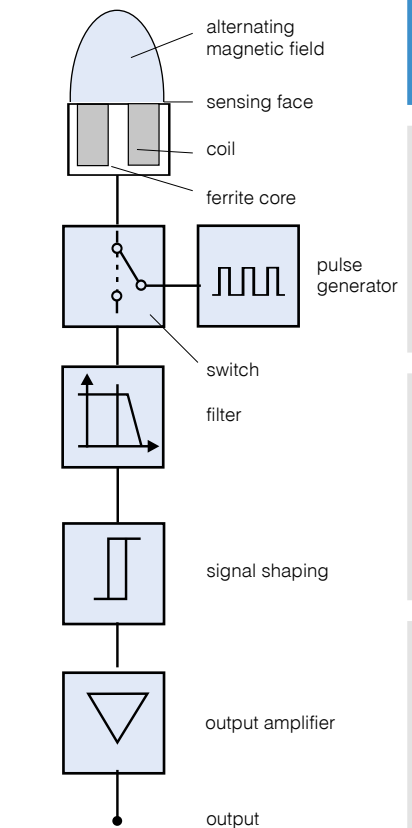

Fig. 4: **Full Inox** family sensors use Condet® pulse generator technology instead of an oscillator

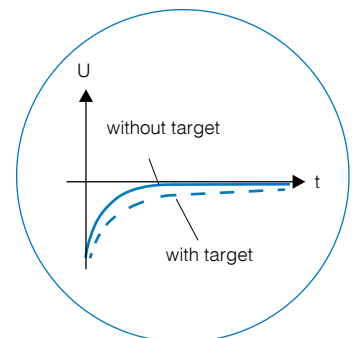

Fig. 6 (detail fig. 5): Effect of a target on the measured signal

INTRODUCTION

PRODUCT RANGES

BASIC

First choice in all environments

Contrinex **Basic** range inductive sensors have a worldwide and well-deserved reputation for uncompromising accuracy and exceptional reliability. With best-in-class sensing distances between **1.5 mm** and **40 mm**, the **Basic** range offers fit-and-forget operation, delivering world-class performance and a highly attractive total cost of ownership.

Available in sizes from M8 to M30 and C44, with optional \varnothing 6.5 plain and 8 mm square-section models, **Basic** range inductive sensors are ideal for general position-sensing and presence-sensing applications in almost any industry. Embeddable or non-embeddable variants are available, with either hard-wired, hermetically sealed connecting cables or integral metal connectors. **Basic** range devices, whether from the **Classics** (Fig. 1), **Extra Distance** (Fig. 2) or **Full Inox** (Fig. 4) technology families, all utilize Contrinex application-specific integrated circuits (ASICs) that ensure highly repeatable results at operating temperatures between -25°C and $+70^{\circ}\text{C}$. An **IO-Link** interface is also available for communication in PNP NO versions.



MINIATURE

Full functionality, smallest size

Size is often a critical constraint when selecting sensors for position- or presence-sensing. The Contrinex **Miniature** range, which includes the smallest self-contained inductive sensors on the market, meets this constraint without compromising on functionality.

Sensors from this range use either **Classics** (Fig. 1), **Extra Distance** (Fig. 2) or **Full Inox** (Fig. 4) technology. Available in plain and threaded sizes from \varnothing 3 to M5 and as a 5 mm square-section type, **Miniature** range inductive sensors are ideal for applications where space is limited, including tool-selection, robotic position-sensing and control of micro-mechanisms.

Extremely robust, thanks to chip-scale package (CSP) technology, a glass-fiber reinforced substrate and vacuum encapsulation, the Contrinex **Miniature** range delivers long-term reliability and maximum uptime, even in the most demanding environments. The low mass and **high switching frequency** of these sensors makes them particularly suitable for high-dynamic applications where inertia is a major consideration.

These embeddable devices are available in 3-wire DC, NPN and PNP versions with a choice of NO or NC configurations. An LED output state indicator is standard. All the important protection functions are included, such as short-circuit and overload protection, full polarity reversal protection, induction protection, EMC protection, power-on reset, etc.

With a sensing range up to **3 mm**, Contrinex miniature inductive sensors combine world-class quality with a highly attractive total cost of ownership. An **IO-Link** interface is also available for communication in PNP NO versions.



EXTREME

Extreme durability in harsh environments

Only the toughest sensors survive the most extreme environments, and **Extreme** range inductive sensors from the **Full Inox** family are ideally equipped for the job. Thanks to one-piece stainless-steel (V2A/ AISI 303) construction and a hermetically sealed cable entry, **Extreme** sensors are corrosion-resistant, impervious to oil, and pressure-resistant to **100 bar**. Rugged, reliable and highly accurate, the **Extreme** range is at home in the most challenging circumstances.



Developed to withstand the harshest industrial operating conditions, **Extreme** sensors are rated to **IP 68** and **IP 69K**, delivering fit-and-forget performance with minimal downtime. With operating distances up to **40 mm**, the **Extreme** range senses both ferrous and non-ferrous materials with **Factor 1** performance, and is available in sizes from M8 to M30 and C23. An **IO-Link** interface is also available for communication in PNP NO versions.

ANALOG OUTPUT

Continuous analog output for precision control

Engineers needing a reliable, repeatable, highly accurate means of measuring the position of a target object should look no further than Contrinex **Analog Output** inductive sensors. This range of sensors has been developed on the platform of **Extra Distance** (Fig. 2) technology for excellent temperature stability, repeat accuracy, and the best long-range sensing capability on the market. With a measurement range of **zero to 40 mm** and detection accuracy on the micron scale, the **Analog Output** sensor range is ideally suited for measuring linear, angular and rotational position (Fig. 7). They offer world-class performance and an attractive total cost of ownership in applications from vibration monitoring and end-position approach regulation, to position monitoring, metal sorting and sheet-metal forming.

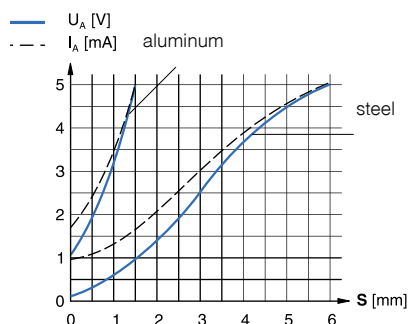

Fig. 7

Analog Output inductive sensors are available in sizes from M8 to M30, with the option of an 8 mm square-section model. Voltage outputs are included for all sizes, while sizes M12 and above feature both voltage and current outputs.

2-WIRE

Easy installation and high switching frequency

The **2-Wire** range of DC, AC/DC and NAMUR sensors is constructed on the **Classics** (Fig. 1) technology platform and includes sizes from Ø 3 to M30, plus a 5 x 5 mm square-section



type. Devices are available for embeddable or non-embeddable mounting and connection is by means of cable or connector. With a sensing range up to 15 mm, Contrinex **2-Wire** sensors ensure optimal equipment utilization.

EXTRA PRESSURE

Pressure resistant up to 200 bar

Dependable, accurate presence- and position-sensing at pressures up to **200 bar** requires world-class performance and build quality. The **Extra Pressure** range of pressure-resistant inductive sensors delivers exactly that, operating continuously in permanently pressurized conditions. This makes the range especially suitable for offshore installations, the chemical industry, motor lubrication systems and atomic fuel element monitoring. A stainless-steel housing with bonded ceramic or brazed sapphire sensing face and protection class **IP 68** guarantees robustness and exceptional reliability in miniature packages sized from Ø 3 to Ø 6.5.

The **Extra Pressure** range is also ideal for high-vacuum environments and satellite applications, offering fit-and-forget capability and a sealed cable-entry that ensures no loss of service or interruptions to production.

Sensors from this range use either **Classics** (Fig. 1) or **Extra Distance** (Fig. 2) technology and have equivalent electrical properties. For optimum impermeability, LED and connector versions are not available in this range.

Sensors from the **Extra Pressure** range detect parts at sensing distances up to **2.5 mm**, and offer a highly attractive total cost of ownership. An **IO-Link** interface is also available for communication in PNP NO versions.



HIGH PRESSURE

Resistant to pressure and dynamic stress up to 500 bar (peak 1000 bar)

For reliable, accurate sensing in the most demanding pneumatic and hydraulic applications, Contrinex offers a unique range of **High Pressure** sensors with permanent operating pressures of **100 ... 500 bar** and peak pressures up to **1000 bar**.

Suitable for operating temperatures up to 100°C and resistant to more than 1 million pressure cycles, their IP 68 and IP 69K protection and oil impermeability make them the robust, reliable choice for the hydraulic industry. Fit-and-forget operation virtually eliminates sensor replacement costs. Exceptional performance and world-class quality are assured in sizes from M5 to M18.



INTRODUCTION

Contrinex **High Pressure** sensors are available in either **Extra Distance** (Fig. 2) or **Full Inox** (Fig 4) versions. Both of these technologies ensure durability without compromising on usable operating distance. Sensor construction is simple and robust, with the whole electronic unit, ferrite core and coil included, safely on the **no-pressure side**. Sealed connection is by means of either flexible PU cable or an integral connector.

Fig. 8 shows an **Extra Distance** version. The stainless steel housing is heat shrunk onto the ceramic disk, making the sensor mechanically resistant, **exceptionally impervious**, and outstanding for applications with **high dynamic pressure stress**, such as piston-control applications. With operating distances of up to 3 mm, they are gas-tight and meet protection class **IP 68**.

Versions from the **Full Inox** family have a practically indestructible pressure- and corrosion-resistant one-piece stainless steel housing (V4A / AISI 316L / DIN 1.4404). They provide excellent detection of all metals with good conductivity, both ferromagnetic and non-ferromagnetic. These corrosion resistant sensors are suitable for the harshest conditions and meet protection classes **IP 68 & IP 69K**. An **IO-Link** interface is also available for communication in PNP NO versions.

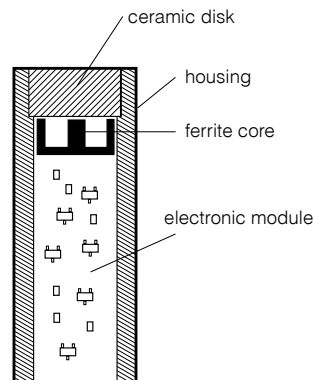

Fig. 8

HIGH TEMPERATURE

Temperature resistant up to 180°C (230°C with external amplifier)

Contrinex **High Temperature** inductive sensors are designed for continuous operation at temperatures from 0°C up to 180°C (up to 230°C with remote electronics). The range is ideal for the harshest environments, including automotive paint shops, metal-treatment plants and glass manufacturing.



EXTRA TEMPERATURE

Temperature resistant up to 120°C

Inductive sensors from the **Extra Temperature** range offer the ideal solution for position- and presence-sensing applications at temperatures from as low as minus 40°C up to 120°C. Industrial processes often generate heat, resulting in temperatures that would damage a standard sensor, but the stainless-steel construction and robust electronics of Contrinex **Extra Temperature** sensors ensure reliable, accurate operation and minimal downtime, even in the most demanding environments.

Sensors from this range use either conventional **Classics** (Fig. 1) or all-metal **Full Inox** (Fig. 4) technology. Individually compensated for repeatable, highly accurate operation across the full operating temperature range, **Extra Temperature** inductive sensors accommodate sensing distances up to 25 mm, minimizing the risk of collision damage.

Available in sizes from M5 to M18, the **Extra Temperature** range delivers best-in-class performance at elevated temperatures in the harsh environments of the automotive, molding and metal-processing industries. An **IO-Link** interface is also available for communication in PNP NO versions.



High Temperature sensors use **Classics** (Fig. 1) technology. Embeddable, non-embeddable and quasi-embeddable versions are available. For temperatures up to 180°C, sensors feature built-in amplifiers and include highly durable 100% silicone-free types. Connection is by means of an FEP, Teflon or silicone cable. For 230°C types, the amplifiers are built into an M12 stainless-steel housing, which is connected by means of a standard 3 m Teflon cable, and thus removed from the hot area. Stainless steel construction and sensing distances up to 25 mm minimize the risk of mechanical damage during operation, ensuring maximum plant availability and a highly attractive total cost of ownership. Contrinex **High Temperature** sensors are available in sizes from M8 to M50.

WELD-IMMUNE

Immune to magnetic fields and resistant to weld spatter

Contrinex **Weld-Immune** inductive sensors are ideal for the hostile working environments found in automotive factories and other industrial welding plants. The range includes sensors from two technology platforms: **Classics** (Fig. 1) and **Full Inox** (Fig. 4).

Classics devices, with protection class IP 67, are available either in PTFE-coated cylindrical brass housings or a PBTP 40 x 40 mm cubic form. They resist solder and the strong magnetic fields present during industrial welding processes. They have identical operating distances on steel and non-ferrous metals.

Weld-Immune sensors built on the **Full Inox** platform have a long operating distance and Factor 1 on steel and aluminum. One-piece, stainless-steel (V2A / AISI 303) construction makes these sensors the most durable on the market, ensuring minimal down-time. These practically indestructible sensors withstand the welding environment for years, resisting electromagnetic fields, welding spatter, cleaning and impacts.

All **Weld-Immune** sensors are embeddable and have an integral S12 connector. Best-in-class sensing ranges of up to **15 mm** eliminate the risk of collision - a frequent hazard when operating in close proximity to moving machine parts.

Developed for extreme accuracy throughout the welding cycle, **Weld-Immune** sensors continuously detect part presence and machine position to ensure optimal equipment utilization and prevent errors in production. These sensors provide excellent repeatability at temperatures between -25°C and +85°C (-13 to +185°F).



DOUBLE-SHEET

Detection of double-sheets in metalworking

For double-sheet detection, sensors from the **Full Inox** (Fig. 4) family are used. Its inductive technology enables discrimination between one and two conductive metal sheets of a defined thickness, achieving sensitivity of 0.8 - 1.2 mm per sheet. This discrimination aids in the prevention of double feeds into blanking and forming processes which ultimately saves damage to tooling. The one-piece, stainless-steel construction of these sensors makes them the most durable on the market. They withstand the impacts that are a common hazard in double-sheet detection applications close to moving sheet metal, ensuring minimal down-time.



CHIP-IMMUNE

For the harshest machining environments

Even when covered with chips of steel, stainless steel, aluminum, brass, copper or titanium, **Chip-Immune** inductive sensors from the **Full Inox** technology family will reliably detect targets made of these metals. The sensors achieve this with a slightly modified form of Condet® technology. In a one-piece stainless steel housing with **IP 68/IP 69K** protection rating and a wide operating temperature range from -25 to +85°C (-13 to +185°F), they are particularly suitable for use in the harsh environments of the machining industry. Depending on sensor diameter (**M12**, **M18** or **M30**), operating distances of 3, 5 or 12 mm are available. In the PNP version, sensors also include an **IO-Link** interface for point-to-point communication with the controller of the system.



INTRODUCTION

MARITIME

DNV-GL approved for ships, ports and offshore

The **Maritime** range of embeddable inductive sensors, certified by Germanischer Lloyd, offers unrivalled performance features based on **Full Inox** technology (Fig. 4). With a one-piece housing in V4A/AISI 316L stainless steel and an enclosure rating of **IP 68/IP 69K**, they are not only impervious, but also corrosion-proof and resistant to salt water. Their EMC protection also meets specific maritime requirements, particularly with regard to power supply variations and low frequency immunity. They offer the longest service life of any inductive sensor on the market, even in the harshest marine environments. The maximum operating pressure is 80 bar or 500 bar (peak 800 bar) for P12G high-pressure types. Depending on sensor size (**M12**, **C23**, **M18** or **M30**), operating distances of 6, 7, 10 or 20 mm are available. In the PNP version, sensors also include an **IO-Link** interface for point-to-point communication with the controller of the system. The range also includes **M10** types with **Classics** technology.



Conversion of temperature	
Celsius	Fahrenheit
-40	-40
-25	-13
0	+32
+70	+158
+85	+185
+100	+212
+120	+248
+180	+356
+230	+446

Conversion of pressure	
Bar	PSI
1	14.5
80	1160
100	1451
200	2901
500	7255
800	11603
1000	14510

WASHDOWN

Ecolab approved for strictest production hygiene

Washdown inductive sensors are certified to operate continuously and reliably in the harsh conditions of the food, beverage and pharmaceutical industries, ensuring uninterrupted production. With **Ecolab** approval and rated to **IP 68** and **IP 69K**, they are pressure resistant up to **80 bar**, **food safe** and **corrosion resistant**.

Washdown sensors are available in conventional **Classics** (Fig. 1) technology, size M12, or **Full Inox** (Fig. 4) technology, sizes M12, M18 and M30. **Full Inox** types have a totally impervious one-piece housing in stainless-steel (V4A / AISI 316L), including the sensing face. They are therefore highly resistant to the corrosive chemicals used for clean-in-place or wash-down processes. With Factor 1 on steel and aluminum and extended sensing ranges up to 40 mm, **Full Inox** technology minimizes the possibility of impact damage - a common hazard in confined operating spaces.

Washdown sensors meet the increasingly demanding sensing needs of the food, beverage and pharmaceutical industries, delivering best-in-class performance with an attractive total cost of ownership. An **IO-Link** interface is also available for communication in PNP NO versions.



IO-LINK FUNCTIONALITY* WITH INDUCTIVE SENSORS (PNP N.O. TYPES)

Data monitoring:

- 1 Switching state is monitored continuously. This not only monitors the signal itself, but also the state at 80% of the switching distance. One can therefore ensure that the sensor is not working at the limit of its specifications.

Diagnosis:

- 2 The operating state of the sensor is checked. In case of wire break, under-voltage, LC oscillator break or installation of the wrong sensor, information is provided directly through IO-Link to enable fast repair, maintenance and replacement.

NO/NC selection:

- 3 The output switching mode can be selected as NO or NC. A single sensor type is configurable for the various needs of an application. This helps reduce the number of different sensor types required in stock.

Switching timer:

- 4 The timing of output switching can be configured. Depending on the needs of an application, output switching can be delayed or the duration stretched through programming.

Detection counter:

- 5 Detection events are counted. By registering the number of detections, it is possible to calculate the speed or number of parts. The counter can be reset by means of a unique IO-Link message.

Temperature:

- 6 The internal temperature of the sensor is measured continuously, which provides an indication about the ambient temperature in the application. Moreover, the maximum temperature measured is saved for diagnosis and preventive maintenance purposes.

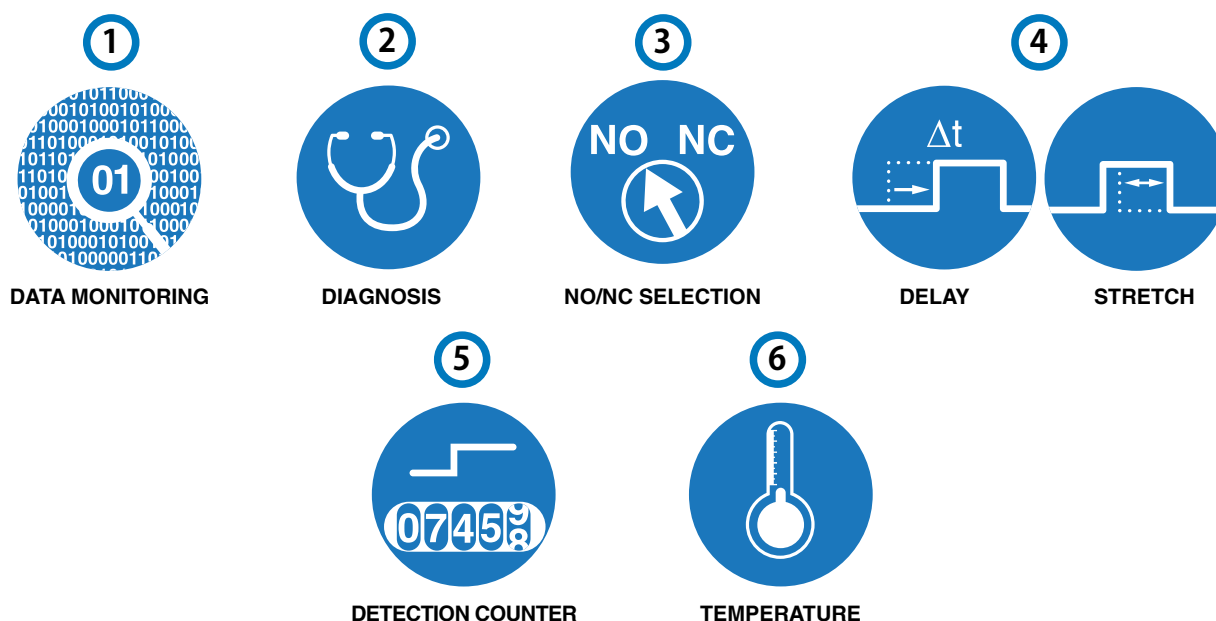

* Functionalities may vary depending on series and sensor type

1 + 1 = 2



FIRST CHOICE IN ALL ENVIRONMENTS

BASIC

INDUCTIVE SENSORS

KEY ADVANTAGES

Classics, Extra Distance and Full Inox

- ✓ High quality ASIC sensors
- ✓  IO-Link
- ✓ Exceptional price-performance ratio
- ✓ Excellent accuracy
- ✓ Outstanding temperature compensation
- ✓ Vibration and shock resistant
- ✓ Long operating distance

Full Inox

- ✓ Extremely robust one-piece stainless-steel housing
- ✓ Corrosion resistant
- ✓ IP 68 and IP 69K water resistant
- ✓ Pressure resistant up to 80 bar (1160 psi)

RANGE OVERVIEW	Housing size	Classics	Extra Distance	Full Inox
BASIC	∅ 6.5 mm	p. 31-35	p. 35	
	M8	p. 35-41, 43-44	p. 42-45	p. 41
	C8	p. 45-46	p. 46	
	M12	p. 47-51	p. 50-54	p. 47-48
	M18	p. 54-57	p. 57-59	p. 55
	M30	p. 60-61, 64	p. 62-65	p. 61
	C44	p. 66-67		

FAMILY

HOUSING SIZE MM

OPERATING DISTANCE MM

WIRING DIAGRAMS

PNP NO

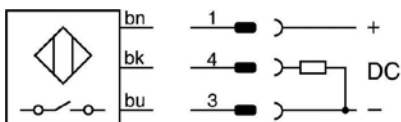

NPN NO

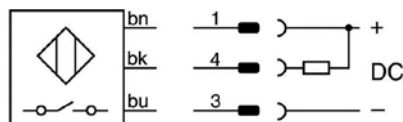

PNP NC

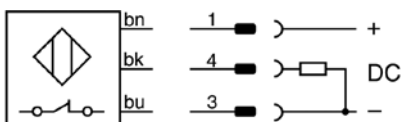

NPN NC

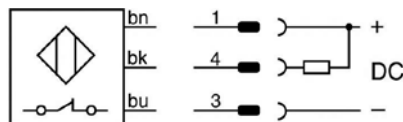

PNP Changeover

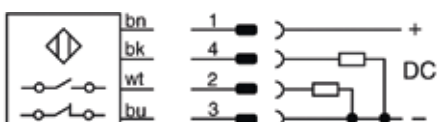

NPN Changeover

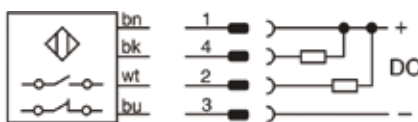

INDUCTIVE

DATA

Housing material

Connection

Degree of protection

Mounting

Max. switching frequency

Supply voltage range

Ambient temperature range

Output current

PNP NO

NPN NO

Other types available

BASIC

CLASSICS	CLASSICS	CLASSICS	CLASSICS
Ø 6.5	Ø 6.5	Ø 6.5	Ø 6.5
1.5	1.5	1.5	1.5 (4)

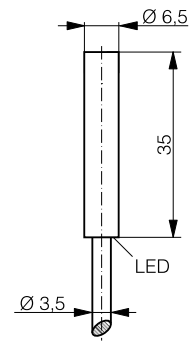
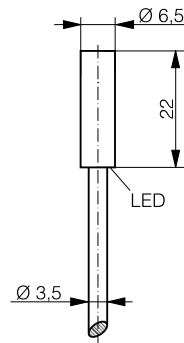
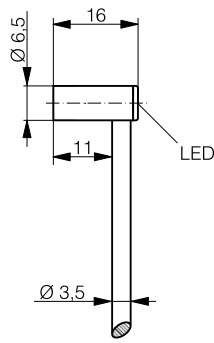
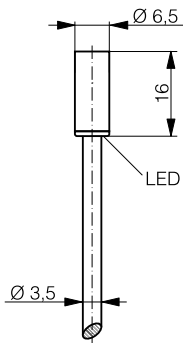

IO-Link	IO-Link	IO-Link	IO-Link
Stainless steel V2A	Stainless steel V2A	Stainless steel V2A	Stainless steel V2A
PVC cable	PVC cable	PVC cable	PVC cable
IP 67	IP 67	IP 67	IP 67
Embeddable	Embeddable	Embeddable	Embeddable
5000 Hz	5000 Hz	5000 Hz	5000 Hz
10 ... 30 VDC	10 ... 30 VDC	10 ... 30 VDC	10 ... 30 VDC
-25 ... +70°C / -13 ... +158°F	-25 ... +70°C / -13 ... +158°F	-25 ... +70°C / -13 ... +158°F	-25 ... +70°C / -13 ... +158°F
≤ 200 mA	≤ 200 mA	≤ 200 mA	≤ 200 mA
DW-AD-603-065-120	DW-AD-603-065-400	DW-AD-603-065-121	DW-AD-603-065
DW-AD-601-065-120	DW-AD-601-065-400	DW-AD-601-065-121	DW-AD-601-065
PNP NC, NPN NC	PNP NC, NPN NC	PNP NC, NPN NC	PNP NC, NPN NC, length 30 mm, non-embeddable (Sn 4 mm)

Inductive

Photoelectric

Safety

RFID

Connectivity

Accessories

Glossary

Index

BASIC

FAMILY

CLASSICS

CLASSICS

CLASSICS

HOUSING SIZE MM

Ø 6.5

Ø 6.5

Ø 6.5

OPERATING DISTANCE MM

1.5

1.5

1.5



INDUCTIVE

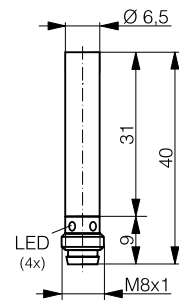
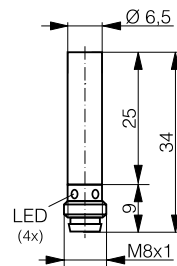
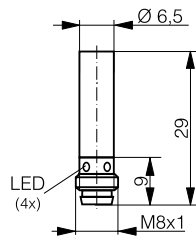

DATA

IO-Link

IO-Link

IO-Link

Housing material

Stainless steel V2A

Stainless steel V2A

Stainless steel V2A

Connection

Connector S8

Connector S8

Connector S8

Degree of protection

IP 67

IP 67

IP 67

Mounting

Embeddable

Embeddable

Embeddable

Max. switching frequency

5000 Hz

5000 Hz

5000 Hz

Supply voltage range

10 ... 30 VDC

10 ... 30 VDC

10 ... 30 VDC

Ambient temperature range

-25 ... +70°C / -13 ... +158°F

-25 ... +70°C / -13 ... +158°F

-25 ... +70°C / -13 ... +158°F

Output current

≤ 200 mA

≤ 200 mA

≤ 200 mA

PNP NO

DW-AS-603-065-129

DW-AS-603-065-123

DW-AS-603-065-124

NPN NO

DW-AS-601-065-129

DW-AS-601-065-123

DW-AS-601-065-124

Other types available

PNP NC, NPN NC

PNP NC, NPN NC

PNP NC, NPN NC

BASIC

CLASSICS	CLASSICS	CLASSICS	CLASSICS
Ø 6.5	Ø 6.5	Ø 6.5	Ø 6.5
1.5 (4)	2	2	2

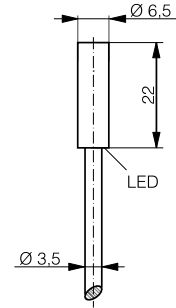
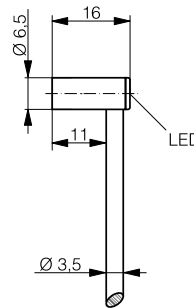
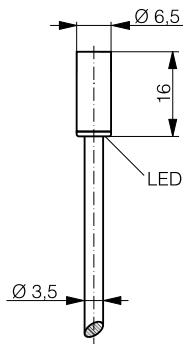
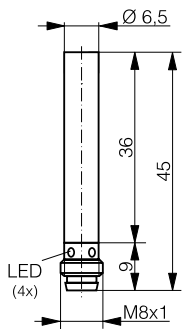

IO-Link	IO-Link	IO-Link	IO-Link
Stainless steel V2A	Stainless steel V2A	Stainless steel V2A	Stainless steel V2A
Connector S8	PVC cable	PVC cable	PVC cable
IP 67	IP 67	IP 67	IP 67
Embeddable	Embeddable	Embeddable	Embeddable
5000 Hz	5000 Hz	5000 Hz	5000 Hz
10 ... 30 VDC	10 ... 30 VDC	10 ... 30 VDC	10 ... 30 VDC
-25 ... +70°C / -13 ... +158°F	-25 ... +70°C / -13 ... +158°F	-25 ... +70°C / -13 ... +158°F	-25 ... +70°C / -13 ... +158°F
≤ 200 mA	≤ 200 mA	≤ 200 mA	≤ 200 mA
DW-AS-603-065-001	DW-AD-623-065-120	DW-AD-623-065-400	DW-AD-623-065-121
DW-AS-601-065-001	DW-AD-621-065-120	DW-AD-621-065-400	DW-AD-621-065-121
PNP NC, NPN NC, S12, non-embeddable (Sn 4 mm)	PNP NC, NPN NC	PNP NC, NPN NC	PNP NC, NPN NC

BASIC

INDUCTIVE

FAMILY	CLASSICS	CLASSICS	CLASSICS
HOUSING SIZE MM	Ø 6.5	Ø 6.5	Ø 6.5
OPERATING DISTANCE MM	2	2	2

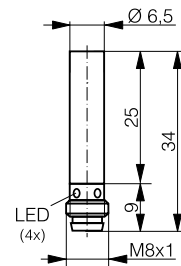
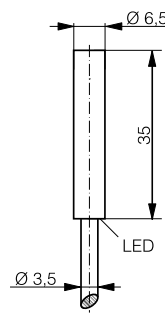
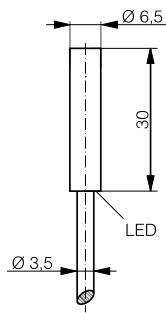

DATA	IO-Link	IO-Link	IO-Link
Housing material	Stainless steel V2A	Stainless steel V2A	Stainless steel V2A
Connection	PVC cable	PVC cable	Connector S8
Degree of protection	IP 67	IP 67	IP 67
Mounting	Embeddable	Embeddable	Embeddable
Max. switching frequency	5000 Hz	5000 Hz	5000 Hz
Supply voltage range	10 ... 30 VDC	10 ... 30 VDC	10 ... 30 VDC
Ambient temperature range	-25 ... +70°C / -13 ... +158°F	-25 ... +70°C / -13 ... +158°F	-25 ... +70°C / -13 ... +158°F
Output current	≤ 200 mA	≤ 200 mA	≤ 200 mA
PNP NO	DW-AD-623-065-122	DW-AD-623-065	DW-AS-623-065-123
NPN NO	DW-AD-621-065-122	DW-AD-621-065	DW-AS-621-065-123
Other types available	PNP NC, NPN NC	PNP NC, NPN NC	PNP NC, NPN NC, length 29 mm

BASIC

CLASSICS	EXTRA DISTANCE	EXTRA DISTANCE	CLASSICS
Ø 6.5	Ø 6.5	Ø 6.5	M8
2	3	3	1.5

Inductive

Photoelectric

Safety

RFID

Connectivity

Accessories

Glossary

Index

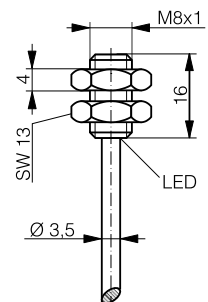
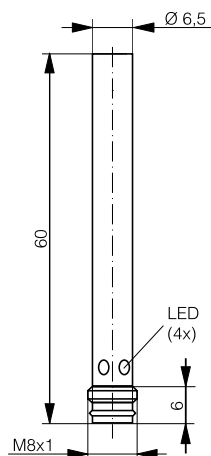
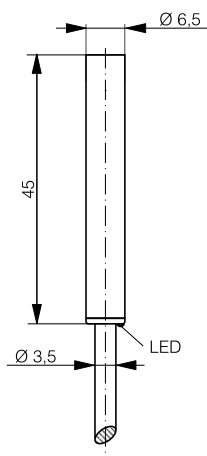
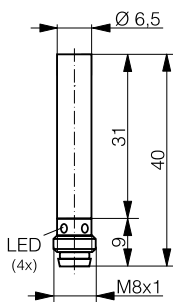

* IO-Link available from Q4/18

IO-Link	* IO-Link	* IO-Link	IO-Link
Stainless steel V2A	Chrome-plated brass	Chrome-plated brass	Stainless steel V2A
Connector S8	PVC cable	Connector S8	PVC cable
IP 67	IP 67	IP 67	IP 67
Embeddable	Quasi-embeddable	Quasi-embeddable	Embeddable
5000 Hz	1000 Hz	1000 Hz	5000 Hz
10 ... 30 VDC	10 ... 30 VDC	10 ... 30 VDC	10 ... 30 VDC
-25 ... +70°C / -13 ... +158°F	-25 ... +70°C / -13 ... +158°F	-25 ... +70°C / -13 ... +158°F	-25 ... +70°C / -13 ... +158°F
≤ 200 mA	≤ 200 mA	≤ 200 mA	≤ 200 mA
DW-AS-623-065-124	DW-AD-503-065	DW-AS-503-065-001	DW-AD-603-M8-120
DW-AS-621-065-124	DW-AD-501-065	DW-AS-501-065-001	DW-AD-601-M8-120
PNP NC, NPN NC, length 45 mm, S12	PNP NC, NPN NC	PNP NC, NPN NC, length 66 mm	PNP NC, NPN NC

BASIC

INDUCTIVE

FAMILY	CLASSICS	CLASSICS	CLASSICS
HOUSING SIZE	M8	M8	M8
OPERATING DISTANCE MM	1.5	1.5	1.5

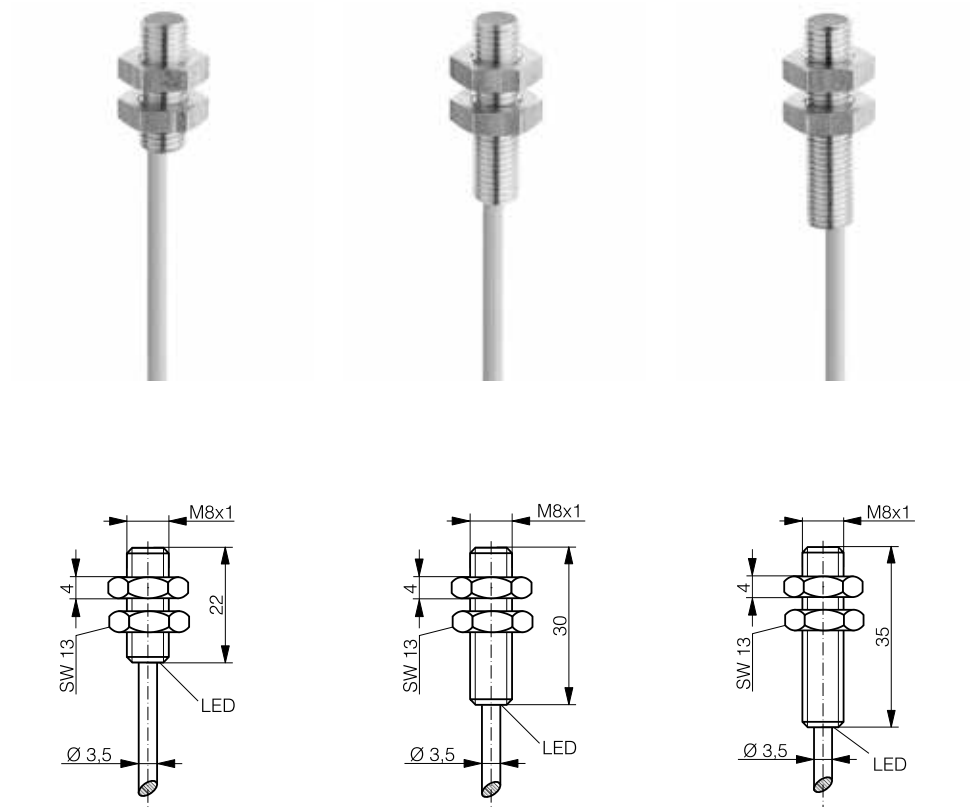

DATA	IO-Link	IO-Link	IO-Link
Housing material	Stainless steel V2A	Stainless steel V2A	Stainless steel V2A
Connection	PVC cable	PVC cable	PVC cable
Degree of protection	IP 67	IP 67	IP 67
Mounting	Embeddable	Embeddable	Embeddable
Max. switching frequency	5000 Hz	5000 Hz	5000 Hz
Supply voltage range	10 ... 30 VDC	10 ... 30 VDC	10 ... 30 VDC
Ambient temperature range	-25 ... +70°C / -13 ... +158°F	-25 ... +70°C / -13 ... +158°F	-25 ... +70°C / -13 ... +158°F
Output current	≤ 200 mA	≤ 200 mA	≤ 200 mA
PNP NO	DW-AD-603-M8-121	DW-AD-603-M8-122	DW-AD-603-M8
NPN NO	DW-AD-601-M8-121	DW-AD-601-M8-122	DW-AD-601-M8
Other types available	PNP NC, NPN NC	PNP NC, NPN NC	PNP NC, NPN NC

BASIC

CLASSICS	CLASSICS	CLASSICS	CLASSICS
M8	M8	M8	M8
1.5	1.5	1.5	1.5

Inductive



Photoelectric

Safety

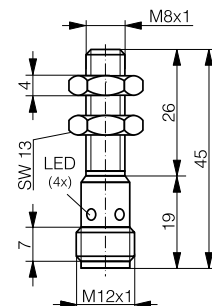
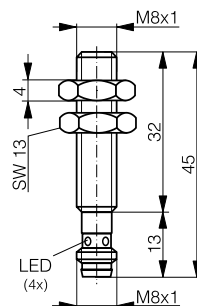
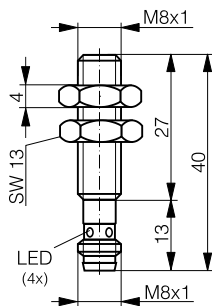
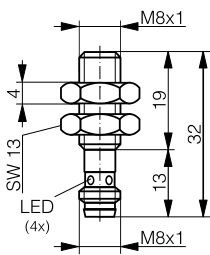

RFID

Connectivity

Accessories

IO-Link	IO-Link	IO-Link	IO-Link
Stainless steel V2A	Stainless steel V2A	Stainless steel V2A	Stainless steel V2A
Connector S8	Connector S8	Connector S8	Connector S12
IP 67	IP 67	IP 67	IP 67
Embeddable	Embeddable	Embeddable	Embeddable
5000 Hz	5000 Hz	5000 Hz	5000 Hz
10 ... 30 VDC	10 ... 30 VDC	10 ... 30 VDC	10 ... 30 VDC
-25 ... +70°C / -13 ... +158°F	-25 ... +70°C / -13 ... +158°F	-25 ... +70°C / -13 ... +158°F	-25 ... +70°C / -13 ... +158°F
≤ 200 mA	≤ 200 mA	≤ 200 mA	≤ 200 mA
DW-AS-603-M8-123	DW-AS-603-M8-124	DW-AS-603-M8-001	DW-AS-603-M8
DW-AS-601-M8-123	DW-AS-601-M8-124	DW-AS-601-M8-001	DW-AS-601-M8
PNP NC, NPN NC	PNP NC, NPN NC	PNP NC, NPN NC	PNP NC, NPN NC, length 39 mm

Glossary

Index

BASIC

INDUCTIVE

FAMILY	CLASSICS	CLASSICS	CLASSICS
HOUSING SIZE	M8	M8	M8
OPERATING DISTANCE MM	2	2	2

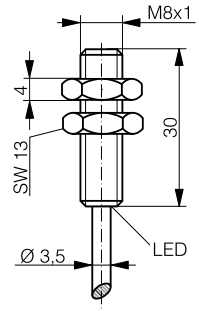
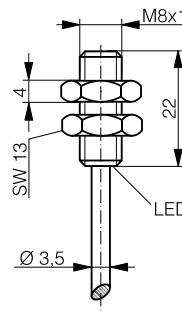
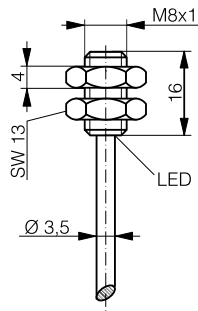

DATA	IO-Link	IO-Link	IO-Link
Housing material	Stainless steel V2A	Stainless steel V2A	Stainless steel V2A
Connection	PVC cable	PVC cable	PVC cable
Degree of protection	IP 67	IP 67	IP 67
Mounting	Embeddable	Embeddable	Embeddable
Max. switching frequency	5000 Hz	5000 Hz	5000 Hz
Supply voltage range	10 ... 30 VDC	10 ... 30 VDC	10 ... 30 VDC
Ambient temperature range	-25 ... +70°C / -13 ... +158°F	-25 ... +70°C / -13 ... +158°F	-25 ... +70°C / -13 ... +158°F
Output current	≤ 200 mA	≤ 200 mA	≤ 200 mA
PNP NO	DW-AD-623-M8-120	DW-AD-623-M8-121	DW-AD-623-M8-122
NPN NO	DW-AD-621-M8-120	DW-AD-621-M8-121	DW-AD-621-M8-122
Other types available	PNP NC, NPN NC	PNP NC, NPN NC	PNP NC, NPN NC

BASIC

CLASSICS	CLASSICS	CLASSICS	CLASSICS
M8	M8	M8	M8
2	2	2	2

Inductive



Photoelectric

Safety

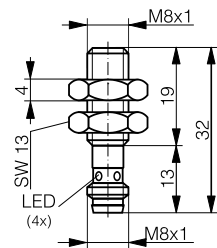
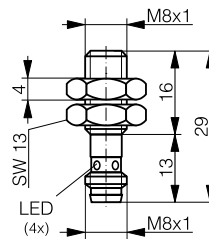
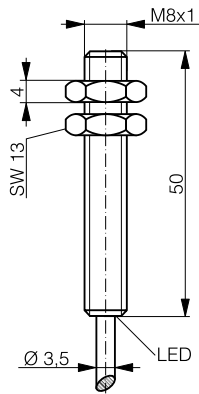
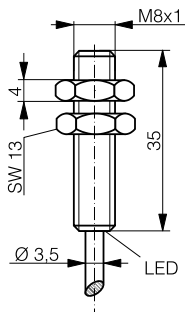

RFID

Connectivity

Accessories

IO-Link	IO-Link	IO-Link	IO-Link
Stainless steel V2A	Stainless steel V2A	Stainless steel V2A	Stainless steel V2A
PVC cable	PVC cable	Connector S8	Connector S8
IP 67	IP 67	IP 67	IP 67
Embeddable	Embeddable	Embeddable	Embeddable
5000 Hz	5000 Hz	5000 Hz	5000 Hz
10 ... 30 VDC	10 ... 30 VDC	10 ... 30 VDC	10 ... 30 VDC
-25 ... +70°C / -13 ... +158°F	-25 ... +70°C / -13 ... +158°F	-25 ... +70°C / -13 ... +158°F	-25 ... +70°C / -13 ... +158°F
≤ 200 mA	≤ 200 mA	≤ 200 mA	≤ 200 mA
DW-AD-623-M8	DW-AD-623-M8-177	DW-AS-623-M8-129	DW-AS-623-M8-123
DW-AD-621-M8	DW-AD-621-M8-177	DW-AS-621-M8-129	DW-AS-621-M8-123
PNP NC, NPN NC	PNP NC, NPN NC	PNP NC, NPN NC	PNP NC, NPN NC

Glossary

Index

BASIC

INDUCTIVE

FAMILY	CLASSICS	CLASSICS	CLASSICS	CLASSICS
HOUSING SIZE	M8	M8	M8	M8
OPERATING DISTANCE MM	2	2	2	2

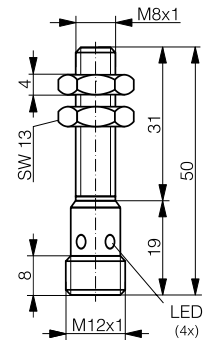
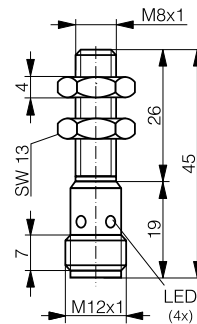
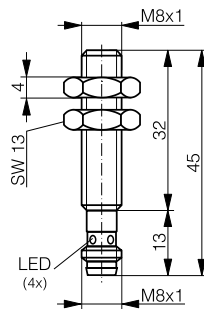
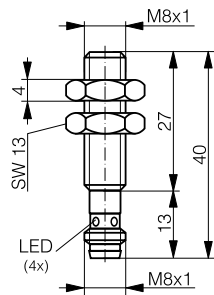

DATA	IO-Link	IO-Link	IO-Link	IO-Link
Housing material	Stainless steel V2A	Stainless steel V2A	Stainless steel V2A	Stainless steel V2A
Connection	Connector S8	Connector S8	Connector S12	Connector S12
Degree of protection	IP 67	IP 67	IP 67	IP 67
Mounting	Embeddable	Embeddable	Embeddable	Embeddable
Max. switching frequency	5000 Hz	5000 Hz	5000 Hz	5000 Hz
Supply voltage range	10 ... 30 VDC	10 ... 30 VDC	10 ... 30 VDC	10 ... 30 VDC
Ambient temperature range	-25...+70°C/-13...+158°F	-25...+70°C/-13...+158°F	-25...+70°C/-13...+158°F	-25...+70°C/-13...+158°F
Output current	≤ 200 mA	≤ 200 mA	≤ 200 mA	≤ 200 mA
PNP NO	DW-AS-623-M8-124	DW-AS-623-M8-001	DW-AS-623-M8	DW-AS-623-M8-193
NPN NO	DW-AS-621-M8-124	DW-AS-621-M8-001	DW-AS-621-M8	
Other types available	PNP NC, NPN NC	PNP NC, NPN NC	PNP NC, NPN NC	

BASIC

FULL INOX	FULL INOX	CLASSICS	CLASSICS	CLASSICS
M8	M8	M8	M8	M8
2	2	2.5	2.5	2.5

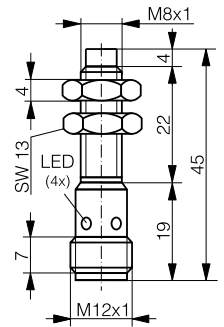
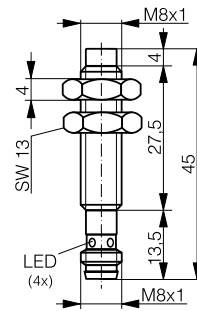
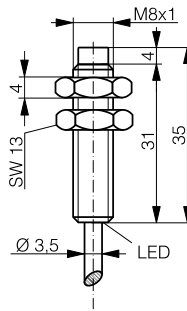
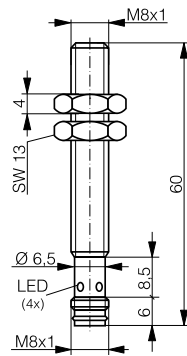
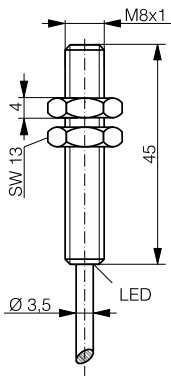

IO-Link	IO-Link	IO-Link	IO-Link	IO-Link
Stainless steel V2A	Stainless steel V2A	Stainless steel V2A	Stainless steel V2A	Stainless steel V2A
PUR cable	Connector S8	PVC cable	Connector S8	Connector S12
IP 68	IP 68 / IP 69K	IP 67	IP 67	IP 67
Embeddable	Embeddable	Non-embeddable	Non-embeddable	Non-embeddable
100 Hz	100 Hz	4500 Hz	4500 Hz	4500 Hz
10 ... 30 VDC	10 ... 30 VDC	10 ... 30 VDC	10 ... 30 VDC	10 ... 30 VDC
-25 ... +70°C/-13 ... +158°F	-25 ... +70°C/-13 ... +158°F	-25 ... +70°C/-13 ... +158°F	-25 ... +70°C/-13 ... +158°F	-25 ... +70°C/-13 ... +158°F
≤ 200 mA	≤ 200 mA	≤ 200 mA	≤ 200 mA	≤ 200 mA
DW-AD-703-M8-BAS	DW-AS-703-M8-001-BAS	DW-AD-613-M8	DW-AS-613-M8-001	DW-AS-613-M8
DW-AD-701-M8-BAS	DW-AS-701-M8-001-BAS	DW-AD-611-M8	DW-AS-611-M8-001	DW-AS-611-M8
		PNP NC, NPN NC, lengths 22 & 30 mm	PNP NC, NPN NC, lengths 32 & 40 mm	PNP NC, NPN NC

BASIC

INDUCTIVE

FAMILY	EXTRA DISTANCE	EXTRA DISTANCE	EXTRA DISTANCE
HOUSING SIZE	M8	M8	M8
OPERATING DISTANCE MM	3	3	3

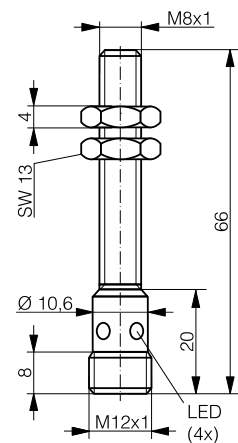
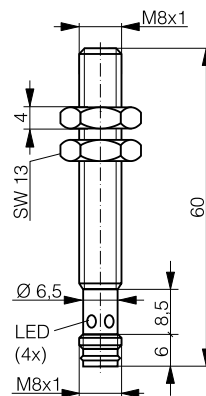
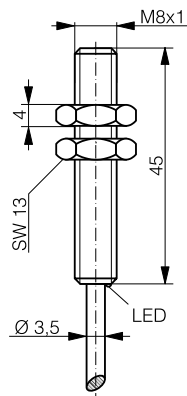

* IO-Link available from Q4/18

DATA	* IO-Link	* IO-Link	* IO-Link
Housing material	Chrome-plated nickel silver	Chrome-plated nickel silver	Chrome-plated nickel silver
Connection	PVC cable	Connector S8	Connector S12
Degree of protection	IP 67	IP 67	IP 67
Mounting	Embeddable	Embeddable	Embeddable
Max. switching frequency	1000 Hz	1000 Hz	1000 Hz
Supply voltage range	10 ... 30 VDC	10 ... 30 VDC	10 ... 30 VDC
Ambient temperature range	-25 ... +70°C / -13 ... +158°F	-25 ... +70°C / -13 ... +158°F	-25 ... +70°C / -13 ... +158°F
Output current	≤ 200 mA	≤ 200 mA	≤ 200 mA
PNP NO	DW-AD-503-M8	DW-AS-503-M8-001	DW-AS-503-M8
NPN NO	DW-AD-501-M8	DW-AS-501-M8-001	DW-AS-501-M8
Other types available	PNP NC, NPN NC, length 35 mm	PNP NC, NPN NC	PNP NC, NPN NC

BASIC

EXTRA DISTANCE	CLASSICS	EXTRA DISTANCE	EXTRA DISTANCE
M8	M8	M8	M8
4	4	4	4

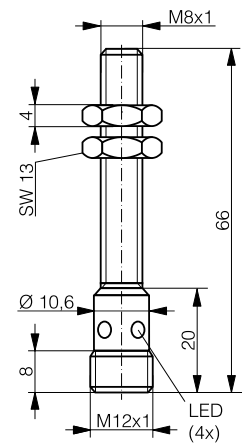
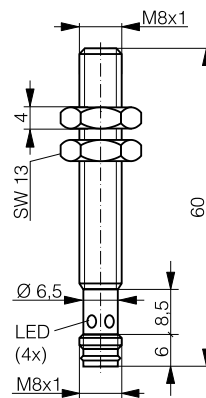
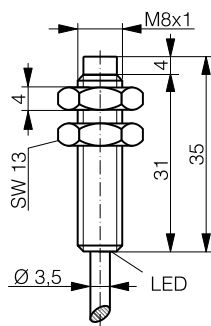
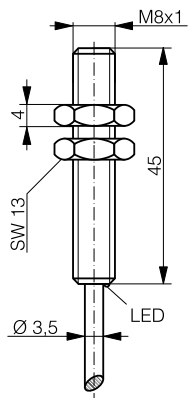

* IO-Link	IO-Link	* IO-Link	* IO-Link
Chrome-plated nickel silver	Stainless steel V2A	Chrome-plated nickel silver	Chrome-plated nickel silver
PVC cable	PVC cable	Connector S8	Connector S12
IP 67	IP 67	IP 67	IP 67
Embeddable	Non-embeddable	Embeddable	Embeddable
500 Hz	3500 Hz	500 Hz	500 Hz
10 ... 30 VDC	10 ... 30 VDC	10 ... 30 VDC	10 ... 30 VDC
-25 ... +70°C / -13 ... +158°F	-25 ... +70°C / -13 ... +158°F	-25 ... +70°C / -13 ... +158°F	-25 ... +70°C / -13 ... +158°F
≤ 200 mA	≤ 200 mA	≤ 200 mA	≤ 200 mA
DW-AD-523-M8	DW-AD-633-M8	DW-AS-523-M8-001	DW-AS-523-M8
DW-AD-521-M8	DW-AD-631-M8	DW-AS-521-M8-001	DW-AS-521-M8
PNP NC, NPN NC, length 35 mm	PNP NC, NPN NC	PNP NC, NPN NC	PNP NC, NPN NC

Inductive

Photoelectric

Safety

RFID

Connectivity

Accessories

Glossary

Index

BASIC

INDUCTIVE

FAMILY	CLASSICS	EXTRA DISTANCE	EXTRA DISTANCE
HOUSING SIZE MM	M8	M8	M8
OPERATING DISTANCE MM	4	6	6

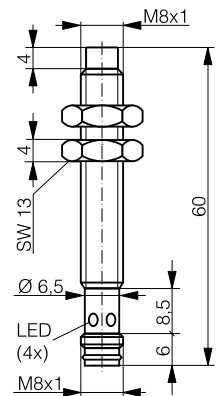
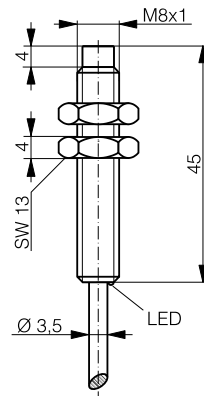
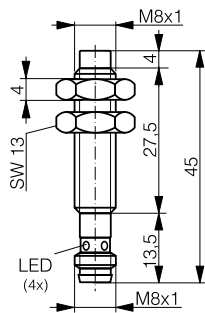

* IO-Link available from Q4/18

DATA	IO-Link	* IO-Link	* IO-Link
Housing material	Stainless steel V2A	Chrome-plated brass	Chrome-plated brass
Connection	Connector S8	PVC cable	Connector S8
Degree of protection	IP 67	IP 67	IP 67
Mounting	Non-embeddable	Non-embeddable	Non-embeddable
Max. switching frequency	3500 Hz	500 Hz	500 Hz
Supply voltage range	10 ... 30 VDC	10 ... 30 VDC	10 ... 30 VDC
Ambient temperature range	-25 ... +70°C / -13 ... +158°F	-25 ... +70°C / -13 ... +158°F	-25 ... +70°C / -13 ... +158°F
Output current	≤ 200 mA	≤ 200 mA	≤ 200 mA
PNP NO	DW-AS-633-M8-001	DW-AD-513-M8	DW-AS-513-M8-001
NPN NO	DW-AS-631-M8-001	DW-AD-511-M8	DW-AS-511-M8-001
Other types available	PNP NC, NPN NC	PNP NC, NPN NC, length 35 mm	PNP NC, NPN NC

BASIC

EXTRA DISTANCE	CLASSICS	CLASSICS	CLASSICS
M8	□ 8 x 8	□ 8 x 8	□ 8 x 8
6	1.5	1.5	2

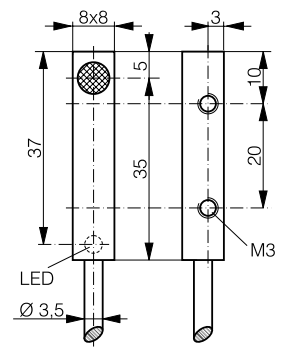
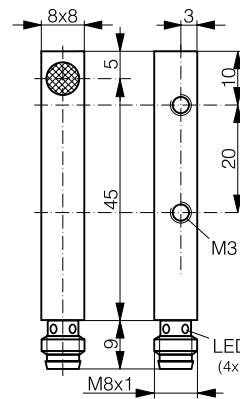
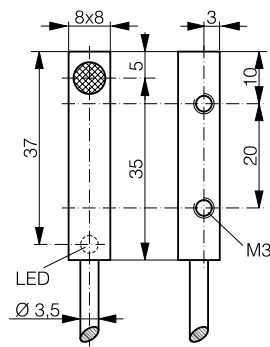
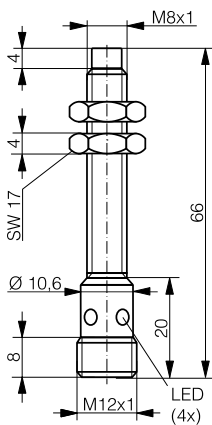

* IO-Link	IO-Link	IO-Link	IO-Link
Chrome-plated brass	Zamak	Zamak	Zamak
Connector S12	PVC cable	Connector S8	PVC cable
IP 67	IP 67	IP 67	IP 67
Non-embeddable	Embeddable	Embeddable	Embeddable
500 Hz	3500 Hz	3500 Hz	5000 Hz
10 ... 30 VDC	10 ... 30 VDC	10 ... 30 VDC	10 ... 30 VDC
-25 ... +70°C / -13 ... +158°F	-25 ... +70°C / -13 ... +158°F	-25 ... +70°C / -13 ... +158°F	-25 ... +70°C / -13 ... +158°F
≤ 200 mA	≤ 200 mA	≤ 200 mA	≤ 200 mA
DW-AS-513-M8	DW-AD-603-C8	DW-AS-603-C8-001	DW-AD-623-C8
DW-AS-511-M8	DW-AD-601-C8	DW-AS-601-C8-001	DW-AD-621-C8
PNP NC, NPN NC	PNP NC, NPN NC	PNP NC, NPN NC	PNP NC, NPN NC

Inductive

Photoelectric

Safety

RFID

Connectivity

Accessories

Glossary

Index

BASIC

INDUCTIVE

FAMILY	CLASSICS	EXTRA DISTANCE	EXTRA DISTANCE
HOUSING SIZE MM	□ 8 x 8	□ 8 x 8	□ 8 x 8
OPERATING DISTANCE MM	2	3	3

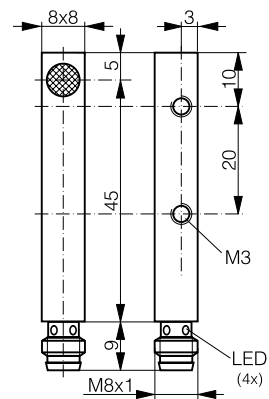
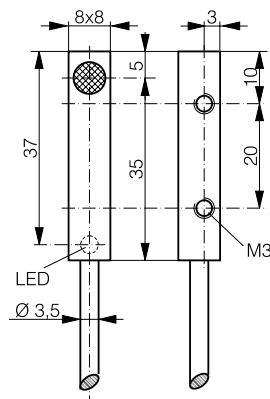
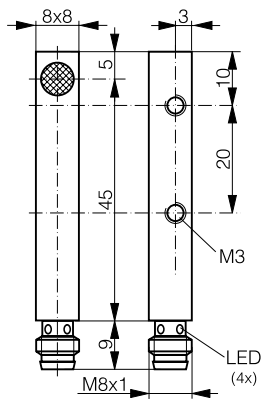

* IO-Link available from Q4/18

DATA	IO-Link	* IO-Link	* IO-Link
Housing material	Zamak	Zamak	Zamak
Connection	Connector S8	PVC cable	Connector S8
Degree of protection	IP 67	IP 67	IP 67
Mounting	Embeddable	Quasi-embeddable	Quasi-embeddable
Max. switching frequency	5000 Hz	1000 Hz	1000 Hz
Supply voltage range	10 ... 30 VDC	10 ... 30 VDC	10 ... 30 VDC
Ambient temperature range	-25 ... +70°C / -13 ... +158°F	-25 ... +70°C / -13 ... +158°F	-25 ... +70°C / -13 ... +158°F
Output current	≤ 200 mA	≤ 200 mA	≤ 200 mA
PNP NO	DW-AS-623-C8-001	DW-AD-503-C8	DW-AS-503-C8
NPN NO	DW-AS-621-C8-001	DW-AD-501-C8	DW-AS-501-C8
Other types available	PNP NC, NPN NC	PNP NC, NPN NC	PNP NC, NPN NC

BASIC

CLASSICS	CLASSICS	CLASSICS	CLASSICS	FULL INOX
M12	M12	M12	M12	M12
2	2	2	2	3

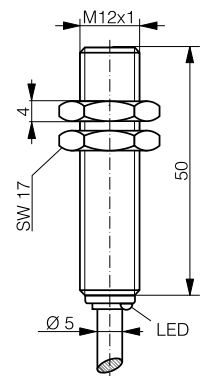
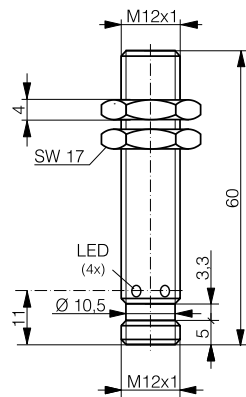
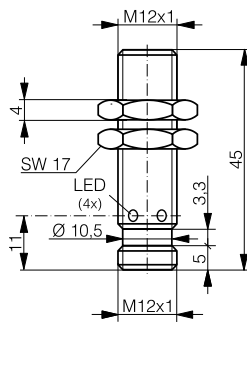
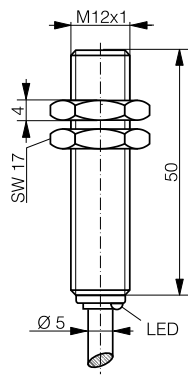
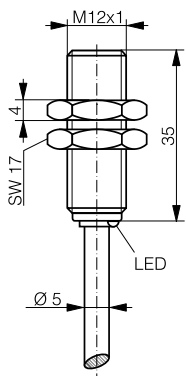

IO-Link	IO-Link	IO-Link	IO-Link	IO-Link
Nickel-plated brass	Nickel-plated brass	Nickel-plated brass	Nickel-plated brass	Stainless steel V2A
PVC cable	PVC cable	Connector S12	Connector S12	PUR cable
IP 67	IP 67	IP 67	IP 67	IP 68
Embeddable	Embeddable	Embeddable	Embeddable	Embeddable
3000 Hz	3000 Hz	3000 Hz	3000 Hz	100 Hz
10 ... 30 VDC	10 ... 30 VDC	10 ... 30 VDC	10 ... 30 VDC	10 ... 30 VDC
-25 ... +70°C/-13 ... +158°F	-25 ... +70°C/-13 ... +158°F	-25 ... +70°C/-13 ... +158°F	-25 ... +70°C/-13 ... +158°F	-25 ... +70°C/-13 ... +158°F
≤ 200 mA	≤ 200 mA	≤ 200 mA	≤ 200 mA	≤ 200 mA
DW-AD-603-M12-120	DW-AD-603-M12	DW-AS-603-M12-120	DW-AS-603-M12	DW-AD-703-M12-BAS
DW-AD-601-M12-120	DW-AD-601-M12	DW-AS-601-M12-120	DW-AS-601-M12	DW-AD-701-M12-BAS
PNP NC, NPN NC	PNP NC, NPN NC	PNP NC, NPN NC	PNP NC, NPN NC	

Inductive

Photoelectric

Safety

RFID

Connectivity

Accessories

Glossary

Index

BASIC

INDUCTIVE

FAMILY	FULL INOX	CLASSICS	CLASSICS	CLASSICS
HOUSING SIZE	M12	M12	M12	M12
OPERATING DISTANCE MM	3	4	4	4

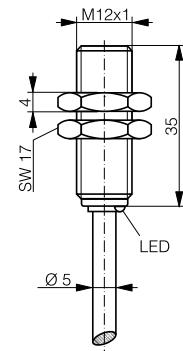
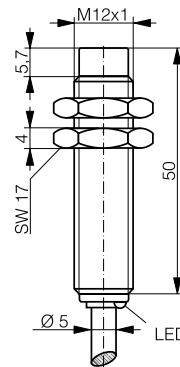
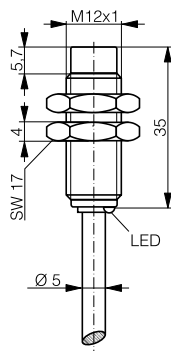
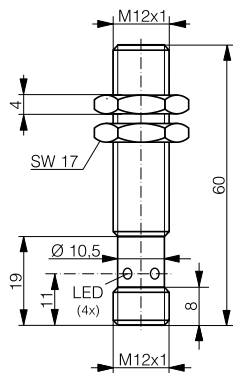

DATA	IO-Link	IO-Link	IO-Link	IO-Link
Housing material	Stainless steel V2A	Nickel-plated brass	Nickel-plated brass	Nickel-plated brass
Connection	Connector S12	PVC cable	PVC cable	PVC cable
Degree of protection	IP 68 & IP 69K	IP 67	IP 67	IP 67
Mounting	Embeddable	Non-embeddable	Non-embeddable	Embeddable
Max. switching frequency	100 Hz	2000 Hz	2000 Hz	2500 Hz
Supply voltage range	10 ... 30 VDC	10 ... 30 VDC	10 ... 30 VDC	10 ... 30 VDC
Ambient temperature range	-25...+70°C/-13...+158°F	-25...+70°C/-13...+158°F	-25...+70°C/-13...+158°F	-25...+70°C/-13...+158°F
Output current	≤ 200 mA	≤ 200 mA	≤ 200 mA	≤ 200 mA
PNP NO	DW-AS-703-M12-BAS	DW-AD-613-M12-120	DW-AD-613-M12	DW-AD-623-M12-120
NPN NO	DW-AS-701-M12-BAS	DW-AD-611-M12-120	DW-AD-611-M12	DW-AD-621-M12-120
Other types available		PNP NC, NPN NC	PNP NC, NPN NC	PNP NC, NPN NC

BASIC

CLASSICS	CLASSICS	CLASSICS	CLASSICS
M12	M12	M12	M12
4	4	4	4

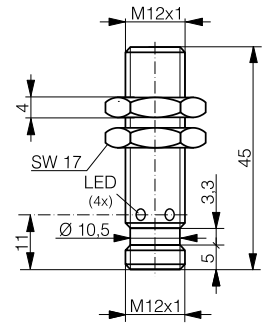
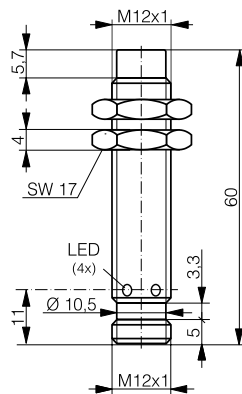
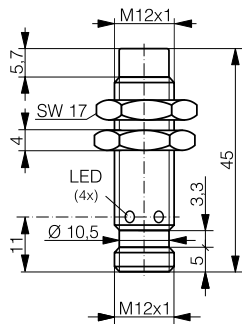
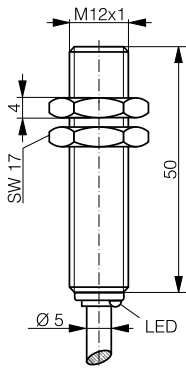

IO-Link	IO-Link	IO-Link	IO-Link
Nickel-plated brass	Nickel-plated brass	Nickel-plated brass	Nickel-plated brass
PVC cable	Connector S12	Connector S12	Connector S12
IP 67	IP 67	IP 67	IP 67
Embeddable	Non-embeddable	Non-embeddable	Embeddable
2500 Hz	2000 Hz	2000 Hz	2500 Hz
10 ... 30 VDC	10 ... 30 VDC	10 ... 30 VDC	10 ... 30 VDC
-25 ... +70°C / -13 ... +158°F	-25 ... +70°C / -13 ... +158°F	-25 ... +70°C / -13 ... +158°F	-25 ... +70°C / -13 ... +158°F
≤ 200 mA	≤ 200 mA	≤ 200 mA	≤ 200 mA
DW-AD-623-M12	DW-AS-613-M12-120	DW-AS-613-M12	DW-AS-623-M12-120
DW-AD-621-M12	DW-AS-611-M12-120	DW-AS-611-M12	DW-AS-621-M12-120
PNP NC, NPN NC	PNP NC, NPN NC	PNP NC, NPN NC	PNP NC, NPN NC

Inductive

Photoelectric

Safety

RFID

Connectivity

Accessories

Glossary

Index

BASIC

INDUCTIVE

FAMILY	CLASSICS	EXTRA DISTANCE	EXTRA DISTANCE
HOUSING SIZE	M12	M12	M12
OPERATING DISTANCE MM	4	6	6

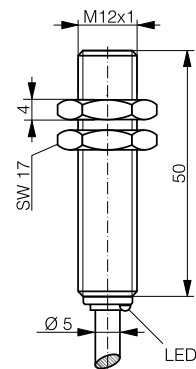
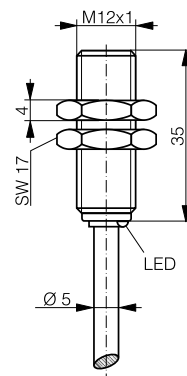
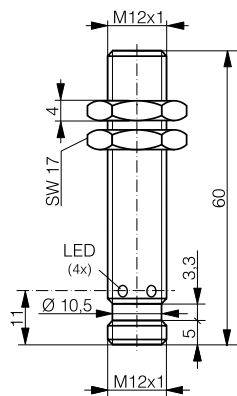

* IO-Link available from Q4/18

DATA	IO-Link	* IO-Link	* IO-Link
Housing material	Nickel-plated brass	Chrome-plated brass	Chrome-plated brass
Connection	Connector S12	PVC cable	PVC cable
Degree of protection	IP 67	IP 67	IP 67
Mounting	Embeddable	Quasi-embeddable	Quasi-embeddable
Max. switching frequency	2500 Hz	800 Hz	800 Hz
Supply voltage range	10 ... 30 VDC	10 ... 30 VDC	10 ... 30 VDC
Ambient temperature range	-25 ... +70°C / -13 ... +158°F	-25 ... +70°C / -13 ... +158°F	-25 ... +70°C / -13 ... +158°F
Output current	≤ 200 mA	≤ 200 mA	≤ 200 mA
PNP NO	DW-AS-623-M12	DW-AD-503-M12-120	DW-AD-503-M12
NPN NO	DW-AS-621-M12	DW-AD-501-M12-120	DW-AD-501-M12
PNP NC	DW-AS-624-M12		
Other types available	NPN NC	PNP NC, NPN NC	PNP NC, NPN NC

BASIC

EXTRA DISTANCE	EXTRA DISTANCE	CLASSICS	CLASSICS
M12	M12	M12	M12
6	6	8	8

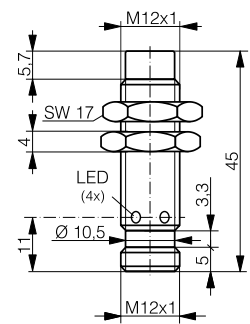
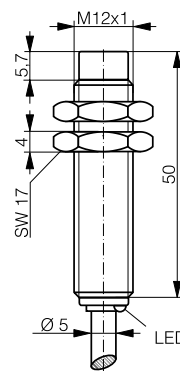
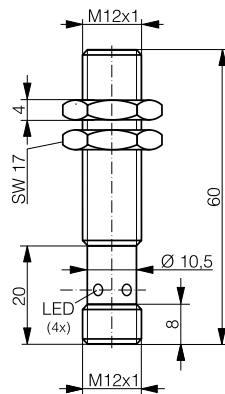
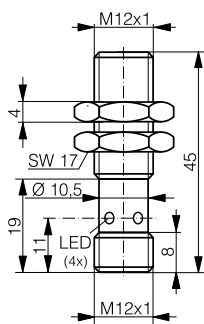

* IO-Link	* IO-Link	IO-Link	IO-Link
Chrome-plated brass	Chrome-plated brass	Nickel-plated brass	Nickel-plated brass
Connector S12	Connector S12	PVC cable	Connector S12
IP 67	IP 67	IP 67	IP 67
Quasi-embeddable	Quasi-embeddable	Non-embeddable	Non-embeddable
800 Hz	800 Hz	1400 Hz	1400 Hz
10 ... 30 VDC	10 ... 30 VDC	10 ... 30 VDC	10 ... 30 VDC
-25 ... +70°C / -13 ... +158°F	-25 ... +70°C / -13 ... +158°F	-25 ... +70°C / -13 ... +158°F	-25 ... +70°C / -13 ... +158°F
≤ 200 mA	≤ 200 mA	≤ 200 mA	≤ 200 mA
DW-AS-503-M12-120	DW-AS-503-M12	DW-AD-633-M12	DW-AS-633-M12-120
DW-AS-501-M12-120	DW-AS-501-M12	DW-AD-631-M12	DW-AS-631-M12-120
	DW-AS-504-M12	DW-AD-634-M12	DW-AS-634-M12-120
PNP NC, NPN NC	NPN NC	NPN NC, length 35 mm	NPN NC, length 60 mm

BASIC

INDUCTIVE

FAMILY	EXTRA DISTANCE	EXTRA DISTANCE	EXTRA DISTANCE
HOUSING SIZE	M12	M12	M12
OPERATING DISTANCE MM	8	8	8

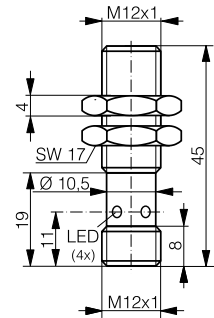
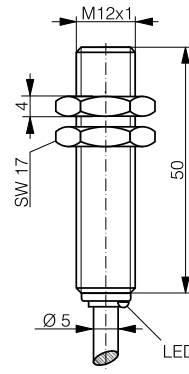
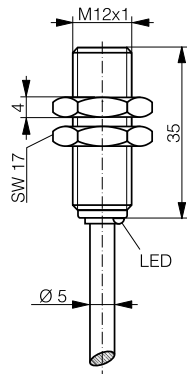

* IO-Link available from Q4/18

DATA	* IO-Link	* IO-Link	* IO-Link
Housing material	Chrome-plated brass	Chrome-plated brass	Chrome-plated brass
Connection	PVC cable	PVC cable	Connector S12
Degree of protection	IP 67	IP 67	IP 67
Mounting	Quasi-embeddable	Quasi-embeddable	Quasi-embeddable
Max. switching frequency	400 Hz	400 Hz	400 Hz
Supply voltage range	10 ... 30 VDC	10 ... 30 VDC	10 ... 30 VDC
Ambient temperature range	-25 ... +70°C / -13 ... +158°F	-25 ... +70°C / -13 ... +158°F	-25 ... +70°C / -13 ... +158°F
Output current	≤ 200 mA	≤ 200 mA	≤ 200 mA
PNP NO	DW-AD-523-M12-120	DW-AD-523-M12	DW-AS-523-M12-120
NPN NO	DW-AD-521-M12-120	DW-AD-521-M12	DW-AS-521-M12-120
Other types available	PNP NC, NPN NC	PNP NC, NPN NC	PNP NC, NPN NC

BASIC

EXTRA DISTANCE	EXTRA DISTANCE	EXTRA DISTANCE	EXTRA DISTANCE
M12	M12	M12	M12
8	10	10	10

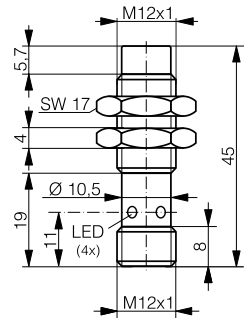
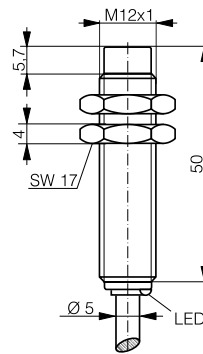
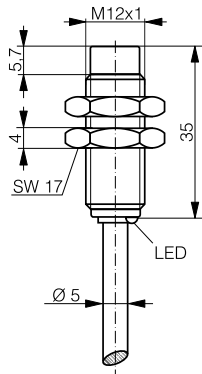
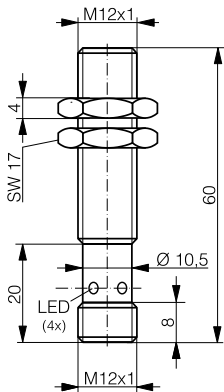

* IO-Link	* IO-Link	* IO-Link	* IO-Link
Chrome-plated brass	Chrome-plated brass	Chrome-plated brass	Chrome-plated brass
Connector S12	PVC cable	PVC cable	Connector S12
IP 67	IP 67	IP 67	IP 67
Quasi-embeddable	Non-embeddable	Non-embeddable	Non-embeddable
400 Hz	400 Hz	400 Hz	400 Hz
10 ... 30 VDC	10 ... 30 VDC	10 ... 30 VDC	10 ... 30 VDC
-25 ... +70°C / -13 ... +158°F	-25 ... +70°C / -13 ... +158°F	-25 ... +70°C / -13 ... +158°F	-25 ... +70°C / -13 ... +158°F
≤ 200 mA	≤ 200 mA	≤ 200 mA	≤ 200 mA
DW-AS-523-M12	DW-AD-513-M12-120	DW-AD-513-M12	DW-AS-513-M12-120
DW-AS-521-M12	DW-AD-511-M12-120	DW-AD-511-M12	DW-AS-511-M12-120
PNP NC, NPN NC	PNP NC, NPN NC	PNP NC, NPN NC	PNP NC, NPN NC

Inductive

Photoelectric

Safety

RFID

Connectivity

Accessories

Glossary

Index

BASIC

INDUCTIVE

FAMILY	EXTRA DISTANCE	CLASSICS	CLASSICS	CLASSICS
HOUSING SIZE	M12	M18	M18	M18
OPERATING DISTANCE MM	10	5	5	5

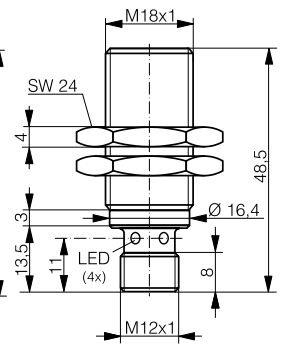
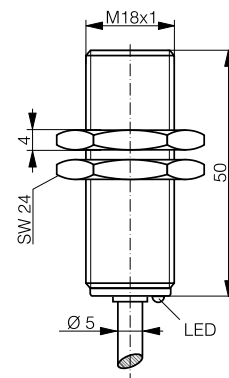
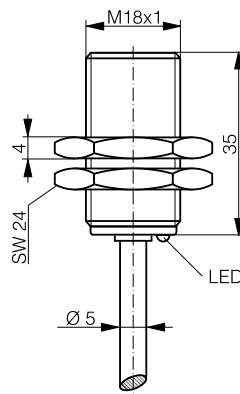
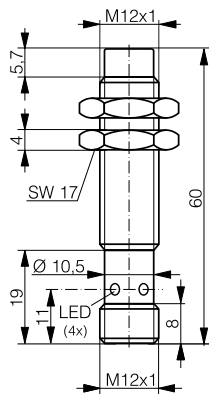

* IO-Link available from Q4/18

DATA	* IO-Link	IO-Link	IO-Link	IO-Link
Housing material	Chrome-plated brass	Nickel-plated brass	Nickel-plated brass	Nickel-plated brass
Connection	Connector S12	PVC cable	PVC cable	Connector S12
Degree of protection	IP 67	IP 67	IP 67	IP 67
Mounting	Non-embeddable	Embeddable	Embeddable	Embeddable
Max. switching frequency	400 Hz	2000 Hz	2000 Hz	2000 Hz
Supply voltage range	10 ... 30 VDC	10 ... 30 VDC	10 ... 30 VDC	10 ... 30 VDC
Ambient temperature range	-25...+70°C/-13...+158°F	-25...+70°C/-13...+158°F	-25...+70°C/-13...+158°F	-25...+70°C/-13...+158°F
Output current	≤ 200 mA	≤ 200 mA	≤ 200 mA	≤ 200 mA
PNP NO	DW-AS-513-M12	DW-AD-603-M18-120	DW-AD-603-M18	DW-AS-603-M18-120
NPN NO	DW-AS-511-M12	DW-AD-601-M18-120	DW-AD-601-M18	DW-AS-601-M18-120
PNP NC	DW-AS-514-M12		DW-AD-604-M18	
Other types available	NPN NC	PNP NC, NPN NC	NPN NC	PNP NC, NPN NC

BASIC

CLASSICS	FULL INOX	FULL INOX	CLASSICS	CLASSICS
M18	M18	M18	M18	M18
5	5	5	8	8

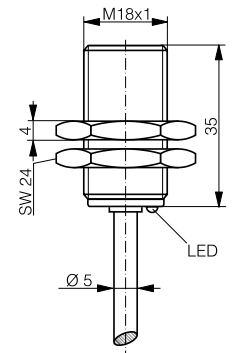
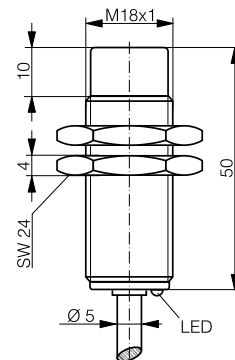
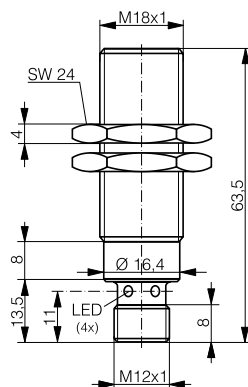
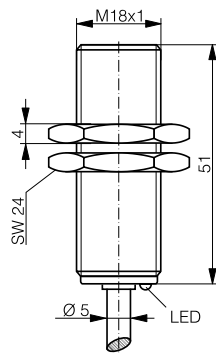
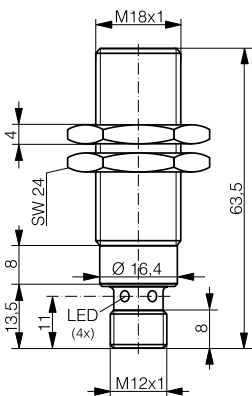

Inductive

Photoelectric

Safety

RFID

Connectivity

Accessories

Glossary

Index

IO-Link	IO-Link	IO-Link	IO-Link	IO-Link
Nickel-plated brass	Stainless steel V2A	Stainless steel V2A	Nickel-plated brass	Nickel-plated brass
Connector S12	PUR cable	Connector S12	PVC cable	PVC cable
IP 67	IP 68	IP 68 & IP 69K	IP 67	IP 67
Embeddable	Embeddable	Embeddable	Non-embeddable	Embeddable
2000 Hz	100 Hz	100 Hz	2000 Hz	1500 Hz
10 ... 30 VDC	10 ... 30 VDC	10 ... 30 VDC	10 ... 30 VDC	10 ... 30 VDC
-25 ... +70°C/-13 ... +158°F	-25 ... +70°C/-13 ... +158°F	-25 ... +70°C/-13 ... +158°F	-25 ... +70°C/-13 ... +158°F	-25 ... +70°C/-13 ... +158°F
≤ 200 mA	≤ 200 mA	≤ 200 mA	≤ 200 mA	≤ 200 mA
DW-AS-603-M18-002	DW-AD-703-M18-BAS	DW-AS-703-M18-BAS	DW-AD-613-M18	DW-AD-623-M18-120
DW-AS-601-M18-002	DW-AD-701-M18-BAS	DW-AS-701-M18-BAS	DW-AD-611-M18	DW-AD-621-M18-120
DW-AS-604-M18-002			DW-AD-614-M18	
NPN NC			NPN NC, length 35 mm	PNP NC, NPN NC

BASIC

INDUCTIVE

FAMILY	CLASSICS	CLASSICS	CLASSICS
HOUSING SIZE	M18	M18	M18
OPERATING DISTANCE MM	8	8	8

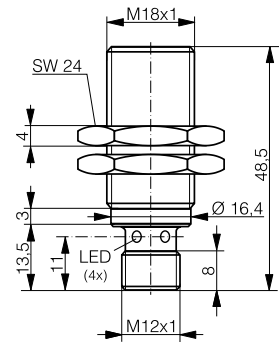
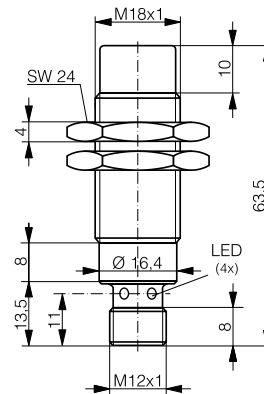
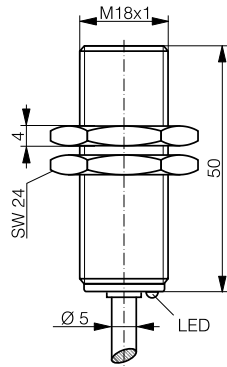

DATA	IO-Link	IO-Link	IO-Link
Housing material	Nickel-plated brass	Nickel-plated brass	Nickel-plated brass
Connection	PVC cable	Connector S12	Connector S12
Degree of protection	IP 67	IP 67	IP 67
Mounting	Embeddable	Non-embeddable	Embeddable
Max. switching frequency	1500 Hz	2000 Hz	1500 Hz
Supply voltage range	10 ... 30 VDC	10 ... 30 VDC	10 ... 30 VDC
Ambient temperature range	-25 ... +70°C / -13 ... +158°F	-25 ... +70°C / -13 ... +158°F	-25 ... +70°C / -13 ... +158°F
Output current	≤ 200 mA	≤ 200 mA	≤ 200 mA
PNP NO	DW-AD-623-M18	DW-AS-613-M18-002	DW-AS-623-M18-120
NPN NO	DW-AD-621-M18	DW-AS-611-M18-002	DW-AS-621-M18-120
PNP NC		DW-AS-614-M18-002	
Other types available	PNP NC, NPN NC	NPN NC, length 35 mm	PNP NC, NPN NC

BASIC

CLASSICS	CLASSICS	CLASSICS	EXTRA DISTANCE
M18	M18	M18	M18
8	12	12	12

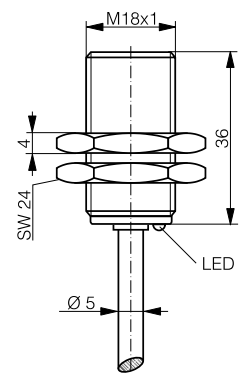
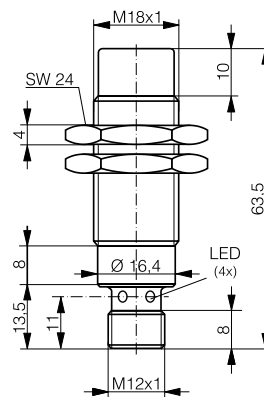
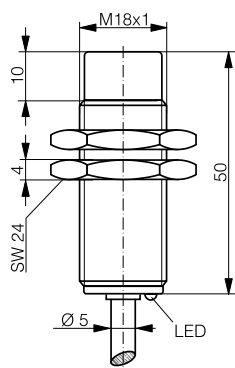
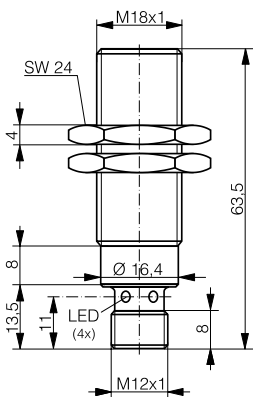

* IO-Link available from Q4/18

IO-Link	IO-Link	IO-Link	* IO-Link
Nickel-plated brass	Nickel-plated brass	Nickel-plated brass	Chrome-plated brass
Connector S12	PVC cable	Connector S12	PVC cable
IP 67	IP 67	IP 67	IP 67
Embeddable	Non-embeddable	Non-embeddable	Quasi-embeddable
1500 Hz	500 Hz	500 Hz	600 Hz
10 ... 30 VDC	10 ... 30 VDC	10 ... 30 VDC	10 ... 30 VDC
-25 ... +70°C / -13 ... +158°F	-25 ... +70°C / -13 ... +158°F	-25 ... +70°C / -13 ... +158°F	-25 ... +70°C / -13 ... +158°F
≤ 200 mA	≤ 200 mA	≤ 200 mA	≤ 200 mA
DW-AS-623-M18-002	DW-AD-633-M18	DW-AS-633-M18-002	DW-AD-503-M18-120
DW-AS-621-M18-002	DW-AD-631-M18	DW-AS-631-M18-002	DW-AD-501-M18-120
DW-AS-624-M18-002			
NPN NC	PNP NC, NPN NC	PNP NC, NPN NC	PNP NC, NPN NC

BASIC

FAMILY

EXTRA DISTANCE

EXTRA DISTANCE

EXTRA DISTANCE

HOUSING SIZE

M18

M18

M18

OPERATING DISTANCE MM

12

12

12

INDUCTIVE

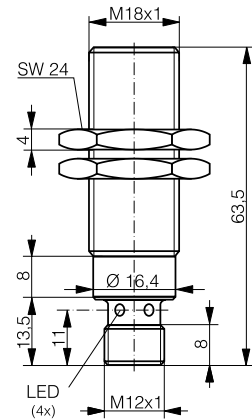
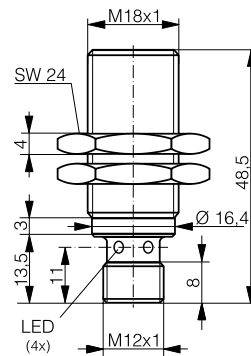
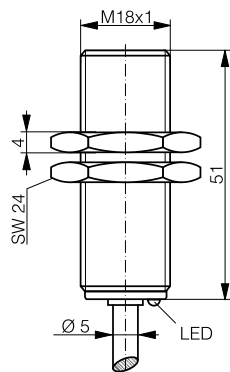

* IO-Link available from Q4/18

DATA	* IO-Link	* IO-Link	* IO-Link
Housing material	Chrome-plated brass	Chrome-plated brass	Chrome-plated brass
Connection	PVC cable	Connector S12	Connector S12
Degree of protection	IP 67	IP 67	IP 67
Mounting	Quasi-embeddable	Quasi-embeddable	Quasi-embeddable
Max. switching frequency	600 Hz	600 Hz	600 Hz
Supply voltage range	10 ... 30 VDC	10 ... 30 VDC	10 ... 30 VDC
Ambient temperature range	-25 ... +70°C / -13 ... +158°F	-25 ... +70°C / -13 ... +158°F	-25 ... +70°C / -13 ... +158°F
Output current	≤ 200 mA	≤ 200 mA	≤ 200 mA
PNP NO	DW-AD-503-M18	DW-AS-503-M18-120	DW-AS-503-M18-002
NPN NO	DW-AD-501-M18	DW-AS-501-M18-120	DW-AS-501-M18-002
PNP NC			DW-AS-504-M18-002
Other types available	PNP NC, NPN NC	PNP NC, NPN NC	NPN NC

BASIC

EXTRA DISTANCE	EXTRA DISTANCE	EXTRA DISTANCE	EXTRA DISTANCE
M18	M18	M18	M18
20	20	20	20

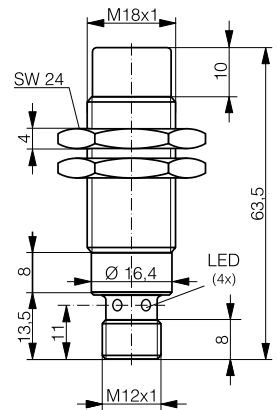
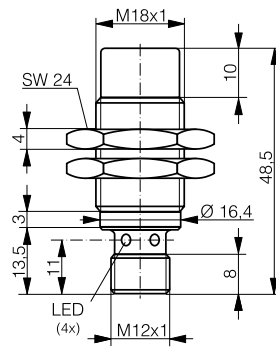
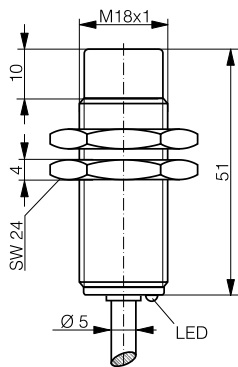
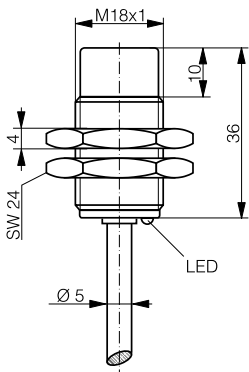

* IO-Link	* IO-Link	* IO-Link	* IO-Link
Chrome-plated brass	Chrome-plated brass	Chrome-plated brass	Chrome-plated brass
PVC cable	PVC cable	Connector S12	Connector S12
IP 67	IP 67	IP 67	IP 67
Non-embeddable	Non-embeddable	Non-embeddable	Non-embeddable
500 Hz	500 Hz	500 Hz	500 Hz
10 ... 30 VDC	10 ... 30 VDC	10 ... 30 VDC	10 ... 30 VDC
-25 ... +70°C / -13 ... +158°F	-25 ... +70°C / -13 ... +158°F	-25 ... +70°C / -13 ... +158°F	-25 ... +70°C / -13 ... +158°F
≤ 200 mA	≤ 200 mA	≤ 200 mA	≤ 200 mA
DW-AD-513-M18-120	DW-AD-513-M18	DW-AS-513-M18-120	DW-AS-513-M18-002
DW-AD-511-M18-120	DW-AD-511-M18	DW-AS-511-M18-120	DW-AS-511-M18-002
	DW-AD-514-M18		DW-AS-514-M18-002
PNP NC, NPN NC	NPN NC	PNP NC, NPN NC	NPN NC

Inductive

Photoelectric

Safety

RFID

Connectivity

Accessories

Glossary

Index

BASIC

INDUCTIVE

FAMILY	CLASSICS	CLASSICS	CLASSICS
HOUSING SIZE	M30	M30	M30
OPERATING DISTANCE MM	10	10	10

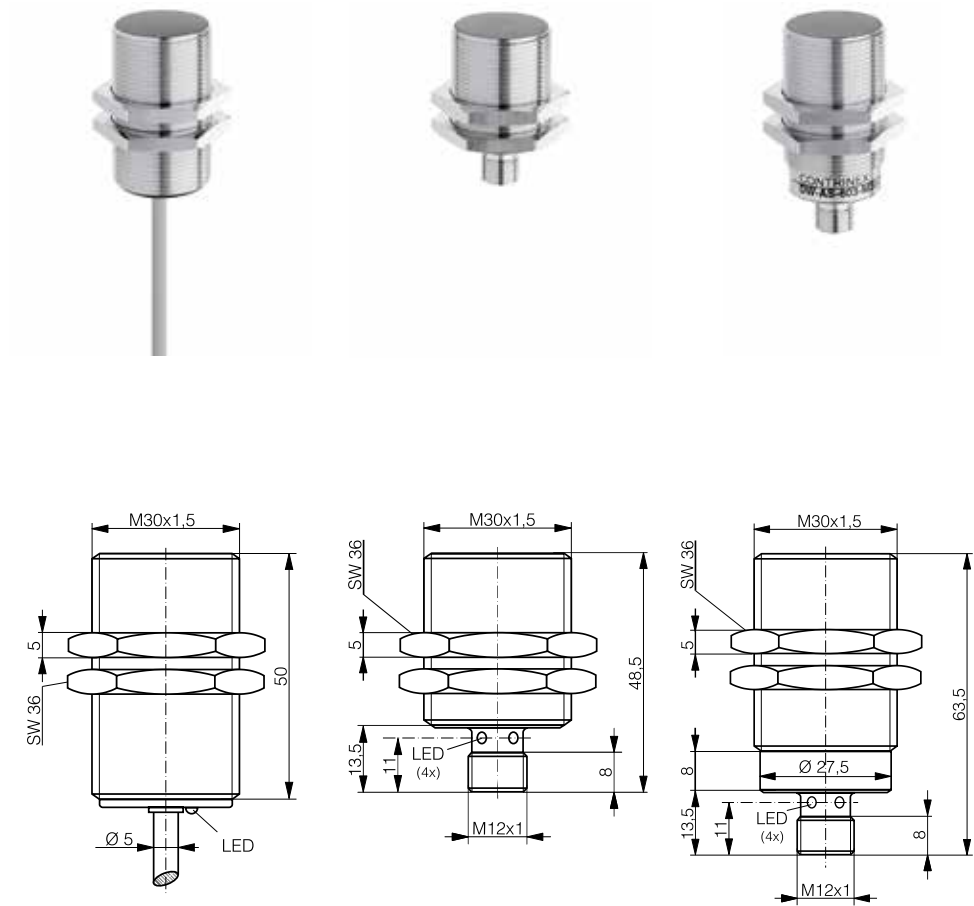

DATA	IO-Link	IO-Link	IO-Link
Housing material	Nickel-plated brass	Nickel-plated brass	Nickel-plated brass
Connection	PVC cable	Connector S12	Connector S12
Degree of protection	IP 67	IP 67	IP 67
Mounting	Embeddable	Embeddable	Embeddable
Max. switching frequency	1200 Hz	1200 Hz	1200 Hz
Supply voltage range	10 ... 30 VDC	10 ... 30 VDC	10 ... 30 VDC
Ambient temperature range	-25 ... +70°C / -13 ... +158°F	-25 ... +70°C / -13 ... +158°F	-25 ... +70°C / -13 ... +158°F
Output current	≤ 200 mA	≤ 200 mA	≤ 200 mA
PNP NO	DW-AD-603-M30	DW-AS-603-M30-120	DW-AS-603-M30-002
NPN NO	DW-AD-601-M30	DW-AS-601-M30-120	DW-AS-601-M30-002
PNP NC			
Other types available	PNP NC, NPN NC, length 35 mm	PNP NC, NPN NC	PNP NC, NPN NC

BASIC

FULL INOX	FULL INOX	CLASSICS	CLASSICS
M30	M30	M30	M30
10	10	15	15

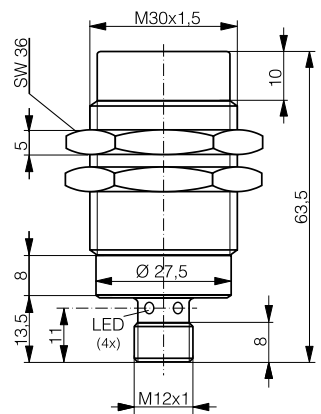
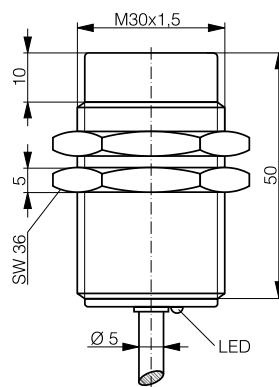
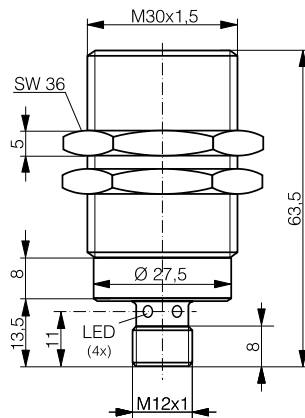
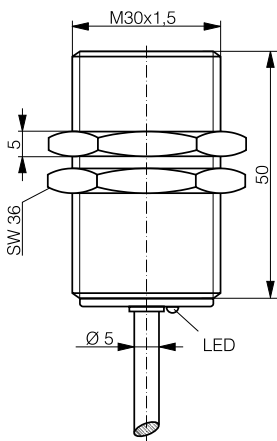

IO-Link	IO-Link	IO-Link	IO-Link
Stainless steel V2A	Stainless steel V2A	Nickel-plated brass	Nickel-plated brass
PUR cable	Connector S12	PVC cable	Connector S12
IP 68	IP 68 & IP 69K	IP 67	IP 67
Embeddable	Embeddable	Non-embeddable	Non-embeddable
50 Hz	50 Hz	700 Hz	700 Hz
10 ... 30 VDC	10 ... 30 VDC	10 ... 30 VDC	10 ... 30 VDC
-25 ... +70°C / -13 ... +158°F	-25 ... +70°C / -13 ... +158°F	-25 ... +70°C / -13 ... +158°F	-25 ... +70°C / -13 ... +158°F
≤ 200 mA	≤ 200 mA	≤ 200 mA	≤ 200 mA
DW-AS-703-M30-BAS	DW-AD-703-M30-BAS	DW-AD-613-M30	DW-AS-613-M30-002
DW-AS-701-M30-BAS	DW-AD-701-M30-BAS	DW-AD-611-M30	DW-AS-611-M30-002
		PNP NC, NPN NC, length 35 mm	PNP NC, NPN NC, length 48.5 mm

Inductive

Photoelectric

Safety

RFID

Connectivity

Accessories

Glossary

Index

BASIC

FAMILY

EXTRA DISTANCE

EXTRA DISTANCE

HOUSING SIZE

M30

M30

OPERATING DISTANCE MM

22

22

INDUCTIVE

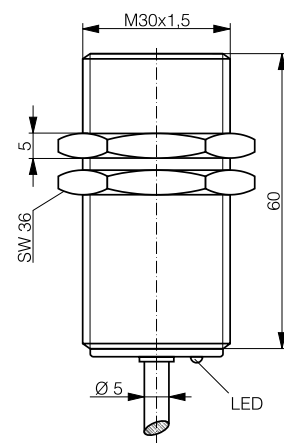
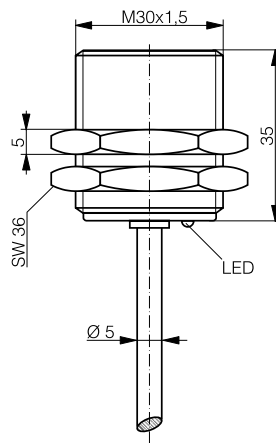

* IO-Link available from Q4/18

DATA	* IO-Link	* IO-Link
Housing material	Chrome-plated brass	Chrome-plated brass
Connection	PVC cable	PVC cable
Degree of protection	IP 67	IP 67
Mounting	Quasi-embeddable	Quasi-embeddable
Max. switching frequency	200 Hz	200 Hz
Supply voltage range	10 ... 30 VDC	10 ... 30 VDC
Ambient temperature range	-25 ... +70°C / -13 ... +158°F	-25 ... +70°C / -13 ... +158°F
Output current	≤ 200 mA	≤ 200 mA
PNP NO	DW-AD-503-M30-120	DW-AD-503-M30
NPN NO	DW-AD-501-M30-120	DW-AD-501-M30
PNP NC		DW-AD-504-M30
Other types available	PNP NC, NPN NC	NPN NC

BASIC

EXTRA DISTANCE	EXTRA DISTANCE
M30	M30
22	22

Inductive
Photoelectric
Safety
RFID
Connectivity
Accessories
Glossary
Index

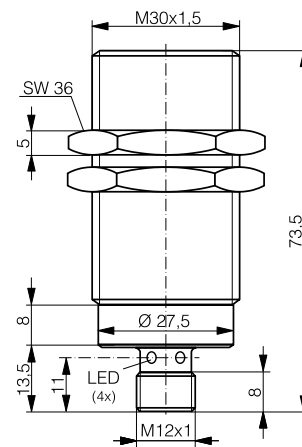
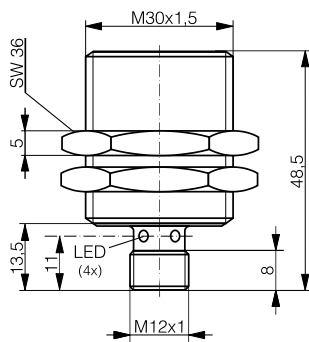

* IO-Link	* IO-Link
Chrome-plated brass	Chrome-plated brass
Connector S12	Connector S12
IP 67	IP 67
Quasi-embeddable	Quasi-embeddable
200 Hz	200 Hz
10 ... 30 VDC	10 ... 30 VDC
-25 ... +70°C / -13 ... +158°F	-25 ... +70°C / -13 ... +158°F
≤ 200 mA	≤ 200 mA
DW-AS-503-M30-120	DW-AS-503-M30-002
DW-AS-501-M30-120	DW-AS-501-M30-002
	DW-AS-504-M30-002
PNP NC, NPN NC	NPN NC

BASIC

FAMILY

CLASSICS

CLASSICS

EXTRA DISTANCE

HOUSING SIZE

M30

M30

M30

OPERATING DISTANCE MM

25

25

40

INDUCTIVE

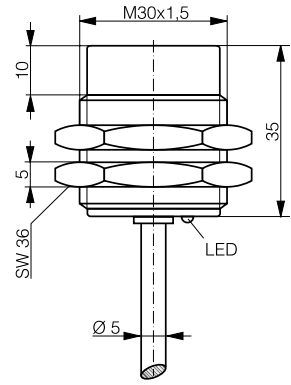
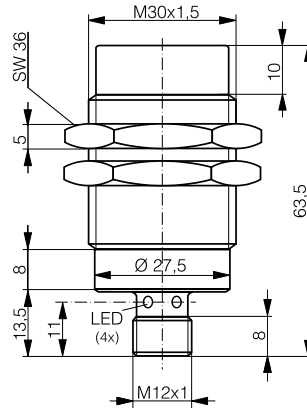
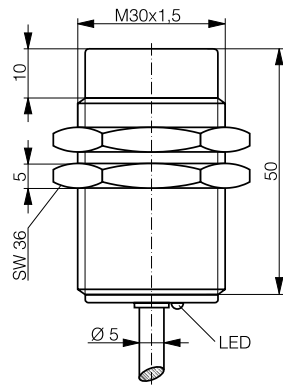

* IO-Link available from Q4/18

DATA	IO-Link	IO-Link	* IO-Link
Housing material	Nickel-plated brass	Nickel-plated brass	Chrome-plated brass
Connection	PVC cable	Connector S12	PVC cable
Degree of protection	IP 67	IP 67	IP 67
Mounting	Non-embeddable	Non-embeddable	Non-embeddable
Max. switching frequency	200 Hz	200 Hz	100 Hz
Supply voltage range	10 ... 30 VDC	10 ... 30 VDC	10 ... 30 VDC
Ambient temperature range	-25 ... +70°C / -13 ... +158°F	-25 ... +70°C / -13 ... +158°F	-25 ... +70°C / -13 ... +158°F
Output current	≤ 200 mA	≤ 200 mA	≤ 200 mA
PNP NO	DW-AD-633-M30	DW-AS-633-M30-002	DW-AD-513-M30-120
NPN NO	DW-AD-631-M30	DW-AS-631-M30-002	DW-AD-511-M30-120
PNP NC			
Other types available			PNP NC, NPN NC

BASIC

EXTRA DISTANCE	EXTRA DISTANCE	EXTRA DISTANCE
M30	M30	M30
40	40	40

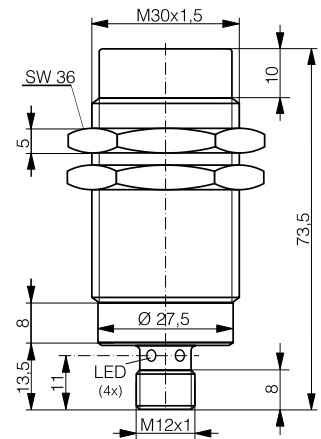
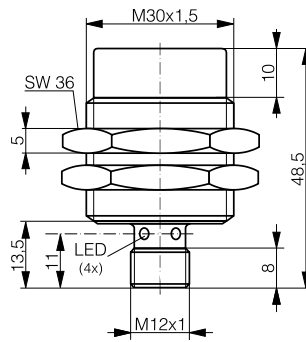
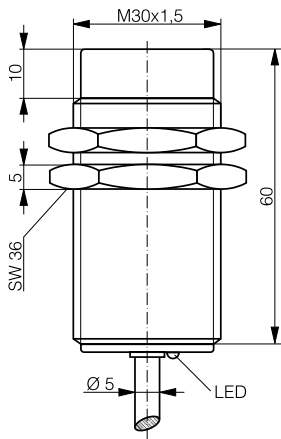

* IO-Link	* IO-Link	* IO-Link
Chrome-plated brass	Chrome-plated brass	Chrome-plated brass
PVC cable	Connector S12	Connector S12
IP 67	IP 67	IP 67
Non-embeddable	Non-embeddable	Non-embeddable
100 Hz	100 Hz	100 Hz
10 ... 30 VDC	10 ... 30 VDC	10 ... 30 VDC
-25 ... +70°C / -13 ... +158°F	-25 ... +70°C / -13 ... +158°F	-25 ... +70°C / -13 ... +158°F
≤ 200 mA	≤ 200 mA	≤ 200 mA
DW-AD-513-M30	DW-AS-513-M30-120	DW-AS-513-M30-002
DW-AD-511-M30	DW-AS-511-M30-120	DW-AS-511-M30-002
		DW-AS-514-M30-002
PNP NC, NPN NC	PNP NC, NPN NC	

Inductive

Photoelectric

Safety

RFID

Connectivity

Accessories

Glossary

Index

BASIC

FAMILY

CLASSICS

CLASSICS

HOUSING SIZE MM

□ 40 x 40

□ 40 x 40

OPERATING DISTANCE MM

15

20

INDUCTIVE

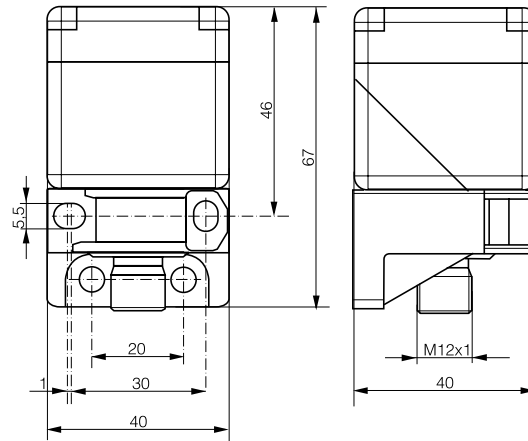

DATA

IO-Link

IO-Link

Housing material

PA GF

PA GF

Connection

Connector S12

Connector S12

Degree of protection

IP 68 / IP 69K

IP 68 / IP 69K

Mounting

Embeddable

Embeddable

Max. switching frequency

100 Hz

100 Hz

Supply voltage range

10 ... 30 VDC

10 ... 30 VDC

Ambient temperature range

-25 ... +85°C / -13 ... +185°F

-25 ... +85°C / -13 ... +185°F

Output current

≤ 200 mA

≤ 200 mA

PNP NO + NC

DW-AS-60A-C44

DW-AS-62A-C44

NPN NO + NC

DW-AS-60B-C44

DW-AS-62B-C44

Other types available

BASIC

CLASSICS	CLASSICS
□ 40 x 40	□ 40 x 40
30	40

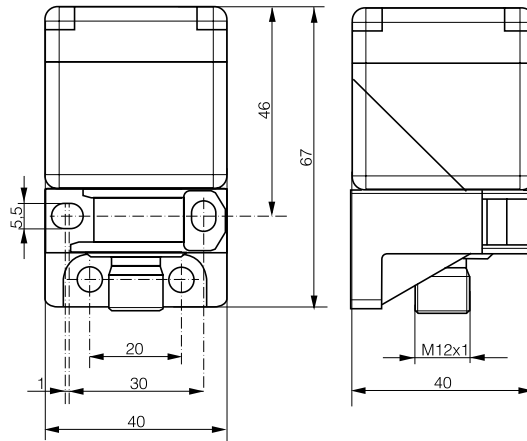

IO-Link	IO-Link
PA GF	PA GF
Connector S12	Connector S12
IP 68 / IP 69K	IP 68 / IP 69K
Non-embeddable	Non-embeddable
100 Hz	100 Hz
10 ... 30 VDC	10 ... 30 VDC
-25 ... +85°C / -13 ... +185°F	-25 ... +85°C / -13 ... +185°F
≤ 200 mA	≤ 200 mA
DW-AS-61A-C44	DW-AS-63A-C44
DW-AS-61B-C44	DW-AS-63B-C44

Inductive
Photoelectric
Safety
RFID
Connectivity
Accessories
Glossary
Index



FULL FUNCTIONALITY, SMALLEST SIZE

MINIATURE INDUCTIVE SENSORS

KEY ADVANTAGES

Classics, Extra Distance and Full Inox

- ✓ High quality ASIC sensors with  IO-Link interface
- ✓ Smallest self-contained inductive sensors on the market
- ✓ Outstanding temperature stability from -25°C (-13°F) to +70°C (+158°F) or +85°C (+185°F) for Full Inox types
- ✓ High switching frequency up to 5000 Hz
- ✓ Electronics vacuum potted for optimum long-term reliability under high stress

Full Inox

- ✓ Extremely robust one-piece stainless-steel housing
- ✓ Corrosion resistant
- ✓ Water resistant
- ✓ Pressure resistant up to 120 bar (1740 psi)

RANGE OVERVIEW	Housing size	Classics	Extra Distance	Full Inox
MINIATURE	∅ 3 mm	p. 71-72		
	M4	p. 72-73		
	∅ 4 mm	p. 73-75	p. 75	p. 75
	M5	p. 76-77	p. 77	p. 78
	C5	p. 78-79		

FAMILY

HOUSING SIZE MM

OPERATING DISTANCE MM

INDUCTIVE

WIRING DIAGRAMS

PNP NO

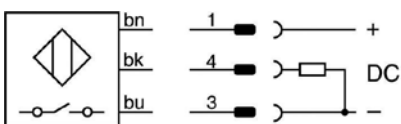

PNP NC

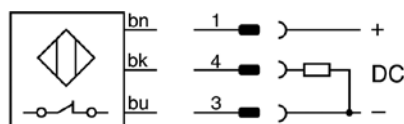

NPN NO

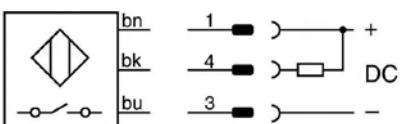

DATA

Housing material

Connection

Degree of protection

Mounting

Max. switching frequency

Supply voltage range

Ambient temperature range

Output current

PNP NO

NPN NO

PNP NC

Other types available

MINIATURE

CLASSICS	CLASSICS	CLASSICS	CLASSICS
Ø 3	Ø 3	Ø 3	Ø 3
0.6	0.6	1	1

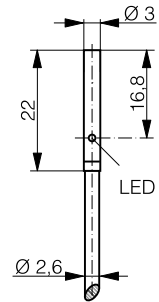
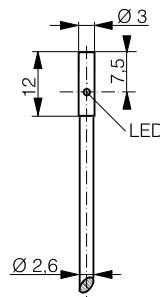
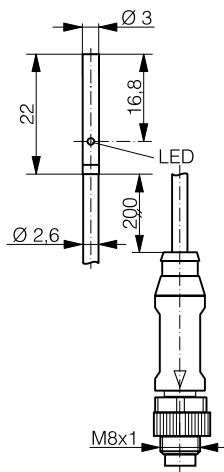
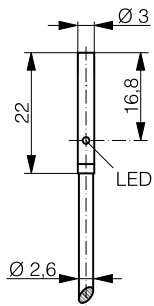

IO-Link	IO-Link	IO-Link	IO-Link
Stainless steel V2A	Stainless steel V2A	Stainless steel V2A	Stainless steel V2A
PUR cable	PUR cable / Connector S8	PUR cable	PUR cable
IP 67	IP 67	IP 67	IP 67
Embeddable	Embeddable	Embeddable	Embeddable
5000 Hz	5000 Hz	8000 Hz	3000 Hz
10 ... 30 VDC	10 ... 30 VDC	10 ... 30 VDC	10 ... 30 VDC
-25 ... +70°C / -13 ... +158°F	-25 ... +70°C / -13 ... +158°F	-25 ... +70°C / -13 ... +158°F	-25 ... +70°C / -13 ... +158°F
≤ 100 mA	≤ 100 mA	≤ 100 mA	≤ 100 mA
DW-AD-603-03	DW-AV-603-03-276	DW-AD-623-03-960	DW-AD-623-03
DW-AD-601-03	DW-AV-601-03-276	DW-AD-621-03-960	DW-AD-621-03
DW-AD-604-03			
NPN NC	PNP NC, NPN NC		PNP NC, NPN NC

Inductive

Photoelectric

Safety

RFID

Connectivity

Accessories

Glossary

Index

MINIATURE

INDUCTIVE

FAMILY	CLASSICS	CLASSICS	CLASSICS
HOUSING SIZE MM	Ø 3	M4	M4
OPERATING DISTANCE MM	1	0.6	0.6

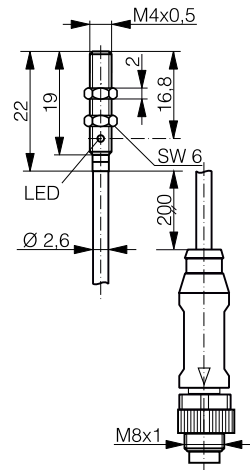
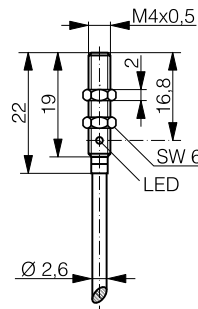
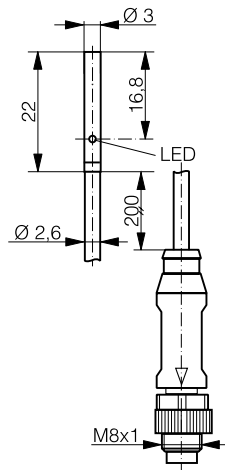

DATA	IO-Link	IO-Link	IO-Link
Housing material	Stainless steel V2A	Stainless steel V2A	Stainless steel V2A
Connection	PUR cable / Connector S8	PUR cable	PUR cable / Connector S8
Degree of protection	IP 67	IP 67	IP 67
Mounting	Embeddable	Embeddable	Embeddable
Max. switching frequency	3000 Hz	5000 Hz	5000 Hz
Supply voltage range	10 ... 30 VDC	10 ... 30 VDC	10 ... 30 VDC
Ambient temperature range	-25 ... +70°C / -13 ... +158°F	-25 ... +70°C / -13 ... +158°F	-25 ... +70°C / -13 ... +158°F
Output current	≤ 100 mA	≤ 100 mA	≤ 100 mA
PNP NO	DW-AV-623-03-276	DW-AD-603-M4	DW-AV-603-M4-276
NPN NO	DW-AV-621-03-276	DW-AD-601-M4	DW-AV-601-M4-276
PNP NC		DW-AD-604-M4	
Other types available	PNP NC, NPN NC	NPN NC	PNP NC, NPN NC

MINIATURE

CLASSICS	CLASSICS	CLASSICS	CLASSICS
M4	M4	M4	Ø 4
1	1	1	0.8

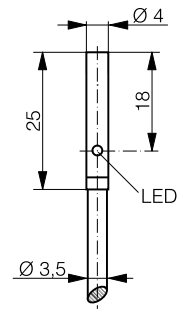
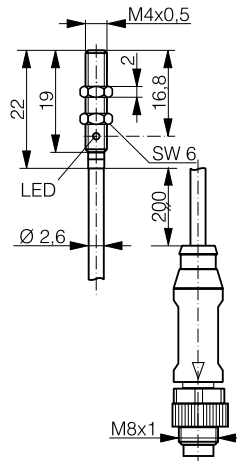
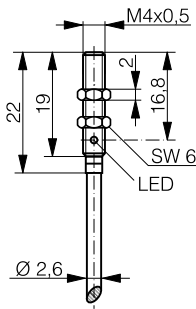
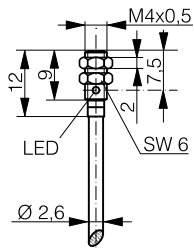

IO-Link	IO-Link	IO-Link	IO-Link
Stainless steel V2A	Stainless steel V2A	Stainless steel V2A	Stainless steel V2A
PUR cable	PUR cable	PUR cable / Connector S8	PVC cable
IP 67	IP 67	IP 67	IP 67
Embeddable	Embeddable	Embeddable	Embeddable
8000 Hz	3000 Hz	3000 Hz	5000 Hz
10 ... 30 VDC	10 ... 30 VDC	10 ... 30 VDC	10 ... 30 VDC
-25 ... +70°C / -13 ... +158°F	-25 ... +70°C / -13 ... +158°F	-25 ... +70°C / -13 ... +158°F	-25 ... +70°C / -13 ... +158°F
≤ 100 mA	≤ 100 mA	≤ 100 mA	≤ 200 mA
DW-AD-623-M4-960	DW-AD-623-M4	DW-AV-623-M4-276	DW-AD-603-04
DW-AD-621-M4-960	DW-AD-621-M4	DW-AV-621-M4-276	DW-AD-601-04
			DW-AD-604-04
	PNP NC, NPN NC	PNP NC, NPN NC	NPN NC

Inductive

Photoelectric

Safety

RFID

Connectivity

Accessories

Glossary

Index

MINIATURE

FAMILY

CLASSICS

CLASSICS

CLASSICS

HOUSING SIZE MM

Ø 4

Ø 4

Ø 4

OPERATING DISTANCE MM

0.8

0.8

1.5

INDUCTIVE

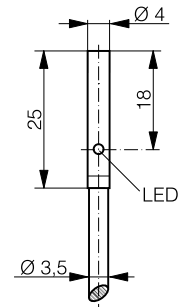
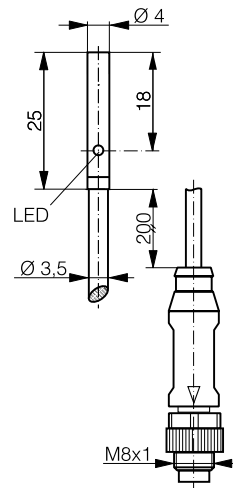
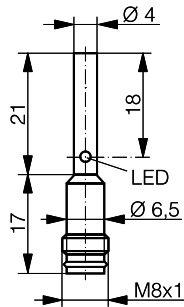

DATA

IO-Link

IO-Link

IO-Link

Housing material

Stainless steel V2A

Stainless steel V2A

Stainless steel V2A

Connection

Connector S8

PVC cable / Connector S8

PVC cable

Degree of protection

IP 67

IP 67

IP 67

Mounting

Embeddable

Embeddable

Embeddable

Max. switching frequency

5000 Hz

5000 Hz

3000 Hz

Supply voltage range

10 ... 30 VDC

10 ... 30 VDC

10 ... 30 VDC

Ambient temperature range

-25 ... +70°C / -13 ... +158°F

-25 ... +70°C / -13 ... +158°F

-25 ... +70°C / -13 ... +158°F

Output current

≤ 200 mA

≤ 200 mA

≤ 200 mA

PNP NO

DW-AS-603-04

DW-AV-603-04-236

DW-AD-623-04

NPN NO

DW-AS-601-04

DW-AV-601-04-236

DW-AD-621-04

PNP NC

DW-AD-624-04

Other types available

PNP NC, NPN NC

PNP NC, NPN NC, PUR cable

NPN NC, pigtail

MINIATURE

CLASSICS	EXTRA DISTANCE	EXTRA DISTANCE	FULL INOX
Ø 4	Ø 4	Ø 4	Ø 4
1.5	2.5	2.5	3

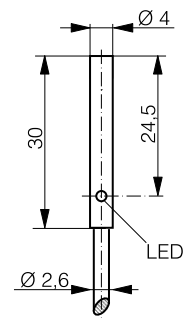
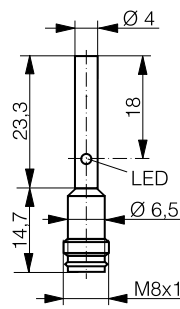
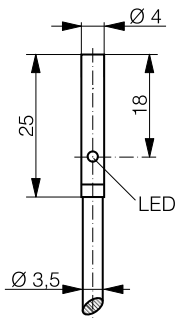
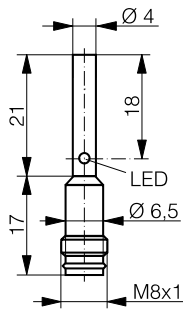

* IO-Link available from Q4/18

IO-Link	* IO-Link	* IO-Link	IO-Link
Stainless steel V2A	Nickel silver	Nickel silver	Stainless steel V2A
Connector S8	PVC cable	Connector S8	PVC cable
IP 67	IP 67	IP 67	IP 67
Embeddable	Embeddable	Embeddable	Non-embeddable
3000 Hz	800 Hz	800 Hz	1200 Hz
10 ... 30 VDC	10 ... 30 VDC	10 ... 30 VDC	10 ... 30 VDC
-25 ... +70°C / -13 ... +158°F	-25 ... +70°C / -13 ... +158°F	-25 ... +70°C / -13 ... +158°F	-25 ... +85°C / -13 ... +185°F
≤ 200 mA	≤ 200 mA	≤ 200 mA	≤ 200 mA
DW-AS-623-04	DW-AD-503-04	DW-AS-503-04	DW-AD-713-04
DW-AS-621-04	DW-AD-501-04	DW-AS-501-04	DW-AD-711-04
		DW-AS-504-04	
PNP NC, NPN NC	PNP NC, NPN NC, pigtail	NPN NC	pigtail

MINIATURE

FAMILY

CLASSICS

CLASSICS

CLASSICS

HOUSING SIZE

M5

M5

M5

OPERATING DISTANCE MM

0.8

0.8

1.5

INDUCTIVE

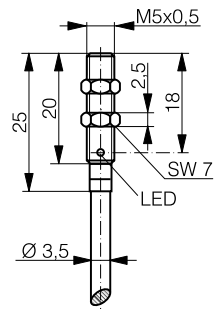
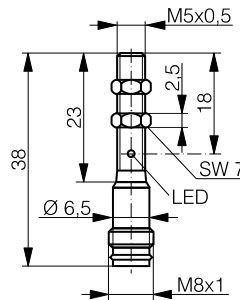
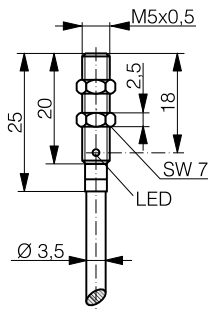

DATA

IO-Link

IO-Link

IO-Link

Housing material

Stainless steel V2A

Stainless steel V2A

Stainless steel V2A

Connection

PVC cable

Connector S8

PVC cable

Degree of protection

IP 67

IP 67

IP 67

Mounting

Embeddable

Embeddable

Embeddable

Max. switching frequency

5000 Hz

5000 Hz

3000 Hz

Supply voltage range

10 ... 30 VDC

10 ... 30 VDC

10 ... 30 VDC

Ambient temperature range

-25 ... +70°C / -13 ... +158°F

-25 ... +70°C / -13 ... +158°F

-25 ... +70°C / -13 ... +158°F

Output current

≤ 200 mA

≤ 200 mA

≤ 200 mA

PNP NO

DW-AD-603-M5

DW-AS-603-M5

DW-AD-623-M5

NPN NO

DW-AD-601-M5

DW-AS-601-M5

DW-AD-621-M5

PNP NC

DW-AD-604-M5

DW-AS-604-M5

DW-AD-624-M5

Other types available

NPN NC, pigtail

NPN NC

NPN NC, pigtail

MINIATURE

CLASSICS	EXTRA DISTANCE	EXTRA DISTANCE
M5	M5	M5
1.5	2.5	2.5

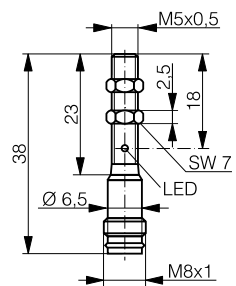
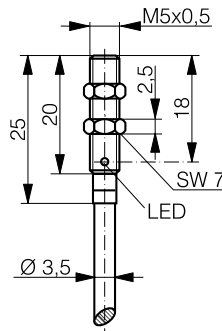
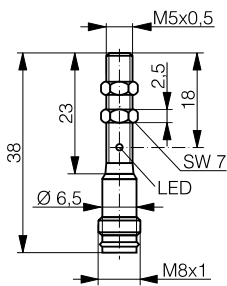

* IO-Link available from Q4/18

IO-Link	* IO-Link	* IO-Link
Stainless steel V2A	Nickel silver	Nickel silver
Connector S8	PVC cable	Connector S8
IP 67	IP 67	IP 67
Embeddable	Quasi-embeddable	Quasi-embeddable
3000 Hz	800 Hz	800 Hz
10 ... 30 VDC	10 ... 30 VDC	10 ... 30 VDC
-25 ... +70°C / -13 ... +158°F	-25 ... +70°C / -13 ... +158°F	-25 ... +70°C / -13 ... +158°F
≤ 200 mA	≤ 200 mA	≤ 200 mA
DW-AS-623-M5	DW-AD-503-M5	DW-AS-503-M5
DW-AS-621-M5	DW-AD-501-M5	DW-AS-501-M5
DW-AS-624-M5	DW-AD-504-M5	DW-AS-504-M5
NPN NC	NPN NC	NPN NC

MINIATURE

FAMILY

FULL INOX

CLASSICS

HOUSING SIZE MM

M5

□ 5 x 5

OPERATING DISTANCE MM

3

0.8

INDUCTIVE

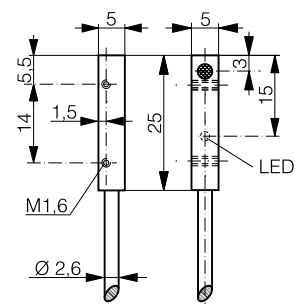
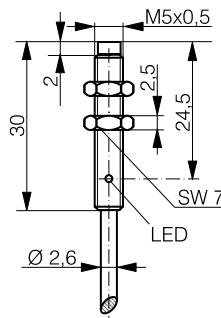

DATA

IO-Link

IO-Link

Housing material

Stainless steel V2A

Chrome-plated brass

Connection

PVC cable

PUR cable

Degree of protection

IP 67

IP 67

Mounting

Non-embeddable

Embeddable

Max. switching frequency

1200 Hz

5000 Hz

Supply voltage range

10 ... 30 VDC

10 ... 30 VDC

Ambient temperature range

-25 ... +85°C / -13 ... +185°F

-25 ... +70°C / -13 ... +158°F

Output current

≤ 200 mA

≤ 200 mA

PNP NO

DW-AD-713-M5

DW-AD-603-C5

NPN NO

DW-AD-711-M5

DW-AD-601-C5

PNP NC

DW-AD-604-C5

Other types available

Pigtail

NPN NC, pigtail

MINIATURE

CLASSICS

□ 5 x 5

1.5

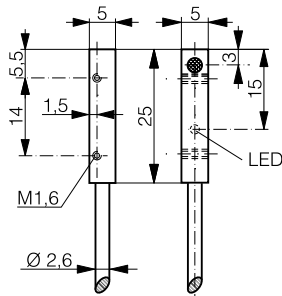

Inductive

Photoelectric

Safety

RFID

Connectivity

Accessories

Glossary

Index

 IO-Link

Chrome-plated brass

PUR cable

IP 67

Embeddable

3000 Hz

10 ... 30 VDC

-25 ... +70°C / -13 ... +158°F

≤ 200 mA

DW-AD-623-C5

DW-AD-621-C5

DW-AD-624-C5

NPN NC, pigtail



EXTREME DURABILITY IN HARSH ENVIRONMENTS

EXTREME

INDUCTIVE SENSORS

KEY ADVANTAGES

- ✓ Mechanically and chemically extremely robust
- ✓ Corrosion resistant
- ✓ IP 68 and IP 69K, water resistant
- ✓ Pressure resistant up to 100 bar (1451 psi)
- ✓  IO-Link

RANGE OVERVIEW

Housing size

Full Inox

EXTREME

M8

p. 83-84

M12

p. 84-86

M18

p. 87-88

M30

p. 89-90

C23

p. 91

FAMILY

HOUSING SIZE

OPERATING DISTANCE MM

INDUCTIVE

WIRING DIAGRAMS

PNP NO

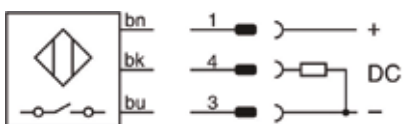

PNP NC

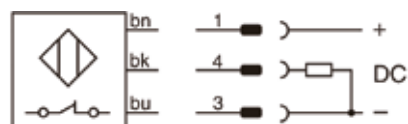

NPN NO



DATA

Sensing face material

Housing material

Connection

Degree of protection

Mounting

Max. switching frequency

Supply voltage range

Ambient temperature range

Output current

PNP NO

NPN NO

PNP NC

Other types available

EXTREME

FULL INOX	FULL INOX	FULL INOX	FULL INOX
M8	M8	M8	M8
3	3	3	6

Inductive



Photoelectric

Safety

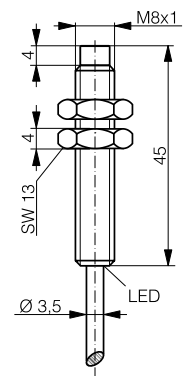
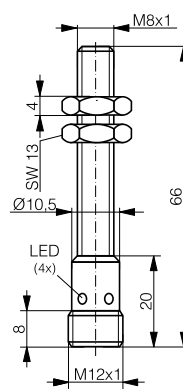
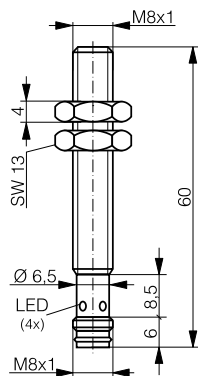
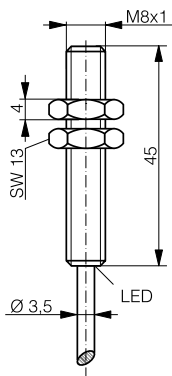

RFID

Connectivity

IO-Link	IO-Link	IO-Link	IO-Link
Stainless steel V2A	Stainless steel V2A	Stainless steel V2A	Stainless steel V2A
Stainless steel V2A	Stainless steel V2A	Stainless steel V2A	Stainless steel V2A
PUR cable	Connector S8	Connector S12	PUR cable
IP 68	IP 67	IP 67	IP 68
Embeddable	Embeddable	Embeddable	Non-embeddable
1000 Hz	1000 Hz	1000 Hz	700 Hz
10 ... 30 VDC	10 ... 30 VDC	10 ... 30 VDC	10 ... 30 VDC
-25 ... +85°C / -13 ... +185°F	-25 ... +85°C / -13 ... +185°F	-25 ... +85°C / -13 ... +185°F	-25 ... +85°C / -13 ... +185°F
≤ 200 mA	≤ 200 mA	≤ 200 mA	≤ 200 mA
DW-AD-703-M8	DW-AS-703-M8-001	DW-AS-703-M8	DW-AD-713-M8
DW-AD-701-M8	DW-AS-701-M8-001	DW-AS-701-M8	DW-AD-711-M8
DW-AD-704-M8			DW-AD-714-M8
NPN NC, pigtail	PNP NC, NPN NC	PNP NC, NPN NC	NPN NC

Accessories

Glossary

Index

EXTREME

FAMILY

FULL INOX

FULL INOX

FULL INOX

HOUSING SIZE

M8

M8

M12

OPERATING DISTANCE MM

6

6

2 (4)

INDUCTIVE

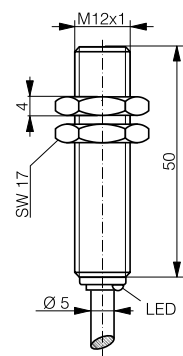
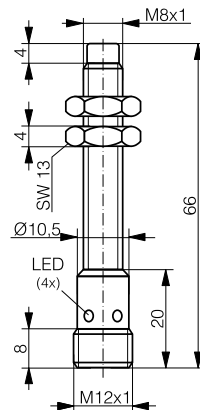
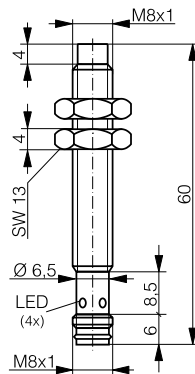

DATA

IO-Link

IO-Link

IO-Link

Sensing face material

Stainless steel V2A

Stainless steel V2A

Stainless steel V2A

Housing material

Stainless steel V2A

Stainless steel V2A

Stainless steel V2A

Connection

Connector S8

Connector S12

PUR cable

Degree of protection

IP 67

IP 67

IP 68 / IP 69K

Mounting

Non-embeddable

Non-embeddable

Embeddable

Max. switching frequency

700 Hz

700 Hz

850 Hz

Supply voltage range

10 ... 30 VDC

10 ... 30 VDC

10 ... 30 VDC

Ambient temperature range

-25 ... +85°C / -13 ... +185°F

-25 ... +85°C / -13 ... +185°F

-25 ... +85°C / -13 ... +185°F

Output current

≤ 200 mA

≤ 200 mA

≤ 200 mA

PNP NO

DW-AS-713-M8-001

DW-AS-713-M8

DW-AD-703-M12-303

NPN NO

DW-AS-711-M8-001

DW-AS-711-M8

DW-AD-701-M12-303

PNP NC

Other types available

PNP NC, NPN NC

PNP NC, NPN NC

PNP NC, NPN NC,
non-embeddable (Sn 4 mm)

EXTREME

FULL INOX	FULL INOX	FULL INOX	FULL INOX
M12	M12	M12	M12
2 (4)	6	6	10

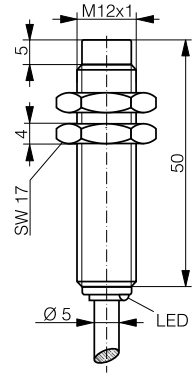
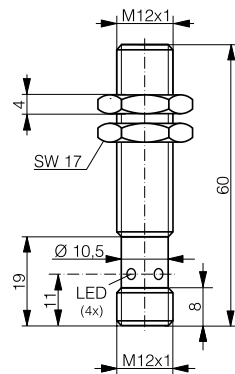
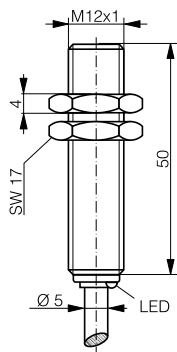
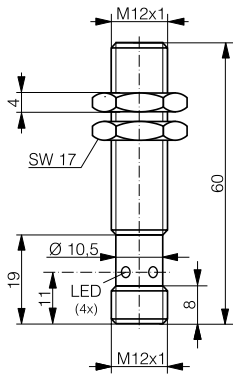

IO-Link	IO-Link	IO-Link	IO-Link
Stainless steel V2A	Stainless steel V2A	Stainless steel V2A	Stainless steel V2A
Stainless steel V2A	Stainless steel V2A	Stainless steel V2A	Stainless steel V2A
Connector S12	PUR cable	Connector S12	PUR cable
IP 68 / IP 69K	IP 68 / IP 69K	IP 68 / IP 69K	IP 68 / IP 69K
Embeddable	Embeddable	Embeddable	Non-embeddable
850 Hz	600 Hz	600 Hz	400 Hz
10 ... 30 VDC	10 ... 30 VDC	10 ... 30 VDC	10 ... 30 VDC
-25 ... +85°C / -13 ... +185°F	-25 ... +85°C / -13 ... +185°F	-25 ... +85°C / -13 ... +185°F	-25 ... +85°C / -13 ... +185°F
≤ 200 mA	≤ 200 mA	≤ 200 mA	≤ 200 mA
DW-AS-703-M12-303	DW-AD-703-M12	DW-AS-703-M12	DW-AD-713-M12
DW-AS-701-M12-303	DW-AD-701-M12	DW-AS-701-M12	DW-AD-711-M12
		DW-AS-704-M12	
PNP NC, NPN NC, non-embeddable (Sn 4 mm)	PNP NC, NPN NC	NPN NC	PNP NC, NPN NC

Inductive

Photoelectric

Safety

RFID

Connectivity

Accessories

Glossary

Index

EXTREME

INDUCTIVE

FAMILY	FULL INOX	FULL INOX	FULL INOX
HOUSING SIZE	M12	M12	M12
OPERATING DISTANCE MM	10	15	15

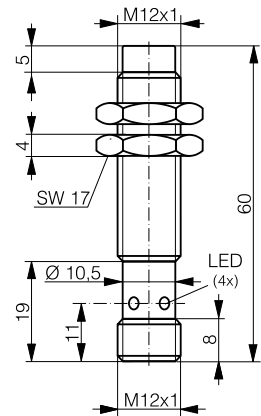
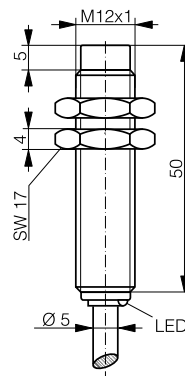
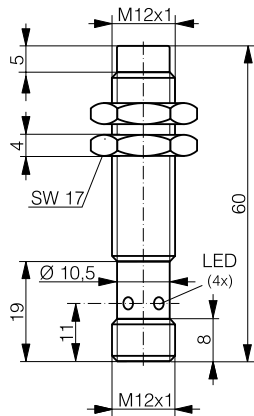

DATA	IO-Link	IO-Link	IO-Link
Sensing face material	Stainless steel V2A	Stainless steel V2A	Stainless steel V2A
Housing material	Stainless steel V2A	Stainless steel V2A	Stainless steel V2A
Connection	Connector S12	PUR cable	Connector S12
Degree of protection	IP 68 / IP 69K	IP 68 / IP 69K	IP 68 / IP 69K
Mounting	Non-embeddable	Non-embeddable	Non-embeddable
Max. switching frequency	400 Hz	300 Hz	300 Hz
Supply voltage range	10 ... 30 VDC	10 ... 30 VDC	10 ... 30 VDC
Ambient temperature range	-25 ... +85°C / -13 ... +185°F	-25 ... +85°C / -13 ... +185°F	-25 ... +85°C / -13 ... +185°F
Output current	≤ 200 mA	≤ 200 mA	≤ 200 mA
PNP NO	DW-AS-713-M12	DW-AD-733-M12	DW-AS-733-M12
NPN NO	DW-AS-711-M12	DW-AD-731-M12	DW-AS-731-M12
PNP NC			
Other types available	PNP NC, NPN NC		

EXTREME

FULL INOX	FULL INOX	FULL INOX	FULL INOX	Inductive
M18	M18	M18	M18	
5	5 (8)	10	10	



Photoelectric

Safety

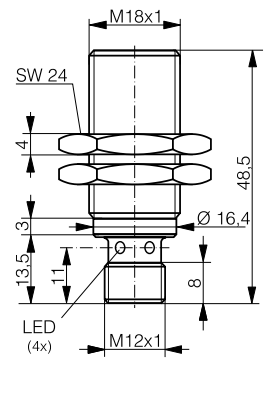
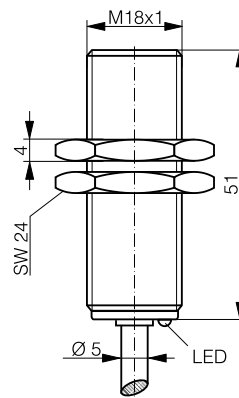
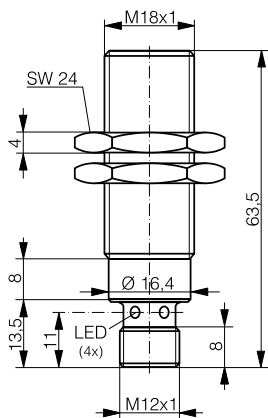
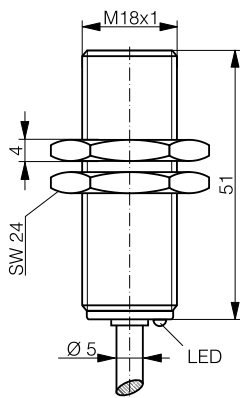

RFID

Connectivity

IO-Link	IO-Link	IO-Link	IO-Link	Accessories
Stainless steel V2A	Stainless steel V2A	Stainless steel V2A	Stainless steel V2A	Stainless steel V2A
Stainless steel V2A	Stainless steel V2A	Stainless steel V2A	Stainless steel V2A	
PUR cable	Connector S12	PUR cable	Connector S12	IP 68 / IP 69K
IP 68 / IP 69K	IP 68 / IP 69K	IP 68 / IP 69K	IP 68 / IP 69K	
Embeddable	Embeddable	Embeddable	Embeddable	Embeddable
500 Hz	500 Hz	200 Hz	200 Hz	
10 ... 30 VDC	10 ... 30 VDC	10 ... 30 VDC	10 ... 30 VDC	10 ... 30 VDC
-25 ... +85°C / -13 ... +185°F	-25 ... +85°C / -13 ... +185°F	-25 ... +85°C / -13 ... +185°F	-25 ... +85°C / -13 ... +185°F	
≤ 200 mA	≤ 200 mA	≤ 200 mA	≤ 200 mA	≤ 200 mA
DW-AD-703-M18-303	DW-AS-703-M18-303	DW-AD-703-M18	DW-AS-703-M18-120	
DW-AD-701-M18-303	DW-AS-701-M18-303	DW-AD-701-M18	DW-AS-701-M18-120	
		DW-AD-704-M18		
PNP NC, NPN NC	PNP NC, NPN NC, non-embeddable (Sn 8 mm)	NPN NC, length 35 mm	PNP NC, NPN NC	Index

Accessories

Glossary

Index

EXTREME

INDUCTIVE

FAMILY	FULL INOX	FULL INOX	FULL INOX
HOUSING SIZE	M18	M18	M18
OPERATING DISTANCE MM	10	20	20

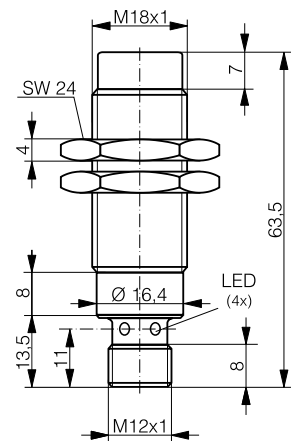
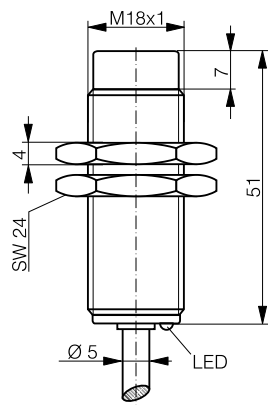
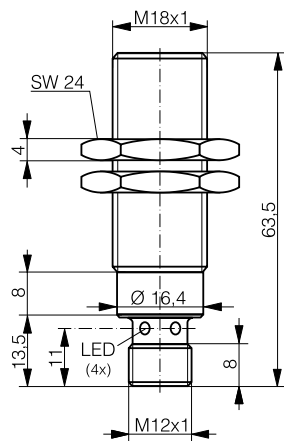

DATA	IO-Link	IO-Link	IO-Link
Sensing face material	Stainless steel V2A	Stainless steel V2A	Stainless steel V2A
Housing material	Stainless steel V2A	Stainless steel V2A	Stainless steel V2A
Connection	Connector S12	PUR cable	Connector S12
Degree of protection	IP 68 / IP 69K	IP 68 / IP 69K	IP 68 / IP 69K
Mounting	Embeddable	Non-embeddable	Non-embeddable
Max. switching frequency	200 Hz	200 Hz	200 Hz
Supply voltage range	10 ... 30 VDC	10 ... 30 VDC	10 ... 30 VDC
Ambient temperature range	-25 ... +85°C / -13 ... +185°F	-25 ... +85°C / -13 ... +185°F	-25 ... +85°C / -13 ... +185°F
Output current	≤ 200 mA	≤ 200 mA	≤ 200 mA
PNP NO	DW-AS-703-M18-002	DW-AD-713-M18	DW-AS-713-M18-002
NPN NO	DW-AS-701-M18-002	DW-AD-711-M18	DW-AS-711-M18-002
PNP NC	DW-AS-704-M18-002		
Other types available	NPN NC	PNP NC, NPN NC	PNP NC, NPN NC

EXTREME

FULL INOX	FULL INOX	FULL INOX	FULL INOX
M30	M30	M30	M30
10	10	20	20

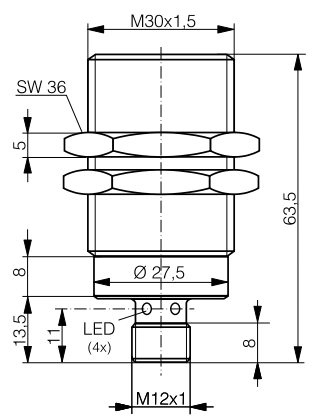
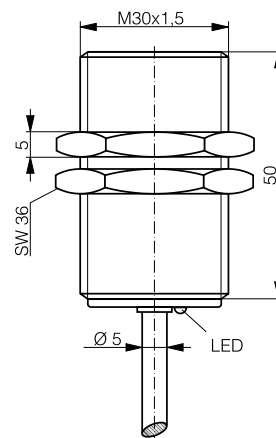
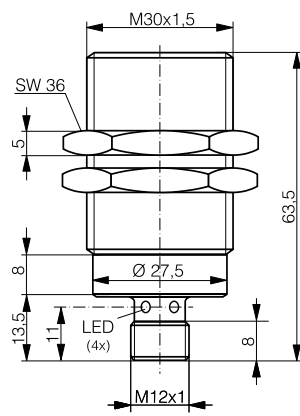
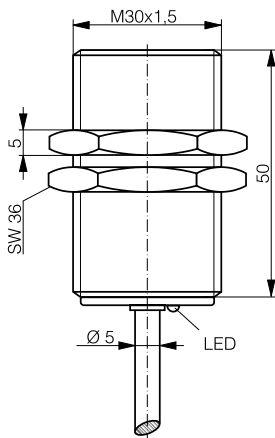

IO-Link	IO-Link	IO-Link	IO-Link
Stainless steel V2A	Stainless steel V2A	Stainless steel V2A	Stainless steel V2A
Stainless steel V2A	Stainless steel V2A	Stainless steel V2A	Stainless steel V2A
PUR cable	Connector S12	PUR cable	Connector S12
IP 68 / IP 69K	IP 68 / IP 69K	IP 68 / IP 69K	IP 68 / IP 69K
Embeddable	Embeddable	Embeddable	Embeddable
250 Hz	250 Hz	100 Hz	100 Hz
10 ... 30 VDC	10 ... 30 VDC	10 ... 30 VDC	10 ... 30 VDC
-25 ... +85°C / -13 ... +185°F	-25 ... +85°C / -13 ... +185°F	-25 ... +85°C / -13 ... +185°F	-25 ... +85°C / -13 ... +185°F
≤ 200 mA	≤ 200 mA	≤ 200 mA	≤ 200 mA
DW-AD-703-M30-303	DW-AS-703-M30-303	DW-AD-703-M30	DW-AS-703-M30-002
		DW-AD-701-M30	DW-AS-701-M30-002
		DW-AD-704-M30	
NPN NC		NPN NC	PNP NC, NPN NC

Inductive

Photoelectric

Safety

RFID

Connectivity

Accessories

Glossary

Index

EXTREME

FAMILY

FULL INOX

FULL INOX

HOUSING SIZE

M30

M30

OPERATING DISTANCE MM

40

40

INDUCTIVE

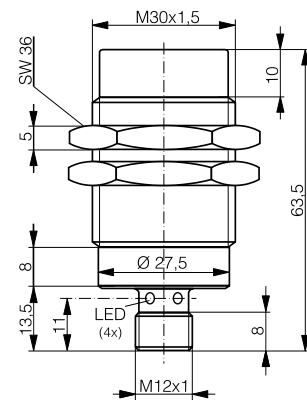
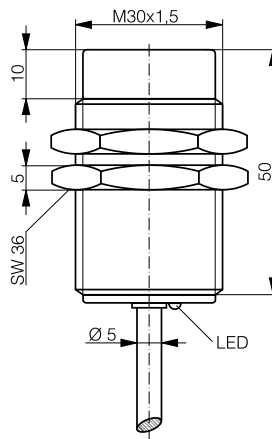

DATA

IO-Link

IO-Link

Housing material

Stainless steel V2A

Stainless steel V2A

Sensing face material

Stainless steel V2A

Stainless steel V2A

Connection

PUR cable

Connector S12

Degree of protection

IP 68 & IP 69K

IP 68 & IP 69K

Mounting

Non-embeddable

Non-embeddable

Max. switching frequency

90 Hz

90 Hz

Supply voltage range

10 ... 30 VDC

10 ... 30 VDC

Ambient temperature range

-25 ... +85°C / -13 ... +185°F

-25 ... +85°C / -13 ... +185°F

Output current

≤ 200 mA

≤ 200 mA

PNP NO

DW-AD-713-M30

DW-AS-713-M30-002

NPN NO

DW-AD-711-M30

DW-AS-711-M30-002

Other types available

PNP NC, NPN NC

PNP NC, NPN NC

EXTREME

FULL INOX	FULL INOX
C23	C23
7	7

Inductive



Photoelectric

Safety

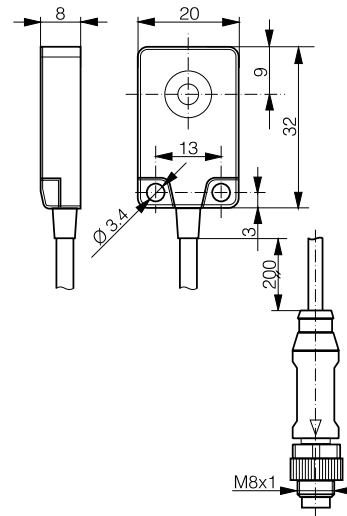
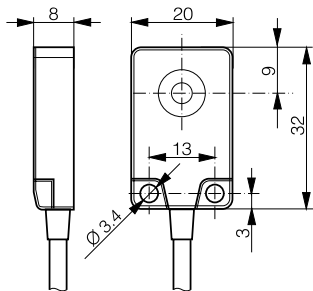

RFID

Connectivity

Accessories

IO-Link	IO-Link
Stainless steel V4A/AISI/316L	Stainless steel V4A/AISI/316L
Stainless steel V4A/AISI/316L	Stainless steel V4A/AISI/316L
PUR cable	PUR cable / Connector S8
IP 68 & IP 69K	IP 68 & IP 69K
Embeddable	Embeddable
180 Hz	180 Hz
10 ... 30 VDC	10 ... 30 VDC
-25 ... +85°C / -13 ... +185°F	-25 ... +85°C / -13 ... +185°F
≤ 200 mA	≤ 200 mA
DW-AD-703-C23	DW-AV-703-C23-276
DW-AD-701-C23	DW-AV-701-C23-276

Glossary

Index



ANALOG OUTPUT FOR DISTANCE CONTROL



ANALOG OUTPUT

INDUCTIVE SENSORS

KEY ADVANTAGES

- ✓ Longest sensing ranges
- ✓ Best temperature stability
- ✓ Excellent repeat accuracy
- ✓ Resolution in μm range

RANGE OVERVIEW

Housing size

Extra Distance

ANALOG

C8

p. 95

M8

p. 95-96

M12

p. 96-97

M18

p. 97-98

M30

p. 98-99

FAMILY

HOUSING SIZE MM

SENSING RANGE MM

INDUCTIVE

WIRING DIAGRAMS

Analog C8/M8

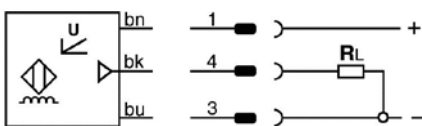

Analog M12/M18/M30

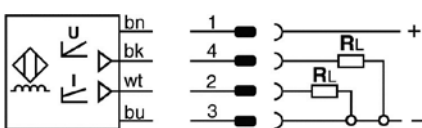

DATA

Bandwidth (-3 dB)

Output voltage

Housing material

Connection

Degree of protection

Mounting

Supply voltage range

Ambient temperature range

Output current

Output 0...10 V

Output 0...5 V

Other types available

ANALOG OUTPUT

EXTRA DISTANCE	EXTRA DISTANCE	EXTRA DISTANCE	EXTRA DISTANCE
□ 8 x 8	□ 8 x 8	M8	M8
0 ... 4	0 ... 4	0 ... 4	0 ... 4

Inductive

Photoelectric

Safety

RFID

Connectivity

Accessories

Glossary

Index

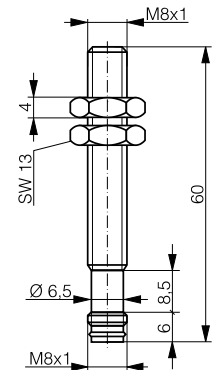
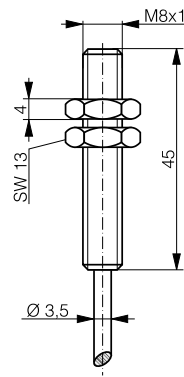
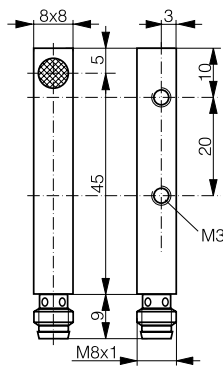
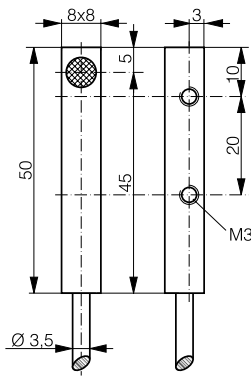

1,600 Hz (at s = 2 mm)	1,600 Hz (at s = 2 mm)	1,600 Hz (at s = 2 mm)	1,600 Hz (at s = 2 mm)
0 ... 10 V	0 ... 10 V	0 ... 5 V / 0 ... 10 V (-390)	0 ... 10 V
Chrome-plated brass	Chrome-plated brass	Chrome-plated brass	Chrome-plated brass
PUR cable	Connector S8	PUR cable	Connector S8
IP 67	IP 67	IP 67	IP 67
Quasi-embeddable	Quasi-embeddable	Quasi-embeddable	Quasi-embeddable
15 ... 30 VDC	15 ... 30 VDC	10 ... 30 VDC / 15 ... 30 VDC (-390)	15 ... 30 VDC
-25 ... +70°C / -13 ... +158°F	-25 ... +70°C / -13 ... +158°F	-25 ... +70°C / -13 ... +158°F	-25 ... +70°C / -13 ... +158°F
-	-	-	-
DW-AD-509-C8-390	DW-AS-509-C8-390	DW-AD-509-M8-390	DW-AS-509-M8-390
		DW-AD-509-M8	
			On request

ANALOG OUTPUT

INDUCTIVE

FAMILY	EXTRA DISTANCE	EXTRA DISTANCE	EXTRA DISTANCE
HOUSING SIZE	M8	M12	M12
SENSING RANGE MM	0 ... 4	0 ... 6	0 ... 6

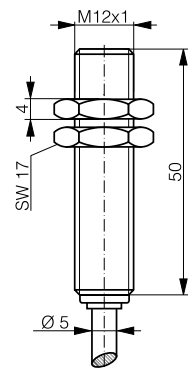
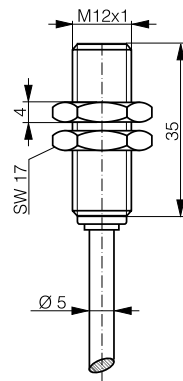
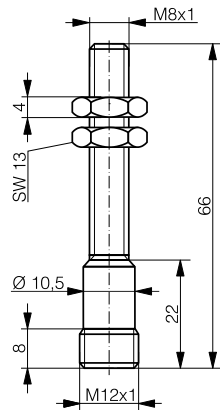

DATA			
Bandwidth (-3 dB)	1,600 Hz (at s = 2 mm)	1,000 Hz (at s = 3 mm)	1,000 Hz (at s = 3 mm)
Output voltage	0 ... 10 V	0 ... 5 V / 0 ... 10 V (-390)	0 ... 5 V / 0 ... 10 V (-390)
Housing material	Chrome-plated brass	Chrome-plated brass	Chrome-plated brass
Connection	Connector S12	PUR cable	PUR cable
Degree of protection	IP 67	IP 67	IP 67
Mounting	Quasi-embeddable	Quasi-embeddable	Quasi-embeddable
Supply voltage range	15 ... 30 VDC	10 ... 30 / 15 ... 30 VDC (-320)	10 ... 30 / 15 ... 30 VDC (-390)
Ambient temperature range	-25 ... +70°C / -13 ... +158°F	-25 ... +70°C / -13 ... +158°F	-25 ... +70°C / -13 ... +158°F
Output current	-	1 ... 5 mA (-120 only)	1 ... 5 mA / 4 ... 20 mA (-390)
Outputs 0...5 V / 1...5 mA		DW-AD-509-M12-120	DW-AD-509-M12
Output 0...10 V	DW-AS-509-M8-393	DW-AD-509-M12-320	
Outputs 0...10 V / 4...20 mA			DW-AD-509-M12-390
Other types available	On request		

ANALOG OUTPUT

EXTRA DISTANCE	EXTRA DISTANCE	EXTRA DISTANCE	EXTRA DISTANCE
M12	M12	M18	M18
0 ... 6	0 ... 6	0 ... 10	0 ... 10

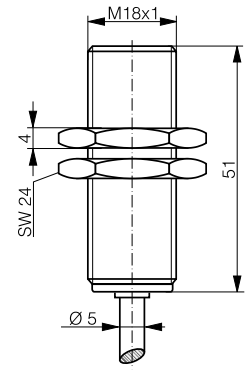
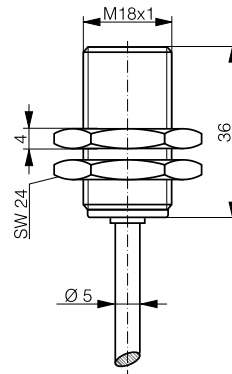
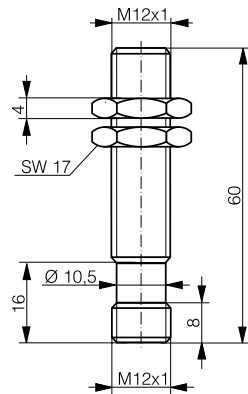
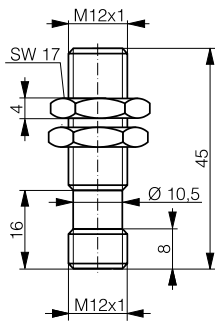

1,000 Hz (at s = 3 mm)	1,000 Hz (at s = 3 mm)	500 Hz (at s = 5 mm)	500 Hz (at s = 5 mm)
0 ... 5 V / 0 ... 10 V (-320)	0 ... 5 V / 0 ... 10 V (-390)	0 ... 5 V / 0 ... 10 V (-320)	0 ... 5 V / 0 ... 10 V (-390)
Chrome-plated brass	Chrome-plated brass	Chrome-plated brass	Chrome-plated brass
Connector S12	Connector S12	PUR cable	PUR cable
IP 67	IP 67	IP 67	IP 67
Quasi-embeddable	Quasi-embeddable	Quasi-embeddable	Quasi-embeddable
10 ... 30 / 15 ... 30 VDC (-320)	10 ... 30 / 15 ... 30 VDC (-390)	10 ... 30 / 15 ... 30 VDC (-320)	10 ... 30 / 15 ... 30 VDC (-390)
-25 ... +70°C / -13 ... +158°F	-25 ... +70°C / -13 ... +158°F	-25 ... +70°C / -13 ... +158°F	-25 ... +70°C / -13 ... +158°F
1 ... 5 mA (-120 only)	1 ... 5 mA / 4 ... 20 mA (-390)	1 ... 5 mA / 4 ... 20 mA (-320)	1 ... 5 mA / 4 ... 20 mA (-390)
DW-AS-509-M12-120	DW-AS-509-M12	DW-AD-509-M18-120	DW-AD-509-M18
DW-AS-509-M12-320			
	DW-AS-509-M12-390	DW-AD-509-M18-320	DW-AD-509-M18-390
			On request

Inductive

Photoelectric

Safety

RFID

Connectivity

Accessories

Glossary

Index

ANALOG OUTPUT

INDUCTIVE

FAMILY	EXTRA DISTANCE	EXTRA DISTANCE	EXTRA DISTANCE
HOUSING SIZE	M18	M18	M30
SENSING RANGE MM	0 ... 10	0 ... 20	0 ... 20

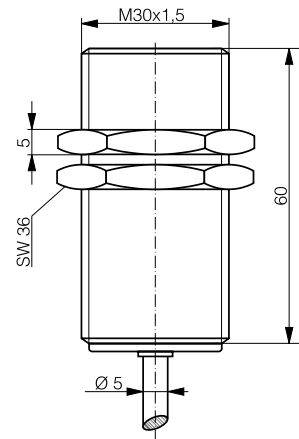
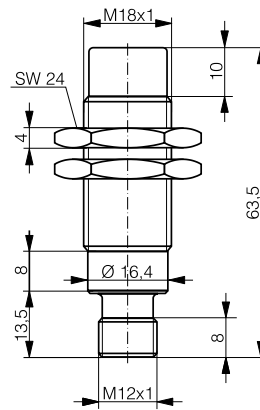
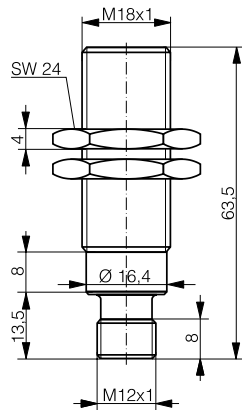

DATA			
Bandwidth (-3 dB)	500 Hz (at s = 5 mm)	250 Hz (at s = 10 mm)	200 Hz (at s = 10 mm)
Output voltage	0 ... 5 V / 0 ... 10 V (-390)	0 ... 5 V / 0 ... 10 V (-390)	0 ... 5 V / 0 ... 10 V (-390)
Housing material	Chrome-plated brass	Chrome-plated brass	Chrome-plated brass
Connection	Connector S12	Connector S12	PUR cable
Degree of protection	IP 67	IP 67	IP 67
Mounting	Quasi-embeddable	Non-embeddable	Quasi-embeddable
Supply voltage range	10 ... 30 / 15 ... 30 VDC (-390)	10 ... 30 / 15 ... 30 VDC (-390)	10 ... 30 / 15 ... 30 VDC (-390)
Ambient temperature range	-25 ... +70°C / -13 ... +158°F	-25 ... +70°C / -13 ... +158°F	-25 ... +70°C / -13 ... +158°F
Output current	1 ... 5 mA / 4 ... 20 mA (-390)	1 ... 5 mA / 4 ... 20 mA (-390)	1 ... 5 mA / 4 ... 20 mA (-390)
Outputs 0...5 V / 1...5 mA	DW-AS-509-M18-002	DW-AS-519-M18-002	DW-AD-509-M30
Outputs 0...10 V / 4...20 mA	DW-AS-509-M18-390	DW-AS-519-M18-390	DW-AD-509-M30-390
Other types available	On request	On request	On request

ANALOG OUTPUT

EXTRA DISTANCE	EXTRA DISTANCE	EXTRA DISTANCE	EXTRA DISTANCE
M30	M30	M30	M30
0 ... 20	0 ... 40	0 ... 40	0 ... 40

Inductive



Photoelectric

Safety

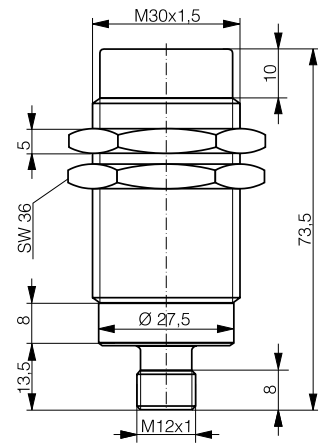
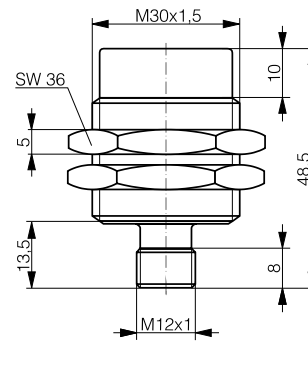
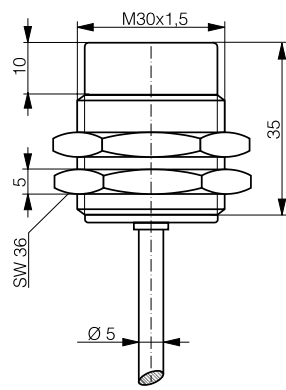
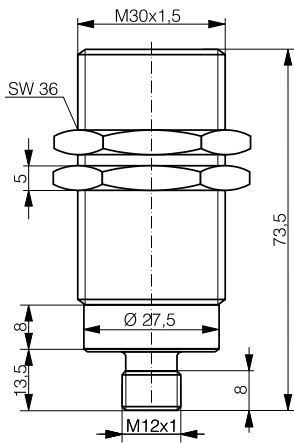

RFID

Connectivity

200 Hz (at s = 10 mm)	100 Hz (at s = 20 mm)	100 Hz (at s = 20 mm)	100 Hz (at s = 20 mm)
0 ... 5 V / 0 ... 10 V (-390)	0 ... 5 V / 0 ... 10 V (-320)	0 ... 5 V / 0 ... 10 V (-320)	0 ... 5 V / 0 ... 10 V (-390)
Chrome-plated brass	Chrome-plated brass	Chrome-plated brass	Chrome-plated brass
Connector S12	PUR cable	Connector S12	Connector S12
IP 67	IP 67	IP 67	IP 67
Quasi-embeddable	Non-embeddable	Non-embeddable	Non-embeddable
10 ... 30 / 15 ... 30 VDC (-390)	10 ... 30 / 15 ... 30 VDC (-320)	10 ... 30 / 15 ... 30 VDC (-320)	10 ... 30 / 15 ... 30 VDC (-390)
-25 ... +70°C / -13 ... +158°F	-25 ... +70°C / -13 ... +158°F	-25 ... +70°C / -13 ... +158°F	-25 ... +70°C / -13 ... +158°F
1 ... 5 mA / 4 ... 20 mA (-390)	1 ... 5 mA / 4 ... 20 mA (-320)	1 ... 5 mA / 4 ... 20 mA (-320)	1 ... 5 mA / 4 ... 20 mA (-390)
DW-AS-509-M30-002	DW-AD-519-M30-120	DW-AS-519-M30-120	DW-AS-519-M30-002
DW-AS-509-M30-390	DW-AD-519-M30-320	DW-AS-519-M30-320	DW-AS-519-M30-390
On request	On request	On request	On request

Accessories

Glossary

Index

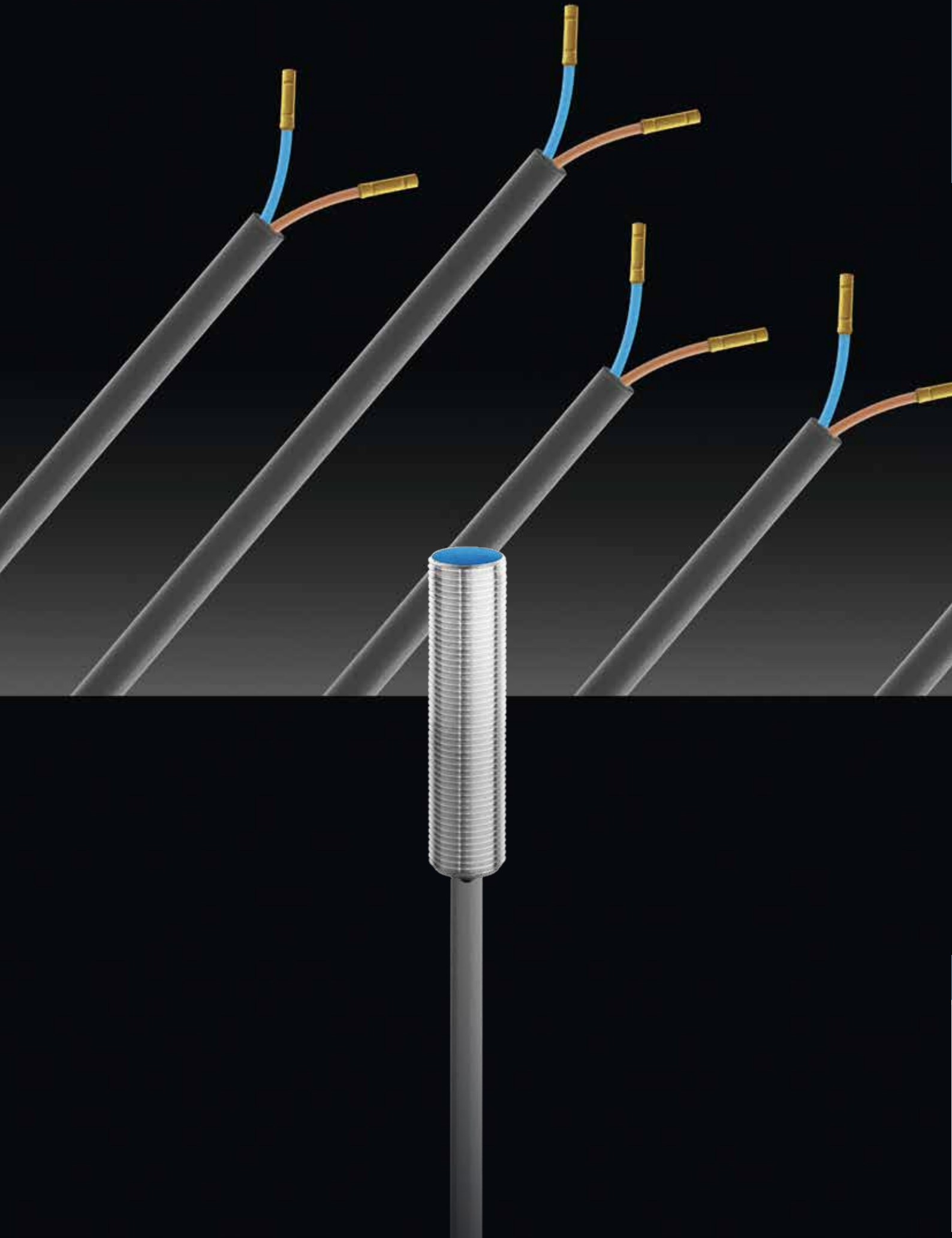

EASY INSTALLATION AND HIGH
SWITCHING FREQUENCY

2-WIRE

INDUCTIVE SENSORS



KEY ADVANTAGES

- ✓ Two-wire sensors for series connection
- ✓ Sizes from Ø 3 mm to M30 and 5 x 5 mm
- ✓ DC and AC/DC types
- ✓ NAMUR types with switching frequencies up to 10,000 Hz

RANGE OVERVIEW	Housing size	Classics
2-WIRE	Ø 3 mm	p. 103
	M4	p. 103
	Ø 4 mm	p. 104
	M5	p. 105
	C5	p. 105
	Ø 6.5 mm	p. 106, 110
	M8	p. 107, 110-113
	M12	p. 107, 114-119
	M18	p. 108, 119-123
	M30	p. 109, 124-127

FAMILY

HOUSING SIZE MM

OPERATING DISTANCE MM

INDUCTIVE

WIRING DIAGRAMS

2-wire DC NO

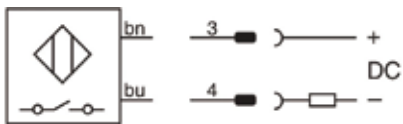

NAMUR

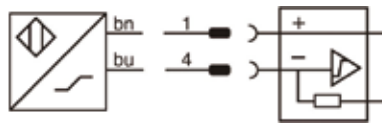

2-wire DC NC

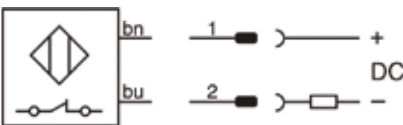

2-wire AC/DC NO

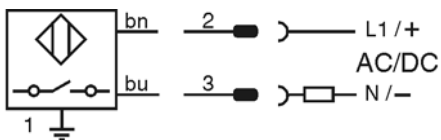

2-wire AC/DC NC

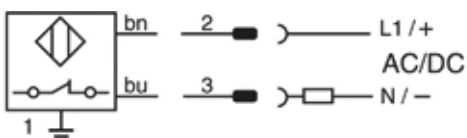

DATA

Housing material

Connection

Degree of protection

Mounting

Max. switching frequency

Supply voltage range

Ambient temperature range

Output current

NAMUR

Other types available

* damped / non-damped

2-WIRE

CLASSICS	CLASSICS	CLASSICS	CLASSICS
Ø 3	Ø 3	M4	M4
0.6	0.6	0.6	0.6

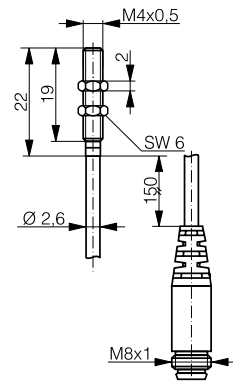
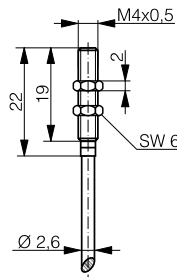
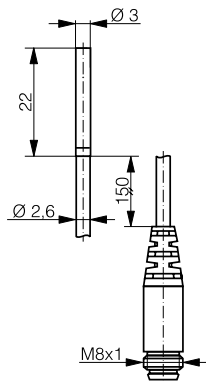
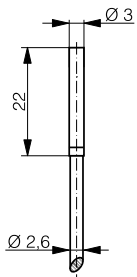

NAMUR

NAMUR

NAMUR

NAMUR

Stainless steel V2A	Stainless steel V2A	Stainless steel V2A	Stainless steel V2A
PUR cable	PUR cable / Connector S8	PUR cable	PUR cable / Connector S8
IP 67	IP 67	IP 67	IP 67
Embeddable	Embeddable	Embeddable	Embeddable
10,000 Hz	10,000 Hz	10,000 Hz	10,000 Hz
7.7 ... 9 VDC	7.7 ... 9 VDC	7.7 ... 9 VDC	7.7 ... 9 VDC
-25 ... +70°C / -13 ... +158°F	-25 ... +70°C / -13 ... +158°F	-25 ... +70°C / -13 ... +158°F	-25 ... +70°C / -13 ... +158°F
≤ 1 / ≥ 2.2 mA*	≤ 1 / ≥ 2.2 mA*	≤ 1 / ≥ 2.2 mA*	≤ 1 / ≥ 2.2 mA*
DW-AD-605-03	DW-AS-605-03	DW-AD-605-M4	DW-AS-605-M4

Inductive

Photoelectric

Safety

RFID

Connectivity

Accessories

Glossary

Index

2-WIRE

INDUCTIVE

FAMILY	CLASSICS	CLASSICS	CLASSICS
HOUSING SIZE MM	Ø 4	Ø 4	Ø 4
OPERATING DISTANCE MM	0.8	0.8	0.8

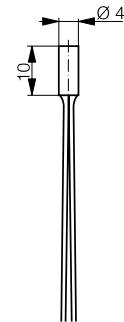
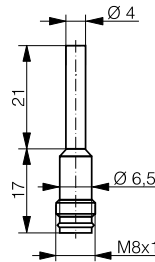
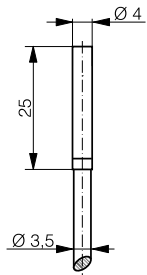

NAMUR

NAMUR

NAMUR

DATA			
Housing material	Stainless steel V2A	Stainless steel V2A	Stainless steel V2A
Connection	PVC cable	Connector S8	Single wires
Degree of protection	IP 67	IP 67	IP 67
Mounting	Embeddable	Embeddable	Embeddable
Max. switching frequency	10,000 Hz	10,000 Hz	10,000 Hz
Supply voltage range	7.7 ... 9 VDC	7.7 ... 9 VDC	7.7 ... 9 VDC
Ambient temperature range	-25 ... +70°C / -13 ... +158°F	-25 ... +70°C / -13 ... +158°F	-25 ... +70°C / -13 ... +158°F
Output current	≤ 1 / ≥ 2.2 mA*	≤ 1 / ≥ 2.2 mA*	≤ 1 / ≥ 2.2 mA*
NAMUR	DW-AD-605-04	DW-AS-605-04	DW-AD-605-04K
Other types available			
* damped / non-damped			

2-WIRE

CLASSICS	CLASSICS	CLASSICS	CLASSICS
M5	M5	5 x 5	5 x 5
0.8	0.8	0.8	0.8

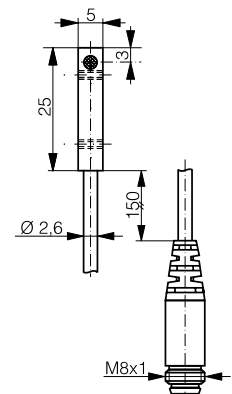
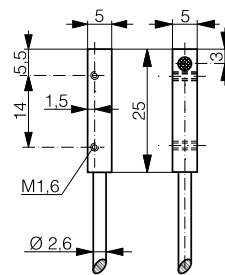
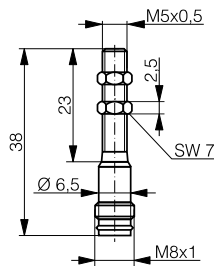
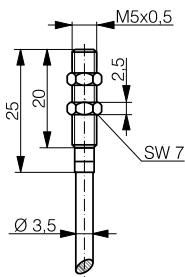

NAMUR

NAMUR

NAMUR

NAMUR

Stainless steel V2A	Stainless steel V2A	Chrome-plated brass	Chrome-plated brass
PVC cable	Connector S8	PUR cable	PUR cable / Connector S8
IP 67	IP 67	IP 67	IP 67
Embeddable	Embeddable	Embeddable	Embeddable
10,000 Hz	10,000 Hz	10,000 Hz	10,000 Hz
7.7 ... 9 VDC	7.7 ... 9 VDC	7.7 ... 9 VDC	7.7 ... 9 VDC
-25 ... +70°C / -13 ... +158°F	-25 ... +70°C / -13 ... +158°F	-25 ... +70°C / -13 ... +158°F	-25 ... +70°C / -13 ... +158°F
≤ 1 / ≥ 2.2 mA*	≤ 1 / ≥ 2.2 mA*	≤ 1 / ≥ 2.2 mA*	≤ 1 / ≥ 2.2 mA*
DW-AD-605-M5	DW-AS-605-M5	DW-AD-605-C5	DW-AS-605-C5

Inductive

Photoelectric

Safety

RFID

Connectivity

Accessories

Glossary

Index

2-WIRE

FAMILY

CLASSICS

CLASSICS

HOUSING SIZE MM

Ø 6.5

Ø 6.5

OPERATING DISTANCE MM

1.5

1.5

INDUCTIVE

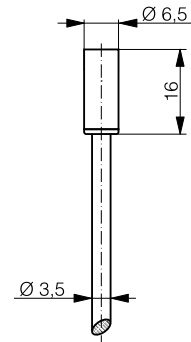
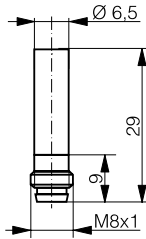

NAMUR

NAMUR

DATA

Housing material

Stainless steel V2A

Stainless steel V2A

Connection

Connector S8

PVC cable

Degree of protection

IP 67

IP 67

Mounting

Embeddable

Embeddable

Max. switching frequency

10,000 Hz

10,000 Hz

Supply voltage range

7.7 ... 9 VDC

7.7 ... 9 VDC

Ambient temperature range

-25 ... +70°C / -13 ... +158°F

-25 ... +70°C / -13 ... +158°F

Output current

≤ 1 / ≥ 2.2 mA*

≤ 1 / ≥ 2.2 mA*

NAMUR

DW-AS-605-065-129

DW-AD-605-065-120

Other types available

* damped / non-damped

2-WIRE

CLASSICS	CLASSICS	CLASSICS
M8	M12	M12
1.5	2	2

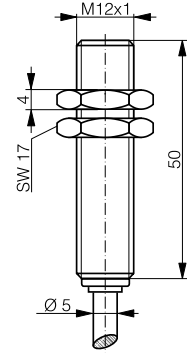
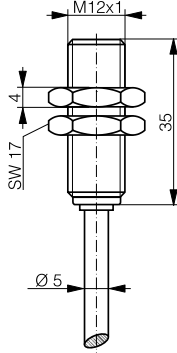
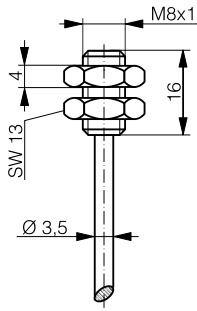

NAMUR

NAMUR

NAMUR

Stainless steel V2A	Chrome-plated brass	Chrome-plated brass
PVC cable	PVC cable	PVC cable
IP 67	IP 67	IP 67
Embeddable	Embeddable	Embeddable
10,000 Hz	2500 Hz	2500 Hz
7.7 ... 9 VDC	7.7 ... 9 VDC	7.7 ... 9 VDC
-25 ... +70°C / -13 ... +158°F	-25 ... +70°C / -13 ... +158°F	-25 ... +70°C / -13 ... +158°F
≤ 1 / ≥ 2.2 mA*	≤ 1 / ≥ 2.2 mA*	≤ 1 / ≥ 2.2 mA*
DW-AD-605-M8-120	DW-AD-605-M12-120	DW-AD-605-M12
	Non-embeddable	Non-embeddable

Inductive

Photoelectric

Safety

RFID

Connectivity

Accessories

Glossary

Index

2-WIRE

FAMILY

CLASSICS

CLASSICS

HOUSING SIZE

M18

M18

OPERATING DISTANCE MM

5

5

INDUCTIVE

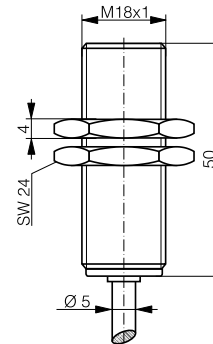
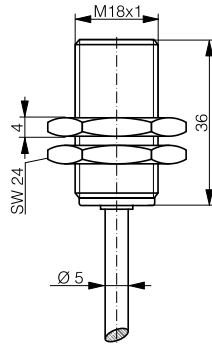

NAMUR

NAMUR

DATA

Housing material

Chrome-plated brass

Chrome-plated brass

Connection

PVC cable

PVC cable

Degree of protection

IP 67

IP 67

Mounting

Embeddable

Embeddable

Max. switching frequency

1000 Hz

10,000 Hz

Supply voltage range

7.7 ... 9 VDC

7.7 ... 9 VDC

Ambient temperature range

-25 ... +70°C / -13 ... +158°F

-25 ... +70°C / -13 ... +158°F

Output current

≤ 1 / ≥ 2.2 mA*

≤ 1 / ≥ 2.2 mA*

NAMUR

DW-AD-605-M18-120

DW-AD-605-M18

Other types available

* damped / non-damped

2-WIRE

CLASSICS	CLASSICS
M30	M30
10	10

Inductive



Photoelectric

Safety

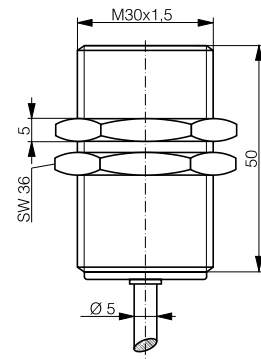
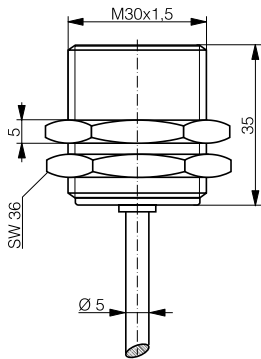

RFID

Connectivity

NAMUR

NAMUR

Accessories

Chrome-plated brass
PVC cable
IP 67
Embeddable
400 Hz
7.7 ... 9 VDC
-25 ... +70°C / -13 ... +158°F
≤ 1 / ≥ 2.2 mA*
DW-AD-605-M30-120

Chrome-plated brass
PVC cable
IP 67
Embeddable
400 Hz
7.7 ... 9 VDC
-25 ... +70°C / -13 ... +158°F
≤ 1 / ≥ 2.2 mA*
DW-AD-605-M30

Glossary

Index

2-WIRE

FAMILY

CLASSICS

CLASSICS

HOUSING SIZE MM

Ø 6.5

M8

OPERATING DISTANCE MM

1.5

1.5

INDUCTIVE

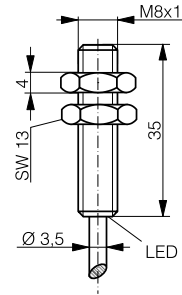
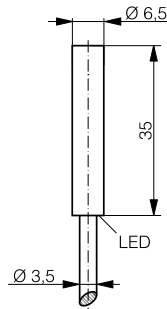

DATA

Housing material

Stainless steel V2A

Stainless steel V2A

Connection

PVC cable

PVC cable

Degree of protection

IP 67

IP 67

Mounting

Embeddable

Embeddable

Max. switching frequency

5000 Hz

5000 Hz

Supply voltage range

10 ... 65 VDC

10 ... 65 VDC

Ambient temperature range

-25 ... +70°C / -13 ... +158°F

-25 ... +70°C / -13 ... +158°F

Output current

100 mA

≤ 100 mA

DC 2-wire NO

DW-DD-605-065

DW-DD-605-M8

DC 2-wire NC

DW-DD-606-M8

Other types available

2-WIRE

CLASSICS	CLASSICS
M8	M8
1.5	1.5

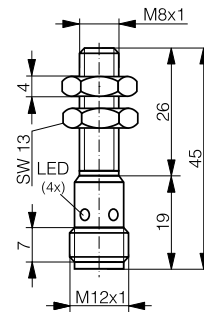
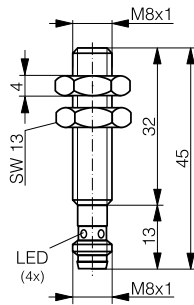

Stainless steel V2A	Stainless steel V2A
Connector S8	Connector S12
IP 67	IP 67
Embeddable	Embeddable
5000 Hz	5000 Hz
10 ... 65 VDC	10 ... 65 VDC
-25 ... +70°C / -13 ... +158°F	-25 ... +70°C / -13 ... +158°F
≤ 100 mA	≤ 100 mA
DW-DS-605-M8-001	DW-DS-605-M8
DW-DS-606-M8-001	DW-DS-606-M8

Inductive
Photoelectric
Safety
RFID
Connectivity
Accessories
Glossary
Index

2-WIRE

FAMILY

CLASSICS

CLASSICS

HOUSING SIZE

M8

M8

OPERATING DISTANCE MM

2

2

INDUCTIVE

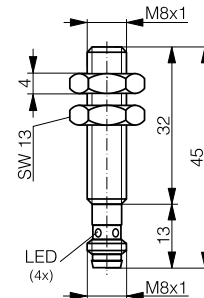
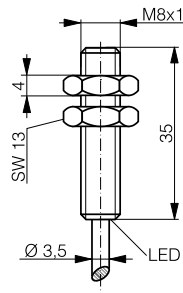

DATA

Housing material	Stainless steel V2A	Stainless steel V2A
Connection	PVC cable	Connector S8
Degree of protection	IP 67	IP 67
Mounting	Embeddable	Embeddable
Max. switching frequency	5000 Hz	5000 Hz
Supply voltage range	10 ... 65 VDC	10 ... 65 VDC
Ambient temperature range	-25 ... +70°C / -13 ... +158°F	-25 ... +70°C / -13 ... +158°F
Output current	≤ 100 mA	≤ 100 mA
DC 2-wire NO	DW-DD-625-M8	DW-DS-625-M8-001
DC 2-wire NC	DW-DD-626-M8	DW-DS-626-M8-001
Other types available		

2-WIRE

CLASSICS	CLASSICS	CLASSICS
M8	M8	M8
2.5	2.5	2.5

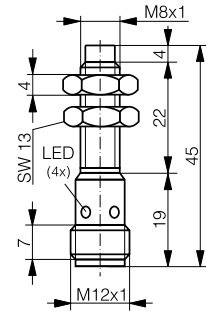
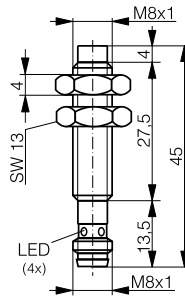
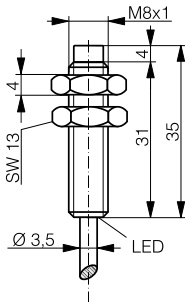

Stainless steel V2A	Stainless steel V2A	Stainless steel V2A
PVC cable	Connector S8	Connector S12
IP 67	IP 67	IP 67
Non-embeddable	Non-embeddable	Non-embeddable
5000 Hz	5000 Hz	5000 Hz
10 ... 65 VDC	10 ... 65 VDC	10 ... 65 VDC
-25 ... +70°C / -13 ... +158°F	-25 ... +70°C / -13 ... +158°F	-25 ... +70°C / -13 ... +158°F
≤ 100 mA	≤ 100 mA	≤ 100 mA
DW-DD-615-M8	DW-DS-615-M8-001	DW-DS-615-M8
DW-DD-616-M8	DW-DS-616-M8-001	DW-DS-616-M8

2-WIRE

INDUCTIVE

FAMILY	CLASSICS	CLASSICS	CLASSICS
HOUSING SIZE	M12	M12	M12
OPERATING DISTANCE MM	2	2	2

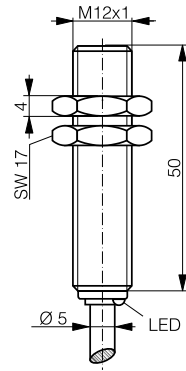
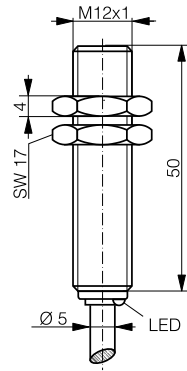
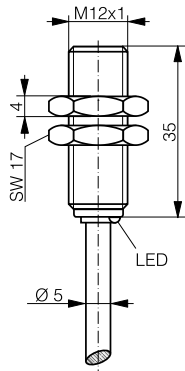

DATA			
Housing material	Chrome-plated brass	Chrome-plated brass	Chrome-plated brass
Connection	PVC cable	PVC cable	PVC cable
Degree of protection	IP 67	IP 67	IP 67
Mounting	Embeddable	Embeddable	Embeddable
Max. switching frequency	3000 Hz	3000 Hz	25 Hz (AC) / 3000 Hz (DC)
Supply voltage range	10 ... 65 VDC	10 ... 65 VDC	20 ... 265 VAC / 10 ... 320 VDC
Ambient temperature range	-25 ... +70°C / -13 ... +158°F	-25 ... +70°C / -13 ... +158°F	-25 ... +70°C / -13 ... +158°F
Output current	≤ 100 mA	≤ 100 mA	≤ 200 mA
DC 2-wire NO	DW-DD-605-M12-120	DW-DD-605-M12	
DC 2-wire NC	DW-DD-606-M12-120	DW-DD-606-M12	
AC/DC 2-wire NO			DW-AD-607-M12
AC/DC 2-wire NC			DW-AD-608-M12
Other types available			

2-WIRE

CLASSICS	CLASSICS	CLASSICS	CLASSICS
M12	M12	M12	M12
2	2	2	4

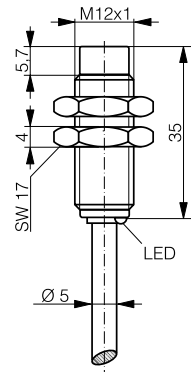
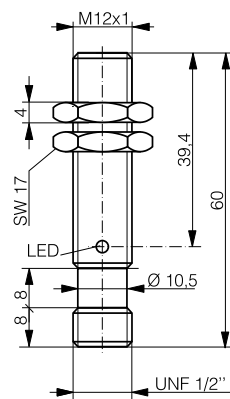
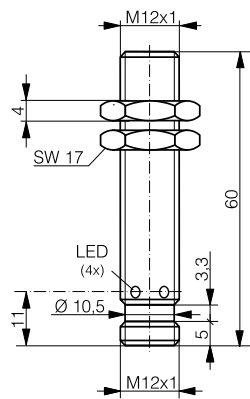
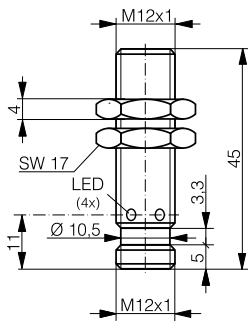

Chrome-plated brass	Chrome-plated brass	Chrome-plated brass	Chrome-plated brass
Connector S12	Connector S12	Connector 1/2"	PVC cable
IP 67	IP 67	IP 67	IP 67
Embeddable	Embeddable	Embeddable	Non-embeddable
3000 Hz	3000 Hz	25 Hz (AC) / 3000 Hz (DC)	2500 Hz
10 ... 65 VDC	10 ... 65 VDC	20 ... 265 VAC / 10 ... 320 VDC	10 ... 65 VDC
-25 ... +70°C / -13 ... +158°F	-25 ... +70°C / -13 ... +158°F	-25 ... +70°C / -13 ... +158°F	-25 ... +70°C / -13 ... +158°F
≤ 100 mA	≤ 100 mA	≤ 200 mA	≤ 100 mA
DW-DS-605-M12-120	DW-DS-605-M12		DW-DD-615-M12-120
DW-DS-606-M12-120	DW-DS-606-M12		DW-DD-616-M12-120
		DW-AS-607-M12-069	

Inductive

Photoelectric

Safety

RFID

Connectivity

Accessories

Glossary

Index

2-WIRE

INDUCTIVE

FAMILY	CLASSICS	CLASSICS	CLASSICS
HOUSING SIZE	M12	M12	M12
OPERATING DISTANCE MM	4	4	4

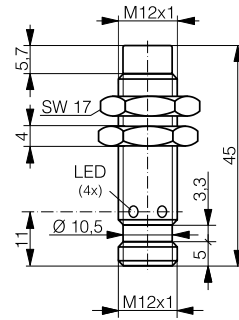
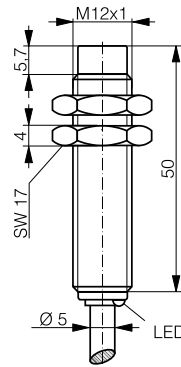
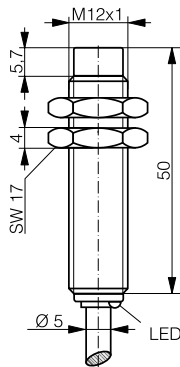

DATA			
Housing material	Chrome-plated brass	Chrome-plated brass	Chrome-plated brass
Connection	PVC cable	PVC cable	Connector S12
Degree of protection	IP 67	IP 67	IP 67
Mounting	Non-embeddable	Non-embeddable	Non-embeddable
Max. switching frequency	2500 Hz	25 Hz (AC) / 2000 Hz (DC)	2500 Hz
Supply voltage range	10 ... 65 VDC	20 ... 265 VAC / 10 ... 320 VDC	10 ... 65 VDC
Ambient temperature range	-25 ... +70°C / -13 ... +158°F	-25 ... +70°C / -13 ... +158°F	-25 ... +70°C / -13 ... +158°F
Output current	≤ 100 mA	≤ 200 mA	≤ 100 mA
DC 2-wire NO	DW-DD-615-M12		DW-DS-615-M12-120
DC 2-wire NC	DW-DD-616-M12		DW-DS-616-M12-120
AC/DC 2-wire NO		DW-AD-617-M12	
AC/DC 2-wire NC		DW-AD-618-M12	
Other types available			

2-WIRE

CLASSICS	CLASSICS	CLASSICS	CLASSICS
M12	M12	M12	M12
4	4	4	4

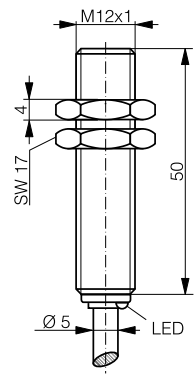
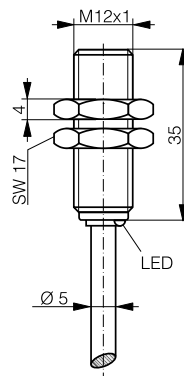
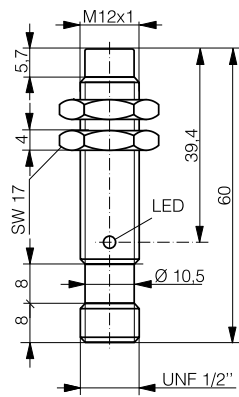
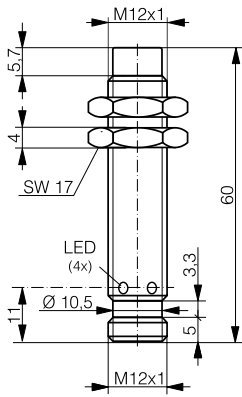

Chrome-plated brass	Chrome-plated brass	Chrome-plated brass	Chrome-plated brass
Connector S12	Connector 1/2"	PVC cable	PVC cable
IP 67	IP 67	IP 67	IP 67
Non-embeddable	Non-embeddable	Embeddable	Embeddable
2000 Hz	25 Hz (AC) / 2000 Hz (DC)	2000 Hz	2000 Hz
10 ... 65 VDC	20 ... 265 VAC / 10 ... 320 VDC	10 ... 65 VDC	10 ... 65 VDC
-25 ... +70°C / -13 ... +158°F	-25 ... +70°C / -13 ... +158°F	-25 ... +70°C / -13 ... +158°F	-25 ... +70°C / -13 ... +158°F
≤ 100 mA	≤ 200 mA	≤ 100 mA	≤ 100 mA
DW-DS-615-M12	DW-AS-617-M12-069	DW-DD-625-M12-120	DW-DD-625-M12
DW-DS-616-M12	DW-AS-618-M12-069	DW-DD-626-M12-120	DW-DD-626-M12

Inductive

Photoelectric

Safety

RFID

Connectivity

Accessories

Glossary

Index

2-WIRE

INDUCTIVE

FAMILY	CLASSICS	CLASSICS	CLASSICS
HOUSING SIZE	M12	M12	M12
OPERATING DISTANCE MM	4	4	4

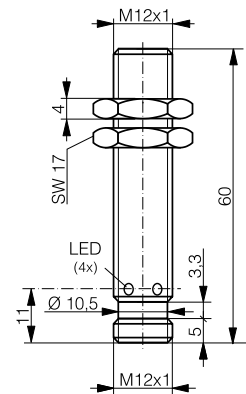
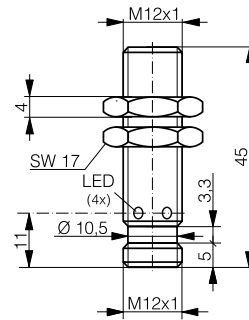
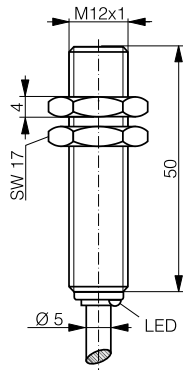

DATA			
Housing material	Chrome-plated brass	Chrome-plated brass	Chrome-plated brass
Connection	PVC cable	Connector S12	Connector S12
Degree of protection	IP 67	IP 67	IP 67
Mounting	Embeddable	Embeddable	Embeddable
Max. switching frequency	25 Hz (AC) / 2000 Hz (DC)	2000 Hz	2000 Hz
Supply voltage range	20 ... 265 VAC / 10 ... 320 VDC	10 ... 65 VDC	10 ... 65 VDC
Ambient temperature range	-25 ... +70°C / -13 ... +158°F	-25 ... +70°C / -13 ... +158°F	-25 ... +70°C / -13 ... +158°F
Output current	≤ 200 mA	≤ 100 mA	≤ 100 mA
DC 2-wire NO		DW-DS-625-M12-120	DW-DS-625-M12
DC 2-wire NC		DW-DS-626-M12-120	DW-DS-626-M12
AC/DC 2-wire NO	DW-AD-627-M12		
AC/DC 2-wire NC	DW-AD-628-M12		
Other types available			

2-WIRE

CLASSICS	CLASSICS	CLASSICS	CLASSICS
M12	M18	M18	M18
4	5	5	5

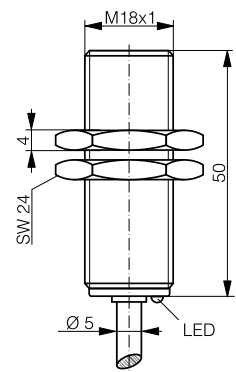
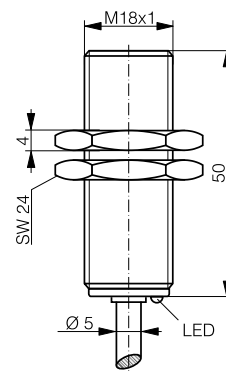
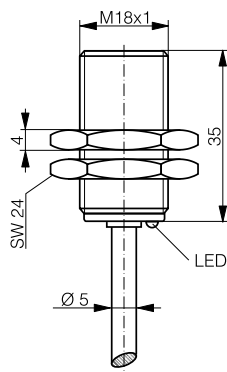
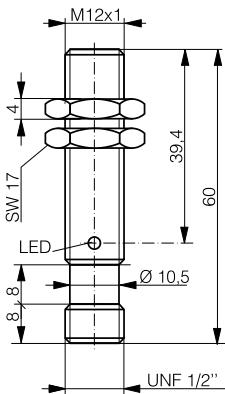

Chrome-plated brass	Chrome-plated brass	Chrome-plated brass	Chrome-plated brass
Connector 1/2"	PVC cable	PVC cable	PVC cable
IP 67	IP 67	IP 67	IP 67
Embeddable	Embeddable	Embeddable	Embeddable
25 Hz (AC) / 2000 Hz (DC)	1500 Hz	1500 Hz	25 Hz (AC) / 1500 Hz (DC)
20 ... 265 VAC / 10 ... 320 VDC	10 ... 65 VDC	10 ... 65 VDC	20 ... 265 VAC / 10 ... 320 VDC
-25 ... +70°C / -13 ... +158°F	-25 ... +70°C / -13 ... +158°F	-25 ... +70°C / -13 ... +158°F	-25 ... +70°C / -13 ... +158°F
≤ 200 mA	≤ 100 mA	≤ 100 mA	≤ 200 mA
	DW-DD-605-M18-120	DW-DD-605-M18	DW-AD-607-M18
	DW-DD-606-M18-120	DW-DD-606-M18	DW-AD-608-M18
DW-AS-627-M12-069			
DW-AS-628-M12-069			

Inductive

Photoelectric

Safety

RFID

Connectivity

Accessories

Glossary

Index

2-WIRE

INDUCTIVE

FAMILY	CLASSICS	CLASSICS	CLASSICS
HOUSING SIZE	M18	M18	M18
OPERATING DISTANCE MM	5	5	5

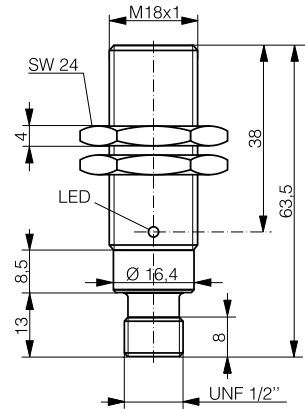
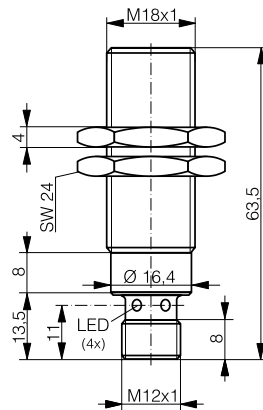
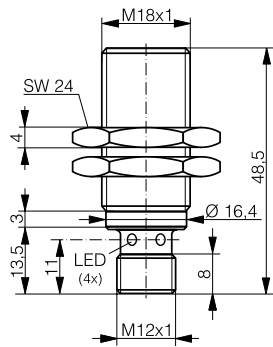

DATA			
Housing material	Chrome-plated brass	Chrome-plated brass	Chrome-plated brass
Connection	Connector S12	Connector S12	Connector 1/2"
Degree of protection	IP 67	IP 67	IP 67
Mounting	Embeddable	Embeddable	Embeddable
Max. switching frequency	1500 Hz	1500 Hz	25 Hz (AC) / 1500 Hz (DC)
Supply voltage range	10 ... 65 VDC	10 ... 65 VDC	20 ... 265 VAC / 10 ... 320 VDC
Ambient temperature range	-25 ... +70°C / -13 ... +158°F	-25 ... +70°C / -13 ... +158°F	-25 ... +70°C / -13 ... +158°F
Output current	≤ 100 mA	≤ 100 mA	≤ 200 mA
DC 2-wire NO	DW-DS-605-M18-120	DW-DS-605-M18-002	
DC 2-wire NC	DW-DS-606-M18-120	DW-DS-606-M18-002	
AC/DC 2-wire NO			DW-AS-607-M18-069
AC/DC 2-wire NC			DW-AS-608-M18-069
Other types available			

2-WIRE

CLASSICS	CLASSICS	CLASSICS	CLASSICS
M18	M18	M18	M18
8	8	8	8

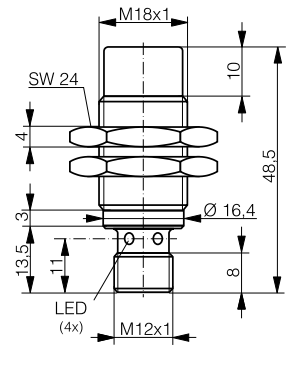
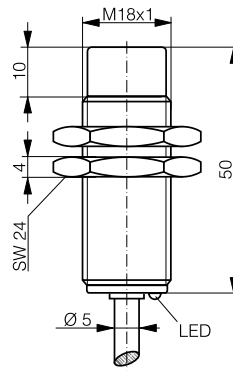
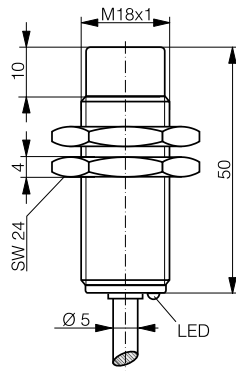
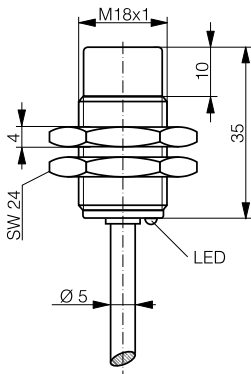

Inductive

Photoelectric

Safety

RFID

Connectivity

Accessories

Glossary

Index

Chrome-plated brass	Chrome-plated brass	Chrome-plated brass	Chrome-plated brass
PVC cable	PVC cable	PVC cable	Connector S12
IP 67	IP 67	IP 67	IP 67
Non-embeddable	Non-embeddable	Non-embeddable	Non-embeddable
1200 Hz	1200 Hz	25 Hz (AC) / 1200 Hz (DC)	1200 Hz
10 ... 65 VDC	10 ... 65 VDC	20 ... 265 VAC / 10 ... 320 VDC	10 ... 65 VDC
-25 ... +70°C / -13 ... +158°F	-25 ... +70°C / -13 ... +158°F	-25 ... +70°C / -13 ... +158°F	-25 ... +70°C / -13 ... +158°F
≤ 100 mA	≤ 100 mA	≤ 200 mA	≤ 100 mA
DW-DD-615-M18-120	DW-DD-615-M18	DW-AD-617-M18	DW-DS-615-M18-120
DW-DD-616-M18-120	DW-DD-616-M18	DW-AD-618-M18	DW-DS-616-M18-120

2-WIRE

INDUCTIVE

FAMILY	CLASSICS	CLASSICS	CLASSICS
HOUSING SIZE	M18	M18	M18
OPERATING DISTANCE MM	8	8	8

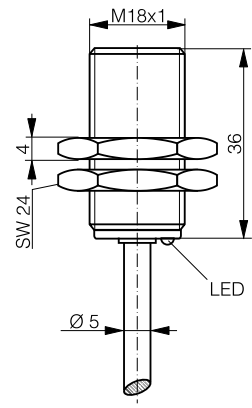
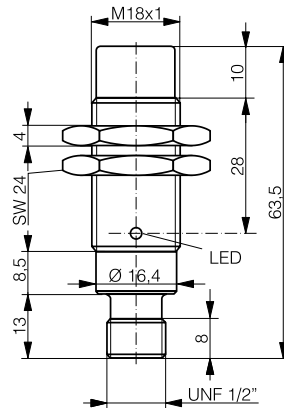
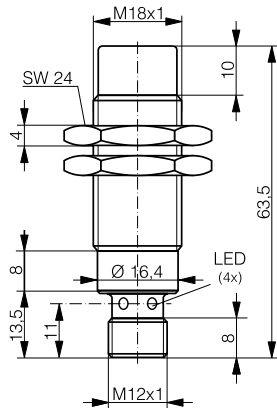

DATA			
Housing material	Chrome-plated brass	Chrome-plated brass	Chrome-plated brass
Connection	Connector S12	Connector 1/2"	PVC cable
Degree of protection	IP 67	IP 67	IP 67
Mounting	Non-embeddable	Non-embeddable	Quasi-embeddable
Max. switching frequency	1200 Hz	25 Hz (AC) / 1200 Hz (DC)	1000 Hz
Supply voltage range	10 ... 65 VDC	20 ... 265 VAC / 10 ... 320 VDC	10 ... 65 VDC
Ambient temperature range	-25 ... +70°C / -13 ... +158°F	-25 ... +70°C / -13 ... +158°F	-25 ... +70°C / -13 ... +158°F
Output current	≤ 100 mA	≤ 200 mA	≤ 100 mA
DC 2-wire NO	DW-DS-615-M18-002		DW-DD-625-M18-120
DC 2-wire NC	DW-DS-616-M18-002		DW-DD-626-M18-120
AC/DC 2-wire NO		DW-AS-617-M18-069	
AC/DC 2-wire NC		DW-AS-618-M18-069	
Other types available			

2-WIRE

CLASSICS	CLASSICS	CLASSICS
M18	M18	M18
8	8	8

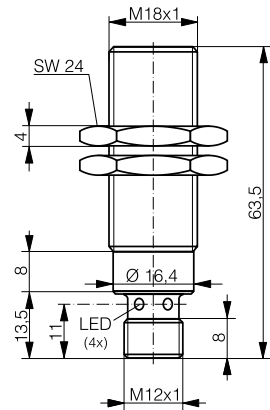
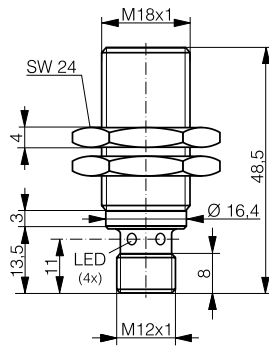
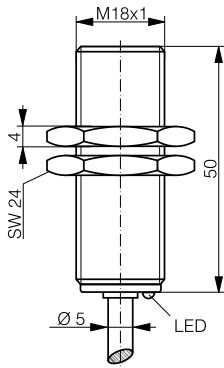

Chrome-plated brass	Chrome-plated brass	Chrome-plated brass
PVC cable	Connector S12	Connector S12
IP 67	IP 67	IP 67
Quasi-embeddable	Quasi-embeddable	Quasi-embeddable
1000 Hz	1000 Hz	1000 Hz
10 ... 65 VDC	10 ... 65 VDC	10 ... 65 VDC
-25 ... +70°C / -13 ... +158°F	-25 ... +70°C / -13 ... +158°F	-25 ... +70°C / -13 ... +158°F
≤ 100 mA	≤ 100 mA	≤ 100 mA
DW-DD-625-M18	DW-DS-625-M18-120	DW-DS-625-M18-002
DW-DD-626-M18	DW-DS-626-M18-120	DW-DS-626-M18-002

Inductive

Photoelectric

Safety

RFID

Connectivity

Accessories

Glossary

Index

2-WIRE

FAMILY

CLASSICS

CLASSICS

HOUSING SIZE

M30

M30

OPERATING DISTANCE MM

10

10

INDUCTIVE

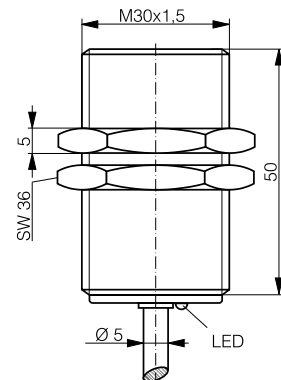
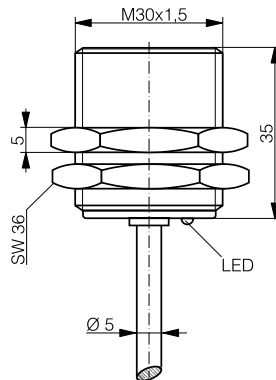

DATA

Housing material

Chrome-plated brass

Chrome-plated brass

Connection

PVC cable

PVC cable

Degree of protection

IP 67

IP 67

Mounting

Embeddable

Embeddable

Max. switching frequency

600 Hz

600 Hz

Supply voltage range

10 ... 65 VDC

10 ... 65 VDC

Ambient temperature range

-25 ... +70°C / -13 ... +158°F

-25 ... +70°C / -13 ... +158°F

Output current

≤ 100 mA

≤ 100 mA

DC 2-wire NO

DW-DD-605-M30-120

DW-DD-605-M30

DC 2-wire NC

DW-DD-606-M30-120

DW-DD-606-M30

AC/DC 2-wire NO

AC/DC 2-wire NC

Other types available

2-WIRE

CLASSICS	CLASSICS	CLASSICS	CLASSICS
M30	M30	M30	M30
10	10	10	10

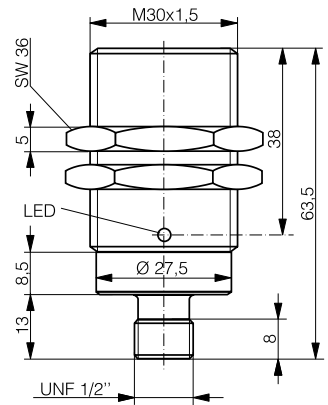
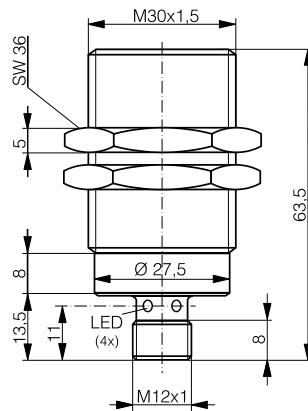
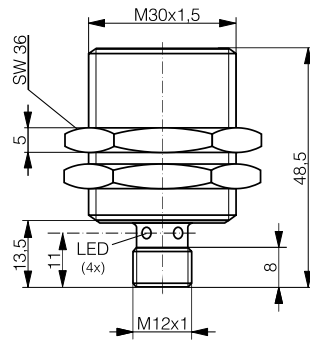
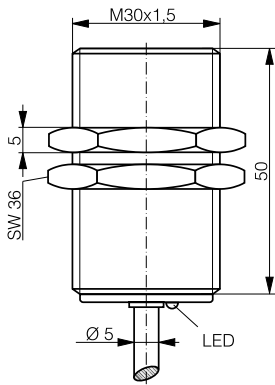

Chrome-plated brass	Chrome-plated brass	Chrome-plated brass	Chrome-plated brass
PVC cable	Connector S12	Connector S12	Connector 1/2"
IP 67	IP 67	IP 67	IP 67
Embeddable	Embeddable	Embeddable	Embeddable
25 Hz (AC) / 600 Hz (DC)	600 Hz	600 Hz	25 Hz (AC) / 600 Hz (DC)
20 ... 265 VAC / 10 ... 320 VDC	10 ... 65 VDC	10 ... 65 VDC	20 ... 265 VAC / 10 ... 320 VDC
-25 ... +70°C / -13 ... +158°F	-25 ... +70°C / -13 ... +158°F	-25 ... +70°C / -13 ... +158°F	-25 ... +70°C / -13 ... +158°F
≤ 200 mA	≤ 100 mA	≤ 100 mA	≤ 200 mA
DW-AD-607-M30	DW-DS-605-M30-120	DW-DS-605-M30-002	DW-AS-607-M30-069
DW-AD-608-M30	DW-DS-606-M30-120	DW-DS-606-M30-002	DW-AS-608-M30-069

Inductive

Photoelectric

Safety

RFID

Connectivity

Accessories

Glossary

Index

2-WIRE

INDUCTIVE

FAMILY	CLASSICS	CLASSICS	CLASSICS
HOUSING SIZE	M30	M30	M30
OPERATING DISTANCE MM	15	15	15

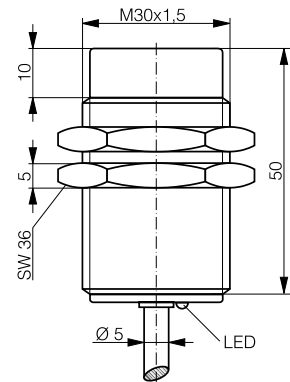
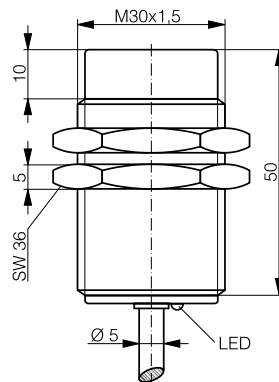
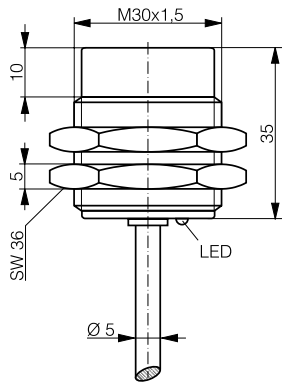

DATA			
Housing material	Chrome-plated brass	Chrome-plated brass	Chrome-plated brass
Connection	PVC cable	PVC cable	PVC cable
Degree of protection	IP 67	IP 67	IP 67
Mounting	Non-embeddable	Non-embeddable	Non-embeddable
Max. switching frequency	500 Hz	500 Hz	25 Hz (AC) / 500 Hz (DC)
Supply voltage range	10 ... 65 VDC	10 ... 65 VDC	20 ... 265 VAC / 10 ... 320 VDC
Ambient temperature range	-25 ... +70°C / -13 ... +158°F	-25 ... +70°C / -13 ... +158°F	-25 ... +70°C / -13 ... +158°F
Output current	≤ 100 mA	≤ 100 mA	≤ 200 mA
DC 2-wire NO	DW-DD-615-M30-120	DW-DD-615-M30	
DC 2-wire NC	DW-DD-616-M30-120	DW-DD-616-M30	
AC/DC 2-wire NO			DW-AD-617-M30
AC/DC 2-wire NC			DW-AD-618-M30
Other types available			

2-WIRE

CLASSICS	CLASSICS	CLASSICS
M30	M30	M30
15	15	15

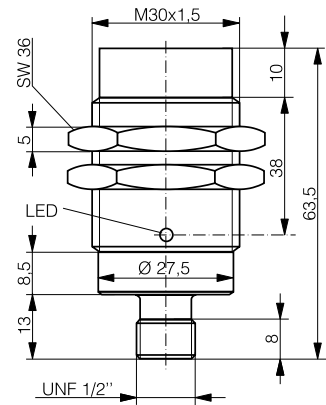
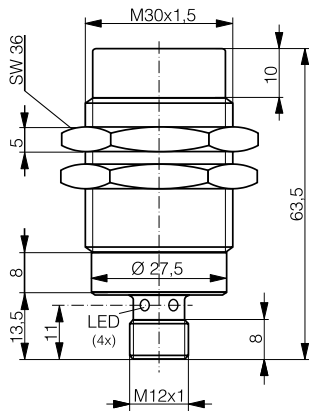
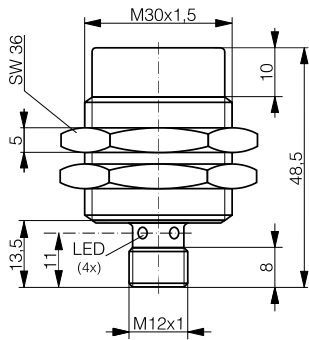

Chrome-plated brass	Chrome-plated brass	Chrome-plated brass
Connector S12	Connector S12	Connector 1/2"
IP 67	IP 67	IP 67
Non-embeddable	Non-embeddable	Non-embeddable
500 Hz	500 Hz	25 Hz (AC) / 500 Hz (DC)
10 ... 65 VDC	10 ... 65 VDC	20 ... 265 VAC / 10 ... 320 VDC
-25 ... +70°C / -13 ... +158°F	-25 ... +70°C / -13 ... +158°F	-25 ... +70°C / -13 ... +158°F
≤ 100 mA	≤ 100 mA	≤ 200 mA
DW-DS-615-M30-120	DW-DS-615-M30-002	DW-AS-617-M30-069
DW-DS-616-M30-120	DW-DS-616-M30-002	DW-AS-618-M30-069

Inductive

Photoelectric

Safety

RFID

Connectivity

Accessories

Glossary

Index

PRESSURE



PRESSURE RESISTANT UP TO 200 BAR (2901 PSI)

EXTRA PRESSURE

INDUCTIVE SENSORS

KEY ADVANTAGES

- ✓ Pressure resistant up to 200 bar (2901 psi)
- ✓ High quality ASIC sensors with  IO-Link interface
- ✓ Mechanically and chemically rugged
- ✓ Impervious: IP 68
- ✓ Gas-tight sensing face
- ✓ Miniature devices

RANGE OVERVIEW	Housing size	Classics	Extra Distance
EXTRA PRESSURE	∅ 3 mm	p. 131	
	∅ 4 mm	p. 131	
	M5	p. 131	
	∅ 6.5 mm		p. 131

FAMILY

HOUSING SIZE MM

OPERATING DISTANCE MM

INDUCTIVE

WIRING DIAGRAMS

PNP NO

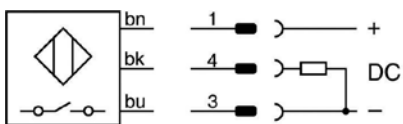

NPN NO

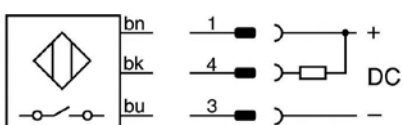

DATA

Sensing face material

Operating pressure

Housing material

Connection

Degree of protection

Mounting

Max. switching frequency

Supply voltage range

Ambient temperature range

Output current

PNP NO

NPN NO

Other types available

EXTRA PRESSURE

CLASSICS	CLASSICS	CLASSICS	EXTRA DISTANCE
Ø 3	Ø 4	M5	Ø 6.5
0.8	0.6	0.6	2.5

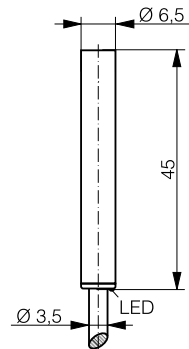
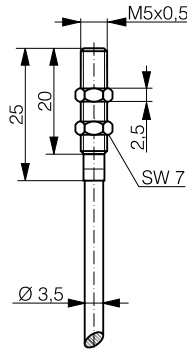
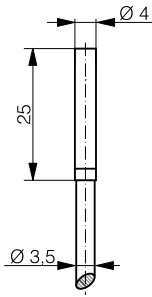
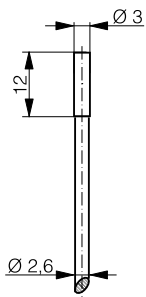

* IO-Link available from Q4/18

IO-Link	IO-Link	IO-Link	* IO-Link
Ceramic ZrO ₂	Sapphire	Sapphire	Ceramic ZrO ₂
200 bar	20 bar	20 bar	20 bar
Stainless steel V2A	Stainless steel V2A	Stainless steel V2A	Stainless steel V2A
PUR cable	PUR cable	PUR cable	PUR cable
IP 68	IP 68	IP 68	IP 68
Embeddable	Embeddable	Embeddable	Embeddable
8000 Hz	5000 Hz	5000 Hz	1000 Hz
10 ... 30 VDC	10 ... 30 VDC	10 ... 30 VDC	10 ... 30 VDC
-25 ... +70°C / -13 ... +158°F	-25 ... +70°C / -13 ... +158°F	-25 ... +70°C / -13 ... +158°F	-25 ... +70°C / -13 ... +158°F
≤ 100 mA	≤ 200 mA	≤ 200 mA	≤ 200 mA
DW-AD-623-03E-961	DW-AD-603-04E	DW-AD-603-M5E	DW-AD-503-065E
	DW-AD-601-04E	DW-AD-601-M5E	DW-AD-501-065E
PNP NC, NPN NC	PNP NC, NPN NC	PNP NC, NPN NC	PNP NC, NPN NC

Inductive

Photoelectric

Safety

RFID

Connectivity

Accessories

Glossary

Index



PRESSURE RESISTANT UP TO 500 BAR (7255 PSI)

HIGH PRESSURE INDUCTIVE SENSORS

KEY ADVANTAGES

- ✓ Highest operating (500 bar / 7255 psi) and peak pressure (1000 bar / 14510 psi) on the market
- ✓ Resistant to pressure cycles - 50 times longer lifetime under pressure than the market standard
- ✓ Gas-tight sensing face
- ✓ Large temperature range -25°C ... +100°C (-13°F ... +212°F)
- ✓ High quality ASIC sensors with  IO-Link interface

RANGE OVERVIEW	Housing size	Extra Distance	Full Inox
HIGH PRESSURE	M5 / P5	p. 135	
	M8 / P8	p. 135	
	M12 / P12	p. 135-137	p. 137
	M14 / P20	p. 137-138	

FAMILY

HOUSING SIZE

OPERATING DISTANCE MM

INDUCTIVE

WIRING DIAGRAMS

PNP NO

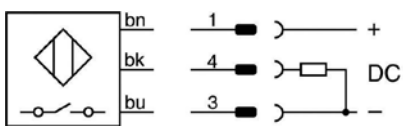

NPN NO

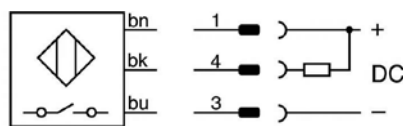

PNP NC

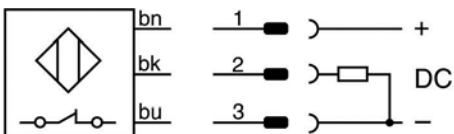

DATA

Sensing face material

Operating pressure

Peak pressure

Housing material

Connection

Degree of protection

Mounting

Max. switching frequency

Supply voltage range

Ambient temperature range

Output current

PNP NO

NPN NO

PNP NO ($S_n = 1.5 \text{ mm}$)

PNP NC ($S_n = 1.5 \text{ mm}$)

PNP NO ($S_n = 2.5 \text{ mm}$)

Other types available

HIGH PRESSURE

EXTRA DISTANCE	EXTRA DISTANCE	EXTRA DISTANCE	EXTRA DISTANCE
M5 (P5)	M5 (P5)	M8 (P8)	M12 (P12)
1	1	1.5	1.5 (2.5)

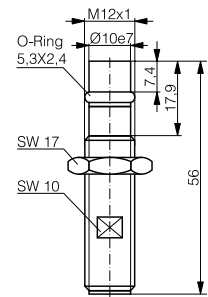
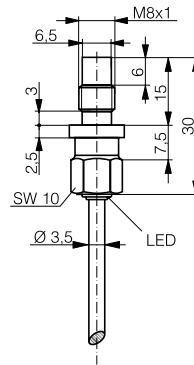
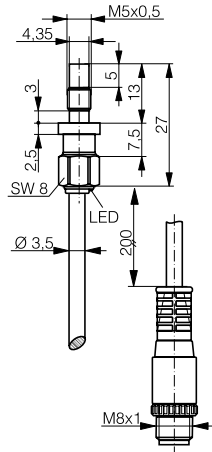
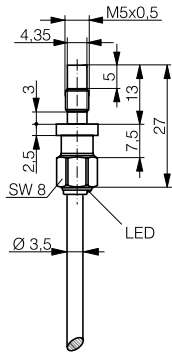

* IO-Link available from Q4/18

* IO-Link	* IO-Link	* IO-Link	* IO-Link
Ceramic ZrO ₂	Ceramic ZrO ₂	Ceramic ZrO ₂	Ceramic ZrO ₂
500 bar	500 bar	500 bar	500 bar
1000 bar	1000 bar	1000 bar	1000 bar
Stainless steel V4A / AISI 316L	Stainless steel V4A / AISI 316L	Stainless steel V4A / AISI 316L	Stainless steel V2A
PUR cable	PUR cable / Connector S8	PUR cable	Connector S12
IP 68	IP 68	IP 68	IP 68
Embeddable	Embeddable	Embeddable	Embeddable
1000 Hz	1000 Hz	800 Hz	600 Hz
10 ... 30 VDC	10 ... 30 VDC	10 ... 30 VDC	10 ... 30 VDC
-25 ... +100°C / -13 ... +212°F	-25 ... +100°C / -13 ... +212°F	-25 ... +100°C / -13 ... +212°F	-25 ... +100°C / -13 ... +212°F
≤ 200 mA	≤ 200 mA	≤ 200 mA	≤ 200 mA
DW-AD-503-P5	DW-AV-503-P5-276	DW-AD-503-P8	
DW-AD-501-P5	DW-AV-501-P5-276	DW-AD-501-P8	
			DW-AS-503-P12-630
			DW-AS-504-P12-630
			DW-AS-523-P12-630
PNP NC, NPN NC	PNP NC, NPN NC	PNP NC, NPN NC	NPN NO, NPN NC

HIGH PRESSURE

FAMILY

EXTRA DISTANCE

EXTRA DISTANCE

EXTRA DISTANCE

HOUSING SIZE

M12 (P12)

M12 (P12)

M12 (P12)

OPERATING DISTANCE MM

1.5 (2.5)

1.5 (2.5)

1.5 (2.5)

INDUCTIVE

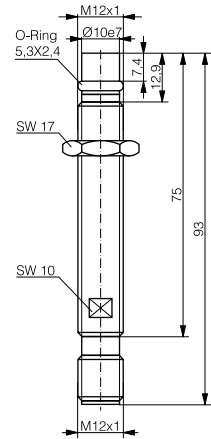
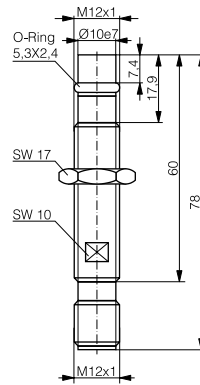
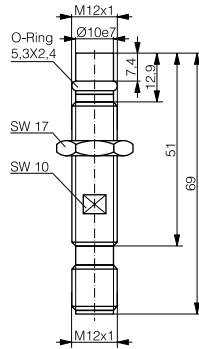

* IO-Link available from Q4/18

DATA	* IO-Link	* IO-Link	* IO-Link
Sensing face material	Ceramic ZrO ₂	Ceramic ZrO ₂	Ceramic ZrO ₂
Operating pressure	500 bar	500 bar	500 bar
Peak pressure	1000 bar	1000 bar	1000 bar
Housing material	Stainless steel V2A	Stainless steel V2A	Stainless steel V2A
Connection	Connector S12	Connector S12	Connector S12
Degree of protection	IP 68	IP 68	IP 68
Mounting	Embeddable	Embeddable	Embeddable
Max. switching frequency	600 Hz	600 Hz	600 Hz
Supply voltage range	10 ... 30 VDC	10 ... 30 VDC	10 ... 30 VDC
Ambient temperature range	-25 ... +100°C / -13 ... +212°F	-25 ... +100°C / -13 ... +212°F	-25 ... +100°C / -13 ... +212°F
Output current	≤ 200 mA	≤ 200 mA	≤ 200 mA
PNP NO	DW-AS-503-P12	DW-AS-503-P12-627	DW-AS-503-P12-621
NPN NO	DW-AS-501-P12	DW-AS-501-P12-627	DW-AS-501-P12-621
Other types available	PNP NC, NPN NC, 2.5 mm operating distance	PNP NC, NPN NC, 2.5 mm operating distance	PNP NC, NPN NC, 2.5 mm operating distance

HIGH PRESSURE

EXTRA DISTANCE	EXTRA DISTANCE	FULL INOX	EXTRA DISTANCE
M12 (P12)	M12 (P12)	M12 (P12)	M14 (P20)
1.5 (2.5)	1.5 (2.5)	1.5	3

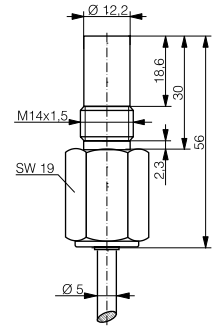
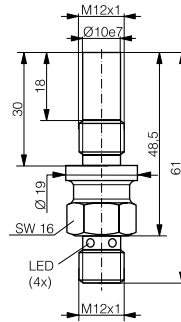
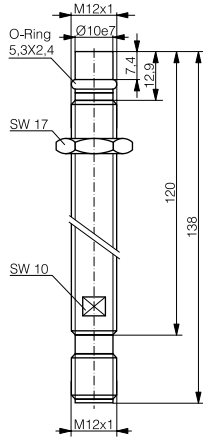
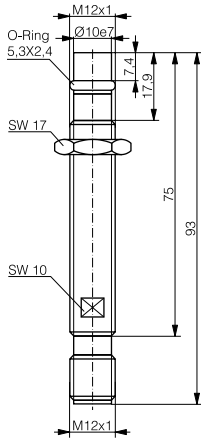

* IO-Link	* IO-Link	IO-Link	* IO-Link
Ceramic ZrO ₂	Ceramic ZrO ₂	Stainless steel V4A / AISI 316L	Ceramic ZrO ₂
500 bar	500 bar	500 bar	500 bar
1000 bar	1000 bar	800 bar	1000 bar
Stainless steel V2A	Stainless steel V2A	Stainless steel V4A / AISI 316L	Stainless steel V4A / AISI 316L
Connector S12	Connector S12	Connector S12	PUR cable
IP 68	IP 68	IP 68 / IP 69K	IP 68
Embeddable	Embeddable	Embeddable	Embeddable
600 Hz	600 Hz	850 Hz	500 Hz
10 ... 30 VDC	10 ... 30 VDC	10 ... 30 VDC	10 ... 30 VDC
-25 ... +100°C / -13 ... +212°F	-25 ... +100°C / -13 ... +212°F	-25 ... +85°C / -13 ... +185°F	-25 ... +100°C / -13 ... +212°F
≤ 200 mA	≤ 200 mA	≤ 200 mA	≤ 200 mA
DW-AS-503-P12-635	DW-AS-503-P12-622	DW-LS-703-P12G	DW-AD-503-P20
DW-AS-501-P12-635	DW-AS-501-P12-622		DW-AD-501-P20
PNP NC, NPN NC, 2.5 mm operating distance	PNP NC, NPN NC, 2.5 mm operating distance	PUR cable, pigtail	PNP NC, NPN NC

Inductive

Photoelectric

Safety

RFID

Connectivity

Accessories

Glossary

Index

HIGH PRESSURE

FAMILY

EXTRA DISTANCE

HOUSING SIZE

M14 (P20)

OPERATING DISTANCE MM

3

INDUCTIVE

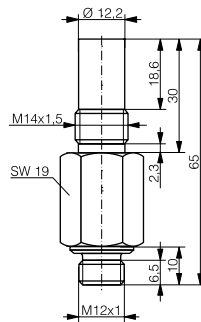

* IO-Link available from Q4/18

DATA

* IO-Link

Sensing face material	Ceramic ZrO ₂
Operating pressure	500 bar
Peak pressure	1000 bar
Housing material	Stainless steel V4A / AISI 316L
Connection	Connector S12
Degree of protection	IP 68
Mounting	Embeddable
Max. switching frequency	500 Hz
Supply voltage range	10 ... 30 VDC
Ambient temperature range	-25 ... +100°C / -13 ... +212°F
Output current	≤ 200 mA
PNP NO	DW-AS-503-P20
NPN NO	DW-AS-501-P20
Other types available	PNP NC, NPN NC



CONTRINEX
DW-AD-703-C23
5m 7 mm
PNP NO 638718 A
CE
IO-Link

CONTRINEX
DW-AS-612-1

CONTRINEX
is 400

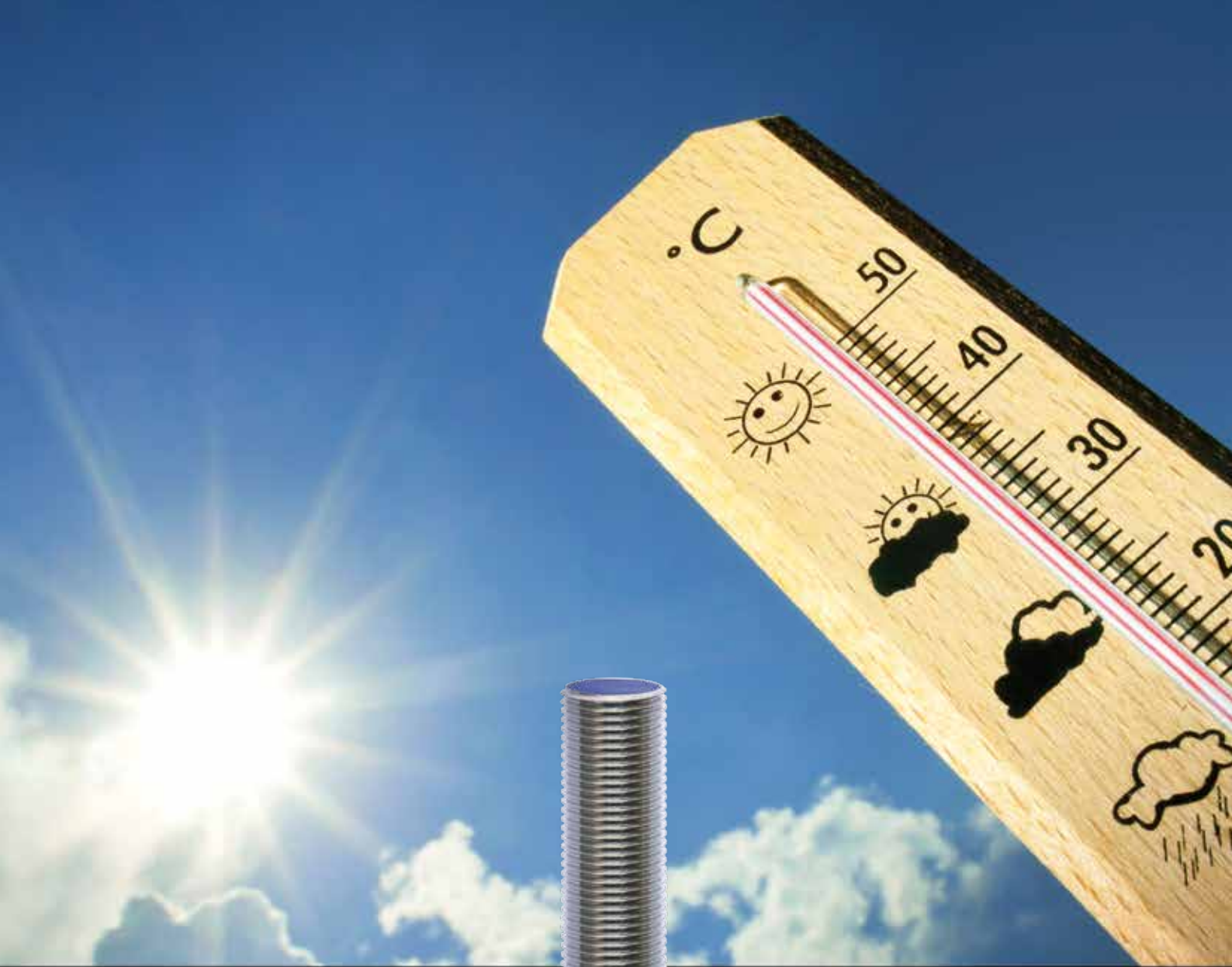

TEMPERATURE RESISTANT UP TO +120°C (+248°F)

EXTRA TEMPERATURE INDUCTIVE SENSORS

KEY ADVANTAGES

- ✓ Temperature resistant up to +120°C (+248°F)
- ✓ Excellent long term reliability
- ✓ Outstanding accuracy
- ✓ High quality ASIC sensors with  IO-Link interface

RANGE OVERVIEW	Housing size	Classics
EXTRA TEMPERATURE	M5	p. 143
	M8	p. 143
	M12	p. 143
	M18	p. 143

FAMILY

HOUSING SIZE

OPERATING DISTANCE MM

INDUCTIVE

WIRING DIAGRAMS

PNP NO

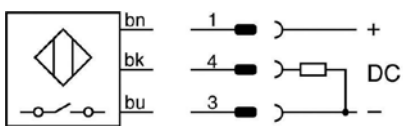

NPN NO

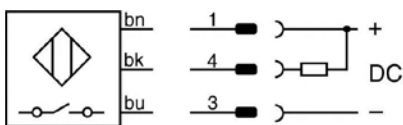

DATA

Housing material

Connection

Degree of protection

Mounting

Max. switching frequency

Supply voltage range

Ambient temperature range

Output current

PNP NO

NPN NO

Other types available

EXTRA TEMPERATURE

CLASSICS	CLASSICS	CLASSICS	CLASSICS	CLASSICS
M5	M8	M12	M12	M18
0.8	4	2	4	5

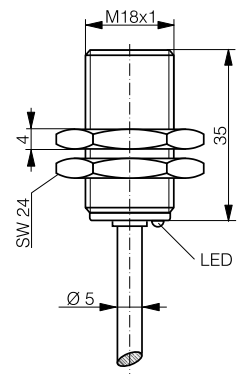
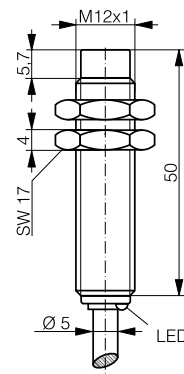
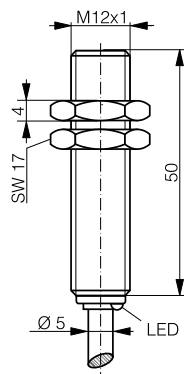
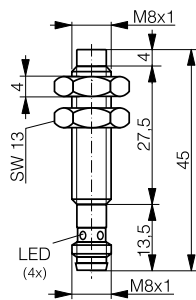
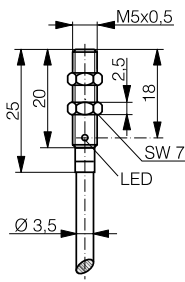

IO-Link	IO-Link	IO-Link	IO-Link	IO-Link
Stainless steel V2A	Stainless steel V2A	Nickel-plated brass	Nickel-plated brass	Nickel-plated brass
Silicone cable 2 m	Connector S8	PVC cable 6 m	PVC cable 5 m	PUR cable 2 m
IP 67	IP 67	IP 67	IP 67	IP 67
Embeddable	Non-embeddable	Embeddable	Non-embeddable	Embeddable
5000 Hz	3500 Hz	3000 Hz	2000 Hz	2000 Hz
10 ... 30 VDC	10 ... 30 VDC	10 ... 30 VDC	10 ... 30 VDC	10 ... 30 VDC
-25...+120°C / -13...+248°F	0...+85°C / +32 ...+185°F	-25...+100°C / -13...+212°F	-25...+100°C / -13...+212°F	-40...+100°C / -40...+212°F
≤ 200 mA	≤ 200 mA	≤ 200 mA	≤ 200 mA	≤ 200 mA
DW-AD-603-M5-735	DW-AS-633-M8-732	DW-AD-603-M12-734	DW-AD-613-M12-733	DW-AD-603-M18-718
DW-AD-601-M5-735				

Inductive

Photoelectric

Safety

RFID

Connectivity

Accessories

Glossary

Index



TEMPERATURE RESISTANT UP TO +230°C (+446°F)



HIGH TEMPERATURE INDUCTIVE SENSORS

KEY ADVANTAGES

- ✓ Highest long-term stability due to fully potted electronics
- ✓ 100 % silicone-free
- ✓ Long sensor life
- ✓ Reliable sensing in high temperature applications
- ✓ Compact construction with integral amplifier for temperatures up to +180°C (+356°F)
- ✓ External amplifier module for temperatures up to +230°C (+446°F)

RANGE OVERVIEW

Housing size

Classics

HIGH TEMPERATURE

M8

p. 147

M12

p. 147

M18

p. 147-148

M30

p. 148-149

M50

p. 149

ADDITIONAL RANGES

PART REFERENCE	HOUSING SIZE	OPERATING DISTANCE MM
DW-HD-623-M8-100	M8	2
DW-HD-621-M8-100	M8	2
DW-HD-603-M12-200	M12	3
DW-HD-601-M12-200	M12	3
DW-HD-603-M18-310	M18	5
DW-HD-601-M18-310	M18	5
DW-HD-603-M30-310	M30	10
DW-HD-601-M30-310	M30	10
DW-HD-603-M50-411	M50	20
DW-HD-601-M50-411	M50	20
DW-HD-613-M50-411	M50	25
DW-HD-611-M50-411	M50	25

FAMILY

HOUSING SIZE

OPERATING DISTANCE MM

INDUCTIVE

WIRING DIAGRAMS

PNP NO

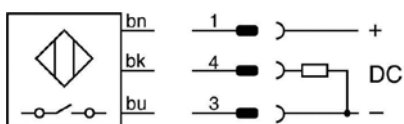

NPN NO

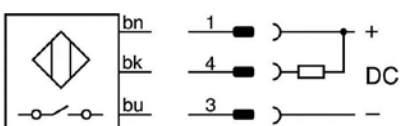

DATA

Amplifier

Housing material

Connection

Degree of protection

Mounting

Max. switching frequency

Supply voltage range

Ambient temperature range

Output current

PNP NO

NPN NO

Other types available

HIGH TEMPERATURE

CLASSICS	CLASSICS	CLASSICS	CLASSICS
M8	M12	M12	M18
2	3	4	5

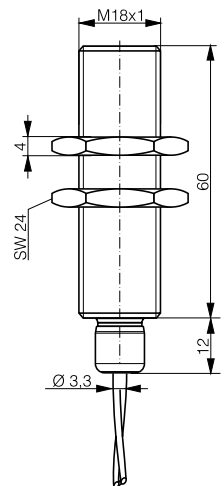
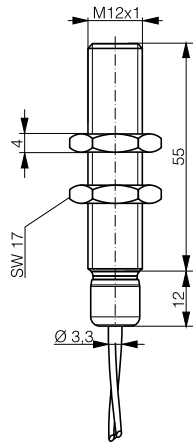
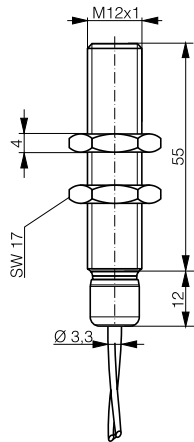
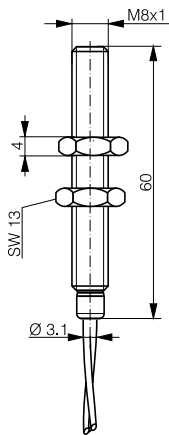

100% SILICONE FREE	100% SILICONE FREE	100% SILICONE FREE	100% SILICONE FREE
Built-in	Built-in	Built-in	Built-in
Ferritic stainless steel	Ferritic stainless steel	Ferritic stainless steel	Ferritic stainless steel
FEP cable 2 m	FEP cable 2 m	FEP cable 2 m	FEP cable 2 m
IP 67	IP 67	IP 67	IP 67
Embeddable	Embeddable	Embeddable	Embeddable
1500 Hz	1200 Hz	1200 Hz	1000 Hz
10 ... 30 VDC	10 ... 30 VDC	10 ... 30 VDC	10 ... 30 VDC
-25 ... +140°C / -13 ... +284°F	-25 ... +180°C / -13 ... +356°F	-25 ... +180°C / -13 ... +356°F	-25 ... +180°C / -13 ... +356°F
120 mA (≤ 100°C) / 80 mA (> 100°C)	120 mA (≤ 100°C) / 70 mA (> 100°C)	120 mA (≤ 100°C) / 70 mA (> 100°C)	≤ 150 mA
DW-HD-623-M8-610	DW-HD-603-M12-810	DW-HD-623-M12-810	DW-HD-603-M18-810
DW-HD-621-M8-610	DW-HD-601-M12-810	DW-HD-621-M12-810	DW-HD-601-M18-810

Inductive

Photoelectric

Safety

RFID

Connectivity

Accessories

Glossary

Index

HIGH TEMPERATURE

INDUCTIVE

FAMILY	CLASSICS	CLASSICS
HOUSING SIZE	M30	M18
OPERATING DISTANCE MM	10	5

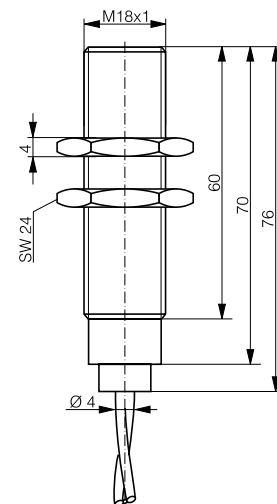
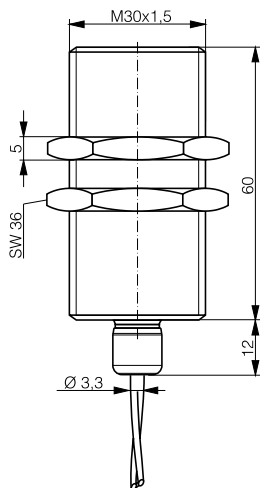

DATA	100% SILICONE FREE	
Amplifier	Built-in	External
Housing material	Ferritic stainless steel	Stainless steel V2A
Connection	FEP cable 2 m	Teflon cable 3 m
Degree of protection	IP 67	IP 67
Mounting	Embeddable	Embeddable
Max. switching frequency	500 Hz	300 Hz
Supply voltage range	10 ... 30 VDC	10 ... 30 VDC (amplifier)
Ambient temperature range	-25 ... +180°C / -13 ... +356°F	0 ... +230°C / +32 ... +440°F
Output current	≤ 150 mA	≤ 200 mA (amplifier)
PNP NO	DW-HD-603-M30-810	DW-HD-603-M18-411
NPN NO	DW-HD-601-M30-810	DW-HD-601-M18-411
Other types available		

HIGH TEMPERATURE

CLASSICS	CLASSICS	CLASSICS
M30	M50	M50
10 (15)	25	25

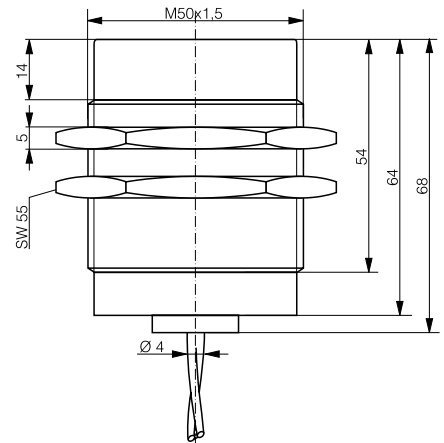
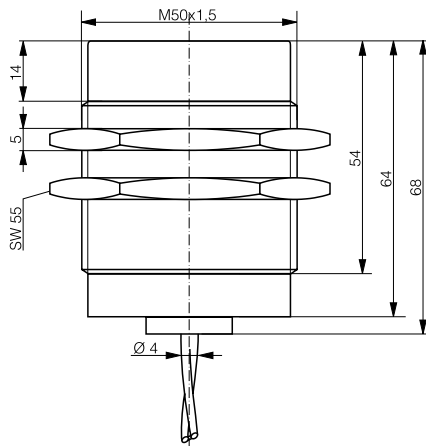
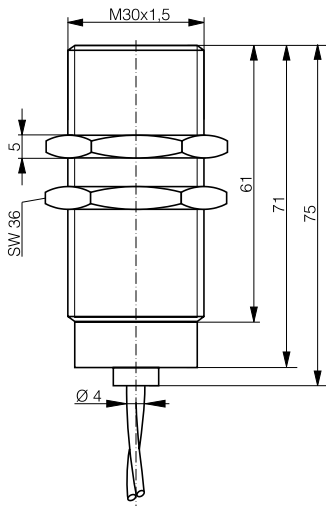

External	External	External
Stainless steel V2A	Stainless steel V2A	Stainless steel V2A
Teflon cable 3 m	Teflon cable 5 m	Teflon cable 20 m
IP 67	IP 67	IP 67
Embeddable	Non-embeddable	Non-embeddable
200 Hz	150 Hz	150 Hz
10 ... 30 VDC (amplifier)	10 ... 30 VDC (amplifier)	10 ... 30 VDC (amplifier)
0 ... +230°C / +32 ... +440°F	-40 ... +230°C / -40 ... +440°F	0 ... +230°C / + 32 ... +440°F
≤ 200 mA (amplifier)	≤ 200 mA (amplifier)	≤ 200 mA (amplifier)
DW-HD-603-M30-411	DW-HD-613-M50-511	DW-HD-613-M50-503
DW-HD-601-M30-411		
Non-embeddable (Sn 15 mm)	For other cable lengths please ask	For other cable lengths please ask

Inductive

Photoelectric

Safety

RFID

Connectivity

Accessories

Glossary

Index



DURABLE AND RELIABLE IN WELDING CELLS



WELD- IMMUNE

INDUCTIVE SENSORS

KEY ADVANTAGES

- ✓ Resistant to electromagnetic fields of up to 40 millitesla
- ✓ Extremely robust
- ✓ Easy to clean - even using harsh methods
- ✓ No false switching caused by metal dust or chips
- ✓ Factor 1 on steel and aluminum
- ✓ No extra protection needed
- ✓ Long operating distances

RANGE OVERVIEW	Housing size	Full Inox
WELD- IMMUNE	M8	p. 153
	M12	p. 153
	M18	p. 153

FAMILY

HOUSING SIZE

OPERATING DISTANCE MM

INDUCTIVE

WIRING DIAGRAM

PNP NO

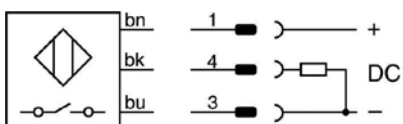

DATA

Sensing face material

Welding systems MF

Welding systems 50 Hz

Housing material

Connection

Degree of protection

Mounting

Max. switching frequency

Supply voltage range

Ambient temperature range

Output current

PNP NO

PNP NO

Other types available

WELD-IMMUNE

FULL INOX	FULL INOX	FULL INOX
M8	M12	M18
3	6	10

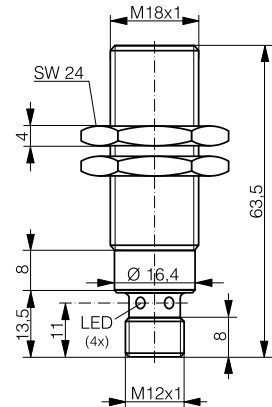
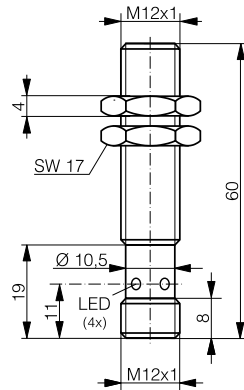
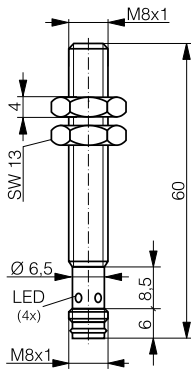

Stainless steel V2A	Stainless steel V2A	Stainless steel V2A
Up to 15 kA	Up to 15 kA	Up to 15 kA
≤ 40 mT (-673) / 500 ms (-761)	≤ 40 mT (-673) / 500 ms (-761)	≤ 40 mT (-673) / 500 ms (-761)
Stainless steel V2A	Stainless steel V2A	Stainless steel V2A
Connector S8	Connector S12	Connector S12
IP 68 / IP 69K	IP 68 / IP 69K	IP 68 / IP 69K
Embeddable	Embeddable	Embeddable
15 Hz (-673) / 1 Hz (-761)	15 Hz (-673) / 1 Hz (-761)	15 Hz (-673) / 1 Hz (-761)
10 ... 30 VDC	10 ... 30 VDC	10 ... 30 VDC
-25 ... +85°C / -13 ... +185°F	-25 ... +85°C / -13 ... +185°F	-25 ... +85°C / -13 ... +185°F
≤ 200 mA	≤ 200 mA	≤ 200 mA
DW-AS-703-M8-673	DW-AS-703-M12-673	DW-AS-703-M18-673
DW-AS-703-M8-761	DW-AS-703-M12-761	DW-AS-703-M18-761

Inductive

Photoelectric

Safety

RFID

Connectivity

Accessories

Glossary

Index



FOR THE HARSHTEST MACHINING ENVIRONMENTS

CHIP- IMMUNE

INDUCTIVE SENSORS

KEY ADVANTAGES

- ✓ Detection not influenced by chips of steel, stainless steel, aluminum, brass, copper or titanium
- ✓ Detection of targets made of the above metals
- ✓ Robust, one-piece stainless-steel housing, protection rating IP 68 and IP 69K
- ✓ Temperature range -25 to +85°C (-13 to +185°F)
- ✓ Size M12, M18 and M30
- ✓ Operating distances up to 12 mm
- ✓  **IO-Link**

RANGE OVERVIEW

Housing size

Full Inox

CHIP- IMMUNE

M12

p. 157

M18

p. 157

M30

p. 157

FAMILY

HOUSING SIZE

OPERATING DISTANCE MM

INDUCTIVE

WIRING DIAGRAM

PNP NO

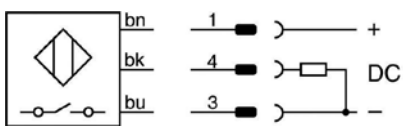

DATA

Sensing face material

Housing material

Connection

Degree of protection

Mounting

Max. switching frequency

Supply voltage range

Ambient temperature range

Output current

PNP NO

Other types available

CHIP-IMMUNE

FULL INOX	FULL INOX	FULL INOX
M12	M18	M30
3	5	12

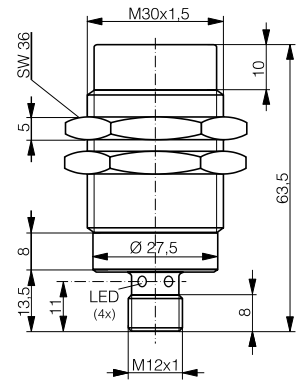
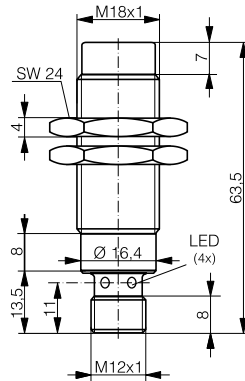
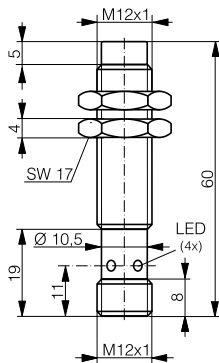

IO-Link	IO-Link	IO-Link
Stainless steel V2A	Stainless steel V2A	Stainless steel V2A
Stainless steel V2A	Stainless steel V2A	Stainless steel V2A
Connector S12	Connector S12	Connector S12
IP 68 / IP 69K	IP 68 / IP 69K	IP 68 / IP 69K
Non-embeddable	Non-embeddable	Non-embeddable
≤ 400 Hz	≤ 200 Hz	≤ 90 Hz
10 ... 30 VDC	10 ... 30 VDC	10 ... 30 VDC
-25 ... +85°C / -13 ... +185°F	-25 ... +85°C / -13 ... +185°F	-25 ... +85°C / -13 ... +185°F
≤ 200 mA	≤ 200 mA	≤ 200 mA
DW-AS-713-M12-967	DW-AS-713-M18-967	DW-AS-713-M30-967
NPN on request	NPN on request	NPN on request

Inductive

Photoelectric

Safety

RFID

Connectivity

Accessories

Glossary

Index



DOUBLE-SHEET

INDUCTIVE SENSORS

KEY ADVANTAGES

- ✓ Double-sheet detection (steel and aluminum) with sensitivity of 0.8 - 1.2 mm per sheet
- ✓ Full Inox: extremely robust one-piece stainless-steel housing
- ✓ Corrosion resistant
- ✓ IP 68 and IP 69K
- ✓ Pressure resistant up to 80 bar

RANGE OVERVIEW	Housing size	Full Inox
DOUBLE-SHEET	M30	p. 161

FAMILY

HOUSING SIZE

OPERATING DISTANCE MM

INDUCTIVE

WIRING DIAGRAM

PNP NO

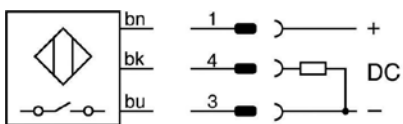

DATA

Housing material

Connection

Degree of protection

Mounting

Max. switching frequency

Supply voltage range

Ambient temperature range

Output current

PNP NO

Description

DOUBLE-SHEET

FULL INOX		
M30		
3 ... 5		

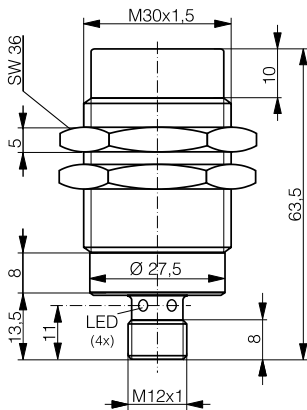

Stainless steel V2A		
Connector S12		
IP 68 / IP 69K		
Non-embeddable		
10 Hz		
10 ... 30 VDC		
-25 ... +85°C / -13 ... +185°F		
≤ 200 mA		
DW-AS-713-M30-618		
Double-sheet		

Inductive
Photoelectric
Safety
RFID
Connectivity
Accessories
Glossary
Index



FOR SHIPS, PORTS AND OFFSHORE



MARITIME

INDUCTIVE SENSORS

KEY ADVANTAGES

- ✓ GL approved, class DNV-GL-CG-0339
- ✓ Extremely rugged sensors, fit for Industry 4.0
- ✓ Special EMC protection
- ✓ Resistant to corrosion and salt water
- ✓ Impervious, enclosure rating IP 68 or IP 69K
- ✓ Temperature range -25 ... +85°C (-13 ... +185°F)
- ✓ Full Inox types: one-piece stainless-steel housing (V4A/AISI 316L), factor 1 on steel and aluminum
- ✓ Pressure-resistance available up to 500 bar (800 bar peak)
- ✓  **IO-Link** interface

RANGE OVERVIEW

Housing size

Full Inox

MARITIME

M12

p. 165

M18

p. 166

M30

p. 166-167

C23

p. 167

FAMILY

HOUSING SIZE

OPERATING DISTANCE MM

INDUCTIVE

WIRING DIAGRAMS

PNP NO

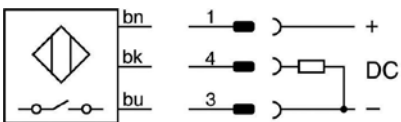

DATA

Housing material

Connection

Degree of protection

Mounting

Max. switching frequency

Supply voltage range

Ambient temperature range

Output current

PNP NO

Other types available

MARITIME

FULL INOX	FULL INOX	FULL INOX	FULL INOX
M12 (P12)	M12 (P12)	M12	M12
1.5	1.5	6	6

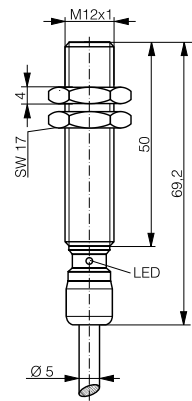
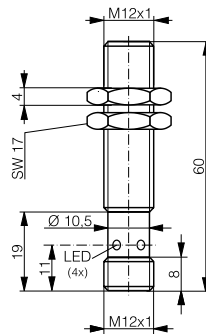
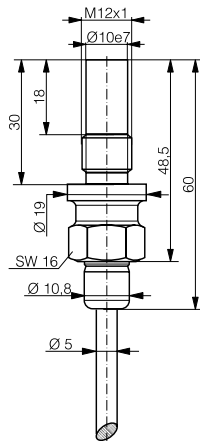
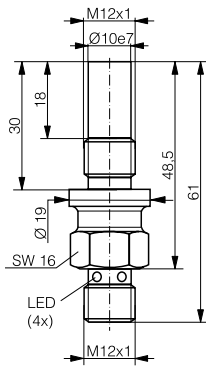

IO-Link	IO-Link	IO-Link	IO-Link
Stainless steel V4A/AISI 316L	Stainless steel V4A/AISI 316L	Stainless steel V4A/AISI 316L	Stainless steel V4A/AISI 316L
Connector S12	PUR cable	Connector S12	PUR cable
IP 68 / IP 69K	IP 68 / IP 69K	IP 68 / IP 69K	IP 68 / IP 69K
Embeddable	Embeddable	Embeddable	Embeddable
850 Hz	850 Hz	600 Hz	600 Hz
10 ... 30 VDC	10 ... 30 VDC	10 ... 30 VDC	10 ... 30 VDC
-25 ... +85°C / -13 ... +185°F	-25 ... +85°C / -13 ... +185°F	-25 ... +85°C / -13 ... +185°F	-25 ... +85°C / -13 ... +185°F
≤ 200 mA	≤ 200 mA	≤ 200 mA	≤ 200 mA
DW-MS-703-P12G	DW-MD-703-P12G	DW-MS-703-M12	DW-MD-703-M12

Inductive

Photoelectric

Safety

RFID

Connectivity

Accessories

Glossary

Index

MARITIME

FAMILY

FULL INOX

FULL INOX

FULL INOX

HOUSING SIZE

M18

M18

M30

OPERATING DISTANCE MM

10

10

20

INDUCTIVE

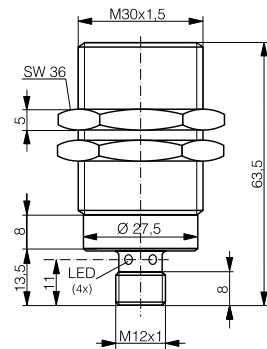
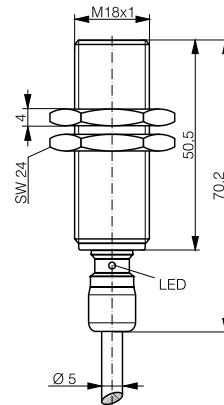
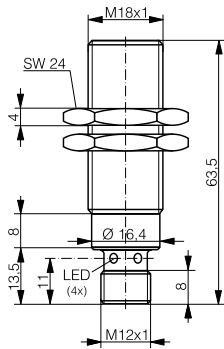

DATA

IO-Link

IO-Link

IO-Link

Housing material

Stainless steel V4A/AISI 316L

Stainless steel V4A/AISI 316L

Stainless steel V4A/AISI 316L

Connection

Connector S12

PUR cable

Connector S12

Degree of protection

IP 68 / IP 69K

IP 68 / IP 69K

IP 68 / IP 69K

Mounting

Embeddable

Embeddable

Embeddable

Max. switching frequency

200 Hz

200 Hz

125 Hz

Supply voltage range

10 ... 30 VDC

10 ... 30 VDC

10 ... 30 VDC

Ambient temperature range

-25 ... +85°C / -13 ... +185°F

-25 ... +85°C / -13 ... +185°F

-25 ... +85°C / -13 ... +185°F

Output current

≤ 200 mA

≤ 200 mA

≤ 200 mA

PNP NO

DW-MS-703-M18-002

DW-MD-703-M18

DW-MS-703-M30-002

Other types available

MARITIME

FULL INOX	FULL INOX	FULL INOX
M30	C23	C23
20	7	7

Inductive



Photoelectric

Safety

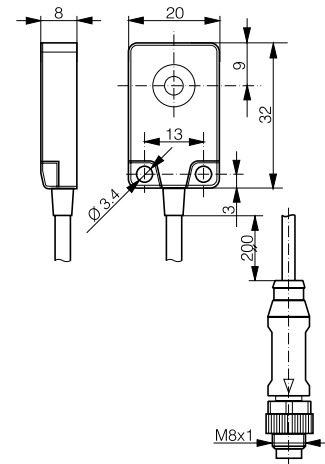
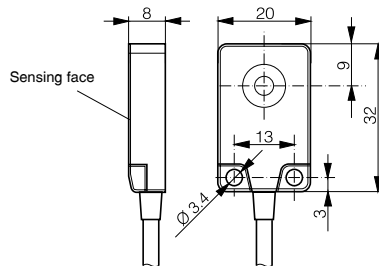
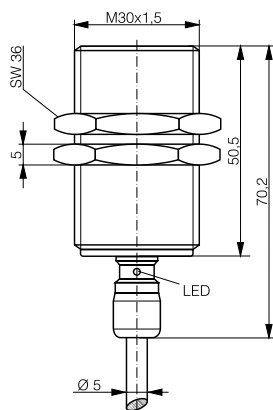

RFID

Connectivity

Accessories

IO-Link	IO-Link	IO-Link
Stainless steel V4A/AISI 316L	Stainless steel V4A/AISI 316L	Stainless steel V4A/AISI 316L
PUR cable	PVC cable	PVC cable + connector S8
IP 68 / IP 69K	IP 68 / IP 69K	IP 68 / IP 69K
Embeddable	Embeddable	Embeddable
125 Hz	180 Hz	180 Hz
10 ... 30 VDC	10 ... 30 VDC	10 ... 30 VDC
-25 ... +85°C / -13 ... +185°F	-25 ... +85°C / -13 ... +185°F	-25 ... +85°C / -13 ... +185°F
≤ 200 mA	≤ 200 mA	≤ 200 mA
DW-MD-703-M30	DW-MD-703-C23	DW-MV-703-C23-276

Glossary

Index



ECOLAB APPROVED FOR HARSHTEST CLEANING PROCESSES

WASHDOWN

INDUCTIVE SENSORS

KEY ADVANTAGES

- ✓ Corrosion resistant
- ✓ Food safe
- ✓ IP 68 / IP 69K protection
- ✓  IO-Link interface
- ✓ Extremely rugged Full Inox types:
one-piece stainless-steel housing, factor 1 on steel and
aluminum, Ecolab approved

RANGE OVERVIEW	Housing size	Classics	Full Inox
WASHDOWN	M12	p. 171	p. 171-172
	M18		p. 172-173
	M30		p. 173-174

FAMILY

HOUSING SIZE

OPERATING DISTANCE MM

INDUCTIVE

WIRING DIAGRAM

PNP NO

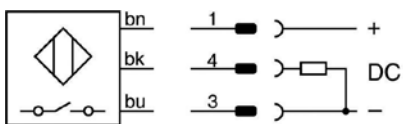

DATA

Operating pressure

Housing material

Connection

Degree of protection

Mounting

Max. switching frequency

Supply voltage range

Ambient temperature range

Output current

PNP NO

Other types available

WASHDOWN

CLASSICS	FULL INOX	FULL INOX	FULL INOX
M12	M12	M12	M12
2	6	6	10

Inductive

Photoelectric

Safety

RFID

Connectivity

Accessories

Glossary

Index

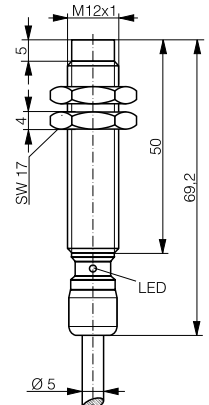
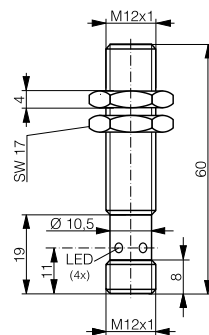
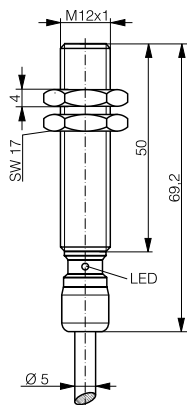
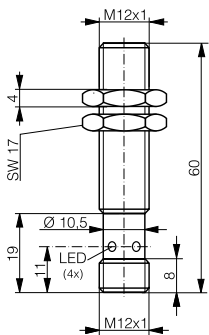

IO-Link	IO-Link	IO-Link	IO-Link
-	80 bar	80 bar	80 bar
PPS/Stainless steel V4A	Stainless steel V4A/AISI 316L	Stainless steel V4A/AISI 316L	Stainless steel V4A/AISI 316L
Connector S12	TPE-S cable	Connector S12	TPE-S cable
IP 68 / IP 69K	IP 68 / IP 69K	IP 68 / IP 69K	IP 68 / IP 69K
Embeddable	Embeddable	Embeddable	Non-embeddable
1700 Hz	600 Hz	600 Hz	400 Hz
10 ... 30 VDC	10 ... 30 VDC	10 ... 30 VDC	10 ... 30 VDC
-40 ... +120°C / -40 ... +248°F	-25 ... +85°C / -13 ... +185°F	-25 ... +85°C / -13 ... +185°F	-25 ... +85°C / -13 ... +185°F
≤ 200 mA	≤ 200 mA	≤ 200 mA	≤ 200 mA
DW-LS-603-M12	DW-LD-703-M12	DW-LS-703-M12	DW-LD-713-M12
	NPN NO, PNP NC, NPN NC	NPN NO, PNP NC, NPN NC	NPN NO, PNP NC, NPN NC

WASHDOWN

INDUCTIVE

FAMILY	FULL INOX	FULL INOX	FULL INOX
HOUSING SIZE	M12	M18	M18
OPERATING DISTANCE MM	10	10	10

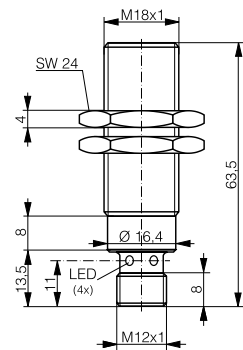
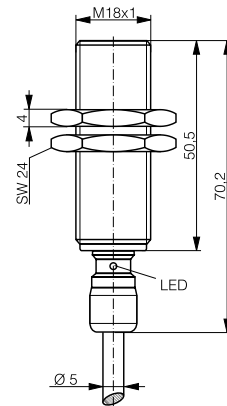
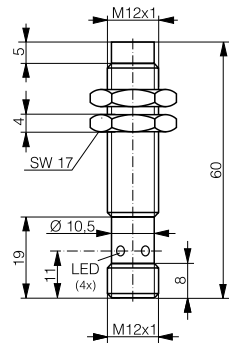

DATA	IO-Link	IO-Link	IO-Link
Operating pressure	80 bar	60 bar	60 bar
Housing material	Stainless steel V4A/AISI 316L	Stainless steel V4A/AISI 316L	Stainless steel V4A/AISI 316L
Connection	Connector S12	TPE-S cable	Connector S12
Degree of protection	IP 68 / IP 69K	IP 68 / IP 69K	IP 68 / IP 69K
Mounting	Non-embeddable	Embeddable	Embeddable
Max. switching frequency	400 Hz	300 Hz	300 Hz
Supply voltage range	10 ... 30 VDC	10 ... 30 VDC	10 ... 30 VDC
Ambient temperature range	-25 ... +85°C / -13 ... +185°F	-25 ... +85°C / -13 ... +185°F	-25 ... +85°C / -13 ... +185°F
Output current	≤ 200 mA	≤ 200 mA	≤ 200 mA
PNP NO	DW-LS-713-M12	DW-LD-703-M18	DW-LS-703-M18-002
Other types available	NPN NO, PNP NC, NPN NC	NPN NO, PNP NC, NPN NC	NPN NO, PNP NC, NPN NC

WASHDOWN

FULL INOX	FULL INOX	FULL INOX
M18	M18	M30
20	20	20

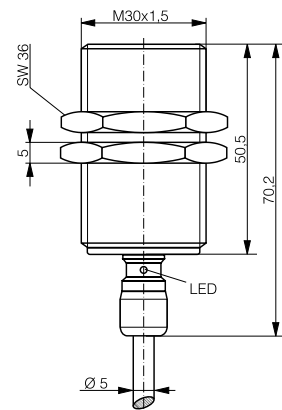
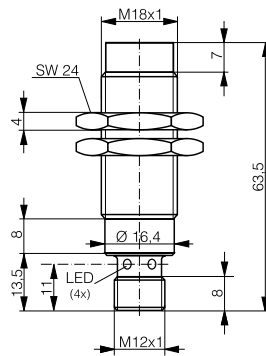
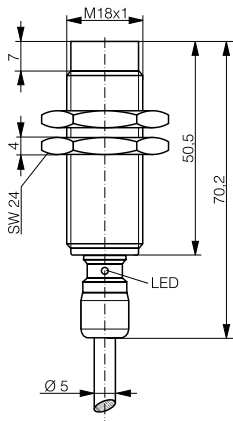

IO-Link	IO-Link	IO-Link
60 bar	60 bar	40 bar
Stainless steel V4A/AISI 316L	Stainless steel V4A/AISI 316L	Stainless steel V4A/AISI 316L
TPE-S cable	Connector S12	TPE-S cable
IP 68 / IP 69K	IP 68 / IP 69K	IP 68 / IP 69K
Non-embeddable	Non-embeddable	Embeddable
200 Hz	200 Hz	100 Hz
10 ... 30 VDC	10 ... 30 VDC	10 ... 30 VDC
-25 ... +85°C / -13 ... +185°F	-25 ... +85°C / -13 ... +185°F	-25 ... +85°C / -13 ... +185°F
≤ 200 mA	≤ 200 mA	≤ 200 mA
DW-LD-713-M18	DW-LS-713-M18-002	DW-LD-703-M30
NPN NO, PNP NC, NPN NC	NPN NO, PNP NC, NPN NC	NPN NO, PNP NC, NPN NC

Inductive

Photoelectric

Safety

RFID

Connectivity

Accessories

Glossary

Index

WASHDOWN

INDUCTIVE

FAMILY	FULL INOX	FULL INOX	FULL INOX
HOUSING SIZE	M30	M30	M30
OPERATING DISTANCE MM	20	40	40

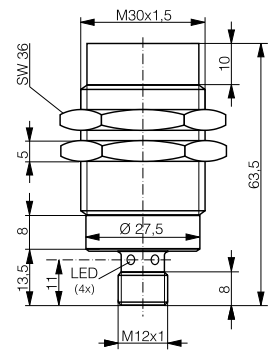
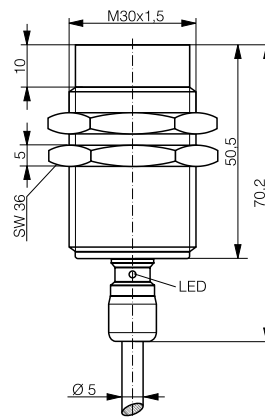
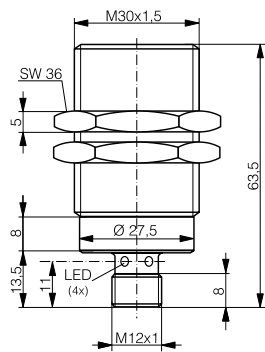

DATA	IO-Link	IO-Link	IO-Link
Operating pressure	40 bar	40 bar	40 bar
Housing material	Stainless steel V4A/AISI 316L	Stainless steel V4A/AISI 316L	Stainless steel V4A/AISI 316L
Connection	Connector S12	TPE-S cable	Connector S12
Degree of protection	IP 68 / IP 69K	IP 68 / IP 69K	IP 68 / IP 69K
Mounting	Embeddable	Non-embeddable	Non-embeddable
Max. switching frequency	100 Hz	90 Hz	90 Hz
Supply voltage range	10 ... 30 VDC	10 ... 30 VDC	10 ... 30 VDC
Ambient temperature range	-25 ... +85°C / -13 ... +185°F	-25 ... +85°C / -13 ... +185°F	-25 ... +85°C / -13 ... +185°F
Output current	≤ 200 mA	≤ 200 mA	≤ 200 mA
PNP NO	DW-LS-703-M30-002	DW-LD-713-M30	DW-LS-713-M30-002
Other types available	NPN NO, PNP NC, NPN NC	NPN NO, PNP NC, NPN NC	NPN NO, PNP NC, NPN NC



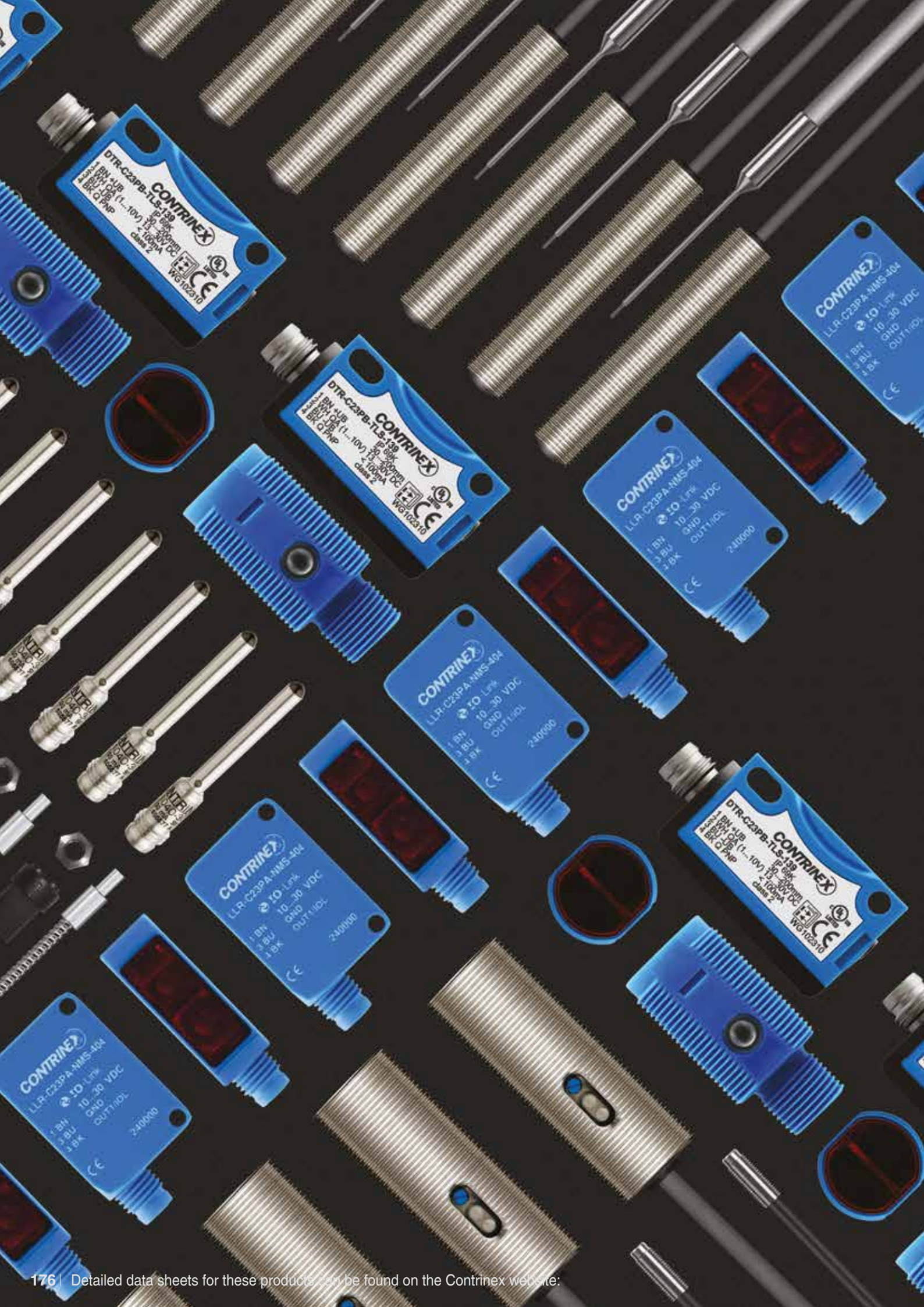



PHOTOELECTRIC SENSORS

HIGHLIGHTS:



- ✓ Complete C23 series with first-class sensing ranges
- ✓ Excellent background suppression sensors
- ✓ Smallest self-contained miniature sensors on the market
- ✓ Wide range of fiber-optic amplifiers, including  IO-Link
- ✓ Excellent color and contrast recognition sensors

















NEW:

- ✓ C23 sensors with patented UV technology for transparent object detection, including  IO-Link
- ✓ M18 series with short plastic housing and  IO-Link
- ✓ Distance measurement sensors in C23 and C55 size with  IO-Link
- ✓ Detection and measurement light grids



PROGRAM OVERVIEW

	SERIES		1040	1050	1120	M18P	1180
	HOUSING SIZE IN MM		∅ 4 IO-Link 2019	M5 IO-Link 2019	M12 IO-Link 2019	M18 IO-Link	M18 IO-Link 2019
	OPERATING PRINCIPLE	SENSING RANGE	CYLINDRICAL				
STANDARD	Diffuse	0 ... 1500 mm			☑ p.191	☑ p.196	☑ p.200-201, 205 
	Background suppression	2 ... 5000 mm				☑ p.195	☑ p.199-200
	Reflex	0 ... 8000 mm			☑ p.192	☑ p.197	☑ p.202-203
	Through-beam	0 ... 50,000 mm			☑ p.192-193 	☑ p.197	☑ p.203-204, 206 
MINIATURE	Diffuse	0 ... 90 mm	☑ p.229-231	☑ p.232-234			
	Background suppression	2 ... 120 mm					
	Reflex	0 ... 3000 mm					
	Through-beam	0 ... 2000 mm	☑ p.231	☑ p.235			
TRANSPARENT OBJECT	Reflex, UV light	0 ... 1200 mm					
	Reflex, red light	10 ... 5000 mm					
FIBER OPTIC SENSORS AND FIBERS	Amplifier	0 ... 200 mm					
	Plastic fiber	0 ... 1800 mm					
	Glass fiber	0 ... 1500 mm					
DISTANCE	Short range	20 ... 200 mm					
	Medium range	60 ... 5000 mm					
COLOR AND CONTRAST	Color	30 ... 40 mm					
	Contrast	12 mm					
LIGHT GRIDS	Detection	80 ... 8000 mm					
	Measurement	300 ... 4000 mm					

											Inductive
0507	C12	C23	3030	3060	4040	4050	C55	DGI	MGI		
5x7x40	13x21x7 13x27x7	20x30x10 20x34x12  IO-Link	30x30x15	31x60x10  IO-Link	40x40x19	40x50x15  IO-Link	50x50x23  IO-Link	40x20xH	40x20xH		Photoelectric
CUBIC											Safety
		 p.210	p.215-216			p.221					
		 p.209	p.213-214			p.221	p.225 				
		 p.211	p.217-218			p.222					
		 p.211	p.219			p.222					RFID
p.237											
	p.239-240										
	p.240										
	p.241										Connectivity
		 p.245									
		 p.246-247									
			p.253-254	 p.257-259	p.261						Accessories
			p.262-271	p.262-271							
			p.277		p.272-276						
		p.283 									Glossary
							 p.285 				
						p.289					
						 p.289					
								p.293			Index
									p.295		

PROGRAM OVERVIEW

HOUSING SIZE	SENSING RANGE						PAGE
	1 mm	10 mm	100 mm	1000 mm	10,000 mm	100,000 mm	
DIFFUSE							
∅ 4 mm / M5	10 mm						229, 232
∅ 4 mm / M5	20 mm						230, 233
∅ 4 mm / M5	50 mm						231, 234
5 x 7 mm	20 mm						237
5 x 7 mm	50 mm						237
5 x 7 mm	90 mm						237
M12	300 mm						191
M18P	1200 mm						196
M18 (M18W)	600 mm						200-201
M18 ⚠	250 mm						205
M18 ⚠	600 mm						205
C23	1500 mm						210
30 x 30 mm	600 mm						215
30 x 30 mm	1200 mm						216
40 x 50 mm	1200 mm						221
BACKGROUND SUPPRESSION							
M18P	250 mm						195
M18 (M18W)	120 mm						199-200
C12	15 mm						239
C12	30 mm						240
C12	120 mm						239
C23	300 mm						209
30 X 30 mm	200 mm						213-214
40 X 50 mm	500 mm						221
C55 ⚠	5000 mm						225
REFLEX							
M12	1500 mm						192
M18P	7000 mm						197
M18 (M18W)	2000 mm						202-203
C12	3000 mm						240
C23	8000 mm						211
C23 (TRU)	1200 mm						245
C23 (TRR)	5000 mm						246-247
30 X 30 mm	2000 mm						217
30 X 30 mm	4000 mm						218
40 X 50 mm	4000 mm						222
ANALOG OUTPUT							
30 x 30 mm	100 mm						213

HOUSING SIZE	SENSING RANGE						PAGE
	1 mm	10 mm	100 mm	1000 mm	10,000 mm	100,000 mm	
THROUGH-BEAM							
Ø 4 mm						250 mm	231
M5						250 mm	235
M12					10,000 mm	192	
M12 ⚠					50,000 mm	193	
M18P					30,000 mm	197	
M18 (M18W)					20,000 mm	203-204	
M18 ⚠					50,000 mm	206	
C12					2000 mm	241	
C23					30,000 mm	211	
30 x 30 mm					6000 mm	219	
30 x 30 mm					12,000 mm	219	
40 x 50 mm					50,000 mm	222	
FIBER-OPTIC AMPLIFIER							
30 x 30 mm						60 mm	253
30 x 30 mm						120 mm	254
31 x 60 mm						100 mm	259
31 x 60 mm						200 mm	257-258
40 x 40 mm						150 mm	261
CONTRAST							
40 x 50 mm						12 mm	289
COLOR							
40 x 50 mm						40 mm	289
DISTANCE MEASURING							
C23						80 mm	283
C23 ⚠						100 mm	283
C23					200 mm	283	
C55 ⚠					5000 mm	285	
LIGHT GRIDS							
40 x 20.5 mm (Detection grid)					8000 mm	293	
40 x 20.5 mm (Measurement grid)					4000 mm	295	

Inductive

Photoelectric

Safety

RFID

Connectivity

Accessories

Glossary

Index

INTRODUCTION

OPERATING PRINCIPLE

The light-emitting diode (LED) emits a beam of modulated light towards the target. This beam is interrupted by the target, causing partial reflection. A part of the reflected light reaches the sensing face of the receiver. Depending on the operating principle, either the interrupted beam or the reflected light is used for further processing.

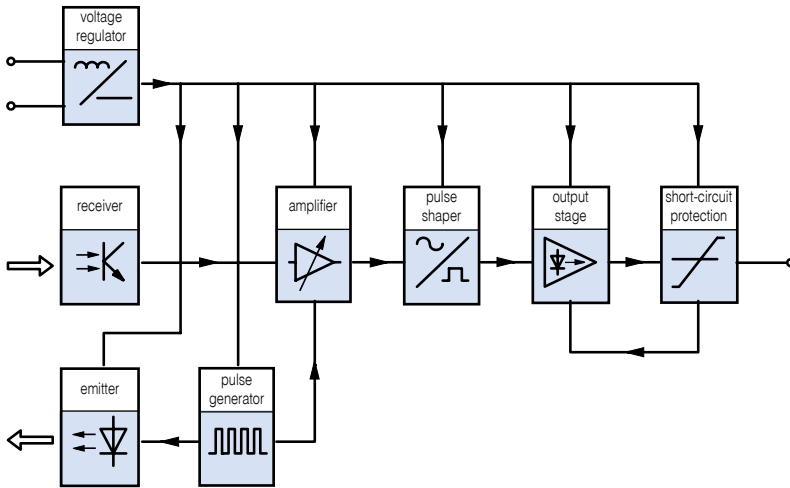

Fig. 9: Functional blocks of a photoelectric sensor

between reflections from the target and reflections from background objects, only triggering the sensor when the signal reaches a value that relates to the preset target distance.

The sensing range is practically insensitive to the target's size, color, shape and surface finish, and background-suppression sensors provide highly reliable detection of "difficult" targets, even against a light background. Stable, accurate detection of small, fast-moving parts on conveyors or automated machinery is possible over the entire sensing range, eliminating false triggering by objects in the background.

REFLEX

Long sensing range in a single-housing device

A reflex, or reflective, photoelectric sensor contains a transmitter and a receiver in a single housing, and emits a pulsed, focused light beam toward a distant reflector. Reflected light returns to the sensor, arriving at the receiver. When a target object interrupts the light beam, the receiver detects the reduced light intensity and triggers the sensor.

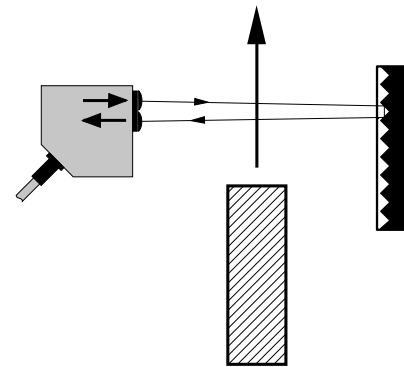

Fig. 11: Reflex sensing

The relatively high level of reflected light allows reflex sensors to achieve sensing distances up to eight meters. For applications where the target object itself reflects light back toward the sensor, models with polarization filters are available. The filters ensure that only light returned from the reflector reaches the receiver, ensuring reliable detection, even with reflective targets.

TECHNOLOGY FAMILIES

Contrinex photoelectric devices are divided into five **technology families**, depending on their operating principle. The program includes energetic **diffuse** sensors, diffuse sensors with **background suppression**, **reflex** sensors, **through-beam** sensors and sensors with **analog** output.

DIFFUSE

Versatile and cost-effective

A diffuse-mode, or energetic-diffuse, photoelectric sensor is a reflective sensor, containing a transmitter and a receiver in a single housing. The sensor emits a light beam toward a distant target that acts as a reflector, returning part of the transmitted light to the sensor. The receiver detects the amount of light reflected by the target, triggering the sensor when the light intensity reaches a threshold value.

Diffuse-mode sensors are cost-effective as they do not require separate reflectors or receivers, and detect reflective targets with ease. Sensing range depends on the target's size, shape, color and surface finish, although sensor sensitivity is adjustable during installation to compensate for targets with poor reflective qualities.

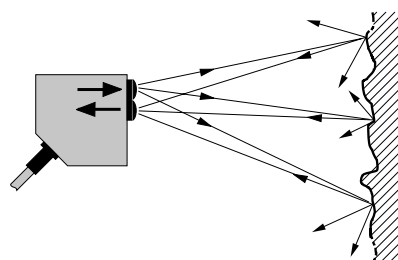

Fig. 10: Diffuse sensing

BACKGROUND SUPPRESSION

Excellent suppression of light-colored backgrounds

Diffuse-mode photoelectric sensors with background suppression emit a focused light beam toward a distant target. Part of the beam is reflected from the target and returns to the sensor, striking a position-sensitive receiver. The receiver distinguishes

THROUGH-BEAM

Emitter and receiver in separate housings for sensing ranges from 0 to 50 m

A through-beam photoelectric sensor comprises an emitter and receiver, each mounted in a separate housing. The emitter is aligned so that the greatest possible amount of pulsed light from its emitting diode reaches the receiver (Fig. 12). The receiver, which is mounted beyond the target area, processes incoming light in such a way that it is clearly separated from ambient and other light sources. Any interruption of the light beam by a target triggers the sensor, causing its output signal to switch. For reliable operation, the target must be completely opaque, and its size should be at least equal to the diameter of the receiver's aperture.

Contrinex through-beam photoelectric sensors are ideal for industrial applications where sensing components must be mounted some distance from the target area. Through-beam sensors utilize infrared, visible and laser light sources to detect opaque and semi-transparent targets, reliably and repeatably, at extended distances. They are available in cylindrical versions from subminiature ($\varnothing 4$) to small (M18) and cubic versions from miniature (20 mm x 30 mm x 10 mm) to small (40 mm x 50 mm x 15 mm).

ANALOG OUTPUT

Precise distance control

Photoelectric sensors with analog outputs are ideal for measuring absolute values of distance. Using background suppression-mode technology, analog photoelectric sensors produce an output signal that is accurately calibrated and approximately proportional to the distance of the target from the sensor. Users have a choice of current or voltage outputs that are compatible with all modern control systems.

Contrinex analog photoelectric sensors provide all the advantages of standard diffuse-mode sensors, and measure target distances up to 100 mm.

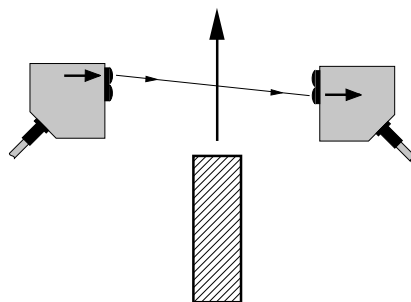

Fig. 12: Through-beam sensing

of process data, continuous diagnosis of sensor status, advanced parameter settings, sensitivity adjustment, a remote teach function and easy checking of sensor ID, to ensure the right sensor is at the right place. See page 186.

MINIATURE

Smallest on the market

The Contrinex **Miniature** range packs exceptional position- and presence-sensing performance into the smallest self-contained photoelectric sensors on the market. Designers have the choice of through-beam or diffuse sensors in $\varnothing 4$ and **M5** cylindrical metal housings that offer multiple mounting methods and beam orientation. For fully embedded applications, sensors with spherical sapphire-glass lenses produce focused, cylindrical light beams.

Types with a **5 mm x 7 mm** stainless-steel housing and a narrowly focused, cylindrical light beam are suitable for vertical or horizontal mounting directly on the supporting surface. Best-in-class sensing distances of up to 90 mm allow them to be positioned at a safe distance from the target.

The **C12** Series (13.5 mm x 21.8 mm x 7.7 mm) with small visible light spot thanks to red pinpoint LED offers long sensing ranges up to 2000 mm in a through-beam type and 3000 mm in a polarized reflex type. Two background suppression types are available with fixed sensing ranges up to 15 mm or 30 mm. A third type with 3-turn potentiometer (13.5 mm x 27.5 mm x 7.7 mm) reliably detects objects up to 120 mm.

PRODUCT RANGES

STANDARD

First-class performance for general use

Contrinex **Standard** photoelectric sensors are ideal for general position- and presence-detection in almost any industry. With first-class sensing ranges and outstanding background suppression characteristics, the Standard range of sensors delivers very high accuracy and reliability. Light sources include infrared, laser and pinpoint LED.

The **Standard** range offers a wide choice of cubic sizes: **C23** (20 x 30 x 10 mm), **3030** (30 x 30 x 15 mm), **4050** (40 x 50 x 15 mm) and **C55** (50 x 50 x 23 mm). Cylindrical types are available in sizes **M12** and **M18**, including some M18 types with housings adapted for right-angle detection.

Standard C23 and **M18P** series are high quality ASIC sensors with an integral **IO-Link** interface in PNP types. This makes them particularly suitable for smart factory applications. IO-Link extends sensor functionality to include continuous monitoring



INTRODUCTION

TRANSPARENT OBJECT

Outstanding reliability and ease of adjustment

The Contrinex **TRU-C23** photoelectric sensor is ideally suited for the presence control of transparent objects. Its patented technology uses **UV light**. Since transparent materials like plastic or glass absorb large amounts of polarized UV light, it is very easy to set the threshold at which the sensor switches. The shape or thickness of the target has no influence on detection. In addition, sensor performance is unaffected by dirt, water drops or aging.



The sensor system comprises an LED that emits polarized UV light and a UV reflector. Overall, the sensor's operating range is around **1200 mm**. Special optics with autocollimation ensure reliable detection and no blind zone, even close to the sensor or through a small notch. For applications requiring the detection of thicker or larger transparent objects, the **C23 Transparent Standard** can be the ideal solution. It operates with polarized, red light and has a maximum operating range up to **5000 mm**. Typical fields of application can be found in the food, pharmaceutical and packaging industries. Both sensor types include an IO-Link interface (see page 186).

FIBER-OPTIC SENSORS AND FIBERS

Reliable short and long-range sensing

The highly versatile **Fiber-Optic** range includes the self-contained **3030** and **4040** series (30 mm x 30 mm x 15 mm and 40 mm x 40 mm x 19 mm) and the DIN-rail mounted **3060** series (31 mm x 60 mm x 10 mm), suitable for multiple-sensor applications. **Synthetic fibers** are available for general use and **glass fibers** for high temperatures and aggressive environments.

Customers requiring intrinsically safe photoelectric sensors with DIN-rail-mounted electronics need not look beyond the Contrinex **3060** series of fiber-optic amplifiers. In a Crastin® housing, every model combines ease of set-up with market-leading features, including **IO-Link** (see page 186). With switching times as low as 0.1 millisecond, 3060 fiber-optic amplifiers are ideal for sensing fast-moving targets in demanding environments, including robotics, precision handling systems and printed circuit board production.

Distance setting is accomplished either by adjustment of a multi-turn potentiometer or by use of a teach-in function with manual fine adjustment. An optional digital display (model 3066) is also available. Using blue-light sources (model 3360), detecting glass is possible at distances up to 100 mm.

Fiber-optic sensors are common in explosive environments or in the presence of strong electromagnetic fields, but also in confined spaces. With bend-radii as small as 2 mm, reliable, accurate sensing is possible even in the most inaccessible areas.



DISTANCE

High precision and direct digital transmission

DTR-C23 and **DTL-C23** sensors use a triangulation method for highly accurate distance measurement at short range. Types with red light (DTR-C23) measure distances of **20 to 80 mm** or **30 to 200 mm**, while the measurement range for laser types (DTL-C23) is **20 to 100 mm**. Applications include small-part detection, position or height checking and monitoring material thickness on winding rolls.

For ranges up to **5000 mm**, **DTL-C55** sensors use the optical time-of-flight (TOF) method. In the **IO-Link** version, measurements are passed directly to the control system as millimeter values in digital form, with no need for an analog-to-digital converter and no signal drop for long lines. In addition, IO-Link provides diagnostic and other functions (see page 186). With two virtual switching points settable either via teach-in or direct parameter write-in, this sensor is ideal for use in mobile logistics, such as forklift trucks.

With both methods, distance measurement is largely independent of target color or surface characteristics. Detected distances can be output via an adjustable analog output and, for a digital output, a switching window of acceptance may be configured by teach-in.

The housings of **DTR-C23** and **DTL-C23** sensors (20 mm x 34 mm x 12 mm) and **DTL-C55** sensors (50 mm x 50 mm x 23 mm) have an **IP67/IP69K** enclosure rating. DTL-C55 sensors have **Ecolab** certification.



COLOR AND CONTRAST

Excellent resolution for smallest variations

Color photoelectric sensors utilize energetic-diffuse sensing technology to detect variations in target color, allowing color sorting or color control. A “teach-in” function is used to program up to three separate outputs. Contrinex color photoelectric sensors also feature five selectable tolerance levels for each output, enabling the sensor to recognize or ignore even the smallest variations of color.

Contrast sensors are ideal for detecting print marks in printing, labelling and packaging processes. Using a narrowly focused light beam and RGB emission technology, contrast sensors automatically select the best emission color (red, green or blue) during the teach-in procedure. Excellent contrast resolution, a high switching frequency (up to 10 kHz) and five tolerance levels ensure accurate detection and positioning, even when contrast differences are minimal. The integral **IO-Link** interface may be used to reduce changeover times through remote teach-in and parameterization. Other control functions, including monitoring, diagnosis and switching timer adjustment are also available (see page 289).

Contrinex color and contrast sensors have a rugged PBTP housing (40 mm x 50 mm x 15 mm) with **IP67** enclosure rating and are available in cable or adjustable (0°, 45° or 90°) connector versions.



LIGHT GRIDS

Fast detection, counting and measurement

The use of infrared **light grids** for non-contact measurement offers many advantages, including fast response times, reliable detection of the most varied objects and immunity to interference from ambient light. Potential applications for these keen-eyed, robust sensors are to be found in such fields of application as logistics or automated packaging systems and in harsh environments such as warehouses and the wood industry.

With the **DGI** (detection) and **MGI** (measurement) series, Contrinex presents compact infrared light grids as a robust plug-and-play solution. With a cross-section of only 40 x 20.5 mm, these space-saving devices are easily integrated into different systems. DGI types offer detection heights up to 2010 mm and are capable of detecting objects with diameters

of 0.9, 2, 4, 8 or 25 mm, depending on type. With response times between 0.8 and 4.8 ms, even small objects moving at high speed can be reliably detected and counted. Fields of application include the production of small parts or foil, packaging equipment and the pharmaceutical industry. In addition to detecting the presence of an object, MGI measurement types can also determine its dimensions and position. These sensors offer measurement heights up to 1438 mm and a resolution of 5 or 12 mm. Measurements are output as analog values of 0-10 V or as a 4-20 mA signal.



IO-LINK FUNCTIONALITY* WITH PHOTOELECTRIC SENSORS (PNP TYPES)

Data monitoring:

- 1 Detection status is monitored and continuously transmitted through IO-Link process data. This data contains both the detection state and the stability of detection (sufficient detection margin). It is possible, therefore, to determine whether the sensor is working too close to its detection threshold, for example due to window contamination.

Diagnosis:

- 2 The operating state of the sensor is checked. In case of wire break, under-voltage, disturbances on the receiver, sensor malfunction or installation of the wrong sensor, information is provided directly through IO-Link to enable fast repair, maintenance and replacement.

Sensitivity and teach:

- 3 The sensitivity of the sensor can be adjusted remotely by changing the threshold. Alternatively, the teach function can be used to adapt the threshold to the application. Calibrated sensing ranges ensure easy sensor replacement by uploading the existing sensitivity to the replacement sensor.

Light-on/Dark-on selection:

- 4 The output switching mode can be selected as light-on or dark-on. A single sensor type is configurable for the various needs of an application. This helps reduce the number of different sensor types required in stock.

Switching timer:

- 5 The timing of output switching can be configured. Depending on the needs of an application, output switching can be delayed or the duration stretched.

Sensor mode:

- 6 3 different modes are selectable depending on the application needs: "Normal", "Fast" and "Fine". "Normal" mode is a good balance of speed and precision. In "Fast" mode, speed is higher and in "Fine" mode precision is higher.

Sequence selection:

- 7 For cross-talk immunity with through-beam sensors, up to 9 different emitting sequences can be selected to pair the emitter with the receiver.

Detection counter:

- 8 Detection events are counted. By registering the number of detections, it is possible to calculate the speed or number of parts. The counter can be reset by means of a unique IO-Link message.

Temperature:

- 9 The internal temperature of the sensor is measured continuously, which provides an indication about the ambient temperature in the application. Moreover, the maximum temperature measured is saved for diagnosis and preventive maintenance purposes.

* Functionalities may vary depending on series and sensor type

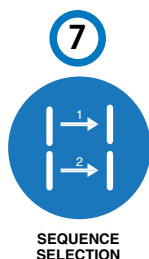
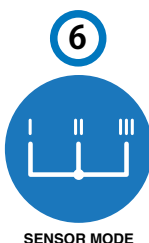
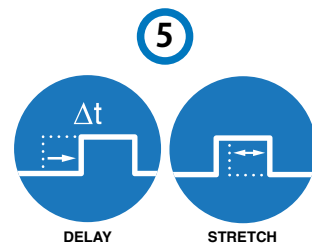
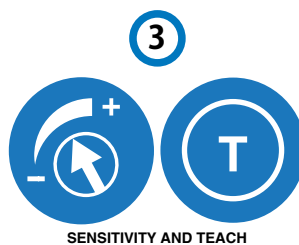



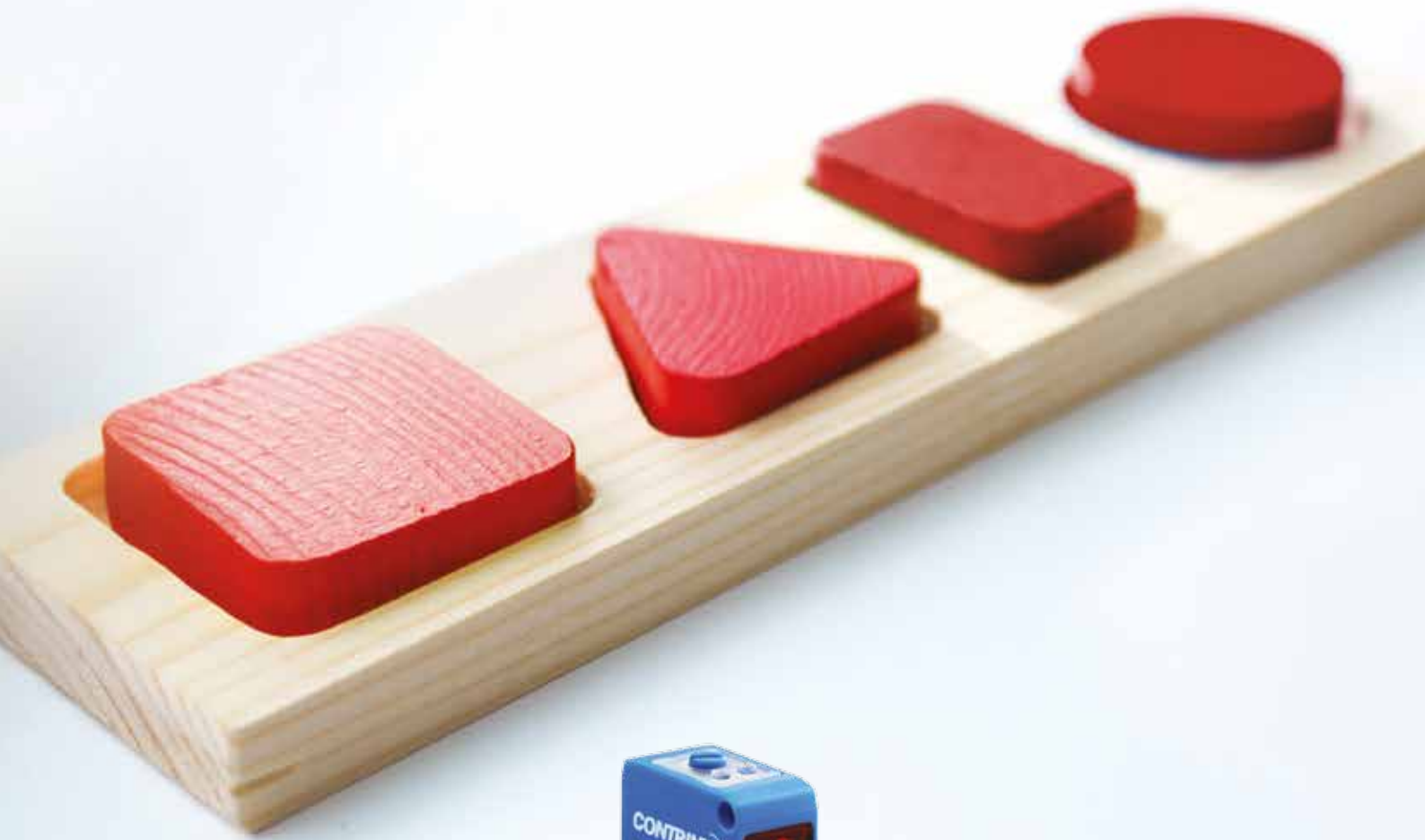

FIRST-CLASS PERFORMANCE FOR GENERAL USE

STANDARD

PHOTOELECTRIC SENSORS

KEY ADVANTAGES

- ✓ First-class sensing ranges
- ✓ Outstanding background suppression characteristics
- ✓ Cubic sizes : C23 (20 x 30 x 10 mm), 3030 (30 x 30 x 15 mm), 4050 (40 x 50 x 15 mm) and C55 (50 x 50 x 23 mm)
- ✓ Cylindrical M12 and M18 series with metal housing
- ✓ M18P series with short, plastic housing
- ✓ C23 and M18P series: high quality ASIC sensors with an integral  IO-Link interface in PNP types
- ✓ Light sources: red, infrared, laser and pinpoint LED

RANGE OVERVIEW	Series	Diffuse	Background suppression	Reflex	Through-beam
STANDARD	1120 (M12)	p. 191		p. 192	p. 192-193
	M18P (M18)	p. 196	p. 195	p. 197	p. 197
	1180 (M18)	p. 200-201, 205	p. 199-200	p. 202-203	p. 203-204, 206
	C23 (20x30x10)	p. 210	p. 209	p. 211	p. 211
	3030 (30x30x15)	p. 215-216	p. 213-214	p. 217-218	p. 219
	4050 (40x50x15)	p. 221	p. 221	p. 222	p. 222
	C55 (50x50x23)		p. 225		

STANDARD 1120

PHOTOELECTRIC SENSORS

ADVANTAGES

- ✓ M12 sensor series
- ✓ Rugged metal housing
- ✓ Shock & vibration resistant due to fully potted electronics
- ✓ Laser types (protection class 2) for accurate detection of smallest targets
- ✓ Sensing range up to 50 m
- ✓  **IO-Link** in 2019

WIRING DIAGRAM

PNP or NPN, 1 output



OVERVIEW	1120	1121L
Housing material	Chrome-plated brass	Stainless steel V2A
Degree of protection	IP 67	IP 67
Laser protection class	--	2
Supply voltage range	10...36 VDC	10 ... 36 VDC
Ambient temperature range	-25...+55 °C / -13...+131 °F	-10...+50 °C / +14...+122 °F
Output current	≤ 200 mA	≤ 200 mA
Switching frequency	≤ 1000 Hz	≤ 5000 Hz

1120 SERIES



1120

PHOTOELECTRIC

HOUSING SIZE	M12	M12
OPERATING PRINCIPLE	DIFFUSE SENSOR	DIFFUSE SENSOR
SENSING RANGE MM	300	300

Inductive



Photoelectric

Safety

RFID

Connectivity

Accessories

Glossary

Index

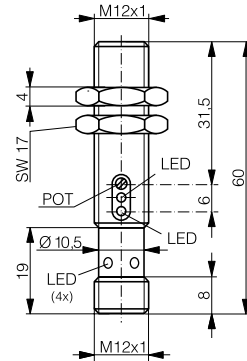
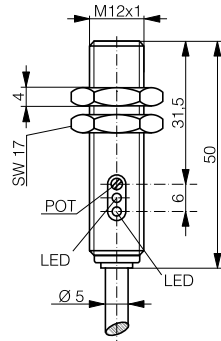

DATA	IO-Link 2019	IO-Link 2019
Light source	LED red 660 nm	LED red 660 nm
Setup	Potentiometer	Potentiometer
PNP Light-ON	LTK-1120-303	
NPN Light-ON	LTK-1120-301	LTS-1120-301
Other types available		

STANDARD

PHOTOELECTRIC

HOUSING SIZE	M12	M12
OPERATING PRINCIPLE	REFLEX SENSOR	THROUGH-BEAM SENSOR
SENSING RANGE MM	1500	10,000

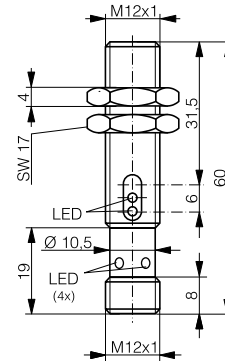
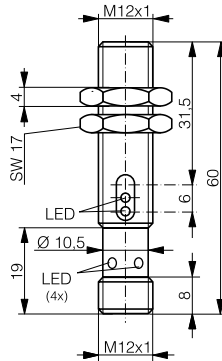

DATA	IO-Link 2019	IO-Link 2019
Light source	LED red polarized 660 nm	LED red 660 nm
Setup	-	-
Emitter		LLS-1120-200 (emitter)
PNP Dark-ON	LRS-1120-304	LLS-1120-204 (receiver)
NPN Dark-ON	LRS-1120-302	LLS-1120-202 (receiver)
Other types available	Cable version	Cable version

1120 SERIES



1120

M12	
THROUGH-BEAM SENSOR	
50,000	

Inductive

Photoelectric

Safety

RFID

Connectivity

Accessories

Glossary

Index

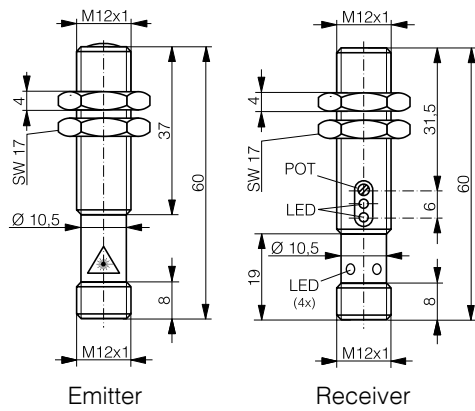

Emitter

Receiver



Laser red pulsed 660 nm

-

LLS-1121L-200 (emitter)

LLS-1121L-204 (receiver)

LLS-1121L-202 (receiver)

Cable version

STANDARD M18 PLASTIC

PHOTOELECTRIC SENSORS

ADVANTAGES

- ✓ First-class sensing ranges
- ✓ Short housing: M18 x 33 mm (cable version), M18 x 37 mm (connector version)
- ✓ Excellent background suppression characteristics with pinpoint LED
- ✓ Mutual interference immunity
- ✓  **IO-Link** on all PNP sensors
- ✓ Easy flush mounting
- ✓ Easy-to-mount special accessories for right-angle emission

WIRING DIAGRAMS

PNP or NPN, 1 output



PNP or NPN, 2 outputs

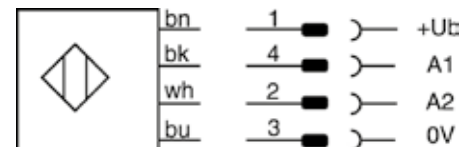

OVERVIEW	M18P
Housing material	ABS / PMMA
Degree of protection	IP 67
Supply voltage range	10 ... 30 VDC
Ambient temperature range	-25 ... +65°C / -13 ... +149°F
Output current	≤ 200 mA
Compatible mounting brackets	See pages 300-301
Accessories	See pages 441-455

M18P SERIES



M18P

PHOTOELECTRIC

HOUSING SIZE	M18	M18
OPERATING PRINCIPLE	DIFFUSE SENSOR WITH BACKGROUND SUPPRESSION	DIFFUSE SENSOR WITH BACKGROUND SUPPRESSION
SENSING RANGE MM	250	250

Inductive

Photoelectric

Safety

RFID

Connectivity

Accessories

Glossary

Index

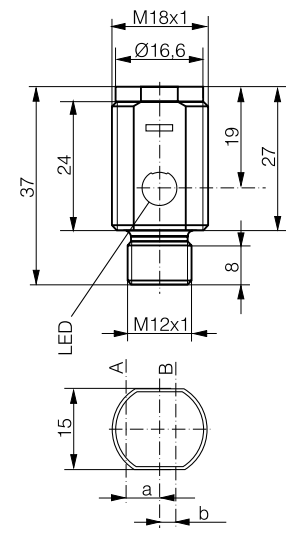
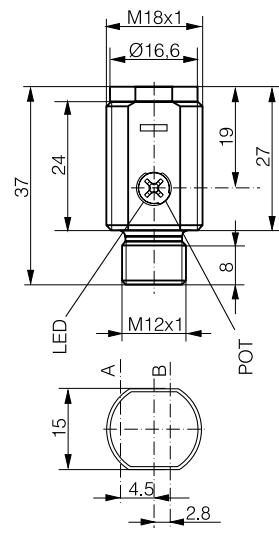

DATA	IO-Link	IO-Link
Light source	LED red pinpoint 640 nm	LED red pinpoint 640 nm
Switching frequency (normal mode)	≤ 700 Hz	≤ 700 Hz
Setup	Potentiometer	Teach button or IO-Link
PNP Light-ON	LHR-M18PA-PMS-403	LHR-M18PA-TMS-403
PNP Light-ON + Dark-ON	LHR-M18PA-PMS-603	LHR-M18PA-TMS-603
PNP Light-ON + stability alarm	LHR-M18PA-PMS-60C	LHR-M18PA-TMS-60C
NPN Light-ON	LHR-M18PA-PMS-301	LHR-M18PA-TMS-301
NPN Light-ON + Dark-ON	LHR-M18PA-PMS-101	LHR-M18PA-TMS-101
NPN Light-ON + stability alarm	LHR-M18PA-PMS-10A	LHR-M18PA-TMS-10A
Other types available	Cable version	Cable version

STANDARD

PHOTOELECTRIC

HOUSING SIZE	M18	M18
OPERATING PRINCIPLE	DIFFUSE SENSOR	DIFFUSE SENSOR
SENSING RANGE MM	1200	1200

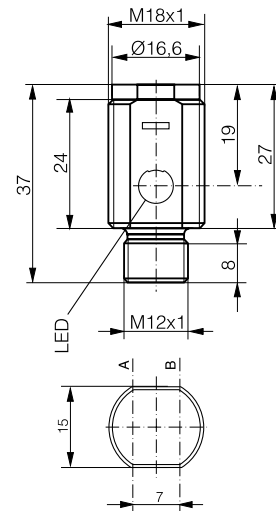
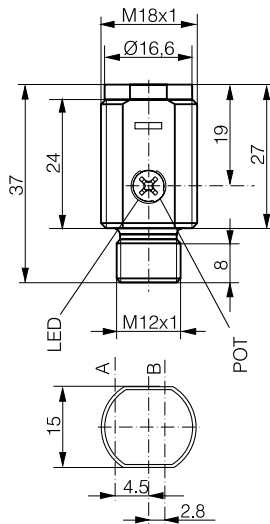

DATA	IO-Link	IO-Link
Light source	LED red 630 nm	LED red 630 nm
Switching frequency (normal mode)	≤ 1500 Hz	≤ 1500 Hz
Setup	Potentiometer	IO-Link
PNP Light-ON	LTR-M18PA-PMS-403	LTR-M18PA-NMS-403
PNP Light-ON + Dark-ON	LTR-M18PA-PMS-603	
PNP Light-ON + stability alarm	LTR-M18PA-PMS-60C	
NPN Light-ON	LTR-M18PA-PMS-301	
NPN Light-ON + Dark-ON	LTR-M18PA-PMS-101	
NPN Light-ON + stability alarm	LTR-M18PA-PMS-104	
Other types available	Cable version	Cable version

M18P SERIES



M18P

HOUSING SIZE	M18	M18
OPERATING PRINCIPLE	REFLEX SENSOR	THROUGH-BEAM SENSOR
SENSING RANGE MM	7000	30,000

Inductive

Photoelectric

Safety

RFID

Connectivity

Accessories

Glossary

Index

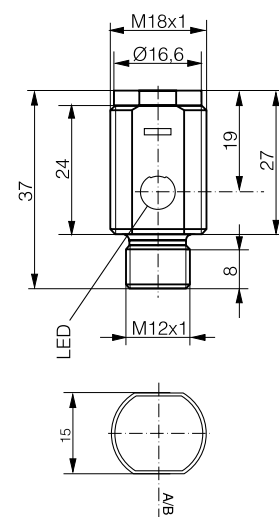
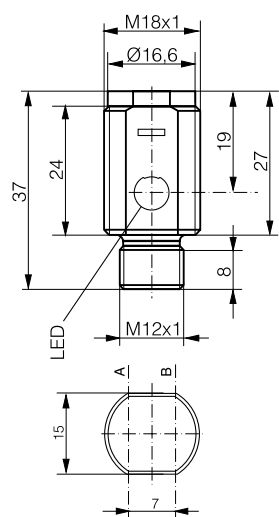

DATA	IO-Link	IO-Link
Light source	LED red polarized 630 nm	LED red 630 nm
Switching frequency (normal mode)	≤ 1500 Hz	≤ 1000 Hz
Setup	IO-Link	IO-Link
Emitter		LLR-M18PA-NMS-400
PNP Dark-ON	LRR-M18PA-NMS-404	LLR-M18PA-NMS-404
PNP Light-ON + Dark-ON	LRR-M18PA-NMS-603	LLR-M18PA-NMS-603
PNP Dark-ON + stability alarm	LRR-M18PA-NMS-60D	LLR-M18PA-NMS-60D
NPN Dark-ON	LRR-M18PA-NMS-302	LLR-M18PA-NMS-302
NPN Light-ON + Dark-ON	LRR-M18PA-NMS-101	LLR-M18PA-NMS-101
NPN Dark-ON + stability alarm	LRR-M18PA-NMS-10B	LLR-M18PA-NMS-10B
Other types available	Cable version	Cable version

STANDARD M18

PHOTOELECTRIC SENSORS

ADVANTAGES

- ✓ M18 sensor series
- ✓ Models for lateral sensing
- ✓ Rugged metal housing
- ✓ Shock & vibration resistant due to fully potted electronics
- ✓ Laser types (protection class 2) for accurate detection of smallest targets
- ✓ Sensing range up to 50 m
- ✓  IO-Link in 2019

WIRING DIAGRAMS

PNP or NPN, 1 output

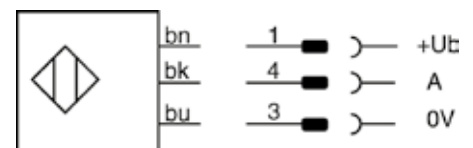

PNP or NPN, 2 outputs

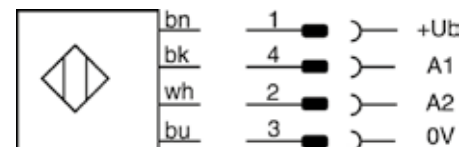

OVERVIEW	1180 / 1180W	1180L
Housing material	Chrome-plated brass	Stainless steel V2A
Degree of protection	IP 67	IP 67
Laser protection class	-	2
Supply voltage range	10 ... 36 VDC	10 ... 36 VDC
Ambient temperature range	-25 ... +55°C / -13 ... +131°F	-10 ... +50°C / +14 ... +122°F
Output current	≤ 200 mA	≤ 200 mA
Switching frequency	≤ 1000 Hz	LT: ≤ 1000 Hz/LL: ≤ 5000 Hz

1180 SERIES



1180

HOUSING SIZE	M18	M18
OPERATING PRINCIPLE	DIFFUSE SENSOR WITH BACKGROUND SUPPRESSION	DIFFUSE SENSOR WITH BACKGROUND SUPPRESSION
SENSING RANGE MM	120	120

Inductive

Photoelectric

Safety

RFID

Connectivity

Accessories

Glossary

Index

PHOTOELECTRIC

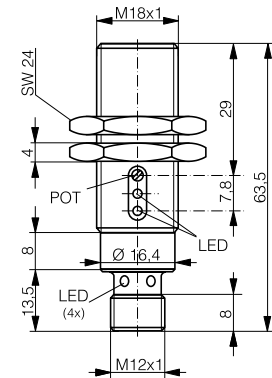
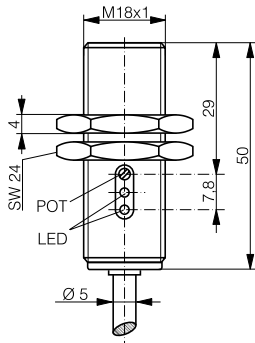

DATA	IO-Link 2019	IO-Link 2019
Light source	LED red 680 nm	LED red 680 nm
Setup	Potentiometer	Potentiometer
PNP Light-ON	LHK-1180-303	LHS-1180-303
NPN Light-ON	LHK-1180-301	LHS-1180-301
Other types available		

STANDARD

HOUSING SIZE

M18

M18

OPERATING PRINCIPLE

DIFFUSE SENSOR WITH
BACKGROUND SUPPRESSION

DIFFUSE SENSOR

SENSING RANGE MM

120

600

PHOTOELECTRIC

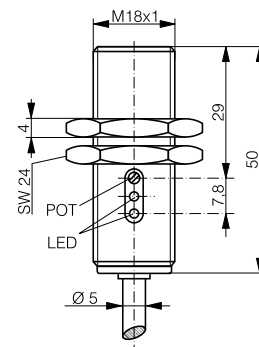
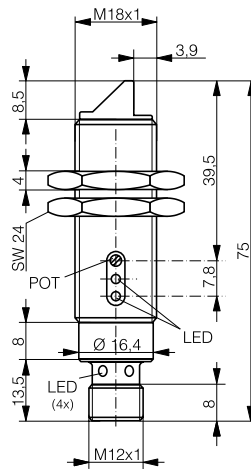

DATA

IO-Link 2019

IO-Link 2019

Light source

LED red 680 nm

LED red 630 nm

Setup

Potentiometer

Potentiometer

PNP Light-ON

LHS-1180W-303

NPN Light-ON

LHS-1180W-301

PNP Light-ON + Dark-ON

LTK-1180-103

NPN Light-ON + Dark-ON

LTK-1180-101

Other types available

Cable version

1180 SERIES



1180

STANDARD

HOUSING SIZE

M18

M18

OPERATING PRINCIPLE

REFLEX SENSOR

REFLEX SENSOR

SENSING RANGE MM

2000

2000

PHOTOELECTRIC

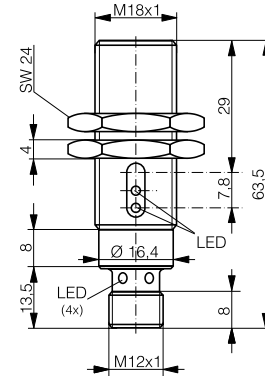
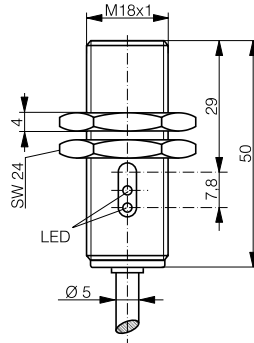

DATA

IO-Link 2019

IO-Link 2019

Light source

LED red polarized 660 nm

LED red polarized 660 nm

Setup

-

-

PNP Dark-ON

LRK-1180-304

LRS-1180-304

NPN Dark-ON

LRK-1180-302

LRS-1180-302

Emitter

PNP Light-ON + Dark-ON

NPN Light-ON + Dark-ON

Other types available

1180 SERIES



1180

M18	M18
REFLEX SENSOR	THROUGH-BEAM SENSOR
2000	20,000

Inductive

Photoelectric

Safety

RFID

Connectivity

Accessories

Glossary

Index

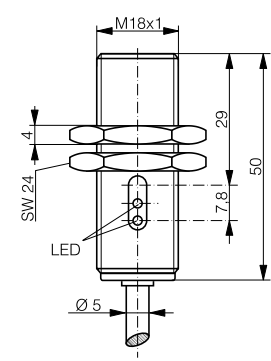
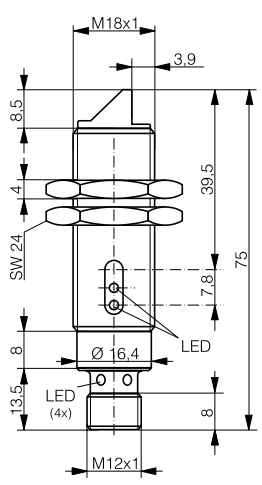

IO-Link 2019	IO-Link 2019
LED red polarized 660 nm	LED red 660 nm
-	-
LRS-1180W-304	
LRS-1180W-302	
	LLK-1180-000
	LLK-1180-003 (receiver)
	LLK-1180-001 (receiver)
Cable version	

STANDARD

HOUSING SIZE

M18

M18

OPERATING PRINCIPLE

THROUGH-BEAM SENSOR

THROUGH-BEAM SENSOR

SENSING RANGE MM

20,000

20,000

PHOTOELECTRIC

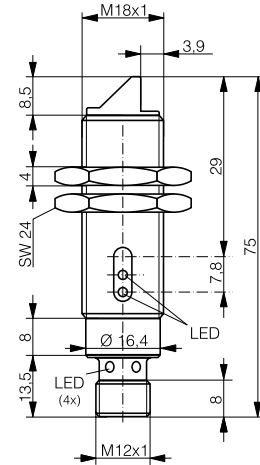
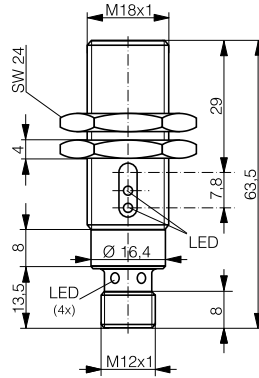

DATA

IO-Link 2019

IO-Link 2019

Light source

LED red 660 nm

LED red 660 nm

Setup

-

-

Emitter

LLS-1180-000

LLS-1180W-000

PNP Light-ON + Dark-ON

LLS-1180-003 (receiver)

LLS-1180W-003 (receiver)

NPN Light-ON + Dark-ON

LLS-1180-001 (receiver)

LLS-1180W-001 (receiver)

Other types available

Cable version

1180 SERIES



1180

M18	M18
DIFFUSE SENSOR	DIFFUSE SENSOR
250	600

- Inductive
- Photoelectric
- Safety
- RFID
- Connectivity
- Accessories
- Glossary
- Index

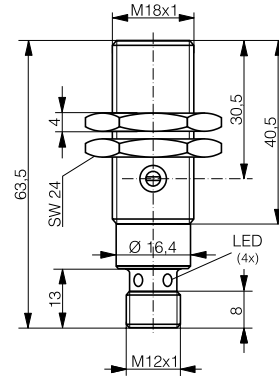
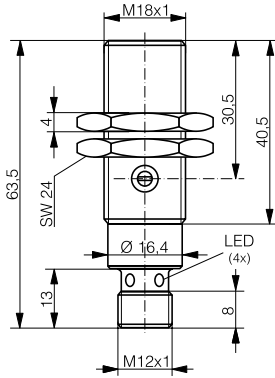

Laser red pulsed 660 nm Potentiometer
LTS-1180L-103-516
LTS-1180L-101-516 Cable version

Laser red pulsed 660 nm Potentiometer
LTS-1180L-103
LTS-1180L-101 Cable version

STANDARD

HOUSING SIZE

M18

M18

OPERATING PRINCIPLE

THROUGH-BEAM SENSOR

THROUGH-BEAM SENSOR

SENSING RANGE MM

50,000

50,000

PHOTOELECTRIC

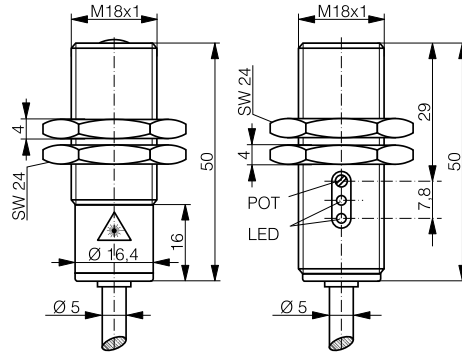

Emitter

Receiver

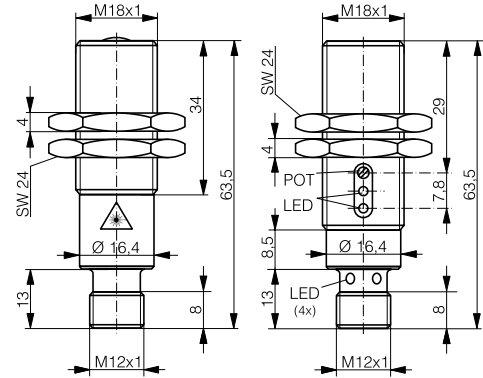

Emitter

Receiver

DATA



Light source

Laser red pulsed 660 nm

Laser red pulsed 660 nm

Setup

Potentiometer (receiver)

Potentiometer (receiver)

Emitter

LLK-1181L-000

LLS-1181L-000

PNP Light-ON + Dark-ON

LLK-1181L-003 (receiver)

LLS-1181L-003 (receiver)

NPN Light-ON + Dark-ON

LLK-1181L-001 (receiver)

LLS-1181L-001 (receiver)

Other types available



STANDARD C23

PHOTOELECTRIC SENSORS

ADVANTAGES

- ✓ First-class sensing ranges
- ✓ Small plastic housing, 20 mm x 30 mm x 10 mm
- ✓ Excellent background suppression characteristics with pinpoint LED
- ✓  **IO-Link** interface available on PNP types
- ✓ Mutual interference immunity
- ✓ Versions available with stability alarm as second output
- ✓ Enclosure rating IP67, Ecolab approved
- ✓ Versatile mounting brackets for ease of installation

WIRING DIAGRAMS

PNP or NPN, 1 output

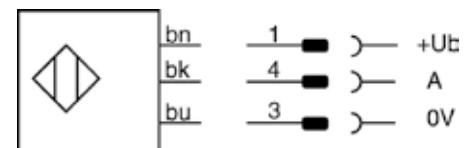

PNP or NPN, 2 outputs

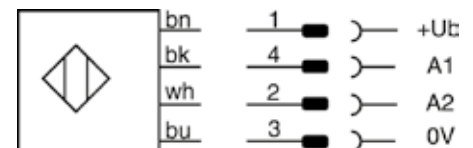

OVERVIEW	C23
Housing material	ABS / PMMA
Degree of protection	IP 67
Supply voltage range	10 ... 30 VDC
Ambient temperature range	-25 ... +65°C / -13 ... +149 °F
Output current	≤ 100 mA
Compatible mounting brackets	See pages 296-298

C23 SERIES



C23

HOUSING SIZE MM

□ 20 X 30 X 10

□ 20 X 30 X 10

OPERATING PRINCIPLE

DIFFUSE SENSOR WITH BACKGROUND SUPPRESSION

DIFFUSE SENSOR WITH BACKGROUND SUPPRESSION

SENSING RANGE MM

300

300

Inductive

Photoelectric

Safety

RFID

Connectivity

Accessories

Glossary

Index

PHOTOELECTRIC

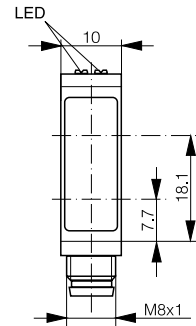
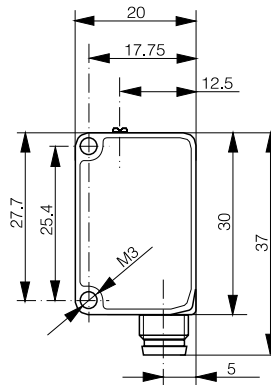

DATA

IO-Link

IO-Link

Light source

Red pinpoint LED 640 nm

Red pinpoint LED 640 nm

Switching frequency (normal mode)

≤ 1000 Hz

≤ 1000 Hz

Setup

Potentiometer

Teach button or IO-Link

PNP Light-ON

LHR-C23PA-PMS-403

LHR-C23PA-TMS-403

PNP Light-ON + Dark-ON

LHR-C23PA-PMS-603

LHR-C23PA-TMS-603

PNP Light-ON + stability alarm

LHR-C23PA-PMS-60C

LHR-C23PA-TMS-60C

NPN Light-ON

LHR-C23PA-PMS-301

LHR-C23PA-TMS-301

NPN Light-ON + Dark-ON

LHR-C23PA-PMS-101

LHR-C23PA-TMS-101

NPN Light-ON + stability alarm

LHR-C23PA-PMS-10A

LHR-C23PA-TMS-10A

Other types available

Cable version

Cable version

STANDARD

HOUSING SIZE MM

□ 20 X 30 X 10

□ 20 X 30 X 10

OPERATING PRINCIPLE

DIFFUSE SENSOR

DIFFUSE SENSOR

SENSING RANGE MM

1500

1500

PHOTOELECTRIC

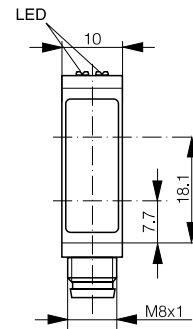
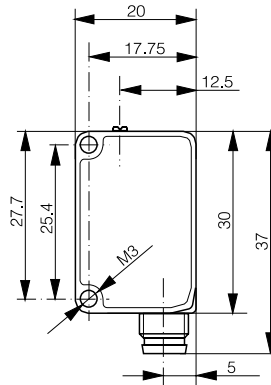

DATA

IO-Link

IO-Link

Light source

Red LED 630 nm

Red LED 630 nm

Switching frequency (normal mode)

≤ 1500 Hz

≤ 1500 Hz

Setup

Potentiometer

IO-Link

PNP Light-ON

LTR-C23PA-PMS-403

LTR-C23PA-NMS-403

PNP Light-ON + Dark-ON

LTR-C23PA-PMS-603

PNP Light-ON + stability alarm

LTR-C23PA-PMS-60C

NPN Light-ON

LTR-C23PA-PMS-301

NPN Light-ON + Dark-ON

LTR-C23PA-PMS-101

NPN Light-ON + stability alarm

LTR-C23PA-PMS-104

Other types available

Cable version

Cable version

C23 SERIES



C23

HOUSING SIZE MM	□ 20 X 30 X 10	□ 20 X 30 X 10
OPERATING PRINCIPLE	REFLEX SENSOR	THROUGH-BEAM SENSOR
SENSING RANGE MM	8000	30,000

Inductive



Photoelectric

Safety

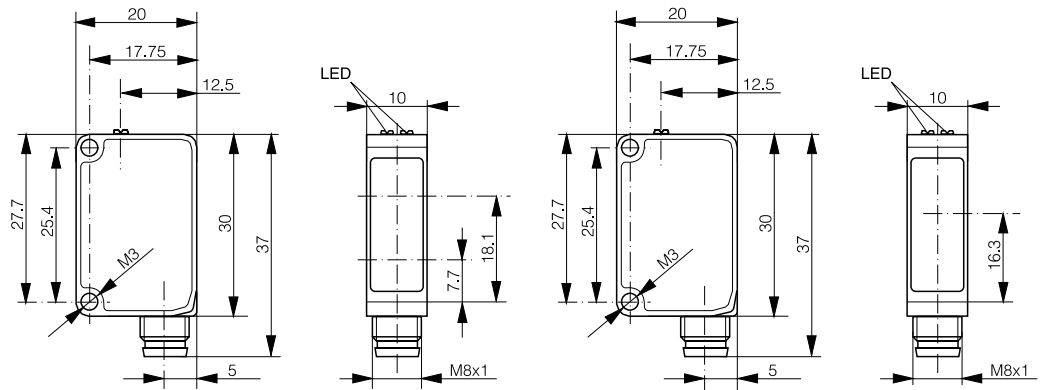

RFID

Connectivity

Accessories

DATA	IO-Link	IO-Link
Light source	LED red polarized 630 nm	LED red polarized 630 nm
Switching frequency (normal mode)	≤ 1500 Hz	≤ 1000 Hz
Setup	IO-Link	IO-Link
Emitter		LLR-C23PA-NMS-400
PNP Dark-ON	LRR-C23PA-NMS-404	LLR-C23PA-NMS-404
PNP Light-ON + Dark-ON	LRR-C23PA-NMS-603	LLR-C23PA-NMS-603
PNP Dark-ON + stability alarm	LRR-C23PA-NMS-60D	LLR-C23PA-NMS-60D
NPN Dark-ON	LRR-C23PA-NMS-302	LLR-C23PA-NMS-302
NPN Light-ON + Dark-ON	LRR-C23PA-NMS-101	LLR-C23PA-NMS-101
NPN Dark-ON + stability alarm	LRR-C23PA-NMS-10B	LLR-C23PA-NMS-10B
Other types available	Cable version	Cable version

Glossary

Index



STANDARD 3030

PHOTOELECTRIC SENSORS

ADVANTAGES

- ✓ Complete miniature sensor series 30 x 30 x 15 mm in rugged Crastin housings
- ✓ Sensing range up to 12,000 mm for through-beam type
- ✓ Shock & vibration resistant due to fully potted electronics
- ✓ Diffuse sensors with precise background suppression
- ✓ Polarizing filter (reflex sensors)
- ✓ High system reserves (excess gain)
- ✓ Pre-failure warning (pollution monitoring)
- ✓ Changeover outputs
- ✓ Analog outputs

WIRING DIAGRAMS

PNP or NPN, 1 output

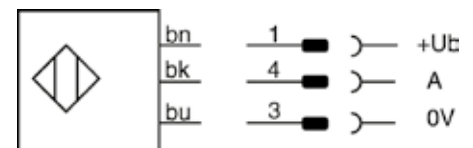

PNP or NPN, 2 outputs

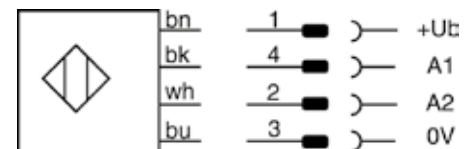

Analog, 2 outputs

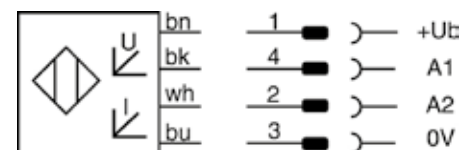

OVERVIEW	3#3#
Housing material	PBTP (Crastin)
Degree of protection	IP 67
Supply voltage range	10 ... 36 VDC / 15 ... 36 VDC (LA#-3130-119)
Ambient temperature range	-25 ... +55°C / -13 ... +131 °F
Output current	≤ 200 mA / -- (LA)
Compatible mounting brackets	See page 301



3030 SERIES

HOUSING SIZE MM	□ 30 X 30 X 15	□ 30 X 30 X 15
OPERATING PRINCIPLE	WITH ANALOG OUTPUT	DIFFUSE SENSOR WITH BACKGROUND SUPPRESSION
SENSING RANGE MM	100	200

Inductive

Photoelectric

Safety

RFID

Connectivity

Accessories

Glossary

Index

PHOTOELECTRIC

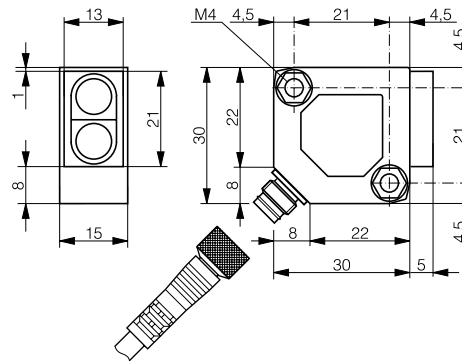

DATA		
Light source	LED red 660 nm	LED red 660 nm
Max. switching frequency		500 Hz
Setup	Potentiometer	Potentiometer
Analog output	LAS-3130-119	
PNP Light-ON + Dark-ON		LHS-3130-103
NPN Light-ON + Dark-ON		LHS-3130-101
Other types available	Cable version	

STANDARD

HOUSING SIZE MM

□ 30 X 30 X 15

□ 30 X 30 X 15

OPERATING PRINCIPLE

DIFFUSE SENSOR WITH
BACKGROUND SUPPRESSION

DIFFUSE SENSOR WITH
BACKGROUND SUPPRESSION

SENSING RANGE MM

200

200

PHOTOELECTRIC

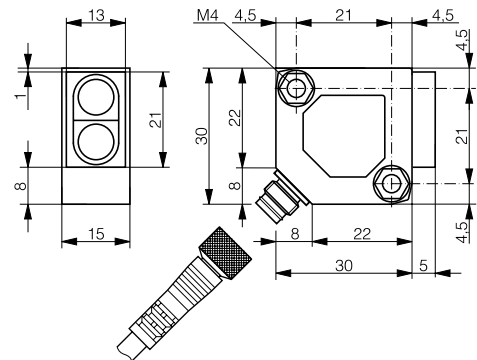
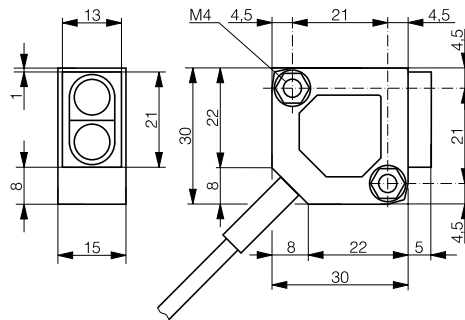

DATA

Light source

LED red 660 nm

LED red 660 nm

Max. switching frequency

500 Hz

500 Hz

Setup

Potentiometer

Potentiometer

PNP Light-ON

LHK-3131-303

LHS-3131-303

NPN Light-ON

LHK-3131-301

LHS-3131-301

Other types available

3030 SERIES



3030

□ 30 X 30 X 15
DIFFUSE SENSOR
600

□ 30 X 30 X 15
DIFFUSE SENSOR
600

Inductive



Photoelectric

Safety

RFID

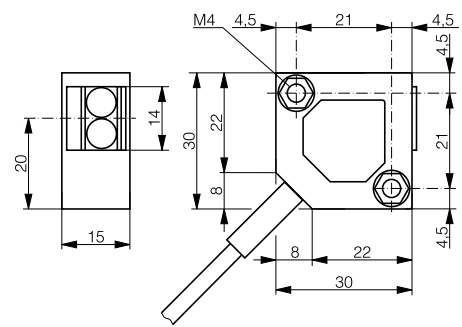
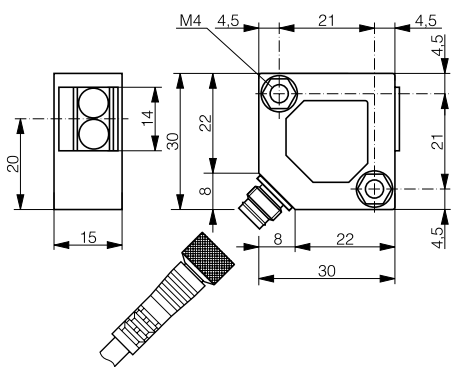

Connectivity

Accessories

Glossary

IR LED 880 nm
1000 Hz
Potentiometer
LTS-3031-303
LTS-3031-301

IR LED 880 nm
1000 Hz
Potentiometer
LTK-3031-303
LTK-3031-301

Index

STANDARD

HOUSING SIZE MM

□ 30 X 30 X 15

□ 30 X 30 X 15

OPERATING PRINCIPLE

DIFFUSE SENSOR

DIFFUSE SENSOR

SENSING RANGE MM

1200

1200

PHOTOELECTRIC

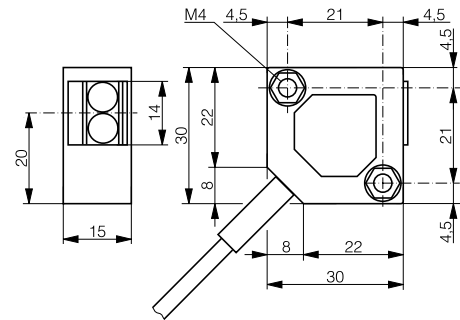
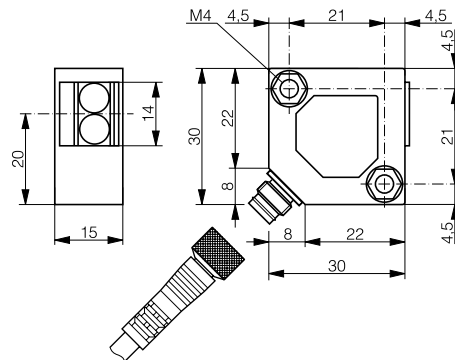

DATA

Light source

IR LED 880 nm

IR LED 880 nm

Max. switching frequency

1000 Hz

1000 Hz

Setup

Potentiometer

Potentiometer

PNP Light-ON + Dark-ON

LTS-3030-103

LTK-3030-103

NPN Light-ON + Dark-ON

LTS-3030-101

LTK-3030-101

PNP Dark-ON

NPN Dark-ON

Other types available

3030 SERIES



3030

□ 30 X 30 X 15
REFLEX SENSOR
2000

□ 30 X 30 X 15
REFLEX SENSOR
2000

Inductive



Photoelectric

Safety

RFID

Connectivity

Accessories

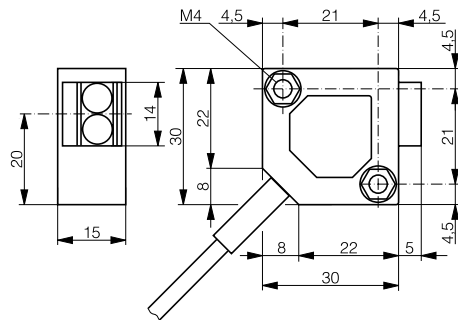
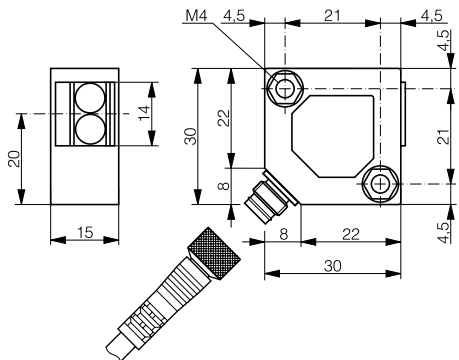

Glossary

LED red polarized 660 nm
1000 Hz
Potentiometer

LED red polarized 660 nm
1000 Hz
Potentiometer

Index

LRS-3031-304
LRS-3031-302

LRK-3031-304
LRK-3031-302

STANDARD

HOUSING SIZE MM

□ 30 X 30 X 15

□ 30 X 30 X 15

OPERATING PRINCIPLE

REFLEX SENSOR

REFLEX SENSOR

SENSING RANGE MM

4000

4000

PHOTOELECTRIC

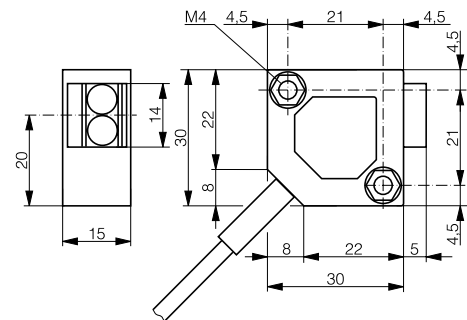
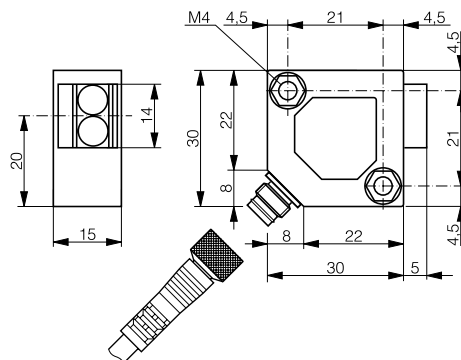

DATA

Light source

LED red polarized 660 nm

LED red polarized 660 nm

Max. switching frequency

1000 Hz

1000 Hz

Setup

Potentiometer

Potentiometer

Emitter

PNP Light-ON + Dark-ON

LRS-3030-103

LRK-3030-103

NPN Light-ON + Dark-ON

LRS-3030-101

LRK-3030-101

PNP Dark-ON

NPN Dark-ON

Other types available

3030 SERIES



3030

□ 30 X 30 X 15

THROUGH-BEAM SENSOR

6000

□ 30 X 30 X 15

THROUGH-BEAM SENSOR

12,000

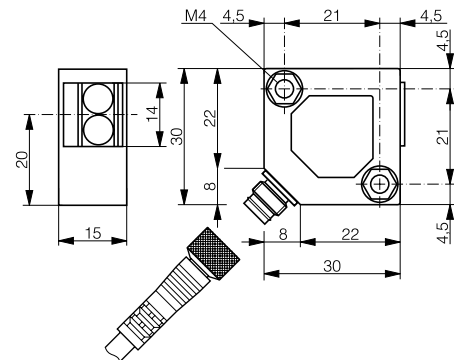
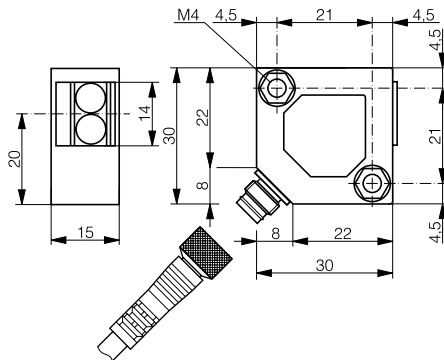

Inductive

Photoelectric

Safety

RFID

Connectivity

Accessories

Glossary

Index

IR LED 880 nm

1000 Hz

Potentiometer

LLS-3031-200

LLS-3031-204 (receiver)

LLS-3031-202 (receiver)

Cable version

IR LED 880 nm

1000 Hz

Potentiometer

LLS-3030-000

LLS-3030-003 (receiver)

STANDARD 4050

PHOTOELECTRIC SENSORS

ADVANTAGES

- ✓ Compact plastic housing, 40 mm x 50 mm x 15 mm
- ✓ Excellent background suppression characteristics
- ✓ Reflex types with special autocollimation optics
- ✓ Adjustable connector
- ✓ Ecolab tested and approved

WIRING DIAGRAMS

PNP or NPN, 2 outputs

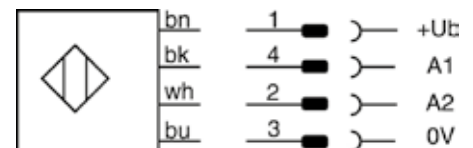

Emitter



OVERVIEW	4050
Housing material	PBTP
Degree of protection	IP 67
Supply voltage range	10 ... 36 VDC
Ambient temperature range	-5 ... +55°C / 23 ... +131°F
Output current	≤ 200 mA
Compatible mounting brackets	See page 302

4050 SERIES



4050

HOUSING SIZE MM	□ 40 X 50 X 15	□ 40 X 50 X 15
OPERATING PRINCIPLE	DIFFUSE SENSOR WITH BACKGROUND SUPPRESSION	DIFFUSE SENSOR
SENSING RANGE MM	500	1200

Inductive

Photoelectric

Safety

RFID

Connectivity

Accessories

Glossary

Index

PHOTOELECTRIC

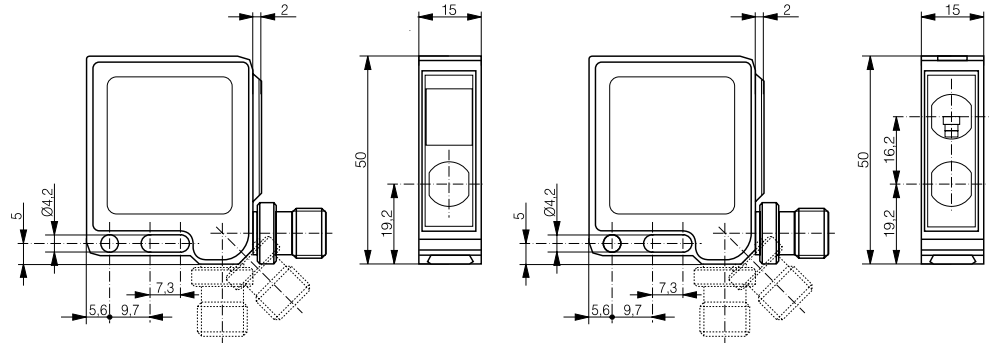

DATA		
Light source	LED red 630 nm	LED red 630 nm
Max. switching frequency	500 Hz	1500 Hz
Setup	Potentiometer	Potentiometer
PNP Light-ON + Dark-ON	LHS-4150-103	LTS-4150-103
NPN Light-ON + Dark-ON	LHS-4150-101	LTS-4150-101
Other types available	Cable version	Cable version

STANDARD

HOUSING SIZE MM

□ 40 X 50 X 15

□ 40 X 50 X 15

OPERATING PRINCIPLE

REFLEX SENSOR

THROUGH-BEAM SENSOR

SENSING RANGE MM

4000

50,000

PHOTOELECTRIC



AUTOCOLLIMATION

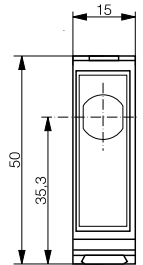
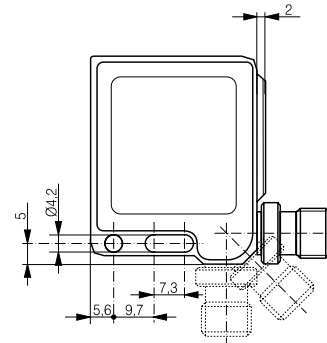
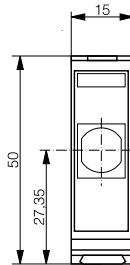
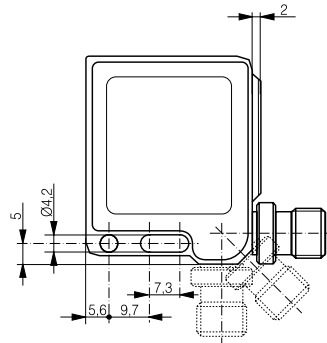

DATA

Light source

LED red polarized 680 nm

LED red 630 nm

Max. switching frequency

1500 Hz

1500 Hz

Setup

Potentiometer

Potentiometer

PNP Light-ON + Dark-ON

LRS-4150-103

LLS-4150-003 (receiver)

NPN Light-ON + Dark-ON

LRS-4150-101

LLS-4150-001 (receiver)

Emitter

LLS-4150-000

Other types available

Cable version

Cable version



STANDARD C55

PHOTOELECTRIC SENSORS

ADVANTAGES

- ✓ Compact plastic housing 50 mm x 50 mm x 23 mm, IP67 & IP69K, Ecolab certified
- ✓ Time-Of-Flight principle for background suppression
- ✓ Laser class 1 emission
- ✓ Range up to 5000 mm
- ✓ Reliable detection of tilted objects

WIRING DIAGRAM

PNP / NPN auto-detect, 2 outputs + Teach



OVERVIEW	C55
Housing material	ABS / PMMA
Degree of protection	IP 67 / IP 69K
Supply voltage range	18 ... 30 VDC
Ambient temperature range	-40 ... +60°C / -40 ... +140°F
Output current	≤ 100 mA
Switching frequency	≤ 500 Hz
Setup	Teach button
Compatible mounting brackets	See page 299

C55 SERIES



C55

HOUSING SIZE MM

□ 50 X 50 X 23

OPERATING PRINCIPLE

DIFFUSE SENSOR WITH BACKGROUND SUPPRESSION

SENSING RANGE MM

5000

Inductive

Photoelectric

Safety

RFID

Connectivity

Accessories

Glossary

Index

PHOTOELECTRIC

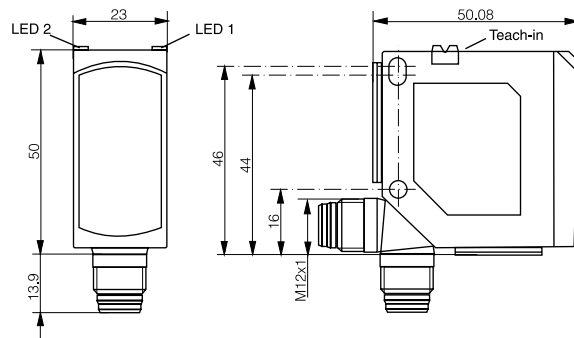

DATA



Light source

Laser class 1 red 650 nm

Light spot size

5 mm x 4 mm at 3000 mm

PNP/NPN auto-detect (x2)

LHL-C55PA-TMS-107-501

Other types available

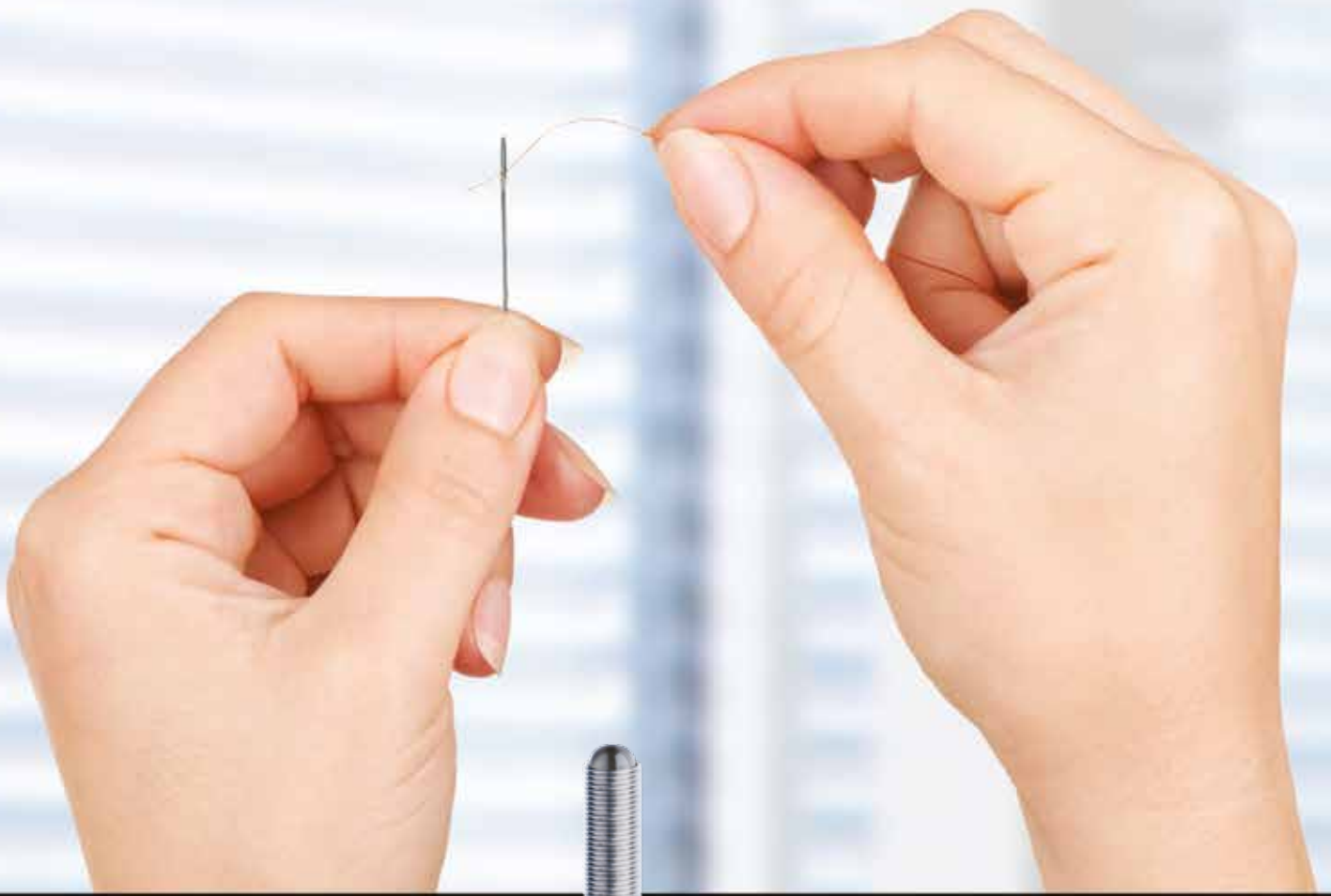

SMALLEST ON THE MARKET

MINIATURE PHOTOELECTRIC SENSORS

KEY ADVANTAGES

1040/1050/0507 series

- ✓ Rugged diffuse or through-beam sensors in steel housing :
Ø 4, M5 or 5 mm x 7 mm x 40 mm
- ✓ Steel sensors with sapphire-glass sensing face, scratch and chemically resistant
- ✓ Accurate target detection due to cylindrical light beam
- ✓  IO-Link in 2019

C12 series

- ✓ Plastic housing, 13 mm x 21 mm / 27 mm x 7 mm
- ✓ Red pinpoint LED, small visible light spot
- ✓ Long sensing ranges
- ✓ Excellent background suppression up to 120 mm with 3-turn potentiometer

RANGE OVERVIEW

MINIATURE

Series	Diffuse	Background suppression	Reflex	Through-beam
1040 (Ø4)	p. 229-231			p. 231
1050 (M5)	p. 232-234			p. 235
0507 (5x7x40)	p. 237			
C12 (13x21/27x7)		p. 239-240	p. 240	p. 241

MINIATURE 1040/1050

PHOTOELECTRIC SENSORS

ADVANTAGES

- ✓ Rugged metal housing
- ✓ Rugged sapphire-glass or glass sensing face, scratch & chemically resistant
- ✓ Shock & vibration resistant due to fully vacuum-potted electronics
- ✓ Accurate target detection due to cylindrical light beam

WIRING DIAGRAM

PNP or NPN, 1 output



OVERVIEW	1040 / 1050
Housing material	Stainless steel V2A
Light source	IR LED 880 nm
Degree of protection	IP 67
Supply voltage range	10 ... 30 VDC
Ambient temperature range	0 ... +55 °C / 32 ... +131 °F
Output current	≤ 100 mA
Switching frequency	≤ 250 Hz

1040 SERIES



1040

PHOTOELECTRIC

HOUSING SIZE MM	Ø 4	Ø 4
OPERATING PRINCIPLE	DIFFUSE SENSOR	DIFFUSE SENSOR
SENSING RANGE MM	10	10

Inductive



Photoelectric

Safety

RFID

Connectivity

Accessories

Glossary

Index

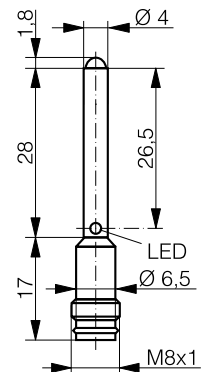
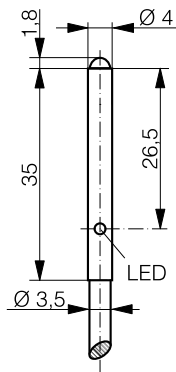

DATA	IO-Link 2019	IO-Link 2019
Lens material	Sapphire glass	Sapphire glass
PNP Light-ON	LTK-1040-303-505	LTS-1040-303-505
NPN Light-ON	LTK-1040-301-505	LTS-1040-301-505
Other types available		

MINIATURE

HOUSING SIZE MM

Ø 4

Ø 4

OPERATING PRINCIPLE

DIFFUSE SENSOR

DIFFUSE SENSOR

SENSING RANGE MM

20

20

PHOTOELECTRIC

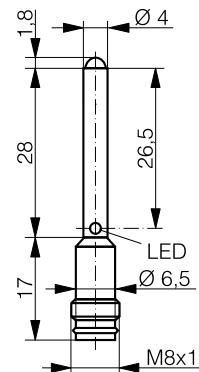
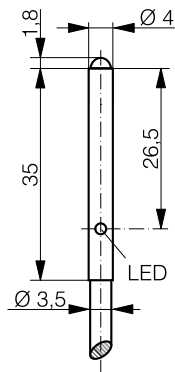

DATA

IO-Link 2019

IO-Link 2019

Lens material

Sapphire glass

Sapphire glass

Emitter

PNP Light-ON

LTK-1040-303-506

LTS-1040-303-506

NPN Light-ON

LTK-1040-301-506

LTS-1040-301-506

PNP Dark-ON

NPN Dark-ON

Other types available

1040 SERIES



1040

Ø 4	Ø 4	Ø 4
DIFFUSE SENSOR	DIFFUSE SENSOR	THROUGH-BEAM SENSOR
50	50	250

Inductive



Photoelectric

Safety

RFID

Connectivity

Accessories

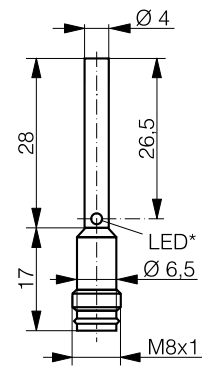
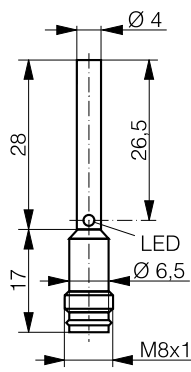
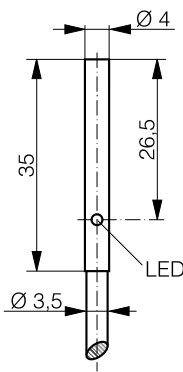

* receiver only

IO-Link 2019	IO-Link 2019	IO-Link 2019
Glass	Glass	Glass
LTK-1040-303	LTS-1040-303	LLS-1040-200
LTK-1040-301	LTS-1040-301	LLS-1040-204 (receiver)
		LLS-1040-202 (receiver)
		Cable version

Glossary

Index

MINIATURE

HOUSING SIZE

M5

M5

OPERATING PRINCIPLE

DIFFUSE SENSOR

DIFFUSE SENSOR

SENSING RANGE MM

10

10

PHOTOELECTRIC

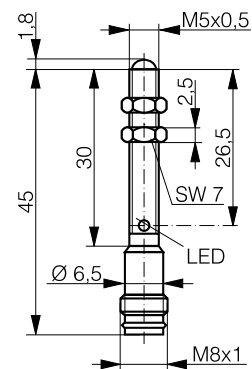
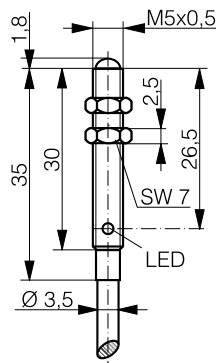

DATA

IO-Link 2019

IO-Link 2019

Lens material

Sapphire glass

Sapphire glass

PNP Light-ON

LTK-1050-303-505

LTS-1050-303-505

NPN Light-ON

LTK-1050-301-505

LTS-1050-301-505

Other types available

1050 SERIES



1050

M5	M5
DIFFUSE SENSOR	DIFFUSE SENSOR
20	20

Inductive



Photoelectric

Safety

RFID

Connectivity

Accessories

Glossary

Index

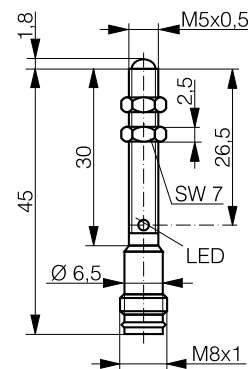
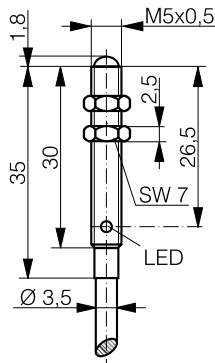

IO-Link 2019
Sapphire glass
LTK-1050-303-506
LTK-1050-301-506

IO-Link 2019
Sapphire glass
LTS-1050-303-506
LTS-1050-301-506

MINIATURE

HOUSING SIZE

M5

M5

OPERATING PRINCIPLE

DIFFUSE SENSOR

DIFFUSE SENSOR

SENSING RANGE MM

50

50

PHOTOELECTRIC

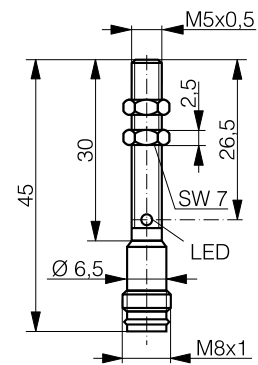
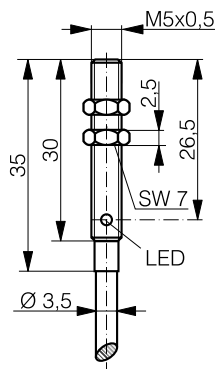

DATA

 IO-Link 2019

 IO-Link 2019

Lens material

Glass

Glass

Emitter

PNP Light-ON

LTK-1050-303

LTS-1050-303

NPN Light-ON

LTK-1050-301

LTS-1050-301

PNP Dark-ON

NPN Dark-ON

Other types available

1050 SERIES



1050

M5	
THROUGH-BEAM SENSOR	
250	

Inductive



Photoelectric

Safety

RFID

Connectivity

Accessories

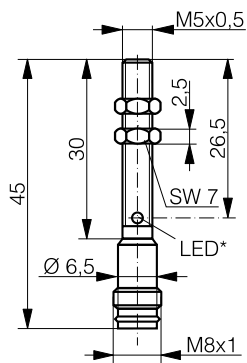

* receiver only

Glossary

IO-Link 2019	
Glass	
LLS-1050-200	
LLS-1050-204 (receiver)	
LLS-1050-202 (receiver)	
Cable version	

Index

MINIATURE 0507

PHOTOELECTRIC SENSORS

ADVANTAGES

- ✓ Rugged metal housing
- ✓ Rugged sapphire-glass or glass sensing face, scratch & chemically resistant
- ✓ Shock & vibration resistant due to fully vacuum-potted electronics

WIRING DIAGRAM

PNP or NPN, 1 output

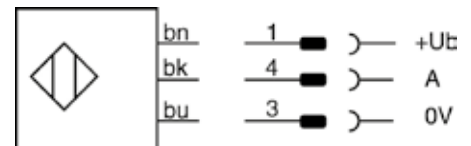

OVERVIEW	0507
Housing material	Stainless steel V2A
Light source	IR LED 880 nm
Degree of protection	IP 67
Supply voltage range	10 ... 30 VDC
Ambient temperature range	0 ... +55°C / 32 ... +131 °F
Output current	≤ 100 mA
Switching frequency	≤ 250 Hz

0507 SERIES



0507

HOUSING SIZE MM	□ 5 X 7 X 40	□ 5 X 7 X 40	□ 5 X 7 X 40
OPERATING PRINCIPLE	DIFFUSE SENSOR	DIFFUSE SENSOR	DIFFUSE SENSOR
SENSING RANGE MM	20	50	90

Inductive

PHOTOELECTRIC



Photoelectric

Safety

RFID

Connectivity

Accessories

Glossary

Index

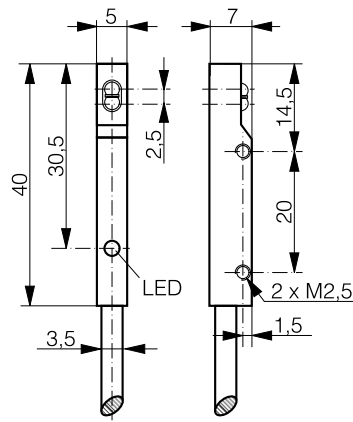

DATA			
Lens material	Sapphire glass	Sapphire glass	Sapphire glass
PNP Light-ON	LTK-0507-303-501	LTK-0507-303	LTK-0507-303-502
NPN Light-ON	LTK-0507-301-501	LTK-0507-301	
Other types available			

MINIATURE C12

PHOTOELECTRIC SENSORS

ADVANTAGES

- ✓ Long sensing ranges
- ✓ Background suppression up to 120 mm
- ✓ Excellent background suppression characteristics
- ✓ 45° angle cable outlet for easy installation

WIRING DIAGRAM

PNP or NPN, 1 output



OVERVIEW	C12
Housing material	ABS / PMMA
Light source	Red pinpoint LED 640 nm
Degree of protection	IP 67
Supply voltage range	10 ... 30 VDC
Ambient temperature range	-20 ... +50°C / -4 ... +122 °F
Output current	≤ 50 mA
Switching frequency	≤ 800 Hz

C12 SERIES



C12

PHOTOELECTRIC

HOUSING SIZE MM	□ 13 X 27 X 7	□ 13 X 21 X 7
OPERATING PRINCIPLE	DIFFUSE SENSOR WITH BACKGROUND SUPPRESSION	DIFFUSE SENSOR WITH BACKGROUND SUPPRESSION
SENSING RANGE MM	120	15

Inductive

Photoelectric

Safety

RFID

Connectivity

Accessories

Glossary

Index

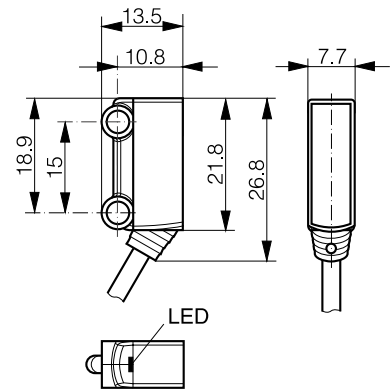
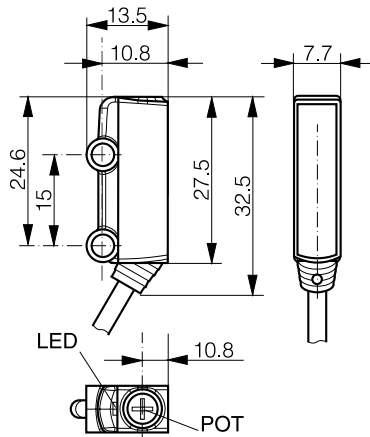

DATA		
Setup	3-turn potentiometer	-
PNP Light-ON	LHR-C12PA-PLK-303	LHR-C12PA-NSK-303
NPN Light-ON	LHR-C12PA-PLK-301	LHR-C12PA-NSK-301
Other types available	0.2 m cable + connector S8	0.2 m cable + connector S8

MINIATURE

HOUSING SIZE MM

□ 13 X 21 X 7

□ 13 X 21 X 7

OPERATING PRINCIPLE

DIFFUSE SENSOR WITH
BACKGROUND SUPPRESSION

REFLEX SENSOR

SENSING RANGE MM

30

3000

PHOTOELECTRIC

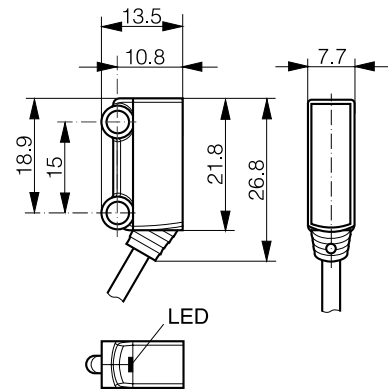
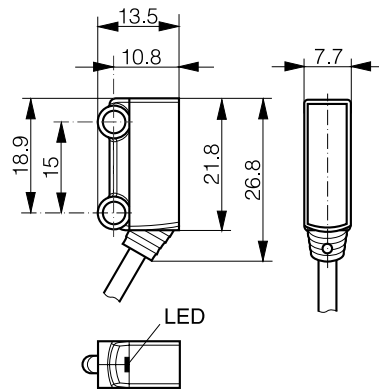

DATA

Setup

-

-

Emitter

PNP Light-ON

LHR-C12PA-NMK-303

NPN Light-ON

LHR-C12PA-NMK-301

PNP Dark-ON

LRR-C12PA-NMK-304

NPN Dark-ON

LRR-C12PA-NMK-302

Other types available

0.2 m cable + connector S8

0.2 m cable + connector S8

C12 SERIES



C12

□ 13 X 21 X 7	
THROUGH-BEAM SENSOR	
2000	

Inductive

Photoelectric

Safety

RFID

Connectivity

Accessories

Glossary

Index

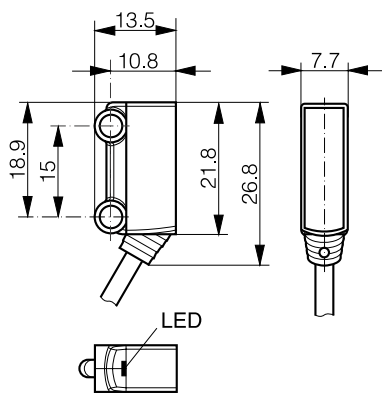

-	
LLR-C12PA-NMK-300	
LLR-C12PA-NMK-304 (receiver)	
LLR-C12PA-NMK-302 (receiver)	
0.2 m cable + connector S8	



OUTSTANDING RELIABILITY AND EASE OF ADJUSTMENT

TRANSPARENT OBJECT

PHOTOELECTRIC SENSORS

KEY ADVANTAGES

C23 Transparent UV

- ✓ Extremely reliable detection thanks to strong absorption of UV light by plastic and glass material
- ✓ Easy sensor set-up, even for thinnest transparent objects
- ✓ Low environmental sensitivity minimizes threshold adjustments and maximizes uptime
- ✓ Sensing range up to 1200 mm
- ✓  IO-Link

C23 Transparent Standard

- ✓ Sensing range up to 5000 mm
- ✓ Red polarized light
- ✓  IO-Link

RANGE OVERVIEW

TRANSPARENT OBJECT

Series

C23 (20x30x10)

Reflex, UV light

p. 245

Reflex, red light

p. 246-247

TRANSPARENT OBJECT C23

PHOTOELECTRIC SENSORS

ADVANTAGES

C23 Transparent UV

- ✓ Extremely reliable detection thanks to strong absorption of UV light by plastic and glass material
- ✓ Easy sensor set-up, even for thinnest transparent objects
- ✓ Low environmental sensitivity minimizes threshold adjustments and maximizes uptime
- ✓ Autocollimated, polarized UV light beam eliminates blind zone, allowing detection of targets close to the sensor or through a small notch
- ✓ Sensing range up to 1200 mm
- ✓ Adjustment by teach button or  IO-Link
- ✓ Mutual interference immunity
- ✓ Enclosure rating IP 67, Ecolab approved

C23 Transparent Standard

- ✓ Sensing range up to 5000 mm
- ✓ Red polarized light
- ✓ Suitable for thicker or larger transparent objects
- ✓ Adjustment by potentiometer or by teach button or  IO-Link
- ✓ Enclosure rating IP 67, Ecolab approved

WIRING DIAGRAM

PNP or NPN, 2 outputs

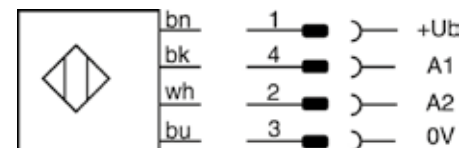

OVERVIEW	C23 TRANSPARENT UV	C23 TRANSPARENT STANDARD
Housing material	ABS / PMMA	ABS / PMMA
Degree of protection	IP 67	IP 67
Supply voltage range	15 ... 30 VDC	10 ... 30 VDC
Ambient temperature range	-25 ... +55°C / -13 ... +131°F	-25 ... +65°C / -13 ... +149 °F
Output current (total both outputs)	≤ 100 mA	≤ 100 mA
Compatible reflectors	See pages 304-305	See pages 303-304
Compatible mounting bracket	See pages 296-297	See pages 296-297

C23 UV LIGHT



C23

HOUSING SIZE MM

□ 20 X 30 X 10

□ 20 X 30 X 10

OPERATING PRINCIPLE

TRANSPARENT REFLEX

TRANSPARENT REFLEX

SENSING RANGE MM

1200

1200

Inductive

Photoelectric

Safety

RFID

Connectivity

Accessories

Glossary

Index

PHOTOELECTRIC

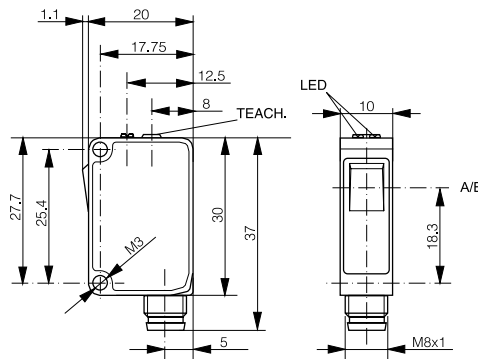

A: emitter axis B: receiver axis

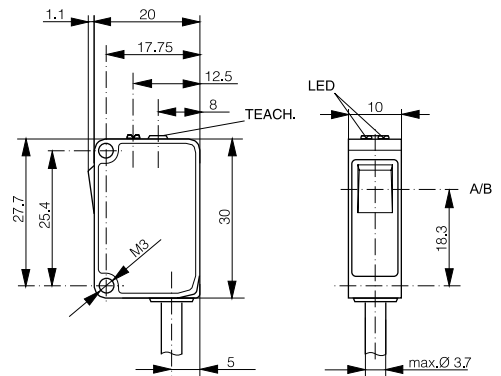

A: emitter axis B: receiver axis

DATA

IO-Link

IO-Link

Light source

LED UV 275 nm, Risk Group 2

LED UV 275 nm, Risk Group 2

Switching frequency (normal mode)

≤ 1000 Hz

≤ 1000 Hz

Setup

Teach button or IO-Link

Teach button or IO-Link

PNP Light-ON + Dark-ON

TRU-C23PA-TMS-603

TRU-C23PA-TMK-603

PNP Dark-ON + stability alarm

TRU-C23PA-TMS-60D

TRU-C23PA-TMK-60D

NPN Light-ON + Dark-ON

TRU-C23PA-TMS-101

TRU-C23PA-TMK-101

NPN Dark-ON + stability alarm

TRU-C23PA-TMS-10B

TRU-C23PA-TMK-10B

Other types available

TRANSPARENT

HOUSING SIZE MM

□ 20 X 30 X 10

□ 20 X 30 X 10

OPERATING PRINCIPLE

TRANSPARENT REFLEX

TRANSPARENT REFLEX

SENSING RANGE MM

5000

5000

PHOTOELECTRIC

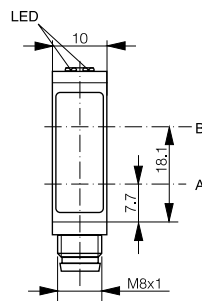
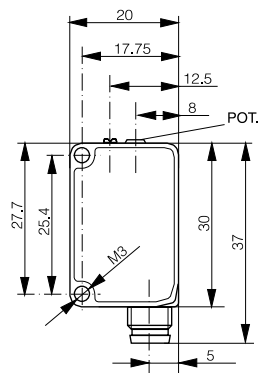

A: emitter axis B: receiver axis

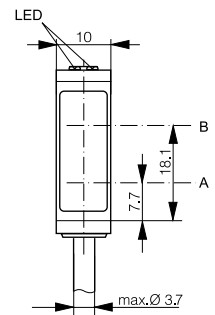
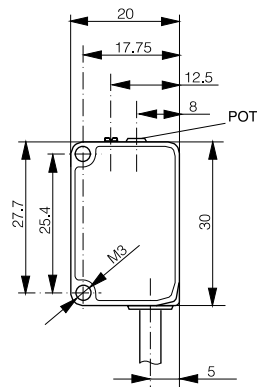

A: emitter axis B: receiver axis

DATA

IO-Link

IO-Link

Light source

LED red polarized 630 nm

LED red polarized 630 nm

Switching frequency (normal mode)

≤ 1500 Hz

≤ 1500 Hz

Setup

Potentiometer

Potentiometer

PNP Light-ON + Dark-ON

TRR-C23PA-PMS-603

TRR-C23PA-PMK-603

PNP Dark-ON + stability alarm

TRR-C23PA-PMS-60D

TRR-C23PA-PMK-60D

NPN Light-ON + Dark-ON

TRR-C23PA-PMS-101

TRR-C23PA-PMK-101

NPN Dark-ON + stability alarm

TRR-C23PA-PMS-10B

TRR-C23PA-PMK-10B

Other types available

C23 RED LIGHT



C23

□ 20 X 30 X 10
TRANSPARENT REFLEX
5000

□ 20 X 30 X 10
TRANSPARENT REFLEX
5000

Inductive

Photoelectric

Safety

RFID

Connectivity

Accessories

Glossary

Index

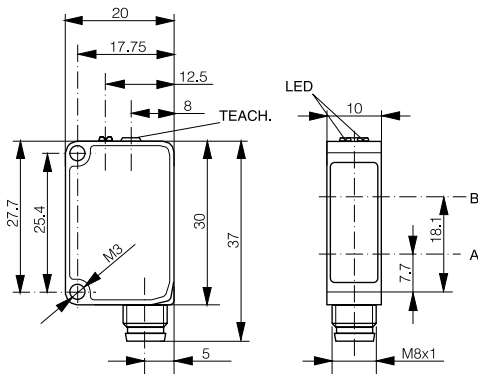

A: emitter axis B: receiver axis

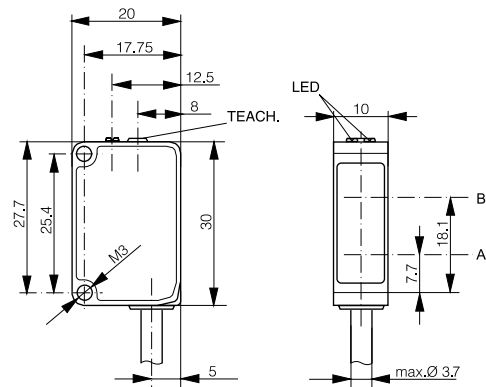

A: emitter axis B: receiver axis

IO-Link
LED red polarized 630 nm ≤ 1500 Hz
Teach button or IO-Link
TRR-C23PA-TMS-603
TRR-C23PA-TMS-60D
TRR-C23PA-TMS-101
TRR-C23PA-TMS-10B

IO-Link
LED red polarized 630 nm ≤ 1500 Hz
Teach button or IO-Link
TRR-C23PA-TMK-603
TRR-C23PA-TMK-60D
TRR-C23PA-TMK-101
TRR-C23PA-TMK-10B



RELIABLE SHORT AND LONG-RANGE SENSING

FIBER OPTIC PHOTOELECTRIC SENSORS

KEY ADVANTAGES

Fiber-optic sensors

- ✓ Robust 3030 and 4040 series (30 mm x 30 mm x 15 mm and 40 mm x 40 mm x 19 mm)
- ✓ DIN-rail mounted 3060 series (31 mm x 60 mm x 10 mm) suitable for multiple-sensor applications
- ✓ Distance setting by potentiometer or teach-in
- ✓  IO-Link

Fibers

- ✓ Large selection of types, including cylindrical light beam, multi-beam, liquid level monitoring and low & high temperature
- ✓ Diffuse or through-beam sensing, axial or radial
- ✓ Synthetic fibers with bending radii from 2 mm, suitable for cutting on-site
- ✓ Glass fibers for high temperatures and aggressive environments

RANGE OVERVIEW	Series	Amplifier	Plastic fiber	Glass fiber
FIBER OPTIC	3030 (30x30x15)	p. 252-254	p. 262-270	p. 277
	3060 (31x60x10)	p. 256-259	p. 262-270	
	4040 (40x40x19)	p. 260-261		p. 272-276

PROGRAM OVERVIEW

AMPLIFIERS	SERIES	3030	3031	
	HOUSING SIZE	30 x 30 x 15 mm	30 x 30 x 15 mm	
	MAX. DISTANCE	120 mm	60 mm	
	SETUP	Potentiometer	Potentiometer	
	FOR USE WITH SYNTHETIC FIBERS	p. 254	p. 253	
	FOR USE WITH GLASS FIBERS	p. 254	p. 253	

OPTICAL FIBERS	HOUSING SIZE		Ø 2.3 mm	M3	Ø 3.2 mm	Ø 4 mm	
	SYNTHETIC FIBERS	Diffuse	p. 263	p. 263			
		Through-beam		p. 266	p. 266		
		Cylindrical light beam				p. 268	
		Liquid level monitoring					
		Low and high temperatures					
		Multi-beam detection					
	GLASS FIBERS	Diffuse					
		Through-beam					



	3060	3066	3360	4040
	31 x 60 x 10 mm	31 x 60 x 10 mm	31 x 60 x 10 mm	40 x 40 x 19 mm
	200 mm	200 mm	100 mm	150 mm
	Potentiometer	Teach /  IO-Link	Potentiometer	Potentiometer
	p. 258	p. 257	p. 259	
				p. 261

Inductive

Photoelectric

Safety

	M4	M5	Ø 6 mm	M6	Ø 8 mm	M8	□ 18 x 32 mm
				p. 264-265			
	p. 266-267			p. 267			
		p. 268					
						p. 269	
	p. 270			p. 270			
							p. 269
			p. 273-274	p. 277	p. 273-274		
	p. 277		p. 275, 276		p. 275-276		

RFID

Connectivity

Accessories

Glossary

Index

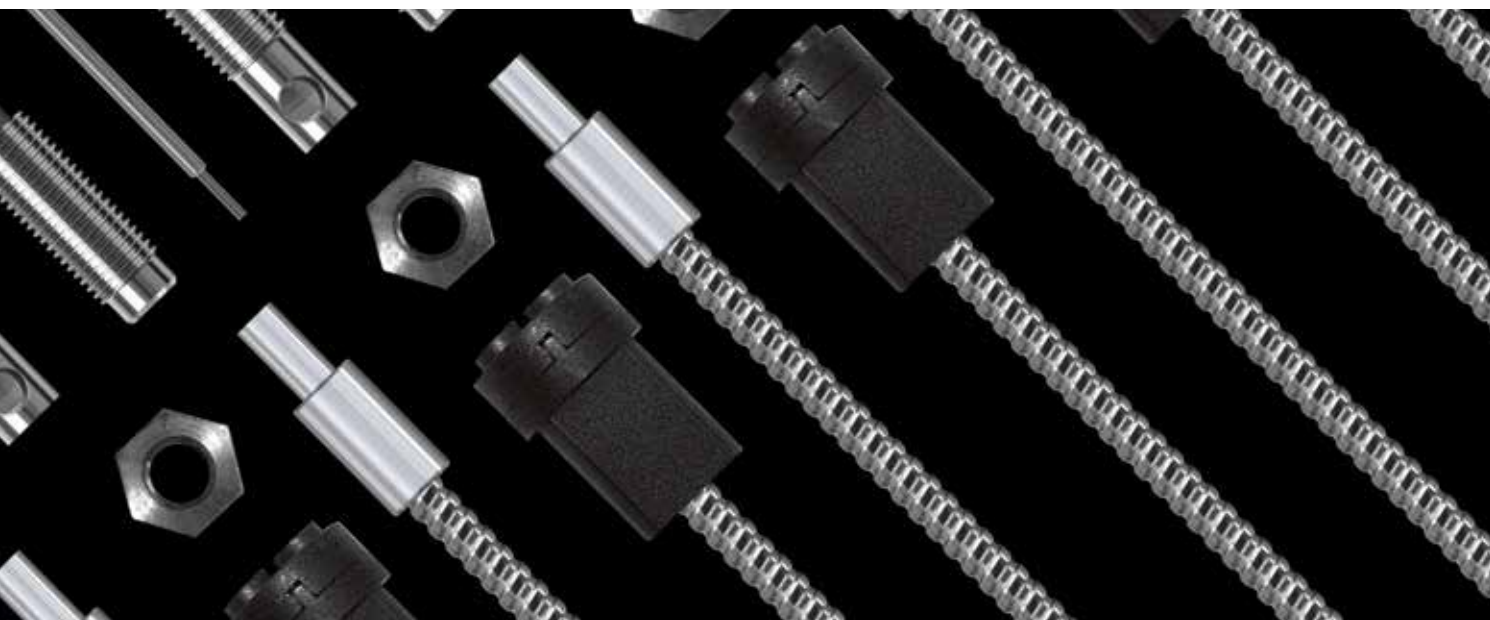

AMPLIFIER 3030

PHOTOELECTRIC SENSORS

ADVANTAGES

- ✓ Fiber-optic amplifiers in rugged Crastin housing
30 x 30 x 15 mm
- ✓ Shock & vibration resistant due to fully potted electronics
- ✓ Sensing range up to 120 mm

WIRING DIAGRAMS

PNP or NPN, 1 output



PNP or NPN, 2 outputs

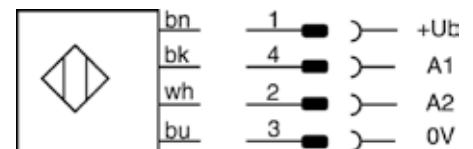

OVERVIEW	3030
Housing material	PBTP (Crastin)
Degree of protection	IP 67
Supply voltage range	10 ... 36 VDC
Ambient temperature range	-25 ... +55°C / -13 ... +131°F
Output current (total both outputs)	≤ 200 mA
Setup	Potentiometer
Compatible mounting bracket	See page 271

3030 SERIES



3030

HOUSING SIZE MM

□ 30 X 30 X 15

□ 30 X 30 X 15

OPERATING PRINCIPLE

FIBER-OPTIC AMPLIFIER

FIBER-OPTIC AMPLIFIER

SENSING RANGE MM

60

60

Inductive

Photoelectric

Safety

RFID

Connectivity

Accessories

Glossary

Index

PHOTOELECTRIC

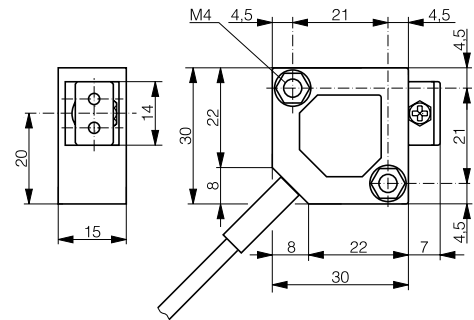
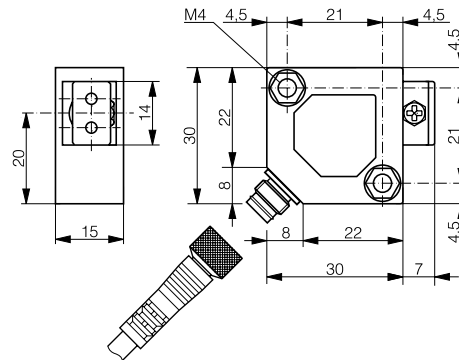

DATA

Light source

LED red 660 nm

LED red 660 nm

Max. switching frequency

1000 Hz

1000 Hz

PNP Light-ON

LFS-3031-303

LFK-3031-303

PNP Dark-ON

LFS-3031-304

LFK-3031-304

NPN Light-ON

LFS-3031-301

LFK-3031-301

NPN Dark-ON

LFS-3031-302

LFK-3031-302

Other types available

AMPLIFIER

HOUSING SIZE MM

□ 30 X 30 X 15

□ 30 X 30 X 15

OPERATING PRINCIPLE

FIBER-OPTIC AMPLIFIER

FIBER-OPTIC AMPLIFIER

SENSING RANGE MM

120

120

PHOTOELECTRIC

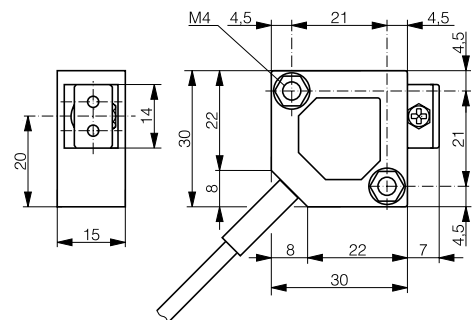
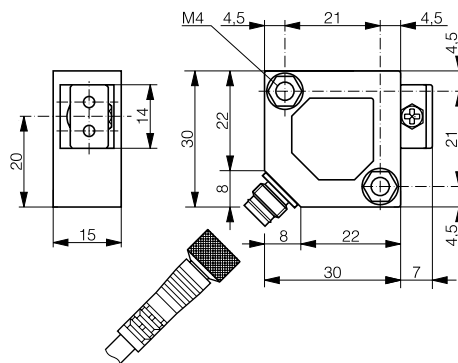

DATA

Light source

LED red 660 nm

LED red 660 nm

Max. switching frequency

1000 Hz

1000 Hz

PNP Light-ON + Dark-ON

LFS-3030-103

LFK-3030-103

NPN Light-ON + Dark-ON

LFS-3030-101

LFK-3030-101

Other types available



AMPLIFIER 3060

PHOTOELECTRIC SENSORS

ADVANTAGES

- ✓ Complete series of fiber-optic amplifiers for plastic fibers and DIN-rail mounting
- ✓ Small housings 31 x 60 x 10 mm
- ✓ Sensing ranges up to 200 mm
- ✓  **IO-Link**
- ✓ Blue light version for glass detection

WIRING DIAGRAMS

PNP or NPN, 2 outputs

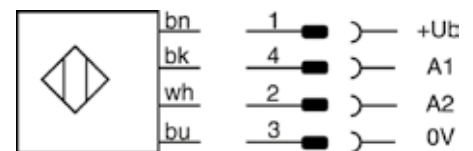

PNP or NPN, 1 output + teach-in

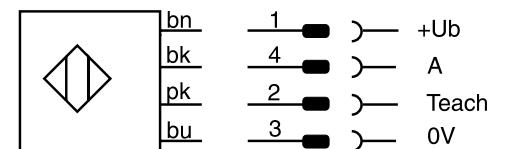

OVERVIEW	3060
Housing material	PBTP (Crastin)
Degree of protection	IP 64
Supply voltage range	10 ... 30 VDC
Ambient temperature range	-25 ... +55°C / -13 ... +131°F // -5 ... +55°C / +23 ... +131°F (3066)
Output current	≤ 200 mA
Compatible mounting bracket	See page 271

3060 SERIES



3060

PHOTOELECTRIC

HOUSING SIZE MM	□ 31 X 60 X 10	□ 31 X 60 X 10
OPERATING PRINCIPLE	FIBER-OPTIC AMPLIFIER	FIBER-OPTIC AMPLIFIER
SENSING RANGE MM	200	200

Inductive

Photoelectric

Safety

RFID

Connectivity

Accessories

Glossary

Index

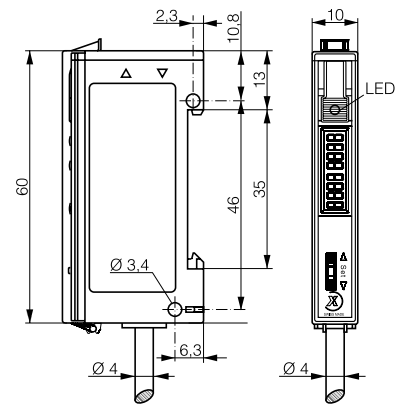
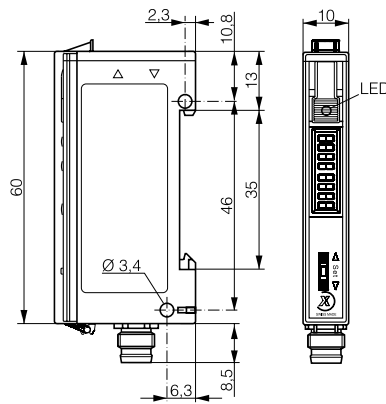

DATA	IO-Link	
Light source	LED red 680 nm	LED red 680 nm
Max. switching frequency	4000 Hz	4000 Hz
Setup	Teach-in	Teach-in
PNP Light-ON/Dark-ON switchable	LFS-3066-403	LFK-3066-403
NPN Light-ON/Dark-ON switchable	LFS-3066-301	LFK-3066-301
Other types available		

AMPLIFIER

HOUSING SIZE MM

□ 31 X 60 X 10

□ 31 X 60 X 10

OPERATING PRINCIPLE

FIBER-OPTIC AMPLIFIER

FIBER-OPTIC AMPLIFIER

SENSING RANGE MM

200

200

PHOTOELECTRIC

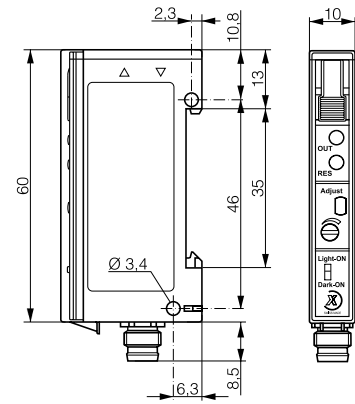
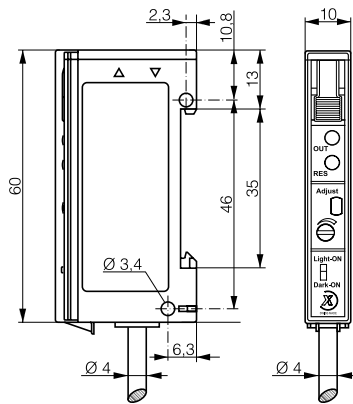

DATA

Light source

LED red 680 nm

LED red 680 nm

Max. switching frequency

1500 Hz

1500 Hz

Setup

Potentiometer

Potentiometer

PNP Light-ON/Dark-ON switchable
+ Excess gain

LFK-3060-103

LFS-3060-103

NPN Light-ON/Dark-ON switchable
+ Excess gain

LFK-3060-101

LFS-3060-101

Other types available

3060 SERIES



3060

□ 31 X 60 X 10
FIBER-OPTIC AMPLIFIER - BLUE LIGHT
100

□ 31 X 60 X 10
FIBER-OPTIC AMPLIFIER - BLUE LIGHT
100

Inductive

Photoelectric

Safety

RFID

Connectivity

Accessories

Glossary

Index

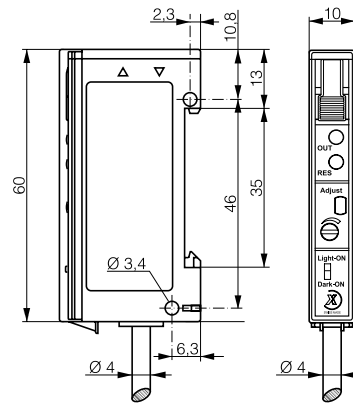
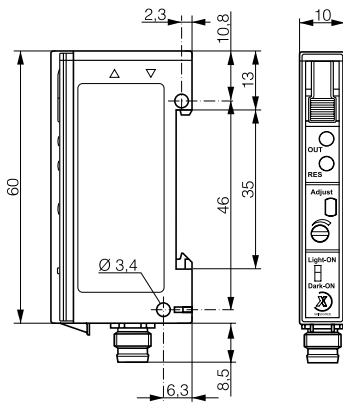

LED blue 465 nm
1500 Hz
Potentiometer
LFS-3360-103
LFS-3360-101

LED blue 465 nm
1500 Hz
Potentiometer
LFK-3360-103
LFK-3360-101

AMPLIFIER 4040

PHOTOELECTRIC SENSORS

ADVANTAGES

- ✓ Fiber-optic amplifiers for glass fibers
- ✓ Rugged Crastin housing 40 x 40 x 19 mm
- ✓ Shock and vibration resistant due to fully potted electronics
- ✓ Long operating distance of 150 mm with LFG-1030-050 glass fiber
- ✓ Convenient sensitivity adjustment by 20-turn potentiometer

WIRING DIAGRAM

PNP or NPN, 2 outputs

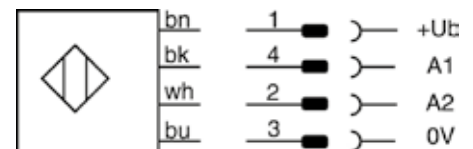

OVERVIEW	4040
Housing material	PBTP (Crastin)
Degree of protection	IP 67
Supply voltage range	10 ... 36 VDC
Ambient temperature range	-25 ... +55°C / -13 ... +131°F
Output current (total of both outputs)	≤ 200 mA
Switching frequency	≤ 1000 Hz
Compatible mounting bracket	See page 271



4040

4040 SERIES

HOUSING SIZE MM

□ 40 X 40 X 19

OPERATING PRINCIPLE

FIBER-OPTIC AMPLIFIER

SENSING RANGE MM

150

Inductive

Photoelectric

Safety

RFID

Connectivity

Accessories

Glossary

Index

PHOTOELECTRIC

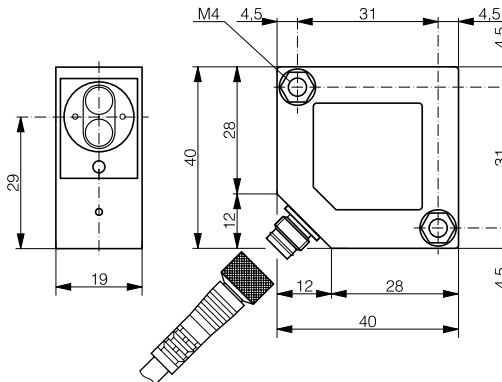

DATA

Light source

IR LED 880 nm

Setup

Potentiometer

PNP Light-ON + Dark-ON (connector)

LFS-4040-103

PNP Light-ON + Dark-ON (cable)

LFK-4040-103

SYNTHETIC OPTICAL FIBERS

- ✓ Very small dimensions
- ✓ Long sensing ranges
- ✓ Small bending radii
- ✓ Can be cut on site
- ✓ Large selection of types
- ✓ Mechanically rugged sensing head

TECHNICAL DATA	
Ambient temperature range	-25 ... +70°C / -55 ... +105°C* (-13 ... +158°F / -67 ... +221°F*)
Standard length	2 m ± 0.1 m (other lengths on request)
Fiber bending radii:	
miniature / multi-beam	15 mm
standard / coaxial	25 mm
low & high temperature	25 mm
liquid level monitoring	25 mm
flexible	2 mm
luminous (enhanced brightness)	40 mm
Bending radius of light-outlet tube	25 mm
Tensile load	30 N max.
Fiber material	PMMA
Sleeve material	Polyethylene
Sensing head material	Stainless steel V2A / PBTP**
Sensing head light-outlet tube material	Stainless steel V2A
Optical attenuation:	
standard / luminous (enhanced brightness)	0.2 dB / m max. at 660 nm
miniature / low & high temperature	0.2 dB / m max. at 660 nm
flexible / coaxial / multi-beam	0.3 dB / m max. at 660 nm
Angle of incidence	See data sheets
Tightening torque:	
M3	1 Nm
M4	2 Nm
M5	3 Nm
M6	4 Nm
M8	10 Nm

* LFP-1002-020-002 / LFP-2002-020-002

** LFP-1011-020

SYNTHETIC OPTICAL FIBERS

DIFFUSE SENSING

Dimensions: light emission on the left

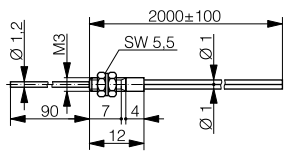
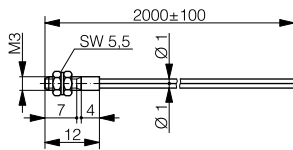
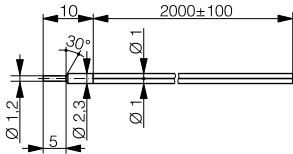

Housing size: Ø 2.3 mm	Miniature	
Part reference	LFP-1012-020	
Sensing range	with series 3030	40 mm (with 2 m fiber length)
	with series 3031	20 mm (with 2 m fiber length)
	with series 3#6#	70 mm (with 2 m fiber length)
Outside fiber	1 separable double fiber, Ø 1 mm*	
Inner fiber	Ø 0.5 mm	
Special characteristics	Highest resolution	
* Adaptor included in delivery package		

Housing size: M3	Miniature	
Part reference	LFP-1001-020	
Sensing range	with series 3030	40 mm (with 2 m fiber length)
	with series 3031	20 mm (with 2 m fiber length)
	with series 3#6#	70 mm (with 2 m fiber length)
Outside fiber	1 separable double fiber, Ø 1 mm*	
Inner fiber	Ø 0.5 mm	
Special characteristics	Highest resolution	
* Adaptor included in delivery package		

Housing size: M3	Miniature	
Part reference	LFP-1004-020	
Sensing range	with series 3030	40 mm (with 2 m fiber length)
	with series 3031	20 mm (with 2 m fiber length)
	with series 3#6#	70 mm (with 2 m fiber length)
Outside fiber	1 separable double fiber, Ø 1 mm*	
Inner fiber	Ø 0.5 mm	
Special characteristics	Sensing head with bendable light-outlet tube for ease of positioning; highest resolution	
* Adaptor included in delivery package		

Inductive

Photoelectric

Safety

RFID

Connectivity

Accessories

Glossary

Index

SYNTHETIC OPTICAL FIBERS

DIFFUSE SENSING

Dimensions: light emission on the left

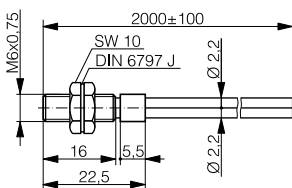
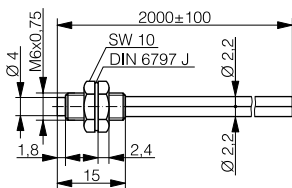
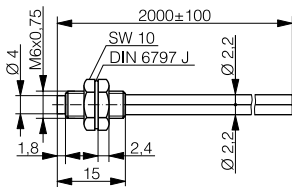
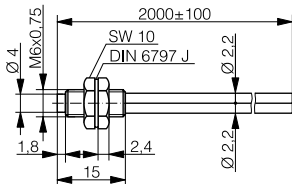

Housing size: M6	Standard	
Part reference	LFP-1002-020	
Sensing range	with series 3030	120 mm (with 2 m fiber length)
	with series 3031	60 mm (with 2 m fiber length)
	with series 3#6#	200 mm (with 2 m fiber length)
Outside fiber	1 separable double fiber, \varnothing 2.2 mm	
Inner fiber	\varnothing 1.0 mm	
Special characteristics	Long sensing range	

Housing size: M6	Flexible	
Part reference	LFP-1102-020	
Sensing range	with series 3030	90 mm (with 2 m fiber length)
	with series 3031	45 mm (with 2 m fiber length)
	with series 3#6#	150 mm (with 2 m fiber length)
Outside fiber	1 separable double fiber, \varnothing 2.2 mm	
Inner fiber	151 x \varnothing 75 μ m	
Special characteristics	Very small bending radius	

Housing size: M6	Luminous (enhanced brightness)	
Part reference	LFP-1202-020	
Sensing range	with series 3030	160 mm (with 2 m fiber length)
	with series 3031	80 mm (with 2 m fiber length)
	with series 3#6#	260 mm (with 2 m fiber length)
Outside fiber	1 separable double fiber, \varnothing 2.2 mm	
Inner fiber	\varnothing 1.5 mm	
Special characteristics	Longest sensing range	

Housing size: M6	Coaxial	
Part reference	LFP-1003-020	
Sensing range	with series 3030	120 mm (with 2 m fiber length)
	with series 3031	60 mm (with 2 m fiber length)
	with series 3#6#	200 mm (with 2 m fiber length)
Outside fiber	1 separable double fiber, \varnothing 2.2 mm	
Inner fiber	\varnothing 1.0 mm	
Special characteristics	Coaxial arrangement of fibers, thus axially symmetric beam	

SYNTHETIC OPTICAL FIBERS

DIFFUSE SENSING

Dimensions: light emission on the left

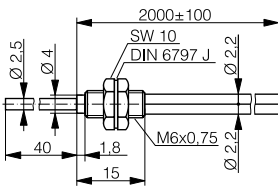
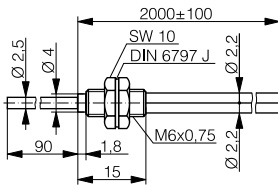

Housing size: M6	Standard	
Part reference	LFP-1005-020	
Sensing range	with series 3030	120 mm (with 2 m fiber length)
	with series 3031	60 mm (with 2 m fiber length)
	with series 3#6#	200 mm (with 2 m fiber length)
Outside fiber	1 separable double fiber, Ø 2.2 mm	
Inner fiber	Ø 1.0 mm	
Special characteristics	Sensing head with bendable light-outlet tube for ease of positioning	
	Long sensing range	

Housing size: M6	Standard	
Part reference	LFP-1013-020	
Sensing range	with series 3030	120 mm (with 2 m fiber length)
	with series 3031	60 mm (with 2 m fiber length)
	with series 3#6#	200 mm (with 2 m fiber length)
Outside fiber	1 separable double fiber, Ø 2.2 mm	
Inner fiber	Ø 1.0 mm	
Special characteristics	Sensing head with bendable light-outlet tube for ease of positioning	
	Long sensing range	

Inductive

Photoelectric

Safety

RFID

Connectivity

Accessories

Glossary

Index

SYNTHETIC OPTICAL FIBERS

THROUGH-BEAM SENSING

Dimensions: light emission on the left

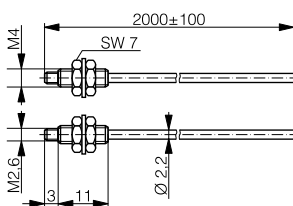
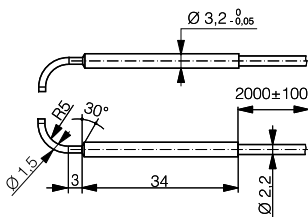
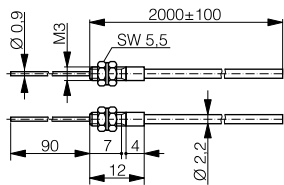
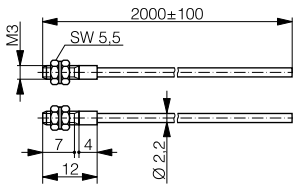

Housing size: M3	Miniature	
Part reference	LFP-2001-020	
Sensing range	with series 3030	120 mm (with 2 m fiber length)
	with series 3031	60 mm (with 2 m fiber length)
	with series 3#6#	200 mm (with 2 m fiber length)
Outside fiber	2 individual fibers, Ø 2.2 mm	
Inner fiber	Ø 0.5 mm	
Special characteristics	Highest resolution	

Housing size: M3	Miniature	
Part reference	LFP-2003-020	
Sensing range	with series 3030	120 mm (with 2 m fiber length)
	with series 3031	60 mm (with 2 m fiber length)
	with series 3#6#	200 mm (with 2 m fiber length)
Outside fiber	2 individual fibers, Ø 2.2 mm	
Inner fiber	Ø 0.5 mm	
Special characteristics	Sensing head with bendable light-outlet tube for ease of positioning	
	Highest resolution	

Housing size: Ø 3.2 mm	Standard 90°	
Part reference	LFP-2006-020	
Sensing range	with series 3030	120 mm (with 2 m fiber length)
	with series 3031	60 mm (with 2 m fiber length)
	with series 3#6#	200 mm (with 2 m fiber length)
Outside fiber	2 individual fibers, Ø 2.2 mm	
Inner fiber	Ø 1.0 mm	
Special characteristics	Lateral sensing	

Housing size: M4	Standard	
Part reference	LFP-2002-020	
Sensing range	with series 3030	400 mm (with 2 m fiber length)
	with series 3031	200 mm (with 2 m fiber length)
	with series 3#6#	700 mm (with 2 m fiber length)
Outside fiber	2 individual fibers, Ø 2.2 mm	
Inner fiber	Ø 1.0 mm	
Special characteristics	Long sensing range	

SYNTHETIC OPTICAL FIBERS

THROUGH-BEAM SENSING

Dimensions: light emission on the left

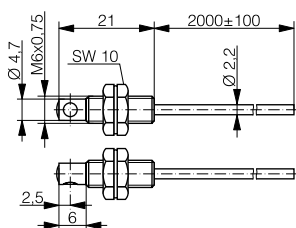
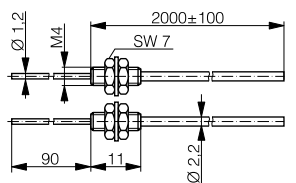
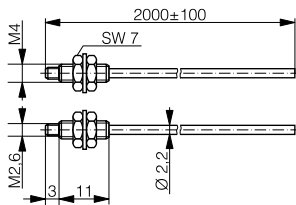
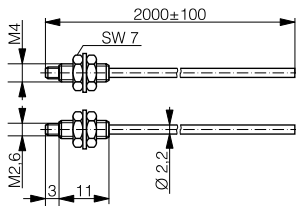

Housing size: M4		Flexible
Part reference	LFP-2102-020	
Sensing range	with series 3030	300 mm (with 2 m fiber length)
	with series 3031	150 mm (with 2 m fiber length)
	with series 3#6#	550 mm (with 2 m fiber length)
Outside fiber	2 individual fibers, Ø 2.2 mm	
Inner fiber	151 x Ø 75 µm	
Special characteristics	Very small bending radius	

Housing size: M4		Luminous (enhanced brightness)
Part reference	LFP-2202-020	
Sensing range	with series 3030	500 mm (with 2 m fiber length)
	with series 3031	250 mm (with 2 m fiber length)
	with series 3#6#	900 mm (with 2 m fiber length)
Outside fiber	2 individual fibers, Ø 2.2 mm	
Inner fiber	Ø 1.5 mm	
Special characteristics	Longest sensing range	

Housing size: M4		Standard
Part reference	LFP-2004-020	
Sensing range	with series 3030	400 mm (with 2 m fiber length)
	with series 3031	200 mm (with 2 m fiber length)
	with series 3#6#	700 mm (with 2 m fiber length)
Outside fiber	2 individual fibers, Ø 2.2 mm	
Inner fiber	Ø 1.0 mm	
Special characteristics	Sensing head with bendable light-outlet tube for ease of positioning	
	Long sensing range	

Housing size: M6		Standard 90°
Part reference	LFP-2005-020	
Sensing range	with series 3030	1100 mm (with 2 m fiber length)
	with series 3031	550 mm (with 2 m fiber length)
	with series 3#6#	1800 mm (with 2 m fiber length)
Outside fiber	2 individual fibers, Ø 2.2 mm	
Inner fiber	Ø 1.0 mm	
Special characteristics	Lateral sensing	
	Long sensing range	

Inductive

Photoelectric

Safety

RFID

Connectivity

Accessories

Glossary

Index

SYNTHETIC OPTICAL FIBERS

APPLICATION-SPECIFIC CYLINDRICAL LIGHT BEAM

Dimensions: light emission on the left

- ✓ Diffuse fibers particularly suitable for the detection of objects in recesses and behind covers (through holes and gaps)
- ✓ Extremely small sensing heads
- ✓ Quasi-cylindrical light beam
- ✓ Recessed mounting possible
- ✓ Sapphire glass optical parts, thus easy to clean

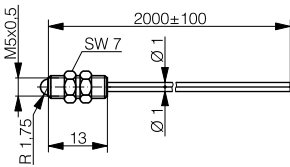
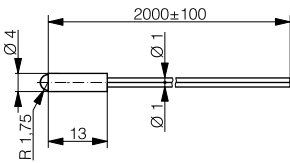

Housing size: \varnothing 4 mm	Miniature / spherical optics	
Part reference	LFP-1006-020	
Sensing range	with series 3030	100 mm (with 2 m fiber length)
	with series 3031	60 mm (with 2 m fiber length)
	with series 3#6#	140 mm (with 2 m fiber length)
Outside fiber	1 separable double fiber, \varnothing 1 mm*	
Inner fiber	\varnothing 0.5 mm	
Special characteristics	Spherical optics for cylindrical light beam	
* Adaptor included in delivery package		

Housing size: M5	Miniature / spherical optics	
Part reference	LFP-1007-020	
Sensing range	with series 3030	100 mm (with 2 m fiber length)
	with series 3031	60 mm (with 2 m fiber length)
	with series 3#6#	140 mm (with 2 m fiber length)
Outside fiber	1 separable double fiber, \varnothing 1 mm*	
Inner fiber	\varnothing 0.5 mm	
Special characteristics	Spherical optics for cylindrical light beam	
* Adaptor included in delivery package		

Response curves (with series 3030):

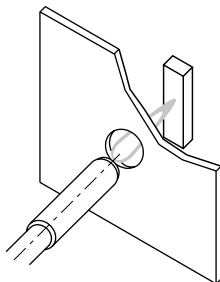

Detection through holes and gaps

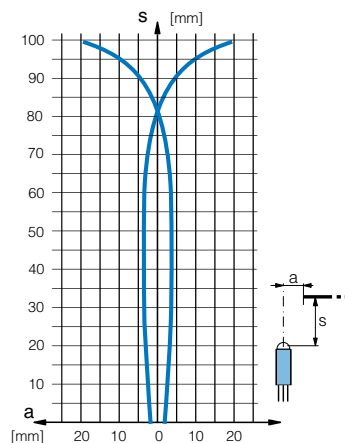

LFP-1006-020

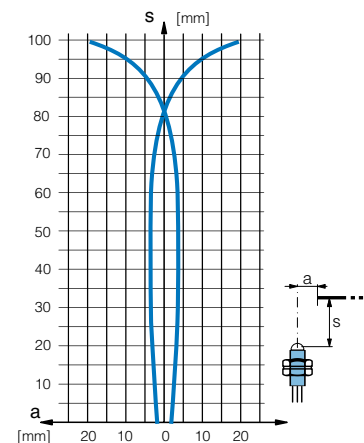

LFP-1007-020

SYNTHETIC OPTICAL FIBERS

APPLICATION-SPECIFIC MULTI-BEAM

- ✓ Multi-beam diffuse fiber
- ✓ Detection of objects across the whole width of the sensing head (28 mm)
- ✓ Suitable for rough environments, thanks to PBTP housing
- ✓ Lateral mounting

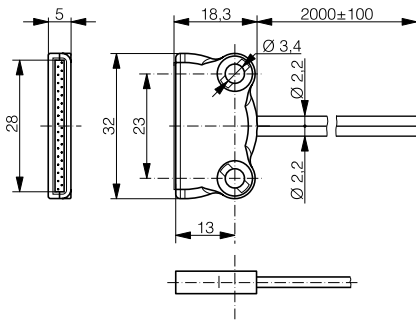

Housing size:	□ 18 x 32	Multi-beam
Part reference	LFP-1011-020	
Sensing range	with series 3030	90 mm (with 2 m fiber length)
	with series 3031	45 mm (with 2 m fiber length)
	with series 3#6#	150 mm (with 2 m fiber length)
Outside fiber	2 separate fibers, \varnothing 2.2 mm	
Inner fiber	16 x \varnothing 0.265 mm	
Special characteristics	Wide detection range (28 mm)	

Response curves (with series 3030):

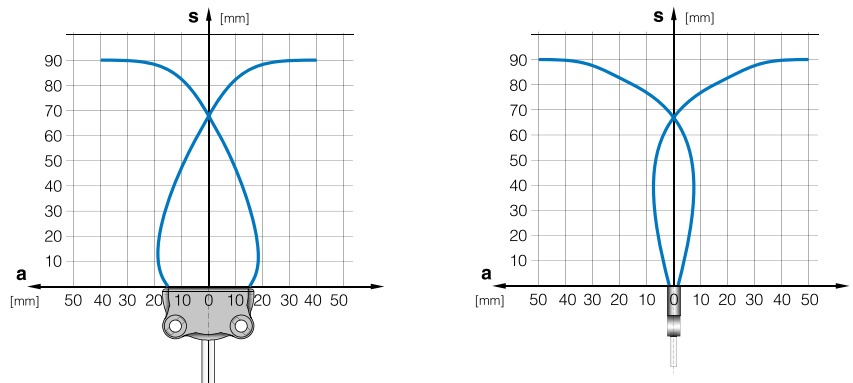

APPLICATION-SPECIFIC LIQUID LEVEL MONITORING

- ✓ Contact liquid detection (with the exception of white milky liquids)
- ✓ Fully potted optical parts
- ✓ Scratch-resistant, easy-to-clean glass prism
- ✓ Impervious (degree of protection: IP 68)

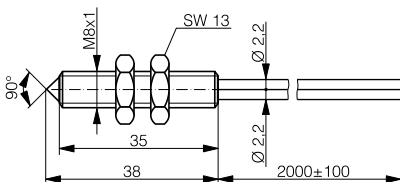

Housing size:	M8	Liquid level monitoring
Part reference	LFP-1010-020	
Outside fiber	2 separate fibers, \varnothing 2.2 mm	
Inner fiber	\varnothing 0.5 mm	
Special characteristics	Contact liquid detection	

Operating principle:

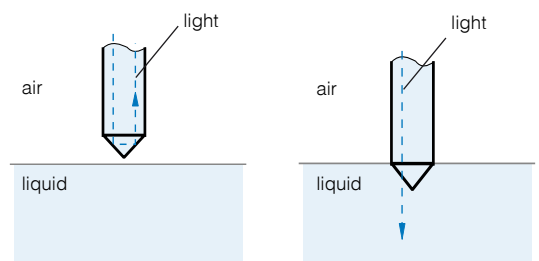

SYNTHETIC OPTICAL FIBERS

APPLICATION-SPECIFIC LOW & HIGH TEMPERATURES

Dimensions: light emission on the left

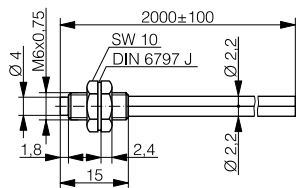
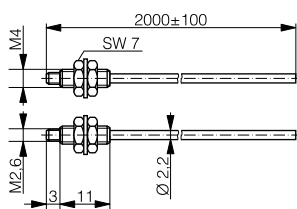

- ✓ Diffuse (LFP-1002-020-002) and through-beam (LFP-2002-020-002) fibers
- ✓ Extended temperature range : -55 ... +105°C / -67 ... +221°F
- ✓ Very small dimensions
- ✓ Long sensing ranges
- ✓ Small bending radii
- ✓ Can be cut on site

Housing size: M4	Low & high temperature resistant	
Part reference	LFP-2002-020-002	
Sensing range	with series 3030	300 mm (with 2 m fiber length)
	with series 3031	150 mm (with 2 m fiber length)
	with series 3#6#	550 mm (with 2 m fiber length)
Outside fiber	2 individual fibers, Ø 2.2 mm	
Inner fiber	Ø 1.0 mm	
Special characteristics	Extended temperature range of -55...+105°C / -67...+221°F	

Housing size: M6	Low & high temperature resistant	
Part reference	LFP-1002-020-002	
Sensing range	with series 3030	90 mm (with 2 m fiber length)
	with series 3031	45 mm (with 2 m fiber length)
	with series 3#6#	150 mm (with 2 m fiber length)
Outside fiber	1 separable double fiber, Ø 2.2 mm	
Inner fiber	Ø 1.0 mm	
Special characteristics	Extended temperature range of -55...+105°C / -67...+221°F	

SYNTHETIC OPTICAL FIBERS

ACCESSORIES

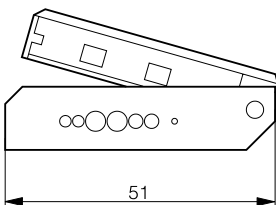
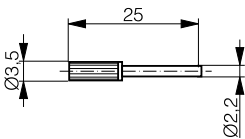
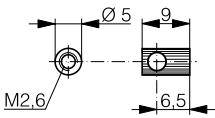
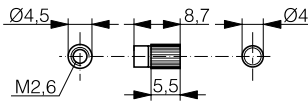

Axial front lens for increased sensing ranges

Part reference	LFP-0001-000	
Sensing range	with series 3030	3000 mm (2 m fibers)
	with series 3031	1500 mm (2 m fibers)
	with series 3#6#	5000 mm (5 m fibers)
Can be used with	LFP-2#02-020	
Delivery package	1 pair	

90° front lens for increased sensing ranges

Part reference	LFP-0002-000	
Sensing range	with series 3030	1000 mm (2 m fibers)
	with series 3031	500 mm (2 m fibers)
	with series 3#6#	1700 mm (2 m fibers)
Can be used with	LFP-2#02-020	
Delivery package	1 pair	

Adaptor

Part reference	LFP-0003-000
Suitable for	fine synthetic optical fibers

Cutting tool

Part reference	LXF-0000-000
Suitable for	all synthetic optical fibers

UNIVERSAL MOUNTING BRACKET

For 3030 / 3031 series
Material: stainless steel V2A
Part reference: **LXW-3030-000**

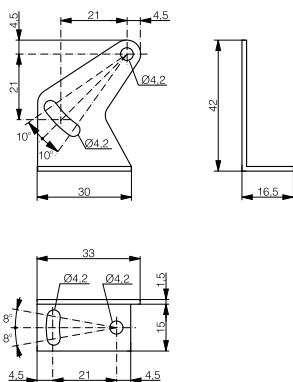

UNIVERSAL MOUNTING BRACKET

For 4040 series
Material: stainless steel V2A
Part reference: **LXW-4040-000**

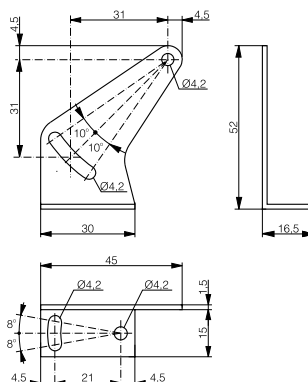

UNIVERSAL MOUNTING BRACKET

For 3#6# series
Material: stainless steel V2A
Part reference: **LXW-3060-000**

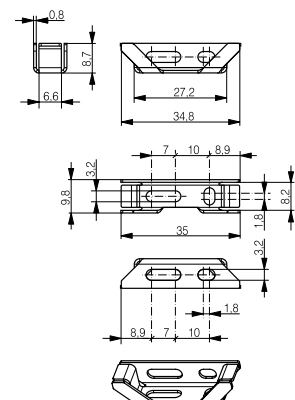

Inductive

Photoelectric

Safety

RFID

Connectivity

Accessories

Glossary

Index

GLASS OPTICAL FIBERS

- ✓ For high ambient temperatures (models with chrome-plated brass and silicone sleeves)
- ✓ Executions for extreme environmental conditions
- ✓ Small dimensions
- ✓ Long sensing ranges
- ✓ Suitable for the detection of smallest objects
- ✓ Large selection of types

TECHNICAL DATA		
Ambient temperature range	PVC sleeve	0 ... +70°C
		32 ... +158°F
	Wound brass sleeve	-25 ... +160°C
		-13 ... +320°F
	Silicone sleeve	-25 ... +150°C
		-13 ... +302°F
Protection degree of sensing head	IP 65 (optional up to IP 68)	
Protection degree of optical fiber	PVC sleeve	IP 67
	Wound brass sleeve	IP 54
	Silicone sleeve	IP 67
Standard lengths	250 mm, 500 mm, 1000 mm	
Sensing head material	Aluminum	
Sensing head light-outlet tube material	Stainless steel	
Optical attenuation	0.01 dB / m max. at 880 nm	
Angle of incidence	See data sheets	

Depending on the type involved, glass optical fibers consist of 200 to 5000 individual fibers with diameters of 30 to 50 μm . The fiber bundle is surrounded by a sleeve, which can be selected according to the application:

- PVC sleeve: the economical solution if no special stresses are to be expected.
- Wound sleeve of chrome-plated brass: for permanent operating temperatures of up to +160°C (+320°F), and maximum protection against crushing.
- Silicone sleeve with stainless-steel braiding for strain relief: for use in corrosive media, at temperatures of up to +150°C (+302°F), and where mechanical strain relief is required.

The sensing heads are available with straight or right-angle light outlets. The range comprises models for use as diffuse sensors (emitting and receiving fiber bundles in the same sleeve) and as through-beam sensors (the fiber bundles are in separate sleeves). In order to cover various application needs, a number of different bundle cross-sections are available: large cross-sections for long sensing ranges, small cross-sections for short ranges, high resolutions, and detection of small objects.

GLASS OPTICAL FIBERS

AXIAL DIFFUSE SENSING

Dimensions: light emission on the right

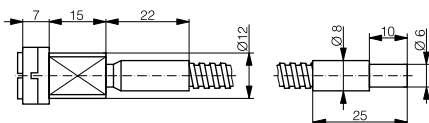
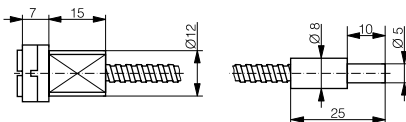
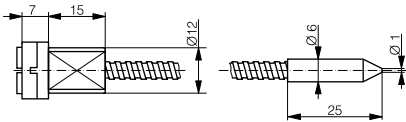
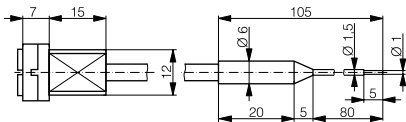
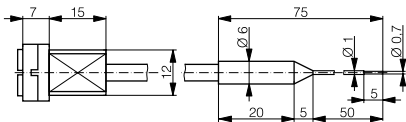

length of glass fiber in cm, standard lengths -025 (250 mm) / -050 (500 mm) / -100 (1000 mm)

Housing size: \varnothing 6 mm

Part reference	LFG-1005-###
Sensing range	with series 4040 5 mm
Special characteristics	With bendable light-outlet tube For the detection of smallest objects
Sleeve	Silicone, \varnothing 4.7 mm
Min. bending radius	20 mm / light-outlet tube: 5 mm (do not bend the inner and outer 10 mm)
Max. tensile load	10 N

Housing size: \varnothing 6 mm

Part reference	LFG-1015-###
Sensing range	with series 4040 15 mm
Special characteristics	With bendable light-outlet tube For places difficult to access
Sleeve	Silicone, \varnothing 4.7 mm
Min. bending radius	20 mm / light-outlet tube: 5 mm (do not bend the inner and outer 10 mm)
Max. tensile load	10 N

Housing size: \varnothing 6 mm

Part reference	LFG-1010-###
Sensing range	with series 4040 15 mm
Special characteristics	For the detection of smallest objects in places difficult to access
Sleeve	Wound sleeve of chrome-plated brass, \varnothing 4.7 mm
Min. bending radius	23 mm
Max. tensile load	20 N

Housing size: \varnothing 8 mm

Part reference	LFG-1020-###
Sensing range	with series 4040 50 mm
Special characteristics	Multi-purpose medium sensing range model
Sleeve	Wound sleeve of chrome-plated brass, \varnothing 4.7 mm
Min. bending radius	25 mm
Max. tensile load	50 N

Housing size: \varnothing 8 mm

Part reference	LFG-1030-###
Sensing range	with series 4040 150 mm
Special characteristics	For long sensing range
Sleeve	Wound sleeve of chrome-plated brass, \varnothing 6.7 mm
Min. bending radius	25 mm
Max. tensile load	50 N

Inductive

Photoelectric

Safety

RFID

Connectivity

Accessories

Glossary

Index

GLASS OPTICAL FIBERS

RADIAL DIFFUSE SENSING

length of glass fiber in cm, standard lengths -025 (250 mm) / -050 (500 mm) / -100 (1000 mm)

Dimensions: light emission on the right

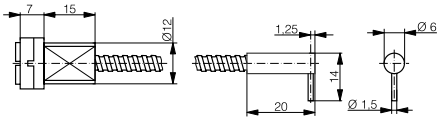

Housing size: Ø 6 mm

Part reference	LFG-2010-###
Sensing range	with series 4040 15 mm
Special characteristics	For the detection of smallest objects in places difficult to access
Leg length	14 mm
Sleeve	Wound sleeve of chrome-plated brass, Ø 4.7 mm
Min. bending radius	23 mm
Max. tensile load	20 N

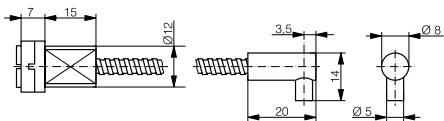

Housing size: Ø 8 mm

Part reference	LFG-2020-###
Sensing range	with series 4040 30 mm
Special characteristics	Multi-purpose medium sensing range model
Leg length	14 mm
Sleeve	Wound sleeve of chrome-plated brass, Ø 4.7 mm
Min. bending radius	25 mm
Max. tensile load	50 N

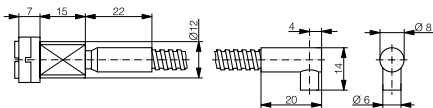

Housing size: Ø 8 mm

Part reference	LFG-2030-###
Sensing range	with series 4040 150 mm
Special characteristics	For long sensing range
Leg length	14 mm
Sleeve	Wound sleeve of chrome-plated brass, Ø 6.7 mm
Min. bending radius	25 mm
Max. tensile load	50 N

GLASS OPTICAL FIBERS

AXIAL THROUGH-BEAM SENSING

length of glass fiber in cm, standard lengths -025 (250 mm) / -050 (500 mm) / -100 (1000 mm)

Dimensions: light emission on the right

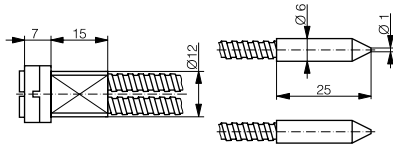

Housing size: Ø 6 mm

Part reference	LFG-3010-050
Sensing range	with series 4040 200 mm
Special characteristics	For the detection of smallest objects in places difficult to access
Sleeve	Wound sleeve of chrome-plated brass, Ø 4.7 mm
Min. bending radius	23 mm
Max. tensile load	20 N

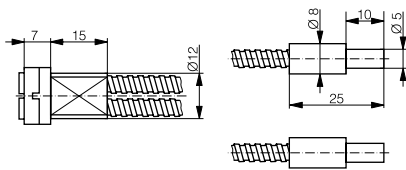

Housing size: Ø 8 mm

Part reference	LFG-3020-050
Sensing range	with series 4040 800 mm
Special characteristics	Multi-purpose medium sensing range model
Sleeve	Wound sleeve of chrome-plated brass, Ø 4.7 mm
Min. bending radius	25 mm
Max. tensile load	50 N

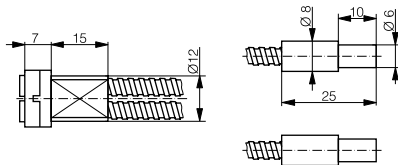

Housing size: Ø 8 mm

Part reference	LFG-3030-###
Sensing range	with series 4040 1500 mm
Special characteristics	For long sensing range
Sleeve	Wound sleeve of chrome-plated brass, Ø 4.7 mm
Min. bending radius	25 mm
Max. tensile load	50 N

Inductive

Photoelectric

Safety

RFID

Connectivity

Accessories

Glossary

Index

GLASS OPTICAL FIBERS

RADIAL THROUGH-BEAM SENSING

length of glass fiber in cm, standard lengths -025 (250 mm) / -050 (500 mm) / -100 (1000 mm)

Dimensions: light emission on the right

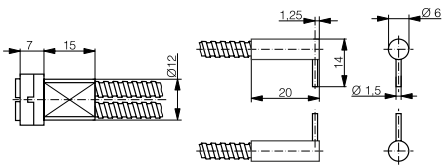

Housing size: Ø 6 mm

Part reference	LFG-4010-###
Sensing range	with series 4040 200 mm
Special characteristics	For the detection of smallest objects in places difficult to access
Leg length	14 mm
Sleeve	Wound sleeve of chrome-plated brass, Ø 4.7 mm
Min. bending radius	23 mm
Max. tensile load	20 N

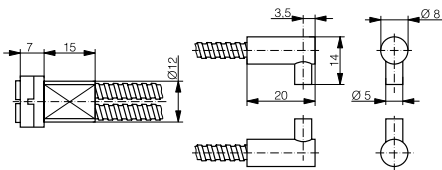

Housing size: Ø 8 mm

Part reference	LFG-4020-###
Sensing range	with series 4040 800 mm
Special characteristics	Multi-purpose medium sensing range model
Leg length	14 mm
Sleeve	Wound sleeve of chrome-plated brass, Ø 4.7 mm
Min. bending radius	25 mm
Max. tensile load	50 N

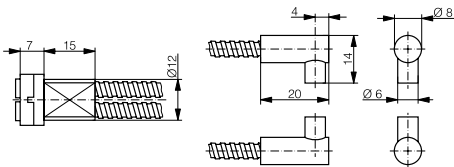

Housing size: Ø 8 mm

Part reference	LFG-4030-100
Sensing range	with series 4040 1500 mm
Special characteristics	For long sensing range
Leg length	14 mm
Sleeve	Wound sleeve of chrome-plated brass, Ø 4.7 mm
Min. bending radius	25 mm
Max. tensile load	50 N

GLASS OPTICAL FIBERS

Dimensions: light emission on the right

for series 3030 / 3031 sensors
(connection as with synthetic fibers)

Housing size: M6	Diffuse sensing
Part reference	LFG-1022-050
Sensing range	with series 3030 120 mm with series 3031 60 mm
Special characteristics	For difficult environmental conditions
Sleeve	Wound sleeve of chrome-plated brass, \varnothing 4.6 mm
Min. bending radius	25 mm
Max. tensile load	20 N

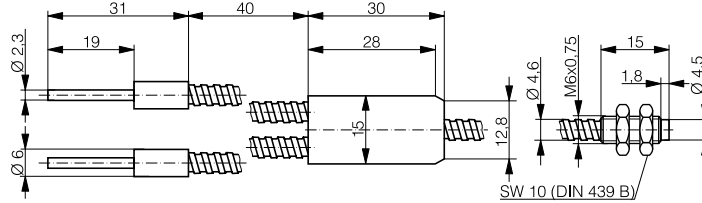

Housing size: M4	Through-beam sensing
Part reference	LFG-3022-050
Sensing range	with series 3030 500 mm with series 3031 250 mm
Special characteristics	For difficult environmental conditions
Sleeve	Wound sleeve of chrome-plated brass, \varnothing 4.6 mm
Min. bending radius	25 mm
Max. tensile load	20 N

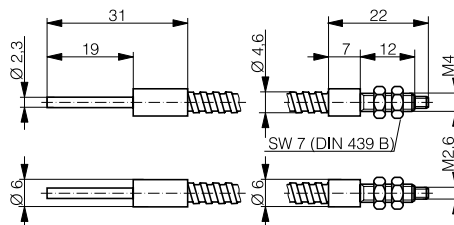

Inductive

Photoelectric

Safety

RFID

Connectivity

Accessories

Glossary

Index

GLASS OPTICAL FIBERS

ACCESSORIES

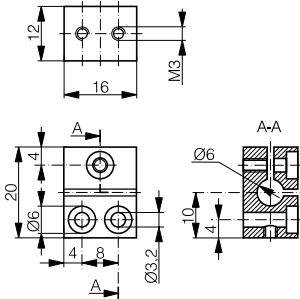

For \varnothing 6 mm heads	Fiber mounting clamp
Part reference	LXG-0000-060
Characteristics	Mounting clamp for axial and radial light-outlet tubes
Material	Nickel-plated brass
Suitable for the following fibers	LFG-1005-### / LFG-1015-###
	LFG-1010-### / LFG-2010-###
	LFG-3010-### / LFG-4010-###

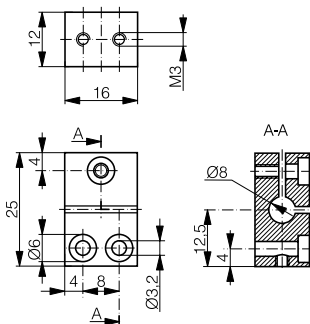

For \varnothing 8 mm heads	Fiber mounting clamp
Part reference	LXG-0000-080
Characteristics	Mounting clamp for axial and radial light-outlet tubes
Material	Nickel-plated brass
Suitable for the following fibers	LFG-1020-### / LFG-1030-###
	LFG-2020-### / LFG-2030-###
	LFG-3020-### / LFG-3030-###
	LFG-4020-### / LFG-4030-###





HIGH PRECISION AND DIRECT DIGITAL TRANSMISSION

DISTANCE

PHOTOELECTRIC SENSORS

KEY ADVANTAGES

C23 Distance measuring sensors

- ✓ Two distance measurement ranges: 20...80 mm and 30...200 mm
- ✓ Housing 20 mm x 34 mm x 12 mm
- ✓ High precision and repeatability
- ✓ Settable analog range for optimum distance measurement
- ✓ Enclosure rating IP 67 / IP 69K

C55 distance measuring sensors

- ✓ Distance measurement up to 5000 mm
- ✓ Housing 50 mm x 50 mm x 23 mm
- ✓ High precision and repeatability
- ✓ Settable analog range for optimum distance measurement
- ✓ Enclosure rating IP 67 / IP 69K, Ecolab approved
- ✓  IO-Link

RANGE OVERVIEW

Series

Short range

Medium range

DISTANCE

C23 (20x34x12)

p. 282-283

C55 (50x50x23)

p. 284-285



DISTANCE C23

PHOTOELECTRIC SENSORS

ADVANTAGES

- ✓ Two distance measurement ranges: 20...80 mm and 30...200 mm
- ✓ Housing 20 mm x 34 mm x 12 mm
- ✓ High precision and repeatability
- ✓ Settable analog range for optimum distance measurement
- ✓ Enclosure rating IP 67 / IP 69K

WIRING DIAGRAM

PNP or NPN + analog, 2 outputs



OVERVIEW	C23 DISTANCE
Housing material	ABS / PMMA
Degree of protection	IP 67 / IP 69K
Supply voltage range	13 ... 30 VDC
Ambient temperature range	-20 ... +60°C / -4 ... +140°F
Output current	≤ 100 mA
Switching frequency	≤ 1000 Hz
Setup	Teach button
Compatible mounting bracket	See pages 297-298

C23 SERIES



C23

HOUSING SIZE MM	□ 20 X 34 X 12	□ 20 X 34 X 12	□ 20 X 34 X 12
OPERATING PRINCIPLE	DISTANCE MEASURING SENSOR	DISTANCE MEASURING SENSOR	DISTANCE MEASURING SENSOR
SENSING RANGE MM	80	100	200

Inductive



Photoelectric

Safety

RFID

PHOTOELECTRIC

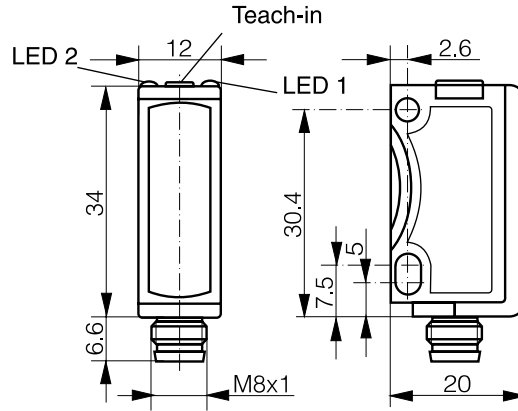

Connectivity

Accessories

DATA			
Light source	LED red 632 nm	Laser class 1, red 650 nm	LED red 632 nm
Light spot size	5 mm at 50 mm	1.5 mm at 80 mm	7 mm at 60 mm
Resolution	0.12 mm	0.12 mm	0.68 mm
Linearity	+/- 0.4 mm	+/- 0.25 mm	+/- 2 mm
Repeatability	≤ 0.4 mm	≤ 0.25 mm	≤ 1 mm
PNP Light-ON+Dark-ON+Analog 1...10V	DTR-C23PB-TMS-139		DTR-C23PB-TLS-139
NPN Light-ON+Dark-ON+Analog 1...10V	DTR-C23PB-TMS-129		DTR-C23PB-TLS-129
PNP/NPN auto-detect+Analog 1...10V		DTL-C23PB-TMS-139-501	
Other types available			

Glossary

Index

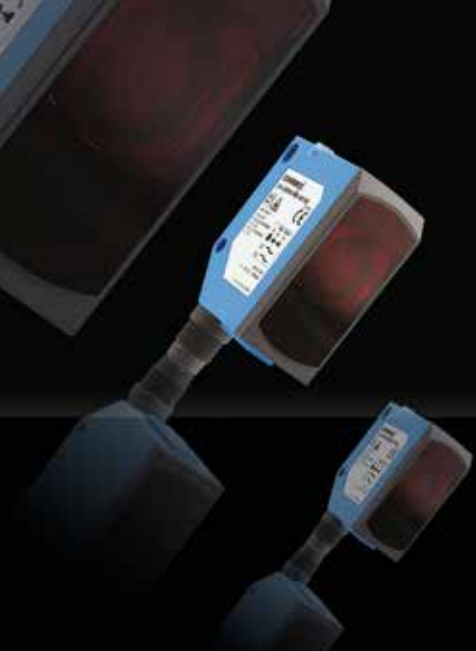

DISTANCE C55

PHOTOELECTRIC SENSORS

ADVANTAGES

- ✓ Distance measurement up to 5000 mm
- ✓ Housing 50 mm x 50 mm x 23 mm
- ✓ High precision and repeatability
- ✓ Settable analog range for optimum distance measurement
- ✓ Enclosure rating IP67/IP69K, Ecolab approved
- ✓  IO-Link

WIRING DIAGRAMS

PNP / NPN auto-detect + analog, 2 outputs + teach-in



PNP / NPN auto-detect, 1 output + teach-in

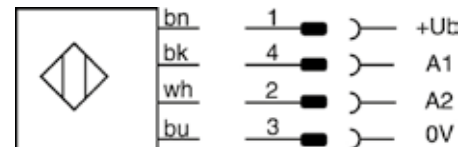

OVERVIEW	C55 DISTANCE
Housing material	ABS / PMMA
Degree of protection	IP 67 / IP 69K
Supply voltage range	18 ... 30 VDC
Ambient temperature range	-40 ... +60°C / -40 ... +140°F
Output current	≤ 100 mA
Switching frequency	≤ 250 Hz (DTL) / ≤ 500 Hz (-505)
Setup	Teach button / or IO-Link (-505)
Compatible mounting bracket	See page 299

C55 SERIES



C55

HOUSING SIZE MM

□ 50 X 50 X 23

□ 50 X 50 X 23

OPERATING PRINCIPLE

DISTANCE MEASURING SENSOR

DISTANCE MEASURING SENSOR

SENSING RANGE MM

5000

5000

Inductive

Photoelectric

Safety

RFID

Connectivity

Accessories

Glossary

Index

PHOTOELECTRIC

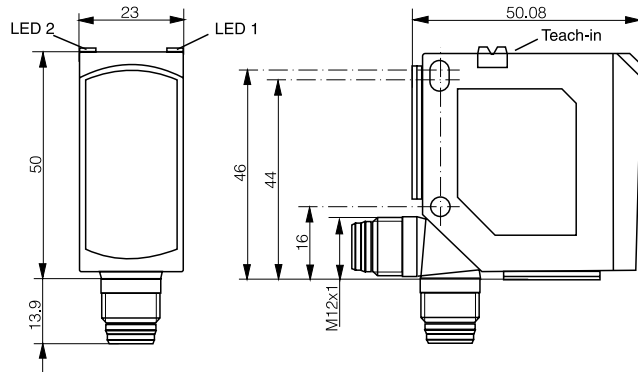

DATA



IO-Link 

Light source

Laser class 1 red 650 nm

Laser class 1 red 655 nm

Light spot size

5 mm x 4 mm at 3000 mm

5 mm x 4 mm at 3000 mm

Resolution

< 5 mm

< 5 mm

Linearity

+/- 30 mm

+/- 30 mm

PNP/NPN auto-detect + Analog 4 ... 20 mA

DTL-C55PA-TMS-119-502

PNP/NPN auto-detect + Analog 0 ... 10 V

DTL-C55PA-TMS-119-503

PNP/NPN auto-detect, Light-ON / Dark-ON

DTL-C55PA-TMS-407-505

Other types available



EXCELLENT RESOLUTION FOR SMALLEST VARIATIONS

A watercolor palette with several colors including pink, yellow, blue, and green, positioned in the top left corner of the page.

COLOR AND CONTRAST PHOTOELECTRIC SENSORS

KEY ADVANTAGES

- ✓ Rugged housing, 40 mm x 50 mm x 15 mm
- ✓ Connector adjustable at 0°, 45° and 90°
- ✓ 5 switching tolerance levels

Color sensors

- ✓ 3 color teach channels with independent outputs
- ✓ High positioning tolerance
- ✓ High switching frequency: up to 4 kHz

Contrast sensors

- ✓ Detection of very small print marks thanks to a narrow, collimated light spot
- ✓ RGB emission technology with best emission color automatically selected
- ✓  **IO-Link**

RANGE OVERVIEW	Series	Color	Contrast
COLOR AND CONTRAST	4050 (40x50x15)	p. 289	p. 289



COLOR AND CONTRAST

4050

PHOTOELECTRIC SENSORS

ADVANTAGES

- ✓ Rugged housing, 40 mm x 50 mm x 15 mm
- ✓ Connector adjustable at 0°, 45° and 90°
- ✓ 5 switching tolerance levels

Color sensors

- ✓ 3 color teach channels with independent outputs
- ✓ High positioning tolerance
- ✓ High switching frequency: up to 4 kHz

Contrast sensors

- ✓ Detection of very small print marks thanks to a narrow, collimated light spot
- ✓ RGB emission technology with best emission color automatically selected
- ✓ Excellent tolerance to target distance variations
- ✓ High switching frequency: up to 10 kHz
- ✓  **IO-Link**

WIRING DIAGRAMS

PNP or NPN, 3 outputs



PUSH-PULL, 1 output + teach or switching mode selector

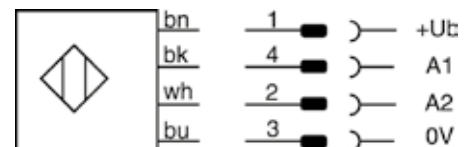

OVERVIEW	4050 COLOR	4050 CONTRAST
Housing material	PBTP	PBTP
Degree of protection	IP 67	IP 67
Supply voltage range	10 ... 30 VDC	10 ... 30 VDC
Ambient temperature range	-5 ... +55°C / 23 ... +131°F	-5 ... +55°C / 23 ... +131°F
Output current	≤ 200 mA	≤ 100 mA
Switching frequency	4000 Hz	10,000 Hz
Compatible mounting bracket	See page 302	See page 302

4050 SERIES



4050

HOUSING SIZE MM	40 X 50 X 15	40 X 50 X 15
OPERATING PRINCIPLE	COLOR SENSOR (DIFFUSE)	CONTRAST SENSOR (DIFFUSE)
SENSING RANGE MM	40	12

Inductive

Photoelectric

Safety

RFID

Connectivity

Accessories

Glossary

Index

PHOTOELECTRIC

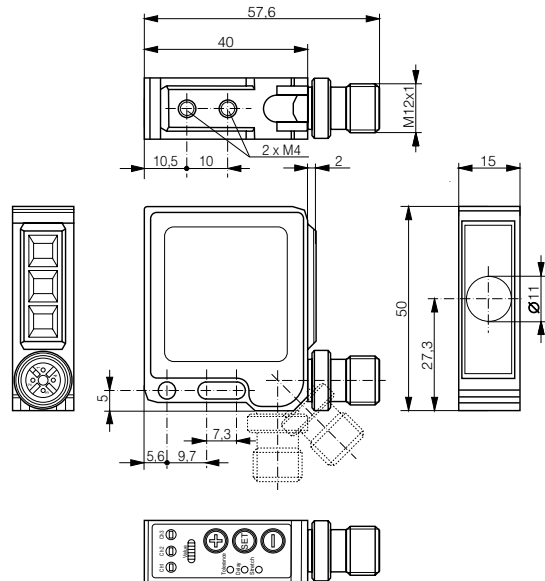

DATA		IO-Link
Light source	LED white	LED red, green, blue (autoselect)
Light spot size (distance)	Ø 4 mm (35 mm)	1.5 x 3.5 mm (12 mm)
No-load supply current	≤ 35 mA	≤ 35 mA
Setup	Teach button	Teach button or Teach input or IO-Link
3 x PNP Light-ON	FTS-4155-303	
3 x NPN Light-ON	FTS-4155-301	
PUSH-PULL		KTS-4155-407
Other types available	Cable version	Cable version

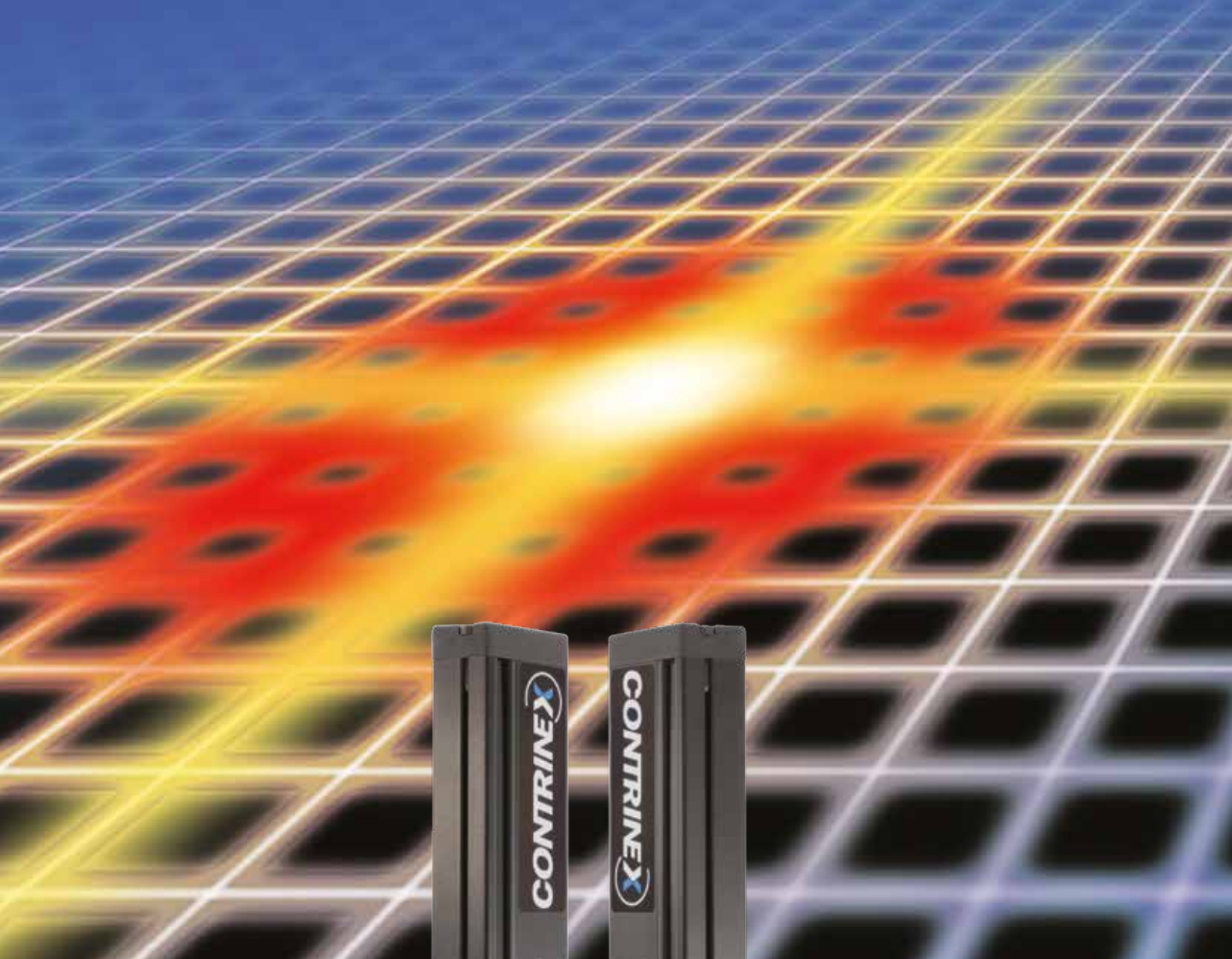

LIGHT GRIDS PHOTOELECTRIC SENSORS

KEY ADVANTAGES

- ✓ Plug-and-play installation
- ✓ Small installation space with cross-section: 40 x 20.5 mm

DGI series

- ✓ Fast, precise detection and counting
- ✓ Resolution of 0.9 mm to 25 mm, capable of detecting even the smallest object
- ✓ Detection range up to 8000 mm
- ✓ Beam height from 75 mm up to 2010 mm

MGI series

- ✓ Easy, reliable measurement of position and dimensions
- ✓ Center beam spacing 5 mm and 12 mm
- ✓ Measurement range up to 4000 mm
- ✓ Beam height from 230 mm up to 1420 mm

RANGE OVERVIEW

LIGHT GRIDS

Series

DGI (40x20.5xH)

MGI (40x20.5xH)

Detection

p. 293

Measurement

p. 295



LIGHT GRIDS DETECTION

PHOTOELECTRIC SENSORS

ADVANTAGES

- ✓ Compact aluminum housing (40 mm x 20.5 mm x height)
- ✓ Resolution of 0.9 mm to 25 mm, capable of detecting even the smallest object
- ✓ Detection range up to 8000 mm
- ✓ Beam height from 75 mm up to 2010 mm
- ✓ 2 push-pull outputs (PNP + NPN), Light-ON + Dark-ON
- ✓ Fast response time from 0.8 to 4.8 ms
- ✓ Potentiometer for fine adjustment on 0.9 mm and 2 mm resolution grids

WIRING DIAGRAM

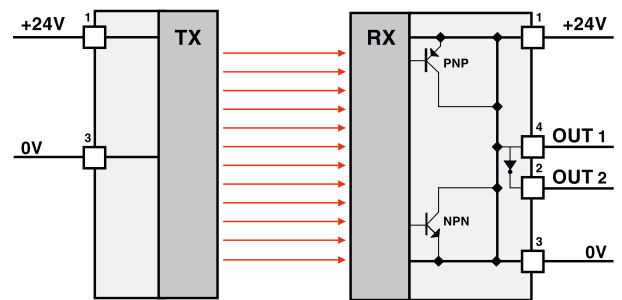

OVERVIEW	DETECTION GRID
Housing material	Aluminum
Window material	PMMA
Degree of protection	IP 65
Light source	LED, infrared
Supply voltage range	24 VDC ± 20 %
Ambient temperature range	-5 ... +50°C / +23 ... +122°F
Output current	≤ 80 mA
Compatible mounting bracket	See page 299

DETECTION GRID



DGI

HOUSING SIZE MM	40 X 20.5 X H
OPERATING PRINCIPLE	DETECTION GRID
SENSING RANGE MM	8000

Inductive

Photoelectric

Safety

RFID

Connectivity

Accessories

Glossary

Index

PHOTOELECTRIC

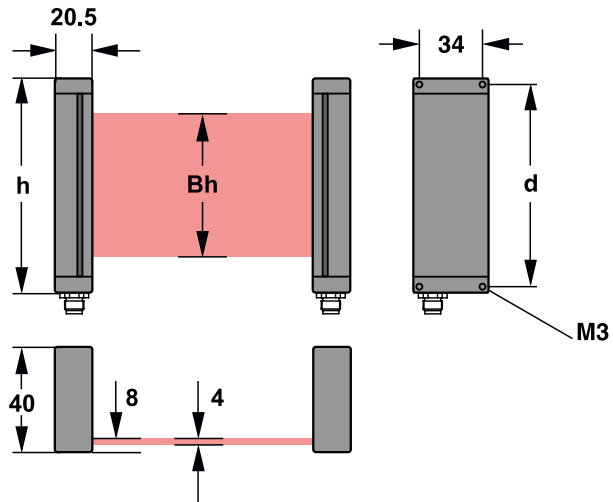

AVAILABLE TYPES					
PART REFERENCE	RESOLUTION (MM)	HEIGHT h (MM)	BEAM HEIGHT Bh (MM)	DETECTION RANGE (MM)	POTENTIOMETER
DGI-01A-0075-PMS-107	0.9	100	75	100...400	✓
DGI-01A-0155-PMS-107	0.9	180	155	150...400	✓
DGI-02A-0075-PMS-107	2	100	75	80...800	✓
DGI-02A-0155-PMS-107	2	180	155	150...800	✓
DGI-04A-0075-NMS-107	4	100	75	80...800	-
DGI-04A-0155-NMS-107	4	180	155	150...800	-
DGI-08A-0190-NMS-107	8	212	190	300...4000	-
DGI-08A-0480-NMS-107	8	500	480	300...4000	-
DGI-25A-0480-NMS-107	25	500	480	300...8000	-
DGI-25A-0960-NMS-107	25	980	960	300...8000	-
DGI-25A-2010-NMS-107	25	2036	2010	300...8000	-



LIGHT GRIDS MEASUREMENT

PHOTOELECTRIC SENSORS

ADVANTAGES

- ✓ Compact aluminum housing (40 mm x 20.5 mm x height)
- ✓ Center beam spacing 5 mm and 12 mm
- ✓ Measurement range up to 4000 mm
- ✓ Beam height from 230 mm up to 1420 mm
- ✓ Analog output 0-10 V or 4-20 mA
- ✓ Fast response time from 3 to 14 ms
- ✓ 4 switching modes selectable through multi-switch

WIRING DIAGRAM

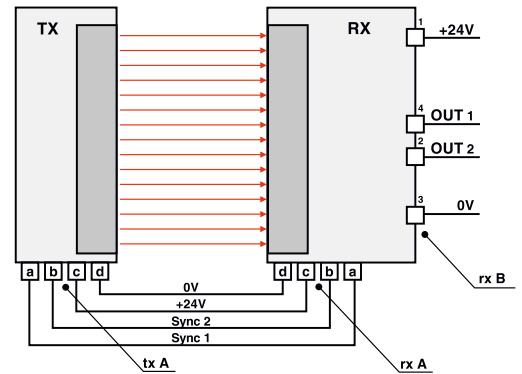

OVERVIEW	MEASUREMENT GRID
Housing material	Aluminum
Window material	PMMA
Degree of protection	IP 65
Light source	LED, infrared
Supply voltage range	24 VDC ± 20 %
Ambient temperature range	-5 ... +50°C / +23 ... +122°F
Analog output	4 ... 20 mA / 0 ... 10 V
Compatible mounting bracket	See page 299

MEASUREMENT GRID



HOUSING SIZE MM

40 X 20.5 X H

OPERATING PRINCIPLE

MEASUREMENT GRID

SENSING RANGE MM

4000

Inductive

Photoelectric

Safety

RFID

Connectivity

Accessories

Glossary

Index

PHOTOELECTRIC

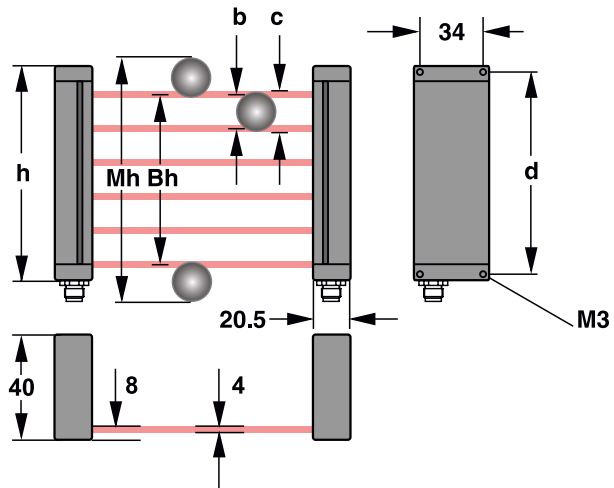

AVAILABLE TYPES

PART REFERENCE	CENTER BEAMS SPACING b (MM)	HEIGHT h (MM)	BEAM HEIGHT Bh (MM)	MEASUREMENT HEIGHT Mh (MM)
MGI-05A-0232-NMS-149	5	260	232	240
MGI-05A-0472-NMS-149	5	500	472	480
MGI-05A-0952-NMS-149	5	980	952	960
MGI-12A-0458-NMS-149	12	500	458	478
MGI-12A-0938-NMS-149	12	980	938	958
MGI-12A-1418-NMS-149	12	1460	1418	1438

PHOTOELECTRIC ACCESSORIES

UNIVERSAL MOUNTING BRACKET

For C23PA series

Material: stainless steel V2A

Part reference: **LXW-C23PA-000**

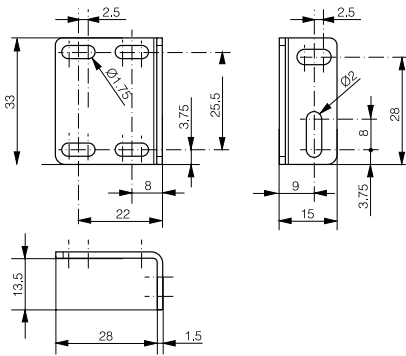

UNIVERSAL MOUNTING BRACKET

For C23PA series

Material: stainless steel V2A

Part reference: **LXW-C23PA-001**

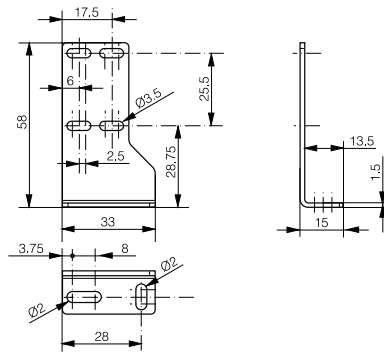

UNIVERSAL MOUNTING BRACKET

For C23PA series

Material: stainless steel V2A

Part reference: **LXW-C23PA-002**

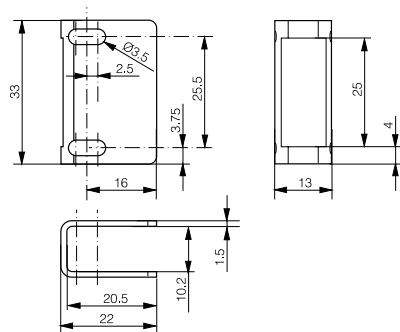

UNIVERSAL MOUNTING BRACKET

For C23PA series
 Material: stainless steel V2A
 Part reference: **LXW-C23PA-003**

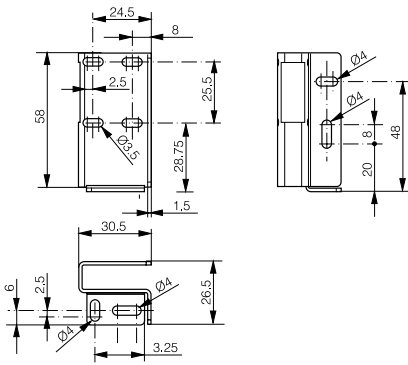

UNIVERSAL MOUNTING BRACKET

For C23PB distance sensors
 Material: aluminum anodised
 Part reference: **LXW-C23PB-000**

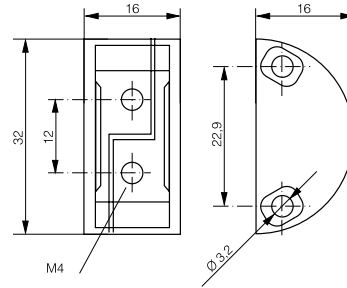

UNIVERSAL MOUNTING BRACKET

For C23PB distance sensors
 Material: aluminum
 Part reference: **LXW-C23PB-001**

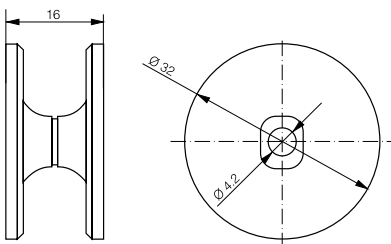

PHOTOELECTRIC ACCESSORIES

UNIVERSAL MOUNTING BRACKET

For C23PB distance sensors
 Material: stainless steel V2A
 Part reference: **LXW-C23PB-002**

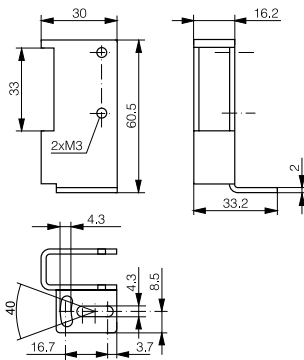

UNIVERSAL MOUNTING BRACKET

For C23PB distance sensors
 Material: stainless steel V2A
 Part reference: **LXW-C23PB-003**

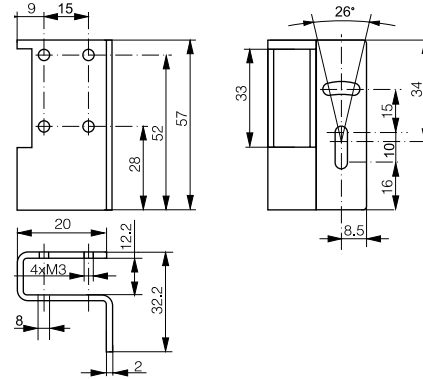

UNIVERSAL MOUNTING BRACKET

For C23PB distance sensors
 Material: nickel-plated steel
 Part reference: **LXW-C23PB-004**

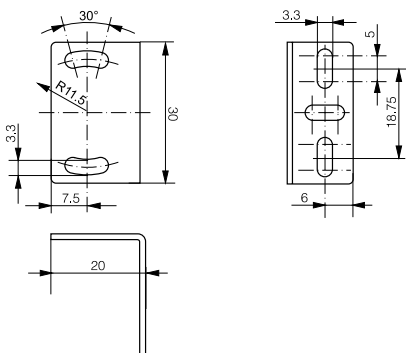

UNIVERSAL MOUNTING BRACKET

For C55 series

Material: stainless steel V2A

Part reference: **LXW-C55PA-000**

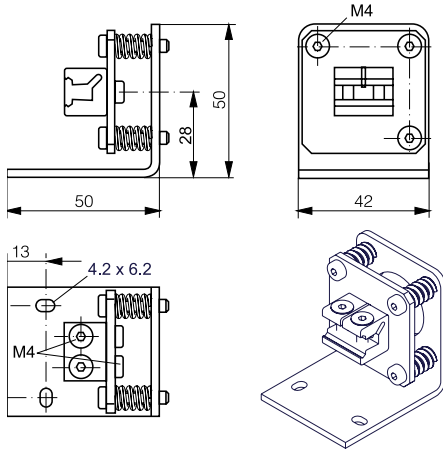

UNIVERSAL MOUNTING BRACKET

For light grids

Material: stainless steel V2A

Part reference: **LXW-DGMGA-000**

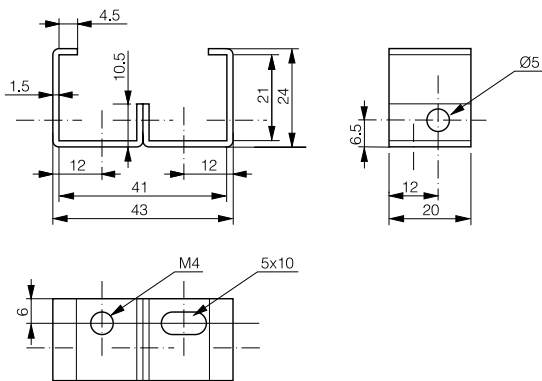

PHOTOELECTRIC ACCESSORIES

UNIVERSAL MOUNTING BRACKET

For M18PA series

Material: ABS

Part reference: **LXW-M18PA-000**

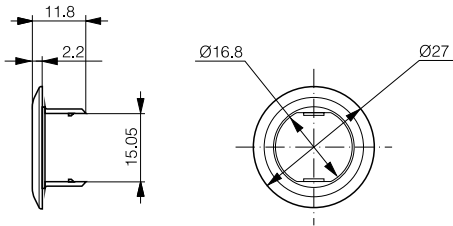

UNIVERSAL MOUNTING BRACKET

For M18PA series

Material: ABS

Part reference: **LXW-M18PA-001**

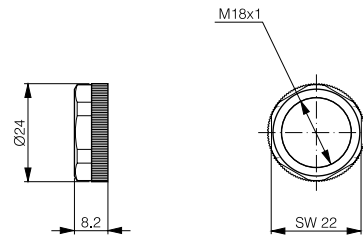

SPECIAL MOUNTING FOR 90°

For M18PA series

Material: ABS / PMMA

Part reference: **LHW-M18PA-000**

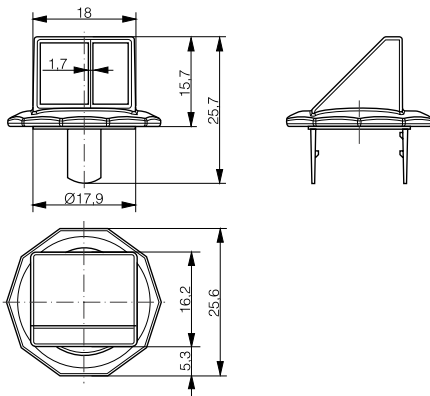

SPECIAL MOUNTING FOR 90°

For M18PA series

Material: ABS / PMMA

Part reference: **LLW-M18PA-000**

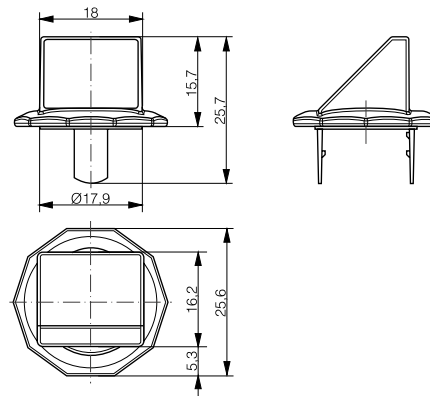

SPECIAL MOUNTING FOR 90°

For M18PA series
 Material: ABS / PMMA
 Part reference: **LTW-M18PA-000**

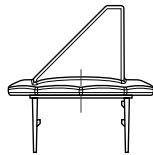
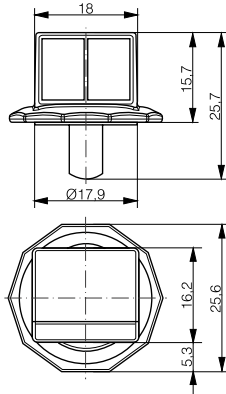

UNIVERSAL MOUNTING BRACKET

For 3#30 / 3#31 series
 Material: stainless steel V2A
 Part reference: **LXW-3030-000**

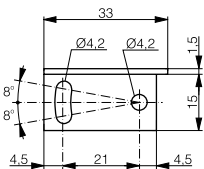
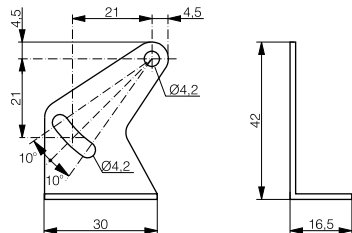

DIN-RAIL MOUNTING BRACKET

(TS35) for 3#30 / 3#31 series
 Material: stainless steel V2A
 Part reference: **LXW-3030-001**

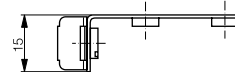
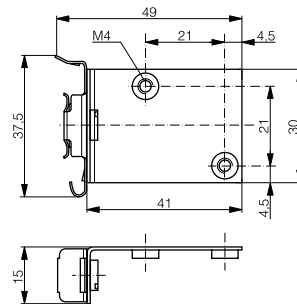

PHOTOELECTRIC ACCESSORIES

UNIVERSAL MOUNTING BRACKET

For 4050 series

Material: stainless steel V2A

Part reference: **LXW-4050-000**

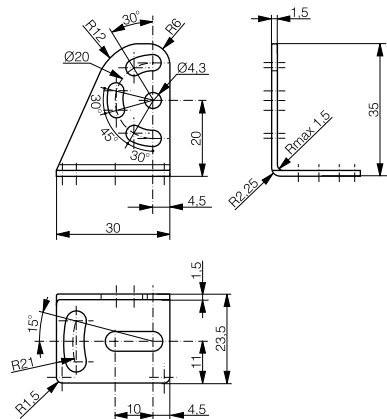

CLAMP BRACKET

For 4050 series

Material: aluminum

Part reference: **LXW-4050-002**

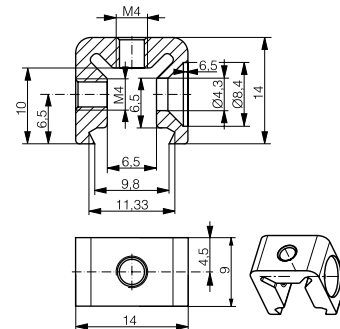

REFLECTOR Ø 26 MM

Part reference: **LXR-0000-025**

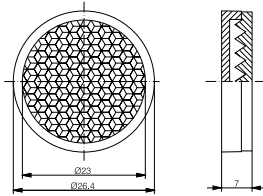

REFLECTOR Ø 46 MM

Part reference: **LXR-0000-046**

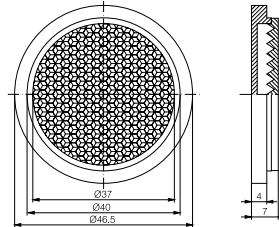

REFLECTOR Ø 82 MM

Part reference: **LXR-0000-084**

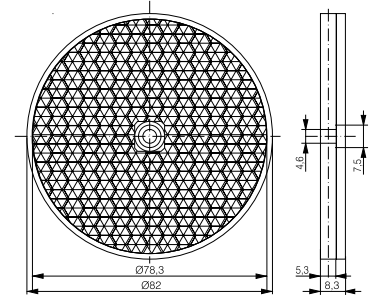

REFLECTOR 32 X 20 MM

Part reference: **LXR-0001-032**

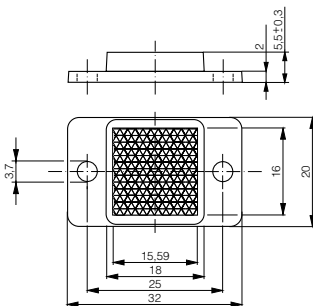

REFLECTOR 60 X 20 MM

Part reference: **LXR-0001-062**

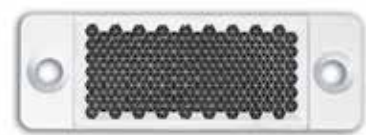
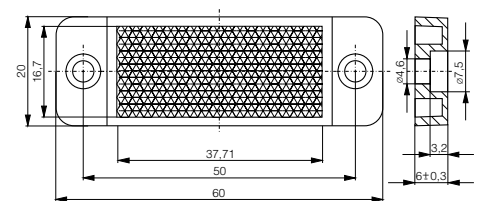

PHOTOELECTRIC ACCESSORIES

REFLECTOR 60 X 51 MM

Part reference: **LXR-0001-065**

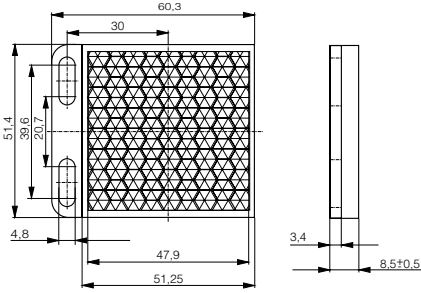

REFLECTOR 60 X 41 MM

Part reference: **LXR-0001-064**

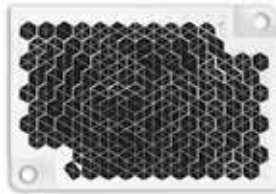
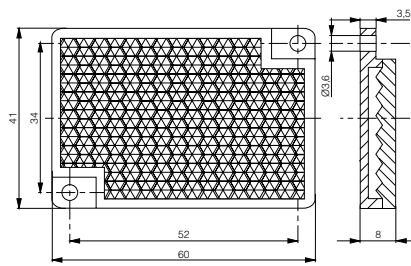

REFLECTOR 85 X 85 MM

Part reference: **LXR-0001-088**

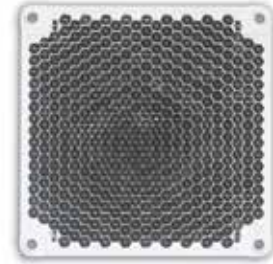
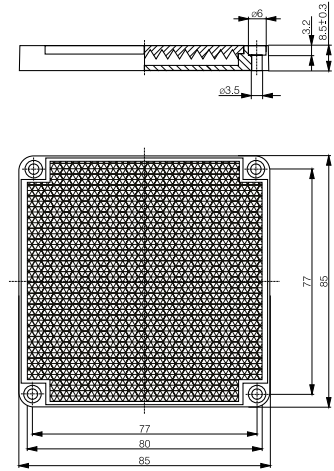

REFLECTOR Ø 26 MM FOR UV

Part reference: **LXU-0000-025**

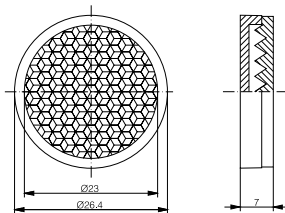

REFLECTOR Ø 82 MM FOR UV

Part reference: **LXU-0000-084**

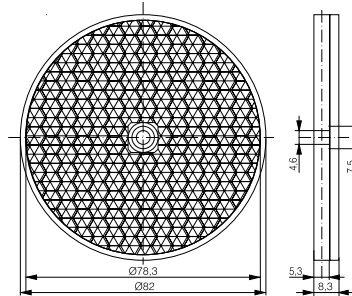

REFLECTOR 32 X 20 MM FOR UV

Part reference: **LXU-0001-032**

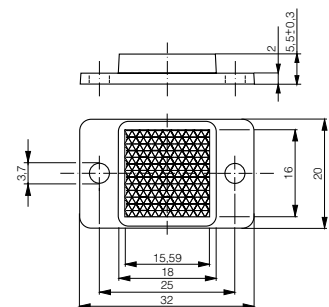

REFLECTOR 60 X 41 MM FOR UV

Part reference: LXU-0001-064

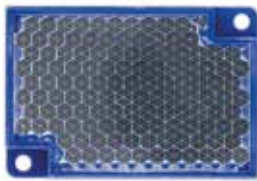
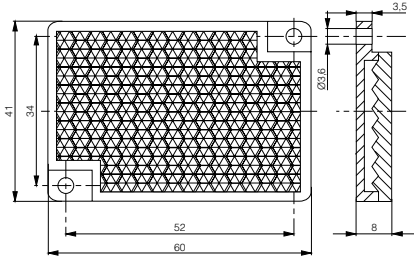

REFLECTIVE ROLL 25 MM X 22.8 M

Part reference: LXR-0003-025

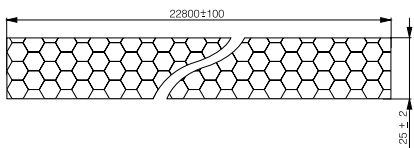

REFLECTIVE FOIL 100 X 100 MM

Part reference: LXR-0002-100

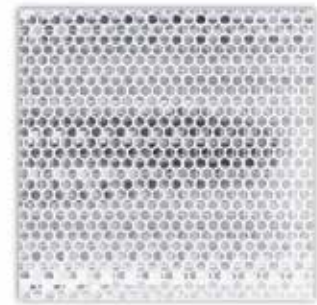
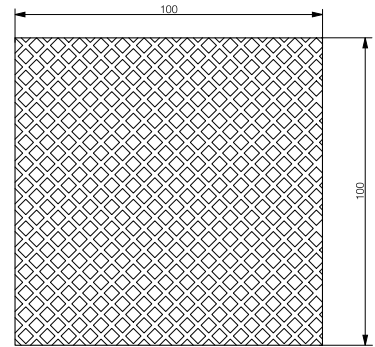

REFLECTIVE ROLL 50 MM X 22.8 M

Part reference: LXR-0003-050

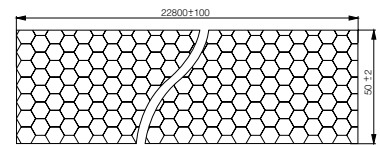





CONTRINEX

SAFETINEX

SAFETY LIGHT CURTAINS, SAFETY SENSORS AND RELAYS

LIGHT CURTAIN HIGHLIGHTS

- ✓ Finger, Hand and Body Access resolutions
- ✓ Operating range from 0.25...50 m
- ✓ Protective heights from 142...1827 mm
- ✓ Category 2 or 4 according to EN/ISO 13849-1
- ✓ Certified TÜV, CE and UL
- ✓ IP 65 and IP 67
- ✓ Permanent autocontrol
- ✓ 2 channel selection
- ✓ Low power consumption





NEW

- ✓ Slim Type 2 safety light curtains
- ✓ Slim Type 4 safety light curtains with wireless configuration through Bluetooth®
- ✓ Magnetic and RFID safety sensors
- ✓ Signal filter

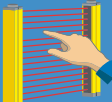
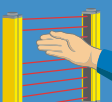

CONTRINEX

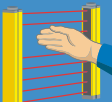
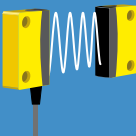
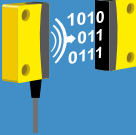
PROGRAM OVERVIEW

PRODUCT TYPE		RESOLUTION	HOUSING	CATEGORY	FEATURES	PAGE
LIGHT CURTAINS	BASIC	 14 mm	STANDARD	Cat. 4	<ul style="list-style-type: none"> ✓ Max. operating range 3.5 m ✓ Operating temperature -35 ... +60°C ✓ IP 65, IP 67 	p. 315-319
		 30 mm	STANDARD	Cat. 4	<ul style="list-style-type: none"> ✓ Max. operating range 12 m ✓ Operating temperature -35 ... +60°C ✓ IP 65, IP 67 	p. 321-325
			STANDARD	Cat. 2	<ul style="list-style-type: none"> ✓ Operating temperature 0 ... +50°C ✓ IP 65, IP 67 	p. 327-330
			SLIM	Cat. 2	<ul style="list-style-type: none"> ✓ No blind zone ✓ Flexible mounting and connection 	p. 333-336
		 300 mm 400 mm 500 mm	STANDARD	Cat. 4	<ul style="list-style-type: none"> ✓ Max. operating range 50 m ✓ Operating temperature -35 ... +60°C ✓ IP 65, IP 67 	p. 339-342
	EXTENDED	 30 mm	SLIM	Cat. 4	<ul style="list-style-type: none"> ✓ No blind zone ✓ Beam coding (3 channels), EDM, start and restart interlock configurable functions ✓ Wireless configuration through Bluetooth® 	p. 345-348
SAFETY SENSORS	MAGNETIC		36 mm x 26 mm x 13 mm	up to Cat. 4	<ul style="list-style-type: none"> ✓ Magnetically coded, ISO 14119 type 4 ✓ Detection through metal plate possible ✓ IP6K9K, Ecolab 	p. 351-353
			88 mm x 25 mm x 13 mm	up to Cat. 4	<ul style="list-style-type: none"> ✓ Magnetically coded, ISO 14119 type 4 ✓ Detection through metal plate possible ✓ IP6K9K, Ecolab 	p. 351-353
	RFID		36 mm x 26 mm x 13 mm	Cat. 4	<ul style="list-style-type: none"> ✓ RFID coded, ISO 14119 type 4 ✓ Cascadable up to 30 units ✓ EDM and diagnostic function 	p. 355-357
ACCESSORIES	RELAY		22.5 mm x 99 mm x 114.5 mm	Cat. 4	<ul style="list-style-type: none"> ✓ Performance Level (PL) e and category 4 according to EN/ISO 13849-1 ✓ Manual or automatic restart ✓ Short response time 	p. 359-361
	OTHERS					p. 362-367

ADVANTAGES OF SAFETINEX LIGHT CURTAINS

Safetinx safety light curtains offer the following advantages:

- Very short response time:
 - Finger protection Type 4 Basic (YBB): 5.2 to 43.6 ms
 - Hand protection Type 4 Basic (YBB): 5.2 to 24.4 ms
 - Hand protection Type 4 Extended (YBES): 5 to 14 ms*
 - Access control Type 4 Basic (YCA): 4.2 to 6.7 ms
 - Hand protection Type 2 Basic (YBB): 14 to 66 ms
 - Hand protection Type 2 Basic (YBBS): 6 to 29 ms
- Up to 50 m operating distance
- 2-channel selection minimizing safety relevant cross-talk between neighboring AOPDs (type 4 only)
- Fully compliant with industry standards and certified by internationally recognized organizations
- Devices with TÜV certification, either Type 4 with Performance Level e, or Type 2 with Performance Level c
- Beam synchronized, no need for wired connection between sender and receiver
- Short-circuit protected outputs and voltage-reversal protection
- Low power consumption
- Built-in alignment system and easy adjustment of the units thanks to the high flexibility of the Safetinx bracket
- Various connector versions to fit any application
- Robust aluminum housing coated with resistant finish
- Compact design: 42 mm x 48 mm or 26 mm x 26 mm housing profile
- Competitive price
- EDM and restart interlock (Extended types)
- Easy configuration through Bluetooth® (Extended types)

Furthermore, Safetinx light curtains and access control barriers have been designed to provide users with a comfortable work environment. Their use involves no additional unproductive movements and no waste of time. Users can freely access and move around the machine in complete safety.

* Provisional data

ADVANTAGES OF SAFETINEX SENSORS

Safetinx safety sensors offer the following advantages:

Magnetic and RFID types (YSM and YSR)

- Long switching distance for more installation flexibility, up to 18 mm
- Cat. 4 according to ISO 13849-1
- Type 4 coding according to ISO 14119
- Extremely compact size: 36 mm x 26 mm x 13 mm
- PVC cable or M12 pigtail connection
- Enclosure rating IP6K9K, ECOLAB® certified
- TÜV and UL certification

Magnetic types only (YSM)

- Frontal or 90° actuation
- Actuator can be mounted behind a stainless-steel plate
- Two sizes available: 36 mm x 26 mm x 13 mm; 88 mm x 25 mm x 13 mm

RFID types only (YSR)

- Serial connection (up to 30 devices)
- EDM (external device monitoring) and Feedback signal
- Random or teachable RFID code, Type 4 according to ISO 14119

INTRODUCTION

SAFETINEX SAFETY SYSTEMS

Safetinx products offer high-quality safeguarding solutions for both personnel and machinery. The range comprises light curtains of Type 2 or 4 according to the international standard ISO 13849. Resolution is suitable to protect hands (30 mm), fingers (14 mm) or full body (3 to 6 beams). A choice of standard or slim profile is available in various lengths up to almost 2 meters. Wireless configuration through Bluetooth® is available with Extended Type 4 devices.

The portfolio also comprises safety sensors with either a magnetic or RFID operating principle.

Safetinx products have been developed in compliance with the applicable international safety standards and have obtained the required product certification for use in the European Union, the United States of America and all other countries where the applicable IEC standards have been adopted. A complete range of Safetinx light curtains and access control barriers is offered for the highest safety requirements: safety category 4, PL e according to EN/ISO 13849-1, Type 4 according to IEC 61496-1 and -2. In addition, hand protection devices are available with a Type 2 safety rating (IEC 61496-1 and -2) which meet category 2, PL c according to EN/ISO 13849-1.

Safety sensors also meet the requirements of safety category 4 according to EN/ISO 13849-1. Their magnetic or RFID coding is rated type 4 according to EN/ISO 14119 and housings are ECOLAB® certified.

All Safetinx products have TÜV certification.

SAFEGUARDING FUNCTION

In all cases, the primary function of the protective device is to stop the machine before the hazardous point is reached and to prevent unintentional machine start-up. This function must comply with the category of the safety-related components of the machine.

LIGHT CURTAINS

Whenever a safety system around a danger zone is necessary, the first consideration is whether or not optical protection is suitable at all. For this to be the case, it must be possible for the machine control to be electrically influenced by means of the device's semiconductor output. Moreover, it must also be possible to instantly terminate or exit the hazardous process in every operating phase. Further, there must be no danger of injury due to heat, radiation or from materials or components ejected by the machine. If such danger exists, then either the optical system is not suitable, or the danger must be otherwise excluded by applying additional safety measures.

The selection of a specific safeguarding measure involves an evaluation of the hazard, in order to determine the applicable safety level and resolution of the protective device.

The resolution of the safety light curtain or access control barrier must be chosen according to the application and the required safeguarding function. It is defined as the minimum size of an object that can be reliably and safely detected at any position when placed in the protective field. The choice of a specific resolution depends on the part of the body which needs protection (finger, hand or whole body).

APPLICATION AREAS

The Safetinx YBB, YBBS and YBES ranges are best suited where finger and hand protection is required close to the hazardous area (point of operation). Depending on the application, a resolution of either 14 mm (finger protection) or 30 mm (hand protection) will be advisable. Safetinx YCA access control barriers, on the other hand, are suitable for the protection of people potentially entering a larger dangerous area.

Thanks to their Type 4, category 4, PL e safety level, Safetinx devices can be used on equipment requiring high protection reliability, such as machine tools, robots, hydraulic presses, automated stock management, weaving looms, etc.

If the result of the risk assessment allows their use, Type 2 devices (category 2, PL c) offer cost effective and safe solutions.



SAFETY SENSORS

For any machine requiring a fixed guard-door or cover, contactless safety sensors ensure reliable state monitoring (door open or closed). A magnetically or RFID-coded system (type 4 according to ISO 14119) makes them immune to mutual interference and highly resistant to tampering.

Sensors with magnetic coding can be mounted behind a stainless steel plate, which further reduces accessibility. Types with random or teachable RFID coding provide individual feedback and can be connected in series, allowing up to 30 sensors to connect with just one relay or controller.

For the monitoring of guard doors, hoods or covers, contactless safety sensors must be chosen with an appropriate coding technology (magnetic, RFID) to minimize the risk of tampering.

SAFEGUARDING FUNCTION

For any machine requiring a fixed guard-door or cover, Safetinx YSM and YSR contactless safety sensors provide state monitoring (door open or closed). The magnetic or RFID coding is classified as type 4 according to ISO 14119. Security level is Category 4 according to ISO 13849-1. The IP6K9K enclosure rating and ECOLAB® approval make the sensors suitable for washdown applications.

YSM types with magnetic coding are suitable for simple monitoring tasks, being very economic and easy to wire. It is also possible to mount the actuator behind a stainless steel plate.

YSR types with RFID coding are suitable for more complex tasks. Since each sensor can provide individual feedback, it is possible to identify which guard-doors are open and which are closed. YSR sensors can also be connected in series, allowing up to 30 sensors to connect with just one relay or controller. YSR types are therefore particularly suitable for applications using multiple sensors, such as long packaging or assembly lines. They are not sensitive to vibration and provide self-tested OSSD signals.



OPERATING PRINCIPLE OF LIGHT CURTAINS

Safetinx YBB, YBBS and YBES light curtains and YCA access control barriers operate with infrared beams. When the device detects a finger, a hand or a person entering the defined hazardous area, the protective equipment immediately stops the machine, or renders it harmless. When operating in manual restart mode, the reset button enabling the operator to restart the machine must be located outside the hazardous area. From there, the operator must have a full view of the hazardous area to make sure that nobody is in danger before restarting the machine.

Safetinx light curtains and access control barriers are designed to ensure protection of operators working in hazardous areas. A high reliability is achieved by implementing a fail-safe system: devices are thus permanently self-controlled. An internal failure deactivates the output signals, as would an intrusion into the protective field.

Safetinx light curtains and access control barriers are active optoelectronic protective devices (AOPDs) that include a sender and a receiver unit between which coded infrared beams are sequentially exchanged. The receiver unit is connected to a safety relay which transmits signals to the machine control system. Synchronization between the sender and receiver devices is performed optically, i.e. wired connection between the two units is not necessary.

Reception of all beams activates the two independently generated semiconductor outputs (OSSDs) of the receiver unit. The interruption of one or more beams deactivates the outputs within the response time of the AOPD. Any internal fault is detected by the device's permanent self-control function and has the same result as an intrusion into the protective field.

AOPD DETECTION CAPABILITY

The light curtain or barrier detection capability (or resolution) is the sum of the distance between two adjacent beams and their combined diameters. The choice for a specific resolution depends on the part of the body which needs protection (finger, hand, whole body).

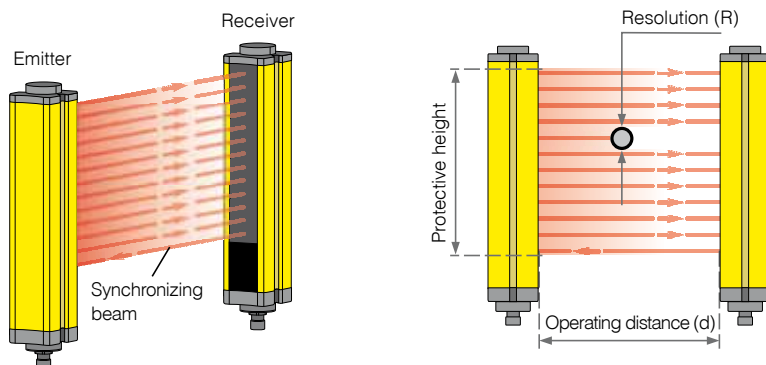

SELF PROTECTED OUTPUTS

Both OSSD1 and OSSD2 are self-protected and actively monitored PNP outputs. Both outputs are controlled by independent current-monitored high-side switches. Thanks to continuous monitoring, any short-circuit between an output and the power supply or ground is detected within the response time, leading to the deactivation of the other output. Similarly, a cross-circuit between the two outputs is also detected and both OSSDs are deactivated within the specified response time. The OSSD outputs are switched off and remain in that state as long as the fault remains.

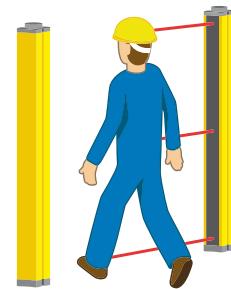

Access control

Beam separation > 30 mm

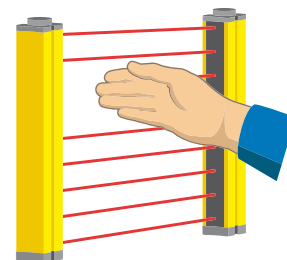

Hand protection

Beam resolution 30 mm

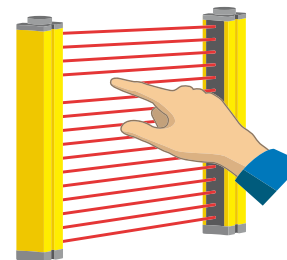

Finger protection

Beam resolution 14 mm

OPERATING PRINCIPLE OF SAFETY SENSORS

Safetinx YSM and YSR safety sensors comprise two parts: a main module and an actuator. They communicate with a contactless system of either magnetic or RFID coding. When the system detects that a guard door, hood or cover is open, the protective equipment immediately stops the machine, or renders it harmless.

YSM magnetic safety sensors use a coded magnet as an actuator and two reed contacts to open or close communication. Unlike light curtains, these sensors do not have OSSD outputs with self-check. They act simply as contactors that open or close depending on the presence or absence of a magnet. It is therefore necessary to apply power to the reed contacts.

YSR RFID safety sensors use an RFID tag as an actuator and a read and write module (RWM) as a contactor. These sensors have self-checking OSSD outputs, similar to light curtains. They are therefore connected in the same way as light curtains to a relay or controller. The RFID tag can be universally and randomly coded or can be teachable, which means the user pairs it with an RWM at first use to create a unique combination.





CONTRINEX SAFETINEX

Power

Channel



CONTRINEX

CONTRINEX
1-1-1
Test
Channel



LIGHT CURTAINS BASIC

FINGER PROTECTION TYPE 4

MAIN FEATURES

- ✓ Resolution: 14 mm
- ✓ Operating range: 0.25 ... 3.5 m
- ✓ Protective height: 142 ... 1690 mm
- ✓ Category 4, PL e according to EN/ISO 13849-1
- ✓ Type 4 according to IEC 61496-1 and -2
- ✓ Certified TÜV, CE and UL
- ✓ IP 65, IP 67 with operating temperatures as low as -35°C (-31°F)
- ✓ Housing profile 42 mm x 48 mm
- ✓ 2-channel selection
- ✓ Optical synchronization
- ✓ Permanent autocontrol

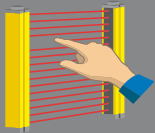

FINGER PROTECTION

LEDS

LED indicators on the YBB **sender** unit

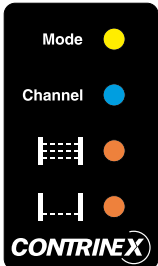

Mode:

Yellow when test mode is active

Channel:

Blue when channel 1 is selected

Purple when channel 2 is selected

Alignment (full):

Steady orange when the screen is not fully aligned

Blinking orange when the first third of the screen is aligned

Off when screen is fully aligned

Alignment (low beam):

Steady orange when the lowest beam is not aligned

Blinking orange when the lowest beam is aligned

Off when screen is fully aligned

LED indicators on the YBB **receiver** unit



Power:

Green when power is ON

Channel:

Blue when channel 1 is selected

Purple when channel 2 is selected

Status ON:

Green when OSSD outputs are ON

Status OFF:

Red when OSSD outputs are OFF

TECHNICAL DATA

Dimensions	42 mm x 48 mm x Ht
Resolution	14 mm
Protective height	142 ... 1690 mm
Supply voltage range	24 VDC \pm 20 %
Current consumption sender	50 mA max. / 1.5 W max.
Current consumption receiver (excl. load)	160 mA max. / 4.7 W max.
Output current	0.2 A max. per output
Safety level (EN/ISO 13849-1)	Category 4, PLe
Safety type (IEC 61496-1 and -2)	Type 4
Protection class (IEC 61140)	III
Ambient temperature range	-35 ... +60°C (-31 ... +140°F)
Storage temperature range	-40 ... +70°C (-40 ... +158°F)
Degree of protection (EN 60529)	IP 65 + IP 67
Housing material	Aluminum
Material of optical parts	PMMA
Operating range	0.25 ... 3.5 m
Sender wavelength	IR 950 nm

HOUSING

Aluminum profile 42 mm x 48 mm with dual fixing groove.

ELECTRONIC PROTECTION

Safetinx light curtains are self-protected against overloads and short-circuits. They can also withstand short high-voltage overloads.

CONNECTION

Safetinx light curtains with M12 5-pole connector are standard.

DOCUMENTATION

Detailed data sheets for these products can be found on the Contrinex website www.contrinex.com or ordered free of charge from our distributors.

DIMENSIONS

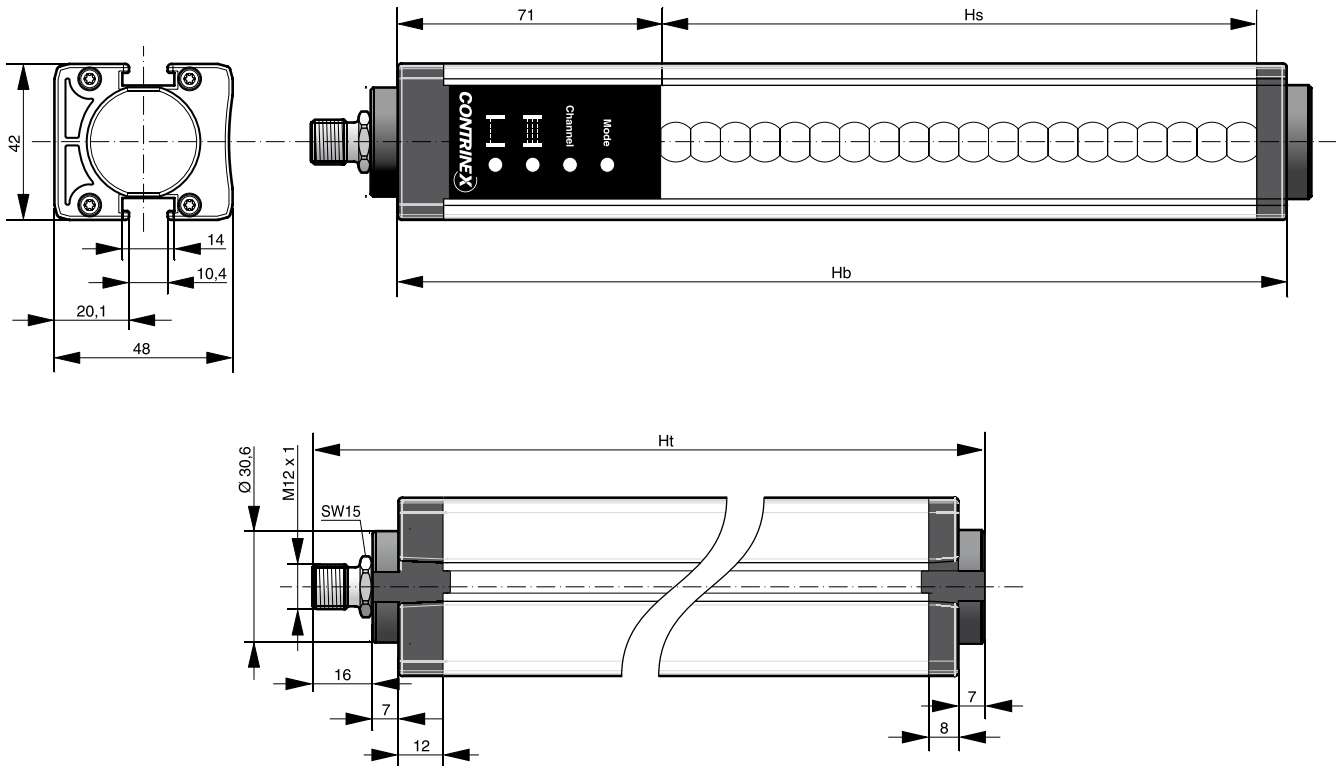

PIN ASSIGNMENT

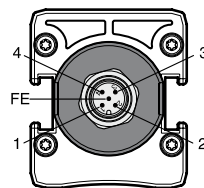

M12 connector

ASSIGNMENT	FUNCTION	PINS/WIRES ON SENDER		PINS/WIRES ON RECEIVER	
		M12 CONNECTOR	CABLE	M12 CONNECTOR	CABLE
Supply voltage	24 VDC for channel 1 / 0 V for channel 2	1	brown	1	brown
Supply voltage	0 V for channel 1 / 24 VDC for channel 2	3	blue	3	blue
Test mode	0 V: test active / 24 V: test inactive	4	black	-	-
Output	OSSD1	-	-	2	white
Output	OSSD2	-	-	4	black
Functional earth	Shield	FE	gray	FE	gray

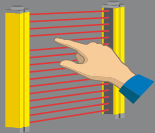

FINGER PROTECTION



TYPE-SPECIFIC DATA

Type	0150	0250	0400
Total height (Ht) [mm]	251	380	509
Housing height (Hb) [mm]	221	350	479
Protective height (Hs) [mm]	142	271	400
Number of beams	17	33	49
Current consumption [mA]	135	140	145
Response time [ms]	5.2	8.4	11.6

PART REFERENCE (BOLD: PREFERRED TYPES)

PNP / Connector M12	Sender	YBB-14S4-0150-G012	YBB-14S4-0250-G012	YBB-14S4-0400-G012
	Receiver	YBB-14R4-0150-G012	YBB-14R4-0250-G012	YBB-14R4-0400-G012
	Kit (sender + receiver)	YBB-14K4-0150-G012	YBB-14K4-0250-G012	YBB-14K4-0400-G012

TYPE-SPECIFIC DATA

Type	1000	1200	1300
Total height (Ht) [mm]	1154	1283	1412
Housing height (Hb) [mm]	1124	1253	1382
Protective height (Hs) [mm]	1045	1174	1303
Number of beams	129	145	161
Current consumption [mA]	175	185	190
Response time [ms]	27.6	30.8	34

PART REFERENCE (BOLD: PREFERRED TYPES)

PNP / Connector M12	Sender	YBB-14S4-1000-G012	YBB-14S4-1200-G012	YBB-14S4-1300-G012
	Receiver	YBB-14R4-1000-G012	YBB-14R4-1200-G012	YBB-14R4-1300-G012
	Kit (sender + receiver)	YBB-14K4-1000-G012	YBB-14K4-1200-G012	YBB-14K4-1300-G012



0500	0700	0800	0900
638	767	896	1025
608	737	866	995
529	658	787	916
65	81	97	113
150	160	165	170
14.8	18	21.2	24.4

YBB-14S4-0500-G012	YBB-14S4-0700-G012	YBB-14S4-0800-G012	YBB-14S4-0900-G012
YBB-14R4-0500-G012	YBB-14R4-0700-G012	YBB-14R4-0800-G012	YBB-14R4-0900-G012
YBB-14K4-0500-G012	YBB-14K4-0700-G012	YBB-14K4-0800-G012	YBB-14K4-0900-G012

1400	1600	1700
1541	1670	1799
1511	1640	1769
1432	1561	1690
177	193	209
195	200	210
37.2	40.4	43.6

YBB-14S4-1400-G012	YBB-14S4-1600-G012	YBB-14S4-1700-G012
YBB-14R4-1400-G012	YBB-14R4-1600-G012	YBB-14R4-1700-G012
YBB-14K4-1400-G012	YBB-14K4-1600-G012	YBB-14K4-1700-G012





CONTRINEX SAFETINEA

CONTRINEX

Power

Channel

LIGHT CURTAINS BASIC

HAND PROTECTION TYPE 4

MAIN FEATURES

- ✓ Resolution: 30 mm
- ✓ Operating range: 0.25 ... 12 m
- ✓ Protective height: 279 ... 1827 mm
- ✓ Category 4, PL e according to EN/ISO 13849-1
- ✓ Type 4 according to IEC 61496-1 and -2
- ✓ Certified TÜV, CE and UL
- ✓ IP 65, IP 67 with operating temperatures as low as -35°C (-31°F)
- ✓ Housing profile 42 mm x 48 mm
- ✓ 2-channel selection
- ✓ Optical synchronization
- ✓ Permanent autocontrol

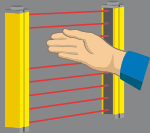

HAND PROTECTION

LEDS

LED indicators on the YBB **sender** unit

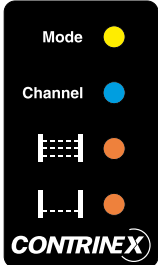

Mode:

Yellow when test mode is active

Channel:

Blue when channel 1 is selected

Purple when channel 2 is selected

Alignment (full):

Steady orange when the screen is not fully aligned

Blinking orange when the first third of the screen is aligned

Off when screen is fully aligned

Alignment (low beam):

Steady orange when the lowest beam is not aligned

Blinking orange when the lowest beam is aligned

Off when screen is fully aligned

LED indicators on the YBB **receiver** unit



Power:

Green when power is ON

Channel:

Blue when channel 1 is selected

Purple when channel 2 is selected

Status ON:

Green when OSSD outputs are ON

Status OFF:

Red when OSSD outputs are OFF

TECHNICAL DATA

Dimensions	42 mm x 48 mm x Ht
Resolution	30 mm
Protective height	279 ... 1827 mm
Supply voltage range	24 VDC ± 20 %
Current consumption sender	45 mA max. / 1.5 W max.
Current consumption receiver (excl. load)	130 mA max. / 4.7 W max.
Output current	0.2 A max. per output
Safety level (EN/ISO 13849-1)	Category 4, PLe
Safety type (IEC 61496-1 and -2)	Type 4
Protection class (IEC 61140)	III
Ambient temperature range	-35 ... +60°C (-31 ... +140°F)
Storage temperature range	-40 ... +70°C (-40 ... +158°F)
Degree of protection (EN 60529)	IP 65 + IP 67
Housing material	Aluminum
Material of optical parts	PMMA
Operating range	0.25 ... 12 m
Sender wavelength	IR 850 nm

HOUSING

Aluminum profile 42 mm x 48 mm with dual fixing groove.

ELECTRONIC PROTECTION

Safetinx light curtains are self-protected against overloads and short-circuits. They can also withstand short high-voltage overloads.

CONNECTION

Safetinx light curtains with M12 5-pole connector are standard.

DOCUMENTATION

Detailed data sheets for these products can be found on the Contrinex website www.contrinex.com or ordered free of charge from our distributors.

DIMENSIONS

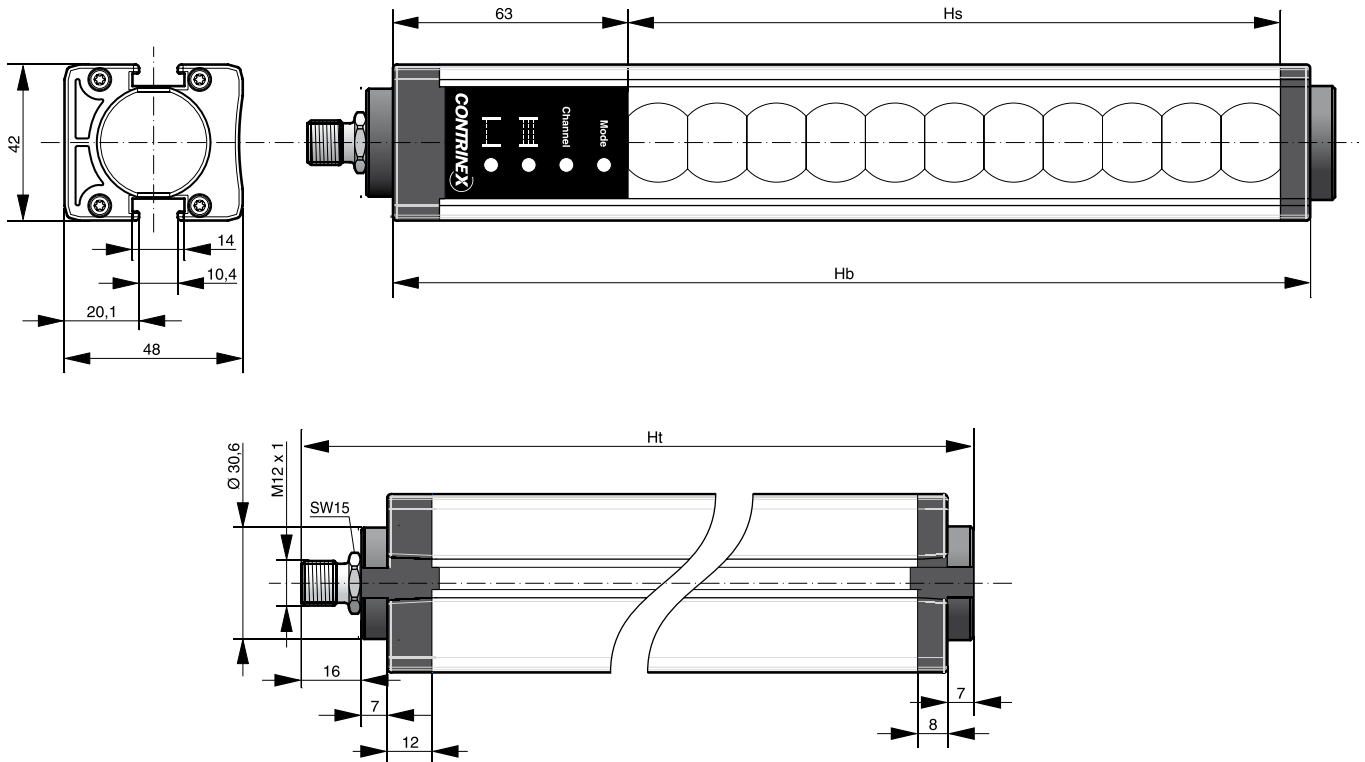

PIN ASSIGNMENT

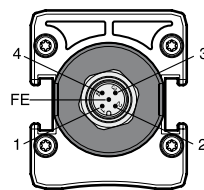

M12 connector

ASSIGNMENT	FUNCTION	PINS/WIRES ON SENDER		PINS/WIRES ON RECEIVER	
		M12 CONNECTOR	CABLE	M12 CONNECTOR	CABLE
Supply voltage	24 VDC for channel 1 / 0 V for channel 2	1	brown	1	brown
Supply voltage	0 V for channel 1 / 24 VDC for channel 2	3	blue	3	blue
Test mode	0 V: test active / 24 V: test inactive	4	black	-	-
Output	OSSD1	-	-	2	white
Output	OSSD2	-	-	4	black
Functional earth	Shield	FE	gray	FE	gray

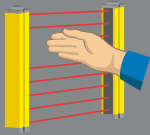

HAND PROTECTION



TYPE-SPECIFIC DATA

Type	0250	0400	0500
Total height (Ht) [mm]	380	509	638
Housing height (Hb) [mm]	350	479	608
Protective height (Hs) [mm]	279	408	537
Number of beams	17	25	33
Current consumption [mA]	125	130	130
Response time [ms]	5.2	6.8	8.4

PART REFERENCE (BOLD: PREFERRED TYPES)

PNP / Connector M12	Sender	Receiver	Kit (sender + receiver)
	YBB-30S4-0250-G012	YBB-30R4-0250-G012	YBB-30K4-0250-G012
	YBB-30S4-0400-G012	YBB-30R4-0400-G012	YBB-30K4-0400-G012
	YBB-30S4-0500-G012	YBB-30R4-0500-G012	YBB-30K4-0500-G012

TYPE-SPECIFIC DATA

Type	1200	1300	1400
Total height (Ht) [mm]	1283	1412	1541
Housing height (Hb) [mm]	1253	1382	1511
Protective height (Hs) [mm]	1182	1311	1440
Number of beams	73	81	89
Current consumption [mA]	150	155	160
Response time [ms]	16.4	18	19.6

PART REFERENCE (BOLD: PREFERRED TYPES)

PNP / Connector M12	Sender	Receiver	Kit (sender + receiver)
	YBB-30S4-1200-G012	YBB-30R4-1200-G012	YBB-30K4-1200-G012
	YBB-30S4-1300-G012	YBB-30R4-1300-G012	YBB-30K4-1300-G012
	YBB-30S4-1400-G012	YBB-30R4-1400-G012	YBB-30K4-1400-G012



0700767
737
666
41
135
10**0800**896
866
795
49
140
11.6**0900**1025
995
924
57
140
13.2**1000**1154
1124
1053
65
145
14.8YBB-30S4-0700-G012
YBB-30R4-0700-G012
YBB-30K4-0700-G012YBB-30S4-0800-G012
YBB-30R4-0800-G012
YBB-30K4-0800-G012YBB-30S4-0900-G012
YBB-30R4-0900-G012
YBB-30K4-0900-G012YBB-30S4-1000-G012
YBB-30R4-1000-G012
YBB-30K4-1000-G012**1600**1670
1640
1569
97
160
21.2**1700**1799
1769
1698
105
165
22.8**1800**1928
1898
1827
113
170
24.4YBB-30S4-1600-G012
YBB-30R4-1600-G012
YBB-30K4-1600-G012YBB-30S4-1700-G012
YBB-30R4-1700-G012
YBB-30K4-1700-G012YBB-30S4-1800-G012
YBB-30R4-1800-G012
YBB-30K4-1800-G012



TEST

ALIGN

POWER

CONTRINEX

POWER

ALIGN

POWER

CONTRINEX

LIGHT CURTAINS BASIC

HAND PROTECTION TYPE 2

MAIN FEATURES

- ✓ Resolution: 30 mm
- ✓ Operating range: 0.25 ... 12 m
- ✓ Protective height: 150 ... 1827 mm
- ✓ Category 2, PL c according to EN/ISO 13849-1
- ✓ Type 2 according to IEC 61496-1 and -2
- ✓ Certified TÜV, CE
- ✓ Housing profile 42 mm x 48 mm
- ✓ Enclosure rating IP 65, IP 67
- ✓ Optical synchronization
- ✓ Permanent autocontrol

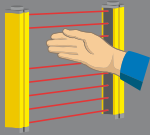

HAND PROTECTION

LEDS

LED indicators on the YBB **sender** unit

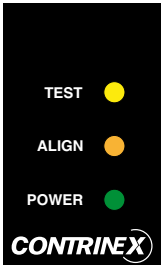

Test:

Yellow when intrusion simulation is active
Off when there is no intrusion simulation

Alignment:

Steady orange when the lowest beam is not aligned

Quick blinking orange when the lowest beam is aligned

Blinking orange when at least 6 beams are aligned

Off when screen is fully aligned

Power:

Green when power is ON

LED indicators on the YBB **receiver** unit

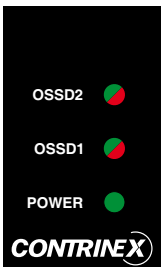

OSSD2:

Green when OSSD2 is ON
Red when OSSD2 is OFF

OSSD1:

Green when OSSD1 is ON
Red when OSSD1 is OFF

Power:

Green when power is ON

TECHNICAL DATA

Dimensions	42 mm x 48 mm x Ht
Resolution	30 mm
Protective height	150 ... 1827 mm
Supply voltage range	24 VDC \pm 20 %
Current consumption sender	27 mA max. / 0.8 W max.
Current consumption receiver (excl. load)	58 mA max. / 1.7 W max.
Output current	0.2 A max. per output
Safety level (EN/ISO 13849-1)	Category 2, PLc
Safety type (IEC 61496-1 and -2)	Type 2
Protection class (IEC 61140)	III
Ambient temperature range	0 ... +50°C (+32 ... +122°F)
Storage temperature range	-25 ... +70°C (-13 ... +158°F)
Degree of protection (EN 60529)	IP 65 + IP 67
Housing material	Aluminum
Material of optical parts	PMMA
Operating range	0.25 ... 12 m
Sender wavelength	IR 850 nm

HOUSING

Aluminum profile 42 mm x 48 mm with dual fixing groove.

ELECTRONIC PROTECTION

Safetinx light curtains are self-protected against overloads and short-circuits. They can also withstand short high-voltage overloads.

CONNECTION

Safetinx light curtains are connected via a standard M12 5-pole connector.

DOCUMENTATION

Detailed data sheets for these products can be found on the Contrinex website www.contrinex.com or ordered free of charge from our distributors.

DIMENSIONS

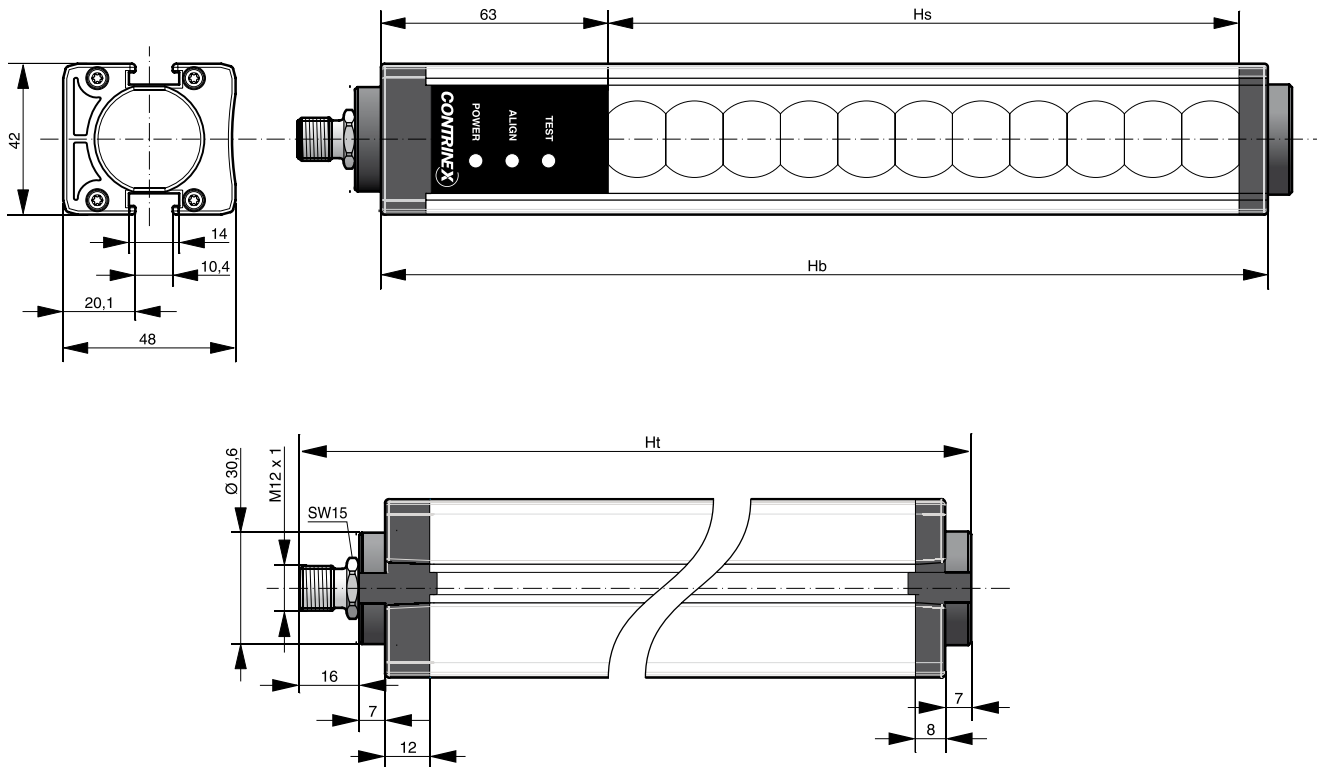

PIN ASSIGNMENT

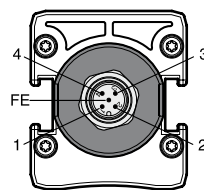

M12 connector

ASSIGNMENT	FUNCTION	PINS ON SENDER		PINS ON RECEIVER	
		M12 CONNECTOR	CABLE	M12 CONNECTOR	CABLE
Supply voltage	24 VDC	1	brown	1	brown
Supply voltage	0 V	3	blue	3	blue
Test mode	0 V: test active / 24 V: test inactive	4	black	-	-
Output	OSSD1	-	-	2	white
Output	OSSD2	-	-	4	black
Functional earth	Shield	FE	gray	FE	gray

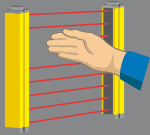

HAND PROTECTION



TYPE-SPECIFIC DATA

Type	0150	0250	0400	0500
Total height (Ht) [mm]	251	380	509	638
Housing height (Hb) [mm]	221	350	479	608
Protective height (Hs) [mm]	150	279	408	537
Number of beams	9	17	25	33
Current consumption [mA]	70	74	77	79
Response time [ms]	14	18	22	26

PART REFERENCE (BOLD: PREFERRED TYPES)

PNP / Connector M12	Sender	YBB-30S2-0150-G012	YBB-30S2-0250-G012	YBB-30S2-0400-G012	YBB-30S2-0500-G012
	Receiver	YBB-30R2-0150-G012	YBB-30R2-0250-G012	YBB-30R2-0400-G012	YBB-30R2-0500-G012
	Kit (sender + receiver)	YBB-30K2-0150-G012	YBB-30K2-0250-G012	YBB-30K2-0400-G012	YBB-30K2-0500-G012

TYPE-SPECIFIC DATA

Type	0700	0800	0900	1000
Total height (Ht) [mm]	767	896	1025	1154
Housing height (Hb) [mm]	737	866	995	1124
Protective height (Hs) [mm]	666	795	924	1053
Number of beams	41	49	57	65
Current consumption [mA]	80	81	81	82
Response time [ms]	30	34	38	42

PART REFERENCE (BOLD: PREFERRED TYPES)

PNP / Connector M12	Sender	YBB-30S2-0700-G012	YBB-30S2-0800-G012	YBB-30S2-0900-G012	YBB-30S2-1000-G012
	Receiver	YBB-30R2-0700-G012	YBB-30R2-0800-G012	YBB-30R2-0900-G012	YBB-30R2-1000-G012
	Kit (sender + receiver)	YBB-30K2-0700-G012	YBB-30K2-0800-G012	YBB-30K2-0900-G012	YBB-30K2-1000-G012

TYPE-SPECIFIC DATA

Type	1200	1300	1400	1600
Total height (Ht) [mm]	1283	1412	1541	1670
Housing height (Hb) [mm]	1253	1382	1511	1640
Protective height (Hs) [mm]	1182	1311	1440	1569
Number of beams	73	81	89	97
Current consumption [mA]	83	83	84	84
Response time [ms]	46	50	54	58

PART REFERENCE (BOLD: PREFERRED TYPES)

PNP / Connector M12	Sender	YBB-30S2-1200-G012	YBB-30S2-1300-G012	YBB-30S2-1400-G012	YBB-30S2-1600-G012
	Receiver	YBB-30R2-1200-G012	YBB-30R2-1300-G012	YBB-30R2-1400-G012	YBB-30R2-1600-G012
	Kit (sender + receiver)	YBB-30K2-1200-G012	YBB-30K2-1300-G012	YBB-30K2-1400-G012	YBB-30K2-1600-G012

TYPE-SPECIFIC DATA

Type	1700	1800		
Total height (Ht) [mm]	1799	1928		
Housing height (Hb) [mm]	1769	1898		
Protective height (Hs) [mm]	1698	1827		
Number of beams	105	113		
Current consumption [mA]	85	85		
Response time [ms]	62	66		

PART REFERENCE (BOLD: PREFERRED TYPES)

PNP / Connector M12	Sender	YBB-30S2-1700-G012	YBB-30S2-1800-G012		
	Receiver	YBB-30R2-1700-G012	YBB-30R2-1800-G012		
	Kit (sender + receiver)	YBB-30K2-1700-G012	YBB-30K2-1800-G012		







LIGHT CURTAINS BASIC

HAND PROTECTION TYPE 2 SLIM

MAIN FEATURES

- ✓ Resolution: 30 mm
- ✓ Operating range: 0.25 ... 8 m
- ✓ Protective height: 170 ... 1610 mm
- ✓ No blind zone
- ✓ Category 2, PL c according to EN/ISO 13849-1
- ✓ Type 2 according to IEC 61496-1 and -2
- ✓ Certified TÜV, CE
- ✓ Enclosure rating IP 65
- ✓ Housing profile 26 mm x 26 mm
- ✓ Optical synchronization
- ✓ Permanent autocontrol

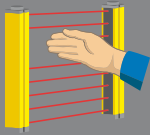

HAND PROTECTION

LEDS

LED indicators on the YBBS **sender** unit



Test:

Yellow when intrusion simulation is active
Off when there is no intrusion simulation

Alignment:

Steady orange when the lowest beam is not aligned

Quick blinking orange when the lowest beam is aligned

Slow blinking orange when at least 6 beams are aligned

OFF when screen is fully aligned

Power:

Green when power is ON

LED indicators on the YBBS **receiver** unit



OSSD2:

Green when OSSD2 is ON

Red when OSSD2 is OFF

OSSD1:

Green when OSSD1 is ON

Red when OSSD1 is OFF

Power:

Green when power is ON

TECHNICAL DATA

Dimensions	26 mm x 26 mm x Ht
Resolution	30 mm
Protective height	170 ... 1610 mm
Supply voltage range	24 VDC \pm 20 %
Current consumption sender	42 mA max. / 1.2 W max.
Current consumption receiver (excl. load)	29 mA max. / 0.8 W max.
Output current	max. 400 mA per output (at 50°C / 122°F)
Safety level (EN/ISO 13849-1)	Category 2, PLc
Safety type (IEC 61496-1 and -2)	Type 2
Protection class (IEC 61140)	III
Ambient temperature range	0 ... +55°C (+32 ... +131°F)
Storage temperature range	-25 ... +70°C (-13 ... +158°F)
Degree of protection (EN 60529)	IP 65
Housing material	Aluminum profile, PC front screen
Material of optical parts	PMMA
Operating range	0.25 ... 8 m
Sender wavelength	IR 850 nm

HOUSING

Aluminum profile 26 mm x 26 mm with dual fixing groove.

ELECTRONIC PROTECTION

Safetinx light curtains are self-protected against overloads and short-circuits. They can also withstand short high-voltage overloads.

CONNECTION

Safetinx light curtains are connected via a standard M12 5-pole pigtail.

DOCUMENTATION

Detailed data sheets for these products can be found on the Contrinex website www.contrinex.com or ordered free of charge from our distributors.

DIMENSIONS

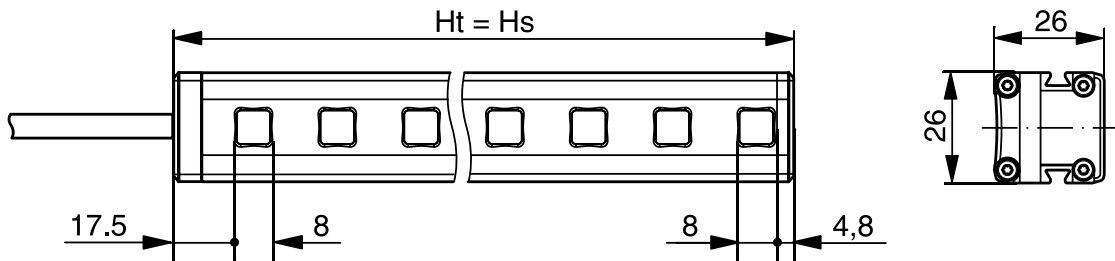

PIN ASSIGNMENT

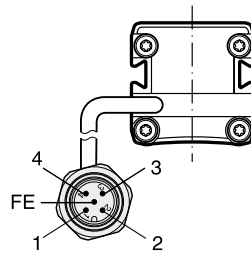

M12 pigtail

ASSIGNMENT	FUNCTION	PINS/WIRES ON SENDER		PINS/WIRES ON RECEIVER	
		M12	OPEN CABLE	M12	OPEN CABLE
Supply voltage	24 VDC	1	brown	1	brown
Supply voltage	0 V	3	blue	3	blue
Test mode	0 V: test active 24 V: test inactive	4	black	-	-
Output	OSSD1	-	-	2	white
Output	OSSD2	-	-	4	black
Functional earth	Shield	FE	gray	FE	gray

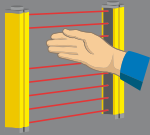

HAND PROTECTION



TYPE-SPECIFIC DATA

Type	0170	0330	0490	0650
Total height (Ht) [mm]	170	330	490	650
Protective height (Hs) [mm]	170	330	490	650
Number of beams	8	16	24	32
Current consumption [mA]	42	49	54	57
Response time [ms]	6	9	11	14

PART REFERENCE (BOLD: PREFERRED TYPES)

PNP / Connector M12	Sender	YBBS-30S2-0170-P012	YBBS-30S2-0330-P012	YBBS-30S2-0490-P012	YBBS-30S2-0650-P012
	Receiver	YBBS-30R2-0170-P012	YBBS-30R2-0330-P012	YBBS-30R2-0490-P012	YBBS-30R2-0650-P012
	Kit (sender + receiver)	YBBS-30K2-0170-P012	YBBS-30K2-0330-P012	YBBS-30K2-0490-P012	YBBS-30K2-0650-P012

TYPE-SPECIFIC DATA

Type	0810	0970	1130	1290
Total height (Ht) [mm]	810	970	1130	1290
Protective height (Hs) [mm]	810	970	1130	1290
Number of beams	40	48	56	64
Current consumption [mA]	61	63	65	67
Response time [ms]	16	19	21	24

PART REFERENCE (BOLD: PREFERRED TYPES)

PNP / Connector M12	Sender	YBBS-30S2-0810-P012	YBBS-30S2-0970-P012	YBBS-30S2-1130-P012	YBBS-30S2-1290-P012
	Receiver	YBBS-30R2-0810-P012	YBBS-30R2-0970-P012	YBBS-30R2-1130-P012	YBBS-30R2-1290-P012
	Kit (sender + receiver)	YBBS-30K2-0810-P012	YBBS-30K2-0970-P012	YBBS-30K2-1130-P012	YBBS-30K2-1290-P012

TYPE-SPECIFIC DATA

Type	1450	1610		
Total height (Ht) [mm]	1450	1610		
Protective height (Hs) [mm]	1450	1610		
Number of beams	72	80		
Current consumption [mA]	68	71		
Response time [ms]	26	29		

PART REFERENCE (BOLD: PREFERRED TYPES)

PNP / Connector M12	Sender	YBBS-30S2-1450-P012	YBBS-30S2-1610-P012		
	Receiver	YBBS-30R2-1450-P012	YBBS-30R2-1610-P012		
	Kit (sender + receiver)	YBBS-30K2-1450-P012	YBBS-30K2-1610-P012		

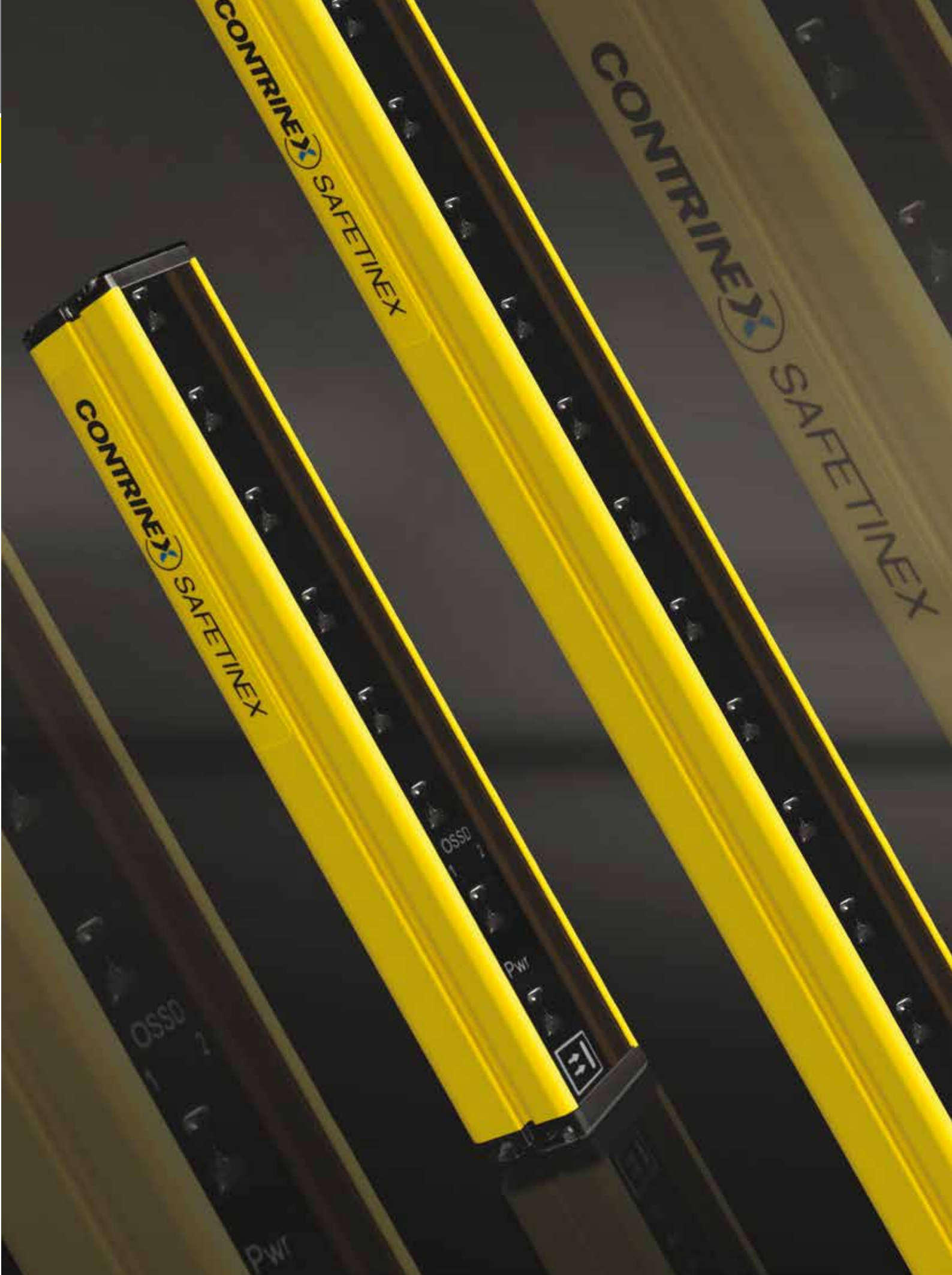



BARRIERS BASIC

ACCESS CONTROL TYPE 4

MAIN FEATURES

- ✓ Beam gap: 300, 400 or 500 mm (3 to 6 beams)
- ✓ Operating range: 1 ... 15 m or 10 ... 50 m (can be configured)
- ✓ Protective height: 832 ... 1532 mm
- ✓ Category 4, PL e according to EN/ISO 13849-1
- ✓ Type 4 according to IEC 61496-1 and -2
- ✓ Certified TÜV, CE and UL
- ✓ IP 65, IP 67 with operating temperatures as low as -35°C (-31°F)
- ✓ Housing profile 42 mm x 48 mm
- ✓ 2-channel selection
- ✓ Optical synchronization
- ✓ Permanent autocontrol



ACCESS CONTROL

LEDS

LED indicators on the YCA **sender** unit

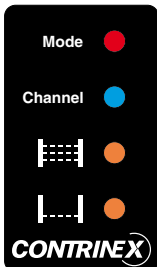

Mode:

Off when max. operating range 15 m
 Blue when max. operating range 50 m
 Red or purple in case of wiring error

Channel:

Blue when channel 1 selected
 Purple when channel 2 selected

Alignment (full):

Steady orange when screen not fully aligned
 Blinking orange when first third of screen aligned
 Off when screen is fully aligned

Alignment (low beam):

Steady orange when lowest beam not aligned
 Blinking orange when lowest beam aligned
 Off when screen fully aligned

LED indicators on the YCA **receiver** unit



Power:

Green when power ON

Channel:

Blue when channel 1 selected
 Purple when channel 2 selected

Status ON:

Green when OSSD outputs ON

Status OFF:

Red when OSSD outputs OFF

TECHNICAL DATA

Dimensions	42 mm x 48 mm x Ht
Beam gap	300, 400 or 500 mm (3 to 6 beams)
Protective height	832 ... 1532 mm
Supply voltage range	24 VDC \pm 15%
Current consumption sender	35 mA max. / 1.0 W max.
Current consumption receiver (excl. load)	75 mA max. / 2.2 W max.
Output current	0.2 A max. per output
Safety level (EN/ISO 13849-1)	Category 4, PLe
Safety type (IEC 61496-1 and -2)	Type 4
Protection class (IEC 61140)	III
Ambient temperature range	-35 ... +60°C (-31 ... +140°F)
Storage temperature range	-40 ... +70°C (-40 ... +158°F)
Degree of protection (EN 60529)	IP 65 + IP 67
Housing material	Aluminum
Material of optical parts	PMMA
Operating range	1 ... 15 m / 10 ... 50 m (can be configured)
Sender wavelength	IR 850 nm

HOUSING

Aluminum profile 42 mm x 48 mm with dual fixing groove.

CONFIGURATION OF OPERATING RANGE

Depending on wiring, the maximum operating range can be fixed to either 50 m or 15 m.

ELECTRONIC PROTECTION

Safetinex access control barriers are self-protected against overloads and short-circuits. They can also withstand short high-voltage overloads.

CONNECTION

Safetinex light curtains with M12 5-pole connector are standard.

DOCUMENTATION

Detailed data sheets for these products can be found on the Contrinex website www.contrinex.com or ordered free of charge from our distributors.

DIMENSIONS

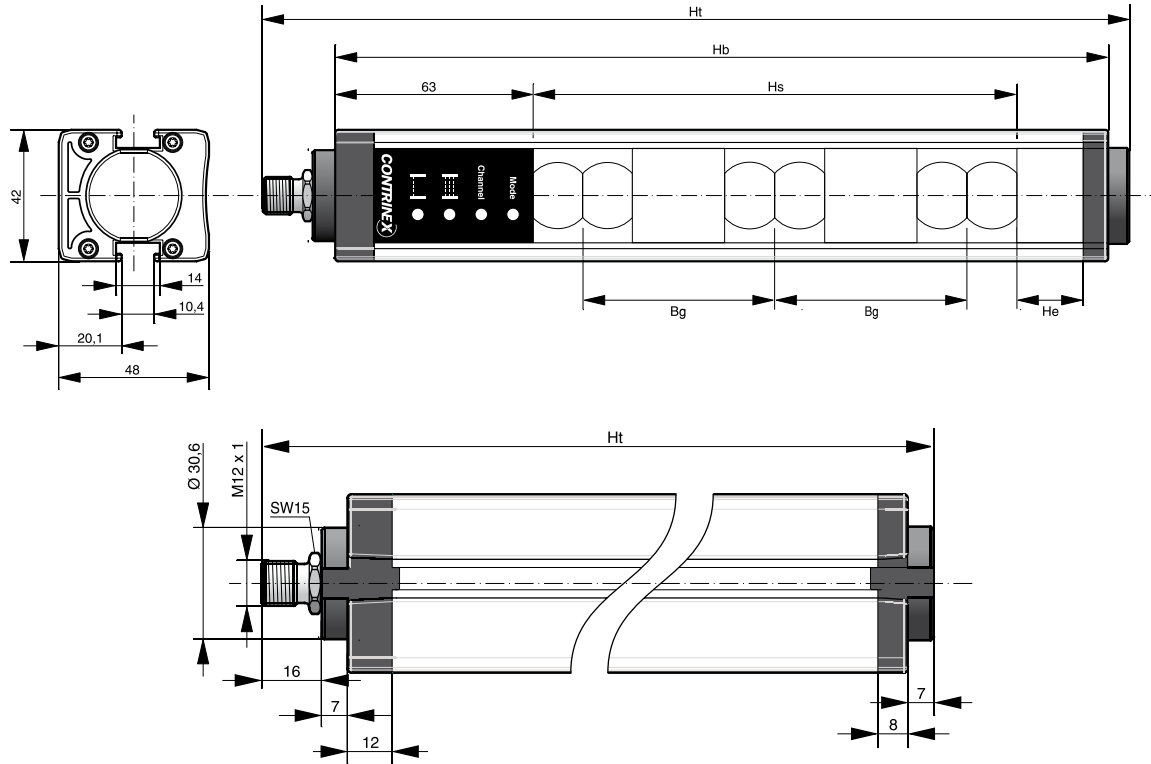

PIN ASSIGNMENT

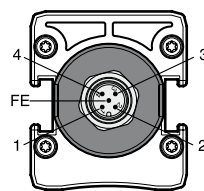

M12 connector

ASSIGNMENT	FUNCTION	PINS/WIRES ON SENDER		PINS/WIRES ON RECEIVER	
		M12 CONNECTOR	CABLE	M12 CONNECTOR	CABLE
Supply voltage	24 VDC for channel 1 / 0 V for channel 2	1	brown	1	brown
Supply voltage	0 V for channel 1 / 24 VDC for channel 2	3	blue	3	blue
Operating range selection	24 V: operating range 10 ... 50 m 0 V: operating range 1 ... 15 m	4	black	-	-
Operating range selection	0 V: operating range 10 ... 50 m 24 V: operating range 1 ... 15 m	2	white	-	-
Output	OSSD1	-	-	2	white
Output	OSSD2	-	-	4	black
Functional earth	Shield	FE	gray	FE	gray



ACCESS CONTROL



TYPE-SPECIFIC DATA

	4	5	6
Number of beams	4	5	6
Beam gap (Bg) [mm]	300	300	300
Total height (Ht) [mm]	1154	1412	1670
Housing height (Hb) [mm]	1124	1382	1640
Protective height (Hs) [mm]	932	1232	1532
Height extension (He) [mm]	121	79	37
Current consumption [mA]	110	110	110
Response time [ms]	5.0	5.9	6.7

PART REFERENCE (BOLD: PREFERRED TYPES)

PNP / Connector M12	Sender	YCA-50S4-4300-G012	YCA-50S4-5300-G012	YCA-50S4-6300-G012
	Receiver	YCA-50R4-4300-G012	YCA-50R4-5300-G012	YCA-50R4-6300-G012
	Kit (sender + receiver)	YCA-50K4-4300-G012	YCA-50K4-5300-G012	YCA-50K4-6300-G012

TYPE-SPECIFIC DATA

	3	4	3
Number of beams	3	4	3
Beam gap (Bg) [mm]	400	400	500
Total height (Ht) [mm]	1025	1412	1154
Housing height (Hb) [mm]	995	1382	1124
Protective height (Hs) [mm]	832	1232	1032
Height extension (He) [mm]	92	79	21
Current consumption [mA]	110	110	110
Response time [ms]	4.2	5.0	4.2

PART REFERENCE (BOLD: PREFERRED TYPES)

PNP / Connector M12	Sender	YCA-50S4-3400-G012	YCA-50S4-4400-G012	YCA-50S4-3500-G012
	Receiver	YCA-50R4-3400-G012	YCA-50R4-4400-G012	YCA-50R4-3500-G012
	Kit (sender + receiver)	YCA-50K4-3400-G012	YCA-50K4-4400-G012	YCA-50K4-3500-G012



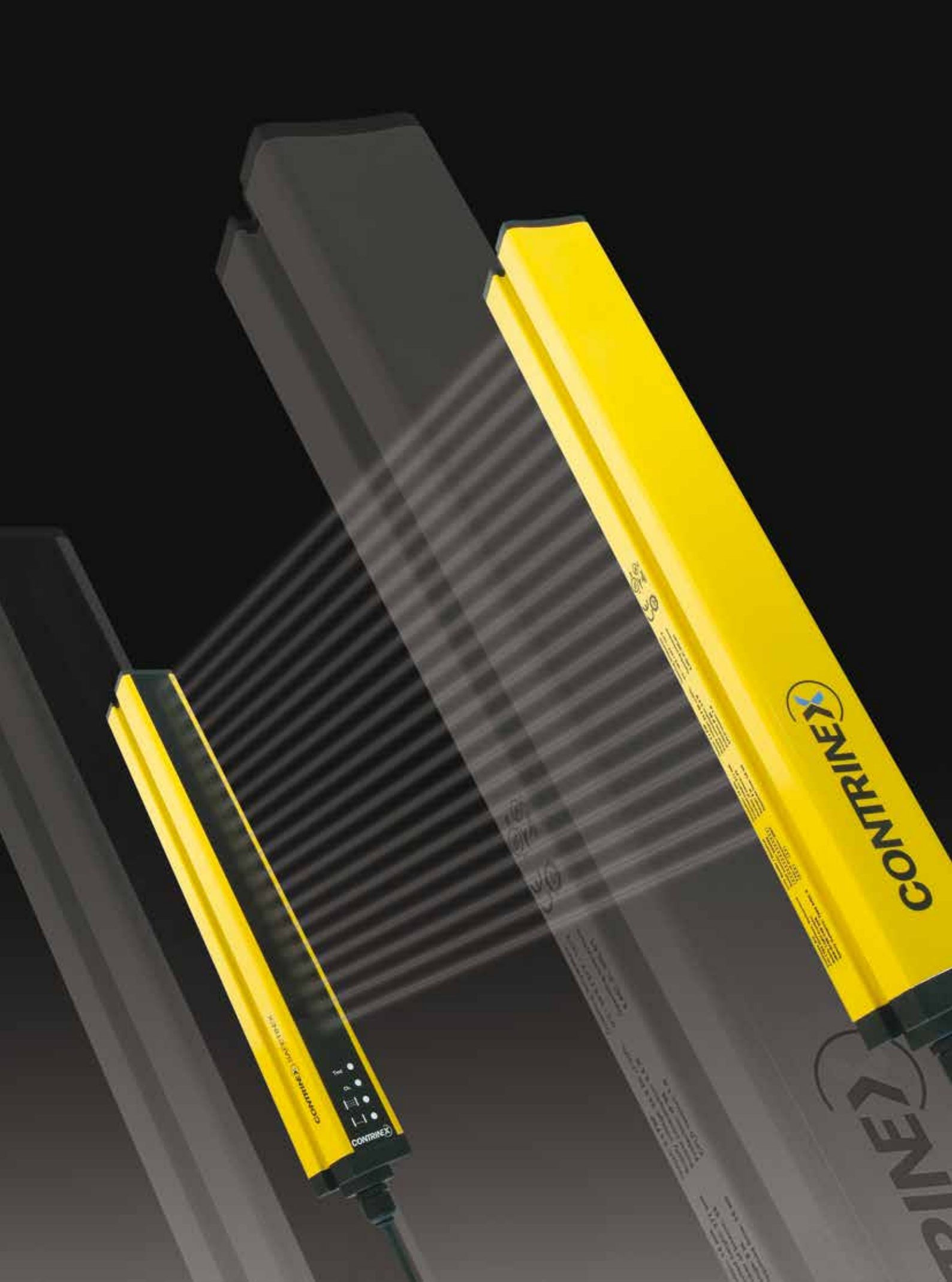





LIGHT CURTAINS EXTENDED

HAND PROTECTION TYPE 4 SLIM

MAIN FEATURES

- ✓ Resolution: 30 mm
- ✓ Operating range: 0.25 ... 10 m*
- ✓ Protective height: 170 ... 1610 mm
- ✓ Wireless configuration through Bluetooth®
- ✓ No blind zone
- ✓ Category 4, PL e according to EN/ISO 13849-1
- ✓ Type 4 according to IEC 61496-1 and -2
- ✓ SIL 3 according to IEC 61508
- ✓ Certified TÜV, CE and UL**
- ✓ Enclosure rating IP 65
- ✓ Housing profile 26 mm x 26 mm
- ✓ Beam coding (3 channels), EDM, start and restart interlock configurable functions
- ✓ Optical synchronization
- ✓ Permanent autocontrol

* Provisional data ** Pending

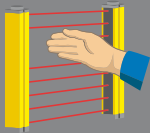

HAND PROTECTION

LEDS

LED indicators on the YBES **sender** unit



Bluetooth®:

Blue when communication through Bluetooth® is enabled

Quick blinking blue when data are exchanged (1 Hz)

OFF when communication through Bluetooth® is disabled

Beam coding:

Purple when "Beam Coding #1" option is enabled

Yellow when "Beam Coding #2" option is enabled

Cyan when "Beam Coding #3" option is enabled

Test:

Yellow when intrusion simulation is enabled

OFF when there is no intrusion simulation

LED indicators on the YBES **receiver** unit



OSSD:

Green when both OSSD1 and OSSD2 are ON

Red when both OSSD1 and OSSD2 are OFF

Interlock:

Yellow when light curtain is waiting for restart/start

OFF when restart/start is initiated or when automatic restart is configured

Bluetooth®:

Blue when communication through Bluetooth® is enabled

Blinking blue when data are exchanged (1 Hz)

OFF when communication through Bluetooth® is disabled

TECHNICAL DATA

Dimensions	26 mm x 26 mm x Ht
Resolution	30 mm
Protective height	170 ... 1610 mm
Supply voltage range	24 VDC ± 20 %
Current consumption sender	tbd
Current consumption receiver (excl. load)	tbd
Output current	max. 400 mA per output (at 50°C / 122°F)
Safety level (EN/ISO 13849-1)	Category 4, PL _e
Safety type (IEC 61496-1 and -2)	Type 4
Protection class (IEC 61140)	III
Ambient temperature range	0 ... +55°C (+32 ... +131°F)
Storage temperature range	-25 ... +70°C (-13 ... +158°F)
Degree of protection (EN 60529)	IP 65
Housing material	Aluminum profile, PC front screen
Material of optical parts	PMMA
Operating range	0.25 ... 10 m*
Sender wavelength	IR 850 nm

* Provisional data

HOUSING

Aluminum profile 26 mm x 26 mm with dual fixing groove.

ELECTRONIC PROTECTION

Safetinx light curtains are self-protected against overloads and short-circuits. They can also withstand short high-voltage overloads.

CONNECTION

Safetinx light curtains with M12 5-pole (sender) and M12-8 pole (receiver) pigtail are standard.

DOCUMENTATION

Detailed data sheets for these products can be found on the Contrinex website www.contrinex.com or ordered free of charge from our distributors.

Alignment:

Steady orange when no beam is aligned

Blinking orange when less of total beam number are aligned (frequency about 1 Hz)

OFF when all beams are fully aligned

EDM:

Orange when EDM is enabled

OFF when EDM is disabled

Beam Coding:

Purple when "Beam Coding #1" option is enabled

Yellow when "Beam Coding #2" option is enabled

Cyan when "Beam Coding #3" option is enabled

DIMENSIONS

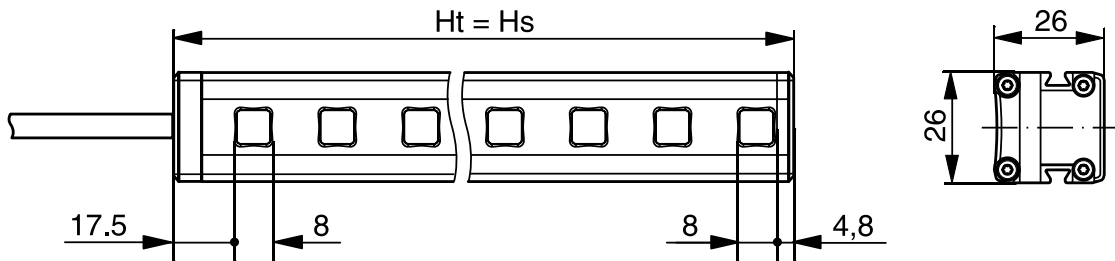

PIN ASSIGNMENT

Sender

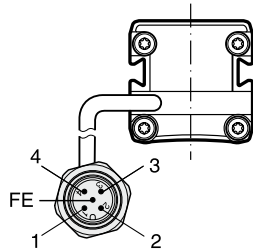

M12 pigtail, 5 pins

Receiver

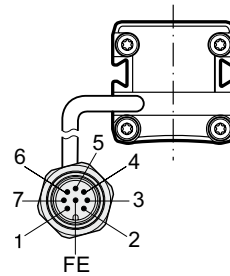

M12 pigtail, 8 pins

ASSIGNMENT	FUNCTION	PINS/WIRES ON SENDER		PINS/WIRES ON RECEIVER	
		M12	OPEN CABLE	M12	OPEN CABLE
Supply voltage	24 VDC	1	brown	2	brown
Supply voltage	0 V	3	blue	7	blue
Test mode	24 V: test inactive 0 V: test active	4	black	-	-
Output	OSSD1	-	-	5	grey
Output	OSSD2	-	-	6	pink
Functional earth	Shield	FE	gray	FE	red
EDM	EDM input	-	-	4	yellow
Restart Interlock	Input for restart button	-	-	1	white
Not used	-	2	white	3	green

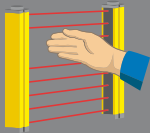

HAND PROTECTION



TYPE-SPECIFIC DATA

Type	0170	0330	0490
Total height (Ht) [mm]	170	330	490
Protective height (Hs) [mm]	170	330	490
Number of beams	8	16	24
Current consumption [mA]	tbd	tbd	tbd
Response time [ms]	5	6	7

PART REFERENCE (BOLD: PREFERRED TYPES)

PNP / Connector M12	Sender	YBES-30S4-0170-P012	YBES-30S4-0330-P012	YBES-30S4-0490-P012
	Receiver	YBES-30R4-0170-P012	YBES-30R4-0330-P012	YBES-30R4-0490-P012
	Kit (sender + receiver)	YBES-30K4-0170-P012	YBES-30K4-0330-P012	YBES-30K4-0490-P012

TYPE-SPECIFIC DATA

Type	0650	0810	0970
Total height (Ht) [mm]	650	810	970
Protective height (Hs) [mm]	650	810	970
Number of beams	32	40	48
Current consumption [mA]	tbd	tbd	tbd
Response time [ms]	8	9	10

PART REFERENCE (BOLD: PREFERRED TYPES)

PNP / Connector M12	Sender	YBES-30S4-0650-P012	YBES-30S4-0810-P012	YBES-30S4-0970-P012
	Receiver	YBES-30R4-0650-P012	YBES-30R4-0810-P012	YBES-30R4-0970-P012
	Kit (sender + receiver)	YBES-30K4-0650-P012	YBES-30K4-0810-P012	YBES-30K4-0970-P012

TYPE-SPECIFIC DATA

Type	1130	1290	1450
Total height (Ht) [mm]	1130	1290	1450
Protective height (Hs) [mm]	1130	1290	1450
Number of beams	56	64	72
Current consumption [mA]	tbd	tbd	tbd
Response time [ms]	11	12	13

PART REFERENCE (BOLD: PREFERRED TYPES)

PNP / Connector M12	Sender	YBES-30S4-1130-P012	YBES-30S4-1290-P012	YBES-30S4-1450-P012
	Receiver	YBES-30R4-1130-P012	YBES-30R4-1290-P012	YBES-30R4-1450-P012
	Kit (sender + receiver)	YBES-30K4-1130-P012	YBES-30K4-1290-P012	YBES-30K4-1450-P012

TYPE-SPECIFIC DATA

Type	1610		
Total height (Ht) [mm]	1610		
Protective height (Hs) [mm]	1610		
Number of beams	80		
Current consumption [mA]	tbd		
Response time [ms]	14		

PART REFERENCE (BOLD: PREFERRED TYPES)

PNP / Connector M12	Sender	YBES-30S4-1610-P012		
	Receiver	YBES-30R4-1610-P012		
	Kit (sender + receiver)	YBES-30K4-1610-P012		

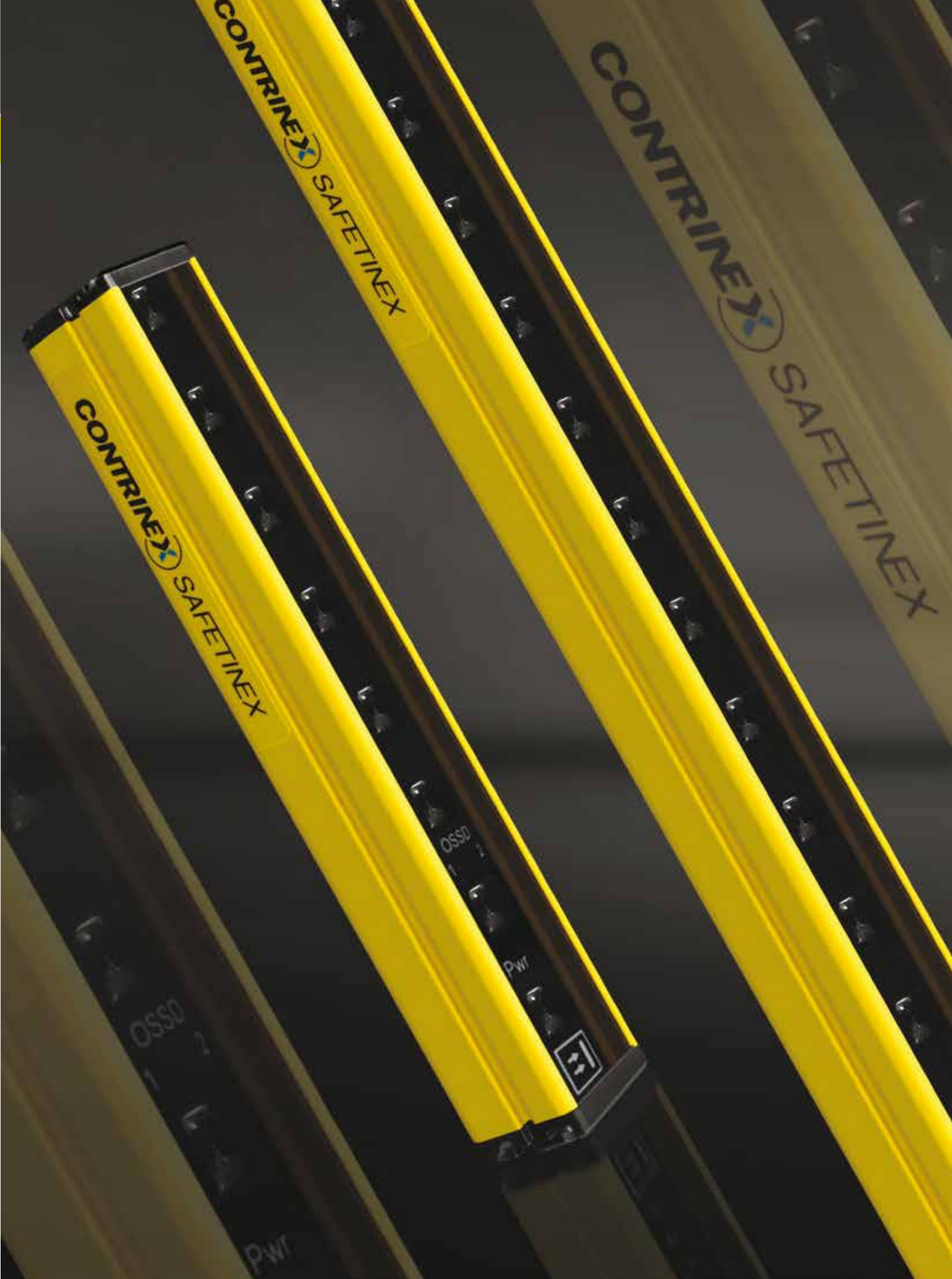

CONTRINEX SAFETINEX

CONTRINEX SAFETINEX

CONTRINEX SAFETINEX

OSSD

Pwr



OSSD

Pwr

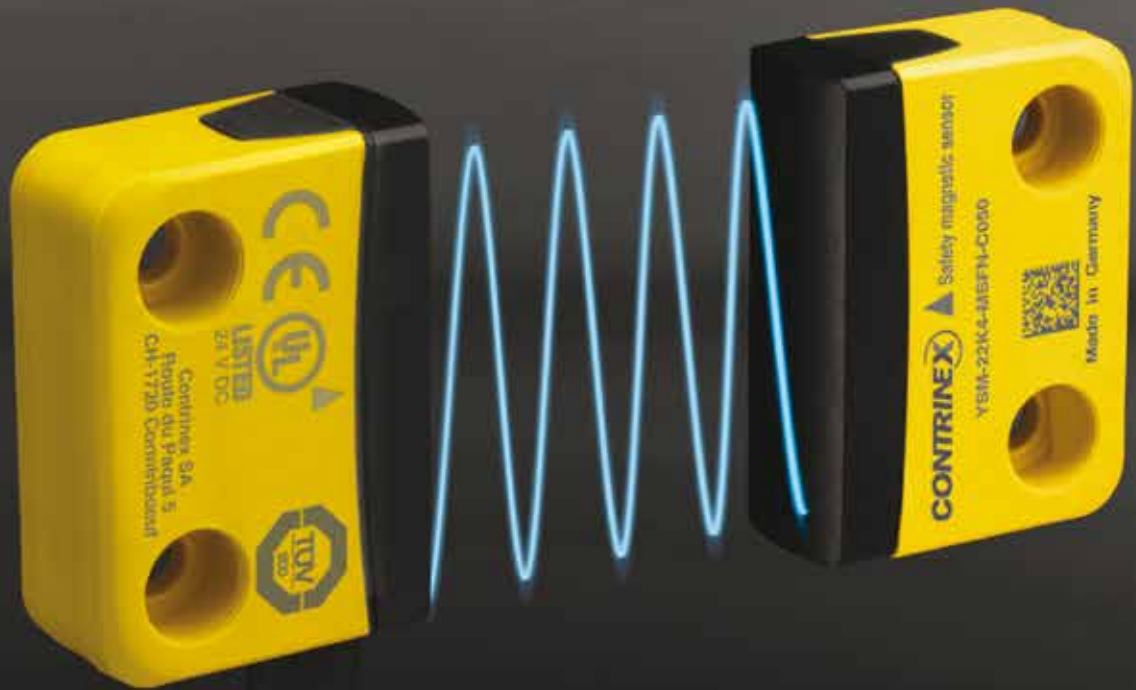

SENSORS

NON-CONTACT MAGNETICALLY CODED

MAIN FEATURES

- ✓ Safety sensor with frontal or 90° actuation
- ✓ Magnetically coded, ISO 14119 type 4
- ✓ Up to category 4, PL e according to EN/ISO 13849-1
- ✓ Operating distance up to 18 mm
- ✓ PVC cable or M12 pigtail connection
- ✓ Sizes 36 mm x 26 mm x 13 mm and 88 mm x 25 mm x 13 mm
- ✓ Certified TÜV, CE and UL
- ✓ IP6K9K, Ecolab

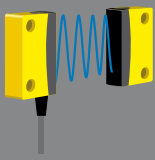

MAGNETIC SENSORS

TECHNICAL DATA

Supply voltage range	24 VDC \pm 20 %
Load current	max 200 mA (-25°C...+80°C)
Safe switch on distance Sao	4 or 8 mm
Safe switch off distance Sar	10, 17 or 18 mm
Dimensions	36 mm x 26 mm x 13 mm (YSM-22 series) 88 mm x 25 mm x 13 mm (YSM-78 series)
Output	2x NO Reed contact
Minimum air gap Somin	0.5 mm
Ambient temperature range	-25 ... +80°C (-13 ... +176°F)
Storage temperature range	-25 ... +80°C (-13 ... +176°F)
Enclosure rating	IP 67 (EN 60529) and IP 6K9K (ISO 20653)
Housing material	PBT yellow, PC black
Connection	5 m PVC cable 4 x 0,25 mm ² or 0.15 m PVC pigtail with M12 4-pins connector
Safety level*	Cat.4 / PL e (EN ISO 13849-1) SIL _{CL} 3 (IEC/EN 62061) SIL 3 (IEC/EN 61508)
Content in each bag	Sensor and actuator (kit)

* Short circuit recognition through differing voltages or pulsed signals required

DIMENSIONS

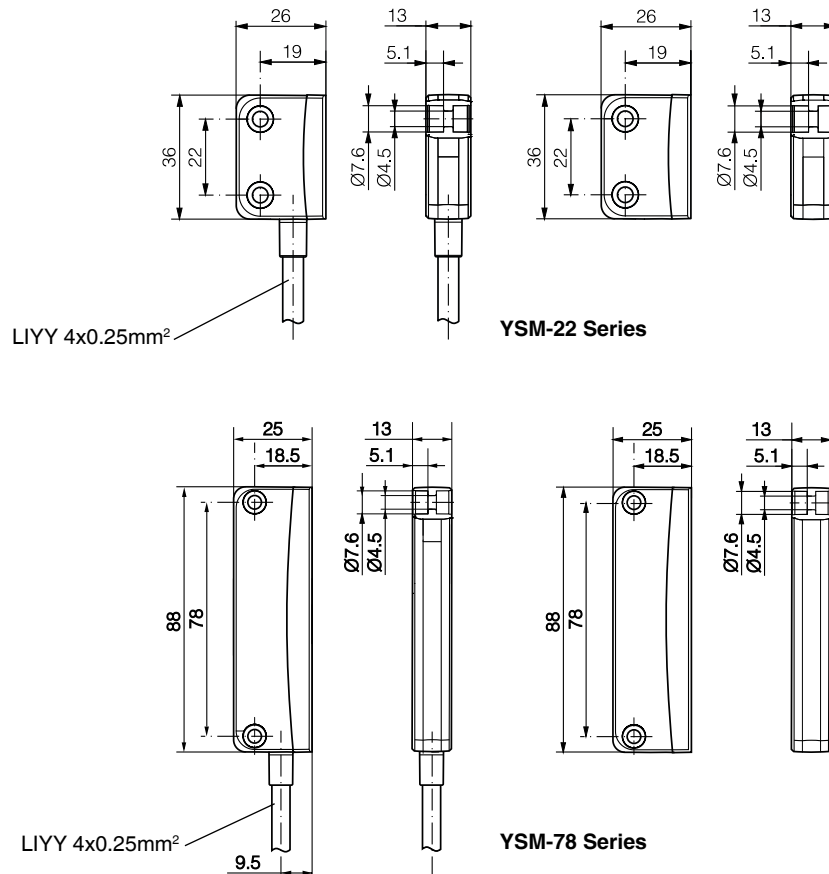

PIN ASSIGNMENT

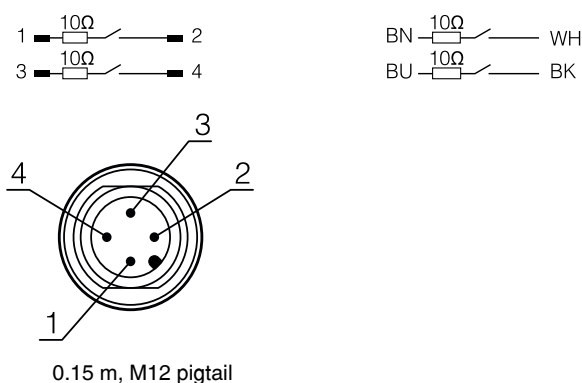

ASSIGNMENT	FUNCTION	PINS/WIRES ON SENDER	
		M12	OPEN CABLE
Supply voltage	24 VDC	1	brown
Supply voltage	24 VDC	3	blue
Output	NO contact 1	2	white
Output	NO contact 2	4	black



YSM-22 SERIES

Part reference	Dimensions [mm]	Sao	Sar	Actuation	Hysteresis	Connection
YSM-22K4-MSFN-C050	36 x 26 x 13	4 mm	10 mm	Frontal	1.5 mm	PVC, 5 m, 4 wire
YSM-22K4-MEFN-C050	36 x 26 x 13	8 mm	17 mm	Frontal	2.5 mm	PVC, 5 m, 4 wire
YSM-22K4-MSAN-C050	36 x 26 x 13	4 mm	10 mm	90°	1.5 mm	PVC, 5 m, 4 wire
YSM-22K4-MEAN-C050	36 x 26 x 13	8 mm	17 mm	90°	2.5 mm	PVC, 5 m, 4 wire
YSM-22K4-MSFN-P012	36 x 26 x 13	4 mm	10 mm	Frontal	1.5 mm	PVC, 0.15 m + M12 4-pin
YSM-22K4-MEFN-P012	36 x 26 x 13	8 mm	17 mm	Frontal	2.5 mm	PVC, 0.15 m + M12 4-pin
YSM-22K4-MSAN-P012	36 x 26 x 13	4 mm	10 mm	90°	1.5 mm	PVC, 0.15 m + M12 4-pin
YSM-22K4-MEAN-P012	36 x 26 x 13	8 mm	17 mm	90°	2.5 mm	PVC, 0.15 m + M12 4-pin

YSM-78 SERIES

Part reference	Dimensions [mm]	Sao	Sar	Actuation	Hysteresis	Connection
YSM-78K4-MEFN-C050	88 x 25 x 13	8 mm	18 mm	Frontal	3.5 mm	PVC, 5 m, 4 wire
YSM-78K4-MEAN-C050	88 x 25 x 13	8 mm	18 mm	90°	3.5 mm	PVC, 5 m, 4 wire
YSM-78K4-MEFN-P012	88 x 25 x 13	8 mm	18 mm	Frontal	3.5 mm	PVC, 0.15 m + M12 4-pin
YSM-78K4-MEAN-P012	88 x 25 x 13	8 mm	18 mm	90°	3.5 mm	PVC, 0.15 m + M12 4-pin



SENSORS

NON-CONTACT RFID CODED

MAIN FEATURES

- ✓ Safety sensor with RFID coding (random or teachable) ISO 14119 type 4
- ✓ Category 4, PL e according to EN/ISO 13849-1
- ✓ Operating distance up to 18 mm
- ✓ PVC cable or M12 pigtail connection
- ✓ Compact size 36 mm x 26 mm x 13 mm
- ✓ Cascadable up to 30 units
- ✓ EDM and diagnostic function
- ✓ Certified TÜV, CE and UL
- ✓ IP6K9K, Ecolab

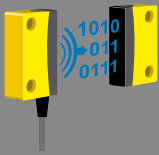

RFID SENSORS

TECHNICAL DATA

Supply voltage range	24 VDC \pm 10 %
Load current	max 400 mA (-25°C...+70°C)
Safe switch on distance Sao	8 mm
Safe switch off distance Sar	18 mm
Dimensions	36 mm x 26 mm x 13 mm
Output	2x OSSD
Ambient temperature range	-25 ... +70°C (-13 ... +158°F)
Storage temperature range	-25 ... +70°C (-13 ... +158°F)
Enclosure rating	IP 67 (EN 60529) and IP 6K9K (ISO 20653)
Housing material	PBT yellow, PC black
Connection	5 m PVC cable 8 x 0,25 mm ² or 0.15 m PVC pigtail with M12 8-pins connector
Safety level	Cat.4 / PL e (EN ISO 13849-1) SIL _{cl} 3 (IEC/EN 62061) SIL 3 (IEC/EN 61508)
Content in each bag	Sensor and actuator (kit)

DIMENSIONS

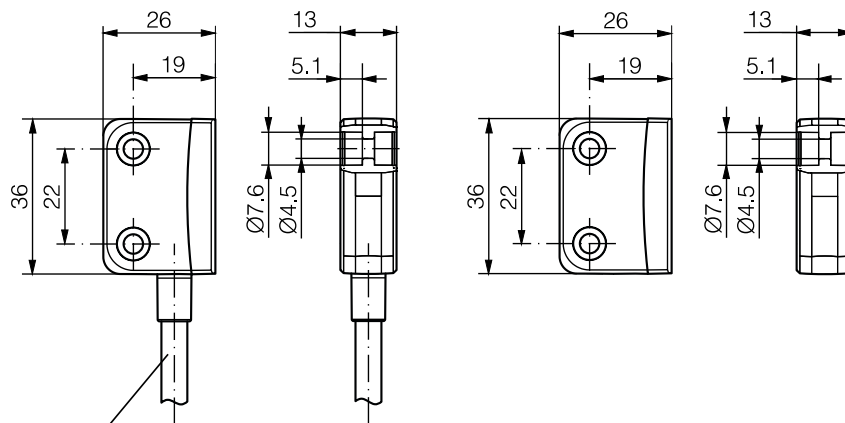

LIYY 8 x 0.25 mm²

PIN ASSIGNMENT

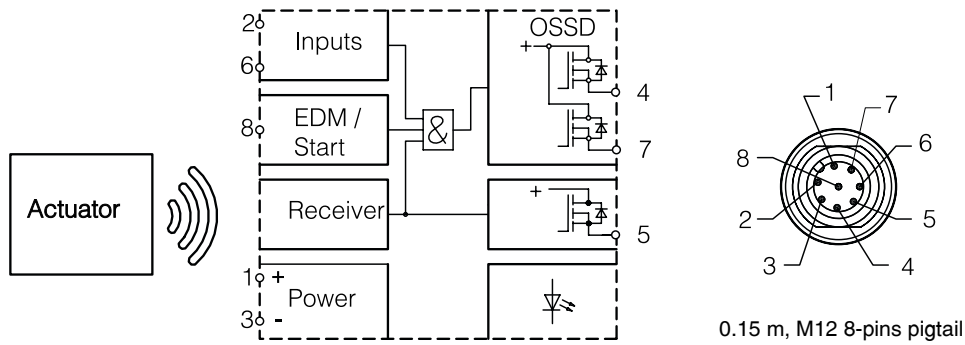

ASSIGNMENT	FUNCTION	PINS/WIRES ON SENDER	
		M12	OPEN CABLE
Supply voltage	24 VDC	1 (white)	brown
Input	Safety input 1	2 (brown)	white
Supply voltage	GND	3 (green)	blue
Output	OSSD 1	4 (yellow)	black
Output	Diagnostic	5 (grey)	grey
Input	Safety input 2	6 (pink)	pink
Output	OSSD 2	7 (blue)	violet
Input	EDM	8 (red)	orange



YSR-22 SERIES

Part reference	Dimensions [mm]	Sao	Sar	Actuation	Connection
YSR-22K4-RESE-C050	36 x 26 x 13	8 mm	18 mm	Random code	PVC, 5 m, 4 wire
YSR-22K4-TESE-C050	36 x 26 x 13	8 mm	18 mm	Teachable code	PVC, 5 m, 4 wire
YSR-22K4-RESE-P012	36 x 26 x 13	8 mm	18 mm	Random code	PVC, 0.15 m, M12 8-pins
YSR-22K4-TESE-P012	36 x 26 x 13	8 mm	18 mm	Teachable code	PVC, 0.15 m, M12 8-pins



SAFETY

RELAY

MAIN FEATURES

- ✓ For safety light curtains, access control barriers, sensors and emergency stop buttons
- ✓ Safety Integrity Level (SIL) 3 according to IEC/EN 61508
- ✓ Claimed Level (SIL CL) 3 according to IEC/EN 62061
- ✓ Performance Level (PL) e and category 4 according to EN/ISO 13849-1
- ✓ Safety category 4 according to EN 954-1
- ✓ Certified TÜV, CE and UL
- ✓ Outputs:
 - ✓ 3 N.O. safety contacts
 - ✓ 1 N.C. monitoring contact
- ✓ Manual or automatic restart
- ✓ LED indicator for channel 1, 2 and power supply
- ✓ 22.5 mm wide, DIN-rail-mountable housing

RELAY



YRB-4EML-31S

APPLICATION AREA

This safety relay is a SIL 3, PL e and category 4 device, designed for the protection of people and machines. It can be used in applications together with:

- Electro-sensitive protective equipment type 4 or type 2 (light curtains and access control barriers)
- Magnetic and RFID sensors
- Emergency stop button

TECHNICAL DATA

INPUT DATA

Nominal input voltage U_N	24 V AC/DC
Input voltage range (factor)	0.85 ... 1.1
Typical input current	150 mA AC / 70 mA DC
Voltage at input/start and feedback circuit	approx. 24 V DC
Typical response time	25 ms (manual start) / 100 ms (automatic start)
Typical release time	10 ms
Recovery time	1 s
Operating voltage display	Green LED
Status display	Green LED
Protective circuit	Fuse PTC resistor

OUTPUT DATA

Contact type	3 enabling current paths / 1 signaling current path
Contact material	AgSnO ₂ , + 0.2 μm Au
Minimum switching voltage	15 V AC/DC
Maximum switching voltage	250 V AC/DC
Limiting continuous current	6 A
Maximum inrush current	6 A
Inrush current, minimum	25 mA
Sq. Total current	72 A ² ($I_{TH}^2 = I_1^2 + I_2^2 + I_3^2$) (see data sheet)
Interrupting rating (ohmic load) max.	144 W (24 V DC, τ = 0 ms) 288 W (48 V DC, τ = 0 ms) 77 W (110 V DC, τ = 0 ms) 88 W (220 V DC, τ = 0 ms) 1500 VA (250 V AC, τ = 0 ms)
Maximum interrupting rating (inductive load)	48 W (24 V DC, τ = 40 ms) 40 W (48 V DC, τ = 40 ms) 35 W (110 V DC, τ = 40 ms) 33 W (220 V DC, τ = 40 ms)

GENERAL DATA

Relay type	Electromechanically forcibly guided, dust-proof relay
Nominal operating mode	100% operating factor
Degree of protection	IP 20
Min. degree of protection of inst. location	IP 54
Mounting position	any
Mounting type	DIN rail mounting

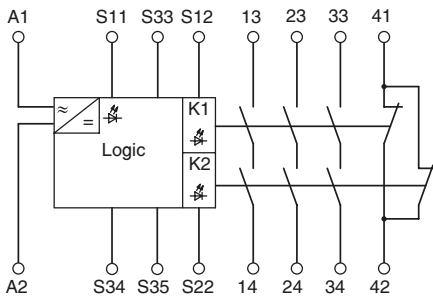

Relay block diagram

Air and creepage distances between the power circuits	DIN EN 50178/VDE 0160
Rated insulation voltage	250 V
Rated surge voltage / insulation	4 kV / basic insulation (safe isolation, reinforced insulation, and 6 kV between A1- A2 / logic / enabling and signaling current paths)
Pollution degree	2
Surge voltage category	III

PART REFERENCE

Safety relay	YRB-4EML-31S
--------------	--------------

MANUAL/AUTOMATIC RESTART MODE (LIGHT CURTAINS/SAFETY SENSORS)

Two-channel light grid monitoring (cross-circuit detection via light grid)

- Manual activation
- Automatic activation with jumper at S33-S35
- Suitable up to category 4, PL e (EN ISO 13849-1), SILCL 3 (EN 62061)

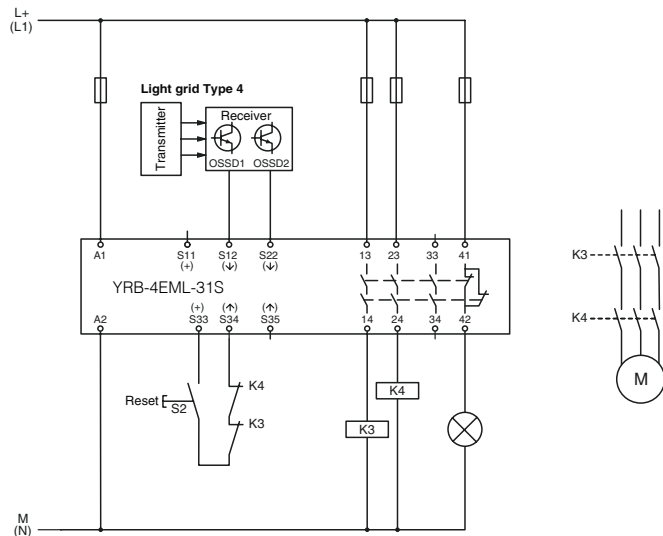

AUTOMATIC/MANUAL RESTART MODE (SAFETY SENSORS)

Two-channel safety door monitoring without cross-circuit detection, with monitored reset button

- Manual activation
- Automatic activation with jumper at S33-S35
- Suitable up to category 3, PL d (EN ISO 13849-1), SILCL 2 (EN 62061)

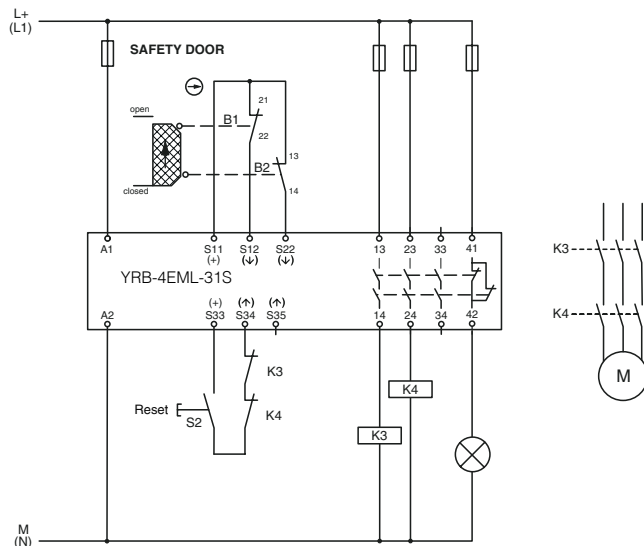

ACCESSORIES

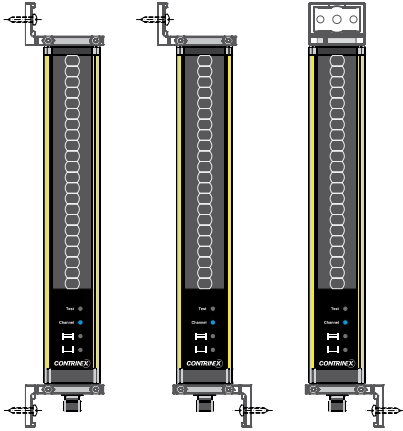

TOP/BOTTOM MOUNTING BRACKET FOR YBB & YCA

Synthetic swivel mounting bracket

A pair of YXW-0001-000 mounting brackets is supplied with each light curtain or access control barrier unit.

DIMENSIONS

TOP/BOTTOM MOUNTING BRACKETS

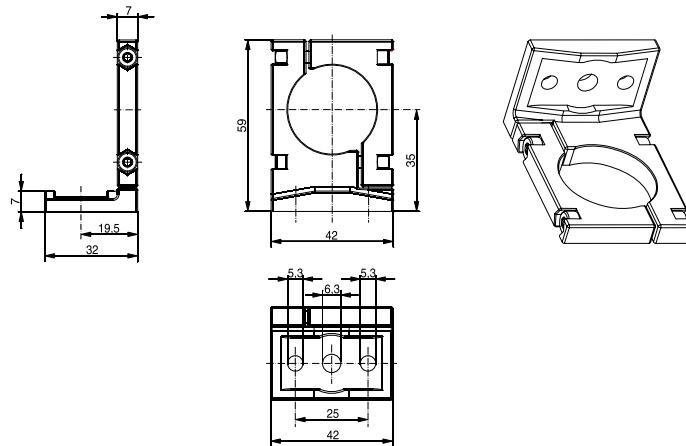

PART REFERENCE

Top/bottom mounting brackets, synthetic (pair)

YXW-0001-000

DIMENSIONS

SLIDING T-NUTS FOR SIDE MOUNTING

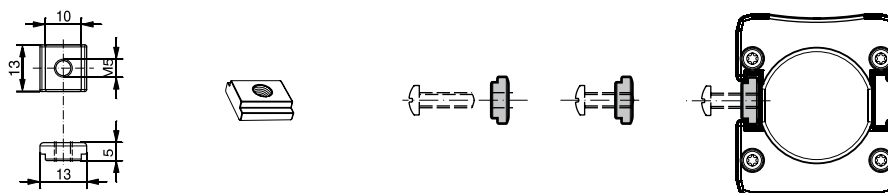

PART REFERENCE

T-nuts for side mounting, metal (pair)

YXW-0003-000

ACCESSORIES

MOUNTING BRACKETS FOR YBBS & YBES

- Synthetic or metal mounting bracket
- Easy-to-use

A pair of YXW-0005-000 mounting brackets is supplied with each light curtain.



DIMENSIONS

TOP/BOTTOM MOUNTING BRACKETS

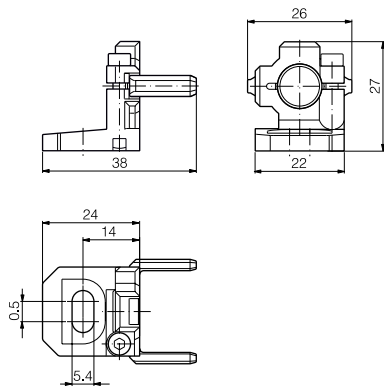

SIDE MOUNTING BRACKETS

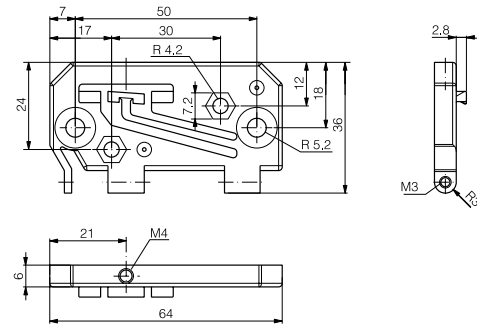

PART REFERENCE

Top/bottom mounting brackets, synthetic (pair)
Side mounting brackets, metal (pair)

YXW-0005-000
YXW-0006-000

DIMENSIONS

SIDE/END MOUNTING BRACKETS

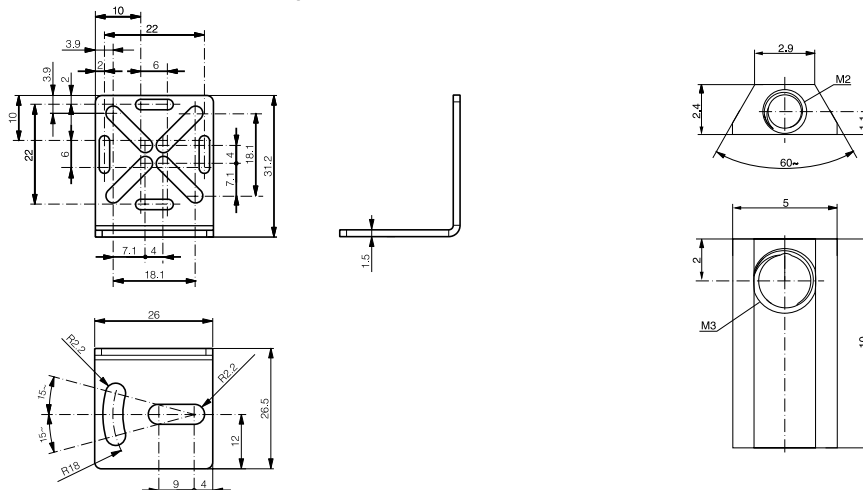

PART REFERENCE

Side/end mounting brackets, metal (pair)

YXW-0007-000

Inductive

Photoelectric

Safety

RFID

Connectivity

Accessories

Glossary

Index

SAFETY FILTER



Pin assignment female



Pin assignment male

MAIN FEATURES

- Suitable for safety light curtain
- Plug & play solution, easy to use

TECHNICAL DATA

Material	PUR
Weight	20 g
Enclosure rating	IP 65
Connection	M12, 5 pins (1x socket, 1x plug)

PART REFERENCE

Safety filter	YXF-0001-000
---------------	--------------

SAFETY FILTER



LASER ALIGNMENT TOOL

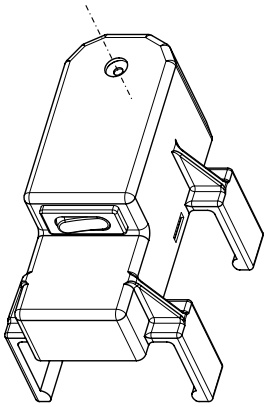

MAIN FEATURES

- Easily clippable onto Safetindex YBB and YCA devices
- Range: up to 50 m
- Output power < 1 mW (class 2)
- Standard AA batteries

TECHNICAL DATA

Laser module optical output power	< 1 mW (class 2)
Laser beam spot size at 10m	< 10 mm
Range	≤ 50 m
Housing material	PA with 30% fiberglass
Dimensions	80 mm x 48 mm x 56 mm

PART REFERENCE

Laser alignment tool	YXL-0001-000
----------------------	--------------

LASER ALIGNMENT TOOL



Inductive

Photoelectric

Safety

RFID

Connectivity

Accessories

Glossary

Index

DEVICE COLUMNS

DIMENSIONS

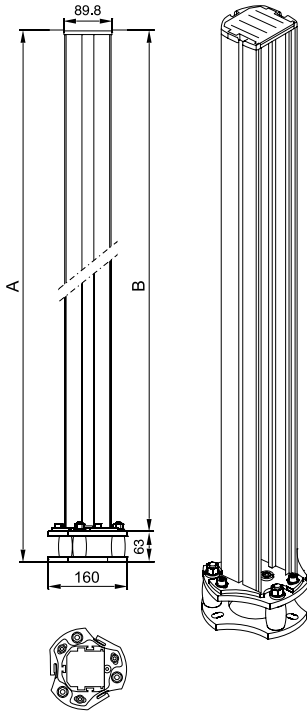

DEVICE COLUMNS FOR LIGHT CURTAINS AND ACCESS CONTROL BARRIERS

- Robust protective profile, attractive design
- Special spring elements automatically reset position in case of mechanical impact
- Complete assembly kit for both device and floor mounting included
- Easy to mount: vertical and axial adjustments can be quickly completed in just a few steps

APPLICATION AREA

Free-standing floor mounting for safety light curtains and access control barriers, such as Safetinex YBB and YCA models

TECHNICAL DATA

Housing
Surface

Aluminum profile and steel floor plates
Powder-varnished, yellow (RAL 1021)

PART REFERENCE

Device column	Total height (A) [mm]	Housing height (B) [mm]	Suitable for
YXC-1060-F00	1060	977	YBB-####-0150-#### to YBB-####-0800-####
YXC-1360-F00	1360	1277	YBB-####-0900-####, YBB-####-1000-####, YCA-####-3400-####, YCA-####-4300-####
YXC-1660-F00	1660	1577	YBB-####-1200-#### to YBB-####-1400-####, YCA-####-3500-####, YCA-####-5300-####, YCA-####-4400-####
YXC-1960-F00	1960	1877	YBB-####-1600-####, YBB-####-1700-####, YCA-####-6300-####

MIRROR COLUMNS

DIMENSIONS

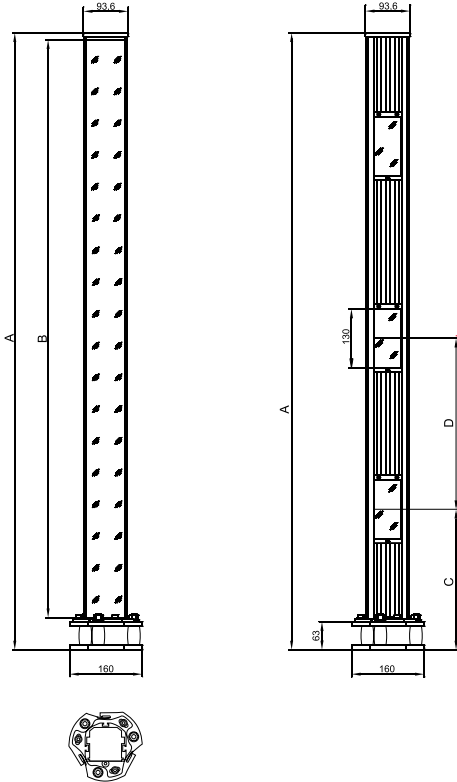

MIRROR COLUMNS FOR LIGHT CURTAINS AND ACCESS CONTROL BARRIERS

- Robust protective profile, attractive design
- **Special spring elements automatically reset position in case of mechanical impact**
- Complete assembly kit for both device and floor mounting included
- Easy to mount: vertical and axial adjustments can be quickly completed in just a few steps
- Single mirror or exchangeable and separately adjustable individual mirrors in accordance with EN 999

APPLICATION AREA

The mirror columns YXC-####-M## are used for the beam deflection of safety light curtains and access control barriers, such as Safetinex YBB and YCA models, in order to achieve multi-sided safeguarding of danger zones, while eliminating the need for additional light curtains or access control barriers. Spring elements at the base of the column provide for automatic reset following mechanical impact.

YXC-####-M11 models feature a single large mirror and are therefore suitable for use with light curtains as well as access control barriers. YXC-1360-M23, on the other hand, features 3 or 4 smaller mirrors and may consequently only be used with access control barriers.

TECHNICAL DATA

Housing
Surface

Aluminum profile and steel floor plates
Powder-varnished, yellow (RAL 1021)

PART REFERENCE

Single-mirror column	Total height (A) [mm]	Mirror height (B) [mm]	Multi-mirror column	Total height (A) [mm]	Beam gap (D) [mm]	Height lowest beam (C) [mm]
YXC-1060-M11	1060	974	YXC-1360-M23	1360	2 x 400	300
YXC-1360-M11	1360	1274				
YXC-1660-M11	1660	1574				
YXC-1960-M11	1960	1874				

Inductive

Photoelectric

Safety

RFID

Connectivity

Accessories

Glossary

Index

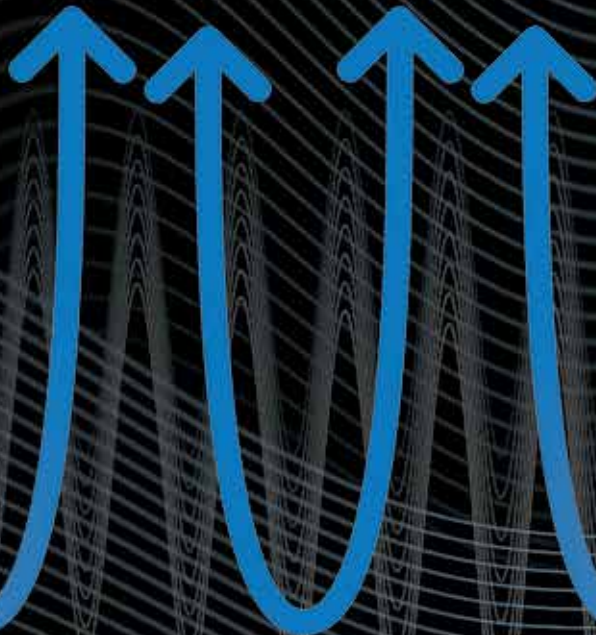
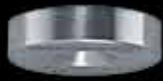

RADIO FREQUENCY IDENTIFICATION SYSTEMS (RFID)

RFID

LOW AND HIGH FREQUENCY

HIGHLIGHTS

- ✓ Low- and high-frequency (LF and HF) systems networkable on ContriNET or on conventional PC using USB connection
- ✓ Widest fieldbus coverage on market

LF system

- ✓ All-metal housings, IP 68 and IP 69K
- ✓ Food safe and saltwater resistant (316L/V4A)
- ✓ All tags embeddable in metal

HF system

- ✓ ISO/IEC 15693 compatible
- ✓ Fast data transfer time
- ✓ User-defined password protection features

NEW

- ✓ HF Read/Write Modules with  IO-Link
- ✓ LF and HF VHT tags for high temperatures and harsh environments
- ✓ LF and HF Read/Write Modules with USB connection

INTRODUCTION

RFID SYSTEMS

RFID (Radio Frequency IDentification) is used in numerous automation and logistics domains. It allows objects to be identified by means of electronic labels (transponders or tags).

Compared to classic systems, such as bar codes or laser marking, RFID technology offers important advantages. Transponder information can be read or written even when there is no direct line of sight between it and the Read/Write Module. In addition, information can be added, modified or replaced. It is a useful technology for automated production, reducing human error while increasing reliability, flexibility and traceability.

Conident[®] (also called ConID) is the general name of the Contrinex RFID system, including transponders, Read/Write Modules and interfaces in both low frequency (LF) and high frequency (HF) technology.

ContriNET is the product name of the Contrinex RFID network and protocol. The ContriNET protocol uses an RS485 physical layer, which allows LF and/or HF Read/Write Modules to be daisy-chained, reducing the total number of interfaces.

- Up to 10 ContriNET RWMs with one USB interface

- Up to 31 ContriNET RWMs with one industrial bus interface

- Up to 254 ContriNET RWMs on a half-duplex RS485 interface

While the usual interfaces allow connection of a limited number of Read/Write Modules (typically 4), ContriNET RWMs can be used to reduce the number of interfaces, which makes the cost of a ConID system more economic than solutions proposed by the competitors.

In principle, a ContriNET network can extend to a length of 200 m

An RFID system always has the structure illustrated on page 371.

TECHNOLOGY

LOW FREQUENCY (LF) RFID (31.25 KHZ)

Contrinex LF RFID technology features not only conventional plastic components, but also a range of all-metal Read/Write Modules and transponders in stainless steel. These devices are particularly suitable for difficult operating environments where they will be exposed to cleaning, harsh chemicals, water and frost. They are also highly resistant to mechanical shocks.

- Non-standard technology (proprietary data communication)

- Reads and writes through metal

- Works in a metallic environment (fully embeddable)

- High resistance in harsh environments

- Very high temperature tags (VHT 180C / 356F) embeddable in metal

HIGH FREQUENCY (HF) RFID (13.56 MHZ)

Contrinex HF RFID technology complies with ISO/IEC 15693 and is therefore open to any components that meet this standard. HF systems allow fast communication between transponders and Read/Write Modules as well as extended functionality for tag data protection.

ISO/IEC 15693

Anti-collision, in case of multiple tag detection

Very high temperature tags (VHT 180C / 356F) embeddable in metal Ultra high temperature tags (UHT 250C / 482F)

RFID COMPONENTS

TRANSPONDERS (TAGS)

A transponder is an electronic product that stores data. Transponder memory includes a unique preset number as an identifier and a memory area for writing user application data in relation to tagged product information. Writeable data may include, for example, the object's history or the parameters of operations to which it will be subjected.

READ/WRITE MODULES (RWMS)

A Read/Write Module is a device that allows data to be read from or written to a transponder.

INTERFACES

An interface connects the Read/Write Modules to an industrial fieldbus. ConID interfaces are available for PROFIBUS, DeviceNet, EtherNet/IP, PROFINET, EtherCAT, POWERLINK, Ethernet TCP/IP and USB.

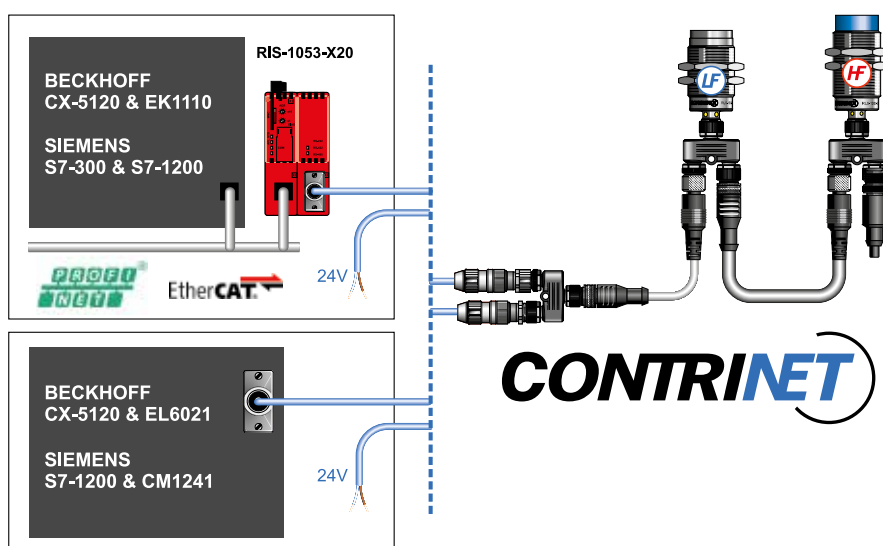

Communication between the RWM and any tags is provided by the modulation of a carrier frequency.

PRODUCT FAMILIES

BASIC

Contrinex Basic RFID components are ideal for general identification and monitoring tasks in almost any industry. The family includes low- and high-frequency passive, plastic transponders (tags) and threaded Read/Write Modules (RWMs). All devices are insensitive to dirt. HF components (13.56 MHz) are fully ISO/IEC 15693-compliant, while LF components (31.25 kHz) utilize a proprietary data communication protocol. If the ContriNET protocol is used, LF and HF components can share one network, including the full range of interfaces.

LF Basic tags are embeddable and available in diameters of 20 mm, 30 mm and 50 mm. Maximum read/write distances when used with Basic M30 RWMs range from 25 mm to 41 mm. Housings have an IP67 enclosure rating and are temperature resistant from -40 ... +125°C (-40 to +257°F). **LF Basic RWMs** are non-embeddable and, when used with a 50 mm Basic tag, offer maximum read/write distances of 37 mm for the M18 type and 41 mm for the M30 type.

HF Basic tags are non-embeddable and available in diameters from 9 mm to 50 mm. Maximum read/write distances when used with Basic M30 RWMs range from 14 mm to 60 mm. Housings have an IP67 enclosure rating and are temperature resistant from -40 ... +125°C (-40 to +257°F). HF Basic RWMs are non-embeddable and, when used with a 50 mm Basic tag, offer maximum read/write distances of 42 mm for the M18 type and 60 mm for the M30 type.

INTRODUCTION

EXTREME

The **Extreme** family of metal, low-frequency components is particularly suitable for use in harsh environments, such as the steel industry, agriculture and other outdoor applications. It comprises stainless-steel (V2A / AISI 304) passive tags and threaded RWMs that utilize proprietary LF data communication (31.25 kHz). All components are insensitive to dirt and designed for outstanding performance in metallic environments. If the ContriNET protocol is used, these LF components can share one network with HF types, including the full range of interfaces.

LF Extreme tags are readable/writable through metal and available in diameters of 10 mm, 16 mm, 26 mm, M16 and M30. Mounting is fully embeddable, including in metal, and maximum read/write distances when used with Extreme M30 RWMs range from 4 mm to 13 mm. Housings have an IP68 enclosure rating and are temperature resistant from -40 ... +95°C (-40 to +203°F). In addition, a non-embeddable M30 type is also available with a maximum read/write distance of 12 mm and an IP68 & IP69K enclosure rating. LF Extreme RWMs are non-embeddable and, when used with a 26 mm Extreme tag, offer maximum read/write distances of 12 mm for the M18 type and 13 mm for the M30 type. They have an IP68 & IP69K enclosure rating.

WASHDOWN

The **Washdown** family of full-metal, low-frequency components has been designed for demanding wash-in-place applications within the food, pharmaceutical and other industries. Passive tags from this family offer the highest mechanical and chemical resistance, being fully sealed, laser welded and made of food-grade stainless steel (V4A / AISI 316L). As a result, they are highly corrosion-proof, saltwater resistant and withstand aggressive solvents.

With an enclosure rating of IP68 & IP69K, Washdown components resist high-pressure cleaning and function reliably in water. They have also been optimized for a wide operating temperature range: -40 to +125°C (-40 to +257°F). If the ContriNET protocol is used, LF RWMs can share one network with HF types, including the full range of interfaces.

LF Washdown tags are readable/writable through metal, insensitive to dirt and available in diameters of 10 mm, 16 mm, 26 mm, M16 and M30. Mounting is fully embeddable, including in metal, and maximum read/write distances when used with Washdown M30 RWMs range from 4 mm to 13 mm. In addition, a non-embeddable M30 tag is also available with a maximum read/write distance of 12 mm.

LF Washdown RWMs are non-embeddable and, when used with a 26 mm Washdown tag, offer maximum read/write distances of 12 mm for the M18 type and 13 mm for the M30 type.

HIGH TEMPERATURE

With 100 % silicone-free construction and thermal cycling reliability of 1000 hours (or 1000 cycles), passive tags from the High Temperature family are ideal for use in paintshops and other high temperature environments. Tags are insensitive to dirt and their housings have an IP68 & IP69K enclosure rating. HF tags (13.56 MHz) are fully ISO/IEC 15693-compliant, while LF tags (31.25 kHz) utilize proprietary data communication.



LF High Temperature, embeddable tags are suitable for the range $-40 \dots +180^{\circ}\text{C}$ (-40 to $+356^{\circ}\text{F}$). Thanks to full-metal, stainless-steel (V4A / AISI 316L) housings, they are food safe, corrosion-proof and can withstand aggressive solvents. Tag diameter is 26 mm and, when used with a Basic M30 LF RWM, the maximum read/write distance is 26 mm.

HF High Temperature tags offer the highest temperature resistance with a range of non-embeddable, silicone-free LCP types for temperatures from $-25 \dots +250^{\circ}\text{C}$ (-13 to $+482^{\circ}\text{F}$). Based on EEPROM or FRAM technology, memory size ranges from 128 Bytes to 2048 Bytes. Tag diameter is 50 mm and, when used with a Basic M30 HF RWM, the maximum read/write distance is 60 mm. Life expectancy is exceptionally long, even under intense read/write and temperature cycling.

For temperatures in the range $-25 \dots +180^{\circ}\text{C}$ (-13 to $+356^{\circ}\text{F}$), a PPS type is also available. With a diameter of 26 mm, this HF tag is suitable for embeddable mounting in metal. The maximum read/write distance with a Basic M30 RWM is 31 mm.

IO-Link

The **IO-Link** family of high frequency read/write modules (HF RWMs) with IO-Link interface V 1.1 has been designed for easy, cost-effective integration into existing control systems.

These non-embeddable HF RWMs are available in sizes M18 and M30. When used with a 50 mm diameter tag, they offer maximum read/write distances of 42 mm for the M18 type and 60 mm for the M30 type. They can be operated either as IO-Link devices or in standard I/O mode (SIO) with conditional binary outputs. In stand-alone SIO mode the conditional output switch enables either tag detection or data block comparison.

With two operating modes and simplified plug-and-play installation, these HF RWMs reduce installation costs, typically in the logistics, mechanical engineering and automotive industries.

USB

The USB family of low- and high-frequency read/write modules (RWMs) is ideal for user access control stations and tag programming by PC. USB RWMs are robust, economical and easy to mount thanks to standard threaded housings. Available in four sizes (M18/M30 x 35 mm and M18/M30 x 50 mm), they offer read/write distances up to 60 mm with a tag diameter of 50 mm. HF RWMs (13.56 MHz) are fully ISO/IEC 15693-compliant, while LF RWMs (31.25 kHz) utilize proprietary data communication. Host communication relies on the hexadecimal-based ContriNET protocol, which allows LF and HF RWMs to use the same demo software as standard (Basic) ContriNET RWMs. Drivers are available for Windows XP, 7, 10, CE4 & CE5 operating systems.



SUPPORT TOOLS

For each product, a dedicated package of all the necessary support tools (software, firmware, drivers, DLL files, 3D-CAD models, etc.) can be downloaded from the relevant product-finder page on the Contrinex website.

APPLICATIONS

WASHING STATIONS

In the harsh environment of a washing station, RFID transponders and Read/Write Modules (RWMs) are exposed to hot water, mechanical shocks, corrosive chemicals and high-pressure jetting. Despite these challenges, identification systems must operate continuously with high reliability.

Typically, RFID tags are mounted on the part carriers. On arrival at the washing station, information from the tag is used to select the correct washing cycle for the part type and process.

LF Washdown advantages

ConIdent® Washdown passive tags require no power source, minimal maintenance and function reliably in water. Designed to withstand high pressure cleaning and aggressive solvents, their rugged, full-metal, laser welded housings are fully sealed against water penetration (IP 68 or IP 69K) and withstand temperatures up to 125C (+257F). Their extended sensing range reduces the risk of mechanical damage. RWMs that withstand pressure washing are also available.



MACHINE TOOLS

The presence under pressure of lubricating and cooling fluids, combined with metal particles, makes the machine tool environment particularly difficult. Identification components must resist fluid penetration to prevent machine downtime and ensure the RFID system reliability.

An industrial network of Read/Write Modules (RWMs), interfaces and tags forms a complete RFID system to control the path of each workpiece through all machining cycles, programming and logging every step.

LF Extreme advantages

Components from the ConIdent® Extreme family offer outstanding performance in metallic environments. All-metal tags and RWMs are insensitive to dirt and resistant to corrosion, impact and abrasion. When embedded in metal, they are impervious with an IP68 & IP69K enclosure rating. Tags are optimized for operating temperatures from -40 to +95C (-40 to +203F) and RWMs, which utilize proprietary data communication (31.25 kHz), are not influenced by the presence of metal particles.



TESTING LINES

Product testing lines may comprise several test stations, each performing a fixed sequence of tests. For efficient real-time monitoring, identification systems must integrate well into the overall control system.

In a typical RFID system, part carriers are equipped with tags and every test station has a Read/Write Module (RWM). To program the testing machine, the RWM reads from each tag the type of test required for an individual part. After each test, the RWM writes the results back into the appropriate tag memory address/location. Test reports are automatically forwarded to the controller for product acceptance or rejection and fault correction.

HF Basic advantages

ConIdent® HF Basic tags and RWMs are fully compatible with ISO/IEC 15693, with fast data transfer times and a comprehensive range of interfaces for the widest fieldbus coverage on the market. Thanks to user-defined password protection features, data security is also excellent. HF Basic RWMs use the powerful ContriNET protocol, which allows LF and HF RWMs to be daisy-chained on the same network. The HF RFID system also includes IO-Link and USB families. IO-Link RWMs allow easy system integration and USB RWMs enable direct connection to a PC.



PAINT SHOPS

Identification components in paint shops are exposed to a variety of rinsing, coating and burning operations, including electrophoresis. Since soiling makes visual identification difficult or impossible, rugged RFID systems are an excellent solution.

The RFID tag accompanies each product throughout all painting processes. It can store individual data, including customer requirements, directly on the product or carrier. This allows highly automated customized processes, with smaller batches and central data storage.

HF High Temperature advantages

The ConIdent® High Temperature family includes 100 % silicone-free tags that are ideal for paint-shop applications. Life expectancy is exceptionally long, even under intense read/write and temperature cycling.

Tag RTP-0263-020, for embedded or non-embedded mounting in metal; Ø 26 mm (1.02"), temperature resistant up to 180C (356F)

Tag RTP-0502-022, RTP-0502-062, RTP-0502-082, non-embeddable; Ø 50 mm (1.97"), temperature resistant up to 250C (482F) and 100 % silicone-free



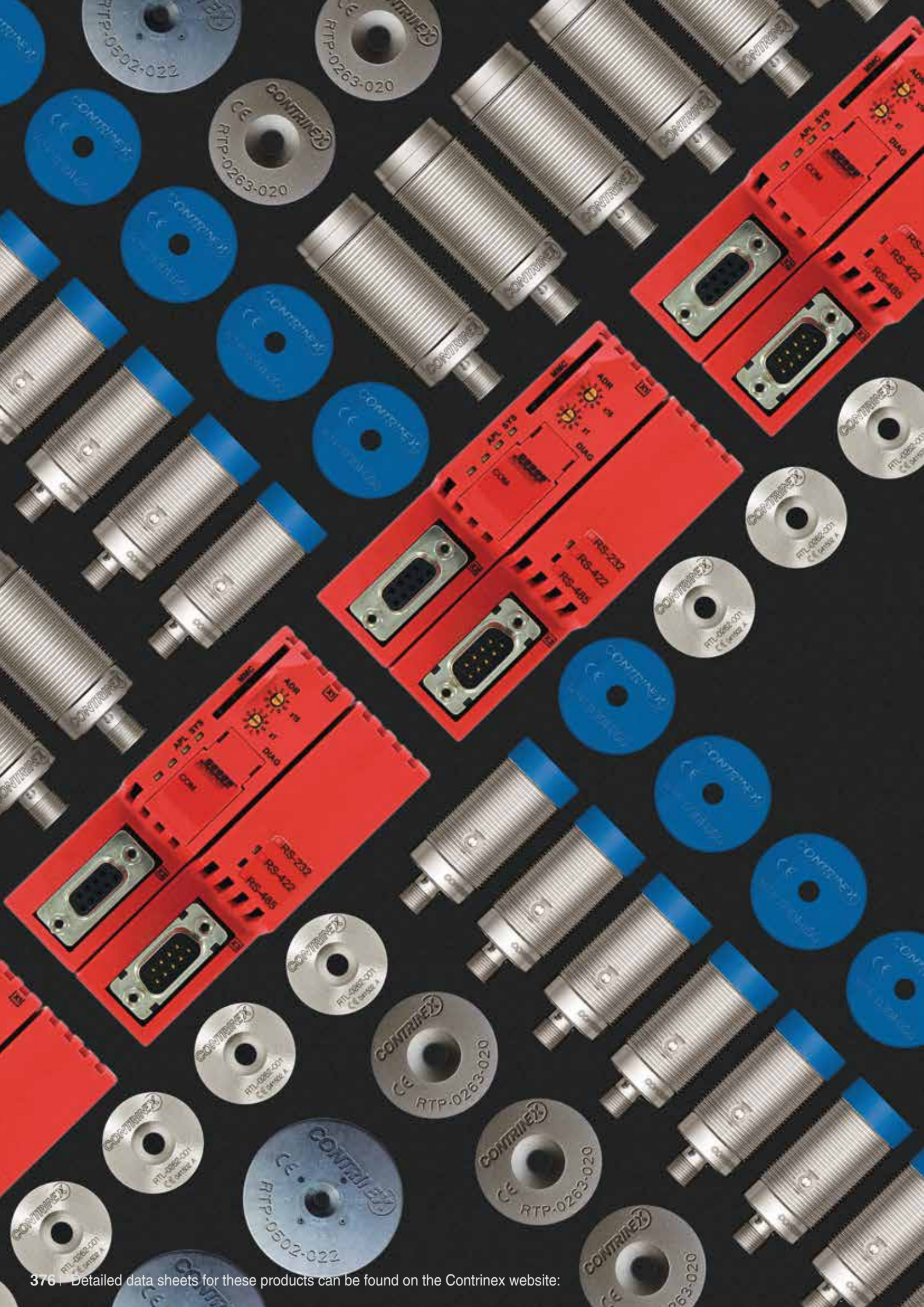



RFID

		TRANSPONDERS	391-401
		READ/WRITE MODULES (RWM)	402-417
		INTERFACES	418-429
		ACCESSORIES	430-439

PROGRAM OVERVIEW

LF LOW FREQUENCY

FAMILY	HOUSING SIZE	READ/ WRITE DISTANCE	BASIC	EXTREME	WASHDOWN	HIGH TEMPERATURE
TRANSPONDER	∅ 10	0 ... 13 mm		p. 394	p. 396	
	∅ 16	0 ... 19 mm		p. 394	p. 396	
	M16	0 ... 13 mm		p. 395	p. 397	
	∅ 20	0 ... 28 mm	p. 393			
	∅ 26	0 ... 26 mm		p. 394	p. 396	p. 397
	∅ 30	0 ... 29 mm	p. 393			
	M30	0 ... 23 mm		p. 395	p. 397	
	∅ 50	0 ... 41 mm	p. 393			
FAMILY	HOUSING SIZE	READ/ WRITE DISTANCE	BASIC	EXTREME	WASHDOWN	USB
RWM	M18	0 ... 36 mm	p. 404	p. 404	p. 405	p. 414
	M30	0 ... 41 mm	p. 404	p. 405	p. 405	p. 414
FAMILY	HOUSING SIZE	TCP / IP	PROFIBUS	DEVICENET	PROFINET ETHERNET-IP ETHERCAT POWERLINK	USB
INTERFACE	100 x 52		p. 420	p. 421	p. 421	
	120 x 80 155 x 96	p. 423				
	67 x 66					p. 428



HIGH FREQUENCY

FAMILY	HOUSING SIZE	READ/ WRITE DISTANCE	BASIC	HIGH TEMPERATURE
TRANSPONDER	∅ 9	0 ... 14 mm	p. 400	
	∅ 16	0 ... 31 mm	p. 400	
	∅ 20	0 ... 25 mm	p. 399	
	∅ 26	0 ... 31 mm		p. 400
	∅ 30	0 ... 45 mm	p. 399	
	∅ 50	0 ... 50 mm	p. 399	

Inductive

Photoelectric

Safety

Rfid

FAMILY	HOUSING SIZE	READ/ WRITE DISTANCE	BASIC	IO-LINK	USB
RWM	M18	0 ... 42 mm	p. 406	p. 411	p. 415
	M30	0 ... 60 mm	p. 406	p. 411	p. 415

Connectivity

Accessories











FAMILY	HOUSING SIZE	TCP / IP	PROFIBUS	DEVICENET	PROFINET ETHERNET-IP ETHERCAT POWERLINK	USB
INTERFACE	100 x 52		p. 420	p. 421	p. 421	
	120 x 80 155 x 96	p. 423				
	67 x 66					p. 428

Glossary

Index



LOW FREQUENCY





TRANSPONDER	TYPE	PART NO.	IC	USER DATA (BYTE)	MOUNTING
	Full metal - V2A	RTF-1300-000	EM4056	240	Non-embeddable
	Full metal - V4A	RTL-0102-001	EM4056	240	Embeddable
	Full metal - V4A	RTL-0162-001	EM4056	240	Embeddable
	Full metal - V4A	RTL-0262-001	EM4056	240	Embeddable
	Full metal - V4A	RTL-0262-003	EM4056	240	Embeddable
	Full metal - V4A	RTL-1302-001	EM4056	240	Non-embeddable
	Full metal - V4A	RTL-2162-001	EM4056	240	Embeddable
	Full metal - V4A	RTL-2302-001	EM4056	240	Embeddable
	Metal - V2A	RTM-0100-000	EM4056	240	Embeddable
	Metal - V2A	RTM-0160-000	EM4056	240	Embeddable
	Metal - V2A	RTM-0260-000	EM4056	240	Embeddable

TRANSPONDER OVERVIEW

MAX. READING DISTANCE (MM) S _{MAX} MEASURED IN FREE AIR	TEMPERATURE RANGE				Inductive	
	MIN (°C)	MAX (°C)	TESTED			Photoelectric
			DURATION	CYCLES		
21 RLS-1181-030	-40	+80 Operating	-	-	Inductive	
23 RLS-1301-030	-40	+95 Storage	-	-		
13 RLS-1181-030	-40	+125 Operating	-	-	Photoelectric	
14 RLS-1301-030	-40	+125 Storage	-	-		
17 RLS-1181-030	-40	+125 Operating	-	-	Safety	
19 RLS-1301-030	-40	+125 Storage	-	-		
23 RLS-1181-030	-40	+125 Operating	-	-	RFID	
26 RLS-1301-030	-40	+125 Storage	-	-		
23 RLS-1181-030	-40	+125 Operating	1000 h	1000	RFID	
26 RLS-1301-030	-40	+180 Storage	-	-		
16 RLS-1181-030	-40	+125 Operating	-	-	Connectivity	
18 RLS-1301-030	-40	+125 Storage	-	-		
13 RLS-1181-030	-40	+125 Operating	-	-	Connectivity	
13 RLS-1301-030	-40	+125 Storage	-	-		
16 RLS-1181-030	-40	+125 Operating	-	-	Accessories	
18 RLS-1301-030	-40	+125 Storage	-	-		
13 RLS-1181-030	-40	+80 Operating	-	-	Glossary	
14 RLS-1301-030	-40	+95 Storage	-	-		
17 RLS-1181-030	-40	+80 Operating	-	-	Glossary	
19 RLS-1301-030	-40	+95 Storage	-	-		
23 RLS-1181-030	-40	+80 Operating	-	-	Index	
26 RLS-1301-030	-40	+95 Storage	-	-		



LOW FREQUENCY

TRANSPONDER	TYPE	PART NO.	IC	USER DATA (BYTE)	MOUNTING
	Metal - V2A	RTM-2160-000	EM4056	240	Embeddable
	Metal - V2A	RTM-2300-000	EM4056	240	Embeddable
	Plastic STD	RTP-0201-000	EM4056	240	Embeddable
	Plastic STD	RTP-0301-000	EM4056	240	Embeddable
	Plastic STD	RTP-0501-000	EM4056	240	Embeddable

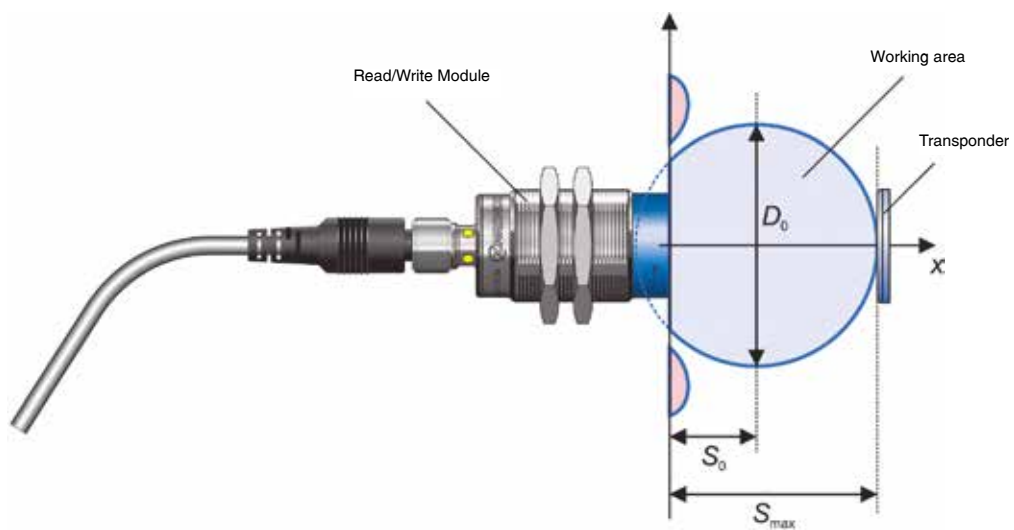

RFID performance, operating zone

TRANSPONDER OVERVIEW

MAX. READING DISTANCE (MM) S _{MAX} MEASURED IN FREE AIR	TEMPERATURE RANGE				Inductive	
	MIN (°C)	MAX (°C)	TESTED			Photoelectric
			DURATION	CYCLES		
13 RLS-1181-030	-40	+80	Operating	-	-	
13 RLS-1301-030	-40	+95	Storage	-	-	
16 RLS-1181-030	-40	+80	Operating	-	-	
18 RLS-1301-030	-40	+95	Storage	-	-	
25 RLS-1181-030	-40	+125	Operating	100 h	100	Safety
28 RLS-1301-030	-40	+125	Storage			
26 RLS-1181-030	-40	+125	Operating	100 h	100	
29 RLS-1301-030	-40	+125	Storage			
36 RLS-1181-030	-40	+125	Operating	-	-	RFID
41 RLS-1301-030	-40	+125	Storage	-	-	

$$D_0 = 2 \cdot (S_{max} - S_0)$$





$$V_{R_{max}} = \frac{D_0}{T_R} = \frac{2 \cdot (S_{max} - S_0)}{T_0 + N \cdot T_{R0}}$$

$$V_{W_{max}} = \frac{D_0}{T_W} = \frac{2 \cdot (S_{max} - S_0)}{T_0 + N \cdot T_{W0}}$$

RFID performance, calculation of maximum read and write speed





HIGH FREQUENCY

TRANSPONDER	TYPE	PART NO.	IC	USER DATA (BYTE)	MOUNTING
	Plastic STD	RTP-0201-020	I-Code SLI-S	160	Non-embeddable
	Plastic VHT	RTP-0263-020	I-Code SLI-S	160	Embeddable
	Plastic STD	RTP-0301-020	I-Code SLI-S	160	Non-embeddable
	Plastic STD	RTP-0501-020	I-Code SLI-S	160	Non-embeddable
	Plastic STD	RTP-0090-020	I-Code SLI-S	160	Non-embeddable
	Plastic STD	RTP-0160-020	I-Code SLI-S	160	Non-embeddable
	Plastic UHT	RTP-0502-022	I-Code SLI-S	160	Non-embeddable
	Plastic UHT	RTP-0502-062	MB89R118C	2000	Non-embeddable
	Plastic UHT	RTP-0502-082	I-Code SLI	112	Non-embeddable

TRANSPONDER OVERVIEW

MAX. READING DISTANCE (MM) S _{MAX} MEASURED IN FREE AIR	TEMPERATURE RANGE				Inductive	
	MIN (°C)	MAX (°C)	TESTED			Photoelectric
			DURATION	CYCLES		
14 RLS-1183-020	-25	+85 Operating	-	-	Safety	
25 RLS-1303-020	-40	+125 Storage	-	-		
21 RLS-1183-020	-25	+180 Operating	1000 h	1000	RFID	
31 RLS-1303-020	-40	+180 Storage	-	-		
26 RLS-1183-020	-25	+85 Operating	-	-	Connectivity	
45 RLS-1303-020	-40	+125 Storage	-	-		
31 RLS-1183-020	-25	+85 Operating	-	-	Accessories	
47 RLS-1303-020	-40	+125 Storage	-	-		
14 RLS-1183-020	-20	+85 Operating	500 h	500	Glossary	
14 RLS-1303-020	-20	+110 Storage	-	-		
19 RLS-1183-020	-20	+85 Operating	500 h	500	Index	
31 RLS-1303-020	-20	+110 Storage	-	-		
38 RLS-1183-020	-25	+150 Operating	1000 h	1000		
50 RLS-1303-020	-25	+250 Storage	-	-		
21.5 RLS-1183-020	-25	+150 Operating	1000 h	1000		
44.5 RLS-1303-020	-25	+250 Storage	-	-		
33 RLS-1183-020	-25	+150 Operating	1000 h	1000		
42.5 RLS-1303-020	-25	+250 Storage	-	-		

READ/WRITE MODULES

RWM	TYPE	PART NO.	STANDARD	ENCLOSURE RATING	MOUNTING
	Full metal - V2A	RLS-1180-030	Proprietary	IP 68 / IP 69K	Non-embeddable
	Plastic head	RLS-1181-030	Proprietary	IP 67	Non-embeddable
	USB - Plastic head	RLS-1181-230	Proprietary	IP 67	Non-embeddable
	Full metal - V2A	RLS-1300-030	Proprietary	IP 68 / IP 69K	Non-embeddable
	Plastic head	RLS-1301-030	Proprietary	IP 67	Non-embeddable
	USB - Plastic head	RLS-1301-230	Proprietary	IP 67	Non-embeddable
	USB - Plastic head	RLS-1181-220	ISO/IEC 15693	IP 67	Non-embeddable
	USB - Plastic head	RLS-1181-220-120	ISO/IEC 15693	IP 67	Non-embeddable
	IO-Link - Plastic head	RLS-1181-320	ISO/IEC 15693	IP 67	Non-embeddable
	Plastic head	RLS-1183-020	ISO/IEC 15693	IP 67	Non-embeddable
	USB - Plastic head	RLS-1301-220	ISO/IEC 15693	IP 67	Non-embeddable
	USB - Plastic head	RLS-1301-220-120	ISO/IEC 15693	IP 67	Non-embeddable
	IO-Link - Plastic head	RLS-1301-320	ISO/IEC 15693	IP 67	Non-embeddable
	Plastic head	RLS-1303-020	ISO/IEC 15693	IP 67	Non-embeddable

OVERVIEW

MAX. READING DISTANCE (MM) S _{MAX} MEASURED IN FREE AIR	TEMPERATURE RANGE				Inductive	
	MIN (°C)	MAX (°C)	TESTED			Photoelectric
			DURATION	CYCLES		
12 RTP-0301-000	-25	+80	Operating	-	-	
	-25	+80	Storage			
36 RTP-0501-000	-25	+80	Operating	-	-	Photoelectric
	-25	+80	Storage			
36 RTP-0501-000	-25	+70	Operating	-	-	Photoelectric
	-25	+70	Storage			
12 RTP-0301-000	-25	+80	Operating	-	-	Safety
	-25	+80	Storage			
41 RTP-0501-000	-25	+80	Operating	-	-	Safety
	-25	+80	Storage			
41 RTP-0501-000	-25	+70	Operating	-	-	RFID
	-25	+70	Storage			
31 RTP-0501-020	-25	+70	Operating	-	-	RFID
	-25	+70	Storage			
31 RTP-0501-020	-25	+70	Operating	-	-	Connectivity
	-25	+70	Storage			
40.5 RTP-0502-082	-25	+80	Operating	-	-	Connectivity
	-25	+80	Storage			
31 RTP-0501-020	-25	+80	Operating	-	-	Accessories
	-25	+80	Storage			
60 RTP-0501-020	-25	+70	Operating	-	-	Accessories
	-25	+70	Storage			
60 RTP-0501-020	-25	+70	Operating	-	-	Glossary
	-25	+70	Storage			
62.5 RTP-0502-022	-25	+80	Operating	-	-	Glossary
	-25	+80	Storage			
50 RTP-0502-022	-25	+80	Operating	-	-	Index
	-25	+80	Storage			

MAX. CONVEYOR SPEED

LF

HF

RWM	TYPE	PART NO.	STANDARD	ENCLOSURE RATING	MOUNTING
	Full metal - V2A	RLS-1180-030	Proprietary	IP 68 / IP 69K	Non-embeddable
	Plastic head	RLS-1181-030	Proprietary	IP 67	Non-embeddable
	USB - Plastic head	RLS-1181-230	Proprietary	IP 67	Non-embeddable
	Full metal - V2A	RLS-1300-030	Proprietary	IP 68 / IP 69K	Non-embeddable
	Plastic head	RLS-1301-030	Proprietary	IP 67	Non-embeddable
	USB - Plastic head	RLS-1301-230	Proprietary	IP 67	Non-embeddable
	USB - Plastic head	RLS-1181-220	ISO/IEC 15693	IP 67	Non-embeddable
	USB - Plastic head	RLS-1181-220-120	ISO/IEC 15693	IP 67	Non-embeddable
	IO-Link - Plastic head	RLS-1181-320	ISO/IEC 15693	IP 67	Non-embeddable
	Plastic head	RLS-1183-020	ISO/IEC 15693	IP 67	Non-embeddable
	USB - Plastic head	RLS-1301-220	ISO/IEC 15693	IP 67	Non-embeddable
	USB - Plastic head	RLS-1301-220-120	ISO/IEC 15693	IP 67	Non-embeddable
	IO-Link - Plastic head	RLS-1301-320	ISO/IEC 15693	IP 67	Non-embeddable
	Plastic head	RLS-1303-020	ISO/IEC 15693	IP 67	Non-embeddable

FOR READ/WRITE OPERATIONS

S_{MAX} (MM)	S_0 (MM)	D_0 (MM)	N	V_{RMAX} 32 BITS DATA(CM/S)	V_{WMAX} 32 BITS DATA(CM/S)	TARGET	
12	0	24	2	8.3	5.6	RTP-0301-000	Inductive
36	12	48	2	16.6	11.2	RTP-0501-000	Photoelectric
36	12	48	2	16.6	11.2	RTP-0501-000	
12	0	24	2	8.3	5.6	RTP-0301-000	Safety
41	15	52	2	17.9	12.1	RTP-0501-000	
41	15	52	2	17.9	12.1	RTP-0501-000	RFID
31	8	46	1	230	191.7	RTP-0501-020	
31	8	46	1	230	191.7	RTP-0501-020	Connectivity
40.5	15.5	50	1	250	208.3	RTP-0502-082	
31	8	46	1	230	191.7	RTP-0501-020	Accessories
60	27	66	1	330	275	RTP-0501-020	
60	27	66	1	330	275	RTP-0501-020	Glossary
62.5	29.5	66	1	330	275.0	RTP-0502-022	
50	27	66	1	330	275	RTP-0502-022	Index

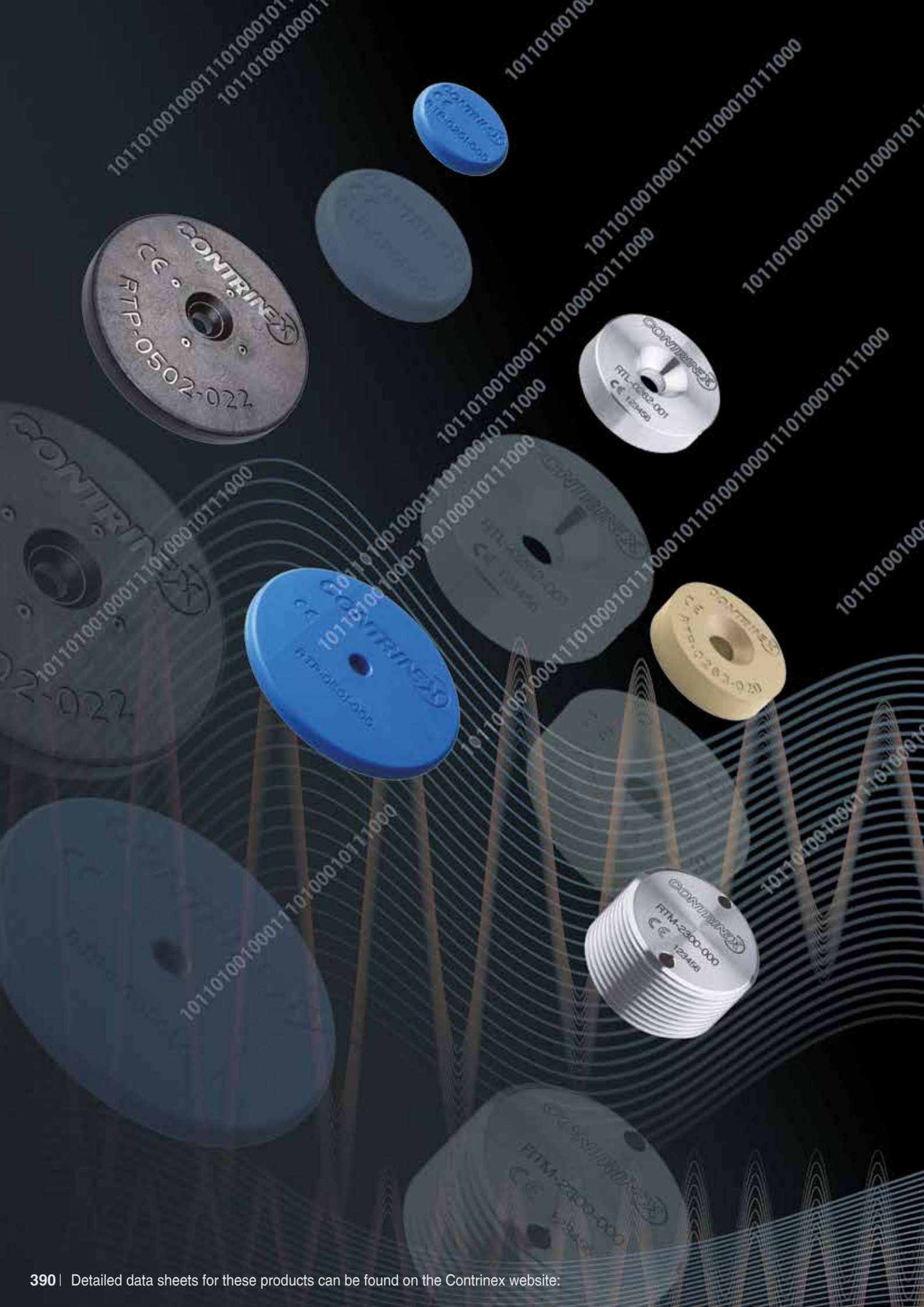

TRANSPONDERS FOR ALL ENVIRONMENTS

TRANSPONDERS



LOW FREQUENCY



HIGH FREQUENCY

KEY ADVANTAGES

- ✓ Passive (no battery)

LF

- ✓ Stainless steel tags (transponders) for harsh environments
- ✓ Insensitive to dirt
- ✓ Tags for temperatures up to 180C (356F)
- ✓ All tags embeddable in metal
- ✓ Tags readable/writeable through metal
- ✓ Food safe and saltwater resistant tags, IP68 & IP69K

HF

- ✓ Compatible with ISO/IEC 15693
- ✓ Insensitive to dirt
- ✓ Tags for temperatures up to 250C (482F)
- ✓ PPS tags that can be embedded in metal, IP68 & IP69K



LOW FREQUENCY

STRUCTURE OF MEMORY

FAMILY

HOUSING SIZE MM

MAX. READ/WRITE DISTANCE MM

TECHNICAL DATA

Compatible IC type	EM4056
Read/write memory	240 bytes
Read only memory	12 bytes
Number of bits per block	16 bits
Standard	Proprietary

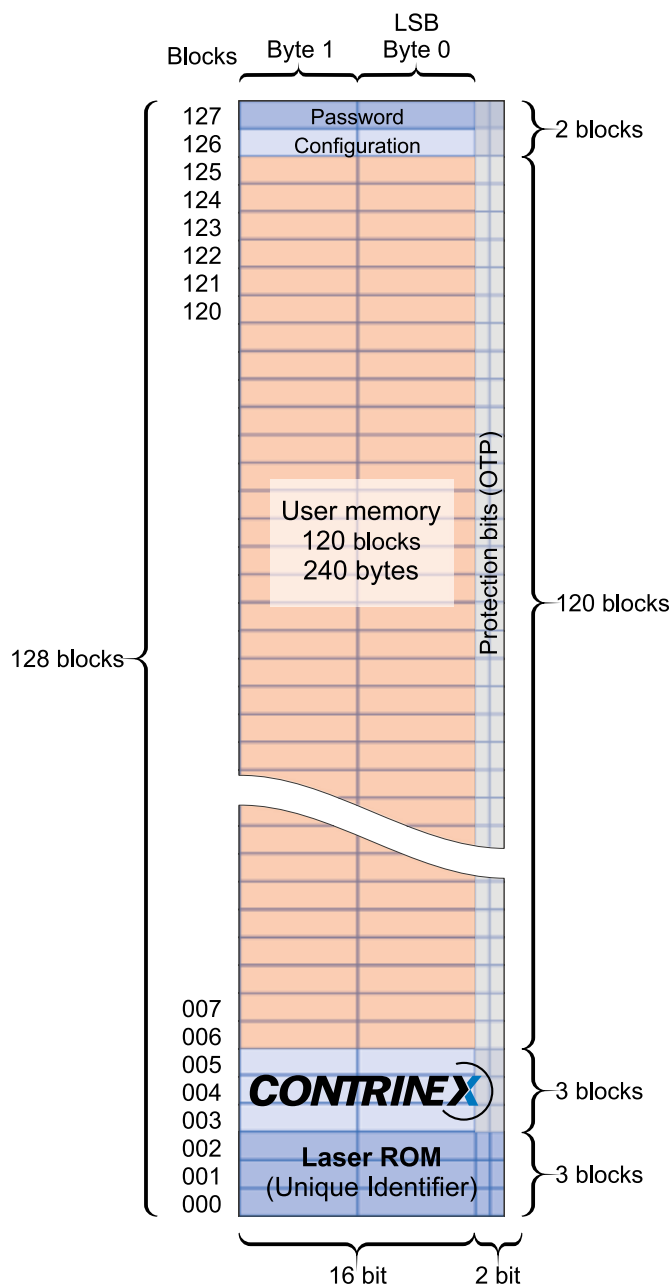

DATA

Housing material
Mounting
Ambient temperature range
Storage temperature range
Weight
Part reference

Various tag memory protection possibilities are provided, including password protection and OTP read and write protection of data blocks.

TRANSPONDERS

BASIC	BASIC	BASIC
Ø 20	Ø 30	Ø 50
28	29	41

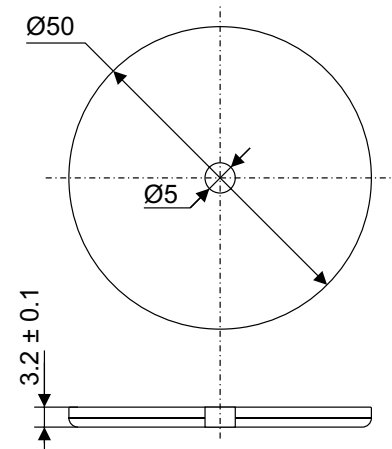
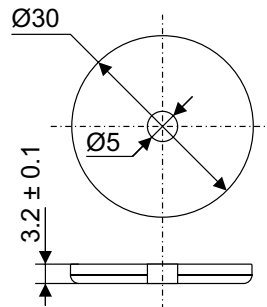
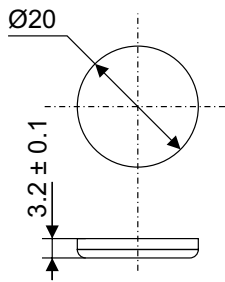

PBTP glass-fiber reinforced Embeddable -40 ... +125°C / -40 ... +257°F -40 ... +125°C / -40 ... +257°F 1.3 g RTP-0201-000	PBTP glass-fiber reinforced Embeddable -40 ... +125°C / -40 ... +257°F -40 ... +125°C / -40 ... +257°F 2.3 g RTP-0301-000	PBTP glass-fiber reinforced Embeddable -40 ... +125°C / -40 ... +257°F -40 ... +125°C / -40 ... +257°F 5.7 g RTP-0501-000
--	--	--

Inductive

Photoelectric

Safety

R-1D

Connectivity

Accessories

Glossary

Index



LOW FREQUENCY

FAMILY	EXTREME	EXTREME	EXTREME
HOUSING SIZE MM	Ø 10	Ø 16	Ø 26
MAX. READ/WRITE DISTANCE MM	13	19	26

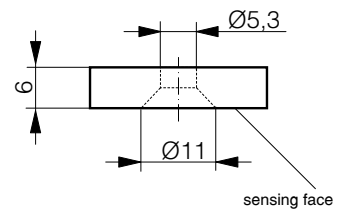
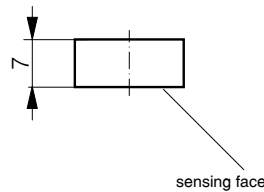
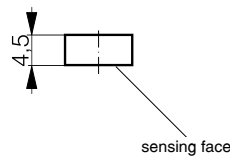
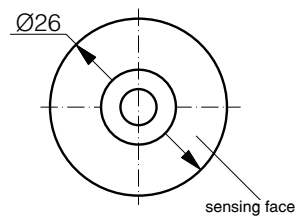
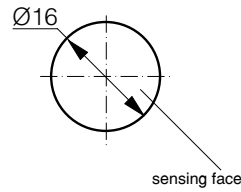
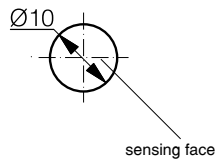

DATA			
Housing material	Stainless steel V2A	Stainless steel V2A	Stainless steel V2A
Mounting	Embeddable	Embeddable	Embeddable
Ambient temperature range	-40 ... +80°C / -40 ... +176°F	-40 ... +80°C / -40 ... +176°F	-40 ... +80°C / -40 ... +176°F
Storage temperature range	-40 ... +95°C / -40 ... +203°F	-40 ... +95°C / -40 ... +203°F	-40 ... +95°C / -40 ... +203°F
Weight	1.1 g	2.7 g	7.0 g
Part reference	RTM-0100-000	RTM-0160-000	RTM-0260-000

TRANSPONDERS

EXTREME	EXTREME	EXTREME
M16	M30	M30
13	18	23

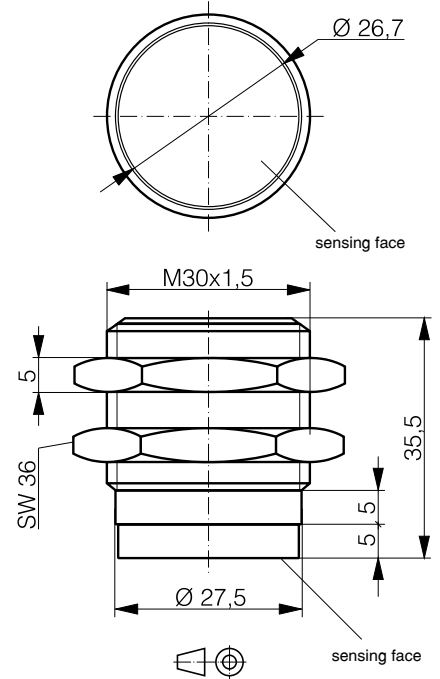
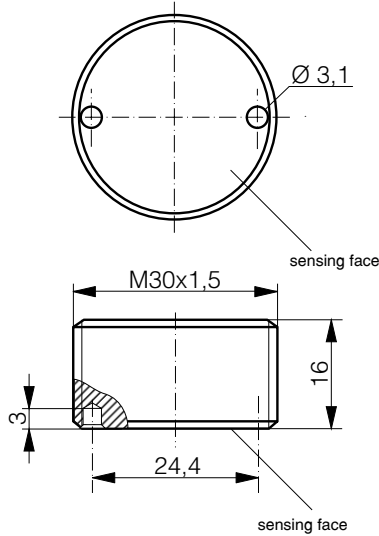
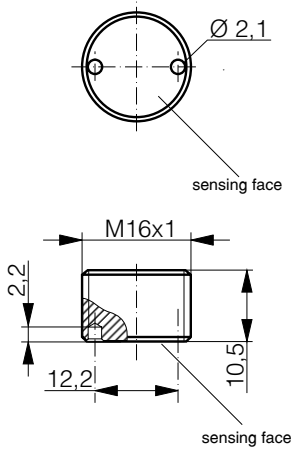

Stainless steel V2A	Stainless steel V2A	Stainless steel V2A
Embeddable	Embeddable	Non-embeddable
-40 ... +80°C / -40 ... +176°F	-40 ... +80°C / -40 ... +176°F	-40 ... +80°C / -40 ... +176°F
-40 ... +95°C / -40 ... +203°F	-40 ... +95°C / -40 ... +203°F	-40 ... +95°C / -40 ... +203°F
6.9 g	31.4 g	98.7 g
RTM-2160-000	RTM-2300-000	RTF-1300-000

Inductive

Photoelectric

Safety

RFID

Connectivity

Accessories

Glossary

Index



LOW FREQUENCY

FAMILY	WASHDOWN	WASHDOWN	WASHDOWN
HOUSING SIZE MM	Ø 10	Ø 16	Ø 26
MAX. READ/WRITE DISTANCE MM	13	19	26

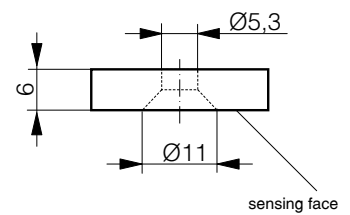
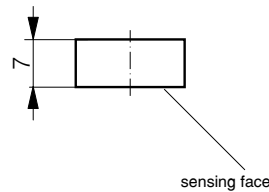
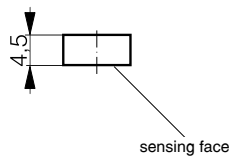
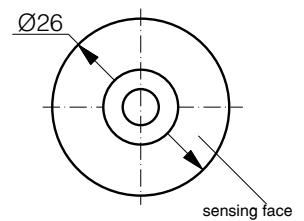
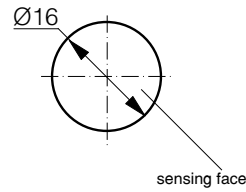
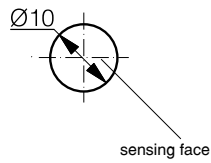

DATA			
Housing material	Stainless steel V4A	Stainless steel V4A	Stainless steel V4A
Mounting	Embeddable	Embeddable	Embeddable
Ambient temperature range	-40 ... +125°C / -40 ... +257°F	-40 ... +125°C / -40 ... +257°F	-40 ... +125°C / -40 ... +257°F
Storage temperature range	-40 ... +125°C / -40 ... +257°F	-40 ... +125°C / -40 ... +257°F	-40 ... +125°C / -40 ... +257°F
Weight	1.5 g	3.3 g	12.5 g
Part reference	RTL-0102-001	RTL-0162-001	RTL-0262-001

TRANSPONDERS

WASHDOWN	WASHDOWN	WASHDOWN	HIGH TEMPERATURE
M16	M30	M30	Ø 26
13	18	23	26

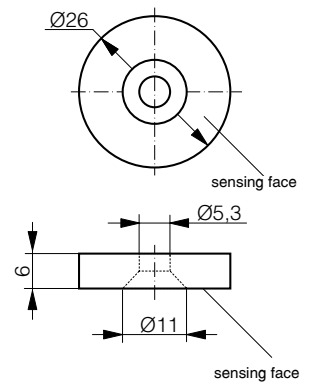
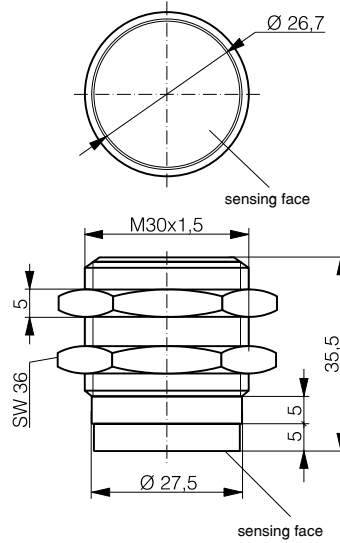
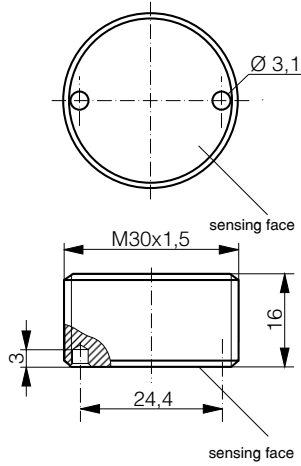
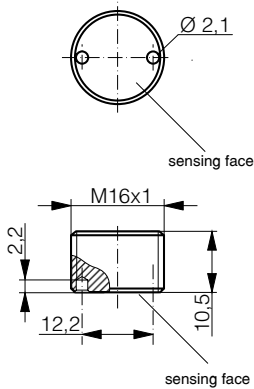

Stainless steel V4A	Stainless steel V4A	Stainless steel V4A	Stainless steel V4A
Embeddable	Embeddable	Non-embeddable	Embeddable
-40 ... +125°C / -40 ... +257°F	-40 ... +125°C / -40 ... +257°F	-40 ... +125°C / -40 ... +257°F	-40 ... +180°C / -40 ... +356°F
-40 ... +125°C / -40 ... +257°F	-40 ... +125°C / -40 ... +257°F	-40 ... +125°C / -40 ... +257°F	-40 ... +180°C / -40 ... +356°F
7.9 g	33.1 g	44.1 g	12.5 g
RTL-2162-001	RTL-2302-001	RTL-1302-001	RTL-0262-003

Inductive

Photoelectric

Safety

RF-ID

Connectivity

Accessories

Glossary

Index



HIGH FREQUENCY

STRUCTURE OF MEMORY

FAMILY

HOUSING SIZE MM

MAX. READ/WRITE DISTANCE MM

TECHNICAL DATA

-020 OR -022

Compatible IC type	NXP I-Code SLI-S
Read/write memory	160 bytes
Read only memory	96 bytes
Number of bits per block	32 bits
Standard	ISO/IEC 15693

TECHNICAL DATA

-062

Compatible IC type	FUJITSU MB89R118C
Read/write memory	2000 bytes
Read only memory	48 bytes
Number of bits per block	64 bits
Standard	ISO/IEC 15693

TECHNICAL DATA

-082

Compatible IC type	NXP I-Code SLI
Read/write memory	112 bytes
Read only memory	16 bytes
Number of bits per block	32 bits
Standard	ISO/IEC 15693

Various tag memory protection possibilities are provided, including password protection and OTP write protection of data blocks.

DATA

Housing material
Mounting
Ambient temperature range
Storage temperature range
Weight
Part reference

TRANSPONDERS

BASIC	BASIC	BASIC
Ø 20	Ø 30	Ø 50
25	45	47

Inductive

Photoelectric

Safety

R-FID

Connectivity

Accessories

Glossary

Index

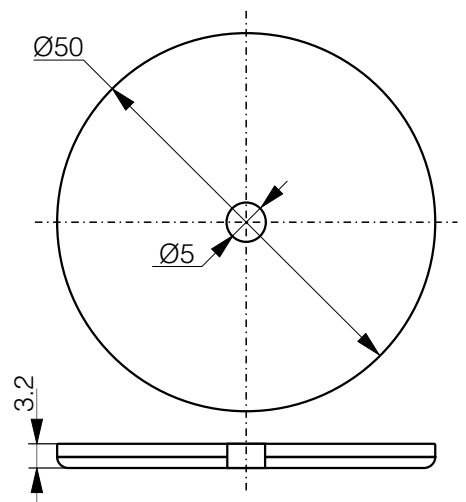
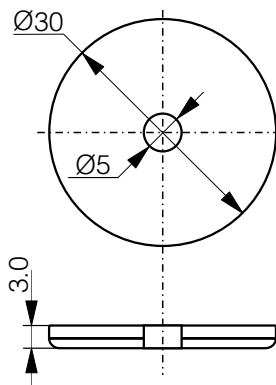
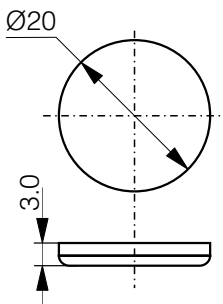

PBTP glass-fiber reinforced	PBTP glass-fiber reinforced	PBTP glass-fiber reinforced
Non-embeddable	Non-embeddable	Non-embeddable
-25 ... +85°C / -13 ... +185°F	-25 ... +85°C / -13 ... +185°F	-25 ... +85°C / -13 ... +185°F
-40 ... +125°C / -40 ... +257°F	-40 ... +125°C / -40 ... +257°F	-40 ... +125°C / -40 ... +257°F
1.3 g	2.7 g	6.6 g
RTP-0201-020	RTP-0301-020	RTP-0501-020



HIGH FREQUENCY

FAMILY	BASIC	BASIC	HIGH TEMPERATURE
HOUSING SIZE MM	Ø 9	Ø 16	Ø 26
MAX. READ/WRITE DISTANCE MM	14	31	31

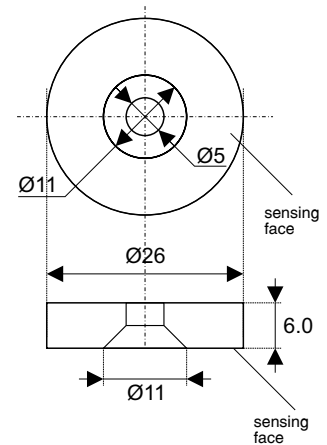
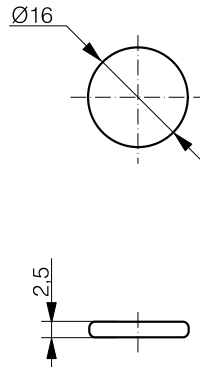
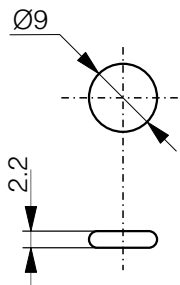

DATA			
Housing material	PPS + Epoxy	PPS + Epoxy	PPS, silicone free
Mounting	Non-embeddable	Non-embeddable	Embeddable
Ambient temperature range	-20 ... +85°C / -4 ... +185°F	-20 ... +85°C / -4 ... +185°F	-25 ... +180°C / -13 ... +356°F
Storage temperature range	-20 ... +110°C / -4 ... +230°F	-20 ... +110°C / -4 ... +230°F	-40 ... +180°C / -40 ... +356°F
Weight	0.25 g	0.75 g	3.3 g
Part reference	RTP-0090-020	RTP-0160-020	RTP-0263-020

TRANSPONDERS

HIGH TEMPERATURE	HIGH TEMPERATURE	HIGH TEMPERATURE
Ø 50	Ø 50	Ø 50
50	44	42

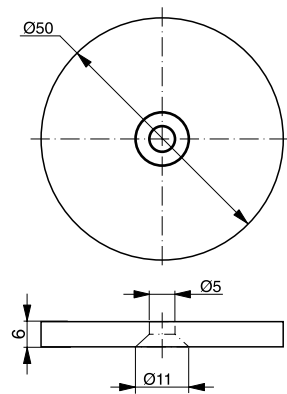
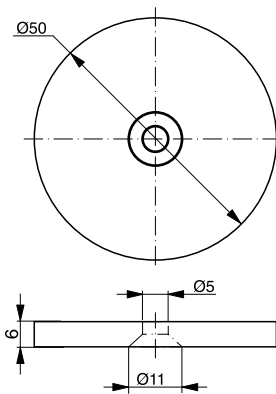
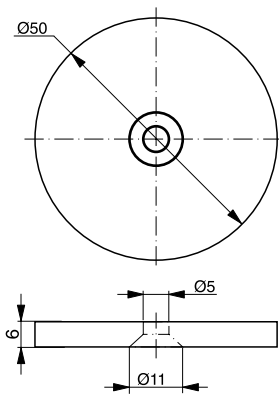

LCP, silicone free	LCP, silicone free	LCP, silicone free
Non-embeddable	Non-embeddable	Non-embeddable
-25 ... +150°C / -13 ... +302°F	-25 ... +150°C / -13 ... +302°F	-25 ... +150°C / -13 ... +302°F
-40 ... +250°C / -40 ... +482°F	-40 ... +250°C / -40 ... +482°F	-40 ... +250°C / -40 ... +482°F
16.9 g	16.9 g	16.9 g
RTP-0502-022	RTP-0502-062	RTP-0502-082

Inductive

Photoelectric

Safety

RFID

Connectivity

Accessories

Glossary

Index



CONTRINET READ/ WRITE MODULES



LOW FREQUENCY



HIGH FREQUENCY

KEY ADVANTAGES

- ✓ Powerful RS485 network protocol for LF and HF systems
- ✓ Threaded Read/Write Modules (RWMs) with S12 connector and RS485 output
- ✓ LF and HF RWMs can be mixed on the same network
- ✓ Rugged all-metal LF RWMs with impervious sensing face



READ/WRITE MODULES

FAMILY	BASIC	BASIC	EXTREME
HOUSING SIZE	M18	M30	M18
MAX. READ/WRITE DISTANCE MM	36	41	12

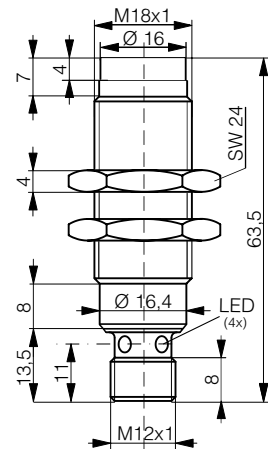
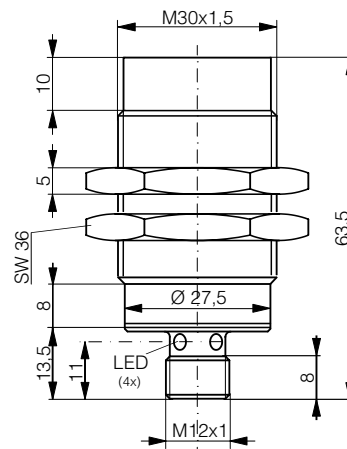
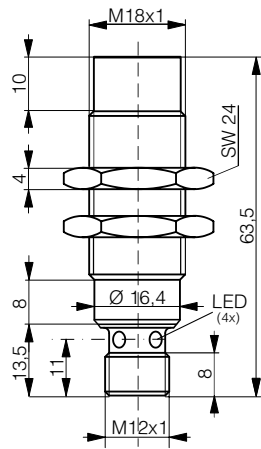

DATA			
Housing material	PBTP / chrome-plated brass	PBTP / chrome-plated brass	Stainless steel V2A
Max. current consumption	30 mA	30 mA	30 mA
Mounting	Non-embeddable	Non-embeddable	Non-embeddable
Ambient temperature range	-25...+80°C / -13...+176°F	-25...+80°C / -13...+176°F	-25...+80°C / -13...+176°F
Storage temperature range	-25...+80°C / -13...+176°F	-25...+80°C / -13...+176°F	-25...+80°C / -13...+176°F
Connection type	Connector S12	Connector S12	Connector S12
Weight (incl. nuts)	37 g	127 g	37 g
Part reference	RLS-1181-030	RLS-1301-030	RLS-1180-030

READ/WRITE MODULES

EXTREME	WASHDOWN	WASHDOWN
M30	M18	M30
12	12	12

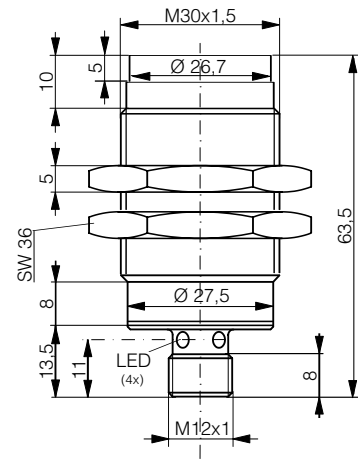
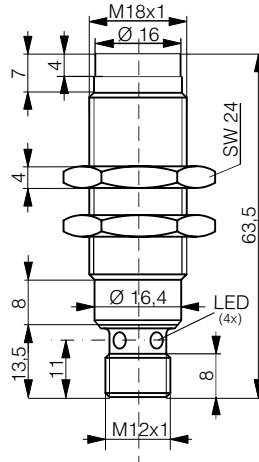
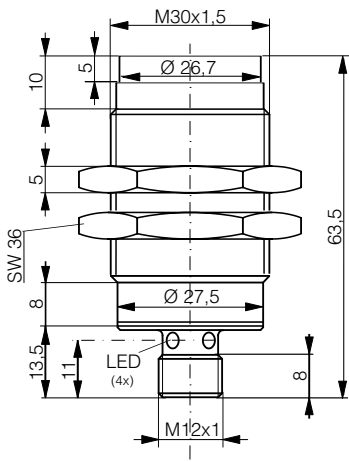

Stainless steel V2A	Stainless steel V4A	Stainless steel V4A
30 mA	30 mA	30 mA
Non-embeddable	Non-embeddable	Non-embeddable
-25...+80°C / -13...+176°F	-40...+125°C / -40...+257°F	-40...+125°C / -40...+257°F
-25...+80°C / -13...+176°F	-40...+125°C / -40...+257°F	-40...+125°C / -40...+257°F
Connector S12	Connector S12	Connector S12
127 g	37 g	127 g
RLS-1300-030	RLS-1182-031	RLS-1302-031

Inductive

Photoelectric

Safety

RF-ID

Connectivity

Accessories

Glossary

Index



READ/WRITE MODULES

FAMILY	BASIC	BASIC
HOUSING SIZE	M18	M30
MAX. READ/WRITE DISTANCE MM	31	50

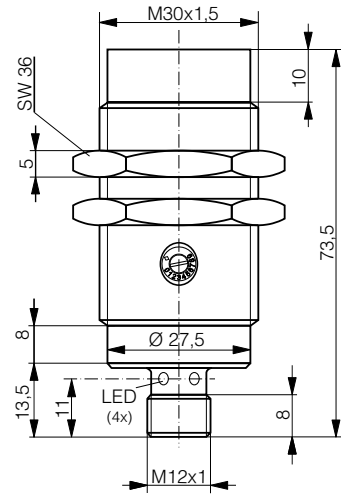
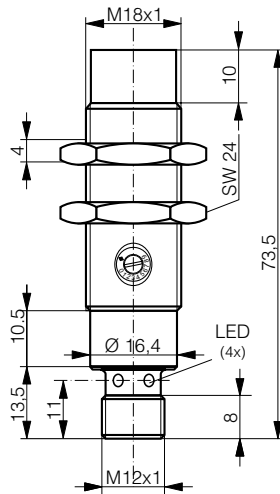

DATA		
Housing material	PBTP / Stainless steel V2A	PBTP / Stainless steel V2A
Max. current consumption	60 mA	60 mA
Mounting	Non-embeddable	Non-embeddable
Ambient temperature range	-25...+80°C / -13...+176°F	-25...+80°C / -13...+176°F
Storage temperature range	-25...+80°C / -13...+176°F	-25...+80°C / -13...+176°F
Connection type	Connector S12	Connector S12
Weight (incl. nuts)	37 g	95 g
Part reference	RLS-1183-020	RLS-1303-020





1001101010011010010010010010010110101
1001101010011010010010010010010110101001010
1001101010011010010010010010





IO-LINK - EASY TO GO!

IO-LINK READ/ WRITE MODULES



HIGH FREQUENCY

KEY ADVANTAGES

- ✓ Threaded Read/Write Modules (RWMs) with S12 connector
- ✓  IO-Link interface V1.1
- ✓ M18 and M30
- ✓ Two operating modes:
 - ✓ As  IO-Link device, three process-data configurations:
 - ✓ Scan UID
 - ✓ Scan user data
 - ✓ Scan read/write command
 - ✓ As stand-alone SIO with conditional output switch:
 - ✓ Tag presence
 - ✓ Data block comparison



HIGH FREQUENCY

AT A GLANCE

- High frequency Read/Write Modules (RWMs) with IO-Link interface
- Compatible with ISO 15693 transponders (4- or 8-byte memory block)
- IO-Link interface V1.1
- Two operating modes:
 - As IO-Link device, three process-data configurations:
 - Scan UID
 - Scan user data
 - Scan read/write command
 - As stand-alone SIO with conditional output switch:
 - Tag presence
 - Data block comparison

FAMILY

HOUSING SIZE

MAX. READ/WRITE DISTANCE MM

WIRING DIAGRAM

PIN	SIGNAL	FUNCTION
1	L+	+24 V
2	Q2	DO (tag presence or data comparison)
3	L-	OV
4	C/Q1	SDCI/SIO (tag presence or data comparison)

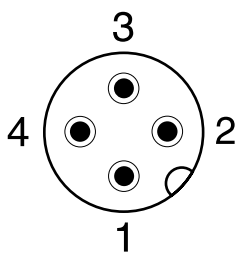

DATA

- Housing material
- Max. current consumption
- Mounting
- Ambient temperature range
- Storage temperature range
- Connection type
- Degree of protection
- Weight (with nuts)
- Part reference

READ/WRITE MODULES

IO-LINK	IO-LINK	
M18	M30	
40	62	

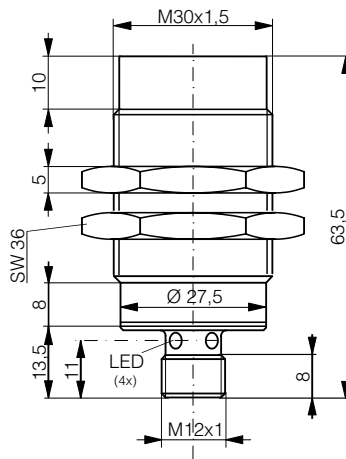
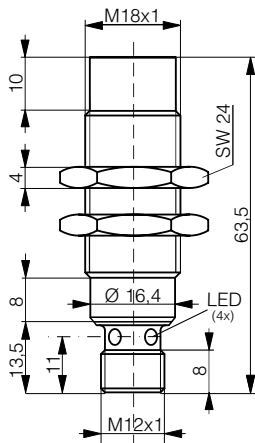

IO-Link	IO-Link	
PBTP / Chrome-plated brass	PBTP / Chrome-plated brass	
50 mA	50 mA	
Non-embeddable	Non-embeddable	
-25 ... +80°C / -13 ... +176°F	-25 ... +80°C / -13 ... +176°F	
-25 ... +80°C / -13 ... +176°F	-25 ... +80°C / -13 ... +176°F	
Connector S12	Connector S12	
IP 67	IP 67	
51 g	120 g	
RLS-1181-320	RLS-1301-320	

Inductive

Photoelectric

Safety

RFID

Connectivity

Accessories

Glossary

Index



USB – DIRECT TO PC

USB READ/WRITE MODULES



LOW FREQUENCY



HIGH FREQUENCY

KEY ADVANTAGES

- ✓ Direct connection of Read/Write Module (RWM) to PC
- ✓ Compatible with ContriNET LF/HF DEMO software
- ✓ LF and HF types in sizes M18 and M30



READ/WRITE MODULES

FAMILY	USB	USB
HOUSING SIZE	M18	M30
MAX. READ/WRITE DISTANCE MM	36	41

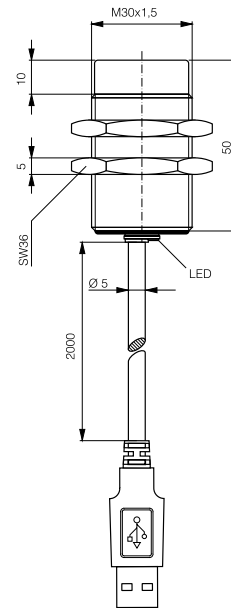
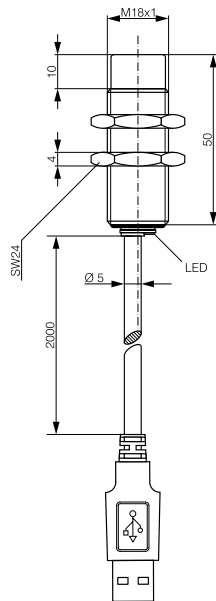

DATA		
Housing material	PBTP / chrome-plated brass	PBTP / chrome-plated brass
Max. current consumption	200 mA	200 mA
Mounting	Non-embeddable	Non-embeddable
Ambient temperature range	-25 ... +80°C / -13 ... +176°F	-25 ... +80°C / -13 ... +176°F
Storage temperature range	-25 ... +80°C / -13 ... +176°F	-25 ... +80°C / -13 ... +176°F
Connection type	USB A male	USB A male
Weight (incl. nuts)	107 g	144 g
Part reference	RLS-1181-230	RLS-1301-230



READ/WRITE MODULES

USB	USB	USB	USB
M18	M18	M30	M30
31	31	60	60

Inductive

Photoelectric

Safety

RF-ID

Connectivity

Accessories

Glossary

Index

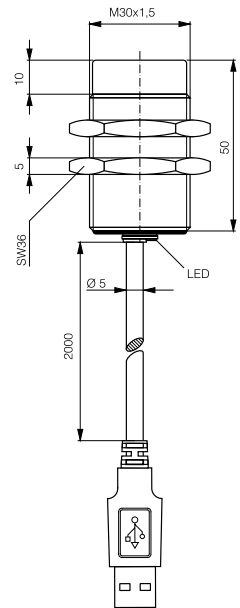
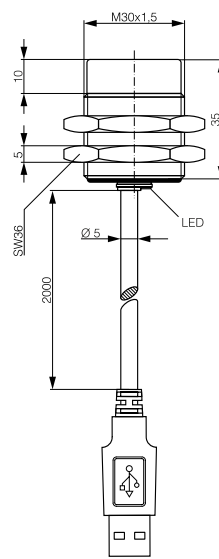
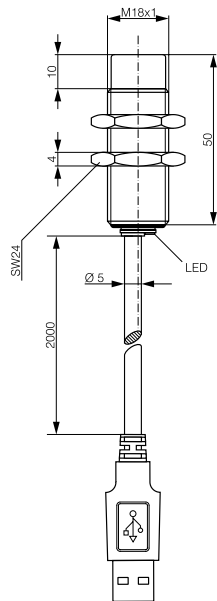
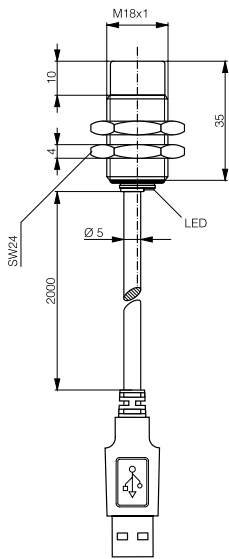

PBTP / chrome-plated brass 200 mA Non-embeddable -25 ... +70°C / -13 ... +158°F -25 ... +70°C / -13 ... +158°F USB A male 97 g RLS-1181-220-120	PBTP / chrome-plated brass 200 mA Non-embeddable -25 ... +70°C / -13 ... +158°F -25 ... +70°C / -13 ... +158°F USB A male 107 g RLS-1181-220	PBTP / chrome-plated brass 200 mA Non-embeddable -25 ... +70°C / -13 ... +158°F -25 ... +70°C / -13 ... +158°F USB A male 144 g RLS-1301-220-120	PBTP / chrome-plated brass 200 mA Non-embeddable -25 ... +70°C / -13 ... +158°F -25 ... +70°C / -13 ... +158°F USB A male 165 g RLS-1301-220
--	---	---	---

APPLICATION WITH USB READ/WRITE MODULE



The default address of USB read/write modules is 254.

USB read/write modules are not networkable, but they have a ContriNET firmware. In particular, they are compatible with ContriNET HF/LF DEMO software and other ContriNET support tools.





MARKET-LEADING FIELDBUS COVERAGE

INTERFACES



LOW FREQUENCY



HIGH FREQUENCY

KEY ADVANTAGES

- ✓ Widest fieldbus coverage on market
- ✓ Interfaces for connection of ContriNET to PROFIBUS, DeviceNet, EtherNet/IP, PROFINET, EtherCAT, POWERLINK and Ethernet TCP/IP
- ✓ Comprehensive accessories including T-connectors and line terminators

NEW:

- ✓ TCP/IP interface in lightweight plastic, 120 mm x 80 mm x 30 mm

INTERFACES

FIELDBUS

PROFIBUS-DP

HOUSING SIZE MM

100 X 52 X 64



AT A GLANCE

- Compact, ready-to-use device
- Allows connection of ContriNET to an industrial fieldbus
- Synthetic housing in ABS
- Mounting on rail DIN EN 60715

FIELDBUS

PROFIBUS	RIS-1053-120
DeviceNet	RIS-1053-220
EtherNet/IP	RIS-1053-320
PROFINET	RIS-1053-520
EtherCAT	RIS-1053-620
POWERLINK	RIS-1053-820

FIRMWARE

On SD card

Selectable using the RIS-1053-X20 card configurator software

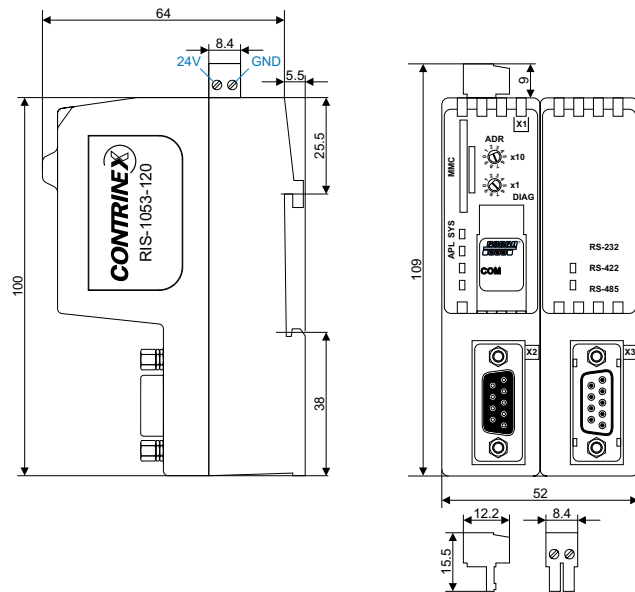

DATA

Housing material	ABS
Mounting	DIN rail EN 60715
Ambient temperature range	0 ... +50°C / +32 ... +122°F
Storage temperature range	0 ... +50°C / +32 ... +122°F
Weight	150 g
Part reference	RIS-1053-120

INTERFACES

DEVICENET

ETHERNET/IP / PROFINET IO
ETHERCAT / POWERLINK

100 X 52 X 64

100 X 52 X 64

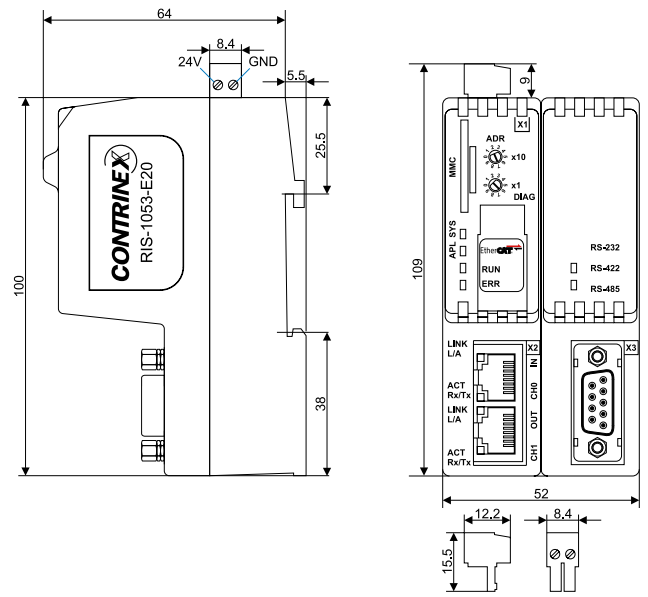
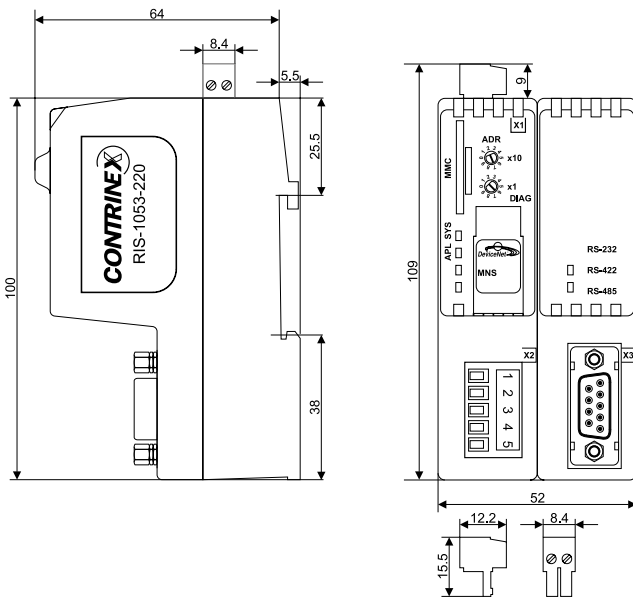

Inductive

Photoelectric

Safety

RFID

Connectivity

Accessories

Glossary

Index

ABS

DIN rail EN 60715

0 ... +50°C / +32 ... +122°F

0 ... +50°C / +32 ... +122°F

150 g

RIS-1053-220

ABS

DIN rail EN 60715

0 ... +50°C / +32 ... +122°F

0 ... +50°C / +32 ... +122°F

150 g

RIS-1053-E20

INTERFACES

CONTRINET APPLICATION WITH INTERFACES

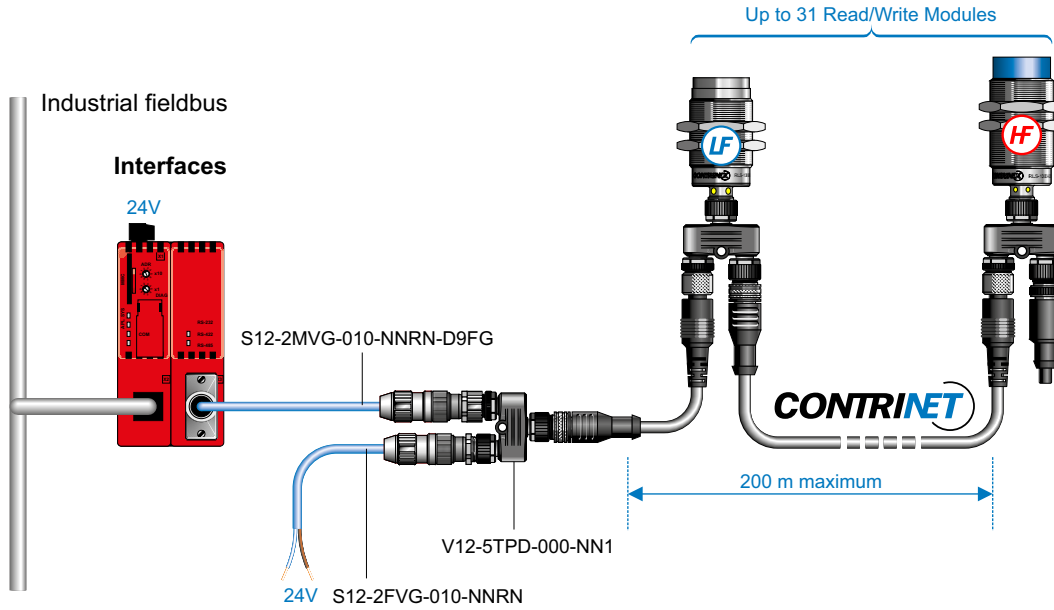

ACCESSORIES TO CONNECT INTERFACES TO CONTRINET

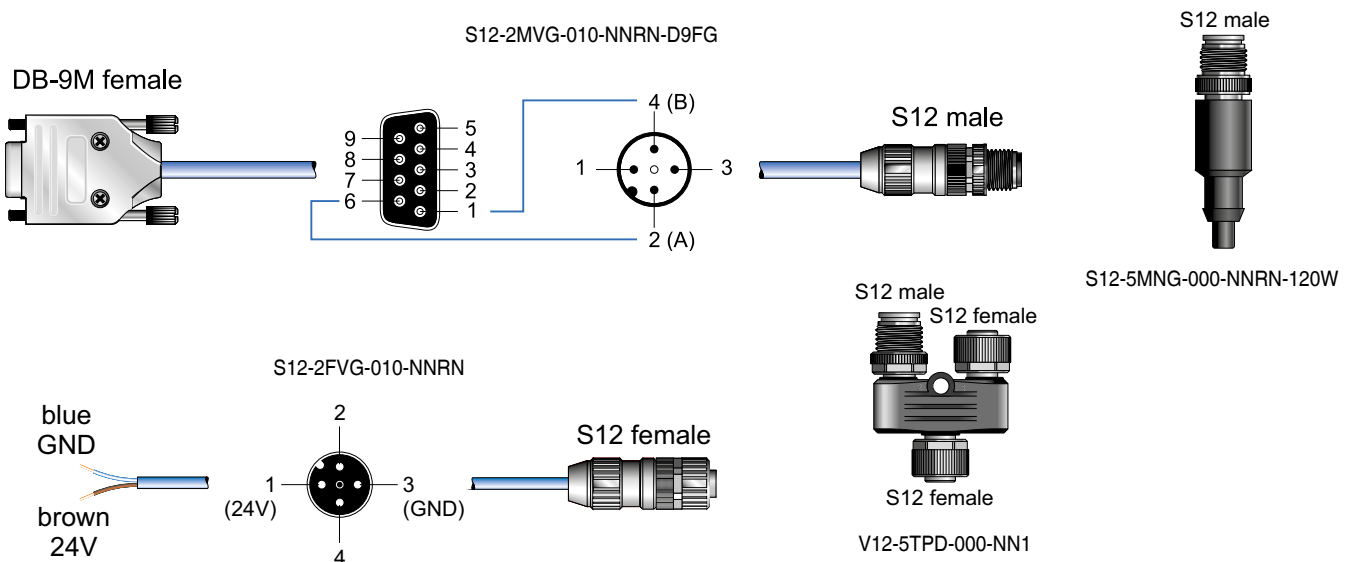

*Other cables available on pages 438-439

DATA

S12-2MVG-010-NNRN-D9FG	S12 - DB9 - RS485 - PVC 1 m
S12-2FVG-010-NNRN	24V - S12 power supply cable
V12-5TPD-000-NN1	S12 T-connector
S12-4MNG-000-NNT2	S12 male connector
S12-4FNG-000-NNT2	S12 female connector
S12-5MNG-000-NNRN-120W	S12 Contrinet terminator 120 Ω

INTERFACES

TCP/IP INDUSTRIAL INTERFACE

HOUSING SIZE MM

155 X 96 X 44

120 X 80 X 30

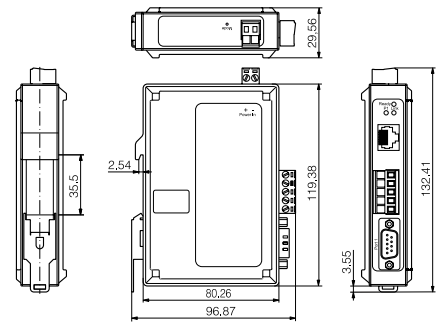
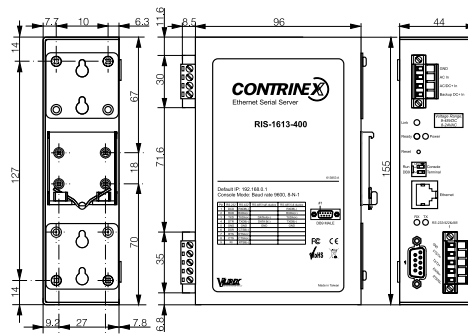

DATA

Housing material	Metal	Plastic
Mounting	DIN rail EN 60715	DIN rail EN 60715
Ambient temperature range	-10 ... +80°C / -14 ... +176°F	-40 ... +80°C / -40 ... +176°F
Storage temperature range	-20 ... +85°C / -14 ... +185°F	-40 ... +85°C / -40 ... +185°F
Weight (with nuts)	635 g	149.7 g
Part reference	RIS-1613-400	RIS-1208-400

Inductive

Photoelectric

Safety

RFID

Connectivity

Accessories

Glossary

Index

INTERFACES

APPLICATION EXAMPLES WITH RIS-1613-400

RIS-1613-400 Miniconnect

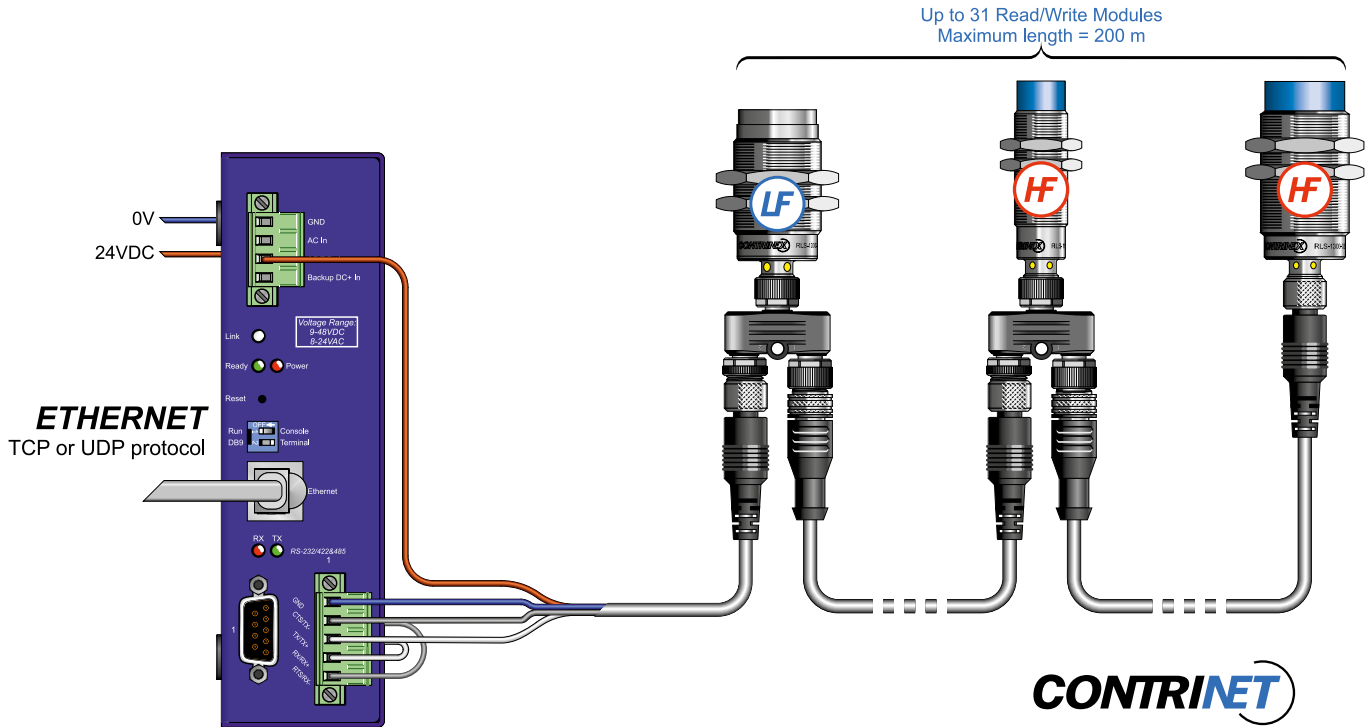

RIS-1613-400 DB-9M

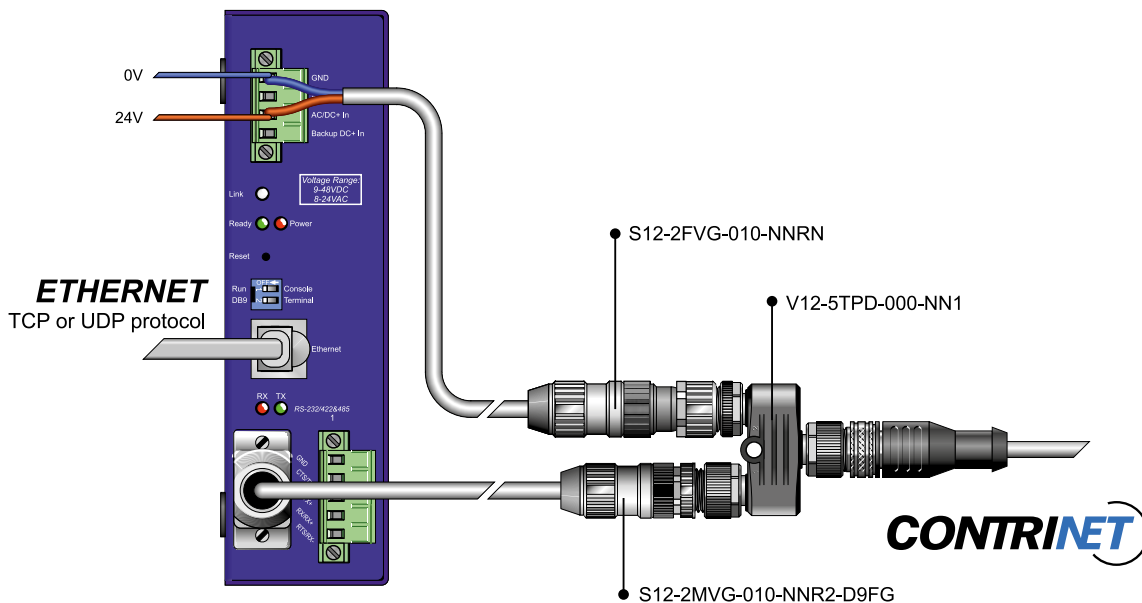

INTERFACES

APPLICATION EXAMPLES WITH RIS-1208-400

RIS-1208-400 Miniconnect

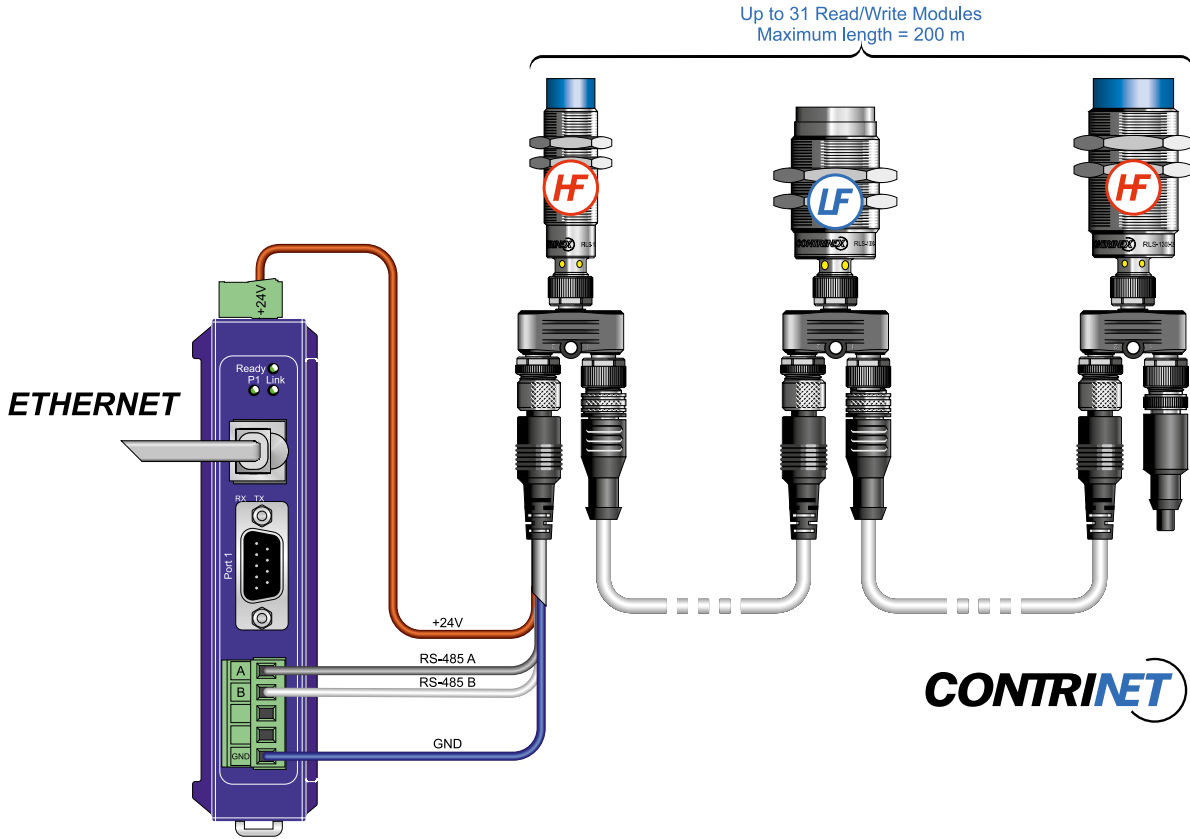

RIS-1208-400 S12-2MVG

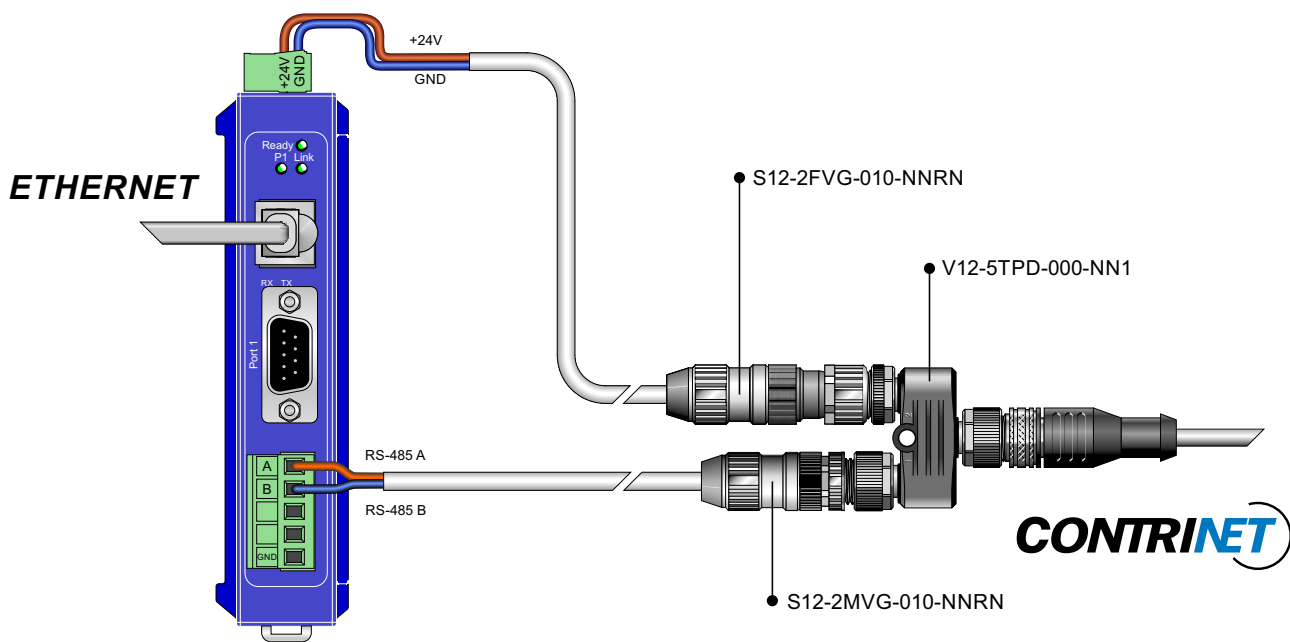

Inductive

Photoelectric

Safety

RFID

Connectivity

Accessories

Glossary

Index

INTERFACES

ACCESSORIES TO CONNECT INTERFACES TO CONTRINET

S12-2MVG-010-NNR2-D9FG

DB-9M female

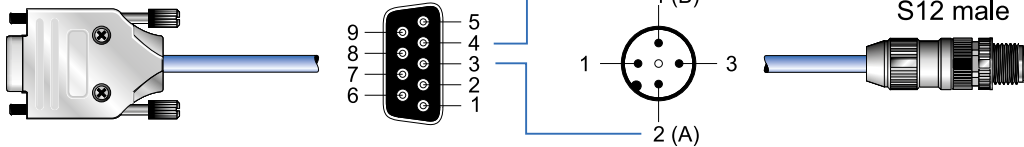

S12-2FVG-010-NNRN

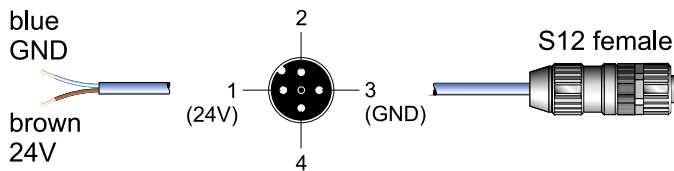

V12-5TPD-000-NN1

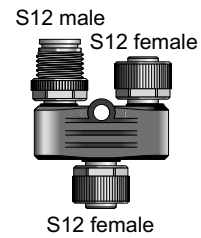

S12-2MVG-010-NNRN

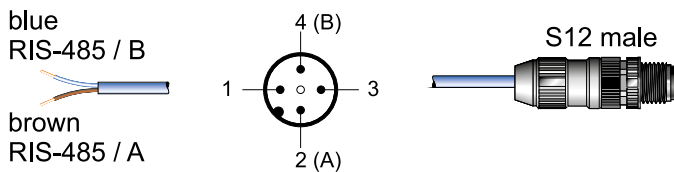

S12-5MNG-000-NNRN-120W



*Other cables available on pages 438-439

DATA

S12-2MVG-010-NNR2-D9FG	S12 - DB9 - RS485 - PVC 1 m - RIS-1613-400
S12-2FVG-010-NNRN	S12 - 24V - power supply cable
V12-5TPD-000-NN1	S12 T-connector
S12-5MNG-000-NNRN-120W	S12 ContriNET terminator 120 Ω
S12-2MVG-010-NNRN	S12 - RS485 - PVC 1 m



INTERFACES

USB ADAPTOR

HOUSING SIZE MM

67 X 66 X 28

AT A GLANCE

- Synthetic ABS housing
- Serial RS485 connection to Contrinet
- USB connection to control PC

LEDS

Red LED:

Describes the connection control PC - USB connector.

Green LED:

Indicates that the device is fed by an external power supply unit.

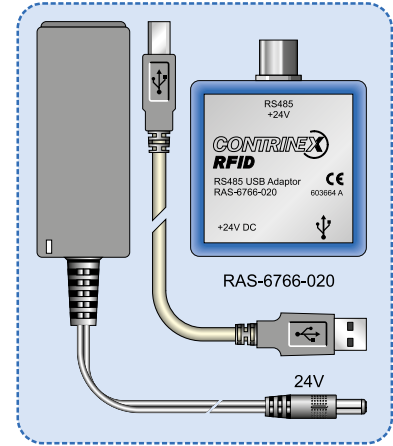

The set contains:
1 USB adaptor, 1 power supply, 1 USB cable

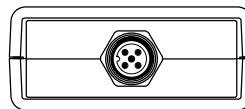
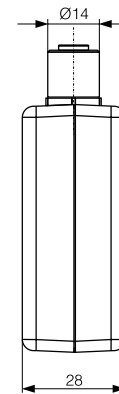
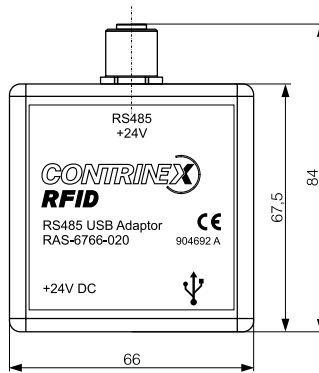
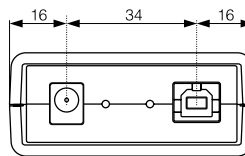

DATA

Housing material	ABS
Power supply	24 V
Max. current consumption	625 mA
Connection (RS485 side)	Connector S12
Ambient temperature range	0 ... +50°C / +32 ... +122°F (with external power supply unit)
Storage temperature range	-40 ... +85°C / -40 ... +185°F
Weight	67 g
Part reference	RAS-6766-020

INTERFACES

APPLICATION WITH USB ADAPTOR

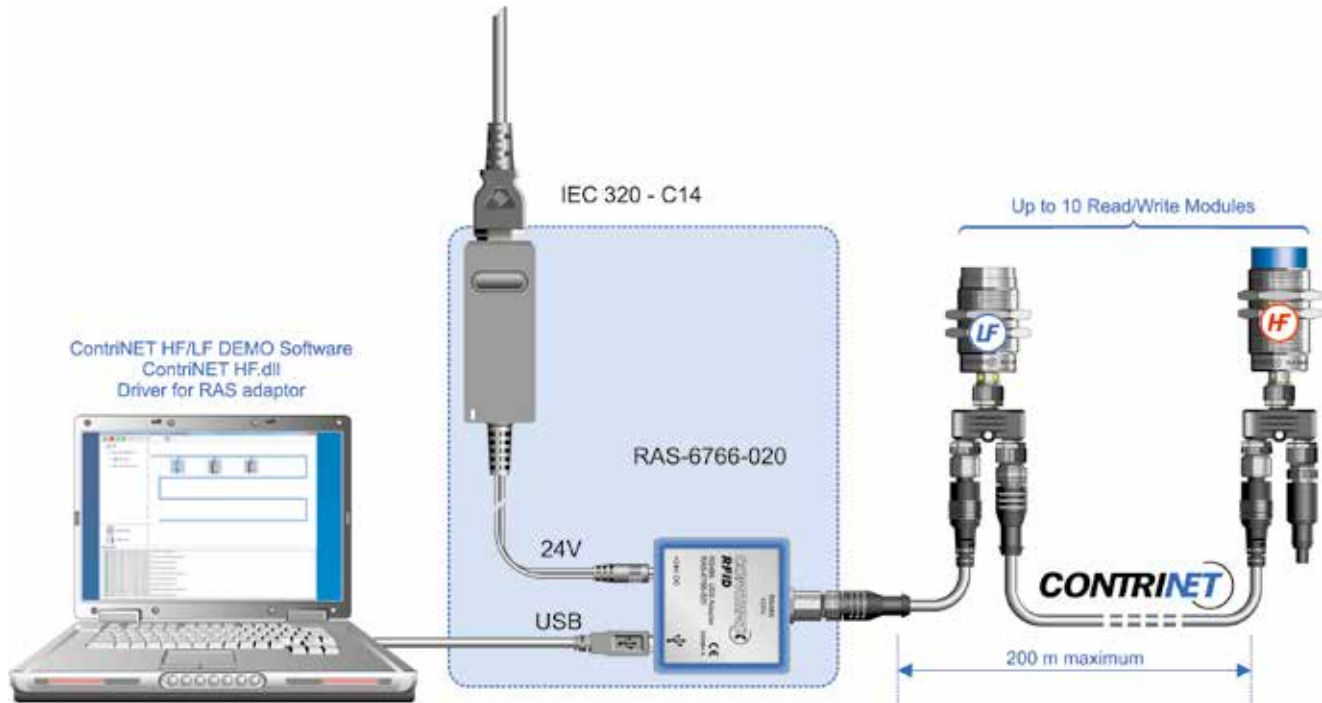

CONNECTION

The adaptor acts as the interface between a network of Read/Write Modules and the USB port of the control PC. The delivery package includes a USB cable.

EXTERNAL POWER SUPPLY UNIT

An external power supply unit (24V / 15W, 625 mA) is included in the delivery package.

DRIVERS AND SOFTWARE

Drivers compatible with the various Windows versions and software for demonstration and training (ContriNET HF/LF) can be downloaded from the RAS-6766-020 product page of the Contrinex website.

Inductive

Photoelectric

Safety

RFID

Connectivity

Accessories

Glossary

Index



ACCESSORIES



LOW FREQUENCY



HIGH FREQUENCY

RFID ACCESSORIES

- ✓ Starter kits
- ✓ Handheld device
- ✓ RFID couplers
- ✓ Cables for RFID couplers
- ✓ Standard cables
- ✓ Quick-lock cables



ACCESSORIES

STARTER KITS

DIMENSIONS MM

255 X 205 X 60

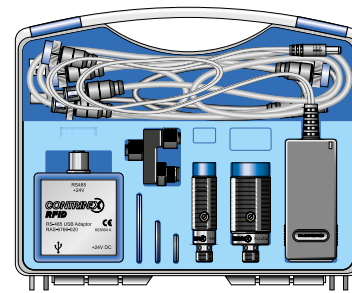
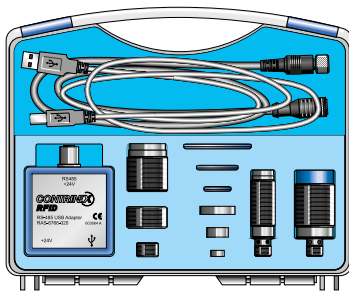

The low-frequency starter kit contains all components necessary for a simple RFID application:

- 1 USB adaptor RAS-6766-020
- 1 Full-metal Read/Write Module M18
- 1 Read/Write Module M30
- 1 set of transponders
- Cable connectors

The necessary Contrinet HF/LF software can be downloaded from the starter kit product page of the Contrinex website.

The high-frequency starter kit contains all components necessary for a simple RFID application:

- 1 USB adaptor RAS-6766-020
- 1 Read/Write Module M18
- 1 Read/Write Module M30
- 1 set of transponders
- Cable connectors

The necessary Contrinet HF/LF software can be downloaded from the starter kit product page of the Contrinex website.

DATA

STARTER-KIT RFID LF	1 USB adaptor, 2 RWMs, 6 tags, 2 T-connectors, 1 power supply, 1 USB cable, 2 connecting cables
STARTER-KIT RFID HF	1 USB adaptor, 2 RWMs, 5 tags, 2 T-connectors, 1 power supply, 1 USB cable, 2 connecting cables



ACCESSORIES

HANDHELD DEVICE

DIMENSIONS MM

155 X 75 X 49 (WITH DOCKING STATION)



RPA-0111-000 / RPA-0112-000

The handheld LF read/write device may be used to read and write ConID LF transponders. Its most important features are as follows:

- Portable and light
- No connector
- Robust and ergonomic housing
- Simple navigation
- Integrated RFID Read/Write Module
- Alphanumeric LC display with 16 characters
- 34 alphanumeric and function keys
- Integrated clock and calendar
- Belt clip
- 128 KB memory

The handheld read/write device features a NiMH battery pack, which charges automatically when positioned on its docking station. The latter enables the read/write device to communicate by means of an RS232 interface.

DATA

RPA-0111-000	Handheld read/write device with docking station with EU adapter
RPA-0110-000	Handheld read/write device without docking station
RPA-0101-000	Docking station with EU adapter
RPA-0112-000	Handheld read/write device with docking station with US adapter
RPA-0102-000	Docking station with US adapter

Inductive

Photoelectric

Safety

RFID

Connectivity

Accessories

Glossary

Index



ACCESSORIES

AT A GLANCE

- Metal threaded cylindrical housings
- Sensing face of PBTP (polybutylene terephthalate) or stainless steel V2A
- Insensitive to dirt
- Passive (without power supply)

An RFID coupler consists of two coupling heads linked by a cable. It is passive and enables data to be transferred between the Read/Write Module and the transponder, acting as a contact-free extension for data transfer.

A coupler is used whenever a double mechanical interface is required.

CONNECTION

The coupling heads feature 4-pole S12 connectors. The cable connectors have been designed specifically for use with RFID couplers and are equipped with 4-pole sockets at both ends.



The coupling heads must not be connected to the power supply, nor to an interface device.

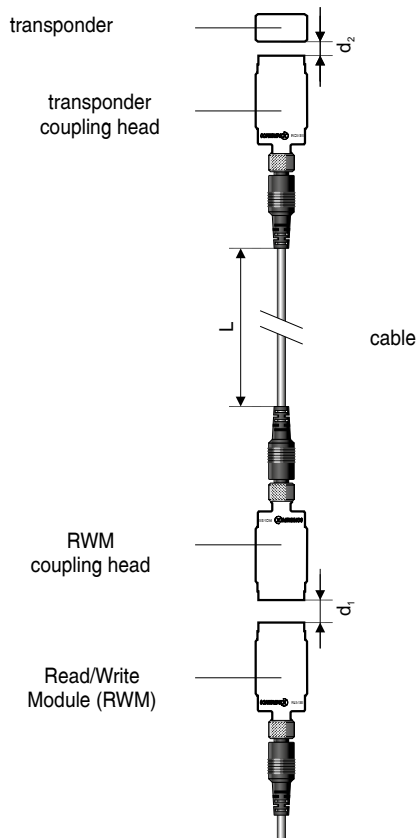

HOUSING SIZE

DATA

Housing material
Sensing face material
Mounting
Ambient temperature range
Storage temperature range
Connection type
Degree of protection
Weight (with nuts)
Part reference

ACCESSORIES

RFID COUPLERS

M18	M30	M18	M30
COUPLING HEAD	COUPLING HEAD	COUPLING HEAD	COUPLING HEAD

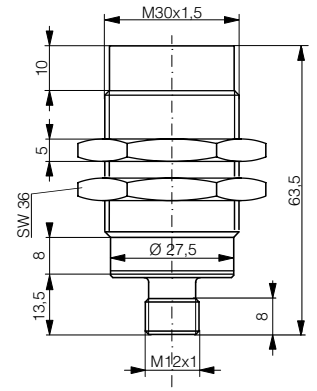
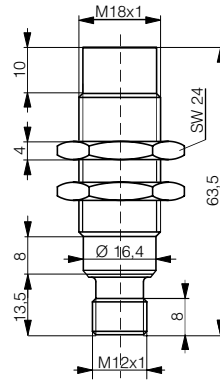
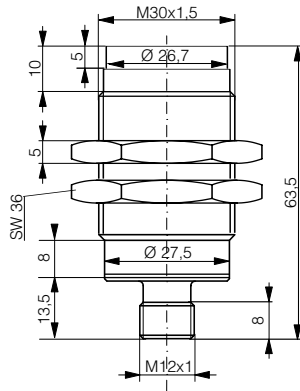
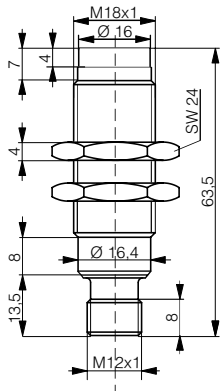

Stainless steel V2A	Stainless steel V2A	Chrome-plated brass	Chrome-plated brass
Stainless steel V2A	Stainless steel V2A	PBTP	PBTP
Non-embeddable	Non-embeddable	Non-embeddable	Non-embeddable
-25 ... +80°C / -13 ... +176°F	-25 ... +80°C / -13 ... +176°F	-25 ... +80°C / -13 ... +176°F	-25 ... +80°C / -13 ... +176°F
-25 ... +80°C / -13 ... +176°F	-25 ... +80°C / -13 ... +176°F	-25 ... +80°C / -13 ... +176°F	-25 ... +80°C / -13 ... +176°F
Connector S12	Connector S12	Connector S12	Connector S12
IP 68 & IP 69 K	IP 68 & IP 69 K	IP 67	IP 67
51 g	120 g	51 g	120 g
RCS-1180-000*	RCS-1300-000*	RCS-1181-000*	RCS-1301-000*

* Coupling heads must not be connected to the power supply, nor to an interface device!

Inductive

Photoelectric

Safety

RFID

Connectivity

Accessories

Glossary

Index



ACCESSORIES

AT A GLANCE

- Metal threaded cylindrical housings
- Sensing face of PBTP (polybutylene terephthalate)
- Insensitive to dirt
- Passive (without power supply)

An RFID coupler consists of two coupling heads linked by a cable. It is passive and enables data to be transferred between the Read/Write Module and the transponder, acting as a contact-free extension for data transfer.

A coupler is used whenever a double mechanical interface is required.

HOUSING SIZE

DATA

- Housing material
- Sensing face material
- Mounting
- Ambient temperature range
- Storage temperature range
- Connection type
- Degree of protection
- Weight (with nuts)
- Part reference

ACCESSORIES

RFID COUPLERS

M18

COUPLING HEAD

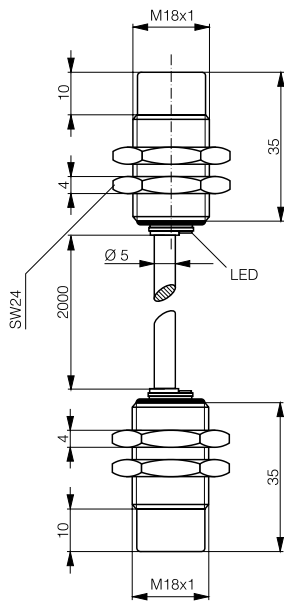

Inductive

Photoelectric

Safety

RFID

Connectivity

Accessories

Glossary

Index

Chrome-plated brass

PBTP

Non-embeddable

-25 ... +80°C / -13 ... +176°F

-25 ... +80°C / -13 ... +176°F

PVC cable

IP 67

80 g

RCK-1181-020



ACCESSORIES

CABLES

CABLES FOR RFID COUPLERS LF

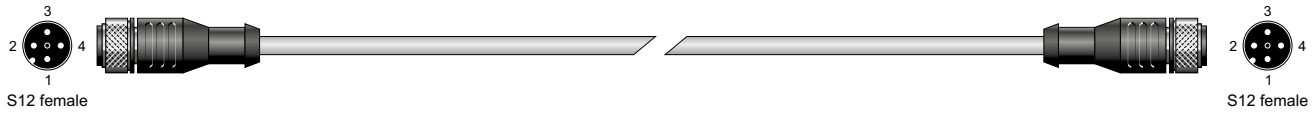

PART REFERENCE	TYPE	CABLE	LENGTH
S12-4FUG-010-NNRN-12FG	Socket straight / socket straight	PUR	1 m
S12-4FUG-020-NNRN-12FG	Socket straight / socket straight	PUR	2 m
S12-4FUG-050-NNRN-12FG	Socket straight / socket straight	PUR	5 m

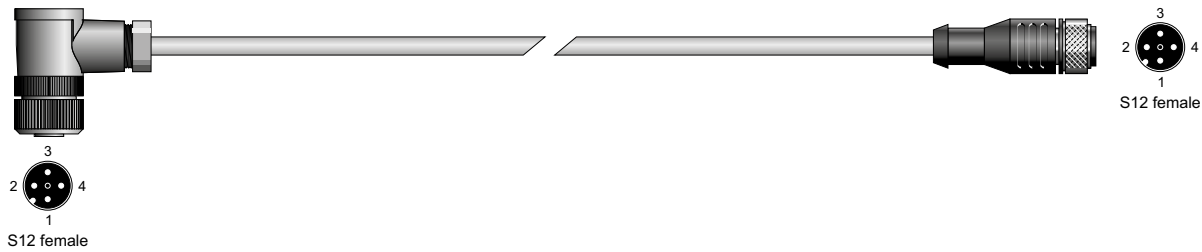

PART REFERENCE	TYPE	CABLE	LENGTH
S12-4FUW-010-NNRN-12FG	Socket right angle / socket straight	PUR	1 m
S12-4FUW-020-NNRN-12FG	Socket right angle / socket straight	PUR	2 m
S12-4FUW-050-NNRN-12FG	Socket right angle / socket straight	PUR	5 m

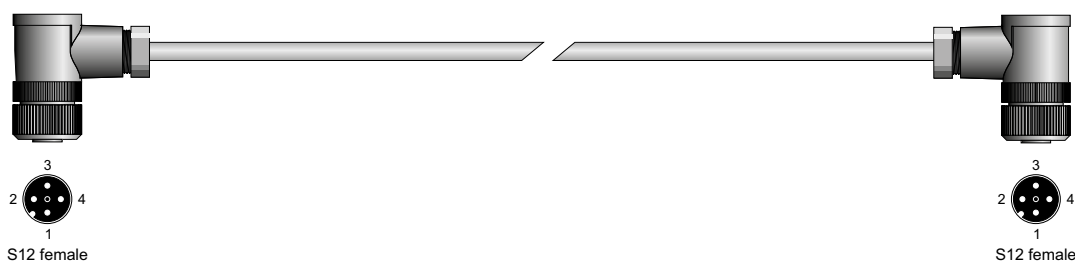

PART REFERENCE	TYPE	CABLE	LENGTH
S12-4FUW-010-NNRN-12FW	Socket right angle / socket right angle	PUR	1 m
S12-4FUW-020-NNRN-12FW	Socket right angle / socket right angle	PUR	2 m
S12-4FUW-050-NNRN-12FW	Socket right angle / socket right angle	PUR	5 m

CABLES

STANDARD CABLES



PART REFERENCE	TYPE	CABLE	LENGTH
S12-4FVG-006-12MG	Socket straight / plug straight	PVC	0.6 m
S12-4FVG-020-12MG	Socket straight / plug straight	PVC	2 m
S12-4FVG-050-12MG	Socket straight / plug straight	PVC	5 m
S12-4FUG-006-12MG	Socket straight / plug straight	PUR	0.6 m
S12-4FUG-020-12MG	Socket straight / plug straight	PUR	2 m
S12-4FUG-050-12MG	Socket straight / plug straight	PUR	5 m

QUICK-LOCK CABLES

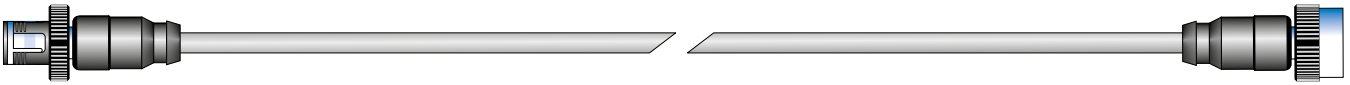

PART REFERENCE	TYPE	CABLE	LENGTH
S12-4FVG-003-NNNQ-12MG	Socket straight / plug straight	PVC	0.3 m
S12-4FVG-006-NNNQ-12MG	Socket straight / plug straight	PVC	0.6 m
S12-4FUG-003-NNNQ-12MG	Socket straight / plug straight	PUR	0.3 m
S12-4FUG-006-NNNQ-12MG	Socket straight / plug straight	PUR	0.6 m

Inductive

Photoelectric

Safety

RF-ID

Connectivity

Accessories

Glossary

Index

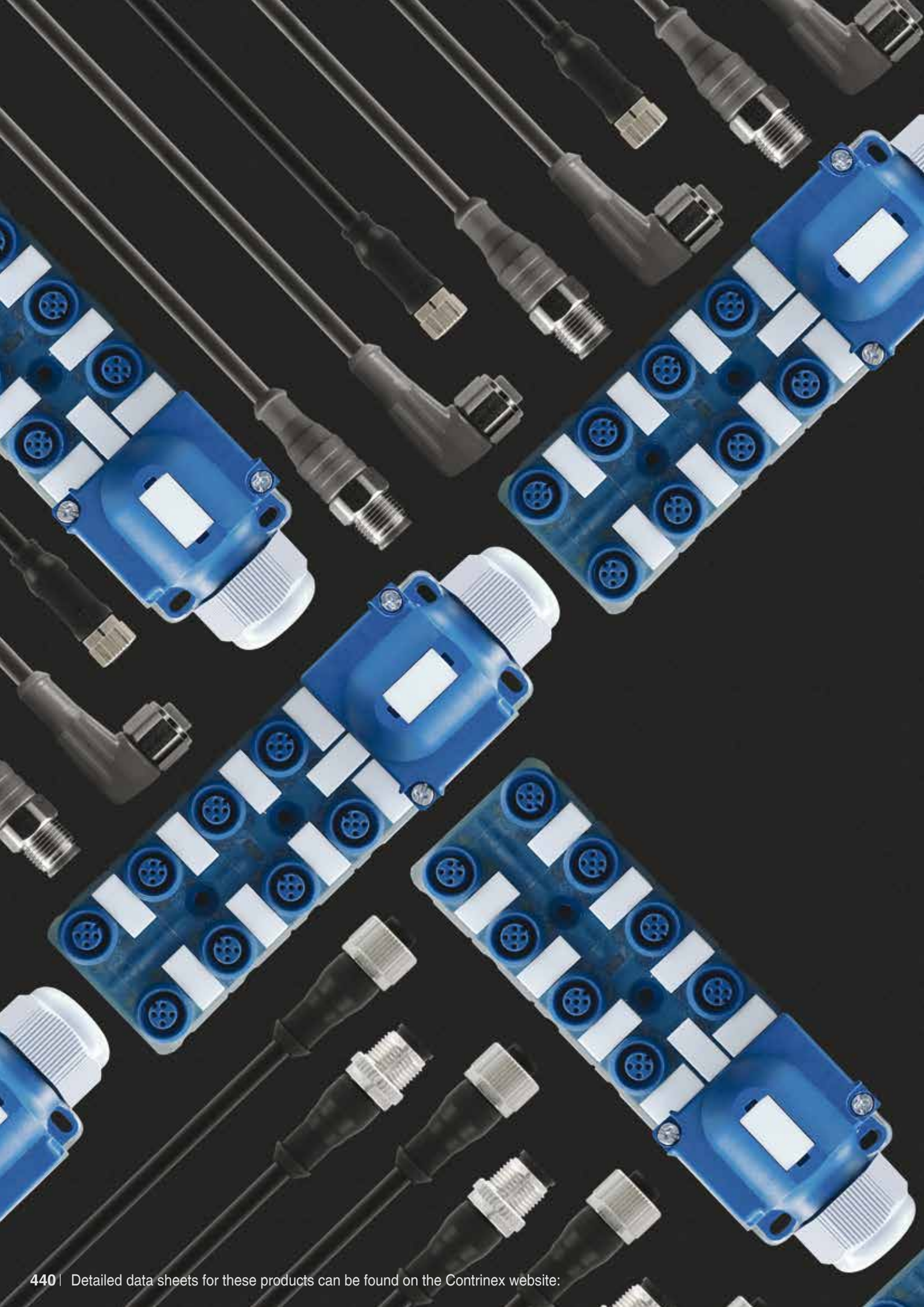











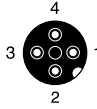

CONNECTIVITY

HIGHLIGHTS:

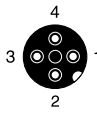
- ✓ Comprehensive cable and connector program
- ✓ IP 69K and Ecolab-tested cables for the food and beverage industry
- ✓ UL-approved cables and connectors
- ✓ Cables with straight or right-angle sockets
- ✓ Distribution boxes
- ✓ Field-attachable connectors
- ✓ T-connectors
- ✓ User-friendly standard portfolio

CABLES / CONNECTORS DESCRIPTION

SOCKET	TYPE	PIN ASSIGNMENT	TYPE
	M8 straight socket		M12 4-pole socket
	M12 straight socket		M8 3-pole socket
	M8 right angle socket		M8 4-pole socket
	M12 right angle socket		M12 4-pole socket
PLUG	TYPE	PIN ASSIGNMENT	TYPE
	M8 straight plug		M8 3-pole plug
	M12 straight plug		M12 3-pole dual key plug (S13)



example

CONNECTING CABLES PVC WITH OPEN ENDED WIRES

PART REFERENCE	SOCKET			CABLE	
	Size	Pins	Config.	Material	Length
S08-3FVG-020	M8	3-pole	straight	PVC	2 m
S08-3FVG-050	M8	3-pole	straight	PVC	5 m
S08-3FVG-100	M8	3-pole	straight	PVC	10 m
S08-3FVW-020	M8	3-pole	right angle	PVC	2 m
S08-3FVW-050	M8	3-pole	right angle	PVC	5 m
S08-3FVW-100	M8	3-pole	right angle	PVC	10 m
S08-4FVG-020	M8	4-pole	straight	PVC	2 m
S08-4FVG-050	M8	4-pole	straight	PVC	5 m
S08-4FVG-100	M8	4-pole	straight	PVC	10 m
S08-4FVW-020	M8	4-pole	right angle	PVC	2 m
S08-4FVW-050	M8	4-pole	right angle	PVC	5 m
S08-4FVW-100	M8	4-pole	right angle	PVC	10 m
S12-3FVG-020	M12	3-pole	straight	PVC	2 m
S12-3FVG-050	M12	3-pole	straight	PVC	5 m
S12-3FVG-100	M12	3-pole	straight	PVC	10 m
S12-3FVW-020	M12	3-pole	right angle	PVC	2 m
S12-3FVW-050	M12	3-pole	right angle	PVC	5 m
S12-3FVW-100	M12	3-pole	right angle	PVC	10 m
S12-4FVG-020	M12	4-pole	straight	PVC	2 m
S12-4FVG-050	M12	4-pole	straight	PVC	5 m
S12-4FVG-100	M12	4-pole	straight	PVC	10 m
S12-4FVW-020	M12	4-pole	right angle	PVC	2 m
S12-4FVW-050	M12	4-pole	right angle	PVC	5 m
S12-4FVW-100	M12	4-pole	right angle	PVC	10 m
S12-5FVG-020	M12	5-pole	straight	PVC	2 m
S12-5FVG-050	M12	5-pole	straight	PVC	5 m
S12-5FVG-100	M12	5-pole	straight	PVC	10 m
S12-5FVG-150	M12	5-pole	straight	PVC	15 m
S12-5FVG-250	M12	5-pole	straight	PVC	25 m
S12-5FVW-020	M12	5-pole	right angle	PVC	2 m
S12-5FVW-050	M12	5-pole	right angle	PVC	5 m
S12-5FVW-100	M12	5-pole	right angle	PVC	10 m

Inductive

Photoelectric

Safety

RFID

Connectivity

Accessories

Glossary

Index



CONNECTING CABLES PUR WITH OPEN ENDED WIRES

PART REFERENCE	SOCKET			CABLE	
	Size	Pins	Config.	Material	Length
S08-3FUG-020	M8	3-pole	straight	PUR	2 m
S08-3FUG-050	M8	3-pole	straight	PUR	5 m
S08-3FUG-100	M8	3-pole	straight	PUR	10 m
S08-3FUW-020	M8	3-pole	right angle	PUR	2 m
S08-3FUW-050	M8	3-pole	right angle	PUR	5 m
S08-3FUW-100	M8	3-pole	right angle	PUR	10 m
S08-4FUG-020	M8	4-pole	straight	PUR	2 m
S08-4FUG-050	M8	4-pole	straight	PUR	5 m
S08-4FUG-100	M8	4-pole	straight	PUR	10 m
S08-4FUW-020	M8	4-pole	right angle	PUR	2 m
S08-4FUW-050	M8	4-pole	right angle	PUR	5 m
S08-4FUW-100	M8	4-pole	right angle	PUR	10 m
S12-3FUG-020	M12	3-pole	straight	PUR	2 m
S12-3FUG-050	M12	3-pole	straight	PUR	5 m
S12-3FUG-100	M12	3-pole	straight	PUR	10 m
S12-3FUW-020	M12	3-pole	right angle	PUR	2 m
S12-3FUW-050	M12	3-pole	right angle	PUR	5 m
S12-3FUW-100	M12	3-pole	right angle	PUR	10 m
S12-4FUG-020	M12	4-pole	straight	PUR	2 m
S12-4FUG-050	M12	4-pole	straight	PUR	5 m
S12-4FUG-100	M12	4-pole	straight	PUR	10 m
S12-4FUG-150	M12	4-pole	straight	PUR	15 m
S12-4FUG-200	M12	4-pole	straight	PUR	20 m
S12-4FUG-250	M12	4-pole	straight	PUR	25 m
S12-4FUW-020	M12	4-pole	right angle	PUR	2 m
S12-4FUW-050	M12	4-pole	right angle	PUR	5 m
S12-4FUW-100	M12	4-pole	right angle	PUR	10 m
S12-4FUW-150	M12	4-pole	right angle	PUR	15 m
S12-4FUW-200	M12	4-pole	right angle	PUR	20 m
S12-4FUW-250	M12	4-pole	right angle	PUR	25 m
S12-5FUG-020	M12	5-pole	straight	PUR	2 m
S12-5FUG-050	M12	5-pole	straight	PUR	5 m
S12-5FUG-100	M12	5-pole	straight	PUR	10 m
S12-5FUG-150	M12	5-pole	straight	PUR	15 m
S12-5FUG-250	M12	5-pole	straight	PUR	25 m
S12-5FUG-150-NWSN	M12	5-pole	straight	PUR/shielded	15 m
S12-5FUG-250-NWSN	M12	5-pole	straight	PUR/shielded	25 m

PART REFERENCE	SOCKET			CABLE	
	Size	Pins	Config.	Material	Length
S12-8FUG-020	M12	8-pole	straight	PUR	2 m
S12-8FUG-050	M12	8-pole	straight	PUR	5 m
S12-8FUG-100	M12	8-pole	straight	PUR	10 m
S12-8FUG-020-NWSN	M12	8-pole	straight	PUR/shielded	2 m
S12-8FUG-050-NWSN	M12	8-pole	straight	PUR/shielded	5 m
S12-8FUG-100-NWSN	M12	8-pole	straight	PUR/shielded	10 m
S12-8FUG-150-NWSN	M12	8-pole	straight	PUR/shielded	15 m



CONNECTING CABLES PVC/TPE WITH OPEN ENDED WIRES FOR FOOD APPLICATIONS IP 69K

PART REFERENCE	SOCKET			CABLE	
	Size	Pins	Config.	Material	Length
S08-3FVG-020-NNLN	M8	3	straight	PVC	2 m
S08-3FVW-020-NNLN	M8	3	right angle	PVC	2 m
S12-4FAG-050-NNLN	M12	4	straight	TPE-S	5 m
S12-4FAG-100-NNLN	M12	4	straight	TPE-S	10 m
S12-4FAW-250-NNLN	M12	4	right angle	TPE-S	25 m
S12-4FVG-020-NNLN	M12	4	straight	PVC	2 m
S12-4FVG-050-NNLN	M12	4	straight	PVC	5 m
S12-4FVG-100-NNLN	M12	4	straight	PVC	10 m
S12-4FVW-020-NNLN	M12	4	right angle	PVC	2 m
S12-4FVW-100-NNLN	M12	4	right angle	PVC	10 m
S12-5FVG-020-NNLN	M12	5	straight	PVC	2 m
S12-5FVG-100-NNLN	M12	5	straight	PVC	10 m



example

CONNECTING CABLES PUR WITH OPEN ENDED WIRES FOR AC SENSORS (230 V MAX)

PART REFERENCE	SOCKET			CABLE	
	Size	Pins	Config.	Material	Length
S13-3FUG-020	UNF 1/2"	3	straight	PUR	2 m
S13-3FUG-050	UNF 1/2"	3	straight	PUR	5 m
S13-3FUW-020	UNF 1/2"	3	right angle	PUR	2 m
S13-3FUW-050	UNF 1/2"	3	right angle	PUR	5 m



example

CONNECTING CABLES PVC

PART REFERENCE	SOCKET			CABLE		PLUG	
	Size	Pins	Config.	Material	Length	Size	Config.
S08-3FVG-006-08MG	M8	3	straight	PVC	0.6 m	M8	straight
S08-3FVG-020-08MG	M8	3	straight	PVC	2 m	M8	straight
S08-3FVG-050-08MG	M8	3	straight	PVC	5 m	M8	straight
S12-4FVG-006-12MG	M12	4	straight	PVC	0.6 m	M12	straight
S12-4FVG-020-12MG	M12	4	straight	PVC	2 m	M12	straight
S12-4FVG-050-12MG	M12	4	straight	PVC	5 m	M12	straight



example

CONNECTING CABLES PUR

PART REFERENCE	SOCKET			CABLE		PLUG	
	Size	Pins	Config.	Material	Length	Size	Config.
S08-3FUG-006-08MG	M8	3	straight	PUR	0.6 m	M8	straight
S08-3FUG-020-08MG	M8	3	straight	PUR	2 m	M8	straight
S08-3FUG-050-08MG	M8	3	straight	PUR	5 m	M8	straight
S12-4FUG-006-12MG	M12	4	straight	PUR	0.6 m	M12	straight
S12-4FUG-020-12MG	M12	4	straight	PUR	2 m	M12	straight
S12-4FUG-050-12MG	M12	4	straight	PUR	5 m	M12	straight



example

CONNECTING CABLES PVC FOR FOOD APPLICATIONS

PART REFERENCE	SOCKET			CABLE		PLUG	
	Size	Pins	Config.	Material	Length	Size	Config.
S12-4FAG-020-NNLN-12MG	M12	4	straight	TPE-S	2 m	M12	straight
S12-4FAG-100-NNLN-12MG	M12	4	straight	TPE-S	10 m	M12	straight
S12-4FVG-020-NNLN-12MG	M12	4	straight	PVC	2 m	M12	straight
S12-4FVG-050-NNLN-12MG	M12	4	straight	PVC	5 m	M12	straight
S12-4FVG-100-NNLN-12MG	M12	4	straight	PVC	10 m	M12	straight



example

CONNECTING CABLES M8/M12

PART REFERENCE	SOCKET			CABLE		PLUG	
	Size	Pins	Config.	Material	Length	Size	Config.
S08-3FUG-020-12MG	M8	3	straight	PUR	2 m	M12	straight
S08-4FUG-006-12MG	M8	4	straight	PUR	0.6 m	M12	straight
S08-3FVG-020-12MG	M8	3	straight	PVC	2 m	M12	straight
S08-4FVG-020-12MG	M8	4	straight	PVC	2 m	M12	straight



example

T-CONNECTOR

PART REFERENCE	CONNECTION 1		CABLE		CONNECTION 2	CONNECTION 3
	Size	Pins	Material	Length	Size	Size
V12-4TPD-000-NN1	M12 plug	4	-	No cable	M12 socket	M12 plug
V12-4TPD-000-NNN	M12 plug	4	-	No cable	M12 socket	M12 plug
V12-5TPD-000-NN1	M12 plug	5	-	No cable	M12 socket	M12 plug
V12-8TPD-000-NN2	M12 plug	8	-	No cable	M12 socket	M12 plug
V12-8TPD-000-NN3	M12 plug	8	-	No cable	M12 socket	M12 plug



example

DISTRIBUTION BOXES

PART REFERENCE	SOCKET			CONNECTION
	Size	Pins	Number of connections	Type
V08-30PE-000-NNN	M8	3	Universal - Hood	No cable
V08-31PD-050-UYN	M8	3	10 Plug Distribution box	PUR cable 5 m
V08-31PH-050-UNN	M8	3	10 Outputs - Hood	PUR cable 5 m
V08-34PB-000-NYN	M8	3	4 Plug Distribution box	No cable (hood needed)
V08-34PD-050-UYN	M8	3	4 Plug Distribution box	PUR cable 5 m
V08-38PB-000-NYN	M8	3	8 Plug Distribution box	No cable (hood needed)
V08-38PD-050-UYN	M8	3	8 Plug Distribution box	PUR cable 5 m
V08-38PH-050-UNN	M8	3	8 Outputs - Hood	PUR cable 5 m
V12-50PE-000-NNN	M12	5	Universal - Hood	No cable
V12-54MG-023-NYN	M12	5	4 Plug Distribution box	Connector M23
V12-54PB-000-NYN	M12	5	4 Plug Distribution box	No cable (hood needed)
V12-54PD-020-UYN	M12	5	4 Plug Distribution box	PUR cable 2 m
V12-54PD-050-UYN	M12	5	4 Plug Distribution box	PUR cable 5 m
V12-54PD-100-UYN	M12	5	4 Plug Distribution box	PUR cable 10 m
V12-54PY-050-UYN	M12	5	4 Plug Distribution box + Hood	PUR cable 5 m
V12-58MD-050-UYN	M12	5	8 Plug Metal Distribution box	PUR cable 5 m
V12-58MD-100-UYN	M12	5	8 Plug Metal Distribution box	PUR cable 10 m
V12-58MG-023-NYN	M12	5	8 Plug Metal Distribution box	Connector M23
V12-58PB-000-NYN	M12	5	8 Plug Distribution box	No cable (hood needed)
V12-58PD-020-UYN	M12	5	8 Plug Distribution box	PUR cable 2 m
V12-58PD-050-UYN	M12	5	8 Plug Distribution box	PUR cable 5 m
V12-58PD-100-UYN	M12	5	8 Plug Distribution box	PUR cable 10 m
V12-58PY-020-UYN	M12	5	8 Plug Distribution box + Hood	PUR cable 2 m
V12-58PY-050-UYN	M12	5	8 Plug Distribution box + Hood	PUR cable 5 m



example

FIELD ATTACHABLE CONNECTORS

PART REFERENCE	SOCKET			CABLE	
	Size	Pins	Config.	Outer Ø	Wire Ø
S08-3FNG-000-NNT1	M8	3	straight	3.0 - 5.0	0.08 - 0.38
S08-3FNG-000-NNT2	M8	3	straight	4.0 - 8.0	0.14 - 0.50
S08-3MNG-000-NNT1	M8	3	straight	3.0 - 5.0	0.08 - 0.38
S08-3MNG-000-NNT2	M8	3	straight	4.0 - 8.0	0.14 - 0.50
S12-3FNG-000-NNT1	M12	3	straight	3.0 - 5.0	0.08 - 0.38
S12-3MNG-000-NNT1	M12	3	straight	3.0 - 5.0	0.08 - 0.38
S12-4FNG-000-NNT1	M12	4	straight	3.0 - 5.0	0.08 - 0.38
S12-4FNG-000-NNT2	M12	4	straight	4.0 - 8.0	0.14 - 0.50
S12-4FNG-000-NNT3	M12	4	straight	5.5 - 8.0	0.50 - 1.00
S12-4FNW-000-NNT1	M12	4	right angle	3.0 - 5.0	0.08 - 0.38
S12-4MNG-000-NNT1	M12	4	straight	3.0 - 5.0	0.08 - 0.38
S12-4MNG-000-NNT2	M12	4	straight	4.0 - 8.0	0.14 - 0.50
S12-4MNG-000-NNT3	M12	4	straight	5.5 - 8.0	0.50 - 1.00
S12-4MNW-000-NNT1	M12	4	right angle	3.0 - 5.0	0.08 - 0.38

CABLES WITH INTEGRATED LED

PART REFERENCE	SOCKET			CABLE		
	Size	Pins	Config.	Material	Length	LED
S08-3FUW-020-YNNN	M8	3	right angle	PUR	2 m	PNP
S08-3FUW-050-YNNN	M8	3	right angle	PUR	5 m	PNP
S12-3FUW-020-YNNN	M12	3	right angle	PUR	2 m	PNP
S12-3FUW-050-YNNN	M12	3	right angle	PUR	5 m	PNP
S12-3FUW-100-YNNN	M12	3	right angle	PUR	10 m	PNP
S12-3FVW-050-YNNN	M12	3	right angle	PVC	5 m	PNP

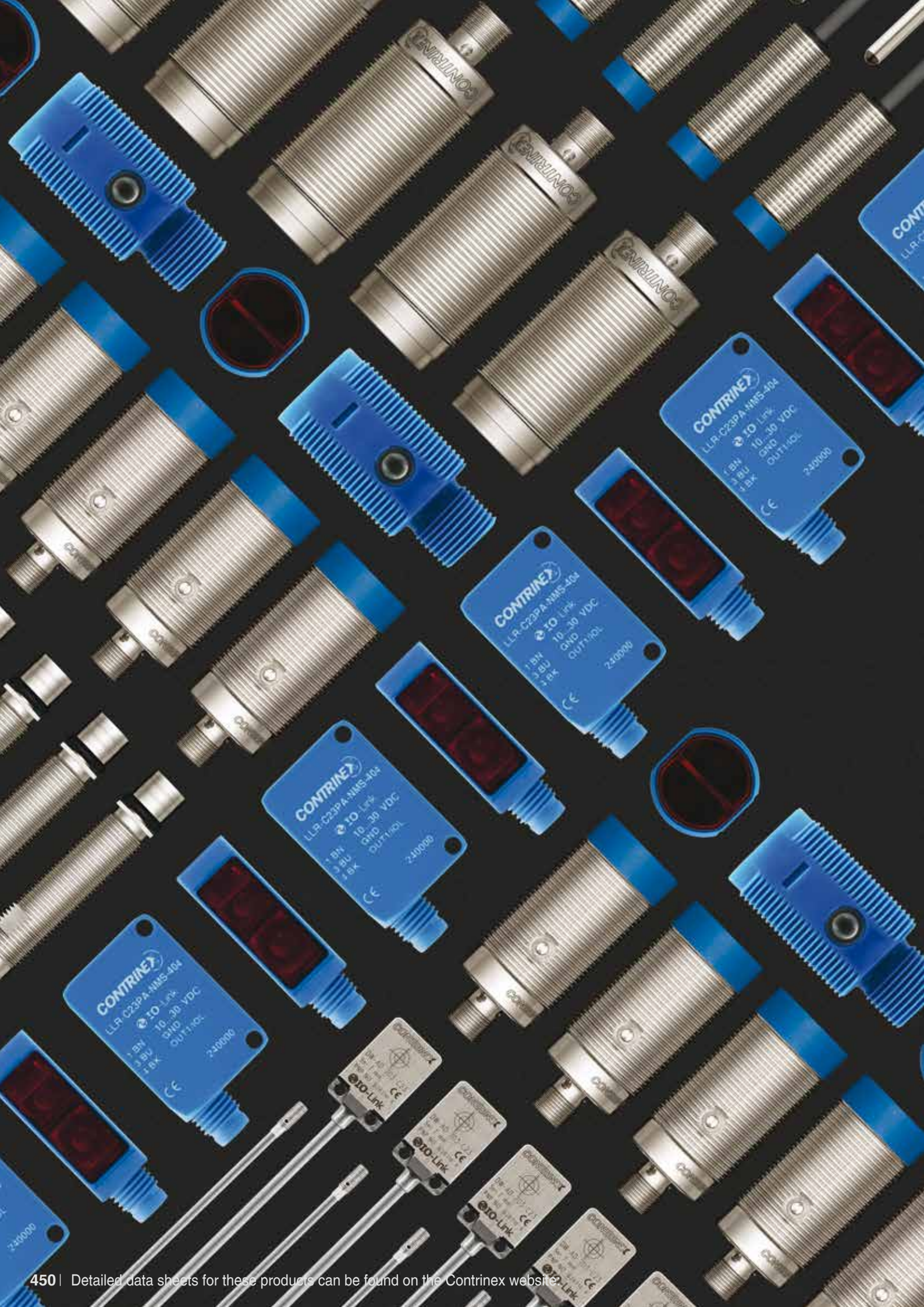



ACCESSORIES

HIGHLIGHTS:

- ✓ Sensor testers for fast field checks
- ✓ Sensor mounting clamps
- ✓ Bases for mounting clamps
- ✓ Mechanical stops
- ✓ Amplifiers for 3-wire and NAMUR sensors



ACCESSORIES

SENSOR MOUNTING CLAMPS

Ø3, Ø4, Ø5, Ø6.5, Ø8

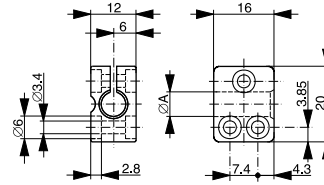

TECHNICAL DATA

Part reference	Type	A			
ASU-0001-030	without limit stop	Ø 3 mm			
ASU-0001-040	without limit stop	Ø 4 mm			
ASU-0001-050	without limit stop	Ø 5 mm			
ASU-0001-065	without limit stop	Ø 6.5 mm			
ASU-0001-080	without limit stop	Ø 8 mm			
ASU-0002-080	with limit stop	Ø 8 mm			

Material: PA 6 black

Screw: DIN 912, M3 zinc-plated

Nut: DIN 934, M3 zinc-plated

Ø12, Ø18

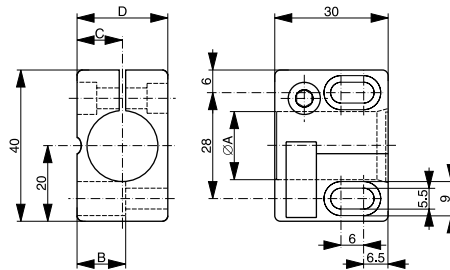

TECHNICAL DATA

Part reference	Type	A	B	C	D
ASU-0001-120	without limit stop	Ø 12 mm	9.75 mm	9 mm	18 mm
ASU-0002-120	with limit stop	Ø 12 mm	9.75 mm	9 mm	18 mm
ASU-0001-180	without limit stop	Ø 18 mm	12.85 mm	12 mm	24 mm
ASU-0002-180	with limit stop	Ø 18 mm	12.85 mm	12 mm	24 mm

Material: PA 6 GK (Ø 18 mm), PA 6 (Ø 12 mm) black

Screw: DIN 912, M5 zinc-plated

Nut: DIN 934, M5 zinc-plated

Ø30

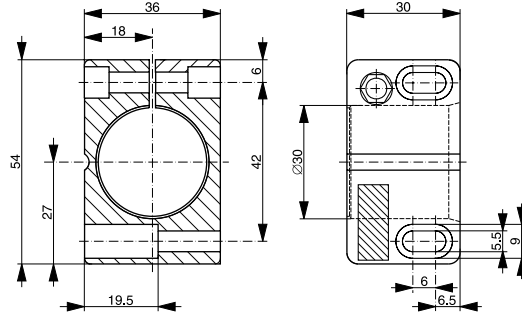

TECHNICAL DATA

Part reference	Type				
ASU-0001-300	without limit stop	Ø 30 mm			
ASU-0002-300	with limit stop	Ø 30 mm			

Material: PA 6 GK black

Screw: DIN 912, M5 x 25 zinc-plated

Nut: DIN 934, M5 zinc-plated

BASES FOR MOUNTING CLAMPS Ø12, Ø18

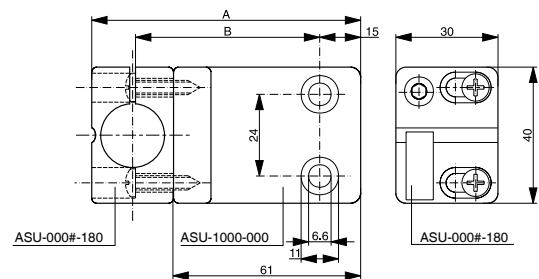

TECHNICAL DATA

Part reference	Type	A with Ø 12 mm / Ø 18 mm	B with Ø 12 mm / Ø 18 mm
ASU-1000-000	horizontal	79 mm / 85 mm	55 mm / 58 mm

Material: PA 6 black

Screws: DIN 7981, Ø 4.2 zinc-plated

ACCESSORIES

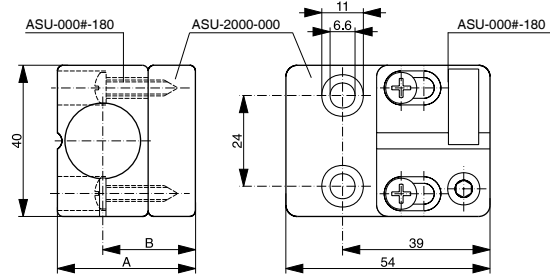

TECHNICAL DATA

Part reference	Type	A with \varnothing 12 mm / \varnothing 18 mm	B with \varnothing 12 mm / \varnothing 18 mm
ASU-2000-000	vertical	30.5 mm / 36.5 mm	21.5 mm / 24.5 mm

Material: PA 6 black

Screws: DIN 7981, \varnothing 4.2 zinc-plated

MECHANICAL STOPS

FOR M5 AND M8 INDUCTIVE SENSORS

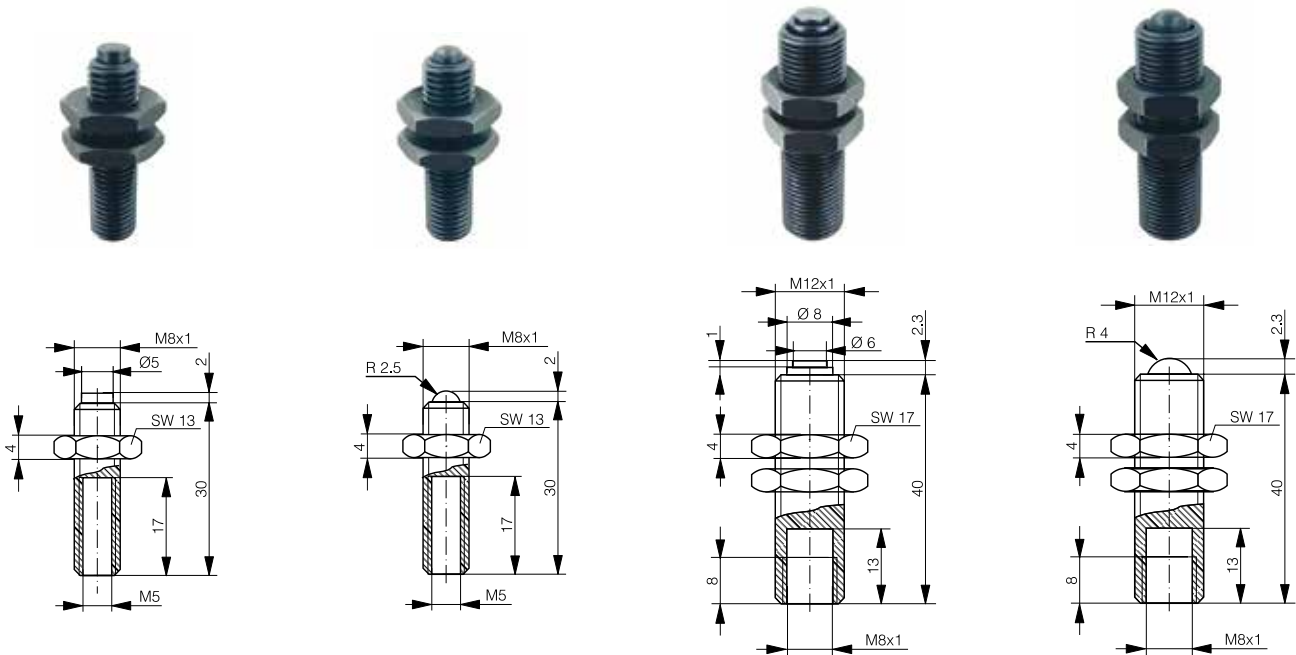

TECHNICAL DATA

Part reference	Inner diameter	Outer diameter	Plunger type	Max. force on housing	Max. force on plunger
AMS-0001-M08	M5 x 0.5	M8 x 1	Flat ¹⁾	8000 N	2000 N
AMS-0002-M08	M5 x 0.5	M8 x 1	Spherical ²⁾	8000 N	2000 N
AMS-0001-M12	M8 x 1	M12 x 1	Flat ¹⁾	15,000 N	2000 N
AMS-0002-M12	M8 x 1	M12 x 1	Spherical ²⁾	15,000 N	2000 N

Material: Steel XC 48, black

Max. tightening torque: 30 Nm (M08), 50 Nm (M12)

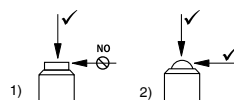

AMPLIFIERS

These devices are built into user-friendly clamping frames that can be snapped onto various standard rails, thanks to their universal foot.

Dimensions (all types):

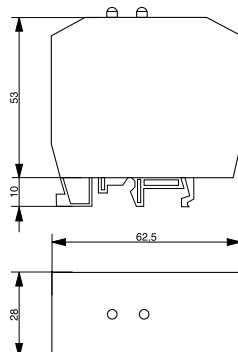

AMPLIFIERS FOR 3-WIRE SENSORS

DW-AZ-100-A3

These devices are suitable for NPN and PNP N.O. sensors. Operating the switch activates the relay, and the contact closes. A wire bridge between B and D inverts this function.

TECHNICAL DATA	
Supply voltage	220 VAC
Power drain	0.5 VA
Output voltage	18.5 VDC
Output current	20 mA max.

Wiring diagram:

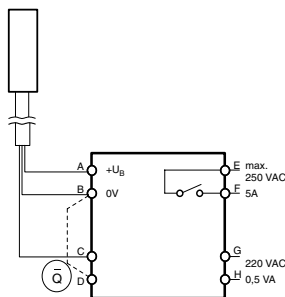

AMPLIFIERS FOR NAMUR SENSORS

DW-AZ-100-AN

These devices are suitable for NAMUR sensors. Operating the switch activates the relay, and the contact closes. A wire bridge between C and D inverts this function.

Output current and impedance correspond to NAMUR standard (DIN 19234).

TECHNICAL DATA

Supply voltage	220 VAC
Power drain	0.5 VA

Wiring diagram:

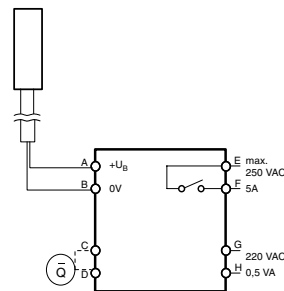

SENSOR TESTER

ATE-0000-010

For fast field checks of various sensor types (inductive, capacitive, photoelectric and ultrasonic) 10 ... 30 V.

- Suitable for PNP and NPN devices, NO, NC or push-pull versions
- LED and acoustic indicators
- Built-in steel target (non-standardized) for checking inductive sensors
- Automatic switch off after approx. 120 sec. of non-use
- Up to 100 mA sensor current
- Rechargeable LiPo battery 9V 600mAh (included)
- Battery life longer than 2 hours at 50 mA current supply
- Micro-USB interface to recharge battery with universal mobile phone charger



DW-AZ-100-DN

These devices are suitable for NAMUR sensors. Operating the switch activates the relay, and the contact closes. A wire bridge between C and D inverts this function.

Output current and impedance correspond to NAMUR standard (DIN 19234).

TECHNICAL DATA

Supply voltage	24 VDC
No-load supply current	20 mA max.

Wiring diagram:

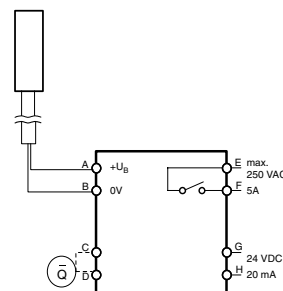

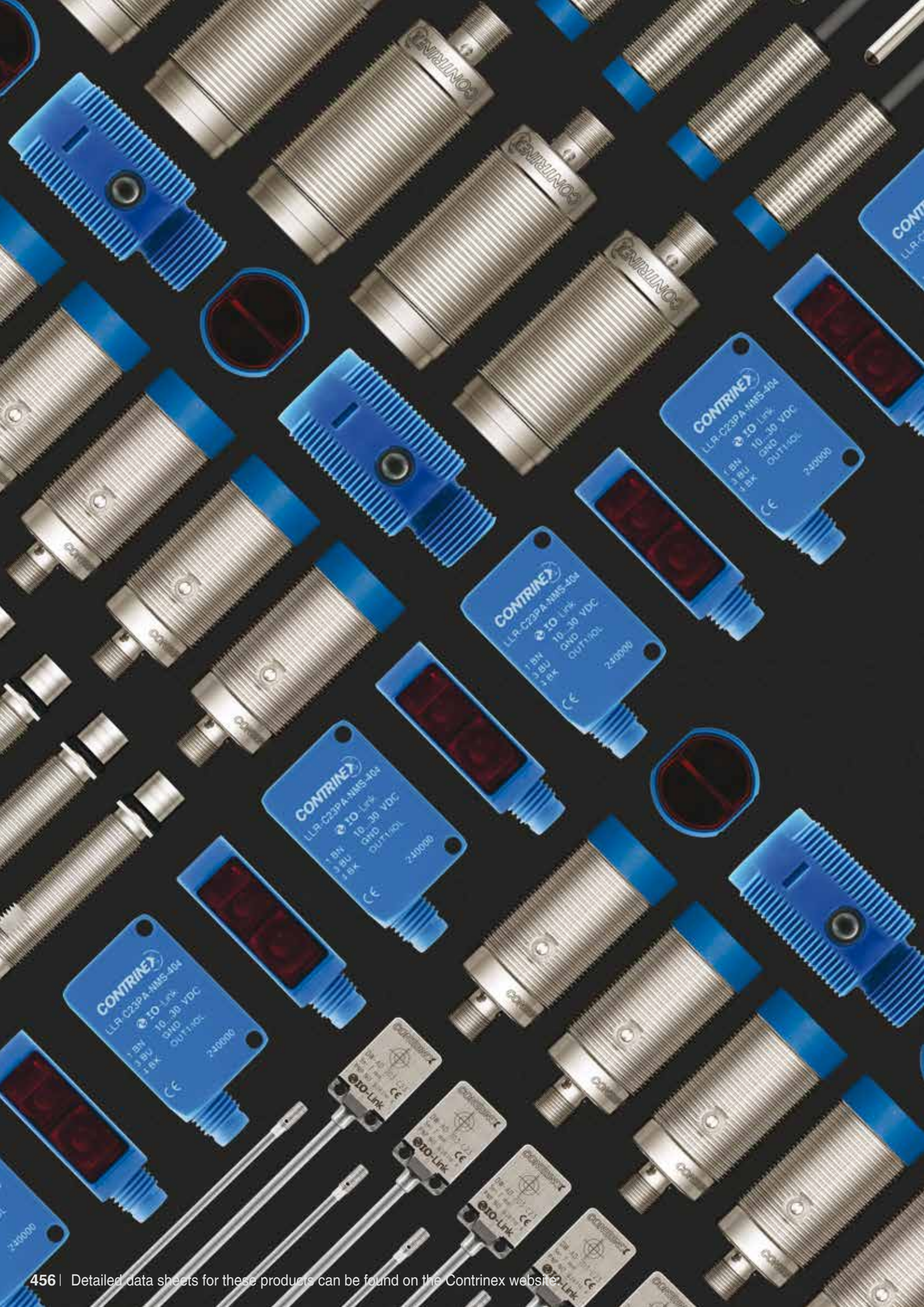



GLOSSARY

HIGHLIGHTS:

- ✓ Clearance
- ✓ Connectors
- ✓ Correction factors
- ✓ Degrees of protection
- ✓ EMC
- ✓ Excess gain
- ✓ Hysteresis
- ✓ Mounting
- ✓ Oil resistance
- ✓ Operating distance
- ✓ Parallel connection
- ✓ Switching frequency
- ✓ Tightening torque
- ✓ Turn-on/turn-off time



 **INDUCTIVE SENSORS**

 **PHOTOELECTRIC SENSORS**

A

ADJUSTMENT (POTENTIOMETER)



The sensitivity is adjusted by means of the built-in single or multi-turn potentiometer (if provided). Turning it clockwise increases the sensitivity. Multi-turn potentiometers cannot be turned over their end position (no stops).

THROUGH-BEAM SENSORS / REFLEX SENSORS

The potentiometer is normally set to the maximum sensitivity (turned clockwise). This provides the maximum system reserve (excess-gain) signal.

DIFFUSE SENSORS

Set the sensitivity so that the target is reliably detected; for reliable operation, the green LED should light up, or the yellow LED should not flash (series 1040/1050/0507). On removing the object, if the output remains ON (detection of the background), the sensitivity must be reduced slightly.

DIFFUSE SENSORS WITH BACKGROUND SUPPRESSION

The setup must ensure that the target is clearly identified, and any background excluded. The target should first be positioned at the maximum foreseen distance from the emitter, and the potentiometer adjusted so that the output just switches. The target is then removed and the potentiometer adjusted so that the background just causes the output to switch. Finally, the potentiometer is set to half way between the two previous readings. Where there is no background, the potentiometer should be set to the maximum distance.

ALIGNMENT



THROUGH-BEAM SENSORS

First place the receiver and fix it in its final position. Then align the emitter accurately onto the receiver.

REFLEX SENSORS

First place the reflector as required and fix it firmly in position. Fit the reflex sensor with the optical axis aligned on the reflector so that it switches reliably. Test with target. Reduce sensitivity if necessary.

DIFFUSE SENSORS

Align the unit's optical axis with the target so that switching occurs reliably. Check that enough system reserves (excess gain) are available, i.e. the green LED must light up (series 1120, 1180, 1180W, 3030, 3031, 3060, 4040, 4050 and C23). Finally, fix the device firmly.

DIFFUSE SENSORS WITH BACKGROUND SUPPRESSION

Line up the beam on the center of the target, before fixing the device firmly.

AMBIENT LIGHT LIMIT



Ambient light is that which is produced by external light sources. The illumination intensity is measured on the light incidence surface. The sensors are basically insensitive to ambient light due to the use of modulated light. There is nevertheless an upper limit for the intensity of any external light and this is referred to as the ambient light limit. It is given for sunlight (unmodulated light) and halogen lamps (light modulated at twice the mains frequency). Reliable operation of the units is no longer possible at light intensities above the relevant ambient light limit.

AMBIENT TEMPERATURE



The specified ambient temperature range **must not be exceeded** in order to avoid damaging the sensor and rendering its performance unreliable.

ANALOG OUTPUT



Devices with analog output deliver an analog output signal approximately proportional to the target distance. For most models, voltage and current outputs are available **simultaneously**.

AUTOCOLLIMATION



Photoelectric sensors using the autocollimation principle are characterized by the fact that the optical axes of the emitting and receiving channels are identical. This is possible with light from one of the channels being deflected by means of a semi-transparent mirror (Fig. 13). This principle completely eliminates the interfering blind zone often found in the proximity of the sensor, which is of special advantage when using reflex sensors.

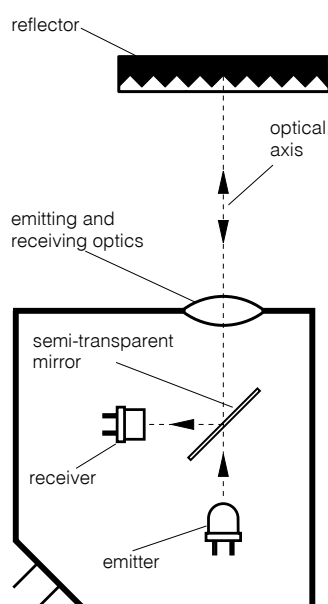

Fig. 13

B

BACKGROUND SUPPRESSION



The light pulse from the emitting diode leaves the optical system as a focused, almost parallel, light beam. On meeting an object in its path, part of the beam is diffusely reflected, and in turn, part of this reflected light falls on the PSD (**P**osition-**S**ensitive **D**evice) housed in the same sensor (Fig. 14).

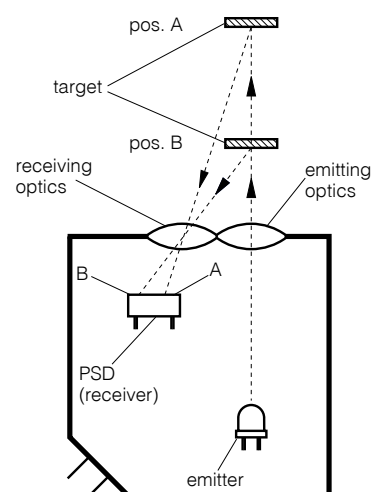

Fig. 14

Depending on the distance of the target from the device, the light falls on a particular spot of the PSD, and a corresponding reception signal is emitted, indicating that an object is present at a certain distance from the device. The analyzing circuit compares the signal received with the preset operating distance (adjusted by means of the built-in potentiometer), and, if the distance of the object is less than, or equal to, the preset operating distance, the output is switched. Contrary to an energetic diffuse sensor, the operating distance depends only to a very small extent on the target's size or color, or on the nature of its surface. The object can therefore be easily discerned, even against a light background.

C

CAPACITANCE



The maximum switchable capacitance is the greatest permissible total capacitance at the device's output so that **reliable switching** is still guaranteed. Contributing to this total capacitance in particular are the lead capacitance (approx. 100 ... 200 pF per m) and the load's input capacitance. The value is given in the individual data sheets. These can be found on the Contrinex website (www.contrinex.com), or ordered from our sales offices.

CE MARK



All sensors in this catalog meet the requirements of European standards EN 60947-1 and EN 60947-5-2, and therefore correspond to EMC directive 2004/108/EC, as well as low-voltage directive 2006/95/EC. Consequently, they are labeled with the CE mark.

CE

However, this mark is **neither a quality seal, nor an official test label** certified by any authority. By applying the CE mark, the manufacturer confirms (under his own responsibility) that the protective requirements for the product meet the applicable EU directives, and consequently that the corresponding EU standards have been complied with. The CE mark enables the free importation of goods into the EU, as well as their free circulation within the EU.

CHANGEOVER



Devices with changeover outputs provide one output for the light-ON or NO signal, and another for the dark-ON or NC signal. Both functions are available simultaneously for maximum connection flexibility to the control unit. Moreover, logical connections may be implemented without using series connection. Connecting both outputs to the control unit allows additional security monitoring.

CLASSICS FAMILY



The **Classics** family (600 series) is one of three inductive sensing technologies offered by Contrinex. **Classics** family sensors rely on conventional inductive oscillator and coil technology (see page 20).

Sensors are sized from Ø 3 up to M30 and C44 (40 mm x 40 mm). PNP, NPN and 2-wire AC/DC output configurations are available, combined with sensing distances between 0.6 mm and 40 mm.

The **Classics** technology family includes devices from the following ranges: **Basic, Miniature, 2-Wire, Extra Pressure, Extra Temperature, High Temperature** and **Washdown**.

CLEARANCE



Inductive sensors must not mutually influence each other. For this reason, a minimum distance **A** between devices of diameter **D** must be observed (Fig. 15).

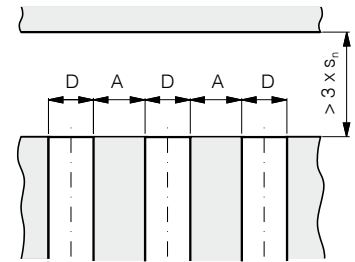

Fig. 15

EXTRA DISTANCE (SERIES 500, 520*)

Size D	(quasi)-embed. A (mm)	non-emb. A (mm)
Ø 4	6 (embeddable)	---
M5	5 (embeddable)	---
Ø 6.5	9.5	---
M8	8 / *16	20
C8	8	---
M12	18 / *34	30
M18	26	60
M30	50	120

CLASSICS (SERIES 600, 620*)

Size D	embeddable A (mm)	non-emb. A (mm)
Ø 3	0 / *2	---
M4	0 / *1	---
Ø 4	0 / *1	---
M5	0 / *1	---
C 5	0 / *1	---
Ø 6.5	3 / *3.5	--- / *15.5
M8	2 / *4	10 / *14
C8	2 / *2	---
M12	4 / *12	28 / *33
M18	7 / *22	32
M30	10	50
C44	35	120

DIFFUSE SENSORS (FIG. 16)

Series	distance a (mm)
Series 1040 / 50	50
Series 1040 / 50...505	15
Series 1040 / 50...506	30
Series 1120	150
Series 1180 / 1180W	500
Series 3030	500
Series 3031	250
Series 4050	150

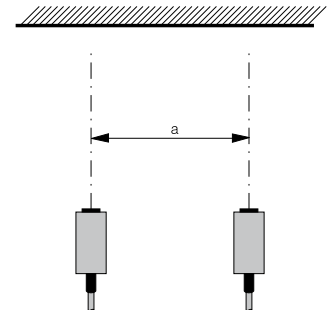

Fig. 16

FULL INOX (SERIES 700)

Size D	embeddable A (mm)	non-emb. A (mm)
M8	14	52
M12	38	108
M18	42	182
M30	80	270



Photoelectric sensors must not mutually influence each other. For this reason, a minimum distance “a” between them has to be respected, which depends strongly on the model used and the actual sensitivity setting. The following values should therefore be considered as rough guidelines only. The values given are for maximum sensitivity.

DIFFUSE SENSORS WITH BACKGROUND SUPPRESSION

Series	distance a (mm)
Series 1180 / 1180W	50
Series 3130	50
Series 3131	50
Series 4050	100

REFLEX SENSORS (FIG. 17)

Series	distance a (mm)
Series 1120	150
Series 1180 / 1180W	250
Series 3030	500
Series 3031	250
Series 4050	200

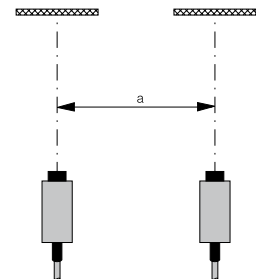

Fig. 17

THROUGH-BEAM SENSORS (FIG. 18)

Series	distance a (mm)
Series 1040 / 50	50
Series 1120	150
Series 1180 / 1180W	250
Series 3030	500
Series 3031	250
Series 4050	500

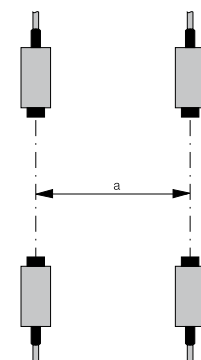

Fig. 18

FIBER-OPTIC AMPLIFIERS

The value “a” depends strongly on the specific type of fiber used. General recommendations are therefore not possible.

CONDET® TECHNOLOGY



An innovative technology for producing inductive sensors. Contrary to conventional technology, in which a high-frequency magnetic field is generated in front of the sensing face, here the coil is triggered by an alternating polarity **pulsed current**. This technology is used in the Full Inox family (700 series) (see also page 21). It permits:

- generally long operating distances
- long operating distances also on non-ferrous metals, such as aluminum, brass, copper, etc.
- **one-piece** stainless steel housing (sensing face included)

CONDIST® TECHNOLOGY



Developed by Contrinex, this innovative technology makes use of a high-performance oscillator for inductive sensors. Operating distances from **2.2 to 4 times** the standard values are possible thanks to excellent temperature and voltage stability. Devices of the Extra distance family (500 and 520 series) work with such an oscillator (see also page 20).

CONNECTORS



PIN ASSIGNMENT SIZE S8:

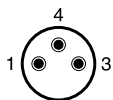

NO and NC

+U _B	pin 1	brown
0V	pin 3	blue
output	pin 4	black

NAMUR

L+	pin 1	brown
L-	pin 4	blue

Analog output

+U _B	pin 1	brown
0V	pin 3	blue
voltage output	pin 4	black

PIN ASSIGNMENT SIZE S12:

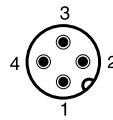

NO

+U _B	pin 1	brown
0V	pin 3	blue
output	pin 4	black

NC

+U _B	pin 1	brown
0V	pin 3	blue
output	pin 2	white

2-wire DC / NO

L-	pin 3	brown
L+	pin 4	blue

2-wire DC / NC

L-	pin 1	brown
L+	pin 2	blue

Analog output

+U _B	pin 1	brown
0V	pin 3	blue
voltage output	pin 4	black
current output	pin 2	white

PIN ASSIGNMENT SIZE 1/2":



2-wire AC/DC / NO and NC

L1	pin 3	blue
L2	pin 2	brown
GND	pin 1	yellow/green



PIN ASSIGNMENT SIZE S8 3 POLE:

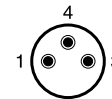

NO and NC

+U _B	pin 1	brown
0V	pin 3	blue
output	pin 4	black

PIN ASSIGNMENT SIZE S12 3 POLE:

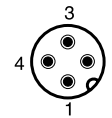

NO

+U _B	pin 1	brown
0V	pin 3	blue
output	pin 4	black

NC

+U _B	pin 1	brown
0V	pin 3	blue
output	pin 2	white

PIN ASSIGNMENT SIZE S12 5 POLE:

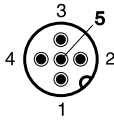

NO and NC

+U _B	pin 1	brown
output 2	pin 2	white
0V	pin 3	blue
output 1	pin 4	black
test	pin 5	gray

PIN ASSIGNMENT SIZE S8 4 POLE:



NO and NC

+U _B	pin 1	brown
output 2	pin 2	white
0V	pin 3	blue
output 1	pin 4	black

Teach

+U _B	pin 1	brown
output 2	pin 2	white
0V	pin 3	blue
output 1	pin 4	black

PIN ASSIGNMENT SIZE S12 4 POLE:

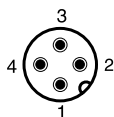

NO and NC

+U _B	pin 1	brown
output 2	pin 2	white
0V	pin 3	blue
output 1	pin 4	black

CORRECTION FACTORS



The specified operating distance **s** of inductive sensors refers to exactly defined measuring conditions (see **OPERATING DISTANCE**).

Other arrangements generally result in a reduction of the operating distance. The following data are to be considered as **guidelines** only; according to size and version, there can be wide variations. Exact values are given in the individual data sheets. These can be found on the Contrinex website (www.contrinex.com), or ordered directly from our sales offices.

CLASSICS (SERIES 600 / 620)

Material influence (indicative values):

Target material	Operating distance
Steel type FE 360	$s_n \times 1.00$
Aluminum	$s_n \times 0.55$
Brass	$s_n \times 0.64$
Copper	$s_n \times 0.51$
Stainless steel (V2A)	$s_n \times 0.85$

Geometrical influence:

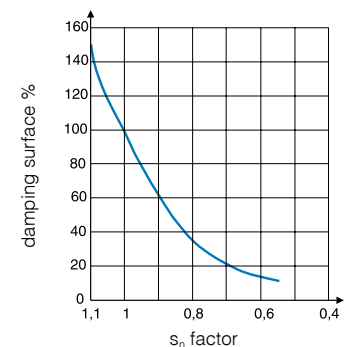

When using foils, an increase in the usable operating distance can be expected.

EXTRA DISTANCE (SERIES 500 / 520*)

Material influence (indicative values):

Target material	Operating distance
Steel type FE 360	$s_n \times 1.00$
Aluminum	$s_n \times 0.36 / *0.28$
Brass	$s_n \times 0.44 / *0.37$
Copper	$s_n \times 0.32 / *0.24$
Stainless steel (V2A)	$s_n \times 0.69$

Geometrical influence:

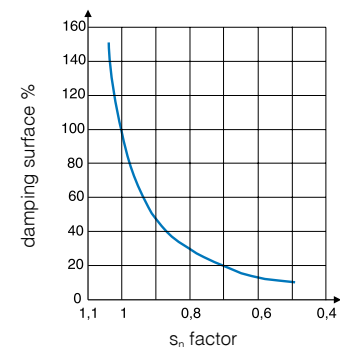

When using foils, an increase in the usable operating distance can be expected.

FULL INOX (SERIES 700)

Material influence (indicative values):

Target material	Operating distance
Steel type FE 360	$s_n \times 1.0$
Aluminum	$s_n \times 1.0$
Brass	$s_n \times 1.3$
Copper	$s_n \times 0.8$
Stainless steel (1 mm thick)	$s_n \times 0.5$
Stainless steel (2 mm thick)	$s_n \times 0.9$

Geometrical influence:

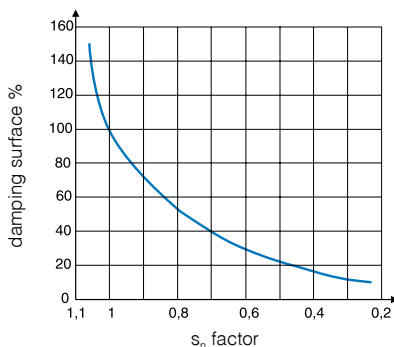

When using foils, a **decrease** in the usable operating distance can be expected.



Test card (Kodak paper, white)	100%
Paper, white	80%
PVC, gray	57%
Newspaper, printed	60%
Wood, lightly colored	73%
Cork	65%
Plastic, white	70%
Plastic, black	22%
Neoprene, black	20%
Automobile tires	15%
Aluminum sheet, untreated	200%
Aluminum sheet, black anodized	150%
Aluminum sheet, matt (brushed finish)	120%
Stainless steel, polished	230%

The specified sensing ranges of energetic diffuse sensors are achieved using standard matt white paper of the specified dimensions as the target surface. For other target surface materials, the correction factors listed here apply (these are guideline values only).

D

DARK-ON



The “dark-ON” function means that the relevant output is switched (carrying current) when **no** light is reaching the receiver.

DEGREES OF PROTECTION



The IP degrees of protection are defined in DIN 40050 / IEC 60529. The meaning of the **first numeral** is:

6 The housing provides complete protection against contact with electrically conducting or moving parts, and full protection against dust penetration.

and the **second numeral**:

4 Protection against water splashes: water splashed against the housing from any direction must have no harmful effect.

Test conditions: spraying with oscillating tube or spray nozzle; water pressure 1 bar; delivery rate 10 l/min \pm 5%; duration 5 minutes.

5 Protection against water jets: water projected by a nozzle from any direction under specified conditions must have no harmful effect.

Test conditions: nozzle with 6.3 mm diameter; delivery rate 12.5 l/min \pm 5%; distance 3 m; duration 3 minutes.

7 Protection against water when device is immersed in water under specified pressure and time conditions. Water must not penetrate in damaging quantities.

Test conditions: immersion depth in water 1 m; duration 30 minutes.

8 Protection against water when device is immersed in water indefinitely under specified pressure conditions. Water must not penetrate in damaging quantities.

Test conditions used by Contrinex: immersion depth in water 5 m; duration \geq 1 month.

9K Protection against water which, if directed against the housing from any direction and under considerably increased pressure, must have no harmful effect.

Test conditions: sensor mounted on table turning at 5 ± 1 rpm; spraying with flat nozzle; delivery rate 14 - 16 l/min; distance 100 - 150 mm; angles 0°, 30°, 60° and 90°; temperature $80 \pm 5^\circ\text{C}$ ($176 \pm 41^\circ\text{F}$); pressure 8,000 - 10,000 kPa (80 - 100 bar / 1160.8 - 1451 psi); duration 30 sec per position.

Devices with degree of protection **IP 67** are thus **not intended for prolonged operation in water**, or in prolonged humid conditions. Tolerance to liquids other than water must be examined from case to case.

E

EMBEDDABLE MOUNTING



See **MOUNTING**.

EMC



The EMC (**E**lectromagnetic **C**ompatibility) resistance of the devices satisfies the highest demands. For exact values, please refer to the data sheets.

All devices comply with the EU directive no. 2004/108/EC. In addition, they undergo severe field testing.

EXCESS-GAIN INDICATION (SYSTEM RESERVE INDICATION)



The excess-gain indication circuit detects the excess radiation power which falls on the light incidence surface and is processed by the light receiver. The excess gain can decrease in time due to dirt, a change in the target's reflection factor, and aging of the emitter diode, so that reliable operation can no longer be guaranteed. Some devices are therefore equipped

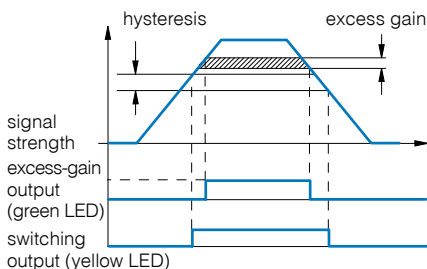

Fig. 19

with a second LED (green), which lights up when less than approximately 80% of the available operating distance is used. Models with an excess-gain output make the excess-gain signal available to the user for further processing. Thus, operating conditions which are no longer reliable can be recognized in time.

EXTRA DISTANCE FAMILY



The **Extra Distance** family (series 500/520) is one of three inductive sensing technologies offered by Contrinex. **Extra Distance** family sensors rely on conventional inductive oscillator and coil technology, but with a completely different signal evaluation circuit for better stability and therefore **long operating distances**. The most important contribution to this comes from the Contrinex Condist® oscillator (see pages 20-21).

Sensors are sized from Ø 4 to M30, with long operating distances up to 40 mm.

The Extra Distance technology family includes devices from the **Basic, Miniature, Extra Pressure, High Pressure** and **Analog Output** ranges.

F

FULL INOX FAMILY



The **Full Inox** family (series 700) is one of three inductive sensing technologies offered by Contrinex. **Full Inox** family sensors rely on Contrinex's Condet® technology (see page 21).

Full Inox sensors have a one-piece, stainless steel housing and are exceptionally robust and chemically resistant. They are not only the most durable inductive sensors on the market, but also offer long operating distances on any conductive metal.

Sensors are sized from Ø 4 to M30 and cuboid variant of 20 x 32 x 8 mm, with long operating distances up to 40 mm and protection class IP 67 and IP 69K

The **Full Inox** technology family includes devices from the **Basic, Miniature, Extreme, High Pressure, Washdown, Weld-Immune, Chip-Immune, Double-Sheet** and **Maritime** ranges.

H

HYSTERESIS



Hysteresis (differential travel) causes a defined switching behavior of the device (Fig. 20). The sensing range always refers to the switch-on point.

Distance hysteresis is only useful for the diffuse sensor model and its related fiber version.

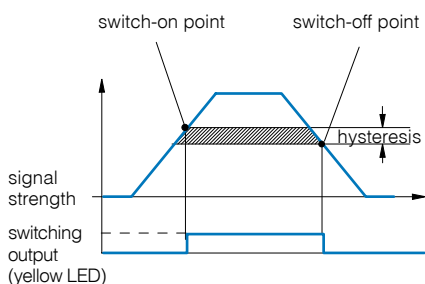

Fig. 20



Hysteresis (differential travel) causes a defined switching behavior of the device (Fig. 21). The operating distance always refers to the switch-on point. Namur devices and those with analog output have continuous transmission behavior, i.e. there is no hysteresis.

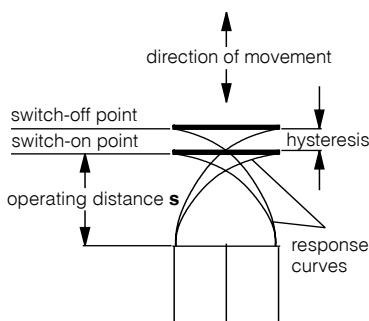

Fig. 21

I

INDUCTION PROTECTION



When inductive loads are switched off, the output voltage, without a protective circuit, would increase to a high value, which could destroy the output transistor. Contrinex sensors therefore contain a **Zener diode** at the output to limit the switch-off voltage to a safe value (3-wire types). When connecting an inductive load with a current >100 mA and simultaneously a switching frequency >10 Hz, the mounting of a **free-wheeling diode** directly to the load is recommended (due to the leakage power in the built-in Zener diode).

INSTALLATION



Photoelectric sensors can be easily and reliably installed in any position, using the mounting accessories supplied with most devices. The installation position should preferably protect the units against dirt and other contamination.



For inductive sensors, see **MOUNTING**.

INSULATION VOLTAGE



The devices in this catalog are designed for an insulation voltage (between connecting leads and housing) of 75 VDC / 50 VAC (for supply voltages up to 75 VDC / 50 VAC) or 300 VDC / 250 VAC (for supply voltages between 75 VDC / 50 VAC and 300 VDC / 250 VAC).

IP 64 / IP 65 / IP 67 / IP 68 / IP 69K



Refer to **DEGREES OF PROTECTION**.

IR LIGHT



IR is the abbreviation of “**Infra-Red**”. This refers to any electromagnetic radiation with a wavelength exceeding that of normal visible light, which is approx. 380 to 780 nm. Wavelengths of approx. 780 to 1500 nm are typically used. IR light cannot be used with synthetic fibers, due to high attenuation. Instead, visible red light is used. As the usual polarization filters cannot be used in the IR range, visible red light is also used for reflex sensors.



LEAD LENGTHS



For the sensor, long leads mean:

- a capacitive load at the output (see **CAPACITANCE**)
- increased influence of interference signals

Even under favorable conditions, lead lengths should not exceed **300 m**.

LEADS



The standard built-in leads are **not** suitable for **repeated bending stresses**. In such cases, high-flexibility PUR cables (special executions) or connectors with corresponding connecting cables (see pages 441-449) must be used.

LEAKAGE CURRENT



Leakage current is the current that flows through the output transistor and thereby through the load when the output is OFF (to be taken into account particularly where switches are connected in parallel).

LED



Most of the inductive devices in this catalog are equipped with a built-in yellow light-emitting diode (LED). It indicates the switching state: **output activated = yellow LED on**.



All photoelectric sensors have one or two **Light Emitting Diodes (LEDs)** built in. The yellow LED lights up when the output is switched (for switches with 2 outputs: the light-ON output). During a short-circuit or overload, the yellow LED does not operate. The green LED (if provided) lights up when enough system reserves (excess gain) for reliable operation are available, i.e. when an object is present in the reliable sensing area (diffuse sensors), or when enough light from the uninterrupted beam reaches the receiver (reflex and through-beam sensors).

LIGHT-ON



Light-ON means that the relevant output is switched (carrying current) when light is reaching the receiver.

LOAD RESISTANCE



From the selected supply voltage U_b and the specified maximum output current of the sensor, the lowest permissible load resistance for trouble-free operation can be calculated.

Example: With a voltage of 24 V and a specified maximum permissible output current of 200 mA, the minimum load resistance is 120 ohm; at 15 V, it is 75 ohm.

M

MAGNETIC FIELDS



Strong fields can saturate the ferrite core of inductive sensors, thereby increasing the operating distance, or even provoking false switching. However, no lasting damage is caused. **High-frequency fields** of several kHz (700 series), or several hundred kHz (other series), may seriously interfere with the switch functioning, since the oscillator frequency of the devices lies in this range. If difficulties with interfering magnetic fields are encountered, shielding is recommended.

MODULATED LIGHT



The photoelectric sensors listed in this catalog operate with modulated light, i.e. the light emitter is switched on only for a short period and remains switched off for much longer (ratio approx. 1:25). In diffuse and reflex sensors, the receiver is only active during the light pulse, and is disabled during the pulse gap. Operation with modulated light provides the following advantages:

- The devices are largely insensitive to ambient light
- Longer sensing ranges are possible
- Heat generation is reduced, which prolongs the operating life of the emitting diodes

MODULATION FREQUENCY



The photoelectric devices in this catalog are operated with modulated light, which makes them largely insensitive to ambient light. The modulation frequency f_{cy} is in the range of several kHz.

If a device is operated in the proximity of another device with the same modulation frequency, interference can occur.

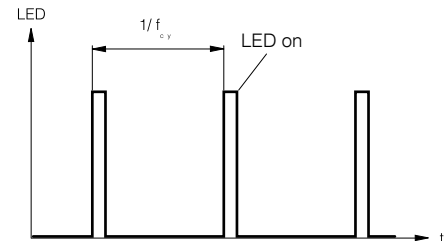

Fig. 22

MOUNTING



For photoelectric sensors, see [INSTALLATION](#).



EMBEDDABLE SENSORS

Embeddable sensors may be flush mounted in all metals. For trouble-free operation, a free zone according to Fig. 23 should be observed.

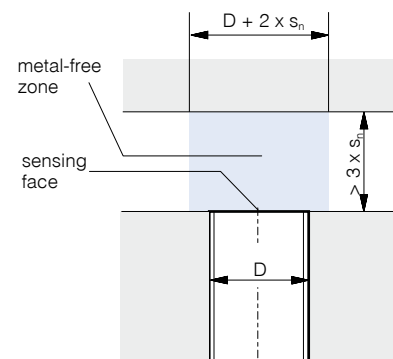

Fig. 23

QUASI-EMBEDDABLE SENSORS

When installing quasi-embeddable Extra Distance sensors (500 and 520 series) in conductive materials (metals), the devices must **protrude** by a distance **X**, according to Fig. 24. Further, a free zone of $3 \times s_n$ must be observed. Flush mounting in non-conducting materials is permitted.

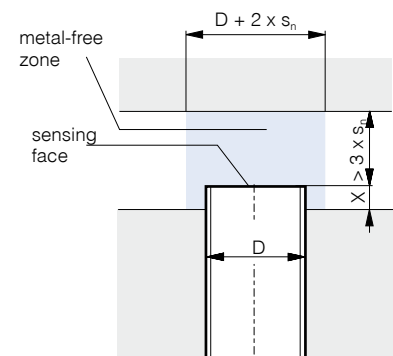

Fig. 24

Mounting in steel and in non-ferrous metals:

Housing size D	X (mm)
Ø 6.5	1
C8	1
M12	2
M18	4
M30	6

Mounting in stainless steel:

Housing size D	X (mm)
Ø 6.5	0.0
C8	0.0
M12	1.0
M18	1.5
M30	2.0

NON-EMBEDDABLE SENSORS

When mounting non-embeddable sensors in conducting materials (metals), minimum distances to the conducting material must be maintained according to Fig. 25. Flush mounting in non-conducting materials is permitted.

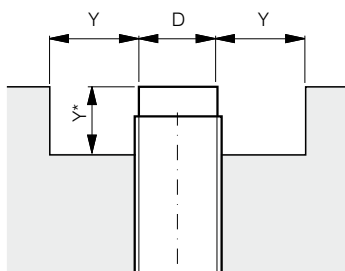

Fig. 25

Housing size D	Y (mm)
M8	8
M12	12
M18	22
M30	40
C44	60 / *40

N

NC



The output is closed when the switch is not activated. It is open when the switch is activated.

NO



The output is open when the switch is not activated. It is closed when the switch is activated.

NO-LOAD SUPPLY CURRENT



No-load supply current is understood as the inherent consumption of the sensor for operating the LED, amplifier, etc., in the non-activated state. It does not include the current flowing through the load.

NON-EMBEDDABLE MOUNTING



See **MOUNTING**.

NPN CONFIGURATION



The output device contains an NPN transistor, which switches the load towards zero voltage. The load is connected between the output terminal and the positive supply voltage $+U_B$ (Fig. 26).

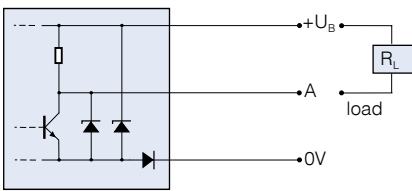

Fig. 26



OIL RESISTANCE



Long-term contact with any oils may affect plastics and weaken their resistance. However, inductive Full Inox sensors (series 700), as well as the sealed (series E) and high-pressure-resistant (series P) types can be used in **oily environments** without restriction. For all other types, this is not necessarily the case.

Thus, please observe the following:

Lubricating oils:

Generally cause no problems. Use versions with oil-resistant PUR cable (special executions).

Hydraulic oils, cutting oils:

These attack most plastics. In particular, PVC cables discolor and become brittle. Measures:

- Wherever possible, avoid contact with these liquids, particularly at the sensing face.
- Use versions with oil-resistant PUR cable.



For photoelectric sensors, housing, optical unit, and cable should be considered separately:

Housing

The PBTP / polybutyleneterephthalate (Crastin®) used for the housing is highly resistant to all conventional types of oil, in particular, to cutting and hydraulic oils, as well as drilling emulsions.

Optics

The windows are generally of glass (with the exception of series 4150 and 5050), and are therefore not affected. However, oil on the light in- and outputs changes their optical properties. The effects should be examined from case to case.

Cable

The PVC cable used as standard is not resistant to most types of oil, and becomes brittle in long-term use. The optional PUR cable should therefore be used in oily environments.

OPERATING DISTANCE



The operating distance of inductive sensors is the distance at which a target approaching the sensing face triggers a signal change. The operating distance is measured according to IEC 60947-5-2 / EN 60947-5-2, using a **standard square target** moving axially (Fig. 27). This target is made of steel, e.g. type FE 360 in accordance with ISO 630, with a smooth surface, square shape, and thickness of 1 mm (Fig. 28). The sides equal the **diameter** of the inscribed circle of the sensing face or **three times the rated operating distance s_n** of the sensor, whichever is the greater.

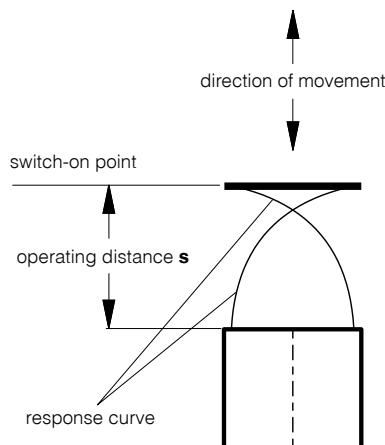

Fig. 27

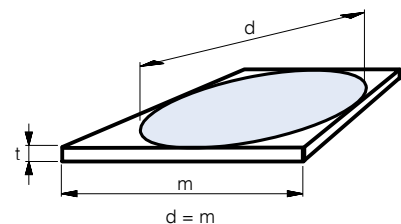

Fig. 28

Rated operating distance s_n

This is the operating distance for which the sensor is designed. It can be found under "technical data".

Effective operating distance s_r

The measured operating distance for a given switch according to IEC 60947-5-2 / EN 60947-5-2.

$$0.9 s_n \leq s_r \leq 1.1 s_n$$

This means that the manufacturing tolerance must not exceed $\pm 10\%$.

Usable operating distance s_u

This distance takes into account expected additional deviations caused by temperature and supply voltage fluctuations within the specified range.

$$0.9 s_r \leq s_u \leq 1.1 s_r$$

The temperature and supply voltage ranges can be found under “technical data”.

Assured operating distance s_a

$$0 \leq s_a \leq 0.81 s_n$$

This operating distance is guaranteed by the manufacturer for all specified operating conditions. It is the **basis for a safe design**.



See [SENSING RANGE](#).

OPTICAL FIBERS



An optical fiber can consist of a bundle of glass fibers, or one or more synthetic fibers. It is used to conduct light from one place to another, even around bends and curves. This is possible thanks to the phenomenon of total reflection. Total reflection always occurs when light coming from a material with a higher refractive index falls on an interface with a medium having a lower refractive index, in such a way that the critical angle required for total reflection is never reached.

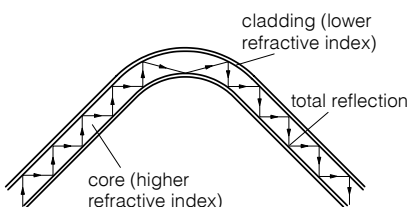

Fig. 29

The fibers consist of a core (with a higher refractive index) and a cladding (with a lower refractive index). Due to total reflection, the light is reflected backwards and forwards in the core, and can thus go round bends and curves.

OUTPUT CURRENT



The devices are designed for a given maximum output current. If this current is exceeded, even for only a short time, the **overload protection** trips. Incandescent lamps, capacitors, and other heavily capacitive loads (e.g. long leads) have a similar effect to overload (see also [CAPACITANCE](#)).

OUTPUT RESISTANCE



In order that the output voltage, even without external load, follows the switching state, Contrinex sensors contain a built-in output resistance (pull-up or pull-down resistor). For operation at high switching frequencies, an additional external load resistor must be added (to reduce the electrical time constant).

OVERVOLTAGE PROTECTION



For maximum operating reliability and ease of use, Contrinex sensors feature a built-in protection circuit against very short, non-periodic supply voltage peaks, which complies with the requirements of IEC 60947-5-2.

P

PARALLEL CONNECTION



Connecting sensors in parallel, in order to perform logic functions, is possible without any problem (Figs. 30 and 31).

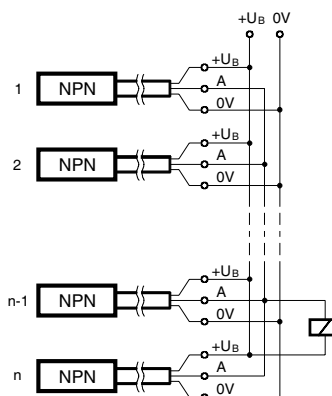

Fig. 30

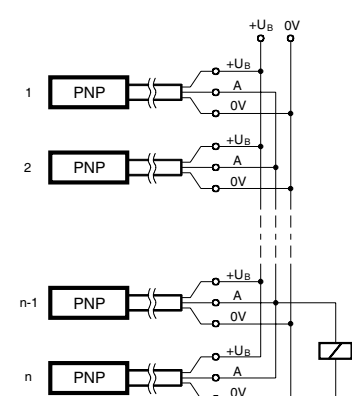

Fig. 31

Please note:

- The no-load supply current increases.
- Leakage currents add up, so that, even when closed, an inadmissible voltage drop can occur at the output.

PNP CONFIGURATION



The output device contains a PNP transistor, which switches the load towards the positive supply voltage $+U_B$. The load is connected between the output terminal and the negative supply voltage 0V (Fig. 32).

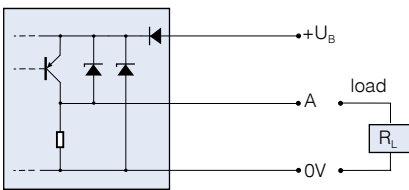

Fig. 32

POLARITY REVERSAL PROTECTION



Virtually all sensors in this catalog are protected against **any polarity reversal** at all terminals.

POLARIZATION FILTER

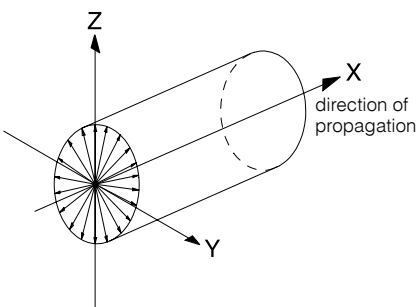

Fig. 33

Natural light (including the light from the emitter diodes) is not polarized (Fig. 33). When light has passed through a polarizing filter however, only that part of the original light which oscillates in the filter polarization direction is still present (Fig. 34). Polarization is retained after reflection by mirrored surfaces, only the direction of polarization may be altered. Diffuse reflection, on the other hand, destroys polarization. This difference can be used to suppress the disruptive effects caused by mirrored surfaces, by means of selection and configuration of suitable filters.

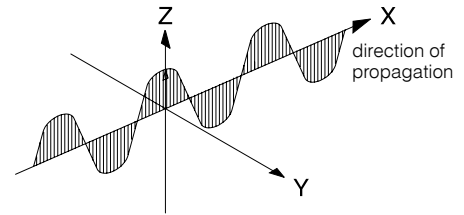

Fig. 34

POWER-ON RESET



When switched on, the sensor output is activated for a short time due to physical reasons, even without the presence of a target in front of the sensing face. Sensors with power-on reset therefore include an additional circuit that closes the output for a short time during the switching-on phase, so suppressing an error signal (this function is also known as "switch-on pulse suppression").

POWER SUPPLY UNITS



Circuit recommendations for suitable power supply units are shown in Figs. 35 and 36.

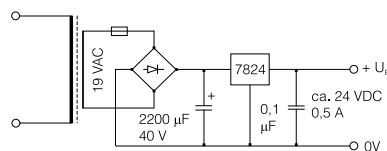

Fig. 35

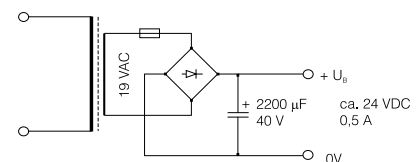

Fig. 36

Please observe:

- Unsuitable power supply units are the most frequent reason for sensor problems!
- A transformer and rectifier are not sufficient; at least a smoothing capacitor is essential (due to the ripple content).
- Transformers with a 24 V output, rear-position rectifier and smoothing capacitor deliver a no-load voltage of well above 30 V. Consequently, devices with a maximum supply voltage of 30 V can be damaged.

R

REFLECTORS



By means of built-in polarization filters, polarized reflex sensors are designed so that they respond only to the light reflected from special reflectors. These operate according to the principle of the 3-way mirror (Fig. 37). The choice of the correct reflector for a specific application is determined by the required operating distance and installation possibilities. The reflector must be installed perpendicularly to the optical axis (tolerance $\pm 15^\circ$).

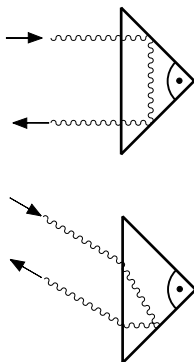

Fig. 37

REPEAT ACCURACY



Repeat accuracy (according to IEC 60947-5-2/EN 60947-5-2) is understood to be the repeat accuracy of the effective operating distance s , over an 8-hour period at an ambient temperature of $23 \pm 5^\circ\text{C}$ ($73.4 \pm 41^\circ\text{F}$) and with a specified supply voltage U_B . The specified repeat accuracy refers to this definition. Successive measurements made immediately one after the other generally lead to much better repeat accuracy.

RESPONSE DIAGRAM



The specified values for the operating distance refer to an **axial** approach of the target. For staggered or lateral movements, type-specific response curves are valid. Two typical examples are shown below (Fig. 38 and Fig. 39):

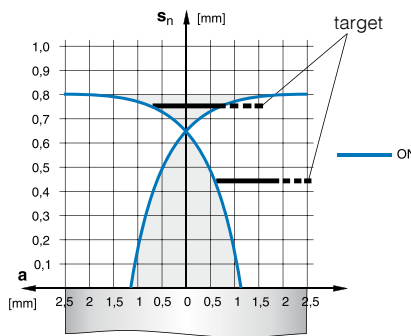

Fig. 38 DW-AD-603-M5

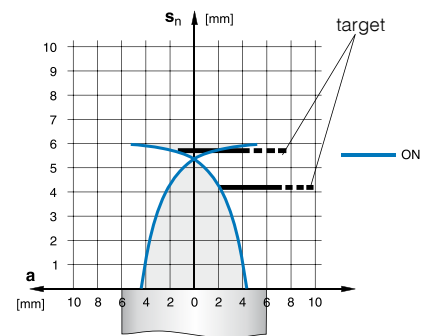

Fig. 39 DW-AD-503-M12

Depending on series, size, and mounting type (embeddable or non-embeddable), the response diagrams differ. Response diagrams for switch types not shown here are readily available from the corresponding individual data sheets. These can be found on the Contrinex website (www.contrinex.com), or ordered from our sales offices.

RIPPLE CONTENT



Too much ripple content causes undefined switching behavior. To remedy this, use a larger smoothing capacitor, or a stabilized power supply unit. The specified maximum supply voltage U_B must not be exceeded, not even during U_{SS} peaks.

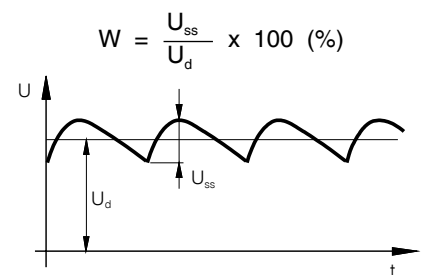

Fig. 40

S

SAFETY



The devices in this catalog have not been designed for safety-relevant use. In cases where the safety of people is dependent on their functioning, it is the user's responsibility to ensure that the relevant standards, in particular ISO 13849-1, and regulations are complied with. Contrinex assumes no liability for personal injury.

SENSING RANGE



The specified sensing range of photo-electric sensors is the maximum usable distance between the device and the standard target (diffuse sensors); between the device and the reference reflector (reflex sensors), and between the emitter and the receiver (through-beam sensors). The potentiometer must be set for maximum sensitivity, or for diffuse sensors with background suppression, for maximum sensing range. Moreover, the specified reflector (reflex sensors) or standard target (diffuse sensors) must be used.

SERIES CONNECTION



The connection of sensors in series in order to achieve logic functions is possible, but not recommended. The same effect can be achieved by the **parallel connection** of sensors with **NC function** (instead of the series connection of models with NO function), or vice versa. However, please note that, as a result, the output signal is inverted.

SHOCK RESISTANCE



The sensors in this catalog are tested for resistance to a shock of 30 g (30 times gravitational acceleration) for a period of 11 ms, according to IEC 60068-2-27.

SHORT-CIRCUIT PROTECTION



The devices in this catalog feature built-in pulse protection against short-circuits and overloads, which alternately closes and opens the output when the maximum output current is exceeded, until the short-

circuit is eliminated. Short-circuits between the output and the supply voltage terminals do not damage the sensor, and are allowed in permanence. The same applies to overloads. During short-circuits, the LEDs do not function.

SPHERICAL OPTICS



Spherical lenses are special versions of double convex lenses. They feature a short focal length and a good light incidence area. Fig. 41 shows such a design in sensor type LT#-1040/1050-30#-50# (see pages 229-235).

For diffuse sensors, the sphere is cut in two to separate the reception from the emission channel.

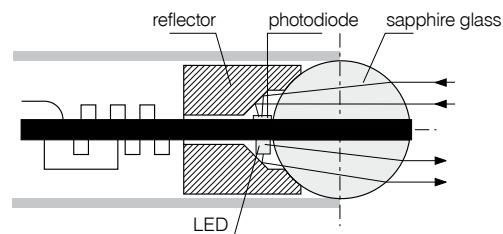

Fig. 41

The emitter and receiver chips are mounted as closely as possible to the surface of the sphere and slightly off the optical axis (see Fig. 41). This causes the emitted beam to intersect the receiver's sensing range at a specific distance from the device, resulting in a relatively short sensing range, but a virtually cylindrical detection zone. A cylindrical detection zone is particularly useful in some applications, such as the detection of targets through narrow holes or gaps.

STANDARDS



The sensors in this catalog comply, either completely or to a great extent, with the following standards:

- IEC 60947-5-1, **IEC 60947-5-2**, EN 60947-5-1, **EN 60947-5-2**
- IEC 61000-4-1, 61000-4-2, 61000-4-3, 61000-4-4, DIN EN 55011, DIN EN 55081-2, DIN EN 50140
- IEC 60529 / DIN 40050
- IEC 60947-1 / EN 60947-1 / DIN VDE 0660, part 100, part 100 A3, part 200, part 208
- DIN EN 50008, 50010, 50025, 50026, 50032, 50036, 50037, 50038, 50040, 50044

SUPPLY VOLTAGE U_B



The specified maximum supply voltages must **not be exceeded**. For maximum operating reliability and ease of use, Contrinex sensors contain a built-in protection circuit against very short, non-periodic, supply voltage peaks, which complies with the requirements of IEC 60947-5-2. Operating voltages below the lower specified limit, even for short periods, do not damage the switches, but impede their operation.

SWITCHING FREQUENCY



The maximum switching frequency of inductive sensors indicates the highest permissible number of pulses per second for a constant pulse/pause ratio of 1 : 2 at **half the rated operating distance s_n** . Measurement is according to IEC 60947-5-2 / EN 60947-5-2 (Fig. 42).

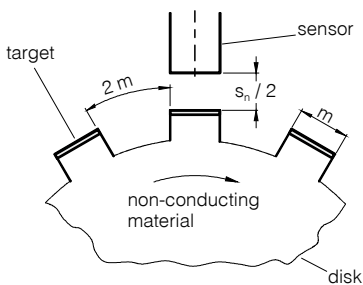

Fig. 42



In the case of photoelectric sensors, the frequency of operating cycles (f) is determined from the formula:

$$f = \frac{1}{t_{on} + t_{off}}$$

where:

t_{on} is the turn on time

t_{off} is the turn off time

t_{on} and t_{off} are measured in accordance with IEC60947-5-2 2007 paragraph 8.5.3. (see also **Turn-on/turn-off time**, in this glossary).

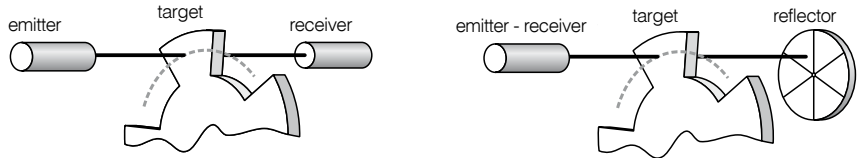

Fig. 43: Through-beam and reflex modes: the light beam must be fully broken by the target.

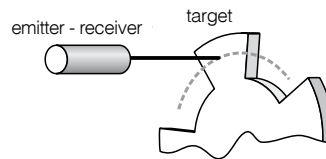

Fig. 44: Diffuse mode: the target must be of the same material as the standard target.

T

TEACH-IN



Some devices have a teach-in capability instead of a potentiometer to adjust their sensing range, etc. Teach-in is achieved either directly by pressing a button or remotely via IO-Link.

TEMPERATURE DRIFT



The set sensing ranges are subject to slight temperature influences. Due to built-in temperature compensation, this effect is much less important for devices of the 4040 series (approx. 0.1 % / °C) than for the other switches (approx. 0.3 % / °C). The sensing range, as a function of ambient temperature, follows approximately the curves shown in Fig. 45.

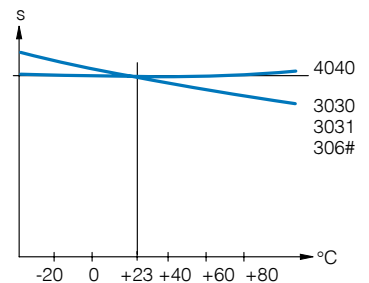

Fig. 45



The specified operating distances refer to a nominal ambient temperature of 23°C (73.4°F). The operating distance, as a function of ambient temperature, follows approximately the curve shown in Fig. 46.

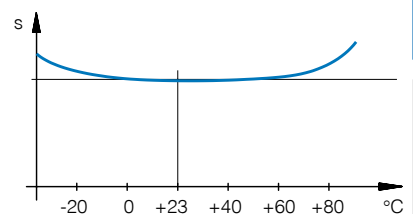

Fig. 46

The temperature of the target itself has practically no influence on the operating distance. Within the permitted temperature range of, as a rule, -25°C to $+70^{\circ}\text{C}$ (-13°F to $+158^{\circ}\text{F}$), the operating distance varies by a maximum of $\pm 10\%$ compared to its value at 23°C (73.4°F).

TURN-ON / TURN-OFF TIME



The output **turn-on** time t_{on} is the minimum period of time required for a sensor to detect the **presence** of a light beam and output an ON signal.

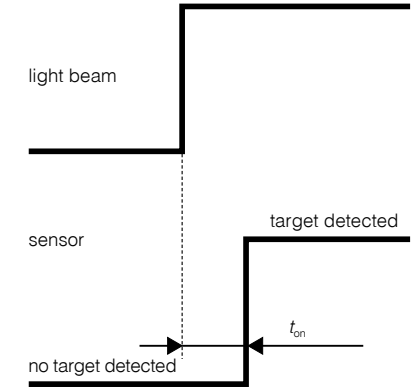

Fig. 47: Output turn-on time

The output **turn-off** time t_{off} is the minimum period of time required for a sensor to detect the **absence** of a light beam and output an OFF signal.

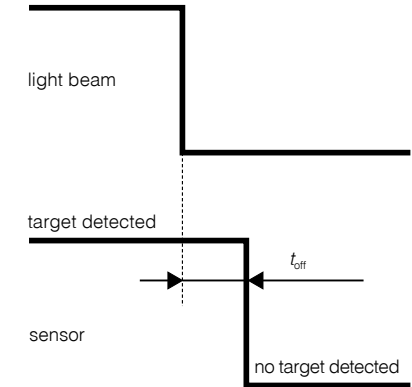

Fig. 48: Output turn-off time

t_{on} and t_{off} are measured in accordance with IEC60947-5-2 2007 paragraph 8.5.3.

TEST INPUT



The emitters of through-beam sensors are provided with a test input. Light emission can be switched on and off by means of this input, which, together with the corresponding evaluation of the receiver reaction, permits very efficient sensor monitoring.

TIGHTENING TORQUE



Over-tightening of the nuts can mechanically damage cylindrical sensors. The specified maximum permissible tightening torques must therefore not be exceeded.



FULL INOX (SERIES 700)

Housing size D	M (Nm)
M8	8
M12	20
M18	50
M30	150



SERIES 1040 / 50, 1120, 1180, 1180W

Housing size D	M (Nm)
M5	1.5
M12	10
M18 / M18W	20

CLASSICS / EXTRA DISTANCE (SERIES 500*, 520*, 600, 620)

Housing size D	M (Nm)
M4	0.8
M5	1.5
C5	0.2
M8	8 / *4
C8	1
M12	10**
M18	25
M30	70
C44	2.5

** 6 Nm for the first 10 mm

TIME DELAY BEFORE AVAILABILITY



The time delay before availability is the maximum time the sensor requires for **operating readiness** after the supply voltage has been switched on.

V

VIBRATION RESISTANCE



The sensors in this catalog are tested for resistance to vibrations of 1 mm amplitude at 55 Hz, according to IEC 60068-2-6.

VOLTAGE DROP



In the switched-through condition, a (current dependent) voltage drop develops across the output transistor; the output voltage, therefore, does not entirely reach the corresponding supply voltage (to be particularly taken into account with series connection and electronic inputs).

W

WIRE-BREAK PROTECTION



All sensors in this catalog are equipped with wire-break protection. If a voltage supply lead breaks, the output is disabled, thus avoiding an error signal.

WIRING



Sensor cables must not be laid in parallel in the same cable runs as cables connected to **inductive loads** (i.e. protection solenoids, magnetic rectifiers, motors, etc.), or which conduct currents from **electronic motor drives**. Leads should be kept as short as possible; however, with suitable wiring (low coupling capacitance, small interference voltages), they can be up to 300 m long.

To reduce electromagnetic interference, apply the following measures:

- Maintain the distance to interfering cables > 100 mm
- Use shields
- Install inductances (contactors, magnetic rectifiers, relays) with RC networks or varistors

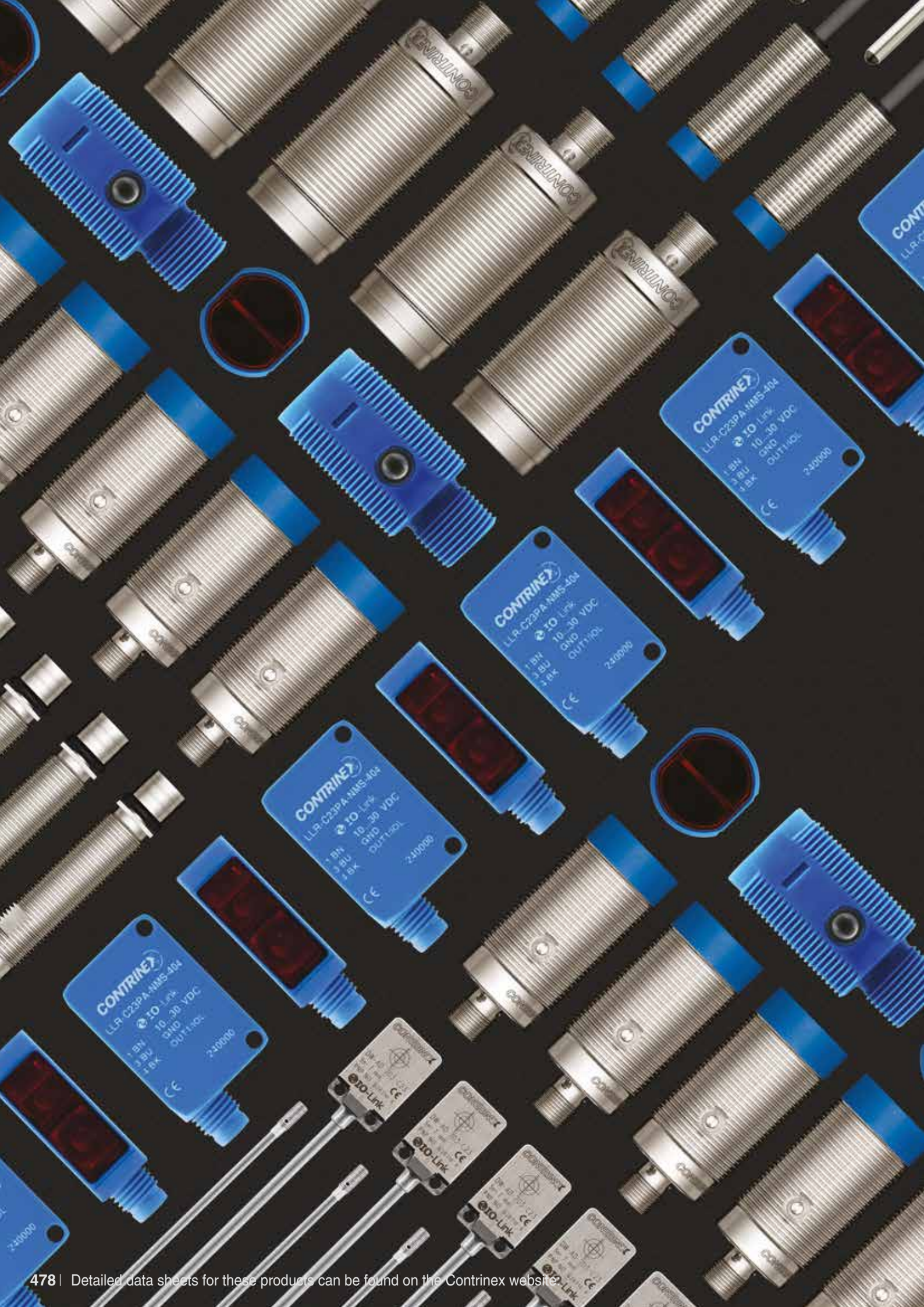

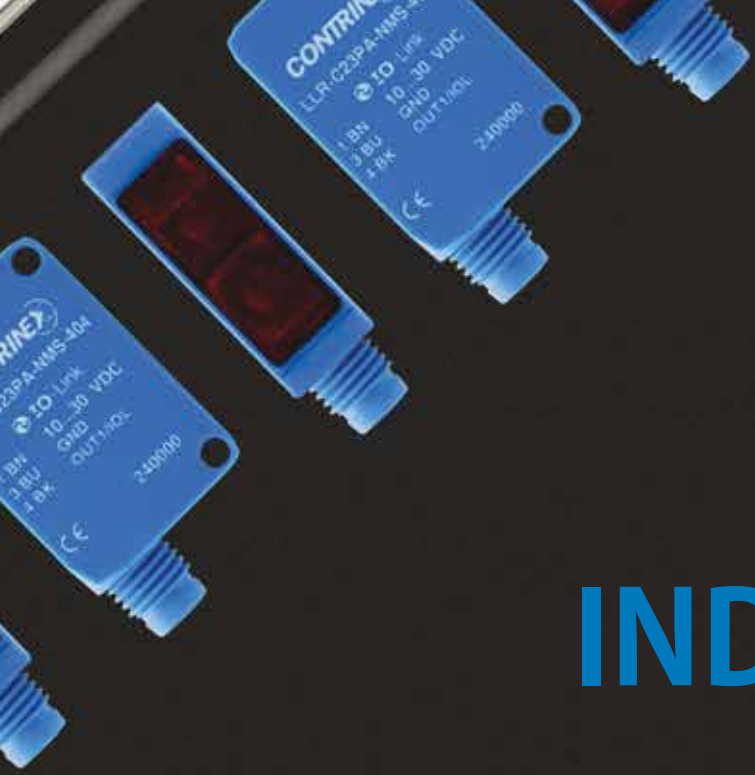

INDEX

HIGHLIGHTS:

- ✓ **Inductive:** sensor type, connection, series, output, housing
- ✓ **Photoelectric:** sensor type, series, dimensions, execution
- ✓ **Safety:** light curtains, safety switches, relays, accessories
- ✓ **RFID:** transponders, read/write modules, interfaces
- ✓ **Connectivity:** distribution boxes, cables and connectors

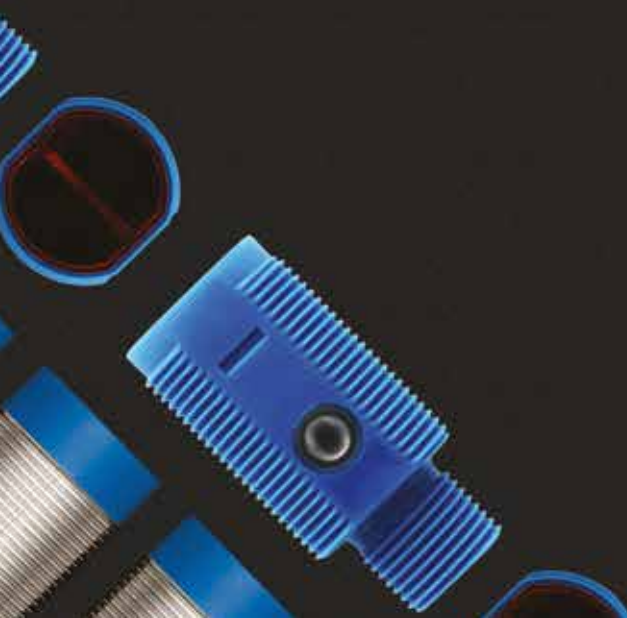

INDUCTIVE SENSORS

DW-AD-503-M8E (-12X/-XXX)

INDUCTIVE SENSOR DW

SENSOR TYPE

Conventional	A
2-wire DC (NAMUR excepted)	D
High-temperature	H
Food and sea-water	L
Maritime	M

CONNECTION

Cable	D
Connector	S
Cable + connector	V

SERIES

500 / 520 (Extra Distance)	5
600 / 620 (Classics)	6
700 (Full Inox)	7

Embeddable / quasi-embeddable	0
Non-embeddable	1
Increased operating distance, (quasi-)embeddable	2
Increased operating distance, non-embeddable	3

OUTPUT

NPN NO	1
NPN NC	2
PNP NO	3
PNP NC	4
PNP changeover	A
NPN changeover	B

SHORT / SPECIAL EXECUTIONS

Series E (impervious)	E
Series 700P (all-metal & high-pressure resistant)	G

HOUSING SIZE

Threaded	
M4	4
M5	5
M8	8
M12	12
M18	18
M30	30
M50	50
Smooth	
Ø 3 mm	3
Ø 4 mm	4
Ø 6.5 mm	65
Ø 8 mm	80
5 x 5 mm	5
8 x 8 mm	8
20 x 32 mm	23
40 x 40 mm	44

HOUSING

Threaded cylindrical housing	M
Rectangular housing	C
Smooth cylindrical housing	0
High-pressure resistant	P

OUTPUT

2-wire DC	
NO / NAMUR	5
NC	6

2-wire AC/DC	
NO	7
NC	8
Analog	9

INDUCTIVE SENSORS

<i>Part reference</i>	<i>Chapter/page</i>	<i>Part reference</i>	<i>Chapter/page</i>	<i>Part reference</i>	<i>Chapter/page</i>
DW-AD-501-04	1/75	DW-AD-519-M30-120	1/99	DW-AD-605-04	1/104
DW-AD-501-065	1/35	DW-AD-519-M30-320	1/99	DW-AD-605-04K	1/104
DW-AD-501-065E	1/131	DW-AD-521-M8	1/43	DW-AD-605-065-120	1/106
DW-AD-501-C8	1/46	DW-AD-521-M12	1/52	DW-AD-605-C5	1/105
DW-AD-501-M5	1/77	DW-AD-521-M12-120	1/52	DW-AD-605-M4	1/103
DW-AD-501-M8	1/42	DW-AD-523-M8	1/43	DW-AD-605-M5	1/105
DW-AD-501-M12	1/50	DW-AD-523-M12	1/52	DW-AD-605-M8-120	1/107
DW-AD-501-M12-120	1/50	DW-AD-523-M12-120	1/52	DW-AD-605-M12	1/107
DW-AD-501-M18	1/58	DW-AD-601-03	1/71	DW-AD-605-M12-120	1/107
DW-AD-501-M18-120	1/57	DW-AD-601-04	1/73	DW-AD-605-M18	1/108
DW-AD-501-M30	1/62	DW-AD-601-04E	1/131	DW-AD-605-M18-120	1/108
DW-AD-501-M30-120	1/62	DW-AD-601-065	1/31	DW-AD-605-M30	1/109
DW-AD-501-P5	1/135	DW-AD-601-065-120	1/31	DW-AD-605-M30-120	1/109
DW-AD-501-P8	1/135	DW-AD-601-065-121	1/31	DW-AD-607-M12	1/114
DW-AD-501-P20	1/137	DW-AD-601-065-400	1/31	DW-AD-607-M18	1/119
DW-AD-503-04	1/75	DW-AD-601-C5	1/78	DW-AD-607-M30	1/125
DW-AD-503-065	1/35	DW-AD-601-C8	1/45	DW-AD-608-M12	1/114
DW-AD-503-065E	1/131	DW-AD-601-M4	1/72	DW-AD-608-M18	1/119
DW-AD-503-C8	1/46	DW-AD-601-M5	1/76	DW-AD-608-M30	1/125
DW-AD-503-M5	1/77	DW-AD-601-M5-735	1/143	DW-AD-611-M8	1/41
DW-AD-503-M8	1/42	DW-AD-601-M5E	1/131	DW-AD-611-M12	1/48
DW-AD-503-M12	1/50	DW-AD-601-M8	1/36	DW-AD-611-M12-120	1/48
DW-AD-503-M12-120	1/50	DW-AD-601-M8-120	1/35	DW-AD-611-M18	1/55
DW-AD-503-M18	1/58	DW-AD-601-M8-121	1/36	DW-AD-611-M30	1/61
DW-AD-503-M18-120	1/57	DW-AD-601-M8-122	1/36	DW-AD-613-M8	1/41
DW-AD-503-M30	1/62	DW-AD-601-M12	1/47	DW-AD-613-M12	1/48
DW-AD-503-M30-120	1/62	DW-AD-601-M12-120	1/47	DW-AD-613-M12-120	1/48
DW-AD-503-P5	1/135	DW-AD-601-M18	1/54	DW-AD-613-M12-733	1/143
DW-AD-503-P8	1/135	DW-AD-601-M18-120	1/54	DW-AD-613-M18	1/55
DW-AD-503-P20	1/137	DW-AD-601-M30	1/60	DW-AD-613-M30	1/61
DW-AD-504-M5	1/77	DW-AD-603-03	1/71	DW-AD-614-M18	1/55
DW-AD-504-M30	1/62	DW-AD-603-04	1/73	DW-AD-617-M12	1/116
DW-AD-509-C8-390	1/95	DW-AD-603-04E	1/131	DW-AD-617-M18	1/121
DW-AD-509-M8	1/95	DW-AD-603-065	1/31	DW-AD-617-M30	1/126
DW-AD-509-M8-390	1/95	DW-AD-603-065-120	1/31	DW-AD-618-M12	1/116
DW-AD-509-M12	1/96	DW-AD-603-065-121	1/31	DW-AD-618-M18	1/121
DW-AD-509-M12-120	1/96	DW-AD-603-065-400	1/31	DW-AD-618-M30	1/126
DW-AD-509-M12-320	1/96	DW-AD-603-C5	1/78	DW-AD-621-03	1/71
DW-AD-509-M12-390	1/96	DW-AD-603-C8	1/45	DW-AD-621-03-960	1/71
DW-AD-509-M18	1/97	DW-AD-603-M4	1/72	DW-AD-621-04	1/74
DW-AD-509-M18-120	1/97	DW-AD-603-M5	1/76	DW-AD-621-065	1/34
DW-AD-509-M18-320	1/97	DW-AD-603-M5-735	1/143	DW-AD-621-065-120	1/33
DW-AD-509-M18-390	1/97	DW-AD-603-M5E	1/131	DW-AD-621-065-121	1/33
DW-AD-509-M30	1/98	DW-AD-603-M8	1/36	DW-AD-621-065-122	1/34
DW-AD-509-M30-390	1/98	DW-AD-603-M8-120	1/35	DW-AD-621-065-400	1/33
DW-AD-511-M8	1/44	DW-AD-603-M8-121	1/36	DW-AD-621-C5	1/79
DW-AD-511-M12	1/53	DW-AD-603-M8-122	1/36	DW-AD-621-C8	1/45
DW-AD-511-M12-120	1/53	DW-AD-603-M12	1/47	DW-AD-621-M4	1/74
DW-AD-511-M18	1/59	DW-AD-603-M12-120	1/47	DW-AD-621-M4-960	1/73
DW-AD-511-M18-120	1/59	DW-AD-603-M12-734	1/143	DW-AD-621-M5	1/76
DW-AD-511-M30	1/65	DW-AD-603-M18	1/54	DW-AD-621-M8	1/39
DW-AD-511-M30-120	1/64	DW-AD-603-M18-120	1/54	DW-AD-621-M8-120	1/38
DW-AD-513-M8	1/44	DW-AD-603-M18-718	1/143	DW-AD-621-M8-121	1/38
DW-AD-513-M12	1/53	DW-AD-603-M30	1/60	DW-AD-621-M8-122	1/38
DW-AD-513-M12-120	1/53	DW-AD-604-03	1/71	DW-AD-621-M8-177	1/39
DW-AD-513-M18	1/59	DW-AD-604-04	1/73	DW-AD-621-M12	1/49
DW-AD-513-M18-120	1/59	DW-AD-604-C5	1/78	DW-AD-621-M12-120	1/48
DW-AD-513-M30	1/65	DW-AD-604-M4	1/72	DW-AD-621-M18	1/56
DW-AD-513-M30-120	1/64	DW-AD-604-M5	1/76	DW-AD-621-M18-120	1/55
DW-AD-514-M18	1/59	DW-AD-605-03	1/103	DW-AD-623-03	1/71

Inductive

Photoelectric

Safety

RFID

Connectivity

Accessories

Glossary

Index

INDUCTIVE SENSORS

<i>Part reference</i>	<i>Chapter/page</i>	<i>Part reference</i>	<i>Chapter/page</i>	<i>Part reference</i>	<i>Chapter/page</i>
DW-AD-623-03-960	1/71	DW-AD-711-M5	1/78	DW-AS-504-M5	1/77
DW-AD-623-03E-961	1/131	DW-AD-711-M8	1/83	DW-AS-504-M18-002	1/58
DW-AD-623-04	1/74	DW-AD-711-M12	1/85	DW-AS-504-M30-002	1/63
DW-AD-623-065	1/34	DW-AD-711-M18	1/88	DW-AS-504-P12-630	1/135
DW-AD-623-065-120	1/33	DW-AD-711-M30	1/90	DW-AS-509-C8-390	1/95
DW-AD-623-065-121	1/33	DW-AD-713-04	1/75	DW-AS-509-M8-390	1/95
DW-AD-623-065-122	1/34	DW-AD-713-M5	1/78	DW-AS-509-M8-393	1/96
DW-AD-623-065-400	1/33	DW-AD-713-M8	1/83	DW-AS-509-M12	1/97
DW-AD-623-C5	1/79	DW-AD-713-M12	1/85	DW-AS-509-M12-120	1/97
DW-AD-623-C8	1/45	DW-AD-713-M18	1/88	DW-AS-509-M12-320	1/97
DW-AD-623-M4	1/73	DW-AD-713-M30	1/90	DW-AS-509-M12-390	1/97
DW-AD-623-M4-960	1/73	DW-AD-714-M8	1/83	DW-AS-509-M18-002	1/98
DW-AD-623-M5	1/76	DW-AD-731-M12	1/86	DW-AS-509-M18-390	1/98
DW-AD-623-M8	1/39	DW-AD-733-M12	1/86	DW-AS-509-M30-002	1/99
DW-AD-623-M8-120	1/38	DW-AS-60A-C44	1/66	DW-AS-509-M30-390	1/99
DW-AD-623-M8-121	1/38	DW-AS-60B-C44	1/66	DW-AS-511-M8-001	1/44
DW-AD-623-M8-122	1/38	DW-AS-61A-C44	1/67	DW-AS-511-M8	1/45
DW-AD-623-M8-177	1/39	DW-AS-61B-C44	1/67	DW-AS-511-M12	1/54
DW-AD-623-M12	1/49	DW-AS-62A-C44	1/66	DW-AS-511-M12-120	1/53
DW-AD-623-M12-120	1/48	DW-AS-62B-C44	1/66	DW-AS-511-M18-002	1/59
DW-AD-623-M18	1/56	DW-AS-63A-C44	1/67	DW-AS-511-M18-120	1/59
DW-AD-623-M18-120	1/55	DW-AS-63B-C44	1/67	DW-AS-511-M30-002	1/65
DW-AD-624-04	1/74	DW-AS-501-04	1/75	DW-AS-511-M30-120	1/65
DW-AD-624-C5	1/79	DW-AS-501-065-001	1/35	DW-AS-513-M8-001	1/44
DW-AD-624-M5	1/76	DW-AS-501-C8	1/46	DW-AS-513-M8	1/45
DW-AD-627-M12	1/118	DW-AS-501-M5	1/77	DW-AS-513-M12	1/54
DW-AD-628-M12	1/118	DW-AS-501-M8-001	1/42	DW-AS-513-M18-002	1/59
DW-AD-631-M8	1/43	DW-AS-501-M8	1/42	DW-AS-513-M12-120	1/53
DW-AD-631-M12	1/51	DW-AS-501-M12	1/51	DW-AS-513-M18-120	1/59
DW-AD-631-M30	1/64	DW-AS-501-M12-120	1/51	DW-AS-513-M30-002	1/65
DW-AD-633-M8	1/43	DW-AS-501-M18-002	1/58	DW-AS-513-M30-120	1/65
DW-AD-633-M12	1/51	DW-AS-501-M18-120	1/58	DW-AS-514-M18-002	1/59
DW-AD-633-M30	1/64	DW-AS-501-M30-002	1/63	DW-AS-514-M30-002	1/65
DW-AD-701-C23	1/91	DW-AS-501-M30-120	1/63	DW-AS-519-M18-002	1/98
DW-AD-701-M8	1/83	DW-AS-501-P12	1/136	DW-AS-519-M18-390	1/98
DW-AD-701-M8-BAS	1/41	DW-AS-501-P12-621	1/136	DW-AS-519-M30-002	1/99
DW-AD-701-M12	1/85	DW-AS-501-P12-622	1/137	DW-AS-519-M30-120	1/99
DW-AD-701-M12-303	1/84	DW-AS-501-P12-627	1/136	DW-AS-519-M30-320	1/99
DW-AD-701-M12-BAS	1/47	DW-AS-501-P12-635	1/137	DW-AS-519-M30-390	1/99
DW-AD-701-M18	1/87	DW-AS-501-P20	1/138	DW-AS-521-M8-001	1/43
DW-AD-701-M18-303	1/87	DW-AS-503-04	1/75	DW-AS-521-M8	1/43
DW-AD-701-M18-BAS	1/55	DW-AS-503-065-001	1/35	DW-AS-521-M12	1/53
DW-AD-701-M30	1/89	DW-AS-503-C8	1/46	DW-AS-521-M12-120	1/52
DW-AD-701-M30-BAS	1/61	DW-AS-503-M5	1/77	DW-AS-523-M8-001	1/43
DW-AD-703-C23	1/91	DW-AS-503-M8-001	1/42	DW-AS-523-M8	1/43
DW-AD-703-M8	1/83	DW-AS-503-M8	1/42	DW-AS-523-M12	1/53
DW-AD-703-M8-BAS	1/41	DW-AS-503-M12	1/51	DW-AS-523-M12-120	1/52
DW-AD-703-M12	1/85	DW-AS-503-M12-120	1/51	DW-AS-523-P12-630	1/135
DW-AD-703-M12-303	1/84	DW-AS-503-M18-002	1/58	DW-AS-601-04	1/74
DW-AD-703-M12-BAS	1/47	DW-AS-503-M18-120	1/58	DW-AS-601-065-001	1/33
DW-AD-703-M18	1/87	DW-AS-503-M30-002	1/63	DW-AS-601-065-123	1/32
DW-AD-703-M18-303	1/87	DW-AS-503-M30-120	1/63	DW-AS-601-065-124	1/32
DW-AD-703-M18-BAS	1/55	DW-AS-503-P12	1/136	DW-AS-601-065-129	1/32
DW-AD-703-M30	1/89	DW-AS-503-P12-621	1/136	DW-AS-601-C8-001	1/45
DW-AD-703-M30-303	1/89	DW-AS-503-P12-622	1/137	DW-AS-601-M5	1/76
DW-AD-703-M30-BAS	1/61	DW-AS-503-P12-627	1/136	DW-AS-601-M8-001	1/37
DW-AD-704-M8	1/83	DW-AS-503-P12-630	1/135	DW-AS-601-M8	1/37
DW-AD-704-M18	1/87	DW-AS-503-P12-635	1/137	DW-AS-601-M8-123	1/37
DW-AD-704-M30	1/89	DW-AS-503-P20	1/138	DW-AS-601-M8-124	1/37
DW-AD-711-04	1/75	DW-AS-504-04	1/75	DW-AS-601-M12	1/47

INDUCTIVE SENSORS

<i>Part reference</i>	<i>Chapter/page</i>	<i>Part reference</i>	<i>Chapter/page</i>	<i>Part reference</i>	<i>Chapter/page</i>
DW-AS-601-M12-120	1/47	DW-AS-621-M8	1/40	DW-AS-703-M18-120	1/87
DW-AS-601-M18-002	1/55	DW-AS-621-M8-123	1/39	DW-AS-703-M18-303	1/87
DW-AS-601-M18-120	1/54	DW-AS-621-M8-124	1/40	DW-AS-703-M18-673	1/153
DW-AS-601-M30-002	1/60	DW-AS-621-M8-129	1/39	DW-AS-703-M18-761	1/153
DW-AS-601-M30-120	1/60	DW-AS-621-M12	1/50	DW-AS-703-M18-BAS	1/55
DW-AS-603-04	1/74	DW-AS-621-M12-120	1/49	DW-AS-703-M30-002	1/89
DW-AS-603-065-001	1/33	DW-AS-621-M18-002	1/57	DW-AS-703-M30-303	1/89
DW-AS-603-065-123	1/32	DW-AS-621-M18-120	1/56	DW-AS-703-M30-BAS	1/61
DW-AS-603-065-124	1/32	DW-AS-623-04	1/75	DW-AS-704-M12	1/85
DW-AS-603-065-129	1/32	DW-AS-623-065-123	1/34	DW-AS-704-M18-002	1/88
DW-AS-603-C8-001	1/45	DW-AS-623-065-124	1/35	DW-AS-711-M8-001	1/84
DW-AS-603-M5	1/76	DW-AS-623-C8-001	1/46	DW-AS-711-M8	1/84
DW-AS-603-M8-001	1/37	DW-AS-623-M5	1/77	DW-AS-711-M12	1/86
DW-AS-603-M8	1/37	DW-AS-623-M8-001	1/40	DW-AS-711-M18-002	1/88
DW-AS-603-M8-123	1/37	DW-AS-623-M8	1/40	DW-AS-711-M30-002	1/90
DW-AS-603-M8-124	1/37	DW-AS-623-M8-123	1/39	DW-AS-713-M8-001	1/84
DW-AS-603-M12	1/47	DW-AS-623-M8-124	1/40	DW-AS-713-M8	1/84
DW-AS-603-M12-120	1/47	DW-AS-623-M8-129	1/39	DW-AS-713-M12	1/86
DW-AS-603-M18-002	1/55	DW-AS-623-M8-193	1/40	DW-AS-713-M12-967	1/157
DW-AS-603-M18-120	1/54	DW-AS-623-M12	1/50	DW-AS-713-M18-002	1/88
DW-AS-603-M30-002	1/60	DW-AS-623-M12-120	1/49	DW-AS-713-M18-967	1/157
DW-AS-603-M30-120	1/60	DW-AS-623-M18-002	1/57	DW-AS-713-M30-002	1/90
DW-AS-604-M5	1/76	DW-AS-623-M18-120	1/56	DW-AS-713-M30-618	1/161
DW-AS-604-M18-002	1/55	DW-AS-624-M5	1/77	DW-AS-713-M30-967	1/157
DW-AS-605-03	1/103	DW-AS-624-M12	1/50	DW-AS-731-M12	1/86
DW-AS-605-04	1/104	DW-AS-624-M18-002	1/57	DW-AS-733-M12	1/86
DW-AS-605-065-129	1/106	DW-AS-627-M12-069	1/119	DW-AV-501-P5-276	1/135
DW-AS-605-C5	1/105	DW-AS-628-M12-069	1/119	DW-AV-503-P5-276	1/135
DW-AS-605-M4	1/103	DW-AS-631-M8-001	1/44	DW-AV-601-03-276	1/71
DW-AS-605-M5	1/105	DW-AS-631-M12-120	1/51	DW-AV-601-04-236	1/74
DW-AS-607-M12-069	1/115	DW-AS-631-M18-002	1/57	DW-AV-601-M4-276	1/72
DW-AS-607-M18-069	1/120	DW-AS-631-M30-002	1/64	DW-AV-603-03-276	1/71
DW-AS-607-M30-069	1/125	DW-AS-633-M8-001	1/44	DW-AV-603-04-236	1/74
DW-AS-608-M18-069	1/120	DW-AS-633-M8-732	1/143	DW-AV-603-M4-276	1/72
DW-AS-608-M30-069	1/125	DW-AS-633-M12-120	1/51	DW-AV-621-03-276	1/72
DW-AS-611-M8-001	1/41	DW-AS-633-M18-002	1/57	DW-AV-621-M4-276	1/73
DW-AS-611-M8	1/41	DW-AS-633-M30-002	1/64	DW-AV-623-03-276	1/72
DW-AS-611-M12	1/49	DW-AS-701-M8-001	1/83	DW-AV-623-M4-276	1/73
DW-AS-611-M12-120	1/49	DW-AS-701-M8	1/83	DW-AV-701-C23-276	1/91
DW-AS-611-M18-002	1/56	DW-AS-701-M8-001-BAS	1/41	DW-AV-703-C23-276	1/91
DW-AS-611-M30-002	1/61	DW-AS-701-M12	1/85	DW-DD-605-065	1/110
DW-AS-613-M8-001	1/41	DW-AS-701-M12-303	1/85	DW-DD-605-M8	1/110
DW-AS-613-M8	1/41	DW-AS-701-M12-BAS	1/48	DW-DD-605-M12	1/114
DW-AS-613-M12	1/49	DW-AS-701-M18-002	1/88	DW-DD-605-M12-120	1/114
DW-AS-613-M12-120	1/49	DW-AS-701-M18-120	1/87	DW-DD-605-M18	1/119
DW-AS-613-M18-002	1/56	DW-AS-701-M18-303	1/87	DW-DD-605-M18-120	1/119
DW-AS-613-M30-002	1/61	DW-AS-701-M18-BAS	1/55	DW-DD-605-M30	1/124
DW-AS-614-M18-002	1/56	DW-AS-701-M30-002	1/89	DW-DD-605-M30-120	1/124
DW-AS-617-M12-069	1/117	DW-AS-701-M30-BAS	1/61	DW-DD-606-M8	1/110
DW-AS-617-M18-069	1/122	DW-AS-703-M8-001	1/83	DW-DD-606-M12	1/114
DW-AS-617-M30-069	1/127	DW-AS-703-M8	1/83	DW-DD-606-M12-120	1/114
DW-AS-618-M12-069	1/117	DW-AS-703-M8-001-BAS	1/41	DW-DD-606-M18	1/119
DW-AS-618-M18-069	1/122	DW-AS-703-M8-673	1/153	DW-DD-606-M18-120	1/119
DW-AS-618-M30-069	1/127	DW-AS-703-M8-761	1/153	DW-DD-606-M30	1/124
DW-AS-621-04	1/75	DW-AS-703-M12	1/85	DW-DD-606-M30-120	1/124
DW-AS-621-065-123	1/34	DW-AS-703-M12-303	1/85	DW-DD-615-M8	1/113
DW-AS-621-065-124	1/35	DW-AS-703-M12-673	1/153	DW-DD-615-M12	1/116
DW-AS-621-C8-001	1/46	DW-AS-703-M12-761	1/153	DW-DD-615-M12-120	1/115
DW-AS-621-M5	1/77	DW-AS-703-M12-BAS	1/48	DW-DD-615-M18	1/121
DW-AS-621-M8-001	1/40	DW-AS-703-M18-002	1/88	DW-DD-615-M18-120	1/121

Inductive

Photoelectric

Safety

RFID

Connectivity

Accessories

Glossary

Index

INDUCTIVE SENSORS

<i>Part reference</i>	<i>Chapter/page</i>	<i>Part reference</i>	<i>Chapter/page</i>
DW-DD-615-M30	1/126	DW-DS-626-M18-120	1/123
DW-DD-615-M30-120	1/126	DW-HD-601-M12-200	1/146
DW-DD-616-M8	1/113	DW-HD-601-M12-810	1/111
DW-DD-616-M12	1/116	DW-HD-601-M18-310	1/146
DW-DD-616-M12-120	1/115	DW-HD-601-M18-411	1/148
DW-DD-616-M18	1/121	DW-HD-601-M18-810	1/147
DW-DD-616-M18-120	1/121	DW-HD-601-M30-310	1/146
DW-DD-616-M30	1/126	DW-HD-601-M30-411	1/149
DW-DD-616-M30-120	1/126	DW-HD-601-M30-810	1/148
DW-DD-625-M8	1/112	DW-HD-601-M50-411	1/146
DW-DD-625-M12	1/117	DW-HD-603-M12-200	1/146
DW-DD-625-M12-120	1/117	DW-HD-603-M12-810	1/147
DW-DD-625-M18	1/123	DW-HD-603-M18-411	1/148
DW-DD-625-M18-120	1/122	DW-HD-603-M18-310	1/146
DW-DD-626-M8	1/112	DW-HD-603-M18-810	1/147
DW-DD-626-M12	1/117	DW-HD-603-M30-310	1/146
DW-DD-626-M12-120	1/117	DW-HD-603-M30-411	1/149
DW-DD-626-M18	1/123	DW-HD-603-M30-810	1/148
DW-DD-626-M18-120	1/122	DW-HD-603-M50-411	1/146
DW-DS-605-M8-001	1/111	DW-HD-611-M50-411	1/146
DW-DS-605-M8	1/111	DW-HD-613-M50-411	1/146
DW-DS-605-M12	1/115	DW-HD-613-M50-503	1/149
DW-DS-605-M12-120	1/115	DW-HD-613-M50-511	1/149
DW-DS-605-M18-002	1/120	DW-HD-621-M8-100	1/146
DW-DS-605-M18-120	1/120	DW-HD-621-M8-610	1/147
DW-DS-605-M30-002	1/125	DW-HD-621-M12-810	1/147
DW-DS-605-M30-120	1/125	DW-HD-623-M8-100	1/146
DW-DS-606-M8-001	1/111	DW-HD-623-M8-610	1/147
DW-DS-606-M8	1/111	DW-HD-623-M12-810	1/147
DW-DS-606-M12	1/115	DW-LD-703-M12	1/171
DW-DS-606-M12-120	1/115	DW-LD-703-M18	1/172
DW-DS-606-M18-002	1/120	DW-LD-703-M30	1/173
DW-DS-606-M18-120	1/120	DW-LD-713-M12	1/171
DW-DS-606-M30-002	1/125	DW-LD-713-M18	1/173
DW-DS-606-M30-120	1/125	DW-LD-713-M30	1/174
DW-DS-615-M8-001	1/113	DW-LS-603-M12	1/171
DW-DS-615-M8	1/113	DW-LS-703-M12	1/171
DW-DS-615-M12	1/117	DW-LS-703-M18-002	1/172
DW-DS-615-M12-120	1/116	DW-LS-703-M30-002	1/174
DW-DS-615-M18-002	1/122	DW-LS-703-P12G	1/137
DW-DS-615-M18-120	1/121	DW-LS-713-M12	1/172
DW-DS-615-M30-002	1/127	DW-LS-713-M18-002	1/173
DW-DS-615-M30-120	1/127	DW-LS-713-M30-002	1/174
DW-DS-616-M8-001	1/113	DW-MD-703-C23	1/167
DW-DS-616-M8	1/113	DW-MD-703-M12	1/165
DW-DS-616-M12	1/117	DW-MD-703-M18	1/166
DW-DS-616-M12-120	1/116	DW-MD-703-M30	1/167
DW-DS-616-M18-002	1/122	DW-MD-703-P12G	1/165
DW-DS-616-M18-120	1/121	DW-MS-703-M12	1/165
DW-DS-616-M30-002	1/127	DW-MS-703-M18-002	1/166
DW-DS-616-M30-120	1/127	DW-MS-703-M30-002	1/166
DW-DS-625-M8-001	1/112	DW-MS-703-P12G	1/165
DW-DS-625-M12	1/118	DW-MV-703-C23-276	1/167
DW-DS-625-M12-120	1/118		
DW-DS-625-M18-002	1/123		
DW-DS-625-M18-120	1/123		
DW-DS-626-M8-001	1/112		
DW-DS-626-M12	1/118		
DW-DS-626-M12-120	1/118		
DW-DS-626-M18-002	1/123		



PHOTOELECTRIC SENSORS

NEW DESIGNATION SINCE 2013

LTR-C23PA-PMS-403 (-XXX)

SENSOR TYPE

Diffuse	LT
Retro-reflex	LR
Through-beam	LL
Background suppression	LH
Distance diffuse	DT
Transparent retro-reflex	TR

EMISSION TYPE

Red	R
Laser	L
UV	U

HOUSING TYPE

Cubic	C
Cylindrical threaded	M

HOUSING SIZE

Cubic 1# mm x 2# mm	12
Cubic 2# mm x 3# mm	23
Cubic 5# mm x 5# mm	55
Cylindrical 18 mm	18

HOUSING MATERIAL

Plastic	P
---------	---

PERFORMANCE

Standard	A, B
----------	------

ADJUSTMENT TYPE

No teach or potentiometer	N
Potentiometer	P
Teach button	T

SPECIAL EXECUTIONS

OUTPUT

4-wire devices, NPN

Light-ON + Dark-ON	01
Light-ON + stability alarm	0A
Dark-ON + stability alarm	0B

4-wire devices, PNP

Light-ON + Dark-ON	03
Light-ON + stability alarm	0C
Dark-ON + stability alarm	0D

3-wire devices, NPN

Light-ON	01
Dark-ON	02

3-wire devices, PNP

Light-ON	03
Dark-ON	04

Other

3- or 4-wire through-beam sensor (emitter)	00
Analog	#9
Special	##

4-wire sensor	1
3-wire sensor	3
3-wire sensor with IO-Link	4
4-wire sensor with IO-Link	6

CONNECTION TYPE

Cable	K
Connector	S
Cable + connector	V

DETECTION DISTANCE

Short	S
Standard	M
Long	L
Extra long	X

PHOTOELECTRIC SENSORS

LTS-1180-303 (-XXX)

PHOTOELECTRIC SENSOR	L
COLOR SENSOR	F
CONTRAST SENSOR	K

SENSOR TYPE

With analog output	A
For fibers / fiber	F
With background suppression	H
Through-beam sensor	L
Reflex sensor	R
Diffuse sensor	T
Accessories	X
Device with cable	K
Device with connector	S
Device with pigtail	V
Synthetic optical fiber	P
Glass optical fiber	G
Reflector (standard)	R
Reflector for UV light	U
Cutting tool	F
Mounting bracket	W

SERIES

Cylindrical devices	
Ø 4	1040
M5	1050
M12	1120
M12 laser	112#L
M18	1180
M18 laser	118#L
M18 with lateral light emission	1180W

Rectangular devices	
5 x 7 mm	0507
30x30 mm (high-performance)	3#30
30x30 mm (standard)	3#31
31x60 mm (standard)	3060
31x60 mm (teach-in)	3065
31x60 mm (teach-in & digital display)	3066
31x60 mm (blue light)	3360
40 x 40 mm	4040
40 x 50 mm	415#

Synthetic optical fibers	
Diffuse sensor	1###
Through-beam sensor	2###
Miniature / standard / coaxial	#0##
Flexible	#1##
Luminous (enhanced brightness)	#2##

Glass optical fibers	
Axial diffuse sensor	1###
Radial diffuse sensor	2###
Axial through-beam sensor	3###
Radial through-beam sensor	4###
Accessories	0###

SPECIAL EXECUTIONS

EXECUTION

3- or 4-wire through-beam sensor (emitter)	00
4-wire devices, NPN, output:	
Light-ON + Dark-ON or switchable	01
Light-ON and excess gain	02
4-wire devices, PNP, output:	
Light-ON + Dark-ON or switchable	03
Light-ON and excess gain	04
3-wire devices, NPN, output:	
Light-ON	01
Dark-ON	02
3-wire devices, PNP, output:	
Light-ON	03
Dark-ON	04

DIMENSIONS

Synthetic optical fibers	
Length in dm (2 m)	020
Length in dm (5 m)	050
Length in dm (10 m)	100
Glass optical fibers	
Length in cm (0.25 m)	025
Length in cm (0.50 m)	050
Length in cm (1 m)	100
Length in cm (2 m)	200
Accessories	
General	###

4-wire through-beam sensor	0
4-wire basic device	1
3-wire through-beam sensor	2
3-wire basic device	3
With IO-Link	4

Inductive

Photoelectric

Safety

RFID

Connectivity

Accessories

Glossary

Index

PHOTOELECTRIC SENSORS

LIGHT GRIDS

DGI-02A-0075-PMS-107

LIGHT GRID TYPE

Detection grid	DG
Measurement grid	MG

LIGHT SOURCE

Infrared	I
----------	----------

RESOLUTION / CENTER BEAM SPACING

Resolution in mm (DGI)	##
Center beam spacing in mm (MGI)	##

SERIES

Standard	A
----------	----------

DIMENSIONS

Beam height in mm	####
-------------------	-------------

OUTPUT

Analog	49
Push-Pull	07

NUMBER OF WIRES

4-wire	1
--------	----------

CONNECTION TYPE

Connector	S
-----------	----------

SENSING RANGE

Standard	M
----------	----------

ADJUSTMENT TYPE

No potentiometer	N
Potentiometer	P

PHOTOELECTRIC SENSORS

<i>Part reference</i>	<i>Chapter/page</i>	<i>Part reference</i>	<i>Chapter/page</i>	<i>Part reference</i>	<i>Chapter/page</i>
DGI-01A-0075-PMS-107	2/293	LHS-1180W-301	2/200	LRK-1180-302	2/202
DGI-01A-0155-PMS-107	2/293	LHS-1180W-303	2/200	LRK-1180-304	2/202
DGI-02A-0075-PMS-107	2/293	LHS-3130-101	2/213	LRK-3030-101	2/218
DGI-02A-0155-PMS-107	2/293	LHS-3130-103	2/213	LRK-3030-103	2/218
DGI-04A-0075-NMS-107	2/293	LHS-3131-301	2/214	LRK-3031-302	2/217
DGI-04A-0155-NMS-107	2/293	LHS-3131-303	2/214	LRK-3031-304	2/217
DGI-08A-0190-NMS-107	2/293	LHS-4150-101	2/221	LRR-C12PA-NMK-302	2/240
DGI-08A-0480-NMS-107	2/293	LHS-4150-103	2/221	LRR-C12PA-NMK-304	2/240
DGI-25A-0480-NMS-107	2/293	LLK-1180-000	2/203	LRR-C23PA-NMS-101	2/211
DGI-25A-0960-NMS-107	2/293	LLK-1180-001 (receiver)	2/203	LRR-C23PA-NMS-10B	2/211
DGI-25A-2010-NMS-107	2/293	LLK-1180-003 (receiver)	2/203	LRR-C23PA-NMS-302	2/211
DTL-C23PB-TMS-139-501	2/283	LLK-1181L-000	2/206	LRR-C23PA-NMS-404	2/211
DTL-C55PA-TMS-119-502	2/285	LLK-1181L-001 (receiver)	2/206	LRR-C23PA-NMS-603	2/211
DTL-C55PA-TMS-119-503	2/285	LLK-1181L-003 (receiver)	2/206	LRR-C23PA-NMS-60D	2/211
DTL-C55PA-TMS-407-505	2/285	LLR-C12PA-NMK-300	2/241	LRR-M18PA-NMS-101	2/197
DTR-C23PB-TLS-129	2/283	LLR-C12PA-NMK-302 (receiver)	2/241	LRR-M18PA-NMS-10B	2/197
DTR-C23PB-TLS-139	2/283	LLR-C12PA-NMK-304 (receiver)	2/241	LRR-M18PA-NMS-302	2/197
DTR-C23PB-TMS-129	2/283	LLR-C23PA-NMS-101	2/211	LRR-M18PA-NMS-404	2/197
DTR-C23PB-TMS-139	2/283	LLR-C23PA-NMS-10B	2/211	LRR-M18PA-NMS-603	2/197
FTS-4155-301	2/289	LLR-C23PA-NMS-302	2/211	LRR-M18PA-NMS-60D	2/197
FTS-4155-303	2/289	LLR-C23PA-NMS-400	2/211	LRS-1120-302	2/192
KTS-4155-407	2/289	LLR-C23PA-NMS-404	2/211	LRS-1120-304	2/192
LAS-3130-119	2/213	LLR-C23PA-NMS-603	2/211	LRS-1180-302	2/202
LHK-1180-301	2/199	LLR-C23PA-NMS-60D	2/211	LRS-1180-304	2/202
LHK-1180-303	2/199	LLR-M18PA-NMS-101	2/197	LRS-1180W-302	2/203
LHK-3131-301	2/214	LLR-M18PA-NMS-10B	2/197	LRS-1180W-304	2/203
LHK-3131-303	2/214	LLR-M18PA-NMS-302	2/197	LRS-3030-101	2/218
LHL-C55PA-TMS-107-501	2/225	LLR-M18PA-NMS-400	2/197	LRS-3030-103	2/218
LHR-C12PA-NMK-301	2/240	LLR-M18PA-NMS-404	2/197	LRS-3031-302	2/217
LHR-C12PA-NMK-303	2/240	LLR-M18PA-NMS-603	2/197	LRS-3031-304	2/217
LHR-C12PA-NSK-301	2/239	LLR-M18PA-NMS-60D	2/197	LRS-4150-101	2/222
LHR-C12PA-NSK-303	2/239	LLS-1040-200	2/231	LRS-4150-103	2/222
LHR-C12PA-PLK-301	2/239	LLS-1040-202 (receiver)	2/231	LTK-0507-301-501	2/237
LHR-C12PA-PLK-303	2/239	LLS-1040-204 (receiver)	2/231	LTK-0507-301	2/237
LHR-C23PA-PMS-101	2/209	LLS-1050-200	2/235	LTK-0507-303-501	2/237
LHR-C23PA-PMS-10A	2/209	LLS-1050-202 (receiver)	2/235	LTK-0507-303-502	2/237
LHR-C23PA-PMS-301	2/209	LLS-1050-204 (receiver)	2/235	LTK-0507-303	2/237
LHR-C23PA-PMS-403	2/209	LLS-1120-200 (emitter)	2/192	LTK-1040-301-505	2/229
LHR-C23PA-PMS-603	2/209	LLS-1120-202 (receiver)	2/192	LTK-1040-301-506	2/230
LHR-C23PA-PMS-60C	2/209	LLS-1120-204 (receiver)	2/192	LTK-1040-301	2/231
LHR-C23PA-TMS-101	2/209	LLS-1121L-200 (emitter)	2/193	LTK-1040-303-505	2/229
LHR-C23PA-TMS-10A	2/209	LLS-1121L-202 (receiver)	2/193	LTK-1040-303-506	2/230
LHR-C23PA-TMS-301	2/209	LLS-1121L-204 (receiver)	2/193	LTK-1040-303	2/231
LHR-C23PA-TMS-403	2/209	LLS-1180-000	2/204	LTK-1050-301-505	2/232
LHR-C23PA-TMS-603	2/209	LLS-1180-001 (receiver)	2/204	LTK-1050-301-506	2/233
LHR-C23PA-TMS-60C	2/209	LLS-1180-003 (receiver)	2/204	LTK-1050-301	2/234
LHR-M18PA-PMS-101	2/195	LLS-1180W-000	2/204	LTK-1050-303-505	2/232
LHR-M18PA-PMS-10A	2/195	LLS-1180W-001 (receiver)	2/204	LTK-1050-303-506	2/233
LHR-M18PA-PMS-301	2/195	LLS-1180W-003 (receiver)	2/204	LTK-1050-303	2/234
LHR-M18PA-PMS-403	2/195	LLS-1181L-000	2/206	LTK-1120-301	2/191
LHR-M18PA-PMS-603	2/195	LLS-1181L-001 (receiver)	2/206	LTK-1120-303	2/191
LHR-M18PA-PMS-60C	2/195	LLS-1181L-003 (receiver)	2/206	LTK-1180-101	2/200
LHR-M18PA-TMS-101	2/195	LLS-3030-000	2/219	LTK-1180-103	2/200
LHR-M18PA-TMS-10A	2/195	LLS-3030-003 (receiver)	2/219	LTK-3030-101	2/216
LHR-M18PA-TMS-301	2/195	LLS-3031-200	2/219	LTK-3030-103	2/216
LHR-M18PA-TMS-403	2/195	LLS-3031-202 (receiver)	2/219	LTK-3031-301	2/215
LHR-M18PA-TMS-603	2/195	LLS-3031-204 (receiver)	2/219	LTK-3031-303	2/215
LHR-M18PA-TMS-60C	2/195	LLS-4150-000	2/222	LTR-C23PA-NMS-403	2/210
LHS-1180-301	2/199	LLS-4150-001 (receiver)	2/222	LTR-C23PA-PMS-101	2/210
LHS-1180-303	2/199	LLS-4150-003 (receiver)	2/222	LTR-C23PA-PMS-104	2/210

Inductive

Photoelectric

Safety

RFID

Connectivity

Accessories

Glossary

Index

PHOTOELECTRIC SENSORS

<i>Part reference</i>	<i>Chapter/page</i>	<i>Part reference</i>	<i>Chapter/page</i>
LTR-C23PA-PMS-301	2/210	TRU-C23PA-TMK-101	2/245
LTR-C23PA-PMS-403	2/210	TRU-C23PA-TMK-10B	2/245
LTR-C23PA-PMS-603	2/210	TRU-C23PA-TMK-603	2/245
LTR-C23PA-PMS-60C	2/210	TRU-C23PA-TMK-60D	2/245
LTR-M18PA-NMS-403	2/196	TRU-C23PA-TMS-101	2/245
LTR-M18PA-PMS-101	2/196	TRU-C23PA-TMS-10B	2/245
LTR-M18PA-PMS-104	2/196	TRU-C23PA-TMS-603	2/245
LTR-M18PA-PMS-301	2/196	TRU-C23PA-TMS-60D	2/245
LTR-M18PA-PMS-403	2/196		
LTR-M18PA-PMS-603	2/196		
LTR-M18PA-PMS-60C	2/196		
LTS-1040-301-505	2/229		
LTS-1040-301-506	2/230		
LTS-1040-301	2/231		
LTS-1040-303-505	2/229		
LTS-1040-303-506	2/230		
LTS-1040-303	2/231		
LTS-1050-301-505	2/232		
LTS-1050-301-506	2/233		
LTS-1050-301	2/234		
LTS-1050-303-505	2/232		
LTS-1050-303-506	2/233		
LTS-1050-303	2/234		
LTS-1120-301	2/191		
LTS-1180-101	2/201		
LTS-1180-103	2/201		
LTS-1180L-101-516	2/205		
LTS-1180L-101	2/205		
LTS-1180L-103-516	2/205		
LTS-1180L-103	2/205		
LTS-1180W-101	2/201		
LTS-1180W-103	2/201		
LTS-3030-101	2/216		
LTS-3030-103	2/216		
LTS-3031-301	2/215		
LTS-3031-303	2/215		
LTS-4150-101	2/221		
LTS-4150-103	2/221		
MGI-05A-0232-NMS-149	2/295		
MGI-05A-0472-NMS-149	2/295		
MGI-05A-0952-NMS-149	2/295		
MGI-12A-0458-NMS-149	2/295		
MGI-12A-0938-NMS-149	2/295		
MGI-12A-1418-NMS-149	2/295		
TRR-C23PA-PMK-101	2/246		
TRR-C23PA-PMK-10B	2/246		
TRR-C23PA-PMK-603	2/246		
TRR-C23PA-PMK-60D	2/246		
TRR-C23PA-PMS-101	2/246		
TRR-C23PA-PMS-10B	2/246		
TRR-C23PA-PMS-603	2/246		
TRR-C23PA-PMS-60D	2/246		
TRR-C23PA-TMK-101	2/247		
TRR-C23PA-TMK-10B	2/247		
TRR-C23PA-TMK-603	2/247		
TRR-C23PA-TMK-60D	2/247		
TRR-C23PA-TMS-101	2/247		
TRR-C23PA-TMS-10B	2/247		
TRR-C23PA-TMS-603	2/247		
TRR-C23PA-TMS-60D	2/247		

OPTICAL FIBERS & ACCESSORIES

<i>Part reference</i>	<i>Chapter/page</i>	<i>Part reference</i>	<i>Chapter/page</i>
LFG-1005-###	2/273	LFS-3031-304	2/253
LFG-1010-###	2/273	LFS-3060-101	2/258
LFG-1015-###	2/273	LFS-3060-103	2/258
LFG-1020-###	2/273	LFS-3066-301	2/257
LFG-1022-050	2/277	LFS-3066-403	2/257
LFG-1030-###	2/273	LFS-3360-101	2/259
LFG-2010-###	2/274	LFS-3360-103	2/259
LFG-2020-###	2/274	LFS-4040-103	2/261
LFG-2030-###	2/274	LHW-M18PA-000	2/300
LFG-3010-050	2/275	LLW-M18PA-000	2/300
LFG-3020-###	2/275	LTW-M18PA-000	2/301
LFG-3022-050	2/277	LXF-0000-000	2/271
LFG-3030-###	2/275	LXG-0000-060	2/278
LFG-4010-###	2/276	LXG-0000-080	2/278
LFG-4020-###	2/276	LXR-0000-025	2/303
LFG-4030-100	2/276	LXR-0000-046	2/303
LFK-3030-101	2/254	LXR-0000-084	2/303
LFK-3030-103	2/254	LXR-0001-032	2/303
LFK-3031-301	2/253	LXR-0001-062	2/303
LFK-3031-302	2/253	LXR-0001-064	2/304
LFK-3031-303	2/253	LXR-0001-065	2/304
LFK-3031-304	2/253	LXR-0001-088	2/304
LFK-3060-101	2/258	LXR-0002-025	2/305
LFK-3060-103	2/258	LXR-0002-100	2/305
LFK-3066-301	2/257	LXR-0003-050	2/305
LFK-3066-403	2/257	LXU-0000-025	2/304
LFK-3360-101	2/259	LXU-0000-032	2/304
LFK-3360-103	2/259	LXU-0000-084	2/304
LFK-4040-103	2/261	LXU-0001-064	2/305
LFP-0001-000	2/271	LXW-3030-000	2/301
LFP-0002-000	2/271	LXW-3030-001	2/301
LFP-0003-000	2/271	LXW-3060-000	2/271
LFP-1001-020	2/263	LXW-4040-000	2/271
LFP-1002-020-002	2/270	LXW-4050-000	2/302
LFP-1002-020	2/264	LXW-4050-002	2/302
LFP-1003-020	2/264	LXW-C23PA-000	2/296
LFP-1004-020	2/263	LXW-C23PA-001	2/296
LFP-1005-020	2/265	LXW-C23PA-002	2/296
LFP-1006-020	2/268	LXW-C23PA-003	2/296
LFP-1007-020	2/268	LXW-C23PB-000	2/297
LFP-1010-020	2/269	LXW-C23PB-001	2/297
LFP-1011-020	2/269	LXW-C23PB-002	2/298
LFP-1012-020	2/263	LXW-C23PB-003	2/298
LFP-1013-020	2/265	LXW-C23PB-004	2/298
LFP-1102-020	2/264	LXW-C55PA-000	2/299
LFP-1202-020	2/264	LXW-DGMGA-000	2/299
LFP-2001-020	2/266	LXW-M18PA-000	2/300
LFP-2002-020-002	2/270	LXW-M18PA-001	2/300
LFP-2002-020	2/266		
LFP-2003-020	2/266		
LFP-2004-020	2/267		
LFP-2005-020	2/267		
LFP-2006-020	2/266		
LFP-2102-020	2/267		
LFP-2202-020	2/267		
LFS-3030-101	2/254		
LFS-3030-103	2/254		
LFS-3031-301	2/253		
LFS-3031-302	2/253		
LFS-3031-303	2/253		

Inductive

Photoelectric

Safety

RFID

Connectivity

Accessories

Glossary

Index

SAFETY PRODUCTS

LIGHT CURTAINS AND SAFETY SENSORS

YBB-30S4-0800-G012

SAFETY PRODUCT

Y

PRODUCT TYPE

Basic standard barrier (light curtain)	BB
Access control barrier (light curtain)	CA
Basic slim barrier	BBS
Extended slim barrier	BES
Magnetic sensor	SM
RFID sensor	SR

ADDITIONAL INFORMATION

Resolution (YBB)	
14 mm (finger)	14
30 mm (hand)	30
Operating distance (YCA)	
50 m	50
Hole spacing (YSM, YSR)	
22 mm	22
78 mm	78

MODULE

Receiver	R
Sender	S
Kit (sender + receiver)	K
Reed sensor	R
Read - write RFID sensor	L
Actuator	A

CONNECTION TYPE

Cable, 5 m, PVC	C050
M12 connector, 5 pins	G012
M12 Pigtail, 0.3 m, 5 or 8 pins	P012

ADDITIONAL INFORMATION

Light curtain	
Protective height rounded in mm	####
Coding (safety sensor)	
Random RFID	R###
Teachable RFID	T###
Magnetic	M###
Distance (safety sensor)	
Standard	#S##
Extended	#E##
Actuation (safety sensor)	
Frontal	##F#
90°	##A#
All sides	##S#
Options (safety sensor)	
No option	N
Restart button	R
EDM	E
with LED	L

CATEGORY

Category 2	2
Category 4	4

Part reference	Chapter/page	Part reference	Chapter/page	Part reference	Chapter/page
YBB-14K4-0150-G012	3/318	YBB-30K2-1300-G012	3/330	YBES-30K4-0810-P012	3/348
YBB-14K4-0250-G012	3/318	YBB-30K2-1400-G012	3/330	YBES-30K4-0970-P012	3/348
YBB-14K4-0400-G012	3/318	YBB-30K2-1600-G012	3/330	YBES-30K4-1130-P012	3/348
YBB-14K4-0500-G012	3/319	YBB-30K2-1700-G012	3/330	YBES-30K4-1290-P012	3/348
YBB-14K4-0700-G012	3/319	YBB-30K2-1800-G012	3/330	YBES-30K4-1450-P012	3/348
YBB-14K4-0800-G012	3/319	YBB-30K4-0250-G012	3/324	YBES-30K4-1610-P012	3/348
YBB-14K4-0900-G012	3/319	YBB-30K4-0400-G012	3/324	YBBS-30K2-0170-P012	3/336
YBB-14K4-1000-G012	3/318	YBB-30K4-0500-G012	3/324	YBBS-30K2-0330-P012	3/336
YBB-14K4-1200-G012	3/318	YBB-30K4-0700-G012	3/325	YBBS-30K2-0490-P012	3/336
YBB-14K4-1300-G012	3/318	YBB-30K4-0800-G012	3/325	YBBS-30K2-0650-P012	3/336
YBB-14K4-1400-G012	3/319	YBB-30K4-0900-G012	3/325	YBBS-30K2-0810-P012	3/336
YBB-14K4-1600-G012	3/319	YBB-30K4-1000-G012	3/325	YBBS-30K2-0970-P012	3/336
YBB-14K4-1700-G012	3/319	YBB-30K4-1200-G012	3/324	YBBS-30K2-1130-P012	3/336
YBB-30K2-0150-G012	3/330	YBB-30K4-1300-G012	3/324	YBBS-30K2-1290-P012	3/336
YBB-30K2-0250-G012	3/330	YBB-30K4-1400-G012	3/324	YBBS-30K2-1450-P012	3/336
YBB-30K2-0400-G012	3/330	YBB-30K4-1600-G012	3/325	YBBS-30K2-1610-P012	3/336
YBB-30K2-0500-G012	3/330	YBB-30K4-1700-G012	3/325	YCA-50K4-3400-G012	3/342
YBB-30K2-0700-G012	3/330	YBB-30K4-1800-G012	3/325	YCA-50K4-3500-G012	3/342
YBB-30K2-0800-G012	3/330	YBES-30K4-0170-P012	3/348	YCA-50K4-4300-G012	3/342
YBB-30K2-0900-G012	3/330	YBES-30K4-0330-P012	3/348	YCA-50K4-4400-G012	3/342
YBB-30K2-1000-G012	3/330	YBES-30K4-0490-P012	3/348	YCA-50K4-5300-G012	3/342
YBB-30K2-1200-G012	3/330	YBES-30K4-0650-P012	3/348	YCA-50K4-6300-G012	3/342

SAFETY PRODUCTS

LIGHT CURTAINS AND SAFETY SENSORS

<i>Part reference</i>	<i>Chapter/page</i>
YSM-22K4-MEAN-C050	3/353
YSM-22K4-MEAN-P012	3/353
YSM-22K4-MEFN-C050	3/353
YSM-22K4-MEFN-P012	3/353
YSM-22K4-MSAN-C050	3/353
YSM-22K4-MSAN-P012	3/353
YSM-22K4-MSFN-C050	3/353
YSM-22K4-MSFN-P012	3/353
YSM-78K4-MEAN-C050	3/353
YSM-78K4-MEAN-P012	3/353
YSM-78K4-MEFN-C050	3/353
YSM-78K4-MEFN-P012	3/353
YSR-22K4-RESE-C050	3/357
YSR-22K4-RESE-P012	3/357
YSR-22K4-TESE-C050	3/357
YSR-22K4-TESE-P012	3/357

Inductive

Photoelectric

Safety

RFID

Connectivity

Accessories

Glossary

Index

SAFETY PRODUCTS

SAFETY ACCESSORIES

YRB-4EML-241

SAFETY PRODUCT	Y		MIRROR / DEVICE COLUMN	
PRODUCT TYPE			Device (protection) column	F00
Basic relay	RB		Single mirror column	M11
Light curtain column	XC		3 mirror column	M23
Laser alignment tool	XL		4 mirror column	M24
Mounting brackets	XW		STANDARD ACCESSORIES	000
Filter	XF		RELAY	
Spacer	XS		2 channels, type 4, width 22.5 mm	31S
ADDITIONAL INFORMATION			2 channels, type 4, width 45 mm	242
Relay (YRB)				
Standard functions, 3 NO, 1NC contacts	4EML			
Muting functions, 3 NO contacts	0330			
Column (YXC)				
Column height in mm (e.g. 1060 mm)	1060			
Laser alignment tool (YXL)				
Standard <1 mW (class 2)	0001			
Filter (YXF)				
Standard filter	0001			
Spacer (YXS)				
For YSM-22 series	2200			
For YSM-78 series	7800			
Mounting brackets (YXW)				
Top/bottom brackets (YBB/YCA)	0001			
Sliding T-nuts (YBB/YCA)	0003			
Top/bottom brackets (YBBS/YBES)	0005			
Side brackets (YBBS/YBES)	0006			
Side/end brackets (YBBS/YBES)	0007			

Part reference	Chapter/page
YRB-4EML-31S	3/361
YXC-1060-F00	3/366
YXC-1060-M11	3/367
YXC-1360-F00	3/366
YXC-1360-M11	3/367
YXC-1360-M23	3/367
YXC-1660-F00	3/366
YXC-1960-F00	3/366
YXC-1660-M11	3/367
YXC-1960-M11	3/367
YXF-0001-000	3/364
YXL-0001-000	3/365
YXW-0001-000	3/362
YXW-0003-000	3/362
YXW-0005-000	3/363
YXW-0006-000	3/363
YXW-0007-000	3/363



RFID PRODUCTS

TRANSPONDERS

RTM-0160-000

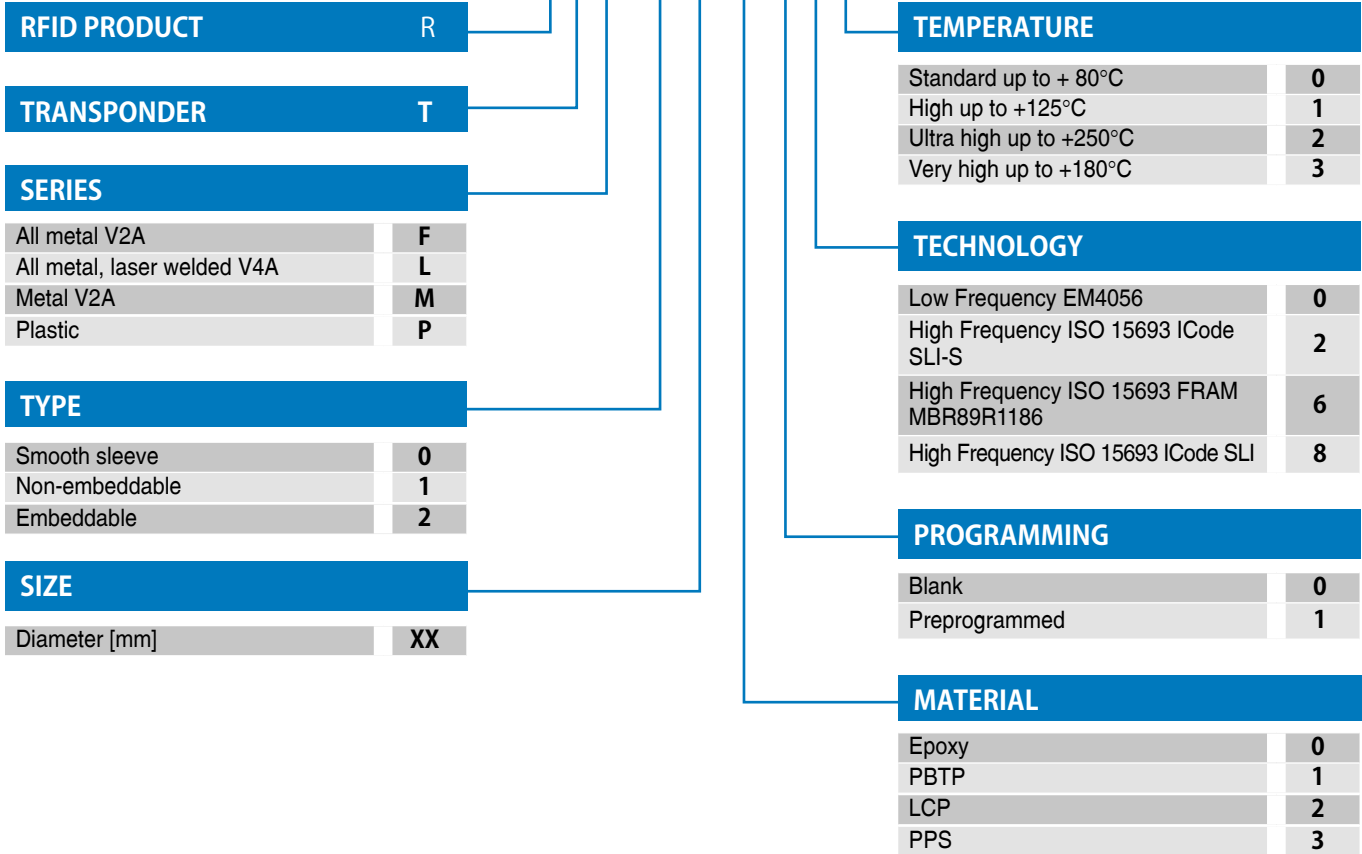

Part reference	Chapter/page	Part reference	Chapter/page
RTF-1300-000	4/395	RTP-0201-000	4/393
RTL-0102-001	4/396	RTP-0201-020	4/399
RTL-0162-001	4/396	RTP-0263-020	4/400
RTL-0262-001	4/396	RTP-0301-000	4/393
RTL-0262-003	4/397	RTP-0301-020	4/399
RTL-1302-001	4/397	RTP-0501-000	4/393
RTL-2162-001	4/397	RTP-0501-020	4/399
RTL-2302-001	4/397	RTP-0502-022	4/401
RTM-0100-000	4/394	RTP-0502-062	4/401
RTM-0160-000	4/394	RTP-0502-082	4/401
RTM-0260-000	4/394		
RTM-2160-000	4/395		
RTM-2300-000	4/395		
RTP-0090-020	4/400		
RTP-0160-020	4/400		

RFID PRODUCTS

READ/WRITE MODULES

RLS-1181-030 (-120)

RFID PRODUCTS	R	SHORT HOUSING	
READ/WRITE MODULE	L	TEMPERATURE	
CONNECTION	S	Standard up to + 80°C	0
S12 connector, 4-pins		High up to +125°C	1
USB A male		TECHNOLOGY	
TYPE		ContriNET HF	2
Non-embeddable	1	ContriNET LF	3
SIZE		NETWORK	
M18	18	ContriNET	0
M30	30	USB	2
		IO-Link	3
		MATERIAL	
		Stainless steel V2A	0
		PBTP / chrome-plated brass	1
		Stainless steel V4A	2
		PBTP / stainless steel V2A	3

Part reference	Chapter/page
RLS-1180-030	4/404
RLS-1181-030	4/404
RLS-1181-220	4/415
RLS-1181-220-120	4/415
RLS-1181-230	4/414
RLS-1181-320	4/411
RLS-1182-031	4/405
RLS-1183-020	4/406
RLS-1300-030	4/405
RLS-1301-030	4/404
RLS-1301-220	4/415
RLS-1301-220-120	4/415
RLS-1301-230	4/414
RLS-1301-320	4/411
RLS-1302-031	4/405
RLS-1303-020	4/406

Inductive

Photoelectric

Safety

RFID

Connectivity

Accessories

Glossary

Index

RFID PRODUCTS

INTERFACES

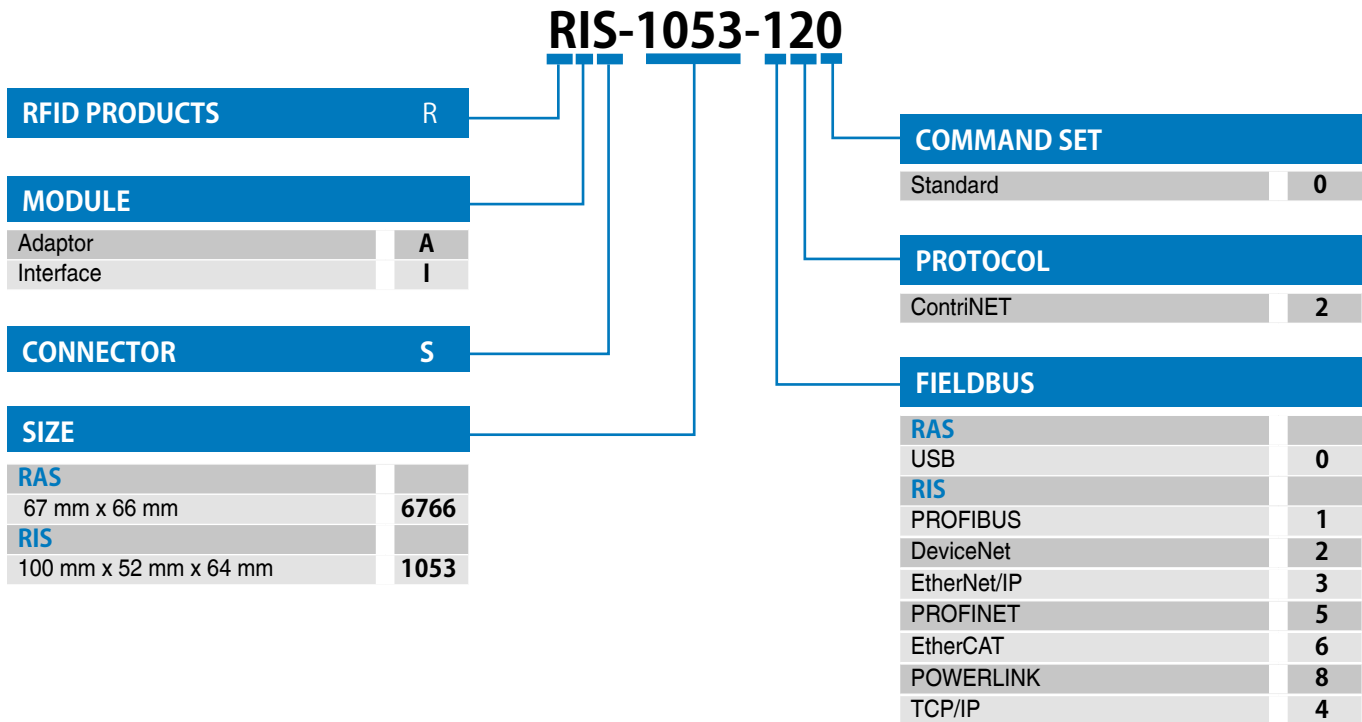

<i>Part reference</i>	<i>Chapter/page</i>
RAS-6766-020	4/428
RIS-1053-120	4/420
RIS-1053-220	4/421
RIS-1053-320	4/421
RIS-1053-520	4/421
RIS-1053-620	4/421
RIS-1053-820	4/421
RIS-1613-400	4/423
RIS-1208-400	4/423



DISTRIBUTION BOXES

V12-58PD-050-UYN (-###)

DISTRIBUTION BOX OR T-CONNECTOR

V

CONNECTIONS

Accessory	00
M8	08
M12	12

POLE NUMBER OF CONNECTIONS

3-pole	3
4-pole	4
5-pole	5
8-pole	8

NUMBER OF CONNECTIONS

Hood for all types	0
2 connections	T
4 connections	4
6 connections	6
8 connections	8
10 connections	1

MATERIAL

Plastic	P
Metal	M

SPECIAL EXECUTIONS

TECHNOLOGY

Standard (passive distribution box)	N
Wiring according diagram no.	#

LED

Yes	Y
No	N

CABLE MATERIAL

No cable	N
PVC	V
PUR	U

CONNECTION

No cable	000
Cable 0.3 m	003
Cable 2 m	020
Cable 5 m	050
Cable 10 m	100
Connector M12	012
Connector M23	023

TYPE

Distribution box with cable / T-connector	D
Distribution box for straight connection	G
Distribution box for right-angle connection	W
Base element without hood	B
Hood with cable	H
Hood without cable	E
Base element + hood with cable	Y

AND T-CONNECTORS

<i>Part reference</i>	<i>Chapter/page</i>	<i>Part reference</i>	<i>Chapter/page</i>
V08-30PE-000-NNN	5/446	V12-4TPD-000-NN1	5/447
V08-31PD-050-UYN	5/446	V12-4TPD-000-NNN	5/447
V08-31PH-050-UNN	5/446	V12-5TPD-000-NN1	5/447
V08-34PB-000-NYN	5/446	V12-8TPD-000-NN2	5/447
V08-34PD-050-UYN	5/446	V12-8TPD-000-NN3	5/447
V08-38PB-000-NYN	5/446		
V08-38PD-050-UYN	5/446		
V08-38PH-050-UNN	5/446		
V12-50PE-000-NNN	5/446		
V12-54MG-023-NYN	5/446		
V12-54PB-000-NYN	5/446		
V12-54PD-020-UYN	5/446		
V12-54PD-050-UYN	5/446		
V12-54PD-100-UYN	5/446		
V12-54PY-050-UYN	5/446		
V12-58MD-050-UYN	5/446		
V12-58MD-100-UYN	5/446		
V12-58MG-023-NYN	5/446		
V12-58PB-000-NYN	5/446		
V12-58PD-020-UYN	5/446		
V12-58PD-050-UYN	5/446		
V12-58PD-100-UYN	5/446		
V12-58PY-020-UYN	5/446		
V12-58PY-050-UYN	5/446		

Inductive

Photoelectric

Safety

RFID

Connectivity

Accessories

Glossary

Index

CABLES / CONNECTORS

S12-4FAG-020[-NNLN-12MG]

CONNECTION CABLE

S

CONNECTOR SIZE FEMALE

M8	08
M12	12
M12 ACDC	13
M23	23

NUMBER OF POLES

3-pole	3
4-pole	4
5-pole	5
8-pole	8
11-pole	B
19-pole	J

CONNECTOR TYPE

Female (socket)	F
Male (plug)	M

CABLE MATERIAL

No cable	N
PVC	V
PUR	U
TPE-S	A

CABLE EXIT (FEMALE)

Straight	G
Right-angle	W

CABLE LENGTH

No cable	000
0.3 m	003
0.6 m	006
1 m	010
1.5 m	015
2 m (standard)	020
5 m	050
10 m	100
15 m	150
20 m	200
25 m	250

CABLE EXIT (MALE)

Straight	G
Right-angle	W

CONNECTOR TYPE

Male (plug)	M
Female (socket)	F

CONNECTOR SIZE MALE

M8	08
M12	12
M23	23

CONNECTION TYPE

Standard	N
Quick-lock	Q
Cable Ø 3.0 - 5.0 mm / wire 0.08 - 0.38 mm ²	1
Cable Ø 4.0 - 8.0 mm / wire 0.14 - 0.50 mm ²	2
Cable Ø 5.5 - 8.0 mm / wire 0.5 - 1.0 mm ²	3

APPLICATION

Standard	N
Food	L
RFID	R
Field attachable	T
Safety	S

EXECUTION

Standard or no cable	N
Shielded	W

LED

Yes, PNP	Y
Yes, NPN	Z
No	N

CABLES / CONNECTORS

<i>Part reference</i>	<i>Chapter/page</i>	<i>Part reference</i>	<i>Chapter/page</i>	<i>Part reference</i>	<i>Chapter/page</i>
S08-3FNG-000-NNT1	5/449	S12-3MNG-000-NNT1	5/449	S12-5FVW-020	5/443
S08-3FNG-000-NNT2	5/449	S12-4FAG-020-NNLN-12MG	5/447	S12-5FVW-050	5/443
S08-3FUG-006-08MG	5/446	S12-4FAG-050-NNLN	5/445	S12-5FVW-100	5/443
S08-3FUG-020	5/444	S12-4FAG-100-NNLN	5/445	S12-8FUG-020	5/445
S08-3FUG-020-08MG	5/446	S12-4FAG-100-NNLN-12MG	5/447	S12-8FUG-050	5/445
S08-3FUG-020-12MG	5/447	S12-4FAW-250-NNLN	5/445	S12-8FUG-100	5/445
S08-3FUG-050	5/444	S12-4FNG-000-NNT1	5/449	S12-8FUG-020-NWSN	5/445
S08-3FUG-050-08MG	5/446	S12-4FNG-000-NNT2	5/449	S12-8FUG-050-NWSN	5/445
S08-3FUG-100	5/444	S12-4FNG-000-NNT3	5/449	S12-8FUG-100-NWSN	5/445
S08-3FUW-020	5/444	S12-4FNW-000-NNT1	5/449	S12-8FUG-150-NWSN	5/445
S08-3FUW-020-YNNN	5/449	S12-4FUG-006-12MG	5/446	S13-3FUG-020	5/446
S08-3FUW-050	5/444	S12-4FUG-020	5/444	S13-3FUW-020	5/446
S08-3FUW-050-YNNN	5/449	S12-4FUG-020-12MG	5/446	S13-3FUG-050	5/446
S08-3FUW-100	5/444	S12-4FUG-050	5/444	S13-3FUW-050	5/446
S08-3FVG-006-08MG	5/446	S12-4FUG-050-12MG	5/446		
S08-3FVG-020	5/443	S12-4FUG-100	5/444		
S08-3FVG-020-08MG	5/446	S12-4FUG-150	5/444		
S08-3FVG-020-12MG	5/447	S12-4FUG-200	5/444		
S08-3FVG-020-NNLN	5/445	S12-4FUG-250	5/444		
S08-3FVG-050	5/443	S12-4FUW-020	5/444		
S08-3FVG-050-08MG	5/446	S12-4FUW-050	5/444		
S08-3FVG-100	5/443	S12-4FUW-100	5/444		
S08-3FVW-020	5/443	S12-4FUW-150	5/444		
S08-3FVW-020-NNLN	5/445	S12-4FUW-200	5/444		
S08-3FVW-050	5/443	S12-4FUW-250	5/444		
S08-3FVW-100	5/443	S12-4FVG-006-12MG	5/446		
S08-3MNG-000-NNT1	5/449	S12-4FVG-020	5/443		
S08-3MNG-000-NNT2	5/449	S12-4FVG-020-12MG	5/446		
S08-4FUG-006-12MG	5/447	S12-4FVG-020-NNLN	5/445		
S08-4FUG-020	5/444	S12-4FVG-020-NNLN-12MG	5/447		
S08-4FUG-050	5/444	S12-4FVG-050	5/443		
S08-4FUG-100	5/444	S12-4FVG-050-12MG	5/446		
S08-4FUW-020	5/444	S12-4FVG-050-NNLN-12MG	5/447		
S08-4FUW-050	5/444	S12-4FVG-050-NNLN	5/445		
S08-4FUW-100	5/444	S12-4FVG-100	5/443		
S08-4FVG-020	5/443	S12-4FVG-100-NNLN	5/445		
S08-4FVG-020-12MG	5/447	S12-4FVG-100-NNLN-12MG	5/447		
S08-4FVG-050	5/443	S12-4FVW-020	5/443		
S08-4FVG-100	5/443	S12-4FVW-020-NNLN	5/445		
S08-4FVW-020	5/443	S12-4FVW-050	5/443		
S08-4FVW-050	5/443	S12-4FVW-100	5/443		
S08-4FVW-100	5/443	S12-4FVW-100-NNLN	5/445		
S12-3FNG-000-NNT1	5/449	S12-4MNG-000-NNT1	5/449		
S12-3FUG-020	5/444	S12-4MNG-000-NNT2	5/449		
S12-3FUG-050	5/444	S12-4MNG-000-NNT3	5/449		
S12-3FUG-100	5/444	S12-4MNW-000-NNT1	5/449		
S12-3FUW-020	5/444	S12-5FUG-020	5/444		
S12-3FUW-020-YNNN	5/449	S12-5FUG-050	5/444		
S12-3FUW-050	5/444	S12-5FUG-100	5/444		
S12-3FUW-050-YNNN	5/449	S12-5FUG-150	5/444		
S12-3FUW-100	5/444	S12-5FUG-150-NWSN	5/444		
S12-3FUW-100-YNNN	5/449	S12-5FUG-250	5/444		
S12-3FVG-020	5/443	S12-5FUG-250-NWSN	5/444		
S12-3FVG-050	5/443	S12-5FVG-020	5/443		
S12-3FVG-100	5/443	S12-5FVG-020-NNLN	5/445		
S12-3FVW-020	5/443	S12-5FVG-050	5/443		
S12-3FVW-050	5/443	S12-5FVG-100	5/443		
S12-3FVW-100	5/449	S12-5FVG-100-NNLN	5/445		
S12-3FVW-100	5/443	S12-5FVG-150	5/443		
S12-3MNG-000-NNT1	5/449	S12-5FVG-250	5/443		

Inductive

Photoelectric

Safety

RFID

Connectivity

Accessories

Glossary

Index



ALL OVER THE WORLD

EUROPE

Austria
Belgium*
Croatia
Czech Republic
Denmark
Estonia
Finland
France*
Germany*
Great Britain*
Greece
Hungary
Ireland
Italy*
Luxembourg
Netherlands
Norway
Poland
Portugal*
Romania
Russian Federation
Slovakia
Slovenia

Spain
Sweden
Switzerland*
Turkey
Ukraine

AFRICA

Morocco
South Africa

THE AMERICAS

Argentina
Brazil*
Canada
Chile
Mexico*
Peru
United States*

ASIA

China*
India*
Indonesia

Japan*

Korea
Malaysia
Pakistan
Philippines
Singapore
Taiwan
Thailand
Vietnam

AUSTRALASIA

Australia
New Zealand

MIDDLE EAST

Israel
United Arab Emirates

Terms of delivery and right to change design reserved.

* Contrinex subsidiary

HEADQUARTERS

CONTRINEX AG Industrial Electronics
Route du Pâqui 5 - PO Box - CH 1720 Corminboeuf - Switzerland
Tel: +41 26 460 46 46 - Fax: +41 26 460 46 40
Internet: www.contrinex.com - E-mail: info@contrinex.com



www.contrinex.com

