



msi[™]

FM2-A85XMA-E35

FM2-A75MA-E35

FM2-A55M-E35

series

MS-7721 (v1.x) Mainboard

G52-77211XA

Copyright Notice

The material in this document is the intellectual property of **MICRO-STAR INTERNATIONAL**. We take every care in the preparation of this document, but no guarantee is given as to the correctness of its contents. Our products are under continual improvement and we reserve the right to make changes without notice.

Trademarks

All trademarks in this manual are properties of their respective owners.

- MSI® is registered trademark of Micro-Star Int'l Co.,Ltd.
- NVIDIA® is registered trademark of NVIDIA Corporation.
- ATI® is registered trademark of AMD Corporation.
- AMD® is registered trademarks of AMD Corporation.
- Intel® is registered trademarks of Intel Corporation.
- Windows® is registered trademarks of Microsoft Corporation.
- AMI® is registered trademark of American Megatrends Inc.
- Award® is a registered trademark of Phoenix Technologies Ltd.
- Sound Blaster® is registered trademark of Creative Technology Ltd.
- Realtek® is registered trademark of Realtek Semiconductor Corporation.
- JMicron® is registered trademark of JMicron Technology Corporation.
- Netware® is registered trademark of Novell, Inc.
- Lucid® is trademark of LucidLogix Technologies, Ltd.
- VIA® is registered trademark of VIA Technologies, Inc.
- ASMedia® is registered trademark of ASMedia Technology Inc.
- iPad, iPhone, and iPod are trademarks of Apple Inc.

Revision History

Revision	Revision History	Date
V1.0	First release	2012/08
V1.1	Add FM2-A85XMA-E35	2012/12

Technical Support

If a problem arises with your system and no solution can be obtained from the user's manual, please contact your place of purchase or local distributor. Alternatively, please try the following help resources for further guidance.



Visit the MSI website for technical guide, BIOS updates, driver updates, and other information:

<http://www.msi.com/service/download/>



Contact our technical staff at:

<http://support.msi.com>

Safety Instructions

- Always read the safety instructions carefully.
- Keep this User's Manual for future reference.
- Keep this equipment away from humidity.
- Lay this equipment on a reliable flat surface before setting it up.
- The openings on the enclosure are for air convection hence protects the equipment from overheating. **DO NOT COVER THE OPENINGS.**
- Make sure the voltage of the power source is at 110/220V before connecting the equipment to the power inlet.
- Place the power cord such a way that people can not step on it. Do not place anything over the power cord.
- Always Unplug the Power Cord before inserting any add-on card or module.
- All cautions and warnings on the equipment should be noted.
- Never pour any liquid into the opening that can cause damage or cause electrical shock.
- If any of the following situations arises, get the equipment checked by service personnel:
 - The power cord or plug is damaged.
 - Liquid has penetrated into the equipment.
 - The equipment has been exposed to moisture.
 - The equipment does not work well or you can not get it work according to User's Manual.
 - The equipment has been dropped and damaged.
 - The equipment has obvious sign of breakage.
- **DO NOT LEAVE THIS EQUIPMENT IN AN ENVIRONMENT ABOVE 60°C (140°F), IT MAY DAMAGE THE EQUIPMENT.**

FCC-B Radio Frequency Interference Statement

This equipment has been tested and found to comply with the limits for a Class B digital device, pursuant to Part 15 of the FCC Rules. These limits are designed to provide reasonable protection against harmful interference in a residential installation. This equipment generates, uses and can radiate radio frequency energy and, if not installed and used in accordance with the instructions, may cause harmful interference to radio communications. However, there is no guarantee that interference will not occur in a particular installation. If this equipment does cause harmful interference to radio or television reception, which can be determined by turning the equipment off and on, the user is encouraged to try to correct the interference by one or more of the measures listed below.

- Reorient or relocate the receiving antenna.
- Increase the separation between the equipment and receiver.
- Connect the equipment into an outlet on a circuit different from that to which the receiver is connected.
- Consult the dealer or an experienced radio/television technician for help.

Notice 1

The changes or modifications not expressly approved by the party responsible for compliance could void the user's authority to operate the equipment.

Notice 2

Shielded interface cables and A.C. power cord, if any, must be used in order to comply with the emission limits.

VOIR LA NOTICE D'INSTALLATION AVANT DE RACCORDER AU RESEAU.

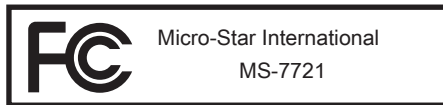

This device complies with Part 15 of the FCC Rules. Operation is subject to the following two conditions:

- 1) this device may not cause harmful interference, and
- 2) this device must accept any interference received, including interference that may cause undesired operation.

CE Conformity

Hereby, Micro-Star International CO., LTD declares that this device is in compliance with the essential safety requirements and other relevant provisions set out in the European Directive.



Radiation Exposure Statement

This equipment complies with FCC radiation exposure limits set forth for an uncontrolled environment. This equipment and its antenna should be installed and operated with minimum distance 20 cm between the radiator and your body. This equipment and its antenna must not be co-located or operating in conjunction with any other antenna or transmitter.

European Community Compliance Statement

The equipment complies with the RF Exposure Requirement 1999/519/EC, Council Recommendation of 12 July 1999 on the limitation of exposure of the general public to electromagnetic fields (0–300GHz). This wireless device complies with the R&TTE Directive.

Taiwan Wireless Statements

無線設備警告聲明

經型式認證合格之低功率射頻電機，非經許可，公司、商號或使用者均不得擅自變更頻率、加大功率或變更原設計之特性及功能。

低功率射頻電機之使用不得影響飛航安全及干擾合法通信；經發現有干擾現象時，應立即停用，並改善至無干擾時方得繼續使用。前項合法通信，指依電信法規定作業之無線電通信。低功率射頻電機須忍受合法通信或工業、科學及醫療用電波輻射性電機設備之干擾。

警告使用者：這是甲類資訊產品，在居住的環境中使用時，可能會造成無線電干擾，在這種情況下，使用者會被要求採取某些適當的對策。

Japan VCCI Class B Statement

クラス B 情報技術装置

この装置は、情報技術装置等電波障害自主規制協議会（VCCI）の基準に基づくクラスB情報技術装置です。この装置が家庭内でラジオやテレビジョン受信機に近接して使われると、受信障害を引き起こすことがあります。取扱説明書にしたがって正しい取り扱いをしてください。

Korea Warning Statements

당해 무선설비는 운용중 전파혼신 가능성이 있음

Battery Information



European Union:

Batteries, battery packs, and accumulators should not be disposed of as unsorted household waste. Please use the public collection system to return, recycle, or treat them in compliance with the local regulations.



Taiwan:

For better environmental protection, waste batteries should be collected separately for recycling or special disposal.

廢電池請回收



California, USA:

The button cell battery may contain perchlorate material and requires special handling when recycled or disposed of in California.

For further information please visit:

<http://www.dtsc.ca.gov/hazardouswaste/perchlorate/>

CAUTION: There is a risk of explosion, if battery is incorrectly replaced.

Replace only with the same or equivalent type recommended by the manufacturer.

Chemical Substances Information

In compliance with chemical substances regulations, such as the EU REACH Regulation (Regulation EC No. 1907/2006 of the European Parliament and the Council), MSI provides the information of chemical substances in products at:

http://www.msi.com/html/popup/csr/evmtprrt_pcm.html

WEEE (Waste Electrical and Electronic Equipment) Statement

ENGLISH

To protect the global environment and as an environmentalist, MSI must remind you that...



Under the European Union (“EU”) Directive on Waste Electrical and Electronic Equipment, Directive 2002/96/EC, which takes effect on August 13, 2005, products of “electrical and electronic equipment” cannot be discarded as municipal wastes anymore, and manufacturers of covered electronic equipment will be obligated to take back such products at the end of their useful life. MSI will comply with the product take back requirements at the end of life of MSI-branded products that are sold into the EU. You can return these products to local collection points.

DEUTSCH

Hinweis von MSI zur Erhaltung und Schutz unserer Umwelt

Gemäß der Richtlinie 2002/96/EG über Elektro- und Elektronik-Altgeräte dürfen Elektro- und Elektronik-Altgeräte nicht mehr als kommunale Abfälle entsorgt werden. MSI hat europaweit verschiedene Sammel- und Recyclingunternehmen beauftragt, die in die Europäische Union in Verkehr gebrachten Produkte, am Ende seines Lebenszyklus zurückzunehmen. Bitte entsorgen Sie dieses Produkt zum gegebenen Zeitpunkt ausschliesslich an einer lokalen Altgerätesammelstelle in Ihrer Nähe.

FRANÇAIS

En tant qu'écologiste et afin de protéger l'environnement, MSI tient à rappeler ceci...

Au sujet de la directive européenne (EU) relative aux déchets des équipement électriques et électroniques, directive 2002/96/EC, prenant effet le 13 août 2005, que les produits électriques et électroniques ne peuvent être déposés dans les décharges ou tout simplement mis à la poubelle. Les fabricants de ces équipements seront obligés de récupérer certains produits en fin de vie. MSI prendra en compte cette exigence relative au retour des produits en fin de vie au sein de la communauté européenne. Par conséquent vous pouvez retourner localement ces matériels dans les points de collecte.

РУССКИЙ

Компания MSI предпринимает активные действия по защите окружающей среды, поэтому напоминаем вам, что...

В соответствии с директивой Европейского Союза (ЕС) по предотвращению загрязнения окружающей среды использованным электрическим и электронным оборудованием (директива WEEE 2002/96/ЕС), вступающей в силу 13 августа 2005 года, изделия, относящиеся к электрическому и электронному оборудованию, не могут рассматриваться как бытовой мусор, поэтому производители вышеперечисленного электронного оборудования обязаны принимать его для переработки по окончании срока службы. MSI обязуется соблюдать требования по приему продукции, проданной под маркой MSI на территории ЕС, в переработку по окончании срока службы. Вы можете вернуть эти изделия в специализированные пункты приема.

ESPAÑOL

MSI como empresa comprometida con la protección del medio ambiente, recomienda: Bajo la directiva 2002/96/EC de la Unión Europea en materia de desechos y/o equipos electrónicos, con fecha de rígor desde el 13 de agosto de 2005, los productos clasificados como “eléctricos y equipos electrónicos” no pueden ser depositados en los contenedores habituales de su municipio, los fabricantes de equipos electrónicos, están obligados a hacerse cargo de dichos productos al termino de su período de vida. MSI estará comprometido con los términos de recogida de sus productos vendidos en la Unión Europea al final de su periodo de vida. Usted debe depositar estos productos en el punto limpio establecido por el ayuntamiento de su localidad o entregar a una empresa autorizada para la recogida de estos residuos.

NEDERLANDS

Om het milieu te beschermen, wil MSI u eraan herinneren dat...

De richtlijn van de Europese Unie (EU) met betrekking tot Vervuiling van Electriche en Electronische producten (2002/96/EC), die op 13 Augustus 2005 in zal gaan kunnen niet meer beschouwd worden als vervuiling. Fabrikanten van dit soort producten worden verplicht om producten retour te nemen aan het eind van hun levenscyclus. MSI zal overeenkomstig de richtlijn handelen voor de producten die de merknaam MSI dragen en verkocht zijn in de EU. Deze goederen kunnen geretourneerd worden op lokale inzamelingspunten.

SRPSKI

Da bi zaštitili prirodnu sredinu, i kao preduzeće koje vodi računa o okolini i prirodnoj sredini, MSI mora da vas pedesti da...

Po Direktivi Evropske unije (“EU”) o odbačenju ekelektronskoj i električnoj opremi, Direktiva 2002/96/EC, koja stupa na snagu od 13. Avgusta 2005, proizvodi koji spadaju pod “elektronsku i električnu opremu” ne mogu više biti odbačeni kao običan otpad i proizvođači ove opreme biće prinuđeni da uzmu natrag ove proizvode na kraju njihovog uobičajenog veka trajanja. MSI će poštovati zahtev o preuzimanju ovakvih proizvoda kojima je istekao vek trajanja, koji imaju MSI oznaku i koji su prodati u EU. Ove proizvode možete vratiti na lokalnim mestima za prikupljanje.

POLSKI

Aby chronić nasze środowisko naturalne oraz jako firma dbająca o ekologię, MSI przypomina, że...

Zgodnie z Dyrektywą Unii Europejskiej (“UE”) dotyczącą odpadów produktów elektrycznych i elektronicznych (Dyrektywa 2002/96/EC), która wchodzi w życie 13 sierpnia 2005, tzw. “produkty oraz wyposażenie elektryczne i elektroniczne” nie mogą być traktowane jako śmieci komunalne, tak więc producenci tych produktów będą zobowiązani do odbierania ich w momencie gdy produkt jest wycofywany z użycia. MSI wypełni wymagania UE, przyjmując produkty (sprzedawane na terenie Unii Europejskiej) wycofywane z użycia. Produkty MSI będzie można zwracać w wyznaczonych punktach zbiorczych.

TÜRKÇE

Çevreci özelliğiyle bilinen MSI dünyada çevreyi korumak için hatırlatır:

Avrupa Birliği (AB) Kararnamesi Elektrik ve Elektronik Malzeme Atığı, 2002/96/EC Kararnamesi altında 13 Ağustos 2005 tarihinden itibaren geçerli olmak üzere, elektrikli ve elektronik malzemeler diğer atıklar gibi çöpe atılmayacak ve bu elektronik cihazların üreticileri, cihazların kullanım süreleri bittikten sonra ürünleri geri toplamakla yükümlü olacaktır. Avrupa Birliği'ne satılan MSI markalı ürünlerin kullanım süreleri bittiğinde MSI ürünlerin geri alınması isteği ile işbirliği içerisinde olacaktır. Ürünlerinizi yerel toplama noktalarına bırakabilirsiniz.

ČESKY

Záleží nám na ochraně životního prostředí - společnost MSI upozorňuje...

Podle směrnice Evropské unie ("EU") o likvidaci elektrických a elektronických výrobků 2002/96/EC platné od 13. srpna 2005 je zakázáno likvidovat "elektrické a elektronické výrobky" v běžném komunálním odpadu a výrobci elektrických výrobků, na které se tato směrnice vztahuje, budou povinni odebírat takové výrobky zpět po skončení jejich životnosti. Společnost MSI splní požadavky na odebírání výrobků značky MSI, prodávaných v zemích EU, po skončení jejich životnosti. Tyto výrobky můžete odevzdat v místních sběrnách.

MAGYAR

Annak érdekében, hogy környezetünket megvédjük, illetve környezetvédőként fellépve az MSI emlékezteti Önt, hogy ...

Az Európai Unió („EU”) 2005. augusztus 13-án hatályba lépő, az elektromos és elektronikus berendezések hulladékairól szóló 2002/96/EK irányelve szerint az elektromos és elektronikus berendezések többé nem kezelhetőek lakossági hulladékként, és az ilyen elektronikus berendezések gyártói köteleessé válnak az ilyen termékek visszavételére azok hasznos élettartama végén. Az MSI betartja a termékvisszavétellel kapcsolatos követelményeket az MSI márkánév alatt az EU-n belül értékesített termékek esetében, azok élettartamának végén. Az ilyen termékeket a legközelebbi gyűjtőhelyre viheti.

ITALIANO

Per proteggere l'ambiente, MSI, da sempre amica della natura, ti ricorda che....

In base alla Direttiva dell'Unione Europea (EU) sullo Smaltimento dei Materiali Elettrici ed Elettronici, Direttiva 2002/96/EC in vigore dal 13 Agosto 2005, prodotti appartenenti alla categoria dei Materiali Elettrici ed Elettronici non possono più essere eliminati come rifiuti municipali: i produttori di detti materiali saranno obbligati a ritirare ogni prodotto alla fine del suo ciclo di vita. MSI si adegnerà a tale Direttiva ritirando tutti i prodotti marchiati MSI che sono stati venduti all'interno dell'Unione Europea alla fine del loro ciclo di vita. È possibile portare i prodotti nel più vicino punto di raccolta

CONTENTS

Copyright Notice	ii
Trademarks	ii
Revision History.....	ii
Technical Support.....	iii
Safety Instructions.....	iii
FCC-B Radio Frequency Interference Statement.....	iv
CE Conformity	iv
Radiation Exposure Statement.....	v
European Community Compliance Statement	v
Taiwan Wireless Statements	v
Japan VCCI Class B Statement	v
Korea Warning Statements	v
Battery Information	vi
Chemical Substances Information.....	vi
WEEE (Waste Electrical and Electronic Equipment) Statement	vii
Chapter 1 Getting Started.....	1-1
Packing Contents.....	1-2
Optional Accessories	1-2
Assembly Precautions.....	1-3
Mainboard Specifications.....	1-4
Connectors Quick Guide.....	1-6
Back Panel Quick Guide	1-8
APU (Accelerated Processing Units)	1-10
Mounting Screw Holes	1-13
Power Supply	1-14
Memory	1-15
Expansion Slots	1-17
Video/ Graphics Cards.....	1-18
Internal Connectors.....	1-19
Jumper	1-26
Drivers and Utilities	1-28
Chapter 2 BIOS Setup.....	2-1
Entering.....	2-2
Overview	2-2
Boot device priority bar	2-3
Operation	2-4

SETTINGS	2-5
OC	2-10
ECO	2-15
BROWSER.....	2-16
Installing Winki	2-16
UTILITIES	2-17
Updating the BIOS with Live Update.....	2-19
SECURITY	2-20
Appendix A Realtek Audio.....	A-1
Software Configuration.....	A-2
Hardware Default Setting	A-4
Appendix B AMD RAID.....	B-1
RAID Configuration	B-2
Installing Driver	B-8
Installing OS on 2.2TB RAID.....	B-10
Appendix C Install Windows XP Notes.....	C-1
Installing Windows XP with IDE Mode	C-2
Installing Windows XP with AHCI Mode.....	C-3

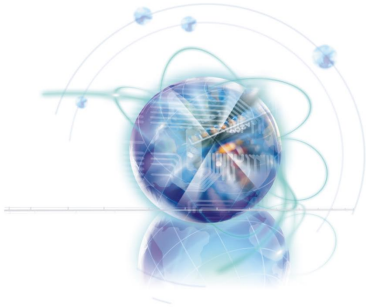

Chapter 1

Getting Started

Thank you for choosing the **FM2-A85XMA-E35/ FM2-A75MA-E35/ FM2-A55M-E35** Series (MS-7721 v1.X) Micro-ATX mainboard. The Series mainboards are based on **AMD® A85X/ A75/ A55** chipset for optimal system efficiency. Designed to fit the advanced **AMD® FM2** processor, the **FM2-A85XMA-E35/ FM2-A75MA-E35/ FM2-A55M-E35** Series mainboards deliver a high performance and professional desktop platform solution.

Packing Contents

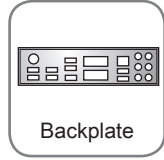

Optional Accessories



* These pictures are for reference only and may vary without notice.

* The packing contents may vary according to the model you purchased.

* If you need to purchase the optional accessories or request part numbers, please visit the MSI website at <http://www.msi.com/index.php> or consult the dealer.

Assembly Precautions

- The components included in this package are prone to damage from electrostatic discharge (ESD). Please adhere to the following instructions to ensure successful computer assembly.
- Always turn off the power supply and unplug the power cord from the power outlet before installing or removing any computer component.
- Ensure that all components are securely connected. Loose connections may cause the computer to not recognize a component or fail to start.
- Hold the mainboard by the edges to avoid touching sensitive components.
- It is recommended to wear an electrostatic discharge (ESD) wrist strap when handling the mainboard to prevent electrostatic damage. If an ESD wrist strap is not available, discharge yourself of static electricity by touching another metal object before handling the mainboard.
- Store the mainboard in an electrostatic shielding container or on an antistatic pad whenever the mainboard is not installed.
- Before turning on the computer, ensure that there are no loose screws or metal components on the mainboard or anywhere within the computer case.
- Do not use the computer in a high-temperature environment.
- Do not boot the computer before installation is completed. This could cause permanent damage to the components as well as injury to the user.
- If you need help during any installation step, please consult a certified computer technician.



Important

A screwdriver (not included) may be required for computer assembly.

Mainboard Specifications

Processor Support

- AMD® A10/A8/A6/A4-series processors for the FM2 package

Chipset

- AMD® A85X/ A75/ A55 chipset

Memory Support

- 2x DDR3 DIMMs support DDR3 2133(OC)/ 1866/ 1600/ 1333/ 1066 DRAM (16GB Max)
- Supports Dual-Channel mode

LAN

- Supports LAN 10/100/1000 Fast Ethernet by Realtek® RTL8111E

Audio

- Integrated HD audio codec by Realtek® ALC887
- 8-channel audio with jack sensing

SATA

- 6x SATA 6Gb/s ports by AMD® A85X/ A75 (FM2-A85XMA-E35/ FM2-A75MA-E35)
- 6x SATA 3Gb/s ports by AMD® A55 (FM2-A55M-E35)

RAID

- SATA1~6 support RAID 0/ 1/ 5/ 10/ JBOD by AMD® A85X (FM2-A85XMA-E35)
- SATA1~6 support RAID 0/ 1/ 10/ JBOD by AMD® A75/ A55 (FM2-A75MA-E35/ FM2-A55M-E35)

USB 3.0 (FM2-A85XMA-E35/ FM2-A75MA-E35)

- 2x USB 3.0 rear IO ports by AMD® A85/ A75
- 1x USB 3.0 onboard connector by AMD® A85/ A75

Connectors & Buttons

- Back panel
 - 1x PS/2 keyboard/ mouse port
 - 6x USB 2.0 ports, 2x USB 3.0 ports (FM2-A85XMA-E35/ FM2-A75MA-E35)
 - 8x USB 2.0 ports (FM2-A55M-E35)
 - 1x LAN port
 - 1x VGA port*
 - 1x DVI-D port* supporting Dual-link DVI.
 - 1x HDMI port*
 - 6x audio ports
 - * This platform supports dual-display function (HDMI+VGA, HDMI+DVI, VGA+DVI) and triple-display function (HDMI+VGA+DVI).
- On-Board
 - 2x USB 2.0 connectors, 1x USB 3.0 connector (FM2-A85XMA-E35/ FM2-A75MA-E35)
 - 3x USB 2.0 connectors (FM2-A55M-E35)
 - 1x Front Panel Audio connector
 - 1x TPM Module connector
 - 1x Parallel connector

- 1x Serial connector
- 1x Chassis Intrusion connector

Slots

- 1x PCIe 2.0 x16 slot
- 2x PCIe 2.0 x1 slots
- 1x PCI slot

Form Factor

- Micro-ATX (24.4 cm X 22.8 cm)

Mounting Screw Holes

- 6x mounting holes

Dual-Graphics

- Supports AMD® Dual Graphics Technology
 - Please visit the AMD official website to find the supported Dual Graphics combinations of APU and discrete GPU for achieving this technology.



For the latest information about processors, please visit <http://www.msi.com/service/cpu-support/>



For more information on compatible components, please visit <http://www.msi.com/service/test-report/>

Connectors Quick Guide

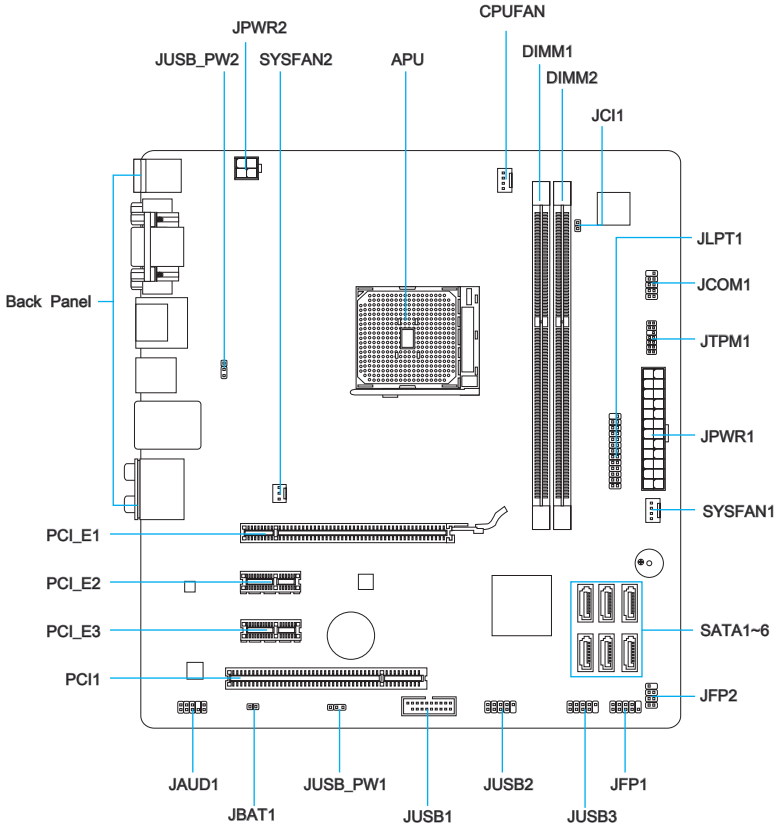

Connectors Reference Guide

Port Name	Port Type	Page
Back Panel		1-8
CPU	FM2 APU Socket	1-10
CPUFAN,SYSFAN1~2	Fan Power Connectors	1-20
DIMM1~2	DDR3 Memory Slots	1-15
JAUD1	Front Panel Audio Connector	1-21
JBAT1	Clear CMOS Jumper	1-27
JCI1	Chassis Intrusion Connector	1-25
JCOM1	Serial Port Connector	1-23
JFP1, JFP2	Front Panel Connectors	1-21
JLPT1	Parallel Port Header	1-23
JPWR1	ATX 24-pin Power Connector	1-14
JPWR2	ATX 4-pin Power Connector	1-14
JTPM1	TPM Module connector	1-22
JUSB_PW1~2	USB power Jumper	1-26
JUSB1	USB 3.0/ 2.0 Expansion Connector	1-24
JUSB2~3	USB 2.0 Expansion Connectors	1-22
PCI_E1	PCIe x16 Expansion Slot	1-17
PCI_E2, 3	PCIe x1 Expansion Slots	1-17
PCI	PCI Expansion Slot	1-17
SATA1~6	SATA 6Gb/s / 3Gb/s Connectors	1-19

Back Panel Quick Guide

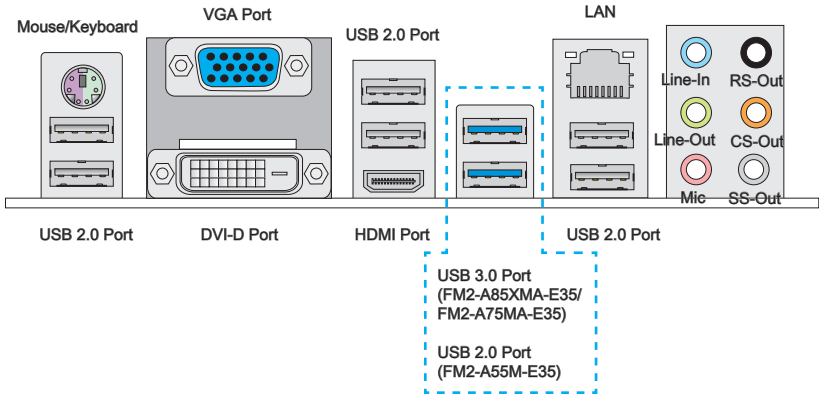

▶ Mouse/Keyboard

A combination PS/2® mouse/keyboard DIN connector for a PS/2® mouse/keyboard.

▶ USB 2.0 Port

The USB 2.0 port is for attaching USB 2.0 devices such as keyboard, mouse, or other USB 2.0-compatible devices.

▶ USB 3.0 Port (FM2-A85XMA-E35/ FM2-A75MA-E35)

USB 3.0 port is backward-compatible with USB 2.0 devices. It supports data transfer rate up to 5 Gbit/s (SuperSpeed).



In order to use USB 3.0 devices, you must connect to a USB 3.0 port. If a USB cable is used, it must be USB 3.0 compliant.

▶ LAN

The standard RJ-45 LAN jack is for connecting to a Local Area Network (LAN).

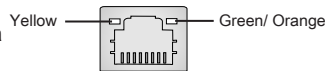

LED	Color	LED State	Condition
Left	Yellow	Off	LAN link is not established.
		On(Steady)	LAN link is established.
		On(flashing)	The computer is communicating with another computer on the network.
Right	Green	Off	10 Mbits/sec data rate
		On	100 Mbits/sec data rate
	Orange	On	1000 Mbits/sec data rate

▶ VGA Port

The DB15-pin female connector is provided for monitor.

▶ DVI-D Port

The DVI-D (Digital Visual Interface- Digital) connector can be connected to a LCD monitor, or a CRT monitor with an adapter. To connect a monitor, please refer to the monitor's manual for more information.

▶ HDMI Port

The High-Definition Multimedia Interface (HDMI) is an all-digital audio-video interface that is capable of transmitting uncompressed streams. HDMI supports all types of TV formats, including standard, enhanced, or high-definition video, plus multi-channel digital audio on a single cable.



Important

This platform supports dual-display function (HDMI+VGA, HDMI+DVI, VGA+DVI) and triple-display function (HDMI+VGA+DVI).

	HDMI+VGA	HDMI+DVI	VGA+DVI	HDMI+VGA+DVI
Extend mode (Extend the desktop to the second monitor)	○	○	○	○
Clone mode (Two monitors have the same screen)	○	○	○	○

▶ Audio Ports

These connectors are used for audio devices. The color of the jack refers to the function of the connector.

- Blue-Line in: Used for connecting external audio outputting devices.
- Green- Line out: Used as a connector for speakers or headphone.
- Pink- Mic: Used as a connector for a microphone.
- Black- RS-Out: Rear surround sound line out in 4/ 5.1/ 7.1 channel mode.
- Orange- CS-Out: Center/ subwoofer line out in 5.1/ 7.1 channel mode.
- Gray- SS-Out: Side surround sound line out in 7.1 channel mode.

APU (Accelerated Processing Units)

Introduction to FM2 APU

The surface of APU. Remember to apply some thermal paste on it for better heat dispersion.



Important

Overheating

Overheating can seriously damage the APU and mainboard. Always make sure the cooling fans work properly to protect the APU from overheating. Be sure to apply an even layer of thermal paste (or thermal tape) between the APU and the heatsink to enhance heat dissipation.

Replacing the APU

When replacing the APU, always turn off the system's power supply and unplug the power supply's power cord to ensure the safety of the APU.

Overclocking

This mainboard is designed to support overclocking. Before attempting to overclock, please make sure that all other system components can tolerate overclocking. Any attempt to operate beyond product specifications is not recommend. MSI does not guarantee the damages or risks caused by inadequate operation beyond product specifications.

APU & Cooler Installation

When you are installing the APU, **make sure the APU has a cooler attached on the top to prevent overheating**. Meanwhile, do not forget to apply some thermal paste on APU before installing the heat sink/cooler fan for better heat dispersion.

Follow the steps below to install the APU & cooler correctly. Wrong installation will cause the damage of your APU & mainboard.

1. Pull the lever sideways away from the socket. Make sure to raise the lever up to a 90-degree angle.
2. Look for the gold arrow of the APU. The gold arrow should point as shown in the picture. The APU can only fit in the correct orientation.

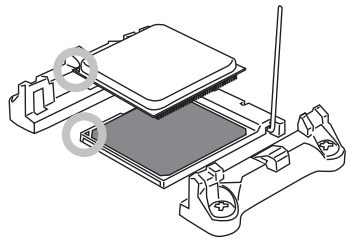
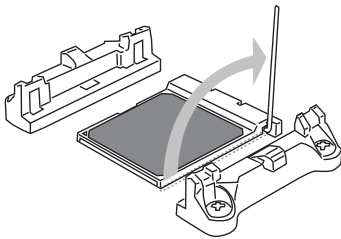

3. If the APU is correctly installed, the pins should be completely embedded into the socket and can not be seen. Please note that any violation of the correct installation procedures may cause permanent damages to your mainboard.
4. Press the APU down firmly into the socket and close the lever. As the APU is likely to move while the lever is being closed, always close the lever with your fingers pressing tightly on top of the APU to make sure the APU is properly and completely embedded into the socket.

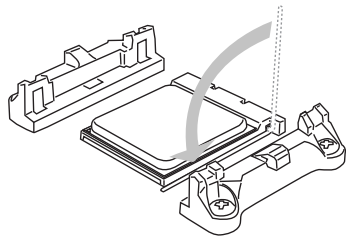
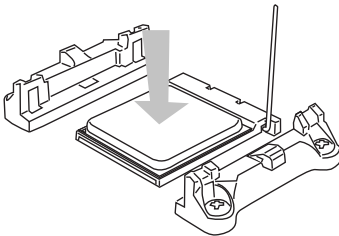

5. Position the cooling set onto the retention mechanism.
Hook one end of the clip to hook first.

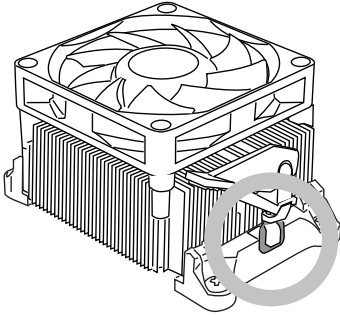

6. Then press down the other end of the clip to fasten the cooling set on the top of the retention mechanism.
Locate the Fix Lever and lift up it .

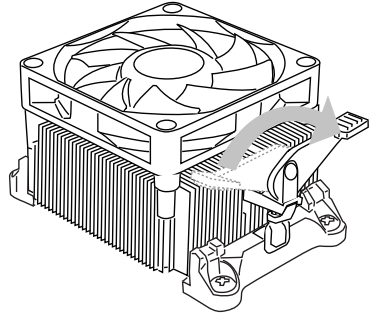

7. Fasten down the lever.

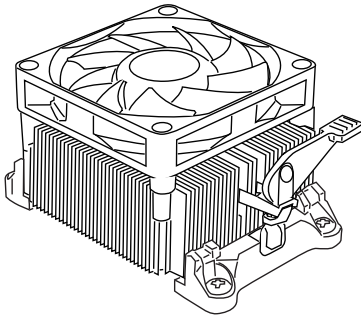

8. Attach the APU Fan cable to the APU fan connector on the mainboard.

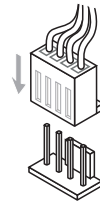

Important

- While disconnecting the Safety Hook from the fixed bolt, it is necessary to keep an eye on your fingers, because once the Safety Hook is disconnected from the fixed bolt, the fixed lever will spring back instantly.
- Confirm that the APU cooler has formed a tight seal with the APU before booting your system.
- Please refer to the documentation in the APU cooler package for more details about APU cooler installation.

Mounting Screw Holes

When installing the mainboard, first install the necessary mounting stands required for an mainboard on the mounting plate in your computer case. If there is an I/O back plate that came with the computer case, please replace it with the I/O backplate that came with the mainboard package. The I/O backplate should snap easily into the computer case without the need for any screws. Align the mounting plate's mounting stands with the screw holes on the mainboard and secure the mainboard with the screws provided with your computer case. The locations of the screw holes on the mainboard are shown below. For more information, please refer to the manual that came with the computer case.

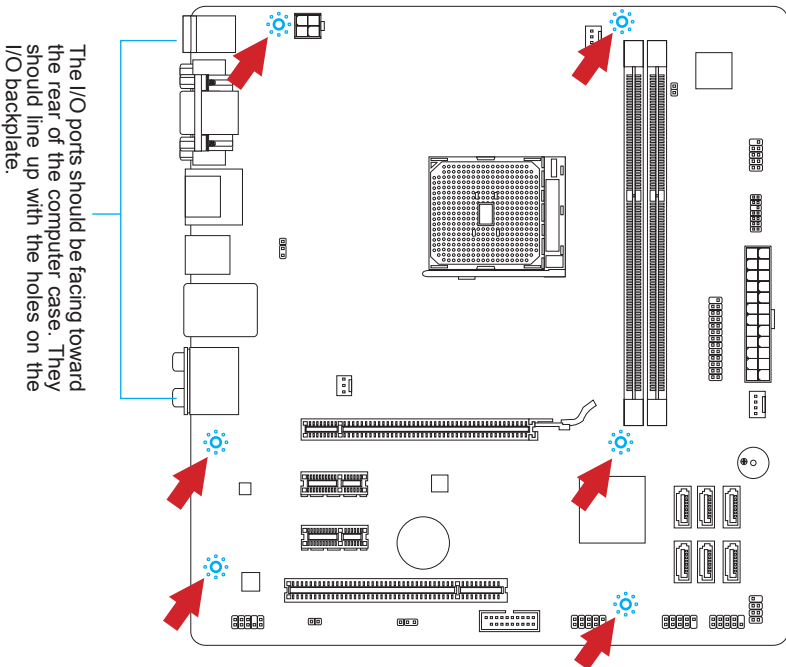

Important

- Install the mainboard on a flat surface free from unnecessary debris.
- To prevent damage to the mainboard, any contact between the mainboard circuitry and the computer case, except for the mounting stands, is prohibited.
- Please make sure there are no loose metal components on the mainboard or within the computer case that may cause a short circuit of the mainboard.

Power Supply

JPWR1: ATX 24-pin Power Connector

This connector allows you to connect an ATX 24-pin power supply. To connect the ATX 24-pin power supply, align the power supply cable with the connector and firmly press the cable into the connector. If done correctly, the clip on the power cable should be hooked on the mainboard's power connector.

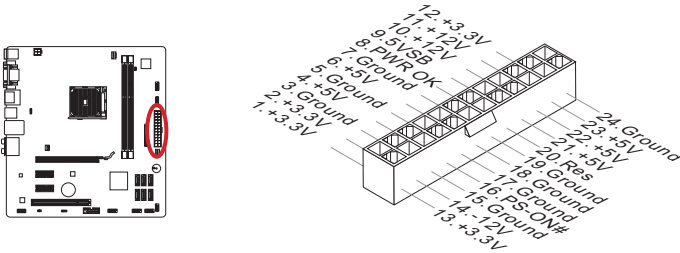

JPWR2: ATX 4-pin Power Connector

This connector provides 12V power to the APU.

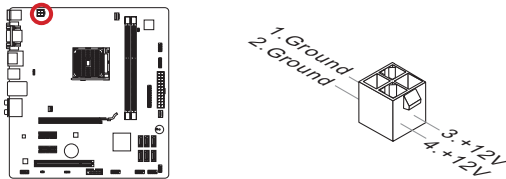

Important

Make sure that all the power cables are securely connected to a proper ATX power supply to ensure stable operation of the mainboard.

Memory

These DIMM slots are used for installing memory modules. For more information on compatible components, please visit <http://www.msi.com/service/test-report/>

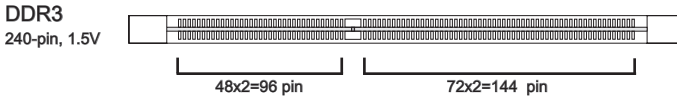

Dual-Channel mode Population Rule

In Dual-Channel mode, the memory modules can transmit and receive data with two data bus channels simultaneously. Enabling Dual-Channel mode can enhance system performance. The following illustrations explain the population rules for Dual-Channel mode.

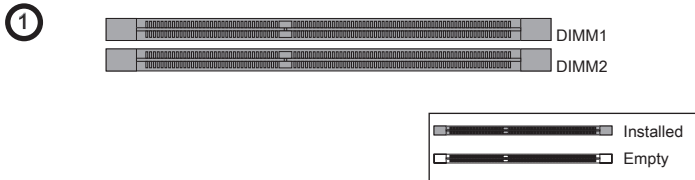

Important

- DDR3 memory modules are not interchangeable with DDR2, and the DDR3 standard is not backward compatible. Always install DDR3 memory modules in DDR3 DIMM slots.
- To ensure system stability, memory modules must be of the same type and density in Dual-Channel mode.
- Due to chipset resource usage, the system will only detect up to 15+ GB of memory (not full 16 GB) when all DIMM slots have 8GB memory modules installed.

Installing Memory Modules

1. Unlock the DIMM slot by pushing the mounting clips to the side. Vertically insert the memory module into the DIMM slot. The memory module has an off-center notch on the bottom that will only allow it to fit one way into the DIMM slot.
2. Push the memory module deep into the DIMM slot. The plastic clips at each side of the DIMM slot will automatically close when the memory module is properly seat and an audible click should be heard.
3. Manually check if the memory module has been locked in place by the DIMM slot's side clips.

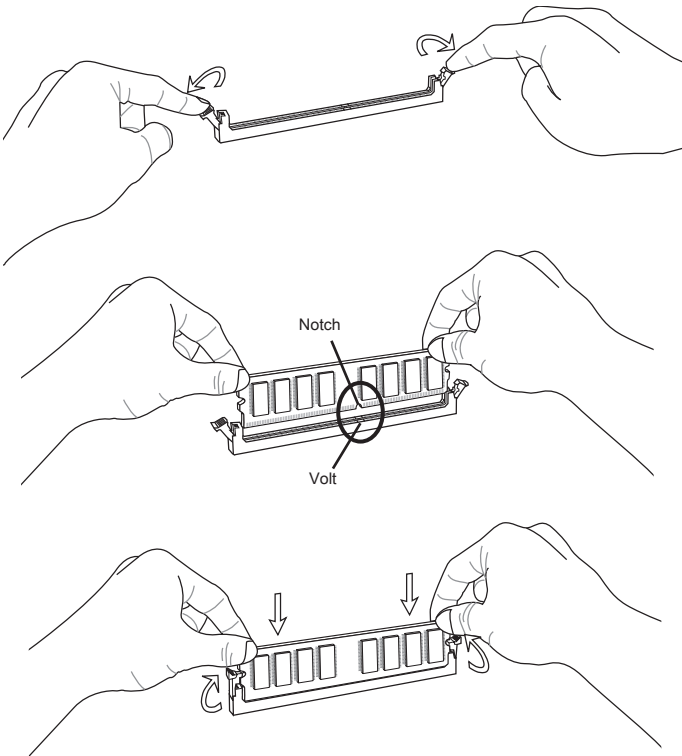

Expansion Slots

This mainboard contains numerous ports for expansion cards, such as discrete graphics or audio cards.

PCIe (Peripheral Component Interconnect Express) Slot

The PCIe slot supports the PCIe interface expansion card.

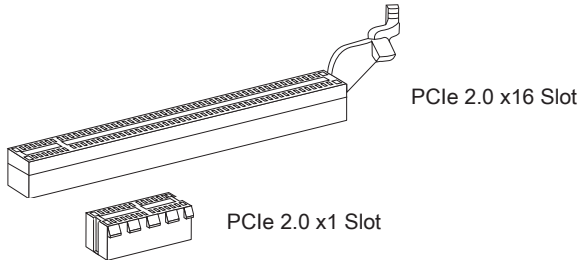

PCI (Peripheral Component Interconnect) Slot

The PCI slot supports additional LAN, SCSI, USB, and other add-on cards that comply with PCI specifications.

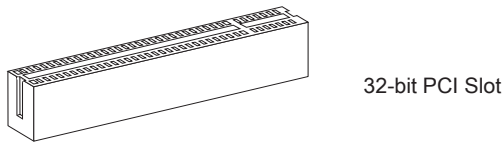

PCI Interrupt Request Routing

IRQ, or interrupt request lines, are hardware lines over which devices can send interrupt requests to the processor. The PCI IRQ pins are typically connected to the PCI bus pins as followed:

	Order1	Order2	Order3	Order4
PCI Slot1	INT E#	INT F#	INT G#	INT H#



When adding or removing expansion cards, always turn off the power supply and unplug the power supply power cable from the power outlet. Read the expansion card's documentation to check for any necessary additional hardware or software changes.

Video/ Graphics Cards

If available, this mainboard takes advantage of the APU's integrate graphics processor, but discrete video cards can be installed by way of the mainboard's expansion slots. Adding on one or more discrete video cards will significantly boost the system's graphics performance. For best compatibility, MSI graphics cards are recommended.

Single Video Card Installation

1. Determine what type of expansion slot the video card will use. Locate the expansion slot on the mainboard. Remove any protective expansion slot covers from the computer case.
2. Line up the video card on top of the expansion slot with the display ports facing out of the computer case.
3. Push the video card into its expansion slot. Depending on the expansion slot used, there should be clip on the expansion slot that will lock in place.
4. If needed, screw the edge of the graphics card to the computer case. Some video cards might require a power cable directly from the power supply.
5. Please consult your video card's manual for further instructions regarding driver installation or other special settings.

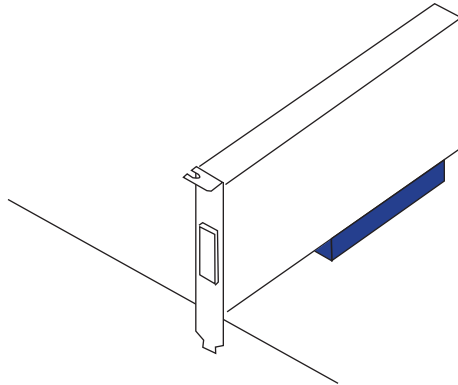

Internal Connectors

SATA1~6: Serial ATA Connector

This connector is a high-speed Serial ATA interface port. Each connector can connect to one Serial ATA device. Serial ATA devices include disk drives (HDD), solid state drives (SSD), and optical drives (CD/ DVD/ Blu-Ray).

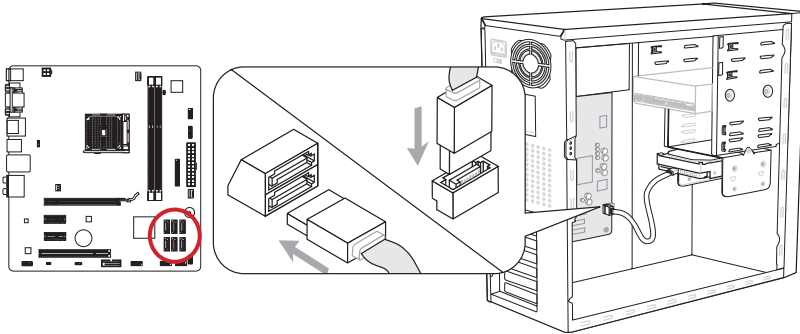

* The MB layout in this figure is for reference only.

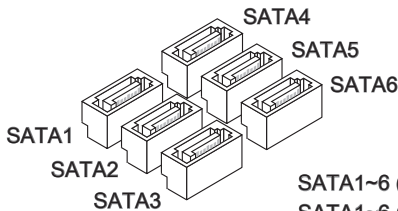

SATA1~6 (6Gb/s, by AMD® A85X) (FM2-A85XMA-E35)
 SATA1~6 (6Gb/s, by AMD® A75) (FM2-A75MA-E35)
 SATA1~6 (3Gb/s, by AMD® A55) (FM2-A55M-E35)



Important

- Many Serial ATA devices also need a power cable from the power supply. Such devices include disk drives (HDD), solid state drives (SSD), and optical drives (CD / DVD / Blu-Ray). Please refer to the device's manual for further information.
- Many computer cases also require that large Serial ATA devices, such as HDDs, SSDs, and optical drives, be screwed down into the case. Refer to the manual that came with your computer case or your Serial ATA device for further installation instructions.
- Please do not fold the Serial ATA cable at a 90-degree angle. Data loss may result during transmission otherwise.
- SATA cables have identical plugs on either sides of the cable. However, it is recommended that the flat connector be connected to the mainboard for space saving purposes.

CPUFAN, SYSFAN1~2: Fan Power Connectors

The fan power connectors support system cooling fans with +12V. If the mainboard has a System Hardware Monitor chipset on-board, you must use a specially designed fan with a speed sensor to take advantage of the CPU fan control. Remember to connect all system fans. Some system fans may not connect to the mainboard and will instead connect to the power supply directly. A system fan can be plugged into any available system fan connector.

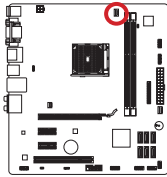

CPUFAN

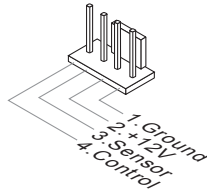

CPUFAN

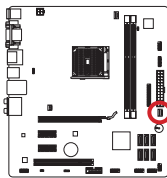

SYSFAN1

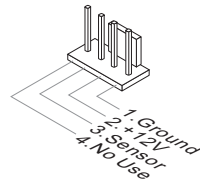

SYSFAN1

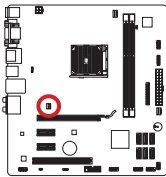

SYSFAN2

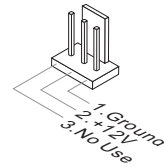

SYSFAN2



Important

- Please refer to your processor's official website or consult your vendor to find recommended CPU cooling fans.
- The CPUFAN and SYSFAN1 connectors support Smart fan control. The Control Center utility can be installed to automatically control the CPU fan speeds according to the APU's and system's temperature.
- If there are not enough ports on the mainboard to connect all system fans, adapters are available to connect a fan directly to a power supply.
- Before first boot up, ensure that there are no cables impeding any fan blades.

JFP1, JFP2: Front Panel Connectors

These connectors connect to the front panel switches and LEDs. The JFP1 connector is compliant with the Intel® Front Panel I/O Connectivity Design Guide. When installing the front panel connectors, please use the enclosed mConnectors to simplify installation. Plug all the wires from the computer case into the mConnectors and then plug the mConnectors into the mainboard.

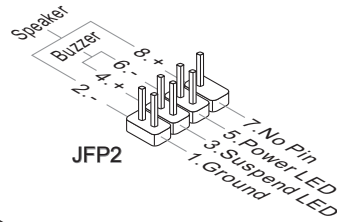
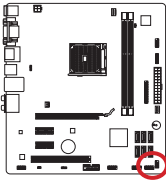

JFP2

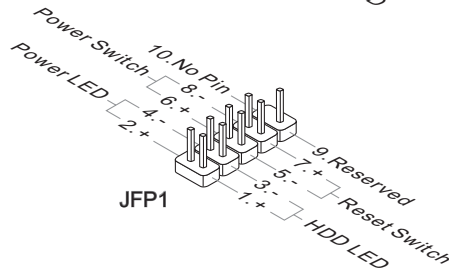

JFP1



Important

- On the connectors coming from the case, pins marked by small triangles are positive wires. Please use the diagrams above and the writing on the mConnectors to determine correct connector orientation and placement.
- The majority of the computer case's front panel connectors will primarily be plugged into JFP1.

JAUD1: Front Panel Audio Connector

This connector allows you to connect the front audio panel located on your computer case. This connector is compliant with the Intel® Front Panel I/O Connectivity Design Guide.

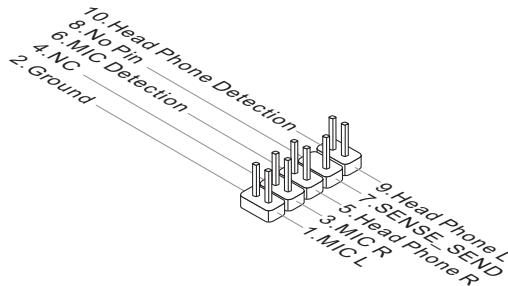
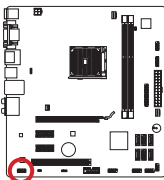

JUSB2~3: USB 2.0 Expansion Connectors

This connector is designed for connecting high-speed USB peripherals such as USB HDDs, digital cameras, MP3 players, printers, modems, and many others.

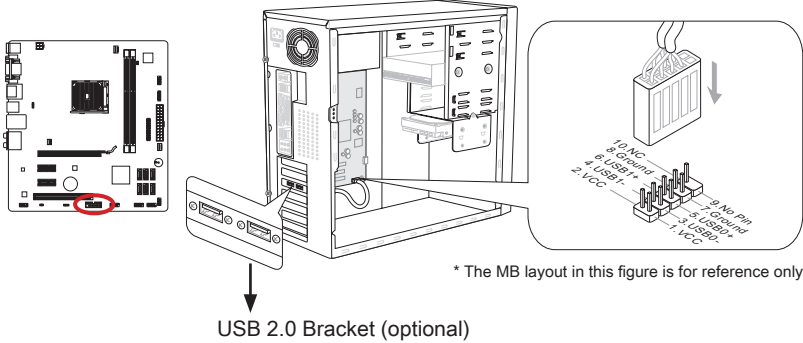

Important

Note that the VCC and GND pins must be connected correctly to avoid possible damage.

JTPM1: TPM Module connector

This connector connects to a TPM (Trusted Platform Module). Please refer to the TPM security platform manual for more details and usages.

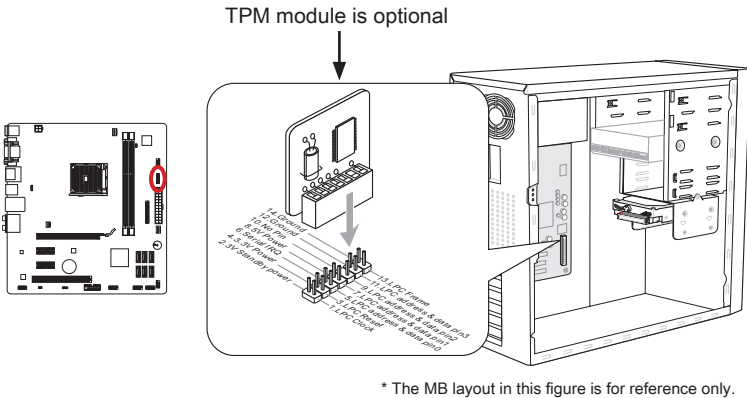

JLPT1: Parallel Port Header

This connector is used to connect an optional parallel port bracket. The parallel port is a standard printer port that supports Enhanced Parallel Port (EPP) and Extended Capabilities Parallel Port (ECP) mode.

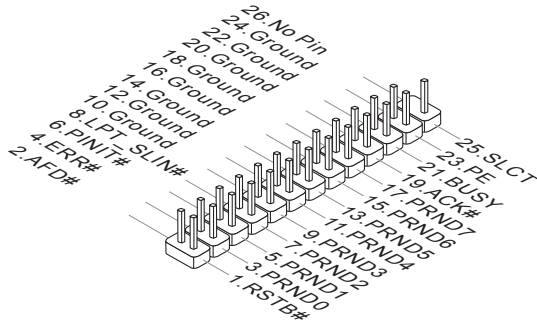
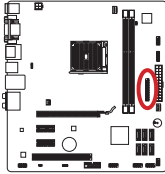

JCOM1: Serial Port Connector

This connector is a 16550A high speed communication port that sends/receives 16 bytes FIFOs. You can attach a serial device.

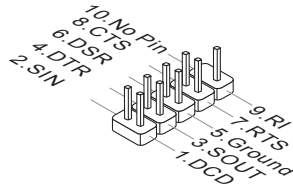
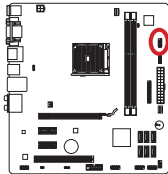

JUSB1:

The JUSB1 of FM2-A85XMA-E35/ FM2-A75MA-E35 is USB 3.0 connector, and the JUSB1 of FM2-A55M-E35 is USB 2.0 connector.

USB 3.0 Expansion Connector (FM2-A85XMA-E35/ FM2-A75MA-E35)

The USB 3.0 port is backwards compatible with USB 2.0 devices. It supports data transfer rates up to 5Gbits/s (SuperSpeed).

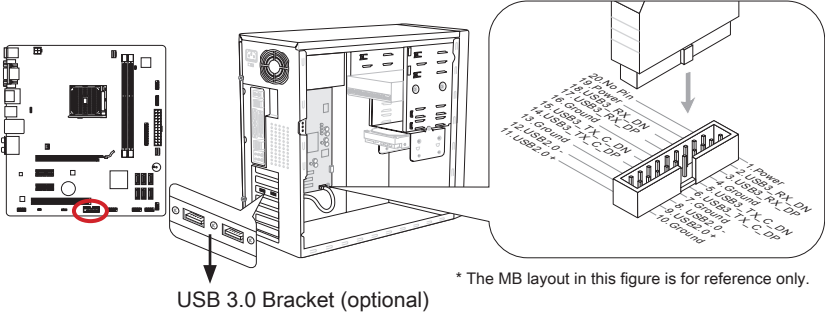

* The MB layout in this figure is for reference only.

USB 3.0 Bracket (optional)

Important

- Note that the VCC and GND pins must be connected correctly to avoid possible damage.
- To use a USB 3.0 device, you must connect the device to a USB 3.0 port through an optional USB 3.0 compliant cable.

USB 2.0 Expansion Connector (FM2-A55M-E35)

The USB 2.0 port supports data transfer rates up to 480Mbit/s (Hi-Speed).

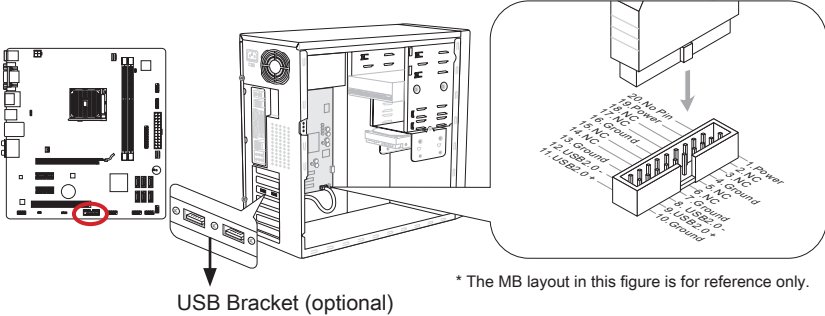

* The MB layout in this figure is for reference only.

USB Bracket (optional)

Important

Note that the VCC and GND pins must be connected correctly to avoid possible damage.

JCI1: Chassis Intrusion Connector

This connector connects to the chassis intrusion switch cable. If the computer case is opened, the chassis intrusion mechanism will be activated. The system will record this intrusion and a warning message will flash on screen. To clear the warning, you must enter the BIOS utility and clear the record.

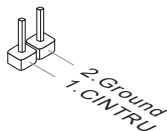
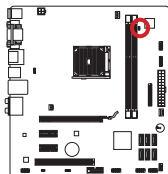

Jumper

JUSB_PW1~2: USB power Jumper

The USB ports on the rear IO panel are controlled by JUSB_PW2. The JUSB1 and JUSB2 are controlled by JUSB_PW1. These jumpers allow you to enable/ disable the “wakeup from S3/S4/S5 by USB and PS/2 device” function

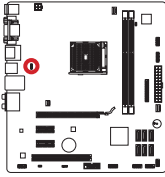

JUSB_PW2
(for back panel USB connectors)



Close 1-2

Keep USB power to VCC5 (default)



Close 2-3

Keep USB power to 5VSB

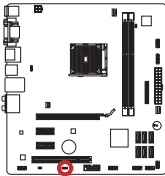

JUSB_PW1
(for on-board USB connectors)



Close 1-2

Keep USB power to VCC5 (default)



Close 2-3

Keep USB power to 5VSB



Important

If you set the jumper to Enabled, the power supply must be able to provide at least 2A currents.

JBAT1: Clear CMOS Jumper

There is CMOS RAM onboard that is external powered from a battery located on the mainboard to save system configuration data. With the CMOS RAM, the system can automatically boot into the operating system (OS) every time it is turned on. If you want to clear the system configuration, set the jumpers to clear the CMOS RAM.

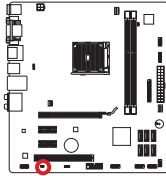

Keep Data



Clear Data



Important

You can clear the CMOS RAM by shorting this jumper while the system is off. Afterwards, open the jumper. Do not clear the CMOS RAM while the system is on because it will damage the mainboard.

Drivers and Utilities

After you install the operating system you will need to install drivers to maximize the performance of the new computer you just built. MSI mainboard comes with a Driver Disc. Drivers allow the computer to utilize your mainboard more efficiently and take advantage of any special features we provide.

You can protect your computer from viruses by installing the bundled security program. The bundle also includes a variety of powerful and creative utilities.

Total Installer

Total Installer is very easy to use and does a great job of finding necessary drivers. Please follow the steps below to install drivers and utilities for your new computer.

1. Insert MSI Driver Disc into the optical drive. The setup screen will automatically appear if autorun is enabled in OS.
2. Click Total Installer. A popup dialog will appear listing all necessary drivers.



Click here

3. Select all checkbox on driver listing dialog.
4. Click **Install** button.
5. The software installation will then be in progress, after it has finished it will prompt you to restart.
6. Click **OK** button to finish.
7. Restart your computer.

You can also use the same method to install the utilities.

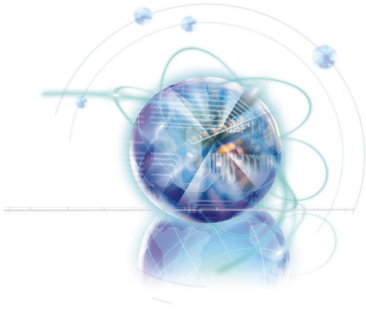

Chapter 2

BIOS Setup

CLICK BIOS II is a revolutionary UEFI interface that allows you to setup and configure your system for optimum use. Using your mouse and keyboard, users can change BIOS settings, monitor CPU temperature, select the boot device priority and view system information such as the CPU name, DRAM capacity, the OS version and the BIOS version. Users can import and export parameter data for backup or for sharing with friends. By connecting to the Internet within CLICK BIOS II, users can browse webpages, check mail and use Live Update your system.

Entering

Power on the computer and the system will start the Power On Self Test (POST) process. When the message below appears on the screen, please key to enter CLICK BIOS II:

Press DEL key to enter Setup Menu, F11 to enter Boot Menu

If the message disappears before you respond and you still need to enter CLICK BIOS II, restart the system by turning the computer OFF then back ON or pressing the RESET button. You may also restart the system by simultaneously pressing <Ctrl>, <Alt>, and <Delete> keys.



Important

The items under each BIOS category described in this chapter are under continuous update for better system performance. Therefore, the description may be slightly different from the latest BIOS and should be held for reference only.

Overview

After entering Click BIOS II, the following screen is displayed.

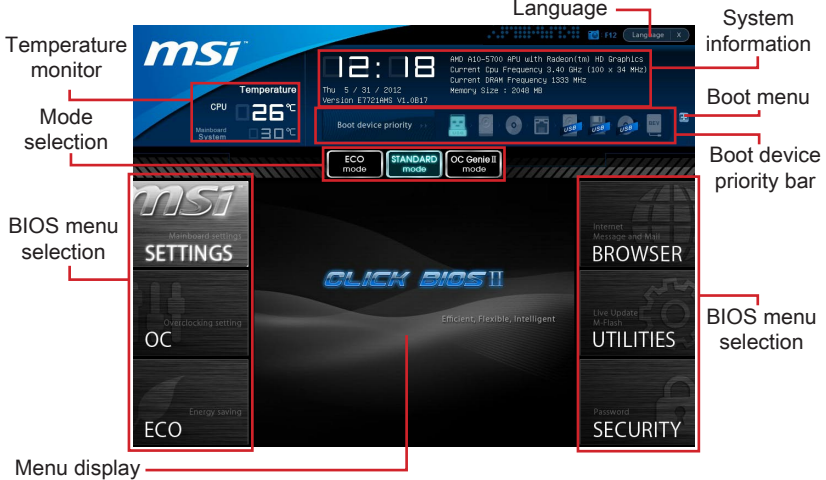

Important

The pictures in this guide are for reference only and may vary from the product you purchased. Please refer to the actual screens of your system for detailed information.

► Temperature monitor

This block shows the temperature of the processor and the mainboard.

► System information

This block shows the time, date, CPU name, CPU frequency, DRAM frequency, DRAM capacity and the BIOS version.

► BIOS menu selection

The following options are available:

- **SETTINGS** - Use this menu to specify your settings for chipset features and boot devices.
- **OC** - This menu contains items of the frequency and voltage adjustments. Increasing the frequency can get better performance, however high frequency and heat can cause instability, we do not recommend general users to over-clock.
- **ECO** - This menu is related to energy-saving settings.
- **BROWSER** - This feature is used to enter the MSI Winki web browser.
- **UTILITIES** - This menu contains utilities for backup and update.
- **SECURITY** - The security menu is used to keep unauthorized people from making any changes to the settings. You can use these security features to protect your system.

► Boot device priority bar

You can move the device icons to change the boot priority.

► Boot menu

This button is used to open a boot menu. Click the item to boot the system from the device instantly.

► Mode selection

This feature allows you to load presets of energy saving or overlocking.

► Menu display

This area provides BIOS settings and information to be configured.

► Language

This allows you to select the language of the BIOS setting.

Boot device priority bar

This bar shows the priority of the boot devices. The lighted icons indicate that the devices are available.

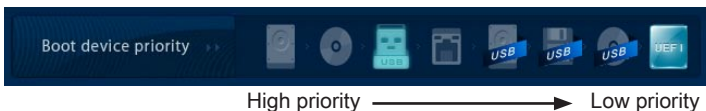

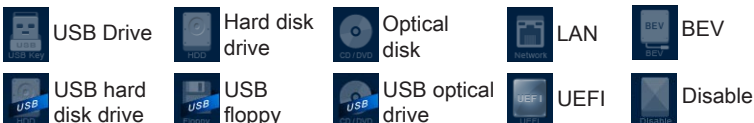

Click and draw the icon to left or right to specify the boot priority.

■ Boot device icon list



Operation

CLICK BIOS II allows you to control BIOS settings with the mouse and the keyboard. The following table lists and describes the hot keys and the mouse operations.

Hot key	Mouse	Description
<↑ ↓ → ←>	 Move the cursor	Select Item
<Enter>	 Click/ Double-click the left button	Select Icon/ Field
<Esc>	 Click the right button	Jump to the Exit menu or return to the previous from a submenu
<+>	X	Increase the numeric value or make changes
<->		Decrease the numeric value or make changes
<F1>		General Help
<F4>		CPU Specifications
<F5>		Enter Memory-Z
<F6>		Load optimized defaults
<F8>		OC Profile Load From USB
<F9>		OC Profile Save to USB
<F10>		Save Change and Reset
<F12>		Save a screenshot to a FAT/FAT32 USB drive

Sub-Menu

If you find a point symbol to the left of certain fields, that means a sub-menu can be launched for additional options. You can use the arrow keys or mouse to highlight the field and press <Enter> or double-click the left mouse button to enter the sub-menu. If you want to return to the previous menu, just press <Esc> or click the right mouse button.

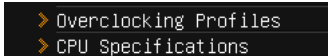

General Help

The General Help screen lists the appropriate keys to use for navigation. You can call up this screen from any menu by simply pressing <F1>. Press <Esc> to exit the Help screen.

SETTINGS

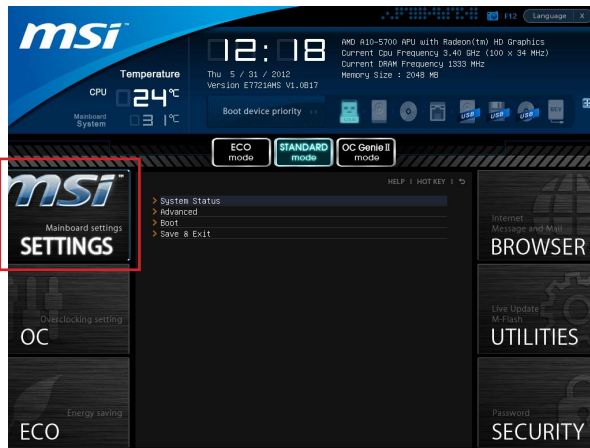

System Status

► System Date

This allows you to set the system date that you want (usually the current date). The format is <day> <month> <date> <year>.

day	Day of the week, from Sun to Sat, determined by BIOS. Read-only.
month	The month from Jan. through Dec.
date	The date from 1 to 31 can be keyed by numeric function keys.
year	The year can be adjusted by users.

► System Time

This allows you to set the system time that you want (usually the current time). The time format is <hour> <minute> <second>.

► SATA Port1~6

Shows devices connected to specific SATA ports.



Important

If your device is not displayed, turn off computer and re-check SATA cable and power cable connections to the device.

► System Information

Shows detailed system information, including CPU type, BIOS version, and Memory (read only).

Advanced

► PCI Subsystem Settings

Press <Enter> to enter the sub-menu.

▶ PCI Latency Timer

Controls how long each PCI device can hold the bus before another takes over. When set to higher values, every PCI device can conduct transactions for a longer time and thus improve the effective PCI bandwidth.

▶ ACPI Settings

Press <Enter> to enter the sub-menu.

▶ ACPI Standby State

Specifies the power saving mode for ACPI function

[S1] Sleep Mode. Hardware remains on.

[S3] Suspend to RAM. Turns off hardware. (Recommended)

▶ Power LED

Configures how the system uses power LEDs on the case to indicate sleep/suspend state.

[Single] The power LED turns off during the sleep/suspend mode.

[Dual] The power LED changes its color to indicate the sleep/suspend state.

[Blinking] The power LED blinks to indicate the sleep/suspend state.

▶ Integrated Peripherals

Press <Enter> to enter the sub-menu.

▶ Onboard LAN Controller

This item allows you to enable/ disable the onboard LAN controller.

▶ LAN Option ROM

This item is used to decide whether to invoke the Boot ROM of the onboard LAN.

▶ Network Stack

This item is used to enable/ disable UEFI network stack.

▶ Ipv4 PXE Support

This item appears when you set "Enabled" in [Network Stack] field and is used to enable/ disable the Ipv4 PXE boot support.

▶ Ipv6 PXE Support

This item appears when you set "Enabled" in [Network Stack] field and is used to enable/ disable the Ipv6 PXE boot support.

▶ SATA Mode

This item is used to specify RAID/ IDE/ AHCI mode for SATA port.



Important

- Windows XP is not natively supported to be installed in the storage device with AHCI mode. *If you still prefer to install Windows XP as the operating system, please refer to Appendix Install Windows XP Notes.*
- *You cannot switch between AHCI and IDE if you already have your operating system installed.*

▶ Board SATA RAID ROM

This item is used to switch RAID ROM. The default setting is “Legacy ROM”. If you plan to install Windows on a RAID volume greater than 2.2TB, please set this option to “UEFI DRIVER” and refer to section “Installing OS on 2.2TB RAID” chapter B “AMD RAID”.

▶ HD Audio Controller

This item allows you to enable/ disable the HD audio controller.

▶ HPET

The HPET (High Precision Event Timers) is a component that is part of the chipset. You can enable it, and will provide you with the means to get to it via the various ACPI methods.

▶ Integrated Graphics Configuration

Press <Enter> to enter the sub-menu.

▶ Initiate Graphic Adapter

Choose which adapter you wish to make the primary option

[PEG] PCI-Express Graphics Device

[IGD] Integrated Graphics Display

▶ USB Configuration

Press <Enter> to enter the sub-menu.

▶ USB Controller

This item allows you to enable/ disable the integrated USB 2.0 controller.

▶ Legacy USB Support

Enable or disable support for USB keyboards, mice and floppy drives. You will be able to use these devices with operating systems that do not support USB.

▶ Super IO Configuration

Press <Enter> to enter the sub-menu.

▶ Serial(COM) Port 0 Configuration

Press <Enter> to enter the sub-menu.

▶ Serial (COM) Port0

This item allows you to enable/ disable the serial port.

▶ Serial (COM) Port0 Settings

Select an address and corresponding interrupt for the serial port.

▶ Parallel(LPT) Port Configuration

Press <Enter> to enter the sub-menu.

▶ Parallel(LPT) Port

This item allows you to enable/ disable the parallel port.

▶ Parallel(LPT) Port Settings

Select an address and corresponding interrupt for the parallel port.

▶ Device Mode

Select the device mode for the parallel port.

▶ Hardware Monitor

Press <Enter> to enter the sub-menu.

▶ CPU Smart Fan Target

Controls CPU fan speed automatically depending on the current temperature and to keep it with a specific range. If the current CPU temperature reaches the target value, the smart fan function will be activated.

▶ SYS Fan1 Control

This item allows users to select how percentage of speed for the SYSFAN1.

▶ CPU/ System Temperature, CPU FAN/ SYS FAN 1 Speed

These items show the current status of all of the monitored hardware devices/ components such as CPU temperature/ system temperature and all fans' speeds.

▶ Power Management Setup

Press <Enter> to enter the sub-menu.

▶ EuP 2013

Energy Using Products Lot 6 2013 (EUP) reduces power consumption when system is off or in standby mode.

Note: When enabled, the system will not support RTC wake up event functions.

▶ Restore after AC Power Loss

This item specifies whether your system will reboot after a power failure or interrupt occurs. Settings are:

[Power Off] Always leaves the computer in the power off state.

[Power On] Always leaves the computer in the power on state.

[Last State] Restore the system to the status before power failure or interrupt occurred.

▶ Wake Up Event Setup

Press <Enter> to enter the sub-menu.

▶ Wake Up Event By

Setting to [BIOS] activates the following fields, and use the following fields to set the wake up events. Setting to [OS], the wake up events will be defined by OS.

▶ Resume By RTC Alarm

The field is used to enable or disable the feature of booting up the system on a scheduled time/date.

▶ Date/ HH:MM:SS

If Resume By RTC Alarm is set to [Enabled], the system will automatically resume (boot up) on a specific date/hour/minute/second specified in these fields (using the <+> and <-> to select the date & time settings).

▶ Resume By PCI or PCI-E Device

When set to [Enabled], the feature allows your system to be awakened from the power saving modes through any event on PCI or PCIe device.

▶ Resume From S3 by USB Device

The item allows the activity of the USB device to wake up the system from S3 (Suspend to RAM) sleep state.

▶ **Resume From S3/S4/S5 by PS/2 Mouse/ Keyboard**

These items determine whether the system will be awakened from what power saving modes when input signal of the PS/2 mouse/ keyboard is detected.

Boot

▶ **Full Screen Logo Display**

This item enables this system to show the company logo on the boot-up screen. [Enabled] Shows a still image (logo) on the full screen at boot.

[Disabled] Shows the POST messages at boot.

== Boot Option Priorities==

▶ **1st~9th Boot**

These items are used to prioritize the installed boot devices.

▶ **Hard Disk Drive BBS Priorities/ CD/DVD ROM Drive BBS Priorities/ USB HardDisk Drive BBS Priorities/ UEFI Boot Drive BBS Priorities**

▶ **1st~8th Boot**

These items are used to prioritize the installed Hard Disk Drive/ CD/DVD ROM Drive/ USB HardDisk drives/ UEFI boot drives.

Save & Exit

▶ **Discard Changes and Exit**

Use this item to abandon all changes and exit setup.

▶ **Save Changes and Reboot**

Use this item to save changes and reset the system.

▶ **Save Changes**

Use this item to save changes.

▶ **Discard Changes**

Use this item to abandon all changes.

▶ **Restore Defaults**

Use this item to load the optimized default values set by the BIOS vendor.

== **Boot Override** ==

The installed storage devices will appear on this menu, you can select one of them be a boot device.

▶ **Built-in EFI Shell**

Use this item to enter the EFI Shell.

OC

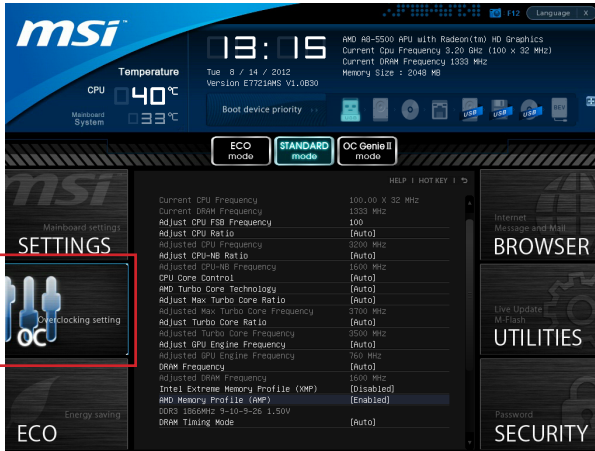

Important

- *Overclocking your PC manually is only recommended for advanced users.*
- *Overclocking is not guaranteed, and if done improperly, can void your warranty or severely damage your hardware.*
- *If you are unfamiliar with overclocking, we advise you to use OC Genie for easy overclocking.*

▶ **Current CPU / DRAM Frequency**

These items show the current clocks of CPU and Memory speed. Read-only.

▶ **Adjust CPU FSB Frequency**

Allows you to set the CPU FSB clock. You may overclock the CPU by adjusting this value. Please note that overlocking behavior and stability is not guaranteed.

▶ **Adjust CPU Ratio**

Controls the multiplier that is used to determine internal clock speed of the processor. This feature can only be changed if the processor supports this function.

▶ **Adjusted CPU Frequency**

It shows the adjusted CPU frequency. Read-only.

▶ **Adjust CPU-NB Ratio**

This item is used to adjust CPU-NB clock ratio.

▶ **Adjusted CPU-NB Frequency**

It shows the adjusted CPU-NB frequency. Read-only.

▶ **CPU Core Control**

This item is used to control number of CPU cores. When set to [Auto], the CPU will

operate under the default number of cores. When set to [Manual], you will be able to enable/disable the specific CPU core.

▶ **AMD Turbo Core Technology**

This technology automatically increases the frequency of active CPU cores to improve performance.

▶ **Adjust Max Turbo Core Ratio**

This item is used to adjust Max Turbo Core ratio

▶ **Adjusted Max Turbo Core Frequency**

It shows the adjusted Max Turbo Core frequency. Read-only.

▶ **Adjust Turbo Core Ratio**

This item is used to adjust Turbo Core ratio.

▶ **Adjusted Turbo Core Frequency**

It shows the adjusted Turbo Core frequency. Read-only.

▶ **Adjust GPU Engine Frequency**

This item is used to adjust the integrated graphics frequency.

▶ **Adjusted GPU Engine Frequency**

It shows the adjusted integrated graphics frequency. Read-only.

▶ **DRAM Frequency**

This item allows you to adjust the DRAM frequency. Please note the overclocking behavior is not guaranteed.

▶ **Adjusted DRAM Frequency**

It shows the adjusted DRAM frequency. Read-only.

▶ **Intel Extreme Memory Profile (XMP)**

Choose to apply an Intel Extreme Memory Profile (XMP) to increase system performance. When the Intel Extreme Memory Profile (XMP) is enabled, the AMD Memory Profile (AMP) will be forced to be disabled.

▶ **AMD Memory Profile (AMP)**

Choose to apply an AMD Memory Profile (AMP) to increase system performance. When AMD Memory Profile (AMP) is enabled, the Intel Extreme Memory Profile (XMP) will be forced to be disabled.

▶ **DRAM Timing Mode**

Select whether DRAM timing is controlled by the SPD (Serial Presence Detect) EEPROM on the DRAM module. Setting to [Auto] enables DRAM timings and the following "Advanced DRAM Configuration" sub-menu to be determined by BIOS based on the configurations on the SPD. Selecting [Link] or [Unlink] allows users to configure the DRAM timings for each channel and the following related "Advanced DRAM Configuration" sub-menu manually.

▶ **Advanced DRAM Configuration**

Press <Enter> to enter the sub-menu.

▶ **Command Rate**

This setting controls the DRAM command rate.

▶ **tCL**

Controls CAS latency which determines the timing delay (in clock cycles) of starting a read command after receiving data.

▶ **tRCD**

Determines the timing of the transition from RAS (row address strobe) to CAS (column address strobe). The less clock cycles, the faster the DRAM performance.

▶ **tRP**

Controls number of cycles for RAS (row address strobe) to be allowed to pre-charge. If insufficient time is allowed for RAS to accumulate before DRAM refresh, the DRAM may fail to retain data. This item applies only when synchronous DRAM is installed in the system.

▶ **tRAS**

Determines the time RAS (row address strobe) takes to read from and write to memory cell.

▶ **tRFC**

This setting determines the time RFC takes to read from and write to a memory cell.

▶ **tWR**

Determines minimum time interval between end of write data burst and the start of a pre-charge command. Allows sense amplifiers to restore data to cell.

▶ **tWTR**

Determines minimum time interval between the end of write data burst and the start of a column-read command; allows I/O gating to overdrive sense amplifiers before read command starts.

▶ **tRRD**

Specifies the active-to-active delay of different banks.

▶ **tRTP**

Time interval between a read and a precharge command.

▶ **tFAW**

This item is used to set the tFAW (four activate window delay) timing.

▶ **tWCL**

This item is used to set the tWCL (Write CAS Latency) timing.

▶ **tCKE**

This item is used to set the Pulse Width for DRAM module.

▶ **tRTL**

This item is used to set Round Trip Latency settings.

▶ **Advanced Channel 1/ 2 Timing Configuration**

Press <Enter> to enter the sub-menu. And you can set the advanced memory timing for each channel.

▶ **Spread Spectrum**

This function reduces the EMI (Electromagnetic Interference) generated by modulating clock generator pulses.



Important

- If you do not have any EMI problem, leave the setting at [Disabled] for optimal system stability and performance. But if you are plagued by EMI, select the value of Spread Spectrum for EMI reduction.
- The greater the Spread Spectrum value is, the greater the EMI is reduced, and the system will become less stable. For the most suitable Spread Spectrum value, please consult your local EMI regulation.
- Remember to disable Spread Spectrum if you are overclocking because even a slight jitter can introduce a temporary boost in clock speed which may just cause your overclocked processor to lock up.

▶ CPU Voltage/ CPU-NB Voltage/ NB Voltage/ DRAM Voltage/ SB Voltage

These items are used to adjust the voltage of CPU, Memory and chipset.

▶ Overclocking Profiles

Press <Enter> to enter the sub-menu.

▶ Overclocking Profile 1/ 2/ 3/ 4/ 5/ 6

Press <Enter> to enter the sub-menu.

▶ Set Name for Overclocking Profile 1/ 2/ 3/ 4/ 5/ 6

Give a name by typing in this item.

▶ Save Overclocking Profile 1/ 2/ 3/ 4/ 5/ 6

Save the current overclocking settings to ROM for selected profile.

▶ Load/ Clear Overclocking Profile 1/ 2/ 3/ 4/ 5/ 6

Load/ Clear the stored profile settings from ROM.

▶ OC Profile Save to USB

Save the current overclocking settings to USB drive.

▶ OC Profile Load from USB

Load the stored settings from USB drive.

▶ CPU Specifications

Press <Enter> to enter the sub-menu. This sub-menu highlights all the key features of your CPU. The information will vary by model and is read-only. You can also access this information at any time by pressing [F4]. Press <Enter> to enter the sub-menu.

▶ CPU Technology Support

Press <Enter> to enter the sub-menu. The sub-menu shows the installed CPU technologies. Read only.

▶ MEMORY-Z

Press <Enter> to enter the sub-menu. This sub-menu highlights all the settings and timings of your DIMMs. This information will vary by model and is read-only. You can also access this information at any time by pressing [F5]. Press <Enter> to enter the sub-menu.

▶ DIMM1~2 Memory SPD

Press <Enter> to enter the sub-menu. The sub-menu displays the informations of installed memory.

► CPU Features

Press <Enter> to enter the sub-menu.

► AMD Cool'n'Quiet

The Cool'n'Quiet technology can effectively and dynamically lower CPU speed and power consumption.



Important

To ensure that Cool'n'Quiet function is activated and will be working properly, it is required to double confirm that:

- Run BIOS Setup, select OC Menu and find CPU Feature > AMD Cool'n'Quiet, and set this item to "Enabled".
- Enter Windows, and select [Start]->[Settings]->[Control Panel]->[Power Options]. Enter Power Options Properties tag, and select Minimal Power Management under Power schemes.

► SVM Mode

This item allows you to enable/disable the AMD SVM (Secure Virtual Machine) Mode.

► Core C6 State

This item allows you to enable/ dsiable C6 state support. When the CPU enters C6 state, all cores will save architectural state and reduce core voltages to zero volts. Wake up the CPU from C6 state will take a lot longer.

ECO

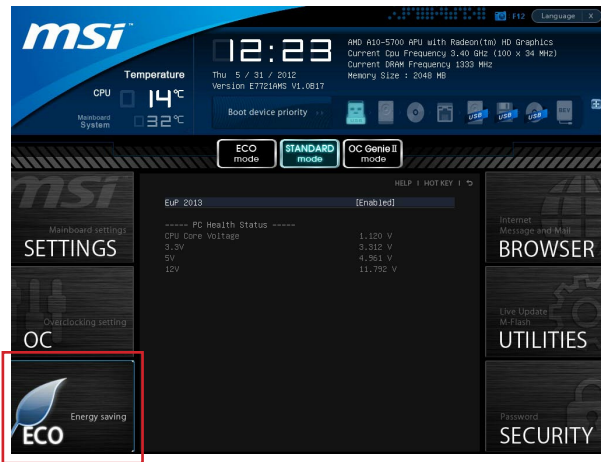
**Important**

Once you click the "ECO" button in the pre-set area, some items in ECO menu will be fixed and un-adjustable.

► **EuP 2013**

Energy Using Products Lot 6 2013 (EUP) reduces power consumption when system is off or in standby mode.

Note: When enabled, the system will not support RTC wake up event functions.

► **CPU Core Voltage/ 3.3V/ 5V/ 12V**

These items show the amperages. Read only.

BROWSER

Please install the MSI "Winki" application first in the Windows operating system with the MSI Driver Disc before using the browser. Then you can click the BROWSER to access the Internet, e-mail and instant messaging.



Installing Winki

To install Winki, follow the steps below:



1. Power on your computer and enter Windows operating system.
2. Insert MSI Driver Disc into the optical drive. The setup screen will automatically appear.
3. Click Driver tab.
4. Click OTHERS button.
5. Select Winki to start installing.
6. When finished, restart your computer.

UTILITIES

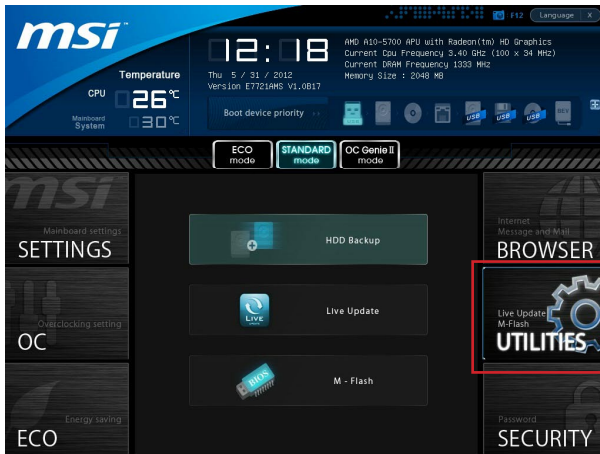

► HDD Backup

Hard disk storage backups and restoring is one of the most common and important tasks. Use this utility to create an image of your HDD partitions and re-load them when necessary.



Important

The HDD Backup can't back up (/restore) image to (/from) a partition where itself was installed, so it's strongly recommended to divide HDD into 2 partitions at least (1st for OS; 2nd for data).

For HDD with single partition only, the requirements for HDD Backup are:

1. An additional partition from another HDD (ex. USB HDD) for HDD Backup to back up (/restore) image to (/from) it.
2. Executing Winki stored in USB flash drive/ MSI Driver Disc by pressing <F11> to choose boot device during POST.

► Live Update

This tool can detect and update your BIOS online so that you won't need to spend time searching manually.



Important

HDD Backup and Live Update request Winki, please install the "Winki" software application from MSI Driver Disc in Windows first. And then you can access these two utilities by clicking their respective buttons.

► M-Flash

► BIOS Boot Function

This allows you to enable/ disable the system to boot from the BIOS file inside USB drive (FAT/ 32 format only).

► Select one file to Boot

When the BIOS Boot function as sets to [Enabled], this item is selectable. This item allows to select particular BIOS file from the USB/ Storage (FAT/ 32 format only) drive. And the system will boot from selected BIOS file.

► Save BIOS to storage

Please setup a specific folder in specific USB/ Storage drive to save BIOS file from BIOS ROM chip data. Note: it only supports FAT/ 32 file system drive.

► Select one file to update BIOS



This item allows you to select a particular BIOS file from the USB/ Storage (FAT/ 32 format only) drive for updating BIOS.

Updating the BIOS with Live Update

This section tells you how to update the BIOS by using the Live Update utility before entering Operating System. Live Update will update the BIOS automatically when connecting to the Internet. To update the BIOS with the Live Update utility:

1. Click Live Update button  on the BIOS UTILITIES menu. (The Winki must be installed).



2. Setup the connection by click the setting button  if necessary.
3. Click the next button .
4. Live Update will automatically detect the version of BIOS and download the appropriate file.

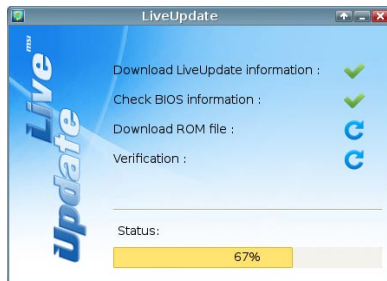

5. Click the confirm button  to update the BIOS.



Important

Do not unplug or shut off your system during BIOS Flash. Incorrect BIOS flashing can cause the motherboard to not POST. Please ensure you have the correct version and model of your motherboard BIOS when updating.

SECURITY

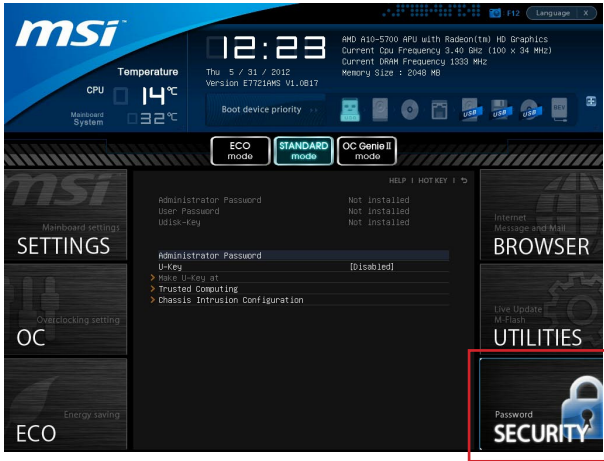

► **Administrator Password**

Set the administrative password that will be required to enter the BIOS.

► **User Password**

Set the user password that will be required to enter the operating system.



When selecting the Administrative / User Password items, a password box will appear on the screen. Type the password then press <Enter>. The password typed now will replace any previous set password from CMOS memory. You will be prompted to confirm the password. You may also press <Esc> to abort the selection.

To clear a set password, press <Enter> when you are prompted to enter a new password. A message will confirm the password is being disabled. Once the password is disabled, you can enter the setup and OS without authorization.

► **U-Key**

Enable or disable USB driver device as key. This requires the USB device to be plugged in for access to the computer..

► **Make U-Key at**

When the “U-Key” as sets to [Enabled], this item is selectable. This item allows you to specify the USB drive.

► **Trusted Computing**

Press <Enter> to enter the sub-menu.

► **TCG/TPM Support**

Setting the option to [Yes] enables TPM (Trusted Platform Module) to the system.

▶ **Chassis Intrusion Configuration**

Press <Enter> to enter the sub-menu.

▶ **Chassis Intrusion**

Enables or disables the feature of recording the chassis intrusion status and issuing a warning message if opened. To clear the warning logs, set the field to [Reset]. The setting of the field will return to [Enabled] later.

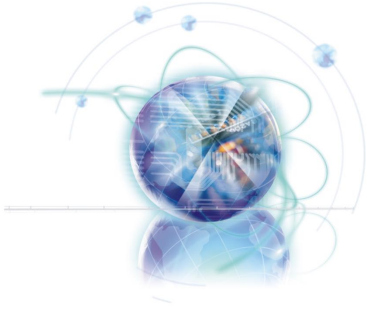

Appendix A

Realtek Audio

The Realtek audio provides 10-channel DAC that simultaneously supports 7.1 sound playback and 2 channels of independent stereo sound output (multiple streaming) through the Front-Out-Left and Front-Out-Right channels.

Software Configuration

After installing the audio driver (see Chapter 1 - Driver and Utilities), the “Realtek HD Audio Manager” icon will appear at the notification area (lower right of the screen). You may double click the icon and the GUI will pop up accordingly.

double click the icon

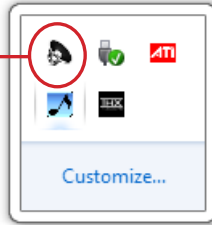

It is also available to enable the audio driver by clicking the Realtek HD Audio Manager from the Control Panel.

Software panel overview

The following figure describes the function of the Realtek HD Audio Manager panel.

Device Selection

Application Enhancement

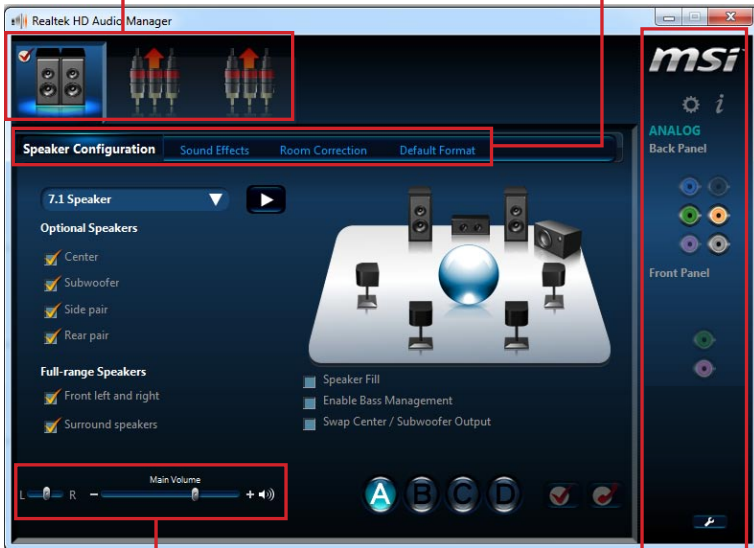

Volume Adjustment

Jack status panel

■ Device Selection

Here you can select an audio output source to change the related options. The “check” sign (in orange) indicates the device as default.

■ Volume Adjustment

You can control the volume or balance the right/left side of the speakers that you plugged in front or rear panel by adjusting the bar.

■ Application Enhancement

The array of options will provide you a complete guidance of anticipated sound effect for both output and input device.

■ Jack status panel

This panel depicts all render and capture devices currently connected with your computer.

Auto popup dialog

When you plug into the device at the jack, a dialogue window will pop up asking you which device is currently connected.

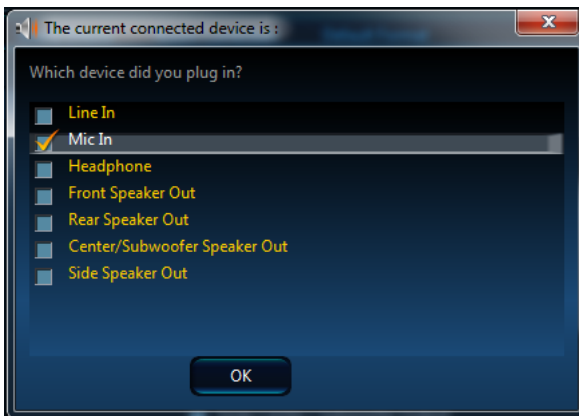

As you know, each jack corresponds to its default setting, you can refer to the next section “Hardware Default Setting”.

Hardware Default Setting

The following diagrams are audio back panel default setting.

- Backpanel audio jacks to 2-channel speakers diagram

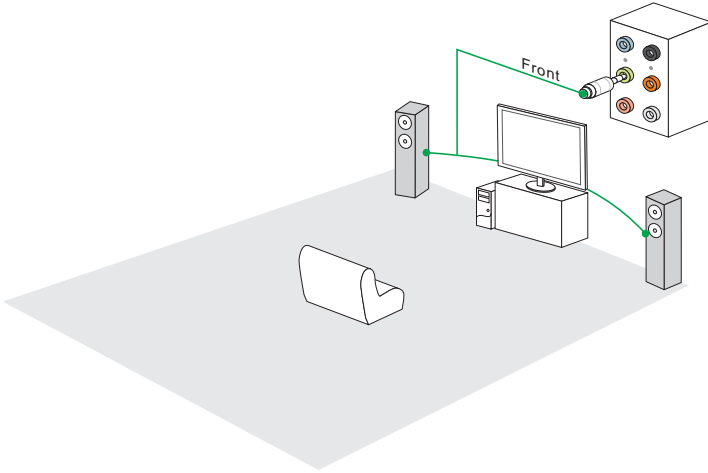

- Backpanel audio jacks to 4-channel speakers diagram

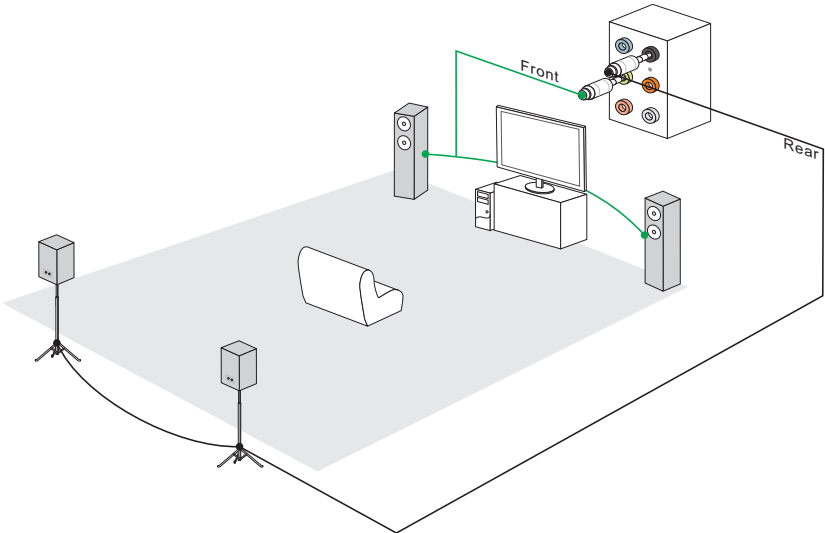

- Backpanel audio jacks to 6-channel speakers diagram

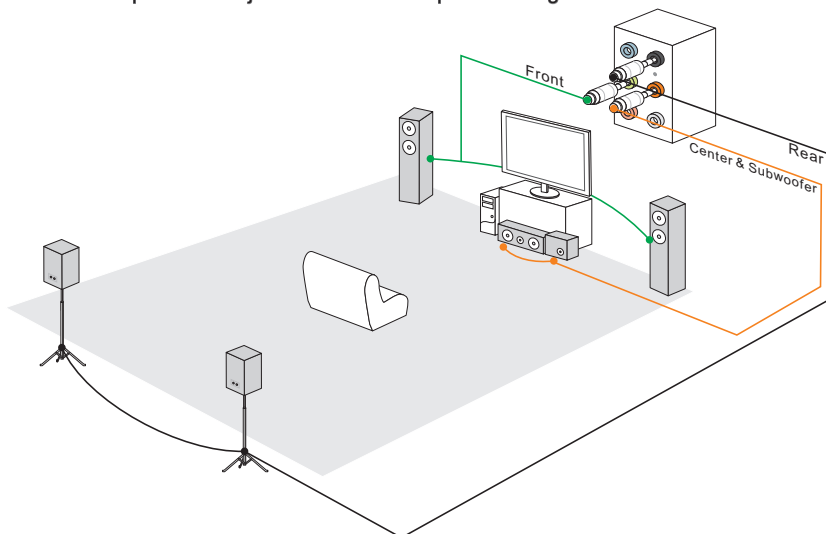

- Backpanel audio jacks to 8-channel speakers diagram

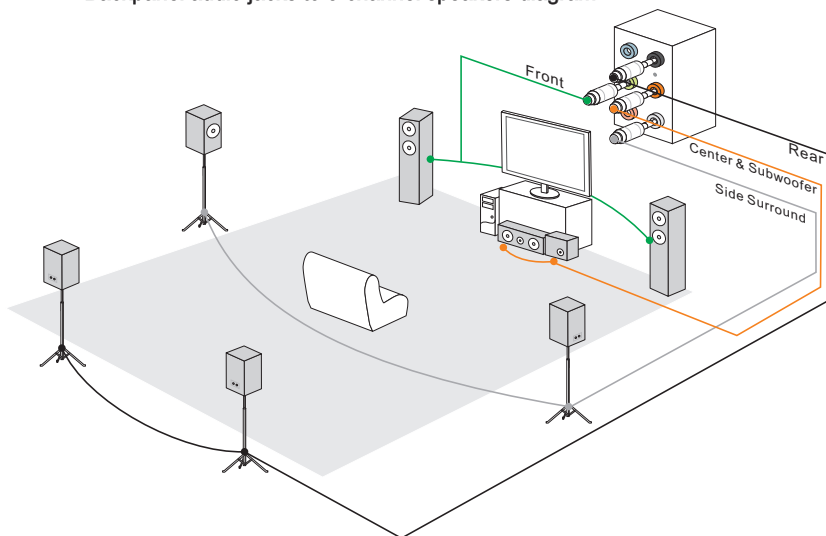

Lined writing area with multiple horizontal lines.

msi™

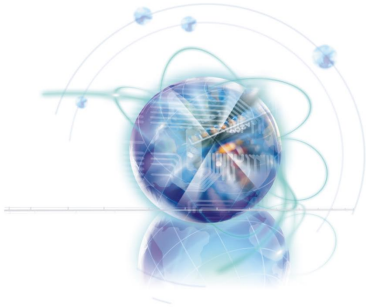

Appendix B

AMD RAID

The integrate one SATA host controller separately, and support RAID function for performance and reliability.

The SATA RAID provides support for RAID 0 (Striping), RAID 1 (Mirroring), RAID 10 (Striping & Mirroring) & RAID 5 (striping with parity) (optional). RAID 0 greatly improves hard disk I/O performance by concurrently striping data across multiple drives. RAID 1 makes sure data is not lost if a drive fails as data is simultaneously written to two drives. Drives configured for RAID Striping are said to form a RAID 0 set, while drives configured for RAID Mirroring are said to form a RAID 1 set. RAID 10 is implemented as a mirrored array whose segments are RAID 0 arrays. RAID 10 has same fault tolerance as mirroring and reduces overhead by striping. It needs at least four drives to form a RAID 10. RAID 5 defines techniques for parity data.

RAID Configuration

Creating and deleting RAID set and performing other RAID setting up operations are done in the RAID BIOS. During bootup, a screen similar to the one below will appear for about few seconds. Press <Ctrl-F> to enter RAID Option ROM utility.

Press <Ctrl-F> to enter RAID Option ROM utility...

Important

Be sure to enable the RAID function for SATA device in BIOS before configuring the RAID Option ROM Utility.

The RAID Option ROM utility menu screen will appear. The Main Menu is used to choose the operation to be performed.



View Drives Assignments

This window displays the model number, capacities and assignment of the drives physically attached to the SATA host adapter.

[View Drives Assignments]				
Port : ID	Drive Model	Capabilities	Capacity (GB)	Assignment
01 : 00	ST32000641AS	SATA 6G	2000.39	<Single Disk>
	Extent 1		2000.39	<Single Disk>
02 : 00	ST32000641AS	SATA 6G	2000.39	<Single Disk>
	Extent 1		2000.39	<Single Disk>

[Keys Available]				
[↑] Up	[↓] Down	[PaUp / PaDn] Switch Page	[Ctrl + H] Full Erase	
[ESC] Exit				

LD View / LD Define Menu (Creating RAID)

The selection of the RAID configuration should be based upon factors including performance, data security, and the number of drives available. It is best to carefully consider the long-term role of the system and plan the data storage strategy. RAID sets can be created either automatically, or to allow the greatest flexibility, manually.

1. Press 2 on the Main Menu screen to enter the LD View Menu.

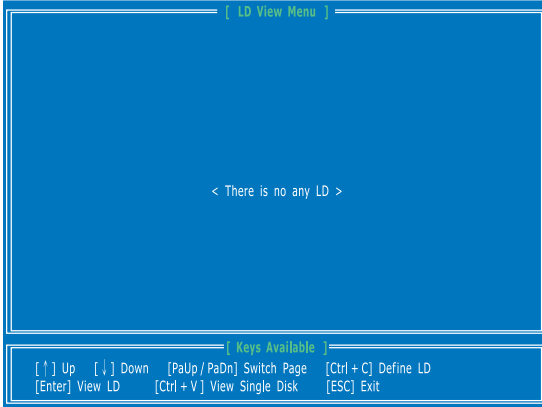

2. And then press [Ctrl + C] keys to enter the LD Define Menu. Use the space key to choose a RAID mode (RAID 0/ 1/ 5/ 10) and use the arrow key to move to the "Drives Assignments" window.

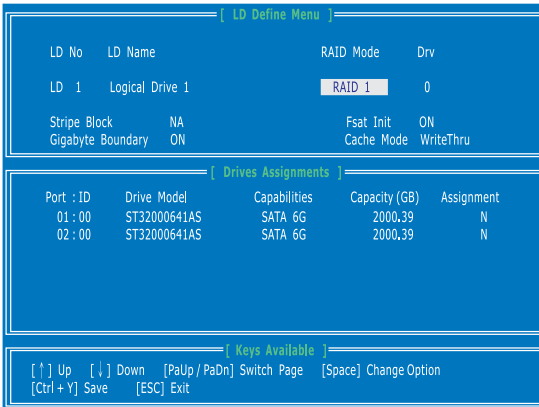

- Stripe Block Size, the default 64KB is best for most applications. RAID 0 or 10 only.
 - Gigabyte Boundary, allows use of slightly smaller replacement drives.
3. On the Drives Assignments window, use the arrow key to choose the hard drives which you want to make part of the LD, use the space key to change the assignment to "Y". Then press [Ctrl+Y] to save the configuration.

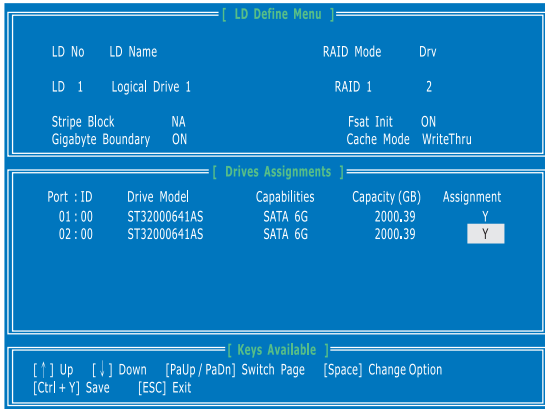

4. A message will show, press [Ctrl + Y] to input a LD name as your desire or press any key to save default LD name.

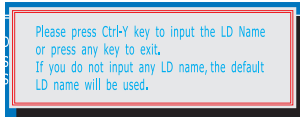

5. Another message will show, press [Ctrl-Y] if you are sure to erase the MBR data of the disk. Or press any key to ignore this option.

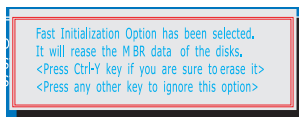

- 6. The message will show up on the bottom, press any key to use maximum capacity or press [Ctrl-Y] to modify array capacity manually.

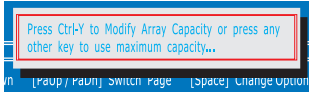

Important

- The default capacity is the full capacity of the selected hard drives.
- If you allocate the first LD capacity manually, you can create second LD with remaining capacity of the selected hard drives.

- 7. The LD creation is done, the screen shows the LD information as below. Press ESC key to the main screen.

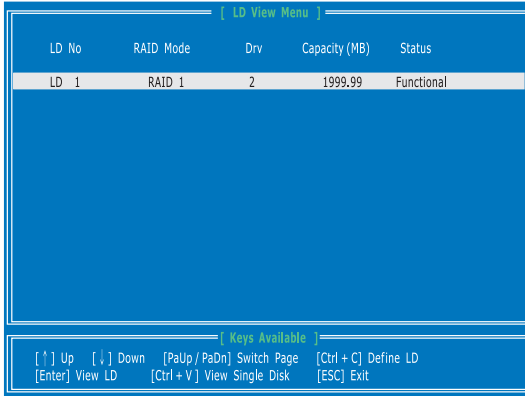

- 8. Press ESC key to exit the utility, a message "System is going to REBOOT! Are You Sure?" will display, answer "Y" to exit it and the system will reboot.

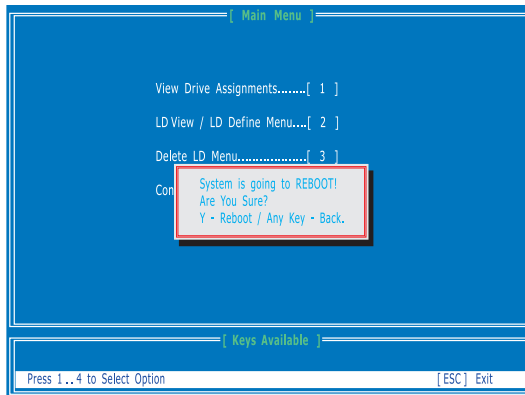

Delete LD Menu (Deleting RAID)

1. Press "3" on the main to enter the Delete LD Menu.
2. Choose a LD No. you want to delete and press [Del] or [Alt+D] delete the RAID set.

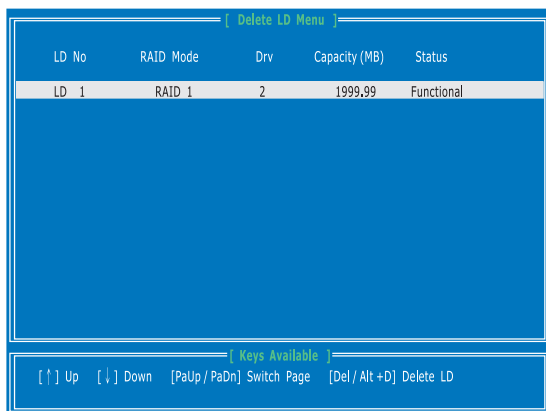

3. On the next screen, a message will display to inform you, press "Ctrl+Y" to delete the RAID set or other key to abort it. Press "Ctrl+Y" to complete the deletion.

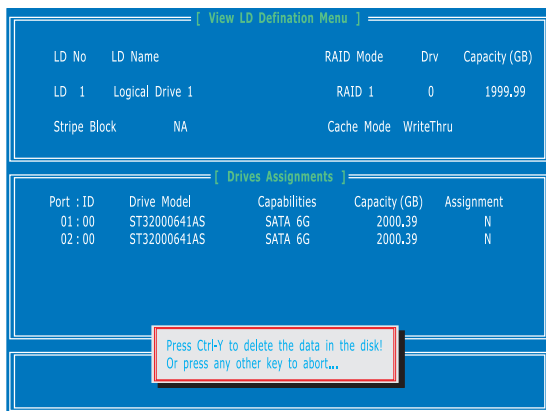

Installing Driver

■ New Windows 7/ Windows XP Installation

The following details the installation of the drivers while installing operating system.

1. When you start installing Windows XP, you may encounter a message stating, "Setup could not determine the type of one or more mass storage devices installed in your system". If this is the case, then you are already in the right place and are ready to supply the driver. If this is not the case, then press F6 when prompted at the beginning of Windows setup.
2. Press the "S" key to select "Specify Additional Device".
3. You should be prompted to insert a floppy disk containing the AMD® RAID driver into the A: drive.

Note: For Windows XP, you can use the USB floppy drive only.

For Windows 7 you can use CD/ DVD/ USB drive.



Important

Please follow the instruction below to make an "AMD® RAID Driver" for yourself.

- Insert the MSI Driver Disc into the optical drive.
 - Click the "Browse CD" on the Setup screen.
 - Copy all the contents in \\ChipSet\AMD\Packages\Drivers\SBDrv_for_Hudson\SB9xx\RAID\ (and then, please select a folder which was classified according to OS.)
 - The driver diskette for AMD® RAID Controller is done.
4. For Windows 7: During the Operating system installation, after selecting the location to install Windows 7 click on "Load Driver" button to install a third party SCSI or RAID driver.
 5. When prompted, insert the floppy disk or media (CD/DVD or USB) you created in step 3 and press Enter.
 6. You should be shown a list of available SCSI Adapters.
 7. Select the appropriate RAID controller and press ENTER.
 8. The next screen should confirm that you have selected the RAID controller. Press ENTER again to continue.
 9. You have successfully installed the RAID driver, and Windows setup should continue.
 10. Leave the disk in the floppy drive until the system reboots itself. Windows setup will need to copy the files from the floppy again after the RAID volume is formatted, and Windows setup starts copying files.

■ Existing Windows Driver Installation

1. Insert the MSI Driver Disc into the optical drive.
2. The Disc will auto-run and the setup screen will appear.
3. Under the Driver tab, click on AMD chipset drivers by your need. The AMD chipset drivers includes RAID Driver.
4. The drivers will be automatically installed.

■ Confirming Windows Driver Installation

1. From Windows, open the Control Panel from My Computer followed by the System icon.
2. Choose the Hardware tab, then click the Device Manager tab.
3. Click the "+" in front of the SCSI and RAID Controllers hardware type. The driver AMD RAID Controller should appear.

Installing OS on 2.2TB RAID

If you plan to install 64bit operating system on a RAID volume greater than 2.2TB, you can only manually create and load the RAID array in EFI shell.



WARNING

Create raid array will erase all the data stored on hard drives! Make sure to back up your files! There is no way to reverse the process!

The following describes an example of how to install Windows 7 64bit on a RAID 0 volume greater than 2.2TB.

1. Access BIOS → SETTING → Advanced → Integrated Peripherals submenu.
2. Set the “SATA Mode” option to “RAID Mode”.
3. Set the “Board SATA RAID ROM” option to “UEFI DRIVER”.

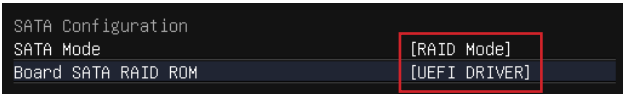

4. Save and then reboot. Press F11 while system booting to access boot device selecting menu.

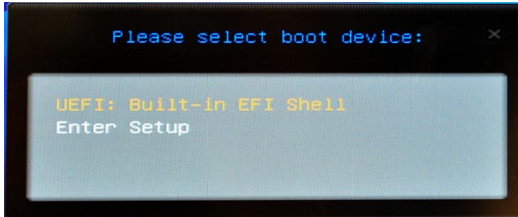

5. Select “UEFI: Built-in EFI Shell” to access the EFI Shell environment.
6. Type “drvcfg” at the EFI shell prompt, it will show values of current configurable items.

```
Shell> drvcfg
Configurable Components
  Drv[40] Ctrl[B2] Lang[eng]
```

7. Refer to the value in [Drv] and [Ctrl], Type example “drvcfg -s 40 b2”.

```
Shell> drvcfg -s 40 b2
```

8. The RAID ROM will be loaded.

9. Delete all logical drivers by selecting “Logical Driver Main Menu” → “Logical Driver Delete Menu”.

```
+ Logical Drive Main Menu
+ Logical Drive List Menu
+ Logical Drive Create Menu
+ Logical Drive Delete Menu
```

10. Make sure there are not any logical drivers (as shown below).

```
+ Logical Drive Delete Menu
- <Not Found Any Logical Drive>
```

11. Back to “Logical Driver Main Menu” and select “Logical Driver Create Menu”.

```
+ Logical Drive Main Menu
+ Logical Drive List Menu
+ Logical Drive Create Menu
+ Logical Drive Delete Menu
```

12. Select “Usable Physical Drive List”.

```
+ Logical Drive Create Menu
+ Usable Physical Drive List
+ Basic Setting
- Raid Mode      : <RAID 0>
- Stripe Block (KB) : <64>
- Initialization  : <Fast>
- Gigabyte Boundary : <Enable>
- Read Policy     : <Read Ahead>
- Write Policy    : <Write Back>
- Ld Name        : _
+ Ld Size Setting
```

13. Choose RAID member disks by pressing arrow key and space key.

```
+ Logical Drive Create Menu
- Hxxxxxx HD12345678 | 1500.30 GB [x]
- Wxx HD34567890 | 3000.59 GB [x]
```

14. Back to “Logical Driver Main Menu” and fill “Ld Name”.

A screenshot of the 'Logical Drive Create Menu' interface. The menu is displayed on a grey background with blue text for expandable sections. The 'Basic Setting' section is expanded, showing a list of configuration options. The 'Ld Name' option is highlighted with a black background and white text, showing the value 'raidsys_'. Other options include Raid Mode (<RAID 0>), Stripe Block (KB) (<64>), Initialization (<Fast>), Gigabyte Boundary (<Enable>), Read Policy (<Read Ahead>), and Write Policy (<Write Back>). The 'Ld Size Setting' section is also visible but not expanded.

- + Logical Drive Create Menu
 - + Usable Physical Drive List
 - + Basic Setting
 - Raid Mode : <RAID 0>
 - Stripe Block (KB) : <64>
 - Initialization : <Fast>
 - Gigabyte Boundary : <Enable>
 - Read Policy : <Read Ahead>
 - Write Policy : <Write Back>
 - Ld Name : **raidsys_**
 - + Ld Size Setting

15. Select “Ld Size Setting” → “Start to Create”.

A screenshot of the 'Logical Drive Create Menu' interface, similar to the previous one. In this view, the 'Ld Size Setting' section is expanded, showing 'Ld Max Size' as 3000.60 GB and 'Ld Size (GB)' as [0]. The 'Start To Create' option at the bottom is highlighted with a black background and white text. The 'Ld Name' field now shows 'raidsys_' without a cursor.

- + Logical Drive Create Menu
 - + Usable Physical Drive List
 - + Basic Setting
 - Raid Mode : <RAID 0>
 - Stripe Block (KB) : <64>
 - Initialization : <Fast>
 - Gigabyte Boundary : <Enable>
 - Read Policy : <Read Ahead>
 - Write Policy : <Write Back>
 - Ld Name : raidsys_
 - + Ld Size Setting**
 - Ld Max Size : 3000.60 GB
 - Ld Size (GB) : [0]
 - + Start To Create**

16. When prompt “Are You Sure To Create Logical Drive?” press Enter to confirm it.

A blue rectangular box containing the text: 'Are You Sure To Create Logical Drive?' followed by 'Enter' Key - YES / 'Esc' Key -NO on the next line.

17. When prompt “Successful To Create Logical Drive” press Enter to continue.



Successful To Create Logical Drive
Enter Key - Continue

18. Exit RAID ROM by pressing F10. When prompt “Are you Sure To Exit” press Y.



Are You Sure To Exit? (y / n)

19. After exiting RAID ROM, system will prompt you to restart computer (shown as below). Insert Windows 7 64bit DVD into the DVD drive. Press Enter to reboot.

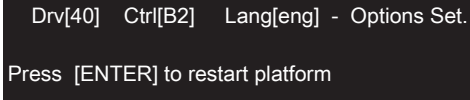

Drv[40] Ctrl[B2] Lang[eng] - Options Set.
Press [ENTER] to restart platform

20. Press F11 while system booting to access boot device selecting menu.
21. Select DVD drive that contain Windows 7 64bit DVD. System will start the Windows 7 64bit installation by booting from the Windows 7 64bit DVD.

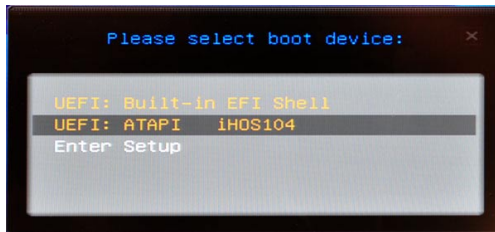

22. When require HDD driver, insert a USB flash drive that contain AMD RAID driver into a USB 2.0 port (not USB 3.0 port) and click Browse.

Important

You can find the AMD RAID driver from MSI Driver Disc. The path is
 \\ChipSet\AMD\Packages\Drivers\SBDrv_for_Hudson\SB9xx\RAID\W764A
 Please copy all the files in the folder to a USB flash drive.



23. Select "Removable Disk" from Browse for Folder dialog then click OK.

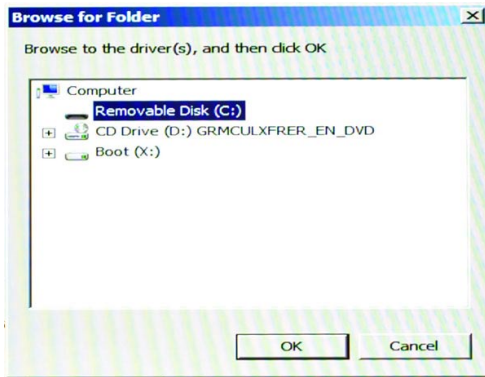

24. Install "AMD AHCI Compatible RAID Controller".

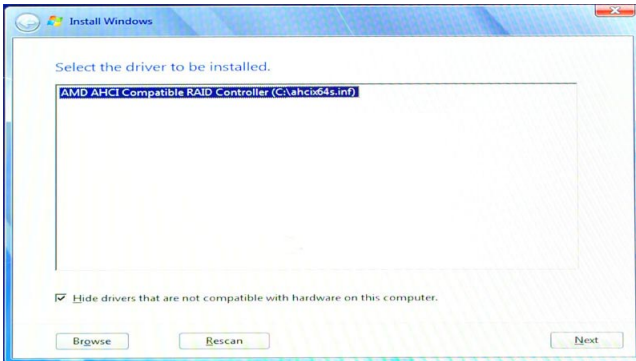

25. Windows 7 64bit can find the RAID volume now. Please continue the installing procedure.

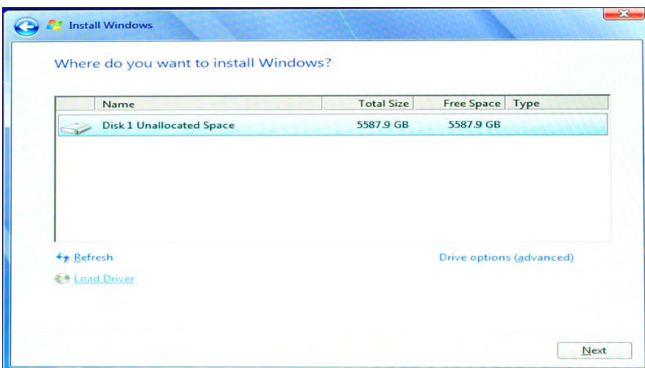

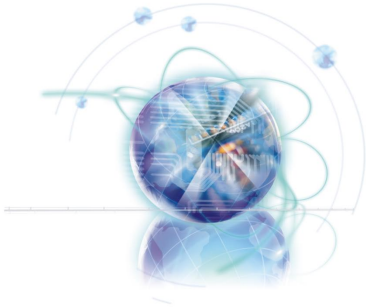

Appendix C

Install Windows XP

Notes

This chapter describes how to install Windows XP with IDE or AHCI mode.

Installing Windows XP with IDE Mode

You will fail and encounter a blue screen while installing Windows XP, because it is not natively supported to be installed in the storage device with AHCI mode. If you still prefer to install Windows XP as the operating system, please change the BIOS item as below.

1. Refer to Chapter 2 to access BIOS.
2. Go to SETTINGS → Integrated Peripherals → SATA Mode.

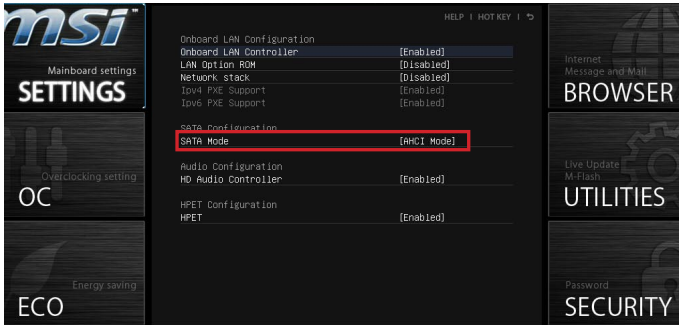

3. Set this item to IDE mode.
4. Go to SETTINGS → Save & Exit → Save changes and reboot.
5. Install the Windows XP operating system.

Installing Windows XP with AHCI Mode

If you prefer to install Windows XP as the operating system with AHCI mode, please prepare AHCI drivers for Windows XP in advanced.

Creating an AHCI Driver Disc

Please follow the instruction below to make an "AHCI Driver" for yourself.

1. Insert the MSI DVD into the DVD-ROM drive.
2. Click the "Browse CD" on the Setup screen.
3. Copy all the contents from \\ChipSet\AMD\Packages\Drivers\SBDrv_for_Hudson\SB9xx\AHCI\XP to a formatted floppy diskette.
4. The driver diskette is done.

Installing the Windows XP Operating System:

Please follow the below steps:

1. Access BIOS, set SATA Mode to AHCI mode, save, exit and reboot.
2. Ensure the USB Floppy Disk Drive is connected to the computer.
3. Install Windows XP. When Windows Setup screen appears a message "Press F6 if you need to install a third party SCSI or RAID driver....", press "F6" key.
4. Insert the floppy disk containing the AHCI drivers into the floppy disk drive.
5. When the next screen appears, press the "S" key to specify an additional device.
6. From the provided list, select the AMD AHCI Compatible Controller.
7. Follow the on-screen instructions to complete the installation.

