

2017 SHOOTING GEAR CATALOG

DUTY GEAR | SPORTING | CONCEALMENT | ACCESSORIES





CHOOSE THE BEST FOR YOUR SHOOTING NEEDS

From competitive and shooting sports enthusiasts, to those who use our products for personal protection, for more than 52 years our goal has been simple: offer innovative products with the best quality, functionality and ease of use.

Our shooting gear catalog represents some of the most renowned brands in the shooting industry with products offering both outstanding performance and reliability. These brands have long set the standard for innovation and quality within the shooting sports and personal defense markets. As you peruse these pages, you will find a wide selection of new products and classic mainstays - all designed to meet, and even exceed, your shooting needs.



HOLSTERS, BELTS & ACCESSORIES

Time honored tradition, handcrafted workmanship, and quality have always been hallmarks of the Bianchi® brand. From the early days in 1958 when John Bianchi built his first leather holster in his garage to present day, the focus remains on design, function, security and comfort to provide our customers with the best combination of innovative time-tested designs.



The Bianchi® Allusion™ series offers the beauty of leather and the fit and feel of a rigid laminate holster, allowing for formed features such as the retention detent in the trigger guard area for enhanced security, and a holster that stays open when worn in the waistband.

Premium grade, vegetable tanned cowhide has an unmistakable look and feel, and ages beautifully. Our hand-rubbed natural oil finish gives our holsters a lustrous look and distinctive leather scent. These timeless luxuries, combined with the benefit of a sturdy, thermoformed synthetic offers increased rigidity and a quick and seamless draw for quite possibly, the perfect holster.

Each holster is thermoformed and molded using special tooling and forming machines. Our proprietary blend of adhesives securely bonds the leather to the synthetic material during the laminate process. Handcrafted features remain, such as our border stitching using our special lockstitch machines.

Allusion construction lets us build in other technological advances, including anti-bacterial mesh to defeat the challenges of IWB holsters' lack of comfort due to hotspots, sweat created by body contact heat and sweat/bacteria buildup. This natural chemical reaction can cause a material breakdown in some leather holsters. And our molded detents in the trigger guard help support firearm retention.

The perfect combination of traditional quality and cutting edge technology for good looks and optimum performance.



Premium grade hand-selected full grain vegetable tanned cowhide finished with a lustrous leather dressing

Thermoformed retention detent

High-quality rigid thermoformed material thin and lightweight

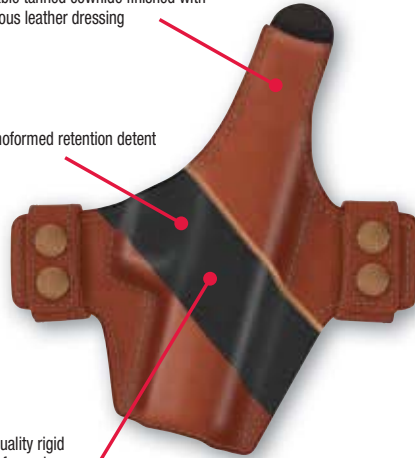

Anti-bacterial nanotechnology and anti-microbial low density closed-cell foam repels absorption of sweat

Premium grade hand-selected full grain vegetable tanned cowhide finished with a lustrous leather dressing

Anti-bacterial/microbial spacer mesh allows airflow for moisture and heat dissipation



SUBVERSION™ IWB 155

- Premium full grain leather exterior with a laminate synthetic liner for a smooth draw and long lasting wear
- Belt retention strap wraps under belt and offers adjustability for cant
- Anti-bacterial and anti-microbial foam padding on inside liner of leather backing to help prevent germs and odor from accumulating against the body
- Padded liner provides added comfort not normally found on bare leather designs
- Slight detent in trigger guard for enhanced handgun retention
- Fits ups to 1.75" (45mm) belt widths
- Available in Plain Black finish

SEE ADDITIONAL IWB HOLSTERS ON PAGE 11

NEW



BELT SLIDE HOLSTERS



ASSENT™ 126

ALLUSION™

- Premium full grain leather exterior with a laminate synthetic liner for a smooth draw and long lasting wear
- Open-top design for quick draw and easy re-holster
- Trigger guard detent for enhanced weapon retention
- Holster covers muzzle of gun, protecting handgun and clothing
- Low-profile, contoured body hugging design
- Dual belt loops fit 1.5" (38mm) belt widths
- Available in Plain Tan or Plain Black finish

For light-mounted
handguns



REVEAL™ 140

- Premium full grain leather exterior with a laminate synthetic liner for a smooth draw and long lasting wear
- Specifically designed to fit weapons with gun mounted lights
- Thumb break strap and trigger guard detent for enhanced weapon retention
- Low-profile, contoured body-hugging design
- Dual belt slots fit up to 1.5" (38mm) belts for better, tighter fit with belt
- Available in Plain Tan, Plain Black, Basketweave Tan or Basketweave Black finish

ALLUSION™



CONFIDENTIAL™ 131

- Premium full grain leather exterior with a laminate synthetic liner for a smooth draw and long lasting wear
- Thumb break strap and trigger guard detent for enhanced weapon retention
- Holster covers muzzle of gun, protecting handgun and clothing
- Low-profile, contoured body hugging design
- Dual belt loops fit 1.5" (38mm) belt widths
- Available in Plain Tan or Plain Black finish

ALLUSION™

BELT SLIDE HOLSTERS



CONSENT™ 125

- Premium leather exterior with a laminate synthetic liner for a smooth draw and long lasting wear
- Dual snap belt loop for easy on/off access and added security
- Open-top design for quick draw and easy reholster
- Trigger guard detent for enhanced weapon retention
- Holster covers muzzle of the gun, protecting your handgun and clothing
- Low-profile, contoured body-hugging design
- Fits 1.5" (38mm) belt width
- Available in full grain leather, Plain Tan or Plain Black finish



CLASSIFIED™ 130

- Premium leather exterior with a laminate synthetic liner for a smooth draw and long lasting wear
- Dual snap belt loop for easy on/off access and added security
- Thumb break strap and trigger guard detent for enhanced weapon retention
- Holster covers muzzle of the gun, protecting your handgun and clothing
- Low-profile, contoured body-hugging design
- Fits 1.5" (38mm) belt width
- Available in full grain leather, Plain Tan or Plain Black finish

BELT SLIDE HOLSTERS



P.I.™ **58**

- Open-top for quick access and draw with a low-profile, compact design
- Heavy 30° cant for SOB (small of back) or rear hip carry
- All molding to the front of the holster, providing more comfortable fit for wearer
- Low-profile ultra hi-ride design effectively conceals firearm with minimal bulk
- Dual belt slots fit up to 1.5" (38mm) belts for tighter fit with belt
- Available in full grain leather, Plain Tan or Plain Black finish



SERPENT™ **56**

- Reinforced, rectangular thumb snap for quick snap release and to help guard against strap falling into trigger guard when re-holstering
- Deeply molded contours on front of holster for fit and classic good looks
- Dual belt slots fit up to 1.5" (38mm) belts for tighter fit with belt
- Available in full grain leather, Plain Tan or Plain Black finish



FOLDAWAY™ **101**

- Minimalist design fits many different gun models
- Design catches and holds trigger guard to help keep weapon secure and stable
- Can be folded away flat onto the belt when not in use
- Keeps as close to the body as possible without being an IWB holster
- Fits 1.5" (38mm) belt widths
- Also available in a combo pack which includes both Plain Tan and Plain Black holsters
- Available in full grain leather, Plain Tan or Plain Black finish



REMEDY™ **57**

- Open-top for quick access and draw
- Deeply molded contours on front of holster for fit and classic good looks
- Low-profile, hi-ride design effectively conceals firearm with minimal bulk
- Dual belt slots fit up to 1.5" (38mm) belts for tighter fit with belt
- Available in full grain leather, Plain Tan or Plain Black finish

BELT SLIDE HOLSTERS

Auto Retention

PATENTED



CARRYLOK™ 82

- Provides the speed of an open-top holster with the security of Auto Retention™, which retains weapon upon holstering
- FingerLok™ retention mechanism secures pistol by the trigger guard upon inserting the weapon in the holster; depress lever to draw
- Features stay-open design for efficient one-handed holstering
- 16° butt forward carry
- Fits up to 1.75" (45mm) belt widths
- Available in full grain leather, Plain Tan or Plain Black finish



MINIMALIST™ WITH SLOTS 105

- A compact, open-top design ideal for daily wear
- Features elastic loop retainer tab for secure retention
- Belt slide design provides excellent stability for weapon
- Slots designed to pull firearm in close to the hips for optimum concealment
- Suede lining
- Fits belt widths up to 1.75" (45mm)
- Available in full grain leather, Plain Tan or Plain Black finish



VENOM™ 75

- Slim profile and compact design in a full-sized holster
- Rear belt slot pulls holster close to body for excellent concealability
- Open muzzle design allows various barrel lengths
- Contour molded for exact gun fit
- Fits up to 1.75" (45mm) belt width
- Available in full grain leather, Plain Tan or Plain Black finish



PIRANHA™ 77

- Unique, low-cut front provides user with a swift draw stroke
- 15° strongside cant
- Three-slot design allows custom adjustment for user preference; features both strongside and cross draw carry
- Fits up to 1.75" (45mm) belt width
- Available in full grain leather, Plain Tan or Plain Black finish



LIGHTNIN® 55L

- Designed specifically for hammerless revolvers
- Finger-snap strap crosses behind trigger guard for a middle finger release
- Fully suede lined
- Rides high and close to the body for maximum comfort and concealability
- Fits up to 1.75" (45mm) belt width
- Available in full grain leather, Plain Tan finish



BLACK WIDOW™ 5

- Features ultra hi-ride carry and thumb snap closure
- Compact profile for excellent concealability
- Dual belt slots for superior stability
- Open muzzle design allows various barrel lengths
- Fits up to 1.75" (45mm) belt width
- Available in full grain leather, Plain Tan or Plain Black finish

BELT SLIDE/PADDLE HOLSTERS



SHADOW® II 7

- Ultra hi-ride for excellent concealability
- Three-slot design allows user to vary the carry angle for his/her preference
- Strongside or cross draw carry, open muzzle design
- Molded and pre-curved to fit the body for maximum comfort
- Fits up to 1.75" (45mm) belt width
- Available in full grain leather, Plain Tan or Plain Black finish



SPECIAL AGENT® 59

- Features our close-fit paddle design for comfort and concealability
- Exclusive, non-slip paddle features molded elastomer ridges that retain paddle, yet it offers easy on/off convenience
- Paddle design offers virtually limitless range of cant, permitting both strongside and cross draw carry
- Adjustable for various carry heights on the waist/hip
- Available in full grain leather, Plain Tan finish



ACCUMOLD® PADDLE THUMBSNAP 7500

- Easy on/off convenience; exclusive, injection-molded non-slip paddle; adjustable for various carry heights on the waist/hip
- Paddle design offers virtually limitless range of cant, permitting both strongside and cross draw carry
- AccuMold trilaminate construction with ballistic weave fabric, exterior high-density closed-cell foam center and a Coptex™ lining for a smooth draw
- Available in Black Ballistic Weave finish



SHOULDER HOLSTERS



Two harness sizes fit torsos up to 56" (128cm)

#X15[®] SHOULDER HOLSTER X15

- Dual spring closure provides firearm retention and stability
- Half lined with full grain leather for a smooth draw
- Detachable retainer strap
- Fully adjustable soft leather harness that fits up to a 48" chest, 52" (128cm) harness available separately
- Available in full grain leather, Plain Tan finish



Fits torsos up to 48" (122 cm)

AGENT[™] X16

- Crafted from premium full grain cowhide, hand-boned for a precise fit
- Featherweight, slimline design for all day comfort and concealability
- Comes with a choice of either contour-molded magazine pouch or a low-profile speedloader panel, and X-style pivoting harness design moves with body
- Includes two suede leather tie-downs to secure holster and offside pouch to belt
- Offered for both revolvers and semiautos
- Available in full grain leather, Plain Tan finish

AGENT[™] ACCESSORIES

- X16A Double Magazine Pouch
- X16R Speedloader Panel
- X16T Tie-Down Accessory
- X16P Offside Accessory Panel



X16A



X16R



X16T



X16P

INSIDE WAISTBAND HOLSTERS



PROFESSIONAL™ TUCKABLE 100T

- Tuckable version of the popular Bianchi® Model 100 Professional™
- Designed to be worn inside the waistband yet allows for a tucked-in shirt
- C-clip provides strong attachment to belt while minimizing visibility on belt's exterior
- Three-way adjustable cant on C-clip for draw customization
- Deep concealment design with high back to comfortably shield torso against a gun's rough edges
- Features a non-slip suede lined exterior next to body
- Fits up to 1.5" (38mm) belt widths
- Available in full grain leather, Plain Tan or Plain Black finish



PATENT PENDING



WAISTBAND

6

- Worn inside the waistband
- Soft suede construction
- Ultra-thin profile provides optimum concealment
- Strongside or cross draw
- Heavy-duty spring-steel clip fits up to 1.75" (45mm) belts
- Available in Rust suede finish



ATB™ WAISTBAND

6D

- Inside waistband design provides comfort and concealability
- Thumb break design for those who prefer more security in an IWB holster
- Adjust-A-Break™ thumb break provides adjustability for a variety of gun models
- Ultra-thin and lightweight suede design for concealability
- Strongside or cross draw
- Heavy-duty 1.75" (45mm) clip keeps holster securely in place
- Available in Rust suede finish



PROFESSIONAL™

100

- Deep concealment design with high back to comfortably shield torso against gun's rough edges
- Features a non-slip suede-lined exterior next to body
- Rides at optimum angle inside waistband to ensure proper firing grip
- Heavy-duty spring-steel belt clip securely anchors holster to belt or trousers
- Fits up to 1.75" (45mm) belts
- Available in full grain leather, Plain Tan or Plain Black finish

INSIDE WAISTBAND HOLSTERS



PISTOL POCKET® 3S

- Inside the waistband with dual snap attachment to belt
- Fully adjustable swivel offers various carry options
- Open muzzle design
- Thumb break design for those who prefer more security in an IWB holster
- Can be worn both strongside and cross draw
- 1.75" (45mm) belt loop
- Available in full grain leather, Plain Tan finish



PATENT PENDING



Back

 ALLUSION™

SUPPRESSION™ 135

- Premium full grain leather exterior with a synthetic liner for a smooth draw and long lasting wear
- Dual tuckable J-Hook provides strong attachment to belt while minimizing visibility on belt's exterior
- Anti-bacterial and anti-microbial foam padding on inside liner of leather backing to prevent germs and odor from accumulating
- Padded and breathable liner against the body provides added comfort and better ventilation
- Slight detent in trigger guard for enhanced weapon retention
- Available in full grain leather, Plain Tan or Plain Black finish

SUBDUE™ IWB 145

- Premium full grain leather exterior with a laminate synthetic liner for a smooth draw and long lasting wear
- Heavy-duty spring-steel belt clip securely anchors holster to belt or trousers
- Anti-bacterial and anti-microbial foam padding on inside liner of leather backing to prevent germs and odor from accumulating against the body
- Padded liner provides added comfort not normally found on bare leather designs
- Slight detent in trigger guard for enhanced weapon retention
- Fits up to 1.75" (45mm) belt widths



Back

 ALLUSION™

ANKLE/POCKET HOLSTERS



NEGOTIATOR™ ANKLE HOLSTER 150

- Neoprene leg strap expands to fit comfortably around leg
- Lined with genuine sheepskin for comfort and breathability
- 2" adjustable elastic leg strap secures and keeps holster in place
- Holster is canted for ease of draw
- Available in full grain leather, Plain Black finish



NEGOTIATOR™ ANKLE HOLSTER WITH 3" STRAP 150L

- Same product features and benefits as 150 except with 3" extended leg strap

POCKET PIECE™ 152

- Full grain leather interior for a smooth draw
- Vertical assist finger pad to facilitate removing gun from holster
- Dual pocket hooks to help prevent holster movement when drawing
- Model-specific design for better fit
- Available in full grain leather, rough side out to help grip clothing



Back

SPORTING HOLSTERS

LAWMAN™

1L

- Western style, front strap closure; fits single-action revolvers
- Hi-ride carry, open muzzle design
- Full suede lining
- Fold over belt loop fits 1.75" (45mm) to 2.25" (58mm) belts
- Available in full grain leather, Plain Tan finish



THUMBSNAP

5BHL

- Features integral thumb snap closure
- Strongside hi-ride carry; carries gun close to body for added comfort
- Full suede lining
- 2" -3" holsters fit 1.75" (45 mm) belt slots
- 4" and larger holsters include 1.75" (45mm) and 2.25" (58mm) belt slots
- Available in full grain leather, Plain Tan finish



THUMBSNAP

19L

- Wide belt loop provides stable carry close to the body; hi-ride for maximum comfort and concealability
- Integral thumb snap enhances handgun retention
- Full suede lining
- 1.75" (45mm) belt loop
- Available in full grain leather, Plain Tan finish



CYCLONE™

111

- Thumb snap closure for secure fit and covered trigger guard design for both hunting and concealment applications
- Fully suede lined
- Unique belt loop design allows either strongside or cross draw carry
- Quick release thumb snap
- Hi-ride carry, open muzzle design
- 1.75" (45mm) belt slot
- Available in full grain leather, Plain Tan finish



BIANCHI® ACCUMOLD®

What sets AccuMold® apart from other synthetic products is a Bianchi-developed method of molding to contour the laminate to the exact shape of the equipment it will carry. Simply put, they look better and work better.

Our trilaminate construction comprises a ballistic weave fabric exterior with a high density, closed-cell foam center and a smooth Coptex™ knit lining. This provides a long-lasting, durable product with excellent protective qualities.

Holster belt loops feature our unique heavy-duty Quick-Slide™ injection-molded polymer belt loop. Once positioned on your belt, it's there to stay . . . until you deliberately move or remove it.

We put the same amount of planning and innovation into designing our AccuMold accessories. Take, for example, our single-column magazine pouches. Unlike conventional magazine pouches, which expand only on the front side, AccuMold pouch cavities expand both front and rear, which makes for a snugger fit, a trimmer look, and less strain on the equipment. We employ the same design principle on all our accessory pouches, which, like the magazine pouches, expand to accommodate their bulkier contents.

All these small details add up to make Bianchi AccuMold the product to which all others are compared.



Injection molded Quick-Slide belt loop for sturdy, long-lasting wear

KEY BENEFITS

- Lightweight – almost 50% lighter than leather
- Offers the fit and function of leather at the price of nylon
- Washes easily with soap and water
- Thermo-molding keeps the holster or pouch open, allowing the user to replace the handgun or accessory using only one hand
- Durable quality for season after season of use
- Ballistic weave exterior for excellent abrasion resistance
- Contour-molded to fit the equipment it will carry



Bianchi Roll-Top lid offers a smooth, snug fit



Precision contour molding





ACCUMOLD® SPORTING HOLSTER 7000

- Ideal for field, hunting and concealment carry
- Contour molded high-density trilaminate AccuMold construction for an exacting fit
- Hi-ride carry with closed muzzle and 10° forward cant that aids in both comfort and presentation
- Unique Coptex™ polyknit lining for a smooth draw
- Sleek front strap closure incorporates Adjust-A-Strap™ feature to ensure a secure fit over the hammer
- 1.75" (45mm) injection-molded belt slot
- Available in Black Ballistic Weave finish



ACCUMOLD® THUMBSNAP 7001

- Suitable for both outdoor and concealment applications, this holster rides at a 10-13° cant for a fast, instinctive draw
- Thumb snap design incorporates the Bianchi® Adjust-A-Strap™ feature to ensure a secure fit over the hammer
- Contour molded high-density trilaminate AccuMold construction for an exacting fit
- Coptex™ 100% polyknit inner lining for a smooth draw
- 1.75" (45mm) injection-molded belt slot
- Available in Black Ballistic Weave finish



ACCUMOLD® DOUBLE MAGAZINE POUCH 7302

- Injection-molded belt loop for horizontal or vertical carry
- Hook & loop closure
- 4 sizes
- Fits up to a 2.25" (58mm) belt width



ACCUMOLD® SINGLE MAGAZINE POUCH 7303

- Hook & loop closure
- 4 sizes
- Dual web belt loop fits up to a 2.25" (58mm) belt width



NYLON BELT 7201

- Four-part laminate for long-lasting shape and exceptional durability
- Hook & loop closure for quick on/off ease
- Firm polyethylene center strip sandwiched between a high-density foam, with a ballistic weave outer and a durable nylon lining
- 1.75" (45mm) belt width
- Available in Black Ballistic Weave finish

BELTS/POUCHES



RANGER BELT B4

- Full grain leather, unlined
- Popular Western billet design
- Solid brass buckle
- 1.75" (45mm) width
- Plain Tan or Basket Tan finish



B12 SHOWN

FANCY STITCHED BELT B9/B12

- Full grain leather with natural oil tan finish reverses to suede
 - Reversible, with fancy stitch design
 - Solid brass buckle
 - Plain Tan or Plain Black finish
- B9** 1.75" (45mm) width
B12 1.5" (38mm) width



CONTOUR BELT B21

- Fancy stitch design
- Solid brass buckle
- Two thicknesses of heavy full grain leather
- Contoured to wrap smoothly around waist
- 1.75" (45mm) width
- Plain Tan finish



B28 SHOWN

PROFESSIONAL™ BELT B28/B29

- Premium full grain leather, oil tanned to a rich, lustrous finish
 - Solid brass buckle on tan; chrome plated brass on black belt
 - Specify exact waist size when ordering
 - Available in Plain Tan or Plain Black finish
- B28** 1.25" (32mm) width
B29 1.5" (38mm) width



OPEN TOP MAGAZINE POUCH 20A

- Heavy-duty, spring-steel clip
- Quick and compact
- Fits belts up to 1.75" (45mm)
- Available in full grain leather, Plain Tan finish



OPEN TOP MAGAZINE POUCH 21

- Dual belt loop straps secure pouch to belt
- Can be angled for right or left hand carry
- Designed for use with the Bianchi Model 120 holster
- Fits up to 1.75" (45mm) belts
- Available in full grain leather, Plain Tan finish



MAG/CUFF PADDLE 45

- Paddle adjustable for carry height and angle
- Provides easy one-handed draw for handcuffs
- Fits standard, oversized and hinged handcuffs
- Available in full grain leather, Plain Tan or Plain Black finish

BIANCHI® SPEED STRIPS™ 580

- The original design, developed by John Bianchi as a compact loading device for revolvers
- Speed Strips™ fit in most single mag/knife pouches and trouser or shirt pockets
- Injection molded from a flexible urethane material, they hold 6-rounds and load two at a time
- Available for .38/.357 and .44/.45 caliber



GUN CASES



RANGE PORTFOLIO™ 4452

- Comfortably carries one or two firearms in its dual, thickly padded sleeves
- Roomy interior pocket for cleaning accessories, etc., and elastic web loops for magazines or other equipment
- Constructed of 750-denier fabric with a cushioned padding to protect the firearm
- Conveniently zips open flat to use as a range pad
- Features outside carry strap for hearing protection



DELUXE PISTOL CASE 4451

- A slim, portfolio design featuring wraparound web carry handles and an outside essentials pocket
- Constructed of 750-denier fabric with a cushioned padding to protect the firearm
- Thick, dense padding to cushion and protect firearm
- Conveniently opens flat to use as a shooting rest or pad



PISTOL CASE 4450

- Constructed of 750-denier fabric with a cushioned padding to protect the firearm
- Thick, dense padding cushions and protects firearm
- Outside zippered pocket for small essentials
- Conveniently opens flat to use as a shooting rest or pad
- Integrated carry handle
- Fits most popular revolvers and pistols



Revisit the handcrafted glory of the Old West with our line of cowboy gear and enjoy the quality of our world-famous genuine leather holsters and belts. We use only premium grade, full grain, vegetable tanned cowhide – the highest quality, most expensive leather. Developed and used by the world-class shooters of Team Bianchi, this is authentic cowboy gear that was designed to perform both in and out of the arena. Above all, it carries the legendary name Bianchi® and is designed and produced in America.



COMPETITION

Cowboy Action Shooting continues to be one of the fastest growing outdoor shooting sports in the country, bringing together shooters from around the world for a variety of competitions. Our Team Bianchi shooter, Kenda Lenseigne, is one of the top athletes in the mounted shooting discipline. Kenda holds several world records and is a four time CMSA World Point Champion.

These competitions are held in regional matches that test accuracy, speed, reloading, and sometimes even best costume (most Single Action Shooting Society (SASS) events heavily encourage western cowboy wear). Several events mirror their more mainstream counterparts, such as cowboy 3-Gun but others, such as quick draw competitions sponsored by the Cowboy Fast Draw Association (CFDA) and mounted shooting events, led by the Cowboy Mounted Shooting Association (CMSA), are purely Cowboy Action Shooting in nature.



Photo by Yamil Sued



HONDO™

- Designed for mounted shooting with a hidden stainless tension adjustment to provide a customized, smooth draw
- Belt loop adjusts 35° forward and rearward for cant customization and personalized draw
- Holster is reinforced with corrosion-resistant steel and welt area is double stitched with heavy nylon thread for added strength
- Suede lining in holster and belt for better grip while riding
- Adjustable for cross draw carry
- Belt is fancy stitched and padded for comfort, and is 2.25" (58mm) wide with tapered ends
- Premium grade full grain cowhide; available in Chestnut Tan or Plain Black finish



CALIFORNIA OUTLAW™

- Smooth, full grain leather lining in holster for a quicker draw
- Hidden tension adjustment to provide a customized, smooth draw
- Suede lined belt is 2.25" (58mm) wide with billet ends; choose cartridge loops for .38 or .45 Long Colt
- Cross draw holster is available as an optional second holster; order California Outlaw™ CD Holster
- Premium grade full grain cowhide; available in Chestnut Tan or Plain Black finish



TEXAS OUTLAW™

- Classic drop loop-style cowboy rig with suede lined belt and steel lined holster
- Smooth leather lined for a rapid draw
- Reinforced with rawhide to hold the holster open with a flared top for faster, instinctive re-holstering
- Belt is 3" (76mm) wide with billet ends; choose cartridge loops for .38 or .45 Long Colt
- Cross draw holster is available as an optional second holster; order Texas Outlaw™ CD Holster
- Premium grade full grain cowhide; available in Chestnut Tan or Plain Black finish



WILD CLEARWATER™

- Designed specifically for the Colt 1911 series of pistols
- Holster and belt feature a smooth, full grain leather lining for a quicker draw and sturdiness on the hip
- Multi-angle belt loop for customized strongside and cross draw carry
- Hidden stainless tension adjustment for a customized, smooth draw
- Belt loop adjusts 35° forward and rearward for cant customization and personalized draw
- Belt is 2.25" (58mm) wide with tapered ends
- Select a second Wild Clearwater holster to use as cross draw or for use as dual strongside holster
- Premium grade full grain cowhide; available in Chestnut Tan or Plain Black finish



CLEARWATER™

- Holster and belt feature a smooth, full grain leather lining for a quicker draw and sturdiness on the hip
- Multi-angle belt loop for customized strong side and cross draw carry
- Hidden stainless tension adjustment for a customized, smooth draw
- Belt loop adjusts 35° forward and rearward for cant customization and personalized draw
- Belt is 2.25" (58mm) wide with tapered ends; choose cartridge loops for .38 or .45 Long Colt
- Select a second Clearwater holster to use as cross draw or for use as dual strongside holster
- Premium grade full grain cowhide; available in Chestnut Tan or Plain Black finish

GOLD MINER™

- Classic drop loop-style cowboy rig with suede lined belt and leather lined holster
- Holster is smooth leather lined for a rapid draw
- Stitched with heavy nylon thread for added strength
- Reinforced with corrosion-resistant steel with flared top for faster, instinctive re-holstering
- Belt is 3" (76mm) wide with billet ends; choose cartridge loops for .38 or .45 Long Colt
- Cross draw holster is available as an optional second holster; order Texas Outlaw™ CD Holster
- Premium grade full grain cowhide; available in Chestnut Tan or Plain Black finish

WILD CLEARWATER™ DUAL MAGAZINE POUCH

- Double stitched welt with heavy nylon thread for extra strength
- Specifically designed for use with two 1911-style magazines
- Available in Chestnut Tan with white stitching or Plain Black with black stitching



NEW

HONDITO™ BELT

- Designed for mounted shooting and at proper width for use with Kenda Lenseigne holsters
- Adjustable for cross draw carry
- Belt is fancy-stitched and padded for comfort, and is 2" (50.8mm) wide with tapered ends
- Premium grade full grain cowhide; available in Chestnut Tan or Plain Black finish

BIANCHI® COWBOY



Kenda Lenseigne



KENDA LENSEIGNE
SIGNATURE SERIES

The Kenda Lenseigne Signature Series, is a collaboration between world renowned mounted shooter Kenda Lenseigne and the Bianchi Cowboy Team. In her role as a Team Bianchi shooter, she helped design the Signature Series from the ground up as performance-focused mounted rigs, incorporating features that shooters need including correct cross draw and strongside cant, as well as a proper cut for the high waist wear that mounted shooters routinely use.

SMOKECHASER™

- Designed for mounted shooting with a hidden tension adjustment to provide a customized smooth draw and a weight lifter style elongated back for support
- Strongside holster provides 10° cant, cross draw 20°
- Holster is reinforced with corrosion-resistant steel and welt area is double stitched with heavy nylon thread for added strength
- Suede lining in holster and belt for better grip while riding and performing in matches
- Two-piece 2" wide belt available in either straight or 1.5" drop design
- Full grain floral embossed cowhide with snake pattern lambskin insert; available in Black or Cognac finish



PATH BLAZER™

- Designed for mounted shooting with a hidden tension adjustment to provide a customized smooth draw and a weight lifter style elongated back for support
- Strongside holster provides 10° cant, cross draw 20°
- Holster is reinforced with corrosion-resistant steel and welt area is double stitched with heavy nylon thread for added strength
- Suede lining in holster and belt for better grip while riding and performing in matches
- Two-piece 2" wide belt available in either straight or 1.5" drop design
- Premium grade full grain cowhide with basketweave insert; available in Chestnut Tan or Black finish



TEAM BIANCHI MEMBER



KENDA LENSEIGNE

- 4-Time Overall World Champion - the only woman in CMSA history to accomplish this (to beat all the men)
- 13 World Records
- 2010 and 2011 CMSA Overall National Champion
- 4-Time CMSA World Point Champion Cowgirl
- 2015 CMSA Hall of Fame Inductee



BIANCHI® COWBOY

NEW

LONG GUN HOLDER

- Designed to fit 16" lever action rifles and shotguns
- Saddle mount
- Available in premium full grain leather, Chestnut Tan finish



LONG GUN SCABBARD

- Designed to fit 16" rifles and carbines
- Closed muzzle with drain hole
- Includes 3 tie downs to secure scabbard, 2 horizontal and 1 vertical
- Adjustable ride height strap for snug carry on saddle horn
- Premium grade full grain, vegetable tanned leather
- Available in Chestnut Tan or Plain Black; solid brass buckles on tan models and chrome covered brass buckles on black



GETAWAY™

- Designed for mounted shooting with a hidden tension adjustment to provide a customized smooth draw and a weight lifter style elongated back for support
- Strongside holster provides 10° cant, cross draw 20°
- Holster is reinforced with corrosion-resistant steel and welt area is double stitched with heavy nylon thread for added strength
- Suede lining in holster and belt for better grip while riding and performing in matches
- Two-piece 2" wide belt available in either straight or 1.5" drop design
- Premium grade, full grain cowhide; Chestnut Tan or Plain Black finish



CATTLE DRIVER™

- Designed for mounted shooting with a hidden tension adjustment to provide a customized smooth draw and a weight lifter style elongated back for support
- Strongside holster provides 10° cant, cross draw 20°
- Holster is reinforced with corrosion-resistant steel and welt area is double stitched with heavy nylon thread for added strength
- Suede lining in holster and belt for better grip while riding and performing in matches
- Two-piece 2" wide belt available in either straight or 1.5" drop design
- Premium grade full grain cowhide; Chestnut Tan with tan/white cow hair inserts; or Plain Black with black/white cow hair inserts



FEED BUCKET ORGANIZER

- Designed to fit as a liner inside a 12-quart feed bucket
- Multiple pockets keep shooting gear organized and easily accessible
- Constructed of durable nylon
- Bucket not included



HOLSTERS, BELTS & ACCESSORIES

The Safariland® brand is committed to providing the highest quality and most technologically advanced holsters, belts, and accessories to sporting and personal defense customers. Competitive shooters, including Team Safariland, have relied on Safariland shooting gear to win for more than 30 years. Comprised with some of the best shooters in the world, Team Safariland helps us design and test product to ensure they meet and exceed your needs.

BELT SLIDE HOLSTERS



PATENT PENDING

GLS™ OPEN TOP CONCEALMENT BELT SLIDE HOLSTER 537

- GLS™ (Grip Lock System) secures weapon once holstered; retention is deactivated with the middle finger upon a standard shooting grip on the weapon
- Soft, flexible holster body allows holster to mold around wearer
- Tension adjustment to customize tailor weapon fit to user preferences
- Fits 1.5" (38mm) belt loops
- Available in Black, Flat Dark Earth, Olive Drab, and Foliage Green finishes



PATENTED

PRD™ OPEN TOP CONCEALMENT BELT SLIDE HOLSTER 547

- Pinch Retention Device (PRD™) secures weapon once it is fully seated in the holster by clamping onto both sides of the trigger guard; draw is initiated by pulling up through device
- Low-profile design with wide weight disbursement for a comfortable carry and high concealability
- Fits 1.5" (38mm) - 2" (50mm) belt loops
- Available in all STX finishes



GLS
grip locking system

GRIP LOCKING SYSTEM

The GLS, a unique retention system in which the middle finger is used to release the gun. Once a proper shooting grip is obtained, the middle finger will sit directly on the lever of the GLS. As the gun is drawn out of the holster the lever is depressed and the firearm is drawn straight out. The GLS holster line offers a lower profile and compact design, perfect for concealment. Additionally, the low cut sides allow for a rapid draw and easy re-holstering.

BELT/PADDLE/CLIP-ON HOLSTERS

7TS



GLS
grip locking system

PATENT PENDING

PRO-FIT™ PADDLE & BELT LOOP COMBO HOLSTER 578

- GLS™ (Grip Lock System) secures weapon once holstered; retention is deactivated with the middle finger upon a standard shooting grip on the weapon
- Designed to fit multiple weapons in one holster, adjustment available to further customize fit
- Body is proprietary nylon blend that is non-abrasive to a firearm's finish, maintains very high heat tolerance, low cold tolerance
- Low-cut and compact design make concealment easy while also allowing for a quick draw
- Available in SafariSeven™ material Plain Black and FDE Brown finishes

SEE PAGE 31 FOR KEY FEATURES OF SAFARISEVEN MATERIAL

NEW FOR 2017! **NEW**
**HOLSTER BODY SIZE NOW AVAILABLE
FOR NARROW FRAME GLOCK, S&W SHIELD,
SPRINGFIELD XD MODELS**



PATENT PENDING

HI-RIDE BELT SLIDE 576

- Rides 1" higher than standard belt slide
- Available in 1.5" (38mm) belt width



PATENT PENDING

BELT LOOP 577

- Injection-molded belt loop is user adjustable for cant and can be worn cross draw
- Available for 1.5" (38mm), 1.75" (45mm), 2" (50mm), or 2.25" (58mm) belt slots; please specify



PATENT PENDING

BELT CLIP 579

- Features 745BL Belt Clip for easy attachment and detachment from belt
- Fits belt widths from 1.5" (38m) to 2.25" (58mm)

OPEN TOP CONCEALMENT PADDLE AND BELT LOOP COMBO 5188

- Designed for light mounted weapons
- Compact and lightweight
- Low-cut sides for ease of draw and added comfort
- Genuine SafariLaminate™ wraparound construction
- Injection-molded paddle designed for enhanced concealability and comfort
- Adjustable injection-molded belt loop fits 1.5" (38 mm), 1.75" (45 mm), 2" (50 mm) and 2.25" (58 mm); please specify
- Belt loop is user-adjustable for cant angle; can even be worn crossdraw
- IDPA approved
- Available in STX finishes



HI-RIDE BELT SLIDE 5186

- Rides 1" higher than standard belt slide
- Available in 1.5" (38mm) belt width



BELT/PADDLE/CLIP-ON HOLSTERS



PATENTED



PATENTED

ALS® CONCEALMENT BELT LOOP 6377

- Injection-molded belt loop is user adjustable for cant and can be worn crossdraw
- Available for 1.5" (38mm), 1.75" (45mm), 2" (50mm) or 2.25" (58mm) belt slots; please specify



PATENTED

HI-RIDE BELT SLIDE 6376

- Rides 1" higher than standard belt slide
- Available in 1.5" (38mm) belt width



PATENTED

BELT CLIP 6379

- Features 745BL Belt Clip for easy attachment and detachment from belt
- Fits belt widths from 1.5" (38mm) to 2.25" (58mm)

ALS® CONCEALMENT PADDLE & BELT LOOP COMBO 6378

- ALS® (Automatic Locking System) secures weapon once holstered; simple straight up draw once ALS is deactivated by thumb while obtaining shooting grip
- Injection-molded paddle design is highly concealable and rides close to body
- Injection-molded belt loop is user adjustable for cant angle and can be worn crossdraw
- Adjustable injection-molded belt loop fits 1.5" (38mm), 1.75" (45mm), 2" (50mm), and 2.25" (58mm); please specify
- IDPA approved
- ALS retention in an open-top design that is drawn with a natural thumb only operation; no fingers in the trigger guard area
- Optional ALS® Guard available for increased security
- Genuine SafariLaminate™ construction with suede lining to help protect the gun's finish
- Available in STX finishes



PATENTED

ALS® LOW SIGNATURE HOLSTER 6378USN

- ALS® (Automatic Locking System) secures weapon once holstered, simple straight up draw once release is deactivated
- Reduces Infrared (IR) Signature
- Compact profile for minimal interference with other equipment
- Can be used with QLS 19 Quick Locking Fork; allows various carry configurations and rapid transition from mounting points when used with the QLS 22 Receiver Plate (not included)
- ALS retention in an open-top design that is drawn with a natural thumb only operation; no fingers in trigger guard area
- Optional ALS Guard (Model 6006) available for increased security
- Genuine SafariLaminate™ construction with suede lining to help protect the weapon's finish
- Available in MultiCam®, Ranger Green, Tan, Black, and Khaki
- Available for: Beretta M9/M9A1/92F, Glock 19/23, and Sig Sauer P226



AUTOMATIC LOCKING SYSTEM



The ALS® or Automatic Locking System provides a high level of security without adding thumb breaks, snaps, or levers requiring the use of the trigger finger. With several patents to its credit, the key to this system is an internal locking device that secures the weapon in all directions simply upon re-holstering. Holsters with this advanced ergonomic design are completely operable with the thumb, making training easy, and the straight-up draw makes it very instinctive to use, yet difficult for anyone other than the wearer to access.



With a firing grip on the handgun, the thumb instinctively rests on the ALS lever.



Upon drawing, simply depress the lever and draw the gun straight-up and out of the holster.

BELT/PADDLE/CLIP-ON HOLSTERS



HI-RIDE BELT SLIDE 5196

- Rides 1" higher than standard belt slide
- Available in 1.5" (38mm) belt width



5198 IS NOW AVAILABLE IN RED

OPEN TOP CONCEALMENT PADDLE & BELT LOOP COMBO WITH DETENT 5198

- Compact and lightweight
- Detent in trigger guard for reliable weapon security
- Low-cut sides for ease of draw and added comfort
- Adjustable Injection-molded belt loop fits 1.5" (38mm), 1.75" (45mm), 2" (50mm), and 2.25" (58mm), please specify
- Belt loop is user adjustable for cant; can even be worn cross draw
- Injection-molded paddle design is highly concealable and rides close to the body
- IDPA approved
- Genuine SafariLaminate™ construction
- Available in STX finishes



BELT CLIP 5199

- Features 745BL Belt Clip for easy attachment and detachment from belt
- Fits belt widths from 1.5" (38mm) to 2.25" (58mm)



HI-RIDE BELT SLIDE 566

- Rides 1" higher than standard belt slide
- Available in 1.5" (38mm) belt width



BELT CLIP 569

- Features 745BL Belt Clip for easy attachment and detachment from belt
- Fits belt widths from 1.5" (38mm) to 2.25" (58mm)

CUSTOM FIT PADDLE & BELT LOOP COMBO 568

- 6 pistol and 4 revolver fits accommodate over 200 different weapons
- Injection-molded paddle designed for concealability and comfort
- Adjustable injection-molded belt loop fits 1.5" (38mm), 1.75" (45mm), 2" (50mm), and 2.25" (58mm); please specify
- IDPA approved
- Genuine SafariLaminate™ construction with suede lining to help protect the gun's finish
- Available in STX Plain Black finish



CUSTOM FIT BELT LOOP 567

- Adjustable injection-molded belt loop fits 1.5" (38mm), 1.75" (45mm), 2" (50mm), and 2.25" (58mm); please specify
- Belt loop is user-adjustable for cant angle; can even be worn cross draw

BELT/PADDLE/CLIP-ON HOLSTERS

7TS™

7TS™ ALS® CONCEALMENT PADDLE & BELT LOOP COMBO HOLSTER 7378

- ALS® (Automatic Locking System) secures weapon once holstered, simple straight up draw once release is deactivated
- Open-top design without SLS for quick retrieval of weapon
- ALS (Automatic Locking System) secures weapon once holstered; simple straight up draw once ALS is deactivated by thumb while obtaining shooting grip
- Matte finish designed to decrease reflection and can be maintained with a simple scouring pad
- Injection-molded paddle design is highly concealable and rides close to body
- Also includes Injection-molded belt loop is user adjustable for cant and can be worn cross draw
- Available for 1.5" (38mm), 1.75" (45mm), 2" (50mm) or 2.25" (58mm) belt slots
- Available in SafariSeven™ Plain Black and FDE Brown finishes

ALS
automatic locking system

PATENTED &
PATENT PENDING



PATENTED &
PATENT PENDING

BELT LOOP 7377

- Injection-molded belt loop is user adjustable for cant and can be worn cross draw
- Available for 1.5" (38mm), 1.75" (45mm), 2" (50mm), or 2.25" (58mm) belt slots; please specify



PATENTED &
PATENT PENDING

BELT CLIP 7379

- Features 745BL Belt Clip for easy attachment and detachment from belt
- Fits belt widths from 1.5" (38 mm) to 2.25" (58mm)



PATENTED &
PATENT PENDING

HI-RIDE BELT SLIDE 7376

- Rides 1" higher than standard belt slide
- Available in 1.5" (38mm) belt width

7TS™ THE 7TS SERIES

The 7TS™ Series is extremely rugged and offers the ultimate in durability. Constructed of SafariSeven™ materials, a proprietary DuPont™ nylon blend, these holsters are practically impervious to the elements. SafariSeven allows very high tolerances to heat and cold and requires virtually no maintenance to keep them functioning and looking good. These holsters feature precision injection molding and are incredibly lightweight.

SEVEN FEATURES OF THE 7TS

1. Proprietary nylon blend that is completely non-abrasive to a firearm's finish
2. Raised stand-off surfaces in interior of holster creates air space around the weapon allowing dirt and moisture to quickly clear any contact with the firearm
3. Very high heat tolerance; structurally sound at 300° F
4. Very low cold tolerance; structurally sound at -50° F
5. Can be submerged in water indefinitely and still maintain shape and function
6. Matte finish decreases reflection and can be maintained with a simple scouring pad
7. Compatible with all Safariland® holster mounting options



BELT SLIDE/IWB HOLSTERS



RANGE SERIES OPEN TOP CONCEALMENT LOW RIDE OFFSET HOLSTER 5195

- Compact and lightweight
- Low-cut sides for ease of draw
- Offset belt loop allows for a straight up draw
- Detent in trigger guard for added security
- Modular offset adapter accommodates the QLS 19 Locking Fork, 745BL and 567BL
- IDPA approved; also recommended for female shooters
- Available for 1.5" (38mm) or 1.75" (45mm) belt widths
- Available in STX finishes



RANGE SERIES OPEN TOP MID RIDE HOLSTER 5197

- Compact and lightweight
- Detent in trigger guard for reliable weapon security
- Low-cut sides for ease of draw and added comfort
- Full grain leather cant adjustable belt loop eliminates common belt-bulging and does not interfere with draw
- IDPA approved
- Genuine SafariLaminate™ construction
- Available for 1.5" (38mm) or 1.75" (45mm) belt widths
- Available in STX finishes



PRO-FIT™ IWB 575

- GLS™ (Grip Locking System) secures firearm once holstered; retention is deactivated with the middle finger upon obtaining a standard shooting grip on the firearm
- Designed to fit multiple firearms in one holster
- Body is proprietary nylon blend that is non-abrasive to firearm's finish
- Low-cut compact design make concealment easy while allowing for a quick draw
- Inside-the-waist for deep concealment
- Fully adjustable cant
- Available in SafariSeven™ material, Plain Black



PATENT PENDING

IWB/POCKET HOLSTERS



INSIDE-THE-PANTS CONCEALMENT HOLSTER 27

- J-shaped belt hook can be worn with any belt
- Open-top SafariLaminate™ holster designed as an undercover off-duty holster
- A polymer insert keeps the holster open for easy weapon reholstering
- Available in Plain Black finish



WALLET PROFILE HOLSTER 22

- Back of holster is designed to give "print" impression of a wallet
- Hinged design allows backing to swing away from holster, making for a sure grip on the weapon and easy draw
- Holster will stay open; simply drop handgun into the pocket and it holsters itself
- Suede outer material grips clothing for less movement of holster
- Firm, moisture-proof membrane layer prevents perspiration from penetrating the holster and collecting on the gun
- Available in Black Suede finish



Low-Profile Draw

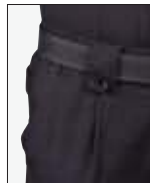

Shown in Pocket

INSIDE-THE-POCKET HOLSTER 25

- Extra-thin, extra-soft holster for extra-deep concealment
- Holster will stay open; simply drop handgun into the pocket and it holsters itself
- Suede outer material grips clothing for less movement of holster
- Firm, moisture-proof membrane layer prevents perspiration from penetrating the holster and collecting on the gun
- Available in Black Suede finish



IWB HOLSTER 18

- Open-top design
- Firm SafariLaminate™ construction allows holster to stay open for ease of reholstering
- SafariSuede™ outer material grips clothing for less movement of holster
- Fits both 1.25" (32mm) and 1.5" (38mm) belt widths
- Double-snap belt loop is adjustable for cant angle
- Available in Black Sueded finish

SHOULDER HOLSTERS



ALS
automatic locking system



Back View



Can Be Worn Vertical or Horizontal

PATENTED

ALS® SHOULDER HOLSTER 1051

- ALS® (Automatic Locking System) secures weapon once holstered
- SafariLaminate™ construction for ease of draw and reholstering with one hand
- Vertical or horizontal carry options
- Harness system is comfortable and fully adjustable
- For pistols only
- Dual magazine pouch included on strong side
- Available in STX Plain Black finish



ALS
automatic locking system



PATENTED

ALS® UNIVERSAL SHOULDER HOLSTER 1053

- ALS® (Automatic Locking System) secures weapon once holstered
- Adjustable strap to fit most body types
- Lightweight elastic single side harness provides stability for handgun
- Harness and mounting system also sold separately and can be used with any ALS concealment holster (excluding revolvers)

7TS™ ALS® LIGHTWEIGHT SHOULDER HOLSTER 7053

- ALS® (Automatic Locking System) secures weapon once holstered; simple straight out draw once ALS is deactivated by thumb while obtaining shooting grip
- Proprietary SafariSeven™ material nearly impervious to heat, cold and water
- One handed reholstering
- Lightweight, adjustable elastic single side harness provides stability for handgun
- Belt tie-downs not needed due to lightweight and compact design
- Harness compatible with all 7TS holsters
- Available in SafariSeven™ Plain Black and FDE finishes



7TS™

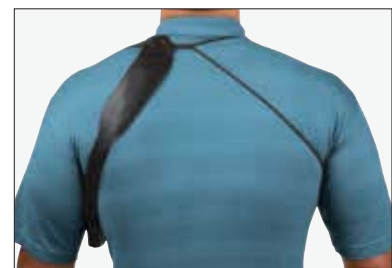

PATENTED & PATENT PENDING

ALS
automatic locking system

BELTS & POUCHES



81



CD-AUTO



079



123



With Leatherman® tool

71



074



572



574

INJECTION MOLDED SINGLE MAG POUCH 71

- Flexible “accordion” design allows for multiple fits and minimal size
- Fits magazines, flashlights, knives and multi-tools
- Can now be ordered as a tactical accessory to be used in conjunction with Safariland leg shrouds or the QAS System
- Also available as an IWB, belt clip, or MOLLE compatible
- Fits from 1.5" (38mm) to 2.25" (58mm)
- Available in Black or FDE Brown finishes

OPEN TOP SINGLE MAGAZINE POUCH 074

- Paddle-style single magazine holder
- Features built-in locking mechanism that keeps the holder in place at all times
- Fits belts up to 1.5" (38mm) wide
- Adjustable tension device
- Available in Plain Black or STX finishes

OPEN TOP DOUBLE MAGAZINE POUCH – SNAP 079

- Low-cut design for easy magazine grasp
- For use on belts up to 1.75" (45mm) wide
- Adjustable tension device
- Available in Plain Black, Basketweave, or STX finishes

OPEN TOP SINGLE MAGAZINE – SNAP 81

- Features a low-cut design
- Back side folds over to form snap-type belt loop
- For use on belts up to 1.75" (45mm)
- Available in Plain Black finish

MAGAZINE POUCH – HORIZONTAL 123

- Single magazine holder – carries magazines in a horizontal position
- Hook and loop belt attachment wraps around belt
- Available in Plain Black finish

OPEN TOP DOUBLE MAGAZINE POUCH – PADDLE 572

- Low-cut design allows for quick access
- Unique paddle design features a self-locking belt hook
- Adjustable tension device
- Available in Plain Black, Basketweave, or STX finishes

MAGAZINE HOLDER AND LIGHT POUCH – PADDLE 574

- Low-cut design allows for quick access
- Adjustable tension device
- Unique paddle design features a self-locking hook
- For use on belts up to 1.75" (45mm)

AUTO MAGAZINE HOLDER CD-AUTO

- Black metal clip-on design
- Carries single magazine in a butt-up, mid-ride position
- Ideal for plainclothes or off-duty use
- Now available for single stack 9mm pistols



MOLLE SLIDING ADAPTER (MSA)

- Compatible with Model 71 Tactical Universal Magazine Pouch
- Easily slides and locks into MOLLE webbing; removable in seconds
- Minimal space used on MOLLE vests
- Permits multiple pouches lined up side to side



PLAINCLOTHES BELT L820/ L830

- Made of SafariLaminate™ with a vegetable-tanned leather support to accommodate holsters for larger handguns
- Features a solid brass or chrome buckle
- Available in Plain Black with solid brass or chrome buckle

L820 1.25" (32mm)

L830 1.5" (38mm)

TACTICAL HOLSTERS

SAFARILAND® TACTICAL HOLSTERS CAN BE CONFIGURED WITH ANY OF THESE ATTACHMENT SYSTEMS



Drop Flex Adapter



Universal Flex Adapter



Single Strap LP with D-Ring



Single Strap



Single Strap with Quick Release



PATENTED



PATENTED

WITH QUICK-RELEASE LEG STRAP 6355



SLS TACTICAL HOLSTER 6004



WITH QUICK-RELEASE LEG STRAP 6005

ALS® TACTICAL HOLSTER 6354

- ALS® (Automatic Locking System) secures weapon once holstered; simple straight up draw once release is deactivated
- Open-top design without SLS for quick retrieval of weapon
- Hood Guard is standard; optional ALS Guard available
- SafariLaminate™ thermal-molded construction protects handgun and sights
- Adjustable vertical leg strap
- Standard double strap and leg shroud with mounting holes for optional accessories
- Offered for weapons with and without rail mounted lights
- Suede lined to protect handgun's finish
- Leg shroud features silicone lining for non-slip traction
- Available in STX Tactical® Black, Foliage Green, OD Green, FDE Brown, and Coyote Brown finishes

- SLS allows for a smoother, single-motion draw and greater protection against attempted weapon takeaways
- Features the SLS (Self Locking System) rotating hood system
- Hood Guard is standard; optional Sentry available
- Thermal-molded SafariLaminate™ construction protects handgun and sights
- Standard double strap and leg shroud with mounting holes for optional accessories
- Suede lined to protect handgun's finish
- Leg shroud features silicone lining for non-slip traction
- Available in STX Tactical® Black, Foliage Green, OD Green, FDE Brown, and Coyote Brown finishes
- Also available Model 6004USN in Cordura® finishes



TACTICAL HOLSTERS/ACCESSORIES



PATENTED



PATENTED

WITH QUICK-RELEASE LEG STRAP 6305

ALS®/SLS TACTICAL HOLSTER 6304

- ALS® (Automatic Locking System) secures weapon once holstered
- SLS allows for a smoother, single motion draw and greater protection against attempted weapon takeaways
- Hood Guard is standard; optional Sentry available
- Mounted to the same leg shroud assembly as the popular 6005 series
- Simple straight up draw once all releases are deactivated
- Thermal-molded SafariLaminate™ construction protects handgun and sights
- Standard double strap and leg shroud with mounting holes for optional accessories
- Adjustable vertical leg strap
- Offered for weapons with and without rail mounted lights
- Suede lined to protect handgun's finish
- Leg shroud features silicone lining for non-slip traction
- Available in STX Tactical® Black, Foliage Green, OD Green, FDE Brown, and Coyote Brown finishes



Shown with 568BL

UNIVERSAL FLEX ADAPTER 6004UFA

- Allows user to wear a thigh rig below the hip without shifting weight farther down the leg
- Keeps rig from sliding on belt
- Can be used on belt widths up to 2.25" (58mm)
- For use in conjunction with the 6004-10 leg shroud

ELS TACTICAL BELT 4332



- Features full length hook lining for use with Safariland® 99 Liner Belt or Bianchi® 8106 Liner Belt
- Buckleless design features two large knobs for locking in ELS mounting holes
- Pre-cut ELS mounting holes for straight up or angled attachment of ELS Receiver Plates
- Available in Nylon Look, FDE Brown, and Foliage Green finishes
- Fits 2" (50mm) belt widths



ELS 35 Receiver Plates not included

DROP FLEX ADAPTER ON SINGLE LEG SHROUD WITH QLS 22 6004-27

- Allows user to wear a thigh rig below the hip without shifting weight further down the leg
- Keeps rig from sliding on belt
- Can be used on belt widths up to 2.25" (58mm)
- Includes QLS 22 Receiver Plate; can also be ordered with no plate
- Available in Black, Foliage Green, OD Green and FDE Brown finishes



SINGLE STRAP LEG SHROUD WITH QUICK-RELEASE 6005-10

- Features harness and shroud only to mount accessories and holsters
- Leg shroud features silicone lining for non-slip traction
- Ambidextrous



RIFLE MAG POUCH 774

- Clip-on belt attachment to fit 1.5" (38mm) to 2.25" (58mm) belts
- Adjustable for carry angle
- SafariLaminate™ construction with tension device
- Ambidextrous
- Can be ordered with MLS 16 or ELS 34 Locking Fork attached



SINGLE MAG POUCH 76

- Single mag pouch with flap for multiple handgun models
- Can be ordered with MLS 16 or ELS 34 Locking Fork attached



79

SLIMLINE OPEN TOP MAGAZINE POUCH 79 / 779

- Magazines are oriented "face out" to save space on belt
- Durable SafariLaminate™ thermal-molded construction
- Fits 2.25" (58mm) belt widths
- Part of the 6004/6005 tactical system
- 79 - Vertical belt slots
- 779 - Vertical and horizontal belt slots; provides triple magazine retention without flap in an area comparable to standard dual magazine pouches



779

RAPID LIGHT SYSTEM

With the Safariland® Rapid Light System (RLS™), you get a professional-quality hand-held light and weapon-mounted light all in one. You can clip it onto your belt, hold it in your hand, or quickly mount it to your weapon for an instant tactical advantage. There's no need to buy an expensive holster to carry a light-mounted weapon. No reason to carry a second primary light. You will always have a bright light whenever and wherever you need it. It's the only light you need.



RLS™ RAPID LIGHT SYSTEM

1. Ambidextrous
2. Super-bright LED technology (190 lumens) – bright enough to be your primary light. Prism Reflector System penetrates light up to 350 ft.
3. Uses three AAA batteries – no expensive proprietary batteries needed
4. Integral clip for easy securement to belt or garment – no dedicated light mount holster required
5. Fits most handgun models that incorporate an integral rail system – also mounts to rifles and shotguns that have a Picatinny rail
6. Quickly transitions from standard flashlight to tactical illumination
7. Can be operated with either thumb, or change to other side to operate with trigger finger. Push button provides controllable on/off illumination of target to minimize loss of handgrip, sight picture and exposure
8. RLS™ mount will accommodate most hand-held compact lights in the range of .970 (24.6mm)- 1.060 (26.9mm) in diameter

SEE ENHANCED ROGERS LIGHT SYSTEM (MODEL 65139)
WITH SUPER BRIGHT LED LIGHT (980 LUMENS) ON PAGE 68



Slide RLS onto
Tactical Rail



Lock RLS into place with a
quick upward motion



Easily and securely attaches
to waistband or belt with
integral clip



Push-button illumination



Three AAAs provide over
40-hours' use

RLSP

RLS LIGHT WITH PRESSURE SWITCH

- RLS™ Light System with tape pressure switch
- 8" cord for versatile positioning
- Pressure switch split for low 10 lumens or high 190 lumens



RAPID LIGHT SYSTEM



PATENTED

RLS™ MOUNT RLSM

- Provides a small mounting platform on duty belt to attach the RLS™ light
- Will also accommodate any light, laser, or other accessory that will fit on a Picatinny or light rail
- Fits belt widths up to 2.25" (58mm)
- Also fits on leg shroud, MLS or ELS Locking Fork
- Included with RLS



(RLS™ shown with SureFire®)

RLS™ REDUCTION SLEEVE RLSR

- Enables the RLS mounting system to be used with lights of both .90" and .80" diameters
- Slides inside RLS mount to easily accept narrower lights



TAIL CAP FOR RLS™ LIGHT RLSP-TC

- Tape pressure switch for RLS Light System
- Eight-inch cord for versatile positioning
- Made to work with existing 190 lumen RLS lights



RLS™ LIGHT WITH PRESSURE SWITCH RLSP

- RLS Light System with tape pressure switch
- Eight-inch cord for versatile positioning
- Pressure switch split for low 10 lumens or high 190 lumens

ROGERS' RAIL LITE™ RRL

- Ambidextrous design fits on any Picatinny/1913 rail
- Tail on/off switch is positioned right at shooters forward thumb
- Easy snap on and off installation
- Made of a heavy-duty polymer yet is extremely lightweight
- External rib design for added strength and grip
- 28 Lumen Streamlight® Microstream® flashlight included



PATENT PENDING



HEARING PROTECTION



SAFARILAND® ELECTRONIC HEARING PROTECTION

- Electronic Noise Compression technology - sound compressed and reduced to safe hearing levels
- Features sound localization for maximum situational awareness and sound detection
- Low distortion speaker technology for superior sound quality
- 325-hour run time with two AAA batteries
- Proprietary Earcup design layered with sound barrier technology; offered in Black
- Single-sided controls
- Rubber cheek wells



NEW



NEW

SAFARILAND® RANGE KIT PROFESSIONAL EYE & EAR PROTECTION

- Kit includes: HD glasses, (1) pair of ear plugs with case, (1) passive headset
- High noise reduction rating
- High quality ear seals
- Color: Gun Metal Grey



NEW



LIBERATOR HP™ ADVANCED HEARING PROTECTION

- First of its kind Dual Mode headset: has Electronic Noise Compression and Active Noise Cancellation
- Industry leading sound localization for maximum situational awareness and sound detection
- First of its kind Dual Fuel – Runs on either two AAA or one CR123 batteries
- First headset with user audio profiles modifiable by using Near Field Communications technology
- Industry leading 700-hour run time
- Proprietary high definition speakers and speaker enclosures
- Modular headset suspension, user adjustable to be either over-the-head or behind-the-head for maximum comfort
- Proprietary Earcup design layered with sound barrier technology
- Available in Black, OD Green, and Flat Dark Earth

HEARING PROTECTION



SAFARILAND® IN-EAR IMPULSE HEARING PROTECTION

Helps guard against hearing damage caused by automatic fire and single gun shots, artillery fire and explosions, reducing them to safe levels, less likely to cause long term damage.

- Automatically engages to protect hearing
- Still allows for ambient audio
- Proprietary material for long wear comfort
- Includes key chain aluminum transport/storage case
- No batteries required
- Two sets of ear inserts included

33
dB
NOISE REDUCTION RATING



075-2 HEARING PROTECTION HOLDER

- Clips on to belt
- Available in Black



GUN CASES



Backpack Shoulder Carry

DUAL RIFLE CASE 4552

- Rugged ballistic pack cloth construction
- Heavy-duty lockable zippers, one adjustable outside covered accessory pouch
- Large dual handgun/accessory pouch with individual hook and loop enclosed handgun areas
- Closed-cell protective foam padding and 2" perimeter lip
- Assorted accessory pockets inside case
- Adjustable padded shoulder harness for shoulder carry
- Includes adjustable backpack-style carry straps that tuck away in storage pocket when not in use
- Available in 36" and 46" lengths, in Black and FDE Brown



SHOOTERS' RANGE BAG 4555

- Removable center carry compartment has zippered, padded side panels for four separate handgun compartments
- Adjustable hook and loop dividers to personalize accessory space
- Magazine pouches conveniently sewn into main storage area
- Two large exterior pocket and a fully lined interior
- Full-wrap carry handles make it easy to move gear to different shooting stations
- Outer carry bag has dual zipper top for easy access and full coverage, flat side zipper pocket, ID window, and large outside zippered pocket for towel, shooting glasses or hearing protection
- Overall dimensions: 14" x 9" x 10"



GUN CASES



3-GUN CASE 4556

- Rugged ballistic pack cloth construction
- Heavy-duty lockable zippers, two adjustable outside accessory pouches
- Large dual handgun/accessory pouch with individual hook and loop enclosed handgun storage areas and four pistol mag pouches large enough for extended magazines
- Closed-cell protective foam padding and 2" perimeter lip
- Assorted accessory pockets inside case
- Adjustable padded shoulder harness for shoulder carry
- Includes adjustable backpack-style carry straps that tuck away in storage pocket when not in use
- Unique zippered barrel expansion slot on side of case can be opened to allow use of longer firearms (up to 51") while still fully encompassing weapon muzzle
- 46" overall length (with expansion slot closed)
- Available in Black



PREMIUM DUAL HANDGUN CASE 4553

- Rugged ballistic pack cloth construction
- Full interior closed-cell foam surrounded by soft lining for safe handgun storage
- Four outside magazine/accessory pouches
- Dual concealed pockets to individually protect handgun
- Wraparound handles
- 12" overall length
- Available in Black



QUICK ATTACHMENT SYSTEM

QLS (QUICK LOCKING SYSTEM)

- The QLS provides officers the ability to easily and quickly remove and secure their weapon without having to remove weapon from holster. Especially effective in correctional institutions and courthouse appearances
- Also effective for concealed carry in ease of transferring gun from body to other mounting point, such as vehicle
- Mount almost any Safariland duty holster on an equipment belt with use of the Safariland UBL
- Provides a highly versatile holster system with a quick, easy and secure attachment to a variety of locations – belt, thigh rig, furniture, or vehicle, etc. Can also be used with the Safariland MLS 16 Accessory Locking Fork for attachment to MOLLE vests
- QLS System passes Level I Retention™ pull test



HOLSTER LOCKING FORK QLS 19

- Mounts directly to the back of duty holsters, then connects to the QLS 22 Receiver Plate
- Colors: Black, Foliage Green, OD Green, FDE Brown, and Coyote Brown

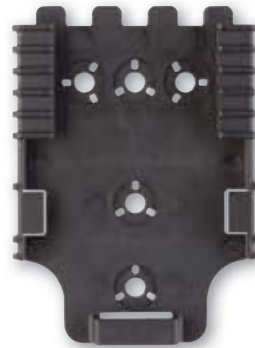

RECEIVER PLATE QLS 22

- Mounting platform for the QLS 19 Duty Locking Fork. Attaches directly to Universal Belt Loop (UBL), or other mounting platforms
- Colors: Black, Foliage Green, OD Green, FDE Brown, and Coyote Brown

COMPETITION

QLS ON A COMPETITION RIG

1. QLS w/ belt loop
2. Holster w/ QLS 19 on back
3. Full Production Class Rig

1



2



3



CONCEALMENT/PERSONAL PROTECTION

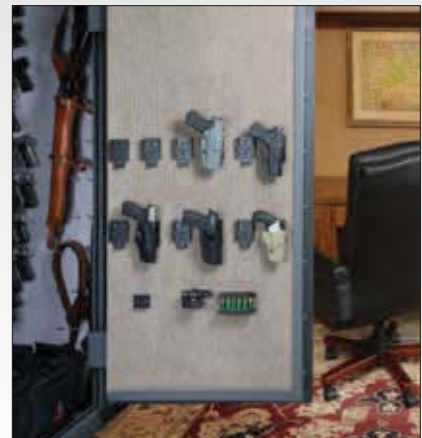

QLS AT HOME

1. QLS 22 attached to dresser
2. QLS 22 on dresser w/ QLS 19 on holster

QLS IN VEHICLE

1. QLS 22 on paddle w/ QLS 19 on holster
2. Removing holster from QLS 22
3. Transferring holster to QLS 22 mounted in vehicle

EQUIPMENT LOCKING SYSTEM

ELS (EQUIPMENT LOCKING SYSTEM)

- Provides a mounting platform for any tactical and competition accessories to be placed in various locations, including belt clips and tactical rigs or directly on MOLLE loops with the use of an MLS 16 Locking Fork
- Fork attaches to any tactical or competition accessory, including the 774 Rifle Mag Pouch, 78 Slimline Dual Magazine Pouch, and 773 Open Top Competition Magazine Pouches
- Receiver plate mounts to any thigh rig, 744BL belt clip or MLS 16 fork (for use of ELS on MOLLE loops), or can be attached directly to the pre-cut mounting holes on any QAS belt
- A quick pinch of the thumb and index finger allows the removal of any product attached to the fork unit for attachment on any other ELS 35 location
- May be purchased with or placed directly onto the 744BL belt clip for convenient waistline location
- Useful in quickly switching out accessories while maintaining the same root product, whether it be a belt, thigh rig or magazine pouches for a competition event, etc.
- Very small receiver footprint (1 7/8" W x 2 3/4")



**EQUIPMENT LOCKING FORK
ELS 34**

- Mounts to any tactical accessory, then connects to the ELS 35 Receiver Plate
- Colors: Black, Foliage Green, OD Green, FDE Brown, and Coyote Brown



**EQUIPMENT RECEIVER PLATE
ELS 35**

- Mounting platform for tactical thigh rig or any other two-hole accessory location
- Colors: Black, Foliage Green, OD Green, FDE Brown, and Coyote Brown

COMPETITION

ELS ON A COMPETITION BELT

1. 032 Belt w/ ELS 34 & ELS 35
2. ELS 34 on mag pouch
3. 032 ELS competition belt fully rigged w/ holster



CONCEALMENT/PERSONAL PROTECTION

ELS AT HOME

1. ELS 35 attached to dresser
2. ELS 35 on dresser w/ ELS 34 on OC spray holder



COMPETITION RIGS

Team Safariland has completed another year of extensive field testing and shooting in competitive events, with the ELS System at the core. The combinations with this system are endless, it's changing the way shooters are rigging up for competitions.

For USPSA handgun, Multigun and Steel Challenge events, it all starts with the Model 030 under belt. Next is the 032 ELS Competition outer belt. We designed it to be very strong, to hold your holster and high-capacity magazines in place, yet it's light and comfortable. Finally, by attaching the Quick Locking Kit for holsters and the Equipment Locking Kits for pouches and shell holders, a truly modular system is attained. This system makes it quick and easy to change out equipment from division and/or for whatever the course of fire demands.

Take a look below at what Team Safariland recommends and uses for each shooting discipline.

Keith Comshaw
Team Safariland Manager



IDPA RIG

IDPA shooting simulates self-defense scenarios and real life encounters using off the shelf handguns in a concealed manner. The holsters, belts, and magazine pouches used in this sport are from our concealment line, and are not what we typically refer to as competition equipment. Team Safariland has been hard at work developing new products and creating new features which incorporate the needs of IDPA shooters. The Range Series is well-suited for IDPA.

THE IDPA RIG SHOWN INCLUDES:

- Model 5197 Holster, page 45
- Model 779 Mag pouch, page 33
- Model 773 Mag pouch, page 47
- Model 332 Belt, page 46



3-GUN RIG – TACTICAL CLASS

For Tactical Scope Multi-Gun rig, we either use a thigh rig, featuring the Drop Flex Adapter and either a 5197 or 6354 holster which provides added protection to the handgun, or mount a 014 using the QLS System as Mike Voigt does. We also have the option to mount a leg shroud on the left side to carry more ammo if needed.

THE 3-GUN RIG - TACTICAL CLASS SHOWN INCLUDES:

- Model 5197 holster, page 45
- Model 774 Mag pouch, page 47
- Model 086 Shotgun holder, page 48
- Model 032 Belt, page 46
- Model ELS Kit, page 41
- Model 030 Underbelt, page 46
- Model 773 Mag pouch, page 47
- Model QLS Kit, page 40



3-GUN RIG – OPEN CLASS

When it comes to Multi-Gun competitions the versatility of the ELS System really comes into play. One of the biggest challenges with 3-Gun competitions is reconfiguring your rig for each course of fire. Not so with our ELS and QLS Systems. For Open Division 3-Gun competition, Mike Voigt likes to mount the 014 holster to a QLS Fork so that he can easily remove the holster when changing to stages where it's not needed. Speed is always paramount in competitions; this was a key factor in the design of the Model 6005-12. Both Mike Voigt and Maggie Reese, working very closely with the Safariland R&D team helped to design this model, which they currently use in 3-Gun competitions.

THE 3-GUN RIG - OPEN CLASS SHOWN INCLUDES:

- Model 014 Holster, page 46
- Model QLS Kit, page 40
- Model 773 Mag pouch, page 47
- Model 774 Mag pouch, page 47
- Model ELS Kit, page 41
- Model 032 Belt, page 46
- Model 6005-12 Speedloader Holder, page 48
- Model 030 Underbelt, page 46

COMPETITION RIGS



PRODUCTION CLASS & SINGLE STACK RIG

The Production division is shot with standard handguns. Most popular in the division are Glocks, Smith & Wesson M&Ps, and Springfield XD's. Production division rigs are similar to Single Stack rigs with the exception of the handgun; in the Single Stack division a traditional 1911 is used. For both divisions, team members use the model 5197 holster mounted to a QLS System or the 5199 with belt clip. Most of us use the Model 771 pouch with the open front in the first reload location, and the Model 773 closed front pouches, which provide extra security, for the rest of the magazines. Rob Leatham even likes this set up for L-10. Keeping the handguns and magazines in the same location enables the shooter to focus more on the competition and not relearning different positions.

THE PRODUCTION CLASS & SINGLE STACK RIG SHOWN INCLUDES:

- Model 5197 Holster, page 45
- Model 771 Mag pouch, page 47
- Model QLS Kit, page 40
- Model ELS Kit, page 41
- Model 773 Mag pouch, page 47
- Model 032 Belt, page 46



PRODUCTION CLASS RIG



SINGLE STACK RIG



OPEN/LIMITED CLASS RIG

USPSA is a fast-paced action shooting sport with many different shooting positions shot against the clock for accuracy. Open division generally uses a high capacity, compensated 1911 with a red dot sight. Limited requires a high-capacity 1911 with iron sights and L-10 uses a 1911 with 10 rounds maximum. For the Open, Limited and L-10 Divisions, the ELS Receiver Plates can be mounted in four different configurations; plus with the angle adjustments on the ELS Fork, there is a full 90° of adjustment available for your mag pouches. There are various configurations for the 014: either slide the belt loop through the belt or mount the 014 rod directly to the belt.

THE OPEN/LIMITED CLASS RIG SHOWN INCLUDES:

- Model 014 Holster, page 46
- Model 771 Mag pouch, page 47
- Model 030 Underbelt, page 46
- Model ELS Kit, page 41
- Model 773 Mag pouch, page 47
- Model 332 Belt, page 46



BIANCHI® CUP RIG

The Bianchi Cup Open Division gun is a piece of art, generally a 1911 with a shroud for the barricade event, and an electronic red dot sight; these guns are truly a sight to be seen. The Metallic division is based on the 1911 with iron sights. For Bianchi Cup Open or Metallic divisions, either mount your 014 holster using the belt included, or as Doug Koenig prefers, mount the vertical adjustment rod directly to the belt. We use the Model 776 mag pouch, allowing us to carry eight magazines in a small area of space.

THE BIANCHI CUP RIG SHOWN INCLUDES:

- Model 014 Holster, page 46
- Model 771 Mag pouch, page 47
- Model 030 Underbelt, page 46
- Model ELS Kit, page 41
- Model 776 Mag pouch, page 47
- Model 332 Belt, page 46

TEAM SAFARILAND

TEAM SAFARILAND

Since its inception in 1985, Team Safariland has been an integral part of developing and testing competition products. Safariland continually pushes the envelope with new and innovative competition holsters and accessories. Our newest gear, the ELS Competition belt, has raised the bar for competition equipment, and the Model 014 Open Class holster brings a technological-edge to competitors.



TOM CAMPBELL

- 2001 USPSA Limited 10 national Champion
- 1977-1988 Member of USPSA Shooting Team
- 1985 European Champion
- 1986 USPSA Team Captain
- 24 years at Safariland, over 46 years total in the industry



SCOTT CARNAHAN

- Team Safariland Captain
- 3-Time USPSA National Class Champion
- NRA Open Action Pistol Distinguished Badge #103
- 2009 NRA Bianchi Cup National Class Champion
- 2012 NRA USA Action Pistol World Team member for the Bianchi Cup



JULIE GOLOB

- First and Only USPSA Seven Division Ladies National Champion
- 15-Time USPSA Ladies National Champion
- 3-Time Bianchi Cup Ladies Champion
- 7-Time Ladies World Speed Shooting Champion
- 4-Time IDPA Ladies National Champion



DOUG KOENIG

- 21-Time Masters Champion
- 2016 and 17-Time Bianchi Cup Champion
- 2013 and 5-Time European Bianchi Cup Champion
- 3-Time Steel Challenge World Speed Shooting Champion
- 1990 IPSC World Champion
- 2014 and 6-Time World Action Pistol Champion



ROB LEATHAM

- 28-Time USPSA / IPSC National Champion
- 8-Time IPSC World Champion
- 10-Time NRA Bianchi Cup / Action Pistol Champion
- 8-Time Steel Challenge Champion
- 7-Time USPSA / IPSC Senior Champion
- First and only Six-Division USPSA Overall National Champion



KIPPI LEATHAM

- 2014 Western States Single Stack Classic Runner Up
- 2011 USPSA Area 3 Production Ladies Champion
- 2011 USPSA Ladies Production World Team, IPSC Silver Medalist
- 4-Time USPSA National Ladies Champion
- 4-Time USA IPSC Gold Team Member and Women's World Team Champion



KENDA LENSEIGNE

- 4-Time Overall World Champion - the only woman in CMSA history to accomplish this (to beat all the men)
- 13 World Records
- 2010 and 2011 CMSA Overall National Champion
- 4-Time CMSA World Point Champion Cowgirl
- 2015 CMSA Hall of Fame Inductee



BOBBY MCGEE

- 2014 CA State IDPA - 1st Place ESP
- 2014 WA State IDPA - 1st Place ESR
- 2014 AZ State IDPA - ESR Division Champion
- 2013 IDPA Puerto Rico ESR National Champion
- 6-Time WA State IDPA Champion



MAGGIE REESE

- 2016 US - IPSC Handgun Champion
- 3-Time National Champion USPSA Multi-Gun
- 2-Time National Team Member IPSC World Handgun
- Multi-Time Ladies Champion at Superstition Mountain Mystery 3 Gun, MGM IronMan, 3 Gun Rocky Mountain
- Host of Modern Shooter on the Sportsman's Channel!



BILL ROGERS

- Author of "Be Fast, Be Accurate, Be The Best"
- Author of "Reactive Pistol Shooting" video by Panteao
- Author of "Reactive Rifle Shooting" videos by Panteao
- Rogers Shooting School - 1976 - present: owner, operator and lead instructor
- Inventor of and patented the "Kydex" holster
- Responsible for more than 40 patents in the firearms field



BOB VOGEL

- 2016 IPSC Standard Champion
- IPSC World Champion and 2-Time IDPA World Champion
- 4-Time USPSA National Champion
- 8-Time IDPA National Champion
- 8-Time Indoor IDPA National Champion
- 4-Time Pro-Am Champion



MICHAEL VOIGT

- 13-Time USPSA MultiGun National Champion
- 2-Time IPSC World Handgun Champion
- 7-Time IPSC World Champion Team member
- 5-Time International Tactical Rifle Champion
- 2-Time IPSC Continental Shotgun Champion
- 2-Time IPSC Continental Handgun Champion

COMPETITION



RANGE SERIES OPEN TOP CONCEALMENT BELT LOOP WITH DETENT 5197

- Compact and lightweight
- Detent in trigger guard for reliable weapon security
- Low-cut sides for ease of draw and added comfort
- Full grain leather cant adjustable belt loop eliminates common belt-bulging and does not interfere with draw
- IDPA approved
- Genuine SafariLaminate™ construction
- Available for 1.5" (38mm) or 1.75" (45mm) belt widths
- Available in STX finishes



RANGE SERIES OPEN TOP CONCEALMENT LOW RIDE OFFSET HOLSTER 5195

- Compact and lightweight
- Low-cut sides for ease of draw
- Offset belt loop allows for a straight up draw
- Detent in trigger guard for added security
- Modular offset adapter accommodates the QLS 19 Locking Fork, 745BL and 567BL
- IDPA approved; also recommended for female shooters
- Available for 1.5" (38mm) or 1.75" (45mm) belt widths
- Available in STX finishes



NRA BIANCHI CUP

A world-class event founded in 1979 by Bianchi International to establish practical pistol shooting as a professional sport. In 1984, the National Rifle Association made the event its national championship of action shooting. The 38th annual event will be held at the Green Valley Rifle & Pistol Club in Columbia, Missouri. Event dates are May 25th-27th, 2017.

COMPETITION HOLSTERS/BELTS



PATENTED



OPEN CLASS COMPETITION HOLSTER 014

- Body machined out of aluminum to stabilize the handgun, yet offers little resistance for a secure and fast draw
- Ball joint on holster allows complete freedom of movement to customize the handgun draw
- Fully adjustable nosepiece accommodates barrels from 5" to 7.5" (13cm – 19cm)
- Fits a variety of competition handguns, with or without red dot or magnified optics
- Injection-molded adjustable trigger guard lock
- Front nosepiece designed to retain handgun and help prevent gun from being knocked out of the holster once seated
- Incorporates a simple push lock which secures weapon into the trigger block
- Available in Black and Red



RIGID COMPETITION BELT 334

- Reinforced to hold heavy competition handguns and ammunition
- Single Safariland branded keeper
- Hook liner for use with Safariland 030 Buckleless Competition Underbelt
- 1.5" (38 mm) belt width



RANGE BELT 332

- Reinforced to hold heavy competition handguns and ammunition
- Non-slip inner lining
- Available in Black, FDE Brown, and Foliage Green nylon finishes
- 1.5" (38mm) belt width



ELS COMPETITION BELT 032

- Reinforced to hold heavy competition handguns and ammunition
- Hook lined to attach to 030 under belt
- Pre-cut holes to mount ELS 35 Receiver Plates in multiple locations and angles
- Available in Nylon Look and Basketweave finishes
- 1.75" (45mm) belt width



CUP CHALLENGE COMPETITION HOLSTER 002

- Features dual-tension screws on the holster body, one in back of cylinder and the other in back of barrel, allowing a balanced retention of the handgun
- Hook and loop lined belt tab provides a firm and adjustable carry when used with Safariland 032 competition belt
- Accommodates both scoped and non-scoped revolvers as well as most revolvers with standard, heavy, and slab side barrels
- Built-in removable muzzle strap protects front sights
- Available in STX Tactical® or STX Basketweave finishes



COMPETITION UNDER BELT – LOOP LINED 030

- Loop on outer side to connect to model 032
- Available in Black with web finish
- 1.5" (38mm) belt width

COMPETITION ACCESSORIES

Shown with ELS 34



O14 ADAPTER

- Allows for various mounting options for the O14 holster
- Available in Black

PART NO.	DESCRIPTION
014-744BL	014 Adapter with 744BL Belt Loop
014-745BL	014 Adapter with 745BL Belt Loop
014-ELS	014 Adapter with ELS 34 Locking Fork



USPSA-KIT

- Ball joint on kit allows complete freedom of movement to customize the handgun draw
- Adjustable height bar for personalized holster height
- Designed to fit 1.5" (38 mm) to 1.75" (45 mm) belt widths and locks down with set screws
- Designed for use with Model 5197 Concealment Holster



OPEN FRONT MAGAZINE POUCH 771/773

- Features two magazine tensioning screws on back side of the holster to adjust tension on both the middle and end of the magazine
- Built-up channel for clearance of the bullet during the draw
- Available in STX Tactical or STX Basketweave finishes
- Can be ordered with MLS 16 or ELS 34 Locking Fork attached

771 Straight top with internal rollers

773 Angled top



COMPETITION MAGNETIC MAGAZINE HOLDER 776

- Magazines are oriented "bullets out" to save space on belt
- Designed with internal magnets to keep magazines in place
- Durable nylon construction
- Hook and loop closure to protect magazines when not in use
- Includes a snap loop attachment to hold flap in place
- Available with 744BL Belt Clip or ELS 34 Locking Fork



RIFLE MAG POUCH 774

- Clip-on belt attachment to fit 1.5" (38mm) to 2.25" (58mm) belts
- Adjustable for carry angle
- SafariLaminate™ construction with tension device
- Ambidextrous
- Can be ordered with MLS 16 or ELS 34 Locking Fork attached

SHOOTERS LOADING BLOCK J-KTR, J-LP

- Convenient trays hold wadcutter, semi-wadcutter or round nosed .38 or .357 ammunition
- Popular for all speedloaders



SPEEDLOADER

- Injection-molded construction
- Large frame versions offer maximum grip clearance



COMP I



COMP II



COMP III

COMP I Popular for concealment use

COMP II Popular for duty use

COMP III Popular for competition use

COMPETITION ACCESSORIES



Shotgun Loaders
Not Included



080-12



081-12

SHOTGUN SPEEDLOADER HOLDER 6005-12

- Designed to be worn on the thigh
- Provides quick access to up to 5 shotgun speedloaders
- Cup and retention clip system keeps loaders stable, even while running
- Include ELS 34 Locking Fork on a leg strap to work in conjunction with 032 ELS Competition Belt or can be used with standard belts



085



086

NEW
SIZE



SHOTGUN SHELL HOLDERS 080-12/081-12

- Molded shotgun shell holder holds (2) 12-gauge shells
- Belt clip features an extended bottom hook for security
- Fits belts up to 2.25" (58 mm) wide
- **081-12** features mounting holes

085

- Provides (4) 12-gauge shells
- All shells can be grasped and employed at once
- Available on an ELS 34 Locking Fork, 744BL Belt Clip, ELS 34/ELS 35 Locking Fork and Plate combo, or plain for direct leg shroud mounting
- Model 085 has a one piece back tensor allowing shells to remain in place even when some are removed
- Fits 2.75" shells only

086

- Holds (2), (4), (6) or (8) 12-gauge shotgun shells
- Unique retaining plate keeps the shotgun shells from dislodging, and are quickly removed a few at a time or all at once
- Sturdy aluminum back plate allows for ride height and cant adjustments
- Available with ELS 34 Locking Fork or 745BL Belt Clip



HARDWARE KIT

- Kit provides the necessary materials: screws, rollers, washers, T-nuts, hook and Allen wrench to service Safariland holsters



OVAL SPACER-KIT



HDA-KIT



T-SPACER-KIT



CUSTOMIZED-KIT

SPACER KITS

Spacer kits are available that position the holster away from the body to accommodate various body shapes. For use with 3-hole patterned holsters

Model	Kit Contents
T-SPACER-KIT	2 T-Spacers, 6 Screws, & 1 Allen Wrench
HDA-KIT	2 T-Spacers, 6 Rollers, 22 Screws, 1 HDA Plate, & 1 Allen Wrench
OVAL SPACER-KIT	2 Oval Spacers, 8 screws, & 1 Allen Wrench
CUSTOMIZED-KIT	2 T-Spacers, 6 Rollers, 22 Screws, & 1 Allen Wrench

APPAREL & ACCESSORIES



9250

SAFARILAND® HAT TS-9250/9255

- Adjustable size fits all
- Low-profile design
- Embroidered logo on front and Safariland on back
- Available in Black (9250) and Tan (9255)



COFFEE TUMBLER SAF-CUP-2

- 16 oz. stainless tumbler with black matte finish
- Safariland logo printed in red and liquid gold on one side



COFFEE MUG 935/SAF-CUP-MUG

- Bianchi is gloss with metallic logo; 14-oz. capacity
- Safariland is matte; 17-oz. capacity



Back

SAFARILAND® LONG-SLEEVE PERFORMANCE T-SHIRT TS-2900

- Team Safariland competition long-sleeved shirt
- Moisture-wicking fabric helps keep the wearer cool in hot environments and warm in cold ones
- Black with silk-screened Safariland logo on front, back, and forearms
- Available in sizes S-XXL



SAFARILAND® PERFORMANCE T-SHIRT TS-3200

- Moisture-wicking fabric helps keep the wearer cool in hot environments and warm in cold ones
- Black with silk-screened Safariland logo on upper front chest and upper back
- Available in sizes S-XXL



SAFARILAND® MEN'S/WOMENS PERFORMANCE POLO SHIRT TS-6600/TS-6610

- Moisture-wicking fabric helps keep the wearer cool in hot environments and warm in cold ones
- Black with embroidered Safariland logo on upper left chest
- Available in sizes S-XXL



NEW

TS-6600 SAFARILAND® MEN'S PERFORMANCE POLO SHIRT

- 100% polyester wicks away perspiration to keep you cool in the heat and warm when it's cold
- Safariland logo on chest of shirt
- Available in White
- S-XXL



930

930S

BIANCHI®/SAFARILAND® COASTERS 930/930S

- Vegetable tanned full grain premium leather
- Suede lined with border stitching
- Set of six in leather holder
- Embossed with brand logo



DECAL BIA-DECAL /SAF-DECAL

- Bianchi – 9.25" x 4.75; adhesive on back
- Safariland – 6" x 6"; adhesive on back
- Safariland – 3" x 3" adhesive on back (not shown)



FIREARMS ACCESSORIES

For decades these three legacy brands have made up the most honored names in the firearms accessories marketplace with products ranging from premium cleaning accessories and maintenance equipment to chemicals, and scope mounts. KleenBore®, Break Free® and the Rogers brand have been proud suppliers of products for our military, law enforcement, and hunting and shooting enthusiasts.

CLEANING KITS

CLASSIC CLEANING KITS

- These Classic kits feature the best made cleaning components in the industry
- Securely packaged in a rugged, reusable polypropylene storage carrying case
- Rods in the Handgun, Rifle and Muzzleloading Kits are made of a smooth, high-grade steel with a black oxide finish and rotating handles
- Plastic muzzle guard protects the crown of the barrel
- Shotgun kits feature a polished aluminum, three-sectioned rod set
- 2 oz. Break Free® CLP® to clean, lubricate and protect the firearm
- Double-ended nylon utility gun brush
- 100% cotton patches



CLASSIC HANDGUN KITS

Part #	Caliber/Gauge
K211	.22
K215	.32
PK210	.38/.357/9mm
K220	.40/.41/10mm
K212	.44/.45

CLASSIC RIFLE KITS

K205	.22/.223/5.56mm
K204	.243/.25/6.5mm
K206	.264/.270/7mm
K207	.30/7.62mm
K208	.338/8mm
K209	.41/.45

CLASSIC SHOTGUN KITS

SH0216	12
SH0217	20

CLASSIC UNIVERSAL MUZZLELOADING KIT

BK214	All Handguns/Rifles/Shotguns
-------	------------------------------

CLASSIC SMALL BORE KITS

K17	.17
K20	.204

CLASSIC UNIVERSAL KITS

UK213	All Handguns/Rifles/Shotguns
SAF300	All Handguns/Rifles/Shotguns

CLASSIC KIT CONTENTS

	STEEL ROD WITH SWIVEL HANDLE		ALUMINUM ROD		SHOTGUN ACCESSORY ADAPTER	ACCESSORY ADAPTER	NYLON BRISTLE GUN BRUSH	PHOSPHOR BRONZE BORE BRUSH	COTTON BORE MOP	SLOTTED PATCH HOLDER	BRASS CLEANING JAG	BREAK FREE® CLP®	COTTON CLEANING PATCHES	MUZZLE GUARDS
	SECTIONS	LENGTH"	SECTIONS	LENGTH"										
UNIVERSAL	4	30			•	•	•			2		•	•	•
RIFLE	4	30				•	•	•		•		•	•	•
HANDGUN	1	10				•	•	•		•		•	•	•
SHOTGUN			3	32			•	•	•	•		•	•	
MUZZLELOADING	5	37			•	•	•			2		•	•	•
SMALL BORE	3	34					•	•	•		•	•	•	

CLEANING KITS



TACTICAL MAINTENANCE SYSTEM

TAC100

- A universal gun care system to cover all the popular law enforcement firearms (.223/5.56mm | .30/7.62mm | .38/.357/9mm | .40/.41/10mm | .44/45 calibers | 12-gauge)
- Rugged, zippered bi-fold pouch with internal compartments
- Five-piece steel universal cleaning rod with muzzle guard
- Six phosphor bronze brushes (popular enforcement calibers and gauges)
- Five brass patch jags
- 2 oz. No. 10 Copper Cutter Solvent
- ½ oz. Break Free® Lubricant/Protectant
- Assorted cotton patches
- Silicone Gun and Reel Cloth
- Shotgun adapter
- Shotgun patch holder
- Double-ended nylon gun brush
- Chamber-Flag

FIELD PACK KITS

- These compact, easy to carry, go anywhere kits are favorites of hunters, law enforcement and the military
- Everything needed for a complete cleaning is included in the rugged nylon pouch with a belt keeper or modular webbing attachments, hook and loop closures and compartments for rod and accessories
- In the field or on the range, these kits are compact enough to carry for fast and easy removal of impacted mud, snow or a squib load



Part #	Color	Caliber/Gauge
POU300T	Tan	Universal
POU301B	Black	All Caliber - Handgun/Rifle
POU302B	Black	AR-15/M16 .223/5.56mm
POU302T	Tan	AR-15/M16 .223/5.56mm
POU302DC-M	Digital Camo Marine	AR-15/M16 .223/5.56mm



POCKIT HANDGUN KITS

- Handle holds all kit items for convenient storage and carry
- Two-piece sectional steel rods
- Phosphor brush, cotton mop, and brass jag
- The first rod section with muzzle guard, cleans 2" to 5" barrels including most semi-automatics
- Second rod section included for barrels up to 8 3/8"
- Rod sections accept all KleenBore® handgun accessories (#8-32)

- POC220** .22 caliber
- POC222** .38/.357/9mm
- POC224** .40/.41/10mm
- POC226** .44/.45 caliber



CLEANING KITS

CABLEKLEEN™ CABLE PULL THROUGH CLEANING KIT

- A pull through cleaning kit that performs a complete cleaning with each pass
- The combination of the cable's integrated solvent-soaked patch and patch holder brush allows it to be pulled through the bore followed by a wet or dry patch making cleaning quicker and more efficient than using patches and brushes individually
- Each kit contains:
 - > Pull through cable
 - > Caliber specific phosphor bronze patch holder brushes
 - > Cable T-handle and scraper/T-handle fittings
 - > Caliber specific foam squeegee
 - > Triple-action utility brush
 - > Universal cotton patch-pack
 - > ½ oz. BreakFree® CLP® solution

Part#	Description	Caliber/Gauge
CPT-U	Universal	.223/.30/.35/.40/.44/.45/5.56/7.62/9/10mm/12-gauge
CPT-H	Handgun	.22/.357/.38/.40/.44/.45 5.56/9/10mm
CPT-RS	Rifle/Shotgun	.223/.270/.30 5.56/7/7.62mm/12-gauge
CPT-T/3	Tactical/3-Gun	.223/.357/.38/.40 5.56/9/10mm /12-gauge



COMPACT HANDGUN CLEANING KIT CK210

- For cleaning .38/.357 and 9mm handguns
- Precision brass cleaning rods with tight threads for long use
- Robust construction with excellent strength and durability
- Value pack of three components (bronze brush, nylon brush & cotton mop) are perfect for use in light duty and heavy cleaning situations
- Includes a great quality brass patch holder for fast bore cleaning with patches
- All threads are standard #8-32 and interchangeable with most commercially available components
- Comes with sturdy polymer case with internal padding for easy carry and convenient storage

Part#	Use	Caliber/Gauge
SK205	Rifle	.223/5.56mm
SK207	Rifle	.30/7.62mm
SK210	Handgun	.38/.357/9mm
SK220	Handgun	.40/.41/10mm
SK212	Handgun	.44/.45
SK216	Shotgun	12-Gauge

.22 RIMFIRE CLEANING KIT CPT-R

- The Rimfire Cleaning Cable can be used for any .22 caliber rifle or handgun
- The patch holder and brush are permanently attached to this cable to minimize cleaning set-up or steps
- Combines pull-through cleaning technology with dual purpose components
- Comes in a zippered pouch with a tethered clip



KLEENPAK™

- Lightweight and compact
- Caliber specific
- Portable and self-contained
- Packaged in a resealable pouch
- Each kit contains:
 - > Pull through cable with caliber specific brush/mop combination cleaning accessory attached
 - > Nylon Utility Brush
 - > 2ml BreakFree® CLP® solution
 - > CLP Weapon Wipe

CLEANING RODS

VALU-PAK ROD SETS

- This economical cleaning kit is the perfect alternative to purchasing a full kit at full kit price
- All components are the same high quality components as all our rods and accessories with precise specifications and a smooth, tight fit
- Caliber specific kits listed include muzzle guards, patch holders, phosphor bronze brushes and mops
- The VP60 does not contain brushes or mops because of its universal nature
- All items are nicely packed in a storable, reusable clamshell package



- VP60** Universal Handgun/Rifle/Shotgun
- VP61** .22/.223/.225/5.56mm Rifle
- VP63** .30-30/.30-06/.308/7.62mm Rifle

DELUXE ONE-PIECE RODS

- A variety of non-segmented rods in stainless steel and in an array of lengths to meet your needs
- Won't bow, break, bend or fray, which can cause damage to precious rifling

Part#	Caliber/Gauge	Length	Accessories
DR102	.22-.45 Rifle	33"	Slotted Patch Holder
DR106	.22-.45 Benchrest	44"	Slotted Patch Holder



Deluxe Stainless Steel Rod

CLASSIC ONE-PIECE RODS

- A variety of non-segmented rods in steel and aluminum in an array of lengths
- Won't bow, break, bend or fray, which can cause damage to precious rifling

Part#	Caliber/Gauge	Length	Material	Accessories
OP105	.17 Cal./Airgun	33"	Steel	Brush, Mop, Brass Jag
OP106	.22-.45 Handgun	6 1/2"	Steel	Slotted Patch Holder
OP107	.22-.45 Rifle	33"	Steel	Slotted Patch Holder
OP108	Shotgun All Gauges	34"	Aluminum	Slotted Patch Holder Accessory Adapter



Classic One-Piece Steel Rod



Classic One-Piece
Aluminum Shotgun Rod

MULTI-SECTIONAL CLEANING RODS

- KleenBore® rods are precision-machined to exacting tolerances and surface smoothness smoothly allowing brushes and jags to travel efficiently down the bore
- Won't bow, break, bend or fray, which can cause damage to precious rifling
- Durable handles on the rifle and handgun models rotate
- All multi-section rods are packaged in well-made vinyl pouches for long-term storage



S170 SHOWN

Part#	Caliber/Gauge	Sections	Length	Material	Accessories
A171	Shotgun All Gauges	3	32"	Aluminum	Slotted Patch Holder, Shotgun Accessory Adapter
S170	.22-.45 Handgun/Rifle	4	30"	Steel	Slotted Patch Holder, Accessory Adapter
SB169	.17 Small Bore	3	34"	Steel	Phosphor Bronze Brush, Cotton Bore Mop, Jag

CLEANING RODS

SAF-T-CLAD® BORE CLEANING RODS

- Saf-T-Clad® products are the result of a technological breakthrough involving epoxy thermal setting resins
- Resins are carefully applied in the United States on high-grade, solid-steel rods, and securely bond our Saf-T-Clad coating
- This process provides a smooth surface for the ultimate in rifling and bore protection
- For shooters who do a lot of cleaning and expect absolute precision from their equipment

Part#	Description	Caliber	Length	Sections
SAF303	Small Bore Rod	.17/.204	33"	1
SAF302	Handgun Rod	.22-.45	8"	1
SAF400	One-Piece Rifle Rod	.22-.45	33"	1

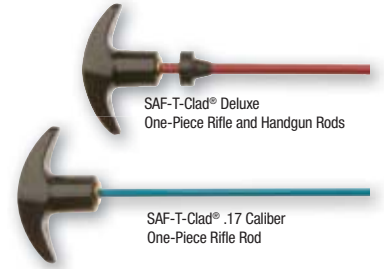

SAF-T-CLAD® UNIVERSAL ROD SET SAF301

- Compact, reusable clamshell case contains a five-section 30" rod with black nylon muzzle guard
- Handgun/rifle patch holder, shotgun patch holder and accessory adapter (.22-.45, all gauges)



MUZZLE GUARD ACC14

- Using a muzzle guard can prevent the damage to the sensitive barrel crown when cleaning from the muzzle end
- A muzzle guard keeps the cleaning rod centered
- Works equally as well when cleaning bolt-action rifles from the muzzle or breech
- Brass for .203 dia. Handgun/Rifle rods



CLAYMATE® SHOTGUN CLEANING TOOL CM270

- The ClayMate is a compact two-section shotgun cleaning tool
- The soft fibers of ClayMate effectively pick up unburned powder, which is lifted by a screw-on phosphor bronze brush providing unbelievably quick and effective cleaning
- Also included is a screw on bore mop for applying a light coating of a favorite KleenBore® solvent or lubricant
- Total assembled length is 36", breakdown length is 19" for easy storage in a gun case or range bag
- Can be easily washed and reused
- For 12/16-gauge



CHAMBERMATE 12-GAUGE SHOTGUN CLEANING TOOL SC225/SC205

- The ChamberMate is a rugged tool with a strong aluminum rod and sure grip handle
- A heavy-duty phosphor bronze brush with tapered nose is made to fit difficult-to-clean areas and is ideal for quickly cleaning 12-gauge muzzle ports from the inside out
- The 12-gauge brush (SC205) is available by itself and is great for cleaning powder fouling and plastic from chambers and choke area

BORE BRUSHES & MORE



PHOSPHOR BRONZE BRUSHES

- These precisely designed brushes feature KleenBore® carefully-made, thicker, straight bronze wire bristles
- Designed with rounded, smoother bristle
- These bronze brushes offer more safe and effective cleaning power
- Will not easily bend from force down the bore
- Guaranteed not to damage precious rifling

Rifle Bore Brushes

A175	.17/.200 Caliber
A177	.22/.223/5.56mm
A178	.243/.25/6mm/6.5mm
A179	.270/7mm
A180	.30/7.62mm
A163	.338/8mm
A181	.35/9mm
A160	.375/.380 Caliber
A182	.44/.45 Caliber
A194	.50 Caliber

Handgun Bore Brushes

A188	.22 Caliber
A189	.32 Caliber
A190	.38/.357/9mm
A191	.40/.41/10mm
A192	.44/.45 Caliber
A193	.50 Caliber

Shotgun Bore Brushes

A183	.410-Gauge
A184	20-Gauge
A186	12-Gauge



BLACK NYLON BORE BRUSHES

- Rugged, stiff, black nylon bore brushes are recommended by many major firearms manufacturers for bore cleaning

Rifle Bore Brushes

A175N	.17/.200 Caliber
A177N	.22/.223/5.56mm
A178N	.243/.25/6 mm/6.5mm
A179N	.270/7mm
A180N	.30/7.62mm

Handgun Bore Brushes

A188N	.22 Caliber
A190N	.38/.357/9mm
A191N	.40/.41/10mm
A192N	.44/.45 Caliber

Shotgun Bore Brushes

A186N	12-Gauge
--------------	----------



MILITARY-STYLE BRUSHES

- All KleenBore® military-style brushes are designed specifically for M16 and AR-15 or similar style rifles
- The M16 brush features core wire looped through a brass coupling that is threaded in #8-36
- The chamber brush is configured with two diameters; the first stage of phosphor bronze cleans the chamber area, while the second stage of stainless steel cleans the bolt-lock area
- Bore brushes are made of phosphor bronze with a brass wire core for a longer life for rigorous cleaning
- Please note the #8-36 thread is not commercially standard, but will fit most KleenBore multi-section rods, standard configuration is #8-32

M16B	.223/5.56mm (bore)
M16C	.223/5.56mm (chamber)



COTTON BORE MOPS

- 100% cotton provides the absolute best absorbency over any synthetic-fiber mop
- Thickest, best cleaning and lubrication mops on the market

Smallbore /Airgun

MOP17	.17/.20 Caliber (#3-48 thread)
--------------	--------------------------------

Handgun & Rifle

MOP22	.22/.223/5.56mm
MOP30	.30/7.62mm
MOP9	.357/.38/9mm
MOP40	.40/10mm
MOP45	.44/.45 Caliber

Shotgun

MOP20	20-Gauge
MOP12	12-Gauge



CABLEKLEEN™ PATCHHOLDER BRUSHES

- Ideal for dual-stage cleaning with cable pull-through kits

Phosphor Bronze

A177MPH	.22/.223/5.56mm
A179MPH	.270/7mm
A180MPH	.30/7.62mm
A181MPH	.35/9mm
A186MPH	12-Gauge
A191MPH	.40/10mm
A192MPH	.44/.45

Nylon

N177MPH	.22/.223/5.56mm
N181MPH	.35/9mm
N186MPH	12-Gauge
N191MPH	.40/10mm



BLACKPOWDER BRUSHES .50 CALIBER BP194

- The bristles extend completely to the tip to clean the entire chamber

BRUSH & MOP THREAD SIZE

TYPE	THREAD SIZE
Handgun/Rifle/Patch Holder	#8-32
Shotgun/Blackpowder	5/16"-27
Small Bore .17, .204 caliber	#3-48
M16/AR-15 Military-Style Brushes	#8-36

CLEANING ACCESSORIES/ADAPTERS

CABLEKLEEN™ TRIPLE ACTION UTILITY BRUSH

UT221C

- Allows you to get into tight areas to clean. Three different banks of bristles to clean bolts, bolt faces, rails, receivers, and other gun parts as necessary

NYLON BRISTLE GUN BRUSH

UT221

- This military-style brush is great for cleaning any type of firearm, especially where a gentle touch is required. Nylon bristles are rugged and solvent-resistant

STAINLESS STEEL GUN BRUSH

UT222

- Rugged stainless steel bristles make short work of caked-on powder residue and burn marks on revolver top straps, frames and cylinders

PHOSPHOR BRONZE GUN BRUSH

UT223

- A superb, general purpose, gentle-on-the-finish brush for cleaning powder and lubrication residue from handguns, rifles and shotguns



UT221C



UT221



UT222



UT223



MAGBRUSH MAGAZINE BRUSHES

- Important item for competitive shooters, law enforcement and the military
- The MagBrush removes gummy residue, dust, dirt and unburned powder from inside the magazine
- Provides quicker, easier magazine release and increased cartridge-feed reliability

- MAG200** .22/.25/.380/9mm Straight Stacked
- MAG202** 9mm/10mm/.40/.45 Staggered
- MAG204** .38/.40/10mm/.45 Straight Stacked
- MAG206** AR-15/M-16/AK-47



MAGSWAB MAGAZINE SWAB

MAG208

- 9mm staggered/.38/10mm/.40/.45
- Companion to the MagBrush series, the MagSwab can be used with a solvent to mop clean the inside of magazines
- Have an additional MagSwab on hand to solely apply a light coat of lubricant to protect both areas after cleaning



ACC10



ACC11



ACC16



ACC17

ROD ADAPTERS

These carefully crafted accessories guarantee perfect, smooth mating to rods, preventing peeling or mismatched segments that can seriously damage bores

SLOTTED PATCH HOLDERS

Part#	Description	Use/Caliber/Gauge
ACC10	Steel Handgun/Rifle	.22-.45
ACC11	Brass Handgun/Rifle	.22-.45
ACC16	Nylon Shotgun	All Gauges

ACCESSORY/CONVERSION ADAPTERS

ACC17	Aluminum Accessory Adapter	Accepts all KleenBore shotgun accessories (5/16-27)
-------	----------------------------	---

CLEANING JAGS

CLEANING JAGS

- A metal jag, draped with a proper sized patch, completely covers the entire bore for efficient, thorough cleaning
- For ease of use, KleenBore® unique design incorporates a special barbed point at the tip of the jag to secure the cleaning patch and prevent solvent soaked patches from falling off

AIRGUN/ SMALL BORE CLEANING JAG

Part#	Caliber/Gauge
JAG226	.177/.200 Airgun
JAG17	.17-.204 Caliber

HANDGUN/RIFLE CLEANING JAGS

JAG227	.22-.25 Caliber
JAG228	.270-.32 Caliber
JAG229	.38/.357/9mm
JAG230	.40/.41/.410/10mm
JAG231	.44/.45 Caliber

SHOTGUN CLEANING JAGS

JAG233	20/16-Gauge
JAG234	12-Gauge



COTTON PATCHES/CLOTHS

GUN CLEANING PATCHES

Premium quality 100% cotton flannel provides maximum absorbency and bore protection. These patches are precision cut to ensure the proper fit and maximum cleaning performance when used in conjunction with our cleaning jags or patch holders.

These same quality 100% cotton patches are available bulk-packaged for high volume users such as competition shooters, gun clubs, law enforcement agencies, gunsmiths, and others.

Part#	Size	Caliber/Gauge	Quantity
P200	7/8"	Small Bore	100 count
P201	1 1/4"	.22-.270 Caliber	100 count
P202	1 3/4"	.28-.35 Caliber	75 count
P203	2 1/4"	.38-.45/.410 - 20-Gauge	50 count
P204	3"	12/16-Gauge	25 count
P206	4"	Big Bore Shotgun	25 count
CP16B	1 1/4"	.22-.270 Caliber	500 count
CP17B	1 3/4"	.28-.35 Caliber	500 count
CP13B	2 1/4"	.38-.45/.410 - 20-Gauge	250 count
CP18B	2 1/4"	.38-.45/.410 - 20-Gauge	500 count
CP14B	3"	12/16-Gauge	250 count
CP19B	3"	12/16-Gauge	500 count
CP21B	1 1/4"	.22-.270 Caliber	1000 count



SILICONE GUN & REEL CLOTH GC220S

- Restore and protect the luster of a firearm with our top-quality silicone injected cotton flannel
- Returns a brilliant sheen to firearms surface
- Removes handling marks, fingerprint oil, and provides a layer of rust protection
- 100 square-inch cloth



LEAD AWAY® CLEANING CLOTH GC221

- This chemically treated cloth is ideal for removing tough lead and carbon build-up
- Excellent for removing burn rings on cylinders and on stainless steel
- 110 square-inch cloth
- **Caution:** excessive rubbing may remove bluing



LEAD AWAY® PATCHES LP199

- Lead Away® Patches wipe away stubborn carbon and lead build-up
- (25) 1 1/4" square patches in a re-sealable clamshell package

RANGE ACCESSORIES



SHOOTERS PREMIUM RANGE BAG KBSB1

- Extremely durable 18" x 13" x 10" nylon range bag with heavy-duty zippers
- Six different compartments with two removable gun pouches in zippered cases
- Padded top and side pockets safeguard eye wear and hearing protection
- Convenient option to hand carry or use the padded nylon shoulder strap
- 14" x 10" x 10" center pocket has two dividers providing multiple configurations

VAPOR CORROSION INHIBITOR (VCI) GUNNSOCKS

- Corrosion in storage can be a real problem for firearms collectors and enthusiasts
- Utilizes the KleenBore® Vapor Corrosion Inhibitor technology
- VCI technology penetrates into the smallest cracks and crevices of firearms that oils cannot reach, offering long-term protection
- VCI Gunnysock better fits scoped firearms and provides a cushioning layer of fabric around valuable firearms
- Slides over mounted scope
- Perfect for seasonal storage and travel

GSVCI160 Handgun
GSVCI161 Rifle/Shotgun



BORE INSPECTOR® BL304

- Fiber optic lights the bore of handguns, rifles and shotguns to make checking for leading, fouling, and rust fast and easy
- Ideal for regular firearms maintenance or for examining used guns prior to purchase
- Two AAA replaceable batteries supplied



CHAMBER FLAG

- On the range and when transporting or storing semi-automatic handguns, a chamber flag immediately indicates that the gun is clear and no round can be chambered
- Comes with 2 per pack

CF9 .45/9mm
CF22 .22 Caliber



BAD GUY TARGET K5

- 23" x 35"
- Paper

CLEANERS/SOLVENTS



NO. 10 COPPER CUTTER (2 oz.) C10

- Reformulated for even better removal of copper and other fouling, this premium, high-strength solvent rapidly turns blue as it aggressively cuts through copper
- No blue, no copper
- Also ideal for removing plastic fouling
- Child-resistant cap



Made in the USA



GUNK-OUT™ CLEANER DEGREASER (15 oz.) G05A

- Gunk-Out quickly blasts away caked-on oil contaminated with dirt, dust and powder residues
- This chemical is also great for flushing out loosened fouling and for degreasing prior to bluing

NO. 10 GUN CLEANING SOLVENT

- Tried and true, No. 10 is a fast, efficient solvent that quickly penetrates and lifts lead, powder residue, and metal fouling for quick, easy cleaning

S10 2 oz. with Child-Resistant Cap
S10S 2 oz. with Pump Spray



S10 S10S



BLACK MAGIC™ BLUING SOLUTION (2 oz.) GB2

- This premier, high performance cold bluing solution, previously available only to gunsmiths, produces a deep, penetrating action to restore worn or scratched gun metal to like-new finish
- Black Magic is the choice of major firearms manufacturers for touching up guns before they leave the factory
- Packaged in a container with a child-resistant cap and expert, easy-to-follow instructions
- Child-resistant cap

CLEANERS/LUBRICANTS/PROTECTANTS

Made in the
USA



CLEANER LUBRICANT PRESERVATIVE (CLP®)

- Originally developed for the U.S. Military and proven in the world's most extreme conditions
- Break Free® CLP® is the gold standard formula for the ONE STEP lubricating and protectant firearm solution
- More than a superior lubricant, CLP actually cleans firing residue and other contaminants from the bore, moving parts and exterior of firearms while simultaneously reducing friction and protecting from corrosion

Part#	Description	Accessory
CLP-2	4 oz. Aerosol Spray	Extender Tube
CLP-3	1/2 oz. Squeeze Bottle	Dropper Tip
CLP-4	4 oz. Squeeze Bottle	Extender Tube
CLP-5	1 Pint Bottle	Trigger Spray
CLP-7	1 Gallon Jug	–
CLP-8	1 Liter Bottle	Trigger Spray
CLP-11	2 oz. Bottle	Pump Spray
CLP-12	12 oz. Aerosol Spray	Extender Tube
CLP-16	.68 oz. Squeeze Bottle	–
CLP-20	2 oz. Bottle	Child-resistant Cap
CLP-PS	7.5ml Tube	Needle Applicator



MULTI-SURFACE WIPES BFI-WW

Break Free® Multi-Surface Wipes are soft, absorbent, non-woven cloth wipes pre-saturated with Break Free CLP®. Eliminates the need for messy oils, cleaners and cut cloths.

- Cleans and maintains small arms and rifles for use in all weather conditions
- Ideal for fishing equipment, knives and other outdoor gear
- Includes twenty 6¾" x 3" wipes



INDIVIDUAL MULTI-SURFACE WIPES BFI-IWW

- Individually packaged Break Free® Multi-Surface Wipes
- Packaged in a POP countertop display of 50 each

LUBRICANTS/PRESERVATIVES



COLLECTOR® (4 oz.) CO-4

Developed to protect firearms for up to five years in storage, Collector® exceeds stringent military specifications. Recommended for the occasional hunter or sports shooter as well as knife and sword collectors. It's ideal for seasonal sports equipment before placing in storage. In one test, Collector protected steel panels from rust and corrosion for over 1200 hours in 100% humidity.

- Does not degrade to waxy residue under heat or pressure
- Resists damage from fingerprint residue and minimizes the need for frequent wipe down
- Perfect for gun collectors, armories and museums

Made in the
USA



LP PRECISION SHOOTER® LP-PS

- Needle-style applicator that delivers 7.5ml of LP
- Allows precision lubrication where the slide meets the frame in hard to reach areas to prevent rust
- Formulated for semi-automatic firearms



LP-5 LP-4

LUBRICANT PRESERVATIVE (LP)

- Originally developed for fully automatic cannons used by the U.S. military. Break Free® has taken this technology designed to keep weapons working under sustained fire and brought it to the consumer market
- Contains specially formulated polymerized synthetic oils for improved boundary film strength, plus multiple ingredients to reduce friction, stop build-up of foreign particles and inhibit rust and corrosion
- Safe for all gunmetal and gunmetal finishes from blued steel to titanium as well as polymer composite firearms. Also prevents galling on stainless steel
- Non-solvent formula minimizes drain off when firearm is holstered

- LP-3 .5 oz. squeeze bottle with dropper tip
- LP-4 4 oz. squeeze bottle with extender tube
- LP-5 1 pint bottle with trigger sprayer



CLEANERS/SOLVENTS



BORE CLEANING FOAM (3.06 oz.) BCF-3

- Gently cleans using a chemical reaction to remove copper and brass compounds with no mechanical friction
- Quickly removes residue in 15 minutes
- Protects with a film that slows down renewed accumulation of similar residues
- Foam application runs less than other cleaning agents, such as ammonia-based products
- Efficiently removes normal combustion waste, eliminating the need for a second cleaner
- Non-toxic, odorless, PH value of 12
- Usable in temperatures between -30° and 50° Celsius



CARBON CUTTER® (4 oz.) CAC-4

- Carbon Cutter® was specially formulated to cut carbon buildup from your firearm.
- Carbon Cutter® liquefies the carbon from any weapon barrel.
- Ideal for removing carbon from black powder rifles
- Removes blackpowder
- No ammonia
- PH neutral

Made in the
USA



POWDER BLAST™ (12 oz.) GC-16

- Powder Blast™ keeps all guns clean and dry by blasting away firing residues. Use it on trigger groups and mechanisms to quickly and easily remove contaminants, without leaving a white residue or unpleasant odor
- Eliminates powder residue, plastic streaking, grease and oil build-up
- No disassembly required – the extender tube provides easy access to hard-to-reach areas
- Will not hydrolyze to form hydrochloric acid, unlike products containing 1,1,1 Trichloroethane
- After using Powder Blast, protect firearms with Break Free® CLP®, or Collector® products

ACCESSORIES/MOUNTS



PRO GUNSMITH SCREWDRIVER SET T0045

- 26 hardened steel bits: Phillips, Slotted, Hex, Torx, and Posi-Drive
- Three long bits for recoil pad and see-thru mount installation
- A full-featured screwdriver with 1/4" socket drive adapter
- All housed in a sturdy molded case with individual compartments for each item



SPORTING RIFLE MOUNTS T0045

- Requires no gunsmithing and installs in minutes
- The quick-detach mounts have return-to-zero capability and sport extra-long ring mount rails to achieve maximum eye relief adjustments
- Popular hunting mounts include a pair of 1" InterLock™ rings and carry limited lifetime warranty protection
- B-Square is the leading manufacturer of Ruger to Weaver adapters
- The adapters lock onto the firearm and provide an extra long Weaver style rail so you can mount any optic on your Ruger rifle

Part#	Model	Finish
14502	Ruger Mini-14 181 series and later	Black
14506	Ruger Mini-14 181 series and later	Stainless Steel
14600	Savage 340, 840, 890, 322 Hornet Stevens 322, 325, 342 Westernfield	Black



MILITARY MOUNTS

- B-Square scope mounts for sporting rifles require no gunsmithing and install in minutes
- The quick-detach mounts have return-to-zero capability and sport extra-long ring mount rails to achieve maximum eye relief adjustments
- Popular hunting mounts include a pair of 1" InterLock™ rings and carry limited lifetime warranty protection
- B-Square is the leading manufacturer of Ruger to Weaver adapters
- The adapters lock onto the firearm and provide an extra long Weaver style rail so you can mount any optic on a Ruger rifle

MODERN MILITARY MOUNTS

Part#	Model
18600	AK-47/MAK-90 - 1" Rings Included

BUBBLE LEVEL

- Ensures bore alignment and reticle alignment at a glance
- White scribed line on housing for quick reference

T1005 11mm Dovetail
T1006 Weaver



RUGER TO WEAVER® ADAPTERS T0045

- Unique cam system locks base in place
- Ruger 96/44, M77/22, M77/44, M77/ ML Mini 14 & Mini 30 Ranch
- Adapts most Ruger rifles with integral receiver mounts
- Standard dovetail base
- Rings not included

14507 Matte Black finish
14508 Stainless finish



MOUNTS/RINGS

HANDGUN MOUNTS

- No gunsmithing required; handgun mounts integrate with the handgun's original components to assure optimum performance with every trigger pull, and are superior to any grip-mounted system
- Rimfire mounts use existing screw holes for a rock solid foundation
- Revolver mounts lock to the firearm using the ventilated rib or existing pre-drilled holes
- Rib mounts are full length for maximum eye relief adjustment
- Every mount is specifically designed to precisely follow the handgun's aesthetic lines
- Rings not included



REVOLVER

Part#	Model	Finish
42214	Browning Buckmark .22 Universal	Black

SEMI AUTO PISTOL

Part#	Model	Finish
42306	Taurus 44 Magnum, 607, 608 6" & 8" barrel with vent rib	Stainless Steel

SHOTGUN SADDLE MOUNTS

B-Square Shotgun Saddle Mounts are the industry standard for mounting optics on shotguns without having to use a gunsmith. Perfect for slug guns as well as today's tight patterning turkey shotguns, B-Square saddle mounts are carefully contoured to provide a nearly "factory fit" and are designed to channel recoil away from the mounting screws. The full length rail on top of the mount allows for maximum scope placement options for proper eye relief. These innovative designs provide a convenient, secure and stable platform for mounting optics on shotguns.

- Available for most popular shotguns
- Channels recoil away from mounting screws
- Full length receiver rail for maximum eye relief
- Easy to install
- Includes 1" rings

Part#	Mfg.	Model
16305	Benelli	Nova 12-Gauge
16500	Maverick	88 12-Gauge
16500	Mossberg	500 12-Gauge
16585	Mossberg	535/835 12-Gauge
16812	Remington	870 (12 & 20-Gauge w/ serial X/N)
16812	Remington	870 Express 3.5" Mag
16820	Remington	870 20-Gauge Express LT
16900	Winchester/ USRAC	1200, 1300, 1400, 1500 12-Gauge

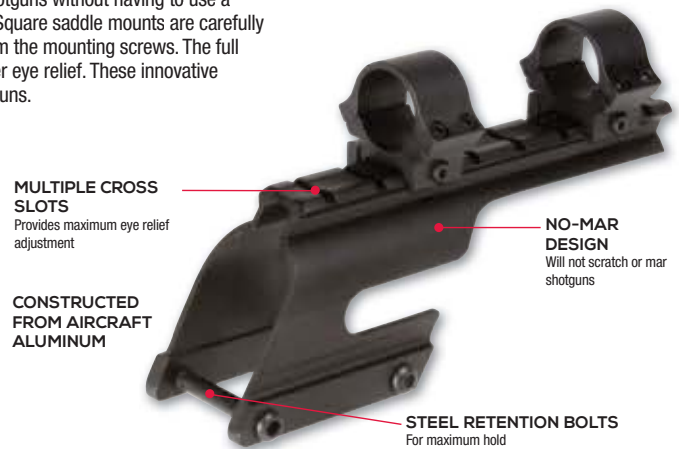

SPORT UTILITY SCOPE RINGS

- Wraparound design
- Lightweight, affordable strength
- Maximum scope retention and twice the clamping area
- Hex key included



Sport Utility Rings

SPORT UTILITY RINGS

Ring Size	Rail Style	Black Matte Finish		
		Low	Med	High
1"	Std.	20052	20054	20056
1"	3/8"	27052	27054	27056
30mm	Std.	20062	20064	20066

UNIVERSAL CANTILEVER MOUNT 16175

- Rings not included
- Ribs up to 3/8"



3/8" TO WEAVER ADAPTER AIRGUN MOUNTS 17025

- 2-piece base
- Rings not included

AR ACCESSORIES



Bill Rogers is a renowned firearms expert, entrepreneur and manufacturer of high-quality products for recreational and tactical shooters. Our Rogers line of AR accessories designed for shooters who want the best in black gun accessories. With innovative products ranging from forend rail kits, grip adapters, magazine doublers and adjustable stocks, to a variety of complementary rails, mounts and ring sets, this line was developed for novice to expert shooters who are driven to optimize the performance of their favorite AR series weapons.

22028

AR FURNITURE KIT

One convenient kit that groups the necessary Rogers items to upgrade a basic AR-15

- Kit includes:
 - > Super-Stoc
 - > Mag Grip
 - > Dual Mag Coupler
 - > Tri-Rail
 - > Single Point Harness
 - > Available in Black and Flat Dark Earth



22048

ROGERS SUPER-STOC® COLLAPSIBLE GUN STOCK

- Can be locked down to virtually eliminate movement in the stock
- Provides comfortable, secure shoulder rest for weapon
- Can be quickly converted to fit commercial or Mil-Spec buffer tubes
- Sling loop and quick detach mounting point provided for wide variety of harness/sling options
- Removable recoil pad
- Dual-release unlocking lever
- Survives 2 ft fully loaded drop test
- Lightweight , 7.3 oz
- Available in Black, Flat Dark Earth and OD
- Made in the USA



Made in the
USA



22028

SUPER-STOC CHEEK PAD

- Cut to fit Rogers Super-Stoc®, but will fit most rifle stocks
- Made of soft neoprene
- Simple peel and stick installation



Made in the
USA

66411

DUAL MAG COUPLER

- Quick, efficient reload with second magazine
- Proper staggering of magazine to clear ejection port
- (2) top round protectors keep cartridges in proper position and dirt out of magazines
- Protects base pad of magazine when dropped
- Does not crush magazine
- Excellent for seated and prone shooting positions
- Available in Black and Flat Dark Earth
- Made in the USA



AR ACCESSORIES



Made in the
USA

64322

TRI-RAIL

- Allows for quick attachment of (3) rails to forward end of AR15, M4 and M-16 rifles
- Can attach (2) accessories to upper forearm and (1) to bottom rail
- Lightweight
- Can be reversed to have (1) rail on top with (2) below
- Locks securely into place using holes in standard forend
- Available in Black and Flat Dark Earth
- Made in the USA



Made in the
USA

1028

MAG GRIP

- Easy to install – no tools or hardware required
- Composed of a lightweight, heavy-duty polymer
- Top of grip is extended to provide greater control and comfort
- Provides improved weak hand weapon control
- Beveled opening at the bottom facilitates smoother & faster reloads
- Available in Black and Flat Dark Earth
- Made in the USA

ROGERS ACCESSORIES

64101

MAG WELL GRIP

- Drop-in fiber reinforced polymer composite adapter
- Flare at the bottom of the grip aids in stability
- Funnels magazine into the grip helping in rapid reload situations
- Protects end of grip in case of accidental impact
- No modification to the gun to install grip
- Specifically designed for Glock models 17, 22, 34, 35 & GEN 4

64107 17, 22, 24, 31, 34, 35 & 37 GLOCK GEN 1/2/3
64180 19, 23 GLOCK GEN 1/2/3/4



ROGERS ACCESSORIES



64351 SINGLE POINT HARNESS

- Provides comfortable, secure shoulder rest for weapon
- Allows easy transition from low ready, to firing, to around the back positions to free up hands
- Quick detachment point provides instantaneous attachment and detachment from the weapon
- Features a lock-out system to prevent against accidental detachment
- 160 lbs. break-away prevents accidental and potentially dangerous entrapment
- Single point attachment bracket comes standard for the AR-15/M4 rifle with collapsible stock buffer tubes
- Made of durable nylon
- Available in Black and Flat Dark Earth

64352 with No Adapter
64370 with Remington Adapter
64371 with Mossberg 500-590



Made in the
USA

64374 SINGLE POINT HARNESS ADAPTER KIT

- Mounting adapter interface between the Rogers Single Point Harness line and AR-15/M4 firearms
- Engineered for OEM quality, style and performance on AR-15/M4 platform
- Features a lock-out system to prevent against accidental detachment
- Installs easily between the stock and buffer tube
- 160 lbs. break-away safety feature prevents accidental and potentially dangerous entrapment

64372 Rem 870, 100, 1187
64373 Mossberg 500-590



65139 ROGERS LIGHT SYSTEM

- Attaches to gun in two quick and easy steps - quickly transitions from standard flashlight to weapon illumination
- Super bright LED light (980 Lumens)
- Four different brightness settings, including strobe
- Fits most handgun models that incorporate an integral rail system, also mounts to rifles and shotguns that have a Picatinny rail
- Integral Clip to easily secure to belt
- Ambidextrous



66015/66019 SHOTGUN SHELL HOLDER

- Molded shotgun shell holder to hold two 12-gauge shells
- Available as screw mounting platform for shotgun stock or other surfaces, or with a belt clip

66015 Clip On
66019 Rivet On



64098 ROGERS SIGHT MOUNT

- Quick-detach mount for red-dot optics with a Picatinny Rail
- Quickly remove and attach optics without the use of tools or cumbersome fasteners
- Solid mounting system that will hold zero
- Included shims allow height adjustment so optics can be co-witnessed with iron sights

ROGERS ACCESSORIES

64388

ADVANCED GUN CLEANING SOLUTION KIT

- Remove or dissolve any carbon, burnt powder residue, copper fouling, and lead fouling, to completely clean any pistol, rifle or shotgun
- Kit includes:
 - > Advanced Bore Cleaning Solution
 - > Action Cleaning Gel
 - > Gun Cleaning Rinse Concentrate
 - > Premium Lubricant Spray Nozzle
 - > Complete cleaning instructions



PATENTED

64339

ULTIMATE BORE SQUEEG-E® KIT

- Patented Squeeg-e provides advanced cleaning without the use of patches
- Complete system includes everything needed to clean all firearms from a .22 pistol to a 12-gauge shotgun

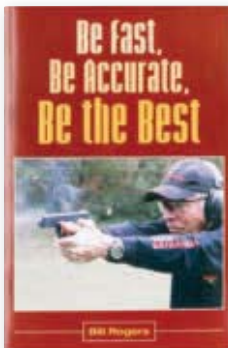

66502

BE FAST, BE ACCURATE, BE THE BEST. BOOK

Bill shares his life experiences to bring the readers into the world of Reactive Shooting. He then takes them through a step by step program to make them safer and more competent gun handlers, as well as giving them the skills to survive a real life battle.

64394

TAP RACK TRAINING AID

- Most efficient way to practice dry fire drills
- Place in the magazine to prevent the slide stop from engaging
- Slide passes over training aid so device does not need to be re-loaded into the magazine for continual training
- Can be used improperly seated in magazine for malfunction drills
- Available in 3, 20 and 100-packs in Orange, Yellow and Blue



64394 9mm & 40 cal.
64395 45 ACP
64396 5.56

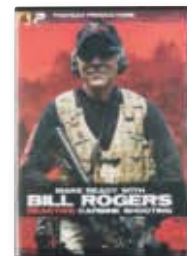
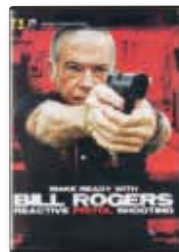

66500/66501

MAKE READY WITH BILL ROGERS DVDS

- Reactive Pistol Shooting - Bill Rogers walks you through Rogers Shooting School steps to teach reactive pistol shooting and how to accurately draw and knock down plates in .5 seconds
- Reactive Carbine Shooting - Successfully engage and hit small reactive targets that are moving and only exposed for a fraction of a second



GLOVES

The Hatch® name has been synonymous with the finest in protective performance gloves since 1967. Using the finest leathers and advanced synthetic materials, Hatch offers an extensive line up of quality designs for cut-resistance, cold weather, hard-knuckle protection and more to meet the needs of uniformed duty, tactical, corrections, military and industrial safety/medical rehabilitation markets.

TASK SPECIFIC GLOVES

The Task Specific Line of gloves was created to precisely meet the demands of shooting enthusiasts, uniformed and tactical law enforcement and the military. Extensive research and field testing led to the development of nine distinctive glove models, each designed to fulfill the needs of a different task and with the five points of innovation consistent throughout the line.

FIVE POINTS OF INNOVATION



SIGNATURE ERGO-CUT[®] FLOATING THUMB



ALL-SOFT COMPRESSION CUFF



ARTICULATED STRAP



TOUCHSCREEN KNUCKLE



PATENTED TRIGGER FINGER CUT RING



PATENTED

TASK MEDIUM TSK324

- Durable synthetic palm with touchscreen capabilities in all fingers
- Soft and lightweight, breathable stretch material on back of hand
- Hatch touchscreen technology
- Reinforced fingertips
- Sizes: S-2XL



PATENTED

TASK LIGHT LEATHER TSK323

- Genuine goatskin leather palm
- Soft and lightweight, breathable stretch material on back of hand
- Touchscreen feature on middle finger knuckle
- Great for fine motor skill requirements
- Sizes: S-2XL



PATENTED

TASK HEAVY KNUCKLE TSK326

- Patented Z-pattern palm with diamond grip for heavy-duty applications
- Shock absorbing TPR (Thermoplastic Rubber) knuckle
- Durable synthetic palm material with touchscreen technology in index finger
- Soft, lightweight and breathable stretch material on back of hand
- Reinforced fingertips
- Sizes: S-2XL

SEE THE ENTIRE TASK SERIES LINE AT SAFARILAND.COM/HATCH



ROGERS SHOOTING GLOVE

- Interlocking textured pads run up both sides of the fingers and palms for excellent grip
- Trigger finger and edge of palm are not textured to allow for quick indexing of the handgun
- LYCRA[®] material is stitched into panels to allow for greater dexterity and air flow
- Provides better grip, less hand fatigue, and helps prevent blistering
- Adjustable hook and loop straps on back of hand
- Sizes S-XL

CONSUMER WARNING:

Safariland® and Bianchi® holsters and duty gear products are designed to meet the demand for high-performance products for law enforcement and civilians. Fitted and used properly, a holster is a valuable aid in carrying a firearm. Because holsters are used to carry firearms, however, any person purchasing or using a Safariland or Bianchi holster should read and understand the following warning and all instructions included with his or her holster, as well as be thoroughly familiar with the proper and safe use of his or her firearm in the circumstances in which he or she is using it.

Close tolerances for holster/handgun fit require consistent handgun specifications and characteristics as well as extremely precise holster design. Safariland produces its products in this manner of quality materials with efficiency and safety in mind. Although these warnings may not pertain to all Safariland products, or all circumstances, they should be read prior to the purchase, sale or use of any Safariland or Bianchi product. Some products have special and/or supplemental instructions and/or safety information that must be read prior to their use.

TRAINING AND PRACTICE

Use of a handgun under any circumstance may be dangerous. **SERIOUS INJURY OR EVEN DEATH** may result without proper training in the safe handling of firearms. Proper training should be obtained from an accredited firearms safety program conducted by competent, qualified instructors in the military, police academies or National Rifle Association-affiliated instruction programs. A firearm should not be carried or used without a thorough knowledge of its characteristics and safe use in the circumstances in which it is intended to be used. It is also the user's responsibility to be certain that his or her firearm is in proper, safe operating condition.

We strongly recommend a regular holster practice regime be utilized to ensure the continued capabilities of both the Safariland product and its user. The Safariland Training Group has many shooting courses available.

PROPER HOLSTER FIT

NEVER PLACE A LOADED HANDGUN IN A HOLSTER WITHOUT FIRST TESTING FOR PROPER FIT WITH THE HANDGUN UNLOADED. Although Safariland attempts to provide accurate information regarding which specific holster models were designed to accommodate a specifically identified handgun, or handguns, Safariland does not warrant the accuracy of such information and specifically disclaims any responsibility or liability for, or consequences resulting from, errors or inaccuracies in such information. Users are advised not to rely on such compatibility information but are advised to personally verify holster/handgun compatibility in each and every case using actual products.

Handgun manufacturers continually update manufacturing specifications in their quest for better products. These changes may occur one or more times within a particular handgun model year, and make it difficult for proper handgun identification and holster fit.

The slightest change in handgun design can have a major safety effect on the close tolerance of Safariland and Bianchi products. These changes may not affect other holster brands that do not maintain The Safariland Group's high standards.

If the user has any questions or doubt concerning holster fit, contact The Safariland Group immediately as to which version of a particular handgun you and/or your customer may possess and its compatibility with Safariland or Bianchi holsters.

Be advised that it is the user's responsibility to periodically check his or her holster and related hardware for proper fit and function. Should any product, including a Safariland or Bianchi product, become worn, loose, broken, defective or ill-fitting, **CEASE USE IMMEDIATELY.**

OTHER VERY IMPORTANT WARNINGS

DO NOT use Safariland or Bianchi holsters with custom or modified guns or broken, worn or inferior manufactured guns, including guns that are not of original factory specifications. **DO NOT** use after-market grips not manufactured by Safariland, grip adapters, target hammers, target triggers or trigger shoes. After-market handgun modifications may cause improper holster fit and **ACCIDENTAL HANDGUN DISCHARGE.** Never attempt to modify Safariland or Bianchi products in any way.

Do not attempt to cock a handgun while holstered, as such cocking can cause severe damage to either the handgun or holster, or both, and may cause an **ACCIDENTAL DISCHARGE.**

Some users of certain handgun models insist on carrying the weapon in what is referred to as a cocked and locked condition (i.e., the gun is cocked with the safety engaged). Safariland does not recommend or approve of any such practice, and advises against it. This condition for such handguns should be reserved only for the most advanced, experienced and skilled professional shooters under conditions that require the handgun to be drawn and fired under extremely short time constraints. Carrying a handgun in this condition **INCREASES THE RISK OF ACCIDENTAL DISCHARGE.** It should only be used by those who have the training and experience to recognize the inherent risks associated with it.

It should be noted that **NO HOLSTER IS COMPLETELY SNATCH-PROOF OR TAKEAWAY-PROOF.** Therefore, the user must exercise extreme diligence at all times in any situation where another person may attempt to take the user's handgun. The handgun should be held in place by the user whenever vigorous activity, such as running, jumping, falling or tumbling, is encountered or attempted. **ALWAYS** keep safety straps snapped if the holster is so equipped.

Keep thumb on back of hammer or slide when inserting handgun in holster to help ensure no movement occurs during insertion. Always keep fingers clear of trigger when drawing or replacing handgun in holster. Place index finger on outside of trigger guard to avoid inadvertent strap or foreign object interference when reholstering.

KEY SYMBOLS

Below is a list of commonly used symbols throughout this catalog.



Some products that we carry may not be shipped by air due to government regulations and restrictions



Our newest and latest products

TO ENSURE YOUR SATISFACTION

Your product is carefully crafted from the finest materials. For product longevity and your own safety, here are some commonsense guidelines:

Inspecting Your Product

Thoroughly read the safety information in this catalog and other information included with your purchase.

Make sure your handgun fits properly, safely and to your satisfaction.

Visually inspect your handgun for any defects in material or workmanship.

Check the retainer strap, spring or other retaining device and be certain that your handgun is properly and safely secured for your application.

Visually inspect all stitchings, snaps, springs, clips and rivets for looseness, breakage or other damage.

Pay special attention to points of strain and critical points, such as belt loops, welts, retainer straps, springs or other retaining devices.

Look for any sign that leather or other materials have become dry or brittle.

Should your holster or other product become worn, loose, defective or ill-fitting, cease use immediately.

CARE AND STORAGE

LEATHER

Storage

Store your leather product in a cool, dry place. High humidity can cause mildew, while dry heat and direct sunlight can cause drying and cracking. If you leave your handgun in the holster or other product, check it daily for moisture, condensation or corrosion. Changing atmospheric conditions, heavy perspiration and other factors could create such conditions.

Care

Treat the interior of your holster with spray silicone to help protect against excess moisture. Spray silicone also speeds the draw by reducing friction.

If your product becomes water-soaked, reshape it as best you can and allow it to air-dry at room temperature. Do not use a hot oven – it will shrink, harden and crack the leather.

Because Bianchi leather is hand finished with our special leather dressing, should your leather product become dry or scratched, you can treat the exterior with a commercial leather dressing that does not contain lacquer. (Be careful when using Neat's foot oil; large amounts will soften the leather.)

Brass cartridges or other brass hardware when stored with leather will acquire a greenish residue called "verdigris." It is a natural product of a chemical reaction between brass and vegetable tanned leather, and it wipes off. (Using nickel-plated cartridges in belt loops will avoid this condition.)

SAFARILAMINATE™

Storage

These products have been field-proven to withstand a wide variety of environmental conditions. These products should be stored in a cool, dry environment when not in use. We do not recommend storing these products in a vehicle trunk or other areas where extreme heat can exceed the outside environment.

Never store your SafariLaminate products near a heat source that emits high temperatures (200°F), which can deform or destroy the polymer from which many SafariLaminate products are manufactured. If you have accidentally exposed your equipment to a heat source you should immediately remove it from the area, allow it to cool to room temperature and then operate it to ensure correct function.

Cleaning

These products are best cleaned with a solution of warm, soapy water and a soft brush. A toothbrush and dish soap work well. If decontamination is required, an antibacterial soap or 10% solution of household chlorine bleach may be used. After cleaning, simply rinse off with fresh water and let air-dry. Be sure the product is completely dry inside and out prior to use.

When these products are exposed to salt spray or immersed in salt water, it is important to thoroughly rinse them in warm water as soon as possible. Never use solvents such as acetone to clean any products, as this could result in damage to the product.

HOW TO MEASURE BARREL LENGTH

Before you order a holster, please be sure you have the correct barrel measurement for your handgun. This measurement is very easy to do, and it will ensure that you get the holster that's exactly right for your gun.



BELT SIZING FOR A PERFECT FIT

Belts are sized from the middle of the belt to the buckle tongue.

To be certain of your correct size, use a tape measure.

Dress belts are sized to your exact waist measurement.



QUALITY, INNOVATION & PERFORMANCE



The Safariland Group has grown into a company with dozens of leading brands renowned not just for their quality and innovation, but for their performance.

LEADING BODY WORN TECHNOLOGY



BODY WORN CAMERAS



VIEVU® is a leading provider of body worn and video technologies, providing secure, high-quality video cameras for law enforcement, security, emergency medical services and retailers. VIEVU Solution, the company's next generation fully-hosted cloud evidence management system, is built on Microsoft® Azure Government Cloud, the first enterprise cloud

to directly support the FBI's Criminal Justice Information Services Division. VIEVU also provides Automated Video Redaction technology, a highly advanced redaction tool built to automatically blur faces and objects recorded on body worn cameras. VIEVU received the highest score in an evaluation of body worn video by the U.S. Department of Homeland Security.



BODY WORN CAMERA AUTO-ACTIVATION SYSTEM



AUTOMATIC.
SIMPLE.
RELIABLE.

NEW

THE WORLD'S FIRST HOLSTER & CAMERA AUTO-ACTIVATION SYSTEM

With the ever increasing need for transparency, in a world dominated by technology and enhanced scrutiny, Safariland® introduces the world's first holster and Camera Auto-activation System (CAS™). The Safariland holster and camera auto-activation system removes the decision making process of turning on a camera during a potentially life threatening situation, so an officer can be completely focused on the events at hand.

Safariland holster and camera auto-activation technology tell your story.

HOW THE CAMERA AUTO-ACTIVATION SYSTEM WORKS

FIREARM DRAW

As an officer removes their firearm from the Safariland 7TS™ holster, the Camera Auto-activation System is triggered, activating the VIEVU® body worn camera.

RELIABLE CONNECTION

Wired connection ensures consistent auto-activation.

CAMERA ACTIVATION

Initiated by the firearm draw, the camera automatically begins recording until stopped by the officer.

PRE-EVENT RECORD

Once the firearm is drawn, every critical moment is captured, including the 30 seconds prior.

BODY WORN CAMERA AUTO-ACTIVATION SYSTEM

BODY WORN CAMERAS | CONCEALABLE ARMOR | TACTICAL ARMOR | COMMUNICATIONS | PATROL BIKE | DUTY GEAR/HOLSTERS | PROTECTIVE GEAR | FIREARMS ACCESSORIES | LETHAL | PERFORMANCE APPAREL | SURVIVABILITY SYSTEMS | FORENSICS | ARMOR SYSTEMS | TRAINING GROUP



FOCUS ON THE SITUATION.
TRUST YOUR CAMERA IS ON.
TELL YOUR STORY.

7TS

PATENTED &
PATENT PENDING



SAFARILAND® 7TS™ DUTY HOLSTER

- 30-day battery life with replaceable batteries
- Features the ALS® (Automatic Locking System) and SLS (Self Locking System) Rotating Hood
- SafariSeven™ proprietary nylon blend is non abrasive to a firearm's finish
- Extremely high heat and cold tolerances; holster is structurally sound from 300° to -50°
- Two models are offered, the 7360 ALS®/SLS Mid-Ride with Level III Retention™ and the 7280 SLS Mid-Ride with Level II Retention™



VIEVU® LE4 BODY WORN CAMERA

- Captures 95° undistorted field of view
- Continuous record for over 12 hours without recharging battery
- Extremely durable billet aluminum
- Pre & post event recording
- 1080, 720 and widescreen 848 x 480 video resolution



MULTIPLE
MOUNTING
OPTIONS



VIEVU SOLUTION

- Secure storage on the Microsoft Azure Government Cloud
- CJIS compliant and meets all FBI data security requirements
- VIEVU smartphone app enables livestream videos and metadata additions

BODY WORN CAMERAS



LE5 LITE™ CAMERA & SOFTWARE

- 95° wide undistorted field of view
- Lightweight design
- Stores over 24 hours of footage
- Weatherproof IP65 non-submersible
- Compatible with VIEVU® Solution Secure Microsoft Azure Government Cloud or VIEVU Veripatrol™ on-site



MULTIPLE
MOUNTING
OPTIONS

NEW



LE4 CAMERA & SOFTWARE

- Designed to meet the needs and safety of law enforcement
- Built on years of policing and camera experience
- An integrated camera and software solution that is easy to use and seamless
- Backed by the Microsoft Azure Government Cloud – VIEVU and Microsoft comply with all FBI data security requirements





MULTIPLE
MOUNTING
OPTIONS



VIEVU® SOFTWARE & EVIDENCE MANAGEMENT



SECURE CLOUD HOSTED EVIDENCE MANAGEMENT

-  SECURE MICROSOFT AZURE CLOUD
-  COMPLIES WITH FBI CJIS STANDARDS
-  DESKTOP & MOBILE PLATFORMS

VIEVU® SOLUTION | HOSTED

The next generation of fully hosted evidence management system built on the Microsoft Azure Government Cloud.

- Easy to use and deploy with a simple website interface
- Amazing performance
- Unlimited scalability
- Secure external video sharing
- Add metadata and upload video from the field
- Case file management for all digital evidence and storage
- For all file types (video, pictures, documents, reports, etc.)

AUTOMATED VIDEO REDACTION (AVR)

VIEVU Solution includes AVR, a highly advanced video redaction tool built to automatically blur faces and objects without user involvement.

- Fully automated redaction of faces and objects
- Optimized for high movement, low light, shadows and low resolution body worn video
- Over 10x faster to redact a video than other solutions
- Seamless integration with subscriptions to the VIEVU solution

MULTI-DOCK NETWORK

Simple connection to a department's existing network to automatically download and recharge up to 10 LE4 and LE5 LITE™ cameras. The multi-dock can be mounted in a rack or on the wall to maximize floor space.



MADE FOR PERFORMANCE



CONCEALABLE ARMOR

SAFARILAND.
ARMOR

Safariland® Body Armor is purpose-built for protection, comfort and fit for the demanding way an officer moves and works. Designed for maximum coverage and maneuverability, each ballistic panel and carrier features

technologically advanced materials and design elements. Best-in-class ballistic performance optimizes coverage, weight, thinness and flexibility throughout the entire line.



EVERY LAYER IS BUILT TO PERFORM

DEFIES THE ELEMENTS

Heat-sealed TPU cover helps prevent bullet penetration and keeps the panel dry even in extreme conditions. Soft nylon shell increases comfort and durability.

DISPERSED ENERGY

Ballistic subsets made of high-performance ballistic materials disperses a bullet's impact yet is thin, light and flexible

THE RIGHT FIT

Specific male and female panels feature a contoured biomorphic design with perimeter stitching to enhance comfort and stopping power.

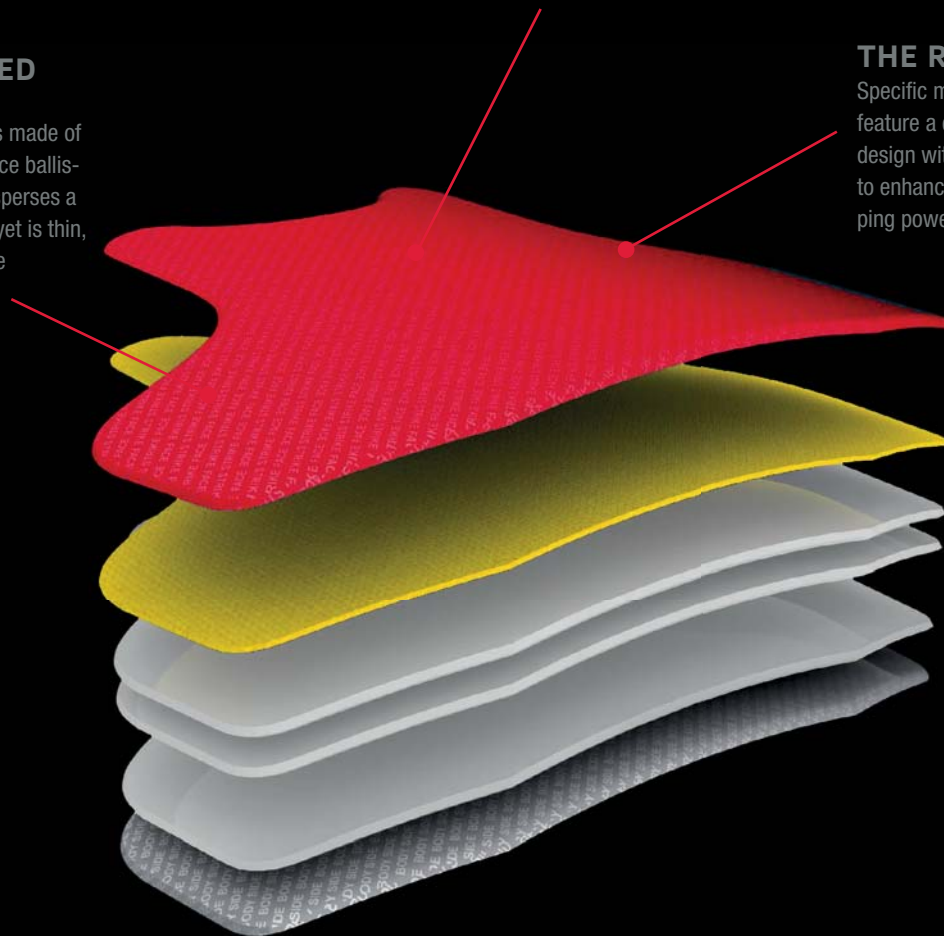

Each ballistic panel is engineered to provide unparalleled protective performance, while ergonomically designed to follow the body's natural shape and movement for flexibility and enhanced range of motion. With maximum coverage, stopping power, and all-day comfort,

CONCEALABLE ARMOR

NIJ standards are just the starting point. Each panel is engineered to provide maximum flexibility and lightness for comfort and fit, and to deliver the ultimate performance in wearability and stopping power.

HARDWIRE
ARMOR SYSTEMS

HARDWIRE®

This new soft armor is a combination of perfectly interlaced multi-functional fibers and game changing polymer technology. Hardwire's proprietary manufacturing technology equates to the lightest armor in the world, with unprecedented stopping power.



Model	NIJ Model	Threat Type	Areal Density	Thickness	V50 (9mm)	V50 (.357 Mag)	V50 (.357 Sig)	V50 (.44 Mag)
Hardwire 68	HW-2015-10-SB	IIIA	0.68	0.18	-	-	1755	1661
Hardwire 74	HW-2015-09-SB	IIIA	0.74	0.19	-	-	1791	1634



CONCEALABLE ARMOR



SUMMIT™

Providing unparalleled comfort and a soft, flexible feel, this panel provides exceptional ballistic performance and reduces heat buildup with the use of advanced, exclusive materials. It is unsurpassed in providing heightened protection against an array of special threats.

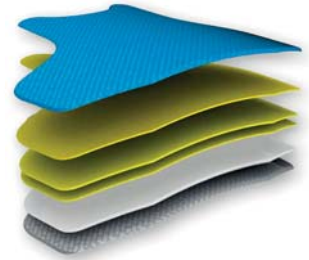

Model	NIJ Model	Threat Type	Areal Density	Thickness	V50 (9mm)	V50 (.357 Mag)	V50 (.357 Sig)	V50 (.44 Mag)
SM02	BA-2000S-SM02	II	0.79	0.190	1770	1676	-	-
SM02F	BA-2000S-SM02F	II	0.79	0.190	1717	1659	-	-
SM02	BA-3A00S-SM02	IIIA	1.04	0.250	-	-	1868	1720
SM02F	BA-3A00S-SM02F	IIIA	1.04	0.250	-	-	1863	1638



NEW

MATRIX™

One of our most economical ballistic packages. This package is an excellent choice for officers who demand the perfect balance of comfort, value and flexibility in a hybrid design.

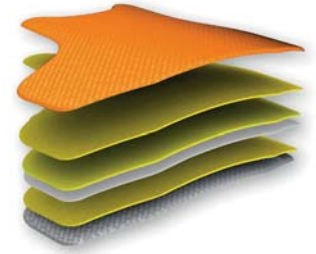

Model	NIJ Model	Threat Type	Areal Density	Thickness	V50 (9mm)	V50 (.357 Mag)	V50 (.357 Sig)	V50 (.44 Mag)
MR02	BA-2000S-MR02	II	0.89	0.212	1678	1625	-	-
MR02F	BA-3A00S-MR02	II	0.89	0.212	-	-	-	-
MR02	BA-3A00S-MR02	IIIA	1.20	0.290	-	-	1858	1697
MR02F	BA-3A00S-MR02	IIIA	1.20	0.290	-	-	1805	1603



PRISM®

Offers an unprecedented degree of protection against correctional threats. Combines several of the most advanced woven aramid corrections materials available for protection against circular penetrators and multi-threat protection for both stab and ballistic threats.

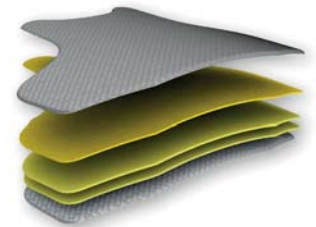

Model	NIJ Model	Threat Type	Areal Density	Thickness
Prism	PS-1.0	Spike 1	0.29	0.079
Prism	PS-2.0	Spike 2	0.42	0.098
Prism	PS-3.0	Spike 3	0.58	0.118

CONCEALABLE ARMOR



SX™

The thinnest, lightest and one of the strongest ballistic panels available. Born of breakthrough technologies and exclusive materials, SX offers unmatched performance for comfort, flexibility, durability and strength in a hybrid design.



Model	NIJ Model	Threat Type	Areal Density	Thickness	V50 (9mm)	V50 (.357 Mag)	V50 (.357 Sig)	V50 (.44 Mag)
SX02	BA-2000S-SX02	II	0.59	0.160	1817	1699	-	-
SX02F	BA-2000S-SX02F	II	0.61	0.165	1810	1699	-	-
SX02	BA-3A00S-SX02	IIIA	0.83	0.190	-	-	1912	1740
SX02F	BA-3A00S-SX02F	IIIA	0.85	0.20	-	-	1891	1670

DuPont™ **Kevlar®** **Honeywell** —SAATI



XTREME®

Versatile and flexible, this high-performance ballistic panel delivers all-condition comfort with maximum stopping power. Designed to reduce trauma upon impact, it features a contoured, biomorphic design with advanced perimeter stitching to enhance performance.



Model	NIJ Model	Threat Type	Areal Density	Thickness	V50 (9mm)	V50 (.357 Mag)	V50 (.357 Sig)	V50 (.44 Mag)
XT03	BA-2000S-XT03	II	0.85	0.180	1680	1610	-	-
XT03F	BA-2000S-XT03F	II	0.85	0.180	1698	1671	-	-
XT03	BA-3A00S-XT03	IIIA	1.15	0.250	-	-	1822	1638
XT03F	BA-3A00S-XT03F	IIIA	1.15	0.250	-	-	1823	1659

Honeywell **TEXTECH** INDUSTRIES DuPont™ **Kevlar®** —SAATI



BODY WORN CAMERAS | CONCEALABLE ARMOR | TACTICAL ARMOR | COMMUNICATIONS | PATROL BIKE | DUTY GEAR/HOLSTERS | PROTECTIVE GEAR | FIREARMS ACCESSORIES | LETHAL | PERFORMANCE APPAREL | SURVIVABILITY SYSTEMS | FORENSICS | ARMOR SYSTEMS | TRAINING GROUP

HYPERX™

NEXT GENERATION SCALABLE ARMOR SYSTEM ENHANCED COVERAGE WITHOUT COMPROMISING COMFORT

The culmination of ergonomics and ballistic protection, the HyperX™ system steps out of the future and into the present as the new way armor will be worn. This scalable system is customizable with plate pockets both in the base layer for enhanced coverage, and in the carrier for hard or soft armor trauma plate protection. Lightweight for exceptional comfort, the technical fabrics provide sleek, body contouring, and athletic styling in an integrated system. Consisting of a T-shirt base layer made with lightweight compression four-way stretch fabric that moves and flexes, and a ballistic carrier with an interchangeable system to keep the body warm or cool in extreme conditions, the HyperX system exemplifies the future of armor.

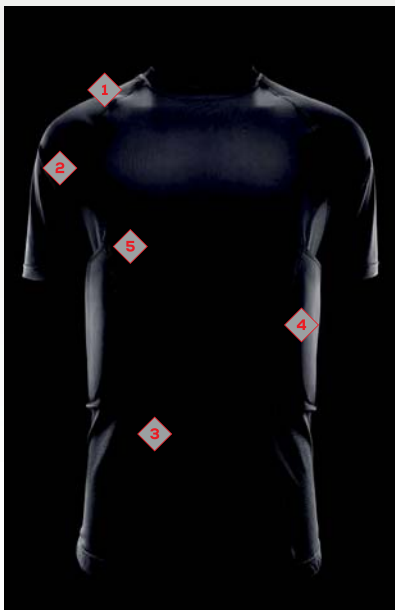

HYPERX™ BASE LAYER PERFORMANCE T-SHIRT

1. Lightweight compression four-way stretch fabric moves, flexes and stays flat
2. Hexagon knit pattern to ensure close body contouring
3. Knit mesh side construction for enhanced breathability
4. Side plate pockets for removable ballistic panels
5. Ventilated side mesh panels for added breathability

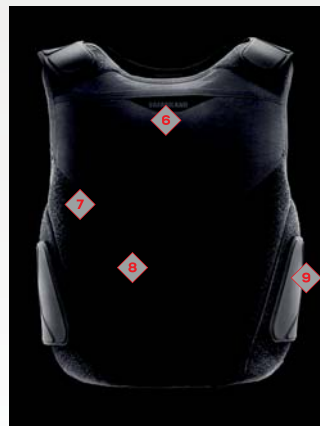

HYPERX™ INTEGRATED CARRIER

6. Front and back plate pocket for additional threat plates
7. High-profile VELCRO® Brand hook and loop for extra strength
8. Interchangeable detachable liner system for easy care and seasonal comfort
9. Removable contoured ergonomic straps

COVERT CARRIERS

Ergonomic designs, lightweight fabrics and contoured stitch lines are the platform on which comfort and mobility are built into every covert carrier. From the ultra-concealable F1 to the premier features of the P1, these covert carriers are a sampling of how Safariland® Armor covers all the bases for fit, comfort, and performance.

P1

- Lightweight four-way stretch ripstop shell fabric
- High-performance Luxicool® cooling spacer mesh liner
- Complementary lightweight spacer mesh liner for improved airflow
- Removable contoured ergonomic straps, with controlled stretch
- Front and back plate pockets
- Zip out front and back panels for easy accessibility with zipper garage
- Strategically located ergonomic VELCRO® Brand channels for easy fastening and removal
- High-profile VELCRO® Brand fasteners for extra strength and durability



BACK



M1

- Front and rear plate pockets
- Removable contoured ergonomic straps, with controlled stretch
- Durable hexagon ripstop shell fabric
- X-Static® silver antimicrobial wicking mesh liner
- Full row high-profile VELCRO® Brand closures
- Strategically located ergonomic VELCRO® Brand channels for easy fastening and removal



BACK



COVERT CARRIERS

F1

- Second skin construction for ultra-concealability
- Ergonomic design for multi-directional mobility
- Pullover one-piece with no zippers
- Maximum comfort for all day use
- Internal side entry for easy panel insertion
- Lightweight compression
- Breathable high performance laminated four-way stretch fabric
- High-performance Luxicool® cooling spacer mesh liner
- Antibacterial odor-control finish



BACK



E1

- High-profile VELCRO® Brand loop throughout
- Easy access front plate pocket
- Ultra lightweight poly microfiber outer shell fabric
- X-Static® silver antimicrobial wicking mesh liner



BACK



OVERT CARRIERS

V1 CLEAN

- Custom clean laser-cut MOLLE loops allow for VIEVU® camera chest and shoulder placement
- Laser-cut webbing for mic attachment on shoulders
- Removable ID pull down tabs
- Custom configured embellishment options
- Front hidden pockets with internal mesh pockets
- Clamshell VELCRO® Brand-adjustable shoulder closures
- Adjustable sides
- Quick access angled hidden gun pocket
- Front opening loading plate pocket
- Back top loading plate pocket
- Discreet zippers for panel insertion
- Ribbed channel spacer cooling mesh throughout
- Back neck hidden drag strap
- Invista 100% Cordura® nylon - 500-denier
- Ergonomic textured zipper pulls
- Medical quality soft flexible breathable cummerbund elastic



BACK



FRONT OPENING

SIDE OPENING

V1 WEBLESS

- Invista 100% Cordura® nylon 500-denier
- Newly designed angular laser cut webbing for improved strength - AWS 2.0
- Clamshell VELCRO® Brand-adjustable shoulder attachments
- Adjustable sides
- Front side opening loading plate pocket feature
- Back top loading plate pocket
- Discreet zippers for panel insertion
- Ribbed channel spacer cooling liner mesh throughout
- High-profile VELCRO® Brand hook and loop for extra strength and durability
- Back neck hidden drag strap
- Ergonomic textured zipper pulls
- Medical quality soft flexible breathable cummerbund elastic



BACK



FRONT OPENING

SIDE OPENING

OVERT CARRIERS

V1 POCKET

- Clamshell VELCRO® Brand-adjustable shoulder attachments
- Adjustable sides
- Hidden pockets with internal mesh pockets
- Front side opening loading plate pocket
- Back top loading plate pocket
- Discreet zippers for panel insertion
- Front opening zipper design offers convenient on & off
- Ribbed channel spacer cooling mesh liner throughout
- High profile VELCRO® Brand hook and loop for extra strength and durability
- Back neck hidden drag strap
- Laser cut webless MOLLE loop pouches (Mag, Radio, OC Spray, Baton/Flashlight)
- Ultra lightweight durable construction
- Invista 100% Cordura® nylon - 500-denier
- Ergonomic textured zipper pulls
- Medical quality, soft flexible and breathable cummerbund elastic



BACK



FRONT OPENING

SIDE OPENING

U1 UNIFORM

- Classic pin-tuck uniform pocket shirt design
- Soil-repellent 100% polyester shell fabric
- Front hidden pocket with additional internal mesh pockets
- Clamshell VELCRO® Brand-adjustable shoulder attachments
- Adjustable sides
- Quick access angled hidden gun pocket
- Front side opening loading plate pocket
- Back top loading plate pocket
- Discreet zippers for panel insertion
- Ribbed channel spacer cooling liner mesh throughout
- High-profile VELCRO® Brand closure for extra strength and durability
- Back neck hidden drag strap



BACK



FRONT OPENING

SIDE OPENING

OVERT CARRIERS



V1 EMS

- Invista 100% Cordura® nylon - 500-denier
- Durable accessory pouches (Radio, Baton/Flashlight, Utility, Medical)
- Clamshell VELCRO® Brand-adjustable shoulder attachments
- Adjustable sides
- Front side opening loading plate pocket feature
- Back top loading plate pocket
- Discreet zippers for panel insertion
- Ribbed channel spacer cooling liner mesh throughout
- High-profile VELCRO® Brand hook and loop for extra strength and durability
- Back neck hidden drag strap
- Ergonomic textured zipper pulls
- Medical quality soft flexible breathable cummerbund elastic



V1 HI-VIS CLEAN

- Invista 100% Cordura® nylon - 500-denier
- Clamshell VELCRO® Brand-adjustable shoulder attachments
- Adjustable sides
- Front side opening loading plate pocket feature
- Back top loading plate pocket
- Discreet zippers for panel insertion
- Front opening zipper design offers convenient on & off
- Ribbed channel spacer cooling liner mesh throughout
- High-profile VELCRO® Brand hook and loop for extra strength and durability
- Back neck hidden drag strap
- Quick access angled hidden gun pocket
- Ergonomic textured zipper pulls
- Medical quality soft flexible breathable cummerbund elastic
- Front zipper opening and traditional side opening versions available



V1 FIXED POCKET FIREARMS INSTRUCTOR

WEBLESS

- Invista 100% Cordura® nylon - 500-denier
- Newly designed angular laser cut webbing for improved strength - AWS 2.0
- Clamshell VELCRO® Brand-adjustable shoulder attachments
- Adjustable sides
- Front side opening loading plate pocket feature
- Back top loading plate pocket
- Discreet zippers for panel insertion
- Front opening zipper design offers convenient on & off
- Ribbed channel spacer cooling liner mesh throughout
- High-profile VELCRO® Brand hook and loop for extra strength and durability
- Back neck hidden drag strap
- Quick access angled hidden gun pocket
- Ergonomic textured zipper pulls
- Medical quality soft flexible breathable cummerbund elastic
- Front zipper opening and traditional side opening versions available



V1 HI-VIS WEBLESS

- Invista 100% Cordura® nylon - 500-denier
- Newly designed angular laser cut webbing for improved strength - AWS 2.0
- Clamshell VELCRO® Brand-adjustable shoulder attachments
- Adjustable sides
- Discreet zippers for panel insertion
- Front side opening loading plate pocket feature
- Back top loading plate pocket
- Ribbed channel spacer cooling liner mesh throughout
- High-profile VELCRO® Brand hook and loop for extra strength and durability
- Back neck hidden drag strap
- Quick access angled hidden gun pocket
- Ergonomic textured zipper pulls
- Medical quality soft flexible breathable cummerbund elastic

ARMOR SOLUTIONS



TACTICAL ARMOR



Lab tested and field proven: PROTECH® Tactical is proud to be one of the most well-known and widely respected tactical brands in the world. Through innovative designs and cutting edge technologies, we continually strive to be the experts in tactical body armor, accessories and equipment. Staying ahead of the competition and ensuring we fulfill our

purpose of protecting the protectors, we collaborate with companies driven by the same passion for quality products and design ingenuity. Protech and its exclusive partners set the standard for quality and innovation across a range of products designed to perform and protect in the world's most demanding security environments.



TECHNOLOGIES



HARDWIRE ARMOR SYSTEMS

Hardwire® Ballistic Technologies

In collaboration with Hardwire, LLC, PROTECH® Tactical now offers their most coveted carriers and plate rack systems with the lightest Level II and Level IIIA body armor on the market, as well as lightweight Type III plates.

Hardwire panels and plates are produced using manufacturing processes never used before in ballistics, setting a new standard in shock dissipation, momentum transfer efficiency and overall ballistic performance.



PROTECH® Tactical is pleased to partner with FirstSpear® LLC, bringing an array of load-bearing platforms and closure system offerings to your favorite PROTECH carriers.

FirstSpear® 6/12™ LOAD-BEARING PLATFORM

Durable and lightweight, the laser cut slits of the 6/12™ technology provide an extremely lightweight option for the operator. This new offering expands our breadth of load-bearing platforms and is compatible with all pouches offered in the PROTECH® Tactical line.



FirstSpear® 6/12 POUCH BACKERS

The latest in pouch backer technology, FirstSpear® in partnership with Safariland, brings you the 6/12™ backer system, compatible with PROTECH® carriers featuring FirstSpear 6/12 load-bearing platform.



FirstSpear® Tubes™ RAPID RELEASE CLOSURE SYSTEM

The Tubes™ closure is a highly sought-after rapid release system that utilizes polymer tubes for shoulder-to-carrier and cummerbund-to-carrier attachment points.



A multi-year partnership with Blue Force Gear® enables Safariland users to choose between some of the most cutting-edge pouch and material technologies available, in both tactical and concealable categories.

Blue Force Gear® Helium Whisper® POUCH BACKERS

Helium Whisper® is a revolutionary pouch attachment system that capitalizes on the lightweight and durable properties of state-of-the-art ULTRAcomp™ material.

SCALABLE PLATE RACK SYSTEM



SHOWN IN AWS FST VARIANT WITH OPTIONAL TRIPLE M4 MAG CARRY SET

OPTIONAL ACCESSORIES

Ballistic Internal Yoke, Ballistic Collar, Ballistic Shoulders, Ballistic Throat, Non-Ballistic Shoulders, Structured Upper Arms, Lower Abdomen/Spine, Ballistic Tactical Belt, Triple M4 Mag Carry Set, Ballistic Panel Inserts

SHIFT 360™

SCALABLE PLATE RACK SYSTEM

The Shift 360™ System is a sleek and innovative plate rack design that offers the operator ultimate scalability based on mission-specific requirements.

- Highest speed and most dynamic situational scalable plate rack on the market
- Features design refinements for increased fit, form and function such as cummerbund upgrades, reinforced attachment system and new closure system & load-bearing platform offerings

LOAD BEARING PLATFORM OPTIONS

- Advanced Webless System (AWS)
- FirstSpear® 6/12™ (6/12)
- Traditional Modular Webbing (TMW)

COLOR OPTIONS

- **AWS:** Black, Ranger Green, Tan, MultiCam®, Tactical Green, Coyote
- **612:** Black, Ranger Green, Tan, MultiCam®, Tactical Green, Coyote
- **TMW:** Black, Navy, Ranger Green, Tan, MultiCam®, Tactical Green, Woodland Digital Camo, Urban Digital Camo, Coyote, A-Tacs AU Camo™

CLOSURE SYSTEM OPTIONS

- Shift 360 FirstSpear® Tubes™ (FST)
- Shift 360 Single-Point Quick Release (QRS)
- Shift 360 VELCRO® Brand Hook and Loop (VCS)



FRONT
SHOWN IN AWS QRS VARIANT



BACK
SHOWN IN AWS FST VARIANT

COLORS



TACTICAL PLATE RACKS



NEW

CYPHER™

ULTRA LOW PROFILE PLATE RACK

- State-of-the-art low profile tactical platform with concealable features
- 10"x12" front and back plate pockets featuring top-load orientation with zipper
- 10-point, fully adjustable strap system featuring a unique material hybridization of laser cut ULTRAComp® and elastic to secure with supreme comfort
- Lightweight material configuration
- Interior padding for long-wear comfort

LOAD BEARING PLATFORM OPTIONS

- Clean (CLN)

COLOR OPTIONS

- CLN: Black, Tactical Green, Coyote

CLOSURE SYSTEM OPTIONS:

- Cypher VELCRO® Brand Hook and Loop (VCS)

OPTIONAL ACCESSORIES

- Ballistic Panel Inserts (Shooters Cut Only)
- PROTECH® Tactical Shooters Cut Rifle Plates



FRONT



BACK

COLORS

BLACK

TACTICAL GREEN

COYOTE



TACTICAL PLATE RACKS



SHOWN IN TMW BKL VARIANT

TAC™ PH PLATE HARNESS

- Dynamic active shooter plate harness with design upgrades developed for enhanced fit, form and function
- 10"x12" front and back plate pockets
- Adjustable shoulder straps
- Low-profile side buckle closure straps
- Keeper loops for excess side strap management
- Reinforced extraction strap

LOAD BEARING PLATFORM OPTIONS

- Traditional Modular Webbing (TMW)

COLOR OPTIONS

- **TMW:** Black, Navy, Ranger Green, Tan, MultiCam®, Tactical Green, Woodland Digital Camo, Urban Digital Camo, Coyote, A-Tacs AU Camo™

CLOSURE SYSTEM OPTIONS

- TAC PH Buckle Closure (BKL)
- TAC PH FirstSpear® Tubes™ (FST)

OPTIONAL ACCESSORIES

- Structured Upper Arms
- LT and TP Pouch Lines
- Ballistic Panel Inserts (Shooters Cut Only)
- PROTECH® Tactical Shooters Cut Rifle Plates

COLORS



SHOWN IN AWS BKL VARIANT

TAC™ PR PLATE RACK

- Optimal first responder plate rack tried and true among domestic US agencies
- Adjustable cummerbund for additional accessory attachment and unrivaled speed donning with integrated pull-strap system
- 10"x12" front and back plate pockets featuring bottom-load orientation
- Officer extraction strap
- Interior padding for long-wear comfort

LOAD BEARING PLATFORM OPTIONS

- Advanced Webless System (AWS)
- Traditional Modular Webbing (TMW)

COLOR OPTIONS

- **AWS:** Black, Ranger Green, Tan, MultiCam®, Tactical Green, Coyote
- **TMW:** Black, Navy, Ranger Green, Tan, MultiCam®, Tactical Green, Woodland Digital Camo, Urban Digital Camo, Coyote, A-Tacs AU Camo™

CLOSURE SYSTEM OPTIONS

- (BKL) Buckle Closure

OPTIONAL ACCESSORIES

- Structured Upper Arms
- LT and TP Pouch Lines
- Ballistic Panel Inserts
- PROTECH Tactical Rifle Plates

COLORS



TACTICAL VESTS



SHOWN IN AWS FST VARIANT

FAST ATTACK VEST

- Versatile tactical platform for high-risk tactical operations offers a comprehensive panel array for the urban operator
- Front, back, shoulders and side panel array
- Front and rear plate pockets accommodate 10"x12" or Medium SAPI/ Swimmers rifle plates
- Internal and external cummerbunds for a highly adjustable fit

LOAD BEARING PLATFORM OPTIONS

- Advanced Webless System (AWS)
- FirstSpear® 6/12™ (6/12)
- Traditional Modular Webbing (TMW)

COLOR OPTIONS

- **AWS:** Black, Ranger Green, Tan, MultiCam®, Tactical Green, Coyote
- **612:** Black, Ranger Green, Tan, MultiCam®, Tactical Green, Coyote
- **TMW:** Black, Navy, Ranger Green, Tan, MultiCam®, Tactical Green, Woodland Digital Camo, Urban Digital Camo, Coyote, A-Tacs AU Camo™

CLOSURE SYSTEM OPTIONS

- Fast Attack FirstSpear® Tubes™ (FST)
- Fast Attack Single-Point Quick Release (QRS)
- Fast Attack VELCRO® Brand Hook and Loop (VCS)

OPTIONAL ACCESSORIES

Ballistic Collar, Ballistic Throat, Structured Upper Arms, Lower Abdomen, Standard or Enhanced Groin, Spacer Mesh inserts (TMW model only), PROTECH Tactical Rifle Plates



FRONT
SHOWN IN AWS VCS VARIANT



BACK
SHOWN IN AWS FST VARIANT

COLORS



TACTICAL VESTS



SHOWN IN AWS VCS VARIANT

OPTIONAL ACCESSORIES

Ballistic Collar, Ballistic Throat, Structured Upper Arms, Standard or Enhanced Groin, Spacer Mesh inserts (TMW model only), PROTECH Tactical Rifle Plates

TITAN™ ASSAULT VEST

- A full-coverage vest designed for entry teams with the ability to add protection with a host of ballistic accessories
- External front & back plate pockets accommodate 8"x10" and 10"x12" plates
- External top-loading 12"x8.5" auxiliary dump pouch
- AWS model features a low-profile front platform due a shortened cummerbund length
- Hidden integrated dual wire channel
- Built-in mic tabs
- Reinforced rescue strap

LOAD BEARING PLATFORM OPTIONS

- Advanced Webless System (AWS)
- Traditional Modular Webbing (TMW)

COLOR OPTIONS

- **AWS:** Black, Ranger Green, Tan, MultiCam®, Tactical Green, Coyote
- **TMW:** Black, Navy, Ranger Green, Tan, MultiCam®, Tactical Green, Woodland Digital Camo, Urban Digital Camo, Coyote, A-Tacs AU Camo™

CLOSURE SYSTEM OPTIONS

- Titan Assault FirstSpear® Tubes™ (FST)
- Titan Assault VELCRO® Brand Hook and Loop (VCS)



FRONT
SHOWN IN AWS VCS VARIANT



BACK
SHOWN IN AWS VCS VARIANT

COLORS



TACTICAL VESTS



SHOWN IN AWS FST VARIANT

ALL PURPOSE VEST

- BALCS US military shape provides a perfect balance of maneuverability and coverage
- 10"x12" or SAPI front and back plate pockets with bottom load orientation
- External top-loading auxiliary pouch
- Available in 8 sizes
- Highly adjustable cummerbund closure system

LOAD BEARING PLATFORM OPTIONS

- Advanced Webless System [AWS]
- FirstSpear® 6/12™ [6/12]
- Traditional Modular Webbing [TMW]

COLOR OPTIONS

- **AWS:** Black, Ranger Green, Tan, MultiCam®, Tactical Green, Coyote
- **612:** Black, Ranger Green, Tan, MultiCam®, Tactical Green, Coyote
- **TMW:** Black, Navy, Ranger Green, Tan, MultiCam®, Tactical Green, Woodland Digital Camo, Urban Digital Camo, Coyote, A-Tacs AU Camo™

CLOSURE SYSTEM OPTIONS

- Shift 360 FirstSpear® Tubes™ (FST)
- Shift 360 Single-Point Quick Release (QRS)
- Shift 360 VELCRO® Brand Hook and Loop (VCS)

OPTIONAL ACCESSORIES

Ballistic Internal Yoke, Ballistic Collar, Ballistic Throat, Ballistic Shoulders, Non-ballistic Shoulder Pads, Structured Upper Arms, PROTECH Tactical Rifle Plates, Ballistic Groin



FRONT
SHOWN IN AWS VCS VARIANT



BACK
SHOWN IN AWS VCS VARIANT

COLORS



BALLISTIC PANELS

PROTECH® Tactical specializes in offering a full range of ballistic solutions with lightweight performance and value. PROTECH Tactical armor models are NIJ Standard-0101.06 approved, are special threat tested, and feature dynamic material hybridization for optimum protection against a full array of threats.

HARDWIRE®

This new soft armor is a combination of perfectly interlaced multi-functional fibers and game changing polymer technology. Hardwire's proprietary manufacturing technology equates to the lightest armor in the world, with unprecedented stopping power.

Model	NIJ Model	Threat Type	Areal Density	Thickness	V50 (9mm)	V50 (.357 Mag)	V50 (.357 Sig)	V50 (.44 Mag)
Hardwire 68	HW-2015-10-SB	IIIA	0.68	0.18	-	-	1755	1661
Hardwire 74	HW-2015-09-SB	IIIA	0.74	0.19	-	-	1791	1634

NEW



SX™

The thinnest, lightest and one of the strongest ballistic panels available. Born of breakthrough technologies and exclusive materials, SX offers unmatched performance for comfort, flexibility, durability and strength in a hybrid design.

Model	NIJ Model	Threat Type	Areal Density	Thickness	V50 (9mm)	V50 (.357 Mag)	V50 (.357 Sig)	V50 (.44 Mag)
SX02	BA-2000S-SX02	II	0.59	0.160	1817	1699	-	-
SX02	BA-3A00S-SX02	IIIA	0.83	0.190	-	-	1912	1740



SUMMIT™

Providing unparalleled comfort and a soft, flexible feel, this panel provides exceptional ballistic performance and reduces heat buildup with the use of advanced, exclusive materials. It is unsurpassed in providing heightened protection against an array of special threats.

Model	NIJ Model	Threat Type	Areal Density	Thickness	V50 (9mm)	V50 (.357 Mag)	V50 (.357 Sig)	V50 (.44 Mag)
SM02	BA-2000S-SM02	II	0.79	0.190	1770	1676	-	-
SM02	BA-3A00S-SM02	IIIA	1.04	0.250	-	-	1868	1720



XTREME®

Versatile and flexible, this high-performance ballistic panel delivers all-condition comfort with maximum stopping power. Designed to reduce trauma upon impact, it features a contoured, biomorphic design with advanced perimeter stitching to enhance performance.

Model	NIJ Model	Threat Type	Areal Density	Thickness	V50 (9mm)	V50 (.357 Mag)	V50 (.357 Sig)	V50 (.44 Mag)
XT03	BA-2000S-XT03	II	0.85	0.180	1680	1610	-	-
XT03	BA-3A00S-XT03	IIIA	1.15	0.250	-	-	1822	1638



MATRIX™

The Matrix is one of our most economical ballistic packages. This package is an excellent choice for officers who demand the perfect balance of comfort, value and flexibility in a hybrid design.

Model	NIJ Model	Threat Type	Areal Density	Thickness	V50 (9mm)	V50 (.357 Mag)	V50 (.357 Sig)	V50 (.44 Mag)
MR02	BA-2000S-MR02	II	0.89	0.212	1678	1625	-	-
MR02	BA-3A00S-MR02	IIIA	1.20	0.290	-	-	1858	1697

NEW



TACTICAL SOFT ACCESSORIES

Build your armor system ballistic protection with optional accessories from PROTECH® Tactical

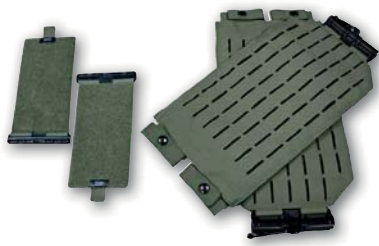

FIRSTSPEAR® TUBES™ RETROFIT CUMMERBUND KIT



BALLISTIC THROAT PROTECTOR



BALLISTIC GROIN PROTECTOR



STRUCTURED UPPER ARM PROTECTORS



TACTICAL BALLISTIC BELT

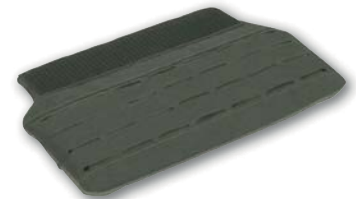

LOWER ABDOMEN/SPINE PROTECTOR

CANINE ARMOR

BARK-9™ HIGH-SPEED CANINE ARMOR SYSTEM

- Designed for the modern K-9 officer with features to suit today's modern police, SWAT or special operations canine
- Reinforced stitching for durability
- Restraint handle and D-rings for adjustable leash attachment
- Hook and loop ID attachment platforms
- Additional modular webbing for video/surveillance equipment attachment
- Rugged 1000-denier Cordura® nylon for long-lasting wear
- Detachable spine extension [2" of ballistic overlap]
- Various ballistic packages available
- Sizes Small to X-Large



POUCH TECHNOLOGIES

PROTECH® Tactical understands the importance of having essential mission-specific gear and accessories at your fingertips. Our tactical pouch line ensures that you're equipped and ready for the task at hand with outstanding durability and lightweight properties in a variety of configurations.



BODY WORN
CAMERAS
CONCEALABLE
ARMOR
TACTICAL
ARMOR
COMMUNICATIONS
PATROL
BIKE
DUTY GEAR/
HOLSTERS
PROTECTIVE
GEAR
FIREARMS
ACCESSORIES
LETHAL
PERFORMANCE
APPAREL
SURVIVABILITY
SYSTEMS
FORENSICS
ARMOR
SYSTEMS
TRAINING
GROUP

TRADITIONAL POUCH BACKERS

MOLLE

Our traditional line of pouches feature economic and durable nylon Cordura® nylon composition, resisting mission wear and tear over time.

- 1000-denier Cordura® nylon material
- Compatible with all load-bearing platforms – Traditional Modular Webbing, Advanced Webless System and FirstSpear® 6/12



HELIUM WHISPER® POUCH BACKERS

BLUE FORCE GEAR

Helium Whisper® is a revolutionary pouch attachment system that capitalizes on the lightweight and durable properties of state-of-the-art ULTRAcamp™ material.

- Patented single component construction eliminates bulky multi-piece weight of sewn together nylon and looping
- Wear and tear resistant ULTRAcamp material



6/12™ POUCH BACKERS

FIRSTSPEAR®

The latest in pouch backer technology, FirstSpear® in partnership with Safariland, brings you the 6/12™ backer system, compatible with PROTECH® carriers featuring FirstSpear 6/12 load-bearing platform.

- Approximately 40% weight reduction compared to traditional pouches
- Overall improved signature management

TACTICAL EQUIPMENT

PORTAL LADDER

- The Portal Ladder™ is a unique foldable ladder that provides mission flexibility and versatility to tactical teams
- Portable – hand carry strap allows for quick and easy movement through confined spaces. Backpack harness allows for hands-free carrying
- Night use/vision compatible
- Non-conductive composite material

Available in 5 height offerings:

6 ft – 21 lbs.	12 ft – 42 lbs.
8 ft – 28 lbs.	14 ft – 49 lbs.
10 ft – 35 lbs.	

PORTAL Ladder



WEAPONS TRUNK BOX

WITH TYPE IIIA BALLISTIC SHIELD LID

The PROTECH® Tactical Weapons Trunk Box features a type IIIA ballistic shield which is integrated into the box as the lid. Fleet-friendly, the weapons trunk box allows for secure long-arm weapon storage, with the larger trunk accommodating other mission-specific gear such as helmets and plate racks.

- Offered in a standard 36" x 16" with the options of a 7" height (36 lb. total weight/14 lb. shield) or 12" height (49 lb. total weight/14 lb. shield)
- Key lock or 3-digit rotary combination
- Side ventilation holes
- Collapsible/spring-loaded rubber padded carry handles
- Full length tongue and groove rear hingestrength and weight standards for Class 1A working load rating of 300 lbs.

NEW



HARD ARMOR PLATES

PROTECH® offers an extensive range of tactical armor plates designed to increase your protection with virtually any vest configuration or threat. Our independently tested, NIJ-0101.06 certified and NIJ-0101.04/05 certified line of single-and multi-curve rifle plates are available in either a shooter's cut or rectangular cut with clipped corners.

NIJ-0101.06 COMPLIANT

Made in the
USA



2113MC-3 TYPE III



2230 TYPE IV



HARDWIRE TYPE III

PROTECH® Hard Armor Plates (NIJ 0101.06 Type III) 7.62 mm x 51 mm, 147 gr., FMJ (NATO) (M80 Military Designation) - 6 Shots

Model	Size (approx.)	Weight (approx.)	Thickness (approx.)	Curvature / Cut	Armor Materials / Construction	Special Threat Testing (Independent NIJ Laboratory)
2113MC-3	10" X 12" (25.4cm x 30.5 cm)	3.2 lbs (1.4 kg)	1.14 in. (2.9 cm)	Multi/Shooters	Polyethylene	<ul style="list-style-type: none"> • 7.62 X 39MM, 123 GR. MSC • 5.56 X 45MM, 55 GR. M193
2113MC-3	10" X 12" (25.4cm x 30.5 cm)	3.5 lbs (1.5 kg)	1.14 in. (2.9 cm)	Multi/Rectangle	Polyethylene	
2113MC-3	8" X 10" (20.3cm x 25.4cm)	2.3 lbs. (1.0 kg)	1.14 in. (2.9 cm)	Multi/Rectangle	Polyethylene	
2120-5	10" X 12" (25.4cm x 30.5 cm)	5.8 lbs. (2.6 kg)	0.95 in. (2.4 cm)	Multi/Shooters	Ceramic/ Polyethylene/ Fiberglass	<ul style="list-style-type: none"> • 7.62 x 54Rmm, 150 gr. LPS [Rimmed] • 7.62 x 51mm, 180 gr. PSP [300 Win. Mag] • 7.62 x 39mm, 123 gr. MSC • 5.56 x 45mm, 62 gr. Bonded SP • 5.56 x 45mm, 62 gr. [M855][SS109] • 5.56 x 45mm, 55gr. [M193]
2120-5	8" X 10" (20.3cm x 25.4cm)	4.6 lbs. (2.1 kg)	0.95 in. (2.4 cm)	Multi/Rectangle	Ceramic/ Polyethylene/ Fiberglass	
Hardwire® Standard	10" X 12" (25.4cm x 30.5 cm)	4.3 lbs. (1.9 kg)	1.25 in. (3.2 cm)	Single/Shooters	Polyethylene	<ul style="list-style-type: none"> • 7.62 x 39mm, PS Ball [AK 47 Steel Core]
Hardwire Standard	10" X 12" (25.4cm x 30.5 cm)	4.5 lbs. (2.0 kg)	1.25 in. (3.2 cm)	Single/Rectangle	Polyethylene	
Hardwire Standard	8" X 10" (20.3cm x 25.4cm)	2.9 lbs. (1.3 kg)	1.25 in. (3.2 cm)	Single/Rectangle	Polyethylene	
Hardwire Multi-Curve	10" X 12" (25.4cm x 30.5 cm)	2.8 lbs. (1.27 kg)	1.25 in. (3.2 cm)	Multi/Shooters	Polyethylene	
Hardwire Multi-Curve	10" X 12" (25.4cm x 30.5 cm)	3.5 lbs. (1.58 kg)	1.25 in. (3.2 cm)	Multi/Rectangle	Polyethylene	
Hardwire Multi-Curve	8" X 10" (20.3cm x 25.4cm)	2.3 lbs. (1.0 kg)	1.25 in. (3.2 cm)	Multi/Rectangle	Polyethylene	
Hardwire Lightweight	10" X 12" (25.4cm x 30.5 cm)	2.8 lbs. (1.27 kg)	1.0 in. (1.5 cm)	Single/Shooters	Polyethylene	
Hardwire Lightweight	10" X 12" (25.4cm x 30.5 cm)	3.0 lbs. (1.36 kg)	1.0 in. (1.5 cm)	Single/Rectangle	Polyethylene	
Hardwire Lightweight	8" X 10" (20.3cm x 25.4cm)	2.0 lbs. (0.91 kg)	1.0 in. (1.5 cm)	Single/Rectangle	Polyethylene	

NEW

PROTECH® Hard Armor Plates (NIJ 0101.06 Type IV) 7.62 mm x 63 mm, 166 gr., AP, (30-06) (M2 AP Military Designation) - 1 Shot

Model	Size (approx.)	Weight (approx.)	Thickness (approx.)	Curvature / Cut	Armor Materials / Construction	Special Threat Testing (Independent NIJ Laboratory)
2230	10" x 12" (25.4cm x 30.5cm)	7.5 lbs. (3.4kg)	1.2 in. (2.9cm)	Multi / Shooters	Ceramic/ Aramid / Unequal®	• 7.62 mm x 51 mm, 147 gr., FMJ (NATO) (M80 Military Designation) - 6 Shots
2014G	10" x 12" (25.4cm x 30.5cm)	6.9 lbs. (3.1kg)	0.99 in. (2.50 cm)	Single / Shooters	Ceramic / Glass	• None
2014G	10" x 12" (25.4cm x 30.5cm)	8.3 lbs. (3.8kg)	0.99 in. (2.50 cm)	Single / Rectangle	Ceramic / Glass	
2014G	8" X 10" (20.3cm x 25.4cm)	5.2 lbs. (2.4kg)	0.99 in. (2.50 cm)	Single / Rectangle	Ceramic / Glass	

NIJ-0101.04/05 I.R. COMPLIANT



2116G TYPE IV



9812-R1 TYPE IV

PROTECH® Hard Armor Plates (NIJ 0101.04 / 2005 IR Type IV) 7.62 mm x 63 mm, 166 gr., AP, (30-06) (M2 AP Military Designation) - 1 Shot

Model	Size (approx.)	Weight (approx.)	Thickness (approx.)	Curvature / Cut	Armor Materials / Construction	Special Threat Testing (Independent NIJ Laboratory)
2116G	8" X 10" (20.3cm x 25.4cm)	5.2 lbs. (2.4 kg)	0.69 in. (1.75cm)	Single/ Rectangle	Ceramic/ Glass Composite	• None
9812-R1	9.5" X 12.5" (24.1cm x 31.8cm)	5.4 lbs. (2.5 kg)	0.75 in. (1.9cm)	Multi/SAPI-ESAPI	Ceramic/ Polyethylene	• 7.62 x 39mm, 120 gr. API BZ

BODY WORN
CAMERAS
CONCEALABLE ARMOR
TACTICAL ARMOR
COMMUNICATIONS
PATROL BIKE
DUTY GEAR/
HOLSTERS
PROTECTIVE GEAR
ACCESSORIES
FIREARMS
LETHAL
PERFORMANCE APPAREL
SURVIVABILITY SYSTEMS
FORENSICS
ARMOR SYSTEMS
TRAINING GROUP

HARD ARMOR PLATES



TYPE III MINI SIDE PLATE



TYPE III MINI SIDE PLATE

PROTECH® Mini Side & Independently Tested Stand Alone Plates (Non-Certified)

Model	Size (approx.)	Weight (approx.)	Thickness (approx.)	Curvature / Cut	Armor Materials / Construction	Special Threat Testing (Independent NIJ Laboratory)
9812-R1	6" X 8" (15.2cm x 20.3cm)	2.2 lbs. (1.0 kg)	0.75 in. (1.9 cm)	Single/ Rectangle	Ceramic/ Polyethylene	• .30 Caliber [.30-06] 166 gr. M2 AP
9812-R1	6" X 6" (15.2 cm x 15.2 cm)	1.6 lbs. (0.7 kg)	0.75 in. (1.9 cm)	Single/ Rectangle	Ceramic/ Polyethylene	
2230	6" X 6" (15.2 cm x 15.2 cm)	2.5 lbs. (1.0 kg)	0.8 in. (2.1 cm)	Single/ Rectangle	Ceramic/ Aramid	
2120	6" X 6" (15.2 cm x 15.2 cm)	1.9 lbs. (0.9 kg)	0.81 in. (2.1 cm)	Single/ Rectangle	Ceramic/ Polyethylene	
2113	6" X 6" (15.2 cm x 15.2 cm)	1.1 lbs. (0.5 kg)	1.14 in. (2.89 cm)	Single/ Rectangle	Polyethylene	<ul style="list-style-type: none"> • 5.56 x 45mm, 55 gr. M193 • 7.62 x 51mm, 147 gr. FMJ [NATO][M80] • 7.62 x 39mm, 123 gr. MSC • 7.62 x 54Rmm, 150 gr. LPS • 7.62 x 51mm, 180 gr. PSP • 5.56 x 45mm, 62 gr. [M855][SS109]
Hardwire®	6" X 6" (15.2cm x 15.2cm)	1.3 lbs. (0.59 kg)	1.25 in. (3.2 cm)	Single/ Rectangle	Polyethylene	
Hardwire MC	6" X 6" (15.2cm x 15.2cm)	1.0 lbs. (0.45 kg)	1.25 in. (3.2 cm)	Single/ Rectangle	Polyethylene	
Hardwire LT	6" X 6" (15.2cm x 15.2cm)	0.9 lbs. (0.41 kg)	1.0 in. (1.5 cm)	Single/ Rectangle	Polyethylene	
2230 6"x 6"	6" x 6" (15.2cm x 15.2cm)	2.5 lbs. (1.0kg)	0.8 in. (2.0cm)	Single / Rectangle	Ceramic / Aramid	• 7.62mm x 63mm, 166 gr., AP, (30-06) (M2 AP) (1 Shot)

NEW

INDEPENDENTLY TESTED

X-CAL™



X-CAL LP



X-CAL US

X-CAL™ In-Conjunction With (ICW) Special Threat Plates

Model	Size (approx.)	Weight (approx.)	Thickness (approx.)	Curvature / Cut	Armor Materials / Construction	Special threats tested against a 10" x 12" size plate (Independent NIJ Laboratory)
X-CAL-LP*	10" x 12" (25.4cm x 30.5cm)	5.1 lbs. (2.31 kg)	0.43 in. (1.09cm)	Single / Rectangle	Ceramic / Spall Wrap	<ul style="list-style-type: none"> • 5.56mm x 45mm, 62 gr. FMJ (M855 / SS109) (6 Shots) • 7.62mm x 39mm, 123 gr. MSC (3 Shots) • 7.62mm x 39mm, 119 gr. API BZ (3 Shots) • 7.62mm x 54Rmm, 150 gr. LPS FMJ (3 Shots) * (ICW Certain Packages Only) • 7.62mm x 51mm, 148 gr. (NATO / .308 M80 Ball) (2 Shots)
	7" x 9" (17.78cm x 22.86cm)	3.3 lb. (1.5kg)		Single / Rectangle		
	5" x 8" (12.7cm x 20.32cm)	2.2 lb. (1kg)		Single / Rectangle		
X-CAL™ US						
Model	Size (approx.)	Weight (approx.)	Thickness (approx.)	Curvature / Cut	Armor Materials / Construction	Special threats tested against a 10" x 12" size plate (Independent NIJ Laboratory)
X-CAL US	10" x 12" (25.4cm x 30.5cm)	3.9 lbs. (1.8 kg)	0.75 in. (2.0cm)	Multi/Swimmers	Ceramic/ Polyethylene	<ul style="list-style-type: none"> • 5.56 x 45mm, 55 gr. (M193 Ball) • 5.56 x 45mm, 62 gr. (M855 Ball) • 7.62 x 39mm, 123 gr. (PS Ball) • 7.62 x 54Rmm, 148 gr. (LPS) • 7.62 x 51mm, 149 gr. (M80)(FMJ)
	8" x 10" (20.3cm x 25.4cm)	2.6 lbs. (1.2 kg)		Multi/Rectangle		
	10.25" x 13.25" (26.7cm x 33.7cm)	5.3 lbs. (2.4 kg)		Multi/SAPI-ESAPI		
	9.5" x 12.5" (24.1cm x 31.8cm)	3.9 lbs. (1.8 kg)		Multi/SAPI-ESAPI		
	8.75" x 11.75" (22.2cm x 29.8cm)	3.3 lbs. (1.5 kg)		Multi/SAPI-ESAPI		

* X-CAL plates must be worn in-conjunction with Safariland soft flexible body armor - refer to product specification for details.

SPECIAL THREAT PLATES

IMPAC™



IMPAC™ Special Threat Plates (Non-Certified)

Model	Size (approx.)	Weight (approx.)	Thickness (approx.)	Curvature / Cut	Armor Materials / Construction	Special Threat Testing (Independent NIJ Laboratory)
IMPAC-HT (Handgun Threats)	5" x 7" (12.7cm x 17.78cm)	0.25 lb. (0.11kg)	0.25 in. (0.64cm)	Single/ Rectangle	Polyethylene	<ul style="list-style-type: none"> • Speer .357 SIG FMJ FN (3 Shots) • Speer .44 Mag SJHP (1 Shot) • Winchester Ranger 9mm +P+ 127 gr. SXT (3 Shots) • Speer .357 SIG 125 gr. Gold Dot HP (3 Shots) • Norinco 7.62mm Tokarev, 85 gr. FMJ (3 Shots) • FN 5.7mm x 28mm SS197 (Blue Tip) 40 gr. (3 Shots) • FN 5.7mm x 28mm SS195 L.F. (Belgium) 28 gr. JHP (3 Shots)
	5" x 8" (12.7cm x 20.32cm)	0.30 lb. (0.14kg)		Single/ Rectangle		
	7" x 9" (17.78cm x 22.86cm)	0.45 lb. (0.20kg)		Single/ Rectangle		
	10" x 12" (25.4cm x 30.5cm)	0.70 lb. (0.32kg)		Single/ Shooters		
	10" X 12" (25.4 cm x 30.5 cm)	0.78 lb. (0.32 kg)		Single/Rectangle		
	7" X 8" (17.7 cm x 20.3 cm)	0.45 lb. (0.20 kg)		Single/Upper Arm		
	7" X 6" (17.7 cm x 15.2 cm)	0.42 lbs. (0.17 kg)		Single/Upper Arm		
IMPAC-HT1 (Handgun / Spike 1 Threats)	5" x 7" (12.7cm x 17.78cm)	0.4 lb. (0.2kg)	0.3 in. (0.76cm)	Single/ Rectangle	Stainless Steel/ Unidirectional Polyethylene	<ul style="list-style-type: none"> • Speer .357 SIG, 125 gr. FMJ (3 Shots) • Speer .44 Mag, 240 gr. SJHP (1 Shot) • Winchester Ranger 9mm +P+ 127 gr. SXT (3 Shots) • Speer .357 SIG 125 gr. Gold Dot HP (3 Shots) • Norinco 7.62mm Tokarev, 85 gr. FMJ (3 Shots) • FN 5.7mm x 28mm, 28 gr. SS19F (Belgium) (3 Shots) • FN 5.7mm x 28mm, 40 gr. SS197 (Blue Tip) (3 Shots) • Spike Protection Level 1 • 24 J – Strike Energy • 36 J – Over test Strike Energy
	5" x 8" (12.7cm x 20.32cm)	0.5 lb. (0.22kg)		Single/ Rectangle		
	7" x 9" (17.78cm x 22.86cm)	0.6 lb. (0.3kg)		Single/ Rectangle		
	10" x 12" (25.4cm x 30.5cm)	0.9 lb. (0.4kg)		Single/ Shooters		
	7" X 9" (17.7 cm x 22.9 cm)	0.6 lb. (0.3 kg)		Single/ Rectangle		
	10" X 12" (25.4 cm x 30.5 cm)	0.9 lb. (0.4 kg)		Single/Shooters		
IMPAC CT/DT Correctional/ Duty Threats	5" x 7" (12.7cm x 17.7cm)	0.52 lbs. (0.24 kg)	0.2 in. (0.5 cm)	Single/Rectangle	Fiberglass Composite	<ul style="list-style-type: none"> • American Eagle 9mm, 115 gr. FMJ (3 Shots) • .40 S&W Ranger, 165 gr. SXT (3 Shots) • Federal .45 ACP, 230 gr. HST +P (3 Shots) • Spike Instrument @ Protection Level 3 for E1 Strike/E2 Overstrike (3 Drops) • P1 Edged Blade @ Protection Level 3 for E1 Strike/E2 Overstrike (3 Shots) • S1 Edged Blade @ Protection Level 3 for E1 Strike/E2 Overstrike (3 Shots)
	5" x 8" (12.7cm x 20.3cm)	0.57 lbs. (0.26 kg)		Single/Rectangle		
	7" x 9" (17.7cm x 22.9cm)	0.83 lbs. (0.37 kg)		Single/Rectangle		
	10" x 12" (25.4cm x 30.5cm)	1.38 lbs. (0.62 kg)		Single/Shooters		
IMPAC MT Multi-Threats	5" x 7" (12.7cm x 17.7cm)	0.73 lbs. (0.33 kg)	0.4 in. (1.0 cm)	Single/Rectangle	Fiberglass Composite	<ul style="list-style-type: none"> • Speer .357 SIG FMJ FN (3 Shots) • Speer .44 Mag SJHP (1 Shot) • Winchester Ranger 9 mm +P+ 127 gr. SXT (3 Shots) • Speer .357 SIG 125 gr. Gold Dot HP (3 Shots) • Norinco 7.62 mm Tokarev, 85 gr. FMJ (3 Shots) • FN 5.7 mm x 28 mm SS197 (Blue Tip) 40 gr. (3 Shots) • FN 5.7 mm x 28 mm SS195 L.F. (Belgium) 28 gr. JHP (3 Shots) • Aquila IQ 9mm 65 gr. HP (3 Shots) • Remington 9mm 101 gr. Plated Frangible Disintegrator (3 Shots) • Spike Instrument @ Protection Level 3 for E1 Strike/E2 Overstrike (3 Drops) • P1 Edged Blade @ Protection Level 3 for E1 Strike/E2 Strike/E2 Overstrike (3 Drops) • S1 Edged Blade @ Protection Level 3 for E1 Strike/E2 Overstrike (3 Drops)
	5" x 8" (12.7cm x 20.3cm)	0.81 lbs. (0.37 kg)		Single/Rectangle		
	7" x 9" (17.7cm x 22.9cm)	1.23 lbs. (0.56 kg)		Single/Rectangle		
	10" x 12" (25.4cm x 30.5cm)	2.0 lbs. (0.91 kg)		Single/Shooters		
IMPAC-RT Rifle Threats	5" X 7" (12.7 cm x 17.7 cm)	1.15 lb. (0.5 kg)	0.94 in. (2.4 cm)	Single/Rectangle	Polyethylene	<ul style="list-style-type: none"> • 7.62 mm x 51 mm, 147 gr., FMJ (NATO) (2 Shots) • 7.62 mm x 39 mm, 123 gr., Mild Steel Core (MSC) (2 Shots) • .22 Cal. 17gr. FSP Fragmentation • .30 Cal. 44gr. FSP Fragmentation
	5" X 8" (12.7 cm x 20.3 cm)	1.25 lb. (0.6 kg)		Single/Rectangle		
	7" X 9" (17.7 cm x 22.9 cm)	2.0 lb. (0.9 kg)		Single/Rectangle		
IMPAC-RT Plus Rifle Threats	5" X 7" (12.7 cm x 17.7 cm)	2.75 lb. (1.3 kg)	0.56 in. (1.4 cm)	Flat/Rectangle	Steel/Fiberglass/ Spall Wrap	<ul style="list-style-type: none"> • 7.62 mm x 51 mm, 147 gr., FMJ (NATO) (1 Shot) • 7.62 mm x 39 mm, 123 gr., Mild Steel Core (MSC) (2 Shots) • 5.56 mm x 45 mm, 55gr. (M193) (3 Shots) • 5.56 mm x 45 mm, 62gr. (M855) (SS109) (3 Shots)
	5" X 8" (12.7 cm x 20.3 cm)	3.1 lb. (1.4 kg)		Flat/Rectangle		
	7" X 9" (17.7 cm x 22.9 cm)	4.65 lb. (2.1 kg)		Flat/Rectangle		
	10" X 12" (25.4 cm x 30.5 cm)	7.25 lb. (3.3 kg)		Flat/Rectangle		
	10" X 12" (25.4 cm x 30.5 cm)	8.2 ls. (3.7 kg)		Flat/Rectangle		

BODY WORN CAMERAS
 CONCEALABLE ARMOR
 TACTICAL ARMOR
 COMMUNICATIONS
 PATROL BIKE
 DUTY GEAR/HOLSTERS
 PROTECTIVE GEAR
 ACCESSORIES
 FIREARMS
 LETHAL
 PERFORMANCE APPAREL
 SURVIVABILITY SYSTEMS
 FORENSICS
 ARMOR SYSTEMS
 TRAINING GROUP

BALLISTIC HELMETS

PROTECH® Tactical and the Delta™ line of ballistic helmets set the industry standard for ergonomic comfort, superb ballistic performance and innovative technologies. Our broad product range, including suspension systems and accessories, allows users to choose the helmet configuration that's precisely right for the mission at hand.

Made in the
USA

All PROTECH helmets and corresponding accessories are offered in Black, Foliage Green, Coyote Brown and Tactical Green

COLORS AVAILABLE



DX, D5 & D4 MODELS AVAILABLE IN FULL, MID AND HIGH-CUT



FULL-CUT



MID-CUT



HIGH-CUT



NEW

DELTA X™

AN ULTRA-LIGHTWEIGHT BALLISTIC HELMET DESIGNED FOR 9MM PROTECTION AND ULTIMATE COMFORT

- Tested against NIJ 0106.01 protocol, modified to address type IIIA 9mm round and velocity
- 17 gr. V50 ≥ 2600 ft/s (792 m/s)
- Warrior/ACH [brimless] style: Full-, Mid- and High-cut
- 40% lighter than traditional ACH helmets and comprised of polyethylene and other fibers in a matrix composite
- Highest fragmentation performance and lightest IIIA 9mm FMJ helmet on the market
- Retention and suspension system offering includes the Team Wendy® CAM Fit™ and EPIC Air™ Systems

Delta X Ballistic Helmet	Full-Cut	Mid-Cut	High-Cut
Finished Large Shell Weight (Suspension not included)	1.47 lbs. (0.67 kg)	1.37 lbs. (0.62 kg)	1.26 lbs. (0.57 kg)



NEW

DELTA 5™

A LIGHTWEIGHT BALLISTIC HELMET DESIGNED FOR YOUR FRONTLINE AND SPECIAL FORCES NEEDS

- Tested against NIJ 0106.01 protocol, modified to address type IIIA rounds and velocities, 9mm & .44 Magnum
- 17 gr. V50 ≥ 2400 ft/s (731 m/s)
- Warrior/ACH [brimless] style: Full-, Mid-, High-cut
- 30% lighter than traditional ACH helmets and comprised of polyethylene and other fibers in a matrix composite
- Retention and suspension system offerings include Team Wendy® CAM Fit™ and EPIC Air™ and Protech R2S™ Ratchet systems

Delta 5 Ballistic Helmet	Full-Cut	Mid-Cut	High-Cut
Finished Large Shell Weight (Suspension not included)	1.87 lbs. (0.85 kg)	1.74 lbs. (0.79 kg)	1.60 lbs. (0.53 kg)

BALLISTIC HELMETS



DELTA 4™

THE PATRIARCH ACH/WARRIOR STYLE BALLISTIC HELMET OFFERING TRUSTED AND TESTED PROTECTION AND COMFORT

- Tested against NIJ 0106.01 protocol, modified to address type IIIA rounds and velocities, 9mm and .44 Magnum
- 17 gr. V50 \geq 2058 ft/s (627 m/s)
- Warrior/ACH [brimless] style: Full-, Mid-, High-cut
- Retention and suspension system offering includes Team Wendy® CAM Fit™ and EPIC Air™, R2S™ Ratchet, Mesh Crown and Comfort padding systems

Delta 4 Ballistic Helmet	Full-Cut	Mid-Cut	High-Cut
Finished Large Shell Weight (Suspension not included)	2.50 lbs. (1.13 kg)	2.35 lbs. (1.07 kg)	2.15 lbs. (0.98 kg)



PASGT

FULL COVERAGE BALLISTIC HELMET FOR PERSONNEL ARMOR SYSTEM GROUND TROOPS

- Tested against NIJ 0106.01 protocol, modified to address type IIIA rounds and velocities, 9mm & .44 Magnum
- 17 gr. V50 \geq 2058 ft/s (627 m/s)
- Personnel Armor System Ground Troops design – Full-cut with brim
- Available with R2S Ratchet, Mesh Crown or Pad retention and suspension systems

PASGT Ballistic Helmet	Small-Medium	Large-X-Large	Jumbo
Finished Large Shell Weight (Suspension not included)	2.40 lbs. (1.08kg)	2.60 lbs. (1.18 kg)	2.80 lbs. (1.27 kg)



HELMET SUSPENSION SYSTEMS

PROTECH® Tactical is proud to partner with companies driven by the same passion to outfit users in the industry's highest quality and most cutting-edge technologies and products. Our partnership with Team Wendy® allows for our Delta™ line of helmets to be outfitted in the lightest and most innovative retention and suspension systems currently on the market.

NEW



TEAM WENDY® EPIC AIR™ SUSPENSION

- EPIC Air takes helmet liner systems to a whole new level with lightweight features, ultimate comfort design and blunt trauma protection
- Zorbium™ impact liner feature milspec moisture wicking and loop fabric with antimicrobial comfort pads
- Air channels allow for air flow and temperature control
- Exceeds ACH blunt impact requirements (AR/PD 10-02)



NEW

TEAM WENDY® CAM FIT™ RETENTION

- CAM Fit is the most efficient yet durable retention system available, based on a dial ratchet mechanism for quick and secure placement.
- CAM-lock™ sliders allow for one handed adjustability
- Boa® Closure system stabilizes helmet weight by distributing a light, even pressure around the head
- Adjustment straps and chin cup designed for a close, comfortable fit to the wearer's face

NEW

R2S™ SYSTEM PROTECH R2S RATCHET WITH PADDING SUSPENSION SYSTEM

- PROTECH's trusted ratchet system that features easy adjustment and a durable hold
- Enhanced security and customizable fit for any head size
- 2" diameter ratchet dial at nape for easy adjustment
- Fas-Trac® components allow for effortless tightening while creating resistance to prevent loosening during use



PADDING SUSPENSION SYSTEM

A traditional padding suspension available in Non-FAT or Milspec, 8-pad configuration for a more customized fit



MESH CROWN SUSPENSION SYSTEM

Our patriarch suspension featuring a 4-point height-adjustable, floating mesh crown component with chin strap



HELMET ACCESSORIES

NON-BALLISTIC FACE SHIELD



- Manufactured of polycarbonate and coated with scratch-resistant material
- Meets NIJ-0104.02 Riot Face Shield Standard
- Detachable system
- Locking mechanism for stowed and deployed orientations
- Rubber liquid barrier seal at helmet/shield interface

BALLISTIC FACE SHIELDS

PROTECH® Tactical ballistic face shields are compatible with all standard cut ballistic helmets. The face shields are easily secured to the helmet using a 360° band fastening system.



- Manufactured of polycarbonate/acrylic laminate
- Curved design offers complete facial protection from the helmet brim to below the chin area
- Unique band-fastening system permits quick attachment or detachment and eliminates drilling that could affect ballistic integrity

	702L	702M	702MT
Material	Polycarbonate/acrylic laminate	Polycarbonate/acrylic laminate	Polycarbonate/acrylic laminate
Single/Multi-Hit	Single (9mm FMJ 124 gr.)	Multiple (9mm FMJ 124 gr.)	Multiple (9mm FMJ 124 gr., .44 Mag 240 gr. & 7.62 x 25mm Tokarev)
Size	6" x 15" (15.24cm x 38.10cm)	6" x 15" (15.24cm x 38.10cm)	6" x 15" (15.24cm x 38.10cm)
Weight (Approx.)	2.3 lbs (1.04kg)	2.5 lbs. (1.13kg)	2.5 lbs. (1.13kg)



NVG SHROUD

- Lightweight and low-profile aerospace grade metal and carbon fiber
- Designed for compatibility and solid mounting for NVG mounts
- Three hole standard pattern
- Available colors: Black, Tactical Green, Coyote Brown and Foliage Green



ACH-ARC ACCESSORY SIDE RAIL SET

- Industry standard side helmet attachment system
- Open architecture design allows for a multitude of headborne accessory attachments
- Kit available with or without bungees
- Comes with hardware, (2) Wing-Loc adapters and (2) Picatinny adapters
- Available colors: Tactical Green, Coyote Brown and Foliage Green

Shown with TCI Liberator II Communications System

BALLISTIC SHIELDS

Nobody does ballistic shields like PROTECH® Tactical. Our NIJ Type IIIA, III and IV offerings are the culmination of more than 30 years of experience. With a wide-range of sizes and configurations the PROTECH family of shields are ideal for patrol and tactical officers alike.

INTRUDER SERIES

Made in the
USA



INTRUDER™ G2™



2035 LED
INTRUDER™ HS



2035 WL
INTRUDER™ HS



2035 W
INTRUDER™ HS

PROTECH® Intruder™ Shields (NIJ 0108.01 Type IIIA)									
9mm, 124 gr., FMJ - 5 Shots / .44 Magnum, 240 gr. LSWC - 5 Shots									
Product	Model #	Size (approx.)	Ballistic Coverage (approx.)	Weight (approx.)	Areal Density (approx.)	Armor Materials / Construction (Shield Body)	Viewport / Viewport Size	Armor Materials / Construction (Viewport)	Special Threat Testing (Independent NIJ Laboratory)
Intruder G2	2035G2	20" x 34" (50.8cm x 86.36cm)	660 in ² (4258.1cm ²)	21 lbs. (9.5kg)	1 lb./ft ² (4.88kg/m ²)	Polyethylene	Yes / 6.75" x 15.5" (17.2cm x 39.37cm) (at widest points)	Acrylic / Polycarbonate	<ul style="list-style-type: none"> •Tokarev 7.62x25mm 85 gr. FMJ [steel jacket] (5 Shots) •5.7x28mm 40 gr. SS197/Blue Tip (5 Shots) •WIN. Ranger 9mm 127 gr. +P+ SXT (5 Shots) •.357 SIG 125 gr. TMJ (5 Shots) •.44 Mag 240 gr. SJHP (5 Shots)
Intruder HS (w/ LED)	2035LED	20" x 34" (50.8cm x 86.36cm)	660 in ² (4258.1cm ²)	20 lbs. (9.1kg)	1 lb./ft ² (4.88kg/m ²)	Polyethylene	Yes / 4" x 16.75" (10.16cm x 42.55cm)	Acrylic / Polycarbonate	<ul style="list-style-type: none"> •Tokarev 7.62x25mm 85 gr. FMJ [steel jacket] (5 Shots) •5.7x28mm 40 gr. SS197/Blue Tip (5 Shots) •WIN. Ranger 9mm 127 gr. +P+ SXT (5 Shots) •.357 SIG 125 gr. TMJ (5 Shots) •.44 Mag 240 gr. SJHP (5 Shots)
Intruder HS (w/ HIL)	2035WL	20" x 34" (50.8cm x 86.36cm)	660 in ² (4258.1cm ²)	21 lbs. (9.5kg)	1 lb./ft ² (4.88kg/m ²)	Polyethylene	Yes / 4" x 16.75" (10.16cm x 42.55cm)	Acrylic / Polycarbonate	<ul style="list-style-type: none"> •Tokarev 7.62x25mm 85 gr. FMJ [steel jacket] (5 Shots) •5.7x28mm 40 gr. SS197/Blue Tip (5 Shots) •WIN. Ranger 9mm 127 gr. +P+ SXT (5 Shots) •.357 SIG 125 gr. TMJ (5 Shots) •.44 Mag 240 gr. SJHP (5 Shots)
Intruder HS (no lights)	2035W	20" x 34" (50.8cm x 86.36cm)	660 in ² (4258.1cm ²)	16.5 lbs. (7.5kg)	1 lb./ft ² (4.88kg/m ²)	Polyethylene	Yes / 4" x 16.75" (10.16cm x 42.55cm)	Acrylic / Polycarbonate	[All Testing completed on 2035W]

*All Intruder G2 and Intruder Shields are available with Horizontal or 3-Position Handle Component



BALLISTIC SHIELDS

BODY BUNKER SERIES



3148S 2436S
BODY BUNKER®



BODY BUNKER® BREACHER™

PROTECH® Body Bunker® Shields (NIJ 0108.01 Type IIIA)									
9mm, 124 gr. FMJ - 5 Shots / .44 Magnum, 240 gr. LSWC - 5 Shots									
Product	Model #	Size (approx.)	Ballistic Coverage (approx.)	Weight (approx.)	Areal Density (approx.)	Armor Materials / Construction (Shield Body)	Viewport / Viewport Size	Armor Materials / Construction (Viewport)	Special Threat Testing (Independent NIJ Laboratory)
Body Bunker (24x36)	2436S	24" x 36" (60.96cm x 91.44cm)	864 in ² (5574.18cm ²)	21 lbs. (9.5kg)	1 lb./ft ² (4.88kg/m ²)	Polyethylene	Yes / 4" x 16" (10.16cm x 41cm)	Acrylic / Polycarbonate	<ul style="list-style-type: none"> •Tokarev 7.62x25mm 85 gr. FMJ [steel jacket] (5 Shots) •5.7x28mm 28 gr. SS195/HP (5 Shots) [Testing completed on Defender] •5.7x28mm 40 gr. SS197/Blue Tip (5 Shots) [Testing completed on Defender]
Body Bunker (31x48)	3148S	31" x 48" (78.74cm x 121.92cm)	1488 in ² (9599.98cm ²)	31 lbs. (14.1kg)	1 lb./ft ² (4.88kg/m ²)	Polyethylene	Yes / 4" x 16" (10.16cm x 41cm)	Acrylic / Polycarbonate	<ul style="list-style-type: none"> •WIN. Ranger 9mm 127 gr. +P+ SXT (5 Shots) [Testing completed on Defender] •.357 SIG 125 gr. TMJ (5 Shots) [Testing completed on Mighty Mite]
Body Bunker Breacher (31x48)	3148SB	31" x 48" (78.74cm x 121.92cm)	1488 in ² (9599.98cm ²)	32 lbs. (14.5kg)	1 lb./ft ² (4.88kg/m ²)	Polyethylene	Yes / 4" x 16" (10.16cm x 41cm)	Acrylic / Polycarbonate	<ul style="list-style-type: none"> •22 Cal. FSP 17 gr. Fragmentation •.44 Mag 240 gr. S.JHP (5 Shots)

FIRST RESPONDER SERIES



TSI SHIELDS



PROTECH® First Responder Shields (NIJ 0108.01 Type IIIA)									
9mm, 124 gr. FMJ - 5 Shots / .44 Magnum, 240 gr. LSWC - 5 Shots									
Product	Model #	Size (approx.)	Ballistic Coverage (approx.)	Weight (approx.)	Areal Density (approx.)	Armor Materials / Construction (Shield Body)	Viewport / Viewport Size	Armor Materials / Construction (Viewport)	Special Threat Testing (Independent NIJ Laboratory)
TSI 1	2034I	20" x 34" (50.8cm x 86.36cm)	680 in ² (4387.1cm ²)	15 lbs. (6.8kg)	1.5 lbs/ft ² (7.32kg/m ²)	Aramid	Yes / 4" x 10" (10.16cm x 25.4cm)	Acrylic / Polycarbonate	<ul style="list-style-type: none"> •.357 Sig 125 gr. TMJ (5 Shots) [Testing completed on 2436I] •9mm 127 gr. +P+ SXT (5 Shots) [Testing completed on 2436I] •5.7x28mm 40 gr. SS197/Blue Tip (5 Shots) [Testing completed on 2436I]
TSI 2	2436I	24" x 36" (60.96cm x 91.44cm)	864 in ² (5574cm ²)	16 lbs. (7.26kg)	1.5 lbs/ft ² (7.32kg/m ²)	Aramid	Yes / 4" x 10" (10.16cm x 25.4cm)	Acrylic / Polycarbonate	
TSI 3	2048I	20" x 48" (50.8cm x 121.92cm)	960 in ² (6193.5cm ²)	16.5 lbs. (7.48kg)	1.5 lbs/ft ² (7.32kg/m ²)	Aramid	Yes / 4" x 10" (10.16cm x 25.4cm)	Acrylic / Polycarbonate	

BODY WORN
CAMERAS
CONCEALABLE
ARMOR
TACTICAL
ARMOR
COMMUNICATIONS
PATROL
BIKE
DUTY GEAR/
HOLSTERS
PROTECTIVE
GEAR
ACCESSORIES
FIREARMS
LETHAL
LESS
PERFORMANCE
APPAREL
SURVIVABILITY
SYSTEMS
FORENSICS
ARMOR
SYSTEMS
TRAINING
GROUP

BALLISTIC SHIELDS

ENTRY SERIES

NEW



MIGHTY MITE



DEFENDER



2448B Entry II



2237 Entry I

ENTRY I & II



ENTRY 1 FR

**PROTECH® Entry Shields (NIJ 0108.01 Type IIIA)
9mm, 124 gr. FMJ - 5 Shots / .44 Magnum, 240 gr. LSWC - 5 Shots**

Product	Model #	Size (approx.)	Ballistic Coverage (approx.)	Weight (approx.)	Areal Density (approx.)	Armor Materials / Construction (Shield Body)	Viewport / Viewport Size	Armor Materials / Construction (Viewport)	Special Threat Testing (Independent NJ Laboratory)
Mighty Mite	1630	18" x 30" (45.72cm x 76.2cm)	540 in ² (3484cm ²)	14 lbs. (6.35kg)	1 lb./ft ² (4.88kg/m ²)	Polyethylene	Yes / 4" x 10" (10.16cm x 25.4cm)	Acrylic / Polycarbonate	
Defender	1934	20" x 34" (50.8cm x 86.36cm)	680 in ² (4387.1cm ²)	16 lbs. (7.25kg)	1 lb./ft ² (4.88kg/m ²)	Polyethylene	Yes / 4" x 16" (10.16cm x 41cm)	Acrylic / Polycarbonate	<ul style="list-style-type: none"> • Tokarev 7.62x25mm 85 gr. FMJ [steel jacket] (5 Shots) • 5.7x28mm 28 gr. SS195/HP (5 Shots) • 5.7x28mm 40 gr. SS197/Blue Tip (5 Shots)
Entry I	2237	24" x 36" (60.96cm x 91.44cm)	864 in ² (5574.2cm ²)	21 lbs. (9.5kg)	1 lb./ft ² (4.88kg/m ²)	Polyethylene	Yes / 4" x 16" (10.16cm x 41cm)	Acrylic / Polycarbonate	<ul style="list-style-type: none"> • WIN. Ranger 9mm 127 gr. +P+ SXT (5 Shots) • .357 SIG 125 gr. TMJ (5 Shots) • .22 Cal. FSP 17 gr. Fragmentation • .44 Mag 240 gr. SJHP (5 Shots)
Entry II	2448B	24" x 48" (60.96cm x 121.92cm)	1152 in ² (7432.2cm ²)	24 lbs. (10.89kg)	1 lb./ft ² (4.88kg/m ²)	Polyethylene	Yes / 4" x 16" (10.16cm x 41cm)	Acrylic / Polycarbonate	
Entry 1 FR (First Responder)	2237 MUST	24" X 36" (60cm x 91cm)	864 in ² (2195 cm ²)	15 lbs. (7 kg)	1 lbs./ft ² (4.88 kg/m ²)	Polyethylene	4" X 10" (5cm x 25cm)	Polycarbonate	<ul style="list-style-type: none"> • Remington 9mm, 124 gr. FMJ • Speer .44 Magnum, 240 gr. LSWC • Tokarev 7.62x25mm, 85 gr. FMJ • FN 5.7x28mm, 40 gr. SS197 [Blue Tip] • FN 5.7x28mm, 28 gr. SS195LF • Winchester 9mm, 127 gr. SXT • Speer .357 SIG, 125 gr. TMJ • .22 Cal, 17 gr. FSP



BALLISTIC SHIELDS

FIRST RESPONDER SERIES

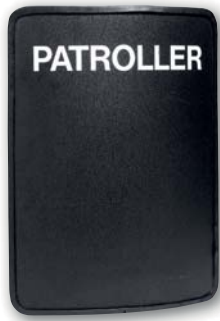

PATROLLER™



PATROLLER™ FR



PROTECH® First Responder Shields (NIJ 0108.01 Type IIIA) 9mm, 124 gr. FMJ - 5 Shots / .44 Magnum, 240 gr. LSWC - 5 Shots

Product	Model #	Size (approx.)	Ballistic Coverage (approx.)	Weight (approx.)	Areal Density (approx.)	Armor Materials / Construction (Shield Body)	Viewport / Viewport Size	Armor Materials / Construction (Viewport)	Special Threat Testing (Independent NIJ Laboratory)
Patroller	2418	18" x 24" (45.72 x 60.96cm)	432 in ² (2789.09cm ²)	8.5 lbs. (3.86kg)	1 lb./ft ² (4.88kg/m ²)	Polyethylene	N/A	N/A	<ul style="list-style-type: none"> •Tokarev 7.62x25mm 85 gr. FMJ [steel jacket] (5 Shots) •5.7x28mm 28 gr. SS195/HP (5 Shots) •5.7x28mm 40 gr. SS197/Blue Tip (5 Shots)
Patroller FR (First Responder)	2231NV	22" x 31" (55.8cm x 78.7cm)	682 in ² (4399.9cm ²)	9.6 lbs. (4.4kg)	1 lb./ft ² (4.88kg/m ²)	Polyethylene	N/A	N/A	<ul style="list-style-type: none"> •WIN. Ranger 9mm 127 gr. +P+ SXT (5 Shots) •357 SIG 125 gr. TMJ (5 Shots) •.44 Mag 240 gr. S.JHP (5 Shots) •.22 Cal. FSP 17 gr. Fragmentation



STRIKE SHIELD
Type IIIA



BARRIER BLANKET



PROTECH® Ballistic Type IIIA and/or Fragmentation Barrier Blankets (NIJ 0108.01 Type IIIA and/or MIL-STD-662F) 9mm, 124 gr. FMJ - 5 Shots / .44 Magnum, 240 gr. LSWC - 5 Shots and/or 2 / 4 / 16 / 64 gr. RCC (Round Circular Cylinder) V50 BL(P)

Product	Model #	Size (approx.)	Ballistic Coverage (approx.)	Weight (approx.)	Areal Density (approx.)	Thickness (Approx.)	Armor Materials / Construction	Outer Cover Material	Special Threat Testing (Independent NIJ Laboratory)
Strike Shield	SS2028	20" x 28" (50.8cm x 71.1cm)	560 in ² (3612.9cm ²)	10 lbs. (4.5kg)	2 lb/ft ² (9.8kg/m ²)	.430 in. (1.1cm)	Aramid	1000-denier Cordura® nylon	<ul style="list-style-type: none"> •2 gr. RCC (V50 avg. - 2879 fps / 878 mps) [Testing completed on 3910] •4 gr. RCC (V50 avg. - 2522 fps / 769 mps) [Testing completed on 3910]
Ballistic Barrier Blanket IIIA	3910	4' x 6' (1.2 m x 1.8 m)	24 ft ² (2.2 m ²)	48 lbs. (21.8kg)	2 lb/ft ² (9.8kg/m ²)	.430 in. (1.1cm)	Aramid	1000-denier Cordura® nylon	<ul style="list-style-type: none"> •16 gr. RCC (V50 avg. - 2064 fps / 629 mps) [Testing completed on 3910] •64 gr. RCC (V50 avg. - 1737 fps / 529 mps) [Testing completed on 3910]
Fragmentation Barrier Blanket	3909	4' x 6' (1.2 m x 1.8 m)	24 ft ² (2.2 m ²)	35 lbs. (15.9kg)	1.46 lb/ft ² (7.1kg/m ²)	.300 in. (0.8cm)	Aramid	1000-denier Cordura® nylon	<ul style="list-style-type: none"> •2 gr. RCC (V50 avg. - 2560 fps / 780 mps) •4 gr. RCC (V50 avg. - 2190 fps / 668 mps) •16 gr. RCC (V50 avg. - 1817 fps / 1817 mps) •64 gr. RCC (V50 avg. - 1495 fps / 456 mps)

BODY WORN
CAMERAS
CONCEALABLE
ARMOR
TACTICAL
ARMOR
COMMUNICATIONS
PATROL
BIKE
DUTY GEAR/
HOLSTERS
PROTECTIVE
GEAR
ACCESSORIES
LETHAL
PERFORMANCE
APPAREL
SURVIVABILITY
SYSTEMS
FORENSICS
ARMOR
SYSTEMS
TRAINING
GROUP

BALLISTIC SHIELDS

NATO AND ASSAULT SERIES

NEW



NATO 1, 2 & 3 ENHANCED

ASSAULT 1, 2 & 3

PROTECH® NATO Shields (NIJ 0108.01 Type III)									
7.62mm x 51mm, 147 gr., FMJ (NATO) (M80 Military Designation) - 5 Shots									
Product	Model #	Size (approx.)	Ballistic Coverage (approx.)	Weight (approx.)	Areal Density (approx.)	Armor Materials / Construction (Shield Body)	Viewport / Viewport Size	Armor Materials / Construction (Viewport)	Special Threat Testing (Independent NJ Laboratory)
NATO 1 Enhanced	1632P	17" x 32" (43.18cm x 81.3cm)	544 in ² (3509.67cm ²)	28 lbs. (12.7kg)	4 lbs/ft ² (19.53kg/m ²)	Polyethylene	Yes / 2" x 10" (5.08cm x 25.4cm)	Ballistic Glass / Acrylic	<ul style="list-style-type: none"> •7.62mm x 39mm, 123 gr., Mild Steel Core (MSC) •22 Cal. 17gr. FSP Fragmentation •.30 Cal. 44gr. FSP Fragmentation
NATO 2 Enhanced	1936P	20" x 34" (50.8cm x 86.36cm)	680 in ² (4387.09cm ²)	34 lbs. (15.4kg)	4 lbs/ft ² (19.53kg/m ²)	Polyethylene	Yes / 2" x 10" (5.08cm x 25.4cm)	Ballistic Glass / Acrylic	
NATO 3 Enhanced	2448P	26" x 48" (66.04cm x 121.92cm)	1248 in ² (8051.60cm ²)	81 lbs. (36.7kg)	6 lb/ft ² (29.29kg/m ²)	Polyethylene	Yes / 4" x 16" (10.16cm x 41cm)	Ballistic Glass / Acrylic	
NATO SS	2032	20" X 32" (51cm x 81cm)	640 in ² (4131 cm ²)	35 lbs. (16 kg)	4 lbs./ft ² (19.53 kg/m ²)	Polyethylene	Yes / 4" x 10" (5cm x 25cm)	Polycarbonate	<ul style="list-style-type: none"> • 7.62mm FMJ (.308 Winchester) • 7.62 x 39mm, 123 gr. MSC • .22 Cal, 17 gr. FSP • .30 Cal, 44 gr. FSP • 5.56 x 45mm, 55 gr. M193 Ball • 5.56 x 45mm, Tactical Bonded Projectile • 5.56 x 45mm, M855 Ball • 7.62 x 39mm, PS Ball Projectile

PROTECH® Assault Shields (NIJ 0108.01 Type III)									
7.62mm x 51mm, 147 gr., FMJ (NATO) (M80 Military Designation) - 5 Shots									
Product	Model #	Size (approx.)	Ballistic Coverage (approx.)	Weight (approx.)	Areal Density (approx.)	Armor Materials / Construction (Shield Body)	Viewport / Viewport Size	Armor Materials / Construction (Viewport)	Special Threat Testing (Independent NJ Laboratory)
Assault 1	Assault 1	16" x 24" (40.64cm x 60.96)	384 in ² (2477.41cm ²)	12 lbs. (5.4kg)	4 lbs/ft ² (19.53kg/m ²)	Polyethylene	N/A	N/A	<ul style="list-style-type: none"> • 7.62mm x 39mm, 123 gr., Mild Steel Core (MSC) (5 Shots) [Testing completed on Assault 1] • 22 Cal. 17gr. FSP Fragmentation • .30 Cal. 44gr. FSP Fragmentation
Assault 2	Assault 2	16" x 30" (40.64cm x 76.2cm)	480 in ² (3096.77cm ²)	15 lbs. (6.8kg)	4 lbs/ft ² (19.53kg/m ²)	Polyethylene	N/A	N/A	
Assault 3	Assault 3	16" x 39" (40.64cm x 99.06cm)	624 in ² (4025.80cm ²)	19 lbs. (8.6kg)	4 lbs/ft ² (19.53kg/m ²)	Polyethylene	N/A	N/A	



BALLISTIC SHIELDS

PHOENIX SERIES



**PROTECH® Phoenix IV™ Shield (NIJ 0108.01 Type IV)
7.62mm x 63mm, 166 gr., AP, (30-06) (M2 AP Military Designation) - 5 Shots**

Product	Model #	Size (approx.)	Ballistic Coverage (approx.)	Weight (approx.)	Areal Density (approx.)	Armor Materials / Construction (Shield Body)	Viewport / Viewport Size	Armor Materials / Construction (Viewport)	Special Threat Testing (Independent NIJ Laboratory)
Phoenix IV (Three Panels)	2448V	24" x 48" (60.96cm x 121.92cm)	1152 in ² (7432.24cm ²)	157 lbs. (71.2kg)	11.25 lb/ft ² (54.92kg/m ²)	Ceramic / Polyethylene	N/A	N/A	None
Phoenix IV (Extra Panel)	2448V	17" x 24" (43.18cm x 60.96cm)	384 in ² (2477.41cm ²)	50 lbs. (22.7kg)	11.25 lb/ft ² (54.92kg/m ²)	Ceramic / Polyethylene	N/A	N/A	None
Phoenix IV (Extra Panel w/ Viewport)	2448V	17" x 24" (43.18cm x 60.96cm)	384 in ² (2477.41cm ²)	65 lbs. (29.5kg)	11.25 lb/ft ² (54.92kg/m ²)	Ceramic / Polyethylene	Yes / 6" x 12" (15.24cm x 30.48cm)	Ballistic Glass	None

NEW

SHIELD SUPPORT HOOK

Designed to reduce the load-carrying fatigue of extended shield deployment on the user by allocating shield weight onto the attachment.

- Compatible on traditional modular webbing and webless load-bearing platforms
- Easy weave and snap function allows for quick donning and doffing
- Adjustable slide buckle to accommodate users/shield size [up to 36" in length]
- Compatible with all Protech® ballistic shields NIJ 0108.01 types II and IIIA – *comes standard with each NATO shield order*



BODY WORN
CAMERAS
CONCEALABLE ARMOR
TACTICAL ARMOR
COMMUNICATIONS
PATROL BIKE
DUTY GEAR/HOLSTERS
PROTECTIVE GEAR
FIREARMS ACCESSORIES
LETHAL
LESS
PERFORMANCE APPAREL
SURVIVABILITY SYSTEMS
FORENSICS
ARMOR SYSTEMS
TRAINING GROUP

LEADING COMMUNICATION PRODUCTS



COMMUNICATIONS



Industry-leading TCI™ communications products are the brand of choice among law enforcement, military and various related markets. The Liberator II™ and Liberator III™ headset systems are in use with all of the branches of the U.S. military, law enforcement agencies and customers

in over sixty countries. Celebrating 20 years, our digital hearing protection technologies meet or exceed all military specifications for hearing conservation while still providing the wearer with excellent situational awareness of their surroundings.



SINGLE & DUAL COMMUNICATIONS

LIBERATOR IV™

ADVANCED SINGLE COMMUNICATION HEADSET

- Single communication headset
- Multiple Push-To-Talk options
- Backwards compatible with TCI single communications systems
- Industry leading sound localization for maximum situational awareness and threat detection
- First of its kind Dual Fuel – runs on either two AAA or one CR123
- First headset with user audio profiles modifiable with simple keystrokes on the headset
- Upgradeable/updateable software by using NFC technology
- Industry leading 700-hour run time
- Proprietary high definition speakers and speaker enclosures
- Advanced RF and TDMA PCB protection technology
- Boom microphone featuring advanced RF and Acoustics Interference Shielding
- Modular headset suspension, user adjustable to be either over-the-head, behind-the-head, or helmet mounted
- Unique helmet mount – rear rail mount, universal, can fit both high-cut and mid-cut helmets with rails, comfort headband for full-cut helmets
- Proprietary Earcup design layered with sound barrier technology; offered in Black, OD Green, and Flat Dark Earth



LIBERATOR V™

ADVANCED DUAL COMMUNICATION HEADSET

- Dual communications headset
- R.4 dual communications Push-To-Talk available - compatible with R.A.C.E.
- Backwards compatible with TCI dual communications systems
- First of its kind Dual Mode headset – Electronic Noise Compression and Active Noise Cancellation
- Industry leading sound localization for maximum situational awareness and threat detection
- First of its kind Dual Fuel – runs on either two AAA or one CR123
- First headset with user audio profiles modifiable with simple keystrokes on the headset
- Upgradeable/updateable software by using NFC technology
- Industry leading 700-hour run time
- Proprietary high definition speakers and speaker enclosures
- Advanced RF and TDMA PCB protection technology
- Boom microphone featuring advanced RF and Acoustics Interference Shielding
- Modular headset suspension, user adjustable to be either over-the-head, behind-the-head, or helmet mounted
- Unique helmet mount – rear rail mount, universal, can fit both high-cut and mid-cut helmets with rails, comfort headband for full-cut helmets
- Proprietary Earcup design layered with sound barrier technology; offered in Black, OD Green, and Flat Dark Earth



SINGLE & DUAL COMMUNICATIONS

LIBERATOR III™ LITE COMMUNICATION HEADSET

- Digital Threat Compression Technology (DTCT) and Digital Situational Awareness Enhancement (DSAE) for maximum protection and performance for the user
- REV6 digital sound processing supports noise compression with spatial situational awareness
- Dual-comm/dual-radio capable, supports military communications and/or law enforcement/first responder systems
- 600-hour battery life on two AAA batteries
- Provides a comfortable fit with MICH, ACH, OpsCore, and other commonly used ballistic helmets
- Dual-button, quick disconnect, Push-to-Talk assembly included
- Optional headset colors and configurations available



LIBERATOR III™ ITJCS COMMUNICATION HEADSET (MILITARY)

- Exceptional headsets for TACP, JTAC, Combat Control, CCT, PJ and CAS operators who require secure dual radio capabilities in a highly modular communication kit
- Digital Threat Compression Technology (DTCT) and Digital Situational Awareness Enhancement (DSAE) for maximum protection and performance for the user
- REV6 digital sound processing supports noise compression with spatial situational awareness
- Dual-comm/dual-radio capable; supports military communications systems
- High-performance Cobra noise canceling microphone with NVG compatible lip light
- 600-hour battery life on two AAA batteries
- Provides a comfortable fit with MICH, ACH, OpsCore, and other commonly used ballistic helmets
- Dual-button, quick disconnect, Push-to-Talk assembly included
- Multiple interface cables included
- Optional headset colors and configurations available



LIBERATOR II™ DIGITAL TACTICAL HEADSET

- Digital tactical headset allowing an operator to interface, monitor and transmit on one radio
- Digital Threat Compression Technology (DTCT) and Digital Situational Awareness Enhancement (DSAE) for maximum protection and performance for the user
- REV6 digital sound processing supports noise compression with spatial situational awareness
- Single radio capable; supports military communications and/or law enforcement/first responder systems
- Long and industry-leading 600-hour battery life on two AAA batteries
- Provides a comfortable fit with MICH, ACH, OpsCore, and other commonly used ballistic helmets
- Quick disconnect single-button, Push-to-Talk assembly included
- Optional headset colors and configurations available



TACTICAL HEADSETS WITH DIGITAL HEARING PROTECTION

R.A.C.E.

RADIO AUDIO CHANNEL ENHANCEMENT (R.A.C.E.) MODIFICATION

R.A.C.E. is an audio modification made to TCI dual communications based on Push-to-Talk (PTT) assemblies. When one radio is receiving audio that sound will be heard in both Earcups, regardless of which radio is receiving. When both radios receive at the same time, the system reverts back to the traditional dual communications audio environment, with radio audio coming from the corresponding Earcup.

- Liberator III™ can be effectively used with only one radio, similar to Liberator II™
- Improves audio quality for individuals with hearing loss on one ear
- Audio still secure – absolutely no bleed through between radios
- Situational Awareness and Localization Audio still separate from Radio Audio
- Modification available on all new dual comm PTT's, or retrofit to previously purchased PTTs

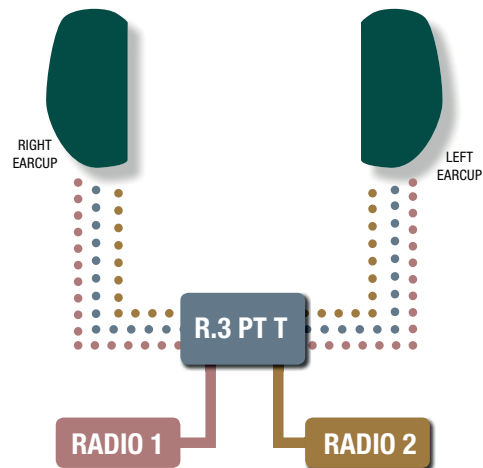

SPLIT AUDIO WHEN BOTH RADIOS ARE IN USE
Radio 1 > Right Earcup Radio 2 > Left Earcup

STEREO WHEN ONE RADIO IS IN USE
Radio 1 stereo > Right & Left Earcups
Radio 2 stereo > Right & Left Earcups

HELMET MOUNTING SOLUTIONS

HELMET MOUNTING SOLUTIONS

HELMET RAIL AND UNIVERSAL HEADSET MOUNTING ADAPTORS

- Compatibility with Ops Core type, Team Wendy type, and Crye type rails
- Billet Aluminum – more durable than polymer mounts used elsewhere
 - Extended vertical adjustment
 - Uses common Phillips head set screw
 - Non-reflective surface
- Offered with TCI manufactured rail mount Improved long lasting locking ratchet
 - Designed to offer more vertical torque support than other mounts
 - Improved long lasting locking ratchet
 - Smoother rotational movement with grip surfaces
 - Non-reflective wire forms
- Can swap between over-the-head suspension and rail helmet mount
- Retrofit service for all existing Liberator II/III's - Warranty maintained



WIRELESS COMMUNICATIONS

LIBERATOR III™

TACTICAL BLUETOOTH MODULE

- IP-67 water durability
- Six hours of continuous operation, 10 days of standby time, 90 minutes to recharge
- High quality receive and transmit audio
- Newer secure/reliable Bluetooth technology for easy pairing and operations
- 50 ft. wireless range
- No need to use PTT button while speaking on cell phone
- Secures portable radio calls from cell phone calls
- Wireless access to music via Bluetooth device
- Battery status prompts/warnings
- Answer/end call, control volume and use voice operations without removing phone from pocket
- Includes Micro – USB charging cable



GAS MASK SOLUTIONS

GAS MASK ADAPTER (GMA)

- An economical and easily operated solution to gas mask connectivity
- Easily converts existing communications systems
- Answer/end call, control volume and use voice operations without removing phone from pocket
- Includes Micro – USB charging cable



ALPHA PUSH-TO-TALK (APTT)

- Gas mask connectivity comes standard
- Various options available such as cell phone, volume control, and remote PTT functionality
- Includes ambidextrous MOLLE loop-attachable clothing clip
- Utilizes the legacy U94 form factor with more advanced and reliable construction
- Available with 18 in. radio interface cable and 2-pin gas mask receptacle
- Answer/end call, control volume and use voice operations without removing phone from pocket
- Includes Micro – USB charging cable



MOBILE FORCE FIELD (MFF) KIT

- Connects PTT assemblies directly to a gas mask for clear audio transmissions
- Includes tubeless audio receiver, NIOSH-approved gas mask cable, military-approved connectors, enforced cables and a one-piece, over-molded system for longevity

MODULAR ANTENNA SYSTEMS



M.A.S.T.™

MODULAR ANTENNA SYSTEM TACTICAL

- Increase radio antenna efficiency, line-of-sight range, user ergonomics, and to relocate tactical radio antennas
- Version 1: TNC-M to TNC-F
- Version 2: TNC-M to BNC-M with BNC-TNC quick disconnect adaptor available in straight or 90°
- Version 4: SMA-F to SMA-F
- Version 5: (Water proof IP-67) TNC-M tight angle to TNC-F
- Includes cable, M.A.S.T. antenna harness, and MALICE Clip
- Compatible with modular webbing systems
- 24" or 42" high-durability overmolded cable options available
- Compatible with military radios with TNC connections or law enforcement/first responder radios with SMA connections
- Harness available in Black, OD Green, Coyote Tan and Foliage Green



M.A.S.T.™ VERSION 2

QUICK DISCONNECT VERSION
MILITARY-MBITR/PRC-152/
PRC-154



M.A.S.T.™ VERSION 3

SATCOM VERSION



M.A.S.T.™ VERSION 4

FIXED VERSIONS MOTOROLA XTS,
APX, KENWOOD NX300



M.A.S.T.™ VERSION 5

WATERPROOF, IP68 FIXED VERSION
MILITARY-MBITR/PRC-152/PRC-154

NEW



M.A.S.T.™ VERSION DOJ

INLINE – QUICK DISCONNECT VERSIONS
MOTOROLA XTS, APX, KENWOOD NX300



THROAT MICROPHONE SYSTEM

TTMK III™

TACTICAL THROAT MICROPHONE

- Offers the latest in throat conduction microphone technology
- Dual communications; upgradeable with AMC connector for use with TCI "U" series advanced Push-to-Talk (PTT) and accessories
- Well suited for use with gas masks, respirators, and/or use with NBC/WMD/HAZMAT ensembles
- Low-profile, usable with a wide array of protective face shields and ballistic helmets
- Can be worn under clothing for low visibility mission sets
- Includes TCI's PTT, a Soundwaves/FC R3™ Earcoil for crisp and clear receive audio and headset storage bag
- Users can select either our TACT-LITE™ Earmolds or the Sound-Attenuation Ear-Insert as their earpiece
- Supports over 250 different radio interfaces and manufacturers
- Custom configurations on request



LOW-PROFILE HEADSETS

TECS

TACTICAL ENFORCEMENT LOW-VISIBILITY MODULAR EARPIECE

- Crystal clear audio delivered to inner-ear using Soundwaves/FC R4 Earcoil and choice of ear-insert types
- Noise-canceling/waterproof microphone
- TCI Push-to-Talk (PTT) assembly included
- Supports military or law enforcement/first responder radio systems.
- Durable, yet provided with flexible cables
- PTT compatible with other TCI headset products allowing future augmentation of the system and capabilities



SAS II

SPECIAL AIR SERVICE LOW-VIS

- Developed to provide spec-ops and tactical units with a durable, low-profile communication solution that could be used for tactical and low-visibility missions. It provides phenomenal acoustical performance
- Multi-use system for tactical and low-visibility applications
- Crystal clear audio delivered to inner-ear using soundwaves/FC R4 Earcoil and choice of ear insert types
- Noise-canceling/waterproof microphone
- Fixed Push-to-Talk assembly included
- Supports military or law enforcement/first responder radio systems
- Durable, yet supplied with flexible cables



BONE CONDUCTION HEADSETS

TABC III

TACTICAL ASSAULT BONE CONDUCTION HEADSET

- Binaural Dynamic Audio Resonance System “DARS” is our proprietary sound reproduction system that provides pristine audio fidelity that bypasses the ear drum and goes directly to the cochlea through the mandible (jaw bone)
- State-of-the-art, bone-to-bone conduction transducers and noise-canceling boom microphone
- Supports military or law enforcement/first responder radio systems
- TCI Tactical Push-to-Talk (PTT) included, dual communications version upon request
- Lightweight, adjustable headset fits under ballistic helmets or other non-ballistic rigid or soft head gear
- Designed to leave user’s ears unobstructed for natural situational awareness and peripheral hearing



HEARING PROTECTION

LIBERATOR HP™

ADVANCED HEARING PROTECTION

- First of its kind Dual Mode headset: has Electronic Noise Compression and Active Noise Cancellation
- Industry leading sound localization for maximum situational awareness and sound detection
- First of its kind Dual Fuel – Runs on either two AAA or one CR123 batteries
- First headset with user audio profiles modifiable by using Near Field Communications technology
- Industry leading 700-hour run time
- Proprietary high definition speakers and speaker enclosures
- Modular headset suspension, user adjustable to be either over-the-head or behind-the-head for maximum comfort
- Proprietary Earcup design layered with sound barrier technology
- Available in Black, OD Green, and Flat Dark Earth

NEW



PATROL KITS

TWO-WIRE PATROL KIT

- Lightweight (less than 2 oz.)
- Quick-detach Hirose connector included
- Cable lengths optimized for threading through suits, uniforms, body armor, and other tactical apparel
- Moisture-inhibiting acoustic tubing can be used for surveillance or as a lightweight replacement for the bulky shoulder-worn speaker microphone handset
- Two ear piece types included: silicone gel tip for partial occlusion and foam tip for full occlusion and comfort
- In-ear tips provide better sound clarity, require lower radio volume, increase radio battery run-time
- Available for Motorola XTS and APX radios; other radios available upon request



10-2 RECEIVE ONLY KIT

- Earpiece kit provides seamless audio directly from an operator's remote speaker microphone
- Isolated audio for enhanced audio reception in loud noise situations
- Compatible with any remote speaker mic with a 3.5mm non-threaded receptacle
- Allows officer to leave portable radio volume turned on while in the vehicle
- Includes moisture inhibiting acoustic tubing, durable 14" coiled 3.5mm cable, acoustically enhanced audio transducer and three semi-custom Earmolds in various sizes; Small, Medium, Large

CIPS KIT COVERT IN PLAIN SIGHT KIT

- Provides plainclothes officers a solution to remain covert when communicating via a portable radio
- Allows officers to use a portable radio while wearing earbuds commonly associated with smartphones or MP3 players
- The portable radio is connected to a mini Push-to-Talk (PTT) Sniper Ring, so the officer is able to key the radio and use the microphone in the smartphone headset without any indication to outsiders that a tactical radio is in use
- Lightweight (less than 2oz.)
- Cable lengths optimized for threading through clothing
- Quick detach system to transition to personal electronics
- PTT available in Beige (exclusive to TCI) and Black
- Initially available for Motorola XTS, APX radios and Harris P5300/XG-75; other radios available upon request

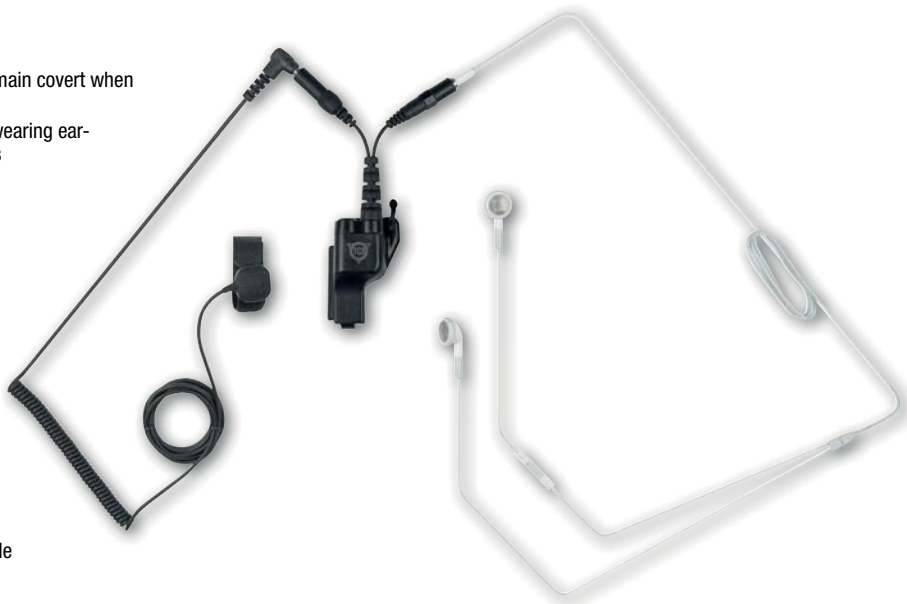

ENGINEERED SUPERIORITY



INTEGRATED REAR RACK
for superior payload strength

SLOPING TOPTUBE
means more stand over clearance

SEMI-INTEGRATED CABLE ROUTING
allows for easy access, mechanic friendly routing of cables

7005 ALUMINUM TUBING
ideally engineered shape and wall thickness for extra performance and durability

SHADOW DERAILLEUR
tucks in 1/2" more reducing bike profile which protects the drivetrain if bike is tossed down

KICK STAND
frame specifically designed for heavy-duty kick stand

29-INCH WHEELS
add stability and confidence and make it easy to roll over small obstacles such as stairs

HYDRAULIC DISC BRAKES
additional stopping power

29ER

SAFARILAND®/KONA® PATROL BIKE

All bike purchases now include the following items at no additional charge:

- Top tube, fork, and helmet decals, please specify police or sheriff

PATROL BIKE



The Safariland®/Kona® Patrol Bike is the first patrol bike designed specifically to meet the needs of bike patrol officers. Safariland partnered with Kona, one of the world's

finest mountain bike manufacturers, and collaborated with bike patrol officers from around the country to research and develop a best-in-class solution for bike patrol.



4558 SAFARILAND® BIKE GEAR BAG

- Spacious main interior compartment
- Collapsible “false floor” for sensitive items carried on duty
- Exterior bungee draw string to hold jackets, windbreakers, etc.
- Top pocket houses battery pack with extra elastic for secure battery storage
- Reflective tabs for officer safety and awareness
- Two-way, exterior pouch to hold CPR mask
- Sewn loop platforms for attachment of customized patches (sold separately)



NITERIDER POLICE LIGHT & SIREN SYSTEM

- Headlight and tail light run on rechargeable Li-Ion battery
- Both headlight and tail light feature bright white and colored red and blue LED lights

INNOVATION NOT IMITATION.®



SAFARILAND DUTY GEAR



Safariland® holsters and accessories are the overwhelming choice for law enforcement officers and competition shooters around the world. Known for quality, performance and technological advancements in design, new products are

continually being developed with the most knowledgeable and experienced users in the industry, and field tested by users and our world-renowned Team Safariland shooters to provide you with the best available final product.



BODY WORN CAMERA AUTO-ACTIVATION SYSTEM

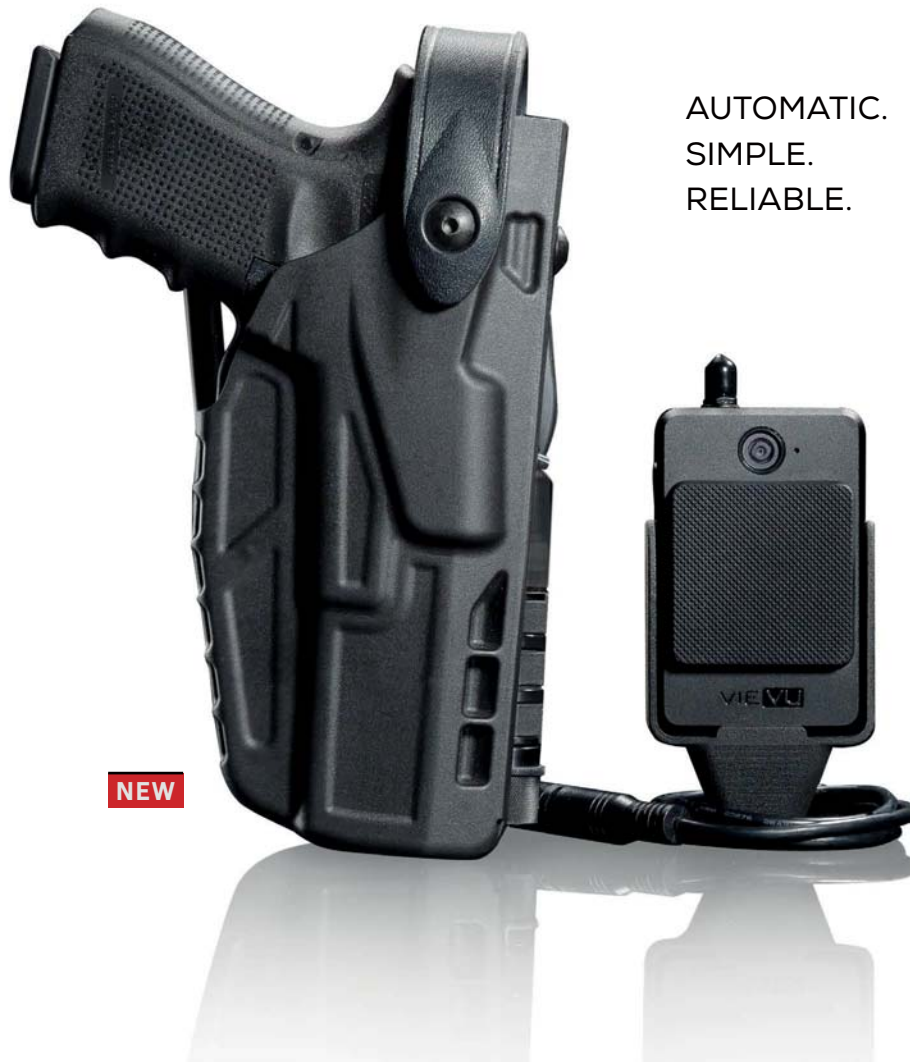

AUTOMATIC.
SIMPLE.
RELIABLE.

NEW

THE WORLD'S FIRST HOLSTER & CAMERA AUTO-ACTIVATION SYSTEM

With the ever increasing need for transparency, in a world dominated by technology and enhanced scrutiny, Safariland® introduces the world's first holster and Camera Auto-activation System (CAS™). The Safariland holster and camera auto-activation system removes the decision making process of turning on a camera during a potentially life threatening situation, so an officer can be completely focused on the events at hand.

Safariland holster and camera auto-activation technology, tell your story.

HOW THE CAMERA AUTO-ACTIVATION SYSTEM WORKS

FIREARM DRAW

As an officer removes their firearm from the Safariland 7TS™ holster, the Camera Auto-activation System is triggered, activating the VIEVU® body worn camera.

RELIABLE CONNECTION

Wired connection ensures consistent auto-activation.

CAMERA ACTIVATION

Initiated by the firearm draw, the camera automatically begins recording until stopped by the officer.

PRE-EVENT RECORD

Once the firearm is drawn, every critical moment is captured, including the 30 seconds prior.

BODY WORN CAMERA AUTO-ACTIVATION SYSTEM

BODY WORN CAMERAS | CONCEALABLE ARMOR | TACTICAL ARMOR | COMMUNICATIONS | PATROL BIKE | **DUTY GEAR/ HOLSTERS** | PROTECTIVE GEAR | FIREARMS ACCESSORIES | LETHAL | PERFORMANCE APPAREL | SURVIVABILITY SYSTEMS | FORENSICS | ARMOR SYSTEMS | TRAINING GROUP

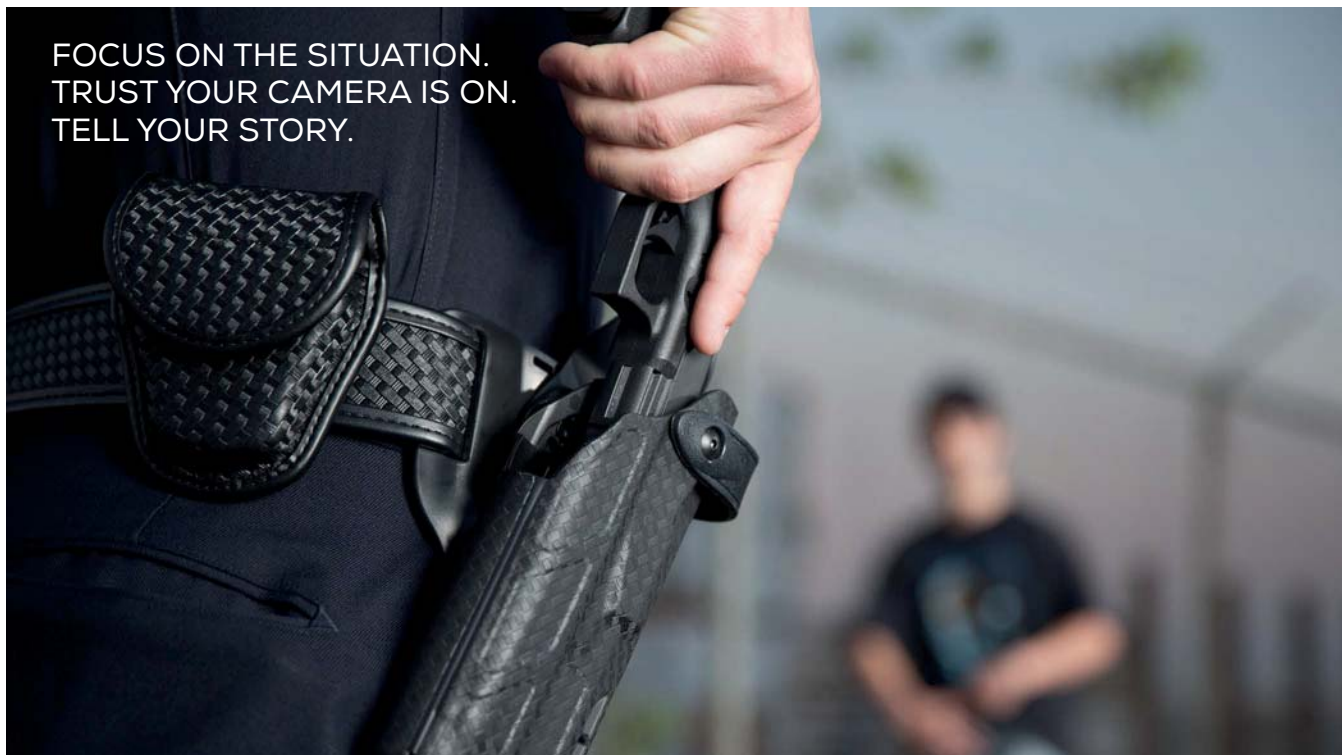

FOCUS ON THE SITUATION.
TRUST YOUR CAMERA IS ON.
TELL YOUR STORY.

7TS

PATENTED &
PATENT PENDING



SAFARILAND® 7TS™ DUTY HOLSTER

- 30-day battery life with replaceable batteries
- Features the ALS® (Automatic Locking System) and SLS (Self Locking System) Rotating Hood
- SafariSeven™ proprietary nylon blend is non abrasive to a firearm's finish
- Extremely high heat and cold tolerances; holster is structurally sound from 300° to -50°
- Three models are offered, the 7360 ALS®/SLS Mid-Ride with Level III Retention, 7390 ALS®) Level I Retention™ and the 7280 SLS Mid-Ride with Level II Retention



VIEVU® LE4 BODY WORN CAMERA

- Captures 95° undistorted field of view
- Continuous record for over 12 hours without recharging battery
- Extremely durable billet aluminum
- Pre & post event recording
- 1080, 720 and widescreen 848 x 480 video resolution



MULTIPLE
MOUNTING
OPTIONS



VIEVU SOLUTION

- Secure storage on the Microsoft Azure Government Cloud
- CJIS compliant and meets all FBI data security requirements
- VIEVU smartphone app enables livestream videos and metadata additions

SAFARILAMINATE™ CONSTRUCTION

SAFARISEVEN™ MATERIAL FEATURES

Proprietary nylon blend that is completely non-abrasive to a firearm's finish. Raised stand-off surfaces in interior of holster creates air space around the weapon allowing dirt and moisture to quickly clear any contact with the firearm.

- Very high heat tolerance; structurally sound at 300°F
- Can be submerged in water indefinitely and still maintain shape and function
- Very low cold tolerance; structurally sound at -50°F
- Matte finish decreases reflection and can be maintained with a simple scouring pad
- Compatible with all Safariland® holster mounting options

SAFARILAND FINISHES / COLORS

Traditional Leather Look - SafariLaminate construction offered in Plain, Basketweave, Hi Gloss, and Nylon-Look

STX Tactical® - SafariLaminate construction with an exclusive "haircell" finish. It's famous for its incredible strength and abrasion-resistance, available in several colors

STX SafariLaminate construction offered in Plain, Basketweave and Hi Gloss

SafariSeven™ - An injection molded design with a proprietary nylon blend completely non-abrasive to the firearm's finish offered in Plain Black, Basketweave, Hi Gloss and FDE Brown

STX TACTICAL® COLORS AVAILABLE



7TS COLORS AVAILABLE



RETENTION LEVELS

Officer safety is critical. That's why Safariland® created the Retention Level system as a guide to holster selection. The holsters in this catalog are classified by their Retention Levels to help you choose the right holster for your needs. In the interest of safety for police officers, Safariland introduced the Retention Level system in 1985, providing useful holster selection information to the marketplace. This system helped officers evaluate and make informed decisions on the type of holster needed for different scenarios and environments. Safariland set this initial standard, and to this day is the only holster manufacturer with established, strict testing criteria to evaluate the Retention Level of a duty holster.



The ALS® or Automatic Locking System provides a high level of security without adding thumb breaks, snaps, or levers requiring the use of the trigger finger.



1. The ALS is a unique design that locks into the ejection port and is operated by the thumb once the SLS is released.
2. The Hood Guard helps protect the ALS from impact and premature release, especially in an attempted takeaway. Included with all duty and tactical versions.
3. Constructed of SafariLaminate™, a thermal-molded holster to help protect the handgun and gun-mounted accessories for years of use.



The SLS or Self Locking System rotating hood has been tested and proven for many years on the 6280 and 6004 series of holsters. Simply push down and rotate forward as you obtain your shooting grip.



1. The SLS rotating hood has been tested and proven for many years on the 6280 and 6004 series of holsters. Simply push down and rotate forward as you obtain your shooting grip. To close, pull back on the hood, and the SLS self locks. There are no snaps or straps to manipulate.
2. The Hood Guard helps protect the SLS from impact and premature release, especially in an attempted takeaway. Included with all duty and tactical versions.
3. Optional Sentry lever increases Retention Level by one.



Much like the ALS® with its intuitive draw, the GLS™ or Grip Locking System, is automatically disengaged when taking a shooting grip.



1. The GLS retention device operated by the middle finger, simply obtain a shooting grip to release the mechanism.
2. Automatically locks weapon in place upon holstering.

LEVEL I RETENTION™



PATENTED & PATENT PENDING

7390 7TS™ ALS® LEVEL I RETENTION™ MID-RIDE DUTY HOLSTER

- ALS® (Automatic Locking System) secures weapon once holstered; simple straight up draw once release is deactivated
- Open-top design without SLS for quick retrieval of weapon
- Optional ALS Guard available for increasing level of security by one to a Level II Retention™
- A proprietary nylon blend that is completely non-abrasive to a firearm's finish
- Raised stand-off surfaces in holster's interior creates air space around the weapon, allowing dirt and moisture to quickly clear any contact with the firearm
- Very high heat and low cold tolerances; structurally sound from 300° F to -50° F
- Available in SafariSeven™ Plain, Basketweave, Hi-Gloss and FDE Brown finishes



PATENTED & PATENT PENDING

7392 WITH HI-RIDE UBL

- Hi-ride version



PATENTED & PATENT PENDING

7395 WITH LOW-RIDE UBL

- 1.5" (38mm) Belt Drop version



PATENTED

ALS
automatic locking system

6390 ALS® LEVEL I WITH MID-RIDE UBL

- ALS® (Automatic Locking System) secures weapon once holstered; simple straight up draw once the release is deactivated
- Optional ALS Guard available for increasing level of security by one to Level II Retention™
- Open-top design without SLS for quick retrieval of weapon
- SafariLaminate™ thermal-molded construction protects handgun and sights
- Available in STX finishes
- Available in RDS model



PATENTED

6392 WITH HI-RIDE UBL

- Hi-ride version



PATENTED

6395 WITH LOW-RIDE UBL

- 1.5" (38mm) Belt Drop version



200 TOP GUN LEVEL I RETENTION™ WITH MID-RIDE UBL

- Features a top draw, mid-ride, straight-drop cant and a thumb break with a one-way directional snap
- Adjustable holster tensioning device easily allows the controlling of friction with the turn of a screw
- Available in Plain Black, Basketweave, Hi Gloss or Nylon Look finishes



2 HI-RIDE LEVEL I RETENTION™ DUTY

- Hi-ride version



2005 WITH LOW-RIDE UBL

- 1.5" (38mm) Belt Drop version

LEVEL II RETENTION™



6280 SLS LEVEL II RETENTION™ WITH MID-RIDE UBL

- SLS (Self Locking System) Rotating Hood
- Top draw and straight-drop cant
- Level III Retention™ with optional Sentry installed
- Available in RDS model
- Available in Plain Black, Basketweave, Hi Gloss, Nylon Look, STX or STX Tactical® finishes (all colors)



6282 WITH HI-RIDE UBL

- Hi-ride version



6285 WITH LOW-RIDE UBL

- 1.5" (38mm)
Belt Drop version



PATENT PENDING

7280 7TS™ SLS MID-RIDE LEVEL II RETENTION™

- SLS (Self Locking System) Rotating Hood
- Level III Retention™ with optional Sentry installed
- A proprietary nylon blend that is completely non-abrasive to a firearm's finish
- Raised stand-off surfaces in holster's interior creates air space around the weapon allowing dirt and moisture to quickly clear any contact with the firearm
- Very high heat and low cold tolerances; structurally sound from 300° F to -50° F
- Available in SafariSeven™ Plain, Basketweave, Hi-Gloss and FDE Brown finishes



PATENT PENDING



PATENT PENDING

7282 WITH HI-RIDE UBL

- Hi-ride version

7285 WITH LOW-RIDE UBL

- 1.5" (38mm)
Belt Drop version



295 LEVEL II RETENTION™ WITH MID-RIDE UBL

- Features front wraparound thumb break and an internal trigger guard lock for secure weapon retention
- Mid-ride belt position and slightly forward grip cant allow for comfortable carry and quick, easy draw
- Offered in 2" (50mm) or 2.25" (58mm) belt slots
- Available in Plain Black, Basketweave, Hi Gloss or Nylon Look finishes



2955 WITH LOW-RIDE UBL

- 1.5" (38mm)
Belt Drop version

LEVEL III & IV RETENTION™



PATENTED

6360 ALS®/SLS MID-RIDE LEVEL III RETENTION™



- ALS® (Automatic Locking System) secures weapon once holstered
- SLS (Self Locking System) Rotating Hood
- Level IV Retention™ with optional Sentry installed
- Slim, compact design allows weapon to ride close to body
- Simple straight up draw once all releases are deactivated
- Available in RDS model
- Available in Plain Black, Basketweave, Hi Gloss, Nylon Look, STX or STX Tactical® finishes (all colors)

ALS
automatic locking system



PATENTED



PATENTED

6362 WITH HI-RIDE UBL

- Hi-ride version

6365 WITH LOW-RIDE UBL

- 1.5" (38mm) Belt Drop version



PATENTED &
PATENT PENDING

7360 7TS™ ALS®/SLS MID-RIDE LEVEL III RETENTION™

- ALS® (Automatic Locking System) secures weapon once holstered; simple straight up draw once release is deactivated
- SLS (Self Locking System) Rotating Hood
- Level IV Retention™ with optional Sentry installed
- A proprietary nylon blend that is completely non-abrasive to a firearm's finish
- Raised stand-off surfaces in holster's interior creates air space around the weapon allowing dirt and moisture to quickly clear any contact with the firearm
- Very high heat and low cold tolerances; structurally sound from 300° F to -50° F
- Available in SafariSeven™ Plain, Basketweave, Hi-Gloss and FDE Brown finishes



PATENTED &
PATENT PENDING



PATENTED &
PATENT PENDING

7362 WITH HI-RIDE UBL

- Hi-ride version

7365 7TS™ ALS®/SLS WITH LOW-RIDE UBL

- 1.5" (38mm) Belt Drop version



070 SSIII LEVEL III RETENTION™ WITH MID-RIDE UBL

- Mid-ride belt position and slightly forward grip cant allow for comfortable carry and quick, easy draw
- Top thumb break and middle finger release tab, internal ejection port lock
- Offered for 2.25" (58mm) belt slot only
- Available in Plain Black, Basketweave, Hi Gloss or Nylon Look finishes



0705 WITH LOW-RIDE UBL

- 1.5" (38mm) Belt Drop version

EDW HOLSTERS

Safariland® offers a wide array of holster models to address the market expansion in the use of EDWs, or electronic discharge weapons. The Safariland SLS has improved the offerings of the EDW holster from a simple device, holding a weapon in a Retention Level-quality holster.

7520

7TS™ SLS EDW HOLSTER WITH CLIP

- Level II Retention™ holster
- SLS (Self Locking System) Rotating Hood
- A proprietary nylon blend that is completely non-abrasive to a cartridge's finish
- Raised stand-off surfaces in holster's interior creates air space around the weapon, allowing dirt and moisture to quickly clear any contact with the cartridge
- Clip-on style belt loop with ability to fit 1.5" (38mm), 1.75" (45mm), 2" (50mm) or 2.25" (58mm); belt clip is user-adjustable for cant angle
- Designed for vertical or cross draw carry
- Closed bottom with drain hole to protect cartridge and officer
- Very high and low heat tolerances; structurally sound from 300°F to -50°F
- Available in SafariSeven™, Plain Black, Basketweave and Hi-Gloss



PATENT PENDING



6287

SLS EDW BELT LOOP

- Level II Retention™ holster
- Rides close to body
- SLS (Self Locking System) Rotating Hood
- Adjustable cant, can be worn strongside or cross draw
- Closed bottom with drain hole to protect cartridge and officer
- SafariLaminate™ construction with suede lining
- Available in Plain Black or STX Tactical® finishes (all colors)



6520

SLS EDW HOLSTER WITH CLIP

- Level II Retention™ holster
- SLS (Self Locking System) Rotating Hood
- Clip-on style belt loop with ability to fit 1.5" (38mm), 1.75" (45mm), 2" (50mm) or 2.25" (58mm); belt clip is user-adjustable for cant angle
- Designed for vertical or cross draw carry
- Closed bottom with drain hole to protect cartridge and officer
- SafariLaminate™ construction with suede lining
- Available in Plain Black, Basketweave, Hi Gloss, Nylon Look, STX or STX Tactical® finishes (all colors)



521-CAP

EDW CARTRIDGE ACCESSORY PLATE

- Attaches to the 745BL Belt Clip
- Provides convenient storage area for additional EDW cartridge
- Available for Models 520 & 6520
- Available in Plain Black, Basketweave, Hi Gloss or Nylon Look finishes
- Holster sold separately

DUTY HOLSTER ACCESSORIES

HOLSTER MOUNTING PLATFORMS

Safariland® offers the broadest line of holsters for law enforcement, so it follows that we would also provide the most extensive line of mounting platforms and accessories for our holsters. These options add versatility, comfort, and convenience as you perform your duties.

UNIVERSAL BELT LOOP (UBL) STYLES

- Will not pinch or add pressure to hip bone (support ridge removed from the belt shank)
- Locks onto the duty belt with belt slot design, no belt tension screws needed; will not damage top of belt
- Compatible with any holster with the 3-hole pattern



6070UBL-PAD

MID-RIDE

6075UBL-PAD

LOW-RIDE

- Provides a soft pad between the body and Universal Belt Loop (UBL)
- Helps address comfort issues associated with wearing a duty belt for long periods of time
- Works equally well for both male and female officers

RIDE HEIGHTS FOR VARIOUS BODY STYLES



Mid-ride: standard ride height



Low-ride: drop version 1.5" below waist



Mid-ride with HDA: drop version 2" below waist



6070UBL

2" OR 2.25"
MID-RIDE UBL



6075UBL

2" OR 2.25"
LOW-RIDE UBL



6072UBL

2" OR 2.25"
HI-RIDE UBL



P2201

CONVERTS 2.25" UBL
TO A 2" BELT SLOT



6281HDA

DROPS HOLSTER
BY 2"



HRA

HI-RIDE
ADAPTER LIFTS
HOLSTER BY 2"

SPACER KITS

Spacer kits are available to position the holster away from the body to accommodate various body shapes. The kits are designed for use with Safariland 3-hole pattern holsters and tactical accessories.



T-SPACER-KIT

- Positions holster farther away from body for a smooth and comfortable draw
- For use on holsters only



HDA-KIT

- Designed to lower holster by 2" (50mm)
- For use on holsters only, right and left hand specific



OVAL SPACER-KIT

- Positions upper portion of holster farther away from body without spacing the bottom any further, giving an increased "outward" cant



CUSTOMIZED-KIT

- Positions holster farther away from body for a smooth and comfortable draw
- For use with holsters or accessories

DUTY BELTS

• All belts available in Black unless otherwise specified, and buckles are offered in a choice of chrome or brass finish



031
D-RING BELT 1.5" (38MM)

- Reinforced instructor-style belt
- Lined with loop material



51
GARRISON WITH SQUARE BUCKLE 1.75" (45MM)

- Full grain leather construction
- Includes removable square chrome or brass buckle



99/999
BUCKLELESS™ REVERSIBLE BELT 1.5" (38MM)

- Loop can be worn on the outside, creating a Buckleless system
- Order 999 for belt without loop lining



992
REVERSIBLE SAFARILAMINAT™ BELT 1.5" (38MM)

- Lined with loop material
- Designed to be worn under duty belts with hook as the foundation of the Safariland® Buckleless™ system
- The 992 is the contour version of the 99



942
CONTOURED BUCKLELESS™ BELT 2" (50MM) OR 2.25" (58MM)

- Tip of belt points to the right side of the officer
- Greater all-day comfort by distributing weight evenly; no sharp edges to dig into hips
- Lined with hook to mate with 99 underbelt
- Features a hidden brass hook closure



87/87V
SAM BROWNE BELT 2.25" (58MM)

- Standard duty belt with a suede lining
- 4-stitch design with free-sliding keeper to hold belt tip in place
- Double-tongued buckle and center belt stud fasten belt firmly around waist
- 87V with hook lining



146/146V
BORDER PATROL WITH BUCKLE 2.25" (58MM)

- Billeted belt design with 1.25" billets and buckle
- The 1.25" (32mm) and 2.25" (58mm) keepers hold the interior and exterior belt tips in place
- 146V version features hook lining



872
CONTOURED BELT 2.25" (58MM)

- 4-stitch design with suede lining and free-sliding keeper to hold belt tip in place
- 2.25" (58mm) duty belt is contoured for proper alignment and greater comfort
- Greater all-day comfort; no sharp edges to dig into hips



875
SAM BROWNE STITCHED EDGE 2.25" (58MM)

- Standard duty belt with a plain border stitch
- Double-tongued buckle and center belt stud fasten belt firmly around waist



4330
PADDED UNDER BELT

- 3" padded belt liner for use with duty or tactical belts
- Padding extends beyond edges of belt to help with weight distribution and remove pinch point
- Anti-bacterial and anti-microbial mesh interior



94/94P
BUCKLELESS™ BELT 2.25" (58MM)

- Features a hidden brass hook and a hook and loop closure on both ends
- Belt is lined with a band of hook and loop and attaches to the lining on the Model 99 or 992, completing the Buckleless system
- 94P without hook and loop



4332
ELS™ TACTICAL BELT 2" (50MM)

- Features full length hook lining
- Buckleless™ design features two large knobs for locking in ELS mounting holes
- Pre-cut ELS mounting holes for straight up or angled attachment of ELS Receiver Plates
- Available in Nylon Look, Tan or Foliage Green finishes
- ELS sold separately (see page 91)



4832
LIGHTWEIGHT DUTY BELT 2.25" (58MM)

- Full length hook lining for use with Safariland Model 99 or 4325
- Buckleless™ design featuring hidden brass hook
- Up to 30% lighter than standard duty belts



4320
PADDED BELT LINER

- Provides a padded buffer between duty belt and body
- Helps eliminate possible bruising and other comfort issues associated with wearing a duty belt for long periods of time



4325
NYLON BUCKLELESS™ REVERSIBLE BELT 1.5" (38MM)

- Hook and loop closure
- Lined with loop material

HOLSTER MOUNTING PLATFORMS



566BL

- Rides 1" or 2" higher than standard 567BL belt loop
- Fit belt widths up to 1.5" (38mm)



567BL

1.5" TO 2.25"

- Seven different options available up to 2.25"



745BL BELT CLIP

- Designed with a 3-hole pattern, allowing interchangeability among various Safariland holsters
- Clips on/off belt without having to remove other accessories on rig
- Made of durable nylon; will pass a Level I Retention™ pull test
- Fits belt widths from 1.5" (38mm) to 2.25" (58mm)

PATENTED



568BL UP TO 1.75"

- Fits up to 1.75" belt widths
- No belt necessary for use



565BL HI-RIDE CONCEALMENT BELT LOOP

- Can be used on any Safariland® 3-hole pattern holster
- Available in 11.5" or 1.75" belt width



6004-DFA DROP FLEX ADAPTER

- Allows user to wear a thigh rig below the hip without shifting weight farther down the leg
- Keeps rig from sliding on belt no keeper needed
- Can be used on belt widths up to 2.25" (58mm)
- For use in conjunction with the 6004-10 Leg Shroud



6004-UFA UNIVERSAL FLEX ADAPTER

- Allows user to wear a thigh rig below the hip without shifting weight farther down the leg
- Hole pattern on UFA makes connecting to various mounts possible, including the 568BL Paddle, ELS Fork, QLS Fork, or 745BL Belt Clip
- For use in conjunction with 6004-10 Leg Shroud



with QLS



with ELS



with 568BL



SLS/ALS® ACCESSORIES

Four uniquely designed accessories for Safariland® duty holsters with the SLS (Self Locking System) and ALS® (Automatic Locking System) systems. Available for the following models:

- SLS: 6004, 6005, 6034, 6035, 6230, 6235, 6280, 6285, 6287, 6520, 7004, 7005, 7280, 7285 and 7520
- ALS®: 6304, 6305, 6354, 6355, 6360, 6365, 6384, 6385, 6390, 6395, 7304, 7305, 7354, 7355, 7360, 7365, 7384, 7385, 7390 and 7395



SLS (SELF LOCKING SYSTEM)



FRONT VIEW



6000 SLS HOOD GUARD

- Features a uniquely designed accessory protection for the SLS holster system
- Will adapt to any SLS holster
- Colors: Black, Tan, Foliage Green



BACK VIEW



6001 SLS SENTRY

- Features a uniquely designed accessory protection for the SLS holster system
- Will adapt to any SLS holster and increase the retention level by one
- Color: Black



6002 SLS SENTRY & HOOD GUARD

- Features the Sentry installed into the Hood Guard
- Will adapt to any SLS holster
- Colors: Black, Tan, Foliage Green
- Sentry only available in Black



ALS (AUTOMATIC LOCKING SYSTEM)



6006 ALS® GUARD

- Provides additional security for select ALS® concealment, tactical and duty holsters
- Fits the following models: 6354, 6355, 6377, 6378, 6379, 6384, 6385, 6390, 6395, 7354, 7355, 7378, 7377, 7379, 7384, 7385, 7390 and 7395
- Covers ALS lever to prevent any accidental or unauthorized use
- Can be retrofitted onto existing ALS concealment holsters
- Color: Black



LOCKED



UNLOCKED

6007 ALS HOOD GUARD

- Features a uniquely designed accessory protection for the ALS holster system
- Will adapt to any ALS holster
- Colors: Black, Tan, Foliage Green

6008 HOOD GUARD & ALS GUARD

- Features the ALS guard installed into the hood guard
- Fits the following models: 6354, 6355, 6377, 6378, 6379, 6384, 6385, 6390, 6395, 7354, 7355, 7377, 7378, 7379, 7384, 7385, 7390 and 7395
- Covers ALS lever to prevent any accidental or unauthorized use
- Colors: Black, Tan, Foliage Green (ALS Guard Black only)

DUTY ACCESSORIES

- Durable SafariLaminate™ construction for long-lasting wear
- All accessories are designed to fit 2.25" (58mm) duty belts unless otherwise specified
- Finishes offered: traditional leather look; in Plain, Basketweave or Hi Gloss; STX Tactical® in all colors
- Many Safariland® duty accessories are available with hidden snap closure.
- Snap versions available in Chrome, Brass or Black

NOTE: Items noted with (*) are available in STX finish



78* SLIMLINE DOUBLE MAGAZINE POUCH

- Magazines are oriented "bullets out" to save space on belt
- Optimal for use on tactical rigs due to minimal width
- Vertical and horizontal belt slots
- Also available in tactical mounting configuration



79* SLIMLINE OPEN-TOP DOUBLE MAGAZINE POUCH

- Magazines are oriented "bullets out" to save space on duty belt
- Optimal use on tactical rigs due to minimal width
- Vertical belt slots
- Also available in tactical mounting configuration



777* SLIMLINE TRIPLE MAGAZINE POUCH

- Magazines are oriented "bullets out" to save space on belt
- Optimal for use on tactical rigs due to minimal width
- Vertical and horizontal belt slots
- Also available in tactical mounting configuration



775* SLIMLINE OPEN-TOP TRIPLE MAGAZINE POUCH

- Adjustable angle positions designed into belt loop
- Provides triple magazine retention without flap in an area comparable to standard dual magazine pouches
- Adjustable tension device to help retain magazines in pouch
- Also available in tactical mounting configuration

DUTY ACCESSORIES

77*

DOUBLE MAGAZINE POUCH

- Several sizes to fit most popular magazines
- Also available in tactical mounting configuration



72



73



74*



75*



76*



277*



307* Light



307* EDW



306*



308*



35*



135*

BATON HOLDER

- Fits 16" (406cm), 21" (533cm) or 26" (660cm) expandable batons
- 26" length also fits Streamlight® Stinger® flashlight
- Available in two sizes for 1.5" and 2"-2.25" (38mm-58mm) belts

72

DOUBLE MAGAZINE AND CUFF POUCH

- Designed to fit two handgun magazines and one pair of handcuffs
- Adjustable tension device to help retain magazines in pouch

73

OPEN-TOP DOUBLE MAGAZINE POUCH

- Features adjustable angle positions for both vertical and horizontal carry
- Tension screw allows retention adjustment

74*

HANDGUN/RIFLE COMBINATION MAGAZINE POUCH

- Designed to carry two handgun magazines and one rifle magazine
- Adjustable tension device to help retain magazine in pouch
- Optimal for duty officers with carbine or rifle within vehicle

75*

OPEN-TOP DOUBLE MAGAZINE POUCH

- Span between pouches, plus low cut, allows for a quick and easy draw
- Tension screw allows retention adjustment

76*

SINGLE MAGAZINE POUCH

- Several sizes to fit most popular magazines
- Also available in tactical mounting configuration

277*

QUAD MAGAZINE POUCH

- Designed with space for up to four 1911-style magazines; also offered in 10-round versions
- Center divider retains extra magazine while fixed magazine is in use
- Vertical or horizontal belt slots for standard or low-profile positions

307*

LIGHT/EDW CARTRIDGE HOLDERS

- Pouch fits most popular gun mounted lights
- Also designed for the Taser® cartridge
- Fits 2" to 2.25" (50mm-58mm) belt widths
- Also available in tactical mounting configuration

306*

OPEN-TOP MINI-FLASHLIGHT HOLDER

- Half-sheath style fully protects selected mini flashlights

308*

HAND-HELD FLASHLIGHT HOLDER

- Flap closure style to fit select hand-held lights
- Also available in tactical mounting configuration

35*

BATON HOLDER

- Extended baton can be reholstered
- Fits 16" (406cm), 21" (533cm) or 26" (660cm) expandable batons
- Also available in tactical mounting configuration

DUTY ACCESSORIES



62

63

65

654



655

HK-11



67/67S

168

169S

170

Does Not Include Key



62

BELT KEEPER

- Slot fits up to 1.75" (45mm) belts
- Hidden snap

63

SLOTTED BELT KEEPER

- Slotted, two-snap belt keeper
- Slot fits up to 1.75" (45mm) belt widths

65

BELT KEEPER

- Standard 0.75" (19mm) belt keeper
- Available in two sizes for 2" and 2.25" (50mm-58mm) belts

654

SLOTTED BELT KEEPER

- Slot fits up to 1.75" (45mm) belt widths
- 4-snap closure

655

HEAVY-DUTY BELT KEEPER

- Rugged, heavy-duty, two-snap belt keeper
- Extra wide at 1.25" (32mm)

HK-11

HIDE-A KEYPER™

- Hidden handcuff key in inside of belt keeper

67/67S

BATON RING

- Also fits C-cell flashlights
- 67 (not shown) is without snap

168

KEY RING (DOES NOT INCLUDE KEY)

- Heavy-duty metal spring hook
- Protective flap
- 2-snap design

169S

KEY RING

- Heavy-duty metal spring hook
- 1-snap design

170

SILENT KEY HOLDER

- SafariLaminate™ construction
- Hook and loop adjustable pouch

DUTY ACCESSORIES



38-8* IMPACT ROUND CASE, TOP FLAP

- Closed top pouch for 37/40mm less lethal rounds
- Designed for the Defense Technology® eXact iImpact™ and Direct Impact® rounds
- Can be ordered for 2.25" (58mm) belt
- Also available in tactical mounting configuration



37-8*



692S



730



37*



38*



090



90



190*



290



690



764



768



33*

37-8* OPEN TOP IMPACT ROUND HOLDER

- Open-top pouch for 37/40mm less lethal rounds
- Can be ordered for 2.25" (58mm) belt slide or mount on leg and vest accessory
- Also available in tactical mounting configuration

692S BATON RING WITH SNAP

- For side-handle batons
- Snaps/slides on duty belt

730 HEAVY-DUTY FLASHLIGHT RING

- Features a shatter-resistant nylon ring
- 1-snap closure
- For D-cell and C-cell flashlights

37* OPEN TOP MACE®/OC SPRAY HOLDER

- Open-top for quick access
- Also available in tactical mounting configuration

38* MACE®/OC HOLDER

- Top flap for added security
- Also available in tactical mounting configuration

090/090H OPEN TOP HANDCUFF CASE

- Open-top thermoformed design
- Fits chain or hinged cuffs

90/90H HANDCUFF CASE

- Specify chain or hinged cuffs

190*/190H* HANDCUFF CASE

- Specify chain (190) or hinged (190H)
- Also available in tactical mounting configuration

290/290H DOUBLE HANDCUFF CASE

- Specify chain or hinged cuffs
- 290H (not shown) fits hinged cuffs

690 HANDCUFF STRAP

- Saves space on duty belt
- 1-snap design

764 RECORDER CASE

- Features a protective pouch and an adjustable bungee cord tie-down with a snap closure

768 COMPACT SPARE CUFF™ HOLDER

- Metal clip attachment to fit 2" to 2.25" (50mm-58mm) duty belt

33* SURGICAL GLOVE HOLDER

- Hook and loop closure
- Holds one or three pair of surgical gloves; please specify

DUTY ACCESSORIES



761*

762*

763

766

BACK



080-12



081-12



CD-2



371



340



761*

ADJUSTABLE RADIO HOLDER

- Adjustable bungee cord tie-down with a snap closure
- Fits most standard portable police radios

762*

RADIO HOLDER WITH SWIVEL

- Features a detachable swivel belt loop for easy retrieval
- Protective pouch and adjustable bungee cord tie-down with a snap closure

763

UNIVERSAL RADIO HOLDER - PORTABLE

- Universal fit
- Features an adjustable band to fit almost any standard portable police radio
- Bottom lip prevents the radio from falling through

766

RADIO HOLDER

- Adjustable bungee cord tie-down with snap closure
- Utilizes 745BL Belt Attachment – giving users the ability to clip on or off of the belt without removing other accessories
- Fits belt widths from 1.5" (38mm) to 2.25" (58mm)

080-12

SHOTGUN SHELL HOLDER

- Molded shotgun shell holder holds two 12-Gauge shells
- Belt clip features an extended bottom hook for security

081-12

SHOTGUN SHELL HOLDER

- Molded shotgun shell holder holds two 12-Gauge shells
- Includes mounting holes

CD-2

SPEEDLOADER HOLDER

- Strong, epoxy-coated steel clips
- Lined with a vinyl pad insert to ensure loader stability
- CD-2 clips firmly onto any belt up to 2" (50mm) wide
- Metal construction

371

SINGLE SPEEDLOADER HOLDER

- Ultra-low profile and quick, easy single-action draw – providing the fastest "top-flap" speedloader holder available
- Design carries cartridges on either side of the belt
- Allows user to grip both sides of the loader while unsnapping the top flap
- Fits 1.75" (45mm) belts

340

DOUBLE SPEEDLOADER HOLDER

- Standard double speedloader
- Chrome or brass snap

TACTICAL & MILITARY

Safariland® tactical gear is a breed apart. Safariland products are battle-proven worldwide and offer an unmatched combination of quality, functionality and versatility in every product that carries our name. From leg-drop holsters and MOLLE-compatible attachment systems, to munitions carriers and more, Safariland gives you the tactical advantage you need to carry the day – day in and day out.

- All tactical holster models feature a double strap leg shroud with mounting holes for optional accessories
- All holsters available in STX Tactical® finishes (all colors) unless noted

COLORS AVAILABLE

STX TACTICAL®



7TS™



TACTICAL HOLSTERS CAN BE CONFIGURED WITH ANY OF THESE ATTACHMENTS SYSTEMS



7304

7TS™ ALS® TACTICAL HOLSTER



- ALS® (Automatic Locking System) secures weapon once holstered; simple straight up draw once release is deactivated
- SLS (Self Locking System) Rotating Hood
- Optional Sentry
- Constructed of SafariSeven™, a proprietary nylon blend that is completely non-abrasive to a firearm's finish
- Raised stand-off surfaces in holster's interior creates air space around the weapon allowing dirt and moisture to quickly clear any contact with the firearm
- Very high heat and low cold tolerances; structurally sound from 300°F to -50°F
- Available in SafariSeven™ Plain Black and FDE Brown finishes



PATENTED & PATENT PENDING



7TS™



PATENTED & PATENT PENDING

7305

7TS™ ALS® TACTICAL HOLSTER WITH QUICK-RELEASE LEG STRAP

TACTICAL & MILITARY

7TS

7004

7TS™ SLS TACTICAL HOLSTER

- SLS (Self Locking System) Rotating Hood
- Optional Sentry
- Constructed of SafariSeven™, a proprietary nylon blend that is completely non-abrasive to a firearm's finish
- Raised stand-off surfaces in holster's interior creates air space around the weapon allowing dirt and moisture to quickly clear any contact with the firearm
- Very high heat and low cold tolerances; structurally sound from 300°F to -50°F
- Available in SafariSeven™ Plain Black and FDE Brown finishes



PATENTD & PATENT PENDING



7005

7TS™ SLS TACTICAL HOLSTER WITH QUICK-RELEASE LEG STRAP

7354

7TS™ ALS® TACTICAL HOLSTER

- ALS® (Automatic Locking System) secures weapon once holstered, simple straight up draw once release is deactivated
- Open-top design without SLS for quick retrieval of weapon
- Constructed of SafariSeven™, a proprietary nylon blend that is completely non-abrasive to a firearm's finish
- Raised stand-off surfaces in holster's interior creates air space around the weapon allowing dirt and moisture to quickly clear any contact with the firearm
- Very high heat and low cold tolerances; structurally sound from 300°F to -50°F
- Available in SafariSeven™ Plain Black and FDE Brown finishes
- Also optimized for MOLLE vest use (OMV version), Models 7384 and 7385



PATENTED & PATENT PENDING



PATENTED & PATENT PENDING

7355

7TS™ ALS® TACTICAL HOLSTER WITH QUICK-RELEASE LEG STRAP

6304RDS

ALS®/SLS TACTICAL HOLSTER

- ALS® (Automatic Locking System) secures weapon once holstered, simple straight up draw once release is deactivated
- SLS (Self Locking System) Rotating Hood
- For use with Red Dot Optic-equipped weapons
- Cordura® nylon wrap finish reduces infrared (IR) signature
- SafariLaminate™ thermal-molded construction protects handgun and sights
- Suede lined to protect handgun's finish
- Available in Cordura® Nylon, MultiCam®, Ranger Green, Coyote, Khaki or STX finishes



PATENTED & PATENT PENDING



BODY WORN
CAMERAS
CONCEALABLE ARMOR
TACTICAL ARMOR
COMMUNICATIONS
PATROL BIKE
DUTY GEAR/HOLSTERS
PROTECTIVE GEAR
FIREARMS ACCESSORIES
LETHAL
PERFORMANCE APPAREL
SURVIVABILITY SYSTEMS
FORENSICS
ARMOR SYSTEMS
TRAINING GROUP

TACTICAL & MILITARY



6004
SLS TACTICAL HOLSTER

- Features the SLS (Self Locking System) rotating hood system allowing for a smoother, single-motion draw and greater protection against attempted weapon takeaways
- Hood Guard is standard; optional Sentry available
- Suede lined to protect handgun's finish



6005
SLS TACTICAL HOLSTER WITH QUICK-RELEASE LEG STRAP

Shown here with optional Double Magazine Pouch mounted



6004USN
LOW SIGNATURE SLS TACTICAL HOLSTER

- Features the SLS (Self Locking System) rotating hood system
- SLS allows for a smoother, single-motion draw
- Genuine SafariLaminate™ construction with suede lining to help protect the weapon's finish
- Cordura® nylon wrap finish reduces Infrared (IR) Signature
- Available in MultiCam®, Ranger Green, Coyote, Khaki and Black finishes



6304
ALS®/SLS TACTICAL HOLSTER

- ALS® (Automatic Locking System) secures weapon once holstered
- SLS allows for a smoother, single motion draw and greater protection against attempted weapon takeaways
- Hood Guard is standard; optional Sentry available
- Simple straight up draw once all releases are deactivated
- Suede lined to protect handgun's finish



6305
ALS®/SLS TACTICAL HOLSTER WITH QUICK-RELEASE LEG STRAP

PATENTED



6354
ALS® TACTICAL HOLSTER

- ALS® (Automatic Locking System) secures weapon once holstered; simple straight up draw once release is deactivated
- Open-top design without SLS for quick retrieval of weapon
- Suede lined to protect handgun's finish



6355
ALS® TACTICAL HOLSTER WITH QUICK-RELEASE LEG STRAP

PATENTED

PATENTED

ALS
automatic locking system

ALS
automatic locking system

TACTICAL & MILITARY

BODY WORN
CAMERAS
CONCEALABLE
ARMOR
TACTICAL
ARMOR
COMMUNICATIONS
PATROL
BIKE
DUTY GEAR/
HOLSTERS
PROTECTIVE
GEAR
ACCESSORIES
FIREARMS
LETHAL
LESS
PERFORMANCE
APPAREL
SURVIVABILITY
SYSTEMS
FORENSICS
ARMOR
SYSTEMS
TRAINING
GROUP

6034

SLS AMBIDEXTROUS MILITARY TACTICAL HOLSTER

- Features the SLS (Self Locking System) rotating hood system allowing for a smoother, single-motion draw and greater protection against attempted weapon takeaways
- Ambidextrous body design
- Designed to accommodate the Beretta M9/92F or Sig P226 pistol with or without a light or LAM unit
- Hood Guard is standard; optional Sentry available
- Also available with Mid-ride UBL (6230) or Low-ride UBL (6235)



6035

SLS MILITARY TACTICAL HOLSTER

6384

ALS® OMV TACTICAL HOLSTER

- ALS® (Automatic Locking System) secures weapon once holstered; simple straight up draw once release is deactivated
- Holster is optimized for MOLLE vest use (OMV), with lower center of gravity than most other Safariland® duty and tactical holsters for less pulling on vest
- Open-top design without SLS for quick retrieval of weapon
- Hood Guard is standard; optional ALS Guard available
- Suede lined to protect handgun's finish



6385

ALS® OMV TACTICAL HOLSTER WITH QUICK-RELEASE LEG STRAP

- Adjustable vertical leg strap with quick release detachable leg harness



6384 Holster with MLS 16 on Vest



ALS® MILITARY KIT

- ALS® (Automatic Locking System) secures weapon once holstered, simple straight up draw once release is deactivated
- Open-top design without SLS for quick retrieval of weapon
- Single strap leg shroud with Quick Locking Receiver Plate (QLS 22) and a 568BL Paddle
- 567BL Injection Molded Belt Loop with a Quick Locking Receiver Plate (QLS 22). The 567BL can be modified to fit 1.5", 1.75", 2" and 2.25" belt slot with a 1" drop
- Adjustable shoulder harness with Quick Locking Receiver Plate (QLS 22)
- MOLLE Locking Fork (MLS16) with Quick Locking Receiver Plate (QLS 22) mount included for MOLLE chest carry



PATENTED & PATENT PENDING



PATENTED

6378USN

ALS® LOW SIGNATURE HOLSTER

- ALS® (Automatic Locking System) secures weapon once holstered, simple straight up draw once release is deactivated
- Reduces Infrared (IR) Signature
- Compact profile for minimal interference with other equipment
- Optional ALS Guard (Model 6006) available for increased security
- Available in MultiCam®, Ranger Green, Coyote or Khaki finishes
- Available for Beretta M9/M9A1/92F, Glock 19/23 and Sig Sauer P226

LEG SHROUDS & ACCESSORIES

All leg shrouds and accessories are available in Black, Foliage Green, OD Green, FDE Brown or Coyote Brown finishes.

ADDITIONAL PRODUCTS ON PAGES 85, 86, 88, 89, 90 AND 91

ALL TACTICAL ACCESSORIES ON THIS PAGE CAN BE ORDERED WITH THE MLS 16 OR ELS 34 LOCKING FORK ALREADY ATTACHED

6005-6

STANDARD DOUBLE LEG SHROUD WITH QUICK-RELEASE STRAP

- Features harness and shroud to mount holsters and accessories
- Leg shroud features silicon strap for non-slip traction
- Ambidextrous

36

OC HOLDER

- Made specifically to hold the MK-9 series of aerosols
- Open-top design for quick retrieval yet sturdy product retention

34

OC HOLDER

- Made specifically to hold the Defense Technology® Instantaneous Blast
- Open-top design for quick retrieval yet sturdy product retention

085

SHOTGUN SHELL HOLDER



6005-6 shown here with accessories attached

6004-10

SINGLE STRAP LEG SHROUD

- Lower profile leg shroud
- Can mount accessories on both sides of holster or used for three accessories
- Adjustable vertical leg strap to adjust ride height



6004-10 shown here with accessories attached

774

RIFLE MAG POUCH

40

DISTRACTION DEVICE® HOLDER

- Fits several Defense Technology® Distraction Device® models

37-8

OPEN TOP IMPACT ROUND HOLDER

- Belt slide or mount on leg and vest accessory



6004-6

STANDARD DOUBLE LEG SHROUD

- Features harness and shroud to mount holsters and accessories
- Ambidextrous

37-8

OPEN TOP IMPACT ROUND HOLDER

76

SINGLE MAG POUCH

78

SLIMLINE DOUBLE MAGAZINE POUCH



6004-6 shown here with accessories attached

LEG SHROUDS & ACCESSORIES



Shown here with 568BL Paddle and 6004-10 Single Strap Leg Shroud

6004-27

DROP FLEX ADAPTER ON SINGLE LEG SHROUD W/ QLS 22

- Allows user to wear a thigh rig higher on the leg with more stability, eliminating leg shroud movement
- Sits low enough for use with body armor and in vehicles, while also providing two mounting points for accessories
- Includes QLS 22 Receiver Plate (can also be ordered with MLS Receiver Plate or plain)
- Fits belt widths up to 2.25" (58mm)
- Available in Black, Foliage Green, FDE Brown or Coyote Brown finishes

6004UFA

UNIVERSAL FLEX ADAPTER

- Allows user to wear a thigh rig below the hip without shifting weight farther down the leg
- Hole pattern on UFA makes connecting to various mounts possible including 568BL Paddle, ELS Fork, QLS Fork or 745BL Belt Clip
- For use in conjunction with 6004-10 Leg Shroud



PATENT PENDING

6009-110

SINGLE STRAP LEG SHROUD WITH D-RING

- Utilizes a unique D-Ring on the strap for increased leg flexibility
- Single leg strap design
- Minimally-sized leg shroud for decreased footprint on the thigh

6005-10

SINGLE STRAP LEG SHROUD WITH QUICK-RELEASE

- Features harness and shroud only to mount accessories and holsters
- Leg straps feature silicone strips for non-slip traction
- Ambidextrous

086

SHOTGUN SHELL HOLDER

- Holds (2), (4), (6) or (8) 12-Gauge shotgun shells
- Unique retaining plate keeps the shotgun shells from dislodging, and are quickly removed a few at a time or all at once
- Sturdy aluminum back plate allows for ride height and cant adjustments
- Available with ELS 34 Locking Fork or 744BL Belt Clip

6009VE

D-RING STRAP WITH ENHANCED HOOK & LOOP BELT ATTACHMENT



6009VE

6009-11

D-RING STRAP

- Provides easy lateral movement
- Fits all Safariland® tactical shrouds



6005VE

QUICK-RELEASE BUCKLE WITH ENHANCED HOOK & LOOP BELT ATTACHMENT

- Fits Safariland® tactical leg shrouds
- Belt attachment portion can be detached when not needed
- Secondary hook and loop flap ensures continuous attachment to belt when in use
- 6009VE model provides easy lateral movement



6005VE

6004-11

VERTICAL LEG STRAP

- Fits tactical holster systems
- Replacement strap for standard tactical rigs



LEG SHROUDS & ACCESSORIES

6005-23

MLS ACCESSORY FORKS ON QUICK-RELEASE STRAP

- Allows mounting of any tactical holster, with quick-release leg strap, directly to the MOLLE loops on the side of a vest or MOLLE web belt
- Enables user to forgo wearing a belt and put the weight onto a load-bearing vest and thigh rig
- Ideal for combining with a tactical vest, without having to make any changes to a duty belt, to be ready as a first responder
- Also available with QLS fork



6009-23

MLS ACCESSORY FORK ON D-RING

- Allows mounting of any tactical holster with D-Ring strap directly to the MOLLE loops on the side of a vest or MOLLE web belt
- Enables user to forgo wearing a belt and put the weight onto a load-bearing vest and thigh rig



TMA

TACTICAL MOLLE ADAPTER

- For use with Safariland® 3-hole patterned holsters
- Easily adjusts with Phillips screwdriver
- Full 360° cant
- Comes standard with MLS 16 MOLLE Locking Fork or as stand alone model
- Available in Black



PRA

PICATINNY RAIL ADAPTER

- Allows the placement of any 2-hole pattern Safariland® tactical or competition accessory onto Picatinny rail systems



MSA

MOLLE SLIDING ADAPTER

- Compatible with Model 71 Tactical Universal Magazine Pouch
- Easily slides and locks into MOLLE webbing; removable in seconds
- Minimal space used on MOLLE vests
- Permits multiple pouches lined up side to side



774

RIFLE MAG POUCH

- Clip-on belt attachment to fit 1.5" (38mm) to 2.25" (58mm) belts
- Adjustable for carry angle
- SafariLaminate™ thermal-molded construction with tension device
- Ambidextrous
- Can be ordered with ELS Locking Forks attached
- Available in Black, Foliage Green, FDE Brown or Coyote Brown finishes



4555

SHOOTERS' RANGE BAG

- Removable center carry compartment has zippered, padded side panels for four separate handgun compartments
- Adjustable hook and loop dividers to personalize accessory space
- Magazine pouches conveniently sewn into main storage area
- Two large exterior pockets, two large end pockets with flap closure, and a fully lined interior
- Full-wrap carry handles make it easy to move gear to different shooting stations
- Outer carry bag has dual zipper top for easy access and full coverage, flat side zipper pocket, ID window, and large outside zippered pocket for towel, shooting glasses or hearing protection
- Overall dimensions: 14" x 9" x 10"

GUN CASES

Safariland® gun cases are feature-laden, made from rugged ballistic pack cloth and are offered in Black only unless otherwise specified



4553 PREMIUM DUAL HANDGUN CASE

- Full interior closed-cell foam surrounded by soft lining for safe handgun storage
- Four outside magazine/accessory pouches
- Dual concealed pockets to individually protect handgun
- 12" length to carry up to 6" handguns
- Wraparound handles



4552 DUAL RIFLE CASE

- Heavy-duty lockable zippers, one adjustable outside covered accessory pouch
- Large dual handgun/accessory pouch with individual hook and loop enclosed handgun areas
- Closed-cell protective foam padding and 2" perimeter lip
- Assorted accessory pockets inside case
- Adjustable padded shoulder harness for shoulder carry
- Includes adjustable backpack-style carry straps that tuck away in storage pocket when not in use
- Available in Black or Tan and in 36" or 46" lengths



4556 3-GUN COMPETITION CASE

- Heavy-duty lockable zippers, two adjustable outside accessory pouches
- Large dual handgun/accessory pouch with individual hook and loop enclosed handgun storage areas, and four pistol mag pouches large enough for extended magazines
- Closed-cell protective foam padding and 2" perimeter lip
- Assorted accessory pockets inside case
- Adjustable padded shoulder harness for shoulder carry
- Includes adjustable backpack-style carry straps that tuck away in storage pocket when not in use
- Unique zippered barrel expansion slot on side of case can be opened to allow use of longer firearms (up to 51")
- 46" overall length (with expansion slot closed)



QUICK ATTACHMENT SYSTEMS

Safariland® Quick Attachment Systems, consisting of the QLS, ELS and MLS, represent the coming together of technology, with the requirement for modular and versatile products. Originally designed for the military to quickly transfer the holster from the leg to the vest, the QAS family has now gone beyond strictly military functions to include law enforcement, concealed carry and sporting applications. Whether the scenario facing you involves the need to adjust holster location to conserve space while boarding an APC, or to quickly switch out magazine types before the latest 3-Gun match, the QAS family of products will help accomplish your goals.



MLS (MOLLE LOCKING SYSTEM)

- Provides a holster or accessory with a quick, easy, and secure attachment to any MOLLE loop-equipped apparel
- Allows for quick removal and installation between attachment points such as the MOLLE vest, belt loop, and/or tactical leg shroud
- Allows many types of Safariland holsters and accessories to be mounted at various orientations and angles to suit the needs and preferences of the individual user
- Operator can rearrange gear quickly and easily without the use of tools
- Allows holstered weapons and accessories to be removed without removing apparel, such as vest, leg shroud or belt
- Mount almost any holster or accessory in the right position for any mission

MLS16

1. MLS 16 ACCESSORY LOCKING FORK

- Threads directly through MOLLE loops to mount pouches, or into the back of the QLS 22 or ELS 35 for attachment of pouches and holsters to vests
- Colors: Black, Foliage Green, OD Green, FDE Brown or Coyote Brown finishes



ELS (EQUIPMENT LOCKING SYSTEM)

- Provides a mounting platform for any tactical and competition accessories to be placed in various locations, including belt clips and tactical rigs or directly on MOLLE loops with the use of an MLS 16 Locking Fork
- Fork attaches to any tactical or competition accessory, including the 774 Rifle Mag Pouch, 78 Slimline Dual Magazine Pouch, and Impact Round cases
- Receiver plate mounts to any thigh rig, 744BL belt clip or MLS 16 fork (for use of ELS on MOLLE loops), or can be attached directly to the pre-cut mounting holes on any QAS belt
- A quick pinch of the thumb and index finger allows the removal of any product attached to the fork unit for attachment on any other ELS 35 location
- May be purchased with or placed directly onto the 744BL belt clip for convenient waistline location
- Useful in quickly switching out accessories while maintaining the same root product, whether it be a belt, thigh rig or magazine pouches for a competition event, etc.
- Very small receiver footprint (1 7/8" W x 2 3/4" H)



ELS 34 & 35

1. ELS 34 EQUIPMENT LOCKING FORK

- Mounts to any tactical accessory, then connects to the ELS 35 Receiver Plate
- Colors: Black, Foliage Green, OD Green, FDE Brown, or Coyote Brown finishes

2. ELS 35 EQUIPMENT RECEIVER PLATE

- Mount platform for tactical thigh rig or any other two-hole accessory location
- Colors: Black, Foliage Green, OD Green, FDE Brown, or Coyote Brown finishes

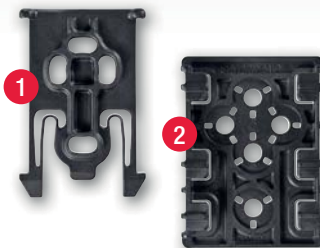

QUICK ATTACHMENT SYSTEMS

QLS (QUICK LOCKING SYSTEM)

- The QLS provides officers the ability to easily and quickly remove and secure their weapon without having to remove weapon from holster. Especially effective in correctional institutions and courthouse appearances
- Effective for concealed carry in ease of transferring gun from body to other mounting point, such as vehicle
- Mount almost any Safariland® duty holster on an equipment belt with use of the Safariland UBL
- Provides a highly versatile holster system with a quick, easy and secure attachment to a variety of locations – belt, thigh rig, furniture, or vehicle, etc. Can also be used with the Safariland MLS 16 Accessory Locking Fork for attachment to MOLLE vests
- QLS System passes Level I Retention™ pull test



QLS 19 & 22

FOR DUTY USE – PASSES LEVEL I RETENTION™ TEST

1. QLS 19 DUTY HOLSTER LOCKING FORK

- Mounts directly to the back of any 3-hole pattern holsters, then connects to the QLS 22 Receiver Plate
- Colors: Black, Foliage Green, OD Green, FDE Brown or Coyote Brown finishes

2. QLS 22 DUTY RECEIVER PLATE

- Mounting platform for the QLS 19 Duty Locking Fork. Attaches directly to Universal Belt Loop (UBL), thigh rig or other mounting platforms
- Colors: Black, Foliage Green, OD Green, FDE Brown or Coyote Brown finishes

3. QLS 22L DUTY RECEIVER PLATE

- Same as the QLS 22 with an extra locking feature

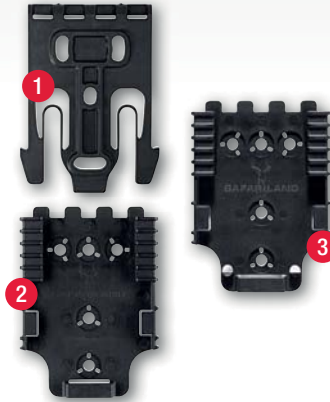

QAS BELTS

FOR MORE INFORMATION PLEASE SEE CORRESPONDING PAGE



4332
ELS TACTICAL BELT 2" (50MM)



032
ELS COMPETITION BELT 1.75" (45MM)

QLS DUTY/TACTICAL

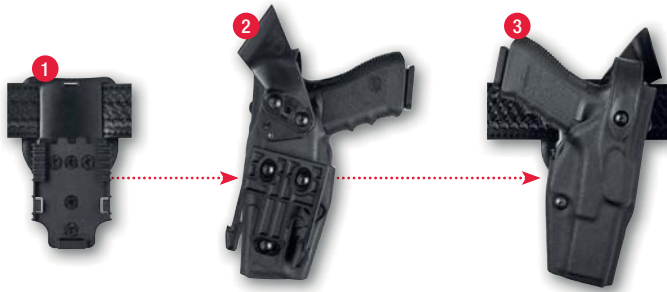

QLS ON A DUTY BELT

1. QLS 22 W/ UBL ON BELT
2. QLS 19 ON HOLSTER BACK
3. QLS 22 W/ UBL W/ QLS 19 ON HOLSTER

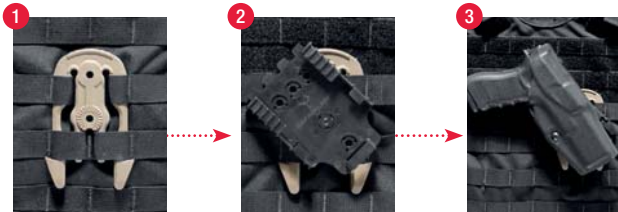

QLS ON A MOLLE VEST

1. MLS 16 ON VEST
2. QLS 22 W/ MLS 16 ON VEST
3. QLS 22 ON MLS 16 W/ QLS 19 ON HOLSTER

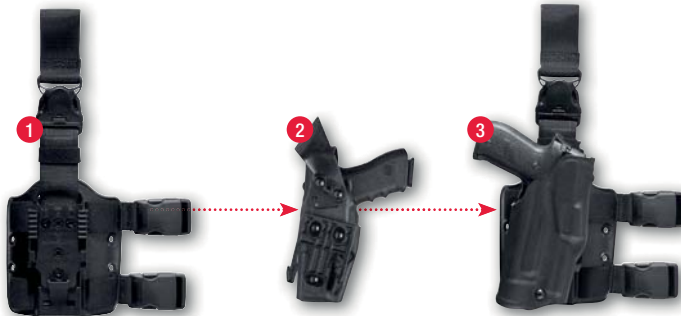

QLS ON A THIGH RIG

1. ATTACH QLS 22 TO THIGH RIG
2. ATTACH QLS 19 TO BACK OF HOLSTER
3. QLS 22 ON SHROUD W/ QLS 19 HOLSTER

CONCEALMENT/ PERSONAL PROTECTION



QLS IN VEHICLE

1. QLS 22 ON PADDLE W/ QLS 19 ON HOLSTER
2. REMOVING HOLSTER FROM QLS 22
3. TRANSFERRING HOLSTER TO QLS 22 MOUNTED IN VEHICLE



QLS AT HOME

1. QLS 22 ATTACHED TO DRESSER
2. QLS 22 ON DRESSER W/ QLS 19 ON HOLSTER

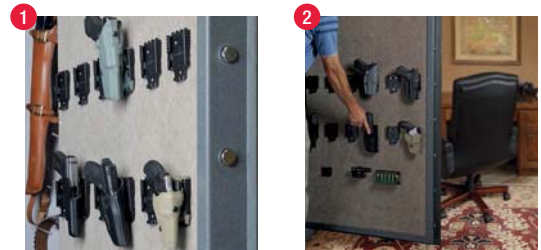

QLS AT HOME

1. QLS 22 ON SAFE WALL
2. QLS 22 ON SAFE WALL W/ QLS 19 ON HOLSTER

MLS TACTICAL

MLS ON A VEST

1. HOLSTER W/ MLS 15 THREADED DIRECTLY THROUGH MOLLE LOOPS



6004-24

MLS ACCESSORY FORK ON SMALL MOLLE PLATE

- A mount with the MLS 16 Accessory Fork already affixed; attaches to existing MOLLE pouches, then is easily threaded directly through MOLLE loops

ELS TACTICAL



ELS ON A LEG SHROUD

1. (2) ELS 35s ON LEG SHROUD
2. ELS 34 W/ RIFLE MAG POUCH & ELS 34 W/ PISTOL MAG POUCH
3. (2) ELS 35s ON LEG SHROUD W/ (2) ELS 34s ON RIFLE & PISTOL MAG POUCH



ELS ON A TACTICAL BELT

1. 4332 TACTICAL BELT
2. ELS 34 W/ RIFLE MAG POUCH
3. ELS 34 W/ 40MM GRENADE HOLDER
4. 4332 BELT W/ (3) ELS 35 RECEIVER PLATES AND READY TO MOUNT ACCESSORIES WITH ELS FORKS

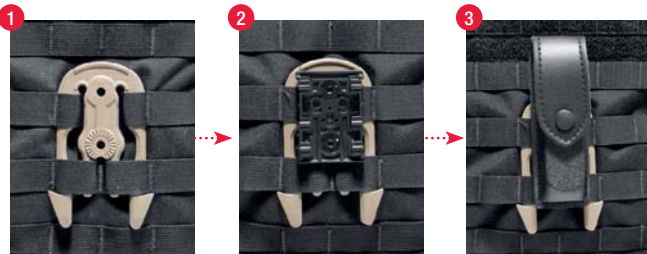

ELS ON MOLLE VEST

1. MLS 16 ON VEST
2. ELS 35 W/ MLS 16 ON VEST
3. ELS 34 W/ MAG POUCH W/ ELS 35 ON MLS 16 ON VEST

COMPETITION

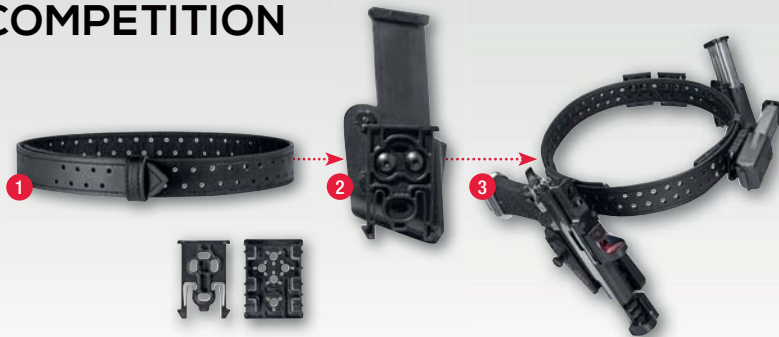

ELS ON A COMPETITION BELT

1. 032 BELT W/ ELS 34 & ELS 35
2. ELS 34 ON MAG POUCH
3. 032 ELS COMPETITION BELT FULLY RIGGED W/ HOLSTER, (4) ELS 35s & (2) 773 MAG POUCHES W/ ELS 34s



6005-23

MLS ACCESSORY FORK ON QUICK RELEASE HARNESS

- Allows mounting of any tactical holster with quick-release leg strap directly into the MOLLE loops on the side of a vest or MOLLE web belt
- Enables user to forgo wearing a belt and put the weight onto a load-bearing vest and thigh rig



6009-23

MLS ACCESSORY FORK ON D-RING

- Allows mounting of any tactical holster with D-Ring strap directly to the MOLLE loops on the side of a vest or MOLLE web belt
- Enables user to forgo wearing a belt and put the weight onto a load-bearing vest and thigh rig

QAS KITS

Kit	Contents
QUICK-KIT 1	(1) QLS 19, (1) QLS 22
QUICK-KIT 2	(1) QLS 19, (1) QLS 22L
QUICK-KIT 3	(1) QLS 19, (2) QLS 22
QUICK-KIT 4	(1) QLS 19, (2) QLS 22L
ELS-KIT 1	(2) ELS 34, (2) ELS 35

*ALL KITS INCLUDE MOUNTING HARDWARE

LIGHT SYSTEMS

Safariland® brings innovative designs to today's light systems. The popular Rapid Light System (RLS™) offers a quality hand-held light and a weapon-mounted light all in one.

RLS™ RAPID LIGHT SYSTEM

1. Ambidextrous
2. Super-bright LED technology (190 lumens) – bright enough to be your primary light. Prism Reflector System penetrates light up to 350 ft.
3. Uses three AAA batteries – no expensive proprietary batteries needed
4. Integral clip for easy securement to belt or garment – no dedicated light mount holster required
5. Fits most handgun models that incorporate an integral rail system – also mounts to rifles and shotguns that have a Picatinny rail
6. Quickly transitions from standard flashlight to tactical illumination
7. Can be operated with either thumb, or change to other side to operate with trigger finger. Push button provides controllable on/off illumination of target to minimize loss of handgrip, sight picture and exposure
8. RLS™ mount will accommodate most hand-held compact lights in the range of .970 (24.6mm)- 1.060 (26.9mm) in diameter

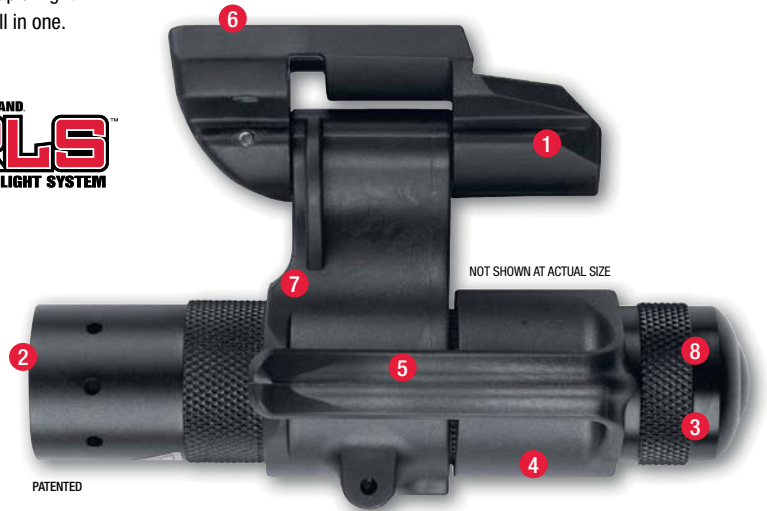

Slide RLS onto Tactical Rail



Lock RLS into place with a quick upward motion

SEE ENHANCED 65139 ROGERS LIGHT SYSTEM WITH SUPER BRIGHT LED LIGHT (980 LUMENS) ON PAGE 178



Easily and securely attaches to waistband or belt with integral clip



Push-button illumination



Three AAAs provide over 40 hours' use

RLSP RLS LIGHT WITH PRESSURE SWITCH

- RLS™ Light System with tape pressure switch
- 8" cord for versatile positioning
- Pressure switch split for low 10 lumens or high 190 lumens



LIGHT SYSTEMS

RLSR

RLS™ REDUCTION SLEEVE

- Enables the RLS™ mounting system to be used with lights of both .90" and .80" diameters
- Slides inside RLS mount to easily accept narrower lights



(RLS™ shown with SureFire®)

RLSM

MOUNT FOR DUTY BELT

- Provides a small mounting platform on duty belt to attach the RLS™ light
- Will also accommodate any light, laser, or other accessory that will fit on a Picatinny or light rail
- Fits belt widths up to 2.25" (58mm)
- Also fits on leg shroud, MLS or ELS Locking Fork
- Included with RLS



RRL

ROGERS RAIL LITE

- Ambidextrous design fits on any Picatinny/1913 rail
- Tail on/off switch is positioned right at shooters forward thumb
- Easy snap on and off installation
- Made of a heavy-duty polymer yet is extremely lightweight
- External rib design for added strength and grip
- Streamlight® Microstream® 28 lumen flashlight included



BELT SLIDE CONCEALMENT HOLSTERS

Whether needing a holster for deep concealment, long hours of wear, or for a reliable off-duty carry holster, Safariland® offers them all. Our holsters offer quality, performance and innovation in a variety of popular designs and finishes.

- All concealment holster models are available in 1.5" (38mm), 1.75" (45mm), 2" (50mm), or 2.25" (58mm) belt slots, unless noted otherwise

537

GLS™ OPEN-TOP CONCEALMENT BELT SLIDE HOLSTER

- GLS™ (Grip Lock System) secures weapon once holstered; retention is deactivated with the middle finger upon a standard shooting grip on the weapon
- Soft, flexible holster body allows holster to mold around wearer
- Tension adjustment to customize tailor weapon fit to user preferences
- Fits 1.5" (38mm) belt widths
- Available in Plain Black



PATENT PENDING



547

PRD™ OPEN-TOP CONCEALMENT BELT SLIDE HOLSTER

- Pinch Retention Device (PRD™) secures weapon once it is fully seated in the holster by clamping onto both sides of the trigger guard; draw is initiated by pulling up through device
- Low-profile design with wide weight disbursement for a comfortable carry and high concealability
- Fits 1.5" (38mm) or 1.75" (45mm) belt widths
- Available in all STX Finishes

7367

7TS™ ALS® / SLS CONCEALMENT BELT SLIDE HOSLER

- ALS® (Automatic Locking System) secures weapon once holstered, simple straight up draw once release is deactivated
- SLS (Self Locking System) Rotating Hood; optional Sentry
- Injection-molded belt loop is user adjustable for cant and can be worn crossdraw
- Constructed of SafariSeven™, a proprietary nylon blend that is completely non-abrasive to a firearm's finish
- Raised stand-off surfaces in holster's interior creates air space around the weapon allowing dirt and moisture to quickly clear any contact with the firearm
- Very high heat and low cold tolerances structurally sound from 300°F to -50°F
- Available in SafariSeven™ Plain Black and FDE Brown finishes

7TS™



PATENTED &
PATENT PENDING

BELT SLIDE CONCEALMENT HOLSTERS

BODY WORN
CAMERAS
CONCEALABLE
ARMOR
TACTICAL
ARMOR
COMMUNICATIONS
PATROL
BIKE
DUTY GEAR/
HOLSTERS
PROTECTIVE
GEAR
ACCESSORIES
LETHAL
PERFORMANCE
APPAREL
SURVIVABILITY
SYSTEMS
FORENSICS
ARMOR
SYSTEMS
TRAINING
GROUP

7TS



PATENTED &
PATENT PENDING

7379

WITH BELT CLIP

- Features 745BL Belt Clip for easy attachment and detachment from belt
- Fits belt widths from 1.5" (38mm) to 2.25" (58mm), release is deactivated



PATENTED &
PATENT PENDING

7377

7TS™ ALS® CONCEALMENT BELT LOOP HOLSTER

- ALS® (Automatic Locking System) secures weapon once holstered, simple straight up draw once release is deactivated
- Open-top design without SLS for quick retrieval of weapon
- Constructed of SafariSeven™, a proprietary nylon blend that is completely non-abrasive to a firearm's finish
- Raised stand-off surfaces in holster's interior creates air space around the weapon allowing dirt and moisture to quickly clear any contact with the firearm
- Very high heat and low cold tolerances; structurally sound from 300°F to -50°F
- Injection-molded belt loop is user adjustable for cant and can be worn crossdraw
- Available in SafariSeven™ Plain Black and FDE Brown finishes

ALS
automatic locking system



PATENTED

6377

ALS® CONCEALMENT BELT LOOP HOLSTER

- ALS® (Automatic Locking System) secures weapon once holstered; simple straight up draw once ALS is deactivated by thumb while obtaining shooting grip
- Injection-molded belt loop is user adjustable for cant and can be worn crossdraw
- Slim and low-profile design for improved concealment
- Low-ride design for ease of draw
- Optional ALS® Guard available for increased security
- Available in STX finishes



PATENTED

6379

WITH BELT CLIP

- Features 745BL Belt Clip for easy attachment and detachment from belt
- Fits belt widths from 1.5" (38mm) to 2.25" (58mm)

567

CUSTOM FIT BELT LOOP HOLSTER

- 6 pistol and 4 revolver fits accommodate over 200 different weapons and are IDPA approved
- Belt loop is user-adjustable for cant angle; can also be worn cross draw
- Genuine SafariLaminate™ thermal-molded construction with suede lining to help protect the gun's finish
- Available in STX Plain Black finish



PATENTED



PATENTED

569

WITH BELT CLIP

- Features 745BL Belt Clip for easy attachment and detachment from belt
- Fits belt widths from 1.5" (38mm) to 2.25" (58mm)

BELT SLIDE CONCEALMENT HOLSTERS



5197

RANGE SERIES OPEN-TOP MID-RIDE HOLSTER

- Adjustable belt loop eliminates common belt-bulging and does not interfere with draw
- Compact and lightweight with low-cut sides for ease of draw
- Detent in trigger guard for reliable weapon security
- Belt loop is user adjustable for cant angle; can also be worn cross draw
- IDPA approved
- Available in 1.5" (38mm) and 1.75" (45mm) belt widths
- Available in Black or Red, in STX finish



PATENT PENDING

5199

WITH BELT CLIP

- Features 745BL Belt Clip for easy attachment and detachment from belt
- Fits belt widths from 1.5" (38mm) to 2.25" (58mm)

5195

RANGE SERIES OPEN-TOP LOW-RIDE HOLSTER

- Compact and lightweight
- Low-cut sides for ease of draw
- Offset belt loop allows for a straight up draw
- Detent in trigger guard for added security
- Modular offset adapter accommodates the QLS19 locking fork, 745BL and 567BL
- IDPA approved; also recommended for female shooters
- Available in Black or Red, in STX finish



5195BL

RANGE SERIES LOW RIDE BELT LOOP



6287

SLS CONCEALMENT BELT LOOP HOLSTER

- Concealment version of the SLS holster
- Features a unique rotating hood design and semi-high-ride position with slightly forward cant
- Rides close to the body, aiding in concealment and weapon retention
- Adjustable tension device
- Available in Plain Black or STX Tactical® finishes



6367

ALS®/SLS BELT LOOP HOLSTER

- ALS® (Automatic Locking System) secures weapon once holstered; simple straight up draw once all releases are deactivated
- Includes SLS hood assembly and Hood Guard
- Optional Sentry available
- Available in Plain Black or STX Tactical® finishes

PATENTED

PADDLE/BELT SLIDE CONCEALMENT HOLSTERS

7378

7TS™ ALS® CONCEALMENT PADDLE AND BELT LOOP COMBO



- ALS® (Automatic Locking System) secures weapon once holstered; simple straight up draw once release is deactivated
- Open-top design without SLS for quick retrieval of weapon
- Constructed of SafariSeven™, a proprietary nylon blend that is completely non-abrasive to a firearm's finish
- Raised stand-off surfaces in holster's interior creates air space around the weapon allowing dirt and moisture to quickly clear any contact with the firearm
- Very high heat and low cold tolerances; structurally sound from 300°F to -50°F
- Includes injection-molded belt loop; is user adjustable for cant and can be worn crossdraw
- Available in SafariSeven™ Plain Black and FDE Brown finishes



PATENTED & PATENT PENDING



PATENTED & PATENT PENDING

7376

HI-RIDE BELT SLIDE

- Rides 1" higher than standard belt slide
- Available in 1.5" (38mm) and 1.75" (45mm) belt widths

6378

ALS® CONCEALMENT PADDLE & BELT LOOP COMBO

- ALS® (Automatic Locking System) secures weapon once holstered; simple straight up draw once ALS is deactivated by thumb while obtaining shooting grip
- Injection-molded paddle design is highly concealable and rides close to body
- Injection-molded belt loop is user adjustable for cant and can be worn crossdraw
- IDPA approved
- Optional ALS® Guard available for increased security
- Genuine SafariLaminate™ thermal-molded construction with suede lining to help protect the gun's finish
- Available in STX finishes



PATENTED



PATENTED

6376

HI-RIDE BELT SLIDE

- Rides 1" higher than standard belt slide
- Available in 1.5" (38mm) belt width



568

CUSTOM FIT PADDLE & BELT LOOP COMBO

- 6 pistol and 4 revolver fits accommodate over 200 different weapons
- Injection-molded paddle designed for concealability and comfort
- IDPA approved
- Genuine SafariLaminate™ thermal-molded construction with suede lining to help protect the gun's finish
- Available in STX Plain Black finish



PATENTED



PATENTED

566

HI-RIDE BELT SLIDE

- Rides 1" higher than standard belt slide
- Available in 1.5" (38mm) belt widths

BODY WORN
CAMERAS
CONCEALABLE
ARMOR
TACTICAL
ARMOR
COMMUNICATIONS
PATROL
BIKE
DUTY GEAR/
HOLSTERS
PROTECTIVE
GEAR
ACCESSORIES
FIREARMS
LETHAL
LESS
PERFORMANCE
APPAREL
SURVIVABILITY
SYSTEMS
FORENSICS
ARMOR
SYSTEMS
TRAINING
GROUP

PADDLE/BELT SLIDE CONCEALMENT HOLSTERS

5198

OPEN-TOP CONCEALMENT PADDLE & BELT LOOP COMBO

- Detent in trigger guard for reliable weapon security
- Low-cut sides for ease of draw and added comfort
- Belt loop is user adjustable for cant angle; can even be worn cross draw
- Injection-molded paddle design is highly concealable and rides close to the body
- IDPA approved
- Genuine SafariLaminate™ thermal-molded construction
- Available in STX finishes
- Model 5188 available for light mounted weapons



**NEW
COLOR**

5198 is now available in Red



5196

HI-RIDE BELT SLIDE

- Rides 1" higher than standard belt slide
- Available in 1.5" (38mm) belt width

578

GLS™ PRO-FIT™ CONCEALMENT PADDLE & BELT LOOP COMBO HOLSTER

- GLS™ (Grip Lock System) secures weapon once holstered; retention is deactivated with the middle finger upon a standard shooting grip on the weapon
- Designed to fit over 250 pistols in one holster, adjustment available to further customize fit
- Body is proprietary nylon blend that is non-abrasive to a firearm's finish, maintains very high heat tolerance, low cold tolerance
- Low-cut and compact design make concealment easy while also allowing for a quick draw
- Injection-molded paddle design is highly concealable and rides close to body
- Injection-molded belt loop is user adjustable for cant and can be worn cross draw
- Available in SafariSeven™ Plain Black and FDE Brown finishes

7TS



GLS
grip locking system

PATENT PENDING

**NEW
FOR 2017**

HOLSTER BODY SIZE NOW AVAILABLE FOR FOR NARROW FRAME GLOCK, SMITH & WESSON SHIELD, SPRINGFIELD XDS



576

HI-RIDE BELT SLIDE

- Rides 1" higher than standard belt slide
- Available in 1.5" (38mm) belt width



577

WITH BELT LOOP

- Injection-molded belt loop is user adjustable for cant and can be worn cross draw
- Available for 1.5" (38mm), 1.75" (45mm), 2" (50mm), or 2.25" (58mm) belt slots; please specify



579

WITH BELT CLIP

- Features 745BL Belt Clip for easy attachment and detachment from belt
- Fits belt widths from 1.5" (38mm) to 2.25" (58mm)

PADDLE/BELT SLIDE CONCEALMENT HOLSTERS

22

WALLET PROFILE HOLSTER

- Back of holster is designed to give “print” impression of a wallet
- Hinged design allows backing to swing away from holster, making for a sure grip on the weapon and easy draw
- Holster will stay open; simply drop handgun into the pocket and it holsters itself
- Suede outer material grips clothing for less movement of holster
- Firm, moisture-proof membrane layer prevents perspiration from penetrating the holster and collecting on the gun
- Available in Black Suede finish

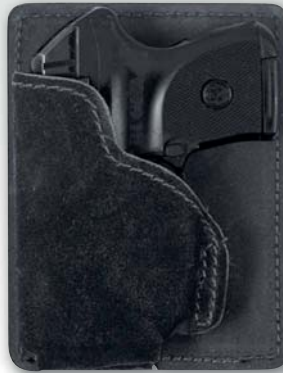

25

INSIDE-THE-POCKET HOLSTER

- Extra-thin, extra-soft holster for extra-deep concealment
- Holster will stay open; simply drop handgun into the pocket and it holsters itself
- Suede outer material grips clothing for less movement of holster
- Firm, moisture-proof membrane layer prevents perspiration from penetrating the holster and collecting on the gun
- Available in Black sueded finish

575

GLS™ PRO-FIT INSIDE WAISTBAND HOLSTER

- GLS™ (Grip Locking System) secures firearm once holstered; retention is deactivated with the middle finger upon obtaining a standard shooting grip on the firearm
- Designed to fit multiple firearms in one holster
- Body is proprietary nylon blend that is non-abrasive to firearm’s finish
- Low-cut compact design make concealment easy while allowing for a quick draw
- Inside-the-waist for deep concealment
- Fully adjustable cant
- Available in SafariSeven™ Plain Black

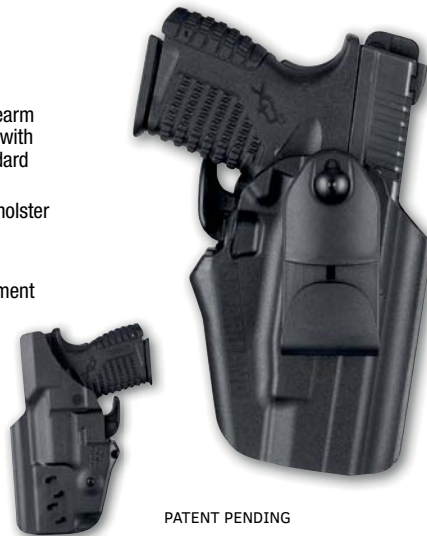

PATENT PENDING



Low-Profile Draw

Shown in Pocket

18

IWB HOLSTER

- Open-top design
- Firm SafariLaminate™ construction allows holster to stay open for ease of reholstering
- SafariSuede™ outer material grips clothing for less movement of holster
- Fits both 1.25" (32mm) and 1.5" (38mm) belt widths
- Double-snap belt loop is adjustable for holster cant
- Available in Black sueded finish



27

INSIDE-THE-PANTS CONCEALMENT HOLSTER

- J-shaped belt hook can be worn with any belt
- Designed for undercover duty use with open-top design for quick access
- SafariLaminate™ thermal-molded construction
- A polymer insert keeps the holster open for easy weapon reholstering
- Available in Plain Black finish



BODY WORN
CAMERAS
CONCEALABLE
ARMOR
TACTICAL
ARMOR
COMMUNICATIONS
PATROL
BIKE
DUTY GEAR/
HOLSTERS
PROTECTIVE
GEAR
FIREARMS
ACCESSORIES
LETHAL
PERFORMANCE
APPAREL
SURVIVABILITY
SYSTEMS
FORENSICS
ARMOR
SYSTEMS
TRAINING
GROUP

SHOULDER HOLSTERS



7053

7TS™ ALS® LIGHTWEIGHT SHOULDER HOLSTER

- ALS (Automatic Locking System) secures weapon once holstered; simple straight out draw once ALS is deactivated by thumb while obtaining shooting grip
- Proprietary SafariSeven™ material nearly impervious to heat, cold and water
- One handed reholstering
- Lightweight, adjustable elastic single side harness provides stability for handgun
- Belt tie-downs not needed due to lightweight and compact design
- Harness compatible with all 7TS holsters
- Available in SafariSeven Plain Black and FDE finishes

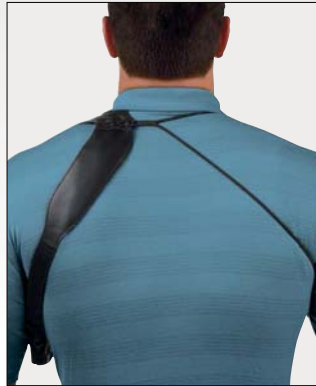

Back View



PATENTED & PATENT PENDING

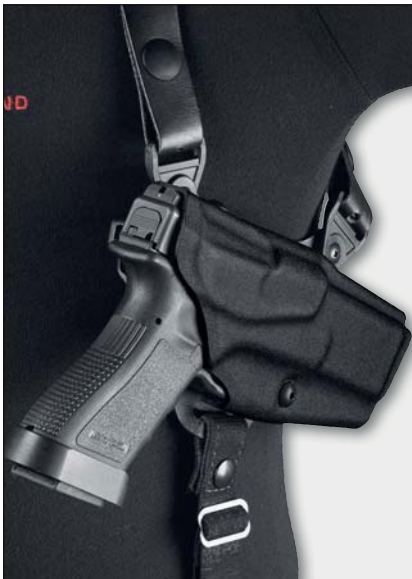

PATENTED



Can Be Worn Vertical or Horizontal



Back View



PATENTED

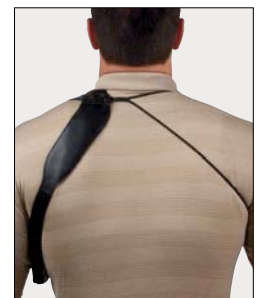

Back View

1051

ALS® SHOULDER HOLSTER

- ALS® (Automatic Locking System) secures weapon once holstered
- SafariLaminate™ thermal-molded construction for ease of draw and reholstering with one hand
- Vertical or horizontal carry options
- Harness system is comfortable and fully adjustable
- For pistols only
- Dual magazine pouch included on strong side
- Available in Plain or STX Plain Black finishes

1053

ALS® UNIVERSAL SHOULDER HOLSTER

- ALS (Automatic Locking System) secures weapon once holstered
- Adjustable strap to fit most body types
- Lightweight elastic single side harness provides stability for handgun
- Harness and mounting system sold separately from holster and can be used with any ALS concealment holster (excluding revolvers)

CONCEALMENT ACCESSORIES

BODY WORN CAMERAS | CONCEALABLE ARMOR | TACTICAL ARMOR | COMMUNICATIONS | PATROL BIKE | DUTY GEAR/HOLSTERS | PROTECTIVE GEAR | FIREARMS ACCESSORIES | LETHAL | PERFORMANCE APPAREL | SURVIVABILITY SYSTEMS | FORENSICS | ARMOR SYSTEMS | TRAINING GROUP



574 MAGAZINE HOLDER AND LIGHT POUCH - PADDLE

- Adjustable tension device
- Paddle design features a self-locking hook
- Fits belt widths up to 1.75" (45mm)



074 OPEN-TOP SINGLE MAGAZINE POUCH

- Paddle-style single magazine holder
- Fits belt widths up to 1.5" (38mm)
- Adjustable tension device
- Available in Plain Black or STX finishes



71 INJECTION MOLDED SINGLE MAG POUCH

- Flexible "accordion" design allows for multiple fits and minimal size
- Fits magazines (single or double stack), flashlights, knives and multi-tools
- Available in Black or Tan
- Fits 1.5" (38mm) to 2.25" (58mm) belt widths
- Can now be ordered as a tactical accessory to be used with Safariland® leg shrouds or the QAS System; also available as an IWB, with a belt clip, or for use with the MSA

81 OPEN-TOP SINGLE MAGAZINE-SNAP

- Back side folds over to form snap-type belt loop
- For use on belts up to 1.75" (45mm)
- Available in Plain Black finish

CD-AUTO AUTO MAGAZINE HOLDER

- Black metal clip-on design

079 OPEN-TOP DOUBLE MAGAZINE POUCH – SNAP

- For use on belts up to 1.75" (45mm) wide
- Adjustable tension device
- Available in Plain Black, Basketweave, or STX finishes

123 MAGAZINE POUCH – HORIZONTAL

- Carries magazines in a horizontal position
- Hook and loop belt attachment wraps around belt
- Available in Plain Black finish

572 OPEN-TOP DOUBLE MAGAZINE POUCH – PADDLE

- Adjustable tension device
- Available in Plain Black, Basketweave, or STX finishes

573 MAGAZINE HOLDER & HANDCUFF POUCH

- Paddle design features a self-locking belt hook
- Adjustable tension device
- Available in Plain Black finish

590 MAGAZINE HOLDER & HANDCUFF POUCH

- Paddle design features a self-locking belt hook
- Adjustable tension device
- Available in Plain Black finish

7350 BADGE HOLDER

- Three sizes for star and shield
- Metal clip

7352 BADGE HOLDER

- Shaped for shield-style badges

L820/L830 PLAINCLOTHES BELT 1.25" (32MM) & 1.5" (38MM)

- SafariLaminate™ construction with a vegetable-tanned leather support to accommodate holsters for larger handguns
- Available in Plain Black with solid brass or chrome buckle



81



CD-AUTO



079



123



572



573



590



7350



7352



L820/L830

HEARING PROTECTION



NEW

SAFARILAND® RANGE KIT PROFESSIONAL EYE & EAR PROTECTION

- Kit includes: HD glasses, (1) pair of ear plugs with case, (1) passive headset
- High noise reduction rating
- High quality ear seals
- Color: Gun Metal Grey

SAFARILAND® ELECTRONIC HEARING PROTECTION

- Electronic Noise Compression technology - sound compressed and reduced to safe hearing levels
- Features sound localization for maximum situational awareness and sound detection
- Low distortion speaker technology for superior sound quality
- 325-hour run time with 2 x AAA batteries
- Proprietary Earcup design layered with sound barrier technology; offered in Black
- Single-sided controls
- Rubber cheek wells



NEW



NEW



LIBERATOR HP™ ADVANCED HEARING PROTECTION

- First of its kind Dual Mode headset: has Electronic Noise Compression and Active Noise Cancellation
- Industry leading sound localization for maximum situational awareness and sound detection
- First of its kind Dual Fuel – Runs on either two AAA or one CR123 batteries
- First headset with user audio profiles modifiable by using Near Field Communications technology
- Industry leading 700-hour run time
- Proprietary high definition speakers and speaker enclosures
- Modular headset suspension, user adjustable to be either over-the-head or behind-the-head for maximum comfort
- Proprietary Earcup design layered with sound barrier technology
- Available in Black, OD Green, and Flat Dark Earth

HEARING PROTECTION



IN-EAR IMPULSE HEARING PROTECTION IN-EAR PROTECTION

Helps guard against hearing damage caused by automatic fire and single gun shots, artillery fire and explosions, reducing them to safe levels, less likely to cause long term damage.

33
dB
NOISE REDUCTION RATING

- Automatically engages to protect hearing
- Still allows for ambient audio
- Proprietary material for long wear comfort
- Includes key chain aluminum transport/storage case
- No batteries required
- Two sets of ear inserts included:
(2) medium and (2) large



075-2 HEARING PROTECTION HOLDER

- Clips on to belt
- Available in Black



COMPETITION

TEAM SAFARILAND

Since its inception in 1985, Team Safariland has been an integral part of developing and testing competition products. Safariland continually pushes the envelope with new and innovative competition holsters and accessories. Our newest gear, the ELS Competition belt, has raised the bar competition equipment, and the Model 014 Open Class holster brings a technological-edge to competitors.



TOM CAMPBELL

- 2001 USPSA Limited 10 national Champion
- 1977-1988 Member of USPSA Shooting Team
- 1985 European Champion
- 1986 USPSA Team Captain
- 24 years at Safariland, over 46 years total in the industry



SCOTT CARNAHAN

- Team Safariland Captain
- 3-Time USPSA National Class Champion
- NRA Open Action Pistol Distinguished Badge #103
- 2009 NRA Bianchi Cup National Class Champion
- 2012 NRA USA Action Pistol World Team Member for the Bianchi Cup



JULIE GOLOB

- First and only Six Division USPSA Female National Champion
- 13-Time USPSA Ladies National Champion
- 3-Time Bianchi Cup Ladies Champion
- 7-Time ladies World Speed Shooting Champion
- 4-Time IDPA Ladies National Champion



DOUG KOENIG

- 21-Time Masters Champion
- 2016 and 17-Time Bianchi Cup Champion
- 2013 and 5-Time European Bianchi Cup Champion
- 3-Time Steel Challenge World Speed Shooting Champion
- 1990 IPSC World Champion
- 2014 and 6-Time World Action Pistol Champion



ROB LEATHAM

- 28-Time USPSA / IPSC National Champion
- 8-Time IPSC World Champion
- 7-Time USPSA / IPSC Senior Champion
- 4-Time USPSA Classic Nationals Aggregate Champion
- 10-Time NRA Bianchi Cup / Action Pistol Champion
- 8-Time Steel Challenge Champion



KIPPI LEATHAM

- 2014 Western States Single Stack Classic Runner Up
- 2011 USPSA Area 3 Production Ladies Champion
- 2011 USPSA Ladies Production World Team, IPSC Silver Medalist
- 4-Time USPSA National Ladies Champion
- 4-Time USA IPSC Gold Team Member and Women's World Team Champion



KENDA LENSEIGNE

- 4-Time Overall World Champion - the only woman in CSMA history to accomplish this (beat out all the men)
- 13 World Records
- 2010 and 2011 CMSA Overall National Champion
- 4-Time CMSA World Point Champion Cowgirl
- 2015 CMSA Hall of Fame Inductee



BOBBY MCGEE

- 2014 CA State IDPA – 1st Place ESP
- 2014 WA State IDPA – 1st Place ESR
- 2014 AZ State IDPA – ESR Division Champion
- 2013 IDPA Puerto Rico ESR National Champion
- 6-Time WA State IDPA Champion



MAGGIE REESE

- 2016 US - IPSC Handgun Champion
- 3-Time National Champion USPSA Multi-Gun
- 2-Time National Team Member IPSC World Handgun
- Multi-time Ladies Champion at Superstition Mountain Mystery
- 3-Time Ironman's 3 Gun "Iron Maiden" champion
- Host of Modern Shooter on the Sportsman's Channel



BILL ROGERS

- Author of "Be Fast, Be Accurate, Be The Best"
- Author of "Reactive Pistol Shooting" video by Panteao
- Author of "Reactive Rifle Shooting" videos by Panteao
- Rogers Shooting School - 1976 - present: owner, operator and lead instructor
- Inventor of and patented the "Kydex" holster
- Responsible for more than 40 patents in the firearms field



BOB VOGEL

- 2016 IPSC Standard Champion
- IPSC World Champion and 2-Time IDPA World Champion
- 4-Time USPSA National Champion
- 8-Time IDPA National Champion
- 4-Time Pro-Am Champion



MICHAEL VOIGT

- 13-Time USPSA MultiGun National Champion
- 2-Time IPSC World Handgun Champion
- 7-Time IPSC World Champion Team member
- 5-Time International Tactical Rifle Champion
- 2-Time IPSC Continental Shotgun Champion
- 2-Time IPSC Continental Handgun Champion

COMPETITION RIGS

Team Safariland has completed another year of extensive field testing and shooting in competitive events, with the ELS System at the core. The combinations with this system are endless and it's changing the way shooters are rigging up for competitions.



Photo: Yanni Sued



Production/Single Stack Division Rig

The Production division is shot with standard handguns. Most popular in the division are Glocks, Smith & Wesson M&Ps, and Springfield XD's. Production division rigs are similar to Single Stack rigs with the exception of the handgun; in the Single Stack division a traditional 1911 is used. For both divisions, team members use the model 5197 holster mounted to a QLS System or the 5199 with belt clip. Most of us use the Model 771 pouch with the open front in the first reload location, and the Model 773 closed front pouches, which provide extra security for the rest of the magazines. Rob Leatham even likes this set up for L-10. Keeping the handguns and magazines in the same location enables the shooter to focus more on the competition and not relearning different positions.



Bianchi Cup Open Division Rig

The Bianchi Cup Open Division gun is a piece of art, generally a 1911 with a shroud for the barricade event, and an electronic red dot sight; these guns are truly a sight to be seen. The Metallic division is based on the 1911 with iron sights. For Bianchi Cup Open or Metallic divisions, either mount your 014 holster using the belt included, or as Doug Koenig prefers, mount the vertical adjustment rod directly to the belt. We use either the Slimline pouches that hold the magazines perpendicular, facing out from the belt, or the new Model 776 mag pouch, allowing us to carry eight magazines in a small area of space.



Multi-Gun Rig

When it comes to Multi-Gun competitions the versatility of the ELS System really comes into play. One of the biggest challenges with 3-Gun competitions is reconfiguring your rig for each course of fire. Not so with our ELS and QLS Systems. For Open Division 3-Gun competition, Mike Voigt likes to mount the 014 holster to a QLS Fork so that he can easily remove the holster when changing to stages where it's not needed. Speed is always paramount in competitions; this was a key factor in the design of the Model 6005-12. Both Mike Voigt and Maggie Reese, working very closely with the Safariland R&D team helped to design this model, which they currently use in 3-Gun competitions. Mike also uses the models 773 and 774 handgun and rifle pouches to further give him the edge needed to win matches.

For Tactical Scope Multi-Gun rig, we either use a thigh rig, featuring the Drop Flex Adapter, and either a 5197 or 6354 holster which provides added protection to the handgun, or mount a 014 using the QLS System as Mike Voigt does. We also have the option to mount a leg shroud on the left side to carry more ammo if needed.



IDPA Division Rig

IDPA shooting simulates self-defense scenarios and real life encounters using off the shelf handguns in a concealed manner. The holsters, belts, and magazine pouches used in this sport are from our concealment line, and are not what we typically refer to as competition equipment. Team Safariland has been hard at work developing new products and creating new features which incorporate the needs of IDPA shooters. The Range Series which includes the 5195, 5197 holsters and the 332 belt and are well-suited for IDPA. These holsters and belt, used in conjunction with some of Safariland's tried and true pouches like models 079, 074 or 773 with the 744BL Belt Clip attached, is a winning combination for any IDPA shooter.



For USPSA handgun, Multi-Gun and Steel Challenge it all starts with the model 030 under belt. Next is the 032 ELS Competition outer belt. We designed it to be very strong to hold your holster and high capacity magazines in place, yet light and comfortable. Finally by attaching the Quick Locking Kit for larger capability and the Equipment Locking Kits for pouches and shell holders, a truly modular system is attained. This system makes it easy to change out holsters and accessories for whatever the course of fire calls and the ability to change from division to division.

Vice President Marketing, Equipment Products

COMPETITION HOLSTERS



5197 RANGE SERIES OPEN-TOP MID-RIDE HOLSTER

- Adjustable belt loop eliminates common belt-bulging and does not interfere with draw
- Compact and lightweight
- Detent in trigger guard for reliable weapon security
- Low-cut sides for ease of draw and added comfort
- Available in 1.5" (38mm) or 1.75" (45mm belt widths)
- Belt loop is user adjustable for cant angle; can even be worn cross draw
- IDPA approved
- Genuine SafariLaminate™ thermal-molded construction
- Available in STX finishes including red



5195 RANGE SERIES OPEN-TOP LOW-RIDE HOLSTER

- Compact and lightweight
- Low-cut sides for ease of draw
- Offset belt loop allows for a straight up draw
- Detent in trigger guard for added security
- Modular offset adapter accommodates the QLS19 locking fork, 745BL and 567BL
- IDPA approved; recommended for female shooters
- Available in STX finishes including red



002 CUP CHALLENGE COMPETITION HOLSTER

- Features dual-tension screws on the holster body, one in back of cylinder and the other in back of barrel, allowing a balanced retention of the handgun
- Loop lined belt tab provides a firm and adjustable carry when used with the Safariland Model 032 hook-lined competition belt
- Accommodates both scoped and non-scoped revolvers as well as most revolvers with standard, heavy, and slab side barrels
- Built-in removable muzzle strap protects front sights
- Available in STX Tactical® or STX Basketweave finishes



014 OPEN CLASS COMPETITION HOLSTER

- Body machined out of aluminum to stabilize the handgun, yet offers little resistance for a secure and fast draw
- Ball joint on holster allows complete freedom of movement to customize the handgun draw
- Fully adjustable nosepiece accommodates barrels from 5" to 7.5" (13cm – 19cm)
- Fits a variety of competition handguns, with or without red dot or magnified optics
- Injection-molded adjustable trigger guard lock
- Front nosepiece designed to retain handgun and help prevent gun from being knocked out of the holster once seated
- Incorporates a simple push lock which secures weapon into the trigger block
- Also available for Glock, S&W and M&P
- Available in Black or Red finishes

PATENTED

Legal for the following divisions: Bianchi Cup Open Division, Steel Challenge Limited and Open Division, USPSA Open, Limited, & Limited-10 and USPSA Multi-Gun All Divisions



USPSA KIT USPSA KIT

- Ball joint on kit allows complete freedom of movement to customize the handgun draw
- Adjustable height bar for personalized holster height
- Designed to fit 1.5" (38 mm) to 1.75" (45 mm) belt widths and locks down with set screws
- Designed for use with Model 5197 Concealment Holster



014 ADAPTER 014 ADAPTER

- Allows for various mounting options for the 014 holster
- Available in Black

COMPETITION ACCESSORIES



4556 3-GUN COMPETITION CASE

- Heavy-duty lockable zippers, two adjustable outside accessory pouches
- Large dual handgun/accessory pouch with enclosed handgun storage areas and four pistol mag pouches large enough for extended magazines

- Unique zippered barrel expansion slot allows for barrels up to 51"
- 46" overall length (with expansion slot closed)

SEE MORE ON PAGE 87



4555 SHOOTERS' RANGE BAG

- Removable center carry compartment has zippered, padded side panels for four separate handgun compartments
- Magazine pouches sewn into main storage area

- Two large exterior pockets and a fully lined interior
- Overall dimensions: 14" x 9" x 10"

SEE MORE ON PAGE 87



776 COMPETITION MAGNETIC MAGAZINE HOLDER

- Magazines are oriented "bullets out" to save space on belt
- Designed with internal magnets to be used as a tension device
- Durable nylon construction with hook and loop closure
- Includes a snap loop attachment to hold flap in place
- Available with 744BL Belt Clip or ELS 34 Locking fork



774 RIFLE MAG POUCH

- FDE Brown or Coyote Brown finishes

SEE MORE ON PAGE 86



030 BUCKLELESS™ COMPETITION UNDERBELT 1.5" (38MM)

- Loop on outer side to connect to model 032
- Available in Black with web finish



334 RIGID COMPETITION BELT 1.5" (38MM)

- Reinforced to hold heavy competition handguns and ammunition
- Single Safariland® branded keeper
- Hook liner for use with Safariland 030 underbelt (like on 032)



032 ELS COMPETITION BELT 1.75" (45MM)

- Reinforced to hold heavy competition handguns and ammunition
- Hook lined to attach to 030 underbelt
- Pre-cut holes to mount ELS 35 Receiver Plates in multiple locations and angles
- Available in Nylon Look and Basketweave finishes



332 RANGE BELT 1.5" (38MM)

- Reinforced to hold heavy competition handguns and ammunition
- Highly tactile interior to grip clothing
- Available in Cordura® nylon, Black, Coyote Brown, Khaki Ranger Green



771/773 OPEN-TOP SINGLE MAGAZINE POUCH

- Features two magazine tensioning screws on back side of the holster to adjust tension on both the middle and end of the magazine
- Built-up channel for clearance of the bullet during the draw
- Available in STX Tactical or STX Basketweave finishes

COMPETITION ACCESSORIES

086

SHOTGUN SHELL HOLDER

- Holds (2), (4), (6) or (8) 12-Gauge shotgun shells
- Unique retaining plate keeps the shotgun shells from dislodging, and are quickly removed a few at a time or all at once
- Sturdy aluminum back plate allows for ride height and cant adjustments
- Available with ELS 34 Locking Fork or 745BL Belt Clip



PATENT PENDING



081-12



080-12

PATENT PENDING

080-12/081-12

SHOTGUN SHELL HOLDER

- Molded shotgun shell holder holds (2) 12-Gauge shells
- Belt clip features an extended bottom hook for security
- Fits belts up to 2.25" (58mm) wide
- 081-12 features mounting holes

085

QUAD SHOTGUN SHELL HOLDER

- Provides (4) 12-Gauge shells when needed
- All shells can be grasped and employed at once
- Available on an ELS 34 Locking Fork, 744BL Belt Clip, ELS 34/ELS 35 Locking Fork and Plate combo, or plain for direct leg shroud mounting
- Tensioners provide solid retaining system to hold shells, even when some are removed on model 085
- For use with 2 3/4" shells



6005-12

SHOTGUN SPEEDLOADER HOLDER

- Designed to be worn on the thigh
- Provides quick access to up to five shotgun speedloaders
- Cup and retention clip system keeps loaders stable, even while running
- Includes ELS 34 Fork on leg strap to work in conjunction with 032 ELS Competition Belt or can also be used with conventional competition belts using existing belt loop



PATENT PENDING

COMP I / II / III

SPEEDLOADER

- Injection-molded construction
- Large-frame versions offer maximum grip clearance



COMP I

COMP II

COMP III

J-KTR, J-LP SHOOTERS LOADING BLOCK

- Convenient trays hold wadcutter, semi-wadcutter or round nosed .38 or .357 ammunition
- Popular for all speedloaders



SAFARILAND ACCESSORIES



HARDWARE KIT

- Kit provides the necessary materials: screws, rollers, washers, T-nuts, hook, and Allen wrench to service Safariland holsters



TS-9250/9255

SAFARILAND® HAT

- Adjustable size fits all
- Low-profile design
- Embroidered logo on front and Safariland on back and on edge of bill
- Available in Black and Tan



DVD

TRAINING DVDS

- Wide selection of informative training DVDs available



Back

TS-2900

SAFARILAND® LONG SLEEVE PERFORMANCE SHIRT

- Team Safariland competition long-sleeved shirt
- Moisture-wicking fabric helps keep the wearer cool in hot environments and warm in cold ones
- Black with silk-screened Safariland logo on front, back and forearms
- Available in sizes S-XXL



TS-3200

SAFARILAND® PERFORMANCE T-SHIRT

- Moisture-wicking fabric helps keep the wearer cool in hot environments and warm in cold ones
- Black with silk-screened Safariland logo on upper front chest and upper back
- Available in sizes S-XXL



TS-6600/TS-6610

SAFARILAND® MEN'S / WOMEN'S PERFORMANCE POLO SHIRT

- Moisture-wicking fabric helps keep the wearer cool in hot environments and warm in cold ones
- Black with embroidered Safariland logo on upper left chest
- Available in sizes S-XXL



TS-6600

SAFARILAND® MEN'S PERFORMANCE POLO SHIRT

- 100% polyester wicks away perspiration to keep you cool in the heat and warm when it's cold
- Safariland logo on chest of shirt
- Available in White
- S-XXL



SAF-CUP-MUG

COFFEE MUG

- Matte Black finish with Safariland and logo in red and liquid gold on both sides
- Ceramic
- 17 oz. capacity



SAF-CUP-2

COFFEE TUMBLER

- 16 oz. stainless tumbler with Matte Black finish
- Safariland logo printed in red and liquid gold on one side



SAF DECAL

SAFARILAND DECAL

- Small 3" x 3"
- Large 6" x 6"

THE WORLD'S FINEST GUNLEATHER



BIANCHI DUTY GEAR



Recognized by shooting enthusiasts and professionals the world over, the Bianchi® hallmarks of handcrafted workmanship, innovative yet functional design and quality are just as strong today as they were more than 58 years ago. These are the hallmarks that have been maintained

since 1958, when John Bianchi built his first leather holster in his garage. To this day, the focus remains on providing customers with the best combination of innovation and handcrafted, time-tested designs.

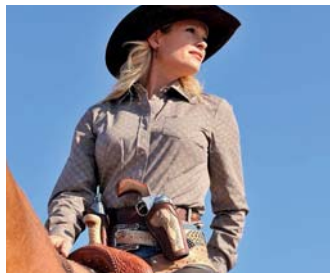

BIANCHI® MATERIALS AND TECHNOLOGY

Bianchi® offers a variety of materials to meet the needs of those who use our products. From AccuMold® ballistic weave to leather and leather/laminate combinations, Bianchi has a material that works for you. Our premium grade full grain leather and ballistic weave fabrics are long lasting, durable, and offer the professional look desired by law enforcement and sports enthusiasts alike.



AccuMold®

A state-of-the-art molded synthetic nylon product constructed from our trilaminate material, made up of a ballistic weave outer fabric, a firm, high-density closed-cell foam center; and a smooth Coptex™ lining. All AccuMold® gear is contour molded to precisely fit the gear it was designed to carry.



AccuMold® Elite™

We've taken our patented AccuMold technology and dressed it up. The AccuMold® Elite™ line offers the same construction of AccuMold, but with a Duraskin™ outer material that looks amazingly like leather. You can't tell the difference until you pick it up and see that it's almost half the weight of leather.



PatrolTek™

PatrolTek™ duty belts and accessories are made using our molded trilaminate technology but at a price to meet the demands of ever-tightening budgets. Now you don't have to give up function and wear to get duty gear at a great price.



ACCUMOLD

BALLISTIC
WEAVE

ACCUMOLD ELITE

DURASKIN™
PLAIN

DURASKIN™
BASKET

DURASKIN™
HI GLOSS

PATROLTEK

600-DENIER
WOVEN

LEATHER

PLAIN
TAN

PLAIN
BLACK



PINCH® RETENTION DEVICE – PRD™

Our exclusive PRD is formed of a high strength polymer. When the weapon is firmly seated in the holster, the PRD grips the trigger guard, holding the weapon in place until you're ready to draw.



Auto
Retention

FINGERLOK™ RETENTION

The FingerLok™ device provides Auto Retention™ when the weapon is holstered, and is released by sweeping the device with the middle finger when drawing.



PATENTED

BIANCHI® MATERIALS AND TECHNOLOGY

Design, function, security, and comfort have always been at the forefront when developing new Bianchi products. Our research and development team continually focuses on new materials and new technologies to offer the best in the industry.



ALLUSION™ SERIES

The Bianchi® Allusion™ series brings you the best of leather and synthetic materials for superior performance and good looks. We start out with a thermo-formed, synthetic shell precisely formed to the firearm. Then we wrap it with our premium grade, full grain, vegetable-tanned cowhide and give it our finishing touches, including burnished edges and our leather dressing that gives the holster that distinctive leather look and smell. With the Allusion series, we are also able to add features not typically found with leather-only construction, such as our retention detent, smooth draw and re-holstering.

The Allusion series perfectly matches tradition and cutting edge technology, bringing leather holsters into the 21st century.

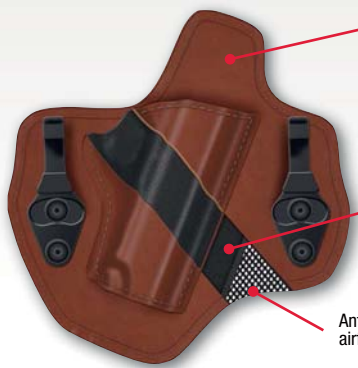

Premium grade hand-selected full grain vegetable tanned cowhide finished with a lustrous leather dressing

Antibacterial nanotechnology and antimicrobial low density closed-cell foam repels absorption of sweat

Antibacterial/microbial spacer mesh allows airflow for moisture and heat dissipation

Thermoformed retention detent

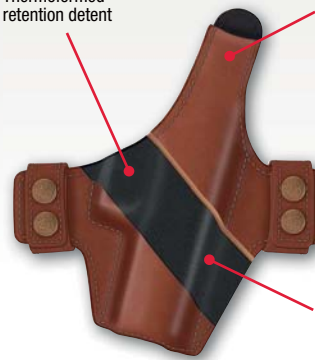

Premium grade hand-selected full grain vegetable tanned cowhide finished with a lustrous leather dressing

High-quality rigid thermoformed material that is thin and lightweight



BIANCHI GUNLEATHER®

Many people love traditional leather. It wears beautifully, and nothing quite smells or feels the same. Bianchi leather is full grain cowhide – the best available. We choose different weights based on the product requirements, handcrafting and molding it to perfection the old-fashioned way, by not cutting corners.



ERGOTEK™ DUTY BELTS

Bianchi ErgoTek™ duty belts redistribute the weight of the duty gear, away from the edges of the belt and over its wide closed-cell foam cushioned surface. For even more stability and added holster support, a high-density internal polymer stiffener runs the full length and width of the belt. You'll notice immediately that the ErgoTek belt is both light in weight and far more comfortable than a traditional duty belt. Plus, these belts are lined with hooks to work in conjunction with the Bianchi 7205 Liner Belt.

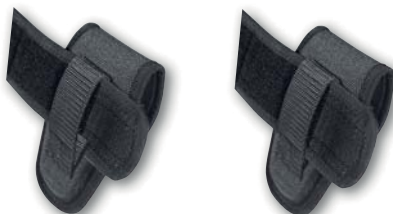

DUAL BELT LOOP

Bianchi offers its most popular duty accessories with a uniquely designed belt loop that allows for snug carry on either a 2" (50mm) duty belt or 2.25" (58mm) duty belt. This feature is available on both our top end AccuMold® & AccuMold® Elite™ accessory lines, as well as our PatrolTek™ accessory line.

DUTY HOLSTERS

Bianchi® offers a variety of materials to meet the needs of those who use our products. From AccuMold® ballistic weave to leather and leather/laminate combinations, Bianchi has a material that works for you. Our premium grade full grain leather and ballistic weave fabrics are long lasting, durable, and offer the professional look desired by law enforcement and sports enthusiasts alike.



AccuMold®

7105 CRUISER™ DUTY HOLSTER

- A hi-ride duty holster that positions pistol close to the body
- Top-draw design
- Made with 50% greater density foam than standard civilian AccuMold® holsters, for firmness and strength
- Unique Coptex™ inner lining helps protect gun finish and provides a smooth draw
- Quick-Slide™ injection-molded belt loop fits up to 2.25" (58mm) belts
- Available in Black Ballistic Weave finish



AccuMold®

7120 DEFENDER® DUTY HOLSTER

- Top-draw holster with mid-ride and traditional metal reinforced thumb snap closure
- Pinch® Retention Device (PRD™) enhances firearm retention by gripping the pistol's trigger guard
- Unique Coptex™ inner lining helps protect gun finish and provides a smooth draw
- Metal reinforced 2.25" (58mm) jacket slot belt loop, curved for comfort
- Available in Black Ballistic Weave finish



AccuMold® *Elite*

7920 DEFENDER® II DUTY HOLSTER

- Top draw holster with mid-ride carry and metal reinforced thumb snap closure
- Contour molded, trilaminate construction with 50% greater density foam than civilian AccuMold® holsters
- Internal Pinch® retention device grips the pistol's trigger guard
- Soft Coptex™ poly-knit inner lining
- Metal reinforced 2.25" (58mm) jacket slot belt loop, curved for comfort
- Available in Plain Black, Basketweave Black and Hi Gloss Duraskin™ finish



AccuMold®

7115 VANGUARD™ DUTY HOLSTER

- Straight drop duty holster with mid-ride and top draw Molded internal Tension™ Strips
- Contour-molded, trilaminate construction with 50% greater density foam than civilian AccuMold® holsters
- Metal reinforced thumb snap closure
- Soft Coptex™ poly-knit inner lining
- Metal reinforced 2.25" (58mm) jacket slot belt loop, curved for comfort
- Available in Black Ballistic Weave finish



DUTY BELTS

Today's officers carry a lot of equipment on their duty belts, often more than twenty pounds. That's why Bianchi® offers some of the most comfortable, functional, and professional duty belts available. Equipment belts are constructed with either four-part or five-part laminate for long-lasting shape and exceptional durability. Four-part laminate features a firm polyethylene center strip sandwiched between a high-density, closed-cell foam, with a durable nylon lining, and either a weave or Duraskin™ exterior depending on the model. Belts with buckles feature the CopLok buckle which is a polymer, shatter-resistant buckle with a 3-point release for added security.

AccuMold®



7200 DUTY BELT - LOOP 2.25" (58MM)

- Five-part laminate construction
- Ballistic weave fabric exterior with loop lining
- CopLok buckle



7225 ERGOTEK™ DUTY BELT 2.25" (58MM)

PATENTED

- Five-part laminate construction
- Load support cushions on inner lining distribute weight of duty belt over entire waist for comfort during the entire shift
- Ballistic weave fabric with loop lining for use with Bianchi® 7205 Liner Belt
- Accepts standard holsters and pouches
- CopLok buckle



7203 NYLON DUTY BELT - HOOK 2.25" (58MM)

- Five-part laminate construction
- Ballistic weave fabric exterior with hook lining
- CopLok buckle



7215 NYLON DUTY 2" (50MM)

- Five-part laminate construction
- Ballistic weave fabric exterior with hook lining
- Austri Alpin Cobra buckle



7216 NYLON DUTY 2.25" (58MM)

- Five-part laminate construction
- Ballistic weave fabric exterior with hook lining
- Austri Alpin Cobra buckle
- Rescue Loop



7210 DUTY BELT 2" (50MM)

- Five-part laminate construction
- Ballistic weave fabric exterior with loop lining
- CopLok buckle



PATENTED

7220 DUTY BELT 2" (50MM)

- Ballistic weave nylon with full-length hook lining
- Both ends are skived, allowing a lower profile around the buckle
- CopLok buckle



7235 DUTY BELT SYSTEM 2.25" (58MM)

- Five-part laminate construction
- Ballistic weave fabric exterior with loop lining
- Includes duty belt, liner, and 4 attached keepers
- CopLok buckle

AccuMold™ Elite



7950 DUTY BELT 2.25" (58MM)

- Four-part laminate construction
- Duraskin™ exterior with loop lining for use with Bianchi® 7205 Liner Belt
- CopLok buckle



PATENTED

7955 ERGOTEK™ DUTY BELT 2.25" (58MM)

- Four-part laminate construction
- Duraskin™ exterior with loop lining for use with Bianchi® 7205 Liner Belt
- Load support cushions on inner lining spread load of duty belt over entire waist
- CopLok buckle



7960 SAM BROWNE BELT 2.25" (58MM)

- Four-part laminate construction
- Duraskin™ exterior with loop lining for use with Bianchi® 7205 Liner Belt
- Load support cushions on inner lining spread load of duty belt over entire waist



PATENTED

7965 ERGOTEK™ SAM BROWNE BELT 2.25" (58MM)

- Four-part laminate construction
- Load support cushions on belt lining spread weight of gear over entire waist
- Provides a padded buffer between stiff outer belt with accessories and the wearer
- Duraskin™ exterior with loop lining for use with Bianchi® 7205 Liner Belt



7970 BUCKLELESS™ DUTY BELT 2.25" (58MM)

- Four-part laminate construction
- Positive 3-way retention using hook and loop, retaining stud and belt keeper
- Duraskin™ exterior with loop liner for use with Bianchi® 7205 Liner Belt



7980 DUTY BELT 2" (50MM)

- Four-part laminate construction
- Duraskin™ exterior with loop lining for use with Bianchi® 7205 Liner Belt
- CopLok buckle

BODY WORN
CAMERAS
CONCEALABLE ARMOR
TACTICAL ARMOR
COMMUNICATIONS
PATROL BIKE
DUTY GEAR/HOLSTERS
PROTECTIVE GEAR
ACCESSORIES
FIREARMS
LETHAL
PERFORMANCE APPAREL
SURVIVABILITY SYSTEMS
FORENSICS
ARMOR SYSTEMS
TRAINING GROUP

DUTY BELTS

PatrolTek™ LEATHER



B2
SAM BROWNE BELT 2.25" (58MM)

- Highest grade full grain leather
- Unlined



B8G
GARRISON BELT 1.75" (45MM)

- Heavyweight, full grain leather
- Unlined
- Garrison style buckle
- Nickel or brass finish buckle
- Solid brass or chrome plated brass buckle



B5
DRESS BELT 1.5" (38MM)

- Full grain leather
- Perfect for casual or dress
- Unlined
- Solid brass or chrome plated brass buckle

PatrolTek™



8100
WEB BELT 2" (50MM)

- Loop lined for use with 8105 Liner Belt
- Tough, double-layered web construction
- Smooth, edge-bound finish for extra comfort
- CopLok buckle



8110
**WEB BELT WITH
HOOK LINING 2" (50MM)**

- Hook lined for use with 8106 Liner Belt
- Tough, double-layered web construction
- Smooth, edge-bound finish for extra comfort
- CopLok buckle



8300
DUTY BELT SYSTEM 2" (50MM)

- Hook and loop lining
- Tough, double-layered web construction
- Includes duty belt, liner and 4 attached keepers
- CopLok buckle



8105
LINER BELT – HOOK 1.5" (38MM)

- Hook surface for use with 8100 Duty Belt
- Tough web construction
- Hook and loop closure for quick on/off ease



8106
LINER BELT – LOOP 1.5" (38MM)

- Loop surface for use with 7203 Duty Belt
- Tough web construction
- Hook and loop closure for quick on/off ease



7205
LINER BELT 1.5" (38MM)

- Hook and loop closure for quick on/off ease
- Lined with hook



7201
**TRAINING, HOOK AND LOOP
BELT 1.75" (45MM)**

- Four-part laminate construction
- Hook and loop closure for quick on/off ease



7221
BALLISTIC BELT 2" (50MM)

- Ballistic weave trilaminate construction
- Both ends are skived for a lower profile around the buckle
- CopLok shatter-resistant, polymer buckle features 3-point release for added security
- Available in FDE Brown, OD Green, Foliage Green, or Black finishes



7202
GUN BELT 1.75" (45MM)

- Four-part laminate construction
- Shatter-resistant polymer buckle

DUTY POUCHES

AccuMold®

- This Bianchi® technology features a method of molding to contour the laminate to the exact shape of the equipment it will carry
- Its trilaminate construction features a ballistic weave fabric exterior with a high-density, closed-cell foam center and a smooth Coptex™ knit lining
- Magazine pouch cavities expand both front and rear, making for a snugger fit, a trimmer look and less strain on the equipment
- These pouches feature our exclusive Roll Top™ lid for a smooth, rounded closure and a custom fit for equipment of various sizes
- Reinforced hidden snap or hook and loop closure
- All molded accessories feature the dual molded belt loop to fit both 2" (50mm) and 2.25" (58mm) belt widths unless otherwise noted



7301
SPEEDLOADER POUCH

- AccuMold® trilaminate with ballistic weave exterior and Coptex™ lining



7302
DOUBLE MAGAZINE POUCH

- Injection-molded belt loop for horizontal or vertical carry
- Hook and loop or hidden snap closure



7303
SINGLE MAGAZINE POUCH

- Hook and loop or hidden snap closure



7320
TRIPLE THREAT™ II
DOUBLE MAGAZINE POUCH

- Injection-molded belt loop for vertical or horizontal carry
- Tension screw adjustment permits various drawing angles
- Fits 2.25" (58mm) belt widths



7335
EDW SINGLE POUCH

- Holds one Taser® X26P cartridge



7336
EDW SINGLE POUCH

- Holds two Taser® X26P cartridges

DUTY POUCHES



7300

COVERED HANDCUFF CASE

- Two sizes hold one pair chain or hinged handcuffs
- Hook and loop or hidden snap closure
- Available with MOLLE strap

7334

OPEN TOP HANDCUFF CASE

- Holds one pair chain handcuffs

7317

DOUBLE HANDCUFF CASE

- Holds two pair standard chain handcuffs
- Hook and loop or hidden snap closure

7318

ULTIMATE HINGE HAND CUFF CASE

- Holds one pair Hiatt® 8142 cuffs
- Hook and loop or hidden snap closure

7307

MACE®/OC SPRAY HOLDER

- Two sizes for MK-2, MK-3 and MK-4 canisters
- Hook and loop or hidden snap closure
- Available with MOLLE strap

7308

OPEN TOP MACE®/OC HOLDER

- Three sizes fit MK-2, MK-3 and MK-4 canisters

7310

MINI-LIGHT HOLDER

- Fits AA-cell lights
- Hook and loop or hidden snap closure

7311

COMPACT LIGHT HOLDER

- Three sizes fit most compact lights
- Hook and loop or hidden snap closure

7312

EXPANDABLE BATON HOLDER

- Covered hole in back allows baton to be placed in pouch fully expanded
- Available with MOLLE strap

7326

COMPACT LIGHT HOLDER

- Three sizes fit most compact lights
- Hook and loop or hidden snap closure



DUTY POUCHES



7314
7314S



7324
7324S



ARS



7323



7337

7314/7314S

UNIVERSAL RADIO HOLDER

- Elastic security strap with snap closure
- Fits most hand-held radios
- 7314S features a two-piece adjustable swivel base and mount

7324/7324S

SLIMLINE RADIO HOLDER

- Holds compact hand-held radios
- Elasticized security strap
- 7324S features a two-piece adjustable swivel base and mount
- Available with MOLLE strap

7323

ADJUSTABLE RADIO HOLDER

- Holds compact hand-held radios
- Elasticized security strap

ARS

RADIO SWIVEL ATTACHMENT

- 2.25" (58mm) belt loop
- Sold separately for ease of transferring radios among users

7337

SMARTPHONE CASE

- Fits most popular sizes
- Features the Safariland® 744BL Belt Clip
- Can be attached to Safariland leg shroud with ELS Fork (sold separately)
- Helps protect smartphone from damage or dirt
- Fits 1.5" (38mm) to 2.25" (58mm) belts



7315



7328



7337



7405K



7405



7406



7404



7409



7409K

7315

GLOVE HOLDER

- Holds most pocket pagers or two pair latex gloves
- Hook and loop or hidden snap closure

7328

FLAT GLOVE HOLDER

- Holds two pair latex gloves
- Hook and loop or hidden snap closure

7316

SILENT KEY HOLDER

- Roll Top™ wraparound design
- Hook and loop closure

7405/7405K

KEY HOLDER

- 1" web keeper with polymer key holder attached
- Sewn (7405) or dual snap (7405K) closure

7406

BELT KEEPER

- 1" web
- Dual-snap or hook and loop closure
- Sold in 4-pack

7404

BATON RING

- Fits standard and side-handle batons
- Sturdy, 1" web with injection-molded ring

7409/7409K

FLASHLIGHT RING

- Molded ring locks flashlight in place
- 1" web



DUTY POUCHES



- Lightweight – up to 50% lighter than leather in most applications
- More affordable than leather
- Improved comfort translates into better officer performance in the field
- Same beautiful look as leather – the crisp, professional appearance of premium leather without the weight, maintenance and cost
- Reinforced hidden snap closure unless specified otherwise
- Abrasion-resistant – exhibits a high level of resistance to the daily knocks, scuffs and abrasions of duty use
- Easily cleaned with only mild soap and water. Bio-safe: washing with disinfectant soap or bleach solution will handle contamination problems. Great for correctional institution duty
- All molded accessories feature the dual belt loop to fit both 2" (50mm) and 2.25" (58mm) widths unless otherwise noted



7902



7903



7915



7922



7935



7936



7900



7917



7918



7934

7902 DOUBLE MAGAZINE POUCH

- Vertical or horizontal carry
- Four sizes to fit most magazines
- Injection-molded belt loop
- Chrome, brass or hidden snap

7903 SINGLE MAGAZINE/KNIFE POUCH

- Three sizes fit most magazines
- Hidden snap

7915 GLOVE HOLDER

- Holds most standard pagers or two pair latex gloves
- Chrome, brass or hidden snap

7922 TRIPLE THREAT™ II DOUBLE MAGAZINE POUCH

- Injection-molded belt loop for vertical or horizontal carry
- Tension screw adjustment permits various drawing angles

7935 EDW SINGLE POUCH

- Holds one Taser® X26P cartridge

7936 EDW DOUBLE POUCH

- Holds 2 Taser® X26P cartridges

7900 COVERED HANDCUFF CASE

- Holds one pair chain or hinged handcuffs
- Chrome, brass or hidden snap

7917 DOUBLE HANDCUFF CASE

- Holds two pair chain handcuffs
- Chrome, brass, or hidden snap
- Dual web belt loop fit 2" (50mm) and 2.25" (58mm) belts

7918 ULTIMATE HINGE HANDCUFF CASE

- Holds one pair Hiatt® Model UL handcuffs or similar

7934 OPEN TOP HANDCUFF CASE

- Holds one pair chain or hinged handcuffs





7911



7926



7907



7908



7912



7928



7916



7937



7914S



7923



7904



7909



7906

7911 COVERED COMPACT LIGHT HOLDER

- Three sizes fit most compact lights; e.g., Streamlight® and SureFire®
- Chrome, brass or hidden snap

7926 COMPACT LIGHT HOLDER

- Two sizes fit most compact lights; e.g., SureFire® 6P, 6R; Streamlight® Stinger XT, Poly Stinger, Scorpion
- Slides on to 2.25" (58mm) belts

7907 MACE®/OC SPRAY HOLDER

- Two sizes for MK-2, MK-3 and MK-4 canisters
- Chrome, brass or hidden snap

7908 OPEN TOP MACE®/OC SPRAY HOLDER

- Three sizes for MK-2, MK-3 and MK-4 canisters
- Sturdy web belt loop

7912 EXPANDABLE BATON HOLDER

- Covered hole in back allows baton to be placed in pouch fully expanded

7928 FLAT GLOVE HOLDER

- Holds two pair latex gloves
- Hook and loop closure only
- 2.25" (58mm) belt loop

7916 SILENT KEY HOLDER

- Roll Top™ wraparound design
- Hook and loop closure

7937 SMARTPHONE CASE

- Fits most popular sizes
- Features the Safariland® 744BL Belt Clip
- Can be attached to Safariland leg shroud with ELS Fork (sold separately)
- Fits 1.5" (38mm) to 2.25" (58mm) belts

7914S UNIVERSAL RADIO HOLDER

- Holds most hand-held radios
- Elasticized security strap with snap closure
- Two-piece adjustable swivel mount for comfort when riding in a vehicle

7923 ADJUSTABLE RADIO HOLDER

- Two sizes hold compact hand-held radios
- Elasticized security strap
- Slim design offers less bulk

7904 SIDE-HANDLE BATON HOLDER

- Fits straight and side-handle batons
- Sturdy, injection-molded ring
- One-way snap-on belt loop

7909 D-CELL LIGHT HOLDER

- Molded ring locks flashlight in place
- Snap-on belt loop

7906 BELT KEEPER

- Dual snap closure
- Sold in 4-pack
- 1" width; available in chrome, brass or hidden snaps

DUTY POUCHES

PatrolTek™

- With significant cost savings compared to premium brands, PatrolTek™ also offers the quality and functionality you've come to expect from Bianchi®
- Contour molded technology
- Pleated pouch lids offer a smooth closure and great fit
- Reinforced hidden snap closure unless specified
- Trilaminar with 600-denier woven finish
- All molded accessories feature the dual belt loop to fit both 2" (50mm) and 2.25" (58mm) widths unless otherwise noted
- Lightweight and weatherproof
- Easily cleaned with soap and water
- Stays flexible in cold weather



8002



8003



8020



8015



8035



8036



8016

8002

DOUBLE MAGAZINE POUCH

- Vertical or horizontal carry

8003

SINGLE MAGAZINE POUCH

- Four sizes to fit most magazines
- Hook and loop or hidden snap closure

8020

TRIPLE THREAT™ II DOUBLE MAGAZINE POUCH

- Injection-molded belt loop for vertical or horizontal carry
- Tension screw adjustment permits various drawing angles

8035

EDW SINGLE POUCH

- Holds one Taser® X26P cartridge

8036

EDW DOUBLE POUCH

- Holds two Taser® X26P cartridges

8015

GLOVE HOLDER

- Holds most standard pagers or two pairs latex gloves

8016

SILENT KEY HOLDER

- Wraparound hook and loop closure





8000



8017



8018



8034



8038S



8001



8010



8011



8026

8000

COVERED HANDCUFF CASE

- Holds one pair chain or hinged cuffs
- Hidden snap closure

8017

DOUBLE HANDCUFF CASE

- Holds two pairs chain handcuffs
- Hook and loop closure

8018

ULTIMATE HINGE HANDCUFF CASE

- Holds one pair Hiatt® Model 8142 cuffs
- Hook and loop or hidden snap closure
- Dual web belt loop fits 2" (50mm) and 2.25" (58mm) belts

8034

OPEN TOP HANDCUFF CASE

- Pull-through style
- Holds one pair chain cuffs

8038S

RIGID HANDCUFF CASE

- Holds one pair Hiatt® Model 8132 Rigid Cuff or similar
- Adjustable swivel mount

8001

SINGLE HANDCUFF CASE WITH KEY SLOT

- Holds one pair chain or hinged cuffs
- Slot to hold spare cuff key in lid

8010

MINI-LIGHT HOLDER

- Fits AA-cell lights
- Hook and loop or hidden snap closure

8011

COMPACT LIGHT HOLDER

- Hidden snap closure
- Full flap helps secure light

8026

COMPACT LIGHT HOLDER

- Two sizes fit most 1" diameter lights





8006



8006I



8007



8008

8006

BELT KEEPER

- 1" web
- Black finished brass snaps
- Sold in 4-pack

8006I

SLIDE-ON BELT KEEPER

- 1" web
- Keeps duty belt secure to liner belt
- Black finished brass snaps

8007

MACE®/OC SPRAY HOLDER

- Two sizes for MK-2, MK-3 and MK-4 canisters

8008

OPEN TOP MACE®/OC SPRAY HOLDER

- Three sizes for MK-2, MK-3 and MK-4 canisters
- Open-top design for quick access

8009

FLASHLIGHT RING

- 1" web
- Molded plastic ring locks flashlight in position
- Fits D-cell lights
- Available in sewn or snap version



8009



8012



8013S



PATENTED

8014
8014S

8012

EXPANDABLE BATON HOLDER

- Baton holder w/ hole in back for reholstering expanded baton
- Three sizes to fit 16", 21" and 26" Monadnock® and similar batons

8013S

EXPANDABLE BATON HOLDER WITH SWIVEL

- Adjustable swivel mount
- Can be used with Monadnock® Wedge™ Cap
- 2" (50mm) width belt loop

8014/8014S

UNIVERSAL RADIO HOLDER

- Holds most hand-held radios
- Adjustable elastic security strap with snap closure
- 8014S features a two-piece adjustable swivel base and mount



8028



8037

8028

FLAT GLOVE HOLDER

- Holds two pairs of latex gloves
- Trim and compact

8037

SMARTPHONE CASE

- Fits most popular sizes
- Features the Safariland® 744BL Belt Clip
- Can be attached to Safariland Leg Shroud with ELS Fork (purchased separately)
- Fits 1.5" (38mm) to 2.25" (58mm) belts

DUTY POUCHES

PatrolTek™ LEATHER

- Bianchi® design and quality at a value price
- Durable construction for the rigors of daily use
- Full line of essential duty accessories
- Available in Plain or Basketweave finish with chrome, brass, or hidden snap hardware



20C



29



31



31C



32A



32P



33



35P



36A



37BL



37M



37S

20C

DOUBLE MAGAZINE POUCH

- Vertical or horizontal carry
- Two sizes for most 9mm/.40, or .45 single stack magazines
- Chrome, brass or hidden snaps

29

TRIPLE THREAT™ MAGAZINE POUCH

- Vertical or horizontal carry
- Two sizes for most 9mm/.40, or .45 single stack magazines
- Chrome, brass or black snaps

31

KEY FLAP

- Wide flap eliminates key wear on clothing
- Chrome, brass or black snaps

31C

SILENT KEY HOLDER

- Keeps key quiet
- Hook and loop closure
- Chrome, brass or black snaps

32A

EXPANDABLE BATON HOLDER

- Available for both 21" and 26" batons
- One-way directional snap for strength

32P

BATON HOLDER

- Available for both 21" and 26" batons
- One-way directional snap for strength
- Chrome, brass or black snaps

33

BELT KEEPER

- Full 1" wide
- Chrome, brass or black snaps
- Sold in 4-pack

35P

HANDCUFF CASE

- Holds linked or hinged cuffs
- Chrome, brass or hidden snaps

36A

MACE®/OC SPRAY POUCH

- Available for MK-4 canisters
- One-way directional snap for strength
- Chrome, brass or hidden snaps

37BL

D-CELL LIGHT HOLDER

- Molded ring holds flashlight in place
- One-way directional snap for strength
- Chrome, brass or black snaps

37M

MINI LIGHT HOLDER

- Fits AA-cell lights
- Snap-on belt loop

37S

COMPACT LIGHT HOLDER

- Two sizes to fit most compact flashlights
- Slide-on belt loop

MILITARY HOLSTERS

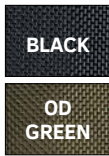

MILITARY PRODUCT COLOR OFFERINGS

Model	Finish	Model	Finish
UM84I	Black, OD	M12	OD
UM84II	Black, OD	M13	Black, OD
UM84III	Black, OD	M1020	Black, OD
UM84R	Black, OD	M1025	Black, OD
UM92I	Black, OD	M1030	Black, OD
UM92II	Black, OD	M1415	Black, OD
UM84H	Black, OD	M1425	Black
		M1430	Black, OD



UM84

UNIVERSAL MILITARY HOLSTER

- Commercial offering of the military standard issue M12 holster
- System can be worn 14 different ways
- Removable flap for conversion to thumb break
- Ambidextrous
- Equipped with Quick-Lock™ belt fastener
- Includes field cleaning rod
- Available for revolvers and semi-autos
- Fits up to 2.25" (58mm) belt



T6505

TAC HOLSTER

- Quick-Lock™ clip for attachment to T6510 Accessory Panel, to any MOLLE attachment system or on an equipment belt up to 2.25" (58mm) wide
- Features polymer trigger guard shield that protects and stabilizes
- Rugged Ranger™ trilaminate construction
- Ambidextrous
- Available in Black Ballistic Weave finish



UM92I/UM92II

UNIVERSAL MILITARY HOLSTER

- Commercial offering of the military standard issue M12 holster with the addition of a polymer trigger guard insert that stabilizes the trigger guard of certain large frame autos; ideal for Sig Sauer and Glock weapons
- Ambidextrous
- Includes field cleaning rod
- Equipped with Quick-Lock™ belt fastener
- Two sizes to fit 4" - 5" semi-autos
- Compatible with all UM84 accessories
- Fits up to 2.25" (58mm) belt



M12

UNIVERSAL MILITARY HOLSTER

- U.S. Armed Forces standard issue for the Beretta M9 sidearm
- Removable flap for conversion to thumb break
- Ambidextrous
- System can be worn 14 different ways
- Converts to shoulder holster with M13 or UM84H
- Equipped with Quick-Lock™ belt fastener
- Includes field cleaning rod



T6500

TAC HOLSTER LT

- Adjustable to fit most pistols with tactical lights mounted
- Quick-Lock™ belt clip for attachment to T6510 Accessory Panel, to any MOLLE attachment system or to an equipment belt up to 2.25" (58mm) wide
- Secondary retainer strap for a double lock on the thumb break for additional retention when required
- Rugged Ranger™ trilaminate construction
- Available in Black Ballistic Weave finish

MILITARY HOLSTERS



M1030

M1025 MILITARY MAGAZINE POUCH

- Holds two magazines
- Trim & compact
- Quick-Lock™ belt fastener attaches securely to web belt
- Fits up to 2.25" (58mm) belt
- Available in Black and OD



M1425 TACTICAL HIP EXTENDER

- Provides a rigid platform and upper attachment point for accessories
- Includes a high-mounted leg strap
- Features Quick-Lock™ belt fastener
- Available in Black, Universal Digital Camo
- Fits up to 2.25" (58mm) belt



HOLSTER NOT INCLUDED

M1430 UNIVERSAL MILITARY ADAPTER

- Adapter kit allows Safariland® MLS 15 Locking Fork to attach to the back of the UM84/UM92 Universal Military Holsters
- Locking Fork allows the holster to be mounted directly into MOLLE loops
- Allows quick switching of holster from leg to vest or any other mounting point
- Designed to break away at the military-specified pressure of 140 lbs.
- Also compatible with QLS 19 Locking Fork to be used with QLS 22 Receiver Plate



M1020 WEB PISTOL BELT

- Tough mil-spec nylon construction
- Official military plastic buckle
- One size fits 30"-48" (76cm-122cm) lengths and 2.25" (58mm) width
- Available in Black and OD Green



M1415 THUMB SNAP SYSTEM

- For use when flap is removed from UM92/UM84/M12
- Offers faster performance in tactical situations
- Provides added retention
- Available in Black and OD



M13 CHEST HARNESS

- Cross-chest design is ideal for helicopter and other close-quarter use
- Ambidextrous design
- Completely adjustable
- Dual positioning
- Available in Black and OD

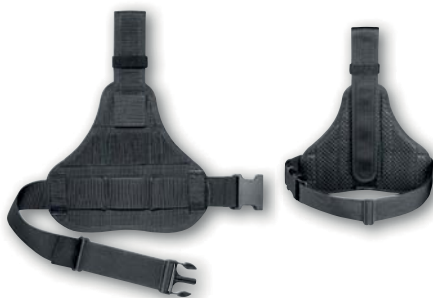

T6510 MODULAR ACCESSORY PANEL

- Five attachment points to mount accessories (two are bi-directional)
- Adjustable ambidextrous leg strap with 2" quick-release buckle for quick deployment
- Hook and loop vertical adjustment to custom-tailored panel location on thigh
- Non-slip Gription™ mesh backing keeps panel securely in place on leg
- Web attachment points for use with Bianchi® military holster with Quick-Lock™ belt fastener



T6521 DOUBLE AR15 POUCH

- Holds two 30-round mil-spec (or other similar width) AR15 type magazines
- Dual hook/loop and snap closure for added security
- Quick-Lock™ belt clip for secure attachment
- Rugged ballistic trilaminate construction
- Available in Black Ballistic Weave finish



T6523 TRIPLE AR15 POUCH

- Holds three 30-round mil-spec (or other similar width) AR15 type aluminum magazines
- Dual hook/loop and snap closure for added security
- Unique interior polymer "frame" retains magazines even if some are removed
- Rugged ballistic weave trilaminate construction
- Sewn belt loop fits both 2" (50mm) or 2.25" (58mm) widths

ALLUSION™ CONCEALMENT HOLSTERS



The Bianchi® Allusion series brings you the best of leather and synthetic materials for superior performance and good looks. We start out with a thermo-formed, synthetic shell precisely formed to the firearm. Then we wrap it with our premium grade Bianchi Gunleather® and give it our finishing touches, including burnished edges and our leather finish. The Allusion series perfectly matches tradition and cutting edge technology. Key design features include:

- Premium full grain leather exterior with a laminate synthetic liner for a smooth draw and long lasting wear
- Low-profile, contoured body-hugging designs
- Holster covers muzzle of gun, protecting handgun and clothing
- Available in Plain Tan or Plain Black finish (most models)

BELT SLIDE



126 ASSENT™

- Open-top design for quick draw and easy re-holster
- Trigger guard detent for enhanced weapon retention
- Dual belt loops fit 1.5" (38mm) belt widths



140 REVEAL™

- Thumb break strap for enhanced weapon retention
- Specifically designed to fit weapons with gun mounted lights
- Dual belt slots fit up to 1.5" (38mm) belts for better, tighter fit with belt
- Available in Plain Tan, Plain Black, Basketweave Tan, or Basketweave Black finish



ALLUSION™ CONCEALMENT HOLSTERS

BELT SLIDE



125 CONSENT™

- Trigger guard detent for enhanced weapon retention
- Dual snap belt loop for easy on/off access and added security
- Open-top design for quick draw and easy reholster
- Fits 1.5" (38mm) belt width



130 CLASSIFIED™

- Thumb break strap and trigger guard detent for enhanced weapon retention
- Dual snap belt loop for easy on/off access and added security
- Fits 1.5" (38mm) belt width



131 CONFIDENTIAL™

- Thumb break strap and trigger guard detent for enhanced weapon retention
- Dual belt loop fits 1.5" (38mm) belt widths

INSIDE WAIST



135 SUPPRESSION™ IWB

- Premium full grain leather exterior with a laminate synthetic liner for a smooth draw and long lasting wear
- Dual tuckable C-clip design for attachment to the belt provides strong belt retention on the holster while also minimizing its visibility
- Anti-bacterial and anti-microbial foam padding on inside liner of leather backing to prevent germs and odor from accumulating
- Padded liner provides added comfort not normally found on bare leather designs
- Slight detent in trigger guard for enhanced weapon retention
- Fits up to 1.5" (38mm) belt widths
- Available in Plain Tan or Plain Black finish



PATENT
PENDING



145 SUBDUE™ IWB

- Premium full grain leather exterior with a laminate synthetic liner for a smooth draw and long lasting wear
- Heavy-duty spring-steel belt clip securely anchors holster to belt or trousers
- Anti-bacterial and anti-microbial foam padding on inside liner of leather backing to prevent germs and odor from accumulating against the body
- Padded liner provides added comfort not normally found on bare leather designs
- Slight detent in trigger guard for enhanced weapon retention
- Fits up to 1.75" (45mm) belt widths
- Available in Plain Black finish

155 SUBVERSION™ IWB HOLSTER

- Premium full grain leather exterior with a laminate synthetic liner for a smooth draw and long lasting wear
- Belt retention strap wraps under belt and offers adjustability for cant.
- Anti-bacterial and anti-microbial foam padding on inside liner of leather backing to help prevent germs and odor from accumulating against the body
- Padded liner provides added comfort not normally found on bare leather designs
- Slight detent in trigger guard for enhanced handgun retention
- Fits up to 1.75" (45mm) belt widths
- Available in Plain Black finish

NEW



CONCEALMENT HOLSTERS

BELT SLIDE



57 REMEDY™

- Open-top for quick access and draw; ideal for rear hip carry
- Deeply molded contours on front of holster for comfortable fit and classic good looks
- Dual belt slots fit up to 1.5" (38mm) belts for better, tighter fit with belt
- Low-profile, hi-ride design effectively conceals firearm with minimal bulk
- Available in full grain leather, Plain Tan or Plain Black finish



58 P.I.™

- Open-top for quick access and draw with a low-profile, compact design
- Heavy 30° cant for hip carry
- All molding to the front of the holster, providing more comfortable fit for wearer
- Low-profile, ultra hi-ride design effectively conceals firearm with minimal bulk
- Dual belt slots fit up to 1.5" (38mm) belts for better, tighter fit with belt
- Available in full grain leather, Plain Tan or Plain Black finish



56 SERPENT™

- Reinforced, rectangular thumb snap for quick snap release and helps guard against strap falling into trigger guard when re-holstering
- Deeply molded contours on front of holster for comfortable fit and classic good looks
- Dual belt slots fit up to 1.5" (38mm) belts for better, tighter fit with belt
- Available in full grain leather, Plain Tan or Plain Black finish



7 SHADOW® II

- Ultra hi-ride for excellent concealability
- Three-slot design allows user to vary the carry angle for his/her preference
- Strongside or cross draw carry, open muzzle design
- Molded and pre-curved to fit the body for maximum comfort
- Fits up to 1.75" (45mm) belt width
- Available in full grain leather, Plain Tan or Plain Black finish

CONCEALMENT HOLSTERS

BELT SLIDE



105 MINIMALIST™ WITH SLOTS

- A compact, open-top design ideal for daily wear
- Features elastic loop retainer tab for secure retention
- Belt slide design provides excellent stability for weapon
- Slots designed to pull firearm in close to the hips for optimum concealment
- Suede lined; fits belt widths up to 1.75" (45mm)
- Available in full grain leather, Plain Tan or Plain Black finish



55L LIGHTNIN®

- Designed specifically for hammerless revolvers
- Finger-snap strap crosses behind trigger guard for a middle finger release
- Fully suede lined
- Rides high and close to the body for maximum comfort and concealability
- Fits up to 1.75" (45mm) belt width
- Available in full grain leather, Plain Tan finish

101 FOLDAWAY™

- Minimalist design fits many different gun models
- Design catches and holds trigger guard to help keep weapon secure and stable
- Can be folded away flat onto the belt when not in use for inconspicuous appearance
- Keeps as close to the body as possible without being an IWB holster
- Fits 1.5" (38mm) belt widths
- Available in full grain leather, Plain Tan or Plain Black finish



CONCEALMENT HOLSTERS

BELT SLIDE



75

VENOM™

- Slim profile and compact design in a full-sized holster
- Rear belt slot pulls holster close to body for excellent concealability
- Contour molded for exact gun fit
- Fits up to 1.75" (45mm) belt width
- Available in full grain leather, Plain Tan or Plain Black finish



77

PIRANHA™

- Unique, low-cut front provides user with a swift draw stroke
- 15° strongside cant
- Three-slot design allows custom adjustment for user preference; features both strongside and cross draw carry
- Fits up to 1.75" (45mm) belt width
- Available in full grain leather, Plain Tan or Plain Black finish



5

BLACK WIDOW™

- Features ultra hi-ride carry and thumb snap closure
- Compact profile for excellent concealability
- Dual belt slots for superior stability
- Fits up to 1.75" (45mm) belt width
- Available in full grain leather, Plain Tan or Plain Black finish



PATENTED

82

CARRYLOK™

**Auto
Retention**

- Provides the speed of an open top holster with the security of Auto Retention™, which retains gun upon holstering
- FingerLok™ retention mechanism secures pistol by the trigger guard upon inserting the firearm in the holster, depress lever to draw
- Features stay-open design for efficient one-handed holstering
- 16° butt forward carry
- Fits up to 1.75" (45mm) belt widths
- Available in full grain leather, Plain Tan or Plain Black finish

CONCEALMENT HOLSTERS

INSIDE WAIST



3S PISTOL POCKET®

- Inside the waistband with dual snap attachment to belt
- Fully adjustable swivel offers various carry options
- Thumb break design for those who prefer more security in an IWB holster
- Open muzzle design
- Can be worn both strongside and cross draw
- 1.75" (45mm) belt loop
- Available in full grain leather, Plain Tan finish



100T PROFESSIONAL™ TUCKABLE

PATENT PENDING

- Designed to be worn inside the waistband yet allow for a tucked in shirt
- C-clip attachment provides strong belt retention on holster while minimizing its visibility
- Three-way adjustable cant on C-clip for draw customization
- Deep concealment design with high back to comfortably shield torso against a gun's rough edges
- Features a non-slip suede lined exterior next to body
- Fits up to 1.5" (38mm) belt widths
- Available in full grain leather, Plain Tan or Plain Black finish



100 PROFESSIONAL™

- Deep concealment design with high back to comfortably shield torso against gun's rough edges
- Features a non-slip suede-lined exterior next to body
- Rides at optimum angle inside waistband to ensure proper firing grip
- Heavy-duty spring-steel belt clip securely anchors holster to belt or trousers
- Fits up to 1.75" (45mm) belts
- Available in full grain leather, Plain Tan or Plain Black finish



6D ATB™ WAISTBAND

- Inside waistband design provides comfort and concealability
- Thumb break design for those who prefer more security in an IWB holster
- Adjust-A-Break™ thumb break provides adjustability for a variety of gun models
- Ultra-thin and lightweight suede design for concealability
- Hi-ride; strongside or cross draw
- Heavy-duty 1.75" (45mm) clip keeps holster securely in place
- Available in Rust suede finish



6 WAISTBAND

- Worn inside the waistband
- Ultra-thin profile provides optimum concealment
- Hi-ride; strongside or cross draw
- Heavy-duty spring-steel clip fits up to 1.75" (45mm) belts
- Available in Rust suede finish



CONCEALMENT HOLSTERS

PADDLE



7500

ACCUMOLD® PADDLE THUMBSNAP

- Easy on/off convenience; exclusive, injection-molded non-slip paddle; adjustable for various carry heights on the waist/hip
- Paddle design offers virtually limitless range of cant, permitting both strongside and cross draw carry
- AccuMold trilaminate construction with ballistic weave fabric, exterior high-density closed-cell foam center and a Coptex™ lining for a smooth draw
- Available in Black Ballistic Weave finish



59

SPECIAL AGENT®

- Features our close-fit paddle design for comfort and concealability
- Exclusive, non-slip paddle features molded elastomer ridges that retain paddle, yet it offers easy on/off convenience
- Paddle design offers virtually limitless range of cant, permitting both strongside and cross draw carry
- Adjustable for various carry heights on the waist/hip
- Available in full grain leather, Plain Tan finish



CONCEALMENT HOLSTERS

ANKLE / POCKET



4025

INSIDE THE POCKET HOLSTER

- Extra-thin, soft holster for in pocket concealment
- Molded design keeps holster open allowing for easier draw and re-holstering into the pocket
- Unique three-layer laminate has a moisture proof membrane to keep perspiration from penetrating holster and collecting on weapon



152

POCKET PIECE™

- Full grain leather interior for a smooth draw
- Vertical Assist finger pad for facilitating draw from pocket
- Designed with dual “pocket hooks” to prevent holster movement when drawing
- Model-specific design for better fit
- Leather is rough side out to cling to pocket interior
- Available in full grain leather, rough side out to help grip clothing



150

NEGOTIATOR™ ANKLE HOLSTER

- Neoprene leg strap expands to fit comfortably around leg
- Lined with genuine sheepskin for comfort and breathability
- 2” adjustable elastic leg strap secures and keeps holster in place
- Holster is canted for ease of draw
- Available in full grain leather, Plain Black finish



CONCEALMENT HOLSTERS

SHOULDER HOLSTERS

X16

AGENT™

- Crafted from premium full grain cowhide, hand-boned for a precise fit
- Featherweight, slimline design for all day comfort and concealability
- Comes with a choice of either contour molded magazine pouch or a low-profile speedloader panel, and X-style pivoting harness that is flexible, strong and contours to the torso
- Includes two suede leather tie-downs to secure holster and offside pouch to belt
- Offered for both revolvers and semiautos
- Available in full grain leather, Plain Tan finish



The X16 harness has a pivoting design that moves with the body and adjusts to fit male and female torsos up to 48" (122cm).



AGENT™ ACCESSORIES

X16A

DOUBLE MAGAZINE POUCH



X16T

TIE-DOWN ACCESSORY



X16P

OFFSIDE ACCESSORY PANEL



X16R

SPEEDLOADER PANEL



X15

#X15® SHOULDER HOLSTER

- Dual spring closure provides firearm retention and stability
- Half lined with full grain leather for a smooth draw
- Detachable retainer strap
- Fully adjustable soft leather harness that adjusts to a 48" chest
- Available in full grain leather, Plain Tan finish



The X15 harness adjusts to fit male and female torsos up to an optional 52" (128cm)

BELTS AND POUCHES

ACCESSORIES

Bianchi Gunleather® pouches and belts are made from premium grade vegetable-tanned cowhide and hand-rubbed to a rich, lustrous finish. Available in Plain Tan and Plain Black unless otherwise specified.



B28/B29

PROFESSIONAL™ BELT 1.25" (32MM) & 1.5" (38MM)

- Premium full grain leather, oil tanned to a rich, lustrous finish
- Solid brass buckle on tan; chrome plated brass on black belt



20A

OPEN TOP MAGAZINE POUCH

- Heavy-duty, spring-steel clip
- Fits belts up to 1.75" (45mm)



21

OPEN TOP IWB MAGAZINE POUCH

- Dual belt loop straps secure pouch to belt
- Can be angled for right or left hand carry
- Fits up to 1.75" (45mm) belts



45

MAG/CUFF PADDLE

- Paddle adjustable for carry height and angle
- Provides easy one-handed draw for handcuffs
- Fits standard, oversized and hinged handcuffs



4065

IWB MAGAZINE POUCH

- Extra thin, soft ballistic weave fabric, for comfortable, deep concealed carry
- Rustproof steel clip to keep magazine pouch in place
- Fits belts up to 1.75" (45 mm)



580

SPEED STRIPS™

- The original compact strip loading device developed by John Bianchi more than 50 years ago
- Injection-molded from a flexible urethane material, they hold six rounds and load two at a time
- Speed Strips™ fit in most single mag/knife pouches and trouser or shirt pockets
- A perfect slim backup for speedloaders
- Available for .38/.357 and .44/.45 caliber



SPORTING HOLSTERS

Built for durability and comfort, Bianchi offers a collection of sporting holsters and accessories designed to meet your needs. Bianchi's sporting line has something for everyone whether for hunting, range or field use.



1L LAWMAN™

- Western style, front strap closure; fits single-action revolvers
- Hi-ride carry, open muzzle-design
- Full suede lining
- Foldover belt loop fits 1.75" (45mm) to 2.25" (58mm) belts
- Available in full grain leather, Plain Tan finish



111 CYCLONE™

- Thumb snap closure for secure fit and covered trigger guard design for both hunting and concealment applications
- Unique belt loop design allows either strongside or cross draw carry
- Quick release thumb snap
- Hi-ride carry, open muzzle design for both semiautos and revolvers
- Fully suede lined with a 1.75" (45mm) belt slot
- Available in full grain leather, Plain Tan finish



5BHL THUMBSNAP

- Features integral thumb snap closure
- Strongside hi-ride carry; carries gun close to body for added comfort
- Fully suede lined
- 2"-3" holsters fit 1.75" (45mm) belt slots
- 4" and larger holsters include 1.75" (45mm) and 2.25" (58mm) belt slots; revolvers only
- Available in full grain leather, Plain Tan finish



B4 RANGER BELT 1.75" (45MM)

- Popular Western billet design
- Solid brass buckle
- Full grain leather, Plain Tan or Basket Tan finish



B9 FANCY STITCHED BELT 1.75" (45MM)

- Natural oil tan finish reverses to suede
- Reversible, with fancy stitch design
- Solid brass buckle
- Full grain leather, Plain Tan finish

19L THUMBSNAP

- Wide belt loop provides stable carry close to the body; hi-ride for maximum comfort and concealability
- Integral thumb snap enhances handgun retention
- Fully suede lined
- 1.75" (45mm) belt loop; semi-autos only
- Available in full grain leather, Plain Tan finish



B12 SPORT STITCHED BELT 1.5" (38MM)

- Natural oil tan finish reverses to suede
- Reversible, with fancy stitch design
- Solid brass buckle
- Full grain leather, Plain Tan or Plain Black finish



B21 CONTOUR BELT 1.75" (45MM)

- Fancy stitch design
- Solid brass buckle
- Two thicknesses of heavy full grain leather
- Contoured to wrap smoothly around waist
- Full grain leather, Plain Tan finish

SPORTING HOLSTERS & CASES

All Bianchi® gun cases are constructed of 750-denier fabric with a cushioned padding to protect the firearm. Feature laden, they all zip open flat to use as a shooting rest or pad.

BODY WORN
CAMERAS
CONCEALABLE
ARMOR
TACTICAL
ARMOR
COMMUNICATIONS
PATROL
BIKE
DUTY GEAR/
HOLSTERS
PROTECTIVE
GEAR
FIREARMS
ACCESSORIES
LETHAL
PERFORMANCE
APPAREL
SURVIVABILITY
SYSTEMS
FORENSICS
ARMOR
SYSTEMS
TRAINING
GROUP

7000 ACCUMOLD® SPORTING HOLSTER

- Ideal for field, hunting and concealment carry
- Contour molded, high-density trilaminate AccuMold® construction for an exacting fit
- Hi-ride carry with closed muzzle and 10° forward cant that aids in both comfort and presentation
- Unique Coptex™ poly-knit lining for a smooth draw
- Sleek front strap closure incorporates Adjust-A-Strap™ feature to ensure a secure fit over the hammer
- 1.75" (45mm) injection-molded belt slot
- Available in Black Ballistic Weave finish



7001 ACCUMOLD® THUMBSNAP

- Suitable for both outdoor and concealment use, this holster rides at a 10- to 13° cant for a fast, instinctive draw
- Thumb snap design incorporates the Bianchi® Adjust-A-Strap™ feature to ensure a secure fit over the hammer
- Contour molded, high-density trilaminate AccuMold® construction for an exacting fit
- Coptex™ 100% polyknit lining for a smooth draw
- 1.75" (45mm) injection-molded belt slot
- Available in Black Ballistic Weave finish



7201 TRAINING BELT 1.75" (45MM)

- Four-part laminate for long-lasting shape and exceptional durability
- Hook and loop closure for quick on/off ease
- Firm polyethylene center strip sandwiched between a high-density foam, with a ballistic weave outer and a durable nylon lining



4452 RANGE PORTFOLIO™

- Comfortably carries one or two firearms in its dual, thickly padded sleeves
- Roomy interior pocket for cleaning accessories, etc., and elastic web loops for magazines or other equipment
- Features outside carry strap for hearing protectors



4451 DELUXE PISTOL CASE

- A slim, portfolio design featuring wraparound web carry handles and an outside essentials pocket
- Thick, dense padding to cushion and protect firearm



4450 PISTOL CASE

- Thick, dense padding cushions and protects firearm
- Outside zippered pocket for small essentials
- Convenient carry handle

Size	Barrel Length
Small	Up to 3"
Medium	Up to 5"
Large	Up to 7.5"

BIANCHI® COWBOY



Revisit the handcrafted glory of the Old West with our line of cowboy gear and enjoy the quality of our world-famous genuine leather holsters and belts. We use only premium grade, full grain, vegetable-tanned cowhide – the highest quality, most expensive leather. Developed and used by the world-class shooters of Team Bianchi, this is authentic cowboy gear that was designed to perform both in and out of the arena. Above all, it carries the legendary name Bianchi® and is designed and produced in America.



KENDA LENSEIGNE SIGNATURE SERIES RIGS FEATURE:

- A hidden tension adjustment to provide a customized smooth draw during mounted shooting and a weight lifter style elongated back for support
- Corrosion-resistant steel reinforced holster and welt area is double stitched with heavy nylon thread for added strength
- Strongside holster provides 10° cant, cross draw 20°
- Full grain leather lining in holster and belt for better grip while riding and performing in matches
- Two-piece 2" wide belt available in either straight or 1.5" drop design

SMOKECHASER™

- Full grain floral embossed cowhide with snake pattern lambskin insert; available in Black or Cognac, floral finish



PATH BLAZER™

- Premium grade full grain cowhide with basketweave insert; available in Chestnut Tan or Black, plain finish



GETAWAY™

- Premium grade, full grain cowhide; Chestnut Tan or Black, plain finish



BIANCHI® COWBOY



KENDA LENSEIGNE
SIGNATURE SERIES



KENDA LENSEIGNE



Photo by Mark Quigley

The Kenda Lenseigne Signature Series by Bianchi® Cowboy was developed by Kenda Lenseigne, first ever female Overall World and National Champion and holder of six world records, along with the Bianchi Cowboy Shooting Team, encompasses every design aspect required for record breaking mounted shooting performance.



CATTLE DRIVER™

- Premium grade full grain cowhide; Chestnut Tan with tan/white cowhide inserts or Plain Black with black/white cow hair inserts



LIMITED EDITION KENDA LENSEIGNE SERIES RIGS

- Special color and finish combination offered



LONG GUN HOLDER

- Designed to fit 16" lever action rifles and shotguns
- Saddle mount
- Available in premium full grain leather, Chestnut Tan or Plain Matte Black finish



LONG GUN SCABBARD

- Designed to fit 16" rifles and carbines
- Closed muzzle with drain hole
- Includes three tie-downs to secure scabbard, two horizontal and one vertical
- Adjustable ride height strap for snug carry on saddle horn
- Solid brass buckles on tan models, chrome covered brass buckles on black
- Available in premium full grain leather, Chestnut Tan or Plain Matte Black finish



FEED BUCKET ORGANIZER

- Designed to fit as a liner inside a 12-quart feed bucket
- Multiple pockets keep shooting gear organized and easily accessible
- Constructed of durable nylon
- Bucket not included

BIANCHI® COWBOY



CLEARWATER™

- Holster and belt feature a smooth, full grain leather lining for a quicker draw and sturdiness on the hip
- Multi-angle belt loop for customized strong side and cross draw carry
- Belt loop adjusts 35° forward and rearward for cant customization and personalized draw
- Belt is 2.25" (58mm) wide with tapered ends; choose cartridge loops for .38 or .45 Long Colt
- Select a second Clearwater holster (shown) for cross draw or use as dual strongside holster
- Premium grade full grain cowhide; available in Chestnut Tan or Plain Black finish



WILD CLEARWATER™

- Smooth, full grain leather lining for a quick draw
- Specifically designed for Colt 1911 style pistols
- Full-length Sight Channel™ and adjustable for cross draw carry
- Belt loop adjusts 35° forward and rearward for cant customization and personalized draw
- Flared top for faster, instinctive re-holstering
- Available in Chestnut Tan with white stitching or Plain Black with black stitching



HONDO™

- Designed for mounted shooting Suede lining in holster and belt for better grip while riding
- Adjustable for cross draw carry
- Belt is fancy stitched and padded for comfort, and is 2.25" (58mm) wide with tapered ends
- Belt loop adjusts 35° forward and rearward for cant customization and personalized draw
- Premium grade full grain cowhide; available in Chestnut Tan or Plain Black finish



HONDITO™ BELT

- Designed for mounted shooting and at proper width for use with Kenda Lenseigne holsters
- Adjustable for cross draw carry
- Belt is fancy stitched and padded for comfort, and is 2" (50.8mm) wide with tapered ends
- Premium grade full grain cowhide; available in Chestnut Tan or Plain Black finish



WILD CLEARWATER™ DUAL MAGAZINE POUCH

- Double stitched welt with heavy nylon thread for extra strength
- Specifically designed for use with two 1911-style magazines
- Available in Chestnut Tan or Plain Black

BIANCHI® COWBOY



CALIFORNIA OUTLAW™

- Smooth, full grain leather lining in holster for a quicker draw
- Suede lined belt is 2.25" (58mm) wide with billet ends; choose cartridge loops for .38 or .45 Long Colt
- Cross draw holster (shown) sold separately
- Premium grade full grain cowhide; available in Chestnut Tan or Plain Black finish



GOLD MINER™

- Classic drop loop-style cowboy rig with suede lined belt and leather lined holster
- Holster has a smooth leather lining for a rapid draw and is worn completely vertical
- Stitched with heavy nylon thread for added strength
- Belt is 3" (76mm) wide with billet ends; choose cartridge loops for .38 or .45 Long Colt
- Cross draw holster (shown) is sold separately
- Premium grade full grain cowhide; available in Chestnut Tan or Plain Black finish

TEXAS OUTLAW™

- Classic drop loop-style cowboy rig with suede lined belt and steel lined holster
- Smooth leather lined for a rapid draw
- Reinforced with rawhide to hold the holster open with a flared top for faster, instinctive re-holstering
- Belt is 3" (76mm) wide with billet ends; choose cartridge loops for .38 or .45 Long Colt
- Cross draw holster is available as an optional second holster; order Texas Outlaw™ CD Holster
- Premium grade full grain cowhide; available in Chestnut Tan or Plain Black finish



THE POWER OF PROTECTION



PROTECTIVE GEAR



The Hatch® brand is known as one of the finest in protective performance gloves for law enforcement, tactical, military, medical and industrial safety markets. Only the finest

leathers, along with synthetic and high-tech materials, are used to ensure the protective gear performs to the world's most uncompromising standards.



THE HATCH® DIFFERENCE

THE POWER OF PROTECTION



BROAD, ALL-INCLUSIVE PRODUCT LINE

Hatch provides hand protection for law enforcement, military, shooting and other tactical applications.



INTENTIONAL RESEARCH AND DEVELOPMENT

Each product development series begins with a general survey of the market, gathering input from end users and observation in the field. Then field testing is conducted, final adjustments made and a product is ready for introduction to the market.



THE RIGHT MATERIALS FOR THE RIGHT JOB

Hatch incorporates high grade materials to enhance the features required for each application. For example, our duty gloves are made of sheepskin leather to provide an enhanced sense of touch while conducting a field search.

FIVE POINTS OF INNOVATION - TASK SERIES

ALL MODELS IN THE HATCH TASK SPECIFIC LINE FEATURE THESE FIVE INNOVATIVE FEATURES



TOUCHSCREEN-COMPATIBLE KNUCKLE FOR USE WITH ELECTRONICS

The knuckle pad provides the ability to quickly swipe the phone to take or send a call without having to remove gloves or worry about contaminating the device.



HATCH SIGNATURE ERGO-CUT™ THUMB PATTERN FOR AN ACCURATE AND COMFORTABLE FIT

Conforms to the natural curvature of the hand and offers greater dexterity and freedom of movement than a "single palm pattern". Because we have opposable thumbs, a single piece palm bunches up and twists on the thumb when the hands are clasped.



ARTICULATED STRAP

Accommodates a larger watch as it is angled away from the wrist.



ALL-SOFT CUFF TO FLEX AROUND A WRISTWATCH

Many gloves are primarily made with a "ridged cuff", which is actually a detriment to a watch wearer in that the cuff then has to be pushed over or under the watch. With a soft compression cuff, the cuff gently compresses around the watch during wrist flexion, and allows the watch to be usable without having to constantly adjust the cuff.



HATCH PATENTED CUT-RING

This feature allows for the optional removal of the index finger for trigger control, without unraveling the remaining edge.

ADVANCED TOUCHSCREEN SYSTEM



FOCUS ON FUNCTIONALITY

Hatch offers a full line of gloves designed specifically for use with touchscreen devices. Each glove is designed with purpose and intention based on the job at hand. Our newest Touchscreen gloves feature embedded ATS™ technology in the index knuckle allowing an officer to access a touchscreen device without worry of contaminating their device during grimy situations.



DUTY GLOVES

TASK SERIES

See more gloves in the Task Specific Series line in the Tactical and Traffic sections

TSK324 TASK MEDIUM

- Durable synthetic palm with touchscreen capabilities in all fingers
- Soft and lightweight, breathable stretch material on back of hand
- Hatch touchscreen technology
- Reinforced fingertips
- Sizes: S-2XL



PATENTED



PATENTED

TSK323 TASK LIGHT LEATHER

- Genuine goatskin leather palm
- Soft and lightweight, breathable stretch material on back of hand
- Touchscreen feature on middle finger knuckle
- Great for fine motor skill requirements
- Sizes: S-2XL



PATENTED

TSK325 TASK MEDIUM W/ KEVLAR®

- Kevlar® slash-resistant palm liner
- Durable synthetic palm with touchscreen technology in all fingers
- Soft, lightweight and breathable stretch material on back of hand
- Reinforced fingertips
- Sizes: S-2XL



PATENTED

TSK326 TASK HEAVY KNUCKLE

- Patented Z-pattern palm with diamond grip for heavy-duty applications
- Shock absorbing TPR (Thermoplastic Rubber) knuckle
- Durable synthetic palm material with touchscreen technology in index finger
- Soft, lightweight and breathable stretch material on back of hand
- Reinforced fingertips
- Sizes: S-2XL



DUTY TOUCHSCREEN GLOVES



TDG-100 PATROLMAN TOUCHSCREEN DUTY **CE**

- Touchscreen-compatible leather on thumb, index finger and knuckle
- Performance-fit gusset back to improve overall flexibility
- Perforated leather for cooling or ventilation for all-day comfort
- Soft, sheepskin leather materials for increased tactility
- Neoprene cuff, closure-less design for easy on and off application
- Sizes S-2XL



TWG-100 PATROLMAN TOUCHSCREEN WITH COOLMAX® **CE**

- Touchscreen-compatible leather on thumb, index finger and knuckle
- COOLMAX® performance fabric for comfort in warmer climates
- Soft, sheepskin leather materials for increased tactility
- Four-way stretch nylon spandex finger sidewalls
- Hook and loop closure
- Sizes S-2XL



TUG-100 TECHNICIAN TOUCHSCREEN UTILITY **CE**

- Touchscreen-compatible synthetic leather on thumb, index finger and knuckle
- Reinforced rubberized fingertips and spandex back
- Rugged synthetic materials for durability
- Hook and loop closure
- Sizes S-2XL



DUTY GLOVES

NS430

SPECIALIST® ALL-WEATHER NEOPRENE SHOOTING/DUTY



- Constructed of neoprene for comfort, flexibility and warmth
- Palm made of Synsi-feel™ synthetic leather for excellent grip and accurate feel
- Extreme-Grip™ sewn onto palm and fingertips for maximum grip
- Hook and loop closure
- Sizes XS-2XL



SG20P

DURA-THIN™ POLICE SEARCH DUTY



- Unlined and constructed from soft, durable premium leather that is cut "second-skin" thin for superior feel and dexterity while shooting, searching, handcuffing or driving
- Short elasticized cuff provides a snug fit and will not interfere with jacket or shirt cuff
- Sizes S-2XL

CT250

COOLTAC™ POLICE DUTY



- Lightweight glove design offers excellent comfort in warm climates
- 3-D knit spacer performance fabric on back
- Palm is constructed of ultra-thin leather for dexterity
- Extreme-Grip™ provides weapon control and reinforcement of wear area
- Features the Hatch® Signature Ergo-Cut™ for excellent fit
- Hook and loop closure
- Sizes S-2XL

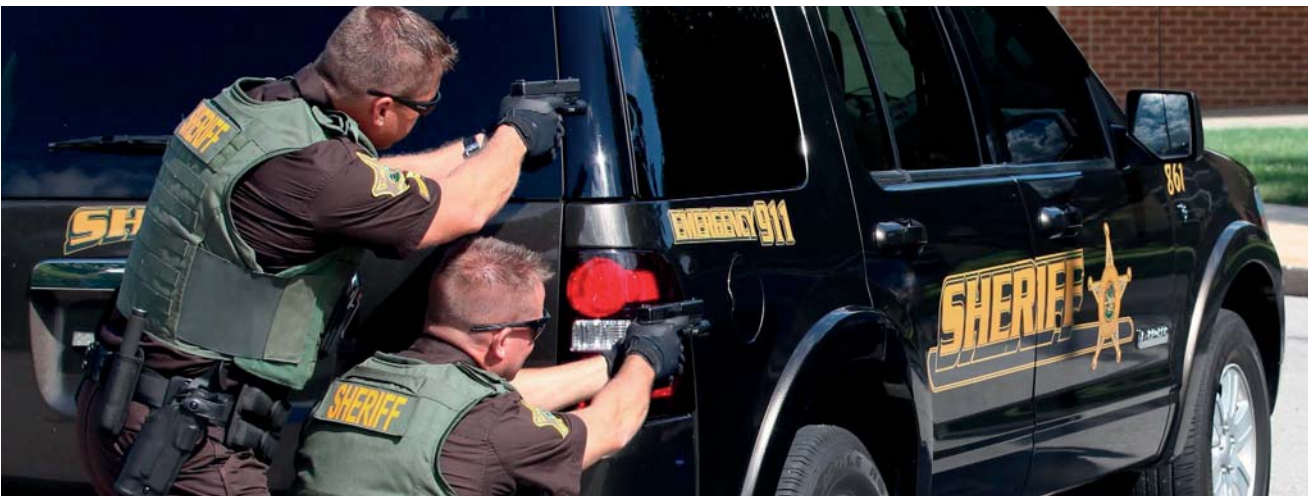

CUT RESISTANT GLOVES

RFK300

RESISTER™ WITH KEVLAR® CE

- Constructed of goatskin leather
- KEVLAR® knit liners provide moderate cut resistance
- Short elasticized cuff
- Sizes XS-3XL

DuPont™
Kevlar®



SGX11

STREET GUARD™ WITH DYNEEMA® CE

- Dyneema® liner for the ultimate in cut protection, comfort and dexterity for the entire hand
- Digitized synthetic leather palm with Extreme-Grip™ non-slip cradle, offering sure grip and positive weapon control
- Neoprene and spandex back allows air circulation for maximum comfort while providing a proper, snug fit
- Hook and loop closure
- Sizes XS-3XL

SB8500

FRISKMASTER™ SUPERMAX™ CE

- Premium goatskin leather construction
- Dyneema® liner offers unparalleled cut protection to prevent injuries from knives, razors and other sharp objects - for the ultimate in cut protection, comfort and dexterity
- Dyneema® offers the cut protection required for the highest rating in the EN 388 test standard
- Extended, elasticized cuff
- Sizes XS-3XL



Honeywell
SPECTRA

FM2000

FRISKMASTER™ WITH HONEYWELL SPECTRA® CE

- Honeywell Spectra® knit liner protects from sharp objects
- Constructed of premium leather
- Wrist length elasticized cuff
- Sizes XS-3XL



CUT RESISTANT GLOVES

SGK100

STREET GUARD™ WITH KEVLAR®



- Design offers excellent protection from cuts and sharp objects over the entire hand
- Digitized synthetic leather palm with Extreme-Grip™ non-slip cradle, offering a sure grip and positive weapon control
- KEVLAR® lining palm and fingers as an extra safeguard
- Neoprene and spandex back provides maximum comfort while providing a proper, snug fit
- Hook and loop closure
- Sizes XS-3XL



DuPont™
Kevlar®



PPG2

ARMORTIP™ PUNCTURE PROTECTIVE GLOVE



- Synthetic suede leather palm
- Exclusive ArmorTip® system offers optimum protection on the leading edges of the fingertips and thumb
- Neoprene and spandex back with hook and loop closure
- Sizes XS-3XL

CYCLING GLOVES



LIQUICELL®

FLG250

SHEARSTOP™ FULL-FINGER CYCLE



- LiquiCell® technology provides superior comfort and performance
- Strategically placed grip pads for control
- Terry cloth thumb for sweat removal
- Spandex back for exceptional fit
- Hook and loop closure
- Sizes S-2XL



HLG250

SHEARSTOP™ HALF-FINGER CYCLE

- Same features as the FLG250
- Sewn-in loops for easy removal
- Sizes S-2XL



PC290

LYCRA® CYCLING



- Comfortable fit with a sure grip and great control
- Synthetic leather palm with foam padding provide grip
- Lycra® back and hook and loop wrist closure provides a snug, yet forgiving fit
- Absorbent terry cloth on the back of the thumb to wipe away perspiration
- Sizes S-2XL

TACTICAL GLOVES

APG30 ARCTIC PATROL™ CE



- Constructed of a breathable, waterproof Hipora® insert, polyester lining and water-resistant polyester shell
- A polyester lining provides additional warmth and comfort
- 3M Thinsulate™ insulation
- Rubberized Sure-Grip™ palm with “trigger control” index finger provides grip and control for use with a firearm
- Sizes S-2XL



EWS530 ELITE WINTER SPECIALIST® CE

- Nylon back with goatskin palm for durability and dexterity
- Thin polyester insulation lining for warmth; wicking action pulls perspiration from hand to prevent the loss of body heat
- 3M Thinsulate™ lining and water-resistant shell
- Spandex wrist cuff for a snug fit keeps out cold weather
- Extreme-Grip on thumb cradle for enhanced weapon control
- Adjustable hook and loop closure on outer shell helps to keep out debris
- Sizes S-2XL



Thinsulate
INSULATION

WPG100 WINTER PATROL

- Made of leather and a water-resistant shell
- Digitized print in the palm increases surface area to allow for a better grip
- C70 Thinsulate™ insulation with a soft brushed tricot inner liner
- Leather cinch strap provides a snug fit to block out cold
- Sizes S-2XL



NS430L WINTER SPECIALIST® ALL-WEATHER NEOPRENE SHOOTING/DUTY

- Palm made of Synsi-feel™ synthetic leather provides excellent grip and accurate feel
- Extreme-Grip™ sewn onto the palm and fingertips (except the index finger) to facilitate trigger control
- Dual inner lining of 3M Thinsulate™ insulation and breathable, water-proof Hipora® work together to keep the hand warm and dry
- Hook and loop closure
- Sizes S-2XL

TACTICAL GLOVES

BODY WORN
CAMERAS
CONCEALABLE
ARMOR
TACTICAL
ARMOR
COMMUNICATIONS
PATROL
BIKE
DUTY GEAR/
HOLSTERS
PROTECTIVE
GEAR
FIREARMS
ACCESSORIES
LETHAL
PERFORMANCE
APPAREL
SURVIVABILITY
SYSTEMS
FORENSICS
ARMOR
SYSTEMS
TRAINING
GROUP



TSK327 TASK HEAVY SOGL

- Heavy-duty Nomex® and goatskin leather construction
- Hinged EVA foam knuckle for shock absorption and maximum dexterity
- Z-pattern palm reinforcement with EVA foam shock absorption
- Sizes: S-2XL

DuPont™
Nomex.

PATENTED



PATENTED

TSK328C TASK HEAVY SOGL LT

- Soft and lightweight, breathable stretch material on back of hand
- Hinged EVA foam knuckle for shock absorption and maximum dexterity
- Z-pattern palm reinforcement with EVA foam shock absorption
- Sizes: S-2XL



DuPont™
Nomex.

PATENTED

TSK329 TASK HEAVY SOGHK

- Heavy-duty Nomex® and goatskin leather construction
- Hinged hard knuckle for shock absorption and maximum dexterity
- Z-pattern palm reinforcement with EVA foam shock absorption
- Sizes: S-2XL



TSK330C TASK HEAVY SOGHK LT

- Soft and lightweight, breathable stretch material on back of hand
- Hinged EVA foam knuckle for shock absorption and maximum dexterity
- Z-pattern palm reinforcement with EVA foam shock absorption
- Sizes: S-2XL



TACTICAL GLOVES

KSG500

SHOOTING GLOVES WITH KEVLAR® CE

- Lightweight, comfortable shooting gloves designed for use in SWAT and tactical operations
- KEVLAR® interlock fabric construction
- Form-fitting design and thin, yet durable leather palm provides excellent dexterity, agility and grip for high-performance shooting
- Short, open cuff allows easy pull on and removal
- Sizes S-2XL

DuPont™
Kevlar®



HMG100

HATCH® MECHANIC'S

- Synthetic suede leather palm with high-density foam padded reinforcements
- KEVLAR® abrasion-resistant heel pad
- Flexible, breathable spandex back with ergonomically split high-density foam padding
- Reinforced fingertips with Toughtek™ grip patches
- Double-layered reinforced cradle
- Elasticized wrist with hook and loop closure
- Sizes S-2XL

DuPont™
Nomex®



BNG190

FLIGHT GLOVES WITH NOMEX® IIIA

- NOMEX® IIIA blend construction
- Durable, yet soft premium leather palm
- Engineered to U.S. military specifications
- Sewn entirely with NOMEX thread
- Sizes S-2XL



LR25

REACTOR™

- Designed for rappelling tactical entry and shooting. It is also excellent for disturbance control operations
- Thick foam padding on the back is ergonomically split to improve dexterity
- Tested leather construction makes the gloves extremely strong and durable
- An additional layer of leather in the palm provides added durability during rapid rappels, and unpadded index finger allows maximum trigger control
- Hook and loop closure
- Sizes S-2XL

TACTICAL GLOVES

SOG-600 OPERATOR™ TACTICAL



- Durable leather palm sewn with all NOMEX® thread
- NOMEX® / KEVLAR® blend construction
- Elasticized wrist keeps the Operator taut, while the elasticized gauntlet keeps out foreign objects and prevents snagging
- Patented Cut-Ring stitching allows optional removal of the index finger for trigger control without unraveling the remaining edge
- SOG available in Black only
- Sizes S-2XL



DuPont™
Nomex.
DuPont™
Kevlar.

PATENTED



PATENTED

EFG-100 CONTACT™ TOUCHSCREEN FLIGHT WITH NOMEX® IIIA

- Touchscreen-compatible leather on all fingers and index finger knuckle
- Durable leather palm
- Cut-out panel for wristwatch
- Also available in a Berry compliant model
- Sizes S-2XL

DuPont™
Nomex.



RIOT CONTROL GLOVES



PATENTED

SP100 DEFENDER™ II WITH STEEL SHOT

- Double layered leather palm, spandex back and Ergo-Cut™ design
- Foam padded fingers with 4 oz. ounces of steel shot in each knuckle area
- Spandex fabric allows for freedom of movement
- Hook and loop closure
- Sizes S-2XL

Not available for sale in some states. Check local city and state laws pertaining to SAP Gloves.

TACTICAL GLOVES



TSK331 TASK HI VIZ

- Durable synthetic Hi Viz suede with reflective striping on palm
- Hatch® touchscreen technology on knuckle
- Perfect for low-light, traffic management and high visibility requirements
- Available in Yellow and Orange
- Sizes: S-2XL



RTG100 REFLECTIVE TRAFFIC CE

- Constructed of fluorescent polyester cotton blend fabric
- 3M reflective strips around the circumference reflect at oncoming lights, allowing others to read your hand signals clearly
- Rib knit cuff
- Sizes S-2XL



WG1000S WHITE COTTON PARADE CE

- For special occasions and formal events in either law enforcement or military engagements, as well as for directing traffic or crowds
- Constructed of 100% medium-weight cotton
- Snap cuff design
- Sizes S-XL



DNR100 DAYNITE™ REFLECTIVE CE

- Constructed of black spandex with patches of a retro-reflective microprism material with cube-corner prisms, three times more efficient at reflecting light than glass bead systems
- Allows the wearer to be seen by motorists at the critical viewing distances of 100 to 600 feet
- The stretchable spandex fabric allows the DayNite™ glove to be worn alone or over virtually any other glove
- Hold palm outward to reveal the red STOP signal, and use the yellow-green markers on outside of hand to direct traffic onward
- Sizes S/M, L/XL

KNEE & ELBOW PADS

BODY WORN
CAMERAS
CONCEALABLE ARMOR
TACTICAL ARMOR
COMMUNICATIONS
PATROL BIKE
DUTY GEAR/HOLSTERS
PROTECTIVE GEAR
FIREARMS ACCESSORIES
LETHAL
PERFORMANCE APPAREL
SURVIVABILITY SYSTEMS
FORENSICS
ARMOR SYSTEMS
TRAINING GROUP



PATENTED

XTAK100/200/300/400/500/600

XTAK™ KNEE PADS

- Extremely light and flexible with superior protection and shock absorption with the flexibility to move the way your body moves
- Unique X-shaped thermal plastic urethane (TPU) shell
- EVA high-density foam for superior shock absorption
- Lightweight TPU and Cordura® nylon construction
- Forceful spring-back action that gives you the protection you need
- COOLMAX® inner surface for wicking moisture away
- Anti-slip inner surface to keep pad secured
- Elastic adjustable straps with Hatch® Rapid Deployment Clips and hook and loop closure for secure fit
- One size fits all



XTAK150/250/350/450/550/650

XTAK™ ELBOW PADS

- Elbow pads with similar features as the XTAK™ knee pads
- Dual elastic straps with hook and loop fasteners
- One size fits all



PATENTED



EP300 CENTURION™ ELBOW PADS

- Elbow pads with similar features as the KP250

KP250 CENTURION™ KNEE PADS

- 1/2", dual-density foam covered in durable Cordura® nylon
- Polyurethane thermoplastic nonslip caps fastened with color-keyed grommets provide additional shock absorption and ensure long-lasting wear
- Dual hook and loop fastened 1.5" wide (3.8cm) elastic straps with reinforced bar tacking provide a comfortable and secure fit for all sizes
- Hatch® Rapid Deployment Clips for quick on and off
- One size fits all



NE35 CENTURION™ NEOPRENE ELBOW PADS

- Elbow pads feature one layer of polyurethane foam and elastic non-adjustable closure

NK45 CENTURION™ NEOPRENE KNEE PADS

- Padding consists of shock-absorbing 10mm foam and a second layer of polyurethane foam, covered by a neoprene outer layer
- Strategically placed Eastex® Slip-Not™ material provides excellent grip and extends wear
- Non-reflective and silent
- Flexible design fits comfortably under or over clothing
- Hook and loop elastic closures provide a comfortable and secure fit
- One size fits all

BAGS

S7 SLING PACK

Convenient carry bag for everything from magazines to cell phones

- Constructed of heavy-duty 1000-denier nylon
- Three exterior compartments and eight interior pockets and one hidden padded compartment on side closest to body
- MOLLE loops cover the front of the bag for easy attachment of accessories
- One key clip, two pen/pencil pockets; multiple magazine/clip holders
- Unique C-Clip on back for easy-on/easy off access and minimizes bouncing while running
- Heavy-duty hardware for durability
- Weight: 2 lbs. (32 oz.), 0.9 kg.



A6 MUNITIONS BAG

- Designed to organize a 37/40mm launcher and plenty of munitions
- Features two clear vinyl document pockets (one interior, one exterior) and several large exterior zipper pouches for additional gear
- Constructed of durable nylon and heavy-duty hardware with two molded rubber carry handles
- 2" wide padded nylon shoulder straps allow the A6 to be carried as a backpack and stowed away when not in use
- Durable 600-denier polyester and 420-denier nylon inside with PVC reinforcement construction
- Exterior dimensions: 38"L x 18.5"W x 4"H (96.52cm x 46.99cm x 10.16cm)



BAGS

E4

EXOTECH® CARRY BAG

- Designed to carry and store the ExoTech® riot suit
- Constructed of Cordura® nylon
- Nylon web carry handles are on both sides and ends
- Features a separate helmet section
- Padded shoulder strap



M2

MISSION SPECIFIC GEAR BAG

- Designed to carry riot or SWAT gear and includes a separate helmet storage area
- Water-resistant Cordura® nylon
- Heavy-duty zippers and removable nylon web shoulder strap
- Removable rigid bottom in the main compartment and padded exterior walls in the helmet compartment
- Three zippered cargo pockets and two zippered mesh pockets on the exterior hold a wide variety of items
- Nylon web carry handles are on both the sides and ends
- Hook and loop straps on the padded top can secure a baton or flashlight
- Exterior dimensions: 34"L x 13"W x 12"H (86.4cm x 33cm x 30.5cm)



G3

GIANT SWAT BAG

- Construction consists of water-resistant polyester shell with PVC backing and heavy-duty reinforced handles and straps
- Nylon web carry handles are on both the sides and ends
- The G3 may be worn as a backpack using the 2"-wide (5cm) padded adjustable straps affixed to the bottom
- The exterior features two zippered mesh end pockets and a total of five clear vinyl map/document pockets on the top and sides
- The interior has four expandable zippered mesh pockets, four zippered pockets and one zippered pouch with padded walls for fragile gear
- Exterior dimensions: 41.5"L x 14"W x 12"H (105.4cm x 35.56cm x 30.48cm)

D1

PATROL DUTY BAG

- Water-resistant nylon with PVC backing with heavy-duty zippers and removable nylon web shoulder strap
- The spacious interior compartment has an adjustable divider and removable rigid bottom, two zippered cargo pockets and six pen/pencil pockets
- The exterior features two zippered cargo pockets, two flip-top pockets and three open-top pockets
- Hook and loop straps on the padded top can secure a baton or flashlight
- Exterior dimensions: 25"L x 10"W x 12"H (63.5cm x 25.4cm x 30.48cm)



PRECISE & SUPERIOR PERFORMANCE



FIREARMS ACCESSORIES



For decades these three legacy brands have made up the most honored names in the firearms accessories marketplace with products ranging from premium cleaning accessories and maintenance equipment to chemicals and

scope mounts. KleenBore®, Break Free® and Rogers have been proud suppliers of products for our military, law enforcement, and hunting and shooting enthusiasts.



CLEANING KITS

CLASSIC CLEANING KITS

- These Classic kits feature the best made cleaning components in the industry
- Securely packaged in a rugged, reusable polypropylene storage carrying case
- Rods in the Handgun, Rifle and Muzzleloading Kits are made of a smooth, high-grade steel with a black oxide finish and rotating handles
- Plastic muzzle guard protects the crown of the barrel
- Shotgun kits feature a polished aluminum, three-sectioned rod set
- 2 oz. Break Free® CLP® to clean, lubricate and protect the firearm
- Double-ended nylon utility gun brush
- 100% cotton patches



CLASSIC HANDGUN KITS

Part #	Caliber/Gauge
K211	.22
K215	.32
PK210	.38/.357/9mm
K220	.40/.41/10mm
K212	.44/.45

CLASSIC RIFLE KITS

K205	.22/.223/5.56mm
K204	.243/.25/6.5mm
K206	.264/.270/7mm
K207	.30/7.62mm
K208	.338/8mm
K209	.41/.45

CLASSIC SHOTGUN KITS

SH0216	12
SH0217	20

CLASSIC UNIVERSAL MUZZLELOADING KIT

BK214	All Handguns/Rifles/Shotguns
-------	------------------------------

CLASSIC SMALL BORE KITS

K17	.17
K20	.204

CLASSIC UNIVERSAL KITS

UK213	All Handguns/Rifles/Shotguns
SAF300	All Handguns/Rifles/Shotguns

CLASSIC KIT CONTENTS	STEEL ROD WITH SWIVEL HANDLE		ALUMINUM ROD		SHOTGUN ACCESSORY ADAPTER	ACCESSORY ADAPTER	NYLON BRISTLE GUN BRUSH	PHOSPHOR BRONZE BORE BRUSH	COTTON BORE MOP	SLOTTED PATCH HOLDER	BRASS CLEANING JAG	BREAK FREE® CLP®	COTTON CLEANING PATCHES	MUZZLE GUARDS
	SECTIONS	LENGTH"	SECTIONS	LENGTH"										
UNIVERSAL	4	30			•	•	•			2		•	•	•
RIFLE	4	30				•	•	•		•		•	•	•
HANDGUN	1	10				•	•	•		•		•	•	•
SHOTGUN			3	32					•	•		•	•	
MUZZLELOADING	5	37			•	•	•			2		•	•	•
SMALL BORE	3	34					•	•	•		•	•	•	

CLEANING KITS

CABLEKLEEN™

CABLE PULL-THROUGH CLEANING KIT

- A pull-through cleaning kit that performs a complete cleaning with each pass
- The combination of the cable's integrated solvent-soaked patch and patch holder brush allows it to be pulled through the bore, followed by a wet or dry patch making cleaning quicker and more efficient than using patches and brushes individually
- Each kit contains:
 - » Pull-through cable
 - » Caliber specific phosphor bronze patch holder brushes
 - » Cable T-handle and scraper/T-handle fittings
 - » Caliber specific foam squeegee
 - » Triple-action utility brush
 - » Universal cotton patch-pack
 - » ½ oz. Break Free® CLP® solution

Part#	Description	Caliber/Gauge
CPT-U	Universal	.223/.30/.35/.40/.44/.45/5.56/7.62/9/10mm/12-Gauge
CPT-H	Handgun	.22/.357/.38/.40/.44/.45 5.56/9/10mm
CPT-RS	Rifle/Shotgun	.223/.270/.30 5.56/7/7.62mm/12-Gauge
CPT-T/3	Tactical/3-Gun	.223/.357/.38/.40 5.56/9/10mm /12-Gauge



CPT-R

.22 RIMFIRE CLEANING KIT

- The Rimfire Cleaning Cable can be used for any .22 caliber rifle or handgun
- The patch holder and brush are permanently attached to this cable to minimize cleaning set-up or steps
- Combines pull-through cleaning technology with dual purpose components
- Comes in a zippered pouch with a tethered clip

KLEENPAK™

- Lightweight and compact
- Caliber specific
- Portable and self-contained
- Packaged in a resealable pouch
- Each kit contains:
 - » Pull-through cable
 - » Nylon utility brush
 - » 2ml Break Free® CLP® solution
 - » CLP® Weapon Wipe

Part#	Use	Caliber/Gauge
SK205	Rifle	.223/5.56mm
SK207	Rifle	.30/7.62mm
SK210	Handgun	.38/.357/9mm
SK220	Handgun	.40/.41/10mm
SK212	Handgun	.44/.45
SK216	Shotgun	12-Gauge



SPECIALTY KITS



POLICE KITS

- Tailored specifically to meet the cleaning needs of firearms that are used heavily in the field
- The police handgun kits and the shotgun kit include a 1/4" diameter, precision ground stainless steel rod
- The 5.56mm, 7.62mm and .30-06 kits include a solid steel, black oxide rod
- Both rods feature a muzzle guard to prevent damage to the bore and a rotating handle that provides a precise clean by allowing the rod to tightly follow the rifling
- Each kit features a 2 oz. bottle of powerful No. 10 Copper Cutter to counter the effects of jacketed rounds
- Includes 1/2 oz. Break Free® Lubricant/Protectant – a synthetic oil specially formulated for modern firearms
- Kits also include 100% cotton patches, a doubled-ended nylon brush, a Silicone Gun and Reel cloth and caliber specific jags, brushes and mops

PS50	.38/.357/9mm	PS53	5.56mm
PS51	.40/.41/10mm	PS54	7.62mm
PS52	.44/.45	PS55	.30-06



TAC100

TACTICAL MAINTENANCE SYSTEM

- A universal gun care system to cover all the popular law enforcement firearms including: .223/5.56mm, .30/7.62mm, .38/.357/9mm, .40/.41/10mm, .44/45 calibers and 12-Gauge
- Rugged, zippered bi-fold pouch with internal compartments
- Five-piece steel universal cleaning rod with muzzle guard
- Six phosphor bronze brushes (popular enforcement calibers and gauges)
- Five brass patch jags
- 2 oz. No. 10 Copper Cutter Solvent
- 1/2 oz. Break Free® Lubricant/Protectant
- Assorted cotton patches
- Silicone Gun and Reel Cloth
- Shotgun adapter
- Shotgun patch holder
- Double-ended nylon gun brush
- Chamber-Flag



POCKIT

HANDGUN KIT

- Unique design of the Pockit handgun kit packs a two-section steel cleaning rod and accessories into a storage handle
- Holds a phosphor brush, cotton mop and brass jag for easy, convenient storage and carrying
- First rod section with muzzle guard, cleans up to 5" barrels
- Second rod section extends the length up to 8 3/8"
- Rod sections accept all KleenBore® handgun accessories (#8-32 thread style)
- Pockit cleaning sets are offered in a variety of popular handgun calibers

POC220	.22
POC222	.38/.357/9mm
POC224	.40/.41/10mm
POC226	.44/.45

FIELD PACK CLEANING KITS

CK210

COMPACT HANDGUN CLEANING KIT

- For cleaning .38/.357 and 9mm handguns
- Precision brass cleaning rods with tight threads for long use
- Robust construction with excellent strength and durability
- Value pack of three components (bronze brush, nylon brush & cotton mop) are perfect for use in light duty and heavy cleaning situations
- Includes a great quality brass patch holder for fast bore cleaning with patches
- All threads are standard #8-32 and interchangeable with most commercially available components
- Comes with sturdy polymer case with internal padding for easy carry and convenient storage



FIELD PACK KITS

- These compact, easy to carry, go anywhere kits are favorites of hunters, law enforcement and the military
- Everything needed for a complete cleaning is included in the rugged nylon pouch with a belt keeper or modular webbing attachments, hook and loop closures and compartments for rod and accessories
- In the field or on the range, these kits are compact enough to carry for fast and easy removal of impacted mud, snow or a squib load



POU302T



Part #	Color	Caliber/Gauge
POU300T	Tan	Universal
POU301B	Black	All Caliber - Handgun/Rifle
POU302B	Black	AR-15/M16 .223/5.56mm
POU302T	Tan	AR-15/M16 .223/5.56mm
POU302DC-M	Digital Camo Marine	AR-15/M16 .223/5.56mm

CLEANING RODS

DELUXE ONE-PIECE RODS

- A variety of non-segmented rods in stainless steel and in an array of lengths to meet your needs
- All rods are carefully crafted to be strong, no-fray and remain straight in the barrel. won't bow, break, bend or fray, which can cause damage to precious rifling



Deluxe Stainless Steel Rod

Part#	Caliber/Gauge	Length	Accessories
DR102	.22-.45 Rifle	33"	Slotted Patch Holder
DR106	.22-.45 Benchrest	44"	Slotted Patch Holder

CLASSIC ONE-PIECE RODS

- A variety of non-segmented rods in steel and aluminum in an array of lengths
- All rods are carefully crafted to be strong, no-fray and remain straight in the barrel. won't bow, break, bend or fray, which can cause damage to precious rifling



Classic One-Piece Steel Rod



Classic One-Piece Aluminum Shotgun Rod

Part#	Caliber/Gauge	Length	Material	Accessories
OP105	.17 Cal./Airgun	33"	Steel	Brush, Mop, Brass Jag
OP106	.22-.45 Handgun	6 1/2"	Steel	Slotted Patch Holder
OP107	.22-.45 Rifle	33"	Steel	Slotted Patch Holder
OP108	Shotgun All Gauges	34"	Aluminum	Slotted Patch Holder Accessory Adapter



VALU-PAK ROD SETS

- This economical cleaning kit is the perfect alternative to purchasing a full kit
- All components are the same high quality components as all of our rods and accessories with precise specifications and a smooth, tight fit
- Caliber specific kits include muzzle guards, patch holders, phosphor bronze brushes and cotton mops
- The VP60 does not contain brushes or mops because of its universal nature
- All items are nicely packed in a storable, reusable clamshell case

VP60	Universal Handgun/Rifle/Shotgun
VP61	.22/.223/.225/5.56 Rifle
VP63	.30-.30/.30-066/.308/7.62mm Rifle

MULTI-SECTIONAL CLEANING RODS

- KleenBore® rods are precision-machined to exacting tolerances and surface smoothness
- Won't bow, break, bend or fray, which can cause damage to precious rifling
- Durable nylon handles on the rifle and pistol models rotate smoothly, allowing brushes and jags to travel efficiently down the bore
- All multi-section rods are packaged in well-made vinyl pouches for long-term storage



Part#	Caliber/Gauge	Sections	Length	Material	Accessories
A171	Shotgun All Gauges	3	32"	Aluminum	Slotted Patch Holder, Shotgun Accessory Adapter
S170	.22-.45 Handgun/Rifle	4	30"	Steel	Slotted Patch Holder, Accessory Adapter
SB169	.17 Small Bore	3	34"	Steel	Phosphor Bronze Brush, Cotton Bore Mop, Jag

CLEANING RODS

SAF-T-CLAD® CLEANING RODS

- Saf-T-Clad® products are the result of a technological breakthrough involving epoxy thermal setting resins
- Resins are carefully applied in the United States on local, high-grade, solid-steel rods, and securely bond our Saf-T-Clad coating
- This special process provides an unbelievably smooth surface for the ultimate in rifling and bore protection
- An excellent choice for shooters who do a lot of cleaning and expect absolute precision and protection for their equipment

Part#	Description	Caliber	Length	Sections
SAF303	Small Bore Rod	.17/.204	33"	1
SAF302	Handgun Rod	.22-.45	8"	1
SAF400	One-Piece Rifle Rod	.22-.45	33"	1



SAF-T-Clad® Deluxe
One Piece Rifle and Handgun Rods



SAF-T-Clad® .17 Caliber
One Piece Rifle Rod



SAF301 UNIVERSAL ROD SET

- Compact, reusable clamshell case contains a four-piece sectional rod with black nylon muzzle guard for up to 30" of length
- Handgun/rifle patch holder, shotgun patch holder and accessory adapter (.22-.45, all Gauges)

MUZZLE GUARD

- Use of a muzzle guard can prevent damage to the sensitive barrel crown when cleaning from the muzzle end
- Muzzle guard keeps the cleaning rod centered
- Works equally well when cleaning bolt-action rifles from the muzzle or breech

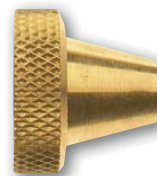

ACC14

ACC14 Brass for .203 dia. Handgun/Rifle rods

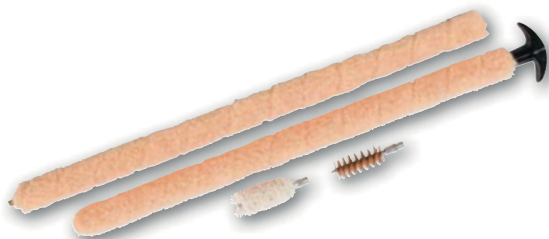

CLAYMATE® SHOTGUN CLEANING TOOL

- The ClayMate® is a compact two-section shotgun cleaning tool
- The soft fibers of ClayMate effectively pick up unburned powder, which is lifted by a screw-on phosphor bronze brush - provides unbelievably quick and effective cleaning
- Includes a screw on bore mop for applying a light coating of a favorite KleenBore® solvent or lubricant
- Total assembled length is 36"; breakdown length is 19" for easy storage in a gun case or range bag
- ClayMate can be easily washed and reused

CM270 12/16 Gauge ClayMate Shotgun Cleaning Tool



SC225 / SC205 CHAMBERMATE 12-GAUGE CLEANING TOOL

- The ChamberMate is a rugged tool with a strong aluminum rod and sure grip handle
- A heavy-duty phosphor bronze brush with tapered nose is made to fit difficult-to-clean areas and is ideal for quickly cleaning muzzle ports from the inside out
- The brush is great for cleaning powder fouling and plastic from chambers and choke area

SC225 12-Gauge

BODY WORN
CAMERAS
CONCEALABLE
ARMOR
TACTICAL
ARMOR
COMMUNICATIONS
PATROL
BIKE
DUTY GEAR/
HOLSTERS
PROTECTIVE
GEAR
FIREARMS
ACCESSORIES
LETHAL
LESS
PERFORMANCE
APPAREL
SURVIVABILITY
SYSTEMS
FORENSICS
ARMOR
SYSTEMS
TRAINING
GROUP

BORE BRUSHES & MOPS



PHOSPHOR BRONZE BRUSHES

- These precisely designed brushes feature KleenBore® carefully-made, thicker, straight bronze wire bristles
- Designed with rounded, smoother bristle tips rather than sharp, crimped, narrow imported brushes
- These bronze brushes offer more safe and effective cleaning power
- Will not easily bend from force down the bore
- Will not damage precious rifling

Rifle Bore Brushes

A175	.17/.200 Caliber
A177	.22/.223/5.56mm
A178	.243/.25/6mm/6.5mm
A179	.270/7mm
A180	.30/7.62mm
A163	.338/8mm
A181	.35/9mm
A160	.375/.380 Caliber
A182	.44/.45 Caliber
A194	.50 Caliber

Handgun Bore Brushes

A188	.22 Caliber
A189	.32 Caliber
A190	.38/.357/9mm
A191	.40/.41/10mm
A192	.44/.45
A193	.50 Caliber

Shotgun Bore Brushes

A183	.410-Gauge
A184	20-Gauge
A186	12-Gauge



BLACK NYLON BORE BRUSHES

- Rugged, stiff, black nylon bore brushes are recommended for many major firearms manufacturers for bore cleaning
- Dense, heavy-duty, thick nylon bristles to other wire
- Effective for even the toughest cleaning jobs

Rifle Bore Brushes

A175N	.17/.200 Caliber
A177N	.22/.223/5.56mm
A178N	.243/.25/6mm/6.5mm
A179N	.270/7mm
A180N	.270/7mm

Handgun Bore Brushes

A190N	.38/.357/9mm
A191N	.40/.41/10mm
A192N	.44/.45 Caliber

Shotgun Bore Brushes

A186N	12-Gauge
-------	----------



MILITARY-STYLE BRUSHES

- All KleenBore® military-style brushes are designed specifically for M16 and AR-15 or similar style rifles
- The chamber brush is configured with two diameters; the first stage of phosphor bronze cleans the chamber area, while the second stage of stainless steel cleans the bolt-lock area
- Bore brushes are made of phosphor bronze with a brass wire core for a longer life, for rigorous cleaning
- Please note the #8-36 thread is not commercially standard, but will fit most KleenBore multi-section rods

M16B	.223/5.56mm (bore)
M16C	.223/5.56mm (chamber)



CABLEKLEEN™ PATCH HOLDER BRUSHES

- Ideal for dual-stage cleaning with cable pull-through kits



BP194 BLACKPOWDER BRUSHES .50 CALIBER

- The bristles extend completely to the tip to clean the entire chamber

BRUSH & MOP THREAD SIZE

Type	Thread Size
Handgun/Rifle/Patch Holder	#8-32
Shotgun/Blackpowder	5/16"-27
Small Bore .17, .204 Caliber	#3-48
M16/AR-15 Military-Style Brushes	#8-36

Phosphor Bronze

A177MPH	.22/.223/5.56mm
A179MPH	.270/7mm
A180MPH	.30/7.62mm
A181MPH	.35/9mm
A186MPH	12-Gauge
A191MPH	.40/10mm
A192MPH	.44/.45 Caliber

Nylon

N177MPH	.22/.223/5.56mm
N181MPH	.35/9mm
N186MPH	12-Gauge
N191MPH	.40/10mm



COTTON BORE MOPS

- 100% cotton provides the excellent absorbency and fouling removal
- Thickest, best cleaning and lubrication mops on the market

Smallbore /Airgun

MOP17	.17/.20 Caliber (#3-48 thread)
-------	--------------------------------

Handgun & Rifle

MOP22	.22 Cal. / .223 Cal./ 5.56mm
MOP30	.30 Cal. / 7.62mm
MOP9	.357 Cal. / .38 Cal. / 9mm
MOP40	.40 Cal. / 10mm
MOP45	.44 Cal. / .45 Cal.

Shotgun

MOP20	20-Gauge
MOP12	12-Gauge



UTILITY BRUSHES & ACCESSORIES

UT221C

CABLEKLEEN™ TRIPLE ACTION UTILITY BRUSH

- Allows you to get into tight areas to clean. Three different banks of bristles to clean bolts, bolt faces, rails, receivers, and other gun parts as necessary



UT221C

UT221

NYLON BRISTLE GUN BRUSH

- This military-style brush is great for cleaning any type of firearm, especially where a gentle touch is required. Nylon bristles are rugged and solvent-resistant



UT221

UT222

STAINLESS STEEL GUN BRUSH

- Rugged stainless steel bristles make short work of caked-on powder residue and burn marks on revolver top straps, frames and cylinders



UT222

UT223

PHOSPHOR BRONZE GUN BRUSH

- A superb, general purpose, gentle-on-the-finish brush for cleaning powder and lubrication residue from handguns, rifles and shotguns



UT223



MAG200

MAGBRUSH

- Important item for competitive shooters, law enforcement and the military
- The MagBrush removes gummy residue, dust, dirt and unburned powder from inside the magazine
- Provides quicker, easier magazine release and increased cartridge-feed reliability

MAG200 MagBrush	.22/.25/.380/9mm Straight Stacked
MAG202 MagBrush	9mm/10mm/.40/.45 Staggered
MAG204 MagBrush	.38/.40/10mm/.45 Straight Stacked
MAG206 MagBrush	AR-15/M-16/AK-47



MAG208

MAGSWAB

- 9mm staggered/.38/10mm/.40/.45
- Companion to the MagBrush series, the MagSwab can be used with a solvent to mop clean the inside of magazines
- Have an additional MagSwab on hand to solely apply a light coat of lubricant to protect both areas after cleaning



ACC10



ACC11



ACC16



ACC17

ROD ADAPTERS

These carefully crafted accessories guarantee perfect, smooth mating to rods, preventing peeling or mismatched segments that can seriously damage bores

SLOTTED PATCH HOLDERS

Part#	Description	Use/Caliber/Gauge
ACC10	Steel Handgun/Rifle	.22-.45
ACC11	Brass Handgun/Rifle	.22-.45
ACC16	Nylon Shotgun	All Gauges

ACCESSORY/CONVERSION ADAPTERS

ACC17	Aluminum Accessory Adapter	Accepts all KleenBore® shotgun accessories (5/16-27)
-------	----------------------------	--

CLEANING JAGS

CLEANING JAGS

- A metal jag, draped with a proper sized patch, completely covers the entire bore for efficient, thorough cleaning
- For ease of use, the KleenBore® unique design incorporates a special barbed point at the tip of the jag to secure the cleaning patch and prevent solvent soaked patches from falling off

AIRGUN/ SMALL BORE CLEANING JAG

Part#	Caliber/Gauge
JAG226	.177/.200 Airgun
JAG17	.17-.204 Caliber

HANDGUN/RIFLE CLEANING JAGS

JAG227	.22-.25 Caliber
JAG228	.270-.32 Caliber
JAG229	.38/.357/9mm
JAG230	.40/.41/.410/10mm
JAG231	.44/.45 Caliber

SHOTGUN CLEANING JAGS

JAG233	20/16-Gauge
JAG234	12-Gauge



COTTON PATCHES & CLOTHS

GUN CLEANING PATCHES

- P Premium quality 100% cotton flannel provides maximum absorbency and bore protection.
- Precision cut to ensure the proper fit and maximum cleaning performance when used in conjunction with our cleaning jags or patch holders
- These same quality 100% cotton patches are available bulk-packaged for high volume users such as competition shooters, gun clubs, law enforcement agencies, gunsmiths, and others

Part#	Size	Caliber/Gauge	Quantity
P200	7/8"	Small Bore	100 count
P201	1 1/4"	.22-.270 Caliber	100 count
P202	1 3/4"	.28-.35 Caliber	75 count
P203	2 1/4"	.38-.45/.410 - 20-Gauge	50 count
P204	3"	12/16-Gauge	25 count
P206	4"	Big Bore Shotgun	25 count
CP16B	1 1/4"	.22-.270 Caliber	500 count
CP17B	1 3/4"	.28-.35 Caliber	500 count
CP13B	2 1/4"	.38-.45/.410 - 20-Gauge	250 count
CP18B	2 1/4"	.38-.45/.410 - 20-Gauge	500 count
CP14B	3"	12/16-Gauge	250 count
CP19B	3"	12/16-Gauge	500 count
CP21B	1 1/4"	.22-.270 Caliber	1000 count



GC220S SILICONE GUN & REEL CLOTH

- Restore and protect the luster of a firearm with our top-quality silicone injected cotton flannel
- Returns a brilliant sheen to firearms surface
- Removes handling marks, fingerprint oil, and provides a layer of rust protection
- 100 square inch cloth



GC221 LEAD AWAY® CLEANING CLOTH

- This chemically treated cloth is ideal for removing tough lead and carbon build-up
- Excellent for removing burn rings on cylinders and on stainless steel
- 110 square inch cloth

Caution: Excessive rubbing may remove bluing

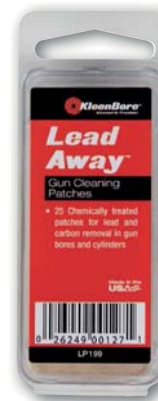

LP199 LEAD AWAY® PATCHES

- Lead Away Patches wipe away stubborn carbon and lead build-up
- (25) 1 1/4" square patches in a re-sealable clamshell package with hanger hole

BODY WORN CAMERAS | CONCEALABLE ARMOR | TACTICAL ARMOR | COMMUNICATIONS | PATROL BIKE | DUTY GEAR/HOLSTERS | PROTECTIVE GEAR | FIREARMS ACCESSORIES | LETHAL | PERFORMANCE APPAREL | SURVIVABILITY SYSTEMS | FORENSICS | ARMOR SYSTEMS | TRAINING GROUP

BAGS & ACCESSORIES



KBSB1 SHOOTERS PREMIUM RANGE BAG

- Extremely durable 18" x 13" x 10" nylon range bag with heavy-duty zippers
- Six different compartments with two removable gun pouches in zippered cases
- Padded top and side pockets safeguard eye wear and hearing protection
- Convenient option to hand carry or use the padded nylon shoulder strap
- 14" x 10" x 10" center pocket has two dividers providing multiple configurations

GUNNYSOCKS

VAPOR CORROSION INHIBITOR (VCI)

- Corrosion in storage can be a real problem for firearms collectors and enthusiasts
- Utilizes the KleenBore® Vapor Corrosion Inhibitor technology
- VCI technology penetrates into the smallest cracks and crevices of firearms that oils cannot reach, offering long-term protection
- VCI Gunnysock better fits scoped firearms and provides a cushioning layer of fabric around valuable firearms
- Slides over mounted scope
- Perfect for seasonal storage and travel

GSVCI160 Handgun
GSVCI161 Rifle/Shotgun



CHAMBER FLAG

- On the range and when transporting or storing semi-automatic handguns, a chamber flag immediately indicates that the gun is clear and no round can be chambered
- Comes with two per pack

CF9 .45/9mm
CF22 .22 Caliber



K5 BAD GUY TARGET

- 23" x 35"
- Paper

CLEANING SOLVENTS



Made in the
USA



NO. 10

GUN CLEANING SOLVENT (2 OZ.)

- Tried and true, No. 10 is a fast, efficient solvent that quickly penetrates and lifts lead, powder residue, and metal fouling for quick, easy cleaning

S10 2 oz. with Child-resistant cap
S10S 2 oz. with Pump Spray

GB2

BLACK MAGIC™ BLUING SOLUTION (2 OZ.)

- This premier, high performance cold bluing solution, previously available only to gunsmiths, produces a deep, penetrating action to restore worn or scratched gun metal to like-new finish
- Black Magic is the choice of major firearms manufacturers for touching up guns before they leave the factory
- Packaged in a container with a child-resistant cap and expert, easy-to-follow instructions



C10

NO. 10 COPPER CUTTER (2 OZ.)

- Reformulated for even better removal of copper and other fouling, this premium, high-strength solvent rapidly turns blue as it aggressively cuts through copper
- No blue, no copper
- Also ideal for removing plastic fouling
- Child-resistant cap

GO5A

GUNK-OUT™ CLEANER DEGREASER (15 OZ.)

- Gunk-Out quickly blasts away caked-on oil contaminated with dirt, dust and powder residues
- This chemical is also great for flushing out loosened fouling and for degreasing prior to bluing



CLEANER, LUBRICANT & PROTECTANTS

Made in the
USA



CLEANER LUBRICANT PRESERVATIVE (CLP®)

- Originally developed for the U.S. Military and proven in the world's most extreme conditions
- Break Free® CLP® is the gold standard formula for the ONE STEP lubricating and protectant firearm solution
- More than a superior lubricant, CLP actually cleans firing residue and other contaminants from the bore, moving parts and exterior of firearms while simultaneously reducing friction and protecting from corrosion



Made in the
USA

BFI-WW MULTI-SURFACE WIPES

Break Free® Multi-Surface Wipes are soft, absorbent, nonwoven cloth wipes pre-saturated with Break Free® CLP®. Eliminates the need for messy oils, cleaners and cut cloths.

- Cleans and maintains small arms and rifles for use in all weather conditions
- Ideal for fishing equipment, knives and other outdoor gear
- Includes twenty 6 3/4" x 3" wipes



BFI-IWW POP COUNTERTOP DISPLAY

- 50 individually packaged Break Free® Multi-Surface Wipes

Part#	Description	Accessory
CLP-2	4 oz. Aerosol Spray	Extender Tube
CLP-3	1/2 oz. Squeeze Bottle	Dropper Tip
CLP-4	4 oz. Squeeze Bottle	Extender Tube
CLP-5	1 Pint Bottle	Trigger Spray
CLP-7	1 Gallon Jug	-
CLP-8	1 Liter Bottle	Trigger Spray
CLP-11	2 oz. Bottle	Pump Spray
CLP-12	12 oz. Aerosol Spray	Extender Tube
CLP-16	.68 oz. Squeeze Bottle	-
CLP-20	2 oz. Bottle	Child-resistant cap
CLP-PS	7.5ml Tube	Needle Applicator



DP-2 COLLECTOR® KIT

- **4 oz. CLP®:** Cleans, lubricates and preserves using the highest quality synthetic oils and special friction reducing, anti-wear additives and rust inhibitors
- **4 oz. Collector:** Developed to protect firearms for up to five years in storage. Will not degrade under heat or pressure and resists damage caused by fingerprint residue

LUBRICANT/PRESERVATIVES

Made in the
USA



CO-4 COLLECTOR® (4 OZ.)

Developed to protect firearms for up to five years in storage, Collector® exceeds stringent military specifications. Recommended for the occasional hunter or sports shooter, as well as knife and sword collectors. It's ideal for seasonal sports equipment before placing in storage. In one test, Collector protected steel panels from rust and corrosion for over 1200 hours in 100% humidity.

- Does not degrade to waxy residue under heat or pressure
- Resists damage from fingerprint residue and minimizes the need for frequent wipe down
- Perfect for gun collectors, armories and museums



LUBRICANT PRESERVATIVE (LP)

- Originally developed for fully automatic cannons used by the U.S. military, Break Free® has taken this technology designed to keep weapons working under sustained fire and brought it to the consumer market
- Contains specially formulated polymerized synthetic oils for improved boundary film strength, plus multiple ingredients to reduce friction, stop build-up of foreign particles and inhibit rust and corrosion
- Safe for all gunmetal and gunmetal finishes from blued steel to titanium, as well as polymer composite firearms. Also prevents galling on stainless steel
- Non-solvent formula minimizes drain off when firearm is holstered

LP-3	.5 oz. squeeze bottle with dropper tip
LP-4	4 oz. squeeze bottle with extender tube
LP-5	1 pint bottle with trigger sprayer
LP-PS	7.5 ml tube with needle applicator

CLEANERS & SOLVENTS

Made in the
USA



BCF-3 BORE CLEANING FOAM (3.06 OZ.)

- Gently cleans using a chemical reaction to remove copper and brass compounds with no mechanical friction
- Quickly removes residue in 15 minutes
- Protects with a film that slows down renewed accumulation of similar residues
- Foam application runs less than other cleaning agents, such as ammonia-based products
- Efficiently removes normal combustion waste, eliminating the need for a second cleaner
- Non-toxic, odorless, PH value of 12
- Usable in temperatures between -30° and 50° Celsius



CAC-4 CARBON CUTTER® (4 OZ.)

- Carbon Cutter® was specially formulated to cut carbon buildup from your firearm
- Carbon Cutter liquefies the carbon from any weapon barrel
- Ideal for removing carbon from black powder rifles
- Removes blackpowder
- No ammonia
- PH neutral



GC-16 POWDER BLAST™ (12 OZ.)

- Powder Blast™ keeps all guns clean and dry by blasting away firing residues. Use it on trigger groups and mechanisms to quickly and easily remove contaminants, without leaving a white residue or unpleasant odor
- Eliminates powder residue, plastic streaking, grease and oil build-up
- No disassembly required – the extender tube provides easy access to hard-to-reach areas
- Will not hydrolyze to form hydrochloric acid, unlike products containing 1,1,1 Trichloroethane
- After using Powder Blast, protect firearms with Break Free® CLP®, or Collector® products

BODY WORN CAMERAS | CONCEALABLE ARMOR | TACTICAL ARMOR | COMMUNICATIONS | PATROL BIKE | DUTY GEAR/HOLSTERS | PROTECTIVE GEAR | FIREARMS ACCESSORIES | LETHAL | LESS | PERFORMANCE APPAREL | SURVIVABILITY SYSTEMS | FORENSICS | ARMOR SYSTEMS | TRAINING GROUP

AR ACCESSORIES



Our Rogers line of AR accessories designed for shooters who want the best in black gun accessories. With innovative products ranging from forend rail kits, grip adapters, magazine doublers and adjustable stocks, to a variety of complementary rails, mounts and ring sets, this line was developed for novice to expert shooters who are driven to optimize the performance of their favorite AR series weapons.

22028 AR FURNITURE KIT

One convenient kit that groups the necessary Rogers items to upgrade a basic AR-15

- Includes: Rogers Super-Stoc® gun stock, Mag Grip, Dual Mag Coupler, Tri-Rail and Single Point Harness
- Available in Black and Flat Dark Earth



22048 ROGERS SUPER-STOC® COLLAPSIBLE GUN STOCK

- Can be locked down to virtually eliminate movement in the stock
- Provides comfortable, secure shoulder rest for weapon
- Can be quickly converted to fit commercial or Mil-Spec buffer tubes
- Sling loop and quick detach mounting point provided for wide variety of harness/sling options
- Removable recoil pad
- Dual-release unlocking lever
- Survives 2 ft fully loaded drop test
- Lightweight, 7.3 oz
- Available in Black, Flat Dark Earth and OD

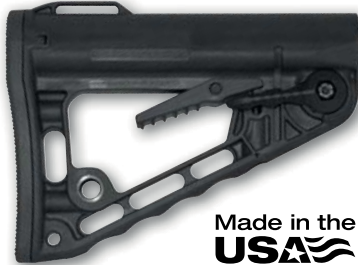

Made in the
USA



22028 ROGERS SUPER-STOC® CHEEK PAD

- Cut to fit Rogers Super-Stoc, but will fit most rifle stocks
- Made of soft neoprene
- Simple peel and stick installation



66411 DUAL MAG COUPLER

- Quick, efficient reload with second magazine
- Proper staggering of magazine to clear ejection port
- (2) top round protectors keep cartridges in proper position and dirt out of magazines
- Protects base pad of magazine when dropped
- Does not crush magazine
- Excellent for seated and prone shooting positions
- Available in Black and Flat Dark Earth

Made in the
USA



AR ACCESSORIES



Made in the
USA

64322 TRI-RAIL

- Allows for quick attachment of (3) rails to forward end of AR15, M4 and M-16 rifles
- Can attach (2) accessories to upper forearm and (1) to bottom rail
- Lightweight
- Can be reversed to have (1) rail on top with (2) below
- Locks securely into place using holes in standard forend
- Available in Black and Flat Dark Earth



Made in the
USA

1028 MAG GRIP

- Easy to install – no tools or hardware required
- Composed of a lightweight, heavy-duty polymer
- Top of grip is extended to provide greater control and comfort
- Provides improved weak hand weapon control
- Beveled opening at the bottom facilitates smoother & faster reloads
- Available in Black and Flat Dark Earth

ROGERS ACCESSORIES

64101 MAG WELL GRIP

- Drop-in fiber reinforced polymer composite adapter
- Flare at the bottom of the grip aids in stability
- Funnels magazine into the grip helping in rapid reload situations
- Protects end of grip in case of accidental impact
- No modification to gun is required to install grip
- Specifically designed for Glock models 17, 22, 34, 35 & GEN 4

64107 17, 22, 24, 31, 34, 35 & 37 GLOCK GEN 1/2/3
64180 19, 23 GLOCK GEN 1/2/3/4



ROGERS ACCESSORIES



64351 SINGLE POINT HARNESS

- Provides comfortable, secure shoulder rest for weapon
- Allows easy transition from low ready, to firing, to around the back positions to free up hands
- Quick detachment point provides instantaneous attachment and detachment from the weapon
- Features a lock-out system to help prevent accidental detachment
- 160 lbs. break-away prevents accidental and potentially dangerous entrapment
- Single point attachment bracket comes standard for the AR-15/M4 rifle with collapsible stock buffer tubes
- Made of durable nylon
- Available in Black and Flat Dark Earth

64352 with No Adapter
64370 with Remington Adapter
64371 with Mossberg 500-590



Made in the
USA

64374 SINGLE POINT HARNESS ADAPTER KIT

- Mounting adapter interface between the Rogers Single Point Harness line and AR-15/M4 firearms
- Engineered for OEM quality, style and performance on AR-15/M4 platform
- Features a lock-out system to prevent against accidental detachment
- Installs easily between the stock and buffer tube
- 160 lbs. break-away safety feature prevents accidental and potentially dangerous entrapment

64372 Rem 870, 100, 1187
64373 Mossberg 500-590

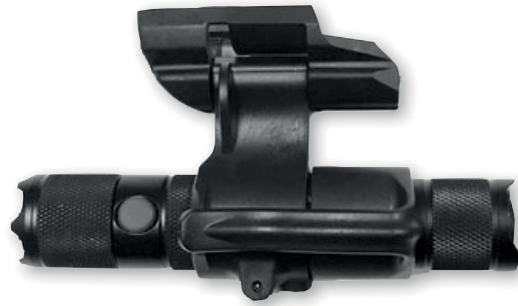

65139 ROGERS LIGHT SYSTEM

- Attaches to gun in two quick and easy steps - quickly transitions from standard flashlight to weapon illumination
- Super bright LED light (980 Lumens)
- Four different brightness settings, including strobe
- Fits most handgun models that incorporate an integral rail system, also mounts to rifles and shotguns that have a Picatinny rail
- Integral clip to easily secure to belt
- Ambidextrous



66015/66019 SHOTGUN SHELL HOLDER

- Molded shotgun shell holder to hold two 12-Gauge shells
- Available as screw mounting platform for shotgun stock or other surfaces, or with a belt clip

66015 Clip On
66019 Rivet On



64098 ROGERS SIGHT MOUNT

- Quick-detach mount for red-dot optics with a Picatinny Rail
- Quickly remove and attach optics without the use of tools or cumbersome fasteners
- Solid mounting system that will hold zero
- Included shims allow height adjustment so optics can be co-witnessed with iron sights

ROGERS ACCESSORIES

64388

ADVANCED GUN CLEANING SOLUTION KIT

- Remove or dissolve any carbon, burnt powder residue, copper fouling, and lead fouling, to completely clean any pistol, rifle or shotgun.
- Kit includes:
 - Advanced Bore Cleaning Solution
 - Action Cleaning Gel
 - Gun Cleaning Rinse Concentrate
 - Premium Lubricant Spray Nozzle
 - Complete cleaning instructions



PATENTED

64339

ULTIMATE BORE SQUEEG-E™ CLEANING KIT

- Patented Squeeg-e provides advanced cleaning without the use of patches
- Complete system includes everything needed to clean all firearms from a .22 pistol to a 12-Gauge shotgun

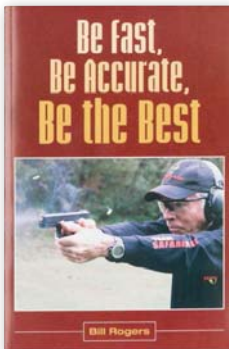

66502

BE FAST, BE ACCURATE, BE THE BEST. BOOK

Bill shares his life experiences to bring the readers into the world of Reactive Shooting. He then takes them through a step by step program to make them safer and more competent gun handlers, as well as giving them the skills to survive a real life battle.

64394

TAP RACK TRAINING AID

- Most efficient way to practice dry fire drills
- Place in the magazine to prevent slide stop from engaging
- Slide passes over training aid so device does not need to be re-loaded into the magazine for continual training
- Can be used improperly seated in magazine for malfunction drills
- Available in 3, 20 and 100-packs in Orange, Yellow and Blue



64394	9mm & 40 cal.
64395	45 ACP
64396	5.56

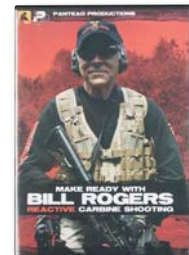
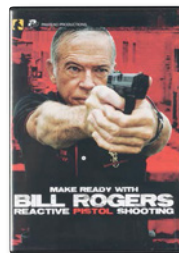

66500/66501

MAKE READY WITH BILL ROGERS - DVDS

- Reactive Pistol Shooting - Bill Rogers walks you through Rogers Shooting School steps to teach reactive pistol shooting and how to accurately draw and knock down plates in .5 seconds.
- Reactive Carbine Shooting - Successfully engage and hit small reactive targets that are moving and only exposed for a fraction of a second.

WE ARE YOUR FORCE OPTION



LESS LETHAL



The Defense Technology® brand offers a complete range of the industry's most trusted less lethal products. Manufactured to exacting specifications and quality standards, the products have led the industry for decades. From duty aerosols and

less lethal impact munitions to our Distraction Device® products, chemical munitions and more, Defense Technology products are the choice of law enforcement, corrections and military personnel around the world.



OC AEROSOLS

THE FINEST TRAINING AIDS FOR THE FINEST PRODUCTS

First Defense® is the world's most widely used pepper spray in law enforcement and corrections. In recognizing the diverse environments and challenges our public safety professionals face each day, our comprehensive First Defense line utilizes a color code system to identify the intensity of that product.

The First Defense family of OC aerosol sprays are EDW safe.



.2% White Band

56125	MK-2 Stream
5039	MK-3 Stream
5439	MK-3 Stream/360°
5049	MK-4 Stream
5449	MK-4 Stream/360°
5069	MK-6 Stream
56185	MK-8 Stream
5099	MK-9 Stream
5746	MK-46V Stream
5846L	MK-46H Stream
5546	MK-46R Stream

.4% Yellow Band

56325	MK-2 Stream
56324	MK-2 Cone
5239	MK-3 Stream
5239A	MK-3 Stream/360°
56334	MK-3 Cone
56332	MK-3 Foam
5249	MK-4 Stream
5249A	MK-4 Stream/360°
56344	MK-4 Cone
56342	MK-4 Foam
5269	MK-6 Stream
5299	MK-9 Stream
56392	MK-9 Foam
56346V	MK-46V Stream
56346H	MK-46H Stream
56346R	MK-46R Stream

.7% Orange Band

56725	MK-2 Stream
3005	MK-3 Stream
56733	MK-3 Stream/360°
3035	MK-3 Cone
4005	MK-4 Stream
56343	MK-4 Stream/360°
4035	MK-4 Cone
6005	MK-6 Stream
56764	MK-6 Cone
56785	MK-8 Stream
56784	MK-8 Cone
56795	MK-9 Stream
9005	MK-9 Fogger
43896	MK-9S Vapor
43890	MK-9S Vapor w/ Wand Adapter
56746V	MK-46V Stream
56746H	MK-46H Stream
56746R	MK-46R Stream

1.3% Red Band

56825	MK-2 Stream
56824	MK-2 Cone
56822	MK-2 Foam
43345	MK-3 Stream
56833	MK-3 Stream/360°
43344	MK-3 Cone
56842	MK-3 Foam
43445	MK-4 Stream
56843	MK-4 Stream/360°
43444	MK-4 Cone
56832	MK-4 Foam
43665	MK-6 Stream
56864	MK-6 Cone
56884	MK-8 Cone
56895	MK-9 Stream
43953	MK-9 Fogger
43950	MK-9 Fogger w/ Wand Adapter
56792	MK-9 Foam
43046	MK-46V Stream
56846H	MK-46H Stream
43046R	MK-46R Stream

OC/CS Grey Band *Non-EDW Safe

56025	MK-2 Stream*
56035	MK-3 Stream*
56045	MK-4 Stream*
56095	MK-9 Stream*
56046V	MK-46V Stream*
56046H	MK-46H Stream*
56046R	MK-46R Stream*

Inert *Non-EDW Safe

5129	MK-2 Stream
5125	MK-2 Cone*
5126	MK-2 Foam
5139	MK-3 Stream
5439I	MK-3 Stream/360°
5139F	MK-3 Cone*
5136	MK-3 Foam
5149	MK-4 Stream
5449I	MK-4 Stream/360°
5149F	MK-4 Cone*
5146	MK-4 Foam
5169	MK-6 Stream
5189	MK-8 Stream
5199	MK-9 Stream
5199F	MK-9 Fogger*
5196	MK-9 Foam
49950	MK-9 Fogger w/ Wand Adapter*
5546I	MK-46R Stream

OC AEROSOLS



CHOOSING YOUR PEPPER SPRAY IS EASY, JUST ANSWER THESE THREE QUESTIONS AND USE THE CHART BELOW:

- 1 WHAT INTENSITY DO YOU NEED?
- 2 HOW DO YOU WANT TO DELIVER THE OC?
- 3 HOW MUCH PRODUCT WILL YOU NEED?



STREAM AEROSOL SIZE SPECS

MK-2:	7-10 Short bursts	10-12 ft.
MK-3:	10-12 Short bursts	10-12 ft.
MK-4:	20-25 Short bursts	10-12 ft.
MK-6:	12-14 Short bursts	10-12 ft.
MK-8:	5-7 Short bursts	10-12 ft.
MK-9:	14 Short bursts	18-20 ft.
MK-46:	26 Short bursts	25-30 ft.

	MK-2	MK-3	MK-4	MK-6	MK-8	MK-9	MK-46V	MK-46H
INDOOR/OUTDOOR								
DA								
INTENSITY		360°	360°					
.4%		360°	360°					
.7%		360°	360°					
1.3%		360°	360°					
OC/CS								
INERT		360°	360°					

CHART KEY

STREAM	CONE	FOAM	360°
DUTY AEROSOL	CROWD MANAGEMENT	INDOOR/OUTDOOR	

BODY WORN CAMERAS | CONCEALABLE ARMOR | TACTICAL ARMOR | COMMUNICATIONS | PATROL BIKE | DUTY GEAR/HOLSTERS | PROTECTIVE GEAR | ACCESSORIES | FIREARMS | LETHAL | PERFORMANCE APPAREL | SURVIVABILITY SYSTEMS | FORENSICS | ARMOR SYSTEMS | TRAINING GROUP

LESS LETHAL IMPACT MUNITIONS



PATENTED



DIRECT IMPACT® ADJUSTABLE RANGE 40MM DIRECT FIRE MUNITIONS WITH PAYLOAD OPTIONS

- Projectile design has unique user-adjustable gas-bleed feature
- Allows velocity and kinetic energy to be adjusted for two design points, addressing close-in and extended range engagements
- Standard range velocity allows for engagements of 1.5 – 40 meters
- Extended range velocity allows for engagements of 40 – 70 meters
- Crushing nose dampens blunt trauma while delivering payload

OC CS MARKING INERT



DIRECT IMPACT® STANDARD RANGE 40MM DIRECT FIRE MUNITIONS WITH PAYLOAD OPTIONS

- Accurate to 120 feet / 36.6 meters
- Crushing nose dampens blunt trauma while delivering payload
- Passed extensive human effects assessments for blunt impact and penetration

OC CS MARKING INERT



DIRECT IMPACT® LE EXTENDED RANGE 40MM DIRECT FIRE MUNITIONS WITH PAYLOAD OPTIONS

- Accurate to 230 feet / 70 meters
- Crushing nose dampens blunt trauma while delivering payload
- Passed extensive human effects assessments for blunt impact and penetration
- Do not use at distances closer than 33 feet / 10 meters

OC CS MARKING INERT



PATENTED



DIRECT IMPACT® RELOADABLE TRAINING KITS

40MM RELOADABLE TRAINING ROUND

- Provides the same point of impact accuracy as the 40mm munitions it simulates
- The most cost-effective way to conduct training
- Reloading the munitions takes seconds and one hex key
- For use on inanimate targets
- Available in 50-Shot or 250-Shot Kits
- Available in Standard Range or LE Extended Range

Direct Impact Adjustable Range

6320-A	Direct Impact OC
6322-A	Direct Impact CS
6323-A	Direct Impact Inert
6326-A	Direct Impact Marking

Direct Impact Standard Range

6320	Direct Impact OC (NTOA APPROVED 2008)	
6322	Direct Impact CS	
6323	Direct Impact Inert (NTOA APPROVED 2008)	
6326	Direct Impact Marking (NTOA APPROVED 2008)	

Direct Impact Extended Range

6320LE	Direct Impact OC
6322LE	Direct Impact CS
6323LE	Direct Impact Inert
6326LE	Direct Impact Marking

Reloadable Training Kits

6530-50	Direct/Exact Impact 50-Shot Kit
6530	Direct/Exact Impact 250-Shot Kit
6530LE-50	Extended Range Direct/Exact Impact 50-Shot Kit
6530LE	Extended Range Direct/Exact Impact 250-Shot Kit

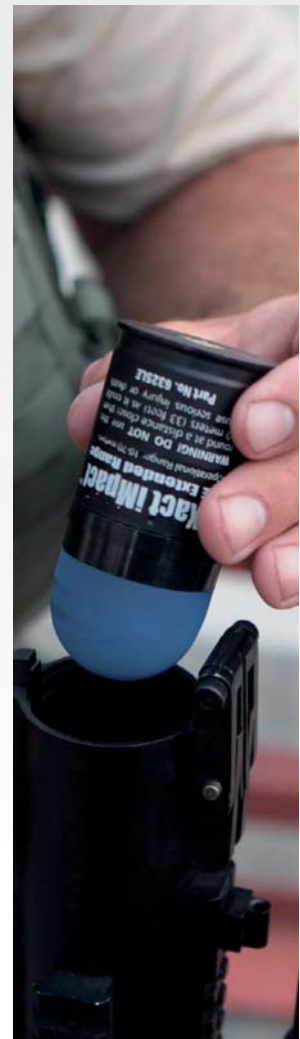

LESS LETHAL IMPACT MUNITIONS



PATENTED



EXACT iMPACT™ ADJUSTABLE RANGE 40MM DIRECT FIRE MUNITIONS

- Projectile design has unique user-adjustable gas-bleed feature
- Allows velocity and kinetic energy to be adjusted for two design points, addressing close-in and extended range engagements
- Standard range velocity allows for engagements of 1.5 – 40 meters
- Extended range velocity allows for engagements of 40 – 70 meters



PATENTED



EXACT iMPACT™ STANDARD RANGE 40MM DIRECT FIRE MUNITIONS

- Most accurate direct fire munitions
- Accurate to 120 feet / 36.6 meters
- Produced under exclusive license from U.S. Army
- Passed extensive human effects assessments for blunt impact and penetration



EXACT iMPACT™ LE EXTENDED RANGE 40MM DIRECT FIRE MUNITIONS

- Most accurate direct fire munitions
- Accurate to 230 feet / 70 meters
- Passed extensive human effects assessments for blunt impact and penetration
- Do not use at distances closer than 33 feet / 10 meters



EXACT iMPACT™ 24-SHOT RELOADABLE TRAINING KIT 40MM RELOADABLE TRAINING ROUND

- Foam nose bodies are reuseable
- Pre-loaded bases are fast to make ready and disposable afterwards
- The training munitions deliver similar accuracy as the live munitions

eXact iMPact Adjustable Range

6325-A eXact iMPact

eXact iMPact Standard Range

6325 eXact iMPact

eXact iMPact Extended Range

6325LE eXact iMPact

Reloadable Training Kits

6525 eXact iMPact 24-Shot Kit

6530-50 Direct/Exact Impact 50-Shot Kit

6530 Direct/Exact iMPact 250-Shot Kit

6530LE-50 Extended Range Direct/Exact Impact 50-Shot Kit

6530LE Extended Range Direct/Exact Impact 250-Shot Kit

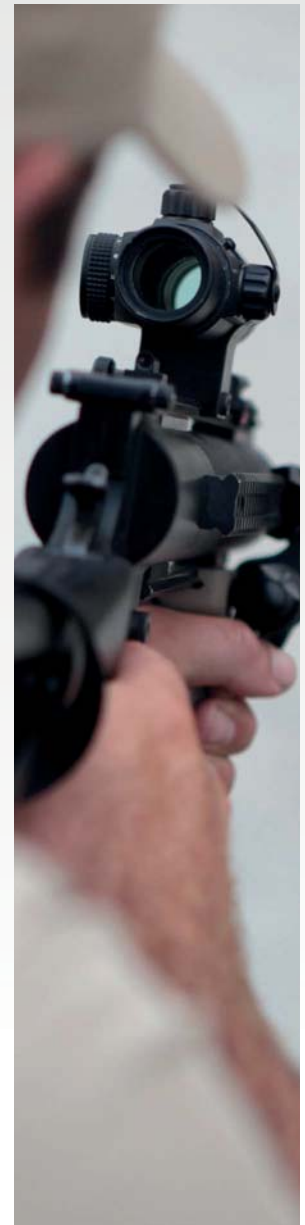

LESS LETHAL IMPACT MUNITIONS

37MM 37/40MM 40MM ROUNDS

- Comprehensive offering of area and direct fire munitions
- Available in 37mm, 37/40mm or 40mm munitions
- Widely used by corrections and law enforcement agencies for crowd control or single subject compliance



Area Control Munitions



STINGER® 32 CAL. RUBBER BALLS

STINGER® 60 CAL. RUBBER BALLS

Direct Fire Munitions



MULTIPLE WOOD BATON

MULTIPLE FOAM BATON

MULTIPLE RUBBER BATON

BEAN BAG

12-GAUGE ROUNDS

- Comprehensive offering of area and direct fire munitions
- Widely used by corrections and law enforcement agencies for single subject compliance

Area Control Munitions

Direct Fire Munitions



STINGER® 32 CAL. RUBBER BALLS

DRAG STABILIZED™ ROUND

FIN STABILIZED ROUND

STINGER® 68 CAL. SINGLE, DOUBLE OR TRIPLE RUBBER BALL

40mm Rounds

- 6096 Stinger® 32 Cal. Rubber Balls
- 6097 Stinger® 60 Cal. Rubber Balls
- 6098 Multiple Wood Baton
- 6064 Multiple Rubber Baton
- 6099 Multiple Foam Baton
- 6025 Bean Bag

37/40mm Rounds

- 6296 Stinger® 32 Cal. Rubber Balls
- 6297 Stinger® 60 Cal. Rubber Balls
- 6298 Multiple Wood Baton
- 6299 Multiple Foam Baton
- 6225 Bean Bag

37mm Rounds

- 1196 Stinger® 32 Cal. Rubber Balls (5.5")
- 1197 Stinger® 32 Cal. Rubber Balls
- 1198 Stinger® 60 Cal. Rubber Balls (5.5")
- 1199 Stinger® 60 Cal. Rubber Balls
- 1176 Multiple Wood Baton
- 1177 Multiple Rubber Baton
- 1178 Multiple Foam Baton
- 1225 Bean Bag



12-GAUGE

Stinger® 32 Cal. Rubber Balls

- 3016 Standard Velocity
- 3020 High Velocity

Stinger® 68 Cal. Rubber Balls

- 3070 Single Rubber Ball
- 3071 Double Rubber Ball
- 3072 Triple Rubber Ball

Drag Stabilized™

- 3027 Bean Bag Round
- 3028 Marking Bean Bag Round

Fin Stabilized

- 3021 Fin Stabilized Round

WARNING/SIGNAL MUNITIONS



AERIAL WARNING/SIGNALING MUNITIONS WITH PAYLOAD

40MM 50/100/200/300 METERS

- Designed to travel the indicated distance and deflagrate 20 ft. above the target when launcher is held at a 15° elevation angle
- Delivers a sound and light output which are noticeable in day or night conditions
- Produces 170 dB of sound output at 5 ft
- Produces 5 million candelas for 7.5 milliseconds
- Tactile feature on the nose of the cone to indicate designated distance



AERIAL WARNING/SIGNALING MUNITIONS

40MM 50/100/200/300 METERS

- Designed to travel the indicated distance and deflagrate 20 ft. above the target when launcher is held at a 15° elevation angle
- Delivers a sound and light output which are noticeable in day or night conditions
- Produces 170 dB of sound output at 5 ft
- Produces 5 million candelas for 7.5 milliseconds
- Tactile feature on the nose of the cone to indicate designated distance



AERIAL WARNING/SIGNALING MUNITIONS

12-GAUGE 50/100 METERS

- Designed to travel the indicated distance and deflagrate 20 ft. above the target when shotgun is held at a 5° elevation angle
- Delivers a sound and light output which are noticeable in day or night conditions
- Produces 170 dB of sound output at 5 ft
- Produces 2.2 million candelas for 7.5 milliseconds

40mm Aerial Warning/Signaling Munitions w/Payload

60280C	50 meters
60290C	100 meters
60300C	200 meters
60310C	300 meters

6028CN	50 meters
6029CN	100 meters
6030CN	200 meters
6031CN	300 meters

6028CS	50 meters
6029CS	100 meters
6030CS	200 meters
6031CS	300 meters

6028IM	50 meters
6029IM	100 meters
6030IM	200 meters
6031IM	300 meters

40mm Aerial Warning/Signaling Munitions

6028WS	50 meters
6029WS	100 meters
6030WS	200 meters
6031WS	300 meters

12-Gauge Aerial Warning/Signaling Munitions

3031	50 meters
3029	100 meters

THE SAFARILAND TRAINING GROUP

LESS LETHAL INSTRUCTOR PROGRAM

This hallmark program provides the necessary training for a changing world. The program is comprised of four 8-hour instructor level classes covering OC Aerosols, Less Lethal Impact and Chemical Munitions and Distraction Device® models. The student will acquire a general working knowledge of Defense Technology® products, both technically and tactically, along with the skills necessary to conduct in-service training.



PYROTECHNIC CHEMICAL GRENADES

Defense Technology® offers a large assortment of chemical grenades providing options for most any tactical situation. These high-volume pyrotechnic grenades utilize a standard M201A1 type fuze and deliver large plumes of smoke and/or agent.



FLAMELESS TRI-CHAMBER

- The design of this grenade allows the contents to burn within an internal can and disperse the agent safely with reduced risk of fire
- Designed primarily for tactical situations to detect and/or dislodge a barricaded subject
- It is not recommended to launch this grenade

OC CN CS SMOKE



HAN-BALL™

- Fast burning pyrotechnic grenade with a rubber ball exterior
- Delivers a high volume of agent in 15 seconds

OC CN CS SMOKE



TRIPLE-CHASER®

- Grenade separates into three sub-munitions to cover greater area and payload coverage
- Sub-munitions land approximately 20 ft. apart with an approximate burn time of 20-30 seconds

OC CN CS SMOKE



SPEDE-HEAT™

- Long-burning, continuous discharge grenade delivers a high-volume of smoke and agent
- Burn time approximately 30-40 seconds

OC CN CS



WHITE & COLORED SMOKE

- Smoke is discharged for approximately 30-40 seconds
- Ideal for signaling, communication, distraction and crowd control
- Smoke Colors: White, Black, Blue, Green, Red or Yellow
- Maximum HC Smoke Grenades are also available in Large- and Military-Style canisters

SMOKE



RIOT CONTROL

- Same long-burning, continuous discharge capabilities as the Spede-Heat™ grenade in a smaller canister
- Delivers a high-volume of smoke and agent
- Burn time approximately 30-40 seconds

OC CN CS



POCKET TACTICAL

- Though this device is slightly over 4" in length, it produces a smoke cloud so fast it appears to be an enveloping screen produced by a full size tactical grenade
- Burn time 20-40 seconds
- Smoke Colors: White, Blue, Green, Red or Yellow

OC CN CS SMOKE

Flameless Tri-Chamber

1030	OC
1031	CN
1032	CS
1033	Saf-Smoke™

Han-Ball™

1099	OC
1091	CN
1092	CS
1093	Saf-Smoke™

Triple-Chaser®

1020	OC
1025	CN
1026	CS
1027	Saf-Smoke™

Spede-Heat™

1070	OC
1071	CN
1072	CS

Riot Control

1080	OC
1081	CN
1082	CS

White & Colored Smoke

1062	Black Smoke
1063	Saf-Smoke™
1064	Blue Smoke
1065	Green Smoke
1067	Red Smoke
1069	Yellow Smoke
1073	Large-Style Max HC Smoke
1083	Military-Style Max HC Smoke

Pocket Tactical

1019	OC
1015	CN
1016	CS
1017	Saf-Smoke™
1017B	Saf-Smoke™ Blue
1067G	Saf-Smoke™ Green
1017R	Saf-Smoke™ Red
1017Y	Saf-Smoke™ Yellow

NON-PYROTECHNIC CHEMICAL GRENADES

Defense Technology® offers a large assortment of grenades providing munitions for most any tactical situation. These non-pyrotechnic chemical grenades provide heavy concentrations of payload that immediately contaminate the area and are non-flammable and safe for indoor usage.



AEROSOL OC VAPOR

- Delivers a very high concentration of agent in a powerful mist and requires very minimal decontamination
- Removing the subject from the affected area to fresh air resolves respiratory effects within minutes

OC INERT



INSTANTANEOUS BLAST

- Upon initiation of the detonator there is enough force to split at six machined grooves on the outside surface of the canister expelling the powder payload
- Well suited for affecting numerous subjects grouped within a contained area, using wind to the advantage

OC CN CS INERT



FLAMELESS EXPULSION

- This compact grenade features a CO₂ cartridge which utilizes the released pressure to expel the powder payload
- Most commonly used in tactical deployments by law enforcement or corrections and can affect a confined area of up to approximately 1,500 sq ft.

OC CN CS INERT



OC AEROSOL FOGGER

- Delivers a payload of 1.3 MC% in less than 15 seconds and is ideal for area denial areas such as attics or garages with minimal cleanup
- Available in 1 oz. and 6 oz. canisters

OC INERT

Aerosol OC Vapor

1056 OC Vapor
1055 Inert Vapor

Instantaneous Blast

1040 OC
1041 CN
1042 CS
1043 Inert / Practice

Flameless Expulsion

2040 OC
2041 CN
2042 CS
2043 Inert / Practice

OC Aerosol Fogger

56814 1.3% 1 oz.
56854 1.3% 6 oz.
56544I Inert 1 oz.
56594I Inert 6 oz.

OC/CS Aerosol

1050 OC/CS (Not Shown)



BODY WORN CAMERAS
CONCEALABLE ARMOR
TACTICAL ARMOR
COMMUNICATIONS
PATROL BIKE
DUTY GEAR/HOLSTERS
PROTECTIVE GEAR
FIREARMS ACCESSORIES
LESSL
PERFORMANCE APPAREL
SURVIVABILITY SYSTEMS
FORENSICS
ARMOR SYSTEMS
TRAINING GROUP

PYROTECHNIC CHEMICAL PROJECTILES



SKAT SHELL® 40MM & 37MM PYROTECHNIC CHEMICAL MUNITIONS

- Delivers four or five pyrotechnic sub-munitions
- Can be launched to 100 yards
- Force multiplier for mobile field force teams
- Affects a wider area at once

OC CN CS SMOKE



SPEDE-HEAT™ SHORT RANGE 37MM PYROTECHNIC CHEMICAL MUNITIONS

- Single dual-ported short range canister will travel 75 yards
- Available with either a chemical payload or Saf-Smoke™
- Allows for an effective and rapidly developed release line regardless of your position relative to the target group

OC CN CS SMOKE



SPEDE-HEAT™ LONG RANGE 40MM & 37MM PYROTECHNIC CHEMICAL MUNITIONS

- Single dual-ported long range canister will travel 150 yards
- 37mm available with either a chemical payload, colored or Saf-Smoke™
- 40mm only available with chemical payload or Saf-Smoke™
- Allows for an effective and rapidly developed release line regardless of your position relative to the target group

OC CN CS SMOKE



GROUND MARKER 40MM PYROTECHNIC CHEMICAL MUNITIONS

- Delivers pyrotechnic smoke or irritant payload downrange at 100, 200 or 300 meters
- Available with a chemical payload, Saf-Smoke™ or colored smoke
- Applications for this product include crowd direction and control, marking and obscuration

OC CN CS SMOKE

Skat Shell® 40mm

6170	OC
6171	CN
6172	CS
6173	Saf-Smoke™

Skat Shell™ 37mm

1170	OC
1171	CN
1172	CS
1173	Saf-Smoke™

Spede-Heat™ 37mm Short Range

2000	OC
2001	CN
2002	CS
2003	Saf-Smoke™

Spede-Heat™ 37mm Long Range

1187	OC
1181	CN
1182	CS
1183	Saf-Smoke™
1184	Green
1185	Red

Spede-Heat™ 40mm Long Range

6180	OC
6181	CN
6182	CS
6183	Saf-Smoke™

Ground Marker 100m

6480	OC
6482	CS
6483	Saf-Smoke™

Ground Marker 200m

6580	OC
6582	CS
6583	Saf-Smoke™

Ground Marker 300m

6680	OC
6682	CS
6683	Saf-Smoke™



NON-PYROTECHNIC CHEMICAL PROJECTILES

BODY WORN CAMERAS | CONCEALABLE ARMOR | TACTICAL ARMOR | COMMUNICATIONS | PATROL BIKE | DUTY GEAR/HOLSTERS | PROTECTIVE GEAR | ACCESSORIES | FIREARMS | **LETHAL** | PERFORMANCE APPAREL | SURVIVABILITY SYSTEMS | FORENSICS | ARMOR SYSTEMS | TRAINING GROUP



FERRET® BARRICADE PENETRATOR

LIQUID & POWDER

- Available in 37mm, 40mm and 12-Gauge
- Frangible projectile filled with chemical agent
- Upon impacting a barrier, the nose cone ruptures and instantaneously delivers the agent payload inside a structure

OC CN CS INERT

Ferret® Liquid



37MM OR 40MM



12-GAUGE

Ferret® Powder



37MM OR 40MM



12-GAUGE

Ferret® Liquid

1260	40mm OC
1261	40mm CN
1262	40mm CS
1263	40mm Inert
1160	37mm OC
1161	37mm CN
1162	37mm CS
1163	37mm Inert
3010	12-Ga OC
3011	12-Ga CN
3012	12-Ga CS
3013	12-Ga Inert

Ferret® Powder

1290	40mm OC
1291	40mm CN
1292	40mm CS
1293	40mm Inert
1190	37mm OC
1191	37mm CN
1192	37mm CS
1193	37mm Inert
3090	12-Ga OC
3091	12-Ga CN
3092	12-Ga CS
3093	12-Ga Inert

Muzzle Blast Powder

6040	40mm OC
6041	40mm CN
6042	40mm CS
6043	40mm Inert
6240	37/40mm OC
6241	37/40mm CN
6242	37/40mm CS
6243	37/40mm Inert
1140	37mm OC
1141	37mm CN
1142	37mm CS
1143	37mm Inert
3040	12-Ga OC
3041	12-Ga CN
3042	12-Ga CS
3043	12-Ga Inert

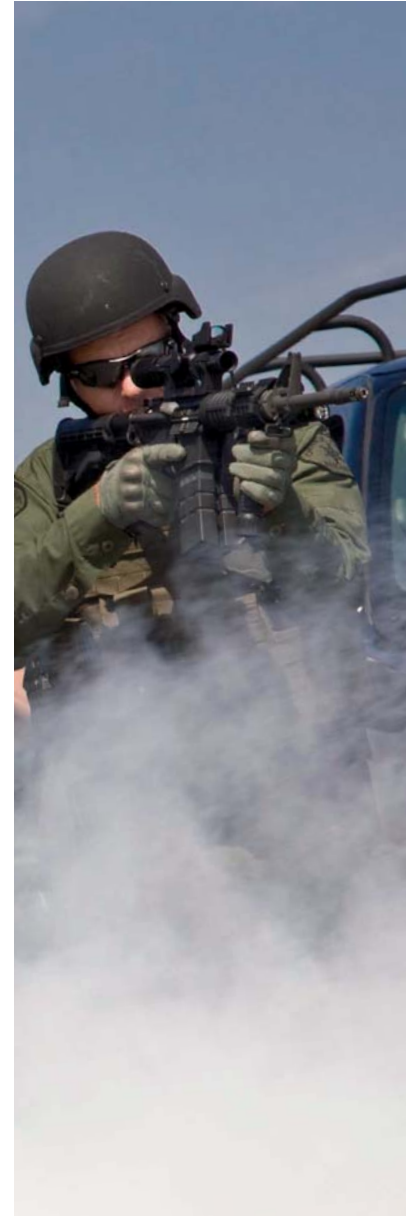

MUZZLE BLAST

12-GAUGE, 37MM, 37/40MM & 40MM

- Available in 12-Gauge, 37mm, 37/40mm & 40mm
- Deploys a heavy concentration of agent directly on suspect or to area
- Immediately contaminates the area

OC CN CS INERT



12-GAUGE



37MM



40MM

TACTICAL DEVICES



LOW ROLL™ 12-GRAM DISTRACTION DEVICE®

- Produces 175 dB of sound output at 5 ft.
- Produces 6 - 8 million candelas for 10 milliseconds
- Utilizes standard military-style M201A1 fuze
- Hex design reduces rolling when deployed
- Available in both non-reloadable and reloadable options

Low Roll™ Distraction Device®

8902NR	Non-Reloadable Low Roll™
8902NRSC	Non-Reloadable Low Roll™ with Safety Clip
8933	Low Roll™ Reloadable DD Body

Low Roll II™ Distraction Device®

8922	Non-Reloadable Low Roll II
8922NRSC	Non-Reloadable Low Roll II with Safety Clip

Distraction Device® Reloads

8901	12-Gram Reload
8901SC	12-Gram Reload with Safety Clip
7001CI	12-Gram Command Initiated Reload
8907CI	4-Gram Command Initiated Reload
8908CI	8-Gram Command Initiated Reload



LOW ROLL II™ 11-GRAM DISTRACTION DEVICE®

- Produces 175 dB of sound output at 5 ft.
- Produces 6 - 8 million candelas for 10 milliseconds
- Utilizes standard military-style M201A1 fuze
- Smaller profile, superior performance
- Hex design reduces rolling when deployed
- Only available in non-reloadable option



DISTRACTION DEVICE® RELOADS

RELOADABLE DISTRACTION DEVICE®

Defense Technology® offers a variety of reload options for Distraction Device® munitions.

- Produces 175 dB of sound output at 5 ft.
- Produces 6 - 8 million candelas for 10 milliseconds
- Utilizes standard military-style M201A1 fuze
- 7001CI intended for use with WallBanger™
- 7007 reduced charge 4-Gram reload for training purposes



Distraction Device®
Reload



Distraction Device®
Reload w/Safety Clip



12-Gram Command
Initiated Reload



Reduced Charge
4-Gram Reload

TACTICAL DEVICES



LOW ROLL™ TRAINING SIMULATOR

This reloadable training simulator is similar in fit, weight, delay time and deployment procedures to our Low Roll™ Distraction Device® models. It provides a safe way to introduce operators to the use of the Defense Technology® Low Roll Distraction Device product. The reloadable pneumatic simulator will deliver 130 dBA of sound output at 5 ft. while not producing any flame, spark, light, heat or marring to the deployment environment.

- Safest way to teach how to deploy a Distraction Device® model
- Designed for force-on-force training in “live” environments
- For use in schools, offices, mass transit
- Low cost allows for increased training opportunities on a set budget



Low Roll™ Training Simulator

8950AS	Starter Kit
8952AS	Maintenance Kit
8953AS	Simulator Only
8954AS	32 Endcaps & Pull Rings

Low Roll/Low Roll II™ Training Bodies, Fuzes & Reloads

8933T	Low Roll Training Body
1697T	Training Fuze
1697TSC	Training Fuze with Safety Clip
7007	4-Gram Reload
7007SC	4-Gram Reload with Safety Clip
7008TC	Distraction Device® Body Thread Cleaner (Not Shown)



LOW ROLL™ / LOW ROLL II™ TRAINING BODY & FUZE

- Same weight and function as the live Low Roll™ or Low Roll II™ munitions
- Color-coded military training blue
- Low cost allows for increased training opportunities on a set budget
- 8933T and 8922T bodies only accept the 1697T & 1697TSC Training Fuzes
- Non-ATF controlled item
- Delivers 120 dB of sound output at 5 ft.

TRAINING FUZE

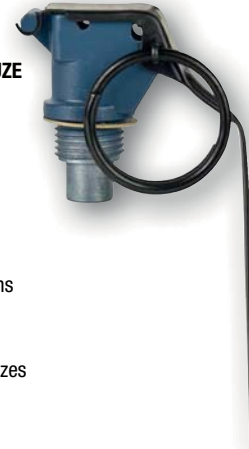

CLEANING / MAINTENANCE



7009

DELUXE CLEANING / MAINTENANCE KIT

- Kit includes: nylon utility brush, cleaner handle, small bore brush, 15/16” wrench, large bore brush, tweezers, thread cleaner and Break Free® CLP® cleaner
- Complete cleaning kit for Distraction Device® units

7002

DD BODY CLEANING KIT

- Kit includes: 15/16” wrench, tweezers and brush
- Simple field expedient cleaning kit



TACTICAL DEVICES



STINGER® RUBBER BALL GRENADES

- Maximum effect device delivering three stimuli for psychological and physiological effects: rubber pellets, light and sound
- Widely used by law-enforcement and corrections for crowd management and compliance
- Available with 32 Cal. or 60 Cal. Rubber Balls

OC CS



RUBBER BALL BLAST GRENADES

- Maximum effect device delivering three stimuli for psychological and physiological effects: light, sound and payload
- Widely used by law enforcement and corrections for crowd management and compliance

OC CN CS INERT



12-GAUGE MUZZLE BANG / LAUNCHING CARTRIDGE

- Muzzle Bang produces 170 dB of sound output
- Crowd control use for warning, intimidation or diversion
- Launching cartridge used in conjunction with 1370 Launching Cup
- Project Pocket Tactical Grenades further than hand throwing



TKO 12-GAUGE BREACHING ROUND

- Disintegrates on contact
- Instantly delivers full energy to door / lock as it turns to dust
- Safe to use at close distances

Stinger® Rubber Ball Grenades

1087	60 Cal. Rubber Balls
1087SC	60 Cal. Rubber Balls with Safety Clip
1088	32 Cal. Rubber Balls with CS Payload
1088SC	32 Cal. Rubber Balls with CS Payload & Safety Clip
1089	32 Cal. Rubber Balls with OC Payload
1089SC	32 Cal. Rubber Balls with OC Payload & Safety Clip
1090	32 Cal. Rubber Balls
1090SC	32 Cal. Rubber Balls with Safety Clip

Rubber Ball Blast Grenades

1095	Rubber Ball Blast with OC
1095SC	Rubber Ball Blast with OC & Safety Clip
1096	Rubber Ball Blast with CN
1096SC	Rubber Ball Blast with CN & Safety Clip
1097	Rubber Ball Blast with CS
1097SC	Rubber Ball Blast with CS & Safety Clip
1098	Rubber Ball Blast with Inert Powder
1098SC	Rubber Ball Blast with Inert Powder & Safety Clip

12-Gauge Tactical

1210	12-Gauge Muzzle Bang/Launching Cartridge
3105	TKO 12-Gauge Breaching Round

TACTICAL DEVICES



8930 TYPE 3 MAGAZINE, DD TRANSPORT BOX

- ATF Compliant Type 3 Magazine
- Constructed of 11-Gauge steel
- Lined with ½" Masonite-type hardboard
- 1" side overlap of door
- Locking mechanism is compatible with a 3/8" diameter shackle
- Designed for two designated explosive devices



COMMAND INITIATED RELOAD

- Command Initiated fuze for WallBanger™ or break and rake missions
- Produces 175 dB of sound output
- Produces 6 – 8 million candelas for 10 milliseconds

Command Initiated Reload

7030	Staging Spike (Not Shown)
7020	20' Thermo Tubing (Not Shown)
7001CI	Command Initiated 12-Gram Reload
8907CI	Command Initiated 4-Gram Reload (Not Shown)
8908CI	Command Initiated 8-Gram Reload (Not Shown)



7040 INITIATOR



7023 SPLICING TUBES (30 PACK)



150944 1000' THERMO TUBE

- Thermo tube provides stand-off capabilities

7001CI 12-GRAM COMMAND INITIATED RELOAD

BODY WORN CAMERAS | CONCEALABLE ARMOR | TACTICAL ARMOR | COMMUNICATIONS | PATROL BIKE | DUTY GEAR/HOLSTERS | PROTECTIVE GEAR | FIREARMS ACCESSORIES | LESS LETHAL | PERFORMANCE APPAREL | SURVIVABILITY SYSTEMS | FORENSICS | ARMOR SYSTEMS | TRAINING GROUP

LAUNCHERS

Renowned for its smooth single action and reliability, the Defense Technology® launchers are a recognized platform in the less lethal arena. Whether for crowd management, tactical deployment, or first responders, this family of launchers provides accuracy, quality and value.



1425

40MM TACTICAL SINGLE LAUNCHER

- Lightweight (3.5lbs)
- Low cost
- Lateral single point sling mount
- Adjustable integrated front grip/light rail
- Picatinny top rail w/bead sight
- Single/Double action S&W trigger group
- Ambidextrous breech release
- 14" barrel
- Precision manufactured by Lewis Machine & Tool exclusively for Defense Technology
- NTOA member tested and recommended



Launchers

1425	40mm Single w/ Expandable Stock
1426	40mm Single w/ Folding Stock
1427	40mm Single w/ Pistol Grip

Also available in 9" or 11" Barrels and Selected Colors for Cerakote™ Barrels or Stocks



1440

40MM TACTICAL 4-SHOT LAUNCHER

- Lightweight
- Low cost tactical 4-shot cylinder
- Pump action advance
- Quad rail
- Single/Double action S&W trigger group with safety mechanism
- Ambidextrous breech release
- Precision manufactured by Lewis Machine & Tool exclusively for Defense Technology
- NTOA member tested and recommended

Launchers

1440	40mm Tactical 4-Shot
------	----------------------

LAUNCHERS



1415 37MM TACTICAL SINGLE LAUNCHER

- Lightweight (3.5lbs)
- Low cost
- Lateral single point sling mount
- Adjustable integrated front grip/light rail
- Picatinny top rail w/bead sight
- Single/Double action S&W trigger group
- Ambidextrous breech release
- 14" barrel
- Precision manufactured by Lewis Machine & Tool exclusively for Defense Technology
- NTOA member tested and recommended

Launchers

1415	37mm Single w/ Expandable Stock
1416	37mm Single w/ Folding Stock
1417	37mm Single w/ Pistol Grip

Also available in Selected Colors for Cerakote™ Barrels or Stocks



1820 LAUNCHER CARRY SYSTEM BAG

- Multi-function bag for grenadier officer
- Able to carry single or multi-launcher
- For tactical or mobile field force deployments
- Safariland® MLS, QLS, ELS Quick Attachment System compatible
- Choose one of two Accessory Pouch Kits (sold separately) to complete system

OLIVE

BLACK

LCS / Accessory Pouch Kits

1821	Accessory Pouch Kit #1 Black
1831	Accessory Pouch Kit #1 Olive
1822	Accessory Pouch Kit #2 Black
1832	Accessory Pouch Kit #2 Olive
1820	Launcher Carry System Bag Black
1830	Launcher Carry System Bag Olive

1821 ACCESSORY POUCH KIT #1

- Gas mask pouch
- 32 – 37/40mm munitions pouches
- Two – grenade pouches

OLIVE

BLACK



MILITARY MUNITIONS

The Defense Technology® brand continues to deliver reliable and effective tools to meet the challenges of asymmetrical warfare. From our military sponsored 40mm eXact iMPact™ round, to our smoke devices and 12-gauge less lethal impact rounds, our products are manufactured to exacting specifications and quality standards. Defense Technology® is the leading provider of non-lethal munitions to the US Military, including 5 Type-classified products.



M1012/3021M

12-GAUGE NL POINT CONTROL CARTRIDGE

- Direct fire, short range 12-Gauge round
- Fin stabilized accuracy
- Specifically developed for routing, protecting chemical devices or targeting instigators

NSN# 1305-01-470-2405

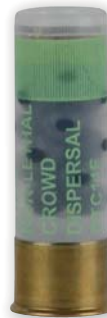

M1013/3020M

12-GAUGE NL CROWD DISPERSAL CARTRIDGE

- Direct fire, short range 12-Gauge round
- Obtain compliance from a safe distance
- Specifically developed for routing, protecting chemical devices

NSN# 1305-01-470-2139



M1029/6095M

40MM NL CROWD DISPERSAL CARTRIDGE

- The custom 48 cal. rubber balls have increased weight and mass
- Direct / indirect fire munitions deliver massive pain compliance

NSN# 1310-01-475-0628



XM1116/3028M

12-GAUGE NL EXTENDED RANGE DRAG STABILIZED™, MARKING CARTRIDGE

- Highly accurate regardless of heat or cold conditions
- Designed for location with pre-set stand-off distances
- Drag Stabilized™ round delivers impressive energy at all effective ranges

NSN# 1305-01-536-1520



XM1091/6326M

40MM NL EXTENDED RANGE MARKING CARTRIDGE

- Direct fire munitions with payload options
- Unmatched accuracy out to 100 meters
- Crushing nose dampens blunt trauma while delivering payload

NSN# 1310-01-536-1536



M1030/3105M

12-GAUGE SHOTGUN BREACHING CARTRIDGE

- Disintegrates on contact
- Delivers enormous energy to locks / doors
- Safe to use at close distances
- Indoor / outdoor deployment

NSN# 1305-01-475-7440

MILITARY MUNITIONS

BODY WORN CAMERAS | CONCEALABLE ARMOR | TACTICAL ARMOR | COMMUNICATIONS | PATROL BIKE | DUTY GEAR/HOLSTERS | PROTECTIVE GEAR | FIREARMS ACCESSORIES | LESS LETHAL | PERFORMANCE APPAREL | SURVIVABILITY SYSTEMS | FORENSICS | ARMOR SYSTEMS | TRAINING GROUP

M37/5846

DISPENSER, RIOT CONTROL AGENT, MID-SIZE

- Military version of a portable, high output aerosol system
- Accessory wands provide greater delivery options
- Refillable dispenser increases readiness in the field
- Indoor / outdoor deployable

NSN# 1040-01-463-0157



COLORED SMOKE GRENADES

- High volume pyrotechnic grenades
- Delivers large plumes of smoke
- Utilizes standard fuze
- Launching capabilities utilizing Defense Technology® launching cups
- Outdoor deployment

Colored Smoke Grenades

1064	Blue (NSN# 1330-01-541-4960)
1065	Green (NSN# 1330-01-541-4961)
1067	Red (NSN# 1330-01-541-6862)
1069	Yellow (NSN# 1330-01-541-4959)



XM104/1090M STINGER® RUBBER BALL GRENADE

- An area deployment device
- Maximum stimulus overload via light, sound, and impact delivery



COURTESY US MILITARY

PROTECT AND RESTRAIN



LESS LETHAL



The Monadnock® brand has a rich history of pioneering state-of-the-art American-made batons and training aids that has defined the way law enforcement professionals operate, train with and purchase batons for more than a half century. Our heritage and expertise focuses on our primary objective: providing the highest quality products to the men and women who depend on them every day.

Additionally, Monadnock now offers the legendary Hiatt® brand of metal restraints, along with riot control suits and accessories in both hard and soft shell versions, offering a one-stop-shop for protective less lethal gear. There's a reason Monadnock products are the preferred choice of law enforcement professionals around the world – we simply build our products better.



AUTOLOCK® X3™ HG BATONS

The Monadnock® AutoLock® X3™ HG incorporates improvements found in the AutoLock X3™ series of batons, along with larger diameter shafts for those who prefer a baton with a stouter feel. Some of the features found in the X3 HG are an integrated nose guide for more efficient holstering and grip protection, improved positive locking design for reliability, a more stable feel with tightened tolerances and a corrosion-resistant finish and components.

SAFETY TIP®

NEW

BLACK ELECTROLESS NICKEL FINISH

Improves corrosion resistance on the inside and outside of the baton

Made in the
USA

SMOOTH NOSE PIECE

Featured on the baton handle for more efficient holstering and transition from the holster to the hand

IMPROVED POSITIVE LOCKING DESIGN

An updated cam and stainless steel ball bearing design offers reliably consistent locking action and a more solid feel in the hand when performing or demonstrating techniques

STANDARD END CAP

The patented AutoLock® baton features a push button in the end cap to easily close the baton after it has been deployed

SUPER GRIP® HANDLE

PATENTED

LIMITED REPAIR OR
REPLACEMENT WARRANTY

AUTOLOCK® X3™ HG

Model	Length	Weight	Finish	Grip Style	Tip Style	End Cap Style	Holder Plain
9643	21" (53.34cm)	17 oz. (.48 kg)	Black Electroless Nickel	Super Grip®	Safety Tip®	Standard	3080

AUTOLOCK® X3™ BATONS

The Monadnock® AutoLock® X3™ expandable baton improves its original positive locking design with notable improvements which include an updated cam and stainless steel ball bearing design which offers reliably consistent locking action. A more solid feel in the hand when performing or demonstrating techniques and a new smooth plastic nose on the baton handle for more efficient holstering and transition from the holster to the hand. New blackened electroless nickel finish improves corrosion resistance on the inside and outside of the baton.

AUTOLOCK™ X3

TIP OPTIONS

Available with either a Safety Tip®, 3xT Tactical Targeting Tip, or a Power Safety Tip® (shown here)

BLACK ELECTROLESS NICKEL FINISH

Improves corrosion resistance on the inside and outside of the baton

SMOOTH PLASTIC NOSE

Featured on the baton handle for more efficient holstering and transition from the holster to the hand

IMPROVED POSITIVE LOCKING DESIGN

An updated cam and stainless steel ball bearing design offers reliably a reliably consistent locking action and more solid feel in the hand when performing or demonstrating techniques

Made in the USA

END CAP OPTIONS

The patented AutoLock® baton features a push button in the end cap to easily close the baton after it has been deployed

Baton is shown with optional Wedge™ Baton Cap accessory

Hindi Baton Cap™ accessory also available

GRIP OPTIONS

Available with either Super Grip® (shown here) or firm Foam Grip

9870

PATENTED

LIMITED REPAIR OR REPLACEMENT WARRANTY

AUTOLOCK® X3™

Model	Length	Weight	Finish	Grip Style	Tip Style	End Cap Style	Holder Plain	Holder Basketweave
9865	16" (40.64cm)	17 oz. (.48 kg)	Black Electroless Nickel	Foam Grip	Safety Tip®	Standard	3042	3642
9866	16" (40.64cm)	17 oz. (.48 kg)	Black Electroless Nickel	Super Grip®	Safety Tip	Standard	3042	3642
9867	16" (40.64cm)	17 oz. (.48 kg)	Black Electroless Nickel	Foam Grip	Safety Tip	Wedge	3042	3642
9868	16" (40.64cm)	17 oz. (.48 kg)	Black Electroless Nickel	Super Grip®	Safety Tip	Wedge	3042	3642
9869	18" (45.72cm)	19 oz. (.54 kg)	Black Electroless Nickel	Foam Grip	Power Safety Tip®	Standard	3042	3642
9870	18" (45.72cm)	19 oz. (.54 kg)	Black Electroless Nickel	Super Grip	Power Safety Tip	Standard	3042	3642
9871	18" (45.72cm)	19 oz. (.54 kg)	Black Electroless Nickel	Foam Grip	Power Safety Tip	Wedge	3042	3642

BODY WORN CAMERAS | CONCEALABLE ARMOR | TACTICAL ARMOR | COMMUNICATIONS | PATROL BIKE | DUTY GEAR/HOLSTERS | PROTECTIVE GEAR | FIREARMS ACCESSORIES | LETHAL | PERFORMANCE APPAREL | SURVIVABILITY SYSTEMS | FORENSICS | ARMOR SYSTEMS | TRAINING GROUP

AUTOLOCK® X3™ BATONS

AUTOLOCK® X3™ (CONTINUED)

Model	Length	Weight	Finish	Grip Style	Tip Style	End Cap Style	Holder Plain	Holder Basketweave
9872	18" (45.72cm)	19 oz. (.54 kg)	Black Electroless Nickel	Super Grip®	Power Safety Tip®	Wedge	3042	3642
9850	21" (53.34cm)	19 oz. (.54 kg)	Black Electroless Nickel	Foam Grip	Safety Tip®	Standard	3030	3630
9851	21" (53.34cm)	19 oz. (.54 kg)	Black Electroless Nickel	Super Grip	Safety Tip	Standard	3030	3630
9852	21" (53.34cm)	19 oz. (.54 kg)	Black Electroless Nickel	Foam Grip	Safety Tip	Wedge	3030	3630
9853	21" (53.34cm)	19 oz. (.54 kg)	Black Electroless Nickel	Super Grip	Safety Tip	Wedge	3030	3630
9860	22" (55.88cm)	22 oz. (.62 kg)	Black Electroless Nickel	Foam Grip	Power Safety Tip	Standard	3034	3634
9861	22" (55.88cm)	22 oz. (.62 kg)	Black Electroless Nickel	Super Grip	Power Safety Tip	Standard	3034	3634
9862	22" (55.88cm)	22 oz. (.62 kg)	Black Electroless Nickel	Foam Grip	Power Safety Tip	Wedge	3034	3634
9863	22" (55.88cm)	22 oz. (.62 kg)	Black Electroless Nickel	Super Grip	Power Safety Tip	Wedge	3034	3634
9873	26" (66.04cm)	24 oz. (.68 kg)	Black Electroless Nickel	Foam Grip	Power Safety Tip	Standard	3056	3656
9874	26" (66.04cm)	24 oz. (.68 kg)	Black Electroless Nickel	Super Grip	Power Safety Tip	Standard	3056	3656
9875	26" (66.04cm)	24 oz. (.68 kg)	Black Electroless Nickel	Foam Grip	Power Safety Tip	Wedge	3056	3656
9876	26" (66.04cm)	24 oz. (.68 kg)	Black Electroless Nickel	Super Grip	Power Safety Tip	Wedge	3056	3656

AUTOLOCK® HG (HEAVY GAUGE) BATONS

Made in the
USA

BLACK CHROME FINISH

POWER SAFETY TIP®

The Power Safety Tip® provides a weight-forward balance and the ability to draw the baton in a passive manner

END CAP OPTIONS

The patented AutoLock® baton features a push button in the end cap to easily close the baton after it has been deployed

Choose from the optional Wedge™ Baton Cap or Hindi Baton Cap™ accessories for enhanced baton retention

GRIP OPTIONS

Available with either Super Grip® (shown here) or firm Foam Grip

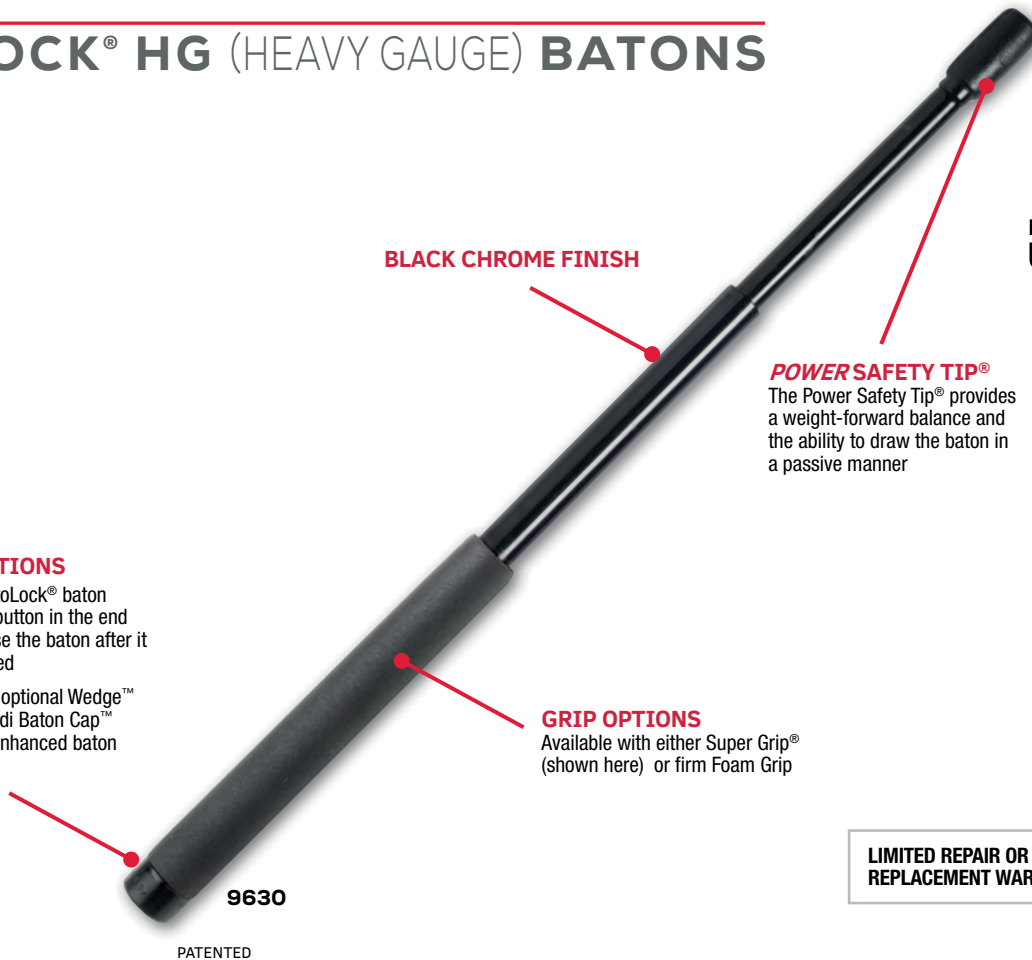

LIMITED REPAIR OR REPLACEMENT WARRANTY

AUTOLOCK™ HG BLACK CHROME FINISH

Model	Length	Weight	Finish	Grip Style	Tip Style	Holder Plain
9630	22" (55.88cm)	21 oz. (.57kg)	Black Chrome	Foam Grip	Power Safety Tip®	3084
9641R	21" (53.34cm)	18 oz. (.51kg)	Black Chrome	Super Grip®	Safety Tip®	3080

AUTOLOCK® BATONS



TIP OPTIONS

Available with either a Safety Tip®, 3xT Tactical Targeting Tip, or a Power Safety Tip® (shown here)

FINISH OPTIONS

Available with Nickel (shown here) or Black Chrome

Made in the USA

END CAP OPTIONS

The patented AutoLock® baton features a push button in the end cap to easily close the baton after it has been deployed

Choose from the optional Wedge™ Baton Cap or Hindi Baton Cap™ accessories for enhanced baton retention

POSITIVE LOCKING DESIGN

The patented cam and ball-bearing locking mechanism ensures the baton will stay locked open while striking, blocking or jabbing

GRIP OPTIONS

Available with either firm Foam Grip (shown here) or Super Grip®

9230

PATENTED

LIMITED REPAIR OR REPLACEMENT WARRANTY

AUTOLOCK®

Model	Length	Weight	Finish	Grip Style	Tip Style	Holder Plain	Holder Basketweave
9170	18" (45.72cm)	19 oz. (.54kg)	Black Chrome	Foam Grip	Power Safety Tip®	3042	3642
9172	18" (45.72cm)	19 oz. (.54kg)	Black Chrome	Super Grip®	Power Safety Tip	3042	3642
9120	21" (53.34cm)	19 oz. (.54kg)	Black Chrome	Foam Grip	Safety Tip®	3030	3630
9141	21" (53.34cm)	19 oz. (.54kg)	Black Chrome	Super Grip	Safety Tip	3030	3630
9130	22" (55.88cm)	22 oz. (.62kg)	Black Chrome	Foam Grip	Power Safety Tip	3034	3634
9152	22" (55.88cm)	22 oz. (.62kg)	Black Chrome	Super Grip	Power Safety Tip	3034	3634
9121	26" (66.04cm)	24 oz. (.68kg)	Black Chrome	Foam Grip	Power Safety Tip	3056	3656
9146	26" (66.04cm)	24 oz. (.68kg)	Black Chrome	Super Grip	Power Safety Tip	3056	3656
9220	21" (53.34cm)	19 oz. (.54kg)	Nickel	Foam Grip	Safety Tip	3030*	3630
9241	21" (53.34cm)	19 oz. (.54kg)	Nickel	Super Grip	Safety Tip	3030*	3630
9230	22" (55.88cm)	22 oz. (.62kg)	Nickel	Foam Grip	Power Safety Tip	3034*	3634
9252	22" (55.88cm)	22 oz. (.62kg)	Nickel	Super Grip	Power Safety Tip	3034*	3634

*DESIGNATE 45 DEGREE LOCKING HOLDER WITH /L AFTER PART NUMBER

BODY WORN CAMERAS | CONCEALABLE ARMOR | TACTICAL ARMOR | COMMUNICATIONS | PATROL BIKE | DUTY GEAR/HOLSTERS | PROTECTIVE GEAR | FIREARMS ACCESSORIES | LESS LETHAL | PERFORMANCE APPAREL | SURVIVABILITY SYSTEMS | FORENSICS | ARMOR SYSTEMS | TRAINING GROUP

BATON TRAINING / SERVICE

THE SAFARILAND TRAINING GROUP

MONADNOCK® EXPANDABLE BATON

(MEB) INSTRUCTOR COURSE

This dynamic two-day course is like no other because it provides you with useful defensive skills in all three zones of defense, especially for close quarter battles (CQB). It relies heavily on practical hands-on applications and is intended for first responders who want instruction in the proper uses of straight batons (expandable or rigid) used for self-defense and subject-control, for escort and handcuffing.

Contact the Safariland Training Group for details to take or host this course.



6500

AUTOLOCK® STARTER SERVICE KIT

- Kit allows you to service, repair and maintain the AutoLock baton when necessary
- Kit includes all relevant replacement parts including releases, rods, springs, cams, pliers and ball bearings
- Available for 16"/18", 21"/22", and 26" options

6500

FULL SERVICE KITS

- Also available for 6500-16/18", 6500-21-22" and 6500-26" options



CLASSIC FRICTION LOCK BATONS

Classic Friction **LOCK** BATONS



STANDARD STEEL TIP

FINISH OPTIONS

Mariner Series available in Nickel or Detective® Series available in Black Chrome (shown here)

Made in the
USA

END CAP OPTIONS

Standard Bore Guide End Cap centers the tip and shaft over an internal retention spring. Due to the reliable design of these batons, repairs are rarely needed

Choose from the optional Wedge Baton Cap™ or Hindi Baton Cap™ accessories for enhanced baton retention

FRICTION LOCKING TECHNOLOGY

The use of precision dies forms concentric tapers which significantly improve the lock open function of Monadnock batons

FOAM GRIP

Offers the highest tear strength allowing for quickest access from the Front Draw Holder

2521

**LIMITED REPAIR OR
REPLACEMENT WARRANTY**

CLASSIC FRICTION LOCK

Model	Length	Weight	Finish	Grip Style	Tip Style	Holder Plain*	Holder Basketweave*
2516	16" (40.64cm)	14 oz. (.40kg)	Black Chrome	Foam Grip	Standard	3025	3625
2521	21" (53.34cm)	17 oz. (.48kg)	Black Chrome	Foam Grip	Standard	3027	3627
2562	21" (53.34cm)	17 oz. (.48kg)	Black Chrome	Super Grip®	Standard	3027	3627
2526	21" (53.34cm)	20 oz. (.57kg)	Black Chrome	Foam Grip	Standard	3027/3032	3627/3632
2530	21" (53.34cm)	17 oz. (.48kg)	Nickel	Foam Grip	Standard	3027	3627
2534	26" (66.04cm)	20 oz. (.57kg)	Nickel	Foam Grip	Standard	3027/3032	3627/3632

*360° LOCKING HOLDER; 45° LOCKING HOLDERS ALSO AVAILABLE

BATON KITS



Made in the
USA

PATROL KITS

- Added savings with three amazing tools in one complete package
 - » AutoLock® 22" Black Chrome Expandable Baton
 - » Bright hard coat Hindi Baton Cap™
 - » Front Draw® Holder made of durable polycarbonate with a clip-on attachment
- Choose from 360° or 45° swivel locking holder models
- Hindi Baton Cap™ adds baton retention and officer confidence
- Choose Foam Grip or Super Grip®
- Includes Power Safety Tip® providing larger, more effective striking force



*Comes with Patrol Kit only



AUTOLOCK® PATROL KIT				
Description	360° Part No.	45° Part No.	Grip	End Cap
AutoLock® 22", BC, Power Safety Tip®, Hindi Baton Cap™	9330	9334	Foam Grip	Hindi Baton Cap
AutoLock 22", BC, Power Safety Tip, Hindi Baton Cap	9352	9354	Super Grip®	Hindi Baton Cap

DUTY KITS

- Save money purchasing these popular baton and holder sets!
 - » AutoLock® 22" Baton w/Power Safety Tip®
 - » Front Draw® 360° swivel locking holder made of durable polycarbonate with a clip-on attachment
- Choose Foam Grip or Super Grip®
- Includes Power Safety Tip providing larger, more effective striking force

AUTOLOCK DUTY KIT			
Description	360° Part No.	Grip	End Cap
AutoLock® 22", BC, Power Safety Tip®	9530	Foam Grip	Standard Cap
AutoLock 22", BC, Power Safety Tip	9552	Super Grip®	Standard Cap

*Same popular kit as above with the exclusion of the Hindi Baton Cap, includes baton and holder only



BATON KITS

Classic Friction LOCK BATONS

PATROL KITS

- Added savings with three amazing tools in one complete package
 - » 21" and 26" Classic Friction Lock Black Chrome Expandable Baton
 - » Standard Steel Tip
 - » Bright hard coat Hindi Baton Cap™
 - » Polycarbonate Front Draw® Holder
- Clip-on polycarbonate holder—choose from 360° or 45° swivel locking models
- Hindi Baton Cap™ adds baton retention and officer confidence
- Choose Foam Grip or Super Grip®

Made in the
USA



*Comes with Patrol Kit only



CLASSIC FRICTION LOCK PATROL KIT

Description	360° Part No.	45° Part No.	Grip	End Cap
Friction Lock 21" BC, Hindi Baton Cap	2620	2680	Foam Grip	Hindi Baton Cap
Friction Lock 26" BC, Hindi Baton Cap	2630	2690	Foam Grip	Hindi Baton Cap

DUTY KITS

- Save money purchasing these popular baton and holder sets!
 - » 21" and 26" Friction Lock Baton w/Standard Tip
 - » Front Draw® 360° swivel locking holder made of durable polycarbonate with a clip-on attachment
- Choose Foam Grip or Super Grip®

CLASSIC FRICTION LOCK DUTY KIT

Description	360° Part No.	Grip	End Cap
Friction Lock 21", Standard Tip	2721	Foam Grip	Standard Cap
Friction Lock 26", Standard Tip	2726	Foam Grip	Standard Cap

*Same popular kit as above with the exclusion of the Hindi Baton Cap, includes baton and holder only



PR-24[®] SIDE-HANDLE BATONS

PR-24[®]
Control Batons

TRUMBULL STOP HANDLE

keeps the baton in your hand and increases baton retention and subject-control holds

BLACK POWDER COAT FINISH

Made in the
USA

POSITIVE LOCKING TECHNOLOGY

When the pin lock is engaged, the PR-24 baton is ready for use and designed for close quarter confrontations

GRIP OPTIONS

Available with either a Knurled Grip (shown here) or firm Foam Grip

Super Grip[®] is available for Control Device models only

1102

LIMITED REPAIR OR
REPLACEMENT WARRANTY

PR-24® SIDE-HANDLE BATONS

1121



PR-24® BLACK ANODIZED

Part No.	Model	Type	Length	Weight	Diameter	Grip Style	Shaft Finish	Holder Plain
1100	PR-24X	Expandable	24" (60.96cm)	24 oz. (.68kg)	1.25" (3.2cm)	Knurled	Black Polycarbonate	3010
1101	PR-24XTS	Expandable	24" (60.96cm)	24 oz. (.68kg)	1.25" (3.2cm)	Knurled	Black Polycarbonate	3010
1102	PR-24FX	Expandable	24" (60.96cm)	31 oz. (.88kg)	1.25" (3.2cm)	Knurled	Black Powder Coat	3010
1105	PR-24NX	Expandable	24" (60.96cm)	31 oz. (.88kg)	1.25" (3.2cm)	Foam	Black Powder Coat	3010
1121	Control Device 21	Expandable	21" (53.34cm)	16 oz. (.45kg)	1" (2.5cm)	Super Grip®	Black Powder Coat	3015
1124	Control Device 24	Expandable	24" (60.96cm)	18 oz. (.51kg)	1" (2.5cm)	Super Grip	Black Powder Coat	3015

1000



PR-24® BLACK POLYCARBONATE

Part No.	Model	Type	Length	Weight	Diameter	Grip Style	Holder Plain	Holder Basketweave
1000	PR-24STS	Rigid	24" (60.96cm)	24 oz. (.68kg)	1-1/4" (3.2cm)	Grenade	3010	N/A
1001	PR-24S	Rigid	24" (60.96cm)	24 oz. (.68kg)	1-1/4" (3.2cm)	Grenade	3010	N/A

THE SAFARILAND TRAINING GROUP

MONADNOCK® PR-24® BATON

INSTRUCTOR COURSE

This intensive two-day instructor-level course provides the student with useful defensive skills in all three zones of defense, especially for close quarter battles (CQB). It relies heavily on practical hands-on applications and is intended for first responders who want instruction in the proper uses of Control Device/PR-24® batons (expandable or rigid) used for self-defense and subject-control, for escort and handcuffing.



SEE INDEX ON PAGE 248 FOR INFORMATION ON CLASSES LISTED THROUGHOUT THIS CATALOG

EXPANDABLE STRAIGHT BATONS

SX & MX SERIES

- Uses a pin and spring to create a mechanical (or positive locking) mechanism that keeps baton open and makes it easy to close
- Baton locks in handle and may be locked in the extended open position with the push of a button
- Weight-forward shaft technology for increased “knock-down” power
- Aluminum polycarbonate composition impervious to rusting
- Model 2502: 24” closed and expands to 36” in the open position; can be used as a straight baton closed and a riot baton in the open position
- Available in either 1 ¼” and 1” diameters

LIMITED REPAIR OR
REPLACEMENT WARRANTY

Made in the
USA

2502



SX EXPANDABLE STRAIGHT BATONS

Part No.	Model	Length	Weight	Diameter	Material	Finish	Grip Style	Holder Plain
2502	SX-24/36 Riot Baton	36” (91.44cm)	24 oz. (.68kg)	1.25” (3.2cm)	Aluminum/Polycarbonate	Black	Knurled	3011
2503	SX-24	24” (60.96cm)	19 oz. (.54kg)	1.25” (3.2cm)	Aluminum/Polycarbonate	Black	Foam	3011

2506



MX EXPANDABLE STRAIGHT BATONS

Part No.	Model	Length	Weight	Diameter	Material	Finish	Grip Style	Holder Plain	Holder Basketweave
2506	MX-21	21” (53.34cm)	13 oz. (.37kg)	1” (2.54cm)	Aluminum	Black	Foam	3006	3606
2507	MX-24	24” (60.96cm)	14 oz. (.40kg)	1” (2.54cm)	Aluminum	Black	Foam	3006	3606

RIGID BATONS

2006



PLP BATONS

- Polycarbonate material provides an extremely durable finish
- Stronger in cold weather and does not warp in heat
- Excellent impact resistance
- Weather and dent resistant, and won't warp, peel or splinter
- 1” diameter

PLP BATONS

Part No.	Model	Length	Weight	Diameter	Material	Finish	Grip Style	Holder Plain	Holder Basketweave
2006	PLP-24	24” (60.96cm)	14.4 oz. (.41kg)	1” (2.5cm)	Polycarbonate	Black	Foam	3006	3606
2007	PLP-26	26” (66.04cm)	15 oz. (.43kg)	1” (2.5cm)	Polycarbonate	Black	Foam	3006	3606
2009	PLP-36	36” (91.44cm)	20.8 oz. (.59kg)	1 1/4” (2.5cm)	Polycarbonate	Black	N/A	3006	3606

RIGID BATONS

LIMITED REPAIR OR
REPLACEMENT WARRANTY

2015



MP BATONS

- Polycarbonate material provides an extremely durable finish
- 1 ¼" diameter; choose from a variety of grips
- Stronger in cold weather and will not warp in heat
- Excellent impact resistance
- Resists denting and won't splinter
- 24", 26", 36" (60.96cm, 66.04cm, 91.44cm)

Made in the
USA

MP BATONS

Part No.	Model	Length	Weight	Diameter	Material	Finish	Grip Style	Holder
2001	MP24	24" (60.96cm)	20 oz. (.57kg)	1.25" (3.2cm)	Polycarbonate	Black	Knurled	3011
2002	MP26	26" (66.04cm)	21.6 oz. (.61kg)	1.25" (3.2cm)	Polycarbonate	Black	Knurled	3011
2003	MP26 (LAPD Style, No Grip)	26" (66.04cm)	21.6 oz. (.61kg)	1.25" (3.2cm)	Polycarbonate	Black	Plain	3011
2004	MP36 Riot Baton	36" (91.44cm)	30 oz. (.85kg)	1.25" (3.2cm)	Polycarbonate	Black	Knurled	3011
2011	36" Riot Baton	36" (91.44cm)	19 oz. (.54kg)	1.25" (3.2cm)	Thermoplastic	Black	Grenade	3011
2015	MPNYPD26 (Thong/Grommet)	26" (66.04cm)	19 oz. (.54kg)	1.25" (3.2cm)	Polycarbonate	Black	Foam	3011
2154	GG-36	36" (91.44cm)	19 oz. (.54kg)	1.25" (3.2cm)	Polycarbonate	Black	Grenade	3011

2906



PERSUADER™

- Lightweight and compact – 5 1/2" in length
- Grooved black polycarbonate with convenient key ring attachment
- Last chance self defense tool

WOOD BATONS

- Traditional design
- Made from a natural hardwood for long-lasting service
- Available with thong

2800



WOOD BATONS

Part No.	Model	Length	Weight	Diameter	Material	Finish	Grip Style	Holder
2800	2800	36" (91.44cm)	18 oz. (.51kg)	1.25" (3.2cm)	Hardwood	Natural	Ring	Ring
2800 /B	2800	36" (91.44cm)	18 oz. (.51kg)	1.25" (3.2cm)	Hardwood	Black	Ring	Ring
2801	2801	26" (66.04cm)	13 oz. (.37kg)	1.25" (3.2cm)	Hardwood	Black	Plain	Ring

BATON ACCESSORIES

Monadnock® offers a wide selection of baton holders in different styles and materials to fit the needs of each of its batons. Safariland® and Bianchi® Duty Gear also offer baton holders for several Monadnock baton styles.

FRONT DRAW® BATON HOLDERS

Made in the
USA

- Designed with clip-on backs specifically for easy removal from a duty belt
- Made from durable polycarbonate, all holders feature a molded tension spring for baton security
- Choose from three models:
 - » 360° with 8 locking position
 - » 45° with 2 locking positions
 - » 90° swivel providing the ability to lock at any preferred angle
- Fits 2.25" (58mm) belt widths



3011

3627

3034

3800

PATENTED

SIDE-HANDLE BATON HOLDER

- Designed with the Safariland® 774BL belt clip and retention clip for cross draw carry (right hand model will sit on left side of body and left hand model sits on right side of body)
- 90° swivel provides the ability to lock at any preferred angle
- Available for both PR-24® and Control Device batons in both left- and right-handed versions
- Unique retention device secures baton by side-handle for security
- Fits 2.25" belt widths



3774



FRONT

CD AND PR HOLDER MODELS CLIP ON BACK NO STRAP

Part No.	Description	Length	Weight	Baton Diameter	Material	Finish
3770	Expandable Baton Holder	3.25" (8.26cm)	1.6 oz. (.045kg)	1" (2.54cm)	STX	Tactical
3771	Expandable Baton Holder	3.25" (8.26cm)	1.6 oz. (.045kg)	1" (2.54cm)	STX	Tactical
3772	Expandable Baton Holder	3.25" (8.26cm)	1.6 oz. (.045kg)	1" (2.54cm)	STX	Basket Weave
3773	Expandable Baton Holder	3.25" (8.26cm)	1.6 oz. (.045kg)	1" (2.54cm)	STX	Basket Weave
3774	Expandable Baton Holder	3.25" (8.26cm)	1.6 oz. (.045kg)	1.25" (3.17cm)	STX	Tactical
3775	Expandable Baton Holder	3.25" (8.26cm)	1.6 oz. (.045kg)	1.25" (3.17cm)	STX	Tactical
3776	Expandable Baton Holder	3.25" (8.26cm)	1.6 oz. (.045kg)	1.25" (3.17cm)	STX	Basket Weave
3777	Expandable Baton Holder	3.25" (8.26cm)	1.6 oz. (.045kg)	1.25" (3.17cm)	STX	Basket Weave

BATON CAPS



6210



6213

PATENTED



Friction Lock style



AutoLock style

PATENTED

HINDI BATON CAP™

- Offers enhanced baton retention and maximum striking power during physical altercations while being safer to the suspect without limiting the use of force

WEDGE™ BATON CAP

- This tapered design offers a natural grip for maximum baton retention while in the field or performing techniques in a training environment



BATON TIP, GRIP AND FINISH OPTIONS

Monadnock batons feature a wide variety of grips, tips and finishes to allow you to choose the tool that best fits your duty requirements.

TIPS



Standard Steel Tip
Allows for opening the baton in a high-profile manner; may gain psychological advantage for officer over subject.



Safety Tip®
Reduces sharp edges; urethane covering allows passive drawing of the baton.



Power Safety Tip®
Engineered to put more weight forward to better balance the baton in the hand and improve kinetic energy transfer at the moment of impact. The larger tip surface may turn a subject's pockets inside out, reducing the risk of getting stuck with sharp objects.



3xT Tactical Training Targeting Tip
Featuring the *Power Safety Tip* that helps criminal justice professionals improve their striking skill because they can clearly see the track of the baton's tip during demonstrations, practice and/or in the street. Lime green only.

GRIPS



Foam Grip
Offers the highest tear strength and allows quick access from the Front Draw® Holder.



Super Grip®
The fluted surface texture provides excellent baton retention in and out of the holder.



Knurled Grip
The knurled grip enhances baton retention while performing strikes, blocks or jabbing techniques.



Grenade Grip
Offers a ridged handle design for a sure grip.

FINISHES



Black Chrome



Polycarbonate



Nickel



Black Anodized Aluminum



Blackened Electroless Nickel



TRAINING AIDS

The finest training aids for the finest products. Proper training with the right tools makes all the difference. Our line of practical training aids significantly enriches learning during practice exercises. Resistance training builds confidence. Our Universal Training Bags and foam batons can be used during dynamic or scenario training to improve skills and reduce the risk of injury.



MONADNOCK® PRACTICE SUIT

- Color-coded based on the escalation-of-trauma charts
- Provides realistic training opportunities
- Easy to put on and take off
- Breathable liner
- Cleans with soap and water



Training batons are recommended for use with static dynamic baton training



STRAIGHT TRAINING BATONS

- High-density, closed-cell foam white training baton
- Flexible design for lower impact while practicing techniques



ULTIMATE STRAIGHT TRAINING BATON

- Durable DuPont™ nylon cover
- 1/2" closed high-density cell foam
- Tip dipped in vinyl
- Energy absorbing construction allows scenarios to be performed with greater ease and comfort



SIDE-HANDLE TRAINING BATON

- High-density, closed-cell white foam training side handle baton
- Flexible for lower impact while practicing techniques



ULTIMATE SIDE-HANDLE TRAINING BATON

- Durable DuPont nylon cover
- 1/2" closed high-density cell foam
- Tip dipped in vinyl
- Energy absorbing construction allows scenarios to be performed with greater ease and comfort

Model	Description	Length	Weight	Diameter
5103	Straight Training Baton	24" (60.96 cm)	9.4 oz.	1.25"
5105	Straight Training Baton	36" (91.44 cm)	9.8 oz.	1.25"
5106	Ultimate Straight Training Baton	24" (60.96 cm)	9 oz.	2"
5101	Side-Handle Training Baton	24" (60.96 cm)	10 oz.	1.25"
5107	Ultimate Side-Handle Training Baton	24" (60.96 cm)	17 oz.	2.25"

Training batons are recommended for use with static dynamic baton training



5006 UNIVERSAL TRAINING BAG 2 (UTB2)

- Features a high-tech Force Deceleration Core to dissipate training blows from knees, elbows, fists or training-baton strikes with ease and comfort
- Offers six hand positions to create multiple target positions around the human body, which develops target acquisition and application skills for more realism in training
- Easy to carry and store



5002 UNIVERSAL TRAINING BAG (UTB)

- Helps bridge the gap between static and dynamic movement in training
- Tactically used for baton physical encounter training:
 - » Simulated training scenarios
 - » Punching, kicking, elbowing, kneeling, etc.
 - » Action-reaction response drills, including unarmed self-defense training and baton training
- Easy to carry and store

CASCO™ BATONS

CASCO™



STANDARD STEEL TIP

FINISH
Carbon steel component shaft with a black wear-resistant finish

Made in the
USA

END CAP OPTIONS
Standard Bore Guide end cap centers the tip and shaft over an internal retention spring. Due to the reliable design of these batons, repairs are rarely needed

FRICTION LOCKING TECHNOLOGY
The use of precision dies forms concentric tapers which significantly improve the lock open function

RUBBERIZED GRIP
for a great hold

1-YEAR LIMITED WARRANTY

CASCO™ FRICTION LOCK BATONS

Model	Length	Weight	Finish	Grip Style	Tip Style	Kit with Holder
7531	16" (40.64 cm)	14 oz. (.40 kg)	Black Gun	Rubber Grip	Standard Steel Tip	
7532	16" (40.64 cm)	14 oz. (.40 kg)	Black Gun	Rubber Grip	Standard Steel Tip	X
7533	21" (53.34 cm)	17 oz. (.48 kg)	Black Gun	Rubber Grip	Standard Steel Tip	
7534	21" (53.34 cm)	17 oz. (.48 kg)	Black Gun	Rubber Grip	Standard Steel Tip	X
7535	26" (66.04 cm)	20 oz. (.57 kg)	Black Gun	Rubber Grip	Standard Steel Tip	
7536	26" (66.04 cm)	20 oz. (.57 kg)	Black Gun	Rubber Grip	Standard Steel Tip	X

BODY WORN CAMERAS | CONCEALABLE ARMOR | TACTICAL ARMOR | COMMUNICATIONS | PATROL BIKE | DUTY GEAR/HOLSTERS | PROTECTIVE GEAR | FIREARMS ACCESSORIES | **LESS LETHAL** | PERFORMANCE APPAREL | SURVIVABILITY SYSTEMS | FORENSICS | ARMOR SYSTEMS | TRAINING GROUP

EXOTECH®

HARD SHELL RIOT CONTROL SYSTEM

The cost-effective, lightweight ExoTech® System offers hard-shell protection without sacrificing mobility and can be quickly donned or doffed with ease for rapid riot control response. Each piece of the ExoTech system fastens and adjusts quickly with durable polypropylene and elastic straps with hook and loop closures, allowing a custom fit for a wide variety of body types. The contour molded polyethylene outer shell provides substantial protection from blunt force trauma.



ECB100

UPPER BODY/SHOULDER

- Polyethylene outer shell
- L2500 EVA foam & 3mm polyethylene plate chest/back/arm padding
- EVA foam & polyethylene plate shoulder padding



OPTIONAL REFLECTIVE LABELS



- 6595** POLICE
- 6596** SHERIFF
- 6597** CORRECTIONS

TS70

HARD-SHELL SHIN GUARD

- Hard polyethylene shells with interior leg-brace support can safely withstand a substantial blow to the leg from non-ballistic weapons or flying debris
- Includes adjustable, removable foot protector
- Non-reflective outer surface



HUEX100

HYDRATION SYSTEM

- Includes bladder and carrier
- High-quality, odorless bladder
- 70 oz. capacity
- Features Bite Me™ revolutionary flow control valve for 360° activation and leak free operation
- Compatible with both ExoTech® and Centurion® Riot Control Systems



EFP150

FOREARM

- Polyethylene outer shell
- EVA foam & polyurethane sponge padding
- Mesh inner lining



ETP200

THIGH & GROIN SECTIONS

- Polyethylene outer shell
- Laminated EVA foam & L2500 EVA foam
- Mesh inner lining



KNP100

NECK PROTECTOR WITH KEVLAR®

- Offers protection for your throat, neck and larynx; designed to be worn with the Centurion™ and / or ExoTech® riot suits
- Design provides heat, abrasion and cut protection
- Comfortable stretch knit construction



KS19

PROTECTIVE SLEEVES WITH KEVLAR®

- 2-ply, 7 oz. 100% KEVLAR® and resists bites, scratches or cuts from sharp objects
- Design provides a moderate amount of heat, abrasion and cut protection
- Excellent for deploying flash bangs

CENTURION™

SOFT SHELL RIOT CONTROL SYSTEM

This protective piece is a must for riot control and cell extractions, effectively protecting the torso and shoulders from blunt force trauma. The lightweight, cellular pad design provides ample protection and allows excellent mobility. Includes attachment points for our HUEX100 Hydration System.



CPX2500 SOFT-SHELL
TORSO PROTECTOR

GP300 SOFT-SHELL
GROIN PROTECTOR

FP100 SOFT-SHELL
FOREARM PROTECTOR

TS70 HARD-SHELL
SHIN GUARD



CENTURION™

OPTIONAL REFLECTIVE LABELS



6595 POLICE



6596 SHERIFF



6597 CORRECTIONS

- Hook and loop compatible
- Dimensions: 3" W x 8 11/16" L x 1/8" D (7.6cm x 22.1cm x .3cm)
- Not shown: State (6772)



CPX2500

CENTURION™ UPPER BODY AND SHOULDER PROTECTION

- Torso protection consists of durable EVA foam with 7mm sponge foam on the interior for comfort
- Shoulder pad features hard-shell plastic plates with durable foam padding
- Will safely absorb blows delivered from blunt objects



TS70

HARD-SHELL SHIN GUARD

- Hard polyethylene shells with interior leg-brace support can safely withstand a substantial blow to the leg from non-ballistic weapons or flying debris
- Includes adjustable, removable foot protector
- Non-reflective outer surface



TPX200

CENTURION™ THIGH/GROIN PROTECTION SYSTEM

- Specifically designed for blunt trauma protection during riot control situations
- Multilayer protective design with 420-denier outer fabric covers hip and thigh areas and has an adjustable and removable groin protector
- Provides excellent shock-absorbing protection, and is flexible and comfortable



GP300

CENTURION™ GROIN PROTECTOR

- Hook and loop fasteners provide groin protection without hindering mobility
- Construction consists of durable EVA foam pads with sponge foam covering on the inside for comfort and surrounded by a black polyester mesh rigging
- Fastens easily to the CPX2500 with 1" elastic and non-elastic straps
- Weight: 8 oz.
- One size fits all

NON-BALLISTIC RIOT SHIELDS

2036H/2448H PEACEKEEPER SHIELD

- Constructed of 4mm shatter-resistant polycarbonate
- Lightweight
- Ambidextrous

2036C/2448C PEACEKEEPER II SHIELD

- Constructed of 4mm shatter-resistant polycarbonate
- Lightweight
- Ambidextrous if rotated 180°
- Comfort-molded cradle handle features high-density foam for comfort and strength



FRONT
Optional Police Decal
Shown



Comfort-Molded Handle

- 2036C: 20" x 36" (50.8cm x 91.4cm)
Weight: 6 lbs.
- 2448C: 24" x 48" (60.9cm x 121.9cm)
Weight: 6.8 lbs.



Triangle Handle

- 2036H: 20" x 36" (50.8cm x 91.4cm)
Weight: 6 lbs.
- 2448H: 24" x 48" (60.9cm x 121.9cm)
Weight: 6.8 lbs.



Optional Sheriff Decal
Shown

2448E CAPTURE SHIELD

Capture Handle
2448E: 24" x 48" (60.9cm x 121.9cm)

NON-BALLISTIC RIOT HELMETS

TR-1000



NON-BALLISTIC RIOT HELMET

- Durable injection-molded polycarbonate shell
- High-retention strap system with flexible chin cup and quick connect release buckle
- High density foam neck protector for added comfort
- Combi-Fit Pad System provides sizing options for most head sizes
- Weight: 3.6 lbs (1.63 kg)

INTEGRATED NON-BALLISTIC RIOT FACE SHIELD

- Molded polycarbonate for clear viewing area
- Brim extends outward for extra clearance to accept gas masks
- Dual liquid barrier which channels liquid back away from lens and away from field of vision
- Meets NIJ standard 0104.02 Riot helmet requirements



THE SAFARILAND TRAINING GROUP

C.E.R.T.

CORRECTIONAL EMERGENCY RESPONSE TEAM BASIC INSTRUCTOR COURSE

Designed for operators and on-scene supervisors, this exciting course teaches students how to operate in a high-risk correctional environment and handle unruly, belligerent and dangerous inmates. It teaches tactics designed for a successful outcome and prepares students to become instructors in those tactics.



DISPOSABLE RESTRAINTS

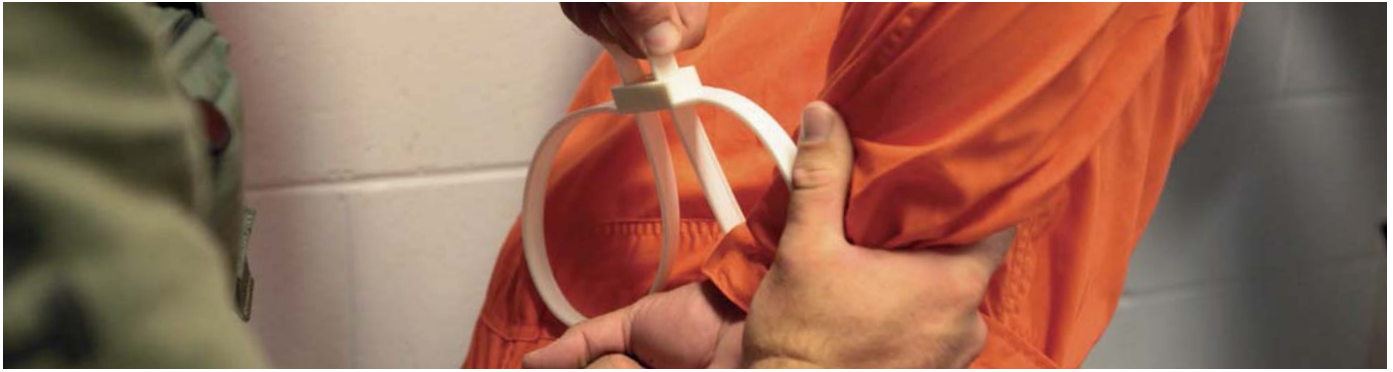

SPARECUFF™



8210-3 SPARE CUFF™

- Standard single cuff for controlling both wrists/forearms and ankles
- 22" (55.88cm) when laid flat
- ½" (1.27cm) wide with beveled edges to reduce potential for subject injury
- Available in quantities of ten

White 10 pack – 8210-3-10
White 100 pack – 8210-3-10B
Black 10 pack – 8210-3-2
Black 100 pack – 8210-3-2B



8210-0 COMPACT SPARE CUFF™

- Compact version of Spare Cuff restraints
- User-friendly and easy to carry and store
- Ideal backup to steel handcuffs; can be carried in pocket, briefcase, glove compartment, etc.
- Available in quantities of three with an included Safety Cutter™

White 3 pack w/Safety Cutter – 8712
Black 3 pack w/Safety Cutter – 8713

DOUBLECUFF™



8220-3 DOUBLE CUFF™

- The Double Cuff feature gives the officer greater control and the ability to stabilize the subject after one cuff is in place
- Two individual cuffs rather than the standard single cuff for controlling both wrists/forearms or ankles
- Standard length is 34" (86.36cm)
- Available in quantities of ten

White 10 pack – 8220-3-10
White 100 pack – 8220-3-10B
Black 10 pack – 8220-3-2
Black 100 pack – 8220-3-2B



8220-0 COMPACT DOUBLE CUFF™

- Compact version of Double Cuff restraints
- User-friendly and easy to carry and store
- Ideal backup to steel handcuffs; can be carried in pocket, briefcase, glove compartment, etc.
- Available in quantities of three with an included Safety Cutter™

White 3 pack w/Safety Cutter – 8710
Black 3 pack w/Safety Cutter – 8711

CUTTERS



8500-1 SAFETY CUTTER™

- Lever action for smooth cutting of disposable plastic restraints
- Simple, fast, one-squeeze operation
- Pocket-sized for easy carry



8500-0 CUFF CUTTER

- Can be used on any disposable restraint
- Pocket-sized for easy carry and storage
- Inexpensive and durable

METAL RESTRAINTS



TAKE CONTROL. AND KEEP IT.

Hiatt® handcuffs offer a variety of unique features designed to address the needs of today's law enforcement personnel. Our fast back-loading application allows an open cuff to be snapped back into place with a quick motion of the wrist and then reapplied without having to release the offender's hand. With 18 teeth, 3 independent retaining bars with 6 teeth on each, we make it extremely difficult to pick, while providing increased strength as the shackle engages the additional teeth. Finally, True Swing Technology ensures the swing arm is balanced and centered so it locks into the center of the shackle every time.



2010HD DOUBLE-LOCK CHAIN STYLE

Crafted from heavy-duty high carbon steel with reinforced steel swivels. Double key hole handcuffs make removing Hiatt handcuffs much easier. With key holes on both sides of the cuff, there is always one facing up for ease of access.



2010H / 2015H STANDARD CHAIN STYLE

Made from top quality steel, the chain style model features reinforced steel swivels for added strength and durability.

2010H – Nickel Plate Model
2015H – Black Finish Model

LIMITED REPAIR OR
REPLACEMENT WARRANTY



2050H / 2075H STANDARD HINGE STYLE

Crafted from high quality steel, the hinge style cuffs feature heavy-duty, solid hinges for reinforced holding power.

2050H – Nickel Plate Model
2075H – Black Finish Model



2054H / 2055H OVERSIZED HINGE STYLE

17% larger than the standard model, oversized hinge style cuffs are ideal for restraining larger subjects who have trouble placing their hands behind their backs.

2054H – Nickel Plate Model
2055H – Black Finish Model

BODY WORN CAMERAS | CONCEALABLE ARMOR | TACTICAL ARMOR | COMMUNICATIONS | PATROL BIKE | DUTY GEAR/HOLSTERS | PROTECTIVE GEAR | FIREARMS ACCESSORIES | LESS LETHAL | PERFORMANCE APPAREL | SURVIVABILITY SYSTEMS | FORENSICS | ARMOR SYSTEMS | TRAINING GROUP

METAL RESTRAINTS



2103H / 2105H RIGID STYLE NON-FOLDING

The Rigid handcuff provides a firm, comfortable grip that molds to the shape of your hand for added control and ease of application.

- 2103H – Nickel Plate Model
- 2105H – Black Finish Model



2105H

UL-1-H / UL-5-H ULTIMATE - FOLDING STYLE

With heavy-duty construction this cuff features oversized rivet heads for added strength. Folds easily for storage.

- UL-1-H – Nickel Plate Model
- UL-5-H – Black Finish Model



UL-1-H

8400 HANDCUFF KEYS

- Lightweight, oversized handcuff key
- Textured grip allows solid grasp of key, even in wet conditions
- 8400-1 features pocket clip
- 8400-2 features key ring



8400-1



8400-2

LIMITED REPAIR OR
REPLACEMENT WARRANTY



HIATT/MONADNOCK TRAINING

THE SAFARILAND TRAINING GROUP

HIATT® TACTICAL HANDCUFFING



INSTRUCTOR TRAINING COURSE

Handcuffs are used more than any other tool in law enforcement and, unfortunately, many officers are placed in vulnerable positions or hurt during the handcuffing process. This course presents simple, effective techniques that allow officers to quickly control and handcuff an individual by using handcuffing skills that can be performed whether a subject assumes a kneeling, standing or prone position.



THE SAFARILAND TRAINING GROUP

MONADNOCK® DEFENSIVE TACTICS SYSTEM

(MDTS) INSTRUCTOR COURSE

This powerful two-day course shows you how to use your hands, elbows, knees and feet for protection against an attack, especially in close quarter battles (CQB). It relies heavily on practical hands-on applications and is intended for first responders who want instruction in how to use their personal weapons for self-defense and subject-control, for escort and handcuffing.



PROTECTION AND PERFORMANCE



PERFORMANCE APPAREL



Mustang Survival® has become the leading supplier of personal protective equipment to the most demanding maritime and aviation customers including the coast guard, military, fighter pilots, law enforcement, SAR professionals and commercial mariners. Our system, comprised of flotation protection, dry solutions and thermal management products, provides the most durable, versatile and high

performing solutions specifically designed to help save lives.

Through constant innovation and inspired technical solutions, Mustang Survival® strives to bolster performance, encourage exploration and inspire adventure in the marine environment. We are committed to the protection and enhancement of those who push themselves to extremes.



INTEGRATED EOD SOLUTIONS



SURVIVABILITY SYSTEMS



EXPLOSIVE ORDNANCE DISPOSAL (EOD)

Med-Eng® has developed the world's leading brand of bomb suits and blast protective ensembles based on 35 years of relentless research into blast effects on the human body. The complete solutions we provide to Bomb Disposal Technicians and EOD Operators also include personal blast sensors, and purpose-built robots and EOD equipment to maximize safety and complete the mission effectively.

PERSONAL PROTECTIVE EQUIPMENT

Med-Eng bomb suits are trusted to save lives in over 100 countries and territories. Now, as bomb techs face the challenges of a new century, Med-Eng proudly introduces the EOD® 10. It sets a new gold standard for the highest levels of balanced protection, ergonomics and sophisticated operational capabilities. For tactical missions where high mobility is paramount, the TAC 6 offers an excellent balance of lighter weight protection and modularity.

ROBOTS, EOD TOOLS AND SEARCH

Med-Eng provides multi-mission robots, and well-proven Hook and Line (HAL®) systems, EOD Tools and Search equipment. These systems maximize stand-off distances and are trusted to meet operational requirements. They are designed for a variety of threat-related tasks, ranging from Improvised Explosive Device (IED) disposal to security search.

INTEGRATED SOLUTIONS



SURVIVABILITY SYSTEMS



CREW SURVIVABILITY

Med-Eng's customized Blast Attenuation Seats and Thermal Management systems are battle-tested to maximize military vehicle crew survivability. Whether the threat is from an Improvised Explosive Device (IED) or the effects of heat on vehicle crews and their mission-critical electronic systems, Med-Eng® can rapidly design, test, install and support proven and fully integrated solutions.

COOLING & HEATING SOLUTIONS

Heat can be devastating to vehicle crews and their electronics. Med-Eng has fielded over 10,000 personal cooling systems, plus customized Micro Climate Solutions to cool and protect electronics from vibration, dust and humidity. These technologies can also be applied to law enforcement tactical vehicles to keep highly trained teams physically ready despite the heat inside their vehicles. In these installations, the use of DC battery power makes cooling possible during silent-watch mode.

BLAST ATTENUATION SEATS

Military vehicle crews facing incredibly violent threats from IEDs require protection against both the upward and 'slam down' phases of a blast event. Med-Eng Blast Attenuation Seats provide this level of carefully engineered performance and protection. Med-Eng provides seats for all vehicle positions (Driver, Commander, Troop/Crew, Operator, and Gunner) and can easily integrate to all mounting vehicle locations (Ceiling, Sponson, and Floor) in either new vehicle builds or retrofit programs.

YOUR FORENSICS SOURCE



FORENSICS

FORENSICS SOURCE.

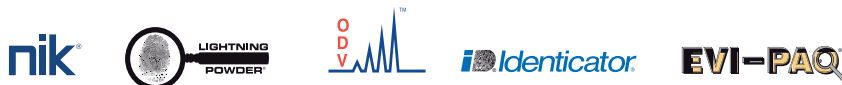

Forensics Source™ serves as a one-stop shop for the finest forensics products for all types of investigative, collection, processing and lab-related activities. These products are marketed under the Forensics Source umbrella and are built

on our legendary commitment to innovation, quality and customer care. Our goal is simple: to provide forensics professionals with access to the best products available in the forensics market.



FORENSICS SOURCE BRANDS

LIGHTNING POWDER®

The LIGHTNING POWDER® brand is the most extensive line of fingerprint and evidence marking products available.

EVI-PAQ®

Always evolving to meet the practical needs of forensics professionals in the field, EVI PAQ® products provide the solutions to marking, packaging and identifying crime scene evidence.

NIK®

The most accurate narcotics field identification, specimen and evidence collection kits available in the industry.

ODV™

The ODV™ line continues to lead the field for presumptive drug testing, from narcotic field tests in crushable glass ampoules to the innovation of NARCOPOUCH® kits which provide a portable chemistry lab.

IDENTICATOR®

For the highest-quality fingerprinting products, agencies worldwide look to the IDENTICATOR® brand. Combining non-smearing with instantly permanent qualities in both ink and inkless systems.

ADVANCED PRODUCT SOLUTIONS



ARMOR SYSTEMS



From Ballistic Resistant Enclosure® (BRE®) units and Armored Fighting Positions (AFP) to lightweight composite armor for sea, air and land vehicles, PROTECH® offers a complete

range of advanced product solutions for government facilities, military installations, private and public corporations, and original equipment manufacturers (OEM).



ARMOR SYSTEMS

GUARD BOOTHS

Standard and customized guard booths are available in sizes ranging from 4' x 4' to 10' x 20' or greater. Size, layout, and configuration variants offer solutions for each client's specific requirements.

- All levels of ballistic protection featuring ARMOR-LOK™
- Blast and fragmentation protection
- Multi-layer “no-spall” or “low-spall” transparent armor
- Ballistic- and blast-resistant gunports and window systems
- All-welded construction
- Chemical, biological, radiological and nuclear (CBRN) filtration systems
- Fully engineered HVAC systems
- High-performance coatings
- Electrical systems to meet any requirement
- Customized interiors
- Standard units or custom-designed to meet specifications
- Restrooms available
- Conduit-penetration protection
- Exterior lighting systems



Our exclusive ARMOR-LOK™ designs offer seamless 360° protection to all areas of each structure to include windows, doors and gunport systems with zero vulnerability

GUARD TOWERS

PROTECH's fully engineered bullet-resistant & (optional) blast-resistant guard towers are turn-key solutions for perimeter security applications at nuclear facilities, military installations, border crossings, chemical/petroleum plants, correctional facilities, and other industrial locations.

- Offering the same features as our BRE® units, these units are fixed on pedestals and tower systems for elevated security
- All levels of ballistic protection featuring ARMOR-LOK™
- Fully engineered, blast- and hurricane-rated tower designs
- 360° seamless protection
- Constructed with structural steel components
- Galvanized stair systems
- Prefabricated towers
- Optional catwalks and shooting stations



CUSTOM ARMOR

Our complete manufacturing and fabrication capabilities enable us to work with end users, original equipment manufacturers (OEM), or prime contractors to design and develop advanced armor systems for virtually any application. From vehicle platforms to structural or shelter systems, from personnel to critical infrastructure protection, we are positioned well to meet a broad range of ballistic and blast requirements.

TRAILER ARMOR KITS

- With our in-house engineering PROTECH® offers the ability to rapidly produce lightweight, customized armor kits and components for unique applications

STEEL ARMOR COMPONENTS AND ASSEMBLIES

- Offering full MIG and TIG welded steel and/or aluminum armor assemblies, our technicians are AWS Certified for unlimited plate thickness
- Steels include: MIL-A-46177, MIL-A-46100, MIL-A-12560, AR500

COMPOSITE ARMOR SOLUTIONS

- From flat panel construction to unique 3-dimensional parts, our fabrication capabilities enable us to produce tooling in-house for most applications



ARMOR SYSTEMS

ARMOR FIGHTING POSITIONS

- Ballistic and fragmentation protection
- ARMOR-LOK™ design
- Lifting lugs for ease of installation
- Durable, textured finish with high-performance coatings
- Gunports

APPLICATIONS INCLUDE:

- Vital asset protection
- Check point security
- Perimeter protection
- Fixed fighting locations
- Supplemental guard house security
- Replacement of sandbags and concrete structures

The PROTECH® engineering and design team is ready to address all of your ballistic and security concerns. We will develop the system that works for you.



BOAT ARMOR

- Mission-specific modular kits to full OEM integration, the PROTECH® line of maritime armor offers systems for all types of protection requirements
- Broad portfolio of lightweight composite systems for ball and armor-piercing (AP) threats, addressing most small arms protection requirements
- Polyethylene systems affording least-weight penalty, which are buoyant and unaffected by freshwater, saltwater and UV rays
- Superior multi-hit, ballistic performance solutions
- Exterior coatings, which enable protection against the harshest of environments, for long-term serviceability



AIRCRAFT ARMOR

- PROTECH® Armor Systems line of land and air products include a wide array of ballistic, blast and fragmentation solutions
- Ballistic panels are easily installed and removed by front-line personnel. In most cases, no special tooling is required and armor systems can be easily transferred from one aircraft to another
- The availability of replacement panels eliminates the full replacement of the kit, thus reducing cost and aircraft downtime
- Polyurea protective coatings afford optimal durability, performance and slip resistance
- Excellent resistance to, and protection from, a variety of environmental and chemical situations



REAL-WORLD TRAINING SOLUTIONS



TRAINING GROUP

THE SAFARILAND *TRAINING GROUP*

The Safariland Training Group provides the most up-to-date and comprehensive training programs available anywhere in the world. Our newly enhanced and expanded programs build individual skills and provide solutions for criminal justice, military, corrections and privately licensed security

personnel. What sets us apart is our team of highly-experienced instructors. Their real-world experiences in law enforcement provide practical and proven tactics to enhance the performance of your team.



TRAINING GROUP

ADVANCED BIKE PATROL INSTRUCTOR DEVELOPMENT AND TACTICS COURSE

This advanced instructor-level bicycle operations course covers offensive and defensive tactics, enforcement tactics for urban and rural settings, crowd management and instructor development, including online resources. This course promises to bring new ideas and strategies to existing bicycle programs and is appropriate for line or supervisory personnel who ride with an emphasis on increasing bicycle safety in the community, including bicycle rodeos.



BALLISTIC SHIELD INSTRUCTOR COURSE

This intensive three-day course provides instructors with the techniques and skills required to train their department's personnel while operating with a ballistic shield. Students will learn drills, shooting techniques and tactics for the ballistic shield officer, while being required to make presentations, supervise range drills and develop course(s) of fire.



COUNTER AMBUSH TACTICS FOR OFFICER SURVIVAL OPERATOR COURSE

This training program consists of one day of classroom lecture and one day of practical exercises and scenario training, based on the real-world incidents that have injured and killed an ever increasing number of officers. Our instructors have extensive experience in the world of law enforcement, violent attacks on police officers and tactical responses to neutralize the threat.



CROWD MANAGEMENT AND MOBILE FIELD FORCE OPERATOR COURSE

Featuring a proliferation of small- to large-scale riots, this operator-level course meets the needs of agencies that are tasked with crowd control. With classroom and practical application, this four-day course is for everyone from the patrolman to the supervisor, covering all aspects of dealing with situations from an orderly protest to a large-scale riot.



TRAINING GROUP

LOW-LIGHT BUILDING SEARCHES INSTRUCTOR COURSE

This course is designed to give first-responding officers the knowledge, tools and tactics necessary to not only survive a low-light encounter during a building search, but to WIN it. The curriculum focuses on the different options available while working in low-light or no-light conditions.

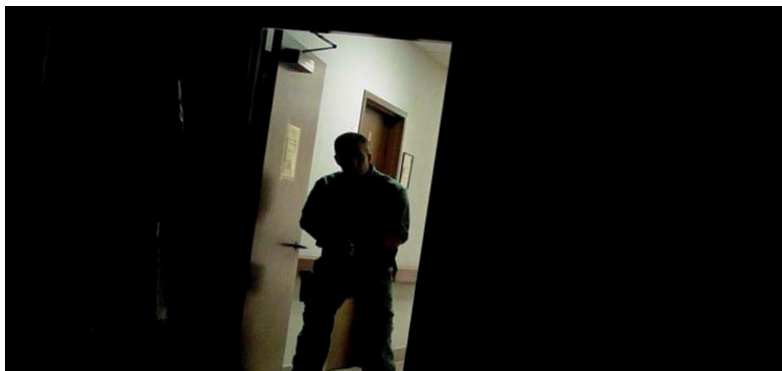

PATROL RIFLE INSTRUCTOR COURSE

For most agencies, the patrol rifle is the long arm of choice and using it properly is vital. In many training environments, the emphasis is put on taking all the time needed, and pulling the trigger repeatedly. This two-day course will stress the need for speed relative to first shot readiness, and then shift to first shot effectiveness. The goal is to teach students to deploy with speed and to fire with precision.



RIOT SHIELD AND RIOT BATON INSTRUCTOR COURSE

This is a two-day, highly dynamic instructor level course that teaches officers proper usage of the Monadnock® riot shields and batons in Crowd Management/Mobil Field Force situations. Course content draws from our time tested Monadnock Expandable Baton, Monadnock Defensive Tactics System and PROTECH® Tactical Shield Instructor programs. It relies heavily on tactics to protect officers from thrown objects and close-in crowds while utilizing the shield, baton protection for self-defense and subject control, as well as small unit tactics for control and arrest of subjects.



TACTICAL BREACHING INSTRUCTOR COURSE

This three-day, instructor-level course provides students with the necessary tools and tactics to deploy onto an objective and make forced entry through the means of a manual ram and/or pry bar, shotgun breaching rounds and flash-bang breaching.



ALSO AVAILABLE:

- Active Shooter Operator
- Advanced Sniper Development Instructor
- Combat Medicine for Law Enforcement Operator
- Controlled Structure Searching Operator
- Critical Incident Command Operator
- Emergency Response to an Armed Intruder
- Female Officer Survival Operator
- High-Risk Warrant Service Operator
- Hostage Rescue Operator
- Shoot-House Instructor
- Startle Response to an Ambush Operator