

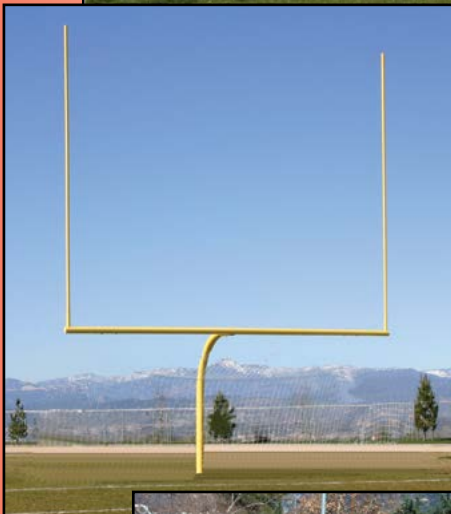

# **LA** *Steelcraft*

**QUALITY EQUIPMENT FOR SPORTS AND SITE-AMENITIES  
SINCE 1950**



## Basketball

Straight Post Basketball Combinations	4
Curved Post Basketball Combinations	5
Fan Shaped Backboards	6-7
Rectangle Shaped Backboards	8-10
Endurance Playground Basketball System	11
Goal Rims	12-13
Goal Rim Nets, Basketball Parts	14
Post Pads	15

## Baseball

Traditional Backstops	16
Arch Backstops	17
Full Size Permanent Backstops	18-19
Batting Helmet Rack/Baseline Foul/Fair Poles	21
Protective Fencing	22
Baseball Netting	23
Dugout Seating	24
Bases & Accessories	25
Baseball Bases (Cont.)	26-27

## Soccer

Professional Goals	28
Standard & European Goals	29
Soccer Accessories	30

## Football

Goal Posts/Combo Football & Soccer, Accessories	31
---	----

## Nets Sports

Net Game Posts	32
Volleyball & Badminton	33
Volleyball Court Nets & Post Sleeves	34
Post, Nets Post Sleeves	34
Net Post Accessories	35-36
Tennis	37-38

## Fitness

Climbers	39
Exercise Bars & Beams	40-41

## Fitness Courses

Police/Military Academy Training Fitness & Obstacle Courses	42-45
Thoreson Fitness Course	
"Muscle Beach" Travel Rings	

# Playgrounds

Ball Walls and Tetherball	46
Play Essentials	47
Pedestal Sandbox	48
Playcurb Borders, Traditional Slides	49
Climbers	50-51
Swings	52-53
Swing Accessories	54-55



# Bleachers

Portable Bleachers	56
Aluminum Bleachers, Transporter System, Seating	57
Rolling Bleachers & Bleacher Accessories	58
Guardrail Retrofit for Bleachers	59



# Site Amenities

Skate Board & Scooter Racks	60
Bike Racks	61
Bollard, Traditional & Single Face Bike Racks	62
The Wave Bike Racks, Bike Locker	63



# Site Accessories

BBQ's, Parking Bollards & Trash Receptacles	64
---	----

# Flagpoles

External Halyard	65
Internal Halyard	66
Flags and Accessories	67

# Tables and Benches

Fiberglass Tables	68-71
Food Court Tables	72-73
Stand Alone Tables	74
ADA-Accessible & Specialty Tables	75
Site Benches	76-77
Wood Tables	78
Double Plank Tables & Benches	79
Aluminum/Wood Site Benches	80-82
Aluminum Tables	83
Expanded Metal Tables & Benches	84-85
Umbrellas	86-87



# Colors & Finishes

Powder & Fiberglass	88
---------------------	----

# Terms & Conditions

Terms & Conditions	89-91
--------------------	-------



# Straight Post Basketball Combinations

**Choose your post size:** 3-1/2"OD, 4-1/2"OD, 5-9/16"OD and 6-5/8"OD. Not all post sizes are available with each model. All Straight Posts and Extensions are schedule 40 galvanized steel pipe, neatly capped for weather protection. Extensions are 2-3/8" OD, Brace sets 1.029" OD.



**POWDER  
COAT OPTION  
AVAILABLE ON  
POSTS-SEE  
PAGE 88**

## STRAIGHT SINGLE POSTS

Model	Length	Diameter	Extension	Lbs.
1233	15'-6"	3-1/2"OD	3'	165 lbs.
1244	16'	4-1/2"OD	4'	224 lbs.
1254	16'-6"	5-9/16"OD	4'	293 lbs.
1256	16'-6"	5-9/16"OD	6'	317 lbs.
1266	16'-6"	6-5/8"OD	6'	389 lbs.

## STRAIGHT BACK TO BACK MODELS

Model	Length	Diameter	Extension	Lbs.
12033	15'-6"	3-1/2"OD	3'	209 lbs.
12044	16'	4-1/2"OD	4'	276 lbs.
12054	16'-6"	5-9/16"OD	4'	351 lbs.
12056	16'-6"	5-9/16"OD	6'	392 lbs.
12066	16'-6"	6-5/8"OD	6'	465 lbs.

**NOTE: POST INSTALLATION MAY REQUIRE STEEL REINFORCEMENT IN FOOTING - CHECK WITH LOCAL BUILDING CODES IF REQUIRED IN YOUR AREA.**

# Curved Post Basketball Combinations

**Choose your post size:** 3-1/2" OD, 4-1/2" OD, 5-9/16" OD and 6-5/8" OD. All posts are schedule 40 steel pipe. All Curved Posts are galvanized steel pipe with 1.029" OD galvanized braces. Backboard attachment plates are 3/16" x 6" x 6" hot dipped galvanized steel. Not all post sizes are available with each model. Length of curved models allow for setting at official height.

All Back-to-Backs come with an Interlocking double pipe bracket to lock both posts together.



## CURVED SINGLE POSTS

Model	Diameter	Extension	Lbs.
12C33	3-1/2"OD	3'	128 lbs.
12C34	3-1/2"OD	4'	136 lbs.
12C44	4-1/2"OD	4'	194 lbs.
12C46	4-1/2"OD	6'	215 lbs.
12C54	5-9/16"OD	4'	263 lbs.
12C56	5-9/16"OD	6'	292 lbs.
12C66	6-5/8"OD	6'	379 lbs.

## CURVED BACK TO BACK MODELS

Model	Diameter	Extension	Lbs.
12C034	3-1/2"OD	4'	275 lbs.
12C044	4-1/2"OD	4'	388 lbs.
12C046	4-1/2"OD	6'	431 lbs.
12C054	5-9/16"OD	4'	526 lbs.
12C056	5-9/16"OD	6'	585 lbs.
12C066	6-5/8"OD	6'	790 lbs.

**NOTE: POST INSTALLATION MAY REQUIRE STEEL REINFORCEMENT IN FOOTING - CHECK WITH LOCAL BUILDING CODES IF REQUIRED IN YOUR AREA.**

# Fan Shaped Backboards

**Our backboard hole pattern fits all of our goal rings!**

## MODEL -01 AND -02 STEEL PLATE

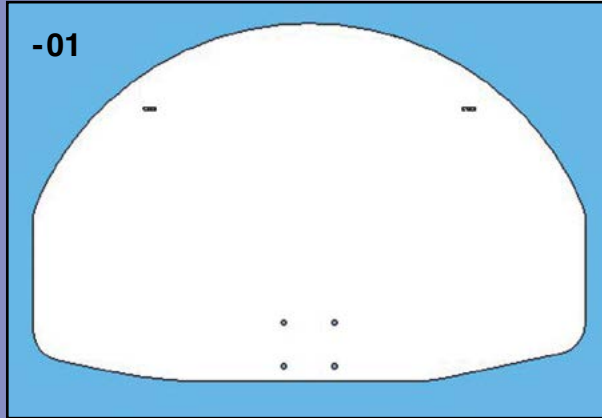

**Model -01-** Electrostatic White Powder Coat, as shown. 115 lbs.

**Model -02-** Hot Dipped Galvanized version. 115 lbs.

One piece, solid 1/4" thick mill flat steel, A36 steel, roller leveled after plasma cutting, with 2 welded 1" X 2-1/4" brace attachment flanges. Front mount 5" X 5" goal mounting pattern. 54" x 35"

**LIFETIME LIMITED WARRANTY**

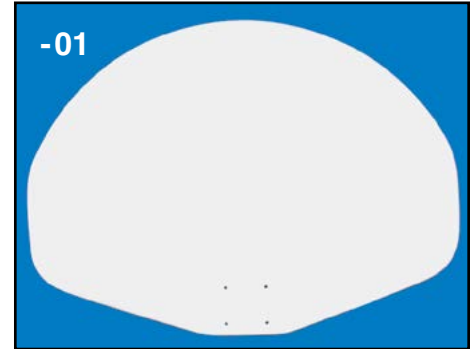

## MODEL -03 13 GAUGE STEEL

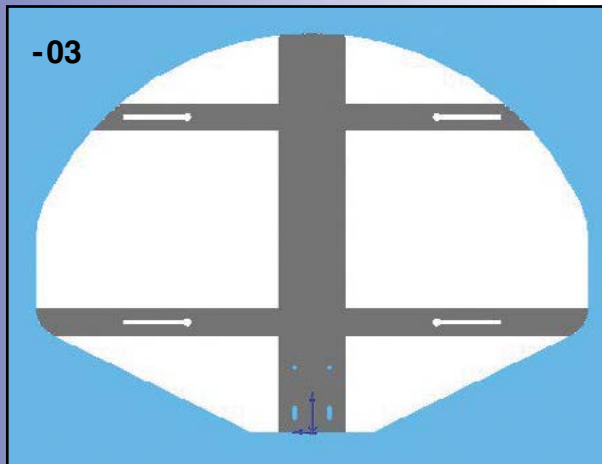

**Model -03-** White Powder Coat Fan. 80 lbs.

Formed from a single sheet of 13 gauge steel with 1-3/8" flanged edges. Reinforced with 12 gauge and 10 gauge vertical and horizontal channels for vibration-free action and a vertical strongback channel reinforcement that strengthens the critical rim area. Specially designed bolt keeper "keyway" system which allows for easy installation. Front mount 5" x 5" goal mounting pattern. 54" x 36"

**LIFETIME LIMITED WARRANTY**

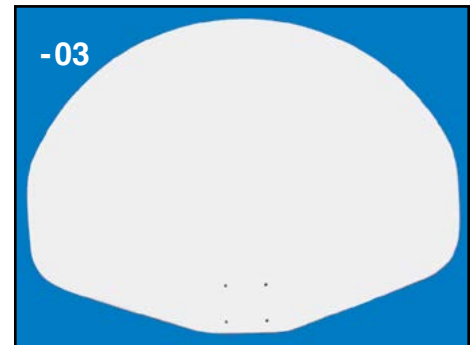

## MODEL -04 AND -05 FIBERGLASS

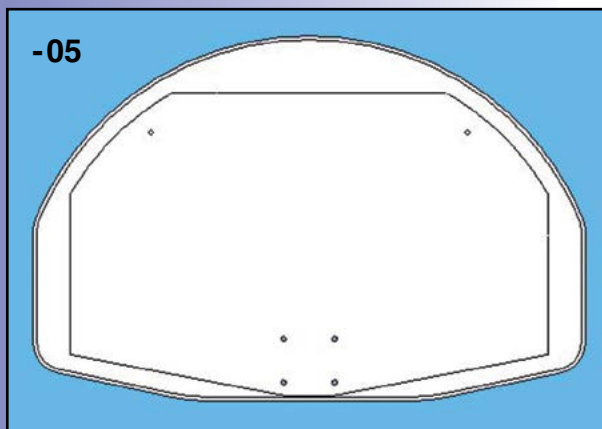

**Model -04-** Standard Fiberglass. 61 lbs.

Single 3/16" shell over 5/8" striated O.S.B. core. The back is then sprayed over with our special mix of resin and fiberglass to seal unit. 54" x 39"

**Model -05-** Deluxe Fiberglass. 64 lbs.

Opposing 3/16" sealed shells over resin impregnated 1-1/8" honeycomb core. All goal rim fastening holes are made through custom solid inserts (1-1/8" thick) pre-installed and built into the honeycomb.

These backboards are designed for outdoor exposure and will not be affected by moisture.

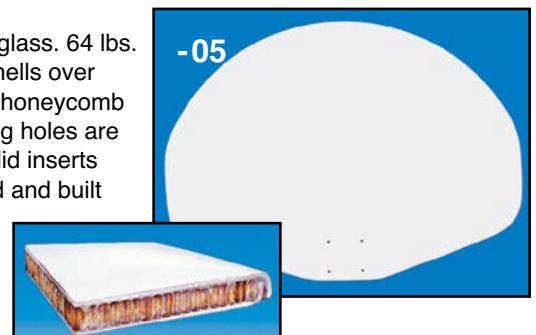

**LIFETIME LIMITED WARRANTY**

THE -05 BACKBOARD RESIN IMPREGNATED 1-1/8" HONEYCOMB CORE LASTS A LIFETIME!

## MODEL -10, -11 AND -11X ALUMINUM

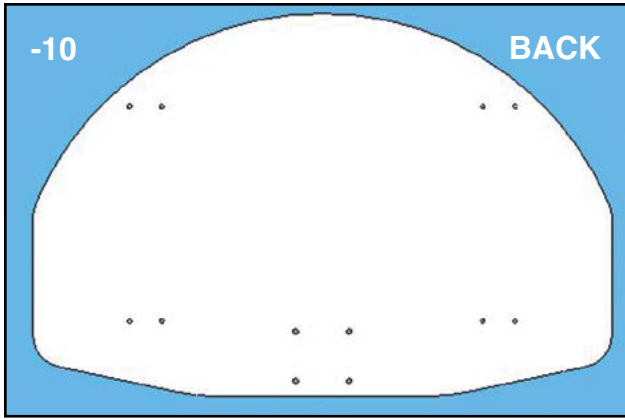

**Model -10-** Satin Finish, as shown. 72 lbs.

Permanent mold casting guarantees consistent quality. 12 board mounting holes are reinforced with cast in threaded steel inserts. Extra heavy reinforcing ribs. 12 mounting holes allow board to be mounted on many types of systems: Direct mount, retrofit to existing center or dual post systems. 36-1/2" x 54"

**Model -11-** Electrostatically Powder Coated White. 72 lbs.

Solid one piece cast aluminum with 1-1/2" flanged edges and extra-heavy duty ribbing. 12 mounting holes with cast-in threaded inserts accommodate a variety of mounting systems. 54" x 36".

**LIFETIME LIMITED WARRANTY**

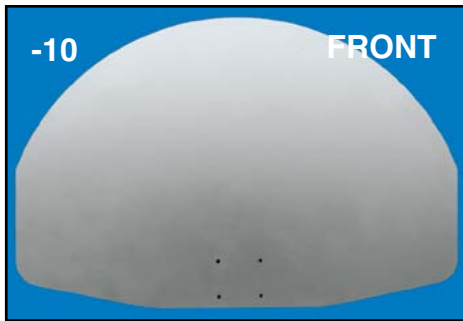

**Model -11X-** Model -11 with Orange Target and Border. 72 lbs.

**LIFETIME LIMITED WARRANTY**

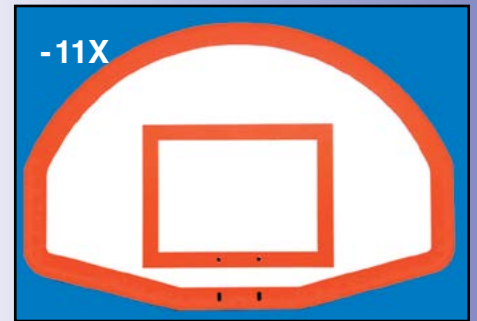

## MODEL -06 TEMPERED GLASS

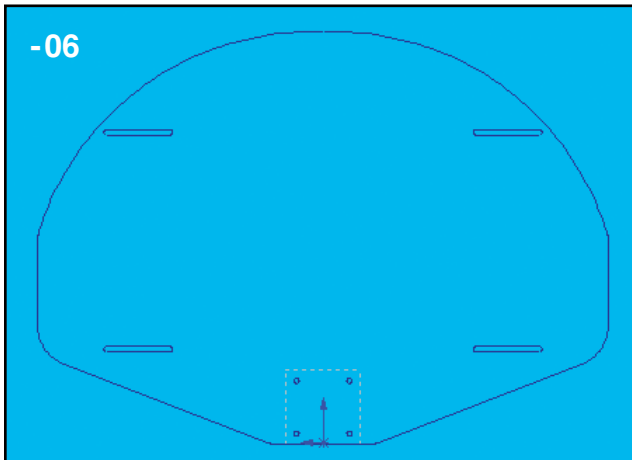

**Model -06-** Tempered Glass. 125 lbs.

Institutional quality glass backboard. These glass boards have NCAA compliant rim-restrainers plus target and borders fire etched into the glass. Maintenance free brushed aluminum frame. 1/2" glass thickness. 5" x 5" goal rim mounting pattern. 54" x 39"

**TEN YEAR WARRANTY**

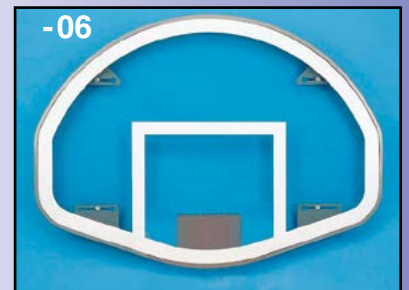

**NOTE: We do not encourage using fixed rims on glass backboards. We recommend Goal Rim: Collegiate 2K.**

## ORANGE TARGETS AND BORDERS

For Fan and Rectangular Boards. Black targets and borders available for international regulations.

Model	Description
OTA	Target
OBM	Border
OTA/OBM	Target and Border

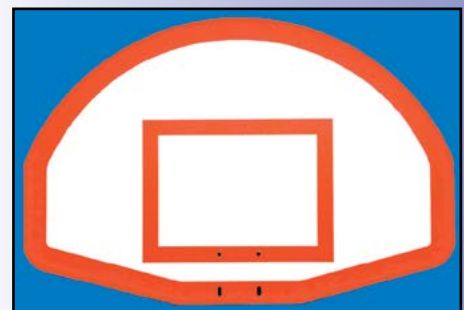

**OTA/OBM**

# Rectangle Shaped Backboards

**Our backboard hole pattern fits all of our goal rings!**

## MODEL -07 AND -08 STEEL PLATE



**Model -07-** Electrostatic White Powder Coat. 275 lbs.

**Model -08-** Hot Dipped Galvanized, as shown. 275 lbs.  
**SPECIAL ORDER ONLY**

Made from A-36, 1/4" mill flat steel plate, roller leveled after cutting. 2-1/2" flanged top and bottom edge adds strength and reduces warpage. 48" x 72"

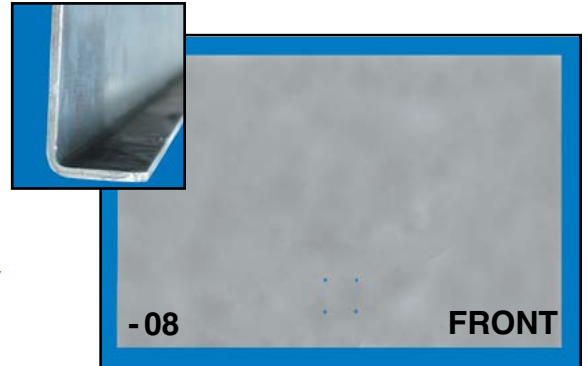

**LIFETIME  
LIMITED  
WARRANTY**

## MODEL -09 AND -09X FIBERGLASS

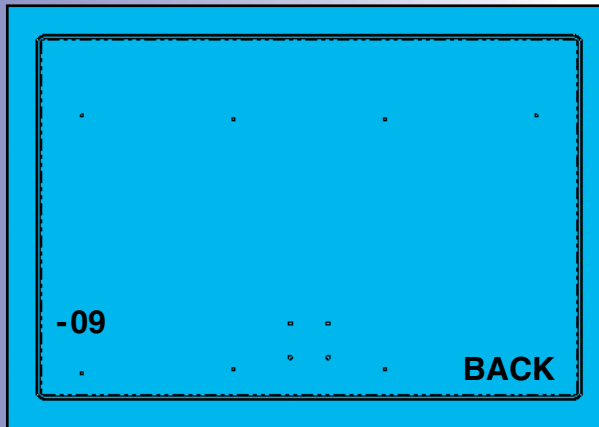

**Model -09-** Deluxe Fiberglass (standard size). 90 lbs.

Double 3/16" shell over resin treated honeycomb core. All goal rim fastening holes are made through custom solid inserts (1-18" thick) pre-installed and built into the honeycomb. All components are bonded together at the same time to form a unitized construction. These backboards are designed for outdoor exposure and will not be affected by moisture. White Gel Coat Finish. 48" x 72".

**Model -09X-** Deluxe Fiberglass Shortboard (NCAA). 90 lbs.

NCAA recommended with our exclusive double shell. 42" x 72"

**LIFETIME  
LIMITED  
WARRANTY**

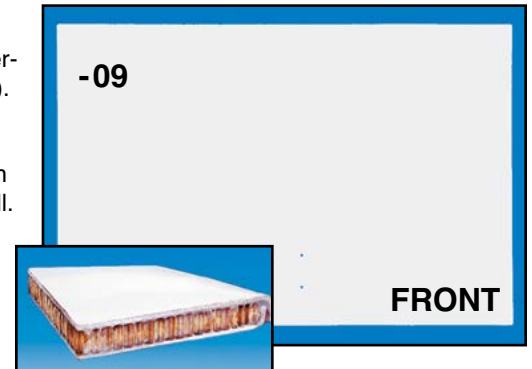

**THE -09 BACKBOARD RESIN IMPREGNATED 1 1/8" HONEYCOMB CORE LASTS A LIFETIME!**

## MODEL -12P PERFORATED STEEL

**Model -12P-** Perforated Steel. 170 lbs.

Rugged 11 gauge steel face has 1/4" diameter perforations to provide an open area to minimize windresistance. Rear support frame allows for multiple mounting conversions. Durable white powder coated finish with a silk screened orange target and border. 5" x 5" goal mounting pattern. Goal ring and net not included. 42" x 72".





## MODEL -12 12 GAUGE STEEL

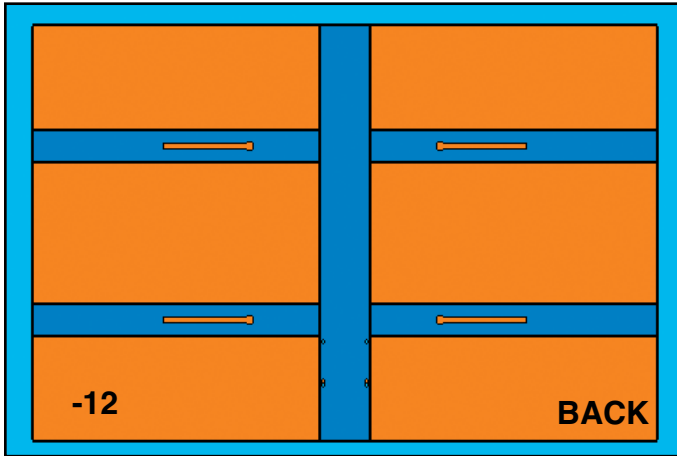

**Model -12-** White Powder Coat Rectangle. 147 lbs.

Formed from a single sheet of 12 gauge steel with 1-1/2" flanged edges. Lighter weight and less expensive than our Steel Plate Boards. All 4 edges are drawn back to increase strength. Vertical and horizontal reinforcement channels make for a rigid, durable board with reduced vibration and noise.

12 & 10 gauge vertical & horizontal reinforcing channels make a vibrations free unit.  
48" x 72"

**LIFETIME  
LIMITED  
WARRANTY**



## MODEL -12X 12 GAUGE STEEL - SHORTBOARD

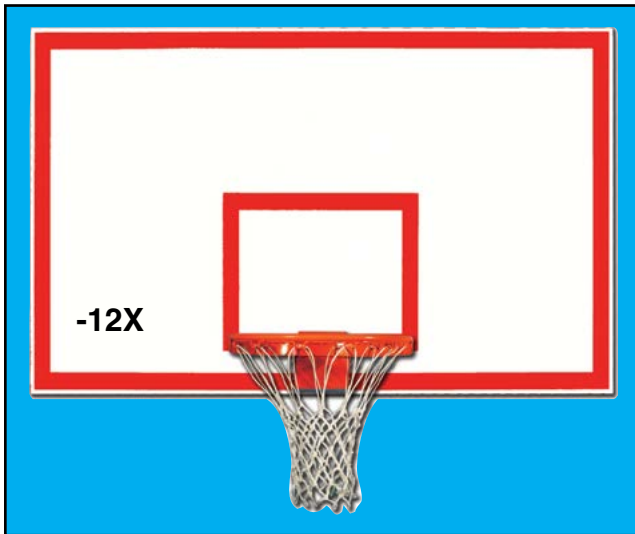

**Model -12X-** White Powder Coat Rectangle. 131 lbs.

Same as Model -12 but 42" x 72"

**TEN YEAR  
WARRANTY**

## ORANGE TARGETS AND BORDERS

For Fan and Rectangular Boards. Black targets and borders available for international regulations. Replacement Shooter's Square for existing backboards. Ready to apply without messy adhesive or paint. Official size. Utilizes H-D self adhesive vinyl used for exterior automotive detailing. Installs in about 5 minutes- instructions and applicator included.

Model	Description
OTA	Target
OBM	Border
OTA/OBM	Target and Border
RSS	Replacement Shooter's Square



## MODEL -13 AND -13X TEMPERED GLASS

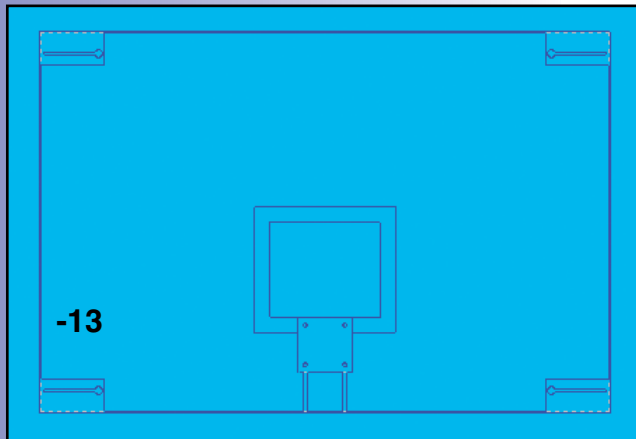

**Model -13** - Tempered Glass. 240 lbs.

These glass boards have NCAA compliant rim-restrainers plus target and borders fire etched into the glass. Maintenance free brushed aluminum frame.  
48" x 72"

**Model -13X**- Tempered Glass Shortboard.  
210 lbs.

Same as Model -13 but  
42" x 72"

**TEN YEAR  
WARRANTY**

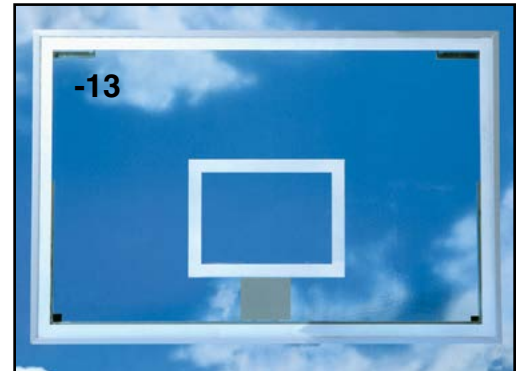

**NOTE: We do not encourage using fixed rims on glass backboards. We recommend Goal Rim: Collegiate 2K.**

## MODEL -BB60A38 - Acrylic



**Model - BB60A38** - Acrylic. 90 lbs.

These durable clear acrylic backboards are versatile for indoor or outdoor use.

3/8" uv-resistant acrylic permanently attached to a heavy-duty welded steel tubular uni-frame with struts for added support. Designed to allow for direct mounting to gooseneck or straightarm pots. With integral hole to permanently attach board to post and allow for goal replacement without removing the board.

42" x 60" Acrylic Rectangular Backboard  
5" x 5" Mounting Hole Spacing  
90 lbs.

**TWO YEAR  
WARRANTY**

**SHOWN WITH OPTIONAL PADDING.**

**NOTE: We do not encourage using fixed rims on glass backboards. We recommend Goal Rim: Collegiate 2K.**

## MODEL -BB72A38 - Acrylic



**Model - BB72A38** - Acrylic. 111 lbs.

42" x 72" Acrylic Rectangular Backboard  
5" x 5" Mounting Hole Spacing  
111 lbs.

**TWO YEAR  
WARRANTY**

**SHOWN WITH OPTIONAL PADDING.**

**NOTE: We do not encourage using fixed rims on glass backboards. We recommend Goal Rim: Collegiate 2K.**

# Endurance Playground Basketball System



Developed for hard-hitting, demanding players. Designed after months of rigorous testing by our team of engineers to match those players strength and stamina. 6" x 6" x 1/4" thick schedule 40 square steel upright post. Exclusive heavy-duty triangular extension arm (4', 5' or 6' available). Protected by galvanizing the post, extension arm and braces first, then baking on a black powder coat finish for a longer life.

Available with our new model 12X steel backboard with target and border and with our UPGN (Ultimate Playground Goal Rim and Net) or also available with our new acrylic backboards with a breakaway goal rim and net.

**LIMITED LIFETIME  
WARRANTY ON POST,  
EXTENSION ARM AND  
BRACING COMPONENTS**

**Shown with optional backboard  
and post padding.**

## **MODELS WITH 12X STEEL BACKBOARD and UPGN RIM**

**GP105S72** - 5' Extension - 509 LBS.

**GP106S72** - 6' Extension - 519 LBS.

## **MODELS WITH ACRYLIC BACKBOARDS and BREAKAWAY RIM**

**GP104A72** - 4' Extension - 499 LBS.

**GP104A60** - 4' Extension - 447 LBS.

**GP105A72** - 5' Extension - 509 LBS.

**GP105A60** - 5' Extension - 457 LBS.

**GP106A72** - 6' Extension - 519 LBS.

**GP106A60** - 6' Extension - 467 LBS.

**Outdoor backboard padding, pricing and information  
available upon request.**

# Goal Rims With Nets

ALL L.A. STEELCRAFT GOAL RIMS ARE MADE IN THE U.S.A. OF THE FINEST MATERIALS. THE RANGE OF TYPES SHOWN COVERS EVERY APPLICATION AND SITE WE'VE SEEN IN 58 YEARS OF MANUFACTURING BASKETBALL SYSTEMS. ALL GOAL RIMS INCLUDE NETS.

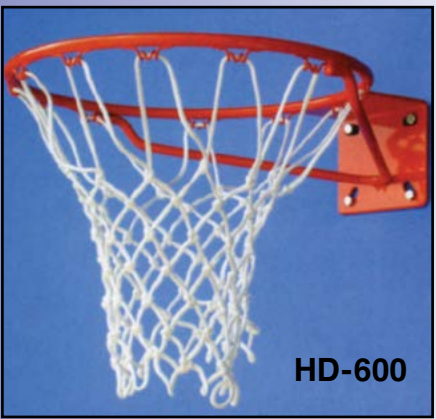

### MODEL HD-600

High alloy carbon steel 5/8" diam. rim. Consistently true rebounds. Broader bar/rim weld contact, adds durability. 1/2" diam. bracer bars add strength. Goal rim will withstand 800 lbs. before sustaining permanent bend. Universal mounting pattern. Uses nylon net. 18 lbs.



### MODEL 600-N

This rugged double goal rim uses two 5/8" cold roll steel rings welded together and double braced with 1/2" and 5/16" Bracer Bars for extra rigidity. Nylon Net slips easily over 12 "net ties". Goal rim will withstand 800 lbs. before sustaining permanent bend. Universal mounting pattern. 20 lbs.



### MODEL TITAN 775

### MODEL TITAN 775-C (with chain net) not shown

Originally designed for New York Park & Rec. Handles static load of 1000 lbs. 2 steel rims 3/4" and 1/2" with a 3/16" wing plate. 5/8" braces and 8" x 7" backplate reinforced with 1-1/2" plate. Powder coated official orange enamel. Comes with nylon net or chain net and mounting hardware.  
25 lbs.- TITAN 775  
27 lbs.- TITAN 775-C

## LIFETIME WARRANTY



### MODEL COLLEGIATE 2K

Most popular break-away on the market. Damper prevents fly-back. Positive lock, continuous no-tie rim. NCAA and high school specifications. Use on backboards with 5" x 5" mounting holes. Nylon Net. 27 lbs.



### MODEL 600 DOUBLE GOAL RIM

Two 5/8" cold roll steel rims accommodate "s" hooks for a steel chain net. Double braced for extra rigidity. Chain net is especially designed for use with double-ring goal. Goal rim withstands 800 lbs. Universal mounting pattern. 20 lbs.

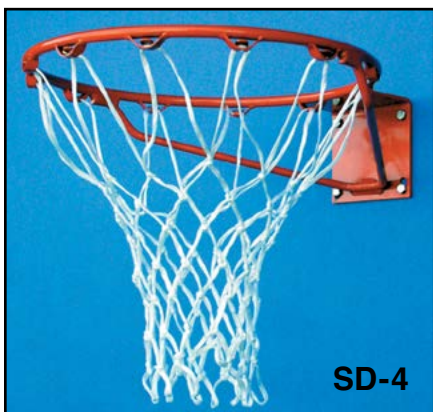

### MODEL SD-4 ROUGHNECK GORILLA

For heavy use courts. Single 5/8" rim with 1/2" alloy steel bracer bars and special "T" ties. Ring will withstand over 1400 lbs. of force before bending. Double ring available. Net ties take over 2000 lbs. of force before breaking. Long lasting baked on powder coat finish. The #1 choice of prisons and extreme high use courts throughout the country. Comes with heavy duty nylon net and zinc mounting hardware.

SD-4S Single Roughneck Gorilla - 17 lbs.

SD-4D Double Roughneck Gorilla II - 21 lbs.

### LIFETIME LIMITED WARRANTY



### MODEL UPGN

With unconditional lifetime replacement warranty. Double 5/8", solid rim design. 3/16" x 1" "No Fail" net locks add strength and eliminates netlock breakage. 3/16" Thick "Box" design back-plate and rim supports. Durable baked-on powder coated finish. Nylon or chain net available on this model. Add N for nylon or C for chain to model number when ordering.

UPGN - 27 lbs.

UPGC - 34 lbs.



### REMOVABLE GOAL RIM BRACKET

Guard against unauthorized use or theft of goal rims. Remove the goal when finished playing. Goal back plate slides tightly into universal adapter plate. Universal hole pattern will bolt to most backboards. Works with most front mount goals with 5" to 7" back plates. Not for use with goals with mechanism housing. Heavy gauge steel with welded flange. Orange powder coated finish. The GSUAP has a quick removal goal adapter and weighs 6 lbs.

## GOAL RIM NETS

Nylon nets are easy to replace and very resilient. Nylon nets come standard with most of our goal rims. See pages 12-13 for all of our goal rim models. Chain net is especially designed for double-rim goals. Our TITAN775 and Model 600 goal rim works well with chain nets. Indoor/Outdoor Zinc coated regulation size 13 gauge steel chain net. Will not stretch, shrink or tangle. Attaches with provided "S" hooks.



**GAW:** The GAW Anti-Whip basketball net is the net of choice for professional play. 120 count nylon hourglass design. Stiffened upper loops help keep net from whipping up.



**WN:** The WN Nylon Web Playground Basketball Net offers a safer alternative to chain nets or playgrounds. Nylon web design. Fits all 12 loops, not the goals. Won't rot or decay. Includes "S" hooks for rim attachment.

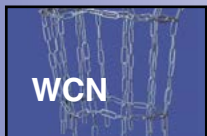

**WCN:** Welded steel chain net for double ring goal rims only.

Model	Description	Weight
BCN -12	Chain Net	1-1/2 lbs.
BNN -120	Nylon Net	8 oz.
GAW	120 Count Nylon	1 lb.
WN	Nylon Web Design	3 lbs.
WCN	Welded Steel Chain Net	1 lbs.

## Basketball Extensions

### EXTENSIONS ONLY FOR EXISTING BASKETBALL POST

Extensions are 3', 4', or 6' offset from post. ZE Extensions are for FAN boards and have 2 braces. RZE Extension are for Rectangle boards and have 4 or 5 braces depending on backboard. Curved Posts are one piece and do not require extensions. Wall mount extensions are also available. Wall mount channels are: 5" x 1-3/4" x .190". Extension pipes are 2-3/8" OD galvanized. Braces are 1" OD galvanized pipe. **Extension length measured from front of face plate to facing edge of post.**



ZE - Series  
(for fan boards)



RZE - Series  
(for rectangle boards)



WM - Series  
(for wall mount option)

Model	Board Type	Ext. Length	No. Braces	To Fit Pole Diam.	Weight
ZE-33	Fan	3'	2	3-1/2"OD	44 lbs
ZE-44	Fan	4'	2	4-1/2"OD	52 lbs
ZE-45	Fan	4'	2	5-9/16"OD	58 lbs
ZE-65	Fan	6'	2	5-9/16"OD	74 lbs
ZE-66	Fan	6'	2	6-5/8"OD	76 lbs
RZE-44	Rectangle	4'	4/5	4-1/2"OD	66 lbs
RZE-45	Rectangle	4'	4/5	5-9/16"OD	68 lbs
RZE-65	Rectangle	6'	4/5	5-9/16"OD	91 lbs
RZE-66	Rectangle	6'	4/5	6-5/8"OD	93 lbs

Model	Extension Length	Weight
Wall Mount For Fan Shaped Boards		
WMEF1	1'	35 lbs.
WMEF3	3'	50 lbs.
WMEF4	4'	65 lbs.
WMEF6	6'	90 lbs.
Wall Mount For Rectangular Boards		
WMER1	1'	65 lbs.
WMER3	3'	80 lbs.
WMER4	4'	100 lbs.
WMER6	6'	120 lbs.

# Post Pads

Constructed with an 18 oz. nylon reinforced vinyl cover. Filler is a 4" thick high-density, 70 ILD polyurethane foam. Two inch wide velcro strip fastener for easy installation and removal. **Zipper-lock and grommet lacing closures available.** Custom pads available for square posts. Custom lettering and logo printing available on all models.

**NOTE: RUNNING INTO POST PADS REPRESENTS A CLEAR AND PRESENT DANGER, INJURY MAY OCCUR.**

**GREAT FOR:  
FOOTBALL, BASKETBALL  
PLAYGROUNDS**

MODEL	POST SIZE
<b>6 Ft. Model (Sold Individually)</b>	
PP-625	2-7/8" OD
PP-634	3-1/2" OD
PP-645	4-1/2" OD
PP-656	5-9/16" OD
PP-666	6-5/8" OD
<b>7 Ft. Model (Sold Individually)</b>	
PP-725	2-7/8" OD
PP-734	3-1/2" OD
PP-745	4-1/2" OD
PP-756	5-9/16" OD
PP-766	6-5/8" OD



**PP-645SQ square model with custom imprint**



**PROTECTION FOR YOUR PLAYERS!**

	LIME		CHARCOAL		KELLY
	BLACK		BROWN		LIGHT BLUE
	GRAY		WHITE		PURPLE
	ROYAL		ORANGE		RED
	BURGUNDY		NAVY		YELLOW
	GREEN		PINK		TAN

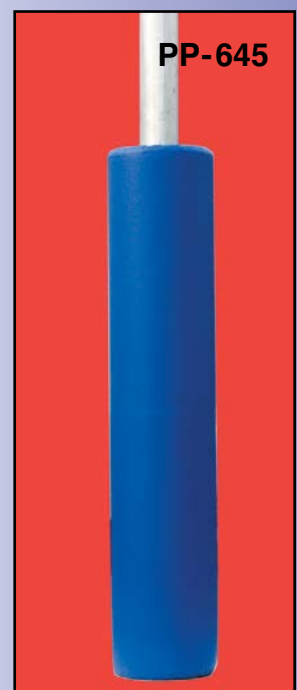

Shown in Royal.

# Traditional Backstops



All our Traditional Backstops feature Schedule 40 Galvanized steel pipe, chain link fabric in 2" -9 gauge GBW/K.K. with 5 rear and 3 side-wing planks (**ADA planking styles also available**). Reinforced with 12 truss-rod wing-panel sections. Strongest in the industry! Heavy duty galvanized steel construction. **Custom sizes available.** All traditional backstops come with 2" x 12" Douglas Fir Planking.

**Also available with powder coated frames and bonded vinyl chain link fabric!**

**BS-45**

**GREAT FOR COLLEGE OR HIGH SCHOOL!**

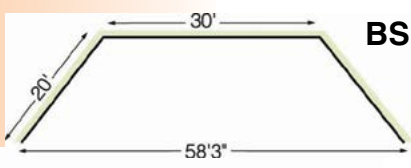

**BS-25**

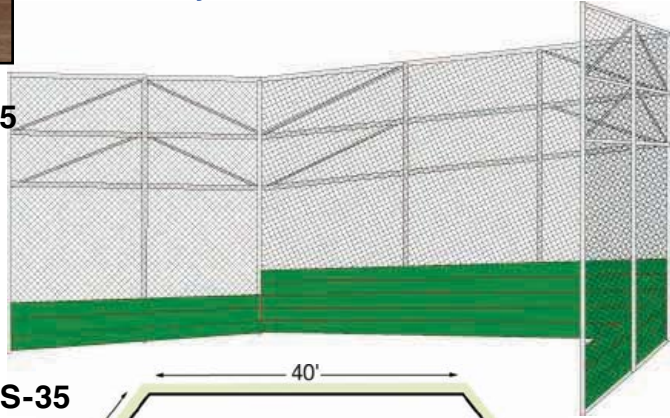

**BS-35**

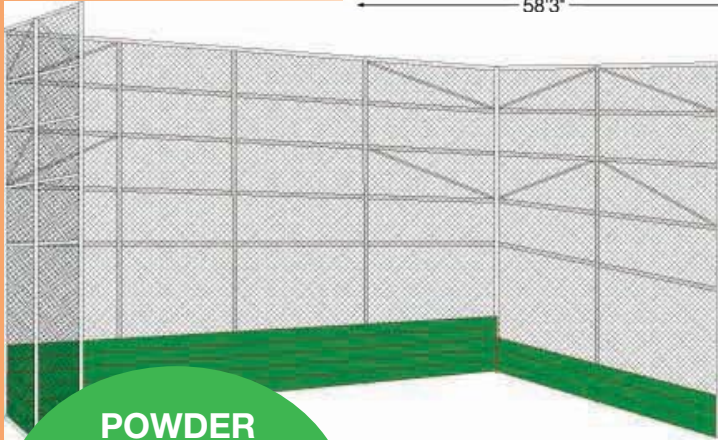
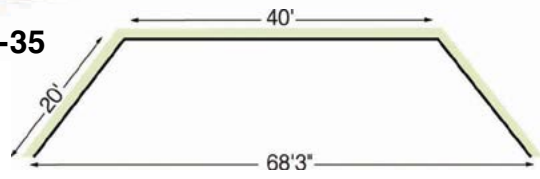

**BS-45**

**POWDER COAT OPTION AVAILABLE ON POSTS-SEE PAGE 88**

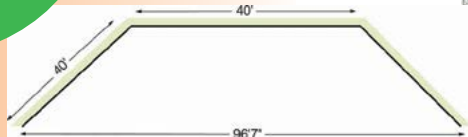

Models	BS-25	BS-35	BS-45
Height	20'	30'	30'
Width Opening	58'-3"	68'-3"	96'-7"
Depth	14'-2"	14'-2"	28'-3"
Sched. 40 Vertical Posts	4-1/2" OD	5-9/16" OD	5-9/16" OD
Horizontal Rails	1-5/8" OD	1-5/8" OD	1-5/8" OD
Wing Width	20'	20'	40'
Rear Panel Width	30'	40'	40'
Fabric Panels/Wings	2"-9 GA	2"-9 GA	2"-9 GA
Shipping Weight	4,650 lbs.	7,950 lbs.	11,900 lbs.

**NOTE: POST INSTALLATION MAY REQUIRE STEEL REINFORCEMENT IN FOOTING-CHECK WITH LOCAL BUILDING CODES IF REQUIRED IN YOUR AREA.**



# Arch Backstops

Specified by architects and developers for its classic, graceful form and function, the arch backstop is available in layback or perpendicular styles - extensions available for perpendicular.

All L.A. Steelcraft baseball backstops feature 9 ga. and 11 ga. hot dipped galvanized knuckle-knuckle fabric, galvanized pipes, fittings and hardware, for corrosion resistance. **No welding necessary.**

**L.A. Steelcraft offers an optional powder coated color system with bonded vinyl coated fabric and polyester coated fittings.**

Backstops come with installation video, plus written assembly details and footing instructions.

Pipe Dimensions ( All AB Models are schedule 40 galvanized steel pipe)		
<b>Arch</b>	<b>Vertical Ribs</b>	<b>Horizontal Ribs</b>
2-7/8" OD	2-3/8" OD	1-1/16" OD

## PERPENDICULAR WITH EXTENSION

Extensions provide maximum foul capture and allow additional space behind home plate. *Weights & prices include extensions.*

Model	Extension	Weight
AB-62P5	5'	5,375 lbs.
AB-62P10	10'	6,060 lbs.
AB-50P5	5'	3,850 lbs.
AB-50P10	10'	5,390 lbs.
AB-40P5	5'	3,050 lbs.
AB-40P10	10'	4,150 lbs.
AB-30P5	5'	2,450 lbs.
AB-30P10	10'	3,430 lbs.

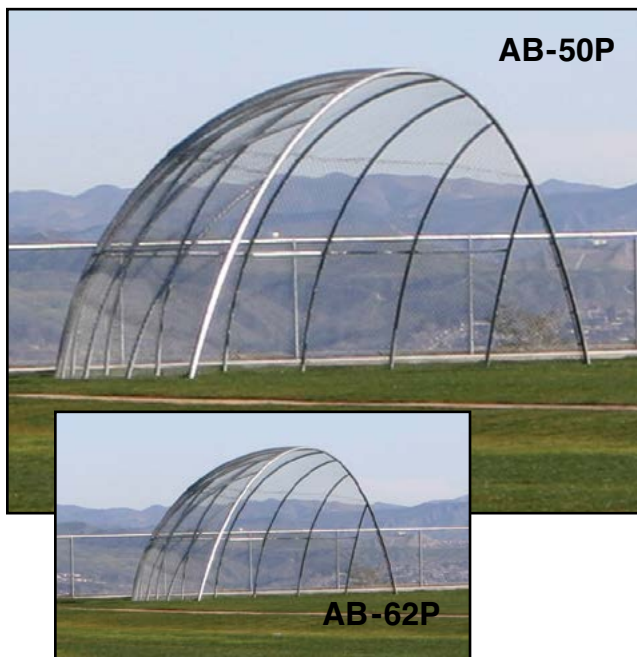
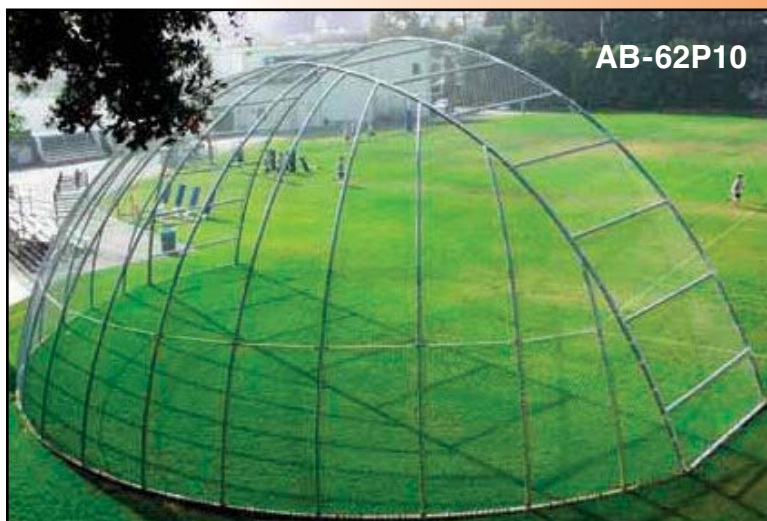

## PERPENDICULAR STYLE

Offers the most control of foul-balls. Available in four sizes, with optional extension.

Model	Height	Width	Depth	Weight
AB-62P	20'	62'	20'	4,000 lbs.
AB-50P	14'6"	50'	14'6"	2,750 lbs.
AB-40P	15'6"	40'	15'6"	2,250 lbs.
AB-30P	15'	30'	15'	1,750 lbs.

## LAYBACK STYLE

The 25° slope allows for more space above home plate and full view of the field for spectators. Available in four models

Model	Height	Width	Depth	Weight
AB-62L	18'	62'	20'	3,500 lbs.
AB-50L	13'6"	50'	14'6"	2,500 lbs.
AB-40L	14'	40'	15'6"	2,250 lbs.
AB-30L	13'6"	30'	15'	1,600 lbs.



# Full Size Permanent Backstops



Bolt-together design eliminates field welding. All posts and rails are galvanized pipe, hardware is corrosion resistant and fabric is hot dipped galvanized knuckle-knuckle finish.

Custom designed sizes and posts available.

Sold without Planking, see information below on planking options.

Power coated frame, vinyl coated fabric and polyester coated fitting available at additional fee.

**POWDER  
COAT OPTION  
AVAILABLE ON  
POSTS-SEE  
PAGE 88**

## BASEBALL FIELD PACKAGES

These field packages consist of a full size permanent backstop with rear planking (3 boards high), two 12' fiberglass dugout benches (Model LBF-12C) and two 6' x 20' protection fences (Model 620KD). Your choice of backstop - either our 1035T model or the 1235T model.

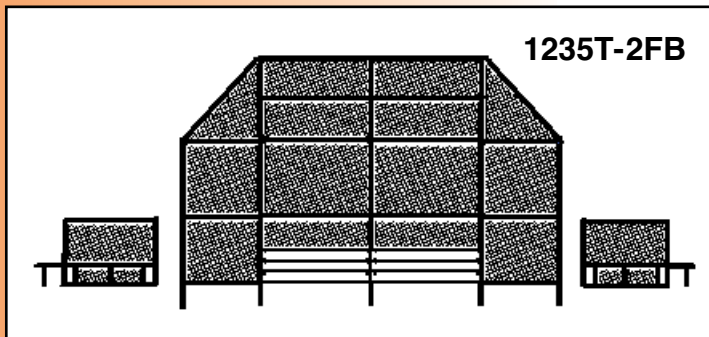

## No Welding Necessary

Model Number	1035T-2FB	1235T-2FB
Height Opening	17'6"	19'6"
Width Opening	34'	34'
Depth	7'6"	7'6"
Vertical End Posts	2-7/8"	2-7/8"
Vertical Posts	2-7/8"	2-7/8"
Horizontal Rails	1-5/8"	1-5/8"
Rear Panel Width	20'	20'
Panel Height	10'	12'
Wing Length	10'	10'
Hood Supports	2-3/8"	2-3/8"
Fabric Panel Gauge	2"-9 GA	2"-9 GA
Fabric Hood Gauge	2"-11 GA	2"-11 GA
Wt. of Complete Pkg.	2,160 lbs.	2,448 lbs.
Benches- 2 ea.	LBF-12C	LBF-12C
Protection Fencing	620-KD	620-KD

## REAR & WING PLANKING FOR FULL SIZE PERMANENT BACKSTOPS

Rear and wing planks are optional for all full-sized and junior backstops: Hardware and attachment brackets are corrosion resistant and are included. Planks are 2" X 12" Douglas Fir Wood.



Model	Descriptions	Weight
<b>Wing Panels</b>		
WP3/ADA	3 high both wings	258 lbs.
WP4	4 high both wings	344 lbs.
WP5	5 high both wings	430 lbs.
<b>Rear Panels</b>		
Series 35T RP3-35T/ADA	3 high x 20'	258 lbs.
RP4-35T	4 high x 20'	344 lbs.
RP5-35T	5 high x 20'	430 lbs.
Series 44T RP3-44T/ADA	3 high x 30'	387 lbs.
RP4-44T	4 high x 30'	473 lbs.
RP5-44T	5 high x 30'	645 lbs.
Series 54T RP3-54T/ADA	3 high x 40'	516 lbs.
RP4-54T	4 high x 40'	602 lbs.
RP5-54T	5 high x 40'	860 lbs.

**All full sized baseball backstops can be modified with heavier posts, call with your specifications.**

### 35T SERIES FULL SIZE BACKSTOPS

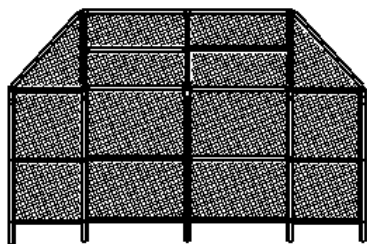

**1035T WITHOUT PLANKING**

Model Number	1035T	1235T	1435T	1635T
Height Opening	17'6"	19'6"	21'6"	23'6"
Width Opening	34'	34'	34'	34'
Depth	7'6"	7'6"	7'6"	7'6"
Vertical End Posts	2-7/8"	2-7/8"	3-1/2"	4-1/2"
Vertical Posts	2-7/8"	2-7/8"	3-1/2"	4-1/2"
Horizontal Rails	1-5/8"	1-5/8"	1-5/8"	1-5/8"
Rear Panel Width	20'	20'	20'	20'
Panel Height	10'	12'	14'	16'
Wing Length	10'	10'	10'	10'
Hood Supports	2-3/8"	2-3/8"	2-3/8"	2-3/8"
Fabric Panel Gauge	2"-9 GA	2"-9 GA	2"-9 GA	2"-9 GA
Fabric Hood Gauge	2"-11 GA	2"-11 GA	2"-11 GA	2"-11 GA
Weight	1,200	1,488	1,776	2,064

### 44T SERIES FULL SIZE BACKSTOPS

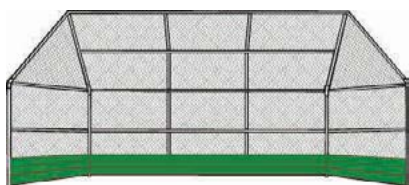

**1044T w/ PLANKS**

Planks sold separately.

Model Number	1044T	1244T	1444T	1644T
Height Opening	16'6"	19'6"	21'6"	23'6"
Width Opening	44'	44'	44'	44'
Depth	7'6"	7'6"	7'6"	7'6"
Vertical End Posts	2-7/8"	2-7/8"	3-1/2"	4-1/2"
Vertical Posts	2-7/8"	2-7/8"	3-1/2"	4-1/2"
Horizontal Rails	1-5/8"	1-5/8"	1-5/8"	1-5/8"
Rear Panel Width	30'	30'	30'	30'
Panel Height	10'	12'	14'	16'
Wing Length	10'	10'	10'	10'
Hood Supports	2-3/8"	2-3/8"	2-3/8"	2-3/8"
Fabric Panel Gauge	2"-9 GA	2"-9 GA	2"-9 GA	2"-9 GA
Fabric Hood Gauge	2"-11 GA	2"-11 GA	2"-11 GA	2"-11 GA
Weight	1,409	1,697	1,985	2,273

### 54T SERIES FULL SIZE BACKSTOPS

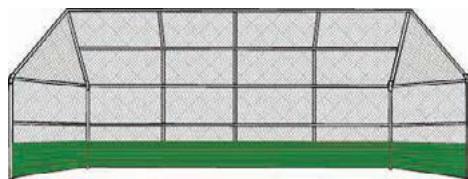

**1054T w/ PLANKS**

Planks sold separately.

Model Number	1054T	1254T	1454T	1654T
Height Opening	17'6"	19'6"	21'6"	23'6"
Width Opening	54'	54'	54'	54'
Depth	7'6"	7'6"	7'6"	7'6"
Vertical End Posts	2-7/8"	2-7/8"	3-1/2"	4-1/2"
Vertical Posts	2-7/8"	2-7/8"	3-1/2"	4-1/2"
Horizontal Rails	1-5/8"	1-5/8"	1-5/8"	1-5/8"
Rear Panel Width	40'	40'	40'	40'
Panel Height	10'	12'	14'	16'
Wing Length	10'	10'	10'	10'
Hood Supports	2-3/8"	2-3/8"	2-3/8"	2-3/8"
Fabric Panel Gauge	2"-9 GA	2"-9 GA	2"-9 GA	2"-9 GA
Fabric Hood Gauge	2"-11 GA	2"-11 GA	2"-11 GA	2"-11 GA
Weight	1,618	1,906	2,194	2,482

**NOTE: POST INSTALLATION MAY REQUIRE STEEL REINFORCEMENT IN FOOTING-CHECK WITH LOCAL BUILDING CODES IF REQUIRED IN YOUR AREA.**

# Junior Backstops

## JUNIOR SIZED BASEBALL BACKSTOPS



Great for softball or where space is limited. These heavy-duty backstops are available with or without Hoods, in portable or direct bury types. One is permanently installed in concrete footings, the other is freestanding and portable. Backstops are furnished complete with all parts necessary for assembly. No field welding needed.

The hood corners are pre-fabricated and wired at the factory, on 810 models with hoods.



	810J-3S	810JH-4S	810KD	810JH-4C	1024KD	1024-4C
Height Opening	10'	13'	10'	13'	10'	17'6"
Width Opening	20'6"	20'6"	20'6"	20'6"	24'	24'
Depth	6'	6'	6'	6'	7'4"	7'4"
Vertical Posts	2-3/8"	2-3/8"	2-3/8"	2-3/8"	2-3/8"	2-3/8"
Horizontal Rails	1-5/8"	1-5/8"	1-5/8"	1-5/8"	1-5/8"	1-5/8"
Wing Height	10'	10'	10'	10'	10'	10'
Wing Length	8'6"	8'6"	8'6"	8'6"	10'	10'
Rear Panel Height	10'	10'	10'	10'	10'	10'
Rear Panel Width	8'6"	8'6"	8'6"	8'6"	10'	10'
Top Horizontal Rails	1-5/8"	1-5/8"	1-5/8"	1-5/8"	1-7/8"	1-7/8"
Hood Support	No Hood	1-7/8"	No Hood	1-7/8"	No Hood	2-3/8"
Fabric Panels/Wings	2"-9 GA	2"-9 GA	2"-9 GA	2"-9 GA	2"-9 GA	2"-9 GA
Fabric Hood	No Hood	2"-11 GA	No Hood	2"-11 GA	No Hood	2"-11 GA
Weight	680 lbs.	1000 lbs.	575 lbs.	855 lbs.	575 lbs.	1115 lbs.

Model 1024-4C requires corner fabrication, similar to Full Size Backstops.

## WHEEL ASSEMBLY



Our 810J-3S and 810JH-4S can be fitted with wheels for easy adjustments and movement. The wheel assembly slips easily onto the front uprights and the pneumatic tires roll across grass with minimum impact. The backstop's bottom frame is extended to provide a place for a hand transporter or manual move.

For backstop anchors and transporter see page ?

We suggest ordering with Portable Backstop.

Model	Weight
BB-WA	30 lbs.



# Baseball Racks

**POWDER COAT OPTION AVAILABLE ON POSTS-SEE PAGE 88**

## BATTING HELMET RACK



Dugout space saving Helmet Rack is made of 2" x 2" square structural steel upright with 12 each formed 3/8" hot rolled steel helmet holders, welded to upright and hot dipped galvanized finish. Approx. 72" high x 18" wide x 12" deep. SM = Surface Mount model.



Model	Description	Weight
BHT-12	18" W x 72" H	25 lbs.
BHT-12-SM	18" W x 72" H	30 lbs.

## BAT RACKS



All galvanized steel welded unit with cold galvanizing compound treated welds. Approx. 20" high by 6" deep. Powder coating available at additional cost. SM = Surface Mount model.

Model	Description	Weight
BR-15	Galv. holds 15	140 lbs.
BR-8	Galv. holds 8	75 lbs.
BR-15SM	Galv. holds 15	140 lbs.
BR-8SM	Galv. holds 8	75 lbs.

## Baseline Foul/Fair Poles

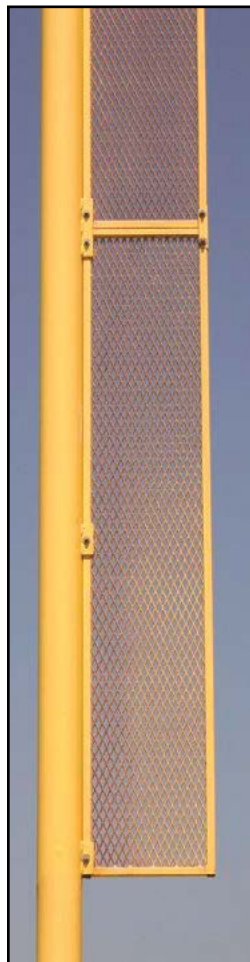

### SLEEK CONTINUOUS LOOK.

A steel foul line pole available in three heights, with frames of 1" tubing and wing panels filled with 3/4"-9 gauge expanded metal. The entire unit is sandblasted then electrostatically powder coated yellow. Exclusive continuous outside diameter, non-stepped pole.

Can be installed In Ground, or Surface Mounted (see models below ending with SM). **SOLD IN PAIRS.**

**FLP model Foul Poles bottom starts 8 ft. above grade. All measurements are "above grade". CUSTOM DESIGNED FOUL POLES AVAILABLE WITH OR WITHOUT WINGS.**

Model	Pipe Diam.	Height	Weight
FLP-20	4-1/2" OD	20'	580 lbs.
FLP-30	5-9/16" OD	30'	1,282 lbs.
FLP-40	6-5/8" OD	40'	1,880 lbs.
FLP-20SM	4-1/2" OD	20'	494 lbs.
FLP-30SM	5-9/16" OD	30'	1,078 lbs.
FLP-40SM	6-5/8" OD	40'	1,852 lbs.

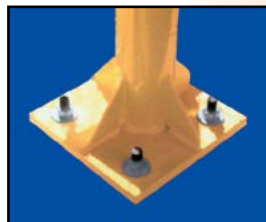

Surface mount for foul poles shown left.

# Protective Fencing

## SIDELINE FENCING

Model	Size	Weight
610KD	6' high x 10' long	280 lbs.
620KD	6' high x 20' long	560 lbs.
1010KD	10' high x 10' long	385 lbs.
1020KD	10' high x 20' long	665 lbs.

Sideline Fencing extends the protected area of any backstop and provides an ideal enclosure for small dugouts. Fencing is 2"-9GA, HDG, Knuckle-Knuckle fabric on 2-3/8" uprights and 1-5/8" vertical posts.

**Sold in Pairs.**



All L.A. Steelcraft fencing is knuckle to knuckle.

## PORTABLE FENCING & PROTECTION

Model	Size	Weight
PORTABLE FENCING		
OP410	10' x 4'	100 lbs.
PITCHER PROTECTION SCREENS		
PPS-M	6' x 7'	70 lbs.
PPS-N	6' x 7'	55 lbs.
FIELD/BASEMAN'S SCREEN		
FPS-M	6' x 7'	65 lbs.
FPS-N	6' x 7'	50 lbs.

Galvanized steel pipe, 2" mesh 11 gauge H.D.G. = (M) or 2" Knotted Latex Netting = (N).



# Baseball Netting

## BACKSTOP BASEBALL NETTING

We are proud to provide quality baseball and softball netting, canopy netting and dugout netting used for professional, collegiate, municipal and local stadiums.

Our protective netting is manufactured using polyester, which is stronger, more abrasion resistant and UV-resistant than nylon netting. Polyester netting is an ideal material for outdoor use and provides long lasting performance. We manufacture 5 different knotted netting sizes (thicknesses) in our standard 1-3/4" mesh, ranging from light duty to heavy duty netting. Framing and hardware is also available.

We offer custom sizes and configurations to fit your field and facility. We also offer installations of cable suspended backstops systems to ensure maximum protection for your ball field.

Our baseball netting is manufactured in the USA and offers a low cost, high quality product for your facility.

Call us and we can help you with designing, manufacturing and installation of any special baseball project that you want to complete.

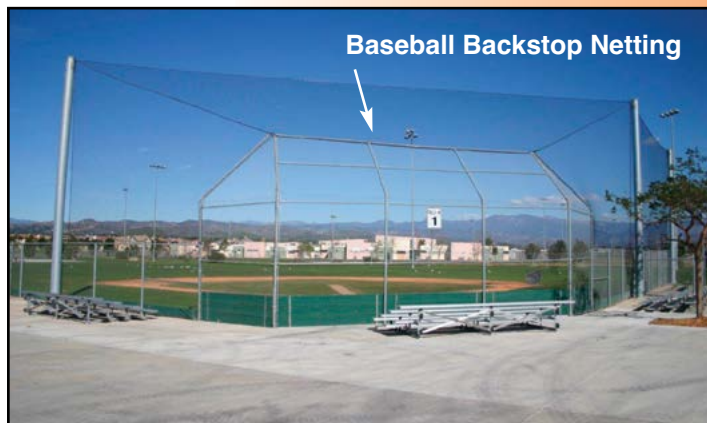
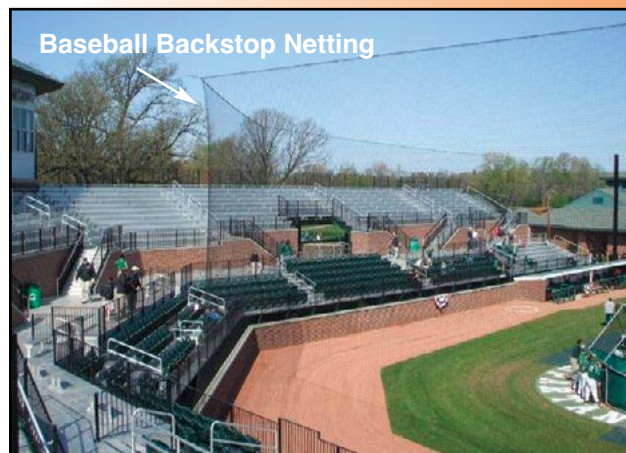

## PROTECTIVE BARRIER NETTING

Often sports fields are situated close to locations such as parking lots, roadways and housing where ball containment is desirable and also necessary for safety.

Our barrier netting (available for all sports and various sizes) can help provide spectator safety, personnel, property and injury protection at a cost effective solution for all type of sporting and recreational areas.

Our custom barriers nets are built with top quality materials in the USA and can be crafted with accessories including posts and hardware. We can also offer installation services. Please contact us with your requirements.

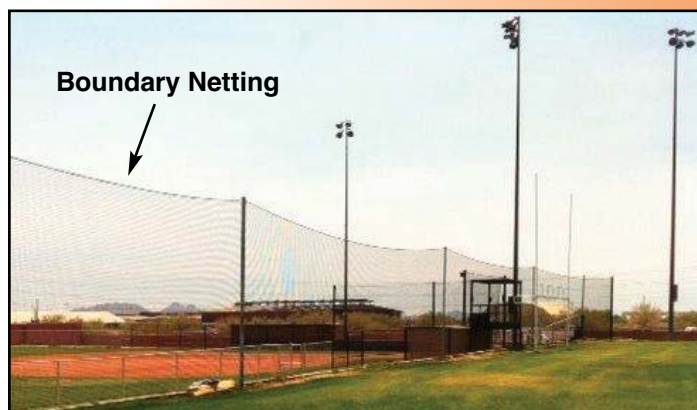

# Dugout Seating



Aluminum planking end caps used for seat benches are 2" x 12" (9-1/2" x 1-3/4" ) extruded aluminum alloy 6063T6 with a clear anodized finish as per AA-M10L22A31 Class II (204R1) 0.4 mil minimum thickness to resist corrosion and stains. The aluminum planks weighs 1.98 pounds per foot and come with end caps.

## PLANK PLAYER/LOCKER ROOM BENCH

Perfect for dugouts, locker rooms or sidelines. Surface Mount or In Ground install available. All Galvanized Frames. Add SM to model number for surface mount option.



Model	Description	Length	Frames	Space	Weight
LBA-8P	Aluminum	7-1/2'	2	1' x 7-1/2'	33 lbs.
LBA-15P	Aluminum	15'	3	1' x 15'	66 lbs.
LBW-6P	Wood	6'	2	1' x 6'	39 lbs.
LBW-8P	Wood	8'	2	1' x 8'	46 lbs.
LBW-15P	Wood	15'	4	1' x 15'	89 lbs.
LB-FP	Galvanized Frame only w/ plate per pair				18 lbs.
LB-FC	Galv. Frame only for direct bury per pair				8 lbs.



60%  
RECYCLED  
ALUMINUM 

## PLAYER BENCH WITH BACK

Perfect for dugouts, locker rooms or sidelines. Portable or direct bury install. All Galvanized Frames. 2" X 10" seat and back rest plank size.

Model	Description	Length	Frames	Space	Weight
PBA-8P	Aluminum	7-1/2'	2	2' x 7-1/2'	77 lbs.
PBA-15P	Aluminum	15'	4	2' x 15'	148 lbs.
PBW-6P	Wood	6'	2	2' x 6'	89 lbs.
PBW-8P	Wood	8'	2	2' x 8'	103 lbs.
PBW-15P	Wood	15'	4	2' x 15'	193 lbs.
PB-FS	Galvanized Direct Bury Frame per pair				45 lbs.
PB-FP	Galvanized Portable Frame per pair				47 lbs.



## PLAYERS BENCH WITH REAR SHELF

Dugout bench with space for gloves, caps, batting helmets, water bottles and gloves. Can also be used as additional seating. Powder coated steel frame with 2" x 12" anodized aluminum seat plank and 2" x 10" backrest with plastic roto-molded end caps.



Model	Seats	Length	Weight
PBA-8RS	5	7'- 6"	125 lbs.
PBA-15RS	10	15'	240 lbs.
PBA-21RS	14	21'	315 lbs.
PBA-24RS	16	24'	345 lbs.
PBA-27RS	18	27'	405 lbs.
PBA-30RS	20	30'	450 lbs.





**All Play Home Plate 300-AS**  
 No-Corner bevels extend into apron. Molded 5/16" vinyl is ready to install.  
 One piece white vinyl covers wood filled core, 3" high. 20 lbs.



**Major League Base 100ML Set of 3**  
 15" x 15" x 3" Finest quality vinyl covered bonded polyurethane padding. Strapless base easily bolts to anchor plate. Uses 205-BA anchors. 22 lbs.



**Stake Down Home Plate 310-SHP**  
 White Top with Black beveled edges and 227-FAS ground anchor. Stanchion and mounting plate are powder coated for longer life. 21 lbs.



**Base Anchor 205-BA Set of 3**  
 Set of 3 anchor stakes, 3 anchor plates. Anchors for use with 100ML bases. 6 lbs.

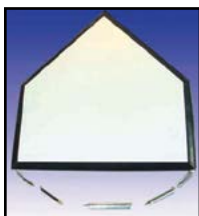

**Economy Home Plate 380-HP**  
 Regulation size with white rope and black beveled edges. 3/4" Molded in bottom receive 5 zinc plated 4" spikes. 12 lbs.



**Major League Base 175 MLB Set of 3**  
 15" x 15" x 3" One piece, textured white rubber base for all skill levels. Modular heavy gauge non-collapsible, non-impact. Aluminum stanchion fits male and female ground anchors. 42 lbs.



**Stake Plug - Set of 3 230-SP**  
 1" Plug with domed cap should be used when bases are removed. Durable plastic fits snugly to keep elements out. 3 lbs. per set.



**Double First Base 110DBL**  
 Regulation size: 15" x 30" x 15". One piece all rubber construction. Modular heavy gauge non-collapsible textured white rubber. Aluminum stanchion fits a male or female ground anchor. 26 lbs.



**Economy Pitcher's Mound 490-CC**  
 Regulation size 6" x 24" and made of white 3/4" rubber with 3 metal spikes. 8 lbs.



**Dig Out Tool 505**  
 Removes excess dirt in and around ground anchor. 2 lbs.



**Base Anchor 227-FAS (female) Set of 3** For use with 175MLB bases. 3 lbs.  
**Base Anchor 225-BAS (male) Set of 3** For use with 175MLB bases. 3 lbs.



**Firm Grip Pitcher Plate 410-FG**  
 Made of tough vinyl, easy to install, limits depth of holes in front of plate. Regulation 6" x 24" with wood block filled core. 18 lbs.

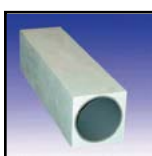

**Four-Way-Last -Long Pitcher Plate 450-C1**  
 Regulation 6" x 24" poly vinyl with PVC. Rotate sides for extended use. 18 lbs.

SLIDING INTO BASEBALL BASE REPRESENTS A CLEAR AND PRESENT DANGER. SERIOUS INJURY MAY OCCUR.

# Baseball Bases (Continued)



## MAJOR LEAGUE MAGNETIC BASES **SAFE-T**

Set of 3 regulation size 15" x 15" x 3"  
3 magnetic adjustable plates adjust hold for all ages and skill levels. Durable one piece all rubber base cover modular heavy gauge non-collapsible textured white rubber. Universal stanchion pan for excellent durability. Fits 227-FAS. and 225-BAS ground anchors (sold separately). 75 lbs.

Adjustable Plates and Stanchion

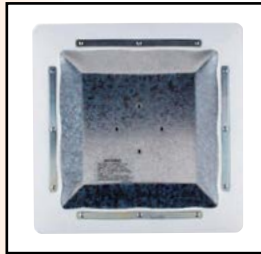
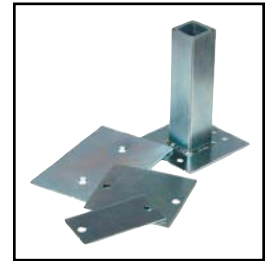

Back

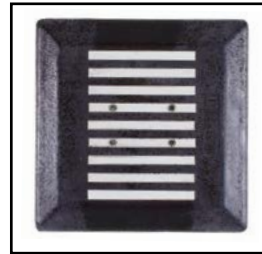

Magnetic Plate



Back



## ECONOMY RELEASE BASE **6185-EBA**

Set of 3 regulation size 15" x 15" x 3"  
3 magnetic adjustable plates adjust hold for all ages and skill levels. Durable one piece all rubber base cover. Universal stanchion pan for excellent durability. Fits 227 - FAS and 225 - BAS ground anchors (sold separately). 45 lbs.



Back



Back



Universal Modular Base Stanchion



## SAFETY BASE **150-SB**

Set of 3 regulation size 15" x 15" x 2 1/2: slide-over safety base for all skill levels. Modular one-piece all rubber construction with tapered sides. Heavy-duty non-collapsible textured white rubber. Universal stanchion pan for excellent durability. Fits 227 - FAS and 225 - BAS ground anchors (sold separately). 26 lbs.

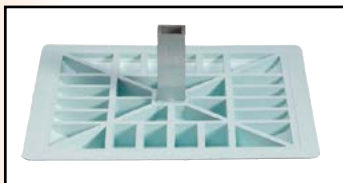



### PRO-STYLE BASE SET WITH METAL PAN 120-PRO

Set of 3 regulation size 15" x 15" x 3"  
Durable rubber base cover. Universal stanchion pan for excellent durability.  
Fits 227 - FAS and 225 - BAS ground anchors (sold separately).  
35 lbs.



### PITCHERS PLATE ANCHOR TOP PLATE 490-PAT (FOR REMOVABLE PITCHERS PLATE)

Bolts to 490 - CC (sold separately), fits into: 490 - GAS (sold separately). Simply allows you to remove pitchers plate after games or practice, perfect for multi-use fields. Attachment hardware included.  
10 lbs.



### DOUBLE GROUND ANCHOR STAKE 490-GAS

Secures removable pitchers plate or double first bases with ground anchor system. This new anchor system can be installed quickly and easily.  
10 lbs.

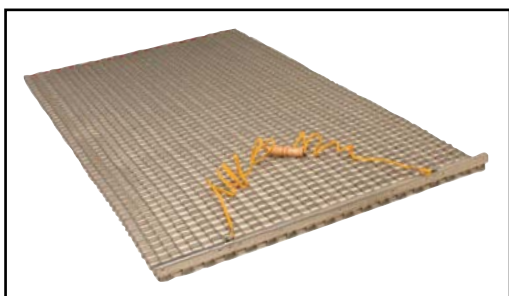

### FIELD DRAG MATS 330-FD

Regular field drag 2' x 6'  
13 ga. x 1" x 1" mesh strip crimped steel.  
Nylon rope attachment with wood handle for easy pulling.  
25 lbs.



### FIELD DRAG MATS 220-FD

Large field drag, as above 6' x 6'  
65 lbs.

# Soccer

## Professional Goals



AGS-A21

Steel reinforced roto-molded corners!

### ALUMI-LITE PREMIUM GOAL

Alumi-lite goals meet NFSHSA, NCAA and FIFA specifications. Our premium **ALUMINUM** goal - light-weight and durable with the strength of steel. Available in 4 sizes, with crossbars and post of 4" round, .124 wall aluminum, finished in white baked enamel. Backstays and ground bar are 1 5/8" galvanized steel tube to prevent rust.

**Includes special 3mm nets (SGN - A series), 4 steel "S" hold-downs and all hardware. SOLD IN PAIRS WITH NETS!**



**PORTABLE GOALS CAN TIP OVER CAUSING INJURY AND DEATH TO THOSE WHO CLIMB ON THEM. USE ANCHORS AT ALL TIMES.**

Model (one pair)	Size	Weight
AGS-A24	24' x 8'	514 lbs.
AGS-A21	21' x 7'	378 lbs.
AGS-A18	18' x 6' x 6"	337 lbs.
AGS-A12	12' x 6' x 6"	294 lbs.

Steel reinforced roto-molded corners!



FGS-S24-3



FGS-S24-KD

### PRO GOAL FGS-S24

Official 24' wide x 8' deep. The front supports and front crossbar are **2" X 4" STEEL** with "no tie" net holders. The back crossbar and stays are 1 7/8" OD Galvanized Pipe. Goals are knocked down (KD) and **SOLD WITH NETS (SGN - 2RN NETS INCLUDED WITH FGS-S24-KD GOALS).**

**4" X 4" SIZE AVAILABLE - SEE KD MODEL BELOW**

Sturdy slip joint for easy secure assembly. Includes our best net, Model SGN-2RN & 4 steel hold-downs. No field welding required. Front pieces are white powder coat finish.

- \* FGS-S24-2 has back crossbar and no center stay.
- FGS-S24-1 has no back crossbar or center stay.
- FGS-S24-KD is a 4" x 4" model.

**SOLD IN PAIRS WITH NETS!**

Model (one pair)	Description	Weight
FGS-S24-3	3 stays	1,350 lbs.
FGS-S24-2	Backbar	976 lbs.
FGS-S24-1	Side Stays	911 lbs.
FGS-S24-KD	3 stays 4" x 4"	1,450 lbs.

**ALL GOALS CAN BE MODIFIED FOR USE WITH GROUND SLEEVES.**



## STANDARD GOAL - FGS -24

Official 24' wide x 8' high and 8' deep all galvanized steel pipe. Front sides and crossbar are 2 3/8" and Backstays are 1 7/8" OD. Each goal is anchored with two 1/2" x 18" steel hold-downs. Goals are knocked down (KD).

FGS-24-2 has no center stay.

FGS-24-1 has no top-back cross bar or center stay.

Suggested nets for this goal: SGN-2RN or SGN-E series.

Model (one pair)	Size	Description	Weight
FGS-24-3	24'x8'x8'	3 stays	908 lbs.
FGS-24-2	24'x8'x8'	Backbar	930 lbs.
FGS-24-1	24'x8'x8'	Side Stays	865 lbs.
FGS-24-KD	24'x8'x8'	3 stays	1,100 lbs.

**NETS SOLD SEPARATELY**

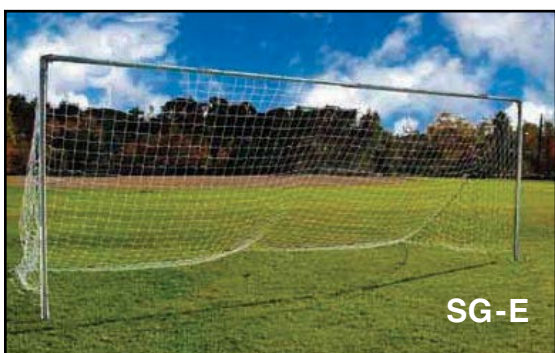

## ECONOMY GOAL SG-E

An economical way to start your soccer program. SG-E Goals are **Direct Bury** installation into footings or optional **278-E4 Sleeved Install** for easy take-down and storage. All 2 7/8" OD galvanized pipe, with heavy-duty galvanized fittings.

Suggested nets for this goal: SGN-2RN or SGN-E series.

Model (one pair)	Size	Weight
SG-E	24' x 8'	520 lbs.
278-E4 (sleeve)	Set of 4	84 lbs.

**NETS SOLD SEPARATELY**



## EUROPEAN GOAL FGS-ES

European styled back stays added to 4" x 4" x .120" wall square tubing uprights and crossbars. Available for **Direct Bury** installation into footings for optional **350-E4 Sleeved install** for easy take down and storage. White powder coat finish.

Suggested nets for this goal: SGN - 2RN or SGN - E series.

Model (one pair)	Size	Weight
FGS-ES	24' x 8'	740 lbs.
350-E4 (sleeve)	Set of 4	104 lbs.

**NETS SOLD SEPARATELY**



## MODIFIED EUROPEAN GOAL SG-F

This highly efficient practice goal has been designed and engineered just as our standard european model FGS-ES shown above, but without the back stays.

Suggested nets for this goal: SGN-2RN or SGN-E series.

Model (one pair)	Size	Weight
SG-F	24' x 8'	640 lbs.
350-E4 (sleeve)	Set of 4	104 lbs.

**NETS SOLD SEPARATELY**

**ALL GOALS CAN BE MODIFIED FOR USE WITH GROUND SLEEVES.**

# Soccer Accessories

## SOCCER NETS



Model	Description	Weight
SGN-A824	3mm Nylon-white- ALUMI-LITE	13 lbs.
SGN-A721	3mm Nylon-white- ALUMI-LITE	12 lbs.
SGN-A618	3mm Nylon-white- ALUMI-LITE	11 lbs.
SGN-A612	3mm Nylon-white- ALUMI-LITE	15 lbs.
SGN-2RN	Nylon Rubberized- FGS-S24 & FGS-24	15 lbs.
SGN-2R	Nylon Rubberized- FGS-S24KD & Combo	17 lbs.
SGN-E	Economy Net (Orange Poly)- FGS-S24KD & Combo	12 lbs.

All soccer nets include hook and loop net ties.

## PORTABLE WHEELS AND TRANSPORTER

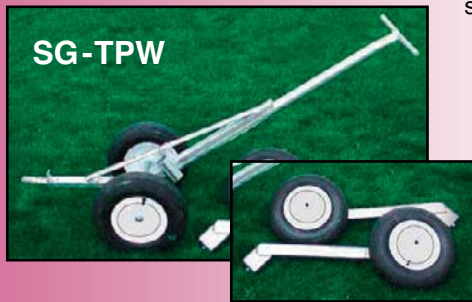

For Pro Goal and Standard Goal only. Also for use with baseball backstops. Easy to install with one bolt. Includes 2 pneumatic wheels to move one goal at a time. Made of corrosion resistant galvanized steel. Wheels for transport only, not to be used during play. Please specify Goal Model when ordering a transporter for steel models.

Model	Description	Weight
SG-PW	Wheels Only	20 lbs.
SG-T	Universal Transporter	62 lbs.
SG-TPW	Set	82 lbs.
AGS-PW	AlumiLite Model Transporter	21 lbs.
AGS-TPW	Alumi-Lite Model Set	83 lbs.

## SOCCER ACCESSORIES

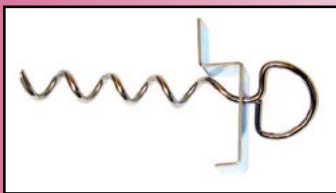

**HCA Stabilizing Auger Anchor:**  
Coil style. For added Security.  
(Set of 4).



**SG-ANC Soccer Anchor:**  
Fits all Soccer Goals for positive  
anchoring. (Set of 4).



**CF2P PVC Field Boundary Flags:**  
3/4" PVC tubing in 2 pieces that sleeve  
together. 5' high when assembled.  
Comes with orange flags. (Set of 4).



**CFF2 Fiberglass Field Boundary Flags:**  
1/4" Fiberglass tubing in 2 pieces that  
sleeve together. 5' high when assembled.  
Comes with orange flags. (Set of 4).

Model	Description	Weight
NS-20	Set of 20 Net Stakes	5 lbs.
VNS-25	Velcro Roll	6 lbs.
PNH	Plastic Self Locking Net Holders	1 lb.
HCA	Auger Type Soccer Anchor	8 lbs.
SG-ANC	Soccer Anchor	40 lbs.
CF2P	PVC Boundary Flags	5 lbs.
CFF2	Fiberglass Boundary Flags	4 lbs.



**PORTABLE GOALS CAN  
TIP OVER CAUSING INJURY  
AND DEATH TO THOSE WHO CLIMB ON  
THEM. USE ANCHORS AT ALL TIMES.**

# Football

New 8' extend models to choose from!

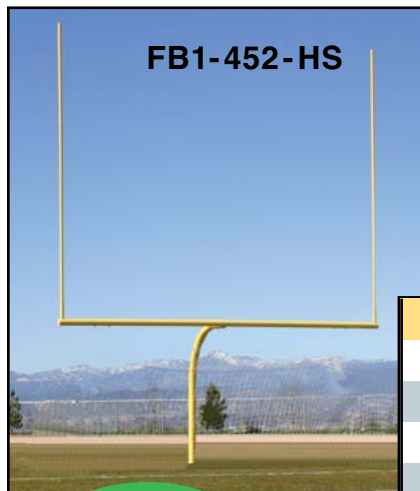

FB1-452-HS

WHITE OR  
YELLOW  
POWDER COAT  
OPTION - SEE  
PAGE 88

## FOOTBALL GOAL POSTS (PAIRS)

NCAA official and national rules compliant. We offer four models each for college or high school. Goals feature: A single bent center post with a welded steel lift ring formed from standard wall galvanized pipe; A cross beam of 5" OD tube; and the 20 foot uprights are 2-3/8" OD pipe. **Installs in provided adjustable centering ground sleeves.** The uprights and the cross arm are capped to protect against corrosive elements. Center posts extend 4', 5' or 6' with radius bend. 30' uprights also available at additional cost.

Specify if goal is for high school or college with model numbers ending in **HS for High School - C for College.**

Priced in pairs (two goals). Includes 2 Self-Centering Ground Sleeves, without caps.

Model	Description	Extends	Opening	Weight
FB1-452-C	4-1/2" Ctr. Post	4'	18'6"	954 lbs.
FB1-552-C	5-9/16" Ctr. Post	5'	18'6"	1,280 lbs.
FB1-652-C	6-5/8" Ctr. Post	6'	18'6"	1,630 lbs.
FB1-852-C	6-5/8" Ctr. Post	8'	18'6"	1,710 lbs.
FB1-452-HS	4-1/2" Ctr. Post	4'	23'4"	1,248 lbs.
FB1-552-HS	5-9/16" Ctr. Post	5'	23'4"	1,350 lbs.
FB1-652-HS	6-5/8" Ctr. Post	6'	23'4"	1,700 lbs.
FB1-852-HS	6-5/8" Ctr. Post	8'	23'4"	1,780 lbs.

## COMBINATION FOOTBALL AND SOCCER GOAL

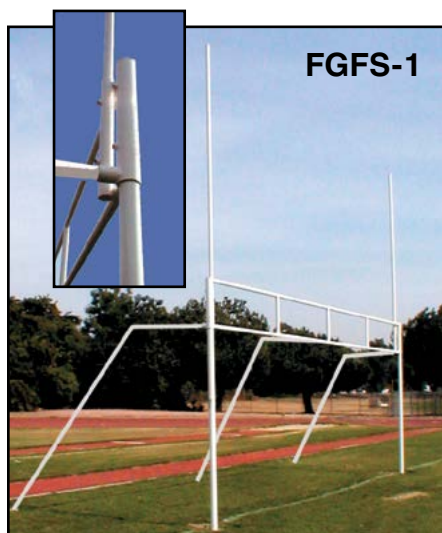

FGFS-1

A regulation 24' wide by 8' high soccer goal combined with regulation football goal with 10' high crossbars and uprights at 23' 4" or 18' 6" apart. Priced in Pairs. Front support legs: 2 7/8" OD galvanized pipe. Rear support legs: 1 7/8" OD galvanized pipe. Cross Arm made of 2 3/8" OD galvanized pipe. Uprights of sturdy 10' x 2 3/8" OD galvanized pipe. Sold without nets. See page 28 for nets available. Please specify if for College or High School.



For our  
collection  
of Post  
Pads see  
page 15.

Model	Rear Supports	Weight
FGFS-1	3	1,350 lbs.
FGFS-1A	2	1,000 lbs.

*Shown in soccer configuration. Remove rear supports for football.*

## FOOTBALL ACCESSORIES

Model	Description	Weight
WS-42	Wind Streamers	1 lb.
W-PYLON	Weighted Pylons	15 lbs.
A-PYLON	Anchored Pylons	20 lbs.

### WS-42 Wind Streamers:

4" W x 42" L with grommets. (Set of 4).

### W-PYLON Weighted Anchorless Pylons:

No anchor system required. A safe foam filler with a weighted shot bottom. Bright, visible fluorescent orange color. (Set of 4).

### A-PYLON Anchored Pylons:

These official sized pylons anchor into the ground for stability. A soft, foam rubber core with orange vinyl cover and a 'spring-back' coil system. Includes anchors. (Set of 4).

**NOTE: POST INSTALLATION MAY REQUIRE STEEL REINFORCEMENT IN FOOTING-CHECK WITH LOCAL BUILDING CODES IF REQUIRED IN YOUR AREA.**

# Net Sports

**POWDER  
COAT OPTION  
AVAILABLE ON  
POSTS - SEE  
PAGE 88**

## Net Game Posts

Our **COMBINATION NET POSTS** are fabricated from galvanized pipe **complete with moveable fittings**. Post sizes 2-3/8" OD to 4-1/2" OD. All models adapt to volleyball or badminton, with top and bottom cable or rope tie downs at regulation heights. Sold in pairs (except center posts).

These virtually indestructible combination net posts easily and quickly convert from volleyball to badminton by loosening the hardware and sliding them to any height or position, then re-tightening. Posts can be installed in any surface including sand.

**Sand installation requires you to extend posts, see information on page 34 and in price list.**

*Powder Coat finish available on all posts at additional cost.*

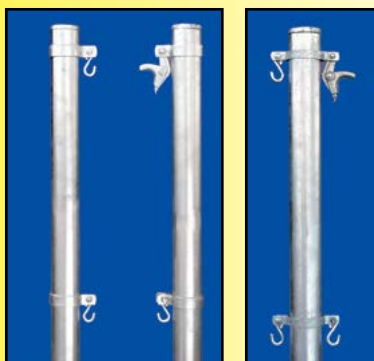

### SUPER VALUE COMBO POSTS

**POST SET**

Model	Post Size	Weight
VBP2-BC	2-3/8" OD	78 lbs.
VBP25-BC	2-7/8" OD	128 lbs.
VBP3-BC	3-1/2" OD	174 lbs.

**CENTER POST**

Model	Post Size	Weight
VBP2-CSDC	2-3/8" OD	40 lbs.
VBP25-CSDC	2-7/8" OD	66 lbs.
VBP3-CSDC	3-1/2" OD	91 lbs.

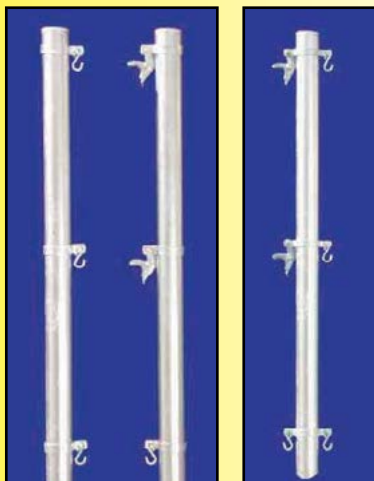

### INTERMEDIATE COMBINATION POSTS

**POST SET**

Model	Post Size	Weight
VBP2-PEI	2-3/8" OD	80 lbs.
VBP25-PEI	2-7/8" OD	125 lbs.
VBP3-PEI	3-1/2" OD	157 lbs.

**CENTER POST**

Model	Post Size	Weight
VBP2-PEIC	2-3/8" OD	40 lbs.
VBP25-PEIC	2-7/8" OD	66 lbs.
VBP3-PEIC	3-1/2" OD	91 lbs.

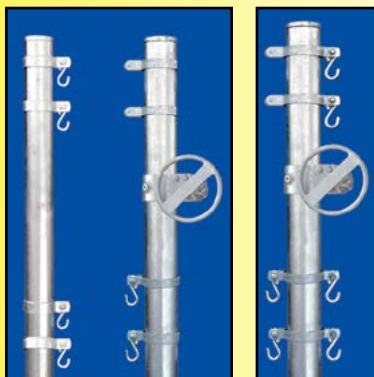

### STANDARD COMBINATION POSTS

**POST SET**

Model	Post Size	Weight
VBBM2-BG	2-3/8" OD	86 lbs.
VBBM25-BG	2-7/8" OD	136 lbs.
VBBM3-BG	3-1/2" OD	182 lbs.

**CENTER POST**

Model	Post Size	Weight
VBBM2-BGC	2-3/8" OD	50 lbs.
VBBM25-BGC	2-7/8" OD	74 lbs.
VBBM3-BGC	3-1/2" OD	95 lbs.

**NOTE: POST INSTALLATION MAY REQUIRE STEEL REINFORCEMENT IN FOOTING- CHECK WITH LOCAL BUILDING CODES IF REQUIRED IN YOUR AREA.**



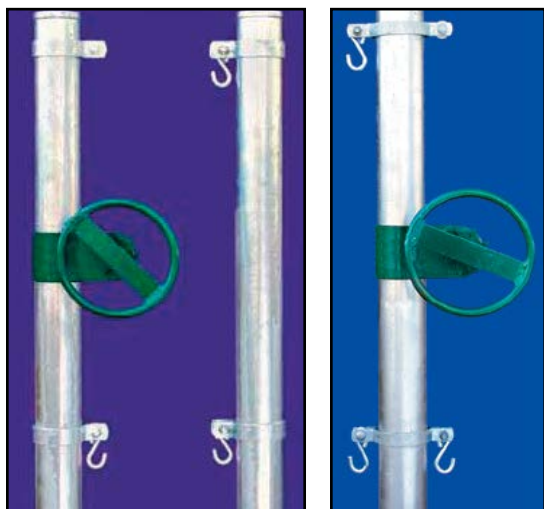

## QUALITY GAME POSTS

Our Intermediate Game Posts are virtually indestructible. Comes with galvanized tightener- shown with powder coat option. **Optional Powder Coat available at additional cost.**

### POST SET

Model	Post Size	Weight
VBP2-BG	2-3/8" OD	86 lbs.
VBP25-BG	2-7/8" OD	136 lbs.
VBP3-BG	3-1/2" OD	182 lbs.

### CENTER POST

Model	Post Size	Weight
VBP2-BGC	2-3/8" OD	35 lbs.
VBP25-BGC	2-7/8" OD	55 lbs.
VBP3-BGC	3-1/2" OD	71 lbs.



## HD ALL GAME POSTS

Our "Top-of-the-Line" features heaviest duty components. Strong enough for Tennis!

### POST SET

Model	Post Size	Weight
AGP-25	2-7/8" OD	135 lbs.
AGP-3	3-1/2" OD	187 lbs.
AGP-4	4-1/2" OD	287 lbs.

### CENTER POST

Model	Post Size	Weight
AGP-25C	2-7/8" OD	73 lbs.
AGP-3C	3-1/2" OD	101 lbs.
AGP-4C	4-1/2" OD	131 lbs.



## VBP4-SQ-AL (Aluminum)

Constructed of 4" square high strength alloy aluminum uprights. Each upright shall have a continuous groove for net attachment hardware and winch to provide for infinite net heights from ground to 7' - 11 5/8". One upright shall have a net tensioning winch to adjust the tension of the top net cable. All hardware shall be galvanized or plated to protect against corrosion.

**INSTALL IN SAND** Installation in sand requires you to extend posts. See per foot pricing by post size in current price list.

Model	Post Size	Weight
VBP4-SQ-AL	4" SQ.	50 lbs.

Optional Equipment:  
**4-SQ-SL:** 4" ground sleeve with cap (sold separately)  
**4-SQ-AL-SCK:** Conversion kit for Sand/Beach Volleyball (sold separately)

Recommended Net: ODVBNET Outdoor Net (for details see page 34)

## BOUNDARIES

Model BR-C is a 30' x 60' nylon rope boundary. Includes: grass-stakes, sand-plates w/bungee cord connectors and winder. Specify nylon Color: Yellow or Black. Model BW-B-C is a 2" wide tape webbing boundary. Premeasured 30' x 60' court with adjustable lengths. Both sand plates and grass anchors are included. Specify color: Black or Blue.

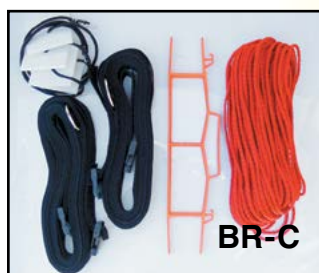

Model	Description	Weight
BW-B-C	2" Web	9 lbs.
BR-C	Nylon Rope	4 lbs.

# Volleyball Court Nets & Post Sleeves

## COURT NETS

We offer a complete line of court netting for tennis, volleyball, badminton paddle tennis and combination posts. Quality ranges from international competition nets to intramural and economy. Your choice of 5/32" vinyl coated aircraft cable or #8 braided nylon rope through top band. Call for quotations on custom sized nets.

**Check out the newest edition to our court nets below! The YMCA-32 is a heavy duty competition net. Another great option from L. A. Steelcraft.**



MODEL	SIZE	DESCRIPTION	MESH	WEIGHT
YMCA-32	32' x 39"	#42 Black nylon netting, top/bottom cable, wood dowel end binding.	4"	10 lbs.
E-COMP-32	32' x 39"	#42 Black nylon netting, white top/bottom/end binding. Coated. Aircraft cable top/bottom, wood dowel in end binding.	4"	8 lbs.
VB-1200	32' x 36"	3mm Braided black polyethylene netting, white top/bottom/end binding. Coated aircraft cable top/bottom, wood dowel in end binding.	4"	15 lbs.
NVC-32	30' x 36"	CABLE THROUGH TOP, ROPE THROUGH BOTTOM BINDING 18" Black nylon netting, white top/bottom/end binding. Vinyl coated. Top cable, #8 braided nylon rope bottom	4"	6 lbs.
NVC-30	30' x 36"	"	4"	5 lbs.
NVC-27	27' x 36"	"	4"	4 lbs.
NVR-32	32' x 36"	ROPE THROUGH TOP BINDING ONLY - ROPE TIE OFFS #18 Black nylon netting, white top/bottom/end binding. #8 Braided nylon rop bottom.	4"	6 lbs.
NVR-30	30' x 36"	"	4"	5 lbs.
NVR-27	27' x 36"	"	4"	4 lbs.
ODVBNET	32' x 36"	2mm Twisted polyethylene netting, 2" heavy-duty vinyl top and 1 1/2" bottom. Top cable and nylon rope bottom	4"	5 lbs.
COMBO. NETS - VOLLEYBALL, BADMINTON & PADDLE TENNIS				
NCN-20	20' x 2'6"	#18 Black nylon netting, white top/bottom/end binding. #8 Nylon rope tie-off	1"	5 lbs.
NCN-30	30' x 2'6"	"	1"	5.5 lbs.
NCN-C	30' x 2'6"	FOR COATED CABLE ONLY		

## POST SLEEVES

All caps have pipe or hole for drainage and can be installed flush with court surface. Installing in concrete recommended.

**"A" Series Sleeve** - With Plug type galvanized steel cap. Drainage hole in welded base should be installed in gravel layer. Galvanized pipe sleeve.

Model	Post Size	Depth	Weight
238-A	2-3/8" OD	18"	16 lbs.
278-A	2-7/8" OD	24"	23 lbs.
350-A	3-1/2" OD	30"	27 lbs.
450-A	4-1/2" OD	36"	42 lbs.

**"E" Series sleeve** - With Locking and sealing steel cap - key wrench provided. Steel pipe welded construction. Drain pipe welded to steel base. Steel rod supports post above debris.

Model	Post Size	Depth	Weight
238-E	2-3/8" OD	18"	14 lbs.
278-E	2-7/8" OD	24"	21 lbs.
350-E	3-1/2" OD	30"	25 lbs.
450-E	4-1/2" OD	36"	40 lbs.



"D" Series post sleeves available. Allen Hinge Cap type sleeve.

Post Accessories are Hot Dipped Galvanized after fabrication and come complete with key wrench. **Net Tightener available with optional powder coated colors for an additional fee.** All parts available in: 2 3/8", 2 7/8", 3 1/2", 4 1/2" OD's.

## HEAVY DUTY SERIES NET ATTACHMENT HARDWARE



**NRF Series: Net Tightener**

Model	Post Size	Weight
NRF-2	2-3/8" OD	7 lbs.
NRF-25	2-7/8" OD	7 lbs.
NRF-3	3-1/2" OD	7 lbs.
NRF-4	4-1/2" OD	7 lbs.



**NEAD Series: Double Moveable Eye**

Model	Post Size	Weight
NEAD-2	2-3/8" OD	2.2 lbs.
NEAD-25	2-7/8" OD	2.2 lbs.
NEAD-3	3-1/2" OD	2.2 lbs.
NEAD-4	4-1/2" OD	2.2 lbs.



**NPA-E Series: Moveable Side Pulley with Eye**

Model	Post Size	Weight
NPA-E-2	2-3/8" OD	2.8 lbs.
NPA-E-25	2-7/8" OD	2.8 lbs.
NPA-E-3	3-1/2" OD	2.8 lbs.
NPA-E-4	4-1/2" OD	2.8 lbs.



**NPT Series: Over The Top Pulley**

Model	Post Size	Weight
NPT-2	2-3/8" OD	3.7 lbs.
NPT-25	2-7/8" OD	3.7 lbs.
NPT-3	3-1/2" OD	3.7 lbs.
NPT-4	4-1/2" OD	3.7 lbs.



**NEA Series: Single Moveable Eye**

Model	Post Size	Weight
NEA-2	2-3/8" OD	1.8 lbs.
NEA-25	2-7/8" OD	1.8 lbs.
NEA-3	3-1/2" OD	1.8 lbs.
NEA-4	4-1/2" OD	1.8 lbs.



**NPAD Series: Moveable Side Pulley, Double**

Model	Post Size	Weight
NPAD-2	2-3/8" OD	2.3 lbs.
NPAD-25	2-7/8" OD	2.6 lbs.
NPAD-3	3-1/2" OD	2.8 lbs.
NPAD-4	4-1/2" OD	3.2 lbs.



**NPA Series: Moveable Side Pulley**

Model	Post Size	Weight
NPA-2	2-3/8" OD	2.6 lbs.
NPA-25	2-7/8" OD	2.6 lbs.
NPA-3	3-1/2" OD	2.6 lbs.
NPA-4	4-1/2" OD	2.6 lbs.

## INTERMEDIATE SERIES NET ATTACHMENT HARDWARE



**DBP Series: Double Braceband with Eye and Pulley**

Model	Post Size	Weight
DBP-2	2-3/8" OD	0.9 lbs.
DBP-25	2-7/8" OD	1.1 lbs.
DBP-3	3-1/2" OD	1.5 lbs.



**DBE Series: Double Braceband with Eyes**

Model	Post Size	Weight
DBE-2	2-3/8" OD	0.9 lbs.
DBE-25	2-7/8" OD	1.1 lbs.
DBE-3	3-1/2" OD	1.3 lbs.



**BC Series: Braceband with Tightening Clamp**

Model	Post Size	Weight
BC-2	2-3/8" OD	0.6 lbs.
BC-25	2-7/8" OD	1.7 lbs.
BC-3	3-1/2" OD	1.9 lbs.



**BE Series: Braceband with Eye**

Model	Post Size	Weight
BE-2	2-3/8" OD	0.4 lbs.
BE-25	2-7/8" OD	0.5 lbs.
BE-3	3-1/2" OD	0.6 lbs.



**BP Series: Braceband with Pulley**

Model	Post Size	Weight
BP-2	2-3/8" OD	0.3 lbs.
BP-25	2-7/8" OD	0.5 lbs.
BP-3	3-1/2" OD	0.6 lbs.

## POST CAPS



**CID Series: Internal Aluminum Drive Cap. Caps wedge into top of post, making it very difficult to remove.**

Model	Post Size	Weight
CID-238	2-3/8" OD	0.3 lbs.
CID-278	2-7/8" OD	0.5 lbs.
CID-350	3-1/2" OD	0.7 lbs.
CID-450	4-1/2" OD	0.9 lbs.

# Tennis



## WIMBLEDON SERIES - PREMIER TENNIS POSTS

Our **WIMBLEDON SERIES** features sleek steel posts coated with green or black acrylic urethane. The chrome and stainless steel winding mechanisms utilizes a rust-resistant internal worm-gear winder that is jam-resistant and self-locking to prevent recoil during tightening. The handle is removable and the net lacing rods are welded to the posts. Complete with Special Ground-Sleeves and Center Net Anchor. Available in Black or Green.

Model	Description	Weight
CTR-3	3" OD x 11 GA.	63 lbs.
ATA-3W	3" x 3" x 3/16"	68 lbs.

## TENNIS POSTS

Galvanized posts supplied with heavy duty hardware. Sold in pairs. Powder coating available for an additional fee.

NOTE: Models come with net anchors, but without center tie down straps or sleeves (sold separately).



**POWDER COAT OPTION AVAILABLE ON POSTS - SEE PAGE 88**

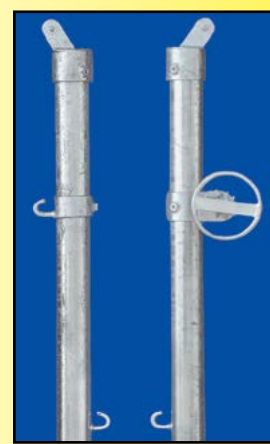

Model TP4S (not shown) Post set for use with steel nets. Neatly capped and predrilled to receive steel net draw bolts. (Bolts come with NTS steel nets.) Galvanized. For use only with NTS nets seen on page 39.

Model	Post Size	Weight
TP3-ZT	3-1/2" OD	106 lbs.
TP4-ZT	4-1/2" OD	180 lbs.
TP3-2ZT	3-1/2" OD	117 lbs.
TP4-2ZT	4-1/2" OD	180 lbs.
TP3-ZS	3-1/2" OD	111 lbs.
TP4-ZS	4-1/2" OD	178 lbs.
TP4S (For Steel Nets)	4-1/2" OD	138 lbs.

## PRO-QUALITY TAMPER PROOF TENNIS SYSTEM



Pro-quality tennis system includes posts, tensioning hardware, nets-NT-42W, adjustable filler-panels, and features a unique net-tightener that is fully enclosed to prevent tampering or vandalism. Our exclusive "NET-GUARD" Adjuster is the heart of this system. The mechanism is completely enclosed and permits positive net tightening that absolutely will not slip. There are no protruding pulleys or wheels. The ratchet action adjuster is accessible only to authorized personnel.

Posts and tightener are galvanized, but available in blue or green powder coat for additional fee.

NT-42-W Net is 3 mm braided black polyethylene cord, 285 lb. break strength with vinyl covered aircraft top cable rated 3000 lbs. tensile strength.

**POWDER  
COAT OPTION  
AVAILABLE ON  
POSTS - SEE  
PAGE 88**

Model	Description	Weight
NG-400	Complete set 3-1/2" OD posts	141 lbs.
NG-401	Complete set 4-1/2" OD posts	213 lbs.
NG-500	Net Guard tightener retrofit kit 3-1/2" OD	11 lbs.
NG-501	Net Guard tightener retrofit kit 4-1/2" OD	15 lbs.
NT-42-W	Replacement Deluxe Net 42' x 42' w/ panels	16 lbs.



## TENNIS NETS

All nets are 42' long except the NTS Steel Net.. Tie Down Straps are recommended for proper net height adjustment.

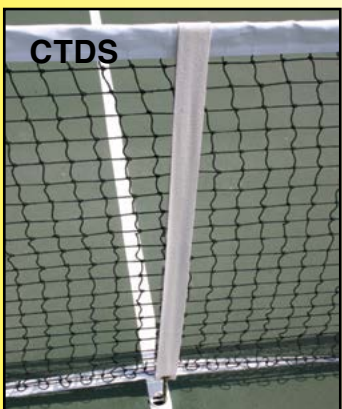

Model	Description	Weight
NT-42-W	3mm braided black polyethylene with wrap-a-round vinyl panels	16 lbs.
*40LS	Net body 3.5mm braided polyethylene twine, extra heavy duty spun polyester headband sewn with 5 rows of Dacron thread. Net supported by 5mm PVC coated aircraft cable.	22 lbs.
30LS	Net body 3.5mm braided polyethylene twine, extra heavy duty spun polyester headband sewn with 4 rows of Dacron thread. Net supported by 5mm PVC coated aircraft cable.	22 lbs.
NT-42-PRO	Top 5 mesh of net is doubled for extra strength. Top cable-vinyl covered aircraft cable, dowel in each end.	21 lbs.
TN-36	Braided 3.5mm polyethylene - 2 ply vinyl coated polyester. Headband-side and bottom vinyl tapes. 5/32" vinyl coated galvanized steel cable. Fiberglass side pocket with dowels.	25 lbs.
TN-28	Braided 3mm polyethylene - 2 ply vinyl coated polyester headband side and bottom tapes. 5/32" vinyl coated galvanized steel cable, wood side pocket with dowels.	22 lbs.
TN-42SD	#36 Rubberized Dacron Nylon - vinyl coated headband bottom and sides, 5/32" aircraft cable vinyl coated. Wood dowel in side pocket.	19 lbs.
NT-36-D	Same as above without wood dowels.	15 lbs.
NTS	14 GA. copper bearing steel wire, dbl. weave. Locked mesh construction. Ends equipped with draw-bolt. Includes vision strip. 36' - 4" long w/support cables. <b>For use only with TP4S posts.</b>	80 lbs.
VS	Replacement vision strip.	3 lbs.
CTDS	Center Tie-Down Strap - attaches to center net anchor.	3 lbs.
NTCA	Center Net Anchor.	2 lbs.

\*Same net that has been used on the center court at Wimbledon

# Fitness

## Climbers

**POWDER  
COAT OPTION  
AVAILABLE ON  
POSTS - SEE  
PAGE 88**



### JUNIOR TEAM CLIMBER

The Junior Team Climber (JCT-1011) is a safe, sturdy, fun and versatile unit for younger groups - Jr. High and Elementary ages. The answer to school physical fitness programs in one integrated apparatus. Features: Overhead ladder, 3 chin-up bars, 1 climbing pole, 2 climbing walls and 2 short ladders. Comes Galvanized or Powder Coated.  
SEE TABLE BELOW

### TEAM CLIMBER

A versatile unit for training individuals or groups, body-building and coordination. Geared to High School and College physical fitness programs, this one unit supplies a variety of activities and challenges, plus team competition. Features: Overhead ladder, 4 chin-up bars, 3 parallel bars, 1 climbing pole, 2 climbing walls and 2 short ladders. Comes galvanized or powder coated.



Model	CT-1824	JCT-1011
Height	10'	7'
Length	20'-10"	10'
Width	21'	11'
Support Legs	2-3/8" OD	1-7/8" OD
Cross Members	1-5/16" OD	1-5/16" OD
No. Horiz. Bars	4	3
Parallel Bars-3	1-7/8" OD	-
Climb Poles-1	1-7/8" OD	1-7/8" OD
Required Area	33' x 33'	22' x 23'
Weight	1475 lbs.	1,150 lbs.

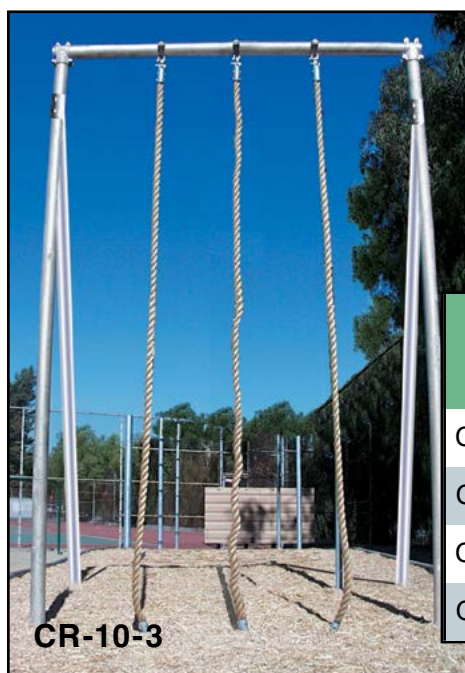

### ROPE AND POLE CLIMB

The 16' High Climb is a challenge for any young adult. The 10' High Climb is ideal for the over 12 age group. These Climbs are just the thing for High School and College men and women to develop the stamina and strength needed for competitive sports. Pole Climb not shown.

Model	Height	Header & Post	Brace	Climbing Rope	Climbing Pole	Header Length	Req'd Area	Weight
CR-16-3	16'	3-1/2"	2-3/8"	1-1/2"	-	12'	24' x 16'	600 lbs.
CP-16-3	16'	3-1/2"	2-3/8"	-	1-5/8"	12'	24' x 16'	615 lbs.
CR-10-3	10'	3-1/2"	1-5/8"	1-1/2"	-	12'	24' x 16'	370 lbs.
CP-10-3	10'	3-1/2"	1-5/8"	-	1-5/8"	12'	24' x 16'	385 lbs.

**NOTE: POST INSTALLATION MAY REQUIRE STEEL REINFORCEMENT IN FOOTING-  
CHECK WITH LOCAL BUILDING CODES IF REQUIRED IN YOUR AREA.**

# Exercise Bars and Beams

## ADJUSTABLE HORIZONTAL BARS COMPLETE ASSEMBLIES

All horizontal bars are solid cold rolled steel welded to pipe sleeves - Hot Dip Galvanized and hand smoothed after galvanizing for a safe, durable finish. Posts are galvanized pipe capped with aluminum drive caps. All bars are adjustable to heights indicated on chart. Bars have 1-1/8" diameter. Powder coated colors available.



	Model	Height	Uprights	Bars	Weight
<b>HEAVY DUTY</b>					
Triple	HB3-789	7'8'9"	3-1/2" OD	6'L	417 lbs.
Double	HB3-89	8'9"	3-1/2" OD	6'L	312 lbs.
Single	HB3-9	9'	3-1/2" OD	6'L	210 lbs.
<b>INTERMEDIATE</b>					
Triple	HB25-567	5'6'7"	2-7/8" OD	5' L	255 lbs.
Double	HB25-67	6'7"	2-7/8" OD	5'L	190 lbs.
Single	HB25-7	7"	2-7/8" OD	5'L	140 lbs.
<b>STANDARD</b>					
Triple	HB2-567	5'6'7"	2-3/8" OD	5'L	181 lbs.
Double	HB2-67	6'7"	2-3/8" OD	5'L	140 lbs.
Single	HB2-7	7'	2-3/8" OD	5'L	87 lbs.
Double Jr.	HB2-7	3'4"	2-3/8" OD	5'L	100 lbs.

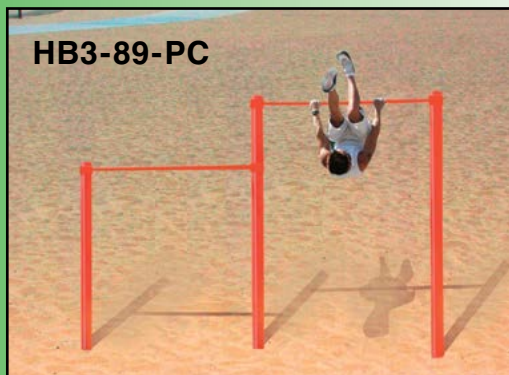

## BAR WITH SLEEVE FITTINGS ONLY

Model	Bar Length	Fittings For Pipe	Weight
HB3	6'	3-1/2" OD	24 lbs.
HB25	5'	2-7/8" OD	22 lbs.
HB2	5'	2-3/8" OD	20 lbs.

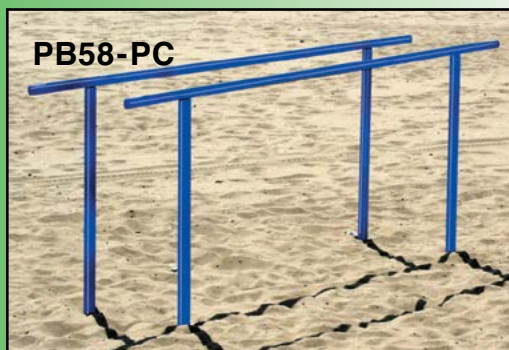

## ADJUSTABLE PARALLEL BARS

Made of galvanized pipe, adjustable bars are oval shaped and neatly capped.

Model	Height	Uprights	Bars	Length	Weight
PB 58	5' to 5'6"	2-3/8"	2" x 1-1/2"	8'	160 lbs.
PB 28	18" to 24"	2-3/8"	2" x 1-1/2"	8'	119 lbs.

**POWDER  
COAT OPTION  
AVAILABLE ON  
POSTS - SEE  
PAGE 88**



## NON-ADJUSTABLE PARALLEL & LOW BARS

Made of a single piece of galvanized pipe rolled to shape.



Model	Pair or Single	Height	Uprights	Bars	Length	Weight
PB 56	Pair	4'6"	1-7/8"	1-7/8"	6'	96 lbs.
PB 36	Pair	3'	1-7/8"	1-7/8"	6'	84 lbs.
PB 26	Pair	2'	1-7/8"	1-7/8"	6'	80 lbs.
LBS 3	Single	3'	1-7/8"	1-7/8"	10'	50 lbs.
LBS 4	Single	4'	1-7/8"	1-7/8"	10'	56 lbs.

## BALANCE BEAMS

4" x 4" x 15' long square structural steel channel with non-skid beam surface. Colors: Red, Yellow or White.

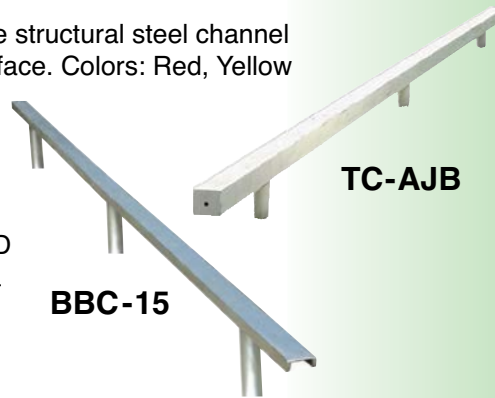

**POWDER COAT OPTION AVAILABLE ON POSTS - SEE PAGE 88**

The 15' long Galvanized 3" steel channel beam is supported 12" above the ground by three 2-3/8" OD Galvanized Pipe uprights. This model will provide a lifetime of maintenance-free service.

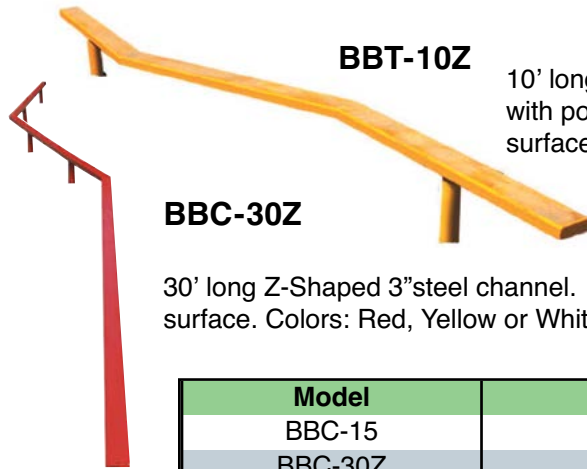

10' long Z-Shaped 3-1/2" x 1-1/2" steel tubing with powder coated finish and non-skid beam surface. Colors: Red, Yellow or White.



30' long Z-Shaped 3" steel channel. Finished in enamel with non-skid surface. Colors: Red, Yellow or White.

Model	Length	Surface	Weight
BBC-15	15' L	Galvanized	100 lbs.
BBC-30Z	30' L	Powder Coat	201 lbs.
TC-AJB	15' L	Powder Coat	250 lbs.
BBT-10Z	10' L	Powder Coat	67 lbs.
BBC-15P	15' L	Powder Coat	125 lbs.

Portable Balance Beam Model BBC-15P(Not Shown): 15' L, 3" W steel channel beam. Supported 12" above ground by three 2-3/8" OD steel pipe portable uprights. Powder Coated with non-skid beam surface.

## STRETCHING EQUIPMENT

L.A. Steelcraft offers a series of events to build muscle and flexibility. These items are special order and are not shown in this catalog. They all come galvanized or with a powder coat finish.

Model	Description	Weight
LSS-4	Leg Stretch Station	85 lbs.
SJT-8	Standing Jump Touch	140 lbs.
LL-2	Leg Lift	84 lbs.

# Fitness Courses

## POLICE/MILITARY ACADEMY TRAINING FITNESS & OBSTACLE COURSES

Over the 64 years LA Steelcraft has worked to develop various pieces of physical fitness apparatuses that have been used for a full range of police, military and school obstacle courses. We designed and built the Los Angeles Police Department S.W.A.T. Team obstacle course. LA Steelcraft has worked in conjunction with various high school academy personnel to design courses.

We also have two options for the Thoreson Fitness Course (150 & 75 meters), which were designed for elementary schools and high schools, with educator and world record holder in the decathlon, Dave Thoreson. These courses were designed to develop complete physical fitness and mental stamina, advance self-awareness and increases self-esteem. Or, you can create your own obstacle course by selecting any of the obstacles in this section, to put together a custom course for your specific requirements. Please contact us for more information and details about our Thoreson Fitness Courses.

## COMBINATION CLIMBERS

This main event comes with your choice of poles or ropes. Incline ladder and horizontal ladder with four each attached horizontal bar workout stations. 11'-6" high rope/pole climb in combinations of 2 or 4. 6' or 8' high ladder, with 2 chinning bars per side. Ladder unit in 20' or 30' lengths.

Replacement parts are listed below..



Model	Description	Size	Weight
TFG-S-20/2	2 rope/ pole climber	20' L	675 lbs.
TFG-S-30/2	2 rope/pole climber	30' L	900 lbs.
TFG-D-20/4	4 rope/pole climber	20' L	1,250 lbs.
TFG-D-30/4	4 rope/pole climber	30' L	1,700 lbs.

## “MUSCLE BEACH” TRAVEL RINGS

The LA Steelcraft Travel Rings, featured on many YouTube videos and TV programs, are one of the main attractions at the historic Muscle Beach in Venice Beach/Santa Monica. Our “Muscle Beach” Travel Ring apparatus is based on LA Steelcraft’s standard physical fitness items manufactured out of galvanized pipe.

Available in 2 standard styles(Doomed & Gabled) and heights and lengths to suit your particular needs.



Site specific, call for more information.



### VAULT WALLS

Steel reinforced thermo plastic roto-molded vault walls, 8' wide. Available in 4', 5' and 6' heights for added difficulty. Wall sections (tongue and groove) are slid together (2 sections make up 1 wall). Red/Green directional labels included.

Model	Description	Size	Weight
VW4	4' Vault Wall	8' W x 4' H	255 lbs.
VW5	5' Vault Wall	8' W x 5' H	295 lbs.
VW6	6' Vault Wall	8' W x 6' H	315 lbs.



### BALANCE BEAMS

We offer several lengths and styles of balance beams. Available in 10', 15' and 30' lengths. Straight and Z-shaped formations. Powder coated or galvanized steel. Top sand strip for traction. Most models set at 12" above grade.

Model	Description	Size	Weight
TC-AJB	Standard Balance Beam	4" x 4" x 15' L	250 lbs.
AJB-21	Standard Balance Beam	4" x 4" x 21' L	350 lbs.
BBC-15	Steel Balance Beam	3" x 3" x 15' L	100 lbs.
BBC-30Z	Z-Shaped Beam	4" x 4" x 30' L	201 lbs.
BBT-10Z	Z-Shaped Beam	4" x 4" x 10' L	67 lbs.
PBB-10	Junior Balance Beam	3" x 4" x 10' L	90 lbs.

For additional photos of other Balance Beam models, see page 42.



### CARGO CLIMBERS

Cargo Chain Net Climber- A chain link Cargo Net 8' H x 6' W, fabricated from 3-1/2" OD uprights and top horizontal top bar, galvanized proof coil chain with graphitic steel post fitting.

Chain Link Climbing Fence- 6'-3" H x 8' W, fabricated from 3 1/2" OD uprights, 2-3/8" OD horizontal rails (top and bottom), 2" mesh x 9 gage galvanized chain link with knuckle/knuckle salvage.



Model	Description	Size	Weight
CCN	Cargo Climber w/ Chain Net	8' H x 6' W	250 lbs.
CCF	Climber w/ Chain Link Fence	6'-3" H x 8' W	225 lbs.



### ZIG ZAG RUN

Incorporates Balance Beam and Slalom Posts with sharp cut-back and leap maneuvers.

**POWDER COAT OPTION AVAILABLE ON POSTS - SEE PAGE 88**

Model	Description	Size	Weight
ZZR-1	Zig Zag Run w/ 3 Slalom	15' L	400 lbs.
ZZR-2	Zig Zag Run w/ 5 Slalom	30' L	430 lbs.

**NOTE: YOU MAY WANT TO CONSIDER UTILIZING "PIT AREAS" WITH ENGINEERED WOOD FIBER TO BE USED UNDER/IN FRONT OF/BEHIND CERTAIN OBSTACLES AS A PROTECTIVE RESILIENT SURFACING.**



### TURNING BARS

Polyurethane powder coated steel. 1-7/8" OD or 2-3/8" OD uprights. 3', 4' or 5' high by 8' long.

Model	Description	Size	Weight
TB3-1	Turning Bar- 1-7/8" OD	3' H x 8' L	61 lbs.
TB4-1	Turning Bar- 1-7/8" OD	4' H x 8' L	71 lbs.
TB5-1	Turning Bar- 1-7/8" OD	5' H x 8' L	78 lbs.
TB3-2	Turning Bar- 2-3/8" OD	3' H x 8' L	80 lbs.
TB4-2	Turning Bar- 2-3/8" OD	4' H x 8' L	91 lbs.
TB5-2	Turning Bar- 2-3/8" OD	5' H x 8' L	99 lbs.



### PARALLEL BARS

We offer several lengths and heights of this classic obstacle. 3', 4' and 5'-6" heights and 8' and 10' lengths available. Powder coated or galvanized steel. Bars 1-7/8" OD, spaced 21" apart at top. Bars angled for leg movement. Add PC to any model to have powder coat added. Additional cost for powder coated models.

Model	Description	Size	Weight
PLB3/8	Parallel Bars	3' H x 8' L	122 lbs.
PLB4/8	Parallel Bars	4' H x 8' L	142 lbs.
PLB5/8	Parallel Bars	5'-6" H x 8' L	151 lbs.
PLB3/10	Parallel Bars	3' H x 10' L	128 lbs.
PLB4/10	Parallel Bars	4' H x 10' L	134 lbs.
PLB5/10	Parallel Bars	5'-6" H x 10' L	157 lbs.

**POWDER COAT OPTION AVAILABLE ON POSTS - SEE PAGE 88**



### HURDLE JUMPS

These jumps are made of steel reinforced thermo plastic roto-molded, 24" high x 8' long. Excellent in sets of three for endurance training, spaced approx. 8' to 10' apart, as space permits. Jump sections (tongue & groove) are slid together ( 2 sections make-up 1 jump). Sold individually. Brown only.

Model	Description	Size	Weight
LJ	Hurdle Jump	34" H x 8' L	100 lbs.



### DECLINE LADDER AND CLIMBER

This event builds upper arm strength. Available in swinging ring or fixed bar models. Declines from a height of 8' to 7' . 9 hand loops, 2-7/8" OD uprights and header, with 1-3/8" OD ladder start step on IL models. Approx. 8' H x 11' L x 2'x6" W with powder coat finish.



Model	Description	Size	Weight
DHRC	Declining Ring Climber	8' H x 11' L	330 lbs.
IL-9	Incline Ladder- 9 Ring	8' H x 11' L	280 lbs.
IL-13	Incline Ladder- 13 Ring	8' H x 13' L	310 lbs.
SL-09	Serpentine Loop- 9 Ring	8' H x 11' L	280 lbs.
SL-13	Serpentine Loop- 13 Ring	8' H x 13' L	310 lbs.
DHRC-L	Leveled Ring Climber	8' H x 11' L	330 lbs.
IL-9-L	Leveled Ladder	8' H x 11' L	280 lbs.



LCB

### CRAWL UNDER BARS

Set of Crawl/Roll Under bars, totaling 2' H x 4' L x 8' W, fabricated from three each 1-5/8" OD formed steel posts and flat bar, spaced 24" apart and finished with a polyurethane powder coated finish. Also provided is a 6' long padding for the entrance header area.

Model	Description	Size	Weight
LCB	Crawl Under Bars	2' H x 4' L x 8' W	150 lbs.

**POWDER COAT OPTION AVAILABLE ON POSTS - SEE PAGE 88**

### TIRE STATION

A wonderful event to include in a course. 5, 7 or 9 interlocking tire combinations. Tire sections with interior ground anchors. Length and width vary with number of recycled tires.



TS5

Model	Description	Size	Weight
TS5	Tire Station	5 Tires	200 lbs.
TS7	Tire Station	7 Tires	280 lbs.
TS9	Tire Station	9 Tires	360 lbs.

### SLALOM POSTS

Steel reinforced beige thermo plastic roto-molded Slalom Posts, 3' and 5' high. Designed for course marking and running obstacles. Steel post is inserted into roto-molded post and secured into place with supplied hardware.



TSP

Model	Description	Size	Weight
SSP	Short Slalom Post	3' H	20 lbs.
TSP	Tall Slalom Post	5' H	30 lbs.

### WINDOW WALLS

Window Wall, 8' H x 8' W, fabricated from steel and wood, with 1/2" M.D.O. Duraply exterior plywood surface. Window area opening to be 4' x 3' and have special padding around inside of opening. Painted finish to be done by others.



WWC

Model	Description	Size	Weight
WWC	Window Wall, Plywood	8' H x 8' W	550 lbs.

**NOTE: YOU MAY WANT TO CONSIDER UTILIZING "PIT AREAS" WITH ENGINEERED WOOD FIBER TO BE USED UNDER/IN FRONT OF/BEHIND CERTAIN OBSTACLES AS A PROTECTIVE RESILIENT SURFACING.**

# Playgrounds

## BALL WALLS



Precheck construction of Ball Walls pre-approved for safety of structural design and fire and life safety, for use on school grounds, by the state of California- Department of general Services- Division of the state architect under it's own PC number, in conjunction with Title 24, California code of regulations.

Sets of signed prints and building specifications are on file with the division of the state architect at their area offices in Los Angeles, Sacramento, San Diego & Oakland, California.

Support Posts- 4" square steel-tube, 3/8" wall thickness, extends 4' into 6' concrete footings.

Internal Frame- Horizontal steel studs 2" x 4" "C" channel, spaced 16" horizontally.

Weatherproof Panel Sheets- 1/2" M.D.O. plywood is permanently bonded with overlay of phenol-type resin impregnated fiber. This superior plywood forms a smooth playing surface on both sides of the wall.

Frame Capped- with galvanized sheet metal, sides and top, preventing moisture from penetrating wood.

Assembly- All parts are factory pre-cut. Installation instructions included to simplify assembly. Steel reinforcements for footings not included.

Painting not included. It is recommended that the owner apply one primer coat and two coats of outdoor enamel after the ball wall is installed.

**An appropriate fee is charged for calculations to be submitted to a regulatory agency for approval.**

Custom sizes available in 8' or 12' high by 8' multiple lengths.

**POWDER COAT OPTION AVAILABLE ON POSTS - SEE PAGE 88**

Model	Description	Weight
BW24-12S	24'L x 12'H 4 supports	2,600 lbs.
BW16-12S	16'L x 12'H 3 supports	1,800 lbs.
BW16-8S	16'L x 8'H 3 supports	1,300 lbs.



# Play Essentials

**POWDER COAT OPTION AVAILABLE ON POSTS - SEE PAGE 88**

## FUNBALL

Funball is a unique way for children to develop hand-to-eye coordination while having fun. One piece Roto-Molded "Top Basket" with colorful molded-in colors and number graphics. 3 funnel openings with 12" OD exit holes accommodate most playground balls. Top basket can be set at 9' or lower on the 2-7/8" OD galvanized post. Post can be powder coated at an additional charge. Ships from North Carolina, 28117, class 250. 2-7/8 " OD E Sleeve included in FB-100S model.

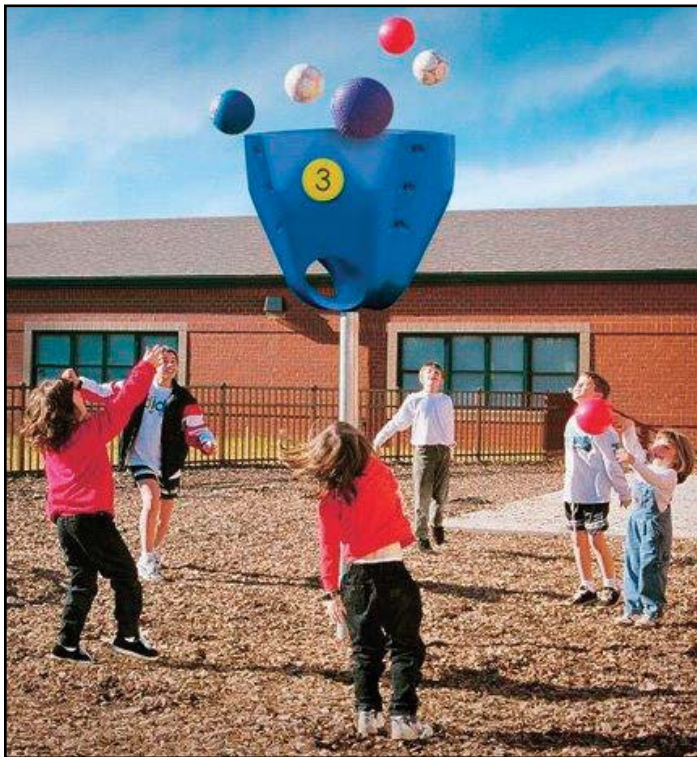

Model	Weight
FB-100	61 lbs.
FB-100S	82 lbs.

## TETHERBALL



Our model TBPCB is a complete outfit: Post, red foul marker, cap, chain, swive snap, ball and rope. 2-3/8" OD post allows 10' from footing to rugged 3/8" eye bolt. Installation in concrete or optional sleeve. Galvanized steel proof coil chain is 38" long and fastened to the welded eye with heavy duty "S" hook. Heavy duty quick-snap allows for easy removal of ball. Post can be powder coated at an additional cost. Optional ground sleeve 238E included with model TBPCBS. Replacement parts available as per table below.

Model	Description	Weight
TBPCB	Post, cap, chain, snap and ball	48 lbs.
TBPC	Replacement Post, cap, chain, snap	47 lbs.
TBB	Replacement Ball with Rope	1-1/4 lbs.
TBCS	Replacement bolt, chain and snap	2 lbs.
TBPCBS	Tetherball Complete Set w/ E Sleeve (2-3/8" OD)	62 lbs.

## PEDESTAL SANDBOX



**Fiberglass top allows sand box to be used as a table!**

Our pedestal Sand Box allows all children to play in sand without tracking it back inside. It is made of 100% rotationally molded, industrial strength plastic and will not chip or crack. Includes custom tailored vinyl cover with velcro fasteners.



Pedestal base fills with water or sand to stabilize unit and help prevent tipping. Colors available: Green, Blue, and Beige.



**With Vinyl Cover**



**With Fiberglass Top**

Model	Description	Weight
SBX100	47-1/4" Diam. x 30" H	68 lbs.
SBX101	47-1/4" Diam. x 24" H	64 lbs.
SBX54F	54" Fiberglass Table Top (optional)	44 lbs.

## CHILDREN'S TABLES

Along with our traditional tables set at junior height, L.A. Steelcraft now offers three new models designed just for children. For more details see Page 73. Ships from: IL., 62278





## PLAYCURB BORDERS

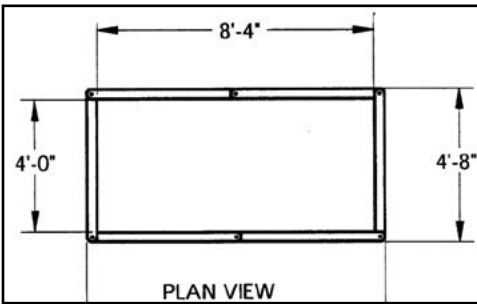

Note: Each dimension is increased by 4'-4" (52") for each length added in any direction.

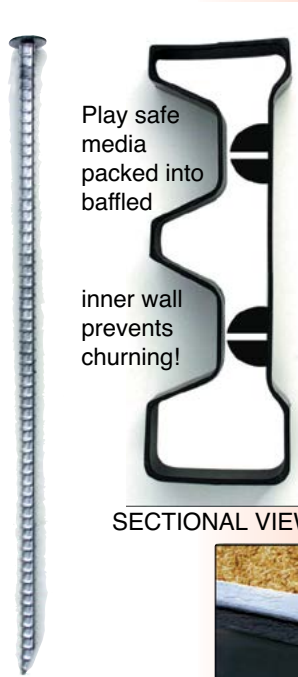

Rotosteel Playcurb Border has been designed to contain wood chips, sand and other loose play-safe media. Our wall thickness and density is among the highest in the industry. Baffled inner-wall prevents wood fiber and other play-safe media from churning. UV-stabilized, will never fade or splinter. Held in place with a 3/4" x 30" galvanized steel stake with flush cap-included.  
**Model PCB4, 10 lbs. each, class 100**



## TRADITIONAL SLIDES

### Slide Chute

Surface is 16 gauge stainless steel type 304 and 2b finish w/ a 19-1/2" wide sliding surface. The side rails are fabricated from 4-1/2" x 1-1/2" 14 gauge welded seam tubing with ends capped, hot dipped galvanized after fabrication. The sliding surface is attached to the slide rails with welds and steel blind pop rivets every four inches. The exit region is sandwiched between the structural tube and a 3/16" thick x 3" wide x 23" long galvanized steel strip on the underside of the chute.



Model	Chute Height	Chute Length	Overall Length	Req'd Area	Weight
SL510RMH	5'	10'	13'	27' x 14'	400 lbs.
SL612RMH	6'	12'	15'	30' x 14'	480 lbs.
SL816RMH	8'	16'	20'	33' x 14'	575 lbs.
Replacement Hoods & Chutes					
SLHD	Hood with rail only- Indicate rail length				30 lbs.
SL510-SSC	-	10'	-	-	158 lbs.
SL612-SSC	-	12'	-	-	191 lbs.
SL816-SSC	-	16'	-	-	240 lbs.

# Climbers



## GEOCLIMBER

This lightweight climber is easy to install. Each piece is color coded and bolts together with standard tools. Our Button-Hub was designed for safety and strength. It has no sharp edges, is smooth and completely eliminates the possibility of entrapment of little arms and legs.

**ASTM Designation F-1487-9.2.1** The Use Zone for stationary play equipment shall not extend less than 72 in. (1830mm) from the perimeter of the play structure.

Model	Base Diam.	Dome Height	Use Zone Perimeter	Weight
BC-10-4	10'	4'	22'	215 lbs.
BC-12-5	12'	5'	24'	238 lbs.
BC-14-6	14'	6'	26'	288 lbs.

## CONICAL CLIMBER

The sloped sides of our *Conical Climber* makes climbing safer and offers more play area. Two sizes to meet the requirements of any age group.

	CB101B	CB301
Overall Height	10'	8'-4"
Diameter of Base	12'-2"	10'-8"
Sloping Side Height	6'-8"	5'-2"
Leg Size	1-5/16"	1-1/16"
Climbing Pole	1-1/16"	1-1/16"
Side Rungs	1-1/16"	1-1/16"
Use Zone Perimeter	24'-2"	22'-8"
Weight	370 lbs.	260 lbs.



## DOME CLIMBER

Our Dome Climbers come in various sizes and climbing pole configurations that build upperbody strength and agility.

KD= Knock Down, W= Welded, A= Assembled

All welded or assembled units for delivery/Will Call Only

Model	Ht.	Base Diam.	Climb Poles	Legs & Rungs	Rung Spacing	Use Zone Parameter	Weight
CD48	8'	6'	4	1-1/16"	20" x 26"	18' diam.	263 lbs.
CD47-KD	7'	4'	1	1-1/16"	15" x 24"	16' diam.	136 lbs.
CD47-W	7'	4'	1	1-1/16"	15" x 24"	16' diam.	156 lbs.
CD47-A	7'	4'	1	1-1/16"	15" x 24"	16' diam.	146 lbs.

**POWDER  
COAT OPTION  
AVAILABLE ON  
POSTS - SEE  
PAGE 88**

## HORIZONTAL LADDER

Fun and body-building exercise. Heavy duty galvanized pipe. All rungs are 20" wide, welded 12" on centers. All models have two step rungs on the end ladders except Model 716 which has three.

Model	Height	Length	Rungs	Ladders & Rails	Required Area	Weight
716PW	7'-6"	16'	1-1/16" OD	2-3/8"	28' x 14'	310 lbs.
616PW	6'-6"	16'	1-1/16" OD	2-3/8"	28' x 14'	300 lbs.
612PW	6'-0"	12'	1-1/16" OD	2-3/8"	24' x 14'	260 lbs.
510EPW	5'-6"	10'	1-1/16" OD	1-7/8"	22' x 14'	183 lbs.
508PC	5'	8'	1-5/16" OD	2-3/8"	20' x 14'	275 lbs.



## RAINBOW ARCH

Rainbow Arch Climbers offer fun and exercise in various sizes.

\* Crossed arches, T-Shape.

Model	Ht.	Span	Width	Use Zone	Weight
CA48	4'	8'	2'	14' x 20'	115 lbs.
CA510	5'	10'	2'	14' x 20'	130 lbs.
CA613	6'	13'	2'	14' x 25'	187 lbs.
CA816	8'	16'	2'	14' x 28'	220 lbs.
CSA615	6'	15'	5'	17' x 27'	291 lbs.
*CDA620	6'	20'	15'	27' x 32'	516 lbs.



# Swings

**Swing Sets - strongest, safest materials available.**

All Headers and Legs are made of galvanized pipe and all fittings are hot dipped galvanized. Every swing comes with our 624-VB Seat, which has a vandal-proof stainless steel insert and heavy-duty rivets. All chains are hot dipped proof coil.

Specify galvanized or powder coat on order. For powder coat options see color page at back of catalog.

L.A Steelcraft swing set models are complete packages with all the accessories!

**POWDER COAT OPTION AVAILABLE ON POSTS - SEE PAGE 88**



It is required that an acceptable impact absorbing surface pursuant to CPSC guidelines and ASTM standards be used under and around all playground equipment.

## BIPOD / TRIPOD SWINGS



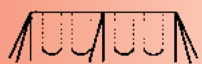
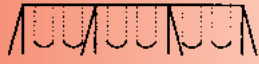

Model	Height	End Supports	Header Size	Header Length	Leg Size	Seats Per Span	Clearance Req'd	Weight
2282	8'	BI	2-3/8"	10'	1-7/8"	2	32' x 25'	193 lbs.
2202	10'	BI	2-3/8"	10'	1-7/8"	2	40' x 26'	221 lbs.
2284	8'	BI	2-3/8"	20'	1-7/8"	2	32' x 35'	311 lbs.
2204	10'	BI	2-3/8"	20'	1-7/8"	2	40' x 36'	379 lbs.
2384	8'	TRI	2-3/8"	21'-6"	1-7/8"	2	32' x 43'	380 lbs.
2304	10'	TRI	2-3/8"	21'-6"	1-7/8"	2	40' x 45'	436 lbs.
2286	8'	BI	2-3/8"	30'	1-7/8"	2	32' x 45'	438 lbs.
2206	10'	BI	2-3/8"	30'	1-7/8"	2	40' x 46'	463 lbs.
2386	8'	TRI	2-3/8"	31'-6"	1-7/8"	2	32' x 53'	530 lbs.
2306	10'	TRI	2-3/8"	31'-6"	1-7/8"	2	40' x 55'	574 lbs.
2388	8'	TRI	2-3/8"	41'-6"	1-7/8"	2	32' x 63'	700 lbs.
2308	10'	TRI	2-3/8"	41'-6"	1-7/8"	2	40' x 65'	765 lbs.
3384	8'	TRI	3-1/2"	21'-6"	2-3/8"	2	32' x 43'	473 lbs.
3304	10'	TRI	3-1/2"	21'-6"	2-3/8"	2	40' x 45'	521 lbs.
3386	8'	TRI	3-1/2"	31'-6"	2-3/8"	2	32' x 45'	620 lbs.
3306	10'	TRI	3-1/2"	31'-6"	2-3/8"	2	40' x 46'	896 lbs.



## UNIPOD SWINGS

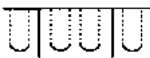

**POWDER  
COAT OPTION  
AVAILABLE ON  
POSTS - SEE  
PAGE 88**

	Model	Height	Header Size	Header Length	Leg Size	Clearance Required	Weight
	3172	7'	3-1/2"	10'-6"	3-1/2"	28' x 23'	262 lbs.
	3182	8'	3-1/2"	10'-6"	4-1/2"	32' x 23'	275 lbs.
	3192	9'	3-1/2"	10'-6"	4-1/2"	36' x 23'	285 lbs.
	3174	7'	3-1/2"	20'	3-1/2"	28' x 32'	345 lbs.
	3184	8'	3-1/2"	20'	4-1/2"	32' x 32'	365 lbs.
	3194	9'	3-1/2"	20'	4-1/2"	36' x 32'	461 lbs.
	3176	7'	3-1/2"	31'	3-1/2"	28' x 43'	500 lbs.
	3186	8'	3-1/2"	31'	4-1/2"	32' x 43'	525 lbs.
	3196	9'	3-1/2"	31'	4-1/2"	36' x 43'	588 lbs.



**SEE OUR LARGE  
SELECTION OF  
SWING ACCESSORIES ON  
PAGES 54 - 55**

## TREE SWINGS

Model	Height	Header Size	Header Length	Leg Size	Req'd Area	Weight
TS-4372	7'	3-1/2"	10'-6"	4-1/2"	28' x 23'	350 lbs.
TS-4382	8'	3-1/2"	10'-6"	4-1/2"	32' x 23'	360 lbs.

**NOTE: POST INSTALLATION MAY REQUIRE STEEL REINFORCEMENT IN FOOTING-  
CHECK WITH LOCAL BUILDING CODES IF REQUIRED IN YOUR AREA.**

# Swing Accessories

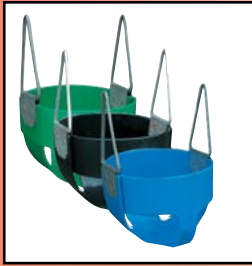

**FULLY ENCLOSED INFANT SEAT W/ HEAVY DUTY RUST PROOF STAINLESS STEEL INSERT:**  
Vandal proof, 70 DURO EPDM rubber with .020 Stainless Steel insert, rust proof hardware.  
National Test Lab Results: 5000 lbs.

IS-100-B	Black	10 lbs.
IS-100-X	Blue	10 lbs.
IS-100-G	Green	10 lbs.

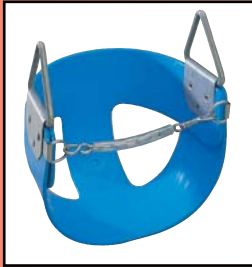

**COMMERCIAL POLYMER HALF BUCKET SEAT:**

Colors resist fading better than rubber, .020 one-piece stainless steel insert, tab and ring with safety chain.  
Galvanized triangle hardware.

34B-VB	Black	5 lbs.
34B-VX	Blue	5 lbs.
34B-VG	Green	5 lbs.



**VANDAL PROOF SWING SEAT W/ STEEL INSERT:**

Galvanized triangle hardware, 70 DURO EDPM rubber, with a .020 Stainless Steel insert to prevent vandalizing, and measures 6" x 24" x 5/16" thick. National Test Lab Results: 5573 lbs.

624-VB	Black	4.5 lbs.
624-VX	Blue	4.5 lbs.
624-VG	Green	4.5 lbs.



**NON-TILT SWING HANGERS:**

3/8" Galv. non-tilt hanger available only on the 624 and 34B series swing seats.  
Sold in pairs for one full seat. Not available as retrofit item.

**Must be ordered with seat.**

NTH	2 lbs.
-----	--------



**ALUMINUM SWING RINGS & TRIANGLES:**

6" diameter polished aluminum round ring with wider grip handle, meets ASTM standards. The yellow and blue handles are plastisol coated.

309-RP	Aluminum	Round	6 lbs.
309-TP	Aluminum	Triangle	7 lbs.
309-RPY	Yellow	Round	6 lbs.
309-TPY	Yellow	Triangle	7 lbs.
309-RPB	Blue	Round	6 lbs.
309-TPB	Blue	Triangle	7 lbs.
*309-MB	Aluminum	Round	2 lbs.

\*Note: Not for school use.



**ZINC PLATED STEEL "S" HOOKS:**

336A connects chain to swing hangers. 336B connects chain to swing seat. 336C connects to swing seat.

336A	3/8"	3 oz.
336B	5/16"	2 oz.
336C	3/8" x 4"	4 oz.

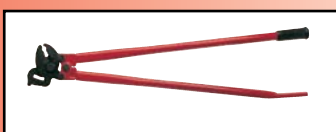

**S-HOOK PLIER & CHAIN CUTTER:**

Will close and open S-hooks and features a chain cutter for cutting up to 5/16" chains.

T-100	16 lbs.
-------	---------

**STAMPED GALVANIZED STEEL PIPE SWING HANGERS:**

Feature an "oil-lite" bronze bearing and axle bolts with lock tight nuts. Requires special allen wrench.

GH-20	2-3/8"	3 lbs.
GH-30	3-1/2"	4 lbs.
GH-45	4-1/2"	5 lbs.

**REPLACEMENT IRON PENDULUM:**

1" wide replacement pendulum with oil lite bronze bearing.

SPB	12 oz.
-----	--------

**REPLACEMENT SHACKLE:**

Saves the cost and hassle of installing an S-hook. Bolt ping has a tamper proof head.

SSB	1 lb.
-----	-------

**"S" HOOK REPLACEMENT - H172**

Double shackle with bolt.

H172	6 oz..
------	--------

**SWING SHACKLE - H170**

With bolt.

H170	4 oz..
------	--------

**REPLACEMENT SAFETY CHAIN:**

Covered with a plastic cover, has a snap hook and two S-hooks for fastening to half-bucket seats.

S-1	8 oz.
-----	-------

**COATED CHAIN:**

**CC8** 8-1/2 ft. chain with 4 ft. coated.

**CC5** 5-1/2ft. of 3/16" chain with 4 ft. coated.

Colors: Red, Blue, Green and Yellow

CC5	spec. color	3 lbs.
CC8	spec. color	4 lbs.

**CHAIN:**

Straight Welded links, proof-coil, hot dipped galvanized.

333A	3/16"	8 oz./ft.
333B	5/16"	1 lb./ft.
333C	1/4"	11 oz./ft.

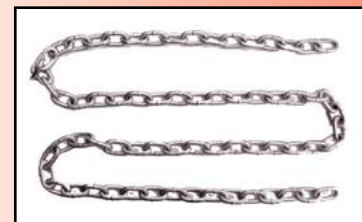

# Bleachers



BL0315SA



BL0515SA

## PORTABLE BLEACHERS

L.A. Steelcraft bleachers meet all current uniform building codes. Engineered to eliminate expensive aisles and hand rails. Individual galvanized steel frames are welded into one solid structure, then Hot Dipped Galvanized. Guardrails have a H.D.G. finish. All bolts, nuts and washers have anti-corrosion protection. All bleachers have 6" seat rise and 24" back spacing. First seat is 11-7/8" high. 5-row bleachers are provided with our vertical guardrail system. Our 3-row and 4-row bleachers do not require guardrails. Our 5-row Bleacher with Guardrail System utilizes a 12" nominal aluminum seat plank that qualifies as a step. Only the 5th row is above 30". The front row is 11-7/8" above grade. Footboards are 10" nominal aluminum plank.

**Bleacher Transportation System available for these models on page 58.**



BL0415SA



Aluminum (with Roto-mold end caps) or Fiberglass Planking available.

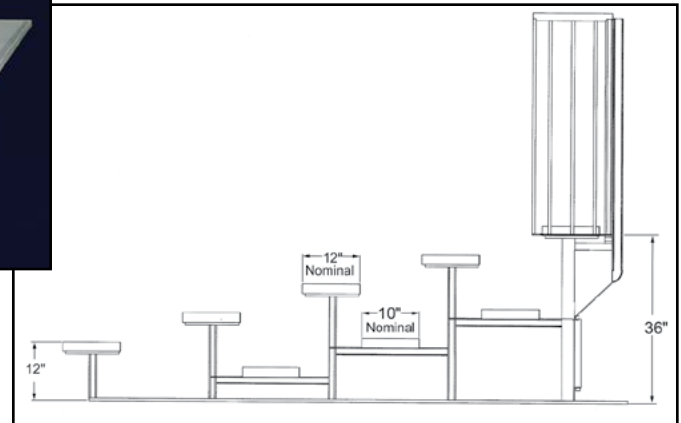

Model	Description	Seats	Approx. Space	Depth FR-Back	Height Top Seat	Weight
BL0315SA	3-Row x 15' Aluminum Seats & Footboards	30	4'-8" x 15'	4'-8"	23-7/8"	380 lbs.
BL0315SG	3-Row x 15' Fiberglass Seats & Alum. Ftbd.	30	4'-8" x 15'	4'-8"	23-7/8"	444 lbs.
BL0321SA	3-Row x 21' Aluminum Seats & Footboards	42	4'-8" x 21'	4'-8"	23-7/8"	531 lbs.
BL0415SA	4-Row x 15' Aluminum Seats & Footboards	40	7'-8" x 15'	7'-8"	29-7/8"	506 lbs.
BL0415SG	4-Row x 15' Fiberglass Seats & Alum Ftbd.	40	7'-8" x 15'	7'-8"	29-7/8"	552 lbs.
BL0421SA	4-Row x 21' Aluminum Seats & Footboards	56	7'-8" x 21'	7'-8"	29-7/8"	708 lbs.
BL0515SA	5-Row x 15' Aluminum Seats & Footboards	50	9'-6" x 15'	9'-6"	35-7/8"	877 lbs.
BL0515SG	5-Row x 15' Fiberglass Seats & Alum. Ftbd.	50	9'-6" x 15'	9'-6"	35-7/8"	909 lbs.
BL0521SA	5-Row x 21' Aluminum Seats & Footboards	70	9'-6" x 21'	9'-6"	35-7/8"	1,225 lbs.



## ALL ALUMINUM BLEACHERS

All aluminum construction - 5 year warranty. Design and construction in accordance with the current Edition of the Uniform Building Code. 12" wide nominal seat plank on all models. Double floor planks starting on row 3 with double riser boards on top row only for 4 and 5 row models. Also available in 30' lengths.



Center aisles, handrails and wheelchair cutouts available on all PN models. Ships from CA zip 92408.



Model	Description	Seats	Approx. Space	Depth FR-Back	Height Top Seat	Weight
PN203-15	3-Row x 15' Aluminum Seats & Footboards	30	4'-8" x 15'	4'-8"	23-7/8"	210lbs.
PN203-21	3-Row x 21' Aluminum Seats & Footboards	42	4'-8" x 21'	4'-8"	23-7/8"	285 lbs.
PN204-15	4-Row x 15' Aluminum Seats & Footboards	40	6'-9" x 15'	6'-9"	29-7/8"	315 lbs.
PN204-21	4-Row x 21' Aluminum Seats & Footboards	56	6'-9" x 21'	6'-9"	29-7/8"	430 lbs.
PN205-15	5-Row x 15' Aluminum Seats & Footboards	50	9'-6" x 15'	9'-6"	35-7/8"	710 lbs.
PN205-21	5-Row x 21' Aluminum Seats & Footboards	70	9'-6" x 21'	9'-6"	35-7/8"	935 lbs.

## TRANSPORTER SYSTEM

Transporter system available for all of our PN Model bleachers on this page.

Model	Description	Weight
BT-PN500	Transport	100 lbs.

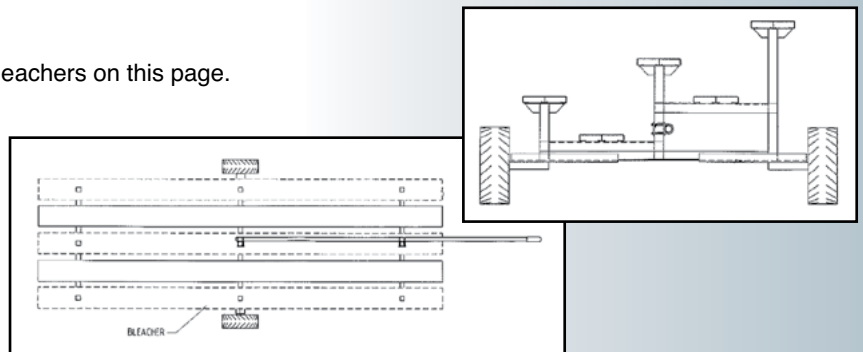

## CUSTOM SEATING

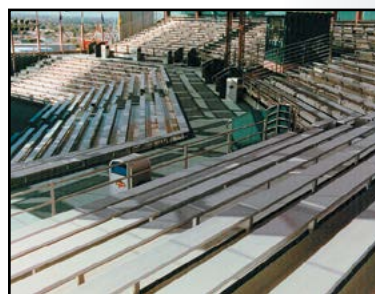

Our All Aluminum custom bleachers fit virtually any application. From unusual architectural designs that fit perfectly into unusual spaces, to stadium seating for thousands. We build the finest seating structures from the best materials. Elevated style bleacher and grandstands are available: Provided with front walkways, stair systems, ramps, handrails and special railing applications.

# Rolling Bleachers & Bleacher Accessories

## ROLL-A-BLEACHERS

Sturdy, lightweight L.A. Steelcraft Roll-A-Bleachers are equipped with anodized aluminum seats and footboards by rectangular STEEL TUBING finishes in black enamel. Available in 3 or 4 row configurations. First row is 11-7/8" from grade.

The 5" diameter non-marking, rubber wheels with ball bearing swivel casters make them extremely easy to move. Bottom casters lock for safety. Frames can be powder coated in school colors for additional fee. Guardrail systems not required on these 3 and 4 row models.

Rows	Model	Length	Seat'g Space	Depth	Height	Weight
3	RB8/3	7'-6"	15	64"	23-7/8"	185 lbs.
3	RB15/3	15'	30	64"	23-7/8"	265 lbs.
4	RB8/4	7'-6"	20	90"	29-7/8"	214 lbs.
4	RB15/4	15'	40	90"	29-7/8"	331 lbs.

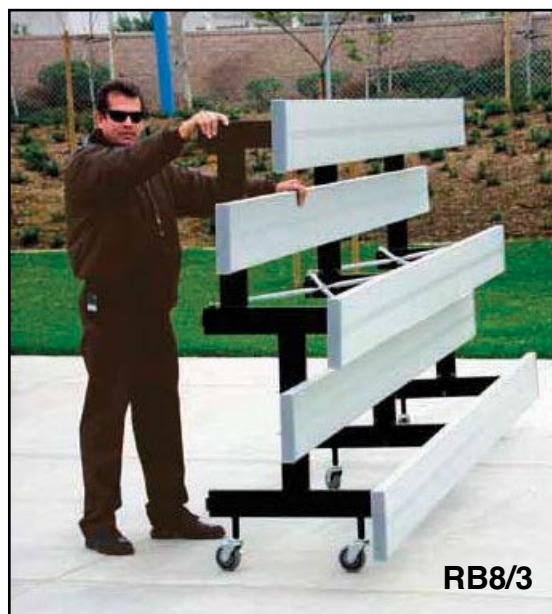

RB8/3

## TIP & ROLL BLEACHERS

Sturdy, and extremely lightweight, ALL ALUMINUM Tip & Roll Bleachers are equipped with anodized aluminum seat planks and mill finish foot planks, supported by square tubing. Available in 3 or 4 row configurations. First row is 11-7/8" from grade.

The 5" diameter non-marring, cushion rubber wheels with double ball bearing swivel casters make them extremely easy to move. Guardrail systems not required on these 3 and 4 row models.

Rows	Model	Length	Seat'g Space	Depth	Height	Weight
3	PN203-RB7.5	7'-6"	15	5'-6"	23-7/8"	125 lbs.
3	PN203-RB15	15'	30	5'-6"	23-7/8"	225 lbs.
3	PN203-RB21	21'	42	5'-6"	23-7/8"	300 lbs.
4	PN204-RB7.5	7'-6"	20	7'-6"	29-7/8"	180 lbs.
4	PN204-RB15	15'	40	7'-6"	29-7/8"	330 lbs.
4	PN204-RB21	21'	56	7'-6"	29-7/8"	445 lbs.



PN203-RB7.5

## REPLACEMENT CAPS

Replacement end caps with pop rivets for attachment to planks for aluminum bleachers.

To Fit BL Series- 9- 5/8" x 1- 3/4"

To Fit PN Series- 9 1/2" x 1 1/2"

Model	Description	Weight
CAP10	10"	1 lb.
CAP12	12"	1.5 lbs.



CAP10

## TRANSPORTER SYSTEM

Transporter system available for all of our BL Model bleachers on page 56.

Model	Description	Weight
BT-BL500	Transport	100 lbs.

The U.S. Consumer Products Safety Commission has responded to fatal and serious injuries due to falls from bleachers by issuing guidelines to help prevent these incidents. We have engineered a guardrail system that can be installed on most bleachers and comply with the CPSC guidelines.

The system discourages climbing as all the rails are vertical. Openings in the guardrail are small enough to prevent a child from falling from a height that could result in a serious injury. All of the materials are rigid and very durable. **NO CHAIN LINK FENCING IS USED.** With basic dimensions, we can configure our system to fit your guardrail requirements.

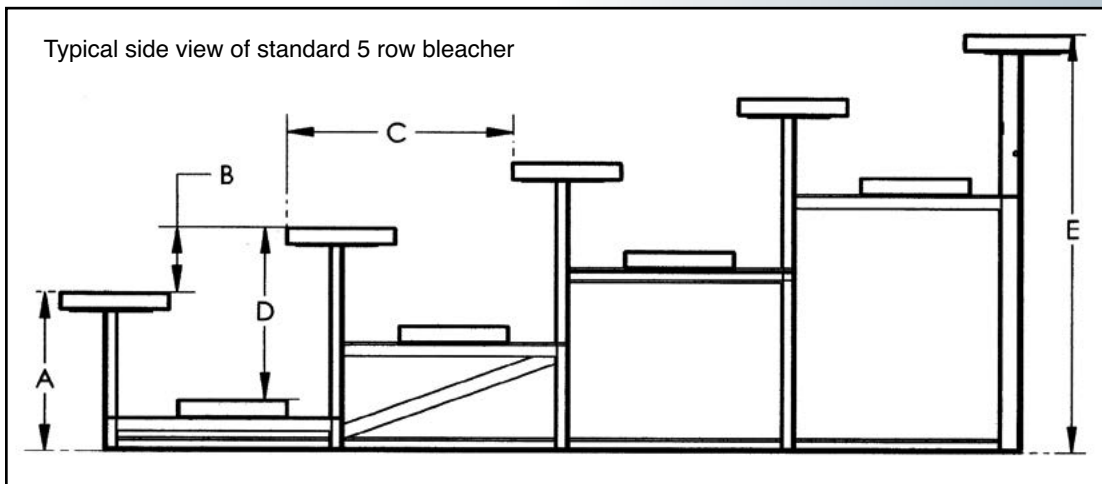

**Easy To Assemble:**

This system has been carefully designed and engineered to allow anyone who wants to bring their bleachers up to current CPSC guidelines to do so quickly and easily. The combination of our exclusive fittings and panels along with your specific dimensions, lets us customize your retro-fit with an easy to use and affordable system.

For a quote, fill in Dimensions below and return to L.A. Steelcraft.

Item	Dimensions	Description
A		Height of 1st Row
B		Rise From Row to Row
C		Row Spacing
D		Height From Seat to Footboard
E		Height of Last Row Seat
F		Seat Plank Width & Length
G		Thickness of Seat Plank
H		Footboard Width & Length
I		Footboard Thickness

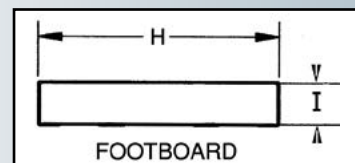
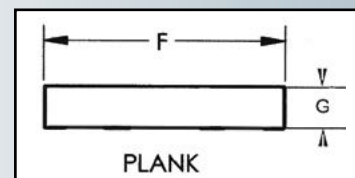

**Brace Band:**  
The Guardrails are fastened to the Back Supports with sturdy Brace Bands.

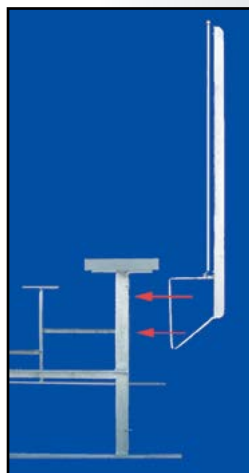

**Back Support Post:**  
Our Back Support Post mounts to any existing bleacher's back row brace. Locate the post under the seat support, then mark and drill holes in your support. The railing will be fastened to these supports with bracebands on top, and a convenient clip and channel attachment on the bottom.



**Corner Sections:**  
The Corner Sections are bolted together, and the top rails are held fast with another of our exclusive Roto-Steel inserts.



**Guard Rails:**  
The 36" x 45" Guard Rail Sections bolt together, and the top rail is held in place by our exclusive Roto-Steel insert that reveals only a smooth contoured abutment.

# Site Amenities

## Board & Scooter Racks



### IDEAL LOCATIONS:

**Schools**  
**Skate Parks**  
**Retail Areas**  
**Teen Centers**  
**Public Spaces**  
**Community Buildings**  
**Any place bike racks are found!**

### GENESIS 7 - WALL MOUNT

Designed for skateboards and scooters, this Boardloch Brand™ board rack functions just like a bike rack. Board racks for this equipment allow riders to be responsible for their own property. Meets the needs of your skateboard and scooter riding population. The rack is constructed of heavy gauge steel, and is zinc plated for added durability in harsh outdoor environments. Each rack secures up to five skateboards or scooters. The rack is designed to mount to concrete, brick, or other durable surfaces. The dimensions of the rack are 24" L x 12" W x 10" D. Padlocks not included. Locks are provided by owners of skateboard or scooter. Anchoring hardware not included. Pedestal model also available.

### SPARTAN 14



### SPARTAN 14



### SPARTAN 7

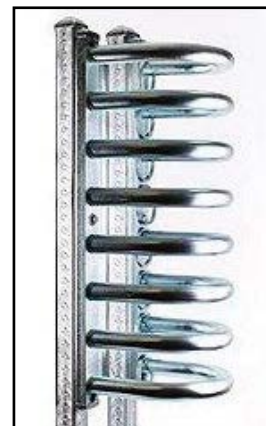

Model	Cap.	Height	Depth	Width	Weight
GENESIS 7	7	24"	10"	12"	35 lbs.
SPARTAN 7	7-Pedestal	36"	13"	15"	70 lbs.
SPARTAN 14	14-Pedestal	36"	26"	15"	105 lbs.

## DOUBLE FACE BIKE RACK

Main section is a single welded unit. Center frames bolt together (no field welding necessary). End frames and rails are 2-3/8" OD, pickets are 1-3/8" OD.

Model	Cap.	Length	Depth	Height	Weight
HDBR-5	8	5'	42"	38"	145 lbs.
HDBR-10	18	10'	42"	38"	240 lbs.
HDBR-20	36	20'	42"	38"	409 lbs.



**HDBR-5**

**POWDER COAT OPTION AVAILABLE ON POSTS - SEE PAGE 88**

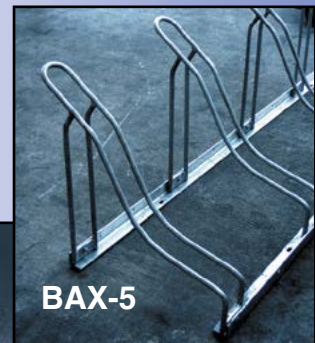

**BAX-5**

## "BA" SERIES BIKE RACK

Features our "Separate Wheel Holder" that can be spaced 16" apart facing one direction, or opposing directions, 8" apart for two sided loading. Wheel Holders are individual welded units made of 1/2" steel rod. Holder base is bolted to 1-1/2" x 1-1/2" x 3/16" steel angle running the length of the rack. Angle runners and wheel holders are hot dip galvanized after fabrication. Angle runners are provided with holes for anchoring. Bike holder accommodates all size of bike wheels.

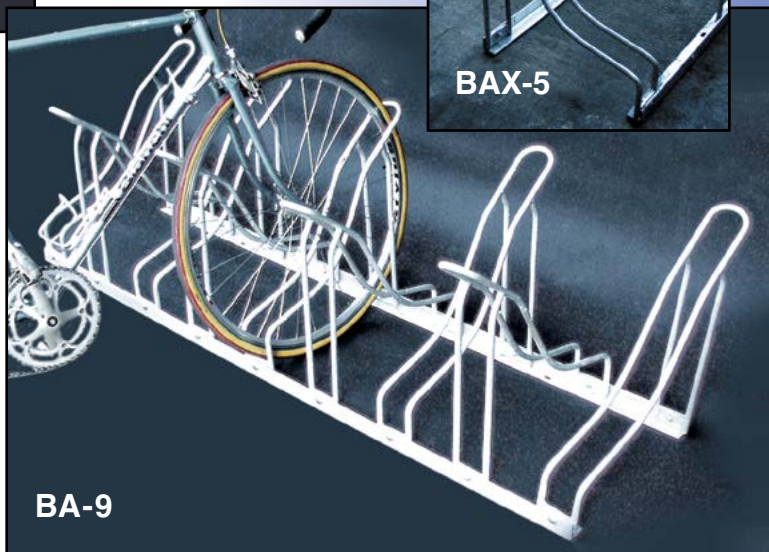

**BA-9**

### BA Loads Both Sides-

### BAX Loads One Side-

Model	Cap.	Length	Width	Height	Weight
BA-4	4	27"	22"	20-1/4"	32 lbs.
BA-9	9	67"	22"	20-1/4"	68 lbs.
BA-15	15	115-1/4"	22"	20-1/4"	127 lbs.
BAX-2	2	19"	19-3/4"	20-1/4"	20 lbs.
BAX-5	5	67"	19-3/4"	20-1/4"	52 lbs.
BAX-8	8	115-1/4"	19-3/4"	20-1/4"	85 lbs.



### BOLLARD STYLE BIKE RACK

Available in 4-1/2" OD or 5 9/16" OD capped galvanized pipe, with 1, 2, or 3 rails of 1- 3/8" OD galvanized pipe. These units come galvanized or finished in electrostatically applied powder coat finish.

Direct bury only.

**POWDER COAT OPTION AVAILABLE ON POSTS - SEE PAGE 88**

Model	Cap.	Loop Lengths	Width	Height	Posts	Weight
BBR4-1	1	16"	9"	36"	4-1/2" OD	58 lbs.
BBR4-2	2	16"	13"	36"	4-1/2" OD	60 lbs.
BBR4-3	3	16"	12"	36"	4-1/2" OD	62 lbs.
BBR5-1	1	16"	10"	36"	5-9/16" OD	63 lbs.
BBR5-2	2	16"	14"	36"	5-9/16" OD	65 lbs.
BBR5-3	3	16"	13"	36"	5-9/16" OD	67 lbs.

### TRADITIONAL BIKE RACKS

These traditional bicycle racks are designed to last a lifetime. Manufactured of 1- 5/8" and 7/8" galvanized pipe, with galvanized fittings - single or double face, permanent, in-ground or portable styles.

DR- Loads 2 sides

SR- Loads 1 side

Specify Portable/Surface Mount of In-Ground Model.



Model	Cap.	Length	Depth	Height	Weight
DR-15	33	15'	32"	36"	300 lbs.
DR-30	66	30'	32"	36"	600 lbs.
SR-15	15	15'	17"	36"	255 lbs.
SR-30	30	30'	17"	36"	400 lbs.

### SINGLE FACE BIKE RACKS

This portable rack is made of 1-5/8" and 7/8" galvanized steel pipe. Powder coat finish available at additional cost.

Model	Cap.	Length	Depth	Height	Weight
WM-7	7	10'	20"	38"	98 lbs.
WM-11	11	15'	20"	38"	150 lbs.



## “THE WAVE” BIKE RACK



WLBR-11

**POWDER COAT OPTION AVAILABLE ON POSTS - SEE PAGE 88**



HP SERIES

**WLBR Series-** This contemporary Bike Rack is fabricated from 2- 3/8” OD schedule 40 galvanized pipe and comes either **galvanized or powder coated finish**. Rack height is approx 36” above ground. **Yellow, Black, Brown, Green, Red, White or Blue**. Price includes either inground or surface mounting. Please specify when ordering. Shipped F.O.B. from Oregon 97210.

Model	Cap.	Width	Weight
WLBR-3	3	14”	25 lbs.
WLBR-5	5	38”	50 lbs.
WLBR-7	7	64”	75 lbs.
WLBR-9	9	87”	100 lbs.
WLBR-11	11	110”	125 lbs.
WLBR-13	13	134”	150 lbs.

Add SM to model number for surface mount option.

**HP Series Rack-** This bike rack is fabricated from 2-3/8” OD schedule 40 galvanized pipe and comes either galvanized or powder coated finish. Rack height is approx. 36” above ground. Price includes either in-ground or surface mounting. Please specify when ordering. Shipped F.O.B. from Oregon 97210.

Model	Cap.	Width	Weight
HP-1	2	30”	40 lbs.



SC SERIES

**KR Series Rack-** This rack can be made to accommodate one, (KR-1), two (KR-2) or three (KR-3) bikes. It has a 4-1/2” OD sch. 40 steel pipe main post and a 1-5/16” OD dia. steel bar to secure the bikes. Rack height is approx. 36” above ground. Shipped F.O.B. from Oregon 97210.

**SC Series Rack-** SC Rack holds 2 bikes at 2 points of contact in an upright position for secure locking. Each unit is constructed of 2-3/8” OD sch. 40 steel pipe. Rack height is approx. 32-1/2” above ground. Shipped F.O.B. from Oregon 97210.

Model	Cap.	Width	Weight
SC-2	2	36”	40 lbs.



KR SERIES



FIN SERIES

**FIN Series Rack-** FIN Rack holds 2 bikes at 2 points of contact in an upright position for secure locking. Each unit is constructed of .375” x 3” mild steel flat bar. Rack height is approx. 36” above ground. Shipped F.O.B. from Oregon 97210.

Model	Cap.	Width	Weight
FIN-2	2	16.5”	35 lbs.



BV-1

**BV-1-** These space-saving bike lockers are weatherproof and secure and will adapt to any venue. Each unit holds one bike (two bike capacity lockers also available). The pistol style door handle is locked with a user-supplied standard U-shaped lock or padlock. Shipped F.O.B. for Oregon 97210.

Model	Cap.	Dimensions	Weight
BV-1	1	30” W x 47” H x 76” Long	350 lbs.

# Site Accessories



630



650

## PEDESTAL BAR-B-QUES

Heavy-duty design for parks and campgrounds. Four position adjustable grill captive to stove. Spring-type handgrip prevents burns. Stove rotates 360° on post for draft control, while locked on post to prevent removal. Front lip reduces ash spill-out yet provides easy clean-out. Walls are formed from a single sheet of 12 gauge steel sheet. The grills have an all welded construction of 3/8" diameter steel round with outside frame of 1/2" steel round. Firebox is made from 7 gauge steel, is welded between sidewalls and has corner openings for drainage. Stove and accessories are painted with temperature/rust resistant black paint. Support post is 3-1/2" OD galvanized steel pipe x 35" long.

Dimensions: Stove size: 20" wide x 15" deep x 10" high.

Installed Height: 34" above grade to top. **Rear Utility Shelf option available at additional cost.**

Model	Description	Weight
630	Single Pedestal Bar-B-Que	75 lbs.
630-SM	Single Pedestal Bar-B-Que, surface mount (must be anchored)	86 lbs.
650-D	Back to Back Double Bar-B-Que	140 lbs.

**POWDER COAT OPTION AVAILABLE ON POSTS - SEE PAGE 88**

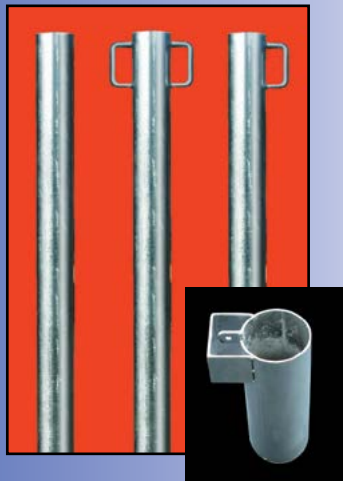

## PARKING BOLLARDS

Heavy-duty galvanized pipe bollards available in 3-1/2" OD, 4-1/2" OD or 5 9/16" OD. 36" above grade recommended. Comes without eyelets or caps on locking option/sleeve. Available for permanent in-ground installation or with optional sleeves. **Optional powder coating (white, yellow or black) available upon request.** Barrier chain and attachment hooks sold separately.

Model	Size	Weight	A-Type Sleeve	Locking Sleeve
PB3	3-1/2" OD	38 lbs.	PB3A	PB3L
PB4	4-1/2" OD	54 lbs.	PB4A	PB4L
PB5	5-9/16" OD	73 lbs.	PB5A	PB5L
C (cap)	-	.5 lbs.	-	-
E (eyelet)	-	.5 lbs.	-	-
L (locking option)	-	-	-	-

## EXPANDED METAL TRASH RECEPTACLES



TPP-32R SHOWN W/ FLAT TOP OPTION

The UltraCoat trash receptacles are designed to compliment our table and benches. We all know that trash is a by-product of a good time when people gather for a meal or snack but trash collection does not have to be an eyesore. Shown with optional Flat Top Lid. Lids available: Flat Top, Rain Bonnet or Dome Top. Not shown: Optional Post Package or Plastic Liner. Shipped F.O.B. from Illinois 62278



RAIN BONNET



DOMESTOP

Model	Description	Capacity (Gal)	Weight
TPP-32R	Receptacle	32 gal.	70 lbs.
TPP-55R	Receptacle	55 gal.	118 lbs.
Accessories			
FT-32	Flat Top	For 32 gal.	7 lbs.
FT-55	Flat Top	For 55 gal.	15 lbs.
DTOS-32	Dome Top	For 32 gal.	32 lbs.
RB-32	Rain Bonnet	For 32 gal.	13 lbs.
RB-55	Rain Bonnet	For 55 gal.	26 lbs.
RL-32	Plastic Liner	For 32 gal.	5 lbs.
RL-55	Plastic Liner	For 55 gal.	6 lbs.
KIT-IG	In Ground Mount	For 32 gal.	10 lbs.
KIT-SM	Surface Mount	For 55 gal.	10 lbs.



# Flagpoles

## ARCHITECTURAL SERIES- EXTERNAL HALYARD GROUND SET CONE TAPERED ALUMINUM FLAGPOLES

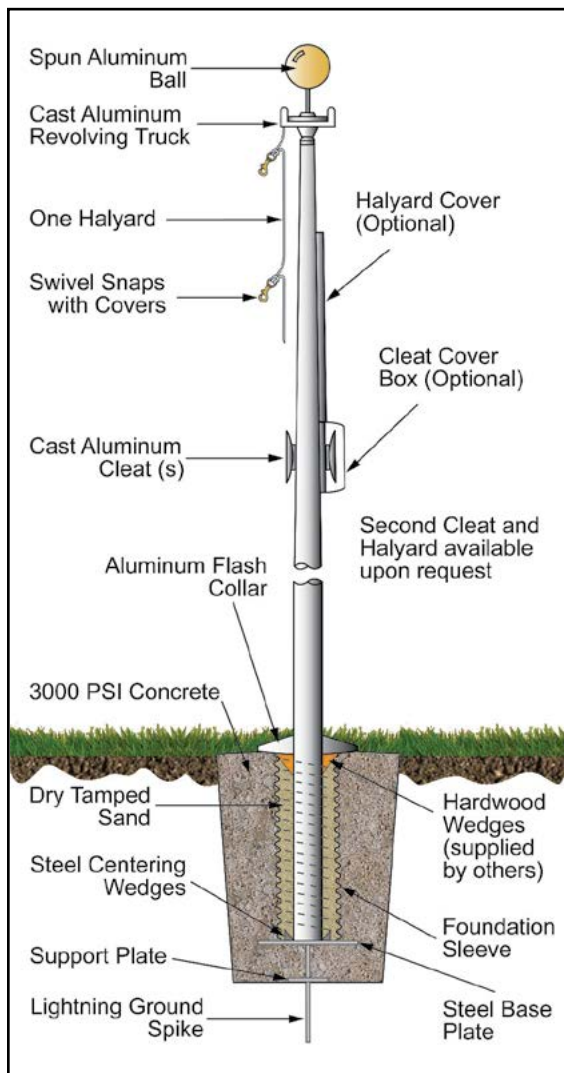

Our cone tapered ground set aluminum flagpoles are precision fabricated from new, 6063-T6 tubing, utilizing the industry's most sophisticated, state-of-the-art manufacturing processes. The conical portion tapers appx. 1" in every 5" - 6". Poles with overall lengths of less than 38" - 6" are shipped in one piece. Longer lengths are shipped in sections and will be factory fitted with a self-aligning sleeve which requires no field welding. Upon proper assembly a hairline joint will occur. All poles are double spiral wrapped with protective paper and shipped in a hard fiber tube. **Ships from factory in Wisconsin 53154.**

## FEATURES

- GOLD ANODIZED ALUMINUM BALL ORNAMENT
  - CAST ALUMINUM REVOLVING TRUCK WITH PULLEY
  - SOLID BRAIDED POLYPROPYLENE HALYARD
  - SWIVEL FLAG SNAPS WITH VINYL SNAP COVERS
  - CAST ALUMINUM CLEAT WITH MOUNTING SCREWS
  - SPUN ALUMINUM FLASH COLLAR
  - GALVANIZED STEEL FOUNDATION SLEEVE
- FLAGS SOLD SEPARATELY  
SEE PAGE**

Model	Exposed Height	Overall Length	Butt Diameter	Top Diameter	Wall	Constant Wind Unflagged	Speed Flagged	Flag Size	Weight
EC-20	20'	23'	5"	3"	.188	315 MPH	120+ MPH	3' x 5'	132 lbs.
EC-25	25'	27'	5-1/2"	3 1/2"	.188	222 MPH	120+ MPH	4' x 6'	191 lbs.
EC-30	30'	33'	6"	3 1/2"	.188	221 MPH	120+ MPH	5' x 8'	227 lbs.
EC-35	35'	38-1/2'	7"	3 1/2"	.188	200 MPH	120 MPH	6' x 10'	281 lbs.
EC-40	40'	44'	8"	3 1/2"	.188	203 MPH	120 MPH	8' x 12'	319 lbs.
EC-45	45'	49'	8"	3 1/2"	.188	166 MPH	100 MPH	8' x 12'	371 lbs.
EC-50	50'	55'	10"	4"	.188	185 MPH	115 MPH	10' x 15'	523 lbs.
EC-60	60'	66'	12"	4"	.250	213 MPH	120 MPH	12' x 18'	843 lbs.
EC-70	70'	77'	12"	4"	.250	169 MPH	105 MPH	15' x 25'	988 lbs.
EC-80	80'	88'	12"	4"	.375	174 MPH	105 MPH	20' x 30'	1,367 lbs.

**OPTIONAL FLAGPOLE FINISHES** All flagpole shafts are highly polished with fine grain aluminum oxide cloth resulting in a high quality, deep satin luster finish. The elegant soft sheen remains maintenance free. In addition to the satin, the following Anodized Finishes are available as **Optional Finishes at an additional cost:** Clear, Light Bronze, Dark Bronze, and Black. Please specify which finish on orders.

## DELUXE IH SERIES- INTERNAL HALYARD GROUND SET CONE TAPERED ALUMINUM FLAGPOLES

These deluxe internal halyard flagpoles contain a winch, mounted inside the flagpole shaft, operable only with a removable crank handle. As the stainless steel cable unwinds from the winch it passes through the inside of the flagpole shaft, over the truck sheave to the outside of the shaft, where the retaining ring provides a sliding anchor. A counterweight, heavily coated with neoprene, attached to the retaining ring, allows the halyard to be lowered for fastening or removing the flag. The halyard is then raised completely out of reach of vandals. The improved winch is gearless and self-locking at any point, eliminating the need for a separate brake. This direct drive winch provides rapid raising or lowering of the flag with little effort. This new, improved design does not require any welding. No monthly lubrication is needed.

**Ships from factory in Wisconsin, 53154.** Flags sold separately, see page 67.

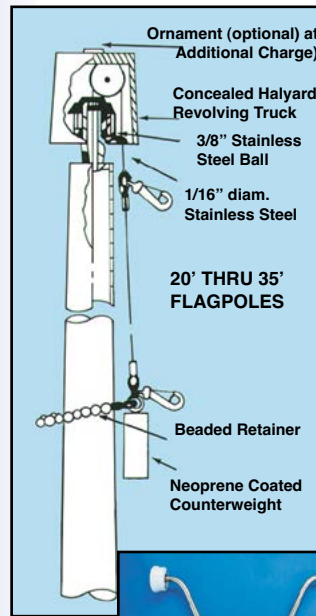
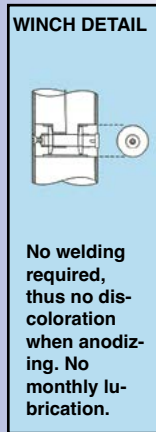
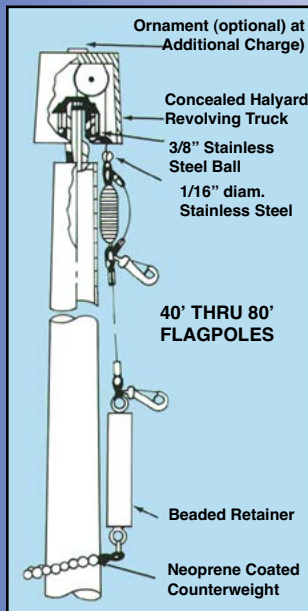

Model	Exposed Height	Overall Length	Butt Diameter	Top Diameter	Wall	Constant Wind Unflagged	Speed Flagged	Flag Size	Weight
EC-20IH	20'	23'	5"	3"	.188	315 MPH	120+ MPH	3' x 5'	132 lbs.
EC-25IH	25'	27'	6"	3-1/2"	.188	222 MPH	120+ MPH	4' x 6'	191 lbs.
EC-30IH	30'	33'	6"	3-1/2"	.188	221 MPH	120+ MPH	5' x 8'	227 lbs.
EC-35IH	35'	38-1/2'	7"	3-1/2"	.188	200 MPH	120 MPH	6' x 10'	281 lbs.
EC-40IH	40'	44'	8"	3-1/2"	.188	203 MPH	120 MPH	8' x 12'	319 lbs.
EC-45IH	45'	49'	8"	3-1/2"	.188	166 MPH	100 MPH	8' x 12'	371 lbs.
EC-50IH	50'	55'	10"	4"	.188	185 MPH	115 MPH	10' x 15'	523 lbs.
EC-60IH	60'	66'	12"	4"	.250	213 MPH	120 MPH	12' x 18'	843 lbs.
EC-70IH	70'	77'	12"	4"	.250	169 MPH	105 MPH	15' x 25'	488 lbs.
EC-80IH	80'	88'	12"	4"	.375	174 MPH	105 MPH	20' x 30'	1,367 lbs.

### OPTIONAL FLAGPOLE FINISHES

All flagpole shafts are highly polished with fine grain aluminum oxide cloth resulting in a high quality, deep satin luster finish. The elegant soft sheen remains maintenance free. In addition to the satin, the following Anodized Finishes are available as **Optional Finishes at an additional cost:** Clear, Light Bronze, Medium Bronze, Dark Bronze, and Black. Please specify which finish on orders.

# Flags & Accessories



**NYLON FLAGS**



**POLYESTER FLAGS**

Recognized as America's #1 choice of U.S. Flags. Expertly crafted using heavy weight bunting made of 100% nylon or polyester with vertical stitching and reinforced corners. These nylon flags offer lustrous beauty, superior wear plus excellent flyability, even in the slightest breeze. Beautifully embroidered snow-white stars are standard on all flags through sizes 8' x 12'. All seams are double and vertically stitched and fly ends have either 2, 4 or 6 rows of double-stitching for added durability. Reinforced corners are found on all flags and are finished with heavy-duty, no-shrink white header material for the strongest headers in the industry. Flags through sizes 6' x 10' feature strong, durable solid brass grommets. Flags 8' x 12' and larger are finished with super strong nylon rope sewn into the header with galvanized metal thimbles securely attached. Nylon flags 8' x 12' and larger with printed fields have chrome plated metal D-Rings sewn into the header.

Model	Size
NF5	3' x 5'
NF6	4' x 6'
NF8	5' x 8'
NF10	6' x 10'
NF12	8' x 12'

Model	Size
PF5	3' x 5'
PF6	4' x 6'
PF8	5' x 8'
PF10	6' x 10'
PF12	8' x 12'

**Outdoor nylon state flags, custom corporate flags and religious flags (Christian, Israel (Zion), Papal and Episcopal) are also available. Call for pricing.**

Engraved brass plaques are available and are curved to fit the butt diameter of the flagpole. Letter styles available: Block and Roman. Plaques are attached to the flagpole with matching rivets which are included. Call for pricing.



## CLEAT COVER BOXES

Model	Fits Pole Diameter	Type of Lock
CB	4" - 12"	Padlock

Cast aluminum with stainless steel hinge pins. Design allows for easy installation utilizing the cleat holes to mount the cleat cover box. Comes complete with padlock. Padlock style subject to change. Satin finish supplied unless stated. **Clear, Bronze or Black optional finishes available at additional charge.**



## BALL ORNAMENTS

Optional gold anodized aluminum ball ornaments for internal halyard flagpoles.



Model	Diameter
SB103	3"
SB104	4"
SB105	5"
SB106	6"
SB108	8"
SB110	10"
SB112	12"



## HALYARD COVERS

This 1-03/4" wide by 1" deep aluminum channel must be used with the cleat cover box (as shown) by providing additional protection 5" or 10" above the cleat cover box. Satin finish supplied unless stated.

Model	Length
HC-5	5'
HC-10	10'

## SHOE BASE MOUNTING PLATE- OPTION

Flagpoles can be adapted for shoe base mounting. Our shoe base is cast from A-356 aluminum alloy and is heat-treated to a T-6 condition. Base is joined to pole with a continuous circumferential weld at outside top and inside bottom of shoe base. Anchor bolts have double nuts, two flat washers and one lock washer. **Ships from our factory in Wisconsin, 53154.**

Add SB to model# for shoe base option.

**If Shoe Base option is selected, Foundation Sleeve is not furnished.**

**Nautical and Vertical/Diagonal wall mount flagpoles also available.**



**Architectural Series Flagpoles shown-Budget Series- External & Internal also available.**

# Tables & Benches

## Fiberglass Tables

### TRADITIONAL RECTANGLE TABLE WITH ATTACHED BENCHES



Optional Umbrella available - see page 87- 88

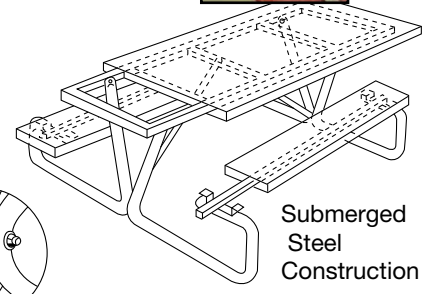

Submerged Steel Construction

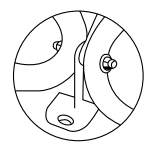

Optional Anchor Strap Model No. TP-A , 2 required for this model

Fiberglass top and seats with steel spine for no sagging. Easy access, no frame interference for seats. Seats 6 to 8 people.  
 OPTIONAL: Adding Recta-Brella, requires 2 umbrella holes at additional charge.  
 OPTIONAL: If anchoring, 2 anchor straps (TP-A) are required at additional charge.

SEE PAGES 86 - 87 FOR UMBRELLAS!

Model	Length	Overall Width	Top Width	Top Height	Seat Height	Weight
TP8-FA	8'	65"	30"	29"	18"	180 lbs.
TP8-FJ	8'	62"	30"	25"	15-1/2"	175 lbs.
TP6-FA	6'	65"	30"	29"	18"	150 lbs.
TP6-FJ	6'	62"	30"	25"	15-1/2"	145 lbs.
TP6FN	6'	56"	30"	21"	13-1/2"	135 lbs.
TP8FN	8'	56"	30"	21"	13-1/2"	165 lbs.

### PARTS AND ACCESSORIES FOR THE TRADITIONAL RECTANGLE TABLE

\*Indicate Adult or Junior and table length.

Model	Description	Weight
TP8-T	Fiberglass Top, 30" W x 8' L	65 lbs.
TP6-T	Fiberglass Top, 30" W x 6' L	50 lbs.
TP8-S	Fiberglass Seat, 10" W x 8' L	31 lbs.
TP6-S	Fiberglass Seat, 10" W x 6' L	24 lbs.
TP-F	Frames*	48 lbs.
TP-B	Braces*	5 lbs.
TP-A	Anchor Strap (optional)	2 lbs.
	Rectangle Tables require 2 brackets	
UH-2	Umbrella Holes upon request-2	4 lbs.
	Rectangle Tables require 2 holes	
PK	Fiberglass Patch Kit, indicate color	4 lbs.

Lots of fiberglass colors to choose from!

## KING ARTHUR ROUND TABLE WITH ATTACHED BENCHES

Fiberglass top and seats, with steel spine for no sagging. Easy access for 8 people. OPTIONAL: If adding an Aluminum or Fiberglass umbrella, requires 1 umbrella hole at additional charge. For anchoring, 4 anchor straps (TR-A) are required at additional charge.



Model	Diameter	Top Height	Seat Height	Overall Width	Weight
TRF-48A	48"	29"	18-1/2"	77-1/2"	179 lbs.
TRF-54A	54"	29"	18-1/2"	77-1/2"	192 lbs.
TRF-54N	54"	21"	13-1/2"	77-1/2"	187 lbs.

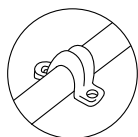

Optional Anchor Strap  
Model No. TR-A, 4 Required

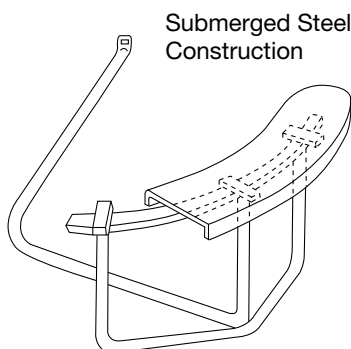

Submerged Steel Construction



Submerged Steel Spline Insert

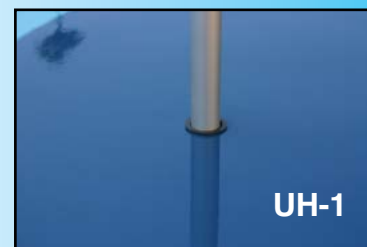

UH-1

Optional Umbrella Hole  
For Umbrellas see page 87 - 88

## PARTS AND ACCESSORIES FOR THE KING ARTHUR ROUND TABLE

\*Indicate Adult or Nursery for frames and centering disc.

Model	Description	Weight
TRF-A/N	Frames with centering disc*	89 lbs.
TRF-48	Fiberglass top, 48" diam.	38 lbs.
TRF-54	Fiberglass top, 54" diam.	44 lbs.
TRF-S	"Kidney Seat"	13 lbs.
TR-A	Anchor Strap (optional)	1 lb.
	Round Tables require 4 brackets	
UH-1	Umbrella hole upon request	2 lbs.
	Round Table requires 1 hole	
CD	Centering Disc*	4 lbs.

## ROUND TABLE WITH ATTACHED INDIVIDUAL STOOLS

1-5/8" OD galvanized pipe for frames. Fiberglass top with steel spine for no sagging. 8 individual stools for easy access. (Available with umbrella hole at additional charge. Required for use with round Fiberglass or Aluminum umbrellas. Optional anchor straps available at additional cost. 4 brackets (TR-A) are required on this model if anchoring.)



Model	Description	Top Diam.	Top Height	Seat Height	Overall Width	Weight
TRF8-48	F/G Round Table	48"	29"	18-1/2"	81"	149 lbs.
TRF8-54	F/G Round Table	54"	29"	18-1/2"	81"	155 lbs.

### PARTS AND ACCESSORIES FOR TRF8 SERIES

Model	Description	Weight
TRF-48	48" Diam. Top Only	38 lbs.
TRF-54	54" Diam Top Only	44 lbs.
RS-12	12" Diam. Stool Only	8 lbs.
TRF-AS	Frame only	89 lbs.
TR-A	Anchor Strap (optional)	1 lb.
UH-1	Umbrella Hole upon request only (1 required)	2 lbs.
CD	Center Disc	4 lbs.

## RUGGED HEAVY DUTY PEDESTAL FIBERGLASS TABLE

2" square tubular frames, powder coated finish, double pedestal legs per bench. Surface mount frame comes with 6" x 6" plates. (Available with umbrella hole on request for an extra charge.)



Model	Description	Top Diam.	Top Height	Seat Height	Weight
48-TPC	Direct Bury	48"	30"	18"	225 lbs.
48-TPP	Surface Mount	48"	30"	18"	215 lbs.
54-TPC	Direct Bury	54"	30"	18"	245 lbs.
54-TPP	Surface Mount	54"	30"	18"	235 lbs.

### PARTS AND ACCESSORIES FOR TPC/TPP SERIES

Specify direct bury or surface mount frame.

Model	Description	Weight
TP-48F	Frame only for 48"	90 lbs.
TP-54F	Frame only for 54"	95 lbs.
TRF-S	"Kidney Seat"	13 lbs.
TRF-48	Fiberglass Top 48" Diam.	38 lbs.
TRF-54	Fiberglass Top 54" Diam.	44 lbs.
UH-1	Umbrella Hole	2 lbs.



Skate Stoppers protect your tables and benches from the damage skateboarders can do. These Stoppers are specially designed for fiberglass surfaces. Suggested to be used every 6" inches along the rails of tops and seats. Sold in kits of 20, 60, 100 or 250. All kits include application hardware.

Model	Description
FRO12BC	Wood, Fiberglass or Aluminum
FRO25PC	Expanded Metal (Not Shown)

## EXTRA STRENGTH RECTANGLE TABLE AND BENCHES W/ REINFORCED SUPPORT BRACING

1- 5/8" OD galvanized tubular frames. 1-1/16" OD galvanized support bracing under top and each bench with 1/2" tie bar. Galvanized foot pad welded to leg frames for added stability. No anchor strap required.



Lots of fiberglass colors to choose from!

Model	Description	Top Diam.	Top Height	Seat Height	Overall Width	Weight
TP-3026	F/G HD Support	30" x 96"	26"	15-1/2"	65"	195 lbs.
TP-3030	F/G HD Support	30" x 96"	30"	18"	65"	205 lbs.
TP-30F	Frame Only	-	-	-	-	85 lbs.

### PARTS AND ACCESSORIES FOR TP-30 SERIES \*Indicate 26" or 30" height for frames.

Model	Description	Weight
TP-30F	Frames Only 26" or 30"*	85 lbs.
TP-30B	Braces Only (set of 3)	34 lbs.
TP8-T	30" x 96" top only	65 lbs.
TP8-S	Fiberglass seat 10"W x 8' L	31 lbs.
UH-2	Umbrella Holes (2)	4 lbs.



### PEDESTAL FRAME DESIGN

1-5/8" OD galvanized steel pipe. Built to seat 4 comfortably. Perfect for small families. Meets the need of fast food industry. This table should be used in a fixed location with frame anchored. Anchor straps available at additional charge.

Model	Description	Top Diam.	Top Height	Seat Height	Overall Width	Weight
TP4-TBF	4 Seater	30" x 48"	30"	18"	60"	90 lbs.

### PARTS AND ACCESSORIES FOR TP4-TBF SERIES

Model	Description	Weight
TB4-T	30" x 48" top only	41 lbs.
TB4-S	10" x 48" seat only	20 lbs.
TP-A	Anchor Strap	2 lbs.
PK	Fiberglass Patch Kit	4 lbs.

# Food Court Tables



TRF-35S

## TRF-35S ROUND TOP TABLE WITH SEPARATE ROUND SEATS FOR PERMANENT INSTALLATION

Round top table with separate round seats for in-ground installation. Table Frame: 2-7/8" OD pipe with powder-coated finish. Stool Frame: 2-3/8" OD pipe with powder-coated finish. Seat: 12" diameter fiberglass. Ideal for fast food areas. Optional surface mount (add SM to model number) at additional charge. (Available with umbrella hole on request, for an extra charge).

Model	Top Diameter	Top Height	Seat Height	Overall Width	Weight
TRF-30S	30"	29"	18"	Adjust.	95 lbs.
TRF-35S	35"	29"	18"	Adjust.	100 lbs.

## TCF-35S ROUND TOP TABLE WITH ROUND SEATS ATTACHED TO A SINGULAR CENTER COLUMN

Round fiberglass top table with individual round seats attached to center column. Frames 2" sq. tubular steel with powder coated finish. Seat: 12" diameter fiberglass. Ideal for fast food areas. Optional surface mount (add SM to model number) at additional charge. (Available with umbrella hole on request, for an extra charge).



TCF 35S-4

Model	Top Diameter	Top Height	Seat Height	Overall Width	No. of Seats	Weight
TCF 35S-4	35"	29"	18"	67"	4	120 lbs.
TCF 35S-5	35"	29"	18"	67"	5	125 lbs.
TCF 35S-6	35"	29"	18"	67"	6	130 lbs.
TCF 30S-4	30"	29"	18"	67"	4	105 lbs.



TRF-30T/4

## TRF-30T/4 ROUND TABLE WITH SUPPORTED STOOLS

Round fiberglass table with supported stools. For deck mount installation (as shown) add "D" to model number. 2" square tubular steel frames with powder coated finish. 12" diameter seats. Ideal for fast food areas. (Available with umbrella hole on request, for an extra charge).

Model	Top Diameter	Top Height	Seat Height	Overall Width	Weight
TRF-30T/4	30"	29"	18"	62"	130 lbs.
TRF-35T/4	35"	29"	18"	67"	140 lbs.

## PARTS AND ACCESSORIES FOR ROUND FOOD COURT TABLES

Model	Description	Weight
TCF-30T	30" Diam. top only	32 lbs.
TCF-35T	35" Diam. top only	38 lbs.
RS-12	12" Diam. stool only	8 lbs.
UH-1	Umbrella Hole (1)	2 lbs.



## TBW-RECTANGLE TOP TABLE WITH BUCKET SEATS

Rectangle fiberglass top table with four bucket seats. 2" square tubular steel frame with a powder coated finish. Fiberglass seats are veiled bucket style (standard seat color is white. Other colors are available at extra charge). Ideal for fast food areas.



Model	Description	Top Size	Top Height	Seat Height	Overall Width	Weight
TBW-4B	Deck Mount	30" x 48"	29"	18"	48" x 76"	118 lbs.
TBW-4BP	Permanent	30" x 48"	29"	18"	48" x 76"	122 lbs.



## TBW-4 RECTANGLE TOP TABLE WITH BENCH SEATS

Fiberglass rectangle table with bench seats for portable or permanent installation. 2" square tubular steel with powder coated finish. Seat is 2" x 10" fiberglass with steel insert. Ideal for fast food areas.

Model	Mount	Top Size	Top Height	Seat Height	Overall Width	Weight
TBW-4	Deck-Mount	30" x 48"	29"	18"	48" x	125 lbs.
TBW-4P	Permanent	30" x 48"	29"	18"	48" x	130 lbs.

## EARLY CHILDHOOD ULTRACOAT EXPANDED METAL TABLES

These children's tables are designed for the "little people" in our elementary, preschools and daycares. The children's size tables are made from diamond patterns and reduced in height to accommodate the kids. Special UltraCoat thermo-plastic tables. We offer both a square and rectangular model. Available colors: Green, Blue, Red, Brown, Black, Beige and Burgundy. For other UltraCoat models see page 85 Ships from: IL 62278.

Model	Description	Top Size	Seat Size	Frame Size	Table Height	Seat Height	Weight
TPP-46-KT	46" Square	46" x 46"	12" x 36"	1-5/8" OD	20-1/2"	12-1/2"	170 lbs.
TPP-48-KT	48" Rectangle	24" x 48"	12" x 48"	1-5/8" OD	20-1/2"	12-1/2"	124 lbs.
TPP-72-KT	72" Rectangle	24" x 72"	12" x 72"	1-5/8" OD	20-1/2"	12-1/2"	195 lbs.



# Stand Alone Tables



## UTILITY TABLE

Excellent table for conference rooms, workshops, laundry room, etc.. Utility table- 1-5/8" OD galvanized steel frames.

Model	Top Size	Top Height	Seat Height	Overall Width	Weight
TP8-FFA	30" x 96"	29"	N/A	30" x 96"	114 lbs.
TP6-FFA	30" x 72"	29"	N/A	30" x 72"	95 lbs.
TP8-FFJ	30" x 96"	25"	N/A	30" x 96"	112 lbs.
TP6-FFJ	30" x 72"	25"	N/A	30" x 72"	93 lbs.
TP-FF	Frames-adult or junior				54 lbs.
TP8-T	Fiberglass top, 30"W x 8'L				65 lbs.
TP6-T	Fiberglass top 30" W x 6'L				50 lbs.



TP6-FFA



TRF-54FFN

## BALLERINA ROUND TABLE

Round table without seats- 1-5/8" OD galvanized steel frames. Ideal for nurseries, patios, work tables, etc. (Available with umbrella hole on request, for an extra charge.)

Model	Top Size	Top Height	Seat Height	Overall Width	Weight
TRF-48FFA	48"	29"	N/A	60"	72 lbs.
TRF-54FFA	54"	29"	N/A	66"	89 lbs.
TRF-54FFN	54"	21"	N/A	66"	87 lbs.
TRF-FF	Frames Only (Specify Adult or Junior Frames)				30 lbs.
CD	Center Disc (Specify Adult or Junior Size)				4 lbs.
TRF-48	Fiberglass Top 48" Diam.				38 lbs.
TRF-54	Fiberglass Top, 54" Diam.				44 lbs.



## CLIO STAND-UP TABLE

The Hyperion Clio Stand-Up Table is perfect for food courts and other stand-up locations. Features rotosteel, a hybrid of rotationally molded polyethylene and steel, to support our fiberglass tops. Has a 48" or 54" diameter top and stands at a height of 40". Tables have been carefully designed for easy flexible installation. They can be permanently anchored to masonry surfaces, or filled with water or sand for Semi-Permanent installations.

Model	Height	Weight
Clio-48	42" (48" Diam.)	130 lbs.
Clio-54	42" (54" Diam.)	160 lbs.

**Hyperion Color Selection:**  
Sand, Steel Gray or Sea Green.

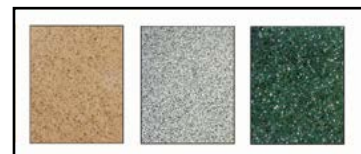

# ADA-Accessible & Specialty Tables



These much needed styles of picnic tables feature extended height to allow for comfortable wheelchair access. Frames: 1-5/8" OD galvanized steel pipe. Braces: 1" OD galvanized steel pipe. Top and seat: Steel reinforced heavy duty fiberglass shells. All tables can be adapted for use with umbrellas. **All these tables should be used in a fixed location with frames anchored.** 10" nominal plank seating.



TP8-FW1

## ADA TRADITIONAL RECTANGLE TABLE

Traditional all-purpose rectangle table seats 6 on 6' long benches on two sides of table and also allows access of up to 2 wheelchairs on ends of table. Requires 2 anchor brackets (TP-A) at additional charge. See page 69 for anchors.

Model	Description	Top Size	Top Height	Seat Height	Overall Width	Weight
TP8-FW1	Wheelchair	30" x 96"	31"	17-1/2"	65"	170 lbs.

## ADA DIAGONAL RECTANGLE TABLE

All purpose rectangle table seats for 6 people with staggered 6' long offset benches on 2 sides of table and allows for access of up to 1 wheelchair on each side. This table should be used in a fixed location with frames anchored. Requires two TP-A anchor straps at additional charge. See page 69 for anchors.



TP8-FN1M

Model	Description	Top Size	Top Height	Seat Height	Overall Width	Weight
TP8-FN1M	Wheelchair	30" x 96"	31"	18-1/2"	65"	170 lbs.
TP8-FN1MJR	Wheelchair	30" x 96"	23"	13-1/2"	65"	165 lbs.



TRF-48W

## ADA KING ARTHUR ROUND TABLE

Traditional King Arthur Round Table adapted to seat 4 people on 2 kidney seats, plus access for 2 wheelchairs. For anchoring, 4 anchor straps (TR-A) are required at additional charge.

Model	Description	Top Size	Top Height	Seat Height	Overall Width	Weight
TRF-48W	Wheelchair	48"	31"	17-1/2"	77-1/2"	155 lbs.
TRF-54W	Wheelchair	54"	31"	17-1/2"	77-1/2"	161 lbs.

## ADA RECTANGLE TABLE WITH SHORT BENCHES

Traditional all-purpose rectangle table seats 4 people with 4' long benches on both sides of table and also allows for access of up to 2 wheelchairs on each end. This table should be used in a fixed location with frames anchored. Use two TP-A anchors. Anchor straps at additional charge. See page 69 for anchors.



TP8-FW2

Model	Description	Top Size	Top Height	Seat Height	Overall Width	Weight
TP8-FW2	Wheelchair	30" x 96"	31"	17-1/2"	65"	160 lbs.

# Site Benches



PBF-6/2

## MULTI PEDESTAL PARK BENCH

2" x 1" x 3/16" frames. Hot dipped galvanized channel welded to 1-5/8" OD steel pipes.

Model	Description	Length	Frames	Ground Space	Weight
PBF-6/2	Pedestal	6'	2	2' x 6'	70 lbs.
PBF-8/2	Pedestal	8'	2	2' x 8'	84 lbs.
PBF-12/3	Pedestal	12'	3	2' x 12'	129 lbs.
PBF-16/4	Pedestal	16'	4	2' x 16'	168 lbs.
PBF-PF	Frame only per pair				22 lbs.

## PORTABLE CHanneled PARK BENCH

Frames: 2" x 1" x 3/16" channel with 1/2" rod support. HDG after fabrication. 1" galvanized pipe braces. Specify bench length when ordering frames only.

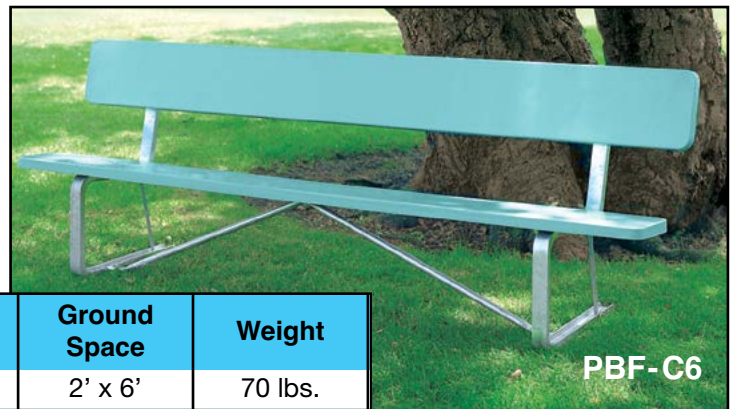

PBF-C6

Model	Description	Length	Frames	Ground Space	Weight
PBF-C6	Portable	6'	2	2' x 6'	70 lbs.
PBF-C8	Portable	8'	2	2' x 8'	84 lbs.
PBF-C12	Portable	12'	3	2' x 12'	129 lbs.
PBF-CF	Frame only per pair				35 lbs



PBP-6

## PERMANENT OR PORTABLE PARK BENCHES

Specify bench length when ordering frames only.

Lots of fiberglass colors to choose from!

Model	Description	Length	Frames	Ground Space	Weight
PBP-6	Portable	6'	2	2'6" x 6'	95 lbs.
PBP-8	Portable	8'	2	2'6" x 8'	109 lbs.
PBP-12	Portable	12'	3	2'6" x 12'	120 lbs.
PBS-6	Permanent	6'	2	2' x 6'	95 lbs.
PBS-8	Permanent	8'	2	2' x 8'	109 lbs.
PBS-12	Permanent	12'	3	2' x 12'	120 lbs.
PBP-FP	Frame only for portable per pair				47 lbs.
PBP-FS	Frame only for permanent per pair				45 lbs.

## HEAVY DUTY PEDESTAL PARK BENCH

2" x 1" x 3/16" seat and back brackets, hot dipped galvanized channel. Double 2-3/8" OD galvanized pipe support legs.



PBF-6/1

Model	Description	Length	Frames	Ground Space	Weight
PBF-6/1	Pedestal	6'	1	2' x 6'	95 lbs.
PBF-8/1	Pedestal	8'	1	2' x 8'	109 lbs.
PBF-6F		Frame only 6' model			47 lbs.
PBF-8F		Frame only 8' model			61 lbs.



YBF-6

## PORTABLE YARD BENCH

3/16" x 3" frame with steel spine. Hot dipped galvanized after fabrication. 1.029" OD galvanized steel brace. Ideal for school yards, locker rooms, etc. Specify bench length when ordering frames only.

Model	Description	Length	Frames	Ground Space	Weight
YBF-6	Portable	6'	2	15" x 6'	35 lbs.
YBF-8	Portable	8'	2	15" x 8'	55 lbs.
YBF-12	Portable	12'	3	15" x 12'	85 lbs.
YBF-F		Frame only per pair			21 lbs.

## TRADITIONAL LOCKER ROOM, FIELD AND DUGOUT BENCHES

1-5/8" OD galvanized steel frames.



LBF-8P

Model	Description	Length	Frames	Ground Space	Weight
LBF-6P	6" x 6" Plate	6'	2	10" x 6'	39 lbs.
LBF-8P	6" x 6" Plate	8'	3	10" x 8'	55 lbs.
LBF-12P	6" x 6" Plate	12'	4	10" x 12'	74 lbs.
LBF-6C	Direct Bury	6'	2	10" x 6'	37 lbs.
LBF-8C	Direct Bury	8'	3	10" x 8'	53 lbs.
LBF-12C	Direct Bury	12'	4	10" x 12'	71 lbs.
LBF-FP		Frame Only with plate per pair (surface mount)			18 lbs.
LBF-FC		Frame Only for concrete pair			8 lbs.

## ACCESSORIES FOR BENCHES

\*Indicate Seat or Back. All our planks are 10" wide. Frames only are listed with bench models. CSF Models are Fiberglass Bench Covers.

Model	Description	Weight
PBF6-S/B	6' Fiberglass Seat or Back*	24 lbs.
PBF8-S/B	8' Fiberglass Seat or Back*	31 lbs.
PBF12-S/B	12' Fiberglass Seat or Back*	48 lbs.
CSF10	10" W- 6', 8', 12', 16' Lengths	per ft.
CSF11	11-1/2" W- 8', 12' Lengths	per ft.

# Wood Tables

Wood planking used for all seats and tops on both tables and benches are nominal 2" x 10" (9-1/2" x 1-1/2") A-1 clear Southern Yellow Pine, DI-65. All planks are kiln dried (KD), surfaced on four sides (S4S) and with eased edges (EE). Planks are available in either natural (ready to finish) or with redwood stained finish.



## TRADITIONAL HEAVY DUTY PICNIC TABLE WITH BENCHES

2-3/8" OD galvanized frames. 1.029 OD galvanized pipe bracing. All welded end frames with angle top and seat supports.

TP8-HD2



Natural (ready to finish) or redwood stained finish.

Model	Description	Top Size	Top Height	Seat Height	Overall Width	Weight
TP6-HD2	Traditional	30" x 72"	29"	18"	68"	205 lbs.
TP8-HD2	Traditional	30" x 96"	29"	18"	68"	240 lbs.
HD2-W	Frame Only	-	-	-	-	100 lbs.

## THE ORIGINAL "TOUGH ONE"

1-5/8" OD or 2-3/8" OD galvanized steel pipe frames with angle iron plank holders. All welded frames. 1" braces on 1-5/8" and 1-1/4" braces on 2-3/8". 2" x 10" nominal planks.

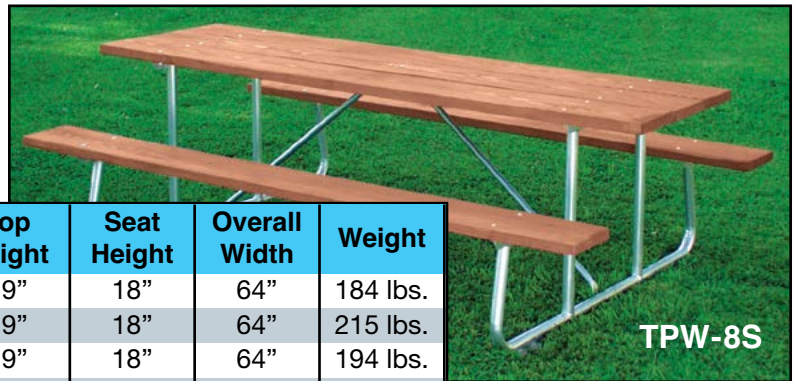

TPW-8S

Model	Description	Top Size	Top Height	Seat Height	Overall Width	Weight
TPW-6S	1-5/8" Frame	30" x 72"	29"	18"	64"	184 lbs.
TPW-8S	1-5/8" Frame	30" x 96"	29"	18"	64"	215 lbs.
TPW-6HD	2-3/8" Frame	30" x 72"	29"	18"	64"	194 lbs.
TPW-8HD	2-3/8" Frame	30" x 96"	29"	18"	64"	230 lbs.
W-S	1-5/8" Frame Only	-	-	-	-	78 lbs.
W-HD	2-3/8" Frame Only	-	-	-	-	93 lbs.



## STANDARD WOOD PLANK TABLE

1-5/8" OD or 2-3/8" OD galvanized steel pipe frames with angle iron plank holders. All welded frames. 1" braces on 1-5/8" and 1-1/4" braces on 2-3/8". 2" x 10" nominal planks.



TPW-82GA

Model	Description	Top Size	Top Height	Seat Height	Overall Width	Weight
TPW-82GA	Adult	30" x 8'	28-1/2"	18"	96" x 65"	212 lbs.
TPW-62GA	Adult	30" x 6'	28-1/2"	18"	72" x 65"	197 lbs.
TPW-82GJ	Junior	30" x 8'	25-1/2"	15-1/2"	96" x 62"	190 lbs.
TPW-62GJ	Junior	30" x 6'	25-1/2"	15-1/2"	72" x 62"	185 lbs.
TPW-GA	Frame only- specify junior or adult					52 lbs.

## EXTRA STRENGTH WOOD TABLE

1-5/8" tubular galvanized frames. 1-1/16" OD galvanized support bracing under top and each bench with 1/2" tie bar. Galvanized pads welded to leg frames for added stability.



TPW-3030

Model	Description	Top Size	Top Height	Seat Height	Overall Width	Weight
TPW-3026	HD Wood	30" x 96"	26"	15-1/2"	65"	195 lbs.
TPW-3030	HD Wood	30" x 96"	30"	18"	65"	205 lbs.
TP-30FW	Frame Only					85 lbs.
Indicate Height desired 26" or 30"						

# Double Plank Tables & Benches

## THE ORIGINAL "4 LIVES" DOUBLE PLANK TABLE

Planks can be rotated to four surfaces when needed. Steel end caps prevent plank end damage and gives extra long life. Planks can be furnished natural or stained redwood finish. 2-3/8" OD galvanized steel pipe frames with 3" x 2" x 3-1/16" angle supports and steel top and seat caps. 2" x 10" nominal planks.

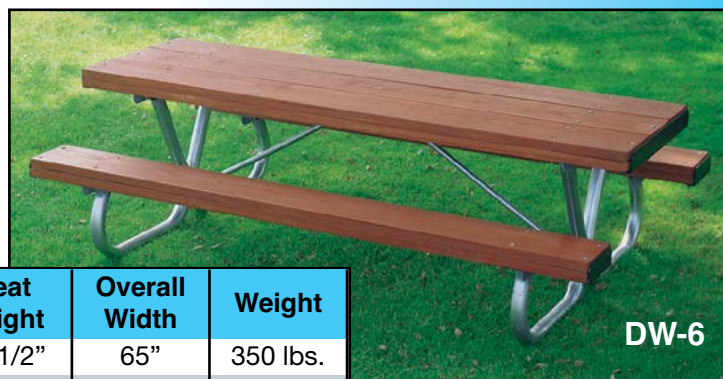

Model	Description	Top Size	Top Size	Seat Height	Overall Width	Weight
DW-6	Dbl. Plank	30" x 72"	29-1/2"	17-1/2"	65"	350 lbs.
DW-8	Dbl. Plank	30" x 96"	29-1/2"	17-1/2"	65"	420 lbs.
DW-F	Frame and Braces Only					140 lbs.
Indicate Table Length 6' or 8'						



## "4 LIVES" DOUBLE PLANK PARK BENCH

(For permanent style, add "PS" to model #) Utilizes combination of 2-3/8" OD galvanized steel pipe and 2" x 6" double Southern Yellow Pine to make a rugged park bench that will withstand years of heavy use. All frames, braces and end caps are black powder coated finish.

Model	Description	Length	Frames	Ground Space	Weight
DW-PB-6	Dbl. Plank	6'	2	2' x 6'	148 lbs.
DW-PB-8	Dbl. Plank	8'	2	2' x 8'	197 lbs.
DW-PB-P	Portable Frames Only				55 lbs.
DW-PB-PS	Direct Bury Frames Only				53 lbs.

## "4 LIVES" DOUBLE PLANK YARD BENCH

Utilizes 2" x 6" double planked Southern Yellow Pine along with a heavy duty 4" x 4" square tubing leg with a 12" x 12" x 1/4" steel plate, with a 3" x 2" x 3/16" angle seat support. Frame and end caps are black powder coated finished.



Model	Description	Length	Frames	Ground Space	Weight
DW-YB-6	Dbl. Plank	6'	2	1' x 6'	87 lbs.
DW-YB-8	Dbl. Plank	8'	2	1' x 8'	116 lbs.
DW-YB-P	Surface Mount Plate Frame Only				40 lbs.
DW-YB-PS	Direct Bury Frame Only				45 lbs.



Top, seats and end caps are 3" x 2" x 3/16" steel angle iron with black powder coat finish.

Steel end caps are removed to allow for the double planks to be rotated and then easily re-assembled to protect plank ends from cracking or damage. This feature, along with the double planking, gives you "4 lives" from our tables and benches.

3" x 2" x 3/16" steel end caps provide ultimate protection to the plank ends and prevents warpage.

# Aluminum/Wood Site Benches

Aluminum planking used for seats and tops on both tables and benches are 2" x 10" (9-1/2" x 1-3/4") extruded aluminum alloy 6063T6 with a clear anodized finish as per AA-M10L22A31 Class II (204R1) 0.4 mil minimum thickness to resist corrosion and stains. The aluminum planks come with roto-molded end caps. 2" x 12" aluminum seats available at additional cost. L.A. Steelcraft uses 60% recycled aluminum in our aluminum benches and tables.

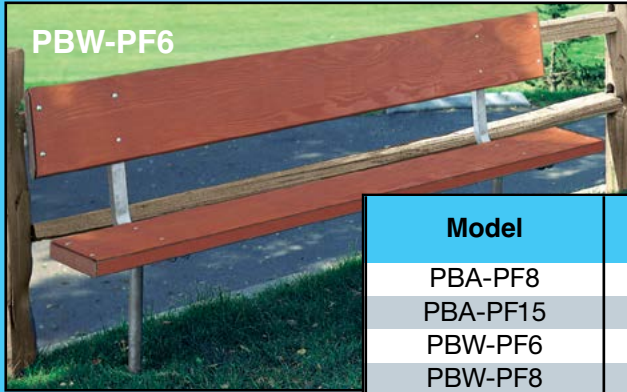

## PLAYER BENCH

2" x 1" x 3/16" frame, channel welded to 1-5/8" OD galvanized steel pipe. This bench is for direct bury application used for dugouts and as Permanent player benches.

Model	Description	Length	Frames	Ground Space	Weight
PBA-PF8	Aluminum	7'-6"	2	2' x 7-1/2'	52 lbs.
PBA-PF15	Aluminum	15'	4	2' x 15'	104 lbs.
PBW-PF6	Wood	6'	2	2' x 6'	64 lbs.
PBW-PF8	Wood	8'	2	2' x 8'	78 lbs.
PBW-PF15	Wood	15'	4	2' x 15'	149 lbs.
PBA-PF	Formed Channel and Pipe Frame (Aluminum)				22 lbs.
PBW-PF	Formed Channel and Pipe Frame (Wood)				22 lbs.

## PLANK YARD BENCH

Each bench has a single plank on hot dipped galvanized frames made from 3" x 3/16" thick steel with 1" OD galvanized pipe braces.

Model	Description	Length	Frames	Ground Space	Weight
YBA-8	Aluminum	7-1/2'	2	15" x 7-1/2'	36 lbs.
YBA-15	Aluminum	15'	4	15" x 15'	74 lbs.
YBW-6	Wood	6'	2	15" x 6'	42 lbs.
YBW-8	Wood	8'	2	15" x 8'	49 lbs.
YBW-15	Wood	15'	4	15" x 15'	95 lbs.
YBF-A	Frame for Aluminum Planking per pair				21 lbs.
YBF-W	Frame for Wood Planking per pair				21 lbs.

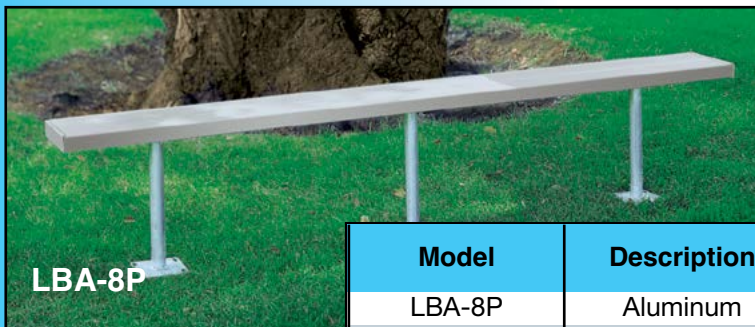

## PLANK PLAYER/LOCKER ROOM BENCH

Comes with 2 styles of pedestal frames. (For Direct Bury frames, add "FC" to model #). Direct Bury, or with a 6" x 6" plate for attachment to existing decks. Frames are 1-5/8" OD galvanized pipe.

Model	Description	Length	Frames	Ground Space	Weight
LBA-8P	Aluminum	7-1/2'	2	1' x 7-1/2'	33 lbs.
LBA-15P	Aluminum	15'	4	1' x 15'	66 lbs.
LBW-6P	Wood	6'	2	1' x 6'	39 lbs.
LBW-8P	Wood	8'	2	1' x 8'	46 lbs.
LBW-15P	Wood	15'	4	1' x 15'	89 lbs.
LB-FP	Frame only with Plate per pair				18 lbs.
LB-FC	Frame only for Direct Bury per pair				8 lbs.

60%  
RECYCLED  
ALUMINUM





## PLAYER BENCH WITH BACK

(For Direct Bury Frames, add "FS" to model #) Mounted on 2-3/8" OD frame of galvanized pipe. Braces are 1" OD galvanized pipe. Ideal for dugouts and team benches.



Shown with our two types of wood available. Stained or untreated.

Model	Description	Length	Frames	Ground Space	Weight
PBA-8P	Aluminum	7-1/2'	2	2' x 7-1/2'	77 lbs.
PBA-15P	Aluminum	15'	4	2' x 15'	148 lbs.
PBA-36P	Aluminum	36'	7	2' x 36'	355 lbs.
PBW-6P	Wood	6'	2	2' x 6'	89 lbs.
PBW-8P	Wood	8'	2	2' x 8'	103 lbs.
PBW-15P	Wood	15'	4	2' x 15'	193 lbs.
PBP-FS	Direct Bury Frame per pair				45 lbs.
PBP-FP	Portable Frame per pair				47 lbs.

## PORTABLE PARK BENCH

2" x 1" x 3/16" frames, channel welded with 1/2" rod support. Hot dipped galvanized after fabrication. Braces are 1" galvanized pipe. This portable park bench is great for tennis courts and site furnishings.



Model	Description	Length	Frames	Ground Space	Weight
PBA-C8	Aluminum	7'-6"	2	2' x 7-1/2'	65 lbs.
PBA-C15	Aluminum	15'	4	2' x 15'	130 lbs.
PBW-C6	Wood	6'	2	2' x 6'	77 lbs.
PBW-C8	Wood	8'	2	2' x 8'	91 lbs.
PBW-C15	Wood	15'	4	2' x 15'	165 lbs.
PBA-CF	Bent Channel Frame (Aluminum)				35 lbs.
PBW-CF	Bent Channel Frame (Wood)				35 lbs.

## SKATE STOPPERS FOR WOOD & ALUMINUM BENCHES

Skate Stoppers protect your benches from the damage skateboarders can do. These Stoppers

are specially designed for wood and aluminum surfaces. Suggested to be used every 6" inches along the rails of seats. For additional information see page 70. Sold in kits of 20, 60, 100 or 250. All kits include application hardware.

# Aluminum/Wood Site Tables



## PRESTIGE RECTANGLE TABLE

This unit is for direct bury application. Frame: 3" x 3" pedestal with 2" x 2" bench pedestal. Black powder coat finish. 2 benches per frame.

60%  
RECYCLED  
ALUMINUM



Model	Description	Top Size	Top Height	Seat Height	Overall Width	Weight
TP-2A-45	Aluminum	30" x 45"	30"	18"	65"	108 lbs.
TP-2A-72	Aluminum	30" x 72"	30"	18"	65"	130 lbs.
TP-2A-90	Aluminum	30" x 90"	30"	18"	65"	145 lbs.
TP-2W-48	Wood	30" x 48"	30"	18"	65"	140 lbs.
TP-2W-72	Wood	30" x 72"	30"	18"	65"	175 lbs.
TP-2W-96	Wood	30" x 96"	30"	18"	65"	210 lbs.



## PRESTIGE SQUARE TABLE

Frame: 3" x 3" pedestal with 2" x 2" bench pedestal. Black powder coat finish. 4 benches per frame.



Model	Description	Top Size	Top Height	Seat Height	Overall Width	Weight
TP-4A-38S	Dir. Bry-Alum	38" x 38"	30"	18"	66"	165 lbs.
TP-4A-38P	Sur. Mnt-Alum	38" x 38"	30"	18"	66"	155 lbs.
TP-4W-38S	Dir. Bry-Wd	38" x 38"	30"	18"	66"	175 lbs.
TP-4W-38P	Sur. Mnt-Wd	38" x 38"	30"	18"	66"	165 lbs.
4W-P	Frame only Surface Mount					80 lbs.
4W-S	Frame only Direct Bury					80 lbs.



## PEDESTAL FRAME DESIGN

1-5/8" OD galvanized steel pipe frames. Built to seat 4 comfortably. Perfect for small families or tight areas. Meets the needs of fast food industry. This table should be used in a fixed location with frame anchored. Comes with Roto-molded end caps.

Model	Description	Top Size	Top Height	Seat Height	Overall Width	Weight
TP4-TBA	Aluminum	30" x 48"	30"	18"	60"	78 lbs.
TP4-TBW	Wood	30" x 48"	30"	18"	60"	90 lbs.
TPA-4F	Frame only set					38 lbs.



# Aluminum Tables

## EXTRA STRENGTH ALUMINUM TABLE

Extra strength to support extra weights and severe usage. 1-5/8" OD tubular galvanized steel pipe frames. Seat support bracing 1-1/16" OD galvanized pipe with 1/2" tie bars. Galvanized foot pads welded to leg frames for added stability. Comes with Roto-molded end caps.

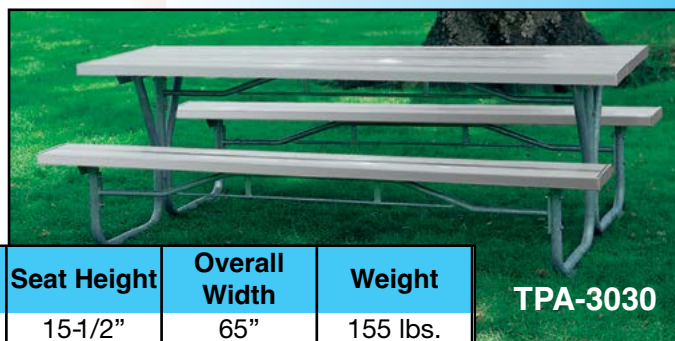

TPA-3030

Model	Description	Top Size	Top Height	Seat Height	Overall Width	Weight
TPA-3026	Junior	30" x 90"	26"	15-1/2"	65"	155 lbs.
TPA-3030	Adult	30" x 90"	30"	18"	65"	160 lbs.
TP-30FA	Frame only- Specify Adult or Junior					85 lbs.



TPA-8A

## STANDARD ALUMINUM PLANK TABLE

1-5/8" OD galvanized pipe frames with top supports of 1-1/2" x 1-1/2" x 3/16" angle iron. Braces are 1" OD galvanized pipe. Each table has five planks with two end frames and braces. Comes with Roto-molded end caps.

Model	Description	Top Size	Top Height	Seat Height	Overall Width	Weight
TPA-8A	Adult	30" x 90"	28-1/2"	18"	65"	135 lbs.
TPA-8J	Junior	30" x 90"	25"	15-1/2"	62"	131 lbs.
TPA-GA	Frame only- Specify Adult or Junior					52 lbs.

## THE "TOUGH ONE" ALUMINUM TABLE

The "Tough One" in aluminum for heavy duty demands for parks and recreation areas. Frame: Choices of 1-5/8" OD or 2-3/8" OD galvanized steel pipe, welded end frames with top angle iron plank holder. Bracing 1" OD on S frames; 1-1/4" OD on HD frames. Comes with Roto-molded end caps.



TPA-8S

Model	Description	Top Size	Top Height	Seat Height	Overall Width	Weight
TPA-8S	1-5/8"	30" x 90"	29"	18"	64"	153 lbs.
TPA-8HD	2-3/8"	30" x 90"	29"	18"	64"	168 lbs.
W-SA	Frame only per set					78 lbs.
W-HDA	Frame only per set					93 lbs.

## TRADITIONAL HEAVY DUTY PICNIC TABLE WITH BENCHES

2-3/8" OD galvanized frames. Bracing: 1" OD galvanized steel pipe. All welded end frames with angle top and seat supports. Comes with Roto-molded end caps.



TPA-HD2-A

Model	Description	Top Size	Top Height	Seat Height	Overall Width	Weight
TPA-HD2-A	2-3/8" Frame	30" x 90"	29"	18"	68"	175 lbs.
HD-2A	Frame only per set					100 lbs.

## SKATE STOPPERS FOR WOOD & ALUMINUM TABLES

Skate Stoppers protect your benches from the damage skateboarders can do. These Stoppers are specially designed for wood & aluminum surfaces. Suggested to be used every 6" inches along the rails of seats. For additional information see page 70. Sold in kits of 20, 60, 100 or 250. All kits include application hardware.

60%  
RECYCLED  
ALUMINUM



# Expanded Metal Tables & Benches

Heat treated Plastisol is the toughest finish on site furnishings. It is permanently bonded to the expanded metal and structural steel to a thickness of 1/4" (25-30 times thicker than paint). Open weave design discourages standing water, graffiti and carving. Seat planks are 2" thick x 10" wide. Tops are 2" thick x 32" wide. All frames powder coated: Blue, Black, Green or Brown. Plastisol colors: Blue, Green, Brown Red and Beige. Expanded Metal ships from Indiana, 46982.

## SUPER RUGGED EXPANDED METAL TABLE

This is a super rugged table with all welded end frames of 2-3/8" OD pipe and 1-1/4" OD steel pipe braces. Powder coated frames and braces.

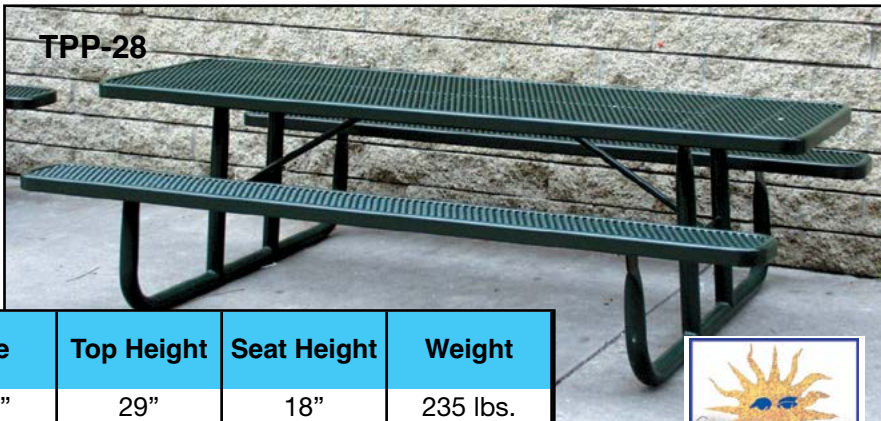

TPP-28



Model	Description	Top Size	Top Height	Seat Height	Weight
TPP-26	Expnd Mtl.	32" x 72"	29"	18"	235 lbs.
TPP-28	Expnd Mtl.	32" x 96"	29"	18"	276 lbs.

## EXPANDED METAL PLAYERS BENCH

Players Bench. 2-3/8" OD steel frames. "SM" frames have plate welded to the post for surface mount applications. Players bench ideally suited for dugouts, athletic fields and also site furnishings. Powder coated frames and braces.



LPP-8SM

Model	Description	Length	Frames	Ground Space	Weight
LPP-6PF	Portable	6'	2	1' x 6'	62 lbs.
LPP-6IG	In Ground	6'	2	1' x 6'	64 lbs.
LPP-6SM	Surface Mount	6'	2	1' x 6'	68 lbs.
LPP-8PF	Portable	8'	2	1' x 8'	72 lbs.
LPP-8IG	In Ground	8'	2	1' x 8'	74 lbs.
LPP-8SM	Surface Mount	8'	2	1' x 8'	78 lbs.

## PLAYERS BENCH W/ BACK REST

Players Bench with back rest, 2-3/8" OD frames. "SM" frames have plate welded to the post for surface mount applications. Players benches ideally suited for dugouts, athletic fields and also site furnishings. Powder coated frames and braces.

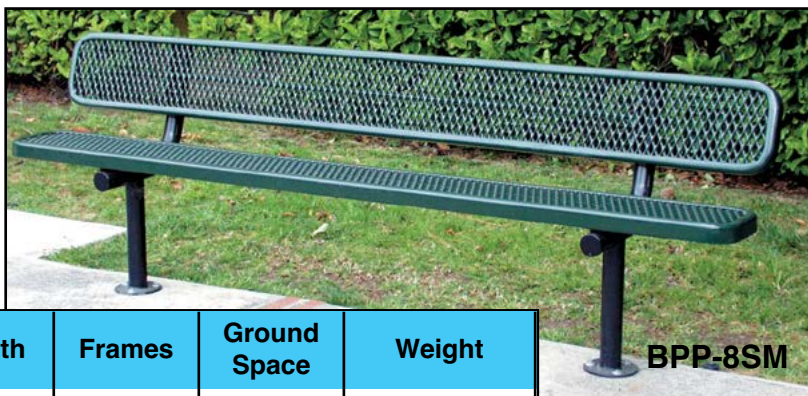

BPP-8SM

Model	Description	Length	Frames	Ground Space	Weight
BPP-6PF	Portable	6'	2	6' x 30"	126 lbs.
BPP-6IG	In Ground	6'	2	6' x 30"	122 lbs.
BPP-6SM	Surface Mount	6'	2	6' x 30"	120 lbs.
BPP-8PF	Portable	8'	2	8' x 30"	142 lbs.
BPP-8IG	In Ground	8'	2	8' x 30"	146 lbs.
BPP-8SM	Surface Mount	8'	2	8' x 30"	140 lbs.

**“ULTRACOAT”** thermoplastic coated steel tables are the new choice in coatings for steel tables and benches. The application of **Ultracoat** by a fluidized powder bed, causes the powder to melt to the steel at 500 degrees Fahrenheit. The coating, **which is PVC free**, is approximately 50 MILS and ideal for site furnishings. The process allows bonding of the coating to steel that is nearly indestructible and the smooth gloss finish makes a very good looking product that is easy to maintain. Tops, seats and frames offered in: Green, Blue, Red, Brown, Black, Beige and Burgundy. Tops and seats have **Ultracoat** finish and the frames have a baked on powder coat finish. The open weave diamond pattern expanded metal material for the tops and seats is 9-gauge with 3/4” openings and comes standard with an umbrella hole on round and square tops. Frames utilize a 1-5/8” heavy wall tubing for the portable style tables and 4” x 4” square tubing for the surface mount or direct bury styles. Ships from: IL 62278.

### SQUARE EXPANDED METAL TABLE



Model	Description	Top Size	Seat Size	Frame Size	Table Height	Seat Height	Weight
TPP-46SQ	Portable	46” x 46”	12” x 36”	1-5/8”	30”	18-1/4”	189 lbs.
TPP-46SQ-SM	Surface Mount	46” x 46”	12” x 36”	4” x 4”	30”	18-1/4”	252 lbs.
TPP-46SQ-IG	In Ground	46” x 46”	12” x 36”	4” x 4”	30”	18-1/4”	252 lbs.

### ROUND EXPANDED METAL TABLES

Model	Description	Top Size	Seat Size	Frame Size	Table Height	Seat Height	Weight
TPP-46RD	Portable	46”	12” x 36” Concave	1-5/8”	30”	18-1/4”	187 lbs.
TPP-46RD-SM	Surface Mount	46”	12” x 36” Concave	4” x 4”	30”	18-1/4”	251 lbs.
TPP-46RD-IG	In Ground	46”	12” x 36” Concave	4” x 4”	30”	18-1/4”	251 lbs.



NEW GARDEN UMBRELLA FOR EXPANDED METAL TABLES!  
SEE PAGE- 86-87

### ADA EXPANDED METAL TABLES

Model	Description	Top Size	Seat Size	Frame Size	Table Height	Seat Height	Weight
TPP-46SQ-ADA*	Square-ADA Portable	46” x 54”	12” x 36”	1-5/8”	30-1/2”	18-1/4”	205 lbs.
TPP-46SQ-ADA-SM	Square-ADA Surface Mnt	46” x 54”	12” x 36”	4” x 4”	30-1/2”	18-1/4”	220 lbs.
TPP-46SQ-ADA-IG	Square-ADA In Ground	46” x 54”	12” x 36”	4” x 4”	30-1/2”	18-1/4”	220 lbs.
TPP-46RD-ADA*	Round- ADA Portable	46”	12” x 36” Concave	1-5/8”	30-1/2”	18-1/4”	195 lbs.
TPP-46RD-ADA-SM	Round- ADA Surface Mnt	46”	12” x 36” Concave	4” x 4”	30-1/2”	18-1/4”	209 lbs.
TPP-46RD-ADA-IG	Round- ADA In Ground	46”	12” x 36” Concave	4” x 4”	30-1/2”	18-1/4”	209 lbs.
TPP-28-ADA*	30” x 96” Rectangle ADA Portable	30” x 96”	12” x 72”	2-3/8”	30-1/2”	18-3/4”	254 lbs.



\* These tables should be used in a fixed location with frames anchored. Square and round accessible(ADA) tables have 3 seats per table.

# Umbrellas

## FIBERGLASS ROUND UMBRELLA

Made of maintenance free fiberglass, with heavy duty anodized aluminum staff (1-1/2" OD) and adjustments for time-of-day shading. Colors to match all L.A. Steelcraft standard fiberglass colors, not polished granite finishes. (Colored background with white star as shown). Pipe mast locks into furnished PVC ground sleeve. Requires 1 hole in table top.

Model	Diameter	Weight
FRB-6 Fiber	6'	67 lbs.
FRB-7 Fiber	7'	73 lbs.

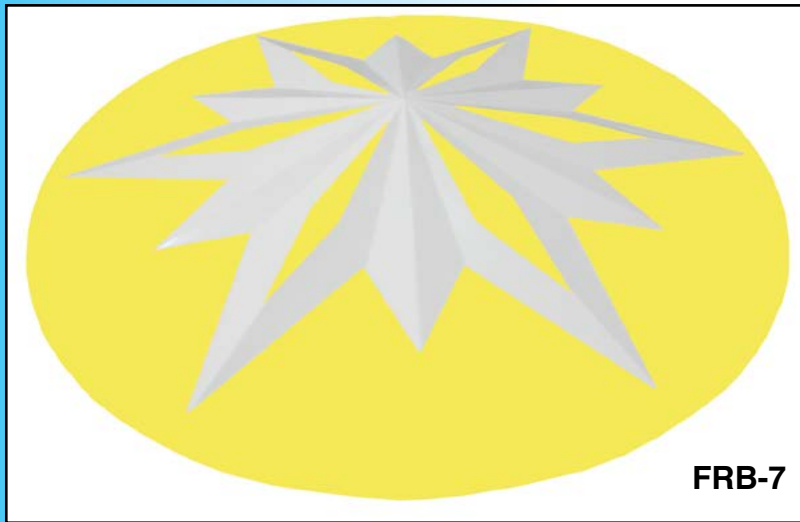

Table sold separately. See page 69 for table.

## ALUMINUM ROUND UMBRELLA

Aerodynamically designed, these umbrellas feature swivels that make them virtually topple-proof. The swivel permits easy turning of the umbrellas for maximum shade. Umbrella has a sturdy 7' diameter frame with aluminum braces and ribs for lasting durability. Designed to fit any standard table with one center hole, the umbrella's 1-1/2" OD mast pipe locks into a furnished PVC ground sleeve.

Panel Colors Available: White, Royal Blue, Camel, Red, Vanilla, French Blue, and Seafoam. Note: Aluminum umbrella colors do not match fiberglass colors but are complimentary. Aluminum Umbrellas ship from factory in Arizona, 85019.

Model	Diameter	Weight
SCU-7	7'	70 lbs



### FIBERGLASS- RECTANGLE “RECTA-BRELLA”

Now you can have shade for your traditional rectangle tables. Available in all L.A. Steelcraft colors (mix and match). The poles are 1-5/8" OD galvanized pipe. Shown with model TP8-FA. Requires 2 holes in table top.



Table sold separately. See page 69 for table.  
Not available for 6' table.  
Recommend anchoring at a fixed location.

Model	Dimension	Weight
RB-F	6' x 8'	153 lbs.



### GARDEN UMBRELLAS

The Garden Umbrella adds the needed protection from the sun for all of the round and square expanded metal tables. Works with expanded metal tables only. With all the color options available you can match the colors of the tables to suit your taste. Includes manual or crank opening, aluminum poles, and textiline closed weave fabric. Available solid or alternating color options: Blue, Green, Yellow, Red, Burgundy and Beige



Textiline Closed Weave Fabric

Model	Diameter	Weight
GU75CWT-C (Crank Open)	7-1/2' Diameter with Closed Weave	20 lbs.
GU75CWT-M (Manual Open)	7-1/2' Diameter with Closed Weave	20 lbs.

# Colors & Finishes

## POWDER COATING COLORS:

Powder Coating Colors below are representations only and may vary by process or change over time.

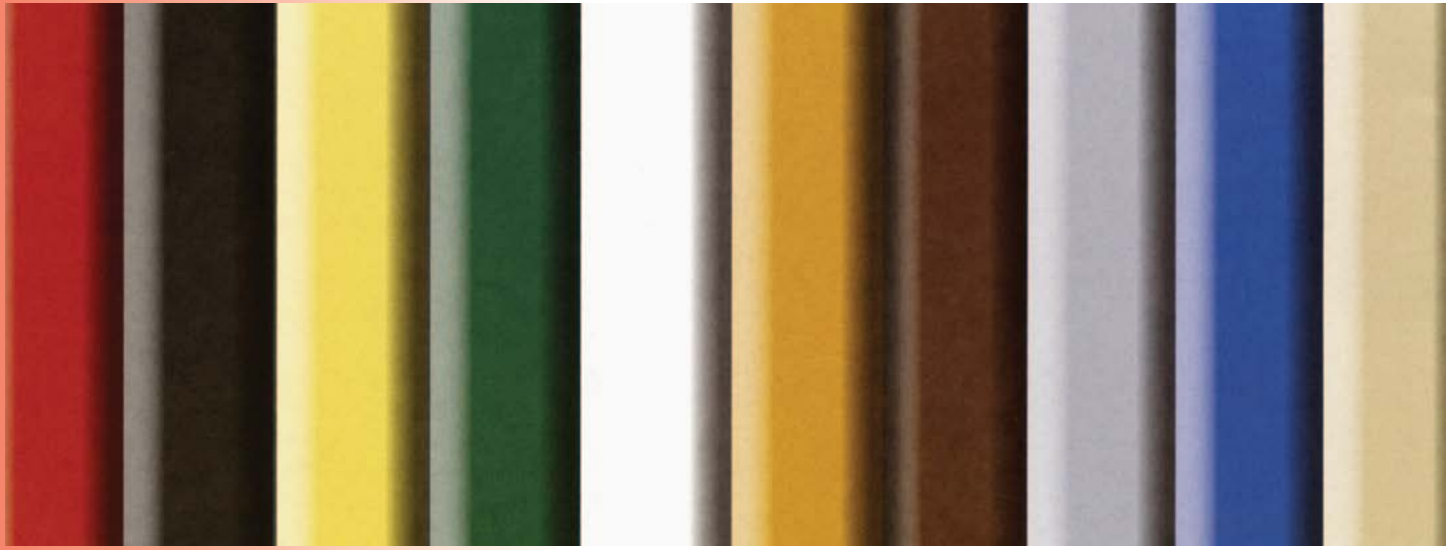

RED BARON	BLACK	SAFETY YELLOW	EVER- GREEN	SKY WHITE	FEDERAL YELLOW	BROWN	SILVER	BLUE STREAK	CAMEL
--------------	-------	------------------	----------------	--------------	-------------------	-------	--------	----------------	-------

## FIBERGLASS COLORS:

These colors are reproductions and only approximate the actual colors. Custom color matching available on request, at an additional charge.



RED	TANGERINE	YELLOW	DARK GREEN	LIGHT GREEN	WHITE	BROWN	DARK BLUE	LIGHT BLUE	BEIGE	TEAL
#7741	#7755	#7736	#7746	#7785	#7781	#7766	#7711	#7713	#7761	#7731

## DESIGNER FIBERGLASS FINISHES:



SEA GREEN	SAND	STEEL GRAY
--------------	------	---------------

## SPECIAL ORDER POWDER COATING COLORS

CUSTOM COLOR MATCHING AVAILABLE
1-5 Items = 10% additional charge
6-10 Items = 5% additional charge
Over 10 items = no additional charge



## RETURNS

No returns will be accepted unless prior authorization has been received from L.A. Steelcraft Products, and then there will be a minimum 20% handling charge plus all freight charges associated with the shipping and return.

## SPECIFICATIONS

L.A. Steelcraft Products reserves the right to discontinue or change specifications without notice.

## PRODUCT WARRANTY

L.A. Steelcraft Products, Inc. (the "Company"), warrants **all Company built products** (the "Equipment") against defects in material or factory workmanship for a period of **ONE YEAR (against mfg. defects)** from the date of substantial completion (the "Warranty Period").

**Steelcraft's Lifetime Limited Warranty** (on certain product lines) means the "lifetime" of that particular product, piece or part. It does **NOT** mean your or the customers lifetime. The wording "Lifetime Limited Warranty" or "Lifetime of a Product" varies not only product to product but state to state. In California, to use the words "Lifetime Limited Warranty" the product must have a minimum of 3 years of product life.

Our Lifetime Limited Warranty Basketball Equipment has been designed for an expected "lifetime" *of at least 20 years* and is valid only if the product has been subjected to normal use for the purpose in which it was designed; has not been subjected to vandalism, misuse, neglect, or accident or an "Act of God"; has not been subjected to addition or substitution of parts; and has not been modified or altered. In addition to this information all of the other warranty factors of Steelcraft's Standard Warranty also applies to Steelcraft's "Lifetime Limited Warranty" on certain product lines.

If you discover a defect in the materials or factory workmanship of the Equipment during the Warranty period, you must promptly notify the Company in writing. You must include proof of purchase and purchase date, installation date or date of substantial completion. The Company will, at its discretion, repair the defective Equipment at no cost to you, except for the shipping, insurance and installation costs, which shall be your responsibility.

This warranty does not cover any loss or damage caused by (a) improper installation of company, (b) use of the Equipment for purposes other than that which it was intended, (c) disaster such as fire, flood, wind, lightning, or other "Act's of God", (d) Cosmetic considerations, (e) unauthorized alterations or modifications to the Equipment. Your sole and exclusive remedy against the Company shall be for the repair or replacement, at the Company's discretion, of any defective Equipment as provided herein.

**\*IN NO EVENT SHALL THE COMPANY BE LIABLE FOR ANY INCIDENTAL OR CONSEQUENTIAL DAMAGES RELATING**

**TO, ARISING OUT OF THE OR IN CONNECTION WITH THE USE OR PERFORMANCE OF THE EQUIPMENT, INCLUDING AND WITHOUT LIMITATION, ANY LABOR AND/OR OTHER INSTALLATION EXPENSES INCURRED IN CONNECTION WITH THE REPLACEMENT OF THE DEFECTIVE EQUIPMENT WARRANTED HEREUNDER, OR ANY OTHER INDIRECT DAMAGES WITH THE RESPECT TO LOSS OF REVENUE OR PROFITS.** \*Some states do not allow the exclusion or limitation of incidental or consequential damages, so the above limitation or exclusion may not apply to you.

**\*ALL IMPLIED WARRANTIES WITH RESPECT TO EQUIPMENT, INCLUDING AND WITH OUT LIMITATION, THE IMPLIED WARRANTIES OR MERCHANTABILITY AND FITNESS OR A PARTICULAR PURPOSE, ARE HEREBY LIMITED IN DURATION TO THE WARRANTY PERIOD.** \*Some states do not allow limitations on how long an implied warranty lasts, so the above limitation may not apply to you.

**ANY REVISION OR MODIFICATION TO THIS WARRANTY SHALL BE SOLELY BY THE WRITTEN AUTHORIZATION OF THE COMPANY'S CHIEF OPERATING OFFICER.** This warranty gives you specific legal rights. Additional legal rights may vary state to state.

## A WORD ABOUT ENGINEERED DRAWINGS & WET STAMPED CALCULATIONS

This section is regarding the "origination" or "reuse" fees charged for wet stamped and signed calculations that are being requested to be completed by an engineering company.

When L.A. Steelcraft is requested to provide wet stamped and signed calculations both the engineering company and L.A. Steelcraft shares the assumed liability for that item. As such, the engineering company must show responsible "charge", which may require independent verification of local site conditions, etc., this may require contacting the local jurisdiction to verify wind, snow, seismic or soil conditions, etc.

A file for each job may be established and is maintained by the engineer company for a period of ten years. Therefore, a reuse fee is charged to help cover the cost of insurance and office staff time for each set of specific items that wet stamped and signed calculation are requested for.

Every time wet stamped and signed calculation are requested ours and the engineers liability and office staff time is increased without benefit unless some type of origination reuse fee is charged.

L.A. Steelcraft adds on only a modest charge to the charges that L.A. Steelcraft is invoiced by the engineering company for origination calculations. If the product has been already been "engineered" the current reuse fee is \$700.00 per set of wet stamped and signed calculations requested. If the product has NOT been "engineered" the current fee will be quoted by the engineering company per set of wet stamped and signed

**NOTE: POST INSTALLATION MAY REQUIRE STEEL REINFORCEMENT IN FOOTING-CHECK WITH LOCAL BUILDING CODES IF REQUIRED IN YOUR AREA.**

calculations requested AND UP TO AN ADDITIONAL \$600.00 per "back check" by the engineering company, as requested by DSA.

Unless stated in our Quotation Attachment A, any actual samples, calculations, engineered drawings, welding specifications, etc. are not included unless specifically requested in writing by customer/contractor prior to bid date or issuing of purchase order. The costs for these special submittal requirements will be added to the base price of the quotation/bid or purchase price. Please note that any material changes required by the structural engineering will be reviewed by L.A. Steelcraft and may result in additional charges added to the price of the product.

#### POWDER COATING OVER GALVANIZING

One of the most durable protective coatings for steel is provided by applying a polyester powder coating over hot dipped galvanized steel to provide a high grade architectural finish to the steel items.

Polyester powders are thermosetting resins that are applied electrostatically to the steel surface and "stoved" at temperatures around 180 degrees Celsius. This technology produces very uniform coatings that have an attractive architectural finish with excellent atmospheric weathering characteristics. In combination with hot dipped galvanized coatings, the powder coated product ensures maximum durability for steel components, which will generally provide years of rust free life in most architectural applications.

Powder coating by L.A. Steelcraft Products, Inc. includes a light commercial sand blasting of the steel surface, a four stage power alkaline wash and rinse, a power phosphate wash and rinse and drying and prepping to receive an electrostatically applied thermoset, baked on powder coat finish of Dupont's TGIC-Polyester powder with a smooth finish and a 90 degree or above gloss. This powder is rated as having excellent exterior durability, stability and flexibility and as well as having very good corrosion protection, hardness and chemical/solvent resistance.

**For over 55 years  
L.A. Steelcraft has been a major  
manufacturer of  
quality equipment for  
sports, playgrounds, schools  
and industry, servicing  
the entire nation.  
Our corporate offices and  
main fabrication plant  
is in Pasadena, California  
with over 200  
local representatives  
nationwide.**

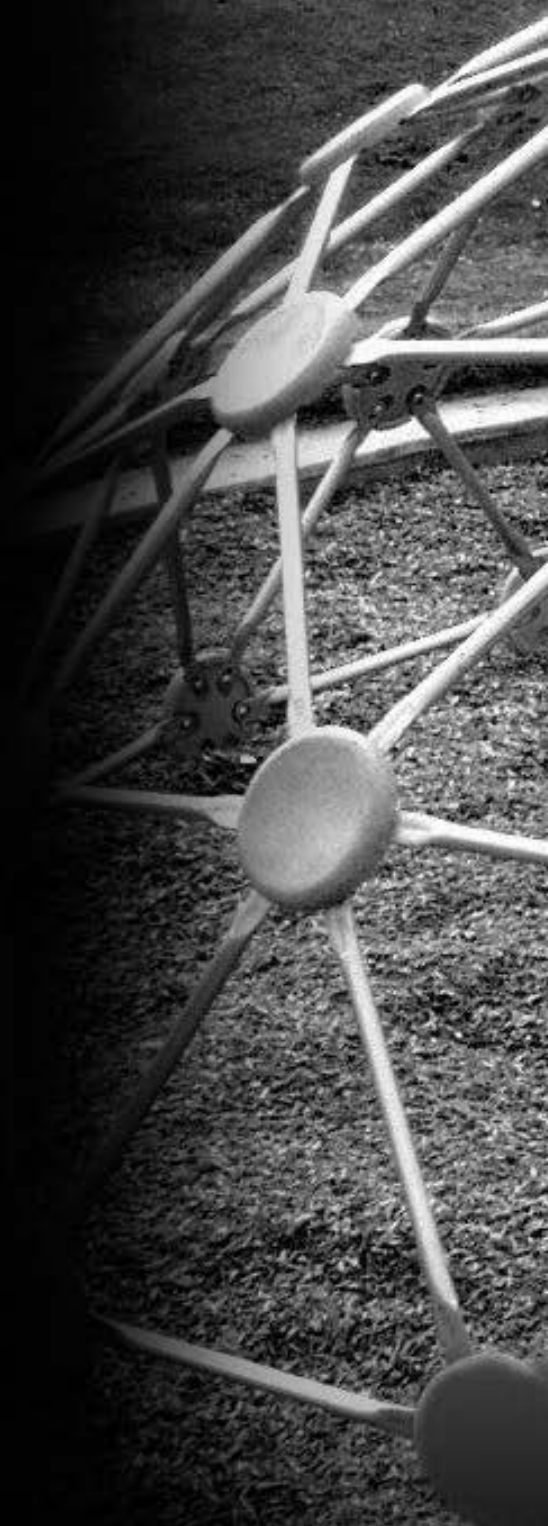

L.A. Steelcraft Products, Inc.  
P. O. Box 90365 Pasadena, CA 91109  
800.371.2438 • 626.798.7401  
Fax: 626.798.1482  
[www.lasteelcraft.com](http://www.lasteelcraft.com)  
2015

