

# AL 140

(SN 11257 and Up)

# AL 240(EU)

(SN 21244 and Up)

# AL 340

(SN 31365 and Up)

# AL 440(EU)

(SN 41250 and Up)

# AL 540

(SN 51242 and Up)

## Articulated Loaders

# GEHL

Form No.  
918496  
GP0313  
English  
Revision G

Original  
Instructions

Supersedes  
918447

# Operator's Manual



# GEHL COMPANY

## WARRANTY

GEHL COMPANY, hereinafter referred to as Gehl, warrants new Gehl equipment to the Original Retail Purchaser to be free from defects in material and workmanship for a period of twelve (12) months from the Warranty Start Date.

### **GEHL WARRANTY SERVICE INCLUDES:**

Genuine Gehl parts and labor costs required to repair or replace equipment at the selling dealer's business location.

---

**GEHL MAKES NO REPRESENTATIONS OR WARRANTIES OF ANY KIND, EXPRESS OR IMPLIED (INCLUDING THE IMPLIED WARRANTIES OF MERCHANTABILITY AND FITNESS FOR PARTICULAR PURPOSE), EXCEPT AS EXPRESSLY STATED IN THIS WARRANTY STATEMENT.**

ANY OF THESE LIMITATIONS EXCLUDED BY LOCAL LAW SHALL BE DEEMED DELETED FROM THIS WARRANTY; ALL OTHER TERMS WILL CONTINUE TO APPLY.

SOME STATES DO NOT PERMIT THE EXCLUSION OR LIMITATION OF THESE WARRANTIES AND YOU MAY HAVE GREATER RIGHTS UNDER YOUR STATE LAW.

---

### **GEHL WARRANTY DOES NOT INCLUDE:**

1. Transportation to selling dealer's business location or, at the option of the Original Retail Purchaser, the cost of a service call.
2. Used equipment.
3. Components covered by their own non-Gehl warranties, such as tires, batteries, trade accessories and engines.
4. Normal maintenance service and expendable, high-wear items.
5. Repairs or adjustments caused by: improper use; failure to follow recommended maintenance procedures; use of unauthorized attachments; accident or other casualty.
6. Liability for incidental or consequential damages of any type, including, but not limited to lost profits or expenses of acquiring replacement equipment.

No agent, employee or representative of Gehl has any authority to bind Gehl to any warranty except as specifically set forth herein.

204927/AP0407

**AL 140, AL 240 (EU), AL 340, AL 440 (EU), AL 540  
Articulated Loaders Operator's Manual**

---

**TABLE OF CONTENTS**

**General Information . . . . . 1**  
Safety Symbol . . . . . 1  
Contents and Use of this Manual . . . . . 1  
Ownership Change . . . . . 2  
Manufacturer Information . . . . . 2  
Machine Designation . . . . . 2  
Serial Number Plate Location . . . . . 3  
Loader Information . . . . . 3  
Proper Machine Use . . . . . 4  
Using Attachments . . . . . 4  
Component Identification . . . . . 5  
Service/Dealership Network . . . . . 6  
Vibration Information . . . . . 6  
    Vibration Measurement and Actions . . . . . 7  
    Vibration Levels . . . . . 7  
**Safety . . . . . 9**  
    2-Post ROPS/FOPS Warning . . . . . 10  
Mandatory Safety Shutdown Procedure . . . . . 10  
Before Starting . . . . . 11  
During Operation . . . . . 12  
    Provision for Stability/Avoiding Rollover Accidents . . . . . 15  
    Electrical Energy . . . . . 16  
Service Safety Practices . . . . . 16  
    Battery Hazards . . . . . 18  
Fire Hazards . . . . . 19  
Crystalline Silica Exposure . . . . . 20  
Transporting the Machine . . . . . 20  
Lifting the Machine with a Crane . . . . . 20  
Hazard and Hazard Avoidance Symbols . . . . . 21  
Safety Decals . . . . . 22  
    New Decal Application . . . . . 22  
    ANSI-Style and Common Safety Decal Locations . . . . . 22  
    ISO-Style Safety Decal Locations . . . . . 27

<b>Specifications</b> .....	<b>31</b>
Fluid Capacities/Lubricants .....	31
Maximum Slopes of Engine Operation .....	32
SAE (Domestic) Weights and Capacities	
AL 500 and AL 300 Series .....	33
ISO 6016 (EU) Weights and Capacities	
AL 500, AL 400 and AL 300 Series .....	34
SAE (Domestic) Weights and Capacities	
AL 100 Series .....	35
ISO (EU) Weights and Capacities	
AL 100 and AL 200 Series .....	36
Engine .....	37
Coolant Compound Table .....	37
Hydraulics .....	38
Electrical System .....	38
Sound Levels .....	38
Wheels .....	38
Wheel/Tire Sets .....	39
ROPS and FOPS .....	40
Vibration Levels .....	40
AL 500, AL 400 Series Dimensions .....	41
AL 300, AL 200 Series Dimensions .....	43
AL 100 Series Dimensions .....	45
Standard Features .....	47
Optional Features .....	48
Common Materials and Densities .....	49
<b>Operation</b> .....	<b>51</b>
Operating Controls .....	52
Controls and Switches .....	52
Instrument Panel and Indicators .....	54
Cab Controls (Cab only) .....	56
Cab Environment Controls .....	56
Air Conditioning Control (option) .....	56
Cab Windshield Wiper	
Controls .....	57
Cab Dome Light .....	57
Cab Defrost .....	57
Warning Indicators .....	58
Operator's Seat Adjustment .....	59
Seat Belt .....	60
Ignition Key Switch .....	60

Steering Column Adjustment . . . . .	60
Control Lever . . . . .	61
Hand Throttle . . . . .	61
12V Accessory Power Outlet . . . . .	62
Operation . . . . .	63
Pre-Operation Checklist . . . . .	63
Extend the ROPS . . . . .	64
Restore the ROPS to the raised position . . . . .	64
4-Post ROPS Side Gates (Option) . . . . .	65
Entering and Exiting . . . . .	66
Engine Start . . . . .	67
Engine Shut Down . . . . .	69
Warm-up . . . . .	69
New Machines . . . . .	70
Driving on Public Roads . . . . .	70
Lift Arm Down-Stop . . . . .	74
Travel . . . . .	74
Slow/Fast Travel Speed Mode Selection . . . . .	76
Differential Lock Operation . . . . .	76
Load Handling . . . . .	77
Parking the Loader . . . . .	77
Multi-purpose Joystick . . . . .	78
AL 100, AL 200(EU), AL 300, AL 400(EU) Self-Leveling Feature . . . . .	79
AL 500 Series Limited Self-Leveling . . . . .	79
Float Positions . . . . .	80
Attachments . . . . .	81
General Instructions . . . . .	81
Connect/Disconnect Attachments . . . . .	81
All-Tach® System Hitch Connection . . . . .	81
All-Tach® System Hitch Disconnection . . . . .	82
Hydraulic Power-A-Tach® System Hitch Connection . . . . .	83
Hydraulic Power-A-Tach® System Hitch Disconnection . . . . .	85
Auxiliary Hydraulics . . . . .	86
Auxiliary Circuit Pressure Relief . . . . .	86
Auxiliary Hydraulics Connections . . . . .	88
Auxiliary Hydraulics Control Buttons . . . . .	89
Operating Attachments . . . . .	92
Bucket . . . . .	92
Loading Loose Material . . . . .	92
Scraping Soft Material . . . . .	92

Scraping Hard Material . . . . .	93
Towing the Loader . . . . .	94
Precautions . . . . .	94
Towing AL 100 Series Machines . . . . .	94
Preparation . . . . .	94
Towing AL 300 Series Machines . . . . .	95
Preparation . . . . .	95
Towing AL 500 and AL 400 Series Machines . . . . .	95
Preparation . . . . .	95
Towing Procedure . . . . .	96
After Towing . . . . .	96
Loading and Transporting . . . . .	97
Crane Lifting . . . . .	99
<b>Maintenance . . . . .</b>	<b>103</b>
Maintenance Schedule . . . . .	104
Check, Clean and Inspect . . . . .	104
Leakage Check . . . . .	105
Lubrication and Filter Changes . . . . .	106
Functional Check . . . . .	106
Dealer Service . . . . .	107
Tilting the Platform . . . . .	107
Tilting Up the Platform . . . . .	107
Tilting the Platform Down . . . . .	108
Engine Maintenance . . . . .	109
Engine Oil . . . . .	109
Checking Engine Oil Level . . . . .	109
Changing Engine Oil and Filter . . . . .	110
Air Cleaner . . . . .	112
Accessing the Outer and Inner Filter Elements . . . . .	113
Changing the Filter Elements . . . . .	113
Engine Cooling System . . . . .	114
Checking Coolant Level . . . . .	114
Cleaning Cooling System . . . . .	114
Draining/Refilling Cooling System . . . . .	115
Fuel System . . . . .	116
Adding Fuel . . . . .	116
Changing Fuel Filter . . . . .	116
Water Separator Maintenance . . . . .	117
Checking and Adjusting V-belt Tension . . . . .	119
Air Conditioning V-Belt . . . . .	119
Air Conditioning Maintenance . . . . .	120

Filter Replacement . . . . .	120
Windshield Washer Reservoir (Cab Only). . . . .	121
Hydraulic System Maintenance . . . . .	122
Hydraulic Oil . . . . .	122
Checking Hydraulic Oil Level . . . . .	122
Changing Hydraulic Oil and Filter . . . . .	123
Hydraulic Hose Maintenance . . . . .	124
Planetary Axles . . . . .	125
Changing Planetary Axle Oil . . . . .	125
Changing Axle Wheel-Hub Oil (AL 500, AL 400 and AL 300 Series). . . . .	125
Changing Axle Center Oil (AL 500, AL 400 and AL 300 Series). . . . .	126
Changing Axle Oil (AL 200 and AL 100 Series) . . . . .	127
Brake Fluid Reservoir (AL 300, AL 400 and AL 500 Series). . .	128
Checking Brake Fluid Reservoir Level . . . . .	128
Wheels and Tires . . . . .	128
Wheel Fasteners . . . . .	128
Tires . . . . .	129
Tire Rotation . . . . .	129
Checking Tire Pressure. . . . .	129
Liquid Tire Ballast (AL 500 Series) . . . . .	129
Lubrication . . . . .	130
Electrical System . . . . .	134
Fuses. . . . .	134
Steering Column Fuses – AL 500/400/300 Series; AL 100 (EU), AL 200 Optional. . . . .	135
Steering Column Fuses – AL 100 Series and AL 200 Standard . . . . .	136
Cab and In-Line Fuses . . . . .	137
Control Modules . . . . .	139
Machine Control Module . . . . .	139
Drive Control Module (AL 500/400 Series) . . . . .	139
Drive Control Module Error Codes . . . . .	140
Battery. . . . .	141
Using a Booster Battery (Jump-Starting). . . . .	142
Remote Battery Terminal . . . . .	143
Storing the Loader . . . . .	144
Before Storage . . . . .	144
After Storage. . . . .	144
Final Shutdown / Decommissioning . . . . .	145

Before Disposal . . . . .	145
Machine Disposal . . . . .	146
Maintenance Log . . . . .	147
<b>Troubleshooting . . . . .</b>	<b>153</b>
<b>Index . . . . .</b>	<b>165</b>
Torque Specifications . . . . .	169
EC Declaration of Conformity . . . . .	171



# CHAPTER 1

## GENERAL INFORMATION

### Safety Symbol



Manitou Americas, in cooperation with the Society of Automotive Engineers, as adopted this safety alert symbol. This symbol identifies potential safety hazards, which, if not properly avoided, could result in injury. When you see this symbol in this manual or on the machine, you are reminded to **BE ALERT!** Your personal safety is involved!

### Contents and Use of this Manual

This operator's manual provides detailed operating procedures for safe, effective and proper machine use. Safe operation is detailed in the *Safety* chapter of this manual, beginning on page 9. Specification, maintenance and troubleshooting information is also included in this manual.

Improper operation, inspection and maintenance of the machine can result in injury or death. Read and understand the contents of this manual completely and become familiar with the machine before operation. Contact your authorized dealer with any questions about information in this manual, if extra manuals are required, or about availability of manuals in other languages.

Throughout this manual, information is provided set in or *italic* type and introduced by the words **Notice** or **Important**. Carefully read and follow these messages to improve operating and maintenance efficiency, to avoid breakdowns and damage, and extend the life of the machine.

**Note:** *Because of ongoing product improvements, illustrations and listings in this manual may not exactly match the machine. Manitou Americas reserves the right to modify and improve products at any time without notice.*

A storage box (A, Fig. 1) behind the seat is provided for manual storage. Store the operator's manual in this box at all times.

**Note:** *AL500 Series machines with air conditioning use a cylindrical manual storage container located next to the operator's seat.*

This manual is considered a permanent part of the machine and should be with the machine at all times. Replace this manual promptly if it becomes damaged, lost, or stolen.



**Figure 1 – Manual Storage Location (except AL500 Series with air conditioning)**

## **Ownership Change**

---

If the machine is resold, include this operator's manual as part of the sale.

If the machine was purchased "used," or if the owner's address has changed, please provide your dealer or Manitou Americas Service Department with the owner's name and current address, along with the machine model and serial numbers. This will allow the registered owner information to be updated, so that the owner can be notified directly in case of an important product issue, such as a safety update program.

## **Manufacturer Information**

---

Products described in this manual manufactured by Manitou Americas, Inc.

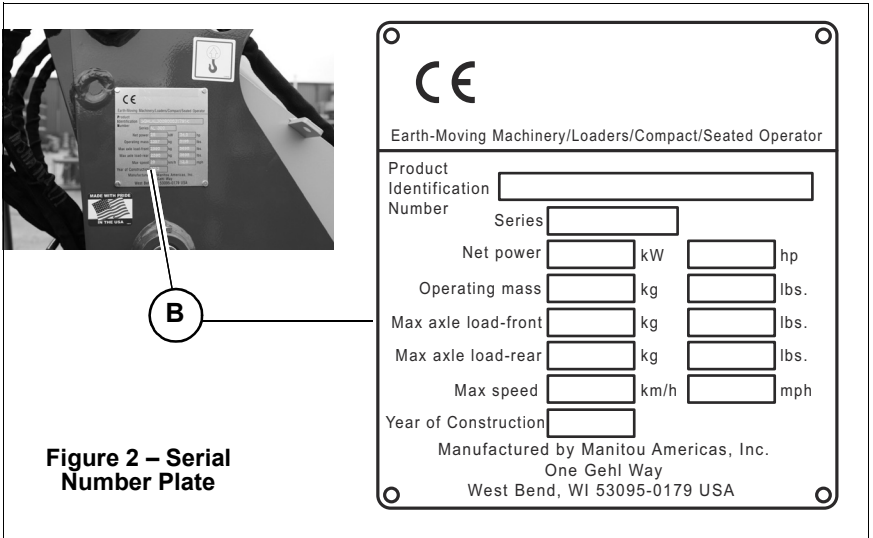
## **Machine Designation**

---

Earth-Moving Machinery/Loaders/Compact/Seated Operator

# Serial Number Plate Location

The serial number placard is located on the front frame on the right side of the machine (B, Fig. 2).



**Figure 2 – Serial Number Plate**

Additionally, the following components also have identification placards:

- Engine
- Hydraulic pump
- Hydraulic drive motor(s)
- Axles

# Loader Information

Use the spaces provided below to record purchase location and date, model and serial number information.

<b>Purchased from</b>	
<b>Date of Purchase</b>	
<b>Loader Model Number</b>	
<b>Loader Serial Number</b>	
<b>Engine Serial Number</b>	
<b>Hydraulic Pump Identification Number</b>	
<b>Drive Motor Identification Number(s)</b>	
<b>Axle Identification Number</b>	

## Proper Machine Use

---

 **WARNING** Improper use of the machine can result in property damage, injury or death.

The machine is designed only for digging, picking up, lifting, transporting and unloading materials. Use with approved attachments is also allowed. Use in any other way is considered as contrary to the intended use. Compliance with, and strict adherence to, the conditions of operation, service and repair, as specified by the manufacturer, also constitute essential elements of the intended use.

The machine was designed and built according to the best available technology and approved safety regulations in the countries where it is sold. However, it is impossible to completely safeguard against abusive and/or improper use. The operator must always consider potential safety risks and hazards during operation. Accident prevention regulations, all other generally recognized regulations on safety and occupational medicine, and all road traffic regulations, must be observed at all times.

The machine must be maintained in proper operating condition. Any damaged or malfunctioning parts must be repaired or replaced immediately.

Any arbitrary modifications carried out to the machine may relieve the manufacturer of liability for any resulting damage or injury.

## Using Attachments

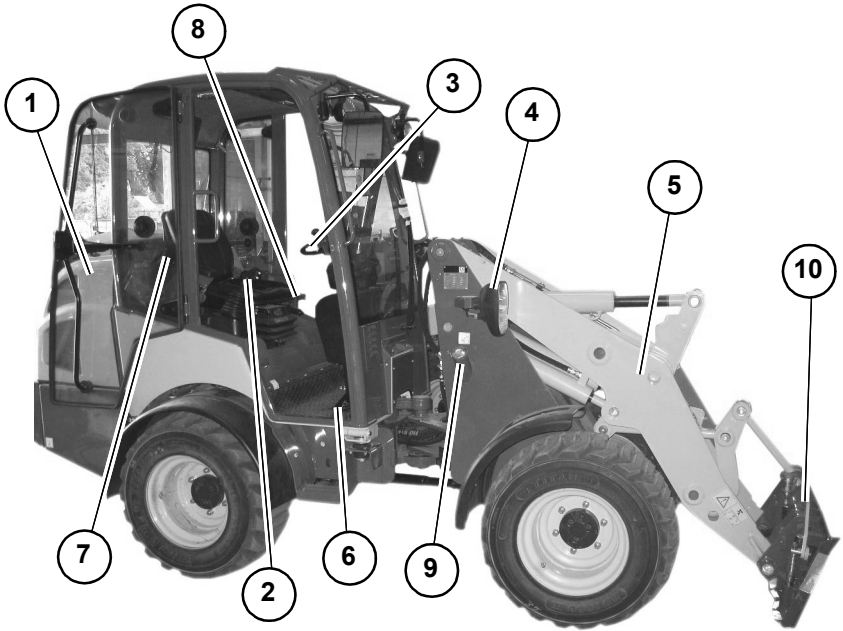
---

Read all documentation provided with attachments to learn how to safely operate and maintain them.

Do not use the machine for any applications or purposes other than those described in this manual or manuals supplied with attachments. Contact the Manitou Americas Service Department before using attachments or equipment not approved by Manitou Americas, or if there are any questions about approved attachments. Use of non-approved attachments or unauthorized modifications is prohibited.

# Component Identification

---



**Figure 3 – Component Identification (AL 500 Series Model Shown)**

- |                                                        |                                                   |
|--------------------------------------------------------|---------------------------------------------------|
| 1. Engine cover                                        | 7. Manual storage box                             |
| 2. Multi-purpose joystick                              | 8. Parking brake (left side)                      |
| 3. Steering column                                     | 9. Fuel filler neck                               |
| 4. Road lights (4 locations)                           | 10. All-Tach® system bracket levers (2 locations) |
| 5. Lift arm                                            |                                                   |
| 6. Speed control pedal (brake/inch pedal on left side) |                                                   |

## Service/Dealership Network

---

Your dealership network stands ready to provide any assistance that may be required, including providing genuine service parts. All service parts should be obtained from your dealer. Provide complete information about the part and include the machine model and serial numbers. Record these numbers in the spaces provided in “Loader Information” on page 3. Refer to the parts manual for a complete listing of service parts.

Manitou Americas strives to continuously improve its products and reserves the right to make changes and improvements in the design and construction of any part without incurring the obligation to install such changes on any previously delivered machine.

## Vibration Information

---

Compact construction equipment is generally used in harsh environments. This type of usage can expose an operator to uncomfortable levels of vibration. It is useful to understand exposure to vibration levels when operating compact equipment and what can be done to reduce vibration exposure. As a result, equipment operation can be more efficient, productive and safe.

An operator’s exposure to vibration occurs in two ways:

- Whole-Body Vibration (WBV)
- Hand-Arm Vibration (HAV)

WBV issues are primarily addressed in this manual, because evaluations have shown that operation of mobile compact construction equipment on work sites typically results in HAV levels less than the allowed exposure limit of 2.5 m/s<sup>2</sup>.

Member States of the European Union must comply with the Physical Agents (vibration) Directive, 2002/44/EC.

Effective control of vibration exposure for an operator involves more than just vibration levels on the machine. The work site, how the machine is used, and proper training all play important roles in reducing vibration exposure.

Vibration exposure results from:

- Work site conditions.
- How the machine is operated.
- The machine characteristics.

Common causes of high WBV levels:

- Using a machine that is improper for the task.
- Work site with potholes, ruts and debris.
- Improper operating techniques, such as driving too fast.
- Incorrect adjustment of the seat and controls.
- Other physical activities while using the machine.

## Vibration Measurement and Actions

The vibration directive places the responsibility for compliance on employers. Actions that should be followed by employers include:

- Assess the levels of vibration exposure.
- Determine from this assessment if operators will be exposed to vibration levels above the limits stated in the directive.
- Take appropriate actions to reduce operator's exposure to vibration.
- Provide operators with information and training to reduce their exposure to vibration.
- Keep good records and update operations and training on a regular basis.

If the assessment concludes that vibration level exposure is too high, one or more of the following actions may be necessary:

1. Train operators
  - Perform operations (accelerating, steering, braking, etc.) in a smooth manner.
  - Adjust the controls, mirrors and seat suspension for comfortable operation.
  - Travel across the smoothest parts of the work site and avoid ruts and potholes.
2. Choose proper equipment for the job
  - Use machines with the proper power and capacity.
  - Select machines with good suspension seats.
  - Look for controls that are easy to use.
  - Ensure good visibility from the operator's position.
3. Maintain the work site
  - Smooth ruts and fill potholes in traffic areas whenever possible.
  - Clean up debris frequently.
  - Vary traffic patterns to avoid exposure to rough terrain.
4. Maintain the equipment
  - Ensure correct tire pressures.
  - Check that seat suspension and all controls work smoothly and properly.

## Vibration Levels

The table lists typical whole-body vibration levels for the machine. See "Vibration Levels" on page 40.





# CHAPTER 2

## SAFETY

This manual and decals on the machine warn of safety hazards and should be read and observed closely.

Before operating the machine, first read and study the safety information in this manual. Additionally, anyone who operates or works on the machine must be familiar with these safety precautions.



**This safety alert symbol means ATTENTION! ALWAYS BE ALERT! YOUR SAFETY IS INVOLVED! This symbol is used throughout this operator's manual and on the decals on the machine.**



**DANGER**

**“DANGER” indicates an imminently hazardous situation, which, if not avoided, will result in death or serious injury.**



**WARNING**

**“WARNING” indicates a potentially hazardous situation, which, if not avoided, could result in death or serious injury.**



**CAUTION**

**“CAUTION” indicates a potentially hazardous situation, which, if not avoided, may result in minor injury or property damage. It is also used to alert users of unsafe practices.**

It is essential that operators are thoroughly trained in the safe operation of the machine and handling loads. Operators must not be physically or mentally impaired. Do not allow minors or unqualified personnel to operate the machine, or to be near the machine unless they are properly supervised. It is recommended that the operator be capable of obtaining a valid motor vehicle operator's license.

Use of this machine is subject to certain hazards that cannot be eliminated by mechanical means, but only by exercising intelligence, care and common sense. Such hazards include: hillside operation, overloading, load instability, poor maintenance, and using the machine for a purpose for which it was not intended or designed.

Manitou Americas always takes operator's safety into consideration during the design process. Guards and shields are provided, which protect the operator and bystanders from moving parts and other hazards. Operators must be alert, however, because some areas cannot be guarded or shielded without preventing or interfering with proper operation.

Different applications may require optional safety equipment. Be sure you know the work site hazards and equip the machine and the operator as necessary. The information in this manual does not replace any applicable safety rules and laws. Before operating the machine, learn the rules and laws for your area. Make sure the machine is equipped as required according to these rules/laws.

Remember that some risks to our health may not be immediately apparent. Exhaust gases and noise pollution may not be visible, but these hazards can cause permanent injuries.

Some photographs in this manual may show doors, guards and shields open or removed for the purposes of illustration only. Be sure that all doors, guards and shields are in the proper operating positions before starting the engine to operate the machine.

## 2-Post ROPS/FOPS Warning

 **WARNING** The machine **MUST** be equipped with a **Falling-Object Protective Structure (FOPS)** when the machine is intended for use in applications where there is a risk of falling objects.

**Machines equipped with two-post ROPS MUST NOT be used where there is a risk of falling objects. A risk of falling objects existing whenever a load is lifted above the operator's head. A two-post ROPS does NOT protect against falling objects. A four-post FOPS MUST be installed on machines used where there is a risk of falling objects.**

## Mandatory Safety Shutdown Procedure

---

BEFORE cleaning, adjusting, lubricating, fueling, or servicing the machine, or leaving it unattended:

1. Bring the machine to a complete stop on a level surface. Avoid parking on an incline or hillside, but if this is not possible, park across the slope and block the tires.
2. Be sure all working equipment and/or attachments are stopped and the auxiliary valve is in neutral.
3. Lower the lift arm and attachment completely.
4. Place forward/reverse drive switch (on top of the joystick) into the neutral position.
5. Apply the parking brake.
6. Move the throttle to low idle position and shut off the engine.
7. Wait for all movement to stop. Turn the ignition key to the "I" or RUN position and move the multi-purpose joystick in all directions to verify that the hydraulic system is de-pressurized.
8. If so equipped, press the auxiliary hydraulics pressure relief control. After pressing, make sure this control returns to the neutral position.
9. Turn off the ignition.
10. Unfasten the seat belt and remove the ignition key and take it with you. Exit the machine using the hand holds.

ONLY when these precautions have been taken can you be sure it is safe to proceed. Failure to follow this procedure could result in death or serious injury.

## Before Starting

---

- Do not remove or modify the Roll-Over Protective Structure (“ROPS”) unless instructed to do so in approved installation instructions. Modifications, such as welding, drilling or cutting, can weaken the structure and reduce the protection it provides. A damaged ROPS cannot be repaired – it must be replaced.
- Never operate the machine without a ROPS or FOPS installed.
- To ensure safe operation, replace damaged or worn-out parts with genuine service parts.
- The machine is designed and intended to be used only with approved attachments. To avoid possible personal injury, equipment damage and performance problems, use only attachments that are approved for use on and within the operating capacity of the machine (see weights and capacity information, starting on page 33). Contact the Manitou Americas service department for information on attachment approval and compatibility with specific machine models. Manitou Americas cannot be responsible if the machine is used with a non-approved attachment.
- Remove all trash and debris from the machine every day, especially in the engine compartment, to minimize the risk of fire.
- Always face the machine and use the hand holds and steps when entering and exiting the machine. Do not jump off the machine. See “Entering and Exiting” on page 66.
- Never use starting aids. Engine pre-heating is used for cold weather starting. Engine pre-heating can cause either or other starting fluid to detonate, causing injury or damage.
- Walk around the machine and inspect it before using it. Look for damage, loose or missing parts, leaks, etc.
- Warn all nearby personnel before starting the machine.
- Check for proper tire pressure in all four tires before operating the machine and add air if necessary. Improperly pressurized tires adversely affect machine stability. Regularly check wheel fasteners for tightness. See “Wheel Fastener Torque” on page 38.
- Contact the proper local authorities for utility line locations BEFORE starting to dig. In North America, contact the North American One-Call Referral System at 8-1-1 in the U.S., or 1-888-258-0808 in the U.S. and Canada.
- Below-ground hazards also include water mains, tunnels and buried foundations. Know what is underneath the work site before starting to dig.
- Before working near power lines (either above-ground or buried cable-type), always contact the power utility and establish a safety plan with them.
- If temperatures are changing, be cautious of dark and wet patches when working or traveling over frozen ground. Stay away from ditches, overhangs and other weak support surfaces.

- The operator's area, steps and hand holds must be free of oil, dirt, ice and unsecured objects.
- If a lighting system is installed, check its operation before working in darkness.
- Always keep lights, mirrors and windows clean. Poor visibility can cause accidents.
- NEVER start the engine if there is any indication that maintenance or service work is in progress, or if a warning tag is attached to the controls.
- Replace damaged safety decals and a lost or damaged operator's manual.
- Terrain and soil conditions at the work site, approaching traffic, weather-related hazards and any above-or below-ground obstacles and hazards should be observed and monitored by all work crew members.
- Adjust the seat to allow full actuation of all controls. Never adjust the seat during machine operation.
- Read the operator's manual provided with each attachment used with the machine before starting the engine.
- Before working on or with the machine, remove jewelry, tie back long hair, and do not wear loose-fitting garments, such as, scarves, ties, unzipped jackets, etc., which could become caught in the moving parts of the machine and cause injury.

## **During Operation**

---

- ALWAYS fasten the seat belt securely and properly. Never operate the machine without the seat belt fastened around the operator.
- Check indicators and displays for normal conditions after starting the engine. Listen for unusual sounds and remain alert for other potentially hazardous conditions.
- Control the machine cautiously and gradually until fully familiar with all the controls and handling.
- Do not overload the machine. See weights and capacities information starting on page 33 for the load limits.
- If the machine is equipped with a 2-post ROPS, do not overfill the attachment and lift loads higher than the operator's head. Objects can fall out of the attachment and roll down the lift arm toward the operator causing severe injury. Install a Falling-Object Protective Structure (FOPS) if the machine is used to lift loads above the operator's head.
- Do not raise or drop a loaded bucket or attachment suddenly. Abrupt movements under load can cause serious instability.
- Check that attachments are securely fastened to the attachment hitch before working.
- Never activate the float function with the bucket or attachment loaded or raised, because this will cause the lift arm to lower or bucket to dump rapidly.
- Never operate the machine without a ROPS or FOPS installed.

- Machine stability is affected by: the weight of the load being carried, height of the load, machine speed, turn angle, width of the machine across the tires, abrupt control movements and driving over uneven terrain. **DISREGARDING ANY OF THESE FACTORS CAN CAUSE THE MACHINE TO TIP, THROWING THE OPERATOR OUT OF THE SEAT OR MACHINE, RESULTING IN DEATH OR SERIOUS INJURY.** Therefore: **ALWAYS** operate with the seat belt fastened around the operator.
- Do not exceed the machine's rated operating capacity; refer to operating capacity tables beginning on page 33. Be aware that effective operating capacity is reduced when the machine is turned.
- Machine stability is reduced when the machine is turned.
- Be aware that attachments effect the handling and balance of the machine. Adjust the operation of the machine as necessary when using attachments.
- Carry the load low. Move the controls smoothly and gradually, and operate at speeds appropriate for the conditions.
- Do not use the machine to lift or transport people. Do not allow others to ride on the machine or attachments, because they could fall or cause an accident.
- Always look to the rear, over both shoulders, before backing up.
- Only start the engine while seated in the operator's seat with the seat belt fastened around the operator.
- Only operate the controls while seated in the operator's seat with the seat belt properly fastened.
- Always keep hands and feet inside the operator's compartment while operating the machine.
- New operators must first operate the machine in an open area away from bystanders. Practice with the controls until the machine can be operated safely and efficiently.
- Wear safety goggles, ear and head protection as needed while operating the machine. Operator must wear protective clothing when appropriate.
- Exhaust fumes can kill. Do not operate the machine in an enclosed area without adequate ventilation. Internal combustion engines deplete the oxygen supply within enclosed spaces and may create a serious hazard unless the oxygen is replaced.
- Do not drive too close to an excavation or ditch. Be sure that the surrounding ground has adequate strength to support the weight of the machine and the load.
- Never allow anyone under a raised lift arm. Lowering the lift arm or a falling load can result in death or serious personal injury.
- Avoid slowing suddenly while carrying a load. Sudden slowing can cause the load to drop off the attachment, or cause the machine to tip over.

- Be aware of overhead obstacles. Any object near the lift arm could represent a potential hazard, or cause the operator to react suddenly and cause an accident. Use a spotter or signal person when working near bridges, phone lines, work site scaffolds, or other obstructions.
- Slow down the work cycle and use slower travel speeds in congested or populated areas. Use commonly understood signals so that other members of the work crew can warn the operator to slow or halt work in a potentially hazardous situation.
- Use a signal person if you cannot see the entire work area clearly, in high traffic areas and whenever the operator's view is not clear.
- Do not place limbs near moving parts. Severing of body parts can result.
- Do not use the loader to lift or transport people.
- Stay alert for people moving through the work area. When loading a truck, the operator should always know where the driver is.
- Exposed hydraulic hoses could react with explosive force if struck by a falling or overhead items. NEVER allow hoses to be hit, bent or interfered with. Replace any hoses that are damaged.
- Do not drive into materials at high speeds to avoid being thrown forward and injured.
- Do not turn off the ignition switch while traveling. Turning off the ignition will cause sudden hydrostatic braking, which may cause possible loss of control, injury and/or tipping of the machine.
- Unless necessary for servicing the machine, the engine hood must not be opened while the engine is running.
- In cold weather, avoid sudden travel movements and stay away from even slight slopes. The machine can slide sideways on icy slopes.
- Snow accumulation can hide potential hazards. Use care while operating and while using the machine to clear snow.
- If the machine becomes damaged or malfunctions, stop the machine immediately and lock and tag it. Repair the damage or malfunction before using the machine again.
- Never jump off the machine. Never get on or off a moving machine. Always leave the machine while facing the machine using the steps and hand-holds as described in "Entering and Exiting" on page 66.

## Provision for Stability/Avoiding Rollover Accidents

- Machine stability is affected by: the weight and center of gravity of the load being carried, height of the load, machine speed, turn angle, width of the machine across the tires, abrupt control movements and driving over uneven and/or soft terrain. **DISREGARDING ANY OF THESE FACTORS CAN CAUSE THE MACHINE TO TIP, THROWING THE OPERATOR OUT OF THE SEAT OR MACHINE, RESULTING IN DEATH OR SERIOUS INJURY.** Do not exceed the machine's rated operating capacity, especially when turning, because this reduces the load that will cause the machine to tip over. Carry the load low, and operate at speeds appropriate for the conditions.
- Operate the controls smoothly to prevent jerking or bouncing. Operate on level, stable surfaces. Load, unload and turn on solid, level ground.
- Drive up and down inclines, not across them. Drive slowly on inclines. Keep the heavy end of the machine pointed uphill.
- Evenly distribute the load on the attachment. Secure unstable loads so they do not shift or fall.
- Do not make sharp turns on inclines. Avoid steep inclines.
- Use care on loose ground. Loose, soft ground or uneven, broken terrain can cause dangerous side-load conditions and possible tipover and injury.
- If you must drive across railroad tracks, ditches, curbs or similar surfaces, cross perpendicular and drive slowly.
- Stay away from steep edges on loading docks, ramps, ditches, retaining walls and trenches.
- Avoid sharp turns and high speeds while carrying loads. The stability of the machine is greatly reduced during sharp turns. Additionally, the load may shift to the side during turns, greatly increasing the possibility of a rollover.
- When unloading trucks or lifting loads off elevated surfaces, approach the load straight ahead and back straight away with the load. Slowly lower the load to the lowest possible transport position before turning.
- To avoid tipping, keep loads as low as possible during transport and while turning. Keep the bottom of the bucket or load no higher than wheel axle height during transport and turning.
- Do not turn the machine when lifting loads. As loads are lifted, a drastic shift in stability can occur, which can greatly increase the possibility of a tip-over or rollover.
- Keep tires inflated to recommended pressure.
- If the machine becomes unstable and starts to tip, keep the seat belt fastened, hold on firmly and brace yourself. Lean away from the point of impact and stay with the machine. If tipping occurs, **DO NOT** jump from the machine. The machine is equipped with rollover protection, which can only protect the operator while in the operator's seat. Trying to escape from a tipping machine can result in death or serious personal injury.

- The ROPS must be replaced if a overturn incident occurs. The protection offered by the ROPS will be impaired if it has been damaged in an overturn incident.
- Never operate the machine without a ROPS or FOPS installed.

## **Electrical Energy**

- Stay away from high-voltage lines. Serious injury or death can result from contact or proximity to high-voltage electric lines. The machine does not have to make physical contact with power lines for current to be transmitted. Use a spotter and hand signals to keep away from power lines not clearly visible to the operator.
- Depending upon the voltage in the power line and atmospheric conditions, strong current shocks can occur if the bucket is closer than 3 m (10 ft.) to the power line. Very high voltage and rainy weather can further increase the safe operating distance.
- If the machine comes into contact with a live wire:
  - Do not leave the machine.
  - If possible, drive the machine out of the danger area.
  - Warn others not to approach or touch the machine.
  - Have the live wire de-energized.
  - Do not leave the machine until the wire has been safely de-energized.
- Work on the machine's electrical system must be performed only by trained technicians.
- Inspect and check the machine's electrical equipment at regular intervals. Problems found, such as loose connections or scorched cables, must be repaired before using the machine.
- Only use proper, original equipment fuses/circuit breakers with the specified current rating. Turn off the machine immediately if there is any indication of a problem with the electrical system.

## **Service Safety Practices**

---

- Only trained and authorized personnel, with a full awareness of safe procedures, should be allowed to operate or perform maintenance or service on the machine.
- Use warning tag/control lockout procedures during service. Alert others that service or maintenance is being performed by tagging operator's controls — and other machine areas if required — with a warning notice.
- Never attempt to bypass the keyswitch to start the engine. Use only the proper jump-starting procedure explained in “Using a Booster Battery (Jump-Starting)” on page 142.



- Never use your hands to search for hydraulic fluid leaks. Instead, use a piece of paper or cardboard. Escaping fluid under pressure can be invisible and can penetrate the skin and cause serious injury. If any fluid is injected into your skin, see a doctor at once. Injected fluid must be surgically removed by a doctor or gangrene may result.
- Always wear safety glasses with side shields when striking metal against metal. In addition, it is recommended that a softer (chip-resistant) material be used to cushion the blow, otherwise, serious injury to the eyes or other parts of the body could result.
- Stay clear from underneath the operator's platform as it is tilted.
- Always secure the operator's platform in the tilted position with the tilt support. Never allow anyone under the operator platform if the tilt support is not in place.
- Always secure the operator's platform to the chassis with anchor bolts, nuts and washers before driving and using the machine.
- Check operator's platform tilt components and tilt support components at regular intervals. Replace damaged or worn parts immediately.
- Do not smoke or have any spark- or flame-producing equipment or materials in the area while filling the fuel tank or working on the fuel or hydraulic systems.
- Keep fuel and other fluid reservoir caps tight. Do not start the engine until caps have been secured.
- Always lower lift arm or elevated items, or securely support/secure them, before performing any maintenance or service on the machine.
- Do not attempt to loosen or disconnect any hydraulic lines, hoses, fittings, covers or caps without first relieving hydraulic circuit pressure. Relieve hydraulic pressure by performing the *Mandatory Safety Shutdown Procedure* (page 10) and slowly loosening the hydraulic reservoir filler cap. Be careful not to touch any hydraulic components that have been in recent operation, because they can be hot and cause burns.
- Do not attempt to remove the radiator cap after the engine has reached operating temperature or if it is overheated. At operating temperatures, engine coolant is extremely hot and under pressure. Always wait for the engine to cool before attempting to relieve pressure and remove the radiator cap. Failure to heed this warning could result in severe burns.
- Use solid support blocking. Never rely on jacks or other inadequate supports when maintenance work is being done. Never work under any equipment supported only by jacks.
- Refer to the parts manual for information about assembly of components. Always use the correct parts and the proper torques — incorrect fastener connections can dangerously weaken assemblies.
- Exhaust fumes can kill. Do not operate the machine in an enclosed area unless there is adequate ventilation.
- Operators should also be aware of any open windows, doors or ductwork into which exhaust gases may be carried, exposing others to danger.

- Do not run the engine if repairs are being performed alone. There should always be at least two people working together if the engine must be run during service.
- Always use adequate tools while working on the machine. Inappropriate tools could break or slip, causing injury, or they may not adequately perform intended functions.
- Unless necessary for servicing the engine, do not open the engine cover while the engine is running.
- Do not use the machine when maintenance is scheduled to be performed. Postponing maintenance can result in a serious reduction of the service life of the machine, more serious and costly equipment failures, and contribute to unsafe operating conditions.
- Only tow the machine as described in this manual. See “Towing the Loader” on page 94.
- Do not work on hot engines, cooling systems or hydraulic systems. Wait for the engine to cool. When engine lubrication oil, gearbox lubricant or other fluids require changing, wait for fluid temperatures to decrease to a moderate level before removing drain plugs.
- All safety equipment must be maintained so it is always in good condition.
- Safety-critical parts must be periodically replaced. Replace the following potentially fire-related components as soon as they begin to show signs of deterioration:
  - Fuel system flexible hoses, fuel tank overflow drain hose and the fuel filler cap.
  - Hydraulic system hoses, especially the pump outlet lines. Replace hydraulic hoses every 6 years from the date of manufacture (month or quarter, and year) is indicated on the hydraulic hoses.
- Keep mounting brackets and hose and cable routing straps tight. Hose routing should have gradual bends.
- After cleaning the machine, examine all fuel, lubricant and hydraulic oil lines for leaks, chafe marks and damage. Tighten any loose connections and repair or replace parts as necessary.
- When handling oil, grease and other chemical substances, follow the product-related safety requirements Material Safety Data Sheet (MSDS) carefully to prevent burning or scalding.
- Do not use the machine in an environment where the hot muffler could present a fire hazard, such as hay or straw storage facilities.

## **Battery Hazards**

- Use the battery disconnect switch, or disconnect the negative battery cable from the negative battery terminal, before performing electrical service or electrical welding on the machine. See “Engine Start” on page 67.

- When disconnecting at the battery terminals, remove the cable connected to the negative terminal first. When installing a battery, connect the positive terminal cable first.
- Sparks and open flames can set off explosive battery gas from incidental contact or static discharge. Turn off all switches and the engine when working on batteries. Keep battery terminals tight. Contact between a loose terminal and post can create an explosive spark.
- When jump-starting from another machine, do not allow the machines to touch. Wear safety glasses or goggles while battery connections are made.
- Never jump-start the machine if it has a frozen battery. The battery could explode. Thaw a frozen battery before charging it or attaching jumper cables.
- Flush eyes with water for 10-15 minutes if battery acid is splashed in the face. Anyone swallowing battery acid must have immediate medical aid. Call the Poison Control Center at 1-800-222-1222 in the United States.

## Fire Hazards

---

- The machine must be cleaned on a regular basis to avoid the buildup of flammable debris, such as leaves, straw, etc. Accumulated debris, particularly in the engine compartment, creates a fire hazard.
- The machine has several components that operate at high temperatures under normal operating conditions, primarily the engine and exhaust systems. Also, the electrical system, if not properly maintained or if damaged, can arc or produce sparks. These conditions make it extremely important to avoid circumstances where explosive dust or gases can be ignited by arcs, sparks or heat.
- Add fuel, oil, antifreeze and hydraulic fluid to the machine only in well-ventilated areas. The machine must be parked with controls, lights and switches turned off. The engine must be turned off before fueling.
- Do not smoke while filling the fuel tank, while working on the fuel or hydraulic systems, or while working around the battery.
- Take care to avoid spilling combustible fluids, such as oil or fuel, on a hot engine.
- Static electricity can produce dangerous sparks at the fuel-filling nozzle. In very cold, dry weather or other conditions that could produce static discharge, keep the tip of the fuel nozzle in constant contact with the fuel filler neck, to provide a ground. Be sure that a ground wire is connected from the machine to the service truck before fueling begins.
- Keep fuel and other fluid reservoir caps tight and do not start the engine until caps have been secured.
- It is recommended that a 2.27 kg (5 lbs.) or larger, multi-purpose “A/B/C” fire extinguisher be mounted within reach of the operator. Check the fire extinguisher periodically and be sure that work site crew members are trained in its use.

- Oil leaks can ignite on hot components. Repair any damaged or leaking components before using machine.

## Crystalline Silica Exposure

---

Exposure to crystalline silica (found in sand, soil and rocks) has been associated with silicosis, a debilitating and often fatal lung disease. A Hazard Review (Pub. No. 2002-129) by the U.S. National Institute for Occupational Safety and Health (NIOSH) indicates a significant risk of chronic silicosis for workers exposed to inhaled crystalline silica over a working lifetime. NIOSH recommends an exposure limit of 0.05 mg/m<sup>3</sup> as a time-weighted average for up to a 10-hr workday during a 40-hr work week. NIOSH also recommends substituting less hazardous materials when feasible, using respiratory protection and regular medical examinations for exposed workers.

## Transporting the Machine

---

Obey federal, state and local over-the-road regulations. Check restrictions regarding weight, height, width and length of a load. The hauling vehicle, trailer and load must all be in compliance with applicable regulations. See “Loading and Transporting” on page 97.

## Lifting the Machine with a Crane

---











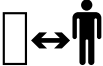


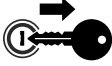







Only lift the machine according to the following guidelines:

- The crane and rigging equipment must have sufficient capacity. See “Weights and Capacities”, starting on page 33.
- Secure the machine against unintentional movement. Use taglines as needed.
- Do not lift the machine with persons on or in the machine.
- Any person guiding the crane operator must be within sight or sound of the crane operator.
- Lift the machine only with the standard bucket installed, with the bucket empty and in the transport position.
- Persons must stay clear of, and not under, the machine when it is lifted.
- Fasten the rigging equipment so the machine is horizontal when it is lifted.
- Do not lift the machine by the cab. Attach the rigging equipment only at the lift points identified by this symbol:



- Lift the machine according to “Crane Lifting” on page 99.

# Hazard and Hazard Avoidance Symbols

 <p>Safety Hazard</p>	 <p>Fire Hazard</p>	 <p>Run-Over Hazard</p>	 <p>Injected Fluid Hazard</p>	 <p>Hot Liquids Hazard</p>
 <p>Poisonous Vapors Hazard</p>	 <p>No Smoking</p>	 <p>No Open Flames</p>	 <p>Read Operator's Manual</p>	 <p>Wear Seatbelt</p>
 <p>Keep Distance</p>	 <p>Wear Eye Protection</p>	 <p>Avoid Power Lines</p>	 <p>Remove Key</p>	 <p>Crush Hazard</p>
 <p>Read Maintenance/Service Information</p>	 <p>Crush Hazard</p>	 <p>Hot Surface Hazard</p>	 <p>Rotating Fan Keep Away</p>	 <p>Safety Lock</p>
 <p>Falling Object Hazard</p>				

# Safety Decals

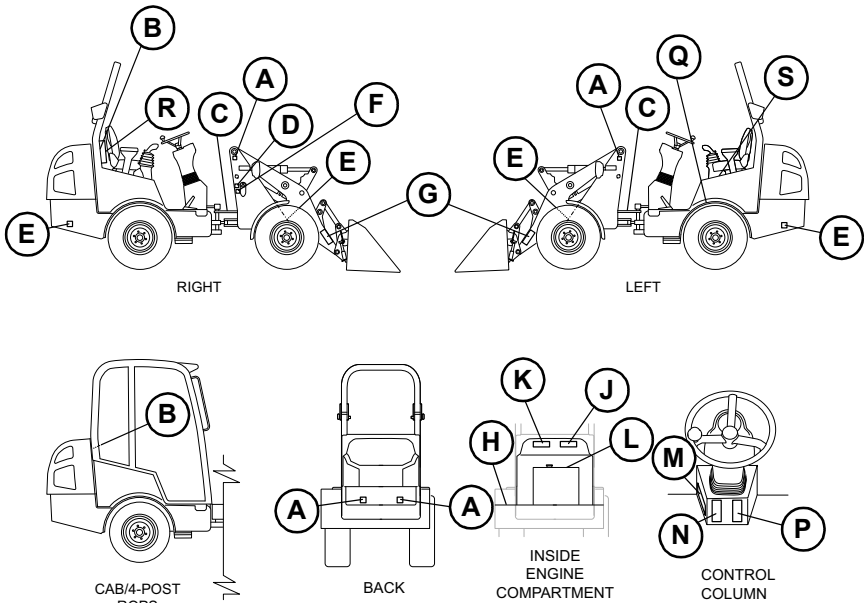
The machine has decals around the machine that provide safety information and precautions. These decals must be kept legible. If missing or illegible, they must be replaced promptly. Replacements can be obtained from your dealer. Refer to the Parts Manual for decal part numbers and ordering information.

## New Decal Application

Surfaces must be free of dirt, dust, grease and foreign material before applying the decal. Remove the smaller portion of the decal backing paper and apply the exposed adhesive to the clean surface, maintaining proper position and alignment. Peel the rest of the backing paper and apply hand pressure to smooth out the decal surface. Refer to the following pages for proper decal locations.

If replacing a part that has a decal on it, ensure that the replacement part has the same decal.

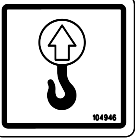

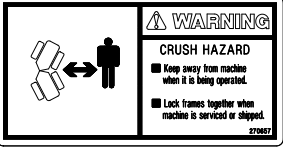


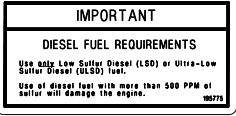
## ANSI-Style and Common Safety Decal Locations



**Figure 4 – ANSI-Style and Common Safety Decal Locations  
(AL 500 Series Shown — Other Series Similar)**

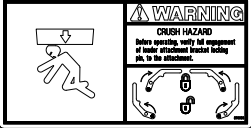
# ANSI-Style and Common Safety Decal Locations (Cont.)

*Note: Refer to Fig. 4 for decal locations.*

<p><b>A</b></p> 	<p><b>Lift Point Decal</b></p> <ul style="list-style-type: none"><li>• Located at the rear of the machine and near the lift holes/rods near the top of the front frame.</li><li>• Apply lift hooks only in these location See “Crane Lifting” on page 99.</li></ul>
<p><b>B</b></p> 	<p><b>WARNING: Do not modify ROPS; replace damaged ROPS; wear seat belt</b></p> <ul style="list-style-type: none"><li>• Located inside the ROPS structure.</li><li>• The protection offered by this ROPS will be impaired if it has been subjected to any modification, structural damage, or has been involved in an overturn incident, this ROPS must be replaced after a rollover. Seat belts must be worn while operating vehicle.</li></ul>
<p><b>C</b></p> 	<p><b>WARNING: Crush Hazard</b></p> <ul style="list-style-type: none"><li>• Located on top of the articulation joint on both sides.</li><li>• Keep away from machine when it is being operated.</li><li>• Lock frames together when machine is serviced or shipped.</li></ul>
<p><b>D</b></p> 	<p><b>USE DIESEL FUEL ONLY!</b></p> <p>Located next to the fuel filler neck.</p>
<p><b>E</b></p> 	<p><b>Tie-down point, located on lift arm (front, both sides) and frame (rear, both sides). Only use tie-down points indicated on loader when transporting loader.</b></p>
<p><b>F</b></p> 	<p><b>IMPORTANT</b></p> <ul style="list-style-type: none"><li>• Located next to the fuel filler neck.</li><li>• Use <b>ONLY</b> Low Sulfur Diesel (LSD) or Ultra-Low Sulfur Diesel (ULSD) fuel.</li><li>• Use of diesel fuel with more than 500 PPM of sulfur will damage the engine. See “Fuel System” on page 116.</li></ul>

Note: Refer to Fig. 4 on page 22 for decal locations.


**G**



**WARNING: Crush Hazard**

- Located on both side of the lift arm.
- Before operating, verify full engagement of loader attachment bracket locking pin to the attachment.


**H**



**USE HYDRAULIC FLUID ONLY!**

Located next to the hydraulic fluid reservoir filler neck.


**J**



**WARNING: Rotating Fan / Hot Surface Hazards**

- Located on the right side of the firewall inside the engine compartment; on machines with air conditioning, located on the back of the air conditioning enclosure.
- Keep hands out or stop engine.
- Do not touch hot engine or hydraulic system parts.

**K**



**WARNING: Avoid Injury or Death**

- Located on the left side of the firewall inside the engine compartment; on machines with air conditioning, located on the back of the air conditioning enclosure.
- Keep safety devices working.
- Jump start per Operator's Manual procedure.
- Clean debris from engine compartment daily to avoid fire. Keep fire extinguisher nearby.
- Do not use hand to find hydraulic leaks. Escaping oil under pressure can be invisible and penetrate skin.
- Allow radiator to cool before removing cap. Loosen cap slowly to avoid burns.



# ANSI-Style and Common Safety Decal Locations (Cont.)

Note: Refer to Fig. 4 on page 22 for decal locations.

**L**

**IMPORTANT**

- Located on top of the radiator inside the engine compartment.
- Do not use ether or other starting fluids to start this engine — warranty may be voided.

**M**

**WARNING: Avoid Injury or Death**

- ALWAYS wear seatbelt.
- No riders! Never use work tool as work platform.
- Keep out from under lift arm unless lift arm is supported.
- Operate only from operator's seat.
- Prevent load rolling down lift arm onto operator.

**WARNING: Avoid Overturn**

Side stability is reduced when: 1) turning; 2) operating on rough terrain or side slopes; and 3) carrying load raised.

- Carry load low.
- Do not exceed Rated Operating Capacity.
- Avoid steep slopes and high speed turns.
- Travel up and down slopes with heavy end uphill.

Located on the left side of the control column.

**N**

**WARNING: Avoid Injury or Death**

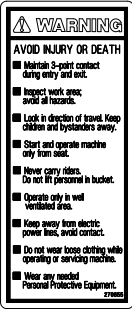
Always follow “Mandatory Safety Shutdown Procedure.”

- 1) Lower equipment to ground.
- 2) Reduce throttle, apply parking brake.
- 3) Shift to neutral.
- 4) Stop engine, remove key.

Located on the control column, facing the operator.

*Note: Refer to Fig. 4 on page 22 for decal locations.*

**P**




**WARNING**  
**AVOID INJURY OR DEATH**  
 ■ Maintain 3-point contact during entry and exit.  
 ■ Inspect work area; avoid all hazards.  
 ■ Lock in direction of travel. Keep children and bystanders away.  
 ■ Start and operate machine only from seat.  
 ■ Never carry riders. Do not lift personnel in bucket.  
 ■ Operate only in well ventilated area.  
 ■ Keep away from electric power lines, avoid contact.  
 ■ Do not wear loose clothing while operating or servicing machine.  
 ■ Wear any needed Personal Protective Equipment. 22000

Located on the control column, facing the operator.

**WARNING: Avoid Injury or Death**

- Maintain 3-point contact during entry and exit.
- Inspect work area; avoid all hazards.
- Look in the direction of travel. Keep children and bystanders away.
- Start and operate machine only from seat.
- Never carry riders. Do not lift personnel in bucket.
- Operate only in well ventilated area.
- Keep away from electric power lines, avoid contact.
- Do not wear loose clothing while operating or servicing machine.
- Wear any needed Personal Protective Equipment.

**Q**




**WARNING**  
 ■ Be sure lock mechanism is securely engaged before working under ROPS/FOPS.  
 ■ Read instructions for use in Operator's Manual. 22000

**WARNING: Crush Hazard**

- Located under the operator's platform on top of the left rear wheel well.
- Be sure lock mechanism is securely engaged before working under ROPS/FOPS.
- Read instructions for use in Operator's Manual.

**R**




**WARNING**  
**AVOID INJURY OR DEATH**  
 Read Operator's Manual and all safety signs before using machine.  
 The owner is responsible to ensure all users are instructed on safe use and maintenance.  
 Check machine before operating. Service per Operator's Manual.  
 Contact dealer (or manufacturer) for information and service parts. 22000

**WARNING: Read Operator's Manual**

- Located behind the operator's seat on the document box cover.
- Read Operator's Manual and all safety signs before using machine.
- The owner is responsible to ensure all users are instructed on safe use and maintenance.
- Check machine before operating. Service per Operator's Manual.
- Contact dealer (or manufacturer) for information and service parts.

**S**

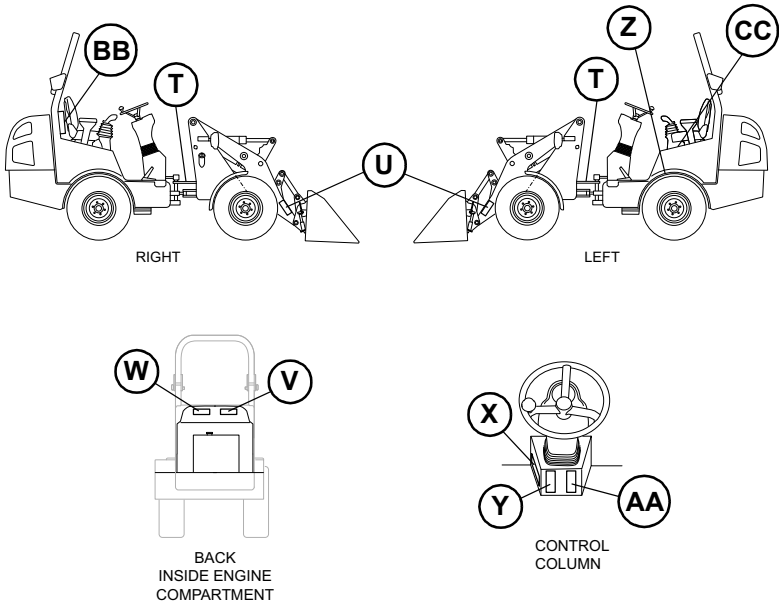


**WARNING**  
 FALLING-OBJECT HAZARD  
 Falling-Object Protective Structure (FOPS) must be installed if there is a risk of falling objects. 22000

**WARNING: Falling Object Hazard**

- 2-Post ROPS machines only.
- Located under the parking hand brake lever.
- Falling-Object Protective Structure (FOPS) must be installed if there is a risk of falling objects.

# ISO-Style Safety Decal Locations



**Figure 5 – ISO-Style Safety Decal Locations (AL 500 Series Shown — Other Series Similar)**





*Note: Refer to Fig. 5 for decal locations.*

	<p><b>WARNING: Crush Hazard</b></p> <ul style="list-style-type: none"> <li>• Located on top of the articulation joint on both sides.</li> <li>• Keep away from the articulation joint when the machine is being operated.</li> <li>• Lock frames together using the steering lock bar when machine is serviced or shipped.</li> </ul>
--	---------------------------------------------------------------------------------------------------------------------------------------------------------------------------------------------------------------------------------------------------------------------------------------------------------------------------------------

	<p><b>WARNING: Crush Hazard</b></p> <ul style="list-style-type: none"> <li>• Located on both sides of the lift arm.</li> <li>• Before operating, verify full engagement of loader attachment bracket locking pin to the attachment.</li> </ul>
--	------------------------------------------------------------------------------------------------------------------------------------------------------------------------------------------------------------------------------------------------

Note: Refer to Fig. 5 on page 27 for decal locations.

**V**













A	B	D	E
			
C			

**WARNING: Rotating Fan / Hot Surface Hazards**

- Located on the right side of the firewall inside the engine compartment; on machines with air conditioning, located on the back of the air conditioning enclosure.

A) Rotating fan hazard.  
B) Keep hands away.  
C) Stop engine.  
D) Hot surface hazard.  
E) Do not touch hot engine or hydraulic system parts.

**W**

A	B	C	D	E	F
					
					

**WARNING: Avoid Injury or Death**









- Located on the left side of the firewall inside the engine compartment; on machines with air conditioning, located on the back of the air conditioning enclosure.

A) Safety alert / Keep safety devices in place and in working order.  
B) Fire hazard / Do not smoke while fueling or servicing the machine. Clean debris from the engine compartment to avoid fires. Keep fire extinguisher nearby.  
C) Run-over hazard / Jump-start the machine only according to the operator's manual. See "Using a Booster Battery (Jump-Starting)" on page 142.  
D) Oil injection hazard / Do not use hands to find hydraulic leaks. Escaping oil under pressure can penetrate skin. Use a piece of cardboard to find leaks.  
E) Burn hazard / Allow radiator to cool before removing cap. Loosen cap slowly to avoid burns.  
F) Suffocation hazard / Operate only in a well-ventilated area.

# ISO-Style Safety Decal Locations (Cont.)

*Note: Refer to Fig. 5 on page 27 for decal locations.*

**(X)**

A	B	C	D
			
			

**General Operating Warnings**

- Located on the left side of the control column.


**A) Crush hazard / Keep out from under lift arm unless lift arm is supported.**

**B) Side tip hazard / Avoid steep slopes and high-speed turns. Travel up and down slopes with heavy end uphill. Fasten seat belt.**

**C) Forward tip hazard / Carry load low. Do not exceed rated operating capacity.**

**D) Fall hazard / No riders! Never use attachment as work platform.**


**(Y)**



**General Safety Shutdown Warning**

- Located on the control column, facing the operator.
- Read the Operator's Manual and all safety signs before using the machine.
- Shutdown Procedure:
  - 1) Lower equipment to the ground.
  - 2) Reduce the throttle and apply the parking brake.
  - 3) Shift to Neutral.
  - 4) Stop the engine and remove the key.

**(Z)**




**WARNING: Crush Hazard**

- Located under the operator's platform on top of the left rear wheel well.
- Be sure cab tilt support is securely engaged before working under operator's platform. See "Tilting the Platform" on page 107.

*Note: Refer to Fig. 5 on page 27 for decal locations.*

**AA**



**General Operating Warnings**

- Located on the control column, facing the operator.

A) Check machine before operating. Service according to Operator's Manual. Contact dealer (or manufacturer) for information and service parts.

B) Maintain 3-point contact during entry and exit. Do not grasp steering wheel during entry and exit.


C) Inspect work area. Avoid all hazards. Look in the direction of travel. Keep children and bystanders away.

D) Start and operate machine only from operator's seat.

E) Keep away from power lines.

F) Wear personal protective equipment as needed. Do not wear loose clothing while operating or servicing machine.


**BB**



**WARNING: Read Operator's Manual**

- Located behind the operator's seat on the document box cover.
- Be sure all users are instructed on safe use and maintenance. Service machine according to the Operator's Manual. Contact dealer (or manufacturer) for information and service parts.

**CC**



**WARNING: Falling Object Hazard**

- Located under the parking brake lever.
- For 2-Post ROPS machines only.
- Falling-Object Protective Structure (FOPS) must be installed if there is a risk of falling objects.

# CHAPTER 3

## SPECIFICATIONS

### Fluid Capacities/Lubricants

	AL 500/400 Series	AL 300 Series	AL 200 Series	AL 100 Series
Diesel Engine Oil				
Specification	API CD or Higher (United States) ACEA E-3, E-4, E-5 (European Union)			
Season/Temp. Range	SAE 10W-30: -20°C (-4°F) to 30°C (86°F) SAE 15W-40: -15°C (5°F) to 40°C (104°F) SAE 20W-50: -10°C (14°F) to 50°C (122°F)			
Capacity	7.4 L (7.8 qts.)	6.7 L (7.2 qts.)		4.4 L (4.6 qts.)
Diesel Fuel	LSD or ULSD <sup>1</sup> low sulfur or ultra-low sulfur, below 500 PPM. Up to 5% (B5) mixture of BioDiesel allowed.			
Specification	1-D or 2-D, ASTM D975-94 (United States) EN 590:96 (European Union) ISO 8217 DMX (International) BS 2869-A1 or A2 (United Kingdom)			
Season/Temp. Range	Dependent on Outside Temperatures			
Capacity	68 L (18 gal.)	57 L (15 gal.)		26 L (7 gal.)
Hydraulic Oil <sup>2</sup> System/Tank				
<i>Hydraulic Oil</i> Specification	UTTO Fluid (Mobil 424 or equivalent)			
Season/Temp. Range	Year-Round			
<i>Biodegradable Oil</i> Specification	Panolin Biofluid LS			
Season/Temp. Range	Year-Round			
Capacity	40 L (10.6 gal.)	26 L (6.9 gal.)		34 L (9.0 gal.)

1. Ultra-Low Sulfur Diesel (ULSD) fuel lubricity must have a maximum scar diameter of 0.45 mm, as measured by ASTM D6079 or ISO 12156-1, or a minimum of 3100 grams, as measured by ASTM D6078. Contact your fuel supplier for details.
2. IMPORTANT! – When adding hydraulic oil, hydraulic tanks in AL 100 Series machines must be vented by removing oil filter cap and lifting oil filter or tanks will not fill evenly. See “Checking Hydraulic Oil Level” on page 122.

	AL 500/400 Series	AL 300 Series	AL 200 Series	AL 100 Series
Axle Oil				
Hubs (each)	0.4 L (0.4 qt.) UTTO Fluid (Mobil 424 or equivalent)		N/A	
Front Center	2.5 L (2.6 qt.) UTTO Fluid (Mobil 424 or equivalent)		3.78 L (4 qts.) 75W90 gear oil or UTTO Fluid (Mobil 424 or equivalent)	
Rear Center	3.2 L (3.4 qt.) UTTO Fluid (Mobil 424 or equivalent)			
Grease				
Specification	KF2K-25 Lithium			
Season/Temp. Range	Year-Round			
Capacity	As Required			
Engine Coolant System/Radiator				
Specification	Long-life coolant ASTM D4985, D6210 (United States) SAE J814C, J1941, J1034 or J2036 (International)			
Season/Temp. Range	Year-Round			
Capacity	6.4 L (6.8 qts.)	5.3 L (5.6 qts.)		
Windshield Washer				
Specification	Windshield Washer Fluid			
Season/Temp. Range	Year-Round			
Capacity	1.3 L (1.4 qts.)		N/A	

## Maximum Slopes of Engine Operation

Continuous Engine Operation	25° for all directions
Intermittent Engine Operation (<3 minutes)	30° for all directions

**⚠ WARNING** The maximum slopes of engine operation listed here may exceed safe operation. See “Provision for Stability/Avoiding Rollover Accidents” on page 15.



## SAE (Domestic) Weights and Capacities AL 500 and AL 300 Series

Description	kg (lbs.) <sup>1</sup>					
	AL 500 Series			AL 300 Series		
	2-Post ROPS	4-Post ROPS	Cab	2-Post ROPS	4-Post ROPS	Cab
Operating Weight	3307 (7290)	3357 (7400)	3452 (7610)	2472 (5450)	2520 (5555)	2649 (5840)
Shipping Weight	3182 (7016)	3235 (7131)	3380 (7451)	2358 (5199)	2406 (5304)	2535 (5589)
Rated Operating Capacity <sup>1, 2</sup>	1118 (2466)	1145 (2460)	1165 (2560)	798 (1760)	834 (1840)	857 (1890)
Static Tipping Loads						
Standard Bucket <sup>2</sup> - Straight	2237 (4932)	2290 (5049)	2330 (5136)	1597 (3521)	1670 (3681)	1721 (3794)
SAE J732 Stan- dard Bucket <sup>2</sup> - 45° Turn (Domestic)	1771 (3904)	1800 (3969)	1860 (4101)	1244 (2743)	1280 (2821)	1319 (2907)
Standard Pallet Forks <sup>3</sup> - Straight	1634 (3602)	1682 (3708)	1703 (3755)	1098 (2420)	1169 (2578)	1247 (2750)
SAE J1197 Stan- dard Pallet Forks <sup>3</sup> - 45°Turn (Domestic)	1278 (2817)	1333 (2939)	1352 (2981)	857 (1889)	909 (2005)	977 (2155)

1. Measured on firm and level ground. Equipped with full fluids and 75 kg (165 lbs.) operator.  
AL 500 Series equipped with 33x15.5-16.5 tires, fluid-filled rear tires (air-filled rear tires have reduced capacities) and counterweight.  
AL 300 Series equipped with 30.5X12.5-16.5 tires.
2. AL 500 Series equipped w/ 1524 mm (60") dirt/construction bucket.  
AL 300 Series equipped w/ 1372 mm (54") dirt/construction bucket.
3. Equipped w/ pallet forks with 1067 mm (42") tines and 533 mm (21") load center.

# ISO 6016 (EU) Weights and Capacities

## AL 500, AL 400 and AL 300 Series

Description	kg (lbs.) <sup>1</sup>							
	AL 500 Series			AL 400 Series		AL 300 Series		
	2-Post ROPS	4-Post ROPS	Cab	2-Post ROPS	4-Post ROPS	2-Post ROPS	4-Post ROPS	Cab
Operating Weight	3307 (6732)	3106 (6847)	3502 (7202)	2740 (6041)	2790 (6151)	2360 (5201)	2434 (5368)	2561 (5646)
Shipping Weight	3021 (6660)	3071 (6770)	3166 (6980)	2618 (5772)	2668 (5882)	2206 (4864)	2254 (4969)	2383 (5254)
Rated Operating Capacity <sup>1, 2</sup>	1118 (2466)	1145 (2460)	1165 (2560)	901 (1987)	901 (1987)	798 (1760)	834 (1840)	857 (1890)
Static Tipping Loads								
Standard Bucket <sup>2</sup> - Straight	1993 (4394)	1993 (4394)	1993 (4394)	1802 (3973)	1802 (3973)	1652 (3642)	1652 (3642)	1652 (3642)
ISO 6016 Standard Bucket <sup>2</sup> - 45° Turn (EU)	1357 (2992)	1357 (2992)	1357 (2992)	1181 (2603)	1181 (2603)	1110 (2447)	1110 (2447)	1110 (2447)
Standard Pallet Forks <sup>3</sup> - Straight	1532 (3377)	1532 (3377)	1532 (3377)	1332 (2937)	1332 (2937)	1270 (2800)	1270 (2800)	1270 (2800)
ISO 6016 Standard Pallet Forks <sup>3</sup> - 45° Turn (EU)	1041 (2295)	1041 (2295)	1041 (2295)	874 (1927)	874 (1927)	840 (1852)	840 (1852)	840 (1852)

1. Measured on firm and level ground. Equipped with full fluids and 75 kg (165 lbs.) operator.  
AL 500 Series equipped with 31x15.5x16.5 tires.  
AL 400 Series equipped with 12 x 16.5.  
AL 300 Series equipped with 10x16.5 EM tires.
2. AL 500/AL 400 Series equipped w/ 1524 mm (60") dirt/construction bucket.  
AL 300 Series equipped w/ 1372 mm (54") dirt/construction bucket.
3. Equipped w/ pallet forks with 1067 mm (42") tines and 533 mm (21") load center.

# SAE (Domestic) Weights and Capacities

## AL 100 Series

Description	kg (lbs.) <sup>1</sup>	
	AL 100 Series	
	2-Post ROPS	4-Post ROPS
Operating Weight	1744 (3845)	1774 (3910)
Shipping Weight	1651 (3640)	1681 (3705)
Rated Operating Capacity <sup>1, 2</sup>	435 (960)	435 (960)
Static Tipping Loads		
Standard Bucket <sup>2</sup> - Straight	873 (1924)	975 (1929)
SAE J732 Standard Bucket <sup>2</sup> - 45° Turn (Angle) (Domestic)	692 (1526)	702 (1547)
Standard Pallet Forks <sup>3</sup> - Straight	629 (1386)	643 (1417)
SAE J1197 Standard Pallet Forks <sup>3</sup> - 45° Turn (Domestic)	497 (1096)	508.5 (1121)

1. Measured on firm and level ground. Equipped with full fluids, 75 kg (165 lbs.) operator and 27x10.50-15 tires.
2. Equipped w/ 1118 mm (44") dirt/construction bucket.
3. Equipped w/ pallet forks with 1067 mm (42") tines and 533 mm (21") load center.

# ISO (EU) Weights and Capacities

## AL 100 and AL 200 Series

Description	kg (lbs.) <sup>1</sup>			
	AL 200 Series		AL 100 Series	
	2-Post ROPS	4-Post ROPS	2-Post ROPS	4-Post ROPS
Operating Weight	2108 (4647)	2169 (4782)	1690 (3728)	1721 (3794)
Shipping Weight	1994 (4396)	2055 (4531)	1534 (3382)	1564 (3447)
Rated Operating Capacity <sup>1, 2</sup>	714 (1574)	714 (1574)	435 (960)	435 (960)
Static Tipping Loads				
Standard Bucket <sup>2</sup> - Straight	1428 (3148)	1428 (3148)	892.5 (1968)	858 (1891)
ISO 6016 Standard Bucket <sup>2</sup> - 45° Turn (EU)	816 (1799)	816 (1799)	438 (965)	438 (965)
Standard Pallet Forks <sup>3</sup> - Straight	1099 (2423)	1099 (2423)	660 (1454)	660 (1454)
ISO 6016 Standard Pallet Forks <sup>3</sup> - 45° Turn	645 (1422)	645 (1422)	334 (737)	334 (737)

1. Measured on firm and level ground. Equipped with full fluids and 75 kg (165 lbs.) operator.  
AL 100 Series equipped with 27x8.50-15 tires.  
AL 200 Series equipped with 27x10.50-15 tires.
2. Equipped w/ 1118 mm (44") dirt/construction bucket.
3. Equipped w/ pallet forks with 1067 mm (42") tines and 533 mm (21") load center.

## Engine

	AL 500/ AL 400 Series	AL 300 Series	AL 200 Series	AL 100 Series
Manufacturer	Yanmar			
Type	4-cylinder, 4-cycle, In-line, Water-cooled Diesel	3-cylinder, 4-cycle, In-line, Water-cooled Diesel		
Engine Model	4TNV88-BKGWL	3TNV88-BKGWL		3TNV76-KGWL
Displacement	2190 cc (133.6 cid)	1642 cc (100.2 cid)		1116 cc (68.1 cid)
Cyl. Bore x Stroke	88 x 90 mm (3.5 x 3.5")			76 x 82 mm (3.0 x 3.2")
Gross Power @ Manuf. Rated rpm	35 kW (47 hp) @ 2800 rpm	26 kW (35 hp) @ 2800 rpm		17.4 kW (23.3 hp) @ 2800 rpm
Adjusted High Idle	2700 rpm	2800 rpm		3000 rpm
Combustion	Direct Injection			Indirect Injection
Starting Aid	Pre-heating Glow Plug			
Max. Travel Speed	20 km/h (12.4 mph)	18.5 km/h (11.5 mph)	13.5 km/h (8.4 mph)	12.5 km/h (7.8 mph)
Operating Range–Ambient Temperature <sup>1</sup>	-15°C (+5°F) – +45°C (+113°F)			

1. Operation above temperature range may result in overheating; operation below temperature range may result in hard-starting. Contact your dealer before operating the machine outside temperature range.

## Coolant Compound Table

Outside Temp.	Water	Anti-Corrosion Agent		Antifreeze
Up to °F (°C)	%by Volume	in <sup>3</sup> /gal (cm <sup>3</sup> /L)	%by Volume	%by Volume
39 (4)	99	2.6 (10)	1	-
14 (-10)	79			20
-4 (-20)	65			34
-13 (-25)	59			40
-22 (-30)	55			45
-44 (-42)	55			50

## Hydraulics

	<b>AL 500/ AL 400 Series</b>	<b>AL 300 Series</b>	<b>AL 200 Series</b>	<b>AL 100 Series</b>
Auxiliary Hydraulics (at 100% theoretical flow)				
Hydraulic System	57 L/min (14 gpm)	45 L/min (12 gpm)		30 L/min (8 gpm)
System Pressure	207 bar (3000 psi)			193 bar (2800 psi)
Drive Hydraulics				
Hydraulic System	117 L/min (31 gpm)	79 L/min (21 gpm)	101 L/min (26.7 gpm)	79 L/min (21 gpm)
System Pressure	410 bar (5940 psi)	350 bar (5075 psi)	320 bar (4640 psi)	
Reservoir Capacity	42 L (11 gals.)	26 L (7 gals.)		34L (9 gals.)
Drive Hydraulics	10749 lbf (47.8 kN)	5705 lbf (25.4 kN)	5273 lbf (23.5 kN)	2433 lbf (10.8 kN)

## Electrical System

Alternator	12V - 55 A
Starter	12V - 2.3 kW
Battery	850 CCA - 74 Ah

## Sound Levels

	<b>All Series</b>
ISO 6395 A-Weighted Sound Power Level	<101 dB(A)
A-Weighted Emission Sound Pressure Level at the Operator's Position	< 85 dB(A)

## Wheels

	<b>AL 500/ AL 400 Series</b>	<b>AL 300 Series</b>	<b>AL 200 Series</b>	<b>AL 100 Series</b>
Wheel Fastener Torque	319 N•m (235 lbf-ft)		165 N•m (122 lbf-ft)	

## Wheel/Tire Sets

Description	Model	Machine Width Millimeters (Inches)
27x8.50-15, 8-ply	AL 100 Series	1044 (41.1)
27x10.50-15, 8-ply	AL 100 Series	1049 (41.3)
27x10.50-15, 10-ply (turf)	AL 100 Series	1049 (41.3)

30.5x12.5-16.5, 8-ply	AL 300 Series	1280 (50.4)
10x16.5, 8-ply	AL 300 Series	1280 (50.4)
29x12.5-15 8-ply (turf)	AL 300 Series	1285 (50.6)

33x15.5-16.5	AL 500 Series	1400 (55.1)
12x16.5	AL 500 Series	1200/1346 (47.2/53.0)
33x13.5-16 NHS 12-ply (turf)	AL500 Series	1368 (53.9)

(EU Only)		
W/T Set 27x10.50-15	AL 100 Series AL 200 Series	958/1079 (37.7/42.5)
W/T Set 27x10.50-15 (wide-stance wheel option)	AL 100 Series AL 200 Series	990/1010 (39.0/39.8)
W/T Set 27x10.50-16	AL 100 Series AL 200 Series	988/1050 (38.9/41.3)
W/T Set 10.0x16.5	AL 100 Series AL 200 Series	948/1097 (37.3/43.2)
W/T Set 10.0x16.5	AL 300 Series	1145/1274 (45.1/50.2)
W/T Set 29x12.50-15	AL 300 Series	1150/1349 (45.3/53.1)
W/T Set 31x15.50-16.5	AL 300 Series	1325/1372 (52.2/54.0)
31x15.5-16.5	AL 500 Series AL 400 Series	1282/1415 (50.5/55.7)
12x16.5	AL 500 Series AL 400 Series	1200/1346 (47.2/53.0)
31x15.5-15	AL 500 Series AL 400 Series	1282/1415 (50.5/55.7)

**Note:** See tire sidewall for inflation pressures, except where noted.

**Important:** AL 500 Series machines with fluid-filled rear tires have increased load capacities.

## ROPS and FOPS

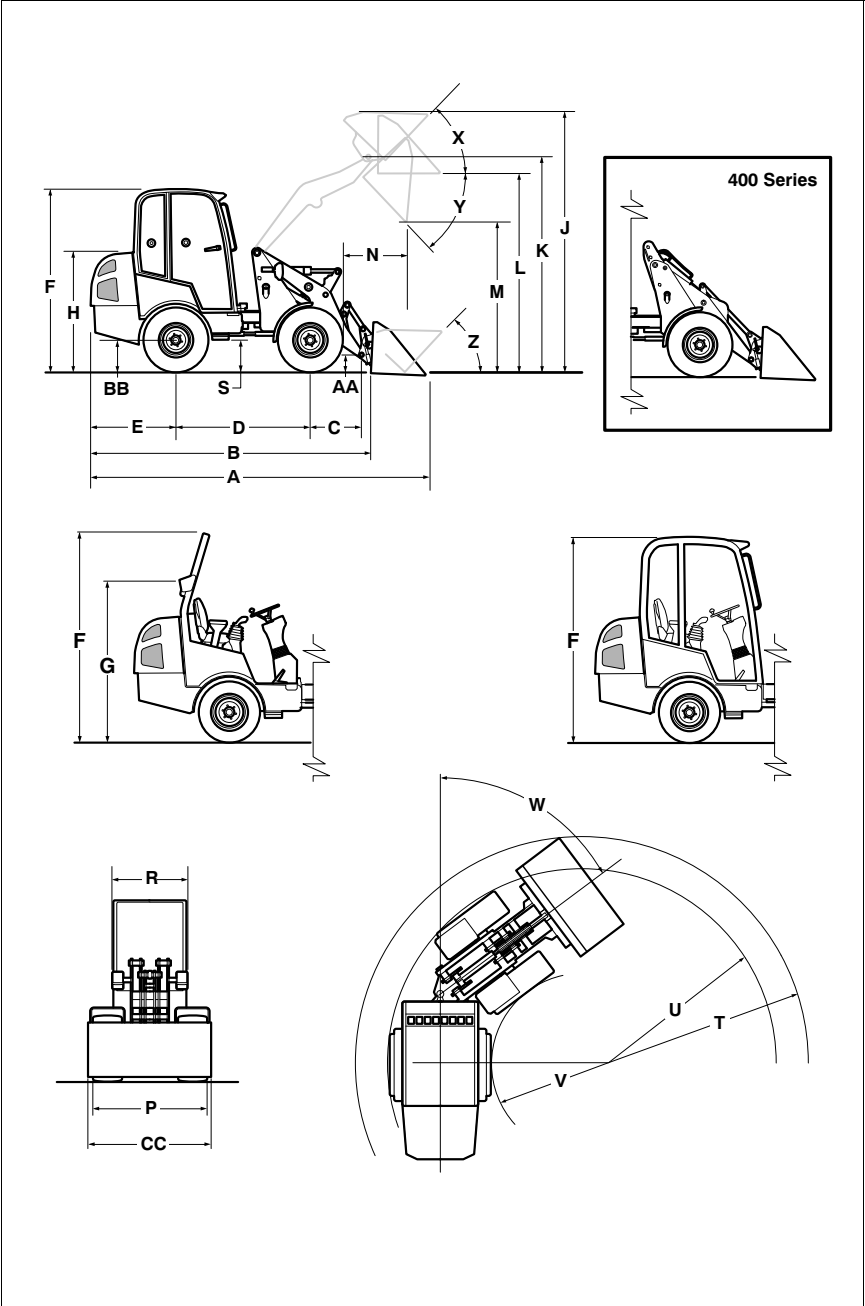
FOPS Rating	Level 1
-------------	---------

### Vibration Levels

	AL100	AL200	AL300	AL400	AL500
<b>Whole Body Vibration (ISO 2631-1) m/s</b>	$\leq 1.03 \text{ m/s}^2$ ( $\pm 0.41\text{k}$ )	$\leq 0.89 \text{ m/s}^2$ ( $\pm 0.45\text{k}$ )	$\leq 0.75 \text{ m/s}^2$ ( $\pm 0.38\text{k}$ )	$\leq 0.88 \text{ m/s}^2$ ( $\pm 0.44\text{k}$ )	$\leq 0.82 \text{ m/s}^2$ ( $\pm 0.41\text{k}$ )
<b>Hand-Arm Vibration (ISO 5349-1) m/s<sup>2</sup></b>	$\leq 2.00 \text{ m/s}^2$ ( $\pm 1.00\text{k}$ )	$\leq 1.37 \text{ m/s}^2$ ( $\pm 0.69\text{k}$ )	$\leq 1.37 \text{ m/s}^2$ ( $\pm 0.69\text{k}$ )	$\leq 1.70 \text{ m/s}^2$ ( $\pm 0.85\text{k}$ )	$\leq 2.23 \text{ m/s}^2$ ( $\pm 1.12\text{k}$ )



# AL 500, AL 400 Series Dimensions

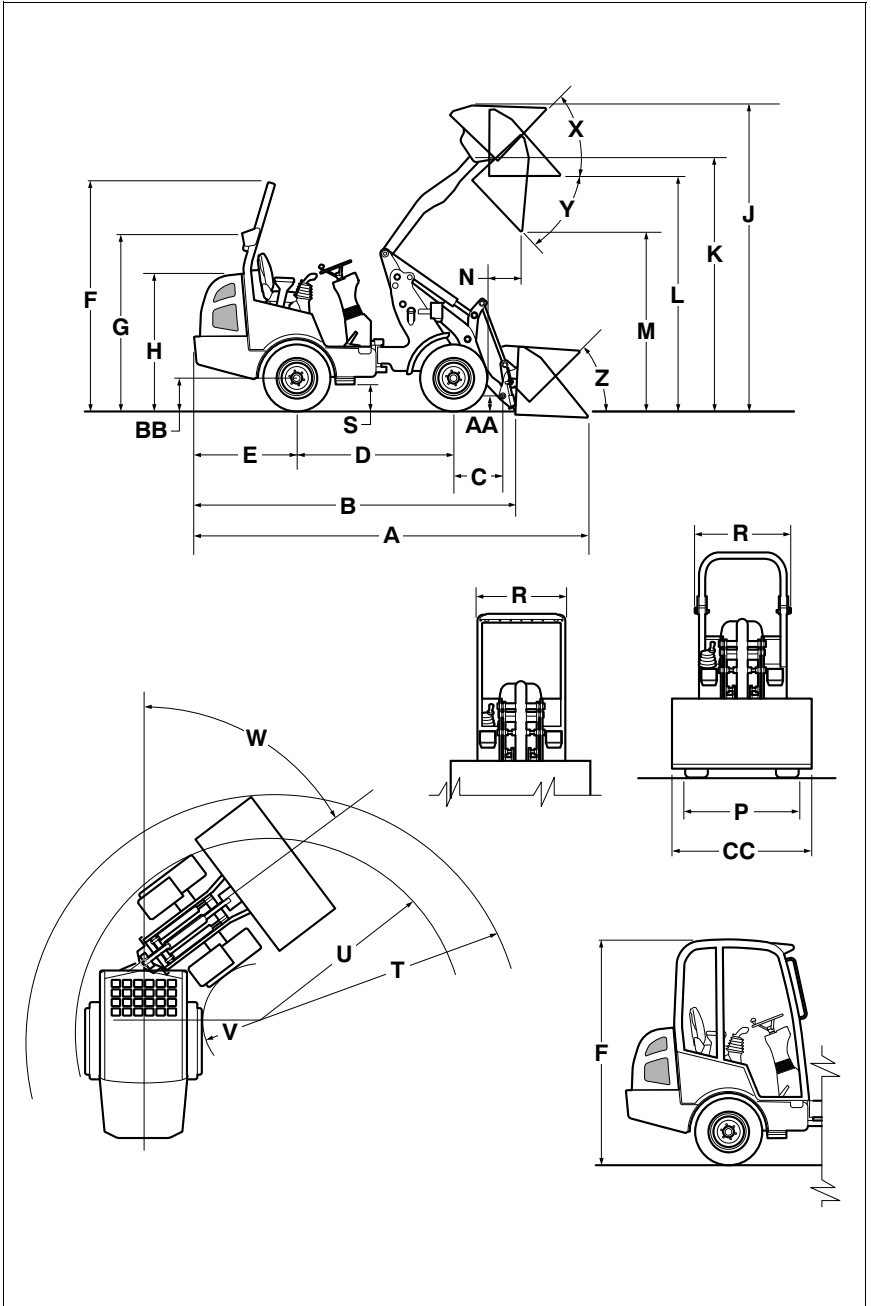


## AL 500, AL 400 Series Dimensions

Ref.	Description	Millimeters (Inches) unless otherwise noted			
		AL 500 Series		AL 400 Series	
		2-Post ROPS	4-Post ROPS/ Cab	2-Post ROPS	4-Post ROPS
A	Length with Bucket on Ground	4511 (177.6)		4224 (166.3)	
B	Shipping Length (without bucket)	3790 (149.2)		3550 (139.8)	
C	Front Wheel Center to Pivot Point	723 (28.5)		570 (22.4)	
D	Wheelbase	1741 (68.5)		1617 (63.7)	
E	Rear Overhang	1184 (46.6)			
F	Height to Top of ROPS/Cab	2473 (97.4)	2310 (90.9)	2473 (97.4)	2310 (90.9)
G	Folded 2-Post ROPS Height	1895 (74.6)	—	1895 (74.6)	—
H	Hood Height	1521 (59.9)			
J	Maximum Reach Height	3617 (142.4)		3550 (139.8)	
K	Bucket Hinge Pin Height	3055 (120.3)		3002 (118.2)	
L	Ground Plane to Bucket Edge Height	2860 (112.6)		2770 (109.1)	
M	Dump Clearance at Full Height	2300 (90.6)		2215 (87.2)	
N	Dump Reach at Full Height	445 (17.5)		267 (10.5)	
P	Width Over Tires <sup>1</sup>	1380 (54.3)		1195 (47.0)	
R	ROPS Width	985 (38.8)	1030 / 1081 (40.6) / (42.6)	985 (38.8)	1030 (40.6)
S	Ground Clearance	265 (10.4)		246 (9.7)	
T	Turning Radius w/ Bucket	3220 (126.8)		3123 (123.0)	
U	Outer Turning Radius	2750 (108.3)		2643 (104.1)	
V	Inner Turning Radius	1365 (53.7)			
W	Articulation Angle from Center	45°			
X	Rollback at Height	45°			
Y	Maximum Dump Angle at Full Height	47°		53°	
Z	Bucket Rollback at Ground	40°			
AA	Attachment Pivot Clearance	212 (8.3)		203 (8.0)	
BB	Wheel Radius	405 (15.9)		385 (15.2)	
CC	Bucket Width (standard)	1524 (60.0)			

1. AL 500 Series wide tire option shown

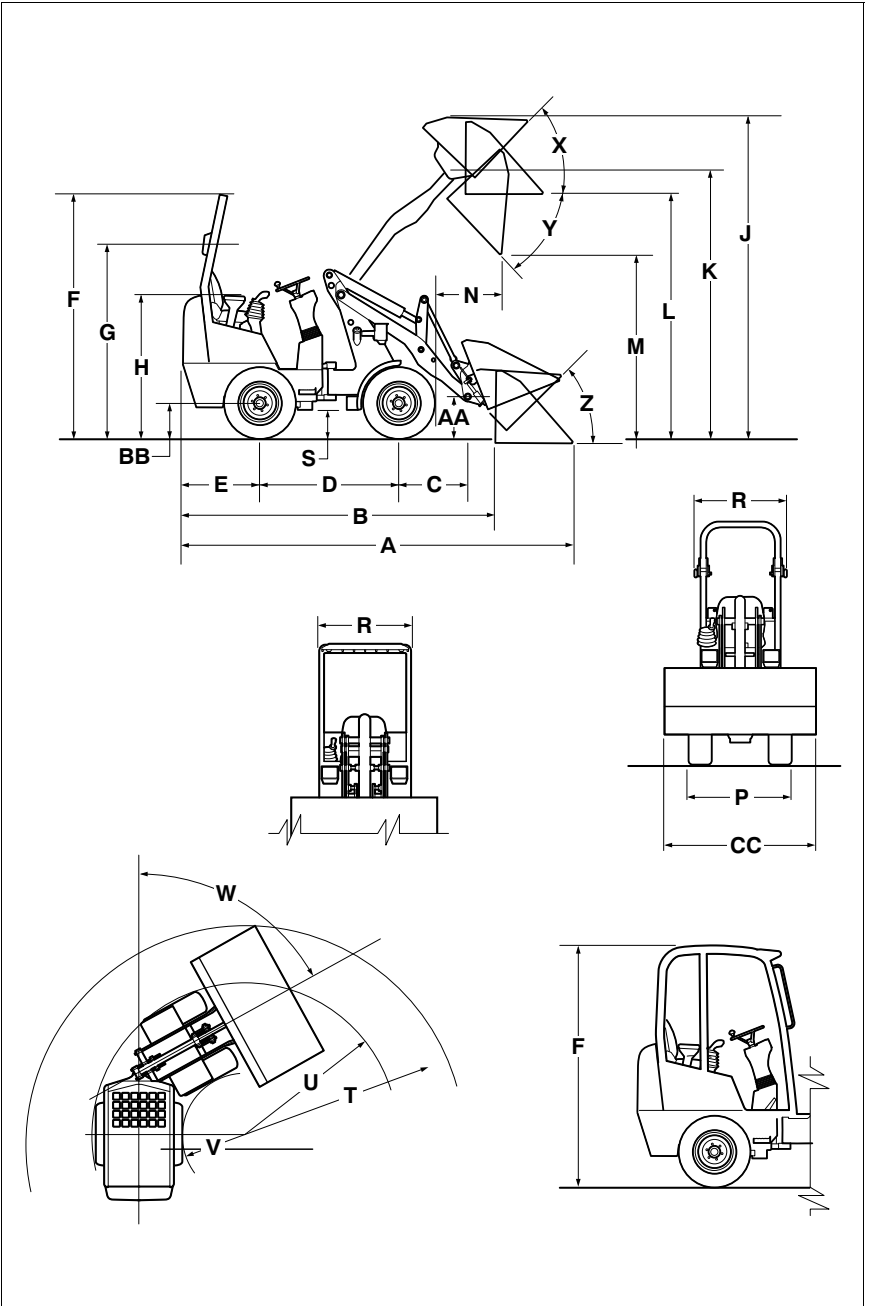
# AL 300, AL 200 Series Dimensions



## AL 300, AL 200 Series Dimensions

Ref.	Description	Millimeters (Inches) unless otherwise noted			
		AL 300 Series		AL 200 Series	
		2-Post ROPS	4-Post ROPS /Cab	2-Post ROPS	4-Post ROPS
A	Length with Bucket on Ground	4050 (159.4)		4040 (159.1)	
B	Shipping Length (without bucket)	3351 (131.9)			
C	Front Wheel Center to Pivot Pin	517 (20.4)			
D	Wheelbase	1627 (64.1)			
E	Rear Overhang	1065 (41.9)			
F	Height to Top of ROPS/Cab	2420 (95.3)	2257 (88.9)	2371 (93.3)	2212 (87.1)
G	Folded 2-Post ROPS Height	1842 (72.5)	—	1773 (69.9)	—
H	Hood Height	1468 (57.8)		1412 (55.6)	
J	Maximum Reach Height	3415 (134.4)		3255 (128.1)	
K	Bucket Hinge Pin Height	2855 (112.4)		2790 (109.9)	
L	Ground Plane to Bucket Edge Height	2650 (104.3)		2565 (101.0)	
M	Dump Clearance at Full Height	2143 (84.4)		2045 (80.5)	
N	Dump Reach at Full Height	312 (12.3)		135 (5.3)	
P	Width Over Tires	1280 (50.4)		1058 (41.7)	
R	ROPS Width	990 (39)	1030 / 1081 (40.6) / (42.6)	990 (39)	1030 (40.6)
S	Ground Clearance	244 (9.6)		235 (9.3)	
T	Turning Radius w/ Bucket	3000 (118.1)		2530 (99.6)	
U	Outer Turning Radius	2630 (103.2)		2120 (83.5)	
V	Inner Turning Radius	1321 (52.0)		1030 (40.6)	
W	Articulation Angle from Center	45°			
X	Rollback Angle at Height	39.7°		29°	
Y	Maximum Dump Angle at Full Height	43°		53°	
Z	Bucket Rollback Angle at Ground	37°			
AA	Attachment Pivot Clearance	215 (8.5)		157 (6.2)	
BB	Wheel Radius	383 (15.1)		340 (13.4)	
CC	Bucket Width (standard)	1372 (54.0)		1050 (41.3)	

# AL 100 Series Dimensions



## AL 100 Series Dimensions

Ref.	Description	Millimeters (Inches) unless otherwise noted	
		2-Post ROPS	4-Post ROPS
A	Length with Bucket on Ground	3419 (134.6)	
B	Shipping Length (without bucket)	2741 (107.9)	
C	Front Wheel Center to Pivot Pin	489 (19.3)	
D	Wheelbase	1348 (53.1)	
E	Rear Overhang	738 (29.1)	
F	Height to Top of ROPS/Cab	2340 (92.1)	2190 (86.2)
G	Folded 2-Post ROPS Height	1863 (73.3)	—
H	Hood Height	1359 (53.5)	
J	Maximum Reach Height	3277 (129.0)	
K	Bucket Hinge Pin Height	2705 (106.5)	
L	Ground Plane to Bucket Edge Height	2504 (98.6)	
M	Dump Clearance at Full Height	1969 (77.5)	
N	Dump Reach at Full Height	394 (15.5)	
P	Width Over Tires	1049 (41.3)	
R	ROPS Width	824 (32.4)	786 (30.9)
S	Ground Clearance	191 (7.5)	
T	Turning Radius w/ Bucket	2530 (99.6)	
U	Outer Turning Radius	2100 (82.7)	
V	Inner Turning Radius	1120 (44.1)	
W	Articulation Angle from Center	45°	
X	Rollback at Height	40°	
Y	Maximum Dump Angle at Full Height	45°	
Z	Bucket Rollback at Ground	40°	
AA	Attachment Pivot Clearance	197 (7.8)	
BB	Wheel Radius	324 (12.8)	
CC	Bucket Width (standard)	1118 (44.0)	

## Standard Features

<ul style="list-style-type: none"> <li>Fuel Level Gauge</li> </ul>	<ul style="list-style-type: none"> <li>Front Auxiliary Hydraulics with Flat-face Couplers</li> </ul>
<ul style="list-style-type: none"> <li>Hourmeter</li> </ul>	<ul style="list-style-type: none"> <li>Dual-Element Air Cleaner with Visual Indicator</li> </ul>
<ul style="list-style-type: none"> <li>Hydraulic Oil Filter Indicator Lamp (AL 500, AL 400 and AL 300 Series)</li> </ul>	<ul style="list-style-type: none"> <li>Pre-heat Starting Assist</li> </ul>
<ul style="list-style-type: none"> <li>High/Low Speed Ranges (AL 500, AL 400 and AL 300 Series)</li> </ul>	<ul style="list-style-type: none"> <li>Automotive-style Hydraulic Drive (All Models Except AL200 Series)</li> </ul>
<ul style="list-style-type: none"> <li>Voltmeter (AL 500, AL 400 and AL 300 Series; AL 100 (EU) and AL 200 Series Optional)</li> </ul>	<ul style="list-style-type: none"> <li>Battery Disconnect Switch (EU only)</li> </ul>
<ul style="list-style-type: none"> <li>Engine Oil Temperature Gauge (AL 500, AL 400 and AL 300 Series; AL 100 (EU) and AL 200 Series Optional)</li> </ul>	<ul style="list-style-type: none"> <li>Lockable Fuel Cap</li> </ul>
<ul style="list-style-type: none"> <li>Tachometer (AL 500, AL 400 and AL 300 Series; AL 100 (EU) and AL 200 Series Optional)</li> </ul>	<ul style="list-style-type: none"> <li>Lift and Tilt Cylinder w/Nitrosteel™ Cylinder Rods</li> </ul>
<ul style="list-style-type: none"> <li>Engine Oil Pressure Indicator Lamp (AL 500, AL 400 and AL 300 Series; AL 100 (EU) and AL 200 Series Optional)</li> </ul>	<ul style="list-style-type: none"> <li>Two-inch Wide Seat Belt</li> </ul>
<ul style="list-style-type: none"> <li>Interior Dome Light (Cab only)</li> </ul>	<ul style="list-style-type: none"> <li>Skid-Steer Loader Type Mechanical All-Tach® or Hydraulic Power-A-Tach® Quick-Attach System (4-Point Available EU Only)</li> </ul>
<ul style="list-style-type: none"> <li>Lockable Engine Cover</li> </ul>	<ul style="list-style-type: none"> <li>Heavy-Duty Axles with Differential Lock (AL 500, AL 400 and AL 300 Series)</li> </ul>
<ul style="list-style-type: none"> <li>Five-way Adjustable Seat</li> </ul>	<ul style="list-style-type: none"> <li>Limited-Slip Differential Axles (AL 100 and AL 200 Series)</li> </ul>
<ul style="list-style-type: none"> <li>Up and Down Attachment Self-leveling (Limited Self-leveling on AL500 Series)</li> </ul>	<ul style="list-style-type: none"> <li>Remote Battery Terminal (EU Only)</li> </ul>
<ul style="list-style-type: none"> <li>Front/Rear Tie-Downs</li> </ul>	<ul style="list-style-type: none"> <li>Hand and Foot Throttle (Hand Throttle AL 500, AL 400 and AL 300 Series)</li> </ul>
<ul style="list-style-type: none"> <li>Steering / Frame Transport Lock</li> </ul>	<ul style="list-style-type: none"> <li>Operator Presence Seat Switch</li> </ul>
<ul style="list-style-type: none"> <li>Braking / Inching Pedal</li> </ul>	<ul style="list-style-type: none"> <li>Tiltable Seat Deck for Service</li> </ul>
<ul style="list-style-type: none"> <li>Multi-Function Joystick</li> </ul>	<ul style="list-style-type: none"> <li>2-Post ROPS, or 4-Post ROPS/FOPS or Cab Level 1 (Cab AL 500 and AL 300 Series)</li> </ul>
<ul style="list-style-type: none"> <li>Horn</li> </ul>	

## Optional Features

<ul style="list-style-type: none"><li>• Three-inch Wide Seat Belt (Where Required by State Law)</li></ul>	<ul style="list-style-type: none"><li>• Backup Alarm</li></ul>
<ul style="list-style-type: none"><li>• Battery Disconnect Switch Kit</li></ul>	<ul style="list-style-type: none"><li>• Strobe Light Kit</li></ul>
<ul style="list-style-type: none"><li>• Engine Block Heater</li></ul>	<ul style="list-style-type: none"><li>• Road Lights (Standard with Cab)</li></ul>
<ul style="list-style-type: none"><li>• Radio (AL 500 and AL 300 Series; 4-Post ROPS and Cab only)</li></ul>	<ul style="list-style-type: none"><li>• Rear View Mirror Kit (4-Post ROPS and Cab only; Mirror Kit Included with Cab)</li></ul>
<ul style="list-style-type: none"><li>• Counterweight (AL 500 Series standard; AL 400 and AL 300 Series optional; AL100 and AL200 Series not available)</li></ul>	



## Common Materials and Densities


Material	Density	
	lbs./ft. <sup>3</sup>	kg/m <sup>3</sup>
Ashes	35-50	560-800
Brick-common	112	1792
Cement	110	1760
Charcoal	23	368
Clay, wet-dry	80-100	1280-1600
Coal	53-63	848-1008
Concrete	115	1840
Cinders	50	800
Coal-anthracite	94	1504
Coke	30	480
Earth-dry loam	70-90	1121-1442
Earth-wet loam	80-100	1281-1602
Granite	93-111	1488-1776
Gravel-dry	100	1602
Gravel-wet	120	1922
Gypsum-crushed	115	1840
Iron ore	145	2320
Lime	60	960
Lime stone	90	1440
Manure-liquid	65	1040
Manure-solid	45	720
Peat-solid	47	752
Phosphate-granular	90	1440
Potash	68	1088
Quartz-granular	110	1760
Salt-dry	100	1602
Salt-rock-solid	135	2160
Sand-dry	108	1728
Sand-wet	125	2000
Sand-foundry	95	1520
Shale-crushed	90	1440
Slag-crushed	70	1120
Snow	15-50	240-800
Taconite	107	1712

*Note: The densities listed are average values and intended only as a guide for bucket selection. For a material that is not in the table, obtain its density value before selecting the appropriate bucket.*



# CHAPTER 4

## OPERATION

 **WARNING** Read and understand this entire manual. Follow warnings and instructions for operation and maintenance. Failure to follow instructions can result in injury or death. Read and understand all safety and instructional decals before operation.

Do not operate the machine unless all guards and shields are in place. Know how to stop the machine before starting.

Use only approved accessories and attachments. Contact the Manitou Americas Service Department for information about approved attachments. Use of non-approved attachments or unauthorized modifications is prohibited.

Check for correct function after adjustments or maintenance.

If any warning indicators illuminate when the engine is running, turn off the engine immediately. Correct the problem before re-starting the engine.

Never adjust the operator's seat or the steering column when the engine is running.

If the machine is equipped with a folding 2-post ROPS, only fold the ROPS temporarily if necessary during transport or for operation inside structures with low overhead doors or clearances.

Always operate the machine with the seat belt fastened. Repair or replace any damaged seat belt and buckle parts before operation.

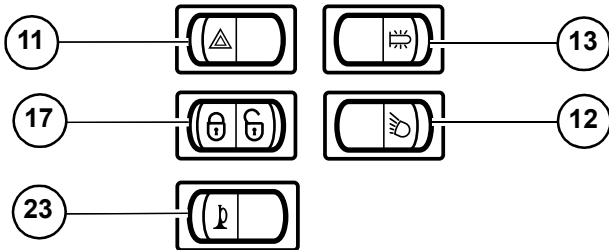
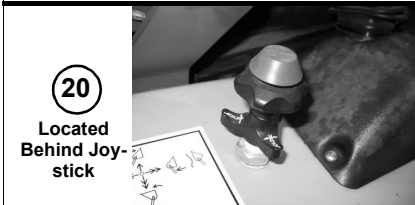
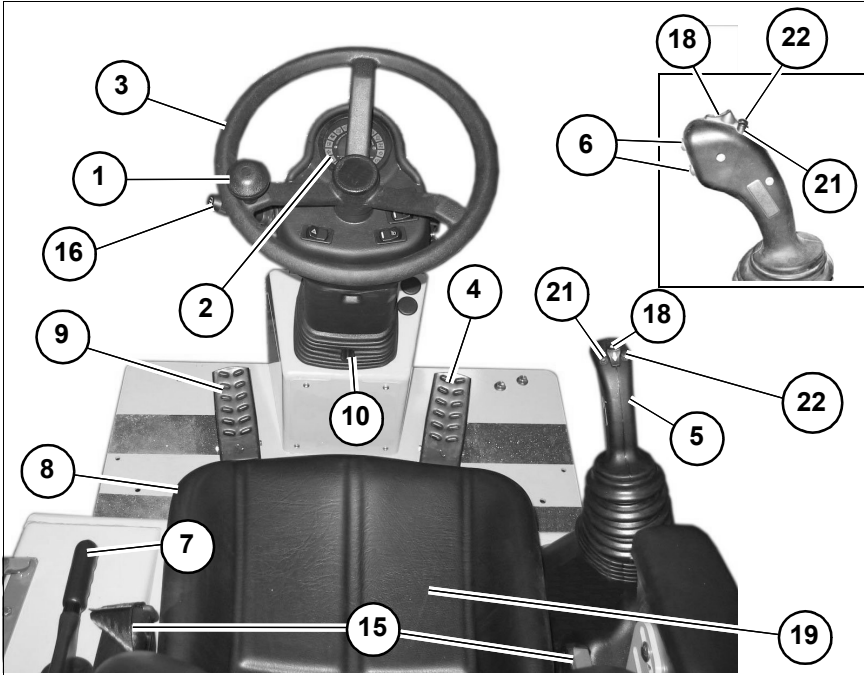
Position the load as low as possible while traveling. Never make turns with the load raised higher than the axles or tipping could occur, which could result in severe injury or death.

If the machine becomes unstable and starts to tip, keep the seat belt fastened, hold on firmly and brace yourself. Lean away from the point of impact and stay with the machine. If tipping occurs, **DO NOT** jump from the machine. The machine is equipped with rollover protection, which only protects the operator while in the operator's seat. Trying to escape from a tipping machine can result in death or serious personal injury.

Travel cautiously, under complete control at all times. Avoid sudden changes of direction while traveling.

# Operating Controls

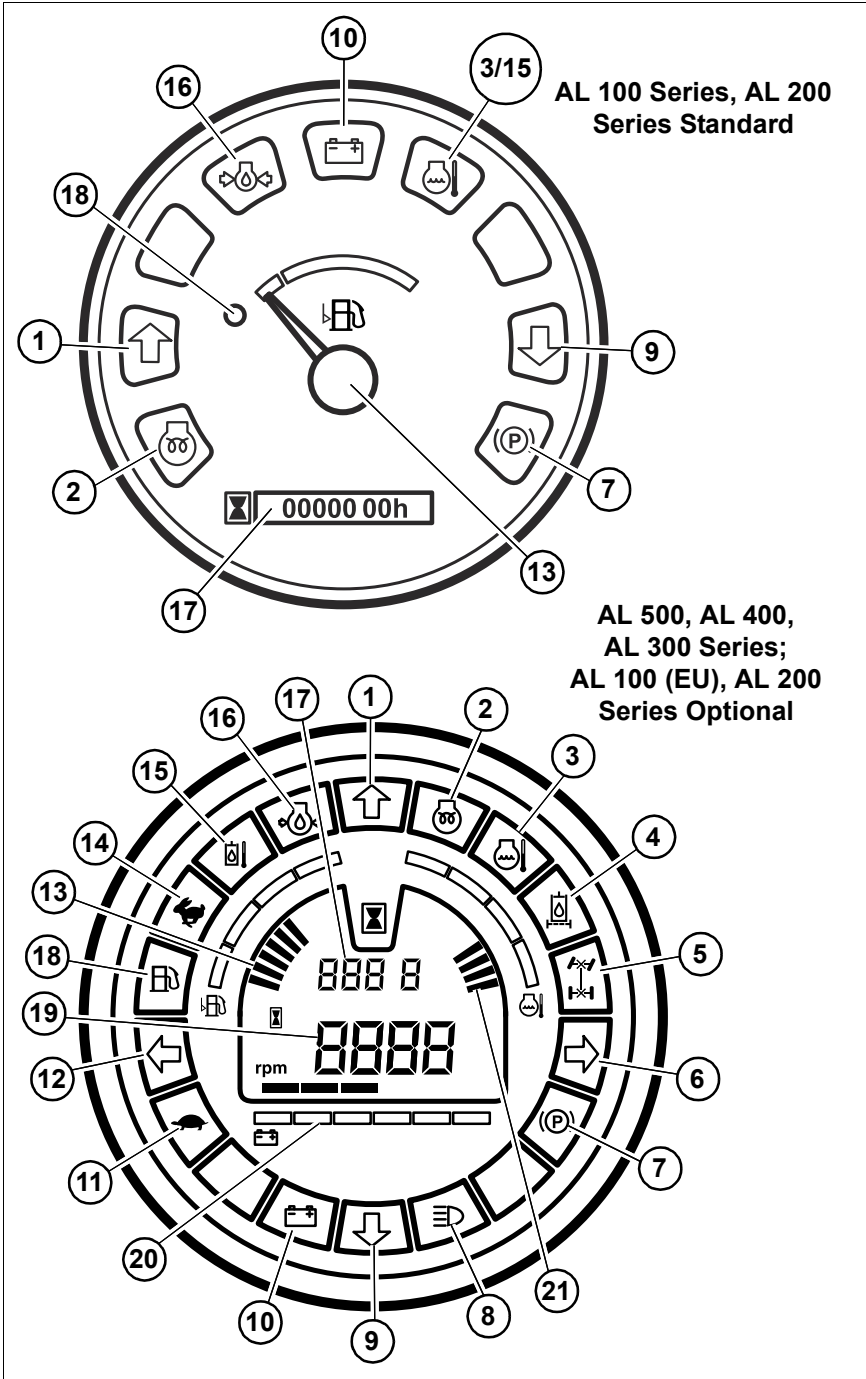
## Controls and Switches



**Note:** Controls 11, 12, 13 and 17 are located on the steering column, below instrument panel 2.

No.	Item	Description
1	Steering knob	Use to turn steering wheel.
2	Instrument panel	Contains warning indicators, operation indicators, and gauges (page 54).
3	Steering wheel	Turn to control travel direction.
4	Accelerator pedal	Press to control engine/travel speed.
5	Multi-purpose joystick	Use to control lift arm/attachment maneuvering and loader drive direction (page 78).
6	Auxiliary hydraulics control buttons	Use to activate auxiliary hydraulics control circuit (page 92).
7	Parking brake lever	Use to engage parking brake (page 67).
8	Operator's seat	Adjust operator's seat position (page 59).
9	Brake/inch pedal	Press to control gradual travel and braking (page 74).
10	Steering column tilt	Use to adjust steering column tilt (page 60). <b>AL 300, AL 400, AL 500; AL 100 (EU), AL 200 optional.</b>
11	Hazard light switch	Press to activate hazard lights. <b>AL 300, AL 400, AL 500; AL 100 (EU), AL 200 optional.</b>
12	Work light switch	Press switch to ON position to activate work lights.
13	Rotating beacon switch (option)	Press switch to ON position to activate optional rotating beacon.
14	Battery disconnect switch (option)	Use switch to connect/disconnect the battery and electrical circuit (page 67). <b>EU models only.</b>
15	Seat belt	Always fasten seat belt before operating loader (page 12).
16	Control lever	Controls road lights, directional indicators and horn (page 61). <b>AL 300, AL 400, AL 500; AL 100 (EU), AL 200 optional.</b>
17	Power-A-Tach® system lock/unlock (option)	Use to lock/unlock attachment.
18	Drive direction switch	Use to control forward/reverse drive direction (page 74).
19	Seat plate	Seat plate according to ISO 7096 (located on seat).
20	Hand throttle	Controls engine speed independently from the accelerator pedal. Does not control travel speed (page 61). <b>AL 300, AL 400, AL 500.</b>
21	Slow/fast speed toggle switch	Toggles between slow/fast travel speed modes. Indicators 11 and 14 (page 54) illuminate to show selection (page 76). <b>AL 300, AL 400, AL 500</b>
22	Differential lock switch	Engages differential lock when depressed. Indicator lamp 5 (page 54) illuminates when the differential lock is engaged (page 76). <b>AL 300, AL 400, AL 500</b>
23	Horn	Press to activate horn. <b>AL 100 Series only; horn button located on "16 – Control Lever" on other models.</b>

# Instrument Panel and Indicators



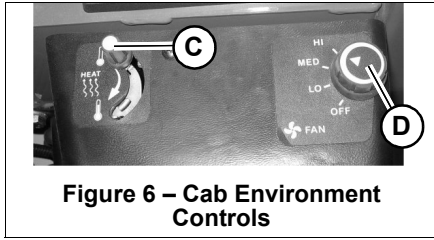
No.	Indicator	Description
1	Forward travel	Drive direction thumb switch on joystick is in forward position (page 68) – the machine will move forward when the travel pedal is pressed when this lamp is lit.
2	Pre-heat	Illuminates when the ignition key is in the “I” (Run) position, goes out when engine pre-heat is complete (page 68).
3	Coolant temperature warning	See page 58.
4	Hydraulic oil filter	See page 58. <b>AL 300, AL 400, AL 500; AL 200 optional.</b>
5	Differential lock	Differential lock engaged (page 76). <b>AL 300, AL 400, AL 500.</b>
6	Right turn/hazard lights	Right turn signal engaged (page 74). Hazard lights (page 52). <b>AL 300, AL 400, AL 500; AL 100 (EU), AL 200 optional.</b>
7	Parking brake	Parking brake engaged (page 67).
8	Road lights	Road lights upper beam engaged (page 52, page 61). <b>AL 300, AL 400, AL 500; AL 100 (EU), AL 200 optional.</b>
9	Rearward travel	Drive direction thumb switch on joystick is in Reverse position (page 67)– the machine will move rearward when the travel pedal is pressed when this lamp is lit.
10	Alternator	Alternator not charging.
11	Slow speed	Low speed drive engaged. See item 22 on page 52. <b>AL 300, AL 400, AL 500.</b>
12	Left turn/hazard lights	Left turn signal engaged (page 74). Hazard lights (page 52). <b>AL 300, AL 400, AL 500; AL 100 (EU), AL 200 optional.</b>
13	Fuel level	Displays the amount of fuel in the tank.
14	Fast speed	High speed drive engaged. See item 22 on page 52. <b>AL 300, AL 400, AL 500; AL 100 (EU), AL 200 optional.</b>
15	Hydraulic oil temperature	See page 58.
16	Engine oil pressure	Engine oil pressure too low.
17	Hour meter	Displays hours of operation.
18	Low fuel	Fuel level too low.
19	Engine rpm	Displays engine rpm. <b>AL 300, AL 400, AL 500; AL 100 (EU), AL 200 optional.</b>
20	Volt meter	Displays system voltage level. Start-up - 3 bars illuminate, if battery is fully charged. During operation - 4-5 bars illuminate. Alternator overheat - 6 bars illuminate, see page 58. <b>AL 300, AL 400, AL 500; AL 100 (EU), AL 200 optional.</b>
21	Engine oil temperature	Displays temperature level. <b>AL 300, AL 400, AL 500; AL 200 optional.</b>

## Cab Controls (Cab only)

### Cab Environment Controls

To operate the cab heater and air circulation fan:

1. Move lever (C, Fig. 6) rearward to increase heat; forward to reduce heat.
2. Turn the fan control (D, Fig. 6) clockwise to increase circulation fan speed; counter-clockwise to decrease circulation fan speed.

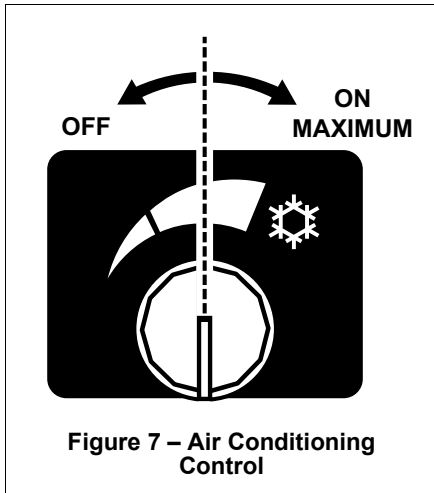


### Air Conditioning Control (option)

Optional air conditioning is controlled by a knob located on the windshield wiper control panel. To operate the air conditioning system:

1. Rotate the air conditioning control knob clockwise to turn on the air conditioning system. The knob has three positions, from off at the “0” position, to full speed at the “3” position.
2. Rotate the air conditioning control knob counterclockwise to the “0” position to turn off the air conditioning system.

**Important:** Do not operate the air conditioning and the cab heater at the same time. Doing so will exceed the capacity of the electrical system and discharge the battery.



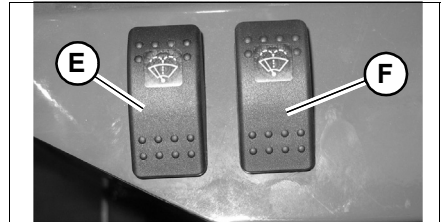


## **Cab Windshield Wiper Controls**

Press the icon side of the wiper switches to the first detent to activate the wiper blades. Press the icon side of the switches past the detent to activate the washer fluid.

**E:** Activates the front wiper and washer.

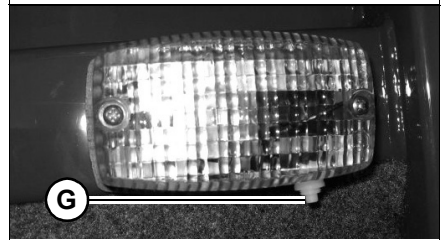
**F:** Activates the rear wiper and washer.



**Figure 8 – Cab Wiper/Windshield Washer Controls**

## **Cab Dome Light**

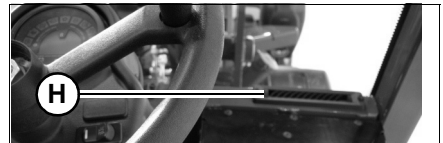
The dome light is located on the cab ceiling. Push button (G, Fig. 9) to turn the light on/off.



**Figure 9 – Cab Dome Light**

## **Cab Defrost**

Turn the vents (H, Fig. 10), located on the left and right sides of the cab, toward the window to defrost the window.



**Figure 10 – Vent**

## Warning Indicators

**Important:** If any of the following indicators illuminate when the engine is running, turn off the engine immediately. Correct the problem before re-starting the engine. During normal operation these indicators should be OFF.

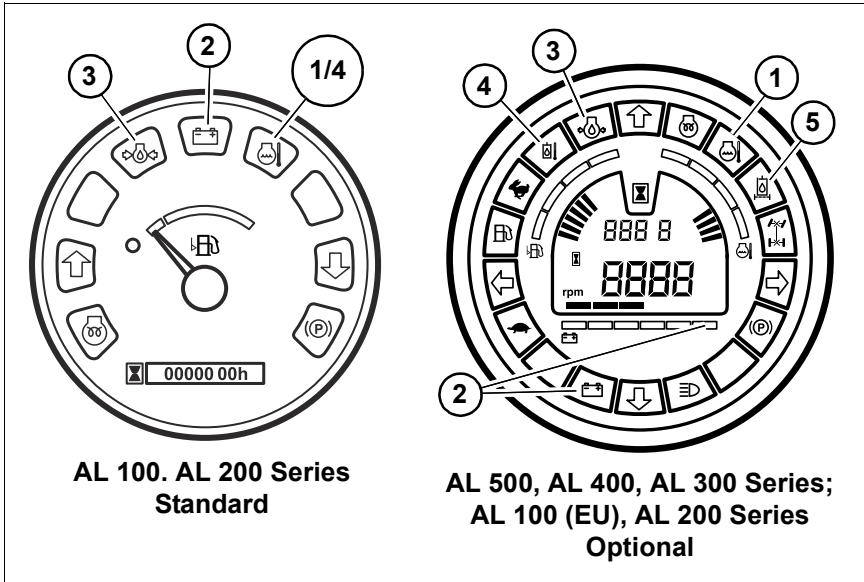


Figure 11 – Warning Indicators

No.	Indicator	Description
1	Engine coolant temperature warning	Temperature is too hot.
2	Volt meter	Alternator overheat (when bezel icon and 6 bars are lit).
3	Engine oil pressure	Pressure is too low.
4	Hydraulic oil temperature	Temperature is too hot.
5	Hydraulic oil filter	Hydraulic oil filter service required. <b>AL 300, AL 400, AL 500.</b>

## Operator's Seat Adjustment

**⚠ WARNING** Never adjust the operator's seat when the engine is running.

Adjust the operator's seat so all controls are easy to reach and the pedals can be completely depressed with your back against the seat back.

- A. **Forward/rearward adjustment:** Pull the lever up, adjust the seat and release the lever. Check that the seat is locked in place.
- B. **Weight adjustment:** While sitting in the seat, rotate the knob until the desired tension is reached.
- C. **Recline adjustment:** Pull the front lever up, recline the seat back as desired and release the lever. Check that the seat is locked in place.
- D. **Height adjustment (AL 400/500 Series):** Rotate knob until the desired seat height is reached.
- E. **Seat Belt:** See the following section.
- F. **Seat tension indicator (AL 100/200/300 Series):** Adjust weight adjustment knob (B) until seat tension indicator is centered.

### AL 500, AL 400 Series



### AL 100, AL 200, AL 300 Series



- A. Forward/rearward lever
- B. Weight adjustment knob
- C. Recline lever
- D. Height adjustment knob
- E. Seat belt
- F. Seat tension indicator

**Figure 12 – Operator's Seat Adjustment**

## Seat Belt

**⚠ WARNING** Always fasten the seat belt securely and properly. Never operate the machine without the seat belt fastened around the operator.

**Important:** Inspect the seat belt for damage before use. Replace if damaged.

Keep the seat belt (E, Fig. 12) clean. Use only soap and water to wash seat belt. Cleaning solvents can damage seat belt.

## Ignition Key Switch

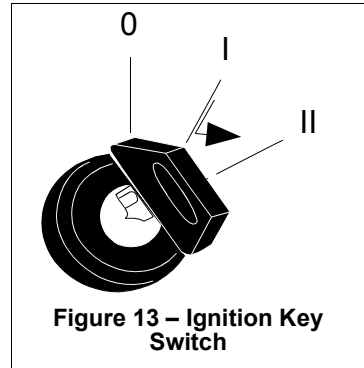
**“0” position:** All power off. Key can be inserted/removed.

**“I” position:** Run position.

**“II” position:** Start position. Holding the switch in this position starts the engine. See “Engine Start” on page 67.

**Note:** Switch must be returned to “0” position between starting attempts to reset the start safety interlock.

**Important:** The drive direction switch on the joystick must be in the neutral position and the operator’s seat must be occupied and/or the parking brake must be applied before the engine will start.



## Steering Column Adjustment

(AL 300, AL 400, AL 500 Series; AL100 (EU), AL 200 Series Optional)

**⚠ WARNING** Never adjust the steering column when the engine is running.

Adjust the steering column for visibility, utility and comfort.

1. Push the adjustment lever (J, Fig. 14) downward.
2. Adjust the steering column to the desired position.
3. Release the adjustment lever.
4. Check that the steering column is locked in place.

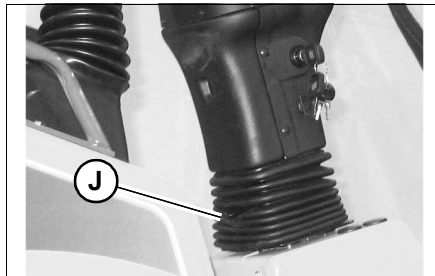


Figure 14 – Steering Column Adjustment

## Control Lever

(AL 300, AL 400, AL 500 Series; AL 100 (EU), AL 200 Series Optional)

The control lever on the steering column controls the following functions:

1. Push the control lever in to activate the horn (K, Fig. 15).
2. Twist the end of the control lever to activate the position lights (L).
3. Push the control lever forward or rearward to activate the turn signals (M).
4. Push the control lever downward to activate the road light “high” beams.
5. Pull the control lever upward to activate the road light “low” beams.

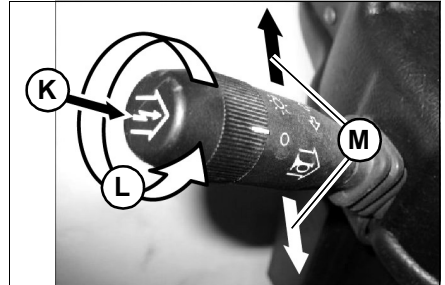


Figure 15 – Control Lever

## Hand Throttle

(AL 300, AL 400, AL 500 Series)

The hand throttle, located to the right of the operator’s seat, controls engine speed independently from the accelerator pedal. The hand throttle does not control travel speed.

1. Loosen the throttle lock ring (N, Fig. 16).
2. Press the red throttle release button (P).
3. Pull/push the throttle control knob (R) and the throttle release button as a unit.

*Note: The throttle can be quickly placed into the idle position by firmly pushing against the throttle release button. For normal operation, move the throttle release button (P) and the throttle control knob (R) as a unit to prevent undue wear on the throttle mechanism.*

4. For fine adjustments, rotate the throttle control knob (R).
5. Tighten the throttle lock ring (N) to lock the throttle in position.

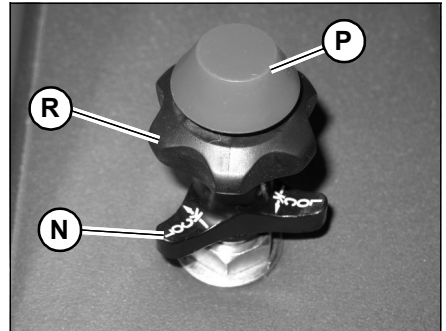
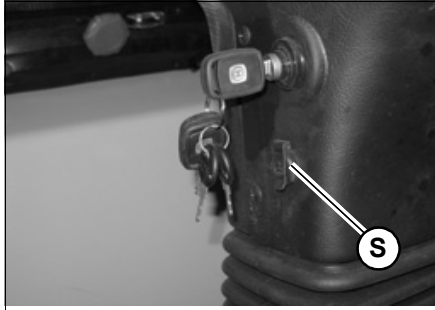


Figure 16 – Hand Throttle

## 12V Accessory Power Outlet

Use the 12V accessory power outlet (*S*, *Fig. 17*), on the steering column. See “Battery” on page 141 for fuse and amperage information.



**Figure 17 – Electric Socket**

# Operation

---

## Pre-Operation Checklist

Check the following before starting the machine (for all fluid level checks, fill if required):

- Fuel, hydraulic, radiator, and engine oil caps for tightness.
- Fluid leaks: fuel, hydraulic oil, engine oil, coolant, etc.
- Radiator coolant level. See “Fluid Capacities/Lubricants” on page 31 for proper mixture.
- Engine coolant level and system for leaks.
- Hydraulic system for leaks.
- Fuel level. See “Fuel System” on page 116.
- Engine oil level. See “Checking Engine Oil Level” on page 109.
- Hydraulic fluid level. See “Checking Hydraulic Oil Level” on page 122.
- Engine cover latch securely fastened.
- Clean engine area of flammable materials.
- Engine fan and accessory belts.
- Air cleaner (air filter restriction indicator). See “Air Cleaner” on page 112.
- Intake hoses.
- Hydraulic hose condition.
- Brake fluid level.
- Tire condition and pressure.
- Condition of any attachments to be used.
- Lift arm and cylinder condition (look for bends/cracks/etc.).
- Frame condition (look for bends/cracks/etc.).
- Cab / ROPS (Rollover Protective Structure).
- FOPS (Falling Object Protective Structure).
- Guards.
- Safety decals (replace as required).
- Safety warnings (securely attached and readable).
- Seat belt (check for proper function/binding) and mounting hardware.
- Horn
- Lights.
- Pivot points for proper operation.
- Broken and/or loose parts (repair as required).

## Extend the ROPS

**⚠ WARNING** If the machine is equipped with a folding 2-Post ROPS, only fold the ROPS temporarily if necessary during transport or if necessary for use inside structures with low overhead doors or clearances. Operating with the ROPS folded back increases the risk of injury or death if a roll-over would occur.

Secure the ROPS into the transport position:

1. Remove the spring pins (both sides) (*T*, *Fig. 18*).
2. Remove the clevis pins (both sides) (*U*, *Fig. 18*).
3. Fold the ROPS rearward.

**⚠ WARNING** Do not allow the ROPS to fall rearward, or damage to the engine cover or injury to nearby persons may occur. Stay clear from underneath the ROPS as it is folded.

4. Insert the clevis pins (both sides) into transport lock position (*V*, *Fig. 19*).
5. Insert the spring pins (both sides) to secure the clevis pins (both sides).

## Restore the ROPS to the raised position

1. Remove the cotter pins (*T*, *Fig. 18*) (both sides) from the clevis pins (both sides) (*U*, *Fig. 18*).
2. Remove the clevis pins (both sides) (*U*).
3. Fold the ROPS upward and forward.
4. Insert the clevis pins (both sides) (*U*).
5. Insert the cotter pins (both sides) (*T*).

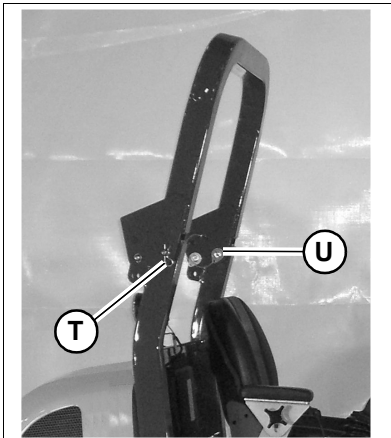


Figure 18 – ROPS Fully Raised

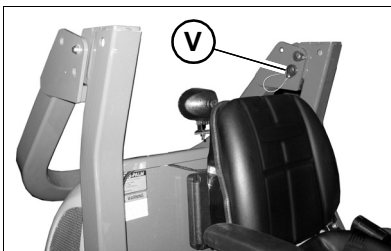


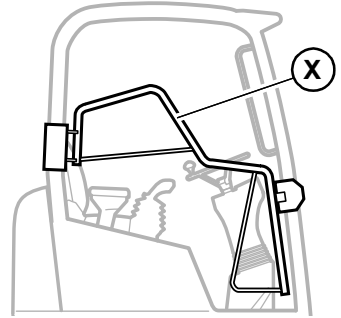
Figure 19 – ROPS Transport Position



## 4-Post ROPS Side Gates (Option)

Optional side gates for the 4-Post ROPS provide the operator additional protection.

### 100 Series



### 200/300/400/500 Series

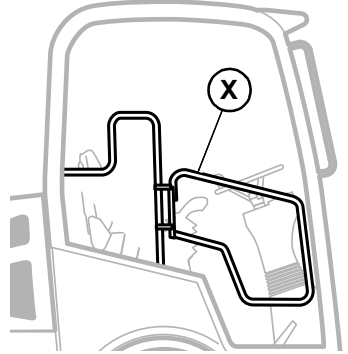


Figure 20 – 4-Post ROPS Side Gates

To open the side gates, lift latch (Y). When closing, pull side gates in until they latch securely.

### 100 Series



### 200/300/400/500 Series

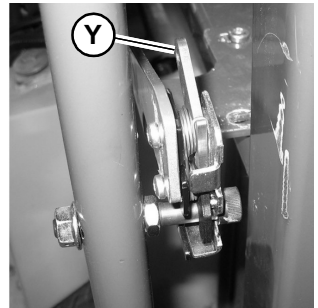


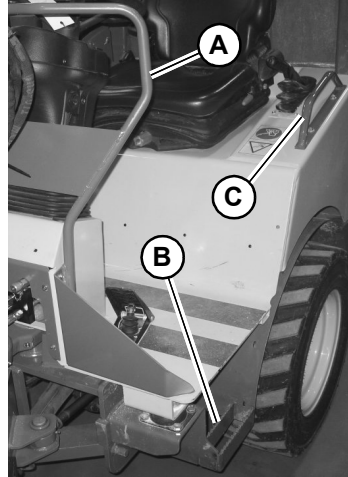
Figure 21 – 4-Post ROPS Side Gates Latches

## Entering and Exiting

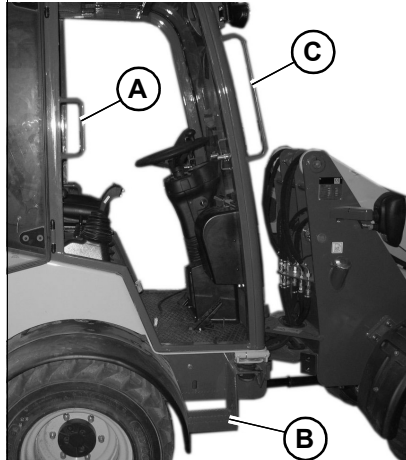
**WARNING** Maintain three-point contact and face the machine at all times when entering and exiting. Do not use the steering wheel for entry or exit. Never jump from the machine. Never enter or exit a moving machine. Failure to maintain three-point contact may result in injury.

**NOTE:** Photos may not exactly match all machines

### 2-Post ROPS



### 4-Post ROPS/Cab



- A. Left hand hold
- B. Step for right foot
- C. Right hand hold

**Figure 22 – Three-Point Mount/Dismount**

## Engine Start

**Important:** The machine cannot be tow-started because there is no direct mechanical connection between the wheels and the engine. Attempting to tow-start the machine can damage the drive system.

**WARNING** Always fasten the seat belt before operating the machine. Repair or replace any damaged seat belt and lock parts before operation.

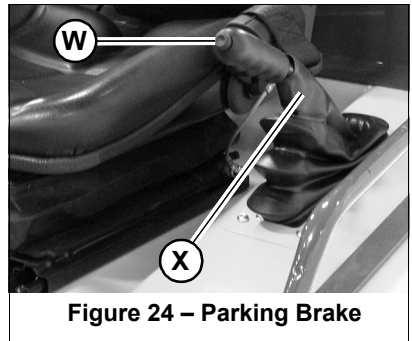
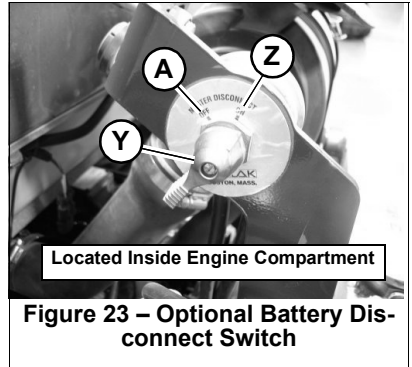
**CAUTION** Do not use starting fluid (ether) with preheat systems. An explosion can result, which can cause engine damage, injury or death.

1. If the machine is equipped with the optional battery disconnect switch (Y, Fig. 23), check that switch (Y) is turned clockwise to the notched position “ON” position (Z).

**Note:** To disconnect battery and lock out all electrical functions, turn switch (Y) counter-clockwise to the “OFF” (A) position.

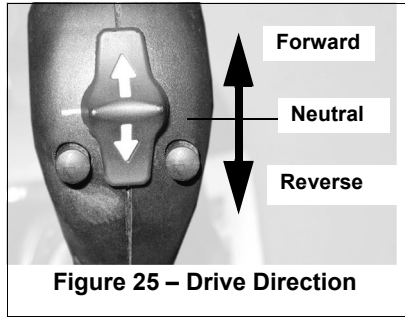
2. Adjust the operator’s seat (see “Operator’s Seat Adjustment” on page 59) and fasten the seat belt.
3. Adjust the steering column (see “Steering Column Adjustment” on page 60).
4. Engage the parking brake (W, Fig. 24), lift the lever (X) into the upright position as shown.

**Note:** When the parking brake is engaged, travel drive is disconnected.



**VERY IMPORTANT!** On AL 300 Series machines, the parking brake must be engaged before starting a cold engine, and the brake must be left engaged for three minutes after starting, or damage to the hydraulic pump may result.

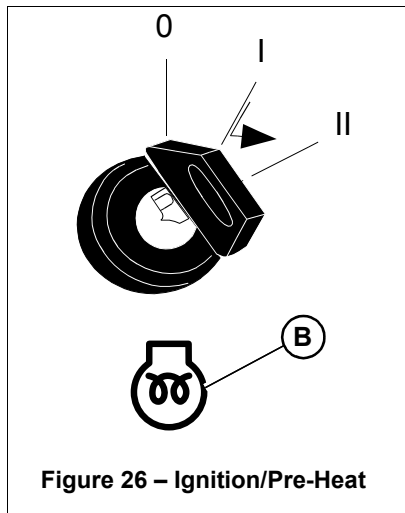
- Place forward/reverse drive switch (Fig. 25) on the top of the joystick into the neutral position.



- Turn the ignition key to the “I” (Run) position (Fig. 26).
- When the pre-heat indicator light (B, Fig. 26) goes off, turn the ignition key to the “II” (Start) position. Release the key when the engine starts.
- If the engine does not start after 15 seconds, turn the key back to the “0” (off) position, wait one minute and repeat steps 6-7. If the engine does not start after several attempts, see “Troubleshooting” on page 153.

*Note:* Return switch to the “0” position between starting attempts.

- Immediately after starting the engine, all warning indicator lamps should go off (see “Warning Indicators” on page 58).
- Proceed to “Warm-up” on page 69.



## Engine Shut Down

1. Perform the “Mandatory Safety Shutdown Procedure” on page 10.
2. Perform a visual inspection:
  - Hydraulic system leaks?
  - Coolant system leaks?
  - Fuel system leaks?
  - Damage to machine (tires, attachment hitch, attachment, etc.)?
3. Completely fill the fuel tank.

## Warm-up

**VERY IMPORTANT!** On AL 300 Series machines, the parking brake must be left engaged for three minutes after starting a cold engine, or damage to the hydraulic pump may result.

*Note: The operator may leave the operator’s seat while warming a cold engine. Apply the parking brake before leaving the operator’s position; the engine will stop if the operator’s seat is not occupied and the parking brake is not applied.*

**Important:** Do not run a cold engine under load; engine life may be shortened.

1. Run the engine at a low, consistent speed for a few minutes before operating any controls. Check for any unusual sounds and vibrations.
2. Check if any indicators illuminate (see “Warning Indicators” on page 58).

**Important:** If unusual sounds or vibrations occur, or if any warning indicators illuminate, stop the engine immediately and determine the cause. Repair or replace parts as necessary before re-starting the engine.

3. Exhaust gas color should be light blue or colorless.

*Note: Black exhaust indicates possible engine malfunction. See “Engine Troubleshooting” on page 153.*

**Important:** Do not run a malfunctioning engine under load; engine life may be shortened.

4. During warm-up, test the following for proper function:
  - Brake/Inch pedal. See “Controls and Switches” on page 52. See “Travel” on page 74.
  - Steering. See “Controls and Switches” on page 52.
  - Accelerator pedal. See “Controls and Switches” on page 52.
  - Multi-purpose joystick. See “Multi-purpose Joystick” on page 78.
  - Forward/reverse drive switch on multi-purpose joystick. See “Travel” on page 74.

## New Machines

1. After starting the engine for the first time, let the engine idle for 15 minutes.
2. After 15 minutes, perform the “Mandatory Safety Shutdown Procedure” on page 10.
3. Check for proper engine oil pressure, engine oil level, diesel fuel leaks, engine oil leaks, coolant leaks, and indicator/gauge operation.
4. During the first hour of operation, vary the engine speed and the load, with short periods of maximum load and engine speed operation.
5. During the first four to five hours of operation, avoid long periods of minimum or maximum load and engine speed operation.
6. During the first 50 hours of operation, check the engine oil pressure and engine temperature frequently.
7. After the first 50 hours of operation, replace engine oil and engine oil filter, and check and adjust cooling fan v-belt. See “Changing Engine Oil and Filter” on page 110, and see “Checking and Adjusting V-belt Tension” on page 119
8. Check the engine oil and coolant levels frequently and refill as necessary. See “Checking Engine Oil Level” on page 109, and “Checking Coolant Level” on page 114.

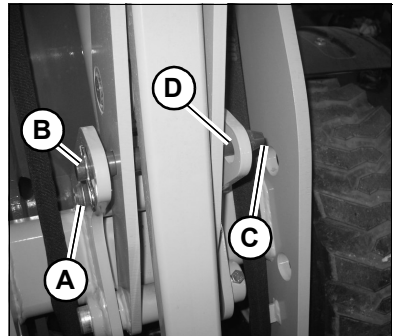
## Driving on Public Roads

Follow the applicable legal regulations of the country where the machine is being used. Regulations are specified in the operation license or in the vehicle papers.

**Important:** *Only the attachments listed in the operation license or vehicle papers are admissible for driving on public roads.*

1. Follow mandatory accident prevention regulations. Complete a functional check of:
  - Brakes
  - Steering
  - Lights
2. Empty the bucket (if applicable).
3. On AL 100 Series machines:
  - a. Lower the lift arm all the way and tilt the attachment hitch back until holes (C, Fig. 30) in the lift arm align with holes (D) in the tilt pivot arm.

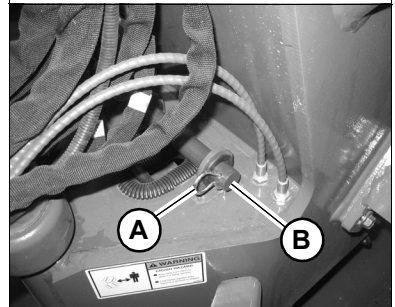
- b. Perform the “Mandatory Safety Shutdown Procedure” on page 10.
- c. Remove a spring pin (A, Fig. 30) from the end of the lift arm lock bar (B). Remove lift arm lock bar (B) from the storage bracket.
- d. Slide the lock bar (B) all the way through holes (C, Fig. 30) in the lift arm and holes (D) in the tilt pivot arm.



**Figure 27 – 100 Series Lift Arm Tilt Lock**

- e. Replace the spring pin (A) into the end of the lock bar (B).

**Important:** Lock bar (B) must pass all the way through holes (C) in the lift arm and holes (D) in the tilt pivot arm, with spring pins (A) installed in lock bar (B) on outsides of the lift arm.

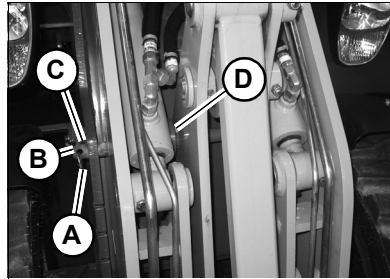


**Figure 28 – AL 100 Series Lift Arm Lock Bar Storage**

4. On AL 200 and AL 300 Series machines:
  - a. If necessary, raise the lift arm to allow for down-stop lock bar (A, Fig. 29) removal.
  - b. Remove spring pins (A) from both ends of the down-stop lock bar (B). Remove lift arm lock bar (B) from the machine.
  - c. Lower the lift arm all the way. Tilt the attachment hitch all the way back.

**Note:** Holes (C) in the frame, in the lift arm and holes (D) in the tilt pivot arm must align to allow down-stop lock bar (A) to pass completely through all the holes.

- d. Perform the “Mandatory Safety Shutdown Procedure” on page 10.
- e. Slide the down-stop lock bar (B) all the way through holes (C) in the frame, holes in the lift arm and holes (D) in the tilt pivot arm.
- f. Replace the lock pins (A) into both ends of the down-stop lock bar (B).



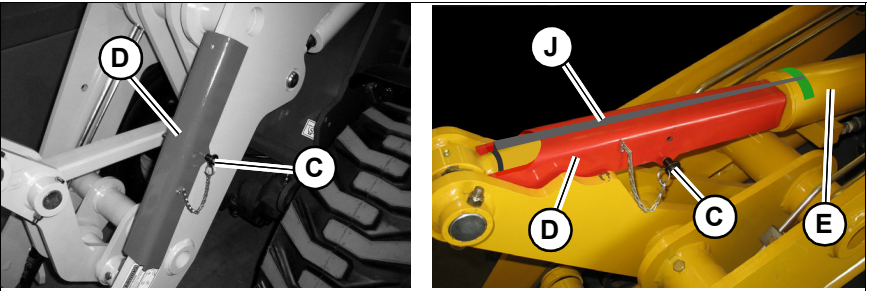
**Figure 29 – AL 200/300 Series  
Lift Arm Down-Stop**

**Important:** Down stop lock bar (B) must pass all the way through holes (C) in the frame, holes in the lift arm and holes (D) in the tilt pivot arm, with spring pins (A) installed in down stop lock bar (B) on outsides of the frame arm.



5. On AL 500 Series machines:

- a. Remove the retainer (C, Fig. 30), and lift the cylinder stop channel (D) off the machine.

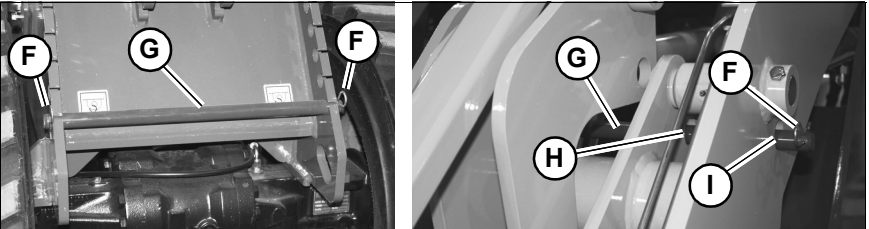


**Figure 30 – Tilt Lock Mechanism (AL 500 Series)**

- b. Tilt the attachment/hitch back as required and place the cylinder stop channel (D) under tilt indicator (J) and over the tilt cylinder (E) to brace the tilt cylinder in the extended position.
- c. Replace the retainer (C) into the cylinder stop channel so it passes under the tilt cylinder rod.
- d. Lower the lift arm as low as possible, but still high enough for required ground clearance.

6. On AL 400 Series machines:

- a. Remove the quick-release pins (F, Fig. 31), and remove the tilt lock pin (G) from the front of the machine.



**Figure 31 – Tilt Lock Mechanism (AL 400 Series)**

- b. Tilt the attachment/hitch as required to align holes (H) in tilt bracket with holes (I) in both sides of the lift arm.
- c. Slide tilt lock pin (G) through holes (H) and (I) so it passes all the way through both sides of the lift arm and tilt bracket. Secure tilt lock pin (G) at both ends with spring pins (F)
- d. Lower the lift arm as low as possible, but still high enough for required ground clearance.

## Lift Arm Down-Stop

The lift arm down stop is designed to limit lift arm downward travel. This feature is useful when changing tire sizes, or when driving the machine over long distances.

1. Empty the bucket (if applicable).
2. Position the lift arm above the down stop hole (A, Fig. 29) position where you want to limit travel, and also high enough to allow removal of the down-stop lock bar (B).
3. Perform the “Mandatory Safety Shut-down Procedure” on page 10.
4. Remove the lock pin (A), and pull the lock bar (B) from the machine.
5. Slide the lock bar (B) all the way through the desired down-stop holes (C).
6. Replace the lock pin (A) into the lock bar.

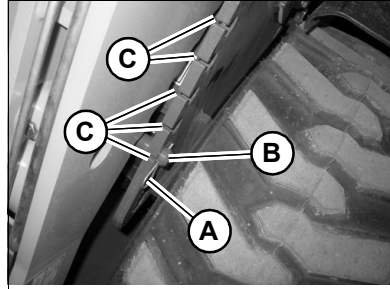


Figure 32 – Lift Arm Down-Stop

## Travel

**WARNING** Do not move the drive direction switch (Fig. 34) while traveling. The machine may react suddenly, causing an accident.

Change drive direction only when stopped. Refer to the drive direction lamps when changing travel direction. See “Controls and Switches” on page 52, and “Instrument Panel and Indicators” on page 54.

**Important:** If the optional backup alarm is installed, and the parking brake is released, the backup alarm activates when the drive direction switch is in reverse.

1. Be sure that the area around the loader is clear of bystanders and obstacles.
2. Using the multi-purpose joystick, raise the lift arm/attachment. Keep the attachment as near to the ground as possible for good stability and visibility. See “Load Handling” on page 77.
3. Release the parking brake. Lift lever (G, Fig. 33) slightly and press button (F) and press lever (G) downward. Release the button.

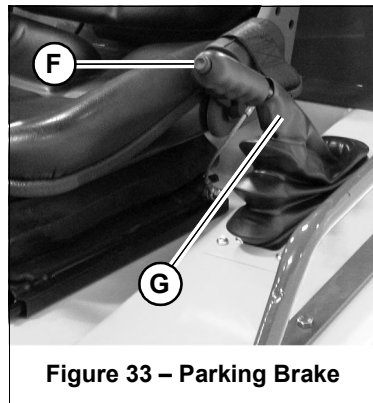
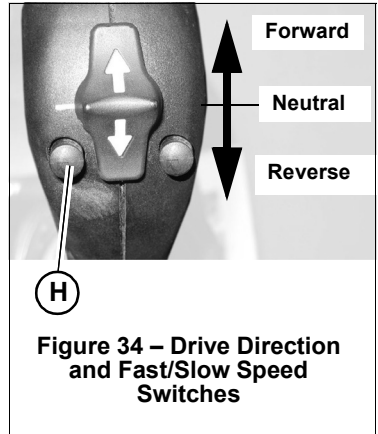


Figure 33 – Parking Brake

*Note:* When the parking brake is engaged, travel drive is disabled.

- Use the drive direction switch to change the loader drive direction.

*Note:* The drive direction indicators should be lit when the drive direction switch is in forward and rearward positions.



Drive direction switch position	
Forward	Indicator for forward drive is on; loader drive is in forward.
Middle	Loader drive is in neutral.
Rearward	Indicator for reverse drive is on; loader drive is in reverse.

**Figure 34 – Drive Direction and Fast/Slow Speed Switches**

- (AL 300, AL 400, AL 500 Series) Select either the high or low drive speed using the slow/fast speed switch (H, Fig. 34) according to the job and work site conditions.
- Slowly press the accelerator pedal. Driving speed is proportional to accelerator pedal movement.

**⚠ WARNING** Travel cautiously and under complete control at all times. Avoid sudden directional changes while traveling.

*Note:* (AL 400/500 Series) Sluggish or inoperative throttle pedal control could indicate the throttle pedal is out of calibration. See your local service center for throttle pedal calibration.

**Important:** If the machine is equipped with a hand throttle, use the accelerator pedal to control travel speed and use the hand throttle to control engine speed. See “Hand Throttle” on page 61.

- Use the brake/inch pedal gradually to regulate travel speeds and braking.

**Important:** Do not use the brake/inch pedal as a footrest.

*Note:* (AL 400/500 Series) Sluggish or inoperative brake/inch pedal control could indicate the brake/inch pedal is out of calibration. See your local service center for brake/inch pedal calibration.

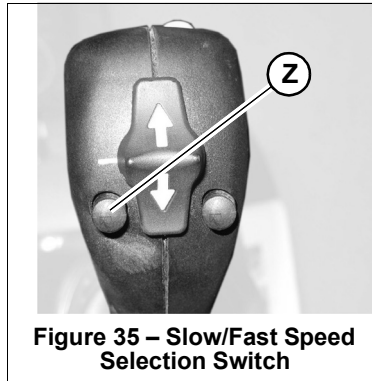
## Slow/Fast Travel Speed Mode Selection

(AL 300, AL 400, AL 500 Series)

**⚠ WARNING** Machine stability is affected by machine speed, especially on rough or hilly terrain, while carrying heavy loads, and while carrying loads raised above the height of the wheel axles. Always operate the machine at speeds appropriate for the conditions, Move the controls smoothly and gradually. Avoid sudden directional changes while traveling in the fast-speed mode.

Always use the slow travel speed mode in congested or populated areas.

To toggle between slow/fast travel speed modes, press the switch (Z, Fig. 35) and hold for one second.



## Differential Lock Operation

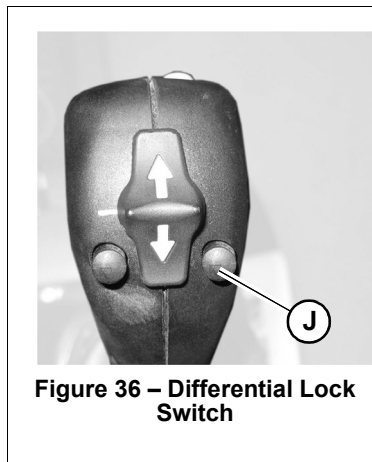
(AL 300, AL 400, AL 500 Series)

**Important:** Stop the machine before engaging the differential lock. Do not engage the differential lock if turning on smooth, dry pavement. Damage to the axles may result.

The differential lock can provide increased traction on loose and slippery surfaces.

**Note:** The differential lock is engaged on both front and rear axles.

To engage the differential lock, press and hold the differential lock switch (J, Fig. 36). Release the switch to disengage the differential lock.



## Load Handling



### **WARNING**

Position the load as low as possible, especially while traveling. Never make turns with the load raised higher than the axles or tipping could occur, resulting in severe injury or death.

Do not exceed the rated operating capacity of the machine. See weights and capacities information starting on page 33.

If the machine becomes unstable and starts to tip, keep the seat belt fastened, hold on firmly and brace yourself. Lean away from the point of impact and stay with the machine. If tipping occurs, **DO NOT** jump from the machine. The machine is equipped with rollover protection, which only protects the operator while in the operator's seat. Trying to escape from a tipping machine can result in death or serious personal injury.

If a tipover occurs:

- Restore the loader to an upright position immediately to prevent oil and fuel leakage. Clean up any fluid leakage.
- Inspect and repair any damage before re-starting the engine.

## Parking the Loader

Park the loader away from traffic on level ground. If this is not possible, park the loader across the incline and block the tires to prevent movement. See "Mandatory Safety Shutdown Procedure" on page 10.

## Multi-purpose Joystick

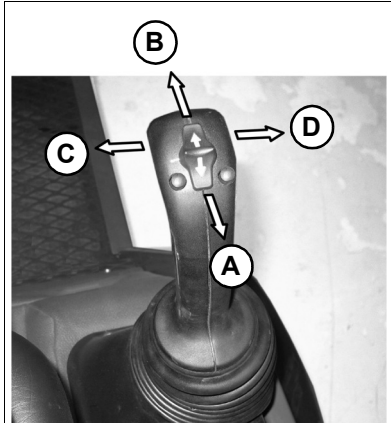
Use the multi-purpose joystick to control lift arm/attachment hydraulic movements. Speed of movement is proportional to how far the joystick is moved and engine speed.

Lift arm:

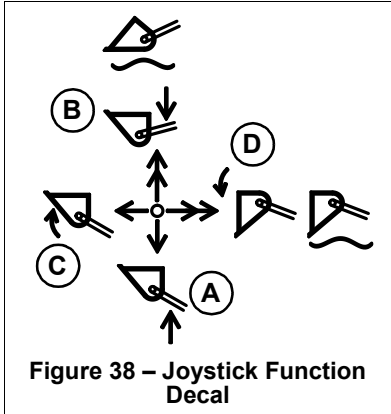
- A. Move the joystick rearward (A, Fig. 37, Fig. 38) to raise the lift arm.
- B. Move the joystick forward (B) to lower the lift arm.

Attachments:

- C. Move the joystick to the left (C) to tilt attachments rearward.
- D. Move the joystick to the right (D) to tilt attachments forward.



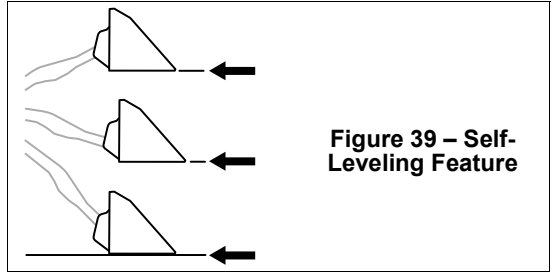
**Figure 37 – Multi-purpose Joystick**



**Figure 38 – Joystick Function Decal**

**AL 100, AL 200(EU),  
AL 300, AL 400(EU)  
Self-Leveling  
Feature**

The self-leveling feature maintains the attachment tilt angle as the lift arm is raised/lowered (Fig. 39)



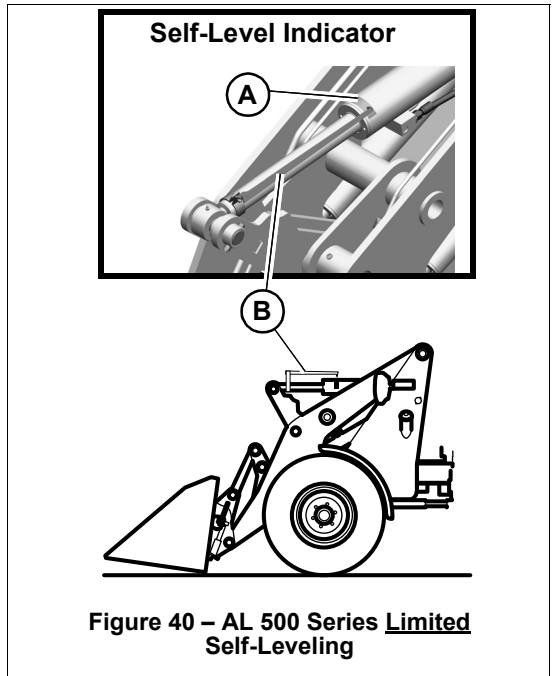
**Figure 39 – Self-Leveling Feature**

**AL 500 Series Limited Self-Leveling**

**⚠ WARNING** Without self-leveling, unintentional dumping (tilting forward) of the attachment can occur when the lift arm is raised or lowered. The pointer on self-level indicator (B, Fig. 40) must be within in the zone of self-level decal (A) or the attachment will not maintain the same attachment tilt angle when the lift arm is raised and lowered.

AL 500 Series machines use a special lift arm design to enhance bucket breakout forces and improve digging ability.

With this lift arm design, the tilt cylinder must be positioned so self-leveling is maintained. To maintain self-leveling on AL 500 Series machines, adjust the tilt cylinder until self-level indicator pointer is within the zone of self-level decal (X).



**Figure 40 – AL 500 Series Limited Self-Leveling**

**⚠ WARNING** Use of forks or unapproved attachments may not allow self-leveling activation due to the orientation of the All-Tach® to the attachment.

## Float Positions

**WARNING** Never engage “float” with the lift arm raised. This will cause the lift arm to fall.

Push the joystick past the first position and into front detent (*E*, Fig. 41, Fig. 42) and right detent (*F*) positions to activate the lift (*E*) and tilt (*F*) float functions.

To disengage float functions, pull the joystick to center position.

*Note:* Lift float may decrease ability to turn.

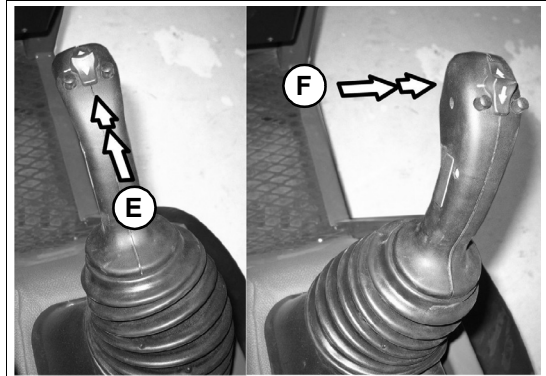


Figure 41 – Joystick Float Positions

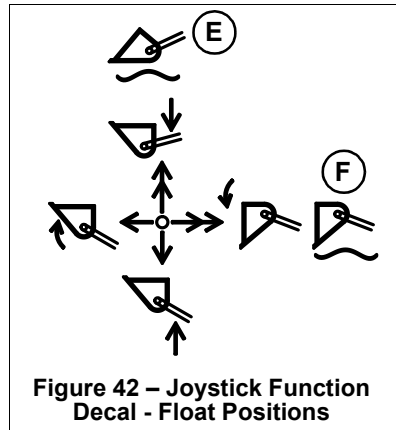


Figure 42 – Joystick Function Decal - Float Positions



# Attachments

---

## General Instructions

**⚠ WARNING** Use only approved attachments. Contact the Manitou Americas Service Department about information about approved attachments. Manitou Americas cannot be responsible if the machine is used with non-approved attachments. Read the operator's manual provided with all attachments used with the machine before starting the engine. A loaded attachment changes the center-of-gravity of the machine. Use caution! Never exceed the rated operating capacity – refer to weights and capacities information starting on page 33. Before using an attachment, check that the attachment is undamaged and properly connected and locked.

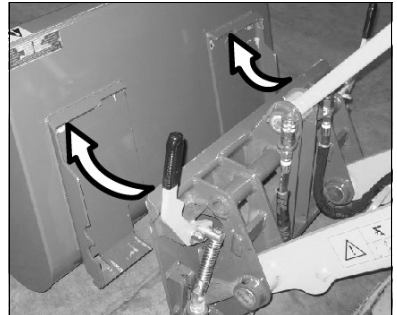
**⚠ WARNING** Practice using an attachment before working with it.

## Connect/Disconnect Attachments

**⚠ WARNING** Check that hitch pins and auxiliary hydraulic connections are properly connected and locked.

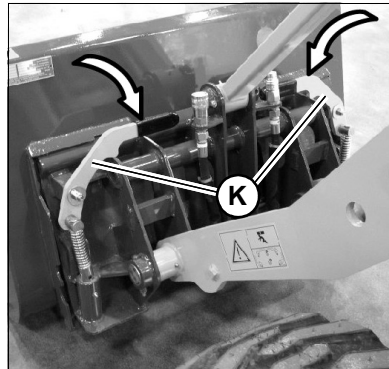
### *All-Tach® System Hitch Connection*

1. Position the attachment so the attachment flange fits over the top lip of the hitch (*Fig. 43*).
2. Pull the joystick rearward until the attachment is flush against the hitch surface.
3. Perform “Mandatory Safety Shutdown Procedure” on page 10.



**Figure 43 – Standard All-Tach® System Hitch Positioning**

4. Push the locking handles (K, Fig. 44) inward and downward until the attachment is locked onto the hitch as shown.
5. Check that the attachment is securely locked onto the hitch: the lip on the attachment must be completely engaged over the top of the hitch, and the locking pins on the bottom of the hitch must be fully engaged down into the attachment.



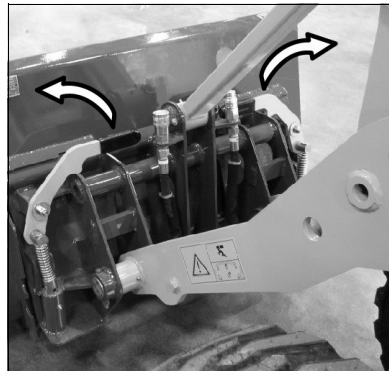
**Figure 44 – Standard All-Tach® System Hitch Locked**

**⚠ WARNING** Check that attachments are securely fastened to the hitch before working, or serious injury or death could result.

6. Perform “Engine Start” on page 67.

### **All-Tach® System Hitch Disconnection**

1. Lower the attachment to the ground. See “Multi-purpose Joystick” on page 78.
2. Turn off the engine. Move the multi-purpose joystick several times in all directions to depressurize the hydraulic system.
3. Pull the locking handles upward until the pins disengage from the attachment (Fig. 45) Perform “Engine Start” on page 67.



**Figure 45 – Standard All-Tach® System Hitch Unlocked**

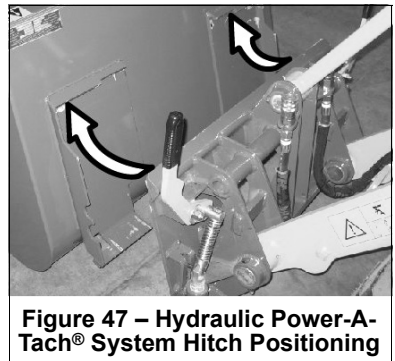
4. Tilt the hitch forward (see “Multi-purpose Joystick” on page 78) and back away from the attachment (*Fig. 46*).





### **Hydraulic Power-A-Tach® System Hitch Connection**

**CAUTION** The hydraulic Power-A-Tach® system hitch lock switch activates the auxiliary hydraulic circuit. Connect the auxiliary hydraulic connections (see “Auxiliary Hydraulics” on page 86) to the attachment after connecting the attachment to the Power-A-Tach® system hitch.

1. Position the attachment so the attachment flange fits over the top lip of the hitch (*Fig. 47*).
2. Pull the joystick rearward until the attachment is flush against the hitch surface.



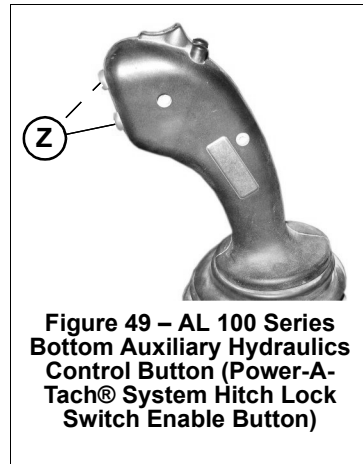
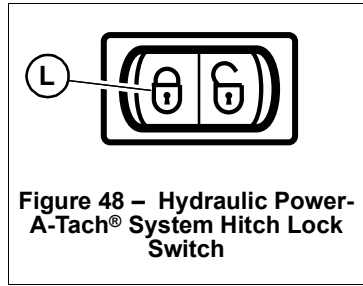
3. Push the  side of the Power-A-Tach® system hitch lock switch (L, Fig. 48) to lock the attachment onto the hitch.

- a. **AL 100 Series machines only:**  
Press and hold the bottom auxiliary hydraulics control button (Z, Fig. 49) and then push the  side of the Power-A-Tach® system hitch lock switch (L, Fig. 48) to lock the attachment onto the hitch.

*Note:* Due to ongoing product improvement and variations during production, it may be necessary to hold the top auxiliary hydraulics control button instead of the bottom button to enable the hitch lock switch on AL 100 Series machines.


4. Make sure the attachment is securely locked onto the hitch: the locking handles (K, Fig. 44) must be horizontal, with the lip on the attachment completely engaged over the top of the hitch, and the hitch pins on the bottom of the hitch fully engaged down into the attachment.


*Note:* 4-point hitch (EU only) locking pins engage out through the sides of the attachment.



## Hydraulic Power-A-Tach® System Hitch Disconnection

**CAUTION** Disconnect the auxiliary hydraulic connections (see “Auxiliary Hydraulics” on page 86) before disconnecting the attachment from the Power-A-Tach® system hitch.

1. Lower the attachment to the ground. See “Multi-purpose Joystick” on page 78.
2. Press the  side of the Power-A-Tach® system hitch lock switch (M, Fig. 50) to unlock the attachment on the hitch.

**AL 100 Series machines:** Press and hold the bottom auxiliary hydraulics control button and then push the  side of the Power-A-Tach® system hitch lock switch (L, Fig. 48) to unlock the attachment.

*Note:* Due to ongoing product improvement and variations during production, it may be necessary to hold the top auxiliary hydraulics control button instead of the bottom button to enable the hitch lock switch on AL 100 Series machines.

3. Tilt the hitch forward (see “Multi-purpose Joystick” on page 78) and back away from the attachment (Fig. 52).

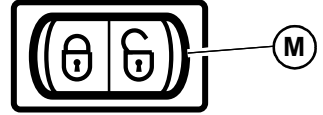


Figure 50 – Hydraulic Power-A-Tach® System Hitch Lock Switch

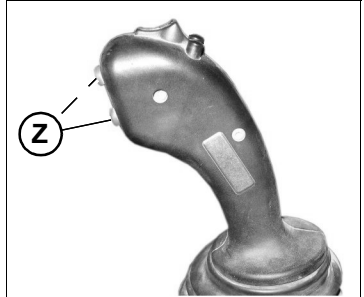


Figure 51 – AL 100 Series Bottom Auxiliary Hydraulics Control Button (Power-A-Tach® System Hitch Lock Switch Enable Button)

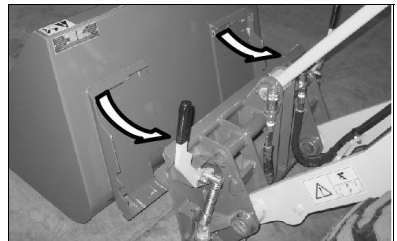


Figure 52 – Hydraulic Power-A-Tach® System Hitch Removal

## Auxiliary Hydraulics

Auxiliary hydraulics are used for hydraulically-powered attachments. The auxiliary hydraulic circuit must be connected to hydraulically-powered attachments before the attachments can be used.

### Auxiliary Circuit Pressure Relief

Relieve pressure in the auxiliary hydraulic circuit before connecting / disconnecting hydraulically powered attachment hoses.

For the following machines:

- AL 100 Series - Serial Numbers 11480 and Up
- AL 200 (EU) Series - Serial Number 21293 and Up
- AL 300 Series - Serial Numbers 31822 and Up
- AL 400 (EU) Series - Serial Numbers 41374 and Up
- AL 500 Series - Serial Numbers 51590 and Up

Stop the engine, push down and pull up on the pressure relief control (*K*, Fig. 53).

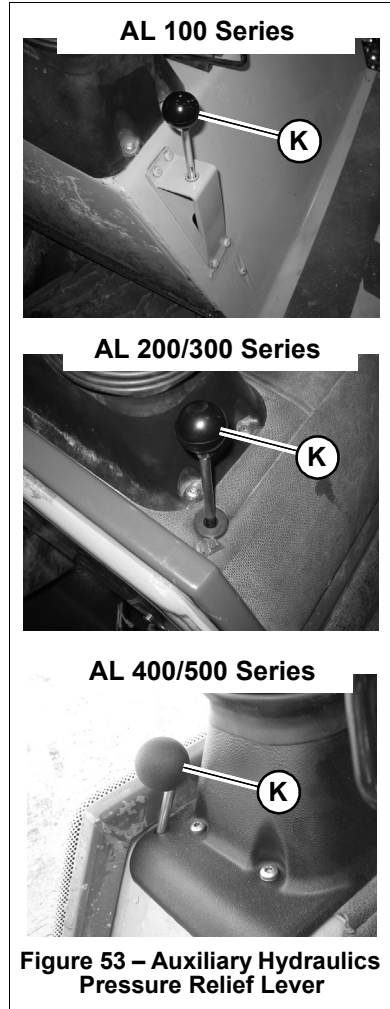
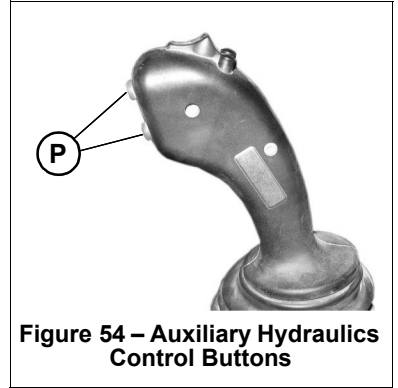


Figure 53 – Auxiliary Hydraulics Pressure Relief Lever

**WARNING** Be sure no one is near the machine when relieving pressure from the auxiliary hydraulics circuit. Stored pressure may cause connected hydraulically-powered attachments to move when the circuit is de-pressurized.

For the following machines:

- AL 100 Series - Serial Numbers 11479 and Before
  - AL 200 (EU) Series - Serial Number 21292 and Before
  - AL 300 Series - Serial Numbers 31821 and Before
  - AL 400 (EU) Series - Serial Numbers 41373 and Before
  - AL 500 Series - Serial Numbers 51589 and Before
1. Lower the lift arm to the ground.
  2. When disconnecting a hydraulically-powered attachment, position it in the storage position. (e.g., bucket grapple should be closed.)
  3. With the engine at idle, pull the joystick to the rear as far as it will go and hold it in this position.
  4. While the lift arm is rising:
    - a. Press and hold one of the auxiliary hydraulics control buttons (*P*, Fig. 54) for three or more seconds.
    - b. Release the button, and then press and hold the other auxiliary hydraulics control button for three or more seconds.
  5. Move the joystick to the neutral position.
  6. Lower the lift arm to the ground.
  7. Perform the “Mandatory Safety Shut-down Procedure” on page 10.



**Figure 54 – Auxiliary Hydraulics Control Buttons**

## Auxiliary Hydraulics Connections

**Important:** Relieve pressure in the auxiliary hydraulic circuit before connecting / disconnecting hydraulically powered attachment hoses. See “Auxiliary Circuit Pressure Relief” on page 86.

**Important:** Be sure that the hydraulic connections are clean. Hydraulic oil contamination can damage the hydraulic system.

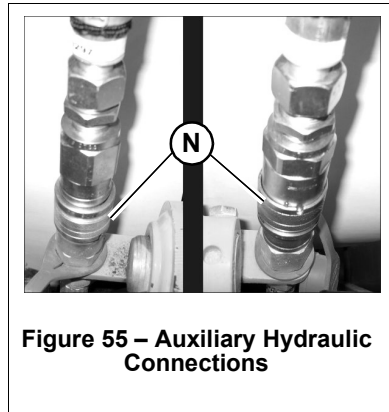
**CAUTION** If a Power-A-Tach® system hitch is installed, connect the auxiliary hydraulic connections to the attachment after connecting the attachment to the Power-A-Tach® system hitch. Disconnect the auxiliary hydraulic connections before disconnecting the attachment from the Power-A-Tach® system hitch.

**To connect:** Press the hose connections firmly down into the auxiliary hydraulic connections until they snap into place.

**To disconnect:** Push down on the locking rings (N, Fig. 55) until the hose connections release.

**Important:** Always cap the hydraulics (Fig. 39) after disconnecting, to protect against hydraulic oil contamination.

**Note:** Connect attachment connectors together when the attachment is not being used, to keep pressure from building in the attachment and to keep the connector mating surfaces clean.





## Auxiliary Hydraulics Control Buttons

Auxiliary hydraulics fluid flow is controlled by two buttons (*P*, Fig. 56) on the front of the joystick.

1. **Top Button:** Press the top button to activate the auxiliary hydraulics flow in the direction opposite of when pressing the bottom button. Release the button to stop the flow.
2. **Bottom Button:** Press the bottom button to activate the auxiliary hydraulics flow in the direction opposite of when pressing the top button. Release the button to stop the flow.
3. **Continuous flow in “Top Button” Direction:** Press the top button, and then press and hold both buttons for two seconds to activate continuous auxiliary hydraulic flow in the “Top Button” direction. Momentarily press either button to stop the flow.
4. **Continuous flow in “Bottom Button” Direction:** Press the bottom button, and then press and hold both buttons for two seconds to activate continuous auxiliary hydraulic flow in the “Bottom Button” direction. Momentarily press either button to stop the flow.

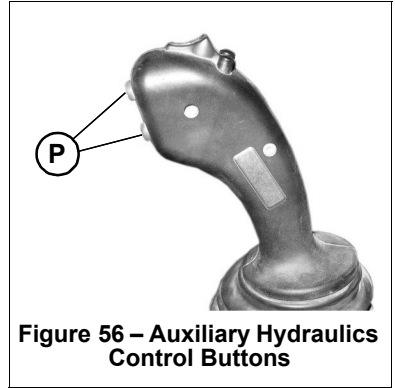


Figure 56 – Auxiliary Hydraulics Control Buttons

## ***Auxiliary Hydraulics Flow and Proportional Control***

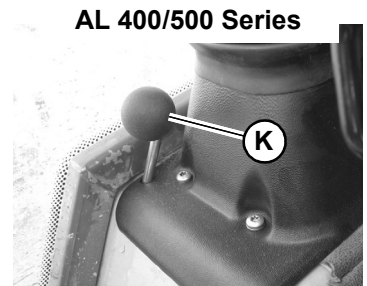
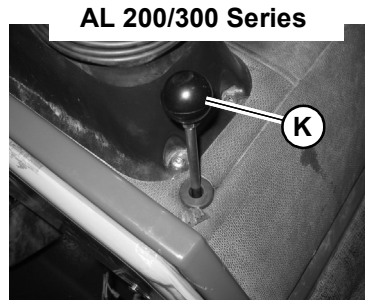
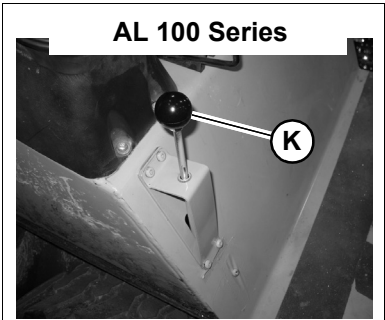
For the following machines ONLY:

- AL 100 Series - Serial Numbers 11480 and Up
- AL 200 (EU) Series - Serial Number 21293 and Up
- AL 300 Series - Serial Numbers 31822 and Up
- AL 400 (EU) Series - Serial Numbers 41374 and Up
- AL 500 Series - Serial Numbers 51590 and Up

The pressure relief control (*K*, *Fig. 57*) can be used for auxiliary hydraulics flow control.


Pulling up on the pressure relief control (*K*) activates auxiliary hydraulics in one direction; pushing down on the pressure relief control (*K*) activates auxiliary hydraulics in the other direction.

Depending upon the distance the pressure relief control (*K*) is pulled up/pressed down controls the auxiliary hydraulics flow rate: the further the control is moved, the greater the flow rate.



**Figure 57 – Auxiliary Hydraulics Flow and Proportional Control**

## Operating Attachments

 **WARNING** Use only approved attachments. Contact the Manitou Americas Service Department about information about approved attachments. Manitou Americas cannot be responsible for safety if the unit is used with non-approved attachments.

Some general guidelines for attachments are included in this section. These guidelines are not a replacement for the attachment manufacturer's operating instructions.

Before installing, operating and servicing attachments, carefully read the manufacturer's operating instructions. Contact the responsible representative for more information.

Contact the Manitou Americas Service Department for more information about approved attachments. Observe maximum operating load capacities. See weights and capacities information starting on page 31.

### Bucket

See "Load Handling" on page 77 for information about driving with a load.

#### ***Loading Loose Material***

1. Lower the bucket and adjust the cutting edge to be parallel to the ground.
2. Drive toward the material to be loaded. Determine the correct driving speed according to the type of material and working conditions.
3. As the cutting edge penetrates the material, raise the lift arm slightly, to load the front axle and to minimize slipping.

*Note: If the bucket has difficulties penetrating the material, use the joystick to raise and lower the bucket.*

4. Tilt back the bucket when it is full.
5. Move the bucket into transport position.

#### ***Scraping Soft Material***

1. Lower the bucket onto the material.
2. Tilt the bucket forward to the desired digging angle.
3. Drive forward so that the edge of the bucket penetrates the material.
4. Reduce the forward angle to cut an even layer of material and to avoid slipping.

## **Scraping Hard Material**

1. Lower the bucket onto the material.
2. Tilt the bucket forward to the desired digging angle.
3. Drive forward, press the bucket slightly downward so that the bucket penetrates the material.

*Note: Avoid extreme tire slipping.*

4. Reduce the tipping angle.
5. While driving forward, operate the joystick to lower and raise the bucket, and to constantly load the front axle.

# Towing the Loader

**⚠ WARNING** Do not use the loader for towing (other vehicles, trailers, equipment, etc.).

**Important:** The machine cannot be tow-started because there is no direct mechanical connection between the wheels and the engine. Attempting to tow-start the machine may damage the drive system.

## Precautions

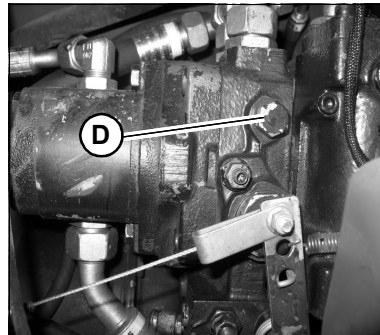
Only tow the loader if the steering and brakes are functional, if it cannot be repaired on-site, and if it cannot be transported using any other method. Only tow the loader until it is moved to a location where it can be safely repaired.

**Important:** If moving the loader more than a few hundred meters, use a flatbed truck or similar vehicle to transport the loader, to prevent overheating the hydraulic system. See “Loading and Transporting” on page 97.

## Towing AL 100 Series Machines

### Preparation

1. Perform the “Mandatory Safety Shut-down Procedure” on page 10.
2. Tilt up the operator’s platform. See “Tilting Up the Platform” on page 107.
3. Loosen the hydraulic system bypass valve (D, Fig. 58) one to two turns.



**Figure 58 – Hydraulic System Bypass Valve (AL 100 Series)**

**⚠ CAUTION** Do not loosen the bypass valve bolts more than one to two turns. The bypass valve can come out of the pump, resulting in a rapid loss of hydraulic fluid.

4. Tilt and secure the operator’s platform back into the operating position. See “Tilting the Platform Down” on page 108.

## Towing AL 300 Series Machines

### Preparation

1. Perform the “Mandatory Safety Shutdown Procedure” on page 10.
2. Disconnect hoses (B) and the electrical connector from the motor. Cap the ends of the hoses to prevent hydraulic fluid loss.
3. Remove bolts (A, Fig. 59) securing drive motor (C).

*Note: Record the position of the hoses for re-assembly.*

4. Remove hydraulic motor (C) from the axle. Support the motor during towing.
5. After towing the machine, replace the motor in the axle and secure the motor with bolts (A).
6. Reconnect hoses (B) and the electrical connector to the motor.

*Note: Reconnect hoses (B) in the same positions where they were removed.*

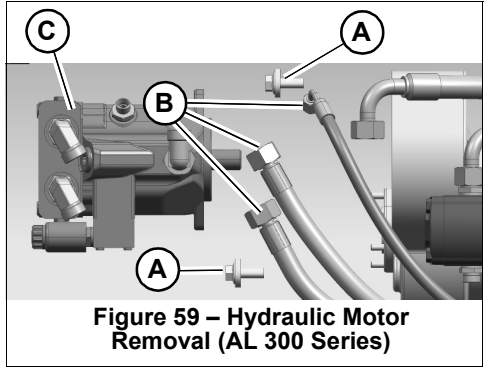
## Towing AL 500 and AL 400 Series Machines

### Preparation

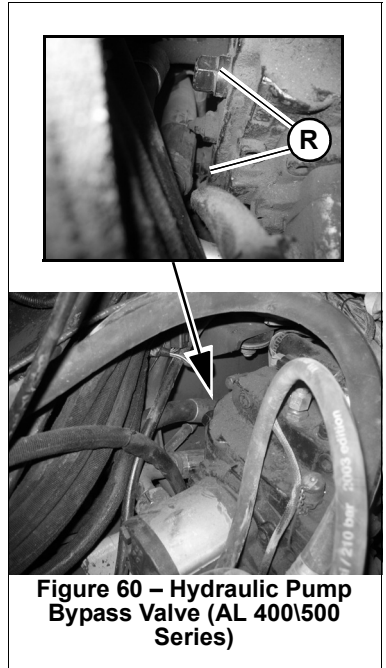
1. Perform the “Mandatory Safety Shutdown Procedure” on page 10.
2. Tilt up the operator’s platform. See “Tilting Up the Platform” on page 107.
3. Loosen the bypass valve bolts (R, Fig. 60) three turns.

**⚠ CAUTION** Do not loosen the bypass valve bolts more than three turns. The bypass valve bolts can come out of the pump, resulting in a rapid loss of hydraulic fluid.

4. Tilt and secure the operator’s platform back into the operating position. See “Tilting the Platform Down” on page 108.



**Figure 59 – Hydraulic Motor Removal (AL 300 Series)**



**Figure 60 – Hydraulic Pump Bypass Valve (AL 400/500 Series)**

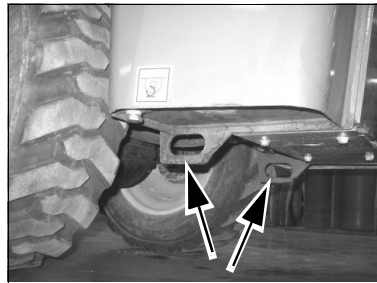
## Towing Procedure

1. Attach the tow bar/cable to the front/rear frame tie-down points or the tow hitch (Fig. 61 and Fig. 62) located at the rear of the loader.

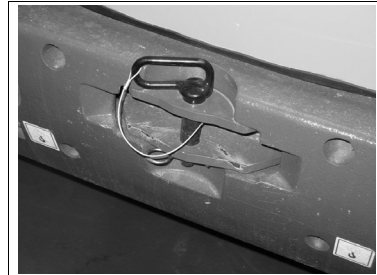
**Important:** Only use a tow bar or tow cable of sufficient capacity.

2. Tow the unit slowly and with caution. Do not tow continuously for longer than three minutes at a time.

**Important:** Tow the machine with another vehicle *ONLY*. Do not tow loads or other vehicles with the machine.



**Figure 61 – Rear Tow/Tie-Down Points (AL 100 Series)**



**Figure 62 – Tow Hitch (AL200, 300, 400, 500 Series)**

**WARNING** Do not allow anyone near the tow bar or tow cable while the loader is being towed. Use a tow cable/tow bar with a capacity of at least three times greater than the towing vehicle's pulling power. Do not exceed 5 km/h (3 mph) while towing, or damage to the hydraulic system could occur.

### After Towing

1. Tilt up the operator's platform. See "Tilting Up the Platform" on page 107.
2. Tighten the bypass valve bolts to 70 Nm (52 lbf-ft).

**Note:** Do not over-torque the bypass valve bolts.

3. Tilt and secure the operator's platform back into the operating position. See "Tilting the Platform Down" on page 108.
4. Secure the loader against rolling away and unauthorized use.



# Loading and Transporting

**⚠ CAUTION** Obey all applicable over-the-road regulations when transporting the machine. Check restrictions regarding weight, width and load length. The hauling vehicle, trailer and load must all be in compliance with regulations. Make sure the transport vehicle and the loading ramp are in proper working condition and have sufficient capacity for the load.

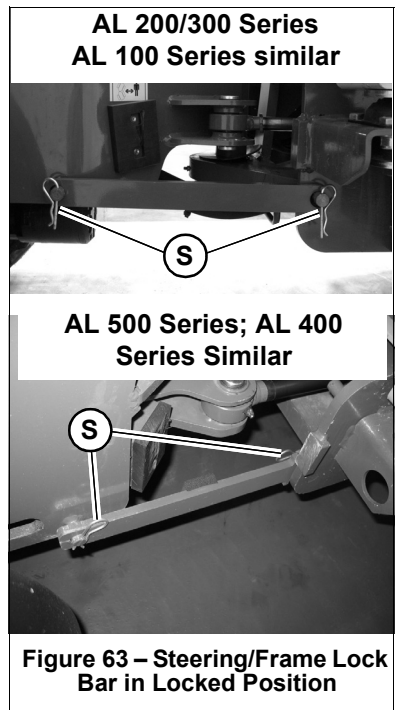
1. Park the transport vehicle on solid, even ground when loading.
2. Clean the loader and transport vehicle.
3. Attach ramps securely to the transport vehicle to prevent them from slipping during loading.

**⚠ CAUTION** Do not use ramps inclined at an angle greater than 17° (30%). Clean dirt, mud, ice and snow from the ramps. Use metal loading ramps with a slip-resistant surface and beveled ends to prevent damage to the tires.

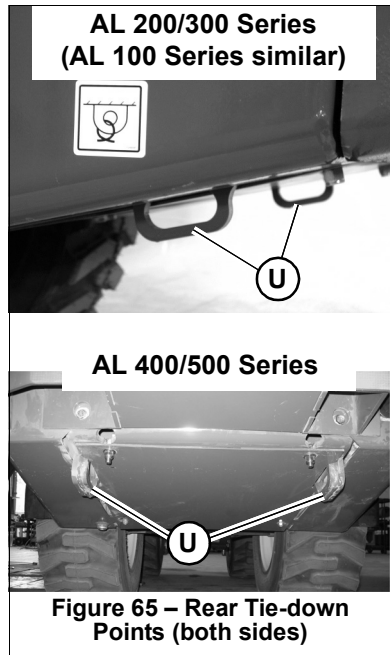
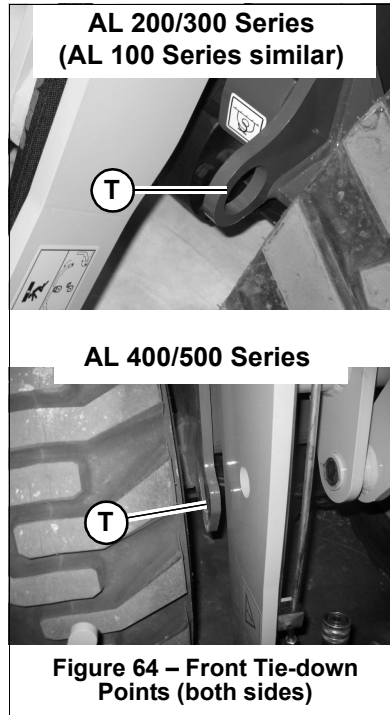
4. Engage the transport vehicle parking brake and chock the wheels.
5. Complete all steps in “Driving on Public Roads” on page 70.
6. Carefully back the loader onto the transport vehicle, so that the heavy end of the loader is near the cab of the transport vehicle.

**⚠ WARNING** Do NOT adjust travel direction while driving up ramps. Instead, back off the ramps and realign the machine with the ramps. Do not allow anyone to walk beside, behind or in front of the loader during loading and unloading. Always use the “slow” travel speed when loading the machine.

7. Perform the “Mandatory Safety Shutdown Procedure” on page 10.
8. Secure the steering lock bar in the transport position using the spring pins (S, Fig. 63) provided.
9. Lock the cab, if so equipped.
10. Chock the machine’s tires to prevent the machine from rolling.



11. Secure the machine to the transport vehicle at the tie-down points (*T*, Fig. 64 and *U*, Fig. 65) to prevent the machine from moving during transport in accordance with applicable over-the-road hauling regulations.

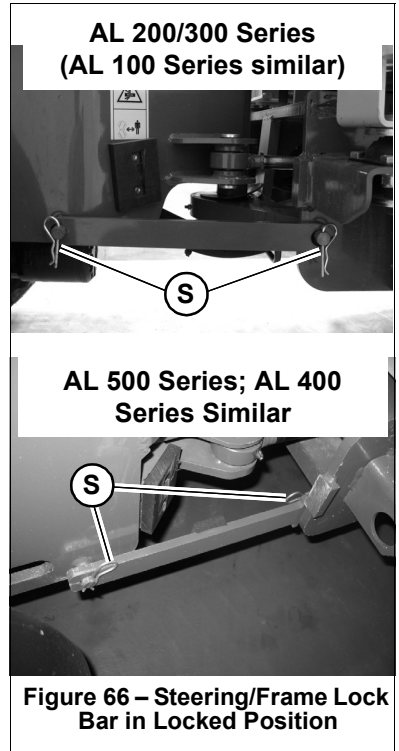


## Crane Lifting

**⚠ WARNING** Always close the cab doors (if applicable) and engine cover before lifting the machine with a crane. Stay clear from underneath the machine as it is lifted. Do not lift machine without proper equipment.

**⚠ WARNING** The crane must have a capacity greater than the weight of the machine. For machine weights, see weights and capacities information starting on page 33.

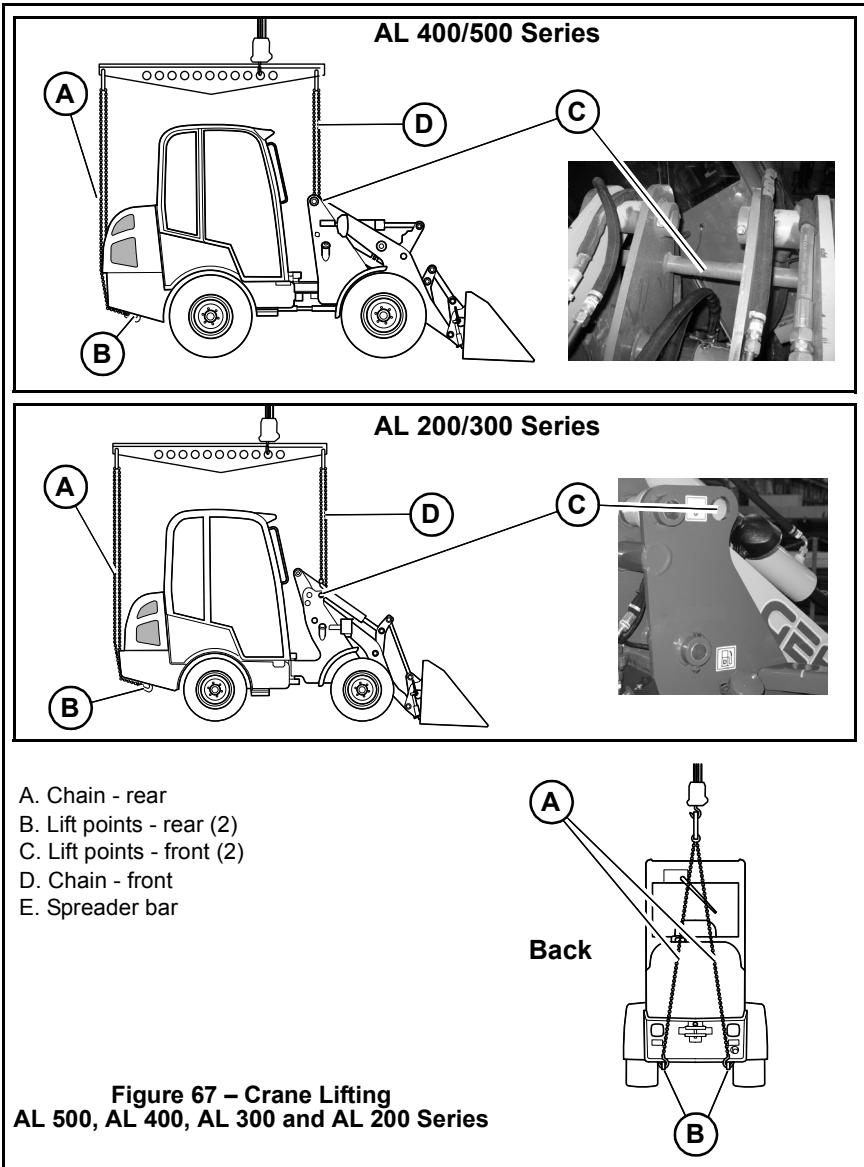
1. Perform the “Mandatory Safety Shutdown Procedure” on page 10.
2. Secure the steering lock bar in the transport position using the spring pins (*S*, Fig. 66) provided.
3. Lock the cab, if so equipped.
4. Close the engine cover, if necessary.



AL 500, AL 400, AL 300 and AL 200 Series:

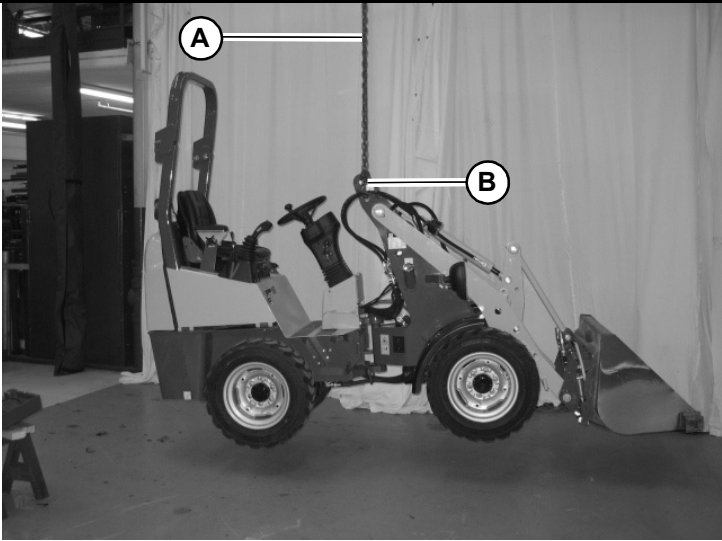
5. Connect spreader bar and chains to front and rear lift points as shown (Fig. 68). The spreader bar should be long enough to prevent the chains from rubbing on the engine hood and the chains should be long enough to clear the ROPS structure.
6. Lift the machine so it remains level (Fig. 67 and Fig. 68).

**Important:** Chains must be routed over the rear bumper to prevent damage to machine.



AL 100 Series:

1. Connect chains to lift points (B, Fig. 68) as shown.
2. Lift the machine as shown in Fig. 68.



- A. Chain
- B. Lift points (2)


**Figure 68 – Crane Lifting  
(AL 100 Series)**





# CHAPTER 5


## MAINTENANCE

Proper care and service improves machine operational readiness and service life. Perform maintenance as indicated in the “Maintenance Schedule” on page 104, or earlier if required by conditions.

 **WARNING** Read and understand the *Safety Chapter*, starting on page 9, before servicing the machine. Follow all applicable warnings and instructions. Check for correct function after servicing the machine. Failure to follow instructions can result in injury or death.

 **WARNING** Fluid leaks from hydraulic hoses or pressurized components can be difficult to see, but pressurized oil can have enough force to pierce the skin and cause serious injury. Always use a piece of wood or cardboard to check for suspected hydraulic leaks. Never use your hands. Obtain immediate medical attention if pressurized oil pierces the skin. Failure to obtain prompt medical assistance could result in gangrene or other serious damage to tissue.

 **CAUTION** Do not use the machine when maintenance is due. Postponed maintenance can result in a serious reduction of the service life of the machine, costly equipment failures, and contribute to unsafe operating conditions.

 **CAUTION** Allow only trained and authorized personnel, with full knowledge of safe procedures, to perform machine maintenance and service.

*Important:* Malfunctions caused by unauthorized modifications and alterations are not covered under warranty.

# Maintenance Schedule

Use the following table with the procedures included in the this chapter, beginning on page 103. For new machine operating guidelines, see “New Machines” on page 70.

**Important:** *The following maintenance intervals apply to average operating conditions and loads. Under extreme operating conditions, more frequent maintenance may be required. The hourmeter indicates total operating time; use the hourmeter to determine when scheduled maintenance is due.*

**⚠ CAUTION** Do not postpone maintenance. Postponed maintenance can result in a serious reduction to the service life of the machine, more serious and costly equipment failures, and contribute to unsafe operating conditions.

## Check, Clean and Inspect

Service Procedure	Maximum Interval				
	10 Hours (or daily)	50 Hours (or weekly)	Monthly	250 Hours (or every six months)	500 Hours (or annually)
Clean machine	X				
Check machine for general wear/damage	X				
Check attachments for wear/damage	X				
Check engine oil level and condition	X				
Check coolant level and condition	X				
Check brake fluid level	X				
Check hydraulic fluid level	X				
Check windshield washer system	X				
Check exhaust for excessive smoke emission	X				
Clean air filter; replace if necessary	X				
Check tire condition and pressure	X				
Check wheel fasteners for damage/tightness	X <sup>1</sup>		X		
Check hydraulic cylinder piston rods for wear/damage; clean if necessary	X				
Check ROPS structure (all fasteners must be installed and securely tightened)	X				



## Check, Clean and Inspect

Service Procedure	Maximum Interval				
	10 Hours (or daily)	50 Hours (or weekly)	Monthly	250 Hours (or every six months)	500 Hours (or annually)
Check coolant system for leaks, dirt and debris; hoses for cracks/damage		X			
Check battery electrolyte level (if applicable)		X			
Check engine and engine mounts		X			
Check for hydraulic system for leaks, proper routing			X		
Check anti-freeze mixture			X		
Check V-belt tension and condition			X		
Check engine cover lock			X		
Check engine idle			X		
Replace fuel filter				X	
Check hinge pins, joint bushings, pivot bolts and bearings					X
Check for exhaust system damage					X
Clean battery terminals					X
Check timing belt					X
Check fuel injectors					X
Check electrical system for damage, wiring routing					X

1. Check before first use and every two hours after tightening until fastener torque stabilizes; every month thereafter.

## Leakage Check

Service Procedure	Maximum Interval				
	10 Hours (or daily)	50 Hours (or weekly)	Monthly	250 Hours (or every six months)	500 Hours (or annually)
Check engine for oil/coolant leaks	X				
Check cooling system for leaks	X				
Check hydraulic system for leaks		X			
Check axles for leaks		X			

## Lubrication and Filter Changes

Service Procedure	Maximum Interval					
	10 Hours (or daily)	50 Hours (or weekly)	Monthly	250 Hours (or every six months)	500 Hours (or annually)	1500 Hours (or annually)
Lubricate grease zerks according to lubrication diagram	X					
Lubricate all levers, cables and hinges with oil			X			
Lubricate driveshaft universal and slip joint			X			
Change engine oil/filter		X <sup>1</sup>		X		
Change axle oil					X	
Change hydraulic fluid and return filter					X	
Change fuel filter; clean pre-filter					X	
Change coolant					X	
Change cabin air filter		X <sup>2</sup>				
Change oil in the axles						X

1. After first 50 hours; every 250 hours thereafter.
2. Replace if needed.

## Functional Check

Service Procedure	Maximum Interval				
	10 Hours (or daily)	50 Hours (or weekly)	Monthly	250 Hours (or every six months)	500 Hours (or annually)
Check seat belt	X				
Check foot brake and parking brake functions; adjust if necessary	X				
Check steering	X				
Check windshield wipers	X				
Check instruments, indicator lights and audible warning devices	X				
Check lighting system (if installed)	X				

## Dealer Service

The following service items require special tools and knowledge and should be performed only by an authorized dealer:

- Engine service not included in this manual
- Hydrostatic components
- Hydraulic system pumps
- Hydraulic valves
- Hydraulic cylinders
- Electrical components other than battery and circuit breakers

## Tilting the Platform

**⚠ WARNING** Always close the cab doors (if applicable) and open the engine cover before tilting the platform. Stay clear from underneath the platform as it is tilted. Always secure the tilt support when platform is tilted.

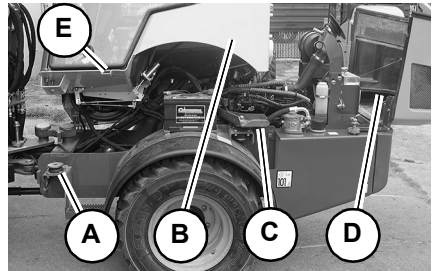
### Tilting Up the Platform

1. Complete “Mandatory Safety Shutdown Procedure” on page 10.
2. Open engine cover (D, Fig. 69).

*Note:* The platform is locked in the lowered position when the engine cover is closed.

3. Remove the platform lock-down hardware from the left front (A) and left rear (C) of the platform (B).

*Note:* AL 100 Series machines, have lock-down hardware at both the right and left front of the platform at position (A).



- A. Platform, Front Mounting
- B. Platform
- C. Platform, Rear Mounting
- D. Engine Cover
- E. Steering Lock Bar Lever Insert

**Figure 69 – Tilted Platform**

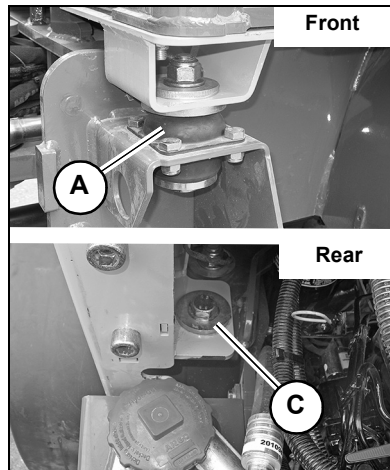
- Securely close the cab doors (if applicable).
- Using the ROPS, cab frame, and/or handles, manually tilt the platform upward.

**Note:** The steering lock bar (*W*, Fig. 71) can be inserted in bracket (*E*) to provide additional leverage for tilting the platform.

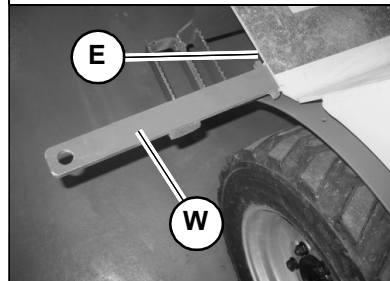
- Engage tilt support (*W*, Fig. 72).

### Tilting the Platform Down

- Slightly lift the platform using the steering lock bar (*W*, Fig. 71) to relieve pressure on the tilt lock to allow it to be disengaged.
- Disengage the tilt lock (*W*). Carefully lower the platform.
- Install platform lock-down nuts, bolts and washers onto the left front and left rear (*A* and *C*, Fig. 69) of the platform.
- Close engine cover (*D*, Fig. 69).

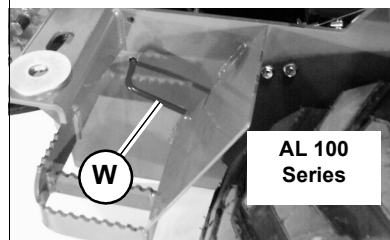


**Figure 70 – Platform Mounting Hardware**



**Figure 71 – Steering Lock Bar/Platform Tilt Bracket**

**AL 200/300/400/500 Series**



**Figure 72 – Tilt Support Lock**

**AL 100 Series**

# Engine Maintenance

**⚠ WARNING** Allow engine and hydraulic system components to cool before maintenance.

## Engine Oil

### Checking Engine Oil Level

1. Position the machine on a level surface.
2. Perform the “Mandatory Safety Shutdown Procedure” on page 10.
3. Wait until the machine has cooled. See “Service Safety Practices” on page 16.
4. Open engine cover.
5. Remove the dipstick (Y, Fig. 73). Wipe dipstick with a clean cloth.
6. Insert the dipstick until it is fully seated, and remove.
7. Read markings on the dipstick, markings represent FULL and LOW (add oil) levels.

See “Maintenance Schedule” on page 104 for the service interval for replacing the engine oil and filter.

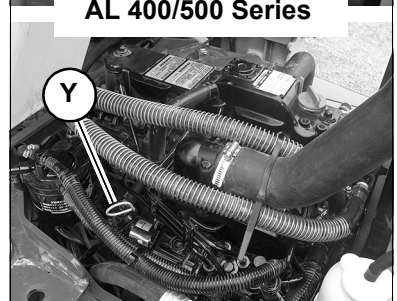
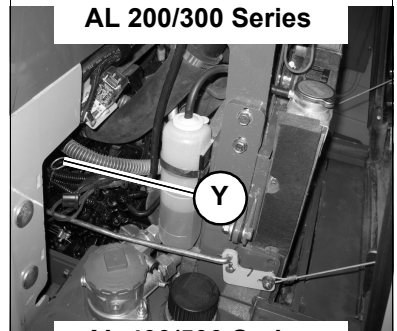
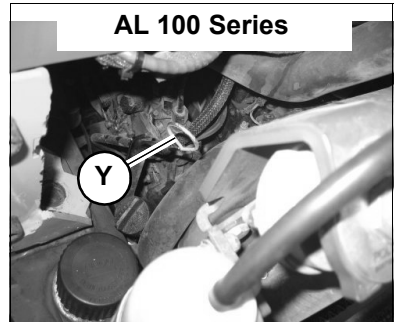
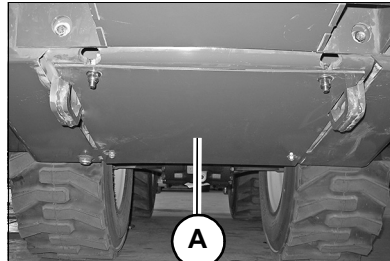


Figure 73 – Engine Oil Dipstick

## Changing Engine Oil and Filter

Change the engine oil and filter after the first 50 hours of use, and every 250 hours thereafter.

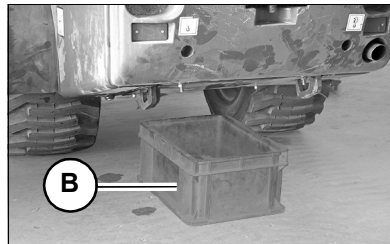
1. Position the machine on a level surface.
2. Perform the “Mandatory Safety Shutdown Procedure” on page 10.
3. Wait until the machine has cooled. See “Service Safety Practices” on page 16.
4. Remove the engine access panel (A, Fig. 74).



**Figure 74 – Engine Access Panel**

**Notice:** Removing engine access panel requires two people.

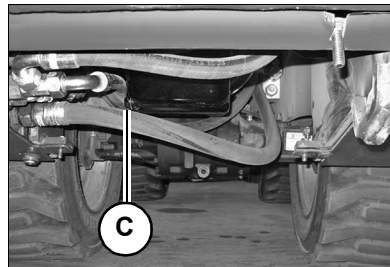
5. Position a waste oil collection container to catch draining oil (B, Fig. 75).



**Figure 75 – Waste Oil Collection Container**

**Important:** Dispose of waste engine oil according to environmental laws or take to a recycling center for proper disposal. DO NOT pour waste engine oil onto the ground or down a drain.

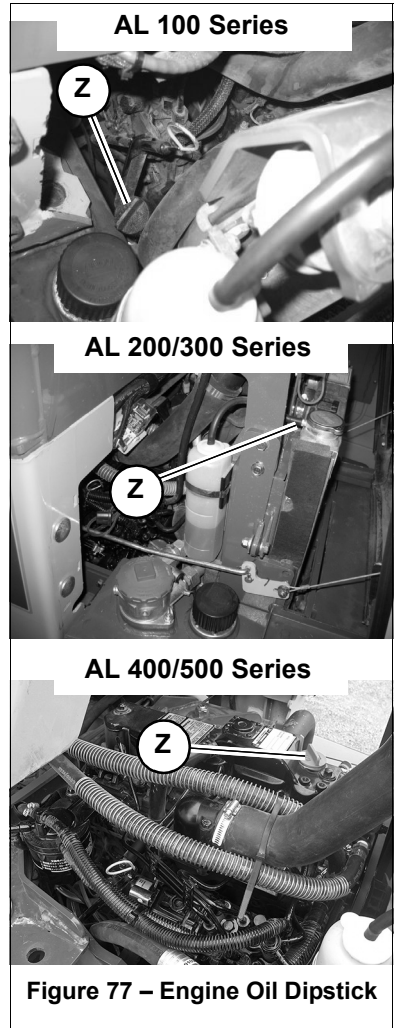
6. Remove the drain plug (C, Fig. 76) from the oil pan and allow the oil to drain into the waste oil collection container.
7. Remove the oil filter, using a filter wrench as necessary.
8. Put clean oil on the new oil filter gasket. Install the filter and tighten 3/4 turn past the point where the gasket contacts the filter head.
9. Reinstall and tighten the drain plug.
10. Reinstall the engine access panel (A, Fig. 74).



**Figure 76 – Oil Pan Drain Plug**

**Notice:** Reinstalling engine access panel requires two people.

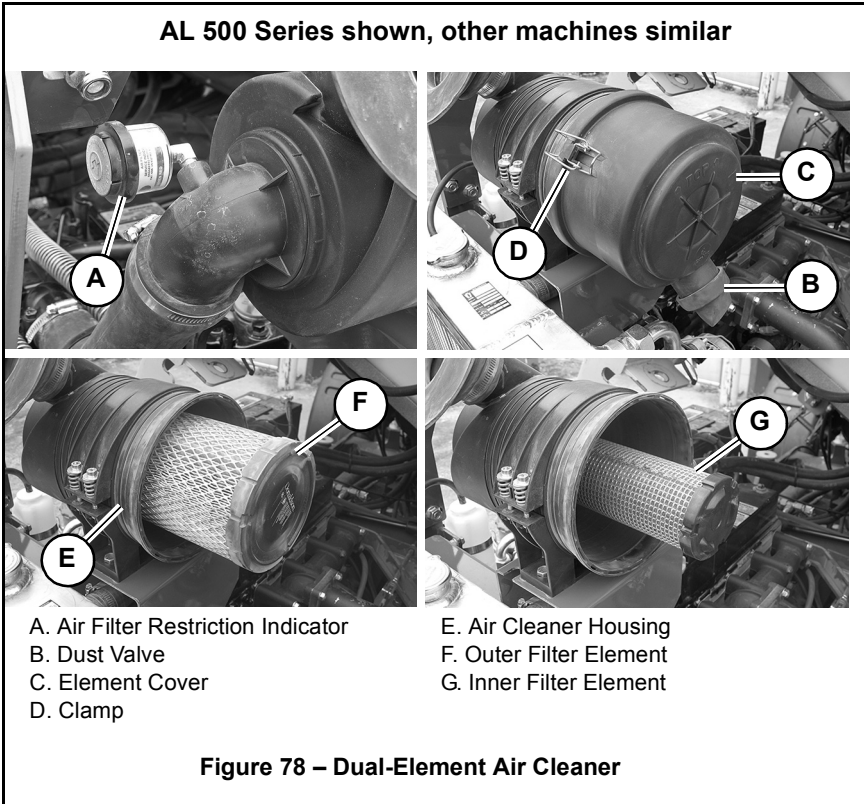
11. Remove the oil fill cap (Z, Fig. 77) and add the recommended oil. See “Fluid Capacities/Lubricants” on page 31. Replace cap (Z).
12. Start the engine and let it run for several minutes at low idle. Stop the engine. Wait until the machine has cooled. See “Service Safety Practices” on page 16.
13. Check for leaks at the oil filter and drain plug. Check the oil level. If necessary, add oil until the oil level is at the full mark on the dipstick.



## Air Cleaner

**Important:** Do not operate the engine without the air cleaner components installed or damage to the engine could occur. Failure to follow air cleaner servicing instructions can cause engine damage.

The air cleaner consists of an outer (primary) filter element, an inner (secondary) filter element, an air filter restriction indicator and a dust valve. If the air cleaner becomes restricted, the air filter restriction indicator (A, Fig. 78) turns red to warn the operator that the element(s) require service. Push the reset button located on the end of the indicator after installing a clean filter element(s). Pinching the dust valve (B, Fig. 78) opens a slit at the end of the valve, allowing accumulated dust in the end of the element cover to drop out without removing the cover.



Only replace the inner element every third time the outer element is replaced, unless the outer element is damaged or the inner element is visibly dirty.

Be sure that the restriction indicator, air cleaner intake hose, clamps and mounting bracket hardware are properly tightened.



### **Accessing the Outer and Inner Filter Elements**

1. Perform the “Mandatory Safety Shutdown Procedure” on page 10.
2. Open the engine cover.
3. Unlatch the clamps on the air cleaner housing and remove the element cover.
4. Clean any debris from the cover.

### **Changing the Filter Elements**

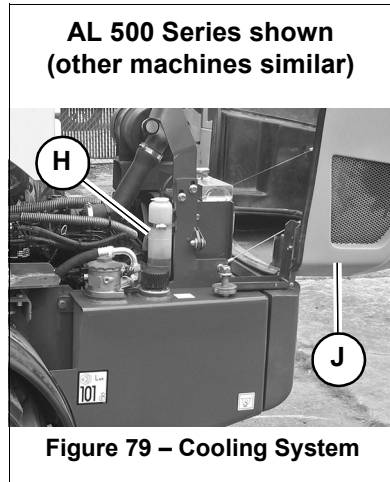
1. Perform the “Mandatory Safety Shutdown Procedure” on page 10.
2. Carefully remove the outer filter element (*F*, *Fig. 78*). Do not remove the inner filter element (*G*) unless it is to be replaced. If the inner filter element will not be replaced, skip to step 8.
3. Before removing inner filter element (*G*) from the housing, clean away any dirt built up in the housing. Leave the inner filter element installed during this step to prevent debris from entering the engine intake manifold.
4. Remove the inner filter element.
5. Clean dust and debris from housing (*E*) and cover (*C*). Leave the inner filter element installed during this step to prevent debris from entering the engine intake manifold.
6. Check the inside of the housing for any damage that may interfere with the elements.
7. Remove the old inner filter element and install the new inner filter element.
8. Reinstall/replace the outer filter element.
9. Latch clamps (*D*) to secure cove (*C*).
10. Check the hose connections and be sure they are all clamped and tightened properly.

# Engine Cooling System

## Checking Coolant Level

1. Perform the “Mandatory Safety Shutdown Procedure” on page 10.
2. Open the engine cover (*J*, Fig. 79). Check the coolant level in the expansion reservoir (*H*, Fig. 79). The expansion reservoir must be 1/3 to 1/2 full for a cold engine and 2/3 to 3/4 full for a hot engine. Add coolant to the expansion reservoir as required.

**Note:** Use a low-silicate ethylene glycol-based coolant, mixed with quality water and supplemental coolant additives (SCAs) suitable for heavy-duty diesel engines. See the engine manual for additional information.



**WARNING** Do not remove the radiator cap when the coolant is hot. Serious burns may occur.

3. Slowly loosen the cap and allow pressure to escape.
4. Remove the cap and add coolant as necessary. See “Fluid Capacities/Lubricants” on page 31 for coolant specification.
5. Reinstall the cap.

## Cleaning Cooling System

1. Perform the “Mandatory Safety Shutdown Procedure” on page 10.
2. Allow engine to cool.
3. Open engine cover.
4. Clean radiator and oil cooler by blowing air/water through the fins.

**Important:** High pressure may bend radiator fins; proceed with caution. Blow air/water in opposite direction of cooling fan to dislodge debris.

## Draining/Refilling Cooling System

1. Perform the “Mandatory Safety Shutdown Procedure” on page 10.
2. Allow engine to cool.
3. Open engine cover.



### WARNING

Do not remove radiator cap when the coolant is hot. Serious burns may occur.

4. Slowly loosen radiator cap (*K*, Fig. 80) and allow pressure to escape. Remove cap.
5. Remove the engine access panel. See “Changing Engine Oil and Filter” on page 110, step 4.
6. Position a collection container, with a capacity of at least 8 L (2 gal.), underneath the radiator drain.

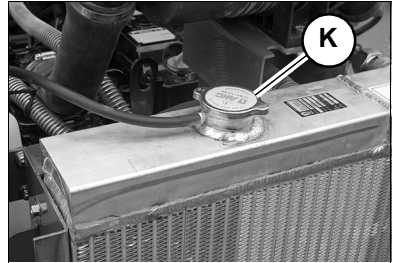


Figure 80 – Radiator Cap

7. Open radiator drain valve (*L*, Fig. 81). Drain valve is located at bottom of radiator, above frame member. The drain valve opening points toward the front of the machine.

**Important:** Drain the coolant into the container. Always dispose of coolant according to environmental laws. DO NOT pour onto the ground or down a drain.

8. Close radiator drain valve.
9. Fill the radiator using a low-silicate ethylene glycol-based coolant, mixed with quality water and supplemental coolant additives (SCAs) suitable for heavy-duty diesel engines. See the engine manual for additional information.

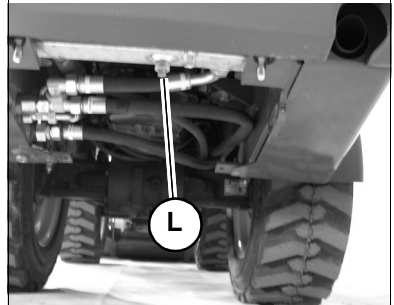


Figure 81 – Cooling System

10. Replace engine access panel.
11. Reinstall radiator cap and tighten securely.
12. Complete all steps in “Checking Coolant Level” on page 114.
13. Run the engine until it is at operating temperature.
14. Perform the “Mandatory Safety Shutdown Procedure” on page 10.
15. Allow the engine to cool.
16. Open the engine cover.
17. Check the coolant level in the expansion reservoir. The reservoir must be 1/3 to 1/2 full for a cold engine and 2/3 to 3/4 full for a hot engine.

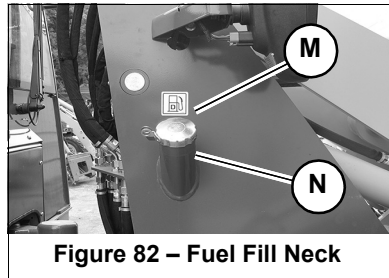
## Fuel System

**⚠ WARNING** Use only proper types and grades of diesel fuel (See “Fluid Capacities/Lubricants” on page 31). Diesel fuel is flammable. Keep the machine away from open flames. Do not smoke when refueling or when working on the engine. Stop the engine before fueling. Failure to follow instructions can cause fire and result in injury or death.

**Important:** The fuel tank is filled at the factory with United States off-road grade diesel fuel, which is dyed red for identification. It may take several fillings of the fuel tank before the red dye is purged from the fuel system.

### Adding Fuel

1. Perform the “Mandatory Safety Shutdown Procedure” on page 10.
2. Remove fuel cap (M, Fig. 82).
3. Inspect the wire-mesh fuel strainer located in the filler neck and remove any accumulated residue that may be present. Replace the strainer if damaged.
4. Add fuel into fuel filler neck (N).



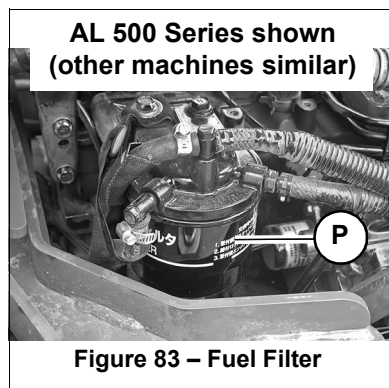
**Important:** The engine requires low sulfur or ultra-low sulfur diesel fuel (below 500 PPM recommended). BioDiesel mixtures of up to a 5% (B5) are acceptable. Ultra-Low Sulfur Diesel (ULSD) fuel lubricity must have a maximum scar diameter of 0.45 mm, as measured by ASTM D6079 or ISO 12156-1, or a minimum of 3100 grams, as measured by ASTM D6078. Contact your fuel supplier for details.

### Changing Fuel Filter

The fuel filter (P, Fig. 83) is located in the fuel line before the fuel pump. Access the fuel filter by opening the engine cover and tilting the platform. See “Tilting Up the Platform” on page 107. Replace the fuel filter at the interval specified in the “Maintenance Schedule” on page 104


The fuel filter is located on the left side of the loader.

1. Perform the “Mandatory Safety Shutdown Procedure” on page 10.
2. Allow the machine to cool completely.



**⚠ WARNING** Fuel spilled on hot components can cause fire and severe burns. Allow the machine to cool completely before removing the fuel filter.

3. Shut off the fuel supply by turning the fuel shut-off valve on top of the water separator to OFF.
4. Remove the fuel filter.

 **WARNING** Watch for, and catch, any fuel drips or leaks. Wipe up spilled fuel and immediately dispose of rags used to clean up fuel spills. Fuel vapors can ignite and cause severe burns.

5. Clean the fuel filter gasket and the fuel filter mounting surfaces where they contact each other with a clean cloth.
6. Lubricate new fuel filter gasket with diesel fuel.
7. Install and tighten the filter 3/4 turn past the point the where the gasket contacts the filter head.
8. Turn shut-off valve on water separator to ON.
9. The engine is self-priming: to remove air from the fuel line before starting, turn the ignition key to the ON position for 30 seconds.

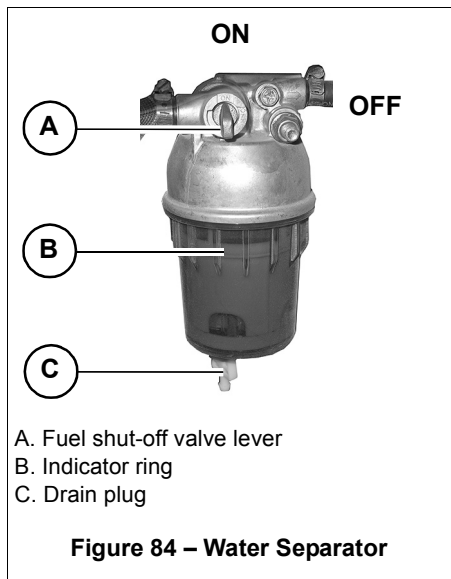
## Water Separator Maintenance

The water separator contains an indicator ring that floats on top of accumulated water. Under normal conditions, this ring sits at the bottom of the separator. If the ring is somewhere between the bottom of the separator and white ring (B, Fig. 84), then accumulated water must be drained.

**Important:** *Water in the fuel system can cause severe engine damage. Drain water from the fuel filter/water separator anytime water is present.*

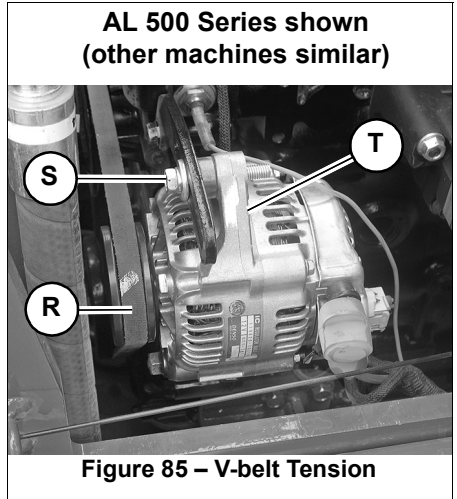
1. Perform the “Mandatory Safety Shutdown Procedure” on page 10.
2. View the water separator through the slot in front of the right-rear tire, near the step.
3. Access the water separator from underneath the loader, near the right-rear wheel. Check for water in water separator by checking the level of the float in the water separator bowl. If water is present, complete steps 4-7.
4. Turn the fuel shut-off valve lever (A, Fig. 84) on the water separator to the OFF position.

5. Place a container underneath the drain plug (C, Fig. 84). Loosen the plug until water begins draining. Allow water to drain until the indicator ring returns to the bottom of the water separator.
6. Tighten the drain plug and discard fuel/water according to environmental laws. DO NOT pour the fuel/water onto the ground or down a drain.
7. Turn the fuel shut-off valve lever (A) on the water separator to the ON position.



## Checking and Adjusting V-belt Tension

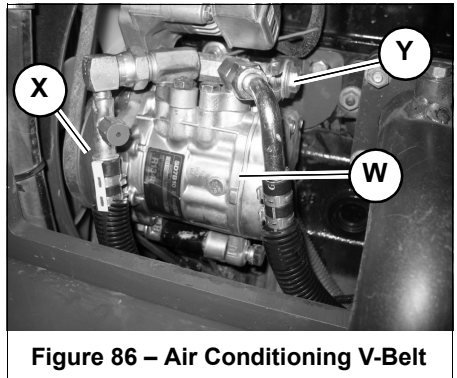
1. Perform the “Mandatory Safety Shutdown Procedure” on page 10.
2. Open the engine cover.
3. Inspect V-belts (*R*, Fig. 85) for damage. If damaged, have belts replaced by your dealer.
4. Press on V-belts (*R*) mid-way between pulleys to check deflection. Belts should deflect no more than 8 mm (5/16”).
5. If deflection is more than 8 mm (5/16”): Loosen the adjustment bolt (*S*) and rotate the alternator (*T*) outward until V-belt tension is correct. Tighten bolt (*S*) and re-check V-belt tension.



### **Air Conditioning V-Belt**

Inspect and service the air conditioning V-belt (*X*, Fig. 86) the same as directed in *Checking and Adjusting V-belt Tension*.

To adjust the air conditioning V-belt tension, Loosen the adjustment bolt (*Y*) and rotate the air conditioning compressor (*W*) downward until V-belt tension is correct. Tighten bolt (*S*) and re-check V-belt tension.



## Air Conditioning Maintenance

Test air conditioning function weekly. Reduced air conditioning function could indicate a low refrigerant level. Low refrigerant or refrigerant leaks can cause air conditioning compressor overheating and failure.

**Important:** Air conditioning system should be filled only by technicians trained in the air conditioning fill processes.

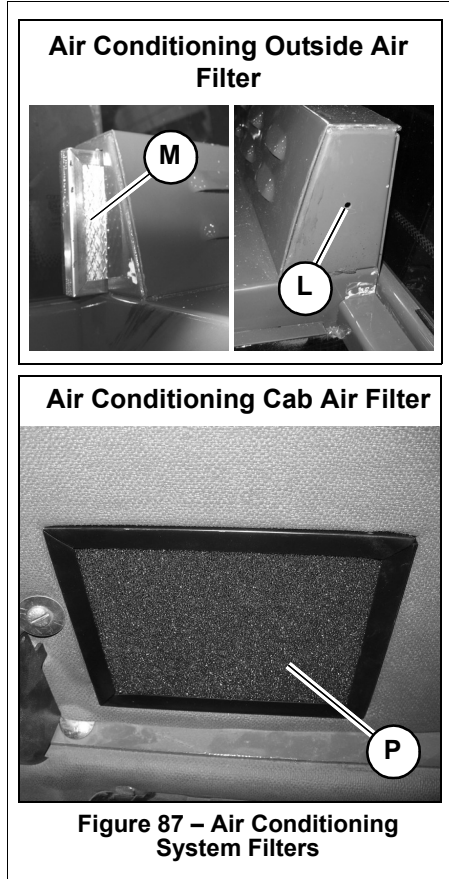
### Filter Replacement

**Air conditioning outside air intake filter element replacement:**

1. Perform the “Mandatory Safety Shutdown Procedure” on page 10.
2. Open the engine cover.
3. Insert a thin screwdriver into hole (L, Fig. 87) on the right side of the outside air filter housing and push to start moving filter element (M) out of the filter housing.
4. On the left side of the outside air filter housing, pull air filter element (M) out of the air conditioning unit.
5. Replace with a new filter element. Make sure the new element is seated all the way into the filter housing, with the outside edge of the filter element flush with the left side of the filter housing.

**Air conditioning cab air filter element replacement:**

1. Slide the operator’s seat as far forward as it will go to provide access to the cab wall behind the seat.
2. Using a screwdriver, carefully pry the old cab air filter element (P) out of the cab wall. Remove and discard the old filter element.
3. Press the new filter element (P) into the opening in the cab wall. Make sure the filter element is completely seated in the opening.



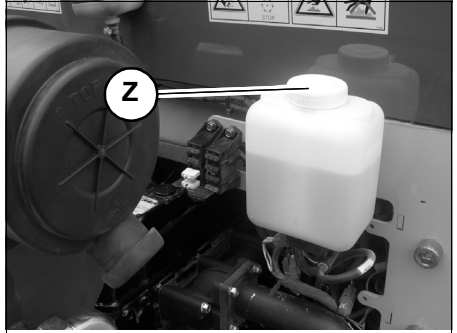
**Figure 87 – Air Conditioning System Filters**



## Windshield Washer Reservoir (Cab Only)

The cab windshield washer reservoir is located inside the engine compartment.

1. Perform the “Mandatory Safety Shutdown Procedure” on page 10.
2. Open the engine cover.
3. As necessary, remove cap (Z, *Fig. 88*) from the windshield washer reservoir and fill with windshield washer fluid.
4. Replace cap (Z) and close the engine cover.



**Figure 88 – Windshield Washer Reservoir (Cab Only)**

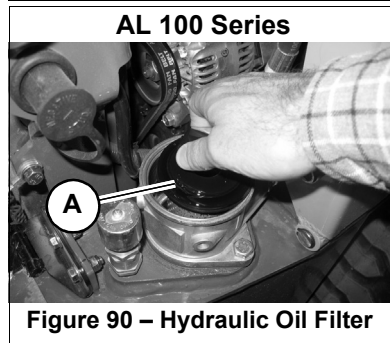
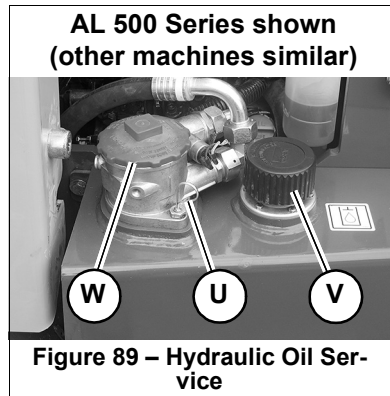
# Hydraulic System Maintenance

**⚠ WARNING** Never use your hands to search for hydraulic fluid leaks; use a piece of paper or cardboard to find leaks. Escaping fluid under pressure can be invisible and can penetrate the skin, causing serious injury. If any fluid is injected into your skin, see a doctor at once. Injected fluid **MUST** be surgically removed, or gangrene may result.

## Hydraulic Oil

### Checking Hydraulic Oil Level

1. Completely lower the lift arm and attachment.
2. Perform the “Mandatory Safety Shutdown Procedure” on page 10.
3. Open the hood.
4. Check the hydraulic oil level by removing the dipstick (U, Fig. 89), located on the left in the engine compartment.
5. If hydraulic oil is required, allow the system to cool.
6. Slowly remove the oil fill cap (V, Fig. 89). Allow the pressure to escape before completely removing the cap.



**Important:** On AL 100 Series machines, remove the hydraulic oil filter cap (W, Fig. 89) and lift the hydraulic oil filter (A, Fig. 90) slightly before adding oil. Lifting the oil filter breaks the air seal and allows the hydraulic tanks to vent, allowing the tanks on both sides of the machine to fill evenly, otherwise, the hydraulic tanks will not fill evenly or completely.

7. Add hydraulic fluid as required. See “Fluid Capacities/Lubricants” on page 31.

**Note:** Do not mix different types/grades of hydraulic fluids.

8. Reinstall the oil fill cap. On AL 100 Series machines, re-seat the hydraulic oil filter and reinstall the hydraulic oil filter cap.

## Changing Hydraulic Oil and Filter

**Note:** The hydraulic oil filter can be changed without changing the hydraulic oil or draining the hydraulic reservoir.

Replace the hydraulic oil if it becomes contaminated, after major repairs, and after 500 hours or one year of use.

1. Perform the “Mandatory Safety Shutdown Procedure” on page 10.
2. Open the hood.
3. Slowly remove the oil fill cap (V, Fig. 89). Allow the pressure to escape before completely removing the cap.
4. Position a waste oil collection container with a capacity of at least 45 liters (11 gallons) underneath the hydraulic oil reservoir.

**Important:** Always dispose of hydraulic fluids according to environmental laws or take to a recycling center for proper disposal. DO NOT pour onto the ground or down a drain.

5. Remove the drain plug (X, Fig. 91) and allow the oil to drain completely.
6. Unscrew the filter cover (W, Fig. 89).
7. Remove the old filter element (Y, Fig. 92). Cover the filter opening on the filter housing with a clean rag while adding oil.
8. Refill the reservoir until the oil is between the two lines on the dipstick (U, Fig. 89).
9. Remove the rag from the filter opening and clean the surface of the filter housing where the element seal contacts the housing. Put clean oil on the rubber gasket of the new filter element (Y, Fig. 92).
10. Install the new filter element (Y, Fig. 92).
11. Reinstall the drain plug.
12. Reinstall the filter cover.

**Note:** Do not mix different types/grades of hydraulic fluids.

13. Start the engine and operate the hydraulic controls.
14. Stop the engine and check for leaks at the hydraulic oil filter and reservoir drain plug.
15. Check the oil level and add oil if necessary.

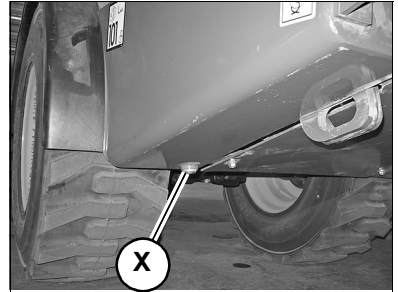


Figure 91 – Hydraulic Oil Drain

**AL 500 Series shown  
(other machines similar)**

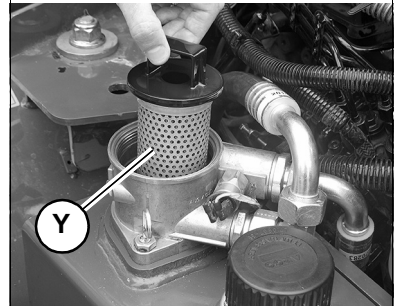


Figure 92 – Hydraulic Oil Service

# Hydraulic Hose Maintenance

**⚠ WARNING** Hydraulic hoses and connections must be inspected by a trained technician before the first use of the machine, and at least annually thereafter, for leaks and/or damage.

Leakages and damaged pressure hose/lines must be immediately repaired or replaced by an authorized service center.

Never use your hands to check for suspected hydraulic leaks. Always use a piece of wood or cardboard.

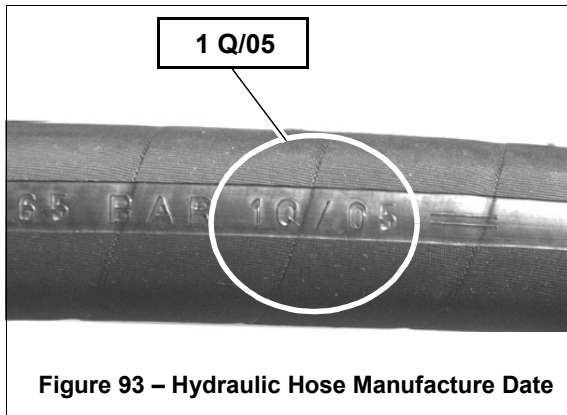
Leaks from hydraulic hoses or pressurized components can be difficult to see, but pressurized oil can have enough force to pierce the skin and cause serious injury.

Obtain immediate medical attention if pressurized oil pierces the skin. Failure to obtain prompt medical assistance could result in gangrene or other serious damage to tissue.

Always relieve hydraulic system pressure before performing any maintenance on the machine. Do not tighten leaking connections when the hydraulic system is under pressure.

Never weld or solder damaged or leaking pressure lines and/or screw connections. Always replace damaged hydraulic components.

Hydraulic hoses must be replaced every six years from the date of manufacture, even if they do not appear damaged. The date of manufacture (month or quarter and year) is indicated on hydraulic hoses. See Figure 93.



# Planetary Axles

## Changing Planetary Axle Oil

Replace the oil in the axles if it becomes contaminated, after the first 500 hours of service, and every 1500 hours or annually thereafter.

1. Warm the axles to operating temperature.
2. Perform the “Mandatory Safety Shutdown Procedure” on page 10. The machine must be parked on a level surface.
3. Complete the following procedures as appropriate for the model machine.

### Changing Axle Wheel-Hub Oil (AL 500, AL 400 and AL 300 Series)

**Note:** Removing the tires and raising the machine on jackstands can make hub oil changing easier.

1. Rotate the oil drain/fill plugs (A, Fig. 94) on the wheel hubs so they are positioned at the top as shown in the figure. Thoroughly clean the area around the plugs and slowly loosen and remove the plugs.
2. Position a waste oil collection containers, capacity 0.5 liters (0.5 quarts) each, underneath the wheel hubs, to catch oil as it drains.

**Important:** Always dispose of waste oil according to environmental laws or take to a recycling center for proper disposal. DO NOT pour onto the ground or down a drain.

3. Rotate the oil drain holes (B, Fig. 95) on the wheel hubs so they are positioned at the bottom as shown in the figure. Allow the oil to completely drain from the hubs.
4. Rotate the holes on the wheel ends so they are positioned to the side as shown (C, Fig. 96).
5. Add oil through the holes to the level line (D) stamped on the hub and shown in Fig. 96. See “Fluid Capacities/Lubricants” on page 31 for the specific oil type and grade.

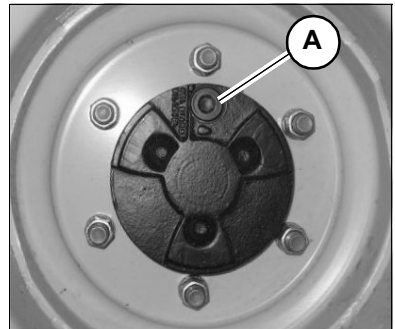


Figure 94 – Wheel-Hub Oil Drain Plug Removal Position

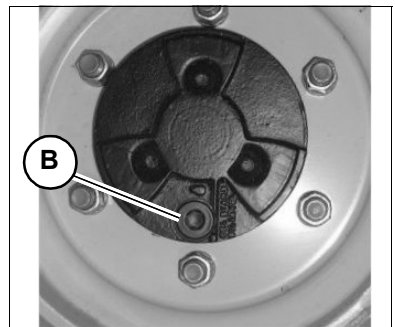
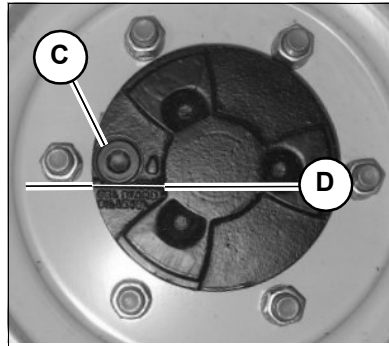


Figure 95 – Wheel-Hub Oil Drain Position

6. Thoroughly clean the oil drain/fill plugs. Replace the plugs with new O-rings and tighten to 70 N•m (52 lbf.-ft.).



**Figure 96 – Wheel-End Axle Oil Level Check**

### **Changing Axle Center Oil (AL 500, AL 400 and AL 300 Series)**

**Note:** Remove the optional counterweight, if it is installed.

1. Position waste oil collection containers, with a capacity of at least 2.5 liters (2.6 quarts) front and 3.2 liters (3.4 quarts) rear, underneath the axle centers to catch oil as it drains.

2. Thoroughly clean the area around the axle center fill plugs (E, Fig. 97), Slowly loosen and remove the plugs.

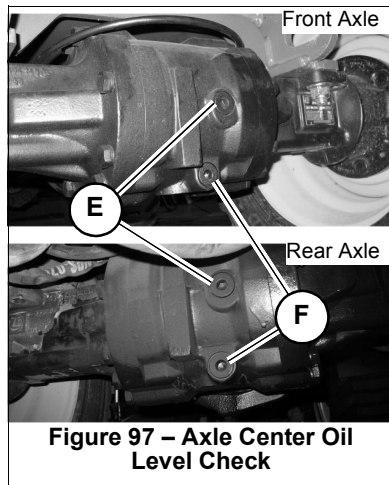
**Important:** Always dispose of waste oil according to environmental laws or take to a recycling center for proper disposal. DO NOT pour onto the ground or down a drain.

3. Thoroughly clean the area around the axle center drain plugs (F, Fig. 97) and slowly loosen and remove the plugs. Allow the oil to completely drain from the axle centers.

4. Thoroughly clean the axle center oil drain plugs. Replace the plugs with new O-rings and tighten the plugs to 70 N•m (52 lbf.-ft.).

5. Add oil through the oil fill holes (E) until it reaches the bottom of the holes. See “Fluid Capacities/Lubricants” on page 31 for the specific oil type and grade.

6. Thoroughly clean the axle center oil fill plugs (E). Replace the plugs with new O-rings and tighten to 70 N•m (52 lbf.-ft.).



**Figure 97 – Axle Center Oil Level Check**

### Changing Axle Oil (AL 200 and AL 100 Series)

1. Position waste oil collection containers, with capacities of at least 5 liters (5 quarts) underneath the axle centers to catch oil as it drains.
2. Thoroughly clean around axle drain plugs (*M*, Fig. 98) and remove the plugs.
3. Thoroughly clean around axle fill plugs (*O*) and remove the plugs. Allow the oil to completely drain.

**Important:** Always dispose of waste oil according to environmental laws or take to a recycling center for proper disposal. DO NOT pour onto the ground or down a drain.

4. Thoroughly clean axle drain plugs. Replace and tighten the plugs.
5. Add oil through the oil fill holes (*O*) until it reaches the bottom of the holes. See “Fluid Capacities/Lubricants” on page 31 for the specific oil type and grade.
6. Thoroughly clean fill plugs (*O*). Replace and tighten the plugs.

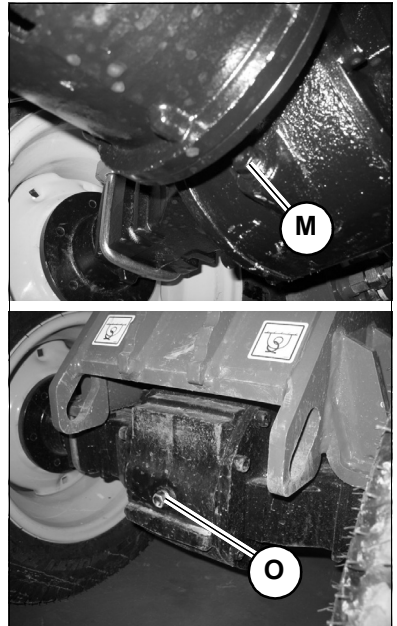


Figure 98 – Axle Oil Drain/Fill

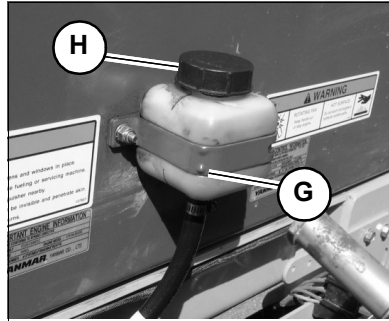
# Brake Fluid Reservoir (AL 300, AL 400 and AL 500 Series)

## Checking Brake Fluid Reservoir Level

1. Perform the “Mandatory Safety Shutdown Procedure” on page 10.
2. Open the engine hood.
3. The brake fluid reservoir (G, Fig. 99) is located against the platform at the front of the engine compartment.

*Note: On machines equipped with air conditioning, the brake fluid reservoir is located on the back of the air conditioning enclosure.*

4. Carefully remove the brake fluid reservoir fill cap (H). Be careful not to allow dirt to fall into the reservoir.
5. The brake fluid reservoir fluid level should not fall below 1/2 full. Add automatic transmission fluid as required.

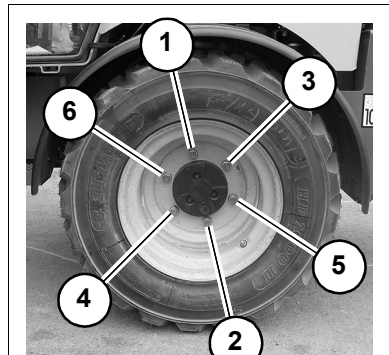


**Figure 99 – Brake Fluid Reservoir (AL 500 Series without Air Conditioning Shown)**

## Wheels and Tires

### Wheel Fasteners

Wheel fastener torque must be checked before initial operation and every two hours thereafter until the wheel mounting hardware torque stabilizes. Torque the wheel fasteners in the order shown (Fig. 100). When tires are removed and replaced, this procedure must be repeated. See “Wheels” on page 38 for wheel fastener torque specifications, wheel rim dimensions and wheel offset measurements.



**Figure 100 – Wheel Fasteners Tightening Order**



## Tires

**⚠ WARNING** Inflating or servicing tires can be dangerous. Only trained personnel should service and mount tires.

*Important:* Keep the same size tire on each side of the loader to prevent excessive wear on tires.

### Tire Rotation

To keep tire wear even, rotate the tires from front to rear and rear to front.

*Important:* The tread bar of all tires should face the same direction.

### Checking Tire Pressure

Correct tire pressure should be maintained for all tires to enhance operating stability and extend tire life. Use a clip-on tire chuck with remote hose and gauge and stand clear of the tire during inflation.

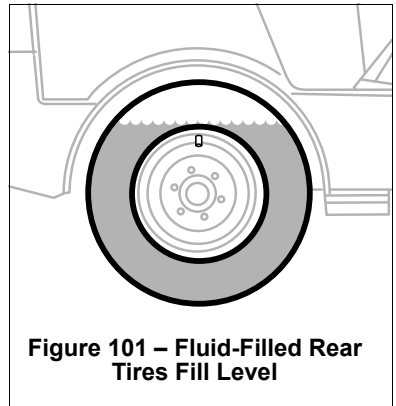
*Note:* See tire sidewall for recommended inflation pressure.

### Liquid Tire Ballast (AL 500 Series)

**⚠ WARNING** On AL 500 Series machines equipped with 33x15.5-16.5 and 31x15.5-16.5 (EU) tires, can have liquid ballast installed in the rear tires to maximum capacity performance.

To prevent corrosion and freezing, use only a good grade of calcium chloride or equivalent fluid as tire ballast.

Mix the liquid tire ballast product according to the manufacturer's instructions. Fill to the level shown in Fig. 101.

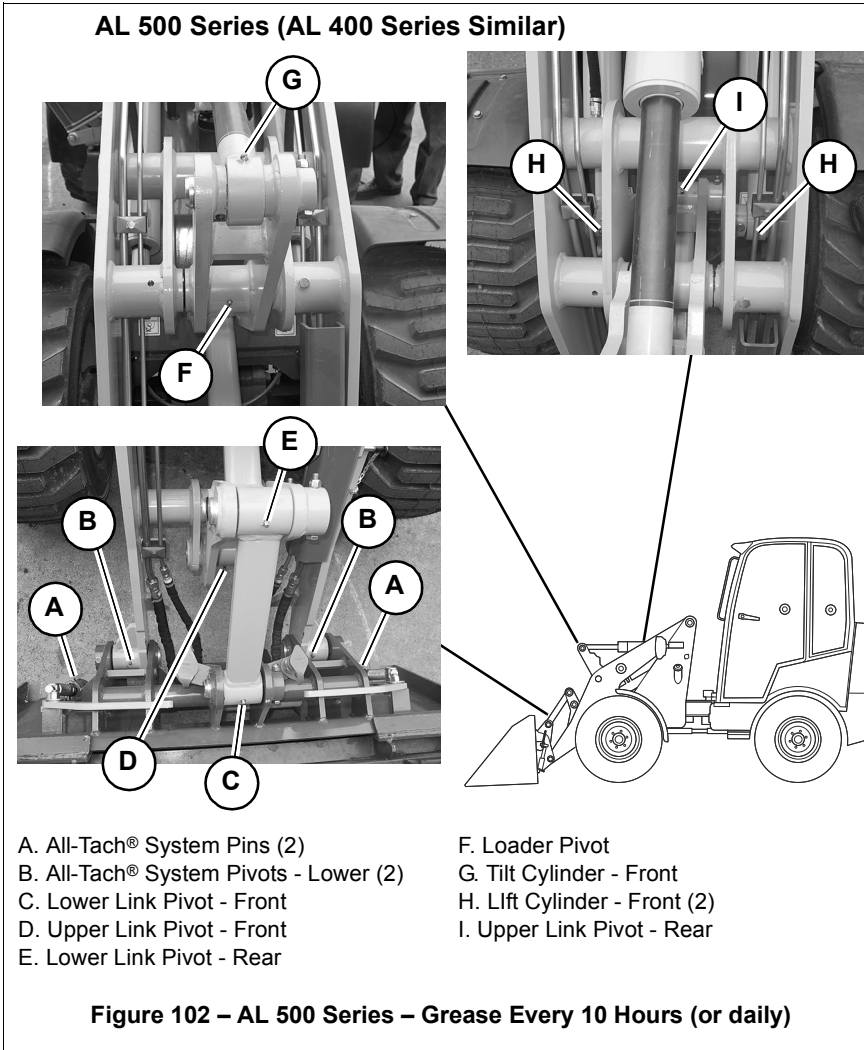


**Figure 101 – Fluid-Filled Rear Tires Fill Level**

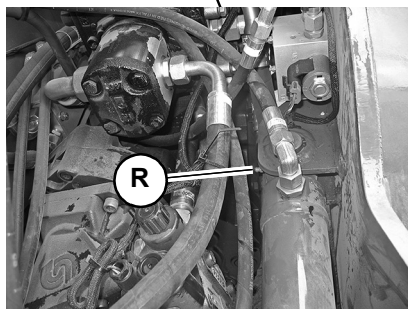
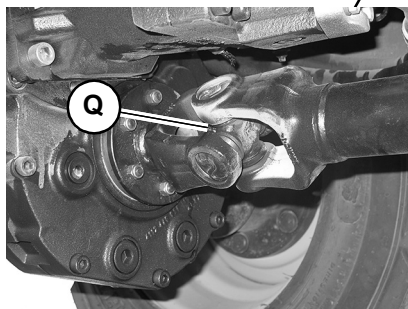
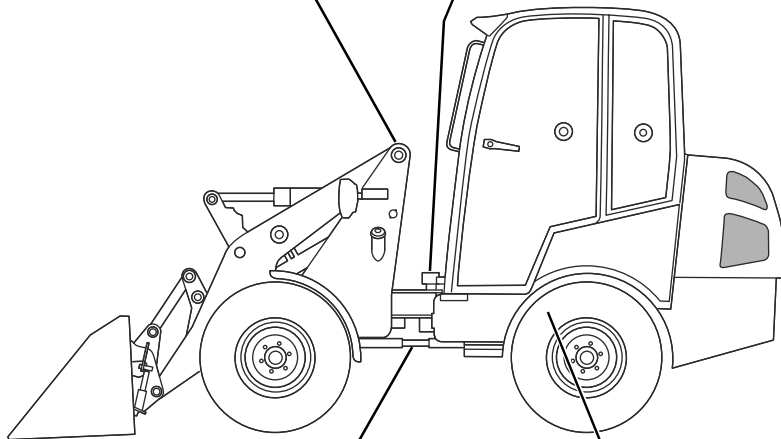
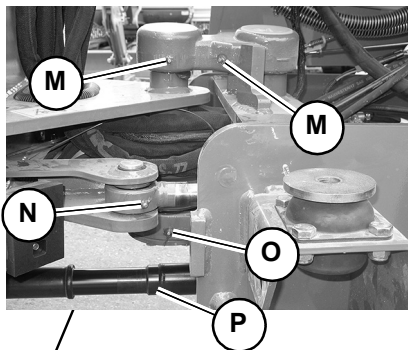
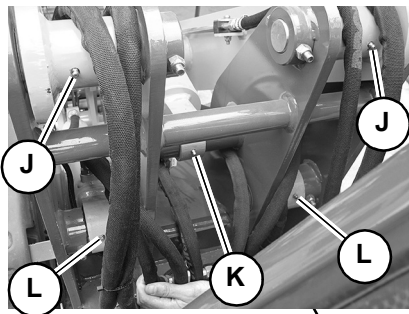
# Lubrication

**Important:** Use of lubricants not corresponding to manufacturer recommendations may invalidate warranty claims. Always dispose of waste lubrication oils and hydraulic fluids according to environmental laws or take to a recycling center for proper disposal. DO NOT pour fluids onto the ground or down a drain.

Refer to the following figures for grease fitting locations. See “Fluid Capacities/Lubricants” on page 31 for proper grease specifications. Wipe dirt from the fittings before greasing them to prevent contamination. Replace any missing or damaged fittings. Avoid excessive greasing to minimize dirt build-up.



## AL 500 Series (AL 400 Series Similar)

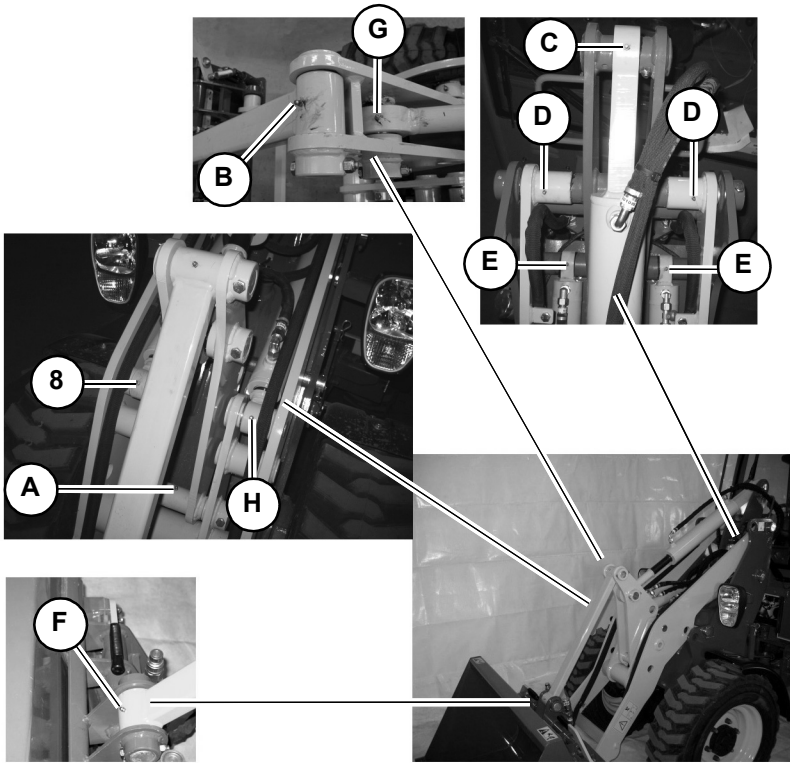


- J. Lift Arm - Upper Pivot (2)
- K. Tilt Cylinder - Rear Pivot
- L. Lift Cylinder - Rear Pivot (2)
- M. Articulation Pivot - Upper (2)
- N. Steering Cylinder - Front

- O. Articulation Pivot - Lower
- P. Driveshaft - Center Telescoping Section
- Q. Driveshaft - Both Ends
- R. Steering Cylinder - Rear (2)

**Figure 103 – AL 500 Series – Grease Every 10 Hours (or daily)**

**AL 200/300 Series Shown (AL 100 Series Similar)**

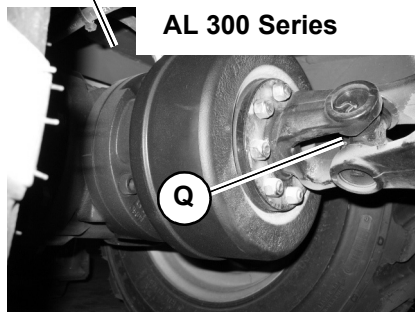
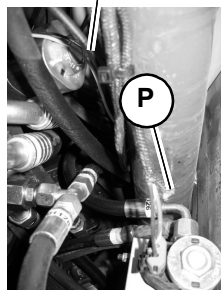
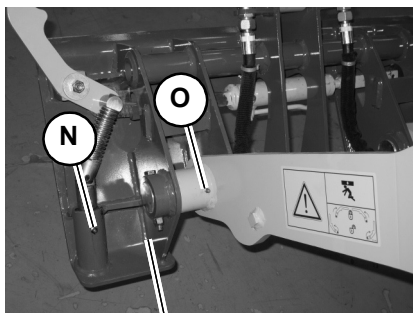
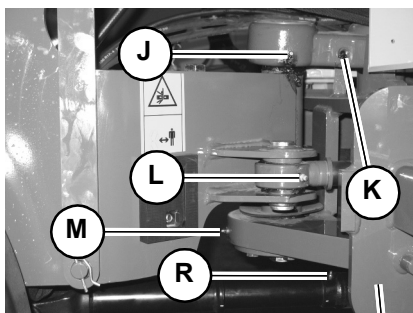


- A. Pivot Arm - Lower
- B. Link Pivot - Upper
- C. Tilt Cylinder - Rear
- D. Lift Arm Pivot (2)

- E. Lift Cylinder - Rear (2)
- F. Attachment Pivot - Upper
- G. Tilt Cylinder - Front
- H. Lift Cylinder - Front (2)

**Figure 104 – AL 300/200/100 Series – Grease Every 10 Hours (or daily)**

**AL 200/300 Series Shown (AL 100 Series Similar)**



**AL 300 Series**

- J. Articulation Pivot - Upper Front
- K. Articulation Pivot - Upper Rear
- L. Steering Cylinder - Front
- M. Articulation Pivot - Lower
- N. All-Tach® System Pins (2)

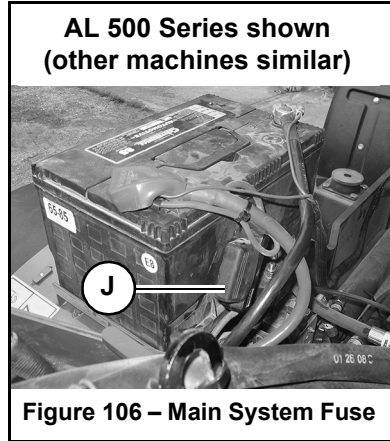
- O. All-Tach® System Pivots - Lower (2)
- P. Steering Cylinder - Rear
- Q. Drive Shaft Ends
- R. Drive Shaft Center Telescoping Section (AL 300 Series)

**Figure 105 – AL300/200/100 Series—Grease Every 10 Hours (or daily)**

# Electrical System

## Fuses

The main system fuse (*J*, *Fig. 106*) is located behind the battery and connected to the positive (+) battery terminal.

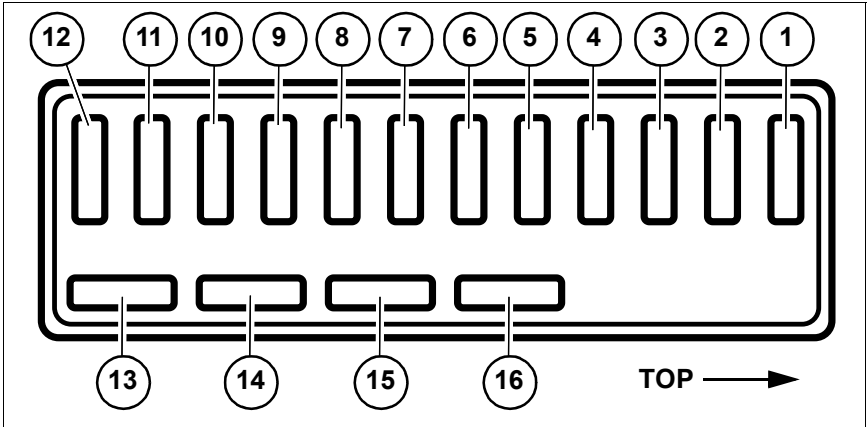


The primary fuse panel (*K*, *Fig. 107*) is located at the left side of the steering column.

- For details see “Steering Column Fuses – AL 500/400/300 Series; AL 100 (EU), AL 200 Optional” on page 135 and “Steering Column Fuses – AL 100 Series and AL 200 Standard” on page 136.

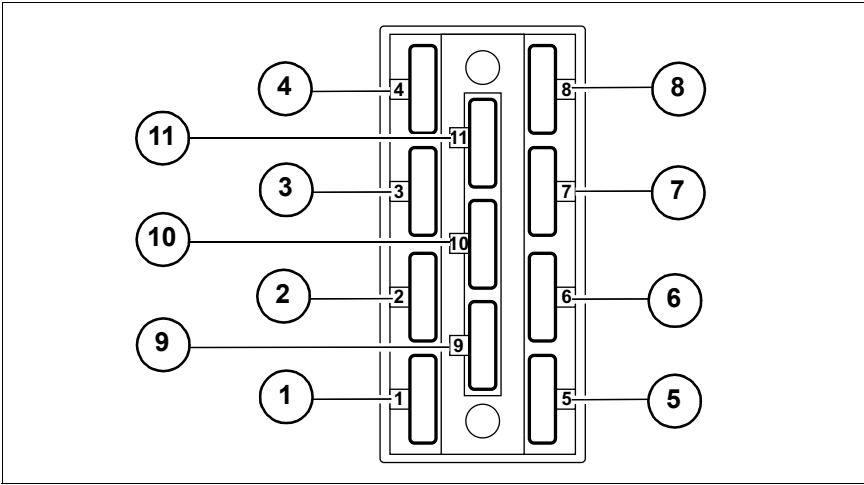


**Steering Column Fuses – AL 500/400/300 Series; AL 100 (EU), AL 200 Optional**



Fuse No.	Rated Current (Amp)	Protected Circuit
1.	5	Instrument panel, differential lock, cab relay
2.	10	Joystick, control module relay
3.	5	Fuel pump, fuel solenoid hold
4.	7.5	Horn, beacon
5.	5	Work light switch, work light relays
6.	10	Power-A-Tach® system
7.	5	Starter relay
8.	10	Turn signals
9.	20	Ignition switch
10.	10	Rear work light
11.	10	Front work light
12.	7.5	12V accessory power outlet
13.	10	High-beam headlights
14.	10	Low-beam headlights
15.	5	Position lights
16.	10	Spare fuse

## Steering Column Fuses – AL 100 Series and AL 200 Standard



Fuse No.	Rated Current (Amp)	Protected Circuit
1.	5	Instrument panel, drive forward and reverse relays
2.	5	Joystick
3.	5	Fuel pump, glow module, fuel solenoid hold
4.	7.5	Horn, beacon
5.	5	Steering column switch lights
6.	10	Power-A-Tach® system
7.	5	Starter relay
8.	20	Ignition switch
9.	10	Rear work light
10.	10	Front work light
11.	7.5	12V accessory power outlet



## Cab and In-Line Fuses

Cab fuses (L, Fig. 108) are located in the engine compartment at the right rear corner of the operator's platform. Open the engine cover to access these fuses.

Additional in-line fuses are located in the wire harness under the platform.

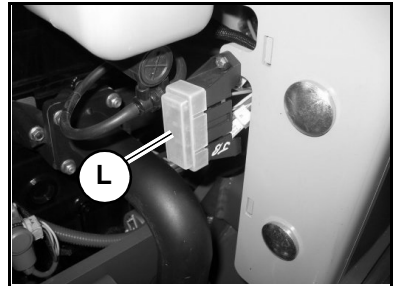


Figure 108 – Cab Fuse Block (inside engine compartment)

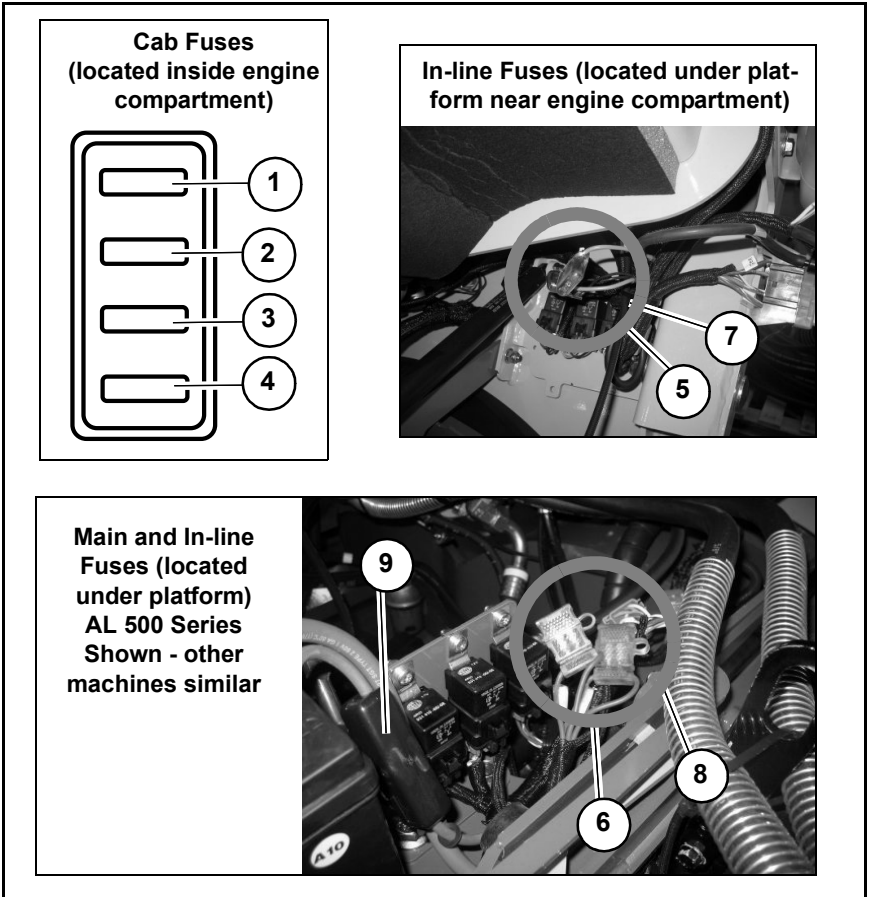


Figure 109 – Cab, Drive, Starter, Glow and Main Fuses

*Note: Refer to Fig. 108 and Fig. 109.*

<b>Fuse No.</b>	<b>Rated Current (Amp)</b>	<b>Protected Circuit</b>
1.	5	Dome light
2.	7.5	Rear wiper motor
3.	10	Front wiper motor
4.	25	Heater
5.	15	Drive module (AL 400/AL 500 Series only)
6.	40	Glow plugs
7.	25	Control module
8.	30	Starter solenoid
9.	60	Main Fuse

## Control Modules

The control modules, located behind the operator's seat on the right, (all models except AL 100 Series), or under the operator's platform (AL 100 Series) provide switching, control logic and diagnostic functions.

### **Machine Control Module**

The machine controller (*N*, Fig. 110) provides the following functions:

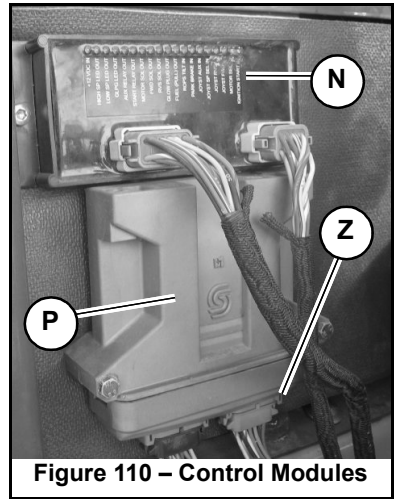
- Glow plug control
- Starter logic
- Sends forward/reverse signal to drive controller
- Safety logic control

### **Drive Control Module (AL 500/400 Series)**

The drive control module provides computerized control of the drive system, and provides error-reporting functionality.

LEDs inside the cover indicate the following:

- Green steady on — Indicates power to the drive controller
- Red/green flashing — Indicates an error in the system



**Figure 110 – Control Modules**

## Drive Control Module Error Codes

Malfunctioning drive function may indicate a control module error condition.

The table on page 140 describes control module error codes. Error codes are indicated by flashing LEDs (*Z, Fig. 110*) located near the electrical connectors at the bottom of the module.


The LED flash pattern for error messages starts with four medium-length flashes, which signal the start of the message, followed by a pause. After the pause, a number of long flashes may occur, indicating the first digit for the code. After another pause, a number of short flashes occur indicating the second digit for the code. After a final pause, the flash pattern then repeats.

More than one error code may be displayed, one after the other.

To illustrate, the flash pattern for error code “13” would be: Four medium flashes (message start), pause, one long flash (first digit of error code), pause, three short flashes (second digit of error code), pause. The flash pattern then repeats.


<b>Error Flash Code</b>	<b>Description</b>
13	Watchdog Ready Error
15	Battery Voltage or Sensor Voltage Error
19	Pump Current Forward Error
23	Pump Current Reverse Error
27	Motor Current Error
31	Engine Speed RPM Error
35	FNR Shortcut Error
39	Inching Error
43	Driving Pedal Error
47	Mode Switch-2 Error
55	Brake Pressure Defeat Error (or Parking Brake Error or Brake Light Error)
59	Motor RPM and Direction Error
70	General CAN Receive Error

## Battery

 **WARNING** Before servicing the battery or electrical system, disconnect the negative battery cable from the negative battery terminal and tie the cable away from the negative battery terminal to prevent sparking and accidental re-connection. Alternately, if the machine is equipped with the optional battery disconnect switch, turn the battery disconnect switch to the “OFF” position.

Refer to “Electrical System” on page 38 for battery specifications. To access the battery, tilt the platform. See “Tilting the Platform” on page 107.

The battery top must be kept clean. Clean it with an alkaline solution (ammonia or baking soda and water). After foaming has stopped, wipe the battery top with a damp towel. Clean corrosion from terminals and cable connection by disconnecting the cables and cleaning the terminals and clamps with the same alkaline solution. Thoroughly dry the battery and cables using a clean towel.

 **WARNING** Explosive gas is produced while a battery is in use or being charged. Keep flames or sparks away from the battery area. ALWAYS charge the battery in a well-ventilated area.

Never lay a metal object on top of a battery, because a short circuit can result.

Battery acid is harmful to skin and fabrics. If acid spills, follow these first-aid tips:

1. Immediately remove any clothing on which acid spill.
2. If acid contacts skin, rinse the affected area with running water for 10 to 15 minutes.
3. If acid contacts eyes, flood eyes with running water for 10 to 15 minutes. See a doctor at once. Never use any medication or eye drops unless prescribed by the doctor.
4. To neutralize battery acid spills, use one of the following mixtures:
  - a. 0.5 kg (1 lbs.) of baking soda in 4 L (4 qts.) of water
  - b. 0.5 L (0.5 qts.) of household ammonia in 4 L (4 qts.) of water

When removing the battery, disconnect the negative (-) battery cable first and re-connect it last during installation.

## Using a Booster Battery (Jump-Starting)

**Note:** The machine may be equipped with the remote battery terminal, allowing for easy access to booster terminals. See “Remote Battery Terminal” on page 143.

**Important:** Only complete these steps if the loader cannot be started using the ignition key switch. See “Engine Start” on page 67.

If the loader does not start because of a “dead” (discharged) battery, start the loader using a battery jumper cable connected to the battery of another vehicle.

**Important:** The loader cannot be tow-started because no direct mechanical connection exists between the wheels and the engine. Attempting to tow-start the machine may damage the drive system.



### **WARNING**

**Do not jump-start a frozen battery, or it may explode. A discharged battery can freeze at 10°C (14°F).**

**Note:** Before jump-starting, check that the battery disconnect switch is not turned off.

The booster battery must have a nominal voltage of 12-volts. The capacity (Amp-hour rating) of the booster battery must be approximately equal to that of the discharged battery. Check the label on the discharged battery for the battery capacity.



### **WARNING**

**Keep metal parts on your clothing and metal watchbands away from the positive (+) terminal of the battery — risk of short circuit.**

1. Turn the key switches of both machines to OFF. Be sure the machines are in neutral and NOT touching each other.
2. Connect the positive jumper cable to the positive (+) terminal on the discharged battery.
3. Connect the negative jumper cable to the negative (-) terminal on the discharged battery.

**Note:** If the machine is equipped with the optional remote battery terminal, connect the cables to the terminal studs on the remote battery terminal. See “Remote Battery Terminal” on page 143.

4. Connect the free end of the positive jumper cable to the positive (+) terminal on the booster battery.
5. Connect the free end of the negative jumper cable to a convenient ground on the machine carrying the booster battery.
6. Start the machine with the discharged battery. See “Engine Start” on page 67. If the engine does not start immediately, stop cranking after 10 seconds and repeat starting procedure after approximately 30 seconds.



## WARNING

When the engine is running, components in the engine compartment rotate. Before removing the jumper cables, be sure that no loose clothing can become caught in the rotating components.

7. After the engine is running, remove the negative jumper cable connected to the booster machine ground.

**Important:** *DO NOT* allow the booster cable ends to touch when removing them. Arcs and direct short circuits can cause severe damage to the electrical system.

8. Disconnect the jumper cables from the machine with the discharged battery.

9. Remove the positive jumper cable from the booster battery.

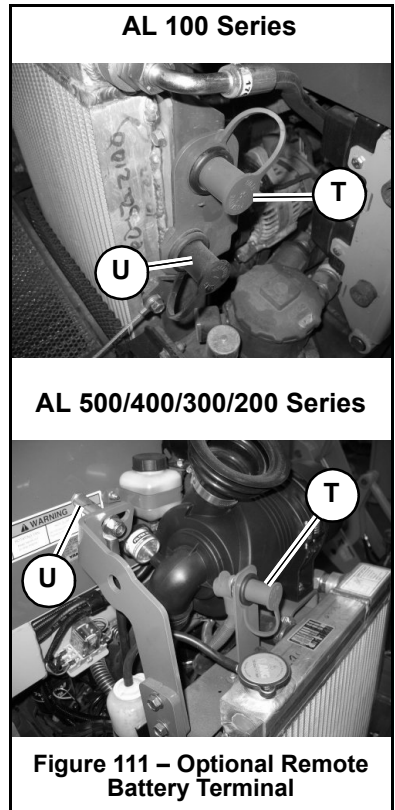
10. Close the engine cover and confirm it is latched securely.

11. Allow the machine to run for at least 30 minutes to re-charge the battery.

### Remote Battery Terminal

The optional remote battery terminal allows access to the battery terminals for jump-starting purposes.

Open the engine hood to access the remote battery terminal. Remove cap (*T*, Fig. 111) for access to the remote connection for the positive battery terminal stud. Stud (*U*) provides a remote connection to the machine ground.



# Storing the Loader

---

## Before Storage

If the loader is to be stored for a long period, in excess of two months, the following procedures are suggested:

1. Wash the entire machine.
2. Perform all steps for long-term engine storage according to the engine operator's manual.
3. Properly inflate the tires. See tire sidewall for recommended inflation pressure.
4. Lubricate all grease fittings.
5. Check all fluid levels and replenish as necessary.
6. Add stabilizer to the fuel per the fuel supplier's recommendations.
7. Remove the battery, charge fully and store in a cool, dry location.
8. If the machine will not be operated for a month or longer, apply grease to all exposed hydraulic cylinder rod areas or retract all cylinders so rod exposure is minimized. Apply grease to any remaining rod areas.
9. Protect exposed cylinder rods.
10. Protect against extreme weather conditions such as moisture, sunlight and temperature.
11. Fill the engine coolant system with the proper mix of antifreeze and water as required for expected temperatures according to "Coolant Compound Table" on page 37.

**Important:** Contact your dealer for additional storage preparation information if the machine will be stored in an environment where temperatures could range below  $-42^{\circ}\text{C}$  ( $-44^{\circ}\text{F}$ ), and/or above  $49^{\circ}\text{C}$  ( $120^{\circ}\text{F}$ ).

## After Storage

1. Check the tire air pressure and adjust inflation as necessary. See tire sidewall for recommended inflation pressure.
2. Replace and re-connect the battery.
3. Check the V-belt tension; adjust as necessary.
4. Check all fluid levels (engine oil, transmission/hydraulic oil, engine coolant and any attached implements); adjust as necessary.
5. Start the engine. Observe all indicators. If all indicators are functioning properly and reading normally, move the machine outside.
6. When outside, park the machine and let the engine idle for at least five minutes.
7. Shut off the engine and walk around machine. Make a visual inspection looking for evidence of leaks.



# Final Shutdown / Decommissioning

---

**Important:** *Dispose of all materials properly. Used oils/fluids/gases/refrigerant are environmental contaminants and may only be disposed of at approved collection facilities. Never drain any oils/fluids onto the ground, dispose of in municipal waste collection containers, or in metropolitan sewer systems or landfills. Check state and local regulations for other material disposal requirements.*

If the machine will no longer be used as intended, shutdown, decommission and dispose of it according to the valid regulations.

## Before Disposal

1. Shutdown the machine according to valid regulations regarding proper shutdown.
2. Park the machine on level, dry ground. Ensure the surface can support the weight of the machine. Ensure the location is protected against access by unauthorized persons.
3. Lower the lift arm completely. Remove any attachments.
4. Place forward/reverse drive switch (on top of the joystick) into the neutral position and apply the parking brake.
5. Move the throttle to the low-idle position and allow the engine to cool for approximately 2 minutes.
6. Shut off the engine.
7. Wait for all movement to stop. Turn the ignition key to the “I” or RUN position and move the multi-purpose joystick in all directions to verify that the hydraulic system is de-pressurized. Verify that the joystick does not cause movement of the lift arm.
8. If so equipped, press the auxiliary hydraulics pressure relief control. After pressing, make sure this control returns to the neutral position.
9. Turn off the ignition. Switch off all electrical switches.
10. Unfasten the seat belt, remove the ignition key and take it with you.
11. Ensure the machine cannot be operated after shutdown until further disposal.
12. Ensure no environmentally hazardous materials, fluids and/or fuel can escape the machine. Specifically check for leaks from the engine, the hydraulic system and the coolant system.
13. Ensure the machine poses no dangers in the place where it is standing.
14. Remove any dirt and/or debris from the engine compartment, the chassis and the cylinder rod surfaces.
15. Remove the battery.
16. If so equipped, lock the cab door. Lock the engine compartment. Remove the key(s) and take it/them with you.

## **Machine Disposal**

Make sure all materials are disposed of in an ecologically sound manner.

Recycling the machine in accordance with the current state of the art at the time of recycling. Observe all accident prevention regulations.

Dispose of all parts at the at the recycling sites specific to the material of the part. Take care to separate different materials for recycling.















# CHAPTER 6

## TROUBLESHOOTING

### Engine Troubleshooting

<b>Problem</b>	<b>Possible Cause</b>	<b>Corrective Action</b>
Engine does not turn over	Drive direction switch in forward/reverse	Place drive direction switch in neutral
	Tripped circuit breaker	Reset circuit breaker
	Blown fuse	Replace fuse.
	Dead battery	Charge or replace battery—see “Using a Booster Battery (Jump-Starting)” on page 142
	Operator not in operator's seat	Operator's seat must be occupied for engine to start
	Battery disconnect switch in open position or malfunctioning	Place battery disconnect switch into closed position— Repair or replace if necessary
	Malfunctioning seat switch	Replace seat switch
	Operator not in seat - or - Parking brake not applied - or - Auxiliary hydraulics pressure relief valve lever not in neutral (later machines only)	Sit in operator's seat - or - Apply parking brake - or - Place auxiliary hydraulics pressure relief valve lever in neutral
Engine stops when operator leaves seat	Parking brake not applied or parking brake malfunction	Apply or repair parking brake

## Engine Troubleshooting

Problem	Possible Cause	Corrective Action
Engine turns over but will not start	Engine cranking speed too slow	Check battery and charge/replace as necessary—tighten battery terminals
	Fuel tank empty	Fill tank and vent fuel system if necessary
	Fuel filter plugged or restricted Paraffin separation in winter	Change fuel filter Use winter grade diesel fuel
	Fuel line leakage	Tighten all threaded connections and clamps
	Glow plug module malfunction	Check connection and voltage—replace as necessary
	Fuel shut-off solenoid not energizing	Check electrical connections/voltage to shut-off solenoid
	Fuel filter restricted	Replace filter
	Fuel pump malfunction	Contact dealer

## Engine Troubleshooting

<b>Problem</b>	<b>Possible Cause</b>	<b>Corrective Action</b>
Engine overheating	Crankcase oil level incorrect	Adjust oil level
	Cooling air circulation restricted	With engine off, remove restriction
	Fan shroud improperly positioned	Contact dealer
	Improper oil grade or oil excessively dirty	Change engine oil—see “Fluid Capacities/Lubricants” on page 31 for proper oil grade
	Exhaust restricted	Allow exhaust to cool; remove restriction
	Air filter restricted	Replace filter(s)
	Low coolant level	Add coolant
	Loose fan belt	Tighten fan belt
	Dirty radiator	Clean radiator
	Thermostat malfunction	Replace thermostat
Engine running but loader will not drive	Parking brake applied	Release parking brake
	Parking brake switch malfunction	Replace parking brake switch
	Blown fuse	Check circuit and replace fuse
	Joystick drive direction slider switch malfunction	Replace joystick handle
	(AL 400/500 Series) Drive system component malfunction	Check drive controller error code
	Operator not in seat	Sit in operator seat

## Indicator Lamp Troubleshooting

Indicator Activated	Possible Cause	Corrective Action
Engine oil pressure	Engine oil pressure too low	Stop engine immediately; check oil level and add oil if necessary; check oil pump
	Engine oil level too low	Add oil
	Oil pump malfunction	Contact dealer
Hydraulic oil temperature	Temperature is too hot	Check cooling system for debris in radiator
		Check hydraulic oil level
Hydraulic oil filter	Hydraulic oil filter service required	Replace filter
Water temperature	Coolant level too low	Add coolant
	Air filter plugged	Replace air filter
	Engine overheating	Check cooling system
Battery voltage	Alternator not charging properly	Adjust v-belt tension; check alternator
Low fuel	Low fuel	Add fuel

## Seal and Hose Troubleshooting

<b>Problem</b>	<b>Possible Cause</b>	<b>Corrective Action</b>
Oil, coolant or fuel leakage	Loose hose connection(s)	Tighten hose connections
	Damaged seals or hoses	Change seals/hoses as necessary
Hydraulic fluid leakage	Loose fittings	Tighten hydraulic connections
	Seals, hoses or lines damaged	Change seals, hoses or lines as necessary

## Hydraulic System Troubleshooting

<b>Problem</b>	<b>Possible Cause</b>	<b>Corrective Action</b>
Hydraulics do not work or work only at a low performance level	Low hydraulic fluid level	Add hydraulic fluid
	Hydraulic fluid is not warm	Allow longer warm-up
	Engine to pump coupling or hydraulic pump damaged	Contact dealer
	Pressure limiting valves set too low or damaged	Contact dealer
	Hydraulic cylinder damaged	Contact dealer
	Control valves damaged	Contact dealer
	Engine speed is too low	Adjust engine speed—see “Accelerator pedal” on page 53 and “Hand Throttle” on page 61
	Dirty/restricted air filter(s)	Replace filter(s)
	Incorrect fuel grade	Change the fuel—see “Fluid Capacities/Lubricants” on page 31 for proper fuel grade
Travel drive system does not work or works only at a low performance level	AL 100 Series hydraulic tanks not evenly filled	See “Checking Hydraulic Oil Level” on page 122.

## Hydraulic System Troubleshooting

<b>Problem</b>	<b>Possible Cause</b>	<b>Corrective Action</b>
Attachment tilts down with tilt control in neutral	Oil leaking past tilt cylinder seals (internal or external)	Contact dealer
	Leaking hydraulic hoses, tubes or fittings between control valve and cylinders	Repair as required
Lift arm does not raise/lower	Lift spool in control valve not actuated or leaking	Contact dealer
	Hydraulic oil leaking past cylinder piston seals	Contact dealer
Attachment tilt not working but lift arm works properly	Tilt spool in control valve not actuated or leaking	Contact dealer
Lift arm does not raise but tilt works properly	Lift spool in control valve not actuated or leaking	Contact dealer
Hydraulic system overheating	Hydraulic oil cooler is dirty	Clean hydraulic oil cooler
	Hydraulic oil level is too low	Add hydraulic oil
	Load too high	Reduce load
	AL 100 Series hydraulic tanks not evenly filled	See "Checking Hydraulic Oil Level" on page 122.
Lift and/or tilt functions too slow	Low engine speed	Increase engine speed
	Low hydraulic oil level	Add oil and check for leaks
	Hydraulic oil leaking past cylinder piston seals	Contact dealer
	Hydraulic pump malfunction	Contact dealer
Lift and/or tilt functions inconsistent/jerky	Air in hydraulic system	Cycle lift and tilt cylinders to maximum stroke and maintain pressure for short time to clear air from system
	Low hydraulic oil level	Add oil and check for leaks
	Cylinder(s) malfunction	Contact dealer
Travel drive performance inconsistent/jerky	AL 100 Series hydraulic tanks not evenly filled	See "Checking Hydraulic Oil Level" on page 122.

## Hydraulic System Troubleshooting

<b>Problem</b>	<b>Possible Cause</b>	<b>Corrective Action</b>
Lift arm does not maintain raised position with multi-purpose joystick centered (neutral)	Oil leaking past lift cylinder seals (internal or external)	Contact dealer
	Oil leaking past lift spool in control valve	Contact dealer
	Leaking hydraulic hoses, tubes or fittings between control valve and cylinders	Contact dealer
Auxiliary hydraulics do not function	Spool in control valve not actuated or leaking	Contact dealer
	Hydraulic oil leaking past seals	Contact dealer
	Auxiliary hydraulic connections improperly connected	Correct hydraulic connections
Auxiliary hydraulics connections difficult to connect/disconnect	Auxiliary hydraulics circuit under pressure	Relieve auxiliary hydraulics circuit pressure—see “Auxiliary Circuit Pressure Relief” on page 86

## Hydrostatic Drive System Troubleshooting

<b>Problem</b>	<b>Possible Cause</b>	<b>Corrective Action</b>
No response from either hydrostatic drive or the lift/tilt systems	Hydraulic oil viscosity too heavy	Allow longer warm-up  Replace with proper grade hydraulic oil—see “Fluid Capacities/Lubricants” on page 31 for proper oil grade
Dynamic braking not effective when drive pedal in neutral	Sticking flushing valve (AL100/200/300 series)	Repair/replace flushing valve

# Hydrostatic Drive System Troubleshooting

Problem	Possible Cause	Corrective Action
Travel drive will not operate in either direction	Parking brake is applied	Release parking brake
	Low hydraulic oil level	Add oil
	Low or no charge pressure	Contact dealer
	Hydrostatic pump(s) relief valves malfunction	Contact dealer
	Brake/inch pedal stuck or malfunctioning	<ol style="list-style-type: none"> <li>1. Check/release brake/inch pedal</li> <li>2. (AL 400/500 Series only) Check drive error code</li> <li>3. (AL 400/500 Series only) Force brake pedal calibration, if necessary</li> </ol>
	Throttle pedal linkage	Check/repair throttle pedal linkage
		(AL 400/500 Series only) Check drive controller error code; force throttle pedal calibration, if necessary
	Electrical connections	Check/inspect electrical connection and harness
AL 100 Series hydraulic tanks not evenly filled	See "Checking Hydraulic Oil Level" on page 122	



# Hydrostatic Drive System Troubleshooting

Problem	Possible Cause	Corrective Action
Travel drive system noisy	Hydraulic oil viscosity too heavy	Allow longer warm-up  See “Fluid Capacities/Lubricants” on page 31 for proper oil grade
	Low hydraulic oil level	Add oil
	AL 100 Series hydraulic tanks not evenly filled	See “Checking Hydraulic Oil Level” on page 122
	Air in hydraulic system	Cycle lift and tilt cylinders to maximum stroke and maintain pressure for short time to clear from system
	Drive motor(s) or hydrostatic pump(s) internal damage/leakage	Contact dealer
Sluggish travel drive acceleration	Low hydraulic oil level	Add oil
	Low hydrostatic system charge pressure	Contact dealer
	Drive motor or hydrostatic pump internal damage/leakage	Contact dealer
	Brake/inch or throttle pedal applied, stuck or malfunctioning	Release/repair the brake/inch pedal  (AL 400/500 Series only) Force pedal calibration, if necessary
	Engine running rough	Poor fuel quality or incorrect grade—See “Fluid Capacities/Lubricants” on page 31 for proper fuel grade
	Sticking flushing valve (AL100/200/300 series)	Repair/replace flushing valve
	AL 100 Series hydraulic tanks not evenly filled	See “Checking Hydraulic Oil Level” on page 122

## Hydrostatic Drive System Troubleshooting

<b>Problem</b>	<b>Possible Cause</b>	<b>Corrective Action</b>
Travel drive overheating	Drive system continuously overloaded	Improve operation procedure
	Lift/tilt or auxiliary system continuously overloaded	Improve operation procedure
	Drive motor(s) or hydrostatic pump(s) internal damage/ leakage	Contact dealer
	Oil cooler fins restricted	Clean oil cooler fins
	Hydraulic oil filter restricted	Replace filter
	Sticking flushing valve (AL100/200/300 series)	Repair/replace flushing valve
	AL 100 Series hydraulic tanks not evenly filled	See "Checking Hydraulic Oil Level" on page 122

## Electrical Troubleshooting

<b>Problem</b>	<b>Possible Cause</b>	<b>Corrective Action</b>
Electrical system does not function	Battery disconnect switch is in OFF position	Turn battery disconnect switch to ON
	Battery terminals or cables loose or corroded	Clean battery terminals and cables and retighten
	Battery malfunction	Test battery—recharge/replace as necessary
	Blown main fuse	Replace main fuse
Instrument display does not activate with key switch on	Blown fuse	Check circuit and replace fuse
	Battery terminals/cables loose/corroded	Clean battery terminals and cables and tighten
Fuel gauge does not work	Fuel gauge sender malfunction	Replace fuel gauge sender
	Loose wiring/terminal connections	Check wiring connections
	Blown fuse	Check circuit and replace fuse

## Electrical Troubleshooting

<b>Problem</b>	<b>Possible Cause</b>	<b>Corrective Action</b>
Engine temperature gauge does not work	Temperature sender malfunction	Replace temperature sender
	Loose wiring/terminal connections	Check wiring connections
	Blown fuse	Check circuit and replace fuse
Hour meter does not work	Loose wiring/terminal connections	Check wiring connections
	Alternator malfunction	Repair/replace alternator
Starter does not engage when key switch turned to START	Poor electrical connections to starter	Check connections
	Battery terminals/cables loose/corroded	Clean battery terminals and cables and tighten
	Starter relay malfunction	Contact dealer
	Battery malfunction	Test battery—recharge/replace as necessary
	Starter solenoid malfunction	Contact dealer
	Starter or pinion malfunctioning	Repair/replace as needed
	Drive direction switch in forward/reverse	Place drive direction switch in neutral
	Various	See “Engine does not turn over” on page 153
	Auxiliary hydraulics pressure relief valve lever not in neutral (later machines only)	Place auxiliary hydraulics pressure relief valve lever in neutral
Work/road lights malfunction	Single light not working—light bulb burned out, faulty wiring	Check and replace light bulb as needed, check wiring connections
	No lights—blown fuse	Check circuit and replace fuse
	Defective light switch or poor ground	Check ground wire connections, replace light switch



# INDEX

- A**
- Accelerator Pedal . . . . . 53, 75
  - Air Cleaner Dust Valve . . . . . 112
  - Air Filter Restriction Indicator . . . 112
  - All-Tach Hitch . . . . . 81, 82
  - Alternator . . . . . 55, 58
  - Attachments . . . . . 78, 81
    - Connecting . . . . . 81
    - Disconnecting . . . . . 85
    - Hydraulic Power-A-Tach
      - Hitch Connection . . . . . 83
    - Hydraulic Power-A-Tach
      - Hitch Disconnection . . . . . 85
    - Operation . . . . . 92
    - Standard Hitch Connection . . 81
    - Standard Hitch Disconnection 85
  - Auxiliary Hydraulics . . . . . 86
    - Control Buttons . . . . . 89
    - Control Lever . . . . . 92
  - Auxiliary Hydraulics Circuit
    - Pressure Relief . . . . . 86
  - Auxiliary Hydraulics Control
    - Lever . . . . . 53
  - Auxiliary Hydraulics Flow and
    - Proportional Control . . . . . 90
  - Axles . . . . . 125
    - Change Oil . . . . . 125
- B**
- Battery . . . . . 141
    - Remote Battery Terminal
      - Option . . . . . 143
  - Battery Disconnect
    - Switch . . . . . 53, 67, 142
  - Beacon Switch . . . . . 53
  - Biodegradable Oil . . . . . 31
  - Booster Battery . . . . . 142
  - Brake/inch Pedal . . . . . 53
  - Brakes . . . . . 130
- C**
- Bypass Valve . . . . . 95
  - Cab . . . . . 57
    - Air Conditioning Control . . . . 56
    - Environment Controls . . . . . 56
    - Windshield Wiper Controls . . . 57
  - Checklist
    - Pre-Operation . . . . . 63
  - Component Identification . . . . . 5
  - Control Lever . . . . . 53, 61
  - Control Modules . . . . . 139
  - Coolant . . . . . 32
    - Radiator . . . . . 32
  - Cooling System . . . . . 114
    - Check Coolant Level . . . . . 114
    - Clean . . . . . 114
    - Drain/Flush . . . . . 115
  - Crane Lifting, Chain Lengths . . . . 40
- D**
- Dealer Service . . . . . 107
  - Densities . . . . . 49
  - Differential Lock . . . . . 55
  - Differential Lock Operation . . . . 76
  - Dimensions . . . . . 41, 43, 44, 46
  - Dome Light . . . . . 57
  - Drive Control Module . . . . . 139
    - Error Codes . . . . . 140
  - Drive Direction Switch . . . 53, 68, 75
  - Drive Speed Switch . . . . . 75
  - Dust Valve . . . . . 112
- E**
- Electrical System . . . . . 134
    - Fuses and Fuse Locations . . 134
    - Steering Column
      - Fuses . . . . . 135, 136
  - Engine Access Panel . . . . . 110
  - Engine Cooling System . . . . . 114
  - Engine Maintenance

Change Oil and Filter . . . . .	110
Engine Oil Pressure . . . . .	55, 58
Engine Oil Temperature . . . . .	55, 58
Engine Oil Type . . . . .	31
Engine rpm . . . . .	55
Engine Service	
Change Fuel Filter . . . . .	116
Engine Shut Down . . . . .	69
Engine Start . . . . .	67

## F

Fast Speed . . . . .	55
Filter Changes . . . . .	106
First 50 Hours of Operation . . . . .	70
Fluid Capacities . . . . .	31
FOPS . . . . .	40
Forward Travel . . . . .	55
Fuel Level . . . . .	55
Fuel System . . . . .	116
Adding Fuel . . . . .	116
Fuel Shut-off Valve Lever . . . . .	118
Fuel Specifications . . . . .	31, 116
Fuel Strainer . . . . .	116
Low Sulfur Diesel . . . . .	116
Ultra-low Sulfur Diesel . . . . .	116
Functional Check . . . . .	106
Fuse Locations . . . . .	134
Fuse Panel, Steering Column . . . . .	134

## G

General Information . . . . .	1
German Road Regulations . . . . .	4
Grease . . . . .	32

## H

Hand Throttle . . . . .	53, 61
Hazard Light Switch . . . . .	53
Hazard Lights . . . . .	55
Hour Meter . . . . .	55
Hydraulic Oil . . . . .	31, 122
Filter . . . . .	123
Hydraulic Oil Filter Indicator . . . . .	55, 58
Hydraulic Oil Pressure . . . . .	55
Hydraulic Oil Temperature . . . . .	58

Hydraulic Power-A-Tach Hitch	
Connection . . . . .	83
Hydraulic Power-A-Tach Hitch	
Disconnection . . . . .	85
Hydraulic System	
Change Oil . . . . .	123
Check Oil Level . . . . .	122

## I

Ignition Key . . . . .	68
Ignition Key Switch . . . . .	60
Inner Filter Element . . . . .	113
Instrument Panel . . . . .	53
Instruments and Indicators . . . . .	54
Introduction . . . . .	1

## J

Jump-Starting . . . . .	142
-------------------------	-----

## L

Leakage Check . . . . .	105
Left Turn . . . . .	55
Lift Arm . . . . .	78
Down-stop . . . . .	74
Load Handling . . . . .	77
Loading and Transporting . . . . .	97
Low Fuel . . . . .	55
Lubricants . . . . .	31
Lubrication . . . . .	106, 130

## M

Machine Control Module . . . . .	139
Main System Fuse . . . . .	134
Maintenance . . . . .	103
Engine Air Cleaner . . . . .	112
Engine Maintenance . . . . .	109
Engine Oil . . . . .	109
Maintenance Log . . . . .	147
Maintenance Schedule . . . . .	104
Check, Clean and Inspect . . . . .	104
Functional Check . . . . .	106
Leakage Check . . . . .	105
Lubrication and Filter	
Changes . . . . .	106
Maintenance Log . . . . .	147

Maximum Slopes of Operation . . .	32
Model Identification . . . . .	5
Multi-Purpose Joystick . . . . .	53, 78
Float Positions . . . . .	80

**N**

New Machines . . . . .	70
------------------------	----

**O**

Oil . . . . .	109
Biodegradable Oil . . . . .	31
Engine Oil . . . . .	31
Hydraulic Oil . . . . .	31, 32
Oil Dipstick . . . . .	109
Oil Pan Drain Plug . . . . .	110
Operation . . . . .	51, 63
Operator's Manual Overview . . . . .	1
Operator's Seat . . . . .	53
Outer Filter Element . . . . .	113

**P**

Parking Brake . . . . .	55, 66, 67, 74
Parking Brake Lever . . . . .	53
Power-A-Tach Lock/Unlock . . . . .	53
Pre-Heat . . . . .	55, 68
Pre-Operation Checklist . . . . .	63

**R**

Radiator . . . . .	32
Radiator Cap . . . . .	115
Radiator Drain Valve . . . . .	115
Rearward Travel . . . . .	55
Remote Battery Terminal Option . . . . .	143
Right Turn . . . . .	55
Road Lights . . . . .	55, 163
ROPS . . . . .	39, 51, 64
4-Post Side Gates . . . . .	65
Extending . . . . .	64

**S**

Safety . . . . .	9
ANSI-Style Safety Decals . . . . .	22
Before Starting . . . . .	11
Crystalline Silica Exposure . . . . .	20

During Operation . . . . .	12
Avoiding Rollover Accidents . . . . .	15
Electrical Energy . . . . .	16
Fire Hazards . . . . .	19
Hazard Symbols . . . . .	21
ISO-Style Safety Decals . . . . .	27
Mandatory Safe Shutdown Procedure . . . . .	10
Safety Decals . . . . .	21, 22
Service Safety Practices . . . . .	16
Battery Hazards . . . . .	18
Seat Belt . . . . .	53
Seat Plate . . . . .	53
Slow Speed . . . . .	55
Specifications . . . . .	31
Axle Oil . . . . .	32
Biodegradable Oil . . . . .	31
Common Materials and Densities . . . . .	49
Coolant . . . . .	32, 37
Diesel Fuel . . . . .	31
Dimensions . . . . .	41, 43
Electrical System . . . . .	37, 38
Engine Oil . . . . .	31
Grease . . . . .	32
Hydraulic Oil . . . . .	31
Hydraulics . . . . .	38
Maximum Slopes of Operation . . . . .	32
Optional Features . . . . .	48
Sound Levels . . . . .	38
Standard Features . . . . .	45
Tires . . . . .	39
Wheel Fastener Torque . . . . .	38
Wheels . . . . .	39
Windshield Washer . . . . .	32
Standard Hitch Connection . . . . .	81
Standard Hitch Disconnection . . . . .	85
Steering Column . . . . .	53
Control Lever . . . . .	61
Steering Column Adjustment . . . . .	60

Steering Wheel .....	53
Steering/Frame Lock Bar ....	97, 99
Storage .....	144
Preparing .....	144
Removing .....	144
Switches .....	52

Windshield Washer .....	32
-------------------------	----

## T

Tie-down Points .....	98
Tilting the Platform .....	107
Down .....	108
Up .....	107
Tipover .....	77
Tire Pressure .....	39
Tires .....	128
Tow Hitch .....	96
Towing .....	94
Transport Vehicle .....	98
Transporting .....	97
Travel .....	74
Troubleshooting .....	153
Electrical .....	162
Engine .....	153
Hydraulic System .....	157
Hydrostatic Drive System ...	159
Indicator Lamp .....	156
Indicator Lamps .....	156
Seal and Hose .....	157
Seals and Hoses .....	157
Turning Knob .....	53

## V

V-belt Tension	
Checking and Adjusting ....	119
Volt Meter .....	55, 58

## W

Warmup .....	69
Warning Indicators .....	58
Water Separator	
Fuel Shut-off Valve Lever ..	118
Wheel Fasteners .....	128
Wheel Rims .....	38
Wheels .....	128



# Torque Specifications

**Note:** Use these torque values when tightening hardware (excluding: locknuts and self-tapping, thread forming and sheet metal screws) unless specified otherwise.

Hydraulic fittings with various seals (light application). All torque values are in lb.-ft. (Nm) unless marked otherwise.					
Thread	Straight pipe fitting with thread and screwed plug (GE)			Non-return valve with elastic seal	Identification aid outside Ø
	Sealing washer	Elastic seal	O-ring		
M10X1.0	7 (9)	13 (18)	11 (15)	13 (18)	0.4 in. (10 mm)
M12X1.5	15 (20)	18 (25)	18 (25)	18 (25)	0.5 in. (12 mm)
M14X1.5	26 (35)	33 (45)	26 (35)	26 (35)	0.6 in. (14 mm)
M16X1.5	33 (45)	41 (55)	30 (40)	37 (50)	0.6 in. (16 mm)
M18X1.5	41 (55)	52 (70)	33 (45)	52 (70)	0.7 in. (18 mm)
M22X1.5	48 (65)	92 (125)	44 (60)	92 (125)	0.9 in. (22 mm)
M27X2.0	66 (90)	133 (180)	74 (100)	107 (145)	1.0 in. (27 mm)
M33X2.0	111 (150)	229 (310)	118 (160)	155 (210)	1.3 in. (33 mm)
M42X2.0	177 (240)	332 (450)	155 (210)	266 (360)	1.7 in. (42 mm)
M48X2.0	214 (290)	398 (540)	192 (260)	398 (540)	1.9 in. (48 mm)
G1/8A	7 (9)	13 (18)	11 (15)	13 (18)	0.4 in. (9.73 mm)
G1/4A	26 (35)	26 (35)	22 (30)	26 (35)	0.5 in. (13.16 mm)
G3/8A	33 (45)	52 (70)	33 (45)	37 (50)	0.7 in. (16.66 mm)
G1/2A	48 (65)	66 (90)	41 (55)	48 (65)	0.8 in. (20.96 mm)
G3/4A	66 (90)	133 (180)	74 (100)	103 (140)	1.0 in. (26.44 mm)
G1A	111 (150)	229 (310)	118 (160)	140 (190)	1.3 in. (33.25 mm)
G1 1/4A	177 (240)	332 (450)	155 (210)	266 (360)	1.7 in. (41.91 mm)
G1 1/2A	214 (290)	398 (540)	192 (260)	398 (540)	1.9 in. (47.80 mm)

Hydraulic fittings with various seals (heavy application). All torque values are in lb.-ft. (Nm) unless marked otherwise.					
Thread	Straight pipe fitting with thread and screwed plug (GE)			Non-return valve with elastic seal	Identification aid outside Ø
	Sealing washer	Elastic seal	O-ring		
M12X1.5	15 (20)	26 (35)	26 (35)	26 (35)	0.5 in. (12 mm)
M14X1.5	26 (35)	41 (55)	33 (45)	33 (45)	0.6 in. (14 mm)
M16X1.5	33 (45)	52 (70)	41 (55)	41 (55)	0.6 in. (16 mm)
M18X1.5	41 (55)	66 (90)	52 (70)	52 (70)	0.7 in. (18 mm)
M20X1.5	41 (55)	92 (125)	59 (80)	74 (100)	0.8 in. (20 mm)
M22X1.5	48 (65)	100 (135)	74 (100)	92 (125)	0.9 in. (22 mm)
M27X2.0	66 (90)	133 (180)	125 (170)	100 (135)	1.0 in. (27 mm)
M33X2.0	111 (150)	229 (310)	229 (310)	155 (210)	1.3 in. (33 mm)
M42X2.0	177 (240)	332 (450)	243 (330)	266 (360)	1.7 in. (42 mm)
M48X2.0	214 (290)	398 (540)	310 (420)	398 (540)	1.9 in. (48 mm)
G1/8A	26 (35)	41 (55)	33 (45)	33 (45)	0.5 in. (13.16 mm)
G1/4A	33 (45)	59 (80)	44 (60)	44 (60)	0.7 in. (16.66 mm)
G3/8A	48 (65)	85 (115)	55 (75)	74 (100)	0.8 in. (20.96 mm)
G1/2A	66 (90)	133 (180)	125 (170)	107 (145)	1.0 in. (26.44 mm)
G3/4A	111 (150)	229 (310)	229 (310)	192 (260)	1.3 in. (33.25 mm)
G1A	177 (240)	332 (450)	243 (330)	266 (360)	1.7 in. (41.91 mm)
G1 1/4A	214 (290)	398 (540)	310 (420)	398 (540)	1.9 in. (47.80 mm)

**With fine-pitch thread. All torque values are in lb.-ft. (Nm) unless marked otherwise.**

Thread	Threads according to DIN 912, DIN 931, DIN 933, etc.			Threads according to DIN 7984	
	8.8	10.9	12.9	8.8	10.9
M8X1.0	18 (25)	27 (37)	32 (43)	16 (22)	24 (32)
M10X1.0	37 (50)	55 (75)	65 (88)	32 (43)	48 (65)
M10X1.25	36 (49)	52 (71)	61 (83)	31 (42)	46 (62)
M12X1.25	64 (87)	96 (130)	111 (150)	55 (75)	81 (110)
M12X1.5	61 (83)	92 (125)	107 (145)	53 (72)	77 (105)
M14X1.5	100 (135)	148 (200)	173 (235)	89 (120)	129 (175)
M16X1.5	155 (210)	229 (310)	266 (360)	133 (180)	195 (265)
M18X1.5	232 (315)	332 (450)	391 (530)	199 (270)	284 (385)
M20X1.5	325 (440)	465 (630)	538 (730)	277 (375)	391 (530)
M22X1.5	435 (590)	620 (840)	723 (980)	369 (500)	524 (710)
M24X2.0	546 (740)	789 (1070)	922 (1250)	465 (630)	664 (900)
M27X2.0	811 (1100)	1143 (1550)	1328 (1800)	679 (920)	959 (1300)
M30X2.0	1106 (1500)	1586 (2150)	1844 (2500)	959 (1300)	1364 (1850)

**With coarse-pitch thread. All torque values are in lb.-ft. (Nm) unless marked otherwise.**

Thread	Threads according to DIN 912, DIN 931, DIN 933, etc.			Threads according to DIN 7984	
	8.8	10.9	12.9	8.8	10.9
M5	4.1 (5.5)	6 (8)	7 (10)	4 (5)	5 (7)
M6	7 (10)	10 (14)	13 (17)	6.3 (8.5)	9 (12)
M8	18 (25)	26 (35)	31 (42)	15 (20)	22 (30)
M10	33 (45)	48 (65)	59 (80)	30 (40)	44 (59)
M12	64 (87)	81 (110)	108 (147)	51 (69)	74 (100)
M14	100 (135)	133 (180)	170 (230)	81 (110)	118 (160)
M16	155 (210)	203 (275)	258 (350)	125 (170)	184 (250)
M18	207 (280)	302 (410)	354 (480)	181 (245)	254 (345)
M20	302 (410)	420 (570)	509 (690)	251 (340)	361 (490)
M22	406 (550)	575 (780)	686 (930)	339 (460)	487 (660)
M24	524 (710)	738 (1000)	878 (1190)	435 (590)	620 (840)
M27	767 (1040)	1092 (1480)	1305 (1770)	642 (870)	922 (1250)
M30	1047 (1420)	1482 (2010)	1770 (2400)	885 (1200)	1254 (1700)



## EC DECLARATION OF CONFORMITY

1. Manufacturer: **Manitou Americas, Inc.**
2. Address: **One Gehl Way  
West Bend, WI 53095-0179 U.S.A.**
3. Technical Construction File Location:  
**Manitou Americas, Inc.  
One Gehl Way  
West Bend, WI 53095-0179  
U.S.A.**
4. Authorized Representative:
5. Address:
6. **We hereby declare that the machine listed below conforms to EC Directives: 2004/108/EC (EMC), 97/23/EC (Pressure Equipment), 2006/42/EC (Machinery) and 2000/14/EC (Noise Emission), as amended by 2005/88/EC.**
7. In accordance with EN/ISO Standards:  
**EN ISO 3450:1996, ISO 6165**
8. Category: **EARTH-MOVING MACHINERY/  
LOADERS/COMPACT/SEATED OPERATOR**
9. Models: **AL 140, AL 240, AL 340, AL 440, AL 540**
10. Directive/Conformity Assessment Procedure/Notified Body:

<b>2004/108/EC</b>	<b>Type-test</b>	<b>Self-certification</b>
<b>97/23/EC</b>	<b>Self-certification</b>	<b>-----</b>
<b>2006/42/EC</b>	<b>Self-certification</b>	<b>-----</b>
<b>2000/14/EC</b>	<b>Annex VIII – Full Quality Assurance</b>	<b>TÜV Industrie Service GmbH – TÜV SÜD Group Westendst. 199, D-80686 München, GERMANY</b>



**THIS OPERATOR'S MANUAL IS  
PROVIDED FOR OPERATOR USE**

**DO NOT REMOVE FROM THIS MACHINE**

**Do not start, operate or work on this machine until you carefully read and thoroughly understand the contents of this Operator's Manual.**

**Failure to follow safety, operating and maintenance instructions can result in serious injury to the operator or bystanders, poor operation, and costly breakdowns.**

**If you have any questions on proper operation, adjustment or maintenance of this machine, contact your dealer or the Gehl Company Service Department before starting or continuing operation.**

# **GEHL**®

**Manitou Americas, Inc.**  
One Gehl Way  
PO Box 179  
West Bend, WI 53095-0179 U.S.A.  
[www.gehl.de/](http://www.gehl.de/) (Gehl Europe)  
[www.gehl.com](http://www.gehl.com) (Gehl USA)