

# CLASSIC & YOUNGTIMER SHOCK ABSORBERS

CATALOGUE 2017-2018

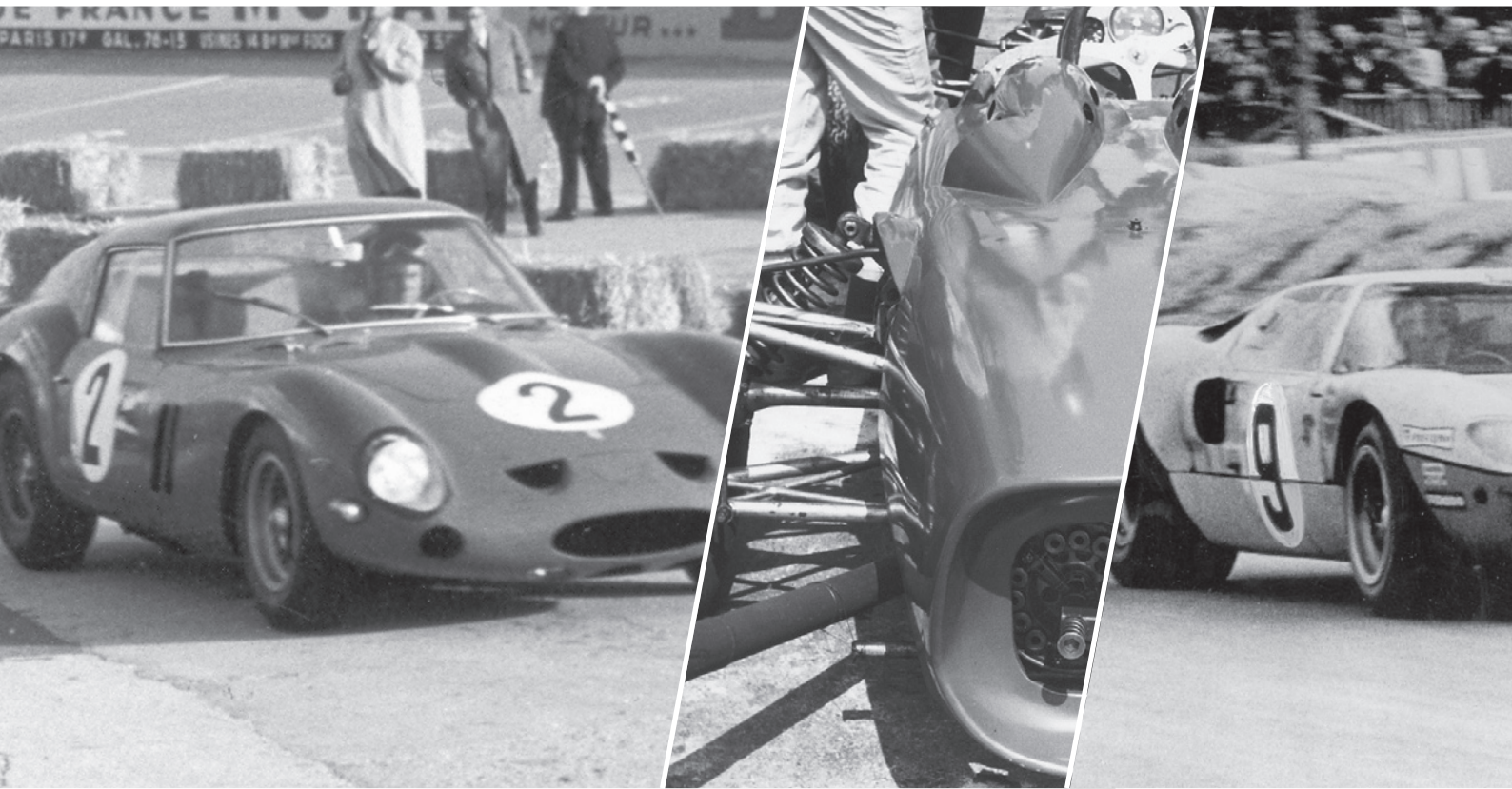



# KONI CLASSIC SHOCK ABSORBER PROGRAM

## KONI RACING - HOW IT ALL STARTED

KONI was founded in 1857 by A. de Koning. Of course the business did not start with making shock absorbers, but with making leather equipment for horses.

Just before the Second World War the company started to work on shock absorbers. These were friction type shock absorbers. After the Second World War, the production of the telescopic shock absorbers started. In the early fifties, KONI decided to play a more prominent role in motor sport in order to enlarge the company's reputation. Of course motor sport was an excellent way to prove to the world that the shock absorbers manufactured in Oud-Beijerland were of very high quality.

The first event that KONI participated in, was the Tulpenrally in 1955, a Dutch organised rally with international status by that time. As a reward for using KONI stickers on their cars, the drivers could have their KONI dampers for next to nothing. The KONI dampers proved to be ideal for rally purposes. What's more, they stood out head and shoulders above their competitors.

KONI CLASSIC

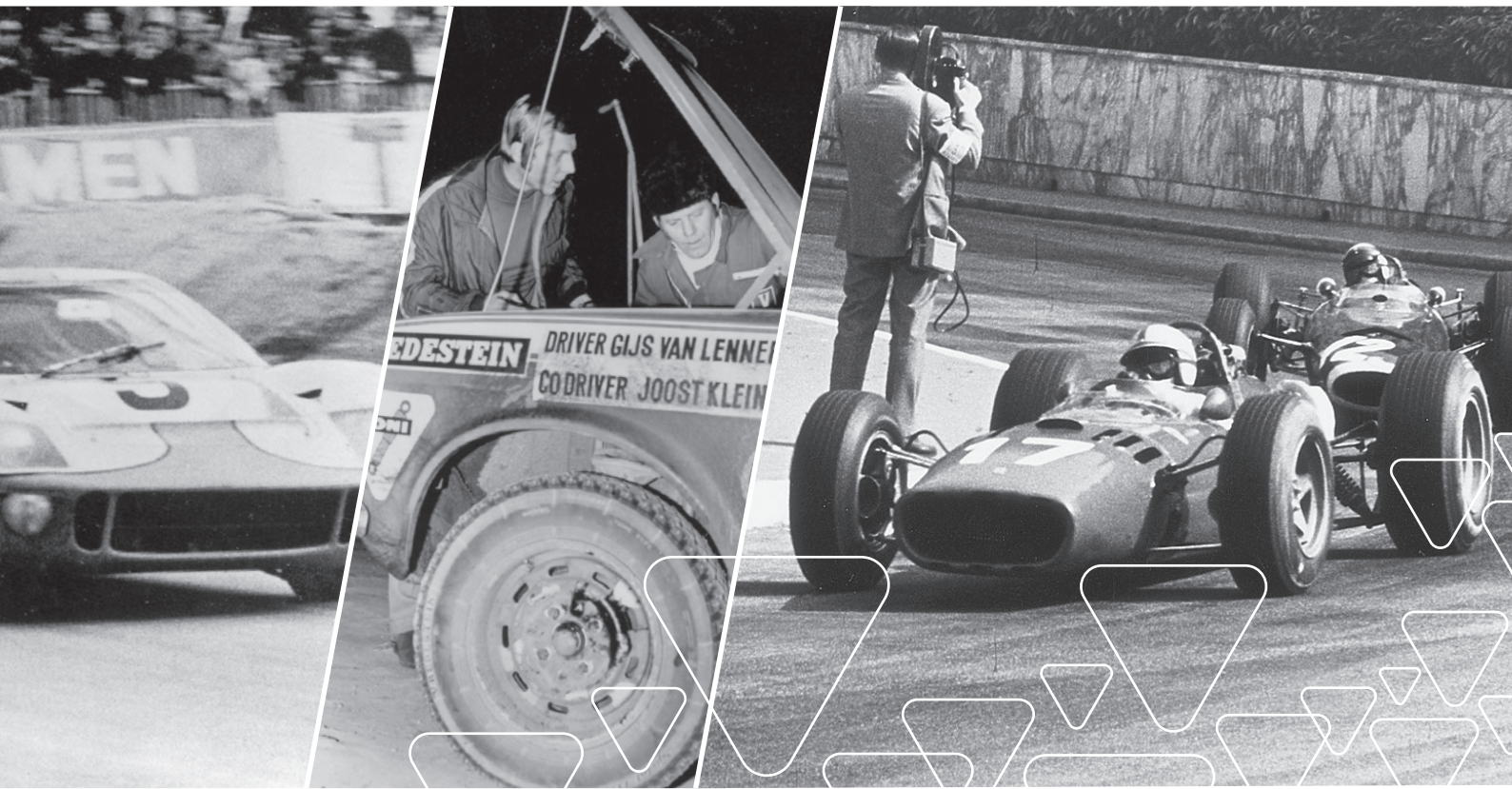

TABLE OF CONTENTS



KONI SPORT





## THE FIRST STEPS AT THE RACETRACKS

After starting with rally, KONI switched to the racing scene. In 1956 KONI entered the Formula 1. On the famous Nordschleife it assisted the Ferrari team in solving their suspension problems.

Until that time, F1 still used the lever arm type shock absorbers. The KONI shock absorbers offered better damping characteristics and the possibility to mount the spring around the damper, which made it more compact. Officially the first Grand Prix that KONI participated in was in 1958 with Ferrari. The Belgian driver Gendebien made his appearance on the Monza track with KONI and took sixth place.

After the start with Ferrari the business went fast and already in 1971 KONI reached its first World Championship win as Tyrrell Ford won the driver's (Jackie Stewart) and constructor's championship.



KONI STR.T

5

KONI RACING

5



Constructions & Operations  
Disposal Instructions

6

Adjustment  
Procedures

7

# CLASSIC & SPORT

---

## KONI CLASSIC

Today's technology in yesterday's cars. Highly evolved damper technology for classics in any stage of their life, with the same superior quality which KONI offers to modern cars. KONI Classic combines a vintage look with safety and road holding.

- Broad application range
- Rebound adjustable
- Black or red with "Classic Wing" logo

- 
- 1 | Modern damper technology
  - 2 | Better handling & classic looks
  - 3 | Superior driving comfort



## KONI SPORT

Looking for a high-speed feeling? KONI supplies the same high-quality parts to sport tuners as they do to the professionals out on the racetrack. The KONI SPORT represents the ultimate in shock absorber technology. This means better road holding, optimum chassis feedback and unlimited performance. It all makes for an unparalleled driving experience.

- Big handling improvements
- Superb ride quality
- External rebound adjustment on most cars
- Best KONI shock for all lowering springs

- 
- 1 | Allows lowering up to 40 mm
  - 2 | Adjustable damping
  - 3 | Superior handling



# TUNING & RACING

---

## KONI STR.T

Unsurpassed price/performance ratio thanks to customized synthesis of quality, technical know how and impressive performance. Perfect road holding and optimum handling thanks to a perfect factory-matched setup based on our long-standing motorsport experience. Individually tailored for every day driving pleasure.

- 100% Performance
- Ideal comfort / road-holding balance
- Improved handling

- 
- 1 | Allows lowering up to 40 mm
  - 2 | Perfect match
  - 3 | 100% street legal



## KONI RACING DAMPERS

The design and operation of KONI racing dampers are a unique proof of KONI's reputation as the leader in the field of damper technology.

They are specifically designed for competition purposes and offer full adjustability while fitted on the car. Their precision adjustment mechanisms allow maximum control over the damping forces generated, especially in the low speed damping range. Please contact your KONI Reseller or Distributor for more information

- Control over the suspension is instant and precise, decisive and smooth
- Period correct & FIA approved
- Stunning price / quality ratio
- Rebuildable

- 
- 1 | Maximum control over the damping forces
  - 2 | Dampers of apparent simplicity
  - 3 | Up to eight pre-programmed damping curves



# LEADING TECHNOLOGY

KONI enhances the look and feel of any car. The state-of-the-art range of shocks and sport kits in this catalogue gives an overview of the many possibilities for customization and personalization. Quite simply, KONI makes driving more individual and more fun. And the car not only looks better—it drives better.

## DISPOSAL INSTRUCTIONS

### GENERAL REMARKS

Appropriate protective measures should be taken when removing oil and gas from discarded and defective shock absorbers.

### PROCEDURE

1. Secure the shock absorber in a horizontal position.
2. Fully extend the piston rod before drilling.
3. Drill a hole with a diameter of about 5 mm at 3 cm from the bottom of the shock absorber to a depth of about 2 cm (see fig. A). Caution: Gas and oil will be expelled from the shock absorber. Take appropriate precautions to control the oil stream.
4. Drill a second hole of about 5 mm at 6 cm from the top of the shock absorber to a depth of about 2 cm, in order to allow all of the oil to flow out (see fig. B).
5. By moving the piston rod in and out, pump out all of the oil (see fig. C).

### ENVIRONMENTAL PROTECTION

The hydraulic oil drained from the shock absorbers should be collected and disposed of in accordance with the appropriate legislation. Information on where to dispose of the oil and other parts can be obtained from local authorities

## CONSTRUCTION & OPERATION

All hydraulic shock absorbers work on the principle of converting kinetic energy (movement) into thermal energy (heat). For that purpose, fluid in the shock absorber is forced to flow through restricted outlets and valve systems, thus generating hydraulic resistance. A telescopic shock absorber (damper) can be compressed and extended; the so called bump stroke and rebound stroke. Telescopic shock absorbers can be subdivided into:

Bi-tube, or twin-tube dampers, available in hydraulic and gas-hydraulic configuration.



**BI-TUBE SHOCK ABSORBER (FIG. A.)**

**MONO-TUBE SHOCK ABSORBER (FIG. B.)**

Mono-tube dampers, also called high pressure gas shocks.

To see video of these products, visit: <https://www.youtube.com/user/originalKONI>

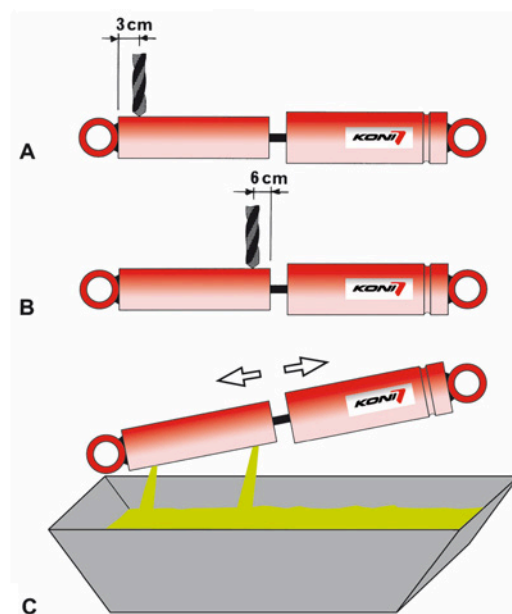

## ADJUSTMENT PROCEDURES

### SERIES 8010, 8041, 8210, 8241, 8610, 8641, 8710, 8741, 8742\*

1. Take the adjustment knob which is supplied and fit it to the top of the damper.
2. To adjust the damping force, the knob has to be turned in the direction of the arrow for increased damping and in the opposite direction for decreased damping. If you feel resistance do not use force, as the damper is in its end position.
3. After adjustment, remove the adjusting knob in order to prevent possible damage to the hood.

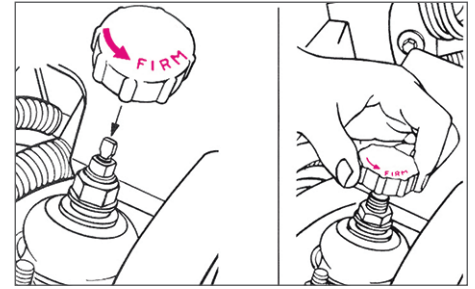

### SERIES 26, 30\*

1. Remove the plastic dust cover to expose the adjusting knob (fig. 2)
2. Depress the knob fully, and hold it in that position while adjusting (fig. 1 & 2).
3. The adjusting device has been provided with a number of distinct stops (clicks), each of which marks an adjustment position (fig.4).
4. To increase rebound damping, turn the piston rod one or more clicks to the right (clockwise), and release the adjusting knob. **DO NOT USE FORCE!** Make sure that the adjusting knob springs fully back into position.

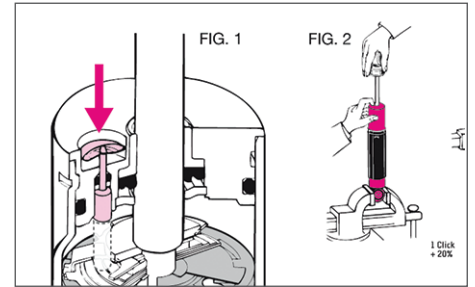

NOTE: 26 Series range limited to 2 clicks, 30 Series range limited to 3 clicks.

### SERIES 76, 80, 82, 84, 86, 87, 88, 90, 92, 8040, 8240\*

1. Fully compress the shock absorber, at the same time turning the dust cover or piston rod slowly to the left (counterclockwise) until the cams of the adjusting nut engage in the recesses of the foot valve assembly (fig.1).

NOTE: Some shock absorbers include a bump rubber concealed under the dust cover and this must be removed prior to adjusting. Do not forget to reinstall.

2. Keeping the shock absorber compressed, make 1 full turn (360°) to the right (clockwise). The total range is about 5 half turns (fig. 2).
3. Extend the shock absorber vertically for at least 1 cm without turning in order to disengage the adjusting mechanism. The dust cap or piston rod may now be turned freely.

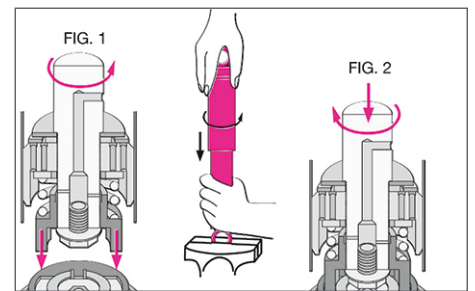

### \*WARNING:

Adjust both left and right dampers identically. Failure to do so may lead to unstable handling and uneven tire tread wear

To see video of these products, visit: <https://www.youtube.com/user/originalKONI>

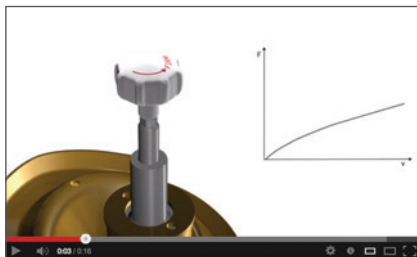

Adjustment Bi-tube external

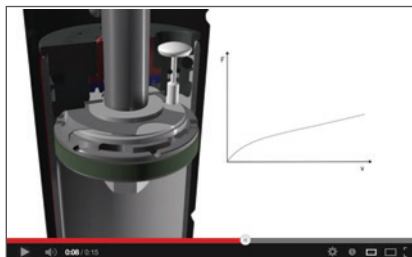

Adjustment Mono-tube

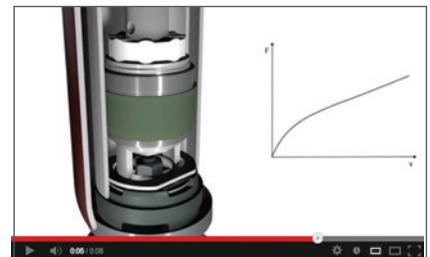

Adjustment Bi-tube regular

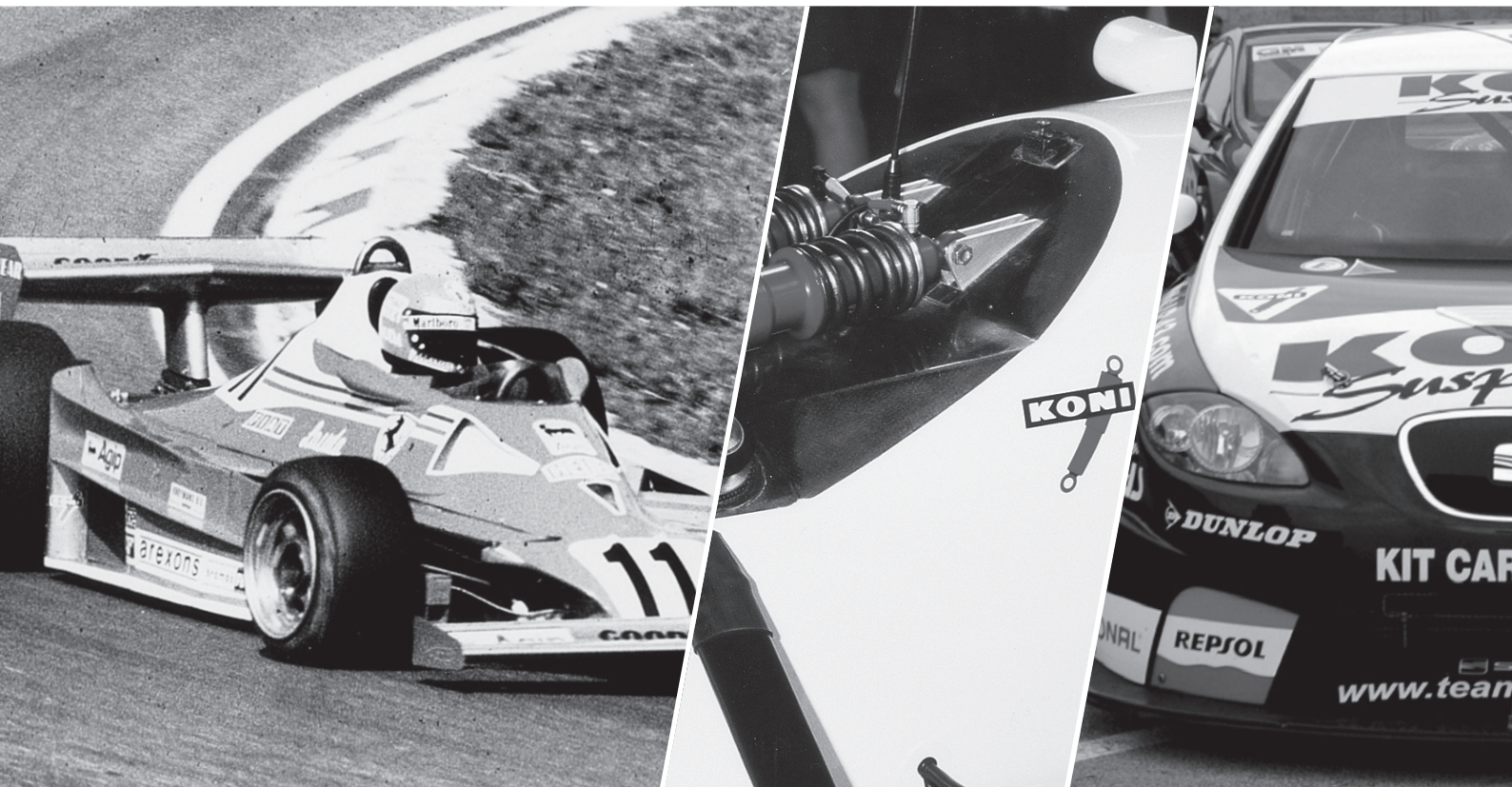

## 8211 Series

---

### Twin Tube Hydraulic Damper

This is a steel-bodied, externally double-adjustable, coilover damper which has been used on World Champion Formula1, Can-Am and virtually every other type of race car ever made. Bump and rebound damping can be adjusted independently without removing the damper from the car. Adjustable spring seats accept 2.25" or 2.50" I.D. springs. These dampers are fully rebuildable and the valving can be adapted to a wide range of applications. Recently updated to include advances in materials and manufacturing techniques, this classic shock design is the premium shock absorber for vintage race cars and restorations, as well as the ultimate non-gas alternative for many new race car applications. The 8211 series have plated steel bodies and are ideal for vintage Formula Ford applications or where special mountings are required and weight is not a concern.







Code	Lmax	Lmin	Stroke
Metal to metal			
1300	282	202	80
1301			
1302	292	207	85
1303			
1304	302	212	90
1305			
1306	312	217	95
1307			
1308	322	222	100
1309			
1310	332	227	105
1311			
1312	342	232	110
1313			
1314	352	237	115
1315			
1316	362	242	120
1317			
1318	372	247	125
1319			
1320	382	252	130
1321			
1322	392	257	135
1323			
1324	402	262	140
1325			
1326	412	267	145
1327			
1328	422	272	150
1329			
1330	432	277	155
1331			

Part number		
Series	Code	Valving
8211	13xx	Bx

Valving	N/mm Spring Rates	Lbs/in
B1	up to 40	up to 225
B2	40 - 60	225 - 330
B3	50 - 80	285 - 450
B6	70 - 125	400 - 700
B7	115 - 170	650 - 950
B8	160 - 270	900 - 1500
B8X	215 and more	1200 and more

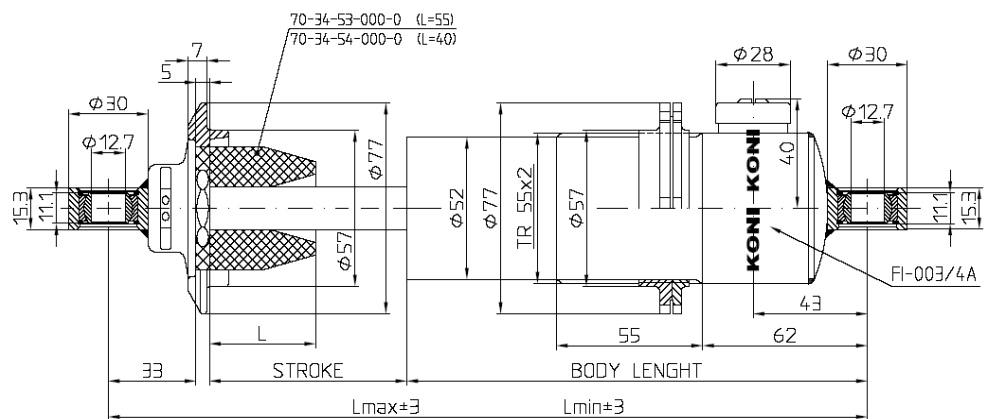



MAKE		Year	product range			Lowering up to ..mm		Notes
Model	Front					Rear		
<b>ALFA ROMEO</b>								
<b>33</b>								
Nuova, incl. 16V & Sport Wagon Front: for Boge original struts only - up to chassisno. 5455777	90-94	Sport	◆ 86-2448Sport					
<b>75</b>								
1.6, 1.8, 2.0, 2.0TD	85-91	Sport	80-2570Sport	80-2571Sport				
1.8 Turbo	86-88	Sport	80-2570Sport	80-2571Sport				
V6	88-91	Sport	80-2570Sport	80-2571Sport				
<b>90</b>								
90	85-87	Sport	80-2570Sport	80-2571Sport				
<b>Alfetta</b>								
Alfetta, excl. GTV	72-86	Sport	80-2241Sport	80-2242Sport				
GTV, GTV6	76-84	Sport	80-2241Sport	80-2242Sport				
GTV, GTV6	85-89	Sport	80-2570Sport	80-2571Sport				
<b>Giulia</b>								
1600 Spider, Sprint, SS	62-09.65	Classic	☞☐ 80-1039	☞ 80-1193				
Giulia, incl. Bertone GTV, Junior	10.65-78	Classic	☞ 80-1551	☞☐ 80-1781				
		Sport	80-1551Sport	☐ 80-1781Sport				
<b>Giulietta</b>								
1300, Berlina 1300	55-64	Classic	☞☐ 80-1039	☞ 80-1193				
Giulietta	78-87	Sport	80-2241Sport	80-2242Sport				
<b>Montreal</b>								
V8	74-76	Sport	80-1551Sport	☐ 80-1781Sport				
<b>Spider</b>								
1300, 1600, 1750, 2000 incl. Duetto, Veloce	67-93	Classic	☞ 80-1551	☞☐ 80-1781				
		Sport	80-1551Sport	☐ 80-1781Sport				
<b>AUDI</b>								
<b>S2</b>								
S2 (B3, 8B) Coupé Quattro 2.3E-20V Turbo	90-95	Sport	86-2086SPD2	86-2433Sport				
S2 Avant	93-95	Sport	86-2086SPD2	☞ 8210-1160Sport				
		Sport Kit			1140-9091	30	30	1,2,13,18
<b>RS2</b>								
RS2 Avant	94-96	Sport	86-2086SPD2	☞ 8210-1160Sport				
		Sport Kit			1140-9691	30	30	1,2,13,18
<b>S4</b>								
S4 Sedan / Avant Quattro	91-05.94	Sport	86-2149Sport	Ⓝ 80-2630Sport				
<b>S6</b>								
S6 (C4) Sedan / Avant Quattro excl. S6 Plus - V8	94-97	STR.T	Ⓢ 8650-1007	ⓃⓈ 8050-1077				
		Sport	86-2149Sport	Ⓝ 80-2630Sport				
<b>50</b>								
50	75-77	Sport	86-1922Sport	80-2315Sport				
<b>80</b>								
80 (B2, 81) Sedan 4-cyl. excl. GTE	79-86	STR.T	Ⓢ 8650-1010					
		Sport	86-2066Sport					
80 (B2, 81) Sedan 5-cyl. and TD	80-84	STR.T	Ⓢ 8650-1010					
		Sport	86-2066Sport					
80 (B3, 89) Sedan excl. 2.0E-16V	87-91	STR.T	Ⓢ 8650-1010					
		Sport	86-2066Sport					
		Sport	☞ 8610-1262Sport					
80 (B3, 89) Sedan incl. 2.0E-16V with Audi Sport Suspension	87-91	STR.T	Ⓢ 8650-1010					
		Sport	86-2066Sport					
		Sport	☞ 8610-1262Sport					
80 (B3, 89Q) Quattro	87-91	STR.T	Ⓢ 8650-1010					
		Sport	86-2066Sport	86-2086Sport				
		Sport	☞ 8610-1262Sport					
80 (B4, 8C) Sedan / Avant 2.0, 2.0E-2.8E, 1.9TD(i)	92-95	STR.T	Ⓢ 8650-1010	Ⓢ 8050-1071				
		Sport	86-2066Sport					
		Sport	☞ 8610-1262Sport					
80 (B4, 8C) Sedan / Avant Quattro Rear: damper unit must be removed from car before it can be adjusted	92-95	STR.T	Ⓢ 8650-1010					
		Sport	☞ 8610-1262Sport	☞ 8210-1160Sport				
		Sport	☞ 8610-1262Sport					
80 (B4, 8G) Cabrio	91-00	STR.T	Ⓢ 8650-1010					
		Sport	86-2066Sport					
		Sport	☞ 8610-1262Sport					
80 (B4, 8C) Sedan / Avant 1.9TD(i)	09.91-95	STR.T	Ⓢ 8650-1010	Ⓢ 8050-1071				
		Sport	86-2066Sport					
		Sport	☞ 8610-1262Sport					
80 (B4, 8C) Sedan / Avant Quattro Rear: damper unit must be removed from car before it can be adjusted	09.91-95	STR.T	Ⓢ 8650-1010					
		Sport	86-2066Sport	☞ 8210-1160Sport				
		Sport	☞ 8610-1262Sport					
80 (B4, 8C) Competition Rear: damper unit must be removed from car before it can be adjusted	94-95	STR.T	Ⓢ 8650-1010					
		Sport	86-2066Sport	☞ 8210-1160Sport				
		Sport	☞ 8610-1262Sport					
<b>90</b>								
90 (B3, 89) Sedan	85-91	STR.T	Ⓢ 8650-1010					
		Sport	86-2066Sport					
		Sport	☞ 8610-1262Sport					

MAKE		product range				Lowering up to ..mm		Notes
Model	Year					Front	Rear	
<b>AUDI - CONTINUED</b>								
with Audi Sport Suspension		STR.T	Ⓒ 8650-1010					
		Sport	86-2066Sport					
		Sport	Ⓜ 8610-1262Sport					
90 (B3, 89) Sedan 2.3E-20V	89-91	STR.T	Ⓒ 8650-1010					
		Sport	86-2066Sport					
		Sport	Ⓜ 8610-1262Sport					
90 (B3, 89Q) Quattro, excl. 2.3E-20V	83-89	STR.T	Ⓒ 8650-1010					
		Sport	86-2066Sport		86-2086Sport			
		Sport	Ⓜ 8610-1262Sport					
90 (B3, 89Q) Quattro 2.3E-20V	89-91	STR.T	Ⓒ 8650-1010					
		Sport	86-2066Sport		86-2433Sport			
		Sport	Ⓜ 8610-1262Sport					
<b>Coupé</b>								
Coupé (B2, 85), excl. Quattro	80-88	STR.T	Ⓒ 8650-1010					
		Sport	86-2066Sport					
		Sport	Ⓜ 8610-1262Sport					
Coupé (B2, 85Q) Quattro, 2.2E, 2.3E, excl. 20V	83-89	STR.T	Ⓒ 8650-1010					
		Sport	86-2066Sport		86-2086Sport			
		Sport	Ⓜ 8610-1262Sport					
Coupé (B3, 8B/B4, 8C) 2.0E, 2.3E(-20V), 2.6E, 2.8E	89-95	STR.T	Ⓒ 8650-1010					
		Sport	86-2066Sport					
		Sport	Ⓜ 8610-1262Sport					
Coupé (B3, 8B) Quattro 2.3E-20V	89-91	STR.T	Ⓒ 8650-1010					
		Sport	86-2066Sport		86-2433Sport			
		Sport	Ⓜ 8610-1262Sport					
<b>100</b>								
100 (C2, 43) Sedan CS Diesel	82-82	Special	▲ 86-2149					
100 (C3, 44 / C4, 4A) Sedan/Avant Rear: M10 top nut	83-94	Special	▲ 86-2149					
		STR.T	Ⓒ 8650-1007					
		Sport	86-2149Sport		Ⓝ 80-2762Sport			
Rear: M12 top nut		STR.T	Ⓒ 8650-1007		ⓃⒸ 8050-1077			
		Sport	86-2149Sport		Ⓝ 80-2630Sport			
100 (C3, 44 / C4, 4A) Sedan/Avant Quattro Rear: M10 top nut	84-92	Special	▲ 86-2149					
		STR.T	Ⓒ 8650-1007					
		Sport	86-2149Sport		Ⓝ 80-2762Sport			
Rear: M12 top nut		STR.T	Ⓒ 8650-1007		ⓃⒸ 8050-1077			
		Sport	86-2149Sport		Ⓝ 80-2630Sport			
<b>200</b>								
200 (C2, 43) 5E, 5T	80-82	Special	▲ 86-2149					
200 (C3, 44) Sedan/Avant Rear: M10 top nut	83-90	Special	▲ 86-2149					
		STR.T	Ⓒ 8650-1007					
		Sport	86-2149Sport		Ⓝ 80-2762Sport			
Rear: M12 top nut		STR.T	Ⓒ 8650-1007		ⓃⒸ 8050-1077			
		Sport	86-2149Sport		Ⓝ 80-2630Sport			
200 (C3, 44) Sedan/Avant Quattro, Turbo excl. 20V Rear: M10 top nut	84-90	Special	▲ 86-2149					
		STR.T	Ⓒ 8650-1007					
		Sport	86-2149Sport		Ⓝ 80-2762Sport			
Rear: M12 top nut		STR.T	Ⓒ 8650-1007		ⓃⒸ 8050-1077			
		Sport	86-2149Sport		Ⓝ 80-2630Sport			
200 (C3, 44) Sedan / Avant Quattro 20V Turbo	89-90	STR.T	Ⓒ 8650-1007		ⓃⒸ 8050-1077			
		Sport	86-2149Sport		Ⓝ 80-2630Sport			
<b>Quattro</b>								
Quattro (B2, 85) 2.1 Turbo 200 Hp (ur-quattro)	81-89	Sport	86-2086Sport		86-2087Sport			
<b>V8</b>								
V8 (D11) 3.6, 4.2	89-94	STR.T	Ⓒ 8650-1007		ⓃⒸ 8050-1077			
		Sport	86-2149Sport		Ⓝ 80-2630Sport			
<b>BEDFORD</b>								
<b>Blitz</b>								
Van	75-80	Classic	☞ 80-2119					
<b>CF</b>								
CF series Front: Pin/Pin-attachment	70-90	Classic	☞ 80-2119					
CF series, with Australian rear suspension Front: Pin/Pin-attachment	70-80	Classic	☞ 80-2119		☞ 80-2134			
<b>Chevanne</b>								
Chevanne (9 TB 40)	76-77	Classic	☞☐ 80-2275		☞ 80-1997			
<b>BMW</b>								
<b>02-Series 114/E10/E20</b>								
1502, 1600-2, 1602, 1802, 2002 incl. Ti, Tii and Turbo	66-77	Sport	86-1519Sport		80-1868Sport			
Touring 1600, 1800, 2000	71-75	Sport	86-1519Sport		80-1868Sport			
<b>3-Series E30</b>								
Sedan, excl. M-Technik for McPherson with housing Ø 45 mm	09.82-91	Sport	ⓂⒸ 8641-1029Sport		☐ 80-2522Sport			
		Sport Short			☐ 80-2522SP1			Lmax -40 mm
		Sport Short			☐ 80-2641Sport			Lmax -30 mm

MAKE		Year	product range				Lowering up to ..mm		Notes	
Model	Front						Rear			
<b>BMW - CONTINUED</b>										
Sedan 318is, 323i, 325i, 324td, excl. M-Technik for McPherson with housing Ø 51 mm	09.82-91	Sport	86-2277Sport	<input type="checkbox"/>	80-2522Sport					
		Sport	ⓂⓂⓂ 8641-1021Sport	<input type="checkbox"/>	80-2522Sport					
		Sport Short	ⓂⓂⓂ 8641-1210Sport						Lmax -20 mm	
		Sport Short		<input type="checkbox"/>	80-2641Sport				Lmax -30 mm	
		Sport Short		<input type="checkbox"/>	80-2522SP1				Lmax -40 mm	
	Sedan with M-Technik for McPherson with housing Ø 51 mm	09.82-91	Sport	86-2277Sport	<input type="checkbox"/>	80-2522Sport				
			Sport Short	ⓂⓂⓂ 8641-1210Sport						Lmax -20 mm
			Sport Short		<input type="checkbox"/>	80-2641Sport				Lmax -30 mm
	up to 8.88: see info inside cover		Sport Short		<input type="checkbox"/>	80-2522SP1				Lmax -40 mm
			Sport	ⓂⓂⓂ 8641-1021Sport	<input type="checkbox"/>	80-2522Sport				
			Sport	ⓂⓂⓂ 8641-1029Sport	<input type="checkbox"/>	80-2522Sport				
	Touring 318i, excl. M-Technik for McPherson with housing Ø 45 mm	09.88-09.89	Sport Short		<input type="checkbox"/>	80-2641Sport				Lmax -30 mm
		Sport Short		<input type="checkbox"/>	80-2522SP1				Lmax -40 mm	
		Sport		<input type="checkbox"/>	80-2522Sport					
Touring, excl. M-Technik for McPherson with housing Ø 51 mm	87-94	Sport	86-2277Sport	<input type="checkbox"/>	80-2522Sport					
		Sport	ⓂⓂⓂ 8641-1021Sport	<input type="checkbox"/>	80-2522Sport					
		Sport Short	ⓂⓂⓂ 8641-1210Sport						Lmax -20 mm	
		Sport Short		<input type="checkbox"/>	80-2641Sport				Lmax -30 mm	
up to 8.88: see info inside cover		Sport Short		<input type="checkbox"/>	80-2522SP1				Lmax -40 mm	
		Sport Short		<input type="checkbox"/>	80-2522SP1				Lmax -40 mm	
		Sport	ⓂⓂⓂ 8641-1021Sport	<input type="checkbox"/>	80-2522Sport					
Cabriolet, incl. M-Technik for McPherson with housing Ø 51 mm	86-93	Sport	86-2277Sport	<input type="checkbox"/>	80-2522Sport					
		Sport Short	ⓂⓂⓂ 8641-1210Sport						Lmax -20 mm	
		Sport Short		<input type="checkbox"/>	80-2641Sport				Lmax -30 mm	
		Sport Short		<input type="checkbox"/>	80-2522SP1				Lmax -40 mm	
up to 8.88: see info inside cover		Sport	ⓂⓂⓂ 8641-1021Sport	<input type="checkbox"/>	80-2522Sport					
		Sport	ⓂⓂⓂ 8641-1144Sport	<input type="checkbox"/>	80-2522Sport					
		Sport Short		<input type="checkbox"/>	80-2641Sport				Lmax -30 mm	
Sedan / Touring 325iX	85-92	Sport Short		<input type="checkbox"/>	80-2522SP1				Lmax -40 mm	
		Sport Short		<input type="checkbox"/>	80-2522SP1				Lmax -40 mm	
<b>M3</b>										
E30	85-91	Sport	86-2277SP1							
		Sport Short	ⓂⓂⓂ 8641-1210Sport						Lmax -20 mm	
		Sport Short		<input type="checkbox"/>	80-2522SP1				Lmax -40 mm	
<b>7-Series E32</b>										
Sedan 730i, 730i-V8, 735i, 740i excl. M-Technik and EDC	03.88-07.90	Sport	ⓂⓂⓂ 8641-1157Sport							
	03.88-07.90	Sport	ⓂⓂⓂ 8641-1157Sport		△					
Sedan 730i, 730i-V8, 735i, 740i excl. M-Technik and EDC	08.90-07.94	Sport	ⓂⓂⓂ 8641-1224Sport							
	08.90-07.94	Sport	ⓂⓂⓂ 8641-1224Sport		△					
<b>Z-Series</b>										
Z1	89-91	Sport	86-2277Sport	<input type="checkbox"/>	80-2522Sport					
		Sport	ⓂⓂⓂ 8641-1021Sport							
<b>BUICK</b>										
<b>Century</b>										
Sedan / Coupé	70-77	Classic	ⓂⓂⓂ 8040-1087	<input type="checkbox"/>	8040-1088					
	73-77	Classic	ⓂⓂⓂ 8040-1087							
Wagon	71-76	Classic	ⓂⓂⓂ 8040-1087							
	77-85	Classic	ⓂⓂⓂ 8040-1087	<input type="checkbox"/>	8040-1088					
	85-90	Classic	ⓂⓂⓂ 8040-1087	<input type="checkbox"/>	8040-1088					
<b>Electra</b>										
Electra	71-76	Classic	ⓂⓂⓂ 8040-1087							
	77-85	Classic	ⓂⓂⓂ 8040-1087	<input type="checkbox"/>	8040-1088					
	85-90	Classic	ⓂⓂⓂ 8040-1087	<input type="checkbox"/>	8040-1088					
<b>Estate</b>										
Estate	71-76	Classic	ⓂⓂⓂ 8040-1087							
	77-85	Classic	ⓂⓂⓂ 8040-1087	<input type="checkbox"/>	8040-1088					
<b>Le Sabre</b>										
LeSabre	71-76	Classic	ⓂⓂⓂ 8040-1087							
	77-85	Classic	ⓂⓂⓂ 8040-1087	<input type="checkbox"/>	8040-1088					
	85-90	Classic	ⓂⓂⓂ 8040-1087	<input type="checkbox"/>	8040-1088					
<b>Riviera</b>										
Coupe	71-76	Classic	ⓂⓂⓂ 8040-1087							
	77-78	Classic	ⓂⓂⓂ 8040-1087	<input type="checkbox"/>	8040-1088					
<b>Roadmaster</b>										
Sedan / Wagon	92-96	Classic	ⓂⓂⓂ 8040-1087	<input type="checkbox"/>	8040-1088					
<b>Skylark</b>										
incl. Special	64-67	Classic		<input type="checkbox"/>	8040-1088					
	68-72	Classic	ⓂⓂⓂ 8040-1087	<input type="checkbox"/>	8040-1088					
	73-79	Classic	ⓂⓂⓂ 8040-1087							
	70-72	Classic	ⓂⓂⓂ 8040-1087	<input type="checkbox"/>	8040-1088					

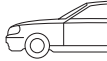
MAKE		Year	product range				Lowering up to ..mm		Notes	
Model	Front						Rear			
<b>CADILLAC</b>										
<b>Calais</b>										
Calais / De Ville		77-84	Classic				8040-1087			8040-1088
<b>CHEVROLET</b>										
<b>Bel Air</b>										
Bel Air, Caprice, Impala, Kingswood Station-Wagon		71-76	Classic				8040-1087			8040-1088
<b>Camaro</b>										
Camaro with mono-leaf spring rear		67-69	Classic				80-1914			80-1915
Camaro with multi-leaf spring rear		68-69	Classic				80-1914			80-1953
Camaro, incl. Z-28		70-81	Classic				8040-1017			8040-1018
Camaro Coupé / Conv		82-92	Sport				8741-1030Sport			30-1265Sport
<b>Caprice</b>										
Caprice Classic, Station-Wagon		77-96	Classic				8040-1087			8040-1088
<b>Chevelle</b>										
Chevelle, Malibu, SS 396, SS 454, Green Brier		68-73	Classic				8040-1087			8040-1088
Chevelle Laguna Coupé and Estate		73-77	Classic				8040-1087			8040-1088
Chevelle Malibu Classic		77-77	Classic				8040-1087			8040-1088
<b>Chevy II</b>										
Nova with multi-leaf spring rear		68-74	Classic				8040-1087			8040-1088
Nova with multi-leaf spring rear		75-79	Classic				8040-1087			
<b>Corvette</b>										
Corvette C2 Coupé / Convertible		63-67	Classic				8040-1019			8040-1020
Corvette C3 Coupé / Convertible		68-83	Classic				8040-1019			8040-1020
Corvette C4 Coupé / Convertible excl. electronically adjustable suspension		88-88	Sport							8241-1098Sport
Corvette C4 Coupé / Convertible disarms electronic suspension		89-96	Sport				8241-1097Sport			8241-1098Sport
<b>El Camino</b>										
El Camino, Monte Carlo		68-77	Classic				8040-1087			8040-1088
<b>Impala</b>										
Impala		65-76	Classic				8040-1087			
Impala		77-90	Classic				8040-1087			8040-1088
<b>K1500 / K2500 / K3500</b>										
K1500 / K2500 / K3500 Pickup AWD		87-99	Heavy Track				82-2372			82-2384
<b>LUV</b>										
LUV Pickup 2WD & AWD		73-81	Heavy Track							80-2458
<b>CHRYSLER AUSTRALIA</b>										
<b>Valiant</b>										
Valiant / Charger / Pacer / Ute and Wagon VE-VK and CL-CM models		62-81	Classic				80-2311			80-2163
<b>CITROEN</b>										
<b>Traction Avant</b>										
Traction 7 and 11 Tourisme TAV		37-56	Classic				80-1114			80-1196
Traction 15 Tourisme TAV		37-56	Classic				80-1196			80-1196
<b>DAIHATSU</b>										
<b>Charmant</b>										
Charmant 1600 EL Sedan (A45)		81-08.83	Sport				86-1991Sport			80-2437Sport
Charmant 1300/1450/1600 Sedan (A35 / A45 / A60)		09.83-88	Sport				86-1991Sport			80-2437Sport
<b>DAIMLER</b>										
<b>2.5</b>										
2.5 Liter V8		64-69	Classic				82-1019			82-1044
<b>Double six</b>										
Double six		64-69	Classic				82-1019			
Double six Rear: 4 pieces		72-02.93	Classic				26-1089			M02
Double six		10.94-98	Classic				26-1592			30-1593
<b>Six</b>										
Six Rear: 4 pieces		64-69	Classic				82-1019			
Six 4.0		10.94-98	Classic							30-1593
<b>Sovereign</b>										
Sovereign		64-69	Classic				82-1019			
Sovereign Rear: 4 pieces		70-86	Classic				26-1089			M02
<b>DODGE</b>										
<b>Challenger</b>										
Challenger rear lower shock mount hole 5/8ths inch		70-74	Classic				80-1538			82-1255
<b>Charger</b>										
Charger, incl. Coronet (Super Bee) rear lower shock mount hole 5/8ths inch		65-72	Classic				80-1538			82-1255
Charger, incl. Coronet (Super Bee) rear lower shock mount hole 5/8ths inch		73-76	Classic							82-1255
<b>D50</b>										
D50 Pickup		79-85	Heavy Track							80-2458

MAKE		Year	product range	 		Lowering up to ..mm		Notes
Model	Front					Rear		
<b>FERRARI</b>								
<b>308</b>								
308 GTB, -GTS	75-85	Classic	☒ 82-1982SP6	☒ 82-1983SP6				
Dino 308 GT4 (2+2) - F 106 AL 100 Rear: for availability contact www.koni.uk.com	73-80	Classic	☒ 82-1982SP6	☒ 82-1831SP1				
<b>365</b>								
365 GT4 (2 + 2)	73-75	Classic		☒ 82-1825SP2				
365 GT4 - BB Rear: 4 pieces	73-76	Classic	☒ 82-1833SP6	☒ 82-1984SP6				
<b>400</b>								
400 GT, 400 Automatic	77-82	Classic		☒ 82-1825SP2				
<b>508</b>								
508 E, CA, Coupe, 2+2 For availability contact www.efkaimport.nl	61-62	Classic		☒ 82-1216	☒ 82-1217			
508E63 Spyder Coupe 2+2 For availability contact www.efkaimport.nl	62-64	Classic		☒ 82-1216				
<b>512</b>								
512 BB, 512 BBi Rear: 4 pieces	76-84	Classic	☒ 82-1833SP6	☒ 82-1984SP6				
<b>539</b>								
539U63 & 62 Coupe Super America For availability contact www.efkaimport.nl	62-64	Classic		☒ 82-1216				
539U63 & 62 Berlinetta Lusso For availability contact www.efkaimport.nl	62-64	Classic		☒ 82-1216				
<b>Dino</b>								
Dino 206 GT, 246 GT, 246 GTS	69-74	Classic	☒ 82-1579SP2	☒ 82-1603SP2				
Dino 308 GT4 (2+2)	73-80	Classic	☒ 82-1982SP6					
<b>FIAT</b>								
<b>124</b>								
124, 124 S, incl. Coupé & Spider 2000	66-80	Sport	80-1877Sport	☐ 80-1878Sport				
<b>126</b>								
126	73-83	Classic	☒▲ 80-2281					
<b>131</b>								
131 2000 Racing / Sport	78-81	Sport		☐ 80-1878Sport				
131 Sedan (Mirafiori)	78-83	Sport		☐ 80-1878Sport				
<b>500</b>								
500, 500 D, 500 Giardiniera	57-75	Classic	☒ 80-1308	☒ 80-1307				
<b>FORD AMERICA</b>								
<b>Bronco</b>								
Bronco AWD	67-77	Heavy Track		82-1518				
<b>Econoline</b>								
Econoline E250 / E350	75-91	Heavy Track		82-1518				
<b>F100</b>								
F100 - 1/2t Pickup 2WD	65-69	Heavy Track		82-1518				
F100 / F150 / F250 Pickup 2WD	70-80	Heavy Track		82-1518				
<b>F250</b>								
F250 - 3/4t Pickup 2WD	65-69	Heavy Track		82-1518				
F250 Crew Cab 2WD	70-79	Heavy Track		82-1518				
F350 - 1t Pickup 2WD	67-69	Heavy Track		82-1518				
F350 Super Cab 2WD	74-79	Heavy Track		82-1518				
<b>Fairmont</b>								
Fairmont Sedan, Futura Coupé, Squire Wagon	78-80	Classic		☒ 8040-1026				On request
Fairmont	81-83	Classic		☒ 8040-1026				On request
<b>Mustang</b>								
Mustang, incl. GT 350	64-70	Classic		☒ 82-1388SP3	☒ 82-1389			
Mustang	71-73	Classic			☒ 82-1389			
Mustang, excl. SVO Rear: with bushing length 36,5 mm	79-86	Classic		☒ 8040-1026				On request
Rear: Quad shock		Classic			☒ 25-1215			
Mustang SVO Rear: Quad shock	84-84	Classic		☒ 8040-1026				On request
		Classic			☒ 25-1215			
Mustang SVO Rear: Quad shock	85-86	Classic	☒ 8741-1054	☒ 8040-1026				On request
		Classic			☒ 25-1215			
Mustang V8, excl. Cobra R	87-93	Classic		☒ 8040-1026				On request
		Sport	☒ 8741-1121Sport	☒ 8041-1026Sport				On request
<b>Pinto</b>								
Pinto Sedan, Runabout	70-80	Classic		☒ 80-2167				
<b>FORD AUSTRALIA</b>								
<b>Bronco</b>								
Bronco (4WD) with front dampers behind the axle, excl. raised suspension	80-96	Heavy Track		82-1969SP2	82-2138SP2			
Bronco (4WD) with Quad suspension excl. extended suspension (front side)	80-96	Heavy Track		☒ 80-2134	82-2138SP2			
excl. extended suspension (rear side)		Heavy Track		82-1969SP2				

MAKE		Year	product range				Lowering up to ..mm		Notes
Model	Front						Rear		
<b>FORD AUSTRALIA - CONTINUED</b>									
<b>Cortina</b>									
	Cortina TE, TF Sedan and Wagon	77-84	Classic			⤴ 80-2319			
<b>Courier</b>									
	Courier	85-92	Heavy Track			80-1905			
<b>Falcon / Fairmont X-Series</b>									
	Falcon GT, GTHQ, Fairmont XR-XD Sedan with lowered suspension	66-82	Classic	⤴ 82-1742SP4		⤴ 80-2319			
	Falcon, Fairmont XR-XY Sedan, Wagon, Ute, Panel Van	66-72	Classic	⤴ 82-1698		⤴ 80-2111			
	Falcon, up to XD with lowered suspension	66-82	Classic	⤴ 82-1742SP4		⤴ 80-2319			
	Falcon, Fairmont XA-XD, XE-XF Wagon	72-87	Classic	⤴ 82-1698		⤴ 80-2319			
	Falcon, Fairlane ZA-ZJ Wagon, Ute and Panel Van	72-87	Classic	⤴ 82-1698		⤴ 80-2319			
	Falcon up to XG Van and Ute (incl. Longreach) with lowered front suspension	72-96	Classic	⤴ 82-1698		⤴ 80-2319			
	Falcon, Fairlane ZK-ZL, Fairmont XE-XF Sedan LTD with Watts link rear suspension	82-87	Classic	⤴ 82-1742SP4		⤴ 80-2513			
<b>Falcon / Fairmont E-series</b>									
	Falcon models EA up to EL Sedan with lowered suspension, incl. XR6 and XR8	88-98	Classic	⤴ 82-2432		⤴ 80-2513			
			Sport	ⓂⓂⓂ 8241-1153Sport		ⓂⓂⓂ 8041-1067Sport			
			Classic	⤴ 82-2432		⤴ 80-2513SP1			
			Sport	ⓂⓂⓂ 8241-1153Sport		ⓂⓂⓂ 8041-1067SP1			
	Falcon models EA up to EL Wagon	88-98	Classic	⤴ 82-2432		⤴ 80-2319			
			Sport	ⓂⓂⓂ 8241-1153Sport					
	Fairmont Ghia models EA up to EL	88-98	Classic	⤴ 82-2432		⤴ 80-2513			
			Sport	ⓂⓂⓂ 8241-1153Sport		ⓂⓂⓂ 8041-1067Sport			
<b>Fairlane / LTD</b>									
	Fairmont Ghia EA, EB, ED, EF, EH, EL	88-98	Classic	⤴ 82-2432		⤴ 80-2513			
			Sport	ⓂⓂⓂ 8241-1153Sport		ⓂⓂⓂ 8041-1067Sport			
	Fairlane NA, NC, NL DA and DC, DF Ltd.	88-98	Classic	⤴ 82-2432		⤴ 80-2513			
			Sport	ⓂⓂⓂ 8241-1153Sport		ⓂⓂⓂ 8041-1067Sport			
<b>F-series</b>									
	F100 / F250 / F350	74-80	Heavy Track	82-1518					
	F100 AWD	81-94	Heavy Track	82-1969SP2					
	F100 / F150	81-94	Heavy Track	82-1969SP2		82-2138SP2			
	F250 / F350	81-94	Heavy Track	82-1969SP2		82-2138SP2			
<b>Galaxie</b>									
	Galaxie, LTD, Landau	73-82	Classic	⤴ 82-1698		⤴ 80-2319			
<b>FORD EUROPE</b>									
<b>Capri</b>									
	Capri, Capri II and III, excl. 2.8i	73-85	Sport	86-1835Sport		□ 80-2256Sport			
<b>Escort</b>									
	Escort Mk1 RS 2000	75-75	Sport	86-1835Sport					
	Escort Mk4 1.6i incl. Cabrio (GAF) (Car will be lowered by approx. 15 mm)	86-08.90	Sport			ⓂⓂⓂ 8741-1119Sport			
	Escort Mk4 RS Turbo	86-08.90	Sport			ⓂⓂⓂ 8741-1119Sport			
	Escort Mk4 XR3i (Car will be lowered by approx. 15 mm)	86-08.90	Sport			ⓂⓂⓂ 8741-1119Sport			
	Escort Mk5 2.0i Turbo-16V Cosworth (4WD)	92-94	Sport			Ⓜ 26-1294Sport			
<b>Orion</b>									
	Orion 1.6i, 1.6i Ghia	84-08.90	Sport			ⓂⓂⓂ 8741-1119Sport			
<b>Sierra</b>									
	Sierra Hatchback / Sedan	06.84-92	Sport	ⓂⓂⓂ 8741-1074Sport					
	Sierra XR4i	06.84-85	Sport	ⓂⓂⓂ 8741-1074Sport					
	Sierra XR 4WD	85-92	Sport	ⓂⓂⓂ 8741-1109Sport		Ⓜ 26-1294Sport			
	Sierra RS Cosworth	86-86	Sport	ⓂⓂⓂ 8741-1124Sport		Ⓜ 26-1294Sport			
	Sierra Cosworth Sedan	87-89	Sport	ⓂⓂⓂ 8741-1124Sport		Ⓜ 26-1294Sport			
	Sierra Cosworth Sedan AWD	90-92	Sport	ⓂⓂⓂ 8741-1109Sport		Ⓜ 26-1294Sport			
<b>HOLDEN (AUSTRALIA)</b>									
<b>Astra</b>									
	Astra TR excl. GSi	91-98	Sport			Ⓜ 8010-1032Sport			
	Astra TR GSi	91-98	Sport	Ⓜ 8610-1283Sport		Ⓜ 8010-1032Sport			
<b>Commodore</b>									
	Commodore VB - VP Sedan only for HD suspension, with short rear dampers	78-93	Classic	⤴ 86-2076SP1					
			Classic			⤴ 80-2597			
			Sport	ⓂⓂⓂ 8641-1066Sport		ⓂⓂⓂ 8041-1094Sport			
	Commodore VP Sedan with IRS (independent rear suspension)	92-93	Classic	⤴ 86-2076SP1		⤴ 80-2738			
			Sport	ⓂⓂⓂ 8641-1066Sport		ⓂⓂⓂ 8041-1194Sport			
	Commodore VB - VP Station Wagon	78-93	Classic	⤴ 86-2076SP1		⤴ 80-2233SP1			
			Sport	ⓂⓂⓂ 8641-1066Sport					
	Commodore VG Ute, Maloo for light duty only	91-93	Classic	⤴ 86-2076SP1		⤴ 80-2233SP1			
			Sport	ⓂⓂⓂ 8641-1066Sport					
	Statesman, Caprice VQ Front: for original struts only. With IRS	90-94	Classic	⤴ 86-2076SP1		⤴ 80-2738			
			Sport	ⓂⓂⓂ 8641-1066Sport		ⓂⓂⓂ 8041-1194Sport			

MAKE		Year	product range					Lowering up to ..mm		Notes
Model				Front	Rear					
<b>HOLDEN (AUSTRALIA) - CONTINUED</b>										
<b>E-, F- and H-series</b>										
Series FJ - FB, EK - EH, HD - HG Standard, Special, Business, Premier, Belmont, Brougham, Kingswood, Monaro, Panel Van and Ute	53-71	Classic	☒ 80-2133	☒ 80-2134						
Series HQ - HZ Sedan, Wagon Belmont, Kingswood, Monaro, Premier, incl. GTS, LE and SS	71-80	Classic	☒ 80-2156SP1	☒ 80-2157SP1						
Series HQ - HZ Panel Van, Ute and Pick-Up 1 Tonne, Belmont, Kingswood and Sandman	71-85	Classic	☒ 80-2156SP1	☒ 80-2320						
<b>Gemini</b>										
Gemini TX, TC, TD, TE, TF, TG Sedan / Coupé	75-85	Classic	☒☐ 80-2275							
		Sport	☐ 82-1886Sport							
Gemini TD, TE, TF, TG Station Wagon / Panel Van	78-85	Classic	☒☐ 80-2275	☒ 80-2134						
<b>Jackaroo</b>										
Jackaroo UBS 13, 16, 52 (4WD) high pressure gas alternative	82-86	Heavy Track	Ⓞ 30-1326							
Jackaroo UBS 16, 17, 52, 55 (4WD) excl. raised suspension	87-91	Heavy Track	Ⓞ 30-1365							
<b>Piazza</b>										
Piazza YB	04.86-90	Classic	☒☐ 80-2275	☒ 80-2233SP1						
		Sport	☐ 82-1886Sport							
<b>Rodeo</b>										
Rodeo KB 26 (2WD) excl. raised suspension	86-89	Heavy Track		☒ 80-1904						
Rodeo KB 46 (4WD) excl. raised suspension	86-89	Heavy Track		☒ 80-1904						
Rodeo TF (4WD) Rear: with PIN/EYE attachment	08.88-98	Heavy Track	Ⓞ 30-1365							
<b>Statesman</b>										
Statesman, Caprice, de Ville	71-85	Classic	☒ 80-2156SP1	☒ 80-2157SP1						
<b>Torana</b>										
Torana LC, LJ (6-cyl.) incl. GTR, XU1	69-74	Classic	☒ 80-2153	☒ 80-2134						
Torana LH, LX, UC (6/8-cyl.) and Sunbird	74-80	Classic	☒ 80-2156SP1	☒ 80-2299						
<b>GMC</b>										
<b>C-1500 / C-2500</b>										
C-1500 / C-2500 Pickup Rear: Lmax. 680 mm	73-86	Heavy Track		82-2384						
<b>K-1500 / K-2500</b>										
K-1500 / K-2500 / K-3500 Pickup (4WD)	87-98	Heavy Track	82-2372	82-2384						
<b>HONDA</b>										
<b>Accord</b>										
Accord Aerodeck 2.2 (CB8) with these KONI Sport dampers the car can be lowered approx. 15 mm	90-92	Sport	N3☒☒☒☒☒ 8041-1185LSport N3☒☒☒☒☒ 8041-1185RSport	R6+R7☒☒☒☒☒ 8041-1168SP4						
Accord Sedan 1.8, 2.0, 2.0i, 2.2i (CB) with these KONI Sport dampers the car can be lowered approx. 15 mm	90-92	Sport	N3☒☒☒☒☒ 8041-1185LSport N3☒☒☒☒☒ 8041-1185RSport	R6+R7☒☒☒☒☒ 8041-1168SP4						
<b>Civic</b>										
CRX Coupé incl. VTEC	89-06.92	Sport	Ⓞ 8040-1077Sport							
CRX Coupé (EG2 - EH6)	07.92-00	STR.T	Ⓞ 8050-1011	Ⓞ 8050-1012						
		Sport	N6☒☒☒☒☒ 8041-1152Sport	R4☒☒☒☒☒ 8041-1153Sport						
		STR.T Kit			1120-8631	30	30	1,2,13		
		Sport Kit			1140-8631	30	30	1,2,13,16		
		Coil-over Kit			1150-5006-1	60	60	1,2,13,16,21,22		
for non-European cars with an eye-attachment on the rear damper (instead of a U-bracket)		STR.T	Ⓞ 8050-1011							
		Sport	N6☒☒☒☒☒ 8041-1152Sport	R4☒☒☒☒☒ 8041-1164Sport						
CRX Coupé incl. VTEC and VTi	07.95-00	STR.T	Ⓞ 8050-1011	Ⓞ 8050-1016						
		Sport	N6☒☒☒☒☒ 8041-1152Sport	R4☒☒☒☒☒ 8041-1213Sport						
		STR.T Kit			1120-7361	35	35	1,2,13		
Sport Kit			1140-7361	35	35	1,2,13,16				
Civic Sedan / Hatchback / CRX Coupé (EC / ED) (up to serie no. S 100.000)	88-88	Sport	Ⓞ 8040-1077Sport							
		Sport	☒☒ 8041-1166SP4							
Civic Sedan / Hatchback (EC / ED / EE) (as from serie no. S 100.000)	89-91	Sport	Ⓞ 8040-1077Sport							
Civic Sedan / Hatchback	92-95	STR.T		Ⓞ 8050-1012						While stocks last
		Sport	N6☒☒☒☒☒ 8041-1152Sport	R4☒☒☒☒☒ 8041-1153Sport						
		Sport Kit			1140-8631	30	30	1,2,13,16		
		Coil-over Kit			1150-5006-1	60	60	13,16,21,22		
		for non-European cars with an eye-attachment on the rear damper (instead of a U-bracket)		STR.T	Ⓞ 8050-1011					
		Sport	N6☒☒☒☒☒ 8041-1152Sport	R4☒☒☒☒☒ 8041-1164Sport						
Sport Kit			1140-8632	30	30	1,2,13,16				
Civic Coupé 1.5 (EG / EH) USA-Versions	93-95	STR.T	Ⓞ 8050-1011	Ⓞ 8050-1012						
		Sport	N6☒☒☒☒☒ 8041-1152Sport	R4☒☒☒☒☒ 8041-1153Sport						
		Coil-over Kit			1150-5006-1	60	60	16,21,22		
<b>Integra</b>										
Integra Sedan / Coupé (DA9) with the KONI Sport dampers the car can be lowered approx. 20 mm	90-93	Sport	P2☒☒☒☒☒ 8041-1200Sport	R1☒☒☒☒☒ 8041-1201Sport						On request
Integra (DC2, DC4) excl. Type R	94-98	STR.T	Ⓞ 8050-1011	Ⓞ 8050-1012						
		Sport	N6☒☒☒☒☒ 8041-1152Sport	R4☒☒☒☒☒ 8041-1153Sport						





MAKE		Year	product range			Lowering up to ..mm		Notes
Model						Front	Rear	
<b>HONDA - CONTINUED</b>								
Integra Type R with the KONI Sport dampers the car can be lowered approx. Fr-Rr: 25-15mm	98-01	STR.T	Ⓢ 8050-1011					
		Sport	N6ⓈⓈⓈ 8041-1152Sport	R4ⓈⓈⓈ 8041-1164Sport				
		Sport Kit			1140-5021	35	35	1,2,13,16, NO TUV
<b>Legend</b>								
Legend Sedan / Coupé (KA7 / KA8) 3.2i-V6 Front uses OE spring seat. With these dampers the car can be lowered approx. Fr-Rr: 20-15mm	91-93	Special	N4ⓈⓈⓈ 8240-1125	R4ⓈⓈⓈ 8240-1126				
<b>NS-X</b>								
NS-X Coupé (NA 1)	90-97	Sport	ⓈⓈⓈ 8241-1117Sport	ⓈⓈⓈ 8241-1118Sport				On request
<b>Passport</b>								
Passport (4WD)	95-01.98	Heavy Track	Ⓢ 30-1365					
Passport (4WD)	02.98-04	Heavy Track	Ⓢ 30-1663	Ⓢ 30-1664				
<b>Prelude</b>								
Prelude (BB) incl. 4WS (4-wheel steering) with the KONI Sport dampers the car can be lowered approx. Fr-Rr: 20-15mm	92-96	Sport	N4ⓈⓈⓈⓈ 8041-1154LSport N4ⓈⓈⓈⓈ 8041-1154RSport	R3ⓈⓈⓈⓈ 8041-1155Sport				
Prelude 2.0, 2.2 VTEC excl. SH (ATTS) with the KONI Sport dampers the car can be lowered approx. Fr-Rr: 20-15mm	97-00	Sport	N4ⓈⓈⓈⓈ 8041-1232Sport	R3ⓈⓈⓈⓈ 8041-1155Sport				
<b>S2000</b>								
S2000 Roadster for Showa OE dampers only	99-08	STR.T	Ⓢ 8050-1117L Ⓢ 8050-1117R	Ⓢ 8050-1118				
		Sport	ⓈⓈⓈ 8041-1278LSport ⓈⓈⓈ 8041-1278RSport	ⓈⓈⓈ 8041-1279Sport				
		STR.T Kit			1120-4171	25	25	1,2,13
		Sport Kit			1140-4171	25	25	1,2,13,16
<b>ISUZU</b>								
<b>Gemini</b>								
Gemini 1600 (PF50, PF60)	75-85	Classic	ⓈⓈⓈ 80-2275					
		Sport	ⓈⓈⓈ 82-1886Sport					
<b>Pickup</b>								
Pickup	82-83	Heavy Track		80-2458				
<b>Trooper</b>								
Trooper (UBS13 / UBS52) 4WD up to chassisno. 4524288	84-86	Heavy Track	Ⓢ 30-1326					
Trooper (UBS16 / UBS52) 4WD as from chassisno. 4524289	-87	Heavy Track	Ⓢ 30-1365					
<b>Van</b>								
Van (WFR 11) 2WD	80-89	Heavy Track		Ⓢ 80-1904				
<b>JAGUAR</b>								
<b>E-type</b>								
E-Type Series 1, 1½, 2 Coupé, 2+2 Coupé, Convertible. Rear: 4 pieces	61-71	Classic	ⓈⓈⓈ 82-1232	ⓈⓈⓈ 80-1491SPA1				
E-Type Series 3 (V12) Coupé, 2+2 Coupé, Convertible. Rear: 4 pieces	71-75	Classic	ⓈⓈⓈ 80-2215	ⓈⓈⓈ 80-2216				
<b>Mk</b>								
Mk 240, 340	67-69	Classic	ⓈⓈⓈ 82-1019	ⓈⓈⓈ 82-1044				
Mk II 2.4 Litre, 3.4 Litre, 3.8 Litre	56-67	Classic	ⓈⓈⓈ 82-1019	ⓈⓈⓈ 82-1044				
Mk VII, VIII, IX	54-59	Classic	ⓈⓈⓈ 82-1027	ⓈⓈⓈ 82-1081				
<b>S</b>								
S 3.8 Litre	64-66	Classic	ⓈⓈⓈ 82-1019					
S 420	64-69	Classic	ⓈⓈⓈ 82-1019					
<b>XJ</b>								
XJ 6 Rear: 4 pieces	69-86	Classic	ⓈⓈⓈ 26-1089	M0ⓈⓈⓈⓈⓈⓈ 30-1090				
XJ 6 3.2 Sport	10.94-10.97	Classic	ⓈⓈⓈ 26-1592	ⓈⓈⓈⓈⓈ 30-1593				
XJ 6 3.2i/4.0 Saloon, Sovereign, incl. l.w.b.	10.94-10.97	Classic		ⓈⓈⓈⓈⓈ 30-1593				
XJ 8 excl. cars with Jaguar CATS suspension	10.97-03	Classic	ⓈⓈⓈ 26-1698	ⓈⓈⓈⓈⓈ 30-1593				
XJ 12 Rear: 4 pieces	72-02.93	Classic	ⓈⓈⓈ 26-1089	M0ⓈⓈⓈⓈⓈⓈ 30-1090				
XJ 12 Saloon, incl. l.w.b.	10.94-10.97	Classic	ⓈⓈⓈ 26-1592	ⓈⓈⓈⓈⓈ 30-1593				
XJ-R Supercharged	10.94-10.97	Classic	ⓈⓈⓈ 26-1592	ⓈⓈⓈⓈⓈ 30-1593				
<b>XJ-S</b>								
XJ-S 12 Rear: 4 pieces	75-96	Classic	ⓈⓈⓈ 26-1089	M0ⓈⓈⓈⓈⓈⓈ 30-1090				
<b>XK</b>								
XK 120	48-54	Classic	ⓈⓈⓈ 80-1105	△				
XK 140	54-57	Classic	ⓈⓈⓈ 82-1027	ⓈⓈⓈ 82-1081				
XK 150 / XK 150 S	57-61	Classic	ⓈⓈⓈ 82-1107					
<b>JEEP</b>								
<b>Cherokee</b>								
Cherokee, series XJ	84-01	Heavy Track	Ⓢ 30-1348	Ⓢ 30-1630				
<b>Grand Cherokee</b>								
Grand Cherokee, series ZJ high pressure gas alternative	93-98	Heavy Track	Ⓢ 8240-1198SPX	Ⓢ 8240-1199SPX				
		Heavy Track		Ⓢ▲ 30-1625				
<b>Wagoneer</b>								
Wagoneer, series XJ	84-00	Heavy Track	Ⓢ 8240-1201SPX	Ⓢ 8240-1202SPX				

MAKE		Year	product range			Lowering up to ..mm		Notes
Model						Front	Rear	
<b>LADA</b>								
<b>Niva</b>								
	Niva (2121) 4WD	78-09	Heavy Track	Ⓒ 30-1324	Ⓒ 30-1325			
<b>Samara</b>								
	Samara 1100, 1300 (2108)	86-00	Special	86-2380	M3ⒺⒺ 80-2586			
			Sport	ⒺⒺ 8641-1329Sport	M3ⒺⒺⒺ 8041-1209Sport			
<b>LANCIA</b>								
<b>Flavia</b>								
	Flavia as from chassiso. 815.000.1560	62-05.67	Classic	▼□ 80-1500	▼ 80-1501			
	Flavia Zagato Sport	64-66	Classic	▼□ 80-1500	▼ 80-1501			
	Flavia	06.67-72	Classic		▼ 80-1501			
<b>Fulvia</b>								
	Fulvia, 1300C	63-76	Classic	▼□ 80-1500	▼ 80-1501			
<b>Ypsilon</b>								
	Ypsilon Y10, incl. Turbo	85-92	Special		□ 80-2584			
<b>LAND ROVER (RANGE-ROVER)</b>								
<b>Discovery</b>								
	Discovery 1	89-94	Heavy Track	Ⓒ 30-1311	Ⓒ 30-1312			
			Heavy Track	Ⓒ 8240-1181SPX	Ⓒ 8240-1190SPX			
	NOTE: these dampers are only for vehicles raised 50mm.		Heavy Track	Ⓒ 30-1311SP1	Ⓒ 30-1312SP1			
	Steering damper (not adjustable)		Heavy Track	Ⓒ 026-1580				
	RAID Dampers: fit vehicles with standard or raised suspension, Front: 0 - 50 mm / Rear: 0 - 40 mm		HT RAID	90-5374SP1	90-5375SP1			
	RAID Dampers: for raised suspension 40 - 60 mm only		HT RAID		90-5401			
<b>Land Rover (Defender)</b>								
	Defender 90	84-99	Heavy Track	Ⓒ 30-1311				
	Defender 90 as from serie no. XA159807	99-16	Heavy Track	Ⓒ 8240-1181SPX	Ⓒ 8240-1182SPX			
	Defender 90 RAID Dampers: fit vehicles with standard or raised suspension, Front: 0 - 50 mm / Rear: 0 - 40 mm	84-16	HT RAID	90-5374SP1	90-5375SP1			
	RAID Dampers: for raised suspension 40 - 60 mm only		HT RAID		90-5401			
	Defender 110	83-99	Heavy Track	Ⓒ 30-1311	Ⓒ 30-1312			
			Heavy Track	Ⓒ 8240-1181SPX	Ⓒ 8240-1190SPX			
	Defender 110 as from serie no. XA159807	99-16	Heavy Track	Ⓒ 8240-1181SPX	Ⓒ 8240-1182SPX			
	Defender 110 RAID Dampers: fit vehicles with standard or raised suspension, Front: 0 - 50 mm / Rear: 0 - 40 mm	84-16	HT RAID	90-5374SP1	90-5375SP1			
	RAID Dampers: for raised suspension 40 - 60 mm only		HT RAID		90-5401			
	Defender 130 as from serie no. XA159807	99-16	Heavy Track	Ⓒ 8240-1181SPX	Ⓒ 8240-1182SPX			
	RAID Dampers: fit vehicles with standard or raised suspension, Front: 0 - 50 mm / Rear: 0 - 40 mm		HT RAID	90-5374SP1	90-5375SP1			
	RAID Dampers: for raised suspension 40 - 60 mm only		HT RAID		90-5401			
<b>Range Rover</b>								
	Range Rover excl. air suspension	71-94	Heavy Track	Ⓒ 30-1311	Ⓒ 30-1312			
			Heavy Track	Ⓒ 8240-1181SPX	Ⓒ 8240-1190SPX			
	RAID Dampers: fit vehicles with standard or raised suspension, Front: 0 - 50 mm / Rear: 0 - 40 mm		HT RAID	90-5374SP1	90-5375SP1			
	RAID Dampers: for raised suspension 40 - 60 mm only		HT RAID		90-5401			
	Range Rover 4.0 Vogue, 4.2 LSE Steering damper (not adjustable)	93-94	Heavy Track	Ⓒ 026-1580				
	Range Rover Classic, excl. air-suspension excl. models with anti-roll bar rear	94-96	Heavy Track	Ⓒ 30-1311	Ⓒ 30-1312			
	with anti-roll bar rear		Heavy Track	Ⓒ 8240-1181SPX	Ⓒ 8240-1190SPX			
	Steering damper (not adjustable)		Heavy Track	Ⓒ 30-1311				
	RAID Dampers: fit vehicles with standard or raised suspension, Front: 0 - 50 mm / Rear: 0 - 40 mm		HT RAID	Ⓒ 026-1580				
	RAID Dampers: for raised suspension 40 - 60 mm only		HT RAID	90-5374SP1	90-5375SP1			
			HT RAID		90-5401			
<b>MAZDA</b>								
<b>MX-5</b>								
	MX-5 / Miata NA / Eunos Roadster 1.6-16V, 1.8-16V with the KONI Sport dampers the car can be lowered approx. Fr-Rr: 20-15mm	89-97	STR.T	Ⓒ 8050-1041	Ⓒ 8050-1042			
			Sport	ⒺⒺⒺ 8041-1203Sport	R1ⒺⒺⒺ 8041-1204Sport			
			STR.T Kit			1120-8391	40	40
			Sport Kit			1140-8391	40	40
<b>MERCEDES-BENZ</b>								
<b>190-series (W201)</b>								
	190, 190E, 190D excl. 2.3 and 2.5-16V	83-93	STR.T	Ⓒ 8750-1067	ⒺⒺ 8050-1060			
			Sport	ⒺⒺ 8741-1092Sport	ⒺⒺ 26-1198Sport			
	190E 2.3-16V	84-90	STR.T	Ⓒ 8750-1067	△			
			Sport	ⒺⒺ 8741-1092Sport	△			
<b>(W111)</b>								
	Sedan & Coupé	59-68	Classic	▼ 80-1415	▼ 80-1416			
	Combi / Colonia	62-67	Classic	▼ 80-1415				
<b>(W114) (W115)</b>								
	Sedan	68-76	Classic	▼Ⓒ 26-1019	▼ⒺⒺ 30-1020			
<b>E-Class (W123)</b>								
	Sedan	76-85	Classic	▼Ⓒ 26-1157	▼ⒺⒺ 30-1020			

MAKE		Year	product range				Lowering up to ..mm		Notes
Model							Front	Rear	
<b>MERCEDES-BENZ - CONTINUED</b>									
	200D, 220D, 240D (taxi-cars)	76-85	Classic		⌄⌄ 26-1157	⌄⌄⌄ 30-1020			
	Combi, 300D Ambulance (S123)	77-85	Classic		⌄⌄ 26-1157	△			
<b>E-Class (W124) (C124)</b>									
	Sedan / Coupé, excl. Sportline excl. 4Matic (AWD)	85-95	STR.T Sport	⌄ 8750-1067	⌄⌄⌄ 8050-1060				
				⌄⌄⌄ 8741-1092Sport	⌄⌄ 26-1198Sport				
<b>S-Class (W108) (W109)</b>									
	Sedan / Coupé	66-72	Classic		⌄ 80-1415	⌄ 80-1416			
<b>S-Class (W116)</b>									
	S-Class, excl. 6.9-Liter	73-80	Classic		⌄⌄ 26-1157	⌄⌄⌄ 30-1020			
<b>S-Class (W126) (C126)</b>									
	Sedan / Coupé	80-91	Classic		⌄⌄ 26-1157	⌄⌄⌄ 30-1020			
<b>S-Class (W140)</b>									
	S-Class These dampers are not adjustable for technical reasons.	91-99	Classic			⌄⌄⌄▲ 030-1579			
<b>SL-Class (W113)</b>									
	230SL, 250SL, 280SL	63-71	Classic		⌄ 80-1415	⌄ 80-1416			
<b>SL-Class (R107)</b>									
	SL-Class	71-91	Classic		⌄⌄ 26-1019	⌄⌄⌄ 30-1020			
<b>180, 180D, 190, 190D, 190B/DB</b>									
	180, 180D, 190, 190D, 190B, 190DB	56-62	Classic		⌄ 80-1092	⌄ 80-1104			
<b>219, 220, 220A, 220S</b>									
	219, 220, 220A, 220S	55-59	Classic		⌄ 80-1092	⌄ 80-1104			
<b>G-Series</b>									
	<b>G-Series (W460)</b> OE: Front: Lmax = 632 mm, Rear: Lmax = 585 mm	79-90	Heavy Track	⌄ 8240-1195SPX	⌄ 8240-1197SPX				
	RAID Dampers: fit vehicles with standard or raised suspension, Front / Rear: 0 - 50 mm		Heavy Track	⌄ 30-1322	⌄ 30-1323				
			HT RAID		90-5384				
	<b>G-Series (W461)</b> OE: Front: Lmax = 632 mm, Rear: Lmax = 585 mm	90-18	Heavy Track	⌄ 8240-1195SPX	⌄ 8240-1197SPX				
	RAID Dampers: fit vehicles with standard or raised suspension, Front / Rear: 0 - 50 mm		Heavy Track	⌄ 30-1322	⌄ 30-1323				
			HT RAID		90-5384				
	OE: Front: Lmax = 585 mm, Rear: Lmax = 585 mm		Heavy Track	⌄ 8240-1196SPX	⌄ 8240-1197SPX				
	RAID Dampers: fit vehicles with raised suspension, Front: 30 - 50 mm / Rear: 0 - 50 mm		HT RAID	90-5383	90-5384				
	<b>G-Series (W463)</b> OE: Front: Lmax = 585 mm, Rear: Lmax = 585 mm	90-18	Heavy Track	⌄ 8240-1196SPX	⌄ 8240-1197SPX				
	RAID Dampers: fit vehicles with raised suspension, Front: 30 - 50 mm / Rear: 0 - 50 mm		HT RAID	90-5383	90-5384				
<b>Commercials</b>									
	L207D, L208D, L209D, L210D (601)	05.77-02.96	Heavy Track	80-2220					
	L208, L210 (601)	05.77-02.96	Heavy Track	80-2220					
	L307D, L308D, L309D, L310D (602)	04.77-02.96	Heavy Track	80-2220					
	L308, L310 (602)	04.77-02.96	Heavy Track	80-2220					
<b>MERCURY</b>									
<b>Bobcat</b>									
	Bobcat Sedan & Runabout	75-80	Classic		⌄ 80-2167				
<b>Capri</b>									
	Capri Rear: with bushing length 36,5 mm	79-86	Classic		⌄⌄ 8040-1026				On request
<b>Cougar</b>									
	Cougar	67-70	Classic		⌄ 82-1388SP3				
	Cougar, excl. XR-7 Rear: with bushing length 36,5 mm	80-82	Classic		⌄⌄ 8040-1026				On request
<b>Marquis</b>									
	Marquis Sedan / Wagon	83-85	Classic		⌄⌄ 8040-1026				On request
<b>MG</b>									
<b>MG-B</b>									
	MG-B as from chassis no. 132.924 - with chrome bumpers	67-75	Classic		⌄+ 80-2716	⌄+ 80-1244SP1			
	MG-B as from chassisno. GHN5 360301 (Europe-Version) - with rubber bumpers	75-82	Classic		⌄+ 80-2716	⌄+ 80-1244SP1			
	as from chassisno. GHN5 360082 (USA-Version) - with rubber bumpers		Classic		⌄+ 80-2716	⌄+ 80-1244SP1			
	MG-B GT Coupé up to chassisno. GHD5 UE 361000	65-75	Classic		⌄+ 80-2716	⌄+ 80-1244SP1			
	MG-B GT Coupé as from chassisno. GHD5 UE 361001	75-82	Classic		⌄+ 80-2716	⌄+ 80-1244SP1			
<b>MG-C</b>									
	MG-C 6-cyl., incl. GT	67-69	Classic			⌄+ 80-1244SP1			
<b>MINI</b>									
<b>Mini Classic</b>									
	Mini 850, 1000, 1100, 1275GT & Cooper models excl. cars with lowered suspension	60-00	Classic		⌄□ 80-1675	⌄□ 80-1794			
			Sport	□ 80-1675Sport	□ 80-1794Sport				
	Mini 850, 1000, 1100, 1275GT & Cooper models with lowered suspension	63-70	Classic		⌄□ 80-1717	⌄□ 80-1795			
	Mini Countryman, Estate, Clubman Estate, Pickup	61-78	Classic		⌄□ 80-1675				
	Mini Traveller, Van, Moke	61-78	Classic		⌄□ 80-1675				
	Mini Innocenti 90L, 120L incl. De Tomaso	74-82	Classic		⌄□ 80-1675	⌄□ 80-1794			
			Sport	□ 80-1675Sport	□ 80-1794Sport				

MAKE		Year	product range				Lowering up to ..mm		Notes
Model							Front	Rear	
<b>MITSUBISHI</b>									
<b>L200</b>									
L200 Pickup (L021P)		79-96	Heavy Track				80-2458		
L200 Double-Cab (4WD) types K22T, K24T, K32T, K33T, K34T		86-03	Heavy Track	Ⓞ 30-1318			Ⓞ 30-1459		
<b>L300</b>									
L300 Bus / Van (L032P / L038P / L062P / L068P)		80-86	Heavy Track				⌄ 80-1904		
L300 Bus (L035G / L037G) 4WD		84-86	Heavy Track	Ⓞ 30-1318			Ⓞ▲ 30-1319		
L300 Bus, Van (P23 / P24 / P25) 4WD		87-03	Heavy Track	Ⓞ 30-1318					
L300 Cab (L032P, L039P)		87-02	Heavy Track				⌄ 80-1904		
<b>Pajero</b>									
Pajero / Montero / Shogun Types L040G, L042G, L043G, L044G (s.w.b.) and types L047G, L048G, L049G Wagon		83-91	Heavy Track	Ⓞ 30-1318			Ⓞ▲ 30-1319		
Pajero / Montero / Shogun 2.5 TD Intercooler, 3.0i s.w.b. and l.w.b. types L144G, L149G and L141G, L146G (with coils springs rear)		89-91	Heavy Track	Ⓞ 30-1318			Ⓞ 30-1408		
<b>MORGAN</b>									
<b>Morgan</b>									
4/4, Plus 4, V8 Rear: excl. 4-seater models		61-05-91	Classic	⌄+ 80-1021			⌄+ 80-1573		
4/4, Plus 4, V8 (with telescopic rear dampers) Rear: only if distance between top & bottom attachments in full droop = 265 mm - 290 mm		06.91-94	Classic	⌄ 80-1021			⌄ 80-2725		
<b>NISSAN</b>									
<b>Cabstar</b>									
Cabstar Pickup (EGF22)		83-00	Heavy Track	□ 80-2402					
<b>E20</b>									
E20 Pickup, Transporter, Van, Microbus		78-79	Heavy Track	□ 80-2402					
<b>King Cab</b>									
King Cab 2WD (GD21, D22)		86-04	Heavy Track				Ⓞ 30-1343		
King Cab 4WD (MD21, D22)		86-04	Heavy Track	Ⓞ 30-1342			Ⓞ 30-1343		
<b>Navara</b>									
Navara D21/D22 4WD with torsion bars front		86-04	Heavy Track	Ⓞ 30-1342			Ⓞ 30-1343		
<b>Pathfinder</b>									
Pathfinder (WD21)		86-95	Heavy Track	Ⓞ 30-1365			Ⓞ 30-1372		
<b>Patrol</b>									
Patrol (VG 60/61)		72-80	Heavy Track						
Steering damper (not adjustable)			Heavy Track	Ⓞ O26-1580					
Patrol / Safari GR/GQ (Y60) with coil springs rear		87-09-97	Heavy Track	Ⓞ 30-1379			Ⓞ 30-1380		
Steering damper (not adjustable)			Heavy Track	82-2347SP1			82-2348SP1		
For vehicles with raised suspension, Front: / Rear: 0 - 50 mm			Heavy Track	Ⓞ O26-1635					
			Heavy Track	82-2347			82-2348		
			Heavy Track	88-1686			88-1687		
			HT RAID	90-5370SP1			90-5371SP1		
<b>Silvia</b>									
Silvia 200 SX (S13) Front: for original struts only, Rear: for KYB only		89-94	Sport	⌄Ⓞ◆ 8641-1364Sport			Ⓞ 8040-1081Sport		
Silvia 240 SX (S13) Front: for original struts only, Rear: for KYB only		89-94	Sport	⌄Ⓞ◆ 8641-1364Sport			Ⓞ 8040-1081Sport		
Silvia (S14) / 200 SX (S15) Front: for original struts only		95-02	Sport	⌄Ⓞ◆ 8641-1364Sport			Ⓞ 8040-1226Sport		
<b>Sunny</b>									
Sunny 1200 Station Wagon (VB110)		70-73	Heavy Track				⌄ 80-1904		
Sunny 120Y Station Wagon (VB210 / VLB210)		74-77	Heavy Track				⌄ 80-1904		
<b>Terrano</b>									
Terrano / Pathfinder Wagon (WD21)		87-93	Heavy Track	Ⓞ 30-1365			Ⓞ 30-1372		
<b>Urvan</b>									
Urvan Bus and Van (E23)		80-87	Heavy Track	□ 80-2402					
<b>Z-Series</b>									
Coupé 240 Z / Fairlady		70-75	Classic	⌄ 86-1811			⌄ 86-1812		On request
Coupé 260 Z / Fairlady (S30 / PS30) up to chassisno. RLS 30-060000		70-74	Classic	⌄ 86-1811			⌄ 86-1812		On request
Coupé 300 ZX / Fairlady, incl. Turbo (Z31) excl. electronically adjustable suspension		84-89	Sport	⌄Ⓞ 8641-1060Sport			Ⓞ 26-1248Sport		
Coupé 300 ZX / Fairlady, incl. Turbo (Z32) disarms electronic suspension		89-96	Sport	⌄Ⓞ 8041-1118Sport			Ⓞ 8040-1119Sport		
<b>NISSAN AUSTRALIA</b>									
<b>160 - 180 - 200</b>									
1600 Sedan (510)		68-72	Classic	⌄ 86-2224			⌄ 80-2299		
Sedan 160B, 180B (610)		72-77	Classic	⌄ 86-2224			⌄ 80-2299		
Sedan 200B (810)		77-81	Classic	⌄ 86-2224			⌄Ⓞ 8240-1099		
<b>Skyline</b>									
Sedan / Coupé (C210 + R30)		78-85	Classic	⌄ 86-2224			⌄Ⓞ 8240-1099		
Sedan / Coupé (R31)		05.86-92	Classic				⌄Ⓞ 8240-1099		
<b>OLDSMOBILE</b>									
<b>88</b>									
88 Delta Royale, 98 Regency		77-85	Classic	⌄Ⓞ 8040-1087			⌄Ⓞ□ 8040-1088		
<b>Custom</b>									
Custom Cruiser		77-93	Classic	⌄Ⓞ 8040-1087			⌄Ⓞ□ 8040-1088		

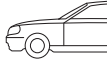
MAKE		Year	product range				Lowering up to ..mm		Notes
Model	Front						Rear		
<b>OLDSMOBILE - CONTINUED</b>									
<b>F 85</b>									
F 85-442, Cutlass Supreme	64-67	Classic			⌘ 8040-1088				
Sedan	68-77	Classic		⌘ 8040-1087	⌘ 8040-1088				
<b>OPEL</b>									
<b>Ascona</b>									
Ascona A Sedan / Voyage & Caravan	70-75	STR.T			Ⓢ 8250-1013				
		Sport		82-1739Sport	□ 82-1801Sport				
Ascona B	76-81	Classic		⌘ 80-2275					
		STR.T		Ⓢ 8250-1014	Ⓢ 8250-1013				
		Sport		□ 82-1886Sport	□ 82-1801Sport				
		Sport Short		□ 82-2085Sport	□ 82-1668SPD1				Lmax -40 mm
<b>Calibra</b>									
Calibra, incl. 16V, V6, Turbo 4WD	90-98	Sport		⌘ 8610-1263Sport	⌘ 8210-1158Sport				
<b>Commodore</b>									
Commodore A GS, GS-E	67-71	Classic			⌘ 80-1997				
Commodore B	76-77	STR.T			Ⓢ 8250-1013				
		Sport			□ 82-1801Sport				
<b>Corsa</b>									
Corsa A, incl. GSi	83-93	STR.T		Ⓢ 8750-1021					
		Sport		⌘ 8710-1276Sport					
<b>GT</b>									
GT	69-72	Classic		⌘ 80-1580	⌘ 80-1997				
		Sport		80-1580Sport	□ 80-1997Sport				
<b>Kadett</b>									
Kadett B Sedan / Coupé / Caravan as from chassiso. 1234068	09.67-73	Classic		⌘ 80-1580	⌘ 80-1997				
		Sport		80-1580Sport	□ 80-1997Sport				
Kadett C Sedan / Coupé / GTE	74-79	STR.T		Ⓢ 8250-1014					
		Sport		□ 82-1886Sport	82-1740sport				Rear = I.D.
		Sport Short		□ 82-2085Sport	□ 82-1668SPD1				Lmax -40 mm
Kadett C Caravan	74-79	Classic		⌘ 80-2275	⌘ 80-1997				
Kadett C City	75-79	Classic		⌘ 80-2275	⌘ 80-1997				
		STR.T		Ⓢ 8250-1014					
		Sport		□ 82-1886Sport	□ 80-1997Sport				
Kadett D Hatchback	80-84	STR.T		Ⓢ 8650-1006					
Kadett D Caravan	80-84	STR.T		Ⓢ 8650-1006					
Kadett E Sedan / Hatchback, incl. GT	85-09.88	STR.T		Ⓢ 8650-1006					
Kadett E Sedan / Hatchback, incl. GT, excl GSi	10.88-91	Sport		⌘ 8641-1068Sport	⌘ 8041-1095Sport				
Kadett E Hatchback GSi, incl. 2.0i-16V	85-09.88	Sport		⌘ 8641-1068Sport					
Kadett E Hatchback/Cabrio(>93) GSi incl. 2.0i-16V	10.88-91	Sport		⌘ 8641-1068Sport	⌘ 8041-1095Sport				
Kadett E Caravan	85-91	STR.T		Ⓢ 8650-1006					
<b>Manta</b>									
Manta A	70-75	Sport		82-1739Sport	82-1740sport				Rear = I.D.
Manta B / CC incl. GT/E & GSi	76-88	Classic		⌘ 80-2275					
		STR.T		Ⓢ 8250-1014	Ⓢ 8250-1013				
		Sport		□ 82-1886Sport	□ 82-1801Sport				
		Sport Short		□ 82-2085Sport	□ 82-1668SPD1				Lmax -40 mm
<b>Omega</b>									
Omega A Sedan, excl. 3000	87-93	Sport			Ⓢ 80-2591Sport				
<b>Rekord</b>									
Rekord D	76-77	STR.T			Ⓢ 8250-1013				
		Sport			□ 82-1801Sport				
<b>Senator</b>									
Senator 2.5i, 2.6i, 3.0i excl. electronically adjustable suspension	88-93	Sport			80-2591Sport				
<b>Vectra</b>									
Vectra A 1.4, 1.6, 1.7D/TD, 1.8, 2.0, 2.5-V6	88-95	Sport		⌘ 8610-1263Sport	⌘ 8041-1095Sport				
Vectra A 1.8, 2.0 GL (4WD) with IRS (independant rear suspension)	89-95	Sport		⌘ 8610-1263Sport	80-2591Sport				
Vectra A 2.0-16V Turbo 4WD	91-95	Sport		⌘ 8610-1263Sport	80-2591Sport				
Vectra A 2000, incl. 4WD with IRS (independant rear suspension)	89-95	Sport		⌘ 8610-1263Sport	80-2591Sport				
<b>PEUGEOT</b>									
<b>205</b>									
205, 1.0, 1.1	83-98	STR.T		Ⓢ 8750-1016L Ⓢ 8750-1016R	Ⓢ 8050-1022				
		Sport		87-5085LSport 87-5085RSport	Ⓢ 30-1314Sport				
205, incl. Cabrio	83-98	STR.T		Ⓢ 8750-1016L Ⓢ 8750-1016R	Ⓢ 8050-1022				
		Sport		87-5085LSport 87-5085RSport	Ⓢ 30-1314Sport				
205 GTi, Rallye	84-94	STR.T		Ⓢ 8750-1016L Ⓢ 8750-1016R	Ⓢ 8050-1022				
		Sport		87-5085LSport 87-5085RSport	Ⓢ 30-1314Sport				
205 Turbo Diesel	91-96	STR.T		Ⓢ 8750-1016L Ⓢ 8750-1016R	Ⓢ 8050-1022				

MAKE		Year	product range	 		Lowering up to ..mm		Notes
Model	Front					Rear		
<b>PEUGEOT - CONTINUED</b>								
			Sport	87-5085LSport 87-5085RSport	⊗ 30-1314Sport			
<b>309</b>								
309 GTD, 1.9GT with anti-roll bar rear	89-93	STR.T		⊗ 8750-1016L ⊗ 8750-1016R	⊗ 8050-1022			
		Sport		87-5085LSport 87-5085RSport	⊗ 30-1314Sport			
309 GTi (incl. -16V)	87-93	STR.T		⊗ 8750-1016L ⊗ 8750-1016R	⊗ 8050-1022			
		Sport		87-5085LSport 87-5085RSport	⊗ 30-1314Sport			
<b>PLYMOUTH</b>								
<b>Barracuda</b>								
Barracuda, 'Cuda rear lower shock mount hole 5/8ths inch	70-74	Classic		⌞ 80-1538	⌞ 82-1255			
<b>Belvedere</b>								
Belvedere, Satellite rear lower shock mount hole 5/8ths inch	62-72	Classic		⌞ 80-1538	⌞ 82-1255			
<b>Road Runner</b>								
Road Runner rear lower shock mount hole 5/8ths inch	68-72	Classic		⌞ 80-1538	⌞ 82-1255			
<b>PONTIAC</b>								
<b>Bonneville</b>								
Bonneville, Catalina and Station Wagon	77-81	Classic		⌞⊗ 8040-1087	⌞⊗□ 8040-1088			
<b>Can-Am</b>								
Can-Am	77-77	Classic		⌞⊗ 8040-1087	⌞⊗□ 8040-1088			
<b>Fiero</b>								
Fiero, incl. GT	84-87	Classic		⌞⊗ 8040-1027	⌞⌞⊗ 8741-1063			On request
Fiero, incl. GT	88-88	Classic			⌞⌞⊗ 8741-1063			On request
<b>Firebird</b>								
Firebird	67-67	Classic		⌞ 80-1914	⌞ 80-1915			
Firebird	68-68	Classic		⌞ 80-1914	⌞ 80-1953			
Firebird	69-69	Classic		⌞ 80-1914				
Firebird, incl. Trans-Am	70-81	Classic		⌞⊗ 8040-1017	⌞⊗ 8040-1018			
Firebird, incl. Trans-Am with 16 inch tyres	82-92	Sport		⌞⊗ 8741-1030Sport	⊗ 30-1265Sport			
Firebird, incl. Trans-Am double adjustable alternative	93-02	Sport		N2⊗⌞⌞⊗ 8241-1139Sport	⌞⊗ 8241-1140Sport			
		Sport			⌞⊗ 8242-1006SP1			On request
<b>Grand Prix</b>								
Grand Prix	69-70	Classic		⌞⊗ 8040-1087	⌞⊗□ 8040-1088			
Grand Prix, LJ, SJ	77-77	Classic		⌞⊗ 8040-1087	⌞⊗□ 8040-1088			
Grand-Am	73-77	Classic		⌞⊗ 8040-1087	⌞⊗□ 8040-1088			
<b>Le Mans</b>								
Le Mans Station Wagon	68-72	Classic			⌞⊗□ 8040-1088			
Le Mans, GTO	68-77	Classic		⌞⊗ 8040-1087	⌞⊗□ 8040-1088			
<b>Parisienne</b>								
Parisienne and Station Wagon	83-86	Classic		⌞⊗ 8040-1087	⌞⊗□ 8040-1088			
<b>Ventura</b>								
Ventura II with multi-leaf spring rear	71-74	Classic		⌞⊗ 8040-1087	⌞⊗□ 8040-1088			
<b>PORSCHE</b>								
<b>356</b>								
356 pre-A	49-50	Classic		⌞ 80-1013	△			
356 pre-A	51-55	Classic		⌞ 80-1013	⌞ 80-1011			
356 A, B, C incl. Super 90, 1600 Super Steering damper - Left hand drive only	55-66	Classic		⌞ 80-1044SP20	⌞ 80-1191SP20			
		Classic		⌞ 76-1099				
<b>911 (912)</b>								
911, 912 (A-series), incl. Targa Front: for original Boge struts only	09.65-08.68	Classic		⌞ 86-1394	⌞⊗ 8040-1083			
		Classic		⌞ 86-1308	⌞⊗ 8040-1083			
911, 912 (B-series), T, S Front: for original Boge struts only	09.68-69	Classic		⌞ 86-1647	⌞ 80-2088			
		Classic		⌞ 86-1638	⌞ 80-2088			
911 (C- and D-series), T, S Front: for original Boge struts only	70-08.71	Classic		⌞ 86-1647	⌞ 80-2088			
		Classic		⌞ 86-1638	⌞ 80-2088			
911 (C- and D-series), E if originally equipped with self-levelling units front	69-08.71	Classic			⌞ 80-2088			
911 (E- and F-series), S, Carrera RS Front: for original Boge struts only	09.71-74	Classic		⌞ 86-1647	⌞ 82-1756			
		Classic		⌞ 86-1638	⌞ 82-1756			
		Classic			⌞ 82-1756			
911 (G-series) Carrera, Turbo Front: for original Boge struts only	75-89	Classic		⌞ 86-1943	⌞□ 82-1962			
		Sport		⌞⊗ 8641-1039Sport	⌞ 8210-1159Sport			
911 (964) Carrera 2+4 Coupé, Targa & Convertible	12.88-12.90	Sport		⌞⊗ 8741-1541LSport ⌞⊗ 8741-1541RSport				

MAKE		Year	product range				Lowering up to ..mm		Notes
Model	Front						Rear		
<b>PORSCHE - CONTINUED</b>									
911 (964) Carrera 2+4 Coupé, Targa & Convertible	01.91-09.93	FSD		8741-1541LSport	8241-1272Sport	2100-4111			
		Sport		8741-1541RSport					
911 (964) Turbo (S)	08.90-09.93	FSD		8741-1541LSport	8241-1272Sport	2100-4111			
		Sport		8741-1541RSport					
911 (964) Carrera RS	06.91-09.93	FSD		8741-1541LSport					
		Sport		8741-1541RSport					
911 (993) Carrera 2 (S) Coupé, Targa, Convertible excl. Bilstein OEM Sport Susp.	10.93-09.97	FSD		8741-1542LSport	8241-1273LSport	2100-4112			
		Sport		8741-1542RSport	8241-1273RSport				
911 (993) Carrera 4 (S) Coupé, Targa, Convertible excl. Bilstein OEM Sport Susp.	10.93-09.97	FSD		8741-1542LSport	8241-1273LSport	2100-4112			
		Sport		8741-1542RSport	8241-1273RSport				
911 (993) Turbo excl. Bilstein OEM Sport Susp.	03.95-09.97	FSD		8741-1542LSport	8241-1273LSport	2100-4112			
		Sport		8741-1542RSport	8241-1273RSport				
911 (996) Carrera 2 (S) Coupé Excl. GT2, GT3, excl. PASM	09.97-08.05	FSD		8741-1543Sport	8241-1274Sport	2100-4110			
		Sport							
911 (996) Carrera 2 (S) Targa, Convertible Excl. GT2, GT3, excl. PASM	09.97-08.05	FSD		8741-1543Sport	8241-1274Sport	2100-4110			
		Sport							
911 (996) Carrera 4 (S) Coupé, Convertible Excl. GT2, GT3, excl. PASM	09.97-08.05	FSD		8741-1543Sport	8241-1274Sport	2100-4110			
		Sport							
911 (996) Turbo (S) Coupé, Convertible Excl. GT2, GT3, excl. PASM	06.00-08.05	FSD		8741-1543Sport	8241-1274Sport	2100-4110			
		Sport							
<b>914</b>									
914, 914-6	70-76	Sport		8641-1077Sport	8241-1050Sport				
<b>924</b>									
924, 924 Turbo	75-08.84	Classic		86-1980					
		Sport		8641-1038Sport	26-1209Sport				
924 Carrera GT	81-81	Classic		86-1980					
		Sport		8641-1038Sport	26-1209Sport				
924 S	09.84-87	Classic		86-1980					
		Sport		8641-1038Sport	8040-1035Sport				
<b>928</b>									
928, 928 S Front: only if originally equipped with BOGE, excl. BOGE dampers with adjustable spring seat	79-93	Classic		8240-1085	8240-1086				
<b>944</b>									
944	81-08.84	Classic		86-1980					
		Sport		8641-1038Sport	26-1209Sport				
944	09.84-86	Classic		86-1980					
		Sport		8641-1038Sport	8040-1035Sport				
944 Front: for original Sachs struts only	86-91	Sport		8641-1414Sport	8040-1035Sport				
		Sport		8641-1414Sport	8040-1035Sport				
944 Turbo, incl. Turbo S Front: for original Sachs struts only	85-89	Sport		8641-1414Sport	8040-1035Sport				
		Sport		8641-1414Sport	8040-1035Sport				
944 S2 Coupé / S2 Cabrio Front: for original Sachs struts only	88-91	Sport		8641-1414Sport	8040-1035Sport				
		Sport		8641-1414Sport	8040-1035Sport				
<b>968</b>									
968, excl. M030 Susp. Front: for original Sachs struts only	92-96	Sport		8641-1414Sport	8040-1035Sport				
<b>RENAULT</b>									
<b>Alpine</b>									
Alpine A108 / A110 Rear: 4 pieces	-75	Classic		80-1743SP3	80-1744SP3				
<b>Avantime</b>									
Avantime	01-03	Special		8740-1385	26-1647				
<b>R5</b>									
R5 Super GTE (C 409)	87-90	Sport			26-1299Sport				
R5 Super GT-Turbo (C405) phase I up to chassiso. F 02 7412 / K 025 7635	85-06.87	Sport			26-1299Sport				
R5 Super GT-Turbo (C405) phase II as from chassiso. F 02 7413 / K 025 7636	07.87-90	Sport		8741-1167Sport	26-1299Sport				
<b>R8</b>									
R8 Gordini (R1134 / R1135) Rear: 4 pieces	64-69	Classic		80-1743SP3	80-1744SP3				
<b>SAAB</b>									
<b>90</b>									
90	85-87	Classic			26-1087				
<b>99</b>									
99, incl. Turbo	79-84	Classic			26-1087				



MAKE		Year	product range			Lowering up to .mm		Notes
Model	Front					Rear		
<b>SAAB - CONTINUED</b>								
<b>900</b>								
900, incl. (16V) Turbo	78-93	Classic	⌄Ⓞ 30-1088	⌄Ⓞ 26-1087				
900, 4- & 6-cyl.	93-98	Sport		⌄Ⓞ 8041-1191Sport				
<b>9000</b>								
9000 Front: for original Sachs struts only	85-98	Sport	⌄Ⓞ◆ 8641-1114Sport	Ⓞ 8040-1057Sport				
<b>SIMCA</b>								
<b>1000 Rallye II</b>								
Rallye II	72-77	Classic	⌄□ 80-2021SPF1	⌄ 82-1857SPF1				On request only
<b>SUZUKI</b>								
<b>SJ</b>								
SJ 410 / SJ 413 Jimny / Samurai (4WD)	88-95	Heavy Track		Ⓞ 26-1369				
<b>TOYOTA</b>								
<b>Carina / Corona</b>								
Carina Sedan / Wagon (TA40A / TA40LG / TA47)	78-81	Sport		86-1991Sport				
Carina Sedan/Coupé/Station Wagon (TA60/TA62/CA60)	82-83	Sport		86-1991Sport				
<b>Celica</b>								
Celica Liftback 2000 (RA40B/L, RA42, RA45)	78-81	Sport		86-1991Sport				
Celica Coupé 1600 (TA40B/L, TA45)	78-81	Sport		86-1991Sport				
Celica Liftback GTS (AA63)	84-85	Sport		86-1991Sport				
<b>Corolla</b>								
Corolla Sedan / Coupé / Station Wagon	75-79	Sport		86-1991Sport				
Corolla GT Coupé DOHC, Liftback DX, SE 1.6 types TE70, TE71, TE72, CE70L Diesel Sedan	80-83	Sport		86-1991Sport	80-2437Sport			
Corolla GT-TC 16 Coupé (AE86) rear wheel drive	83-87	Sport		86-1991Sport	80-2437Sport			
Corolla (EE101 / AE101) 1.3, 1.6 Front: for KYB only, Rear: for KYB Ø 49 mm only	92-97	Sport	⌄◆ 8610-1365Sport					
<b>Hi-Ace</b>								
Hi-Ace 1600 (RH11 / RH20 / RH30)	74-82	Classic		⌄ 80-1904				
Hi-Ace Diesel (LH11 / LH30)	79-82	Classic		⌄ 80-1904				
Hi-Ace 1800 (YH50 / YH60)	83-84	Classic		⌄ 80-1904				
Hi-Ace Diesel (LH50 / LH60)	83-84	Classic		⌄ 80-1904				
Hi-Ace 2.4 Diesel (LH56 / LH66 / LH108 / LH118) AWD	87-95	Heavy Track	Ⓞ 30-1417	Ⓞ 30-1418				
<b>Hi-Lux</b>								
Hi-Lux Pickup (RN36 / -37, LN36 / -46) AWD	79-83	Heavy Track			82-2138			
Hi-Lux Pickup (YN65 / -67, LN65) AWD	84-88	Heavy Track			82-2272			
<b>Landcruiser</b>								
Landcruiser (FJ40 / -42 / -43 / -45, HJ45)	60-79	Heavy Track	⌄ 80-1904		80-1905			
NOTE: these dampers are only for vehicles raised 50mm - additional parts are needed		Heavy Track		82-5020		82-2138		
Landcruiser (BJ40 / -42 / -43 / -45 / -46)	74-84	Heavy Track	⌄ 80-1904		82-2138			
Alternative Rear: heavy duty dampers		Heavy Track		82-5020		82-2297		
Landcruiser (FJ40 / -43 / -45)	80-86	Heavy Track	⌄ 80-1904		82-2138			
Alternative Rear: heavy duty dampers		Heavy Track		82-5020		82-2297		
Landcruiser (HJ41 / -45 / -47)	80-84	Heavy Track	⌄ 80-1904		82-2138			
NOTE: these dampers are only for vehicles raised 50mm - additional parts are needed		Heavy Track		82-5020		82-2297		
Landcruiser Station Wagon (BJ55 / FJ55)	72-80	Heavy Track			82-2138			
Landcruiser (BJ60 / FJ60 / HJ60 / HJ61) Station Wagon, Custom G. up to chassiso. 33417	81-10.85	Heavy Track		82-2205	82-2138			
NOTE: these dampers are only for vehicles raised 50mm - additional parts are needed		Heavy Track		82-2296		82-2297		
Landcruiser (BJ60 / FJ60 / HJ60 / HJ61) Station Wagon, Custom G. as from chassiso. 33418	11.85-89	Heavy Track		82-2205	82-2272			
NOTE: these dampers are only for vehicles raised 50mm - additional parts are needed		Heavy Track		82-2296		82-2294		
Landcruiser (LJ70 / -73, RJ70 / -73, Bundera) (with coil springs) up to chassiso. 09048994	85-89	Heavy Track	Ⓞ 30-1268		Ⓞ 30-1269L Ⓞ 30-1270R			
Landcruiser (FJ75 / HJ75)	84-90	Heavy Track		82-2205	82-2272			
NOTE: these dampers are only for vehicles raised 50mm - additional parts are needed		Heavy Track		82-2296		82-2312		
<b>MR2</b>								
MR2 / Silver 1.6 TC 16 (AW11) Rear: with locknut M42x1	85-07.86	Sport	⌄Ⓞ 8641-1071Sport	⌄Ⓞ 8641-1072Sport				
MR2 / Silver 1.6 TC 16 (AW11) Rear: with locknut M48x1,5	08.86-89	Sport	⌄Ⓞ 8641-1071Sport	⌄Ⓞ 8641-1142Sport				
MR2 / Silver 2.0 TC (SW20)	90-09.96	Sport	⌄Ⓞ 8641-1220Sport	⌄Ⓞ 8641-1221Sport				
		Sport Kit				1140-8841	20	20
<b>Starlet</b>								
Starlet (EP81 / EP82 / NP80) 1.3, 1.5D Front: for original struts only	89-95	Sport		Ⓞ▲ 8040-1216Sport				
<b>Supra</b>								
Supra (MA70) incl. Turbo	86-93	Sport	Ⓞ 8040-1063Sport	Ⓞ 8040-1064Sport				
<b>TRIUMPH</b>								
<b>Herald</b>								
Herald, incl. Convertible & Estate	59-71	Classic	⌄□ 80-1388	⌄□ 80-1389				



MAKE		Year	product range				Lowering up to ..mm		Notes
Model	Year						Front	Rear	
<b>TRIUMPH - CONTINUED</b>									
<b>Vitesse</b>									
Vitesse	62-71	Classic		☒ 80-1388	☒ 80-1389				
<b>GT6</b>									
GT6 Mk I	66-68	Classic		☒ 80-1388	☒ 80-1389				
GT6 Mk II	69-70	Classic		☒ 80-1388					
GT6 Mk III	71-73	Classic		☒ 80-1388					
GT6 Mk III	74-74	Classic		☒ 80-1388	☒ 80-1389				
<b>Spitfire</b>									
Spitfire Mk I (Spitfire 4)	62-65	Classic		☒ 80-1388	☒ 80-1389				
Spitfire Mk II	66-67	Classic		☒ 80-1388	☒ 80-1389				
Spitfire Mk III	68-70	Classic		☒ 80-1388	☒ 80-1389				
Spitfire Mk IV	71-74	Classic		☒ 80-1388	☒ 80-1389				
Spitfire 1500	75-80	Classic		☒ 80-1388	☒ 80-1389				
<b>TR-series</b>									
TR2	53-55	Classic		☒ 80-1005	△				
TR3	55-62	Classic		☒ 80-1005	△				
TR4	61-65	Classic		☒ 80-1005	△				
TR4A with independent rear suspension (IRS)	65-67	Classic		☒☐ 80-1784	△				
TR5	67-69	Classic		☒☐ 80-1784	△				
TR250	68-69	Classic		☒☐ 80-1784	△				
TR6	69-76	Classic		☒☐ 80-1784	△				
<b>VAUXHALL (SEE ALSO OPEL)</b>									
<b>Astra</b>									
Astra Mk1 Hatchback, excl. GTE	80-09.88	Sport		☒☒ 8641-1068Sport					
Astra Mk1 GTE	83-84	Sport		☒☒ 8641-1068Sport					
Astra Mk2 Hatchback, excl. GTE Belmont Saloon	85-09.88	STR.T		☒ 8650-1006					
Astra Mk2 GTE	85-09.88	Sport		☒☒ 8641-1068Sport					
Astra Mk2 Hatchback, excl. GTE Belmont Saloon	09.88-90	Sport		☒☒ 8641-1068Sport	☒☒ 8041-1095Sport				
Astra Mk2 GTE incl. 2.0-16V	09.88-09.91	Sport		☒☒ 8641-1068Sport	☒☒ 8041-1095Sport				
<b>Calibra</b>									
Calibra 2.0i, 2.0i-16V, incl. 4WD	90-97	Sport		☒ 8610-1263Sport	☒ 8210-1158Sport				
<b>Carlton</b>									
Carlton Mk III Saloon excl. 3000	87-93	Sport			80-2591Sport				
<b>Cavalier</b>									
Cavalier Saloon / Hatchback / Coupé	76-81	Classic		☒☐ 80-2275					
		STR.T		☒ 8250-1014	☒ 8250-1013				
		Sport		☐ 82-1886Sport	☐ 82-1801Sport				
Cavalier 1.4, 1.6, 1.7 D/TD, 1.8, 2.0, 2.5-V6	09.88-95	Sport		☒ 8610-1263Sport	☒☒ 8041-1095Sport				
Cavalier SRi 2.0i-16V, incl. 4WD with independent rear suspension (IRS)	89-95	Sport		☒ 8610-1263Sport	80-2591Sport				
<b>Chevette</b>									
Chevette Hatchback	75-84	Classic		☒☐ 80-2275	☒ 80-1997				
		STR.T		☒ 8250-1014					
		Sport		☐ 82-1886Sport	☐ 80-1997Sport				
Chevette Notchback Saloon	76-84	Classic		☒☐ 80-2275					
		STR.T		☒ 8250-1014					
		Sport		☐ 82-1886Sport					
<b>Nova</b>									
Nova, incl. 1.6 GTE	83-91	STR.T		☒ 8750-1021					
		Sport		☒ 8710-1276Sport					
<b>Senator</b>									
Senator 2.6i, 3.0i	88-93	Sport			☒ 80-2591Sport				
<b>VOLGA</b>									
<b>series 3102, 31029, 31022-2.4</b>									
series 3102, 31029, 31022-2.4	82-94	Classic		☒ 80-1689	☒ 80-1690				
<b>VOLKSWAGEN</b>									
<b>Beetle</b>									
1200	53-59	Classic		☒ 80-1349					
1200	60-65	Classic		☒ 80-1349	☒ 80-1350				
		Sport			80-1350Sport				
Steering damper (not adjustable) / * For availability contact info reinekeshop.de		Classic		☒ 76-1293					
1200 A / 1300 / 1500	65-70	Classic		☒☐ 80-1787	☒ 80-1350				
		Sport			80-1350Sport				
Steering damper (not adjustable) / * For availability contact info reinekeshop.de		Classic		☒ 76-1293					
1200 / 1300 with single joint rear axle	71-77	Classic		☒☐ 80-1787	☒ 80-1350				
		Sport			80-1350Sport				
Steering damper (not adjustable) / * For availability contact info reinekeshop.de		Classic		☒ 76-1293					
1200 (made in Mexico) with single joint rear axle	-	Classic		☒☐ 80-1787	☒ 80-1350				
		Sport			80-1350Sport				

MAKE		product range			Lowering up to ..mm		Notes	
Model	Year				Front	Rear		
<b>VOLKSWAGEN - CONTINUED</b>								
Steering damper (not adjustable) / * For availability contact info reinekeshop.de		Classic	⏏ 76-1293					
1200 A / 1300 / 1500 with double joint rear axle (Canada / U.S.A. model)	69-77	Classic	⏏ 80-1787	⏏ 80-2149				
		Sport		80-2149Sport				
Steering damper (not adjustable) / * For availability contact info reinekeshop.de		Classic	⏏ 76-1293					
1300 / 1500 Sportomatic with double joint rear axle	68-70	Classic	⏏ 80-1787	⏏ 80-2149				
		Sport		80-2149Sport				
Steering damper (not adjustable) / * For availability contact info reinekeshop.de		Classic	⏏ 76-1293					
1300 Automatik with double joint rear axle	71-73	Classic	⏏ 80-1787	⏏ 80-2149				
		Sport		80-2149Sport				
Steering damper (not adjustable) / * For availability contact info reinekeshop.de		Classic	⏏ 76-1293					
1302 / 1303	70-73	Classic	⏏ 86-1741	⏏ 80-2149				
		Sport		80-2149Sport				
1303	74-74	Classic		⏏ 80-2149				
		Sport		80-2149Sport				
1303 / Super Beetle (USA)	75-80	Classic	⏏ 86-1980	⏏ 80-2149				
		Sport	⏏ 8641-1038Sport	80-2149Sport				
<b>Karmann Ghia</b>								
Karmann Ghia (Type 14)	60-65	Classic	⏏ 80-1349	⏏ 80-1350				
		Sport		80-1350Sport				
Steering damper (not adjustable)		Classic	⏏ 76-1293					
Karmann Ghia (Type 14)	65-70	Classic	⏏ 80-1787	⏏ 80-1350				
		Sport		80-1350Sport				
Steering damper (not adjustable)		Classic	⏏ 76-1293					
Karmann Ghia (Type 14) with single joint rear axle	71-77	Classic	⏏ 80-1787	⏏ 80-1350				
		Sport		80-1350Sport				
Steering damper (not adjustable)		Classic	⏏ 76-1293					
Karmann Ghia (Type 14) with double joint rear axle	69-77	Classic	⏏ 80-1787	⏏ 80-2149				
		Sport		80-2149Sport				
Steering damper (not adjustable)		Classic	⏏ 76-1293					
<b>Caddy</b>								
Caddy 1	83-92	Classic	⏏ 86-1919					
		STR.T	Ⓞ 8650-1005					
		Sport		86-1919Sport				
		Sport	⏏ 8641-1048Sport					
<b>Corrado</b>								
Corrado 16V, GTI, G60 Front: as from 1992, only for non-sealed struts without dent in housing to clear the tire	88-95	Sport		M3Ⓞ 80-2587Sport				
		Sport	⏏ 8641-1198Sport	T1Ⓞ 8041-1108Sport				
		Sport Kit			1140-7061	30	30	1,2,13,16
		Coil-over Kit			1150-5002-1	60	50	1,2,13,16,21,22
Front: for sealed or non-sealed OE struts with dent in housing to clear the tire		STR.T	Ⓞ 8750-1009					
		Sport		M3Ⓞ 80-2587Sport				
		Sport	⏏ 8741-1259Sport	T1Ⓞ 8041-1108Sport				
		Sport	Ⓞ 8750-1009					
Corrado VR6	91-95	STR.T	Ⓞ 8750-1009					
		Sport		M3Ⓞ 80-2587Sport				
		Sport	⏏ 8741-1259Sport	T1Ⓞ 8041-1108Sport				
		Sport Kit			1140-8721	30	30	1,2,13,16
Coil-over Kit				1150-5002-1	60	50	1,2,13,16,21,22	
<b>Derby</b>								
Derby	75-81	Sport	86-1922Sport	80-2315Sport				
<b>Golf 1</b>								
Golf 1	74-83	Classic	⏏ 86-1919					
		STR.T	Ⓞ 8650-1005	Ⓞ 8050-1010				
		Sport	86-1919Sport	80-2307Sport				
		Sport	⏏ 8641-1048Sport	T3Ⓞ 8041-1101Sport				
Golf 1 Cabrio	79-93	Classic	⏏ 86-1919					
		STR.T	Ⓞ 8650-1005	Ⓞ 8050-1010				
		Sport	86-1919Sport	80-2307Sport				
		Sport	⏏ 8641-1048Sport	T3Ⓞ 8041-1101Sport				
Golf 1 Diesel	78-83	STR.T	Ⓞ 8650-1005	Ⓞ 8050-1010				
		Sport	86-1919Sport	80-2307Sport				
		Sport	⏏ 8641-1048Sport	T3Ⓞ 8041-1101Sport				
		Sport	⏏ 8641-1048Sport	T3Ⓞ 8041-1101Sport				
Golf 1 GTI	76-83	STR.T	Ⓞ 8650-1005	Ⓞ 8050-1010				
		Sport	86-1919Sport	80-2307Sport				
		Sport	⏏ 8641-1048Sport	T3Ⓞ 8041-1101Sport				
		STR.T Kit			1120-5403	25	40	1, 2, 13
Sport Kit			1140-5403	25	40	1, 2, 13, 16		
Front axle load as from 661kg, rear axle load up to 571kg		STR.T Kit			1120-5404	25	40	1, 2, 13
Front axle load as from 661kg, rear axle load as from 571kg		Sport Kit			1140-5404	25	40	1, 2, 13, 16

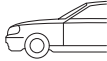
MAKE		product range				Lowering up to ..mm		Notes
Model	Year					Front	Rear	
<b>VOLKSWAGEN - CONTINUED</b>								
<b>Golf 2</b>								
Golf 2 C, CL, GL, GT	09.83-91	STR.T	Ⓢ 8750-1008	Ⓢ 8050-1007				
		Sport	ⓈⓈ 8741-1258Sport	M3Ⓢ 80-2542Sport				
		STR.T Kit			1120-5412	35	35	1,2,13
		Sport Kit			1140-5412	35	35	1,2,13,17
Golf 2 Diesel and Turbo-Diesel	09.83-91	Coil-over Kit			1150-5001-1	65	55	16,21,22
		STR.T	Ⓢ 8750-1008	Ⓢ 8050-1007				
		Sport	ⓈⓈ 8741-1258Sport	M3Ⓢ 80-2542Sport				
Golf 2 GTI 8V	09.83-91	Coil-over Kit			1150-5001-1	65	55	1,2,13,16,21,22
		STR.T	Ⓢ 8750-1008	Ⓢ 8050-1007				
		Sport	ⓈⓈ 8741-1258Sport	M3Ⓢ 80-2542Sport				
		STR.T Kit			1120-5412	35	35	1,2,13
Golf 2 GTI 16V	86-91	Sport Kit			1140-5412	35	35	1,2,13,17
		Coil-over Kit			1150-5001-1	65	55	1,2,13,16,21,22
		STR.T	Ⓢ 8750-1008	Ⓢ 8050-1008				
		Sport	ⓈⓈ 8741-1258Sport	M3Ⓢ 80-2587Sport				
Golf 2 GTI G60	90-91	STR.T Kit			1120-6322	30	30	1,2,13
		Sport Kit			1140-6322	30	30	1,2,13,17
		Coil-over Kit			1150-5001-1	65	55	1,2,13,16,21,22
		STR.T	Ⓢ 8641-1198Sport	Ⓢ 8050-1008				
Golf 2 Syncro 4WD	86-91	Sport	ⓈⓈ 8741-1258Sport					
		STR.T	Ⓢ 8750-1008					
Golf 2 GTI G60 Syncro 4WD	90-91	Sport	ⓈⓈ 8641-1198Sport					
<b>Jetta 1</b>								
Jetta 1, excl. Diesel	79-01.84	Classic	Ⓢ 86-1919					
		STR.T	Ⓢ 8650-1005	Ⓢ 8050-1010				
		Sport	86-1919Sport	80-2307Sport				
		Sport	ⓈⓈ 8641-1048Sport	T3ⓈⓈⓈ 8041-1101Sport				
Jetta 1 Diesel	80-01.84	STR.T	Ⓢ 8650-1005	Ⓢ 8050-1010				
		Sport	86-1919Sport	80-2307Sport				
<b>Jetta 2</b>								
Jetta 2 C, CL, GL	02.84-92	STR.T	Ⓢ 8750-1008	Ⓢ 8050-1007				
		Sport	ⓈⓈ 8741-1258Sport	M3Ⓢ 80-2542Sport				
		STR.T Kit			1120-5412	35	35	1,2,13
		Sport Kit			1140-5412	35	35	1,2,13,17
Jetta 2 Diesel and Turbo-Diesel	02.84-92	Coil-over Kit			1150-5001-1	65	55	1,2,13,16,21,22
		STR.T	Ⓢ 8750-1008	Ⓢ 8050-1007				
		Sport	ⓈⓈ 8741-1258Sport	M3Ⓢ 80-2542Sport				
Jetta 2 GT, excl. 16V	02.84-92	Coil-over Kit			1150-5001-1	65	55	1,2,13,16,21,22
		STR.T	Ⓢ 8750-1008	Ⓢ 8050-1007				
		Sport	ⓈⓈ 8741-1258Sport	M3Ⓢ 80-2542Sport				
		STR.T Kit			1120-5412	35	35	1,2,13
Jetta 2 GT 16V	86-92	Sport Kit			1140-5412	35	35	1,2,13,17
		Coil-over Kit			1150-5001-1	65	55	1,2,13,16,21,22
		STR.T	Ⓢ 8750-1008	Ⓢ 8050-1008				
		Sport	ⓈⓈ 8741-1258Sport	M3Ⓢ 80-2587Sport				
Jetta 2 Syncro 4WD	86-91	Sport Kit			1140-6322	30	30	1, 2, 13, 17
		Coil-over Kit			1150-5001-1	65	55	1,2,13,16,21,22
		STR.T	Ⓢ 8750-1008					
		Sport	ⓈⓈ 8741-1258Sport					
<b>Passat</b>								
Passat 32B, incl. Syncro	81-03.88	Sport	86-2066Sport					
Passat 35i Sedan/Variante, excl. VR6 Front: as from 1991, only for non-sealed struts without dent in housing to clear the tire	04.88-09.96	Sport	ⓈⓈ 8641-1198Sport					
Passat 35i Sedan/Variante VR6 Up to chassisno. 31M320488 only for non-sealed OE struts without dent in housing to clear the tire	91-93	Sport	ⓈⓈ 8641-1198Sport					
Passat 35i Syncro G60 AWD	89-09.91	Sport	ⓈⓈ 8641-1198Sport					
<b>Polo</b>								
Polo 86(C), incl. Coupé & Sedan	75-94	Sport	86-1922Sport	80-2315Sport				
Polo G40	08.88-94	Sport	86-2483Sport	80-2315Sport				
<b>Santana</b>								
Santana 32B	81-12.85	Sport	86-2066Sport					
<b>Scirocco</b>								
Scirocco 1 & 2, incl. GTX-16V (53 / 53B)	74-92	Classic	Ⓢ 86-1919					
		STR.T	Ⓢ 8650-1005	Ⓢ 8050-1010				
		Sport	86-1919Sport	80-2307Sport				
		Sport	ⓈⓈ 8641-1048Sport	T3ⓈⓈⓈ 8041-1101Sport				
<b>Commercials</b>								
Transporter T1	55-67	Classic	Ⓢ 80-1349	Ⓢ 80-1350				
Transporter T2a (Van, Bus) For availability contact www.efkaimport.nl	68-69	Classic	80-1966	80-1967				
Transporter T2a (Van, Bus) up to chassisno. 22.000.096	70-71	Classic	Ⓢ 80-2110	80-1967				

MAKE		Year	product range	 		Lowering up to ..mm		Notes
Model	Front					Rear		
<b>VOLKSWAGEN - CONTINUED</b>								
Transporter T2b (Van, Bus) as from chassiso. 22.000.097	72-79	Classic	☞ 80-2110	80-2220				
Transporter T3 all, excl. Syncro	80-90	Classic	☞ 82-2100	☞ 82-2101				
Caddy 1	83-92	Classic	☞ 86-1919					
		STR.T	Ⓢ 8650-1005					
		Sport	86-1919Sport					
		Sport	☞Ⓢ 8641-1048Sport					
<b>VOLVO</b>								
<b>240-, 260-series</b>								
240-, 260-series	78-93	Sport	☞Ⓢ 8641-1245Sport	ⓈⓈ 26-1129Sport				
<b>740</b>								
740 Sedan / Wagon as from chassiso. F0081680	84-06.88	Sport		ⓈⓈ 30-1479Sport				
740 Sedan / Wagon, excl. Turbo -16V	07.88-92	Sport	☞Ⓢ 8641-1246Sport	ⓈⓈ 30-1479Sport				
<b>760</b>								
760 Sedan / 780 Coupé, incl. Turbo as from chassiso. F0081680	84-07.87	Sport		ⓈⓈ 30-1479Sport				
760 Estate / Wagon, incl. Turbo as from chassiso. F0081680	85-06.88	Sport		ⓈⓈ 30-1479Sport				
760 Sedan / 780 Coupé, incl. Turbo with IRS (independant rear suspension)	07.88-90	Sport	☞Ⓢ 8641-1246Sport					
760 Estate / Wagon, incl. Turbo	07.88-90	Sport	☞Ⓢ 8641-1246Sport	ⓈⓈ 30-1479Sport				
<b>850</b>								
850 Sedan, incl. T-5, T5-R excl. self-levelling systems	92-97	FSD			2100-4017			15
		STR.T	Ⓢ 8750-1060	ⓈⓈ 8050-1080				
		Sport	☞ 8710-1350Sport	Ⓢ 80-2712Sport				
Front axle load up to 1019 kg		STR.T Kit			1120-9581	30	30	1,2,13,15
		Sport Kit			1140-9581	30	30	1,2,13,15,17
Front axle load as from 1020 kg		STR.T Kit			1120-9582	30	30	1,2,13,15
		Sport Kit			1140-9582	30	30	1,2,13,15,17
850 Wagon, excl. T-5, T5-R excl. self-levelling systems	92-97	FSD			2100-4017			15
		STR.T	Ⓢ 8750-1060	ⓈⓈ 8050-1080				
		Sport	☞ 8710-1350Sport	Ⓢ 80-2712Sport				
Front axle load up to 1019 kg		STR.T Kit			1120-9551	35	35	1,2,13,15
		Sport Kit			1140-9551	35	35	1,2,13,15,17
Front axle load as from 1020 kg		STR.T Kit			1120-9553	35	35	1,2,13,15
		Sport Kit			1140-9553	35	35	1,2,13,15,17
<b>940</b>								
940 Sedan / Wagon, excl. 2.0i-16V Turbo and V6 excl. independent rear suspension	90-97	Sport	☞Ⓢ 8641-1246Sport	ⓈⓈ 30-1479Sport				
<b>960</b>								
960 Wagon (V90)	90-94	Sport	☞Ⓢ 8641-1246Sport	ⓈⓈ 30-1479Sport				
<b>Amazon</b>								
Amazon Sedan, excl. GT	57-69	Classic	☞☐ 80-1319	☞ 80-1320				
Amazon Wagon	62-69	Classic	☞☐ 80-1319					

Type	Make & Model	Axle	🔧
<b>O26-SERIES</b>			
O26-1580	Land Rover (Range-Rover) Discovery Land Rover (Range-Rover) Range Rover	Front Front	P/P P/P
O26-1635	Nissan Patrol Nissan Patrol	Front Front	P/P P/P
<b>O30-SERIES</b>			
▲ O30-1579	Mercedes-Benz S-Class (W140)	Rear	P/E
<b>1120-SERIES</b>			
1120-4171	Honda S2000	Kit	
1120-5403	Volkswagen Golf 1	Kit	
1120-5404	Volkswagen Golf 1	Kit	
1120-5412	Volkswagen Golf 2 Volkswagen Jetta 2	Kit Kit	
1120-6322	Volkswagen Jetta 2	Kit	
1120-7361	Honda Civic	Kit	
1120-8391	Mazda MX-5	Kit	
1120-8631	Honda Civic	Kit	
1120-9551	Volvo 850	Kit	
1120-9553	Volvo 850	Kit	
1120-9581	Volvo 850	Kit	
1120-9582	Volvo 850	Kit	
<b>1140-SERIES</b>			
1140-4171	Honda S2000	Kit	
1140-5021	Honda Integra	Kit	
1140-5131	Porsche 911 (912)	Kit	
1140-5132	Porsche 911 (912)	Kit	
1140-5403	Volkswagen Golf 1	Kit	
1140-5404	Volkswagen Golf 1	Kit	
1140-5412	Volkswagen Golf 2 Volkswagen Jetta 2	Kit Kit	
1140-5981	Porsche 911 (912)	Kit	
1140-6322	Volkswagen Golf 2 Volkswagen Jetta 2	Kit Kit	
1140-7061	Volkswagen Corrado	Kit	
1140-7361	Honda Civic	Kit	
1140-8131	Porsche 911 (912)	Kit	
1140-8341	Porsche 911 (912)	Kit	
1140-8391	Mazda MX-5	Kit	
1140-8631	Honda Civic	Kit	
1140-8632	Honda Civic	Kit	
1140-8721	Volkswagen Corrado	Kit	
1140-8841	Toyota MR2	Kit	
1140-9091	Audi S2	Kit	
1140-9531	Porsche 911 (912)	Kit	
1140-9551	Volvo 850	Kit	
1140-9553	Volvo 850	Kit	
1140-9581	Volvo 850	Kit	
1140-9582	Volvo 850	Kit	
1140-9691	Audi RS2	Kit	
<b>1150-SERIES</b>			
1150-5001-1	Volkswagen Golf 2	Kit	
	Volkswagen Jetta 2	Kit	
1150-5002-1	Volkswagen Corrado	Kit	
1150-5006-1	Honda Civic	Kit	
<b>2100-SERIES</b>			
2100-4017	Volvo 850	Kit	
2100-4110	Porsche 911 (912)	Kit	
2100-4111	Porsche 911 (912)	Kit	
2100-4112	Porsche 911 (912)	Kit	
<b>25-SERIES</b>			
25-1215	Ford America Mustang	Rear	E/E
<b>26-SERIES</b>			
26-1019	Mercedes-Benz (W114) (W115) Mercedes-Benz SL-Class (R107)	Front Front	P/E P/E
26-1087	Saab 90 Saab 900 Saab 99	Rear Rear Rear	P/E P/E P/E
26-1089	Daimler Double six Daimler Sovereign Jaguar XJ Jaguar XJ-S	Front Front Front Front	P/E P/E P/E P/E
26-1129Sport	Volvo 240-, 260-series	Rear	E/E
26-1157	Mercedes-Benz E-Class (W123) Mercedes-Benz S-Class (W116) Mercedes-Benz S-Class (W126) (C126)	Front Front Front	P/E P/E P/E
26-1198Sport	Mercedes-Benz E-Class (W124) (C124) Mercedes-Benz 190-series (W201)	Rear Rear	P/E P/E
26-1209Sport	Porsche 924 Porsche 944	Rear Rear	E/E E/E
26-1248Sport	Nissan Z-Series	Rear	P/E
26-1294Sport	Ford Europe Escort Ford Europe Sierra	Rear Rear	E/E E/E
26-1299Sport	Renault R5	Rear	E/E
26-1369	Suzuki SJ	Rear	E/E
26-1592	Daimler Double six Jaguar XJ	Front Front	P/E P/E
26-1647	Renault Avantage	Rear	E/E
26-1698	Jaguar XJ	Front	P/E
<b>30-SERIES</b>			

Type	Make & Model	Axle	🔧
30-1020	Mercedes-Benz (W114) (W115) Mercedes-Benz E-Class (W123) Mercedes-Benz S-Class (W116) Mercedes-Benz S-Class (W126) (C126) Mercedes-Benz SL-Class (R107)	Rear Rear Rear Rear Rear	P/E P/E P/E P/E P/E
30-1088	Saab 900	Front	P/E
30-1090	Daimler Double six Daimler Sovereign Jaguar XJ Jaguar XJ-S	Rear Rear Rear Rear	E/E E/E E/E E/E
30-1265Sport	Chevrolet Camaro Pontiac Firebird	Rear Rear	P/E P/E
30-1268	Toyota Landcruiser	Front	P/P
30-1269L	Toyota Landcruiser	Rear	P/E
30-1270R	Toyota Landcruiser	Rear	E/E
30-1311SP1	Land Rover (Range-Rover) Discovery	Front	P/P
30-1311	Land Rover (Range-Rover) Discovery Land Rover (Range-Rover) Land Rover (Defender)	Front Front	P/P P/P
	Land Rover (Range-Rover) Range Rover	Front	P/P
30-1312SP1	Land Rover (Range-Rover) Discovery	Rear	E/P
30-1312	Land Rover (Range-Rover) Discovery Land Rover (Range-Rover) Land Rover (Defender)	Rear Rear	E/P E/P
	Land Rover (Range-Rover) Range Rover	Rear	E/P
30-1314Sport	Peugeot 205 Peugeot 309	Rear Rear	E/E E/E
30-1318	Mitsubishi L200 Mitsubishi L300	Front Front	P/E P/E
▲ 30-1319	Mitsubishi Pajero Mitsubishi L300 Mitsubishi Pajero	Front Rear Rear	P/E E/E E/E
	Mercedes-Benz G-Series Mercedes-Benz G-Series	Front Rear	E/P P/E
30-1322	Mercedes-Benz G-Series	Rear	P/E
30-1323	Mercedes-Benz G-Series	Rear	P/E
30-1324	Lada Niva	Front	P/E
30-1325	Lada Niva	Rear	E/E
30-1326	Holden (Australia) Jackaroo	Front	P/E
	Isuzu Trooper	Front	P/E
30-1342	Nissan King Cab Nissan Navara	Front Front	P/E P/E
30-1343	Nissan King Cab Nissan Navara	Front Rear	P/E E/E
	Jeep Cherokee	Rear	E/E
30-1348	Jeep Cherokee	Front	P/E
30-1365	Holden (Australia) Jackaroo Holden (Australia) Rodeo Honda Passport Isuzu Trooper	Front Front Front Front	P/E P/E P/E P/E
	Nissan Pathfinder Nissan Terrano	Front Front	P/E P/E
30-1372	Nissan Pathfinder Nissan Terrano	Rear Rear	E/E E/E
30-1379	Nissan Terrano	Rear	E/E
30-1380	Nissan Patrol	Front	P/P
30-1408	Nissan Patrol	Rear	E/E
30-1408	Mitsubishi Pajero	Rear	E/E
30-1417	Toyota Hi-Ace	Front	P/E
30-1418	Toyota Hi-Ace	Rear	E/E
30-1459	Mitsubishi L200	Rear	E/E
30-1479Sport	Volvo 740 Volvo 760 Volvo 940 Volvo 960	Rear Rear Rear Rear	E/E E/E E/E E/E
30-1593	Daimler Double six Daimler Six Jaguar XJ	Rear Rear Rear	P/E P/E P/E
▲ 30-1625	Jeep Grand Cherokee	Rear	E/E
30-1630	Jeep Cherokee	Rear	E/E
30-1663	Honda Passport	Front	P/E
30-1664	Honda Passport	Rear	P/E
<b>76-SERIES</b>			
76-1099	Porsche 356	Front	E/E
76-1293	Volkswagen Beetle Volkswagen Karmann Ghia	Front Front	
<b>80-SERIES</b>			
80-1005	Triumph TR-series	Front	P/E
80-1011	Porsche 356	Rear	E/E
80-1013	Porsche 356	Front	E/E
80-1021	Morgan Morgan	Front	P/E
80-1039	Alfa Romeo Giulia Alfa Romeo Giulietta	Front Front	P/P P/P
80-1044SP20	Porsche 356	Front	E/E
80-1092	Mercedes-Benz 180, 180D, 190, 190D, 190B/DB Mercedes-Benz 219, 220, 220A, 220S	Front Front	P/P P/P
80-1104	Mercedes-Benz 180, 180D, 190, 190D, 190B/DB Mercedes-Benz 219, 220, 220A, 220S	Rear Rear	P/P P/P
80-1105	Jaguar XK	Front	P/E
80-1114	Citroen Traction Avant	Front	E/E
80-1191SP20	Porsche 356	Rear	P/E
80-1193	Alfa Romeo Giulia Alfa Romeo Giulietta	Rear Rear	P/E P/E
80-1196	Citroen Traction Avant	Front	E/E
		Rear	E/E
80-1244SP1	MG MG-B MG MG-C	Rear Rear	E/E E/E
80-1307	Fiat 500	Rear	P/P
80-1308	Fiat 500	Front	P/P
80-1319	Volvo Amazon	Front	P/P

Type	Make & Model	Axle	🔧
80-1320	Volvo Amazon	Rear	P/P
80-1349	Volkswagen Beetle	Front	E/E
	Volkswagen Commercials	Front	E/E
	Volkswagen Karmann Ghia	Front	E/E
80-1350Sport	Volkswagen Beetle	Rear	E/E
	Volkswagen Karmann Ghia	Rear	E/E
80-1350	Volkswagen Beetle	Rear	E/E
	Volkswagen Commercials	Rear	E/E
	Volkswagen Karmann Ghia	Rear	E/E
80-1388	Triumph GT6	Front	P/E
	Triumph Herald	Front	P/E
	Triumph Spitfire	Front	P/E
	Triumph Vitesse	Front	P/E
80-1389	Triumph GT6	Rear	E/E
	Triumph Herald	Rear	E/E
	Triumph Spitfire	Rear	E/E
	Triumph Vitesse	Rear	E/E
80-1415	Mercedes-Benz (W111)	Front	P/E
	Mercedes-Benz S-Class (W108) (W109)	Front	P/E
	Mercedes-Benz SL-Class (W113)	Front	P/E
80-1416	Mercedes-Benz (W111)	Rear	P/E
	Mercedes-Benz S-Class (W108) (W109)	Rear	P/E
	Mercedes-Benz SL-Class (W113)	Rear	P/E
80-1491SPA1	Jaguar E-type	Rear	E/E
80-1500	Lancia Flavia	Front	P/E
	Lancia Fulvia	Front	P/E
80-1501	Lancia Flavia	Rear	E/E
	Lancia Fulvia	Rear	E/E
80-1538	Dodge Challenger	Front	P/E
	Dodge Charger	Front	P/E
	Plymouth Barracuda	Front	P/E
	Plymouth Belvedere	Front	P/E
	Plymouth Road Runner	Front	P/E
80-1551Sport	Alfa Romeo Giulia	Front	P/E
	Alfa Romeo Montreal	Front	P/E
	Alfa Romeo Spider	Front	P/E
80-1551	Alfa Romeo Giulia	Front	P/E
	Alfa Romeo Spider	Front	P/E
80-1573	Morgan Morgan	Rear	E/E
80-1580Sport	Opel GT	Front	P/E
	Opel Kadett	Front	P/E
80-1580	Opel GT	Front	P/E
	Opel Kadett	Front	P/E
80-1675Sport	Mini Mini Classic	Front	E/E
80-1675	Mini Mini Classic	Front	E/E
80-1689	Volga series 3102, 31029, 31022-2.4	Front	P/E
80-1690	Volga series 3102, 31029, 31022-2.4	Rear	P/E
80-1717	Mini Mini Classic	Front	E/E
80-1743SP3	Renault Alpine	Front	P/E
	Renault R8	Front	P/E
80-1744SP3	Renault Alpine	Rear	P/E
	Renault R8	Rear	P/E
80-1781Sport	Alfa Romeo Giulia	Rear	P/P
	Alfa Romeo Montreal	Rear	P/P
	Alfa Romeo Spider	Rear	P/P
80-1781	Alfa Romeo Giulia	Rear	P/P
	Alfa Romeo Spider	Rear	P/P
80-1784	Triumph TR-series	Front	P/E
80-1787	Volkswagen Beetle	Front	P/E
	Volkswagen Karmann Ghia	Front	P/E
80-1794Sport	Mini Mini Classic	Rear	P/E
80-1794	Mini Mini Classic	Rear	P/E
80-1795	Mini Mini Classic	Rear	P/E
80-1868Sport	BMW 02-Series 114/E10/E20	Rear	P/E
80-1877Sport	Fiat 124	Front	P/E
80-1878Sport	Fiat 124	Rear	P/E
	Fiat 131	Rear	P/E
80-1904	Holden (Australia) Rodeo	Rear	E/E
	Isuzu Van	Rear	E/E
	Mitsubishi L300	Rear	E/E
	Nissan Sunny	Rear	E/E
	Toyota Hi-Ace	Rear	E/E
	Toyota Landcruiser	Front	E/E
80-1905	Ford Australia Courier	Rear	E/E
	Toyota Landcruiser	Rear	E/E
80-1914	Chevrolet Camaro	Front	P/E
	Pontiac Firebird	Front	P/E
80-1915	Chevrolet Camaro	Rear	P/E
	Pontiac Firebird	Rear	P/E
80-1953	Chevrolet Camaro	Rear	P/E
	Pontiac Firebird	Rear	P/E
80-1966	Volkswagen Commercials	Front	P/E
80-1967	Volkswagen Commercials	Rear	P/E
80-1997Sport	Opel GT	Rear	P/E
	Opel Kadett	Rear	P/E
	Vauxhall (See also Opel) Chevette	Rear	P/E
80-1997	Bedford Chevanne	Rear	P/E
	Opel Commodore	Rear	P/E
	Opel GT	Rear	P/E
	Opel Kadett	Rear	P/E
	Vauxhall (See also Opel) Chevette	Rear	P/E
80-2021SPF1	Simca 1000 Rallye II	Front	P/E
80-2088	Porsche 911 (912)	Rear	P/E
80-2110	Volkswagen Commercials	Front	E/E
80-2111	Ford Australia Falcon / Fairmont X-Series	Rear	P/P
80-2119	Bedford Blitz	Front	P/P

Type	Make & Model	Axle	🔧
80-2133	Bedford CF	Front	P/P
80-2134	Holden (Australia) E-, F- and H-series	Front	P/E
	Bedford CF	Rear	P/E
	Ford Australia Bronco	Front	P/E
	Holden (Australia) E-, F- and H-series	Front	P/E
	Holden (Australia) Gemini	Rear	P/E
	Holden (Australia) Torana	Rear	P/E
80-2149Sport	Volkswagen Beetle	Rear	E/E
	Volkswagen Karmann Ghia	Rear	E/E
80-2149	Volkswagen Beetle	Rear	E/E
	Volkswagen Karmann Ghia	Rear	E/E
80-2153	Holden (Australia) Torana	Front	E/E
80-2156SP1	Holden (Australia) E-, F- and H-series	Front	P/E
	Holden (Australia) Statesman	Front	P/E
	Holden (Australia) Torana	Front	P/E
80-2157SP1	Holden (Australia) E-, F- and H-series	Rear	P/E
	Holden (Australia) Statesman	Rear	P/E
80-2163	Chrysler Australia Valiant	Rear	E/E
80-2167	Ford America Pinto	Rear	P/P
	Mercury Bobcat	Rear	P/E
80-2215	Jaguar E-type	Front	E/E
80-2216	Jaguar E-type	Rear	E/E
80-2220	Mercedes-Benz Commercials	Front	E/E
	Volkswagen Commercials	Rear	E/E
80-2233SP1	Holden (Australia) Commodore	Rear	P/E
	Holden (Australia) Piazza	Rear	P/E
80-2241Sport	Alfa Romeo Alfetta	Front	P/E
	Alfa Romeo Giulietta	Front	P/E
80-2242Sport	Alfa Romeo Alfetta	Rear	P/P
	Alfa Romeo Giulietta	Rear	P/P
80-2256Sport	Ford Europe Capri	Rear	P/E
80-2275	Bedford Chevanne	Front	P/E
	Holden (Australia) Gemini	Front	P/E
	Holden (Australia) Piazza	Front	P/E
	Isuzu Gemini	Front	P/E
	Opel Ascona	Front	P/E
	Opel Kadett	Front	P/E
	Opel Manta	Front	P/E
	Vauxhall (See also Opel) Cavalier	Front	P/E
	Vauxhall (See also Opel) Chevette	Front	P/E
▲80-2281	Fiat 126	Front	P/P
80-2299	Holden (Australia) Torana	Rear	P/E
	Nissan Australia 160 - 180 - 200	Rear	P/E
80-2307Sport	Volkswagen Golf 1	Rear	P/E
	Volkswagen Jetta 1	Rear	P/E
	Volkswagen Scirocco	Rear	P/E
80-2311	Chrysler Australia Valiant	Front	P/E
80-2315Sport	Audi 50	Rear	P/E
	Volkswagen Derby	Rear	P/E
	Volkswagen Polo	Rear	P/E
80-2319	Ford Australia Cortina	Rear	P/P
	Ford Australia Falcon / Fairmont E-series	Rear	P/P
	Ford Australia Falcon / Fairmont X-Series	Rear	P/P
	Ford Australia Galaxie	Rear	P/P
80-2320	Holden (Australia) E-, F- and H-series	Rear	E/E
80-2402	Nissan Cabstar	Front	P/E
	Nissan E20	Front	P/E
	Nissan Urvan	Front	P/E
80-2437Sport	Daihatsu Charmant	Rear	P/E
	Toyota Corolla	Rear	P/E
80-2458	Chevrolet LUV	Rear	E/E
	Dodge D50	Rear	E/E
	Isuzu Pickup	Rear	E/E
	Mitsubishi L200	Rear	E/E
80-2513SP1	Ford Australia Falcon / Fairmont E-series	Rear	P/E
80-2513	Ford Australia Fairlane / LTD	Rear	P/E
	Ford Australia Falcon / Fairmont E-series	Rear	P/E
	Ford Australia Falcon / Fairmont X-Series	Rear	P/E
80-2522Sport	BMW Z-Series	Rear	P/E
	BMW 3-Series E30	Rear	P/E
80-2522SP1	BMW M3	Rear	P/E
	BMW 3-Series E30	Rear	P/E
80-2542Sport	Volkswagen Golf 2	Rear	P/E
	Volkswagen Jetta 2	Rear	P/E
80-2570Sport	Alfa Romeo Alfetta	Front	P/E
	Alfa Romeo 75	Front	P/E
	Alfa Romeo 90	Front	P/E
80-2571Sport	Alfa Romeo Alfetta	Rear	P/P
	Alfa Romeo 75	Rear	P/P
	Alfa Romeo 90	Rear	P/P
80-2584	Lancia Ypsilon	Rear	E/E
80-2586	Lada Samara	Rear	P/E
80-2587Sport	Volkswagen Corrado	Rear	P/E
	Volkswagen Golf 2	Rear	P/E
	Volkswagen Jetta 2	Rear	P/E
80-2591Sport	Opel Omega	Rear	P/E
	Opel Senator	Rear	P/E
	Opel Vectra	Rear	P/E
	Vauxhall (See also Opel) Carlton	Rear	P/E
	Vauxhall (See also Opel) Cavalier	Rear	P/E
	Vauxhall (See also Opel) Senator	Rear	P/E
80-2597	Holden (Australia) Commodore	Rear	P/E
80-2630Sport	Audi S4	Rear	P/E
	Audi S6	Rear	P/E
	Audi V8	Rear	P/E
	Audi 100	Rear	P/E

Type	Make & Model	Axle	🔧
80-2641Sport	Audi 200	Rear	P/E
80-2712Sport	BMW 3-Series E30	Rear	P/E
80-2716	Volvo 850	Rear	P/E
80-2725	MG MG-B	Front	E/E
80-2738	Morgan Morgan	Rear	E/E
80-2762Sport	Holden (Australia) Commodore	Rear	P/E
	Audi 100	Rear	P/E
	Audi 200	Rear	P/E
<b>8010-SERIES</b>			
8010-1032Sport	Holden (Australia) Astra	Rear	P/E
<b>8040-SERIES</b>			
8040-1017	Chevrolet Camaro	Front	P/E
	Pontiac Firebird	Front	P/E
8040-1018	Chevrolet Camaro	Rear	E/P
	Pontiac Firebird	Rear	E/P
8040-1019	Chevrolet Corvette	Front	P/E
8040-1020	Chevrolet Corvette	Rear	E/E
8040-1026	Ford America Fairmont	Rear	P/E
	Ford America Mustang	Rear	P/E
	Mercury Capri	Rear	P/E
	Mercury Cougar	Rear	P/E
	Mercury Marquis	Rear	P/E
8040-1027	Pontiac Fiero	Front	E/E
8040-1035Sport	Porsche 924	Rear	E/E
	Porsche 944	Rear	E/E
	Porsche 968	Rear	E/E
8040-1057Sport	Saab 9000	Rear	P/E
8040-1063Sport	Toyota Supra	Front	P/E
8040-1064Sport	Toyota Supra	Rear	P/E
8040-1077Sport	Honda Civic	Front	P/E
8040-1081Sport	Nissan Silvia	Rear	P/E
8040-1083	Porsche 911 (912)	Rear	P/E
8040-1087	Buick Century	Front	P/E
	Buick Electra	Front	P/E
	Buick Estate	Front	P/E
	Buick Le Sabre	Front	P/E
	Buick Riviera	Front	P/E
	Buick Roadmaster	Front	P/E
	Buick Skylark	Front	P/E
	Cadillac Calais	Front	P/E
	Chevrolet Bel Air	Front	P/E
	Chevrolet Caprice	Front	P/E
	Chevrolet Chevelle	Front	P/E
	Chevrolet Chevy II	Front	P/E
	Chevrolet El Camino	Front	P/E
	Chevrolet Impala	Front	P/E
	Oldsmobile Custom	Front	P/E
	Oldsmobile F 85	Front	P/E
	Oldsmobile 88	Front	P/E
	Pontiac Bonneville	Front	P/E
	Pontiac Can-Am	Front	P/E
	Pontiac Grand Prix	Front	P/E
	Pontiac Le Mans	Front	P/E
	Pontiac Parisienne	Front	P/E
	Pontiac Ventura	Front	P/E
8040-1088	Buick Century	Rear	E/E
	Buick Electra	Rear	E/E
	Buick Estate	Rear	E/E
	Buick Le Sabre	Rear	E/E
	Buick Riviera	Rear	E/E
	Buick Roadmaster	Rear	E/E
	Buick Skylark	Rear	E/E
	Cadillac Calais	Rear	E/E
	Chevrolet Caprice	Rear	E/E
	Chevrolet Chevelle	Rear	E/E
	Chevrolet Chevy II	Rear	E/E
	Chevrolet El Camino	Rear	E/E
	Chevrolet Impala	Rear	E/E
	Oldsmobile Custom	Rear	E/E
	Oldsmobile F 85	Rear	E/E
	Oldsmobile 88	Rear	E/E
	Pontiac Bonneville	Rear	E/E
	Pontiac Can-Am	Rear	E/E
	Pontiac Grand Prix	Rear	E/E
	Pontiac Le Mans	Rear	E/E
	Pontiac Parisienne	Rear	E/E
	Pontiac Ventura	Rear	E/E
8040-1119Sport	Nissan Z-Series	Rear	P/E
▲ 8040-1216Sport	Toyota Starlet	Rear	P/E
8040-1226Sport	Nissan Silvia	Rear	P/E
<b>8041-SERIES</b>			
8041-1026Sport	Ford America Mustang	Rear	P/E
8041-1067Sport	Ford Australia Fairlane / LTD	Rear	P/E
	Ford Australia Falcon / Fairmont E-series	Rear	P/E
8041-1067SP1	Ford Australia Falcon / Fairmont E-series	Rear	P/E
8041-1094Sport	Holden (Australia) Commodore	Rear	P/E
8041-1095Sport	Opel Kadett	Rear	P/E
	Opel Vectra	Rear	P/E
	Vauxhall (See also Opel) Astra	Rear	P/E
	Vauxhall (See also Opel) Cavalier	Rear	P/E
8041-1101Sport	Volkswagen Golf 1	Rear	P/E
	Volkswagen Jetta 1	Rear	P/E
	Volkswagen Scirocco	Rear	P/E

Type	Make & Model	Axle	🔧
8041-1108Sport	Volkswagen Corrado	Rear	P/E
8041-1118Sport	Nissan Z-Series	Front	P/E
8041-1152Sport	Honda Civic	Front	P/E
	Honda Integra	Front	P/E
8041-1153Sport	Honda Civic	Rear	E/B
	Honda Integra	Rear	E/B
8041-1154LSport	Honda Prelude	Front	P/E
8041-1154RSport	Honda Prelude	Front	P/E
8041-1155Sport	Honda Prelude	Rear	P/E
8041-1164Sport	Honda Civic	Rear	P/E
	Honda Integra	Rear	P/E
8041-1166SP4	Honda Civic	Front	P/E
8041-1168SP4	Honda Accord	Rear	P/E
8041-1185LSport	Honda Accord	Front	P/E
8041-1185RSport	Honda Accord	Front	P/E
8041-1191Sport	Saab 900	Rear	P/E
8041-1194Sport	Holden (Australia) Commodore	Rear	P/E
8041-1200Sport	Honda Integra	Front	P/E
8041-1201Sport	Honda Integra	Rear	P/E
8041-1203Sport	Mazda MX-5	Front	P/E
8041-1204Sport	Mazda MX-5	Rear	P/E
8041-1209Sport	Lada Samara	Rear	P/E
8041-1213Sport	Honda Civic	Rear	P/E
8041-1232Sport	Honda Prelude	Front	P/E
8041-1278LSport	Honda S2000	Front	E/B
8041-1278RSport	Honda S2000	Front	E/B
8041-1279Sport	Honda S2000	Rear	E/B
<b>8050-SERIES</b>			
8050-1007	Volkswagen Golf 2	Rear	P/E
	Volkswagen Jetta 2	Rear	P/E
8050-1008	Volkswagen Golf 2	Rear	P/E
	Volkswagen Jetta 2	Rear	P/E
8050-1010	Volkswagen Golf 1	Rear	P/E
	Volkswagen Jetta 1	Rear	P/E
	Volkswagen Scirocco	Rear	P/E
8050-1011	Honda Civic	Front	P/E
	Honda Integra	Front	P/E
8050-1012	Honda Civic	Rear	E/B
	Honda Integra	Rear	E/B
8050-1016	Honda Civic	Rear	E/B
8050-1022	Peugeot 205	Rear	E/E
	Peugeot 309	Rear	E/E
8050-1041	Mazda MX-5	Front	P/E
8050-1042	Mazda MX-5	Rear	P/E
8050-1060	Mercedes-Benz E-Class (W124) (C124)	Rear	P/E
	Mercedes-Benz 190-series (W201)	Rear	P/E
8050-1071	Audi 80	Rear	P/E
8050-1077	Audi S6	Rear	P/E
	Audi V8	Rear	P/E
	Audi 100	Rear	P/E
	Audi 200	Rear	P/E
8050-1080	Volvo 850	Rear	P/E
8050-1117L	Honda S2000	Front	P/E
8050-1117R	Honda S2000	Front	P/E
8050-1118	Honda S2000	Rear	P/E
<b>82-SERIES</b>			
82-1019	Daimler Double six	Front	P/E
	Daimler Six	Front	P/E
	Daimler Sovereign	Front	P/E
	Daimler 2.5	Front	P/E
	Jaguar Mk	Front	P/E
	Jaguar S	Front	P/E
82-1027	Jaguar Mk	Front	E/E
	Jaguar XK	Front	E/E
82-1044	Daimler 2.5	Rear	P/P
	Jaguar Mk	Rear	P/P
82-1081	Jaguar Mk	Rear	P/E
	Jaguar XK	Rear	P/E
82-1107	Jaguar XK	Front	E/E
82-1216	Ferrari 508	Front	P/E
	Ferrari 539	Front	P/E
82-1217	Ferrari 508	Rear	P/E
82-1232	Jaguar E-type	Front	E/E
82-1255	Dodge Challenger	Rear	E/E
	Dodge Charger	Rear	E/E
	Plymouth Barracuda	Rear	E/E
	Plymouth Belvedere	Rear	E/E
	Plymouth Road Runner	Rear	E/E
82-1388SP3	Ford America Mustang	Front	E/B
	Mercury Cougar	Front	E/B
82-1389	Ford America Mustang	Rear	P/P
82-1518	Ford America Bronco	Front	P/E
	Ford America Econoline	Front	P/E
	Ford America F100	Front	P/E
	Ford America F250	Front	P/E
	Ford Australia F-series	Front	P/E
82-1579SP2	Ferrari Dino	Front	E/E
82-1603SP2	Ferrari Dino	Rear	E/E
82-1668SPD1	Opel Ascona	Rear	P/E
	Opel Kadett	Rear	P/E
	Opel Manta	Rear	P/E
82-1698	Ford Australia Falcon / Fairmont X-Series	Front	E/B
	Ford Australia Galaxie	Front	E/B
82-1739Sport	Opel Ascona	Front	P/E

Type	Make & Model	Axle	🔑
82-1740Sport	Opel Manta	Front	P/E
	Opel Kadett	Rear	
	Opel Manta	Rear	
82-1742SP4	Ford Australia Falcon / Fairmont X-Series	Front	E/B
82-1756	Porsche 911 (912)	Rear	P/E
82-1801Sport	Opel Ascona	Rear	P/E
	Opel Commodore	Rear	P/E
	Opel Manta	Rear	P/E
	Opel Rekord	Rear	P/E
	Vauxhall (See also Opel) Cavalier	Rear	P/E
82-1825SP2	Ferrari 365	Rear	E/E
	Ferrari 400	Rear	E/E
82-1831SP1	Ferrari 308	Rear	E/E
82-1833SP6	Ferrari 365	Front	E/E
	Ferrari 512	Front	E/E
82-1857SPF1	Simca 1000 Rallye II	Rear	P/E
82-1886Sport	Holden (Australia) Gemini	Front	P/E
	Holden (Australia) Piazza	Front	P/E
	Isuzu Gemini	Front	P/E
	Opel Ascona	Front	P/E
	Opel Kadett	Front	P/E
	Opel Manta	Front	P/E
	Vauxhall (See also Opel) Cavalier	Front	P/E
	Vauxhall (See also Opel) Chevette	Front	P/E
82-1962	Porsche 911 (912)	Rear	P/E
82-1969SP2	Ford Australia Bronco	Front	P/E
	Ford Australia F-series	Front	P/E
82-1982SP6	Ferrari Dino	Front	E/E
	Ferrari 308	Front	E/E
82-1983SP6	Ferrari 308	Rear	E/E
82-1984SP6	Ferrari 365	Rear	E/E
	Ferrari 512	Rear	E/E
82-2085Sport	Opel Ascona	Front	P/E
	Opel Kadett	Front	P/E
	Opel Manta	Front	P/E
82-2100	Volkswagen Commercials	Front	P/E
82-2101	Volkswagen Commercials	Rear	E/E
82-2138SP2	Ford Australia Bronco	Rear	E/E
	Ford Australia F-series	Rear	E/E
82-2138	Toyota Hi-Lux	Rear	E/E
	Toyota Landcruiser	Rear	E/E
82-2205	Toyota Landcruiser	Front	P/E
82-2272	Toyota Hi-Lux	Rear	E/E
	Toyota Landcruiser	Rear	E/E
82-2294	Toyota Landcruiser	Rear	E/E
82-2296	Toyota Landcruiser	Front	P/E
82-2297	Toyota Landcruiser	Rear	E/E
82-2312	Toyota Landcruiser	Rear	E/E
82-2347SP1	Nissan Patrol	Front	P/P
82-2347	Nissan Patrol	Front	P/P
82-2348SP1	Nissan Patrol	Rear	E/E
82-2348	Nissan Patrol	Rear	E/E
82-2372	Chevrolet K1500 / K2500 / K3500	Front	E/E
	GMC K-1500 / K-2500	Front	E/E
82-2384	Chevrolet K1500 / K2500 / K3500	Rear	E/E
	GMC C-1500 / C-2500	Rear	E/E
	GMC K-1500 / K-2500	Rear	E/E
82-2432	Ford Australia Fairlane / LTD	Front	E/B
	Ford Australia Falcon / Fairmont E-series	Front	E/B
82-5020	Toyota Landcruiser	Front	E/E
<b>8210-SERIES</b>			
8210-1158Sport	Opel Calibra	Rear	P/E
	Vauxhall (See also Opel) Calibra	Rear	P/E
8210-1159Sport	Porsche 911 (912)	Rear	P/E
8210-1160Sport	Audi RS2	Rear	E/E
	Audi S2	Rear	E/E
	Audi 80	Rear	E/E
<b>8240-SERIES</b>			
8240-1085	Porsche 928	Front	P/E
8240-1086	Porsche 928	Rear	P/E
8240-1099	Nissan Australia Skyline	Rear	P/E
	Nissan Australia 160 - 180 - 200	Rear	P/E
8240-1125	Honda Legend	Front	
8240-1126	Honda Legend	Rear	P/E
8240-1181SPX	Land Rover (Range-Rover) Discovery	Front	P/P
	Land Rover (Range-Rover) Land Rover (Defender)	Front	P/P
	Land Rover (Range-Rover) Range Rover	Front	P/P
8240-1182SPX	Land Rover (Range-Rover) Land Rover (Defender)	Rear	E/P
8240-1190SPX	Land Rover (Range-Rover) Discovery	Rear	E/P
	Land Rover (Range-Rover) Land Rover (Defender)	Rear	E/P
	Land Rover (Range-Rover) Range Rover	Rear	E/P
8240-1195SPX	Mercedes-Benz G-Series	Front	E/P
8240-1196SPX	Mercedes-Benz G-Series	Front	E/P
8240-1197SPX	Mercedes-Benz G-Series	Rear	P/E
8240-1198SPX	Jeep Grand Cherokee	Front	P/E
8240-1199SPX	Jeep Grand Cherokee	Rear	E/E
8240-1201SPX	Jeep Wagoneer	Front	P/E
8240-1202SPX	Jeep Wagoneer	Rear	E/E
<b>8241-SERIES</b>			
8241-1050Sport	Porsche 914	Rear	P/E
8241-1097Sport	Chevrolet Corvette	Front	P/E
8241-1098Sport	Chevrolet Corvette	Rear	P/E
8241-1117Sport	Honda NS-X	Front	P/E
8241-1118Sport	Honda NS-X	Rear	P/E

Type	Make & Model	Axle	🔑
8241-1139Sport	Pontiac Firebird	Front	P/E
8241-1140Sport	Pontiac Firebird	Rear	P/E
8241-1153Sport	Ford Australia Fairlane / LTD	Front	E/E
	Ford Australia Falcon / Fairmont E-series	Front	E/E
8241-1272Sport	Porsche 911 (912)	Rear	
8241-1273LSport	Porsche 911 (912)	Rear	P/E
8241-1273RSport	Porsche 911 (912)	Rear	P/E
8241-1274Sport	Porsche 911 (912)	Rear	P/E
<b>8242-SERIES</b>			
8242-1006SP1	Pontiac Firebird	Rear	P/E
<b>8250-SERIES</b>			
8250-1013	Opel Ascona	Rear	
	Opel Commodore	Rear	
	Opel Manta	Rear	
	Opel Rekord	Rear	
	Vauxhall (See also Opel) Cavalier	Rear	
8250-1014	Opel Ascona	Front	
	Opel Kadett	Front	
	Opel Manta	Front	
	Vauxhall (See also Opel) Cavalier	Front	
	Vauxhall (See also Opel) Chevette	Front	
<b>86-SERIES</b>			
86-1308	Porsche 911 (912)	Front	
86-1394	Porsche 911 (912)	Front	
86-1519SPort	BMW 02-Series 114/E10/E20	Front	
86-1638	Porsche 911 (912)	Front	
86-1647	Porsche 911 (912)	Front	
86-1741	Volkswagen Beetle	Front	
86-1811	Nissan Z-Series	Front	
86-1812	Nissan Z-Series	Rear	
86-1835Sport	Ford Europe Capri	Front	
	Ford Europe Escort	Front	
86-1919Sport	Volkswagen Caddy	Front	
	Volkswagen Commercials	Front	
	Volkswagen Golf 1	Front	
	Volkswagen Jetta 1	Front	
86-1919	Volkswagen Scirocco	Front	
	Volkswagen Caddy	Front	
	Volkswagen Commercials	Front	
	Volkswagen Golf 1	Front	
	Volkswagen Jetta 1	Front	
	Volkswagen Scirocco	Front	
86-1922Sport	Audi 50	Front	
	Volkswagen Derby	Front	
	Volkswagen Polo	Front	
86-1942	Porsche 911 (912)	Front	
86-1943	Porsche 911 (912)	Front	
86-1980	Porsche 924	Front	
	Porsche 944	Front	
	Volkswagen Beetle	Front	
86-1991Sport	Daihatsu Charmant	Front	
	Toyota Carina / Corona	Front	
	Toyota Celica	Front	
	Toyota Corolla	Front	
86-2066Sport	Audi Coupé	Front	
	Audi 80	Front	
	Audi 90	Front	
	Volkswagen Passat	Front	
	Volkswagen Santana	Front	
86-2076SP1	Holden (Australia) Commodore	Front	
86-2086SPD2	Audi RS2	Front	
	Audi S2	Front	
86-2086Sport	Audi Coupé	Rear	
	Audi Quattro	Front	
	Audi 80	Rear	
	Audi 90	Rear	
86-2087Sport	Audi Quattro	Rear	
86-2149Sport	Audi S4	Front	
	Audi S6	Front	
	Audi V8	Front	
	Audi 100	Front	
	Audi 200	Front	
▲ 86-2149	Audi 100	Front	
	Audi 200	Front	
86-2224	Nissan Australia Skyline	Front	
	Nissan Australia 160 - 180 - 200	Front	
86-2277Sport	BMW Z-Series	Front	
	BMW 3-Series E30	Front	
86-2277SP1	BMW M3	Front	
86-2380	Lada Samara	Front	
86-2433Sport	Audi Coupé	Rear	
	Audi S2	Rear	
	Audi 90	Rear	
86-2448Sport	Alfa Romeo 33	Front	
86-2483Sport	Volkswagen Polo	Front	
<b>8610-SERIES</b>			
8610-1262Sport	Audi Coupé	Front	
	Audi 80	Front	
	Audi 90	Front	
8610-1263Sport	Opel Calibra	Front	
	Opel Vectra	Front	
	Vauxhall (See also Opel) Calibra	Front	
	Vauxhall (See also Opel) Cavalier	Front	



Type	Make & Model	Axle	
8610-1283Sport 8610-1365Sport	Holden (Australia) Astra Toyota Corolla	Front Front	
<b>8641-SERIES</b>			
8641-1021Sport	BMW Z-Series	Front	
8641-1029Sport	BMW 3-Series E30	Front	
8641-1038Sport	BMW 3-Series E30 Porsche 924 Porsche 944	Front Front Front	
8641-1039Sport	Volkswagen Beetle	Front	
8641-1048Sport	Porsche 911 (912) Volkswagen Caddy Volkswagen Commercials Volkswagen Golf 1 Volkswagen Jetta 1 Volkswagen Scirocco	Front Front Front Front Front Front	
8641-1060Sport	Nissan Z-Series	Front	
8641-1066Sport	Holden (Australia) Commodore	Front	
8641-1068Sport	Opel Kadett Vauxhall (See also Opel) Astra	Front Front	
8641-1071Sport	Toyota MR2	Front	
8641-1072Sport	Toyota MR2	Rear	
8641-1077Sport	Porsche 914	Front	
8641-1114Sport	Saab 9000	Front	
8641-1142Sport	Toyota MR2	Rear	
8641-1144Sport	BMW 3-Series E30	Front	
8641-1157Sport	BMW 7-Series E32	Front	
8641-1198Sport	Volkswagen Corrado Volkswagen Golf 2 Volkswagen Passat	Front Front Front	
8641-1210Sport	BMW M3 BMW 3-Series E30	Front Front	
8641-1220Sport	Toyota MR2	Front	
8641-1221Sport	Toyota MR2	Rear	
8641-1224Sport	BMW 7-Series E32	Front	
8641-1245Sport	Volvo 240-, 260-series	Front	
8641-1246Sport	Volvo 740 Volvo 760 Volvo 940 Volvo 960	Front Front Front Front	
8641-1329Sport	Lada Samara	Front	
8641-1364Sport	Nissan Silvia	Front	
8641-1414Sport	Porsche 944 Porsche 968	Front Front	
<b>8650-SERIES</b>			
8650-1005	Volkswagen Caddy Volkswagen Commercials Volkswagen Golf 1 Volkswagen Jetta 1 Volkswagen Scirocco	Front Front Front Front Front	
8650-1006	Opel Kadett Vauxhall (See also Opel) Astra	Front Front	
8650-1007	Audi S6 Audi V8 Audi 100 Audi 200	Front Front Front Front	
8650-1010	Audi Coupé Audi 80 Audi 90	Front Front Front	
<b>87-SERIES</b>			
87-5085LSport	Peugeot 205	Front	
87-5085RSport	Peugeot 309 Peugeot 205 Peugeot 309	Front Front Front	
<b>8710-SERIES</b>			
8710-1276Sport	Opel Corsa Vauxhall (See also Opel) Nova	Front Front	
8710-1350Sport	Volvo 850	Front	
<b>8740-SERIES</b>			
8740-1385	Renault Avantime	Front	
<b>8741-SERIES</b>			
8741-1030Sport	Chevrolet Camaro	Front	
8741-1054	Pontiac Firebird	Front	
8741-1063	Ford America Mustang Pontiac Fiero	Front Rear	
8741-1074Sport	Ford Europe Sierra	Front	
8741-1092Sport	Mercedes-Benz E-Class (W124) (C124) Mercedes-Benz 190-series (W201)	Front Front	
8741-1109Sport	Ford Europe Sierra	Front	
8741-1119Sport	Ford Europe Escort Ford Europe Orion	Rear Rear	
8741-1121Sport	Ford America Mustang	Front	
8741-1124Sport	Ford Europe Sierra	Front	
8741-1167Sport	Renault R5	Front	
8741-1258Sport	Volkswagen Golf 2 Volkswagen Jetta 2	Front Front	
8741-1259Sport	Volkswagen Corrado	Front	
8741-1541LSport	Porsche 911 (912)	Front	
8741-1541RSport	Porsche 911 (912)	Front	
8741-1542LSport	Porsche 911 (912)	Front	
8741-1542RSport	Porsche 911 (912)	Front	
8741-1543Sport	Porsche 911 (912)	Front	

Type	Make & Model	Axle	
<b>8750-SERIES</b>			
8750-1008	Volkswagen Golf 2	Front	
8750-1009	Volkswagen Jetta 2	Front	
8750-1016L	Volkswagen Corrado	Front	
8750-1016R	Peugeot 205 Peugeot 309	Front Front	
8750-1021	Peugeot 205 Opel Corsa	Front Front	
8750-1060	Vauxhall (See also Opel) Nova	Front	
8750-1067	Volvo 850 Mercedes-Benz E-Class (W124) (C124) Mercedes-Benz 190-series (W201)	Front Front Front	
<b>88-SERIES</b>			
88-1686	Nissan Patrol	Front	P/P
88-1687	Nissan Patrol	Rear	E/E
<b>90-SERIES</b>			
90-5370SP1	Nissan Patrol	Front	P/P
90-5371SP1	Nissan Patrol	Rear	E/E
90-5374SP1	Land Rover (Range-Rover) Discovery	Front	P/P
	Land Rover (Range-Rover) Land Rover (Defender)	Front	P/P
	Land Rover (Range-Rover) Range Rover	Front	P/P
90-5375SP1	Land Rover (Range-Rover) Discovery	Rear	E/P
	Land Rover (Range-Rover) Land Rover (Defender)	Rear	E/P
	Land Rover (Range-Rover) Range Rover	Rear	E/P
90-5383	Mercedes-Benz G-Series	Front	E/P
90-5384	Mercedes-Benz G-Series	Rear	P/E
90-5401	Land Rover (Range-Rover) Discovery	Rear	E/P
	Land Rover (Range-Rover) Land Rover (Defender)	Rear	E/P
	Land Rover (Range-Rover) Range Rover	Rear	E/P

## New part numbers and applications

(Check masterlist for details)



Part Number	Application	Year	Axle	
<b>80-SERIES</b>				
80-2021SPF1	Simca 1000 Rallye II	72-77	Front	P/E
<b>82-SERIES</b>				
82-1740sport	Opel Kadett Opel Manta	74-79 70-75	Rear Rear	
82-1857SPF1	Simca 1000 Rallye II	72-77	Rear	P/E

Part Number	Application		Axle	





# NOTES

## NOTE



- ⊗ Ammortizzatore a gas
- ☒ CLASSIC colore nero
- ☒ CLASSIC colore rosso
- ☒ Ammortizzatore regolabile esternamente tramite la manopola o il perno senza bisogno di rimuovere l'ammortizzatore dalla vettura
- + Parti aggiuntive su richiesta.
- ◆ Cartuccia speciale per montanti sigillati da imbulonare al fondo del montante dopo aver tagliato il montante originale e rimosso le parti interne. Solo per montanti originali.

### b La scanalatura superiore è standard

- M0 scanalatura superiore 7mm più alto
- M1 scanalatura superiore 10mm più alto
- M2 scanalatura superiore 15mm più alto
- M3 scanalatura superiore 20mm più alto
- M4 scanalatura superiore 25mm più alto
- M5 scanalatura superiore 30mm più alto

### b La scanalatura superiore è standard

- N1 scanalatura inferiore 7mm più bassa
- N2 scanalatura inferiore 10mm più bassa
- N3 scanalatura inferiore 15mm più bassa
- N4 scanalatura inferiore 20mm più bassa
- N5 scanalatura inferiore 25mm più bassa
- N6 scanalatura inferiore 30mm più bassa

### c La scanalatura superiore è standard

- P1 scanalatura inferiore 5mm più bassa
- P2 scanalatura inferiore 6mm più bassa
- P3 scanalatura inferiore 7mm più bassa

### c La scanalatura media è standard

- R1 distanza di 6mm tra scanalatura superiore e inferiore
- R2 distanza di 10mm tra scanalatura superiore e inferiore
- R3 distanza di 15mm tra scanalatura superiore e inferiore
- R4 distanza di 20mm tra scanalatura superiore e inferiore
- R5 distanza di 25mm tra scanalatura superiore e inferiore
- R6 scanalatura superiore 25mm più alto
- R7 scanalatura superiore 15mm più bassa

### e La scanalatura media è standard

- T1 distanza di 7mm tra scanalatura superiore e inferiore
- T2 distanza di 10mm tra scanalatura superiore e inferiore
- T3 distanza di 12mm tra scanalatura superiore e inferiore

### Per BMW Serie 3 E-30 fino ad Agosto 1988 con "M-Technik";

Se il veicolo è equipaggiato con sospensione "M" (Bilstein), sono necessari i seguenti componenti originali per montare la cartuccia KONI:

Tampone di arresto scotimento part no.	31-331-124-449
Copripolvere part no.	31-331-134-314 (31-331-124-519)
Ghiera di serraggio part no.	31-321-115-398 (McPherson housing 45 mm Ø)
Ghiera di serraggio part no.	31-321-117-376 (McPherson housing 51 mm Ø)

## NOTAS



- ⊗ Carga de gás
- ☒ CLASSIC cor preta
- ☒ CLASSIC cor vermelha
- ☒ Regulável externamente por meio de botão ou pino, sem necessidade de retirar o amortecedor do carro.
- + São necessárias peças adicionais.
- ◆ Carga especial McPherson, para bainhas cravadas e parafusadas ao fundo depois de contar a bainha e retirar dos os componentes de origem.

### b Apolo do encaixe é standard

- M0 topo c/encaixe 7mm Altura
- M1 topo c/encaixe 10mm Altura
- M2 topo c/encaixe 15mm Altura
- M3 topo c/encaixe 20mm Altura
- M4 topo c/encaixe 25mm Altura
- M5 topo c/encaixe 30mm Altura

### b Topo de encaixe é standard

- N1 apolo do encaixe 7mm + baixo
- N2 apolo do encaixe 10mm + baixo
- N3 apolo do encaixe 15mm + baixo
- N4 apolo do encaixe 20mm + baixo
- N5 apolo do encaixe 25mm + baixo
- N6 apolo do encaixe 30mm + baixo

### c Topo do encaixe é standard

- P1 apolo do encaixe 5mm + baixo
- P2 apolo do encaixe 6mm + baixo
- P3 apolo do encaixe 7mm + baixo

### c Encaixe de melo é standard

- R1 cada encaixe tem 6mm de diferença
- R2 cada encaixe tem 10mm de diferença
- R3 cada encaixe tem 15mm de diferença
- R4 cada encaixe tem 20mm de diferença
- R5 cada encaixe tem 25mm de diferença
- R6 topo c/encaixe 25mm Altura
- R7 apoio do encaixe 15mm + baixo

### e Encaixe de melo é standard

- T1 cada encaixe tem 7mm de diferença
- T2 cada encaixe tem 10mm de diferença
- T3 cada encaixe tem 12mm de diferença

### Nota-Para a série BMW 3 E-30 com "M-Technik" até Agosto 1988.

Se equipado com (Bilstein) M-Sport, as peças originais são necessárias para substituir a carga (amortecedor) KONI:

Batenta: ref.n°.	31-331-124-449
Fole: ref.n°.	31-331-134-314 (31-331-124-519)
Porca ref.n°.	31-321.115.398 (bainha McPherson 45 mm Ø)
Porca ref.n°.	31-321.117.376 (bainha McPherson 51 mm Ø)

## ANMERKNINGER



- ⊗ Gass-fylt
- ☒ CLASSIC farge sort
- ☒ CLASSIC farge rød
- ☒ Utvendig justerbar ved hjelp av en knapp eller en tapp (sekskant.nøkkel) uten å demontere støttemperen fra bilen.
- + Tilleggsdetaljer, som braketter, er nødvendig.
- ◆ Spesiell McPherson innsats, for forseglede fjærben, skrudd fast i bunnen av fjærbenet etter at fjærbenets øvre del er kappet, og de originale støttemperdelene fjernet.

### b Nedre spor er standard

- M0 øvre spor 7mm høyere
- M1 øvre spor 10mm høyere
- M2 øvre spor 15mm høyere
- M3 øvre spor 20mm høyere
- M4 øvre spor 25mm høyere
- M5 øvre spor 30mm høyere

### b Øvre spor er standard

- N1 nedre spor 7mm lavere
- N2 nedre spor 10mm lavere
- N3 nedre spor 15mm lavere
- N4 nedre spor 20mm lavere
- N5 nedre spor 25mm lavere
- N6 nedre spor 30mm lavere

### c Øvre spor er standard

- P1 nedre spor 5mm lavere
- P2 nedre spor 6mm lavere
- P3 nedre spor 7mm lavere

### c Midtre spor er standard

- R1 øvre/nedre spor hver med 6mm avstand
- R2 øvre/nedre spor hver med 10mm avstand
- R3 øvre/nedre spor hver med 15mm avstand
- R4 øvre/nedre spor hver med 20mm avstand
- R5 øvre/nedre spor hver med 25mm avstand
- R6 øvre spor 25mm høyere
- R7 nedre spor 15mm lavere

### e Midtre spor er standard

- T1 øvre/nedre spor hver med 7mm avstand
- T2 øvre/nedre spor hver med 10mm avstand
- T3 øvre/nedre spor hver med 12mm avstand

### For BMW3 E-30 serie med "M-Teknikk" til August 1988.

Hvis bilen er i "M"-versian (Bilstein), er følgende originaldelene nødvendige for å tilpasse KONI-innsatsen:

Gummianslag: Del nr.	31'331-124-449
Støvkappe: Del nr.	31-331-134-314 (31-331-124-519)
Låserrutter: Del nr.	31-321-115-398 (McPherson hylse 45 mm Ø) eller
Låserrutter: Del nr.	31-321-117-376 (McPherson hylse 51 mm Ø)

## MERKINTÖJEN SELITYKSET



- ⊗ Kaasutäytteen
- ☒ CLASSIC musta
- ☒ CLASSIC punainen
- ☒ Säädettävissä ulkupoletta säätönupilla tai puikolla irottamatta iskunvaimentimia autosta.
- + Vaatit erillisen kiinnikesarjan.
- ◆ Erikois McPherson patruuna umpinalsiin joustintukiin, kiinnitetään puittilla pohjasta kun joustintuki on yläpäädystä katkaistu ja alkuperäiset sisäosat poistettu.

### b Alempi ura on alkuperäinen korkeus

- M0 ylempi ura 7mm korkeampi
- M1 ylempi ura 10mm korkeampi
- M2 ylempi ura 15mm korkeampi
- M3 ylempi ura 20mm korkeampi
- M4 ylempi ura 25mm korkeampi
- M5 ylempi ura 30mm korkeampi

### b Ylempi ura on alkuperäinen korkeus

- N1 alin ura 7mm alempi
- N2 alin ura 10mm alempi
- N3 alin ura 15mm alempi
- N4 alin ura 20mm alempi
- N5 alin ura 25mm alempi
- N6 alin ura 30mm alempi

### c Ylempi ura on alkuperäinen korkeus

- P1 alin ura 5mm alempi
- P2 alin ura 6mm alempi
- P3 alin ura 7mm alempi

### c Keskimäinen ura on alkuperäinen korkeus

- R1 ylä/alauran etäisyys 6mm
- R2 ylä/alauran etäisyys 10mm
- R3 ylä/alauran etäisyys 15mm
- R4 ylä/alauran etäisyys 20mm
- R5 ylä/alauran etäisyys 25mm
- R6 ylämpi ura 25mm korkeampi
- R7 alin ura 15mm alempi

### e Keskimäinen ura on alkuperäinen korkeus

- T1 ylä/alauran etäisyys 7mm
- T2 ylä/alauran etäisyys 10mm
- T3 ylä/alauran etäisyys 12mm

### Huom. BMW 3 E-30 sarja varustettuna "M-Technik" elokuu 1988 asti.

Jos auto on varustettu "M" alustalla (Bilstein), tarvitaan KONI vaimenninta asennettaessa seuraavat alkuperäisosat:

Rajoitinkumi: osa nro	31-331-124.449
Pölysuoja: osa nro	31-331-134.314 (31.331.124-519)
Lukitusmutterit: osa nro	31-321-115-398 (joustintuen kalkaisija 45 mm) tai
Lukitusmutterit: osa nro	31-321-117-376 (joustintuen halkaisija 51 mm)

# NOTES

## SIGNES



Ⓒ Amortisseur à pression de gaz

☞ CLASSIC couleur noir

☞ CLASSIC couleur rouge

☞ Réglage de l'extérieur à l'aide d'une molette. Ou d'une tige sans déposer des amortisseurs du véhicule Filetage.

+ Ferrures de montage nécessaires.

◆ Cartouche de remplacement spéciale se fixant par le fond de la jambe de force d'origine après découpe du sertissage et dépose des pièces internes.

### b La gorge du bas est standard

**M0** gorge de clip inférieure 7 mm plus bas  
**M1** gorge de clip inférieure 10 mm plus bas  
**M2** gorge de clip inférieure 15 mm plus bas  
**M3** gorge de clip inférieure 20 mm plus bas  
**M4** gorge de clip inférieure 25 mm plus bas  
**M5** gorge de clip inférieure 30 mm plus bas

### b La gorge du haut est standard

**N1** gorge de clip inférieure 7 mm plus bas  
**N2** gorge de clip inférieure 10 mm plus bas  
**N3** gorge de clip inférieure 15 mm plus bas  
**N4** gorge de clip inférieure 20 mm plus bas  
**N5** gorge de clip inférieure 25 mm plus bas  
**N6** gorge de clip inférieure 30 mm plus bas

### c La gorge du haut est standard

**P1** gorge de clip inférieure 5 mm plus bas  
**P2** gorge de clip inférieure 6 mm plus bas  
**P3** gorge de clip inférieure 7 mm plus bas

### c La gorge du milieu est standard

**R1** distance entre chaque gorge 6 mm  
**R2** distance entre chaque gorge 10 mm  
**R3** distance entre chaque gorge 15 mm  
**R4** distance entre chaque gorge 20 mm  
**R5** distance entre chaque gorge 25 mm  
**R6** gorge supérieure 25 mm plus haut  
**R7** gorge de clip inférieure 15 mm plus bas

### e La gorge du milieu est standard

**T1** distance entre chaque gorge 7 mm  
**T2** distance entre chaque gorge 10 mm  
**T3** distance entre chaque gorge 12 mm

### Remarque pour BMW 3-séries E30, avec option „M-Technik“ jusqu'à août 1988.

Si le véhicule est équipé avec „M“ Sport pack (amortisseurs Bilstein) le montage du KONI nécessite les pièces d'origine suivantes :

Butée part no.	31-331-124-449
Cache-poussière part no.	31-331-134-314 (31-331-124-519)
Ecrou part no.	31-321-115-398
(pour corps McPherson Ø 45 mm) ou	
Ecrou part no.	31-321-117-376
(pour corps McPherson Ø 51 mm).	

## SONDERZEICHEN



Ⓒ Gasdruckdämpfer

☞ CLASSIC schwarze Farbe

☞ CLASSIC rote Farbe

☞ Mit Hilfe eines Einstellknopfes im eingebauten Zustand von außen nachstellbar.

+ Zusätzliche Anbauteile erforderlich .

◆ McPherson-Federbein-Patrone für gefaltete Federbeine. Befestigung am Boden des Original Federbeines mit Gewindebolzen. Das Federbein wird hierzu geöffnet, die Innenteile entfernt und durch eine Patrone ersetzt.

### b Untere Nut = Standard

**M0** obere Nut 7 mm höher  
**M1** obere Nut 10 mm höher  
**M2** obere Nut 15 mm höher  
**M3** obere Nut 20 mm höher  
**M4** obere Nut 25 mm höher  
**M5** obere Nut 30 mm höher

### b Obere Nut = Standard

**N1** untere Nut 7 mm tiefer  
**N2** untere Nut 10 mm tiefer  
**N3** untere Nut 15 mm tiefer  
**N4** untere Nut 20 mm tiefer  
**N5** untere Nut 25 mm tiefer  
**N6** untere Nut 30 mm tiefer

### c Obere Nut = Standard

**P1** untere Nut je 5 mm tiefer  
**P2** untere Nut je 6 mm tiefer  
**P3** untere Nut je 7 mm tiefer

### c Mittlere Nut = Standard

**R1** obere/untere Nut je 6 mm Abstand  
**R2** obere/untere Nut je 10 mm Abstand  
**R3** obere/untere Nut je 15 mm Abstand  
**R4** obere/untere Nut je 20 mm Abstand  
**R5** obere/untere Nut je 25 mm Abstand  
**R6** obere Nut 25 mm höher  
**R7** untere Nut 15 mm tiefer

### e Mittlere Nut = Standard

**T1** obere/untere Nut je 7 mm Abstand  
**T2** obere/untere Nut je 10 mm Abstand  
**T3** obere/untere Nut je 12 mm Abstand

### Hinweis für BMW 3er Serie E30 bis August 1988 mit M-Technik

Bei verbauten Bilstein Dämpfer sind für den KONI-Einbau orig. BMW-Anbauteile erforderlich:

Anschlaggummi	31-331-124-449
Staubkappe	31-331-134-314 (31-331-124-510)
Verschlussmutter (Federbein Ø 45 mm außen) oder	31-321-115-398
Verschlussmutter (Federbein Ø 51 mm außen)	31-321-117 -376

## NOTAS



Ⓒ Con gas

☞ CLASSIC color negro

☞ CLASSIC color rojo

☞ Regulable exteriormente por medio de tapón. O pasador, sin tener que desmontar los amortiguadores del vehículo.

+ Piezas adicionales requeridas, coma abrazaderas.

◆ Cartucho especial Mc-Pherson para carcasas selladas, fijado al fondo después de cortar la carcasa y quitar las piezas internas originales.

### b La ranura inferior es estándar

**M0** ranura superior 7 mm más alta  
**M1** ranura superior 10 mm más alta  
**M2** ranura superior 15 mm más alta  
**M3** ranura superior 20 mm más alta  
**M4** ranura superior 25 mm más alta  
**M5** ranura superior 30 mm más alta

### b La ranura superior es estándar

**N1** ranura inferior 7 mm más baja  
**N2** ranura inferior 10 mm más baja  
**N3** ranura inferior 15 mm más baja  
**N4** ranura inferior 20 mm más baja  
**N5** ranura inferior 25 mm más baja  
**N6** ranura inferior 30 mm más baja

### c La ranura superior es estándar

**P1** ranura inferior 5 mm más baja  
**P2** ranura inferior 6 mm más baja  
**P3** ranura inferior 7 mm más baja

### c La ranura intermedia es estándar

**R1** ranura superior/inferior a 6 mm de distancia  
**R2** ranura superior/inferior a 10 mm de distancia  
**R3** ranura superior/inferior a 15 mm de distancia  
**R4** ranura superior/inferior a 20 mm de distancia  
**R5** ranura superior/inferior a 25 mm de distancia  
**R6** ranura superior 25 mm más alta  
**R7** ranura inferior 15 mm más baja

### e La ranura intermedia es estándar

**T1** ranura superior/inferior a 7 mm de distancia  
**T2** ranura superior/inferior a 10 mm de distancia  
**T3** ranura superior/inferior a 12 mm de distancia

### Nota para las series BMW E30 con „M- Technik“ hasta agosto de 1988

Si va equipado con el kit deportivo „M“ (Bilstein), se precisan las siguientes piezas originales para montar el cartucho KONI:

Gama de tope Ref.	31-331-124-449
Cubierta antipolvo Ref.	31-331-134-314 (31-331-124-519)
Tuerca de cierre Ref. (carcasa McPherson Ø 45 mm) o	31-321-115-398
Tuerca de cierre Ref. (carcasa McPherson Ø 51 mm)	31-321-117-376

## NOTES

- ⊗ Gas-charged shock absorber.
- 🔽 CLASSIC color black.
- 🔽 CLASSIC color red.
- 🔽 Externally adjustable by means of a knob or pin without removing the shock absorbers from the car.
- + Additional parts, like brackets, required.
- ◆ Special McPherson insert, for sealed struts, bolted to the bottom after cutting the housing and removal of original inner parts. To be used in original struts only.

- ⊗ ☰ Bottom groove is standard
- M0 top groove 7 mm higher
- M1 top groove 10 mm higher
- M2 top groove 15 mm higher
- M3 top groove 20 mm higher
- M4 top groove 25 mm higher
- M5 top groove 30 mm higher

- ⊗ ☰ Top groove is standard
- N1 bottom groove 7 mm lower
- N2 bottom groove 10 mm lower
- N3 bottom groove 15 mm lower
- N4 bottom groove 20 mm lower
- N5 bottom groove 25 mm lower
- N6 bottom groove 30 mm lower

- ⊗ ☰ Top groove is standard
- P1 bottom groove 5 mm lower
- P2 bottom groove 6 mm lower
- P3 bottom groove 7 mm lower

- ⊗ ☰ Middle groove is standard
- R1 top/bottom groove each on 6 mm distance
- R2 top/bottom groove each on 10 mm distance
- R3 top/bottom groove each on 15 mm distance
- R4 top/bottom groove each on 20 mm distance
- R5 top/bottom groove each on 25 mm distance
- R6 top groove 25 mm higher
- R7 bottom groove 15 mm lower

- ⊗ ☰ Middle groove is standard
- T1 top/bottom groove each on 7 mm distance
- T2 top/bottom groove each on 10 mm distance
- T3 top/bottom groove each on 12 mm distance

## Note for BMW 3-series E30 up to August 1988 with "M-Technik"

If equipped with "M" sportpack (Bilstein), the following original parts are required to fit the KONI insert: Bumpstop part no. 31-331-124-449, Dustcover part no. 31-331-134-314 (31-331-124-510), Locking nut part no. 31-321-115-398 (McPherson housing Ø 45 mm) or Locking nut part no. 31-321-117-376 (McPherson housing Ø 51 mm).

## Axle loads

In order to choose the correct KONI STR.T KIT or KONI SPORT KIT with the correct characteristics and amount of lowering for your vehicle, maximum axle loads as indicated by the vehicle manufacturer may be of importance.

Maximum axle loads are in some countries mentioned on the vehicle documents, but can also be found in the car itself. Every vehicle carries a vehicle identification plate (metal plate or sticker), usually located in the engine compartment or on a door sill. Various information and weights are shown, needed are the fields marked with "1" and "2":

1 - Maximum front axle load      2 - Maximum rear axle load

	<b>FORD</b>		
<b>5</b>	<b>e13*2001/116*0144</b>		
<b>1</b>	<b>*WFOXXXGCDW4T701678</b>		
<b>Q</b>	<b>1880</b>	<b>kg</b>	
<b>1Q</b>	<b>3180</b>	<b>kg</b>	
<b>AN</b>	<b>1</b>	<b>995</b>	<b>kg</b>
<b>23</b>	<b>2</b>	<b>1060</b>	<b>kg</b>
<b>S</b>		<b>DA3</b>	<b>1.77</b>

## Important kit notes

- 1 The amount of lowering will be reduced on vehicles fitted with Original Sport Suspension /OEM
- 2 The lowering of the front axle depends on the vehicle specification and weight of the engine.
- 3 For fine tuning, please refer to the original Daimler Benz spring isolators available in different heights (8-23mm).
- 4 A TÜV certificate is necessary despite ABE for vehicles with a 'load dependant' brake power distributor.
- 5 Sedan without self-leveling, Estate/Station Wagon/Combi with self-leveling.
- 6 Additional lowering may occur on vehicles equipped with automatic transmissions.
- 7 Not for Station Wagons/Combi/Estates
- 8 Up to 8.79 please use spring seat no. 171412341A.
- 9 Excludes 4-wheel drive
- 10 As of 9.94 original Volkswagen springs seats might be necessary: 1H0412341 (big) or 357412341 A (small).
- 11 Not suitable for Serial/Original Sport Suspension (OEM)
- 12 Front springs only, torsion bars on the rear axle.
- 13 All wheel/tire combinations are allowed which have been approved by the ABE or other certified Wheel Testing Institutes (Germany, Austria, Switzerland).
- 14 If RH drive shaft diameter is bigger than 42 mm and when lowering 40 mm or more, the RH driveshaft may foul the anti-roll bar. If so you will need to fit a modified anti-roll bar or a longer steering rod from your VW/Audi dealer.
- 15 Excludes self-leveling.
- 16 Front & rear dampers are externally adjustable
- 17 Front dampers are externally adjustable
- 18 Rear dampers are externally adjustable
- 19 Rear dampers must be removed from car before they can be adjusted
- 20 excl. Cooper "S"
- 21 Front: threaded housing with adjustable spring seat
- 22 Rear: threaded housing with adjustable spring seat
- 23 Rear: ride height adjustable (adapter)
- 24 Rear: not ride height adjustable
- 25 With cars up to 5.92 the upper attachment must be replaced by BMW part number 31.331.090.467
- 26 Will be discontinued when current stock is depleted

**Any claims whatsoever derived from this catalogue cannot be accepted. Subject to change without notice. All rights reserved. Reproduction of this catalogue - even in part - is not allowed without our prior written consent.**



for complete catalogue visit  
[www.koni.com/finder](http://www.koni.com/finder)

SINCE 1857 | [koni.com](http://koni.com)