

The Single Habitat Module Concept for Exploration – Mission Planning and Mass Estimates

Joe Chambliss¹ and J. W. Studak²
NASA Johnson Space Center, Houston, Texas, 77058

The Single Habitat Module (SHM) concept approach to the infrastructure and conduct of exploration missions combines many new promising technologies with a central concept of mission architectures that use a single habitat module for all phases of an exploration mission. Integrating mission elements near Earth and fully fueling them prior to departure of the vicinity of Earth provides the capability of using the single habitat both in transit to/from an exploration destination and while exploring the destination. The concept employs the capability to return the habitat and interplanetary propulsion system to Earth vicinity so that those elements can be reused on subsequent exploration missions. This paper provides an overview of the SHM concept and the advantages it provides. The paper also provides a summary of calculations of the mass of the Habitat Propulsion System (HPS) needed to get the habitat from low-Mars orbit (LMO) to the surface and back to LMO, and an overview of trajectory and mission mass assessments related to use of a high specific impulse space-based propulsion system. Those calculations led to the conclusion that the SHM concept results in low total mass required and streamlines mission operations to explore Mars (or other exploration destinations).

Nomenclature

<i>AES</i>	=	Advanced Exploration Systems
<i>CCiCAP</i>	=	Commercial Crew Integrated Capability
<i>CLLS</i>	=	Closed Loop Life Support
<i>Cx</i>	=	Constellation (Program)
<i>DRA</i>	=	Design Reference Architecture
<i>DSH</i>	=	Deep Space Habitat
<i>DV</i>	=	velocity changes
<i>ECLSS</i>	=	Environmental Control and Life Support System
<i>EVA</i>	=	extravehicular activity
<i>fps</i>	=	feet per second
<i>HAT</i>	=	Human Architecture Team
<i>HPS</i>	=	Habitat Propulsion System
<i>HLV</i>	=	heavy-lift launch vehicle
<i>IMLEO</i>	=	Initial Mass in low-Earth orbit
<i>ISP</i>	=	Interplanetary Space Propulsion (system)
<i>ISRU</i>	=	In-Situ Resource Utilization
<i>ISS</i>	=	International Space Station
<i>JSC</i>	=	Johnson Space Center
<i>K</i>	=	Kelvin
<i>kWe</i>	=	kilowatt electricity
<i>LEO</i>	=	low-Earth orbit
<i>LMO</i>	=	low-Mars orbit

¹ Deputy Division System Manager for Exploration, Crew and Thermal Systems Division, 2101 NASA Parkway, Houston, Texas 77062/EC8 and AIAA Associate Fellow

² Aerospace Engineer, Power and Propulsion Division, 2101 NASA Parkway, Houston, Texas 77062/EP4

<i>LSS</i>	= Lunar Surface Systems
<i>MMSEV</i>	= Multi-Mission Space Exploration Vehicle (in this context, configured for in-space or surface mobility)
<i>MPCV</i>	= Multi-Purpose Crew Vehicle
<i>mps</i>	= meters per second
<i>MOX</i>	= liquid methane/liquid oxygen
<i>mT</i>	= metric tons
<i>MW</i>	= megawatt
<i>MWt</i>	= megawatt thermal
<i>NEA</i>	= near-Earth asteroid
<i>NEP</i>	= Nuclear-powered Electric Propulsion
<i>NSO</i>	= Nuclear Safe Orbit
<i>OAB</i>	= Orbiting Assembly Base
<i>SEV</i>	= Surface Exploration Vehicle
<i>SHM</i>	= Single Habitat Module
<i>SLS</i>	= Space Launch System

I. Introduction

When humanity goes to Mars and other exploration destinations, the approach employed will affect the success of the endeavor. Combining the best ideas for the technology with an efficient approach is most likely to result in mission success.

Deep space missions require that the crew be supported in transit and at exploration destinations for long durations. The Single Habitat Module (SHM) concept (Fig. 1) recognizes that crew support requirements for transit and while at a destination are roughly the same and thus could be addressed with a single module. Assuming the heritage of recent decades of human space operations in low-Earth orbit (LEO), the SHM concept starts with assembly of the exploration vehicle at a location near Earth using the capabilities humanity has developed and demonstrated in creating and operating the International Space Station (ISS). The SHM vehicle will include habitation to address crew support requirements and an efficient Interplanetary Space Propulsion (ISP) system to address propelling the vehicle to and from an exploration destination. Assembling and fueling the integrated vehicle near Earth provides the capability to start exploration missions fully fueled to meet the requirements of the mission. Being fully fueled at the start of each mission makes it possible to leave the vicinity of Earth with enough fuel to return a habitat from an exploration destination. Employing only one habitat can dramatically simplify mission conduct and make it possible to reuse mission assets.

The end of a SHM exploration mission results in the ISP system and habitat being returned to the near-Earth staging site. Those core elements are to be refurbished and refueled in space, then reused for subsequent exploration missions.

Such an approach to space exploration would focus development on the fewest possible number of exploration elements (the habitat and ISP) and enable reuse of those elements to provide a human exploration infrastructure that can address many exploration goals. A campaign of exploration missions using the SHM approach should be more quickly achievable and much more affordable (versus independent missions) since fewer elements are required.

This paper provides a description of the SHM concept, including ideas on how the concept could be implemented using a combination of new technologies and past exploration program concepts.

During late 2012, the Habitat Propulsion System (HPS) characteristics were established and the mass of the HPS was calculated. That provided the information needed to finish the first complete mission mass calculation for the SHM concept. The completion of the mass calculations is considered a major step because it enabled the first comparison of the SHM concept with the Mars mission addressed in the 2009 Constellation (Cx) Program Mars Design Reference Architecture (DRA)¹; however, because the SHM mission implementation was chosen to be for an exploration mission with 4 crew to spend 60 days on Mars and used technology options that are different than the 6 crew conjunction mission in the Mars DRA, a direct comparison is inappropriate.

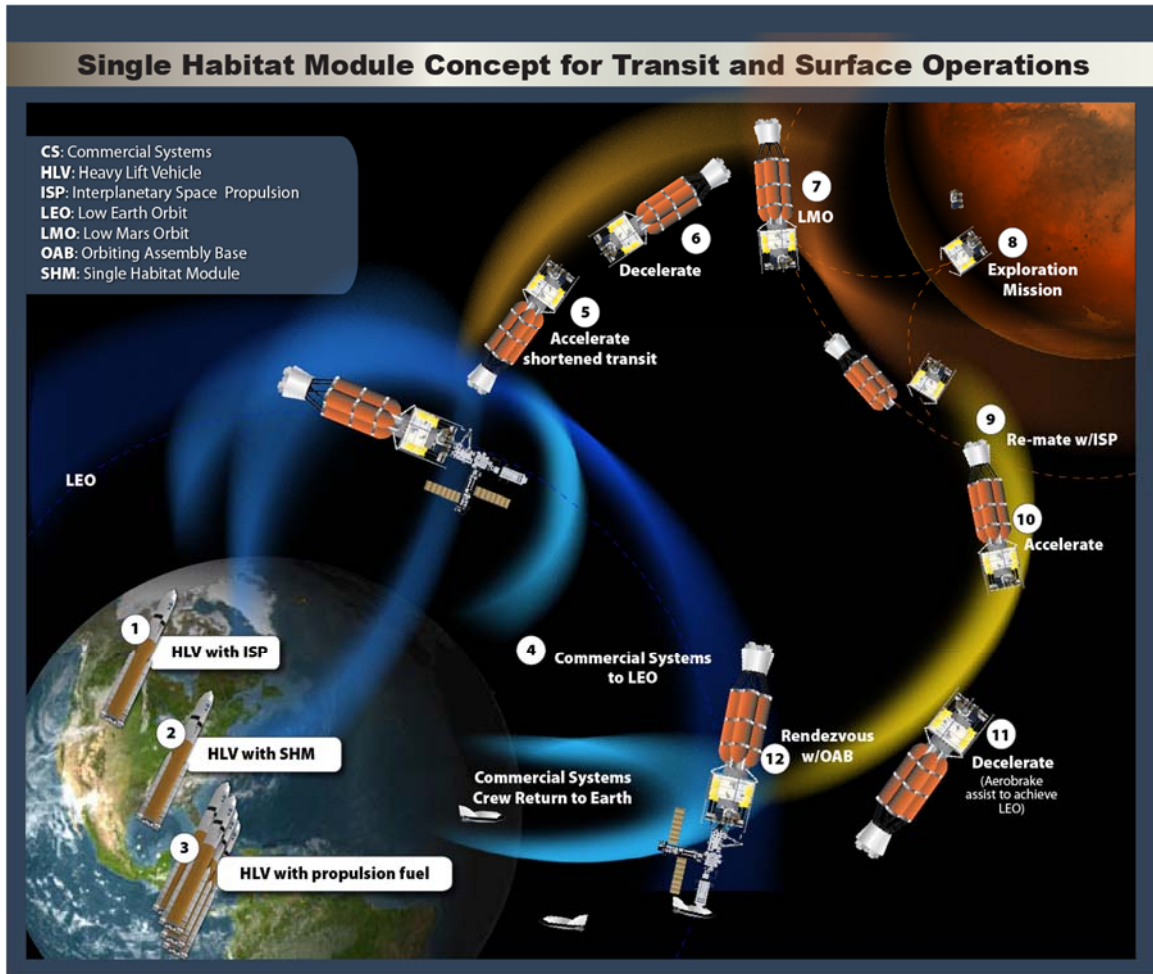

Figure 1. The SHM concept for a Mars surface mission (the design driving mission).

A. Single Habitat Module Concept Mission Operations

As illustrated in Fig. 1 for a Mars mission, each SHM mission would implement the following mission scenario:

- 1 thru 3 – Assemble and fuel the mission elements near Earth
Check out each element at the in-space assembly station
- 4 – Exploration crew to man the Orion or Commercial Crew Integrated Capability (CCiCAP)
- 5 and 6 – Transit to the deep space destination via the ISP system
Accelerate roughly ½ the way to destination then decelerate the rest of the transit to achieve low orbit at destination (use aerocapture assist to decelerate at Mars to aid in achieving low orbit)
- 7 – Separate the habitat with its propulsion system from the ISP system
- 8 – Use the HPS to descend and land at the exploration site on the destination surface
Conduct surface operations using the SHM as the base of operations (this is what it is all about)
- 9 – Ascend to low destination orbit via the HPS and rendezvous with the ISP system
Discard the HPS after re-mating with the ISP system to reduce return mass (possibly discard only the prop tanks to retain the engines for reuse)
- 10 and 11 – Use the ISP system to return to Earth vicinity orbit
Accelerate roughly ½ the way to Earth then decelerate the rest of the transit to Earth vicinity
- 12 – Rendezvous with the in-space assembly base
- 13 – Transfer crew to Orion (or CCiCAP) and use Orion (or CCiCAP) to return crew and samples to Earth

Only steps 7, 8, and 9 are critical to achieving the goal of the SHM concept of enabling use of a single habitat module throughout an exploration mission. Step 9 is the key to achieving the SHM single habitat and reuse goals. Other steps are essential to accomplishing a Mars mission but could be common with other Mars mission approaches.

Those operations would result not only in the conduct of an exploration mission but also in the return of the most critical of mission assets (the ISP and the habitat module) to near-Earth orbit. Returning those elements to near Earth provides the capability to reuse them for the next exploration mission.

A logical progression of missions using the SHM concept would be to develop the SHM habitat and ISP designed to conduct the most challenging exploration mission envisioned (at this date the Mars Surface mission). Those elements would be used for a sequence of progressively more challenging exploration missions. The first would be to conduct a near-Earth asteroid (NEA) rendezvous mission. After returning the SHM to the Earth vicinity, refurbish and resupply the ISP and SHM then conduct a lunar surface mission to test and demonstrate SHM capabilities to conduct a surface mission. Refurbish and resupply the ISP and SHM again at the near-Earth site, then conduct a Mars mission. The exploration sequence could be repeated to other destinations until the life limits of the SHM are reached.

B. Background

The Presidential Budget proposal for fiscal year 2011² contained several concepts that (if realized) can be used to improve the way deep space missions are conducted. It also directed NASA to focus on deep space missions, including a mission to a NEA and ultimately to conduct a human mission to Mars.

The SHM concept of a different approach to crew accommodations and mission conduct puts the new concepts together in a way that can make exploration more efficient and less costly, and would nearly eliminate the waste of mission resources. SHM combines the following concepts: CCiCAP (or Orion) access of crew to LEO; heavy-lift launch vehicle (HLV) launch of large payloads (now funded as the Space Launch System (SLS) Program); fueling (later refueling) (and assembly) in space; Closed Loop Life Support (CLLS); interplanetary space propulsion (probably nuclear powered); green technology (reuse mission assets and likely use of liquid methane as the SHM propellant); aerocapture; and possible ISS utilization. As of 2012, NASA is pursuing all of those new technology and vehicle efforts as currently funded projects or in future plans. The CCiCAP, Orion, and SLS projects are well under way.

This SHM concept was first communicated to the NASA Human Exploration Framework Team via an email in June 2010. It was proposed as a game-changing concept to the NASA Office of the Chief Technologist in September 2010. It was presented at the NASA Johnson Space Center (JSC) Innovation Day in May 2011 and at a Knowledge Capture forum in June 2011 at JSC. During those presentations, the concept was referred to as the Single Crew Module concept. (The change to SHM was made to eliminate confusion with mission concepts others have proposed involving a single crewmember.)

The SHM concept was described at the 2012 ICES conference.³ Progress in understanding the mission that would employ advanced technologies to implement the SHM concept was described at the AIAA Space 2012 conference.⁴ Progress on the SHM concept was presented to the JSC knowledge capture forum on October 17, 2012.

A series of top level assumptions were made to create a mission architecture for a Mars surface exploration mission to quantify the benefit of the SHM concept. In November and December 2012, calculations for the mass of the HPS needed to deliver the single habitat and Multi-Mission Space Exploration Vehicle (MMSEV) to the surface of Mars and return them to low-Mars orbit (LMO) to rendezvous with the IPS were completed. Knowing the HPS mass and the mass of the habitat/MMSEV led to the second iteration of the trajectory and mission mass assuming nuclear-powered electric propulsion. Thus, the first complete mass estimate of the SHM concept was completed.

This paper will summarize the earlier paper results, then it will focus on the way calculation of the HPS and then complete SHM mission mass was addressed and on the results.

II. Single Habitat Module Essentials

To achieve the goal of the SHM concept to efficiently conduct an exploration mission and enable reuse of the critical elements of an exploration mission, those elements must be designed to meet the needs of the most difficult exploration mission envisioned: the surface exploration of Mars. The vehicle that addresses the Mars surface exploration mission would be capable of missions to NEAs or the moon and would thus be reusable for those types of exploration missions.

The design driving case includes a Mars landing and surface exploration followed by return to Earth. Mars surface exploration requires that the habitat be equipped with propulsion capability to descend from LMO to land at

a designated exploration site, support crew operations while on Mars, and then ascend back to LMO to rendezvous with the ISP.

For the SHM approach, it is critical to return the habitat module and the MMSEV (for either in-space and/or surface mobility) to destination orbit then back to Earth since both the module and the MMSEV are essential for crew support and/or to address potential contingencies.

The habitat module of the SHM concept will need to address all life support and crew habitability and command functions for each entire exploration mission. It must provide enough resources for the crew to function during the long zero gravity (or very low acceleration of the ISP) of the to-and-from transit phases and also be compatible with the long-duration surface exploration phase in the partial gravity of Mars or the moon.

Cabin atmosphere leak or contamination and other contingencies must be addressed.

Extravehicular activity (EVA) and mobility capabilities are required to enable exploration at the destination.

III. Single Habitat Module Concept Implementation

If implemented, the SHM concept will have a program to develop the best design for the variety of elements. Design development of the SHM would consider many aspects of the mission to use the technology available during the design period to accomplish the exploration goals. The Cx Program and technology development efforts have provided many options for how to implement such a concept. Many options are possible for the technologies involved in specific parts of each deep space mission. The Advanced Exploration Systems (AES) Program and Office of Chief Technologist efforts will address verifying that new technology candidates are ready to make the new vehicles robust and efficient in accomplishing mission goals. Mass minimization, reliability, and safety will be key design considerations.

Based on the author's knowledge of Cx program planning, new technology development plans and projects and interaction with key new technology development project leads, the features described in the following section and in Fig. 2 make sense for potential design solutions for the SHM concept. If the SHM concept is adopted by an exploration mission development team, other implementation options will probably be considered.

The selected concept implementation takes into consideration technology options that are, or are expected to be, available, as well as vehicle element concepts. This basic concept for SHM implementation was used in mission Initial Mass in low-Earth orbit (IMLEO) mass calculations that will be presented. A later section will address options that will probably lead to less mass to Mars surface and thus much less mission mass.

The CLLS, thermal control, EVA, and command and habitation capabilities (needed to support the crew during the entire mission) need to be as efficient as possible to minimize mass of both equipment and consumables. Long-duration missions have been shown (in exploration trade studies) to greatly benefit from regenerating resources. The longer the mission, the more beneficial regeneration of resources becomes. A single habitat and command module will take advantage of the benefits of regeneration for the entire duration of the mission. The most reliable solution will be employed, combined with appropriate redundancy and sparing.

The intent of the use of CLLS is to recycle as much of the life support products as possible and relevant using the best technological options that are mature when vehicle design is conducted. It is expected that the CLLS will be partially regenerative in that most crew-generated waste products will be regenerated into resources to be used by the crew. It is anticipated that the CLLS will not include bioregenerative technologies since those are better suited for long-duration large crew missions or colonization. The complement of Environmental Control and Life Support System (ECLSS) technologies used in calculating consumables for the SHM Mars mission is based on a combination of ISS heritage technologies and new technologies for improving reliability and level of regeneration of waste products. The technologies used in calculations are those identified in a Deep Space Habitat (DSH) Point of Departure for a long-duration Mars mission study defined in February 2012.

The CLLS implemented will have to address the most demanding of the environments, whether that occurs in transit or during surface operations. The CLLS will minimize waste products, which will partially address planetary protection issues.

Thermal control radiators must address the peak heat loads in transit and at Mars. Radiators that work efficiently in deep space may also work well in a convective Martian atmosphere.

EVA capabilities will be required at the exploration destination. EVA interfaces would need to be robust to address the dust environment and provide the isolation needed for the crew from potential Martian contamination. The suit port concept⁵ would provide very efficient EVA capabilities and would address the dusty environment. The same EVA system can address potential contingencies during transits and at the destination.

The inclusion of an MMSEV would address the exploration mobility and EVA capability needed at the destination. The MMSEV would also be capable of addressing many potential cabin contingencies since it can

function for an extended period of time as an independent spacecraft. It also offers efficient, independent EVA capabilities.

Landing gear is required for the lunar and Mars missions. The landing gear could be detached and left on the surface to reduce return mass.

It must be emphasized that the SHM portrayed in Fig. 2 is only one way the SHM concept could be implemented. The architecture of Fig. 2 does address several areas that have been identified as concerns for long-duration exploration missions. Surrounding the habitat with propulsion propellant provides a substantial amount of radiation protection during the transit from Earth to Mars. Having the propulsion system around the habitat rather than under it takes advantage of the capability to assemble elements in space and results in the MMSEV being positioned such that access for surface exploration does not require removing large modules from the top of a vehicle. The use of aerocapture at Mars reduces the time required to enter LMO and the propellant needed to land the habitat on the surface. Inclusion of the MMSEV for all mission phases provides a contingency habitat capability. The MMSEV also provides efficient EVA capability that can be used not only for exploring at a destination but during transit (if needed). The MMSEV-provided EVA capabilities could also be used during assembly of the SHM and during refurbishment and resupply between exploration missions.

The SHM concept assumes that the capabilities developed during the assembly and operation of the ISS can be used to address assembly of exploration vehicles. Assembly at the ISS for the habitat parts of the vehicle is possible, but final assembly and departure need to be from a Nuclear Safe Orbit (NSO) orbit of at least 500 km (310 mile) altitude. NASA, commercial, and international assets can be employed in the assembly of the SHM and in providing parts of the SHM itself. Reuse of the IPS and habitat elements is to be done after return of those elements to the orbiting assembly base.

Assembly of the SHM, reuse of mission assets, trajectory, and IMLEO initial iteration calculations were presented in the AIAA Space 2012 paper.⁴

IV. Calculation of the Mass of the Single Habitat Module Concept as Implemented for a Mars Mission

The benefits of the SHM approach are only speculation until a set of calculations can establish the important parameters of a mission that uses the SHM approach. An exploration team can go into a fairly detailed assessment of the parts of an exploration mission to establish such parameters. The authors propose that such a team be tasked with a detailed assessment of the SHM concept so that its merits can be better established.

A top-level mission concept of a mission to Mars and initial calculations of mission mass have been undertaken to convince an exploration team to use engineering resources to assess the SHM concept. Mission mass calculations result in an estimate of the IMLEO. The IMLEO for a mission using the SHM approach can then be compared against the IMLEO for similar missions using alternative approaches (e.g., the Mars DRA).

IMLEO is a good starting point to compare the merits of exploration mission approaches because it is the single most significant parameter in determining the feasibility of a mission because IMLEO relates to the cost of launching mission elements into space. However, even the use of IMLEO as a basis of comparison must be qualified because there are other mission parameters that are not directly comparable. For example, missions using high specific impulse, long-duration propulsion systems will have mission profiles significantly different than for a more traditional boost then coast trajectory approach. That difference means the traditional terms of conjunction versus opposition trajectories need significant qualification.

The SHM concept evaluation is focused on the flight elements required to get from Earth to Mars and return to Earth. Thus, the IMLEO in this assessment does not include the mass of the near-Earth infrastructure that is required and assumed to be available. The Orbiting Assembly Base (OAB) is assumed to be available for assembly of the SHM elements. Such an orbiting facility is probably required for other exploration mission approaches as well, and is thus not considered relevant to include in comparisons of approaches.

The capability of the Multi-Purpose Crew Vehicle (MPCV) system to launch a crew to the SHM at the end of its outbound spiral and then to rendezvous with the returning SHM at the start of its inbound spiral is assumed. Based on the missions for which the MPCV is being designed, that capability is likely but would require validation.

Comparison of the SHM must be qualified, due to many factors. However, comparisons can lead to enough insight to determine whether the SHM concept should be studied more thoroughly. The following sections provide data that lead the authors to conclude that the SHM approach can provide significant advantages and, therefore, should be studied more thoroughly.

A. Mars Mission approach for Single Habitat Module

To assess the SHM concept for using a single habitation module for all mission phases, a set of mission assumptions was developed. The mission assumptions were based on the presidential direction² to conduct exploration rather than establish permanent habitation (as was the Cx Program goal for the moon). The approach to conduct exploration of potential sites (to learn about those sites and gain enough knowledge of the site on which to base future exploration, commercialization, or colonization decisions) is deemed prudent.

The SHM mission assumptions used to define the mission were focused on getting to Mars (the most demanding currently envisioned human mission) and conducting exploration for a period thought to be reasonable from the landing site, then initiating the return mission.

The authors made several top-level decisions on the mission content to enable mission definition and parameter estimation:

- 1) A crew of 4 was selected as a minimum crew for a long-duration exploration mission.
 1. Recent trends toward 4 crew missions was a factor in deciding that 4 crew was a good option for an exploration mission.
 2. A crew of 4 is consistent with decreasing the MPCV crew complement to 4 (from 6 originally).
- 2) Start of the mission was selected to be during a period when the transit time to Mars would require a near-minimum amount of fuel and transit time to get to Mars.
 1. That minimizes propellant required during the period when the vehicle is the most massive.
- 3) 60 days of mission operations while on the surface of Mars was established as a period long enough to conduct all exploration that is appropriate from a single landing site.
 1. That allows an estimated 3-4 MMSEV roving traverses of up to 2 weeks each.
- 4) Since the surface mission is 60 days and not the 539 days required for a conjunction trajectory to/from Mars (as in the Mars DRA), the authors decided that In-Situ Resource Utilization (ISRU) implementation is not essential for such an exploration mission.
 1. It is recognized that ISRU on Mars will be very important for longer duration missions and any “exploration” mission should include studies of the potential for use of in-situ resources such as carbon dioxide and water that can be used to make fuel and oxygen.
- 5) Robotic missions to the specific site for the human mission are deemed not to be essential since robotic missions have characterized the Mars surface sufficiently to select suitable landing locations.
 1. The use of the MMSEVs is viewed as the most productive use of robotics combined with humans to enable exploration of a large part of Mars.
- 6) The return trajectory is probably not optimal for fuel use on the return but the mass of elements of the vehicle will be the lowest then. Thus that trajectory may be acceptable.

Refinements to optimize the trajectories to further minimize the mass of SHM elements is viewed as forward work.

The JSC aerospace and flight mechanics division (JSC EG) was contacted for assistance in employing a high specific impulse long-duration propulsion system to define the trajectory and duration of a mission from Earth to and from Mars. Experts in EG (primarily Ellen Braden) have developed programs to define trajectories using such technology, and those programs were used to assess the SHM concept. An initial trajectory analysis established a mission profile with a prediction of the habitat elements in the summer of 2012. That trajectory led to an initial timeline for a Mars mission that was used to resize habitat elements.

That habitat sizing was used to communicate the SHM concept to Bill Studak, JSC propulsion and power division (JSC EP) expert and co-author. The JSC EP expertise in sizing propulsion systems using liquid methane /liquid oxygen (MOX) was used to calculate the size of the HPS needed to land the habitat and then launch it back to LMO.

The estimate of the HPS and habitat element mass was used by EG experts to refine the trajectory and ISP mass.

The approach to calculating the mass of the SHM concept was addressed in the 2012 ICES paper.³ That approach was implemented and resulted in the calculation of the HPS and IPS masses that, combined with the habitat, MMSEV, landing gear, and aerocapture heat shield, complete the calculation of the IMLEO for the SHM as implemented in Fig. 2. To summarize that sequence of calculations for a design driving Mars surface mission:

- 1) The mass of a habitat, MMSEV, and landing gear was estimated for a Mars surface mission based on DSH AES and earlier Cx studies. Consumables mass was calculated based on an assumed set of CLLS equipment and calculation of the length of a Nuclear-powered Electric Propulsion (NEP) propelled mission duration
- 2) The mass of the aerocapture heat shield was estimated based on 20% of the total SHM vehicle mass (based on preliminary heat shield design concepts)

- 3) The mass of the HPS system required to land and then relaunch the habitat/MMSEV was calculated assuming a MOX propellant system
- 4) The trajectory and IMLEO mass was recalculated using the combined habitat, MMSEV, landing gear, heat shield, and HPS mass to be delivered to LMO, then returning the habitat/MMSEV from LMO to LEO
 - a. It was assumed that Orion delivers the crew to the SHM at the end of its spiral leading to departure from Earth; then Orion rendezvous' with the SHM at the start of its spiral toward return to LEO to return the crew to Earth (as the habitat and ISP continue to spiral to LEO). This approach minimizes crew time in transit.

A. Habitat Propulsion System Implementation

Prior Cx exploration scenarios to the moon⁶ or Mars¹ required a propulsion system that was to deliver an unoccupied, long-duration habitat for crew occupation to the surface. The SHM concept requires that the habitat not only be delivered to the surface but also be returned to orbit to rendezvous with the ISP. The propulsion system of planned Cx missions (which has been assessed to be feasible) had significant capability. The primary difference between the Cx and SHM concepts is in the amount of fuel the HPS requires to perform the ascent. Considering that the landing gear is probably left on the surface, and given enough propellant, a system capable of launching the habitat from the .377 g Mars gravity well is viewed as feasible.

The earlier SHM paper⁴ described the way a HPS could be implemented such that propellant tanks provide radiation protection for the habitat during the transit to Mars. That system would employ a MOX propulsion system that would provide redundancy during descent and ascent. The use of MOX propulsion addresses the need for long-term storage of propellants while in transit to Mars. Cryo-coolers may be required to address propellant storage thermal conditioning while at either the moon or Mars.

Summer 2012 trajectory assessments have confirmed that aerocapture makes sense to enter Mars orbit, then to provide braking prior to landing. An aerocapture/heat shield will be used below the MMSEV to aid in the deceleration of the entire SHM to enter Mars orbit. The same aerocapture/heat shield is then used (after habitat separation) to decelerate the habitat during Mars descent. The aerocapture/heat shield is to be detached prior to landing to enable habitat landing. The HPS is required to complete the maneuvers to land on Mars, then to launch the habitat to rendezvous with the ISP in Mars orbit.

1. Propulsion system and fuel mass calculations

The trajectory assessments provided calculations⁴ of the velocity changes (DV) needed to land on Mars (244 meters per second (mps) (800 feet per second (fps)) and the DV needed to ascend and rendezvous with the IPS (1189 mps) (3900 fps). Those DVs were combined with the habitat/MMSEV mass estimates at descent (39,400 kg (86,862 lb)) and ascent (37,400 kg (82,453)) to calculate the mass of the propulsion system (HPS).

To calculate the mass of the fuel required to decelerate the habitat elements to land requires that the mass of the fuel required to return from the Mars surface to LMO be known. The mass of the ascent habitat/MMSEV was used to calculate the fuel and propulsion system (HPS) mass to lift and accelerate that mass by the 3900 fps required. The mass of the fuel required for the descent DV of 244 mps (800 fps) was calculated using that ascent HPS mass and the descent mass of the habitat, MMSEV, and landing gear.

The mass of the propulsion system (the rockets, infrastructure, and tankage) was calculated to be 13,100 kg (28,880 lb) using a MOX engine performance (a little less specific impulse than a liquid oxygen/liquid hydrogen engine but much more tolerant of the long-duration deep space and Mars surface environments) and using propulsion system mass design experience (to estimate the size of the propulsion system for the habitat and propellant mass). That propulsion system is to be used for both descent and ascent.

The mass of propellant needed to provide the 3900 fps DV needed for ascent from Mars and rendezvous with the ISP was calculated to be 93,400 kg (205,912 lb), resulting in a total ascent mass of 143,800 kg (317,025 lb).

All the ascent/rendezvous mass plus the landing gear was included in calculation of the descent mass. To provide the 244 mps (800 fps) DV on descent was calculated to require 38,100 kg (83,996 lb) of MOX propellant.

Combining the masses, the SHM concept requires that the ISP provide transit from Earth to Mars for a combined 184,000 kg (405,650 lb). That mass includes the habitat, MMSEV, HPS, and landing gear. On return from Mars to Earth, the IPS needs to provide transit of only the habitat and MMSEV or 37,400 kg (82,453 lb). The landing gear is left on Mars (or the moon) and the HPS is assumed to be left in Mars orbit since it is not required for the return transit. The HPS and landing gear elements would be replaced during the refurbishment and refueling operations near Earth before the next exploration mission. The logic for calculating the mass of the variety of mission elements is shown in Fig. 3.

Figure 2. Mass Calculation Logic leading to an estimate of the initial mass of the SHM leaving LEO.

The habitat/MMSEV, landing gear, and HPS masses summarized in Table 1 include the first HPS mass calculations for the SHM concept.

Table 1. SHM Mars Mission Mass Budget (mT)

Mission Phase	Payload of the Phase	ISP Fuel Mass	HPS Fuel Mass	Total Vehicle Mass
IMLEO	ISP, Habitat, MMSEV, Landing Gear, Aerocapture Heat Shield, HPS	153	132	512
Arrival in LMO	Same as above	70	132	452
Surface Operations (see below)				
Start of Mars-to Earth transit	ISP, Habitat, MMSEV	70	NA	226
Arrival in LEO at OAB	ISP, Habitat, MMSEV	0	NA	156

Surface Mission Phase	Payload of the Phase	ISP Fuel Mass	HPS Fuel Mass	Total Vehicle Mass
Start of Propulsive Descent	Habitat, MMSEV, Landing Gear, HPS	NA	132	184
Surface Operations	Habitat, MMSEV, Landing Gear, HPS			
Start of Ascent to LMO	Habitat, MMSEV, HPS	NA	94	144
After ISP Rendezvous	Habitat, MMSEV	0	0	38

C. Interplanetary Space Propulsion System Implementation

ISP system efficiency is critical to the feasibility of deep space exploration. Chemical propulsion can work, but the mass required would be very high. Due to the dramatic specific impulse achievable via electric propulsion, a factor of 10 less propellant might be required (versus Space Shuttle vintage chemical propulsion).

High power is required to achieve both the high specific impulse and the moderately high thrust desired for deep space human-sized mission transit. To provide the high power levels needed probably requires that nuclear (versus solar electric) power be employed. Studies by NASA on nuclear-powered propulsion systems have developed concepts for up to 5 megawatt (MW) NEP⁷ systems illustrated in Fig. 3. The feasibility of the NEP concept leads to the mission mass of a SHM that employs a 5 MW system to power the ISP as the basis for trajectory and mass calculations for a mission to the surface of Mars.

Figure 3. Nuclear propulsion study architectures leading to a 5 MW NEP powerplant.

1. Calculation of Initial Single Habitat Module Mass in Low Earth Orbit

The first iteration of SHM IMLEO calculation⁴ established the mission parameters needed to calculate the length of mission, related habitat size, consumables required, and velocity changes required for a NEP-powered mission. That information allowed calculation of the HPS mass, which was estimated to be 144,600 kg (318,788 lb). The HPS mass combined with the rest of the SHM elements (184,000 kg (405,650 lb)) was then used to perform the second iteration of the total mission trajectory, mission duration, and IMLEO.

The second iteration is viewed as the initial estimation of the mass of the SHM concept in IMLEO since it uses the combined mass of all the elements of the mission.

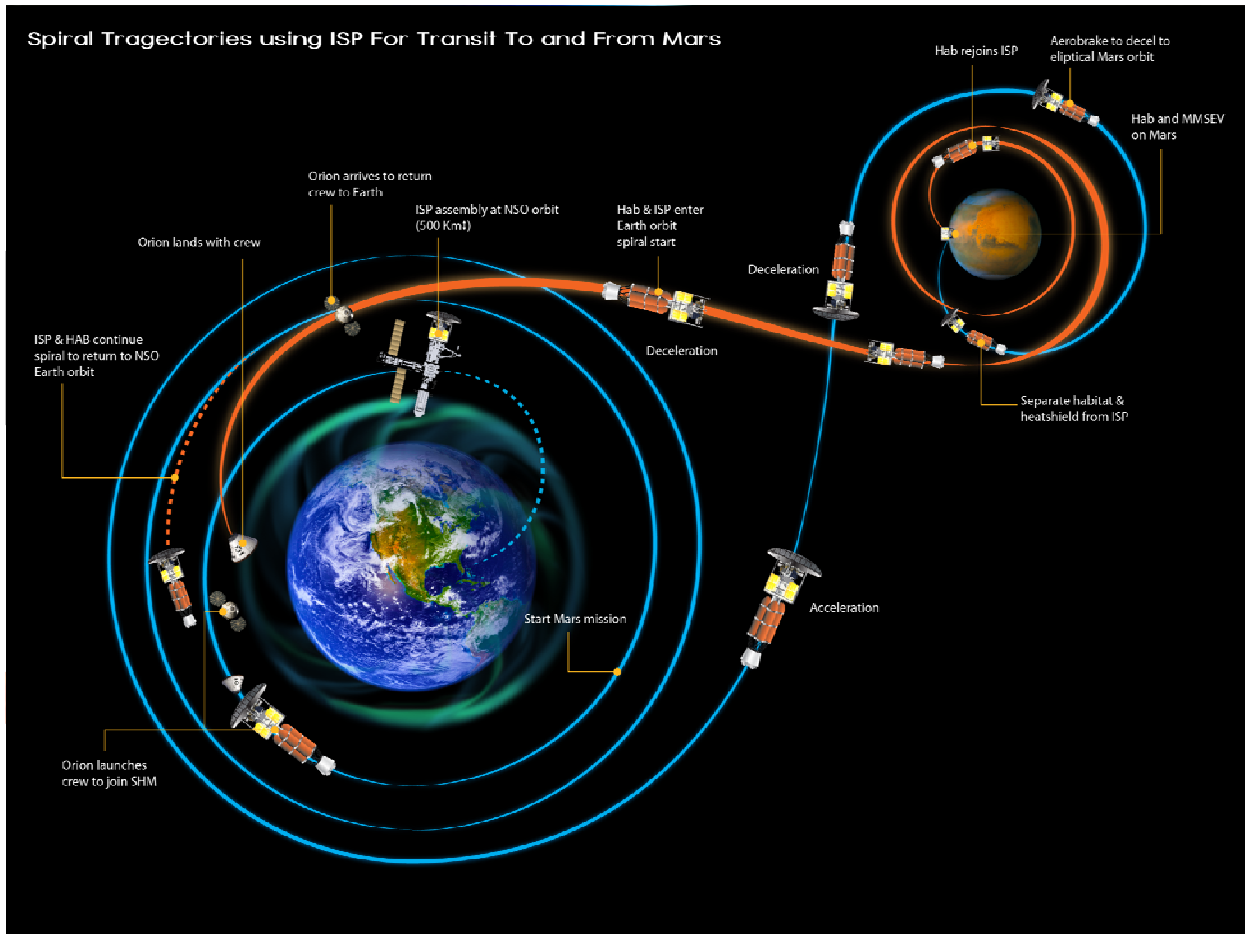

Figure 4. The spiral trajectory resulting from the implementation of a high specific impulse ISP system.

Two cases were assessed to evaluate the effect of added nuclear power on mission mass and mission time. The first used a 5 MW NEP powerplant, whereas the second assumed a 10 MW powerplant. Both cases assumed a starting point at a NSO of 500 km (310 mile) circular LEO, a power delivery efficiency of 0.8, powerplant specific mass of 6 kg/kw, and structures and heliocentric tank mass of 15% of the vehicle mass.

2. Mission Parameters Used in Case Studies

Both cases assume that the SHM starts uncrewed from the NSO and spirals from Earth, increasing velocity until escape from Earth gravity and the transit to Mars. To minimize exploration crew time, it is assumed that the crew is launched to the SHM on an Orion vehicle that rendezvous' with the SHM just prior to escape from the vicinity of Earth. The details of the Orion delivery of the crew and the use of the Orion after crew delivery are details that are future work. It is possible that a crew flies the SHM to that point, hands over SHM control to the exploration crew, and then uses the Orion vehicle to return to Earth. Each case also assumes the use of an aerocapture/heat shield to aid in deceleration of the SHM entire vehicle using the Martian atmosphere as a brake. The same heat shield is used after the habitat elements are separated from the ISP for the Martian descent and landing. The aerocapture/heat shield is used to provide most of the deceleration of the habitat, then it is discarded and the habitat HPS is used to propulsively land on Mars.

Starting the missions was determined to be best at a time when Earth and Mars alignments provided minimal DV requirements for the transit. For missions using NEP, the transit times are different than for those using more historic propulsion systems, thus the Hohman transfer timing is a little different. Considering those parameters, each of the case studies is started on 1/2/2028. Since the transfer of the vehicle to Mars requires more propellant than the return transit, this approach minimized mass required for the Mars-bound transit.

To target a realistic mission on Mars, the authors estimated of the amount of time needed to conduct exploration near the landing site. It was assumed that MMSEV aided exploration of the selected site could be done in 2 months.

That would allow time for three or four MMSEV exploration excursions, each followed by MMSEV resupply and refurbishment at the landing site. It should be noted that the MMSEV is returned to Earth with the habitat because it serves as not only a surface mobility aid, but also as a contingency vehicle to address potential cabin contingencies that could happen at any time during the mission.

The spiral away from Mars takes around 22 days (in Case 1; 18 days for Case 2). It is assumed to start when the crew launches and rendezvous with the ISP. For the return transit, the landing gear is assumed to be left on Mars and the HPS system is assumed to be left in Mars orbit since it has completed its function of returning the habitat and MMSEV to the IPS.

The return from Mars to Earth is thus timed by the near optimum transit to Mars and the duration of the stay on Mars that was selected based on the amount of time needed to conduct exploration at a single site. Return starting at that time is not necessarily optimum, but the return mass is much less than the vehicle mass during the transit to Mars, thus compromising mission efficiency a little to reduce exploration crew time. In Case 1, the return transit was nearly optimal, as shown in Fig. 5. In Case 2, the timing was not optimal, thereby leading to a much longer return and much greater propellant use. More optimum mission timing would improve Case 2 results significantly.

At the end of the mission, both cases assume that the deceleration of the SHM will be done propulsively using the ISP. However, the crew is planned to egress the SHM to board an Orion at the start of the inbound Earth spiral to return to Earth, thereby reducing the time the crew spends on the mission. The SHM elements continue to spiral

toward the assembly station at the NSO. Since nuclear power is employed, the use of an aerocapture/heat shield to decelerate at Earth is not acceptable (otherwise it would be very beneficial).

Results show that the time required to conduct the Mars surface mission can be reduced by increasing the power of the nuclear powerplant by 58 crew days (134 for the total mission). However, the IMLEO increases from 512 to 731 metric tons (mT) with the increase in powerplant power. The Mars-to-Earth return for case 2 was not optimum. Thus even though the time required to reach Mars is less than case 1 (713 versus 985 days); the longer helio-centric return (372 versus 216 days) resulted in the total crew time only being 58 days less. Thus, a trade of higher mission mass versus shorter mission length is required.

The spiral away from Earth is shown in Fig. 4 to illustrate the mission concept and show added detail for that part of the mission.

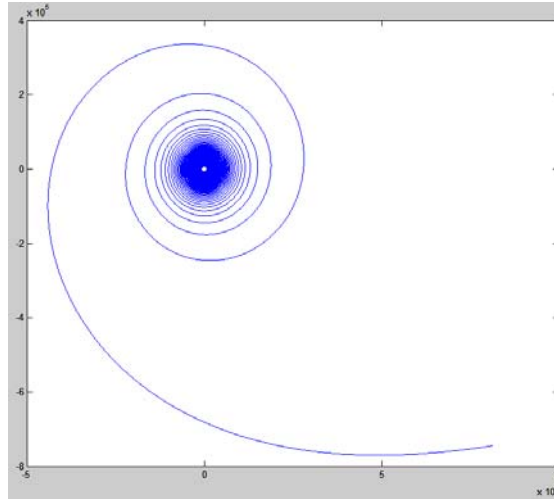

- Earth escape spiral (crew not on board)
 - Initial mass = 512 mT
 - Powerplant = 30 mT
 - Structure = 55 mT
 - Aero shield = 67 mT
 - Propellant used = 51 mT
 - Payload = 309 mT
 - Begins spiral 1/2/2028
 - Assumed constant Isp, 7000 sec
 - Time = 345 days

Figure 4. The Earth Escape Spiral to depart from a 500 km altitude NSO.

The orbital mechanics for using a high ISP approach for a Mars surface mission are shown in Fig. 5.

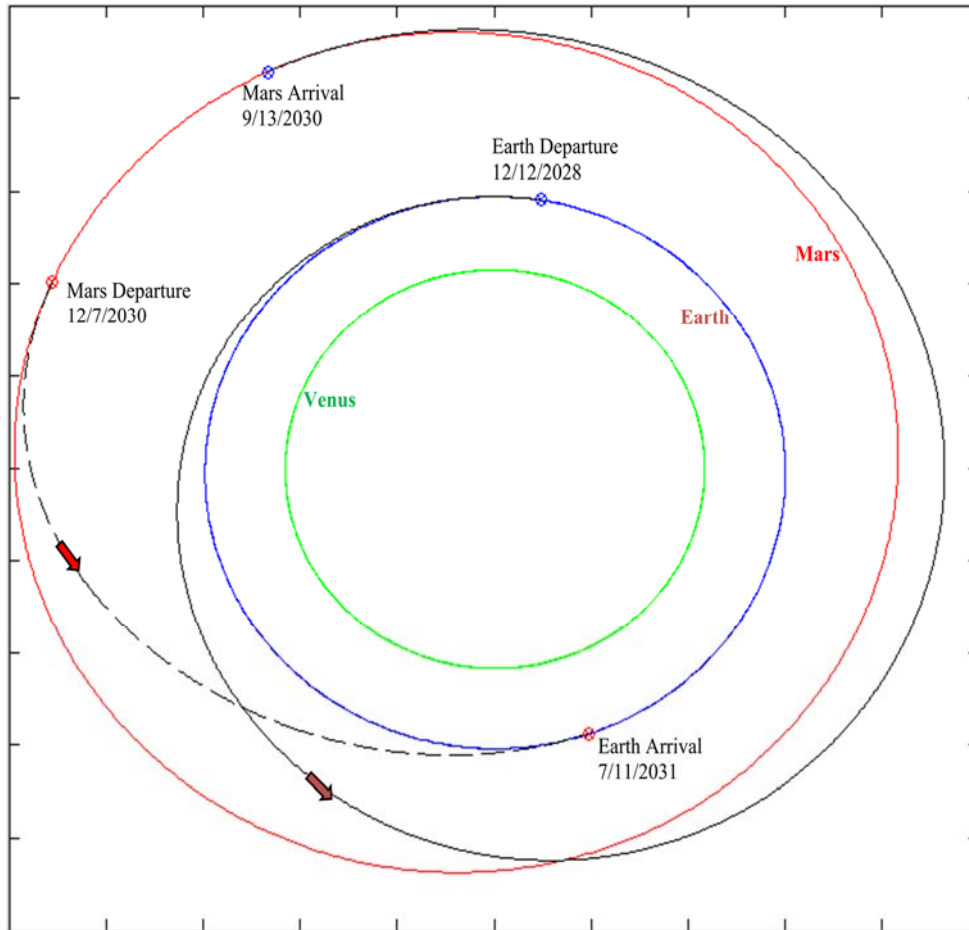

Figure 5. Case 1 - Heliocentric view for a 5 MW powerplant powering the ISP for a SHM mission.

B. Comparison of Single Habitat Module Elements to Those of Apollo and Constellation Exploration Plans

The SHM concept is not directly comparable to past exploration approaches since it employs technology advances that were not considered in the past, and since it reuses mission assets. The SHM approach of developing an exploration capability that can be employed for any exploration destination results in a significantly different complement of mission assets than other approaches.

Many differences between the SHM mission are addressed in the SHM concept and the Mars DRA mission. The Mars DRA employed Nuclear Thermal Rocket technology that is comparable in efficiency to the NEP technology assumed for the SHM concept. However, the Mars DRA planned for a crew of 6 and using a conjunction trajectory to be fuel efficient led to staying on Mars for 539 days. Staying on Mars for that length of time contributed to a decision to employ ISRU to use Martian carbon dioxide and Martian water to make MOX propellant. That length of time on Mars is sufficient to provide a significant amount of ISRU-generated MOX propellant.

The authors feel that the length of time required to have Mars and Earth align to minimize the fuel needed for the return trajectory is much more than enough time for the crew to thoroughly explore the landing site. The SHM target of 60 days probably makes ISRU-generated MOX insufficient to be significant for propulsion. The timing and the complication of adding ISRU to an exploration mission led to not including ISRU in the SHM concept implementation.

The following top-level comparisons can be made, ignoring the differences in crew complement and time spent on Mars. The Mars DRA¹ requires 914 crew days to complete. Thus, the 5 MW SHM concept crewed mission duration is slightly longer than the Mars DRA; however, the IMLEO for the SHM concept is 512 mT compared to 848 mT for the Mars DRA. Based on these preliminary calculations, implementing the SHM concept versus the

Mars DRA concept could save 336 mT (over 40%). Thus, (at a top-level) the SHM concept offers an alternative to exploration of Mars that may be attractive.

However, as noted at the start of each of the case summaries, the mass associated with the Orion vehicle (approximately 11 mT) and the propellant mass associated with Orion transit from LEO to rendezvous with the SHM is not included in the SHM mass estimate. Also, the mass of the Orion and its propellant that rendezvous with the SHM at the end of the return transit is not included in the SHM mass. The mass of the Orion vehicle is included in the Mars DRA mass estimates. Thus, the difference between the concepts will be less than 336 mT. Calculation of those added masses associated with the SHM concept is viewed as future work; however, it is expected that most of the 336 mT difference will be saved if the SHM concept is employed.

Comparing Case 2 versus the Mars DRA shows that 56 days of crew time and 117 mT could be saved if a 10 MW powerplant is employed. However, the 10 MW powerplant is beyond the current nuclear power feasibility studies, thus higher risk would be incurred if that level of power is planned.

1. Qualitative Comparison of the Single Habitat Module Approach versus Constellation and Human Architecture Team Approaches

SHM could be compared directly to the Cx Mars DRA to compare assets and thus understand the benefits. Alternatively, SHM could be compared to the elements required to conduct a lunar sortie mission. Those comparisons would address the benefits of the mission simplification associated with the SHM. However, such comparisons would be somewhat misleading since one of the benefits of the SHM concept is the reuse of mission assets and, when compared to a single mission, those benefits are not considered.

The most appropriate comparison of past approaches and SHM is to compare the combination of NEA, lunar landing, and Mars surface missions. The Cx DRAs require the following: separate crew accommodations for transit, descent, ascent, and surface operations; new vehicles for every mission; prepositioning mission assets at exploration locations; (for the Mars DRA) in-situ resource utilization to provide propellant for the return mission. The SHM simplifies the mission complement of elements since only 1 habitat and ISP is required (+2 refuel and refurbishment operations).

Top-level comparison of elements required to depart from Earth for exploration missions comparing the SHM complement to Human Architecture Team (HAT) NEA mission, Cx Lunar Sortie, and the Cx Mars DRA:

SHM for the three missions	Habitat, MMSEV, ISP plus two refurbishment and refuel operations, plus probably several MPCVs
HAT NEA	Orion, DSH, MMSEV, Solar Electric Propulsion, MPCVs
Cx Lunar Sortie mission	Orion, Altair (Lander, Ascent)
Cx Mars Surface mission	Orion, DSH, Surface Habitat, two Nuclear Thermal Rockets, Surface Exploration Vehicle (SEV), Combined Descent and Ascent Vehicle, Mars Ascent Vehicle

The SHM mission assessed is much simpler and requires less mass than the Mars DRA but addresses different mission goals.

Comparing elements required for the approaches leads to an appreciation of the ways in which the approaches are different. Qualifications to such comparisons are that the masses of the SHM habitat and ISP systems are rough calculation and the SHM refurbishment and refuel process will require launch of materials from Earth. The authors speculate that NEA and Cx Mars DRA missions would also require some level of assembly near Earth prior to departure. The SHM approach of decelerating the ISP and SHM to return to Earth vicinity will require more propulsion capability than the direct atmospheric reentry planned for the HAT NEA and Cx lunar sortie and Mars DRA, but the SHM approach enables reuse of those critical elements.

F. Why Single Habitat Module is Expected to Reduce Cost and Time Required to Explore

The SHM concept was calculated to be a low mass-to-destination approach when the mission from Earth to Mars and back is considered. Part of that savings is because prepositioning a habitat and separate descent and ascent vehicles is not required for the SHM concept. In addition to the low mission mass, fewer exploration elements are required using the SHM concept (versus the Mars DRA), thus a program using the SHM approach should be more streamlined and focused. Development of fewer vehicles should reduce the schedule to start exploration.

Efficiencies in development organizations needed and the cost to conduct missions will be realized because fewer project organizations are needed.

Reusing mission assets for subsequent missions will dramatically reduce the cost and schedule for subsequent exploration missions.

The in-space assembly base (perhaps ISS, but more likely ISS-derived) could be used to support Earth orbit and other Earth vicinity (Lagrangian or lunar) NASA and/or commercial activities between exploration missions. Such a multi-use facility will reduce the cost of the other NASA and/or commercial missions.

V. Summary of Single Habitat Module Approach Benefits

The benefits of the SHM approach center around the single vehicle needed to conduct exploration. Supporting the crew through the entire mission in one habitat simplifies the total mission and enables reuse of mission assets. SHM approach benefits include:

- 1) A single module that addresses crew functions for all mission phases
 - a. This eliminates modules that, in Cx approaches, are required for transit from orbit to destination surface (i.e., Altair descent vehicle), a surface habitat, and an ascent vehicle to return to orbit
 - b. Reducing the number of exploration elements reduces the number of projects required for exploration, thus reducing the size of the organization needed to implement exploration
- 2) Elimination of the need to develop new vehicles for subsequent missions
- 3) Transportation of significantly less mass to destination
- 4) Use of regenerative technologies that minimize mass via use for the entire mission
 - a. Versus less efficient descent, ascent vehicle short-duration technologies
 - b. Eliminates the need for short-duration non-regenerative technologies for descent and ascent vehicles
- 5) No requirement for the repositioning of assets
 - a. Reduces landing accuracy requirements
 - b. Crew arrives at an exploration site that has not been explored robotically via prepositioned assets
 - i. Robotic exploration is currently providing information on where such missions might land, and the crew/robotic synergy afforded in the MMSEV will make exploration efficient and productive
 - c. Crew exploration is all new (not partially redundant)
- 6) Vehicle dimensions that are not constrained by launch vehicles
 - a. Provides architectural freedom to arrange mission elements (e.g., HPS rockets around the habitat)
- 7) The positioning of propellant around the habitat provides protection of the crew from radiation
- 8) Exploration flexibility by allowing the exploration community to use exploration resources to get to new destinations instead of building new vehicles

VI. Summary and Conclusion

The SHM concept has merits and could significantly simplify the conduct of exploration missions. The reuse of mission assets for subsequent exploration missions could dramatically reduce the cost of exploration and could significantly reduce the time required to develop and conduct a Mars mission. Assessment of the use of high specific impulse propulsion has led to a better understanding of the implications that using such technology has on mission planning. The infrastructure in the Orbital Assembly Base could be used to conduct other near-Earth NASA or commercial operations between exploration missions.

The completion of the first estimation of the mass of the vehicle employing the SHM concept has confirmed that the concept is likely to provide substantial mass savings versus the Cx Mars DRA approach for a crewed mission to the surface of Mars.

NASA leaders should consider the SHM concept as an alternative approach for exploration and start a program to implement SHM. Such a program organization should be the advocate for current technology development leading to those technologies being available for use in a SHM program. Exploration programs should initiate development of the assembly station (or address repurposing of the ISS as the assembly station).

More detailed studies should be conducted to refine the SHM concept, specifically to assess the option of the SHM concept presented below as forward work.

VII. Forward Work

The SHM concept will be presented to NASA Exploration Systems to provide them with an understanding of the concept and of the work done to date. It is expected that, given the results of studies performed, management will decide to pursue additional detailed development of the SHM concept leading to organization of a program to implement the SHM approach for exploration. Such a program will provide the “pull” reason to continue development of technologies that will make the SHM concept work.

In mid and late 2012, several engineers commented that it would be important to minimize the mass of the elements that are used to conduct a surface mission. Other studies have established that using 2 MMSEVs to conduct surface exploration is beneficial in several ways. Changes of this nature might impact the SHM concept significantly and may further reduce the IMLEO of the SHM concept while retaining the focus of the SHM concept of using a single module for life support throughout a mission.

The most promising architecture is shown in Fig. 6 wherein all the habitat functions, supplies for transits, and waste generated during the Earth-to-Mars transit are left in LMO and only the required functions are located in a part of the habitat that serves only to support MMSEV exploration of the surface. Using 2 MMSEVs provides habitation volume for the crew and command of descent and ascent functions, and addresses contingencies during long roving operations. The part of the habitat that accompanies the MMSEVs to the surface would be dedicated to providing consumables needed by the crew during the surface stay, including those required by the MMSEVs to conduct surface exploration. Most of the CLSS systems needed for the entire mission are required to support the MMSEVs and the crew during the 60-day surface exploration. The part of the habitat that is used on the surface will include the regenerative life support systems and the volume needed to access those systems, and will house the consumables needed during the surface exploration.

This concept will require two extra hatches (one to interface between the surface habitat and the transit habitat and the other to interface with the second MMSEV). The MMSEV hatches and interface with the surface habitat would be on the side that is consistent with current MMSEV designs (versus the ceiling in the earlier SHM architecture). The added mass for those hatches is expected to be much less than the mass saved by employing this approach to minimize the mass to the surface.

It is anticipated that this approach will result in the mass of parts of the SHM complex that are used for surface exploration being significantly less than the 39,400 kg (86,862 lb) habitat/MMSEV mass of the SHM concept addressed earlier. Reducing that mass will significantly reduce the HPS mass, and that will reduce the mass of the entire complex IMLEO.

Figure 6. Using two MMSEVs as the habitat while on the surface to reduce the mass of the SHM.

The authors will continue to pursue SHM alternatives with those changes to determine how those changes can improve the concept (if resources permit).

Other forward steps include the normal development activities of evaluating technology options to minimize mass and improve functionality of mission elements. Technology and operational options that could lead to reduction of vehicle mass or reduced cost include:

- 1) Using an inflatable habitat structure to reduce structural mass
- 2) Using the ISS as an assembly site
 - a. Eliminates the need for a separate near-Earth assembly base
 - b. Decreases the mass each launch can deliver to space because of the high inclination
- 3) Considering advanced ECLSS technologies to save more than 1000 kg (2205 lb) per year versus ISS-derived technologies alone
- 4) Using a set of propulsion tanks for descent and another for ascent and rendezvous and leave the descent tanks at Mars (to reduce ascent mass)
- 5) Segmenting the ISP prop tanks and discarding tanks when empty (refueling required in any scenario)
- 6) Leaving the SEV on the surface (compromises contingency capabilities during return)
- 7) Leaving one of the two MMSEVs in the 2 MMSEV concept (introduces symmetry issues for ascent)
- 8) Conducting further studies of the trajectory of the SHM concepts that better optimize the transit times

Acknowledgments

The authors gratefully acknowledge the support and encouragement from the Crew and Thermal Systems division of NASA JSC, specifically the division chief Patricia Petete, branch managers Joe Gensler and Craig Dinsmore, and illustrator Jeannie Corte.

The authors gratefully acknowledge the planning for exploration missions done by the Cx Program that provided a moderate level of detail for exploration concepts. Specifically, the Lunar Surface Systems team led by Chris Culbert and Gary Spexarth, the Mars DRA team led by Bret Drake, and the habitation team led by Larry Toups.

Much of the habitat information originated in information from the AES Habitation Systems project that has been led by Kriss Kennedy, Alvin Drew, and Lora Bailey. Molly Anderson provided information on the CLSS elements that make sense for a long-duration habitat as established in a point of departure for the DSH.

Experts at NASA JSC in propulsion and guidance, navigation and control contributed to the concept implementation with the ideas included in this paper on using the advanced high specific impulse technology for design of a Mars mission. Ellen Braden developed much of the mission design parameters relating to the SHM concept. Chris Cerimele also contributed to mission design. Gene Grush provided insights into the HPS needed to implement the SHM concept for a Mars mission. Bill Studak provided insights in to the design features and operation then the calculation of the mass of the HPS.

References

- ¹ Drake, B.G. Editor, Mars Architecture Steering Group, "Human Exploration of Mars – Design Reference Architecture 5.0," NASA document NASA/SP-2009-566, July 2009.
- ² Office of the President of the United States of America, "National Space Policy of the United States of America," June 28, 2010.
- ³ Chambliss, J.P. "The Single Habitat Module for Exploration," The 2012 International Conference on Environmental Systems, AIAA 2012-3416, July 2012
- ⁴ Chambliss, J.P. "The Single Habitat Module Concept – A Streamlined Way to Explore," AIAA Space 2012 Conference and Exposition, AIAA 2012-5204, September, 2012
- ⁵ Boyle, R.M., Mitchell, K., Allton, C and Hsing, J. "Suitport Feasibility – Development and Test of a Suitport and Space Suit for Human Pressurized Space Suit Donning Tests," Paper to the 2012 International Conference on Environmental Systems, AIAA 2012-3631, July 2012.
- ⁶ "Lunar Capability Concept Review (LCCR)," NASA, June 18-20, 2008.
- ⁷ Mason L.S. and Poston D.I. "A Summary of NASA Architecture Studies Utilizing Fission Surface Power Technology," NASA/TM-2011-216819.

The Single Habitat Module Concept for Exploration Mission Planning and Mass Estimates

ICES Paper AIAA-2013-3530

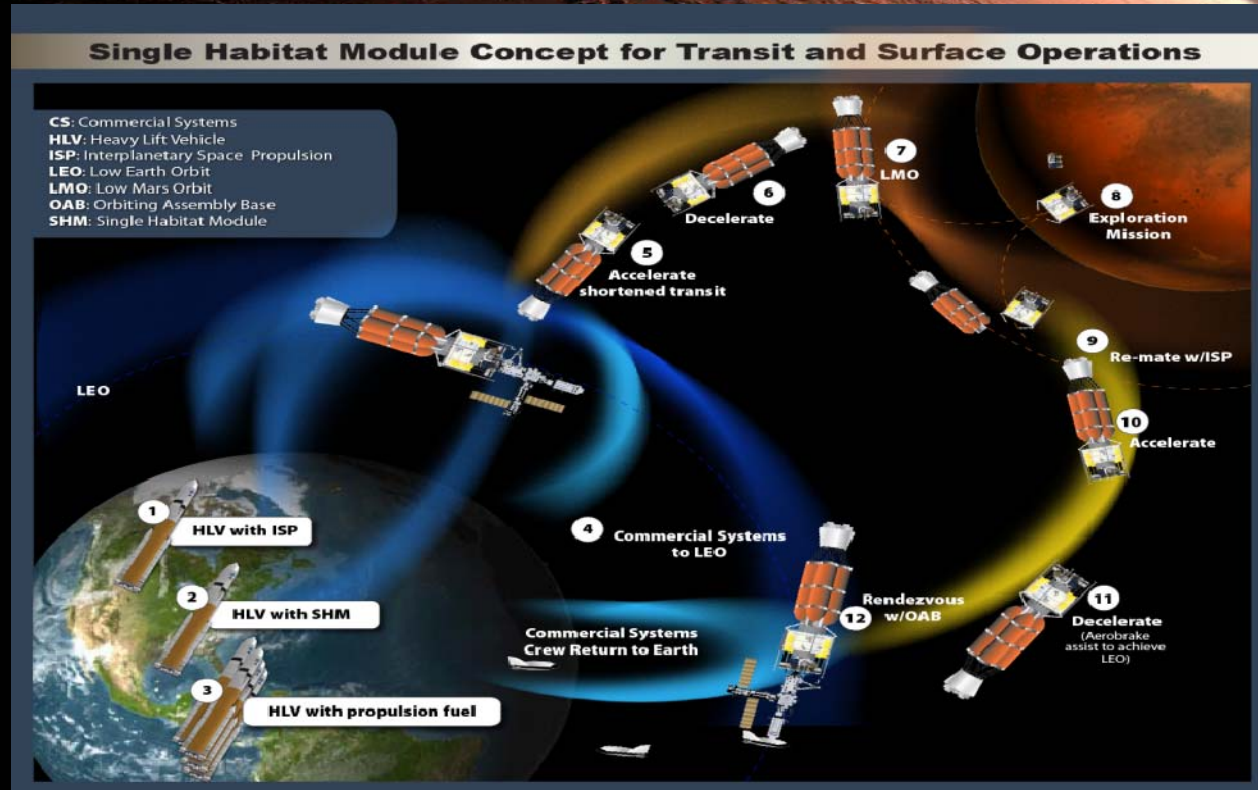

Joe Chambliss – 281-483-9204

Joe.p.chambliss@nasa.gov

Bill Studak – Power and Propulsion

SHM Perspective

- Significant departure – Use one module to support the crew both in transit and while at destination
- Joe Chambliss initiated concept to address revised exploration goals following 2010 presidential direction to NASA
 - Support to evaluate the concept by EC
 - Prop Calculations via JSC/EP (Bill Studak)
 - Trajectory Calculations via JSC/EG (Ellen Braden)
- Synergy of data from CX and HAT, AES and OCT projects, VASIMR SSA

SHM Topics

Overview of the SHM concept

- Essentials of the concept

Results of the first complete top level mass calculation

- Mission trajectory and mass calculation
- Habitat Propulsion System (HPS) mass
- Second iteration trajectory and mass calculation

Top level, qualitative comparison of SHM with recent concepts for exploration missions

- Provided to better understand the concept
- The SHM mission envisioned and assessed is not the Mars DRA mission
 - SHM takes 331 mT less than Mars DRA mass!

Summary of the benefits of the SHM approach

Mass saving option - Split Transit Habitat (TH) and Surface Hab (SH)

- To minimize mass to/from the surface (and thus the prop required)
- Two MMSEVs – minimal function SH
 - Retains the SHM concept goals and benefits

The Basis of the SHM Concept

- It is possible to provide a habitation module with a propulsion system that can not only land but launch the habitat for use in the return transit
 - Changes the way exploration is conducted
 - Results in a significantly different set of assets to conduct a mission
 - No dedicated descent, ascent and surface habitats are needed
- The implications of such a capability are:
 - Mission simplicity
 - The potential to reuse the habitat and in-space propulsion system
 - Probable saving of total mission mass

Single Habitat Module Concept

- Recognizes that crew support requirements for transit and while at a destination are roughly the same and thus could be addressed with a single module
- Starts with assembly at a location near Earth
 - Uses the capabilities humanity has developed and demonstrated in creating and operating the ISS
- The SHM vehicle will include:
 - Habitation to address crew support
 - Includes a propulsion capability to land (from LMO) and return to LMO
 - An efficient In Space Propulsion (ISP) system for propulsion to and from an exploration destination

The SHM concept of a different approach to crew accommodations and mission conduct

- Puts new concepts together in a way that can make exploration more efficient, less costly, and nearly eliminate the waste of mission resources
- SHM combines the following approaches and technologies:
 - Commercial Crew Integrated Capability (CCiCAP) (or Orion) access to LEO
 - Heavy-Lift launch vehicle (HLV) launch of large payloads (now funded as the Space Launch System (SLS) Program)
 - Fueling (later refueling) (and assembly) in space
 - Closed Loop Life Support (CLLS)
 - Interplanetary space propulsion (probably nuclear powered)
 - Green technology (reuse mission assets, liquid methane for habitat propellant)
 - Aerocapture at Mars
 - ISS utilization – Trade
- As of 2013, NASA is pursuing all of those new technology and vehicle development efforts as currently funded projects or in future plans
 - The CCiCAP, Orion, and SLS projects are well under way

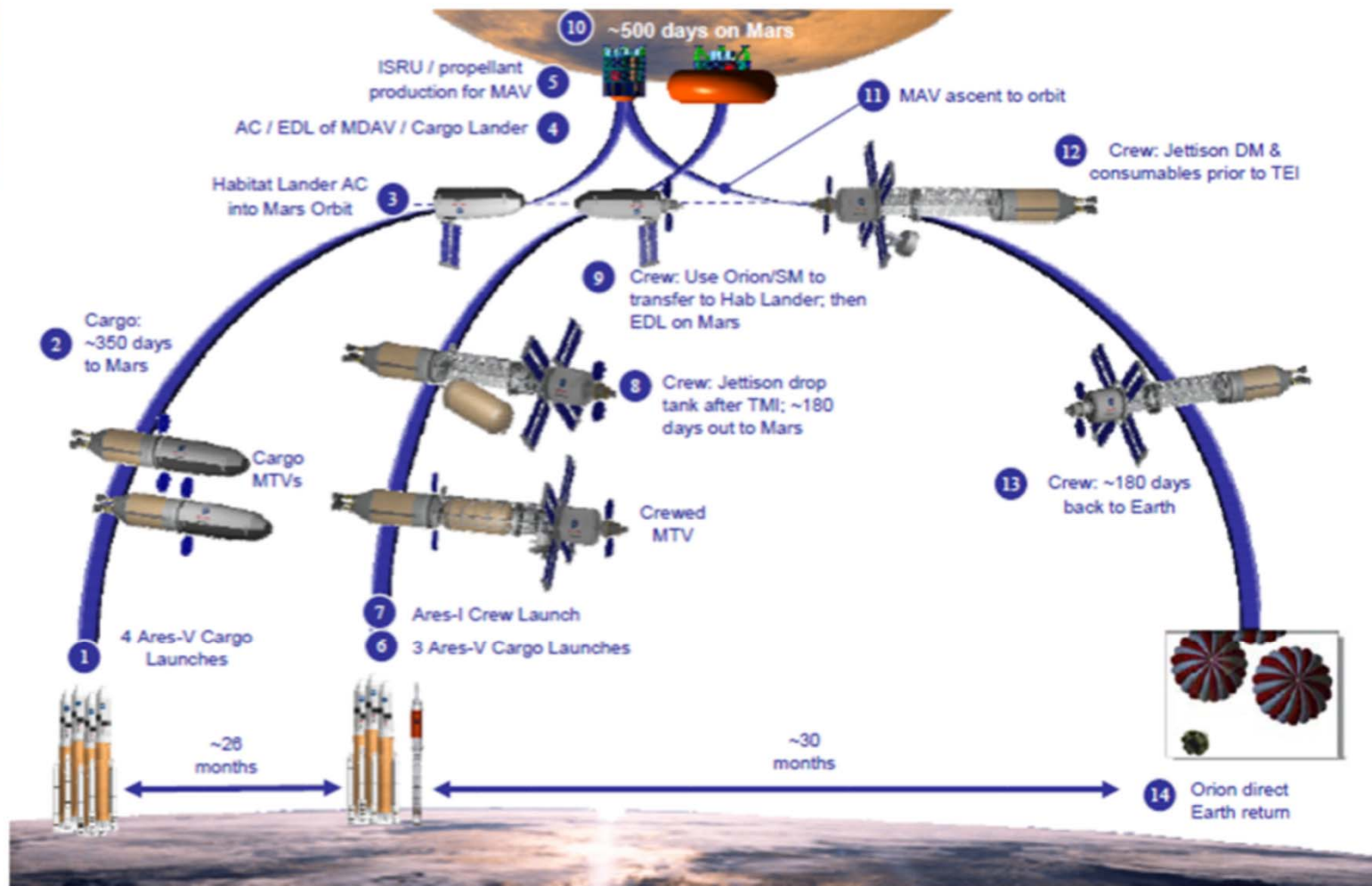

Figure 2-2. Mars Design Reference Architecture 5.0 mission sequence summary (NTR reference).

The Mars DRA is viewed as the Point of Departure

2-2. Mars Design Reference Architecture 5.0 mission sequence summary (NTR reference) for reference

Basics of the SHM Concept

- Assembling and fueling the integrated vehicle near Earth provides the capability to start exploration missions fully fueled to meet the requirements of the mission
 - Makes it possible to leave the vicinity of Earth with enough fuel to return a habitat from an exploration destination
- Employing only one habitat can dramatically simplify mission conduct
 - No dedicated descent, ascent vehicles are used
 - No prepositioning of assets or dedicated surface habitat vehicle is required
- SHM makes it possible to reuse mission assets
 - The end of an SHM exploration mission results in the ISP system and habitat being returned to the near-Earth staging site
 - Refurbish and refuel in space, then reuse for subsequent exploration missions
- SHM provides an infrastructure that can address many exploration goals

Single Habitat Module Concept for Transit and Surface Operations

CS: Commercial Systems
HLV: Heavy Lift Vehicle
ISP: Interplanetary Space Propulsion
LEO: Low Earth Orbit
LMO: Low Mars Orbit
OAB: Orbiting Assembly Base
SHM: Single Habitat Module

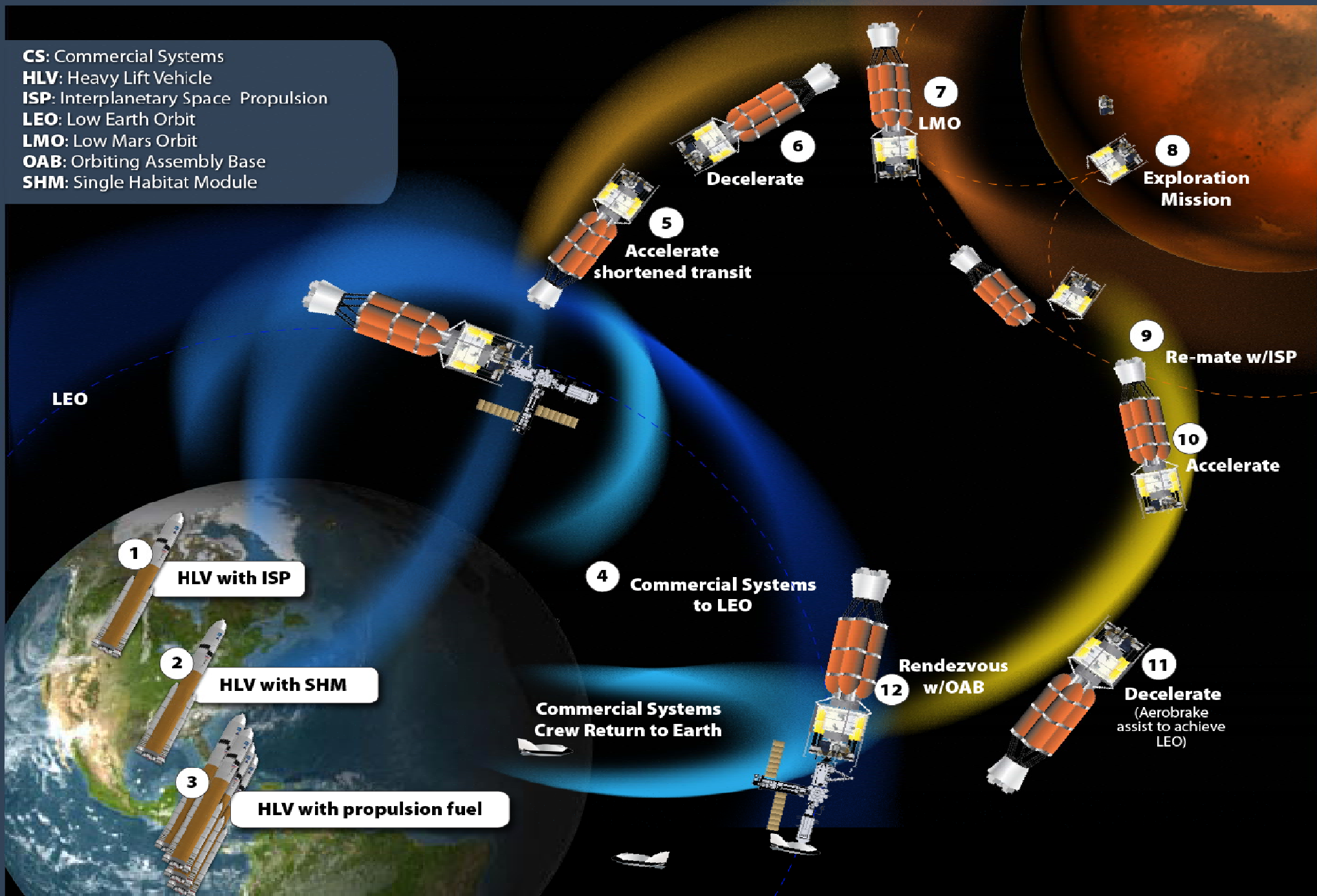

Single Habitat Module Essentials

- Step 9 - Return the habitat module and the MMSEV to destination orbit is the key to achieving the SHM single habitat and reuse goals
 - Other steps are essential to accomplishing a Mars mission but could be common with other Mars mission approaches
- Both the habitat and the MMSEV are essential for crew support or to address potential contingencies throughout the mission
 - The habitat module will need to address all life support and crew habitability and command functions for each entire exploration mission
 - Provide enough resources for the crew to function during the long zero gravity (or very low acceleration of the ISP) of the to-and-from transit phases
 - Must also be compatible with the long-duration surface exploration phase in the partial gravity of Mars or the moon
 - Address cabin atmosphere leak or contamination contingencies
- Provide EVA and mobility capabilities to enable exploration

Single Habitat Module Essentials

Design driving case - Mars landing and surface exploration followed by return to Earth

- The most difficult mission currently envisioned
 - Transit times for Mars missions will be many months
 - Exploration periods on Mars will also be months
- Mars surface exploration requires the habitat have the following qualities:
 - Propulsion capability to descend from Low-Mars Orbit (LMO) to land at a designated exploration site
 - The capability to support crew operations while on Mars
 - Propulsion capability ascend back to LMO to rendezvous with the ISP

Enable reuse of the critical elements of an exploration mission

- Reuse requires designing to meet the needs of the most difficult exploration mission envisioned
- The Mars surface exploration SHM can be used for missions to NEAs or the moon
- Deceleration to achieve return to Earth vicinity
 - Crew to depart via Orion to return to Earth at start of spiral
 - SHM continues spiral to return to Earth vicinity

SHM Questions to Resolve

- Is a propulsion system capable of landing then launching a habitat feasible?
 - How large would such a system be?
 - How much propellant would be required?
- If feasible, how would the mass of such a propulsion system compare to elements of other exploration concepts?
 - For the design driving Mars case, the HPS mass would be compared to the mass of elements that are required for the Mars DRA + the fuel and systems to get those to Mars - those would not be needed in the SHM approach

SHM Mission Assessment

- A scenario for exploration using SHM for a Mars Surface mission was defined
 - Using data from exploration projects
 - Assuming the availability of advanced technologies
 - Trajectory using advanced NEP technology
 - Habitat Propulsion Using MOX
 - (Liquid Methane and Oxygen)
- Assessed the basic SHM mission wherein the entire habitat and MMSEV go to Mars and back
 - Options under consideration to reduce mass to the surface would reduce total mission mass

Top level decisions on the mission content to enable mission definition and thus parameter estimation

A crew of 4 was selected as a minimum crew for a long duration exploration mission

- Trends toward 4 crew missions was a factor in deciding that 4 crew was a good option for an exploration mission
- A crew of 4 is consistent with decreasing the MPCV crew compliment to 4 (from 6 originally)

Start of the mission was selected to be during a period when the transit time to Mars would require a near minimum amount of fuel and transit time to get to Mars

- That minimizes propellant required during the period when the vehicle is the most massive

60 days of mission operations while on the surface of Mars was established as a period long enough to conduct all exploration that is appropriate from a single landing site

- That allows an estimated 3-4 MMSEV roving traverses of up to 2 weeks each

Start return trajectory at the end of surface operation

- Probably not optimal for fuel use on the return but the mass of the remaining elements of the vehicle will be the lowest then

Decided that ISRU implementation is not essential for such an exploration mission

- Surface mission is 60 days (not the 539 days required for a conjunction trajectory employed in the Mars DRA)
- The duration of the mission doesn't allow enough time to manufacture enough prop to be significant

Robotic missions to the specific site for the human mission were deemed not to be essential since robotic missions have characterized the Mars surface sufficiently to select suitable landing locations.

- The use of the MMSEVs is viewed as the most productive use of robotics combined with humans
 - Enables exploration of a large part of Mars

Missions that could also be conducted using the SHM approach include NEO and Lunar missions

- SHM assessment for those missions is viewed as forward work

SHM Implementation

■ When implemented, the SHM concept will have a program to develop the best design for the variety of elements

- Start with the relevant parts of prior programs (such as CX) to use applicable concepts
- The best mix of US and international contributions
- Use the best of the technology options that are ready

■ Mass minimization and safety will be key design considerations

- Closed Loop Life Support (CLLS), thermal control, EVA, habitation, and command capabilities need to be as efficient as possible to minimize mass of both equipment and consumables
 - Needed to support the crew during the entire mission
 - Long-duration missions have been shown in exploration trade studies to greatly benefit from regenerating resources
 - The longer the mission, the more beneficial regeneration of resources becomes
 - The most reliable solution will be employed, combined with appropriate redundancy and sparing
 - The CLLS will minimize waste products, which will partially address planetary protection issues
 - Address the most demanding of the environments, whether that occurs in transit or during surface operations
 - Thermal control radiators must address the peak heat loads in transit and at Mars

Implementation ideas that follow integrate Cx concepts and address issues such as redundancy, surface access and radiation protection

SHM Concept Implementation

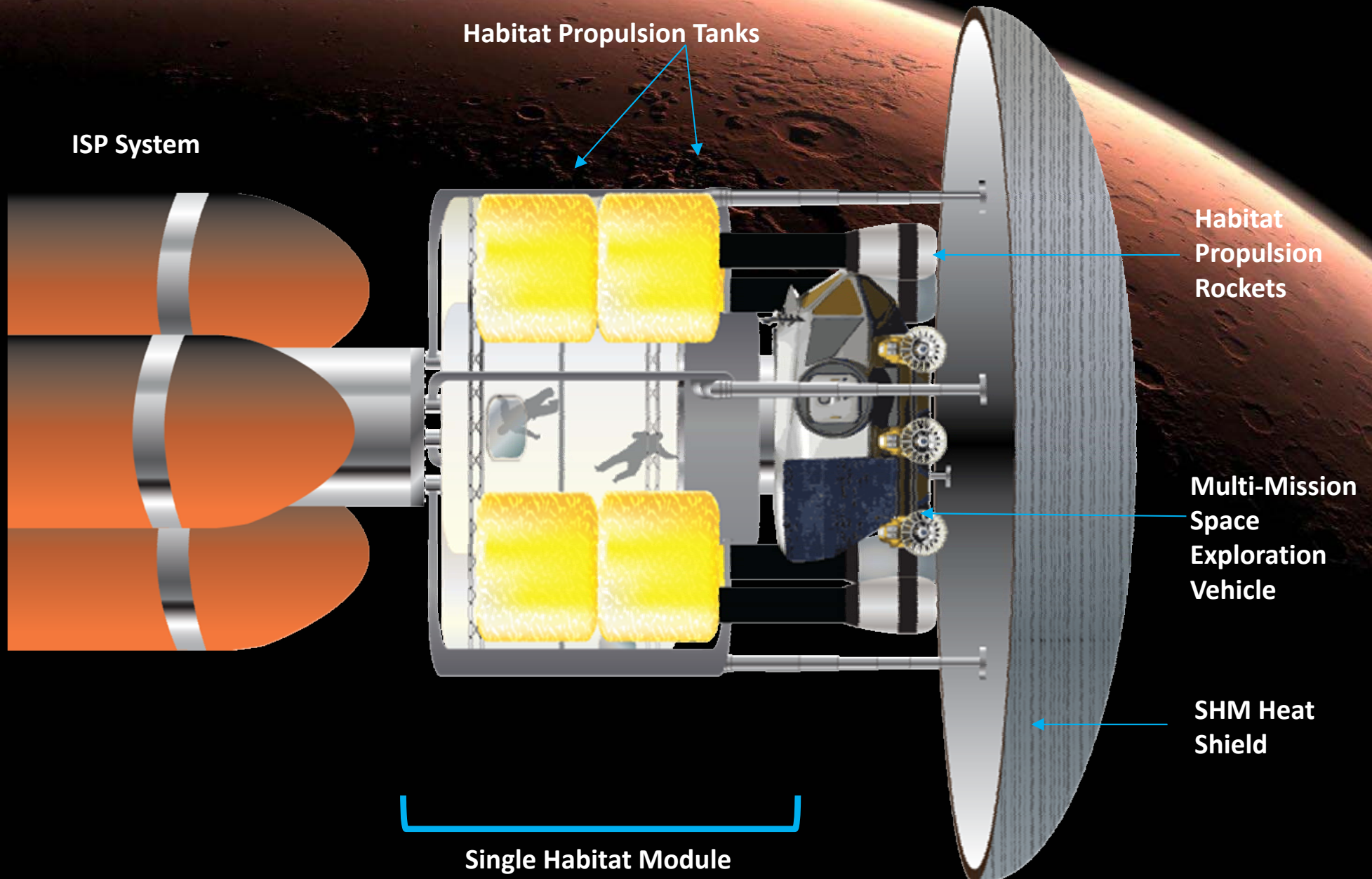

Radiation Protection and Surface Access

■ Radiation Mitigation

- Propellant tanks with MOX surrounding the habitat would provide a significant, high-quality radiation barrier for the Earth to Mars transit
 - CH₄ and LOX have both shown to be effective in blocking radiation
- MMSEV and heat shield at the front end of the SHM provides radiation protection while in transit both to and from the destination
- The ISP provides a radiation barrier at the aft end of the habitat

■ Surface Access

- Addresses access to the destination surface since it will be near the surface after landing
 - Lunar surface systems studies identified a significant problem with getting elements from the top of the descent stage to the surface

SHM Mass Calculation Logic

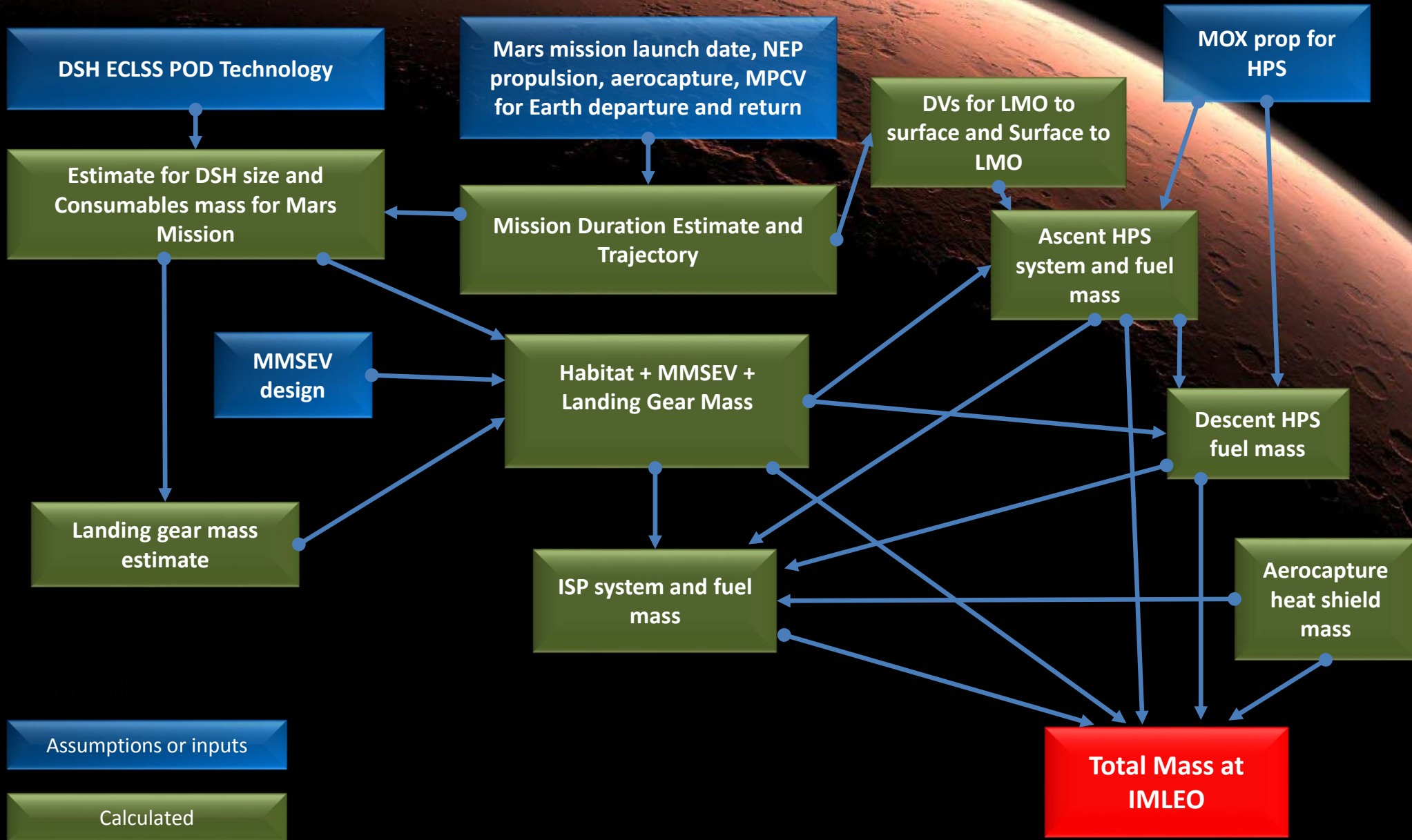

Habitat Mass Estimate

Based on the May 2011 Deep-Space Habitat

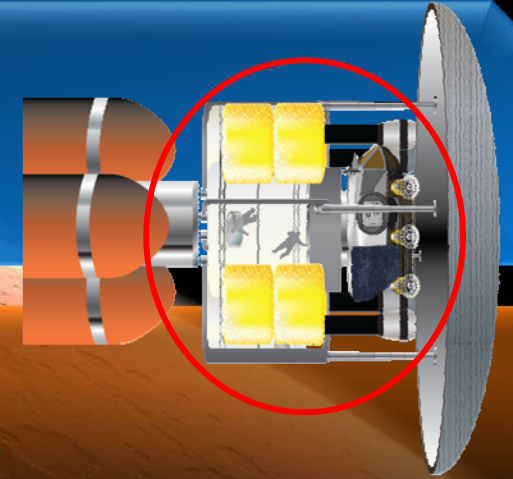

- Habitat, MMSEV, and landing gear estimate
 - Total habitat plus consumables mass – 31.0 mT
 - Revised for a 4-crew 585 crew-day mission
 - 275 m³ habitat volume, 6 -2 crew EVAs in transit, 15 -2 crew EVAs on Mars
 - Habitat landing gear – 2.0 mT
 - Based on Cx Altair estimates
 - MMSEV for Mars – 6.5 mT
 - Based on MMSEV estimates (assumes 28-day capability with 2 crew)
- Those elements result in an estimated mass of habitat, landing system, MMSEV of around 39.6 mT
- The HPS to safely land that equipment, then return subset to LMO
 - Mass to be returned to LMO = 37.6 mT
 - Landing gear assumed left on the surface

Habitat Propulsion System (HPS) Factors

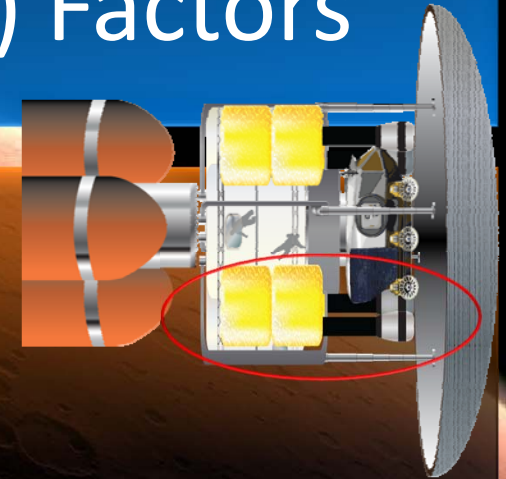

- Propellant for the HPS has to be stored and ready
 - During the transit from Earth to Mars
 - For the duration of the surface exploration on Mars
- Liquid methane/liquid oxygen (MOX) propulsion is probably the best
 - Long-term thermal storage of those propellants is feasible
 - Long-term storage of liquid hydrogen is problematic due to the extremely low (around 20 Kelvin (K) (-253°C (-423°F)) temperature required
 - Thermal conditioning via deep-space cooling can probably address storage of liquid methane (approximately 111 K (-162°C (-259°F)) and liquid oxygen (90 K (-183°C (-297°F)))
 - Cryo-coolers may be required to address storage thermal conditioning while at either the moon or Mars

Habitat Propulsion System Approach

Assessment of the mass of the HPS - EP (Bill Studak) - Assumptions:

- 39.6 mT descent and 37.6 mT ascent mass habitat
- Use a two stage Ascent vehicle's tanks during descent, they are loaded for ascent, with additional propellant for descent, and "losing" 2 mT payload from landing gear for ascent
- Assuming an overall mass fraction of propulsion stage to propellant mass ratio of .14 (a little higher than an ascent vehicle alone, for extra descent prop tankage), and a payload of 37.6 mT on ascent
- No boil-off, etc.
 - The transit environment may be sufficiently cold to avoid boil-off
 - The surface may require cryocooler

Habitat Propulsion System Mass

- Ascent:
 - Propellant stage mass of 13.1 mT
 - For a deltaV of 3900 m/s ascent , propellant mass is 93.4 mT
 - Total ascent mass is 143.8 mT
- Descent:
 - Keep the propellant stage mass of 13.1 mT
 - Descent payload of 145.8 mT (i.e. ascent mass plus 2000kg)
 - For a deltaV of 800 m/s, descent propellant needed is 38.1 mT
 - The Total Descent mass of the Habitat and HPS is 184 mT
 - A check was conducted based on a single vehicle capable of 4700 m/s deltaV - Depending on assumptions and details, get comparable answers from a little lower to a little higher, and the above numbers are pretty good
- The ISP must deliver
 - The total descent mass (184 mT) to LMO
 - Return the habitat (37.4 mT) to Earth LEO

Spiral Trajectories using ISP For Transit To and From Mars

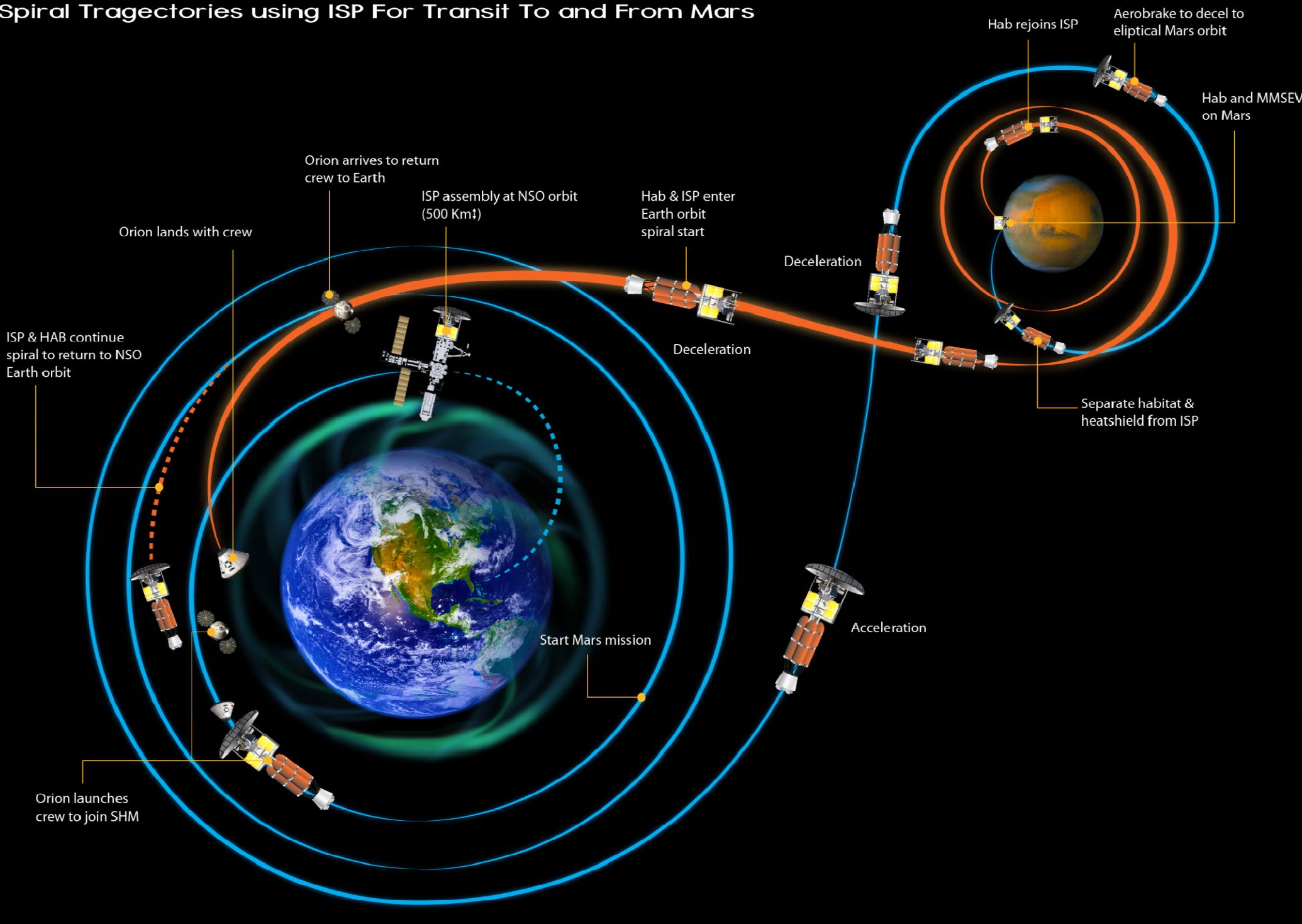



NEP – Nuclear Electric Propulsion Mission Versatility*

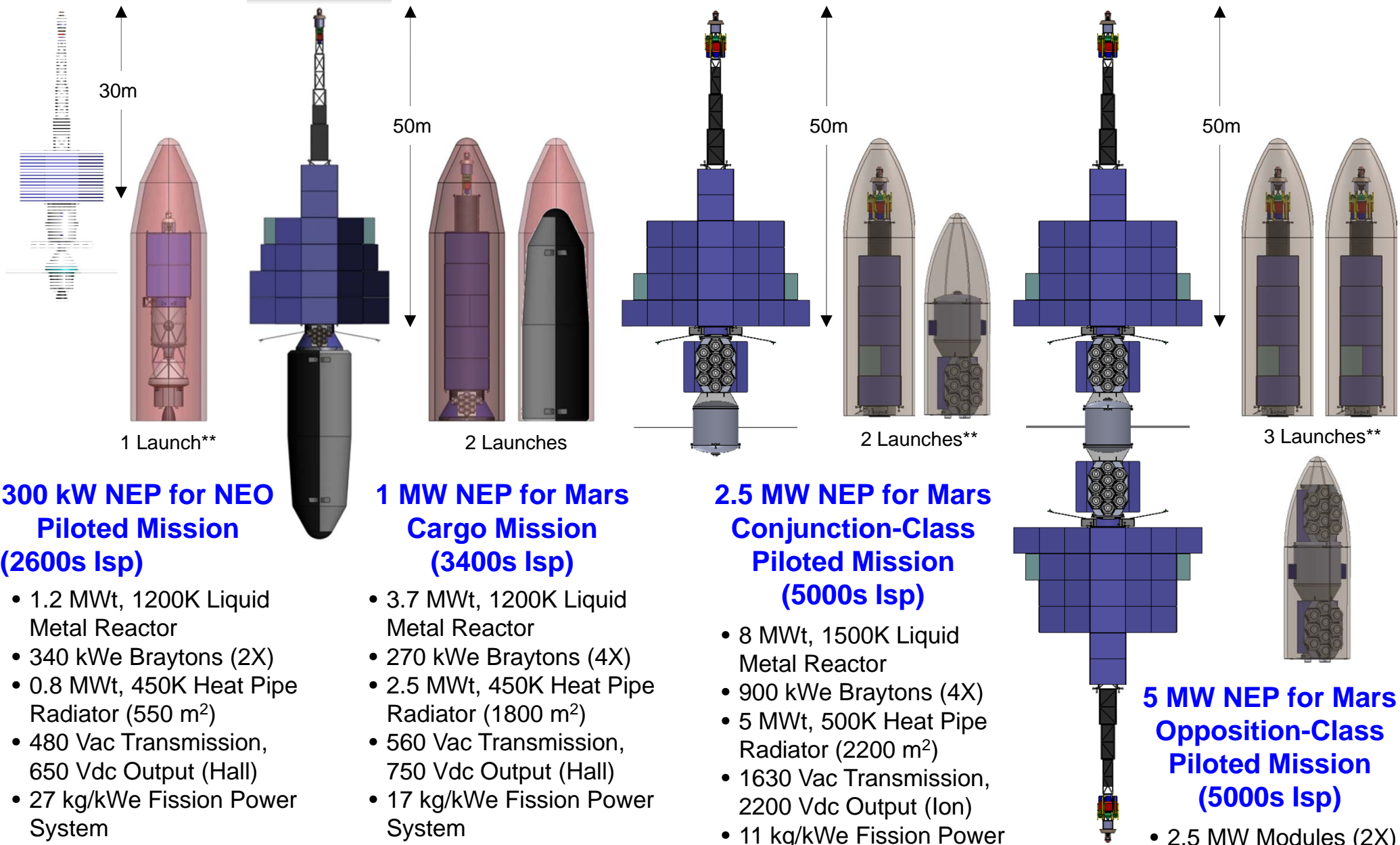

* Mission studies performed by GRC COMPASS Team
 ** Not including separate crew launch for Earth orbit rendezvous

Mission Mass Using Nuclear Electric

- Assumptions to start calculations
 - Time mission start for minimum transit time to Mars (12/12/2028)
 - Start at Nuclear Safe Altitude of 500 km
 - Crew of 4 ingresses SHM near the end of the departure spiral
 - 5 Mw capability for nuclear powerplant
 - Propulsion system Isp best for efficient use of fuel
 - Aerocapture of SHM into elliptical Mars orbit
 - Aerocapture assist to decelerate habitat before landing
 - Exploration on Mars 30 days
 - Crew egresses SHM at start of Earth arrival spiral
 - Orion rendezvous and return of crew to Earth
 - SHM continues spiral to return to NSO Earth orbit

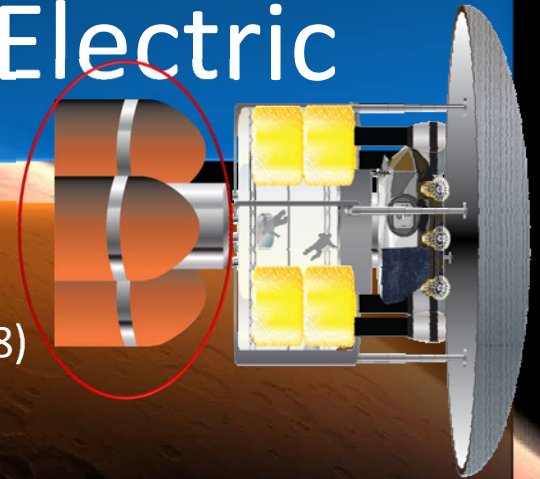

Second Iteration Trajectory Results

- Using the revised habitat and new HPS mass calculations the trajectory analysis and ISP mass were recalculated
 - Resource constrained assessments to one iteration
 - Same assumptions for start date to get to Mars using a reasonable trajectory
 - Changed surface exploration to 60 days based on conjecture that 30 days might be too short
 - 60 days provides enough time for 3-4 MMSEV traverses of around 14 weeks each
 - Evaluated 5 MW and 10 MW powerplant options



Case 1 Results Summary

- IMLEO = 512 mT
- Earth escape spiral
 - Assumed Isp = 7000 sec
 - Propellant mass = 51 mT
 - Time = 345 days
- Earth-Mars heliocentric transfer
 - Departs 12/12/2028
 - Variable Isp
 - Propellant mass = 32 mT
 - Time = 640 days
- 60 Mars surface stay
- Mars escape spiral
 - Assumed Isp = 3000 sec
 - Propellant mass = 18 mT
 - Time = 22 days
- Mars-Earth heliocentric transfer
 - Departs 12/7/2030
 - Variable Isp
 - Propellant mass = 39 mT
 - Time = 216 days
- Earth capture spiral
 - Assumed Isp = 7000 sec
 - Propellant mass = 13 mT
 - Time = 86 days

Total Crew Time = 944 days

Total Vehicle Time = 1375 days



Case 1 - Detailed Breakdown

- Earth escape spiral (crew not on-board)

- Initial mass = 512 mT
 - Powerplant = 30 mT
 - Structure = 55 mT
 - Aero shield = 67 m
 - Propellant used = 51 mt
 - Payload = 309 mt
- Begins spiral 1/2/2028
- Assumed constant Isp, 7000 sec
- Time = 345 days

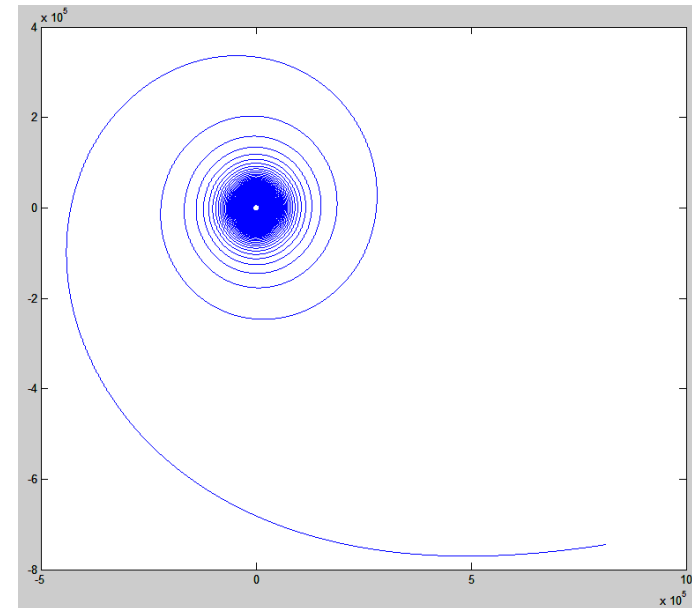

- Earth-Mars heliocentric transfer (crew on-board)

- Departs 12/12/2028
- Variable Isp
- Propellant mass used = 32 mt
- Time = 640 days
- Arrives at Mars 9/13/2030
- Mass delivered to Mars = 429 mt

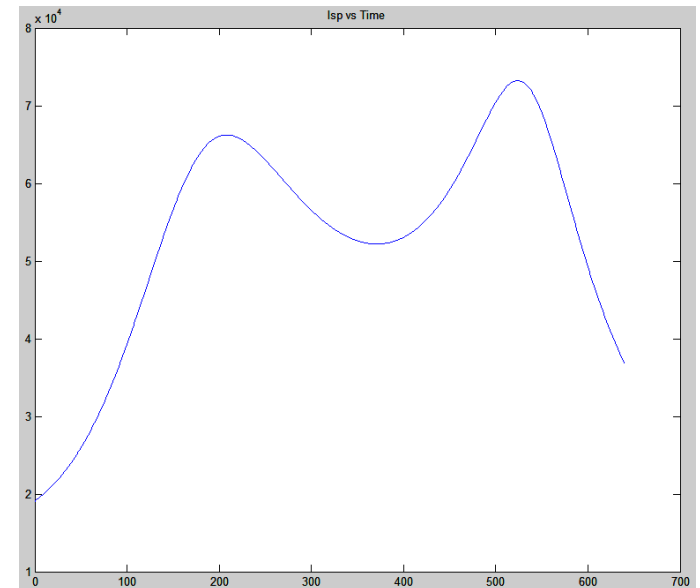

- 60 Day Mars surface stay



Case 1 - Heliocentric View

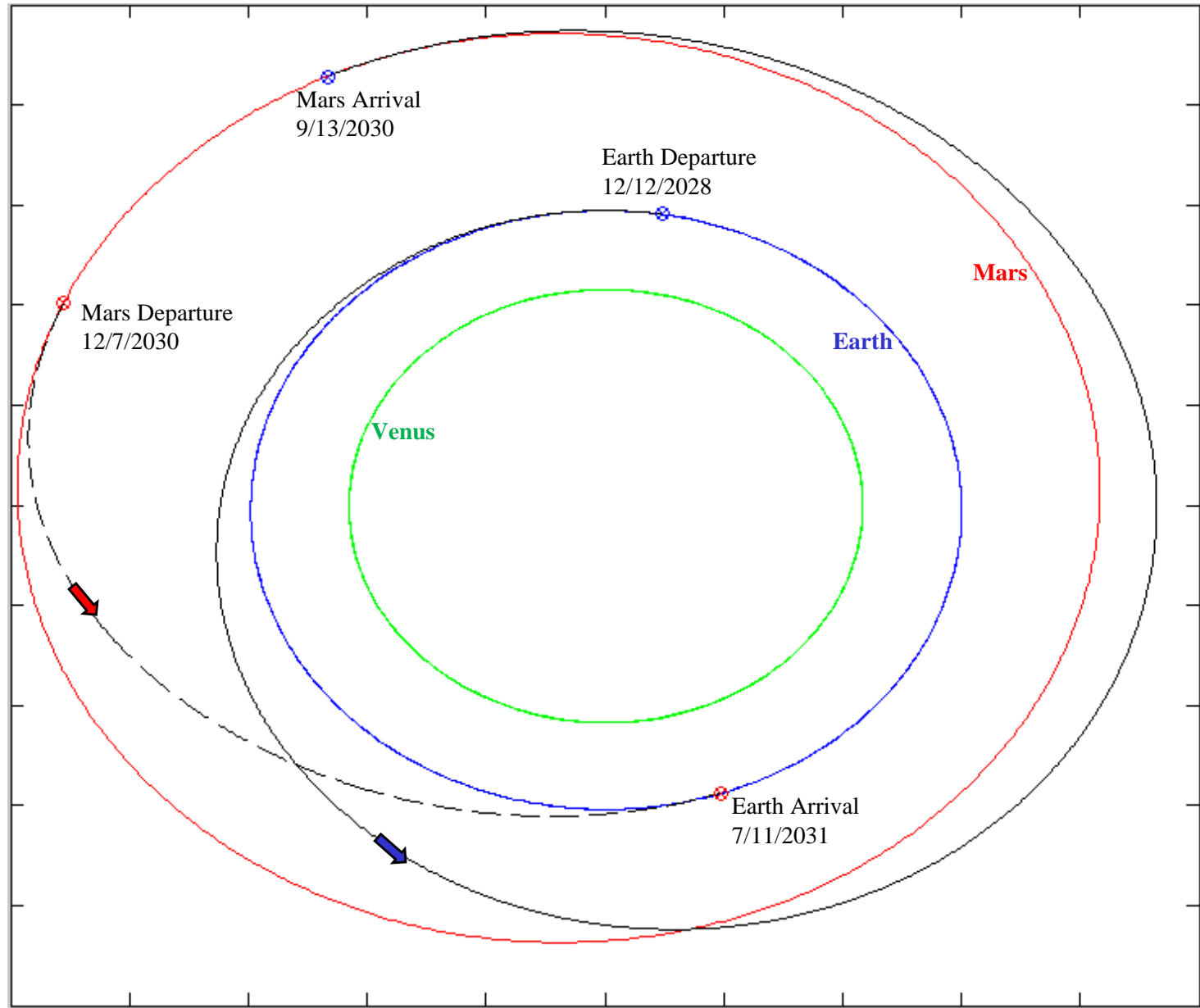

Use a logical progression of information to estimate SHM mass

- 1) ✓ Evaluate mission duration using current implementation concept
 - Nuclear powered, electric propulsion, enough time to explore, Mars Earth locations
- 2) ✓ Establish habitat size and consumables mass based on mission length
- 3) ✓ Estimate the HPS capability and mass
- 4) ✓ Recalculate the capabilities and mass of the ISP system
- 5) ✓ Combine habitat, HPS, and ISP masses for the total SHM vehicle mass
- 6) ✓ Compare the SHM integrated to the Mars DRA masses
 - ✓ Assess savings on single Mars mission
 - ✓ Assess savings on series of exploration missions

Mission Mass Summary

- IMLEO Mass for SHM elements – 512 mT
- Mission length of 944 crew days
- Propulsion system needed to land then launch the 40 mT habitat
 - 13 mT system, 132 mT of MOX propellant
- Interplanetary Space Propulsion system
 - 31 mT powerplant, 153 mT of NEP propellant

SHM Mars Mission Mass Budget (mT)

Earth/Mars Transits

Mission Phase	Payload of the Phase	ISP Fuel Mass	HPS Fuel Mass	Total Vehicle Mass
IMLEO	ISP, Habitat, MMSEV, Landing Gear, Aerocapture Heat Shield, HPS	153	132	512
Arrival in LMO	Same as above	70	132	429
Surface Operations <i>(see table below)</i>				
Start of Mars-to Earth transit	ISP, Habitat, MMSEV	70	NA	203
Arrival in LEO at OAB	ISP, Habitat, MMSEV	0	NA	133

Descent/Ascent

Start of Propulsive Descent	Habitat, MMSEV, Landing Gear, HPS	NA	132	184
Surface Operations	Habitat, MMSEV, Landing Gear, HPS			
Start of Ascent to LMO	Habitat, MMSEV, HPS	NA	94	144
After ISP Rendezvous	Habitat, MMSEV	0	0	38

Comparison with the Mars DRA

- The Mars DRA used a Nuclear Thermal Rocket for efficiency
 - Total Mass = 848 mt , requires 914 crew days
 - Via chemical prop total mass = 1,252 mt
 - Separate crew accommodations for transit, descent, ascent, surface operations
- Comparison
 - Similar total crew time - 944 SHM versus 914 DRA
 - 6 crew in the DRA versus 4 crew in this SHM implementation
 - Stay time - 60 days for SHM versus 538 DRA
 - Mars DRA sets up a base and harvests ISRU
 - SHM mass calculations include the mass required to return to near Earth for reuse
 - **512 mT for SHM versus 848 mT for the DRA**
- **Conclusion - SHM can provide a low mass way to explore**
 - Even if just for a Mars mission
 - Dramatically better if used for series of exploration missions since SHM results in the capability to reuse mission assets

Further investment of exploration resources and attention is merited

Build SHM for Mars; Use it for NEA + Moon + Mars Missions

- The most appropriate comparison of past approaches and SHM is to compare the combination of NEA, lunar landing, and Mars surface missions
 - SHM for the three missions – Habitat, MMSEV, ISP plus two refurbishment and refuel operations – plus several Orion MPCVs
 - HAT NEA – Orion, DSH, MMSEV, Solar Electric Propulsion, MPCVs
 - Cx Lunar Sortie mission – Orion, Altair (Lander, Ascent)
 - Cx Mars Surface mission – Orion, DSH, Surface Habitat, two Nuclear Thermal Rockets, SEV, Combined Descent and Ascent Vehicle, Mars Ascent Vehicle

Single Habitat Module Approach Benefits

- Simplifies the total mission
 - Supporting the crew through the entire mission in one habitat
- Enables reuse of mission assets
 - Eliminates the need to develop new vehicles for subsequent missions
- Transportation of less mass to destination (fewer elements required)
- Benefits of the proposed implementation of SHM
 - Vehicle dimensions are not constrained by launch vehicles
 - Allows architectural freedom to arrange mission elements
 - Positioning of propellant around the habitat protects the crew from radiation
 - Eliminates the need to preposition assets
 - Separate missions to destination are not required
 - Crewed exploration is all new and productive using MMSEV
 - One set of regenerative technologies minimizes mass because the benefits apply to the whole mission
 - Eliminates the need for short-duration, non-regenerative technologies

SHM Rationale for Quicker, Less Expensive Exploration

- Focuses development on the fewest possible number of exploration elements - Habitat and ISP
 - One set of crew accommodations for an entire mission
- Project organizations are minimized
- After the first mission:
 - Only refurbishment and refueling are needed
 - Time between missions minimized
- Between exploration missions the infrastructure in the Orbital Assembly Base could be used to conduct other near-Earth NASA or commercial operations reducing cost of those endeavors

Further reduction of Mission Mass

- Basic concept of the SHM has been evaluated
 - Established an approach to employ new technologies to implement the SHM concept
 - Estimated the mass of elements
 - Established the fundamental benefits
- Comments received during past presentations led to considering a concept that minimizes the mass of the vehicle to go to the surface
 - Would significantly reduce the mass of the HPS

Separable Surface Habitat SHM Option

- A version of SHM that allows a part of the habitat to separate from equipment not needed during the surface exploration
 - What habitation functions are essential for surface operations versus functions required for transit operations?

Function Assessment - Transit Habitat (TH)

- Crew quarters for the transits between Earth and Mars
 - Zero g exercise facilities for conditioning between E and M
- Waste products generated during the transit from E to M
- Consumables that are required during transit from M to E
- Storage of materials (such as water) that are required for transit contingencies – the large storage tanks
- Control systems and interfaces to control the ISP systems
 - Not needed for the descent/ascent vehicle
- Everything needed for the mission that is not essential during surface exploration

Separable Surface Habitat - 2 MMSEV

- The SEV community has concluded that employing 2 MMSEVs offers many benefits during exploration
- Considered the 2 SEV option and found advantages
 - SEVs provide redundant habitation, EVA capabilities and mobility
 - Considering the SEVs as a command center means that command functions during descent and ascent could be based in the SEVs to eliminate that function from the Surface Habitat
 - What a ride – crews in each SEV controlling descent surrounded by heat shield then watching as heat shield separates and Mars is everywhere beneath and rapidly approaching as they approach the surface
- A Surface Hab is still needed to support SEV operations
 - SH functions can be significantly simplified and its size reduced

2 MMSEV SHM Concept

Transit Habitat

- Long term crew quarters
- Transit Consumables and waste storage/processing to/from Mars
- Storage of ECLSS and other gases and fluids
- ISP controls

Surface Habitat

- ECLSS for Entire Mission
- Consumables for surface stay

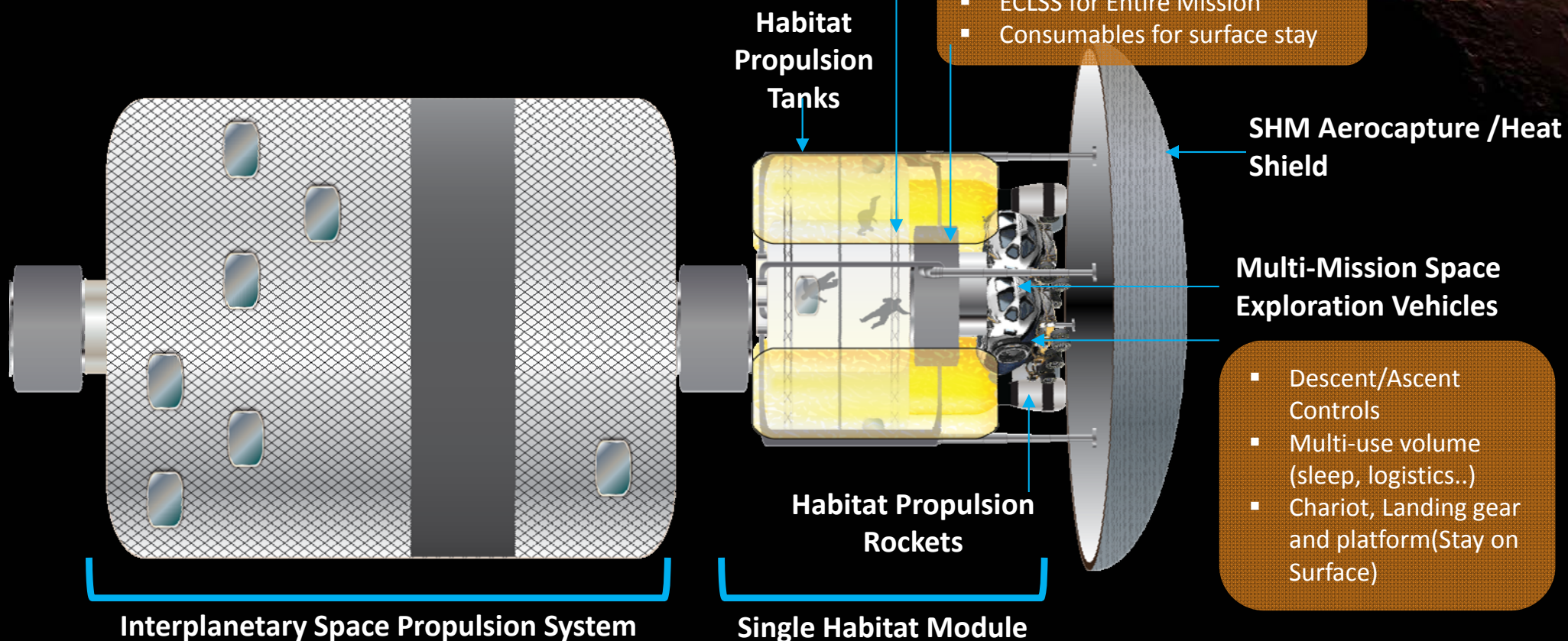

- Descent/Ascent Controls
- Multi-use volume (sleep, logistics..)
- Chariot, Landing gear and platform(Stay on Surface)

Summary and Conclusion

- SHM concept could significantly simplify the conduct of exploration missions
 - Assessment of the use of high specific impulse propulsion has led to a better understanding of the implications that using such technology has on mission planning
 - It is likely that a 2 MMSEV based surface Habitat option will further reduce the SHM mission mass while retaining the focus of the concept (use of and recovery of major mission assets)
- Reuse of mission assets for subsequent exploration missions could dramatically reduce the cost of exploration
 - Since fewer mission elements are needed; the SHM approach could reduce the time required to develop and conduct a Mars mission

Recommendation for the Exploration Community

- Use the SHM information provided as a starting point
- Use analytical expertise and knowledge to assess SHM
 - The tools developed and used by the NASA exploration team are relevant to use to assess SHM
 - Habitat sizing, propulsion system size and fuel estimation, trajectory analysis, launch system capabilities
 - Use expertise to define the best way to get the habitat and HPS to destinations
 - Perform assessments to allow direct comparison of SHM to Mars DRA and other approaches
 - Assess SHM to other exploration destinations
 - NEAs, Lunar Surface...
 - Pursue the Transit and Surface Hab split approach
- Give the mission simplicity of the SHM approach a thorough review

Acknowledgements

- Support and encouragement from the CTSD of NASA JSC, specifically the division chief Patricia Petete, branch managers Joe Gensler and Craig Dinsmore, and illustrator Jeannie Corte
- Planning for exploration missions done by the Cx Program that provided a moderate level of detail for exploration concepts
 - Lunar Surface Systems team led by Chris Culbert and Gary Spexarth
 - Mars DRA team led by Bret Drake
 - Habitation team led by Larry Toups
- Habitat information originated from the AES Habitation Systems project that has been led by Kriss Kennedy, Alvin Drew, and Lora Bailey
 - Molly Anderson provided information on the CLSS elements that make sense for a long-duration habitat as established in a point of departure for the DSH
- Propulsion and guidance, navigation and control contributed to the concept implementation ideas included in this paper on using the advanced high specific impulse technology for design of a Mars mission
 - Ellen Braden developed much of the mission design parameters relating to the SHM concept
 - Chris Cerimele also contributed to mission design
 - Gene Grush provided insights into the HPS needed to implement the SHM concept for a Mars mission.
- Bill Studak/JSC EP provided insights in to the design features and operation then HPS mass calculation



BACK-UP CHARTS

SHM Concept Background

- SHM resulted from the FY10 presidential direction
 - Change focus to Exploration
 - Develop and employ new technologies
- SHM advocated to NASA leads for detailed study and direction
 - HAT in June 2010
 - OCT in September 2010
- Presented to several forums
 - Innovation Day 2011
 - Knowledge Capture in July 2011
 - International Conference on Environmental Systems July 2012
 - AIAA Space 2012 in September 2012
 - Presented the concept to the 10/17/2012 JSC knowledge capture event
- Trajectory assessment using NEP addressed in summer 2012 with JSC EG
- Talked with MSFC/GRC Nuclear Propulsion Team to understand nuclear powerplant
- Completed SHM Mass calculations
 - Worked with EP on mass estimates for Habitat Propulsion System (HPS)
 - Worked with EG to revise Trajectory/Mission Mass assessment in late 2012
- Presented SHM to the NASA Human Architecture Team on 5/23/13
 - Recommended that team use resources to perform more detailed SHM study
- Considering alternative to minimize mass from LMO to/from Mars surface
 - To establish functions required for 60 day surface stay, calculate mass of habitat to accomplish those functions, get recalculation of the HPS mass then revision of trajectory analysis



Case 2 - Heliocentric View

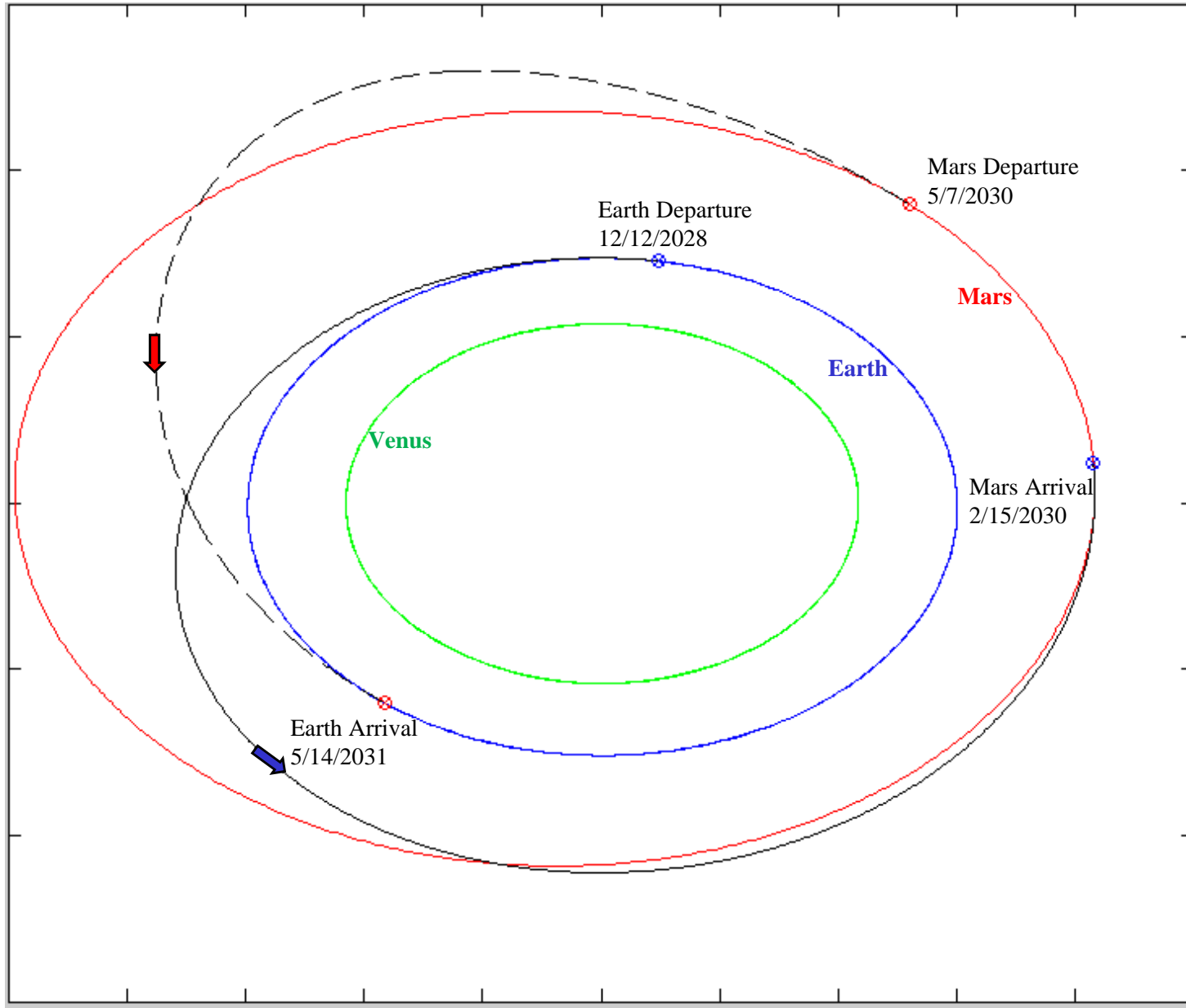

Case Comparison

- For a 5 MW powerplant - 512 mT and 944 crew days
- For a 10 MW powerplant - 731 mT and 886 crew days
- Due to trajectory timing the 10 MW case was not as good a match for return as 5 MW
- Both cases would benefit from optimization of the departure date and return dates
- The shortened mission time (58 days less) achieved using a 10 MW power plant may not merit the added 219 mt mass and technology challenge of going to 10 MW

MMSEV Baseball Card

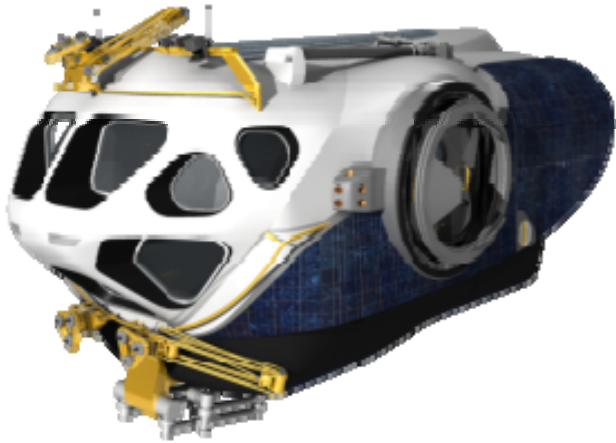

The MMSEV is configured as a destination servicing/exploration system for short term mission durations with the capability to support EVAs from the two suitports and has grappling/docking system. Provides pressurized volume and logistics to support 28 crew days. Supports one- or two-person EVAs via suit ports.

Design Constraints/Parameters

Pressurized Vol.	12.0 m ³
Habitable Vol.	10.8 m ³
Nominal Crew Capacity	2-3
Max Crew Capacity	4
Max Crew-Day Capacity	28 crew-days
# Suit Ports	2
# Manipulators	3
# Equipment / Sample Locks	0

MLI & MMOD Cover External Surfaces
Water in Fusible Heat Sink incl. in Wet mass

Propellants	Hydrazine-Mono
Delta-V budget	
Estimated power, uncrewed	0.5kW
Estimated power, crewed	2.0 kW
Solar power generation	2.5 kW
Total Battery Energy Storage	30.0 kW-h
Depth of Discharge	80%

ECLSS System	Partially closed
TCS Heat rejection	Phase Change + Radiator
Radiation Protection:	Ice Fusible Heat Sink + Polyethylene

Category	Mass, kg
Structure	1641
Protection	40
Propulsion	267
Power	370
Control	55
Avionics	145
ECLSS	643
Other (including PUP)	361
Growth	
DRY MASS SUBTOTAL	4579
Non-cargo	16
Cargo	957
INERT MASS SUBTOTAL	5552
Non-propellant	527
Propellant	
TOTAL WET MASS	6547



Microsoft Office
Excel Worksheet

Version: 4/25/11

Exploration community steps

- Consider the SHM approach
 - Conduct a YA/HAT level assessment of SHM
 - Establish how it really compares against the alternative approaches
 - Evaluate how an exploration campaign that uses SHM would be operated
 - Define the logical steps to get to the OAB
 - Routine transit between Earth and an OAB
- SHM is visualized as the way to get to all destinations
 - It is up to other communities to define the goals for what needs to be done at the destinations
 - A combination of Science, Engineering, Commercialization and colonization goals should be synergized to define exploration goals

DSH ECLSS POD

ARS & WRS & WCS Diagram

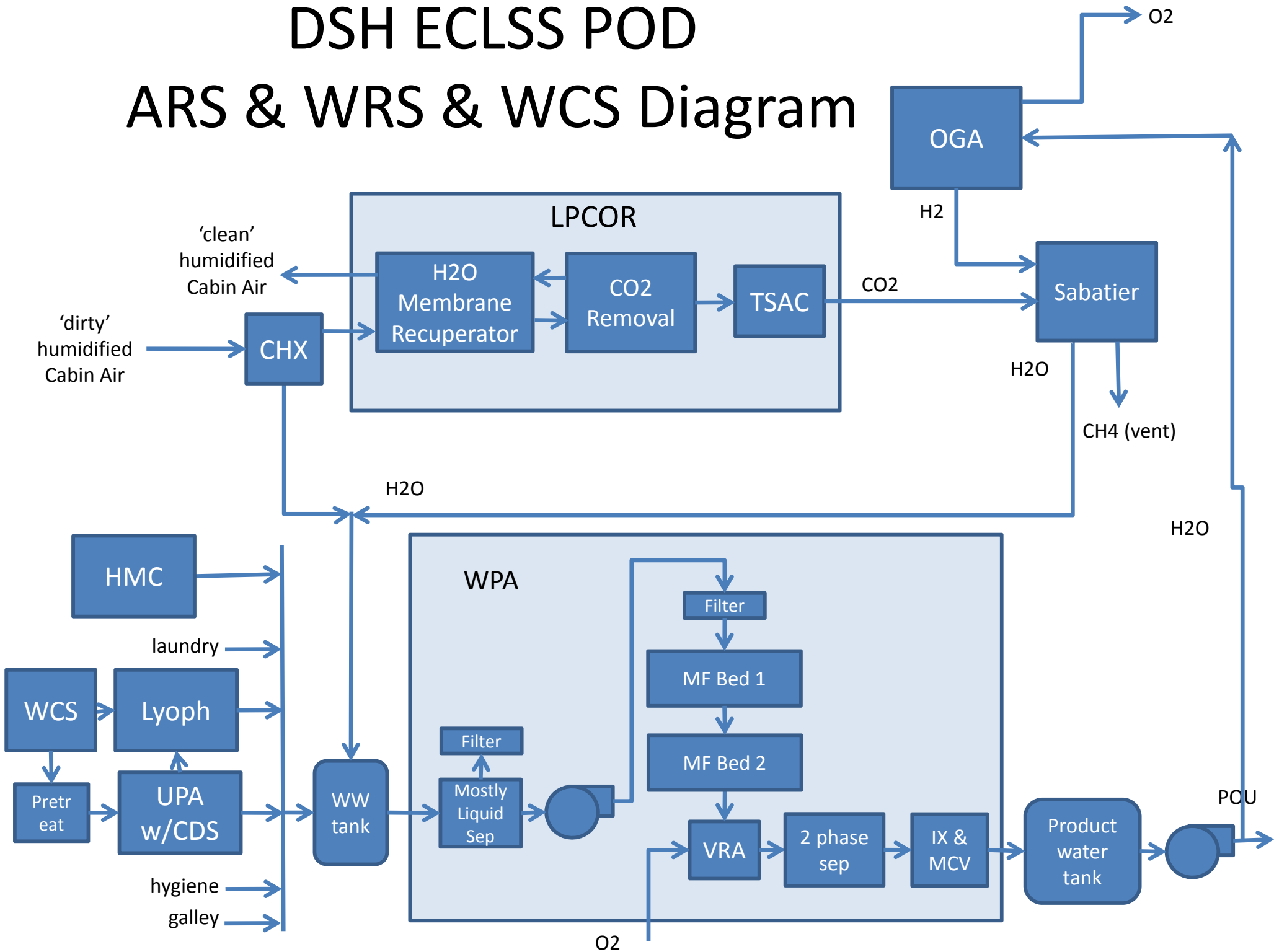

The SHM Concept for Exploration

- Joe Chambliss Biography

- Serves in the EC Special Projects Branch as a Technology Development Engineer
 - More than 39 years of experience joining NASA as a civil servant in 1994
 - Worked with Lockheed, Rockwell, McDonnell Douglas in support of NASA JSC
 - Worked on shuttle, the International Space Station (ISS), Constellation programs, and technology development
 - NASA career started as the system manager for the ISS Thermal Systems Development for the first 6 years of ISS
 - Managed efforts in technology development for life support and thermal control
 - Provided support for Cx Orion, Altair and Lunar Surface Systems projects
 - Deputy manager for Exploration in NASA's Crew and Thermal Systems Division (CTSD) at JSC
 - Deputy manager for Exploration (originally Advanced) Life Support Technology Development
 - Led Life Support for the Advanced Exploration Systems (AES) Habitation Systems Project
 - Contributed to VASIMR rocket heat rejection system design development via SAA with AdAstra
- Bachelor of Science from the University of Texas at Austin
 - Aerospace engineering
- Two Master of Science degrees from Rice University:
 - Aerospace engineering
 - Space physics and astronomy