

(19) World Intellectual Property Organization
International Bureau



(43) International Publication Date
3 May 2007 (03.05.2007)

PCT

(10) International Publication Number
WO 2007/049276 A2

(51) **International Patent Classification:**
A61K 31/739 (2006.01)

(21) **International Application Number:**
PCT/IL2006/001226

(22) **International Filing Date:** 25 October 2006 (25.10.2006)

(25) **Filing Language:** English

(26) **Publication Language:** English

(30) **Priority Data:**
60/729,752 25 October 2005 (25.10.2005) US

(71) **Applicant (for all designated States except US):** MND
DIAGNOSTIC LTD. [IL/IL]; Yozmot Incubator, Granot,
38100 Doar-na Hefer (IL).

(72) **Inventors; and**

(75) **Inventors/Applicants (for US only):** ARAD, Dorit
[IL/IL]; 4 Steimatzy Street, 69639 Tel-aviv (IL). EZRA,
Assaf [IL/IL]; 15 Herzl Street, 59308 Bat-yam (IL).

(74) **Agents:** G.E. EHRLICH (1995) LTD. et al; 11 Men-
achem Begin Street, 52 521 Ramat Gan (IL).

(81) **Designated States (unless otherwise indicated, for every kind of national protection available):** AE, AG, AL, AM, AT, AU, AZ, BA, BB, BG, BR, BW, BY, BZ, CA, CH, CN, CO, CR, CU, CZ, DE, DK, DM, DZ, EC, EE, EG, ES, FI, GB, GD, GE, GH, GM, GT, HN, HR, HU, ID, IL, IN, IS, JP, KE, KG, KM, KN, KP, KR, KZ, LA, LC, LK, LR, LS, LT, LU, LV, LY, MA, MD, MG, MK, MN, MW, MX, MY, MZ, NA, NG, NI, NO, NZ, OM, PG, PH, PL, PT, RO, RS, RU, SC, SD, SE, SG, SK, SL, SM, SV, SY, TJ, TM, TN, TR, TT, TZ, UA, UG, US, UZ, VC, VN, ZA, ZM, ZW

(84) **Designated States (unless otherwise indicated, for every kind of regional protection available):** ARIPO (BW, GH, GM, KE, LS, MW, MZ, NA, SD, SL, SZ, TZ, UG, ZM, ZW), Eurasian (AM, AZ, BY, KG, KZ, MD, RU, TJ, TM), European (AT, BE, BG, CH, CY, CZ, DE, DK, EE, ES, FI, FR, GB, GR, HU, IE, IS, IT, LT, LU, LV, MC, NL, PL, PT, RO, SE, SI, SK, TR), OAPI (BF, BJ, CF, CG, CI, CM, GA, GN, GQ, GW, ML, MR, NE, SN, TD, TG).

Published:

— without international search report and to be republished upon receipt of that report

For two-letter codes and other abbreviations, refer to the "Guidance Notes on Codes and Abbreviations" appearing at the beginning of each regular issue of the PCT Gazette.

(54) **Title:** COMPOSITIONS FOR- DETECTING OF INFLUENZA VIRUSES AND KITS AND METHODS USING SAME

(57) **Abstract:** An isolated composition-of-matter comprising a sialic acid bound to a sialic acid binding domain of a polypeptide is provided. Uses thereof and kits comprising same are also provided.



WO 2007/049276 A2

COMPOSITIONS FOR- DETECTING OF INFLUENZA VIRUSES AND KITS
AND METHODS USING SAME

FIELD AND BACKGROUND OF THE INVENTION

5 The present invention relates to novel compositions that can be used for detecting an influenza virus.

 Influenza A and B viruses are major causes of acute respiratory disease, with an estimated 30-50 million infections annually in the United States alone. Influenza A has been responsible for major epidemics, such as the "Spanish Flu" of 1919 which
10 killed millions of people. Many viral and bacterial infections may present with symptoms similar to those of influenza.

 Due to the multiple mutations and evolution that occurs in the different animal species different subtypes of viruses emerge every season. The avian influenza (H5N1) virus presents an unprecedented epizootic highly pathogenic virus that has
15 crossed the species barrier in Asia. The virus caused human fatalities and further outbreaks indicate that other human populations may also be at risk. It has been shown that the H5N1 is acquiring a more pathogenic nature and has reach a 89 % fatality rate among infants and young children, compared to the 2.5 % mortality rate of the Spanish flu virus. To date a limited, non-sustained human-to-human
20 transmission of H5N1 has been reported. Evidence is consistent with bird-to-human, possibly environment-to-human transmission of H5N1. Once the H5N1 strain will acquire an efficient human-to-human transmission the risk of a pandemic will increase dramatically.

 Laboratory tests for the identification of viruses in clinical material are widely
25 used, and a variety of different detection methodology is available. The textbook, "Laboratory Diagnosis of Viral Infections", Marcel Dekker 1992, Ed E. H. Lennette generally discusses methods which are used for a wide range of viruses, including influenza.

 A number of tests are available for the diagnosis of influenza A and B. The
30 traditional method of identifying influenza viruses has been the use of cell culture, which is highly sensitive and specific. Unfortunately, the time required for culture, isolation and identification of influenza virus can range between 2 and 10 days, thus making it virtually useless in guiding the physician to an appropriate therapy. Since influenza virus infection is normally self-limiting, diagnosis must be rapid if therapy

is to be effective. In other words, such cell culture methods are normally only of value in providing retrospective epidemiological information.

The majority of influenza detection methods and the methods that differentiate between influenza strains or subtypes detect the presence of the influenza genetic material through RT-PCR or PCR [Hassibi et. al., *Biophys Chem.* 2005 Aug 1;116(3):175-85. *Hum Mutat* 2006 M;27(7):644-53; Claas EC, et al., *Lancet.* 1998; 351,p. 472-477]. These methods employ different measures to detect the result of the genetic amplification reaction. RT-PCR and PCR reactions are complicated and thus require expert lab work and might take up to 8 hours.

Some detection methods are based on monoclonal antibodies specific for either type A or B nucleoprotein [U.S. Pat. No. 5,316,910] or for either H1N1 or H2N2 subtypes haemagglutinin [U.S. Pat. No. 5,589,174]. An immuno based assay however is labor-intensive, and requires considerable technical expertise, with the results often being difficult to interpret.

Recently, a few rapid direct tests have become available, which are specific for influenza A. Thus, a monoclonal immunofluorescence assay (IFA) has been reported (Spada, B. et al, *J. Virol. Methods*, 1991 33 305) and at least one enzyme immunoassay (EIA) is available (Ryan-Poirier, K. A. et al, *J. Clin. Microbiol.*, 1992 30 1072). A number of comparisons of these rapid detection methods for influenza A have been reported; see for example Leonardi, G. P. et al, *J. Clin. Microbiol.*, 1994 32 70, who recommended that direct specimen testing be used together with culture isolation, so as to permit both identification of the virus, in time to institute therapy and infection control measures, and to monitor the antigenic constitution of influenza strains prevalent in the community for epidemiological purposes. The IFA method is reported to be labor-intensive, and requires considerable technical expertise, with the results often being difficult to interpret. On the other hand, the ETA method (Directigen FLU-A; Becton Dickinson Microbiology Systems) gave a high level of false-positive results, and it has been recommended that this assay should be used in laboratories only in addition to or as a substitute for direct immunofluorescence tests (Waner, J. L. et al, *J. Clin. Microbiol.*, 1991 29 479).

Influenza virions contain two glycoproteins on their surface, hemagglutinin (HA) and neuraminidase (NA), which recognize sialic acid on host cell glycoconjugates. HA binds to cell surface sialyloligosaccharides and then mediates the entry of the virus into the cell, while NA prevents the aggregation of progeny

virions by removing sialic acid on the oligosaccharides of newly synthesized HA and NA polypeptides. The glycosidic linkage bonding sialic acid (Neu5Ac) with the penultimate saccharide is the substrate of the neuraminidase activity of the influenza virion. The neuraminidase hydrolyzes the linkage, thereby cleaving Neu5Ac from the penultimate saccharide. NA also facilitates the elution of progeny virions from infected cells by removing sialic acid from host cell glycoconjugates [Zambion, J. antimicrobial chemotherapy, 1999, 44, Topic B, 3-9].

The crucial role HA and NA play in the infection of the influenza virus have placed them at the center of attention in influenza research and numerous studies have examined the specificities and preference of HA and NA of the different strains to different substrates.

The HA receptor specificity of influenza viruses differs according to the host species of origin. That is, HA preferentially recognizes the sialic acid-galactose linkages expressed on cells of the host from which the virus was isolated. For example, duck intestinal epithelial cells express primarily *N*-acetylneuramic acid (NeuAc) bound to galactose through an α 2,3 linkage (NeuAc α 2-3Gal), which is preferentially recognized by duck influenza virus HA. Likewise, human virus HA preferentially binds NeuAc α 2-6Gal, the primary linkage of sialic acid expressed on human tracheal epithelial cells. Similarly, the NA specificity for NeuAc α 2-3Gal and NeuAc α 2-6Gal depends on the viral isolate examined.

U.S. Pat. No. 5,252,458 and U.S. Pat. No. 7,081,352 both teach enzymatic based detection methods for the identification of the influenza virus. The enzymatic based assays taught therein detect the presence of a virus through the reaction of a viral neuraminidase with a chromogenic substrate. The chromogenic substrate decomposes to produce light which can then be detected. The chemiluminescent substrate materials include enzymatically triggerable 1,2-dioxetane derivatives of 4-alkoxy-*N*-acetylneuraminic acid and 4,7-dialkoxy-*N*-acetylneuraminic acid and other *N*-neurameric derivatives. U.S. Pat. No. 5,663,055 teaches chromogenic derivatives of *N*-acetylneuraminic acid that exhibit different reactivity with the different types of influenza neuraminidases, thus enabling one to discern the specific type of influenza infection. Thus, influenza type A and B viruses can be distinguished from parainfluenza type 1, 2, 3, and 4, and mumps using the 4,7-dialkoxy-*N*-acetylneuraminic acid. This substrate however, cannot distinguish between different strains of influenza which also include the HA subtyping.

Due to multiple mutations and evolution, the influenza virus develops different subtypes every season. Since there is a global fear that one mutated type may become particularly violent, there is an urgent need to rapidly detect and isolate the violent types of influenza virus both in humans and in birds, in order to monitor and minimize the spread of the pandemic threatened to occur by such viruses.

There is thus a widely recognized need for, and it would be highly advantageous to have, methods and substrates that may be used for the rapid detection different strains of influenza, specifically ones that can become very violent and lethal for people such as H5N1.

10

SUMMARY OF THE INVENTION

According to one aspect of the present invention there is provided an isolated composition-of-matter comprising a sialic acid bound to a sialic acid binding domain of a polypeptide.

15 According to another aspect of the present invention there is provided a composition being of the general formula:

X-Y-Z

wherein:

20 Y comprises a substrate of a neuraminidase, cleavage of X-Y-Z by the neuraminidase forming cleavage products X-Y' and Y''-Z wherein Y' is a first cleavage product of Y and Y'' is a second cleavage product of Y;

X comprises a detectable moiety; and

Z comprises a separating moiety capable of binding to a separate phase of a two phase separating system;

25 wherein the X-Y-Z does not form a contiguous portion of a natural substrate of the viral neuraminidase.

According to yet another aspect of the present invention there is provided a method for detecting at least one pathogen in a sample, the method comprising:

30 (a) contacting the sample with the compositions of the present invention under conditions allowing cleavage of the substrate; and

(b) monitoring cleavage of the substrate, wherein the cleavage of the substrate is indicative of the presence of the at least one pathogen in the sample.

According to yet an additional aspect of the present invention there is provided method of detecting a potentially human pathogenic avian influenza virus in a bird, the method comprising

(a) contacting an avian sample with a neuraminidase substrate, the
5 neuraminidase substrate comprising an $\alpha 2,6$ linkage; and

(b) monitoring cleavage of the substrate, wherein the cleavage of the substrate is indicative of a potentially human pathogenic avian influenza virus.

According to still an additional aspect of the present invention there is provided a method of detecting an avian influenza virus in a human, the method
10 comprising (a) contacting a human sample with a neuraminidase substrate comprising a NeuGc $\alpha 2,3$ linkage; and (b) monitoring cleavage of the substrate, wherein the cleavage of the substrate is indicative of an avian influenza virus in the human.

According to a further aspect of the present invention there is provided a diagnostic kit for detection of at least one influenza virus in a sample, the kit
15 comprising a plurality of compositions of the present invention, and reagents for detecting cleavage of the substrate.

According to yet a further aspect of the present invention there is provided diagnostic kit comprising a packaging material and a plurality of compositions for detecting presence of a plurality of influenza viruses in a sample, wherein each of the
20 compositions is of a general formula,

X-Y-Z

wherein:

Y comprises a substrate of a viral neuraminidase, cleavage of X-Y-Z by the viral neuraminidase forming cleavage products X-Y' and Y''-Z wherein Y' is a first
25 cleavage product of Y and Y'' is a second cleavage product of Y;

X comprises a detectable moiety, and

Z comprises a separating moiety capable of binding to a separate phase of a two phase separating system;

wherein the X-Y-Z does not form a contiguous portion of a natural substrate
30 of the neuraminidase,

wherein each of the X is distinctively detectable and whereas the packaging material comprises a label or package insert indicating that the kit is for detection of plurality of influenza viruses in a sample.

According to further features in preferred embodiments of the invention described below, the sialic acid is attached to at least one carbohydrate via a linker.

According to still further features in the described preferred embodiments, the sialic acid is attached to two carbohydrates wherein a first carbohydrate of the two
5 carbohydrates is attached to a second carbohydrate of the two carbohydrates via a second linker.

According to still further features in the described preferred embodiments, the second linker is selected from the group consisting of an α 1-4 linker, an α 1-3 linker, an α 2-3 linker and an α 1-6 linker.

10 According to still further features in the described preferred embodiments, the composition is hydrolyzable by neuraminidase.

According to still further features in the described preferred embodiments, the carbohydrate is selected from the group consisting of galactose, N-acetylgalactosamine, glucose, mannose, glucoseamine galactoseamine, rhamnose,
15 fucose, inositol, scyllo-inositol, fructose, xylulose, ribulose, ribose, aloes, altrose, arabinose, xylose, gulose, idose, lyxose, talose, neuraminic acid, glucuronic acid glucaric acid, gluconic acid, GaINAc and GlcNAc.

According to still further features in the described preferred embodiments, the linker is selected from the group consisting of an α 2,3 linker, an α 2,6 linker and an
20 cc2,8 linker.

According to still further features in the described preferred embodiments, the sialic acid is naturally occurring.

According to still further features in the described preferred embodiments, the sialic acid is synthetic.

25 According to still further features in the described preferred embodiments, the polypeptide is a hemagglutinin polypeptide.

According to still further features in the described preferred embodiments, the sialic acid binding domain is comprised in a hemagglutinin polypeptide.

30 According to still further features in the described preferred embodiments, the hemagglutinin polypeptide is truncated.

According to still further features in the described preferred embodiments, the hemagglutinin polypeptide is selected from the group consisting of an H1 polypeptide, an H2 polypeptide, an H3 polypeptide, an H4 polypeptide, an H5 polypeptide, an H6 polypeptide an H7 polypeptide, an H8 polypeptide, an H9

polypeptide, an H10 polypeptide, an H11 polypeptide, an H12 polypeptide, an H13 polypeptide, an H14 polypeptide, an H15 polypeptide and an H16 polypeptide.

According to still further features in the described preferred embodiments, the composition further comprises at least one detectable moiety.

5 According to still further features in the described preferred embodiments, the sialic acid is attached to at least one carbohydrate via a linker.

According to still further features in the described preferred embodiments, the detectable moiety is attached to the sialic acid via a linker.

10 According to still further features in the described preferred embodiments, the at least one detectable moiety is a pre-enzyme, and whereas cleavage of the linkage activates the pre-enzyme.

According to still further features in the described preferred embodiments, the at least one detectable moiety is a pre-substrate and whereas cleavage of the linkage releases the pre-substrate to form an active detectable substrate of an enzyme.

15 According to still further features in the described preferred embodiments, the enzyme is β galactosidase.

According to still further features in the described preferred embodiments, the at least one detectable moiety is a FRET pair, and whereas cleavage of the linkage generates a signal from the FRET pair.

20 According to still further features in the described preferred embodiments, the at least one detectable moiety is a Quantum dot, and whereas cleavage of the linkage generates a signal from the Quantum dot.

25 According to still further features in the described preferred embodiments, the at least one detectable moiety comprises a labeling agent selected from the group consisting of an enzyme, a fluorophore, a chromophore, a protein, a peptide, a pre-enzyme, a chemiluminescent substance, a pre-substrate, Quantum Dot and a radioisotope.

According to still further features in the described preferred embodiments, the composition of matter further comprises a separating moiety.

30 According to still further features in the described preferred embodiments, the composition-of-matter is of the general formula:

X-Y-Z

wherein:

Y comprises a substrate of a neuraminidase, cleavage of X-Y-Z by neuraminidase forming cleavage products X-Y¹ and Y"-Z wherein Y¹ is a first cleavage product of Y and Y" is a second cleavage product of Y;

X comprises a detectable moiety; and

5 Z comprises the separating moiety capable of binding to a separate phase of a two phase separating system;

wherein the X-Y-Z does not form a contiguous portion of a natural substrate of the viral neuraminidase.

10 According to still further features in the described preferred embodiments, the detectable moiety comprises a labeling agent selected from the group consisting of an enzyme, a fluorophore, a chromophore, a FRET pair, a protein, a peptide, a pre-enzyme, a chemiluminescent substance, a pre-substrate, Quantum Dot and a radioisotope.

15 According to still further features in the described preferred embodiments, the separating moiety is selected from the group consisting of an immunological binding agent, a magnetic binding moiety, a peptide binding moiety, an affinity binding moiety and a nucleic acid moiety.

According to still further features in the described preferred embodiments, the separating moiety further comprises a detectable moiety.

20 According to still further features in the described preferred embodiments, the pathogen is an influenza virus.

According to still further features in the described preferred embodiments, the sample is a mammalian sample.

25 According to still further features in the described preferred embodiments, the mammalian sample is a human sample.

According to still further features in the described preferred embodiments, the sample is an avian sample.

30 According to still further features in the described preferred embodiments, when the substrate comprises an $\alpha 2,6$ linkage, the cleavage of the substrate is indicative of a potentially human pathogenic avian influenza virus.

According to still further features in the described preferred embodiments, when the substrate comprises an NeuGc $\alpha 2,3$ linkage, the cleavage of the substrate is indicative of avian influenza virus.

According to still further features in the described preferred embodiments, the sample is selected from the group consisting of mucus, saliva, throat wash, nasal wash, spinal fluid, sputum, urine, semen, sweat, feces, plasma, blood, bronchoalveolar fluid, vaginal fluid, tear fluid and tissue biopsy.

According to still further features in the described preferred embodiments, the sample is selected from the group consisting of mucus, saliva, throat wash, nasal wash, spinal fluid, sputum, plasma, blood, bronchoalveolar fluid, tear fluid and tissue biopsy.

According to still further features in the described preferred embodiments, the monitoring is effected using a homogeneous assay.

According to still further features in the described preferred embodiments, the monitoring is effected using a heterogeneous assay.

According to still further features in the described preferred embodiments, the substrate of the viral neuraminidase comprises a sialic acid bound to a sialic acid binding domain of a polypeptide.

According to still further features in the described preferred embodiments, the diagnostic kit further comprises reagents for detecting cleavage of the substrate.

According to still further features in the described preferred embodiments, the each of the plurality of compositions is a substrate for a different neuraminidase.

According to still further features in the described preferred embodiments, the plurality of compositions are attached to a single solid support.

According to still further features in the described preferred embodiments, the distinctive detection is effected by an addressable location on the single solid support.

According to still further features in the described preferred embodiments, the distinctive detection is effected by different detectable moieties.

According to still further features in the described preferred embodiments, the solid support is configured as a bead.

According to still further features in the described preferred embodiments, the bead is selected from the group consisting of a colored bead, a magnetic bead, a tagged bead and a fluorescent bead.

According to still further features in the described preferred embodiments, the diagnostic kit further comprises a substrate for the detection of at least one more virus other than the influenza virus selected from the group consisting of Corona Viruses,

SARS, HMPV (Human Meta pneumo virus), Adeno virus, RSV (Respiratory Syncytial Virus) and Rhino virus.

The present invention successfully addresses the shortcomings of the presently known configurations by providing methods and compositions of matter for
5 the rapid detection of a particular strain of influenza virus.

Unless otherwise defined, all technical and scientific terms used herein have the same meaning as commonly understood by one of ordinary skill in the art to which this invention belongs. Although methods and materials similar or equivalent to those described herein can be used in the practice or testing of the present
10 invention, suitable methods and materials are described below. All publications, patent applications, patents, and other references mentioned herein are incorporated by reference in their entirety. In case of conflict, the patent specification, including definitions, will control. In addition, the materials, methods, and examples are illustrative only and not intended to be limiting.

15

BRIEF DESCRIPTION OF THE DRAWINGS

The invention is herein described, by way of example only, with reference to
20 the accompanying drawings. With specific reference now to the drawings in detail, it is stressed that the particulars shown are by way of example and for purposes of illustrative discussion of the preferred embodiments of the present invention only, and are presented in the cause of providing what is believed to be the most useful and readily understood description of the principles and conceptual aspects of the
25 invention. In this regard, no attempt is made to show structural details of the invention in more detail than is necessary for a fundamental understanding of the invention, the description taken with the drawings making apparent to those skilled in the art how the several forms of the invention may be embodied in practice.

In the drawings:

30 FIG. 1 is a schematic representation of the structure of one embodiment of the substrate of the present invention.

FIG. 2 is a schematic representation of the basic operation of one embodiment of the separation system of the present invention.

FIG. 3 is a schematic representation of the simultaneous detection of three substrate molecules, wherein two of them undergo cleavage.

FIG. 4 is a schematic representation of a dynamic separation system according to one embodiment of the present invention.

5 FIG. 5 is a schematic representation of exemplary sialic acids that may be used according to the present invention.

FIG. 6 is a schematic representation of a neuraminidase substrate for the detection of influenza virus.

10 FIG. 7 is a schematic representation depicting the specificity of a human influenza virus and an avian influenza virus for a human or avian cell respectively.

FIGs. 8A-C is a photograph of an exemplary kit for testing the pathogenicity of avian flu virus. Figure 8A is a photograph of the kit following contact with a sample not comprising influenza virus. Figure 8B is a photograph of the kit following contact with a sample comprising human non-pathogenic avian influenza. Figure 8C is a photograph of the kit following contact with a sample comprising human pathogenic avian influenza.

FIG. 9 is a block diagram illustrating the process of influenza virus detection.

FIG. 10 is a schematic diagram illustrating detection of substrate cleavage using a pre-substrate.

20 FIG. 11 is a schematic diagram for the simultaneous detection of different types of influenza with colored beads.

DESCRIPTION OF THE PREFERRED EMBODIMENTS

The present invention is of a novel substrate for neuraminidase. Specifically, the present invention can be used to detect viruses which express neuraminidase and differentiate between strains thereof.

Before explaining at least one embodiment of the invention in detail, it is to be understood that the invention is not limited in its application to the details set forth in the following description or exemplified by the Examples. The invention is capable of other embodiments or of being practiced or carried out in various ways. Also, it is to be understood that the phraseology and terminology employed herein is for the purpose of description and should not be regarded as limiting.

Diagnosis of viral infection, such as infection by influenza virus, may be carried out by detecting the presence of unique moieties characteristic of the virus.

Virus particles typically carry distinctive antigenic components on the exterior of the virion which may be detected by specific ligand-anti-ligand interactions (e.g. ligand binding moieties, receptors and antibodies), in particular by the use of an antibody specific for a viral epitope. Such interactions rely on the law of mass action, and for this reason may have limited sensitivity. Many virus particles additionally carry specific enzymatic activities on the virion particle. Influenza virus is an example of such a virus, endowed with a virus-specific neuraminidase activity as an integral part of the virion which is exposed to the environment. Its substrate is the glycosidic linkage bonding sialic acid (Neu5Ac) with the penultimate saccharide of host cell surface glycoconjugates. Neuraminidase hydrolyzes the linkage, thereby cleaving Neu5Ac from the penultimate saccharide.

Utilization of the enzymatic activity in such cases offers the potential for increasing the sensitivity of a detection method.

Influenza virions also comprise hemagglutinin (HA) on their surface which, like neuraminidase, also recognizes terminal sialic acids on host cell glycoconjugates. These terminal sialic acids serve as ligands to the HA sialic acid receptor domain. The HA receptor and NA specificity of influenza viruses differs according to the host species of origin. That is, HA and NA preferentially recognize the sialic acid-galactose linkages expressed on cells of the host from which the virus was isolated. The HA-sialic acid complex interacts with the NA to mediate the cleavage of the sialic acid glycosidic linkage on the penultimate saccharide of the glycoconjugates. Many variants of HA (1-16) and NA (1-9) exist, and it is evident that not every combination of NA and HA can form an infective virus. The close interactions between NA and HA towards the sialic acid requires compatibility between these two cell surface particles in order to achieve efficient cleavage.

Whilst conceiving the present invention, the present inventors have conceptualized a novel method for differentiating between influenza virus strains according to their HA-sialic acid glycoconjugate-NA complex specificity. Accordingly, the present inventors envisage a novel neuraminidase substrate molecule comprising sialic acid bound to an HA polypeptide, or portion thereof. Incorporation of the HA polypeptide in the substrate molecule allows for a greater level of differentiation between influenza viruses since it serves to present the sialic acid on the cell surface in a particular fashion thereby enabling the cleavage of this complex by only certain neuraminidases.

Furthermore, the present inventors provide substrates capable of differentiating between human pathogenic avian influenza viruses and human non-pathogenic avian influenza viruses. Such substrates comprise sialic acid bound to a sugar moiety, wherein the linkage between the two provides specificity for either a pathogenic or non-pathogenic avian influenza virus. Specifically, cleavage of sialic acid from a 2,6 linked sugar as well as a 2,3 linked sugar (or 2,8 linked sugar) will indicate that the avian virus is potentially pathogenic to humans.

Thus, according to one aspect of the present invention, there is provided an isolated composition-of-matter comprising a sialic acid bound to a sialic acid binding domain of a polypeptide.

As used herein, the phrase "sialic acid" refers to any member of a family of SIA derivatives. The most common member of the sialic acid family is N-acetylneuraminic acid (2-keto-5-acetamido-3,5-dideoxy-D-glycero-D-galactononulopyranos-1-onic acid (often abbreviated as Neu5Ac, NeuAc, or NANA). A second member of the family is N-glycolylneuraminic acid (Neu5Gc or NeuGc), in which the N-acetyl group of NeuAc is hydroxylated. A third sialic acid family member is 2-keto-3-deoxy-nonulosonic acid (KDN) (Nadano et al. (1986) J. Biol. Chem. 261: 11550-11557; Kanamori et al. (1990) J. Biol. Chem. 265: 21811-21819. Also included are 9-substituted sialic acids such as a 9-O-C1-C6 acyl-Neu5Ac like 9-O-lactyl-Neu5Ac or 9-O-acetyl-Neu5Ac, 9deoxy-9-fluoro-Neu5Ac and 9-azido-9-deoxy-Neu5Ac. For review of the sialic acid family, see, e.g., Varki (1992) Glycobiology 2: 25-40; Sialic Acids: Chemistry, Metabolism and Function, R. Schauer, Ed. (Springer-Verlag, New York (1992). The sialic acids may be naturally occurring or synthetic (i.e. analogues). Exemplary sialic acids and analogues thereof (including ManAc analogues) are illustrated in Figure 5.

Methods of synthesizing sialic acids are well known in the art - see for example "Carbohydrates in Drug Design" (1999, 64, No. 7, 847), "Glycopeptides and Related Compounds. Synthesis, Analysis, and Applications" (1999, 64, No. 9, 1092), "Techniques in Glycobiology" (1999, 64, No. 10, 1215) and Glycochemistry. Principles, Synthesis, and Applications (Wang, P. G., and Bertozzi, C. R., eds., Marcel Dekker, New York-Basel, 2001.

As used herein, the term "bound" refers to any type of bonding including but not limited to covalent bonding, hydrogen bonding, electrostatic binding and receptor substrate affinity bonding.

According to this aspect of the present invention, the sialic acid in the substrate molecule is bound to a sialic acid binding domain of a polypeptide.

As used herein, the phrase "sialic acid binding domain of a polypeptide" refers to any peptide sequence (i.e., naturally occurring or synthetic) that is capable of binding sialic acid and presenting it such that it is capable of being catalytically processed/hydrolyzed by neuraminidase.

The term "peptide" as used herein encompasses native peptides (either degradation products, synthetically synthesized peptides or recombinant peptides) and peptidomimetics (typically, synthetically synthesized peptides), as well as peptoids and semipeptoids which are peptide analogs, which may have, for example, modifications rendering the peptides more stable while in a body or more capable of penetrating into cells. Such modifications include, but are not limited to N terminus modification, C terminus modification, peptide bond modification, including, but not limited to, CH₂-NH, CH₂-S, CH₂-S=O, O=C-NH, CH₂-O, CH₂-CH₂, S=C-NH, CH=CH or CF=CH, backbone modifications, and residue modification. Methods for preparing peptidomimetic compounds are well known in the art and are specified, for example, in Quantitative Drug Design, CA. Ramsden Gd., Chapter 17.2, F. Choplin Pergamon Press (1992), which is incorporated by reference as if fully set forth herein. Further details in this respect are provided hereinunder.

Peptide bonds (-CO-NH-) within the peptide may be substituted, for example, by N-methylated bonds (-N(CH₃)-CO), ester bonds (-C(R)H-C-O-O-C(R)-N-), ketomethylen bonds (-CO-CH₂-), α -aza bonds (-NH-N(R)-CO-), wherein R is any alkyl, e.g., methyl, carba bonds (-CH₂-NH-), hydroxyethylene bonds (-CH(OH)-CH₂-), thioamide bonds (-CS-NH-), olefinic double bonds (-CH=CH-), retro amide bonds (-NH-CO-), peptide derivatives (-N(R)-CH₂-CO~), wherein R is the "normal" side chain, naturally presented on the carbon atom.

These modifications can occur at any of the bonds along the peptide chain and even at several (2-3) at the same time.

Natural aromatic amino acids, Trp, Tyr and Phe, may be substituted for synthetic non-natural acid such as Phenylglycine, Tic, naphthylalanine (NaI), phenylisoserine, threoninol, ring-methylated derivatives of Phe, halogenated derivatives of Phe or o-methyl-Tyr.

In addition to the above, the peptides of the present invention may also include one or more modified amino acids or one or more non-amino acid monomers (e.g. fatty acids, complex carbohydrates etc).

As used herein in the specification and in the claims section below the term "amino acid" or "amino acids" is understood to include the 20 naturally occurring amino acids; those amino acids often modified post-translationally *in vivo*, including, for example, hydroxyproline, phosphoserine and phosphothreonine; and other unusual amino acids including, but not limited to, 2-aminoadipic acid, hydroxylysine, isodesmosine, nor-valine, nor-leucine and ornithine. Furthermore, the term "amino acid" includes both D- and L-amino acids.

Tables 1 and 2 below list naturally occurring amino acids (Table 1) and non-conventional or modified amino acids (e.g., synthetic, Table 2) which can be used with the present invention.

Table 1

<i>Amino Acid</i>	<i>Three-Letter Abbreviation</i>	<i>One-letter Symbol</i>
alanine	Ala	A
Arginine	Arg	R
Asparagine	Asn	N
Aspartic acid	Asp	D
Cysteine	Cys	C
Glutamine	Gln	Q
Glutamic Acid	Glu	E
glycine	Gly	G
Histidine	His	H
isoleucine	Ile	I
leucine	Leu	L
Lysine	Lys	K
Methionine	Met	M
phenylalanine	Phe	F
Proline	Pro	P
Serine	Ser	S
Threonine	Thr	T
tryptophan	Trp	W
tyrosine	Tyr	Y
Valine	Val	V
Any amino acid as above	Xaa	X

15

Table 2

<i>Non-conventional amino acid</i>	<i>Code</i>	<i>Non-conventional amino acid</i>	<i>Code</i>
α -aminobutyric acid	Abu	L-N-methylalanine	Nmala
α -amino- α -methylbutyrate	Mgab	L-N-methylarginine	Nmarg
aminocyclopropane-	Cpro	L-N-methylasparagine	Nmasn
carboxylate		L-N-methylaspartic acid	Nmasp
aminoisobutyric acid	Aib	L-N-methylcysteine	Nmcys

aminonorbonyl-carboxylate	Norb	L-N-methylglutamine	Nmgin
		L-N-methylglutamic acid	Nmglu
cyclohexylalanine	Chexa	L-N-methylhistidine	Nmhis
cyclopentylalanine	Cpen	L-N-methylisoleucine	Nmile
D-alanine	Dal	L-N-methylleucine	Nmleu
D-arginine	Darg	L-N-methyllysine	Nmlys
D-aspartic acid	Dasp	L-N-methylmethionine	Nmmet
D-cysteine	Dcys	L-N-methylnorleucine	Nmle
D-glutamine	Dgln	L-N-methylnorvaline	Nmnva
D-glutamic acid	Dglu	L-N-methylornithine	Nmorn
D-histidine	Dhis	L-N-methylphenylalanine	Nmphe
D-isoleucine	Dile	L-N-methylproline	Nmpro
D-leucine	Dleu	L-N-methylserine	Nmser
D-lysine	Dlys	L-N-methylthreonine	Nmthr
D-methionine	Dmet	L-N-methyltryptophan	Nmtrp
D-ornithine	Dorn	L-N-methyltyrosine	Nmtyr
D-phenylalanine	Dphe	L-N-methylvaline	Nmval
D-proline	Dpro	L-N-methylethylglycine	Nmetg
D-serine	Dser	L-N-methyl-t-butylglycine	Nmbug
D-threonine	Dthr	L-norleucine	Nle
D-tryptophan	Dtrp	L-norvaline	Nva
D-tyrosine	Dtyr	α -methyl-aminoisobutyrate	Maib
D-valine	Dval	α -methyl- γ -aminobutyrate	Mgab
D- α -methylalanine	Dmala	α -methylcyclohexylalanine	Mchexa
D- α -methylarginine	Dmarg	α -methylcyclopentylalanine	Mcpen
D- α -methylasparagine	Dmasn	α -methyl- α -naphthylalanine	Manap
D- α -methylaspartate	Dmasp	α -methylpenicillamine	Mpen
D- α -methylcysteine	Dmcys	N-(4-aminobutyl)glycine	Nglu
D- α -methylglutamine	Dmgln	N-(2-aminoethyl)glycine	Naeg
D- α -methylhistidine	Dmhis	N-(3-aminopropyl)glycine	Norn
D- α -methylisoleucine	Dmile	N-amino- α -methylbutyrate	Nmaabu
D- α -methylleucine	Dmleu	α -naphthylalanine	Anap
D- α -methyllysine	Dmlys	N-benzylglycine	Nphe
D- α -methylmethionine	Dmmet	N-(2-carbamylethyl)glycine	Ngln
D- α -methylornithine	Dmorn	N-(carbamylmethyl)glycine	Nasn
D- α -methylphenylalanine	Dmphe	N-(2-carboxyethyl)glycine	Nglu
D- α -methylproline	Dmpro	N-(carboxymethyl)glycine	Nasp
D- α -methylserine	Dmser	N-cyclobutylglycine	Ncbut
D- α -methylthreonine	Dmthr	N-cycloheptylglycine	Nchep
D- α -methyltryptophan	Dmtrp	N-cyclohexylglycine	Nchex
D- α -methyltyrosine	Dmty	N-cyclodecylglycine	Ncdec
D- α -methylvaline	Dmval	N-cyclododecylglycine	Ncdod
D- α -methylalnine	Dnmala	N-cyclooctylglycine	Ncoct
D- α -methylarginine	Dnmarg	N-cyclopropylglycine	Ncpro
D- α -methylasparagine	Dnmasn	N-cycloundecylglycine	Ncund
D- α -methylasparatate	Dnmasp	N-(2,2-diphenylethyl)glycine	Nbhm
D- α -methylcysteine	Dnmcys	N-(3,3-diphenylpropyl)glycine	Nbhe
D-N-methylleucine	Dnmleu	N-(3-indolylyethyl) glycine	Nhtrp
D-N-methyllysine	Dnmlys	N-methyl- γ -aminobutyrate	Nmgabu
N-methylcyclohexylalanine	Nmchexa	D-N-methylmethionine	Dnmmet

D-N-methylornithine	Dnmorn	N-methylcyclopentylalanine	Nmcpen
N-methylglycine	Nala	D-N-methylphenylalanine	Dnmphe
N-methylaminoisobutyrate	Nmaib	D-N-methylproline	Dnmpro
N-(1-methylpropyl)glycine	Nile	D-N-methylserine	Dnmser
N-(2-methylpropyl)glycine	Nile	D-N-methylserine	Dnmser
N-(2-methylpropyl)glycine	Nleu	D-N-methylthreonine	Dnmthr
D-N-methyltryptophan	Dnmtrp	N-(1-methylethyl)glycine	Nva
D-N-methyltyrosine	Dnmtyr	N-methyl- <i>n</i> -naphthylalanine	Nmanap
D-N-methylvaline	Dnmval	N-methylpenicillamine	Nmpen
γ -aminobutyric acid	Gabu	N-(<i>p</i> -hydroxyphenyl)glycine	Nhtyr
L- <i>t</i> -butylglycine	Tbug	N-(thiomethyl)glycine	Ncys
L-ethylglycine	Etg	penicillamine	Pen
L-homophenylalanine	Hphe	L- α -methylalanine	Mala
L- α -methylarginine	Marg	L- α -methylasparagine	Masn
L- α -methylaspartate	Masp	L- α -methyl- <i>t</i> -butylglycine	Mtbug
L- α -methylcysteine	Mcys	L-methylethylglycine	Metg
L- α -methylglutamine	Mgln	L- α -methylglutamate	Mglu
L- α -methylhistidine	Mhis	L- α -methylhomo phenylalanine	Mhphe
L- α -methylisoleucine	Mile	N-(2-methylthioethyl)glycine	Nmet
D-N-methylglutamine	Dnmgln	N-(3-guanidinopropyl)glycine	Narg
D-N-methylglutamate	Dnmglu	N-(1-hydroxyethyl)glycine	Nthr
D-N-methylhistidine	Dnmhis	N-(hydroxyethyl)glycine	Nser
D-N-methylisoleucine	Dnmile	N-(imidazolethyl)glycine	Nhis
D-N-methylleucine	Dnmleu	N-(3-indolylethyl)glycine	Nhtrp
D-N-methyllysine	Dnmlys	N-methyl- γ -aminobutyrate	Nmgabu
N-methylcyclohexylalanine	Nmchexa	D-N-methylmethionine	Dnmmet
D-N-methylornithine	Dnmorn	N-methylcyclopentylalanine	Nmcpen
N-methylglycine	Nala	D-N-methylphenylalanine	Dnmphe
N-methylaminoisobutyrate	Nmaib	D-N-methylproline	Dnmpro
N-(1-methylpropyl)glycine	Nile	D-N-methylserine	Dnmser
N-(2-methylpropyl)glycine	Nleu	D-N-methylthreonine	Dnmthr
D-N-methyltryptophan	Dnmtrp	N-(1-methylethyl)glycine	Nval
D-N-methyltyrosine	Dnmtyr	N-methyl- <i>n</i> -naphthylalanine	Nmanap
D-N-methylvaline	Dnmval	N-methylpenicillamine	Nmpen
γ -aminobutyric acid	Gabu	N-(<i>p</i> -hydroxyphenyl)glycine	Nhtyr
L- <i>t</i> -butylglycine	Tbug	N-(thiomethyl)glycine	Ncys
L-ethylglycine	Etg	penicillamine	Pen
L-homophenylalanine	Hphe	L- α -methylalanine	Mala
L- α -methylarginine	Marg	L- α -methylasparagine	Masn
L- α -methylaspartate	Masp	L- α -methyl- <i>t</i> -butylglycine	Mtbug
L- α -methylcysteine	Mcys	L-methylethylglycine	Metg
L- α -methylglutamine	Mgln	L- α -methylglutamate	Mglu
L- α -methylhistidine	Mhis	L- α -methylhomophenylalanine	Mhphe
L- α -methylisoleucine	Mile	N-(2-methylthioethyl)glycine	Nmet
L- α -methylleucine	Mleu	L- α -methyllysine	Mlys
L- α -methylmethionine	Mmet	L- α -methylnorleucine	Mnle
L- α -methylnorvaline	Mnva	L- α -methylornithine	Morn
L- α -methylphenylalanine	Mphe	L- α -methylproline	Mpro
L- α -methylserine	mser	L- α -methylthreonine	Mthr
L- α -methylvaline	Mtrp	L- α -methyltyrosine	Mtyr
L- α -methylleucine	Mval Nnbhm	L-N-methylhomophenylalanine	Nmhpe

N-(N-(2,2-diphenylethyl)		N-(N-(3,3-diphenylpropyl)	
carbonylmethyl-glycine	Nnbhm	carbonylmethyl(1)glycine	Nnbhe
l-carboxy-1-(2,2-diphenyl ethylamino)cyclopropane	Nmbc		

The sialic binding domain may be a short peptide sequence (e.g. less than 10 amino acids) that just comprises the sialic acid binding domain, or be comprised in a polypeptide that comprises a sialic acid binding domain as well as other domains e.g. a full length protein or a truncated protein (e.g., 10-50 amino acids). Exemplary short peptide sequences that are capable of binding sialic acids are known in the art, see for example Heerze et al Glycobiology vol 5 no 4 pp. 427-433, 1995.

Examples of polypeptides that are capable of binding sialic acids (i.e. proteins that comprise sialic acid binding domains) are set forth in Table 3 hereinbelow.

10

Table 3

<i>Vertebrate</i>
C-type: Selectins
I-type: Siglecs
Unclassified: Complement factor H, laminin
<i>Inthropod</i>
Crab lectins: Limulin (American horseshoe crab, <i>Limulus polyphemus</i>)
Lobster and prawn lectins: t-agglutinin (lobster, <i>Homarus americanus</i>)
Scorpion lectins: Whip scorpion lectin (<i>Masticoproctus giganteus</i>)
Other insect lectins: Allo A-II (beetle lectin, <i>Allomyrina dichotoma</i>)
<i>Mollusc</i>
Slug and snail lectins: <i>Limax flavus</i> agglutinin (LFA, slug, <i>Limax flavus</i>)
Mussel and oyster lectins: Pacific oyster lectin (<i>Crassostrea gigas</i>)
<i>Protozoal</i>
Parasite lectins: Merozoite erythrocyte-binding antigen (<i>Plasmodium falciparum</i>)
<i>Plant</i>
SN agglutinin (elderberry bark lectin, <i>Satnbuscus nigra</i>), TJ agglutinin (<i>Tricosanthes japonicum</i>), MA agglutinin (<i>Maackia amurensis</i>), wheat-germ agglutinin (<i>Triticum vulgare</i>)
(<i>Tricosanthes japonicum</i>), MA agglutinin (<i>Maackia amurensis</i>), wheat-germ agglutinin (<i>Triticum vulgare</i>)
<i>Bacterial</i>
Bacterial adhesins: S-adhesin (<i>Escherichia coli</i> K99), adhesin I and adhesin II (<i>Helicobacter pylori</i>)
Bacterial toxins: Cholera toxin (<i>Vibrio cholerae</i>), tetanus toxin (<i>Clostridium tetani</i>), botulinum toxin (<i>Clostridium botulinum</i>), pertussis toxin (<i>Bordetella pertussis</i>)
Mycoplasma lectins: <i>Mycoplasma pneumoniae</i> hemagglutinin
<i>Viral</i>
Hemagglutinins: Influenza A and B viruses, Primate polyomaviruses, Rotaviruses
Hemagglutinin-neuraminidases: New Castle disease virus, Sendai virus, fowl plague virus, parainfluenza
Hemagglutinin esterases: Influenza C viruses, human and bovine coronaviruses

According to a preferred embodiment of this aspect of the present invention the present invention, the sialic acid binding domain is a hemagglutinin polypeptide, or part thereof e.g. one of the 16 influenza hemagglutinin variants (H1, H2, H3 H4, H5, H6, H7, H8, H9, H10, H11, H12, H13, H14, H15 or H16. Preferably the amino acid sequence of the hemagglutinin polypeptide of the present invention is at least 80 % homologous to the naturally occurring sequence.

Short peptides that comprise sialic acid binding sites can be synthesized using solid phase peptide synthesis procedures that are well known in the art and further described by John Morrow Stewart and Janis Dillaha Young, [Solid Phase Peptide Syntheses (2nd Ed., Pierce Chemical Company, 1984)]. Synthetic peptides can be purified by preparative high performance liquid chromatography [Creighton T. (1983) Proteins, structures and molecular principles. WH Freeman and Co. N.Y.] and the composition of which can be confirmed by amino acid sequencing.

In cases where longer peptide are desired e.g. full length proteins or truncated proteins, they can be generated using recombinant techniques such as described by Bitter *et al*, (1987) Methods in Enzymol. 153:516-544, Studier *et al*, (1990) Methods in Enzymol. 185:60-89, Brisson *et al*, (1984) Nature 310:511-514, Takamatsu *et al*, (1987) EMBO J. 6:307-311, Coruzzi *et al*, (1984) EMBO J. 3:1671-1680 and Brogli *et al*, (1984) Science 224:838-843, Gurley *et al*, (1986) Mol. Cell. Biol. 6:559-565 and Weissbach & Weissbach, 1988, Methods for Plant Molecular Biology, Academic Press, NY, Section VIII, pp 421-463.

According to a particularly preferred embodiment, the sialic acid of the composition of the present invention is attached to at least one carbohydrate via a linker in such a way that it is a substrate for neuraminidase (i.e. hydrolyzed by neuraminidase).

As used herein, the term "neuraminidase" refers to the enzyme also known as sialidase, acylneuraminy l hydrolase as set forth in EC 3.2.1.18.

Exemplary carbohydrates according to this embodiment of this aspect of the present invention include, but are not limited to galactose, N-acetylgalactosamine, glucose, mannose, glucoseamine galactoseamine, rhamnose, fucose, inositol, scyllo-inositol, fructose, xylulose, ribulose, ribose, aloes, altrose, arabinose, xylose, gulose, idose, lyxose, talose, neuraminic acid, glucuronic acid gluconic acid, gluconic acid GaINAc and GlcNAc.

As used herein, the term linker" refers to a bond, preferably a covalent bond. The link between the carbohydrate and sialic acid may be an $\alpha 2, 3$ link, an $\alpha 2, 6$ link or an $\alpha 2, 8$ link.

The sialic acid may be naturally bound to such a carbohydrate moiety. Alternatively, the carbohydrate may be bound to the sialic acid using chemical procedures which are well known in the art.

The substrate composition of the present invention may comprise a second carbohydrate moiety attached to the first carbohydrate moiety, further mimicking the natural substrate of neuraminidase. Any link is envisaged between the two carbohydrate moieties including for example an $\alpha 1-4$ link, an $\alpha 1-3$ link, an $\alpha 2-3$ link and an $\alpha 1-6$ link.

Since the compositions of the present invention are intended for diagnostic, they preferably comprise a detectable moiety.

As used herein a detectable moiety (also referred to herein as a signaling moiety) refers to a molecule or molecules which can be directly or indirectly detected (visualized, counted etc.). Exemplary detectable moieties include, but are not limited to an enzyme, a pre-enzyme, a pre-substrate, a fluorophore, a chromophore, a protein (e.g., an epitope tag), a peptide, a quantum dot, a chemiluminescent substance, a FRET pair and a radioisotope.

According to one scenario, the detectable moiety is bound to the composition of the present invention via a linker so that the link between the detectable moiety and the sialic acid itself is the cleavage site for the neuraminidase.

According to another scenario, the detectable moiety is bound to the composition of the present invention which already comprises a link which acts as a cleavage site for neuraminidase (e.g. comprises a carbohydrate linked by an $\alpha 2, 3$ or $\alpha 2, 6$ link). In this case the detectable moiety is not bound to the sialic acid moiety via a potential substrate link.

Preferably, the detectable moiety provides a signal upon cleavage of the linker.

An example of such a detectable moiety is a pre-enzyme. Accordingly upon substrate cleavage the enzyme can be activated and detected (via the detection of a catalytic activity of same). An example of such a pre-enzyme is pro-Thrombin (factor II) or other enzymes in this cascade.

Another example of such a detectable moiety is a pre-substrate. Accordingly, upon substrate cleavage, the pre-substrate turns it into an active substrate for a second enzyme. For example the composition of matter of the present invention may comprise NeuAc(2,3)-Xgal. The X-gal is combined with the sialic acid in such a way that it cannot be cleaved by β -galactosidase. Cleavage of the pre-substrate releases free Xgal which becomes a substrate for the β -galactosidase enzyme. Subsequent cleavage of X gal by β -galactosidase produces a detectable color. Pre-substrates are further discussed in Example 8 and illustrated in Figure 10.

Yet another example of such a detectable moiety is a quantum dot. Accordingly upon substrate cleavage, a signal is released from the quantum dot.

A further example of such a detectable moiety is a FRET pair wherein cleavage of the linkage releases the quencher and a FRET signal is generated. For the purposes of the invention, a "quencher moiety" is any substance that is capable of reducing or eliminating the signal emitted by the signaling moiety. For example, the quencher moiety may act by absorption of the signal emitted by the signaling moiety or by an energy transfer mechanism. The distance between the signaling moiety and the quencher moiety is such that presence of the quencher moiety substantially reduces or eliminates the signal emitted from the signaling moiety unless the substrate is cleaved at a position resulting in separation of the signaling and quencher moieties.

Typically one member of the FRET pair is placed on one end of the cleavage sequence, and the other member is placed on the other end of the cleavage sequence. It will be appreciated, however, that if needed (pending on the configuration of detection) all the moieties may be placed on one end of the cleavage sequence.

An exemplary method for preparing a substrate molecule of the present invention comprising a FRET pair is described hereinbelow.

First, the polypeptide sialic acid binding site (e.g. HA) is labeled with a quencher by using NHS ester reactive dyes. Labeling may be accomplished using a reactive succinimidyl-ester (NHS). A covalent amide linkage may be formed between the activated dye and available amino groups (i.e. lysine or N terminal in proteins). One example for labeling using NHS dyes is Fluoro•Spin 331 Protein Labeling & Purification Kit, by emp Biotech GmbH. This dye is designed for the labeling of proteins with molecular weights greater than 25 kD, using a reactive succinimidyl-ester of N-methanthranilic acid (MANT). The conjugates result from the formation of a stable covalent amide linkage. The protein-dye conjugates have fluorescence-

excitation and fluorescence-emission maxima at around 331 nm and 426 nm, respectively. The same principle can be applied to label HA with dabcy1-N-hydroxysuccinimide ester (dabcy1-NHS; available also from Molecular Probes, Inc, Eugene, Oregon, USA,. D-2245) for example. The result will be HA-dabcy1 conjugate.

Next, the sialic acid moiety attached to a carbohydrate sequence is attached to a fluorophore (EDANS) down stream to the sialic acid on one of the carbohydrates in the sequence. The final stage is to connect the labeled sialic acid and HA via ligand-receptor interactions. In this way the fluorophore (EDANS) is placed in close proximity to the quencher (DABCYL) and FRET is made possible. Upon cleavage with NA the fluorophore is released and can be detected.

In one embodiment, the signaling moiety and quencher moiety are separated by no more than 3 or 5 amino acid residues. In another embodiment, the signaling moiety and quencher moiety are separated by no more than 10 amino acid residues. In yet another embodiment, the signaling moiety and quencher moiety are separated by no more than 15 amino acid residues. In yet another embodiment, the signaling moiety and quencher moiety are separated by no more than 20 amino acid residues. Other moieties which are used as means for detection such as further described hereinbelow may be conjugated according to these guidelines. Also, it will be appreciated that any of the detection means (e.g., moieties) may be conjugated directly or indirectly to the substrate either sequentially or by amino acid modification to any one of the amino acids of the peptide cleavage sequence itself.

Fluorescent and colorimetric assays are known to those skilled in the art. See, for example: Biochemistry, Allinger, Wang Q. M. et al., "A continuous calorimetric assay for rhinovirus-14 3C protease using peptide p-nitroanilides as substrates" Anal. Biochem. Vol. 252, pp. 238-45 (1997), and Basak S. et al. "In vitro elucidation of substrate specificity and bioassay of proprotein convertase 4 using intramolecularly quenched fluorogenic peptides" Biochem. J. Vol. 380, pp. 505-14 (2004).

In another embodiment of the present invention, the signaling moiety (i.e. detectable moiety) is a chemiluminescent signaling moiety. The chemiluminescent signaling moiety is attached to one side of the neuraminidase cleavage region of the substrate and a fluorescent accepting quencher moiety is attached at the other side of the cleavage region. U.S Pat. No. 6,243,980, the contents of which are incorporated by reference, describes such a detection system, involving the use of a

chemiluminescent 1, 2-dioxetane compound as the signaling moiety. If the viral neuraminidase is not present in the sample, cleavage of the substrate does not occur. The energy from the I₅ 2-dioxetane decomposition is transferred to the fluorescent accepting moiety and released at a wavelength distinct from the emission spectrum of the 1, 2-dioxetane. If the substrate is cleaved, the fluorescent accepting moiety is separated from the 1, 2-dioxetane and a chemiluminescent emission from the dioxetane compound is observed.

In another embodiment, the signaling moiety is a fluorescent compound and the quencher moiety is a fluorescent compound having an excitation spectrum that overlaps the emission spectrum of the signaling moiety. Here, the two moieties are separated apart at a distance consistent with fluorescent resonance energy transfer so that the fluorescent moiety is capable of acting as a resonance energy donor.

In another embodiment, a quenching group, such as a non-fluorescent absorbing dye is used in place of the fluorescent accepting quenching moiety. Suitable quenching groups are described in U.S. Pat. No. 6,243,980, the contents of which are incorporated by reference.

According to another embodiment of this aspect of the present invention, the substrate composition of the present invention comprises a separating moiety. Such substrate configurations are preferably used in heterogeneous detection assays which are further described hereinbelow.

As used herein the phrase "separating moiety" is any moiety which allows separation of uncleaved and cleaved products. Exemplary separating moieties include, but are not limited to immunological binding agent, a magnetic binding moiety, a peptide binding moiety, an affinity binding moiety and a nucleic acid moiety. Further examples of separating moieties are provided in Examples 1-3 hereinbelow. It will be appreciated that the separating moiety may further comprise a detectable agent. Examples of detectable agent are provided hereinabove.

According to a preferred embodiment, the substrate of the present invention substrate is comprised in a composition which has the following general formula.

X-Y-Z

wherein:

Y comprises a substrate of a neuraminidase, cleavage of X-Y-Z by the neuraminidase forming cleavage products X-Y' and Y''-Z wherein Y' is a first cleavage product of Y and Y'' is a second cleavage product of Y;

X comprises a detectable moiety; and

Z comprises a separating moiety capable of binding to a separate phase of a two phase separating system;

wherein X-Y-Z does not form a contiguous portion of a natural substrate of the viral neuraminidase.

Measures should be taken that the detectable moiety does not bind to the separating moiety.

In any of the embodiments described herein, any of the moieties can be directly linked to the peptide by a covalent bond or indirectly via a spacer molecule having coupling functional groups at each end. Examples of such linkers include an alkyl, a glycol, an ether, a polyether, a polynucleotide and a polypeptide molecule.

As mentioned herein above, the compositions of the present invention may be used for detecting a pathogen in a sample. The method comprises:

(a) contacting the sample with a neuraminidase substrate under conditions allowing -cleavage of the substrate ; and

(b) monitoring cleavage of the substrate, wherein cleavage of the substrate is indicative of the presence of the at least one pathogen in the sample.

A "pathogen" as used herein, refers to any pathogen that comprises neuraminidase on its cell surface. Exemplary pathogens include, but are not limited to influenza A virus, influenza B virus, streptococcus pneumonia, vibrio cholera, salmonella, seed virus, Newcastle disease virus, Mumps virus, La Piedad-Michoacan-Mexico virus, sandai virus, Measles virus Rinderpest virus, Nipah virus, Parainfluenza, Hendra virus and Respiratory Syncytial Virus (RSV). According to a preferred embodiment of this aspect of the present invention, the pathogen is an influenza virus.

Thus, according to one embodiment of this aspect of the present invention, the composition is contacted with the sample being tested for the presence of influenza virus. If the virus is present in the sample, the viral neuraminidase is also present. This enzyme cleaves the substrate and a change in the signal from the signaling moiety (i.e. detectable moiety) can be observed. Such homogenous fluorescent and colorimetric assays are known to those skilled in the art. See, for example: Biochemistry, Allinger, Wang Q. M. et al., "A continuous calorimetric assay for rhinovirus-14 3C protease using peptide p-nitroanilides as substrates" Anal. Biochem. Vol. 252, pp. 238-45 (1997), and Basak S. et al. "In vitro elucidation of substrate

specificity and bioassay of proprotein convertase 4 using intramolecularly quenched fluorogenic peptides" *Biochem. J.* Vol. 380, pp. 505-14 (2004).

As used herein the term "sample" refers to any biological sample (e.g., tissue culture sample or body fluid/tissue sample) which may comprise or be permissive for the virus. Preferably the biological sample refers to body fluids such as whole blood, serum, plasma, cerebrospinal fluid, urine, lymph fluids, various external secretions of the respiratory (e.g., nasal wash sample), intestinal, and genitourinary tracts, tears, saliva, semen, sweat, feces, and milk, as well as white blood cells, malignant tissues, amniotic fluid, and chorionic villi.

The biological sample may be derived from any organism, preferably a mammal (e.g., human) or avian.

As mentioned hereinabove, the method of the present invention is effected by contacting a sample with a neuraminidase substrate. Preferably, the neuraminidase substrate comprises the compositions of the present invention, as described hereinabove. However, it will be appreciated that many neuraminidase substrates are known in the art and may be used according to this aspect of the present invention (see e.g. U.S. Pat. No. 7,081,352).

Preferably, the sample is contacted with the substrate of the present invention in the presence of a buffer which includes enzyme inhibitors. Any buffer may be used according to this aspect of the present invention as long as it does not interfere with the cleavage process.

According to one embodiment of this aspect of the present invention, the sample is left in contact with the substrate composition for a sufficient amount of time so that cleavage of all substrate molecules may take place.

According to another embodiment of this aspect of the present invention, the sample is left in contact with the substrate composition for an amount of time so that the initial cleavage kinetics may be monitored.

According to yet another embodiment the monitoring is effected throughout the cleavage process (i.e. real time monitoring). Figure 9 illustrates a particular embodiment of the method of the present invention.

It will be appreciated that the method of the present invention may also be used to differentiate between viral strains. Different strains of a particular virus comprise different affinities for the substrate molecules of the present invention. For example a first influenza virus strain may comprise a neuraminidase that is efficient in

cleaving sialic acid when it is presented by an H1 polypeptide whereas a second influenza virus strain may comprise a neuraminidase that is efficient in cleaving sialic acid when it is presented by an H2 polypeptide. Likewise, the link between the sialic acid and the carbohydrate (i.e. 2,3, 2,6 or 2,8 link) also confers specificity. Thus, by contacting a sample with a known substrate, it is possible to classify and/or differentiate between viral strains. Exemplary hemagglutinin and neuraminidase pairs associated with particular viruses are presented in Table 5, Example 9.

The method particularly fits monitoring vaccination of avians and humans, since it may be used to detect if the vaccinated species has not developed a violent type of virus.

The method of the present invention may be adapted so that it may be used to distinguish between a human pathogenic avian virus and a human non-pathogenic virus. For example if an avian sample cleaves a sialic acid substrate comprising an cc2,6 linkage, this would be indicative of a potentially human pathogenic avian influenza virus.

The method of the present invention may also be used to determine if a human subject has been infected with an avian influenza virus. For example if a human samples cleaves a sialic acid substrate comprising an NeuGc α 2,3 linkage, this would be indicative of an avian influenza virus infection.

Any assay known in the art for monitoring substrate cleavage can be used in accordance with this aspect of the present invention.

Monitoring substrate cleavage can be effected by either a homogenous or a heterogeneous assay.

As used herein the phrase "homogeneous assay" refers to an assay not requiring separation of signaling moiety from other assay components.

Using the detection methods described herein, the test sample is contacted with the substrate under conditions that allow cleavage of the substrate by the neuraminidase if the virus is present in the sample. In one embodiment, the temperature is controlled. For example, the temperature can be controlled at 37 °C to provide optimal conditions for the enzyme reaction. The signal from the cleaved substrate fragment is then detected using a detection device appropriate to the label used.

A "heterogeneous assay" is an assay in which the solid-phase is separated from another assay component during the assay.

Solid-phases suitable for use in the heterogeneous assay include, but are not limited to test tubes, microtiter plates, microtiter wells, beads, dipsticks, polymer microparticles, magnetic microparticles, nitrocellulose, chip arrays and other solid phases familiar to those skilled in the art. The signaling moiety used in the heterogeneous assay may be any label known to those skilled in the art. Such labels include radioactive, calorimetric, fluorescent and luminescent labels.

A heterogeneous chemiluminescent assay for the detection of proteases is described in U.S. Pat. No. 56,243,980, the contents of which are incorporated by reference. In one embodiment, the homogeneous or heterogeneous assay method of the present invention is automated so that a result can be obtained without the need for medical staff to be exposed to a subject thought to be infected by the viral disease under test. For example, the subject can be tested in a clean room (for example, but not limited to P3 type room). The subject can pick up, or get before entering the room, a diagnostic kit, which can include a solid phase coated with a substrate of the type discussed above. For example, the solid phase can be a tissue which was previously immersed with substrate, or a test stick that can be from the type used to test pregnancy. The subject can supply a sample, such as a saliva sample, at a pre-prepared spot on the solid phase.

The solid phase containing the sample is then incubated to allow the enzymatic reaction to occur. In one embodiment, the reaction temperature is controlled at 37 °C to provide optimal conditions for the enzyme reaction. When the incubation is complete, the sample to be tested can be measured on a spectrophotometer, using a remote control, or a mechanical system operated manually from outside the room. The sample can be tested for a qualitative color or UV detection. After the test the sample can be discarded by an automated system, or a remote operated handle that trashes the sample.

By combining on one plate several substrates of the present invention, each one comprising a particular combination of sialic acid, carbohydrate and hemagglutinin and building a profile of cleavage of each matrix for each type of neuraminidase a system may be created capable of predicting the next type of virus. This can be used for predicting the vaccine type for the season, or detecting the exact type of the influenza virus, and its degree of lethality and violence for human and animals.

In order to detect the presence of a number of viruses at once, it is possible to use any of the methods known in the art or the above described methods adapted for detection of multiple viruses.

The following provides non-exhaustive examples of such means.

5 Microplate- in a X well plate. Each well contains a different and specific substrate corresponding to different viruses. With the addition of the clinical sample, the reaction is monitored using a standard microplate reader at the appropriate wavelengths and records which wells demonstrated enzymatic activity. Since each well contains one specific substrate it is possible to elucidate which viral
10 neuraminidase is present in the clinical sample according to the data provided by the microplate reader. The presence of the enzymes confirms the presence of the viruses.

 Medisel chip technology (Schiffenbauer et al. 2002 *Anticancer Res.* 22:2663-9)
- using Medisel technology it is possible immobilize the specific substrate molecules (corresponding to the viruses of interest) on a chip. With the addition of the clinical
15 sample the reaction is monitored using a laser beam. Since each point on the chip contains one specific substrate it is possible to elucidate which viral enzymes are present in the clinical sample according to the data provided by Medisel device. The presence of the enzymes confirms the presence of the viruses.

 Separation on column- Specific substrates (corresponding to the viruses of
20 interest) can be attached to beads from a commercial source with a unique DNA spacer. With the addition of the clinical sample the reaction is carried out. Once cleavage of a specific substrate occurs (by the specific viral neuraminidase in the clinical sample) the quencher is released and the bead emits fluorescence. The beads are then separated on a column via hybridization to the unique DNA spacer and
25 fluorescent is measured for each type of bead (corresponding to each different virus) using a standard fluorometer at the appropriate wavelengths. Only beads that were cut by the viral neuraminidase emits fluorescence. It is then possible to elucidate which viral neuraminidases are present in the clinical sample. The presence of the enzymes confirms the presence of the viruses.

30 Bead FACS separation - Similar to column separation only, the separation step is done by FACS when each specific peptide is attached to a bead with different color. In this method the spacer can be either DNA or peptide or peptide-mimetic or carbohydrate or any organic moiety spacer [Gonzalez (2005) *Clin. Biochem.* 38:966-72].

Other methods which can be used in accordance with the present invention are described by Tozzoli et al. (2006) Clin. Chem. Lab Med. 44:837-42; Abreu (2005) Ann.N. Y. Acad. Sci. 1050:357-63; Buliard (2005) Ann. Biol. Clin. (Paris) 63:51-8; Yinnaki (2004) J. Immunoassay Immunochem. 25:345-57; Rouquette (2003) 5 120:676-81; Toellner (2006) Clinical Chemistry 52:1575-1583; Horejsh (2005) Nucl. Acids Res. 33, each of which is incorporated herein by reference in its entirety.

Kits which comprise the neuraminidase substrates of the present invention are also envisaged. The different kit components may be packaged in separate containers and admixed immediately before use. Such packaging of the components separately 10 may permit long-term storage without losing the active components' functions. Embodiments in which two or more of components are found in the same container are also contemplated. An exemplary kit may comprise one or more of the following reagents: a wash buffer reagent for use using heterogeneous assays; a negative control reagent free of a neuraminidase capable of cleaving substrate; a positive control 15 containing a neuraminidase capable of cleaving the substrate; (d) a signal generation reagent for development of a detectable signal from the signaling moiety; and (d) a sample collection means such as a syringe, throat swab, or other sample collection device.

The kits of the present invention may, if desired, be presented in a pack which 20 may contain one or more units of the kit of the present invention. The pack may be accompanied by instructions for using the kit. The pack may also be accommodated by a notice associated with the container in a form prescribed by a governmental agency regulating the manufacture, use or sale of laboratory supplements, which notice is reflective of approval by the agency of the form of the compositions.

25 The kit of the present invention may further comprise other substrates (e.g. protease substrates) for detection of other respiratory viruses such as Corona Viruses, SARS, HMPV (Human Meta pneumo virus), Adeno virus, RSV (Respiratory Syncytial Virus) and Rhino virus.

The reagents included in the kits can be supplied in containers of any sort such 30 that the life of the different components are preserved and are not adsorbed or altered by the materials of the container. For example, sealed glass ampules may contain lyophilized reagents, or buffers that have been packaged under a neutral, non-reacting gas, such as nitrogen. Ampules may consist of any suitable material, such as glass, organic polymers, such as polycarbonate, polystyrene, etc. ceramic, metal or any other

material typically employed to hold similar reagents. Other examples of suitable containers include simple bottles that may be fabricated from similar substances as ampules, and envelopes, that may comprise foil-lined interiors, such as aluminum or an alloy. Other containers include test tubes, vials, flasks, bottles, syringes, or the like.

5 Containers may have a sterile access port, such as a bottle having a stopper that can be pierced by a hypodermic injection needle. Other containers may have two compartments that are separated by a readily removable membrane that upon removal permits the components to be mixed. Removable membranes may be glass, plastic, rubber, etc.

10 Kits may also be supplied with instructional materials. Instructions may be printed on paper or other substrate, and/or may be supplied as an electronic-readable medium, such as a floppy disc, CD-ROM, DVD-ROM, Zip disc, videotape, audiotape, etc. Detailed instructions may not be physically associated with the kit; instead, a user may be directed to an internet web site specified by the manufacturer
15 or distributor of the kit, or supplied as electronic mail.

Additional objects, advantages, and novel features of the present invention will become apparent to one ordinarily skilled in the art upon examination of the following examples, which are not intended to be limiting. Additionally, each of the
20 various embodiments and aspects of the present invention as delineated hereinabove and as claimed in the claims section below finds experimental support in the following examples.

EXAMPLES

25 Reference is now made to the following examples, which together with the above descriptions, illustrate the invention in a non limiting fashion.

Generally, the nomenclature used herein and the laboratory procedures utilized in the present invention include molecular, biochemical, microbiological and recombinant DNA techniques. Such techniques are thoroughly explained in the
30 literature. See, for example, "Molecular Cloning: A laboratory Manual" Sambrook et al., (1989); "Current Protocols in Molecular Biology" Volumes HII Ausubel, R. M., ed. (1994); Ausubel et al., "Current Protocols in Molecular Biology", John Wiley and Sons, Baltimore, Maryland (1989); Perbal, "A Practical Guide to Molecular Cloning", John Wiley & Sons, New York (1988); Watson et al., "Recombinant DNA",

Scientific American Books, New York; Birren et al. (eds) "Genome Analysis: A Laboratory Manual Series", Vols. 1-4, Cold Spring Harbor Laboratory Press, New York (1998); methodologies as set forth in U.S. Pat. Nos. 4,666,828; 4,683,202; 4,801,531; 5,192,659 and 5,272,057; "Cell Biology: A Laboratory Handbook",
5 Volumes I-III Cellis, J. E., ed. (1994); "Culture of Animal Cells - A Manual of Basic Technique" by Freshney, Wiley-Liss, N. Y. (1994), Third Edition; "Current Protocols in Immunology" Volumes I-III Coligan J. E., ed. (1994); Stites et al. (eds), "Basic and Clinical Immunology" (8th Edition), Appleton & Lange, Norwalk, CT (1994);
10 Mishell and Shiigi (eds), "Selected Methods in Cellular Immunology", W. H. Freeman and Co., New York (1980); available immunoassays are extensively described in the patent and scientific literature, see, for example, U.S. Pat. Nos. 3,791,932; 3,839,153; 3,850,752; 3,850,578; 3,853,987; 3,867,517; 3,879,262; 3,901,654; 3,935,074; 3,984,533; 3,996,345; 4,034,074; 4,098,876; 4,879,219; 5,011,771 and 5,281,521; "Oligonucleotide Synthesis" Gait, M. J., ed. (1984);
15 "Nucleic Acid Hybridization" Hames, B. D., and Higgins S. J., eds. (1985); "Transcription and Translation" Hames, B. D., and Higgins S. J., eds. (1984); "Animal Cell Culture" Freshney, R. L, ed. (1986); "Immobilized Cells and Enzymes" IRL Press, (1986); "A Practical Guide to Molecular Cloning" Perbal, B., (1984) and "Methods in Enzymology" Vol. 1-317, Academic Press; "PCR Protocols: A Guide To
20 Methods And Applications", Academic Press, San Diego, CA (1990); Marshak et al., "Strategies for Protein Purification and Characterization - A Laboratory Course Manual" CSHL Press (1996); all of which are incorporated by reference as if fully set forth herein. Other general references are provided throughout this document. The
25 procedures therein are believed to be well known in the art and are provided for the convenience of the reader. All the information contained therein is incorporated herein by reference.

EXAMPLE 1

Exemplary substrates and separating systems of the present invention

Figure 1 is a schematic representation of the structure of a substrate of the
30 present invention. The substrate is comprised of 3 parts: X, Y and Z. The core molecule or complex of molecules (segment Y) which has a specific cleavage site is connected in one end to a tagging molecule (X), whose purpose is to detect cleaved substrates. In the other end it is connected to a mechanism segment (Z) that separates between processed and unprocessed substrate. Upon cleavage of molecule Y the

substrate is divided into two parts: (1) Tagging Segment (TS) that contains part X and a part of Y and (2) a Separating segment (SS) that contain Z and a part of Y.

Upon cleavage of the substrate described in Figure 1 by neuraminidase, the Z segment (separating segment) is used to separate between the processed and unprocessed substrate. Therefore, only the TS of the processed substrate (that contains the tagging molecule) binds to the moiety with the high affinity to the tagging molecule. The affinity binding process is therefore detected only for cleaved substrates. In this way it is possible to detect only processed molecules (Figure 2).

Figure 3 illustrates the simultaneous detection of cleavage of a number of substrates using the above described method. Simultaneous detection may occur if the substrates are similar in their separating mechanism (Z) but different in their specific cleavage molecule (Y). In this case each substrate has a unique and different tagging molecule (X) that can be affiliated to its core molecule (Y). After cleavage and separating between processed and unprocessed substrates occurs, only the TS of the different (and processed) substrates are bound by affinity. Any molecule that contains Z (unprocessed substrates or SS of processed substrates) is retained by the separating mechanism. Further separation to the different TSs of the different substrates may be obtained by designing a membrane, chip etc. on which each predetermined locus contain a moiety with affinity to each different TS, e.g. each locus can bind only to one kind of TS. The separated solution then comes in contact with this chip or membrane and affinity binding can occur. By knowing which predetermined loci are bound by affinity to the different TSs one can identify which substrates were processed. Since each substrate is specific to the enzyme that initiated the substrate cleavage one can identify which of the enzymes have cleaved its corresponding substrate, deduce which neuraminidase exists in the solution and consequently deduce which pathogen or agent corresponds to the corresponding enzyme.

Exemplary separating systems:

1. Immobilized Separation System (ISS) - in this system Z is a spacer linked to an immobilized surface via beads, nitrocellulose membrane, biotin-avidin or other affinity pair. After cleavage in a buffered solution any unprocessed substrate or the SS of the processed substrate is removed by separating the immobilized surface (by extraction, centrifugation, filtration etc.) from the buffered solution, leaving only the TS of the processed substrates. In this way it is also possible to monitor the kinetics of each substrate.

2. Dynamic Separation System (DSS) - in this system Z is a special molecule common or unique to all substrates in the buffered solution. After cleavage occurs, the buffered solution comes in contact with a specially designed membrane or chip. The membrane is vertical and at the bottom it has a moiety with affinity corresponding to Z. An adjacent part of the membrane includes different loci corresponding to X of the different substrates. The buffered solution is then pushed along the length of the membrane or chip by capillary or electro force. Any molecule that contains Z (unprocessed substrates or SS of processed substrates) will be retained at the bottom of the membrane (by the affinity moiety corresponding to Z). Only the TS of the processed substrates (do not contain Z) will be able to move up the membrane and bind by affinity to their predetermined loci (Figure 4).
3. Affinity Filtration System (AFS) in this system the buffered solution is filtered through a column with affinity to Z, thus any molecule that contains Z (unprocessed substrates or SS of processed substrates) -will remain in the column. The flow trough will contain only the TS of the processed substrates.

EXAMPLE 2

Neuraminidase detection based on beads and fluorescence (FRET)

This example describes the detection of a presence of avian flu H5N1 virus and other types of influenza in a clinical sample. The influenza family of viruses utilize combinations of specific hemagglutinin and neuraminidase pairs. These pairs exhibit specific cleaving activity. In this example the substrate consists of Hemagglutinin (HA) (or parts of it) with a fluorophore connected to a colored bead (corresponding to Z) on one end. A fluorophore may also be attached either to the HA moiety The HA sialic acid receptor is used to bind between the HA moiety one end and the molecule containing the sialic acid and quencher on the other end. Exemplary sialic acid moieties are illustrated in Figure 5. The other end of the HA molecule ends with the sialic acid receptor which is connected to a sialic acid (corresponding to Y) with a quencher as its residue molecule (corresponding to X) via receptor-substrate affinity (mimicking a natural substrate of neuraminidase). Cleavage of this substrate will result in the separation of the quencher and fluorescence of the bead (Figure 6).

The reaction mixture contains different types of the substrate described above. Each substrate has a different bead color and different linkage to the sialic acid e.g.

2,3 or 2,6 (See Figure 11). The specificity will be defined according to the complex that is created upon cleavage between the neuraminidase, hemagglutinin, and the sialic acid. Due to the different specificity to the different complexes, substrates will be cleaved at different rates. In such a case, each bead can be affiliated to a different NA of the influenza virus family. The reaction mixture comes in contact with the clinical sample and cleavage of the sialic acid can occur by neuraminidase, removing the quencher part of the molecule. After the cleavage occurs, the beads are separated according to different colors using FACS or other existing technologies and fluorescence (at the appropriate wavelength) is measured for each bead type. Since each bead represents a different neuraminidase cleavage site, it is possible to identify which subfamily of the influenza viruses are present in the clinical sample.

It is also possible to abolish the need for HA by designing a substrate with a spacer instead of HA. The sialic acid is covalently attached to the spacer, via one of its residues in such way that it will not interfere with the catalytic activity of the NA (attached to position 3 or 4 on neuraminic acid)- (covalent bond instead of receptor-substrate affinity bond).

It is also possible to replace the beads with any of the other affinity pairs for separation purposes. Thus, allowing neuraminidase detection by any of the other methods described in the examples. FRET pairs can also consists of quantum dots instead of using beads for detecting cleavage (http://www.azonano.com/Details.asp? ArticleID=1726#_QuantumJDot_Technology).

EXAMPLE 3

Matrix determination of influenza types (profiling) for detection of unknown type of influenza virus

Influenza viruses are defined according to the combination of Neuraminidase and HA viral proteins. The name of the virus is defined according to this combination, i.e., H5N1 virus has a combination of HA 5 and neuraminidase 1 on its spike. Due to the multiple mutations and evolution in the virus it develops different subtypes every season. Since there is a global fear that one mutated type becomes a specially violent one (as occurred during the Spanish flu period that killed more then 25 million people in Europe in 1918) there is an urgent need to rapidly detect and isolate the violent types of influenza virus, in order to monitor and minimize the spread of the pandemic threatened to occur by such viruses. Currently there is no way to determine in a rapid

test the exact profile of a specific influenza type in a certain flu season. The method described in this invention enables such a determination.

In the following example a baseline matrix of substrates is constructed from a combination of HI- Hn proteins attached to several types of sialic acid derivatives
 5 linked via 2-3 and 2-6 linkage and comprising different substrate specificities. The panel of substrates is reacted with a panel of neuraminidase enzymes to establish specific profiles of fluorescence. The next step is applying the panel of substrates on an unknown clinical sample. An example of the results obtained is shown in Table 1 hereinbelow. These results are compared to the predetermined profiles in order to
 10 determine the specific type of virus present in the clinical sample.

Table 4

NeuGc α 2-6Gal-R		+				
NeuAc α 2-3Gal-R		-				
NeuAc α 2-6Gal-R		+	+	+	+	
Substrate	H	H	H	H	H	...
NA strain	1	2	3	4	5	...
						...

EXAMPLE 4

15 *Neuraminidase detection based on compartmentalization*

In this example the reaction is separated to different compartments. Each compartment contains a different substrate with different linkage to the sialic acid, (i.e., Neu5ac2-6gal, neu5ac2-3gal Neu-gly-2-3gal) representing specificity to different neuraminidase. The substrate is a sialic acid (correspond to Y) and a biotin as its residue (corresponds to Z).
 20

Following cleavage each compartment is filtered through a filter with avidin. Any molecule that contains biotin (unprocessed substrate or biotin residue of processed substrate) is retained at the filter. The sialic acid of processed substrate is allowed to pass the filter to a segment of the compartment that contains an assay for sialic acid detection. The assay can be based on thio-barbituric acid on one hand. On
 25

another hand ketone derivative of sialic acid as substrate can be used, and thus ketone derivatization detection assay is possible as well. In this method it is determined which compartments undergo cleavage. Since each compartment represents a different neuraminidase cleavage site, it is possible to know which subfamily of the influenza viruses are present in the clinical sample.

EXAMPLE 5

Protease and neuraminidase simultaneous detection based on marker (ISS)

In this example the separation step is already achieved by connecting the substrates to an immobilized surface. The substrates for neuraminidase is as described in Example 2 only instead of beads the HA is connected to a predetermined loci on a membrane, chip etc, specially designed for this purpose. The substrate for proteases is a cleavage sequence (corresponding to Y) connected at one end to a predetermined loci on the membrane, chip etc, via a spacer, if one is required (corresponding to Z). X is based on FRET technology in such way that cleavage of the protease removes a quencher from the substrate. Cleavage of any of the substrates will result in fluorescent intensity.

The membrane then comes in contact with the clinical sample and cleavage can occur. By measuring fluorescent intensity for each locus individually processed substrates may be detected. Since each locus represents a different neuraminidase or protease cleavage site, it is possible to know which viruses are present in the clinical sample.

EXAMPLE 6

Human Pathogenic and non- Pathogenic Avian Influenza veterinarian detection kit

The following example describes an exemplary avian influenza virus detection kit.

iV-acetylneuraminic acid (NeuAc) bound to galactose through an $\alpha 2,3$ linkage (NeuAc $\alpha 2$ -3Gal) is preferentially expressed on duck epithelial cells. Human airway epithelium surface exhibits NeuAc $\alpha 2$ -3Gal and NeuAc $\alpha 2$ -6Gal glycoproteins. Avian influenza viruses that are potentially pathogenic to humans should process both NeuAc $\alpha 2$ -3Gal and NeuAc $\alpha 2$ -6Gal based substrates, while avian influenza viruses that are not pathogenic to humans should process only NeuAc $\alpha 2$ -3Gal based substrate.

The present example envisages a kit that contains both substrates attached to a solid surface and all the reagents needed to perform the test. A clinical specimen is extracted from a diseased bird. The specimen then comes in contact with solid surface and cleavage can occur. If no substrate is cut (Figure 8A) the disease is not influenza.

5 If only the NeuAc α 2-3Gal based substrate is cut (Figure 8B) then the disease is an avian influenza virus which is not pathogenic to humans. If both NeuAc α 2-3Gal and NeuAc α 2-6Gal based substrates are cut (Figure 8C) then the disease is a human pathogenic avian influenza virus.

10

EXAMPLE 7

Human Influenza and Avian Influenza detection kit in humans

The following example describes an exemplary kit for detecting if a virus is a human influenza or a human pathogenic avian influenza.

15 Human tracheal epithelial cells do not possess detectable levels of N-glycolylneuraminic (NeuGc α 2-3Gal) acid current human influenza strains exhibit low NeuGc specificity. Bird epithelial cells do possess detectable levels of NeuGc α 2-3Gal.

20 The present example envisages a kit that contains the above described substrate and NeuAc α 2-3Gal both of which are attached to a solid surface. The kit also contains all the reagents needed to perform the test.

A clinical specimen is extracted from a human patient. The specimen is contacted with the solid surface so that cleavage may occur. If no substrate is cut the disease is not influenza (Figure 8A). If only the NeuAc α 2-3Gal based substrate is cut (Figure 8B) then the disease is human influenza virus. If both NeuAc α 2-3Gal and NeuGc α 2-3Gal based substrates are cut (Figure 8C) then the disease is human pathogenic avian influenza virus.

EXAMPLE 8

Detection using apre-substrate

The pre-substrate design is as follows: Neu5Ac is connected via an α 2,3 to the C3 of the galactose of Xgal. Xgal is a known chromogenic substrate of β -galactosidase (Figure 10).

The pre-substrate comes in contact with the clinical specimen containing influenza. The NA in the specimen cleaves the pre-substrate. Cleavage of the pre-substrate generates free sialic acid and free Xgal. The β -galactosidase already present in the media can then process the Xgal and catalyze the chromogenic reaction. The medium color turns blue.

If the clinical specimen does not contain influenza the sialic acid remains bound to the Xgal. The β -galactosidase (which, can process only terminal galactose containing substrates) can not process the Xgal and the chromogenic reaction will not occur. The medium color does not change color.

15

EXAMPLE 9

Hemagglutinin and neuraminidase pairs

The following example tabulates exemplary influenza virus hemagglutinins and neuraminidase pairs which may be used in the diagnosis of influenza viruses.

5

Table 5

<i>INFLUENZA TYPE</i>	<i>HEMAGGLUTININ</i>	<i>NEURAMINIDASE</i>
Influenza A virus (A/Fort Warren/1/1950(H1N1))		neura(GI:324555 loc:FLANBLAO)
Influenza A virus (A/FortMonmouth/1/1947(H1N1))		
Influenza A virus (A/France/15/1988(H1N1))	hema(GI:305136 locrFLAHAFRAND)	
Influenza A virus (A/Fort Worth/1950(H1N1))		
Influenza A virus (A/bufflehead/Ohio/246/1986(H1N2))	hema(GI:116070I 12 loc:CY017075)	neura(GI: 1160701 17 loc:CY0170770)
Influenza A virus (A/blue-winged teal/ALB/778/1978(H10N3))	hema(GI:82653900 loc:CY005994)	neura(GI:82653905 loc:CY0051890)
Influenza A virus (A/mallard duck/ALB/40/1984(H10N6))	hema(GI:82653919 loc:CY005995)	neura(GI:82653924 loc:CY0052010)
Influenza A virus (A/pintail duck/ALB/584/1984(H10N6))	hema(GI:82653938 loc:CY005996)	neura(GI: 82653943 loc:CY0052080)
Influenza A virus (A/chicken/Germany/N/1949(H10N7))	hema(GI:324365 loc:FLAMS84HA)	neura(GI:324419 loc:FLANABLO)
Influenza A virus (A/duck/IT/701/2005(H10N7))	hema(GI:87130673 loc:DQ374399)	neura(GI:87 130677 loc:DQ3744010)
Influenza A virus (A/duck/Manitoba/1953(H10N7))	hema(GI:324147 loc.-FLAHALM)	neura(GI:324473 loc:FLANALN0)
Influenza A virus (A/mallard duck/ALB/302/1977(H10N7))	hema(GI:82653881 loc:CY005993)	neura(GI:82653886 loc:CY005 1820)
Influenza A virus (A/mallard duck/Minnesota/19/1979(H10N7))	hema(GI: 115278424 loc:CYO14739)	neura(GI: 115278429 loc:CYO147410)
Influenza A virus (A/mallard/ALB/196/1996(H10N7))	hema(GI:82653976 loc:CY005998)	neura(GI:82653981 loc:CY0052330)
Influenza A virus (A/mallard/Alberta/208/2000(H10N7))	hema(GI:82654014 loc:CY006000)	neura(GI:82654019 loc:CY0052510)
Influenza A virus (A/maUard/Alberta/209/2003(H10NT))	hema(GI:82623666 loc:CY005922)	neura(GI:82623671 loc:CY0043540)
Influenza A virus (A/pintail duck/ALB/303/1977(H10N7))	hema(GI:82623647 loc:CY005921)	neura(GI:82623652 loc:CY0043470)
Influenza A virus (A/pintatl/Alberta/129/1993(H10N7))	hema(GI:82653688 loc:CY005982)	neura(GI: 115278082 loc:CY0 145880)
Influenza A virus (A/pintail/Alberta/202/2000(H10N7))	hema(GI:82653995 loc:CY005999)	neura(GI:82654000 loc:CY0052440)
Influenza A virus (A/shorebird/DE/10/2004(H10N7))	hema(GI:82629267 loc:CY005930)	neura(GI:82629291 loc:CY0044350)
Influenza A virus (A/shorebird/DE/122/2004(H10N7))	hema(GI:82654033 loc:CY006001)	neura(GI:82654038 loc:CY0052580)
Influenza A virus (A/quail/Italy/1 117/1965(H10N8))	hema(GI: 115278203 loc:CY014644)	neura(GI:305215 loc:FLANAITALY0)
Influenza A virus (A/duck/Hong Kong/562/1979(H10N9))	hema(GI:l 15278148 loc:CY014619)	neura(GI:l 15278150 loc:CYO146200)

Influenza A virus (A/Anallard/ALB/124/1991(H1N2))		neura(GI:82654076 loc:CY0053060)
Influenza A virus (A/mallard duck/ALB/797/1983(H1 N3))	hema(GI:82654071 loc:CY006003)	neura(GI:82654057 loc:CY0052750)
Influenza A virus (A/duck/England/1/1956(H1 N6))	hema(GI:324141 loc:FLAHALH)	neura(GI:324465 ioc:FLANALJ0)
Influenza A virus (A/duck/New York/12/1978(H1 N6))	hema(GI:324160 loc:FLAHAMD)	neura(GI:324493 loc:FLANAMD0)
Influenza A virus (A/duck/Memphis/546/1974(H1 IN 9))	hema(GI: 115278302 loc:CY0 14687)	neura(GI: 115278307 loc:CY0146890)
Influenza A virus (A/mallard ductøALB/294/1 977(HI IN9))	hema(GI:82623722 loc:CY005923)	neura(GI:82623727 loc:CY0043610)
Influenza A virus (A/mallard duck/Tennessee/I 1457/1985(HI IN 9))	hema(GI: 115278655 loc:CY014806)	neura(GI:l 15278660 loc:C Y O148080)
Influenza A virus (A/mallard/Alberta/245/2003(HI 1 N9))	hema(GI:82623741 loc:CY005924)	neura(GI:82623746 loc:CY0043680)
Influenza A virus (A/pintail/Alberta/84/2000(HI 1N9))	hema(GI:82654090 loc:CY006004)	neura(GI:82654095 loc:CY0053250)
Influenza A virus (A/shorebird/DE/236/2003(HI 1N9))	hema(GI:82654109 loc:CY006005)	neura(GI:826541 14 loc:CY0053320)
Influenza A virus (A/shoveler/Netherlands/19/1999(H 11N9))	hema(GI: 115278378 loc:CY014719)	neura(GI:78103 192 loc:CY0058530)
Influenza A virus (A/mallard duck/Alberta/342/1983(H12N1))	hema(GI:82654128 loc:CY006006)	neura(GI:82654133 loc:CY0053450)
Influenza A virus (A/duck/Alberta/60/1976(H12N5))	hema(GI:324135 loc:FLAHALC)	neura(GI:324453 loc:FLANALD0)
Influenza A virus (A/green-winged teal/ALB/199/1991(H12N5))	hema(GI:82654147 loc:CY006007)	neura(GI:82654152 loc:CY0053520)
Influenza A virus (A/mallard/Ohio/409/1988(H12N5))	hema(GI: 115521388 loc:CY016419)	neura(GI:l 15521393 loc:CY0164210)
Influenza A virus (A/pintail/Alaska/20/2005(H12N5))	hema(GI:l 10733391 loc:CY012840)	neura(GI: 110733396 loc:CY0 128420)
Influenza A virus (A/pintail/Alberta/49/2003(H12N5))	hema(GI:82623628 loc:CY005920)	neura(GI:82623633 loc:CY0043400)
Influenza A virus (A/ruddy turnstone/DE/97/2000(H12N5))	hema(GI:82654166 loc:CY006008)	neura(GI:82654171 loc:CY0053660)
Influenza A virus (A/herring gull/DE/475/1986(H13N2))	hema(GI:82621682 loc:CY005914)	neura(GI:82621687 loc:CY0038960)
Influenza A virus (A/herring gull/NJ/782/1986(H13N2))	hema(GI:82648896 loc:CY005932)	neura(GI:82648920 loc:CY0044520)
Influenza A virus (A/laughing gull/DE/2838/1987(H13N2))	hema(GI:82653631 loc:CY005979)	neura(GI:82653636 IociCYOOSOβóo)
Influenza A virus (A/gull/Maryland/704/1977(H13N6))	hema(GI:l 152783 19 loc:CY014694)	neura(GI:3 24475 loc:FLAN ALOO)
Influenza A virus (A/gull/Minnesota/945/1 980(H 13N 6))	hema(GI: 115278380 loc:CY014720)	neura(GI:78103216 loc:CY0058600)
Influenza A virus (A/shorebird/DE/68/2004(HI 3N9))	hema(GI:82640854 loc:CY005931)	neura(GI:82640870 loc:CY0044450)
Influenza A virus (A/sooty tern/Western Australia/2190/1983(H15N9))	hema(GI:82654775 loc:CY006033)	neura(GI:82654780 loc:CY0057190)
Influenza A virus (A/black duck/Ohio/95/1993(H1N1))	hema(GI:115289120 loc:CY015443)	neura(GI:l 15289125 loc:CY0 154450)
Influenza A virus (A/blue-winged teal/Alberta/141/1992(H1N1))	hema(GI:78095934 loc:CY004539)	neura(GI:109713861 1OC-.AM2605220)

Influenza A virus (A/camel/Mongolia/1982(H1N1))	hema(GI:324242 loc:FLAHEMAGG)	neura(GI:324579 loc:FLANEURAMIO)
Influenza A virus (A/green wing teal/Ohio/430/1987(H1N1))	hema(GP: 110733277 loc:CY011040)	neura(GI: 110733282 loc:CY0U0420)
Influenza A virus (A/Kiev/59/1979(H1N1))	hema(GI:324123 loc:FLAHAGLZZ)	neura(GI:324549 loc:FLANAZZ0)
Influenza A virus (A/mallard duck/ALB/127/1977(H1N1))	hema(GI:78096016 loc:CY004592)	neura(GI:78096021 loc:CY0045940)
Influenza A virus (A/mallard duck/ALB/322/1988(H1N1))	hema(GI:78095915 loc:CY004531)	neura(GI:78095920 loc:CY0045330)
Influenza A virus (A/mallard duck/ALB/46/ 1977(H1N1))	hema(GI:78095761 loc:CY004466)	neura(GI:78095766 loc:CY0044680)
Influenza A virus (A/mallard duck/ALB/965/1979(H1N1))	hema(GI:78095818 loc:CY004490)	neura(GI:78095823 loc:CY0044920)
Influenza A virus (A/mallard/ALB/201/1998(H1N1))	hema(GI:78095858 loc:CY004507)	neura(GI:78095863 loc:CY0045090)
Influenza A virus (A/mallard/ALB/267/1996(H1N1))	hema(GI:78095852 loc:CY004504)	neura(GI:78095854 loc:CY0045050)
Influenza A virus (A/mallard/Ohio/171/1990(H1N1))	hema(GI: 110733258 loc:CY012800)	neura(GI: 110733263 loc:CY0128020)
Influenza A virus (A/mallard/Ohio/56/1999(H1N1))	hema(GI: 110733353 loc:CY012824)	neura(GI: 110733358 loc:CY0128260)
Influenza A virus (A/mallard/Ohio/66/1999(H1N1))	hema(GI: 116069865 loc:CY016955)	neura(GI: 116065068 loc: AATZO10000020)
Influenza A virus (A/New Caledonia/20/1999(H1N1))	hema(GI:94481525 loc:DQ508857)	neura(GI:94481595 loc:DQ5088590)
Influenza A virus (A/New South Wales/18/1999(H1N1))	hema(GI: U 5607688 loc:CY016643)	neura(GI: 115607693 loc:CY0166450)
Influenza A virus (A/New South Wales/26/2000(H1N1))	hema(GI: 115344698 loc:CY016260)	neura(GI: 115344703 loc:CY0162620)
Influenza A virus (A/New South Wales/30/2000(H1N1))	hema(GI: 115521730 loc:CY016563)	neura(GI: 115521735 loc:CY0165650)
Influenza A virus (A/Paris/1694/O1(H1N1))	hema(GI: 114224344 loc:DQ986134)	neura(GI: 114224346 loc:DQ9861350)
Influenza A virus (A/pintail duck/ALB/219/1977(H1N1))	hema(GI:78095780 loc:CY004474)	neura(GI:78095785 loc:CY0044760)
Influenza A virus (A/pintail duck/ALB/238/1979(H1N1))	hema(GI:78095799 loc:CY004482)	neura(GI:78095804 loc:CY0044840)
Influenza A virus (A/pintail duck/Alberta/210/2002(H1N1))	hema(GI:78095951 loc:CY004546)	neura(GI:78095956 loc:CY0045480)
Influenza A virus (A/Puerto Rico/8/34(H1N1))	hema(GI:618457 loc:FLAHAPR834)	neura(GI:89779325 loc:CY0094460)
Influenza A virus (A/South Australia/29/2000(H1N1))	hema(GI: 116070017 loc:CY017019)	neura(GI: 116070022 loc:CY0170210)
Influenza A virus (A/South Australia/45/2000(H1N1))	hema(GI: 115607745 loc:CY016667)	neura(GI: 115607750 loc:CY0166690)
Influenza A virus (A/South Australia/55/2005(H1N1))	hema(GI: 115607764 loc:CY016675)	neura(GI: 115607769 loc:CY0166770)
Influenza A virus (A/South Australia/56/2005(H1N1))	hema(GI: 115607783 loc:CY016683)	neura(GI: 115607788 loc:CY0166850)
Influenza A virus (A/South Australia/57/2005(H1N1))	hema(GI: 115607802 loc:CY016691)	neura(GI: 115607807 loc:CY0166930)
Influenza A virus (A/South Australia/58/2005(H1N1))	hema(GI: 115607821 loc:CY016699)	neura(GI: 115607826 loc:CY0167010)
Influenza A virus (A/South Australia/63/2000(H1N1))	hema(GI: 115607878 loc:CY016723)	neura(GI: 115607883 loc:CY0167250)
Influenza A virus (A/South Australia/64/2000(H1N1))	hema(GI: 115607897 loc:CY016731)	neura(GI: 115607902 loc:CY0167330)
Influenza A virus (A/South Canterbury/15/2001(H1N1))	hema(GI:89788467 loc:CY009868)	neura(GI:89788478 loc:CY0098700)
Influenza A virus (A/South Canterbury/159/2001(H1N1))	hema(GI:90572562 loc:CY010356)	neura(GI:90572567 loc:CY0103580)
Influenza A virus (A/South Canterbury/31/2000(H1N1))	hema(GI:89786008 loc:CY009772)	neura(GI:89786014 loc:CY0097740)
Influenza A virus (A/South Canterbury/35/2000(H1N1))	hema(GI:89113825 loc:CY009204)	neura(GI:89113830 loc:CY0092060)
Influenza A virus (A/South	hema(GI:89786251 loc:CY009780)	neura(GI:89786265

Canterbury/40/2000(H1N1)		loc:CY0097820)
Influenza A virus (A/South Canterbury/50/2000(H1N1))	hema(GI:891 12298 ioc:CY009172)	neura(GI:89 112303 loc:CY0091740)
Influenza A virus (A/South Canterbury/59/2000(H IN1))	hema(GI:89787644 loc:CY009836)	neura(GI:89787656 loc:CY0098380)
Influenza A virus (A/sw/Obihiro/5/1992(H1N1))	hema(GI:902926 loc:FLAHO92)	neura(GI:506201 loc:FLANA092A0)
Influenza A virus (A/swine/Alberta/56626/03(H1N1))	hema(GI:82622866 loc:DQ280203)	neura(GI:82622864 loc:DQ2802020)
Influenza A virus (A/swine/Hong Kong/168/1993(H1N1))	hema(GI: 19123 18 loc:IAU44482)	neura(GI:1912354 loc:IAU478170)
Influenza A virus (A/swine/Hong Kong/273/1994(H1N1))	hema(GI:1912322 loc:IAU45452)	neura(GI:1912356 loc:IAU478180)
Influenza A virus (A/swine/Ontario/1 1112/04(H1N1))	hema(GI:82622972 loc:DQ280250)	neura(GI:82622974 loc:DQ2802510)
Influenza A virus (A/swine/Ontario/23866/04(H1N1))	hema(GI:82622956 loc:DQ280243)	neura(GI:82622954 loc:DQ2802420)
Influenza A virus (A/swine/Ontario/535 18/03(H1N1))	hema(GI:82622902 loc:DQ280219)	neura(GI:82622900 loc:DQ2802180)
Influenza A virus (A/swine/Ontario/5756 1/03(H1N1))	hema(GI:82622848 loc:DQ280195)	neura(GI:82622846 loc:DQ2801940)
Influenza A virus (A/swine/Spain/5 19 15/2003(H1N1))	hema(GI:91 125694 loc:CY010572)	neura(GI:9 1125699 loc:CY0 105740)
Influenza A virus (A/swine/Spain/53207/2004(H1N1))	hema(GI:91 177887 loc.-CYOIOS80)	neura(GI:9 1177892 loc.-CYO 105820)
Influenza A virus (A/Taiwan/OI/1986(H1N1))	hema(GI:94481529 loc:DQ508873)	neura(GI:94481599 loc:DQ5088750)
Influenza A virus (A/Texas/36/1 991 (H1N1))	hema(GI:94481533 loc:DQ508889)	neura(GI:94481603 loc:DQ5088910)
Influenza A virus (A/Texas/36/91(H1N1))	hema(GI:33622377 loc:AY289927)	neura(GI:89 112474 loc:CY0093180)
Influenza A virus (A/USSR/90/1977(H1N1))	hema(GI:94481535 loc:DQ508897)	neura(GI:94481605 loc:DQ5088990)
Influenza A virus (A/WI/4754/1994(H1N1))	hema(GI:1399602 loc:IAU53162)	neura(GI:1399610 loc:IAU53 1660)
Influenza A virus (A/WI/4755/1994(H1N1))	hema(GI: 1399604 loc:IAU53 163)	neura(GI:1399612 loc:IAU531670)
Influenza A virus (A/Wilson- Smith/ 1933(H IN 1))	hema(GI:94481537 loc:DQ508905)	neura(GI:94481607 loc:DQ5089070)
Influenza A virus (A/WSN/1933(H1N1))	hema(GI:324199 loc:FLAHAMY)	neura(GI:414312 loc.-FLANEURAMCO)
Influenza A virus (A/Yamagata/32/1989(H1N1))	hema(GI:506197 loc:FLAHAY89)	neura(GI:506203 loc:FLANAY890)
Influenza A virus (A/Harbin/1/1988(H1N2))	hema(GI:305146 loc:FLAHAHARBJ)	neura(GI:30521 1 loc:FLANAHAHARBJO)
Influenza A virus (A/Harbin/1/1989(H1N2))	hema(GI:305144 loc:FLAHAHARBI)	neura(GI:305209 loc:FLANAHAHARBIO)
Influenza A virus (A/mallard duck/New York/I70/1982(H1N2))	hema(GI: 115278882 loc:CY014901)	neura(GI: 115278887 loc:CY0149030)
Influenza A virus (A/swine/Nagasaki/I/1989(H1N2))	hema(GI:473922 loc:FLASN1)	neura(GI:473924 ioc:FLASN30)
Influenza A virus (A/swine/Nagasaki/ 1/1990(H 1N2))	hema(GI:473923 loc:FLASN2)	neura(GI:473926 loc:FLASN40)
Influenza A virus (A/swine/Ontario/48235/04(H1N2))	hema(GI:82622941 loc:DQ280236)	neura(GI:82622939 loc:DQ2802350)
Influenza A virus (A/swine/Ontario/52 156/03(H 1N2))	hema(GI:82622920 loc:DQ280227)	neura(GI:82622918 loc:DQ2802260)

Influenza A virus (A/swine/Ontario/55383/04(H1N2))		neura(GI:82622885 loc:DQ28021 10)
) Influenza A virus' (A/swine/Taiwan/CO935/2004(H1N2))	hema(GI:82622887 loc:DQ280212)	neura(GI:90025236 loc:DQ4471840)
Influenza A virus (A/Xianfeng/3/1989(H1N2))	hema(GI:90025242 loc:DQ447187)	neura(GI:305235 lociFLANAXIANFO)
Influenza A virus (A/mallard duck/New York/686 I/I 978(H1N5))	hema(GI:305195 loc-.FLAHAXIANF)	
Influenza A virus (A/pintail duck/ALB/63 1/1981(H1N5))	hema(GI: 115279042 1OC:CY014968)	neura(GI: 115279047 loc:CY0149700)
Influenza A virus (A/herring gull/DE/698/1988(H2N1))	hema(GI:78095837 loc:CY004498)	neura(GI:78095842 loc:CY0045000)
Influenza A virus (A/ruddy turnstone/Delaware/34/1993(H2N1))	hema(GI:78068066 loc:CY003907)	neura(GI:78068071 loc:CY0039090)
) Influenza A virus (A/semi- palmated sandpiper/Brazil/43/1990(H2N1))	hema(GI: 115279444 loc:CY015135)	neura(GI: 115279449 loc:CY0151370)
Influenza A virus (A/chicken/New York/13828-3/1995(H2N2))	hema(GI:78097192 loc:CY005413)	neura(GI:78097197 loc:CY0054150)
Influenza A virus (A/duck/Hong Kong/3 19/1978(H2N2))	hema(GI: 115278691 loc:CY014821)	neura(GI:l 15278696 loc:CY0 148230)
Influenza A virus (A/guinea fowl/New York/20221- 11/1995(H2N2))	hema(GI:78097439 loc:CY005538)	neura(GI:78097445 loc:CY0055400)
Influenza A virus (A/Japan/305/1957(H2N2))	hema(GI:l 15278710 loc:CY014829)	neura(GI: 115278715 loc:CY01483 10)
Influenza A virus (A/Japan/305/57(H2N2))	hema(GI:324145 loc:FLAHALK)	neura(GI: 115279066 loc:CY0149780)
Influenza A virus (A/Korea/426/68(H2N2))	hema(GI:37784899 loc:AY209953)	neura(GI:49473494 loc:AY6430880)
Influenza A virus (A/Anallard/Postdam/178- 4/83(H2N2))	hema(GI:37784971 loc:AY209989)	neura(GI:73921303 loc:NC 0073820)
Influenza A virus (A/RI/5+/1957(H2N2))	hema(GI:3 130022 loc:Y17261)	neura(GI:3 130022 loc:Y172610)
Influenza A virus (A/RI/5- /1957(H2N2))	hema(GI:305162 loc:FLAHARI557)	neura(GI:325106 loc:FLAX7F2NA0)
Influenza A virus (A/Taiwan/1964(H2N2))	hema(GI:3051 16 loc:FLAHA575RI)	neura(GI:324569 loc-.FLANBMDO) neura(GI:94481601 loc:DQ5088830)
Influenza A virus (A/duck/Hokkaido/95/01(H2N2))	heraa(GI:94481531 loc:DQ508881)	neura(GI:l 16013 109 loc:AB2761 160)
Influenza A virus (A/mallard duck/ALB/353/1988(H2N3))	hema(GI:45272125 loc:AY422017)	neura(GI:78058799 loc:CY0039380)
Influenza A virus (A/mallard duck/ALB/376/1985(H2N3))	hema(GI:78058794 loc:CY003936)	neura(GI:78058708 loc:CY0038810)
Influenza A virus (A/mallard/ALB/20 1/1996(H2N3))	hema(GI:78058703 loc:CY003879)	neura(GI:78058818 loc:CY0039460)
Influenza A virus (A/mallard/ALB/205/1998(H2N3))	hema(GI:78058813 loc:CY003944)	neura(GI:78059366 loc:CY0039700)
Influenza A virus (A/mallard/ALB/226/1998(H2N3))	hema(GI:78059361 loc:CY003968)	neura(GI:78059432 loc:CY0039780)
Influenza A virus (A/mallard/Alberta/77/1977(H2N3))	hema(GI:78059427 loc:CY003976)	
) Influenza A virus (A/mallard/Alberta/79/2003(H2N3))	hema(GI:78032568 loc:CY003847)	neura(GI:7591473 1 loc:DQ1907370)
) Influenza A virus (A/mallard/Alberta/149/2002(H2N4))	hema(GI:78059465 loc:CY003992)	neura(GI:78059470 loc:CY0039940)
Influenza A virus (A/herring gull/Delaware/47 1/1986(H2N7))	hema(GI:78059446 loc:CY003984)	neura(GI:78059451 1OC-.CY0039860)
Influenza A virus (A/laughing	hema(GI: 1152781 11 loc:CY014601)	neura(GI:78097130 loc:CY0053770)
	hema(GI:78058760 loc:CY003922)	neura(GI:78058765

gull/NJ/798/1986(H2N7))		loc:CY0039240)
Influenza A virus (A/sanderling/NJ/766/1986(H2N7))	hema(GI:78058722 loc:CY003887)	neura(GI:78058727 loc:CY0038890)
Influenza A virus (A/herring gull/DE/692/1988(H2N8))	hema(GI:78095970 loc:CY004554)	neura(GI:78095975 loc:CY0045560)
Influenza A virus (A/herring guU/DE/703/1988(H2N8))	heraa(GI:78058741 loc:CY003914)	neura(GI:78058746 loc:CY0039160)
Influenza A virus (A/blue-winged teal/ALB/16/1997(H2N9))	hema(GI:78059342 loc:CY003960)	neura(GI:78059347 loc:CY0039620)
Influenza A virus (A/duck/Hong Kong/278/1978(H2N9))	hema(GI:78097490 loc:CY005546)	neura(GI:78097495 loc:CY0055480)
Influenza A virus (A/laughing gull/NJ/75/1985(H2N9))	hema(GI:78058665 loc:CY003863)	neura(GI:78058670 loc:CY0038650)
Influenza A virus (A/pintail/Alberta/293/1977(H2N9))	hema(GI:78058646 loc:CY003855)	neura(GI:78058651 loc:CY0038570)
Influenza A virus (A/blue-winged teal/ALB/452/1983(H3N1))	hema(GI:82652632 loc:CY005940)	neura(GI:82652637 loc:CY0046360)
Influenza A virus (A/mallard duck/ALB/26/1976(H3N1))	hema(GI:82652711 loc:CY005943)	neura(GI:82652716 loc:CY0047110)
Influenza A virus (A/swine/IN/PU542/04 (H3N1))	hema(GI:75756565 loc:DQ150433)	neura(GI:75756569 loc:DQ1504350)
Influenza A virus (A/swine/Korea/CN22/2006(H3N1))	hema(GI:14215298 loc:DQ923507)	neura(GI:14215302 loc:DQ9235090)
Influenza A virus (A/swine/Korea/PZ72- 1/2006(H3N1))	hema(GI:14215296 loc:DQ923506)	neura(GI:14215300 loc:DQ9235080)
Influenza A virus (A/swine/MI/PU243/04 (H3N1))	hema(GI:75756549 loc:DQ150425)	neura(GI:75756553 loc:DQ1504270)
Influenza A virus (A/swine/Minnesota/00395/2004(H3N1))	hema(GI:76574373 loc:DQ145537)	neura(GI:76574375 loc:DQ1455380)
Influenza A virus (A/swine/Taiwan/0408/2004(H3N1))	hema(GI:90025240 loc:DQ447186)	neura(GI:90025238 loc:DQ4471850)
Influenza A virus (A/Atru72/1968(H3N2))	hema(GI:324131 loc:FLAHAL)	neura(GI:324238 loc:FLAHAZ0)
Influenza A virus (A/Bangkok/01/1979(H3N2))	hema(GI:94481517 loc:DQ508825)	neura(GI:94481587 loc:DQ5088270)
Influenza A virus (A/Bangkok/1/1979(H3N2))	hema(GI:6578823 loc:AF201843)	neura(GI:324459 loc:FLANALGO)
Influenza A virus (A/Beijing/353/1989(H3N2))	hema(GI:94481519 loc:DQ508833)	neura(GI:94481589 loc:DQ5088350)
Influenza A virus (A/Charlottesville/03/2004(H3N2))	hema(GI:61658421 loc:AY947474)	neura(GI:61658419 loc:AY9474730)
Influenza A virus (A/duck/Hong Kong/7/1975(H3N2))	hema(GI:82654664 loc:CY006026)	neura(GI:82654669 loc:CY0055540)
Influenza A virus (A/Fujian/41/02-like(H3N2))	hema(GI:81535928 loc:DQ227423)	neura(GI:81536342 loc:DQ2274370)
Influenza A virus (A/Istanbul/CTF- 4/2003(H3N2))	hema(GI:114225329 loc:DQ983749)	neura(GI:114225367 loc:DQ9837680)
Influenza A virus (A/Kinmen/618/03(H3N2))	hema(GI:68138151 loc:AY961997)	neura(GI:70673206 loc:AY9733250)
Influenza A virus (A/Kinmen/621/03(H3N2))	hema(GI:68138191 loc:AY962017)	neura(GI:70673208 loc:AY9733260)
Influenza A virus (A/Kinmen/639/04(H3N2))	hema(GI:68138173 loc:AY962008)	neura(GI:70673210 loc:AY9733270)
Influenza A virus (A/Kinmen/641/04(H3N2))	hema(GI:68138165 loc:AY962004)	neura(GI:70673212 loc:AY9733280)
Influenza A virus (A/Kinmen/642/04(H3N2))	hema(GI:68138159 loc:AY962001)	neura(GI:70673214 loc:AY9733290)
Influenza A virus (A/Kinmen/645/04(H3N2))	hema(GI:68138175 loc:AY962009)	neura(GI:70673216 loc:AY9733300)
Influenza A virus (A/Leningrad/360/1986(H3N2))	hema(GI:94481523 loc:DQ508849)	neura(GI:94481593 loc:DQ5088510)

Influenza A virus (A/Memphis/IO2/72(H3N2))	herna(GI:60758 loc:ORIN15)	neura(GI:60762 loc:ORIN170)
Influenza A virus (A/Moscovv/10/99(H3N2))	hema(GI:46981870 loc:AY531035)	neura(GI:92090485 loc:DQ48733 10)
Influenza A virus (A/Moscow/328/2003(H3N2))	hema(GI:7 1558928 loc:DQ086160)	neura(GI: 111662841 loc:DQ8866030)
Influenza A virus (A/Moscow/343/2003(H3N2))	hema(GI:71558922 loc:DQ086157)	neura(GI: 114842929 loc:DQ8877500)
Influenza A virus (A/Moscow/346/2003(H3N2))	hema(GI:70673281 loc:DQ066936)	neura(GI: 111662826 loc:DQ8866020)
Influenza A virus (A/Nelson Marlborough/1/2000(H3N2))	hema(GI:89 113424 loc:CY009124)	neura(GI:89 113429 loc:CY0091260)
Influenza A virus (A/New South Wales/13/1999(H3N2))	hema(GI:l 15291 121 loc:CY0 16068)	neura(GI:l 15291126 loc:CY0160700)
Influenza A virus (A/New South Wales/15/1999(H3N2))	hema(GI:l 15521673 loc:CY016539)	neura(GI:l 15521678 loc:CY0165410)
Influenza A virus (A/New South Wales/16/1999(H3N2))	hema(GI:l 15521692 loc:CY016547)	neura(GI: 115521697 loc:CY0165490)
Influenza A virus (A/New South Wales/17/1999(H3N2))	hema(GI: 115607669 loc:CY016635)	neura(GI: 115607674 loc:CY0 166370)
Influenza A virus (A/New South Wales/2/1999(H3N2))	hema(GI:l 15521597 loc:CY016507)	neura(GI:l 15521602 loc:CY0165090)
Influenza A virus (A/New South Wales/20/1999(H3N2))	hema(GI:l 15291 140 loc:CY016076)	neura(GI:l 15291 145 loc:CY0160780)
Influenza A virus (A/New South Wales/21/1999(H3N2))	hema(GI:l 1552171 1 loc:CY016555)	neura(GI: 115521716 loc:CY0165570)
Influenza A virus (A/New South Wales/22/1999(H3N2))	hema(GI: 115607707 loc:CY016651)	neura(GI:l 15607712 loc:CY0 166530)
Influenza A virus (A/New South Wales/25/2000(H3N2))	hema(GI: 115291 159 loc:CY016084)	neura(GI:l 15291 164 loc:CY0160860)
Influenza A virus (A/New South Wales/27/2000(H3N2))	hema(GI:l 15291 178 loc:CY0 16092)	neura(GI:l 15291 183 loc:CY0 160940)
Influenza A virus (A/New South Wales/28/2000(H3N2))	hema(GI: 115291 197 loc:CY016100)	neura(GI:l 15291202 loc:CY0161020)
Influenza A virus (A/New South Wales/29/2000(H3N2))	hema(GI:l 15291216 loc:CY016108)	neura(GI:l 15291221 loc:CY0161 100)
Influenza A virus (A/New South Wales/32/2000(H3N2))	hema(GI: 115521749 loc:CY016571)	neura(GI:l 15521754 loc:CY0165730)
Influenza A virus (A/New South Wales/33/2000(H3N2))	hema(GI:l 15344717 loc:CY0 16268)	neura(GI: 115344722 loc:CY0162700)
Influenza A virus (A/New South Wales/34/2000(H3N2))	hema(GI: 115521768 loc:CY016579)	neura(GI:l 15521773 loc:CY0165810)
Influenza A virus (A/New South Wales/35/2000(H3N2))	hema(GI:l 15521787 loc:CY016587)	neura(GI:115521792 loc:CY0165890)
Influenza A virus (A/New South Wales/36/2000(H3N2))	hema(GI:l 15291235 loc:CY016116)	neura(GI: 115291240 loc:CY0161 180)
Influenza A virus (A/New South Wales/4/1999(H3N2))	hema(GI: 115607650 loc:CY0 16627)	neura(GI: 115607655 loc:CY0166290)
Influenza A virus (A/New South Wales/5/1999(H3N2))	hema(GI:l 15521616 loc:CY016555)	neura(GI:l 15521621 loc:CY0165170)
Influenza A virus (A/New South Wales/6/1999(H3N2))	hema(GI:l 15521635 loc:CY016523)	neura(GI: 115521640 loc:CY0165250)
Influenza A virus (A/New South Wales/8/1999(H3N2))	hema(GI: 115521654 loc:CY016531)	neura(GI: 115521659 loc:CY0165330)
Influenza A virus (A/Northern Territory/60/1968(H3N2))	hema(GI:106907812 loc:CY01 1120)	neura(GI: 106907950 loc:CY01 11220)
Influenza A virus (A/Ontario/RV 1273/2005(H3N2))	hema(GI:94404583 loc:DQ469962)	neura(GI: 109946640 loc:NC 0082290)
Influenza A virus (A/Panama/2007/1999(H3N2))	hema(GI:94481527 loc:DQ508865)	neura(GI:94481597 loc:DQ5088670)
Influenza A virus (A/Pingtung/303/04(H3N2))	hema(GI:68138157 loc:AY962000)	neura(GI:70673218 loc:AY9733310)
Influenza A virus (A/Pingtung/313/04(H3N2))	hema(GI:68138155 loc:AY961999)	neura(GI:70673220 loc:AY9733320)
Influenza A virus (A/pintail duck/ALB/627/1979(H3N2))	hema(GI:82652618 loc:CY005939)	neura(GI:82652620 loc:CY0046210)
Influenza A virus (A/pintail)	hema(GI:82652542 loc:CY005935)	neura(GI:82652547

duck/ALB/86/1976(H3N2))		loc:CY0045780)
Influenza A virus (A/South Australia/18/2005(H3N2))	hema(GI:1 15521806 loc:CY016595)	neura(GI:1 15521811 loc:CY0 165970)
Influenza A virus (A/South Australia/20/2005(H3N2))	hema(GI:1 15521825 loc:CY0 16603)	neura(GI: 115521830 loc:CY0 166050)
Influenza A virus (A/South Australia/23/2005(H3N2))	hema(GI: 115607726 loc:CY016659)	neura(GI: 115607731 loc:CY0166610)
Influenza A virus (A/South Australia/59/2000(H3N2))	hema(GI: 115607840 loc:CY016707)	neura(GI: 115607845 loc:CY0167090)
Influenza A virus (A/South Australia/62/2000(H3N2))	hema(GI:1 15607859 loc:CY016715)	neura(GI: 115607864 loc:CY0167170)
Influenza A virus (A/South Australia/66/2000(H3N2))	hema(GI:1 15607916 loc:CY016739)	neura(GI: 115607921 loc:CY0167410)
Influenza A virus (A/South Australia/67/2000(H3N2))	hema(GI: 115607935 loc:CY016747)	neura(GI: 115607940 loc:CY0167490)
Influenza A virus (A/South Australia/68/2000(H3N2))	hema(GI: 115607954 loc:CY016755)	neura(GI: 115607959 loc:CY0167570)
Influenza A virus (A/South Australia/71/2000(H3N2))	hema(GI: 115607973 loc:CY016763)	neura(GI:1 15607978 loc:CY0167650)
Influenza A virus (A/South Australia/74/2000(H3N2))	hema(GI: 115607992 loc:CY016771)	neura(GI: 115607997 loc:CY0167730)
Influenza A virus (A/South Canterbury/433/2003(H3N2))	hema(GI:83751991 loc:CY007179)	neura(GI:83751996 loc:CY0071810)
Influenza A virus (A/Stockholm/27/2002(H3N2))	hema(GI:62249308 loc:AY884281)	neura(GI:86140275 loc:NZ AANCOIOOOOIO)
Influenza A virus (A/swine/Alberta/14722/2005(H3N2))	hema(GI:94404585 loc:DQ469970)	neura(GI:94404615 loc:DQ4699680)
Influenza A virus (A/swine/British Columbia/28103/2005(H3N2))	hema(GI:94404587 loc:DQ469978)	neura(GI:94404617 loc:DQ4699760)
Influenza A virus (A/Swine/Iowa/533/99 (H3N2))	hema(GI:9887146 loc:AF25141 1)	neura(GI: 110734303 loc:AF25 14120)
Influenza A virus (A/swine/Manitoba/I 2707/2005(H3N2))	hema(GI:94404589 loc:DQ469986)	neura(GI:94404619 loc:DQ4699840)
Influenza A virus (A/Swine/Minnesota/593/99 (H3N2))	hema(GI: 110632007 loc:AF251427)	neura(GI: 110734304 loc:AF25 14280)
Influenza A virus (A/swine/Ontario/00130/97(H3N2))	hema(GI:99093049 loc:AF251395)	neura(GI:98871 14 loc:AF25 13960)
Influenza A virus (A/swine/Ontario/33853/2005(H3N2))	hema(GI:94404591 loc:DQ469994)	neura(GI:94404621 loc:DQ4699920)
Influenza A virus (A/swine/Spain/54008/2004(H3N2))	hema(GI:91 177906 loc:CY010564)	neura(GI:91 17791 1 loc:CY0 105660)
Influenza A virus (A/Tainan/704/03(H3N2))	hema(Gr.68138179 loc:AY96201 1)	neura(GI:70673222 loc:AY9733330)
Influenza A virus (A/Tainan/712/03(H3N2))	hema(GI:68138181 loc:AY962012)	neura(GI:70673224 loc:AY9733340)
Influenza A virus (A/Tainan/722/03(H3N2))	hema(GI:68138167 loc:AY962005)	neura(GI:70673226 loc:AY9733350)
Influenza A virus (A/Taipei/407/03(H3N2))	hema(GI:68138153 loc:AY961998)	neura(GI:70673228 loc:AY9733360)
Influenza A virus (A/Taipei/416/03(H3N2))	hema(GI:68138171 loc:AY962007)	neura(GI:70673230 loc:AY9733370)
Influenza A virus (A/Taovuan/108/02(H3N2))	hema(GI:68138189 loc:AY962016)	neura(GI:70673232 loc:AY9733380)
Influenza A virus (A/Texas/13 1/2002(H3N2))	hema(GI:6 1658426 loc:AY947476)	neura(GI:61658428 loc:AY9474770)
Influenza A virus (A/turkey/Ontario/3 1232/2005(H3N2))	hema(GI:94404593 loc:DQ470002)	neura(GI:94404623 loc:DQ4700000)
Influenza A virus (A/udorn/1 972(H3N2))	hema(GI:324180 loc:FLAHAMSI)	neura(GI:324523 loc:FLANAMR0)

Influenza A virus (A/Udorn/307/t972(H3N2))	hema(GI:94481543 loc:DQ508929)	neura(GI:94481615 loc:DQ50893 10)
Influenza A virus (A/Wellington/1/2004(H3N2))	hema(GI: 110825840 loc:DQ865948)	neura(GI: 109915209 loc:CY0121060)
Influenza A virus (A/Western Australia/10/2000(H3N2))	hema(GI:l 15521559 loc:CY016491)	neura(GI:l 15521564 loc:CY0164930)
Influenza A virus (A/Western Australia/11/2000(H3N2))	hema(GI: 115289671 loc:CY0 15668)	neura(GI: 115289676 loc:CY0156700)
Influenza A virus (A/Western Australia/12/2000(H3N2))	hema(GI:l 15521578 loc:CY016499)	neura(GI: 115521583 loc:CY0165010)
Influenza A virus (A/Western Australia/13/2001(H3N2))	hema(GI: 115289690 loc:CY015676)	neura(GI: 115289695 loc:-CYO 156780)
Influenza A virus (A/Western Australia/14/2001(H3N2))	hema(GI: 115289709 loc:CY0 15684)	neura(GI:l 15289714 loc:CY0156860)
Influenza A virus (A/Western Australia/15/2001(H3N2))	hema(GI:l 10734306 loc:CY013216)	neura(GI: 1107343 11 loc:CY0132180)
Influenza A virus (A/Western Australia/16/2001(H3N2))	hema(GI: 115289728 loc:CY015692)	neura(GI: 115289733 loc:CY0156940)
Influenza A virus (A/Western Australia/17/2001(H3N2))	hema(GI: 115289747 loc:CY015700)	neura(GI:l 15289752 loc:CY0157020)
Influenza A virus (A/Western Australia/2/2000(H3N2))	hema(GI:l 15289614 loc:CY015644)	neura(GI:l 15289619 loc:CY0156460)
Influenza A virus (A/Western Australia/23/2002(H3N2))	hema(GI: 110734325 loc:CY013224)	neura(GP.110734330 loc:CY0132260)
Influenza A virus (A/Western Australia/25/2002(H3N2))	hema(GI:l 15289766 loc:CY0 15708)	neura(GI: 115289771 loc:CY0157100)
Influenza A virus (A/Western Australia/26/2002(H3N2))	hema(GI: 115289785 loc:CY015716)	neura(GI: 115289790 loc:CY0157180)
Influenza A virus (A/Western Australia/28/2002(H3N2))	hema(GI: 115289804 loc:CY015724)	neura(GI: 115289809 locrCYO 157260)
Influenza A virus (A/Western Australia/29/2002(H3N2))	hema(GI: 115289823 loc:CY015732)	neura(GP.115289828 loc:CY0157340)
Influenza A virus (A/Western Australia/3/2000(H3N2))	hema(GI: 115289633 loc:CY015652)	neura(GI: 115289638 loc:CY0156540)
Influenza A virus (A/Western Australia/30/2002(H3N2))	hema(GI: 115289842 loc:CY015740)	neura(GI: 115289847 loc:CY0 157420)
Influenza A virus (A/Western Australia/31/2002(H3N2))	hema(GI: 115289861 loc:CY0 15748)	neura(GI: 115289866 loc:CY0157500)
Influenza A virus (A/Western Australia/35/2002(H3N2))	hema(GI:l 15289880 loc:CY0 15756)	neura(GI: 115289885 loc:CY0157580)
Influenza A virus (A/Western Australia/36/2002(H3N2))	hema(GI: 115289899 loc:CY015764)	neura(GI: 115289904 loc:CY0157660)
Influenza A virus (A/Western Australia/37/2003(H3N2))	hema(GI:l 15289918 loc:CY015772)	neura(GI: 115289923 loc:CY0157740)
Influenza A virus (A/Western Australia/38/2003(H3N2))	hema(GI: 115289937 loc:CY015780)	neura(GI: 115289942 locrCYO 157820)
Influenza A virus (A/Western Australia/39/2003(H3N2))	hema(GI: 115289956 loc:CY0 15788)	neura(GI: 115289961 loc:CY0157900)
Influenza A virus (A/Western Australia/40/2003(H3N2))	hema(GI:l 15289975 loc:CY015796)	neura(GI: 115289980 loc:CY0157980)
Influenza A virus (A/Western Australia/41/2003(H3N2))	hema(GI:l 15289994 loc:CY015804)	neura(GI: 115289999 loc:CY0158060)
Influenza A virus (A/Western Australia/42/2003(H3N2))	hema(GI:l 15290013 loc:CY015812)	neura(GI: 115290018 loc:CY0158140)
Influenza A virus (A/Western Australia/43/2003(H3N2))	hema(GI: 115290032 loc:CY0 15820)	neura(GI: 115290037 loc:CY0158220)
Influenza A virus (A/Western Australia/44/2003(H3N2))	hema(GI: 115290051 loc:CY015828)	neura(GI: 115290056 loc:CY0158300)
Influenza A virus (A/Western Australia/45/2003(H3N2))	hema(GI: 115290070 loc:CY0 15836)	neura(GI: 115290075 loc:CY0158380)
Influenza A virus (A/Western Australia/46/2003(H3N2))	hema(GI: 115290089 loc:CY015844)	neura(GI: 115290094 loc:CY0158460)
Influenza A virus (A/Western Australia/47/2003(H3N2))	hema(GI: 115290108 loc:CY015852)	neura(GI:l 152901 13 locrCYO 158540)
Influenza A virus (A/Western Australia/48/2003 (H3N2))	hema(GI:l 15290127 loc:CY015860)	neura(GI:l 15290132 locrCYO 158620)
Influenza A virus (A/Western	hema(GI: 115290146	neura(GI:l 15290151

Australia/50/2003(H3N2))	loc:CY015868)	loc:CY0158700)
Influenza A virus (A/Western Australia/51/2004(H3N2))	hema(GI:1 15290165 loc:CY015876)	neura(GP:1 15290170 loc:CY0158780)
Influenza A virus (A/Western Australia/52/2004(H3N2))	hema(GI:1 15290184 loc:CY015884)	neura(GI:1 15290189 loc:CY0158860)
Influenza A virus (A/Western Australia/53/2004(H3N2))	hema(GI: 115290203 loc:CY015892)	neura(GI: 115290208 loc:CY0 158940)
Influenza A virus (A/Western Australia/54/2004(H3N2))	hema(GI: 115290222 loc:CY0 15900)	neura(GI: 115290227 loc:CY0 159020)
Influenza A virus (A/Western Australia/55/2004(H3N2))	hema(GI:l 15290241 loc:CY015908)	neura(GI:l 15290246 loc:CY0159100)
Influenza A virus (A/Western Australia/56/2004(H3N2))	hema(GI: 115290260 loc:CY015916)	neura(GI: 115290265 loc:CY0159180)
Influenza A virus (A/Western Australia/57/2004(H3N2))	hema(GI: 115290279 loc:CY015924)	neura(GI: 115290284 loc:CY0159260)
Influenza A virus (A/Western Australia/58/2004(H3N2))	hema(GI: 115290298 loc:CY015932)	neura(GI: 115290303 loc:CY0159340)
Influenza A virus (A/Western Australia/59/2004(H3N2))	hema(GI:l 152903 17 loc:CY015940)	neura(GI: 115290322 loc:CY0 159420)
Influenza A virus (A/Western Australia/60/2004(H3N2))	hema(GI:l 15290517 loc:CY015948)	neura(GI: 115290530 loc:CY0159500)
Influenza A virus (A/Western Australia/61/2004(H3N2))	hema(GI: 115290820 loc:CY015956)	neura(GI:l 15290835 loc:CY0159580)
Influenza A virus (A/Western Australia/62/2004(H3N2))	hema(GP: 115290874 loc:CY015964)	neura(GI: 115290879 loc:CY0159660)
Influenza A virus (A/Western Australia/63/2004(H3N2))	hema(GI: 115290893 loc:CY015972)	neura(GI: 115290898 loc:CY0159740)
Influenza A virus (A/Western Australia/64/2004(H3N2))	hema(GI: 115290912 loc:CY015980)	neura(GI:l 15290917 loc:CY0159820)
Influenza A virus (A/Western Australia/65/2005(H3N2))	hema(GI: 115290931 loc:CY015988)	neura(GI: 115290936 loc:CY0159900)
Influenza A virus (A/Western Australia/66/2005(H3N2))	hema(GI: 115290950 loc:CY0 15996)	neura(GI: 115290955 loc:CY0159980)
Influenza A virus (A/Western Australia/68/2005(H3N2))	hema(GI: 115290969 loc:CY016004)	neura(GI:l 15290974 loc:CY0160060)
Influenza A virus (A/Western Australia/69/2005(H3N2))	hema(GI: 116069922 loc:CY0 16979)	neura(GI: 116069927 loc:CY0169810)
Influenza A virus (A/Western Australia/70/2005(H3N2))	hema(GI: 115290988 loc:CY016012)	neura(GI: 115290993 loc:CY0160140)
Influenza A virus (A/Western Australia/72/2005(H3N2))	hema(GI: 116069941 loc:CY016987)	neura(GI: 116069946 loc:CY0 169890)
Influenza A virus (A/Western Australia/73/2005(H3N2))	hema(GI:l 15291007 loc:CY016020)	neura(GI:l 15291012 loc:CY0 160220)
Influenza A virus (A/Western Australia/74/2005(H3N2))	hema(GI: 115291026 loc:CY016028)	neura(GI:l 15291031 loc:CY0 160300)
Influenza A virus (A/Western Australia/75/2005(H3N2))	hema(GI: 115291045 loc:CY016036)	neura(GI:l 15291050 loc:CY0160380)
Influenza A virus (A/Western Australia/78/2005(H3N2))	hema(GI:l 15291064 loc:CY016044)	neura(GI:l 15291069 loc:CY0160460)
Influenza A virus (A/Western Australia/8/2000(H3N2))	hema(GI:l 15289652 loc:CY015660)	neura(GI: 115289657 loc:CY0156620)
Influenza A virus (A/X-3 1(H3N2))	hema(Gr:l 111 18357 loc:DQ874876)	neura(GI:8583 1237 loc.AANCOIOOOOOSO)
Influenza A virus (A/Yilan/513/03(H3N2))	hema(GI:68138187 loc:AY962015)	neura(GI:70673236 loc:AY9733400)
Influenza A virus (A/Yilan/515/03(H3N2))	hema(GI:68138177 loc:AY962010)	neura(GI:70673238 loc:AY9733410)
Influenza A virus (A/Yilan/518/03(H3N2))	hema(GI:68138169 loc:AY962006)	neura(GI:70673240 loc:AY9733420)
Influenza A virus (A/Yilan/538/04(H3N2))	hema(GI:68138161 loc:AY962002)	neura(GI:70673242 loc:AY9733430)
Influenza A virus (A/Yilan/549/04(H3N2))	hema(GI:68138163 loc:AY962003)	neura(GI:70673244 loc:AY9733440)
Influenza A virus (A/Yilan/557/04(H3N2))	hema(GP:68138183 loc:AY962013)	neura(GI:70673246 loc:AY9733450)
Influenza A virus (A/Yilan/566/04(H3N2))	hema(GI:68138185 loc:AY962014)	neura(GI:70673248 loc:AY9733460)

Influenza A virus (A/bantam/Nanchang/9-366/2000(H3N3))	hema(GI:82654267 loc:CY006012)	neura(GI:82654251 loc:CY0054070)
Influenza A virus (A/mallard duck/ALB/7 12/1978(H3N3))	hema(GI:82652561 loc:CY005936)	neura(GI:82652566 loc:CY0046010)
Influenza A virus (A/mallard/ALB/394/1988(H3N3))	hema(GI:82652670 loc:CY005942)	neura(GI:82652675 loc:CY0046820)
Influenza A virus (A/mallard duck/ALB/635/1983(H3N5))	hema(GI:82652651 loc:CY005941)	neura(GI:82652656 loc:CY0046510)
Influenza A virus (A/mallard/ALB/1 18/1995(H3N5))	hema(GI:78096146 loc:CY004692)	neura(GI:78096151 loc:CY0046940)
Influenza A virus (A/mallard duck/ALB/676/1 979(H3N6))	hema(GI:82622685 loc:CY005916)	neura(GI:82622690 loc:CY0041230)
Influenza A virus (A/mallard duck/Alberta/33 1/1 985(H3N6))	hema(GI: 115278022 loc:CY014548)	neura(GI: 115278027 loc:CY0 145500)
Influenza A virus (A/mallard duck/New York/157/1986(H3N6))	hema(GI: 115278797 loc:CY014865)	neura(GI:1 15278802 loc:CY0 148670)
Influenza A virus (A/pintail duck/ALB/462/1979(H3N6))	herna(GI:82652599 loc:CY005938)	neura(GI:82652604 loc:CY0046150)
Influenza A virus (A/pintail/Alaska/53/2005(H3N6))	hema(GI: 112787526 loc:CY0 13263)	neura(GI: 112787531 loc:CY0132650)
Influenza A virus (A/black duck/AUS/751/1978(H3N8))	hema(GI:82654756 loc:CY006031)	neura(GI:82654761 loc:CY0056540)
Influenza A virus (A/blue-winged teal/ALB/569/1985(H3N8))	hema(GI:780961 10 loc:CY004670)	neura(GI:780961 15 loc:CY0046720)
Influenza A virus (A/blue-winged teal/Alberta/120/1991(H3N8))	hema(GI: 115278043 loc:CY0 14571)	neura(GI: 115278048 loc:CY0 145730)
Influenza A virus (A/Duck/Hokkaido/8/80 (H3N8))	rtema(GI:3414978 loc:AF079570)	neura(GI: 115334261 loc:AB2752850)
Influenza A virus (A/duck/Nanchang/1681/1992(H3 N8))	hema(GI:82654324 loc:CY006016)	neura(GI:82654329 loc:CY0054700)
Influenza A virus (A/equine/Algiers/1972(H3N8))	hema(GI:323996 loc:FLAEA72HA)	neura(GI:305199 loc:FLANAALGIEO)
Influenza A virus (A/equine/Jilin/1/1989(H3N8))	hema(GI:324097 loc:FLAHAA)	neura(GI:305217 loc:FLANAJILINO)
Influenza A virus (A/equine/Miami/1/1963(H3N8))	hema(GI:324006 loc:FLAEM63HA)	neura(GI:305221 loc:FLANAMIAMIO)
Influenza A virus (A/green-winged teal/ALB/438/1979(H3N8))	hema(GI:82652580 loc:CY005937)	neura(GI:82652585 loc:CY0046080)
Influenza A virus (A/mallard duck/ALB/3 1/1976(H3N8))	hema(GI:8262321 1 loc:CY005917)	neura(GI:82623216 loc:CY0043010)
Influenza A virus (A/mallard duck/ALB/525/1985(H3N8))	hema(GI:78096091 loc:CY004662)	neura(GI:78096096 loc:CY0046640)
Influenza A virus (A/mallard duck/ALB/564/1 979(H3N8))	hema(GI:82622666 loc:CY005915)	neura(GI:82622671 loc:CY0041080)
Influenza A virus (A/mallard duck/New York/174/1982(H3N8))	hema(GI: 115279025 loc:CY014961)	neura(GI: 115279030 loc:CY0149630)
Influenza A virus (A/mallard/Alaska/256/2005(H3N8))	hema(GI: 115289253 loc:CY015492)	neura(GI: 115289258 loc:CY0154940)
Influenza A virus (A/mallard/Alaska/7 15/2005(H3N8))	hema(GI:1 15521369 loc:CY01641 1)	neura(GI:1 15521374 loc:CY0164130)
Influenza A virus (A/mallard/Alberta/156/2001(H3N S))	hema(GI:78096170 loc:CY004702)	neura(GI: 78096 175 loc:CY0047040)
Influenza A virus (A/mallard/Ohio/264/1986(H3N8))	hema(GI: 11552133 1 loc:CY016395)	neura(GI: 115521336 loc:CY0163970)
Influenza A virus (A/pintail duck/ALB/169/1980(H3N8))	hema(GI:82653593 loc:CY005977)	neura(GI:82653598 loc:CY0050450)
Influenza A virus (A/pintail/Alaska/279/2005(H3N8)	hema(GI: 115289272 lociCYOISSOO)	neura(GP.115289277 loc:CY0155020)
Influenza A virus (A/pintail/Ohio/454/1987(H3N8))	hema(GI: 11535341 1 loc:CY016140)	neura(GI: 115353416 loc:CY0161420)
Influenza A virus (A/red-necked	hema(GI: 115278179	neura(GI: 115278181

stint/Australia/4500/1 980(H3N8))	loc:CY014633)	loc:CY0 146340)
Influenza A virus (A/shearwater/Australia/405/1978(H3N8))	hema(GI: 115278152 loc:CY0 14621)	neura(GI:l 15278154 loc:CY0146220)
Influenza A virus (A/mallard duck/ALB/29 1/1977(H4N1))	hema(GI:82653 122 loc:CY005968)	neura(GI:82653 127 loc:CY0049620)
Influenza A virus (A/blue-winged teal/ALB/580/1979(H4N2))	hema(GI:82652901 loc:CY005955)	neura(GI:82652906 loc:CY0047990)
Influenza A virus (A/blue-winged teal/New York/370ac/1979(H4N2))	hema(GI: 115278933 loc:CY014922)	neura(GI: 115278935 loc:CY0149230)
Influenza A virus (A/duck/Hong Kong/24/1976(H4N2))	hema(GI:82654737 loc:CY006030)	neura(GI:82654742 loc:CY0056260)
Influenza A virus (A/green wing teal/Ohio/344/1986(H4N2))	hema(GI:l 15289158 loc:CY015459)	neura(GI: 115289163 loc:CY0154610)
Influenza A virus (A/mallard duck/ALB/1 06/1979(H4N2))	hema(GI:82652882 loc:CY005954)	neura(GI:82652887 loc:CY0047920)
Influenza A virus (A/mallard duck/ALB/354/1978(H4N2))	hema(GI:82652863 loc:CY005953)	neura(GI:82652868 loc:CY0047850)
Influenza A virus (A/mallard duck/ALB/630/1984(H4N2))	hema(GI:82652975 loc:CY005959)	neura(GI:82652980 loc:CY0048320)
Influenza A virus (A/mallard/Ohio/94/1989(H4N2))	hema(GI: 115432880 loc:CY016148)	neura(GI: 115432885 loc:CY0161500)
Influenza A virus (A/mallard/Ohio/97/1 989(H4N2))	hema(GI: 110733315 loc:CY012816)	neura(GI: 110733320 loc:CY0128180)
Influenza A virus (A/pintail duck/ALB/599/1979(H4N2))	hema(GI:82652920 loc:CY005956)	neura(GI:82652925 loc:CY0048060)
Influenza A virus (A/turkey/Minnesota/833/1980(H4 N2))	hema(GI:456423 loc:FLAHAQH)	neura(GI:781 10450 loc:CY0059080)
Influenza A virus (A/blue-winged teal/ALB/136/1990(H4N3))	hema(GI:82653046 loc:CY005964)	neura(GI:82653051 loc:CY0048980)
Influenza A virus (A/mallard/Alberta/300/1977(H4N 3))	hema(GI:82754837 loc:CY005948)	neura(GI:82754842 loc:CY0047510)
Influenza A virus (A/pintail duck/New York/155/1982(H4N3))	hema(GI:l 15278968 loc:CY014937)	neura(GI: 115278973 loc:CY0149390)
Influenza A virus (A/mallard duck/ALB/58 1/1983(H4N4))	hema(GI:82652939 loc:CY005957)	neura(GI:82652944 loc:CY0048130)
Influenza A virus (A/blue-winged teal/ALB/243/1977(H4N6))	hema(GI:82652787 loc:CY005947)	neura(GI:82652792 loc:CY0047440)
Influenza A virus (A/blue-winged teal/ALB/293/ 1994(H4N6))	hema(GI:82653065 loc:CY005965)	neura(GI:82653070 loc:CY0049050)
Influenza A virus (A/blue-winged teal/Alberta/293/2003(H4N6))	hema(GI:82653103 loc:CY005967)	neura(GI:82653108 loc:CY0049550)
Influenza A virus (A/canvasback duck/ALB/274/1977(H4N6))	hema(GI:82652730 loc:CY005944)	neura(GI:82652735 loc:CY0047230)
Influenza A virus (A/duck/Alberta/28/1976(H4N6))	hema(GI:324133 loc:FLAHALB)	neura(GI:60770 loc:ORIN210)
Influenza A virus (A/duck/Hong Kong/365/1978(H4N6))	hema(GI:82654683 loc:CY006027)	neura(GI:82654688 loc:CY0055690)
Influenza A virus (A/gadwall duck/ALB/53/1977(H4N6))	hema(GI:82652749 loc:CY005945)	neura(GI:82652754 loc:CY0047300)
Influenza A virus (A/gray teal/AUS/3/1979(H4N6))	hema(GI:78097725 loc:CY005679)	neura(GI:78097730 loc:CY0056810)
Influenza A virus (A/mallard duck/ALB/161/1977(H4N6))	hema(GI:82652825 loc:CY005951)	neura(GI:82652830 loc:CY0047710)
Influenza A virus (A/mallard/Ohio/298/1987(H4N6))	hema(GI: 110733296 loc:CY012808)	neura(GI: 110733301 loc:CY0128100)
Influenza A virus (A/mallard/Ohio/83/1 986(H4N6))	hema(GI: 115289177 loc:CY015467)	neura(GI:l 15289182 loc:CY0154690)
Influenza A virus (A/pintail duck/ALB/623/1985(H4N6))	hema(GI:82652994 loc:CY005961)	neura(GI:82652999 loc:CY0048550)
Influenza A virus (A/pintail/Alberta/269/200 1(H4N6))	hema(GI:82653084 loc:CY005966)	neura(GI:82653089 loc:CY0049480)
Influenza A virus (A/redhead duck/ALB/74/1977(H4N6))	hema(GI:82652768 loc:CY005946)	neura(GI:82652773 loc:CY0047370)

Influenza A virus (A/ruddy turnstone/DE/5 12/1988(H4N6))	hema(GI:82653013 loc:CY005962)	neura(GI:82653018 loc:CY0048620)
Influenza A virus (A/ruddy turnstone/NJ/47/1985(H4N6))	hema(GI:324230 loc:FLAHAQG)	neura(GI:82652961 loc:CY0048190)
Influenza A virus (A/domestic duck/Minnesota/ 1086/1 980(H4N8))	hema(GI: 115278386 loc:CY0 14723)	neura(GI:1 15278388 loc:CY0 147240)
Influenza A virus (A/mallard duck/ALB/2 10/1 977(H4N8))	hema(GI:82652806 loc:CY005950)	neura(GI:8265281 1 loc:CY0047570)
Influenza A virus (A/mallard duck/New York/ 194/1 982(H4N8))	hema(GI: 115278949 loc:CY0 14929)	neura(GI: 115278954 loc:CY01493 10)
Influenza A virus (A/mallard/Alberta/30/2001(H4N8))	hema(GI:78096738 loc:CY004939)	neura(GI:78096743 10C.-CY0049410)
Influenza A virus (A/mallard/Ohio/338/1986(H4N8))	hema(GI: 115289196 loc:CY0 13248)	neura(GI:1 15289201 loc:CY0154750)
Influenza A virus (A/pintail duck/ALB/220/1977(H4N8))	hema(GI:82652844 loc:CY005952)	neura(GI:82652849 loc:CY0047780)
Influenza A virus (A/pintail/Alberta/207/1999(H4N8))	hema(GI:78096724 loc:CY004933)	neura(GP.78096729 loc:CY0049350)
Influenza A virus (A/red-necked stin(/Australia/4189/1980(H4N8))	hema(GI:1 15278173 loc:CY014630)	neura(GI:1 15278175 loc:CY0146310)
Influenza A virus (A/mallard duck/New York/180/1986(H4N9))	hema(GI: 115278778 loc:CY014857)	neura(GI: 115278783 loc:CY0148590)
Influenza A virus (A/babbler/Fujian/320/04(H5NI))	hema(GI:77701872 loc:DQ188905)	neura(GI:32445988 loc:BX2941480)
Influenza A virus (A/bar-headed goose/Mongolia/1/05(H5NI))	hema(GI:8 16871 14 loc:AB233319)	neura(GI:78045556 locrNC 0075080)
Influenza A virus (A/bar-headed goose/Qinghai/05 10/05(H5NI))	hema(GI:759 11269 loc:DQ137873)	neura(GI:7591 1271 loc:DQ1378740)
Influenza A virus (A/black bulbul/Fujian/439/04(H5NI))	hema(GI:77701874 loc:DQ 188906)	neura(GI:77701884 loc:DQ 18891 10)
Influenza A virus (A/blow fly/Kyoto/93/2004(H5N 1))	hema(GI:78210824 loc:AB212649)	neura(GI:78210826 loc:AB2126500)
Influenza A virus (A/cat/Thailand/KU-02/04(H5N 1))	hema(GI:78458570 loc:DQ236077)	neura(GI:78458617 loc:DQ2360780)
Influenza A virus (A/chicken/Afghanistan/1207/2006 (H5N1))	hema(GI: 107785 189 loc:DQ661910)	neura(GI: 115608035 loc:CY0167890)
Influenza A virus (A/chicken/Bangli Bali/BBPV6-1/2004(H5NI))	hema(GI:93008258 loc:DQ497655)	neura(GI:93008436 loc:DQ4930050)
Influenza A virus (A/chicken/Bangli Bali/BPPV6-2/2004(H5NI))	hema(GI:93008260 loc:DQ497656)	neura(GI:93008434 loc:DQ4930040)
Influenza A virus (A/chicken/Bantul/BBVet-I/2005(H5NI))	hema(GI:84797247 loc:DQ320932)	neura(GI:84797509 loc:DQ3210630)
Influenza A virus (A/chicken/China/1204/04(H5NI))	hema(GI:109941933 loc:AM183671)	neura(GI:109941951 loc:AM1836800)
Influenza A virus (A/chicken/Cote d'Ivoire/1787-34/2006(H5NI))	hema(GI: 115609292 loc:CY01681 1)	neura(GI:1 15609301 loc:CY0168130)
Influenza A virus (A/chicken/Crimea/04/2005(H5N 1))	hema(GI: 109692765 loc:DQ650659)	neura(GI: 109692769 loc:DQ6506610)
Influenza A virus (A/chicken/Crimea/08/2005(H5NI))	hema(GI: 109692773 loc:DQ650663)	neura(GI: 109692777 loc:DQ6506650)
Influenza A virus (A/chicken/Dairi/BPPVI/2005(H5 NI))	hema(GI:93008282 loc:DQ497667)	neura(GI:93008456 loc:DQ4930150)
Influenza A virus (A/chicken/Deli Serdang/BPPVI/2005(H5NI))	hema(GI:93008284 loc:DQ497668)	neura(GI:93008458 loc:DQ4930160)
Influenza A virus (A/chicken/Fujian/1 042/2005(H5N D))	hema(GI:84797135 loc:DQ320876)	neura(GI:84797399 loc:DQ3210080)

Influenza A virus (A/chicken/Guangxi/12/2004(H5N1))	hema(GI:86753761 loc:DQ366330)	neura(GI:86753781 loc:DQ3663320)
Influenza A virus (A/chicken/Guangxi/2439/2004(H5N1))	hema(GI:84797169 loc:DQ320893)	neura(GI:84797433 loc:DQ3210250)
Influenza A virus (A/chicken/Guangxi/2448/2004(H5N1))	hema(GI:84797171 loc:DQ320894)	neura(GI:84797435 loc:DQ3210260)
Influenza A virus (A/chicken/Guangxi/2461/2004(H5N1))	hema(GI:84797173 loc:DQ320895)	neura(GI:84797437 loc:DQ3210270)
Influenza A virus (A/chicken/Guangxi/604/2005(H5N1))	hema(GI:84797179 loc:DQ320898)	neura(GI:84797443 loc:DQ3210300)
Influenza A virus (A/chicken/Gunung Kidal/BBVW/2005(H5N1))	hema(GI:93008250 loc:DQ497651)	neura(GI:93008426 loc:DQ4930000)
Influenza A virus (A/chicken/Hebei/108/02(H5N1))	hema(GI:85062568 loc:DQ343152)	neura(GI:85681810 loc:DQ349H60)
Influenza A virus (A/chicken/Hebei/326/2005(H5N1))	hema(GI:85062564 loc:DQ343150)	neura(GI:85681814 loc:DQ3491180)
Influenza A virus (A/chicken/Hebei/718/2001(H5N1))	hema(GI:85062566 loc:DQ343151)	neura(GI:85681812 loc:DQ3491170)
Influenza A virus (A/chicken/Henan/01/2004(H5N1))	hema(GI:67649668 loc:DQ080022)	neura(GI:16763390 loc:ncr0031970)
Influenza A virus (A/chicken/Henan/wu/2004(H5N1))	hema(GI:115382756 loc:DQ997219)	neura(GI:115382758 loc:DQ9972200)
Influenza A virus (A/chicken/Hubei/327/2004(H5N1))	hema(GI:50956627 loc:AY684706)	neura(GI:50956631 loc:AY6847080)
Influenza A virus (A/chicken/Hubei/wf/2002(H5N1))	hema(GI:115343521 loc:DQ997087)	neura(GI:115343523 loc:DQ9970880)
Influenza A virus (A/chicken/Hubei/wh/1997(H5N1))	hema(GI:115343549 loc:DQ997102)	neura(GI:115343551 loc:DQ9971030)
Influenza A virus (A/chicken/Hubei/wi/1997(H5N1))	hema(GI:115343568 loc:DQ997111)	neura(GI:115343570 loc:DQ9971120)
Influenza A virus (A/chicken/Hubei/wj/1997(H5N1))	hema(GI:115382807 loc:DQ997122)	neura(GI:115382791 loc:DQ9971150)
Influenza A virus (A/chicken/Hubei/wk/1997(H5N1))	hema(GI:115382809 loc:DQ997123)	neura(GI:115382814 loc:DQ9971250)
Influenza A virus (A/chicken/Hubei/wl/1997(H5N1))	hema(GI:115382830 loc:DQ997133)	neura(GI:115382832 loc:DQ9971340)
Influenza A virus (A/chicken/Hubei/wm/1997(H5N1))	hema(GI:115382847 loc:DQ997140)	neura(GI:115382850 loc:DQ9971430)
Influenza A virus (A/chicken/Hubei/wn/2003(H5N1))	hema(GI:115382859 loc:DQ997147)	neura(GI:115382863 loc:DQ9971500)
Influenza A virus (A/chicken/Hubei/wo/2003(H5N1))	hema(GI:115502941 loc:DQ997156)	neura(GI:115502942 loc:DQ9971570)
Influenza A virus (A/chicken/Hunan/999/2005(H5N1))	hema(GI:84797203 loc:DQ320910)	neura(GI:84797467 loc:DQ3210420)
Influenza A virus (A/chicken/Hunan/fg/2004(H5N1))	hema(GI:115396950 loc:DQ997396)	neura(GI:115396952 loc:DQ9973970)
Influenza A virus (A/chicken/Indonesia/R134/03(H5N1))	hema(GI:109941929 loc:AM183669)	neura(GI:109941953 loc:ncrAM1836810)
Influenza A virus (A/chicken/Indonesia/R60/05(H5N1))	hema(GI:109941931 loc:AM183670)	neura(GI:109941955 loc:AMI836820)
Influenza A virus (A/chicken/Jembrana/BPPV6/2004(H5N1))	hema(GI:93008262 loc:DQ497657)	neura(GI:93008438 loc:DQ4930060)

Influenza A virus (A/chicken/Jiangsu/czl/2002(H5N1))	hema(GI:1 15382881 loc:DQ997182)	neura(GI: 115382883 loc:DQ9971830)
Influenza A virus (A/chicken/Jilin/ha/2003(H5N1))	hema(GI: 115502957 (oc:DQ997268)	neura(GI: 115502963 bc:DQ9972710)
Influenza A virus (A/chicken/Jilin/hd/2002(H5N1))	hema(GI: 115502972 loc:DQ997283)	neura(GI: 115502974 loc:DQ9972840)
Influenza A virus (A/chicken/Jilin/he/2002(H5N1))	hema(GI: 115396976 loc:DQ99729i)	neura(GI: 115396977 loc:DQ9972920)
Influenza A virus (A/chicken/Jilin/hfi'2002(H5N1))	hema(GI: 115502990 loc:DQ997377)	neura(GI: 115502992 loc:DQ9973780)
Influenza A virus (A/chicken/Jitin/hg/2002(H5N1))	hema(GI:115396992 loc:DQ997299)	neura(GI: 115396993 loc:DQ9973000)
Influenza A virus (A/chicken/Jilin/hh/2002(H5N1))	hema(GI: 115397012 loc:DQ997308)	neura(GI: 115397014 loc:DQ9973090)
Influenza A virus (A/chicken/Jilin/hj^GC^HSN1))	hema(GI: 115397031 loc:DQ997318)	neura(GI:l 15397032 loc:DQ9973190)
Influenza A virus (A/chicken/Jilin/xw/2003(H5N1))	hema(GI: 115503009 loc:DQ997547)	neura(GI: 115503011 loc:DQ9975480)
Influenza A virus (A/chicken/Krastiodar/0 l/2006(H5N1))	hema(GI: 1087825 19 loc:DQ676834)	neura(GI:l 15520953 loc:DQ6768360)
Influenza A virus (A/chicken/Kulon Progo/BB Vet-XII-i/2004(H5N1))	hema(GI:84 797245 loc:DQ320931)	neura(GI:84797507 loc:DQ3210620)
Influenza A virus (A/chicken/Kulon Progo/BBVet-XH-2/2004(H5N1))	hema(GI:93008248 loc:DQ497650)	neura(GI:93008424 loc:DQ4929990)
Influenza A virus (A/chicken/Kulon Progo/BBVW/2005(H5N1))	hema(GI:93008252 loc:DQ497652)	neura(GI:93008428 loc:DQ4930010)
Influenza A virus (A/chicken/Kupang- 1-NTT/BPPV6/2004(H5N1))	hema(GI:93008272 loc:DQ497662)	neura(GI:93008448 loc:DQ4930110)
Influenza A virus (A/chicken/Kupang-2-NTT/BPPV6/2004(H5N1))	hema(GI:93008268 loc:DQ497660)	neura(GI:93008444 loc:DQ4930090)
Influenza A virus (A/chicken/Kupang-3-NTT/BPPV6/2004(H5N1))	hema(GI:93008270 loc:DQ497661)	neura(GI:93008446 loc:DQ4930100)
Influenza A virus (A/chicken/Kurgan/OS^OOSCHSN1))	hema(GI:90289625 loc:DQ449632)	neura(GI:90289629 loc:DQ4496340)
Influenza A virus (A/chicken/Magetan/BBVW/2005(H5N1))	hema(GI:93008234 loc:DQ497643)	neura(GI:93008410 loc:DQ4929920)
Influenza A virus (A/chicken/Mahachkala/05/2006(H5N1))	hema(GI: 1087825 11 loc:DQ676830)	neura(GI: 1087825 15 loc:DQ6768320)
Influenza A virus (A/chicken/Malang/BBVet-IV/2004(H5N1))	hema(GI:93008232 loc:DQ497642)	neura(GI:93008408 loc:DQ4929910)
Influenza A virus (A/chicken/Malaysia/5858/2004(H5N1))	hema(GI:84797251 loc:DQ320934)	neura(GI:84797515 loc:DQ3210660)
Influenza A virus (A/chicken/Mangarai-NTT/BPPV6/2004(H5N1))	hema(GI:93008264 loc:DQ497658)	neura(GI:93008440 loc:DQ4930070)
Influenza A virus (A/chicken/Ngawi/BPPV4/2004(H5N1))	hema(GI:93008236 loc:DQ497644)	neura(GI:93008412 loc:DQ4929930)
Influenza A virus (A/chicken/Nigeria/1047-30/2006(H5N1))	hema(GI: 115608182 loc:CY016939)	neura(GI:l 15608187 loc:CY0169410)
Influenza A virus (A/chicken/Nigeria/1 047-34/2006(H5N1))	hema(GI: 115608201 loc:CY016947)	neura(GI: 115608206 loc:CYO169490)

Influenza A virus (A/chicken/Nigeria/1 047- 54/2006(H5N1))	hema(GI: 115608 144 loc:CY016923)	neura(GI:l 15608149 loc:CY0169250)
Influenza A virus (A/chicken/Nigeria/1 047- 62/2006(H5N1))	hema(GI:115608163 loc:CY016931)	neura(GI:l 15608168 loc:CY0169330)
Influenza A virus (A/chicken/Nigeria/1047- 8/2006(H5N1))	hema(GI:l 15608106 loc:CY016907)	neura(GI: 1156081 11 loc:CY0169090)
Influenza A virus (A/chicken/Nigeria/64 l/2006(H5N I))	hema(GI:88604738 loc:DQ406728)	neura(GI:95020687 loc:DQ5292960)
Influenza A virus (A/chicken/Nigeria/957- 20/2006(H5N1))	hema(GI: 115344755 loc:CY016284)	neura(GI: 115344760 loc:CY0162860)
Influenza A virus (A/chicken/Pangkalpinang/BPPV3/ 2004(H5N1))	hema(GI:93008274 loc:DQ497663)	neura(GI:93008450 loc:DQ4930120)
Influenza A virus (A/chicken/Pekalongan/BPPV4/20 03(H5N1))	hema(GI:93008238 loc:DQ497645)	neura(GI:93008414 loc:DQ4929940)
Influenza A virus (A/chicken/Purwakarta/BBVet- IV/2004(H5N1))	hema(GI:93008254 loc:DQ497653)	neura(GI:93008430 loc:DQ4930020)
Influenza A virus (A/chicken/Purworejo/BBVW/200 5(H5N1))	hema(GI:93008244 loc:DQ497648)	neura(GI:93 008420 loc:DQ4929970)
Influenza A virus (A/chicken/Salatiga/BBVet- I/2005(H5N1))	hema(GI:84797239 loc:DQ320928)	neura(GI:84797501 loc:DQ3210590)
Influenza A virus (A/chicken/Scotland/1959(H5N1))	hema(GI:l 15279313 loc:CY015081)	neura(GI: 1152793 18 loc:CY0150830)
Influenza A virus (A/chicken/Simalanggang/BPPVI/2 005(H5N1))	hema(GI:93008278 loc:DQ497665)	neura(GI:93008452 loc:DQ4930130)
Influenza A virus (A/chicken/Sragen/BPPV4/2003(H 5N1))	hema(GI:93008240 loc:DQ497646)	neura(GI:93008416 loc:DQ4929950)
Influenza A virus (A/chicken/Sudan/1 784- 10/2006(H5N1))	hema(GI:l 15344793 loc:CY016300)	neura(GI: 115344798 loc:CYO 163020)
Influenza A virus (A/chicken/Sudan/ 1784- 7/2006(H5N1))	hema(GI: 115344774 loc:CY016292)	neura(GI: 115344779 loc:CYO162940)
Influenza A virus (A/chicken/Tarutung/BPPVI/2005(H5N1))	hema(GI:93008286 loc:DQ497669)	neura(GI:93008460 loc:DQ4930170)
Influenza A virus (A/chicken/Tebing Tinggi/BPPVI/2005(H5N1))	hema(GI:93008280 loc:DQ497666)	neura(GI:93008454 loc:DQ4930140)
Influenza A virus (A/chicken/Tula/Russia/Oct- 5/2005(H5N1))	hema(GI: 1106 13449 loc:DQ840519)	neura(GI: 110613459 loc:DQ8405230)
Influenza A virus (A/chicken/Viet Nam/10/2005(H5N1))	hema(GI: 115953503 loc:CY016867)	neura(GI: 115953206 loc:NW 0013645060)
Influenza A virus (A/chicken/Viet Nam/1 l/2005(H5N1))	hema(GI: 115952217 loc:CYO16875)	neura(GI: 115952224 loc:CY0168770)
Influenza A virus (A/chicken/Viet Nam/2/2005(H5N1))	hema(GI: 115953078 loc:CYO 16835)	neura(GI: 115953083 loc:CYO 168370)
Influenza A virus (A/chicken/Viet Nam/6/2005(H5N1))	hema(GI: 115952998 loc:CY016843)	neura(GI: 115953003 loc:CYO 168450)
Influenza A virus (A/chicken/Viet Nam/8/2005(H5N1))	hema(GI: 115952885 loc:CY016851)	neura(GI: 115952892 loc:CY0168530)
Influenza A virus (A/chicken/Viet Nam/9/2005(H5N1))	hema(GI: 115952786 loc:CY016859)	neura(GI: 115952793 loc:CY0168610)
Influenza A virus (A/chicken/Vietnam/132/2004(H5	hema(GI:93008384 loc:DQ497718)	neura(GI:93 008560 loc:DQ4930670)

NI))		
Influenza A virus (A/chicken/Vietnam/133/2004(H5 NI))	hema(GI:93008348 loc:DQ497700)	neura(GI:93008524 loc:DQ4930490)
Influenza A virus (A/chicken/Vietnam/134/2004(H5 NI))	hema(GI:9300837<5 (oc:DQ497714)	neura(GI:93008552 loc:DQ4930630)
Influenza A virus (A/chicken/Vietnam/135/2004(H5 NI))	hema(GI:93008338 loc:DQ497695)	neura(GI:93008514 loc:DQ4930440)
Influenza A virus (A/chicken/Vietnam/147/2004(H5 NI))	hema(GI:93008350 loc:DQ497701)	neura(GI:93008526 loc:DQ4930500)
Influenza A virus (A/chicken/Vietnam/149/2004(H5 NI))	hema(GI:93008340 loc:DQ497696)	neura(GI:93008516 loc:DQ493Q450)
Influenza A virus (A/chicken/Vietnam/159/2004(H5 NI))	hema(GI:93008374 loc:DQ497713)	neura(GI:93008550 loc:DQ4930620)
Influenza A virus (A/chicken/Vietnam/19/2003(H5N D))	hema(GI:93008304 loc:DQ497678)	neura(GI:93008480 loc:DQ4930270)
Influenza A virus (A/chicken/Vietnam/20/2003(H5N I))	hema(GI:93008306 loc:DQ497679)	neura(GI:93008482 loc:DQ4930280)
Influenza A virus (A/chicken/Vietnam/260/2004(H5 NI))	hema(GI:93008360 loc:DQ497706)	neura(GI:93008536 loc:DQ4930550)
Influenza A virus (A/chicken/Vietnam/27/2003(H5N D))	hema(GI:84797259 loc:DQ320938)	neura(GI:84797521 loc:DQ3210690)
Influenza A virus (A/chicken/Vietnam/28/2003(H5N I))	hema(GI:93008310 loc:DQ497681)	neura(GI:93008486 loc:DQ4930300)
Influenza A virus (A/chicken/Vietnam/30/2003(H5N I))	hema(GI:93008312 loc:DQ497682)	neura(GI:93008488 loc:DQ4930310)
Influenza A virus (A/chicken/Vietnam/32/2004(H5N I))	hema(GI:93008322 loc:DQ497687)	neura(GI:93008498 loc:DQ4930360)
Influenza A virus (A/chicken/Vietnam/348/2005(H5 NI))	hema(GI:93008300 loc:DQ497676)	neura(GI:93008476 loc:DQ4930250)
Influenza A virus (A/chicken/Vietnam/393/2005(H5 NI))	hema(GI:93008372 loc:DQ497712)	neura(GI:93008548 loc:DQ4930610)
Influenza A virus (A/chicken/Vietnam/398/2005(H5 NI))	hema(GI:93008354 loc:DQ497703)	neura(GI:93008530 loc:DQ4930520)
Influenza A virus (A/chicken/Vietnam/4/2003(H5NI)	hema(GI:93008330 loc:DQ497691)	neura(GI:93008506 loc:DQ4930400)
Influenza A virus (A/chicken/Vietnam/5/2003(H5NI)	hema(GI:93008332 loc:DQ497692)	neura(GI:93008508 loc:DQ4930410)
Influenza A virus (A/chicken/Vietnam/52/2004(H5N I))	hema(GI:93008344 loc:DQ497698)	neura(GI:93008520 loc:DQ4930470)
Influenza A virus (A/chicken/Vietnam/53/2004(H5N I))	hema(GI:93008368 loc:DQ497710)	neura(GI:93008544 loc:DQ4930590)
Influenza A virus (A/chicken/Vietnam/8/2003(H5N I))	hema(GI:93008334 loc:DQ497693)	neura(GI:93008510 loc:DQ4930420)
Influenza A virus (A/chicken/Vietnam/DT 17i/2G04(HSNI))	hema(GI:84797257 loc:DQ320937)	neura(GI:84797519 loc:DQ3210680)

Influenza A virus (A/chicken/Vietnam/P22/05(H5N1))	hema(GI:109941939 loc:AM183674)	neura(GI: 109941949 loc:AM1836790)
Influenza A virus (A/chicken/Wajo/BBVM/2005(H5 N1))	hema(GI:84797249 loc:DQ320933)	neura(GI:8479751 1 loc:DQ3210640)
Influenza A virus (A/chicken/Wonosobo/BPPV4/200 3(H5N1))	hema(GI:84797241 loc:DQ320929)	neura(GI:84797503 loc:DQ32 10600)
Influenza A virus (A/chicken/Yogyakarta/BBVet- IX/2004(H5N1))	hema(GI:84797243 loc:DQ320930)	neura(GI:84797505 loc:DQ3210610)
Influenza A virus (A/common bussard/Bavaria/2/2006(H5N 1))	hema(GI: 110084604 loc:DQ659679)	neura(GI: 110084606 loc:DQ6596800)
Influenza A virus (A/common pochard/France/06167/2006(H5N1))	hema(GI:88687199 loc:AM23 1714)	neura(GI:88687197 loc:AM23 17130) neura(GI:7737803 1 loc:DQ1824820)
Influenza A virus (A/crested eagle/Belgium/01/2004(H5N1))	hema(GI:6213 1253 loc:AY861372)	neura(GI:77543386 loc:DQ1916900)
Influenza A virus (A/curlew/Shandong/61/04(H5N1))	hema(GI:77543384 ioc:DQ191689)	neura(GP.88714397 loc:DQ3891590)
Influenza A virus (A/Cygnus olor/Astrakhan/Ast05-2- 1/2005(H5N1))	hema(GI:887 14395 loc:DQ389158)	neura(GI:89477185 loc:DQ4405790)
Influenza A virus (A/Cygnus olor/Astrakhan/Ast05-2- 10/2005(H5N1))	hema(GI:89258382 loc:DQ434889)	neura(GI:8621 1368 loc:DQ3587470)
Influenza A virus (A/Cygnus olor/Astrakhan/Ast05-2- 3/2005(H5N1))	hema(GI:8621 1366 loc:DQ358746)	neura(GI:87204337 loc:DQ3639190)
Influenza A virus (A/Cygnus olor/Astrakhan/Ast05-2- 4/2005(H5N1))	hema(GI:87204335 loc:DQ363918)	neura(GI:86278738 loc:DQ3650050)
Influenza A virus (A/Cygnus olor/Astrakhan/Ast05-2- 5/2005(H5N1))	hema(GI:86278736 loc:DQ365004)	neura(GI:86278720 loc:DQ3649970)
Influenza A virus (A/Cygnus olor/Astrakhan/Ast05-2- 6/2005(H5N1))	hema(GI:86278718 loc:DQ364996)	neura(GI:87306787 loc:NZ AANZO 10000020)
Influenza A virus (A/Cygnus olor/Astrakhan/Ast05-2- 7/2005(H5N1))	hema(GI:87204345 loc:DQ363923)	neura(GP.89077645 loc:DQ3995410)
Influenza A virus (A/Cygnus olor/Astrakhan/Ast05-2- 8/2005(H5N1))	hema(GI:89077643 loc:DQ399540)	neura(GI:89077655 loc:DQ3995460) neura(GI: 115608073 loc:CY0168210) neura(GI:61563746 loc:AY9401680)
Influenza A virus (A/cygnus olor/Croatia/ 1/2005(H5N 1))	hema(GI:l 15608068 loc:CY016819)	neura(GI:98418287 loc:DQ5301750) neura(GI: 115609542 loc:CY0 168050)
Influenza A virus (A/Cygnus olor/Italy/742/2006(H5N1))	hema(GI:94961242 loc:DQ412997)	neura(GI:115608092 loc:CY0169010) neura(GI:84797397 loc:DQ32 10070) neura(GI:86753783 loc:DQ3663400)
Influenza A Virus (A/dog/Thailand-Suphanburi/KU- O8/O4(H5N1))	hema(GI:984 18223 loc:DQ530173)	neura(GI:84797413 loc:DQ3210150)
Influenza A virus (A/duck/Cote d'Ivoire/1787-18/2006(H5N1))	hema(GI: 115609536 loc:CY0 16803)	
Influenza A virus (A/duck/Egypt/2253- 3/2006(H5N1))	hema(GP.110631388 loc:DQ862002)	
Influenza A virus (A/duck/Fujian/897/2005(H5N1))	hema(GI:84797133 loc:DQ320875)	
Influenza A virus (A/duck/Guangxi/13/2004(H5N1))	hema(GI:86753763 loc:DQ366338)	
Influenza A virus (A/duck/Guangxi/13 11/2004(H5N1)	hema(GI:84797149 loc:DQ320883)	

Influenza A virus (A/duck/Guangxi/1378/2004(H5NI))	hema(GI:84797151 loc:DQ320884)	neura(GI:84797415 loc:DQ3210160)
Influenza A virus (A/duck/Guangxi/1586/2004(H5NI))	hema(GI:84797153 loc:DQ320885)	neura(GI:84797417 loc:DQ3210170)
Influenza A virus (A/duck/Guangxi/1 681/2004(H5NI))	hema(GI:84797155 loc:DQ320886)	neura(GI:84797419 loc:DQ3210180)
Influenza A virus (A/duck/Guangxi/1 793/2004(H5N 1))	hema(GI:84797157 loc:DQ320887)	neura(GI:84797421 loc:DQ3210190)
Influenza A virus (A/duck/Guangxi/229 1/2004(H5NI))	hema(GI:84797163 loc:DQ3 20890)	neura(GI:84797427 loc:DQ3210220)
Influenza A virus (A/duck/Guangxi/2396/2004(H5NI))	hema(GI:84797167 loc:DQ320892)	neura(GI:8479743 1 loc:DQ32 10240)
Influenza A virus (A/duck/Guangxi/35 1/2004(H5NI))	hema(GI:84797137 loc:DQ320877)	neura(GI:84797401 loc:DQ3210090)
Influenza A virus (A/duck/Guangxi/380/2004(H5NI))	hema(GI:84797139 loc:DQ320878)	neura(GI:84797403 loc:DQ3210100)
Influenza A virus (A/duck/Guangxi/793/2005(H5NI))	hema(GI:84797181 loc:DQ320899)	neura(GI:84797445 loc:DQ32103 10)
Influenza A virus (A/duck/Guangxi/95 1/2005(H5NI))	hema(GI:84797183 loc:DQ320900)	neura(GI:84797447 1OC.-DQ3210320)
Influenza A virus (A/duck/Guangxi/xa/200 1(H5NI))	hema(GI:1 1552691 1 loc:DQ997513)	neura(GI:1 15526913 loc:DQ9975140)
Influenza A virus (A/duck/Guangzhou/20/2005(H5N D))	hema(GI:84797185 loc:DQ320901)	neura(GI:84797449 loc:DQ3210330)
Influenza A virus (A/duck/Hubei/wg/2002(H5NI))	hema(GI: 115343534 loc:DQ997094)	neura(GI: 115343536 loc:DQ9970950)
Influenza A virus (A/duck/Hunan/1265/2005(H5NI))	hema(GI:84797205 loc:DQ32091 1)	neura(GI:84797469 loc:DQ3210430)
Influenza A virus (A/duck/Hunan/127/2005(H5NI))	hema(GI:84797187 loc:DQ320902)	neura(GI:84797451 loc:DQ3210340)
Influenza A virus (A/duck/Hunan/139/2005(H5NI))	hema(GI:84797189 loc:DQ320903)	neura(GI:84797453 loc:DQ32 10350)
Influenza A virus (A/duck/Hunan/149/2005(H5NI))	hema(GI:84797191 loc:DQ320904)	neura(GI:84797455 loc:DQ3210360)
Influenza A virus (A/duck/Hunan/152/2005(H5NI))	hema(GI:84797193 loc:DQ320905)	neura(GI:84797457 loc:DQ32 10370)
Influenza A virus (A/duck/Hunan/157/2005(H5NI))	hema(GI:84797195 loc:DQ320906)	neura(GI:84797459 loc:DQ3210380)
Influenza A virus (A/duck/Hunan/1 60/2005(H5N 1))	hema(GI:84797197 loc:DQ320907)	neura(GI:84797461 loc:DQ3210390)
Influenza A virus (A/duck/Hunan/1608/2005(H5NI))	hema(GI:84797207 loc:DQ320912)	neura(GI:84797471 loc:DQ32 10440)
Influenza A virus (A/duck/Hunan/1652/2005(H5NI))	hema(GI:84797209 loc:DQ320913)	neura(GI:84797473 loc:DQ32 10450)
Influenza A virus (A/duck/Hunan/166/2005(H5NI))	hema(GI:84797199 loc:DQ320908)	neura(GI:84797463 loc:DQ3210400)
Influenza A virus (A/duck/Hunan/182/2005(H5NI))	hema(GI:84797201 loc:DQ320909)	neura(GI:84797465 loc:DQ3210410)
Influenza A virus (A/duck/Kurgan/08/2005(H5NI))	hema(GI:90289674 loc:DQ449640)	neura(GI:90289708 loc:DQ4496420)
Influenza A virus (A/duck/Niger/914/2006(H5NI))	hema(GI:105914725 loc:DQ6591 13)	neura(GI: 116070041 locrCYO170290)
Influenza A virus (A/duck/Novosibirsk/02/05(H5NI))	hema(GI: 112005135 loc:DQ86471 1)	neura(GI:l 12005131 loc:DQ8647100)
Influenza A virus	hema(GI:93008266 loc:DQ497659)	neura(GI:93008442

(A/duck/Parepare/BBVM/2005(H5NI))		loc:DQ4930080)
Influenza A virus (A/duck/Shanghai/xj/2002(H5NI))	hema(GI: 115526951 loc:DQ99753 1)	neura(GI: 115526953 loc:DQ9975320)
Influenza A virus (A/duck/Shantou/4610/2003(H5NI))		neura(GI:84797475 loc:DQ3210460)
Influenza A virus (A/duck/Tuva/01/2006(H5NI))	hema(GI:8479721 1 loc:DQ320914)	neura(GI: 112820 199 loc:DQ8612930)
Influenza A virus (A/duck/Viet Nam/1/2005(H5NI))	hema(GI:l 12820195 loc:DQ861291)	neura(GI: 115609702 loc:CY0168290)
Influenza A virus (A/duck/Viet Nam/12/2005(H5NI))	hema(GI: 115609697 loc:CY016827)	neura(GI: 115763457 loc:NW 0013325600)
Influenza A virus (A/duck/Viet Nam/18/2005(H5NI))	hema(GI:l 15951804 loc:CY016883)	neura(GI:l 16070098 loc:CY0 170690)
Influenza A virus (A/duck/Viet Nam/20/2005(H5NI))	hema(GI: 116070093 loc:CY0 17067)	neura(GI:l 15609762 loc:CY0168930)
Influenza A virus (A/duck/Vietnam/1/2005(H5NI))	hema(GI: 115609756 loc:CY016891)	neura(GI:86753775 loc:DQ3663080)
Influenza A virus (A/duck/Vietnam/148/2004(H5NI))	hema(GI:86753755 loc:DQ366306)	
Influenza A virus (A/duck/Vietnam/15/2003(H5NI))	hema(GI:93008352 loc:DQ497702)	neura(GI:93008528 loc:DQ4930510)
Influenza A virus (A/duck/Vietnam/17/2003(H5NI))	hema(GI:93008288 loc:DQ497670)	neura(GI:93008464 loc:DQ4930190)
Influenza A virus (A/duck/Vietnam/219/2004(H5NI))	hema(GI:93008292 loc:DQ497672)	neura(GI:93008468 loc:DQ4930210)
Influenza A virus (A/duck/Vietnam/220/2004(H5NI))	hema(GI:930083 16 loc:DQ497684)	neura(GI:93008492 loc:DQ4930330)
Influenza A virus (A/duck/Vietnam/258/2004(H5NI))	hema(GI:930083 18 loc:DQ497685)	neura(Gr.93008494 loc:DQ4930340)
Influenza A virus (A/duck/Vietnam/272/2005(H5NI))	hema(GI:93008380 loc:DQ497716)	neura(GI:93008556 loc:DQ4930650)
Influenza A virus (A/duck/Vietnam/283/2005(H5NI))	hema(GI:93008296 loc:DQ497674)	neura(GI:93008472 loc:DQ4930230)
Influenza A virus (A/duck/Vietnam/286/2005(H5NI))	hema(GI:93008364 loc:DQ497708)	neura(GI:93008540 loc:DQ4930570)
Influenza A virus (A/duck/Vietnam/3 17/2005(H5NI))	hema(GI:93008342 loc:DQ497697)	neura(GI:93008518 loc:DQ4930460)
Influenza A virus (A/duck/Vietnam/376/2005(H5NI))	hema(GI:93008326 loc:DQ497689)	neura(GI:93008502 loc:DQ4930380)
Influenza A virus (A/duck/Vietnam/40/2004(H5NI))	hema(GI:93008356 loc:DQ497704)	neura(GI:93008532 loc:DQ4930530)
Influenza A virus (A/duck/Vietnam/48/2004(H5NI))	hema(GI:93008294 loc:DQ497673)	neura(GI:93008470 loc:DQ4930220)
Influenza A virus (A/duck/Vietnam/543/2005(H5NI))	hema(GI:930083 14 loc:DQ497683)	neura(GI:93008490 loc:DQ4930320)
Influenza A virus (A/duck/Vietnam/557/2005(H5NI))	hema(GI:93008382 loc:DQ497717)	neura(GI:93008558 loc:DQ4930660)
Influenza A virus (A/duck/Vietnam/568/2005(H5NI))	hema(GI:93008366 loc:DQ497709)	neura(GI:93008542 loc:DQ4930580)
Influenza A virus (A/duck/Vietnam/8/05(H5NI))	hema(GI:84797261 loc:DQ320939)	neura(GI:84797523 loc:DQ3210700)
Influenza A virus (A/duck/Vietnam/N-	hema(GI:86753759 loc:DQ366322)	neura(GI:86753779 loc:DQ3663240)
	hema(GI:93008324 loc:DQ497688)	neura(GI:93008500 loc:DQ4930370)

TB/2005(H5N1))		
Influenza A virus (A/duck/Vietnam/N- XX/2004(H5N1))	hema(GI:93008320 loc:DQ497686)	neura(GI:93008496 loc:DQ4930350)
Influenza A virus (A/duck/Vietnam/S640/2005(H5N1)	hema(GI:93008336 loc:DQ497694)	neura(GI:93008512 loc:DQ4930430)
Influenza A virus (A/duck/Vietnam/S649/2005(H5N1)	hema(GI:93008346 loc:DQ497699)	neura(GI:93008522 loc:DQ4930480)
Influenza A virus (A/duck/Vietnam/S654/2005(H5N1)	hema(GI:84797255 loc:DQ320936)	neura(GI:84797517 loc:DQ3210670)
Influenza A virus (A/duck/Vietnam/TG24- O1/05(H5N1))	hema(GI: 109941945 loc:AM183677)	neura(GI: 111572513 loc:DQ8396080)
Influenza A virus (A/duck/Zhejiang/bj/2002(H5N1))	hema(GI: 115526968 loc:DQ997410)	neura(GI: 115526970 loc:DQ99741 10)
Influenza A virus (A/Environment/Qinghai/3 1/2005(H5N1))	hema(GI:84797227 loc:DQ320922)	neura(GI:84797491 loc:DQ3210540)
Influenza A virus (A/golden mountain thrush/Fujian/376/04(H5N1))	hema(GI:77543382 loc:DQ191688)	neura(GI:77543388 loc:DQ1916910)
Influenza A virus (A/goose/Fujian/bb/2003(H5N1))	hema(GI: 115526992 loc:DQ997405)	neura(GI: 115526994 loc:DQ9974060)
Influenza A virus (A/Goose/Guangdong/1/96(H5N1))	hema(GI:5805286 loc:AF144305)	neura(GI:73921265 loc:NC 0073610)
Influenza A virus (A/goose/Guangdong/xb/2001(H5 NI))	hema(GI: 115527004 loc:DQ997522)	neura(GI:l 15527006 loc:DQ9975230)
Influenza A virus (A/goose/Guangxi/1 097/2004(H5N I))	hema(GI:84797145 loc:DQ320881)	neura(GI:84797409 loc:DQ3210130)
Influenza A virus (A/goose/Guangxi/1 198/2004(H5N I))	hema(GI:84797147 loc:DQ320882)	neura(GI:8479741 1 loc:DQ3210140)
Influenza A virus (A/goose/Guangxi/1 832/2004(H5N I))	hema(GI:84797159 loc:DQ320888)	neura(GI:84797423 loc:DQ3210200)
Influenza A virus (A/goose/Guangxi/21 12/2004(H5N I))	hema(GI:84797161 loc:DQ320889)	neura(GI:84797425 loc:DQ3210210)
Influenza A virus (A/goose/Guangxi/2383/2004(H5N D)	hema(GI:84797165 loc:DQ320891)	neura(GI:84797429 loc:DQ3210230)
Influenza A virus (A/goose/Guangxi/345/2005(H5N1)	hema(GI:84797175 loc:DQ320896)	neura(GI:84797439 loc:DQ3210280)
Influenza A virus (A/goose/Guangxi/914/2004(H5N1)	hema(GI:84797143 loc:DQ320880)	neura(GI:84797407 loc:DQ3210120)
Influenza A virus (A/goose/Huadong/220/2004(H5N D)	hema(GI: 110287938 loc:DQ836043)	neura(GI: 110287940 loc:DQ8360440)
Influenza A virus (A/goose/Shantou/22 16/2005(H5N D)	hema(GI:84797213 loc:DQ320915)	neura(GI:84797477 loc:DQ3210470)
Influenza A virus (A/goose/Vietnam/264/2004(H5N 1)	hema(GI:93008362 loc:DQ497707)	neura(GI:93008538 loc:DQ4930560)
Influenza A virus (A/goose/Vietnam/3/05(H5N1))	hema(GI:86753757 loc:DQ3663 14)	neura(GI:86753777 loc:DQ3663 160)
Influenza A virus (A/grebe/Tyva/TyvO6- 1/2006(H5N1))	hema(GI: 113204781 loc:DQ9 14808)	neura(GI: 113204783 loc:DQ9 148090)

Influenza A virus (A/grebe/Tyva/Tyv06-2/06(H5NI))	hema(GI: 110555220 loc:DQ852600)	neura(GI: 110555222 loc:DQ8526010)
Influenza A virus (A/grey heron/Hong Kong/728/2004(H5NI))	heraa(GI:84797229 loc:DQ320923)	neura(GI:84797493 loc:DQ3210550)
Influenza A virus (A/grey heron/Hong Kong/837/2004(H5NI))	hema(GI:84797231 loc:DQ320924)	neura(GI:84797495 loc:DQ3210560)
Influenza A virus (A/human/Zhejiang/16/2006(H5NI)	hema(GI: 108946270 loc:DQ643809)	neura(GI: 108946272 loc:DQ6438100)
Influenza A virus (A/mallard/Bavaria/1/2006(H5NI))	hema(GI:90654261 loc:DQ458992)	neura(GI:90654263 loc:DQ4589930)
Influenza A virus (A/mallard/Guangxi/wt/2004(H5N D)	hema(GI: 115527053 loc:DQ997218)	neura(GI: 115527037 loc:DQ99721 10)
Influenza A virus (A/mallard/Italy/835/2006(H5NI))	hema(GI:89994020 loc:DQ449031)	neura(GI: 115608054 loc:CY0167970)
Influenza A virus (A/mallard/Vietnam/16/2003(H5N D)	hema(GI:93008290 loc:DQ497671)	neura(GP.93008466 loc:DQ4930200)
Influenza A virus (A/maliard/Vietnam/2 1/2003(H5N D)	hema(GI:93008308 loc:DQ497680)	neura(GI:93008484 loc:DQ4930290)
Influenza A virus (A/mallard/Vietnam/3/2003(H5NI)	hema(GI:93008328 loc:DQ497690)	neura(GI:93008504 loc:DQ4930390)
Influenza A virus (A/mallardA Vietnam/347/2005(H5 ND)	hema(GI:93008298 loc:DQ497675)	neura(GI:93008474 loc:DQ4930240)
Influenza A virus (A/mallard/Vietnam/352/2005(H5 ND)	hema(GI:93008302 loc:DQ497677)	neura(GI:93008478 loc:DQ4930260)
Influenza A virus (A/migratory duck/Jiangxi/1653/2005(H5NI))	hema(GI:84797215 loc:DQ320916)	neura(GI:84797479 loc:DQ3210480)
Influenza A virus (A/migratory duck/Jiangxi/1657/2005(H5NI))	hema(GI:84797217 loc:DQ320917)	neura(GI:84797481 1OC-DQ32 10490)
Influenza A virus (A/migratory duck/Jiangxi/1701/2005(H5NI))	hema(GI:84797219 loc:DQ320918)	neura(GI:84797483 loc:DQ3210500)
Influenza A virus (A/migratory duck/Jiangxi/2136/2005(H5NI))	hema(GI:84797221 loc:DQ320919)	neura(GI:84797485 loc:DQ3210510)
Influenza A virus (A/migratory duck/Jiangxi/2295/2005(H5NI))	hema(GI:84797223 loc:DQ320920)	neura(GI:84797487 loc:DQ3210520)
Influenza A virus (A/migratory duck/Jiangxi/2300/2005(H5NI))	hema(GI:84797225 loc:DQ320921)	neura(GI:84797489 loc:DQ3210530)
Influenza A virus (A/ostrich/Nigeria/1047- 25/2006(H5NI))	hema(GI: 115608125 loc:CY016915)	neura(GI: 115608130 loc:CY0169170)
Influenza A virus (A/pigeon/Thailand/KU- O3/O4(H5N1))	hema(GI:78458879 loc:DQ236085)	neura(GI:78458928 loc:DQ2360860)
Influenza A virus (A/quail/Boyolali/BPPV4/2004(H5 ND)	hema(GI:93008242 loc:DQ497647)	neura(GI:93008418 loc:DQ4929960)
Influenza A virus (A/quail/Guangxi/575/2005(H5NI)	hema(GI:84797177 loc:DQ320897)	neura(GI:84797441 loc:DQ32 10290)
Influenza A virus (A/quail/Tasikmalaya/BPPV4/2004 (H5N1))	hema(GI:93008256 loc:DQ497654)	neura(GI:93008432 loc:DQ4930030)
Influenza A virus (A/quail/Vietnam/177/2004(H5NI)	hema(GI:93008378 loc:DQ497715)	neura(GI:93008554 loc:DQ4930640)
Influenza A virus (A/quail/Vietnam/282/2005(H5NI)	hema(GI:93008370 loc:DQ49771 1)	neura(GI:93008546 loc:DQ4930600)
Influenza A virus	hema(GI:93 008246 loc:DQ497649)	neura(GI:93008422

(A/quail/Yogyakarta/BBVet-IX/2004(H5N1))		loc:DQ4929980)
Influenza A virus (A/slaty-backed gull/Shandong/59/04(H5N1))	hema(GI:77701878 loc:DQ188908)	neura(GI:77701882 loc:DQ1889100)
Influenza A virus (A/swan/ Astrakhan/Russia/Nov-2/2005(H5N1))	hema(GI:l 10613481 loc:DQ840533)	neura(GI:l10613457 loc:DQ8405220)
Influenza A virus (A/swan/Germany/R65/2006(H5N1))	hema(GI:94471647 loc:DQ464354)	neura(GI:94471645 loc:DQ4643550)
Influenza A virus (A/swan/Slovenia/760/2006(H5N1))	hema(GI:l 16070074 loc:C Y017043)	neura(GI: 116070079 loc:C Y0170450)
Influenza A virus (A/swine/Guangxi/wz/2004(H5N1))	hema(GI:l 15589722 loc:DQ997262)	neura(GI: 115589724 loc:DQ9972630)
Influenza A virus (A/Thailand/NK165/2005(H5N1))	hema(GI:87042573 loc:DQ3 72591)	neura(GI:87042577 loc:DQ3725930)
Influenza A virus (A/turkey/France/06222/2006(H5N1))	hema(GI:89994168 loc:AM236074)	neura(GI:89994170 loc:AM2360750)
Influenza A virus (A/turkey/Kedaton/BPPV3/2004(H5N1))	hema(GI:93008276 loc:DQ497664)	neura(GI:93008462 loc:DQ4930180)
Influenza A virus (A/turkey/Suzdalka/Nov-01/05(H5N1))	hema(GI:78 146041 loc:DQ231240)	neura(GI:78 146121 loc:DQ23 12430)
Influenza A virus (A/Vietnam/CL01/2004(H5N1))	hema(GI:93008386 loc:DQ497719)	neura(GI:82412014 loc:DQ2501590)
Influenza A virus (A/Vietnam/CL02/2004(H5N1))	hema(GI:93008388 loc:DQ497720)	neura(GI:93008564 loc:DQ4930690)
Influenza A virus (A/Vietnam/CL100/2004(H5N1))	hema(GI:93008398 loc:DQ497725)	neura(GI:82412020 IOC.-DQ2501620)
Influenza A virus (A/Vietnam/CL105/2005(H5N1))	hema(GI:93008400 loc:DQ497726)	neura(GI:93008576 loc:DQ4930750)
Influenza A virus (A/Vietnam/CL1 15/2005(H5N1))	hema(GI:93 008402 loc:DQ497727)	neura(GI:82412022 loc:DQ2501630)
Influenza A virus (A/Vietnam/CL1 19/2005(H5N1))	hema(GI:93008404 loc:DQ497728)	neura(GI:824 12024 loc:DQ2501640)
Influenza A virus (A/Vietnam/CL17/2004(H5N1))	hema(GI:93008390 loc:DQ497721)	neura(GI:93008566 loc:DQ4930700)
Influenza A virus (A/Vietnam/CL20/2004(H5N1))	hema(GI:93008392 loc:DQ497722)	neura(GI:93008568 loc:DQ4930710)
Influenza A virus (A/Vietnam/CL2009/2005(H5N1))	hema(GI:93008406 loc:DQ497729)	neura(GI:824 12026 loc:DQ2501650)
Influenza A virus (A/Vietnam/CL26/2004(H5N1))	hema(GI:93008394 loc:DQ497723)	neura(GI:82412016 loc:DQ2501600)
Influenza A virus (A/Vietnam/CL36/2004(H5N1))	hema(GI:93008396 loc:DQ497724)	neura(GI:82412018 loc:DQ2501610)
Influenza A virus (A/wild bird/Vietnam/434/2005(H5N1))	hema(GI:93008358 loc:DQ497705)	neura(GI:93008534 loc:DQ4930540)
Influenza A virus (A/wild duck/Shanghai/59/04(H5N1))	hema(GI:77701876 loc:DQ188907)	neura(GI:77701886 loc:DQ 1889120)
Influenza A virus (A/black duck/New York/184/1988(H5N2))	hema(GI:l 15278814 loc:C Y014872)	neura(GI:l 15278819 loc-.C Y0 148740)
Influenza A virus (A/chicken/Chis/ 15224/1997(H5N2))	hema(GI: 115278374 loc:C Y014717)	neura(GI:82754954 loc:C Y0058400)
Influenza A virus (A/chicken/Hidalgo/28159-232/1994(H5N2))	hema(GI:82654876 loc:C Y006040)	neura(GI:82654881 loc:C Y0058330)
Influenza A virus (A/chicken/Italy/3 12/1997(H5N2))	hema(GI: 11066026 loc:AF194169)	neura(GI: 115279401 IOC-.C Y0151 170)
Influenza A virus (A/chicken/Pennsylvania/1/1983(H5N2))	hema(GI: 115279294 loc:C Y015073)	neura(GI: 115279299 loc:C Y0150750)
Influenza A virus (A/duck	hema(GI:73695581 loc:DQ104701)	neura(GI:73695585

broiler/Malaysia/F1 18/0S/04(H5N2)) Influenza A virus (A/duck broiler/Malaysia/F 189/07/04(H5N2)) Influenza A virus (A/duck/Hong Kong/342/1978(H5N2)) Influenza A virus (A/duck/New Zealand/41/1984(H5N2)) Influenza A virus (A/duckTPotsdam/1402- 6/1986(H5N2)) Influenza A virus (A/mallard duck/ALB/57/1976(H5N2)) Influenza A virus (A/mallard/Bavaria/1/2005(H5N2)) Influenza A virus (A/mallard/BC/373/2005(H5N2)) Influenza A virus (A/mallard/Maryland/789/2002(H5 N2)) Influenza A virus (A/Pekin dubch/Singapore/F59/04/98(H5N2)) Influenza A virus (A/wigeon/Ohio/379/1988(H5N2)) Influenza A virus (A/duck/Hong Kong/205/1977(H5N3)) Influenza A virus (A/goose/Hong Kong/23/1978(H5N3)) Influenza A virus (A/herring gull/NJ/402/1989(H5N3)) Influenza A virus (A/shearwater/ Australia/1 975(H5N 3)) Influenza A virus (A/tern/South Africa/1961(H5N3)) Influenza A virus (A/duck/Potsdam/2216- 4/1984(H5N6)) Influenza A virus (A/shorebird/DE/101/2004(H5N7)) Influenza A virus (A/shorebird/DE/75/2004(H5N7)) Influenza A virus (A/turkey/Ireland/1378/1983(H5N8)) Influenza A virus (A/chicken/Hong Kong/17/1977(H6N1)) Influenza A virus (A/chicken/Tai wan/0 107/02(H6N 1)) Influenza A virus (A/chicken/Taiwan/01 14/O4(H6N1)) Influenza A virus (A/chicken/Taiwan/0204/05(H6NI)) Influenza A virus (A/chicken/Taiwan/0208/02(H6NI)) Influenza A virus (A/chicken/Taiwan/0222/02(H6NI)) Influenza A virus (A/chicken/Tai wan/0305/04(H6N 1)) Influenza A virus	loc:DQ 1047030) hema(GI:73621253 loc:DQ122147) hema(GI:78097538 loc:CY005575) hema(GI:1 15278195 loc:CYO14640) hema(GI:l 15278199 loc:CYO14642) hema(GI:82623227 loc:CY005918) hema(GI:88656455 loc:DQ387854) hema(GI:l 13704456 loc:DQ826532) hema(GP.115607612 loc:CY01661 1) hema(GI:73476632 loc:DQ092869) hema(GI: 110733334 loc:CY01 1248) hema(GI:1 15278140 loc:CY014615) hema(GI:82654702 loc:CY006028) hema(GI:82623819 loc:CY005926) hema(GI:324176 loc:FLAHAMR) hema(GI: 115279080 loc:CY0 14984) hema(GI:4240449 loc:AF082041) hema(GI:82623838 loc:CY005927) hema(GI:82653141 loc:CY005969) hema(GI:323967 loc:FLA1378HA) hema(GI:78097593 loc:CY005605) hema(GI:87246956 loc:DQ376640) hema(GI:87246970 loc:DQ376647) hema(GI:87246980 loc:DQ376652) hema(GI:87246958 loc:DQ376641) hema(GI:87246944 loc:DQ376634) hema(GI:87246972 loc:DQ376648) hema(GI:87246952 loc:DQ376638)	neura(GI:73695583 loc:DQ 1047020) neura(GI:78097543 loc:CY0055770) neura(GI:1 15278197 loc:CY0146410) neura(GI:78097901 loc:CY0057780) neura(GI:82623232 loc:CY0043 190) neura(GI:89158458 loc:DQ4020420) neura(GI: 114154756 loc:DQ9851680) neura(GI:1 15607617 loc:CY0166130) neura(GI:73476634 loc:DQ0928700) neura(GI: 110733339 loc:CY01 12500) neura(GI:78097560 loc:CY0055910) neura(GI:82654707 loc:CY0055840) neura(GI:82623824 loc:CY0043930) neura(GI:324515 loc:FLANAMN0) neura(GI: 115279085 loc:CY0149860) neura(GI:82654799 loc:CY0057260) neura(GI:82623843 loc:CY0044000) neura(GI:82653 146 loc:CY0049780) neura(GI: 115279337 loc:CY0150910) neura(GI:78097598 loc:CY0056070) neura(GI:87247136 loc:DQ3767120) neura(GI:87247150 loc:DQ3767190) neura(GI:87247160 loc:DQ3 767240) neura(GI:87247138 loc:DQ3767130) neura(GI:87247124 loc:DQ3 767060) neura(GI:87247152 loc:DQ3767200) neura(GI:87247132
--	---	--

(A/chicketi/Taiwan/0320/02(H6NI)) Influenza A virus		loc:DQ3767100)
(A/chicken/Taiwan/0329/01(H6NI)) Influenza A virus	hema(GI:87246942 loc:DQ376633)	neura(GI:87247H6 loc:DQ3767020)
(A/chicken/Taiwan/0408/02(H6NI)) Influenza A virus	hema(GI:87246960 loc:DQ376642)	neura(GI:87247140 loc:DQ3767140)
(A/chicken/Taiwan/0705/99(H6NI)) Influenza A virus	hema(GI:87246924 loc:DQ376624)	neura(GI:87247104 loc:DQ3766960)
(A/chicken/Taiwan/0706/03(H6NI)) Influenza A virus	hema(GI:87246964 loc:DQ376644)	neura(GI:87247144 loc:DQ3767160)
(A/chicken/Taiwan/0824/97(H6N 1)) Influenza A virus	heraa(GI:87246918 loc:DQ376621)	neura(GI:87247098 loc:DQ3766930)
(A/chicken/Taiwan/1203/03(H6NI)) Influenza A virus	hema(GI:87246966 loc:DQ376645)	neura(GI:87247146 loc:DQ3767170)
(A/chicken/Taiwan/1205/01(H6NI)) Influenza A virus	hema(GI:87246936 loc:DQ376630)	neura(GI:872471 18 loc:DQ3767030)
(A/chicken/Taiwan/1212/01(H6NI)) Influenza A virus	hema(GI:87246938 loc:DQ37663 1)	neura(GI:87247120 loc:DQ3767040)
(A/chicken/Taiwan/ 12 15/0 1(H6N 1)) Influenza A virus	hema(GI:87246940 loc:DQ376632)	neura(GI:87247122 loc:DQ3767050)
(A/chicken/Taiwan/1 65/99(H6NI)) Influenza A virus	hema(GI:87246928 loc:DQ376626)	neura(GI:87247108 loc:DQ3 766980)
(A/chicken/Taiwan/A342/05(H6N 1) Influenza A virus	hema(GI:87246982 loc:DQ3 76653)	neura(GI:87247162 loc:DQ3767250)
(A/chicken/Taiwan/A37/02(H6NI)) Influenza A virus	hema(GI:87246954 loc:DQ376639)	neura(GI:87247134 loc:DQ37671 10)
(A/chicken/Taiwan/ch 1006/04(H6 NI)) Influenza A virus	hema(GI:87246974 loc:DQ376649)	neura(GI:87247156 loc:DQ3767220)
(A/chicken/Taiwan/G2/87(H6NI)) Influenza A virus	hema(GI:87246914 loc:DQ376619)	neura(GI:87247094 loc:DQ3766910)
(A/chicken/Taiwan/G23/87(H6NI)) Influenza A virus	hema(GI:87246916 loc:DQ376620)	neura(GI:87247096 loc:DQ3 766920)
(A/chicken/Taiwan/na3/98(H6NI)) Influenza A virus	hema(GI:l 1596264 loc:AF3 10984)	neura(GI:87247100 loc:DQ3766940)
(A/chicken/Taiwan/ns2/99(H6NI)) Influenza A virus	hema(GI: 11596266 loc:AF310985)	neura(GI:87247102 loc:DQ3766950)
(A/chicken/Taiwan/PFI/02(H6NI)) Influenza A virus	hema(GI:87246946 loc:DQ376635)	neura(GI:87247126 loc:DQ3767070)
(A/chicken/Taiwan/PF2/02(H6N 1)) Influenza A virus	hema(GI:87246948 loc:DQ376636)	neura(GI:87247128 loc:DQ3767080)
(A/chicken/Taiwan/PF3/02(H6N 1)) Influenza A virus	hema(GI:87246950 loc:DQ376637)	neura(GI:87247130 loc:DQ3767090)
(A/chicken/Taiwan/SP l/00(H6N 1)) Influenza A virus	hema(GI:87246932 loc:DQ376628)	neura(GI:87247U4 loc:DQ3767010)
(A/duck/Hong Kong/d73/1976(H6NI)) Influenza A virus	hema(GI:78097574 loc:CY005597)	neura(GI:78097579 loc:CY0055990)
(A/duck/Kingmen/E322/04(H6N2)) Influenza A virus	hema(GI:87246976 loc:DQ3 76650)	neura(GI:87247154 loc:DQ3767210)
(A/duck/Taiwan/0526/72(H6NI)) Influenza A virus	hema(GI:87246912 loc:DQ376618)	neura(GI:87247092 loc:DQ3 766900)
(A/duck/Taiwan/29-3/00(H6NI)) Influenza A virus	hema(GI:87246934 loc:DQ376629)	neura(GI:872471 12 loc:DQ3 767000)
(A/duck/Taiwan/A68/03(H6NI)) Influenza A virus	hema(GI:87246968 loc:DQ376646)	neura(GI:87247148 loc:DQ3767180)

Influenza A virus (A/duck/Taiwan/WB239/03(H6N1))	hema(GI:87246962 loc:DQ376643)	neura(GI:87247142 loc:DQ3767150)
Influenza A virus (A/duck/Taiwan/WB29/99(H6N1))	hema(GI:87246930 loc:DQ376627)	neura(GI:872471 10 loc:DQ3766990)
Influenza A virus (A/duck/Taiwan/WB459/04(H6N5))	hema(GI:87246978 loc:DQ376651)	neura(GI:87247158 loc:DQ3767230)
Influenza A virus (A/gray teal/Australia/1/1979(H6N1))	hema(GI:1 15278156 loc:CY014623)	neura(GI:l 15278158 loc:CY0146240)
Influenza A virus (A/mallard duck/ALB/730/198 1(H6N1))	hema(GI:78070128 loc:CY004142)	neura(GI:78070133 loc:CY0041440)
Influenza A virus (A/mallard/Ohio/249/1998(H6N1))	hema(GI:l 15289215 loc:CY015476)	neura(GI: 115289220 loc:CY0154780)
Influenza A virus (A/partridge/Taiwan/LUI/99(H6N 1)	hema(GI:87246926 loc:DQ376625)	neura(GI:87247106 loc:DQ3766970)
Influenza A virus (A/pintail/ALB/179/1993(H6N1))	hema(GI:78095514 loc:CY004258)	neura(GI:78095519 loc:CY0042600)
Influenza A virus (A/black duck/Ohio/307/1987(H6N2))	hema(GI:l 15344451 loc:CY016124)	neura(GI: 115344456 loc:CY0161260)
Influenza A virus (A/blue-winged teal/ALB/69/1985(H6N2))	hema(Gr.78070310 loc:CY004194)	neura(GI:78070315 loc:CY0041960)
Influenza A virus (A/chicken/New York/14677-13/1998(H6N2))	hema(GI:l 15278833 loc:CY0 14880)	neura(GI: 115278838 loc:CY0148820)
Influenza A virus (A/duck/Hong Kong/dl34/1977(H6N2))	hema(GI:l 15278142 loc:CY014616)	neura(GI: 115278144 loc:CY0146170)
Influenza A virus (A/duck/New York/16873/1999(H6N2))	hema(GI:l 15278852 locr.CY014888)	neura(GP. 115278857 loc:CY0 148900)
Influenza A virus (A/gadwall/Ohio/37/1999(H6N2))	hema(GI:l 15344489 loc:CY016156)	neura(GI: 115344494 lociCY01 61580)
Influenza A virus (A/green wing teal/Ohio/178/1999(H6N2))	hema(GP.1 13170520 loc:CY013863)	neura(GI:l 13 170525 10C:CY01 38650)
Influenza A virus (A/green wing teal/Ohio/86/1986(H6N2))	hema(GI: 115344508 loc:CY016164)	neura(GI:l 15344513 loc:CY0161660)
Influenza A virus (A/mallard duck/ALB/10/1985(H6N2))	hema(GI: 78070291 loc:CY004186)	neura(GI:78070296 loc:CY0041880)
Influenza A virus (A/mallard duck/ALB/250/1 978(H6N2))	hema(GI:780681 16 loc:CY004034)	neura(GI:78068 121 loc:CY0040010)
Influenza A virus (A/mallard duck/ALB/280/1978(H6N2))	hema(GI:78069873 loc:CY004037)	neura(GI:78069878 loc:CY0040200)
Influenza A virus (A/mallard duck/ALB/290/1978(H6N2))	hema(GI:78069892 loc:CY004038)	neura(GI:78069897 loc:CY0040270)
Influenza A virus (A/mallard duck/ALB/294/1987(H6N2))	hema(GI:78095896 loc:CY004523)	neura(GI:78095901 loc:CY0045250)
Influenza A virus (A/mallard duck/ALB/98/1985(H6N2))	hema(GI:78096842 loc:CY005106)	neura(GI:78096847 loc:CY0051080)
Influenza A virus (A/mallard/Ohio/344/1987(H6N2))	hema(GI:l 15289139 10C.-CY015451)	neura(GI:l 15289144 loc:CY0154530)
Influenza A virus (A/pintail duck/ALB/1 11/1985(H6N2))	hema(GI:78077702 loc:CY004210)	neura(GI:78077848 loc:CY0042120)
Influenza A virus (A/pintail duck/ALB/133/1978(H6N2))	hema(GI:7806991 1 loc:CY004039)	neura(GI:78069916 loc:CY0040410)
Influenza A virus (A/pintail duck/ALB/367/1978(H6N2))	hema(GI:78069920 loc:CY004043)	neura(GI:78069925 loc:CY0040450)
Influenza A virus (A/pintail/Ohio/226/1998(H6N2))	hema(GI: 112787507 loc:CY0 13255)	neura(GI: 112787512 loc:CY0132570)
Influenza A virus (A/pintail/Ohio/294/1988(H6N2))	hema(GI: 110733372 loc:CY012832)	neura(GI:l 10733377 loc:CY0 128340)
Influenza A virus (A/pintail/Ohio/35 1/1987(H6N2))	hema(GI: 115344470 loc:CY016132)	neura(GI: 115344475 loc:CY0161340)
Influenza A virus (A/shoveler/ALB/1 14/1985(H6N2))	hema(GI:78082621 loc:CY004218)	neura(GI:78082659 loc:CY0042200)
Influenza A virus (A/chicken/New York/28263/1989(H6N3))	hema(GI: 115278901 loc:CY014909)	neura(GI: 115278906 loc:CY01491 10)
Influenza A virus (A/mallard	hema(GI:78089045 loc:CY004226)	neura(GI:78089128

duck/ALB/155/1990(H6N3))		loc:CY0042280)
Influenza A virus (A/mallard duck/ALB/191/1990(H6N3))	hema(GI:78093479 loc:CY004234)	neura(GI:78093484 loc:CY0042360)
Influenza A virus (A/mallard duck/ALB/253/1990(H6N3))	hema(GI:78093498 loc:CY004242)	neura(GI:78093503 loc:CY0042440)
Influenza A virus (A/mallard duck/ALB/76/1985(H6N3))	hema(GI:78072375 loc:CY004202)	neura(GI:78072535 loc:CY0042040)
Influenza A virus (A/blue-winged teal/ALB/685/1982(H6N4))	hema(GI:78070272 loc:CY004178)	neura(GI:78070277 loc:CY0041800)
Influenza A virus (A/black duck/AUS/4045/1980(H6N5))	hema(GI:78097752 loc:CY005691)	neura(GI:78097757 loc:CY0056930)
Influenza A virus (A/blue-winged teal/ALB/48/1978(H6N5))	hema(GI:78068281 loc:CY004036)	neura(GI:78068286 loc:CY0040130)
Influenza A virus (A/mallard/ALB/199/1992(H6N5))	hema(GI:78094775 loc:CY004250)	neura(GI:78094780 loc:CY0042520)
Influenza A virus (A/mallard/Alberta/154/2003(H6N5))	hema(GI:78095552 loc:CY004274)	neura(GI:78095557 loc:CY0042760)
Influenza A virus (A/mallard/Ohio/170/1999(H6N5))	hema(GI:115289234 loc:CY015484)	neura(GI:115289239 loc:CY0154860)
Influenza A virus (A/shearwater/Australia/1/1973(H6N5))	hema(GI:115278232 loc:CY014656)	neura(GI:115278234 loc:CY0146570)
Influenza A virus (A/shearwater/Australia/1972(H6N5))	hema(GI:324174 loc:FLAHAMQ)	neura(GI:324431 loc:FLANABMBO)
Influenza A virus (A/blue-winged teal/ALB/266/1982(H6N6))	hema(Gr.78070176 loc:CY004162)	neura(GI:78070181 loc:CY0041640)
Influenza A virus (A/blue-winged teal/MN/993/1980(H6N6))	hema(GI:78103364 loc:CY005881)	neura(GI:78103369 loc:CY0058830)
Influenza A virus (A/mallard duck/ALB/289/1982(H6N6))	hema(GI:78070195 loc:CY004170)	neura(GI:78070200 loc:CY0041720)
Influenza A virus (A/pintail duck/ALB/189/1982(H6N6))	hema(GI:78070138 loc:CY004146)	neura(GI:78070143 loc:CY0041480)
Influenza A virus (A/ruddy turnstone/Delaware/105/1998(H6N8))	hema(GI:115279425 loc:CY015127)	neura(GI:115279430 loc:CY0151290)
Influenza A virus (A/turkey/Minnesota/957/1980(H6N6))	hema(GI:115278486 loc:CY014764)	neura(GI:115278491 loc:CY0147660)
Influenza A virus (A/widgeon/ALB/256/1982(H6N6))	hema(GI:78070157 loc:CY004154)	neura(GI:78070162 loc:CY0041560)
Influenza A virus (A/green wing teal/Ohio/59/1989(H6N8))	hema(GI:115344527 loc:CY016172)	neura(GI:115344532 loc:CY0161740)
Influenza A virus (A/laughing gull/NJ/276/1989(H6N8))	hema(GI:78070048 loc:CY004094)	neura(GI:78070053 loc:CY0040960)
Influenza A virus (A/mallard duck/ALB/761/1978(H6N8))	hema(GI:78069947 loc:CY004054)	neura(GI:78069952 loc:CY0040560)
Influenza A virus (A/mallard duck/New York/90/1982(H6N8))	hema(GI:115279006 loc:CY014953)	neura(GI:115279011 loc:CY0149550)
Influenza A virus (A/mallard/ALB/206/1996(H6N8))	hema(GI:78095533 loc:CY004266)	neura(GI:78095538 loc:CY0042680)
Influenza A virus (A/mallard/Ohio/64/1989(H6N8))	hema(GI:115607631 loc:CY016619)	neura(GI:115607636 loc:CY0166210)
Influenza A virus (A/pintail duck/ALB/628/1979(H6N8))	hema(GI:78070078 loc:CY004114)	neura(GI:78070083 loc:CY0041160)
Influenza A virus (A/shorebird/DE/12/2004(H6N8))	hema(GI:78095571 loc:CY004282)	neura(GI:78095576 loc:CY0042840)
Influenza A virus (A/wood duck/New York/60/1982(H6N8))	hema(GI:115278987 loc:CY014945)	neura(GI:115278992 loc:CY0149470)
Influenza A virus (A/mallard duck/ALB/1151/1979(H6N9))	hema(GI:78070097 loc:CY004129)	neura(GI:78070102 loc:CY0041310)
Influenza A virus (A/pintail duck/ALB/1298/1979(H6N9))	hema(GI:78070116 loc:CY004137)	neura(GI:78070121 loc:CY0041390)
Influenza A virus (A/chicken/Hebei/1/2002(H7N2))	hema(GI:51340283 loc:AY724257)	neura(GI:51340300 loc:AY7242640)

Influenza A virus (A/chicken/Italy/1285/2000(H7N1))	hema(GI:1 15279151 loc:CY015014)	neura(GI: 115279156 loc:CY0150160)
Influenza A virus (A/duck/Nanchang/ 1904/1992(H7 N1))	hema(GI:l 15278134 loc:CY014612)	neura(GI:78097310 loc:CY0054950)
Influenza A virus (A/FPV/Rostock/1934(H7N1))	hema(GI:324095 loc:FLAHA7N1)	neura(GI:324483 loc:FLANAM10)
Influenza A virus (A/mallard/Alberta/34/2001(H7N1))	hema(GI:82653705 loc:CY005983)	neura(GI:82653710 loc:CY0050940) neura(GI:82654847 loc:CY0057900)
Influenza A virus (A/turkey/Italy/4169/1999(H7N1))	hema(GI:82654842 loc:CY006037)	neura(GI: 115278873 loc:CY0148970) neura(GI:82654726 loc:CY0056200) neura(GI:82653234 loc:CY0050170)
Influenza A virus (A/chicken/Pennsylvania/143586/2 002(H7N2))	hema(GI:1 15278871 loc:CY014896)	neura(GI: 1002 19306 loc:DQ5254120) neura(GI:82653617 loc:CY0050520)
Influenza A virus (A/dk/Hong Kong/293/1978(H7N2))	hema(GI:82654721 loc:CY006029)	neura(GI:50059185 loc:AY6502720) neura(GI:68164907 loc:DQ0175030)
Influenza A virus (A/blue-winged teal/ALB/295/1977(H7N3))	hema(GI:82653229 loc:CY005974)	neura(GI:78103 175 loc:CY0058460) neura(GI:82623862 loc:CY0044070)
Influenza A virus (A/cinnamon teal/Bolivia/453 7/200 1(H7N3))	hema(GI:100219289 loc:DQ52541 1)	neura(GI:1 15278520 loc:CY014778)
Influenza A virus (A/green-winged teal/ALB/228/1985(H7N3))	hema(GI:82653612 loc:CY005978)	neura(GI:60764 loc:ORIN180)
Influenza A virus (A/GSC chicken/British Columbia/04(H7N3))	hema(GI:50059180 loc:AY650270)	neura(GI:82653570 loc:CY0050240) neura(GI:82653215 loc:CY0050100)
Influenza A virus (A/mallard/Alberta/24/01(H7N3))	hema(GI:68 164909 loc:DQ017504)	neura(GI:324537 ioc:FLANAN70) neura(GI:82653674 loc:CY0050800) neura(GI:82653655 loc:CY0050730)
Influenza A virus (A/mallard/Netherlands/12/2000(H 7N3))	hema(GI: 115278376 loc:CY014718)	neura(GI: 115278577 loc:CY0 147880) neura(GI:82653 196 loc:CY0050030)
Influenza A virus (A/ruddy turnstone/NJ/65/ 1985(H7N3))	hema(GI:82623857 loc:CY005928)	neura(GI:1 15278558 loc:CY0 147800)
Influenza A virus (A/turkey/Minnesota/ 1200/1980(H 7N3))	hema(GI: 115278520 loc:CY014778)	neura(GI:324162 loc:FLAHAME)
Influenza A virus (A/turkey/Oregon/ 1971(H7N3))	hema(GI:324162 loc:FLAHAME)	neura(GI:82653570 loc:CY0050240) neura(GI:82653215 loc:CY0050100)
Influenza A virus (A/widgeon/ALB/284/1977(H7N3))	hema(GI:82653565 loc:CY005975)	neura(GI:82653570 loc:CY0050240) neura(GI:82653215 loc:CY0050100)
Influenza A virus (A/mallard duck/ALB/224/1977(H7N5))	hema(GI:82653210 loc:CY005973)	neura(GI:324537 ioc:FLANAN70) neura(GI:82653674 loc:CY0050800) neura(GI:82653655 loc:CY0050730)
Influenza A virus (A/FPV/Weybridge(H7N7))	hema(GI:577462 loc:FLAHAJ)	neura(GI: 115278572 1OC-CY014786)
Influenza A virus (A/red knot/NJ/325/1989(H7N7))	hema(GI:82653669 loc:CY005981)	neura(GI: 115278572 1OC-CY014786)
Influenza A virus (A/ruddy tumstone/DE/2378/1988(H7N7))	hema(GI:82653650 loc:CY005980)	neura(GI:82653 196 loc:CY0050030)
Influenza A virus (A/turkey/Minnesota/l/1988(H7N9)	hema(GI: 115278572 1OC-CY014786)	neura(GI: 115278577 loc:CY0 147880) neura(GI:82653 196 loc:CY0050030)
Influenza A virus (A/mallard/ALB/l 94/1992(H8N4))	hema(GI:82653191 loc:CY005972)	neura(GI:324451 loc:FLANALC0) neura(GI:82653 177 loc:CY0049890)
Influenza A virus (A/mallard/Alberta/283/1977(H8N 4))	hema(GI:82653160 loc:CY005970)	neura(GI:324433 loc:FLAN ABMCO) neura(GI:78095703 loc:CY0044220) neura(GI:82623266 loc:CY0043330)
Influenza A virus (A/pintail duck/Alberta/1 14/1979(H8N4))	hema(GI:82653 172 loc:CY005971)	neura(GI:324433 loc:FLAN ABMCO) neura(GI:78095703 loc:CY0044220) neura(GI:82623266 loc:CY0043330)
Influenza A virus (A/turkey/Ontario/61 18/1968(H8N 4))	hema(GI:324129 loc:FLAHAK)	neura(GI:324433 loc:FLAN ABMCO) neura(GI:78095703 loc:CY0044220) neura(GI:82623266 loc:CY0043330)
Influenza A virus (A/laughing gull/DE/5/2003(H9N1))	hema(GI:78095698 loc:CY004420)	neura(GI:324433 loc:FLAN ABMCO) neura(GI:78095703 loc:CY0044220) neura(GI:82623266 loc:CY0043330)
Influenza A virus (A/mallard duck/ALB/396/1983(H9N1))	hema(GI:82623259 loc:CY005919)	neura(GI:324433 loc:FLAN ABMCO) neura(GI:78095703 loc:CY0044220) neura(GI:82623266 loc:CY0043330)

Influenza A virus (A/mallard duck/ALB/506/1983(H9N1))	hema(GI:78096059 loc:CY004642)	ncura(GI:78096064 loc:CY0046440)
Influenza A virus (A/mallard duck/ALB/743/1 983(H9N1))	hema(GI:82653722 loc:CY005984)	neura(GI:82653727 loc:CY0051000)
Influenza A virus (A/ruddy turnstone/DE/273 1/1987(H9N1))	hema(GI:82653777 loc:CY005987)	neura(GI:82653782 loc:CY0051280)
Influenza A virus (A/chicken/Beijing/ne/1999(H9N2))	hema(GI: 115343575 loc:DQ997505)	neura(GI: 115343577 loc:-DQ9975060)
Influenza A virus (A/chicken/Beijing/nl/2002(H9N2))	hema(GI:l 15343590 loc:DQ997497)	neura(GI: 115343594 loc:DQ9974990)
Influenza A virus (A/chicken/Cheongju/ADL040 1/2004(H9N2))	hema(GI:90903132 loc:DQ464352)	neura(GI:90903 134 loc:DQ4643530)
Influenza A virus (A/chicken/China/Guangxi 1/2000(H9N2))	hema(GI:95 116839 loc:DQ485208)	neura(GI:95 116843 loc:DQ4852100)
Influenza A virus (A/chicken/China/Guangxil4/2000(H9N2))	hema(GI:95 116856 loc:DQ485216)	neura(GI:95 116860 loc:DQ4852180)
Influenza A virus (A/chicken/China/Guangxi 17/2000(H9N2))	hema(GI:951 16873 loc:DQ485224)	neura(GI:95 116877 loc:DQ4852260)
Influenza A virus (A/chicken/Hebei/nj/2002(H9N2))	hema(GI:l 15343606 loc:DQ997481)	neura(GI: 115343608 loc:DQ9974820)
Influenza A virus (A/chicken/Henan/ni/2001(H9N2))	hema(GI: 115382742 loc:DQ997474)	neura(GI: 115382747 loc:DQ9974770)
Influenza A virus (A/chicken/Jiangsu/ng/2001(H9N2))	hema(GI: 115382899 loc:DQ997460)	neura(GI: 115382901 loc:DQ9974610)
Influenza A virus (A/chicken/Jiangsu/wa/2002(H9N2))	hema(GI: 115396959 loc:DQ997187)	neura(GI: 115396961 loc:DQ9971880)
Influenza A virus (A/chicken/Korea/SNU0028/00(H9N2))	hema(GI:55469742 loc:AY768552)	neura(GI:857 18297 loc:DQ3479570)
Influenza A virus (A/chicken/Nanchang/4-301/2001(H9N2))	hema(GI:82754922 loc:CY006023)	neura(GI:82754927 loc:CY0055200)
Influenza A virus (A/chicken/ Yunnan/nh/200 1(H9N2))	hema(GI: 115589697 loc:DQ997465)	neura(GI: 115589705 loc:DQ9974680)
Influenza A virus (A/duck/Hokkaido/13/00(H9N2))	hema(GI:38229105 loc:AB 125931)	neura(GI:l 16013101 loc:-AB2761 120)
Influenza A virus (A/duck/Hokkaido/49/98(H9N2))	hema(GI:37677518 loc:AY330333)	neura(GI:891 11567 loc:AB25 19440)
Influenza A virus (A/duck/Hokkaido/9/99(H9N2))	hema(GI:38229101 loc:AB125929)	neura(GI:109150271 loc:AB2624650)
Influenza A virus (A/duck/Hubei/WI/2004(H9N2))	hema(GI:9 13 17034 loc:DQ465400)	neura(GI:57833846 loc:NC 003 1550)
Influenza A virus (A/duck/Nanchang/4-361/2001(H9N2))	hema(GI:82654648 loc:CY006025)	neura(GI:82654653 loc:CY0055260)
Influenza A virus (A/duck/Nanjing/0 1/1 999(H9N2))	hema(GI:109255516 loc:DQ681221)	neura(GI: 109255484 loc:DQ6812050)
Influenza A virus (A/duck/Xuzhou/05/200 1(H9N2))	hema(GI:109255506 loc:DQ681216)	neura(GI: 109255508 loc:DQ6812170)
Influenza A virus (A/duck/Xuzhou/07/2003(H9N2))	hema(GI: 109255480 loc:DQ681203)	neura(GI: 109255500 loc:DQ6812130)
Influenza A virus (A/duck/Zhejiang/03/200 1(H9N2))	hema(GI: 109255488 loc:DQ681207)	neura(GI: 109255492 loc:DQ6812090)
Influenza A virus (A/goose/MN/5733- 1/1 980(H9N2))	hema(GI:82654895 loc:CY006042)	neura(GI:82654900 loc:CY0058750)
Influenza A virus (A/Hong Kong/1073/99(H9N2))	hema(GI: 18996343 loc:AB080226)	neura(GI:32140165 loc:NC 0049090)
Influenza A virus (A/mallard	hema(GI:82653815 loc:CY005989)	neura(GI:82653820

duck/ALB/321/1988(H9N2))		loc:CY0051420)
Influenza A virus (A/mallard/Alberta/1 1/1991(H9N2))	hema(GI:82653834 loc:CY005990)	neura(GI: 115278088 loc:CY0145910)
Influenza A virus (A/mallard/Norway/685/05(H9N2))	hema(GI: 110321604 loc:AM286689)	neura(GI: 110321600 loc:AM2866870)
Influenza A virus (A/swine/Shandong/nc/2005(H9N2)	hema(GI:1 15382782 loc:DQ997437)	neura(GI: 115382784 loc:DQ9974380)
Influenza A virus (A/teal/Norway/500/05(H9N2))	hema(GI: 110321602 loc:AM286688)	neura(GI:1 10321598 loc:AM2866860)
Influenza A virus (A/turkey/Wisconsin/1/1966(H9N2)	hema(GI:324197 loc:FLAHAMX)	neura(GI:324529 loc:FLANAMU0)
Influenza A virus (A/ruddy turnstone/DE/2576/1987(H9N5))	hema(GI:82653741 loc:CY005985)	neura(GI:82653746 loc:CY0051350)
Influenza A virus (A/ruddy turnstone/DE/510/1988(H9N6))	hema(GI:82653796 loc:CY005988)	neura(GI:82653801 loc:CY0051350)
Influenza A virus (A/ruddy turnstone/DE/773/1988(H9N6))	hema(GI:82652523 loc:CY005934)	neura(GI:82652528 loc:CY0045690)
Influenza A virus (A/chicken/Korea/164/04 (H9N8))	hema(GI:1 11662641 loc:DQ885991)	neura(GI: 111662686 loc:DQ8859930)
Influenza B virus (B/Ann Arbor/1/1986)	hema(GI:94481539 loc:DQ508913)	neura(GI:94481609 loc:DQ5089150)
Influenza B virus (B/Arizona/135/2005)	hema(GI:85541364 loc:DQ343768)	neura(GI:85541501 loc:DQ3438230)
Influenza B virus (B/Arizona/140/2005)	hema(GI:85541362 loc:DQ343767)	neura(GI:85541498 loc:DQ3438220)
Influenza B virus (B/Arizona/146/2005)	hema(GI:82571 112 loc:DQ265729)	neura(GI:85541495 loc:DQ3438210)
Influenza B virus (B/Arizona/148/2005)	hema(GI:82571 104 loc:DQ265725)	neura(GI:85541492 loc:DQ3438200)
Influenza B virus (B/Arizona/162/2005)	hema(GI:85541360 loc:DQ343766)	neura(GI:85541489 loc:DQ3438190)
Influenza B virus (B/Arizona/163/2005)	hema(GI:85541358 loc:DQ343765)	neura(GI:85541486 loc:DQ3438180)
Influenza B virus (B/Arizona/164/2005)	hema(GI:85541356 loc:DQ343764)	neura(GI:85541483 loc:DQ3438170)
Influenza B virus (B/Arizona/48/2005)	hema(GI:85541368 loc:DQ343770)	neura(GI:85541507 loc:DQ3438250)
Influenza B virus (B/Arizona/59/2005)	hema(GI:85541366 loc:DQ343769)	neura(GI:85541504 loc:DQ3438240)
Influenza B virus (B/Hong Kong/05/1972)	hema(GI: 10732824 loc:AF305219) hema(GI: 110676604 loc:DQ792897)	neura(GI:94481612 loc:DQ5089230) neura(GI: 110676608 loc:DQ7928990)
Influenza B virus (B/Lee/40)		neura(GI:85541480 loc:DQ3438160)
Influenza B virus (B/Nepal/1078/2005)	hema(GI:85541418 loc:DQ343795)	neura(GI:85541477 loc:DQ3438150)
Influenza B virus (B/Nepal/1079/2005)	hema(GI:85541416 loc:DQ343794)	neura(GI:85541474 loc:DQ3438140)
Influenza B virus (B/Nepal/1080/2005)	hema(GI:85541414 loc:DQ343793)	neura(GI:85541462 loc:DQ3438100)
Influenza B virus (B/Nepal/1087/2005)	hema(GI:85541412 loc:DQ343792)	neura(GI:85541471 loc:DQ3438130)
Influenza B virus (B/Nepal/1088/2005)	heraa(GI:85541410 loc:DQ343791)	neura(GI:85541465 loc:DQ3438110)
Influenza B virus (B/Nepal/1089/2005)	hema(GI:85541408 loc:DQ343790)	neura(GI:85541468 loc:DQ3438120)
Influenza B virus (B/Nepal/1090/2005)	hema(GP.85541406 loc:DQ343789)	neura(GI:85541459 loc:DQ3438090)
Influenza B virus (B/Nepal/1092/2005)	hema(GI:85541404 loc:DQ343788)	neura(GI:85541453 loc:DQ3438070)
Influenza B virus (B/Nepal/1101/2005)	hema(GI:85541402 loc:DQ343787)	neura(GI:85541450 loc:DQ3438060)
Influenza B virus (B/Nepal/1103/2005)	hema(GI:85541400 loc:DQ343786)	

Influenza B virus (B/Nepal/1 104/2005)	hema(GI:85541398 loc:DQ343785)	neura(GI:85541447 loc:DQ3438050)
Influenza B virus (B/Nepal/1 105/2005)	hema(GI:85541396 loc:DQ343784)	neura(GI:85541444 loc:DQ3438040)
Influenza B virus (B/Nepal/1 106/2005)	hema(GI:85541394 loc:DQ343783)	neura(GI:85541441 loc:DQ3438030)
Influenza B virus (B/Nepal/1 108/2005)	hema(GI:85541392 loc:DQ343782)	neura(GI:85541438 loc:DQ3438020)
Influenza B virus (B/Nepal/1 114/2005)	hema(GI:85541390 loc:DQ343781)	neura(GI:85541435 loc:DQ3438010)
Influenza B virus (B/Nepal/1 117/2005)	hema(GI:85541388 loc:DQ343780)	neura(GI:85541432 loc:DQ3438000)
Influenza B virus (B/Nepal/1 118/2005)	hema(GI:85541386 loc:DQ343779)	neura(GI:85541429 loc:DQ3437990)
Influenza B virus (B/Nepal/1 120/2005)	hema(GI:85541384 loc:DQ343778)	neura(GI:85541420 loc:DQ3437960)
Influenza B virus (B/Nepal/1 122/2005)	hema(GI:85541382 loc:DQ343777)	neura(GI:85541423 loc:DQ3437970)
Influenzae virus (B/Nepal/1 13 1/2005)	hema(GI:85541380 loc:DQ343776)	neura(GI:85541519 loc:DQ3438290)
Influenza B virus (B/Nepal/1 132/2005)	hema(GI:85541378 loc:DQ343775)	neura(GI:85541426 loc:DQ3437980)
Influenza B virus (B/Nepal/1 136/2005)	hema(GI:85541376 loc:DQ343774)	neura(GI:85541516 loc:DQ3438280)
Influenza B virus (B/Nepal/1 137/2005)	hema(GI:85541374 loc:DQ343773)	neura(GI:85541513 loc:DQ3438270)
Influenza B virus (B/Nepal/1 139/2005)	hema(GI:85541370 loc:DQ343771)	neura(GI:85541510 loc:DQ3438260)
Influenza B virus (B/Taiwan/H96/02)	hema(GI:98990932 loc:DQ5 14427)	neura(GI:98991026 loc:DQ5144740)
Influenza B virus (B/Taiwan/M214/05)	hema(GI:98990892 loc:DQ5 14407)	neura(GI:98990970 loc:DQ5 144460)
Influenza B virus (B/Taiwan/M227/05)	hema(GI:98990914 loc:DQ514418)	neura(GI:98991018 loc:DQ5 144700)
Influenza B virus (B/Taiwan/M24/04)	hema(GI:98990886 loc:DQ5 14404)	neura(GI:98991030 loc:DQ5 144760)
Influenza B virus (B/Taiwan/M244/05)	hema(GI:98990874 loc:DQ5 14398)	neura(GI:98991000 loc:DQ5 144610)
Influenza B virus (B/Taiwan/M251/05)	hema(GI:98990916 loc:DQ5 14419)	neura(GI:98991014 loc:DQ5 144680)
Influenza B virus (B/Taiwan/M53/05)	hema(GI:98990922 loc:DQ514422)	neura(GI:98990978 loc:DQ5 144500)
Influenza B virus (B/Taiwan/M71/01)	hema(GI:98990864 loc:DQ5 14393)	neura(GI:98990988 loc:DQ5 144550)
Influenza B virus (B/Taiwan/N1013/99)	hema(GI:98990856 loc:DQ5 14389)	neura(GI:98990982 loc:DQ5 144520)
Influenza B virus (B/Taiwan/N1 115/02)	hema(GI:98990898 loc:DQ514410)	neura(GI:98990958 loc:DQ5 144400)
Influenza B virus (B/Taiwan/N1207/99)	hema(GI:98990854 loc:DQ5 14388)	neura(GI:98990984 loc:DQ5 144530)
Influenza B virus (B/Taiwan/N13 16/01)	hema(GI:98990858 loc:DQ514390)	neura(GI:98990986 loc:DQ5 144540)
Influenza B virus (B/Taiwan/N1549/01)	hema(GI:98990860 loc:DQ5 14391)	neura(GI:98990996 loc:DQ5 144590)
Influenza B virus (B/Taiwan/N1582/02)	hema(GI:98990904 loc:DQ5 14413)	neura(GI:98990946 loc:DQ5 144340)
Influenza B virus (B/Taiwan/N1619/04)	hema(GI:98990888 loc:DQ5 14405)	neura(GI:98990964 loc:DQ5 144430)
Influenza B virus (B/Taiwan/N1848/02)	hema(GI:98990910 loc:DQ514416)	neura(GI:98990948 loc:DQ5 144350)
Influenza B virus (B/Taiwan/N1902/04)	hema(GI:98990876 loc:DQ5 14399)	neura(GI:98991008 loc:DQ5 144650)
Influenza B virus (B/Taiwan/N200/05)	hema(GI:98990920 loc:DQ514421)	neura(GI:98991012 loc:DQ5 144670)
Influenza B virus (B/Taiwan/N2050/02)	hema(GI:98990936 loc:DQ5 14429)	neura(GI:98990952 loc:DQ5 144370)
Influenza B virus	hema(GI:98990870 loc:DQ5 14396)	neura(GI:98990994

(B/Taiwan/N232/00)		loc:DQ5 144580)
Influenza B virus		neura(GI:98990992
(B/Taiwan/N2335/01)	hema(GI:98990862	loc:DQ5 14392)
Influenza B virus		loc:DQ5 144570)
(B/Taiwan/N253/03)	hema(GI:98990940	loc:DQ5 1443 1)
Influenza B virus		neura(GI:98990954
(B/Taiwan/N2620/04)	hema(GI:98990894	loc:DQ5 144380)
Influenza B virus		neura(GI:98990966
(B/Taiwan/N3688/04)	hema(GI:98990918	loc:DQ5 144440)
Influenza B virus		neura(GI:98991010
(B/Taiwan/N371/05)	hema(GI:98990924	loc:DQ5 144660)
Influenza B virus		neura(GI:98990976
(B/Taiwan/N376/05)	hema(GI:98990880	loc:DQ5 144423)
Influenza B virus		loc:DQ5 144490)
(B/Taiwan/N3 84/03)	hema(GI:98990908	neura(GI:98991004
Influenza B virus		loc:DQ5 144630)
(B/Taiwan/N3849/02)	hema(GI:98990930	neura(GI:98990980
Influenza B virus		loc:DQ5 144510)
(B/Taiwan/N404/02)	hema(GI:98990900	neura(GI:98991024
Influenza B virus		loc:DQ5 144730)
(B/Taiwan/N473/00)	hema(GI:98990872	neura(GI:98990960
Influenza B virus		loc:DQ5 144410)
(B/Taiwan/N559/05)	hema(GI:98990882	neura(GI:98991002
Influenza B virus		loc:DQ5 144620)
(B/Taiwan/N6 12/01)	hema(GI:98990926	neura(GI:98991006
Influenza B virus		loc:DQ5 144640)
(B/Taiwan/N701/01)	hema(GI:98990928	neura(GI:98990942
Influenza B virus		loc:DQ5 144320)
(B/Taiwan/N767/01)	hema(GI:98990868	neura(GI:98990944
Influenza B virus		loc:DQ5 144330)
(B/Taiwan/N798/05)	hema(GI:98990884	neura(GI:98990974
Influenza B virus		loc:DQ5 144480)
(B/Taiwan/N860/05)	hema(GI:98990896	neura(GI:98991028
Influenza B virus		loc:DQ5 144750)
(B/Taiwan/N872/04)	hema(GI:98990878	neura(GI:98990972
Influenza B virus		loc:DQ5 144470)
(B/Taiwan/N9 13/04)	hema(GI:98990890	neura(GI:98990998
Influenza B virus		loc:DQ5 144600)
(B/Taiwan/S1 17/05)	hema(GI:98990912	neura(GI:98990968
Influenza B virus		loc:DQ5 144450)
(B/Taiwan/S 141/02)	hema(GI:98990906	neura(GI:98991016
Influenza B virus		loc:DQ5 144690)
(B/Taiwan/S76/02)	hema(GI:98990902	neura(GI:98990950
Influenza B virus		loc:DQ5 144360)
(B/Taiwan/S82/02)	hema(GI:98990934	neura(GI:98991020
Influenza B		loc:DQ5 144710)
virus(B/Rochester/02/2001)	hema(GI:6165841 1	neura(GI:98990956
	loc:AY947469)	loc:DQ5 144390)
	hema(GI:ABI84032	neura(GI:61658415
	hemagglutinin	loc:AY9474710)
	[influenza B virus	
	(B/Ohio/le/2005)]	
	gi 1 14942434 gb ABI84032.1 [1 149	
	42434] loc:ABI84032	
	hemagglutinin [influenza B virus	
	(B/Ohio/le/2005)]	
	gi 1 14942434 gb ABI84032. 1 [1 149	neura(GI: 114942438
	42434])	loc:CY0154420)
Influenza B virus (B/Ohio/le/2005)		
Influenza A virus		
Influenza A virus (A/duck/Hong		neura(GI:1 13531 194
Kong/938/80(H10N1))		loc:AB271 1180)
Influenza A virus (A/mallard		
duck/ALB/742/ 1981(H10N1))		
Influenza A virus		neura(GI:82653962
(A/mallard/ALB/5/1995(H10N1))		loc:CY0052260)
Influenza A virus		
(A/pintail/ALB/129/1993(H10N1))		
Influenza A virus		

(A/duck/Alaska/658/1991(H10N2))
 Influenza A virus
 (A/duck/Hokkaido/18/00(H10N4))
 Influenza A virus
 (A/mink/Sweden/1984(H10N4))
 Influenza A virus
 (A/mink/Sweden/E12665/84(H10N4))
 Influenza A virus (A/ruddy turnstone/DE/76/2000(H10N4))
 Influenza A virus (A/ruddy turnstone/Delaware/76/2000(H10N4))
 Influenza A virus (A/curlew sandpiper/Hong Kong/208/89(H10N5))
 Influenza A virus (A/duck/Hokkaido/24/04(H10N5))
 Influenza A virus (A/duck/Hong Kong/934/80(H10N5))
 Influenza A virus (A/duck/Mongolia/149/03(H10N5))
)
 Influenza A virus (A/red knot/Delaware/2S61/87(H10N5))
 Influenza A virus (A/Mallard/Ohio/42/1989(H10N6))
 Influenza A virus (A/chicken/Germany/1949(H10N7))
)
 Influenza A virus (A/chicken/Germany/N/1949(H10N7))
 Influenza A virus (A/duck/Alaska/740/1991(H10N7))
 Influenza A virus (A/duck/Manitoba/1/1953(H10N7))
 Influenza A virus (A/mallard duck/ALB/666/1986(H10N7))
 Influenza A virus (A/mallard/Alberta/1 10/99(H10N7))
)
 Influenza A virus (A/mallard/Alberta/297/77(H10N7))
 Influenza A virus (A/mallard/Alberta/7 1/98(H10N7))
 Influenza A virus (A/mallard/Alberta/90/97(H10N7))
 Influenza A virus (A/mallard/Bavaria/3/2006(H10N7))
))
 Influenza A virus (A/mallard/Ohio/122/1989(H10N7))
)
 Influenza A virus (A/mallard/Ohio/65/1989(H10N7))
 Influenza A virus (A/mallard/Ohio/99/1989(H10N7))
 Influenza A virus (A/redhead duck/ALB/767/1 984(H10N7))
 Influenza A virus (A/ruddy turnstone/DE/108/00(H10N7))
 Influenza A virus (A/ruddy turnstone/DE/1 121/00(H10N7))

neura(GI:1 1465 1174 loc:AB2740420)
 hema(GI:324037 loc:FLAON49HA)
 neura(GI:78095720 IOC-.CY0044290)
 neura(GI:324469 loc:FLANALL0)
 neura(GI:78096916 loc:CY0052150)

Influenza A virus (A/ruddy turnstone/DE/2764/19S7(H10N7))
 Influenza A virus (A/ruddy turnstone/NJ/1 143/00(H10N7))
 Influenza A virus (A/shorebird/Taiwan/3 1/99(H10N7))
 Influenza A virus (A/common scoter/Maryland/297/2005(H10N8))
 Influenza A virus (A/Tongtail duck/Maryland/295/2005(H10N8))
 Influenza A virus (A/mallard/Alberta/223/98 (H10N8))
 Influenza A virus (A/Aurkey/Minnesota/5/1979(H10N8))
 Influenza A virus (A/wild bird feces/Korea/ESI-17/03(H10N8))
 Influenza A virus (A/wild bird feces/Korea/ES 1-9/03(H10N8))
 Influenza A virus (A/Shorebird/Delaware/23/96(H10N9))
 Influenza A virus (A/Aquatic bird/Hong Kong/M603/98(H1 IN1))
 Influenza A virus (A/Black Duck/Ohio/194/1986(H1 IN1))
 Influenza A virus (A/guH/Delaware/2952/88(HI IN1))
 Influenza A virus (A/ruddy turnstone/DeJaware/2589/1987(HI IN1))
 Influenza A virus (A/ruddy turnstone/NJ/51/J985(HI IN1))
 Influenza A virus (A/ruddy turnstone/NJ/842/1989(HI IN1))
 Influenza A virus (A/ruddyturnstone/Delaware/2589/87(HI IN1))
 Influenza A virus (A/duck/New Zealand/164/76(HUN3))
 Influenza A virus (A/WDk/ST/141 1/2000(HI 1N3))
 Influenza A virus (A/American black duck/Ohio/570/1987(HI 1N2))
 Influenza A virus (A/black duck/Ohio/195/1990(HI 1N2))
 Influenza A virus (A/duck/Hong Kong/62/1976(HI 1N2))
 Influenza A virus (A/duck/Nanchang/1749/1992(HI 1N2))
 Influenza A virus (A/green wing teal/Ohio/81/1999(HI 1N2))
 Influenza A virus (A/mallard/MN/7/98(HI 1N2))
 Influenza A virus (A/mallard/Netherlands/7/99(HI IN2))
 Influenza A virus (A/ruddy turnstone/DE/2762/1987(HI 1N2))
 Influenza A virus (A/ruddy

neura(GI:78096928
loc:CY0052200)

hema(GI: 1 1225251 loc:AF3 11750)

neura(GI:1 11662668
loc:DQ8859920)
neura(GI:1 11662708
loc:DQ8859940)

neura(GI: 115278095
loc:CY0145940)
neura(GI:78095735
loc:CY0044410)
neura(GI:78097019
loc:CY0052990)

neura(GI:78097385
loc:CY0055320)

hema(GI:56425028 loc:AY684895)

neura(GI:78096989
loc:CY0052870)

hema(GI: 115278097

turnstone/Delaware/2762/1987(HI 1N2)) loc:CY014595)
 Influenza A virus
 (A/shorebird/Delaware/86/99(HI 1N2))
 Influenza A virus
 (A/swan/Shimane/48/1997(HI 1N2))
)
 Influenza A virus
 (A/duck/NZL/164/1976(HI 1N3))
 Influenza A virus
 (A/mallard/Ohio/102/1986(HI1N3))
)
 Influenza A virus
 (A/mallard/Ohio/149/1990(HI 1N3))
)
 Influenza A virus
 (A/mallard/Ohio/173/1990(HI 1N3))
)
 Influenza A virus
 (A/duck/Yangzhou/906/2002(HI 1N2))
 hema(GI:68137153 loc:DQ080993)
 Influenza A virus
 (A/gull/Delaware/2952/1988(HI 1N4))
 Influenza A virus (A/ruddy turnstone/DE/2589/1987(HI 1N4))
 Influenza A virus
 (A/mallard/Alberta/125/1999(HI 1N6))
 neura(GI:78097051 loc:CY0053190)
 Influenza A virus (A/semi-palmated sandpiper/DE/2109/00(HI 1N6))
 Influenza A virus (A/Duck/Hong Kong/T25/97(HI 1N8))
 Influenza A virus (A/Duck/Hong Kong/T37/97(HI 1N8))
 Influenza A virus
 (A/duck/Ukraine/2/1960(HI 1N8))
 Influenza A virus (A/mallard duck/ALB/763/1983(HI 1N8))
 Influenza A virus (A/Black Duck/Ohio/239/1986(HI 1N9))
 Influenza A virus (A/Duck/Hong Kong/P50/97(HI 1N9))
 Influenza A virus (A/Duck/Hong Kong/P54/97(HI 1N9))
 Influenza A virus
 (A/duck/memphis/546/1976(HI 1N9))
 hema(GI:324154 loc:FLAHAM)
 Influenza A virus (A/green wing teal/Ohio/397/1986(HI 1N9))
 Influenza A virus (A/green wing teal/Ohio/496/1987(HI 1N9))
 Influenza A virus
 (A/gull/Maryland/5/1977(HI 1N9))
 Influenza A virus
 (A/mallard/ALB/126/1991(HI 1N9))
)
 Influenza A virus
 (A/mallard/Alberta/ 122/99 (HI 1N9))
 Influenza A virus
 (A/mallard/Missouri/MO32/2005(HI 1N9))
 Influenza A virus
 (A/mallard/MN/403/99(HI 1N9))

Influenza A virus
 (A/maliard/Ohio/209/1998(HI 1N9)
)
 Influenza A virus
 (A/mallard/Ohio/568/1987(HI 1N9)
)
 Influenza A virus (A/northern
 shoveler/Ohio/359/1987(HI 1N9))
 Influenza A virus (A/redhead
 duck/Alberta/357/1983(HI 1N9)) hema(GI: 115278093
 loc:CY014593)
 Influenza A virus (A/ruddy
 turnstone/DE/637/1988(HI 1N9)) neura(GI:78097004
 loc:CY0052930)
 Influenza A virus (A/sharp-tailed
 sandpiper/Australia/6/2004(HI 1N9
))
 Influenza A virus
 (A/tern/australia/1975(HI 1N9)) hema(GI:324137 loc:FLAHALD)
 Influenza A virus
 (A/tern/Australia/G70C/1975(HI 1
 N9)) neura(GI:324415 loc:FLANA0)
 Influenza A virus (A/white winged
 scoter/Maryland/301/2005(H4N6))
 Influenza A virus (A/laughing
 gull/DE/94/2000(H12N4)) neura(GI:78097082
 loc:CY0053590)
 Influenza A virus (A/laughing
 gull/Delaware/94/2000(H12N4)) hema(GI: 115278104
 loc:CY014598)
 Influenza A virus (A/ruddy
 turnstone/DE/1602/00(H12N4))
 Influenza A virus (A/ruddy
 turnstone/DE/1794/00(H12N4))
 Influenza A virus (A/ruddy
 turnstone/Delaware/67/98(H 12N4))
 Influenza A virus neura(GI: 113373904
 loc:AB2707470)
 (A/duck/Hokkaido/66/01(H12N5))
 Influenza A virus neura(GI: 113373902
 loc:AB2707460)
 (A/duck/Hokkaido/88/01(H12N5))
 Influenza A virus (A/duck/Hong
 Kong/862/80(H12N5)) neura(GI:l 13373906
 loc:AB2707480)
 Influenza A virus (A/laughing
 gull/New Jersey/171/92(H12N5))
 Influenza A virus (A/mallard
 duck/ALB/60/1976(H12N5)) neura(GI:78095671
 loc:CY0043740)
 Influenza A virus
 (A/mallard/Alaska/312/2005(H12N
 5))
 Influenza A virus
 (A/mallard/Alberta/223/77
 (H12N5))
 Influenza A virus
 (A/mallard/Alberta/52/1997(HI 2N
 5))
 Influenza A virus
 (A/mallard/Ohio/407/1987(H12N5)
)
 Influenza A virus (A/pintail
 duck/ALB/306/1983(H12N5)) neura(GI:78097066
 loc:CY0053390)
 Influenza A virus (A/pintail
 duck/Alberta/306/1983(H12N5))
 Influenza A virus
 (A/pintail/Alaska/102/2005(H12N5
))
 Influenza A virus (A/ruddy
 turnstone/DE/1444/00(H12N5))
 Influenza A virus (A/ruddy
 turnstone/DE/748/00(H12N5))
 Influenza A virus (A/ruddy
 turnstone/Delaware/265/98

(H12N8))
 Influenza A virus (A/red-necked
 stint/AUS/5745/1981(H12N9))
 Influenza A virus (A/red-necked
 stint/Australia/5745/1981(H12N9))
 Influenza A virus (A/pilot
 whale/Maine/328
 HN/1984(H13N2))
 Influenza A virus
 (A/turkey/Minnesota/1 0 12/ 1990(H
 13N2))
 Influenza A virus
 (A/whale/Maine/328/1984(H13N2)
)
 Influenza A virus (A/black-headed
 gull/Astrakhan/227/84(H13N6))
 Influenza A virus (A/laughing
 gull/DE/554/1988(H13N3))
 Influenza A virus
 (A/shorebird/NJ/840/1986(H13N3)
)
 Influenza A virus
 (A/tern/Astrakhan/775/83(H13N3))
 Influenza A virus (A/black-headed
 guU/Sweden/1/99(H13N6))
 Influenza A virus
 (A/gull/Astrakhan/227/1984(H13N
 6))
 Influenza A virus
 (A/gull/Maryland/1 8 15/1 979(H13N
 6))
 Influenza A virus
 (A/gull/Maryland/1824/1978(H13N
 9))
 Influenza A virus
 (A/gull/Massachusetts/26/1980(HI
 3N6))
 Influenza A virus
 (A/gull/md/704/1977(H13N6))
 Influenza A virus
 (A/gull/Minnesota/1352/1981(H13
 N6))
 Influenza A virus (A/herring
 gull/DE/660/1988(H13N6))
 Influenza A virus (A/herring
 gull/Delaware/660/1988(H13N6))
 Influenza A virus (A/ring-billed
 guU/Maryland/704/1977(H13N6))
 Influenza A virus
 (A/shorebird/Delaware/224/1997(H
 13N6))
 Influenza A virus
 (A/shorebird/Delaware/224/97
 (H13N6))
 Influenza A virus
 (A/whale/Maine/1/1984(H13N9))
 Influenza A virus (A/mallard
 duck/AST/263/1982(H14N5))
 Influenza A virus (A/mallard
 duck/AST/266/1982(H14N5))
 Influenza A virus (A/mallard
 duck/Astrakhan/263/1982(H14N5))
 Influenza A virus
 (A/mallard/Astrakhan(Gurjev)/263/
 1982(H14N5))
 Influenza A virus
 (A/mallard/Astrakhan(Gurjev)/263/

neura(GI:78097800
 loc:CY0057100)

hema(GI: 115278185
 loc:CY014636)

hema(GI:324216 loc:FLAHAPE)

hema(GI:324212 loc:FLAHAPC)

hema(GI:56425012 loc:AY684887)

neura(GI:324477 loc:FLANALPO)

neura(GI:78097155
 loc:CY0053870)

hema(GI: 1152781 15
 loc:CY014603)

hema(GI:324214 loc:FLAHAPD)

neura(GI: 115279477
 loc:CY01S1480)

neura(GI:324884
 loc:FLANWHANA0)

hema(GI:1 152781 17
 loc:CY0 14604)

82(H14N5))
 Influenza A virus (A/mallard
 duck/AST/244/1982(H14N6))
 Influenza A virus
 (A/mallard/Astrakhan/244/82(H14
 N6))
 Influenza A virus (A/Australian shelduck/Western
 Australia/1756/1983(H15N2))
 Influenza A virus (A/black-headed
 gull/Netherlands/1/00(H13N8)) hema(GI:56425010 loc:AY684886)
 Influenza A virus (A/duck/AUS/341/1983(H15N8)) neura(GI:82654237
 loc:CY0054020)
 Influenza A virus (A/duck/Australia/341/83(H15N8)) hema(GI:1226068
 loc:FLAHEMAC)
 Influenza A virus (A/shearwater/West
 Australia/2576/79(H15N9)) hema(GI:1226070
 loc.-FLAHEMAD)
 Influenza A virus (A/wedge-tailed shearwater/Western
 Australia/2327/1983(H15N9))
 Influenza A virus (A/wedge-tailed shearwater/Western
 Australia/2576/1979(H15N9))
 Influenza A virus (A/whale/Maine/1/84(H13N9))
 Influenza A virus (A/black-headed
 gull/Sweden/2/99(H16N3)) hema(GI:56425014 loc:AY684888)
 Influenza A virus (A/black-headed
 gull/Sweden/3/99(H16N3)) hema(GI:56425016 loc:AY684889)
 Influenza A virus (A/black-legged
 kitty wake/Alaska/295/1975(H16N3
)) hema(GI:115279507
 loc:CY015160)
 Influenza A virus (A/herring
 gull/DE/712/1988(H16N3)) hema(GI:82652506 loc:CY005933)
 Influenza A virus (A/herring
 gull/Delaware/712/1988(H16N3)) neura(GI:115278020
 loc:CY0145690)
 Influenza A virus (A/shorebird/New
 Jersey/840/1986(H16N3)) hema(GI:115278106
 loc:CY014599)
 H1N1 swine influenza virus
 Influenza A virus (A/Aichi/102/1999(H1N1)) hema(GI:8096452 loc:AB043497)
 Influenza A virus (A/Aichi/103/2006(H1N1)) hema(GI:109452188
 loc:AB255395)
 Influenza A virus (A/Aichi/11/2006(H1N1)) hema(GI:109452178
 loc:AB255390)
 Influenza A virus (A/Aichi/111/2006(H1N1)) hema(GI:109452190
 loc:AB255396)
 Influenza A virus (A/Aichi/132/2006(H1N1)) hema(GI:109452192
 loc:AB255397)
 Influenza A virus (A/Aichi/150/2006(H1N1)) hema(GI:109452194
 loc:AB255398)
 Influenza A virus (A/Aichi/168/2005(H1N1)) hema(GI:83414926 loc:AB243744)
 Influenza A virus (A/Aichi/169/2005(H1N1)) hema(GI:83414928 loc:AB243745)
 Influenza A virus (A/Aichi/17/2006(H1N1)) hema(GI:109452180
 loc:AB255391)
 Influenza A virus (A/Aichi/2/2006(H1N1)) hema(GI:109452176
 loc:AB255389)
 Influenza A virus (A/Aichi/21/2006(H1N1)) hema(GI:109452182
 loc:AB255392)
 Influenza A virus (A/Aichi/24/1992(H1N1)) hema(GI:8096438 loc:AB043490)
 Influenza A virus (A/Aichi/25/1996(H1N1)) hema(GI:8096444 loc:AB043493)
 Influenza A virus (A/Aichi/46/2006(H1N1)) hema(GI:109452184
 loc:AB255393)

Influenza A virus (A/Aichi/67/2006(H1N1))	hema(GI: 109452186 loc:AB255394)	
Influenza A virus (A/Aichi/94/1999(H1N1))	hema(GI:8096450 loc:AB043496)	
Influenza A virus (A/Akita/161/1998(H1N1))	hema(GI:343931 19 loc:AB117194)	
Influenza A virus (A/Akita/86/2002(H1N1))	hema(GI:34393061 loc:ABI 17165)	
Influenza A virus (A/Alaska/1 1/2003(H1N1))		
Influenza A virus (A/Alaska/I 173/00(H1N1))	hema(GI:13936241 loc:AY029287)	
Influenza A virus (A/Alma Ata/I417/84(H1N1))	hema(GI:385578 loc:S62154)	
Influenza A virus (A/Arizona/1/1990(H1N1))	hema(GI:3051 18 loc:FLAHAARIZO)	
Influenza A virus (A/Arizona/1/2006(H1N1))		
Influenza A virus (A/Arizona/2/2003(H1N1))		
Influenza A virus (A/Arizona/6/2003(H1N1))		
Influenza A virus (A/Auckland/1 76/99(H1N1))		
Influenza A virus (A/Bangkok/10/83(H1N1))	hema(GI:221303 loc:FLAHABAN)	
Influenza A virus (A/Bayern/7/95(H1N1))		
Influenza A virus (A/Baylor/1 1350/1982(H1N1))		
Influenza A virus (A/Baylor/I 1515/1982(H1N1))		
Influenza A virus (A/Baylor/1 1735/1982(H1N1))		
Influenza A virus (A/Beijing/1 1/1956(H1N1))		
Influenza A virus (A/Beijing/1 1/56 (H1N1))		
Influenza A virus (A/Beijing/262/95(H1N1))	hema(GI:33622379 loc:AY289928)	
Influenza A virus (A/Bel/1942(H1N1))		
Influenza A virus (A/bellamy/1942(Hrø1))		neura(GI:324553 loc:FLANBL0)
Influenza A virus (A/bh/1935(H1N1))		neura(GI:324425 loc:FLANABLCO)
Influenza A virus (A/blue wing teal/Ohio/101/1993(H1N1))		
Influenza A virus (A/Bratislava/47/2000(H1N1))		
Influenza A virus (A/Brazil/006/00(H1N1))	hema(GI:84796530 loc:DQ335991)	
Influenza A virus (A/Brazil/O15/OO(H1N1))	hema(GI:84796558 loc:DQ336005)	
Influenza A virus (A/Brazil/O99/O1(H1N1))	hema(GI:84796532 loc:DQ335992)	
Influenza A virus (A/Brazil/1 1/1978(H1N1))	hema(GI:60775 loc:X00028)	
Influenza A virus (A/Brazil/202/2000(H1N1))		
Influenza A virus (A/Brevig Mission/1/1918(H1N1))		
Influenza A virus (A/Buenos Aires/344/99(H1N1))	hema(GI:33330000 loc:AF53403 1)	
Influenza A virus (A/Buenos Aires/6177/99(H1N1))	hema(GI:33329998 loc:AF534030)	
Influenza A virus (A/Buenos	hema(GI:33329988 loc:AF534025)	

Aires/A64/97(H1N1))		
Influenza A virus (A/Buenos Aires/P27D1/OO(H1N1))	hema(GI:33330026 loc:AF534044)	
Influenza A virus (A/Buenos Aires/TI 14/97(H1N1))	hema(GI:33329990 loc:AF534026)	
Influenza A virus (A/Buenos Aires/TI 18/97(H1N1))	hema(GI:33329992 loc:AF534027)	
Influenza A virus (A/California/1/2003(H1N1))		
Influenza A virus (A/California/10/78(H1N1))		
Influenza A virus (A/California/26/2005(I-IIN1))		
Influenza A virus (A/California/27/2005(H1N1))		
Influenza A virus (A/Cam/1946(H1N1))		
Influenza A virus (A/Cameron/1946(H1N1))		
Influenza A virus (A/Canada/7/1988(H1N1))	hema(GI:305120 loc:FLAHACANAD)	
Influenza A virus (A/Canterbury/OI/2001(H1N1))		neura(GI:91 119012 loc:CY0103980)
Influenza A virus (A/Canterbury/O5/2001(H1N1))		
Influenza A virus (A/Canterbury/O8/2001(H1N1))		neura(GI:89788265 loc:CY0098620)
Influenza A virus (A/Canterbury/O9/200 1(H1N1)).		
Influenza A virus (A/Canterbury/I 00/2000(HIN 1))		neura(GI:90572035 loc:CY0101340)
Influenza A virus (A/Canterbury/ 106/200 1(HI N 1))		neura(GI:91 120839 loc:CY0104780)
Influenza A virus (A/Canterbury/I 19/2001(H1N1))		neura(GI:90572453 loc:CY0103 100)
Influenza A virus (A/Canterbury/125/2001(H1N1))		neura(GI:90572472 loc.-CYOIOSI8o)
Influenza A virus (A/Canterbury/126/2001(H1N1))		neura(GI:90572491 loc:CY0103260)
Influenza A virus (A/Canterbury/139/2001(H1N1))		neura(GI:90572510 loc:CY0103340)
Influenza A virus (A/Canterbury/144/2001(H1N1))		neura(GI:90572529 loc:CY0 103420)
Influenza A virus (A/Canterbury/152/2001(H1N1))		neura(GI:106895995 loc:CY01 10900)
Influenza A virus (A/Canterbury/153/2001(H1N1))		neura(GI:90571672 loc:CY0099820)
Influenza A virus (A/Canterbury/I 55/2001 (HIN I))		neura(GI:90572548 loc:CY0103500)
Influenza A virus (A/Canterbury/16/2001(H1N1))		neura(GI:89788736 loc:CY0098780)
Influenza A virus (A/Canterbury/17/2001(H1N1))		neura(GI:90572073 loc:CY0101500)
Influenza A virus (A/Canterbury/19/2001(H1N1))		neura(GI:90572092 loc:CY0101580)
Influenza A virus (A/Canterbury/20/200 1(H1N1))		neura(GI:94959537 loc:CY0107660)
Influenza A virus (A/Canterbury/21/2001 (H1N1))		neura(GI:905721 11 loc:CY0101660)
Influenza A virus (A/Canterbury/22/2001(H1N1))		neura(GI:94959556 loc:CY O107740)
Influenza A virus (A/Canterbury/23/2000(H1N1))		neura(GI:89785612 loc:CY0097580)
Influenza A virus (A/Canterbury/23/2001(H1N1))		neura(GI:90572130 loc:CY0101740)
Influenza A virus (A/Canterbury/24/200 1(H1N1))		neura(GI:90572149 loc:CY0101820)

Influenza A virus (A/Canterbury/25/2001(H1N1))	neura(GI:90572168 loc:CY0101900)
Influenza A virus (A/Canterbury/26/2001(H1N1))	neura(GI: 109675398 loc:CY01 14100)
Influenza A virus (A/Canterbury/27/2000(H1N1))	neura(GI:90571959 loc:CY0101020)
Influenza A virus (A/Canterbury/27/2001(H1N1))	neura(GI:90572187 loc:CY0101980)
Influenza A virus (A/Canterbury/28/2000(H1N1))	neura(GI:891 12341 loc:CY0091900)
Influenza A virus (A/Canterbury/29/2001(H1N1))	neura(GI:90572206 loc:CY0102060)
Influenza A virus (A/Canterbury/30/2000(H1N1))	neura(GI:89 112322 loc:CY0091820)
Influenza A virus (A/Canterbury/30/2001(H1N1))	neura(GI:90572225 loc:CY0102140)
Influenza A virus (A/Canterbury/32/2000(H1N1))	neura(GI:891 13868 loc:CY0092220)
Influenza A virus (A/Canterbury/33/2000(H1N1))	neura(GI:89161 167 loc:CY0092140)
influenza A virus (A/Canterbury/34/2000(H1N1))	neura(GI:89 112379 loc:CY0092300)
Influenza A virus (A/Canterbury/34/2001(H1N1))	neura(GI:90572244 loc:CY0 102220)
Influenza A virus (A/Canterbury/35/2001(H1N1))	neura(GI:90572263 loc:CY0 102300)
Influenza A virus (A/Canterbury/36/2000(H1N1))	neura(GI:891 12360 loc:CY0091980)
Influenza A-virus (A/Canterbury/37/2000(H1N1))	neura(GI:89780555 loc:CY0095340)
Influenza A virus (A/Canterbury/40/2001(H1N1))	neura(GI:90572282 loc:CY0102380)
Influenza A virus (A/Canterbury/41/2000(H1N1))	neura(GI:89787427 loc:CY0098300)
Influenza A virus (A/Canterbury/41/2001(H1N1))	neura(GI:89789002 loc:CY0098860)
Influenza A virus (A/Canterbury/42/2001(H1N1))	neura(GI:94959575 loc:CY0107820)
Influenza A virus (A/Canterbury/43/2000(H1N1))	neura(GI:90571940 loc:CY0100940)
Influenza A virus (A/Canterbury/45/2001(H1N1))	neura(GI:90572301 loc:CY0102460)
Influenza A virus (A/Canterbury/46/2000(H1N1))	
Influenza A virus (A/Canterbury/47/2000(H1N1))	
Influenza A virus (A/Canterbury/47/2001(H1N1))	neura(GI:90572320 loc:CY0 102540)
Influenza A virus (A/Canterbury/48/2000(H1N1))	neura(GI: 109914424 loc:CY01 17780)
Influenza A virus (A/Canterbury/48/2001(H1N1))	neura(GI:90572339 loc:CY0 102620)
Influenza A virus (A/Canterbury/5/2000(H1N1))	neura(GI:89780752 loc:CY0095420)
Influenza A virus (A/Canterbury/51/2000(H1N1))	neura(GI:90571978 loc:CY0101100)
Influenza A virus (A/Canterbury/51/2001(H1N1))	neura(GI:91 119050 loc:CY0104140)
Influenza A virus (A/Canterbury/53/2001(H1N1))	neura(GI:90572358 loc:CY0102700)
Influenza A virus (A/Canterbury/54/2000(H1N1))	neura(GI:90572016 loc:CY0101260)
Influenza A virus (A/Canterbury/54/2001(H1N1))	neura(GI:9 1125079 loc:CY0105580)
Influenza A virus (A/Canterbury/55/2000(H1N1))	neura(GI: 1099 14443 loc:CY01 17860)
Influenza A virus	neura(GI:89787849

(A/Canterbury/57/2000(H INI))		loc:CY0098460)
Influenza A virus		neura(GI:90571997
(A/Canterbury/58/2000(H1N1))		loc:CY0101180)
Influenza A virus		neura(GI:90572377
(A/Canterbury/58/2001(H1N1))		loc:CY0 102780)
Influenza A virus		neura(GI:89787191
(A/Canterbury/60/2000(H1N1))		loc:CY0098220)
Influenza A virus		neura(GI: 106895976
(A/Canterbury/60/2001(H1N1))		loc:CY01 10820)
Influenza A virus		neura(GI:9 1118993
(A/Canterbury/63/2000(H1N1))		loc:CY0 103900)
Influenza A virus		neura(GI:91 119069
(A/Canterbury/63/2001(H1N1))		loc:CY0 104220)
Influenza A virus		neura(GI:90572396
(A/Canterbury/64/2001(H1N1))		loc:CY0102860)
Influenza A virus		neura(GI:89780969
(A/Canterbury/65/2000(H1N1))		loc:CY0095500)
Influenza A virus		neura(GI:91 119088
(A/Canterbury/65/2001(H1N1))		loc:CY0104300)
Influenza A virus		neura(GI:90571615
(A/Canterbury/66/2001(H1N1))		loc:CY0099580)
Influenza A virus		neura(GI:91 119107
(A/Canterbury/68/2001(H1N1))		loc:CY0104380)
Influenza A virus		neura(GI:91 119418
(A/Canterbury/69/2001(H1N1))		loc:CY0104460)
Influenza A virus		neura(GI:89785821
(A/Canterbury/7/2000(H1N1))		loc:CY0097660)
Influenza A virus		neura(GI:91 119833
(A/Canterbury/70/2001(H1N1))		loc:CY0 104540)
Influenza A virus		neura(GI:9 1120193
(A/Canterbury/71/2001(H1N1))		loc:CY0104620)
Influenza A virus		neura(GI:90572415
(A/Canterbury/72/2001(H1N1))		loc:CY0102940)
Influenza A virus		neura(GI:90572434
(A/Canterbury/73/2001(H1N1))		loc:CY0103020)
Influenza A virus		neura(GI:90571634
(A/Canterbury/74/2001(H1N1))		loc:CY0099660)
Influenza A virus		neura(GI:89786435
(A/Canterbury/76/2000(H1N1))		loc:CY0097900)
Influenza A virus		neura(GI:90571653
(A/Canterbury/76/2001(H1N1))		loc:CY0099740)
Influenza A virus		neura(GI:89787069
(A/Canterbury/78/2000(H1N1))		loc:CY0098140)
Influenza A virus		neura(GI:89786595
(A/Canterbury/79/2000(H1N1))		loc:CY0097980)
Influenza A virus		neura(GI:91 120569
(A/Canterbury/79/2001(H1N1))		loc:CY0104700)
Influenza A virus		neura(GI:91 118974
(A/Canterbury/8/2000(H1N1))		loc:CY0103820)
Influenza A virus		neura(GI:89786801
(A/Canterbury/87/2000(H1N1))		loc:CY0098060)
Influenza A virus		neura(GI:90571577
(A/Canterbury/9/2000(H INI))		loc:CY0099420)
Influenza A virus		neura(GI:90572054
(A/Canterbury/95/2000(H1N1))		loc:CY0101420)
Influenza A virus		
(A/Chaco/R1 12/00(H1N1))	hema(GI:33330028	loc:AF534045)
Influenza A virus		
(A/Charlottesville/28/95(H1N1))	hema(GI: 18 140839	loc:AF398874)
Influenza A virus		
(A/Charlottesville/3 1/95(H1N1))	hema(GI:18140849	loc:AF398878)
Influenza A virus		
(A/Charlottesville/6/2001(H1N1))	hema(GI:50882543	loc:AY682833)
Influenza A virus (A/Chiba-		
C/402/2000(H1N1))	hema(GI:34393125	loc:AB1 17197)
Influenza A virus		
(A/Chiba/1042/1999(H1N1))	hema(GI:34393 121	loc:AB1 17195)

Influenza A virus (A/Chiba/1 108/1999(H1N1))	hema(GI:34393 123 loc:AB1 17196)	
Influenza A virus (A/chicken/Hong Kong/1 4/1976(H1N1))	hema(GI: 19 12328 loc:IAU46782)	
Influenza A virus (A/Chicken/Italy/24/95(H1N1))		
Influenza A virus (A/Chile/1/1983(H1N1))		neura(GI:324541 loc:FLANAX0)
Influenza A virus (A/Chonnam/07/2002(H1N1))	hema(GI:32140347 loc:AY297154)	
Influenza A virus (A/Chonnam/18/2002(H1N1))	hema(GI:32 140355 loc:AY297156)	
Influenza A virus (A/Chonnam/19/2002(H1N1))	hema(GI:32140392 loc:AY299502)	
Influenza A virus (A/Chonnam/5 1/2002(H1N1))	hema(GI:32140384 loc:AY299498)	
Influenza A virus (A/CHR/157/83(H1N1))		
Influenza A virus (A/Chungbuk/50/2002(H1N1))	hema(GI:32140400 loc:AY299506)	
Influenza A virus (A/Colorado/1/1989(H1N1))	hema(GI:324128 loc:FLAHAD)	
Influenza A virus (A/Colorado/1/2006(H1N1))		
Influenza A virus (A/Colorado/20/2005(H1N1))		
Influenza A virus (A/Connecticut/9/1956(H1N1))		
Influenza A virus (A/Cordoba/VA4 18/99(H1N1))	hema(GI:33330024 loc:AF534043)	
Influenza A virus (A/Czechoslovakia/2/1988(H1N1))	hema(GI:305124 loc:FLAHACZECH)	
Influenza A virus (A/Czechoslovakia/2/1 989(H1N1))	hema(GI:305122 loc:FLAHACHECI)	
Influenza A virus (A/Dakar/1 1/97(H1N1))		
Influenza A virus (A/Dakar/17/2000(H1N1))		
Influenza A virus (A/Delaware/1/2006(H1N1))		
Influenza A virus (A/Delaware/2/2006(H1N1))		
Influenza A virus (A/Denmark/39/2000(H1N1))		
Influenza A virus (A/Denmark/40/2000(H1N1))		
Influenza A virus (A/Denmark/40/200 1(H1N1))		
Influenza A virus (A/Denver/1957(H1N1))		
Influenza A virus (A/DSP/43(H1N1))	hema(GI:21717597 loc:AF494246)	
Influenza A virus (A/Dublin/9852/2000(H1N1))		
Influenza A virus (A/duck/Alberta/35/76(H1N1))	hema(GI:4585160 loc:AF091309)	
Influenza A virus (A/duck/AUS/749/1980(H1N1))		neura(GI: 78097741 loc:CY0056860)
Influenza A virus (A/duck/Australia/749/1 980(H1N1))	hema(GI: 115278165 loc:CY0 14627)	
Influenza A virus (A/duck/Australia/749/80(H1N1))	hema(GI:4585166 loc:AF091312)	
Influenza A virus (A/duck/Bavaria/1/77 (H1N1))	hema(GI:4585168 loc:AF091313)	
Influenza A virus (A/duck/Bavaria/2/1977(H1N1))		

Influenza A virus (A/duck/Bavaria/2/77(H1N1))	hema(GI: 1912346 loc:IAU47308)	
Influenza A virus (A/duck/Hokkaido/1 130/01(H1N1))		
Influenza A virus (A/duck/Hokkaido/55/96(H1N1))		neura(GI:1 13531 190 loc:AB271 1160)
Influenza A virus (A/duck/Hong Kong/193/1977(H1N2))		
Influenza A virus (A/duck/Minnesota/1375/198 1(H1N1))	hema(GI: 115278409 loc:CY014733)	
Influenza A virus (A/duck/Miyagi/66/77(H1N1))		neura(GI:1 1353 1186 loc:AB27 11140)
Influenza A virus (A/duck/Miyagi/9/77(H1N1))		
Influenza A virus (A/Duck/Ohio/1 18C/93 (H1N1))		
Influenza A virus (A/Duck/Ohio/I 75/86 (H1N1))		
Influenza A virus (A/Duck/Ohio/I 94/86 (H1N1))		
Influenza A virus (A/Duck/Ohio/30/86 (H1N1))		
Influenza A virus (A/duck/WI/1938/80 (H1N1))	hema(GI:407001 loc-.FLAHINIHA)	
Influenza A virus (A/duck/WI/259/80(H1N1))	hema(GI:407003 loc:FLAHINIHA)	
Influenza A virus (A/Dunedin/2/2000(H1N1))		neura(GI: 109675822 loc:CY01 15860)
Influenza A virus (A/Ecuador/2625/01(H1N1))	hema(GI:17978581 loc:AY063229)	
Influenza A virus (A/Ecuador/2630/01(H1N1))	hema(GI: 17978583 loc:AY063228)	
Influenza A virus (A/Egypt/101/2001(H1N1))		
Influenza A virus (A/Ehime/1/200 1(H1N1))	hema(GI:34393091 loc:ABI 17180)	
Influenza A virus (A/England/19/1955(H1N1))		
Influenza A virus (A/England/19/55(H1N1))		
Influenza A virus (A/England/333/1980(H1N1))		
Influenza A virus (A/Environment/Ohio/1 007/2005(H1N1))		
Influenza A virus (A/EspiritoSanto/13 1/00(H1N1))	hema(GI:65329140 loc:AY971005)	
Influenza A virus (A/EspiritoSanto/141/01(H1N1))	hema(GI:65329142 loc:AY971006)	
Influenza A virus (A/EspiritoSanto/150/00(H1N1))	hema(GI:65329144 loc:AY971007)	
Influenza A virus (A/EspiritoSanto/39/0 1(H1N1))	hema(GI:65329146 loc:AY971008)	
Influenza A virus (A/EspiritoSanto/45/0 1(H1N1))	hema(GI:65329148 loc:AY971009)	
Influenza A Virus (A/Fiji/15899/83(H1N1))		
Influenza A virus (A/Fiji/2/1988(H1N1))	hema(GI:305130 loc:FLAHAFIJI)	
Influenza A virus (A/Finland/1/1982(H1N1))		
Influenza A virus (A/Finland/1/1984(H1N1))		
Influenza A virus (A/Finland/13 1/2002(H1N1))		

Influenza A virus (A/Finland/154/1991(H1N1))		
Influenza A virus (A/Finland/158/1991(H1N1))	hema(GI:305132 lociFLAHAFINLA)	
Influenza A virus (A/Finland/160/1991(H1N1))		
Influenza A virus (A/Finland/164/1991(H1N1))		
Influenza A virus (A/Finland/168/1991(H1N1))		
Influenza A virus (A/Finland/188/1991(H1N1))		
Influenza A virus (A/Finland/196/1991(H1N1))		
Influenza A virus (A/Finland/20/1978(H1N1))		
Influenza A virus (A/Finland/4/1984(H1N1))		
Influenza A virus (A/Finland/42/1986(H1N1))		
Influenza A virus (A/Finland/44/1978(H1N1))		
Influenza A virus (A/Finland/45/1987(H1N1))		
Influenza A virus (A/Finland/5/1984(H1N1))		
Influenza A virus (A/Finland/53/1987(H1N1))		
Influenza A virus (A/Finland/70/1988(H1N1))		
Influenza A virus (A/Finland/72/1988(H1N1))		
Influenza A virus (A/Finland/73/1988(H1N1))		
Influenza A virus (A/Finland/74/1988(H1N1))		
Influenza A virus (A/Finland/75/1988(H1N1))		
Influenza A virus (A/Finland/9/1984(H1N1))		
Influenza A virus (A/Finland/91/1989(H1N1))		
Influenza A virus (A/Finland/92/1978(H1N1))		
Influenza A virus (A/Florida/1/2006(H1N1))		
Influenza A virus (A/Florida/3/2004(H1N1))		
Influenza A virus (A/Florida/3e/2004(H1N1))		neura(GI:115371424 loc:CY0163530)
Influenza A virus (A/Florida/4/2004(H1N1))		neura(GI:115371420 loc:CY0163510)
Influenza A virus (A/Florida/904/00(H1N1))	hema(GI:13936243 loc:AY029288)	
Influenza A virus (A/Fort Monmouth/1/1947(H1N1))	hema(GI:8096354 loc:AB043478)	
Influenza A virus (A/Fort Monmouth/1/1947-mouse adapted(H1N1))	hema(GI:407935 loc:IVU02464)	
Influenza A virus (A/Fort Warren/1/1950(H1N1))		neura(GI:324555 loc:FLANBLAO)
Influenza A virus (A/Fort Worth/1950(H1N1))		
Influenza A virus (A/FortMonmouth/t/1947(H1N1))		
Influenza A virus (A/France/15/1988(H1N1))	hema(GI:305136 loc:FLAHAFRAND)	

Influenza A virus (A/Franch/69O8/1989(H1N1))	hema(GI:305134 loc:FLAHAFRANC)	
Influenza A virus (A/Fukui/1/2001(H1N1))	hema(GI:34393093 loc:ABI 17181)	
Influenza A virus (A/Fukuoka/13/2001E(H1N1))	hema(GI:34393063 loc:ABI 17166)	
Influenza A virus (A/Fukushima/2/1988(H1N1))	hema(GI:305138 loc:FLAHAFUKUS)	
Influenza A virus (A/FW/1/195O(H1N1))		
Influenza A virus (A/Georgia/3/2003(H1N1))		
Influenza A virus (A/Georgia/5/2003(H1N1))		
Influenza A virus (A/Georgia/79/1983(H1N1))		
Influenza A virus (A/Gifu- C/9/2002(H1N1))	hema(GI:34393065 loc:ABI 17167)	
Influenza A virus (A/goose/Hong Kong/8/1976(H1N1))	hema(GI: 1912326 loc:IAU46021)	
Influenza A virus (A/Goroka/2/1990(H1N1))	hema(GI:305142 loc:FLAHAGOROK)	
Influenza A virus (A/Greece/158/2001(H1N1))		
Influenza A virus (A/Greece/204/2001(H1N1))		
Influenza A virus (A/green wing teal/Ohio/72/1999(H1N1))		
Influenza A virus (A/Groningen/9938/1991(H1N1))		
Influenza A virus (A/Groningen/9939/1991(H1N1))		
Influenza A virus (A/Gwangju/5S/2002(H1N1))	hema(GI:32 140402 loc:AY299507)	
Influenza A virus (A/Gwangju/57/2002(H1N1))	hema(GI:32140404 loc:AY299508)	
Influenza A virus (A/Gwangju/58/2002(H1N1))	hema(GI:32140406 loc:AY299509)	
Influenza A virus (A/Gwangju/9O/2002(H1N1))	hema(GI:32140386 loc:AY299499)	
Influenza A virus (A/Hannover/71/2001(H1N1))		
Influenza A virus (A/Hawau71/2003(H1N1))		
Influenza A virus (A/Hawaii/I313/OO(H1N1))	hema(GI: 13936247 loc:AY029290)	
Influenza A virus (A/Hawaii/3/2006(H1N1))		
Influenza A virus (A/Hawaii/3948/00(H1N1))	hema(GI: 13936251 loc:AY029289)	
Influenza A virus (A/Hawaii/6/2003(H1N1))		
Influenza A virus (A/Hawaii/A4/2006(H1N1))		
Influenza A virus (A/Hickox/1940(H1N1))		neura(GI: 112787550 loc:CYO132730)
Influenza A virus (A/Hickox/40(H1N1))		
Influenza A virus (A/Hiroshima/275/1999E(H1N1))	hema(GI:34393127 loc:ABI 17198)	
Influenza A virus (A/Hiroshima/37/2001(H1N1))	hema(GI: 13397870 loc:MVI250060)	
Influenza A virus (A/Hokkaido/1/1988(H1N1))		neura(GI:506198 loc:FLANAH880)
Influenza A virus (A/Hokkaido/2/1992(H1N1))		neura(GI:506199 loc:FLANAH920)
Influenza A virus (A/Hong	hema(GI: 14587050 loc:AF386776)	

Kong/1035/98 (H1N1)
 Influenza A virus (A/Hong
 Kong/107/1971(H1N1))
 Influenza A virus (A/Hong
 Kong/113/98 (H1N1)) hema(GI: 14587048 loc:AF386775)
 Influenza A virus (A/Hong
 Kong/1134/98 (H1N1)) hema(GI: 14587058 loc:AF386780)
 Influenza A virus (A/Hong
 Kong/117/1977(H1N1))
 Influenza A virus (A/Hong
 Kong/2070/99(H1N1))
 Influenza A virus (A/Hong
 Kong/427/98(H1N1))
 Influenza A virus (A/Hong
 Kong/437/2002(H1N1))
 Influenza A virus (A/Hong
 Kong/470/97(H1N1))
 Influenza A virus (A/Hong
 Kong/4847/98(H1N1))
 Influenza A virus (A/Hong
 Kong/52/95(H1N1))
 Influenza A virus (A/Hong
 Kong/59/94(H1N1))
 Influenza A virus (A/Hong
 Kong/747/2001(H1N1))
 Influenza A virus
 (A/Houston/18515/1984(H1N1))
 Influenza A virus
 (A/Houston/23284/1985(H1N1))
 Influenza A virus
 (A/human/Taiwan/0012/00(H1N1)) hema(GI: 14571975 loc:AF362803)
 Influenza A virus
 (A/human/Taiwan/0016/00(H1N1)) hema(GI:14571927 loc:AF362779)
 Influenza A virus
 (A/human/Taiwan/0030/00(H1N1)) hema(GI:14571929 loc:AF362780)
 Influenza A virus
 (A/human/Taiwan/0130/96(H1N1)) heraa(GI: 14571931 loc:AF362781)
 Influenza A virus
 (A/human/Taiwan/0132/96(H1N1)) hema(GI:14571933 loc:AF362782)
 Influenza A virus
 (A/human/Taiwan/0211/96(H1N1)) hema(GI:14571935 loc:AF362783)
 Influenza A virus
 (A/human/Taiwan/0235/96(H1N1)) hema(GI: 14571937 loc:AF362784)
 Influenza A virus
 (A/human/Taiwan/0255/96(H1N1)) hema(GI:14571939 loc:AF362785)
 Influenza A virus
 (A/human/Taiwan/0337/96(H1N1)) hema(GI:14571941 loc:AF362786)
 Influenza A virus
 (A/human/Taiwan/0342/96(H1N1)) hema(GI: 14571943 loc:AF362787)
 Influenza A virus
 (A/human/Taiwan/0464/99(H1N1)) hema(GI:14571945 loc:AF362788)
 Influenza A virus
 (A/human/Taiwan/0562/95(H1N1)) hema(GI:14571947 loc:AF362789)
 Influenza A virus
 (A/human/Taiwan/0563/95(H1N1)) hema(GI: 14571949 loc:AF362790)
 Influenza A virus
 (A/human/Taiwan/0657/95(H1N1)) hema(GI:14571951 loc:AF362791)
 Influenza A virus
 (A/human/Taiwan/0892/99(H1N1)) hema(GI:14571953 loc:AF362792)
 Influenza A virus
 (A/human/Taiwan/1184/99(H1N1)) hema(GI:14571955 loc:AF362793)
 Influenza A virus
 (A/human/Taiwan/1190/95(H1N1)) hema(GI: 14571957 loc:AF362794)
 Influenza A virus
 (A/human/Taiwan/2200/95(H1N1)) hema(GI:14571959 loc:AF362795)
 Influenza A virus
 (A/human/Taiwan/3355/97(H1N1)) hema(GI:14571961 loc:AF362796)

Influenza A virus (A/human/Taiwan/3825/00(H1N1))	hema(GI:14571963 loc:AF362797)	
Influenza A virus (A/human/Taiwan/4360/99(H1N1))	hema(GI:14571965 loc:AF362798)	
Influenza A virus (A/human/Taiwan/44 15/99(H1N1))	hema(GI: 14571967 loc:AF362799)	
Influenza A virus (A/human/Taiwan/4845/99(H1N1))	hema(GI:14571969 loc:AF362800)	
Influenza A virus (A/human/Taiwan/4943/99(H1N1))	hema(GI: 14571971 loc:AF362801)	
Influenza A virus (A/human/Taiwan/5063/99(H1N1))	hema(GI:14571973 loc:AF362802)	
Influenza A virus (A/human/Taiwan/5779/98(H1N1))	hema(GI:14571925 loc:AF362778)	
Influenza A virus (A/Huston/43(H1N1))	hema(GI:21717607 loc:AF494251)	
Influenza A virus (A/Ibaraki/66/1999(H1N1))	hema(GI:34393129 loc:ABI 17199)	
Influenza A virus (A/Ibaraki/90/1998(H1N1))	hema(GI:8096458 loc:AB043500)	
Influenza A virus (A/Iceland/25/2000(H1N1))		
Influenza A virus (A/Iceland/57/2001(H1N1))		
Influenza A virus (A/Idaho/1/2003(H1N1))		
Influenza A virus (A/Idaho/1/2005(H1N1))		
Influenza A virus (A/India/6263/1980(H1N1))		
Influenza A virus (A/India/80(H1N1))		
Influenza A virus (A/Indiana/1/2006(H1N1))		
Influenza A virus (A/Ireland/649/2002(H1N1))		
Influenza A virus (A/Ishikawa/42/1998E(H1N1))	hema(GI:34393131 loc:ABI 17200)	
Influenza A virus (A/Istanbul/CTF-103/2005(H1N1))	hema(GI: 114215662 loc:DQ978388)	
Influenza A virus (A/Istanbul/CTF-111/2005(H1N1))	hema(GI:1 14215664 loc:DQ978389)	
Influenza A virus (A/Istanbul/CTF-117/2005(H1N1))	hema(GI:1 14215666 loc:DQ978390)	
Influenza A virus (A/Istanbul/CTF-119/2005(H1N1))	hema(GI:1 14215668 loc:DQ978391)	
Influenza A virus (A/Istanbul/CTF-122/2005(H1N1))	hema(GI: 114215670 loc:DQ978392)	
Influenza A virus (A/Istanbul/CTF-76/2004(H1N1))	hema(GI:1 14215650 loc:DQ978382)	
Influenza A virus (A/Istanbul/CTF-78/2004(H1N1))	hema(GI:1 14215652 loc:DQ978383)	
Influenza A virus (A/Istanbul/CTF-83/2004(H1N1))	hema(GI:1 14215654 loc:DQ978384)	
Influenza A virus (A/Istanbul/CTF-85/2004(H1N1))	hema(GI:1 14215656 loc:DQ978385)	
Influenza A virus (A/Istanbul/CTF-86/2004(H1N1))	hema(GI:1 14215658 loc:DQ978386)	
Influenza A virus (A/Istanbul/CTF-98/2004(H1N1))	hema(GP,114215660 loc:DQ978387)	
Influenza A virus (A/Istanbul/CTF/1 11/2005(H1N1))		neura(GI: 114225395 loc:DQ9837820)
Influenza A virus (A/Istanbul/CTF/122/2005(H1N1))		neura(GI: 114225397 loc:DQ9837830)
Influenza A virus (A/Istanbul/CTF/78/2004(H1N1))		neura(GI: 114225389 loc:DQ9837790)
Influenza A virus		neura(GI: 114225387)

(Mstanbul/CTF/79/2004(H1N1))		loc:DQ9837780)
Influenza A virus		neura(GI: 114225391
(A/Istanbul/CTF/85/2004(H1N1))		loc:DQ9837800)
Influenza A virus		neura(GI: 114225393
(A/Istanbul/CTF/97/2004(H1N1))		loc:DQ9837810)
Influenza A virus		
(A/Iwate/1003/2001(H1N1))	hema(GI:34393095 loc:ABI 17182)	
Influenza A virus		
(A/Iwate/33/2002(H1N1))	hema(GI:34393067 loc:ABI 17168)	
Influenza A virus		
(A/Johannesburg/159/97(H1N1))		
Influenza A virus		
(A/Johannesburg/82/96(H1N1))		
Influenza A virus		
(A/Kagawa/243/2001(H1N1))	hema(GI:34393097 loc:ABI 17183)	
Influenza A virus		
(A/Kagawa/8/2000(H1N1))	hema(GI:34393133 loc:ABI 17201)	
Influenza A virus		
(A/Kagawa/83/2000(H1N1))	hema(GI:34393 135 loc:ABI 17202)	
Influenza A virus		
(A/Kagoshima/80/2000(H1N1))	hema(GI:34393137 loc:ABI 17203)	
Influenza A virus		
(A/Kalingrad/5/2000(H1N1))		
Influenza A virus		
(A/Kamata/159/1997(H1N1))	hema(GI:8096446 loc:AB043494)	
Influenza A virus		
(A/Kamata/381/1995(H1N1))	hema(GP.8096440 loc:AB043491)	
Influenza A virus		
(A/Kamata/69/1996(H1N1))	hema(GI:8096442 loc:AB043492)	
Influenza A virus		
(A/Kamata/85/1987(H1N1))	hema(GI:8096432 loc:AB043487)	
Influenza A virus		
(A/Kanagawa/92/98(H1N1))		
Influenza A virus	hema(GI:109156238	
(A/Kenitra/15/97(H1N1))	loc:DQ534415)	
Influenza A virus	hema(GI:109156242	
(A/Kenitra/20/97(H1N1))	loc:DQ534417)	
Influenza A virus		neura(GI:1 15371430
(A/Kentucky/1/2005(H1N1))		loc:CY0 163560)
Influenza A virus		
(A/Kentucky/2/2005(H1N1))		
Influenza A virus		
(A/Kentucky/2/2006(H1N1))		
Influenza A virus		
(A/Kentucky/9/2005(H1N1))		
Influenza A virus		
(A/Kentucky/9e/2005(H1N1))		
Influenza A virus		
(A/Kiev/59/79(H1N1))		
Influenza A virus		
(A/Kitakyusyuu/793/2001(H1N1))	hema(GI:34393069 locrABI 17169)	
Influenza A virus		
(A/Kojiya/1/1952(H1N1))	hema(GI:8096362 loc:AB043482)	
Influenza A virus		
(A/Kwangju/27/1995(H1N1))		
Influenza A virus (A/Kyoto-		
03/2002(H1N1))	hema(GI:34393071 loc:ABI 17170)	
Influenza A virus		
(A/Kyoto/1/1995(H1N1))	hema(GI:34393139 locrABI 17204)	
Influenza A virus		
(A/Lackland/3/1978(H1N1))		
Influenza A virus		
(A/Latvia/2524/2001(H1N1))		
Influenza A virus		
(A/Leningrad/109/1991(H1N1))		
Influenza A virus		
(A/Leningrad/133/1991(H1N1))		

Influenza A virus (A/Leningrad/1954/1(H1N1))	hema(GI:324121 loc:FLAHAGGLUT)	
Influenza A virus (A/Lepine/1948(H1N1))	hema(GI:8096356 loc:AB043479)	
Influenza A virus (A/LiaodDa02-2- 4/2001(H1N1))	hema(GI: 110348350 loc:DQ666648)	
Influenza A virus (A/Liaoning/20/2000(H1N1))	hema(GI: 110348356 loc:DQ666651)	
Influenza A virus (A/Liaoning/25/2000(H1N1))	hema(GI:1 10348354 loc:DQ666650)	
Influenza A virus (A/Liaoning/253/2005(H1N1))	hema(GI: 110348346 loc:DQ666646)	
Influenza A virus (A/Liaoning/255/2005(H1N1))	hema(GI: 110348342 loc:DQ666644)	
Influenza A virus (A/Liaoning/256/2005(H1N1))	hema(GI: 110348344 loc:DQ666645)	
Influenza A virus (A/Liaoning/35/2002(H1N1))	hema(GI: 110348352 loc:DQ666649)	
Influenza A virus (A/LiaoShen/064-3/2001(H1N1))	hema(GI: 110348348 loc:DQ666647)	
Influenza A virus (A/London/1/1918(H1N1))	hema(GI:32395285 loc:AY184805)	
Influenza A virus (A/London/1/1919(H1N1))	hema(GI:32395287 loc:AY1 84806)	
Influenza A virus (A/Loyang/4/1957(H1N1))		neura(GI:324557 loc:FLANBLB0)
Influenza A virus (A/Loygang/4/1957(H1N1))		
Influenza A virus (A/Lyon/3043/96 (HWI))	hema(GI:63 18555 loc:AF131993)	
Influenza A virus (A/Lyon/65 1/2001(H1N1))		
Influenza A virus (AMadagascar/57794/2000(HI NI)		
Influenza A virus (A/Madrid/1082/2001(H1N1))		
Influenza A virus (A/Madrid/1216/2002(H1N1))		
Influenza A virus (AMadrid/930/99(H1N1))		
Influenza A virus (A/Malaysia/1954(H1N1))		
Influenza A virus (A/mallard duck/ALB/35/1976(H1N1))		neura(GI:78097952 loc:CY0058050)
Influenza A virus (A/mallard duck/ALB/65/1976(H1N1))		neura(GI:78095593 loc:CY0042910)
Influenza A virus (A/mallard duck/Tennessee/I 1464/1985(H1N1)		neura(GI:1 15278677 loc:CY0148150)
Influenza A virus (A/mallard/Alberta/1 19/98 (H1N1))		
Influenza A virus (A/mallard/Alberta/130/2003(HIN 1))		
Influenza A virus (A/mallard/Alberta/2 11/98(H1N1))	hema(GI:49357135 loc:AY633212)	
Influenza A virus (A/mallard/Alberta/267/1996(HIN D)		
Influenza A virus (A/mallard/Alberta/99/9 1(H1N1))		
Influenza A virus (A/Mallard/France/D-691/02 (H1N1))		neura(GI:93204702 loc:AJ6978770)
Influenza A virus		neura(GI:93204704)

(A/Mallard/France/D-710/02 (H1N1))		loc:AJ6978780)
Influenza A virus (A/Mallard/Italy/24/95(H1N1))		
Influenza A virus (A/mallard/Maryland/1037/2002(H W1))		
Influenza A virus (A/mallard/Maryland/350/2002(HI N1))		
Influenza A virus (A/mallard/Ohio/118/1993(H1N1))		
Influenza A virus (A/mallard/Tennessee/1 1464/85 (H1N1))	hema(GI:4585164 loc:AF091311)	
Influenza A virus (A/Mar del Plata(H1N1))	hema(GI:33330030 loc:AF534046)	
Influenza A virus (A/Marton/43(H1N1))	hema(GI:21717601 loc:AF494248)	
Influenza A virus (A/Maryland/1/2006(H1N1))		
Influenza A virus (A/Maryland72/1980(H1N1))		
Influenza A virus (A/Massachusetts/1/1990(H1N1))	hema(GI:305156 lociFLAHAMASSA)	
Influenza A virus (A/Massachusetts/9/2005(H1N1))		
Influenza A virus (A/Mayo clinic/103/74(H1N1))		-
Influenza A virus (A/MD/12/1991(H1N1))	hema(GI:438591 loc:FLAMDI291A)	
Influenza A virus (A/Meguro/1/1956(H1N1))	hema(GI:8096428 loc:AB043485)	
Influenza A virus (A/Melbourne/1935(H1N1))		neura(GI:324551 loc:FLANBKO)
Influenza A virus (A/Memphis/1/1978(H1N1))		neura(GI: 109 159433 loc:CY0U2980)
Influenza A virus (A/Memphis/1/1979(H1N1))		
Influenza A virus (A/Memphis/1/1983(H1N1))		neura(GI: 110733499 loc:CY0128820)
Influenza A virus (A/Memphis/10/1978(H1N1))		neura(GI:324559 loc:FLANBLCO)
Influenza A virus (A/Memphis/10/1983(H1N1))		neura(GI: 113 170563 loc:CY0138810)
Influenza A virus (A/Memphis/1 1/1978(H1N1))		neura(GI:94959784 IOC-.CY0108780)
Influenza A virus (A/Memphis/1 1/1983(H1N1))		neura(GI:109159488 loc.CY01 13060)
Influenza A virus (A/Memphis/12/1983(H1N1))		neura(GI:94959955 loc:CY0 109500)
Influenza A virus (A/Memphis/13/1978(H1N1))		neura(GI:109159457 IOC-.CY0108860)
Influenza A virus (A/Memphis/13/1983(H1N1))		neura(GI:109159512 loc:CY01 13140)
Influenza A virus (A/Memphis/14/1983(H1N1))		neura(GI:l 12787607 loc-.CY0132970)
Influenza A virus (A/Memphis/14/96-E(H1N1))	hema(GI:31871813 loc:AY282758)	
Influenza A virus (A/Memphis/14/96-EI(H1N1))	hema(GI:3 1871815 loc:AY282759)	
Influenza A virus (A/Memphis/14/96-M(H1N1))	hema(GI:31871809 loc:AY282756)	
Influenza A virus (A/Memphis/14/96-MI(H1N1))	hema(GI:318718U loc:AY282757)	
Influenza A virus (A/Memphis/I 5/1978(H1N1))		neura(GI:t09159465 loc:CY0 108940)

Influenza A virus (A/Memphis/15/1983(H1N1))	neura(GI:109159528 loc:CY0109580)
Influenza A virus (A/Memphis/16/1983(H1N1))	neura(GI: 112787623 loc:CY0109660)
Influenza A virus (A/Memphis/17/1978(H1N1))	neura(GI:109159473 loc:CY0109020)
Influenza A virus (A/Memphis/17/1983(H1N1))	neura(GI:94960012 loc:CY0109740)
Influenza A virus (A/Memphis/18/1983(H1N1))	neura(GI: 110628985 loc:CY0109820)
Influenza A virus (A/Memphis/19/1983(H1N1))	neura(GI: 110628996 loc-CYO 124420)
Influenza A virus (A/Memphis/2/1983(H1N1))	neura(GI:l 10733518 toc:CYO 128900)
Influenza A virus (A/Memphis/20/1978(H1N1))	
Influenza A virus (A/Memphis/20/1983(H1N1))	
Influenza A virus (A/Memphis/2 1/1983(H1N1))	
Influenza A virus (A/Memphis/22/1983(H1N1))	
Influenza A virus (A/Memphis/23/1983(H1N1))	
Influenza A virus (A/Memphis/24/1983(H1N1))	
Influenza A virus (A/Memphis/25/1983(H1N1))	
Influenza A virus (A/Memphis/26/1 983(H1N1))	
Influenza A virus (A/Memphis/27/1983(H1N1))	
Influenza A virus (A/Memphis/28/1983(H1N1))	
Influenza A virus (A/Memphis/29/1983(H1N1))	
Influenza A virus (A/Memphis/3/1983(H1N1))	neura(GI: 110628970 loc:CY0109180)
Influenza A virus (A/Memphis/30/1983(H1N1))	
Influenza A virus (A/Memphis/3 1/1983(H1N1))	
Influenza A virus (A/Memphis/32/1983(H1N1))	
Influenza A virus (A/Memphis/34/1983(H1N1))	
Influenza A virus (A/Memphis/35/1983(H1N1))	
Influenza A virus (A/Memphis/4/1982(H1N1))	
Influenza A virus (A/Memphis/4/1983(H1N1))	neura(GI:l 10733532 loc:CY0 109260)
Influenza A virus (A/Memphis/6/1983(H1N1))	neura(GI:l 15289334 loc:CY0155260)
Influenza A virus (A/Memphis/7/1980(H1N1))	neura(GI:94959860 loc:CY0109100)
Influenza A virus (A/Memphis/7/1983(H1N1))	neura(GI:94959917 loc:CY0 109340)
Influenza A virus (A/Memphis/8/1983(H1N1))	neura(GI:94959936 loc:CY0109420)
Influenza A virus (A/Mendoza/VJ636/00(H1N1))	
Influenza A virus (A/Michigan/1/2003(H1N1))	hema(GI:33330032 loc:AF534047)
Influenza A virus (A/Michigan/4/2003(H1N1))	
Influenza A virus	

(A/Michigan/5/2003(H1N1))
 Influenza A virus
 (A/Michigan/6/2003(H1N1))
 Influenza A virus
 (A/Mie/1/2001(H1N1)) hema(GI:34393099 loc:ABI 17184)
 Influenza A virus
 (A/Minnesota/18/2003(H1N1))
 Influenza A virus
 (A/Minnesota/2/2006(H1N1))
 Influenza A virus
 (A/Misawa/1226/OO(H1N1)) hema(GI: 13936249 loc:AY029292)
 Influenza A virus
 (A/Mississippi/1/2003(H1N1))
 Influenza A virus
 (A/Missouri/3/2006(H1N1))
 Influenza A virus
 (A/Miyagi/472000(H1N1)) hema(GI:34393 141 loc:AB1 17205)
 Influenza A virus
 (A/Miyagi/89/1999(H1N1)) hema(GI:34393143 loc:AB 117206)
 Influenza A virus hema(GI:1177499
 (A/MongoHa/1 11/91 (H1N1)) loc:IVA1 1191H)
 Influenza A virus
 (A/Mongolia/153/88(H1N1))
 Influenza A virus
 (A/Mongolia/162/91(H1N1))
 Influenza A virus
 (A/Mongolia/23 1/85(H1N1))
 Influenza A virus
 (A/Monmouth/1947(H1N1)) -
 Influenza A virus
 (A/Morocco/69/2001(H1N1))
 Influenza A virus
 (A/Moscow/17/98(H1N1))
 Influenza A virus
 (A/Nagano/1 101/2001(H1N1)) hema(GI:34393101 loc:ABI 17185)
 Influenza A virus
 (A/Nagano/1669/1989(H1N1)) hema(GI:8096434 loc:AB043488)
 Influenza A virus
 (A/Nagano/6059/1996(H1N1)) hema(GI:34393 145 loc:AB 117207)
 Influenza A virus
 (A/Nagano/92/1991(H1N1)) hema(GI:8096436 loc:AB043489)
 Influenza A virus
 (A/Nagasaki/142/1999(H1N1)) hema(GI:34393147 loc:ABI 17208)
 Influenza A virus
 (A/Nagoya/16/2000(H1N1)) hema(GI:34393 149 loc:ABI 17209)
 Influenza A virus
 (A/Nagoya/26/200 1(H1N1)) hema(GI:34393103 loc:ABI 17186)
 Influenza A virus
 (A/Nagoya/27/1995(H1N1)) hema(GI:34393151 loc:ABI 17210)
 Influenza A virus
 (A/Nagoya/32/2002(H1N1)) hema(GI:34393073 loc:AB1 17171)
 Influenza A virus
 (A/Nanchang/1 1/1996(H1N1)) neura(GI: 115344646
 loc:CY0162380)
 Influenza A virus neura(GI:l 12789416
 loc:CY0138150)
 (A/Nanchang/13/1996(H1N1)) neura(GI:l 16070003
 loc:CY0170130)
 Influenza A virus neura(GI: 112789435
 loc:CY0 138230)
 (A/Nanchang/14/1996(H1N1)) neura(GI: 112789454
 loc:CY01383 10)
 Influenza A virus neura(GI: 112789473
 loc:CY0138390)
 (A/Nanchang/15/1996(H1N1)) neura(GI: 112789492
 loc:CY0138470)
 Influenza A virus neura(GI:l 15291088
 loc:CY0160540)
 (A/Nanchang/17/1996(H1N1))
 Influenza A virus
 (A/Nanchang/1 9/1 996(H1N 1))
 Influenza A virus
 (A/Nanchang/21/1996(H1N1))

Influenza A virus (A/Nanchang/23/1996(H1N1))		neura(GI: 115344665 loc:CYO162460)
Influenza A virus (A/Nanchang/25/1996(H1N1))		neura(GI: 115344684 loc:CYO 162540)
Influenza A virus (A/Nanchang/26/1996(H1N1))		neura(GI: 11278951 1 loc:CYO138550)
Influenza A virus (A/Nanchang/8/1996(H1N1))		neura(GI: 115344627 loc:CYO162300)
Influenza A virus (A/Nanchang/9/1996(H1N1))		neura(GI: 116069984 loc:CYO170050)
Influenza A virus (A/Nara/13/2001(H1N1))	hema(GI:34393105 loc:AB 117187)	
Influenza A virus (A/Nara/41/2002(H1N1))	hema(GI:34393075 loc:ABI 17172)	
Influenza A virus (A/Nebraska/2/2003(H1N1))		
Influenza A virus (A/Nebraska/4/2003(H1N1))		
Influenza A virus (A/Netherland/813/1991(H1N1))		
Influenza A virus (A/Neuquen/1381/99(H1N1))	hema(GI:33330014 loc:AF534038)	
Influenza A virus (A/Neuquen/P3D1/OO(H1N1))	hema(GI:33330034 loc:AF534048)	
Influenza A virus (A/Nevada/1/2003(H1N1))		
Influenza A virus (A/New Hampshire/1/2005(H1N1))		
Influenza A virus (A/New Hampshire/2/2006(H1N1))		
Influenza A virus (A/New Jersey/1/2006(H1N1))		
Influenza A virus (A/New Jersey/10/2005(H1N1))		
Influenza A virus (A/New Jersey/1 1/1976(H1N1))		neura(GI:324563 loc:FLANBMA0)
Influenza A virus (A/New Jersey/1 1/2005(H1N1))		
Influenza A virus (A/New Jersey/1976(H1N1))		
Influenza A virus (A/New Jersey/3/2003(H1N1))		
Influenza A virus (A/New Jersey/3 13/00(H1N1))	hema(GI: 13936245 loc:AY029291)	
Influenza A virus (A/New Jersey/4/1976(H1N1))		
Influenza A virus (A/New Jersey/8/1976(H1N1))		neura(GI:506200 loc:FLANANJ760)
Influenza A virus (A/New Mexico/2/2003(H1N1))		
Influenza A virus (A/New Mexico/7/2003(H1N1))		
Influenza A virus (A/New South Wales/24/1999(H1N1))		
Influenza A virus (A/New York/1/2003(H1N1))		
Influenza A virus (A/New York/146/2000(H1N1))		
Influenza A virus (A/New York/205/2001(H1N1))		
Influenza A virus (A/New York/208/2001(H1N1))		
Influenza A virus (A/New York/212/2001(H1N1))		
Influenza A virus (A/New York/220/2002(H1N1))		
Influenza A virus (A/New		

York/221/2003(H1N1))
Influenza A virus (A/New
York/222/2003(H1N1))
Influenza A virus (A/New
York/223/2003(H1N1))
Influenza A virus (A/New
York/227/2003(H1N1))
Influenza A virus (A/New
York/228/2003(H1N1))
Influenza A virus (A/New
York/230/2003(H1N1))
Influenza A virus (A/New
York/233/2000(H1N1))
Influenza A virus (A/New
York/234/2000(H1N1))
Influenza A virus (A/New
York/235/2001(H1N1))
Influenza A virus (A/New
York/239/2001(H1N1))
Influenza A virus (A/New
York/24/2003(H1N1))
Influenza A virus (A/New
York/241/2001(H1N1))
Influenza A virus (A/New
York/242/2001(H1N1))
Influenza A virus (A/New
York/246/2001(H1N1))
Influenza A virus (A/New
York/281/2001(H1N1))
Influenza A virus (A/New
York/291/2002(H1N1))
Influenza A virus (A/New
York/292/2003(H1N1))
Influenza A virus (A/New
York/293/2003(H1N1))
Influenza A virus (A/New
York/302/2001(H1N1))
Influenza A virus (A/New
York/303/2001(H1N1))
Influenza A virus (A/New
York/305/2001(H1N1))
Influenza A virus (A/New
York/306/2001(H1N1))
Influenza A virus (A/New
York/307/2001(H1N1))
Influenza A virus (A/New
York/308/2001(H1N1))
Influenza A virus (A/New
York/309/2001(H1N1))
Influenza A virus (A/New
York/310/2001(H1N1))
Influenza A virus (A/New
York/312/2001(H1N1))
Influenza A virus (A/New
York/341/2001(H1N1))
Influenza A virus (A/New
York/342/2001(H1N1))
Influenza A virus (A/New
York/343/2001(H1N1))
Influenza A virus (A/New
York/344/2001(H1N1))
Influenza A virus (A/New
York/345/2001(H1N1))
Influenza A virus (A/New
York/346/2001(H1N1))
Influenza A virus (A/New
York/348/2003(H1N1))

neura(GI:94959727
loc:CY0108540)

neura(GI:85857127
loc:CY0081500)

Influenza A virus (A/New York/350/2003(H1N1))	
Influenza A virus (A/New York/399/2003(H1N1))	
Influenza A virus (A/New York/4/2006(H1N1))	
Influenza A virus (A/New York/441/2001(H1N1))	neura(GI:891 12398 loc:CY0092380)
Influenza A virus (A/New York/442/2001(H1N1))	
Influenza A virus (A/New York/443/2001(H1N1))	
Influenza A virus (A/New York/444/2001(H1N1))	
Influenza A virus (A/New York/445/2001(H1N1))	
Influenza A virus (A/New York/446/2001(H1N1))	
Influenza A virus (A/New York/447/2001(H1N1))	
Influenza A virus (A/New York/483/2003(H1N1))	neura(GI:86806688 loc:CY0085260)
Influenza A virus (A/New York/484/2003(H1N1))	neura(GI:891 12170 loc:CY0089980)
Influenza A virus (A/New York/486/2003(H1N1))	
Influenza A virus (A/New York/488/2003(H1N1))	
Influenza A virus (A/New York/493/2003(H1N1))	
Influenza A virus (A/New York/494/2002(H1N1))	
Influenza A virus (A/New York/495/2002(H1N1))	
Influenza A virus (A/New York/496/2003(H1N1))	
Influenza A virus (A/New York/497/2003(H1N1))	
Influenza A virus (A/New York/604/1995(H1N1))	neura(GI:91 121281 loc:CY0104860)
Influenza A virus (A/New York/605/1995(H1N1))	neura(GI:91 121616 loc:CY0104940)
Influenza A virus (A/New York/607/1995(H1N1))	neura(GI:9 1122026 loc:CY0105020)
Influenza A virus (A/New York/614/1995(H1N1))	neura(GI:94959613 loc:CY0108060)
Influenza A virus (A/New York/615/1995(H1N1))	neura(GI:91 12243 1 loc:CY0105100)
Influenza A virus (A/New York/616/1995(H1N1))	neura(GI: 113 170544 loc:CY0138730)
Influenza A virus (A/New York/620/1995(H1N1))	neura(GI:91 123217 loc:CY0 105260)
Influenza A virus (A/New York/621/1995(H1N1))	neura(GI:91 123616 loc:CY0105340)
Influenza A virus (A/New York/626/1996(H1N1))	neura(GI: 1099 14462 loc:CY01 17940)
Influenza A virus (A/New York/627/1995(H1N1))	neura(GI:91 124014 loc:CY0 105420)
Influenza A virus (A/New York/629/1995(H1N1))	neura(GI: 1099 14482 loc:CY0 118020)
Influenza A virus (A/New York/630/1995(H1N1))	neura(GI: 110733434 loc:CY0128580)
Influenza A virus (A/New York/633/1995(H1N1))	neura(GI: 116069889 loc:CY0169650)
Influenza A virus (A/New York/638/1995(H1N1))	neura(GI:94959651 loc:CY0 108220)
Influenza A virus (A/New York/638/1995(H1N1))	neura(GI: 109914414)

York/640/1996(H1N1))		loc:CY0 108460)
Influenza A virus (A/New York/642/1995(H1N1))		neura(GI: 110733453 loc:CY0 128660)
Influenza A virus (A/New York/643/1995(H1N1))		neura(GI: 112787569 loc:CY0132810)
Influenza A virus (A/New York/644/1995(H1N1))		neura(GI:9 1177632 loc:CY0107420)
Influenza A virus (A/New York/645/1995(H1N1))		neura(GI:109159375 loc:CY01 12740)
Influenza A virus (A/New York/646/1996(H1N1))		neura(GI: 112787588 loc:CY0132890)
Influenza A virus (A/New York/649/1995(H1N1))		neura(GI: 109159394 loc:CY0U2820)
Influenza A virus (A/New York/650/1995(H1N1))		neura(GI:1 10733472 locrCYO 128740)
Influenza A virus (A/New York/651/1995(H1N1))		neura(GI:1 10332211 loc:CY0 108300)
Influenza A virus (A/New York/653/1996(H1N1))		neura(GI: 110733488 loc:CY0108380)
Influenza A virus (A/New York/656/1995(H1N1))		neura(GI: 112787635 loc:CY0133050)
Influenza A virus (A/New York/694/1995(H1N1))		neura(GI: 115289353 loc:CY0155340)
Influenza A virus (A/New York/CI/2003(H1N1))		
Influenza A virus (A/New York/1/18(H1N1))	hema(GI:4325019 loc.AFI 16576)	
Influenza A virus (A/NIB-27(H1N1))		
Influenza A virus (A/NIB/4/1988(H1N1))		
Influenza A virus (A/Niigata/2756/2000(H IN 1))	hema(GI:34393 107 loc:ABl 17188)	
Influenza A virus (A/NJ/8/1976(H1N1))		neura(GI:324201 loc:FLAHANENJ80)
Influenza A virus (A/North Carolina/1/2006(H1N1))		
Influenza A virus (A/North Carolina/3/2003(H1N1))		
Influenza A virus (A/NWS/1933(H1N1))		neura(GI:94425918 loc:AAQHO 10000280)
Influenza A virus (A/Ohio/I01/1983(H1N1))	hema(GI:324203 loc:FLAHAOHA)	
Influenza A virus (A/Ohio/201/1983(H1N1))	hema(GI:324207 locrFLAHAOHH)	
Influenza A virus (A/Ohio/3523/1988(H1N1))		
Influenza A virus (A/Ohio/4/1983(H1N1))		
Influenza A virus (A/Okayama/33/2001(H1N1))	hema(GI:34393109 loc:ABl 17189)	
Influenza A virus (A/Okayama/4/2001(H1N1))	hema(GI:343931 11 loc:AB 117190)	
Influenza A virus (A/Okinawa/I 59/2000(H INI))	hema(GI:34393153 locrABl 1721 1)	
Influenza A virus (A/Okinawa/18/2001(H1N1))	hema(GI:34393 113 loc:AB 117191)	
Influenza A virus (A/Okinawa/225/2002(H1N1))	hema(GI:34393077 loc:ABl 17173)	
Influenza A virus (A/Okinawa/5 1/2000(H1N1))	hema(GI:34393155 loc:ABl 17212)	
Influenza A virus (A/Oklahoma/7/2005(H1N1))		
Influenza A virus (A/Oregon/2/2003(H1N1))		
Influenza A virus (A/Osaka/930/88(H1N1))	hema(GI:221333 loc:FLAHAOSA)	

Influenza A virus (A/Osaka/972/2000(H1N1))	hema(GI:34393 157 loc:AB 117213)	
Influenza A virus (A/Oslo/734/98(H1N1))		
Influenza A virus (A/Ostrava/801/98(H1N1))		
Influenza A virus (A/Otago/5/2005(H1N1))		neura(GI: 112788884 loc:CY0135750)
Influenza A virus (A/oystercatcher/Germany/87(HIN D))		
Influenza A virus (A/Paraguay/CS24/00(H1N1))	hema(GI:33330036 loc:AF534049)	
Influenza A virus (A/Paris/I857/98(H1N1))		
Influenza A virus (A/Pekin Duck/France/M-2060/01 (H1N1))		neura(GI:93204700 loc:AJ6978760)
Influenza A virus (A/Pennsylvania/1/2006(H1N1))		
Influenza A virus (A/Pennsylvania/2/2006(H1N1))		
Influenza A virus (A/Pennsylvania/3/2006(H1N1))		
Influenza A virus (A/Peru/I621/99(H1N1))	hema(GI:8810214 loc:AF2683 13)	
Influenza A virus (A/Peru/1798/99(H1N1))	hema(GI:88 10212 loc:AF2683 12)	
Influenza A virus (A/pigeon/MN/1407/1981(H1N1))		neura(GI:78103338 loc:CY0058680)
Influenza A virus (A/pintail/Ohio/25/1999(H1N1))		
Influenza A virus (A/Podgorica/401 1/2001(H1N1))		
Influenza A virus (A/PR/8/1938(H1N1))		
Influenza A virus (A/Pusan/22/2002(H1N1))	hema(GI:32 140394 loc:AY299503)	
Influenza A virus (A/Pusan/23/2002(H1N1))	hema(GI:32140357 loc:AY297157)	
Influenza A virus (A/Pusan/24/2002(H1N1))	hema(GI:32140376 loc:AY299494)	
Influenza A virus (A/Pusan/44/2002(H1N1))	hema(GI:32 140396 loc:AY299504)	
Influenza A virus (A/Pusan/45/2002(H1N1))	hema(GI:32140380 loc:AY299496)	
Influenza A virus (A/Pusan/46/2002(H1N1))	hema(GI:32140382 loc:AY299497)	
Influenza A virus (A/Pusan/47/2002(H1N1))	hema(GI:32 140398 loc:AY299505)	
Influenza A virus (A/Qingdao/28/1991(H1N1))	hema(GI:305160 loc:FLAHAQINGD)	
Influenza A virus (A/quail/Nanchang/12- 340/2000(H1N1))		
Influenza A virus (A/Raba(/10/97(H1N1))	hema(GI: 109 156240 loc:DQ534416)	
Influenza A virus (A/Rabat/134/97(H1N1))	hema(GI:109156244 loc:DQ534418)	
Influenza A virus (A/Rabat/137/97(H1N1))	hema(GI:109156246 loc:DQ534419)	
Influenza A virus (A/Rhode Island/1/2003(H1N1))		
Influenza A virus (A/Rhode Island/1/2006(H1N1))		
Influenza A virus (A/Rhodes/47(H1N1))	hema(GI:21 717603 loc:AF494249)	
Influenza A virus	hema(GI:65329136 loc:AY971003)	

(A/RiodeJaneiro/20/00(H1N1))
 Influenza A virus
 (A/RiodeJaneiro/21/00(H1N1)) hema(GI:65329138 loc:AY971004)
 Influenza A virus
 (A/RiodeJaneiro/404/01(H1N1)) hema(GI:65329150 loc:AY971010)
 Influenza A virus
 (A/RioGdoSul/358/02(H1N1)) hema(GI:65329152 loc:AY971011)
 Influenza A virus
 (A/Saga/2/1957(H1N1)) hema(GI:8096430 loc:AB043486)
 Influenza A virus (A/Santa
 Fe/R98/OO(H1N1)) hema(GI:33330038 loc:AF534050)
 Influenza A virus
 (A/Sapporo/174/2000(H1N1)) hema(GI:34393159 loc:ABI17214)
 Influenza A virus
 (A/Sapporo/186/2002(H1N1)) hema(GI:34393079 loc:ABI17174)
 Influenza A virus (A/Saudi
 Arabia/13006/99(H1N1))
 Influenza A virus (A/Saudi
 Arabia/7971/2000(H1N1))
 Influenza A virus (A/Sendai-
 H/1544/1999(H1N1)) hema(GI:34393161 loc:ABI17215)
 Influenza A virus
 (A/Seoul/11/2002(H1N1)) hema(GI:32140349 loc:AY297155)
 Influenza A virus
 (A/Seoul/13/2002(H1N1)) hema(GI:32140388 loc:AY299500)
 Influenza A virus
 (A/Seoul/15/2002(H1N1)) hema(GI:32140390 loc:AY299501)
 Influenza A virus
 (A/Seoul/20/1991(H1N1))
 Influenza A virus
 (A/Seoul/24/1995(H1N1))
 Influenza A virus
 (A/Seoul/33/2002(H1N1)) hema(GI:32140378 loc:AY299495)
 Influenza A virus
 (A/Shenzhen/227/95(H1N1)) hema(GI:33622383 loc:AY289930)
 Influenza A virus
 (A/Shiga/12/2002(H1N1)) hema(GI:34393081 loc:ABI17175)
 Influenza A virus
 (A/Shiga/16/2001E(H1N1)) hema(GI:34393115 loc:ABI17192)
 Influenza A virus
 (A/Shiraz/11/2005(H1N1))
 Influenza A virus
 (A/shiraz/12/2005(H1N1))
 Influenza A virus
 (A/Shiraz/15/2005(H1N1))
 Influenza A virus
 (A/Shiraz/17/2005(H1N1))
 Influenza A virus
 (A/Shiraz/19/2005(H1N1))
 Influenza A virus hema(GI:14149045
 loc:DQ981739)
 (A/Shiraz/22/2005(H1N1))
 Influenza A virus
 (A/Shiraz/7/2005(H1N1))
 Influenza A virus
 (A/Shizuoka/761/2000(H1N1)) hema(GI:34393117 loc:ABI17193)
 Influenza A virus hema(GI:305177
 loc:FLAHASICH)
 (A/Sichuan/4/1988(H1N1))
 Influenza A virus
 (A/Singapore/03/1990(H1N1))
 Influenza A virus
 (A/Singapore/06/1990(H1N1))
 Influenza A virus
 (A/Singapore/10/1990(H1N1))
 Influenza A virus
 (A/Singapore/11/1990(H1N1))
 Influenza A virus
 (A/Singapore/12/1990(H1N1))

Influenza A virus (A/Singapore/15/96(H1N1))	
Influenza A virus (A/Singapore/6/1986(H1N1))	hema(GI:221351 loc:FLASHAI)
Influenza A virus (A/Singapore/6/1990(H1N1))	hema(GI:305179 loc:FLAHASINGA)
Influenza A virus (A/SL/2/1987(H1N1))	hema(GI:325077 loc:FLASL287HA)
Influenza A virus (A/South Australia/25/2000(H1N1))	
Influenza A virus (A/South Australia/26/2000(H1N1))	
Influenza A virus (A/South Australia/30/2000(H1N1))	
Influenza A virus (A/South Australia/36/2000(H1N1))	
Influenza A virus (A/South Australia/39/2000(H1N1))	
Influenza A virus (A/South Australia/40/2000(H1N1))	
Influenza A virus (A/South Australia/46/2000(H1N1))	
Influenza A virus (A/South Carolina/1/18 (H1N1))	hema(GI:4325038 loc:AFI 17241)
Influenza A virus (A/South Carolina/6/1988(H1N1))	hema(GI:305185 loc:FLAHASOCA)
Influenza A virus (A/Stockholm/26/1990(H1N1))	hema(GI:305187 loc:FLAHASTOCK)
Influenza A virus (A/Stockholm/8/2001(H1N1))	
Influenza A virus (A/Suita/1/89(H1N1))	hema(GI:221341 loc:FLAHASUT)
Influenza A virus (A/Suita/1/89/(R)(H1N1))	hema(GI:221339 loc:FLAHASUR)
Influenza A virus (A/sw/Belgium/1/98(H1N1))	hema(GI:46520042 loc:AY590824)
Influenza A virus (A/swine/193 1(H1N1))	
Influenza A virus (A/swine/1976/193 1(H1N1))	
Influenza A virus (A/swine/29/1937(H1N1))	
Influenza A virus (A/swine/29/37 (H1N1))	
Influenza A virus (A/swine/41/1949(H1N1))	
Influenza A virus (A/swine/4 1/49(H1N1))	
Influenza A virus (A/swine/Bad Langensalza/59/84(H1N1))	hema(GI:7093 1291 loc:DQ1 18158)
Influenza A virus (A/swine/Bakum/1 832/00(H1N2))	
Influenza A virus (A/swine/Bakum/5/95(H1N1))	hema(GI:70988582 loc:DQ100426)
Influenza A virus (A/swine/Beijing/47/1991(H1N1))	hema(GI: 19 12330 loc:IAU46783)
Influenza A virus (A/swine/Beijing/94/1991(H1N1))	
Influenza A virus (A/swine/Belgium/1/83(H1N1))	hema(GI:4585 174 loc:AF091316)
Influenza A virus (A/swine/Belgium/ 117/96 (H1N1))	
Influenza A virus (A/swine/Belgium/74/85(H1N 1))	
Influenza A virus (A/swine/Belzig/2/2001(H1N1))	hema(GI: 70988620 loc:DQ1 00427)
Influenza A virus	hema(GI: 14994198 loc:AY038349)

(A/Swine/Bes/5C/96(H1N1))
 Influenza A virus
 (A/swine/Best/5J/96(H1N1)) hema(GI: 14994200 loc:AY038350)
 Influenza A virus
 (A/swine/Best/5K/96(H1N1)) hema(GI:14994202 loc:AY038351)
 Influenza A virus
 (A/swine/Best/5M/96(H1N1)) hema(GI: 14994204 loc:AY038352)
 Influenza A virus
 (A/swine/Best/5R/96(H1N1)) hema(GI: 14994206 loc:AY038353)
 Influenza A virus
 (A/swine/Best/5T/96(H1N1)) hema(GI: 14994208 loc:AY038354)
 Influenza A virus
 (A/swine/Boxtel/144#15/97(H1N1))
)
 Influenza A virus
 (A/swine/Cambridge/I/1935(H1N1))
))
 Influenza A virus
 (A/swine/Cambridge/I/35(H1N1))
 Influenza A virus
 (A/swine/Cambridge/1939(H1N1))
 Influenza A virus
 (A/swine/Cambridge/39(H1N1))
 Influenza A virus (A/swine/Cotes
 d'Armor/H21/00(H1N1))
 Influenza A virus (A/swine/Cotes
 d'Armor/1455/99(H1N1))
 Influenza A virus (A/swine/Cotes
 d'Armor/1482/99(H1N1))
 Influenza A virus (A/swine/Cotes
 d'Armor/1488/99(H1N1))
 Influenza A virus (A/swine/Cotes
 d'Armor/1515/99(H1N1))
 Influenza A virus (A/swine/Cotes
 d'Armor/736/2001(H1N1))
 Influenza A virus (A/swine/Cotes
 d'Armor/918/00(H1N1))
 Influenza A virus
 (A/swine/Dongen/6B/96(H1N1)) hema(GI:14994210 loc:AY038355)
 Influenza A virus
 (A/swine/Dongen/6D/96(H1N1)) hema(GI: 14994212 loc:AY038356)
 Influenza A virus
 (A/swine/Dongen/6J/96(H1N1)) hema(GI:14994214 loc:AY038357)
 Influenza A virus
 (A/swine/Dongen/6T/96(H1N1)) hema(GI:14994216 loc:AY038358)
 Influenza A virus
 (A/swine/Ehime/I/80(H1N1))
 Influenza A virus
 (A/swine/England/195852/1992(H1N1))
 Influenza A virus
 (A/Swine/England/195852/92
 (H1N1))
 Influenza A virus
 (A/Swine/Finistere/2899/82(H1N1))
)
 Influenza A virus
 (A/swine/Finistere/3616/84(H1N1))
)
 Influenza A virus
 (A/Swine/France/3614/84(H1N1))
 Influenza A virus
 (A/Swine/France/4203/85(H1N1))
 Influenza A virus
 (A/Swine/France/4510/86(H1N1))
 Influenza A virus
 (A/Swine/France/525/94(H1N1))

Influenza A virus
 (A/swine/Germany/2/1981(H1N1))
 Influenza A virus
 (A/swine/Germany/8533/91(H1N1))
)
 Influenza A virus
 (A/swine/Guangdong/2/01(H1N1)) hema(GI:668 17275 loc:DQ058215)
 Influenza A virus
 (A/swine/Guangdong/71 1/2001(H1N1)) hema(GI:60327789 loc:AY852271)
 Influenza A virus
 (A/swine/Hokkaido/2/198 1(H1N1))
 Influenza A virus hema(GI:3980255
 (A/swine/Hokkaido/2/8 1 (H1N1)) loc:BPFHABFH)
 Influenza A virus (A/swine/Hong Kong/1/1974(H1N1))
 Influenza A virus (A/swine/Hong Kong/172/1993(H1N1)) hema(GI:1912324 loc:IAU46020)
 Influenza A virus (A/swine/Hong Kong/176/1993(H1N1)) hema(GI: 19 12320 loc:IAU45451)
 Influenza A virus
 (A/swine/IDT/Re230/92(H1N1)) hema(GI:5 1704728 loc:AY701753)
 Influenza A virus (A/swine/Ille et Vilaine/1455/99(H1N1))
 Influenza A virus
 (A/swine/Illinois/63(H1N1))
 Influenza A virus
 (A/swine/IN/1726/1988(H1N1))
 Influenza A virus
 (A/Swine/Indiana/1 726/1988(H1N1))
))
 Influenza A virus
 (A/swine/Indiana/1726/88(H1N1))
 Influenza A virus
 (A/swine/Iowa/15/1930(H1N1))
 Influenza A virus
 (A/swine/Iowa/15/30(H1N1)) hema(GI:437888 loc:NDVHNA)
 Influenza A virus
 (A/swine/Iowa/17672/1988(H1N1))
)
 Influenza A virus
 (A/swine/Iowa/17672/88 (H1N1)) hema(GI:1912338 loc:IAU47304)
 Influenza A virus
 (A/swine/Iowa/1946(H1N1))
 Influenza A virus
 (A/swine/Iowa/1976/1931(H1N1)) hema(GI:5 11292 loc:IAUI 1858)
 Influenza A virus
 (A/Swine/Iowa/1976/3 1(H1N1))
 Influenza A virus
 (A/Swine/Iowa/30 (H1N1))
 Influenza A virus
 (A/Swine/Iowa/46(H1N1))
 Influenza A virus (A/swine/Italy-Virus/671/87(H1N1)) hema(GI:4585172 loc:AF0913 15)
 Influenza A virus
 (A/swine/Italy/1095 1/2001(H1N1))
 Influenza A virus
 (A/swine/Italy/1 10971/2001(H1N1))
))
 Influenza A virus
 (A/swine/Italy/13260/2001(H1N1))
 Influenza A virus
 (A/swine/Italy/1390-5/95(H1N1))
 Influenza A virus
 (A/swine/Italy/141/1981(H1N1))
 Influenza A virus
 (A/swine/Italy/141/81(H1N1))

Influenza A virus
(A/swine/Italy/1424-3/95(HINI))
Influenza A virus
(A/swine/Italy/1424-4/95(HINI))
Influenza A virus
(A/swine/Italy/1456-1/96(HINI))
Influenza A virus
(A/swine/Italy/147/1981(HINI))
Influenza A virus
(A/swine/Italy/1492/97(HINI))
Influenza A virus
(A/swine/Italy/1498-2/97(HINI))
Influenza A virus
(A/swine/Italy/1509-6/97(HINI))
Influenza A virus
(A/swine/Italy/151/1981(HINI))
Influenza A virus
(A/swine/Italy/1511/98(HINI))
Influenza A virus
(A/Swine/Italy/I513-1/98(H1N1))
Influenza A virus
(A/swine/Italy/1513-8/98(HINI))
Influenza A virus
(A/swine/Italy/1566/98(HINI))
Influenza A virus
(A/swine/Italy/1589/98(HINI))
Influenza A virus
(A/swine/Italy/1657/99(HINI))
Influenza A virus
(A/swine/Italy/2/1979(HINI))
Influenza A virus
(A/swine/Italy/2/79(HINI))
Influenza A virus
(A/swine/Italy/2034/99(HINI))
Influenza A virus
(A/swine/Italy/3088/00(HIN 1))
Influenza A virus
(A/swine/Italy/3364/00(HINI))
Influenza A virus
(A/swine/Italy/425/1976(HINI))
Influenza A virus
(A/swine/Italy/437/1976(HINI))
Influenza A virus
(A/swrae/Italy/437/76(HINI))
Influenza A virus
(A/swine/Italy/S47/1985(HINI))
Influenza A virus
(A/swine/Italy/594/1986(HINI))
Influenza A virus
(A/swine/Italy/671/1987(HINI))
Influenza A virus
(A/swine/Italy/768/1988(HINI))
Influenza A virus
(A/swine/Italy/835/1989(HINI))
Influenza A virus
(A/swine/Italy/839/1989(HINI))
Influenza A virus
(A/swine/Italy/839/89(HINI))
Influenza A virus
(A/swine/Italy/France/2111/95(HI
NI))
Influenza A virus
(A/swine/Jamesburg/1942(HINI))
Influenza A virus
(A/swine/Jamesburg/42(HIN 1))
Influenza A virus
(A/swine/Korea/S10/2004(HINI))

Influenza A virus
(A/swine/Korea/S 175/2004(HIN 1)
)
Influenza A virus
(A/swine/Leende/15C/96(HINI)) hema(GI:14994184 loc:AY038342)
Influenza A virus
(A/swine/Leende/15E/96(HINI)) hema(GI:14994186 loc:AY038343)
Influenza A virus
(A/swine/Leende/15Q/96(HINI)) hema(GI:14994188 loc:AY038344)
Influenza A virus
(A/swine/Leende/15R/96(HINI)) hema(GI:14994190 loc:AY038345)
Influenza A virus
(A/swine/Leende/15S/96(HINI)) hema(GI:14994192 loc:AY038346)
Influenza A virus
(A/swine/Lot/2979/82(HIN 1))
Influenza A virus
(A/swine/March/52 (HINI))
Influenza A virus
(A/swine/May/1954(HINI))
Influenza A virus (A/swine/May/54
(HINI))
Influenza A virus
(A/swine/Nebraska/1/1992(HINI))
Influenza A virus
(A/swine/Nebraska/1/92(HINI))
Influenza A virus
(A/swine/Nederweerty 13A/96(HIN
1)) hema(GI:14994166 loc:AY038333)
Influenza A virus
(A/swine/Nederweert/13G/96(HIN
D)) hema(GI:14994168 loc:AY038334)
Influenza A virus
(A/swine/Nederweert/13H/96(HIN
I)) hema(GI:14994170 loc:AY038335)
Influenza A virus
(A/swine/Nederweert/13I/96(HINI
) hema(GI:14994172 loc:AY038336)
Influenza A virus
(A/swine/Nederweertf13O/96(HIN
I)) hema(GI:14994174 loc:AY038337)
Influenza A virus
(A/Swine/Netherlands/1/87(H1N1)
)
Influenza A virus
(A/swine/Netherlands/12/1985(HI
NI)) hema(GI:1912336 loc:IAU46943)
Influenza A virus
(A/Swine/Netherlands/12/85(H1N1
)
)
Influenza A virus
(A/Swine/Netherlands/1743/93(H1
NI))
Influenza A virus
(A/swine/Netherlands/25/80(HIN 1
)
)
Influenza A virus
(A/swine/Netherlands/3/1980(HIN
I)) hetna(GI:1912334 loc:IAU46942)
Influenza A virus
(A/swine/Netherlands/3/80(HINI)) hema(GI:4585170 loc:AF0913 14)
Influenza A virus
(A/Swine/Netherlands/386/86(HIN
D))
Influenza A virus
(A/Swine/Netherlands/477/93 (HIN
D))
Influenza A virus

(A/Swme/Netherlands/6O9/96(H1N1))
 Influenza A virus
 (A/Swine/Netherlands/97/81(H1N1))
 Influenza A virus (A/swine/New Jersey/11/76(H1N1)) hema(GI:324158 loc:FLAHAMB)
 Influenza A virus (A/swine/Northern Ireland/1938(H1N1))
 Influenza A virus (A/swine/Ohio/23/1935(H1N1))
 Influenza A virus (A/swine/Ohio/23/35(H1N1))
 Influenza A virus (A/swine/Ontario/2/1981(H1N1))
 Influenza A virus (A/swine/Ontario/2/1981(H1N1))
 Influenza A virus (A/swine/Ontario/2/81(H1N1))
 Influenza A virus (A/swine/Potsdam/123/81(H1N1)) hema(GI:70931303 loc:DQ1 18159)
 Influenza A virus (A/swine/Potsdam/15/81(H1N1)) hema(GI:70931313 loc:DQ1 18160)
 Influenza A virus (A/swine/Potsdam/194/90(H1N1)) hema(GI:70931355 loc:DQ1 18164)
 Influenza A virus (A/swine/Potsdam/282/90(H1N1)) hema(GI:70931342 loc:DQ1 18163)
 Influenza A virus (A/swine/Quebec/192/81(H1N1))
 Influenza A virus (A/swine/Quebec/5393/91(H1N1))
 Influenza A virus (A/swine/Saskatchewan/18789/02(H1N1)) hema(GI:52078154 loc:AY619961)
 Influenza A virus (A/swine/Schwerin/103/89(H1N1)) hema(GI:70931322 loc:DQ1 18161)
 Influenza A virus (A/swine/Schwerin/182/87(H1N1)) hema(GI:70931332 loc:DQ1 18162)
 Influenza A virus (A/swine/Someren/14A/96(H1N1)) hema(GI:14994176 loc:AY038338)
 Influenza A virus (A/swine/Someren/14C/96(H1N1)) hema(GI:14994178 loc:AY038339)
 Influenza A virus (A/swine/Someren/14J/96(H1N1)) hema(GI:14994180 loc:AY038340)
 Influenza A virus (A/swine/Someren/14M/96(H1N1)) hema(GI:14994182 loc:AY038341)
 Influenza A virus (A/swine/Spain/45304/2003(H1N1))
 Influenza A virus (A/swine/Spain/50047/2003(H1N1))
 Influenza A virus (A/swine/St-Hyacinthe/106/1991(H1N1))
 Influenza A virus (A/swine/St-Hyacinthe/148/1990(H1N1)) hema(GI:511797 loc:IAU1 1703)
 Influenza A virus (A/swine/St-Anthonis/16B/96(H1N1)) hema(GI:14994194 loc:AY038347)
 Influenza A virus (A/swine/St-Anthonis/16F/96(H1N1)) hema(GI:14994196 loc:AY038348)
 Influenza A virus (A/swine/Taichung/2008/2002(H1N1)) hema(GI:47176950 loc:AY377929)
 Influenza A virus (A/swine/Tennessee/24/1977(H1N1))

Influenza A virus
 (A/swine/Tennessee/24/77 (H1N1))
 Influenza A virus
 (A/swine/Tennessee/25/1977(HIN
 D))
 Influenza A virus
 (A/swine/Tennessee/26/1977(HIN
 D)
 Influenza A virus
 (A/swine/Tennessee/26/77(H1N1))
 Influenza A virus
 (A/swine/WI/1915/1988(H1N1))
 Influenza A virus
 (A/swine/Wisconsin/1/1957(H1N1
)
 Influenza A virus
 (A/swine/Wisconsin/1/1961(H1N1
)
 Influenza A virus
 (A/swine/Wisconsin/1/1967(H1N1
)
 Influenza A virus
 (A/swine/Wisconsin/1/57(H1N1))
 Influenza A virus
 (A/swine/Wisconsin/1/61(H1N1)) hema(GI:4585156 loc:AF091307)
 Influenza A virus
 (A/swine/Wisconsin/125/97(H1N1
)
 Influenza A virus
 (A/Swine/Wisconsin/136/97(H1N1
)) hema(GI:9408387 loc:AF222027)
 Influenza A virus
 (A/swine/Wisconsin/15/1930(HIN
 I)) neura(GI:324575 loc:FLANBMGO)
 Influenza A virus
 (A/Swine/Wisconsin/163/97(H1N1
)) hema(GI:9408389 loc:AF222028)
 Influenza A virus
 (A/Swine/Wisconsin/164/97(H1N1
)) hema(GI:9408391 loc:AF222029)
 Influenza A virus
 (A/Swine/Wisconsin/ 166/97(H1N1
)) hema(GI:9408393 loc:AF222030)
 Influenza A virus
 (A/Swine/Wisconsin/168/97(H1N1
)) hema(GI:9408395 loc:AF222031)
 Influenza A virus
 (A/swine/Wisconsin/1915/1988(HI
 NI))
 Influenza A virus
 (A/Swine/Wisconsin/235/97(H1N1
)) hema(GI:9408397 loc:AF222032)
 Influenza A virus
 (A/swine/Wisconsin/238/97(H1N1)
) neura(GI:82622992
 loc:DQ2802590)
 Influenza A virus
 (A/Swine/Wisconsin/457/98(H1N1
)) hema(GI:9408401 loc:AF222034)
 Influenza A virus
 (A/swine/Wisconsin/458/98(H1N1
)
 Influenza A virus
 (A/swine/Wisconsin/464/98(H1N1
)
 Influenza A virus
 (A/swine/Wisconsin/OM/2(H1N1))
 Influenza A virus neura(GI:324531

(A/swine/wisconsin/ 15/ 1930(HIN I)) loc:FLANAMVO)
 Influenza A virus
 (A/Switzerland/5389/95 (H1N1)) hema(GI: 14587044 loc:AF386773)
 Influenza A virus
 (A/Switzerland/5684/200 1(H1N1))
 Influenza A virus
 (A/Switzerland/5773/200 1(H1N1))
 Influenza A virus
 (A/Switzerland/8808/2002(H1N1))
 Influenza A virus
 (A/Taiwan/0012/2000 (H1N1))
 Influenza A virus
 (A/Taiwan/0016/2000 (H1N1))
 Influenza A virus
 (A/Taiwan/0030/2000 (H1N1))
 Influenza A virus
 (A/Taiwan/0032/2002(H1N1)) hema(GI:50727488 loc:AY604804)
 Influenza A virus
 (A/Taiwan/006 1/2002(H1N1)) hema(GI:50727470 loc:AY604795)
 Influenza A virus
 (A/Taiwan/0069/2002(H1N1)) hema(GI:50727486 loc:AY604803)
 Influenza A virus
 (A/Taiwan/0078/2002(H1N1)) hema(GI:50727490 loc:AY604805)
 Influenza A virus
 (A/Taiwan/0094/2002(H1N1)) hema(GI:50727474 loc:AY604797)
 Influenza A virus
 (A/Taiwan/01 16/2002(H1N1)) hema(GI:50727472 loc:AY604796)
 Influenza A-virus
 (A/Taiwan/0 130/96 (H1N1))
 Influenza A virus
 (A/Taiwan/021 1/96 (H1N1))
 Influenza A virus
 (A/Taiwan/023 5/96 (H1N1))
 Influenza A virus
 (A/Taiwan/0255/96 (H1N1))
 Influenza A virus
 (A/Taiwan/0342/96 (H1N1))
 Influenza A virus
 (A/Taiwan/0562/95 (H1N1))
 Influenza A virus
 (A/Taiwan/0563/95 (H1N1))
 Influenza A virus
 (A/Taiwan/0657/95 (H1N1))
 Influenza A virus
 (A/Taiwan/O859/2002(H1N1)) hema(GI:50727482 loc:AY604801)
 Influenza A virus
 (A/Taiwan/O983/2002(H1N1)) hema(GI:50727480 loc:AY604800)
 Influenza A virus
 (A/Taiwan/1/1986(H1N1)) hema(GI:221353 loc:FLATHAI)
 Influenza A virus
 (A/Taiwan/1/86(H1N1))
 Influenza A virus
 (A/Taiwan/I 12/1996(H1N1))
 Influenza A virus
 (A/Taiwan/I 12/1996-1(H1N1))
 Influenza A virus
 (A/Taiwan/I 12/1996-2(H1N1))
 Influenza A virus
 (A/Taiwan/I 17/1996(H1N1))
 Influenza A virus
 (A/Taiwan/I 17/1996-1(H1N1))
 Influenza A virus
 (A/Taiwan/I 17/1996-2(H1N1))
 Influenza A virus
 (A/Taiwan/1 17/1996-3(H1N1))
 Influenza A virus

(A/Taiwan/I 17/96(H1N1))
 Influenza A virus
 (A/Taiwan/I 18/1996(H1N1))
 Influenza A virus
 (A/Taiwan/I 18/1996-1(H1N1))
 Influenza A virus
 (A/Taiwan/I 18/1996-2(H1N1))
 Influenza A virus
 (A/Taiwan/I 18/1996-3(H1N1))
 Influenza A virus
 (A/Taiwan/I 184/99 (H1N1))
 Influenza A virus
 (A/Taiwan/I 190/95 (H1N1))
 Influenza A virus
 (A/Taiwan/13/1954(H1N1)) hema(GI:8096364 loc:AB043483)
 Influenza A virus
 (A/Taiwan/1523/2003(H1N1)) hema(GI:50727496 loc:AY604808)
 Influenza A virus
 (A/Taiwan/1566/2003(H1N1)) hema(GI:50727492 loc:AY604806)
 Influenza A virus
 (A/Taiwan/1887/2002(H1N1)) hema(GI:50727476 loc:AY604798)
 Influenza A virus
 (A/Taiwan/1906/2002(H1N1)) hema(GI:50727478 loc:AY604799)
 Influenza A virus
 (A/Taiwan/1922/2002(H1N1)) hema(GI:50727484 loc:AY604802)
 Influenza A virus
 (A/Taiwan/2 157/2001 (H1N1))
 Influenza A virus
 (A/Taiwan/2 175/2001 (H1N1)) hema(GI:32330957 loc:AY303734)
 Influenza A virus
 (A/Taiwan/2200/95 (H1N1))
 Influenza A virus
 (A/Taiwan/2243+C44/1992(H1N1))
)
 Influenza A virus
 (A/Taiwan/2243/1992(H1N1))
 Influenza A virus
 (A/Taiwan/2984/2002(H1N1))
 Influenza A virus
 (A/Taiwan/2985/2002(H1N1)) hema(GI:79081950 loc:DQ249260)
 Influenza A virus
 (A/Taiwan/30017/2002(H1N1))
 Influenza A virus
 (A/Taiwan/30020/2002(H1N1))
 Influenza A virus
 (A/Taiwan/30027/2002(H1N1))
 Influenza A virus
 (A/Taiwan/3355/97 (H1N1))
 Influenza A virus
 (A/Taiwan/3361/2001 (H1N1)) hema(GI:32330971 loc:AY303741)
 Influenza A virus
 (A/Taiwan/3896/2001 (H1N1)) hema(GI:32330983 loc:AY303747)
 Influenza A virus
 (A/Taiwan/4050/2003(H1N1)) hema(GI:50727494 loc:AY604807)
 Influenza A virus
 (A/Taiwan/4360/99 (H1N1))
 Influenza A virus
 (A/Taiwan/44 15/99 (H1N1))
 Influenza A virus
 (A/Taiwan/4845/99 (H1N1))
 Influenza A virus
 (A/Taiwan/5063/99 (H1N1))
 Influenza A virus
 (A/Taiwan/5779/98 (H1N1))
 Influenza A virus
 (A/Taiwan/929/99(H1N1))

Influenza A virus
 (A/Tehran/49/2001(H1N1))
 Influenza A virus
 (A/Texas/1/2003(H1N1))
 Influenza A virus
 (A/Texas/18/2003(H1N1))
 Influenza A virus
 (A/Texas/22/1990(H1N1)) hema(GI:305189
 loc:FLAHATEXAS)
 Influenza A virus
 (A/Texas/3/2006(H1N1))
 Influenza A virus
 (A/TF/15/1951(H1N1)) hema(GI:8096358 loc:AB043480)
 Influenza A virus
 (A/Tokushima/20/1996(H1N1)) hema(GI:34393163 loc:AB117216)
 Influenza A virus
 (A/Tokushima/3/2002(H1N1)) hema(GI:34393083 loc:AB117176)
 Influenza A virus
 (A/Tokyo/1/51(H1N1)) hema(GI:8096360 loc:AB043481)
 Influenza A virus
 (A/Tokyo/62/1999E(H1N1)) hema(GI:34393165 loc:AB117217)
 Influenza A virus
 (A/Trieste/21/2001(H1N1))
 Influenza A virus
 (A/Trinidad/2/1986(H1N1)) hema(GI:305191
 loc:FLAHATRINI)
 Influenza A virus
 (A/turkey/bethlehem-glilit/1492-
 b/1982(H1N1))
 Influenza A virus
 (A/turkey/Bethlehem-Glilit/1492-
 B/82(H1N1))
 Influenza A virus
 (A/turkey/England/647/1977(H1N1
))
 Influenza A virus
 (Murkey/France/87O75/87(H1N1))
 Influenza A virus
 (A/turkey/Germany/3/91(H1N1))
 Influenza A virus
 (A/turkey/Minnesota/12537/1989(
 H1N1))
 Influenza A virus
 (A/turkey/Minnesota/166/81
 (H1N1))
 Influenza A virus
 (A/turkey/Minnesota/1661/1981(H
 IN1)) hema(GI:1912332 loc:IAU46941)
 Influenza A virus
 (A/turkey/Minnesota/1661/81(HIN
 D)) hema(GI:4585162 loc:AF091310)
 Influenza A virus (A/turkey/North
 Carolina/1780/1988(H1N1))
 Influenza A virus (A/turkey/North
 Carolina/1790/1988(H1N1))
 Influenza A virus
 (A/TW/130/96(H1N1))
 Influenza A virus
 (A/TW/3355/97(H1N1))
 Influenza A virus
 (A/TW/4845/99(H1N1))
 Influenza A virus
 (A/TW/4845/99(H1N1))
 Influenza A virus
 (A/Umea/1/2000(H1N1))
 Influenza A virus
 (A/Umea/2/1991(H1N1))
 Influenza A virus
 (A/Uruguay/33/00(H1N1)) hema(GI:33330040 loc:AF534051)

Influenza A virus (A/Uruguay/37/00(H1N1))	hema(GI:33330042 loc:AF534052)	
Influenza A virus (A/Uruguay/38/00(H1N1))	hema(GI:33330044 loc:AF534053)	
Influenza A virus (A/Uruguay/42/00(H1N1))	hema(GI:33330046 loc:AF534054)	
Influenza A virus (A/USA/L3/1947(H1N1))		
Influenza A virus (A/USSR/90/1970(H1N1))		
Influenza A virus (A/USSR/92/1977(H1N1))		
Influenza A virus (A/Victoria/43/1988(H1N1))	hema(GI:305193 lociFLAHAVICTO)	
Influenza A virus (A/Vilnius/48/1991(H1N1))		
Influenza A virus (A/Virginia/O3/2006(H1N1))		
Influenza A virus (A/Virginia/1/2006(H1N1))		
Influenza A virus (A/Virginia/1e/2006(H1N1))		
Influenza A virus (A/Virginia/20/2003(H1N1))		
Influenza A virus (A/Virginia/4/2005(H1N1))		
Influenza A virus (A/Vladimir/16/2001(H1N1))		
Influenza A virus (A/VM1 13- VI(H1N1))	hema(GI:618461 loc:FLAHAVMI IV)	
Influenza A virus (A/Waikato/10/2001(H1N1))		neura(GI:106896403 loc:CY01 11860)
Influenza A virus (A/Waikato/11/2005(H1N1))		neura(GI: 115521488 loc:CY0164610)
Influenza A virus (A/Waikato/12/2000(H1N1))		
Influenza A virus (A/Waikato/13/2005(H1N1))		neura(GI: 112788903 loc:CY0 135830)
Influenza A virus (A/Waikato/14/2005(H1N1))		neura(GI:1 12791695 loc:CY0 135990)
Influenza A virus (A/Waikato/16/2001(H1N1))		neura(GI: 106896422 loc:CY01 11940)
Influenza A virus (A/Waikato/18/2000(H1N1))		neura(GI: 110733890 loc:CY0130420)
Influenza A virus (A/Waikato/18/2001(H1N1))		neura(GI: 106896460 loc:CY01 12100)
Influenza A virus (A/Waikato/19/2000(H1N1))		neura(GI: 109914843 loc:CY01 19540)
Influenza A virus (A/Waikato/20/2001(H1N1))		neura(GI: 106896441 loc:CY0 112020)
Influenza A virus (A/Waikato/3/2001(H1N1))		neura(GI:109675861 loc:CY0 116020)
Influenza A virus (A/Waikato/4/2001(H1N1))		neura(GI: 106896346 loc:CY01 11620)
Influenza A virus (A/Waikato/4/2005(H1N1))		
Influenza A virus (A/Waikato/42/2001(H1N1))		neura(GI: 1068965 17 loc:CY01 12340)
Influenza A virus (A/Waikato/51/2001(H1N1))		neura(GI: 106896498 loc:CY01 12260)
Influenza A virus (A/Waikato/7/2001(H1N1))		neura(GI: 106896365 loc:CY01 11700)
Influenza A virus (A/Waikato/80/2001(H1N1))		neura(GI:109159715 loc:CY01 13940)
Influenza A virus (A/Waikato/92/2001(H1N1))		neura(GI: 115521431 loc:CY0164370)
Influenza A virus		

(A/Washington/1/2006(H1N1))
 Influenza A virus
 (A/Weiss/1943(H1N1))
 Influenza A virus
 (A/Wellington/1/2001(H1N1))
 Influenza A virus
 (A/Wellington/10/2005(H1N1))
 Influenza A virus
 (A/Wellington/11/2000(H1N1))
 Influenza A virus
 (A/Wellington/11/2005(H1N1))
 Influenza A virus
 (A/Wellington/12/2005(H1N1))
 Influenza A virus
 (A/Wellington/13/2005(H1N1))
 Influenza A virus
 (A/Wellington/14/2000(H1N1))
 Influenza A virus
 (A/Wellington/14/2005(H1N1))
 Influenza A virus
 (A/Wellington/16/2000(H1N1))
 Influenza A virus
 (A/Wellington/17/2001(H1N1))
 Influenza A virus
 (A/Wellington/18/2000(H1N1))
 Influenza A virus
 (A/Wellington/2/2000(H1N1))
 Influenza A virus
 (A/Wellington/20/2000(H1N1))
 Influenza A virus
 (A/Wellington/24/2000(H1N1))
 Influenza A virus
 (A/Wellington/24/2001(H1N1))
 Influenza A virus
 (A/Wellington/28/2001(H1N1))
 Influenza A virus
 (A/Wellington/3/2000(H1N1))
 Influenza A virus
 (A/Wellington/3/2001(H1N1))
 Influenza A virus
 (A/Wellington/32/2001(H1N1))
 Influenza A virus
 (A/Wellington/4/2000(H1N1))
 Influenza A virus
 (A/Wellington/5/2000(H1N1))
 Influenza A virus
 (A/Wellington/6/2000(H1N1))
 Influenza A virus
 (A/Wellington/7/2000(H1N1))
 Influenza A virus
 (A/Wellington/7/2005(H1N1))
 Influenza A virus
 (A/Wellington/8/2000(H1N1))
 Influenza A virus
 (A/Wellington/9/2001(H1N1))
 Influenza A virus (A/West
 Coast/31/2001(H1N1))
 Influenza A virus (A/West
 Coast/33/2001(H1N1))
 Influenza A virus (A/West
 Virginia/1/2006(H1N1))
 Influenza A virus
 (A/Wisconsin/10/98 (H1N1))
 Influenza A virus
 (A/Wisconsin/101/1981(H1N1))
 Influenza A virus
 (A/Wisconsin/25/2003(H1N1))

neura(GI: 106896327
 loc:CY01 11540)
 neura(GI: 112788846
 IOC-CY0135590)
 neura(GI: 110629391
 loc:CY0126020)
 neura(GI:113 170886
 loc:CY0140090)
 neura(GI:112788865
 loc:CY0135670)
 neura(GI: 112788922
 loc:CY0135910)
 neura(GI: 115344570
 loc:CY0161980)
 neura(GI: 115289467
 loc:CY0155820)
 neura(GI: 110629410
 loc:CY0126100)
 neura(GI: 110332518
 loc:CY0123060)
 neura(GI:110733871
 loc:CY0130340)
 neura(GI:110733860
 loc:CY0109980)

neura(GI: 116069908
 loc:CY0169730)

neura(GI: 106896536
 loc:CY0112420)
 neura(GI:94960088
 loc:CY0110060)
 neura(GI: 106896384
 loc:CY0111780)
 neura(GI: 109675880
 loc:CY0116100)

neura(GI:110629380
 loc:CY0110140)

neura(GI: 110332390
 loc:CY01122980)

neura(GI: 106896479
 loc:CY0112180)
 neura(GI: 106895957
 loc:CY0110740)
 neura(GI:91119031
 loc:CY0104060)

Influenza A virus (A/Wisconsin/3523/L988(H1N1))		neura(GI:1912352 loc:IAU478160)
Influenza A virus (A/Wisconsin/3523/88 (H1N1))		
Influenza A virus (A/Wisconsin/3623/1988(H1N1))		
Influenza A virus (A/Wisconsin/73/2005(H1N1))		
Influenza A virus (A/WS/1933(H1N1))		neura(GI:414310 loc:FLANEURAMBO)
Influenza A virus (A/WS/7/1933(H1N1))		
Influenza A virus (A/WSN(H1N1))		
Influenza A virus (A/WSN/1940(H1N1))		
Influenza A virus (A/Wuhan/371/95(H1N1))		
Influenza A virus (A/Wyoming/14/2003(H1N1))		
Influenza A virus (A/Wyoming/4/2003(H1N1))		
Influenza A virus (AJX/13(H1N1))		
Influenza A virus (A/Yamagata/120/1986(H1N1))		neura(GI:506202 loc:FLANAY860)
Influenza A virus (A/Yamagata/162/2000(H1N1))	heraa(GI:34393167 loc:ABI 17218)	
Influenza A virus (A/Yamagishi/55(H1N1))	hema(GI:8096426 loc:AB043484)	
Influenza A virus (A/Yamaguchi/12/2002(H1N1))	hema(GI:34393085 loc:ABI 17177)	
Influenza A virus (A/Yamanashi/1/2002(H1N1))	hema(GI:34393087 loc:ABI 17178)	
Influenza A virus (A/Yamanashi/1/1996(H1N1))	hema(GI:34393169 loc:ABI 17219)	
Influenza A virus (A/Yokohama/12/2000(H1N1))	hema(GI:8096454 loc:AB043498)	
Influenza A virus (A/Yokohama/24/2000(H1N1))	hema(GI:34393171 loc:ABI 17220)	
Influenza A virus (A/Yokohama/50/1998(H1N1))	hema(GI:34393173 loc:ABI 17221)	
Influenza A virus (A/Yokohama/62/2002(H1N1))	hema(GI:34393089 loc:ABI 17179)	
Influenza A viruses (A/Taiwan/2/2006(H1N1))		
Influenza A virus (A/1352/O2(H1N2))		
Influenza A virus (A/1496/O2(H1N2))		
Influenza A virus (A/166O/O2(H1N2))		
Influenza A virus (A/575/01(H1N2))		
Influenza A virus (A/576/01(H1N2))		
Influenza A virus (A/Alabama/1/2003(H1N2))		
Influenza A virus (A/Canada/4/2001(H1N2))	hema(GI:24850091 loc:AF503482)	
Influenza A virus (A/duck/NC/91347/01(H1N2))	hema(GI:30522967 loc:AY233393)	
Influenza A virus (A/duck/NZL/4/1/1984(H1N2))		
Influenza A virus (A/Egypt/2/1181/2001(H1N2))	hema(GI:24850099 loc:AF503486)	
Influenza A virus (A/Egypt/84/2001(H1N2))		

Influenza A virus
 (A/Egypt/96/2002(H1N2))
 Influenza A virus
 (A/England/I/O2(H1N2))
 Influenza A virus
 (A/England/I61/O2(H1N1))
 Influenza A virus
 (A/England/18/02(H1N2))
 Influenza A virus
 (A/England/2/2002(H1N2))
 Influenza A virus
 (A/England/3/02(H1N2))
 Influenza A virus
 (A/England/5/02(H1N2))
 Influenza A virus
 (A/England/57/02(H1N2))
 Influenza A virus
 (A/England/627/01(H1N2))
 Influenza A virus
 (A/England/689/01(H1N2))
 Influenza A virus
 (A/England/691/01(H1N2))
 Influenza A virus
 (A/England/73/02(H1N2))
 Influenza A virus
 (A/England/90/O2(H1N2))
 Influenza A virus
 (A/England/97/02(H1N2))
 Influenza A virus
 (A/Georgia/2/2003(H1N2))
 Influenza A virus
 (A/Hebei/24/1989(H1N2))
 Influenza A virus
 (A/India/66139/2001(H1N2))
 Influenza A virus
 (A/India/66193/2001(H1N2)) hema(GI:24850075 loc:AF503474)
 Influenza A virus
 (A/India/77251/2001(H1N2)) hema(GI:24850077 loc:AF503475)
 Influenza A virus
 (A/India/77267/2001(H1N2)) hema(GI:24850083 loc:AF503478)
 Influenza A virus
 (A/India/77302/2001(H1N2)) hema(GI:24850081 loc:AF503477)
 Influenza A virus
 (A/India/77308/2001(H1N2)) hema(GI:24850097 loc:AF503485)
 Influenza A virus
 (A/Israel/6/2002(H1N2))
 Influenza A virus
 (A/Israel/7/2002(H1N2))
 Influenza A virus
 (A/Latvia/686/2002(H1N2))
 Influenza A virus
 (A/Memphis/6/2003(H1N2))
 Influenza A virus
 (A/Michigan/2/2003(H1N2))
 Influenza A virus
 (A/Michigan/3/2003(H1N2))
 Influenza A virus
 (A/murre/Alaska/175/1976(H1N2)) hema(GI:115279524 loc:CY015167)
 Influenza A virus
 (A/Nevada/5/2001(H1N2)) hema(GI:24850095 loc:AF503484)
 Influenza A virus (A/New
 York/2/2003(H1N2))
 Influenza A virus (A/New
 York/209/2003(H1N2))
 Influenza A virus (A/New
 York/211/2003(H1N2))
 Influenza A virus (A/New

York/217/2002(H1N2))	
Influenza A virus (A/New York/219/2003(H1N2))	
Influenza A virus (A/New York/225/2003(H1N2))	
Influenza A virus (A/New York/226/2003(H1N2))	
Influenza A virus (A/New York/229/2003(H1N2))	neura(GI:90571902 loc:CY0100780)
Influenza A virus (A/New York/231/2003(H1N2))	
Influenza A virus (A/New York/294/2003(H1N2))	
Influenza A virus (A/New York/295/2003(H1N2))	
Influenza A virus (A/New York/296/2003(H1N2))	
Influenza A virus (A/New York/297/2003(H1N2))	
Influenza A virus (A/New York/298/2003(H1N2))	
Influenza A virus (A/New York/299/2003(H1N2))	
Influenza A virus (A/New York/3/2003(H1N2))	
Influenza A virus (A/New York/300/2003(H1N2))	
Influenza A virus (A/New York/349/2003(H1N2))	
Influenza A virus (A/New York/400/2003(H1N2))	
Influenza A virus (A/New York/417/2002(H1N2))	
Influenza A virus (A/New York/481/2003(H1N2))	
Influenza A virus (A/New York/482/2003(H1N2))	
Influenza A virus (A/New York/487/2003(H1N2))	
Influenza A virus (A/New York/489/2003(H1N2))	
Influenza A virus (A/New York/490/2003(H1N2))	
Influenza A virus (A/New York/491/2003(H1N2))	
Influenza A virus (A/New York/492/2003(H1N2))	
Influenza A virus (A/New York/78/2002(H1N2))	
Influenza A virus (A/NWS-Mvi(H1N2))	hema(GI: 15553726 loc:AF408861)
Influenza A virus (A/NWS-Tokyo(H1N2))	hema(GI: 15553724 loc:AF408860)
Influenza A virus (A/Oman/I 6353/2001(H1N2))	hema(GI:24850085 loc:AF503479)
Influenza A virus (A/Pennsylvania/1/2003(H1N2))	
Influenza A virus (A/reassortant variant Stubby X-7(F1)Clx2(H1N2))	neura(GI:324545 loc:FLANAX7CI0)
Influenza A virus (A/reassortant variant X-7 (H1N2))	neura(GI:324543 loc:FLANAX70)
Influenza A virus (A/reassortant variant X-7(F1)(H1N2))	neura(GI:324547 loc:FLANAX7F10)
Influenza A virus (A/RI/5+/1957(H1N2))	neura(GI:324443 loc:FLANAKC0)

Influenza A virus (A/Saudi Arabia/2231/2001(H1N2))		
Influenza A virus (A/Saudi Arabia/2581/2001(H1N2))		
Influenza A virus (A/Scotland/122/01(H1N2))		
Influenza A virus (A/Scotland/15/02(H1N2))		
Influenza A virus (A/Singapore/63/2001(H1N2))	hema(GI:24850089 loc:AF503481)	
Influenza A virus (A/Singapore/66/2001(H1N2))	hema(GI:24850093 loc:AF503483)	
Influenza A virus (A/Singapore/73/2001(H1N2))	hema(GI:24850087 loc:AF503480)	
Influenza A virus (A/Stockholm/13/2002(H1N2))		
Influenza A virus (A/SW/AR/12491/OO(H1N2))	hema(GI: 17223844 loc:AY060030)	
Influenza A virus (A/SW/CO/17871/01(H1N2))	hema(GI: 17223876 loc:AY060046)	
Influenza A virus (A/sw/Ehime/1/1980(H1N2))		neura(GI:391684 loc:FLA180NA0)
Influenza A virus (A/sw/Gent/108/01(H1N2))	hema(GI:46520038 loc:AY590822)	
Influenza A virus (A/sw/Gent/24/00(H1N2))		
Influenza A virus (A/sw/Gent/7625/99(H1N2))	hema(GI:46520040 loc:AY590823)	
Influenza A virus (A/SW/IN/1481O-S/O1(H1N2))	hema(GI: 17223862 loc:AY060039)	
Influenza A virus (A/SW/IN/1481O-T/O1(H1N2))	hema(GI: 17223860 loc:AY060038)	
Influenza A virus (A/sw/Kanagawa/2/1978(H1N2))		neura(GI:391686 loc:FLA278NA0)
Influenza A virus (A/SW/KS/1348 1-S/OO(H1N2))	hema(GI: 17223852 loc:AY060034)	
Influenza A virus (A/SW/KS/1348 1-T/OO(H1N2))	hema(GI: 17223850 loc:AY060033)	
Influenza A virus (A/SW/MN/12883/OO(H1N2))	hema(GI: 17223846 loc:AY060031)	
Influenza A virus (A/SW/MN/13 124-S/O1(H1N2))		
Influenza A virus (A/SW/MN/13 130/OO(H1N2))	hema(GI: 17223848 loc:AY060032)	
Influenza A virus (A/SW/MN/16356/O1(H1N2))	hema(GI: 17223854 loc:AY060035)	
Influenza A virus (A/SW/MN/16419/O1(H1N2))	hema(GI: 17223884 loc:AY060050)	
Influenza A virus (A/SW/MN/1 662/99(H1N2))		
Influenza A virus (A/SW/MN/17138/O1(H1N2))	hema(GI: 17223888 loc:AY060052)	
Influenza A virus (A/SW/MN/2286O-S/O1(H1N2))	hema(GI: 17223870 loc:AY060043)	
Influenza A virus (A/SW/MN/2286O-T/O1(H1N2))	hema(GI: 17223868 loc:AY060042)	
Influenza A virus (A/SW/MN/23 124-S/O1(H1N2))	hema(GI:17223880 loc:AY060048)	
Influenza A virus (A/SW/MN/23 124-T/O1 (H1N2))	hema(GI: 17223878 loc:AY060047)	
Influenza A virus (A/SW/MN/3 128/OO(H1N2))	hema(GI: 17223856 loc:AY060036)	
Influenza A virus (A/SW/MN/3227/00(H1N2))	hema(GI: 17223858 loc:AY060037)	
Influenza A virus (A/SW/MN/3327/00(H1N2))		
Influenza A virus	hema(GI: 17223886 loc:AY060051)	

(A/SW/MN/34893/01(HIN2))
 Influenza A virus
 (A/SW/MO/1877/01(H1N2)) hema(GI:17223882 loc:AY060049)
 Influenza A virus
 (A/SW/MO/18777/OI(H1N2))
 Influenza A virus
 (A/SW/NC/17366/O1(H1N2)) hema(GI: 17223864 loc:AY060040)
 Influenza A virus
 (A/SW/NC/453 19/99(HIN2))
 Influenza A virus
 (A/SW/NE/1 8339/01(H1N2)) hema(GI: 17223872 loc:AY060044)
 Influenza A virus
 (A/SW/NE/21 147/01(HIN2)) hema(GI: 17223866 loc:AY060041)
 Influenza A virus
 (A/SW/OH/7802/00(H1N2)) hema(GI: 17223874 loc:AY060045)
 Influenza A virus
 (A/swine/Bakum/1 832/2000(HIN2
)) hema(GI:57791765 loc:AY861443)
 Influenza A virus
 (A/swine/Bakum/1833/00(HIN2))
 Influenza A virus (A/swine/Cotes
 d'Armor/1 122/00(HIN2))
 Influenza A virus (A/swine/Cotes
 d'Armor/2433/98(HIN2))
 Influenza A virus (A/swine/Cotes
 d'Armor/604/99(HIN2))
 Influenza A virus (A/swine/Cotes
 d'Armor/790/97(HIN2))
 Influenza A virus (A/swine/Cotes
 d'Armor/799/00 (H1N2))
 Influenza A virus (A/swine/Cotes
 d'Armor/800/00(HIN2))
 Influenza A virus
 (A/swine/England/1 7394/96(HIN2
))
 Influenza A virus
 (A/swine/England/438207/94(HIN
 2))
 Influenza A virus
 (A/swine/England/690421/95(HIN
 2))
 Influenza A virus
 (A/swine/England/72685/96(HIN2
))
 Influenza A virus
 (A/swine/IDT/Bakuml 832/2000(H
 1N2)) hema(GI:56684143 loc:AY701755)
 Influenza A virus
 (A/Swine/Illinois/100084/01
 (H1N2)) hema(GI: 19422090 loc:AF455682)
 Influenza A virus
 (A/Swine/Illinois/100085A/01
 (H1N2)) hema(GI: 19422088 loc:AF455681)
 Influenza A virus
 (A/Swine/Indiana/9K035/99
 (H1N2)) hema(GI:8515423 loc:AF250124)
 Influenza A virus
 (A/Swine/Indiana/P12439/00
 (H1N2)) hema(GI: 19422086 loc:AF455680)
 Influenza A virus
 (A/Swine/Iowa/930/01(H1N2)) hema(GI: 19422084 loc:AF455679)
 Influenza A virus
 (A/swine/Italy/1081/00(HIN2))
 Influenza A virus
 (A/swine/Italy/1521/98(HIN2))
 Influenza A virus
 (A/swine/Italy/1 654- 1/99(H1N2))

Influenza A virus (A/swine/Italy/2064/99(H1N2))		
Influenza A virus (A/swine/Kanagawa/2/78(H1N2))		
Influenza A virus (A/Swine/Korea/CY02/02(H1N2))	hema(GI:24286062 loc:AY129156)	
Influenza A virus (A/Swine/Minnesota/I 713/00/(H1N2))	hema(GI: 16322986 loc:AY052778)	
Influenza A virus (A/Swine/Minnesota/5555 1/00 (H1N2))	hema(GI: 19422082 loc:AF455678)	
Influenza A virus (A/swine/Miyagi/5/03(H1N2))		neura(GI:1 13373914 loc:AB2707520)
Influenza A virus (A/Swine/North Carolina/93523/01 (H1N2))	hema(GI: 19422080 loc:AF455677)	
Influenza A virus (A/Swine/North Carolina/98225/01(H1N2))	hema(GI: 19422078 loc:AF455676)	
Influenza A virus (A/Swine/Ohio/891/01(H1N2))	hema(GI:8885519 loc:AB029393)	
Influenza A virus (A/swine/Pingtung/7- 12/1999(H1N2))		
Influenza A virus (A/swine/Pingtung/92- 2/2003(H1N2))	hema(GI:47176956 loc:AY377936)	
Influenza A virus (A/swine/Scotland/4 10440/94(H1N2))		
Influenza A virus (A/swine/Zhejiang/1/2004(H1N2))	hema(GI:73665370 loc:DQ139320)	
Influenza A virus (A/Switzerland/3 100/2002(H1N2))		
Influenza A virus (A/Texas/7/2001(H1N2))	hema(GI:24850079 loc:AF503476)	
Influenza A virus (A/Turkey/MO/24093/99(H1N2))	hema(GI: 19848287 loc:AY038014)	
Influenza A virus (A/Virginia/20/2003(H1N2))		
Influenza A virus (A/Wisconsin/12/2001(H1N2))	hema(GI:24850073 loc:AF503473)	
Influenza A virus (A/Yokohama/22/2002(H1N2))	hema(GI:38524535 loc:AB126622)	
Influenza A virus (A/Yokohama/47/2002(H1N2))	hema(GI:38524553 loc:AB 126630)	
Influenza A virus (A/duck/Hong Kong/717/1979(H1N3))		
Influenza A virus (A/duck/NZL/160/1976(H1N3))		neura(GI:78097824 loc:CY0057360)
Influenza A virus (A/herring gull/New Jersey/780/86(H1N3))		
Influenza A virus (A/teal/France/2546/2001(H1N3))		
Influenza A virus (A/whale/P.O./19/1976(H1N3))		
Influenza A virus (A/mallard/Alberta/42/1977(H1N6))		
Influenza A virus (A/murre/Alaska/305/1976(H1N6))	hema(GI:1 15279514 loc:CY015163)	
Influenza A virus (A/murre/Alaska/305/76(H1N6))		
Influenza A virus (A/R(pintail/Shimane/324/98- duck/England/1/56)(H1N6))		
Influenza A virus (A/equine/2/1963(H1N8))		neura(GI:324445 loc:FLANAL0)

Influenza A virus
(A/mallard/Ohio/265/1987(H1N9))
Influenza A virus (A/NWS/33HA-
A/tern/Australia/G70C/75NA(HIN
9))
Influenza A virus
(A/NWS/G70C(H1N9)) hema(GI: 1022837 loc:IAU37727)
Influenza A virus
(A/pintail/Shimane/324/98(H1N9)) neura(GI:1 14841180
loc:AB2743050)
Influenza A virus
(A/duck/Ontario/1977(H2N1)) neura(GI:324567 loc:FLANBMC0)
Influenza A virus (A/green wing
teal/Ohio/175/1986(H2N1))
Influenza A virus
(A/JapanxBellamy/57(H2N1)) hema(GI:13182908 loc:AF231354)
Influenza A virus (A/mallard
duck/ALB/323/1988(H2N1)) neura(GI:78058782
loc:CY00393 10)
Influenza A virus (A/mallard
duck/Alberta/323/1988(H2N1)) hema(GI: 115277994
loc:CY0 14558)
Influenza A virus
(A/mallard/Ohio/30/1986(H2N1))
Influenza A virus
(A/mallard/Stralsund/4 1-
6/81(H2N1))
Influenza A virus (A/ruddy
turnstone/Delaware/34/93 (H2N1))
Influenza A virus (A/ruddy
turnstone/Delaware/8 1/1993(H2N 1
))
Influenza A virus (A/ruddy
tumstone/Delaware/81/93 (H2N1))
Influenza A virus (A/semi-
palmated-
sandpiper/Brazil/43/90(H2N1))
Influenza A virus
(A/shorebird/Delaware/1 11/97
(H2N1))
Influenza A virus
(A/Shorebird/Delaware/122/97(H2
N1))
Influenza A virus
(A/shorebird/Delaware/1 38/97
(H2N1))
Influenza A virus
(A/shorebird/Delaware/24/98
(H2N1))
Influenza A virus
(A/Adachi/2/57(H2N2)) hema(GI:221301
loc:FLAHAADA)
Influenza A virus
(A/Adachi/57(H2N2))
Influenza A virus
(A/Albany/1/63(H2N2)) hema(GI:37784919 loc:AY209963)
Influenza A virus
(A/Albany/1/65(H2N2)) hema(GI:37784933 loc:AY209970)
Influenza A virus
(A/Albany/6/58(H2N2)) hema(GI:8927529 loc:AF270723)
Influenza A virus (A/Albany/7/57
(H2N2)) hema(GI:8927523 loc:AF270720)
Influenza A virus (A/Ann
Arbor/6/1960(H2N2))
Influenza A virus (A/Ann
Arbor/6/60(H2N2)) hema(GI:8927525 loc:AF270721)
Influenza A virus
(A/AnnArbor/7/67(H2N2)) hema(GI:3 7784949 loc:AY209978)
Influenza A virus
(A/berkeley/1/1 968(H2N2))
Influenza A virus hema(GI:37784941 loc:AY209974)

(A/Berkeley/1/66(H2N2))	
Influenza A virus	
(A/Berkeley/1/68(H2N2))	hema(GI:37784969 loc:AY209988)
Influenza A virus	
(A/Berkeley/68(H2N2))	
Influenza A virus (A/Berlin/3/64	hema(GI:408514
(H2N2))	loc:FLABLN64HA)
Influenza A virus	
(A/California/1/66(H2N2))	hema(GI:37784943 loc:AY209975)
Influenza A virus	
(A/Canada/1/66(H2N2))	hema(GI:37784945 loc:AY209976)
Influenza A virus	
(A/Canada/720/05(H2N2))	hetna(GI:63054901 loc:DQ0099I7)
Influenza A virus	
(A/Chicken/NY/29878/91 (H2N2))	hema(GI:5442067 loc:AFI 16198)
Influenza A virus	
(A/chicken/Potsdam/4705/84	hema(GI:408670
(H2N2))	loc:FLAPOT84HA)
Influenza A virus	
(A/Chile/13/57(H2N2))	hema(GI:37784897 loc:AY209952)
Influenza A virus (A/Chile/6/57	
(H2N2))	hema(GI:8927539 loc:AF270728)
Influenza A virus	
(A/Cordoba/522/67(H2N2))	hema(GI:37784951 loc:AY209979)
Influenza A virus	
(A/Davis/1/57(H2N2))	hema(GI:8927521 loc:AF270719)
Influenza A virus (A/duck/Hong	hema(GI:408520
Kong/273/78 (H2N2))	loc:FLAHNG78HA)
Influenza A virus (A/EI	
Salvador/2/57 (H2N2))	hema(GI:8927515 loc:AF270716)
Influenza A virus	
(A/ElSalvador/2/57(H2N2))	
Influenza A virus	
(A/England/1/61 (H2N2))	hema(GI:37784903 loc:AY209955)
Influenza A virus	
(A/England/10/67(H2N2))	hema(GI:37784953 loc:AY209980)
Influenza A virus	
(A England/12/64(H2N2))	hema(GI:37784927 loc:AY209967)
Influenza A virus (A/Georgia/ 1/63	
(H2N2))	hema(GI:37784921 loc:AY209964)
Influenza A virus	
(A/Georgia/1/67(H2N2))	hema(GI:37784955 loc:AY209981)
Influenza A virus (A/Great	
Lakes/0389/1965(H2N2))	
Influenza A virus	
(A/GreatLakes/3/63 (H2N2))	hema(GI:37784923 loc:AY209965)
Influenza A virus	
(A/guinea/NJ/3070/91 (H2N2))	hema(GI:408554 loc:FLANJ91HA)
Influenza A virus	
(A/gull/Delaware/475/1986(H2N2)	
)	
Influenza A virus	
(A/Izumi/5/65(H2N2))	
Influenza A virus	
(A/Izumi/5/65(R)(H2N2))	hema(GI:221323 loc:FLAHAIZR)
Influenza A virus	
(A/Japan/I 70/62(H2N2))	hema(GI:377849 U loc:AY209959)
Influenza A virus	hema(GI:3051 14
(A/Japan/305+/1957(H2N2))	loc:FLAHA3055J)
Influenza A virus (A/Japan/305-	hema(GI:305154
/1957(H2N2))	loc:FLAHAJ3055)
Influenza A virus	
(A/Johannesburg/567/67(H2N2))	hema(GI:37784957 loc:AY209982)
Influenza A virus	
(A/Kaizuka/2/65(H2N2))	hema(GI:221327 loc:FLAHAKAI)
Influenza A virus	
(A/Kayano/57(H2N2))	hema(GI:26453382 loc:AB056699)

Influenza A virus (A/Krasnodar/101/59 (H2N2))	hema(GI:408524 loc:FLAKRA59HA)	
Influenza A virus (A/Kumamoto/1/65(H2N2))	hema(GI:221329 loc:FLAHAKUM)	
Influenza A virus (A/Leningrad/134/17/1957(H2N2))		neura(GI:565251 loc:FLANADO)
Influenza A virus (A/Leningrad/134/1957(H2N2))		
Influenza A virus (A/Leningrad/134/47/1957(H2N2))		neura(GI:565253 loc:FLANAEO)
Influenza A virus (A/Leningrad/134/47/57 (H2N2))		
Influenza A virus (A/Leningrad/134/57 (H2N2))	hema(GI:8927517 loc:AF270717)	
Influenza A virus (A/Malaya/16/58(H2N2))	hema(GI:8927531 loc:AF270724)	
Influenza A virus (A/mallard/MN/26/98(H2N2))		
Influenza A virus (A/mallard/MN/27/98(H2N2))		
Influenza A virus (A/mallard/MT/Y61 (H2N2))	hema(GI:408552 loc:FLAMT61HA)	
Influenza A virus (A/mallard/N.Y./6750/1978(H2N2))		
) Influenza A virus (A/mallard/Netherlands/13/99(H2N2))	hema(GI:56425024 loc:AY684893)	
Influenza A virus (A/mallard/New York/6750/1978(H2N2))		neura(GI:324495 loc:FLANAME0)
Influenza A virus (A/mallard/NY/6750/1978(H2N2))		
Influenza A virus (A/mallard/Potsdam/177-4/1983(H2N2))	hema(GI:78097886 loc:CY005765)	
Influenza A virus (A/montevideo/1/1967(H2N2))		
Influenza A virus (A/Montevideo/2208/67(H2N2))	hema(GI:37784965 loc:AY209986)	
Influenza A virus (A/Murakami/4/64(H2N2))	hema(GI:37784929 loc:AY209968)	
Influenza A virus (A/netherlands/84/1968(H2N2))		
Influenza A virus (A/Netherlands/60/62(H2N2))	hema(GI:37784913 loc:AY209960)	
Influenza A virus (A/Netherlands/65/63(H2N2))	hema(GI:37784925 loc:AY209966)	
Influenza A virus (A/NewJersey/3/65(H2N2))	hema(GI:37784937 loc:AY209972)	
Influenza A virus (A/Ohio/2/59 (H2N2))	hema(GI:8927537 loc:AF270727)	
Influenza A virus (A/Okuda/57(H2N2))	hema(GI:221331 loc:FLAHAOKU)	
Influenza A virus (A/Panama/1/61(H2N2))	hema(GI:37784905 loc:AY209956)	
Influenza A virus (A/Panama/1/66(H2N2))	hema(GI:37784947 loc:AY209977)	
Influenza A virus (A/Panama/1/67(H2N2))	hema(GI:37784959 loc:AY209983)	
Influenza A virus (A/Philippines/2/60(H2N2))	hema(GI:37784901 loc:AY209954)	
Influenza A virus (A/Pintail/Praimoric/625/76 (H2N2))	hema(GI:408674 loc:FLAPRA76HA)	
Influenza A virus (A/Pittsburgh/2/65(H2N2))	hema(GI:37784939 loc:AY209973)	
Influenza A virus	hema(GI:37784961 loc:AY209984)	

(A/Poknd/5/67(H2N2))		
Influenza A virus (A/RI/5+/57 (H2N2))	hema(GI:8927527 loc:AF270722)	
Influenza A virus (A/RI/5-/57 (H2N2))	hema(GI:8927519 loc:AF270718)	
Influenza A virus (A/Sao Paolo/3/59 (H2N2))	hema(GI:8927533 loc:AF270725)	
Influenza A virus (A/SaoPaolo/1/61(H2N2))	hema(GI:37784907 loc:AY209957)	
Influenza A virus (A/SaoPaolo/3/59(H2N2))		
Influenza A virus (A/Singapore/1/1957(H2N2))	hema(GI:305170 loc:FLA HAS157A)	
Influenza A virus (A/Taiwan/1/62(H2N2))	hema(GI:37784915 loc:AY209961)	
Influenza A virus (A/Taiwan/1/64(H2N2))	hema(GI:37784931 loc:AY209969)	
Influenza A virus (A/Taiwan/1/67(H2N2))	hema(GI:37784963 loc:AY209985)	
Influenza A virus (A/Texas/1/68(H2N2))		
Influenza A virus (A/Texas/68(H2N2))		
Influenza A virus (A/Tokyo/1967(H2N2))		neura(GI:324571 loc:FLANBME0)
Influenza A virus (A/Tokyo/3/1967(H2N2))		neura(GI: 1480199 loc:FLANAMPO)
Influenza A virus (A/Tokyo/3/67(H2N2))	hema(GI:37784967 loc:AY209987)	
Influenza A virus (A/Victoria/15681/59(H2N2))	hema(GI:8927535 loc:AF270726)	
Influenza A virus (A/Victoria/5/1968(H2N2))		
Influenza A virus (A/JX-7(F1)/(H2N2))		neura(GI:323969 loc:FLA557NA0)
Influenza A virus (A/Yale/1/61(H2N2))	hema(GI:37784909 loc:AY209958)	
Influenza A virus (A/Yokosuka/3/62(H2N2))	hema(GI:37784917 loc:AY209962)	
Influenza A virus (A/Anas acuta/Priniorje/695/1976(H2N3))		
Influenza A virus (A/black duck/New Jersey/1580/78(H2N3))	hema(GI:13182912 loc:AF231356)	
Influenza A virus (A/blue-winged teal/604/1978(H2N3))		neura(GI:324447 loc:FLANALAO)
Influenza A virus (A/duck/Alberta/77/1977(H2N3))		neura(GI:324439 loc:FLANAKAO)
Influenza A virus (A/duck/Germany/I215/1973(H2N3))	hema(GI:15278357 loc:CY014710)	
Influenza A virus (A/duck/Hokkaido/107/01(H2N3))	hema(GI:45272119 loc:AY422014)	
Influenza A virus (A/duck/Hokkaido/17/01(H2N3))	hema(GI:45272121 loc:AY422015)	
Influenza A virus (A/duck/Hokkaido/86/01(H2N3))	hema(GI:45272123 loc:AY422016)	
Influenza A virus (A/duck/Postdam/1689/85(H2N3))		
Influenza A virus (A/laughing gull/Delaware/34/94(H2N3))		
Influenza A virus (A/mallard duck/New York/66861/1978(H2N3))		
Influenza A virus (A/mallard/Alberta/205/98(H2N3))	hema(GI:49357131 loc:AY633196)	
Influenza A virus (A/mallard/Alberta/226/98(H2N3))	hema(GI:49357139 loc:AY633228)	

Influenza A virus (A/mallard/Alberta/353/88 (H2N3))		
Influenza A virus (A/mallard/Italy/35/1 999(H2N3))		
Influenza A virus (A/mallard/Italy/36/1999(H2N3))		
Influenza A virus (A/mallard/Missouri/MO34/2005(H2N3))		
Influenza A virus (A/matlard/MN/5 1/98(H2N3))		
Influenza A virus (A/Mallard/New York/66861/78 (H2N3))	hema(GI:5442075 loc:AF 116202)	
Influenza A virus (A/mailard/Ontario/56/76 (H2N3))	hema(GI:408600 loc:FLAONT76HA)	
Influenza A virus (A/Peking duck/Potsdam/1689-4/85(H2N3))		
Influenza A virus (A/Pintail duck/Alfaerta/21 1/80 (H2N3))	hema(GI:5442079 loc:AFI 16204)	
Influenza A virus (A/Pintail duck/Alberta/293/77 (H2N3))	hema(GI:5442077 loc:AFI 16203)	
Influenza A virus (A/pintail/Primorie/625/76(H2N3))		
Influenza A virus (A/silkiechicken/Pennsylvania/897/ 96(H2N3))		
Influenza A virus (A/Silky chicken/PA/9600897/96 (H2N3))	hema(GI:5442069 loc:AFI 16199)	
Influenza A virus (A/mallard/Alberta/202/1996(H2N 5))		
Influenza A virus (A/mallard/Alberta/884/1984(H2N 5))		
Influenza A virus (A/tern/Australia/1/04(H2N5))	neura(GI: 110816474 loc:DQ8624740)	
Influenza A virus (A/tern/Australia/1363/2004(H2N5)	neura(GI: 115499986 loc:AB2756300)	
Influenza A virus (A/tern/Australia/ 1378/2004(H2N5)	neura(GI: 115499968 loc:AB2756220)	
Influenza A virus (A/tern/Australia/1 390/2004(H2N5)	neura(GI: 115499994 loc:AB2756140)	
Influenza A virus (A/tern/Australia/1402/2004(H2N5)	neura(GI: 115500024 loc:AB2754080)	
Influenza A virus (A/tern/Australia/9 1/2004(H2N5))	neura(GI: 115529184 loc:AB2758630)	
Influenza A virus (A/mallard/Ohio/669/2002(H2N6))		
Influenza A virus (A/laughing gull/New Jersey/798/86 (H2N7))		
Influenza A virus (A/gull/MD/19/77 (H2N8))	hema(GI:408526 loc:FLAMD77HA)	
Influenza A virus (A/herring gull/DE/677/1988(H2N8))		neura(GI:305205 loc:FLANADE0)
Influenza A virus (A/Ruddy turnstone/DE/142/98 (H2N8))	hema(GI:5442083 loc:AF 116206)	
Influenza A virus (A/blue-winged teal/Alberta/16/97 (H2N9))		
Influenza A virus (A/duck/GDR/72 (H2N9))	hema(GI:408518 loc:FLAGDR72HA)	
Influenza A virus (A/Duck/Nanchang/2-	hema(GI:27465218 loc:AY 180399)	

0485/2000(H2N9))		
Influenza A virus (A/duck/Nanchang/2-0486/2000(H2N9))	hema(GI:1 15278126 loc:CY014608)	
Influenza A virus (A/Duck/Nanchang/2-0492/2000(H2N9))	hema(GI:27465216 loc:AY180398)	
Influenza A virus (A/Duck/Nanchang/3-090/2000(H2N9))	hema(GI:27465226 loc:AY1 80403)	
Influenza A virus (A/duck/Nanchang/4-184/2000(H2N9))	hema(GI: 115278 128 loc:CY014609)	
Influenza A virus (A/Duck/Nanchang/4-190/2000(H2N9))	hema(GI:27465224 loc:AY 180402)	
Influenza A virus (A/gull/Maryland/19/1977(H2N9))		neura(GI: 115278210 loc:CY0 146470)
Influenza A virus (A/gull/MD/19/1977(H2N9))		
Influenza A virus (A/herring gull/DE/670/1988(H2N9))		
Influenza A virus (A/herring gull/Delaware/670/1988(H2N9))	hema(GI:1 15277990 loc:CY014556)	
Influenza A virus (A/Laughing gull/New Jersey/75/85 (H2N9))	hema(GI:5442073 loc:AFI 16201)	
Influenza A virus (A/mallard/Alberta/205/98 (H2N9))		
Influenza A virus (A/pintail/Alberta/22/97(H2N9))	hema(GI:49357173 loc:AY633364)	
Influenza A virus (A/teal/Alberta/16/97(H2N9))	hema(GI:49357179 loc:AY633388)	
Influenza A virus (A/duck/New Zealand/76/84(H3NI))		
Influenza A virus (A/mallard duck/ALB/25/1976(H3NI))		
Influenza A virus (A/mallard/Ohio/181/1986(H3NI))		
Influenza A virus (A/mynah/Haneda- Thai/1976(H3N1))		
Influenza A virus (A/swine/Changhua/72-10 clone B5/2003(H3NI))	hema(GI:40794681 loc:AY377933)	
Influenza A virus (A/swine/Chiai/77- 10/2001(H3NI))	hema(GI:47176943 loc:AY377924)	
Influenza A virus (A/Aichi/104/2006(H3N2))	hema(GI:95 102003 loc:AB259107)	
Influenza A virus (A/Aichi/108/2006(H3N2))	hema(GI:95 102005 loc:AB259108)	
Influenza A virus (A/Aichi/122/2006(H3N2))	hema(GI:95 102007 loc:AB259109)	
Influenza A virus (A/Aichi/1 33/2005(H3N2))	hema(GI:83423476 loc:AB243873)	
Influenza A virus (A/Aichi/134/2006(H3N2))	hema(GI:95 102009 loc:AB2591 10)	
Influenza A virus (A/Aichi/14/2006(H3N2))	hema(GI:99651 186 loc:AB259740)	
Influenza A virus (A/Aichi/143/2005(H3N2))	hema(GI:83423474 loc:AB243872)	
Influenza A virus (A/Aichi/145/2005(H3N2))	hema(GI:83423472 loc:AB243871)	
Influenza A virus (A/Aichi/164/2005(H3N2))	hema(GI:83423470 loc:AB243870)	

Influenza A virus (A/Aichi/165/2005(H3N2))	hema(GI:83423468 loc:AB243869)
Influenza A virus (A/Aichi/166/2005(H3N2))	hema(GI:83423466 loc:AB243868)
Influenza A virus (A/Aichi/167/2005(H3N2))	hema(GI:83423464 loc:AB243867)
Influenza A virus (A/Aichi/173/2006(H3N2))	hema(GI:9965I 191 loc:AB259741)
Influenza A virus (A/Aichi/174/05(H3N2))	hema(GI:83696380 loc:CS228475)
Influenza A virus (A/Aichi/174/2005(H3N2))	
Influenza A virus (A/Aichi/185/2005(H3N2))	hema(GI:99651 159 loc:AB259739)
Influenza A virus (A/Aichi/188/2005(H3N2))	hema(GI:95101991 loc:AB259101)
Influenza A virus (A/Aichi/19/2006(H3N2))	hema(GI:95 101999 loc:AB259105)
Influenza A virus (A/Aichi/197/2005(H3N2))	hema(GI:95101993 loc:AB259102)
Influenza A virus (A/Aichi/2/68(H3N2))	
Influenza A virus (A/Aichi/2/94(H3N2))	hema(GI:8 100084 loc:AB043708)
Influenza A virus (A/Aichi/2 11/2006(H3N2))	hema(GI:9510201 1 loc:AB2591 11)
Influenza A virus (A/Aichi/2 13/2006(H3N2))	hema(GI:95102013 loc:AB2591 12)
Influenza A virus (A/Aichi/4/93(H3N2))	hema(GI:8100082 loc:AB043707)
Influenza A virus (A/Aichi/69/1994(H3N2))	
Influenza A virus (A/Aichi/7/2006(H3N2))	hema(GI:95101995 loc:AB259103)
Influenza A virus (A/Aichi/80/2006(H3N2))	hema(GI:95 102001 loc:AB259106)
Influenza A virus (A/Aichi/9/2006(H3N2))	hema(GI:95101997 loc:AB259104)
Influenza A virus (A/Akita/1/1995(H3N2))	
Influenza A virus (A/Akita/1/94(H3N2))	hema(GI:2271374 loc:AF008825)
Influenza A virus (A/Akita/4/93(H3N2))	hema(GI:49339280 loc:AY661 155)
Influenza A virus (A/Alabama/1/1981(H3N2))	hema(GI:324103 loc:FLAHAB)
Influenza A virus (A/Alaska/1/69(H3N2))	
Influenza A virus (A/Alaska/10/95(H3N2))	hema(GI:2271220 loc:AF008748)
Influenza A virus (A/Alaska/16/95(H3N2))	hema(GI:2271212 loc:AF008744)
Influenza A virus (A/Alaska/18/93(H3N2))	hema(GI:2275416 loc:AF008838)
Influenza A virus (A/Alaska/2/96(H3N2))	hema(GI:2271 170 loc:AF008723)
Influenza A virus (A/Alaska/6/1977(H3N2))	
Influenza A virus (A/Alaska/84(H3N2))	hema(GI:2275466 loc:AF008863)
Influenza A virus (A/Alaska/9/92(H3N2))	hema(GI:2271352 loc:AF008814)
Influenza A virus (A/Amsterdam/I 609/77(H3N2))	hema(GI:49339060 loc:AY661045)
Influenza A virus (A/Amsterdam/41 12/92(H3N2))	hema(GI:49339200 loc:AY661 115)
Influenza A virus (A/Anas	

acuta/Primorje/695/79(H3N2))	
Influenza A virus (A/Ann Arbor/3/93(H3N2))	hema(GI:2275412 loc:AF008836)
Influenza A virus (A/Argentina/207/96(H3N2))	hema(GI:6552534 loc:AF180591)
Influenza A virus (A/Argentina/3 105/93(H3N2))	hema(GI:2271378 loc:AF008827)
Influenza A virus (A/Argentina/3779/94(H3N2))	hema(GI:2271304 loc:AF008790)
Influenza A virus (A/Argentina/39/96(H3N2))	hema(GI:6552549 loc:AF180606)
Influenza A virus (A/Argentina/4057/95(H3N2))	hema(GI:2271252 loc:AF008764)
Influenza A virus (A/Argentina/601/96(H3N2))	hema(GI:6552533 loc:AF 180590)
Influenza A virus (A/Ashburton/280/2004(H3N2))	
Influenza A virus (A/Asuncion/918/2001(H3N2))	
Influenza A virus (A/Athens/1/98 (H3N2))	hema(GI:1223 1911 loc:AF3 15571)
Influenza A virus (A/Athens/135/99 (H3N2))	hema(GI:12231901 loc:AF315566)
Influenza A virus (A/Athens/ 16/98 (H3N2))	hema(GI: 1223 1990 loc:AF3 16820)
Influenza A virus (A/Athens/2/97 (H3N2))	hema(GI: 1223 1905 loc:AF315568)
Influenza A virus (A/Athens/2/98 (H3N2))	hema(GI: 1223 1984 loc:AF3 16817)
Influenza A virus (A/Athens/23/97 (H3N2))	hema(GI:12231909 loc:AF3 15570)
Influenza A virus (A/Athens/7/98 (H3N2))	hema(GI:12231986 loc:AF3 16818)
Influenza A virus (A/Athens/76/98 (H3N2))	hema(GI: 1223 1889 loc:AF3 15560)
Influenza A virus (A/Athens/8/97 (H3N2))	
Influenza A virus (A/Athens/94/98 (H3N2))	hema(GI: 1223 1891 loc:AF3 15561)
Influenza A virus (A/Atlanta/2 11/89(H3N2))	hema(GI:493391 12 loc:AY661071)
Influenza A virus (A/Auckland/10/97(H3N2))	hema(GI:49339372 loc:AY661201)
Influenza A virus (A/Auckland/108/96(H3N2))	hema(GI:6552572 loc:AF180629)
Influenza A virus (A/Auckland/5/96(H3N2))	hema(GI:2271 152 loc:AF008714)
Influenza A virus (A/Auckland/5/97(H3N2))	hema(GI:6552521 loc:AF1 80578)
Influenza A virus (A/Auckland/9/96(H3N2))	hema(GI:2271 154 loc:AF008715)
Influenza A virus (A/Bangkok(H3N2))	
Influenza A virus (A/Bangkok/1/97(H3N2))	hema(GI:6552573 loc:AF180630)
Influenza A virus (A/Bangkok/122/94(H3N2))	hema(GI:2271308 loc:AF008792)
Influenza A virus (A/Bangkok/139/90(H3N2))	hema(GI:762864 loc:FLAH3N2G)
Influenza A virus (A/Bangkok/144/90(H3N2))	hema(GI:762865 loc:FLAH3N2H)
Influenza A virus (A/Bangkok/235/89(H3N2))	hema(GI:762861 loc:FLAH3N2D)
Influenza A virus (A/Bangkok/25(H3N2))	
Influenza A virus (A/Bangladesh/C5-	hema(GI:77023772 loc:DQ179512)

12/2003(H3N2))	
Influenza A virus (A/Bangladesh/C5- 13/2003(H3N2))	hema(GI:77023774 ioc:DQ179513)
Influenza A virus (A/Bangladesh/C5- 15/2003(H3N2))	hema(GI:77023778 loc:DQ179515)
Influenza A virus (A/Bangladesh/C5- 16/2003(H3N2))	hema(GI:77023780 loc:DQ179516)
Influenza A virus (A/Bangladesh/C5- 17/2003(H3N2))	hema(GI:77023782 loc:DQ179517)
Influenza A virus (A/Bangladesh/C5- 18/2003(H3N2))	hema(GI:77023784 loc:DQ179518)
Influenza A virus (A/Bangladesh/C5- 19/2003(H3N2))	hema(GI:77023786 loc:DQ179519)
Influenza A virus (A/Bangladesh/C5- 20/2003(H3N2))	hema(GI:77023788 loc:DQ179520)
Influenza A virus (A/Bangladesh/C5- 21/2003(H3N2))	hema(GI:77023790 loc:DQ179521)
Influenza A virus (A/Bangladesh/C5- 22/2003(H3N2))	hema(GI:77023792 loc:DQ179522)
Influenza A virus (A/Bangladesh/C5- 23/2003(H3N2))	hema(GI:77023794 loc:DQ179523)
Influenza A virus (A/Bangladesh/C5- 24/2003(H3N2))	hema(GI:77023796 loc:DQ179524)
Influenza A virus (A/Bangladesh/C5- 25/2003(H3N2))	hema(GI:77023798 loc:DQ179525)
Influenza A virus (A/Bangladesh/C5- 26/2003(H3N2))	hema(GI:77023800 loc:DQ179526)
Influenza A virus (A/Bangladesh/C5- 27/2003(H3N2))	hema(GI:77023802 loc:DQ179527)
Influenza A virus (A/Bangladesh/C5-6/2002(H3N2))	hema(GI:77023760 loc:DQ179506)
Influenza A virus (A/Bay of Plenty/279/2004(H3N2))	hema(GI:83744587 loc:CY007291)
Influenza A virus (A/Bay of Plenty/332/2004(H3N2))	hema(GI:83744606 loc:CY007299)
Influenza A virus (A/Bay of Plenty/383/2004(H3N2))	hema(GI:83752202 loc:CY0073 15)
Influenza A virus (A/Baylor 1A/81(H3N2))	hema(GI:18139803 loc:AF405206)
Influenza A virus (A/Baylor1B/83(H3N2))	hema(GI:18139805 loc:AF405207)
Influenza A virus (A/Baylor2A/81(H3N2))	hema(GI: 18 139807 loc:AF405208)
Influenza A virus (A/Baylor2B/Texas/25887/83/(H3 N2))	hema(GI:2275472 loc:AF008866)
Influenza A virus (A/Baylor3A/83(H3N2))	hema(GI: 18 139809 loc:AF405209)
Influenza A virus (A/Baylor3B/Texas/24753/85(H3N 2))	hema(GI:2275522 loc:AF008891)
Influenza A virus (A/Baylor4A/83(H3N2))	hema(GI: 1813981 1 loc:AF405210)

Influenza A virus (A/Baylor4B/Texas/39989/88(H3N2))	hema(GI:2275554 loc:AF008907)	
Influenza A virus (A/Baylor5A/Texas/12764/83(H3N2))	hema(GI:2275528 loc:AF008894)	
Influenza A virus (A/Baylor5B/85(H3N2))	hema(GI: 18139813 loc:AF405211)	
Influenza A virus (A/Baylor6A/Texas/12835/83(H3N2))	hema(Gr.2275462 loc:AF008861)	
Influenza A virus (A/Baylor6B/Texas/25784/85(H3N2))	hema(GI:2275524 loc:AF008892)	
Influenza A virus (A/Beijin/352/1989(H3N2))	hema(GI:603790 loc:FLAHA)	
Influenza A virus (A/Beijing/1/1968(H3N2))		
Influenza A virus (A/Beijing/1/68(H3N2))		neura(GI:85816056 loc:CY0081580)
Influenza A virus (A/Beijing/17/97(H3N2))	hema(GI:6552552 loc:AFI 80609)	
Influenza A virus (A/Beijing/244/96(H3N2))	hema(GI:6552529 loc:AF180586)	
Influenza A virus (A/Beijing/281/94(H3N2))	hema(GI:2271248 loc:AF008762)	
Influenza A virus (A/Beijing/32/1992(H3N2))	hema(GI:857407 loc:IAU26830)	
Influenza A virus (A/Beying/32/92(H3N2))	hema(GI:2271348 loc:AF008812)	
Influenza A virus (A/Beijing/337/1989(H3N2))		
Influenza A virus (A/Beijing/337/89 (H3N2))		
Influenza A virus (A/Beijing/352/1989(H3N2))		
Influenza A virus (A/Beijing/353/89(H3N2))	hema(GI:2271092 loc:AF008684)	
Influenza A virus (A/Beijing/39/1975(H3N2))		
Influenza A virus (A/Beijing/39/75(H3N2))		
Influenza A virus (A/Beijing/4/1989(H3N2))		
Influenza A virus (A/Beijing/4/89(H3N2))	hema(GI:2271064 loc:AF008670)	
Influenza A virus (A/Beijing/46/92(H3N2))	hema(GI:2271350 loc:AF008813)	
Influenza A virus (A/Beijing/47/92(H3N2))	hema(GI:2271 120 loc:AF008698)	
Influenza A virus (A/Beijing/57/89(H3N2))	hema(GI:2271048 loc:AF008662)	
Influenza A virus (A/Beijing/62/97(H3N2))	hema(GI:6552551 loc:AFI 80608)	
Influenza A virus (A/Belgium/C2-11/2002(H3N2))	hema(GI:77023564 loc:DQ179408)	
Influenza A virus (A/Belgium/C2-15/2002(H3N2))	hema(GI:77023572 loc:DQ179412)	
Influenza A virus (A/Belgium/C2-2/2002(H3N2))	hema(GI:77023546 loc:DQI 79399)	
Influenza A virus (A/Belgium/C2-3/2002(H3N2))	hema(GI:77023548 loc:DQI 79400)	
Influenza A virus (A/Belgiutn/C2~8/2002(H3N2))	hema(GI:77023558 loc:DQ 179405)	
Influenza A virus (A/Berlin/6/88(H3N2))		
Influenza A virus	hema(GI:49339000 loc:AY661015)	

(A/Bilthoven/1 0684/82(H3N2))	
Influenza A virus	
(A/Bilthoven/15793/68(H3N2))	hema(GI:49339046 loc:AY661038)
Influenza A virus	
(A/Bilthoven/ 16 190/68(H3N2))	hema(GI:49339048 loc:AY661039)
Influenza A virus	
(A/Bilthoven/1 6398/68(H3N2))	hema(GI:49338952 loc:AY660991)
Influenza A virus	
(A/Bilthoven/1 76 1/76(H3N2))	hema(GI:49338982 loc:AY661006)
Influenza A virus	
(A/Bilthoven/1 7938/69(H3N2))	hema(GI:49338956 loc:AY660993)
Influenza A virus	
(A/Bilthoven/21438/71(H3N2))	hema(GI:49338964 loc:AY660997)
Influenza A virus	
(A/Bilthoven/21793/72(H3N2))	hema(GI:49339052 loc:AY661041)
Influenza A virus	
(A/Bilthoven/2 1801/71 (H3N2))	hema(GI:49338966 loc:AY660998)
Influenza A virus	
(A/Bilthoven/2271/76(H3N2))	hema(GI:49338984 loc:AY661007)
Influenza A virus	
(A/Bilthoven/23290/72(H3N2))	hema(GI:49338970 loc:AY661000)
Influenza A virus	
(A/Bilthoven/23337/72(H3N2))	hema(GI:49338972 loc:AY661001)
Influenza A virus	
(A/Bilthoven/2600/75(H3N2))	hema(GI:49339056 loc:AY661043)
Influenza A virus	
(A/Bilthoven/2668/70(H3N2))	hema(GI:49338960 loc:AY660995)
Influenza A virus	
(A/Bilthoven/2813/75(H3N2))	hema(GI:49339026 loc:AY661028)
Influenza A virus	
(A/Bilthoven/3517/73(H3N2))	hema(GI:49338978 loc:AY661004)
Influenza A virus	
(A/Bilthoven/3895/77(H3N2))	hema(GI:49338992 loc:AY661011)
Influenza A virus	
(A/Bilthoven/479 1/81(H3N2))	hema(GI:49338998 loc:AY661014)
Influenza A virus	
(A/Bilthoven/5029/76(H3N2))	hema(GI:49338986 loc:AY661008)
Influenza A virus	
(A/Bilthoven/5 146/74(H3N2))	hema(GI:49339006 loc:AY661018)
Influenza A virus	
(A/Bilthoven/552/73(H3N2))	hema(GI:49338974 loc:AY661002)
Influenza A virus	
(A/Bilthoven/5657/76(H3N2))	hema(GI:49338988 loc:AY661009)
Influenza A virus	
(A/Bilthoven/5930/74(H3N2))	hema(GI:49339054 loc:AY661042)
Influenza A virus	
(A/Bilthoven/593 1/74(H3N2))	hema(GI:49339004 loc:AY661017)
Influenza A virus	
(A/Bilthoven/6022/72(H3N2))	hema(GI:49338968 loc:AY660999)
Influenza A virus	
(A/Bilthoven/628/76(H3N2))	hema(GI:49339058 loc:AY661044)
Influenza A virus	
(A/Bilthoven/6449/71(H3N2))	hema(GI:49338962 loc:AY660996)
Influenza A virus	
(A/Bilthoven/6545/76(H3N2))	hema(GI:49338990 loc:AY661010)
Influenza A virus	
(A/Bilthoven/7398/74(H3N2))	hema(GI:49339024 loc:AY661027)
Influenza A virus	
(A/Bilthoven/748/73(H3N2))	hema(GI:49338976 loc:AY661003)
Influenza A virus	
(A/Bilthoven/808/69(H3N2))	hema(GI:49339050 loc:AY661040)
Influenza A virus	
(A/Bilthoven/908/69(H3N2))	hema(GI:49338954 loc:AY660992)
Influenza A virus	
(A/Bilthoven/93/70(H3N2))	hema(GI:49338958 loc:AY660994)
Influenza A virus	
(A/Bilthoven/9459/74(H3N2))	hema(GI:49338980 loc:AY661005)

Influenza A virus (A/blue wing teal/Ohio/3 1/1999(H3N2))	
Influenza A virus (A/blue wing teal/Ohio/908/2002(H3N2))	
Influenza A virus (A/Bratislava/6/97(H3N2))	
Influenza A virus (A/Brazil/003/00(H3N2))	hema(GI:84796560 loc:DQ336007)
Influenza A virus (A/Brazil/006/00(H3N2))	hema(GI:84796576 loc:DQ336015)
Influenza A virus (A/Brazil/008/00(H3N2))	hema(GI:84796568 loc:DQ33601 1)
Influenza A virus (A/Brazil/009/00(H3N2))	hema(GI:84796574 loc:DQ336014)
Influenza A virus (A/Brazil/010/00(H3N2))	hema(GI:84796572 loc:DQ336013)
Influenza A virus (A/Brazil/01 1/00(H3N2))	hema(GI:84796578 loc:DQ336016)
Influenza A virus (A/Brazil/012/00(H3N2))	hema(GI:84796564 loc:DQ336009)
Influenza A virus (A/Brazil/013/00(H3N2))	hema(GI:84796580 loc:DQ336017)
Influenza A virus (A/Brazil/015/00(H3N2))	hema(GI:84796570 loc:DQ336012)
Influenza A virus (A/Brazil/02/91(H3N2))	hema(GI:487680 loc:FLASPHI)
Influenza A virus (A/Brazil/024/00(H3N2))	hema(GI:84796566 loc:DQ336010)
Influenza A virus (A/Brazil/049/0 ü(H3N2))	hema(GI:84796562 loc:DQ336008)
Influenza A virus (A/Brazil/1 25/0 1(H3N2))	hema(GI:84796582 loc:DQ336006)
Influenza A virus (A/Brazil/18/96(H3N2))	hema(GI:2271 188 loc:AF008732)
Influenza A virus (A/Brazil/1 84/96(H3N2))	hema(GI:6552603 loc:AF180660)
Influenza A virus (A/Brazil/2/95(H3N2))	hema(GI:2271192 loc:AF008734)
Influenza A virus (A/Brazil/3/96(H3N2))	hema(GI:6552601 loc:AF 180658)
Influenza A virus (A/Brazil/309/96(H3N2))	hema(GI:6552594 loc:AF180651)
Influenza A virus (A/Brazil/43/97(H3N2))	hema(GI:6552592 loc:AF180649)
Influenza A virus (A/Brazil/45/96(H3N2))	hema(GI:6552602 loc:AF180659)
Influenza A virus (A/Brazil/51/97(H3N2))	hema(GI:6552591 loc:AF180648)
Influenza A virus (A/Brazil/597/96(H3N2))	hema(GI:6552604 loc:AF180661)
Influenza A virus (A/Brazil/8/96(H3N2))	hema(GI:2271 190 loc:AF008733)
Influenza A virus (A/Brazil/87/96(H3N2))	hema(GI:6552600 loc:AF180657)
Influenza A virus (A/Brazil/91(H3N2))	hema(GI:2271098 loc:AF008687)
Influenza A virus (A/Brisbane/22/96(H3N2))	hema(GI:2271 164 loc:AF008720)
Influenza A virus (A/Brisbane/234/2005(H3N2))	hema(GI: 110825882 loc:DQ865969)
Influenza A virus (A/Brisbane/35/96(H3N2))	hema(GI:2271 156 loc:AF008716)
Influenza A virus (A/Brisbane/8/96(H3N2))	hema(GI:49339364 loc:AY661 197)
Influenza A virus (A/Buenos Aires/32/96(H3N2))	hema(GI:33329986 loc:AF534024)
Influenza A virus (A/Buenos Aires/32/96(H3N2))	hema(GI:33329984 loc:AF534023)

Aires/37/96(H3N2))	
Influenza A virus (A/Buenos Aires/4057/95(H3N2))	hema(GI:33329964 loc:AF534013)
Influenza A virus (A/Buenos Aires/4064/95(H3N2))	hema(GI:33329966 loc:AF534014)
Influenza A virus (A/Buenos Aires/4065/95(H3N2))	hema(GI:33329968 loc:AF534015)
Influenza A virus (A/Buenos Aires/4084/95(H3N2))	hema(GI:33329970 loc:AF534016)
Influenza A virus (A/Buenos Aires/4098/95(H3N2))	hema(GI:33329972 loc:AF534017)
Influenza A virus (A/Buenos Aires/4102/95(H3N2))	hema(GI:33329974 loc:AF534018)
Influenza A virus (A/Buenos Aires/4459/96(H3N2))	hema(GI:33329976 loc:AF534019)
Influenza A virus (A/Buenos Aires/4534/96(H3N2))	hema(GI:33329978 loc:AF534020)
Influenza A virus (A/Buenos Aires/4559/96(H3N2))	hema(GI:33329980 loc:AF534021)
Influenza A virus (A/Buenos Aires/4634/96(H3N2))	hema(GI:33329982 loc:AF534022)
Influenza A virus (A/Buenos Aires/722/01(H3N2))	hema(GI:33330050 loc:AF534056)
Influenza A virus (A/Buenos Aires/M14/99(H3N2))	hema(GI:33330006 loc:AF534034)
Influenza A virus (A/Buenos Aires/M6/99(H3N2))	hema(GI:33330002 loc:AF534032)
Influenza A virus (A/Buenos Aires/M7/99(H3N2))	hema(GI:33330004 loc:AF534033)
Influenza A virus (A/Buenos Aires/T28/98(H3N2))	hema(GI:22536013 loc:AF533712)
Influenza A virus (A/Buenos Aires/V191/98(H3N2))	hema(GI:22536015 loc:AF533713)
Influenza A virus (A/Buenos Aires/V235/98(H3N2))	hema(GI:22536017 loc:AF533714)
Influenza A virus (A/Busan/7/1995(H3N2))	
Influenza A virus (A/Caen/1/84(H3N2))	hema(GI:2275474 loc:AF008867)
Influenza A virus (A/California/10/97(H3N2))	hema(GI:6552584 loc:AF180641)
Influenza A virus (A/Califorπua/13/96(H3N2))	hema(GI:6552579 loc:AF180636)
Influenza A virus (A/California/271/92(H3N2))	hema(GI:2271358 loc:AF008817)
Influenza A virus (A/Califomia/4/94(H3N2))	hema(GI:2275450 loc:AF008855)
Influenza A virus (A/California/5/93(H3N2))	hema(GI:2275406 loc:AF008833)
Influenza A virus (A/California/5/95(H3N2))	hema(GI:2271302 loc:AF008789)
Influenza A virus (A/California/7/2004(H3N2))	hema(GI:110825890 loc:DQ865973)
Influenza A virus (A/Cambodia/9/2005(H3N2))	hema(GI:110825884 loc:DQ865970)
Influenza A virus (A/Canada/101/97(H3N2))	hema(GI:6552590 loc:AF180647)
Influenza A virus (A/Canada/10679/97(H3N2))	hema(GI:6552520 loc:AF180577)
Influenza A virus (A/Canada/124/95(H3N2))	hema(GI:2271282 loc:AF008779)
Influenza A virus (A/Canada/147/95(H3N2))	hema(GI:2271244 loc:AF008760)
Influenza A virus (A/Canada/177/96(H3N2))	hema(GI:2271200 loc:AF008738)
Influenza A virus (A/Canada/2/70(H3N2))	

Influenza A virus (A/Canada/2/97(H3N2))	hema(GI:6552519 loc:AF180576)	
Influenza A virus (A/Canada/228/68(H3N2))		
Influenza A virus (A/Canada/27/96(H3N2))	hema(GI:2271208 loc:AF008742)	
Influenza A virus (A/Canada/333 12/99(H3N2))	hema(GI:213 14288 loc:AF501516)	
Influenza A virus (A/Canada/34300/99(H3N2))		
Influenza A virus (A/Canada/6 1/96(H3N2))	hema(GI:2271 194 loc:AF008735)	
Influenza A virus (A/canberra grammar/1977(H3N2))		
Influenza A virus (A/Canberra/1/9 1(H3N2))	hema(GI:49339122 loc:AY661076)	
Influenza A virus (A/Canberra/5/97(H3N2))	hema(GI:6552525 loc:AF180582)	
Influenza A virus (A/Canberra/9/97(H3N2))	hema(GI:6552515 loc:AF 180572)	
Influenza A virus (A/Canterbury/0 1/2002(H3N2))		
Influenza A virus (A/Canterbury/0 1/2005(H3N2))		
Influenza A virus (A/Canterbury/02/2002(H3N2))		
Influenza A virus (A/Canterbury/02/2005(H3N2))		
Influenza A virus (A/Canterbury/03/2005(H3N2))		
Influenza A virus (A/Canterbury/04/2002(H3N2))		
Influenza A virus (A/Canterbury/05/2002(H3N2))		
Influenza A virus (A/Canterbury/06/2001(H3N2))	neura(GI:90571596 loc:CY0099500)	
Influenza A virus (A/Canterbury/06/2002(H3N2))	neura(GI:858381 14 loc:CY0082620)	
Influenza A virus (A/Canterbury/07/200 1(H3N2))	neura(GI:89781 151 loc:CY0095580)	
Influenza A virus (A/Canterbury/09/2002(H3N2))	neura(GI:85838095 loc:CY0082700)	
Influenza A virus (A/Canterbury/I 0/200 1(H3N2))	neura(GI: 897792 11 loc:CY0093980)	
Influenza A virus (A/Canterbury/10/2002(H3N2))	neura(GI:858 16240 loc:CY0082780)	
Influenza A virus (A/Canterbury/100/2004(H3N2))		
Influenza A virus (A/Canterbury/1 01/2000(H3N2))	neura(GI:86834463 loc:CY0088460)	
Influenza A virus (A/Canterbury/101/2004(H3N2))		
Influenza A virus (A/Canterbury/I 02/2002(H3N2))		
Influenza A virus (A/Canterbury/I 02/2004(H3N2))		
Influenza A virus (A/Canterbury/ 103/2000(H3N2))	neura(GI:86840074 loc:CY0088380)	
Influenza A virus (A/Canterbury/I 03/2004(H3N2))		
Influenza A virus (A/Canterbury/ 104/2004(H3N2))		
Influenza A virus (A/Canterbury/104/2005(H3N2))	neura(GI:85833234 loc:CY0083580)	
Influenza A virus (A/Canterbury/105/2004(H3N2))		
Influenza A virus	neura(GI:87043044)	

(A/Canterbury/1 05/2005(H3N2))	100^0085580)
Influenza A virus	
(A/Canterbury/106/2004(H1N1))	
Influenza A virus	
(A/Canterbury/107/2004(H3N2))	
Influenza A virus	
(A/Canterbury/108/2004(H3N2))	
Influenza A virus	
(A/Canterbury/109/2004(H3N2))	
Influenza A virus	
(A/Canterbury/1 1/2004(H3N2))	
Influenza A virus	
(A/Canterbury/12/2004(H3N2))	
Influenza A virus	neura(GI:89 112246
(A/Canterbury/1 24/2005(H3N2))	loc:CY0090460)
Influenza A virus	neura(GI:90571558
(A/Canterbury/1 25/2005(H3N2))	loc:CY0099340)
Influenza A virus	
(A/Canterbury/127/2005(H3N2))	
Influenza A virus	
(A/Canterbury/129/2005(H3N2))	
Influenza A virus	
(A/Canterbury/13/2002(H3N2))	
Influenza A virus	
(A/Canterbury/1 4/2002(H3N2))	
Influenza A virus	neura(GI:89781837
(A/Canterbury/ 140/200 1(H3N2))	loc:CY0095900)
Influenza A virus	neura(GI:89788032
(A/Canterbury/146/2001(H3N2))	loc:CY0098540)
Influenza A virus	neura(GI:89779306
(A/Canterbury/149/2001(H3N2))	loc:CY0094380)
Influenza A virus	neura(GI:85838076
(A/Canterbury/1 5/2002(H3N2))	loc:CY0082860)
Influenza A virus	
(A/Canterbury/16/2002(H3N2))	
Influenza A virus	
(A/Canterbury/16/2004(H3N2))	
Influenza A virus	
(A/Canterbury/16/2005(H3N2)»	
Influenza A virus	
(A/Canterbury/166/2005(H3N2))	
Influenza A virus	neura(GI:85833081
(A/Canterbury/17/2000(H3N2))	loc:CY0084780)
Influenza A virus	
(A/Canterbury/1 7/2004(H3N2))	
Influenza A virus	neura(GI:891 13391
(A/Canterbury/1 79/1999(H3N2))	loc:CY0091 I00)
Influenza A virus	
(A/Canterbury/1 8/2002(H3N2))	
Influenza A virus	
(A/Canterbury/1 8/2004(H3N2))	
Influenza A virus	neura(GI:85816388
(A/Canterbury/1 86/2005(H3N2))	loc:CY0083660)
Influenza A virus	
(A/Canterbury/19/2002(H3N2))	
Influenza A virus	
(A/Canterbury/19/2004(H3N2))	
Influenza A virus	neura(GI:89 113410
(A/Canterbury/2/2000(H3N2))	loc:CY0091180)
Influenza A virus	
(A/Canterbury/20/2002(H3N2))	
Influenza A virus	
(A/Canterbury/20/2004(H3N2))	
Influenza A virus	
(A/Canterbury/20/2005(H3N2))	neura(GI:85833272
Influenza A virus	loc:CY0083420)
(A/Canterbury/200/2004(H3N2))	

Influenza A virus
 (A/Canterbury/20 1/2004(H3N2))
 Influenza A virus
 (A/Canterbury/202/2004(H3N2))
 Influenza A virus
 (A/Canterbury/204/2004(H3N2))
 Influenza A virus
 (A/Canterbury/204/2005(H3N2))
 Influenza A virus
 (A/Canterbury/205/2004(H3N2))
 Influenza A virus
 (A/Canterbury/205/2005(H3N2))
 Influenza A virus
 (A/Canterbury/206/2004(H3N2))
 Influenza A virus
 (A/Canterbury/206/2005(H3N2))
 Influenza A virus
 (A/Canterbury/207/2004(H3N2))
 Influenza A virus
 (A/Canterbury/208/2004(H3N2))
 Influenza A virus
 (A/Canterbury/209/2004(H3N2))
 Influenza A virus
 (A/Canterbury/21/2002(H3N2))
 Influenza A virus
 (A/Canterbury/21/2004(H3N2))
 Influenza A virus
 (A/Canterbury/21 0/2004(H3N2))
 Influenza- A virus
 (A/Canterbury/2 12/2005(H3N2))
 Influenza A virus
 (A/Canterbury/22/2002(H3N2))
 Influenza A virus
 (A/Canterbury/220/2005(H3N2))
 Influenza A virus
 (A/Canterbury/23/2004(H3N2))
 Influenza A virus
 (A/Canterbury/230/2005(H3N2))
 Influenza A virus
 (A/Canterbury/232/2005(H3N2))
 Influenza A virus
 (A/Canterbury/23 3/2005(H3N2))
 Influenza A virus
 (A/Canterbury/234/2005(H3N2))
 Influenza A virus
 (A/Canterbury/235/2005(H3N2))
 Influenza A virus
 (A/Canterbury/236/2005(H3N2))
 Influenza A virus
 (A/Canterbury/23 7/2005(H3N2))
 Influenza A virus
 (A/Canterbury/238/2005(H3N2))
 Influenza A virus
 (A/Canterbury/24/2004(H3N2))
 Influenza A virus
 (A/Canterbury/24/2005(H3N2))
 Influenza A virus
 (A/Canterbury/242/2005(H3N2))
 Influenza A virus
 (A/Canterbury/245/2005(H3N2))
 Influenza A virus
 (A/Canterbury/247/2005(H3N2))
 Influenza A virus
 (A/Canterbury/248/2005(H3N2))
 Influenza A virus
 (A/Canterbury/250/2005(H3N2))
 Influenza A virus

neura(GI:858 16408
 loc:CY0083740)

neura(GI:87043 120
 loc:CY0085660)

neura(GI:85833215
 loc:CY0083820)

neura(GI:87042991
 loc:CY0085740)
 neura(GI:l 12787492
 loc-.CYO 132420)
 neura(GI:87042972
 (oc:CY0085820)
 neura(GI:85833 196
 loc:CY0083900)
 neura(GI:85833 177
 loc:CY0083980)
 neura(GI:858 17507
 loc:CY0084060)
 neura(GI:85833158
 loc:CY0084140)
 neura(GI:85829293
 loc:CY0084220)

neura(GI:85833139
 loc:CY0084300)

neura(GI:87042953
 loc:CY0085900)
 neura(GI:90571921
 loc:CYO100860)
 neura(GI:87042934

(A/Canterbury/251/2005(H3N2))	loc:CY0085980)
Influenza A virus	neura(GI:87042709
(A/Canterbury/253/2005(H3N2))	loc:CY0086060)
Influenza A virus	neura(GI:87042690
(A/Canterbury/255/2005(H3N2))	loc:CY0086140)
Influenza A virus	neura(GI:87042671
(A/Canterbury/256/2005(H3N2))	loc:CY0086220)
Influenza A virus	neura(GI:87042652
(A/Canterbury/257/2005(H3N2))	loc:CY0086300)
Influenza A virus	neura(GI:87042633
(A/Canterbury/258/2005(H3N2))	loc:CY0086380)
Influenza A virus	
(A/Canterbury/259/2005(H3N2))	
Influenza A virus	neura(GI:89112227
(A/Canterbury/26/2005(H3N2))	loc:CY0090300)
Influenza A virus	neura(GI:85833119
(A/Canterbury/260/2005(H3N2))	loc:CY0084380)
Influenza A virus	neura(GI:87042614
(A/Canterbury/266/2005(H3N2))	loc:CY0086460)
Influenza A virus	neura(GI:85833100
(A/Canterbury/269/2005(H3N2))	loc:CY0084460)
Influenza A virus	
(A/Canterbury/27/2002(H3N2))	
Influenza A virus	neura(GI:87043101
(A/Canterbury/270/2005(H3N2))	loc:CY0086540)
Influenza A virus	
(A/Canterbury/29/2002(H3N2))	
Influenza A virus	
(A/Canterbury/29/2005(H3N2))	
Influenza A virus	neura(GI:89112265
(A/Canterbury/3/2000(H3N2))	loc:CY0091020)
Influenza A virus	
(A/Canterbury/303/2004(H3N2))	
Influenza A virus	
(A/Canterbury/304/2004(H3N2))	
Influenza A virus	neura(GI:85838190
(A/Canterbury/305/2004(H3N2))	loc:CY0082220)
Influenza A virus	neura(GI:85838171
(A/Canterbury/308/2004(H3N2))	loc:CY0082300)
Influenza A virus	neura(GI:85816195
(A/Canterbury/309/2004(H3N2))	loc:CY0082380)
Influenza A virus	
(A/Canterbury/31/2002(H3N2))	
Influenza A virus	neura(GI:85838152
(A/Canterbury/310/2004(H3N2))	loc:CY0082460)
Influenza A virus	
(A/Canterbury/311/2004(H3N2))	
Influenza A virus	neura(GI:85838133
(A/Canterbury/312/2004(H3N2))	loc:CY0082540)
Influenza A virus	
(A/Canterbury/313/2004(H3N2))	
Influenza A virus	
(A/Canterbury/315/2004(H3N2))	
Influenza A virus	
(A/Canterbury/33/2002(H3N2))	
Influenza A virus	
(A/Canterbury/33/2005(H3N2))	
Influenza A virus	
(A/Canterbury/34/2002(H3N2))	
Influenza A virus	neura(GI:89113334
(A/Canterbury/34/2005(H3N2))	loc:CY0090380)
Influenza A virus	
(A/Canterbury/35/2002(H3N2))	
Influenza A virus	neura(GI:91124689
(A/Canterbury/36/2001(H3N2))	loc:CY0105500)
Influenza A virus	neura(GI:89779249
(A/Canterbury/37/2001(H3N2))	loc:CY0094140)

Influenza A virus
 (A/Canterbury/38/2000(H3N2))
 Influenza A virus
 (A/Canterbury/382/2003(H3N2))
 Influenza A virus
 (A/Canterbury/384/2003(H3N2))
 Influenza A virus
 (A/Canterbury/386/2003(H3N2))
 Influenza A virus
 (A/Canterbury/387/2003(H3N2))
 Influenza A virus
 (A/Canterbury/39/2000(H3N2))
 Influenza A virus
 (A/Canterbury/390/2003(H3N2))
 Influenza A virus
 (A/Canterbury/391/2003(H3N2))
 Influenza A virus
 (A/Canterbury/392/2003(H3N2))
 Influenza A virus
 (A/Canterbury/393/2003(H3N2))
 Influenza A virus
 (A/Canterbury/394/2003(H3N2))
 Influenza A virus
 (A/Canterbury/395/2003(H3N2))
 Influenza A virus
 (A/Canterbury/397/2003(H3N2))
 Influenza A virus
 (A/Canterbury/398/2003(H3N2))
 Influenza A virus
 (A/Canterbury/399/2003(H3N2))
 Influenza A virus
 (A/Canterbury/400/2003(H3N2))
 Influenza A virus
 (A/Canterbury/401/2003(H3N2))
 Influenza A virus
 (A/Canterbury/403/2003(H3N2))
 Influenza A virus
 (A/Canterbury/404/2003(H3N2))
 Influenza A virus
 (A/Canterbury/405/2003(H3N2))
 Influenza A virus
 (A/Canterbury/406/2003(H3N2))
 Influenza A virus
 (A/Canterbury/408/2003(H3N2))
 Influenza A virus
 (A/Canterbury/409/2003(H3N2))
 Influenza A virus
 (A/Catterbury/41/2002(H3N2))
 Influenza A virus
 (A/Canterbury/410/2003(H3N2))
 Influenza A virus
 (A/Canterbury/411/2003(H3N2))
 Influenza A virus
 (A/Canterbury/412/2003(H3N2))
 Influenza A virus
 (A/Canterbury/416/2003(H3N2))
 Influenza A virus
 (A/Canterbury/417/2003(H3N2))
 Influenza A virus
 (A/Canterbury/418/2003(H3N2))
 Influenza A virus
 (A/Canterbury/42/2000(H3N2))
 Influenza A virus
 (A/Canterbury/420/2003(H3N2))
 Influenza A virus
 (A/Canterbury/423/2003(H3N2))
 Influenza A virus

neura(GI:85833062
 loc:CY0084860)

neura(GI:891 13315
 loc:CY0090220)

neura(GI:83744319
 loc:CY007U70)

neura(GI:83744338
 loc:CY0071250)
 neura(GI:83744357
 loc:CY007I330)
 neura(GI:83744379

(A/Canterbury/424/2003(H3N2))	loc:CY0071410)
Influenza A virus	neura(GI:87043082
(A/Canterbury/425/2003(H3N2))	loc:CY00S5420)
Influenza A virus	neura(GI:87043063
(A/Canterbury/426/2003(H3N2))	loc:CY0085500)
Influenza A virus	neura(GI:83751920
(A/Canterbury/427/2003(H3N2))	loc:CY0071490)
Influenza A virus	neura(GI:83751939
(A/Canterbury/428/2003(H3N2))	loc:CY0071570)
Influenza A virus	neura(GI:84873521
(A/Canterbury/429/2003(H3N2))	loc:CY0078290)
Influenza A virus	neura(GI:89781480
(A/Canterbury/43/200 1(H3N2))	loc:CY0095740)
Influenza A virus	neura(GI:83751958
(A/Canterbury/430/2003(H3N2))	loc:CY0071650)
Influenza A virus	neura(GI:83751977
(A/Canterbury/43 1/2003(H3N2))	loc:CY0071730)
Influenza A virus	neura(GI:85838432
(A/Canterbury/432/2003(H3N2))	loc.-CYOOS^80)
Influenza A virus	neura(GI:83744535
(A/Canterbury/434/2003(H3N2))	loc:CY0071890)
Influenza A virus	neura(GI:83752015
(A/Canterbury/435/2003(H3N2))	loc.-CY0071970)
Influenza A virus	neura(GI:83752034
(A/Canterbury/436/2003(H3N2))	loc:CY0072050)
Influenza A virus	neura(GI:83752055
(A/Canterbury/437/2003(H3N2))	loc.-CY0072130)
Influenza A virus	neura(GI:83752074
(A/Canterbury/438/2003(H3N2))	loc:CY0072210)
Influenza A virus	neura(GI:83752093
(A/Canterbury/439/2003(H3N2))	loc:CY0072290)
Influenza A virus	neura(GI:89779268
(A/Canterbury/44/200 1(H3N2))	loc:CY0094220)
Influenza A virus	
(A/Canterbury/44/2002(H3N2))	
Influenza A virus	neura(GI:837521 12
(A/Canterbury/440/2003(H3N2))	loc:CY0072370)
Influenza A virus	neura(GI:83752131
(A/Canterbury/441/2003(H3N2))	loc:CY0072450)
Influenza A virus	
(A/Canterbury/442/2003(H3N2))	
Influenza A virus	
(A/Canterbury/443/2003(H3N2))	
Influenza A virus	
(A/Canterbury/444/2003(H3N2))	
Influenza A virus	
(A/Canterbury/46/2002(H3N2))	
Influenza A virus	
(A/Canterbury/47/2002(H3N2))	
Influenza A virus	
(A/Canterbury/48/2002(H3N2))	
Influenza A virus	
(A/Canterbury/49/2000(H3N2))	
Influenza A virus	
(A/Canterbury/49/2002(H3N2))	
Influenza A virus	
(A/Canterbury/50/2000(H3N2))	
Influenza A virus	neura(GI:89781652
(A/Canterbury/50/200 1(H3N2))	loc:CY0095820)
Influenza A virus	
(A/Canterbury/50/2002(H3N2))	
Influenza A virus	
(A/Canterbury/53/2002(H3N2))	
Influenza A virus	neura(GI:89 113448
(A/Canterbury/55/2000(H3N2))	loc:CY0091340)
Influenza A virus	neura(GI:87042595
(A/Canterbury/56/2000(H3N2))	loc.-CY0087500)

Influenza A virus (A/Canterbury/56/2002(H3N2))	
Influenza A virus (A/Canterbury/57/2002(H3N2))	
Influenza A virus (A/Canterbury/58/2000(H3N2))	neura(GI:891 12284 loc:CY0091500)
Influenza A virus (A/Canterbury/58/2002(H3N2))	
Influenza A virus (A/Canterbury/59/2002(H3N2))	
Influenza A virus (A/Canterbury/60/2002(H3N2))	neura(GI:85838056 loc:CY0082940)
Influenza A virus (A/Canterbury/61/2000(H3N2))	neura(GI:89 113505 loc:CY0091660)
Influenza A virus (A/Canterbury/61/2002(H3N2))	neura(GI:87286583 loc:AANZO 10000200)
Influenza A virus (A/Canterbury/62/2000(H3N2))	neura(GI: 106895938 loc:CY0 110660)
Influenza A virus (A/Canterbury/62/2002(H3N2))	neura(GI:85838037 loc:CY0083 100)
Influenza A virus (A/Canterbury/64/2000(H3N2))	neura(GI:891 13467 loc:CY0091420)
Influenza A virus (A/Canterbury/64/2002(H3N2))	neura(GI:85838018 loc:CY0083 180)
Influenza A virus (A/Canterbury/64/2005(H3N2))	neura(GI:85833253 loc:CY0083500)
Influenza A virus (A/Canterbury/66/2000(H3N2))	neura(GI:86867057 loc:CY0087660)
Influenza A virus (A/Canterbury/66/2002(H3N2))	
Influenza A virus (A/Canterbury/67/2000(H3N2))	neura(GI:89 113486 loc:CY0091580)
Influenza A virus (A/Canterbury/67/2005(H3N2))	
Influenza A virus (A/Canterbury/68/2000(H3N2))	neura(GI:86870144 loc:CY0087580)
Influenza A virus (A/Canterbury/68/2002(H3N2))	
Influenza A virus (A/Canterbury/69/2002(H3N2))	
Influenza A virus (A/Canterbury/70/2002(H3N2))	neura(GI:85837999 loc:CY0083260)
Influenza A virus (A/Canterbury/71/2000(H3N2))	neura(GI:86863885 loc:CY0087740)
Influenza A virus (A/Canterbury/72/2002(H3N2))	neura(GI:91 118967 loc:CY0079410)
Influenza A virus (A/Canterbury/73/2000(H3N2))	neura(GI:85829273 loc:CY0084940)
Influenza A virus (A/Canterbury/75/2000(H3N2))	neura(GI: 11552 1355 loc:CY0164050)
Influenza A virus (A/Canterbury/75/2002(H3N2))	
Influenza A virus (A/Canterbury/76/2002(H3N2))	neura(GI:85833538 loc:AAND010000530)
Influenza A virus (A/Canterbury/79/2002(H3N2))	
Influenza A virus (A/Canterbury/80/2000(H3N2))	neura(GI:86861047 loc:CY0087820)
Influenza A virus (A/Canterbury/80/2002(H3N2))	
Influenza A virus (A/Canterbury/81/2000(H3N2))	neura(GI:86856773 loc:CY0087900)
Influenza A virus (A/Canterbury/81/2002(H3N2))	
Influenza A virus (A/Canterbury/84/2000(H3N2))	neura(GI:86854761 loc:CY0087980)
Influenza A virus	neura(GI:86852037)

(A/Canterbury/85/2000(H3N2))		loc:CY0088060)
Influenza A virus		neura(GI:891 13353
(A/Canterbury/87/2000(H3N2))		loc:CY0090780)
Influenza A virus		neura(GI:85822153
(A/Canterbury/88/2000(H3N2))		loc:CY0085020)
Influenza A virus		neura(GI:86846878
(A/Canterbury/89/2000(H3N2))		loc:CY0088220)
Influenza A virus		neura(GI:86830981
(A/Canterbury/90/2000(H3N2))		loc:CY0088620)
Influenza A virus		neura(GI:91 124308
(A/Canterbury/92/2000(H3N2))		loc:CY0090940)
Influenza A virus		neura(GI:86844299
(A/Canterbury/93/2000(H3N2))		loc:CY0088300)
Influenza A virus		neura(GI:89779192
(A/Canterbury/94/2000(H3N2))		loc:CY0093900)
Influenza A virus		neura(GI:891 13372
(A/Canterbury/96/2000(H3N2))		loc:CY0090860)
Influenza A virus		neura(GI: 110628954
(A/Canterbury/97/2000(H3N2))		loc:CY0 124340)
Influenza A virus		neura(GI:8683265 1
(A/Canterbury/98/2000(H3N2))		loc:CY0088540)
Influenza A virus		neura(GI:85822172
(A/Canterbury/99/2000(H3N2))		loc:CY0085100)
Influenza A virus		
(A/Caracas/1/71(H3N2))		
Influenza A virus		
(A/Caracas/422/97(H3N2))	hema(GI:65 52566 loc:AF 180623)	
Influenza A virus		
(A/Caracas/465/96(H3N2))	hema(GI:6552567 loc:AF180624)	
Influenza A virus	hema(GI: 109156266	
(A/Casa/78/98(H3N2))	loc:DQ534429)	
Influenza A virus		
(A/Chaco/140/99(H3N2))	hema(GI:33330008 loc:AF534035)	
Influenza A virus		
(A/Chaco/R538/01(H3N2))	hema(GI:33330048 loc:AF534055)	
Influenza A virus		
(A/Changwon/1 1/1995(H3N2))		
Influenza A virus		
(A/Changwon/9/1995(H3N2))		
Influenza A virus		
(A/Changwon/9/95(H3N2))	hema(GI:2271226 loc:AF008751)	
Influenza A virus		
(A/Charlottesville/10/99 (H3N2))	hema(GI: 11228917 loc:AF297094)	
Influenza A virus		
(A/Charlottesville/49/99 (H3N2))	hema(GI:1 1228921 loc:AF297096)	
Influenza A virus		
(A/Charlottesville/69/99 (H3N2))	hema(GI: 11228923 loc:AF297097)	
Influenza A virus		
(A/Charlottesville/73/99 (H3N2))	hema(GI: 11228919 loc:AF297095)	
Influenza A virus		
(A/Cheju/274/2002(H3N2))	hema(GI:464 10034 loc:AY589648)	
Influenza A virus		
(A/Cheju/3 11/2002(H3N2))	hema(GI:46410036 loc:AY589649)	
Influenza A virus (A/Cheng-		
mei/4/85(H3N2))	hema(GI:2275556 loc:AF008908)	
Influenza A virus		
(A/Cheonnam/323/2002(H3N2))	hema(GI:46410038 loc:AY589650)	
Influenza A virus		
(A/Cheonnam/338/2002(H3N2))	hema(GI:464 10040 loc:AY589651)	
Influenza A virus		
(A/Cheonnam/340/2002(H3N2))	hema(GI:46410042 loc:AY589652)	
Influenza A virus		
(A/Cheonnam/432/2002(H3N2))	hema(GI:46410044 loc:AY589653)	
Influenza A virus		
(A/Chiba/3 8/88(H3N2))	hema(GI:2275500 loc:AF008880)	
Influenza A virus		
(A/Chiba/5/71(H3N2))		

Influenza A virus (A/Chiba/54/92(H3N2))	hema(GI:8 100080 loc:AB043706)
Influenza A virus (A/Chicken/Italy/5783/95(H3N2))	hema(GI: 18091805 loc:AF2 13900)
Influenza A virus (A/Chicken/Italy/5945/95(H3N2))	hema(GI: 1809 1807 loc:AF213901)
Influenza A virus (A/Chicken/Italy/5954/95(H3N2))	hema(GI: 1809 1809 loc:AF2 13902)
Influenza A virus (A/chicken/Korea/S6/03(H3N2))	hema(GI:58429240 loc:AY862607)
Influenza A virus (A/chicken/Nanchang/3 - 120/2001(H3N2))	
Influenza A virus (A/Chile/21 15/96(H3N2))	hema(GI:2271 140 loc:AF008708)
Influenza A virus (A/Chile/6416/2001(H3N2))	hema(GI: 110825888 loc:DQ865972)
Influenza A virus (A/China/C1- 2/2001(H3N2))	hema(GI:77023514 loc:DQ 179383)
Influenza A virus (A/China/C1- 3/2001(H3N2))	hema(GP.77023516 loc:DQ179384)
Influenza A virus (A/China/C1- 5/2001(H3N2))	hema(GI:77023520 loc:DQ179386)
Influenza A virus (A/China/C1- 6/2001(H3N2))	hema(GI:77023522 loc:DQ179387)
Influenza A virus (A/China/C1- 7/2002(H3N2))	hema(GI:77023524 loc:DQ 179388)
Influenza A virus (A/China/C1- 8/2002(H3N2))	hema(GI:77023526 loc:DQ179389)
Influenza A virus (A/Christ Hospital/23 1/82(H3N2))	hema(GI:6690136 loc:IAU77830)
Influenza A virus (A/Christ Church/1/(H3N2))	hema(GI:2275530 loc:AF008895)
Influenza A virus (A/Christ Church/1/96(H3N2))	hema(GI:2271 158 loc:AF008717)
Influenza A virus (A/Christ Church/2/88(H3N2))	hema(GI:2275550 loc:AF008905)
Influenza A virus (A/Christ Church/4/(H3N2))	hema(GI:2275532 loc:AF008896)
Influenza A virus (A/Christ Church/8/93(H3N2))	hema(GI:2275414 loc:AF008837)
Influenza A virus (A/Christchurch/ 10/2004(H3N2))	hema(GI:75750173 loc:CY002905)
Influenza A virus (A/Christchurch/13/2004(H3N2))	hema(GI:75750192 loc:CY002906)
Influenza A virus (A/Christchurch/14/2004(H3N2))	hema(GI:75750230 loc:CY002922)
Influenza A virus (A/Christchurch/15/2004(H3N2))	hema(GI:7575021 1 loc:CY002914)
Influenza A virus (A/Christchurch/ 184/2004(H3N2))	hema(GI:75750287 loc:CY002946)
Influenza A virus (A/Christchurch/20/2005(H3N2))	hema(GI:1 10825880 loc:DQ865968)
Influenza A virus (A/Christchurch/297/2004(H3N2))	hema(GI:75750325 loc:CY002962)
Influenza A virus (A/Christchurch/339/2004(H3N2))	hema(GI:75750344 loc:CY002904)
Influenza A virus (A/Christchurch/89/2004(H3N2))	hema(GI:75750249 loc:CY002930)
Influenza A virus (A/Christchurch/90/2004(H3N2))	hema(GI:75750268 loc:CY002938)
Influenza A virus (A/Chungnam/447/2002(H3N2))	hema(GI:464 10046 loc:AY589654)
Influenza A virus (A/CNIC/1 09/98(H3N2))	
Influenza A virus (A/CNIC/121/98(H3N2))	

Influenza A virus (A/CNIC/125/98(H3N2))	
Influenza A virus (A/CNIC/130/98(H3N2))	
Influenza A virus (A/CNIC/145/98(H3N2))	
Influenza A virus (A/CNIC/146/98(H3N2))	
Influenza A virus (A/CNIC/149/98(H3N2))	
Influenza A virus (A/CNIC/22/95(H3N2))	hema(GI:2271254 loc:AF008765)
Influenza A virus (A/CNIC/3/98(H3N2))	
Influenza A virus (A/CNIC/35/96(H3N2))	hema(GI:2271 166 loc:AF008721)
Influenza A virus (A/CNIC/52/98(H3N2))	
Influenza A virus (A/CNIC/96/98(H3N2))	
Influenza A virus (A/CNIC/97/98(H3N2))	
Influenza A virus (A/Colombia/170/96(H3N2))	hema(GI:6552542 loc:AF180599)
Influenza A virus (A/Colorado/1 1/96(H3N2))	hema(GI:6552559 loc:AF180616)
Influenza A virus (A/Colorado/2/(H3N2))	hema(GI:2275520 loc:AF008890)
Influenza A virus (A/Colorado/2/86(H3N2))	hema(GI:49339076 loc:AY661053)
Influenza A virus (A/Colorado/360/2005(H3N2))	hema(GI:82571088 loc:DQ265717)
Influenza A virus (A/Connecticut/4/(H3N2))	hema(GI:2275490 loc:AF008875)
Influenza A virus (A/Cordoba/1007333/01(H3N2))	hema(GI:33330054 loc:AF534058)
Influenza A virus (A/Cordoba/3278/96(H3N2))	hema(GI:6552532 loc:AF180589)
Influenza A virus (A/Cordoba/V185/98(H3N2))	hema(GI:22536019 loc:AF533715)
Influenza A virus (A/Cordoba/V39 1/98(H3N2))	hema(GI:22536021 loc:AF533716)
Influenza A virus (A/Cordoba/V584/98(H3N2))	hema(GI:22536023 loc:AF533717)
Influenza A virus (A/Cordoba/V65 1/98(H3N2))	hema(GI:22536025 loc:AF533718)
Influenza A virus (A/Cottbus/42/88 (H3N2))	
Influenza A virus (A/Czechoslovakia/ 19/89(H3N2))	hema(GI:2271068 loc:AF008672)
Influenza A virus (A/Czechoslovakia/4/86(H3N2))	hema(GI:2275534 loc:AF008897)
Influenza A virus (A/Daegu/103/98(H3N2))	hema(GI: 14550204 loc:AF386613)
Influenza A virus (A/Daegu/84/97(H3N2))	hema(GI: 14550224 loc:AF386623)
Influenza A virus (A/Daejeon/258/2002(H3N2))	hema(GI:46410048 loc:AY589655)
Influenza A virus (A/Daejeon/390/2002(H3N2))	hema(GI:46410050 loc:AY589656)
Influenza A virus (A/Darwin/1/2005(H3N2))	hema(GI:l 10825878 loc:DQ865967)
Influenza A virus (A/Delaware/3/95(H3N2))	hema(GI:6552607 loc:AF180664)
Influenza A virus (A/Delaware/4/97(H3N2))	hema(GI:6552569 loc:AF180626)
Influenza A virus	hema(GI:47230908 loc:AY53 1041)

(A/Denmark/07/03(H3N2))	
Influenza A virus (A/Denmark/I 0/03(H3N2))	hema(GI:47230918 loc:AY53 1046)
Influenza A virus (A/Denmark/13/03(H3N2))	hema(GI:47230938 loc:AY53 1056)
Influenza A virus (A/Denmark/14- 2/03(H3N2))	hema(GI:47230934 ioc:AY531054)
Influenza A virus (A/Denmark/ 15- 2/03(H3N2))	hema(GI:47230946 loc:AY531060)
Influenza A virus (A/Denmark/16- 2/03(H3N2))	hema(GI:47230926 loc:AY531050)
Influenza A virus (A/Denmark/ 17- 2/03(H3N2))	hema(GI:47230948 loc:AY531061)
Influenza A virus (A/Denmark/ 18- 2/03(H3N2))	hema(GI:47230944 loc:AY531059)
Influenza A virus (A/Denmark/ 19- 2/03(H3N2))	hema(GI:47230932 loc:AY531053)
Influenza A virus (A/Denmark/20/03(H3N2))	hema(GI:47230920 loc:AY531047)
Influenza A virus (A/Denmark/24/03(H3N2))	hema(GI:47230912 loc:AY531043)
Influenza A virus (A/Denmark/32/03(H3N2))	hema(GI:47230910 loc:AY531042)
Influenza A virus (A/Denmark/37/03(H3N2))	hema(GI:47230942 loc:AY531058)
Influenza A virus (A/Denmark/39/03(H3N2))	hema(GI:47230940 loc:AY531057)
Influenza A virus (A/Denmark/41/03(H3N2))	hema(GI:47230922 loc:AY531048)
Influenza A virus (A/Denmark/41/2000(H3N2))	
Influenza A virus (A/Denmark/51 1/98(H3N2))	
Influenza A virus (A/Denmark/52/03 (H3N2))	hema(GI:47230930 loc:AY531052)
Influenza A virus (A/Denmark/58/03(H3N2))	hema(GI:47230906 loc:AY531040)
Influenza A virus (A/Denmark/59/03(H3N2))	hema(GI:47230904 loc:AY531039)
Influenza A virus (A/Denmark/60/03(H3N2))	hema(GI:47230914 loc:AY531044)
Influenza A virus (A/Denmark/61/03(H3N2))	hema(GI:47230924 loc:AY531049)
Influenza A virus (A/Denmark/62/03(H3N2))	
Influenza A virus (A/Denmark/63/03(H3N2))	hema(GI:47230916 loc:AY531045)
Influenza A virus (A/Denmark/70/03(H3N2))	hema(GI:47230928 loc:AY531051)
Influenza A virus (A/Denmark/92/03(H3N2))	hema(GI:47230936 loc:AY531055)
Influenza A virus (A/dove/Korea/S1 1/03(H3N2))	hema(GI:58429250 loc:AY862612)
Influenza A virus (A/duck/Alberta/78/1976(H3N2))	hema(GI:324409 loc:FLAN2HA)
Influenza A virus (A/duck/Alberta/78/76(H3N2))	
Influenza A virus (A/duck/Hokkaido/5/1977(H3N2))	
Influenza A virus (A/duck/Hong Kong/24/76(H3N2))	
Influenza A virus (A/duck/Hong Kong/245/77(H3N2))	hema(GI:418070 loc:FLAHAD245)
Influenza A virus (A/duck/Hong Kong/7/75(H3N2))	
Influenza A virus (A/duck/Hong Kong/940/80(H3N2))	hema(GP.479O23 loc:FLAHAD940)

Influenza A virus (A/duck/Korea/S 10/03(H3N2))	hema(GI:58429248 loc:AY86261 1)	
Influenza A virus (A/duck/Korea/S7/03(H3N2))	hema(GI:58429242 loc:AY862608)	
Influenza A virus (A/duck/Korea/S8/03(H3N2))	hema(GI:58429244 loc:AY862609)	
Influenza A virus (A/duck/Korea/S9/03(H3N2))	hema(GI:58429246 ioc:AY862610)	
Influenza A virus (A/duck/Ontario/05/00 (H3N2))		
Influenza A virus (A/Dunedin/1/2000 (H3N2))		neura(GI: 110629429 loc:CY0126180)
Influenza A virus (A/Dunedin/1/2002(H3N2))		neura(GI:1 15289391 loc:CY0155500)
Influenza A virus (A/Dunedin/10/2002(H3N2))		neura(GI:109159734 loc:CY01 14020)
Influenza A virus (A/Dunedin/1 1/2002(H3N2))		
Influenza A virus (A/Dunedin/12/2002(H3N2))		neura(GI:l 12788561 loc:CY0134230)
Influenza A virus (A/Dunedin/14/2002(H3N2))		neura(GI: 109675994 loc:CY01 16580)
Influenza A virus (A/Dunedin/18/2002(H3N2))		neura(GI: 110734042 loc:CY013 1060)
Influenza A virus (A/Dunedin/3/2000(H3N2))		neura(GI: 112787998 loc:CY0133770)
Influenza A virus (A/Dunedin/3/2002(H3N2))		neura(GI: 110629486 loc:CY0126420)
Influenza A virus (A/Dunedin/38/2003(H3N2))		neura(GI:l- 127886 18 loc:CY0134470)
Influenza A virus (A/Dunedin/4/73(H3N2))	hema(GI:6578821 loc:AF201842)	
Influenza A virus (A/Dunedin/8/2002(H3N2))		neura(GI: 109914977 loc:CY0120100)
Influenza A virus (A/Dunedin/9/2002(H3N2))		neura(GI: 1099 14958 loc:CY0 120020)
Influenza A virus (A/Ecuador/1968/2004 (H3N2))	hema(GI:82571086 loc:DQ265716)	
Influenza A virus (A/England/1/1993(H3N2))		
Influenza A virus (A/England/1972(H3N2))		
Influenza A virus (A/England/2005(H1N1))	hema(GI:82571066 loc:DQ265706)	
Influenza A virus (A/England/220/93(H3N2))	hema(GI:2275420 loc:AF008840)	
Influenza A virus (A/England/247/1993(H3N2))		
Influenza A virus (A/England/260/91(H3N2))	hema(GI:49339120 loc:AY661075)	
Influenza A virus (A/England/261/91(H3N2))	hema(GI:2271 100 loc:AF008688)	
Influenza A virus (A/England/269/93(H3N2))		
Influenza A virus (A/England/284/1993(H3N2))		
Influenza A virus (A/England/286/1993(H3N2))		
Influenza A virus (A/England/289/1993(H3N2))		
Influenza A virus (A/England/32 1/1977(H3N2))		
Influenza A virus (A/England/328/1993(H3N2))		
Influenza A virus (A/England/346/1993(H3N2))		
Influenza A virus		

(A/England/347/1993(H3N2))
 Influenza A virus
 (A/England/42/72(H3N2)) hema(GI:6470274 loc:AF201875)
 Influenza A virus
 (A/England/42/72.var (H3N2))
 Influenza A virus
 (A/England/427/1988(H3N2))
 Influenza A virus
 (A/England/427/88(H3N2)) hema(GI:6406226 loc:AB027386)
 Influenza A virus
 (A/England/471/1993(H3N2))
 Influenza A virus
 (A/England/648/89(H3N2)) hema(GI:2271052 loc:AF008664)
 Influenza A virus
 (A/England/67/1994(H3N2))
 Influenza A virus
 (A/England/68/1994(H3N2))
 Influenza A virus
 (A/England/7/1994(H3N2))
 Influenza A virus
 (A/England/878/1969(H3N2)) hema(GI:324143 loc:FLAHALI)
 Influenza A virus
 (A/England/878/69(H3N2))
 Influenza A virus
 (A/England/88(H3N2)) hema(GI:2271066 loc:AF008671)
 Influenza A virus (A/England/939/1969(H3N2) x
 A/Puerto Rico/8/1934(H3N2))
 Influenza A virus
 (A/Enschede/1285/92(H3N2)) hema(GI:49339162 loc:AY661096)
 Influenza A virus
 (A/Enschede/5458/93(H3N2)) hema(GI:49339270 loc:AY661150)
 Influenza A virus
 (A/environment/Ohio/1001/2005(H3N2))
 Influenza A virus
 (A/environment/Ohio/994/2005(H3N2))
 Influenza A virus
 (A/Ecuador/4/1986(H3N2)) hema(GI:324111 loc:FLAHAD)
 Influenza A virus
 (A/EspiritoSanto/128/00(H3N2)) hema(GI:65307142 loc:AY968024)
 Influenza A virus
 (A/EspiritoSanto/14/99(H3N2)) hema(GI:65307130 loc:AY968018)
 Influenza A virus
 (A/EspiritoSanto/3/99(H3N2)) hema(GI:65307128 loc:AY968017)
 Influenza A virus
 (A/EspiritoSanto/33/99(H3N2)) hema(GI:65307136 loc:AY968021)
 Influenza A virus
 (A/EspiritoSanto/452/01(H3N2)) hema(GI:65307148 loc:AY968027)
 Influenza A virus
 (A/EspiritoSanto/454/01(H3N2)) hema(GI:65307150 loc:AY968028)
 Influenza A virus
 (A/EspiritoSanto/88/02(H3N2)) hema(GI:65307176 loc:AY968041)
 Influenza A virus (A/Europe/C2-5/2002(H3N2)) hema(GI:77023552 loc:DQ179402)
 Influenza A virus hema(GI:109156262
 (A/Fes/273/98(H3N2)) loc:DQ534427)
 Influenza A virus hema(GI:109156260
 (A/Fes/314/98(H3N2)) loc:DQ534425)
 Influenza A virus
 (A/finch/China/R172/02(H3N2)) hema(GI:55056935 loc:AJ704815)
 Influenza A virus
 (A/Finland/1/2002 (H3N2)) hema(GI:76886289 loc:DQ167252)
 Influenza A virus
 (A/Finland/I10/1989(H3N2))
 Influenza A virus
 (A/Finland/12/2002 (H3N2)) hema(GI:76886293 loc:DQ167254)

Influenza A virus (A/Finland/13/2002 (H3N2))	hema(GI:76886295 loc:DQ167255)
Influenza A virus (A/Finland/133/1990(H3N2))	
Influenza A virus (A/Finland/133/90(H3N2))	
Influenza A virus (A/Finland/144/1990(H3N2))	
Influenza A virus (A/Finland/144/90(H3N2))	
Influenza A virus (A/Finland/170/03(H3N2))	hema(GI:49339034 loc:AY661032)
Influenza A virus (A/Finland/170/2003 (H3N2))	.hema(GI:76886303 loc:DQ167259)
Influenza A virus (A/Finland/I80/2003 (H3N2))	hema(GI:76886305 loc:DQ167260)
Influenza A virus (A/Finland/189/1991(H3N2))	
Influenza A virus (A/Finland/189/92(H3N2))	
Influenza A virus (A/Finland/190/92(H3N2))	hema(GI:36143104 loc:AY377538)
Influenza A virus (A/Finland/191/92(H3N2))	hema(GI:36143102 loc:AY377537)
Influenza A virus (A/Finland/2/2002 (H3N2))	hema(GI:76886291 loc:DQ167253)
Influenza A virus (A/Finland/205/92(H3N2))	hema(GI:36143 119 loc:AY377540)
Influenza A virus (A/Finland/206/92(H3N2))	-
Influenza A virus (A/Finland/208/92(H3N2))	
Influenza A virus (A/Finland/21 1/1992(H3N2))	
Influenza A virus (A/Finland/21 1/92(H3N2))	
Influenza A virus (A/Finland/21 5/92(H3N2))	
Influenza A virus (A/Finland/218/92(H3N2))	hema(GI:49339188 loc:AY661 109)
Influenza A virus (A/Finland/219/92(H3N2))	
Influenza A virus (A/Finland/22/2002 (H3N2))	hema(GI:76886297 loc:DQ167256)
Influenza A virus (A/Finland/220/92(H3N2))	hema(GI:49339190 loc:AY661 110)
Influenza A virus (A/Finland/23 1/92(H3N2))	
Influenza A virus (A/Finland/232/92(H3N2))	
Influenza A virus (A/Finland/239/1992(H3N2))	
Influenza A virus (A/Finland/239/92(H3N2))	
Influenza A virus (A/Finland/245/92(H3N2))	hema(GI:36143 107 loc:AY377539)
Influenza A virus (A/Finland/246/92(H3N2))	
Influenza A virus (A/Finland/247/1992(H3N2))	
Influenza A virus (A/Finland/247/92(H3N2))	hema(GI:49339246 loc:AY661 138)
Influenza A virus (A/Finland/250/93(H3N2))	hema(GI:36143 194 loc:AY377546)
Influenza A virus (A/Finland/256/93(H3N2))	hema(GI:38606325 loc:AY462237)
Influenza A virus	

(A/Finland/263/1993(H3N2))	
Influenza A virus	
(A/Finland/263/93(H3N2))	
Influenza A virus	
(A/Finland/269/93(H3N2))	hema(GI:36143 168 loc:AY377545)
Influenza A virus	
(A/Finland/270/93(H3N2))	hema(GI:36143 139 loc:AY377544)
Influenza A virus	
(A/Finland/272/2003 (H3N2))	hema(GI:76886307 loc:DQ167261)
Influenza A virus	
(A/Finland/273/93(H3N2))	hema(GI:36143137 loc:AY377543)
Influenza A virus	
(A/Finland/274/1993(H3N2))	
Influenza A virus	
(A/Finland/274/93(H3N2))	
Influenza A virus	
(A/Finland/276/1993(H3N2))	
Influenza A virus	
(A/Finland/276/93(H3N2))	
Influenza A virus	
(A/Finland/278/1993(H3N2))	
Influenza A virus	
(A/Finland/278/2003 (H3N2))	hema(GI:76886309 loc:DQ 167262)
Influenza A virus	
(A/Finland/278/93(H3N2))	
Influenza A virus	
(A/Finland/28/2002 (H3N2))	hema(GI:76886299 loc:DQ167257)
Influenza A virus	
(A/Finland/280/93(H3N2))	hema(GI: 18653244 loc:AF442483)
Influenza A virus	
(A/Finland/285/2003 (H3N2))	hema(GI:7688631 1 loc:DQ167263)
Influenza A virus	
(A/Finland/29 1/2003 (H3N2))	hema(GI:768863 13 loc:DQ167264)
Influenza A virus	
(A/Finland/292/1993(H3N2))	
Influenza A virus	
(A/Finland/292/93(H3N2))	
Influenza A virus	
(A/Finland/293/2003 (H3N2))	hema(GI:76886315 loc:DQ167265)
Influenza A virus	
(A/Finland/295/1993(H3N2))	
Influenza A virus	
(A/Finland/296/1993(H3N2))	
Influenza A virus	
(A/Finland/300/2003 (H3N2))	hema(GI:768863 17 loc:DQ167266)
Influenza A virus	
(A/Finland/300/93(H3N2))	
Influenza A virus	
(A/Finland/301/2003 (H3N2))	hema(GI:768863 19 loc:DQ 167267)
Influenza A virus	
(A/Finland/302/2003 (H3N2))	hema(GI:76886321 loc:DQ167268)
Influenza A virus	
(A/Finland/303/2003 (H3N2))	hema(GI:76886323 loc:DQ167269)
Influenza A virus	
(A/Finland/304/2003 (H3N2))	hema(GI:76886325 loc:DQ 167270)
Influenza A virus	
(A/Finland/305/2003 (H3N2))	hema(GI:76886327 loc:DQ167271)
Influenza A virus	
(A/Finland/306/2003 (H3N2))	hema(GI:76886329 loc:DQ167272)
Influenza A virus	
(A/Finland/308/2003 (H3N2))	hema(GI:7688633 1 loc:DQ167273)
Influenza A virus	
(A/Finland/309/2003 (H3N2))	hema(GI:76886333 loc:DQ 167274)
Influenza A virus	
(A/Finland/3 10/2003 (H3N2))	hema(GI:76886335 loc:DQ167275)
Influenza A virus	
(A/Finland/3 11/2003 (H3N2))	hema(GI:76886337 loc:DQ167276)

Influenza A virus (A/Finland/3 12/2003 (H3N2))	hema(GI:76886339 loc:DQ167277)
Influenza A virus (A/Finland/3 13/2003 (H3N2))	hema(GI:76886341 loc:DQ167278)
Influenza A virus (A/Finland/3 14/2003 (H3N2))	hema(GI:76886343 loc:DQ167279)
Influenza A virus (A/Finland/3 19/2003 (H3N2))	hema(GI:76886345 loc:DQ167280)
Influenza A virus (A/Finland/320/2003 (H3N2))	hema(GI:76886347 loc:DQ167281)
Influenza A virus (A/Finland/321/93(H3N2))	hema(GI:36143 132 loc:AY377541)
Influenza A virus (A/Finland/323/2003 (H3N2))	hema(GI:76886349 loc:DQ167282)
Influenza A virus (A/Finland/33 1/93(H3N2))	hema(GI:36143 135 loc:AY377542)
Influenza A virus (A/Finland/338/2003 (H3N2))	hema(GI:76886351 loc:DQ167283)
Influenza A virus (A/Finland/338/95 (H3N2))	hema(GI:14133815 loc:AF368436)
Influenza A virus (A/Finland/339/1995(H3N2))	
Influenza A virus (A/Finland/339/95(H3N2))	hema(GI:49339338 loc:AY661 184)
Influenza A virus (A/Finland/342/2003 (H3N2))	hema(GI:76886353 loc:DQ167284)
Influenza A virus (A/Finland/358/2003 (H3N2))	hema(GI:76886355 loc:DQ167285)
Influenza A virus (A/Finland/363/1 995(H3N2))	
Influenza A virus (A/Finland/364/95(H3N2))	hema(GI:36143227 loc:AY377547)
Influenza A virus (A/Finland/371/1995(H3N2))	
Influenza A virus (A/Finland/377/2003 (H3N2))	hema(GI:76886357 loc:DQ167286)
Influenza A virus (A/Finland/380/95(H3N2))	hema(GI:12044311 loc:AF311677)
Influenza A virus (A/Finland/38 1/95(H3N2))	hema(GI:49339362 loc:AY661 196)
Influenza A virus (A/Finland/402/2003 (H3N2))	hema(GI:76886359 loc:DQ167287)
Influenza A virus (A/Finland/420/2003 (H3N2))	hema(GI:76886361 loc:DQ167288)
Influenza A virus (A/Finland/430/2003 (H3N2))	hema(GI:76886363 loc:DQ167289)
Influenza A virus (A/Finland/43 1/2003 (H3N2))	hema(GI:76886365 loc:DQ167290)
Influenza A virus (A/Finland/432/2003 (H3N2))	hema(GI:76886367 loc:DQ 167291)
Influenza A virus (A/Finland/433/2003 (H3N2))	hema(GI:76886369 loc:DQ167292)
Influenza A virus (A/Finland/434/2003 (H3N2))	hema(GI:76886371 loc:DQ1 67293)
Influenza A virus (A/Finland/435/2003 (H3N2))	hema(GI:76886373 loc:DQ 167294)
Influenza A virus (A/Finland/435/96 (H3N2))	hema(GI:14133818 loc:AF368437)
Influenza A virus (A/Finland/437/2003 (H3N2))	hema(GI:76886375 loc:DQ167295)
Influenza A virus (A/Finland/445/96(H3N2))	hema(GI: 120443 13 loc:AF31 1678)
Influenza A virus (A/Finland/447/96 (H3N2))	hema(GI:14133821 loc:AF368438)
Influenza A virus (A/Finland/453/2003 (H3N2))	hema(GI:76886377 loc:DQ1 67296)
Influenza A virus	hema(GI:76886379 loc:DQ 167297)

(A/Finland/455/2004 (H3N2)) Influenza A virus	
(A/Finland/460/97 (H3N2)) Influenza A virus	hema(GI:14133824 loc:AF368439)
(A/Finland/465/2003 (H3N2)) Influenza A virus	hema(GI:76886381 loc:DQ167298)
(A/Finland/478/2004 (H3N2)) Influenza A virus	hema(GI:76886383 loc:DQ167299)
(A/Finland/479/2004 (H3N2)) Influenza A virus	hema(GI:76886385 loc:DQ167300)
(A/Finland/480/2004 (H3N2)) Influenza A virus	hema(GI:76886387 loc:DQ167301)
(A/Finland/481/2004 (H3N2)) Influenza A virus	hema(GI:76886389 loc:DQ167302)
(A/Finland/482/2004 (H3N2)) Influenza A virus	hema(GI:76886391 loc:DQ167303)
(A/Finland/483/2004 (H3N2)) Influenza A virus	hema(GI:76886393 loc:DQ167304)
(A/Finland/484/2004 (H3N2)) Influenza A virus	hema(GI:76886395 loc:DQ167305)
(A/Finland/485/2004 (H3N2)) Influenza A virus	hema(GI:76886397 loc:DQ167306)
(A/Finland/486/2004 (H3N2)) Influenza A virus	hema(GI:76886399 loc:DQ167307)
(A/Finland/51/2002 (H3N2)) Influenza A virus	hema(GI:76886301 loc:DQ167258)
(A/Finland/524/97 (H3N2)) Influenza A virus	hema(Gr. 14133827 loc:AF368440)
(A/Finland/528/97 (H3N2)) Influenza A virus	hema(GI:14133830 loc:AF368441)
(A/Finland/529/97 (H3N2)) Influenza A virus	hema(GI:14133833 loc:AF368442)
(A/Finland/532/97 (H3N2)) Influenza A virus	hema(GI:14133836 loc:AF368443)
(A/Finland/539/97(H3N2)) Influenza A virus	hema(GI:12044309 loc:AF311676)
(A/Finland/541/98 (H3N2)) Influenza A virus	hema(GI:76886287 loc:DQ167251)
(A/Finland/571/98(H3N2)) Influenza A virus	hema(GI:12044315 loc:AF311679)
(A/Finland/572/98(H3N2)) Influenza A virus	hema(GI:12044317 loc:AF311680)
(A/Finland/573/98(H3N2)) Influenza A virus	hema(GI:12044319 loc:AF311681)
(A/Finland/574/98(H3N2)) Influenza A virus	hema(GI:12044321 loc:AF311682)
(A/Finland/575/98(H3N2)) Influenza A virus	hema(GI:12044323 loc:AF311683)
(A/Finland/576/98(H3N2)) Influenza A virus	hema(GI:12044325 loc:AF311684)
(A/Finland/577/98(H3N2)) Influenza A virus	hema(GI:12044327 loc:AF311685)
(A/Finland/578/98(H3N2)) Influenza A virus	hema(GI:12044329 loc:AF311686)
(A/Finland/579/98(H3N2)) Influenza A virus	hema(GI:12044331 loc:AF311687)
(A/Finland/582/98(H3N2)) Influenza A virus	hema(GI:12044333 loc:AF311688)
(A/Finland/583/98(H3N2)) Influenza A virus	hema(GI:12044335 loc:AF311689)
(A/Finland/584/98(H3N2)) Influenza A virus	hema(GI:12044337 loc:AF311690)
(A/Finland/585/98(H3N2)) Influenza A virus	hema(GI:12044339 loc:AF311691)
(A/Finland/586/98(H3N2)) Influenza A virus	hema(GI:12044341 loc:AF311692)
(A/Finland/587/98(H3N2)) Influenza A virus	hema(GI:12044343 loc:AF311693)

Influenza A virus (A/Finland/589/98(H3N2))	hema(GI: 12044345 loc:AF3 11694)
Influenza A virus (A/Finland/590/98(H3N2))	hema(GI: 12044347 loc:AF3 11695)
Influenza A virus (A/Finland/592/98(H3N2))	hema(GI: 12044349 loc:AF3 11696)
Influenza A virus (A/Finland/593/98(H3N2))	hema(GI: 12044351 loc:AF3 11697)
Influenza A virus (A/Finland/594/98(H3N2))	hema(GI: 12044353 loc:AF3 11698)
Influenza A virus (A/Finland/616/99(H3N2))	hema(GI: 18653216 loc:AF442469)
Influenza A virus (AMnland/620/99(H3N2))	
Influenza A virus (A/Finland/638/99(H3N2))	hema(GI: 18653 190 loc:AF442456)
Influenza A virus (A/Finland/644/99(H3N2))	hema(GI: 18653232 loc:AF442477)
Influenza A virus (A/Finland/645/99(H3N2))	hema(GI: 18653224 loc:AF442473)
Influenza A virus (A/Finland/646/99(H3N2))	hema(GI: 18653222 loc:AF442472)
Influenza A virus (A/Finland/656/99(H3N2))	hema(GI: 18653 198 loc:AF442460)
Influenza A virus (A/Finland/657/99(H3N2))	hema(GI: 18653202 loc:AF442462)
Influenza A virus (A/Finland/658/99(H3N2))	hema(GI: 18653204 loc:AF442463)
Influenza A virus (A/Finland/659/99(H3N2))	hema(GI: 18653208 loc:AF442465)
Influenza A virus (A/Finland/660/99(H3N2))	hema(GI: 18653228 loc:AF442475)
Influenza A virus (A/Finland/661/99(H3N2))	hema(GI: 18653212 loc:AF442467)
Influenza A virus (A/Finland/662/99(H3N2))	hema(GI: 18653 192 loc:AF442457)
Influenza A virus (A/Finland/663/99(H3N2))	hema(GI: 18653226 loc:AF442474)
Influenza A virus (A/Finland/664/99(H3N2))	hema(GI: 18653200 loc:AF442461)
Influenza A virus (A/Finland/665/99(H3N2))	hema(GI: 18653210 loc:AF442466)
Influenza A virus (A/Finland/666/99(H3N2))	hema(GI: 18653214 loc:AF442468)
Influenza A virus (A/Finland/678/99(H3N2))	hema(GI: 18653196 loc:AF442459)
Influenza A virus (A/Finland/679/99(H3N2))	hema(GI: 18653234 loc:AF442478)
Influenza A virus (A/Finland/680/99(H3N2))	hema(GI: 18653240 loc:AF442481)
Influenza A virus (A/Finland/68 1/99(H3N2))	hema(GI: 18653230 loc:AF442476)
Influenza A virus (AMnland/682/99(H3N2))	hema(GI: 186532 18 loc:AF442470)
Influenza A virus (A/Finland/683/99(H3N2))	hema(GI: 18653 188 loc:AF442455)
Influenza A virus (A/Finland/684/99(H3N2))	hema(GI: 18653206 loc:AF442464)
Influenza A virus (A/Finland/686/99(H3N2))	hema(GI: 18653236 loc:AF442479)
Influenza A virus (A/Finland/694/99(H3N2))	hema(GI: 18653220 loc:AF442471)
Influenza A virus (A/Finland/695/99(H3N2))	hema(GI: 18653 194 loc:AF442458)
Influenza A virus (A/Finland/697/99(H3N2))	hema(GI: 18653242 loc:AF442482)
Influenza A virus	hema(GI: 18653238 loc:AF442480)

(A/Finland/702/99(H3N2))	
Influenza A virus (A/Finland/C2-10/2002(H3N2))	hema(GI:77023562 loc:DQ179407)
Influenza A virus (A/Finland/C2-12/2002(H3N2))	hema(GI:77023566 loc:DQ179409)
Influenza A virus (A/Finland/C2-13/2002(H3N2))	hema(GI:77023568 loc:DQ179410)
Influenza A virus (A/Finland/C2-14/2002(H3N2))	hema(GI:77023570 loc:DQ17941 1)
Influenza A virus (A/Finland/C2-17/2002(H3N2))	hema(GI:77023576 loc:DQ179414)
Influenza A virus (A/Finland/C2-6/2002(H3N2))	hema(GI:77023554 loc:DQ1 79403)
Influenza A virus (A/Finland/C4-2/2003(H3N2))	hema(GI:77023696 loc:DQ179474)
Influenza A virus (A/Finland/C4-22/2003(H3N2))	hema(GI:77023736 loc:DQ179494)
Influenza A virus (A/Finland/C4-23/2003(H3N2))	hema(GI:77023738 loc:DQ179495)
Influenza A virus (A/Finland/C4-24/2003(H3N2))	hema(GI:77023740 loc:DQ179496)
Influenza A virus (A/Florence/1/93(H3N2))	
Influenza A virus (A/Florida/4/95(H3N2))	hema(GI:6552606 loc:AF 180663)
Influenza A virus (A/France/1/00(H3N2))	hema(GI:49089661 loc:AY633996)
Influenza A virus (A/France/10/00(H3N2))	hema(GI:49089679 loc:AY634005)
Influenza A virus (A/France/I 1/00(H3N2))	hema(GI:49089681 loc:AY634006)
Influenza A virus (A/France/I 109/94(H3N2))	hema(GI:2271322 loc:AF008799)
Influenza A virus (A/France/12/00(H3N2))	hema(GI:49089683 loc:AY634007)
Influenza A virus (A/France/1203/94(H3N2))	hema(GI:2275410 loc:AF008835)
Influenza A virus (A/France/13/00(H3N2))	hema(GI:49089685 loc:AY634008)
Influenza A virus (A/France/14/00(H3N2))	hema(GI:49089687 loc:AY634009)
Influenza A virus (A/France/I 5/00(H3N2))	hema(GI:49089689 loc:AY634010)
Influenza A virus (A/France/16/00(H3N2))	hema(GI:49089691 loc:AY63401 1)
Influenza A virus (A/France/17/00(H3N2))	hema(GI:49089693 loc:AY634012)
Influenza A virus (A/France/I 8/00(H3N2))	hema(GI:49089695 loc:AY634013)
Influenza A virus (A/France/I 9/00(H3N2))	hema(GI:49089697 loc:AY634014)
Influenza A virus (A/France/2/00(H3N2))	hema(GI:49089663 loc:AY633997)
Influenza A virus (A/France/20/00(H3N2))	hema(GI:49089699 loc:AY634015)
Influenza A virus (A/France/21/00(H3N2))	hema(GI:49089701 loc:AY634016)
Influenza A virus (A/France/22/00(H3N2))	hema(GI:49089703 loc:AY634017)
Influenza A virus (A/France/23/00(H3N2))	hema(GI:49089705 loc:AY634018)
Influenza A virus (A/France/24/00(H3N2))	hema(GI:49089707 loc:AY634019)
Influenza A virus (A/France/25/00(H3N2))	hema(GI:49089709 loc:AY634020)
Influenza A virus (A/France/26/00(H3N2))	hema(GI:49089711 loc:AY634021)

Influenza A virus (A/France/27/00(H3N2))	hema(GI:49089713 loc:AY634022)
Influenza A virus (A/France/28/00(H3N2))	hema(GI:49089715 loc:AY634023)
Influenza A virus (A/France/29/00(H3N2))	hema(GI:49089717 loc:AY634024)
Influenza A virus (A/France/3/00(H3N2))	hema(GI:49089665 loc:AY633998)
Influenza A virus (A/France/30/00(H3N2))	hema(GI:49089719 loc:AY634025)
Influenza A virus (A/France/31/00(H3N2))	hema(GI:49089721 loc:AY634026)
Influenza A virus (A/France/32/00(H3N2))	hema(GI:49089723 loc:AY634027)
Influenza A virus (A/France/33/00(H3N2))	hema(GI:49089725 loc:AY634028)
Influenza A virus (A/France/34/00(H3N2))	hema(GI:49089727 loc:AY634029)
Influenza A virus (A/France/35/00(H3N2))	hema(GI:49089729 loc:AY634030)
Influenza A virus (A/France/36/00(H3N2))	hema(GI:49089731 loc:AY634031)
Influenza A virus (A/France/37/00(H3N2))	hema(GI:49089733 loc:AY634032)
Influenza A virus (A/France/38/00(H3N2))	hema(GI:49089735 loc:AY634033)
Influenza A virus (A/France/39/00(H3N2))	hema(GI:49089737 loc:AY634034)
Influenza A virus (A/France/4/00(H3N2))	hema(GI:49089667 loc:AY633999)
Influenza A virus (A/France/40/00(H3N2))	hema(GI:49089739 loc:AY634035)
Influenza A virus (A/France/41/00(H3N2))	hema(GI:49089741 loc:AY634036)
Influenza A virus (A/France/42/00(H3N2))	hema(GI:49089743 loc:AY634037)
Influenza A virus (A/France/43/00(H3N2))	hema(GI:49089745 loc:AY634038)
Influenza A virus (A/France/44/00(H3N2))	hema(GI:49089747 loc:AY634039)
Influenza A virus (A/France/45/00(H3N2))	hema(GI:49089749 loc:AY634040)
Influenza A virus (A/France/46/00(H3N2))	hema(GI:49089751 loc:AY634041)
Influenza A virus (A/France/47/00(H3N2))	hema(GI:49089753 loc:AY634042)
Influenza A virus (A/France/48/00(H3N2))	hema(GI:49089755 loc:AY634043)
Influenza A virus (A/France/49/00(H3N2))	hema(GI:49089757 loc:AY634044)
Influenza A virus (A/France/5/00(H3N2))	hema(GI:49089669 loc:AY634000)
Influenza A virus (A/France/50/00(H3N2))	hema(GI:49089759 loc:AY634045)
Influenza A virus (A/France/51/00(H3N2))	hema(GI:49089761 loc:AY634046)
Influenza A virus (A/France/52/00(H3N2))	hema(GI:49089763 loc:AY634047)
Influenza A virus (A/France/53/00(H3N2))	hema(GI:49089765 loc:AY634048)
Influenza A virus (A/France/54/00(H3N2))	hema(GI:49089767 loc:AY634049)
Influenza A virus (A/France/6/00(H3N2))	hema(GI:49089671 loc:AY634001)
Influenza A virus (A/France/7/00(H3N2))	hema(GI:49089673 loc:AY634002)
Influenza A virus	hema(GI:6552597 loc:AF180654)

(A/France/75/97(H3N2))	
Influenza A virus	
(A/France/8/00(H3N2))	hema(GI:49089675 loc:AY634003)
Influenza A virus	
(A/France/9/00(H3N2))	hema(GI:49089677 loc:AY634004)
Influenza A virus (A/France/C4-16/2003(H3N2))	hema(GI:77023724 loc:DQ179488)
Influenza A virus	
(A/Fujian/133/96(H3N2))	hema(GI:6552546 loc:AF180603)
Influenza A virus	
(A/Fujian/134/1999(H3N2))	hema(GI:62125827 loc:AY963795)
Influenza A virus	
(A/Fujian/137/1999(H3N2))	hema(GI:62 125802 loc:AY963782)
Influenza A virus	
(A/Fujian/182/2003(H3N2))	hema(GI:62125829 loc:AY963796)
Influenza A virus	
(A/Fujian/219/2003(H3N2))	hema(GI:62 125804 loc:AY963783)
Influenza A virus	
(A/Fujian/258/2003(H3N2))	hema(Gr.62125806 loc:AY963784)
Influenza A virus	
(A/Fujian/292/2003(H3N2))	hema(GI:62125808 loc:AY963785)
Influenza A virus	
(A/Fujian/325/2003(H3N2))	hema(GI:62125810 loc:AY963786)
Influenza A virus	
(A/Fujian/4/2004(H3N2))	hema(GI:62125815 loc:AY963789)
Influenza A virus	hema(GI:l 10825876
(A/Fujian/4 11/2002(H3N2))	loc:DQ865966)
Influenza A virus	
(A/Fujian/447/2003(H3N2))	hema(GI:62125812 loc:AY963787)
Influenza A virus	
(A/Fujian/47/96(H3N2))	hema(GI:2271176 loc:AF008726)
Influenza A virus	
(A/Fujian/52/2004(H3N2))	hema(GI:62125817 loc:AY963790)
Influenza A virus	
(A/Fujian/555/2003(H3N2))	hema(GI:62125813 loc:AY963788)
Influenza A virus	
(A/Fukuoka/C29/(H3N2))	hema(GI:2275492 loc:AF008876)
Influenza A virus	
(A/Fukuoka/C29/85(H3N2))	hema(GI:221305 loc:FLAHAFUK)
Influenza A virus	
(A/Fukushima/1 14/96(H3N2))	hema(GI:2271 148 loc:AF008712)
Influenza A virus	
(A/Geneva/3958/96(H3N2))	hema(GI:49339360 loc:AY661 195)
Influenza A virus	
(A/Geneva/5007/89(H3N2))	hema(GI:49339084 loc:AY661057)
Influenza A virus	
(A/Geneva/5 113/92(H3N2))	hema(GI:49339192 loc:AY661 111)
Influenza A virus	
(A/Geneva/6447/91(H3N2))	hema(GI:49339124 loc:AY661077)
Influenza A virus	
(A/Geneva/AI9509/95(H3N2))	hema(GI:49339334 loc:AY661 182)
Influenza A virus	
(A/Genoa/5/98(H3N2))	
Influenza A virus	
(A/Georgia/122/68(H3N2))	
Influenza A virus	
(A/Georgia/3/93(H3N2))	hema(GI:2275422 loc:AF008841)
Influenza A virus	
(A/Germany/49 1/96(H3N2))	hema(GI:2271 198 loc:AF008737)
Influenza A virus	
(A/Germany/578652/95(H3N2))	hema(GI:2271228 loc:AF008752)
Influenza A virus	
(A/Germany/767/95(H3N2))	hema(GI:2271232 loc:AF008754)
Influenza A virus	
(A/goose/HK/10/1976(H3N2))	
Influenza A virus	
(A/Granada/R1 92/96(H3N2))	hema(GI:16417075 loc:AF357936)

Influenza A virus (A/Granada/R195/96(H3N2))	hema(GI:16417077 loc:AF357937)
Influenza A virus (A/Granada/R198/96(H3N2))	hema(GI:16417079 loc:AF357938)
Influenza A virus (A/Granada/RR334/98(H3N2))	hema(GI: 16417085 loc:AF357941)
Influenza A virus (A/Granada/RR356/98(H3N2))	hema(GI: 16417087 loc:AF357942)
Influenza A virus (A/Greece/1/97 (H3N2))	hema(GI: 1223 1903 loc:AF3 15567)
Influenza A virus (A/Greece/I 0/98 (H3N2))	hema(GI: 1223 1988 loc:AF3 16819)
Influenza A virus (A/Greece/103/98 (H3N2))	hema(GI: 1223 1893 loc:AF315562)
Influenza A virus (A/Greece/106/98 (H3N2))	hema(GI:12231895 loc:AF3 15563)
Influenza A virus (A/Greece/109/99 (H3N2))	hema(GI: 1223 1897 loc:AF3 15564)
Influenza A virus (A/Greece/132/99 (H3N2))	hema(GI: 1223 1899 loc:AF3 15565)
Influenza A virus (A/Greece/ 18/98 (H3N2))	hema(GI: 1223 1992 loc:AF316821)
Influenza A virus (A/Greece/ 19/98 (H3N2))	hema(GI: 1223 1887 loc:AF3 15559)
Influenza A virus (A/Greece/4/97 (H3N2))	hema(GI: 1223 1907 loc:AF3 15569)
Influenza A virus (A/Guadeloupe/39/96(H3N2))	hema(GI:6552598 loc:AF 180655)
Influenza A virus (A/Guam/10 14/96(H3N2))	hema(GI:6552596 loc:AF 180653)
Influenza A virus (A/Guam/362/2005(H3N2))	hema(GI:82571084 loc:DQ265715)
Influenza A virus (A/Guandong/243/1972(H3N2))	
Influenza A virus (A/Guandong/28/ 1994(H3N2))	
Influenza A virus (A/Guangdong/0 1/95(H3N2))	
Influenza A virus (A/Guangdong/04/96 (H3N2))	hema(GI:21952433 loc:AF525217)
Influenza A virus (A/Guangdong/07/96(H3N2))	hema(GI:22000807 loc:AF525799)
Influenza A virus (A/Guangdong/08/95 (H3N2))	hema(GI:21952437 loc:AF525219)
Influenza A virus (A/Guangdong/08/96(H3N2))	hema(GI:22000801 loc:AF525686)
Influenza A virus (A/Guangdong/1/96(H3N2))	hema(GI:6552562 loc:AF180619)
Influenza A virus (A/Guangdong/243/1972(H3N2))	
Influenza A virus (A/Guangdong/25/1993(H3N2))	
Influenza A virus (A/Guangdong/25/93(H3N2))	hema(GI:2271380 loc:AF008828)
Influenza A virus (A/Guangdong/27/94(H3N2))	hema(GI:2275436 loc:AF008848)
Influenza A virus (A/Guangdong/28/94(H3N2))	hema(GI:24061723 loc:AY137206)
Influenza A virus (A/Guangdong/3 8/1 977(H3N2))	
Influenza A virus (A/Guangdong/38/1989(H3N2))	
Influenza A virus (A/Guangdong/3 8/77(H3N2))	
Influenza A virus (A/Guangdong/39/1989(H3N2))	
Influenza A virus	hema(GI:2271056 loc:AF008666)

(A/Guangdong/39/89(H3N2)) Influenza A virus	
(A/Guangdong/4/93(H3N2)) Influenza A virus	hema(GI:2271340 loc:AF008808)
(A/Guangdong/89(H3N2)) Influenza A virus	hema(GI:2271058 loc:AF008667)
(A/Guangdong/9/(H3N2)) Influenza A virus	hema(GI:2275506 loc:AF008883)
(A/Guangdong/9/1987(H3N2)) Influenza A virus	
(A/Guangdong/9/87(H3N2)) Influenza A virus	
(A/Guangxi/42/95(H3N2)) Influenza A virus	hema(GI:2271256 loc:AF008766)
(A/Guangzhou/1 1/96(H3N2)) Influenza A virus	hema(GI:2271142 loc:AF008709)
(A/Guangzhou/6/96(H3N2)) Influenza A virus	hema(GI:2271 138 loc:AF008707)
(A/Guangzhou/66/97(H3N2)) Influenza A virus	hema(GI:6552574 loc:AF180631)
(A/Guangzhou/8/96(H3N2)) Influenza A virus	hema(GI:2271 144 loc:AF008710)
(A/Guanxi/1 89/96(H3N2)) Influenza A virus	hema(GI:655253 1 loc:AF 180588)
(A/Guildford/V728/85(H3N2)) Influenza A virus	hema(GI:49339072 loc:AY661051)
(A/Guizhou/1/(H3N2)) Influenza A virus	hema(GI:2275518 loc:AF008889)
(A/Guizhou/3/(H3N2)) Influenza A virus	hema(GI:2275464 loc:AF008862)
(A/Guizhou/54/89(H3N2)) Influenza A virus	hema(GI:2271054 loc:AF008665)
(A/Gumma/346/(H3N2)) Influenza A virus	hema(GI:2275540 loc:AF008900)
(A/Gyeongbuk/2/02(H3N2)) Influenza A virus	hema(GI:36954827 loc:AY377129)
(A/Hanoi/I 84/2002(H3N2)) Influenza A virus	hema(GI:84875439 loc:AB221016)
(A/Hanoi/I 97/2002(H3N2)) Influenza A virus	hema(GI:84875441 loc:AB221017)
(A/Hanoi/217/2002(H3N2)) Influenza A virus	hema(GI:84875443 loc:AB221018)
(A/Hanoi/235/2002(H3N2)) Influenza A virus	hema(GI:84875445 loc:AB221019)
(A/Hanoi/695/2003(H3N2)) Influenza A virus	hema(GI:84875447 loc:AB221020)
(A/Hanoi/ARI99/2003(H3N2)) Influenza A virus	hema(GI:84875449 loc:AB221021)
(A/Hanoi/BM766/2003(H3N2)) Influenza A virus	hema(GI:84875451 loc:AB221022)
(A/Hanoi/BM767/2003(H3N2)) Influenza A virus	hema(GI:84875453 loc:AB221023)
(A/Hanoi/BM768/2003(H3N2)) Influenza A virus	hema(GI:84875455 loc:AB221024)
(A/Hanoi/BM769/2003(H3N2)) Influenza A virus	hema(GI:84875457 loc:AB221025)
(A/Hanoi/HN30109/2004(H3N2)) Influenza A virus	hema(GI:84875461 loc:AB221027)
(A/Hanoi/HN30240/2004(H3N2)) Influenza A virus	hema(GI:84875463 loc:AB221028)
(A/Hanoi/HN3069/2004(H3N2)) Influenza A virus	hema(GI:84875459 loc:AB221026)
(A/Harbin/15/92(H3N2)) Influenza A virus	hema(GI:2271342 loc:AF008809)
(A/Harbin/3/94(H3N2)) Influenza A virus	hema(GI:2275452 loc:AF008856)
(A/Harbin/3/96(H3N2)) Influenza A virus	hema(GI:6552528 loc:AF 180585)

Influenza A virus (A/Hawan/01/1991(H3N2))	
Influenza A virus (A/Hawaii/1/91(H3N2))	hema(GI:2271094 loc:AF008685)
Influenza A virus (A/Hawaii/1/97(H3N2))	hema(GI:6552523 loc:AF180580)
Influenza A virus (A/Hawaii/2/68(H3N2))	
Influenza A virus (A/Hawaii/2/96(H3N2))	hema(GI:2271 160 loc:AF008718)
Influenza A virus (A/Hawaii/3/92(H3N2))	hema(GI:2271354 loc:AF008815)
Influenza A virus (A/Hawke's Bay/83/2004(H3N2))	
Influenza A virus (A/Hebei/12/93(H3N2))	hema(GI:493643 loc:FLAH5)
Influenza A virus (A/Hebei/19/1995(H3N2))	
Influenza A virus (A/Hebei/41/1994(H3N2))	
Influenza A virus (A/Hokkaido/1/1988(H3N2))	hema(GI:603791 loc:FLAHB)
Influenza A virus (A/Hokkaido/1/1993(H3N2))	hema(GI:603792 loc:FLAHC)
Influenza A virus (A/Hokkaido/2/1993(H3N2))	
Influenza A virus (A/Hokkaido/20/89(H3N2))	hema(GI:762859 loc:FLAH3N2B)
Influenza A virus (A/Hong Kong(H3N2))	
Influenza A virus (A/Hong Kong/1/1982(H3N2))	
Influenza A virus (A/Hong Kong/1/1994(H3N2))	
Influenza A virus (A/Hong Kong/1/68(H3N2))	hema(GI:6470272 loc:AF201874)
Influenza A virus (A/Hong Kong/1 1/1973(H3N2))	
Influenza A virus (A/Hong Kong/1 143/99(H3N2))	hema(GI: 14487957 loc:AF382319)
Influenza A virus (A/Hong Kong/1 144/99(H3N2))	hema(GI:14487961 loc:AF382321)
Influenza A virus (A/Hong Kong/1 179/99(H3N2))	hema(GI: 14487965 loc:AF382323)
Influenza A virus (A/Hong Kong/1 180/99(H3N2))	hema(GI: 14487969 loc:AF382325)
Influenza A virus (A/Hong Kong/1 182/99(H3N2))	hema(GI: 14487973 loc:AF382327)
Influenza A virus (A/Hong Kong/14/1974(H3N2))	
Influenza A virus (A/Hong Kong/14/1983(H3N2))	
Influenza A virus (A/Hong Kong/14/1992(H3N2))	
Influenza A virus (A/Hong Kong/1 774/99(H3N2))	
Influenza A virus (A/Hong Kong/1789/2000(H3N2))	
Influenza A virus (A/Hong Kong/2/1988(H3N2))	
Influenza A virus (A/Hong Kong/2/1994(H3N2))	
Influenza A virus (A/Hong Kong/2/2000(H3N2))	
Influenza A virus (A/Hong Kong/2/68(H3N2))	
Influenza A virus (A/Hong	

Kong/221/99(H3N2))
 Influenza A virus (A/Hong Kong/23/1992(H3N2))
 Influenza A virus (A/Hong Kong/24/1985(H3N2))
 Influenza A virus (A/Hong Kong/26/1983(H3N2))
 Influenza A virus (A/Hong Kong/280/97(H3N2)) hema(GI:49339376 loc:AY661203)
 Influenza A virus (A/Hong Kong/3/1969(H3N2))
 Influenza A virus (A/Hong Kong/33/1973(H3N2))
 Influenza A virus (A/Hong Kong/34/1990(H3N2))
 Influenza A virus (A/Hong Kong/34/90(H3N2)) hema(GI:2271040 loc:AF008658)
 Influenza A virus (A/Hong Kong/358/96(H3N2)) hema(GI:6552545 loc:AF180602)
 Influenza A virus (A/Hong Kong/387/97(H3N2)) hema(GI:6552518 loc:AF180575)
 Influenza A virus (A/Hong Kong/391/97(H3N2)) hema(GI:6552514 loc:AF180571)
 Influenza A virus (A/Hong Kong/4/1984(H3N2))
 Influenza A virus (A/Hong Kong/43/1975(H3N2))
 Influenza A virus (A/Hong Kong/434/96(H3N2)) hema(GI:6552513 loc:AF180570)
 Influenza A virus (A/Hong Kong/45/1980(H3N2))
 Influenza A virus (A/Hong Kong/46/1971(H3N2))
 Influenza A virus (A/Hong Kong/46/1980(H3N2))
 Influenza A virus (A/Hong Kong/49/1974(H3N2))
 Influenza A virus (A/Hong Kong/497/97(H3N2))
 Influenza A virus (A/Hong Kong/498/97(H3N2))
 Influenza A virus (A/Hong Kong/5/1983(H3N2))
 Influenza A virus (A/Hong Kong/5/83(H3N2))
 Influenza A virus (A/Hong Kong/50/1972(H3N2))
 Influenza A virus (A/Hong Kong/6/1972(H3N2))
 Influenza A virus (A/Hong Kong/6/1985(H3N2))
 Influenza A virus (A/Hong Kong/6/99(H3N2))
 Influenza A virus (A/Hong Kong/7/1984(H3N2))
 Influenza A virus (A/Hong Kong/7/1985(H3N2))
 Influenza A virus (A/Hong Kong/7/1987(H3N2))
 Influenza A virus (A/Hong Kong/CI-10/2002(H3N2)) hema(GI:77023530 loc:DQ179391)
 Influenza A virus (A/Hong Kong/CI-11/2002(H3N2)) hema(GI:77023532 loc:DQ179392)
 Influenza A virus (A/Hong Kong/CI-13/2002(H3N2)) hema(GI:77023536 loc:DQ179394)
 Influenza A virus (A/Hong Kong/C1-4/2001(H3N2)) hema(GI:77023518 loc:DQ179385)

Influenza A virus (A/Hong Kong/C 1-9/2002(H3N2))	hema(GI:77023528 loc:DQ179390)
Influenza A virus (A/Hong Kong/1/94(H3N2))	hema(GI:2271268 loc:AF008772)
Influenza A virus (A/Hong Kong/23/92(H3N2))	hema(GI:2271372 loc:AF008824)
Influenza A virus (A/Hong Kong/3/95(H3N2))	hema(GI:2271234 loc:AF008755)
Influenza A virus (A/Hong Kong/357/96(H3N2))	hema(GI:2271 146 loc:AF00871 1)
Influenza A virus (A/Hong Kong/38/95(H3N2))	hema(GI:2271242 loc:AF008759)
Influenza A virus (A/Hong Kong/42/96(H3N2))	hema(GI:2271262 loc:AF008769)
Influenza A virus (A/Hong Kong/55/94(H3N2))	hema(GI:2271270 loc:AF008773)
Influenza A virus (A/Hongkong/1/89(H3N2))	hema(GI:49339088 loc:AY661059)
Influenza A virus (A/Hongkong/1/94(H3N2))	hema(GI:49339320 loc:AY661 175)
Influenza A virus (A/Hongkong/1/97(H3N2))	hema(GI:49339374 loc:AY661202)
Influenza A virus (A/HongKong/16/68(H3N2))	
Influenza A virus (A/HongKong/19/68(H3N2))	
Influenza A virus (A/Hongkong/20/96(H3N2))	hema(GI:49339356 loc:AY661 193)
Influenza A virus (A/Hongkong/32/95(H3N2))	hema(GI:49339340 loc:AY661185)
Influenza A virus (A/Hongkong/38/95(H3N2))	hema(GI:49339342 loc:AY661 186)
Influenza A virus (A/Hongkong/49/95(H3N2))	hema(GI:49339344 loc:AY661 187)
Influenza A virus (A/Hongkong/55/94(H3N2))	hema(GI:49339378 loc:AY661204)
Influenza A virus (A/Hongkong/55/95(H3N2))	hema(GI:49339348 loc:AY661 189)
Influenza A virus (A/Hongkong/56/94(H3N2))	hema(GI:49339326 loc:AY661 178)
Influenza A virus (A/Houston/24269/1985(H3N2))	
Influenza A virus (A/Houston/56798/92(H3N2))	hema(GI:49339218 loc:AY661 124)
Influenza A virus (A/Houston/56829/92(H3N2))	hema(GI:49339214 loc:AY661 122)
Influenza A virus (A/Houston/5694 1/92(H3N2))	hema(GI:49339216 loc:AY661 123)
Influenza A virus (A/HT/24269/1985(H3N2))	hema(GI:324105 loc:FLAHAC)
Influenza A virus (A/human/Montreal/MTL 103/00(H3N2))	
Influenza A virus (A/human/Montreal/MTL 152/00(H3N2))	
Influenza A virus (A/human/Montreal/MTL 169/00(H3N2))	
Influenza A virus (A/human/Montreal/MTL 72/00(H3N2))	
Influenza A virus (A/human/Montreal/MTL20/00(H3N2))	
Influenza A virus (A/human/Montreal/MTL29/00(H3N2))	

N2))
Influenza A virus
(A/human/Montreal/MTL30/00(H3
N2))
Influenza A virus
(A/human/Montreal/MTL327/00(H
3N2))
Influenza A virus
(A/human/Montreal/MTL45/00(H3
N2))
Influenza A virus
(A/human/Montreal/MTL50/00(H3
N2))
Influenza A virus
(A/human/Montreal/MTL500/00(H
3N2))
Influenza A virus
(A/human/Montreal/MTL5 12/00(H
3N2))
Influenza A virus
(A/human/Montreal/MTL5 16/00(H
3N2))
Influenza A virus
(A/human/Montreal/MTL63/00(H3
N2))
Influenza A virus
(A/human/Montreal/MTL63 149/00
(H3N2))
Influenza A virus
(A/human/Montreal/MTL63274/00
(H3N2))
Influenza A virus
(A/human/Montreal/MTL63286/00
(H3N2))
Influenza A virus
(A/human/Montreal/MTL63446/00
(H3N2))
Influenza A virus
(A/human/Montreal/MTL63748/00
(H3N2))
Influenza A virus
(A/human/Montreal/MTL638 16/00
(H3N2))
Influenza A virus
(A/human/Montreal/MTL63963/00
(H3N2))
Influenza A virus
(A/human/Montreal/MTL7 1034/00
(H3N2))
Influenza A virus
(A/human/Montreal/MTL7 1044/00
(H3N2))
Influenza A virus
(A/human/Montreal/MTL7 1045/00
(H3N2))
Influenza A virus
(A/human/Montreal/MTL71046/00
(H3N2))
Influenza A virus
(A/human/Montreal/MTL7 1213/00
(H3N2))
Influenza A virus
(A/human/Montreal/MTL7 1973/00
(H3N2))
Influenza A virus
(A/human/Montreal/MTL7 1976/00
(H3N2))

Influenza A virus (A/human/Montreal/MTL72692/00 (H3N2))		
Influenza A virus (A/human/Montreal/MTL72709/00 (H3N2))		
Influenza A virus (A/human/Montreal/MTL8/00(H3 N2))		
Influenza A virus (A/human/Taiwan/0095/96(H3N2))	hema(GI:15055140 loc:AF362820)	
Influenza A virus (A/human/Taiwan/01 18/98(H3N2))	hema(GI:150551 10 loc:AF362805)	
Influenza A virus (A/human/Taiwan/0149/00(H3N2))	hema(GI: 15055 112 loc:AF362806)	
Influenza A virus (A/human/Taiwan/0293/98(H3N2))	hema(GI: 15055 114 loc:AF3 62807)	
Influenza A virus (A/human/Taiwan/0389/99(H3N2))	hema(GI: 15055 116 loc:AF362808)	
Influenza A virus (A/human/Taiwan/0423/98(H3N2))	hema(GI:150551 18 loc:AF362809)	
Influenza A virus (A/human/Taiwan/0464/98(H3N2))	hema(GI:15055120 loc:AF362810)	
Influenza A virus (A/human/Taiwan/0830/99(H3N2))	hema(GI:15055 122 loc:AF362811)	
Influenza A virus (A/human/Taiwan/1008/99(H3N2))	hema(GI:15055124 loc:AF362812)	
Influenza A virus (A/human/Taiwan/1537/99(H3N2))	hema(GI:15055126 loc:AF362813)	
Influenza A virus (A/human/Taiwan/1748/97(H3N2))	hema(GI:15055128 loc:AF362814)	
Influenza A virus (A/human/Taiwan/1986/96(H3N2))	hema(GI:15055130 loc:AF362815)	
Influenza A virus (A/human/Taiwan/203 1/97(H3N2))	hema(GI:15055132 loc:AF362816)	
Influenza A virus (A/human/Taiwan/2548/99(H3N2))	hema(GI:15055134 loc:AF362817)	
Influenza A virus (A/human/Taiwan/3083/00(H3N2))	hema(GI:15055136 loc:AF362818)	
Influenza A virus (A/human/Taiwan/3460/00(H3N2))	hema(GI: 15055 138 loc:AF362819)	
Influenza A virus (A/human/Taiwan/3760/00(H3N2))	hema(GI:15055108 loc:AF362804)	
Influenza A virus (A/Hung Yen/HYO10/2004(H3N2))	hema(GI:84875465 loc:AB221029)	
Influenza A virus (A/Hung Yen/HY012/2004(H3N2))	hema(GI:84875467 loc:AB221030)	
Influenza A virus (A/Hungary/2/71(H3N2))		
Influenza A virus (A/Hutt/82/2000(H3N2))		neura(GI:86848962 loc:CY0088140)
Influenza A virus (A/Ibaraki/1/90(H3N2))	hema(GI:221321 loc:FLAHAIBA)	
Influenza A virus (A/Idaho/3/95(H3N2))	hema(GI:2271204 loc:AF008740)	
Influenza A virus (A/Idaho/4/95(H3N2))	hema(GI:2271206 loc:AF008741)	
Influenza A virus (A/IUinois/5/95(H3N2))	hema(GI:2271288 loc:AF008782)	
Influenza A virus (A/Incheon/260/2002(H3N2))	hema(GI:46410052 loc:AY589657)	
Influenza A virus (A/Inchon/81/99(H3N2))	hema(GI: 14550246 loc:AF386634)	
Influenza A virus (A/Ind/M/Enc/1/2003(H3N2))	hema(GI:56718218 loc:AY702441)	
Influenza A virus (A/Ind/M/Enc/2/2003(H3N2))	hema(GI:56718220 loc:AY702442)	

Influenza A virus (A/Ind/M/URI/1/2003(H3N2))	hema(GI:56718216 loc:AY702440)
Influenza A virus (A/Ind/M/URI/2/2003(H3N2))	hema(GI:56718222 loc:AY702443)
Influenza A virus (A/Ind/P/URI/1/2003(H3N2))	hema(GI:56718230 loc:AY702447)
Influenza A virus (A/Ind/P/URI/2/2003(H3N2))	hema(GI:567 18226 loc:AY702445)
Influenza A virus (A/Ind/P/URI/3/2003(H3N2))	hema(GI:56718224 loc:AY702444)
Influenza A virus (A/Ind/P/URI/4/2003(H3N2))	hema(GI:56718228 loc:AY702446)
Influenza A virus (A/India/236/93(H3N2))	hema(GI:2271 102 loc:AF008689)
Influenza A virus (A/India/237/93(H3N2))	hema(GI:2271 104 loc:AF008690)
Influenza A virus (A/India/C3- 4/2002(H3N2))	hema(GI:77023584 loc:DQ179418)
Influenza A virus (A/India/C3- 45/2002(H3N2))	hema(GI:77023666 loc:DQ179459)
Influenza A virus (A/India/C3- 58/2002(H3N2))	hema(GI:77023692 loc:DQ179472)
Influenza A virus (A/Indiana/01/1990(H3N2))	
Influenza A virus (A/Indiana/1/96(H3N2))	hema(GI:6552558 loc:AF180615)
Influenza A virus (A/Indiana/28 170/99(H3N2))	hema(GI:21314324 loc:AF501534)
Influenza A virus (A/Indiana/3/91(H3N2))	hema(GI:2271086 loc:AF008681)
Influenza A virus (A/Indonesia/I 150/2005(H3N2))	hema(GI: 110825886 loc:DQ865971)
Influenza A virus (A/Indonesia/3 109/91(H3N2))	hema(GI:2271344 loc:AF008810)
Influenza A virus (A/Indonesia/3946/92(H3N2))	hema(GI:2271 112 loc:AF008694)
Influenza A virus (A/Iraq/34/2005(H3N2))	hema(GI:82571082 loc:DQ265714)
Influenza A virus (A/Ireland/10586/99(H3N2))	
Influenza A virus (A/Ireland/1092/2002(H3N2))	
Influenza A virus (A/Israel/C2- 4/2002(H3N2))	hema(GI:77023550 lociDQ1 79401)
Influenza A virus (A/Israel/C2- 7/2002(H3N2))	hema(GI:77023556 loc:DQ179404)
Influenza A virus (A/Israel/C2- 9/2002(H3N2))	hema(GI:77023560 loc:DQ1 79406)
Influenza A virus (A/Istanbul/CTF- 1/2003(H3N2))	hema(GI: 114225323 loc:DQ983746)
Influenza A virus (A/Istanbul/CTF- 11/2004(H3N2))	hema(GI: 114225335 loc:DQ983752)
Influenza A virus (A/Istanbul/CTF- 130/2005(H3N2))	hema(GI: 114225353 loc:DQ983761)
Influenza A virus (A/Istanbul/CTF- 15/2006(H3N2))	hema(GI: 114225361 loc:DQ983765)
Influenza A virus (A/Istanbul/CTF- 2/2003(H3N2))	hema(GI: 114225325 loc:DQ983747)
Influenza A virus (A/Istanbul/CTF- 26/2006(H3N2))	hema(GI: 114225363 loc:DQ983766)
Influenza A virus (A/Istanbul/CTF- 3/2003(H3N2))	hema(GI: 114225327 loc:DQ983748)
Influenza A virus (A/Istanbul/CTF- 3 1/2004(H3N2))	hema(GI:l 14225337 loc:DQ983753)
Influenza A virus (A/Istanbul/CTF- 33/2006(H3N2))	hema(GI: 114225365 loc:DQ983767)
Influenza A virus (A/Istanbul/CTF-	hema(GI:l 14225355

4/2006(H3N2))	loc:DQ983762)	
Influenza A virus (A/Istanbul/CTF-41/2004(H3N2))	hema(GI: 114225339 loc:DQ983754)	
Influenza A virus (A/Istanbul/CTF-45/2004(H3N2))	hema(GI: 114225341 loc:DQ983755)	
Influenza A virus (A/Istanbul/CTF-48/2004(H3N2))	hema(GI:l 14225343 loc:DQ983756)	
Influenza A virus (A/Istanbul/CTF-50/2004(H3N2))	hema(GI: 114225345 loc:DQ983757)	
Influenza A virus (A/Istanbul/CTF-51/2004(H3N2))	hema(GI: 114225347 loc:DQ983758)	
Influenza A virus (A/Istanbul/CTF-53/2004(H3N2))	hema(GI: 114225349 loc:DQ983759)	
Influenza A virus (A/Istanbul/CTF-7/2003(H3N2))	hema(GI:l 14225331 loc:DQ983750)	
Influenza A virus (A/Istanbul/CTF-79/2004(H3N2))	hema(GI: 114225351 loc:DQ983760)	
Influenza A virus (A/Istanbul/CTF-8/2003(H3N2))	hema(GI:l 14225333 loc:DQ983751)	
Influenza A virus (A/Istanbul/CTF-8/2006(H3N2))	hema(GI:l 14225357 loc:DQ983763)	
Influenza A virus (A/Istanbul/CTF-9/2006(H3N2))	hema(GI: 114225359 loc:DQ983764)	
Influenza A virus (A/Istanbul/CTF/10/2004(H3N2))		neura(GI: 114225373 loc:DQ9837710)
Influenza A virus (A/Istanbul/CTF/14/2004(H3N2))		neura(GI: 114225375 loc:DQ9837720)
Influenza A virus (A/Istanbul/CTF/15/2006(H3N2))		neura(GI: 114225385 loc:DQ9837770)
Influenza A virus (A/Istanbul/CTF/30/2004(H3N2))		neura(GI: 114225377 loc:DQ9837730)
Influenza A virus (A/Istanbul/CTF/4/2006(H3N2))		neura(GI: 114225379 loc:DQ9837740)
Influenza A virus (A/Istanbul/CTF/7/2003(H3N2))		neura(GI:l 14225369 loc:DQ9837690)
Influenza A virus (A/Istanbul/CTF/8/2003(H3N2))		neura(GI: 114225371 loc:DQ9837700)
Influenza A virus (A/Istanbul/CTF/8/2006(H3N2))		neura(GI: 114225381 loc:DQ9837750)
Influenza A virus (A/Istanbul/CTF/9/2006(H3N2))		neura(GI:l 14225383 loc:DQ9837760)
Influenza A virus (A/Italy/384/2005(H3N2))	hema(GI:82571080 loc:DQ265713)	
Influenza A virus (A/Italy/C4-12/2003(H3N2))	hema(GI:77023716 loc:DQ179484)	
Influenza A virus (A/Italy/C4-20/2003(H3N2))	hema(GI:77023732 loc:DQ179492)	
Influenza A virus (A/Italy/C4-6/2003(H3N2))	hema(GI:77023704 loc:DQ179478)	
Influenza A virus (A/Japan/1337/2005(H3N2))	hema(GI:82571078 loc:DQ265712)	
Influenza A virus (A/Japan/1383/2005(H3N2))	hema(GI:82571076 loc:DQ265711)	
Influenza A virus (A/Japan/416/97(H3N2))	hema(GI:6552541 loc:AF180598)	
Influenza A virus (A/Japan/86/95(H3N2))	hema(GI:2271278 loc:AF008777)	
Influenza A virus (A/Japan/99/96(H3N2))	hema(GI:2271172 loc:AF008724)	
Influenza A virus (A/Jiangsu/131/2004(H3N2))	hema(GI:57471039 loc:AY854046)	
Influenza A virus (A/Jiangsu/18/2004(H3N2))	hema(GI:58198690 loc:AY851476)	
Influenza A virus (A/Jiangsu/38/2004(H3N2))	hema(GI:57471043 loc:AY854048)	
Influenza A virus (A/Jiangsu/76/2004(H3N2))	hema(GI:57471045 loc:AY854049)	

Influenza A virus (A/Jiangsu/91/2004(H3N2))	hema(GI:57471041 loc:AY854047)
Influenza A virus (A/Jiangsu/A20/2004(H3N2))	hema(GI:58 198692 loc:AY851477)
Influenza A virus (A/Jiangsu/A26/2004(H3N2))	hema(GI:58 198686 loc:AY851474)
Influenza A virus (A/Jiangsu/A29/2004(H3N2))	hema(GI:58 198688 loc:AY851475)
Influenza A virus (A/Jiangsu/Children67/2003(H3N2))	hema(GI:58 198684 loc:AY851473)
Influenza A virus (A/Johannesburg/33/1994(H3N2))	
Influenza A virus (A/Johannesburg/1/03(H3N2))	hema(GI:3753001 1 loc:AY389349)
Influenza A virus (A/Johannesburg/10/03(H3N2))	hema(GI:37530015 loc:AY389351)
Influenza A virus (A/Johannesburg/10/97(H3N2))	hema(GI:6552586 loc:AF180643)
Influenza A virus (A/Johannesburg/17/95(H3N2))	hema(GI:2271214 loc:AF008745)
Influenza A virus (A/Johannesburg/2/95(H3N2))	hema(GI:2271260 loc:AF008768)
Influenza A virus (A/Johannesburg/28/03(H3N2))	hema(GI:37530017 loc:AY389352)
Influenza A virus (A/Johannesburg/29/98(H3N2))	
Influenza A virus (A/Johannesburg/3/97(H3N2))	hema(GI:6552548 loc:AF180605)
Influenza A virus (A/Johannesburg/30/03(H3N2))	hema(GI:37530019 loc:AY389353)
Influenza A virus (A/Johannesburg/33/94(H3N2))	hema(GI:2271272 loc:AF008774)
Influenza A virus (A/Johannesburg/4/03(H3N2))	hema(GI:37530013 loc:AY389350)
Influenza A virus (A/Johannesburg/47/94(H3N2))	hema(GI:49339328 loc:AY661 179)
Influenza A virus (A/Johannesburg/50/03(H3N2))	hema(GI:37530021 loc:AY389354)
Influenza A virus (A/Johannesburg/53/96(H3N2))	hema(GI:6552608 loc:AF180665)
Influenza A virus (A/Johannesburg/64/03(H3N2))	hema(GI:37530023 loc:AY389355)
Influenza A virus (A/Johannesburg/9/97(H3N2))	hema(GI:65 52585 loc:AFI 80642)
Influenza A virus (A/Kamata/14/91(H3N2))	hema(GI:8100071 loc:AB043705)
Influenza A virus (A/Kangwon/1 1/99(H3N2))	hema(GI:14550206 loc:AF386614)
Influenza A virus (A/Kangwon/12/99(H3N2))	hema(GI: 14550208 loc:AF386615)
Influenza A virus (A/Kangwon/78/97(H3N2))	hema(GI:14550222 loc:AF386622)
Influenza A virus (A/Kangwon/88/99(H3N2))	hema(GI:14550210 loc:AF386616)
Influenza A virus (A/Kangwon/93/99(H3N2)»	hema(GI:14550212 loc:AF386617)
Influenza A virus (A/Kasauli/149/92(H3N2))	hema(GI:2271 106 loc:AF008691)
Influenza A virus (A/Kasauli/206/91(H3N2))	hema(GI:2271042 loc:AF008659)
Influenza A virus (A/Kenitra/1 7/97(H3N2))	hema(GI:109156248 loc:DQ534420)
Influenza A virus (A/Kentucky/2/97(H3N2))	hema(GI:6552561 loc:AF180618)
Influenza A virus (A/Kitakyushu/I59/93(H3N2))	hema(GP.493652 loc:FLAH3N2HA1)

Influenza A virus (A/Kitakyushu/93(H3N2))	hema(GI:2271370 loc:AF008823)
Influenza A virus (A/Kobe/768/88(H3N2))	hema(GI:2275502 loc:AF008881)
Influenza A virus (A/Korea/298/2005(H3N2))	hema(GI:82571074 loc:DQ265710)
Influenza A virus (A/Korea/45/96(H3N2))	hema(GI:2271 196 loc:AF008736)
Influenza A virus (A/Korea/572/97(H3N2))	hema(GI:6552539 loc:AF 180596)
Influenza A virus (A/Korea/671/97(H3N2))	hema(GI:6552540 loc:AFI 80597)
Influenza A virus (A/Korea/679/97(H3N2))	hema(GI:6552538 loc:AF180595)
Influenza A virus (A/Kumamoto/1/65(H3N2))	
Influenza A virus (A/Kumamoto/55/76(H3N2))	
Influenza A virus (A/Kwangju/1/1995(H3N2))	
Influenza A virus (A/Kwangju/1/95(H3N2))	hema(GI:2271222 loc:AF008749)
Influenza A virus (A/Kwangju/1/97(H3N2))	hema(GI: 145502 14 loc:AF386618)
Influenza A virus (A/Kwangju/1 05/99(H3N2))	hema(GI: 14550238 loc:AF386630)
Influenza A virus (A/Kwangju/107/97(H3N2))	hema(GI: 14550230 loc:AF386626)
Influenza A virus (A/Kwangju/1 15/99(H3N2))	hema(GI: 14550240 loc:AF386631)
Influenza A virus (A/Kwangju/1 17/99(H3N2))	hema(GI: 14550242 loc:AF386632)
Influenza A virus (A/Kwangju/219/2002(H3N2))	hema(GI:46410054 loc:AY589658)
Influenza A virus (A/Kwangju/243/2002(H3N2))	hema(GI:46410056 loc:AY589659)
Influenza A virus (A/Kwangju/4/97(H3N2))	hema(GI: 145502 16 loc:AF386619)
Influenza A virus (A/Kwangju/63/97(H3N2))	hema(GI:14550218 loc:AF386620)
Influenza A virus (A/Kyongbuk/320/2002(H3N2))	hema(GI:464 10058 loc:AY589660)
Influenza A virus (A/Kyongnam/347/2002(H3N2))	hema(GI:46410060 loc:AY589661)
Influenza A virus (A/Kyounggi/1 02/97(H3N2))	hema(GI: 14550226 loc:AF386624)
Influenza A virus (A/La Plata/12089/97(H3N2))	hema(GI:33329994 loc:AF534028)
Influenza A virus (A/Latvia/1097/2000(H3N2))	
Influenza A virus (A/Los Angeles/2/1987(H3N2))	
Influenza A virus (A/Los Angeles/(H3N2))	hema(GI:2275510 loc:AF008885)
Influenza A virus (A/LosAngeles/2/1987(H3N2))	
Influenza A virus (A/Louisiana/1/93(H3N2))	hema(GI:6552510 loc:AF180567)
Influenza A virus (A/Louisiana/1/95(H3N2))	hema(GI:2271274 loc:AF008775)
Influenza A virus (A/Louisiana/4/93(H3N2))	hema(GI:2271382 loc:AF008829)
Influenza A virus (A/Louisiana/5/95(H3N2))	hema(GI:6552605 loc:AF180662)
Influenza A virus (A/Louisiana/6/93(H3N2))	hema(GI:2271384 loc:AF008830)
Influenza A virus	hema(GI:49339166 loc:AY661098)

(A/Lyon/U49/91(H3N2))	
Influenza A virus	
(A/Lyon/1 182/91(H3N2))	hema(GI:49339168 loc:AY661099)
Influenza A virus	
(A/Lyon/1242/2000(H3N2))	
Influenza A virus	
(A/Lyon/1575/2002(H3N2))	
Influenza A virus (A/Lyon/1781/96	
(H3N2))	hema(GI:63 18561 loc:AF131996)
Influenza A virus	
(A/Lyon/1803/93(H3N2))	hema(GI:49339308 loc:AY661 169)
Influenza A virus	
(A/Lyon/1815/93(H3N2))	hema(GI:49339310 loc:AY661 170)
Influenza A virus	
(A/Lyon/22686/93(H3N2))	hema(GI:493393 12 loc:AY661171)
Influenza A virus	
(A/Lyon/2279/95(H3N2))	hema(GI:49339354 loc:AY661 192)
Influenza A virus	
(A/Lyon/23602/93(H3N2))	hema(GI:493393 14 loc:AY661 172)
Influenza A virus	
(A/Lyon/2573/1998(H3N2))	
Influenza A virus	
(A/Lyon/672/93(H3N2))	hema(GI:49339306 loc:AY661 168)
Influenza A virus	
(A/Lyon/chu23672/91(H3N2))	hema(GI:49339180 loc:AY661 105)
Influenza A virus	
(A/Lyon/chu24 103/9 1(H3N2))	hema(GI:49339182 loc:AY661 106)
Influenza A virus	
(A/Lyon/chu24222/9 1(H3N2))	hema(GI:49339184 loc:AY661 107)
Influenza A virus	
(A/Lyon/onsl 189/91(H3N2))	hema(GI:49339170 loc:AY661 100)
Influenza A virus	
(A/Lyon/onsl276/91(H3N2))	hema(GI:49339176 loc:AY661 103)
Influenza A virus	
(A/Lyon/onsl337/91(H3N2))	hema(GI:49339178 loc:AY661 104)
Influenza A virus	
(A/Lyon/onsl 373/9 1(H3N2))	hema(GI:49339174 loc:AY661 102)
Influenza A virus	
(A/Lyon/onsl594/91(H3N2))	hema(GI:49339172 loc:AY661 101)
Influenza A virus	hema(GI: 1 10825864
(A/Macau/578/2005(H3N2))	loc:DQ865960)
Influenza A virus	
(A/Madrid/252/1993(H3N2))	
Influenza A virus	
(A/Madrid/G10 1/93(H3N2))	hema(GI:49339256 loc:AY661 143)
Influenza A virus	
(A/Madrid/G102/93(H3N2))	hema(GI:49339258 loc:AY661 144)
Influenza A virus	
(A/Madrid/G109/93(H3N2))	hema(GI:49339260 loc:AY661 145)
Influenza A virus	
(A/Madrid/G1 16/93(H3N2))	hema(GI:49339254 loc:AY661 142)
Influenza A virus	
(A/Madrid/G12/91(H3N2))	hema(GI:49339128 loc:AY661079)
Influenza A virus	
(A/Madrtd/G122/93(H3N2))	hema(GI:49339264 loc:AY661 147)
Influenza A virus	
(A/Madrid/G130/93(H3N2))	hema(GI:49339266 loc:AY661 148)
Influenza A virus	
(A/Madrid/G252/93(H3N2))	hema(GI:49339272 loc:AY661 151)
Influenza A virus	
(A/Madrid/G58/92(H3N2))	hema(GI:49339204 loc:AY661 117)
Influenza A virus	
(A/Madrid/G622/96(H3N2))	hema(GI:16417061 loc:AF357929)
Influenza A virus	
(A/Madrid/G7 18/98(H3N2))	hema(GI: 16417063 loc:AF357930)
Influenza A virus	
(A/Madrid/G960/99(H3N2))	hema(GI: 16417065 loc:AF357931)

Influenza A virus (AMadrid/G967/00(H3N2))	hema(GI:16417067 loc:AF357932)
Influenza A virus (A/Madrid/G984/00(H3N2))	hema(GI:16417069 loc:AF357933)
Influenza A virus (A/Madrid/OV3 1/92(H3N2))	hema(GI:49339206 loc:AY661 118)
Influenza A virus (A/Madrid/R165/96(H3N2))	hema(GI:16417071 loc:AF357934)
Influenza A virus (AMadrid/R1 87/96(H3N2))	hema(GI: 16417073 loc:AF357935)
Influenza A virus (A/Madrid/R214/97(H3N2))	hema(GI:16417081 loc:AF357939)
Influenza A virus (A/Madrid/RR444/99(H3N2))	hema(GI:16417091 loc:AF357944)
Influenza A virus (A/Madrid/RR490/99(H3N2))	hema(GI:16417093 loc:AF357945)
Influenza A virus (A/Madrid/RR498/99(H3N2))	hema(GI:16417095 loc:AF357946)
Influenza A virus (A/Madrid/RR599/00(H3N2))	hema(GI:16417099 loc:AF357948)
Influenza A virus (A/Madrid/RR607/00(H3N2))	hema(GI:16417103 loc:AF357950)
Influenza A virus (A/Madrid/RR610/00(H3N2))	hema(GI:16417105 loc:AF357951)
Influenza A virus (A/Madrid/SO 10 15/96(H3N2))	hema(GI:164171 13 loc:AF357955)
Influenza A virus (A/Madrid/SO1023/96(H3N2))	hema(GI:164171 15 loc:AF357956)
Influenza A virus (A/Madrid/SO 1025/96(H3N2))	hema(GI:164171 17 loc:AF357957)
Influenza A virus (A/Madrid/SO1208/97(H3N2))	heraa(GI:164171 19 loc:AF357958)
Influenza A virus (A/Madrid/SO1672/98(H3N2))	hema(Gr.16417121 loc:AF357959)
Influenza A virus (A/Madrid/SO1676/98(H3N2))	hema(GI:16417123 loc:AF357960)
Influenza A virus (A/Madrid/SO 1745/98(H3N2))	hema(GI:16417125 loc:AF357961)
Influenza A virus (A/Madrid/SO1747/98(H3N2))	hema(GI:16417127 loc:AF357962)
Influenza A virus (A/Madrid/SO1798/98(H3N2))	hema(GI: 16417129 loc:AF357963)
Influenza A virus (A/Madrid/SO2017/98(H3N2))	hema(GI:16417131 loc:AF357964)
Influenza A virus (A/Madrid/SO2060/98(H3N2))	hema(GI:16417133 loc:AF357965)
Influenza A virus <A/Madrid/SO2447/99(H3N2))	hema(GI: 1641 7135 loc:AF357966)
Influenza A virus (A/Madrid/SO2523/99(H3N2))	hema(GI: 16417137 loc:AF357967)
Influenza A virus (A/Madrid/SO253 1/99(H3N2))	hema(GI:16417139 loc:AF357968)
Influenza A virus (A/Madrid/SO29 13/00(H3N2))	hema(GI: 16417141 loc:AF357969)
Influenza A virus (AMalaysia/1/68(H3N2))	
Influenza A virus (A/Malaysia/22 1/68(H3N2))	
Influenza A virus (A/Malaysia/434/2003(H3N2))	hema(GI: 110825868 loc:DQ865962)
Influenza A virus (A/Malaysia/434/2004(H3N2))	
Influenza A virus (AMalaysia/778/2005(H3N2))	herna(GI: 110825870 loc:DQ865963)
Influenza A virus (A/Malaysia/99/2005(H3N2))	hema(GI: 110825866 loc:DQ865961)
Influenza A virus (A/Malaysia/C3-	hema(GI:77023684 loc:DQ179468)

54/2002(H3N2))		
Influenza A virus (A/Malaysia/C5-1/2002(H3N2))	hema(GI:77023750 loc:DQ179501)	
Influenza A virus (A/Malaysia/C5-2/2002(H3N2))	hema(GI:77023752 loc:DQ179502)	
Influenza A virus (A/Malaysia/C5-5/2002(H3N2))	hema(GI:77023758 loc:DQ179505)	
Influenza A virus (A/Malaysia/C5-8/2002(H3N2))	hema(GI:77023764 loc:DQ179508)	
Influenza A virus (A/mallard duck/ALB/144/1987(H3N2))		neura(GI:78096129 loc:CY0046780)
Influenza A virus (A/mallard duck/New York/6874/1978(H3N2))		
Influenza A virus (A/Mallard/France/M-2515/01(H3N2))	hema(GI:93204678 loc:AJ697865)	
Influenza A virus (A/mallard/MN/290/99(H3N2))		
Influenza A virus (A/mallard/MN/68/99(H3N2))		
Influenza A virus (A/mallard/N.Y./6874/1978(H3N2))		
Influenza A virus (A/mallard/New York/6874/1978(H3N2))	hema(GI:324412 loc:FLAN2NAE)	
Influenza A virus (A/mallard/New York/6874/78(H3N2))		
Influenza A virus (A/mallard/Ohio/48/1986(H3N2))		
Influenza A virus (A/Mar del Plata/267/99(H3N2))	hema(GI:33330018 loc:AF534040)	
Influenza A virus (A/Marrakech/116/98(H3N2))	hema(GI:109156264 loc:DQ534428)	
Influenza A virus (A/Marrakech/90/98(H3N2))	hema(GI:109156256 loc:DQ534424)	
Influenza A virus (A/Massachusetts/1/95(H3N2))	hema(GI:2271294 loc:AF008785)	
Influenza A virus (A/Mem/6/1986(H3N2))	hema(GI:324295 loc:FLAM686HA)	
Influenza A virus (A/Memphis/1/1968(H3N2))		
Influenza A virus (A/Memphis/1/1971(H3N2))	hema(GI:324152 loc:FLAHALR)	
Influenza A virus (A/Memphis/1/1973(H3N2))		
Influenza A virus (A/Memphis/1/1977(H3N2))		
Influenza A virus (A/Memphis/1/1980(H3N2))		
Influenza A virus (A/Memphis/1/1981(H3N2))		
Influenza A virus (A/Memphis/1/1986(H3N2))		
Influenza A virus (A/Memphis/1/1990(H3N2))		
Influenza A virus (A/Memphis/1/71(H3N2))		
Influenza A virus (A/Memphis/1/73(H3N2))		
Influenza A virus (A/Memphis/1/90(H3N2))		
Influenza A virus (A/Memphis/1/96(H3N2))	hema(GI:2271266 loc:AF008771)	
Influenza A virus (A/Memphis/10/1/1972(H3N2))		

Influenza A virus (A/Memphis/101/1974(H3N2))	
Influenza A virus (A/Memphis/I 02/1972(H3N2))	neura(GI:324417 IocrFLANABO)
Influenza A virus (A/Memphis/1 02/1 974(H3N2))	
Influenza A virus (A/Memphis/1022/1972(H3N2))	
Influenza A virus (A/Memphis/103/1972(H3N2))	
Influenza A virus (A/Memphis/ 103/1 974(H3N2))	
Influenza A virus (A/Memphis/103/1976(H3N2))	
Influenza A virus (A/Memphis/104/1976(H3N2))	neura(GI: 110332153 loc:CY0121940)
Influenza A virus (A/Memphis/105/1972(H3N2))	
Influenza A virus (A/Memphis/105/1976(H3N2))	
Influenza A virus (A/Memphis/106/1976(H3N2))	
Influenza A virus (A/Memphis/108/1976(H3N2))	
Influenza A virus (A/Memphis/109/1972(H3N2))	
Influenza A virus (A/Memphis/I 1/1986(H3N2))	
Influenza A virus (A/Memphis/I 10/1976(H3N2))	
Influenza A virus (A/Memphis/I 10/76(H3N2))	neura(GI:833 14201 loc:CY0068370)
Influenza A virus (A/Memphis/12/1978(H3N2))	
Influenza A virus (AMemphis/12/1985(H3N2))	neura(GI: 109675555 loc:CY01 14740)
Influenza A virus (A/Memphis/I 2/1 988(H3N2))	
Influenza A virus (A/Memphis/13/1988(H3N2))	
Influenza A virus (A/Memphis/137/1976(H3N2))	
Influenza A virus (A/Memphis/14/1985(H3N2))	
Influenza A virus (A/Memphis/14/1998(H3N2))	
Influenza A virus (A/Memphis/14/85(H3N2))	
Influenza A virus (A/Memphis/15/1988(H3N2))	
Influenza A virus (A/Memphis/16/1978(H3N2))	
Influenza A virus (A/Memphis/18/1978(H3N2))	
Influenza A virus (A/Memphis/I 9/ 1978(H3N2))	
Influenza A virus (A/Memphis/2/1971(H3N2))	
Influenza A virus (A/Memphis/2/1972(H3N2))	
Influenza A virus (A/Memphis/2/1977(H3N2))	
Influenza A virus (AMemphis/2/1978(H3N2))	
Influenza A virus (A/Memphis/2/1985(H3N2))	
Influenza A virus	neura(GI:l 15291107)

(AMemphis/2/1986(H3N2))		loc:CY0160620)
Influenza A virus		
(A/Memphis/2/1988(H3N2))		
Influenza A virus		neura(GI: 109675574
(A/Memphis/2/1990(H3N2))		loc:CY01 14820)
Influenza A virus		
(A/Memphis/2/78(H3N2))		
Influenza A virus		neura(GI:89133263
(A/Memphis/2/85(H3N2))		loc:CY0090700)
Influenza A virus		
(A/Memphis/22/1985(H3N2))		
Influenza A virus		
(A/Memphis/24/1995(H3N2))		
Influenza A virus		
(A/Memphis/25/1985(H3N2))		
Influenza A virus		
(A/Memphis/3/ 1971(H3N2))		
Influenza A virus		
(A/Memphis/3/1973(H3N2))		
Influenza A virus		
(A/Memphis/3/1977(H3N2))		
Influenza A virus		
(A/Memphis/3/1980(H3N2))		
Influenza A virus		
(A/Memphis/3/1985(H3N2))		
Influenza A virus		
(A/Memphis/3/1986(H3N2))		
Influenza A virus		
(A/Memphis/3/ 1988(H3N2))		
Influenza A virus		
(A/Memphis/3/88(H3N2))		
Influenza A virus		
(A/Memphis/3 1/03(H3N2))		
Influenza A virus		
(A/Memphis/3 1/98(H3N2))	hema(GI:30385696	loc:AY271794)
Influenza A virus		
(A/Memphis/33/1 983(H3N2))		
Influenza A virus		
(A/Memphis/4/1973(H3N2))		
Influenza A virus		
(A/Memphis/4/1977(H3N2))		
Influenza A virus		
(A/Memphis/4/1980(H3N2))		
Influenza A virus		
(A/Memphis/4/1990(H3N2))		
Influenza A virus		
(A/Memphis/5/1977(H3N2))		
Influenza A virus		
(A/Memphis/5/1980(H3N2))		
Influenza A virus		
(A/Memphis/5/1985(H3N2))		
Influenza A virus		neura(GI: 109159414
(A/Memphis/5/1986(H3N2))		loc:CY0112900)
Influenza A virus		
(A/Memphis/5/1988(H3N2))		
Influenza A virus		
(A/Memphis/5/80(H3N2))		
Influenza A virus		neura(GI:85822100
(A/Memphis/5/85(H3N2))		loc:CY0084540)
Influenza A virus		
(A/Memphis/5/90(H3N2))	hema(GI:493391 10	loc:AY661070)
Influenza A virus		
(A/Memphis/59/1999(H3N2))		
Influenza A virus		
(A/Memphis/6/1986(H3N2))		
Influenza A virus		
(A/Memphis/6/1990(H3N2))		

Influenza A virus (A/Memphis/6/86(H3N2))		
Influenza A virus (A/Memphis/66/1986(H3N2))		
Influenza A virus (A/Memphis/7/1985(H3N2))		
Influenza A virus (A/Memphis/7/1990(H3N2))		
Influenza A virus (A/Memphis/8/1988(H3N2))		neura(GI:94959518 loc:CY0107580)
Influenza A virus (A/Memphis/8/88 (H3N2))		
Influenza A virus (A/Memphis/9/1980(H3N2))		
Influenza A virus (AMendoza/135/99(H3N2))	hema(GI:33330010 loc:AF534036)	
Influenza A virus (A/Mexico/3255/94(H3N2))	hema(GI:2271072 loc:AF008674)	
Influenza A virus (A/Michigan/1/(H3N2))	hema(GI:2275484 loc:AF008872)	
Influenza A virus (A/Michigan/22568/99(H3N2))	hema(GI:2I3 14318 loc:AF50153 1)	
Influenza A virus (A/Michigan/22692/99(H3N2))	hema(GI:21314292 loc:AF501518)	
Influenza A virus (A/Middleburg/41/03(H3N2))	hema(GI:37530025 loc:AY389356)	
Influenza A virus (A/Middleburg/45/03(H3N2))	hema(GI:3 7530027 loc:AY389357)	
Influenza A virus (A/Minas Gerais/154/04(H3N2))	hema(GI:625 11984 loc:AY972829)	
Influenza A virus (A/Minas Gerais/156/04(H3N2))	hema(GI:6251 1980 loc:AY972827)	
Influenza A virus (A/Minas Gerais/160/04(H3N2))	hema(GI:6251 1982 loc:AY972828)	
Influenza A virus (A/Minas Gerais/163/04(H3N2))	hema(GI:625 11988 loc:AY972831)	
Influenza A virus (A/Minnesota/1/96(H3N2))	hema(GI:6552568 loc:AF180625)	
Influenza A virus (A/Minnesota/1/97(H3N2))	hema(GI:6552583 loc:AF180640)	
Influenza A virus (A/Minnesota/6/95(H3N2))	hema(GI:2271216 loc:AF008746)	
Influenza A virus (A/Misiones/195/99(H3N2))	hema(GI:33330012 loc:AF534037)	
Influenza A virus (A/Mississippi/1/(H3N2))	hema(GI:2275526 ioc:AF008893)	
Influenza A virus (A/Mississippi/1/1985(H3N2))		
Influenza A virus (A/Missouri/10/96(H3N2))	hema(GI:6552580 loc:AF180637)	
Influenza A virus (A/Missouri/I 1/96(H3N2))	hema(GI:6552588 loc:AF180645)	
Influenza A virus (A/Missouri/6/96(H3N2))	hema(GI:2271210 loc:AF008743)	
Influenza A virus (A/Montevideo/2722/98(H3N2))		
Influenza A virus (A/Montevideo/2728/98(H3N2))		
Influenza A virus (A/Montevideo/2775/98(H3N2))		
Influenza A virus (A/Montevideo/3 18/96(H3N2))	hema(GI:6552570 loc:AF180627)	
Influenza A virus (A/Moscow/2/97(H3N2))	hema(GI:6552589 loc:AF 180646)	
Influenza A virus (A/Moscow/235/2003(H3N2))		neura(GI: 11484293 1 loc:DQ8877510)
Influenza A virus	hema(GI:6 177875 loc:AB019354)	

(A/Nagasaki/48/95(H3N2)) Influenza A virus	
(A/Nagasaki/76/98(H3N2)) Influenza A virus	hema(GI:6177877 loc:AB019355)
(A/Nagasaki/93/98(H3N2)) Influenza A virus	hema(GI:6 177879 loc:AB019356)
(A/Nagasaki/97/95(H3N2)) Influenza A virus	hema(GI:6 177881 loc:AB019357)
(A/Nagasaki/NO1/2005(H3N2)) Influenza A virus	hema(GI:1091 19863 loc:AB262301)
(A/Nagasaki/N02/2005(H3N2)) Influenza A virus	hema(GI:1091 19865 loc:AB262302)
(A/Nagasaki/N03/2005(H3N2)) Influenza A virus	hema(GI:1091 19867 loc:AB262303)
(A/Nagasaki/N04/2005(H3N2)) Influenza A virus	hema(GI:1091 19869 loc:AB262304)
(A/Nanchang/0058/1994(H3N2)) Influenza A virus	
(A/Nanchang/0074/1994(H3N2)) Influenza A virus	
(A/Nanchang/12/1993(H3N2)) Influenza A virus	
(A/Nanchang/3332/93(H3N2)) Influenza A virus	hema(GI:2271328 loc:AF008802)
(A/Nanchang/3396/93(H3N2)) Influenza A virus	hema(GI:2271368 loc:AF008822)
(A/Nanchang/58/1993(H3N2)) Influenza A virus	
(A/Nanchang/813/95(H3N2)) Influenza A virus	hema(GI:6552571 loc:AF180628)
(A/Nanchang/933/95(H3N2)) Influenza A virus	hema(GI:2271 174 loc:AF008725)
(A/Nanchang/A1/1994(H3N2)) Influenza A virus	
(A/Nanchang/A2/1 994(H3N2)) Influenza A virus	
(A/Nanchang/12/93(H3N2)) Influenza A virus	hema(GI:2271326 loc:AF008801)
(A/Nanjing/13/1980(H3N2)) Influenza A virus	
(A/Nanjing/2/1 982(H3N2)) Influenza A virus	
(A/Nanjing/28/1984(H3N2)) Influenza A virus	
(A/Nanjing/36/1983(H3N2)) Influenza A virus	
(A/Nanjing/49/1977(H3N2)) Influenza A virus	
(A/Nebraska/1 1/95(H3N2)) Influenza A virus	hema(GI:2271224 loc:AF008750)
(A/Nepal/1648/2004(H3N2)) Influenza A virus	hema(GI:61652460 loc:AY945264)
(A/Nepal/I 650/2004(H3N2)) Influenza A virus	hema(GI:61652466 loc:AY945267)
(A/Nepal/1659/2004(H3N2)) Influenza A virus	hema(GI:61652470 loc:AY945269)
(A/Nepal/1660/2004(H3N2)) Influenza A virus	hema(GI:61652464 loc:AY945266)
(A/Nepal/1664/2004(H3N2)) Influenza A virus	hema(GI:6 1652462 loc:AY945265)
(A/Nepal/1667/2004(H3N2)) Influenza A virus	hema(GI:6 1652458 loc:AY945263)
(A/Nepal/1670/2004(H3N2)) Influenza A virus	hema(GI:61652508 loc:AY945288)
(A/Nepal/1672/2004(H3N2)) Influenza A virus	hema(GI:61652506 loc:AY945287)
(A/Nepal/I 675/2004(H3N2)) Influenza A virus	hema(GI:61652504 loc:AY945286)

Influenza A virus (A/Nepal/1678/2004(H3N2))	hema(GI:61652502 loc:AY945285)
Influenza A virus (A/Nepal/1679/2004(H3N2))	hema(GI:61652500 loc:AY945284)
Influenza A virus (A/Nepal/1680/2004(H3N2))	hema(GI:61652498 loc:AY945283)
Influenza A virus (A/Nepal/1685/2004(H3N2))	hema(GI:61652496 loc:AY945282)
Influenza A virus (A/Nepal/1687/2004(H3N2))	hema(GI:61652494 loc:AY945281)
Influenza A virus (A/Nepal/1694/2004(H3N2))	hema(GI:61652468 loc:AY945268)
Influenza A virus (A/Nepal/1697/2004(H3N2))	hema(GI:61652492 loc:AY945280)
Influenza A virus (A/Nepal/1702/2004(H3N2))	hema(GI:61652490 loc:AY945279)
Influenza A virus (A/Nepal/1703/2004(H3N2))	hema(GI:61652488 loc:AY945278)
Influenza A virus (A/Nepal/1707/2004(H3N2))	hema(GI:61652486 loc:AY945277)
Influenza A virus (A/Nepal/1711/2004(H3N2))	hema(GI:61652484 loc:AY945276)
Influenza A virus (A/Nepal/1713/2004(H3N2))	hema(GI:61652482 loc:AY945275)
Influenza A virus (A/Nepal/1717/2004(H3N2))	hema(GI:61652480 loc:AY945274)
Influenza A virus (A/Nepal/1723/2004(H3N2))	hema(GI:61652478 loc:AY945273)
Influenza A virus (A/Nepal/1727/2004(H3N2))	hema(GI:61652476 loc:AY945272)
Influenza A virus (A/Nepal/1729/2004(H3N2))	hema(GI:61652474 loc:AY945271)
Influenza A virus (A/Nepal/1732/2004(H3N2))	hema(GI:61652472 loc:AY945270)
Influenza A virus (A/Netherlands/001/94 (H3N2))	
Influenza A virus (A/Netherlands/002/94 (H3N2))	
Influenza A virus (A/Netherlands/003/93 (H3N2))	
Influenza A virus (A/Netherlands/003/94 (H3N2))	
Influenza A virus (A/Netherlands/006/94 (H3N2))	
Influenza A virus (A/Netherlands/007/94 (H3N2))	
Influenza A virus (A/Netherlands/008/94 (H3N2))	
Influenza A virus (A/Netherlands/009/99 (H3N2))	
Influenza A virus (A/Netherlands/012/93 (H3N2))	
Influenza A virus (A/Netherlands/016/94 (H3N2))	
Influenza A virus (A/Netherlands/017/93 (H3N2))	
Influenza A virus (A/Netherlands/017/94 (H3N2))	
Influenza A virus (A/Netherlands/018/94 (H3N2))	
Influenza A virus (A/Netherlands/020/94 (H3N2))	
Influenza A virus (A/Netherlands/021/94 (H3N2))	
Influenza A virus (A/Netherlands/022/94 (H3N2))	
Influenza A virus	

(A/Netherlands/024/94 (H3N2))	
Influenza A virus	
(A/Netherlands/025/94 (H3N2))	
Influenza A virus	
(A/Netherlands/026/94 (H3N2))	
Influenza A virus	
(A/Netherlands/028/99 (H3N2))	
Influenza A virus	
(A/Netherlands/030/94 (H3N2))	
Influenza A virus	
(A/Netherlands/031/94 (H3N2))	
Influenza A virus	
(A/Netherlands/067/99 (H3N2))	
Influenza A virus	
(A/Netherlands/1/02(H3N2))	hema(GI:49339032 loc:AY661031)
Influenza A virus	
(A/Netherlands/1/95(H3N2))	hetna(GI:49339332 loc:AY661181)
Influenza A virus	
(A/Netherlands/101/93 (H3N2))	hema(GI:49339248 loc:AY661139)
Influenza A virus	
(A/Netherlands/102/99 (H3N2))	
Influenza A virus	
(A/Netherlands/1030/92 (H3N2))	
Influenza A virus	
(A/Netherlands/I 13/99 (H3N2))	
Influenza A virus	
(A/Netherlands/115/93 (H3N2))	hema(GI:49339250 loc:AY661140)
Influenza A virus	
(A/Netherlands/I 18/01(H3N2))	hema(GI:49339014 loc:AY661022)
Influenza A virus	
(A/Netherlands/120/02(H3N2))	hema(GI:49339030 loc:AY661030)
Influenza A virus	
(A/Netherlands/124/01(H3N2))	hema(GI:49339016 loc:AY661023)
Influenza A virus	
(A/Netherlands/126/01(H3N2))	hema(GI:49339018 loc:AY661024)
Influenza A virus	
(A/Netherlands/126/2001(H3N2))	
Influenza A virus	
(A/Netherlands/126/93 (H3N2))	hema(GI:49339252 loc:AY661141)
Influenza A virus	
(A/Netherlands/162/99 (H3N2))	
Influenza A virus	
(A/Netherlands/165/93 (H3N2))	hema(GI:49339262 loc:AY661146)
Influenza A virus	
(A/Netherlands/17/93(H3N2))	hema(GI:49339236 loc:AY661133)
Influenza A virus	
(A/Netherlands/I 72/96(H3N2))	hema(GI:3885875 loc:AF092064)
Influenza A virus	
(A/Netherlands/I 75/99 (H3N2))	
Influenza A virus	
(A/Netherlands/179/93(H3N2))	hema(GI:49339268 loc:AY661149)
Influenza A virus	
(A/Netherlands/18/94(H3N2))	hema(GI:49339010 loc:AY661020)
Influenza A virus	
(A/Netherlands/193/99 (H3N2))	
Influenza A virus	
(A/Netherlands/1968(H3N2))	neura(GI:324561 loc:FLANBMO)
Influenza A virus	
(A/Netherlands/20/03(H3N2))	hema(GI:49339036 loc:AY661033)
Influenza A virus	
(A/Netherlands/200/99 (H3N2))	
Influenza A virus	
(A/Netherlands/205/99 (H3N2))	
Influenza A virus	
(A/Netherlands/209/80(H3N2))	hema(GI:49339064 loc:AY661047)
Influenza A virus	
(A/Netherlands/213/03(H3N2))	hema(GI:49339040 loc:AY661035)

Influenza A virus (A/Netherlands/2 17/03(H3N2))	hema(GI:49339042 loc:AY661036)
Influenza A virus (A/Netherlands/22/03(H3N2))	hema(GI:49339038 loc:AY661034)
Influenza A virus (A/Netherlands/222/03(H3N2))	hema(GI:49339044 loc:AY661037)
Influenza A virus (A/Netherlands/233/82(H3N2))	hema(GI:49339020 loc:AY661025)
Influenza A virus (A/Netherlands/24 1/82(H3N2))	hema(GI:49339066 loc:AY661048)
Influenza A virus (A/Netherlands/241/93(H3N2))	hema(GI:49339290 loc:AY661 160)
Influenza A virus (A/Netherlands/27 1/95(H3N2))	hema(GI:49339352 loc:AY661191)
Influenza A virus (A/Netherlands/279/93 (H3N2))	
Influenza A virus (A/Netherlands/281/93 (H3N2))	
Influenza A virus (A/Netherlands/283/93 (H3N2))	
Influenza A virus (A/Netherlands/284/93 (H3N2))	
Influenza A virus (A/Netherlands/285/93 (H3N2))	
Influenza A virus (A/Netherlands/286/93 (H3N2))	
Influenza A virus (A/Netherlands/287/93 (H3N2))	
Influenza A virus (A/Netherlands/288/93 (H3N2))	
Influenza A virus (A/Netherlands/290/93 (H3N2))	
Influenza A virus (A/Netherlands/294/93 (H3N2))	
Influenza A virus (A/Netherlands/295/93 (H3N2))	
Influenza A virus (A/Netherlands/3/00(H3N2))	hema(GI:49339012 loc:AY661021)
Influenza A virus (A/Netherlands/3/93(H3N2))	hema(GI:49339232 loc:AY661 13 1)
Influenza A virus (A/Netherlands/300/97(H3N2))	hema(GI:49339380 loc:AY661205)
Influenza A virus (A/Netherlands/301/99(H3N2))	hema(GI:49339022 loc:AY661026)
Influenza A virus (A/Netherlands/3 14/93 (H3N2))	
Influenza A virus (A/Netherlands/3 16/93 (H3N2))	
Influenza A virus (A/Netherlands/3 19/93 (H3N2))	
Influenza A virus (A/Netherlands/320/93 (H3N2))	
Influenza A virus (A/Netherlands/324/93 (H3N2))	
Influenza A virus (A/Netherlands/329/93 (H3N2))	
Influenza A virus (A/Netherlands/330/85(H3N2))	hema(GI:49339068 loc:AY661049)
Influenza A virus (A/Netherlands/330/93 (H3N2))	
Influenza A virus (A/Netherlands/332/93 (H3N2))	
Influenza A virus (A/Netherlands/333/93 (H3N2))	
Influenza A virus (A/Netherlands/342/93 (H3N2))	
Influenza A virus	

(A/Netherlands/344/93 (H3N2))
 Influenza A virus
 (A/Netherlands/348/93 (H3N2))
 Influenza A virus
 (A/Netherlands/349/93 (H3N2))
 Influenza A virus
 (A/Netherlands/35/93(H3N2)) hema(GI:3885869 loc:AF092061)
 Influenza A virus
 (A/Netherlands/350/93 (H3N2))
 Influenza A virus
 (A/Netherlands/357/93(H3N2)) hema(GI:49339294 loc:AY661 162)
 Influenza A virus
 (A/Netherlands/365/93 (H3N2))
 Influenza A virus
 (A/Netherlands/371/93 (H3N2)) hema(GI:49339298 loc:AY661 164)
 Influenza A virus
 (A/Netherlands/372/93(H3N2)) hema(GI:2275408 loc:AF008834)
 Influenza A virus
 (A/Netheriands/373/93 (H3N2))
 Influenza A virus
 (A/Netherlands/381/93 (H3N2))
 Influenza A virus
 (A/Netherlands/398/93 (H3N2)) hema(GI:49339302 loc:AY661 166)
 Influenza A virus
 (A/Netherlands/399/93(H3N2)) hema(GI:49339304 loc:AY661 167)
 Influenza A virus
 (A/Netherlands/402/93 (H3N2))
 Influenza A virus
 (A/Netherlands/407/93 (H3N2))
 Influenza A virus
 (A/Netherlands/411/93 (H3N2))
 Influenza A virus
 (A/Netherlands/4 14/98(H3N2)) hema(GI:49339382 loc:AY661206)
 Influenza A virus
 (A/Netherlands/418/93 (H3N2))
 Influenza A virus
 (A/Netherlands/419/93 (H3N2))
 Influenza A virus
 (A/Netherlands/427/98(H3N2)) hema(GI:49339384 loc:AY661207)
 Influenza A virus
 (A/Netherlands/435/93 (H3N2))
 Influenza A virus
 (A/Netherlands/439/93 (H3N2))
 Influenza A virus
 (A/Netherlands/440/93(H3N2)) hema(GI:49339300 loc:AY661 165)
 Influenza A virus
 (A/Netherlands/449/93 (H3N2))
 Influenza A virus
 (A/Netherlands/450/88(H3N2)) hema(GI:49339078 loc:AY661054)
 Influenza A virus
 (A/Netherlands/450/93 (H3N2))
 Influenza A virus
 (A/Netherlands/458/98 (H3N2))
 Influenza A virus
 (A/Netherlands/462/98(H3N2)) hema(GI:49339386 loc:AY661208)
 Influenza A virus
 (A/Netherlands/463/98 (H3N2))
 Influenza A virus
 (A/Netherlands/468/93 (H3N2))
 Influenza A virus
 (A/Netherlands/469/93 (H3N2))
 Influenza A virus
 (A/Netherlands/470/93 (H3N2))
 Influenza A virus
 (A/Netherlands/470/98 (H3N2))
 Influenza A virus
 (A/Netherlands/471/93 (H3N2))

Influenza A virus
(A/Netherlands/472/93 (H3N2))
Influenza A virus
(A/Netherlands/473/93 (H3N2))
Influenza A virus
(A/Netherlands/474/93 (H3N2))
Influenza A virus
(A/Netherlands/475/93 (H3N2))
Influenza A virus
(A/Netherlands/476/93 (H3N2))
Influenza A virus
(A/Netherlands/482/98 (H3N2))
Influenza A virus
(A/Netherlands/487/98(H3N2))
Influenza A virus
(A/Netherlands/5/93(H3N2)) hema(GI:3885867 loc:AF092060)
Influenza A virus
(A/Netherlands/5/98(H3N2)) hema(GI:49339388 loc:AY661209)
Influenza A virus
(A/Netherlands/575/89 (H3N2))
Influenza A virus
(A/Netherlands/576/89 (H3N2))
Influenza A virus
(A/Netherlands/577/89 (H3N2))
Influenza A virus
(A/Netherlands/578/89 (H3N2))
Influenza A virus
(A/Netherlands/579/89 (H3N2))
Influenza A virus
(A/Netherlands/620/89 (H3N2)) hema(GI:49339104 loc:AY661067)
Influenza A virus
(A/Netherlands/621/89 (H3N2))
Influenza A virus
(A/Netherlands/622/89 (H3N2))
Influenza A virus
(A/Netherlands/623/89 (H3N2))
Influenza A virus
(A/Netherlands/625/89 (H3N2))
Influenza A virus
(A/Netherlands/626/89 (H3N2))
Influenza A virus
(A/Netherlands/628/89 (H3N2))
Influenza A virus
(A/Netherlands/629/89 (H3N2))
Influenza A virus
(A/Netherlands/630/89 (H3N2))
Influenza A virus
(A/Netherlands/632/89 (H3N2))
Influenza A virus
(A/NetherIands/633/89 (H3N2))
Influenza A virus
(A/Netherlands/634/89 (H3N2))
Influenza A virus
(A/Netherlands/635/89 (H3N2))
Influenza A virus
(A/Netherlands/636/89 (H3N2))
Influenza A virus
(A/Netherlands/638/89 (H3N2))
Influenza A virus
(A/Netherlands/640/89 (H3N2))
Influenza A virus
(A/Netherlands/641/89 (H3N2))
Influenza A virus
(A/Netherlands/644/89 (H3N2))
Influenza A virus
(A/Netherlands/645/89 (H3N2))
Influenza A virus

(A/Netherlands/646/89 (H3N2))
Influenza A virus
(A/Netherlands/648/89 (H3N2))
Influenza A virus
(A/Netherlands/649/89 (H3N2))
Influenza A virus
(A/Netherlands/650/89 (H3N2)) hema(GI:49339106 loc:AY661068)
Influenza A virus
(A/Netherlands/651/89 (H3N2))
Influenza A virus
(A/Netherlands/652/89 (H3N2))
Influenza A virus
(A/Netherlands/653/90 (H3N2))
Influenza A virus
(A/Netherlands/654/90 (H3N2))
Influenza A virus
(A/Netherlands/656/90 (H3N2))
Influenza A virus
(A/Netherlands/657/90 (H3N2))
Influenza A virus
(A/Netherlands/658/90 (H3N2))
Influenza A virus
(A/Netherlands/701/89 (H3N2))
Influenza A virus
(A/Netherlands/702/89 (H3N2))
Influenza A virus
(A/Netherlands/703/89 (H3N2))
Influenza A virus
(A/Netherlands/704/89 (H3N2))
Influenza A virus
(A/Netherlands/735/89 (H3N2))
Influenza A virus
(A/Netherlands/736/90 (H3N2))
Influenza A virus
(A/Netherlands/737/89 (H3N2))
Influenza A virus
(A/Netherlands/738/89(H3N2)) hema(GI:49339028 loc:AY661029)
Influenza A virus
(A/Netherlands/739/89 (H3N2))
Influenza A virus
(A/Netherlands/740/89 (H3N2))
Influenza A virus
(A/Netherlands/741/89 (H3N2))
Influenza A virus
(A/Netherlands/772e/90 (H3N2))
Influenza A virus
(A/Netherlands/773e/90 (H3N2))
Influenza A virus
(A/Netherlands/774e/90 (H3N2))
Influenza A virus
(A/Netherlands/775e/90 (H3N2))
Influenza A virus
(A/Netherlands/776e/90 (H3N2))
Influenza A virus
(A/Netherlands/777e/90 (H3N2))
Influenza A virus
(A/Netherlands/778e/90 (H3N2))
Influenza A virus
(A/Netherlands/779e/90 (H3N2))
Influenza A virus
(A/Netherlands/780e/90 (H3N2))
Influenza A virus
(A/Netherlands/781e/90 (H3N2))
Influenza A virus
(A/Netherlands/782e/90 (H3N2))
Influenza A virus
(A/Netherlands/783e/90 (H3N2))

Influenza A virus (A/Netherlands/784e/90 (H3N2))	
Influenza A virus (A/Netherlands/785e/90 (H3N2))	
Influenza A virus (A/Netherlands/816/91(H3N2))	hema(GI:49339126 loc:AY661078)
Influenza A virus (A/Netherlands/8 19/92(H3N2))	hema(GI:49339130 loc:AY661080)
Influenza A virus (A/Netherlands/821/92 (H3N2))	
Influenza A virus (A/Netherlands/823/92 (H3N2))	hema(GI:49339186 loc:AY661 108)
Influenza A virus (A/Netherlands/877/91 (H3N2))	
Influenza A virus (A/Netherlands/889/91 (H3N2))	
Influenza A virus (A/Netherlands/9 1/96(H3N2))	hema(GI:49339358 loc:AY661 194)
Influenza A virus (A/Netherlands/935/92(H3N2))	hema(GI:49339164 loc:AY661097)
Influenza A virus (A/Netherlands/938/92(H3N2))	hema(GI:49339220 loc:AY661125)
Influenza A virus (A/Netherlands/944/92 (H3N2))	
Influenza A virus (A/Netherlands/950/92 (H3N2))	
Influenza A virus (A/Netherlands/977/92 (H3N2))	
Influenza A virus (A/Netherlands/978/92 (H3N2))	
Influenza A virus (A/Netherlands/979/92 (H3N2))	
Influenza A virus (A/Netherlands/980/92 (H3N2))	
Influenza A virus (A/Netherlands/981/92 (H3N2))	
Influenza A virus (A/Netherlands/982/92 (H3N2))	
Influenza A virus (A/Netherlands/983/92 (H3N2))	
Influenza A virus (A/Netherlands/984/92 (H3N2))	
Influenza A virus (A/Netherlands/985/92 (H3N2))	
Influenza A virus (A/Netherlands/C4- 25/2003(H3N2))	hema(GI:77023742 loc:DQ179497)
Influenza A virus (A/Netherlands/C4- 26/2003(H3N2))	hema(GI:77023744 loc:DQ179498)
Influenza A virus (A/Neuquen/1016002/01(H3N2))	hema(GI:33330056 ioc:AF534059)
Influenza A virus (A/Neuquen/1 02/99(H3N2))	hema(GI:33330Q16 loc:AF534039)
Influenza A virus (A/Neuquen/1038288/01(H3N2))	hema(GI:33330058 loc:AF534060)
Influenza A virus (A/Neuquen/2260/01 (H3N2))	hema(GI:33330052 loc:AF534057)
Influenza A virus (A/Neuquen/V541/98(H3N2))	hema(GI:22536027 loc:AF533719)
Influenza A virus (A/Neuquen/V690/98(H3N2))	hema(GI:22536029 loc:AF533720)
Influenza A virus (A/Nevada/1/95(H3N2))	hema(GI:2271218 loc:AF008747)
Influenza A virus (A/New Jersey/8/96(H3N2))	hema(GI:6552560 loc:AF180617)
Influenza A virus (A/New	

York/1/2003(H3N2))
Influenza A virus (A/New
York/10/2004(H3N2))
Influenza A virus (A/New
York/100/2002(H3N2))
Influenza A virus (A/New
York/101/2002(H3N2))
Influenza A virus (A/New
York/102/2002(H3N2))
Influenza A virus (A/New
York/103/2002(H3N2))
Influenza A virus (A/New
York/104/2002(H3N2))
Influenza A virus (A/New
York/105/2002(H3N2))
Influenza A virus (A/New
York/106/2002(H3N2))
Influenza A virus (A/New
York/107/2002(H3N2))
Influenza A virus (A/New
York/108/2002(H3N2))
Influenza A virus (A/New
York/109/2002(H3N2))
Influenza A virus (A/New
York/11/2003(H3N2))
Influenza A virus (A/New
York/110/2002(H3N2))
Influenza A virus (A/New
York/111/2002(H3N2))
Influenza A virus (A/New
York/112/2002(H3N2))
Influenza A virus (A/New
York/113/2002(H3N2))
Influenza A virus (A/New
York/114/2002(H3N2))
Influenza A virus (A/New
York/115/2002(H3N2))
Influenza A virus (A/New
York/116/2002(H3N2))
Influenza A virus (A/New
York/117/2002(H3N2))
Influenza A virus (A/New
York/118/2002(H3N2))
Influenza A virus (A/New
York/119/2002(H3N2))
Influenza A virus (A/New
York/12/2003(H3N2))
Influenza A virus (A/New
York/120/2002(H3N2))
Influenza A virus (A/New
York/121/2002(H3N2))
Influenza A virus (A/New
York/122/2002(H3N2))
Influenza A virus (A/New
York/123/2004(H3N2))
Influenza A virus (A/New
York/124/2001(H3N2))
Influenza A virus (A/New
York/125/2002(H3N2))
Influenza A virus (A/New
York/126/2002(H3N2))
Influenza A virus (A/New
York/127/2001(H3N2))
Influenza A virus (A/New
York/128/2002(H3N2))
Influenza A virus (A/New
York/129/2002(H3N2))

Influenza A virus (A/New York/13/2003(H3N2))
Influenza A virus (A/New York/130/2Q02(H3N2))
Influenza A virus (A/New York/131/2001(H3N2))
Influenza A virus (A/New York/132/2002(H3N2))
Influenza A virus (A/New York/133/2002(H3N2))
Influenza A virus (A/New York/13472002(H3N2))
Influenza A virus (A/New York/135/2002(H3N2))
Influenza A virus (A/New York/136/2002(H3N2))
Influenza A virus (A/New York/137/1999(H3N2))
Influenza A virus (A/New York/138/1999(H3N2))
Influenza A virus (A/New York/139/1999(H3N2))
Influenza A virus (A/New York/14/2003(H3N2))
Influenza A virus (A/New York/140/1999(H3N2))
Influenza A virus (A/New York/141/1999(H3N2))
Influenza A virus (A/New York/142/2000(H3N2))
Influenza A virus (A/New York/143/1999(H3N2))
Influenza A virus (A/New York/144/2000(H3N2))
Influenza A virus (A/New York/145/1999(H3N2))
Influenza A virus (A/New York/147/1999(H3N2))
Influenza A virus (A/New York/148/2000(H3N2))
Influenza A virus (A/New York/149/1999(H3N2))
Influenza A virus (A/New York/15/2003_(H3N2))
Influenza A virus (A/New York/150/2000(H3N2))
Influenza A virus (A/New York/151/1999(H3N2))
Influenza A virus (A/New York/152/2000(H3N2))
Influenza A virus (A/New York/153/1999(H3N2))
Influenza A virus (A/New York/154/2000(H3N2))
Influenza A virus (A/New York/155/1999(H3N2))
Influenza A virus (A/New York/156/2000(H3N2))
Influenza A virus (A/New York/157/1999(H3N2))
Influenza A virus (A/New York/158/2000(H3N2))
Influenza A virus (A/New York/159/1999(H3N2))
Influenza A virus (A/New York/16/2003(H3N2))
Influenza A virus (A/New

York/160/2000(H3N2))
Influenza A virus (A/New
York/161/1999(H3N2))
Influenza A virus (A/New
York/162/2000(H3N2))
Influenza A virus (A/New
York/163/1999(H3N2))
Influenza A virus (A/New
York/164/1999(H3N2))
Influenza A virus (A/New
York/165/2000(H3N2))
Influenza A virus (A/New
York/166/1999(H3N2))
Influenza A virus (A/New
York/167/1999(H3N2))
Influenza A virus (A/New
York/168/2000(H3N2))
Influenza A virus (A/New
York/169/2000(H3N2))
Influenza A virus (A/New
York/17/2003(H3N2))
Influenza A virus (A/New
York/170/2000(H3N2))
Influenza A virus (A/New
York/171/1999(H3N2))
Influenza A virus (A/New
York/172/1999(H3N2))
Influenza A virus (A/New
York/173/2000(H3N2))
Influenza A virus (A/New
York/174/2000(H3N2))
Influenza A virus (A/New
York/175/2000(H3N2))
Influenza A virus (A/New
York/176/2000(H3N2))
Influenza A virus (A/New
York/177/1999(H3N2))
Influenza A virus (A/New
York/178/2000(H3N2))
Influenza A virus (A/New
York/179/1999(H3N2))
Influenza A virus (A/New
York/18/2003(H3N2))
Influenza A virus (A/New
York/180/2000(H3N2))
Influenza A virus (A/New
York/181/1999(H3N2))
Influenza A virus (A/New
York/182/2000(H3N2))
Influenza A virus (A/New
York/183/1999(H3N2))
Influenza A virus (A/New
York/184/1999(H3N2))
Influenza A virus (A/New
York/185/1999(H3N2))
Influenza A virus (A/New
York/186/1999(H3N2))
Influenza A virus (A/New
York/187/2000(H3N2))
Influenza A virus (A/New
York/188/1999(H3N2))
Influenza A virus (A/New
York/189/1999(H3N2))
Influenza A virus (A/New
York/19/2003(H3N2))
Influenza A virus (A/New
York/190/2004(H3N2))

hema(GI:5531315 loc:NDV19021)

Influenza A virus (A/New York/191/2005(H3N2))
Influenza A virus (A/New York/192/2003(H3N2))
Influenza A virus (A/New York/193/2003(H3N2))
Influenza A virus (A/New York/194/2003(H3N2))
Influenza A virus (A/New York/195/2003(H3N2))
Influenza A virus (A/New York/196/2003(H3N2))
Influenza A virus (A/New York/197/2003(H3N2))
Influenza A virus (A/New York/198/2003(H3N2))
Influenza A virus (A/New York/199/2003(H3N2))
Influenza A virus (A/New York/2/2003(H3N2))
Influenza A virus (A/New York/20/2003(H3N2))
Influenza A virus (A/New York/200/2004(H3N2))
Influenza A virus (A/New York/201/2003(H3N2))
Influenza A virus (A/New York/202/2003(H3N2))
Influenza A virus (A/New York/203/2003(H3N2))
Influenza A virus (A/New York/204/2003(H3N2))
Influenza A virus (A/New York/206/2005(H3N2))
Influenza A virus (A/New York/207/2004(H3N2))
Influenza A virus (A/New York/21/2003(H3N2))
Influenza A virus (A/New York/210/2005(H3N2))
Influenza A virus (A/New York/213/2003(H3N2))
Influenza A virus (A/New York/214/2003(H3N2))
Influenza A virus (A/New York/215/2003(H3N2))
Influenza A virus (A/New York/216/2003(H3N2))
Influenza A virus (A/New York/218/2004(H3N2))
Influenza A virus (A/New York/22/2003(H3N2))
Influenza A virus (A/New York/224/1998(H3N2))
Influenza A virus (A/New York/23/2003(H3N2))
Influenza A virus (A/New York/232/2004(H3N2))
Influenza A virus (A/New York/236/2004(H3N2))
Influenza A virus (A/New York/237/2004(H3N2))
Influenza A virus (A/New York/238/2005(H3N2))
Influenza A virus (A/New York/24/2003(H3N2))
Influenza A virus (A/New

York/240/1998(H3N2))
Influenza A virus (A/New
York/243/2005(H3N2))
Influenza A virus (A/New
York/244/2004(H3N2))
Influenza A virus (A/New
York/245/2004(H3N2))
Influenza A virus (A/New
York/247/1998(H3N2))
Influenza A virus (A/New
York/248/1999(H3N2))
Influenza A virus (A/New
York/249/1998(H3N2))
Influenza A virus (A/New
York/25/2003(H3N2))
Influenza A virus (A/New
York/250/1998(H3N2))
Influenza A virus (A/New
York/251/1998(H3N2))
Influenza A virus (A/New
York/252/1999(H3N2))
Influenza A virus (A/New
York/253/1999(H3N2))
Influenza A virus (A/New
York/254/1998(H3N2))
Influenza A virus (A/New
York/255/1999(H3N2))
Influenza A virus (A/New
York/256/1998(H3N2))
Influenza A virus (A/New
York/257/1999(H3N2))
Influenza A virus (A/New
York/258/2005(H3N2))
Influenza A virus (A/New
York/259/1999(H3N2))
Influenza A virus (A/New
York/26/2003(H3N2))
Influenza A virus (A/New
York/260/1999(H3N2))
Influenza A virus (A/New
York/261/1999(H3N2))
Influenza A virus (A/New
York/262/1999(H3N2))
Influenza A virus (A/New
York/263/1999(H3N2))
Influenza A virus (A/New
York/264/1999(H3N2))
Influenza A virus (A/New
York/265/1999(H3N2))
Influenza A virus (A/New
York/266/1999(H3N2))
Influenza A virus (A/New
York/267/2003(H3N2))
Influenza A virus (A/New
York/268/2003(H3N2))
Influenza A virus (A/New
York/269/2003(H3N2))
Influenza A virus (A/New
York/27/2003(H3N2))
Influenza A virus (A/New
York/270/2003(H3N2))
Influenza A virus (A/New
York/271/2003(H3N2))
Influenza A virus (A/New
York/272/2003(H3N2))
Influenza A virus (A/New
York/273/2001(H3N2))

Influenza A virus (A/New York/274/2002(H3N2))
Influenza A virus (A/New York/275/2002(H3N2))
Influenza A virus (A/New York/276/2002(H3N2))
Influenza A virus (A/New York/277/1999(H3N2))
Influenza A virus (A/New York/278/1999(H3N2))
Influenza A virus (A/New York/2782/2004 (H3N2))
Influenza A virus (A/New York/279/1999(H3N2))
Influenza A virus (A/New York/28/2003(H3N2))
Influenza A virus (A/New York/280/1999(H3N2))
Influenza A virus (A/New York/282/1999(H3N2))
Influenza A virus (A/New York/283/1999(H3N2))
Influenza A virus (A/New York/284/1999(H3N2))
Influenza A virus (A/New York/285/1999(H3N2))
Influenza A virus (A/New York/286/1999(H3N2))
Influenza A virus (A/New York/287/1998(H3N2))
Influenza A virus (A/New York/288/1999(H3N2))
Influenza A virus (A/New York/289/1998(H3N2))
Influenza A virus (A/New York/29/2003(H3N2))
Influenza A virus (A/New York/290/1999(H3N2))
Influenza A virus (A/New York/3/2003(H3N2))
Influenza A virus (A/New York/3/2006(H3N2))
Influenza A virus (A/New York/30/2003(H3N2))
Influenza A virus (A/New York/301/2001(H3N2))
Influenza A virus (A/New York/304/1998(H3N2))
Influenza A virus (A/New York/31/2004(H3N2))
Influenza A virus (A/New York/3 11/1999(H3N2))
Influenza A virus (A/New York/3 13/1998(H3N2))
Influenza A virus (A/New York/3 14/1999(H3N2))
Influenza A virus (A/New York/3 15/1999(H3N2))
Influenza A virus (A/New York/3 16/1999(H3N2))
Influenza A virus (A/New York/3 17/1999(H3N2))
Influenza A virus (A/New York/3 18/1999(H3N2))
Influenza A virus (A/New York/3 19/2004(H3N2))
Influenza A virus (A/New

hema(GI:82571072 loc:DQ265709)

neura(GI:1 15313981 loc:NC 0083690)

York/32/2003(H3N2))
Influenza A virus (A/New
York/320/1999(H3N2))
Influenza A virus (A/New
York/321/1999(H3N2))
Influenza A virus (A/New
York/322/1999(H3N2))
Influenza A virus (A/New
York/323/1999(H3N2))
Influenza A virus (A/New
York/324/1999(H3N2))
Influenza A virus (A/New
York/325/1999(H3N2))
Influenza A virus (A/New
York/326/1999(H3N2))
Influenza A virus (A/New
York/327/1999(H3N2))
Influenza A virus (A/New
York/328/1998(H3N2))
Influenza A virus (A/New
York/329/1999(H3N2))
Influenza A virus (A/New
York/33/2004(H3N2))
Influenza A virus (A/New
York/330/1998(H3N2))
Influenza A virus (A/New
York/331/1999(H3N2))
Influenza A virus (A/New
York/332/1999(H3N2))
Influenza A virus (A/New
York/333/1999(H3N2))
Influenza A virus (A/New
York/334/2004(H3N2))
Influenza A virus (A/New
York/335/1999(H3N2))
Influenza A virus (A/New
York/336/1999(H3N2))
Influenza A virus (A/New
York/337/1999(H3N2))
Influenza A virus (A/New
York/338/1999(H3N2))
Influenza A virus (A/New
York/339/1999(H3N2))
Influenza A virus (A/New
York/34/2003(H3N2))
Influenza A virus (A/New
York/340/1999(H3N2))
Influenza A virus (A/New
York/347/1999(H3N2))
Influenza A virus (A/New
York/35/2003(H3N2))
Influenza A virus (A/New
York/351/2004(H3N2))
Influenza A virus (A/New
York/352/2005(H3N2))
Influenza A virus (A/New
York/353/2004(H3N2))
Influenza A virus (A/New
York/354/2004(H3N2))
Influenza A virus (A/New
York/355/2004(H3N2))
Influenza A virus (A/New
York/356/2004(H3N2))
Influenza A virus (A/New
York/357/2005(H3N2))
Influenza A virus (A/New
York/358/2004(H3N2))

neura(GI:77543667
loc:CY0033380)

Influenza A virus (A/New York/359/2005(H3N2))
 Influenza A virus (A/New York/36/2003(H3N2))
 Influenza A virus (A/New York/360/2004(H3N2))
 Influenza A virus (A/New York/361/2005(H3N2))
 Influenza A virus (A/New York/362/2004(H3N2))
 Influenza A virus (A/New York/363/2004(H3N2))
 Influenza A virus (A/New York/364/2004(H3N2))
 Influenza A virus (A/New York/365/2004(H3N2))
 Influenza A virus (A/New York/366/2004(H3N2))
 Influenza A virus (A/New York/367/2005(H3N2))
 Influenza A virus (A/New York/368/2004(H3N2))
 Influenza A virus (A/New York/369/2005(H3N2))
 Influenza A virus (A/New York/37/2003(H3N2))
 Influenza A virus (A/New York/37/96(H3N2))
 Influenza A virus (A/New York/370/2004(H3N2))
 Influenza A virus (A/New York/371/2004(H3N2))
 Influenza A virus (A/New York/372/2004(H3N2))
 Influenza A virus (A/New York/373/2005(H3N2))
 Influenza A virus (A/New York/374/2004(H3N2))
 Influenza A virus (A/New York/375/2005(H3N2))
 Influenza A virus (A/New York/376/2005(H3N2))
 Influenza A virus (A/New York/377/2004(H3N2))
 Influenza A virus (A/New York/378/2005(H3N2))
 Influenza A virus (A/New York/379/2004(H3N2))
 Influenza A virus (A/New York/38/2003(H3N2))
 Influenza A virus (A/New York/380/2004(H3N2))
 Influenza A virus (A/New York/381/2004(H3N2))
 Influenza A virus (A/New York/382/2005(H3N2))
 Influenza A virus (A/New York/383/2004(H3N2))
 Influenza A virus (A/New York/384/2005(H3N2))
 Influenza A virus (A/New York/385/2004(H3N2))
 Influenza A virus (A/New York/386/2004(H3N2))
 Influenza A virus (A/New York/3S7/2004(H3N2))
 Influenza A virus (A/New

neura(GI:73665770
 loc:CY0024260)

neura(GI:75 180922
 loc:CY0027300)

neura(GI:66354528
 loc:CY00I2950)

hema(GI:6552593 loc:AF180650)

York/388/2005(H3N2))
Influenza A virus (A/New
York/389/2005(H3N2))
Influenza A virus (A/New
York/39/2003(H3N2))
Influenza A virus (A/New
York/390/2005(H3N2))
Influenza A virus (A/New
York/391/2005(H3N2))
Influenza A virus (A/New
York/392/2004(H3N2))
Influenza A virus (A/New
York/393/2005(H3N2))
Influenza A virus (A/New
York/394/2005(H3N2))
Influenza A virus (A/New
York/395/2005(H3N2))
Influenza A virus (A/New
York/396/2005(H3N2))
Influenza A virus (A/New
York/397/1999(H3N2))
Influenza A virus (A/New
York/398/1999(H3N2))
Influenza A virus (A/New
York/4/2003(H3N2))
Influenza A virus (A/New
York/4/2006(H3N2))
Influenza A virus (A/New
York/40/2003(H3N2))
Influenza A virus (A/New
York/401/2001(H3N2))
Influenza A virus (A/New
York/402/2001(H3N2))
Influenza A virus (A/New
York/403/2002(H3N2))
Influenza A virus (A/New
York/404/2002(H3N2))
Influenza A virus (A/New
York/405/2002(H3N2))
Influenza A virus (A/New
York/406/2002(H3N2))
Influenza A virus (A/New
York/407/2002(H3N2))
Influenza A virus (A/New
York/408/2002(H3N2))
Influenza A virus (A/New
York/409/2002(H3N2))
Influenza A virus (A/New
York/41/2003(H3N2))
Influenza A virus (A/New
York/410/2002(H3N2))
Influenza A virus (A/New
York/411/2002(H3N2))
Influenza A virus (A/New
York/4 12/2002(H3N2))
Influenza A virus (A/New
York/4 13/2002(H3N2))
Influenza A virus (A/New
York/4 14/2002(H3N2))
Influenza A virus (A/New
York/415/2002(H3N2))
Influenza A virus (A/New
York/4 16/2002(H3N2))
Influenza A virus (A/New
York/418/2002(H3N2))
Influenza A virus (A/New
York/419/2002(H3N2))

neura(GI:55775697 loc:NC
0064300)

neura(GI: 110629847
loc:CY0 127940)

-

Influenza A virus (A/New York/42/2003(I-I3N2))
Influenza A virus (A/New York/420/2002(H3N2))
Influenza A virus (A/New York/421/1999(H3N2))
Influenza A virus (A/New York/422/1999(H3N2))
Influenza A virus (A/New York/423/1999(H3N2))
Influenza A virus (A/New York/424/1999(H3N2))
Influenza A virus (A/New York/425/1999(H3N2))
Influenza A virus (A/New York/426/1999(H3N2))
Influenza A virus (A/New York/427/1999(H3N2))
Influenza A virus (A/New York/428/1999(H3N2))
Influenza A virus (A/New York/429/2000(H3N2))
Influenza A virus (A/New York/43/2003(H3N2))
Influenza A virus (A/New York/43/96(H3N2))
Influenza A virus (A/New York/430/2000(H3N2))
Influenza A virus (A/New York/431/2000(H3N2))
Influenza A virus (A/New York/432/2000(H3N2))
Influenza A virus (A/New York/433/2000(H3N2))
Influenza A virus (A/New York/434/2000(H3N2))
Influenza A virus (A/New York/435/2000(H3N2))
Influenza A virus (A/New York/436/2000(H3N2))
Influenza A virus (A/New York/437/2000(H3N2))
Influenza A virus (A/New York/438/2000(H3N2))
Influenza A virus (A/New York/439/2000(H3N2))
Influenza A virus (A/New York/44/2003(H3N2))
Influenza A virus (A/New York/440/2000(H3N2))
Influenza A virus (A/New York/448/1998(H3N2))
Influenza A virus (A/New York/449/1999(H3N2))
Influenza A virus (A/New York/45/2003(H3N2))
Influenza A virus (A/New York/450/1999(H3N2))
Influenza A virus (A/New York/451/1999(H3N2))
Influenza A virus (A/New York/452/1999(H3N2))
Influenza A virus (A/New York/453/1999(H3N2))
Influenza A virus (A/New York/454/1999(H3N2))
Influenza A virus (A/New

hema(GI:65 52582 loc:AFI 80639)

York/455/1999(H3N2))
 Influenza A virus (A/New York/456/1999(H3N2))
 Influenza A virus (A/New York/457/1999(H3N2))
 Influenza A virus (A/New York/458/1999(H3N2))
 Influenza A virus (A/New York/459/1999(H3N2))
 Influenza A virus (A/New York/46/2003(H3N2))
 Influenza A virus (A/New York/460/1999(H3N2))
 Influenza A virus (A/New York/461/2005(H3N2))
 Influenza A virus (A/New York/462/2005(H3N2))
 Influenza A virus (A/New York/463/2005(H3N2))
 Influenza A virus (A/New York/464/2005(H3N2))
 Influenza A virus (A/New York/465/2005(H3N2))
 Influenza A virus (A/New York/466/2004(H3N2))
 Influenza A virus (A/New York/467/2004(H3N2))
 Influenza A virus (A/New York/468/2004(H3N2))
 Influenza A virus (A/New York/469/2004(H3N2))
 Influenza A virus (A/New York/47/2003(H3N2))
 Influenza A virus (A/New York/470/2004(H3N2))
 Influenza A virus (A/New York/471/2004(H3N2))
 Influenza A virus (A/New York/472/2004(H3N2))
 Influenza A virus (A/New York/473/2003(H3N2))
 Influenza A virus (A/New York/474/2003(H3N2))
 Influenza A virus (A/New York/475/2003(H3N2))
 Influenza A virus (A/New York/476/2003(H3N2))
 Influenza A virus (A/New York/477/2003(H3N2))
 Influenza A virus (A/New York/478/2003(H3N2))
 Influenza A virus (A/New York/479/2003(H3N2))
 Influenza A virus (A/New York/48/2003(H3N2))
 Influenza A virus (A/New York/480/2004(H3N2))
 Influenza A virus (A/New York/485/2003(H3N2))
 Influenza A virus (A/New York/49/2003(H3N2))
 Influenza A virus (A/New York/498/2004(H3N2))
 Influenza A virus (A/New York/499/2004(H3N2))
 Influenza A virus (A/New York/5/2004(H3N2))

neura(GI:85816080
 loc:CY0081660)
 neura(GI:86803812
 loc:CY0088700)
 neura(GI:86803781
 loc:CY0088780)
 neura(GI:86803762
 loc:CY0088860)
 neura(GI:86802942
 loc:CY0088940)
 neura(GI:89 113258
 loc:CY0092460)
 neura(GI:86801479
 loc:CY0089020)
 neura(GI:86821069
 loc:CY0089180)

neura(GI:89 113277
 loc:CY0092540)

neura(GI:86798705
 loc:CY0089100)
 neura(GI:891 12417
 loc:CY0092620)

Influenza A virus (A/New York/5/2006(H3N2))		neura(GI: 110734349 loc:CY0132340)
Influenza A virus (A/New York/50/2003(H3N2))		
Influenza A virus (A/New York/50/96(H3N2))	hema(GI:655258I loc:AF180638)	
Influenza A virus (A/New York/500/2004(H3N2))		neura(GI:891 13296 loc:CY0092700)
Influenza A virus (A/New York/501/1997(H3N2))		
Influenza A virus (A/New York/502/1998(H3N2))		neura(GI:85816121 loc:CY0081820)
Influenza A virus (A/New York/503/1997(H3N2))		
Influenza A virus (A/New York/504/1998(H3N2))		neura(GI:868 19445 loc:CY0089260)
Influenza A virus (A/New York/505/1997(H3N2))		
Influenza A virus (A/New York/506/1998(H3N2))		
Influenza A virus (A/New York/507/1997(H3N2))		neura(GI:86818985 loc:CY0089340)
Influenza A virus (A/New York/508/1997(H3N2))		
Influenza A virus (A/New York/509/1997(H3N2))		
Influenza A virus (A/New York/51/2003(H3N2))		
Influenza A virus (A/New York/510/1998(H3N2))		
Influenza A virus (A/New York/51 1/1997(H3N2))		
Influenza A virus (A/New York/5 12/1998(H3N2))		
Influenza A virus (A/New York/5 13/1997(H3N2))		
Influenza A virus (A/New York/5 14/1998(H3N2))		neura(GI:868 18966 loc:CY0089420)
Influenza A virus (A/New York/515/1997(H3N2))		
Influenza A virus (A/New York/5 16/1997(H3N2))		
Influenza A virus (A/New York/5 17/1998(H3N2))		
Influenza A virus (A/New York/518/1998(H3N2))		
Influenza A virus (A/New York/5 19/1998(H3N2))		
Influenza A virus (A/New York/52/2004(H3N2))		
Influenza A virus (A/New York/520/ 1998(H3N2))		
Influenza A virus (A/New York/52 1/1998(H3N2))		
Influenza A virus (A/New York/522/1997(H3N2))		
Influenza A virus (A/New York/523/1998(H3N2))		
Influenza A virus (A/New York/524/1997(H3N2))		
Influenza A virus (A/New York/525/1998(H3N2))		
Influenza A virus (A/New York/526/1997(H3N2))		
Influenza A virus (A/New York/527/1998(H3N2))		
Influenza A virus (A/New		

York/528/1998(H3N2))
 Influenza A virus (A/New York/529/1998(H3N2))
 Influenza A virus (A/New York/53/2003(H3N2))
 Influenza A virus (A/New York/530/1998(H3N2))
 Influenza A virus (A/New York/531/1998(H3N2))
 Influenza A virus (A/New York/532/1998(H3N2))
 Influenza A virus (A/New York/533/1998(H3N2))
 Influenza A virus (A/New York/534/1998(H3N2))
 Influenza A virus (A/New York/535/1998(H3N2))
 Influenza A virus {A/New York/536/1998(H3N2))
 Influenza A virus (A/New York/537/1998(H3N2))
 Influenza A virus (A/New York/538/1998(H3N2))
 Influenza A virus (A/New York/539/1998(H3N2))
 Influenza A virus (A/New York/54/2003(H3N2))
 Influenza A virus (A/New York/540/1998(H3N2))
 Influenza A virus (A/New York/541/1998(H3N2))
 Influenza A virus (A/New York/542/1998(H3N2))
 Influenza A virus (A/New York/543/1998(H3N2))
 Influenza A virus (A/New York/544/1998(H3N2))
 Influenza A virus (A/New York/545/1997(H3N2))
 Influenza A virus (A/New York/546/1998(H3N2))
 Influenza A virus (A/New York/547/1997(H3N2))
 Influenza A virus (A/New York/548/1998(H3N2))
 Influenza A virus (A/New York/549/1998(H3N2))
 Influenza A virus (A/New York/55/2003(H3N2))
 Influenza A virus (A/New York/55/96(H3N2))
 Influenza A virus (A/New York/550/1998(H3N2))
 Influenza A virus (A/New York/554/1996(H3N2))
 Influenza A virus (A/New York/555/1996(H3N2))
 Influenza A virus (A/New York/556/1996(H3N2))
 Influenza A virus (A/New York/557/1996(H3N2))
 Influenza A virus (A/New York/558/1997(H3N2))
 Influenza A virus (A/New York/559/1996(H3N2))
 Influenza A virus (A/New York/56/2003(H3N2))

neura(GI:86818947 loc:CY0089500)
 neura(GI:86817977 loc:CY0089580)
 neura(GI:90571693 loc:CY0099900)
 neura(GI:86816427 loc:CY0089660)
 neura(GI:86813858 loc:CY0085340)
 neura(GI:868J50I3 loc:CY0089740)
 hema(GI:6552555 loc:AF180612)
 neura(GI:86824154 loc:CY0089820)
 neura(GI:110733415 loc:CY0128500)
 neura(GI:94959594 loc:CY0107980)
 neura(GI:110332172 loc:CY0122020)
 neura(GI:109159336 loc:CY0112580)
 neura(GI:89782912 loc:CY0096460)
 neura(GI:109159355 loc:CY0112660)

Influenza A virus (A/New York/560/1997(H3N2))	neura(GI:89917613 loc:CY0094620)
Influenza A virus (A/New York/561/1996(H3N2))	neura(GI:9 1126958 loc:CY0106060)
Influenza A virus (A/New York/562/1996(H3N2))	neura(GI:90571712 loc:CY0099980)
Influenza A virus (A/New York/563/1996(H3N2))	neura(GI:9057173 1 loc:CY0 100060)
Influenza A virus (A/New York/564/1997(H3N2))	neura(GI:89923366 loc:CY0094700)
Influenza A virus (A/New York/565/1996(H3N2))	neura(GI:89928049 loc:CY0094780)
Influenza A virus (A/New York/566/1997(H3N2))	neura(GI:89941272 loc:CY0096540)
Influenza A virus (A/New York/567/1996(H3N2))	neura(GI:90571750 loc:CY0 100140)
Influenza A virus (A/New York/568/1996(H3N2))	neura(GI:89783262 loc:CY0096620)
Influenza A virus (A/New York/569/1997(H3N2))	neura(GI:89779344 loc:CY0094860)
Influenza A virus (A/New York/57/2003(H3N2))	
Influenza A virus (A/New York/570/1996(H3N2))	neura(GI:91 125733 loc:CY0094940)
Influenza A virus (A/New York/571/1996(H3N2))	neura(GI:109675417 loc:CY01 14180)
Influenza A virus (A/New York/572/1996(H3N2))	neura(GI:91 126186 loc:CY0 105900)
Influenza A virus (A/New York/573/1996(H3N2))	neura(GI:89779636 loc:CY0095020)
Influenza A virus (A/New York/574/1996(H3N2))	neura(GI:89941291 loc:CY0096700)
Influenza A virus (A/New York/575/1996(H3N2))	neura(GI:89934134 loc:CY0095100)
Influenza A virus (A/New York/576/1997(H3N2))	neura(GI:899413 10 loc:CY0096780)
Influenza A virus (A/New York/577/1996(H3N2))	neura(GI: 109675436 loc:CY01 14260)
Influenza A virus (A/New York/578/1996(H3N2))	neura(GI:91126558 loc:CY0105980)
Influenza A virus (A/New York/579/1997(H3N2))	neura(GI:89938663 loc:CY0095180)
Influenza A virus (A/New York/58/2003(H3N2))	
Influenza A virus (A/New York/580/1996(H3N2))	neura(GI:89783702 loc:CY0096860)
Influenza A virus (A/New York/581/1997(H3N2))	neura(GI:89941329 loc:CY0096940)
Influenza A virus (A/New York/582/1996(H3N2))	neura(GI:90571769 loc:CY0100220)
Influenza A virus (A/New York/583/1997(H3N2))	neura(GI:89941253 loc:CY0095260)
Influenza A virus (A/New York/584/1996(H3N2))	neura(GI:89789556 loc:CY0099020)
Influenza A virus (A/New York/585/1997(H3N2))	neura(GI:897841 16 loc:CY0097020)
Influenza A virus (A/New York/586/1996(H3N2))	neura(GI:897843 11 loc:CY0097100)
Influenza A virus (A/New York/587/1996(H3N2))	neura(GI:89941348 loc:CY0097180)
Influenza A virus (A/New York/588/1996(H3N2))	neura(GI:89784803 loc:CY0097260)
Influenza A virus (A/New York/589/1996(H3N2))	neura(GI:89785015 loc:CY0097340)
Influenza A virus (A/New York/59/2003(H3N2))	
Influenza A virus (A/New	neura(GI:89941367

York/590/1996(H3N2))	loc:CY0097420)
Influenza A virus (A/New York/591/1996(H3N2))	neura(GI:90571788
Influenza A virus (A/New York/592/1996(H3N2))	loc:CY0100300)
Influenza A virus (A/New York/593/1996(H3N2))	neura(GI:90571807
Influenza A virus (A/New York/594/1996(H3N2))	loc:CY0100380)
Influenza A virus (A/New York/595/1996(H3N2))	neura(GI:89789884
Influenza A virus (A/New York/596/1996(H3N2))	loc:CY0099100)
Influenza A virus (A/New York/597/1997(H3N2))	neura(GI:90571826
Influenza A virus (A/New York/598/1996(H3N2))	loc:CY0 100460)
Influenza A virus (A/New York/599/1996(H3N2))	neura(GI:90571845
Influenza A virus (A/New York/6/2004(H3N2))	loc:CY0100540)
Influenza A virus (A/New York/6/2006(H3N2))	neura(GI:90571864
Influenza A virus (A/New York/600/1996(H3N2))	loc:CY0 100620)
Influenza A virus (A/New York/601/1996(H3N2))	neura(GI:89785393
Influenza A virus (A/New York/602/1996(H3N2))	loc:CY0097500)
Influenza A virus (A/New York/603/1996(H3N2))	neura(GI:1 10332193
Influenza A virus (A/New York/606/1995(H3N2))	loc:CY0122100)
Influenza A virus (A/New York/608/1996(H3N2))	neura(GI:106896014
Influenza A virus (A/New York/609/1995(H3N2))	loc:CY01 11300)
Influenza A virus (A/New York/60A/2003(H3N2))	
Influenza A virus (A/New York/610/1995(H3N2))	neura(GI:1 16069965
Influenza A virus (A/New York/611/1995(H3N2))	loc:CY0169970)
Influenza A virus (A/New York/612/1995(H3N2))	neura(GI:90571883
Influenza A virus (A/New York/613/1996(H3N2))	loc:CY0 100700)
Influenza A virus (A/New York/617/1996(H3N2))	neura(GI:1 15289315
Influenza A virus (A/New York/618/1995(H3N2))	loc:CY0155180)
Influenza A virus (A/New York/619/1996(H3N2))	neura(GI: 106896033
Influenza A virus (A/New York/61A/2003(H3N2))	loc:CY01 11380)
Influenza A virus (A/New York/622/1996(H3N2))	neura(GI:91 127370
Influenza A virus (A/New York/623/1995(H3N2))	loc:CY0106140)
Influenza A virus (A/New York/624/1996(H3N2))	neura(GI:9 1127655
Influenza A virus (A/New York/625/1996(H3N2))	loc:CY0 106220)
Influenza A virus (A/New York/628/1995(H3N2))	neura(GI: 106896049
Influenza A virus (A/New York/62A/2003(H3N2))	loc:CY0106300)
	neura(GI: 106896050
	loc:CY0 106380)
	neura(GI:91 127712
	loc:CY0 106460)
	neura(GI:91 127731
	loc:CY0106540)
	neura(GI:9 1127765
	loc:CY0 106620)
	neura(GI: 1068963 14
	loc:CY0 106700)
	neura(GI:1068963 18
	loc:CY0105180)
	neura(GI: 109675452
	loc:CY0 106780)
	neura(GI: 106896321
	loc:CY0 106860)
	neura(GI:9 1129257
	loc:CY0 106940)
	neura(GI:94959632
	loc:CY0108140)
	neura(GI: 109675460
	loc:CY01 14340)
	neura(GI:91 129603
	loc:CY0 107020)
	neura(GI:9 1129959
	loc:CY0107100)

Influenza A virus (A/New York/63/2003(H3N2))	
Influenza A virus (A/New York/63 1/1996(H3N2))	neura(GI:91 130379 loc:CY0107180)
Influenza A virus (A/New York/632/1996(H3N2))	neura(GI: 109675479 loc:CY01 14420)
Influenza A virus (A/New York/634/1996(H3N2))	neura(GI:91 130725 loc:CY0107260)
Influenza A virus (A/New York/635/1996(H3N2))	neura(GI:109675498 locrCYOI 14500)
Influenza A virus (A/New York/636/1996(H3N2))	neura(GI: 1096755 17 locrCYOI 14580)
Influenza A virus (A/New York/637/1996(H3N2))	neura(GI:9I 131 113 loc:CY0107340)
Influenza A virus (A/New York/639/1995(H3N2))	neura(GI: 110333423 loc:CY0122180)
Influenza A virus (A/New York/64/2003(H3N2))	
Influenza A virus (A/New York/641/1996(H3N2))	neura(GI: 109675536 loc:CY01 14660)
Influenza A virus (A/New York/647/1995(H3N2))	neura(GI:109914501 loc:CY01 18100)
Influenza A virus (A/New York/648/1996(H3N2))	neura(GI: 110332208 loc:CY0107500)
Influenza A virus (A/New York/65/2003(H3N2))	
Influenza A virus (A/New York/652/1995(H3N2))	neura(GI: 109914520 loc:CYOI 18180)
Influenza A virus (A/New York/654/1994(H3N2))	neura(GI: 109675594 loc:CY01 14900)
Influenza A virus (A/New York/655/1994(H3N2))	neura(GI: 110629015 locrCYOI24500)
Influenza A virus (A/New York/657/1994(H3N2))	neura(GI:l 10332219 loc:CY0 122260)
Influenza A virus (A/New York/658/1995(H3N2))	neura(GI: 1096756 13 locrCYOI 14980)
Influenza A virus (A/New York/659/1994(H3N2))	neura(GI:109675632 loc-.CYOI 15060)
Influenza A virus (A/New York/66/2003(H3N2))	
Influenza A virus (A/New York/660/1995(H3N2))	neura(GI: 112787654 loc:CY0133130)
Influenza A virus (A/New York/661/1994(H3N2))	neura(GI: 110629034 loc:CY0124580)
Influenza A virus (A/New York/662/1995(H3N2))	neura(GI: 109675651 loc:CY01 15140)
Influenza A virus (A/New York/663/1994(H3N2))	neura(GI: 110629055 locrCYOI24660)
Influenza A virus (A/New York/664/1995(H3N2))	neura(GI: 110629074 loc:CY0 124740)
Influenza A virus (A/New York/665/1994(H3N2))	neura(GI: 109675670 locrCYOI 15220)
Influenza A virus (A/New York/666/1995(H3N2))	neura(GI: 110629093 loc:CY0 124820)
Influenza A virus (A/New York/667/1995(H3N2))	neura(GI: l 106291 12 loc:CY0124900)
Influenza A virus (A/New York/668/1995(H3N2))	neura(GI:l 1062913 1 loc:CY0124980)
Influenza A virus (A/New York/669/1995(H3N2)»	neura(GI: 109675689 locrCYOI 15300)
Influenza A virus (A/New York/67/2003(H3N2))	
Influenza A virus (A/New York/670/1995(H3N2))	neura(GI: 110332238 locrCYO 122340)
Influenza A virus (A/New York/671/1995(H3N2))	neura(GI: 109675708 locrCYOI 15380)
Influenza A virus (A/New	neura(GI:109675727

York/672/1995(H3N2))	loc:CY0 115460)
Influenza A virus (A/New York/673/1995(H3N2))	neura(GI:l 10733540
Influenza A virus (A/New York/674/1995(H3N2))	loc:CYO128980)
Influenza A virus (A/New York/675/1995(H3N2))	neura(GI: 109675746
Influenza A virus (A/New York/676/1995(H3N2))	loc:CY0 115540)
Influenza A virus (A/New York/677/1995(H3N2))	neura(GI: 110332257
Influenza A virus (A/New York/678/1995(H3N2))	loc:CY0 122420)
Influenza A virus (A/New York/679/1995(H3N2))	neura(GI: 112787673
Influenza A virus (A/New York/68/2004(H3N2))	loc:CY0133210)
Influenza A virus (A/New York/680/1995(H3N2))	neura(GI:l 10332276
Influenza A virus (A/New York/681/1995(H3N2))	loc:CY0 122500)
Influenza A virus (A/New York/682/1995(H3N2))	neura(GI:l 10629150
Influenza A virus (A/New York/683/1995(H3N2))	loc:CY0125060)
Influenza A virus (A/New York/684/1995(H3N2))	neura(GI: 109675765
Influenza A virus (A/New York/685/1995(H3N2))	loc:CY0 115620)
Influenza A virus (A/New York/686/1995(H3N2))	
Influenza A virus (A/New York/687/1995(H3N2))	neura(GI: 110332295
Influenza A virus (A/New York/688/1994(H3N2))	loc:CYO122580)
Influenza A virus (A/New York/689/1995(H3N2))	neura(GI: 110733559
Influenza A virus (A/New York/69/2004(H3N2))	loc:CY0 129060)
Influenza A virus (A/New York/690/1995(H3N2))	neura(GI: 109914539
Influenza A virus (A/New York/691/1995(H3N2))	loc:CY01 18260)
Influenza A virus (A/New York/692/1995(H3N2))	neura(GI:109914558
Influenza A virus (A/New York/693/1995(H3N2))	loc:CY0 118340)
Influenza A virus (A/New York/694/1995(H3N2))	neura(GI:l 10733578
Influenza A virus (A/New York/695/1995(H3N2))	loc:CY0129140)
Influenza A virus (A/New York/696/1994(H3N2))	neura(GI:109914577
Influenza A virus (A/New York/697/1995(H3N2))	loc:CY01 18420)
Influenza A virus (A/New York/698/1995(H3N2))	neura(GI:l 12787692
Influenza A virus (A/New York/699/1995(H3N2))	loc:CY0133290)
Influenza A virus (A/New York/7/2003(H3N2))	neura(GI: 1099 14596
Influenza A virus (A/New York/7/2006(H3N2))	loc:CY0 118500)
Influenza A virus (A/New York/70/2004(H3N2))	
Influenza A virus (A/New York/700/1995(H3N2))	neura(GI: 110733597
Influenza A virus (A/New York/701/1995(H3N2))	loc:CY0129220)
	neura(GI: 110629169
	loc:CY0125140)
	neura(GI: 109 159538
	loc:CY0 113220)
	neura(GI:109675784
	locrCYO1 15700)
	neura(GI:109159557
	loc:CY01 13300)
	neura(GI: 109 159576
	locrCYO1 13380)
	neura(GI:109159595
	locrCYO1 13460)
	neura(GI:109159614
	loc:CY0 113540)
	neura(GI:l 10733616
	loc:CY0129300)
	neura(GI:l 13171561
	loc:CY0141610)
	neura(GI: 110629188
	loc:CY0 125220)

Influenza A virus (A/New York/702/1995(H3N2))	neura(GI:109159633 loc-.CYO1 13620)
Influenza A virus (A/New York/703/1995(H3N2))	neura(GI: 109159652 loc:C Y01 13700)
Influenza A virus (A/New York/704/1994(H3N2))	
Influenza A virus (A/New York/705/1994(H3N2))	neura(GI: 110629207 loc:C Y0 125300)
Influenza A virus (A/New York/706/1993(H3N2))	neura(GI:l 15521412 loc-.C Y0 164290)
Influenza A virus (A/New York/707/1994(H3N2))	neura(GI: 110629226 loc:C Y0125380)
Influenza A virus (A/New York/708/1994(H3N2))	neura(GI: 109 159671 loc:C Y01 13780)
Influenza A virus (A/New York/709/1994(H3N2))	neura(GI:109914615 loc:C Y0 118580)
Influenza A virus (A/New York/71/2001(H3N2))	
Influenza A virus (A/New York/710/1994(H3N2))	neura(GI: 110629245 loc:C Y0125460)
Influenza A virus (A/New York/71 1/1994(H3N2))	neura(GI: 109914634 loc:C Y0118660)
Influenza A virus (A/New York/7 12/1993(H3N2))	neura(GI: 1099 14653 loc:C Y01 18740)
Influenza A virus (A/New York/713/1994(H3N2))	neura(GI: 110629264 loc:C Y0125540)
Influenza A virus (A/New York/7 14/1994(H3N2))	neura(GI: 110629283 locrC Y0 125620)
Influenza A virus (A/New York/715/1994(H3N2))	neura(GI: 109914672 loc:C Y01 18820)
Influenza A virus (A/New York/7 16/1994(H3N2))	neura(GI:109914691 loc:C Y01 18900)
Influenza A virus (A/New York/717/1994(H3N2))	neura(GI: 113 170582 loc:C Y0138890)
Influenza A virus (A/New York/718/1994(H3N2))	neura(GI: 110733635 loc:C Y0129380)
Influenza A virus (A/New York/719/1994(H3N2))	neura(GI:109914710 loc-.C Y0 U 8980)
Influenza A virus (A/New York/72/2004(H3N2))	
Influenza A virus (A/New York/720/1 994(H3N2))	neura(GI:109914729 loc:C Y01 19060)
Influenza A virus (A/New York/721/1994(H3N2))	neura(GI: 109914748 loc:C Y01 19140)
Influenza A virus (A/New York/722/1994(H3N2))	neura(GI:l 103323 14 loc-.C Y0 122660)
Influenza A virus (A/New York/723/1994(H3N2))	neura(GI: 110733654 locrC Y0 129460)
Influenza A virus (A/New York/724/1994(H3N2))	neura(GI:l 10733673 loc:C Y0 129540)
Influenza A virus (A/New York/725/1994(H3N2))	neura(GI: 110733692 loc:C Y0 129620)
Influenza A virus (A/New York/726/1994(H3N2))	neura(GI: 109914767 loc:C Y01 19220)
Influenza A virus (A/New York/727/1994(H3N2))	neura(GI: 1099 14786 loc:C Y O119300)
Influenza A virus (A/New York/728/1994(H3N2))	neura(GI: 109914805 loc:C Y01 19380)
Influenza A virus (A/New York/729/1994(H3N2))	neura(GI: 110332333 loc:C Y0122740)
Influenza A virus (A/New York/73/2004(H3N2))	neura(GI:86808838 loc:C Y0085180)
Influenza A virus (A/New York/730/1994(H3N2))	neura(GI: 110332352 loc:C Y O122820)
Influenza A virus (A/New York/73 1/1 994(H3N2))	neura(GI: 112787759 loc:C Y0 133370)
Influenza A virus (A/New	neura(GI: 109159690

York/732/1994(H3N2))
 Influenza A virus (A/New
 York/733/1994(H3N2))
 Influenza A virus (A/New
 York/734/1994(H3N2))
 Influenza A virus (A/New
 York/735/1994(H3N2))
 Influenza A virus (A/New
 York/736/1994(H3N2))
 Influenza A virus (A/New
 York/737/1994(H3N2))
 Influenza A virus (A/New
 York/738/1994(H3N2))
 Influenza A virus (A/New
 York/739/1994(H3N2))
 Influenza A virus (A/New
 York/74/2002(H3N2))
 Influenza A virus (A/New
 York/740/1994(H3N2))
 Influenza A virus (A/New
 York/741/1994(H3N2))
 Influenza A virus (A/New
 York/742/1994(H3N2))
 Influenza A virus (A/New
 York/743/1994(H3N2))
 Influenza A virus (A/New
 York/744/1994(H3N2))
 Influenza A virus (A/New
 York/745/1994(H3N2))
 Influenza A virus (A/New
 York/746/1994(H3N2))
 Influenza A virus (A/New
 York/747/1994(H3N2))
 Influenza A virus (A/New
 York/748/1994(H3N2))
 Influenza A virus (A/New
 York/749/1994(H3N2))
 Influenza A virus (A/New
 York/75/2002(H3N2))
 Influenza A virus (A/New
 York/750/1994(H3N2))
 Influenza A virus (A/New
 York/751/1993(H3N2))
 Influenza A virus (A/New
 York/752/1993(H3N2))
 Influenza A virus (A/New
 York/753/1994(H3N2))
 Influenza A virus (A/New
 York/754/1993(H3N2))
 Influenza A virus (A/New
 York/755/1993(H3N2))
 Influenza A virus (A/New
 York/756/1993(H3N2))
 Influenza A virus (A/New
 York/757/1993(H3N2))
 Influenza A virus (A/New
 York/758/1993(H3N2))
 Influenza A virus (A/New
 York/759/1993(H3N2))
 Influenza A virus (A/New
 York/76/2002(H3N2))
 Influenza A virus (A/New
 York/760/1993(H3N2))
 Influenza A virus (A/New
 York/761/1993(H3N2))
 Influenza A virus (A/New
 York/762/1993(H3N2))

loc:CY0 113860)
 neura(GI:94960050
 loc:CY0 109900)
 neura(GI: 110332371
 loc:CY0122900)
 neura(GI: 11073371 1
 loc:CY0 129700)
 neura(GI: 110733730
 loc:CY0129780)
 neura(GI: 115289372
 loc:CY0155420)
 neura(GI: 110733749
 loc:CY0129860)
 neura(GI: 110733768
 loc:CY0 129940)

 neura(GI: 110733787
 loc:CY0130020)
 neura(GI: 110733806
 loc:CY0130100)
 neura(GI: 112787922
 loc:CY0 133450)
 neura(GI: 112787941
 loc:CY0133530)
 neura(GI: 112787960
 loc:CY0133610)
 neura(GI: 112787979
 loc:CY0 133690)
 neura(GI: 110629302
 loc:CY0 125700)
 neura(GI: 110629325
 loc:CY0 125780)
 neura(GI: 110629344
 loc:CY0 125860)
 neura(GI: 110629363
 loc:CY0125940)

 neura(GI: 110733825
 loc:CY0130180)
 neura(GI: 109675803
 loc:CY0115780)
 neura(GI: 109914824
 loc:CY0119460)
 neura(GI: 110733844
 loc:CY0130260)
 neura(GI: 110734194
 loc:CY0131700)
 neura(GI: 110734213
 loc:CY0131780)
 neura(GI: 109915247
 loc:CY0121220)
 neura(GI: 112788941
 loc:CY0 136070)
 neura(GI: 109915266
 loc:CY0121300)
 neura(GI: 109915286
 loc:CY0121380)

 neura(GI: 109915305
 loc:CY0121460)
 neura(GI: 109915324
 loc:CY0121540)
 neura(GI: 109915343
 loc:CY0121620)

Influenza A virus (A/New York/763/1993(H3N2))
 Influenza A virus (A/New York/764/1993(H3N2))
 Influenza A virus (A/New York/765/1993(H3N2))
 Influenza A virus (A/New York/766/1993(H3N2))
 Influenza A virus (A/New York/767/1993(H3N2))
 Influenza A virus (A/New York/768/1993(H3N2))
 Influenza A virus (A/New York/769/1993(H3N2))
 Influenza A virus (A/New York/77/2001(H3N2))
 Influenza A virus (A/New York/770/1993(H3N2))
 Influenza A virus (A/New York/771/1993(H3N2))
 Influenza A virus (A/New York/772/1993(H3N2))
 Influenza A virus (A/New York/773/1993(H3N2))
 Influenza A virus (A/New York/774/1993(H3N2))
 Influenza A virus (A/New York/775/1993(H3N2))
 Influenza A virus (A/New York/776/1993(H3N2))
 Influenza A virus (A/New York/777/1993(H3N2))
 Influenza A virus (A/New York/778/1993(H3N2))
 Influenza A virus (A/New York/779/1993(H3N2))
 Influenza A virus (A/New York/780/1993(H3N2))
 Influenza A virus (A/New York/781/1993(H3N2))
 Influenza A virus (A/New York/782/1993(H3N2))
 Influenza A virus (A/New York/783/1993(H3N2))
 Influenza A virus (A/New York/784/1993(H3N2))
 Influenza A virus (A/New York/785/1993(H3N2))
 Influenza A virus (A/New York/786/1993(H3N2))
 Influenza A virus (A/New York/787/1993(H3N2))
 Influenza A virus (A/New York/788/1993(H3N2))
 Influenza A virus (A/New York/789/1993(H3N2))
 Influenza A virus (A/New York/79/2002(H3N2))
 Influenza A virus (A/New York/790/1993(H3N2))
 Influenza A virus (A/New York/791/1993(H3N2))
 Influenza A virus (A/New York/792/1993(H3N2))
 Influenza A virus (A/New York/793/1993(H3N2))
 Influenza A virus (A/New

neura(GI: 109915362 loc:CY0121700)
 neura(GI:109915381 loc:CY0121780)
 neura(GI: 109915400 loc:CY0121860)
 neura(GI:l 12788960 loc:CY0136150)
 neura(GI: 110629695 loc:CY0127300)
 neura(GI: 112788979 loc:CY0136230)
 neura(GI: 112788998 loc:CY0136310)

 neura(GI: 110629714 loc:CY0127380)
 neura(GI: 110629733 loc:CY0127460)
 neura(GI: 112789017 loc:CY0136390)
 neura(GI: 112789036 loc:CY0136470)
 neura(GI: 112789055 loc:CY0136550)
 neura(GI: 110629752 loc:CY0127540)
 neura(GI: 112789074 loc:CY0136630)
 neura(GI:l 10629771 loc:CY0127620)
 neura(GI: 110629790 loc:CY0127700)
 neura(GI:l 10629809 loc:CY0127780)
 neura(GI: 112789093 loc:CY0136710)
 neura(GI:l 10734232 loc:CY0131860)
 neura(GI: 110734251 loc:CY0131940)
 neura(GI: 110734270 loc:CY0132020)
 neura(GI:l 12789112 loc:CY0136790)
 neura(GI: 110734289 loc:CY0132100)
 neura(GI: 110629828 loc:CY0127860)
 neura(GI:l 12789131 loc:CY0136870)
 neura(GI: 112789150 loc:CY0136950)
 neura(GI:l 12789169 loc:CY0137030)

 neura(GI: 112789188 loc:CY0137110)
 neura(GI: 112789207 loc:CY0137190)
 neura(GI: 112789226 loc:CY0137270)
 neura(GI:l 13171523 loc:CY0141450)
 neura(GI: 112789245

York/794/1993(H3N2))	locrCYO 137350)
Influenza A virus (A/New York/795/1993(H3N2))	neura(GI: 112789264 loc:CY0 137430)
Influenza A virus (A/New York/796/1993(H3N2))	neura(GI: 113 171542 loc:CY0141530)
Influenza A virus (A/New York/797/1993(H3N2))	neura(GI: 112789283 loc:CY0137510)
Influenza A virus (A/New York/798/1993(H3N2))	neura(GI: 112789302 loc:CY0 137590)
Influenza A virus (A/New York/799/1993(H3N2))	neura(GI: 112789321 loc:CY0137670)
Influenza A virus (A/New York/79A/2002(H3N2))	
Influenza A virus (A/New York/8/2003(H3N2))	
Influenza A virus (A/New York/8/2006(H1N1))	
Influenza A virus (A/New York/80/200 1(H3N2))	
Influenza A virus (A/New York/800/1993(H3N2))	neura(GI:1 15521545 loc:CY0164850)
Influenza A virus (A/New York/801/1993(H3N2))	neura(GI:1 12789340 loc:CY0137750)
Influenza A virus (A/New York/802/1993(H3N2))	neura(GI: 1 12789359 loc:CY0137830)
Influenza A virus (A/New York/803/1993(H3N2))	neura(GI: 112789378 loc:CY0137910)
Influenza A virus (A/New York/8 1/2002(H3N2))	
Influenza A virus (A/New York/82/2001(H3N2))	
Influenza A virus (A/New York/83/200 1(H3N2))	
Influenza A virus (A/New York/84/200 1(H3N2))	
Influenza A virus (A/New York/85/200 1(H3N2))	
Influenza A virus (A/New York/86/2002(H3N2))	
Influenza A virus (A/New York/87/2002(H3N2))	
Influenza A virus (A/New York/88/2002(H3N2))	
Influenza A virus (A/New York/89/2002(H3N2))	
Influenza A virus (A/New York/9/2003(H3N2))	
Influenza A virus (A/New York/90/2002(H3N2))	
Influenza A virus (A/New York/91/2002(H3N2))	
Influenza A virus (A/New York/92/2002(H3N2))	
Influenza A virus (A/New York/93/2002(H3N2))	
Influenza A virus (A/New York/94/200 1(H3N2))	
Influenza A virus (A/New York/95/2002(H3N2))	
Influenza A virus (A/New York/96/2002(H3N2))	
Influenza A virus (A/New York/97/2002(H3N2))	
Influenza A virus (A/New York/98/2004(H3N2))	
Influenza A virus (A/New York/99/2002(H3N2))	

Influenza A virus (A/New York/C4/2002(H3N2))		neura(GI: 112789397 loc:CY0138070)
Influenza A virus (A/New Jersey/10/95(I-I3N2))	hema(GI:2271284 loc:AF008780)	
Influenza A virus (A/New Jersey/11/94(H3N2))	hema(GI:2271238 loc:AF008757)	
Influenza A virus (A/New Jersey/4/(H3N2))	hema(GI:2275486 loc:AF008873)	
Influenza A virus (A/New Jersey/8/94(H3N2))	hema(GI:2271276 loc:AF008776)	
Influenza A virus (A/New York/13/93(H3N2))	hema(GI:2271366 loc:AF008821)	
Influenza A virus (A/New York/15/94(H3N2))	hema(GI:2275460 loc:AF008860)	
Influenza A virus (A/New York/16/94(H3N2))	hema(GI:2271314 loc:AF008795)	
Influenza A virus (A/New York/17/94(H3N2))	hema(GI:2271306 loc:AF008791)	
Influenza A virus (A/New York/26/93(H3N2))	hema(GI:2275418 loc:AF008839)	
Influenza A virus (A/New York/28/94(H3N2))	hema(GI:2271298 loc:AF008787)	
Influenza A virus (A/New York/28/96(H3N2))	hema(GI:2271264 loc:AF008770)	
Influenza A virus (A/New York/3/93(H3N2))	hema(GI:2275430 loc:AF008845)	
Influenza A virus (A/New York/38/93(H3N2))	hema(GI:2275434 loc:AF008847)	
Influenza A virus (A/New York/42/95(H3N2))	hema(GI:2271316 loc:AF008796)	
Influenza A virus (A/New York/63/93(H3N2))	hema(GI:2271318 loc:AF008797)	
Influenza A virus (A/New York/64/93(H3N2))	hema(GI:2271320 loc:AF008798)	
Influenza A virus (A/New York/9/96(H3N2))	hema(GI:2271178 loc:AF008727)	
Influenza A virus (A/Newcastle/4/2005(H3N2))	hema(GI:110825872 loc:DQ865964)	
Influenza A virus (A/NIB-34(H3N2))		
Influenza A virus (A/Nice/491/97(H3N2))	hema(GI:49339390 loc:AY661210)	
Influenza A virus (A/Nightingale/France/95/125/95(H3N2))	hema(GI:93204680 loc:AJ697866)	
Influenza A virus (A/Niigata/137/96(H3N2))		
Influenza A virus (A/Nijmegen/3126/92(H3N2))	hema(GI:49339196 loc:AY661113)	
Influenza A virus (A/Nijmegen/3129/92(H3N2))	hema(GI:49339198 loc:AY661114)	
Influenza A virus (A/ningbo/17/2002(H3N2))	hema(GI:24895178 loc:AY138518)	
Influenza A virus (A/Ningbo/198/03(H3N2))	hema(GI:51572695 loc:AY695089)	
Influenza A virus (A/Ningbo/217/03(H3N2))	hema(GI:51572697 loc:AY695090)	
Influenza A virus (A/hingbo/25/2002(H3N2))	hema(GI:24895169 loc:AY138517)	
Influenza A virus (A/ningbo/318/04(H3N2))	hema(GI:82468636 loc:DQ256374)	
Influenza A virus (A/ningbo/397/04(H3N2))	hema(GI:82468638 loc:DQ256375)	
Influenza A virus (A/ningbo/65/04(H3N2))	hema(GI:82468632 loc:DQ256372)	
Influenza A virus (A/ningbo/93/04(H3N2))	hema(GI:82468634 loc:DQ256373)	

Influenza A virus (A/Ningxia/10/93(H3N2))	hema(GI:2271338 loc:AF008807)	
Influenza A virus (A/North Carolina/93(H3N2))	hema(GI:2275438 loc:AF008849)	
Influenza A virus (A/Northern Ireland/44233/2003(H3N2))	hema(GI:52082719 loc:AY738729)	
Influenza A virus (A/nt/60/1968(H3N2))		neura(GI:324487 loc:FLANAMA0)
Influenza A virus (A/NT/60/68/(H3N2))		
Influenza A virus (A/NY/1983(H3N2))		
Influenza A virus (A/Ohio/3/95(H3N2))	hema(GI:2271286 loc:AF008781)	
Influenza A virus (A/Ohmuta/T78/1999(H3N2))		
Influenza A virus (A/Ohmuta/T86/1 999(H3N2))		
Influenza A virus (A/Oita/3/83(H3N2))	hema(GI:2275476 loc:AF008868)	
Influenza A virus (A/Oklahoma/323/03(H3N2))	hema(GI:66933143 loc:DQ059385)	
Influenza A virus (A/OMS/7026/89(H3N2))	hema(GI:762863 loc:FLAH3N2F)	
Influenza A virus (A/Oregon/4/80(H3N2))	hema(GI:18139815 loc:AF405212)	
Influenza A virus (A/Oslo/13676/83(H3N2))	hema(GI:49339002 loc:AY661016)	
Influenza A virus (A/Oslo/185/97 (H3N2))	- hema(GI: 14133842 loc:AF368445)	
Influenza A virus (A/Oslo/21/97 (H3N2))	hema(GI:14133839 loc:AF368444)	
Influenza A virus (A/Oslo/2219/93(H3N2))	hema(GI:493393 16 loc:AY661 173)	
Influenza A virus (A/Oslo/2352/93(H3N2))	hema(GI:493393 18 loc:AY661 174)	
Influenza A virus (A/Oslo/244/97 (H3N2))	hema(GI:14133845 loc:AF368446)	
Influenza A virus (A/Otago/02/2005(H3N2))	hema(GI: 110825874 loc:DQ865965)	
Influenza A virus (A/Otago/1/2005(H3N2))		neura(GI:1 13 170962 loc:CY0H0410)
Influenza A virus (A/Otago/2/2005(H3N2))		neura(GI:1 13 171390 loc:CY0140890)
Influenza A virus (A/Otago/3/2005(H3N2))		neura(GI:1 13 171485 loc:CY0141290)
Influenza A virus (A/Otago/4/2005(H3N2))		neura(GI:1 13171466 loc:CY0141210)
Influenza A virus (A/Oviedo/RR605/00(H3N2))	hema(GI:16417101 loc:AF357949)	
Influenza A virus (A/Panama/1/68(H3N2))		
Influenza A virus (A/Parana/291/04(H3N2))	hema(GI:62512010 loc:AY972842)	
Influenza A virus (A/Parana/298/04 (H3N2))	hema(GI:625 11986 loc:AY972830)	
Influenza A virus (A/Parana/306/04(H3N2))	hema(GI:625 12000 loc:AY972837)	
Influenza A virus (A/Parana/308/04(H3N2))	hema(GI:62512002 loc:AY972838)	
Influenza A virus (A/Parana/3 12/04(H3N2))	hema(GI:625 12024 loc:AY972849)	
Influenza A virus (A/Parana/3 13/04(H3N2))	hema(GI:62512012 loc:AY972843)	
Influenza A virus (A/Paris/1/92(H3N2))	hema(GI:2271038 loc:AF008657)	
Influenza A virus	hema(GI:49339234 loc:AY661 132)	

(A/Paris/287/93(H3N2)) Influenza A virus	
(A/Paris/320/92(H3N2)) Influenza A virus	hema(GI:49339134 loc:AY661082)
(A/Paris/325/92(H3N2)) Influenza A virus	hema(GI:49339136 loc:AY661083)
(A/Paris/363/95(H3N2)) Influenza A virus	hema(GI:6552512 loc:AF180569)
(A/Paris/407/92(H3N2)) Influenza A virus	hema(GI:49339138 loc:AY661084)
(A/Paris/417/92(H3N2)) Influenza A virus	hema(GI:49339140 loc:AY661085)
(A/Paris/424/92(H3N2)) Influenza A virus	hema(GI:49339142 loc:AY661086)
(A/Paris/457/92(H3N2)) Influenza A virus	hema(GI:49339144 loc:AY661087)
(A/Paris/467/92(H3N2)) Influenza A virus	hema(GI:49339146 loc:AY661088)
(A/Paris/490/92(H3N2)) Influenza A virus	hema(GI:49339148 loc:AY661089)
(A/Paris/512/92(H3N2)) Influenza A virus	hema(GI:49339150 loc:AY661090)
(A/Paris/548/92(H3N2)) Influenza A virus	hema(GI:49339152 loc:AY661091)
(A/Paris/564/92(H3N2)) Influenza A virus	hema(GI:49339154 loc:AY661092)
(A/Paris/583/92(H3N2)) Influenza A virus	hema(GI:49339156 loc:AY661093)
(A/Paris/597/92(H3N2)) Influenza A virus	hema(GI:49339158 loc:AY661094)
(A/Paris/614/92(H3N2)) Influenza A virus	hema(GI:49339160 loc:AY661095)
(A/Paris/688/93(H3N2)) Influenza A virus	hema(GI:2271360 loc:AF008818)
(A/Paris/80/91(H3N2)) Influenza A virus	hema(GI:2271128 loc:AF008702)
(A/Paris/83/95(H3N2)) Influenza A virus	hema(GI:6552511 loc:AF180568)
(A/Paris/896/97(H3N2)) Influenza A virus	hema(GI:14030466 loc:AF363502)
(A/Paris/906/97(H3N2)) Influenza A virus	hema(GI:14030468 loc:AF363503)
(A/Paris/908/97(H3N2)) Influenza A virus	hema(GI:14030470 loc:AF363504)
(A/Pennsylvania/09/91(H3N2)) Influenza A virus	hema(GP:2271082 loc:AF008679)
(A/Pennsylvania/15/95(H3N2)) Influenza A virus	hema(GI:2271296 loc:AF008786)
(A/Pennsylvania/2/97(H3N2)) Influenza A virus	hema(GI:6552587 loc:AF180644)
(A/Pennsylvania/20109/99(H3N2)) Influenza A virus	
(A/Pennsylvania/7/94(H3N2)) Influenza A virus	hema(GI:2271300 loc:AF008788)
(A/Pennsylvania/9/93(H3N2)) Influenza A virus	hema(GI:2275454 loc:AF008857)
(A/Perth/01/92(H3N2)) Influenza A virus	hema(GI:2271036 loc:AF008656)
(A/Perth/45/2004(H3N2)) Influenza A virus	hema(GI:110825844 loc:DQ865950)
(A/Perth/79/2005(H3N2)) Influenza A virus	hema(GI:110825892 loc:DQ865974)
(A/Peru/166/2005(H3N2)) Influenza A virus	hema(GI:82571070 loc:DQ265708)
(A/Perugia/5/99(H3N2)) Influenza A virus	
(A/Pemgia/7/2000(H3N2))	

Influenza A virus (A/Philippines/104/68(H3N2))	
Influenza A virus (A7Philippines/2/1982(H3N2))	hema(GI:497235 loc:IVU08858)
Influenza A virus (A/Philippines/2/1982/BS(H3N2))	hema(GI:497237 loc:IVU08859)
Influenza A virus (A/Philippines/2/82(H3N2))	hema(GI:733 1124 loc:AF233691)
Influenza A virus (A/Philippines/26/99(H3N2))	
Influenza A virus (A/Philippines/3/68(H3N2))	
Influenza A virus (A/Philippines/498/2005(H3N2))	hema(GI:1 10825858 loc:DQ865957)
Influenza A virus (A/Philippines/625/2005(H3N2))	hema(GI: 1 10825860 loc:DQ865958)
Influenza A virus (A/Philippines/CI-1/2001(H3N2))	hema(GI:77023512 loc:DQ 179382)
Influenza A virus (A/Philippines/C3-15/2002(H3N2))	hema(GI:77023606 loc:DQ179429)
Influenza A virus (A/Philippines/C3-17/2002(H3N2))	hema(GI:77023610 loc:DQ179431)
Influenza A virus (A/Philippines/C3-18/2002(H3N2))	hema(GI:77023612 loc:DQ179432)
Influenza A virus (A/Philippines/C3-2/2002(H3N2))	hema(GI:77023580 loc:DQ179416)
Influenza A virus (A/Philippines/C3-20/2002(H3N2))	hema(GI:77023616 loc:DQ179434)
Influenza-A virus (A/Philippines/C3-21/2002(H3N2))	hema(GI:77023618 loc:DQ179435)
Influenza A virus (A/Philippines/C3-23/2002(H3N2))	hema(GI:77023622 loc:DQ179437)
Influenza A virus (A/Philippines/C3-26/2002(H3N2))	hema(GI:77023628 loc:DQ 179440)
Influenza A virus (A/Philippines/C3-27/2002(H3N2))	hema(GI:77023630 loc:DQ179441)
Influenza A virus (A/Philippines/C3-28/2002(H3N2))	hema(GI:77023632 loc:DQ179442)
Influenza A virus (A/Philippines/C3-3 1/2002(H3N2))	hema(GI:77023638 loc:DQ179445)
Influenza A virus (A/Philippines/C3-32/2002(H3N2))	hema(GI:77023640 loc:DQ179446)
Influenza A virus (A/Philippines/C3-33/2002(H3N2))	hema(GI:77023642 loc:DQ179447)
Influenza A virus (A/Philippines/C3-34/2002(H3N2))	hema(GI:77023644 loc:DQ179448)
Influenza A virus (A/Philippines/C3-35/2002(H3N2))	hema(GI:77023 646 loc:DQ179449)
Influenza A virus (A/Philippines/C3-36/2002(H3N2))	hema(GI:77023648 loc:DQ!79450)
Influenza A virus (A/Philippines/C3-39/2002(H3N2))	hema(GI:77023654 loc:DQ 179453)
Influenza A virus (A/Philippines/C3-41/2002(H3N2))	hema(GI:77023658 loc:DQ179455)
Influenza A virus (A/Philippines/C3-42/2002(H3N2))	hema(GI:77023660 loc:DQ 179456)
Influenza A virus (A/Philippines/C3-43/2002(H3N2))	hema(GI:77023662 loc:DQ!79457)
Influenza A virus (A/Philippines/C3-44/2002(H3N2))	hema(GI:77023664 loc:DQ! 79458)
Influenza A virus (A/Philippines/C3-48/2002(H3N2))	hema(GI:77023672 loc:DQ179462)
Influenza A virus (A/Philippines/C3-50/2002(H3N2))	hema(GI:77023676 loc:DQ 179464)
Influenza A virus (A/Philippines/C3-53/2002(H3N2))	hema(GI:77023682 loc.DQ 179467)
Influenza A virus	hema(GI:77023688 loc:DQ179470)

(A/Philippines/C3-56/2002(H3N2))	
Influenza A virus	
(A/Philippines/C3-57/2002(H3N2))	hema(GI:77023690 loc:DQ179471)
Influenza A virus (A/Poland/C4-17/2003(H3N2))	hema(GI:77023726 loc:DQ179489)
Influenza A virus (A/Port Chalmers/1/1973(H3N2))	hema(GI:3885871 loc:AF092062)
Influenza A virus (A/Pretoria/16/03(H3N2))	hema(GI:3753003 1 loc:AY389359)
Influenza A virus (A/Pretoria/I 7/03(H3N2))	hema(GI:37530033 loc:AY389360)
Influenza A virus (A/Pretoria/2/03(H3N2))	hema(GI:37530029 loc:AY389358)
Influenza A virus (A/Puerto Rico/1/97(H3N2))	hema(GI:6552517 loc:AF180574)
Influenza A virus (A/Puerto Rico/1/90(H3N2))	hema(GI:2271090 loc:AF008683)
Influenza A virus (A/PuertoRico/1/68(H3N2))	
Influenza A virus (A/PuertoRico/3/72(H3N2))	
Influenza A virus (A/Pusan/10/98(H3N2))	hema(GI: 14550202 loc:AF386612)
Influenza A virus (A/Pusan/504/2002(H3N2))	hema(GI:46410032 loc:AY589647)
Influenza A virus (A/Pusan/68/98(H3N2))	hema(GI: 14550234 loc:AF386628)
Influenza A virus (A/Pusan/71/99(H3N2))	hema(GI: 14550244 loc:AF386633)
Influenza A virus (A/Qatar/2039/2005(H3N2))	hema(GI:82571068 loc:DQ265707)
Influenza A virus (A/Qingdao/10/(H3N2))	hema(GI:2275514 loc:AF008887)
Influenza A virus (A/Qingdao/53/92(H3N2))	hema(GI:2271356 loc:AF008816)
Influenza A virus (A/Qu/7/1970(H3N2))	hema(GI:324168 loc:FLAHAMN)
Influenza A virus (A/Queensland/7/70(H3N2))	
Influenza A virus (A/Rabat/18/97(H3N2))	hema(GI:109156250 loc:DQ534421)
Influenza A virus (A/Rabat/227/98(H3N2))	hema(GI: 109 156260 loc:DQ534426)
Influenza A virus (A/Rabat/236/98(H3N2))	hema(GI: 109156254 loc:DQ534423)
Influenza A virus (A/Rabat/33/97(H3N2))	hema(GI:109156252 loc:DQ534422)
Influenza A virus (A/RES VIR-8(H3N2))	
Influenza A virus (A/Rhode Island/7/97(H3N2))	hema(GI:6552599 loc:AF180656)
Influenza A virus (A/Rio/6/69(H3N2))	
Influenza A virus (A/RiodeJaneiro/107/03(H3N2))	hema(GI:6251 1992 ioc:AY972833)
Influenza A virus (A/RiodeJaneiro/17/04(H3N2))	hema(GI:625 12020 loc:AY972847)
Influenza A virus (A/RiodeJaneiro/1 72/00(H3N2))	hema(GI:65307144 loc:AY968025)
Influenza A virus (A/RiodeJaneiro/26/04(H3N2))	hema(GI:62512006 loc:AY972840)
Influenza A virus (A/RiodeJaneiro/28/00(H3N2))	hema(GI:65307140 loc:AY968023)
Influenza A virus (A/RiodeJaneiro/3 10/0 1(H3N2))	hema(GI:65307146 loc:AY968026)
Influenza A virus (A/RiodeJaneiro/346/03(H3N2))	hema(GI:625 12028 loc:AY972851)

Influenza A virus (A/RiodeJaneiro/465/01(H3N2))	hema(GI:65307152 loc:AY968029)
Influenza A virus (A/RiodeJaneiro/470/01(H3N2))	hema(GI:65307154 loc:AY968030)
Influenza A virus (A/RiodeJaneiro/471/01(H3N2))	hema(GI:65307156 loc:AY968031)
Influenza A virus (A/RiodeJaneiro/478/01(H3N2))	hema(GI:65307158 loc:AY968032)
Influenza A virus (A/RiodeJaneiro/533/01(H3N2))	hema(GI:65307162 loc:AY968034)
Influenza A virus (A/RiodeJaneiro/565/01(H3N2))	hema(GI:65307164 loc:AY968035)
Influenza A virus (A/RiodeJaneiro/57/99(H3N2))	hema(GI:65307138 loc:AY968022)
Influenza A virus (A/RiodeJaneiro/580/01(H3N2))	hema(GI:65307166 loc:AY968036)
Influenza A virus (A/RiodeJaneiro/98/03(H3N2))	hema(GI:62511994 loc:AY972834)
Influenza A virus (A/RiodeJaneiro/99/03(H3N2))	hema(GI:62511990 loc:AY972832)
Influenza A virus (A/RioGdoSul/213/04(H3N2))	hema(GI:62512004 loc:AY972839)
Influenza A virus (A/RioGdoSul/205/02(H3N2))	hema(GI:6530716S loc:AY968037)
Influenza A virus (A/RioGdoSul/21/99(H3N2))	hema(GI:65307132 loc:AY968019)
Influenza A virus (A/RioGdoSul/21/04(H3N2))	hema(GI:62511998 loc:AY972836)
Influenza A virus (A/RioGdoSul/212/04(H3N2))	hema(GI:62511996 loc:AY972835)
Influenza A virus (A/RioGdoSul/214/04(H3N2))	hema(GI:62512026 loc:AY972850)
Influenza A virus (A/RioGdoSul/25/99(H3N2))	hema(GI:65307134 loc:AY968020)
Influenza A virus (A/RioGdoSul/406/04(H3N2))	hema(GI:62512018 loc:AY972846)
Influenza A virus (A/RioGdoSul/41/04(H3N2))	hema(GI:62512008 loc:AY972841)
Influenza A virus (A/RioGdoSul/417/04(H3N2))	hema(GI:62512014 loc:AY972844)
Influenza A virus (A/RioGdoSul/523/01(H3N2))	hema(GI:65307160 loc:AY968033)
Influenza A virus (A/Romania/160/94(H3N2))	hema(GI:2271376 loc:AF008826)
Influenza A virus (A/Romania/182/94(H3N2))	hema(GI:2275402 loc:AF008831)
Influenza A virus (A/Rotterdam/100540/92(H3N2))	hema(GI:49339194 loc:AY661112)
Influenza A virus (A/Rotterdam/577/80(H3N2))	hema(GI:49339062 loc:AY661046)
Influenza A virus (A/Rotterdam/5828/77(H3N2))	hema(GI:49338994 loc:AY661012)
Influenza A virus (A/Rotterdam/8179/77(H3N2))	hema(GI:49338996 loc:AY661013)
Influenza A virus (A/ruddy tumstone/Delaware/142/99 (H3N2))	
Influenza A virus (A/Russia/31/93(H3N2))	hema(GI:2271132 loc:AF008704)
Influenza A virus (A/Russia/41/97(H3N2))	hema(GI:6552557 loc:AF180614)
Influenza A virus (A/Russia/46967/94(H3N2))	hema(GI:2271324 loc:AF008800)
Influenza A virus (A/Russia/58/93(H3N2))	hema(GI:2271332 loc:AF008804)
Influenza A virus (A/Saitama/80/96(H3N2))	hema(GI:6552553 loc:AF180610)

Influenza A virus (A/Salamanca/RR593/00(H3N2))	hema(GI: 1641 7097 loc:AF357947)
Influenza A virus (A/Salamanca/RR682/00(H3N2))	hema(GI: 164171 11 loc:AF357954)
Influenza A virus (A/Salta/V793/98(H3N2))	hema(GI:22536031 loc:AF533721)
Influenza A virus (A/San Sebastian/RR390/98(H3N2))	hema(GI: 16417089 loc:AF357943)
Influenza A virus (A/Santa Fe/466/99(H3N2))	hema(GI:33330020 loc:AF534041)
Influenza A virus (A/Santa Fe/5456/97(H3N2))	hema(GI:33329996 loc:AF534029)
Influenza A virus (A/Santa Fe/9/99(H3N2))	hema(GI:33330022 loc:AF534042)
Influenza A virus (A/Santiago/7 198/94(H3N2))	hema(GI:2275458 loc:AF008859)
Influenza A virus (A/Sapporro/92(H3N2))	hema(GI:2271362 loc:AF008819)
Influenza A virus (A/Scotland/142/1993(H3N2))	
Influenza A virus (A/Scotland/160/1993(H3N2))	
Influenza A virus (A/Scotland/173/1993(H3N2))	
Influenza A virus (A/Scotland/174/1993(H3N2))	
Influenza A virus (A/Scotland/2/1993(H3N2))	
Influenza A virus (A/Scotland/C4- 10/2003(H3N2))	hema(GI:77023712 loc:DQ179482)
Influenza A virus (A/Scotland/C4- 14/2003(H3N2))	hema(GI:77023720 loc:DQ179486)
Influenza A virus (A/Scotland/C4- 15/2003(H3N2))	hema(GI:77023722 loc:DQ179487)
Influenza A virus (A/Scotland/C4- 18/2003(H3N2))	hema(GI:77023728 loc:DQ179490)
Influenza A virus (A/Scotland/C4- 19/2003(H3N2))	hema(GI:77023730 loc:DQ179491)
Influenza A virus (A/Scotland/C4- 21/2003(H3N2))	hema(GI:77023734 loc:DQ179493)
Influenza A virus (A/Scotland/C4- 27/2003(H3N2))	hema(GI:77023746 loc:DQ 179499)
Influenza A virus (A/Scotland/C4- 28/2003(H3N2))	hema(GI:77023748 loc:DQ179500)
Influenza A virus (A/Sendai/cl82/1994(H3N2))	
Influenza A virus (A/Sendai/C273/92(H3N2))	hema(GI:49339228 loc:AY661 129)
Influenza A virus (A/Sendai/c373/1995(H3N2))	
Influenza A virus (A/Sendai/c384/1994(H3N2))	
Influenza A virus (A/Seoul/1/90(H3N2))	hema(GI:493391 14 loc:AY661072)
Influenza A virus (A/Seoul/104/97(H3N2))	hema(GI:14550228 loc:AF386625)
Influenza A virus (A/Seoul/I 1/88(H3N2))	hema(GI:14550186 loc:AF386604)
Influenza A virus (A/Seoul/16/89(H3N2))	hema(GI: 14550 188 loc:AF386605)
Influenza A virus (A/Seoul/2/1995(H3N2))	
Influenza A virus (A/Seoul/22/90(H3N2))	hema(GI:14550192 loc:AF386607)
Influenza A virus (A/Seoul/23/91(H3N2))	hema(GI: 14550 194 loc:AF3 86608)
Influenza A virus	hema(GI: 14550232 loc:AF386627)

(A/Seoul/37/98(H3N2)) Influenza A virus	
(A/Seoul/44791(H3N2)) Influenza A virus	hema(GI: 14550 196 loc:AF386609)
(A/Seoul/45/91(H3N2)) Influenza A virus	hema(GI:2271080 loc:AF008678)
(A/Seoul/46/91(H3N2)) Influenza A virus	heraa(GI: 14550198 loc:AF386610)
(A/Seoul/47/91(H3N2)) Influenza A virus	hema(GI: 14550200 loc:AF38661 1)
(A/Seoul/50/91(H3N2)) Influenza A virus	hema(GI: 14550 190 loc:AF3 86606)
(A/Seoul/69/97(H3N2)) Influenza A virus	hema(GI: 14550220 loc:AF386621)
(A/Seoul/8/1995(H3N2)) Influenza A virus	
(A/Seoul/95/98(H3N2)) Influenza A virus	hema(GI:14550236 loc:AF386629)
(A/Shangdong/5/94(H3N2)) Influenza A virus	hema(GI:2271250 loc:AF008763)
(A/Shangdong/9/1993(H3N2)) Influenza A virus	
(A/Shangdong/9/96(H3N2)) Influenza A virus	hema(GI:6552543 loc:AF180600)
(A/Shanghai/1/89(H3N2)) Influenza A virus	hema(GI:2271062 loc:AF008669)
(A/Shanghai/1 1/(H3N2)) Influenza A virus	hema(GI:2275512 loc:AF008886)
(A/Shanghai/1 1/1987(H3N2)) Influenza A virus	
(A/Shanghai/1 1/1987/high yield(H3N2)) Influenza A virus	hema(GI:348125 loc:FLAHASHANZ)
(A/Shanghai/1 1/1987/low yield(H3N2)) Influenza A virus (A/Shanghai/1 1/1987/X99/high yielding reassortant(H3N2))	hema(GI:348123 IocrFLAHASHANY)
(A/Shanghai/1 1/1987/X99a/high yield reassortant(H3N2)) Influenza A virus (A/Shanghai/1 1/1987/X99aE high yield reassortant(H3N2))	
(A/Shanghai/1 1/87(H3N2)) Influenza A virus	
(A/Shanghai/16/1989(H3N2)) Influenza A virus	
(A/Shanghai/16/89(H3N2)) Influenza A virus	hema(GI:2271060 loc:AF008668)
(A/Shanghai/24/90(H3N2)) Influenza A virus	hema(GI:2271044 loc:AF008660)
(A/Shanghai/3 1/1980(H3N2)) Influenza A virus	
(A/Shanghai/3 1/80(H3N2)) Influenza A virus	
(A/Shanghai/6/1990(H3N2)) Influenza A virus	
(A/Shanghai/6/90(H3N2)) Influenza A virus	hema(GI:2271096 loc:AF008686)
(A/Shanghai/9/95(H3N2)) Influenza A virus	hema(GI:2271 180 loc:AF008728)
(A/Shenzhen/157/96(H3N2)) Influenza A virus	hema(GI:6552550 loc:AF 180607)
(A/Shenzhen/43/96(H3N2)) Influenza A virus	hema(GI:2271 134 loc:AF008705)
(A/Shiga/2/91(H3N2)) Influenza A virus	hema(GI:2271088 loc:AF008682)

Influenza A virus (A/Shiga/6/93(H3N2))	hema(GI:49339282 loc:AY661 156)
Influenza A virus (A/Shiraz/20/2005(H3N2))	hema(GI: 114149047 loc:DQ981740)
Influenza A virus (A/Shiraz/3/2005(H3N2))	hema(GI:l 14149051 loc:DQ981742)
Influenza A virus (A/Shiraz/8/2005(H3N2))	hema(GI:l 14149049 loc:DQ981741)
Influenza A virus (A/Shiraz/9/2005(H3N2))	
Influenza A virus (A/Sichuan/02/87(H3N2))	hema(GI:221335 loc:FLAHASIC)
Influenza A virus (A/Sichuan/2/(H3N2))	hema(GI:2275508 loc:AF008884)
Influenza A virus (A/Sichuan/346/98(H3N2))	
Influenza A virus (A/Sichuan/4/93(H3N2))	hema(GI:2271336 loc:AF008806)
Influenza A virus (A/Sichuan/89(H3N2))	hema(GI:2271050 loc:AF008663)
Influenza A virus (A/Singapore/02/2005(H3N2))	hema(Gr. 110825862 loc:DQ865959)
Influenza A virus (A/Singapore/1/68(H3N2))	
Influenza A virus (A/Singapore/1/96(H3N2))	hema(GI:49339366 loc:AY661 198)
Influenza A virus (A/Singapore/12/1989(H3N2))	
Influenza A virus (A/Singapore/ 13/1 989(H3N2))	
Influenza A virus (A/Singapore/ 15/200 1(H3N2))	
Influenza A virus (A/Singapore/27/95(H3N2))	hema(GI:2271236 loc:AF008756)
Influenza A virus (A/Singapore/28/95(H3N2))	hema(GI:2271240 loc:AF008758)
Influenza A virus (A/Singapore/3/93(H3N2))	hema(GI:49339392 loc:AY66121 1)
Influenza A virus (A/Singapore/34/89(H3N2))	hema(GI:49339090 loc:AY661060)
Influenza A virus (A/Singapore/35/89(H3N2))	hema(GI:49339092 loc:AY661061)
Influenza A virus (A/Singapore/36/89(H3N2))	hema(GI:49339094 loc:AY661062)
Influenza A virus (A/Singapore/40/89(H3N2))	hema(GI:49339096 loc:AY661063)
Influenza A virus (A/Singapore/53/89(H3N2))	hema(GI:49339098 loc:AY661064)
Influenza A virus (A/Singapore/7/94(H3N2))	hema(GI:22713 12 loc:AF008794)
Influenza A virus (A/Singapore/70/2005(H3N2))	
Influenza A virus (A/Singapore/8/92(H3N2))	hema(GI:2271 114 loc:AF008695)
Influenza A virus (A/Singapore/91(H3N2))	hema(GI:2271046 loc:AF008661)
Influenza A virus (A/Singapore/C5- 10/2003(H3N2))	hema(GI:77023768 loc:DQ17951O)
Influenza A virus (A/Singapore/C5-1 1/2003(H3N2))	hema(GI:77023770 loc:DQ17951 1)
Influenza A virus (A/Singapore/C5-14/2003(H3N2))	hema(GI:77023776 loc:DQ179514)
Influenza A virus (A/Singapore/C5-7/2002(H3N2))	hema(GI:77023762 loc:DQ 179507)
Influenza A virus (A/Singapore/C5-9/2003(H3N2))	hema(GI: 77023766 loc:DQ179509)
Influenza A virus	hema(GI:2271078 loc:AF008677)

(A/Sophia/1 55/93(H3N2))		
Influenza A virus (A/South Africa/1 147/96(H3N2))		
Influenza A virus (A/South Australia/147/99(H3N2))	hema(GI: 108745449 loc:DQ632594)	
Influenza A virus (A/South Australia/2/2000(H3N2))		
Influenza A virus (A/South Australia/22/2005(H3N2))		
Influenza A virus (A/South Australia/3/2000(H3N2))		
Influenza A virus (A/South Australia/32/2005(H3N2))		
Influenza A virus (A/South Australia/42/2005(H3N2))		
Influenza A virus (A/South Australia/49/2000(H3N2))		
Influenza A virus (A/South Australia/52/2000(H3N2))		
Influenza A virus (A/South Australia/54/97(H3N2))	hema(GI:6552524 loc:AF180581)	
Influenza A virus (A/South Australia/75/2000(H3N2))		
Influenza A virus (A/South Australia/76/2000(H3N2))		
Influenza A virus (A/South Australia/77/2000(H3N2))		
Influenza A virus (A/South Australia/80/2000(H3N2))		
Influenza A virus (A/South Canterbury/37/2002(H3N2))	hema(GI:84874049 loc:CY007907)	
Influenza A virus (A/South Carolina/257 11/99(H3N2))		
Influenza A virus (A/South Dakota/01/1991(H3N2))		
Influenza A virus (A/South Korea/C5-3/2002(H3N2))	hema(GI:77023754 loc:DQ179503)	
Influenza A virus (A/South Korea/C5-4/2002(H3N2))	hema(GI:77023756 loc:DQ1 79504)	
Influenza A virus (A/South Australia/15/94(H3N2))	hema(GI:49339322 loc:AY661 176)	
Influenza A virus (A/South Australia/23/92(H3N2))	hema(GI:49339224 loc:AY661 127)	
Influenza A virus (A/South Australia/25/94(H3N2))	hema(GI:49339324 loc:AY661 177)	
Influenza A virus (A/South Australia/27/92(H3N2))	hema(GI:49339226 loc:AY661 128)	
Influenza A virus (A/South Australia/36/92(H3N2))	hema(GI:2271084 loc:AF008680)	
Influenza A virus (A/South Australia/68/92(H3N2))	hema(GI:2271 116 loc:AF008696)	
Influenza A virus (A/South Australia/8/92(H3N2))	hema(GI:49339222 loc:AY661 126)	
Influenza A virus (A/South Dakota/1/91(H3N2))	hema(GI:2271074 loc:AF008675)	
Influenza A virus (A/Southland/5/2005(H3N2))		neura(GI: 113 17101 1 loc:CY0140570)
Influenza A virus (A/Spain/I 18/93(H3N2))	hema(GI:2271 126 loc:AF008701)	
Influenza A virus (A/Spain/125/93(H3N2))	hema(GI:2275424 loc:AF008842)	
Influenza A virus (A/Spain/190/93(H3N2))	hema(GI:2275426 loc:AF008843)	
Influenza A virus (A/Spain/214/97(H3N2))	hema(GI:6552554 loc:AF18061 1)	
Influenza A virus (A/Spaia/351/95(H3N2))	hema(GI:2271290 loc:AF008783)	

Influenza A virus (A/Spain/378/95(H3N2))	hema(GI:2271280 loc:AF008778)
Influenza A virus (A/Spain/C2- 1/2001(H3N2))	hema(GI:77023544 loc:DQ179398)
Influenza A virus (A/Sri Lanka/146/2005(H3N2))	hema(GI: 110825848 loc:DQ865952)
Influenza A virus (A/Sri lanka/9/98(H3N2))	
Influenza A virus (A/StaCatarina/3 11/02(H3N2))	hema(GI:65307170 loc:AY968038)
Influenza A virus (A/StaCatarina/327/02(H3N2))	hema(GI:65307172 loc:AY968039)
Influenza A virus (A/StaCatarina/339/02(H3N2))	hema(GI:65307174 loc:AY968040)
Influenza A virus (A/StaCatarina/379/04(H3N2))	hema(GI:625 12022 loc:AY972848)
Influenza A virus (A/StaCatarina/380/04(H3N2))	hema(GI:625 12016 loc:AY972845)
Influenza A virus (A/Stockholm/1/93(H3N2))	hema(GI:2275428 loc:AF008844)
Influenza A virus (A/Stockholm/1/99(H3N2))	hema(GI:71 149321 loc:DQ1 14500)
Influenza A virus (A/Stockholm/1 0/85(H3N2))	hema(GI:49339074 loc:AY661052)
Influenza A virus (A/Stockholm/12/05(H3N2))	hema(GI:71 149389 loc:DQ1 14534)
Influenza A virus (A/Stockholm/12/88(H3N2))	hema(GI:49339082 loc:AY661056)
Influenza A virus (A/Stockholm/12/92(H3N2))	hema(GI:49339242 loc:AY661 136)
Influenza A virus (A/Stockholm/13/92(H3N2))	hema(GI:49339244 loc:AY661 137)
Influenza A virus (A/Stockholm/14/1 988(H3N2))	hema(GI:324125 loc:FLAHAH)
Influenza A virus (A/Stockholm/15/04(H3N2))	hema(GI:71 149355 loc:DQ1 14517)
Influenza A virus (A/Stockholm/16/04(H3N2))	hema(GI:7 1149365 loc:DQ1 14522)
Influenza A virus (A/Stockholm/17/04(H3N2))	hema(GI:71 149375 loc:DQ1 14527)
Influenza A virus (A/Stockholni/1 9/98(H3N2))	hema(GI:711493 13 loc:DQ 114496)
Influenza A virus (A/Stockholm/20/91(H3N2))	hema(GI:49339208 loc:AY661 119)
Influenza A virus (A/Stockholm/20/93(H3N2))	hema(GI:49339292 loc:AY661 161)
Influenza A virus (A/Stockholm/25/02(H3N2))	hema(GI:71 149325 loc:DQ1 14502)
Influenza A virus (A/Stockholm/26/02(H3N2))	hema(GI:71 149333 loc:DQ1 14506)
Influenza A virus (A/Stockholm/26/2002(H3N2))	hema(GI:62249228 loc:AY884276)
Influenza A virus (A/Stockholm/27/02(H3N2))	hema(GI:7 1149345 loc:DQ 114512)
Influenza A virus (A/Stockholm/4/(H3N2))	hema(GI:2275470 loc:AF008865)
Influenza A virus (A/Stockholm/7/92(H3N2))	hema(GI:49339210 loc:AY661 120)
Influenza A virus (A/Stockholm/8/(H3N2))	hema(GI:2275536 loc:AF008898)
Influenza A virus (A/Stockholm/8/92(H3N2))	hema(GI:49339212 loc:AY66U21)
Influenza A virus (A/Suita/1/90(H3N2))	hema(GI:221337 locrFLAHASUI)
Influenza A virus (A/sw/Obihiro/1/1993(H3N2))	hema(GI:603794 loc:FLAHE)
Influenza A virus	

(A/sw/Obihiro/1/1994(H3N2))	
Influenza A virus	
(A/sw/Obihiro/2/1993(H3N2))	hema(GI:603795 loc:FLAHF)
Influenza A virus	
(A/sw/Obihiro/3/1993(H3N2))	hema(GI:603796 loc:FLAHG)
Influenza A virus	
(A/sw/Shizuoka/1 10/97(H3N2))	hema(GI:27462162 loc:AF225542)
Influenza A virus	
(A/sw/Shizuoka/1 15/97(H3N2))	hema(GI:27462164 loc:AF225543)
Influenza A virus	
(A/sw/Shizuoka/1 19/97(H3N2))	hema(GI:27462166 loc:AF225544)
Influenza A virus	
(A/swine/Alberta/Biovetl/05(H3N2))	hema(GI:79083072 loc:DQ241763)
Influenza A virus (A/swine/Ange-Gardien/150/1990(H3N2))	hema(GI:460239 loc:IAU07146)
Influenza A virus	
(A/swine/Bakum/8602/99(H3N2))	
Influenza A virus	
(A/swine/Beauce/2 18/9 1(H3N2))	
Influenza A virus	
(A/swine/Belgium/220/92(H3N2))	
Influenza A virus	
(A/Swine/Belgium/23 1/94(H3N2))	hema(GI:3885857 loc:AF092055)
Influenza A virus	
(A/swine/Belgium/87/95(H3N2))	
Influenza A virus	
(A/Swine/Brabant/84(H3N2))	hema(GI:3885865 loc:AF092059)
Influenza A virus	
(A/swine/Breugel/251 1#13/97(H3N2))	
Influenza A virus	
(A/Swine/Breugel/97(H3N2))	hema(GI:3885851 loc:AF092052)
Influenza A virus	
(A/swine/China/8/1978(H3N2))	
Influenza A virus	
(A/swine/Colorado/1/1977(H3N2))	hema(GI:324410 loc:FLAN2HAC)
Influenza A virus	
(A/swine/Colorado/1/77(H3N2))	
Influenza A virus	
(A/Swine/Colorado/23619/99(H3N2))	hema(GI:9988677 loc:AF268I28)
Influenza A virus (A/swine/Cote d'Armor/3633/84(H3N2))	
Influenza A virus	
(A/swine/Dandong/9/1 983(H3N2))	
Influenza A virus	
(A/swine/Dandong/9/83(H3N2))	
Influenza A virus	
(A/swine/Finistere/5 10/94(H3N2))	
Influenza A virus	
(A/swine/Flanders/1/98(H3N2))	
Influenza A virus	
(A/swine/Fujian/668/01(H3N2))	hema(GI:58042507 loc:AY857957)
Influenza A virus	
(A/swine/Gent/1/84(H3N2))	
Influenza A virus	
(A/swine/Gent/70/84(H3N2))	
Influenza A virus	
(A/swine/Guangdong/1/2003(H3N2))	hema(GI:57 165255 loc:AY852273)
Influenza A virus	
(A/swine/Guangdong/3/2003(H3N2))	hema(GI:57 165257 loc:AY852274)
Influenza A virus	
(A/swine/Guangdong/4/2003(H3N2))	hema(GI:57165259 loc:AY852275)

Influenza A virus (A/swine/Guangdong/5/2003(H3N2))	hema(GI:57165261 loc:AY852276)
Influenza A virus (A/swine/Guangdong/6/2004(H3N2))	hema(GI:57165263 loc:AY852277)
Influenza A virus (A/swine/Haaksbergen/2767#13/97(H3N2))	
Influenza A virus (A/swine/Heilongjiang/74/2000(H3N2))	hema(GI:66394790 loc:DQ02191 1)
Influenza A virus (A/swine/Heino/2627# 11/97(H3N2))	
Influenza A virus (A/swine/Hong Kong/1/76(H3N2))	hema(GI:418079 loc:FLAHASI)
Influenza A virus (A/swine/Hong Kong/1 144/02(H3N2))	hema(GI:38154823 loc:AY363525)
Influenza A virus (A/swine/Hong Kong/1 197/02(H3N2))	hema(GI:38154825 loc:AY363526)
Influenza A virus (A/swine/Hong Kong/1212/02(H3N2))	hema(GI:38 154807 loc:AY363517)
Influenza A virus (A/swine/Hong Kong/126/1982(H3N2))	hema(GI:324208 loc:FLAHAPA)
Influenza A virus (A/swine/Hong Kong/126/82(H3N2))	
Influenza A virus (A/swine/Hong Kong/127/1982(H3N2))	
Influenza A virus (A/swine/Hong Kong/127/82(H3N2))	hema(GI:432357 loc:FLAHAS127)
Influenza A virus (A/swine/Hong Kong/13/77(H3N2))	hema(GI:418082 loc:FLAHAS13)
Influenza A virus (A/swine/Hong Kong/13 11/01(H3N2))	hema(GI:38154799 loc:AY363513)
Influenza A virus (A/swine/Hong Kong/2 1/77(H3N2))	hema(GI:4 18083 loc:FLAHAS21)
Influenza A virus (A/Swine/Hong Kong/2405/98(H3N2))	
Influenza A virus (A/Swine/Hong Kong/2422/98(H3N2))	
Influenza A virus (A/Swine/Hong Kong/2429/98(H3N2))	
Influenza A virus (A/swine/Hong Kong/3/1976(H3N2))	
Influenza A virus (A/swine/Hong Kong/3 12/00(H3N2))	hema(GI:38 154795 loc:AY36351 1)
Influenza A virus (A/swine/Hong Kong/4/1976(H3N2))	
Influenza A virus (A/swine/Hong Kong/41 1/02(H3N2))	hema(GI:38 154805 loc:AY363516)
Influenza A virus (A/swine/Hong Kong/4361/99(H3N2))	hema(GI:38154791 loc:AY363509)
Influenza A virus (A/swine/Hong Kong/5 190/99(H3N2))	hema(GI:3815481 1 loc:AY363519)
Influenza A virus (A/swine/Hong Kong/5200/99(H3N2))	hema(GI:38154813 loc:AY363520)
Influenza A virus (A/swine/Hong Kong/5212/99(H3N2))	hema(GI:38154815 loc:AY363521)
Influenza A virus (A/swine/Hong Kong/6/1976(H3N2))	
Influenza A virus (A/swine/Hong Kong/6/76(H3N2))	hema(GI:4 18081 loc:FLAHAS6)
Influenza A virus (A/swine/Hong Kong/72/77(H3N2))	hema(GI:418084 loc:FLAHAS72)
Influenza A virus (A/swine/Hong Kong/7220/00(H3N2))	hema(GI:38 154793 loc:AY363510)

Influenza A virus (A/swine/Hong Kong/74/02(H3N2))	hema(GI:38 154803 loc:AY363515)
Influenza A virus (A/swine/Hong Kong/7982/00(H3N2))	hema(GI:38154817 loc:AY363522)
Influenza A virus (A/swine/Hong Kong/8 1/1978(H3N2))	hema(GI:324210 loc:FLAHAPB)
Influenza A virus (A/swine/Hong Kong/8 1/78(H3N2))	hema(GI:418085 loc:FLAHAS81)
Influenza A virus (A/swine/Hong Kong/82/78(H3N2))	hema(GI:418086 loc:FLAHAS82)
Influenza A virus (A/swine/Hong Kong/9285/01(H3N2))	hema(GI:38154797 loc:AY363512)
Influenza A virus (A/swine/Hong Kong/9296/01(H3N2))	hema(GI:38154819 loc:AY363523)
Influenza A virus (A/swine/Hong Kong/9745/01(H3N2))	hema(GI:38 154821 loc:AY363524)
Influenza A virus (A/swine/Hong Kong/9840/01(H3N2))	hema(GI:38 154801 loc:AY363514)
Influenza A virus (A/swine/Hong Kong/q066/99(H3N2))	hema(GI:38 154809 loc:AY363518)
Influenza A virus (A/swine/IDT/Re220/92(H3N2))	hema(GI:5 1704726 loc:AY701752)
Influenza A virus (A/Swine/Illinois/21587/99(H3N2))	hema(GI:9988669 loc:AF268124)
Influenza A virus (A/swine/Inner Mongolia/547/2001(H3N2))	hema(GI:66394788 loc:DQ021910)
Influenza A virus (A/Swine/Iowa/569/99 (H3N2))	hema(GI:9887163 loc:AF251419)
Influenza A virus (A/swine/Italy/1243/92(H3N2))	
Influenza A virus (A/swine/Italy/13962/95(H3N2))	
Influenza A virus (A/swine/Italy/146 1/96(H3N2))	
Influenza A virus (A/swine/Italy/1475/96(H3N2))	
Influenza A virus (A/swine/Italy/1477/96(H3N2))	
Influenza A virus (A/swine/Italy/1510/98(H3N2))	
Influenza A virus (A/Swine/Italy/1 523/98(H3N2))	
Influenza A virus (A/swine/Italy/1553-2/98(H3N2))	
Influenza A virus (A/swine/Italy/1850/1977(H3N2))	
Influenza A virus (A/swine/Italy/1942/00(H3N2))	
Influenza A virus (A/Swine/Italy/25823/94(H3N2))	hema(GI: 180918 11 loc:AF213903)
Influenza A virus (A/swine/Italy/309/1983(H3N2))	
Influenza A virus (A/swine/Italy/309/83(H3N2))	
Influenza A virus (A/swine/Italy/520/85(H3N2))	
Influenza A virus (A/swine/Italy/526/1985(H3N2))	
Influenza A virus (A/swine/Italy/635/1987(H3N2))	
Influenza A virus (A/swine/Italy/635/87(H3N2))	
Influenza A virus (A/swine/Italy/636/87(H3N2))	
Influenza A virus (A/swine/Italy/809/1989(H3N2))	

Influenza A virus
 (A/swine/Jena/5/96(H3N2))
 Influenza A virus
 (A/swine/Karrenzien/2/87(H3N2))
 Influenza A virus
 (A/swine/Leipzig/145/92(H3N2))
 Influenza A virus
 (A/swine/Lohne/1/97(H3N2))
 Influenza A virus
 (A/swine/Mariahbut/150# 12/97(H3
 N2))
 Influenza A virus
 (A/swine/Mierlo/155#15/97(H3N2)
)
 Influenza A virus
 (A/Swine/Minnesota/9088-2/98
 (H3N2)) hema(GI:5764320 loc:AF153234)
 Influenza A virus
 (A/Swine/Nebraska/209/98
 (H3N2)) hema(GI:9887129 loc:AF251403)
 Influenza A virus
 (A/Swine/Netherlands/784/9 1(H3N
 2)) hema(GI:3885861 loc:AF092057)
 Influenza A virus
 (A/Swine/Netherlands/849/93(H3N
 2)) hema(GI:3885855 loc:AF092054)
 Influenza A virus
 (A/Swine/Netherlands/L2/93(H3N2
)) hema(GI:3885859 loc:AF092056)
 Influenza A virus (A/Swine/North
 Carolina/35922/98 (H3N2)) hema(GI:3777476 loc:AB012948)
 Influenza A virus
 (A/Swine/NorthCarolina/16497/99(
 H3N2)) hema(GP:9988675 loc:AF268127)
 Influenza A virus
 (A/Swine/Oedenrode/7C/96(H3N2)
) hema(GI:3885853 loc:AF092053)
 Influenza A virus
 (A/Swine/Oklahoma/18089/99(H3
 N2)) hema(GI:9988671 ioc:AF268125)
 Influenza A virus
 (A/Swine/Oklahoma/18717/99(H3
 N2)) hema(GI:9988667 loc:AF268123)
 Influenza A virus
 (A/swine/Ommel/1 52# 15/97(H3N2
))
 Influenza A virus
 (A/swine/Ontario/Biovet/05(H3N
 2)) hema(GI:79083042 loc:DQ241762)
 Influenza A virus
 (A/swine/Pingtung/199-
 2/2002(H3N2)) hema(GI:47176946 loc:AY377927)
 Influenza A virus
 (A/swine/Potsdam/35/82(H3N2))
 Influenza A virus
 (A/swine/Quebec/Biovet/05(H3N
 2)) hema(GI:79082902 loc:DQ241761)
 Influenza A virus
 (A/swine/Re220/92(H3N2))
 Influenza A virus
 (A/swine/Shizuoka/120/97(H3N2))
 Influenza A virus
 (A/swine/Spain/33601/2001(H3N2)
)
 Influenza A virus
 (A/swine/Spain/39139/2002(H3N2)
)

Influenza A virus
(A/swine/Spain/42386/2002(H3N2))
)
Influenza A virus
(A/swine/St.Oedenrode/7C/96(H3N2))
Influenza A virus
(A/Swine/Taiwan/73 10/70(H3N2))
Influenza A virus
(A/Swine/Texas/4199-2/98(H3N2))
Influenza A virus
(A/swine/Ukkel/1/1984(H3N2)) hema(GI:32441 1 loc:FLAN2HAD)
Influenza A virus
(A/swine/Ukkel/1/84(H3N2))
Influenza A virus (A/swine/United
Kingdotn/1 19404/91(H3N2))
Influenza A virus
(A/Swine/Utrecht/4/85(H3N2)) hema(GI:3885863 loc:AF092058)
Influenza A virus
(A/swine/Wadayama/5/69(H3N2)) hema(GI:418087 loc:FLAHAS5)
Influenza A virus
(A/Swine/Wisconsin/14094/99(H3N2)) hema(GI:9988673 loc:AF268126)
Influenza A virus
(A/swine/Wisconsin/194/1980(H3N2))
Influenza A virus
(A/Switzerland/7729/98(H3N2)) herna(GI:14161723 loc:AY032978)
Influenza A virus
(A/Switzerland/9243/99 (H3N2))
Influenza A virus
(A/Sydney/05/97(H3N2)) hema(GI:3643242 loc:AF087709)
Influenza A virus
(A/Sydney/05/97-like(H3N2)) hema(GI:3643217 loc:AF087700)
Influenza A virus
(A/Sydney/1/(H3N2)) hema(GI:2275504 loc:AF008882)
Influenza A virus
(A/Sydney/4/97(H3N2)) hema(GI:6552526 loc:AF180583)
Influenza A virus
(A/Sydney/5/97(H3N2)) hema(GI:6552527 loc:AF180584)
Influenza A virus
(A/Sydney/52/2005(H3N2)) hema(GI: 110825850
loc:DQ865953)
Influenza A virus
(A/Sydney/6/97(H3N2)) hema(GI:6552516 loc:AF180573)
Influenza A virus
(A/Tairawhiti/223/2004(H3N2)) neura(GI:85816151
loc:CY0082140)
Influenza A virus
(A/Tairawhiti/369/2004(H3N2))
Influenza A virus
(A/Tairawhiti/68/2004(H3N2))
Influenza A virus
(A/Taiwan/0020/98 (H3N2))
Influenza A virus
(A/Taiwan/0040/2003(H3N2)) hema(GI:50727514 loc:AY604817)
Influenza A virus
(A/Taiwan/0045/98 (H3N2))
Influenza A virus
(A/Taiwan/0097/2003(H3N2)) hema(GI:50727536 loc:AY604828)
Influenza A virus
(A/Taiwan/0104/2001 (H3N2))
Influenza A virus
(A/Taiwan/0122/2003(H3N2)) hema(GI:50727526 loc:AY604823)
Influenza A virus
(A/Taiwan/0132/96 (H1N1))
Influenza A virus
(A/Taiwan/0275/2000 (H3N2)) heraa(GI:32330915 loc:AY303713)
Influenza A virus

(A/Taiwan/0346/98 (H3N2)) Influenza A virus	
(A/Taiwan/0379/2000 (H3N2)) Influenza A virus	hema(GI:32330923 loc:AY303717)
(A/Taiwan/0388/2001(H3N2)) Influenza A virus	hema(GI:50604415 loc:AY625729)
(A/Taiwan/0423/98 (H3N2)) Influenza A virus	
(A/Taiwan/0464/98 (H3N2)) Influenza A virus	
(A/Taiwan/0568/2001(H3N2)) Influenza A virus	hema(GI:50604440 loc:AY625730)
(A/Taiwan/0570/2003(H3N2)) Influenza A virus	herna(GI:50727524 loc:Aÿ604822)
(A/Taiwan/0572/2003(H3N2)) Influenza A virus	hema(GI:50727534 loc:AY604827)
(A/Taiwan/0578/2003(H3N2)) Influenza A virus	hema(GI:50727522 loc:AY604821)
(A/Taiwan/0583/2003(H3N2)) Influenza A virus	hema(GI:50727520 loc:AY604820)
(A/Taiwan/0646/2000 (H3N2)) Influenza A virus	hema(GI:32330935 loc:AY303723)
(A/Taiwan/0964/2001(H3N2)) Influenza A virus	hema(GI:50604469 loc:AY625731)
(A/Taiwan/1/69(H3N2)) Influenza A virus	
(A/Taiwan/1/72(H3N2)) Influenza A virus	
(A/Taiwan/1008/99 (H3N2)) Influenza A virus	
(A/Taiwan/I 143/91(H3N2)) Influenza A virus	hema(GI:2271 130 loc:AF008703)
(A/Taiwan/1523/2003(H3N2)) Influenza A virus	hema(GI:39980625 loc:AY479982)
(A/Taiwan/1537/99 (H3N2)) Influenza A virus	
(A/Taiwan/1566/2003(H3N2)) Influenza A virus	hema(GI:50727532 loc:AY604826)
(A/Taiwan/1568/2003(H3N2)) Influenza A virus	hema(GI:50727518 loc:AY604819)
(A/Taiwan/1748/97 (H3N2)) Influenza A virus	
(A/Taiwan/1990/96 (H3N2)) Influenza A virus	hema(GI:32330951 loc:AY303731)
(A/Taiwan/2/70(H3N2)) Influenza A virus	
(A/Taiwan/20/98(H3N2)) Influenza A virus	hema(GI:4972940 loc:AF139938)
(A/Taiwan/2034/96(H3N2)) Influenza A virus	hema(GI:4972938 loc:AF139937)
(A/Taiwan/2040/2003(H3N2)) Influenza A virus	hema(GI:50727516 loc:AY604818)
(A/Taiwan/21/98(H3N2)) Influenza A virus	hema(GI:4972932 loc:AF139934)
(A/Taiwan/2191/96(H3N2)) Influenza A virus	hema(GI:4972928 loc:AF139932)
(A/Taiwan/2192/96(H3N2)) Influenza A virus	hema(GI:4972936 loc:AF139936)
(A/Taiwan/2195/96 (H3N2)) Influenza A virus	hema(GI:32330961 loc:AY303736)
(A/Taiwan/2332/2001(H3TS12)) Influenza A virus	
(A/Taiwan/2985/2002(H3N2)) Influenza A virus	
(A/Taiwan/3/71(H3N2)) Influenza A virus	
(A/Taiwan/30005/2004(H3N2)) Influenza A virus	hema(GI:79081975 loc:DQ249261)

Influenza A virus (A/Taiwan/3 1001/2004(H3N2))	
Influenza A virus (A/Taiwan/3 13 1/2002(H3N2))	hema(GI:50727502 loc:AY60481 1)
Influenza A virus (A/Taiwan/335 1/97(H3N2))	hema(GI:4972934 loc:AF139935)
Influenza A virus (A/Taiwan/3396/97 (H3N2))	hema(GI:32330975 loc:AY303743)
Influenza A virus (A/Taiwan/3427/97(H3N2))	hema(GI:4972924 loc:AF139930)
Influenza A virus (A/Taiwan/346/98(H3N2))	hβma(GI:4972944 loc:AF139940)
Influenza A virus (A/Taiwan/3469/97(H3N2))	hema(GI:4972930 loc:AF139933)
Influenza A virus (A/Taiwan/3503/97 (H3N2))	hema(GI:32330979 loc:AY303745)
Influenza A virus (A/Taiwan/3513/97(H3N2))	hema(GI:4972926 loc:AF139931)
Influenza A virus (A/Taiwan/3640/2003(H3N2))	hema(GI:79081925 loc:DQ249259)
Influenza A virus (A/Taiwan/3744/2002(H3N2))	hema(GI:50727508 loc:AY604814)
Influenza A virus (A/Taiwan/4050/2003(H3N2))	hema(GI:50727530 loc:AY604825)
Influenza A virus (A/Taiwan/4063/2003(H3N2))	hema(GI:50727528 loc:AY604824)
Influenza A virus (A/Taiwan/4183/2004(H3N2))	
Influenza A virus (A/Taiwan/45/98(H3N2))	hema(GI:4972942 loc:AF139939)
Influenza A virus (A/Taiwan/4673/2002(H3N2))	hema(GI:50727506 loc:AY604813)
Influenza A virus (A/Taiwan/4680/2002(H3N2))	hema(GI:50727504 loc:AY604812)
Influenza A virus (A/Taiwan/4938/2002(H3N2))	hema(GI:50727498 loc:AY604809)
Influenza A virus (A/Taiwan/4954/2002(H3N2))	hema(GI:50727510 loc:AY604815)
Influenza A virus (A/Taiwan/4963/2002(H3N2))	hema(GI:50727500 loc:AY604810)
Influenza A virus (A/Taiwan/5 1/2005(H3N2))	hema(GI: 110825852 loc:DQ865954)
Influenza A virus (A/Taiwan/5 153/2002(H3N2))	hema(GI:50727512 loc:AY604816)
Influenza A virus (A/Taiwan/523/96(H3N2))	hema(GI:2271 184 loc:AF008730)
Influenza A virus (A/Taiwan/7099/2003(H3N2))	hema(GI:50727538 loc:AY604829)
Influenza A virus (A/Taiwan/7100/2003(H3N2))	hema(GI:50727540 loc:AY604830)
Influenza A virus (A/Taiwan/C3- 47/2002(H3N2))	hema(GI:77023670 loc:DQ179461)
Influenza A virus (A/Taiwan/C3- 52/2002(H3N2))	hema(GI:77023680 loc:DQ179466)
Influenza A virus (A/Tasmania/1/97(H3N2))	hema(GI:6552577 loc:AF 180634)
Influenza A virus (A/Tay Nguyen/TN101/2003(H3N2))	hema(GI:84875469 loc:AB221031)
Influenza A virus (A/Tay Nguyen/TN107/2003(H3N2))	hema(GI:84875471 loc:AB221032)
Influenza A virus (A/Tay Nguyen/TNI 16/2003(H3N2))	hema(GI:84875473 loc:AB221033)
Influenza A virus (A/Tay Nguyen/TN152/2003(H3N2))	hema(GI:84875475 loc:AB221034)
Influenza A virus (A/Tay Nguyen/TN 160/2003 (H3N2))	hema(GI:84875477 loc:AB221035)
Influenza A virus	

(A/Tehran/101/68(H3N2))	
Influenza A virus	
(A/Texas/1/77(H3N2))	hema(GI:18158213 loc:AF450246)
Influenza A virus	
(A/Texas/1/96(H3N2))	hema(GI:6552537 loc:AF180594)
Influenza A virus	
(A/Texas/I 7988/84(H3N2))	hema(GI:2275482 loc:AF008871)
Influenza A virus	
(A/Texas/18088/84(H3N2))	hema(GI:2275478 loc:AF008869)
Influenza A virus	
(A/Texas/I 8733/84(H3N2))	hema(GI:2275480 loc:AF008870)
Influenza A virus	
(A/Texas/24752/(H3N2))	hema(GI:2275488 loc:AF008874)
Influenza A virus	
(A/Texas/5/94(H3N2))	hema(GI:2271292 loc:AF008784)
Influenza A virus	
(A/Texas/57/93(H3N2))	hema(GI:2275432 loc:AF008846)
Influenza A virus	
(A/Texas/9/96(H3N2))	hema(GI:6552578 loc:AF180635)
Influenza A virus	hema(GI:1 10825854
(A/Thailand/151/2005(H3N2))	loc:DQ865955)
Influenza A virus	hema(GI: 110825834
(A/Thailand/263/2005(H3N2))	loc:DQ865945)
Influenza A virus	hema(GI: 110825842
(A/Thailand/286/2005(H3N2))	loc:DQ865949)
Influenza A virus	
(A/Thailand/75/94(H3N2))	hema(GI:2271310 loc:AF008793)
Influenza A virus	
(A/Thailand/78/97(H3N2))	hema(GI:6552564 loc:AF180621)
Influenza A virus	
(A/Thailand/79/97(H3N2))	hema(GI:6552563 loc:AF 180620)
Influenza A virus	
(A/Thailand/94/96(H3N2))	hema(GI:6552595 loc:AF180652)
Influenza A virus (A/Thailand/C1-	
12/2002(H3N2))	hema(GI:77023534 loc:DQ179393)
Influenza A virus (A/Thailand/C1-	
14/2002(H3N2))	hema(GI:77023538 loc:DQ179395)
Influenza A virus (A/Thailand/C1-	
15/2002(H3N2))	hema(GI:77023540 loc:DQ179396)
Influenza A virus (A/Thailand/C1-	
16/2002(H3N2))	hema(GI:77023542 loc:DQ179397)
Influenza A virus (A/Thailand/C3-	
1/2002(H3N2))	hema(GI:77023578 loc:DQ179415)
Influenza A virus (A/Thailand/C3-	
10/2002(H3N2))	hema(GI:77023596 loc:DQ 179424)
Influenza A virus (A/Thailand/C3-	
11/2002(H3N2))	hema(GI:77023598 loc:DQ179425)
Influenza A virus (A/Thailand/C3-	
12/2002(H3N2))	hema(GI:77023600 loc:DQ179426)
Influenza A virus (A/Thailand/C3-	
13/2002(H3N2))	hema(GI:77023602 loc:DQ1 79427)
Influenza A virus (A/Thailand/C3-	
14/2002(H3N2))	hema(GI:77023604 loc:DQ179428)
Influenza A virus (A/Thailand/C3-	
16/2002(H3N2))	hema(GI:77023608 loc:DQ179430)
Influenza A virus (A/Thailand/C3-	
19/2002(H3N2))	hema(GI:77023614 loc:DQ179433)
Influenza A virus (A/Thailand/C3-	
22/2002(H3N2))	hema(GI:77023620 loc:DQ179436)
Influenza A virus (A/Thailand/C3-	
24/2002(H3N2))	hema(GI:77023624 loc:DQ179438)
Influenza A virus (A/Thailand/C3-	
25/2002(H3N2))	hema(GI:77023626 loc:DQ179439)
Influenza A virus (A/Thailand/C3-	
29/2002(H3N2))	hema(GI:77023634 loc:DQ179443)
Influenza A virus (A/Thailand/C3-	
3/2002(H3N2))	hema(GI:77023582 loc:DQ179417)

Influenza A virus (A/Thailand/C3-30/2002(H3N2))	hema(GI:77023636 loc:DQ179444)
Influenza A virus (A/Thailand/C3-37/2002(H3N2))	hema(GI:77023650 loc:DQ179451)
Influenza A virus (A/Thailand/C3-38/2002(H3N2))	hema(GI:77023652 loc:DQ179452)
Influenza A virus (A/Thailand/C3-40/2002(H3N2))	hema(GI:77023656 loc:DQ179454)
Influenza A virus (A/Thailand/C3-46/2002(H3N2))	hema(GI:77023668 loc:DQ179460)
Influenza A virus (A/Thailand/C3-49/2002(H3N2))	hema(GI:77023674 loc:DQ179463)
Influenza A virus (A/Thailand/C3-5/2002(H3N2))	hema(GI:77023586 loc:DQ179419)
Influenza A virus (A/Thailand/C3-51/2002(H3N2))	hema(GI:77023678 loc:DQ179465)
Influenza A virus (A/Thailand/C3-55/2002(H3N2))	hema(GI:77023686 loc:DQ179469)
Influenza A virus (A/Thailand/C3-6/2002(H3N2))	hema(GI:77023588 loc:DQ179420)
Influenza A virus (A/Thailand/C3-7/2002(H3N2))	hema(GI:77023590 loc:DQ179421)
Influenza A virus (A/Thailand/C3-8/2002(H3N2))	hema(GI:77023592 loc:DQ179422)
Influenza A virus (A/Thailand/C3-9/2002(H3N2))	hema(GI:77023594 loc:DQ179423)
Influenza A virus (A/Thessalonika/12/97(H3N2))	
Influenza A virus (A/Tianjin/33/92(H3N2))	hema(GI:487662 loc:FLAH13)
Influenza A virus (A/Tianjing/33/92(H3N2))	hema(GI:6552507 loc:AF180564)
Influenza A virus (A/Tianjing/51/97(H3N2))	hema(GI:6552544 loc:AF180601)
Influenza A virus (A/Tianjing/55/96(H3N2))	hema(GI:6552547 loc:AF180604)
Influenza A virus (A/Tilburg/5957/92(H3N2))	hema(GI:49339202 loc:AY661116)
Influenza A virus (A/Tokyo/1275/(H3N2))	hema(GI:2275496 loc:AF008878)
Influenza A virus (A/Tokyo/1276/(H3N2))	hema(GI:2275498 loc:AF008879)
Influenza A virus (A/Tokyo/I 511/98(H3N2))	hema(GI:4760441 loc:AB013806)
Influenza A virus (A/Tokyo/1527/98(H3N2))	hema(GI:4760443 loc:AB013807)
Influenza A virus (A/Tokyo/1539/98(H3N2))	hema(GI:4760445 loc:AB013808)
Influenza A virus (A/Tokyo/1566/98(H3N2))	hema(GI:4760447 loc:AB013809)
Influenza A virus (A/Tokyo/I 567/98(H3N2))	hema(GI:4760449 loc:AB013810)
Influenza A virus (A/Tokyo/1568/98(H3N2))	hema(GI:4760451 loc:AB013811)
Influenza A virus (A/Tokyo/I 569/98(H3N2))	hema(GI:4760453 loc:AB013812)
Influenza A virus (A/Tokyo/1570/98(H3N2))	hema(GI:4760455 loc:AB013813)
Influenza A virus (A/Tokyo/31/72(H3N2))	
Influenza A virus (A/Tokyo/6/73(H3N2))	
Influenza A virus (A/Tonga/23/85(H3N2))	hema(GI:2275552 loc:AF008906)
Influenza A virus (A/Tottori/849AM1AL3/1994(H3N2))	hema(GI:2992515 loc:IAU77837)

Influenza A virus (A/Tottori/849AM2/1994(H3N2))	hema(GI:2992507 loc:IAU77833)
Influenza A virus (A/Tottori/849AM2AL3/1994(H3N2))	hema(GI:2992519 loc:IAU77839)
Influenza A virus (A/Tottori/849AM4/1994(H3N2))	hema(GI:2992511 loc:IAU77835)
Influenza A virus (A/Totlori/872AM1AL3/1994(H3N2))	hema(GI:2992517 loc:IAU77838)
Influenza A virus (A/Tottori/872AM2/1994(H3N2))	hema(GI:2992509 loc:IAU77834)
Influenza A virus (A/Tottori/872AM2AL3/1994(H3N2))	hema(GI:2992521 loc:IAU77840)
Influenza A virus (A/Tottori/872AM4/1994(H3N2))	hema(GI:2992513 loc:IAU77836)
Influenza A virus (A/Tottori/872K4/1994(H3N2))	hema(GI:2992505 loc:IAU77832)
Influenza A virus (A/Toulouse/878/2001(H3N2))	
Influenza A virus (A/Trinidad/47/96(H3N2))	hema(GI:6552530 loc:AF180587)
Influenza A virus (A/Trinidad/50/96(H3N2))	hema(GI:6552536 loc:AF180593)
Influenza A virus (A/Trinidad/51/96(H3N2))	hema(GI:6552535 loc:AF180592)
Influenza A virus (A/Trinidad/697/70(H3N2))	
Influenza A virus (A/Tucuman/V425/98(H3N2))	hema(GI:22536033 loc:AF533722)
Influenza A virus (A/Tucuman/V694/98(H3N2))	hema(GI:22536035 loc:AF533723)
Influenza A virus (A/Turkey/2108/2005(H3N2))	hema(GI:82571090 loc:DQ265718)
Influenza A virus (A/turkey/England/69(H3N2))	
Influenza A virus (A/turkey/Minnesota/764-2/03(H3N2))	hema(GI:56159972 loc:AY779254)
Influenza A virus (A/turkey/North Carolina/12344/03(H3N2))	hema(GI:56159970 loc:AY779253)
Influenza A virus (A/turkey/Ohio/313053/04(H3N2))	hema(GI:84626335 Loc:DQ335771)
Influenza A virus (A/TW/220/04(H3N2))	
Influenza A virus (A/TW/229/03(H3N2))	
Influenza A virus (A/TW/3286/03(H3N2))	
Influenza A virus (A/TW/3446/02(H3N2))	
Influenza A virus (A/TW/3565/02(H3N2))	
Influenza A virus (A/TW/36/04(H3N2))	
Influenza A virus (A/TW/872/02(H3N2))	
Influenza A virus (A/TW/875/04(H3N2))	
Influenza A virus (A/Udorn/307/1972(H3H2))	hema(GP.323994 loc:FLADORNHA)
Influenza A virus (A/Udorn/8/1972(H3N2))	
Influenza A virus (A/Ulan Ude/44/94(H3N2))	hema(GI:2275446 loc:AF008853)
Influenza A virus	hema(GI:2271108 loc:AF008692)

(A/Umea/1/92(H3N2))	
Influenza A virus	
(A/Umea/1982/92(H3N2))	hema(GI:49339238 loc:AY661134)
Influenza A virus	
(A/Umea/2/92(H3N2))	hema(GI:2271110 loc:AF008693)
Influenza A virus	
(A/Umea/2000/92(H3N2))	hema(GI:49339240 loc:AY661135)
Influenza A virus (A/United Kingdom/26554/99(H3N2))	hema(GI:21314314 loc:AF501529)
Influenza A virus (A/United Kingdom/34300/99(H3N2))	hema(GI:21314310 loc:AF501527)
Influenza A virus (A/United Kingdom/C2-16/2002(H3N2))	hema(GI:77023574 loc:DQ179413)
Influenza A virus (A/United Kingdom/C4-1/2003(H3N2))	hema(GI:77023694 loc:DQ179473)
Influenza A virus (A/United Kingdom/C4-11/2003(H3N2))	hema(GI:77023714 loc:DQ179483)
Influenza A virus (A/United Kingdom/C4-13/2003(H3N2))	hema(GI:77023718 loc:DQ179485)
Influenza A virus (A/United Kingdom/C4-3/2003(H3N2))	hema(GI:77023698 loc:DQ179475)
Influenza A virus (A/United Kingdom/C4-4/2003(H3N2))	hema(GI:77023700 loc:DQ179476)
Influenza A virus (A/United Kingdom/C4-5/2003(H3N2))	hema(GI:77023702 loc:DQ179477)
Influenza A virus (A/United Kingdom/C4-7/2003(H3N2))	hema(GI:77023706 loc:DQ179479)
Influenza A virus (A/United Kingdom/C4-8/2003(H3N2))	hema(GI:77023708 loc:DQ179480)
Influenza A virus (A/United Kingdom/C4-9/2003(H3N2))	hema(GI:77023710 loc:DQ179481)
Influenza A virus (A/United Kingdom/897/96(H3N2))	hema(GI:2271202 loc:AF008739)
Influenza A virus	
(A/Uruguay/3/88(H3N2))	
Influenza A virus	
(A/Ushuaia/R127/98(H3N2))	hema(GI:22536037 loc:AF533724)
Influenza A virus	
(A/Ushuaia/R13/98(H3N2))	hema(GI:22536039 loc:AF533725)
Influenza A virus	
(A/Ushuaia/R254/98(H3N2))	hema(GI:22536041 loc:AF533726)
Influenza A virus	
(A/Ushuaia/R270/98(H3N2))	hema(GI:22536043 loc:AF533727)
Influenza A virus	
(A/Ushuaia/R272/98(H3N2))	hema(GI:22536045 loc:AF533728)
Influenza A virus	
(A/Ushuaia/R274/98(H3N2))	hema(GI:22536047 loc:AF533729)
Influenza A virus	
(A/USSR/0270/69(H3N2))	
Influenza A virus	
(A/USSR/039/68(H3N2))	
Influenza A virus	
(A/USSR/26/(H3N2))	hema(GI:2275468 loc:AF008864)
Influenza A virus	
(A/Utah/20997/99(H3N2))	hema(GI:21314322 loc:AF501533)
Influenza A virus	
(A/Utah/25711/99(roN2))	
Influenza A virus	
(A/Utah/25729/99(H3N2))	
Influenza A virus	
(A/Valladolid/4/2001(H3N2))	
Influenza A virus	
(A/Vermont/3/94(H3N2))	hema(GI:2275404 loc:AF008832)
Influenza A virus	
(A/Victoria/1/89(H3N2))	hema(GI:49339100 loc:AY661065)
Influenza A virus	
(A/Victoria/1/93(H3N2))	hema(GI:2271346 loc:AF008811)

Influenza A virus (A/Victoria/104/93(H3N2))	hema(GI:49339284 loc:AY661157)	
Influenza A virus (A/Victoria/1968(H3N2))		neura(GI: 115289296 loc:CY0155100)
Influenza A virus (A/Victoria/2/82(H3N2))		
Influenza A virus (A/Victoria/2/90(H3N2))	hema(GI:493391 16 loc:AY661073)	
Influenza A virus (A/Victoria/29/92(H3N2))	hema(GI:227I 124 loc:AF008700)	
Influenza A virus (A/Victoria/3/1975(H3N2))	hema(GI:60754 loc:V01086)	
Influenza A virus (A/Victoria/30/97(H3N2))	hema(GI:6552576 loc:AF180633)	
Influenza A virus (A/Victoria/4/72(H3N2))		
Influenza A virus (A/Victoria/47/97(H3N2))	hema(GP.6552575 loc:AF 180632)	
Influenza A virus (A/Victoria/5/89(H3N2))	hema(GI:2271070 loc:AF008673)	
Influenza A virus (A/Victoria/68/92(H3N2))	hema(GI:2271118 loc:AF008697)	
Influenza A virus (A/Victoria/7/(H3N2))	hema(GI:2275516 loc:AF008888)	
Influenza A virus (A/Victoria/75/95(H3N2))	hema(GI:49339346 loc:AY661 188)	
Influenza A virus (A/Vienna/47/96M(H3N2))	hema(GI: 14286338 loc:AFO 17270)	
Influenza A virus (A/Vienna/47/96V(H3N2))	hema(GI: 15004991 loc:AF017272)	
Influenza A virus (A/Vienna/8 1/96V(H3N2))	hema(GI:2407251 loc:AF017271)	
Influenza A virus (A/Virginia/1/91(H3N2))	hema(GI:6552609 loc:AF180666)	
Influenza A virus (A/Virginia/21712/99(H3N2))	hema(GI:213 14320 loc:AF501532)	
Influenza A virus (A/Virginia/21716/99(H3N2))	hema(GI:2 13 14286 loc:AF501515)	
Influenza A virus (A/Virginia/21735/99(H3N2))	hema(GI:213143 16 loc:AF501530)	
Influenza A virus (A/Virginia/2 1743/99(H3N2))	hema(GI:213 14304 loc:AF501524)	
Influenza A virus (A/Virginia/21754/99(H3N2))	hema(GI:21314294 loc:AF501519)	
Influenza A virus (A/Virginia/2 1799/99(H3N2))	hema(GI:213 14302 loc:AF501523)	
Influenza A virus (A/Virginia/2 18 17/99(H3N2))	hema(GI:21314306 loc:AF501525)	
Influenza A virus (A/Virginia/2 1822/99(H3N2))	hema(GI:213 14296 loc:AF501520)	
Influenza A virus (A/Virginia/21828/99(H3N2))	hema(GI:21314312 loc:AF501528)	
Influenza A virus (A/Virginia/2 1833/99(H3N2))	hema(GI:21314290 loc:AF501517)	
Influenza A virus (A/Virginia/2 1845/99(H3N2))	hema(GI:21314300 loc:AF501522)	
Influenza A virus (A/Virginia/2 1847/99(H3N2))	hema(GI:213 14326 loc:AF501535)	
Influenza A virus (A/Virginia/25/94(H3N2))	hema(GP.2271258 loc:AF008767)	
Influenza A virus (A/Virginia/G1/99(H3N2))	hema(GI:21314298 loc:AF501521)	
Influenza A virus (A/Wa- 182(H3N2))		
Influenza A virus (A/Waikato/1/2000(H3N2))		neura(GI: 109675842 loc:CY01 15940)
Influenza A virus		neura(GI:109914881)

(A/Waikato/1/2001(H3N2))		locrCYO119700)
Influenza A virus		neura(GI: 109676 127
(A/Waikato/1/2003(H3N2))		loc:CY01 17140)
Influenza A virus		neura(GI: 115344608
(A/Waikato/1/2004(H3N2))		loc:CY0162140)
Influenza A virus		neura(GI: 113 170905
(A/Waikato/1/2005(H3N2))		loc:CY0140170)
Influenza A virus		neura(GI: 115289600
(A/Waikato/10/2005(H3N2))		loc:CY0156380)
Influenza A virus		neura(GI:109915171
(A/Waikato/102/2003(H3N2))		loc:CY0120900)
Influenza A virus		neura(GI: 110333157
(A/Waikato/105/2001(H3N2))		loc:CY0123220)
Influenza A virus		neura(GI: 112788599
(A/Waikato/108/2003(H3N2))		loc:CY0134390)
Influenza A virus		neura(GI: 110333271
(A/Waikato/1 15/2003(H3N2))		loc:CY0123700)
Influenza A virus		neura(GI: 112788656
(A/Waikato/1 2/2004(H3N2))		loc:CY0134630)
Influenza A virus		neura(GI: 113 171504
(A/Waikato/12/2005(H3N2))		loc:CY0141370)
Influenza A virus		neura(GI: 109676260
(A/Waikato/120/2003(H3N2))		loc:CY01 17700)
Influenza A virus		neura(GI: 110333309
(A/Waikato/122/2003(H3N2))		loc:CY0 123860)
Influenza A virus		neura(GI: 110333328
(A/Waikato/129/2003(H3N2))		loc:CY0 123940)
Influenza A virus		neura(GI: 110333347
(A/Waikato/133/2003(H3N2))		loc:CY0124020)
Influenza A virus		neura(GI: 110333366
(A/Waikato/139/2003(H3N2))		loc:CY0124100)
Influenza A virus		neura(GI: 110333385
(A/Waikato/147/2003(H3N2))		loc:CY0124180)
Influenza A virus		neura(GI: 110333404
(A/Waikato/ 148/2003 (H3N2))		loc-.CYO 124260)
Influenza A virus		neura(GI:l 12790012
(A/Waikato/1 5/2000(H3N2))		loc:CY0 133850)
Influenza A virus		neura(GI: 112788580
(A/Waikato/1 5/2003(H3N2))		loc:CY01343 10)
Influenza A virus		neura(GI: 115289581
(A/Waikato/1 5/2005(H3N2))		loc:CY0156300)
Influenza A virus		neura(GI:109915190
(A/Waikato/150/2003(H3N2))		loc:CY0120980)
Influenza A virus		neura(GI:109915130
(A/Waikato/154/2003(H3N2))		loc:CY0 120740)
Influenza A virus		neura(GI:110333214
(A/Waikato/155/2003(H3N2))		loc:CY0 123460)
Influenza A virus		neura(GI: 110333233
(A/Waikato/156/2003(H3N2))		loc:CY0123540)
Influenza A virus		neura(GI:l 12788485
(A/Waikato/1 6/2000(H3N2))		loc:CY0133910)
Influenza A virus		neura(GI: 115289429
(A/Waikato/16/2004(H3N2))		loc:CY0 155660)
Influenza A virus		neura(GI:l 12788504
(A/Waikato/17/2000(H3N2))		loc:CY0133990)
Influenza A virus		neura(GI: 109914900
(A/Waikato/2/2002(H3N2))		loc:CY01 19780)
Influenza A virus		neura(GI:l 13171062
(A/Waikato/2/2005(H3N2))		loc:CY0 140650)
Influenza A virus		neura(GI: 110733947
(A/Waikato/20/2000(H3N2))		loc:CY0130660)
Influenza A virus		
(A/Waikato/20/93 (H3N2))	hema(GI:2275448 loc:AF008854)	
Influenza A virus		neura(GI: 109675975
(A/Waikato/21/2002(H3N2))		loc:CY01 16500)
Influenza A virus		neura(GI: 110734061
(A/Waikato/21/2003(H3N2))		loc:CY013 1140)

Influenza A virus (A/Waikato/21/2004(H3N2))	neura(GI: 110629638 loc:CY0127060)
Influenza A virus (A/Waikato/22/2004(H3N2))	neura(GI: 112788732 loc:CY0135030)
Influenza A virus (A/Waikato/23/2002(H3N2))	neura(GI: 115289410 loc:CY0155580)
Influenza A virus (A/Waikato/25/2002(H3N2))	neura(GI: 110734004 loc:CY0130900)
Influenza A virus (A/Waikato/26/2004(H3N2))	neura(GI: 12950099 loc:CY0135110)
Influenza A virus (A/Waikato/29/2002(H3N2))	neura(GI: 109915015 loc:CY0120260)
Influenza A virus (A/Waikato/29/2003(H3N2))	neura(GI: 110333252 loc:CY0123620)
Influenza A virus (A/Waikato/3/2003(H3N2))	neura(GI: 109676165 loc:CY0117300)
Influenza A virus (A/Waikato/3/2004(H3N2))	neura(GI: 113170658 loc:CY0139210)
Influenza A virus (A/Waikato/3/2005(H3N2))	neura(GI: 113171203 loc:CY0140810)
Influenza A virus (A/Waikato/31/2002(H3N2))	neura(GI: 112788542 loc:CY0134150)
Influenza A virus (A/Waikato/31/2004(H3N2))	
Influenza A virus (A/Waikato/35/2004(H3N2))	neura(GI: 112788770 loc:CY0135270)
Influenza A virus (A/Waikato/36/2002(H3N2))	neura(GI: 110734023 loc:CY0130980)
Influenza A virus (A/Waikato/4/2000(H3N2))	neura(GI: 110629448 loc:CY0126260)
Influenza A virus (A/Waikato/40/2004(H3N2))	neura(GI: 110629676 loc:CY0127220)
Influenza A virus (A/Waikato/43/2004(H3N2))	neura(GI: 112788789 loc:CY0135350)
Influenza A virus (A/Waikato/45/2004(H3N2))	neura(GI: 112788808 loc:CY0135430)
Influenza A virus (A/Waikato/46/2003(H3N2))	neura(GI: 110734080 loc:CY0131220)
Influenza A virus (A/Waikato/5/2000(H3N2))	neura(GI: 109914862 loc:CY0119620)
Influenza A virus (A/Waikato/5/2001(H3N2))	neura(GI: 110733966 loc:CY0130740)
Influenza A virus (A/Waikato/5/2002(H3N2))	neura(GI: 109675918 loc:CY0116260)
Influenza A virus (A/Waikato/51/2002(H3N2))	neura(GI: 109915091 loc:CY0120580)
Influenza A virus (A/Waikato/52/2004(H3N2))	neura(GI: 113170715 loc:CY0139370)
Influenza A virus (A/Waikato/52/2002(H3N2))	neura(GI: 109915072 loc:CY0120500)
Influenza A virus (A/Waikato/53/2003(H3N2))	neura(GI: 110734099 loc:CY0131300)
Influenza A virus (A/Waikato/54/2003(H3N2))	neura(GI: 10734118 loc:CY0131380)
Influenza A virus (A/Waikato/56/2004(H3N2))	neura(GI: 113170734 loc:CY0139450)
Influenza A virus (A/Waikato/58/2002(H3N2))	neura(GI: 109676013 loc:CY0116660)
Influenza A virus (A/Waikato/6/2000(H3N2))	neura(GI: 110733909 loc:CY0130500)
Influenza A virus (A/Waikato/6/2005(H3N2))	
Influenza A virus (A/Waikato/61/2003(H3N2))	neura(GI: 109676222 loc:CY0117540)
Influenza A virus (A/Waikato/64/2004(H3N2))	neura(GI: 113170753 loc:CY0139530)
Influenza A virus	neura(GI: 113170772)

(A/Waikato/68/2004(H3N2))		loc:CY0139610)
Influenza A virus		neura(GI: 113 170791
(A/Waikato/69/2004(H3N2))		loc:CY0139690)
Influenza A virus		neura(GI: 110629467
(A/Waikato/7/2000(H3N2))		loc:CY0 126340)
Influenza A virus		neura(Gr.1 13171 159
(A/Waikato/7/2005(H3N2))		loc:CY0 140730)
Influenza A virus		neura(GI:l 15521469
(A/Waikato/70/2004(H3N2))		loc:CY0164530)
Influenza A virus		neura(GI:l 13170810
(A/Waikato/71/2004(H3N2))		loc:CY0139770)
Influenza A virus		neura(GI:l 13170848
(A/Waikato/72/2004(H3N2))		loc:CY0139930)
Influenza A virus		neura(GI:l 13170867
(A/Waikato/73/2004(H3N2))		loc:CY0140010)
Influenza A virus		neura(GI:109676241
(A/Waikato/75/2003(H3N2))		loc:CY0117620)
Influenza A virus		neura(GI:115344589
(A/Waikato/8/2000(H3N2))		loc:CY0162060)
Influenza A virus		neura(GI:l 15521526
(A/Waikato/8/2005(H3N2))		loc:CY0164770)
Influenza A virus		neura(GI:l 110733928
(A/Waikato/9/2000(H3N2))		loc:CY0130580)
Influenza A virus		neura(GI:l 13171447
(A/Waikato/9/2005(H3N2))		loc:CY0141130)
Influenza A virus		neura(GI:109915149
(A/Waikato/91/2003(H3N2))		loc:CY0120820)
Influenza A virus		neura(GI:l 110734137
(A/Waikato/94/2003(H3N2))		loc:CY0131460)
Influenza A virus		
(A/Washington/ 15/9 1(H3N2))	hema(GI:2271076 loc:AF008676)	
Influenza A virus		
(A/Washington/I 86/94(H3N2))	hema(GI:2271246 loc:AF008761)	
Influenza A virus		
(A/Washington/26/93(H3N2))	hema(GI:2275440 loc:AF008850)	
Influenza A virus		
(A/Washington/41/93(H3N2))	hema(GI:2275444 loc:AF008852)	
Influenza A virus		
(A/Washington/5/96(H3N2))	hema(GI:2271 182 loc:AF008729)	
Influenza A virus		neura(GI:l 13170924
(A/Wellington/1/2005(H3N2))		loc:CY0 140250)
Influenza A virus		neura(GI:109676146
(A/Wellington/10/2003(H3N2))		loc:CY0117220)
Influenza A virus		neura(GI: 110629562
(A/Wellington/14/2004(H3N2))		loc:CY0 126740)
Influenza A virus		neura(GI: 112788675
(A/Wellington/18/2004(H3N2))		loc:CY0134710)
Influenza A virus		
(A/Wellington/19/2004(H3N2))		neura(GI:l 13170943
Influenza A virus		loc:CY0140330)
(A/Wellington/2/2005(H3N2))		
Influenza A virus		
(A/Wellington/2 1/2000(H3N2))		
Influenza A virus		neura(GI: 109675899
(A/Wellington/22/2001(H3N2))		loc:CY01 16180)
Influenza A virus		neura(GP.110629600
(A/Wellington/22/2004(H3N2))		loc:CY0126900)
Influenza A virus		neura(GI: 112788637
(A/Wellington/23/2004(H3N2))		loc:CY0134550)
Influenza A virus		neura(GI: 109676184
(A/Wellington/25/2003(H3N2))		loc:CY01 17380)
Influenza A virus		neura(GI: 113 170601
(A/Wellington/26/2000(H3N2))		loc:CY0138970)
Influenza A virus		
(A/Wellington/26/2004(H3N2))		
Influenza A virus		neura(GI: 113 170677
(A/Wellington/27/2004(H3N2))		loc:CY0134790)

Influenza A virus (A/Wellington/28/2000(H3N2))		neura(GI: 112788523 loc:CY0134070)
Influenza A virus (A/Wellington/28/2003(H3N2))		neura(GI: 109676203 loc:CY0 117460)
Influenza A virus (A/Wellington/29/2000(H3N2))		
Influenza A virus (A/Wellington/3/2003(H3N2))		neura(GI:109676089 loc:CY01 16980)
Influenza A virus (A/Wellington/3/2005(H3N2))		neura(GI: 113 170981 loc:CY0140490)
Influenza A virus (A/Wellington/3/97(H3N2))	hema(GI:6552522 loc:AF 180579)	
Influenza A virus (A/Wellington/30/2000(H3N2))		neura(GI:1 13 170620 loc:CY0139050)
Influenza A virus (A/Wellington/3 1/2004(H3N2))		neura(GI: 110629619 loc:CY0126980)
Influenza A virus (A/Wellington/33/2004(H3N2))		
Influenza A virus (A/Wellington/34/2001(H3N2))		neura(GI: 110333 138 loc:CY0123140)
Influenza A virus (A/Wellington/34/2003(H3N2))		neura(GI: 1099151 11 loc:CY0120660)
Influenza A virus (A/Wellington/34/2004(H3N2))		neura(GI: 115289448 loc:CY0155740)
Influenza A virus (A/Wellington/35/2004(H3N2))		neura(GI:l 10734156 loc:CY0131540)
Influenza A virus (A/Wellington/38/2002(H3N2))		neura(GI: 109675937 loc:CY0 116340)
Influenza A virus (A/Wellington/38/2004(H3N2))		neura(GI: 112788713 loc:CY0134950)
Influenza A virus (A/Wellington/39/2004(H3N2))		
Influenza A virus (A/Wellington/4/2001(H3N2))		
Influenza A virus (A/Wellington/4/2003(H3N2))		neura(GI: 109676108 loc:CY01 17060)
Influenza A virus (A/Wellington/4/2004(H3N2))		neura(GI:l 13 170639 loc:CY0139130)
Influenza A virus (A/Wellington/4/2005(H3N2))		neura(GI: 115289524 loc:CY0156060)
Influenza A virus (A/Wellington/4/85(H3N2))	hema(GI:3885873 loc:AF092063)	
Influenza A virus (A/Wellington/44/2004(H3N2))		neura(GI: 112788694 loc:CY0134870)
Influenza A virus (A/Wellington/45/2004(H3N2))		neura(GI:l 10734175 loc:CY0131620)
Influenza A virus (A/Wellington/47/2003(H3N2))		neura(GI: 110629524 loc:CY0126580)
Influenza A virus (A/Wellington/48/96(H3N2))	hema(GI:2271 162 loc:AF008719)	
Influenza A virus (A/Wellington/49/2003(H3N2))		neura(GI: 110629543 loc:CY0126660)
Influenza A virus (A/Wellington/5/2005(H3N2))		neura(GI: 115289543 loc:CY0156140)
Influenza A virus (A/Wellington/5/89(H3N2))	hema(GI:49339086 loc:AY661058)	
Influenza A virus (AAVellington/52/2004(H3N2))		neura(GI: 110629657 loc:CY0127140)
Influenza A virus (A/Wellington/53/2003(H3N2))		neura(GI: 110333290 loc:CY0123780)
Influenza A virus (A/Wellington/54/2004(H3N2))		
Influenza A virus (A/Wellington/55/2004(H3N2))		
Influenza A virus (A/Wellington/58/2004(H3N2))		neura(GI:l 12788751 loc:CY0135190)
Influenza A virus		neura(GI:l 13170696)

(A/Wellington/59/2004(H3N2))		loc:CY0 139290)
Influenza A virus		
(A/Wellington/59/93(H3N2))	hema(GI:49339286 loc:AY661 158)	
Influenza A virus		neura(GI:109914919
(A/Wellington/6/2002(H3N2))		loc:CY0 119860)
Influenza A virus		neura(GI:109915228
(A/Wellington/6/2004(H3N2))		loc:CY0121 140)
Influenza A virus		neura(GI: 115289562
(A/Wellington/6/2005(H3N2))		loc:CY0156220)
Influenza A virus		neura(GI: 115521450
(A/Wellington/6 1/2004(H3N2))		loc:CY0164450)
Influenza A virus		neura(GI: 112788827
(A/Wellington/62/2004(H3N2))		loc:CY01355 10)
Influenza A virus		neura(GI:1 10333195
(A/Wellington/63/2002(H3N2))		loc:CY0123380)
Influenza A virus		
(A/Wellington/63/2004(H3N2))		neura(GI:1 13170829
Influenza A virus		loc:CY0139850)
(A/Wellington/64/2004(H3N2))		neura(GI: 109675956
Influenza A virus		loc:CY01 16420)
(A/Wellington/66/2002(H3N2))		
Influenza A virus	hema(GI:2271 122 loc:AF008699)	
(A/Wellington/66/92(H3N2))		neura(GI: 110333 176
Influenza A virus		loc:CY0123300)
(A/Wellington/7/2002(H3N2))		
Influenza A virus		neura(GI: 1099 14938
(A/Wellington/7/2004(H3N2))		loc:CY0119940)
Influenza A virus		neura(GI:109914996
(A/Wellington/70/2002(H3N2))		loc:CY0120180)
Influenza A virus		neura(GI:109915053
(A/Wellington/71/2002(H3N2))		loc:CY0120420)
Influenza A virus		neura(GI: 110629581
(A/Wellington/79/2002(H3N2))		loc:CY0126820)
Influenza A virus		neura(GI:1 13 171409
(A/Wellington/8/2004(H3N2))		loc:CY0 140970)
Influenza A virus		neura(GI: 109915034
(A/Wellington/8/2005(H3N2))		loc:CY0120340)
Influenza A virus		neura(GI: 109676032
(A/Wellington/80/2002(H3N2))		loc:CY01 16740)
Influenza A virus		neura(GI: 109676051
(A/Wellington/83/2002(H3N2))		loc:CY0 116820)
Influenza A virus		neura(GI: 109676070
(A/Wellington/84/2002(H3N2))		loc:CY01 16900)
Influenza A virus		neura(GI:94960126
(A/Wellington/86/2002(H3N2))		loc:CY0 110220)
Influenza A virus		neura(GI: 110733985
(A/Wellington/9/2000(H3N2))		loc:CY0130820)
Influenza A virus		neura(GI: 110629505
(A/Wellington/9/2002(H3N2))		loc:CY0 126500)
Influenza A virus		neura(GI: 113 171428
(A/Wellington/9/2003(H3N2))		loc:CY0141050)
Influenza A virus		neura(GI:89781295
(A/Wellington/9/2005(H3N2))		loc:CY0095660)
Influenza A virus (A/West		neura(GI:89779230
Coast/28/2001(H3N2))		loc:CY0094060)
Influenza A virus (A/West		neura(GI:89779287
Coast/32/2001(H3N2))		loc:CY0094300)
Influenza A virus (A/West		
Coast/55/2001(H3N2))		
Influenza A virus (A/West		
Virginia/1/95(H3N2))	hema(GI:2271230 loc:AF008753)	
Influenza A virus (A/Western		
Australia/1/2000(H3N2))		
Influenza A virus (A/Western		
Australia/24/2002(H3N2))		
Influenza A virus (A/Western		
Australia/27/2002(H3N2))		

Influenza A virus (A/Western Australia/32/2002(H3N2))	
Influenza A virus (A/Western Australia/33/2002(H3N2))	
Influenza A virus (A/Western Australia/4/2000(H3N2))	
Influenza A virus (A/Western Australia/49/2003(H3N2))	
Influenza A virus (A/Western Aus(ra)ia/5/2000(H3N2))	
Influenza A virus (A/Western Australia/6/2000(H3N2))	
Influenza A virus (A/Western Australia/67/2005(H3N2))	
Influenza A virus (A/Western Australia/7/2000(H3N2))	
Influenza A virus (A/Western Australia/7 1/2005(H3N2))	
Influenza A virus (A/Western Australia/7 ó/2005(H3N2))	
Influenza A virus (A/Western Australia/79/2005(H3N2))	
Influenza A virus (A/Western Australia/9/2000(H3N2))	
Influenza A virus (A/Whanganui/127/2004(H3N2))	neura(GI:90571539 loc:CY0099260)
Influenza A virus (A/Whanganui/128/2004(H3N2))	
Influenza A viru_s (A/Whanganui/129/2004(H3N2))	
Influenza A virus (A/Whanganui/386/2004(H3N2))	
Influenza A virus (A/Whanganui/4 17/2004(H3N2))	
Influenza A virus (A/Whanganui/69/2004(H3N2))	neura(GI:85838209 loc:CY0082060)
Influenza A virus <A/Wisconsin/3/96(H3N2))	hema(GI:2271 186 loc:AF008731)
Influenza A virus (A/Wiscot tsin AS7/2005(H3N2))	hema(GI: 110825838 loc:DQ865947)
Influenza A virus <A/Wuhan/359/95(H3N2))	hema(GI:2271 168 loc:AF008722)
Influenza A virus (A/Wuzhou/1/94(H3N2))	hema(GI:2275456 loc:AF008858)
Influenza A virus (A/Wuzhou/19/96(H3N2))	hema(GI:2271 136 loc:AF008706)
Influenza A virus (A/Wuzhou/4/93(H3N2))	hema(GI:2271334 Loc:AF008805)
Influenza A virus (A/Wyoming/i/93(H3N2))	hema(GI:2275442 loc:AF008851)
Influenza A virus (A/Wyoming/3/03(H3N2))	hema(GI:46981866 loc:AY531033)
Influenza A virus (A/Wyoming/3/ 1987(H3N2))	herna(GI:3241 17 loc:FLAHAEW)
Influenza A virus (A/Wyoming/3/2003(H3N2))	hema(GI: 110825836 loc:DQ865946)
Influenza A virus (A/X-47(H3N2))	neura(GI: 1389683 loc:FLANAMT0)
Influenza A virus (A/XI 17(H3N2))	
Influenza A virus (A/X121(H3N2))	
Influenza A virus (A/Xiamen/1 81/2004(H3N2))	hema(GI:62 125823 loc:AY963793)
Influenza A virus (A/Xiamen/70/20G4(H3N2))	hema(GI:62125819 loc:AY963791)
Influenza A virus (A/Xiamen/80/2004(H3N2))	hema(GI:62 125821 loc:AY963792)

Influenza A virus (A/Yamagata/56/93(H3N2))	hema(GI:49339274 loc:AY661 152)	
Influenza A virus (A/Yamagata/61/93(H3N2))	hema(GI:49339276 loc:AY661 153)	
Influenza A virus (A/Yamagata/62/93(H3N2))	hema(GI:49339278 loc:AY661 154)	
Influenza A virus (A/Yamagata/96/85(H3N2))	hema(GI:2275544 loc:AF008902)	
Influenza A virus (A/Yamanashi/2/77(H3N2))		
Influenza A virus (A/Yamanashi/497(H3N2))		
Influenza A virus (A/Yilan/508/03(H3N2))		neura(GI:70673234 loc:AY9733390)
Influenza A virus (A/Yilan/516/03(H3N2))		
Influenza A virus (A/Yokohama/68/96(H3N2))	hema(GI:6552565 loc:AF180622)	
Influenza A virus (A/Yokohama/73/92(H3N2))	hema(GI:487681 loc:FLASPH14)	
Influenza A virus (A/Yokohama/C5/85(H3N2))	hema(GI:2275548 loc:AF008904)	
Influenza A virus (A/ZaragozaRR3 15/97(H3N2))	hema(GI:16417083 loc:AF357940)	
Influenza A virus (A/Zaragoza/RR653/00(H3N2))	hema(GI:16417107 loc:AF357952)	
Influenza A virus (A/Zaragoza/RR658/00(H3N2))	hema(GP.16417109 loc:AF357953)	
Influenza A virus (A/Zhangzhou/51/1999(H3N2))	hema(GI:62125825 loc:AY963794)	
Influenza A virus (A/zhejiang/06/99(H3N2))	hema(GI:24895131 loc:AY138513)	
Influenza A virus (A/zhejiang/10/98(H3N2))	hema(GI:24895149 loc:AY138515)	
Influenza A virus (A/Zhejiang/102/03(H3N2))	hema(GI:5 1572693 loc:AY695088)	
Influenza A virus (A/zhejiang/11/2002(H3N2))	hema(GI:24895159 loc:AY138516)	
Influenza A virus (A/zhejiang/12/99(H3N2))		
Influenza A virus (A/Zhejiang/18/98(H3N2))	hema(GI:74422835 loc:DQ174263)	
Influenza A virus (A/Zhejiang/199/05(H3N2))	hema(GI:74422841 loc:DQ174266)	
Influenza A virus (A/Zhejiang/207/05(H3N2))	hema(GI:74422843 loc:DQ174267)	
Influenza A virus (A/Zhejiang/209/05(H3N2))	hema(GI:74422845 loc:DQ174268)	
Influenza A virus (A/Zhejiang/546/04(H3N2))	hema(GI:74422837 loc:DQ174264)	
Influenza A virus (A/Zhejiang/550/04(H3N2))	hema(GI:74422839 loc:DQ174265)	
Influenza A virus (A/Zhejiang/78/03(H3N2))	hema(GI:5 1572685 loc:AY695084)	
Influenza A virus (A/zhejiang/8/2002(H3N2))	hema(GI:24895188 loc:AY138519)	
Influenza A virus (A/Zhejiang/80/03(H3N2))	hema(GI:5 1572687 loc:AY695085)	
Influenza A virus (A/Zhejiang/81/03(H3N2))	hema(GI:5 1572689 loc:AY695086)	
Influenza A virus (A/Zhejiang/92/03(H3N2))	hema(GI:51860810 loc:AY714347)	
Influenza A virus (A/Zhejiang/95/03(H3N2))	hema(GI:51572691 loc:AY695087)	
Influenza A virus (swine/Finistere/127/99(H3N2))		
Influenza A virus H3N2		

Influenza A virus (A/equine/New Market/1979(H3N3))		neura(GI:305225 loc:FLANANEWMAO)
Influenza A virus (A/seal/MA/391 1/1992(H3N3))	hema(GI:608637 loc:FLAHASEALA)	
Influenza A virus (A/seal/MA/3984/1992(H3N3))	hema(GI:608635 loc:FLAHASEAL)	
Influenza A virus (A/swine/Ontario/42729A/01(H3N3))	hema(GI:52078190 loc:AY619977)	
Influenza A virus (A/swine/Ontario/K01477/01(H3N3))	hema(GI:52078172 loc:AY619969)	
Influenza A virus (A/tern/Aslr/775/1983(H3N3))		
Influenza A virus (A/tern/Turkmenia/18/72(H3N3))		
Influenza A virus (A/mallard duck/ALB/1012/1979(H3N4))		
Influenza A virus (A/mallard duck/ALB/438/1985(H3N4))	hema(GI:78096078 loc:CY004657)	
Influenza A virus (A/mallard duck/Alberta/438/1985(H3N4))		
Influenza A virus (A/mallard/MN/35 1/99(H3N4))		
Influenza A virus (A/RuddyTurnstone/Delaware/168/94(H3N4))		
Influenza A virus (A/mallard duck/ALB/663/1979(H3N5))		neura(GI:78096038 loc:CY0046270)
Influenza A virus (A/mallard/MN/280/99(H3N5))		
Influenza A virus (A/RedKnot/Delaware/229/94(H3N5))		
Influenza A virus (A/blue-winged teal/ALB/286/1977(H3N6))		neura(GI:78096009 loc:CY0045890)
Influenza A virus (A/canvasback duck/ALB/102/1976(H3N6))		
Influenza A virus (A/Chicken/Nanchang/1-020/2001(H3N6))	hema(GI:27465230 loc:AY180405)	
Influenza A virus (A/Chicken/Nanchang/1-101/2001(H3N6))	hema(GI:27465234 loc:AY180407)	
Influenza A virus (A/Chicken/Nanchang/12-220/2000(H3N6))	hema(GI:27465236 loc:AY180408)	
Influenza A virus (A/Chicken/Nanchang/12-301/2000(H3N6))	hema(GI:27465238 loc:AY180409)	
Influenza A virus (A/Chicken/Nanchang/2-120/2001(H3N6))	hema(GI:27465240 loc:AY180410)	
Influenza A virus (A/Chicken/Nanchang/2-220/2001(H3N6))	hema(GI:27465242 loc:AY180411)	
Influenza A virus (A/chicken/Nanchang/3-201/01(H3N6))	hema(GI:27465246 loc:AY180413)	
Influenza A virus (A/chicken/Nanchang/7-010/2000(H3N6))		
Influenza A virus (A/Chicken/Nanchang/9-220/2000(H3N6))	hema(GI:27465250 loc:AY180415)	
Influenza A virus (A/duck/Beijing/1/1978(H3N6))		

Influenza A virus (A/duck/Beijing/1/78(H3N6))		
Influenza A virus (A/duck/HK/23 1/1977(H3N6))		neura(GI:78097529 loc:CY0055640)
Influenza A virus (A/Duck/Nanchang/ 1- 100/2001(H3N6))	hema(GI:27465232 loc:AY180406)	
Influenza A virus (A/Duck/Nanchang/ 1- 161/2001(H3N6))	hema(GI:27465256 loc:AY180418)	
Influenza A virus (A/Duck/Nanchang/ 1- 181/2001(H3N6))	hema(GI:27465258 loc:AY180419)	
Influenza A virus (A/Duck/Nanchang/10- 096/2000(H3N6))	hema(GI:27465252 loc:AY180416)	
Influenza A virus (A/Duck/Nanchang/10- 383/2000(H3N6))	hema(GI:27465254 loc:AY180417)	
Influenza A virus (A/Duck/Nanchang/12- 280/2000(H3N6))	hema(GI:27465260 loc:AY180420)	
Influenza A virus (A/Duck/Nanchang/2- 182/2001(H3N6))	hema(GI:27465262 loc:AY180421)	
Influenza A virus (A/duck/Nanchang/8- 174/2000(H3N6))		
Influenza A virus (A/Duck/Nanchang/8- 197/2000(H3N6))	hema(GI:27465266 loc:AY180423)	
Influenza A virus (A/Duck/Nanchang/8- 198/2000(H3N6))	hema(GI:27465268 loc:AY180424)	
Influenza A virus (A/Duck/Nanchang/9- 091/2000(H3N6))	hema(GI:27465270 loc:AY180425)	
Influenza A virus (A/Duck/Nanchang/9- 385/2000(H3N6))	hema(GI:27465272 loc:AY180426)	
Influenza A virus (A/mallard/ALB/129/1991(H3N6))		
Influenza A virus (A/mallard/Alberta/129/1991(H3N6))		
Influenza A virus (A/mallard/Alberta/199/99(H3N6))	hema(GI:49357125 loc:AY633 172)	
Influenza A virus (A/mallard/Alberta/22/76 (H3N6))		
Influenza A virus (A/mallard/Ohio/156/1990(H3N6))		
Influenza A virus (A/mallard/Ohio/296/1988(H3N6))		
Influenza A virus (A/Pigeon/Nanchang/1 1- 045/2000(H3N6))	hema(GI:27465274 loc:AY180427)	
Influenza A virus (A/pigeon/Nanchang/8- 142/2000(H3N6))		
Influenza A virus (A/pigeon/Nanchang/9- 058/2000(H3N3))		
Influenza A virus (A/pintail duck/Alberta/7 12/80(H3N6))		
Influenza A virus (A/pintail/Alberta/166/2003(H3N6))		neura(GI:78095618 loc:CY0043060)

Influenza A virus (A/pintail/MN/479/99(H3N6))		
Influenza A virus (A/Quail/Nanchang/ 10- 028/2000(H3N6))	hema(GI:27465280 loc:AY1 80430)	
Influenza A virus (A/Quail/Nanchang/2- 040/2001(H3N6))	hema(GI:27465286 loc:AY180433)	
Influenza A virus (A/Quail/Nanchang/3- 140/2001(H3N6))	hema(GI:27465282 loc:AY18043 1)	
Influenza A virus (A/quail/Nanchang/7- 026/2000(H3N6))		
Influenza A virus (A/shorebird/Delaware/222/97 (H3N6))		
Equine influenza virus H3N8		
Influenza A virus (A/aquatic bird/Hong Kong/399/99(H3N8))		neura(GI:324423 locrFLANABLBO)
Influenza A virus (A/black duck/Australia/702/1978(H3N8))		
Influenza A virus (A/blue wing teal/Ohio/926/2002(H3N8))		
Influenza A virus (A/canine/Florida/242/2003(H3N8))	hema(GI:76152403 loc:DQ124157)	
Influenza A virus (A/canine/Florida/43/2004(H3N8))	hema(GI:76152407 loc:DQ124190)	
Influenza A virus (A/canine/Iowa/1 3628/2005(H3N8))	hema(GI:76362990 loc:DQ146419)	
Influenza A virus (A/canine/Texas/1/2004(H3N8))	hema(GI:76152419 loc:DQ124196)	
Influenza A virus (A/Dk/ST/5048/2001(H3N8))		
Influenza A virus (A/duck/Beijing/33/04(H3N8))		
Influenza A virus (A/duck/Beijing/40/04(H3N8))		
Influenza A virus (A/duck/Beijing/44/04(H3N8))		
Influenza A virus (A/duck/Burjatia/652/1988(H3N8))		neura(GI:305201 loc:FLANABURJA0)
Influenza A virus (A/Duck/Burjatia/652/88(H3N8))		
Influenza A virus (A/duck/Chabarovsk/1610/1972 (H3N8))		neura(GI:305203 loc.-FLANACHABAO)
Influenza A virus (A/duck/Chabaro vsk/1 6 10/72(H3N 8))		
Influenza A virus (A/duck/Hokkaido/10/1985(H3N8))		neura(GI:1 16013 105 loc:AB2761 H0)
Influenza A virus (A/duck/Hokkaido/8/1980(H3N8))		neura(GI:305213 loc:FLANAHOKKA0)
Influenza A virus (A/Duck/Hong Kong/P151/97(H3N8))		
Influenza A virus (A/Duck/Hong Kong/P169/97(H3N8))		
Influenza A virus (A/Duck/Hong Kong/P185/97(H3N8))		
Influenza A virus (A/duck/Memohis/928/ 1974(H3N8)		neura(GI:305219 lociFLANAMEMPDO)

Influenza A virus (A/duck/Memphis/928/1974(H3N8))	hema(GI:324413 loc:FLAN8HAA)
Influenza A virus (A/duck/Memphis/928/74(H3N8))	
Influenza A virus (A/duck/New Jersey/2000(H3N8))	
Influenza A virus (A/duck/New Zealand/38/1984(H3N8))	
Influenza A virus (A/duck/Norway/1/03(H3N8))	hema(GI:54400030 loc:AJ841293)
Influenza A virus (A/duck/NZL/38/1984(H3N8))	
Influenza A virus (A/duck/South Africa/1108/2004(H3N8))	
Influenza A virus (A/duck/UKR/1/1963(H3N8))	
Influenza A virus (A/duck/Ukraine/1/1963(H3N8))	neura(GI:453643 loc.-FLANAUKRAIO)
Influenza A virus (A/duck/Ukraine/1963(H3N8))	
Influenza A virus (A/eq/Arundel/91/(H3N8))	
Influenza A virus (A/eq/Ella/89/(H3N8))	
Influenza A virus (A/eq/Hong Kong/1/92(H3N8))	
Influenza A virus (A/eq/Kentucky/1/88(H3N8))	
Influenza A virus (A/eq/Kentucky/92(H3N8))	
Influenza A virus (A/eq/Lambourn/92/(H3N8))	
Influenza A virus (A/eq/LaPlata/1/88(H3N8))	
Influenza A virus (A/eq/LaPlata/93(H3N8))	
Influenza A virus (A/eq/Miami/63(H3N8))	
Influenza A virus (A/eq/Newmarket/79(H3N8))	
Influenza A virus (A/eq/Newmarket/93/(H3N8))	
Influenza A virus (A/eq/Newmarket/D63/79(H3N8))	
Influenza A virus (A/eq/Roma/5/91(H3N8))	
Influenza A virus (A/eq/Sussex/89/(H3N8))	
Influenza A virus (A/equi 2/Aby/84(H3N8))	hema(GI:2224789 loc:EIVY14055)
Influenza A virus (A/equi 2/Alvdalen/96(H3N8))	hema(GI:2765371 loc:EIVY14059)
Influenza A virus (A/equi 2/Avesta/93(H3N8))	hema(GI:2326940 loc:BVY10866)
Influenza A virus (A/equi 2/Bollnas/96(H3N8))	hema(GI:2765373 loc:EIVY14060)
Influenza A virus (A/equi 2/Gotland/01(H3N8))	hema(GI:60250543 loc:AY919314)
Influenza A virus (A/equi 2/Skara/88(H3N8))	hema(GI:1430895 loc:MVHNCLI)
Influenza A virus (A/equi 2/Soderala/94(H3N8))	hema(GI:2765369 loc:EIVY14058)
Influenza A virus (A/equi 2/Solvala/79(H3N8))	hema(GI:2276228 loc:EIVY14054)
Influenza A virus (A/equi 2/Visingso/90(H3N8))	hema(GI:2224791 loc:EIVY14056)

Influenza A virus (A/equi- 2/Ludhiana/87(H3N8))		
Influenza A virus (A/equine 2/Suffolk/89(H3N8))		
Influenza A virus (A/equine/Alaska/1/1991(H3N8))		neura(GI:73476661 loc:DQ0973930)
Influenza A virus (A/Equine/Alaska/ 1/9 1(H3N8))	hema(GI:487666 loc:FLAH3N8HAD)	
Influenza A virus (A/equine/Algiers/72 (H3N8))		
Influenza A virus (A/equine/Argentina/1/93(H3N8))	hema(GI:722401 loc:FLAHAH3A)	
Influenza A virus (A/equine/Argentina/1/95(H3N8))	hema(GI:6651508 loc:AF197244)	
Influenza A virus (A/equine/Argentina/1/96(H3N8))	hema(GI:6651512 loc:AF197246)	
Influenza A virus (A/equine/Argentina/2/94(H3N8))	hema(GI:6651510 ioc:AF 197245)	
Influenza A virus (A/Equine/Argentina/97(H3N8))	hema(GI:27446679 loc:AY048077)	
Influenza A virus (A/Equine/Argentina/99(H3N8))	hema(GI:27446687 loc:AY048081)	
Influenza A virus (A/Equine/Argentina/99-2(H3N8))	hema(GI:27446681 loc:AY048078)	
Influenza A virus (A/Equine/Argentina/99-3(H3N8))	hema(GI:27446683 loc:AY048079)	
Influenza A virus (A/Equine/ Argentina/99-4(H3N8))	hema(GI:27446685 loc:AY048080)	
Influenza A virus (A/Equine/Arundel/1 2369/9 1(H3N 8»	hema(GI:487667 loc:FLAH3N8HAE)	
Influenza A virus (A/equine/Berlin/1/91(H3N8))		
Influenza A virus (A/equine/Berlin/2/9 1(H3N8))		
Influenza A virus (A/equine/Berlin/3/89(H3N8))		
Influenza A virus (A/equine/Berlin/4/89(H3N8))		
Influenza A virus (A/equine/California/191/2003(H3 NS))	hema(GI:76152417 loc:DQ124195)	
Influenza A virus (A/equine/Florida/1/93(H3N8))	hema(GI:722407 loc:FLAHAH3D)	
Influenza A virus (A/equine/Florida/1/94(H3N8))	hema(GI:6651504 loc:AF197242)	
Influenza A virus (A/equine/Fontainebleau/1976(H3 NS))	hema(GI:323998 1OC-FLAEF76HA)	
Influenza A virus (A/equine/Fontainebleau/1979(H3 N8))		
Influenza A virus (A/equine/Fontainebleau/76(H3N8))		
Influenza A virus (A/equine/France/1/1976(H3N8))	hema(GI:324414 loc:FLAN8HAB)	
Influenza A virus (A/equine/Grobois/1/98(H3N8))		
Influenza A virus (A/equine/Hong Kong/1/92(H3N8))	hema(GI:461383 loc:EIVH3A)	
Influenza A virus (A/equine/Ibadan/6/9 1(H3N8))		
Influenza A virus (A/equine/Ibadan/9/91(H3N8))		
Influenza A virus (A/equine/ID/3 7875/9 1(H3N8))		

Influenza A virus
 (A/equine/Jillin/1/1989(H3N8))
 Influenza A virus
 (A/equine/Kentucky/1/1 982(H3N8))
)
 Influenza A virus
 (A/equine/Kentucky/1/1987(H3N8)) hema(GI:324002
 loc:FLAEK87HA)
)
 Influenza A virus
 (A/equine/Kentucky/1/8 1(H3N8))
 Influenza A virus
 (A/equine/Kentucky/1/87(H3N8))
 Influenza A virus
 (A/equine/Kentucky/1/90(H3N8)) hema(GI:722405 loc:FLAHAH3C)
 Influenza A virus
 (A/equine/Kentucky/1/91(H3N8)) hema(GI:72241 1 loc:FLAHAH3F)
 Influenza A virus
 (A/equine/Kentucky/1/92(H3N8)) hema(GI:722409 loc:FLAHAH3E)
 Influenza A virus
 (A/equine/Kentucky/1/94(H3N8)) hema(GI:722403 loc:FLAHAH3B)
 Influenza A virus
 (A/equine/Kentucky/1/96(H3N8)) hema(GI:6651516 loc:AF197248)
 Influenza A virus
 (A/equine/Kentucky/1/97(H3N8)) hema(GI:6651518 loc:AF 197249)
 Influenza A virus
 (A/equine/Kentucky/1/98(H3N8)) hema(GI:2059321 loc:AB003182)
 Influenza A virus
 (A/equine/Kentucky/2/1 986(H3N8)) hema(GI:324000
 loc:FLAEK86HA)
)
 Influenza A virus
 (A/equine/Kentucky/5/02(H3N8)) hema(GI:60547106 loc:AY855341)
 Influenza A virus
 (A/equine/Kentucky/5/2002(H3N8))
) hema(GI:76152409 loc:DQ124191)
 Influenza A virus
 (A/equine/Kentucky/9/95(H3N8)) hema(GI:6651514 loc:AF197247)
 Influenza A virus
 (A/equine/Lambourn/22778/92(H3
 N8))
 Influenza A virus
 (A/equine/LaPlata/1/93(H3N8))
 Influenza A virus
 (A/equine/Lichfield/89(H3N8))
 Influenza A virus
 (A/equine/Massachussetts/2 13/200
 3(H3N8)) hema(GI:76152413 loc:DQ124193)
 Influenza A virus
 (A/equine/Miami/1/63(H3N8))
 Influenza A virus
 (A/equine/Miami/1 963(H3N8)) hema(GI:3241 15 loc:FLAHAEM)
 Influenza A virus (A/equine/New
 Market/1976(H3N8)) hema(GI:324010
 loc:FLAENM76HA)
 Influenza A virus (A/equine/New
 Market/1979(H3N8))
 Influenza A virus (A/equine/New
 York/1/1999(H3N8)) hema(GI:76152405 loc:DQ124189)
 Influenza A virus (A/equine/New
 York/452/2003 (H3N8)) hema(GI:76152415 Loc:DQ124194)
 Influenza A virus (A/equine/New
 York/99(H3N8)) hema(GI:33415849 loc:AY273 167)
 Influenza A virus
 (A/equine/Newmarket-Bob
 Champion/89(H3N8))
 Influenza A virus
 (A/equine/NewMarket/D64/79(H3
 NS))
 Influenza A virus hema(GI:7615241 1 loc:DQ124192)

(A/equine/Ohio/1/2003(H3N8))
 Influenza A virus
 (A/equine/Oklahoma/2000(H3N8)) hema(GI:33415851 loc:AY273168)
 Influenza A virus hema(GI:324014)
 (A/equine/Romania/ 1980(H3N8)) loc:FLAER80HA)
 Influenza A virus
 (A/equine/Romania/80(H3N8))
 Influenza A virus
 (A/equine/Rome/5/91(H3N8))
 Influenza A virus hema(GI:324016
 (A/equine/Santiago/ 1/1985(H3N8)) loc:FLAES85HA)
 Influenza A virus (A/equine/Sao paulo/6/1969(H3N8)) neura(GI:305229
 lociFLANASAOPAO)
 Influenza A virus (A/equine/Sao paulo/6/69(H3N8))
 Influenza A virus
 (A/equine/Saskatoon/1/90(H3N8)) hema(GI:6651506 loc:AF197243)
 Influenza A virus
 (A/equine/Suffolk/89(H3N8))
 Influenza A virus
 (A/equine/Sussex/93753/89(H3N8))
)
 Influenza A virus
 (A/equine/Tennessee/5/1 985(H3N8)) hema(GI:324020
 loc:FLAET85HA)
))
 Influenza A virus
 (A/equine/Tennessee/5/1 986(H3N8)) neura(GI:30523 1
 loc:FLANATENNEO)
))
 Influenza A virus hema(GI:324018
 (A/equine/Tokyo/1 971(H3N8)) loc:FLAET71HA)
 Influenza A virus hema(GI:324024
 (A/equine/Uruguay/1/1963(H3N8)) loc:FLAEU63HA)
 Influenza A virus
 (A/equine/Uruguay/1/63(H3N8))
 Influenza A virus
 (A/equine/Wisconsin/1/03(H3N8)) hema(GI:78057300 loc:DQ222913)
 Influenza A virus
 (A/equine/Yvelines/2 136/89(H3N8))
))
 Influenza A virus
 (A/finch/Canada/NS 1301/2001(H3N8))
 Influenza A virus
 (A/finch/China/R1 70/02(H3N8)) hema(GI:55056933 loc:AJ704814)
 Influenza A virus (A/green wing teal/Ohio/466/1987(H3N8))
 Influenza A virus (A/green wing teal/Ohio/960/2002(H3N8))
 Influenza A virus (A/guinea fowl/New York/4-3587/1984(H3N8)) neura(GI:305227
 loc:FLANANEWYOO)
 Influenza A virus (A/guinea fowl/New York/4-3587/84(H3N8))
 Influenza A virus
 (A/Ken/1/1981(H3N8)) neura(GI:32425 1
 loc:FLAKEN INAO)
 Influenza A virus (A/longtail duck/Maryland/29 1/2005(H3N8))
 Influenza A virus
 (A/mallard/651 12/03(H3N8))
 Influenza A virus
 (A/mallard/Alberta/1 17/97(H3N8)) hema(GI:493571 15 loc:AY633132)
 Influenza A virus
 (A/mallard/Alberta/ 127/00(H3N8)) hema(GI:493571 19 loc:AY633 148)
 Influenza A virus
 (A/mallard/Alberta/ 167/98 (H3N8))

Influenza A virus
 (A/mallard/Alberta/242/98(H3N8)) hema(GI:49357143 loc:AY633244)

Influenza A virus
 (A/mallard/Alberta/279/98(H3N8)) hema(GI:49357145 loc:AY633252)

Influenza A virus
 (A/mallard/Alberla/88/76(H3N8))

Influenza A virus
 (A/mallard/Alberta/114/97 (H3N8))

Influenza A virus
 (A/mallard/Edmonton/220/1990(H3N8)) neura(GI:305207
 loc:FLANAEDMON0)

Influenza A virus
 (A/mallard/MN/190/99(H3N8))

Influenza A virus
 (A/mallard/MN/218/99(H3N8))

Influenza A virus
 (A/mallard/MN/225/99(H3N8))

Influenza A virus
 (A/mallard/MN/231/99(H3N8))

Influenza A virus
 (A/mallard/MN/281/99(H3N8))

Influenza A virus
 (A/mallard/MN/283/99(H3N8))

Influenza A virus
 (A/mallard/MN/354/99(H3N8))

Influenza A virus
 (A/mallard/Ohio/649/2002(H3N8))

Influenza A virus
 (A/mallard/Ohio/651/2002(H3N8))

Influenza A virus
 (A/mallard/Ohio/654/2002(H3N8))

Influenza A virus (A/northern
 shoveler/Ohio/35/1986(H3N8))

Influenza A virus (A/northern
 shoveler/Ohio/454/1987(H3N8))

Influenza A virus (A/pet
 bird/China/R7/04(H3N8)) hema(GI:55056937 loc:AJ704816)

Influenza A virus (A/pet bird/Hong
 Kong/1559/99(H3N8))

Influenza A virus
 (A/pintail/Alaska/211/2005(H3N8))

)

Influenza A virus
 (A/pintail/Alaska/315/2005(H3N8))

)

Influenza A virus
 (A/pintail/Alaska/49/2005(H3N8))

Influenza A virus
 (A/pintail/Alaska/779/2005(H3N8))

)

Influenza A virus
 (A/pintail/Alberta/156/97(H3N8)) hema(GI:49357167 loc:AY633340)

Influenza A virus
 (A/pintail/Alberta/37/99(H3N8)) hema(GI:49357175 loc:AY633372)

Influenza A virus
 (A/pintail/Ohio/339/1987(H3N8))

Influenza A virus (A/red-necked
 stint/AUS/4500/1980(H3N8))

Influenza A virus
 (A/sanderling/Delaware/65/99
 (H3N8))

Influenza A virus
 (A/shearwater/AUS/405/1978(H3N8))

)

Influenza A virus
 (A/Shorebird/Delaware/207/98/PA
 (H3N8))

Influenza A virus (A/wild bird feces/Korea/ESD14/03(H3N8))		neura(GI: 111662780 loc:DQ8859980)
Influenza A virus (A/wild bird feces/Korea/ESD3-3/04(H3N8))		neura(GI: 11662743 loc:DQ8859960)
Influenza A virus (A/wild bird feces/Korea/ESD3/03(H3N8))		neura(GI: 11662758 loc:DQ8859970)
Influenza A virus (A/wild bird feces/Korea/KCA1 6/03(H3N8))		neura(GI: 11662725 loc:DQ8859950)
Influenza A virus H3N8		
Influenza A virus (A/mallard/Alberta/3 1/2001(H3N9))		neura(GI:78096168 loc:CY0047010)
)		
Influenza A virus (A/mallard/MN/182/98(H3N9))		
Influenza A virus (A/mallard/ALB/47/1998(H4N1))		neura(GI:78096710 loc:CY0049270)
Influenza A virus (A/mallard/Alberta/47/98(H4N1))	hema(GI:49357153 loc:AY633284)	
Influenza A virus (A/duck/Hong Kong/412/1978(H4N2))		
Influenza A virus (A/mallard/MN/371/98(H4N2))	hema(GI:68193838 loc:DQ021858)	
Influenza A virus (A/mallard/Ohio/275/1987(H4N2))		
Influenza A virus (A/mallard/Ohio/353/1986(H4N2))		
Influenza A virus (A/mallard/Ohio/686/2002(H4N2))		
Influenza A virus (A/duck/Nanchang/1941/1993(H4N4))		
Influenza A virus (A/gray teal/Australia/2/1979(H4N4))		neura(GI: 15278160 loc:CY0146250)
Influenza A virus (A/grey teal/Australia/2/1979(H4N4))	hema(GI:324220 loc:FLAHAQB)	
Influenza A virus (A/mallard duck/ALB/299/1977(H4N4))		neura(GI:78096189 loc:CY0047170)
Influenza A virus (A/mallard duck/Alberta/299/1977(H4N4))	hema(GI: 115278062 loc:CY014579)	
Influenza A virus (A/blue-winged teal/ALB/103/1990(H4N5))	hema(GI:82653032 loc:CY005963)	
Influenza A virus (A/blue-winged teal/ALB/67/ 1990(H4N5))		
Influenza A virus (A/duck/Hokkaido/1058/01(H4N5))		
)		
Influenza A virus (A/duck/Hong Kong/174/77(H4N5))		
Influenza A virus (A/duck/Hong Kong/668/79(H4N5))		
Influenza A virus (A/seal/Massachusetts/133/1982(H4N5))	hema(GI:324234 loc:FLAHAQI)	
Influenza A virus (A/blue-winged teal/ALB/562/1985(H4N6))	hema(GI:78096245 loc:CY004847)	
Influenza A virus (A/blue-winged teal/LA/166B/88(H4N6))	hema(GI:68193834 loc:DQ021856)	
Influenza A virus (A/blue-winged teal/LA/240B/88(H4N6))		
Influenza A virus (A/blue-winged teal/LA/69B/87(H4N6))	hema(GI:68 193852 loc:DQ021865)	
Influenza A virus (A/blue-winged teal/LA/B 156/88(H4N6))	hema(GI:68193850 loc:DQ021864)	
Influenza A virus (A/blue-winged teal/LA/B 182/86(H4N6))		
Influenza A virus (A/blue-winged teal/LA/B 182/88(H4N6))	hema(GI:68193818 loc:DQ021848)	

Influenza A virus (A/blue-winged teal/OH/240B/88(H4N6))	hema(GI:68 193836 loc:DQ021857)	
Influenza A virus (A/blue-winged teal/Ohio/989/2002(H4N6))		
Influenza A virus (A/budgerigar/Hokkaido/I/1977(H4N6))	hema(GI:324222 loc:FLAHAQC)	
Influenza A virus (A/chicken/Nanchang/2-0527/2000(H4N6))		
Influenza A virus (A/Chicken/Nanchang/3-0128/2000(H4N6))	hema(GI:27465290 loc:AY180435)	
Influenza A virus (A/Chicken/Nanchang/4-008/2000(H4N6))	hema(GI:27465292 loc:AY180436)	
Influenza A virus (A/duck/Czechoslovakia/1956(H4N6))		
Influenza A virus (A/duck/Czechoslovakia/1956(N4N6))	hema(GI:324218 loc:FLAHAQA)	
Influenza A virus (A/duck/england/I/1962(H4N6))		
Influenza A virus (A/Duck/Nanchang/2-0147/2000(H4N6))	hema(GI:27465302 loc:AY180441)	
Influenza A virus (A/duck/Nanchang/4-165/2000(H4N6))		
Influenza A virus (A/Duck/Nanchang/4-173/2000(H4N6))	hema(GI:27465306 loc:AY1 80443)	
Influenza A virus (A/Duck/Nanchang/4-191/2000(H4N6))	hema(GI:27465300 loc:AY1 80440)	
Influenza A virus (A/Duck/Nanchang/662/98(H4N6))		
Influenza A virus (A/duck/Nanchang/dlO6/1997(H4N6))		
Influenza A virus (A/duck/New Zealand/3 1/1976(H4N6))	hema(GI:324224 loc:FLAHAQD)	
Influenza A virus (A/duck/New Zealand/3 1/76(H4N6))		
Influenza A virus (A/duck/NZL/3 1/1976(H4N6))		
Influenza A virus (A/duck/Taiwan/10-2/00(H4N6))		
Influenza A virus (A/environment/Maryland/ 1067/2002(H4N6))		
Influenza A virus (A/gray teal/Australia/3/1 979(H4N6))		
Influenza A virus (A/green-winged teal/AK/281/98(H4N6))		
Influenza A virus (A/herring gull/DE/665/1 988(H4N6))	neura(GI:78096282 loc:CY0048760)	
Influenza A virus (A/knot/DE/54 1/1988(H4N6))	neura(GI:78096265 loc:CY0048690)	
Influenza A virus (A/mallard duck/ALB/20/1976(H4N6))	neura(GI:78095630 loc:CY0043 110)	
Influenza A virus (A/mallard duck/ALB/25/ 1985(H4N6))	neura(GI:78096235 loc:CY0048390)	
Influenza A virus (A/mallard/ALB/49/1 995(H4N6))	neura(GI:78096676 loc:CY0049130)	

Influenza A virus
(A/mallard/Alberta/1 11/99(H4N6)) hema(GI:49357113 loc:AY633124)
Influenza A virus
(A/mallard/Alberta/1 19/00(H4N6)) hema(GI:493571 17 loc:AY633141)
Influenza A virus
(A/mallard/Alberta/136/00(H4N6)) hema(GP.49357121 loc:AY633156)
Influenza A virus
(A/mallard/Alberta/213/98(H4N6))
Influenza A virus
(A/mallard/Alberta/213/99
(H4N6))
Influenza A virus
(A/mallard/Alberta/254/2003(H4N
6)) hema(GI: 115278002
loc:CYO14562)
Influenza A virus
(A/mallard/Alberta/295/98(H4N6)) hema(GI:49357147 loc:AY633260)
Influenza A virus
(A/mallard/Alberta/30/98 (H4N6)) hema(GI:49357149 loc:AY633268)
Influenza A virus
(A/mallard/Maryland/1027/2002(H
4N6))
Influenza A virus
(A/mallard/Maryland/750/2002(H4
N6))
Influenza A virus
(A/mallard/Missouri/MO278/2005(
H4N6))
Influenza A virus
(A/mallard/MN/145/99(H4N6)) - hema(GI:68193820 loc:DQ021849)
Influenza A virus
(A/mallard/MN/192/99(H4N6)) hema(GI:68 193822 loc:DQ021850)
Influenza A virus
(A/mallard/MN/195/99(H4N6)) hema(GI:68193824 loc:DQ021851)
Influenza A virus
(A/mallard/MN/198/99(H4N6)) hema(GI:68 193826 loc:DQ021852)
Influenza A virus
(A/mallard/MN/2/98(H4N6)) hema(GI:68193828 loc:DQ021853)
Influenza A virus
(A/mallard/MN/220/98(H4N6))
Influenza A virus
(A/mallard/MN/348/00(H4N6)) hema(GI:68193842 loc:DQ021860)
Influenza A virus
(A/mallard/MN/530/00(H4N6)) hema(GI:68 193844 loc:DQ021861)
Influenza A virus
(A/mallard/Ohio/129/1989(H4N6))
Influenza A virus
(A/mallard/Ohio/324/1988(H4N6))
Influenza A virus
(A/mallard/Ohio/655/2002(H4N6))
Influenza A virus
(A/mallard/Ohio/657/2002(H4N6))
Influenza A virus
(A/mallard/Ohio/660/2002(H4N6))
Influenza A virus
(A/mallard/Ohio/666/2002(H4N6))
Influenza A virus
(A/mallard/Ohio/667/2002(H4N6))
Influenza A virus
(A/mallard/Ohio/668/2002(H4N6))
Influenza A virus
(A/mallard/Ohio/67 1/2002(H4N6))
Influenza A virus (A/pintail
duck/ALB/159/1977(H4N6)) neura(GI:78096203
loc:CY0047640)
Influenza A virus
(A/pintail/Alaska/3 10/2005(H4N6)
)
Influenza A virus

(A/pintail/Alaska/99/2005(H4N6))
 Influenza A virus neura(GI:78096693
 (A/pintail/ALB/275/1 996(H4N6)) loc:CY0049200)
 Influenza A virus
 (A/pintail/Alberta/1 19/1979(H4N6))
)
 Influenza A virus
 (A/pintail/Alberta/2 10/99(H4N6)) hema(GI:49357171 loc:AY633356)
 Influenza A virus
 (A/quail/California/1/90(H4N6))
 Influenza A virus
 (A/Quail/Nanchang/2-
 0579/2000(H4N6)) hema(GI:27465294 loc:AY180437)
 Influenza A virus
 (A/Quail/Nanchang/4-
 026/2000(H4N6)) hema(GI:27465296 loc:AY180438)
 Influenza A virus
 (A/quail/Nanchang/4-
 034/2000(H4N6))
 Influenza A virus (A/redhead
 duck/ALB/116/1985(H4N6)) neura(GI:82754858
 loc:CY0048440)
 Influenza A virus (A/ruddy
 turnstone/New
 Jersey/47/1985(H4N6))
 Influenza A virus (A/ruddy
 turnstone/NJ/1407/0 1(H4N6))
 Influenza A virus
 (A/swine/Ontario/0191 1-1/99
 (H4N6)) -
 Influenza A virus
 (A/swine/Ontario/0 191 1-2/99
 (H4N6))
 Influenza A virus (A/blue-winged
 teal/Alberta/96/76 (H4N8))
 Influenza A virus (A/blue-winged
 teal/LA/3B/88(H4N8))
 Influenza A virus
 (A/chicken/Alabaraa/1/1 975(H4N8
)) hema(GI:324228 locrFLAHAQF)
 Influenza A virus (A/common
 scoter/Maryland/299/2005(H4N8))
 Influenza A virus (A/domestic
 duck/MN/1086/1980(H4N8))
 Influenza A virus (A/Duck/Hong
 Kong/Y264/97(H4N8))
 Influenza A virus (A/duck/South
 Africa/1233A/2004(H4N8))
 Influenza A virus (A/green-winged
 teal/AK/5937/01(H4N8))
 Influenza A virus (A/guinea
 fowl/NJ/14 190-23/96(H4N8)) hema(GI:68193846 loc:DQ021862)
 Influenza A virus
 (A/maUard/MN/1 54/99(H4N8))
 Influenza A virus
 (A/mallard/MN/212/99(H4N8)) hema(GI:68 193830 loc:DQ021854)
 Influenza A virus
 (A/mallard/MN/347/99(H4N8)) hema(GI:68193854 loc:DQ021866)
 Influenza A virus
 (A/mallard/MN/352/99(H4N8)) hema(GI:68 193856 loc:DQ021867)
 Influenza A virus
 (A/mallard/OH/338/86(H4N8)) hema(GI:68 193848 loc:DQ021863)
 Influenza A virus
 (A/pintail/Alberta/207/99(H4N8)) hema(GI:49357169 loc:AY633348)
 Influenza A virus (A/red-necked
 stint/AUS/4189/1980(H4N8))
 Influenza A virus (A/red-necked
 Stint/Australia/1/2004(H4N8)) hema(GI:84627314 loc:DQ327834)

Influenza A virus (A/turkey/Minnesota/ 141/1978(114 N8))		neura(GI:1 15278443 loc:CY0 147470)
Influenza A virus (A/laughing gull/NJ/72/1985(H4N9))		neura(GI:78096220 loo:CY0048260)
Influenza A virus (A/mallard/MN/263/99(H4N9))	hema(GI:68193832 loc:DQ021855)	
Influenza A virus (A/ruddy turnstone/DE/2368/1 988(H4N9))		
Influenza A virus (A/ruddy turnstone/NJ/49/1985(H4N9))		
Influenza A virus (A/WDk/ST/988/2000(H4N9))		
Influenza A virus (A/Anhui/1/2005(H5N1))	hema(GI:87137936 loc:DQ371928)	
Influenza A virus (A/Anhui/2/2005(H5N1))	hema(GI:87137938 loc:DQ371929)	
Influenza A virus (A/Bar-headed Goose/Qinghai/12/05(H5N1))	hema(GI:91984128 loc:DQ095621)	
Influenza A virus (A/bar-headed goose/Qinghai/1A/2005(H5N1))		
Influenza A virus (A/Bar-headed Goose/Qinghai/5/05(H5N1))	hema(GI:91984124 loc:DQ095617)	
Influenza A virus (A/Bar-headed Goose/Qinghai/59/05(H5N1))	hema(GI:919841 17 loc:DQ095612)	
Influenza A virus (A/Bar-headed Goose/Qinghai/60/05(H5N1))	hema(GI:70955425 loc:DQ095615)	
Influenza A virus (A/Bar-headed Goose/Qinghai/61/05(H5N1))	hema(GI:91984126 loc:DQ095618)	
Influenza A virus (A/Bar-headed Goose/Qinghai/62/05(H5N1))	hema(GI:70955431 loc:DQ095620)	
Influenza A virus (A/Bar-headed Goose/Qinghai/65/05(H5N 1))	hema(GI:70955434 loc:DQ095622)	
Influenza A virus (A/Bar-headed Goose/Qinghai/67/05(H5N1))	hema(GI:70955436 loc:DQ095623)	
Influenza A virus (A/Bar-headed Goose/Qinghai/68/05(H5N1))	hema(GI:919841 19 loc:DQ095613)	
Influenza A virus (A/Bar-headed Goose/Qinghai/75/05(H5N1))	hema(GI:70955429 loc:DQ095619)	
Influenza A virus (A/bird/Thailand/3 .1/2004(H5N1))	hema(GI:50296044 loc:AY651330)	
Influenza A virus (A/black headed gull/HK/12. 1/2003(H5N1))	hema(GI:50296130 loc:AY651373)	
Influenza A virus (A/black-headed goose/Qinghai/1/2005(H5N1))	hema(GI:71025271 loc:DQ100554)	
Influenza A virus (A/black-headed goose/Qinghai/2/2005(H5N1))	hema(GI:71025273 loc:DQ100555)	
Influenza A virus (A/black-headed gull/Qinghai/1/2005(H5N1))	hema(GI:7 1025275 loc:DQ100556)	
Influenza A virus (A/blackbird/Hunan/1/2004(H5N1))	hema(GI:56672736 loc:AY741213)	
Influenza A virus (A/Brown- headed Gull/Qinghai/3/05(H5N1))	hema(GI:91984122 loc:DQ095616)	
Influenza A virus (A/cat/Dagestan/87/06(H5N1))	hema(GP.111380027 loc:DQ864720)	
Influenza A virus (A/cat/Germany/606/2006(H5N1))		neura(GI:99030943 loc:DQ6439840)
Influenza A virus (A/cat/Iraq/820NAMRU3/2006(H5 NI))		neura(GI:1 10227240 loc:DQ8353900)
Influenza A virus (A/chick/Macheng/2004(H5NI))	hema(GI:56418513 loc:AY830774)	
Influenza A virus (A/chicken/4NP25/2004(H5NI))		
Influenza A virus (A/chicken/Adygea/203/06(H5NI))	hema(GI:111380017 loc:DQ864715)	

Influenza A virus (A/chicken/Anhui/M(H5N1))	hema(GI:85679472 loc:DQ356886)
Influenza A virus (A/chicken/Ayutthaya/Thailand/CU-23/04(1-15N1))	hema(GI:54873457 loc:AY770991)
Influenza A virus (A/chicken/Ayutthaya/Thailand/CU-24/04(H5N1))	hema(GI:71277634 loc:DQ083569)
Influenza A virus (A/chicken/Bangkok/Thailand/CU-20/04(H5N1))	hema(GI:71277632 loc:DQ083568)
Influenza A virus (A/chicken/Bangkok/Thailand/CU-21/O4(H5N1))	
Influenza A virus (A/chicken/Bangkok/Thailand/CU-3/04(H5N1))	hema(GI:71277598 loc:DQ083551)
Influenza A virus (A/chicken/Bangkok/Thailand/CU-6/04(H5N1))	hema(GI:71277604 loc:DQ083554)
Influenza A virus (A/chicken/Chachoengsao/Thailand/CU-10/04(H5N1))	hema(GI:71277612 loc:DQ083558)
Influenza A virus (A/chicken/Chachoengsao/Thailand/CU-11/04(H5N1))	hema(GI:71277614 loc:DQ083559)
Influenza A virus (A/chicken/China/1/02(H5N1))	hema(GI:66775624 loc:DQ023145)
Influenza A virus (A/chicken/Chonburi/Thailand/CU-7/04(H5N1))	hema(GI:71277606 loc:DQ083555)
Influenza A virus (A/chicken/Chonburi/Thailand/CU-73/04(H5N1))	hema(GI:71277656 loc:DQ083580)
Influenza A virus (A/chicken/Crimea/1/2005(H5N1))	hema(GI:85372720 loc:DQ340848)
Influenza A virus (A/chicken/Denpasar/O1/2004(H5N1))	hema(GI:108782501 loc:DQ644955)
Influenza A virus (A/chicken/Denpasar/02/2005(H5N1))	hema(GI:108782503 loc:DQ644956)
Influenza A virus (A/chicken/Dovolnoe/03/2005(H5N1))	hema(GI:108782527 loc:DQ676838)
Influenza A virus (A/chicken/Egypt/2253-1/2006(H5N1))	hema(GI:110631386 loc:DQ862001)
Influenza A virus (A/chicken/Egypt/5610NAMRU3-F3/2006(H5N1))	
Influenza A virus (A/chicken/Egypt/5611NAMRU3-AN/2006(H5N1))	
Influenza A virus (A/chicken/Egypt/5612NAMRU3-S/2006(H5N1))	
Influenza A virus (A/chicken/Egypt/960N3-004/2006(H5N1))	hema(GI:90025360 loc:DQ447199)
Influenza A virus (A/chicken/Guangdong/174/04(H5N1))	hema(GI:47716772 loc:AY609312)
Influenza A virus (A/chicken/Guangdong/178/04(H5N1))	hema(GI:57916028 loc:AY737296)
Influenza A virus	hema(GI:57915979 loc:AY737289)

(A/chicken/Guangdong/191/04(H5NI))
 Influenza A virus
 (A/chicken/Henan/12/2004(H5NI))
 Influenza A virus
 (A/chicken/Henan/13/2004(H5NI))
 Influenza A virus
 (A/chicken/Henan/16/2004(H5NI))
 Influenza A virus
 (A/chicken/Henan/2 10/2004(H5NI))
 Influenza A virus
 (A/Chicken/Hong Kong/1203/97(H5N1)) hema(GI:6048748 loc:AF098539)
 Influenza A virus
 (A/Chicken/Hong Kong/220/97(H5N1)) hema(GI:3335402 loc:AF046080)
 Influenza A virus
 (A/Chicken/Hong Kong/258/97(H5N1))
 Influenza A virus (A/chicken/Hong Kong/3 123.1/2002(H5NI)) hema(GI:84797235 loc:DQ320926)
 Influenza A virus
 (A/Chicken/Hong Kong/3 17.5/2001(H5N1)) hema(GI:21326672 loc:AY075027)
 Influenza A virus
 (A/Chicken/Hong Kong/715.5/01(H5N1)) hema(GI:28849370 loc:AF509025)
 Influenza A virus
 (A/Chicken/Hong Kong/728/97(H5N1)) hema(GI:3421263 loc:AF046099)
 Influenza A virus
 (A/Chicken/Hong Kong/751. 1/01(H5N1))
 Influenza A virus
 (A/Chicken/Hong Kong/786/97(H5N1)) hema(GI:4240437 loc:AF082035)
 Influenza A virus
 (A/Chicken/Hong Kong/822. 1/01(H5N1)) hema(GI:28849372 loc:AF509026)
 Influenza A virus
 (A/Chicken/Hong Kong/829.2/01(H5N1)) hema(GI:28849374 loc:AF509027)
 Influenza A virus
 (A/Chicken/Hong Kong/830.2/01(H5N1)) hema(GI:28849376 loc:AF509028)
 Influenza A virus
 (A/Chicken/Hong Kong/858.3/01(H5N1)) hema(GI:28849378 loc:AF509029)
 Influenza A virus (A/chicken/Hong Kong/86.3/2002(H5NI)) neura(GI:84797499 loc:DQ3210580)
 Influenza A virus
 (A/Chicken/Hong Kong/866.3/01(H5N1))
 Influenza A virus
 (A/Chicken/Hong Kong/867. 1/01(H5N1)) hema(GI:28849380 loc:AF509030)
 Influenza A virus
 (A/Chicken/Hong Kong/873.3/01(H5N1)) hema(GI:28849384 loc:AF509032)
 Influenza A virus
 (A/Chicken/Hong Kong/876. 1/01(H5N1)) hema(GI:28849386 loc:AF509033)
 Influenza A virus
 (A/Chicken/Hong Kong/879.1/01(H5N1)) hema(Gr.28849382 loc:AF509031)
 Influenza A virus hema(GI:28849388 loc:AF509034)

(A/Chicken/Hong Kong/891. 1/01 (H5N1))		
Influenza A virus		
(A/Chicken/Hong Kong/893. 1/01 (H5N1))		
Influenza A virus		
(A/Chicken/Hong Kong/893.2/01 (H5N1))		hema(GI:28849390 loc:AF509035)
Influenza A virus (A/chicken/Hong Kong/915/97(H5N1))		hema(GI:4240439 loc:AF082036)
Influenza A virus		
(A/Chicken/Hong Kong/976/97 (H5N1))		hema(GI:6048750 loc:AF098540)
Influenza A virus (A/chicken/Hong Kong/990/97 (H5N1))		hema(GI:4240441 loc:AF082037)
Influenza A virus		
(A/Chicken/Hong Kong/FY150/01 (H5N1))		hema(GI:28849358 loc:AF509019)
Influenza A virus		
(A/Chicken/Hong Kong/FY77/01 (H5N1))		hema(GI:28849352 loc:AF509016)
Influenza A virus		
(A/Chicken/Hong Kong/SF219/01 (H5N1))		hema(GI:28849368 loc:AF509024)
Influenza A virus		
(A/Chicken/Hong Kong/y385/97 (H5N1))		hema(GI:6048752 loc:AF098541)
Influenza A virus		
(A/Chicken/Hong Kong/y388/97 (H5N1))		hema(GI:6048754 loc:AF098542)
Influenza A virus		
(A/Chicken/Hong Kong/YU562/01 (H5N1))		hema(GI:28849354 loc:AF509017)
Influenza A virus		
(A/Chicken/Hong Kong/YU563/01 (H5N1))		hema(GI:28849356 loc:AF509018)
Influenza A virus (A/chicken/Hong Kongi/86.3/2002(H5N1))		hema(GI:84797237 loc:DQ320927)
Influenza A virus		
(A/Chicken/HongKong/FY 150/0 1(H5N1))		hema(GI:28807565 loc:AY221524)
Influenza A virus		
(A/Chicken/HongKong/F Y 150/0 1- MB(H5N1))		hema(GI:28807284 loc:AY221523)
Influenza A virus		
(A/Chicken/HongKong/NT873 .3/0 1(H5N1)»		hema(GI:28806384 loc:AY221522)
Influenza A virus		
(A/Chicken/HongK.ong/NT873.3/0 1-MB(H5N1))		hema(GI:28805557 loc:AY221521)
Influenza A virus		
(A/Chicken/HongKong/YU562/0 1(H5N1))		hema(GI:28810752 loc:AY221529)
Influenza A virus		
(A/Chicken/HongKong/YU822.2/0 1(H5N1))		hema(GI:288 10155 loc:AY221528)
Influenza A virus		
(A/Chicken/HongKong/YU822.2/0 1-MB(H5N1))		hema(GI:28809438 loc:AY221527)
Influenza A virus		
(A/chicken/Hubei/489/2004(H5NI))		hema(GI:55233227 loc:AY770079)
Influenza A virus		
(A/chicken/Indonesia/77/2005(H5 NI))		neura(GI: 111433454 loc:DQ8844610)
Influenza A virus		neura(GI: 113494653 loc:CY0141940)
(A/chicken/Indonesia/CDC24/2005		

(H5N1))		
Influenza A virus (A/chicken/Indonesia/CDC25/2005 (H5N1))		neura(GI:l 13494606 loc:CY0141870)
Influenza A virus (A/chicken/Ivory Coast/1787/2006(H5N1))	hema(GI: 110554872 loc:DQ673901)	
Influenza A virus (A/chicken/Jiande/1218/2001(H5N I))	hema(GI:62910858 loc:DQ003215)	
Influenza A virus (A/chicken/Jilin/9/2004(H5N1))	hema(GI:50365728 loc:AY653200)	
Influenza A virus (A/chicken/Jilin/hk/2004(H5N1))		
Influenza A virus (A/chicken/Jilin/hl/2004(H5N1))		
Influenza A virus (A/chicken/Jilin/hm/2003(H5N1))		
Influenza A virus (A/chicken/jiyuan/l/03/(H5N1))	hema(GI:76800613 loc:DQ211922)	
Influenza A virus (A/chicken/Kamphaengphet-2- 01/2004(H5N1))	hema(GI:66473358 loc:DQ017270)	
Influenza A virus (A/chicken/Kamphaengphet-2- 02/2004(H5N1))	hema(GI:66473434 loc:DQ0 17308)	
Influenza A virus (A/chicken/Kamphaengphet-2- 03/2004(H5N1))	hema(GI:66473366 loc:DQ017274)	
Influenza A virus (A/chicken/Kamphaengphet-2- 04/2004(H5N1))	hema(GI:66473426 loc:DQ017304)	
Influenza A virus (A/chicken/Kamphaengphet-2- 05/2004(H5N1))	hema(GI:66473412 loc:DQ0 17297)	
Influenza A virus (A/chicken/Kamphaengphet-2- 06/2004(H5N1))	hema(GI:66473368 loc:DQ017275)	
Influenza A virus (A/chicken/Korea/ES/03(H5N1))	hema(GI:56548875 loc:AY676035)	
Influenza A virus (A/chicken/Krasnodar/199/06(H5N I))	hema(GI:l 11380023 loc:DQ864718)	
Influenza A virus (A/chicken/Kurgan/3/2005(H5N1))	hema(GI:83940767 loc:DQ323672)	
Influenza A virus (A/chicken/Kyoto/3/2004(H5N1))	hema(GI:58531 138 loc:AB 188824)	
Influenza A virus (A/chicken/Lopburi/Thailand/CU- 38/04(H5N1))	hema(GI:71277648 loc:DQ083576)	
Influenza A virus (A/chicken/luohuo/3/03/(H5N1))	hema(GI:76800619 loc:DQ21 1925)	
Influenza A virus (A/chicken/Malaysia/01/2004(H5N I))		
Influenza A virus (A/chicken/Nakhon Pathom/Thailand/CU- 14/O4(H5N1))	hema(GI:71277620 loc:DQ083562)	
Influenza A virus (A/chicken/Nakhon Sawan/Thailand/CU-12/04(H5N1))	hema(GI:71277616 loc:DQ083560)	
Influenza A virus (A/chicken/Nakhon Sawan/Thailand/CU-13/04(H5N1))	hema(GI:71277618 loc:DQ083561)	
Influenza A virus (A/chicken/Nakhon Sawan/Thailand/CU-39/04(H5N1))	hema(GI:7 1277650 loc:DQ083577)	

Influenza A virus (A/chicken/Nakorn- Patom/Thailand/CU- K2/2004(H5N1))	
Influenza A virus (A/chicken/Nakorn- Patom/Thailand/CU- K3/2004(H5N1))	
Influenza A virus (A/chicken/Nakornsawan-2- 01/2004(H5N1))	hema(GI:66473398 loc:DQ017290)
Influenza A virus (A/chicken/Nakornsawan-2- 02/2004(H5N1))	hema(OI:66473420 loc:DQ017301)
Influenza A virus (A/chicken/Nakornsawan-2- 03/2004(H5N1))	hema(GI:66473430 loc:DQ017306)
Influenza A virus (A/chicken/Nakornsawan-2- 04/2004(H5N1))	hema(GI:66473360 loc:DQ017271)
Influenza A virus (A/chicken/Nakornsawan-2- 05/2004(H5N1))	hema(GI:66473406 loc:DQ017294)
Influenza A virus (A/chicken/Nakornsawan-2- 06/2004(H5N1))	hema(GI:66473422 loc:DQ017302)
Influenza A virus (A/chicken/Nakornsawan-2- 07/2004(H5N1))	hema(GI:66473432 loc:DQ017307)
Influenza A virus (A/chicken/Navapur/Nandurbar/Ind ia/7966/2006(H5N1))	
Influenza A virus (A/chicken/Navapur/Nandurbar/Ind ia/7972/2006(H5N1))	
Influenza A virus (A/chicken/Niger/2130- 7/2006(H5N1))	hema(GI:110273421 loc:DQ838517)
Influenza A virus (A/chicken/Niger/2130- 8/2006(H5N1))	hema(GI:110273419 loc:DQ838516)
Influenza A virus (A/chicken/Nigeria/BA209/2006(H 5N1))	
Influenza A virus (A/chicken/Nigeria/BA210/2006(H 5N1))	
Influenza A virus (A/chicken/Nigeria/BA211/2006(H 5N1))	
Influenza A virus (A/chicken/Nigeria/SO300/2006(H 5N1))	
Influenza A virus (A/chicken/Nigeria/SO452/2006(H 5N1))	
Influenza A virus (A/chicken/Nigeria/SO493/2006(H 5N1))	
Influenza A virus (A/chicken/Nigeria/SO494/2006(H 5N1))	
Influenza A virus (A/chicken/Novosibirsk/64/05(H5 N1))	hema(GI:76097672 loc:DQ190859)
Influenza A virus (A/chicken/Novosibirsk/65/05(H5	hema(GI:76097674 loc:DQ190860)

NI))	
Influenza A virus (A/chicken/Novosibirsk/66/05(H5NI))	hema(GI:76097676 loc:DQ190861)
Influenza A virus (A/chicken/Oita/8/2004(H5NI))	hema(GI:5853 1120 loc:AB188816)
Influenza A virus (A/chicken/Phetchabun-2-01/2004(H5NI))	hema(GI:66473416 loc:DQ017299)
Influenza A virus (A/chicken/Phetchabun-2-02/2004(H5NI))	hema(GI:66473402 loc:DQ017292)
Influenza A virus (A/chicken/Phitsanulok-2-01/2004(H5NI))	hema(GI:66473414 loc:DQ017298)
Influenza A virus (A/chicken/Phitsanulok-2-02/2004(H5NI))	hema(GI:66473408 loc:DQ017295)
Influenza A virus (A/chicken/Phitsanulok-2-03/2004(H5NI))	hema(GI:66473384 loc:DQ017283)
Influenza A virus (A/chicken/Phitsanuksk-2-04/2004(H5NI))	hema(GI:66473400 loc:DQ017291)
Influenza A virus (A/chicken/Prachinburi/Thailand/CU-104/04(H5NI))	hema(GI:7 1277660 loc:DQ083582)
Influenza A virus (A/chicken/Prachinburi/Thailand/CU-8/04(H5NI))	hema(GI:71277608 loc:DQ083556)
Influenza A virus (A/chicken/Ratchaburi/Thailand/CU-68/04(H5NI))	hema(GI:7 1277652 loc:DQ083578)
Influenza A virus (A/chickeri/Saraburi/Thailand/CU-17/04(H5NI))	hema(GI:7 1277626 loc:DQ083565)
Influenza A virus (A/chicken/Saraburi/Thailand/CU-27/04(H5NI))	hema(GI:7 1277640 loc:DQ083572)
Influenza A virus (A/chicken/Scotland/59(H5NI))	hema(GI:60702 loc:ORAIVHA)
Influenza A virus (A/chicken/Shandong/K01/2004(H5NI))	hema(GI: 109630638 loc:DQ767725)
Influenza A virus (A/Chicken/Shantou/ 810/OSCHSNI)	hema(GI:70955440 loc:DQ095626)
Influenza A virus (A/chicken/Sudan/1784/2006(H5NI))	hema(GI:1 1063 1390 loc:DQ862003)
D)	
Influenza A virus (A/chicken/Sudan/21 15-12/2006(H5NI))	hema(GI:110631382 loc:DQ861999)
Influenza A virus (A/chicken/Sudan/21 15-9/2006(H5NI))	hema(GI:1 10631384 loc:DQ862000)
Influenza A virus (A/chicken/Sukhothai-2-01/2004(H5NI))	hema(GI:66473372 loc:DQ0 17277)
Influenza A virus (A/chicken/Sukhothai-2-02/2004(H5NI))	hema(GI:66473370 loc:DQ017276)
Influenza A virus (A/chicken/Suphanburi/Thailand/CU-1/04(H5NI))	hema(GI:71277596 loc:DQ083550)
Influenza A virus (A/chicken/Suphanburi/Thailand/C	hema(GI:71277610 loc:DQ083557)

U-9/04(H5Ni)) Influenza A virus (A/chicken/Suzdalka/Nov- U/05(H5N1))	hema(GI:78 146106 loc:DQ231242)
Influenza A virus (A/chicken/Suzdalka/Nov- 12/05(H5N1))	hema(GI:78 146083 loc:DQ231241)
Influenza A virus (A/chicken/Tambov/570- 2/05(H5N1))	hema(GI:l 11380019 loc:DQ864716)
Influenza A virus (A/chicken/Thailand/Bangkok- 01/2004(H5N1))	hema(GI:46244271 loc:AY553805)
Influenza A virus (A/chicken/Thailand/Bangkok- 02/2004(H5N1))	hema(GI:46244273 loc:AYS53806)
Influenza A virus (A/chicken/Thailand/CH- 2/2004(H5N1))	hema(GI:55793690 ioc:AY649382)
Influenza A virus (A/chicken/Thailand/CKFI/2004(H 5N1))	hema(GI:45331163 loc:AY535023)
Influenza A virus (A/chicken/Thailand/CU-21/2004 (H5N1))	hema(GI:55247881 loc:AY779050)
Influenza A virus (A/chicken/Thailand/CU- K1/2004(H5N1))	hema(GI:46361433 loc:AY590563)
Influenza A virus (A/chicken/Thailand/CU- K1N1/2004(H5N1))	
Influenza A virus (A/chicken/Thailand/Kamphaengph et-01/2004(H5N1))	hema(GI:46244253 loc:AY553796)
Influenza A virus (A/chicken/Thailand/Kamphaengph et-3-01/2005(H5N1))	
Influenza A virus (A/chicken/Thailand/Karnphaengph et-3-02/2005(H5N1))	
Influenza A virus (A/chicken/Thailand/Kamphaengph et-3-03/2005(H5N1))	
Influenza A virus (A/chicken/Thailand/Kamphaengph et-3-04/2005(H5N1))	
Influenza A virus (A/chicken/Thailand/Kamphaengph et-3-05/2005(H5N1))	
Influenza A virus (A/chicken/Thailand/Kamphaengph et-3-06/2005(H5N1))	
Influenza A virus (A/chicken/Thailand/Kamphaengph et-3-07/2005(H5N1))	
Influenza A virus (A/chicken/Thailand/Kanchanaburi /CK-160/2005(H5N1))	
Influenza A virus (A/chicken/Thailand/KFINF/2004(H5N1))	
Influenza A virus (A/chicken/Thailand/KHHP/4NP25 /2004(H5N1))	hema(GI:44983324 loc:AY534914)
Influenza A virus (A/chicken/Thailand/Khonkaen- 01/2004(H5N1))	hema(GI:46244283 loc:AY553811)

Influenza A virus (A/chicken/Thailand/LV 1NF/2004(H5N1))	
Influenza A virus (A/chicken/Thailand/LV3NF/2004(H5N1))	
Influenza A virus (A/chicken/Thailand/M3NF/2004(H5N1))	
Influenza A virus (A/chicken/Thailand/Mahasarakham-OI/2004(H5N1))	hema(GI:46244281 loc:AY553810)
Influenza A virus (A/chicken/Thailand/Nakornsawan-01/2004(H5N1))	hema(GI:46244285 loc:AY552000)
Influenza A virus (A/chicken/Thailand/Nakornsawan-02/2004(H5N1))	hema(GI:46244257 loc:AY553798)
Influenza A virus (A/chicken/Thailand/Nontaburi/CK-162/2005(H5N1))	hema(GI:85062798 loc:DQ334776)
Influenza A virus (A/chicken/Thailand/Pathumthan-01/2004(H5N1))	hema(GI:46244269 loc:AY553804)
Influenza A virus (A/chicken/Thailand/Phetchabun-01/2004(H5N1))	hema(GI:46244259 loc:AY553799)
Influenza A virus (A/chicken/Thailand/Phetchabun-02/2004(H5N1))	hema(GI:46244261 loc:AY553800)
Influenza A virus (A/chicken/Thailand/Phichit-01/2004(H5N1))	hema(GI:46244251 loc:AY553795)
Influenza A virus (A/chicken/Thailand/Phitsanulok-01/2004(H5N1))	hema(GI:46244229 loc:AY553784)
Influenza A virus (A/chicken/Thailand/Phitsanulok-02/2004(H5N1))	hema(GI:46244247 loc:AY553793)
Influenza A virus (A/chicken/Thailand/Phitsanulok-03/2004(H5N1))	hema(GI:46244249 loc:AY553794)
Influenza A virus (A/chicken/Thailand/Sukhothai-01/2004(H5N1))	hema(GI:46244231 loc:AY553785)
Influenza A virus (A/chicken/Thailand/Sukhothai-02/2004(H5N1))	hema(GI:46244263 loc:AY553801)
Influenza A virus (A/chicken/Thailand/Tak-01/2004(H5N1))	hema(GI:46244287 loc:AY552001)
Influenza A virus (A/chicken/Thailand/Udonthani-01/2004(H5N1))	hema(GI:46244275 loc:AY553807)
Influenza A virus (A/chicken/Thailand/Udonthani-02/2004(H5N1))	hema(GI:46244277 loc:AY553808)
Influenza A virus (A/chicken/Thailand/Udonthani-03/2004(H5N1))	hema(GI:46244279 loc:AY553809)
Influenza A virus (A/chicken/Thailand/Uthairathani-01/2004(H5N1))	hema(GI:46244241 loc:AY553790)
Influenza A virus (A/chicken/Thailand/Uttaradit-01/2004(H5N1))	hema(GI:46244237 loc:AY553788)
Influenza A virus	hema(GI:46244239 loc:AY553789)

(A/chicken/Thailand/Uttaradit-02/2004(H5N1))		
Influenza A virus		
(A/chicken/Tula/10/2005(H5N1))	hema(GI:82621 197 loc:DQ279301)	
Influenza A virus		
(A/chicken/Uthaihani-2-01/2004(H5N1))	hema(GI:66473410 loc:DQ017296)	
Influenza A virus		
(A/chicken/Uthaihani-2-02/2004(H5N1))	hema(GI:66473404 loc:DQ017293)	
Influenza A virus		
(A/chicken/Uthaihan i-2-03/2004(H5N1))	hema(GI:66473396 loc:DQ0 17289)	
Influenza A virus		
(A/chicken/Uthaihani-2-04/2004(H5N1))	hema(GI:66473392 loc:DQ017287)	
Influenza A virus		
(A/chicken/Uthaihani-2-05/2004(H5N1))	hema(GI:66473374 locDQO 17278)	
Influenza A virus		
(A/chicken/Uttaradit-2-01/2004(H5N1))	hema(GI:66473380 loc:DQ017281)	
Influenza A virus		
(A/chicken/Uttaradit-2-02/2004(H5N1))	hema(GI:66473382 loc:DQ017282)	
Influenza A virus		
(A/chicken/Uttaradit-2-03/2004(H5N1))	hema(GI:66473376 loc:DQ017279)	
Influenza A virus (A/chicken/Viet Nam/17/2005(H5N1))		
Influenza A virus (A/chicken/Viet Nam/33/2004(H5N1))		
Influenza A virus (A/chicken/Viet Nam/AG-O10/2004(H5N1))	hema(GI:57924625 loc:AY724789)	
Influenza A virus (A/chicken/Viet Nam/CT-018/2004(H5N1))	hema(GI:57924805 loc:AY724793)	
Influenza A virus (A/chicken/Viet Nam/CT-437/2005(H5N1))		
Influenza A virus (A/chicken/Viet Nam/DN-045/2004(H5N 1))	hema(GI:57924439 loc:AY724785)	
Influenza A virus (A/chicken/Viet Nam/DT-0 15/2004(H5N1))	hema(GI:57924727 loc:AY724791)	
Influenza A virus (A/chicken/Viet Nam/DT-171/2004(H5N1))	hema(GI:561 19215 loc:AY720942)	
Influenza A virus (A/chicken/Viet Nam/HauGiang- 178/2004(H5N1))	hema(GI:5 1628269 loc:AY728892)	
Influenza A virus (A/chicken/Viet Nam/HauGiang-617/2004(H5N1))	hema(GI:5 1628336 loc:AY728894)	
Influenza A virus (A/chicken/Viet Nam/HCM-022/2004(H5N1))	hema(GI:57924375 loc:AY724783)	
Influenza A virus (A/chicken/Viet Nam/KG-076/2004(H5N I))		
Influenza A virus (A/chicken/Viet Nam/LA-024/2004(H5N1))	hema(GI:57924853 loc:AY724795)	
Influenza A virus (A/chicken/Viet Nam/LD-080/2004(H5N1))	hema(GI:72398650 loc:DQ099760)	
Influenza A virus (A/chicken/Viet Nam/TG-023/2004(H5N1))	hema(GI:72398646 loc:DQ099758)	
Influenza A virus (A/chicken/Viet Nam/TN-025/2004(H5N1))	hema(GI:72398640 loc:DQ099755)	
Influenza A virus (A/chicken/Viet Nam/VL-008/2004(H5N1))	hema(GI:57924521 loc:AY724787)	
Influenza A virus		
(A/chicken/Vietnam/486A/2004(H5N1))		neura(GI:l 11433452 loc:DQ8844600)
Influenza A virus		
(A/chicken/Vietnam/C58/04(H5N1	herna(GI:58618439 loc:AY818136)	

))	
Influenza A virus (A/chicken/Vietnam/CM/2004(H5 NI))	hema(GI:45934598 loc:AY576927)
Influenza A virus (A/chicken/Vietnam/HD 1/2004(H5 NI))	hema(GP.46318020 loc:AY574187)
Influenza A virus (A/chicken/Vietnam/HD2/2004(H5 NI))	hema(GI:463 18026 loc:AY574190)
Influenza A virus (A/chicken/Vietnam/P41/05(H5NI))	hema(GI:109941935 loc:AM183672)
Influenza A virus (A/chicken/Vietnam/P78/05(H5NI))	hema(GI:109941937 loc:AM183673)
Influenza A virus (A/chicken/Volgograd/236/06(H5N I))	hema(GI:1 11380025 loc:DQ864719)
Influenza A virus (A/chicken/Yamaguchi/7/2004(H5 NI))	hema(GI:5853 1088 loc:AB 166862)
Influenza A virus (A/chicken/Yichang/lung- 1/O4(H5N1))	hema(GI:50952819 loc:AY623430)
Influenza A virus (A/Chicken/Yunnan/447/05(H5NI))	hema(GI:91984130 loc:DQ095624)
Influenza A virus (A/Chicken/Yunnan/493/05(H5NI))	hema(GI:91984132 loc:DQ095625)
Influenza A virus (A/chicken/Yunnan/KOOI/2004(H5 NI))	
Influenza A virus (A/chicken/zhengzhou/1/02/(H5NI)	hema(GI:76800615 loc:DQ21 1923)
Influenza A virus (A/chicken/zhoukou/2/02/(H5NI))	hema(GI:76800617 loc:DQ21 1924)
Influenza A virus (A/chicken/zz/02/2004(H5NI))	
Influenza A virus (A/Chinese pond heron/Hong Kong/18/2005(H5NI))	hema(GI:84797233 loc:DQ320925)
Influenza A virus (A/Ck/HK/2133.1/2003(H5NI))	hema(GI:50296090 loc:AY651353)
Influenza A virus (A/Ck/HK/3 1.2/2002(H5NI))	hema(GI:50296076 loc:AY651346)
Influenza A virus (A/Ck/HK/3 1.4/02 (H5NI))	hema(GI:47834879 loc:AY575875)
Influenza A virus (A/Ck/HK/3 169.1/2002(H5NI))	hema(GI:50296086 loc:AY651351)
Influenza A virus (A/Ck/HK/3 176.3/2002(H5NI))	hema(GI:50296084 loc:AY651350)
Influenza A virus (A/Ck/HK/37.4/2002(H5NI))	hema(GI:50296078 loc:AY651347)
Influenza A virus (A/Ck/HK/409.1/02 (H5NI))	hema(GI:47834887 loc:AY575879)
Influenza A virus (A/Ck/HK/61.9/02 (H5NI))	hema(GI:47834881 loc:AY575876)
Influenza A virus (A/Ck/HK/96. 1/02 (H5NI))	hema(GI:47834885 loc:AY575878)
Influenza A virus (A/Ck/HK/FY157/2003(H5NI))	hema(GI:50296098 loc:AY651357)
Influenza A virus (A/Ck/HK/NT93/2003(H5NI))	hema(GI:50296092 loc:AY651354)
Influenza A virus (A/Ck/HK/SSP141/2003(H5NI))	hema(GI:50296096 loc:AY651356)

Influenza A virus (A/Ck/HK/WF157/2003(H5N1))	hema(GI:50296094 loc:AY651355)
Influenza A virus (A/Ck/HK/YU22/2002(H5N1))	hema(GI:50296082 loc:AY651349)
Influenza A virus (A/Ck/HK/YU324/2003(H5N1))	hema(GI:50296100 loc:AY651358)
Influenza A virus (A/Ck/HK/YU777/02 (H5N1))	hema(GI:47834883 loc:AY575877)
Influenza A virus (A/Ck/Indonesia/2A/2003(H5N1))	hema(GI:50296030 loc:AY651323)
Influenza A virus (A/Ck/Indonesia/4/2004(H5N1))	hema(GI:50296032 loc:AY651324)
Influenza A virus (A/Ck/Indonesia/5/2004(H5N1))	hema(GI:50296034 loc:AY651325)
Influenza A virus (A/Ck/Indonesia/BL/2003(H5N1))	hema(GI:50296026 loc:AY651321)
Influenza A virus (A/Ck/Indonesia/PA/2003(H5N1))	hema(GI:50296024 loc:AY651320)
Influenza A virus (A/Ck/ST/4231/2003(H5N1))	hema(GI:50296120 loc:AY651368)
Influenza A virus (A/Ck/Thailand/1/2004(H5N1))	hema(GI:50296036 loc:AY651326)
Influenza A virus (A/Ck/Thailand/73/2004(H5N1))	hema(GI:50296038 loc:AY651327)
Influenza A virus (A/Ck/Thailand/9.1/2004(H5N1))	hema(GI:50296040 loc:AY651328)
Influenza A virus (A/Ck/Viet Nam/35/2004(H5N1))	hema(GI:50296060 loc:AY651338)
Influenza A virus (A/Ck/Yiet Nam/36/2004(H5N1))	hema(GI:50296062 loc:AY651339)
Influenza A virus (A/Ck/Viet Nam/37/2004(H5N1))	hema(GI:50296064 loc:AY651340)
Influenza A virus (A/Ck/Viet Nam/38/2004(H5N1))	hema(GI:50296066 loc:AY651341)
Influenza A virus (A/Ck/Viet Nam/39/2004(H5N1))	hema(GI:50296068 loc:AY651342)
Influenza A virus (A/Ck/Viet Nam/C57/2004(H5N1))	hema(GI:50296070 loc:AY651343)
Influenza A virus (A/Ck/YN/115/2004(H5N1))	hema(GI:50296128 loc:AY651372)
Influenza A virus (A/Ck/YN/374/2004(H5N1))	hema(GI:50296126 loc:AY651371)
Influenza A virus (A/crow/Bangkok/Thailand/2004(H5N1))	
Influenza A virus (A/crow/Bangkok/Thailand/CU-15/O4(H5N1))	hema(GI:71277622 loc:DQ083563)
Influenza A virus (A/crow/Bangkok/Thailand/CU-25/O4(H5N1))	hema(GI:71277636 loc:DQ083570)
Influenza A virus (A/crow/Bangkok/Thailand/CU-35/O4(H5N1))	hema(GI:71277646 loc:DQ083575)
Influenza A virus (A/crow/Bangkok/Thailand/CU-4/O4(H5N1))	hema(GI:71277600 loc:DQ083552)
Influenza A virus (A/crow/Kyoto/53/2004(H5N1))	hema(GI:58531156 loc:AB189053)
Influenza A virus (A/crow/Osaka/102/2004(H5N1))	hema(GI:58531174 loc:AB189061)
Influenza A virus (A/crow/Thailand/Cü-KAF3/2004(H5N1))	hema(GI:46361443 loc:AY590572)
Influenza A virus (A/Cygnus cygnus/Iran/754/2006(H5N1))	hema(GI:89477112 loc:DQ440535)
Influenza A virus (A/Cygnus	hema(GI:85376991 loc:DQ343502)

olor/Astrakhan/Ast05-2-2/2005(H5N1))	
Influenza A virus (A/Cygnus olor/Czech Republic/5 170/2006(H5N1))	
Influenza A virus (A/Cygnus olor/Czech Republic/6719/2006(H5N1))	neura(GI:95 116644 loc:DQ5340210)
Influenza A virus (A/cygnus olor/Italy/808/2006(H5N1))	
Influenza A virus (A/Djibouti/569 1NAMRU3/2006(H5N1))	hema(GI: 1097273 17 loc:DQ666146)
Influenza A virus (A/Dk/HK/821/02 (H5N1))	hema(GI:47834877 loc:AY575874)
Influenza A virus (A/Dk/HN/101/2004(H5N1))	hema(GI:502961 14 loc:AY651365)
Influenza A virus (A/Dlc/HN/303/2004(H5N1))	hema(GI:502961 12 loc:AY651364)
Influenza A virus (A/Dk/HN/5806/2003(H5N1))	hema(GI:502961 10 loc:AY651363)
Influenza A virus (A/Dk/Indonesia/MS/2004(H5N1))	hema(GI:50296028 loc:AY651322)
Influenza A virus (A/Dk/ST/4003/2003(H5N1))	hema(GI:502961 18 loc:AY651367)
Influenza A virus (A/Dk/Thailand/71. 1/2004(H5N1))	hema(GI:50296046 loc:AY651331)
Influenza A virus (A/Dk/Viet Nam/1 1/2004(H5N1))	hema(GI:50296072 loc:AY651344)
Influenza A virus (A/Dk/YN/6255/2003(H5N1))	hema(GI:50296122 loc:AY651369)
Influenza A virus (A/Dk/YN/6445/2003 (H5N 1))	hema(GI:50296124 loc:AY651370)
Influenza A virus (A/domestic cat/Iraq/820/2006(H5N1))	hema(GI:89275862 loc:DQ435200)
Influenza A virus (A/domestic goose/Iraq/812/2006(H5N1))	hema(GI:89275864 loc:DQ435201)
Influenza A virus (A/Duck/Anyang/AVL-1/2001 (H5N1))	hema(GI:21359659 loc:AF468837)
Influenza A virus (A/duck/Badung-Bali/05/2005(H5N1))	hema(GI: 108782509 loc:DQ644959)
Influenza A virus (A/duck/Buleleng-Bali/04/2005(H5N1))	hema(GI: 108782507 loc:DQ644958)
Influenza A virus (A/duck/China/E3 19-2/03(H5N I))	hema(GI:41207462 loc:AY5 18362)
Influenza A virus (A/duck/Chonburi/Thailand/CU-2/04(H5N1))	
Influenza A virus (A/duck/Chonburi/Thailand/CU-5/04(H5N1))	hema(GI:71277602 loc:DQ083553)
Influenza A virus (A/duck/Fujian/01/2002(H5N1))	hema(GI:47156268 loc:AY585357)
Influenza A virus (A/duck/Fujian/13/2002(H5N1))	hema(GI:47 156270 loc:AY585358)
Influenza A virus (A/duck/Fujian/1 7/200 1(H5N 1))	hema(GI:47156298 loc:AY585372)
Influenza A virus (A/Duck/Fuj ian/1 734/05(H5N 1))	hema(GI:91984137 loc:DQ095629)
Influenza A virus (A/duck/Fuj ian/ 19/2000(H5N 1))	hema(GI:47 156272 loc:AY585359)
Influenza A virus (A/duck/Guangdong/01/2001(H5N I))	hema(GI:47 156274 loc:AY585360)
Influenza A virus	hema(GI:47156300 loc:AY585373)

(A/duck/Guangdong/07/2000(H5N1)) Influenza A virus		
(A/duck/Guangdong/12/2000(H5N1)) Influenza A virus	hema(GI:47156276 loc:AY585361)	
(A/duck/Guangdong/173/04(H5N1)) Influenza A virus	hema(GI:57916076 loc:AY737304)	
(A/duck/Guangdong/22/2002(H5N1)) Influenza A virus	hema(GI:47156278 loc:AY585362)	
(A/duck/Guangdong/40/2000(H5N1)) Influenza A virus	hema(GI:47156302 loc:AY585374)	
(A/duck/Guangdong/DG-01/2005(H5N1)) Influenza A virus		
(A/duck/Guangxi/07/1999(H5N1)) Influenza A virus	hema(GI:47156280 loc:AY585363)	
(A/duck/Guangxi/1378/2004- unchecked(H5N1)) Influenza A virus		
(A/duck/Guangxi/22/2001(H5N1)) Influenza A virus	hema(GI:47156282 loc:AY585364)	
(A/duck/Guangxi/35/2001(H5N1)) Influenza A virus	hema(GI:47156284 loc:AY585365)	
(A/duck/Guangxi/50/2001(H5N1)) Influenza A virus	hema(GI:47156304 loc:AY585375)	
(A/duck/Guangxi/53/2002(H5N1)) Influenza A virus	hema(GI:47156286 loc:AY585366)	
(A/duck/Guangxi/668/2004(H5N1)) Influenza A virus	hema(GI:84797141 loc:DQ320879)	
(A/duck/GX/351/2004(H5N1)) Influenza A virus		
(A/duck/Hokkaido/Vac-1/O4(H5N1)) Influenza A virus (A/Duck/Hong Kong/2986.1/2000(H5N1))		neura(GI:101918589 loc:AB2597140)
Influenza A virus (A/Duck/Hong Kong/380.5/2001(H5N1))	hema(GI:19697771 loc:AY059481)	
Influenza A virus (A/Duck/Hong Kong/573.4/01(H5N1))	hema(GI:21326684 loc:AY075033)	
Influenza A virus (A/Duck/Hong Kong/646.3/01(H5N1))	hema(GI:28849396 loc:AF509038)	
Influenza A virus (A/duck/Hong Kong/821/02(H5N1))	hema(GI:28849398 loc:AF509039)	
Influenza A virus (A/Duck/Hong Kong/p46/97(H5N1))	hema(GI:56548871 loc:AY676033)	
Influenza A virus (A/Duck/Hong Kong/ww381/2000(H5N1))	hema(GI:6048756 loc:AP098543)	
Influenza A virus (A/Duck/Hong Kong/ww382/2000(H5N1))	hema(GI:19697761 loc:AY059476)	
Influenza A virus (A/Duck/Hong Kong/ww461/2000(H5N1))	hema(GI:19697763 loc:AY059477)	
Influenza A virus (A/Duck/Hong Kong/ww487/2000(H5N1))	hema(GI:19697765 loc:AY059478)	
Influenza A virus (A/Duck/Hong Kong/y283/97(H5N1))	hema(GI:19697767 loc:AY059479)	
Influenza A virus (A/duck/Hubei/wp/2003(H5N1))	hema(GI:6048758 loc:AF098544)	
Influenza A virus (A/duck/Hunan/14/O5(H5N1))		neura(GI:115526931 loc:DQ9971640)
Influenza A virus (A/Duck/Hunan/191/05(H5N1))	hema(GI:70955447 loc:DQ095631)	
Influenza A virus	hema(GI:108782505)	

(A/duck/Jembrana-Bali/03/2005(H5N1)) Influenza A virus (A/duck/kaifeng/1/01/(H5N1)) Influenza A virus (A/duck/Korea/ESDI/03(H5N1)) Influenza A virus (A/duck/Laos/3295/2006(H5N1)) Influenza A virus (A/duck/Minnesota/1525/1981(H5N1)) Influenza A virus (A/duck/Minnesota/1525/81(H5N1)) Influenza A virus (A/duck/Nakhon Pathom/Thailand/CU-71/04(H5N1)) Influenza A virus (A/duck/Nakornsawan-2-01/2004(H5N1)) Influenza A virus (A/duck/Nakornsawan-2-02/2004(H5N1)) Influenza A virus (A/duck/Novosibirsk/56/2005(H5ND)) Influenza A virus (A/duck/Phichit-2-01/2004(H5N1)) Influenza A virus (A/duck/Phichit-2-02/2004(H5N1)) Influenza A virus (A/duck/Phitsanulok-2-01/2004(H5N1)) Influenza A virus (A/duck/Phitsanulok-2-02/2004(H5N1)) Influenza A virus (A/duck/Saraburi/Thailand/CU-74/04(H5N1)) Influenza A virus (A/duck/Shandong/093/2004(H5N1)) Influenza A virus (A/duck/Shanghai/08/2001(H5N1)) Influenza A virus (A/duck/Shanghai/13/2001(H5N1)) Influenza A virus (A/duck/Shanghai/35/2002(H5N1)) Influenza A virus (A/duck/Shanghai/37/2002(H5N1)) Influenza A virus (A/duck/Shanghai/38/2001(H5N1)) Influenza A virus (A/duck/Sheyang/1/2005(H5N1)) Influenza A virus (A/duck/South Africa/81/1/2004(H5N1)) Influenza A virus (A/duck/Thailand/CU-2/2004(H5N1)) Influenza A virus (A/duck/Thailand/Kamphaengphet-01/2004(H5N1)) Influenza A virus (A/Duck/Thailand/KU-KPS/2004(H5N1)) Influenza A virus (A/duck/Thailand/Phichit-	loc:DQ644957) hema(GI:56548877 loc:AY676036) hema(GI: 110341044 loc:DQ845348) hema(GI:1 15278393 loc:CY014726) hema(GI:4240447 loc:AF082040) hema(GI:7 1277654 loc:DQ083579) hema(GI:66473364 loc:DQ017273) hema(GI:66473418 loc:DQ017300) hema(GI:78450348 loc:DQ230522) hema(GI:66473386 loc:DQ017284) hema(GI:66473388 loc:DQ0 17285) hema(GI:66473362 loc:DQ017272) hema(GI:66473390 locrDQ0 17286) hema(GI:71277658 loc:DQ083581) hema(GI:47156294 loc:AY585370) hema(GI:47156288 loc:AY585367) hema(GI:47156290 loc:AY585368) hema(GI:47156292 loc:AY585369) hema(GI:47 156306 loc:AY585376) hema(GI:55247877 loc:AY779048) hema(GI:46244255 loc:AY553797) hema(GI:46244233 loc:AY553786)
---	--

01/2004(H5N1))		
Influenza A virus (A/duck/Thailand/Sukhothai- 01/2004(H5N1))	hema(GI:46244245 loc:AY553792)	
Influenza A virus (A/duck/Uthaithani-2- 01/2004(H5N1))	hema(GI:66473394 loc:DQ0 17288)	
Influenza A virus (A/duck/Uthaithani-2- 02/2004(H5N1))	hema(GI:66473424 loc:DQ017303)	
Influenza A virus (A/duck/Uttaradit-2- 01/2004(H5N1))	hema(GI:66473428 loc:DQ017305)	
Influenza A virus (A/duck/Viet Nam/16/2005(H5N1))		
Influenza A virus (A/duck/Viet Nam/19/2005(H5N1))		
Influenza A virus (A/duck/Viet Nam/CM-V7/2004(H5N1))		
Influenza A virus (A/duck/Viet Nam/TG-007A/2004(H5N1))	hema(GI:561 19223 loc:AY720945)	
Influenza A virus (A/duck/Viet Nam/TV-V2/2004(H5N1))		
Influenza A virus (A/duck/Vietnam/AG40- O2/05(H5N1))	hema(GI: 10994 1943 loc:AMI 83676)	
Influenza A virus (A/duck/Vietnam/TG36- H2/O5(H5N1))	hema(GI:109941941 loc:AM183675)	
Influenza A virus (A/duck/Yangzhou/232/2004(H5N I))		
Influenza A virus (A/duck/Yokohama/aqIO/2003(H5 N1))	hema(GI:71000185 loc:AB212280)	
Influenza A virus (A/duck/Zhejiang/1 1/2000(H5N1))	hema(GI:47156296 loc:AY585371)	
Influenza A virus (A/duck/Zhejiang/52/2000(H5N1))	hema(GI:47156308 loc:AY585377)	
Influenza A virus (A/Eg/HK/757.3/02 (H5N1))	hema(GI:47834865 loc:AY575872)	
Influenza A virus (A/egret/Hong Kong/757.2/03(H5N1))	hema(GI:56548873 loc:AY676034)	
Influenza A virus (A/Egypt/2782- NAMRU3/2006(H5N1))	hema(GI:90823033 loc:DQ464377)	
Influenza A virus (A/eka/Thailand/EkAINRC/2004(H5N1))		
Influenza A virus (A/Environment/Hong Kong/437- 10/99 (H5N1))	hema(GI:9863931 loc:AF216737)	
Influenza A virus (A/Environment/Hong Kong/437- 4/99 (H5N1))	hema(GI:9863876 loc:AF216713)	
Influenza A virus (A/Environment/Hong Kong/437- 6/99 (H5N1))	hema(GI:9863895 loc:AF216721)	
Influenza A virus (A/Environment/Hong Kong/437- 8/99 (H5N1))	hema(GI:9863913 loc:AF216729)	
Influenza A virus (A/feline/Indonesia/CDCI/2006(H 5N1))		neura(GI: 113495525 loc:C Y0 142340)
Influenza A virus (A/feral pigeon/HK/862.7/2002(H5N 1))	hema(GI:50296104 loc:AY651360)	
Influenza A virus (A/G.H/HK/793. 1/02 (H5N1))	hema(GI:47834875 loc:AY575873)	

Influenza A virus (A/Gf/HK/38/2002(H5NI))	hema(GI:50296074 loc:AY651345)	
Influenza A virus (A/goose/China/F3/2004(H5NI))	hema(GI:49356775 loc:AY639405)	
Influenza A virus (A/goose/Crimea/615/05(H5NI))	hema(GI:111380021 loc:DQ864717)	
Influenza A virus (A/goose/Guangdong/3/1997(H5N1))		
Influenza A virus (A/goose/Guangxi/1586/2004(H5N1))		
Influenza A virus (A/goose/Guangxi/2396/2004(H5ND))		
Influenza A virus (A/goose/Guangxi/668/2004(H5NI))		neura(GI:84797405 loc:DQ3210110)
Influenza A virus (A/Goose/Hong Kong/30.14.5/2000(H5NI))	hema(GI:21326674 loc:AY075030)	
Influenza A virus (A/Goose/Hong Kong/3014.8/2000(H5NI))	hema(GI:19697773 loc:AY059482)	
Influenza A virus (A/Goose/Hong Kong/385.3/2000(H5NI))	hema(GI:18092165 loc:AF398417)	
Influenza A virus (A/Goose/Hong Kong/385.5/2000(H5NI))	hema(GI:18092167 loc:AF398418)	
Influenza A virus (A/Goose/Hong Kong/76.1/01 (H5NI))	hema(GI:28849392 loc:AF509036)	
Influenza A virus (A/Goose/Hong Kong/w355/97 (H5NI))	hema(GI:6048760 loc:AF098545)	
Influenza A virus (A/Goose/Hong Kong/ww100/01 (H5NI))	hema(GI:28849394 loc:AF509037)	
Influenza A virus (A/Goose/Hong Kong/ww26/2000(H5NI))	hema(GI:19697757 loc:AY059474)	
Influenza A virus (A/Goose/Hong Kong/ww28/2000(H5NI))	hema(GI:19697759 loc:AY059475)	
Influenza A virus (A/Goose/Hong Kong/ww491/2000(H5NI))	hema(GI:19697769 loc:AY059480)	
Influenza A virus (A/Goose/Huadong/1/2000(H5NI))	hema(GI:76786306 loc:DQ201829)	
Influenza A virus (A/goose/Iraq/812NAMRU3/2006(H5NI))		neura(GI:110227238 loc:DQ8353890)
Influenza A virus (A/goose/jiangsu/131/2002(H5NI))		
Influenza A virus (A/goose/Jiangsu/220/2003(H5NI))		
Influenza A virus (A/goose/Jilin/hb/2003 (H5NI))		neura(GI:115527024 loc:DQ9972770)
Influenza A virus (A/goose/Krasnoozerka/627/2005(H5NI))	hema(GI:108782531 loc:DQ676840)	
Influenza A virus (A/goose/Novosibirsk/4/2005(H5NI))	hema(GI:77641488 loc:DQ212792)	
Influenza A virus (A/Goose/Shantou/1621/05(H5NI))		hema(GI:70955443 loc:DQ095628)
Influenza A virus (A/great black-headed gull/Qinghai/1/2005(H5NI))	hema(GI:71068504 loc:DQ100557)	
Influenza A virus (A/Great Black-headed Gull/Qinghai/2/05(H5NI))	hema(GI:70955423 loc:DQ095614)	
Influenza A virus (A/grebe/Novosibirsk/29/2005(H5NI))	hema(GI:78450309 loc:DQ230521)	

Influenza A virus (A/grebe/Tyva/TyvO6- 8/2006(H5N1))		
Influenza A virus (A/grey heron/HK/861 .1/2002(H5N 1))	hema(GI:50296102 loc:AY651359)	
Influenza A virus (A/grey heron/Hong Kong/18/2005(H5N1))		neura(GI:84797497 loc:DQ3210570)
Influenza A virus (A/grey heron/Hong Kong/837/2005(H5N1))		
Influenza A virus (A/Gs/HK/739.2/02 (H5N1))	hema(GI:47834863 loc:AY575871)	
Influenza A virus (A/Gs/Thailand/79/2004(H5N 1))	hema(GI:50296048 loc:AY651332)	
Influenza A virus (A/Guangxi/1/2005(H5N1))	hema(GI:87137940 loc:DQ371930)	
Influenza A virus (A/guinea fowl/Nigeria/957- 12/2006(H5N I))		
Influenza A virus (A/gull/Pennsylvania/4 175/83(H5N I))	hema(GI:4240453 loc:AF082043)	
Influenza A virus (A/Hanoi/03/2004(H5N1))	hema(GI:47600774 loc:AJ7 15872)	
Influenza A virus (A/Hanoi/30408/2005(H5N1))	hema(GI:78096575 loc:AB239125)	
Influenza A virus (A/Hatay/2004/(H5N1))	hema(GI:563 11401 loc:AJ867074)	
Influenza A virus (A/HK/2 12/03 (H5N1))	hema(GI:47834859 loc:AY575869)	
Influenza A virus (A/HK/2 13/03 (H5N1))	hema(GI:47834861 loc:AY575870)	
Influenza A virus (A/Hong Kong/156/97(H5N1))	hema(GI:3335420 loc:AF046088)	
Influenza A virus (A/Hong Kong/213/03(H5N1))	hema(GI:71013497 loc:AB212054)	
Influenza A virus (A/Hong Kong/481/97(H5N1))	hema(GI:3421251 loc:AF046096)	
Influenza A virus (A/Hong Kong/482/97(H5N1))	hema(GI:3421259 loc:AF046098)	
Influenza A virus (A/Hong Kong/483/1997(H5N1))		
Influenza A virus (A/Hong Kong/485/97(H5N1))	hema(GI:4457125 loc:AF102681)	
Influenza A virus (A/Hong Kong/486/97(H5N1))	hema(GI:44571 15 loc:AF102671)	
Influenza A virus (A/Hong Kong/488/97(H5N1))	hema(GI:44571 16 loc:AF102672)	
Influenza A virus (A/Hong Kong/491/97(H5N1))	hema(GI:4457121 loc:AF102677)	
Influenza A virus (A/Hong Kong/503/97(H5N1))	hema(GI:4457123 loc:AF102679)	
Influenza A virus (A/Hong Kong/S07/97(H5N1))	hema(GI:44571 19 loc:AF102675)	
Influenza A virus (A/Hong Kong/5 14/97(H5N1))	hema(GI:4457126 loc:AF102682)	
Influenza A virus (A/Hong Kong/5 16/97(H5N1))	hema(GI:44571 17 loc:AF102673)	
Influenza A virus (A/Hong Kong/532/1997(H5N1))		
Influenza A virus (A/Hong Kong/538/97(H5N1))	hema(GI:4457118 loc:AF102674)	
Influenza A virus (A/Hong Kong/542/97(H5N1))	hema(GI:4457122 loc:AF 102678)	
Influenza A virus (A/HongKong/97/98(H5N1))	hema(GI:4457120 loc:AF102676)	
Influenza A virus (A/human/Iraq/207-	hema(GI:89275866 loc:DQ435202)	

NAMRU3/2006(H5NI))
 Influenza A virus
 (A/Indonesia/5/2005(H5NI))
 Influenza A virus
 (A/Indonesia/CDC184/2005(H5N1
))
 Influenza A virus
 (A/Indonesia/CDC 194P/2005(H5N
 I))
 Influenza A virus
 (A/Indonesia/CDC287E/2005(H5N
D)
 Influenza A virus
 (A/Indonesta/CDC287T/2005(H5N
D)
 Influenza A virus
 (A/Indonesia/CDC292N/2005(H5N
D)
 Influenza A virus
 (A/Indonesia/CDC292T/2005(H5N
 I))
 Influenza A virus
 (A/Indonesia/CDC326/2006(H5N1
))
 Influenza A virus
 (A/Indonesia/CDC326N/2006(H5N
D)
 Influenza A virus
 (A/Indonesia/CDC326N2/2006(H5
 NI))
 Influenza A virus
 (A/Indonesia/CDC326T/2006(H5N
D)
 Influenza A virus
 (A/Indonesia/CDC329/2006(H5N 1
))
 Influenza A virus
 (A/Indonesia/CDC357/2006(H5N1
))
 Influenza A virus
 (A/Indonesia/CDC370/2006(H5N1
))
 Influenza A virus
 (A/Indonesia/CDC370E/2006(H5N
D)
 Influenza A virus
 (A/Indonesia/CDC3 70P/2006(H5N
D)
 Influenza A virus
 (A/Indonesia/CDC3 70T/2006(H5N
D)
 Influenza A virus
 (A/Indonesia/CDC390/2006(H5N1
))
 Influenza A virus
 (Mndonesia/CDC523/2006(H5N1
))
 Influenza A virus
 (A/Indonesia/CDC523E/2006(H5N
D)
 Influenza A virus
 (A/Indonesia/CDC523T/2006(H5N
D)
 Influenza A virus
 (A/Indonesia/CDC582/2006(H5N1
))

neura(GI: 113495546
loc:CY0142370)
 neura(GI: 113495564
loc:CY0 142400)
 neura(GI:l 13495550
loc:CY0142380)
 neura(GI: 113495482
loc:CY0142270)
 neura(GI: 113495488
loc:CY0 142280)
 neura{GI:l 13495558
loc:CY0142390)
 neura(GI: 113495538
loc:CY0 142360)
 neura(GI: 113495494
loc:CY0142290)
 neura(GI:l 13495532
loc:CY0142350)
 neura(GI:l 13495500
loc:CY0 142300)
 neura(GI: 113495506
loc:CY01423 10)
 neura(GI: 1134955 10
loc:CY0 142320)
 neura(GI: 113495517
loc:CY0 142330)
 neura(GI: 113496057
loc:CY0143130)
 neura(GI:l 13496416
locrCYO 143700)
 neura(GI: 113496470
loc:CY0143780)
 neura(GI: 1134965 17
loc:CY0 143860)

Influenza A virus (A/Indonesia/CDC594/2006(H5N1)))	neura(GI:l 13495791 loc:CY0142740)
Influenza A virus (A/Indonesia/CDC595/2006(H5N1)))	neura(GI: 113495850 loc:CY0142820)
Influenza A virus (A/Indonesia/CDC596/2006(H5N1)))	neura(GI: 113495913 loc:CY0 142900)
Influenza A virus (A/Indonesia/CDC597/2006(H5N1)))	neura(GI:l 13495962 loc:CYO 142980)
Influenza A virus (A/Indonesia/CDC599/2006(H5N1)))	neura(GP. 113496007 loc:CYO 143050)
Influenza A virus (A/Indonesia/CDC599N/2006(H5N1 I))	neura(GI:l 13497145 loc-.CYO 144790)
Influenza A virus (A/Indonesia/CDC610/2006(H5N1)))	neura(GI: 113496585 loc:CYO 143980)
Influenza A virus (A/Indonesia/CDC623/2006(H5N1)))	neura(GI: 113496639 loc:CYO 144060)
Influenza A virus (A/Indonesia/CDC623E/2006(H5N I))	neura(GI:113496689 loc:CYO144140)
Influenza A virus (A/Indonesia/CDC624/2006(H5N1)))	neura(GI:l 13496736 loc:CYO144220)
Influenza A virus (A/Indonesia/CDC624E/2006(H5N D))	neura(GI: 113496823 loc:CYO144300)
Influenza A virus (A/Indonesia/CDC625/2006(H5N1)))	neura(GI: 113496872 loc:CYO144380)
Influenza A virus (A/Indonesia/CDC625L/2006(H5N I))	neura(GI:l 13497086 loc:CYO 144700)
Influenza A virus (A/Indonesia/CDC634/2006(H5N1)))	neura(GI: 113496923 loc:CYO144460)
Influenza A virus (A/Indonesia/CDC634P/2006(H5N I))	neura(GI: 113496974 loc:CYO144540)
Influenza A virus (A/Indonesia/CDC634T/2006(H5N I))	neura(GI: 113497027 loc:CYO144620)
Influenza A virus (A/Indonesia/CDC644/2006(H5N1)))	neura(GI: 113497373 loc:CYO145 150)
Influenza A virus (A/Indonesia/CDC644T/2006(H5N I))	neura(GI:l 13497327 loc:CYO145070)
Influenza A virus (A/Indonesia/CDC669/2006(H5N1)))	neura(GI: 113497197 loc:CYO144860)
Influenza A virus (A/Indonesia/CDC669P/2006(H5N I))	neura(GI: 113497244 loc:CYO 144940)
Influenza A virus (A/Indonesia/CDC699/2006(H5N1)))	neura(GI:l 13497295 loc:CYO 145020)
Influenza A virus (A/Indonesia/CDC7/2005(H5N 1))	neura(GI: 113494563 loc:CYO141790)
Influenza A virus (A/Indonesia/CDC739/2006(H5N1)))	neura(GI:l 13972296 loc:CYO1453 10)

))		
Influenza A virus (A/Indonesia/CDC742/2006(H5N1		neura(GI:1 139723 15 loc:CY0145390)
))		
Influenza A virus (A/Indonesia/CDC759/2006(H5N1		neura(GI: 113972329 loc:CY0145450)
))		
Influenza A virus (A/kalij pheasant/Thailand/CU- 4/2004(H5N1))	hema(GI:463 01437 loc:AY590569)	
Influenza A virus (A/Kalji pheasan(/Bangkok/Thailand/2004(H5N1))		
Influenza A virus (A/Kalji Pheasant/Bangkok/Thailand/CU- 18/O4(H5N1))		
Influenza A virus (A/leopard/Suphanburi/Thailand/Le o-1/04(H5N1))	hema(GI:50083246 loc:AY646175)	
Influenza A virus (A/leopard/Thailand/CU- MD/2004(H5N1))	hema(GI:46361441 loc:AY590571)	
Influenza A virus (A/leopard/Thailand/TLV3/2004(H 5N1))	hema(GI:4533 1159 loc:AY535021)	
Influenza A virus (A/leopard/Thailand/TM3/2004(H5 N1))	hema(GI:45331 157 loc:AY535020)	
Influenza A virus (A/little grebe/Thailand/Phichit- 01/2004(H5N1))	hema(GI:46244265 loc:AY553802)	
Influenza A virus (A/littlecuckoo- dove/Tak-2-01/2004(H5N1))	hema(GI:66473378 loc:DQ017280)	
Influenza A virus (A/Mallard duck/Vietnam/133/2004(H5N1))	hema(GI:84797263 loc:DQ320940)	
Influenza A virus (A/Mallard duck/Vietnam/133/2005(H5N1))		neura(GI:84797525 loc:DQ3210710)
Influenza A virus (A/mallard/Italy/3401/2005(H5N1))	hema(GI: 110273403 loc:DQ838508)	
Influenza A virus (A/mallard/Ohio/184/1986(H5N1))		
Influenza A virus (A/mallard/Wisconsin/428/1975(H 5N1))		
Influenza A virus (A/muscovy duck/Thailand/Tak- 01/2004(H5N1))	hema(GI:46244267 loc:AY553803)	
Influenza A virus (A/muscovy duck/Vietnam/MdGL/2004(H5N1))	hema(GI:45934604 loc:AY576930)	
Influenza A virus (A/mute swan/Croatia/1/2005(H5N1))	hema(GI:90103019 loc:DQ453 141)	
Influenza A virus (A/Mynas/Ranong/Thailand/CU- 209/04(H5N1))	hema(GI:7 1277666 loc:DQ083585)	
Influenza A virus (A/open bill/Bangkok/Thailand/2004(H5N1)		
Influenza A virus (A/openbill/Thailand/CU- 2/2004(H5N1))	hema(GI:46361445 loc:AY590577)	
Influenza A virus (A/ostrich/HeNan/14/2002(H5N1))		
Influenza A virus (A/Ostrich/Samut Prakan/Thailand/CU-19/04(H5N1))	hema(GI:7 1277630 loc:DQ083567)	
Influenza A virus (A/ostrich/Samut Prakan/Thailand/CU-31/04(H5N1))	hema(GI:7 1277644 loc:DQ083574)	

Influenza A virus (A/partridge/Thailand/Sukhothai-01/2004(H5NI))	hema(GI:46244243 loc:AY553791)	
Influenza A virus (A/partridge/Thailand/Uttaradit-01/2004(H5NI))	hema(GI:46244235 loc:AY553787)	
Influenza A virus (A/peregrine falcon/HK/D0028/2004(H5N I))	hema(GI:50296108 loc:AY651362)	
Influenza A virus (A/Ph/HK/674.15/02 (H5N1))		
Influenza A virus (A/Ph/HK/675. 14/02 (H5N1))	hema(GI:47834889 loc:AY575880)	
Influenza A virus (A/Ph/HK/sv674.15/02 (H5N1))		
Influenza A virus (A/Ph/ST/44/2004(H5NI))	hema(GI:502961 16 loc:AY651366)	
Influenza A virus (A/Pheasant/HongKong/FY155/01(H5N1))	hema(GI:28808463 loc:AY221526)	
Influenza A virus (A/Pheasant/HongKong/FY155/01-MB(H5N1))	hema(GI:28808108 loc:AY221525)	
Influenza A virus (A/Pigeon/Hong Kong/SF215/01 (H5N1))	hema(GI:28849366 loc:AF509023)	
Influenza A virus (A/pigeon/Samut Prakan/Thailand/CU-202/04(H5NI))	hema(GI:71277662 loc:DQ083583)	
Influenza A virus (A/Qa/Thailand/57/2004(H5NI))	hema(GI:50296042 loc:AY651329)	
Influenza A virus (A/Quail/Hong Kong/SF203/01 (H5N1))	hema(GI:28849364 loc:AF509022)	
Influenza A virus (A/quail/Malaysia/6309/2004(H5N1))	hema(GI:84797253 loc:DQ320935)	
Influenza A virus (A/quail/Malaysia/6309/2005(H5N1))		neura(GI:84797513 loc:DQ32 10650)
Influenza A virus (A/Quail/Shantou/91 1/O5(H5N1))	hema(GI:91984134 loc:DQ095627)	
Influenza A virus (A/quail/Thailand/CU-KTH/2004(H5NI))	hema(GI:46361454 loc:AY590573S2)	
Influenza A virus (A/quail/Thailand/CU-KTNF/2004(H5NI))		
Influenza A virus (A/quail/Thailand/KTHF/2004(H5NI))	hema(GI:44982789 loc:AY534913)	
Influenza A virus (A/quail/Thailand/Nakhon Pathom/QA-161/2005(H5NI))		
Influenza A virus (A/quail/Viet Nam/15/2005(H5NI))		
Influenza A virus (A/quail/Viet Nam/TG-007B/2004(H5NI))	hema(GI:72398644 loc:DQ099757)	
Influenza A virus (A/quail/Vietnam/36/04(H5NI))	hema(GI:58618441 loc:AY818137)	
Influenza A virus (A/quail/yunnan/092/2002(H5N 1))		
Influenza A virus (A/R(duck/Mongolia/54/0 1-duck/Mongolia/47/01)(H5NI))		
Influenza A virus (A/R(turkey/Ontari α7732/66-Bellamy/42)(H5N1))		
Influenza A virus (A/rollers/Bangkok/Thailand/CU-	hema(GI:71277638 loc:DQ083571)	

26/04(1-15N1))		
Influenza A virus (A/SCK/HK/YU100/2002(H5N1))	hema(GI:50296080 loc:AY651348)	
Influenza A virus (A/Silky Chicken/Hong Kong/pl7/97 (H5N1))	hema(GI:6048762 loc:AF098546)	
Influenza A virus (A/Silky Chicken/Hong Kong/SF 189/01 (H5N1))	hema(GI:28849362 loc:AF509021)	
Influenza A virus (A/sparrow/Phang- Nga/Thailand/CU-203/04(H5N1))	hema(GI:71277664 loc:DQ083584)	
Influenza A virus (A/swan/Astrakhaπ/1/2005(H5N1))	hema(GI:84627165 loc:DQ320137)	
Influenza A virus (A/swan/Guangxi/307/2004(H5N1))		
Influenza A virus (A/swine/Anhui/2004(H5N1))		
Influenza A virus (A/swine/Fujian/1/2003(H5N1))	hema(GI:54126496 loc:AY747609)	
Influenza A virus (A/swine/Fujian/FI/2001(H5N1))	hema(GI:54 126527 loc:AY747617)	
Influenza A virus (A/swine/Guangdong/1/2003(H5N I))		
Influenza A virus (A/swine/Guangdong/2/2003(H5N I))		
Influenza A virus (A/swine/Guangdong/4/2003(H5N I))		
Influenza A virus (A/swine/Guangdong/5/2003(H5N I))		
Influenza A virus (A/swine/Henan/wy/2004(H5N1))		neura(GI: 115607428 loc:DQ9972540)
Influenza A virus (A/swine/Shandong/2/03(H5N1))	hema(GI:50261904 loc:AY646424)	
Influenza A virus (A/teal/China/2978.1/2002(H5N1))	hema(GI:50296088 loc:AY651352)	
Influenza A virus (A/Thailand/1(KAN- 1)/2004(H5N1))	hema(GI:46578137 loc:AY555150)	
Influenza A virus (A/Thailand/2(SP- 33)/2004(H5N1))	hema(GI:45453833 loc:AY555153)	
Influenza A virus (A/Thailand/3(SP- 83)/2004(H5N1))	hema(GP.46578415 loc:AY577314)	
Influenza A virus (A/Thailand/4(SP- 528)/2004(H5N1))	hema(GI:54402286 loc:AY626143)	
Influenza A virus (A/Thailand/5(KK- 494)/2004(H5N1))	hema(GI:54299827 loc:AY627885)	
Influenza A virus (A/Thailand/676/2005(H5N I))		neura(GI:85680901 loc:DQ3608360)
Influenza A virus (A/Thailand/EKA2NF/2004(H5N1))		
Influenza A virus (A/Thailand/Kamphaeng phet- Nontaburi/04(H5N1))	hema(GI:56 122600 loc:AY786078)	
Influenza A virus (A/Thailand/LFPN- 2004/2004(H5N1))	hema(GI:50843949 loc:AY679514)	

Influenza A virus (A/tiger/Suphanburi/Thailand/Ti- l/04(H5N1))	hema(GI:50083230 loc:AY646167)
Influenza A virus (A/tiger/Thailand/CU- LV/2004(H5N1))	
Influenza A virus (A/tiger/Thailand/CU- T3/2004(H5N1))	hema(GI:56792949 loc:AY842935)
Influenza A virus (A/tiger/Thailand/CU- T4/O4(H5N1))	hema(GI:62466138 loc:AY972539)
Influenza A virus (A/tiger/Thailand/CU- T5/O4(H5N1))	hema(GI:62466140 loc:AY972540)
Influenza A virus (A/tiger/Thailand/CU- T6/O4(H5N1))	hema(GI:62466142 loc:AY972541)
Influenza A virus (A/tiger/Thailand/CU- T7/2004(H5N1))	hema(GI:58198724 loc:AY866475)
Influenza A virus (A/tiger/Thailand/CU- T8/O4(H5N1))	hema(GI:62466144 loc:AY972542)
Influenza A virus (A/tiger/Thailand/SPB- 1(H5N1))	hema(GI:56553497 loc:AY834279)
Influenza A virus (A/tiger/Thailand/TLV l/2004(H5N I))	hema(GI:45331 161 loc:AY535022)
Influenza A virus (A/tree sparrow/Henan/1/2004(H5N 1))	hema(GI:56672789 loc:AY741215)
Influenza A virus (A/tree sparrow/Henan/2/2004(H5N 1))	hema(GI:56672873 loc:AY741217)
Influenza A virus (A/tree sparrow/Henan/3/2004(H5N1))	hema(GI:56672930 loc:AY741219)
Influenza A virus (A/tree sparrow/Henan/4/2004(H5N1))	hema(GI:56673032 loc:AY741221)
Influenza A virus (A/tree sparrow/HK/864/2002(H5N1))	hema(GI:50296106 loc:AY651361)
Influenza A virus (A/turkey/Egypt/56 13NAMRU3- T/2006(H5N1))	
Influenza A virus (A/turkey/England/50- 92/1991(H5N1))	
Influenza A virus (A/turkey/England/50- 92/91(H5N1))	
Influenza A virus (A/turkey/Israel/345/2006(H5N I))	
Influenza A virus (A/turkey/Turkey/l/2005(H5N1))	hema(GI: 1468922 loc:D86168)
Influenza A virus (A/Viet Nam/1 194/2004(H5N1))	hema(GI:50296050 loc:AY651333)
Influenza A virus (A/Viet Nam/1203/2004(H5N1))	hema(GI:50296052 loc:AY651334)
Influenza A virus (A/Viet Nam/3046/2004(H5N1))	hema(GI:50296054 loc:AY651335)
Influenza A virus (A/Viet Nam/3062/2004(H5N1))	hema(GI:50296056 loc:AY651336)
Influenza A virus (A/Viet Nam/33/2004(H5N1))	
Influenza A virus (A/Viet Nam/BL- 014/05(H5N1))	
Influenza A virus (A/Viet Nam/BL- 014/2005(H5N1))	
Influenza A virus (A/Viet	hema(GI:561 19233 loc:AY720950)

Nam/DN-33/2004(H5N1))		
Influenza A virus (A/Viet Nam/DT-036/2005(H5N1))		
Influenza A virus (A/Viet Nam/HG-1 78/2004(H5N1))		
Influenza A virus (A/Viet Nam/HG-207/2005(H5N 1))		
Influenza A virus (A/Viet Nam/HN/2004(H5N1))		
Influenza A virus (A/Viet Nam/LA-028/2005(H5N1))		
Influenza A virus (A/Viet Nam/VL-020/2005(H5N1))		
Influenza A virus (A/Vietnani/1 196/2004(H5N1))	hema(GI:4 1057634 loc:AY526745)	
Influenza A virus (A/white peafowl/Bangkok/Thailand/2004(H 5N1))		
Influenza A virus (A/white peafowl/Bangkok/Thailand/CU- 16/O4(H5N1))	hema(GI:7 1277624 loc:DQ083564)	
Influenza A virus (A/white peafowl/Bangkok/Thailand/CU- 29/O4(H5N1))	hema(GI:71277642 loc:DQ083573)	
Influenza A virus (A/white peafowl/Thailand/CU- 11/2004(H5N1))	hema(GI:46361439 loc:AY590570)	
Influenza A virus (A/whooper swan/Mongolia/2/06(H5N 1))		neura(GI: 110277998 loc:AB2652020)
Influenza A virus (A/whooper swan/Mongolia/244/2005(H5N1))		
Influenza A virus (A/whooper swan/Mongolia/3/05(H5N I))	hema(GI:8 16871 18 loc:AB233320)	
Influenza A virus (A/whooper swan/Mongolia/4/05(H5N 1))	hema(GI:81687122 loc:AB233321)	
Influenza A virus (A/whooper swan/Mongolia/6/05(H5N1))	hema(GI:81687126 loc:AB233322)	
Influenza A virus (A/wild duck/Guangdong/3 14/2004(H5N1))		
Influenza A virus (A/wild duck/Omsk/103-01/05(H5N1))	hema(GI: 111380029 loc:DQ864721)	
Influenza A virus(A/goose/nfav1 (H5N1))		
Influenza A virus (A/avian/NY/3 1588-2/00(H5N2))	hema(GI:32165559 loc:AY296069)	
Influenza A virus (A/avian/NY/3 1588-3/00(H5N2))	hema(GI:32165561 loc:AY296070)	
Influenza A virus (A/avian/NY/53726/00(H5N2))	hema(GI:32165569 loc:AY296074)	
Influenza A virus (A/Chick/Penn/1370/I983(H5N2))		
Influenza A virus (A/chick/Pennsylvania/1/1983(H5 N2))	hema(GI:323981 loc:FLACP83HA)	
Influenza A virus (A/chicken/Aguascalientes/124- 3705/98 (H5N2))	hema(GI:40732575 loc:AY497081)	
Influenza A virus (A/chicken/Chiapa/28 159-488/95 (H5N2))	hema(GI:40732549 loc:AY497068)	
Influenza A virus (A/chicken/Chiapas/1 5224/97 (H5N2))	heraa(GI:40732561 loc:AY497074)	
Influenza A virus (A/chicken/Chiapas/15405/97 (H5N2))	hema(GI:40732563 loc:AY497075)	

Influenza A virus (A/chicken/Chiapas/15406/97 (H5N2))	hema(GI:40732565 loc:AY497076)
Influenza A virus (A/chicken/Chiapas/15408/97 (H5N2))	hema(GI:40732569 loc:AY497078)
Influenza A virus (A/chicken/Chiapas/28 159-488/95 (H5N2))	
Influenza A virus (A/chicken/El Salvador/10271 1-1/01 (H5N2))	hetna(GI:40732599 loc:AY497093)
Influenza A virus (A/chicken/El Salvador/10271 1-2/01 (H5N2))	hema(GI:40732601 loc:AY497094)
Influenza A virus (A/chicken/Florida/22780- 2/88(H5N2))	
Influenza A virus (A/chicken/Florida/2507/89(H5N2))	
)	
Influenza A virus (A/chicken/Florida/25717/1993(H5 N2))	hema(GI:5H251 loc:IAU05332)
Influenza A virus (A/chicken/Florida/277 16- 2/86(H5N2))	
Influenza A virus (A/chicken/FO/22066/98 (H5N2))	hema(GI:40732571 loc:AY497079)
Influenza A virus -(A/chicken/France/03426a/03(H5N 2))	hema(GI:89994622 loc:AJ632269)
Influenza A virus (A/chicken/Guanajuato/28 159- 331/95 (H5N2))	hema(GI:40732541 loc:AY497064)
Influenza A virus (A/chicken/Guatemala/1 94573/02 (H5N2))	hema(GI:40732603 loc:AY497095)
Influenza A virus (A/chicken/Guatemala/455 11-1/00 (H5N2))	hema(GI:40732589 loc:AY497088)
Influenza A virus (A/chicken/Guatemala/4551 1-2/00 (H5N2))	hema(GI:40732591 loc:AY497089)
Influenza A virus (A/chicken/Guatemala/4551 1-3/00 (H5N2))	hema(GI:40732593 loc:AY497090)
Influenza A virus (A/chicken/Guatemala/455 11-4/00 (H5N2))	hema(GI:40732595 loc:AY497091)
Influenza A virus (A/chicken/Guatemala/455 11-5/00 (H5N2))	hema(GI:40732597 loc:AY497092)
Influenza A virus (A/chicken/Hidalgo/232/94 (H5N2))	hema(GI:40732539 loc:AY497063)
Influenza A virus (A/chicken/Hidalgo/26654- 1368/1994(H5N2))	hema(GI:l 125716 loc:IAU37172)
Influenza A virus (A/chicken/Hidalgo/26654-1368/94 (H5N2))	
Influenza A virus (A/chicken/Hidalgo/28 159-232/95 (H5N2))	
Influenza A virus (A/chicken/Hidalgo/28159-460/95 (H5N2))	hema(GI:40732545 loc:AY497066)
Influenza A virus	

(A/chicken/Italy/330/97(H5N2))	
Influenza A virus (A/chicken/Italy/367/97(H5N2))	hema(GI:12619370 loc:AF 194990)
Influenza A virus (A/chicken/Italy/8/98(H5N2))	hema(GI:9998886 loc:PPA278915)
Influenza A virus (A/chicken/Jalisco/14585- 660/1994(H5N2))	hema(GI:l 125734 loc:IAU37181)
Influenza A virus (A/chicken/Jalisco/14585-660/94 (H5N2))	
Influenza A virus (A/chicken/Jalisco/229-4592/98 (H5N2))	hema(GI:40732579 loc:AY497083)
Influenza A virus (A/chicken/Jalisco/28 159-600/95 (H5N2))	hema(GI:40732557 loc:AY497072)
Influenza A virus (A/chicken/Massachusetts/1 1801/8 6(H5N2))	
Influenza A virus (A/chicken/Mexico/15407/97 (H5N2))	hema(GI:40732567 loc:AY497077)
Influenza A virus (A/chicken/Mexico/232/94 (H5N2))	hema(GI:40732605 loc:AY497096)
Influenza A virus (A/chicken/Mexico/26654- 1374/1994(H5N2))	hema(GI:l 125718 loc:IAU37173)
Influenza A virus (A/Chicken/Mexico/26654- 1374/94 (H5N2))	
Influenza A virus (A/Chicken/Mexico/26654-1374/97 (H5N2))	
Influenza A virus (A/Chicken/Mexico/26654-1734/94 (H5N2))	
Influenza A virus (A/chicken/Mexico/28159-541/95 (H5N2))	hema(GI:40732555 loc:AY497071)
Influenza A virus (A/chicken/Mexico/3 1381- 1/1994(H5N2))	hema(GI:l 125704 loc:IAU37166)
Influenza A virus (A/chicken/Mexico/3 1381- 2/1994(H5N2))	hema(GI: 1125706 loc:IAU37167)
Influenza A virus (A/chicken/Mexico/3 1381- 3/1994(H5N2))	hema(GI: 1125724 loc:IAU37176)
Influenza A virus (A/chicken/Mexico/3 1381- 4/1994(H5N2))	hema(GI: 1125720 loc:IAU37174)
Influenza A virus (A/chicken/Mexico/3 1381 - 5/1994(H5N2))	hema(GI: 1125710 loc:IAU37169)
Influenza A virus (A/chicken/Mexico/3 1381- 6/1994(H5N2))	hema(GI:l 125722 loc:IAU37175)
Influenza A virus (A/chicken/Mexico/3 1381- 7/1994(H5N2))	hema(GI:l 125702 loc:IAU37165)
Influenza A virus (A/chicken/Mexico/3 1381- 8/1994(H5N2))	hema(GI:l 125712 loc:IAU37170)
Influenza A virus (A/Chicken/Mexico/3 1381-	hema(GI: 17028029 locrFLAHSP)

Avilab/94(H5N2))		
Influenza A virus (A/chicken/Mexico/3 1382- 1/1994(H5N2))	hema(GI: 1125708 loc:IAU37168)	
Influenza A virus (A/Chicken/Mexico/3 1382-7/94 (H5N2NSB))		
Influenza A virus (A/chicken/Mexico/37821-771/96 (H5N2))	hema(GP.40732559 loc:AY497073)	
Influenza A virus (A/chicken/Michoacan/28 159- 530/95 (H5N2))	hema(GI:40732551 loc:AY497069)	
Influenza A virus (A/chicken/Morelos/227-4353/98 (H5N2))	hema(GI:40732577 loc:AY497082)	
Influenza A virus (A/chicken/Morelos/28159-538/95 (H5N2))	hema(GI:40732553 loc:AY497070)	
Influenza A virus (A/chicken/Morelos/F0221 89/98 (H5N2))	hema(GI:40732573 loc:AY497080)	
Influenza A virus (A/Chicken/New Jersey/1 2508/86(H5N2))	hema(GI:9621799 loc:AF164658)	
Influenza A virus (A/Chicken/New York/12004-3/87(H5N2))	hema(GI:9621809 loc:AF164663)	
Influenza A virus (A/Chicken/Ohio/22911- 10/86(H5N2))	hema(GI:9621805 loc:AF164661)	
Influenza A virus (A/Chicken/Pennsylvania/1 02 10/86 (H5N2))	hema(GI:9621801 loc:AF164659)	
Influenza A virus (A/chicken/Pennsylvania/13609/19 93(H5N2))	hema(GI:5 14249 loc:IAU0533 1)	
Influenza A virus (A/Chicken/Pennsylvania/13609/93 (H5N2NSB))		
Influenza A virus (A/chicken/Pennsylvania/1 370/198 3(H5N2))		neura(GI:324535 loc:FLANAMY0)
Influenza A virus (A/chicken/Pennsylvania/8 125/198 3(H5N2))		neura(GI:324533 loc:FLANAMW0)
Influenza A virus (A/chicken/Pennsylvania/8 125/83(H5N2))		
Influenza A virus (A/chicken/Puebla/14585- 622/1994(H5N2))	hema(GI: 1125730 loc:IAU37179)	
Influenza A virus (A/Chicken/Puebla/14585-622/94 (H5N2))		
Influenza A virus (A/chicken/Puebla/14586- 654/1994(H5N2))	hema(GI: 1125732 loc:IAU37180)	
Influenza A virus (A/chicken/Puebla/14586-654/94 (H5N2))		
Influenza A virus (A/chicken/Puebla/23 1-5284/98 (H5N2))	hema(GI:40732581 loc:AY497084)	
Influenza A virus (A/chicken/Puebla/28 159-474/95 (H5N2))	hema(GI:40732547 loc:AY497067)	
Influenza A virus (A/chicken/Puebla/6823-607/94		

(H5N2))		
Influenza A virus (A/chicken/Puebla/8623-607/1994(H5N2))	hema(GI:l 125728 loc:IAU37178)	
Influenza A virus (A/Chicken/Puebla/8623-607/94(H5N2))	hema(GI: 1702803 1 loc:FLAHSPA)	
Influenza A virus (A/chicken/Puebla/8624-602/94(H5N2))		
Influenza A virus (A/chicken/Puebla/8624-604/1994(H5N2))	hema(GI: 1125726 loc:IAU37177)	
Influenza A virus (A/chicken/Queretaro/26654-1373/94 (H5N2))		
Influenza A virus (A/chicken/Queretaro/14588-19/1994(H5N2))	hema(GI: 1125736 loc:IAU37182)	
Influenza A virus (A/chicken/Queretaro/14588-19/1995(H5N2))		neura(GI:l 15279354 loc:CY0150980)
Influenza A virus (A/Chicken/Queretaro/14588-19/94(H5N2))		
Influenza A virus (A/Chicken/Queretaro/14588-19/95(H5N2))	hema(GI: 17028033 loc:FLAHSPB)	
Influenza A virus (A/chicken/Queretaro/220 19-853/96 (H5N2))	hema(GI:40732587 loc:AY497087)	
Influenza A virus (A/chicken/Queretaro/26654-1373/1994(H5N2))	hema(GI:l 125714 loc:IAU37171)	
Influenza A virus (A/chicken/Queretaro/7653-20/1995(H5N2))		
Influenza A virus (A/chicken/Queretaro/7653-20/95(H5N2))	hema(GI:1840061 loc:IAU79448)	
Influenza A virus (A/chicken/Tabasco/234-8289/98(H5N2))	hema(GI:40732585 loc:AY497086)	
Influenza A virus (A/chicken/Taiwan/1209/03(H5N2))	hema(GI:463 18052 loc:AY573917)	
Influenza A virus (A/chicken/TX/2983 13/04(H5N2))	hema(GI:61612087 loc:AY849793)	
Influenza A virus (A/chicken/VeraCruz/232-6 169/98(H5N2))	hema(GI:40732583 loc:AY497085)	
Influenza A virus (A/chicken/VeraCruz/28159-398/95 (H5N2))	hema(GI:40732543 loc:AY497065)	
Influenza A virus (A/Chicken/Virginia/400 18/84(H5N2))	hema(GI:9621797 loc:AF164657)	
Influenza A virus (A/chukkar/MN/14591-7/98(H5N2))		
Influenza A virus (A/chukkar/MN/14951-7/98(H5N2))	hema(GI:32 165549 loc:AY296064)	
Influenza A virus (A/chukkar/NY/5 1375/00(H5N2))	hema(GI:32165567 loc:AY296073)	
Influenza A virus (A/ck/Washington/13413/84(H5N2)	hema(GI: 16225942 loc:AF420254)	

))		
Influenza A virus (A/duck/BritishColumbia/CN26- 6/05(H5N2))	hema(GI:83817209 loc:DQ309440)	
Influenza A virus (A/duck/Hong Kong/342/78(H5N2))	hema(GI:902784 loc:IAU20475)	
Influenza A virus (A/duck/ME/151895- 7A/02(H5N2))	hema(GI:32 165579 loc:AY296079)	
Influenza A virus (A/duck/Michigan/1980(H5N2))		
Influenza A virus (A/duck/Minnesota/15 16/198 1(H5 N2))	hema(GI: 115278384 loc:CY014722)	
Influenza A virus (A/duck/MN/1 564/8 1(H5N2))		
Influenza A virus (A/duck/Mongolia/54/0 1(H5N2))	hema(GI:82581224 loc:AB241614)	
Influenza A virus (A/duck/NJ/1 17228-7/01(H5N2))	hema(GI:32165575 loc:AY296077)	
Influenza A virus (A/duck/NY/1 85502/02(H5N2))	hema(GI:32165581 loc:AY296080)	
Influenza A virus (A/duck/NY/186875/02(H5N2))	hema(GI:32165583 loc:AY296081)	
Influenza A virus (A/duck/NY/19 1255-79/02(H5N2))	hema(GI:32165585 loc:AY296082)	
Influenza A virus (A/duck/NY/440 18-1/00(H5N2))	hema(GI:32 165563 loc:AY296071)	
Influenza A virus (A/duck/NY/44018-2/00(H5N2))	hema(GI:32165565 loc:AY296072)	
Influenza A virus (A/duck/Pennsylvania/84(H5N2))	hema(GI:902780 loc:IAU20473)	
Influenza A virus (A/duck/Potsdam/1402- 6/86(H5N2))	hema(GI:4240451 loc:AF082042)	
Influenza A virus (A/duck/Primorie/2621/01(H5N2))	hema(GI:57208072 loc:AJ62181 1)	
Influenza A virus (A/emu/Texas/39442/93(H5N2))		
Influenza A virus (A/emu/Texas/39924/93 (H5N2NSA))		
Influenza A virus (A/environment/NY/5626- 1/98(H5N2))	hema(GI:32 165553 loc:AY296066)	
Influenza A virus (A/environment/NY/5626- 17/98(H5N2))	hema(GI:32165557 loc:AY296068)	
Influenza A virus (A/environment/NY/5626- 2/98(H5N2))	hema(GI:32165555 loc:AY296067)	
Influenza A virus (A/guinea fowl/Italy/330/97(H5N2))		neura(GI:78096760 loc:CY0049690)
Influenza A virus (A/mallard duck/ALB/645/1980(H5N2))		
Influenza A virus (A/mallard duck/PA/10218/84(H5N2))		
Influenza A virus (A/mallard/Alberta/645/80(H5N2))		
Influenza A virus (A/mallard/AR/1 C/200 1(H5N2))		
Influenza A virus (A/mallard/Maryland/252/200 1(H5 N2))		
Influenza A virus (A/maUard/Maryland/258/2001(H5 N2))		

Influenza A virus
 (A/mallard/Maryland/302/2001(H5N2))
 Influenza A virus
 (A/mallard/Maryland/470/2002(H5N2))
 Influenza A virus
 (A/mallard/Maryland/786/2002(H5N2))
 Influenza A virus
 (A/mallard/Maryland/791/2002(H5N2))
 Influenza A virus
 (A/mallard/Maryland/792/2002(H5N2))
 Influenza A virus
 (A/mallard/Maryland/795/2002(H5N2))
 Influenza A virus
 (A/mallard/Maryland/890/2002(H5N2))
 Influenza A virus
 (A/mallard/MI/18/80(H5N2))
 Influenza A virus
 (A/mallard/MN/133/98(H5N2))
 Influenza A virus
 (A/mallard/MN/25/80(H5N2))
 Influenza A virus
 (A/mallard/Netherlands/3/99(H5N2))
 hema(GI:56425026 loc:AY684894)
 Influenza A virus (A/mallard/New York/189/1982(H5N2))
 Influenza A virus
 (A/mallard/NZ/1/97(H5N2))
 Influenza A virus
 (A/mallard/NZ/2/97(H5N2))
 Influenza A virus
 (A/mallard/Ohio/345/88(H5N2)) hema(GI: 1840065 loc:IAU79450)
 Influenza A virus
 (A/mallard/Sweden/2/02(H5N2)) hema(GI:66820041 loc:AY995883)
 Influenza A virus
 (A/mallard/Sweden/2/02(H5N2)) hema(GI:66820053 loc:AY995885)
 Influenza A virus
 (A/mallard/Sweden/3/02(H5N2)) hema(GI:66820115 loc:AY995889)
 Influenza A virus
 (A/mallard/Sweden/64/02(H5N2)) hema(GI:66820199 loc:AY995896)
 Influenza A virus
 (A/mallard/Sweden/7/02(H5N2)) hema(GI:66820047 loc:AY995884)
 Influenza A virus (A/ostrich/South Africa/1/2004(H5N2))
 Influenza A virus
 (A/parrot/CA/6032/04(H5N2)) hema(GI:82504509 loc:DQ256383)
 Influenza A virus
 (A/pheasant/NJ/1355/98(H5N2)) hema(GI:32165551 loc:AY296065)
 Influenza A virus
 (A/poultry/Italy/330/1997(H5N2))
 Influenza A virus
 (A/poultry/Italy/365/1997(H5N2))
 Influenza A virus
 (A/poultry/Italy/367/1997(H5N2))
 Influenza A virus
 (A/poultry/Italy/373/1997(H5N2))
 Influenza A virus
 (A/poultry/Italy/382/1997(H5N2))
 Influenza A virus
 (A/poultry/Italy/392/1997(H5N2))
 Influenza A virus

(A/quail/Oregon/207 19/86(H5N2))
 Influenza A virus (A/ruddy
 turnstone/Delaware/244/9 1
 (H5N2)) hema(GI:5 14247 loc:IAU05330)
 Influenza A virus
 (A/teal/Italy/393 1/2005(H5N2))
 Influenza A virus
 (A/turkey/CA/D020865 1-
 C/02(H5N2)) hema(GI:32 165587 loc:AY296083)
 Influenza A virus
 (A/turkey/CA/D0208652-
 C/02(H5N2))
 Influenza A virus
 (A/turkey/Colorado/72(H5N2)) hema(GI:902778 loc:IAU20472)
 Influenza A virus
 (A/turkey/England/N28/73(H5N2))
 Influenza A virus
 (A/turkey/Minnesota/10734/1995(
 H5N2))
 Influenza A virus
 (A/turkey/Minnesota/1 598/1981(H
 5N2))
 Influenza A virus
 (A/turkey/Minnesota/3/1992(H5N2
))
 Influenza A virus
 (A/turkey/Minnesota/3689-
 1551/1981(H5N2))
 Influenza A virus
 (A/turkey/MN/ 1607/8 1(H5N2))
 Influenza A virus
 (A/turkey/MN/1704/82(H5N2))
 Influenza A virus
 (A/turkey/Ramon/73 (H5N2))
 Influenza A virus
 (A/turkey/TX/14082/81(H5N2))
 Influenza A virus
 (A/turkey/Virginia/40018/84(H5N2
))
 Influenza A virus
 (A/turkey/Virginia/6962/83(H5N2)
)
 Influenza A virus
 (A/unknown/NY/101250-
 18/01(H5N2)) hema(GI:32165573 loc:AY296076)
 Influenza A virus
 (A/unknown/NY/1 18547-
 11/01(H5N2)) hema(GI:32165577 loc:AY296078)
 Influenza A virus
 (A/unknown/NY/98899-
 6/01(H5N2))
 Influenza A virus
 (A/unknown/NY/9899-
 6/01(H5N2)) hema(GI:32165571 loc:AY296075)
 Influenza A virus (A/Anas
 platyrhynchos/Chany
 Lake/9/03(H5N3)) hema(GI:63004175 loc:DQ007623)
 Influenza A virus (A/arctic
 tern/Alaska/300/1975(H5N3))
 Influenza A virus
 (A/chicken/TX/167280-
 4/02(H5N3)) hema(GI:32165591 loc:AY296085)
 Influenza A virus
 (A/duck/France/02 166/2002(H5N3
))
 Influenza A virus (A/duck/Ho Chi
 Minh/014/78(H5N3))

Influenza A virus (A/duck/Hokkaido/10 1/04(H5N3))	hema(GI:82581244 loc:AB241624)	
Influenza A virus (A/duck/Hokkaido/193/04(H5N3))	hema(GI:82581246 loc:AB241625)	
Influenza A virus (A/duck/Hokkaido/299/04(H5N3))	hema(GI:82581248 loc:AB241626)	
Influenza A virus (A/duck/Hokkaido/447/00(H5N3))	hema(GI:82581236 loc:AB241620)	
Influenza A virus (A/duck/Hokkaido/69/00(H5N3))	hema(GI:82581234 loc:AB241619)	
Influenza A virus (A/duck/Hokkaido/84/02(H5N3))	hema(GI:82581242 loc:AB241623)	
Influenza A virus (A/duck/Hong Kong/205/77(H5N3))	hema(GI:4240443 loc:AF082038)	
Influenza A virus (A/duck/Hong Kong/308/78(H5N3))		
Influenza A virus (A/duck/Hong Kong/698/79(H5N3))	hema(GI:4240445 loc:AF082039)	
Influenza A virus (A/duck/Hong Kong/820/80(H5N3))		
Influenza A virus (A/duck/Hong Kong/825/80(H5N3))		
Influenza A virus (A/duck/HongKong/27408/79(H5N 3))		
Influenza A virus (A/duck/Jiangxi/6 151/2003(H5N3))		
Influenza A virus (A/duck/Malaysia/F 119- 3/97(H5N3))	hema(GI: 11596241 loc:AF303057)	
Influenza A virus (A/duck/Miyagi/54/76(H5N3))	hema(GI:82581226 loc:AB241615)	
Influenza A virus (A/duck/Mongolia/500/0 1(H5N3))	hema(GI:82581238 loc:AB241621)	
Influenza A virus (A/duck/Mongolia/596/0 1(H5N3))	hema(GI:82581240 loc:AB241622)	
Influenza A virus (A/duck/Primorie/2633/01(H5N3))	hema(GI: 57208068 loc:AJ621807)	
Influenza A virus (A/duck/Singapore/3/97(H5N3))		
Influenza A virus (A/goose/Hong Kong/23/78(H5N3))		
Influenza A virus (A/goose/HongKong/27404/78(H5 N3))		
Influenza A virus (A/herring gull/NJ/406/1989(H5N3))		neura(GI:78096767 loc:CY0049720)
Influenza A virus (A/mallard/ItaIy/208/2000(H5N3))		
Influenza A virus (A/mallard/Sweden/39/02(H5N3))	hema(GI:66820141 loc:AY995891)	
Influenza A virus (A/mallard/Sweden/58/02(H5N3))	hema(GI:66820183 loc:AY995895)	
Influenza A virus (A/mallard/Wisconsin/1 69/75 (H5N3NSA))		
Influenza A virus (A/mallard/Wisconsin/169/75(H5N 3))	hema(GI: 1840069 loc:IAU79452)	
Influenza A virus (A/ruddy turnstone/NJ/2242/00(H5N3))	hema(GI:32 165589 loc:AY296084)	
Influenza A virus (A/sabines gull/Alaska/296/1 975(H5N3))		neura(GI: 115279500 loc:CY0151570)
Influenza A virus (A/swan/Hokkaido/4/96(H5N3))	hema(GI:82581228 loc:AB241616)	
Influenza A virus	hema(GI:82581230 loc:AB241617)	

(A/swan/Hokkaido/5 1/96(H5N3))
 Influenza A virus
 (A/swan/Hokkaido/67/96(H5N3)) hema(GI:82581232 ioc:AB241618)
 Influenza A virus hema(GI: 110273405
 (A/teal/Italy/3812/2005(H5N3)) loc:DQ838509)
 Influenza A virus (A/tern/South
 Africa/61(H5N3)) hema(GI:902754 loc:IAU20460)
 Influenza A virus
 (A/tem/Turkmenia/18/1972(H3N3)
)
 Influenza A virus
 (A/turkey/CA/6878/79(H5N3))
 Influenza A virus
 (A/turkey/California/6878/79(H5N
 3))
 Influenza A virus
 (A/gull/Delaware/472000(H5N4))
 Influenza A virus
 (A/gull/Delaware/5/2000(H5N4))
 Influenza A virus
 (A/shorebird/Delaware/1 09/2000(H
 5N4))
 Influenza A virus
 (A/shorebird/Delaware/230/2000(H
 5N4))
 Influenza A virus
 (A/shorebird/Delaware/243/2000(H
 5N4))
 Influenza A virus
 (A/mallard/Sweden/40/02(H5N6)) hema(GI:66820155 loc:AY995892)
 Influenza A virus
 (A/mallard/Wisconsin/34/1975(H5
 N6))
 Influenza A virus
 (A/mallard/Denmark/64650/03(H5
 N7)) hema(GI:46981858 loc:AY531029)
 Influenza A virus
 (A/duck/Ireland/1 13/1983(H5N8)) hema(GI:323965 loc:FLA1 13HA)
 Influenza A virus
 (A/duck/NY/1 9 1255-59/02(H5N8)) hema(GI:32 165593 loc:AY296086)
 Influenza A virus (A/herring
 gull/Delaware/281/98 (H5N8))
 Influenza A virus
 (A/shorebird/Delaware/207/98
 (H5N8))
 Influenza A virus
 (A/shorebird/Delaware/27/98
 (H5N8))
 Influenza A virus
 (A/chicken/Italy/9097/97(H5N9))
 Influenza A virus
 (A/mallard/Ohio/556/1987(H5N9)) hema(GI: 1763006 loc:AIU67783)
 Influenza A virus
 (A/mallard/Sweden/22/02(H5N9)) hema(GI:66820077 loc:AY995886)
 Influenza A virus
 (A/mallard/Sweden/27/02(H5N9)) hema(GI:66820093 loc:AY995887)
 Influenza A virus
 (A/mallard/Sweden/28/02(H5N9)) hema(GI:66820107 loc:AY995888)
 Influenza A virus
 (A/mallard/Sweden/37/02(H5N9)) hema(GI:66820123 loc:AY995890)
 Influenza A virus
 (A/mallard/Sweden/49/02(H5N9)) hema(GI:66820161 loc:AY995893)
 Influenza A virus
 (A/mallard/Sweden/52/02(H5N9)) hema(GI:66820173 loc:AY995894)
 Influenza A virus
 (A/mallard/Sweden/79/02(H5N9)) hema(GI:66820213 loc:AY995897)

Influenza A virus
 (A/mallard/Sweden/80/02(H5N9)) hema(GI:66820231 loc:AY995898)
 Influenza A virus
 (A/turkey/Ontario/7732/1966(H5N9)) hema(GI:324191
 loc:FLAHAMUTA)
 Influenza A virus
 (A/turkey/Wisconsin/1968(H5N9))
 Influenza A virus (A/blue-winged
 teal/Alberta/685/82(H6N1))
 Influenza A virus
 (A/chicken/Taiwan/7-5/99(H6N1)) hema(GI: 11596262 loc:AF3 10983)
 Influenza A virus (A/chukka/Hong
 Kong/FY295/00(H6N1))
 Influenza A virus (A/chukka/Hong
 Kong/NT261/00(H6N1))
 Influenza A virus (A/duck/Hong
 Kong/175/77(H6N1))
 Influenza A virus (A/duck/Hong
 Kong/202/77(H6N1))
 Influenza A virus (A/duck/Hong
 Kong/346 1/99(H6N1))
 Influenza A virus (A/duck/Hong
 Kong/73/76(H6N1))
 Influenza A virus (A/duck/Hong
 Kong/D73/76(H6N1))
 Influenza A virus
 (A/duck/Korea/S17/03(H6N1)) hema(GI:58429252 loc:AY862613)
 Influenza A virus
 (A/duck/Pennsylvania/1/1969(H6N
D)
 Influenza A virus
 (A/duck/Pennsylvania/1/69(H6N1))
 Influenza A virus
 (A/duck/Taiwan/9/23-
 3/2000(H6N1))
 Influenza A virus (A/green-winged
 teal/OH/72/99(H6N1,4))
 Influenza A virus
 (A/gull/Maryland/4/77(H6N1))
 Influenza A virus
 (A/hawk/Maryland/1/77(H6N1))
 Influenza A virus
 (A/mallard/Alberta/76/85(H6N 1))
 Influenza A virus
 (A/mallard/Maryland/304/2002(H6
 NI))
 Influenza A virus
 (A/mallard/Maryland/341/2002(H6
 NI))
 Influenza A virus
 (A/mallard/Maryland/852/2002(H6
 NI))
 Influenza A virus
 (A/mallard/Maryland/866/2002(H6
 NI))
 Influenza A virus
 (A/mallard/Maryland/87 1/2002(H6
 NI))
 Influenza A virus
 (A/mallard/Maryland/880/2002(H6
 NI))
 Influenza A virus
 (A/mallard/OH/66/99(H6N1))
 Influenza A virus
 (A/pheasant/Hong
 Kong/FY294/00(H6N1))
 Influenza A virus

(A/pheasant/Hong Kong/FY479/2000(H6N1))
 Influenza A virus
 (A/pheasant/Hong Kong/NT261/00(H6N1))
 Influenza A virus
 (A/pheasant/Hong Kong/SH39/99(H6N1))
 Influenza A virus
 (A/pheasant/Hong Kong/SSP44/2002(H6N1))
 Influenza A virus
 (A/pintail/Alberta/179/93(H6N1)) hema(GP.49357165 loc:AY633332)
 Influenza A virus (A/quail/Hong Kong/1721-20/99(H6N1))
 Influenza A virus (A/quail/Hong Kong/1721-30/99(H6N1))
 Influenza A virus (A/quail/Hong Kong/SF550/00(H6N1))
 Influenza A virus (A/quail/Hong Kong/SF595/00(H6N1))
 Influenza A virus (A/quail/Hong Kong/YU421/2002(H6N1))
 Influenza A virus
 (A/RuddyTurnstone/DeIaware/203/96(H6N1))
 Influenza A virus (A/snow goose/Maryland/353/2005(H6N1))
 Influenza A virus (A/snow goose/Maryland/364/2005(H6N1))
 Influenza A virus (A/snow goose/Maryland/410/2005(H6N1))
 Influenza A virus (A/Teal/Hong Kong/W312/97(H6N1)) hema(GI:9437963 loc:AF250479)
 Influenza A virus (A/turkey/Germany/R30/99(H6N1))
)
 Influenza A virus (A/turkey/Minnesota/1265/80(H6N1))
 Influenza A virus (A/turkey/Minnesota/799/1980(H6N1)) neura(GI:115278455 loc:CY0147520)
 Influenza A virus (A/avian/NY/17150-7/2000(H6N2))
 Influenza A virus (A/black duck/Ohio/101/1986(H6N2))
 Influenza A virus (A/blue-winged teal/ALB/651/1978(H6N2)) neura(GI:78069937 loc:CY0040500)
 Influenza A virus (A/chicken/CA/203/2003(H6N2))
 Influenza A virus (A/chicken/CA/285/2003(H6N2))
 Influenza A virus (A/chicken/CA/375TR/2002(H6N2))
))
 Influenza A virus (A/chicken/CA/625/2002(H6N2))
 Influenza A virus (A/Chicken/California/0139/2001(H6N2)) hema(GI:28194294 loc:AF474033)
 Influenza A virus (A/Chicken/California/1002/2000(H6N2)) hema(GI:28194292 loc:AF474032)
 Influenza A virus (A/chicken/California/1002a/00(H6N2)) hema(GI:21636461 loc:AF457715)

N2))		
Influenza A virus (A/Chicken/California/13 16/2001(H6N2))	hema(GI:28 194296 loc:AF474034)	
Influenza A virus (A/chicken/California/139/01(H6N2))	hema(GI:2 1636457 loc:AF457713)	
Influenza A virus (A/chicken/California/43 1/00(H6N2))	hema(GI:21636436 loc:AF457704)	
Influenza A virus (A/Chicken/California/43 1/2000(H6N2))	hema(GI:28 194286 loc:AF474029)	
Influenza A virus (A/chicken/California/465/00(H6N2))	hema(GI:21636418 loc:AF457696)	
Influenza A virus (A/Chicken/California/465/2000(H6N2))	hema(GI:28194288 loc:AF474030)	
Influenza A virus (A/Chicken/California/650/2000(H6N2))	hema(GI:28194290 loc:AF474031)	
Influenza A virus (A/chicken/California/6643/01(H6N2))	hema(GI:21636400 loc:AF457688)	
Influenza A virus (A/Chicken/California/6643/2001(H6N2))	hema(GI:28 194298 loc:AF474035)	
Influenza A virus (A/Chicken/California/8892/2001(H6N2))	hema(GI:28 194300 loc:AF474036)	
Influenza A virus (A/chicken/California/905/01(H6N2))	hema(GP:21636380 loc:AF457679)	
Influenza A virus (A/Chicken/California/9 174/2001(H6N2))	hema(GI:28194302 loc:AF474037)	
Influenza A virus (A/Chicken/California/9420/2001(H6N2))	hema(GI:28194304 loc:AF474038)	
Influenza A virus (A/chicken/NY/101250-7/2001(H6N2))		
Influenza A virus (A/chicken/NY/14677-13/98(H6N2))	hema(GI:70608872 loc:DQ021663)	
Influenza A virus (A/coot/ALB/134/1987(H6N2))		neura(Gr.78095882 loc:CY0045170)
Influenza A virus (A/cornish cross/CA/139/2001(H6N2))		
Influenza A virus (A/duck/CA/10221/2002(H6N2))		
Influenza A virus (A/duck/Hainan/4/2004(H6N2))	hema(GI:52854772 loc:AY699987)	
Influenza A virus (A/duck/Hainan/6/2004(H6N2))	hema(GI:55 140580 loc:AY773907)	
Influenza A virus (A/duck/HB/4/2002(H6N2))	hema(GI:82659426 loc:DQ285546)	
Influenza A virus (A/duck/Hong Kong/1037-1/98(H6N2))		
Influenza A virus (A/duck/Hong Kong/1037-2/98(H6N2))		
Influenza A virus (A/duck/Hong Kong/1037-3/98(H6N2))		
Influenza A virus (A/duck/Hong Kong/1037-4/98(H6N2))		

Influenza A virus (A/duck/Hong Kong/134/77(H6N2))
 Influenza A virus (A/duck/Hong Kong/3096/99(H6N2))
 Influenza A virus (A/duck/Hong Kong/3 174/99(H6N2))
 Influenza A virus (A/duck/Hong Kong/3 1741/99(H6N2))
 Influenza A virus (A/duck/Hong Kong/323/98(H6N2))
 Influenza A virus (A/duck/Hong Kong/324/98(H6N2))
 Influenza A virus (A/duck/Hong Kong/3600/99(H6N2))
 Influenza A virus (A/duck/Hong Kong/960/80(H6N2))
 Influenza A virus (A/duck/Hong Kong/D134/77(H6N2))
 Influenza A virus (A/duck/Hungary/l/1970(H6N2))
 Influenza A virus (A/duck/Shantou/5540/2001(H6N2))
 Influenza A virus (A/goose/Hong Kong/W375/97(H6N2))
 Influenza A virus (A/green wing teal/Ohio/196/99(H6N2))
 Influenza A virus (A/green wing teal/Ohio/203/1998(H6N2))
 Influenza A virus (A/green-winged teal/OH/196/99(H6N2)) hema(GI:706089 14 loc:DQ021684)
 Influenza A virus (A/guillemot/Sweden/3/00(H6N2)) hema(GI:59803329 loc:AY703832)
 Influenza A virus (A/guinea fowl/Hong Kong/SSP99/2002(H6N2))
 Influenza A virus (A/mallard duck/ALB/205/1978(H6N2)) hema(GI:78069976 loc:CY004066)
 Influenza A virus (A/mallard duck/Alberta/205/1978(H6N2)) neuro(GI: 115 128880 loc:CP0004370)
 Influenza A virus (A/Mallard Duck/Alberta/21 1/85(H6N2))
 Influenza A virus (A/mallard/Alberta/98/85(H6N2)) hema(GI:49357159 loc:AY633308)
 Influenza A virus (A/mallard/Maryland/172/2002(H6N2))
 Influenza A virus (A/mallard/Maryland/345/2002(H6N2))
 Influenza A virus (A/mallard/Maryland/435/2002(H6N2))
 Influenza A virus (A/mallard/Maryland/88 1/2002(H6N2))
 Influenza A virus (A/mallard/NY/016/83(H6N2))
 Influenza A virus (A/mallard/NY/046/83(H6N2))
 Influenza A virus (A/mallard/Ohio/386/1988(H6N2))
 Influenza A virus (A/mallard/Ohio/424/1988(H6N2))
 Influenza A virus (A/mallard/Ohio/648/2002(H6N2))
 Influenza A virus

(A/mallard/Ohio/653/2002(H6N2))
 Influenza A virus
 (A/mallard/Ohio/656/2002(H6N2))
 Influenza A virus
 (A/mallard/Ohio/662/2002(H6N2))
 Influenza A virus
 (A/mallard/Ohio/8 1/1 986(H6N2))
 Influenza A virus (A/mottled
 duck/LA/32M/87(H6N2)) hema(GI:70608862 loc:DQ021658)
 Influenza A virus (A/mottled
 duck/LA/38M/87(H6N2)) hema(GI:70608864 loc:DQ021659)
 Influenza A virus (A/Pekin
 Duck/France/M-43/00(H6N2))
 Influenza A virus (A/Pekin
 Duck/France/M-92/00(H6N2))
 Influenza A virus (A/pintail
 duck/ALB/1303/1979(H6N2))
 Influenza A virus (A/pintail
 duck/ALB/1360/1979(H6N2)) neura(GI:78070067
 loc:CY0041020)
 Influenza A virus (A/pintail
 duck/ALB/647/1978(H6N2))
 Influenza A virus (A/pintail
 duck/Alberta/1360/1979(H6N2)) hema(GI: 115278000
 loc:CY014561)
 Influenza A virus
 (A/pintail/Alberta/1 13/85(H6N2)) hema(GI:49357161 loc:AY633316)
 Influenza A virus
 (A/pintail/Alberta/644/8 1(H6N2))
 Influenza A virus
 (A/pintail/MN/43 1/99(H6N2)) hema(GI:70608868 ioc:DQ021661)
 Influenza A virus
 (A/pintail/Ohio/73/1989(H6N2))
 Influenza A virus (A/quail/Hong
 Kong/SF792/2000(H6N2))
 Influenza A virus (A/Ruddy
 turnstone/Delaware/106/98(H6N2))
 Influenza A virus
 (A/shorebird/Delaware/124/2001(H
 6N2))
 Influenza A virus
 (A/Shorebird/Delaware/127/97(H6
 N2)» hema(GI:21636350 loc:AF457665)
 Influenza A virus
 (A/shorebird/Delaware/208/200 1(H
 6N2))
 Influenza A virus
 (A/Turkey/British
 Colombia/2/97(H6N2))
 Influenza A virus
 (A/turkey/CA/1 623CT/2002(H6N2
))
 Influenza A virus
 (A/turkey/CA/527/2002(H6N2))
 Influenza A virus
 (A/turkey/Canada/63(H6N2)) hema(GI:62288842 loc:AY968676)
 Influenza A virus
 (A/turkey/Germany/R04-
 5/02(H6N2))
 Influenza A virus
 (A/turkey/Germany/R04/99(H6N2
)
)
 Influenza A virus
 (A/turkey/Germany/R14/02(H6N2
)
)
 Influenza A virus
 (A/turkey/Germany/R26/02(H6N2
)
)

Influenza A virus
(A/turkey/Germany/R26/99(H6N2)
)
Influenza A virus
(A/turkey/Massachusetts/3740/196
5(H6N2))
Influenza A virus
(A/turkey/Minnesota/836/1980(H6
N2)) neura(GI: 115278468
loc:CY0147570)
Influenza A virus
(A/turkey/MN/735/79(H6N2))
Influenza A virus
(A/turkey/MN/836/80(H6N2))
Influenza A virus
(A/mallard/MN/346233/00(H6N3)) hema(GI:70608888 loc:DQ021671)
Influenza A virus (A/chicken/Hong
Kong/17/77(H6N4))
Influenza A virus (A/chicken/Hong
Kong/CSW106/2001(H6N4))
Influenza A virus (A/goose/Hong
Kong/17/77 (H6N4))
Influenza A virus (A/gray
teal/AUS/1/1979(H6N4))
Influenza A virus
(A/guU/Delaware/18/2000(H6N4))
Influenza A virus (A/laughing
gull/NY/470/00(H6N4)) hema(GI:70608844 loc:DQ021649)
Influenza A virus
(A/mallard/MD/R326/98(H6N4)) hema(GI:70608906 loc:DQ021680)
Influenza A virus
(A/pheasant/Hong
Kong/CSW2573/2001(H6N4))
Influenza A virus (A/pintail
duck/ALB/1343/1979(H6N4)) hema(GI:78070027 loc:CY004086)
Influenza A virus (A/quail/Hong
Kong/CSW106/2001(H6N4))
Influenza A virus (A/ruddy
turnstone/NJ/892/02(H6N4))
Influenza A virus
(A/Shorebird/Delaware/194/98(H6
N4)) hema(GI:21636348 loc:AF457664)
Influenza A virus
(A/shorebird/Delaware/259/2000(H
6N4))
Influenza A virus
(A/chicken/Taiwan/4801/90(H6N5)
) neura(GI:113373908
loc:AB2707490)
Influenza A virus (A/duck/Hong
Kong/108/76 (H6N5))
Influenza A virus (A/duck/Hong
Kong/943/80(H6N5))
Influenza A virus (A/mallard
duck/ALB/1081/1979(H6N5)) hema(GI:78070011 loc:CY004080)
Influenza A virus (A/mallard
duck/ALB/1270/1979(H6N5))
Influenza A virus
(A/mallard/Alberta/203/92(H6N5)) hema(GI:49357129 loc:AY633188)
Influenza A virus
(A/mallard/MD/R274/98(H6N5)) hema(GI:70608908 loc:DQ021681)
Influenza A virus
(A/mallard/MN/157/98(H6N5)) hema(GI:70608850 loc:DQ021652)
Influenza A virus
(A/mallard/MN/253/99(H6N5)) hema(GI:70608854 loc:DQ021654)
Influenza A virus
(A/mallard/MN/334/99(H6N5)) hema(GI:70608860 loc:DQ021657)
Influenza A virus
(A/mallard/Netherlands/16/99(H6N hema(GI:56425022 loc:AY684892)

5))		
Influenza A virus (A/pintail duck/ALB/1040/1979(H6N5))	hema(GI:78069991 loc:CY004072)	
Influenza A virus (A/pintail duck/ALB/1045/1979(H6N5))	hema(GI:78070001 loc:CY004076)	
Influenza A virus (A/pintail/Alberta/1040/79(H6N5))		
Influenza A virus (A/shearwater/Australia/1/1972(H6N5))		neura(GI:94501924 loc:NZ AAQHO10000280)
Influenza A virus (A/turkey/Germany/R43/98(H6N5))		
)		
Influenza A virus (A/blue wing teal/Ohio/907/2002(H6N6))		
Influenza A virus (A/blue-winged teal/MN/993/80(H6N6))		
Influenza A virus (A/duck/MN/1414/81(H6N6))		
Influenza A virus (A/duck/NY/83779/2002(H6N6))		
Influenza A virus (A/mallard duck/MN/1041/80(H6N6))		
Influenza A virus (A/mallard/Alberta/289/82(H6N6))		
Influenza A virus (A/mallard/Maryland/899/2002(H6No))		
Influenza A virus (A/mallard/Ohio/664/2002(H6N6))		
Influenza A virus (A/pintail/Alberta/189/82(H6N6))		
Influenza A virus (A/sanderling/DE/1258/1986(H6N6))		neura(GI:78097214 loc:CY0054220)
Influenza A virus (A/sanderling/Delaware/1258/1986(H6N6))	hema(GI:115278124 loc:CY014607)	
Influenza A virus (A/sanderling/Delaware/1258/86(H6N6))		
Influenza A virus (A/turkey/Minnesota/957/80(H6N6))		
)		
Influenza A virus (A/goose/Hong Kong/W222/97 (H6N7))		
Influenza A virus (A/black duck/MD/M037/98(H6N8))	hema(GI:70608902 loc:DQ021678)	
Influenza A virus (A/blue-winged teal/ALB/368/1978(H6N8))	hema(GI:78068135 loc:CY004035)	
Influenza A virus (A/blue-winged teal/Alberta/368/78(H6N8))		
Influenza A virus (A/Canada goose/Ohio/127/1989(H6N8))		
Influenza A virus (A/chicken/NY/13237-6/98(H6N8))	hema(GI:70608874 loc:DQ021664)	
Influenza A virus (A/domestic duck/NY/81(H6N8))		
Influenza A virus (A/duck/Hong Kong/221/77 (H6N8))		
Influenza A virus (A/duck/NJ/5832-13/96(H6N8))		
Influenza A virus (A/duck/NY/14933/95(H6N8))		
Influenza A virus (A/duck/NY/5832-13/96(H6N8))	hema(GI:70608870 loc:DQ021662)	

Influenza A virus (A/knot/DE/526/1988(H6N8))		neura(GI:78070038 loc:CY0040900)
Influenza A virus (A/Mallard/Alberta/206/96(H6N8))	hema(GI:21636346 loc:AF457663)	
Influenza A virus (A/mallard/Alberta/2 15/99(H6N8))	hema(GI:49357137 loc:AY633220)	
Influenza A virus (A/mallard/Alberta/232/94(H6N8))	hema(GI:49357141 loc:AY633236)	
Influenza A virus (A/Mallard/Alberta/4/94(H6N8))	hema(GI:21636358 loc:AF457669)	
Influenza A virus (A/mallard/Alberta/76/94(H6N8))	hema(GI:49357157 loc:AY633300)	
Influenza A virus (A/mallard/MD/F123/98(H6N8))	hema(GI:70608904 loc:DQ021679)	
Influenza A virus (A/mallard/MN/107/98(H6N8))	hema(GI:70608846 loc:DQ021650)	
Influenza A virus (A/mallard/MN/1 54/98(H6N8))	hema(GI:70608848 loc:DQ021651)	
Influenza A virus (A/mallard/MN/175/99(H6N8))	hema(GI:70608852 loc:DQ021653)	
Influenza A virus (A/mallard/MN/3 1/98(H6N8))	hema(GI:70608856 loc:DQ021655)	
Influenza A virus (A/mallard/MN/327/98(H6N8))	hema(GI:70608858 loc:DQ021656)	
Influenza A virus (A/maliard/Ohio/1 15/1989(H6N8))		
Influenza A virus (A/mallard/Ohio/217/1998(H6N8))		
Influenza A virus (A/mallard/Ohio/242/1998(H6N8))		
Influenza A virus (A/pintail/Alberta/1 55/94(H6N8))	hema(GI:49357163 loc:AY633324)	
Influenza A virus (A/pintail/MN/410/99(H6N8))	hema(GI:70608866 loc:DQ021660)	
Influenza A virus (A/Redhead/Alberta/291/94(H6N8))	hema(GI:21636360 loc:AF457670)	
Influenza A virus (A/ruddy turnstone/Delaware/1 05/98 (H6N8))		
Influenza A virus (A/Shorebird/Delaware/29/94(H6N 8))	hema(GI:21636352 loc:AF457666)	
Influenza A virus (A/turkey/Canada/1963(H6N8))		
Influenza A virus (A/turkey/France/01019/2001(H6N 8))		
Influenza A virus (A/turkey/France/01062/2001(H6N 8))		
Influenza A virus (A/turkey/Minnesota/501/1978(H6 N8))		neura(GI:305223 loc:FLANAMINNEO)
Influenza A virus (A/WDK/ST/1737/2000(H6N8))		
Influenza A virus (A/wild bird/DE/1 185/02(H6N8))		
Influenza A virus (A/black duck/Ohio/16 1/1 999(H6N9))		
Influenza A virus (A/duck/Hong Kong/182/77 (H6N9))		
Influenza A virus (A/duck/Hong Kong/D182/77(H6N9))		
Influenza A virus (A/Goose/Hong Kong/W217/97(H6N9))		
Influenza A virus (A/African		

starling/England-
 Q/983/1979(H7N1))
 Influenza A virus (A/African
 starling/England/983/79(H7N1))
 Influenza A virus
 (A/chicken/England/71/82(H7N1)) hema(GI:9988507 loc:AF202236)
 Influenza A virus
 (A/chicken/FPV/Rostock/1934(H7
 NI))
 Influenza A virus
 (A/Chicken/Italy/1067/99(H7N1)) hema(GI:56291611 loc:AJ584647)
 Influenza A virus
 (A/chicken/Italy/1081/99(H7N1)) hema(GI:9988545 loc:AF202255)
 Influenza A virus
 (A/chicken/Italy/1082/99(H7N1))
 Influenza A virus
 (A/chicken/Italy/1279/99(H7N1))
 Influenza A virus
 (A/chicken/Italy/13307/99(H7N1))
 Influenza A virus
 (A/chicken/Italy/13474/99(H7N1))
 Influenza A virus
 (A/chicken/Italy/13489/99(H7N1))
 Influenza A virus
 (A/chicken/Italy/267/00(H7N1))
 Influenza A virus
 (A/chicken/Italy/322/01 (H7N1))
 Influenza A virus
 (A/chicken/Italy/444/99(H7N1)) hema(GI:55056925 loc:AJ704810)
 Influenza A virus
 (A/chicken/Italy/445/99(H7N1)) hema(GI:33589188
 loc:INA580353)
 Influenza A virus
 (A/chicken/Italy/4575/99 (H7N1)) hema(GI:32452670
 loc:INA493469)
 Influenza A virus
 (A/chicken/Italy/5074/99(H7N1))
 Influenza A virus
 (A/chicken/Italy/522/00(H7N1))
 Influenza A virus
 (A/chicken/Italy/662/00(H7N1))
 Influenza A virus
 (A/chicken/Italy/78/00(H7N1))
 Influenza A virus
 (A/chicken/Italy/910/00(H7N1))
 Influenza A virus
 (A/chicken/Italy/914/00(H7N1))
 Influenza A virus (A/common iora
 /Singapore/F89/95(H7N1)) hema(GI:9988491 loc:AF202228)
 Influenza A virus
 (A/conure/England/1234/94(H7N1)
) hema(GI:9988517 loc:AF202241)
 Influenza A virus
 (A/conure/England/766/94(H7N1)) hema(GI:9988533 loc:AF202249)
 Influenza A virus (A/duck/Hong
 Kong/301/78(H7N1))
 Influenza A virus
 (A/duck/Hongkong/301/72(H7N1)) hema(GI:62910860 loc:DQ003216)
 Influenza A virus
 (A/duck/Italy/1848/00(H7N1))
 Influenza A virus
 (A/duck/Italy/551/00(H7N1))
 Influenza A virus
 (A/duck/Mongolia/47/01(H7N1))
 Influenza A virus
 (A/duck/Nanchang/1944/92(H7N1)
)
 Influenza A virus (A/fairy
 bluebird/Singapore/F92/94(H7N1)) hema(GI:9988493 loc:AF202229)

Influenza A virus (A/fowl/Rostock/45/1934(H7N1))		neura(GI:115279234 loc:CY0150480)
Influenza A virus (A/FPV/Egypt/45(H7N1))	hema(GI:9988509 loc:AF202237)	
Influenza A virus (A/FPV/Rostock/8/1934(H7N1))		
Influenza A virus (A/Hong Kong/301/78(H7N1))	hema(GI:56121700 loc:AY672090)	
Influenza A virus (A/mallard/France/2525/200 I(H7N I))		
Influenza A virus (A/mallard/France/2526/200 I(H7N I))		
Influenza A virus (A/ostrich/Italy/2332/00(H7N1))		
Influenza A virus (A/ostrich/Italy/984/00(H7N1))		
Influenza A virus (A/ostrich/South Africa/1069/91(H7N1))	hema(GI:9988523 loc:AF202244)	
Influenza A virus (A/ostrich/South Africa/5352/92(H7N1))	hema(GI:902750 loc:IAU20458)	
Influenza A virus (A/ostrich/Zimbabwe/222/96(H7N I))	hema(GI:9988503 loc:AF202234)	
Influenza A virus (A/parakeet/Netherlands/267497/94 (H7N1))	hema(GI:9988537 loc:AF202251)	
Influenza A virus (A/parrot/England/1174/94(H7N1))	hema(GI:9988521 loc:AF202243)	
Influenza A virus (A/parrot/Northern Ireland/VF-73- 67/73(H7N1))	hema(GI:9988539 loc:AF202252)	
Influenza A virus (A/parrot/Ulster/1973(H7N1))		neura(GI:324441 loc:FLANAKBO)
Influenza A virus (A/parrot/Ulster/73(H7N1))		
Influenza A virus (A/pheasant/Italy/1847/00(H7N1))		
Influenza A virus (A/quail/Italy/1764/00(H7N1))		
Influenza A virus (A/Rhea/North Carolina/39482/93 (H7N1NS1))		
Influenza A virus (A/Rhea/North Carolina/39482/93 (H7N1NSA))		
Influenza A virus (A/rhea/North Carolina/39482/93(H7N1))	hema(GI:902770 loc:IAU20468)	
Influenza A virus (A/Shorebird/Delaware/39/95(H7N D))		
Influenza A virus (A/softbill/South Africa/142/92(H7N1))		
Influenza A virus (A/teal/Taiwan/WB2-37- 2TPFE2/98(H7N1))	hema(GI:9988547 loc:AF202256)	
Influenza A virus (A/tsl/1/A/FPV/Rostock/1934(H7 N1))	hema(GI:324236 loc:FLAHATSI)	
Influenza A virus (A/turkey/Italy/1067/99 (H7N1))	hema(GI:14289370 loc:AF364134)	
Influenza A virus (A/turkey/Italy/1081/99 (H7N1))	hema(GI:14289372 loc:AF364135)	
Influenza A virus (A/turkey/Italy/1082/99 (H7N1))	hema(GI:14289374 loc:AF364136)	
Influenza A virus (A/turkey/Italy/1083/99 (H7N1))	hema(GI:14289376 loc:AF364137)	
Influenza A virus	hema(GI:14289378 loc:AF364138)	

(A/turkey/Italy/1085/99 (H7N1))		
Influenza A virus		
(A/turkey/Italy/1086/99 (H7N1))	hema(GI:14289380 loc:AF364139)	
Influenza A virus		
(A/turkey/Italy/1174/99 (H7N1))	hema(GI: 14289382 loc:AF364140)	
Influenza A virus		
(A/turkey/Italy/12598/99(H7N1))		
Influenza A virus		
(A/turkey/Italy/1265/99 (H7N1))	heraa(GI: 14289384 loc:AF364141)	
Influenza A virus		
(A/turkey/Italy/1279/99 (H7N1))	hema(GI: 14289386 loc:AF364142)	
Influenza A virus		
(A/turkey/Italy/13467/99(H7N1))		
Influenza A virus		
(A/turkey/Italy/13468/99(H7N1))		
Influenza A virus		
(A/turkey/Italy/1351/01(H7N1))		
Influenza A virus		
(A/turkey/Italy/1555/99 (H7N1))	hema(GI: 14289390 loc:AF364144)	
Influenza A virus		
(A/turkey/Italy/1713/00(H7N1))		
Influenza A virus		
(A/turkey/Italy/1744/99(H7N1))		
Influenza A virus		
(A/turkey/Italy/2023/00(H7N1))		
Influenza A virus		
(A/turkey/Italy/223/01(H7N1))		
Influenza A virus		
(A/turkey/Italy/2330/00(H7N1))		
Influenza A virus		
(A/turkey/Italy/2379/99 (H7N1))	hema(GI: 14289398 loc:AF364148)	
Influenza A virus		
(A/turkey/Italy/2505/99 (H7N1))	hema(GI: 14289400 loc:AF364149)	
Influenza A virus		
(A/turkey/Italy/2715/99 (H7N1))	hema(GI: 14289402 loc:AF364150)	
Influenza A virus		
(A/turkey/Italy/2716/99 (H7N1))	hema(GI: 14289404 loc:AF364151)	
Influenza A virus		
(A/turkey/Italy/2732/99(H7N1))		
Influenza A virus		
(A/turkey/Italy/284/01(H7N1))		
Influenza A virus		
(A/turkey/Italy/3185/99 (H7N1))	hema(GI: 14289408 loc:AF364153)	
Influenza A virus		
(A/turkey/Italy/3283/99 (H7N1))	hema(GI: 14289410 loc:AF364154)	
Influenza A virus		
(A/turkey/Italy/335/00(H7N1))		
Influenza A virus		
(Murkey/Italy/3466/99 (H7N1))	hema(GI: 14289412 loc:AF364155)	
Influenza A virus		
(A/turkey/Italy/3468/99 (H7N1))	hema(GI:14289414 loc:AF364156)	
Influenza A virus		
(A/turkey/Italy/3489/99 (H7N1))	hema(GI: 14289416 loc:AF364157)	
Influenza A virus		
(A/turkey/Italy/3560/99 (H7N1))	hema(GI:14289418 loc:AF364158)	
Influenza A virus		
(A/turkey/Italy/3620/1999(H7N1))		neura(GI:78097918 loc:CY0057850)
Influenza A virus		
(A/turkey/Italy/3675/99 (H7N1))	hema(GI: 14289420 loc:AF364159)	
Influenza A virus	hema(GI:32452676 loc:INA493472)	
(A/turkey/Italy/3775/99 (H7N1))		
Influenza A virus		
(A/turkey/Italy/3819/99 (H7N1))	hema(GI: 14289422 loc:AF364160)	
Influenza A virus	hema(GI:32452664 loc:INA493466)	
(A/turkey/Italy/3889/99 (H7N1))		
Influenza A virus		
(A/turkey/Italy/4042/99 (H7N1))	hema(GI: 14289424 loc:AF364161)	

Influenza A virus (A/turkey/Italy/4073/99 (H7N1))	hema(GI: 14289392 loc:AF364145)
Influenza A virus (A/turkey/Italy/4169/99 (H7N1))	hema(GI:32452668 loc:INA493468)
Influenza A virus (A/turkey/Italy/421/00(H7N1))	
Influenza A virus (A/turkey/Italy/4294/99 (H7N1))	hema(GI: 14289426 loc:AF364162)
Influenza A virus (A/turkey/Italy/4426/00(H7N1))	
Influenza A virus (A/turkey/Italy/4499/99 (H7N1))	hema(GI: 14289394 loc:AF364146)
Influenza A virus (A/turkey/Italy/4580/99(H7N1))	
Influenza A virus (A/turkey/Italy/4602/99 (H7N1))	hema(GI:32452672 loc:INA493470)
Influenza A virus (A/turkey/Italy/4603/1999(H7N1))	
Influenza A virus (A/turkey/Italy/4620/99 (H7N1))	hema(GI: 14289430 loc:AF364164)
Influenza A virus (A/turkey/Italy/4640/99 (H7N1))	hema(GI:14289434 loc:AF364166)
Influenza A virus (A/turkey/Italy/4644/99 (H7N1))	hema(GI: 14289432 loc:AF364165)
Influenza A virus (A/turkey/Italy/472/99(H7N1))	hema(GI:55056927 loc:AJ70481 1)
Influenza A virus (A/turkey/Italy/4725/99 (H7N1))	hema(GI:14289436 loc:AF364167)
Influenza A virus (A/turkey/Italy/4857/99 (H7N1))	hema(GI: 14289388 loc:AF364143)
Influenza A virus (A/turkey/Italy/491 1/99 (H7N1))	hema(GI: 14289438 loc:AF364168)
Influenza A virus (A/turkey/Italy/5032/99 (H7N1))	hema(GI: 14289442 loc:AF364170)
Influenza A virus (A/turkey/Italy/5074/99 (H7N1))	hema(GI: 14289444 loc:AF364171)
Influenza A virus (Murkey/Italy/5079/99 (H7N1))	hema(GI:14289440 loc:AF364169)
Influenza A virus (A/turkey/Italy/5563/99 (H7N1))	hema(GI: 14289406 loc:AF364152)
Influenza A virus (A/turkey/Italy/577/00(H7N1))	
Influenza A virus (A/turkey/Italy/7002/00(H7N 1))	
Influenza A virus (A/turkey/Italy/977/99 (H7N1))	hema(GI: 14289368 loc:AF364133)
Influenza A virus (A/turkey/Italy/984/99 (H7N1))	hema(GI: 14289446 loc:AF364172)
Influenza A virus (A/turkey/Ontario/HR2/2000(H7N 1))	
Influenza A virus (A/avian/NY/1 18353-1/01(H7N2))	hema(GI:29650351 loc:AY240877)
Influenza A virus (A/avian/NY/7041 1-12/00(H7N2))	hema(GP.29650353 loc:AY240878)
Influenza A virus (A/avian/NY/73063-6/00(H7N2))	hema(GI:29650447 loc:AY240925)
Influenza A virus (A/avian/NY/7421 1-2/00(H7N2))	hema(GI:29650355 loc:AY240879)
Influenza A virus (A/avian/NY/76247-3/00(H7N2))	hema(GI:29650357 loc:AY240880)
Influenza A virus (A/avian/NY/7729-6/00(H7N2))	hema(GI:29650361 loc:AY240882)
Influenza A virus (A/avian/NY/8 1746-5/00(H7N2))	hema(GI:29650359 loc:AY240881)
Influenza A virus (A/blue-winged teal/ALB/221/1978(H7N2))	

Influenza A virus
 (A/chicken/CT/9407/2003(H7N2))
 Influenza A virus
 (A/chicken/DE/HOBO/2004(H7N2))
 hema(GI:56567553 loc:AY831668)

Influenza A virus
 (A/chicken/DE/VIVA/2004(H7N2))
 hema(GI:56567555 loc:AY831669)

Influenza A virus
 (A/chicken/FL/90348-4/01(H7N2))
 hema(GI:29650363 loc:AY240883)

Influenza A virus
 (A/chicken/MD/MINH
 MA/2004(H7N2))
 hema(GI:56567557 loc:AY831670)

Influenza A virus (A/Chicken/New
 Jersey/2062-1/99(H7N2))
 hema(GI:17225085 loc:AF322023)

Influenza A virus (A/Chicken/New
 Jersey/30739-6/00(H7N2))
 hema(GI:17225089 loc:AF322025)

Influenza A virus (A/Chicken/New
 York/13142-5/94 (H7N2))
 hema(GI:29350851 loc:AF072384)

Influenza A virus (A/Chicken/New
 York/13142-5/94 (H7N2NSB))
 hema(GI:29294606 loc:AF072388)

Influenza A virus (A/Chicken/New
 York/13833-7/95 (H7N2))
 hema(GI:29294606 loc:AF072388)

Influenza A virus (A/Chicken/New
 York/13833-7/95 (H7N2NSB))
 hema(GI:4666331 loc:AF072389)

Influenza A virus (A/Chicken/New
 York/19542-5/95 (H7N2))
 hema(GI:4666333 loc:AF072390)

Influenza A virus (A/Chicken/New
 York/3112-1/95 (H7N2))
 hema(GI:4666333 loc:AF072390)

Influenza A virus (A/Chicken/New
 York/3112-1/95 (H7N2NSB))
 hema(GI:4666337 loc:AF072392)

Influenza A virus (A/Chicken/New
 York/3202-7/96 (H7N2))
 hema(GI:4666337 loc:AF072392)

Influenza A virus (A/Chicken/New
 York/3202-7/96 (H7N2NSB))
 heraa(GI:17225087 loc:AF322024)

Influenza A virus (A/Chicken/New
 York/34173-3/99(H7N2))
 hema(GI:4666323 loc:AF072385)

Influenza A virus (A/Chicken/New
 York/4447-7/94 (H7N2))
 hema(GI:4666323 loc:AF072385)

Influenza A virus (A/Chicken/New
 York/4447-7/94 (H7N2NSA))
 hema(GI:4666323 loc:AF072385)

Influenza A virus (A/Chicken/New
 York/6777-3/97 (H7N2NSB))
 hema(GI:29294612 loc:AF072396)

Influenza A virus (A/Chicken/New
 York/6777-3/97(H7N2))
 hema(GI:29294610 loc:AF072393)

Influenza A virus (A/Chicken/New
 York/8030-2/96 (H7N2))
 hema(GI:29294610 loc:AF072393)

Influenza A virus (A/Chicken/New
 York/8030-2/96 (H7N2NSB))
 hema(GI:29294610 loc:AF072393)

Influenza A virus
 (A/Chicken/NJ/118555-
 2/01(H7N2))
 hema(GI:29650365 loc:AY240884)

Influenza A virus
 (A/chicken/NJ/118878-
 5/01(H7N2))
 hema(GI:29650365 loc:AY240884)

Influenza A virus
 (A/chicken/NJ/150383-
 7/02(H7N2))
 hema(GI:29650367 loc:AY240885)

Influenza A virus
 (A/chicken/NJ/151244-
 18/02(H7N2))
 hema(GI:29650369 loc:AY240886)

Influenza A virus
 (A/chicken/NJ/15814-9/99(H7N2))
 hema(GI:29650371 loc:AY240887)

Influenza A virus
 (A/chicken/NJ/15827/99(H7N2))
 hema(GI:29650433 loc:AY240918)

Influenza A virus (A/Chicken/NJ/16224-6/99(H7N2))	
Influenza A virus (A/chicken/NJ/17206/99(H7N2))	hema(GI:29650427 loc:AY240915)
Influenza A virus (A/chicken/NJ/608/02(H7N2))	hema(GI:29650373 loc:AY240888)
Influenza A virus (A/chicken/NJ/9777-7/98(H7N2))	hema(GI:29650375 loc:AY240889)
Influenza A virus (A/chicken/NY/116124/2003(H7N2))	
Influenza A virus (A/chicken/NY/119055-7/01(H7N2))	hema(GI:29650377 loc:AY240890)
Influenza A virus (A/chicken/NY/119256-7/01(H7N2))	hema(GI:29650379 loc:AY240891)
Influenza A virus (A/Chicken/NY/13202-7/96(H7N2))	
Influenza A virus (A/Chicken/NY/13828-3/95(H2N2))	hema(GI:4008160 loc:AB016162)
Influenza A virus (A/chicken/NY/1387-8/98(H7N2))	hema(GI:29650383 loc:AY240893)
Influenza A virus (A/chicken/NY/1398-6/99(H7N2))	hema(GI:29650435 loc:AY240919)
Influenza A virus (A/chicken/NY/14714-2/99(H7N2))	hema(GI:29650439 loc:AY240921)
Influenza A virus (A/Chicken/NY/14858-12/99(H7N2))	hema(GI:29650411 loc:AY240907)
Influenza A virus (A/chicken/NY/21586-8/99(H7N2))	hema(GI:29650387 loc:AY240895)
Influenza A virus (A/Chicken/NY/21665-73/98(H7N2))	
Influenza A virus (A/chicken/NY/22409-4/99(H7N2))	hema(GI:29650389 loc:AY240896)
Influenza A virus (A/chicken/NY/30749-3/00(H7N2))	hema(GI:29650391 loc:AY240897)
Influenza A virus (A/chicken/NY/3181-5/06(H7N2))	hema(GI:11117529 loc:DQ873807)
Influenza A virus (A/chicken/NY/34173-3/99(H7N2))	hema(GI:29650437 loc:AY240920)
Influenza A virus (A/chicken/NY/3572/98(H7N2))	hema(GI:29650431 loc:AY240917)
Influenza A virus (A/Chicken/NY/6013-19/98(H7N2))	
Influenza A virus (A/chicken/NY/6031-19/98(H7N2))	hema(GI:29650393 loc:AY240898)
Influenza A virus (A/chicken/PA/143586/01(H7N2))	hema(GI:29650395 loc:AY240899)
Influenza A virus (A/chicken/PA/143586/2002(H7N2))	
Influenza A virus (A/chicken/PA/149092-1/02(H7N2))	hema(GI:29650397 loc:AY240900)
Influenza A virus	hema(GI:29650399 loc:AY240901)

(A/chicken/PA/9701027/97(H7N2)
)
 Influenza A virus
 (A/Chicken/PA/9701027B/97(H7N2))
 Influenza A virus
 (A/chicken/PA/9701524/97(H7N2)
)
 Influenza A virus
 (A/chicken/PA/9701527/97(H7N2)
)
 Influenza A virus
 (A/chicken/PA/9701530/97(H7N2)
)
 Influenza A virus
 (A/chicken/PA/9800896/98(H7N2)
)
 Influenza A virus
 (A/chicken/PA/9801289/98(H7N2)
)
 Influenza A virus
 (A/Chicken/Pennsylvania/11767-1/97(H7N2NSB))
 Influenza A virus
 (A/Chicken/Pennsylvania/11767-1/97(H7N2))
 Influenza A virus
 (A/Chicken/Pennsylvania/13552-1/98(H7N2))
 Influenza A virus
 (A/Chicken/Pennsylvania/13552-1/98(H7N2NSB))
 Influenza A virus
 (A/Chicken/Rhode Island/4328/95(H7N2))
 Influenza A virus
 (A/Chicken/Rhode Island/4328/95(H7N2NSB))
 Influenza A virus
 (A/chicken/VA/32/02(H7N2))
 Influenza A virus (A/duck/Hong Kong/293/78(H7N2))
 Influenza A virus
 (A/Duck/NJ/117228-7/01(H7N3))
 Influenza A virus
 (A/Duck/PA/143585/01(H7N3))
 Influenza A virus
 (A/Environment/NY/3185-28/2006(H7N2))
 Influenza A virus (A/Goose/New Jersey/8600-3/98(H7N2))
 Influenza A virus (A/guinea fowl/New York/13820-3/1995(H7N2))
 Influenza A virus (A/Guinea Fowl/New York/13820-3/95(H7N2NSB))
 Influenza A virus (A/Guinea Fowl/Pennsylvania/7777-1/96(H7N2NSB))
 Influenza A virus (A/Guinea Fowl/Pennsylvania/7777-1/96(H7N2))
 Influenza A virus
 (A/guineafowl/MA/148081-11/02(H7N2))
 Influenza A virus

hema(GI:29650401 loc:AY240902)

hema(GI:29650403 loc:AY240903)

hema(GI:29650405 loc:AY240904)

hema(GI:29650407 loc:AY240905)

hema(GI:29029459 loc:AF072395)

hema(GI:29029463 loc:AF072398)

hema(GI:4666335 loc:AF072391)

hema(GI:29650409 loc:AY240906)

hema(GI:902756 loc:IAU20461)

hema(GI:112823985 loc:DQ907527)

hema(GI:17225081 loc:AF322021)

neura(GI:115278732 loc:CY0148380)

hema(GI:29029465 loc:AF072394)

hema(GI:29650413 loc:AY240908)

(A/guineafowl/MA/148081/02(H7N2))
 Influenza A virus
 (A/guineafowl/New York/13820-3/97(H7N2))
 Influenza A virus
 (A/guineafowl/NJ/13246-9/98(H7N2)) hema(GI:29650415 loc:AY240909)
 Influenza A virus
 (A/guineafowl/NY/4649-18/2006(H7N2)) hema(GI:112823987 loc:DQ907528)
 Influenza A virus
 (A/guU/Delaware/2838/1987(H7N2))
 Influenza A virus (A/gull/Italy/692-2/93(H7N2)) hema(GI:998853 1 loc:AF202248)
 Influenza A virus (A/laughing gull/Delaware/2838/1987(H7N2))
 Influenza A virus
 (A/pheasant/NJ/30739-9/2000(H7N2))
 Influenza A virus
 (A/psittacine/Italy/1/91(H7N2)) hema(GI:9988519 loc:AF202242)
 Influenza A virus (A/Quail/13989-51/98(H7N2)) hema(GI:17225083 loc:AF322022)
 Influenza A virus (A/Quail/New York/13989-51/98 (H7N2)) hema(GI:29294608 loc:AF072399)
 Influenza A virus (A/Quail/New York/13989-51/98 (H7N2NSA))
 Influenza A virus
 (A/quail/NY/11430/99(H7N2)) hema(GI:29650443 loc:AY240923)
 Influenza A virus
 (A/quail/NY/13989/98(H7N2))
 Influenza A virus
 (A/quail/PA/20304/97(H7N2)) hema(GI:29650445 loc:AY240924)
 Influenza A virus
 (A/Quail/PA/20304/98(H7N2))
 Influenza A virus (A/ruddy turnstone/Delaware/130/99 (H7N2))
 Influenza A virus
 (A/turkey/Israel/Ramon/79(H7N2)) hema(GI:9988505 loc:AF202235)
 Influenza A virus
 (A/turkey/NC/11165/02(H7N2)) hema(GI:29650417 loc:AY240910)
 Influenza A virus (A/turkey/New York/4450-5/94 (H7N2))
 Influenza A virus (A/Turkey/New York/4450-5/94 (H7N2NSB))
 Influenza A virus
 (A/turkey/NJ/9778-8/98(H7N2)) hema(GI:29650419 loc:AY240911)
 Influenza A virus
 (A/Turkey/Pennsylvania/7975/97 (H7N2NSB))
 Influenza A virus
 (A/Turkey/Pennsylvania/7975/97 (H7N2)) hema(GI:29029461 loc:AF072397)
 Influenza A virus
 (A/Turkey/VA/158512/02(H7N2))
 Influenza A virus
 (A/turkey/VA/55/02(H7N2)) hema(GI:29650421 loc:AY240912)
 Influenza A virus
 (A/turkey/VA/66/02(H7N2)) hema(GI:29650423 loc:AY240913)
 Influenza A virus
 (A/turkey/VA/67/02(H7N2)) hema(GI:29650425 loc:AY240914)
 Influenza A virus
 (A/unknown/149717-12/2002(H7N2))

Influenza A virus (A/unknown/NY/7421 1- 5/2001(H7N2))		
Influenza A virus (A/Black Duck/Ohio/415/2001(H7N3))		
Influenza A virus (A/Blue Wing Teal/Ohio/658/2004(H7N3))		
Influenza A virus (A/blue-winged teal/TX/2/01(H7N3))		
Influenza A virus (A/Canada/rv504/2004(H7N3))		neura(GI:1 15279137 loc:CY0150080)
Influenza A virus (A/chicken/British Columbia/04(H7N3))	hema(GI:47834195 loc:AY61 1524)	
Influenza A virus (A/chicken/British Columbia/CN12/2004(H7N3))		
Influenza A virus (A/chicken/British Columbia/CN6/04(H7N3))	hema(GI:45593202 loc:AY559235)	
Influenza A virus (A/chicken/British Columbia/CN7- 3/04 (H7N3))	hema(GI:49473451 loc:AY644402)	
Influenza A virus (A/chicken/British Columbia/GSC human B/04(H7N3))	hema(GI:50542635 loc:AY646078)	
Influenza A virus (A/chicken/British Columbia/NS- 1319-2/G4(H7N3))	hema(GI:52631743 loc:AY730057)	
Influenza A virus (A/chicken/British Columbia/NS- 1390-2/2004(H7N3))		
Influenza A virus (A/chicken/British Columbia/NS- 1479-1/2004(H7N3))		
Influenza A virus (A/chicken/British Columbia/NS- 2035-12/2004(H7N3))		
Influenza A virus (A/chicken/British Columbia/NS1337-1/2004(H7N3))		
Influenza A virus (A/chicken/Chile/1 76822/02(H7N3))	hema(GI:34597702 loc:AY303630)	
Influenza A virus (A/chicken/Chile/176822/03(H7N3))		
Influenza A virus (A/chicken/Chile/184240- 4322/2002(H7N3))	hema(GI:1 15279182 loc:CY015027)	
Influenza A virus (A/chicken/Chile/4322/02(H7N3))	hema(GI:34597704 loc:AY303631)	
Influenza A virus (A/chicken/Chile/4322/03(H7N3))		
Influenza A virus (A/chicken/Chile/4345/02(H7N3))		
Influenza A virus (A/chicken/Chile/4347/02(H7N3))		
Influenza A virus (A/chicken/Chile/4957/02(H7N3))	hema(GI:34597706 loc:AY303632)	
Influenza A virus (A/chicken/Chile/4957/03(H7N3))		
Influenza A virus (A/chicken/Chile/4968/02(H7N3))	hema(GI:34597708 loc:AY303633)	
Influenza A virus (A/chicken/Chile/4968/03(H7N3))		
Influenza A virus	hema(GI:34597710 loc:AY303634)	

(A/chicken/Chile/4977/02(H7N3))
 Influenza A virus
 (A/chicken/Italy/46 16/03(H7N3))
 Influenza A virus (A/Chicken/New Jersey/15086-3/94 (H7N3)H) hema(GI:46663 19 loc:AF072383)
 Influenza A virus (A/Chicken/New Jersey/15086-3/94 (H7N3NSA))
 Influenza A virus (A/Chicken/New York/12273-1 1/99(H7N3)) hema(GI:17225091 loc:AF322026)
 Influenza A virus
 (A/chicken/NJ/15086-3/94(H7N3))
 Influenza A virus
 (A/chicken/NY/14714-9/99(H7N3)) hema(GI:29650385 loc:AY240894)
 Influenza A virus
 (A/chicken/Pakistan/16/99/95(H7N3)) hema(GI:9988501 loc:AF202233)
 Influenza A virus
 (A/chicken/Pakistan/34669/1995(H7N3)) hema(GI:115279197 loc:CY015033)
 Influenza A virus
 (A/chicken/Pakistan/34669/95(H7N3))
 Influenza A virus
 (A/chicken/Pakistan/447/95(H7N3)) hema(GI:9988487 loc:AF202226)
 Influenza A virus
 (A/chicken/Pakistan/CR2/95(H7N3)) hema(GI:9988495 loc:AF202230)
 Influenza A virus
 (A/chicken/Queensland/667/95(H7N3)) hema(GI:9988497 loc:AF20223 1)
 Influenza A virus
 (A/chickert/Victoria/1/92(H7N3)) hema(GI:9988489 loc:AF202227)
 Influenza A virus
 (A/emu/Texas/25414-1/95(H7N3))
 Influenza A virus
 (A/environment/Canada/av4 1/2004(H7N3)) neura(GI:1 15279118 loc:CY0150000)
 Influenza A virus (A/gadwall duck/ALB/291/1977(H7N3))
 Influenza A virus (A/gadwall duck/Alberta/291/1977(H7N3))
 Influenza A virus
 (A/gadwall/MD/3495/83(H7N3))
 Influenza A virus (A/gadwell duck/Maryland/3495/83(H7N3))
 Influenza A virus (A/GSC chicken B/British Columbia/04(H7N3)) hema(GI:50083037 loc:AY648287)
 Influenza A virus
 (A/gull/Heuwiese/899-6/80(H7N3))
 Influenza A virus (A/laughing gull/NY/2455/00(H7N3))
 Influenza A virus (A/mallard duck/ALB/279/1977(H7N3)) hema(GI:82653584 loc:CY005976)
 Influenza A virus (A/mallard duck/ALB/435/1985(H7N3)) neura(GI:78096826 loc:CY0050590)
 Influenza A virus (A/mallard duck/ALB/48/1976(H7N3))
 Influenza A virus (A/mallard duck/Alberta/435/1985(H7N3)) hema(GI: 115278080 loc:CY014587)
 Influenza A virus
 (A/mallard/Alberta/22/200 1(H7N3))
)
 Influenza A virus
 (A/mallard/Alberta/27/200 1(H7N3))

)
 Influenza A virus
 (A/mallard/Alberta/699/81(H7N3))
 Influenza A virus
 (A/mallard/Delaware/418/2005(H7N3))
 Influenza A virus
 (A/mallard/Italy/33/01(H7N3)) hema(GI:47680872 loc:AY586411)
 Influenza A virus
 (A/mallard/Italy/43/2001(H7N3))
 Influenza A virus
 (A/mallard/MN/187/98(H7N3))
 Influenza A virus
 (A/mallard/MN/190/98(H7N3))
 Influenza A virus
 (A/mallard/MN/284/98(H7N3))
 Influenza A virus
 (A/mallard/MN/88/98(H7N3))
 Influenza A virus
 (A/mallard/Netherlands/12/00(H7N3)) hema(GI:37786138 loc:AY338460)
 Influenza A virus
 (A/Mallard/Ohio/322/1998(H7N3))
 Influenza A virus (A/peregrine falcon/U.A.E./188/2384/98(H7N3)) hema(GI:9988543 loc:AF202254)
 Influenza A virus
 (A/pheasant/Minnesota/91/1980(H7N3)) hema(GI:115278382 loc:CY014721)
 Influenza A virus
 (A/pheasant/MN/917/1980(H7N3)) neura(GI:78103389 loc:CY0058900)
 Influenza A virus
 (A/pintail/Alberta/25/2001(H7N3))
 Influenza A virus
 (A/pintail/MN/423/99(H7N3))
 Influenza A virus
 (A/Quail/Arkansas/16309-7/94(H7N3)) hema(GI:4666355 loc:AF072401)
 Influenza A virus
 (A/Quail/Arkansas/16309-7/94(H7N3NSA))
 Influenza A virus
 (A/quail/Italy/4610/03(H7N3))
 Influenza A virus (A/ruddy turnstone/New Jersey/65/1985(H7N3))
 Influenza A virus
 (A/ruddyturnstone/Delaware/135/96(H7N3))
 Influenza A virus
 (A/shorebird/Delaware/2696/88(H7N3))
 Influenza A virus
 (A/turkey/Chile/4418/02(H7N3)) hema(GI:34597712 loc:AY303635)
 Influenza A virus
 (A/turkey/CO/13356/91(H7N3))
 Influenza A virus
 (A/Turkey/Colorado/13356/91(H7N3)) hema(GI:4666353 loc:AF072400)
 Influenza A virus
 (A/Turkey/Colorado/13356/91(H7N3NSA))
 Influenza A virus
 (A/turkey/England/192-328/79(H7N3)) hema(GI:9988525 loc:AF202245)
 Influenza A virus
 (A/turkey/England/1963(H7N3)) neura(GI:115279280 loc:CY0150670)

Influenza A virus
 (A/turkey/England/63(H7N3)) hema(GI:998851 loc:AF202238)
 Influenza A Virus
 (A/turkey/Italy/214845/02(H7N3)) hema(GI:47680866 loc:AY586408)
 Influenza A virus
 (A/turkey/Italy/214845/2002(H7N3
)) hema(GI:45 124756 loc:AJ627491)
 Influenza A virus
 (A/turkey/Italy/220158/2002(H7N3
)) hema(GI:45 124761 loc:AJ627493)
 Influenza A virus
 (A/turkey/Italy/2962/03(H7N3))
 Influenza A virus
 (A/turkey/Italy/3620/03(H7N3))
 Influenza A virus
 (A/turkey/Italy/8000/02(H7N3))
 Influenza A virus
 (A/turkey/Italy/8534/02(H7N3))
 Influenza A virus
 (A/turkey/Italy/8535/02(H7N3))
 Influenza A virus
 (A/turkey/Minnesota/1237/80(H7N
 3)) hema(GI:902766 loc:IAU20466)
 Influenza A virus
 (A/turkey/Minnesota/916/1980(H7
 N3))
 Influenza A virus
 (A/turkey/MN/1200/80(H7N3))
 Influenza A virus
 (A/turkey/MN/1818/82(H7N3))
 Influenza A virus
 (A/turkey/Tennessee/1/79(H7N3))
 Influenza A virus
 (A/turkey/TX/1/79(H7N3))
 Influenza A virus
 (A/Turkey/Utah/24721-10/95
 (H7N3)) hema(GI:4666357 loc:AF072402)
 Influenza A virus
 (A/Turkey/Utah/24721-10/95
 (H7N3NSA))
 Influenza A virus
 (A/ty/It/220158/2002(H7N3))
 Influenza A virus
 (A/widgeon/Alberta/284/77(H7N3)
)
 Influenza A virus (A/blue-winged
 teal/TX/11/01(H7N4))
 Influenza A Virus
 (A/chicken/NSW/1/1997(H7N4))
 Influenza A virus
 (A/duck/Nanchang/1944/1993(H7
 N4))
 Influenza A virus
 (A/mallard/Italy/4810-
 79/2004(H7N4)) hema(GI: 110273417
 loc:DQ838515)
 Influenza A virus (A/softbill/South
 Africa/142/92(H7N4)) hema(GI:902762 loc:IAU20464)
 Influenza A virus (A/ruddy
 turnstone/Delaware/2770/87
 (H7N5))
 Influenza A virus
 (A/turkey/Oregon/1971(H7N5))
 Influenza A virus
 (A/chicken/Brescia/1902(H7N7)) hema(GI:902776 loc:IAU20471)
 Influenza A virus
 (A/chicken/FPV/Weybridge(H7N7)
)

Influenza A virus (A/chicken/Germany/R28/03(H7N7))	hema(GI:55056931 loc:AJ704813)	
Influenza A virus (A/chicken/Ireland/1733/89(H7N7))	hema(GI:9988513 loc:AF202239)	
Influenza A virus (A/chicken/Japan/1924(H7N7))		
Influenza A virus (A/chicken/Jena/1816/87(H7N7))	hema(GI:902772 loc:IAU20469)	
Influenza A virus (A/chicken/Leipzig/79(H7N7))	hema(GI:902752 loc:IAU20459)	
Influenza A virus (A/chicken/Netherlands/1/03(H7N7))	hema(GI:37786134 loc:AY338458)	
Influenza A virus (A/chicken/Victoria/1/1985(H7N7))	hema(GI:324099 loc:FLAHAACV)	
Influenza A virus (A/chicken/Victoria/1985(H7N7))		neura(GI:115279168 loc:CY0150210)
Influenza A virus (A/chicken/Victoria/75(H7N7))	hema(GI:853705 loc:AIVHAGEN)	
Influenza A virus (A/Cor/16/1974(H7N7))		neura(GI:323979 loc:FLACORNAO)
Influenza A virus (A/duck/Germany/15/80(H7N7))	hema(GI:55056919 loc:AJ704797)	
Influenza A virus (A/duck/Heinersdorf/S495/6/86(H7N7))	hema(GI:902764 loc:IAU20465)	
Influenza A virus (A/duck/Hokkaido/114/03(H7N7))		
Influenza A virus (A/duck/Hokkaido/143/03(H7N7))		
Influenza A virus (A/duck/Hokkaido/238/03(H7N7))		
Influenza A virus (A/duck/Hokkaido/249/03(H7N7))		
Influenza A virus (A/duck/Hokkaido/Vac-2/04(H7N7))		neura(GI:83305704 loc:AB2434220)
Influenza A virus (A/duck/Hokkaido/W182/04(H7N7))		
Influenza A virus (A/duck/Hokkaido/W34/04(H7N7))		
Influenza A virus (A/duck/Italy/4692-30/2004(H7N7))	hema(GI:11027341 loc:DQ838512)	
Influenza A virus (A/duck/Mongolia/555/02(H7N7))		
Influenza A virus (A/duck/Mongolia/736/02(H7N7))		
Influenza A virus (A/duck/Taiwan/4201/99(H7N7))		
Influenza A virus (A/England/268/1996(H7N7))	hema(GI:3211723 loc:AF028020)	
Influenza A virus (A/equine/C.Detroit/1/64(H7N7))		
Influenza A virus (A/equine/Cambridge/1/63(H7N7))		
Influenza A virus (A/equine/Cambridge/1/73(H7N7))		
Influenza A virus (A/equine/Cordoba/4/1976(H7N7))		
Influenza A virus (A/equine/Cornell/16/74(H7N7))		

Influenza A virus (A/equine/Detroit/1/64(H7N7))	
Influenza A virus (A/equine/Detroit/3/1964(H7N7))	
Influenza A virus (A/equine/Kentucky/1976(H7N7))	
Influenza A virus (A/equine/iexington/1/66(H7N7))	
Influenza A virus (A/equine/London/1416/1973(I-I7N7))	hema(GI:324126 loc:FLAHAH7)
Influenza A virus (A/equine/London/1417/1973(H7N7))	
Influenza A virus (A/equine/New York/49/1973(H7N7))	
Influenza A virus (A/equine/Newmarket/1/77(H7N7))	
Influenza A virus (A/equine/Prague/1/1956(H7N7))	neura(GI:324505 loc:FLANAMJO)
Influenza A virus (A/equine/Prague/1956(H7N7))	
Influenza A virus (A/equine/Santiago/1/1977(H7N7))	
Influenza A virus (A/equine/Santiago/77(H7N7))	hema(GI:37223517 loc:AY383756)
Influenza A virus (A/equine/Sao Paulo/1/76(H7N7))	
Influenza A virus (A/equine/Switzerland/137/72(H7N7))	
Influenza A virus (A/fowl/Dobson/1927(H7N7))	neura(GI:1 15279101 loc:CY0149930)
Influenza A virus (A/FPV/Dobson(H7N7))	
Influenza A virus (A/FPV/Dobson/'Dutch'/1 927(H7N7))	
Influenza A virus (A/FPV/Dutch/27(H7N7))	
Influenza A virus (A/goose/Italy/4692-11/2004(H7N7))	hema(GI: 110273409 loc:DQ83851 1)
Influenza A virus (A/goose/Leipzig/1 37/8/1979(H7N7))	hema(GI: 1226062 loc:FLAHEMA)
Influenza A virus (A/goose/Leipzig/187-7/1979(H7N7))	neura(GI: 115279217 loc:CY0150410)
Influenza A virus (A/goose/Leipzig/192/7/1979(H7N7))	hema(GI: 1226066 loc:FLAHEMAB)
Influenza A virus (A/macaw/England/626/80(H7N7))	hema(GI:9988535 loc:AF202250)
Influenza A virus (A/mallard/Italy/4234/2004(H7N7))	hema(GI:1 10273407 loc:DQ838510)
Influenza A virus (A/mallard/Italy/4776-36/2004(H7N7))	hema(GI: 110273413 loc:DQ838513)
Influenza A virus (A/mallard/Italy/4810-7/2004(H7N7))	hema(GI: 110273415 loc:DQ838514)
Influenza A virus (A/mallard/MN/ 17/99(H7N7))	
Influenza A virus	

(A/mallard/Sweden/100/02(H7N7))
 Influenza A virus
 (A/mallard/Sweden/102/02(H7N7))
 Influenza A virus
 (A/mallard/Sweden/103/02(H7N7))
 Influenza A virus
 (A/mallard/Sweden/104/02(H7N7))
 Influenza A virus
 (A/mallard/Sweden/105/02(H7N7))
 Influenza A virus
 (A/mallard/Sweden/106/02(H7N7))
 Influenza A virus
 (A/mallard/Sweden/107/02(H7N7))
 Influenza A virus
 (A/mallard/Sweden/56/02(H7N7))
 Influenza A virus
 (A/mallard/Sweden/82/02(H7N7))
 Influenza A virus
 (A/mallard/Sweden/85/02(H7N7))
 Influenza A virus
 (A/mallard/Sweden/87/02(H7N7))
 Influenza A virus
 (A/mallard/Sweden/91/02(H7N9))
 Influenza A virus
 (A/mallard/Sweden/92/02(H7N7))
 Influenza A virus
 (A/mallard/Sweden/93/02(H7N7))
 Influenza A virus
 (A/mallard/Sweden/94/02(H7N7))
 Influenza A virus
 (A/Netherlands/033/03(H7N7))
 Influenza A virus
 (A/Netherlands/065/03(H7N7)) hema(GI:37786130 loc:AY338456)
 Influenza A virus
 (A/Netherlands/084/03(H7N7)) hema(GI:37786141 loc:AY338461)
 Influenza A virus
 (A/Netherlands/124/03(H7N7))
 Influenza A virus
 (A/Netherlands/126/03(H7N7))
 Influenza A virus
 (A/Netherlands/127/03(H7N7)) hema(GI:37786128 loc:AY338455)
 Influenza A virus
 (A/Netherlands/219/03(H7N7)) hema(GI:37786136 loc:AY338459)
 Influenza A virus
 (A/Netherlands/284/03(H7N7)) hema(GI:37786143 loc:AY338462)
 Influenza A virus
 (A/Netherlands/33/03(H7N7)) hema(GI:37786132 loc:AY338457)
 Influenza A virus (A/non-
 psittacine/England-
 Q/1985/89(H7N7)) hema(GI:9988515 loc:AF202240)
 Influenza A virus (A/ostrich/South
 Africa/M320/96(H7N7)) hema(GI:9988541 loc:AF202253)
 Influenza A virus (A/R(duck/Mongolia/736/02-
 duck/Hokkaido/49/98)(H7N7))
 Influenza A virus
 (A/RedKnoiyDelaware/259/94(H7N
 7))
 Influenza A virus (A/ruddy
 turnstone/Delaware/134/99
 (H7N7))
 Influenza A virus
 (A/seal/Mass/I/1980(H7N7))
 Influenza A virus
 (A/seal/Massachusetts/I/80(H7N7))
)
 Influenza A virus
 (A/starling/Victoria/I/1985(H7N7)) hema(GI:324101 loc:FLAHAASV)

Influenza A virus
 (A/starling/Victoria/5156/1985(H7N7))
 Influenza A virus
 (A/starling/Victoria/5156/85(H7N7))
 Influenza A virus
 (A/swan/Germany/62/81(H7N7)) hema(GI:55056921 loc:AJ704798)
 Influenza A virus
 (A/swan/Potsdam/63/6/81(H7N7)) hema(GI:902768 loc:IAU20467)
 Influenza A virus
 (A/swine/England/191973/92(H7N7)) neura(GI: 1835739 loc:IAU859880)
 Influenza A virus
 (A/teal/Iceland/29/1980(H7N7))
 Influenza A virus
 (Meal/Iceland/29/80(H7N7))
 Influenza A virus
 (A/tern/Potsdam/342/6/79(H7N7)) hema(GI:902774 loc:IAU20470)
 Influenza A virus
 (A/turkey/England/647/77(H7N7)) hema(GI:9988529 loc:AF202247)
 Influenza A virus
 (A/turkey/Germany/R11/01(H7N7)) hema(GI:55056929 loc:AJ704812)
 Influenza A virus
 (A/turkey/Ireland/PV74/1995(H7N7)) hema(GI:3211725 loc:AF028021)
 Influenza A virus
 (A/turkey/Ireland/PV8/95(H7N7)) hema(GI:55056923 loc:AJ704799)
 Influenza A virus
 (A/turkey/Northern Ireland/VF-1545 C5/98(H7N7))
 Influenza A virus
 (A/Duck/Ohio/421/87 (H7N8NS1))
 Influenza A virus
 (A/gull/Shimane/91/88(H7N8))
 Influenza A virus
 (A/Mallard/Ohio/421/1987(H7N8))
 Influenza A virus (A/pintail duck/ALB/121/1979(H7N8)) neura(GI:78096814 loc:CY0050400)
 Influenza A virus
 (A/pintail/Alberta/121/79(H7N8))
 Influenza A virus
 (A/swan/Shimane/42/99(H7N8))
 Influenza A virus
 (A/mallard/ALB/114/1999(H7N9))
 Influenza A virus (A/ruddy turnstone/DE/1538/00(H7N9))
 Influenza A virus (A/ruddy turnstone/DE/629/00(H7N9))
 Influenza A virus hema(GI: 115279539 loc:CY015173)
 (A/duck/Alaska/702/1991(H8N2))
 Influenza A virus (A/blue-winged teal/ALB/39/1982(H8N4))
 Influenza A virus (A/green-winged teal/TX/7/01(H8N4))
 Influenza A virus (A/mallard duck/ALB/7/1987(H8N4)) neura(GI:78096786 loc:CY0049980)
 Influenza A virus (A/mallard duck/Alberta/283/1977(H8N4))
 Influenza A virus (A/Mallard Duck/Alberta/357/84(H8N4)) hema(GI:11596272 loc:AF310988)
 Influenza A virus (A/mallard duck/Alberta/7/1987(H8N4)) hema(GI: 115278071 loc:CY014583)
 Influenza A virus
 (A/mallard/Alaska/708/2005(H8N4))
))

Influenza A virus (A/mallard/Alberta/827/1978(H8N4))		neura(GI:324455 loc:FLANALEO)
Influenza A virus (A/pintail/Alaska/246/2005(H8N4))		
Influenza A virus (A/pintail/Alaska/3 14/2005(H8N4))		
Influenza A virus (A/Red Kont/Delaware/254/94(H8N4))	hema(GI: 11596274 loc:AF3 10989)	
Influenza A virus (A/turkey/Ontario/61 18/68(H8N5))		neura(GI:60766 loc:ORIN190)
Influenza A virus (A/duck/NewYork/ 17542-4/86(H9N1))		
Influenza A virus (A/duck/NZL/76/1984(H9N1))		neura(GI:78097853 loc:CY0057480)
Influenza A virus (A/Duck/Shantou/1 588/00(H9N1))	hema(GI:31339427 loc:AF523389)	
Influenza A virus (A/Duck/Shantou/2030/00(H9N1))	hema(GI:3 1339429 loc:AF523390)	
Influenza A virus (A/mallard/Alberta/743/83(H9N1))	hema(GI:493571 11 loc:AY6331 16)	
Influenza A virus (A/shorebird/DE/68/2003(H9N1))		
Influenza A virus (A/avian/China/417-428/98(H9N2))		
Influenza A virus (A/chicken/Alonim/1 552/03(H9N2))	hema(GI:70905174 loc:DQ108914)	
Influenza A virus (A/chicken/Alonim/1 953/1 04(H9N2))	hema(GI:70905202 loc:DQ108928)	
Influenza A virus (A/chicken/Alonim/1965/04(H9N2))	hema(GI:70905204 loc:DQ108929)	
Influenza A virus (A/chicken/Amioz/1527/03(H9N2))	hema(GI:70905168 loc:DQ10891 1)	
Influenza A virus (A/Chicken/Anhui/1/98(H9N2))	hema(GI:18182687 loc:AF46151 1)	
Influenza A virus (A/chicken/Beijing/1/00(H9N2))	hema(Gr.51317988 loc:AY594194)	
Influenza A virus (A/Chicken/Beijing/1/1996(H9N2))		
Influenza A virus (A/Chicken/Beijing/1/94(H9N2))	hema(GI:6006999 loc:AF156380)	
Influenza A virus (A/Chicken/Beijing/1/95(H9N2))	hema(GI:22759080 loc:AF536689)	
Influenza A virus (A/Chicken/Beijing/1/97(H9N2))	hema(GI:18182725 loc:AF461530)	
Influenza A virus (A/Chicken/Beijing/2/97(H9N2))	hema(GI:22759082 loc:AF536690)	
Influenza A virus (A/Chicken/Beijing/3/99(H9N2))	hema(GI:22759084 loc:AF536691)	
Influenza A virus (A/chicken/Beijing/8/98(H9N2))	hema(GI:66733490 loc:DQ064354)	
Influenza A virus (A/chicken/Beijing/8/99(H9N2))		
Influenza A virus (A/chicken/Beijing/9/98(H9N2))	hema(GI:48525701 loc:AY623810)	
Influenza A virus (A/chicken/Beijing/ZH/02(H9N2))		
Influenza A virus (A/chicken/Beit Alfa/1282/03(H9N2))	hema(GI:70906761 loc:DQ104476)	

Influenza A virus (A/chicken/Beit-Aran/29/05(H9N2))	hema(GI:70905208 loc:DQ108931)	
Influenza A virus (A/chicken/Bnei Darom/1557/03(H9N2))	hema(GI:70905176 loc:DQ108915)	
Influenza A virus (A/chicken/China/AG5 18/200 1(H9N2))	hema(GI:57335107 loc:AJ781827)	
Influenza A virus (A/chicken/China/HSS2004(H9N2))		
Influenza A virus (A/chicken/Ein Habsor/1808/04(H9N2))	hema(GI:70905196 loc:DQ108925)	
Influenza A virus (A/chicken/Fujian/25/00(H9N2))	hema(GI:66733492 loc:DQ064355)	
Influenza A virus (A/chicken/Gan Shomron/1292/03(H9N2))	hema(GI:70906765 loc:DQ104478)	
Influenza A virus (A/chicken/Gan Shomron/1465/03(H9N2))	hema(GI:70906769 loc:DQ104480)	
Influenza A virus (A/chicken/Gan Shomron/1543/04(H9N2))	hema(GI:70905170 loc:DQ108912)	
Influenza A virus (A/chicken/Gan Shomron/1465/03(H9N2))		
Influenza A virus (A/Chicken/Gangxi/1/00(H9N2))	hema(GI: 18 182691 loc:AF461513)	
Influenza A virus (A/Chicken/Gangxi/2/00(H9N2))	hema(GI: 18182693 loc:AF46 15 14)	
Influenza A virus (A/Chicken/Gansu/1/99(H9N2))	hema(GI: 18182689 loc:AF461512)	
Influenza A virus (A/chicken/Germany/90/95(H9N2))		
Influenza A virus (A/chicken/Germany/R45/98(H9N2))	hema(GI:57335097 loc:AJ781822)	
Influenza A virus (A/chicken/Guangdong/10/00(H9N2))	hema(GI:66733494 loc:DQ064356)	
Influenza A virus (A/Chicken/Guangdong/1 1/97(H9N2))	hema(GI:333 17958 loc:AF508564)	
Influenza A virus (A/chicken/Guangdong/2 1/02(H9N2))	hema(GI:66733496 loc:DQ064357)	
Influenza A virus (A/chicken/Guangdong/4/00(H9N2))	hema(GI:66733498 loc:DQ064358)	
Influenza A virus (A/chicken/Guangdong/47/01(H9N2))	hema(GI:66733500 loc:DQ064359)	
Influenza A virus (A/chicken/Guangdong/5/97(H9N2))	hema(GI:66733502 loc:DQ064360)	
Influenza A virus (A/chicken/Guangdong/56/0 1(H9N2))	hema(GI:66733504 loc:DQ064361)	
Influenza A virus (A/chicken/Guangdong/6/97(H9N2))	hema(GI:66733506 loc:DQ064362)	
Influenza A virus (A/Chicken/Guangdong/97(H9N2))	hema(GI:22759086 loc:AF536692)	
Influenza A virus (A/chicken/Guangdong/SS/94(H9N2))		neura(GI:1 1 117531 loc:DQ8743950)
Influenza A virus (A/chicken/Guangxi/10/99(H9N2))	hema(GI:66733508 loc:DQ064363)	
Influenza A virus (A/chicken/Guangxi/9/99(H9N2))	hema(GI:66733510 loc:DQ064364)	

Influenza A virus (A/chicken/Hebei/1/00(H9N2))	
Influenza A virus (A/chicken/Hebei/1/01(H9N2))	hema(GI:51317990 loc:AY594195)
Influenza A virus (A/Chicken/Hebei/1/96(H9N2))	hema(GI:22759088 loc:AF536693)
Influenza A virus (A/chicken/Hebei/11/02(H9N2))	
Influenza A virus (A/Chicken/Hebei/2/00(H9N2))	hema(GI:18182727 loc:AF461531)
Influenza A virus (A/Chicken/Hebei/2/98(H9N2))	hema(GI:22759090 loc:AF536694)
Influenza A virus (A/Chicken/Hebei/3/98(H9N2))	hema(GI:22759092 loc:AF536695)
Influenza A virus (A/chicken/Hebei/31/00(H9N2))	hema(GI:66733512 loc:DQ064365)
Influenza A virus (A/Chicken/Hebei/4/98(H9N2))	hema(GI:33317960 loc:AF508565)
Influenza A virus (A/Chicken/Heilongjiang/10/97(H9N2))	hema(GI:33317962 loc:AF508566)
Influenza A virus (A/chicken/Heilongjiang/35/00(H9N2))	hema(GI:66733514 loc:DQ064366)
Influenza A virus (A/chicken/Heilongjiang/48/01(H9N2))	hema(GI:66733516 loc:DQ064367)
Influenza A virus (A/chicken/Henan/1/01(H9N2))	
Influenza A virus (A/chicken/Henan/1/98(H9N2))	
Influenza A virus (A/Chicken/Henan/1/99(H9N2))	hema(GI:18182697 loc:AF461516)
Influenza A virus (A/Chicken/Henan/2/98(H9N2))	hema(GI:18182699 loc:AF461517)
Influenza A virus (A/chicken/Henan/26/00(H9N2))	hema(GI:66733518 loc:DQ064368)
Influenza A virus (A/chicken/Henan/43/02(H9N2))	heraa(GI:66733520 loc:DQ064369)
Influenza A virus (A/chicken/Henan/5/98(H9N2))	hema(GI:66733522 loc:DQ064370)
Influenza A virus (A/Chicken/Henan/62/00(H9N2))	hema(GI:33317964 loc:AF508567)
Influenza A virus (A/Chicken/Henan/98(H9N2))	hema(GI:22759094 loc:AF536696)
Influenza A virus (A/Chicken/Hong Kong/739/94(H9N2))	hema(GI:6006997 loc:AF156379)
Influenza A virus (A/Chicken/Hong Kong/FY20/99(H9N2))	hema(GI:12060609 loc:AF222611)
Influenza A virus (A/chicken/Hong Kong/FY313/2000(H9N2))	
Influenza A virus (A/Chicken/Hong Kong/G23/97(H9N2))	hema(GI:6006987 loc:AF156374)
Influenza A virus (A/Chicken/Hong Kong/G9/97(H9N2))	hema(GI:6006985 loc:AF156373)
Influenza A virus (A/Chicken/Hong Kong/KC12/99(H9N2))	hema(GI:12060611 loc:AF222612)
Influenza A virus (A/Chicken/Hong Kong/NT16/99(H9N2))	hema(GI:12060603 loc:AF222608)
Influenza A virus (A/chicken/Hong Kong/NT471/2002(H9N2))	

Influenza A virus (A/Chicken/Hong Kong/SF2/99(H9N2))	hema(GI:6537267 loc:AF186269)
Influenza A virus (A/chicken/Hong Kong/WF2/99(H9N2))	hema(GI:28779288 loc:AY206677)
Influenza A virus (A/chicken/Hong Kong/WF208/2001(H9N2))	
Influenza A virus (A/chicken/HongKong/AP45/03(H 9N2))	hema(GI:51859746 loc:AY664661)
Influenza A virus (A/chicken/HongKong/BD90/03(H 9N2))	hema(GI:51859748 loc:AY664662)
Influenza A virus (A/chicken/HongKong/CSW153/03 (H9N2))	hema(GI:51859744 loc:AY664660)
Influenza A virus (A/chicken/HongKong/CSW291/03 (H9N2))	hema(GI:51859750 loc:AY664663)
Influenza A virus (A/chicken/HongKong/CSW304/03 (H9N2))	hema(GI:51859752 loc:AY664664)
Influenza A virus (A/chicken/HongKong/FY23/03(H 9N2))	hema(GI:51859754 loc:AY664665)
Influenza A virus (A/chicken/HongKong/NT142/03(H9N2))	hema(GI:51859758 loc:AY664667)
Influenza A virus (A/chicken/HongKong/NT366/03(H9N2))	hema(GI:51859776 loc:AY664676)
Influenza A virus (A/chicken/HongKong/SFI/03(H9 N2))	hema(GI:51859760 loc:AY664668)
Influenza A virus (A/chicken/HongKong/SSP101/03(H9N2))	hema(GI:51859762 loc:AY664669)
Influenza A virus (A/chicken/HongKong/SSP4I8/03(H9N2))	hema(GI:51859778 loc:AY664677)
Influenza A virus (A/chicken/HongKong/TP38/03(H 9N2))	hema(GI:51859764 loc:AY664670)
Influenza A virus (A/chicken/HongKong/WF120/03(H9N2))	hema(GI:51859774 loc:AY664675)
Influenza A virus (A/chicken/HongKong/WF126/03(H9N2))	hema(GI:51859766 loc:AY664671)
Influenza A virus (A/chicken/HongKong/YU427/03(H9N2))	hema(GI:51859780 loc:AY664678)
Influenza A virus (A/chicken/Hubei(H9N2))	hema(GI:63029317 loc:DQ003335)
Influenza A virus (A/chicken/Iarah/1376/03(H9N2))	hema(GI:70905166 loc:DQ108910)
Influenza A virus (A/chicken/India/2056/2003(H9N2))	hema(GI:78057334 loc:DQ223544)
Influenza A virus (A/chicken/India/2543/04(H9N2))	hema(GI:77812659 loc:DQ225271)
Influenza A virus (A/chicken/India/2784/2003(H9N2))	hema(GI:38046017 loc:AY435040)
Influenza A virus (A/chicken/India/2788/2003(H9N2))	hema(GI:38046015 loc:AY435039)

Influenza A virus
 (A/chicken/India/2793/2003(H9N2
)) hema(GI:33 188208 loc:AY336597)
 Influenza A virus
 {A/chicken/Iran/1 1T/99(H9N2))
 Influenza A virus
 (A/chicken/Iran/16/98(H9N2))
 Influenza A virus
 (A/chicken/Iran/261/01(H9N2))
 Influenza A virus
 (A/chicken/Iran/327/2000(H9N2))
 Influenza A virus
 (A/chicken/Iran/430/98(H9N2))
 Influenza A virus
 (A/chicken/Iran/496/99(H9N2))
 Influenza A virus
 (A/chicken/Iran/528/2001(H9N2))
 Influenza A virus
 (A/chicken/Iran/675/01(H9N2))
 Influenza A virus
 (A/chicken/Iran/738/99(H9N2))
 Influenza A virus
 (A/chicken/Iran/772/2000(H9N2))
 Influenza A virus
 (A/chicken/Iran/798/2000(H9N2))
 Influenza A virus
 (A/chicken/Iran/AG54 1/2000(H9N
 2)) hema(GI:57335103 loc:AJ781825)
 Influenza A virus -
 (A/chicken/Iran221/01(H9N2)) hema(GI:34223868 loc:AY345925)
 Influenza A virus
 (A/chicken/Iran222/00(H9N2)) hema(GI:34223870 loc:AY345926)
 Influenza A virus
 (A/chicken/Iran26/00(H9N2)) hema(GI:34223874 loc:AY345928)
 Influenza A virus
 (A/chicken/Iran261/01(H9N2)) hema(GI:34223872 loc:AY345927)
 Influenza A virus
 (A/chicken/Iran327/00(H9N2)) hema(GI:34223876 loc:AY345929)
 Influenza A virus
 (A/chicken/Iran353/98(H9N2)) hema(GI:34223878 loc:AY345930)
 Influenza A virus
 (A/chicken/Iran414/98(H9N2)) hema(GI:34223880 loc:AY34593 1)
 Influenza A virus
 (A/chicken/Iran430/98(H9N2)) hema(GI:34223882 loc:AY345932)
 Influenza A virus
 (A/chicken/Iran577/01(H9N2)) hema(GI:34223896 loc:AY345939)
 Influenza A virus
 (A/chicken/Iran610/98(H9N2)) hema(GI:34223884 loc:AY345933)
 Influenza A virus
 (A/chicken/Iran675/00(H9N2)) hema(GI:34223886 loc:AY345934)
 Influenza A virus
 (A/chicken/Iran685/00(H9N2)) hema(GI:34223888 loc:AY345935)
 Influenza A virus
 (A/chicken/Iran694/99(H9N2)) hema(GI:34223890 loc:AY345936)
 Influenza A virus
 (A/chicken/Iran738/99(H9N2)) hema(GI:34223892 loc:AY345937)
 Influenza A virus
 (A/chicken/Iran796/00(H9N2)) hema(GI:34223898 loc:AY345940)
 Influenza A virus
 (A/chicken/Iran8/0 1(H9N2)) hema(GI:34223894 loc:AY345938)
 Influenza A virus
 (A/chicken/Israel/1304/2003(H9N2
))
 Influenza A virus
 (A/chicken/Israel/ 1376/2003(H9N2
))
 Influenza A virus

(A/chicken/Israel/1475/2003(H9N2
))
 Influenza A virus
 (A/chicken/Israel/1808/2004(H9N2
))
 Influenza A virus
 (A/chicken/Israel/1953/2004(H9N2
))
 Influenza A virus
 (A/chicken/Israel/1966/2004(H9N2
))
 Influenza A virus
 (A/chicken/Israel/416/2006(H9N2)
)
 Influenza A virus
 (A/chicken/Israel/786/2001(H9N2)
)
 Influenza A virus
 (A/chicken/Israel/81 I/2001(H9N2)
)
 Influenza A virus
 (A/chicken/Israel/90658/2000(H9N
 2))
 Influenza A virus
 (A/chicken/Italy/1 69/85(H9N2))
 Influenza A virus
 (A/chicken/Italy/B/94(H9N2))
 Influenza A virus
 (A/Ghicken/Jiangsu/I/00(H9N2)) hema(GI:66733526 loc:DQ064372)
 Influenza A virus
 (A/Chicken/Jiangsu/1/99(H9N2)) hema(GI: 18 182683 ioc:AF461509)
 Influenza A virus
 (A/Chicken/Jiangsu/2/98(H9N2)) hema(GP.18182685 loc:AF461510)
 Influenza A virus
 (A/chicken/Jiangsu/JS-
 I/2002(H9N2)) hema(GI:34398342 loc:AY364228)
 Influenza A virus
 (A/chicken/Jiangsu/WI/00(H9N2))
 Influenza A virus
 (A/chicken/Jilin/53/0I(H9N2)) hema(GI:66733524 loc:DQ064371)
 Influenza A virus
 (A/chicken/Kalanit/ 1946/04(H9N2)
) hema(GI:70905200 loc:DQ 108927)
 Influenza A virus
 (A/chicken/Kalanit/1966/06. 12.04(
 H9N2)) hema(GI:70905206 Ioc:DQ108930)
 Influenza A virus (A/chicken/Kfar
 Monash/636/02(H9N2)) hema(GI:70906737 loc:DQ 104464)
 Influenza A virus
 (A/Chicken/Korea/25232-
 006/96(H9N2))
 Influenza A virus
 (A/Chicken/Korea/38349-
 p96323/96(H9N2)) hema(GI:6007007 loc:AF156384)
 Influenza A virus
 (A/Chicken/Korea/99029/99(H9N2
)) hema(GI:333 17952 loc:AF508561)
 Influenza A virus
 (A/Chicken/Korea/MS96/96(H9N2
)) hema(GI:7769125 loc:AF203008)
 Influenza A virus
 (A/chicken/Korea/S I/2003(H9N2))
 Influenza A virus
 (A/chicken/Korea/S 12/03(H9N2)) hema(GI:58429228 loc:AY862601)
 Influenza A virus
 (A/chicken/Korea/S 15/03(H9N2)) hema(GI:58429234 loc:AY862604)
 Influenza A virus hema(GI:58429236 loc:AY862605)

(A/chicken/Korea/S 16/03(H9N2))
 Influenza A virus
 (A/chicken/Korea/S 18/03(H9N2)) hema(GI:58429238 loc:AY862606)
 Influenza A virus
 (A/chicken/Korea/S20/2004(H9N2))
)
 Influenza A virus
 (A/chicken/Korea/S22/2004(H9N2))
)
 Influenza A virus
 (A/chicken/Korea/S4/03(H9N2)) hema(GI:58429224 loc:AY862599)
 Influenza A virus
 (A/chicken/Korea/S4/2003(H9N2))
 Influenza A virus
 (A/chicken/Korea/S5/03(H9N2)) hema(GI:58429226 loc:AY862600)
 Influenza A virus
 (A/chicken/Korea/SNU0037/00(H9N2)» hema(GI:55469744 loc:AY768553)
 Influenza A virus
 (A/chicken/Korea/SNU0057/00(H9N2)) hema(GI:55469746 loc:AY768554)
 Influenza A virus
 (A/chicken/Korea/SNU0073/00(H9N2)) hema(GI:55469748 loc:AY768555)
 Influenza A virus
 (A7chicken/Korea/SNU0091/00(H9N2)) hema(GI:55469750 loc:AY768556)
 Influenza A virus
 (A/chicken/Korea/SNU0140/00(H9N2)» hema(GI:55469752 loc:AY768557)
 Influenza A virus
 (A/chicken/Korea/SNU0146/00(H9N2)) hema(GI:55469754 loc:AY768558)
 Influenza A virus
 (A/chicken/Korea/SNU1035C/00(H9N2))
 Influenza A virus
 (A/chicken/Korea/SNU1035C/01(H9N2)) hema(GI:55469756 loc:AY768559)
 Influenza A virus
 (A/chicken/Larah/1376/03 (H9N2)) hema(GI:44889526 loc:AY548508)
 Influenza A virus
 (A/Chicken/Liaoning/1/00(H9N2)) hema(GI:18182701 loc:AF461518)
 Influenza A virus
 (A/Chicken/Liaoning/2/00(H9N2)) hema(GI: 181 82703 loc:AF461519)
 Influenza A virus
 (A/chicken/Liaoning/99(H9N2))
 Influenza A virus
 (A/chicken/Maale HaHamisha/90658/00(H9N2)) hema(GI:70906753 loc-.DQ 104472)
 Influenza A virus
 (A/chicken/Maanit/1275/03(H9N2))
) hema(GI:70906723 loc:DQ104457)
 Influenza A virus
 (A7chicken/Maanit/1291/03(H9N2))
) hema(GI:70906763 loc:DQ104477)
 Influenza A virus
 (A/chicken/Maanit/1477/03(H9N2))
) hema(GI:70906775 loc:DQ104483)
 Influenza A virus
 (A/chtcken/Mudanjiang/0823/00(H9N2))
 Influenza A virus
 (A/chicken/Mudanjiang/0823/2000(H9N2))
 Influenza A virus
 (A/Chicken/Nanchang/ 1- hema(GI:27465320 loc:AY180450)

0016/2000(H9N2))	
Influenza A virus (A/Chicken/Nanchang/4- 010/2000(H9N2))	hema(GI:27465314 loc:AY 180447)
Influenza A virus (A/Chicken/Nanchang/4- 361/2001(H9N2))	hema(GI:27465308 loc:AY 180444)
Influenza A virus (A/chicken/Neimeng/ZH/02(H9N2))	
Influenza A virus (A/chicken/Netohah/1373/03 (H9N2))	hema(GI:44889528 loc:AY548509)
Influenza A virus (A/chicken/Neve Ilan/1504/03(H9N2))	hema(GI:70906777 loc:DQ104484)
Influenza A virus (A/chicken/Neve Ilan/1504/03(H9N2))	
Influenza A virus (A/chicken/New Jersey/12220-1/97(H9N2))	
Influenza A virus (A/chicken/Ningxia/4/99(H9N2))	hema(GI:66733532 loc:DQ064375)
Influenza A virus (A/Chicken/Ningxia/5/99(H9N2))	hema(GI:333 17966 loc:AF508568)
Influenza A virus (A/chicken/Pakistan/1/99(H9N2))	
Influenza A virus (A/chicken/Pakistan/1/av74/99(H9 N2))	
Influenza A virus (A/chicken/Pakistan/2/99(H9N2))	
Influenza A virus (A/chicken/Pakistan/3/99(H9N2))	
Influenza A virus (A/chicken/Pakistan/4/99(H9N2))	
Influenza A virus (A/chicken/Pakistan/5/99(H9N2))	
Influenza A virus (A/chicken/Pakistan/AG5 19/98(H9 N2))	hema(GI:57335099 loc:AJ781823)
Influenza A virus (A/chicken/Pardes-Hana- Carcur/1475/03(H9N2))	hema(GI:70906773 loc:DQ104482)
Influenza A virus (A/chicken/Saar/1456/03(H9N2))	hema(GI:70906767 loc:DQ104479)
Influenza A virus (A/chicken/Saudi Arabia/224/98(H9N2))	
Influenza A virus (A/chicken/Saudi Arabia/532/99(H9N2))	
Influenza A virus (A/chicken/Saudi Arabia/534/99(H9N2))	
Influenza A virus (A/chicken/Saudi Arabia/AG5 16/2000(H9))	hema(GI:57335105 loc:AJ781826)
Influenza A virus (A/chicken/Sde Uziah/1747/04(H9N2))	hema(GI:70905156 loc:DQ108905)
Influenza A virus (A/chicken/Sde Uziah/1747/04(H9N2))	
Influenza A virus (A/chicken/Sede Uzziyyahu/1651/04(H9N2))	hema(GI:70905192 loc:DQ108923)
Influenza A virus (A/chicken/Shandong/1/02(H9N2))	hema(GI:5 13 17992 loc:AY594196)
Influenza A virus (A/chicken/Shandong/1/98(H9N2))	
Influenza A virus (A/Chicken/Shandong/2/99(H9N2))	hema(GI: 18 182707 loc:AF461521)
Influenza A virus (A/chicken/Shandong/6/96(H9N2))	hema(GI:66733534 loc:DQ064376)

Influenza A virus (A/chicken/Shandong/7/96(H9N2))	hema(GI:66733536 loc:DQ064377)
Influenza A virus (A/Chicken/Shandong/98(H9N2))	hema(GI:22759098 loc:AF536698)
Influenza A virus (A/Chicken/Shanghai/1/02(H9N2))	hema(GI:30385728 loc:AY281745)
Influenza A virus (A/chicken/Shanghai/10/01(H9N2))	hema(GI:66733538 loc:DQ064378)
Influenza A virus (A/Chicken/Shanghai/2/99(H9N2))	hema(GI:18182709 loc:AF461522)
Influenza A virus (A/chicken/Shanghai/3/00(H9N2))	
Influenza A virus (A/Chicken/Shanghai/3/01(H9N2))	hema(GI:200863 18 loc:AY083840)
Influenza A virus (A/Chicken/Shanghai/4-1/01(H9N2))	hema(GI:18182713 loc:AF461524)
Influenza A virus (A/Chicken/Shanghai/4-2/01(H9N2))	hema(GI:18182715 loc:AF461525)
Influenza A virus (A/Chicken/Shanghai/4/01(H9N2))	hema(GI:20086321 loc:AY083841)
Influenza A virus (A/Chicken/Shanghai/F/98(H9N2))	hema(GI: 18182729 loc:AF461532)
Influenza A virus (A/Chicken/Shaoquan/13/98(H9N2))	hema(GI:21632591 loc:AY043014)
Influenza A virus (A/chicken/Shenzhen/9/97(H9N2))	hema(GI:66733542 loc:DQ064380)
Influenza A virus (A/chicken/Shijiazhuang/2/98(H9N2))	hema(GI:66733540 loc:DQ064379)
Influenza A virus (A/Chicken/Shijiazhuang/2/99(H9N2))	hema(GI:333 17972 loc:AF50857I)
Influenza A virus (A/Chicken/Sichuan/5/97(H9N2))	hema(GI:333 17968 loc:AF508569)
Influenza A virus (A/chicken/SNU0028/2000(H9N2))	hema(GI:9 1178492 loc:DQ473608)
Influenza A virus (A/chicken/SNU0037/2000(H9N2))	hema(GI:91 178494 loc:DQ473609)
Influenza A virus (A/chicken/SNU0057/2000(H9N2))	hema(GI:91 178496 loc:DQ473610)
Influenza A virus (A/chicken/SNU0073/2000(H9N2))	hema(GI:91 178498 loc:DQ47361 1)
Influenza A virus (A/chicken/SNU0091/2000(H9N2))	hema(GI:91 178500 loc:DQ473612)
Influenza A virus (A/chicken/SNU0146/2000(H9N2))	hema(GI:9 1178502 loc:DQ473613)
Influenza A virus (A/chicken/SNU1035C/2001(H9N2))	hema(GI:9 1178504 loc:DQ473614)
Influenza A virus (A/chicken/Talmei Elazar/1304/03(H9N2))	hema(GI:56785893 loc:AY738455)
Influenza A virus (A/chicken/Talmei Elazar/1304/03(H9N2))	
Influenza A virus (A/chicken/Tehran/THI/01(H9N2))	hema(GI:28848785 loc:AY198313)

Influenza A virus (A/chicken/Tehran/TH2/0 1(H9N2))	hema(GI:28848787 loc:AY198314)
Influenza A virus (A/chicken/Tehran/TH3/00(H9N2))	hema(GI:28848789 loc:AY1983 15)
Influenza A virus (A/chicken/Tehran/TH4/99(H9N2))	hema(GI:28848791 loc:AY198316)
Influenza A virus (A/chicken/Tehran/TH5/99(H9N2))	hema(GI:28848793 loc:AY1983 17)
Influenza A virus (A/chicken/Tehran/TH6/98(H9N2))	hema(GI:30983905 loc:AY264870)
Influenza A virus (A/chicken/Tehran/TH7/0 1(H9N2))	hema(GI:28848795 loc:AY198318)
Influenza A virus (A/chicken/Tehran/TH8/00(H9N2))	hema(GI:30983909 loc:AY264872)
Influenza A virus (A/chicken/Tehran/TNI/02(H9N2))	hema(GI:30983907 loc:AY264871)
Influenza A virus (A/chicken/Tehran/TS10/00(H9N2))	hema(GI:28848801 loc:AY198321)
) Influenza A virus (A/chicken/Tehran/TS4/98(H9N2))	hema(GI:30983915 loc:AY264876)
Influenza A virus (A/chicken/Tehran/TS5/99(H9N2))	hema(GI:30983913 loc:AY264875)
Influenza A virus (A/chicken/Tehran/TS6/00(H9N2))	hema(GI:30983912 loc:AY264874)
Influenza A virus (A/chicken/Tehran/TS7/01(H9N2))	hema(GI:3098391 1 loc:AY264873)
Influenza A virus (A/chicken/Tehran/TS8/00(H9N2))	hema(GI:28848797 loc:AY198319)
Influenza A virus (A/chicken/Tehran/TS9/00(H9N2))	hetna(GI:28848799 loc:AY198320)
Influenza A virus (A/chicken/Tel Adashim/132 1/03(H9N2))	hema(GI:70905 158 loc:DQ108906)
Influenza A virus (A/chicken/Tel Adashim/1332/03(H9N2))	hema(GI:70905160 loc:DQ108907)
Influenza A virus (A/chicken/Tel Adashim/1 469/03 (H9N2))	
Influenza A virus (A/chicken/Tel Adashim/1469/303(H9N2))	hema(GI:70906771 loc:DQ104481)
Influenza A virus (A/chicken/Tel Adashim/1506/03 (H9N2))	
Influenza A virus (A/chicken/Tel Adashim/1506/03(H9N2))	hema(GI:70906757 loc:DQ104474)
Influenza A virus (A/chicken/Tel Adashim/786/01 (H9N2))	hema(GI:44889538 loc:AY548514)
Influenza A virus (A/chicken/Tel Adashim/809/01 (H9N2))	hema(GI:44889540 loc:AY548515)
Influenza A virus (A/chicken/Tel Adashim/8 11/01 (H9N2))	hema(GI:44889510 loc:AY548500)
Influenza A virus (A/chicken/Tel Adashim/812/01 (H9N2))	hema(GI:44889512 loc:AY548501)
Influenza A virus (A/chicken/Telmond/1 308/03(H9N 2))	hema(GI:70905188 loc:DQ108921)
Influenza A virus (A/Chicken/Tianjing/1/9 ó(H9N2))	hema(GI:18182717 loc:AF461526)
Influenza A virus (A/Chicken/Tianjing/2/96(H9N2))	hema(GI:18182719 loc:AF461527)
Influenza A virus (A/chicken/Trofa/1568/04(H9N2))	hema(GI:44889516 loc:AY548503)
Influenza A virus (A/chicken/Tzrofa/1568/04(H9N2))	hema(GI:70905184 loc:DQ108919)
Influenza A virus (A/chicken/United Arab Emirates/AG537/99(H9N2))	hema(GI:57335101 loc:AJ781824)
Influenza A virus (A/chicken/ Wangcheng/4/200 1(H9	

N2))		
Influenza A virus (A/chicken/Yanggam/AI96004/1996(H9N2))		
Influenza A virus (A/chicken/Ysodot/1362/03(H9N2))		
)		hema(GI:70905162 loc:DQ108908)
Influenza A virus (A/chicken/Yunan/3/01(H9N2))		
Influenza A virus (A/Chicken/Yunnan/1/99(H9N2))		hema(GI:18182721 loc:AF461528)
Influenza A virus (A/Chicken/Yunnan/2/00(H9N2))		hema(GI:18182723 loc:AF461529)
Influenza A virus (A/chicken/Yunnan/Xie-1/1999(H9N2))		hema(GI:77999548 loc:DQ227352)
Influenza A virus (A/Ck/HK/CSW161/2003(H9N2))		hema(GI:81 174813 loc:DQ226115)
Influenza A virus (A/Ck/HK/NT142/2003(H9N2))		hema(GI:81 174801 loc:DQ226109)
Influenza A virus (A/Ck/HK/WF126/2003(H9N2))		hema(GI:81 174803 loc:DQ2261 10)
Influenza A virus (A/Ck/HIGY U463/2003(H9N2))		hema(GI:8 1174807 loc:DQ2261 12)
Influenza A virus (A/Ck/HK/YU577/2003(H9N2))		hema(GI:81 174809 loc:DQ2261 13)
Influenza A virus (A/ck/Tel Adashim/81 1/01(H9N2))		
Influenza A virus (A/ck/Tel Adashim/812/01(H9N2))		
Influenza A virus (A/dove/Korea/S14/03(H9N2))		hema(GI:58429232 loc:AY862603)
Influenza A virus (A/duck/China(H9N2))		hema(GI:47157066 loc:AY603067)
Influenza A virus (A/duck/Germany/1 13/95(H9N2))		
Influenza A virus (A/duck/HK/784/1979(H9N2))		
Influenza A virus (A/duck/Hokkaido/26/99(H9N2))		hema(GI:38229103 loc:AB 125930)
Influenza A virus (A/duck/Hokkaido/3 1/97(H9N2))		hema(GI:38229097 loc:AB 125927)
Influenza A virus (A/duck/Hong Kong/168/77(H9N2))		
Influenza A virus (A/duck/Hong Kong/289/78(H9N2))		
Influenza A virus (A/duck/Hong Kong/366/78(H9N2))		hema(GI:28778235 loc:AY206674)
Influenza A virus (A/duck/Hong Kong/448/78(H9N2))		herna(GI:28777557 loc:AY206673)
Influenza A virus (A/duck/Hong Kong/552/79(H9N2))		hema(GI:28779292 loc:AY206679)
Influenza A virus (A/duck/Hong Kong/610/79(H9N2))		hema(GI:28779294 loc:AY206680)
Influenza A virus (A/duck/Hong Kong/644/79(H9N2))		hema(GI:28779290 loc:AY206678)
Influenza A virus (A/duck/Hong Kong/702/79(H9N2))		hema(GI:28776802 loc:AY206672)
Influenza A virus (A/duck/Hong Kong/784/1979(H9N2))		neura(GI: 115278146 loc:CY0146180)
Influenza A virus (A/duck/Hong Kong/86/76(H9N2))		
Influenza A virus (A/duck/Hong Kong/D91/76(H9N2))		
Influenza A virus (A/duck/Hong Kong/Y280/97(H9N2))		

Influenza A virus (A/duck/Hong Kong/Y439/97(H9N2))	
Influenza A virus (A/duck/India/3 lg/86(H9N2))	
Influenza A virus (A/duck/Korea/S13/03(H9N2))	hema(GI:58429230 loc:AY862602)
Influenza A virus (A/duck/Korea/S13/2003(H9N2))	
Influenza A virus (A/Duck/Nanchang/1-0070/2000(H9N2))	hema(GI:274653 I6 loc:AYI 80448)
Influenza A virus (A/Duck/Nanchang/10-389/2000(H9N2))	hema(GI:27465322 loc:AY180451)
Influenza A virus (A/Duck/Nanchang/1 1-197/2000(H9N2))	hema(GI:27465326 loc:AY180453)
Influenza A virus (A/Duck/Nanchang/1 1-290/2000(H9N2))	hema(GI:274653 12 loc:AY 180446)
Influenza A virus (A/Duck/Nanchang/1 1-392/2000(H9N2))	hema(GI:27465332 loc:AYI 80456)
Influenza A virus (A/Duck/Nanchang/7-092/2000(H9N2))	hema(GI:27465328 loc:AY180454)
Influenza A virus (A/duck/Nanjing/1/97(H9N2))	hema(GI:66733528 loc:DQ064373)
Influenza A virus (A/duck/Nanjing/2/97(H9N2))	hema(GI:66733530 loc:DQ064374)
Influenza A virus (A/duck/New Zealand/78/1984(H9N2))	
Influenza A virus (A/duck/NY/83 793/2002(H9N2))	
Influenza A virus (A/duck/NZL/78/1 984(H9N2))	
Influenza A virus (A/duck/Shanghai/08/05(H9N2))	hema(GI:78714419 loc:DQ234277)
Influenza A virus (A/Duck/Shantou/1 042/00(H9N2))	hema(GI:3 1339415 loc:AF523383)
Influenza A virus (A/Duck/Shantou/1043/00(H9N2))	hema(GI:31339413 loc:AF523382)
Influenza A virus (A/Duck/Shantou/1605/01(H9N2))	hema(GI:3 1339407 loc:AF523379)
Influenza A virus (A/Duck/Shantou/1 796/00(H9N2))	hema(GI:3 1339399 loc:AF523375)
Influenza A virus (A/Duck/Shantou/1 881/00(H9N2))	hema(GI:31339395 loc:AF523373)
Influenza A virus (A/Duck/Shantou/2088/01(H9N2))	hema(GI:3 1339401 loc:AF523376)
Influenza A virus (A/Duck/Shantou/2102/00(H9N2))	hema(GI:3 1339405 loc:AF523378)
Influenza A virus (A/Duck/Shantou/2 134/00(H9N2))	hema(GI:3 1339409 loc:AF523380)
Influenza A virus (A/Duck/Shantou/2 143/00(H9N2))	hema(GI:3 1339397 loc:AF523374)
Influenza A virus (A/Duck/Shantou/2 144/00(H9N2))	hema(GI:3 1339393 loc:AF523372)
Influenza A virus (A/Duck/Shantou/830/00(H9N2))	hema(GI:3 1339403 loc:AF523377)
Influenza A virus (A/geese/Tel Adashim/829/01(H9N2))	hema(GI:70906747 loc:DQ104469)
Influenza A virus (A/geese/Tel AdashinV830/01(H9N2))	hema(GI:70906749 loc:DQ104470)
Influenza A virus (A/Gf/HK/NTI01/2003(H9N2))	hema(GI:81 174815 loc:DQ2261 16)
Influenza A virus	hema(GI:81 174799 loc:DQ226108)

(A/Gf/HK/SSP607/2003(H9N2))		
Influenza A virus		
(A/goose/Heilongjiang/LJH-1/04(H9N2))	hema(GI:60651765 loc:AY937403)	
Influenza A virus		
(A/goose/Heilongjiang/LJH-2/04(H9N2))	hema(GI:60651767 loc:AY937404)	
Influenza A virus		
(A/Goose/Minnesota/5733/80(H9N2))	hema(GI:5732246 loc:AF156389)	
Influenza A virus		
(A/goose/MN/5733-1243/80(H9N2))		
Influenza A virus		
(A/Guangzhou/333/99(H9N2))	hema(GI:21632599 loc:AY043019)	
Influenza A virus (A/guinea fowl/Hong Kong/WF10/99(H9N2))	hema(GI:28779182 loc:AY206676)	
Influenza A virus		
(A/guineafowl/HongKong/NT1 01/03(H9N2))	hema(GI:5 1859756 loc:AY664666)	
Influenza A virus		
(A/guineafowl/HongKong/NT184/03(H9N2))	hema(GI:5 1859772 loc:AY664674)	
Influenza A virus		
(A/HK/2108/2003(H9N2))	hema(GI:81 174795 loc:DQ226106)	
Influenza A virus (A/Hong Kong/1074/99(H9N2))		
Influenza A virus		neura(GI:82653856 loc:CY0051550)
(A/mallard/ALB/17/1991(H9N2))		
Influenza A virus		
(A/mallard/Alberta/1 1/91(H9N2))	hema(GI:49357155 loc:AY633292)	
Influenza A virus		
(A/mallard/Alberta/17/91(H9N2))	hema(GI:49357123 loc:AY633 164)	
Influenza A virus		
(A/mallard/Alberta/32 1/88(H9N2))	hema(GI:49357151 loc:AY633276)	
Influenza A virus		
(A/mallard/MN/1 53/98(H9N2))		
Influenza A virus		
(A/mallard/MN/1 86/99(H9N2))		
Influenza A virus		
(A/mallard/MN/232/98(H9N2))		
Influenza A virus		
(A/mallard/MN/28 1/98(H9N2))		
Influenza A virus		
(A/mallard/MN/304/98(H9N2))		
Influenza A virus		
(A/mallard/MN/309/98(H9N2))		
Influenza A virus		
(A/mallard/MN/365/99(H9N2))		
Influenza A virus		
(A/ostrich/Eshkol/1436/03(H9N2))	hema(GI:56785895 loc:AY738456)	
Influenza A virus		
(A/ostrich/Israel/1436/2003(H9N2))		
)		
Influenza A virus (A/ostrich/South Africa/9508103/95(H9N2))		
Influenza A virus		
(A/parakeet/Chiba/1/97(H9N2))	hema(GI: 13383278 loc:AB049159)	
Influenza A virus		
(A/parakeet/Narita/92A/98(H9N2))	hema(GI: 13383280 loc:AB049160)	
Influenza A virus (A/Pekin Duck/France/D-1043/02 (H9N2))		neura(GI:93204706 loc:AJ6978790)
Influenza A virus (A/Pekin Duck/France/D- 1080/02 (H9N2))		neura(GI:93204708 loc:AJ6978800)
Influenza A virus (A/pekin duck/Malaysia/F20/1/98(H9N2))		

Influenza A virus (A/pekin duck/Singapore/F91- 5/9/97(H9N2))	
Influenza A virus (A/Ph/HK/CSW1323/2003(H9N2))	hema(GI:81 174797 loc:DQ226107)
Influenza A virus (A/pheasant/GuanDong/GZ 1/03(H 9N2))	
Influenza A virus (A/pheasant/Hong Kong/SSP1 1/99(H9N2))	
Influenza A virus (A/pheasant/HongKong/WF54/03(H9N2))	hema(GI:5 1859770 loc:AY664673)
Influenza A virus (A/pheasant/Ireland/PV18/97(H9N 2))	
Influenza A virus (A/Pigeon/Hong Kong/FY6/99(H9N2))	hema(GI:12060601 loc:AF222607)
Influenza A virus (A/pigeon/Hong Kong/WF286/2000(H9N2))	
Influenza A virus (A/Pigeon/Hong Kong/Y233/97(H9N2))	hema(GI:6006989 loc:AF156375)
Influenza A virus (A/pigeon/HongKong/WF53/03(H9 N2))	hema(GI:5 1859768 loc:AY664672)
Influenza A virus (A/Pigeon/Nanchang/ 11- 145/2000(H9N2))	hema(GI:27465330 loc:AY180455)
Influenza A virus (A/pigeon/Nanchang/2- 0461/2000(H9N2))	hema(GI:1 15278136 loc:CY014613)
Influenza A virus (A/Pigeon/Nanchang/7- 058/2000(H9N2))	hema(GI:27465336 loc:AY180458)
Influenza A virus (A/Quail/Arkansas/29209-1/93 (H9N2))	
Influenza A virus (A/Quail/Hong Kong/A17/99(H9N2))	hema(GI: 12060599 loc:AF222606)
Influenza A virus (A/quail/Hong Kong/A28945/88(H9N2))	hema(GI:28778729 loc:AY206675)
Influenza A virus (A/Quail/Hong Kong/AF157/92(H9N2))	hema(GI:6007001 loc:AF156381)
Influenza A virus (A/quail/Hong Kong/FY298/00(H9N2))	
Influenza A virus (A/Quail/Hong Kong/G1/97 (H9N2))	hema(GI:6006995 loc:AF156378)
Influenza A virus (A/Quail/Hong Kong/NT28/99(H9N2))	hema(GI:6537263 loc:AF186267)
Influenza A virus (A/Quail/Hong Kong/SSP10/99(H9N2))	hema(GI: 12060605 loc:AF222609)
Influenza A virus (A/quail/Hong Kong/YU 1495/2000(H9N2))	
Influenza A virus (A/quail/Hong Kong/YU4 15/2002(H9N2))	
Influenza A virus (A/quail/Nanchang/2- 0460/2000(H9N2))	
Influenza A virus (A/Quail/Nanchang/4- 040/2000(H9N2))	hema(GI:27465318 loc:AY180449)
Influenza A virus (A/Quail/Shanghai/8/96(H9N2))	hema(GI:333 17978 loc:AF508574)
Influenza A virus (A/SCK/HK/WF285/2003(H9N2))	hema(GI:8 1174805 loc:DQ2261 11)
Influenza A virus	hema(GI:81174811 loc:DQ226114)

(A/SCk/HK/YU663/2003(H9N2))
 Influenza A virus
 (A/Shantou/239/98(H9N2)) hema(GI:21632593 loc:AY043015)
 Influenza A virus
 (A/Shaoquan/408/98(H9N2)) hema(GI:21632595 loc:AY043017)
 Influenza A virus
 (A/Shaoquan/447/98(H9N2)) hema(GI:21632597 loc:AY043018)
 Influenza A virus
 (A/shorebird/DE/286/2003(H9N2))
 Influenza A virus
 (A/shorebird/DE/66/2003(H9N2))
 Influenza A virus
 (A/shorebird/Delaware/1 13/2001(H9N2))
 Influenza A virus
 (A/shorebird/Delaware/276/99(H9N2))
 Influenza A virus
 (A/shorebird/Delaware/29/2002(H9N9))
 Influenza A virus
 (A/shorebird/Delaware/77/2001(H9N2))
 Influenza A virus
 (A/Shorebird/Delaware/9/96(H9N2))
 Influenza A virus (A/Silkie Chicken/Hong Kong/SF43/99(H9N2)) hema(GI:6537265 loc:AF 186268) -
 Influenza A virus (A/Silky Chicken/Hong Kong/SF44/99(H9N2)) hema(GI: 12060613 loc:AF222613)
 Influenza A virus (A/silky chicken/Hong Kong/WF266/2002(H9N2))
 Influenza A virus (A/silky chicken/Korea/S3/03(H9N2)) hema(GI:58429222 loc:AY862598)
 Influenza A virus (A/Sw/ShanDong/1/2003(H9N2)) hema(GI:3 1505997 loc:AY294658)
 Influenza A virus (A/swine/Hangzhou/1/2006(H9N2))
)
 Influenza A virus (A/swine/Hong Kong/10/98(H9N2))
 Influenza A virus (A/swine/Hong Kong/2106/98(H9N2))
 Influenza A virus (A/swine/Hong Kong/3297/98(H9N2))
 Influenza A virus (A/swine/Hong Kong/9/98(H9N2))
 Influenza A virus (A/swine/Korea/S 109/2004(H9N2))
)
 Influenza A virus (A/swine/Korea/S 190/2004(H9N2))
)
 Influenza A virus (A/swine/Korea/S452/2004(H9N2))
)
 Influenza A virus (A/swine/Korea/S8 1/2004(H9N2))
 Influenza A virus (A/swine/Korea/S83/2004(H9N2))
 Influenza A virus (A/swine/Shandong/nb/2003(H9N2))
))

Influenza A virus (A/tk/Givat
 Haim/810/25.12.01(H9N2))
 Influenza A virus (A/tk/Kfar
 Vitki/π615/02(H9N2))
 Influenza A virus (A/tk/Neve
 Ilan/90710/00(H9N2))
 Influenza A virus
 (A/turkey/Avichail/1075/02(H9N2))
) hema(GI:70906709 loc:DQ104450)
 Influenza A virus
 (A/turkey/Avigdor/1209/03(H9N2))
) hema(GI:70906715 ioc:DQ104453)
 Influenza A virus
 (A/turkey/Avigdor/1215/03(H9N2))
) hema(GI:70906717 loc:DQ104454)
 Influenza A virus
 (A/turkey/Avigdor/1 920/04(H9N2))
) hema(GI:70905198 loc:DQ 108926)
 Influenza A virus (A/turkey/Beit
 HaLevi/1009/02(H9N2)) hema(GI:70906755 loc:DQ104473)
 Influenza A virus (A/turkey/Beit
 HaLevi/1562/04 (H9N2)) hema(GI:44889522 loc:AY548506)
 Influenza A virus (A/turkey/Beit
 HaLevi/1566/04(H9N2)) hema(GI:44889520 loc:AY548505)
 Influenza A virus (A/turkey/Beit
 Herut/1265/03(H9N2)) hetna(GI:70906721 loc:DQ104456)
 Influenza A virus (A/turkey/Beit
 Herut/1267/03(H9N2)) hema(GI:70906779 loc:DQ104485)
 Influenza A virus (A/turkey/Beit
 HaLevi/1562/03(H9N2))
 Influenza A virus (A/turkey/Beit
 HaLevi/1566/04(H9N2))
 Influenza A virus (A/turkey/Beit
 Herut/1265/03(H9N2))
 Influenza A virus (A/turkey/Beit
 Herut/1267/03(H9N2))
 Influenza A virus
 (A/turkey/Bezat/89/05(H9N2)) hema(GI:70905190 loc:DQ108922)
 Influenza A virus
 (A/turkey/Brosh/1276/03(H9N2)) hema(GI:70906725 loc:DQ104458)
 Influenza A virus
 (A/turkey/CA/6889/80(H9N2))
 Influenza A virus
 (A/turkey/California/1 89/66(H9N2))
)
 Influenza A virus (A/turkey/Ein
 Habsor/1804/04(H9N2)) hema(GI:70905194 loc:DQ108924)
 Influenza A virus (A/turkey/Ein
 Tzurim/1 172/02(H9N2)) herna(Gr.70906711 loc:DQ104451)
 Influenza A virus (A/turkey/Ein
 Tzurim/1738/04(H9N2)) hema(GI:70905186 loc:DQ108920)
 Influenza A virus (A/turkey/Ein
 Tzurim/1 738/04(H9N2))
 Influenza A virus (A/turkey/Emek
 Hefer/1272/03(H9N2)) hema(GI:70906759 loc:DQ104475)
 Influenza A virus
 (A/turkey/Germany/1 76/95(H9N2))
 Influenza A virus
 (A/turkey/Germany/R1 13/95(H9N2))
)) hema(GI:57335091 loc:AJ781819)
 Influenza A virus
 (A/turkey/Germany/R22/96(H9N2))
) hema(GI:57335093 loc:AJ781820)
 Influenza A virus
 (A/turkey/Germany/R33/96(H9N2))
) hema(GI:57335095 loc:AJ781821)
 Influenza A virus hema(GI:57335089 loc:AJ781818)

(A/turkey/Germany/R90/95(H9N2)
)
 Influenza A virus (A/turkey/Givat
 Haim Ehud/1544/04(H9N2)) hema(GI:4768 1482 loc:AY549889)
 Influenza A virus (A/turkey/Givat
 Haim/622/02(H9N2)) hema(GI:70906733 loc:DQ104462)
 Influenza A virus (A/turkey/Givat
 Haim/8 10/01 (H9N2)) hema(GI:44889508 loc:AY548499)
 Influenza A virus (A/turkey/Givat
 Haim/868/02(H9N2)) hema(GI:70906751 loc:DQ104471)
 Influenza A virus (A/turkey/Givat
 Haim/965/02 (H9N2)) hema(GI:44889524 loc:AY548507)
 Influenza A virus (A/turkey/Givat
 Haim/622/02(H9N2))
 Influenza A virus (A/turkey/Givat
 Haim/965/02(H9N2))
 Influenza A virus (A/turkey/Gyvat
 Haim Ehud/1544/03(H9N2)) hema(GI:70905172 loc:DQ108913)
 Influenza A virus (A/turkey/Gyvat
 Haim Ehud/1544/03(H9N2))
 Influenza A virus (A/turkey/Hod
 Ezyon/699/02(H9N2))
 Influenza A virus
 (A/turkey/Israel/1013/2002(H9N2))
 Influenza A virus
 (A/turkey/Israel/1209/2003(H9N2))
 Influenza A virus
 (A/turkey/Israel/1562/2003(H9N2))
 Influenza A virus
 (A/turkey/Israel/1567/2004(H9N2))
 Influenza A virus
 (A/turkey/Israel/369/2006(H9N2))
 Influenza A virus
 (A/turkey/Israel/446/2006(H9N2))
 Influenza A virus
 (A/turkey/Israel/619/2002(H9N2))
 Influenza A virus
 (A/turkey/Israel/8 10/200 1(H9N2))
 Influenza A virus
 (A/turkey/Israel/89/2005(H9N2))
 Influenza A virus
 (A/turkey/Israel/907 10/2000(H9N2
))
 Influenza A virus
 (A/turkey/Israel/965/2002(H9N2))
 Influenza A virus
 (A/turkey/Italy/125/89(H9N2))
 Influenza A virus
 (A/turkey/Italy/245/84(H9N2))
 Influenza A virus
 (A/turkey/Italy/VR86/83(H9N2))
 Influenza A virus (A/turkey/Kfar
 Vitkin/615/02 (H9N2)) hema(GI:44889530 loc:AY548510)
 Influenza A virus (A/turkey/Kfar
 Vitkin/616/02 (H9N2)) hema(GI:44889532 loc:AY548511)
 Influenza A virus (A/turkey/Kfar
 Warburg/1224/03(H9N2)) hema(GI:70906719 loc:DQ104455)
 Influenza A virus (A/turkey/Kfar
 Vitkin/616/02(H9N2))
 Influenza A virus
 (A/turkey/Minnesota/38391-
 6/95(H9N2))
 Influenza A virus
 (A/turkey/Minnesota/467 19-
 5/88(H9N2))
 Influenza A virus
 (A/turkey/Mishmar hema(GI:44889534 loc:AY548512)

Hasharon/6 19/02 (I-I9N2))		
Influenza A virus (A/turkey/Mishmar Hasharon/619/02(H9N2))		
Influenza A virus (A/turkey/MN/51 1/78(H9N2))		
Influenza A virus (A/turkey/Nahalal/1547/04(H9N2))	hema(GI:70905210 loc:DQ108932)	
Influenza A virus (A/turkey/Naharia/1 0 13/02(H9N2))	hema(GI:70906707 loc:DQ104449)	
Influenza A virus (A/turkey/Neve Ilan/90710/00 (H9N2))	hema(GI:44889514 loc:AY548502)	
Influenza A virus (A/turkey/Pavia/40/83(H9N2))		
Influenza A virus (A/turkey/Pennsylvania/1 1086- 2/88(H9N2))		
Influenza A virus (A/turkey/Qevuzat Yavne/1242/03(H9N2))		
Influenza A virus (A/turkey/Sapir/1 199/02(H9N2))	hema(GI:70906713 loc:DQ104452)	
Influenza A virus (A/turkey/Shadmot Dvorah/1567(H9N2))	hema(GI:44889518 loc:AY548504)	
Influenza A virus (A/turkey/Shadmot Dvorah/1567/04(H9N2))	hema(GI:70905182 loc:DQ108918)	
Influenza A virus (A/turkey/Texas/05836- 1/89(H9N2))		
Influenza A virus (A/turkey/TX/28737/8 1(H9N2))		
Influenza A virus (A/turkey/Tzur Moshe/1565/04(H9N2))	hema(GI:70905178 loc:DQ108916)	
Influenza A virus (A/turkey/Yedidia/625/02 (H9N2))	hema(GI:44889536 loc:AY5485 13)	
Influenza A virus (A/turkey/Yedidia/9 11/02(H9N2))	hema(GI:70906705 loc:DQ104448)	
Influenza A virus (A/wild duck/Nanchang/2- 0480/2000(H9N2))		
Influenza A virus (A/Wild Duck/Shantou/4808/0 1(H9N2))	hema(GI:3 133941 1 loc:AF523381)	
Influenza A virus(A/chicken/China(H9N2))	hema(GI:50235452 loc:AY652980)	
Influenza A virus(A/Chicken/Guangxi/KMI/99(H9N2))	hema(GI: 14532428 loc:AY036880)	
Influenza A virus (A/avian/Ireland/PV46B/93(H9N3))		
Influenza A virus (A/mallard/ALB/1 1/1991(H9N3))		
Influenza A virus (A/mallard/France/2518/2001(H9N 3))		
Influenza A virus (A/shorebird/DE/23 1/2003(H9N4))		
Influenza A virus (A/Duck/Hong Kong/702/79(H9N5))	hema(GI: 18996341 loc:AB080225)	
Influenza A virus (A/knot/DE/2552/1987(H9N5))		neura(GI:82623881 loc:CY0044140)
Influenza A virus (A/laughing gull/DE/2718/1987(H9N5))	hema(GI:82653760 loc:CY005986)	
Influenza A virus (A/laughing gull/Delaware/27 18/1987(H9N5))		neura(GI:l 15278086 lociCYO 145900)

Influenza A virus
 (A/pintail/Alberta/49/2003(H9N5))
 Influenza A virus (A/red
 knot/Delaware/2552/87 (H9N5))
 Influenza A virus
 (A/shorebird/DE/261/2003(H9N5)) hema(GI:82653870 loc:CY005992)
 Influenza A virus
 (A/duck/HK/I47/I977(H9N6)) neura(GI:78097649
 loc:CY0056410)
 Influenza A virus (A/duck/Hong
 Kong/147/77(H9N6)) hema(GI:28775925 loc:AY206671)
 Influenza A virus
 (A/shorebird/Delaware/270/2001(H
 9N7))
 Influenza A virus
 (A/shorebird/Delaware/275/2001(H
 9N7))
 Influenza A virus
 (A/shorebird/Delaware/277/2000(H
 9N7))
 Influenza A virus
 (A/turkey/Scotland/70(H9N7))
 Influenza A virus (A/ruddy
 turnstone/Delaware/1 16/98
 (H9N8))
 Influenza A virus (A/wood
 duck/MD/M58/98(H9N8))
 Influenza A virus (A/ruddy
 tumstone/Delaware/103/2002(H9N
 9))
 Influenza A virus (A/ruddy
 turnstone/Delaware/259/98
 (H9N9))
 Influenza A virus
 (A/RuddyTurnstone/Delaware/259/
 98(H9N9))
 Influenza A virus
 (A/shorebird/Delaware/141/2002(H
 9N9))
 Influenza A virus
 (A/shorebird/Delaware/1 8/2002(H9
 N9))

It is appreciated that certain features of the invention, which are, for clarity,
 described in the context of separate embodiments, may also be provided in
 combination in a single embodiment. Conversely, various features of the invention,
 5 which are, for brevity, described in the context of a single embodiment, may also be
 provided separately or in any suitable subcombination.

Although the invention has been described in conjunction with specific
 embodiments thereof, it is evident that many alternatives, modifications and variations
 10 will be apparent to those skilled in the art. Accordingly, it is intended to embrace all
 such alternatives, modifications and variations that fall within the spirit and broad
 scope of the appended claims. All publications, patents and patent applications
 mentioned in this specification are herein incorporated in their entirety by reference

into the specification, to the same extent as if each individual publication, patent or patent application was specifically and individually indicated to be incorporated herein by reference. In addition, citation or identification of any reference in this application shall not be construed as an admission that such reference is available as prior art to

5 the present invention.

WHAT IS CLAIMED IS:

1. An isolated composition-of-matter comprising a sialic acid bound to a sialic acid binding domain of a polypeptide.

2. The isolated composition-of-matter of claim 1, wherein said sialic acid is attached to at least one carbohydrate via a linker.

3. The isolated composition-of-matter of claim 2, wherein said sialic acid is attached to two carbohydrates wherein a first carbohydrate of said two carbohydrates is attached to a second carbohydrate of said two carbohydrates via a second linker.

4. The isolated composition-of-matter of claim 3, wherein said second linker is selected from the group consisting of an α 1-4 linker, an α 1-3 linker, an α 2-3 linker and an α 1-6 linker.

5. The isolated composition-of-matter of claim 1, being hydrolyzable by neuraminidase.

6. The isolated composition-of-matter of claims 2 or 3, wherein said carbohydrate is selected from the group consisting of galactose, N-acetylgalactosamine, glucose, mannose, glucoseamine galactoseamine, rhamnose, fucose, inositol, scyllo-inositol, fructose, xylulose, ribulose, ribose, aloes, altrose, arabinose, xylose, gulose, idose, lyxose, talose, neuraminic acid, glucuronic acid, glucaric acid, gluconic acid, GalNAc and GlcNAc.

7. The isolated composition-of-matter of claim 2, wherein said linker is selected from the group consisting of an α 2,3 linker, an α 2,6 linker and an α 2,8 linker.

8. The isolated composition-of-matter of claim 1, wherein said sialic acid is naturally occurring.

9. The isolated composition-of-matter of claim 1, wherein said sialic acid is synthetic.

10. The isolated composition-of-matter of claim 1, wherein said polypeptide is a hemagglutinin polypeptide.

11. The isolated composition-of-matter of claim 1, wherein said sialic acid binding domain is comprised in a hemagglutinin polypeptide.

12. The isolated composition-of-matter of claim 11, wherein said hemagglutinin polypeptide is truncated.

13. The isolated composition-of-matter of claims 10, 11 or 12, wherein said hemagglutinin polypeptide is selected from the group consisting of an H1 polypeptide, an H2 polypeptide, an H3 polypeptide, an H4 polypeptide, an H5 polypeptide, an H6 polypeptide, an H7 polypeptide, an H8 polypeptide, an H9 polypeptide, an H10 polypeptide, an H11 polypeptide, an H12 polypeptide, an H13 polypeptide, an H14 polypeptide, an H15 polypeptide and an H16 polypeptide.

14. The isolated composition-of-matter of claim 1, further comprising at least one detectable moiety.

15. The isolated composition-of-matter of claim 14, wherein said sialic acid is attached to at least one carbohydrate via a linker.

16. The isolated composition-of-matter of claim 14, wherein said detectable moiety is attached to said sialic acid via a linker.

17. The isolated composition-of-matter of claims 15 or 16, wherein said at least one detectable moiety is a pre-enzyme, and whereas cleavage of said linkage activates said pre-enzyme.

18. The isolated composition-of-matter of claims 15 or 16, wherein said at least one detectable moiety is a pre-substrate and whereas cleavage of said linkage releases said pre-substrate to form an active detectable substrate of an enzyme.

19. The isolated composition-of-matter of claim 18, wherein said enzyme is β galactosidase.

20. The isolated composition-of-matter of claims 15 or 16, wherein said at least one detectable moiety is a FRET pair, and whereas cleavage of said linkage generates a signal from said FRET pair.

21. The isolated composition-of-matter of claims 15 or 16, wherein said at least one detectable moiety is a Quantum dot, and whereas cleavage of said linkage generates a signal from said Quantum dot.

22. The isolated composition-of-matter of claims 15 or 16, wherein said at least one detectable moiety comprises a labeling agent selected from the group consisting of an enzyme, a fluorophore, a chromophore, a protein, a peptide, a pre-enzyme, a chemiluminescent substance, a pre-substrate, Quantum Dot and a radioisotope.

23. The isolated composition-of-matter of claim 1, further comprising a separating moiety.

24. The isolated composition-of-matter of claim 23, being of the general formula:

X-Y-Z

wherein:

Y comprises a substrate of a neuraminidase, cleavage of X-Y-Z by neuraminidase forming cleavage products X-Y' and Y''-Z wherein Y' is a first cleavage product of Y and Y'' is a second cleavage product of Y;

X comprises a detectable moiety; and

Z comprises said separating moiety capable of binding to a separate phase of a two phase separating system;

wherein said X-Y-Z does not form a contiguous portion of a natural substrate of said viral neuraminidase.

25. A composition being of the general formula:

X-Y-Z

wherein:

Y comprises a substrate of a neuraminidase, cleavage of X-Y-Z by said neuraminidase forming cleavage products X-Y' and Y''-Z wherein Y' is a first cleavage product of Y and Y'' is a second cleavage product of Y;

X comprises a detectable moiety; and

Z comprises a separating moiety capable of binding to a separate phase of a two phase separating system;

wherein said X-Y-Z does not form a contiguous portion of a natural substrate of said viral neuraminidase.

26. The composition of claim 25, wherein said detectable moiety comprises a labeling agent selected from the group consisting of an enzyme, a fluorophore, a chromophore, a FRET pair, a protein, a pre-enzyme, a chemiluminescent substance, a pre-substrate, Quantum Dot and a radioisotope.

27. The composition of any of claims 23, 24 or 25, wherein said separating moiety is selected from the group consisting of an immunological binding agent, a magnetic binding moiety, a peptide binding moiety, an affinity binding moiety and a nucleic acid moiety.

28. The composition of any of claims 23, 24 or 25, wherein said separating moiety further comprises a detectable moiety.

29. The composition of claim 28, wherein said detectable moiety is selected from the group consisting of an enzyme, a fluorophore, a chromophore, a protein, a peptide, a pre-enzyme, a FRET pair, a chemiluminescent substance, a pre-substrate, Quantum Dot and a radioisotope.

30. A method for detecting at least one pathogen in a sample, the method comprising:

(a) contacting the sample with the compositions of claims 1 or 25 under conditions allowing cleavage of said substrate; and

(b) monitoring cleavage of said substrate, wherein said cleavage of said substrate is indicative of the presence of said at least one pathogen in the sample.

31. The method of claim 30, wherein the pathogen is an influenza virus.

32. The method of claim 30, wherein the sample is a mammalian sample.

33. The method of claim 32, wherein said mammalian sample is a human sample.

34. The method of claim 30, wherein the sample is an avian sample.

35. The method of claim 34, wherein when said substrate comprises an $\alpha 2,6$ linkage, said cleavage of said substrate is indicative of a potentially human pathogenic avian influenza virus.

36. The method of claim 33, wherein when said substrate comprises an NeuGc $\alpha 2,3$ linkage, said cleavage of said substrate is indicative of avian influenza virus.

37. A method of detecting a potentially human pathogenic avian influenza virus in a bird, the method comprising

(a) contacting an avian sample with a neuraminidase substrate, said neuraminidase substrate comprising an $\alpha 2,6$ linkage; and

(b) monitoring cleavage of said substrate, wherein said cleavage of said substrate is indicative of a potentially human pathogenic avian influenza virus.

38. A method of detecting an avian influenza virus in a human, the method comprising

- (a) contacting a human sample with a neuraminidase substrate comprising a NeuGc α 2,3 linkage; and
- (b) monitoring cleavage of said substrate, wherein said cleavage of said substrate is indicative of an avian influenza virus in the human.

39. The method of any of claims 30, 37 and 38 wherein said sample is selected from the group consisting of mucus, saliva, throat wash, nasal wash, spinal fluid, sputum, urine, semen, sweat, feces, plasma, blood, bronchoalveolar fluid, vaginal fluid, tear fluid and tissue biopsy.

40. The method of any of claim 39, wherein said sample is selected from the group consisting of mucus, saliva, throat wash, nasal wash, spinal fluid, sputum, plasma, blood, bronchoalveolar fluid, tear fluid and tissue biopsy.

41. The method of any of claims 30, 37 and 38, wherein said monitoring is effected using a homogeneous assay.

42. The method of any of claims 30, 37 and 38, wherein said monitoring is effected using a heterogeneous assay.

43. A diagnostic kit for detection of at least one influenza virus in a sample, the kit comprising a plurality of compositions of any of claims 1-7, 14-15 and 24-28, and reagents for detecting cleavage of said substrate.

44. A diagnostic kit comprising a packaging material and a plurality of compositions for detecting presence of a plurality of influenza viruses in a sample, wherein each of said compositions is of a general formula,

X-Y-Z

wherein:

Y comprises a substrate of a viral neuraminidase, cleavage of X-Y-Z by said viral neuraminidase forming cleavage products X-Y' and Y"-Z wherein Y¹ is a first cleavage product of Y and Y" is a second cleavage product of Y;

X comprises a detectable moiety; and

Z comprises a separating moiety capable of binding to a separate phase of a two phase separating system;

wherein said X-Y-Z does not form a contiguous portion of a natural substrate of said neuraminidase,

wherein each of said X is distinctively detectable and whereas said packaging material comprises a label or package insert indicating that the kit is for detection of plurality of influenza viruses in a sample.

45. The diagnostic kit of claim 44, wherein said substrate of said viral neuraminidase comprises a sialic acid bound to a sialic acid binding domain of a polypeptide.

46. The diagnostic kit of claim 45, wherein said sialic acid is attached to at least one carbohydrate via a linker.

47. The diagnostic kit of claim 46, wherein said carbohydrate is selected from the group consisting of galactose, N-acetylgalactosamine, glucose, mannose, glucoseamine galactoseamine, rhamnose, fucose, inositol, scyllo-inositol, fructose, xylulose, ribulose, ribose, aloes, altrose, arabinose, xylose, gulose, idose, lyxose, talose, neuraminic acid, glucuronic acid glucaric acid, gluconic acid and GaINAc, GlcNAc.

48. The diagnostic kit of claim 46, wherein said linker is selected from the group consisting of an α 2,3 linker, an α 2,6 linker and an α 2,8 linker.

49. The diagnostic kit of claim 45, wherein said sialic acid is naturally occurring.

50. The diagnostic kit of claim 45, wherein said sialic acid is synthetic.

51. The diagnostic kit of claim 45, wherein said polypeptide is a hemagglutinin polypeptide.

52. The diagnostic kit of claim 45, wherein said sialic acid binding domain is comprised in a hemagglutinin polypeptide.

53. The diagnostic kit of claim 52, wherein said hemagglutinin polypeptide is truncated.

54. The diagnostic kit of claim 45, wherein said hemagglutinin polypeptide is selected from the group consisting of an H1 polypeptide, an H2 polypeptide, an H3 polypeptide, an H4 polypeptide, an H5 polypeptide, an H6 polypeptide, an H7 polypeptide, an H8 polypeptide, an H9 polypeptide, an H10 polypeptide, an H11 polypeptide, an H12 polypeptide, an H13 polypeptide, an H14 polypeptide, an H15 polypeptide and an H16 polypeptide.

55. The diagnostic kit of claim 44, further comprising reagents for detecting cleavage of said substrate.

56. The diagnostic kit of claim 44, wherein each of said plurality of compositions is a substrate for a different neuraminidase.

57. The diagnostic kit of claim 44, wherein said plurality of compositions are attached to a single solid support.

58. The diagnostic kit of claim 57, wherein said distinctive detection is effected by an addressable location on said single solid support.

59. The diagnostic kit of claim 44, wherein said distinctive detection is effected by different detectable moieties.

60. The diagnostic kit of claim 58, wherein said solid support is configured as a bead.

61. The diagnostic kit of claim 60, wherein said bead is selected from the group consisting of a colored bead, a magnetic bead, a tagged bead and a fluorescent bead.

62. The diagnostic kit of claim 44, further comprising a substrate for the detection of at least one more virus other than said influenza virus selected from the group consisting of Corona Viruses, SARS, HMPV (Human Meta pneumo virus), Adeno virus, RSV (Respiratory Syncytial Virus) and Rhino virus.

FIG.1

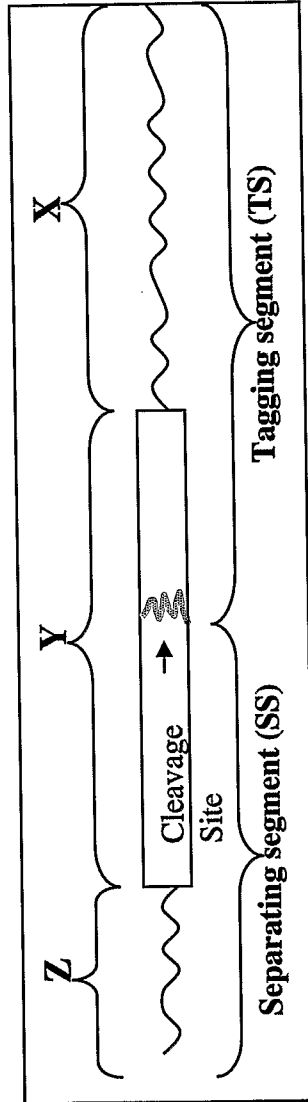

FIG. 2

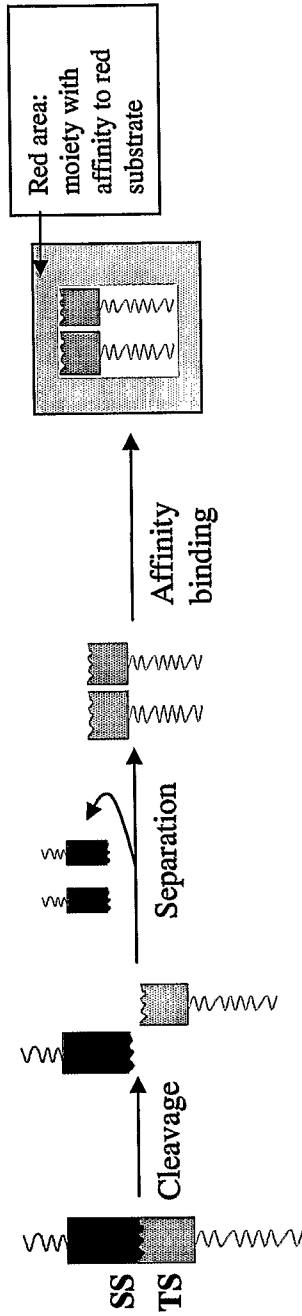
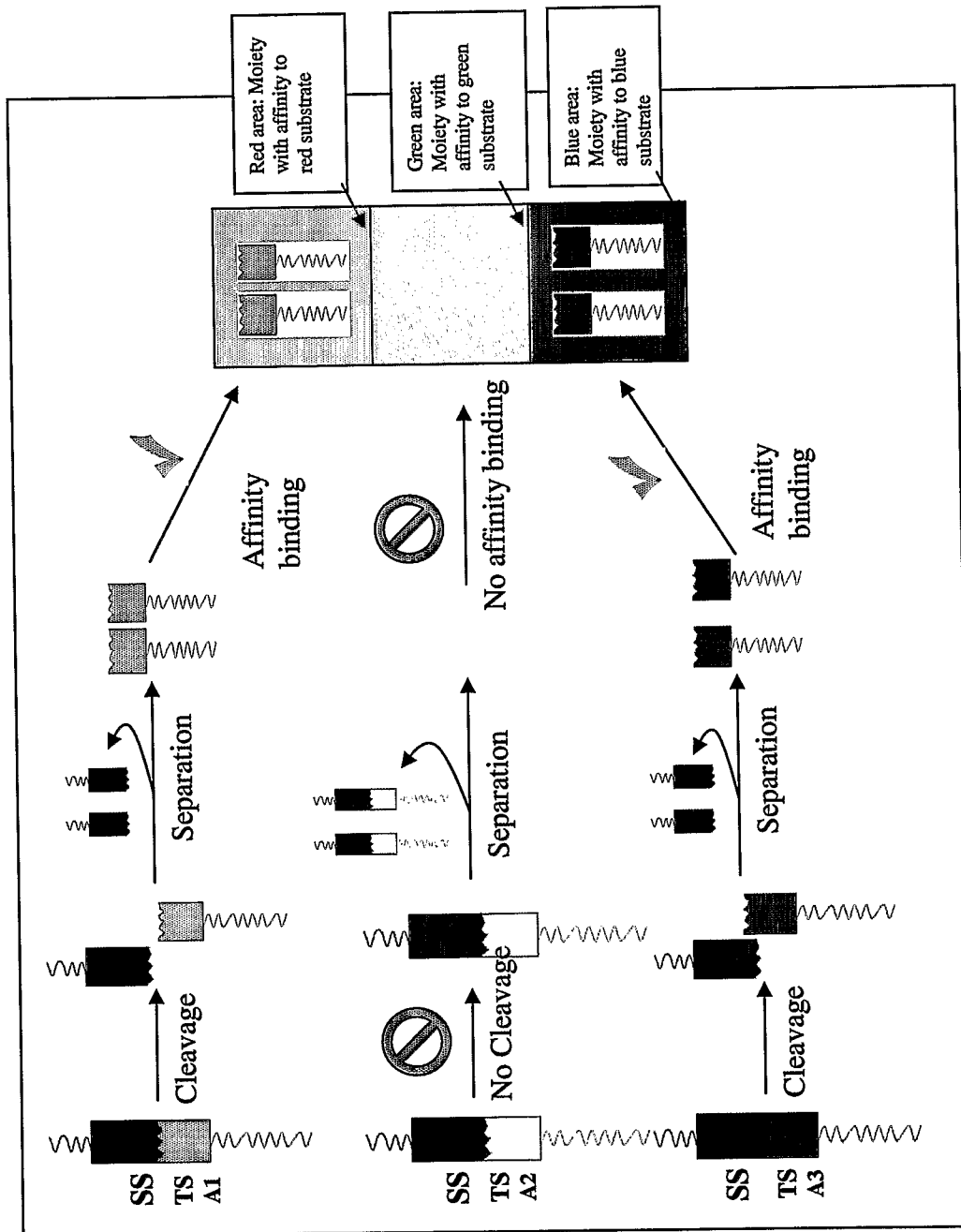

FIG. 3



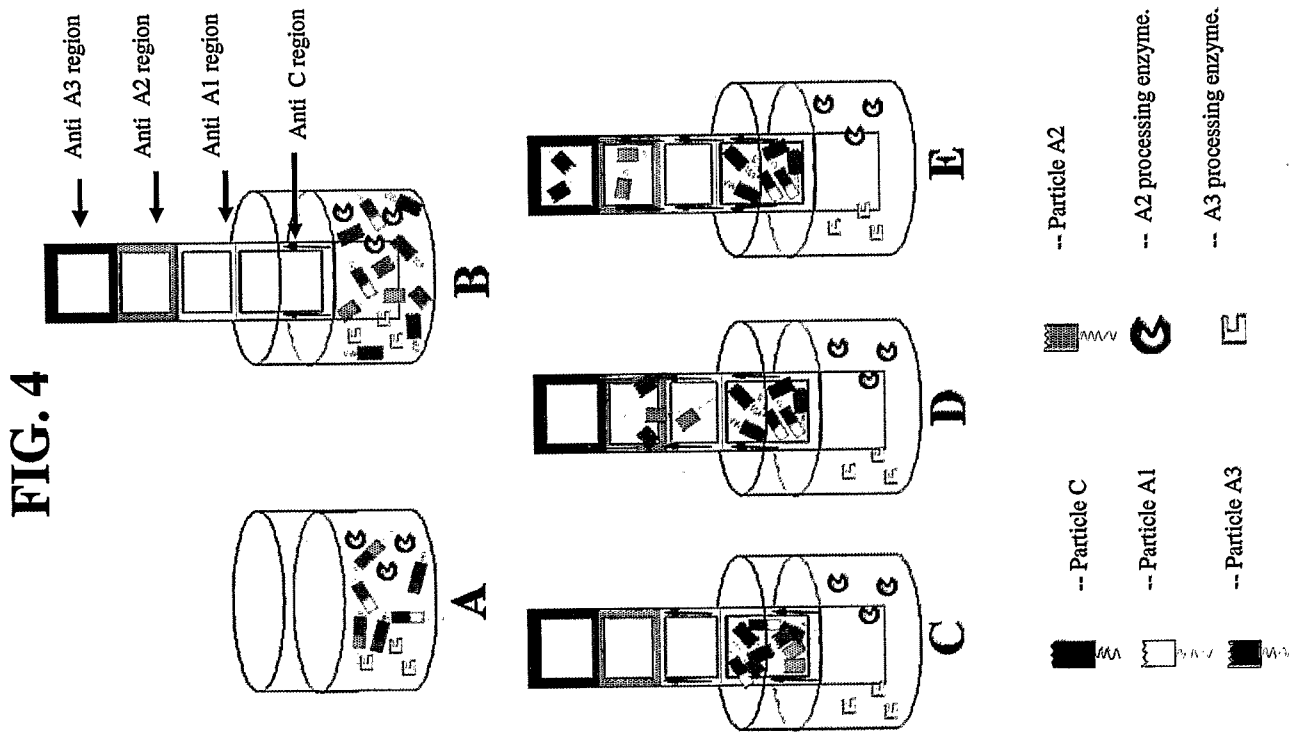

FIG. 5

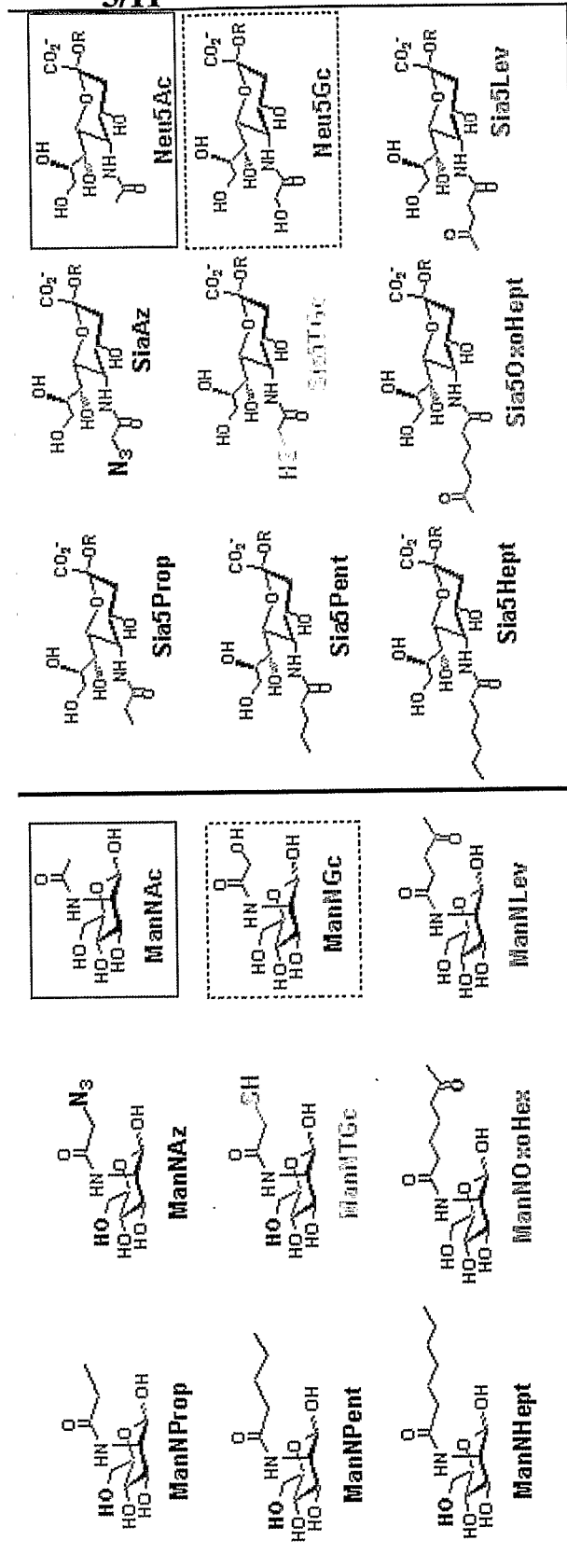

FIG. 6

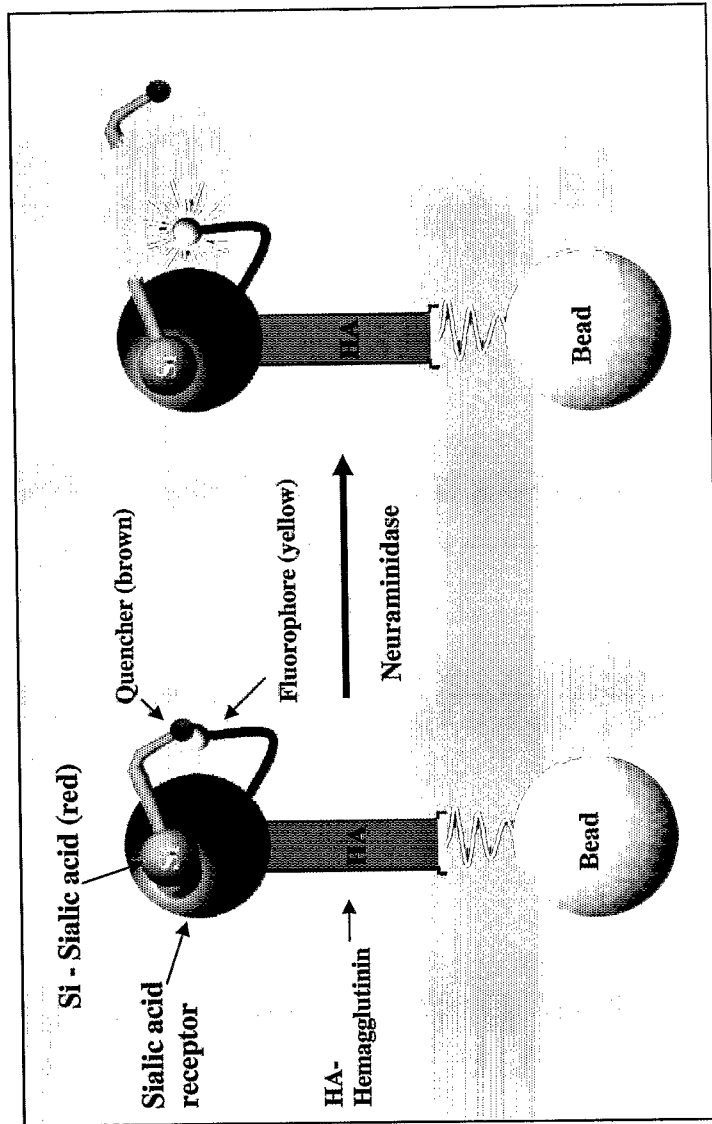
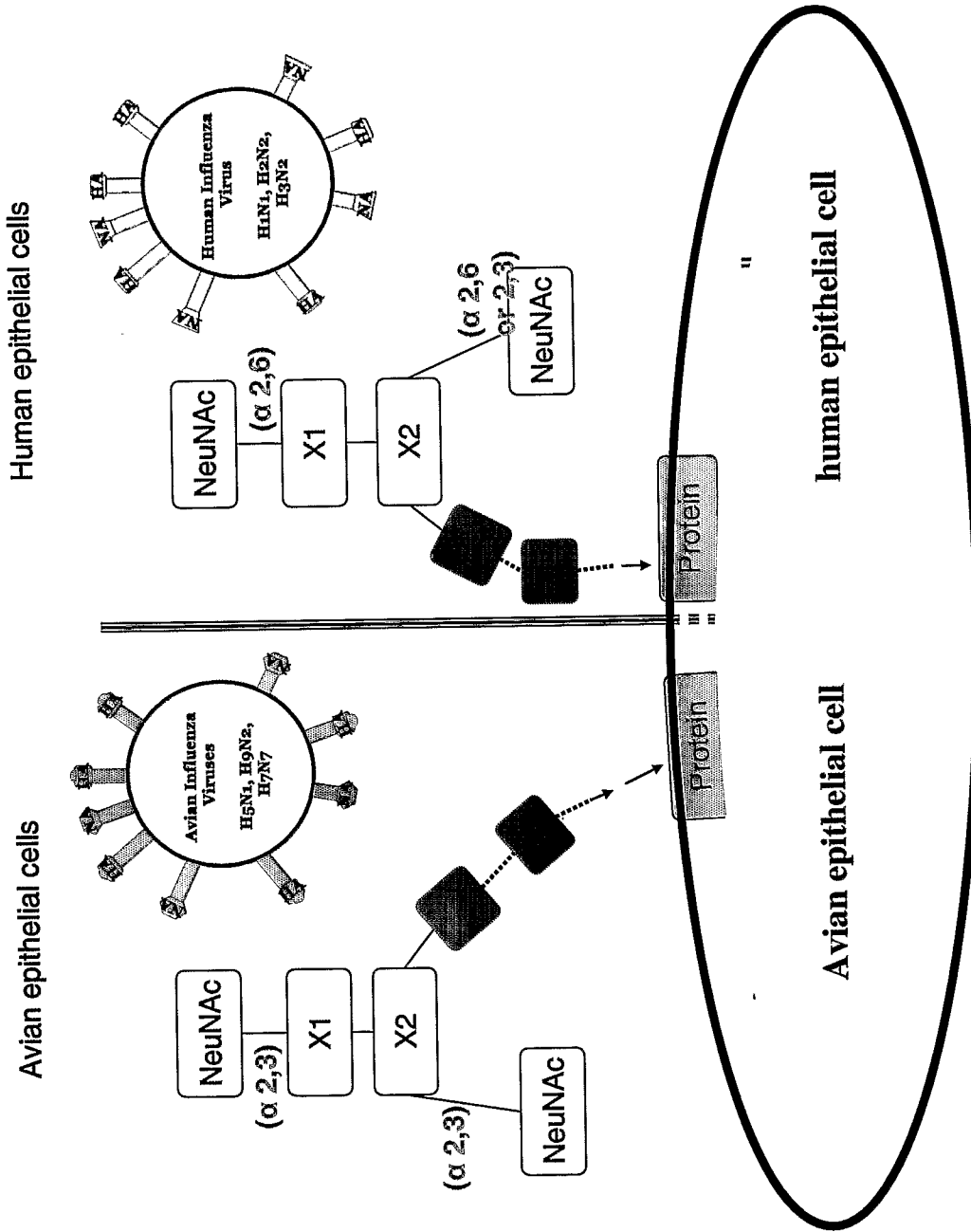
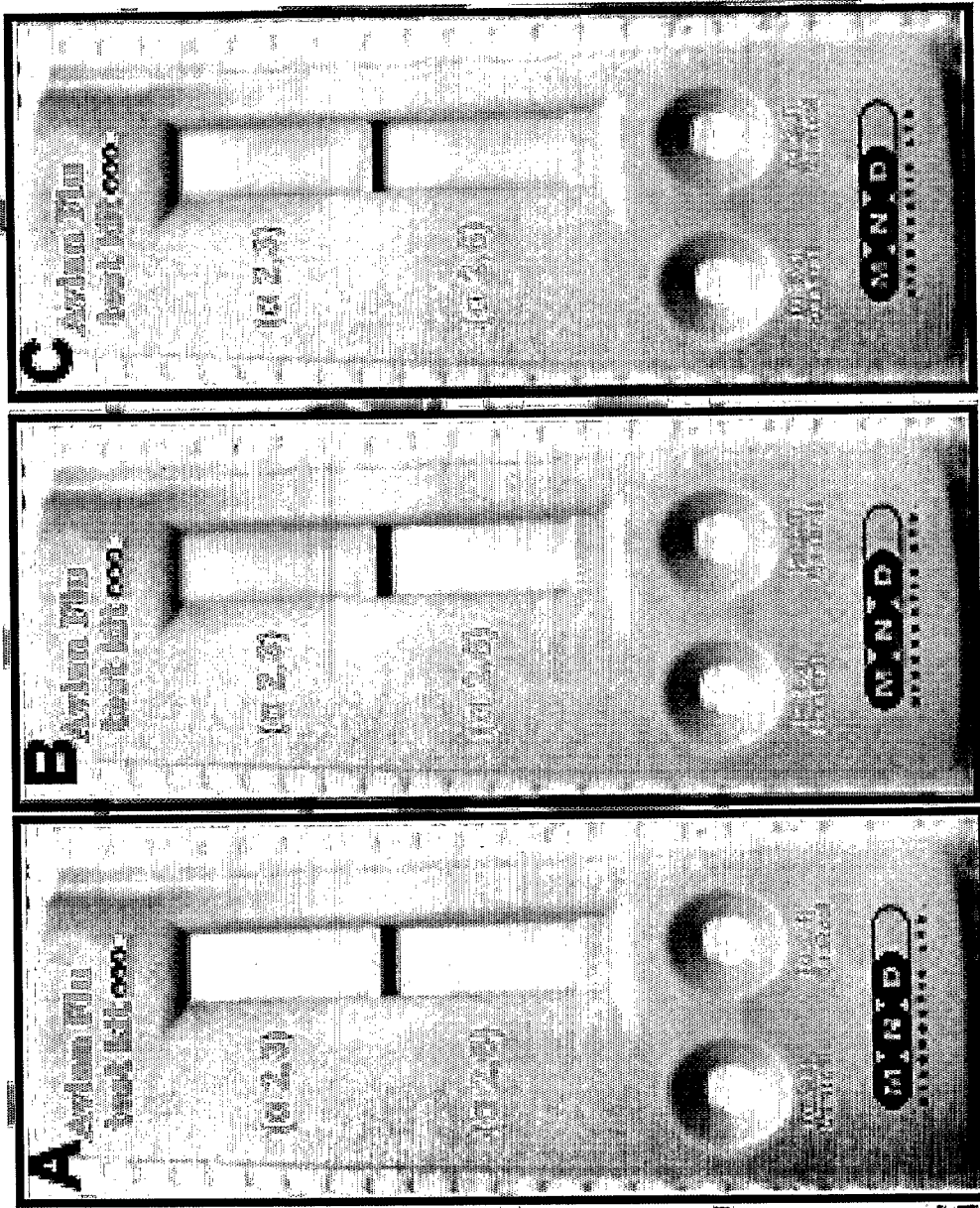

FIG. 7



FIGs. 8A-C



9/11

FIG. 9

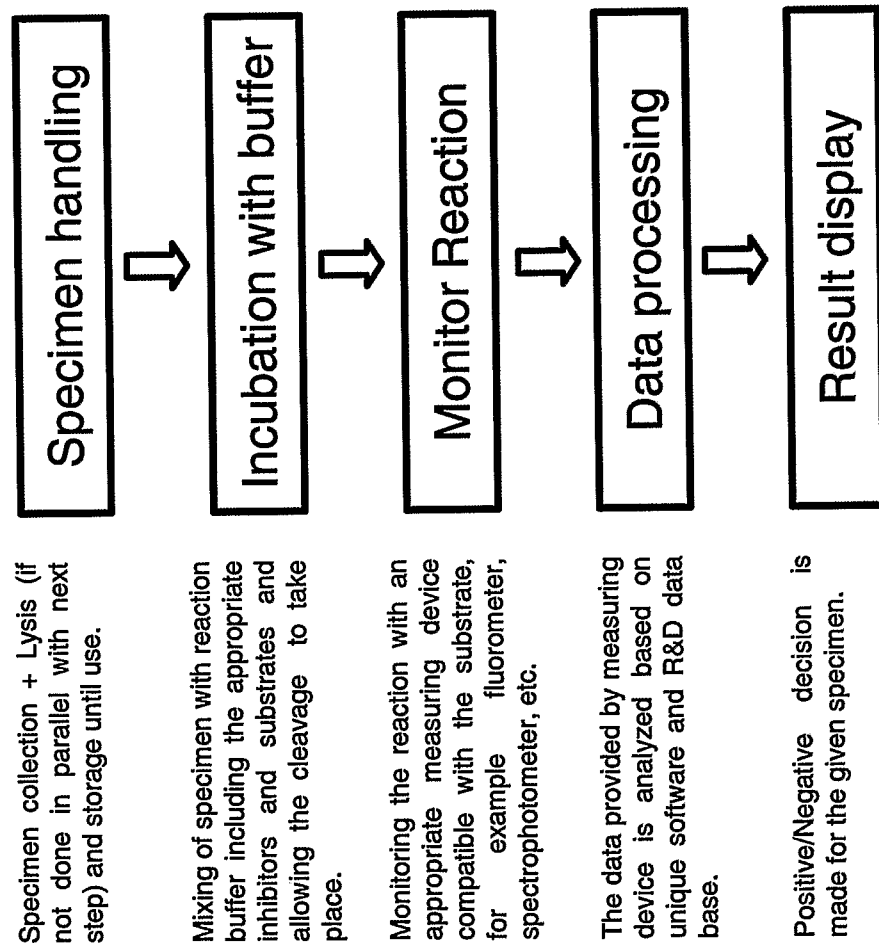

FIG. 10

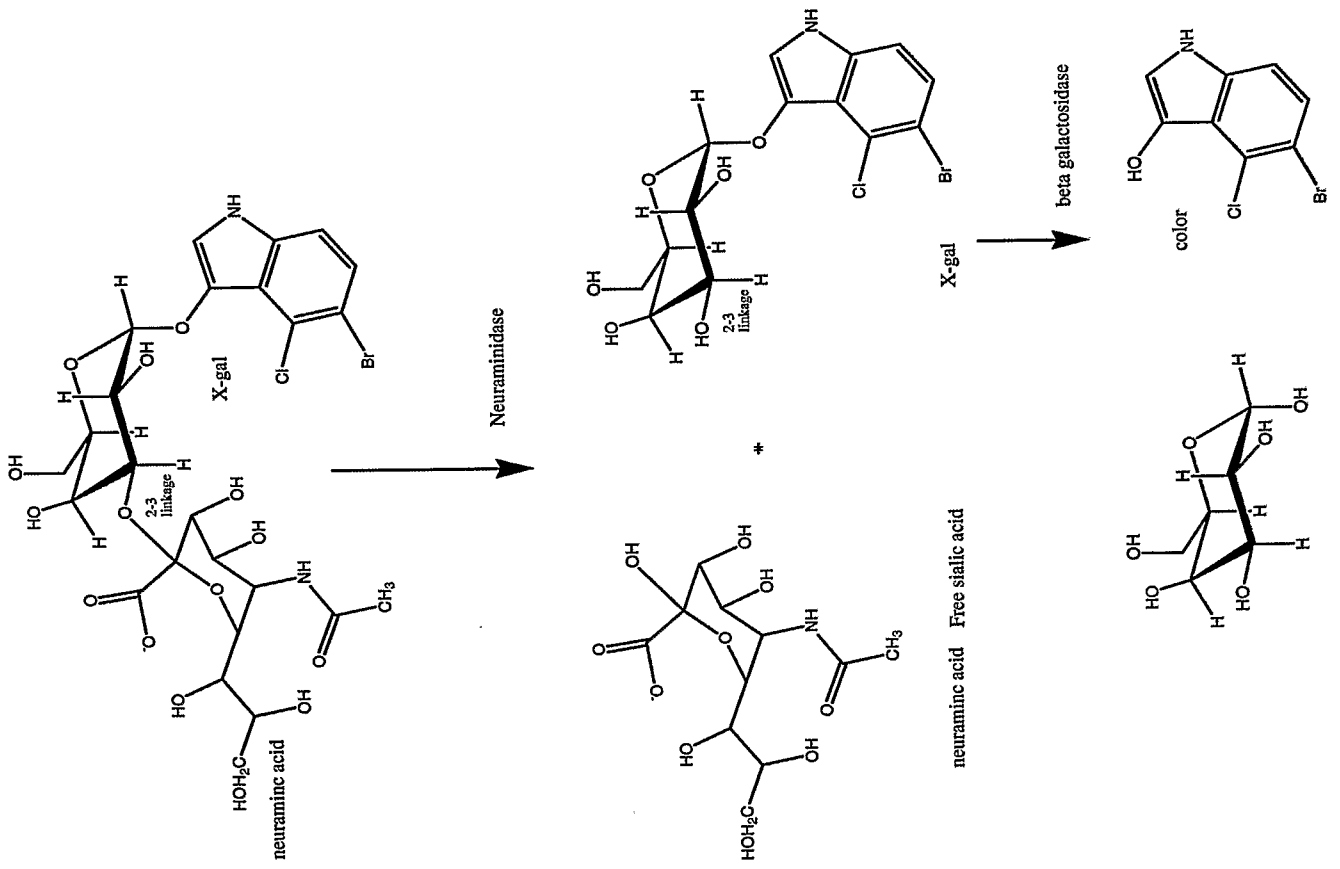

FIG. 11

