



# Public Safety Equipment Catalog



**POLICE • FIRE • EMS • DOT • UTILITY • AGRICULTURE**



- Lightbars
- Dash & Deck Lights
- Sirens & Switches
- Bulbs, Parts & Lenses
- Scene Lighting

- Vehicle Equipment
- Push Bumpers
- Prisoner Transport
- Consoles
- Equipment Mounting

- Equipment Storage
- Tools & Install Supplies
- Flashlights
- Personal Gear
- Laptop & Tablet Mounts

Columbus Office  
8495 Estates Ct  
Plain City, Ohio 43064  
866-320-7277

Cleveland Office  
8291 Darrow Rd  
Twinsburg, Ohio 44087  
855-387-3911

[www.parrpse.com](http://www.parrpse.com)

(PDF Revised - 10/01/15)





# The Parrfect Combination of Products & Services!

- ✔ **Quick fulfillment and shipping** - Large in stock product selection.
- ✔ **Extensive product selection** - Thousands of products available.
- ✔ **One stop shop** - Equipment as well as professional installation services.
- ✔ **Complete vehicle package options** - Save money through vehicle packages.
- ✔ **Expert advice** - From years of parts and installation experience.
- ✔ **Multiple markets** - Police, fire, DOT, utility, towing, construction, agriculture and more.



- Fast & Easy account setup!
- Easy to order! Phone, fax, mail, email or order online
- Open M-F 8:00 – 4:30 EST or online 24/7 at [www.parrpse.com](http://www.parrpse.com)
- Knowledgeable, friendly and experienced sales and service team
- New Products added continually



**Vehicle and product demonstrations:**  
 If you're within a manageable distance we can come to your site with one of our fully equipped demo vehicles to show you some of the latest product options.



Authorized flashlight repair center.



Stay connected and learn about new products and special promotions.  
 We'd love to hear about your unique needs.

**Columbus Office**  
 8495 Estates Ct  
 Plain City, Ohio 43064  
 866-320-7277

[www.parrpse.com](http://www.parrpse.com)  
[info@parrpse.com](mailto:info@parrpse.com)

**Cleveland Office**  
 8291 Darrow Rd  
 Twinsburg, Ohio 44087  
 855-387-3911



## MINI CENTURY™ LED LIGHTBAR



✓ Pg. 8

## WHELEN LIGHTBAR LENS KITS



✓ Pg. 17

## MINI LEGACY® SERIES SUPER-LED LIGHTBAR



✓ Pg. 11

## CODE 3 DEFENDER® LIGHTBAR



✓ Pg. 18

## HIGHLIGHTER™ LED MINI LIGHTBAR



✓ Pg. 11

## INNER-EDGE™ LOW PROFILE FORWARD FACING SERIES



✓ Pg. 20

## MINI LIBERTY™ II LIGHTBAR



✓ Pg. 12

## FLEET RACK™



✓ Pg. 22

## WHELEN LIBERTY™ II LOW PROFILE SUPER-LED® LIGHTBAR



✓ Pg. 14

## SPITFIRE™ ION™ SERIES



✓ Pg. 24

## WHELEN LEGACY™ ALL DUO+™ SUPER-LED® LIGHTBAR



✓ Pg. 16

## REAR HATCH WARNING FOR SUV'S



✓ Pg. 25

**NEW**

## VEHICLE SPECIFIC MOUNT BRACKETS



✓ Pg. 26

## LINV2R™ SUPER-LED® LIGHTHEAD



✓ Pg. 27

## ION™ V-SERIES SUPER-LED® SURFACE MOUNT LIGHTHEAD



✓ Pg. 28

## WHELEN MICRON™ SERIES



✓ Pg. 29

## LINSV2 LIGHTHEAD



✓ Pg. 30

## WHELEN VERTEX™ 360 LED LIGHT



✓ Pg. 33

## WHELEN M6V2 & M9V2 SUPER-LEDSTM



✓ Pg. 35

## MARKED SEDAN EQUIPMENT PACKAGES INCLUDING INSTALLATION



✓ Pg. 40

## MARKED UTILITY EQUIPMENT PACKAGES INCLUDING INSTALLATION



✓ Pg. 41

## CENCOM SAPPHIRE™ SIREN AND LIGHT CONTROL SYSTEM



✓ Pg. 46

## CODE 3 H2 COVERT™ REMOTE SIREN SYSTEM



✓ Pg. 49

## THE GRIP IDLE MANAGEMENT SYSTEM™



✓ Pg. 53





## PRO-GARD SAFESTOP VEHICLE ANTI-THEFT SYSTEM



✓ Pg. 66

## SANTA CRUZ UNIVERSAL GUN RACK



✓ Pg. 82

## HAVIS UNIVERSAL TABLET DOCK



✓ Pg. 68

## PRO-GARD LIGHTED PUSH BUMPERS



✓ Pg. 87

## PRO-GARD TRUNK TRAY



✓ Pg. 75

## E/Z RIDER K-9 PLATFORMS



✓ Pg. 90

## TRUCKVAULT LIFT SYSTEM FOR EXPLORER PPV



✓ Pg. 77

## PIONEER NANO™ NP SERIES WORK/SCENE LIGHTS



✓ Pg. 99

## SETINA HEAVY DUTY CARGO TRUNK SOLUTION



✓ Pg. 77

## THROW-LIGHT TACTICAL



✓ Pg. 104

## PRO-GARD™ CARGO CABINETS & LOCKING WEAPONS DRAWER



✓ Pg. 79

## ELITE BODY ARMOR



✓ Pg. 112

# TABLE OF CONTENTS



<b>Beacons</b>	<b>5 - 7</b>
<b>Mini Lightbars</b>	<b>8 - 12</b>
<b>Lightbars, Undercover &amp; Traffic Advisors</b>	<b>13 - 22</b>
<b>Deck &amp; Dash Lights</b>	<b>23 - 25</b>
<b>Lighthoods</b>	<b>26 - 35</b>
<b>Brake Lights / Auxiliary Lights</b>	<b>36 - 38</b>
<b>Flashers</b>	<b>39</b>
<b>Turn-Key Vehicle Equipment Packages</b>	<b>40 - 41</b>
<b>Replacement Parts &amp; Bulbs</b>	<b>42 - 43</b>
<b>Switch Controls, Sirens &amp; Speakers</b>	<b>44 - 52</b>
<b>Vehicle Electronic Accessories</b>	<b>53 - 57</b>
<b>Install Supplies</b>	<b>58 - 59</b>
<b>Consoles &amp; Accessories</b>	<b>60 - 65</b>
<b>Anti-Theft Systems</b>	<b>66</b>
<b>Computer / Tablet Mounting</b>	<b>67 - 73</b>
<b>Vehicle Storage Units &amp; Organizers</b>	<b>74 - 79</b>
<b>Weapons Storage</b>	<b>80 - 83</b>
<b>Prisoner Transport</b>	<b>84 - 85</b>
<b>Push Bumpers</b>	<b>86 - 87</b>
<b>Partitions &amp; K9 Transport System</b>	<b>88 - 91</b>
<b>Flashlights &amp; Accessories</b>	<b>92 - 97</b>
<b>Spotlight &amp; Scene Lighting</b>	<b>98 - 103</b>
<b>Scene Tools</b>	<b>104</b>
<b>Vehicle Wash</b>	<b>105 - 107</b>
<b>Evidence Collection</b>	<b>108 - 109</b>
<b>Latex &amp; Nitrile Gloves</b>	<b>110</b>
<b>Custom Badges</b>	<b>111</b>
<b>Body Armor</b>	<b>112</b>

The prices shown in this catalog are as accurate as possible. However, because of fluctuating market prices, it is difficult to maintain an exact price. Therefore, prices are subject to change without notice and will be invoiced with the prices in effect at time of shipment, except in the case of daily specials and sales flyers with specific ending periods. Every attempt will be made to notify you prior to shipment of any price variation so you can make a determination. Parr Public Safety Equipment is not responsible for typographical errors. See our full terms and conditions at [www.parrpse.com/terms.html](http://www.parrpse.com/terms.html).

© Copy Right 2014 Parr Public Safety Equipment Inc.



### STROBE AND LED BEACON MOUNTING BRACKETS **WHELEN**

- Mirror mount brackets utilize “U” brackets to mount to West Coast style mirrors
- Shelf mount brackets mount to flat, vertical surfaces
- MIRROR15 and BBKT15 fit all L50 and 1500 series beacons
- MIRROR20 and BBKT20 fit all L20, 2000 and 2500 series beacons

Item #	Description	Price
MIRROR15	West Coast Mirror Mount Bracket	\$39.00 ea
MIRROR20	West Coast Mirror Mount Bracket	\$39.00 ea
BBKT15	Stainless Steel Shelf Mount Bracket	\$39.00 ea
BBKT20	Stainless Steel Shelf Mount Bracket	\$39.00 ea



# WARNING LIGHTS

## LED Beacons



L31HRF Pictured

### WHELEN L31 SERIES SUPER LED® 360° BEACONS



This 360° LED beacon is the brightest in the industry! High-performance Super-LED® optics provides warning like a strobe, plus all the performance characteristics of LEDs. Rugged and reliable, the L360 Series features a built-in flasher, cast aluminum base, Hi/Low Intensity, built-in cruise lights and synchronization ability.

- Model L31 - SAE Class 1 and CA Title XIII Certified
- Model L32 - Amber is SAE Class 1 Certified, Class 2 for all other colors
- 28 selectable Scan-Lock™ flash patterns including 4 simulated rotating patterns
- Alternately or simultaneously flash multiple patterns (Cross-Link™) with up to eight Whelen Super-LED® 360° beacons
- 5 Year Warranty

Item #	Description	Price
L31H*F	Super LED®, Tall, Red, Blue or Amber	\$469.00 ea
L32L*F	Super LED®, Low Profile, Red, Blue or Amber	\$290.00 ea
MMK	Magnetic Mount Kit	\$29.00 ea

\*Specify color: ■ Amber ■ Blue ■ Red □ White Green available by special order, call for pricing.



L32 Series



### WHELEN L22 SERIES SUPER LED® BEACONS



The L22 Beacon with SignalAlert™ and 13 other effective flash patterns. L22 models feature generation 3.5 LED technology that rivals strobe in power, but with significantly lower amp draw. LED has a rated life which exceeds that of comparable flash tubes by more than 50:1.

- 100,000 hour rated life
- Low current draw: only 0.26 amps (average), 0.65 (peak) @12.8V DC
- Amber model is SAE Class 2 Certified
- 5 Year Warranty

Item #	Description	Price
L22HAP	Permanent Mount Beacon, Amber	\$155.00 ea
L22HCP	Permanent Mount Beacon, White	\$165.00 ea
MMK	Magnetic Mount Kit	\$29.00 ea
DH2000*	Replacement Dome	\$49.00 ea

\*Specify color: ■ Amber □ White



### WHELEN L21 SERIES SUPER LED® BEACONS



- Amber model is SAE J845, Class 1 360° Certified
- 100,000 hour rated life
- Low current draw: 0.6 amps (average), 1.5 amps (peak) @12.8V DC
- Combination mounting: pipe, permanent and J-hook
- Permanent mount features Hi/Low power selection, 24 Scan-Lock™ flash patterns, synchronize wire and cruise light with 4 intensity levels
- Supplied with 6" pigtail (permanent mount) or 10' straight cord with LED "On" indicator switch and cigar plug (magnetic mount)

Item #	Description	Price
L21H*P	Permanent Mount Beacon, High Dome, Amber or White	\$199.00 ea
L21L*P	Permanent Mount Beacon, Low Dome, Amber or White	\$199.00 ea
MMK	Magnetic Mount Kit	\$29.00 ea
DH2000*	Replacement Dome (specify color)	\$49.00 ea

\*Specify color: ■ Amber □ White



### WHELEN L41 SERIES SUPER-LED® BEACONS



L41 Series beacons are medium profile Super-LED® beacons that feature ultra high intensity LED technology that rivals strobe in intensity with a fraction of the amp draw. Both models feature encapsulated electronics for moisture and vibration resistance and 25 selectable flash patterns.

- The L41 is SAE Class 1 Certified
- Encapsulated electronics for moisture and vibration resistance
- Five year warranty
- Permanent mount model supplied with five 6" pigtailed
- Magnet mount model supplied with a 10' straight cord and cigar plug with LED indicator On/Off and pattern control switches

Operates on  
12 or 24VDC



Item #	Description	Price
L41*P	Permanent Mount Beacon	\$249.00 ea
L41*M	Magnet Mount Beacon	\$269.00 ea

\*Specify color: ■ Amber ■ Blue □ White ■ Red

### WHELEN L50 SERIES SUPER LED® BEACONS



A small, compact Super-LED beacon featuring exclusive Broadband Energy Radiator™ LED technology that rivals strobe in intensity and draws far less power. Only available in Amber and White.

- The L51 is SAE Class 1 Certified, the L52 is SAE Class 2 Certified
- Durable polycarbonate dome and base
- Five year warranty
- Permanent mount model supplied with four 6" pigtailed
- Magnet mount model supplied with a 10' straight cord and cigar plug with LED indicator On/Off switch



Item #	Description	Price
L51*P	Class 1 Permanent Mount Beacon	\$269.00 ea
L51*M	Class 1 Magnetic Mount Beacon	\$279.00 ea
L52*P	Class 2 Permanent Mount Beacon	\$179.00 ea
L52*M	Class 2 Magnet Mount Beacon	\$189.00 ea

■ Amber □ White

### ACARI™ ROOF TOP MOUNTING PLATFORM

The ACARI™ allows various devices to be installed on a vehicle that would otherwise be attached directly through the top of the truck cab. It has clamps that enter the cab roof through the center high mount brake light opening and tighten down on the vehicle to form a rigid, rugged platform without drilling holes or marring the vehicle's finish.

- Gasketing system allows all wiring to run into the vehicle in an enclosed environment
- Manufactured from 6063 aluminum alloy with a durable clear anodized finish

\*Specify vehicle when purchasing

Item #	Description	Price
RTM-101	22" Rooftop Platform	\$269.00 ea
RTM-201	28" Rooftop Platform	\$289.00 ea
RTM-301	34" Rooftop Platform	\$299.00 ea



Lights not included.

# WARNING LIGHTS

## Mini Lightbars



**NEW**

### MINI CENTURY™ LED LIGHTBAR

Pre-configured lightbars with premium lighting at an off-the-shelf price. Four Linerar6™ corner modules with inboard TIR6™ modules. Multiple Scan-Lock™ flash patterns. Three model lengths to choose from with permanent, stud, magnetic and magnetic/suction mounting. Permanent mount models have 12" pigtail, magnetic has 10' cord and cigar plug with On/Off switch and pattern selection switch. Extruded aluminum platform with compression fit gasket and Clip-Lock™ system allows easy removal of outer lens.

- Available in Red, Blue, Amber and split colors of Red/Blue and Amber/White
- Size: 2-3/8"H x 7-3/4"W x 11-1/2" or 16-1/2" or 23-1/4"L

Item	Description	Price
MC11P*	Mini Century 11.5", Permanent Mount (+\$50 for blue or red)	\$225.00 ea
MC11M*	Mini Century 11.5", Magnet Mount	\$235.00 ea
MC11S*	Mini Century 11.5", Stud Mount (blue add \$50)	\$235.00 ea
MC16P*	Mini Century 16.5", Permanent Mount (+\$50 B or R)	\$245.00 ea
MC16PF	Amber/White	\$259.00 ea
MC16M*	Mini Century 16.5", Magnetic Mount (+\$50 B or R)	\$259.00 ea
MC16S*	Mini Century 16.5", Stud Mount (+\$50 B or R)	\$245.00 ea
MC23V*	Mini Century 23.25", Magnetic/Suction Mount	\$358.98 ea
MC23P*	Mini Century 23.25", Perm Mount (+\$50 B or R)	\$339.00 ea
MC23M*	Mini Century 23.25", Magnet Mount (+\$50 B or R)	\$359.00 ea
MC23S*	Mini Century 23.25", Stud Mount (+\$50 B or R)	\$359.00 ea

\*Specify color

**WHELEN**



**WHELEN**



### RESPONDER® LP DUO™ SERIES MINI LIGHTBAR

DUO™ technology model has different color LEDs in the same module allowing lightbar to flash different colors at a time.

- Available in Red, Blue, Amber and split colors of Red/Blue and Amber/White.
- Class 1, SAE J845 Certified
- 100,000 hour rated life
- 6 Super-LED Linear-LED® modules (R2LP Series)
- Built-in electronic flasher with 30 Scan-Lock™ flash patterns plus 4 simulated rotating patterns (permanent mount versions only)
- ActionScan™ default flash pattern
- Permanent mount includes 6" pigtail; magnetic mounts include 8' straight cord with cigar plug and LED indicator switch
- Polycarbonate base and dome with smooth exterior will not gather dirt and dust. Optional Aluminum base available and other mount options. Contact us for pricing.
- 12 VDC

Dimensions: 17-3/8" L x 6-5/16" W x 3-1/4" H

Item	Description	Price
RDLPP**	DUO, permanent mount, Amber/Blue, Amber/Clear, Amber/Red, Blue/Red, Permanent Mount	\$899.00 ea

\*Specify color:





**WHELEN**



### RESPONDER® LP CON3™ SERIES MINI LIGHTBAR

Toss out your amp-robbing, halogen mini bar and increase your warning power with the Responder Series mini LED lightbar! Whelen's Super-LED® technology provide LEDs that out perform and out last strobes and halogens with a 100,000 hour life rating. Combine that with a rugged polycarbonate base and the result is a mini lightbar that is sure to grab more attention, day or night, and withstand the rigors of the field for years to come!

- 5 Year Warranty on LEDs
- SAE Class 1 Certified
- 6 CON3™ Super-LED® modules: 2 front, 2 rear and 1 on each end
- Built-in flasher with 46 Scan-Lock™ flash patterns including 4 simulated rotating patterns
- Permanent mount includes 6" pigtail, magnetic mount includes 8' straight cord with cigar plug with LED indicator On/Off and pattern select switches
- Dimensions: 17-3/8" L x 6-5/16" W x 3-1/4" H

Item #	Description	Price
R1LPP*	Responder CON3, Permanent Mount, Red or Blue	\$379.00 ea
R1LPM*	Responder CON3, Magnet Mount, Red or Blue	\$399.00 ea
R1LPPA	Responder CON3, Permanent Mount, Amber	\$259.00 ea
R1LPMA	Responder CON3, Magnet Mount, Amber	\$279.00 ea

\*Specify Color, Blue is a special order.

\*\*Add \$75.00 for Green model.



**WHELEN**

### RESPONDER® LP LINEAR-LED™ SERIES MINI LIGHTBAR

Now a low profile, mini-lightbar that provides all the high performance LED warning and signaling benefits in a smaller size that fits all your special applications. Super-LED modules in a rugged aluminum base are built to take the roughest conditions and long hours you face. They're road tested, vibration and moisture resistant and use much lower current than other warning lights. Put a Responder LP to work on your utility, security, fleet, construction or public works vehicle.

Dimensions: 17-3/8" L x 6-5/16" W x 3-1/4" H

Item #	Description	Price
R2LPP*	Responder, Linear 6, Permanent Mount, Red or Blue	\$489.00 ea
R2LPM*	Responder, Linear 6, Magnet Mount, Red or Blue	\$499.00 ea
R2LPPA	Responder, Linear 6, Permanent Mount, Amber	\$339.00 ea
R2LPMA	Responder, Linear 6, Magnet Mount, Amber	\$359.00 ea

\*Specify Color

\*\*Add \$125.00 for Green model.



# WARNING LIGHTS

## Mini Lightbars



### ABLE 2 MINI LIGHTBAR

The Able 2 Low Profile Mini LED Lightbar features an extruded aluminum base and a clear, UV-resistant Lexan dome. Its compact design makes it easy to install, but the 336 high-intensity LEDs make it hard to miss!

- Solid state internal flasher features 7 strobe-type patterns
- Select up to four different colors in each mini bar
- LEDs flash in quarter sections of 84 LEDs each
- Amp Draw: 4.2A (max)
- Dimensions: 2" H x 17-1/4" W x 9-1/8" D
- Weight: Permanent - 2 lbs., 14 oz., Magnetic - 5 lbs., 14 oz.
- Permanent mount includes a 10' cable and mounting hardware
- Magnetic mount uses a 12' straight cord with fused cigar plug with built-in Power and Mode (pattern select) switches



### 7 FLASH PATTERNS:

- Double Alternating Flash
- Quad Alternating Flash
- Quint Alternating Flash
- Mega Alternating Flash
- Double Simultaneous Flash
- Quad Simultaneous Flash
- Random Flash

#### Magnetic Mount

Item #	Description	Price
11.1200.A08	Able 2 Mini LED Light Bar, Amber	\$379.00 ea
11.1200.R08	Able 2 Mini LED Light Bar, Red	\$379.00 ea
11.1200.RB8	Able 2 Mini LED Light Bar, Red/Blue	\$399.00 ea

#### Permanent Mount

Item #	Description	Price
11.1200.A00	Able 2 Mini LED Light Bar, Amber	\$359.00 ea
11.1200.R00	Able 2 Mini LED Light Bar, Red	\$359.00 ea
11.1200.RB0	Able 2 Mini LED Light Bar, Red/Blue	\$379.00 ea



### MINI JUSTICE® SERIES LIGHTBAR

This is a compact, 22" version of the popular, full size Justice lightbar. Mini Justice is easy to operate, upgrade and service, and it's ideal for applications where a full-size lightbar just won't work!

- Eight total LED lighthoods: four corner Linear Super-LED® modules and four inboard CON3™ LED modules with optical spreaders
- Ninety-five Scan-Lock™ flash patterns
- Replace any lighthood by removing one screw and a single connector
- Includes a 10' cord with cigar plug that has an ON/Off switch with LED "On" indicator and a separate flash pattern select switch
- Dimensions: 2 1/4" (57mm) H x 12" (305mm) D x 22"

**WHELEN**

Now Only  
**\$749.00**

Item #	Description	Price
MJEG1*	Mini Justice Lightbar, Magnetic Mount	\$749.00 ea
MJEP1*	Mini Justice Lightbar, Permanent Mount	\$749.00 ea



\*Specify Color. \*\*Add \$125.00 for Green model.



### FRONTIER™ LED MINI LIGHTBAR

Built around Code 3's new Torus™ lighthoods which deliver exceptionally bright straight-on and off-angle warning. It also features their exclusive "Capacitive Touch" which allows the flash patterns to be change with just the touch of a finger.

- (4) Torus™ 6-LED Lighthoods and (4) Torus™ 9-LED Lighthoods in Corners
- Includes permanent and magnet mount hardware
- 21 Selectable flash patterns
- 5 Year LED warranty
- Meets SAE Class I and California Title 13 Requirements with clear lens
- 17.2" L x 3.8" H x 10.8" D



Item #	Description	Price
FX817*	8 LED Frontier, Matching Color LEDs and Lenses	\$419.00 ea
FX816C*	8 LED Frontier, Color LEDs and Clear Lenses	\$419.00 ea

\*Specify Color



### HIGHLIGHTER™ LED PLUS MINI LIGHTBAR

- Low-profile, LED mini-lightbar, only 15.8-inches long x 7.0-inches deep x 2.6-inches tall
- Uniform 360-degree light distribution; no dark spots or shadows
- Select flash patterns via unique MagnetSelect™ feature
- Multiple flash patterns with synchronization capability
- Available with suction cup/magnet mount or permanent mount
- LEDs offered in Amber, Blue, Green, Red and White
- Domes available in Amber, Blue, Clear and Red
- Five-year LED warranty



Item #	Description	Price
454201	Highlighter Permanent Mount	\$475.00 ea
454200	Highlighter Suction / Magnetic Mount	\$499.00 ea



### MINI LEGACY® SERIES SUPER-LED LIGHTBAR

This is a compact, 22" version of the popular, full size Legacy lightbar. Newly designed, high-output one-piece linear combo "Multi-Angled" corner modules produce light forward and rear at the critical 45° angles. The four combo modules produce 360° warning signals.

- Lower profile than Liberty but with increased intensity
- New Diamond Optix™ (Patent Pending) linear reflector optic design



Item #	Description	Price
GT9**M	Mini Legacy Lightbar, Magnetic Mount	\$999.00 ea
GT9**P	Mini Legacy Lightbar, Permanent Mount	\$975.00 ea

\*Specify Color



# WARNING LIGHTS

## Mini Lightbars



EXCLUSIVE LIGHTBAR



### FREEDOM® LED MINI LIGHTBAR

The re-designed, all Linear-LED™ Mini Freedom lightbar, featuring the next generation of ultra bright, ultra wide-angle LED technology. A win/win warning package that is not only superior to strobe bars in impact, but provides a heavy duty, long life operation with low current draw. With its extruded aluminum chassis and tough, poly carbonate lenses, this LED bar will withstand rough treatment and long hours of use.

- Five year HDP (Heavy Duty Professional) warranty on LEDs
- 10 dual level Super-LED warning lights
- Clear outer lenses standard, optional colored lenses available
- Ability to set each pair of LEDs to its own flash pattern (permanent mount version only)
- Lighthoods are driven by an all electronic module that provides proper input power, ensuring equal light intensity from each lighthood
- Permanent mount includes mounting feet and a 16.5', multi-conductor cable
- Stud mount includes 2 bolt mounts with multi-conductor cable

Item #	Description	Price
FNODOTPA	10 Head Super-LED, Perm Mount	\$1,495.00 ea
FNODOTSA	10 Head Super-LED, Stud Mount	\$1,495.00 ea

\*\*Specify Colors - to exchange Red, Amber or Blue module for White, add \$30.00 each.



**WHELEN**

**NEW**

### MINI LIBERTY™ II LIGHTBAR

Offers 30% more illuminated surface area on all warning modules, including corner and inboard modules! Features Whelen's Collimator™ patented optic design which provides unbeaten light output. Sealing points provide lightbar integrity in all weather conditions and aluminum top repels hail or other environmental damages while directing heat away from internal components. 19.31" L

- 4 single color corner modules available
- 1" less in depth allowing for contiguous light
- Lower profile feet are quieter, reducing wind noise, stealth look
- Photocell automatically dims the lightbar at night
- 5 year warranty on LED lighthoods
- Magnetic mount: four 90 lb. pull magnets with 8' cigar lighter plug cord
- Permanent mount: black feet with 16.5', 11 conductor cable (Takedown, Rear Work and Alley only available with permanent mount)



Item #	Description	Price
IT9**P	Mini Liberty II LED, Permanent Mount	\$799.00 ea
IT9**M	Mini Liberty II LED, Magnetic Mount	\$799.00 ea

\*\*Specify Colors - to exchange Red, Amber or Blue module for White, add \$30.00 each. Many lighting options are available.





**WHELEN**

## JUSTICE® SUPER LED® LIGHTBAR

Everything you need, nothing you don't. The Justice® Series was designed for simplicity and flexibility. Each section of the bar can be accessed by simply removing four lens screws - making upgrades, color changes and service a breeze. Packed inside its sleek exterior are Whelen's proven Super-LEDs®, providing maximum lighting protection and reliability.

- Utilizes compact, high-output LR-11 Takedown and Alley lights to maximize space for LED lighting
- Center section available with either a single CON3™ or two LTR3s™ (for split color center section)
- Built upon a black poly carbonate base on an extruded aluminum platform for exceptional durability
- Clear outer lens standard with a moisture resistant compression fit gasket
- Corner modules available with 6 or 9 Super-LEDs®
- 12" wide and only 2-1/4" high (without mounting feet)

**Two series available:** WeCan™ and Competitor™

**WeCan™** offers built-in Traffic Advisor™ control, independent flash pattern plus phase control of each individual lighthouse and optional flashing Takedowns and Alley lights.

**Competitor™** Series offers front, rear and all bar operation control, optional Scan-Lock™ flash patterns, Alley lights, Takedowns or flashing Takedowns, low power operation and optional Traffic Advisor™ with control head.

Item #	Description	Price
JE8SP1*	Justice® Warning Essentials Lightbar, includes Mount Kit	\$1,125.00 ea
JE8****	4 Corner LED Justice Lightbar, 50", Competitor™ Series	\$725.00 ea
JY8****	4 Corner LED Justice Lightbar, 50", WeCan™ Series	\$925.00 ea
JHALF1	Optional Takedown/Alley Light Kit, Competitor™ Series	\$119.00 ea
JALF1	Optional Takedown/Alley Light Kit, WeCan™ Series	\$79.00 ea
JDC*	One CON3™ Inboard	\$69.00 ea
JDH*	Optional Long Throw LEDs for Center Position	\$79.00 ea
MK+	Mount Strap Kit	\$39.00 ea

+Specify Vehicle, \*Specify Colors



**LED Lightbar  
Starting At  
\$725.00**



**Warning Essentials  
50" Lightbar includes:**

- 16 Super-LED® modules
- LED Takedowns
- LED Alleys
- Mount Kit

**\$1125.00**

Additional lightbars and configurations available. Visit [www.parrpse.com](http://www.parrpse.com) for a complete listing.





# WARNING LIGHTS

## Lightbars

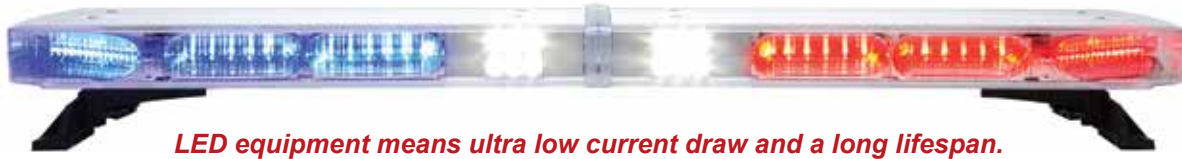

*LED equipment means ultra low current draw and a long lifespan.*

**WHELEN**

### WHELEN LIBERTY™ II LOW PROFILE SUPER-LED® LIGHTBAR

Designed with Whelen's Collimator™ patented optic design which provides unbeaten light output. Plug & Play into Whelen or vehicle manufacturer controllers. Photocell automatically dims the lightbar at night and still meets SAE Class 1 requirements in low power mode. Options include rear single color or DUO+™ Traffic Advisor™. Take-downs are available in 3, 6, or 12 Super-LED® modules. The aluminum top repels hail and other environmental damages and each model has one or two sealing points, assuring lightbar integrity in all weather conditions.

- 30% more illuminated surface area on all warning modules, including corner and inboard modules
- 5 Year HDP® Heavy Duty Professional warranty on LEDs and internal electronics
- LEDs rated for an incredible 100,000 hours of operation!
- Built-in flasher function for Takedowns and Alleys, and control for Traffic Advisor patterns
- Extruded aluminum chassis, providing superb strength and stability
- Lower profile feet for a stealth appearance, with standard clear lenses, making it almost undetectable - until you want to be seen
- Colored filters available for full customization
- Alternate center options are available: color domes for center and end sections with alley window and more
- Dimensions: 2-3/4"H x 12"D x 48.5 or 54"L . Available with standard or low profile mounting feet

Item #	Description	Price
IX*	4 Linear-LED® Lightbar	\$1,025.00 ea
IX88*	8 Linear-LED® Lightbar	\$1,449.00 ea
IX8SP1*	Fully Loaded Model: includes 14 Linear-LEDs®, Flashing LED Takedowns and Alley Lights - no additional options available	\$2,279.00 ea
IA3	Two LED Flashing Alley Lights	\$99.00 pr
ITL3	Two LED Flashing Takedown Lights	\$99.00 pr
ITL6	Two 6 Diode Flashing Takedown Lights	\$159.00 pr
ITL12	Two 12 Diode Flashing Takedown Lights	\$285.00 pr
MK+	Mount Strap Kit	\$39.00 pr

+Specify Vehicle - \*Specify Colors



4 LED Liberty II Lightbar

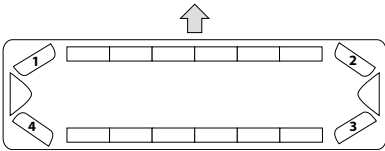

8 LED Liberty II Lightbar

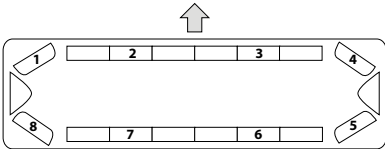

14 LED Liberty II Lightbar

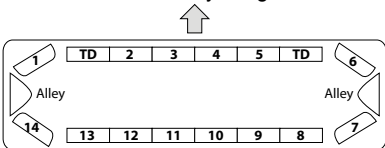

**LED Liberty II  
Lightbars Provide Superior  
Performance & High Reliability**

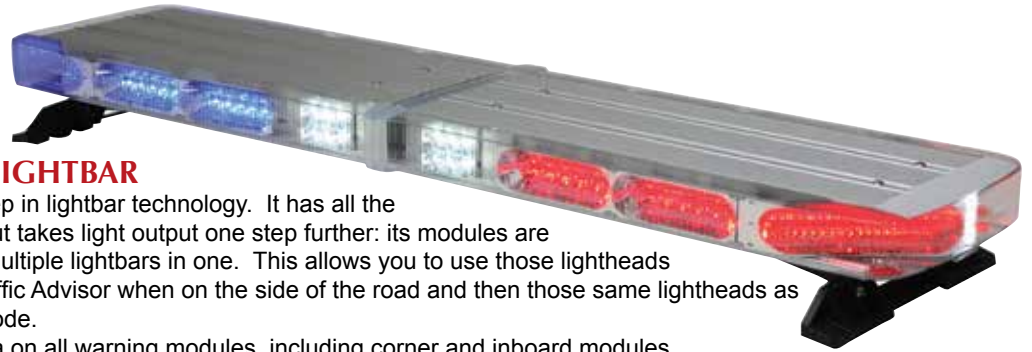

## WHELEN DUO LIBERTY™ II LIGHTBAR

The Duo Liberty is Whelen's next big step in lightbar technology. It has all the great features of the standard Liberty, but takes light output one step further: its modules are able to flash different colors, making it multiple lightbars in one. This allows you to use those lighthoods as, for example, a sequential amber Traffic Advisor when on the side of the road and then those same lighthoods as red and blue warning when in pursuit mode.

- 30% more illuminated surface area on all warning modules, including corner and inboard modules
- 5 Year HDP® Heavy Duty Professional warranty on LEDs and internal electronics
- Built-in flasher function for Takedowns and Alleys, and control for Traffic Advisor patterns
- Extruded aluminum chassis, providing superb strength and stability
- Lower profile feet for a stealth appearance, with standard clear lenses, making it almost undetectable - until you want to be seen
- Alternate center options are available: color domes for center and end sections with alley window and more
- Dimensions: 2-3/4"H x 12"D x 48.5 or 54"L
- Available with standard or low profile mounting feet

Item #	Description	Price
IB8**	4 Extended Duo Color Corner LEDs	\$1,425.00 ea
IB814**	Fully Loaded: 4 Duo Color Corner LEDs, 10 Duo Color Inboard LEDs, Flashing LED Takedown and Alley Lights	Please contact us for pricing.
IA3	Two LED Flashing Alley Lights	\$99.00 pr
ITL3	Two LED Flashing Takedown Lights	\$99.00 pr
ITL6	Two 6 Diode Flashing Takedown Lights	\$159.00 pr
ITL12	Two 12 Diode Flashing Takedown Lights	\$285.00 pr
MK+	Mount Strap Kit	\$39.00 pr

+Specify Vehicle - \*/# Specify Colors



14 LED Liberty Lightbar

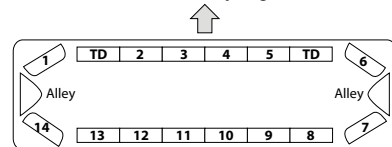

## Lightbars Your Way



We specialize in making lightbars for our customers' specific requirements.

Call today to discuss your lightbar needs and allow us to provide a unique solution.

**866-320-7277**

# WARNING LIGHTS

## Lightbars



**NEW**

The Legacy LED Lightbar was designed from the rugged extrusion up to maximize the performance of the hottest LED on the market.

### WHELEN LEGACY™ ALL DUO+™ SUPER-LED® LIGHTBAR

All warning lighthoods are True DUO+, whether one color or two. Each segment can be operated independently or at the same time, creating the first true DUO lightbar, without the loss of intensity. Ideal when you want to run a Traffic Advisor™ and rear warning at the same time, giving the performance of two lightbars in one.

Newly designed, high-output one-piece linear combo “Multi-Angled” corner modules produce light forward and rear at the critical 45° angles. The four combo modules produce 360° warning signals.

- Lower profile than Liberty but with increased intensity
- New Diamond Optix™ (Patent Pending) linear reflector optic design
- Optional take-downs are available in a 3-LED or 6-LED modules
- Optional alley or DUO+ integrated alley and warning light module ensures no dead spots, no gaps... 360° of continuous light
- Only DUO+ lets you operate the alley and the warning at the same time, full intensity



DUO+ lets you flash the lightbar in multiple colors



Legacy lightbar molds to the vehicle's roof



Complete light coverage with no dead spots between modules

**One piece** UNI-DOME construction with a single sealing point. Each dome slides onto the aluminum extrusion and wraps around all internal components while the wiper seal protects your lightbar from the worst elements.

**Legacy is the first lightbar** with a photocell to automatically dim at night and still meet SAE Class I requirements in low power mode.

Standard lengths: 44", 48" and 54". Height without mounting feet is only 1-5/8".



Multi angled combo corner modules produce light straight out and to front and critical 45° angles

Item #	Description	Price
GB8SP3*	48" Loaded Duo Lightbar	\$2,559.00 ea
GB2SP3*	55" Loaded Duo Lightbar	\$2,559.00 ea
MK+	Strap Kit	\$39.00 ea

Specify Vehicle, \*\* Specify colors



NEW ultra low profile mounting foot.



Bright illuminating take-down lights



## WHELEN LIBERTY™ LIGHTBAR LENS KIT

(Bar must currently have LED Alley or No Alley)

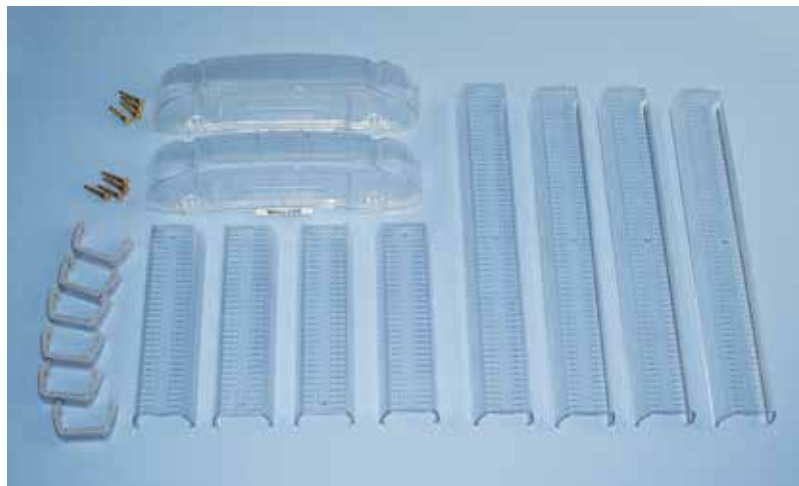

Item	Description	Price
SLENKT1	Basic Lens Kit - Clear Lens	\$179.00 kit
SLENKT2	Colored Lens Kit, Complete	\$239.00 kit



## WHELEN LIBERTY™ LIGHTBAR LENS KIT WITH HALOGEN ALLEY LIGHTS

Item	Description	Price
SLENLRK1	Basic Lens Retrofit Kit w/ LED Alley - Clear Lens	\$265.00 kit
SLENLRK2	Colored Lens Retrofit Kit w/ LED Alley	\$319.00 kit

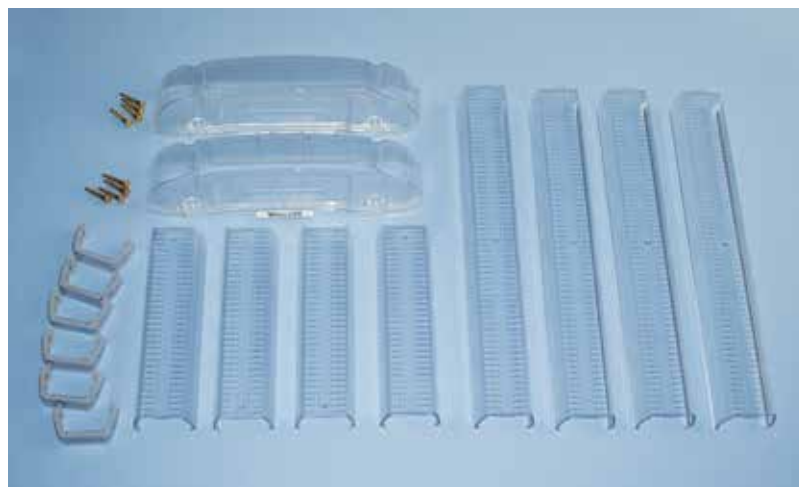

## WHELEN JUSTICE® LIGHTBAR LENS KIT

Item	Description	Price
68-1984693-30	Dome, Justice End Clear	\$139.00 ea
68-1984695-30	Dome, Justice Center Clear (48" bar)	\$90.00 ea



# WARNING LIGHTS

## Lightbars



### CODE 3 DEFENDER® LIGHTBAR



The Defender™ lightbar features the truly unique, patent-pending TriCore™ technology which constitutes a quantum leap forward in signal brightness - far exceeding the intensity and quality of any system.

- 2-2.5 times brighter than any lightbar at key 45 and 60 degree intersection angles
- Far brighter alley and takedown lights than traditional halogen or LEDs
- 2 times brighter signal from rear of the lightbar
- Improved central control circuitry and thermal management
- Improved control of signal brightness - dimming mode meets SAE safety standards
- Universal lighthouse and modular lens design makes service simple
- Unique gasket sealing system and solar barrier keep the bar looking like new
- Dimensions: 47" L x 13.5" D x 2.25" H



Meets all applicable SAE, NFPA, California Title 13 and ECE65 specifications when properly configured.

Item	Description	Price
DF47A1	12 Head Lightbar w/ Tricore Takedowns & Alleys	\$2,350.00 ea
DF47A2	14 Head Lightbar w/ Tricore Takedowns & Alleys	\$2,525.00 ea

Please specify colors



DF47A1



DF47A2



### CODE 3 RX2700™ CC LIGHTBAR

This lightbar Code 3's PriZm™ II lighthoods, which are a custom designed, full-size parabolic reflector offering a premier fill, straight on and off-angle warning signal. They also include the Central Controller for simplified lightbar control.

- Powerful alley and takedown lights don't interrupt the primary warning signal
- New IMPAXX™ LED takedown and alley lights provide officer safety during traffic stops
- Colored IMPAXX LED lights offer additional off-axis warning if takedown or alleys are placed in the main lightbar
- The HotFoot takedown and alley lights can be adjusted horizontally based on officer preference



Item #	Description	Price
2747A2CC	14 Head Lightbar Takedowns & Alleys	\$2,380.00 ea
2747PA1	13 Head Lightbar w/Takedowns & Alleys	\$2,250.00 ea
LEDTDALY	Upgrade Takedowns or Alleys to LED, One Pair	\$149.00 ea

Please specify colors



2747A2CC

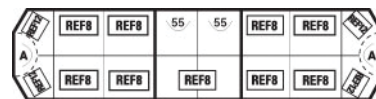

2747A3CC

# WARNING LIGHTS

Lightbars



## FEDERAL SIGNAL LEGEND® LPX LIGHTBAR

Legend LPX is a low-profile lightbar that is populated with Federal Signal's Solaris® LED reflector design which utilizes powerful LEDs to provide 360-degrees of coverage plus superior off-axis light output. The LPX series utilizes the patented ROC (Reliable Onboard Circuitry™) technology for solid-state construction. This rugged design is engineered to supply extended service life by utilizing fewer parts.

- Solaris® LED reflector technology
- Patented ROC (Reliable Onboard Circuitry™) technology
- LEDs offered in Amber, Blue, Green, Red, and White
- Built-in SignalMaster, front/rear cut-off, intersection warning and "dimming" functions
- Same flash patterns and controller options as standard Legend lightbars
- Available in 45", 53" and 61" lengths

**NEW**



FEDERAL SIGNAL

Item #	Description	Price
LPX45*	Signal Legend LPX, 45" Length	\$1,325.00 ea
LPX-53*	Signal Legend LPX, 53" Length	\$1,399.00 ea
MK+	Mount Kit	\$39.00 ea



## FEDERAL SIGNAL LEGEND® LIGHTBAR

Legend uses the patented ROC (Reliable Onboard Circuitry™) technology for solid state construction. ROC eliminates 85% of potential failure points found in a typical lightbar. This rugged design is engineered to reduce repair costs and increase the hours your emergency vehicle stays on the road.

- Low-profile, linear LED lightbar
- FS Convergence Network provides "plug-n-play" installation
- Lightbar can be reconfigured on the vehicle
- Three-button and six-button serial controller available for light control only
- 24", 45", 53", 61" and 70" lengths fit a wide variety of vehicle sizes
- LEDs offered in Amber, Blue, Green, Red and White

**NEW**



FEDERAL SIGNAL

Item #	Description	Price
LGD45*	Signal Legend, 45" Length	\$2,299.00 ea
LGD53*	Signal Legend, 53" Length	\$2,350.00 ea
MK+	Mount Kit	\$39.00 ea



## FEDERAL SIGNAL INTEGRITY® LIGHTBAR

For maximum performance and installation, FS Convergence Network's 'plug-n-play' capability offers ease of installation and programming. FS Convergence Network reduces bulky cables to streamline installation.

- SpectraLux multicolor LED technology available in combinations of Amber, Blue, Red or White
- Solaris LED reflector technology for better optical efficiency and superior off-axis warning
- FS Convergence Network for 'plug-n-play' installation and programming
- ROC (Reliable Onboard Circuitry) reduces failure points found in a typical lightbar
- Optional HotFoot for takedown, alley and warning lights
- Available in 44" and 51" lengths

**NEW**



FEDERAL SIGNAL

Item #	Description	Price
INTG44*	Signal Integrity, 44" Length	\$2,499.00 ea
INTG51*	Signal Integrity, 51" Length	\$2,599.00 ea
MK+	Mount Kit	\$39.00 ea





# WARNING LIGHTS

## Undercover Lighting



### INNER-EDGE™ UNDERCOVER LED LIGHTING SYSTEM

Whelen blazes a path, again, with the latest addition to their lightbar family: the Inner-Edge™. This lightbar features a low-profile design, rugged housing, and, most importantly, superior LED technology. Available for a variety of late model Ford, Chevy and Dodge police vehicles.

- Easily installs to visor anchor points without drilling holes
- Full featured lightbar that is virtually undetectable when not in operation
- Super-LEDs® are low current and vibration and moisture resistant for reliable, long-life operation
- Scan-Lock™ feature provides multiple flash patterns
- Available with LED Takedowns or additional warning LEDs instead at no cost on most models
- Furnished with both TIR3™ & LIN3™ optics inserts that can be installed over 3-LED heads to provide a greater variety of light production

Item #	Description	Price
I35UF8	Eight 3-LED Unit, 2011-2014 Charger, w/Takedowns (pictured above)	\$839.00 ea
I09UFZ	Ten 3-LED Unit, 2005-1/2 to 2011 Crown Vic, No Takedowns (pictured above)	\$839.00 ea
I10UF8	Eight 3-LED Unit, 2005-1/2 to 2011 Crown Vic, w/ Takedowns	\$839.00 ea
I34UF8	Eight 3-LED Unit, 2011 Explorer, w/Takedowns	\$839.00 ea
I08UF8	Eight 3-LED Unit, 2006-2011 Expedition, w/ Takedowns	\$839.00 ea
I17UF8	Eight 3-LED Unit, 2008-2010 F250/350, w/ Takedowns	\$839.00 ea
I13UF8	Eight 3-LED Unit, 2007-2011 Tahoe and 2008-2011 Suburban, w/Takedowns	\$839.00 ea
I06UF8	Eight 3-LED Unit, 2005-2010 Impala, w/Takedowns	\$839.00 ea

\*Specify vehicle type when ordering.



### INNER-EDGE™ LOW PROFILE FORWARD FACING SERIES

**NEW**

NEW XLP extra low profile, 3 LED models with low current switching, removable lens for spot pattern, and low power. XLP housing is shorter and thinner, mounting closer to headliner and windshield for more interior room. Mirrored shroud on driver's side, is available on split models with eight and ten lamps, making it easy to view traffic lights and overhead signs.

- Meets SAE and California Title XIII specifications
- Low profile two piece housings with 3-LED or 6-LED series lighthoods
- Housings are available as single units, slit two piece sets with individual driver and passenger side units or as a single passenger side unit
- Each section houses either five lighthoods or four lighthoods and one Super-LED flashing take-down
- Additional TIR3™ and LIN3™ lenses are supplied with 3-LED models for customizing light dispersion

The Inner Edge fits late model Ford Expedition, Explorer, Police Utility Interceptor, F150/250/350, Fusion, Taurus and Police Interceptor Sedan; Chevy Caprice, Impala, Suburban, Tahoe, Silverado, Dodge Charger, and Durango police vehicles. One piece version fits Ford Expedition, Chevy Suburban, Silverado and Tahoe.

Item #	Description	Price
IX**5P	Front Passenger Side Only, 5 Warning w/ Takedowns	\$489.00
IX**6P	Front Passenger Side Only, 6 Warning	\$489.00
IX**UFZ	Front 10 Head Warning	\$799.00
IX**UFX	Front 12 Head Warning	\$799.00

\*\*Specify Vehicle Year, Make, Model, and Color Configuration



### PREMIUM INNER-EDGE™ UNDERCOVER LED LIGHTING SYSTEM - REAR FACING

Premium Inner-Edge lightbars share all the same characteristics of the standard lightbars: a low-profile design, rugged housing, and easy installation. What sets them apart is their enhanced light output capability. They utilize the LINZ6™ Super-LED®, the latest compact lighthouse design from Whelen, which packs 6 diodes into a head that used to hold 3. The optics are also designed to produce light 180° around the face of each lighthouse.



- Easily installs to visor anchor points without drilling holes
- Super-LEDs® are low current and vibration and moisture resistant for reliable, long-life operation
- Scan-Lock™ feature provides multiple flash patterns
- Available with LED Takedowns or additional warning LEDs at no cost on most models

Item #	Description	Price
I237LR8	Eight LED Rear Deck Warning, Caprice	\$969.00 ea
I235LR8	Eight LED Rear Deck Warning, Charger	\$969.00 ea
I238LR8	Eight LED Rear Deck Warning, Ford Interceptor	\$969.00 ea

**WHELEN**



### CODE3 WINGMAN™ INTERIOR LIGHTING

LED REAR DECK BAR



- Easy to install, mounting brackets are included
- Snug-fit design nearly eliminates signal bleeding into the vehicle interior
- 2 inches tall, it will not block the driver's view of traffic
- Meets applicable SAE standards and CA Title XIII when properly configured

Item #	Description	Price
WM288*	Wingman 2 Taurus 6 Up – Short Model - R, B, or A	\$499.00 ea
WM88*	Wingman Taurus Modules (3 Taurus Modules Each Side of Brake Light)	\$1,399.00 ea

\*Available for Caprice, Impala, Charger, Ford PI Sedan – Specify vehicle type and colors.

Virtually undetectable from outside the vehicle.

Vehicle specific designs provide a custom fit.

Will not block the driver's rear view of traffic.

**THIS HAS BEEN REPLACED BY  
THE SPECTRALUX ILS**

# WARNING LIGHTS

## Traffic Advisors

TACF85



TAL85



### WHELEN LED TRAFFIC ADVISORS™



Whelen LED Traffic Advisors™ deliver twice the amount of light, and draw half the amperage of a halogen traffic arrow of similar size.

- Includes control head and 15' cable
- Interior or exterior mount
- TACF85 lightheads are front load for easy serviceability

Item #	Description	Price
TACF85	CON3™ LED Traffic Advisor	\$729.00 ea
TAL85	5mm LED Traffic Advisor	\$699.00 ea

Amber Only



**NEW**



### FLEET RACK™



Designed for mounting emergency and auxiliary lighting without wire clutter or holes in your truck body!

And because you do not have to pre-drill any holes in the rack, fleet managers will appreciate the well thought out design of this rack for functionality, ease of up-grade and/or transfer from vehicle to vehicle.



- Mounts full size or mini lightbars, beacons, Traffic Advisors™, auxiliary lighting and flood or spot lights
- Pre-drilled access holes accommodate full size lightbars to single beacons
- Advanced design with four vehicle specific models to ensure a perfect fit on your truck
- Slim design takes up minimal bed cargo space
- Black powder coating protects against corrosion, scratches and dings
- Rugged heavy-duty 11 gauge steel tubular framing
- Impervious to weather extremes
- The bolt on system moves easily from vehicle to vehicle
- Models available for Chevrolet Silverado and 2500; Ford Super-Duty, and Ford F150, specify upon ordering
- Heavy-duty screens and window guards protect the driver and passengers of the vehicle
- Window screen is designed not to block the visibility through the rear view window
- \*Lightbar not included\*

Item #	Description	Price
FR01	Standard Rack	\$599.00 ea
TAFR01	Rack w/ LED Traffic Advisor	\$2,750.00 ea



# WARNING LIGHTS

## Deck & Dash Lights

### WHELEN DOMINATOR™ SERIES **WHELEN**

Small size and fully waterproof design make the Dominator the answer to all your secondary warning. It features super bright TIR3™ Super-LED®s housed in a rugged aluminum housing with versatile mounting options, making it perfect for special use vehicles, motorcycles, quads and marine applications. Available as a six or eight head Traffic Advisor™, or in two, four, six and eight light array warning models.

- 5 Year warranty on LEDs
- Dimensions: 1-3/4" H x 2-3/16" D x 7 / 14 / 21 / 28" L

Item #	Description	Price
TAD6	6 Head Traffic Advisor™	\$449.00 ea
TAD8	8 Head Traffic Advisor™	\$529.00 ea
TAD8**	8 Head Traffic Advisor™ with End Flashers	\$539.00 ea
D2**	2 Head Warning Light	\$179.00 ea
D4****	4 Head Warning Light	\$279.00 ea
D6*****	6 Head Warning Light	\$399.00 ea
D8*****	8 Head Warning Light	\$499.99 ea
TADCTL1	Optional Traffic Advisor™ Control Head	\$120.00 ea

\*Specify Colors - Available In ■ Amber ■ Blue □ White ■ Red



### DOMINATOR™ PLUS **WHELEN**

Engineered around the exceptionally bright LINZ6™ LED lighthouse, the Dominator Plus™ is an incredibly versatile, durable workhorse. With its fully waterproof, low profile design, and virtually weather-impervious aluminum housing, it can be installed just about anywhere that is necessary, inside or out.

- 7 selectable Scan-Lock™ flash patterns
- Linear LED diffuser provides almost 180 degrees of horizontal light spread
- Long-life operation, moisture and vibration resistant, low current draw
- Pairs of single units may be synced to one another or other Whelen products
- 5 Year warranty
- Dimensions: 2-3/8" H x 1-7/8" D x 5-1/2" W (Single module) 11" W (Dual Module)

Item #	Description	Price
DP2**	2 Head Warning Light	\$244.00 ea
DP4****	4 Head Warning Light	\$479.00 ea
DP6*****	6 Head Warning Light	\$689.00 ea
DP8*****	8 Head Warning Light	\$879.00 ea
TADP6	6 Head Traffic Advisor™	\$709.00 ea
TADP8	8 Head Traffic Advisor™	\$924.00 ea
TADP8**	8 Head Traffic Advisor™ with End Flashers	\$937.00 ea

\*Specify Color(s) - Available In ■ Amber ■ Blue □ White ■ Red



# WARNING LIGHTS

## Deck & Dash Lights



AVN2



AVN1



AVNBKT5



AVNBKT4



AVNBKT1



AVNBKT2

**WHELEN**



AVNBKT3

### AVENGER™ SERIES LINEAR-LED® LIGHTS

Don't let the small size fool you - this light packs amazing warning power! With latest generation, Linear-LED's, Super-LED's the Avenger™ is effective and reliable, and its slim design and multiple mounting options make it easy to install or transfer from vehicle to vehicle.

- 8 Super-LED's per head (16 total in Dual model)
- 34 selectable flash patterns on Dual model (27 for Single)
- Swivel bail bracket with suction cups standard
- Eight foot straight cord with cigar plug with On/Off and pattern selection switches
- 5 year warranty
- Dimensions: 1-7/8" H x 2-1/2" D (5-5/8" D with shroud) x 5-3/4 or 10-3/4" W

Item #	Description	Price
AVN1*	Avenger™ Single Lighthead	\$159.00 ea
AVN2**	Avenger™ Dual Lighthead	\$279.00 ea
AVNS1*	Avenger™ Single Lighthead, Synchronizable	\$179.00 ea
AVNBKT1	Single Lighthead Mount Bracket	\$11.90 ea
AVNBKT2	Dual Lighthead Mount Bracket	\$13.25 ea
AVNBKT3	Visor Mount Bracket (Dual Avenger™ requires 2 each)	\$11.90 ea
AVNBKT4	Adjustable Height Bracket	\$39.00 ea
AVNBKT5	Headliner Mount Bracket	\$18.00 ea

\*Specify Colors

Available Colors ■Amber ■Blue □White ■Red



### SPITFIRE™ PLUS LINZ6™

**WHELEN**

The SpitFire™ Plus utilizes Whelen's LINZ6™ LED, a 6 diode power house that was introduced as a standalone lighthead. The SpitFire includes suction cups and an angled housing to allow it to fit snugly and securely against the windshield.

Dimensions: 1 9/16" H x 4 3/8" W x 3 1/2" D

Item #	Description	Price
SFP1*	SpitFire Lighthead, Red, Blue or Amber	\$119.00 ea
SFP1#	SpitFire Lighthead, White or Green	\$129.00 ea
SFP1J	SpitFire Lighthead, Split Color, Red/Blue	\$124.00 ea

Available in ■Amber ■Blue □White ■Red ■Green ■Amber/White ■Red/Blue



**NEW**



### SPITFIRE™ ION™ SERIES

**WHELEN**

Ultra compact Super-LED light for interior use. Available in single and split colors. Supplied with 8' straight cord and cigar plug with On/Off switch with LED "On" indicator and pattern selection switch. Synchronizable to other Whelen Sync products. Includes universal bracket and windshield suction cup mount.

1-5/8" H x 3-1/2" D x 4-3/8" L

Item #	Description	Price
SFION*	Spitfire ION, Red, Blue, Amber, or White	\$149.00 ea
SFIOND	Spitfire ION, Split Red/White	\$149.00 ea
SFIONJ	Spitfire ION, Split Red/Blue	\$149.00 ea

Available in ■Amber ■Blue □White ■Red ■Green ■Amber/White ■Red/Blue

# WARNING LIGHTS

## Deck & Dash Lights

### SLIMLIGHTER™ SUPER-LED™ **WHELEN**

Get highly-effective wide-angle and straight-on LED warning out of a package that's less than 2" tall! With its slender design, the SlimLighter™ is a perfect fit for the windshield, dash, deck or headliner. Plus, without glass or filaments to break, the unit is virtually maintenance free!

- LEDs rated for 100,000 hours of operation
- Incredibly low power consumption, only 1/2 an amp
- 21 selectable Scan-Lock™ flash patterns
- Eight foot cord w/ cigar plug and On/Off switch
- Built-in pattern switch
- Available in Amber, Red, Blue and White, or ANY combination of the four
- Includes swivel mounting brackets and suction cups (pictured)
- 5 Year Warranty
- Dimensions: 1-3/4" H x 16-3/8" W x 1-13/16" D

Item #	Description	Price
SLPMM**	Slimlighter™ Super-LED®, Amber, Blue or Red & White	\$299.00 ea
SLPBKT1	Universal Bail Mount Bracket	\$17.00 ea

\*\*Specify Colors ■ Amber ■ Blue ■ Red □ White



### REAR HATCH WARNING ACCESSORIES FOR SUV'S

Get noticed when your hatch is open! Visible lighting provides another layer of visibility and safety when the rear hatch is open on SUV's.

Item #	Description	Price
ION*	ION, Amber, Blue, Red or White	\$119.00 ea
IONGROM	Body Mount Grommet	\$5.95 ea
IONBKT2	Rear Hatch Mount Bracket, Requires 6 IONS	\$61.00 pr
IONBKT4	Rear Hatch Mount Bracket, Requires 2 IONS (not pictured)	\$22.00 pr
IONBKT1	License Plate Bracket (lights not included)	\$26.75 ea
OE13UR8*	8 LED Outer Edge Warning, '08-'14 Tahoe/Sub	\$999.00 ea
OEIONKT*	6 LED Outer Edge Warning, '13-'15 Ford PI Utility	\$715.00 ea

\*Specify Colors ■ Amber ■ Blue ■ Red □ White



IONGROM (x2) with 1 IONR and 1 IONB



OEIONKTRB



IONBKT1 with 2 IONJ



# WARNING LIGHTS

## Lightheads



### FEDERAL SIGNAL MICROPULSE™

Stealth and power are united in the MicroPulse™ LED perimeter lighthead. Offered with several mounting options, the MicroPulse can be mounted on the hood, trunk or any flat surface of a vehicle. Built-in flash patterns create versatility that allows the lighthead to flash as a solid or split-color(MPS6) and operate from a 12-24 VDC power source. Plus multiple MicroPulse lightheads can synchronize for optimum enhancement of any lighting application.

- Multiple mounting options for various applications
- Superior warning with high power LEDs
- Super slim design to offer a wider range of mounting areas
- Single/multi-unit synchronization

Item #	Description	Price
MPS300	3-diode high power LED	\$69.00 ea
MPS600	6-diode high power LED	\$99.00 ea

\*Specify Color(s) - Available In ■ Amber ■ Blue □ White ■ Red



### TIR3™ SUPER-LED® LIGHTHEAD



Get high intensity and wide angle light output from an ultra compact, surface mounted Super-LED® lighthead. Great for getting a little extra punch from those tight spaces. Features 25 selectable Scan-Lock™ flash patterns and fully encapsulated electronics for maximum moisture and vibration resistance.

- Dimensions: 3 5/8" W x 1 5/16" H x 1 5/16" D
- 5 Year warranty

Item #	Description	Price
TIR3*	TIR3™, Amber, Blue or Red	\$59.95 ea
TIR3C	TIR3™, White	\$64.95 ea
RBKT2	Dual TIR3™ Mounting Bracket (not shown)	\$17.50 ea
RBKT1	Single TIR3™ Mounting Bracket (not shown)	\$10.20 ea

\*Specify Color: Available in ■ Amber ■ Blue □ White ■ Red ■ Green



### VEHICLE SPECIFIC MOUNT BRACKETS

These unique light brackets will provide some new custom lighting locations on your vehicle. The brackets fit many standard size Whelen lightheads including LINV2, LINZ, TIR3 and LIN3.

Item #	Description	Price
RBKT5	Tahoe / Under Mirror	\$13.95 pr.
RBKT11	F150 / Rear Bed - Above rear tail light	\$48.00 pr.
RBKT12	F250 - F550 / Rear Bed - Above rear tail light	\$48.00 pr.
RBKT13	Silverado / Rear Bed - Above rear tail light	\$48.00 pr.
RBKT14	GMC 1500 / Rear Bed - Above rear tail light	\$48.00 pr.
RBKT17	Dodge Ram/ Rear Bed - Above rear tail light	\$48.00 pr.

\*Available for multiple vehicles\*



### LINZ6™ SUPER-LED® LIGHTHEAD

**WHELEN**

Horizontal Mount - Here's a rugged little powerhouse that shrugs off moisture and road shock while giving you "heads up" performance... anywhere on your vehicle!

- A sub-compact, full-featured LED lighthead with wide-angle light spread which can be mounted virtually anywhere
- 69 Scan-Lock selectable flash patterns
- Whelen patented Linear-LED® wide-angle optics for maximum visibility
- Minimal current draw and designed for heavy-duty, vibration, moisture and corrosion resistance
- SmartLED® design requires no external flasher
- Split colors available (3x3)
- Dimensions: 1-5/8" D x 4" W x 2" H
- 5 Year LED Warranty

Item #	Description	Price
LINZ6*	LINZ6 Super-LED® Lighthead, Red, Blue, Amber, White	\$99.00 ea
LINZ6+	LINZ6 Super-LED® Lighthead, Split Color, Red/Blue, Red/White, Red/Amber	\$110.00 ea
LINZ6FC	Chrome Flange for LINZ6	\$13.50 ea

\*/+Specify Color: Available in ■ Amber ■ Blue □ White ■ Red ■ Green  
■ Amber/White ■ Red/Blue ■ Red/White ■ Red/Amber

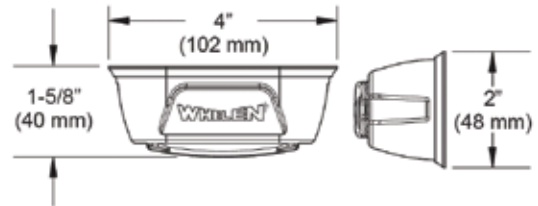

#### Sync Flash Patterns for Alternate/ Simultaneous flashing of lightheads

FLASH PATTERN PHASES	
SignalAlert™ 75	4
CometFlash® 75	4
DoubleFlash 75	4
SingleFlash™ 75	4
ComAlert™ 75	4
LongBurst™ 75	4
PingPong™ 75	4
SSNF 75	2

#### Non-Sync Patterns

SingleFlash 60	2	TripleFlash 120	2
SingleFlash 90	2	SigAlert Cal™	2
SingleFlash 120	2	Action SF 60/120	2
SingleFlash 300	2	Action SF 60/TF120	2
DoubleFlash 150	2	CalScan™	1
ComAlert 150	2	ActionScan™	1
ActionFlash™ 50	2	SteadyFlash 60	1
ActionFlash 150	2	SteadyFlash 75	1
ModuFlash™	2	SteadyFlash 90	1
DoubleFlash 120	2	SteadyFlash 120	1
PingPong 120	2	Steady	1
TripleFlash 75	2		

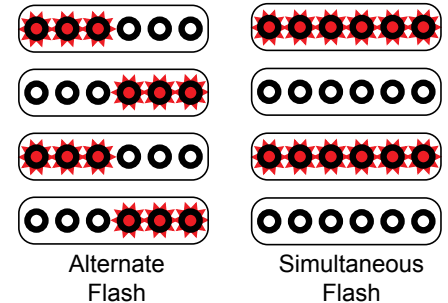

**NEW**



### LINV2R™ SUPER-LED® LIGHTHEAD

Here's a rugged little powerhouse that shrugs off moisture and road shock while giving you "heads up" performance... anywhere on your vehicle!

- Wide-angle light spread which can be mounted virtually anywhere
- Clear non-fluted lens and black ABS flange standard
- Whelen patented Linear-LED® wide-angle optics for maximum visibility
- Minimal current draw
- Designed for heavy-duty, vibration, moisture and corrosion resistance
- No external flasher needed
- Has flash patterns and steady burn
- Dimensions: 4" L x 1.6" W x 2" H
- Warning available in Red, Amber, Blue and White

Item #	Description	Price
LINV2*	Wide Angle Warning Light	\$169.00 ea

\*Specify Colors ■ Amber ■ Blue ■ Red □ White

# WARNING LIGHTS

## Lightheads



Operates on  
12 or 24VDC

**WHELEN**

### ION™ SERIES SUPER-LED® LIGHTHEAD

Perfect for secondary warning anywhere on your vehicle, inside or out. The open heat sink design allows for efficient heat dissipation which increases longevity and light output, making the ION the smallest and most effective Super-LED on the market while using only 6 diodes.

- Includes universal "L" mounting bracket and hardware and a 4 wire 6" pigtail
- SmartLED® design requires no external flasher
- Synchronizable to other Whelen synch products
- 5 Year warranty
- Dimensions: 4" W x 1" H x 1-5/16" D

Item #	Description	Price
ION*	ION, Amber, Blue, Red or White	\$119.00 ea
IONJ	ION, Split Red/Blue	\$119.00 ea
IOND	ION, Split Red/White	\$119.00 ea
IONSM*	Surface Mount Warning Light	\$125.00 ea

\*Specify Color: ■Amber ■Blue ■Red □White  
 ■Amber/White ■Red/Blue ■Red/White ■Red/Amber

**NEW**

### ION™ V-SERIES SUPER-LED® SURFACE MOUNT LIGHTHEAD

ION V-Series lighting is the smallest most effective, Super-LED light in the industry today. Combination light for warning, flood/alley and ground warning (puddle light). Combination 180 degree wide-angle warning, alley/flood and ground illuminating (puddle light). Universal mounting bracket included. Surface mount models include flange, available in black, white or chrome.

- SideKick™ fender mounted models available for Ford Police Interceptor and Chevy Caprice
- Hard coated lenses with HDO™ technology (High Definition Optics)
- Twenty-five Scan-Lock™ flash patterns including fourteen synchronizable patterns
- Warning available in red, amber, blue and white
- Steady-burn white for alley/flood lighting, plus white ground illumination
- Supplied with 10" 6-wire pigtail
- Five year HDP® Heavy-Duty Professional warranty

**WHELEN**



Item #	Description	Price
IONSV3*	Surface Mount, 180 Degree Warning, TD, Puddle, Black Housing	\$199.00 ea
IONSV3*W	White Housing	\$199.00 ea
IONSV3*C	Chrome Housing	\$225.00 ea

\*Specify Color

Replace "\*" symbol in model number with letter indicating lens color or LED color desired:  
 Available in ■Amber ■Blue □White ■Red





### WHELEN 500 SERIES SUPER-LED®

Three-in-one combination light for warning, alley and ground illumination in one remarkably compact surface mount lighthead!

- 180° wide-angle warning light for Class 1 SAE 845 requirements
- Color LEDs with clear outer lens
- Hard-coated lenses with HDO technology
- 25 Scan-Lock
- Steady-burn and synchronize feature for the ally and warning segment
- White ground illumination
- Warning available in Red, Amber, Blue and White.
- Size: 5.38" (L) x 1.63" (W) x 2.13" (H)

Item #	Description	Price
5V3*	Lighthead, Amber, Blue, Red, White	\$229.00 ea
5FLANGEB	Black Flange	\$7.00 ea
5FLANGEC	Chrome Flange	\$10.00 ea

\*Specify Color: ■ Amber ■ Blue ■ Red □ White

**NEW**



### WHELEN MICRON™ SERIES

The smallest and most durable Super-LED lighting product on the market today.

- 25 Scan-Lock™ flash patterns including steady-burn
- Integrate with other Whelen products through our 'synchronize' feature
- Flange and light integrated
- Warning available in Red, Amber, Blue and White
- Size: 0.9" (L) x 0.8" (W) x 4.1" (H)



**NEW**



Item #	Description	Price
MCRNS*	Light with Black Flange	\$110.00 ea
MCRNSC*	Light with Chrome Flange	\$125.00 ea

\*Specify Color: ■ Amber ■ Blue ■ Red □ White

### TORUS 3-UP AND 6-UP LED LIGHTS

Torus technology offers more superior light output than its Optix predecessor.

- 3-Up & 6-Up Models
- 5-Flash Patterns in 3-Up
- 21 Flash Patterns in 6-Up
- Black ABS or Chrome Finish Bezel
- Red, Blue, or Amber Lenses
- Split Colors Available for the 6-UP model
- Amber, Red, Blue, or White LEDs
- Waterproof Plug

3-Up Modules: 4.7" L x 1.8" W x 1.75" D (119 x 46 x 45 mm)

6-Up Modules: 7.5" L x 1.8" W x 1.75" D (191 x 46 x 45 mm)

Item #	Description	Price
TSXB3 - **	3-UP Torus, Black Housing	\$110.00 ea
TSX3 - **	3-UP Torus, Chrome Housing	\$110.00 ea
TSXB6 - **	6-UP Torus, Black Housing	\$195.00 ea
TSX6 - **	6-UP Torus, Chrome Housing	\$195.00 ea

\*Specify Color: ■ Amber ■ Blue ■ Red □ White

**CODE 3**  
PUBLIC SAFETY EQUIPMENT, INC.



# WARNING LIGHTS

## Lightheads



### UNDER-THE-SIDE VIEW MIRROR MOUNT FOR LINSV2 LIGHTHEAD

LINSV2 lighthead mounts for under any flat surface. Vehicle specific adapters allow for mounting under side view mirrors on most standard emergency vehicles. For Two LINSV2 Series lightheads sold separately. (not for use with Mirror Beam)

Item #	Description	Price
LSVBKT37	Mount for Chevy Caprice '11-'16	\$20.00 pr
LSVBKT34	Mount for Ford Explorer '11-'16, PI Utility '13-'16	\$20.00 pr
LSVBKT38	Mount for Ford Taurus '11-'16, PI Sedan '13-'16	\$20.00 pr
LINSV2*	180° Under Mirror Warning Light	\$189.00 ea

\*Specify vehicle when ordering.

\*Specify Color ■ Amber ■ Blue ■ Red □ White

### AMBER/WHITE AND AMBER/GREEN LIGHTHEAD OPTIONS

Amber/White split lightheads and Green lighthead options.

Item #	Description	Price
40AC5SCR	400 Series LED, Amber/Clear	\$185.00 ea
40AG5SCR	400 Series LED, Amber/Green	\$199.00 ea
LINZ6F	Amber/White Linear Super-LED®	\$110.00 ea
LINZ6G	Green Linear Super-LED®	\$135.00 ea
IONF	Amber/White Super-LED® Universal Light	\$119.00 ea
IONG	Green Super-LED® Universal Light	\$179.00 ea
IONSMF	Amber/White Surface Mount Super-LED®, Black	\$125.00 ea
IONSMG	Green Surface Mount Super-LED®, Black	\$189.00 ea
M4G	M4 Series Green	\$169.00 ea
R1LPPF	Responder CON3, Permanent Mount, Amber/White	\$379.00 ea
R1LPMF	Responder CON3, Magnetic Mount, Amber/White	\$399.00 ea
R2LPPF	Responder, Linear 6, Permanent Mount, Amber/White	\$489.00 ea
R2LPMF	Responder, Linear 6, Magnetic Mount, Amber/White	\$499.00 ea



40AG5SCR



40AC5SCR



M4G



IONF



IONSMF



LINZ6F



R1LPPF



R2LPPF

### SIDEKICK™ SERIES

SideKick adds critical lighting coverage to the sides of your 2013 Ford Police Interceptor Sedan or 2012 Chevy Caprice vehicle with incredibly bright ION lightheads.

Features:

- Installs in minutes without removing the fender
- Available in standard or wide angle versions: single and split color
- Single color models have 25 Scan-Lock flash patterns, split colors offer 69 flash patterns
- 0.40 amps average at 12.8 VDC.
- Sold in pairs

**NEW**

Item #	Description	Price
SK01**	Ford Police Interceptor Sedan	\$389.00 pr
SK01V3**	V-Series Combination Lighthead	\$525.00 pr
SK01W**	Wide Angle Warning Light	\$389.00 pr
SK02**	Chevy Caprice	\$389.00 pr
SK02V3**	V-Series Combination Lighthead	\$525.00 pr
SK02W**	Wide Angle Warning Light	\$389.00 pr

\*Specify Color ■ Amber ■ Blue ■ Red ■ Red/Blue ■ Red/White



### MIRROR-BEAM™ SUPER-LED®

**WHELEN**

Whelen Super-LED® Mirror Beams™ put extra unobstructed warning light where you need it: forward and at critical intersection angles.

Features:

- Increased traffic clearing ability and intersection safety
- Mid-level safety signals from outside the vehicle reduce interior clutter and eliminate safety concerns with air bag restraint systems
- Less affected by snow and mud than grille/bumper mounted lighting

Item #	Description	Price
MBDC11**	Mirror Beam™ for 2011-2016 Charger	\$299.00 pr
MBFT11**	Mirror Beam™ for 2013-2016 Taurus and PI Sedan	\$299.00 pr
MBCC11**	Mirror Beam™ for 2011-2016 Caprice	\$299.00 pr
MBFX11**	Mirror Beam™ for 2013-2016 Ford PI Utility	\$299.00 pr
MBDC11JJ	Mirror Beam™ for '11-'14 Charger, Split Red/Blue Heads	\$299.00 pr

\*Specify Color ■ Amber ■ Blue ■ Red



### MIRROR-BEAM™ ION™ V-SERIES™ MIRROR MOUNTED SUPER-LED® SERIES LIGHTHEADS

Add all the high performance and reliability features of the ION V-Series to the mirror glamour cap of your vehicle. Added more mid level performance, more features, and more intersection warning to your vehicle.

Features:

- Multiple Flash Patterns; 180° wide angle lighting
- Models can be synchronized for alternating or simultaneous flashing
- Vehicle specific models. Check with us for current models and years
- Sold in pairs

Item #	Description	Price
VMCC11**	Chevy Caprice 2011-2016	\$449.00 pr
VMDC11**	Dodge Charger 2011-2016	\$449.00 pr
VMFT11**	Ford Taurus 2011-2016 & Police Interceptor 2013-2016	\$449.00 pr
VMFX11**	Ford Explorer, 2011-2015 and Police Interceptor Utility, 2013-2016	\$449.00 pr
VMFF12**	Ford F150, 2012-2014	\$449.00 pr

\*Specify Color ■ Amber ■ Blue ■ Red

Replace " " symbol in model number with letter indicating lens color or LED color desired:

A = Amber; B = Blue; C = Clear/White; R = Red; G = Green





# WARNING LIGHTS

## Lightheads



### 4" ROUND SUPER-LED® **WHELEN**

TIR6™ LED technology delivers powerful warning in a compact 4" package. Available with either a flat or extended lens and 25 selectable Scan-Lock™ flash patterns, including steady burn. All units come standard with synchronize feature to link multiple heads together. Mounting brackets purchased separately.

#### Flat lens

Item #	Description	Price
2F*00Z+R	Flat lens, Amber, Blue or Red	\$149.00 ea
2FC00ZCR	Flat Lens White LED	\$149.00 ea

#### Extended Lens

2E*00Z+R	Extended Lens, Amber, Blue or Red	\$159.95 ea
2EC00ZCR	Extended Lens, White LED	\$159.95 ea

#### Optional Mounting

2FLANGEB	Surface Mount Trim Ring Kit, Black	\$7.50 ea
2FLANGEC	Surface Mount Trim Ring Kit, Chrome	\$13.50 ea
2GROMMET	Grommet Mounting Kit	\$6.00 ea

\*Specify Color  
+Specify Lens Color



2FLANGEB shown with Flat Lens Lighthead



### **WHELEN**

### ROUND FOG LIGHT SUPER-LED® WARNING LIGHT

These 3.5" round PAR36 Super-LED®s are direct replacements for the factory fog lights and provide additional secondary warning lighting.

- Synchronizable for perfectly alternating patterns
- 25 Selectable Scan-Lock™ patterns
- Rugged, wide angle Super-LED®s draw low current but rival strobes in intensity

Item #	Description	Price
PAR28*	LED Warning Light	\$169.00 ea
PAR28D*	LED Driving & Warning Light	\$199.00 ea
P28DC11	Fog Mounting Bracket for Charger	\$6.50 ea
FOGTRIM-CHRG	Dodge Trim Brackets w/Fog Cutout	\$59.00 pr
FECT10*R	LED Warning Light, 2010-2011 Tahoe	\$169.00 ea
FDCT10*	LED Driving & Warning Light, 2010-2011 Tahoe	\$199.00 ea
P28FX11	Mounting Bracket For PI Utility	\$6.50 ea
FOGTRIM-SUV	Trim Brackets for PI Utility	\$79.00 pr

\*Trim bracket required to mount fog lights.

**NEW**



### VERTEX™ COMPETITOR SERIES™ SUPER-LED® LIGHT

Economically priced, 6-LED Vertex with SmartLED electronics built into the base which requires no external flasher. May be internally mounted inside of headlight and taillight assemblies or mounted to exterior surfaces and mounts in any position.

- Available in red, blue, amber and white with multiple flash patterns
- Fully encapsulated for moisture and vibration resistance
- Supplied with 6-inch wire pigtail
- Simple installation via two screws in base
- Original black or chrome flanges
- Size: 1"H x 1-5/8" diameter

Item #	Description	Price
VTC6*	Red, Blue, Amber or White	\$75.00 ea
VTCFB	Flange Kit, Surface Mount, Black	\$7.65 ea
VTCFC	Flange Kit, Surface Mount, Chrome	\$13.60 ea

\*Specify Color ■ Amber ■ Blue ■ Red □ White

### VERTEX™ SUPER-LED® HIDE-AWAY

**WHELEN**

Only 7/8" in height, this small semi-hemispheric LED lighthouse is perfect for most applications where size and intensity are critically important. **Self-contained** unit using an in-line combination lamp driver/flasher.

- Designed surface mount or internal mount within composite head lamps
- 25 selectable Scan-Lock™ flash patterns and synchronize feature
- Includes pre-wired and sealed 9' neoprene cable with in-line flasher



Designed for exterior or concealed mounting.

Item #	Description	Price
VTX609*	Vertex™ Single Lamp w/ 9' Cable	\$85.00 ea
VTXFB	Surface Mount Flange, Black	\$7.65 ea
VTXFC	Surface Mount Flange, Chrome	\$13.60 ea

\*Specify Color ■Amber ■Blue ■Red □White ■Green



### WHELEN VERTEX™ 360 LED LIGHT

Only 7/8" height, this small hemispheric LED lighthouse is perfect for most applications where size and intensity are critically important. Self-contained unit using an in-line combination lamp driver/flasher. This new self-contained LED Hideaway requires only a one inch hole in any composite style head light, cornering light or tail light assembly to deliver true wide angle warning to the front, side and rear of your vehicle... without interference to your vehicle computer and warning equipment! Less than 1" tall, it may also be surface mounted to outside surfaces anywhere on the vehicle!

- Ultra small, self-contained, hemispheric LED light, for surface mount or internal mount within composite head-light, cornering lights and taillight assemblies
- Flange kit options in Black or Chrome allow easy surface mounting anywhere on your vehicle
- 25 Scan-Lock™ flash patterns, includes synchronize feature for alternating and synchronous flashing of multiple lamps
- New lens technology enhances light distribution for optimum dispersion and intensity of the warning signal at critical angles
- Includes pre-wired and sealed 4-C/22 gauge 9' cable to the lighthouse and lamp driver, with power, pattern and synchronize wires
- Lamp and in-line lamp driver are fully encapsulated for moisture and vibration resistance
- Omni-directional lighthouse mounts in any position (orientation), vertically or horizontally
- 10-16 VDC.
- Virtually no RFI/EMI noise emitted, meets SAE J1113-41 Class 5
- Two screws hold the lamp securely in place
- 1" hole makes this LED module backwards compatible to HA238 and standard 1" Hide-A-Way style lamps
- Simple installation with no separate lamp drivers, flashers, ballast or power supplies to install

Available in red, amber, white and blue and split colors. LED color must match color of the lens it is installed behind, except for Clear lens and split colors.

Item #	Description	Price
VTXD609*	Directional Vertex LED Lighthouse, optional shield, Red, Blue, Amber or White	\$109.00 ea
VTXD609*	Directional Vertex LED Lighthouse, optional shield, Split	\$120.00 ea
VTX3609*	360° Vertex LED Lighthouse, Red, Blue, Amber or White	\$109.00 ea
VTX3609*	360° Vertex LED Lighthouse, Split	\$120.00 ea

+Specify Vehicle, \*\* Specify color: ■Amber ■Blue ■Red □White

**WHELEN**

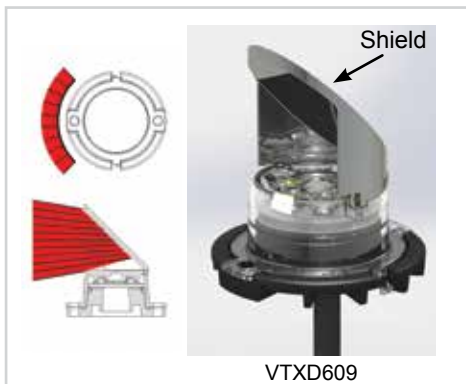

# WARNING LIGHTS

## Lightheads

**WHELEN**



### M2 SERIES SUPER-LED® LIGHTHEADS

**NEW**

Item #	Description	Price
M2**	Warning Red, Blue, Amber or White	\$149.00 ea
M2#	Warning Split Red/White or Red/Blue w/ clear lens	\$159.00 ea
M2FC	Chrome Flange	\$13.50 ea
M2FB	Black Flange	\$7.50 ea

\*\*Specify LED Color then Lens Color, #Specify Split Color

**WHELEN**



3-3/8" H x 5-1/2" W x 1-3/8" D

### M4 SERIES SUPER-LED® LIGHTHEADS

Item #	Description	Price
M4**	Warning, Red, Blue, Amber or White	\$155.00 ea
M4#	Warning, Split Red/White or Red/Blue with Clear Lens	\$165.00 ea
M4FC	Chrome Flange	\$13.50 ea
M4FB	Black Flange	\$7.50 ea
M4FC400	Chrome Flange, Adapts M4 to 400 Series Mounting	\$17.50 ea

\*\*Specify LED Color then Lens Color, #Specify Split Color

**WHELEN**



4-5/16" H x 6-3/4" W x 1-3/8" D

### M6 SERIES SUPER-LED® LIGHTHEADS

Item #	Description	Price
M6**	Warning, Red, Blue, Amber or White	\$179.00 ea
M6#	Warning, Split Red/White or Red/Blue with Clear Lens	\$189.00 ea
M6BTT	Brake/Tail/Turn	\$130.00 ea
M6BUW	Back-up Light	\$175.00 ea
M6T	Amber Turn, Sequential Chevron	\$118.00 ea
M6FC	Chrome Flange	\$13.50 ea
M6FB	Black Flange	\$7.50 ea
M6FC600	Chrome Flange, Adapts M6 to 600 Series Mounting	\$17.50 ea

\*\*Specify LED Color then Lens Color, #Specify Split Color

### M7 SERIES SUPER-LED® LIGHTHEADS

**WHELEN**



3-3/8" H x 7-5/8" W x 1-3/8" D

Item #	Description	Price
M7**	Warning, Red, Blue, Amber or White	\$179.00 ea
M7#	Warning, Split Red/White or Red/Blue with Clear Lens	\$189.00 ea
M7FC	Chrome Flange	\$13.50 ea
M7FB	Black Flange	\$7.50 ea
M7FC700	Chrome Flange, Adapts M7 to 700 Series Mounting	\$22.50 ea

\*\*Specify LED Color then Lens Color, #Specify Split Color



### WHELEN M6V2 & M9V2 SUPER-LEDSTM

Reshape the future of emergency warning lights with the M6V2 and M9V2; a new generation of versatile, compact lightheads that implement Whelen's Super-LED technology and act as all-in-one warning/perimeter or warning/scene lights.

- M6V2 – warning/perimeter
- M9V2 – warning/scene
- Surface mount
- Hard coated lenses
- 21 Scan-Lock™ flash patterns
- Warning available in Red, Amber, Blue and White
- Optional flange available in Chrome or Black
- Size M6V2: 6.75" (L) x 2.25" (W) x 4.3" (H)
- Size M9V2: 9.75" (L) x 2.6" (W) x 6.5" (H)

**NEW**



Item #	Description	Price
M6V2	M6 Series with Perimeter Light	\$469.00 ea
M9V2	M9 Series with Scene Light	\$699.00 ea

\*Specify Color ■Amber ■Blue ■Red □White

### M9 SERIES SUPER-LED® LIGHTHEADS

**WHELEN**

Item #	Description	Price
M9**	Warning, Red, Blue, Amber or White	\$269.00 ea
M9#	Warning, Split Red/White or Red/Blue w/ Clear Lens	\$279.00 ea
M9BTTX	Brake/Tail/Turn	\$290.00 ea
M9BUW	Back-up	\$339.00 ea
M9T	Amber Turn, Arrow	\$339.00 ea
M9FC	Chrome Flange	\$20.25 ea
M9FB	Black Flange	\$7.50 ea
M9FC900	Chrome Flange, Adapts M9 to 900 Series Mounting	\$28.50 ea

\*\*Specify LED Color then Lens Color, #Specify Split Color



6-1/2" H x 10-3/8" W x 1-3/8" D



M9T

M9BUW

M9BTTX

### WHELEN M4 FOG LIGHT HOUSING

**WHELEN**

New housing allows easy mounting of an M4 Super-LED® warning lighthead in the factory fog light position on the 2015 Chevy Tahoe.

Sold as a pair. Black.

Item #	Description	Price
M4CT15B	M4 Fog Light Housing, Black	\$59.00 pair
M4*	Warning Light	\$155.00 ea

\*Specify Color ■Amber ■Blue ■Red □White



**NEW**

# WARNING LIGHTS

## Lightheads



### LED 500 SERIES BRAKE LIGHTS WITH GROMMET MOUNT

Maximum Intensity 5mm LED brake lights. Fully encapsulated to eliminate moisture, salt, chemicals and road shock and covered by a 5 year warranty. Can be mounted with a grommet as pictured or surface mounted with a flange (see page 42 for flanges).

Item #	Description	Price
50R00XRR	LED Brake Lights w/2 flash patterns	\$69.00 ea
5GROMMET	Grommet Mount Kit	\$6.50 ea



### 500 SERIES BACK-UP LIGHTHEAD

Incorporates 48 clear 5mm-LED and a clear non-optic hard coated polycarbonate lens. The hard coated lens provides extended life/luster protection against UV and chemical stresses. Surface mount. Mounts/housings sold separately.

- 12" non-terminated pigtail
- +12V - 0.22 Amp Draw
- 5 Year Warranty
- 1-5/8"H x 5"L

Item #	Description	Price
50C00WCR	LED Back-Up Lighthead	\$159.00 ea

### LED BRAKE/TAIL/TURN LIGHTS

Super LED intensity that rivals strobe in intensity. Optional chrome plated or black mounting options.

Item #	Description	Price
40BTT	400 Series B/T/T Light, LED	\$109.00 ea
60BTT	600 Series B/T/T Light, LED	\$159.00 ea
70BTT	700 Series B/T/T Light, LED	\$135.00 ea
90BTT	900 Series B/T/T Light, LED	\$299.00 ea

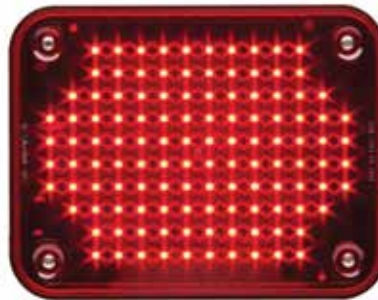

### MODEL 60 HALOGEN B/T/T LIGHT

Item #	Description	Price
60340R	Halogen Lamp	\$10.95 ea
60700	Rubber Grommet	\$2.95 ea
1156	Replacement Bulb	\$.89 ea



### MODEL 60 ECONOMY LED B/T/T

Item #	Description	Price
6050	LED B/T/T Lamp	\$28.75 ea
60700	Rubber Grommet	\$2.95 ea



### MODEL 60 LIFETIME LED

Item #	Description	Price
60250R	LED B/T/T lamp w/ Grommet	\$36.95 ea

### TRUCK-LITE® SUPER 40 4" BACK-UP LIGHT

- Designed for mounting in a 4-1/2" hole
- Not recommended for dome lamp use
- Two lamps required to meet Federal Lighting Regulations
- Available in Halogen or LED

Item #	Description	Price
40844	Super Model 40 Back-up Light	\$9.58 ea
44206C	Model 44 LED Back-up (27LED)	\$99.95 ea
40700	Grommet Mount for Model 40 and 44	\$1.34 ea



### TRUCK-LITE® INCANDESCENT INTERIOR DOME LAMP

Item #	Description	Price
80350	Model 80 Dome Lamp w/Switch	\$13.50 ea
1156	Replacement Bulb	\$0.89 ea



### WHELEN 8" ROUND SUPER-LED INTERIOR LIGHT

- 6 diode Super-LED® light that fits the industry standard 8" cutout
- No mounting hardware required

Item #	Description	Price
8WC00EZR	8" LED Interior Light, White Housing	\$129.00 ea
80C00EZR	8" LED Interior Light, Chrome Housing	\$139.00 ea



### 33 SERIES MARKER & CLEARANCE GROMMET KIT

- World's smallest LED marker lamp for the transportation industry
- Exceeds legal requirements
- Hard-wired lamp design is easily retrofitted
- LEDs draw less current, allowing more power for other vehicle requirements
- Electronics completely sealed in epoxy to resist corrosion & moisture
- Offers trailer engineers & manufacturers new trailer & rear door structure design flexibility
- Requires 3/4" mounting hole
- Reduces lighting costs due to physical damage & heat entrapment

Item #	Description	Price
33050R	33 Series Marker # Clearance Grommet Kit, Red	\$9.74 ea
33050Y	33 Series Lamp, Grommet Mount, Amber	\$12.59 ea
33051R	33 Series Lamp, Flange Mount, Red	\$10.52 ea
33051Y	33 Series Lamp, Flange Mount, Amber	\$13.56 ea

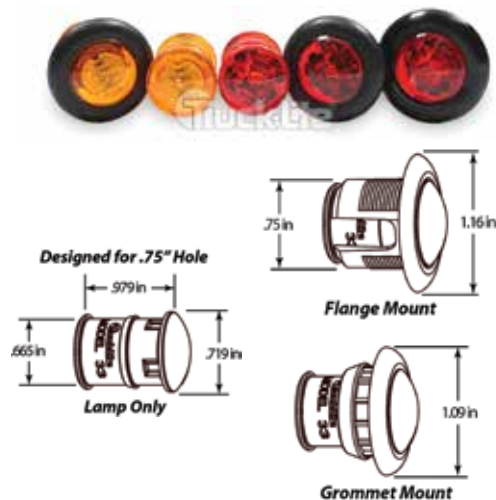



# WARNING LIGHTS

## Vehicle / Trailer Lights



### TRUCK-LITE® MODEL 10 LED MARKER/CLEARANCE LIGHTS

- Standard lamp has 2 diodes
- Omni-Volt lamp has 3 diodes
- Less current draw, resulting in increased battery & alternator life while allowing more power for other vehicle requirements
- Electronics completely sealed in epoxy to resist corrosion & moisture
- Size: 2.54" Diameter

Item #	Description	Price
10250Y	Model 10 LED Marker Light, Amber	\$6.46 ea
10250R	Model 10 LED Marker Light, Red	\$6.46 ea
10050R	Model 10 LED Kit, Red	\$10.54 ea
10050Y	Model 10 LED Kit, Amber	\$10.54 ea

(Kits include rubber grommet & plug assembly)

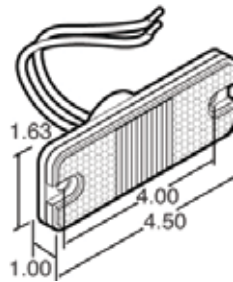

### TRUCK-LITE® MODEL 18 LED MARKER LIGHTS

- Uses standard mounting holes and accessories
- Standard 3 Diode Pattern

Item #	Description	Price
18050R	LED Marker Lamp Kit, Red	\$19.83 ea
18050Y	LED Marker Lamp Kit, Yellow	\$19.83 ea

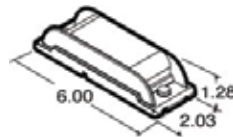

### TRUCK-LITE® MODEL 21 LED MARKER LIGHTS

- Uses standard mounting holes and accessories
- Standard 3 diode pattern

Item #	Description	Price
21051R	LED Marker Light Kit, Red	\$14.55 ea
21051Y	LED Marker Light Kit, Yellow	\$14.55 ea

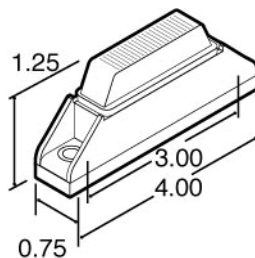

### TRUCK-LITE® MODEL 35 LED MARKER LIGHTS

- Standard 2 diode pattern
- Optimal mounting gasket available

Item #	Description	Price
35001R	LED Marker Lamp Kit, Red	\$10.25 ea
35001Y	LED Marker Lamp Kit, Yellow	\$10.25 ea
97308	Mounting Gasket	\$0.35 ea



92909



92900

### TRUCK-LITE® BACK UP ALARM

- Single sound back-up alarm for light to medium duty use
- Features epoxy sealed solid state electronics & rigid PVC plastic housing
- Connections are made with two #8-32 UNC terminal studs
- Manufacturer's 24 month warranty
- Meets OSHA, SAE J994, Bureau of Mines & all state regulations

Item #	Description	Price
92909	97dB Back-Up Alarm	\$29.72 ea
92900	97dB Back-Up Alarm (Square)	\$24.42 ea

### HEADLIGHT AND TAILLIGHT FLASHER FOR CHEVY

- For use in 2006-2013 Chevy Impala, 2011-2013 Chevy Caprice, and 2007-2015 Chevy Tahoe Police Package Vehicles
- Includes mating plug
- Switches four negative inputs into positive inputs
- Solid state controlled relay output
- Vehicle Speed Sense Feature which can adjust patterns and tones based on vehicle speed
- 2 outlet



SSFP0S16

Item #	Description	Price
SSFP0S16	Headlight/Grille Light Flasher w/Connectors	\$89.00 ea

### WHELEN HALOGEN HEADLIGHT FLASHER

- Solid-state relay output control
- 4 flash patterns
- Weather tight seal
- Easy installation
- High beam override
- Positive or negative switch control
- Not for Chevy Impala



UHF2150A

Item #	Description	Price
UHF2150A	Headlight Flasher, Positive or Negative Switching	\$42.50 ea

### WHELEN UNIVERSAL LED FLASHER

- Four outlet, four channel
- Each channel rated for 5 amps (60 Watts)
- 60 selectable Scan-Lock™ flash patterns
- Allows for alternating, simultaneous and synchronized flashing lightheades
- Channels are short circuit and thermally protected



Item #	Description	Price
ULF44	Whelen Universal LED Flasher	\$69.95 ea



# MOBILE *Services*

Introducing mobile vehicle equipment upfitting and police radar certification.



## Police Radar Certification

Keep radar units accurate and court acceptable without leaving your facility.



Call or visit [www.hallpublicsafety.com](http://www.hallpublicsafety.com) for complete details.

Mobile vehicle equipment upfitting and police radar certification are available through our strategic installation partner Hall Public Safety Upfitters.

# WARNING LIGHTS

## Vehicle Equipment Packages

### MARKED SEDAN EQUIPMENT PACKAGES - INCLUDING INSTALLATION



#### WHELEN® MARKED VEHICLE PACKAGE

Includes: Whelen siren and switch controller, 100 watt speaker with vehicle specific bracket, 4 corner LED system, rear deck LED lights, 2 LED grill lights, 12 Volt auxiliary power outlet, equipment console with cup holder and armrest.

Description	Price
Whelen Marked Vehicle Package, Justice Lightbar	\$4,375.00
Whelen Marked Vehicle Package, Liberty Lightbar	\$4,975.00
Whelen Marked Vehicle Package, Legacy Lightbar	\$5,425.00

#### FEDERAL SIGNAL® MARKED VEHICLE PACKAGE

Includes: Federal Signal siren and switch controller, 100 watt speaker with vehicle specific bracket, 4 corner LED system, rear deck LED lights, 2 LED grill lights, 12 Volt auxiliary power outlet, equipment console with cup holder and armrest.

Description	Price
Federal Signal Marked Vehicle Package, Legend Lightbar	\$4,675.00
Federal Signal Marked Vehicle Package, Argent Lightbar	\$4,999.00
Federal Signal Marked Vehicle Package, Valor Lightbar	\$5,499.00

#### CODE 3® MARKED VEHICLE PACKAGE

Includes: Mastercom siren and switch controller, 100 watt speaker with vehicle specific bracket, 4 corner LED system, rear deck LED lights, 2 LED grill lights, 12 Volt auxiliary power outlet, equipment console with cup holder and armrest.

Description	Price
Code 3 Marked Vehicle Package, 2100 Lightbar	\$4,475.00
Code 3 Marked Vehicle Package, 2700 Lightbar	\$4,875.00

Installation can be performed on site at your location or one of our installation centers. Contact us for details and to learn about year, model and make vehicle options!



**Parr**  
Public Safety Equipment  
Parts & Equipment Provider  
[www.parrpse.com](http://www.parrpse.com)

**Columbus Office**  
8495 Estates Court  
Plain City, OH 43064  
866-320-7277

**Cleveland Office**  
8291 Darrow Dr.  
Twinsburg, OH 44087  
855-387-3911

**Hall Public Safety**  
UPFITTERS  
Installation Services Provider  
[www.hallpublicsafety.com](http://www.hallpublicsafety.com)



# WARNING LIGHTS

## Vehicle Equipment Packages

### MARKED UTILITY VEHICLE EQUIPMENT PACKAGES - INCLUDING INSTALLATION



#### WHELEN® MARKED VEHICLE PACKAGE

Includes: Whelen siren and switch controller, 100 watt speaker with vehicle specific bracket, 4 corner LED system, rear deck LED lights, 2 LED grill lights, 12 Volt auxiliary power outlet, equipment console with cup holder and armrest.

Description	Price
Whelen Marked Vehicle Package, Justice Lightbar	\$4,375.00
Whelen Marked Vehicle Package, Liberty Lightbar	\$4,975.00
Whelen Marked Vehicle Package, Legacy Lightbar	\$5,425.00

#### FEDERAL SIGNAL® MARKED VEHICLE PACKAGE

Includes: Federal Signal siren and switch controller, 100 watt speaker with vehicle specific bracket, 4 corner LED system, rear deck LED lights, 2 LED grill lights, 12 Volt auxiliary power outlet, equipment console with cup holder and armrest.

Description	Price
Federal Marked Vehicle Package, Legend Lightbar	\$4,675.00
Federal Marked Vehicle Package, Argent Lightbar	\$4,999.00
Federal Marked Vehicle Package, Valor Lightbar	\$5,499.00

#### CODE 3® MARKED VEHICLE PACKAGE

Includes: Mastercom siren and switch controller, 100 watt speaker with vehicle specific bracket, 4 corner LED system, rear deck LED lights, 2 LED grill lights, 12 Volt auxiliary power outlet, equipment console with cup holder and armrest.

Description	Price
Code 3 Marked Vehicle Package, 2100 Lightbar	\$4,475.00
Code 3 Marked Vehicle Package, 2700 Lightbar	\$4,875.00

#### Additional Equipment Options with Installation Included

Rear window warning	\$350.00
Rear window warning upgrade	\$425.00
Side window LED lighting	\$350.00
LED spotlight upgrade	\$225.00
Flashing LED's in reverse lights	\$245.00
Push bumper LED lighting	\$275.00
Charge Guard	\$89.00
Secure Idle	\$280.00
Single gun mount	\$340.00
Dual gun mount	\$445.00
Heavy duty computer mount	\$499.00
Rear barrier prisoner seat combo	\$1195.00
Rear cargo barrier	\$200.00
Front recessed partition w/polycarb windows and lower extensions	\$750.00
Center push bumper	\$439.00
Rear window barriers	\$245.00
Rechargeable LED Flashlight with Charger	\$159.00
Stopstick tire deflation system	\$455.00
Two-way radio install kit with antenna	\$85.00
Alternating trunk light package	\$379.00
TufLoc locking storage system (keep spare access)	\$995.00



**Parr**  
Public Safety Equipment  
Parts & Equipment Provider  
www.parrpse.com

**Columbus Office**  
8495 Estates Court  
Plain City, OH 43064  
866-320-7277

**Cleveland Office**  
8291 Darrow Dr.  
Twinsburg, OH 44087  
855-387-3911

**Hall Public Safety**  
UPFITTERS  
Installation Services Provider  
www.hallpublicsafety.com

# WARNING LIGHTS

## Replacement Parts & Bulbs



900 Series

**WHELEN**



400 Series



500 Series

### REMOTE LIGHTHEADS / REPLACEMENT PARTS

#### Replacement Halogen Bulbs

Item #	Description	Price
H27SN12	400 Series Bulb	\$18.50 ea
H35SN12	500 Series Bulb	\$18.50 ea
H60SN12	600, 700, 900 Series Bulb	\$18.50 ea

\*Specify Color: ■ Amber ■ Blue ■ Red □ White

#### Replacement Lenses

Item #	Description	Price
400*	400 Series	\$13.95 ea
500*	500 Series	\$11.25 ea
600*	600 Series	\$34.50 ea
700*	700 Series	\$31.50 ea
900*	900 Series	\$34.50 ea

\*Specify Color: ■ Amber ■ Blue ■ Red □ White

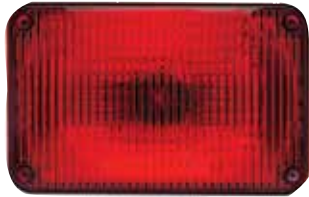

600 Series



700 Series



Black Flange



Flange Required for 500 Series.

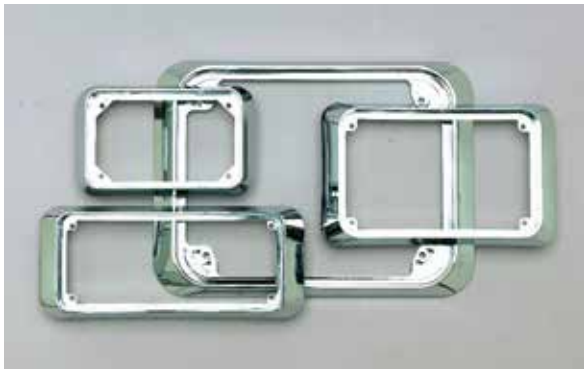

### REMOTE LIGHTHEAD FLANGES

**WHELEN**

Item #	Description	Price
4EFLANGE	400 Series, Chrome	\$10.00 ea
4FLANGEB	400 Series, Black	\$7.00 ea
5FLANGEC	500 Series, Chrome	\$10.00 ea
5FLANGEB	500 Series, Black	\$7.00 ea
6EFLANGE	600 Series, Chrome	\$16.00 ea
6FLANGEB	600 Series, Black	\$7.00 ea
7EFLANGE	700 Series, Chrome	\$10.00 ea
7FLANGEB	700 Series, Black	\$7.00 ea
9EFLANGE	900 Series, Chrome	\$19.00 ea
90FLANGC	900 Series Super-LED Only, Chrome	\$19.00 ea
90FLANGB	900 Series Super-LED Only, Black	\$8.00 ea



**Whelenpartsstore.com**

*Whelen Parts Store is the fast and easy way to find the Whelen parts you need.*

Find parts for common Whelen products like beacons, lightbars, mini-lightbars, dash and deck lighting, sirens and more... Use the online schematics to locate and order the exact part you need.

[www.whelenpartsstore.com](http://www.whelenpartsstore.com)



# WARNING LIGHTS

Replacement Parts & Bulbs

**WHELEN**  
ENGINEERING COMPANY, INC.

## 2015 PICTORIAL REFERENCE GUIDE FOR STROBE, HALOGEN & INCANDESCENT REPLACEMENT BULBS

### STROBE

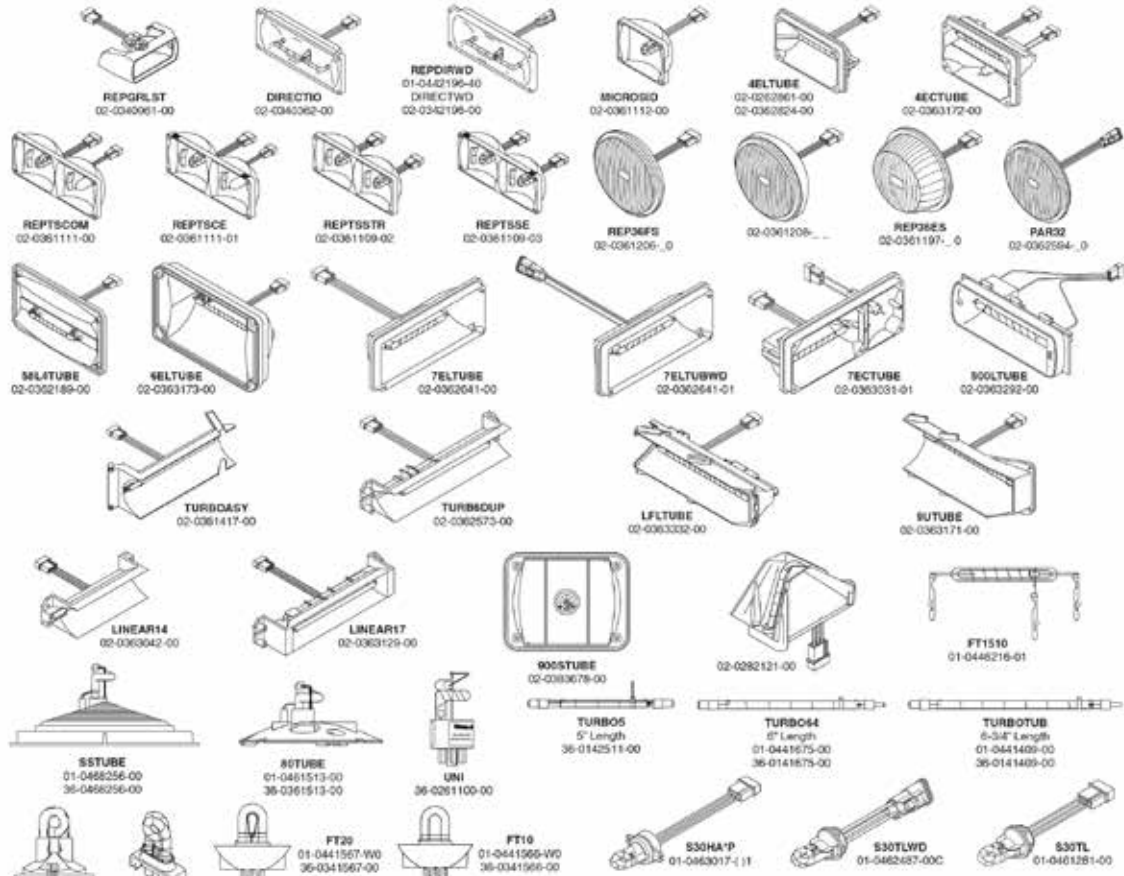

### HALOGEN & INCANDESCENT

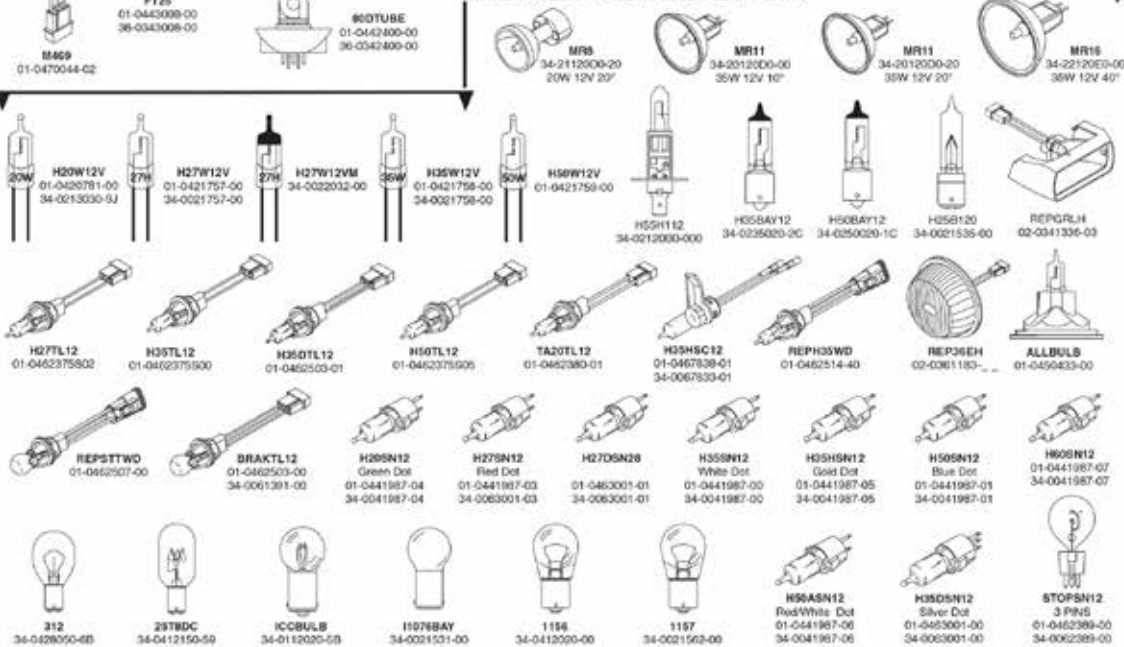



# VEHICLE ACCESSORIES

## Switch Controls



### WHELEN 9-POSITION SWITCH CONTROLS



4 position, 3 function slide switch and 6 push buttons combined to provide a single source for lighting control. Both models offer a momentary contact switch on the 6th push button for low power, trunk lock or gun lock control. Includes bail mounting bracket and 72 stick-on function labels.

Model specific features:

**PCCS9NP:** programmable, progressive slide switch. For use with Whelen's low current style lightbars ONLY (each switch rated for 1/4A).

**PCCS9RW:** 9 built-in 30 amp relays. Can be used with any manufacturer's lightbar.

Item #	Description	Price
PCCS9NP	9 Position Switch Control	\$239.00 ea
PCCS9RW	9 Position High Current Switch Control	\$215.00 ea



### 6-SWITCH CONTROL CENTER



- One 40 amp master and five 20 amp SPST switches
- Backlit legends for nighttime visibility
- Black epoxy-finished steel housing
- Includes 72 stick-on legend tabs and bail mounting bracket
- Dimensions: 2-1/2" H x 6" W x 4-3/4" D

Item #	Description	Price
PCC6W	6 Switch Control Center	\$129.00 ea
PCC6W1	5 Switch + 1 Momentary	\$129.00 ea



### 10-SWITCH CONTROL CENTER



- Ten 25 amp SPST switches
- Backlit legends for nighttime visibility
- Black epoxy-finished steel housing
- Includes 72 stick-on legend tabs and bail mounting bracket
- Dimensions: 2-1/4" H x 6" W x 3-9/16" D

Item #	Description	Price
PCC10W	10 Switch Control Center	\$159.00 ea
PCC10W1	9 Switch + 1 Momentary	\$176.00 ea



### HIGH CURRENT SWITCH BOXES



- Fully-enclosed switch box has four or six lighted, single-pole-single-throw rocker switches
- Durable, black powder-coated steel housing
- Switches are individually fused and pre-wired for easy installation
- 4 Position switch box includes one 40 amp primary switch and three 20 amp switches. Dimensions: 2-1/4" H x 4-1/2" W x 3-7/8" D
- 6 Position switch box includes one 40 amp primary switch and five 20 amp switches. Dimensions: 2-1/2" H x 6" W x 5" D

Item #	Description	Price
05.4000	4 Position Switch Box	\$69.00 ea
05.6040	6 Position Switch Box	\$159.00 ea

### 8 FUNCTION KEY PAD CONTROL CENTER

**WHELEN**

This control center features a compact key pad controller that connects to a remote relay box, allowing you to control multiple lighting devices without a bulky control head taking up usable space under the dash or elsewhere in the cabin. The key pad controller can be mount virtually anywhere, ensuring it is within quick, comfortable reach.

- Eight function control center with three 20 amp relays and five 10 amp relays
- Push-On/Push-Off or momentary activation switches
- LED back lighted membrane switches are designed with a solid rubber overlay for moisture resistance
- Key pad controller dimensions: 2-1/2" H x 4-3/16" W x 7/8" D
- Relay box dimensions: 1-1/4" H x 7-1/4" W x 4-3/4" D

Item #	Description	Price
PCC8R	8 Function Controller w/ Remote Relay Box	\$269.00 ea



### FEDERAL SIGNAL SWITCH CONTROLS

SW400SS switch control provides switching for seven separate lighting or auxiliary functions. Each unit has a three position slide switch and four auxiliary switches.

The slide switch can quickly activate functions or combinations in a progressive sequence. Slide switch positions 1 and 3 each have a 20 amp relay and are fused at 20 amps. Position 2 has a 40 amp relay and a self-resetting 40 amp circuit breaker. The four 20 amp auxiliary switches enable users to activate additional functions from the same panel. Plastic legends can be easily popped out and replaced when control functions change.

Model SW300 has six lighted single-pole, single-throw (SPST) rocker switches for control of virtually any type of lighting function. Switch 1 controls rotating lights and comes prewired to a 40-amp relay and self-resetting circuit breaker. Switches 2-6 have 20-amp capability and are fused on a 20-amp circuit. These five blade-type fuses are mounted on the back of the switch control housing and correspond in sequence to the switches they control. This makes it easy to find any blown fuse for replacement.

Item #	Description	Price
SW400SS	Controller w/ Slide Switch and (4) 20A Switches	\$239.00 ea
SW300-012	Controller w/ Six Rocker Switches	\$189.00 ea



FEDERAL SIGNAL



# VEHICLE ACCESSORIES

Sirens

## 200W PROGRAMMABLE SIREN/LIGHT CONTROLLER

The most customizable, user-friendly siren that Whelen offers.

It shares all of the same great features of the 295SL series plus more!

**WHELEN**



- 9 switch light control: progressive three function slide switch & 6 rubber push buttons
- Slide switch is programmable
- Push buttons are programmable for use as Push On/Off, Momentary, or Timed Output
- 17 Scan-Lock™ siren tones to choose from
- Programmable siren and override tones in any rotary switch position
- Master switch programmable for On/Off operation of the siren only, or siren and switch function. Park kill and timed out relay.
- High current switching: slide switch activates 20A output, each push button activates one 10A output
- LED backlighting
- Dimensions: 3-5/16" H x 6" W x 7" D

**Hands-Free. Most customizable siren on the market!**

Item #	Description	Price
295SLSA6	200W Programmable Siren w/ 9 Switch Light Control	\$499.00 ea



## CENCOM SAPPHIRE™ SIREN AND LIGHT CONTROL SYSTEM

Convenience, reliability and practicality all merge to form this one-of-a-kind controller. Eliminate clutter in your console by controlling your entire warning system from one keypad. Many of its functions can be modified through a user-friendly program, for complete customization, right from your PC!

- Control head includes 3 position slide switch (one 40A and two 20A outputs) and 18 programmable, backlit rubber push buttons with bright LED On/Off indicators
- Operates two 100W speakers
- The single Amplifier/Relay Module (ARM) provides a centralized power point with externally accessed fuses and connectors for ease of service
- Easy to configure using Windows® XP application program (included) that features "drag and drop" programming
- A USB port in the ARM provides easy access for programming
- On/Off, momentary, eight second timer and security double-tap eight-second timer can be programmed through seven switches individually
- Single 20 foot, 8-conductor, 22-gauge cable connects Control Head to AMR for heavy duty service and decreased installation time

**NEW**

**WHELEN**

- Three models to choose from for compatibility with Traffic Advisors™:
  - CCSRN3: operates 2-wire TAs that *do not* require external controls
  - CCSRNTA3: for interface with TAs that *do* require external controls
  - CCSRNT3A: Same as CCSRNTA3, Except with 8 (Positive or Negative) Input Expansion Module, 12 Total Inputs
- 2 year warranty on the system, 5 year on the amplifier
- Includes 136 function labels, twenty foot power and input/output cabling with connectors and bail mounting bracket
- Control head dimensions: 3-1/2" H x 6-7/8" W x 1-5/16" D
- Amp dimensions: 3" H x 8-1/4" W x 3/4" D



Item #	Description	Price
CCSRN3	CenCom Sapphire™ System	\$995.00 ea
CCSRNTA3	CenCom Sapphire™ System w/ Traffic Advisor™ Control	\$1,095.00 ea
CCSRNT3A	CenCom Sapphire™ System w/ 8 Input Expansion Module	\$1,275.00 ea
CCMICX20	20' Microphone Extension Cable	\$85.00 ea
CCTRIM	Trim Ring Option (for semi-flush mounting)	\$46.00 ea





### PA640 100 WATT SIREN W/ LIGHT CONTROL

Crystal controlled microprocessors, integrated circuits, and silicon based output transistors work together to make the PA640 the most reliable, most versatile, totally enclosed siren/light controller available. Wail, Yelp, Priority or Hi-Lo, Manual Peak-and-Hold and Air Horn are all standard tones and can be enabled by a heavy-duty five position rotary switch.

- 100-watt output and 80-amp total switching capacity
- Public Address with volume control
- Meets Class A and SAE J1849 sound output requirements
- Internally programmable tones, switch functions and relay outputs
- Reversed polarity and "dynamic" short circuit protection
- Horn Ring Transfer (HRT) and two built-in flashers included
- Dimensions: 3" H x 6.8" W x 7.75" D

Item #	Description	Price
PA640	PA640 100 Watt Siren/Light Control	\$499.00 ea
PA300	PA300 100 Watt Siren w/o Light Control (Not Pictured)	\$339.00 ea



### XCEL SIREN

Designed and Manufactured in the USA, the XCEL siren offers a host of new features that were designed to make it easy for the officer to use as well as for the installer and service technicians to install.

- 3-Level slide switch can be programmed as independent, semi-progressive, or progressive giving you more options when configuring your siren
- Unique programming features including latching of Auxiliary buttons to level outputs allow the officer to keep their eyes on the road for longer periods of time
- Backlighting on buttons can be adjusted to the officer's preference
- Program CA T13 compliance with the flip of a switch
- Positive or Negative Park-Kill and Horn-Ring Transfer triggers allow for easy installation on all vehicle types

Item #	Description	Price
3492L6S	Full Featured 12V XCEL Siren with Light Controls	\$499.00 ea

**NEW**



### EPSILON™ 200 WATT SIREN

The Epsilon Siren Series provides a wide range of features in a low cost siren that meets SAE Class A sound requirements and is California Title 13 compliant. It features hands-free operation/override through the horn ring, public address and multiple selectable Scan-Lock™ warning tones. It provides lighting control through one 3-function slide switch and six rocker switches.

Item #	Description	Price
EPSL2S9	200 Watt Siren Amplifier w/ 9 Outlets	\$399.00 ea



### 200 WATT MASTERCOM B SIREN/LIGHT CONTROLLER

This MasterCom B siren features built-in lighting control with a 3-level progressive slide switch and 6 push-on/push-off buttons.

- Wail, Yelp, Hyper HiLo, HiLo, Hyper Lo, Air Horn and Radio Rebroadcast
- Instant On
- Adjustable backlighting
- Selectable Hit-N-Go or horn ring scroll mode
- Park Kill, for both lighting & siren
- Includes mounting bail and legends for push buttons
- Automatic short circuit protection

Item #	Description	Price
3892L6	200 Watt MasterCom B Siren w/ Light Control	\$499.00 ea



# VEHICLE ACCESSORIES

## Sirens



EP SL1

**Hands Free**



### EPSILON™ SIREN SERIES

The Epsilon Siren Series provides a wide range of features in a low cost siren that meets SAE Class A sound requirements and is California Title 13 compliant. It features hands-free operation/override through the horn ring, public address and multiple selectable Scan-Lock™ warning tones.

- Compact design, includes noise-canceling microphone
- Programmable outlets
- Nine tones to choose from
- Harmonically rich composite airhorn tones
- Non-destructive short circuit protection
- Two year warranty
- EP SL1 Dimensions: 2-1/4" H x 5-7/8" W x 5-3/4" D

**WHELEN**

Item #	Description	Price
EP SL1	100 Watt Siren Amplifier w/ Microphone & Volume Control	\$229.00 ea



295SL100



295SL101

**Hands Free**



### 100W ELECTRONIC SIREN

- Functions: Radio Rebroadcast, Public Address, Manual, Wail, Yelp, Piercer Tone and Airhorn
- Scan-Lock™ Siren Tones: tones selected via momentary switch for complete user customization
- "Hands-Free" operation: use the horn ring to turn the siren On or Off and access all three siren tones (Wail, Yelp, Piercer) without removing hands from the steering wheel!
- Backward compatible to 295HF100 & WS2100
- Operates up to two 100W Speakers
- 2 Year Warranty
- Dimensions: 2-1/2" H x 6" W x 5-1/2" D

**WHELEN**

295SL100 vs. 295SL101: Same specs, the 100 has a hard wired microphone, whereas the 101 features a removable microphone with volume control knob.

Item #	Description	Price
295SL100	100 Watt Electronic Siren w/ Hard Wired Microphone	\$299.00 ea
295SL101	100 Watt Electronic Siren w/ Removable Microphone	\$349.00 ea



295SLSA1

**Hands Free**



### 100/200W HANDS-FREE ELECTRONIC SIREN

- "Hands Free" operation: the horn ring is used to turn the siren On or Off and access all three siren tones (Wail, Yelp, Piercer) without removing hands from the steering wheel!
- Selectable 100 or 200 watt output
- 17 Scan-Lock™ Siren Tones: allows user selectable siren tones via momentary switch for complete user customization
- Functions: Radio Rebroadcast, Public Address, Manual, Wail, Yelp, Piercer Tone and Airhorn
- "Park-Kill": disables siren when the vehicle is in park
- Volume control knob on faceplate
- Si-Test®: silent, self-diagnostic indicator of siren or speaker failure
- 5 Year Warranty
- Includes bail mounting bracket and function labels
- Dimensions: 2-1/2" H x 6" W x 5-1/2" D

**WHELEN**

Item #	Description	Price
295SLSA1	100/200W Hands-Free Electronic Siren	\$349.00 ea

## CODE 3 H2 COVERT™ REMOTE SIREN SYSTEM

This Code 3 siren comes with eight ear-busting tones that will be heard from miles away. With its programmable features, it becomes much more user friendly.

- Sirens: wail, yelp, hi-lo, hyper-lo, hyper-yelp, whoop, manual wail & air horn
- PA with built-in noise canceling mic
- Radio rebroadcast
- Stand-by
- Siren scroll
- Siren park kill with level 3 Drop-Out option\*
- Horn ring transfer
- Vehicle light control buttons (3 progressive, 4 auxiliary)
- All buttons are backlit with on/off color change
- Push button programmable siren tones
- (2) programmable airhorn pitch tones
- 25' extension cable
- Volume control thumbwheel on hand-held controller
- Siren lock – level 3
- Timed output functions for gun lock operations
- Additional dip switches for optional functions via special order



**NEW**



Item	Description	Price
3599L5	8 Siren Tones, Programmable	\$429.00 ea

## HAND HELD SIREN/LIGHT CONTROLLER

Now you can easily control all light and siren functions from this compact, hand held controller with built-in microphone. Moisture-resistant controller features twelve rubberized, backlit push buttons including progressive three-position push button lighting operation. The amplifier is microprocessor controlled and rated for one or two 100W speakers. The compact controller is ideal for multiple applications including undercover vehicles and vehicles with limited cabin space.

- Hands free siren control through the horn ring
- Twelve easy-to-use illuminated push buttons feature green backlighting that turns to red when activated
- User selectable switch labels
- Progressive three position push button replaces slide switch for lighting control
- Wail, Yelp, Piercer, Manual Siren and Airhorn tones, standard
- Adjustable preset microphone and radio repeat volume
- Mechanical siren tone option
- Nine 10 amp outputs
- Includes 6' coiled cord microphone cable and 20' interconnect cable and programming software



Item	Description	Price
HHS2200	Hand Held Siren/Light Controller	\$429.00 ea



**WHELEN**





# VEHICLE ACCESSORIES

## Speakers - Mounting Kits

**WHELEN**



### PROJECTOR™ 100 WATT RMS SPEAKER

The Projector™ is a compact, multi-port speaker for bumper mounting and concealed installations. It puts high performance, traffic clearing warning sound where it counts: down and in front of the vehicle.

- Made of durable, weather impervious nylon composite material
- 123 dB
- Complies with OSHA 1910.95 guidelines defining "Permissible Noise Exposure"
- All models exceed CA Title XIII, Class A and SAE J1849 requirements
- Dimensions: 6-1/2" H x 6-1/2" W x 2-7/8" D

Item #	Description	Price
SA315P*	Projector™ Series, 100W RMS Speaker, Black	\$199.00 ea

\*Specify Vehicle Mounting Bracket (price includes vehicle mounting bracket of choice)

### MOUNTING KITS

**WHELEN**

(price without speaker purchase)

Item #	Description	Price
SAK1	Universal Mount Bracket, also for '02-'10 Explorer, '04-'06 Tahoe/Suburban	\$29.00 ea
SAK5	Bracket for '00-'03 Tahoe/Suburban, '04-'11 Envoy	\$29.00 ea
SAK9	Universal Swivel/Bail Bracket	\$29.00 ea
SAK23	Bracket for Ford Expedition, '07-'15	\$29.00 ea
SAK24	Bracket for Chevy Tahoe/Suburban, '07-'14	\$29.00 ea
SAK25	Bracket for Chevy Express Van, '06-'16	\$29.00 ea
SAK32	Bracket for Ford E Series E350/450 - '08-'14	\$29.00 ea
SAK34	Bracket for Chevy Impala, '06 - '16 Impala	\$29.00 ea
SAK37	Bracket for Dodge Charger, 2011-2016	\$29.00 ea
SAK38	Bracket for Ford Fusion, 2010-2012	\$29.00 ea
SAK39	Bracket for Ford Taurus, '10 - '15	\$29.00 ea
SAK40/41	Bracket for Ford F250/350, '11 - '16 Driver/Passenger Side	\$29.00 ea
SAK42	Dodge 4500, '11 - '15	\$29.00 ea
SAK44	Ford Explorer, '11 - '16	\$29.00 ea
SAK45	Chevy Caprice, '11 - '16	\$29.00 ea
SAK47	Dodge Ram 1500, Passenger Side, '12 - '16	\$29.00 ea
SAK48	Dodge Ram 1500, Driver Side, '12 - '16	\$29.00 ea
SAK49	Chevy/GMC, Passenger Side, '14 - '15	\$29.00 ea
SAK50	Chevy/GMC, Driver Side, '14 - '15	\$29.00 ea
SAK51	Ford Explorer, '14 - '16 and Ford Police Interceptor Utility, '14 - '16', Passenger Side Lower Grille	\$29.00 ea
SAK52	Ford Explorer, '14 - '16 and Ford Police Interceptor Utility, '13 - '16, Driver Side Lower Grille	\$29.00 ea
SAK53	Ford Fusion, '13 - '16	\$29.00 ea
SAK54	Dodge Durango, '13 - '16	\$29.00 ea
SAK55	Chevy Suburban/Tahoe, '15 - '16 Passenger Side	\$29.00 ea
SAK56	Chevy Suburban/Tahoe, '15 - '16, Driver Side	\$29.00 ea

\*Other vehicle mounting brackets available, call for availability.



SAK37



SAK9

### AS124 ECONOMY SPEAKER

The Federal Signal AS124 series speaker uses advanced housing material and a field-replaceable neodymium driver to provide effective, high quality sound at an affordable price.

Its housing is made from a revolutionary material known as P.E.T. (polyethylene terephthalate) making it lightweight and corrosion and heat resistant.

The speaker can be mounted horizontally or vertically by using supplied stainless steel bolts an associated hardware and is compact enough to mount in a wide variety of locations around your emergency vehicle.

- Meets or exceeds SAE/CCR sound requirements
- Dimensions: 7.7" W x 5.7" H x 4.45" D
- Weight: 6lbs, without mounting hardware

Item #	Description	Price
750501	AS124 Economy Speaker	\$147.00 ea



### DYNAMAX™ SPEAKERS

Federal Signal is making changes to improve the overall design of our popular DynaMax® speaker product line. The most noticeable change is to its housing. DynaMax speaker models currently incorporate an aluminum housing. Soon, DynaMax (ES100C) models, will incorporate a composite plastic housing. As a result, the new ES100C will be lighter in weight and have less depth than current ES100 models. The ES100C has the same impressive 100-watt neodymium driver and produces an increased dB rating.

- Dimensions: 5.8" H x 5.8" W x 2.6" D
- Weight 5.5lbs
- Composite plastic housing

Item #	Description	Price
ES100C	Dynamax™ 100 Watt High Output Speakers	\$199.00 ea



### CODE 3 C3100 SERIES 100 WATT SPEAKERS



- Compact, low profile design
- Neodymium magnet driver for maximum efficiency
- Glass-filled nylon housing makes the C3100 lightweight, yet rugged and weather resistant
- Impedance: 11 ohms @ 100 watts
- Compliant with SAE J1849 and CA Title XIII when used with Code 3 sirens (except models 3000 or 3050)
- 120 dB @ 3 meters
- Dimensions: 6-3/8" H x 6-3/8" W x 3-3/16" D
- Weight: 6.1 pounds

Mounting brackets available for most vehicles.

Item #	Description	Price
C3100**	C3100 Series 100W Speaker	\$199.00 ea

\*\*Please specify vehicle year & make.



**WHELEN**



### ALPHA™ 12R REMOTE SIREN

- Meets Class A requirements with most 100W speakers
- “Hands-Free” operation allows tone selection through horn ring
- 4 siren tones: Wail, Yelp, Piercer, Air Horn
- Controlled by Whelen switches (Alpha1-4, purchased separately) or customer supplied switches
- Easy to install, service or transfer with quick disconnect plugs
- 2 Year Warranty
- Dimensions: 7” W x 4” D x 2-1/4” H

Item #	Description	Price
ALPHASL	Alpha Remote 100W Siren Amplifier	\$189.00 ea

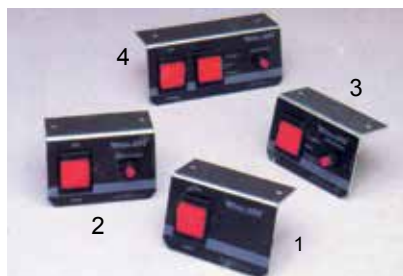

### REMOTE SIREN SWITCH CONTROLS

**WHELEN**

Item #	Description	Pricing
ALPHA1	Single On/Off Switch for “HF” Operation/Tone Control	\$26.00 ea
ALPHA2	Single On/Off Switch Air Horn Push Button	\$26.00 ea
ALPHA3	Single On/Off/On Switch w/ Air Horn Button	\$26.00 ea
ALPHA4	1 On/Off and 1 On/Off/On Switch w/ Air Horn button	\$47.00 ea

Includes “L” mounting bracket.



### WHELEN COMBINATION SIREN/SPEAKER

- Heavy-duty compact 30-watt amplified siren ideal for use on motorcycles, ATV’s, snowmobiles, etc.
- Hands-free operation for wail and yelp tones
- Two way “L” mounting bracket
- Rugged aluminum housing plus water-resistant connectors
- Dimensions: 4-5/16” H x 5-7/16” W x 4-5/8” D

Item #	Description	Price
WSSC30	30 Watt Siren & Speaker Combination	\$169.00 ea



### IDLERIGHT2™ IDLE REDUCTION SYSTEM MODULE

The new generation Idleright system is designed to reduce engine wear, greatly extending the service life of vehicles. Ideal for vehicles that run light bars for extended periods of time while the vehicle is parked. The system is designed to reduce fuel consumption, greatly reducing operation expenses up to 80%

- New universal approach works with existing aftermarket starter technologies
- Installation is greatly simplified, reducing cost and complexity
- Not compatible with vehicle manufacturer (OEM) remote start systems

IR-1002 system is compatible with aftermarket remote starters that are equipped with a negative or positive “activation input”. Some manufactures for reference: Avital, Clifford, Python and VIPER. Contact your remote start installer to determine if a interface module is available for your specific vehicle. If interface is not available, then an additional aftermarket remote start system is required.

Item #	Description	Price
IR-1002	IDLERIGHT2 Idle Reduction System	\$129.00 ea



### THE GRIP IDLE MANAGEMENT SYSTEM™

The GRIP (Governor to Reduce Idle and Pollution) Idle Management System has been created to manage the time that a vehicle spends idling. By using the GRIP system to transfer operation from the engine to the battery when idling, you can: save fuel, reduce carbon emissions, reduce overall operation and engine maintenance, and extend the life cycle of the engine. The Grip system works in conjunction with the vehicle's Controller Area Network (CAN) and receives real-time data on the vehicle's function, making decisions to shut the engine on and off via the GRIP's PLC (Programmable Logic Controller).



**NEW**

#### GRIP SYSTEM KEY FEATURES

- Interior vehicle temperature and battery voltage monitored and maintained during shutdown
- GRIP will only power off the engine while the vehicle is in park or neutral gear position, never while stopped temporarily
- Operator sets and controls climate comfort level
- Optional anti-theft allows vehicle to be monitored securely while operator is out of vehicle
- All vehicle safety systems and auxiliary equipment such as airbag remain active while GRIP shuts vehicle down
- Programmable to meet your fleet's needs
- Easy, non-invasive installation
- Improved environmental metrics for your fleet and business
- The CanFox Cable connects GRIP controller to a computer, allowing for use of the GRIP Diagnostic System (GDS) as well as the Electronic Management Analysis Tool (EMAT).
- GDS allows technicians to see GRIP functions in real time which assists in troubleshooting
- EMAT system converts vehicle metrics collected by GRIP into simple charts for better analytics and function monitoring
- Recycling program allows GRIP to be re-installed on another vehicle
- The basic system contains the following: Controller, Screen, Hood Pin and Temperature Sensor

#### HOOD PIN

The hood pin is a safety feature for servicing the vehicle. The hood pin needs to make contact with a magnet installed on the hood in order for the GRIP system to control the vehicle. This is very important as service can be performed on the vehicle with the hood up. The GRIP will not be able to start the vehicle. The only way to start it at this point would be manually with a key. An icon will appear on the screen when the hood is up for additional safety.

#### TEMPERATURE SENSOR

The temperature sensor transmits the temperature of the cabin to the controller. It is positioned in the vehicle to obtain an optimal reading to ensure accuracy for increased operator comfort.



#### OPTIONS & ACCESSORIES

- Coolant Pump Kit
- Auxiliary Heater (Gas or Diesel-Fired)
- Anti-Theft Features
- Remote Start Kit
- Solenoid
- High Current Kit
- Audible Alarm Kit
- Auxiliary Air Conditioning
- CanFox Cable

#### Big Benefits!

- Save Fuel
- Reduce Co2
- Reduce Operation

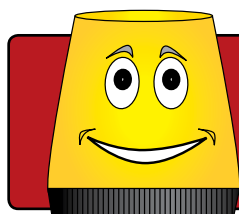

Contact us to learn more about this robust system and for configurations and pricing.

# VEHICLE ACCESSORIES

## Throttle Control & Power Control



VoltGuard Low Voltage Actuator Model 70-VG



### VANNER AUTOMATIC THROTTLE CONTROL

Vanner's Automatic Throttle Control System increases engine RPM, only while in park or neutral, in order to provide higher output of the alternator under heavy electrical loading conditions. Autothrottles can be used on many types of vehicles and are an excellent choice for applications using DC to AC inverters.

Item #	Description	Price
70-VG	VoltGuard® Low Voltage Autothrottle Actuator	\$214.00 ea
73-46	Heavy Duty Automatic Throttle System, includes solenoid/cable assembly and control module assembly	\$360.00 ea
73-48	Accessory Kit, includes ON/OFF toggle Switch, 02264 diode, 8 amp slo-blo fuse and holder	\$40.00 ea



### VANNER BATTERY ISOLATORS

Vanner battery isolators are designed to allow dual battery systems to be charged from a battery charging source while preventing one battery from discharging the other. This protects the engine battery from being discharged by an auxiliary battery operation. Silicon Diode and the low voltage Schottky Diode isolators are available in several current ratings.

- Dimensions: 2-1/2" H x 4-1/2" W x 8" D

Item #	Description	Price
50-140	Silicon 2-leg Isolator, 180 amp alt/165 amp per leg	\$138.00 ea
51-140	Schottky 2-leg Isolator, 250 amp alt/200 amp per leg	\$199.00 ea



### VANNER AMBULANCE INVERTER/CHARGER

- 1050 watts of precisely regulated AC power and a 55 amp battery charger when plugged into shore power
- Meets new GSA K-spec for charging and DC power
- Operates DC loads and check-out lights with a built-in 20 amp power supply, eliminating the need for a secondary DC power source
- Fully-integrated interface module (IFM1) for simplified wiring and reduced labor time & space
- Output wave form: modified sine wave

Item #	Description	Price
20-1050CUL-DC	Ambulance Inverter/Charger, 1050 Watts	\$1,299.00 ea
20-1000TUL-DC	Ambulance Inverter w/out Charger, 1050 Watts	\$1,399.00 ea



### WARNING LIGHT FLASHERS

Vanner's heavy-duty electronic flashers are designed to meet the demanding needs of emergency response vehicles. These flashers are short-circuit protected, provide silent operation and are sealed for protection against the elements and vibration. They produce a variety of lighting patterns and sequences and are available in a broad range of amperage ratings.

Item #	Description	Price
3250GCPE	2 Outlet, 100 Amp Output Alternating Electronic Flasher	\$119.00 ea
3840GCPE	Flasher, complies with AMD and GSA KKK-A-1822 B/C Specs	\$139.00 ea
3860GCPE	Flasher, complies with AMD and GSA KKK-A-1822 C/D/E Specs	\$149.00 ea



### D&R PDU42WB

The Power Distribution Unit with built-in Watchdog shutdown timer is designed to provide a safe and central power point for all electrical devices, reducing the need for independent wire runs within the vehicle. Each circuit can be individually fused, further reducing risk of damage to sensitive electronic devices, and has a red LED to indicate a blown fuse or equipment problem. The PDU provides constant ignition and timed outputs to meet all operational requirements. The timed outputs provide the ability for automatic shutdown of devices such as mobile radios, modems and computers before they drain the battery dangerously low. The time is user-selectable and ranges from 2 minutes to 13 hours (after ignition key is removed).

Dimensions: 5" W x 1-1/2" H x 12" L



Item #	Description	Price
PDU42WB	PDU w/ Watchdog Shut Down Timer	\$275.00 ea

### D&R PDU-8S

This power distribution unit provides you with the power inputs and the power outputs that will enable you to have an organized and reliable display of powered equipment.

- Monitors battery voltage
- Preserves enough charge to start your vehicle
- Automatically disconnects battery
- Simply press button to reconnect



**NEW**



Item #	Description	Price
PDU8S	Power Distribution Unit	\$325.00 ea

### THE BATTERY BRAIN™

The Battery Brain™ from Smart Energy Solutions protects your vehicle's battery from overdraw to ensure there's always enough charge to start the vehicle. Plus, with its automatic disconnect feature, the Battery Brain™ doubles as an anti-theft device!

- Monitors battery voltage
- Preserves enough charge to start your vehicle
- Automatically disconnects battery
- Simply press button to reconnect

Item #	Description	Price
BB412S	Battery Brain Battery Protector	\$99.00 ea



### CHARGE GUARD AUTO SHUT-OFF TIMER

ChargeGuard works by automatically turning mobile equipment on when you start the engine. When you turn the engine off, the equipment stays on for an adjustable period of time, then is automatically disabled.

- Self-contained unit that provides intelligent circuit protection for a vehicle's power system
- Protects mobile electronics from voltage anomalies
- Programmable timer cuts power to electronics to prevent dead batteries
- Regulated by a programmable timer
- Prevents dead batteries
- LED indicates under and over voltage conditions

**NEW**



Item #	Description	Price
CG-X	Chargeguard Auto Shut-off Timer	\$89.95 ea



# VEHICLE ACCESSORIES

## Power Control Systems



### POWERVERTER ULTRA-COMPACT INVERTER

Harness your vehicle's battery to efficiently power small appliances, electronics and office equipment on the road. Continuously supplies up to 700 watts of 120V AC power to 3 AC outlets from any 12V DC power source. Featuring an ultra-compact, lightweight design and an all-metal housing, the PV700HF is among the smallest, most rugged inverters available. Provides a quiet alternative to generator noise and fumes.

- 700 Watts continuous output power; 1400 Watts peak output power (instantaneous)
- 3 AC outlets
- Ultra-compact extruded aluminum housing stands up to the toughest environments
- Cooling fan lengthens inverter service life and maintains cool operation
- Integrated mounting feet assure safe, fixed installation
- Low battery alarm/shutdown detects low battery voltage and shuts down inverter
- Overload alarm/shutdown detects wattage overload on inverter outlets and shuts down inverter as a protective measure
- DC input terminals provide a solid connection to battery with user-supplied cables
- Lighted on/off switch shows inverter operations in cramped or dark environments

Item #	Description	Price
PV700HF	700W PowerVerter Ultra-Compact Inverter	\$129.00 ea

### POWERVERTER® 375 WATT ULTRA-COMPACT INVERTER

Harness your vehicle's battery to efficiently power office equipment on the road. Continuously supplies up to 375 watts of 120V AC power to 2 AC outlets from any 12V battery or automotive DC source. Convenient cigarette lighter DC input jack with 3-ft. cable provides 1-step installation. Portable and compact, the inverter's design is among the most rugged available due to its all-metal housing.

- Ideal for laptops, portable electronics, cell phone chargers and personal printers
- 375 watts continuous output power; 600 watts peak output power (instantaneous)
- 3-ft. cord with cigarette lighter plug
- Low battery alarm with auto-shutoff preserves vehicle battery
- Overload alarm with auto-shutoff prevents wattage overload
- Replaceable fuse protects inverter from overload
- 1 year manufacturer's product warranty



Item #	Description	Price
PV375	PowerVerter® 375-Watt Ultra-Compact Inverter	\$72.00 ea



### VANNER VLT POWER INVERTER

The Vanner VLT inverter is equipped with a 15A ground fault indicating circuit breaker receptacle, providing convenient and safe AC power. Clear, easy-to-read LEDs and bar graphs let you know that the unit's working right, or if something's wrong - no guessing necessary. Over and under voltage LEDs let you know if you have battery or charging system problems. Over temperature and overload LEDs will indicate that either a condition has occurred that must be corrected by removing air restricting material from around the inverter, or excessive load. Quiet, reliable and convenient power to run televisions/monitors, power tools, test equipment, pumps/lights/motors, medical equipment, microwaves and more!

Dimensions: 4.13"H x 10.83"W x 15.35" D

Item #	Description	Price
VLT12-1000	1000W Continuous Output Inverter	\$955.00 ea
VLT12-1500	1500W Continuous Output Inverter	\$1,055.00 ea



### AUTO CHARGE® BATTERY CHARGER SYSTEMS

The Auto Charge 12 is a fully automatic battery charger for vehicles with a single battery system. Unique electronic sensing circuits sense the true battery voltage while eliminating the need for external sense wires. When the battery is fully charged, all charging stops. There is no overcharging and no water boil off. It is ruggedly constructed for mounting in the vehicle. (Multiple battery systems also available- call for details)

Item #	Description	Price
091-165-12	Auto Charge 12, 12 Amp, 12 Volt	\$395.00 ea
091-170-12	Auto Charge 12 High Output, 20 Amp, 12 Volt	\$475.00 ea



### AUTO CHARGE® 1200 BATTERY CHARGER

This is a 40 Amp, high output charger for faster battery recharge. There is no "trickle charge" and therefore no danger of overcharging and water boil-off. It features remote electronic voltage sensing, which eliminates sense wires. It is available with either a built-in or remote bar graph battery charge level indicator.

Item #	Description	Price
091-187-12	Auto Charger 1200 w/ Built-in Bar Graph	\$727.00 ea
091-187-12-REMOTE	Auto Charger 1200 w/ Remote Bar Graph	\$727.00 ea



### AUTO EJECT

- Automatically disconnects shore line power
- Designed specifically for emergency vehicles
- Eliminates broken shore line connections
- 2 year warranty
- Super series are fully sealed for maximum dirt and grime protection

Item #	Description	Price
091-18WP-120*	Auto Eject, 15 Amp, 120 Volt Weatherproof	\$160.00 ea
091-20WP-120*	Auto Eject, 20 Amp, 120 Volt Weatherproof	\$184.00 ea
091-55-15-120*	Super Auto Eject, 15 Amp, 120 Volt	\$249.00 ea
091-55-20-120*	Super Auto Eject, 20 Amp, 120 Volt	\$230.00 ea

\*Specify Cover Color: Yellow, Red, Blue, Gray, Black or White



091-18

091-55

### USB DUAL PORT

**NEW**

- Dual USB Charging Ports
- Quick and easy way to recharge electronic devices in a vehicle
- 3 Amps max output allows charging of both an iPad and iPhone at the same time
- Built-In LED Indicator indicates device is powered
- Designed for easy installation in vehicle switch panels
- Reverse polarity protected
- Can be connected to 12V switched ignition or directly to battery
- 3 Year Warranty

Item #	Description	Price
091-219	USB Dual Port	\$49.00 ea



# VEHICLE ACCESSORIES

## Install Supplies



CH-55014



CH-58027-01



TS-2150



Cable Ties



TS-5050YW

### SWITCHES & INSTALL SUPPLIES

Item #	Description	Price
TS-5050YW	20 Amp On/Off Lighted Rocker Switch, 3/4" Diameter Stem	\$5.99 ea
CH-55014	25 Amp On/Off Small Toggle Switch, 15/32" Diameter Stem	\$5.49 ea
CH-58027-01	25 Amp On/Off Weather Resistant Rocker Switch, 1.45" x .83" Diameter Mount	\$6.50 ea
TS-2150	50 Amp On/Off Large Toggle Switch, Chrome Plated, 15/32" Diameter Stem	\$6.50 ea
800BK	Cable Ties, Heavy Duty, 100/bag, 4"	\$5.95 bg
804BK	Cable Ties, Heavy Duty, 100/bag, 8"	\$7.95 bg
805BK	Cable Ties, Heavy Duty, 100/bag, 11-3/4"	\$26.95 bg
806BK	Cable Ties, Heavy Duty, 100/bag, 15-1/2"	\$29.95 bg
CB50	High-Amp Manual Rest Circuit Breakers (Marine Grade) 50 Amp	\$36.50 ea
CB100	High-Amp Manual Rest Circuit Breakers (Marine Grade) 100 Amp	\$36.50 ea
CB150	High-Amp Manual Rest Circuit Breakers (Marine Grade) 150 Amp	\$36.50 ea
CH-58328*	25 Amp Rocker Switch, 1.45" x .83" Diameter Mount	\$8.69 ea

\*Specify Color: Amber, Clear, Green, Red



CB150



CH-58328



### WIRE - BULK, 100' SPOOL

- Improved GXL type wire
- A must-have for vehicle wiring
- Will not melt when subjected to short circuits

Item #	Description	Price
GXL18	18 ga	\$13.95 sp
GXL16	16 ga	\$17.95 sp
GXL14	14 ga	\$24.95 sp
GXL12	12 ga	\$37.95 sp
GXL10	10 ga	\$56.95 sp
GXL8	8 ga	\$84.95 sp

\*Specify Color (prices subject to change)

### PARALLEL WIRE - BULK

100' spool. Ideal for vehicle equipment power connections, two conductor, Red/Black.

Item #	Description	Price
PPW18	18 ga	\$21.95 sp
PPW16	16 ga	\$29.95 sp
PPW14	14 ga	\$39.95 sp

(Prices subject to change)

### 3 CONDUCTOR SHIELDED STROBE CABLE - BULK

Item	Description	Price
20X	Strobe Cable	\$0.95 ft
500X	500 ft. Strobe Cable	\$350.00 rl

(Prices subject to change)





### AMP WEATHERPROOF CONNECTOR KIT

Item #	Description	Price
W441A	AMP Weatherproof Kit - Pins	\$10.50 ea



### AMP WEATHERPROOF CONNECTOR KIT

Item #	Description	Price
W442A	AMP Weatherproof Kit - Sockets	\$10.50 ea



W441D



W442D

### DEUTSCH WEATHERPROOF CONNECTOR KIT

Item #	Description	Price
W441D	Deutsch Weatherproof Kit - Pins	\$7.00 ea
W442D	Deutsch Weatherproof Kit - Sockets	\$7.00 ea



A441A

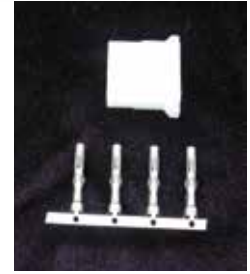

A442A

### AMP MATE-N-LOC®

Item #	Description	Price
A441A	3 Pin Connector Kit	\$2.95 ea
A442A	3 Socket Connector Kit	\$2.95 ea



### AMP CRIMP TOOL

Item #	Description	Price
CRIMPFT	AMP Crimp Tool	\$124.00 ea



### DEUTSCH CRIMP TOOL

Item #	Description	Price
CRIMPD	Crimp Tool for Deutsch Metal Terminals	\$325.00 ea



### PIN EXTRACTION TOOL

Item #	Description	Price
274-223	Pin Extraction Tool	\$12.50 ea

# VEHICLE EQUIPMENT

## Vehicle Specific Consoles



C-VS-1600-EXPL-1  
(‘11-‘15 Explorer)

### VEHICLE SPECIFIC CONSOLES

The most practical addition to the Consolidator® family. Vehicle specific consoles attach directly to the OEM console, or use the existing mounts to replace it all together, for a snug fit and custom appearance. Plus, without any permanent modification required, the resale value of the vehicle is maintained.

- Precision laser-cut steel contours to the OEM interior
- Lifetime warranty
- Excellent for undercover applications
- Extruded aluminum top frame provides substantial base for mounting equipment and accessories
- Includes enough equipment mounting brackets and filler plates to completely enclose the mounting area, less accessories

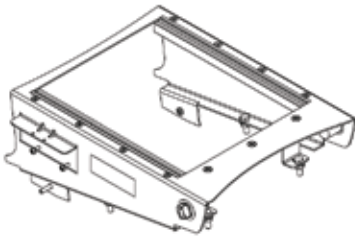

C-VS-1508-INSE  
(‘13-‘15 Interceptor Sedan)

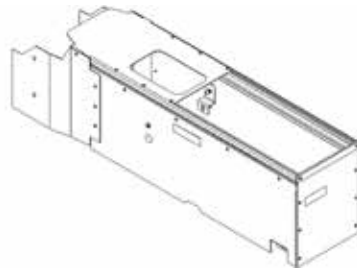

C-VS-1800-ESC-1  
(‘08-‘12 Escape )



C-VS-1600-EXPL-1  
(‘11-‘15 Explorer)



C-VS-1308-INUT  
(‘13-‘15 Ford Police Interceptor SUV)



C-VS-1100-F250-1  
(‘11-‘14 F250)



C-VS-2400-CHGR-2  
(‘11-‘14 Charger)

**Additional Vehicle Specific consoles available. Call for more information.**

Item #	Description	Price
C-VS-2400-CHGR-2	24" VS Console, ‘11-‘16 Charger	\$335.00 ea
C-VS-0809-CHGR-1	Low Profile Angled Console, ‘11-‘16 Dodge Charger	\$379.00 ea
C-VS-1600-EXPL-1	16" VS Console, ‘11-‘15 Explorer	\$295.00 ea
C-VS-1100-F250-1	11" VS Console, ‘11-‘16 F250-550	\$285.00 ea
C-VS-1200-F250-1	12" VS Console, ‘08-‘10 F250-550	\$285.00 ea
C-VS-1508-INSE	23" VS Console, ‘13-‘16 Interceptor Sedan	\$346.50 ea
C-VS-1308-INUT	21" VS Console, ‘13-‘16 Ford Std. Int. Police Int. Utility	\$346.50 ea
C-VS-1400LP-CAPR-2	14" VS, Low Profile Console, ‘11-‘13 Caprice	\$295.00 ea
C-VS-1800-ESC-1	18" VS Console, ‘08-‘12 Ford Escape	\$355.00 ea

\*With center shift console only

\*\*With bucket seats and OEM console only

# VEHICLE EQUIPMENT

## Vehicle Specific Consoles

### HAVIS 20" TAHOE/SUBURBAN CONSOLE

- 12.5" wide 20" vehicle specific console for 2015 Chevrolet Tahoe police pursuit vehicle (ppv)
- This Angled console is vehicle specific and mounts cleanly between the bucket seats and fits to the dash contour for a custom look to your vehicle
- Includes 20" of internal control head and accessory mounting space
- Includes accessory pocket (13" long x 2.5" wide x 8" deep) for single ream of 8 1/2" x 11" paper storage
- Front top panel includes two (2) 12 volt sockets and cutout for OEM 12 aux input module
- Console includes provisions for internal or external side mount poles C-HDM-204 or C-HDM-214 (sold separately)
- Intended to be used for laptop on pole mount applications



**NEW**

C-VS-2000-TAH-2



C-VS-2000-TAH-1

- Compatible with internal cup holder (C-CUP2-I-A06 ) and external cup holder (C-CUP2-E-C) sold separately
  - Only works with side mount arm rest part number C-ARM-102 (sold separately)
  - Includes filler plates (FP) and/or equipment brackets (EB) to completely enclose mounting area less internal mount options
  - Includes internal front electrical equipment mounting shelf with removable front side trim panels for easy access
  - Passenger side front trim panel includes cutout for OEM 120 volt socket (blank plate also included if 120 volt socket is not used)
  - No additional vehicle mounting kit required
  - If using console with a vertical gun rack between seats, a partition with gun alcove is recommended
- Dimensions: 11.87" High Front / 10" High Rear x 12.5" (W) x 23" (L)

Item #	Description	Price
C-VS-2000-TAH-1	2007-2014 Tahoe/Suburban 20" Console	\$520.00 ea
C-VS-2000-TAH-2	2015 - '16 Tahoe/Suburban 20" Console	\$520.00 ea

### HAVIS 10" TAHOE/SUBURBAN CONSOLE

- Fits 2015 Tahoe & Suburban with OEM console only
- Easy to install
- No vehicle mounting kit required
- Only modification required is four (4) 1/8" holes inside storage compartment (see install instructions)
- 8.75" maximum depth
- Includes filler plates (FP) and/or equipment brackets (EB) to completely enclose mounting area less internal mount options
- Due to minimum internal space available, equipment bracket mounting requires drilling (see install instructions)
- Mount control head cutout is only 9.5" inches, however in most applications you will be able to use 10" inches of equipment brackets when using one piece (1P) brackets or filler plates in accessory pocket under OEM arm rest

**NEW**



C-VS-1000-GMC-1

Item #	Description	Price
C-VS-1000-GMC-1	2015 - '16 Tahoe/Suburban 10" Console	\$95.00 ea



# VEHICLE EQUIPMENT

## Console Accessories



C-PS-7-L



C-SW-\*



C-LABEL-\*

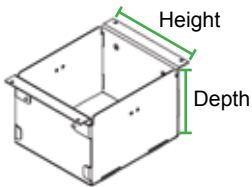

Accessory Pocket, No Lid

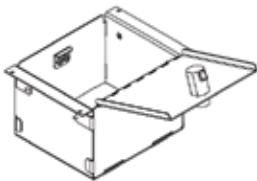

Accessory Pocket w/ Locking Lid, features a lid with a push button slam locking latch and lock.

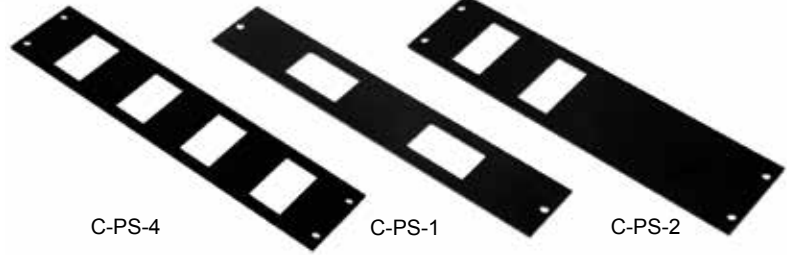

C-PS-4

C-PS-1

C-PS-2

### SWITCH PLATES

Item #	Description	Price
C-PS-1	1.5" Plate w/ 2 Switch Cutouts	\$18.00 ea
C-PS-2	2" Plate w/ 2 Switch Cutouts	\$19.00 ea
C-PS-4	2" Plate w/ 4 Switch Cutouts	\$20.00 ea
C-PS-4-L	3" Plate w/ 4 Switch & Label Cutouts	\$20.00 ea
C-PS-7-L	3" Plate w/ 7 Switch & Label Cutouts	\$32.00 ea

### SWITCHES

- 20A, 18V
- Red pilot light
- Available as On/Off, On/Off/On, Off/On/On and momentary (no pilot light)

Item #	Description	Price
C-SW-1	Switch, On/Off, 3 Prong	\$16.00 ea
C-SW-2	Switch, On/Off/On, 4 Prong	\$17.00 ea
C-SW-3	Switch, Off/On/Off, 5 Prong	\$18.00 ea
C-SW-4	Switch, Momentary	\$17.00 ea

### LABELS

- White plastic with black imprint
- Dimensions: .52" x .88"
- Available with or without print
- Over 100 to choose from, including Left Alley, Right Alley, Takedown, Rear Flash & Wig-Wag

Item #	Description	Price
C-LABEL-S	Label w/ Black Imprint	\$5.00 ea
C-LABEL-B	Blank White Label (no imprint)	\$4.50 ea



C-AP  
3 Sides, mounts at either end of the console.



### ACCESSORY POCKETS

Item #	Description	Price
C-AP	Accessory Pocket, 3" H x 5" D	\$43.00 ea
C-AP-0645	Accessory Pocket, 6" H x 4.5" D	\$47.00 ea
C-AP-0695	Accessory Pocket, 6" H x 9.5" D	\$69.00 ea
C-AP-0995	Accessory Pocket, 9" H x 9.5" D	\$69.00 ea
C-AP-1395	Accessory Pocket, 13" H x 9.5" D	\$69.00 ea
C-AP-0645-L	Accessory Pocket, 6" H x 4.5" D w/ Lid & Lock	\$82.00 ea
C-AP-0945-L	Accessory Pocket, 9" H x 4.5" D w/ Lid & Lock	\$89.00 ea
C-AP-0695-L	Accessory Pocket, 6" H x 9.5" D w/ Lid & Lock	\$111.00 ea
C-AP-0995-L	Accessory Pocket, 9" H x 9.5" D w/ Lid & Lock	\$111.00 ea
C-AP-1395-L	Accessory Pocket, 13" H x 9.5" D w/ Lid & Lock	\$111.00 ea



C-ARM-103



C-CUP2-E-TM

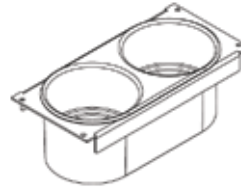

C-CUP2-I  
Internal mount, 4" wide plate

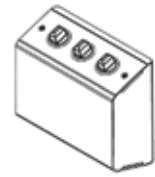

C-AB-LP3  
Mounts to any flat surface



C-ARM-101



C-ARM-102



C-MC



C-MCB



C-ML-MCB



C-ML-LP2



C-LP-3



C-3083-1  
Allows computer to be mounted over top of all horizontal consoles



### OPTIONAL ACCESSORIES

Item #	Description	Price
C-CUP2-E-C	Dual Cup Holder, External Mount	\$33.00 ea
C-CUP2-E-TM	Dual Cup Holder, Trak-Mount Only	\$27.00 ea
C-CUP2-I	Dual Cup Holder, Internal Mount	\$39.00 ea
C-CUP2-E-AS	Dual Cup Holder, External Mount (not shown)	\$35.00 ea
C-AB-LP3	Accessory Box w/ 3 Lighter Plug Outlets	\$61.00 ea
C-ARM	Armrest, Rear Mount	\$59.00 ea
C-ARM-102	Armrest, Side Mount	\$59.00 ea
C-MC	Mic Clip	\$10.00 ea
C-MCB	Mic Clip "L" Bracket	\$11.00 ea
C-ML-MCB	Map Light, Console Side Mount	\$76.00 ea
C-ML-LP2	Map Light w/ 2 Lighter Plug Outlets, Internal Mount	\$98.00 ea
C-LP-2	2 Lighter Plug Outlets, Internal Mount (not shown)	\$33.00 ea
C-LP-3	3 Lighter Plug Outlets, Internal Mount	\$39.00 ea
C-3038-1	9" Slide Rail Computer Mount Bracket	\$42.00 ea
FB15606L	Fuse Panel, 6 Branch	\$19.75 ea
FB15610L	Fuse Panel, 10 Branch (not shown)	\$25.00 ea



### FUSE PANEL, 6 BRANCH

- Uses standard ATC fuses
- Single, central grounding lug

# VEHICLE EQUIPMENT

## Consoles

### SWITCHRITE CONSOLES

14" or 18" Sloped equipment console capable of holding up to 4 to 6 pieces of equipment. A five degree front to rear slope allows for taller equipment to be mounted to the front. With a flat equipment slot prior to the slope the console can accommodate cup holders or other accessories requiring a flat mounting surface. Compatible with the full line of console accessories including cup holders, arm-rests and map lights. Requires Console floor plate and leg kit-specific for each vehicle (purchased separately) Easy installation using standard floor mounting plates. Equipment is quickly accessible for maintenance. Fully airbag compatible.

Product Specifications:

Width: 8.25"

Slope Angle: 5

Equipment slots: 4-6



SRC18RS

SRC14RS

Item #	Description	Price
SRC14RS	14" Switchrite Console w/ Brackets	\$204.00 ea
SRC18RS	18" Switchrite Console w/ Brackets	\$225.00 ea
FLMNT-19*	Floor Mount Plate & Leg Kit	\$79.80 ea

\*Specify vehicle

### OPTIONAL ACCESSORIES



CA-0103



CA-0101



CA-0107



CA-0105



CA-0104



CA-0106



CA-0116



CA-0129

Item #	Description	Price
CA-0103	12 Volt Triple Outlet, Internal Mount	\$30.00 ea
CA-0101	12 Volt Individually Switched Dual Cigar Outlet	\$30.00 ea
CA-0107	Cup Holders, Internal Mount	\$21.00 ea
CA-0105	Ticket Book Holder, 3.5" x 8" x 6" w/ Key Locking Lid, Internal Mount	\$57.00 ea
CA-0104	Ticket Book Holder, Internal Mount	\$33.00 ea
CA-0106	Cup Holders w/ Clipboard Holder Compartment, mounts to the rear of the console	\$50.00 ea
CA-0116	Adjustable Armrest w/ Slide Out Note Pad w/ Adjustable Bracket to Universal Fit Non-D&R Consoles	\$94.50 ea
CA-0129	Maplight, Red/Clear, On/Off, 12" Neck	\$86.00 ea



### HAVIS INTERCEPTOR INTEGRATED CONTROL SYSTEM

The Havis Integrated Control System is designed for saving space, creating police officer comfort, and the ability to integrate on-board technology.



- 12.1" touchscreen display
- Bright, in-dash touch screen, that provides officers with a seamless interface for equipment
- Control all functions of the car
- Includes GPS, radar detection, inputs, and much more
- Available for the Ford Interceptor SUVs and sedans only



**Vehicle Integration:** The Integrated Control System is designed to fit the Ford Police Interceptor Utility and Ford Police Interceptor Sedan dash without permanent modification.

**Safety:** By relocating computers and video sources to the trunk, the Integrated Control System allows for a flush profile of the OEM dash and a clean cockpit while ensuring OEM safety systems are unobstructed.

**Ergonomics:** The placement and orientation of the Touch Screen Display has been approved by the Los Angeles Police Department, one of the largest police forces in the country with over 10,000 officers.



**Display Visibility and Durability:** The ultra-wide viewing angle of the Touch Screen Display gives the driver or passenger full control of the system. The chemically strengthened glass face is also sunlight readable.

Touch screen display with two modes of operation. Video Mode 1 allows you to control the built-in Integrated Control System vehicle applications, and Video Mode 2 allows remote control of an externally mounted computer, laptop or tablet.

- Designed specifically for the 2013-2014 Ford Police Interceptor Utility and Sedan with and without OEM SYNC®; system (not compatible with interior upgrade code 65U)
- Co-developed with Ford to replace and mount in factory dashboard location, providing a professional and clean cockpit layout
- Sunlight readable LCD display with wide viewing angle for driver or passenger operation
- High resolution image with four different illumination levels ranging from dim for night time use to bright for use in the sun
- Integrated Control System vehicle applications include AM/FM radio, NTSC camera viewing, image viewer and real time diagnostics that include system status and vehicle battery levels
- Tactile feel HVAC controls replace factory controls
- Tactile mode button to switch from the two different display options
- Remote mounted A/V extender to simplify laptop/tablet connection
- Steering wheel control buttons can be configured to control the video mode, illumination level and AM/FM radio functions (band, tune, seek, volume)
- System is compatible with a wide range of laptops and tablets and can be connected through VGA or HDMI
- Single Cat6A cable connects the remote mounted A/V extender to the embedded processor and the embedded processor to the touch screen display reducing installation complexities
- Multiple audio sources (AM/FM radio, computer audio or auxiliary input) can be heard through the vehicle speaker system
- Bright, in-dash touch screen, that provides officers with a seamless interface for equipment
- Includes GPS, radar detection, inputs, and much more
- Available for the Ford Interceptor SUVs and sedans only



Item #	Description	Price
ICS-B-F02-101	Integrated Control System for Police Ford Int Utility without OEM Sync	\$3,690.00 ea
ICS-B-F02-102	Integrated Control System for Police Ford Int Utility with OEM Sync	\$3,690.00 ea
ICS-B-F01-101	Integrated Control System for Police Ford Int Sedan without OEM Sync	\$3,690.00 ea
ICS-B-F01-102	Integrated Control System for Police Ford Int Sedan with OEM Sync	\$3,690.00 ea

# VEHICLE EQUIPMENT

## Anti-Theft Systems

**NEW**

### PRO-GARD SAFESTOP VEHICLE ANTI-THEFT SYSTEM

Vehicle maintains functionality of all electronic functions including: air-conditioning and heat; surveillance equipment (cameras, radar, etc); radios; lights; sirens; computers, and more without leaving the vehicle vulnerable to theft. The key is the KEY – once activated, anytime the key is removed from the ignition the anti-theft protections are engaged

Theft protection prevents the vehicle from driving off as well as, activates the “Gun Lock Secure” and “Trunk Lock Secure” features. The Gun Lock Secure feature prevents access to the weapon rack via the momentary switch when theft protection is activated, there is a built in 8 second delay initially to give officers time to grab a weapon if necessary

- The Trunk Lock Secure feature prevents access to trunk contents via the trunk latch release when theft protection is activated
- Once the system is activated, the anti-theft functions allow the vehicle to remain running even after the ignition key is removed; with the ignition key removed, the shifter is locked
- Anti-theft functions cannot be overridden by switching the toggle switch to off once the system is activated, system can only be turned off if the ignition key is reinserted
- Brake Pedal Override option will kill the engine instantly for use with the “Always On Protection”
- The module connects to the ignition system and offers addition connection for protecting gun racks and trunk contents
- Extremely low amp draw means that the system can remain activated 24/7 (Always On Protection) without worries of battery drain
- Available for many vehicles



Safestop Key

Safestop Lock

Safestop Button

Item #	Description	Price
SS002	SafeStop Vehicle Anti-Theft System, Ford/Dodge	\$159.00 ea
SS001	SafeStop Vehicle Anti-Theft System, Chevy	\$179.00 ea

Please specify vehicle make, model and year.

**NEW**

### TREMCO ANTI-THEFT SYSTEM

There are no keys to lose or codes to forget. Deactivation becomes “second nature” to the officer and after a week or so, they don’t even realize they’re using it. This system is 100% reliable, convenient for the user, simple plug-in installation and inexpensive.

- Now Police can leave their cruisers running unattended for emergency situations
- Allows emergency lighting ... computers, radios, heaters, air conditioners, and defrosters to operate while maintaining needed battery current
- Inexpensive. Fast and easy to use with our patented camouflaged system.
- Easy installation in less than ten minutes
- Available for many vehicles



Item #	Description	Price
TREMCO	Tremco Anti-Theft System	\$125.00 ea

Please specify vehicle make, model and year

### SECURE-IDLE ANTI-THEFT SYSTEM

One Secure-Idle device can prevent unwanted liability suits. Police cruisers are stolen on a daily basis and departments face liability suits that could cost them millions.

- Completely Hidden Anti-Theft System for all vehicles
- Keeps your engine running without a key in the ignition
- Superior, fail-safe STARTER OVERRIDE protection
- Secure-Idle will NEVER leave you stranded
- Made in the United States of America
- Quick & easy installation
- 1-year total replacement warranty
- Engineer on-staff to assist in tailoring our product to your application!
- Available for many vehicles

**NEW**



Item #	Description	Price
SI-240	Secure-Idle Anti-Theft System	\$179.00 ea

Please specify vehicle make, model and year.

### COMPUTER DOCKING STATIONS

Havis docking stations provide safe, reliable mobile computer mounting solutions. They allow users to charge their laptop, access external peripherals and secure the laptop to protect against theft and injury, while the optional antenna pass-through improves wireless performance. The intuitive connections, port replicators and quality construction materials make them easy to use and usable for years to come.

### PANASONIC TOUGHBOOKS



- Available for the CF30/31, 19, 52 and U1
- The DS-PAN Series is the only unit with a spring mechanism in the docking head, maximizing device uptime
- The smallest footprint of any comparable product, weighing less and taking up less cabin space than any other dock currently available
- Threaded power input connector ensures no disconnects
- Wear and corrosion resistant stainless steel for all structural and mechanical components

Additional models available. Call for availability.

Item #	Description	Price
DS-PAN-111	Toughbook CF30/31, No Antenna Pass Through	\$714.00 ea
DS-PAN-111-1	Toughbook CF30/31, Single Antenna Pass Through	\$848.00 ea
DS-PAN-221	Toughbook CF18, Mark 1-5 No Pass through	\$815.00 ea
DS-DELL-231	E6400/E6410/E6420/E6430 ATG, No Antenna Pass Through	\$868.00 ea
DS-GD-101	XR1/GD8000, No Antenna Pass Through	\$765.00 ea

\*Power supply sold separately, see below.

### LAPTOP POWER ADAPTERS

The DC laptop power adapter's micro-processor control adjusts the output voltage to the correct operating voltage and amperage requirement for each series of laptops. Adapters are housed in rugged ABS cases & epoxy encapsulated to resist shock and moisture.

- Output short circuit shut down and current limit
- Input noise filter
- Internal overtemperature shut down
- High and low input voltage shut down
- Automatic shut down reset

3 year warranty includes coverage of electronics, cables and connectors. (Adapters available for most Laptop brands - call for other models)

Item #	Description	Price
PA1555-968	Power Adapter For Most Panasonic Laptops, w/ Direct Wire	\$119.95 ea
DE2045-1320	Power Adapter For Most Dell Laptops, 12V Cigar Plug	\$119.95 ea
PA1580-1745	Power Adapter for the Panasonic CF31 Toughbook, 12V Cigar Plug	\$129.95 ea

### DELL XFR AND ATG

Available for the Latitude E6400/XT2 XFR and E6400/E6410/E6420/E6430 ATG



### GENERAL DYNAMICS

Available for the XR1/GD8000





# VEHICLE EQUIPMENT

## Computer Mounting

### HEAVY DUTY COMPUTER MOUNTING PLATFORMS

- Engineered with lightweight aluminum and composite materials to maximize strength while minimizing weight
- Attractive footprint and design provide for improved ergonomics in universal tray application
- Easy to use latch mechanism
- Barrel lock provides security and theft-deterrence

#### UT-101 UNIVERSAL LAPTOP MOUNT



#### SS-UT-X SCREEN STIFFENER

**NEW**



Universal mounting platform is adjustable to fit most laptops currently on the market, including Panasonic, DELL, Lenovo, IBM, Hewlett-Packard and Toshiba.

Compatible Computer Dimensions:  
Width: 11.472 - 14.192"  
Depth: 9.250 - 11.00"  
Height\*: 0.665 - 1.265"

\*Mount only. Base and components sold separately.

- Support for the screen of a variety of laptop computers, fully adjustable tilt for the best visibility
- Minimizes vibration and improves poke resistance for touch screens
- For UT-101, UT-102, UT-X, UT-X-T and UT-X-SD

Item #	Description	Price
UT-101	Universal Laptop Mount	\$255.00 ea

Item #	Description	Price
SS-UT-X	Screen Stiffener	\$69.00 ea

### HAVIS UNIVERSAL TABLET DOCK

**NEW**

- Havis universal tablet mount
- Non-electronic tray is adjustable to fit and secure a large variety of tablet models
- Easy to use and customize to fit your computing needs
- Adjustable lugs accommodate a wide range of tablet and protective case heights
- Thin profile maximizes space inside your mobile workplace
- Fits all VESA 75 pattern mounting equipment
- Rounded corners and edges are ideal for your safety in accidents and airbag deployment, in addition to daily use and operation of universal tablet mount
- Easy to use latch handle makes certain your tablet is safe and secure inside your vehicle
- Lock and key supplied for peace of mind theft deterrence
- Works with optional accessory Havis desktop stand (DS-DA-218, ordered separately)
- Compatible keyboard solutions are available for all tablets.

Dimensions: 9.3" - 11.24" (L), 6.83" - 8.13" (W), 0.55" - 0.93" (H)

Item #	Description	Price
UT-201	Universal Tablet Dock	\$175.00 ea



### HAVIS TABLET DOCKING STATIONS

Havis Docking Stations for tablets are the ideal solution for all your computing needs. Designed with versatility in mind. The low profile design maximizes available space inside of the vehicle.

- Device security; lock and key provided for theft deterrence
- Connections to Medical officials, enterprise, and vehicle workplaces
- Versatile
- Lightweight
- Theft deterrence
- Amazingly Stable
- DS-PAN-504 and DS-PAN-701 are the only Toughbook certified stations
- DS-PAN-504 has an optional power supply ordered separately

Item #	Description	Price
PKG-DS-APP-112	Dock Station & Case for Apple Ipad 4 w/ 12 VDC Power Input, Includes Cigarette Adapter	\$245.00 ea
PKG-DS-APP-122	Dock Station & Case for Apple Ipad Air w/ 12 VDC Power Input, Includes Cigarette Adapter	\$245.00 ea
DS-GTC-201	Docking Station for Getac F110 w/19 VDC	\$465.00 ea
DS-PAN-504	Docking Station for Panasonic FZ-A1	\$405.00 ea
DS-PAN-701	Docking Station for Panasonic FZ-G1	\$465.00 ea



PKG-DS-APP-112



DS-GTC-201



DS-PAN-701



DS-PAN-504



Havis Docking Stations for tablets are the ideal solution for all your computing needs.

# VEHICLE EQUIPMENT

## Computer Mounting

### HEAVY DUTY COMPUTER MOUNTS

Havis Heavy Duty Mounts are rugged, professional grade computer mounts that combine the perfect balance of strength, safety, and ultra-smooth operation, making them worthy of your most mission critical computer devices.

#### Stout.

Heavy gauge steel poles, welded, rigid seat bases along with its universal support arms virtually eliminate wobble and vibration that can make reading difficult.

#### Safe.

A standard stop collar allows the installer to adjust the height and limit the computer from telescoping below desired height. Order the optional top lock

and the entire rotation can be positively locked in place to prevent the unit from spinning in a collision or air bag deployment.

#### Smooth.

Designed with a unique precision machined aluminum clamp and lever along with a PVC split sleeve for no metal-to-metal contact when adjusting the pole. All moving parts have a glossy, ultra smooth e-coat finish which further reduces friction. Order the optional "lift assist" gas shock kit that you can drop in the pole assembly and it will help you do the lifting and prevent heavy equipment from slamming down.



Heavy Duty Mounts are designed to be a modular system with components purchased as individual items.

### 1 VEHICLE SPECIFIC BASES

Item #		Price
C-HDM-102	'00-'14 Tahoe/Yukon	\$80.00 ea
C-HDM-103	'06-'15 Impala	\$98.00 ea
C-HDM-154	'11-'13 Caprice	\$98.00 ea
C-HDM-168	'11-'16 Charger	\$98.00 ea
C-HDM-106	'97-'16 E-Series Van	\$117.00 ea
C-HDM-107	'97-'08 G-Series Van	\$117.00 ea
C-HDM-108	'04-'14 F150 Pickup	\$80.00 ea
C-HDM-109	'97-'16 Expedition	\$80.00 ea
C-HDM-111	'03-'16 RAM Pickup	\$80.00 ea
C-HDM-153	'13-'16 Ford SUV Interceptor	\$99.00 ea
C-HDM-141	'13-'16 Ford Sedan Interceptor	\$120.00 ea
C-DMM-122	'13-'16 Dash Monitor Mount Base for Ford INT Sedan	\$229.00 ea
C-DMM-123	'13-'16 Dash Monitor Mount Base for Ford INT SUV	\$229.00 ea

### 2 TELESCOPING POLES

Item #	Description	Price
C-HDM-201	6" Telescoping Pole	\$143.00 ea
C-HDM-202	9" Telescoping Pole	\$143.00 ea
C-HDM-203	12" Telescoping Pole	\$152.00 ea
C-HDM-204	Console Side Mount (Small)	\$152.00 ea
C-HDM-205	Console Side Mount (Large)	\$161.00 ea

### 3 TOP OFFSET PLATFORMS

Item #	Description	Price
C-HDM-301	0" Fixed Mount	\$12.50 ea
C-HDM-302	3" Fixed Mount	\$17.00 ea
C-HDM-303	6" Fixed Mount	\$17.00 ea
C-HDM-304	9" Fixed Mount	\$17.00 ea
C-HDM-305	9" - 15" Slide Mount	\$121.50 ea

### 4 RECOMMENDED OPTIONS

Item #	Description	Pricing
C-HDM-401	Side Mount Support Arm	\$62.00 ea
C-HDM-402	Safety Lock Assembly	\$62.00 ea
C-HDM-403	Removable Peripheral & Accessory Shelf	\$62.00 ea
C-HDM-406	Gas Shock for C-HDM-202	\$35.00 ea
C-HDM-407	Gas Shock for C-HDM-203	\$35.00 ea





### HAVIS COMPUTER/MDT MOUNTING PLATFORMS

These mounting platforms are designed to accommodate a variety of computers and are available with multiple tilt and swivel combinations, making them incredibly flexible and practical. Side support tabs clamp the computer to the platform so that it stays in place while driving or working, and the rubber pad over the mounting surface suppresses noise and vibration.

- Side support tabs extend up to 2.25" off the platform (0.80" minimum)
- 0.04" thick stainless side tabs make closing the lid easier
- Width: 11.5" min., 16.75" recommended, 17.5" absolute max
- Mount to TCB and Heavy Duty (see page 72) series bases
- Airbag compatible when properly installed

Item #	Description	Price
C-3090	Mounting Platform Only, Universal	\$124.00 ea
C-3089-3	Platform w/ Swivel Only Adapter, Universal	\$149.00 ea
C-3090-3	Platform w/ Tilt/Swivel Adapter, Universal	\$185.00 ea
C-3090-4	Platform w/ Tilt/Swivel/Adjustable Height Adapter	\$195.00 ea
C-3090-7	Platform w/ Low Profile Tilt/Swivel Adapter	\$185.00 ea

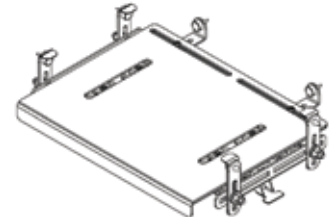

C-3090

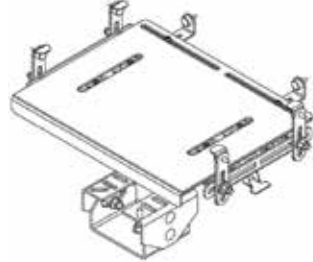
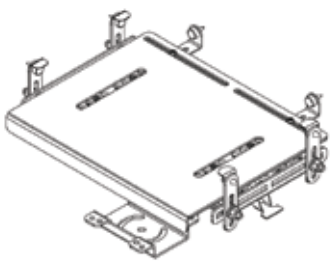

- C-3089-3**
- C-3090 platform with C-3082-1 adapter
  - 360° Swivel only (no Tilt)
  - Low profile
  - Fixed 2.12" height

- C-3090-3**
- C-3090 platform with C-3075-3 adapter
  - 360° Swivel and 85° Tilt
  - Low profile
  - Fixed 3.87" height



Mounting Platform



Tilt/Swivel Adapter



Mounting Base

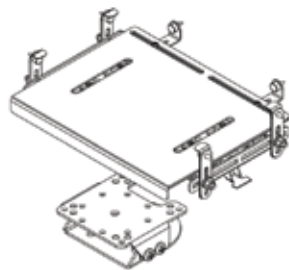
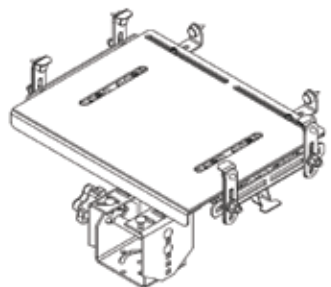

- C-3090-4**
- C-3090 platform with C-3075-4 adapter
  - 360° Swivel and 85° Tilt with locking knob
  - High profile
  - Adjustable 5.37" - 7.87" height
  - Universal

- C-3090-7**
- C-3090 platform with C-3065-3 adapter
  - 360° Swivel and 85° Tilt
  - Lowest profile tilt/swivel adapter
  - Fixed 2.5" height
  - Universal

Item #	Description	Price
C-TCB-2	Universal Console Side Mount, 13" - 20"	\$135.00 ea
C-TCB-5	Ford Expedition, '97-'16	\$159.00 ea
C-TCB-7	Universal Telescoping Base	\$83.00 ea

Other mounts available, call for availability.

# VEHICLE EQUIPMENT

## Tablet Mounting



Front



Back

### RAM UNIVERSAL SMALL TAB-TITE™ FOR 7" TABLETS WITH OR WITHOUT CASES, SLEEVES, SKINS

Universal No-Drill™ vehicle mount with universal small Tab-Tite cradle. The base of the mount clamps to your seat rail without any drilling necessary. Connected to the base is a rigid flexible rod that can be bent to position your device to its optimum viewing location.

Compatible with Google NEXUS 7, Samsung Galaxy Tab™, Dell Streak, BlackBerry® PlayBook™ & Barnes & Noble NOOK color.

Item #	Description	Price
RAM-HOL-TAB-SMU	Universal Small Tab-Tite for Tablets	\$34.20 ea



### RAM POD I UNIVERSAL VEHICLE MOUNT WITH TAB-TITE™ UNIVERSAL CLAMPING CRADLE FOR 10" SCREEN TABLETS

Universal No-Drill™ vehicle mount with universal small Tab-Tite cradle. The base of the mount clamps to your seat rail without any drilling necessary. Connected to the base is a rigid flexible rod that can be bent to position your device to its optimum viewing location.

Compatible with 10" Screen Tablets including the new Apple iPad 1,2,3,4, iPad 1, Motorola XOOM and XOOM 2, HP TouchPad, and more. Fits with or without light duty case.

Item #	Description	Price
RAM-B-316-1-TAB8	Universal Large Tab-Tite for Tablets	\$77.80 ea

## TABLET AND LAPTOP MOUNTING

*Keep your expensive devices safely mounted and fully functional. Mounts available for all industries and computer needs.*

### Mounting Options:

- ✓ Power
- ✓ Dash or floor mount
- ✓ Keyboard options
- ✓ Locking
- ✓ Vehicle, bike, motorcycle, equipment mounted
- ✓ Peripheral mounts

*Contact us about many more options available for today's popular tablets, laptops, GPS units and other mounting needs!*

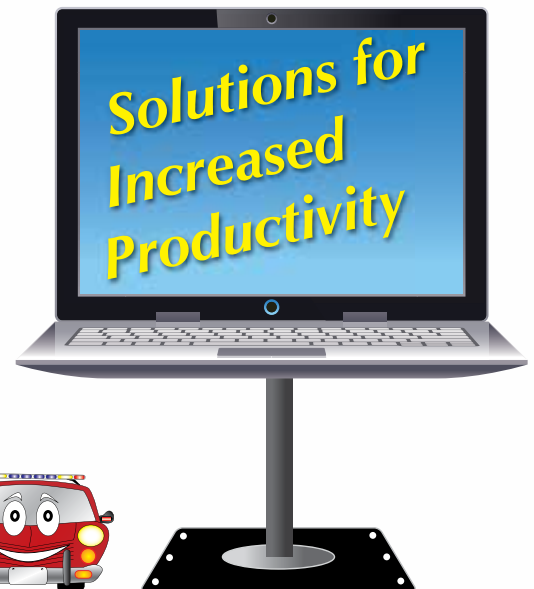

### UNIVERSAL VEHICLE MOUNT FOR IPAD 1,2,3,4 W/O CASE

The RAM-B-316-1-AP8L consists of the RAM POD I universal No-Drill™ vehicle base, flex arm and locking cradle for the Apple iPad 1,2,3 and 4 without case. The base of the mount clamps to your seat rail without any drilling necessary. Connected to the base is a 18" rigid flexible rod that can be bent to position your device to its optimum viewing location.

Item #	Description	Price
RAM-B-316-1-AP8L	Locking Universal Vehicle Mount for iPad 1,2,3,4	\$66.00 ea



RAM-B-316-1-AP8L



RAM-B-316-1-TAB3

### UNIVERSAL VEHICLE MOUNT FOR IPAD 1,2,3,4 W/ CASE

The RAM-B-316-1-TAB3 consists of a single socket arm, flex rod and Tab-Tite™ cradle. It is designed for the iPad 1-4 and NP TouchPad with a case/sleeves/bumpers. The base mounts to your seat rail without any drilling necessary. Connected to the base is a 18" rigid flexible rod that can be bent to position your device to its optimum viewing location.

Item #	Description	Price
RAM-B-316-1-TAB3	Universal Vehicle Mount for iPad 1,2,3,4 w/ or without case	\$87.50 ea



RAM-HOL-MA12U

### GPS CRADLES

RAM Mount offers GPS mounting solutions for practically any flat surface around. RAM Mounts are the perfect choice for securing Garmin, TomTom, Lowrance, Magellan and SPOT GPS devices because of their unique ability to absorb damaging shock and vibration. Below are two popular cradles that both utilize the diamond adapter suction cup which is compatible with many RAM cradles.

Item #	Description	Price
RAM-HOL-GA24U	Cradle for Garmin nuvi 200, 205, 250, 255, 260, 265T, 270	\$8.30 ea
RAM-HOL-MA12U	Cradle for Magellan Maestro 4200, 4210, 4220, 4250	\$9.35 ea
RAP-SB-193U	Suction Cup Mount for Diamond Adapter Cradles	\$8.75 ea



RAM-HOL-GA24U



RAP-SB-193U

### RAM VEHICLE LAPTOP MOUNTS

RAM Vehicle Mounts are designed for the most popular cars, trucks and fleet vehicles on the road. Their heavy-duty steel laptop bases are custom formed to fit specific vehicle models and most require no drilling. The packages below include the mounting base, pole with swing arms and universal laptop tray.

Item #	Description	Pricing
RAM-VB-129-SW1	Dodge Charger Police, 2011-2015	\$189.00 ea
RAM-VB-187-SW1	'13-'16 Ford Interceptor Utility	\$240.00 ea
RAM-VB-143-SW1	2001+ Chevy Express and GMC Savana	\$216.00 ea
RAM-VB-159-SW1	2007+ Chevy Silverado, Avalanche, Tahoe, Suburban and GMC Yukon	\$266.00 ea
RAM-VB-109-SW1	Ford F150, '04 - '14 (not Heritage)	\$240.00 ea
RAM-VB-185-SW1	Ford F-250, F-350, F-450, F-550, F-650, F-750 & Excursion	\$227.00 ea
RAM-VB-138-SW1	2005+ Toyota Tacoma, 2003+ 4Runner	\$228.00 ea

Allow for a 1-3 week lead time.  
Other mounts available, call for availability.



RAM-VB-129-SW1



RAM-VB-187-SW1



# VEHICLE EQUIPMENT

## Trunk Trays

### HAVIS TRUNK MOUNTED RADIO TRAYS

- Slides open to provide easy access to electronics for service
- Manufactured from 14 gauge black powder coated steel
- Automatically locks in place when pushed closed
- Protects electronics from potential damage
- Ships assembled for easy installation



Equipment guards protect sensitive electronics.

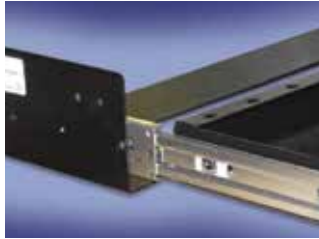

The TTB (Heavy Duty) series uses 250 lb. ball bearing sides.



Consolidates radio and computer electronics into one, easily accessed location, keeping it safe and reducing clutter in the trunk. (C-TTB-CHGR-4 shown)

### HAVIS TRUNK MOUNTED RADIO TRAYS

Item #	Description	Price
C-3311-18-2	17.5" Wide Tray, '06-'15 Impala	\$238.00 ea

### HEAVY DUTY RADIO TRAYS

Item #	Description	Price
C-TTB-CHGR-4	31" Full Width HD Tray, '11-'16 Charger	\$287.00 ea
C-TFD-CHGR-2	30" Premium Fold Down Trunk Tray '11-'16 Charger	\$460.00 ea
C-TFD-INSE-1	Ford Interceptor Sedan Premium Fold Down Tray, '13 - '16	\$460.00 ea
C-TSM-CHGR-P-1	Trunk Side Mount, Passenger Side '11-'16 Charger	\$205.00 ea
C-TTB-INSE-1	36" Full Width HD Tray, '10-'13 Retail Taurus	\$399.00 ea
C-TTB-IMP-2	31" Full Width HD Tray, '06-'13 Impala + 2014 Limited	\$295.00 ea
C-TTB-CAPR-3	30" Full Width HD Tray, '11-'16 Caprice	\$287.00 ea
C-TTP-INUT-200	Ford Interceptor Utility Fold Up Cargo Plate, '13 - '16	\$460.00 ea

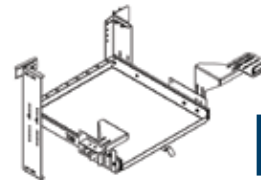

C-3311-18-2

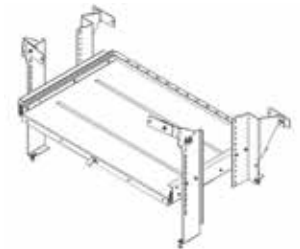

### C-TTB-CHGR-4

- Black powder coated 14 gauge steel
- Adjustable height (7" - 16" clearance in 1" increments) deck to shelf



### C-TSM-CHGR-P-1

- Hinged platform for mounting electronic equipment
- Mounts on side fender area
- Mounting surface 12" W x 14.5" H with 2" x 3" notch in corner
- Locking latch



### C-TFD-CHGR-2

- Premium fold down trunk door assembly with inner equipment tray for mounting electronic components
- Mounts in forward end of trunk to maximize rear trunk space
- Removable inner tray for pre-installation and service
- 30" W x 14" D



### C-TTP-INUT-200

- Premium fold up cargo plate fits 2013-2015 Ford Interceptor Utility
- Plate assembly with fold up equipment platform for mounting electronic components
- Replaces OEM rear cargo floor / spare tire cover and attaches without drilling holes

### PRO-GARD TRUNK TRAY



- Heavy duty steel construction
- Full suspension, ball bearing tracks
- Simplifies electronic equipment access by mounting it all in one location
- Protects electronics when the trunk is used and allows easy access to the spare tire

Item #	Description	Price
TT56FC11	Slide-out Trunk Tray, '11-'15 Charger	\$239.00 ea
TT36FINT13	Trunk Tray Ford Police Interceptor Sedan, '13-'16	\$242.00 ea
TT53FCC11	Trunk Tray Chevy Caprice, '11-'15	\$239.00 ea

Other trunk trays are available. Contact us with your needs.



TT56FC11

### TRUNK DRAWER



Full width trunk equipment tray made from 10 gauge aluminum that slides out for easy equipment placement and maintenance. The front is protected with a perforated aluminum panel. Slide tracks will support 300 lbs. Width: 32", Depth: 15.75"

Item #	Description	Price
932-0015A	Trunk Drawer '11-'15 Charger	\$495.00 ea
932-0029A	Trunk Storage, Ford Police Interceptor Sedan, '13-'16 (not pictured)	\$495.00 ea



### PRO-GARD TRUNK ORGANIZERS



Universal organizer features:

- Made from sturdy, black ABS
- Inserts allow for custom adjustment of up to twelve compartments
- Includes a 3" deep ABS lid

Vehicle specific organizers features:

- Heavy ABS shell, clear polycarb hinged lid with three removable dividers

Item #	Description	Price
TO47UINT13	Trunk Organizer w/ Clear Polycarb Lid, Ford PI Utility, '13 - '16	\$365.00 ea
TO53CC11	Trunk Organizer w/ Clear Polycarb Lid, '11- Current Chevy Caprice	\$286.00 ea
T036INT13	Trunk Organizer Ford Police Interceptor Sedan, '13-'16	\$365.00 ea



Additional organizers are available. Contact us with your needs.

### HAVIS UNIVERSAL STORAGE BOX

- Provides safe and secure mounting of equipment in utility vehicle cargo areas
- Mounts in cargo area behind rear seat or against partition/K9 transport
- Universal mounting design: bolts to any flat surface (drilling may be required)
- Hinge down door allows easy access to equipment
- Equipment protected when in closed position
- Equipment mounts to removable inner door panel for bench top pre-assembly
- Two lockable cam latches with keys
- Two upper and two lower vents
- Includes mount and vent holes for optional 12 volt air circulation fan (part number KK-K9-FAN sold separately)
- Includes wire harness access holes with grommets
- 14-gauge formed steel with a black medium texture powder coat finish

Item #	Description	Price
C-SBX-101	Utility Vehicle Storage Box	\$549.00 ea



Overall size = 38" wide 18" high 10" deep  
Mounting surface = 33.5" wide x 15" deep

# VEHICLE EQUIPMENT

## Vehicle Storage



**TRUCKVAULT FOR SUVs AND VANS**  
 Maximizing the storage potential of any full-size, mid-size and compact SUV, TruckVault™ creates low-profile secure storage for firearms, EMS and other emergency equipment. Carpeted to match the interior of the vehicle and contoured to the curve of the cargo area, their storage units are easy to install and will keep sensitive and dangerous materials out of sight. Custom heights and configurations are always available to meet your storage needs while providing ample cargo room above the unit.



One-Size  
TruckVault



Short-Size  
TruckVault



Mid-Size  
TruckVault



Full-Size  
TruckVault

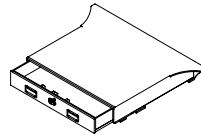

One Drawer  
Standard Height

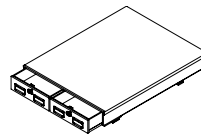

Two Drawer  
Standard Height

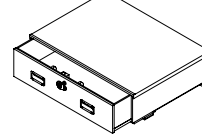

One Drawer  
Magnum Height

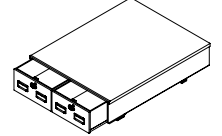

Two Drawer  
Magnum Height

Item #	Description	Price
SUV-short	2 Drawer Standard Vault	\$1,595.00 ea
SUV-Mid	2 Drawer Standard Vault	\$1,795.00 ea

**ALL Truck Vault products are custom built by vehicle. Please contact us with your specific vehicle model and we will be happy to provide an exact quote.**



## TRUCKVAULT COMMAND CENTER

Over the past decade, the TruckVault Mobile Command Center has become an essential piece of equipment in any first responder's arsenal, keeping everything organized and secure. With dozens of pre-configured designs and hundreds of additional options, a TruckVault Command Center provides tactical storage for virtually every piece of equipment used in the field. Features such as a quick-deployment logistics board, table extension, foam inlaid weapons drawer and full-sized cabinet drawers get you command ready in seconds.

Item #	Description	Price
FDTAC	Command Center Cabinet	\$4,795.00 ea

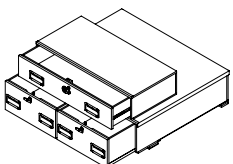

Investigator

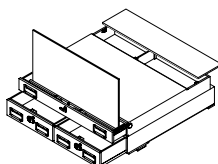

Special Ops Center

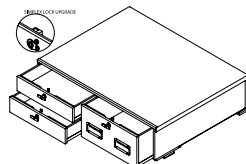

Field Ranger

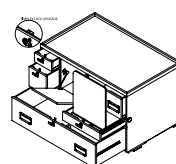

Captain

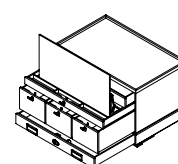

Tac Center

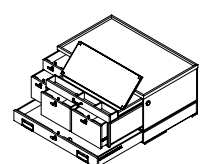

Chief



### TRUCKVAULT LIFT SYSTEM FOR EXPLORER PPV

New TruckVault Lift Technology product allows you to place a full sized TruckVault in your Explorer PPV and retain quick access to your full size spare without a hassle. TruckVault's Lift technology uses air assist cylinders to make lifting the entire unit a snap. Simple in design, it's all steel construction is engineered for heavy service and will last throughout the life of the vehicle.



**NEW**



Shown with a 1-drawer Magnum TruckVault



Item #	Description	Price
T-FDEXRS2-11N	2 Drawer Standard Vault w/ Lift	\$2,195.00 ea
T-FDEXRM-1-LT	1 Drawer Magnum Vault w/ Lift	\$2,395.00 ea

**ALL Truck Vault products are custom built by vehicle. Please contact us with your specific vehicle model and we will be happy to provide an exact quote.**

### TUFBOX™ LOCKING WEAPON DRAWERS

The TufBox™, a locking drawer system, provides a way to secure weapons, store equipment and organize belongings to keep them safe and out of the way. Manufactured with a heavy-duty, metal framework and steel sides, this unit is built to withstand the everyday demands that are expected of all Tufloc products. The TufBox is finished with baked, powder-coating for durable good looks.

Keying options include keyed cylinder or combination with key override.

Item #	Description	Price
36-019	44" x 32" x 15" Storage Cabinet	\$1,550.00 ea
36-009	40" x 32" x 12" Storage Cabinet	\$999.00 ea
36-010	38" x 32" x 12" Storage Cabinet	\$950.00 ea
36-300	Raised Mounting Base	\$275.00 ea

Available for SUV's and cruisers



**NEW**

Contact us with your vehicle information and key options and we will provide a quotation based on your needs.

### SETINA HEAVY DUTY CARGO TRUNK SOLUTION

Store your personal belongings in a place that will not be secure and convenient. Avoid the risk of theft with this new Setina Storage Cabinet.

- Top Box is lockable with a 3 dial code
- Slide out tray holds a capacity of up to 300 lbs
- Very Durable
- Convenient
- Available for the majority of SUV's
- Dimensions: 37.8" (L) x 18.8" (W) x 8.7" (H) - Standard
- Dimensions: 42.8" (L) x 18.5" (W) x 5.1" (H) - Upper Lock Box

\*Requires cargo partition or a freestanding bracket (sold separately)\*

Item #	Description	Price
TK0230ITU12	Cargo Drawer w/ Upper Lock Box	\$1,095.00 ea
TF0237ITU12	Freestanding Bracket Kit	\$69.00 ea
12VS	Cargo Partition	\$359.00 ea

Also available in key lock and other configurations.

**NEW**



# VEHICLE EQUIPMENT

## Vehicle Storage



TS-01

### TRUCK-STOR STORAGE UNITS

Maximize and organize space while protecting your valuables with the TRUCK-STOR storage system. Locking slide-out drawers give you quick, easy access to your equipment, weapons, tools and supplies. Designed and developed in partnership with national enforcement agencies, the TRUCK-STOR provides a flexible, affordable storage solution for Emergency, Enforcement and Utility Vehicles.

- Lightweight aluminum welded construction
- Finished in hard black epoxy paint
- Heavy duty ball bearing slides for smooth operation

This modular system can be configured to provide more than 50 compartments. Add a slide-out work table, shelf or hose/cable drawer to create your command center or workstation. Designed to fit full size SUV and vans. Requires truck delivery.

#### Tactical Storage System (TS-01)

Item #	Description	Price
TS-01-26	Storage System w/ Large Drawer Format 48" W x 12" H x 28.75" L	\$1,149.00 ea
TS-01-34S	Storage System w/ Large Drawer Format 45" W x 12" H x 36.75" L	\$1,299.00 ea
TS-01-34	Storage System w/ Large Drawer Format 48" W x 12" H x 36.75" L	\$1,299.00 ea
TS-01-42	Storage System w/ Large Drawer Format 48" W x 12" H x 44.75" L	\$1,469.00 ea



Ford SUV Storage



### FORD SUV STORAGE

**NEW**

- Single Drawer Storage kit
- Dimensions: Width-40" / Depth-26", Height-12"  
(not including 1-1/2" Top Lip)
- 933-0093A Cabinet constructed from 0.09" (11ga) Aluminum
- Front Locking Pad Latch with dual deadbolts to keep drawer closed
- Grab bar full width of cabinet to help with opening
- Rubber lined drawer bottom and cabinet top
- 1 pair 24" Heavy duty ball bearing slides 500lbs capacity
- Epoxy Powder Coated Midnight Black Wrinkle

Item #	Description	Price
999-0005A	Single Drawer Storage System Kit, Includes Cargo Partition and Subframe	\$2,100.00 ea

## We Install Storage Systems

**Hall Public Safety**  
UPFITTERS

*Through our upfitting partner  
**Hall Public Safety Upfitters.**  
Allow us to come to you and organize your  
next vehicle or bring your vehicle into one  
of our two installation centers.*



**Columbus Office**  
8495 Estates Ct  
Plain City, Ohio 43064  
866-320-7277

**Cleveland Office**  
8291 Darrow Rd  
Twinsburg, Ohio 44087  
855-387-3911



### PRO-GARD™ CARGO CABINETS & LOCKING WEAPONS DRAWER

Pro-gard offers to large sized Cargo Cabinets that feature Gun Racks. Choose from either a Vertical Mount or Horizontal Mount Gun Rack. The large cabinets fit any SUV with a 4' wheel clearance. The Small Cargo Cabinet features a programmable, locking weapon/storage drawer and fits any SUV with a 3.5' wheel clearance. Vehicles: Chevy Suburban, Chevy Tahoe, Ford Expedition and Ford Utility Interceptor.

**NEW**

#### Locking Weapons Drawer for Ford Utility Interceptor

Drawers can be mounted with or without the Cargo Barrier and provide 11 inches of clearance space underneath the drawer. This allows for easy access to the wheel compartment in the load floor.

Programmable Combination Lock

External dimensions: 11" h x 44.5" w x 18" d

Internal dimensions: 6.5" h x 39.5" w x 14.5" d

Item #	Description	Price
CC4701UINT13	2 File Drawer, 1 Part Drawer, 1 Weapon Storage Drawer w/ Lock	\$3,400.00 ea
WSD47UINT13	Weapon Storage Drawer (Includes lift bracket to allow access to spare tire.)	\$1,975.00 ea



Weapons Storage Drawer



### PRO-GARD™ TRUCK BED ORGANIZER

The Pro-Gard Truck Bed Organizer converts the entire truck bed into a storage system that can be accessed entirely from the tailgate. Eliminates the looming openness of the truck bed by creating an easy access storage system. Quickly find any equipment from the tailgate.



- Heavy Duty construction - HDPE deck and drawers with steel sub frame
- 2,000 lbs. deck load rating
- 12" overall height accommodates additional storage space on top of unit
- Each drawer can hold up to 200 lbs.
- Easy installation - No holes drilled installation utilizes existing OEM tie down locations to secure unit
- Snug fit is specific to contours of each OEM make/model truck bed
- Customizable organization
- Two large storage drawers: 61.4" x 18" x 8.5"
- Optional single or dual weapon racks are available
- Removable storage trays and dividers help organize smaller equipment in the oversized drawers
- Water-resistant system sheds rain and downward flow of water from car wash
- Will not work with the RamBox® Cargo Management System

Item #	Description	Price
TBO59RT14	Truck Bed Organizer, 2014 Ram 1500	\$1,425.00 ea
TBO81FT14	Truck Bed Organizer, 2014 Ford F-150	\$1,425.00 ea
TB085SIL14	Truck Bed Organizer, 2014 Chevy Pickup	\$1,425.00 ea
TBOGRS02	Dual Weapon Gun Rack for Truck Bed	\$475.00 ea
TBODLS02	Optional Drawer Lock Set	\$45.00 pr

Specify make, model and year of truck when ordering.



# VEHICLE EQUIPMENT

## Weapons Storage

### SETINA® MOUNTED WEAPON SYSTEMS

Single or double mounting

- One or two weapons can be mounted
- Designed to fit small and large gun locks
- Electric gun locks with key lock override
- Includes 10 second timer with push button switch
- Optional handcuff key locks
- Universal butt plate fits most weapons
- Easy installation with center conduit
- Rugged powder-coated finish

**NEW**  
**SETINA**  
MANUFACTURING

Item #	Description	Price
GK1025	Single T-Rail Mount, Small Lock	\$235.00 ea
GK1026	Single T-Rail Mount, Large Lock	\$249.00 ea
GK1027	Single T-Rail Mount, Universal Lock	\$269.00 ea
GK1029	Dual T-Rail Mount, 1 Small & 1 Large Lock	\$349.00 ea
GK1030	Dual T-Rail Mount, 1 Small & 1 Universal Lock	\$369.00 ea
GK1034	Dual T-Rail Mount, 2 Universal Locks	\$389.00 ea



### SETINA® BLAC-RAC WEAPONS MOUNT

Single or double mounting

- Space-saver mounting
- Can handle a wide variety of weapons platforms
- Handles 30 round magazine when firearm is mounted
- Optics friendly and will not interfere with scopes
- Equipped with quality synthetic non-marring rubber pads
- Absorbs shock and vibration and eliminates rattling
- Receiver width adjustment allows for slim and wide receiver firearms
- Smallest mounting footprint of any weapon mount

**NEW**  
**SETINA**  
MANUFACTURING

Item #	Description	Price
GK11222B	Dual T-Rail Mount w/2 Blac-Rac Locks	\$1,069.00 ea
GK112201	Dual T-Rail Mount, 1 Large Standard Lock & 1 Blac-Rac Lock	\$759.00 ea
1080E	Single T-Rail Mount w/Electric Lock	\$539.00 ea





### SHOTLOCK™ SOLO-VAULT™

The ShotLock Solo-Vault from TruckVault is the world's first shotgun vault. It provides peace of mind knowing that your defense firearm is stored securely, yet ready at a moment's notice. It can be mounted in a vehicle or on virtually any wall, in a closet or behind a door, at home or at the shop.

- Fits pump, semi-auto, side-by-side and over/under shotguns\*
- Will fit most pistol grip shotguns\*
- Accommodates left and right handed shotguns
- 1000+ combination programmable push-button lock
- 14 gauge steel construction

Item #	Description	Price
S-SL001	ShotLock Solo-Vault	\$169.00 ea

\*Some aftermarket applications (tactical rails, lights, saddles, etc.) may not be supported. Please call for details. AR Solo-Vault is also available.

**NEW**



### TUFLOC® SCREEN MOUNTED GUNLOCK

Tufloc® offers the widest range of vehicle weapon racks available, providing secure storage and quick access to your weapons. Padded for weapon protection and rattle-free performance, this rack provides ample headroom for the driver and passengers.

- Electronic gun lock
- Mounting brackets and mounting instructions
- Butt holder
- Trigger guard
- Concealed momentary switch for quick release of lock
- Timer
- Heavy-duty, powder-coated steel construction with a black finish

Padded for weapon protection and rattle-free performance, this rack provides ample headroom for the driver and passengers.

Item #	Description	Price
108BLBS	Screen Mount Vehicle Rack	\$219.95 ea

**NEW**



### TUFLOC® ROLLBAR MOUNTED GUNLOCK

Tufloc offers the widest range of vehicle weapon racks available. Each vehicle rack provides secure storage and quick access. Weapon rack and mount, roll bar.

With Tufloc electrical-mechanical lockheads, you can be certain your weapon stays put until you need it: Dual-release lock, which holds the weapon in place, can only be accessed with a key or by using the 8-second-delay electric timer.

NOTE: Racks are shown securing a shotgun, but Tufloc racks are available for all weapon types. Please specify weapon.

Specify vehicle year, make and model when ordering.

Handcuff key, tubular key, keyed alike or keyed differently.

Item #	Description	Price
108ALAS	Rollbar Mount Vehicle Rack	\$219.95 ea

# VEHICLE EQUIPMENT

## Weapons Storage



### BIG SKY ELS SERIES GUN RACKS

The ELS Series is designed to accommodate the most commonly used law enforcement weapons. The one-piece steel frame eliminates welds, providing maximum strength and durability and ensuring secure storage for years to come. The padded weapon brackets and lock bolt into slotted mounting grooves, allowing for adjustment and proper weapon placement. Each rack comes complete with an electric lock (handcuff, standard or barrel key override), 10 second delay timer, activation switch, trigger or mechanism guard, 1 set of Roll Bar or Flat Plate mounting brackets, hardware and wiring instructions.

Item #	Description	Price
ELS-300	Shotgun Rack	\$273.95 ea
ELS-310-340	Gun Lock Inserts	\$24.95 ea
UCB	Undercover Adjustable Mount	\$99.95 ea
ELS-210	Shotgun Rack	\$199.95 ea
ELS-220	Shotgun/Rifle Rack	\$247.95 ea
ELS-270	Rifle Rack	\$273.95 ea

The ELS-300 is an insert-based rack that accommodates multiple weapons.



### REPLACEMENT GUN RACK PARTS

Item #	Description	Price
G701	Solenoid	\$19.00 ea
G4904H	Gun Lock Only for Shotguns	\$99.00 ea
G4904R-NPG	Gun Lock Only for AR-15	\$112.00 ea
G1002	10 Second Gunlock Timer	\$41.00 ea



G701



G4904H



G1002

**NEW**

### SANTA CRUZ UNIVERSAL GUN RACK

Fully adjustable, universal gun rack for securing any long arm on a flat surface.

- SC-5 gun lock (specify key: #2 or handcuff)
- SC-1900 or 1901 butt plate
- SC-502 18" flat bar
- SC-9903 L bracket
- nuts and bolts
- installation instructions

Item #	Description	Price
SC-917-5	Universal Gun Rack	\$216.75 ea

\*Some aftermarket applications (tactical rails, lights, saddles, etc.) may not be supported. Please call for details.







### PRO-GARD UNIVERSAL MOUNT GUN RACK

Pro-gard's gun racks are constructed of high grade steel and accommodate a variety of weapons. The multiple mounting configurations and quick installation design make them the solution to any number of storage requirements and allow quick access to weapons. From automatic to non-lethal, free up space inside the vehicle and keep your protection secure. For added convenience, Pro-gard gun racks come complete with mounting hardware, timer and momentary switch, and either a handcuff, straight or vending machine key override.

- Ideal for partition, trunk and screen installations

Item #	Description	Price
G5000UT	Universal Mount Gun Rack	\$278.00 ea

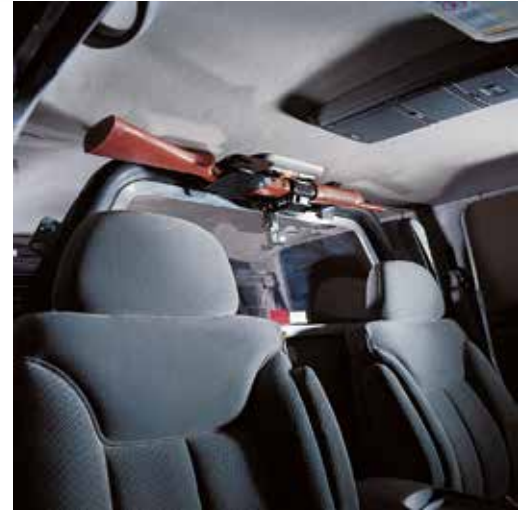

### PRO-GARD™ TRI-LOCK WEAPON MOUNTING SYSTEM

- Weapon mounting can be configured at time of install allowing for greater flexibility in weapon type, weapon style, and/or weapon accessories
- Accommodated nearly any weapon with any configuration of accessories
- Available for vertical partition mount
- Comes with momentary switch and 8-second delay timer
- Long gun locks available in Pro-gard's three key styles: Straight, handcuff or vending
- Accommodates up to three weapons
- This weapon mounting system gives officers the flexibility to mount two long weapons in either a Vertical Partition Mount or a Self-supporting Mount

#### Partition Mount

Item #	Description	Price
GVPMS*	Tri-Lock Single Weapon Rack (Partition Mount)	\$339.00 ea
GVPMD*	Tri-Lock Dual Weapon Rack (Partition Mount)	\$425.00 ea

\*\* For Chevy Caprice models add \$25 per unit.

#### Self Supporting Mount

Item #	Description	Price
GVMS*	Tri-Lock Single Weapon Self Supporting Rack	\$399.00 ea
GVMD*	Tri-Lock Dual Weapon Self Supporting Rack	\$449.00 ea

\*\* For Chevy Caprice models add \$75 per unit.

**NEW**



Tri-Lock Self Supporting



Tri-Lock Partition Mount

### FLOOR MOUNT SERIES

A quick, simple solution to weapon mounting needs.



Item #	Description	Price
G4906	Vertical Partition Mount for Non-Recessed Partition	\$278.00 ea
G4908	Muzzle Down Mount in Passenger Compartment	\$278.00 ea
G7000-1	Single Vertical Gun Rack, Floor Mount (not pictured)	\$299.00 ea



G4908



G4906

# VEHICLE EQUIPMENT

## Prisoner Transport

### PRO-GARD WINDOW ARMOR

Designed to prevent the rear windows from being kicked out, Pro-gard window armor provides maximum protection! Available in steel bars or 1/4" polycarbonate panels.



- Will not interfere with side curtain airbag deployment
- Steel bars feature a durable powder coated finish
- Clear polycarbonate panels have a steel frame to prohibit flexing and offer a low-profile, camouflaged option



Steel Bars



Polycarbonate

Item #	Description	Price
WB56NPC11	Steel Bars, '11-'15 Charger	\$220.00 pr
WBP56NPC11	Polycarb Panels, '11-'15 Charger	\$220.00 pr
WB53CC11	Steel Bars, '11-'15 Caprice	\$220.00 pr
WBP53CC11	Polycarb Panels, '11-'14 Caprice	\$220.00 pr
WB52I06	Steel Bars, '06-'15 Impala	\$220.00 pr
WBP57T07	Polycarb Panels, '07-'14 Tahoe	\$220.00 pr
WBP57T15	Polycarb Panels, '15 Tahoe	\$220.00 pr
WBP36NPINT13	Polycarb Panels, '13-'16 Ford Sedan Interceptor	\$220.00 pr
WBP47NPUINT13	Polycarb Panels, '13-'16 Ford SUV Interceptor	\$220.00 pr

\*\*Due to the weight and dimensions of this item, additional freight charges apply.

### PRO-GARD DOOR PANELS

Prevent access to the window release or door latch from the interior of vehicle with ABS door panels. They are used in conjunction with Pro-gard window armor to complete your prisoner containment upfit.

- Eliminates crevices and cracks of OEM door panels where contraband can be hidden
- Prevents costly damage to door hardware



ABS Door Panel

Item #	Description	Price
DP56C11	ABS Door Panels, '11-'15 Charger	\$113.00 pr
DP53C11	ABS Door Panels, '11-'15 Caprice	\$113.00 pr
DP52I06	ABS Door Panels, '06-'15 Impala	\$113.00 pr
DP57T07	ABS Door Panels, '07-'14 Tahoe/Suburban	\$113.00 pr
DP57T15	ABS Door Panels, '15 Tahoe/Suburban	\$113.00 pr
DP47UINT13	ABS Door Panels, '13-'16 Ford SUV Interceptor	\$113.00 pr
DP36INT13	ABS Door Panels, '13-'16 Ford Sedan Interceptor	\$113.00 pr

\*\*Due to the weight and dimensions of this item, additional freight charges apply.

### READY BUCKLE SEAT BELT SYSTEM

The Ready Buckle is a patented ELR/ALR retractor seat belt system, mounted to the center top of the rear deck.



This patented system helps prevent the officer from needing to lean over the prisoner to seat belt them into the rear seat. Once the officer buckles the prisoner in, the officer can easily pull the belt back until it ratchets, which will automatically tighten the belt if the prisoner struggles. This minimizes the risk to the officer of being injured and keeping the prisoner secure.

- The original outboard buckling system for police vehicles
- A certified seat belt system, not a police strap or lap belt
- Road tested for nearly a decade
- Tested and documented by an approved national research lab for FMVSS 207/209/210
- Ready Buckle nearly doubled the safety standards in its latest 2013 testings

Laguna furnishes you all parts built and tested for the manner it was designed for. Laguna will never advise you to relocate or reuse OEM parts in a manner not used or indicated by the vehicle manufacturer.



Available for Dodge Chargers, Chevy Caprice, Chevy Impala, Chevy Tahoe, Ford Police Interceptor Utility & Sedan. Contact us for other vehicle options.

Item #	Description	Price
DC9502RB	Dodge Charger	\$659.00 ea
FT3501RB	Ford Police Interceptor Sedan	\$659.00 ea

\*\*Due to the weight and dimensions of this item, additional freight charges apply.

### PRO-GARD ABS PRISONER TRANSPORT SEATS

- Product design fits tight with other equipment to deter both the spread of pathogens and prisoners hiding contraband
- Easy to clean up
- Available in charcoal grey only
- Standard seats have a straight back, contoured seats feature a padded, carved out back that provides arm/back comfort for cuffed prisoners

Item #	Description	Price
S56C06	Standard Seat, '11-'15 Charger	\$399.00 ea
SCS56C06	Contoured Seat, '11-'15 Charger	\$414.00 ea
S53CC11	Standard Seat, '11-'15 Caprice	\$399.00 ea
S52I06	Standard Seat, '11-'15 Impala	\$399.00 ea
S5702T07	Standard Seat, '11-'15 Tahoe w/ Polycarb Window Cargo Barrier	\$905.00 ea
S5705T07	Standard Seat, '11-'15 Tahoe w/ 7ga. Wire Window Cargo Barrier	\$905.00 ea
S36INT13	Standard Seat, '13-'16 Ford Sedan	\$399.00 ea
S4705UINT13	Standard Seat, '13-'16 Ford SUV w/ 7ga. Wire Window Cargo Barrier	\$995.00 ea



Standard



Contoured

### PRO-GARD ABS FLOOR PANS

Item #	Description	Price
FP56C06	Floor Pan, '11-'15 Charger	\$161.00 ea
FP53CC11	Floor Pan, '11-'15 Caprice	\$161.00 ea
FP52I06	Floor Pan, '06-'15 Impala	\$156.00 ea
FP36INT13	Floor Pan, '13-'16 Ford Sedan	\$156.00 ea

\*\*Due to the weight and dimensions of this item, additional freight charges apply.



### PRO-GARD REAR CARGO BARRIERS

Available with either a 7 gauge wire screen or 1/4" polycarbonate window and features 14 gauge steel construction and a durable powder coated finish. Price includes mounting hardware and side filler panels.

Item #	Description	Price
B5705T07	7ga. Wire Window, '07-'14 Tahoe	\$356.00 ea
B5702T07	Polycarb Window, '07-'14 Tahoe	\$412.00 ea
B5705T15	7ga. Wire Window, '15 Tahoe	\$385.00 ea
B5702T15	Polycarb Window, '15 Tahoe	\$412.00 ea
B4702UINT13	7ga. Wire Window, '13-'16 Ford SUV Interceptor	\$385.00 ea
B4705UINT13	Polycarb Window, '13-'16 Ford SUV Interceptor	\$412.00 ea

\*\*Due to the weight and dimensions of this item, additional freight charges apply.



**Pro-gard**  
PRODUCTS LLC.



# VEHICLE EQUIPMENT

## Push Bumpers



### SETINA LIGHTED PUSH BUMPERS

Lighted push bumpers add to your front end lighting coverage with LED warning lights that are integrated into the push bumper.

- Side mounted LEDs increase intersection visibility, front facing LEDs provide secondary warning for pursuits
- Completely factory pre-assembled and wired for quick, easy installation
- Available in steel or high-strength, aircraft grade aluminum that is 40% lighter for better fuel economy and front end weight limitations
- Standard LEDs available in your choice of either SoundOff Predator II, XP63, or Whelen LINZ6, Larger LEDs available in either Federal Signal Impaxx, Viper EXT, or Whelen TIR6
- 2 Light model has front facing LEDs only, 4 light model has 2 front and 2 side

Item #	Description	Price
PB450L2	Lighted Push Bumper, 2 Standard LEDs	\$599.00 ea
PB450L4	Lighted Push Bumper, 4 Standard LEDs	\$725.00 ea

\*Prices are for Sedan models. For SUVs, add \$30.00.



Does not interfere with SRS airbag systems

**SETINA**  
MANUFACTURING



### SETINA PUSH BUMPERS

- PB100 available in 12" or 16", and aluminum or steel versions
- PB100 features rugged one-piece main structure loop made of 3/8" x 2-1/2" aluminum or steel
- Replaceable mar-resistant hard rubber push pads available (at additional charge)
- Does not interfere with SRS (airbag) system
- Black powder coated finish
- PB300 features a 3/16" aluminum main plate and lower support cross brace and a 2-1/2" x 1-3/4" oval extruded aluminum upper cross support
- PB400 features one piece, heavy duty construction

Item #	Description	Price
PB100	12" Aluminum or Steel Push Bumper	\$210.00 ea
PB100	16" Aluminum or Steel Push Bumper	\$219.00 ea
PB300C	Deluxe Aluminum Push Bumper for Cars	\$299.00 ea
PB300SUV	Deluxe Aluminum Push Bumper for SUVs	\$321.00 ea
PB400C	Deluxe Aluminum Push Bumper for Cars	\$269.00 ea
PB400SUV	Deluxe Aluminum Push Bumper for SUVs	\$279.00 ea

\*Specify vehicle



PB400C



PB400C

### PRO-GARD PUSH BUMPERS

Push bumpers are designed to protect the grille and bumper while pushing other vehicles. Pro-gard push bumpers are constructed of high-strength steel, for superior durability and maximum protection, and the vertical beams are covered with dense, hardened rubber, protecting the disabled vehicle from damage.

- Transferable by simple mounting bracket changes
- Quick and easy “no holes drilled” installation
- Auxiliary light and speaker mounting platform
- Durable powder coated finish
- Extend only 6” out from vehicle’s bumper, minimally affecting turn radius

Item #	Description	Price
PB56C11	Dodge Charger, '11-'14	\$235.00 ea
PB57T11	Chevy Tahoe/Suburban, '07-'14	\$269.00 ea
PB57T15	Chevy Tahoe/Suburban, 2015	\$269.00 ea
PB47UINT13	Ford Interceptor SUV, '13-'15	\$269.00 ea
PB36INT13	Ford Interceptor Sedan, '13-'16	\$269.00 ea

\*\*Due to the weight and dimensions of this item, additional freight charges apply.



**Pro-gard**  
PRODUCTS LLC.



PB57T11



PB56C11



PB47UNIT13

### PRO-GARD LIGHTED PUSH BUMPERS

Pro-gard’s steel push bumpers offer superior design and easy installation. Most push bumpers are installed with patented no holes drilled no trim cut installation and include a platform for auxiliary light and speaker mounting. The powder coated finish will keep the push bumper as new looking as the day it was installed.

- Available in Sedan or SUV versions
- Sedan style features 2 ION LED’s; SUV version features either 2 ION or 4ION LED’s
- Choose from light patterns: All Red, Blue or 1/2 Red/1/2 Blue With Integrated Dominator® Lightbar
- Available in Sedan or SUV versions
- Sedan style features a 6 LED Dominator Lightbar, SUV version features an 8 LED Dominator Lightbar
- Choose from light patterns: All Red, Blue or 1/2 Red / 1/2 Blue

Item #	Description	Price
PB47UINT13LED**	Ford Interceptor SUV, '13-'15, Six Head Lightbar	\$666.00 ea
PB47UINT13ION**	Ford Interceptor SUV, '13-'15, Two ION	\$695.00 ea
PB36INT13LED**	Ford Interceptor Sedan, '13-'15, Six Head Lightbar	\$795.50 ea
PB36INT13ION**	Ford Interceptor Sedan, '13-'15, Two ION	\$695.00 ea
PB53CC11LED**	Chevy Caprice '11-'15, Six Head Lightbar	\$795.50 ea
PB53CC11ION**	Chevy Caprice '11-'15, Two ION	\$695.00 ea
PB56C11LED**	Charger, '11-'15, Six Head Lightbar	\$795.50 ea
PB56C11ION2**	Charger, '11-'15, Two ION	\$695.00 ea



**NEW**



# VEHICLE EQUIPMENT

## Partitions



10-RP



7-S

**SETINA**  
MANUFACTURING



12-VS



12-VSP

### SETINA SECURITY SCREEN FOR SEDANS

Engineered with the highest quality materials to maximize officer safety.

Setina partition features:

- 14 gauge steel seat back protector plate and all aluminum channeling
- Heavy duty roll bar type framework
- Window available in 1/4" uncoated scratch-resistant polycarbonate or vinyl coated 11-gauge expanded metal
- Include polycarbonate side filler panels for increased security
- Available with a recess panel for additional storage or gun rack (at additional charge)
- Available for most current, American-made emergency response vehicles
- Side curtain airbag compatible models available for most vehicles (at additional charge)

\*Coated polycarbonate guaranteed for a period of 7 years by manufacturer against abrasion, coating failure and breakage.

Item #	Description	Price
7-S	Full Metal Screen	\$469.00 ea
8-S	Half Polycarb, Half Metal Screen	\$495.00 ea
10-S	Center Sliding Window (Polycarb)	\$514.00 ea
10-RP	Center Sliding Polycarb Window & Recess Panel	\$595.00 ea
10-VS	Center Sliding Window for SUV	\$690.00 ea
LOWEREXT	Full Width Lower Extension Panel	\$58.00 ea
BUCKETPLATE	Lower Extension Panels for Bucket Seats	\$64.00 ea

\*\*Due to the weight and dimensions of this item, additional freight charges apply.



8-S



10-S

### SETINA VAN/SUV PARTITION FOR REAR COMPARTMENT

- Window available in 11 gauge vinyl-coated metal (shown) with 1-1/2" x 3/4" diamond openings (shown) or solid, 1/4 polycarbonate
- 1-1/2" x 3/4" Aluminum framework with 5/8" extrusion
- 14 gauge steel seat back protector panel
- Upper support brackets made of 3/16" x 2" Steel
- Available for most current, American-made emergency response vehicles

Item #	Description	Price
12-VS	Van/SUV Rear Compartment Partition, Metal Screen	\$367.00 ea
12-VSP	Van/SUV Rear Compartment Partition, Polycarbonate	\$399.00 ea

\*\*Due to the weight and dimensions of this item, additional freight charges apply.

Additional partitions available. Call for more information.



### PRO-GARD SECURITY SCREENS

High quality construction that provides peace of mind and lasts for years. Maintain control over your prisoners during transport with a partition that is designed to be easy to install and provides maximum safety.

Pro-gard partition features:



- 14 gauge steel construction and anodized aluminum window frame
- Durable powder coated finish
- Window available in polycarbonate, metal screen or a combination
- Includes clear polycarbonate side filler panels for increased security
- Available for most current, American-made emergency response vehicles
- Recess Panel provides additional space for storage or gun rack
- Side curtain airbag compatible models available at no extra charge for applicable vehicles



Item #	Description	Price
P5602C11	Stationary Polycarb Window, '11-'15 Charger	\$520.00 ea
P5604C11	Center Siding Polycarb Window, '11-'15 Charger	\$537.00 ea
P5612C11	1/2 Polycarb, 1/2 Metal Screen Window, '11-'15 Charger	\$537.00 ea
P5204I06	Center Sliding Polycarb Window, '06-'15 Impala	\$537.00 ea
P3604INT13A	Center Sliding Polycarb Window, '13-'16 Ford Interceptor Sedan	\$537.00 ea
P5304CC14A	Center Sliding Polycarb Window, 2015 Caprice	\$537.00 ea
P5304CC11A	Center Sliding Polycarb Window, '11-'13 Caprice	\$537.00 ea
SEATP	Under Seat Protector Panel Kit	\$55.00 ea
RECESSP	Add-on Recess Panel Kit for Partitions	\$78.00 ea

\*\*Due to the weight and dimensions of this item, additional freight charges apply.

### PRO-GARD SUV/TRUCK PARTITIONS

Item #	Description	Price
P4702U13A	Stationary Polycarb Window, '13-'16 Utility Interceptor	\$467.00 ea
P4704U13A	Center Sliding Polycarb Window, '13-'16 Ford Utility	\$506.00 ea
P5904RT13A	Center Sliding Polycarb Window, '13-'15 Dodge Ram	\$565.00 ea
P8102FT09A	Stationary Polycarb Window, '09-'13 F150, 4 Door Only	\$460.00 ea
P5704T10A	Center Sliding Polycarb Window, '07-'14 Tahoe	\$538.00 ea
B5705T07	Rear Cargo Barrier w/ Metal Screens, '09-'14 Tahoe, Police Package Only	\$356.00 ea
SEATP	Under Seat Protector Panel Kit	\$61.00 ea
RECESSP	Add-On Recess Panel Kit for Partitions	\$78.00 ea

\*\*"A" denotes side curtain airbag compatible

\*\*Due to the weight and dimensions of this item, additional freight charges apply.

Add \$150 to any partition for Space-Saver Plus option



Additional partitions available. Call for more information.



Space Saver Partition  
Increase prisoner legroom



Center Sliding Window

# VEHICLE EQUIPMENT

## K-9 Transport Systems



**NEW**



### E/Z RIDER K-9 PLATFORMS

The Original E/Z Rider K9 Platform unit is fully contoured for vehicle specific, perfect fit. Front Panel made of mill finish aluminum, fully welded with double-walled impact panels and lexan head rest protectors and round vertical bars. Offers the maximum amount of durability and comfort.

- Virtual roll bar
- 1 1/4" radius square punched design for maximized visibility and strength
- Rear drop window
- Escape door on a sliding track
- Spring loaded locking system
- Easy cleaning
- Enhanced airflow
- Window guards and door panels included (black coat)
- Aluminum or gray powder coated finish
- \*Fittings for the majority of police vehicles



Item #	Description	Price
K9 INSERT	K-9 insert for SUV	\$1,999.00 ea
POWDERCOAT	Powder Paint Coat for K-9 Insert, Black	\$380.00 ea
RUBBERLINER	Deluxe Rubber liner for American Aluminum K-9 insert	\$150.00 ea

\*\*Due to the weight and dimensions of this item, additional freight charges apply. Available for several vehicles both sedans and SUV's. Specify vehicle when ordering.

**NEW**



© ACEK9.COM

### K-9 HOT N' POP SYSTEMS

The HP-5010, K9 HOT-N-POP® Pro, is a combination K9 HEAT ALARM® Pro and K9 Door Popper® system. The unit monitors vital components including temperature sensors, vehicle battery voltage, and engine stall. The information is shown on a 32-character backlit alphanumeric display. If an alarm condition is detected, the unit will activate a S.O.S. Horn Honk signal, siren and light-bar activation, and dual window drop.



- K9 transport option for 2011-up Dodge/Chrysler/Jeep, Charger, Durango, Jeep & Ram trucks
- Includes heat alarm pro KK-K9-HA-2510B
- Includes remote door pop system KK-K9-DP-3000-H for sedans, SUV's and trucks
- Order optional C-EB35-RHP-1P bracket if mounting control head in console
- Note: specify year, make and Model of vehicle when ordering to insure correct adapters are sent with unit
- Effective 12/1/10 KK-K9-HA-RBM-TG K9 remote pager/beeper module is no longer included as a standard feature with this item and must be purchased separately
- As of 10/1/12 KK-K9-HAP-ESFS-K engine stall sensor is no longer included as a standard feature and must be purchased separately
- Sept 2011- sept 2012 the no K9 left behind feature was included and now it is an optional feature (part # KK-K9-H-NKLB-K must be purchased separately)

\*Specify year, make and Model of vehicle when ordering to insure correct adapters are sent with unit.

Item #	Description	Price
KK-K9-HP-5010B-32-AVA	K-9 Hot n' Pop Dual Sensor Transport System	\$1,129.00 ea

\*\*Due to the weight and dimensions of this item, additional freight charges apply.





### K9 TRANSPORT SYSTEMS

K9 transport kits from Havis are single-compartment units that provide safety and comfort for you and your canine partner. They must be assembled in the vehicle.

- Include aluminum side door panels, interior hinged window guards, rubber matting and dome light with switch
- Constructed of heavy gauge aluminum for superior, long-lasting durability
- Radius corners, molded edges and proper-sized ventilation holes that maximize airflow while maintaining safety
- White powder cot finish eliminates discoloring of fur
- Designed to maximize officer room and visibility

### K9 TRANSPORT SYSTEMS FOR SEDANS

- Available for the Caprice, Ford Police Interceptor Sedan, Impala and Charger
- Includes single compartment housing with one sliding front door and aluminum fold-down interior window guards and door panels
- Rear guard folds down to allow easy access to the rear window deck
- Sedan kit dimensions: 27" D x 59" W x 35" H

### K9 TRANSPORT SYSTEMS FOR SUVs

- Available for the Trailblazer, Durango, Explorer, Suburban, Tahoe, Yukon, Yukon XL, Ford Interceptor Utility, F-250, Expedition and Excursion
- Includes housing with one front sliding door, two side door panels, aluminum fold-down interior window guards and door panels
- Small SUV kit dimensions: 42" D x 38" W x 33" H
- Large SUV kit dimensions: 48" D x 47" W x 34" H
- Available 32" Deep SUV kit has the same height and width dimensions, but its more shallow design frees up space in the cargo area

### K9/PRISONER TRANSPORT SYSTEMS FOR SUVs

- Available for Tahoe, Yukon, Suburban, Excursion and Expedition
- Feature K9 space on the driver side and prisoner space on the passenger side



K9 Kit for Ford SUV Utility



K9 Kit for Tahoe



K9 Kit for Charger

Item	Description	Price
KK-K9-F18-K	K9 Kit for Ford SUV Utility	\$2,359.00
KK-K9-C20-K	K9 Kit for Tahoe	\$2,359.00
KK-K9-D24-K	K9 Kit for Charger	\$2,359.00

## We Install K9 Systems

*Through our upfitting partner  
Hall Public Safety Upfitters.*

*Allow us to come to you and organize your next vehicle or bring your vehicle into one of our two installation centers.*

**Columbus Office**  
8495 Estates Ct  
Plain City, Ohio 43064  
866-320-7277

**Cleveland Office**  
8291 Darrow Rd  
Twinsburg, Ohio 44087  
855-387-3911

**Hall Public Safety**  
UPFITTERS



# FLASHLIGHTS

## Streamlight Flashlights



### STREAMLIGHT STINGER LED

The Stinger DS® LED is the only rechargeable flashlight with a fully independent dual switch. Access any of the three variable lighting modes and strobe via the tail cap or the head-mounted switch. Head switch operates independently from the tail cap switch.

Item	Description	Price
75812	Stinger DS LED Rechargeable Dual Switch w/ DC Charger	\$129.00 ea
75813	Stinger DS LED Rechargeable Dual Switch w/ AC/DC Charger	\$149.00 ea
75712	Stinger LED Rechargeable w/ DC Charger (Not Pictured)	\$119.00 ea
75713	Stinger LED Rechargeable w/ AC/DC Charger (Not Pictured)	\$145.00 ea



### STREAMLIGHT LED POLYSTINGER®

Deep-dish parabolic reflector produces a long-range targeting beam w/ optimum peripheral illumination. Optimized electronics provides regulated intensity.

- Light output: High - up to 24,000 candela (peak beam intensity), 185 lumens; Medium- up to 12,000 candela (peak beam intensity), 95 lumens; Low – 6,000 candela (peak beam intensity), 50 lumens
- Runtime: High – up to 2 hrs.; Medium – up to 3.75 hrs.; Low – up to 7.5 hrs.;
- Strobe – up to 5.5 hrs
- Limited lifetime warranty

Item #	Description	Price
76112	PolyStinger LED w/ DC Charger, Black	\$119.00 ea
76113	PolyStinger LED w/ AC/DC 2 Holders, Black	\$139.00 ea
76162	PolyStinger LED w/ DC Charger, Yellow	\$119.00 ea
76163	PolyStinger LED w/ AC/DC 2 Holders, Yellow	\$139.00 ea



### STINGER DS LED HP

The Stinger DS® LED HP delivers 267% more intensity than a Stinger DS® LED! DUAL SWITCH TECHNOLOGY - Access any of the three variable lighting modes and strobe via the tailcap or the head-mounted switch. Switches operate independently.

- C4® LED Technology. Shock-proof with a 50,000 hr. lifetime
- 3-cell, 3.6 Volt sub-C NiCd battery is rechargeable up to 1000 times
- 6000 series machined aircraft aluminum with non-slip rubberized comfort grip
- O-ring sealed
- Unbreakable polycarbonate lens with scratch-resistant coating

High: 48,000 candela (peak beam intensity) 200 lumens

Medium: 24,000 candela (peak beam intensity) 100 lumens

Low: 11,000 candela (peak beam intensity) 50 lumens

- Deep-dish parabolic reflector produces a long-range targeting beam w/ optimum peripheral illumination
- Optimized electronics provides regulated intensity
- Runtime: High: 2 hrs. Medium: 3.75 hrs. Low: 7.25 hrs. Strobe: 5.5 hrs.

Limited lifetime warranty

Item #	Description	Price
75861	Stinger DS LED HP 120V AC	\$149.00 ea
75862	Stinger DS LED HP 12V DC	\$144.00 ea

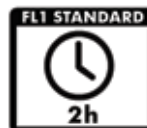

### STRION® RECHARGEABLE

Streamlight®, known the world over for pioneering big ideas in rechargeable flashlights, proudly presents their smallest idea ever: The Strion®, the brightest, most compact rechargeable flashlight in the business. Its exclusive Lithium Ion battery technology packs 12,000 candlepower into a bulletproof, 5.3" long package. That's almost as powerful as the #1 rechargeable light for law enforcement, the Stinger®, but in a body only two-thirds the size and less than half the weight! The Strion® is a small light that is making big waves in the industry.

- Light Output: High - 8,800 candela (peak beam intensity), 160 lumens; Medium - 4,400 candela (peak beam intensity), 80 lumens; Low - 2,300 candela (peak beam intensity), 40 lumens
- Run times: High - Up to 2 continuous hours; Medium - Up to 4 continuous hours; Low - Up to 7.5 continuous hours; Strobe - Up to 5.5 continuous hours

Item	Description	Price
74304	Strion® LED Rechargeable System w/ DC Charger	\$119.00 ea
74302	Strion® LED Rechargeable w/ AC/DC Chargers	\$159.00 ea



### STREAMLIGHT® SL-20™-LED

The SL-20 is an impressive 13 inch, 1.9 pound display of Streamlight power. Provides up to 30,000 candlepower throughout 1.5 hours of continuous operation between charges and is crafted from aircraft grade aluminum. Features 1 pre-focused halogen bulb and 3 white LEDs. Nickel-cadmium 6 volt, 2.4 amp hour, 1/2 D battery rechargeable up to 1000 times. Can be used with 100V, 120V, 230V, or 240V AC or 12V DC chargers.

Item #	Description	Price
20202	Combination Halogen/LED Flashlight w/ DC Charger, Aluminum	\$139.00 ea
25102	Combination Halogen/LED Flashlight w/ DC Charger, Polymer	\$109.00 ea
20602	C4 LED Flashlight w/ Charger, Aluminum	\$139.00 ea
25202	C4 LED Flashlight w/ Charger, Polymer	\$109.00 ea



### MAG CHARGER® SYSTEM



**Rechargeable**

This rugged and reliable unit includes a rechargeable 5-D Mag-Lite®, 12VDC cigar lighter adapter, 110VAC converter, battery pack and charger/mounting cradle. Get all the essentials in one, complete package!

Item #	Description	Price
RL2019	Mag Charger® LED w/ 12VDC Charger	\$115.00 ea
RL1019	Mag Charger® LED System w/ AC/DC Chargers	\$125.00 ea
ARXX235	Battery Pack for Charger System	\$29.95 ea
ARXX035	110VAC Converter Charger	\$9.95 ea
LR00001	Halogen Bulb	\$4.95 ea
ARXX185	Recharging Cradle	\$25.50 ea
109-000-521	Switch/Collar Seal (2003-2013)	\$2.50 ea
ARXX205	12V DC Charger w/ Cigar Adapter Plug	\$6.25 ea
109028	Switch Seal - New Electronic Switch	\$2.50 ea



**LED**

**Rechargeable**



**LED**

**Rechargeable**



ARXX185

ARXX205

ARXX235

ARXX235

# FLASHLIGHTS

## Tactical Streamlight Flashlights



85010



Only 5.72" long & 5.3 oz with batteries!



### STREAMLIGHT SCORPION® LED

The brightest, lightest personal flashlight ever created; and the only tactical light with a rubberized grip and tailcap switch.

- Two 3 volt lithium batteries with a storage life of up to 10 years (included)
- Machined aluminum, wrapped with a rubber-armored sleeve for safety, and a secure grip
- O-ring sealed for moisture protection
- Anti-roll head keeps your beam straight and locked on the target when placed on a flat surface
- 1 watt super high-flux Luxeon® LED
- Incredible stamina: 1-3/4 hrs. run time at regulated maximum intensity; 2 additional hours of declining usable output

Item #	Description	Price
85010	Scorpion LED Flashlight	\$59.95 ea
85011	Scorpion X C4 LED Flashlight	\$59.95 ea
85175	Lithium Batteries (pair)	\$4.50 pr
85905	Black Nylon Holster	\$9.00 ea



### STREAMLIGHT® SUPER-TAC X

High and low intensity modes, strobe mode and the latest in power LED technology with C4® LED, and a 50,000 hour lifetime. Built with an unbreakable polycarbonate with scratch-resistant coating. O-ring sealed.

#### 3 modes:

**High** – 40,000 candela peak beam intensity, 200 Lumens, 2.5 hours runtime

**Low** – 2000 candela peak beam intensity, 10 Lumens, 50 hours runtime

#### Strobe

- Deep-dish parabolic reflector produces a long range targeting
- Two 3 Volt "CR 123A" lithium batteries, with a shelf life of ten years
- Multi-function, push button tactical tailswitch
- 6.62" L x 2.2" W x 9" D (16.81 x 5.59 x 2.29 cm)
- 7.1 oz (200 g)
- Black



Item #	Description	Price
88700	Super-Tac X LED Tactical Flashlight	\$89.00 ea

### PT 1L & 2L ULTRA-COMPACT TACTICAL LIGHT

The combination of small size and C4® LED output results in one of the brightest tactical personal carry lights for its size. Includes high, low and strobe modes.

C4 LED illumination output and run times:

HIGH - 110 lumens/1.75 Hours

LOW - 12 lumens/14 Hours

STROBE - 3 Hours

- Includes 1 CR123A lithium battery
- Includes 2 CR123A for PT 2L model
- Solid State power regulation provides maximum light output throughout battery life
- Rubber push button tail cap switch
- IPX7 rated design; waterproof to 1 meter for 30 minutes
- Impact-resistant tempered glass lens
- Unbreakable pocket clip
- Anti-roll head
- Includes nylon holster



88030  
Length: 3.35"



88031  
Length: 4.68"

Item #	Description	Price
88030	PT 1L w/ White LED	\$49.95 ea
88031	PT 2L Tactical Light w/ White LED, w/2 CR123 batteries	\$59.95 ea



### STREAMLIGHT® LITEBOX®

When an ordinary flashlight just won't cut it, the LiteBox® gives you what you need to penetrate the blackest night, densest smoke and thickest fog. This versatile rechargeable flashlight is now better than ever. It's been given a tougher, weatherproof housing made of ABS thermoplastic and an innovative swivel neck that allows 360 degree rotation of the lamp head. A zero-maintenance battery provides up to 8 hours of reliable lighting and recharges up to 500 times. Available with a high-intensity halogen beam in either spot or flood. The Fire System includes a flashlight and hard-wire charger/mounting rack that is easily secured with only four screws. The Industrial System includes the same but can be charged using AC or DC power for maximum versatility. Shoulder strap is standard.

Item #	Description	Price
4530*1	Firebox Rechargeable, Orange, Standard, 45301	\$179.00 ea
4530*2	Firebox Rechargeable, Orange, Vehicle Mount, 45302	\$169.00 ea
45102	Litebox Vehicle Mount, Orange, 12V, Flood	\$155.00 ea
45107	Litebox Vehicle Mount, Orange, 12V, Spot	\$155.00 ea



**Rechargeable**

### STREAMLIGHT® E-SPOT LITEBOX

An industrial-duty, rechargeable, portable lantern featuring C4® LED technology that provides incredible brightness, runtime and reliability.

#### 2 levels of lighting:

High – 55,000 candela peak beam intensity; 540 lumens

Low – 32,000 candela peak beam intensity; 330 lumens

#### Runtime:

High – 7 hours to the 10% output level    Low – 15 hours to the 10% output level

- Jumper selectable high or low setting to allow selection of more light output or more runtime
- 3 C4® LEDs and deep dish parabolic reflectors to produce a large spot pattern
- LEDs are impervious to shock with a 50,000 hour lifetime
- Zero-maintenance 6V, 12Ah sealed lead acid battery. Rechargeable up to 500 times
- Rubberized impact bumper
- Rack meets requirements of NFPA 1901-14.1.11.2 (2003) mounted in any position
- Limited lifetime warranty

Item #	Description	Price
45851	E-Spot Litebox Standard System w/ 120V AC & 12V DC Charge Cords, Orange	\$199.00 ea
45855	E-Spot Litebox Vehicle Mount System w/ DC Charge Cord and Mounting Rack, Orange	\$199.00 ea
45815	E-Flood FireBox Vehicle Mount System w/ Dual Rear LEDs, DC Charge Cord & Shoulder Strap	\$220.00 ea



**Rechargeable**

### STREAMLIGHT® FIRE VULCAN® LED

Combines all the great features of the halogen Fire Vulcan® with the power and reliability of LED technology!

- C4 LED is impervious to shock with a 50,000 hour lifetime
- Up to 80,000 candela peak central intensity; recharges in 5 hours
- Deep-dish parabolic reflector produces a tight beam with optimum peripheral illumination
- Run times: steady high LED & taillights: up to 3 hours to the 10% output level; low: up to 6 hours

Item #	Description	Price
44451	Fire Vulcan LED, 12V DC, Vehicle Charger	\$199.00 ea
44450	Fire Vulcan, 12V/120V, Standard Charger	\$209.00 ea



**Rechargeable**

# FLASHLIGHTS

## Streamlight Flashlights



LED

### STREAMLIGHT SURVIVOR®

- Featuring the latest in C4 LED technology with microprocessor controlled high and low intensity modes and emergency flash
- High Beam: up to 21,000 candela peak beam intensity; 100 lumens - Low Beam: Up to 7,500 candela peak beam intensity; 32 lumens
- Runtimes: NiCd - High: 3.5 hours; Low: 10+ hours; Flash: 7+ hours - Alkaline - High: 4 hours; Low: 14+ hours; Flash: 7+ hours
- Unbreakable polycarbonate with silicone anti-scratch coating is assembled in a heavy duty bezel

Item #	Description	Price
90540	Survivor® LED Alkaline Model, Orange	\$69.00 ea
90503	Survivor® LED Rechargeable w/ AC/DC Charger, Orange	\$149.00 ea

Dual power source: 4 "AA" alkaline batteries or rechargeable nickel cadmium battery pack. No tools needed to change batteries.



LED

90757

### STREAMLIGHT KNUCKLEHEAD®



Shockproof C4® premium LED technology combined with a deep dish parabolic reflector produces a focused beam for longer distances – 210 meters on high beam. Features a 210 degree articulating head that rotates a full 360 degrees 4 modes: High – 11,000 candela peak beam intensity, 180 Lumens, 3.5 hour runtime, Low – 3300 candela peak beam intensity, 55 lumens, 16 hour runtime, Moonlight – 20 day runtime, Flash – 8 hour runtime

- Dual power source: accepts rechargeable NiCd battery pack or 4 "AA" alkaline batteries
- Removable magnet with 135 lb pull strength features a replaceable rubber boot
- Optimized electronics provide regulated intensity
- High-impact, super-tough nylon polymer construction for exceptional durability

Item #	Description	Price
90744	Knucklehead® LED Alkaline Model, Orange	\$99.00 ea
90757	Knucklehead® LED Rechargeable w/ AC/DC Charger, Orange	\$179.00 ea

Dual power source: 4 "AA" alkaline batteries or rechargeable nickel cadmium battery pack.



NEW

Rechargeable

### STREAMLIGHT® PORTABLE SCENE LIGHT

- C4 LED Technology
  - Three user-selectable outputs
  - Selectable diffuser settings for two beam widths
  - Lead acid batteries rechargeable for up to 500 times
  - Batteries continue charge while operating directly from 12V
  - Integral D-rings allow attachment of the included shoulder strap
  - Pole extends up to 72"
  - Cord built into the pole to avoid snags
  - Stabilization legs provide balance on uneven surfaces
  - 25 lbs provides weight stabilization
  - High-impact thermoplastic housing
  - Limited lifetime warranty
- Size: 22" (L) x 6.5" (W) x 6.7" (H)



Item #	Description	Price
45670	Portable Scene Light, Rechargeable, 12V	\$579.00 ea



### LAMPS & BULBS

Item #	Description	Price
20110	SL-20X Lamp Module	\$15.95 ea
24003	3C-XP Lamp Module	\$15.95 ea
25127	SL-20XP-LED - Lamp Module	\$15.95 ea
33004	3C Xenon Lamp Assembly	\$12.00 ea
33221	3C White LED Lamp Module	\$30.00 ea
45901	8 Watt Bi-Pin Bulb (100 Hr) (LiteBox, Vulcan, Fire Vulcan)	\$8.50 ea
45902	20 Watt Bi-Pin Bulb (100 Hr) (LiteBox)	\$8.50 ea
45903	8 Watt Bi-Pin Bulb (300 Hr) (LiteBox)	\$10.50 ea
45908	8 Watt Flood Lamp Assembly (LiteBox)	\$19.00 ea
45910	20 Watt Flood Lamp Assembly (LiteBox)	\$19.00 ea
45911	8 Watt Spot Lamp Assembly (LiteBox)	\$19.00 ea
45913	20 Watt Spot Lamp Assembly (LiteBox)	\$19.00 ea
45915	8 Watt Dual Filament Lamp Assembly	\$28.00 ea
45921	8 Watt Dual Filament (LiteBox)	\$15.00 ea
51101	Twin-Task 2D Xenon Bulb	\$7.50 ea
51102	Twin-Task 3C Xenon Bulb	\$7.50 ea
51103	Twin-Task 3AA Xenon Bulb	\$7.50 ea
51104	Twin-Task 1L Xenon Bulb	\$7.50 ea
51105	Twin-Task 2L Xenon Bulb	\$7.50 ea
68220	4AA Xenon Lamp Assembly	\$12.50 ea
75914	Bulb (Stinger, Stinger XT, PolyStinger)	\$7.50 ea
78914	Bulb (UltraStinger)	\$8.50 ea
85914	Xenon Bulb (Scorpion, TL-2, NF-2)	\$6.50 ea
90320	Xenon Bulb (Survivor Div 1)	\$8.50 ea
74914	Strion Bulb	\$7.50 ea
78915	Bulb (Stinger HP, Stinger XT HP)	\$8.50 ea

### MAG CHARGER® SYSTEM

This rugged and reliable unit includes a rechargeable 5-D Mag-Lite® with 12 volt DC cigarette lighter adapter and 110 volt AC converter, charging unit, battery pack and mounting bracket.

Item #	Description	Price
RL1019	Mag Charger® System	\$125.00 ea
ARXX235	Battery Pack for Charger System	\$29.95 ea
ARXX035	110 Volt AC	\$9.95 ea
LR00001	Halogen Bulb	\$4.95 ea
ARXX185	Recharging Cradle	\$25.50 ea
109-000-521	Switch/Collar Seal (2003-2013)	\$2.50 ea
109-028	Switch Seal, New	\$2.50 ea

\*Call for Quantity Pricing.

### BATTERIES

Item #	Description	Price
20175	Battery Stick (SL-20X-LED)	\$45.00 ea
20170	Battery Stick (SL-20X) (NiCad Batteries)	\$45.00 ea
44007	Battery (Vulcan/Fire Vulcan)	\$35.00 ea
45937	Battery (LiteBox)	\$45.00 ea
64030	"N" Cell Batteries - 6 pack (3N)	\$8.00 pk
65030	AAAA Batteries - 6 pack	\$7.50 pk
74175	Battery Stick (Strion)	\$29.00 ea
75175	Battery Stick, (Stinger, Stinger XT, Stinger HP, Stinger XT HP, PolyStinger)	\$19.00 ea
77175	Battery Stick (SL-20XP-LED, UltraStinger)	\$35.00 ea
85175	Lithium Batteries (2) Pack	\$4.50 pk
90337	Battery Pack Assembly (White Sleeve, NiCad Battery) (Survivor Div 1)	\$42.50 ea



### CHARGERS

Item #	Description	Price
22050	DC2 Direct Wire Charge Cord	\$11.50 ea
22051	DC1 Charge Cord (All Rechargeables)	\$11.50 ea
22052	Charge Sleeve Assembly (SL-20X/SL-20X-LED/SL-20XP-LED)	\$10.50 ea
22311	120V AC Charge Cord (All Rechargeables except UltraStinger Fast Charger)	\$18.00 ea
22665	120V AC Fast Charge Cord (Required when fast charging UltraStinger)	\$24.00 ea
44100	Charging Rack (Vulcan) Yellow	\$19.00 ea
44101	Charging Rack (Vulcan, Fire Vulcan) Orange	\$19.00 ea
44130	Direct Wire 12V DC Charging Rack (Vulcan) Yellow	\$37.50 ea
44131	Direct Wire 12V DC Mounting Rack (Vulcan, Fire Vulcan) Orange	\$37.50 ea
45070	Mounting Rack (LiteBox) Orange	\$24.00 ea
45071	Direct Wire 12V DC Mounting Rack (LiteBox) Orange	\$42.50 ea
74102	Charger Holder (Strion)	\$33.50 ea
75100	Charger Holder Stinger (10 Hour) (All Stingers)	\$19.00 ea
75103	Charger Holder Fast Charge (2.5 hour) (All Stingers)	\$37.50 ea



# SPOTLIGHT & SCENE LIGHTING

## Work Lights & Compartment Lighting



**WHELEN**

### PERIMETER ENHANCEMENT LIGHT, SUPER-LED®

Multi-purpose design for illuminating the work area around emergency and utility vehicles. The Perimeter Enhancement Light can also be used in a wide range of other applications such as hose beds, walkways, under-body ground illumination, pick-up truck beds and utility vehicles where white illumination is needed. Super-LED lightheads provide reliable, bright light which will stand up to harsh environments and vibration.

- Downward projected, reliable, ground lighting for the perimeter of your vehicle
- Six diode Super-LED module in a rugged polycarbonate housing; available in Chrome or Black
- Steady-burn, White light is projected downward at a 40° angle to illuminate a large area
- Mounts to vertical surfaces and may be mounted inverted
- Supplied with 6" pigtail connector, customer supplied switching required
- Molded rubber gasket protects body panels
- 5 year HDP® Heavy-Duty Professional warranty

Item #	Description	Price
PELCC	Chrome Flange, White LED	\$160.00 ea
PELCB	Black Flange, White LED	\$160.00 ea

### FLUORENT PLUS™ SUPER-LED® COMPARTMENT TUBE LIGHTING

Fluorent Plus™ are the brightest LED tube light assemblies in the business. Designed for compartment lighting in increments of 9" for a custom fit with off-the-shelf convenience.

- Fluorent Plus Series utilizes two diodes per inch for greater illumination
- Clear light tubes
- Rugged 120° Super-LED light assemblies provide light without taking up valuable compartment space.
- Light tube can be rotated to direct light where it is needed when using the "C" clip mounting
- Standard sizes available in 9" increments up to 63"
- Custom lengths available
- Includes both "C" clips for snap-in mounting and "P" clips for fixed mounting
- 5 year HDP® Heavy-Duty Professional warranty

Item #	Description	Price
F09PC	9" Non-Frosted Lens	\$69.00 ea
F18PC	18" Non-Frosted Lens	\$105.00 ea
F27PC	27" Non-Frosted Lens	\$136.00 ea
F36PC	36" Non-Frosted Lens	\$179.00 ea

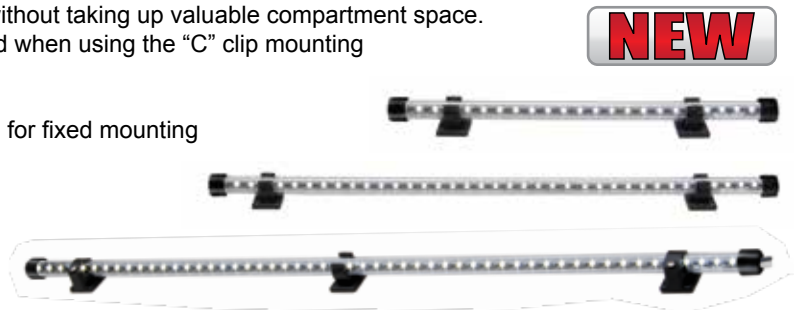

**WHELEN**



### PAR-36 ROUND SUPER-LED® WORK LIGHT WITH STUD/SWIVEL MOUNT

PAR-36 Super-LED worklights are rated to last thousands of hours and provide remarkably bright light. Available in either spot or flood beam pattern, these versatile work lights feature stainless steel mounting hardware.

Item #	Description	Price
P*BS6	6 Super-LED Flood or Spot, Black Housing	\$179.00 ea
P*BS6S	6 Super-LED Flood or Spot, Black Housing, switch	\$185.00 ea
P*BS12	12 Super-LED Flood or Spot, Black Housing	\$235.00 ea
P*BS12S	12 Super-LED Flood or Spot Black Housing, switch	\$239.00 ea

\*Specify spot or flood.

Unity post mounted spotlights are the only emergency/auxiliary lighting products that offer the convenience and safety of instant light when and where you want it. The interior control handle with fingertip switch provides 340° (UNITY®HID) or 360° (THE BEAM®) continuous horizontal rotation and up to 120° of vertical adjustment.

### 330 & 325 SERIES POST MOUNTED 6" SPOTLIGHTS

Features:	330 Series	325 Series
Chrome or Black Plastic Head	X	X
Rubber Grip Handle	X	X
12 Volts	X	X
100 Hours Lamp Life	X	X

Item #	Description	Price
330 Series	6" Post Mounted (with mount kit)	\$144.00 ea
325 Series	6" Post Mounted (with mount kit)	\$144.00 ea
UMNTKIT	Mount Kit for Post Mounted Spotlights	\$35.00 ea

(Prices may vary depending on vehicle type and application.)



### REPLACEMENT LED SPOTLIGHT



Designed especially for the Unity® spotlight, PAR-46 LED spotlight lightheads are a drop-in replacement for outdated halogen lamps.

- Industry standard brass slotted head connection point
- Replaceable hard coated polycarbonate lens provides increased durability and longevity
- 12VDC Super-LED® spotlight draws only 2.3 amps
- Provides more lumens per watt than traditional sources:  
Whelen LED PAR-46: 2000 Lumens, 30 Watts  
Halogen Lamp: 1000 Lumens, 50 Watts

Item #	Description	Price
P46SLC	LED Replacement 2° Spotlight	\$215.00 ea
P46FLC	LED Replacement 8° Spotlight	\$215.00 ea



P46SLC

P46FLC

### PIONEER NANO™ NP SERIES WORK/SCENE LIGHTS

Rugged, heavy-duty tiny light with a giant attitude.

- Three and six diode models
- Three diode models produce 1100 Lumens, 6 diode produces 1800
- Rugged, die-cast aluminum housing, powder coated Black or White
- Solid-state electronics are rugged and reliable, built for the long haul
- 12 VDC, 24V models available for 6 diode models
- Heavy-duty housing, electronics and mounting
- 8° spotlight pattern, comes standard
- Includes an additional 40" x 20" floodlight lens
- Optic lens changes easily via four screws in picture frame fixture
- Rated to last thousands of hours with remarkable bright light
- Nano Pioneer Series is rated IP67 for dust and water resistance
- Five-year HDP® Heavy-Duty Professional warranty

Item #	Description	Price
NP3BW	3-LED, with Bail Mount, White	\$159.00 ea
NP3BB	3-LED, with Bail Mount, Black	\$159.00 ea
NP6BW	6-LED, with Bail Mount, White	\$199.00 ea
NP6BB	6-LED, with Bail Mount, Black	\$199.00 ea



**NEW**

# SPOTLIGHT & SCENE LIGHTING

## Floodlight Pole Assemblies

### POLE ASSEMBLIES FOR PIONEER™ SERIES

Whelen took their knowledge and expertise of LED technology and applied it to scene lights, creating the Pioneer Series. Upgrade your halogen or HID lighting and save on amp draw and eye strain!

- Extruded aluminum pole assemblies
- 12" outer body, 57" adjustable pole assembly
- Outer body luminescent strips that glow in the dark after exposure to light
- Outer body certified to NFPA
- Cradle and sensor available with certain models
- With a cradle to stop/hold it securely and a sensor to insure its safely seated for travel
- 15.8" access handrails or handhelds
- Optional electromagnetic sensor indicates if the pole has been seated properly into the cradle for travel
- Requires pole/pedestal mount adapter. (purchased separately)
- Silver stand-off mounting brackets available in 3" to 5" and 5" to 7" adjustable, and 2" non-adjustable

**WHELEN**



86930UA3  
Bottom Push-Up



870870A1  
Through Body Mount



8728301  
Large Folding Tripod



8731200  
Ground Tripod

Pole/Mount	Mounting Configuration	Price
86930UA3	Bottom Push-Up, 2" Side Mount	\$539.00
86930UV3	Bottom Push-Up, 2" Side Mount w/ Cradle	\$639.00
86930UW3	Bottom Push-Up, 2" Side Mount w/ Cradle and Sensor	\$699.00
870870A1	Through Body Mount, 30" Body and 20" Legs	\$479.00
8728321	Small Folding Tripod w/ Cable, No plug	\$749.00
8728301	Large Folding Tripod, 50" Body and 30" Legs w/ Cable	\$879.00
8731200	Ground Tripod w/ Cable	\$245.00



# SPOTLIGHT & SCENE LIGHTING

## Floodlights

### PIONEER™ & PIONEER PLUS™ SUPER-LED® FLOODLIGHTS

Whelen took their knowledge and expertise of LED technology and applied it to scene lights, creating the Pioneer Series. Upgrade your halogen or HID lighting and save on amp draw and eye strain! Floodlights are instant On/Off eliminating the ramp up time and high current in-rush required by high intensity discharge and other light sources.

- Available in 12- and 24VDC and UL® approved 120VAC
- Pioneer LEDs are remarkably efficient, operating at a high lumen to watt ratio
- Rugged die cast aluminum, powder coated housing, available in white or black
- Pioneer Plus lights are designed for greater output and produce more than twice the number of usable lumens than standard Pioneer lights

## NO INSECTS

Pioneer Floodlights produce NO ultra violet rays that attract insects during nighttime operations! (Pioneer lights emit no EMI based on SAE 1113-42, Class 5 testing.)



300W Halogen



PFP1

Traffic cones are at 25' intervals up to 200' from the light source and a width of 75'

### Lighthouse Output



Item #	Lamp Type	Volts	Amps	Watts	Usable Lumens
PFA1	Single Flood	12	3	35	3,000
PFA2	Dual Flood	12	6	70	6,000
PFP1	Single Flood	12	6	75	7,000
PFP2	Dual Flood	12	12	150	14,000
PTP1	Single 2° Spot	12	5.4	70	4,500
PSP1	Single 8° Spot	12	6	75	7,000
PCP2	Flood & 8° Spot	12	12	75/75	7,000/7,000
PFP1AC	Single Flood	120	.625	75	5,500
PFP2AC	Dual Flood	120	1.25	150	11,000

Lumens are a total quantity of light, while candlepower is a measure of light intensity in one direction. Usable lumens are a measure of light intensity at zero degrees horizontal and vertical from the viewpoint of the observer.

Item #	Description	Price
PFA1	Pioneer Floodlight	\$545.00 ea
PFA2	Pioneer Dual Floodlight	\$959.00 ea
PFP1	Pioneer Plus Floodlight	\$733.00 ea
PFP2	Pioneer Plus Dual Floodlight	\$1,279.00 ea
PTP1	Pioneer Plus 2° Spotlight	\$733.00 ea
PSP1	Pioneer Plus 8° Spotlight	\$733.00 ea
PCP2	Pioneer Plus Floodlight/8° Spotlight	\$1,279.00 ea
PFP1AC	Pioneer Plus Floodlight 120VAC	\$879.00 ea
PFP2AC	Pioneer Plus Dual Floodlight, 120VAC	\$1,529.00 ea
PFLASH	Pioneer Flasher	\$89.00 ea

Add a Pedestal Mount for \$209.00 ea, or Pedestal Mount and On/Off Switch for \$229.00 on any model. Pioneer flasher allows floodlights to be flashed for added secondary warning in "Clearing Right of Way" mode.



PFLASH



PFA1



PFA2



PFP1



PFP2



PTP1



PSP1



PCP2

# SPOTLIGHT & SCENE LIGHTING

## Scene Lights

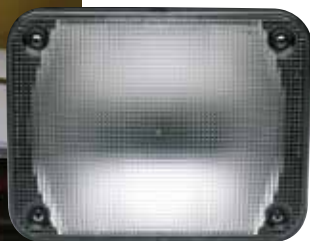

### MODEL 900 SERIES SCENE LIGHT

A 26° gradient scene light featuring Whelen's own Opti-Scenelight™ optics, which produce excellent lighting coverage throughout the work area with only a single 35 watt snap-in bulb. Flush mount design requires recess hole.

Dimensions: 9-1/8" W x 7-1/8" H x 3-1/4" D

Item #	Description	Price
90E000ZR	Model 900 Series Scenelight	\$129.00 ea
9EFLANGE	900 Series Chrome Flange	\$19.00 ea
H35SN12	35 Watt Replacement Bulb	\$18.50 ea

**WHELEN**



M9

M6



### M SERIES SUPER-LED® SCENE LIGHTS

LED scene lights feature inner optics that direct light downward without angle brackets.

- Super-LEDs provide unmatched high intensity output with low current consumption
- Lens and reflector are a sealed assembly, eliminating water infiltration
- Dimensions: M6: 4-5/16" H x 6-3/4" W x 1-3/8" D  
M9: 6-1/2" H x 10-3/8" W x 1-3/8" D

Item #	Description	Price
M6ZC	M6 Gradient Scene Light, White	\$299.00 ea
M9LZC	M9 Gradient Scene Light, White	\$449.00 ea



MODEL 7900



MODEL 5149

### GOLIGHT SEARCH LIGHTS

Covering all the angles. Make the most of extreme candlepower!

- Cr5 PentaBeam technology
- 400,000 Candlepower light source
- Projects up to one half mile
- 370° Rotation with 120° Tilt
- Sealed from rain, snow and dirt
- 3 Year Limited Warranty

**GOLIGHT**

Item #	Description	Price
5149	Remote Controlled Portable Search Light, Gray Includes: Wired Remote Control, Suction Cup, Permanent Mount Shoe, Amber Snap-on Lens and Heavy Nylon Carrying Case.	\$125.00 ea
7900	Remote Controlled Portable Search Light, White. Includes: Programmable, Wireless Remote, Suction Cup, Permanent Mount Shoe, Amber Snap-on Lens and Heavy Nylon Carrying Case.	\$215.00 ea

### EVOLUTION LAMPHEAD

The lamphead has an unique parabolic reflector that projects the light directly onto the action area and also illuminates the immediate working area around the vehicle. The long life rugged LEDs allow for low maintenance and expense over the operational life. The LED light output is instant-on at full intensity and provides immediate restarts with no warm-up time required.

- Low Power: 13 Amps at 12 VDC Generates 15,000 Lumens
- Long Operating Life - LEDs Rated at 50,000 Hours
- Full Brightness at Power On - Instant Restart



**NEW**



Item #	Description	Price
FCA100-V08	LED Scenelgt, EVOLUITION, DC 8000 lm, lamphead	\$879.00 ea
FCA100-V15	LED Scenelgt, EVOLUTION, DC15000 lm, lamphead	\$1,059.00 ea

### SPECTRA LAMPHEADS

The advanced lens design generates a uniform flood and spot combination light pattern. This light pattern provides enhanced work area visibility as well as illuminates objects at a farther distance. Lamphead is available in a surface mount configuration. The slim body design keeps the lamphead closer to the vehicle.

- Combination of Flood and Spot LEDs
- Unique Lens Design and LED Array Provide More Light
- Available in 15k or 20k Lumens, 12/24 VDC and 120/240 VAC
- Innovative Cooling Fins Provide Higher Efficiency
- Long Operating Life - LEDs Rated at 50,000 Hours
- Instant-On at Full Intensity



Item #	Description	Price
SPA100-J20	LED Scenelgt, SPECTRA, 240VAC 20k lm, lamphead	\$1,485.00 ea
SPA100-K20	LED Scenelgt, SPECTRA, 120VAC 20k lm, lamphead	\$1,485.00 ea
SPA100-Q15	LED Scenelgt, SPECTRA, DC 15k lm, lamphead	\$1,250.00 ea
SPA100-Q20	LED Scenelgt, SPECTRA, DC 20k lm, lamphead	\$1,485.00 ea

## EQUIPMENT DEMONSTRATION VEHICLE



Our professional sales consultants can come to your site with one of our fully equipped demo vehicles to show you the latest product options and share new ideas for equipment use and mounting. Contact us today to schedule a time to meet!



# SCENE TOOLS

## Scene Tools

### THE BIGEASY™



Unlock almost any car on the road!

- Available in high visibility pink, or glow-in-the dark to see the tool at night or through tinted windows
- Improved non-marring wedge and paint protector prevent damage to the vehicle's paint
- Lock knob lifter slides between the window to lift knobs at the top of the door

Item #	Description	Price
32900	BigEasy™ Lockout Kit	\$36.00 ea
32911	BigEasy™ Public Safety Lockout Kit	\$59.00 ea
32935	BigEasy™ Storage Pouch	\$29.00 ea
32955	BigEasy™ Glo Lockout Kit	\$68.00 ea

32900 Includes:  
BigEasy Classic  
Lock Knob Lifter  
Paint Protector  
Non Marring wedge

32911 Includes:  
BigEasy Classic  
Lock Knob Lifter  
Paint Protector  
Non Marring wedge  
Easy Wedge Inflatable

32955 Includes:  
BigEasy Glo  
Lock Knob Lift  
Paint Protector  
Non-marring wedge  
Easy Wedge Inflatable

BigEasy Classic

32900



Paint Protector

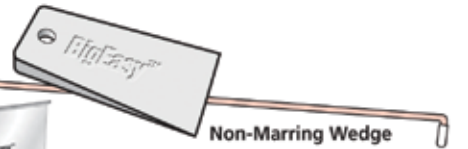

Non-Marring Wedge

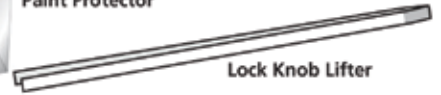

Lock Knob Lifter



32911

(Pictured with optional carrying case)

32955 Includes:  
BigEasy Glo  
Lock Knob Lift  
Paint Protector  
Non-marring wedge  
Easy Wedge Inflatable



**NEW**

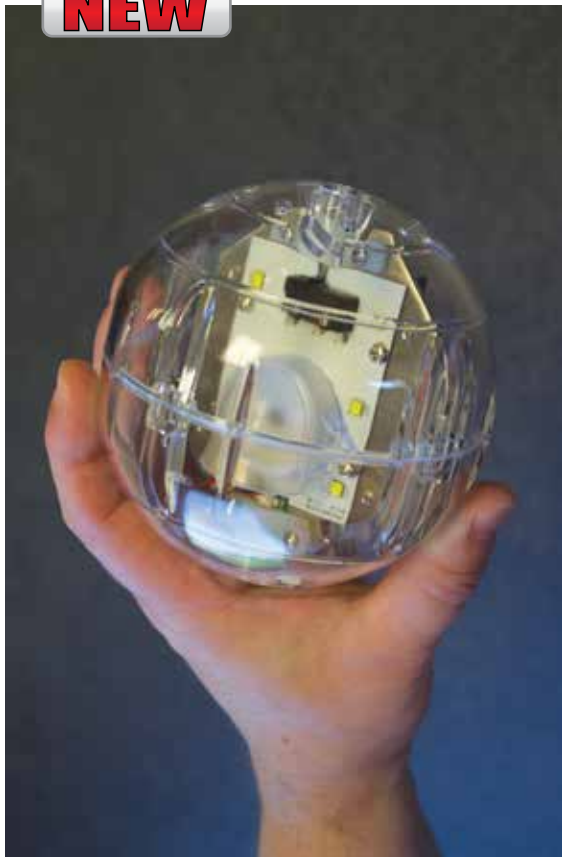

### THROW-LIGHT TACTICAL

This is a non-lethal device that can provide you with 360° of steady illumination. Along with that comes a disorienting strobe and siren. The Throw-light can be used to light up a room, distract, and much more. Also, for your convenience, there is a Combination Kit that will allow you to carry up to three of these lights at ease in a durable, hard-sided case, along with three chargers and remotes to match.

- Over 100 db of deafening sound
- Disorienting strobe
- Remote activation
- Rechargeable LiPo battery
- 360 degree illumination
- Safe and effective alternative to flashbangs and other tactical products
- Can be rolled or thrown into the most demanding situations
- Keeps law enforcement out of harms way
- Waterproof

Item #	Description	Price
SLTAC-01	Throw Light Tactical	\$299.95 ea
SLTAC-KIT	Throw-Light Tactical Combination Kit	\$959.00 ea



Remote:  
Press Once: Steady Burn  
Press Twice: Disorienting Strobe and Siren

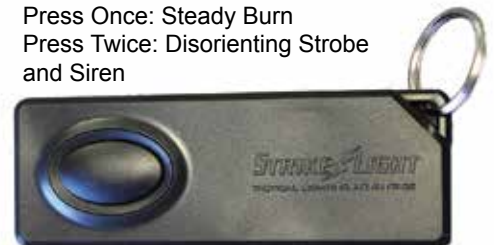

### VEHICLE WASH

Shield Solutions® Vehicle Wash has a unique sheeting action which reduces the need for drying. Product is easy to apply with our foamer and leaves a clean and shiny surface. Vehicle Wash can also be used in bucket washing or in a pressure washer.

- Dries virtually spot free
- Easy to use! Simply: Foam, Brush and rinse
- Cost effective and safe on vehicle surfaces
- pH neutral formula and works with hard water
- Tested safe on light lenses and light bars
- Available in a combination starter kit, in 1 gallon bottles or in a 5 gallon pail

**NEW**



Item #	Description	Price
VW101	1 Gallon	\$19.75 ea
VW105	5 Gallon Pail	\$72.50 ea

### ALUMINUM & METAL CLEANER/BRIGHTENER

This product is designed to make the cleaning and maintenance of all polished metal surfaces fast, safe and easy. Requires no polishing or buffing. Provides the desired effects with minimal effort.

- Cleans and brightens aluminum, chrome and stainless steel
- Removes oxidation and rust stains
- Easy to use and safe on vehicle surfaces
- Excellent for stainless steel wheels and diamond plate
- Available in a combination kit or a 1 gallon bottle

**NEW**



Item #	Description	Price
AC101	1 Gallon	\$26.25 ea

### WASH & WAX

Each application leaves a deep shine and surface protection. Foam it on or use in bucket washing or a pressure washer.

- Highly concentrated formula
- Contains Carnuba Wax
- Easy to use and safe. Tested safe on light lenses and light bars
- Simply foam, brush and rinse
- Available in 1 gallon bottles or in a 5 gallon pail

**NEW**



Item #	Description	Price
WW101	1 Gallon	\$20.25 ea
WW105	5 Gallon Pail	\$82.50 ea

# VEHICLE WASH

## Vehicle Cleaners



### TURNOUT GEAR & PPE WASH

Shield Solutions® Turnout Gear & PPE Wash meets recommendations set forth by NFPA 1851, 2008 ed. related to detergents used for the cleaning of turnout gear. Gentle, yet strong enough to meet the challenges of cleaning turnout gear.

- pH neutral (6.5 to 7.5) formula is safe on reflective materials
- Will not corrode hardware or damage fabrics
- Highly concentrated formula, for machine or hand washing.
- Can be used for all laundry needs.
- Available in 1 gallon bottles or in a 5 gallon pail.

**NEW**

Item #	Description	Price
GW101	1 Gallon	\$29.50 ea
GW105	5 Gallon Pail	\$129.50 ea



### HOSE END FOAM SPRAYER

Easy to use sprayer attaches to the end of a hose for simplified washing. Durable and helps reduce waste of cleaners.

Item #	Description	Price
HF001	Hose End Foam Sprayer	\$67.25 ea

**NEW**



### TELESCOPING WASH BRUSH

Durable aluminum handle wash brush has a telescoping handle that extends from 3 feet to 6 feet. Great for reaching all areas of a vehicle. 10" bi-level brush head with clear coat safe heavy flagged soft bristles.

Item #	Description	Price
TB001	Telescoping Brush	\$31.50 ea

**NEW**



### 48 OZ. PUMP UP FOAM SPRAYER

Compact, easy-to-use foam sprayer simplifies the vehicle cleaning process. The foamer is proportioned so you just fill and use. Helps improve cleaner performance. Two styles: Vehicle Wash Foam Sprayer and Metal Cleaner Foam Sprayer.

Item #	Description	Price
PF001	Foam Sprayer for Aluminum	\$29.50 ea
PF002	Foam Sprayer for Vehicle Wash	\$29.50 ea

**NEW**



### BASIC VEHICLE CLEANING KIT

This Shield Solutions® combination kit includes starter components for effectively washing emergency vehicles, trailers and more!

- (1) 5 gallon pail of vehicle wash
- (1) Hose End Foamer
- (1) Telescoping Wash Brush (3' to 6')

Item #	Description	Price
VCK1	Basic Vehicle Cleaning Kit	\$165.00 ea

**NEW**



### DELUXE VEHICLE CLEANING KIT

This Shield Solutions® combination kit includes the same great components as the Basic Vehicle Cleaning Kit but also includes extra components to further improve the cleaning experience.

- (1) 5 gallon pail of vehicle wash
- (1) Hose End Foamer
- (1) Telescoping Wash Brush (3' to 6')
- (12) Micro Fiber Towels - 14" x 14", reusable
- (1) 32 oz. Tire Finish
- (1) 32 oz. De-greaser
- (1) 32 oz. Glass Cleaner
- (1) 32 oz. Spray Detailer

Item #	Description	Price
DVCK2	Deluxe Vehicle Cleaning Kit	\$215.00 ea

**NEW**



### ALUMINUM & METAL CLEANER BASIC KIT

This Shield Solutions® Aluminum & Metal Cleaner Kit includes product and accessories to make the cleaning and maintenance of polished metal surfaces fast, easy and safe. Great for diamond tread.

- (1) 1 gallon bottle of aluminum and metal cleaner/brightener
- (1) Pump Up Foam Sprayer (For Alum cleaner)
- (1) Soft Bristle Scrub Brush

Item #	Description	Price
DPK1	Aluminum & Metal Cleaner Basic Kit	\$215.00 ea

**NEW**



## Can't Find What You're Looking For?

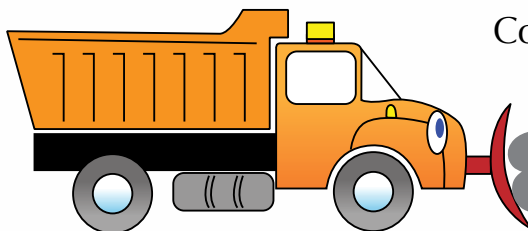

Contact our sales team. We have many more products available that are not featured in the catalog.

# 866-320-7277

# EVIDENCE COLLECTION

## Evidence Collection Bags & Tape

### KEEPSAFE® TAMPER EVIDENCE BAGS

**NEW**

Evidence Collection bags allow forensics laboratories, law enforcement officials, and security professionals to fulfill their tamper-evident and forensic packaging needs. We understand that collecting and preserving evidence is an important part of criminal investigation so our bags include advanced sealing technology made from durable performance films designed to excel in any forensic application or laboratory. Bags offer tamper evidence and chain-of-custody. Protect evidence in these easy-to-seal, tamper-resistant polybags. Pre-printed bags have all the information fields required for proper evidence and chain of custody tracking for submission to the crime laboratory.



- Clear material allows viewing of contents
- Easy-to-seal, tamper-resistant, void closure seal
- Sequential numbers and bar code for traceability
- Available in three stock sizes. 6 x 10, 10 x 13 and 12 x 16
- Available 100 per package

Item #	Description	Price
PPSE-EVD0610	KeepSafe Tamper Evidence Bags, 6" x 10"	\$16.50 pk
PPSE-EVD1013	KeepSafe Tamper Evidence Bags, 10" x 13"	\$21.00 pk
PPSE-EVD1216	KeepSafe Tamper Evidence Bags, 12" x 16"	\$27.50 pk



Tear Off Receipt

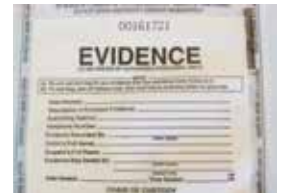

Writing Area

### EVIDENCE TAPE

**NEW**

Unique packaging size is ideal for evidence collection and other forensic kits. Protects the integrity of your collected evidence! This tamper evident tape features sawtooth edges and unique adhesive properties that cause the tape to tear, break or leave behind small pieces when an attempt is made to lift or remove.

- With tape in place, it's very evident when an unauthorized attempt is made to remove
- Unique blister packaging is compact and easy to store
- Bold and prominent repeating EVIDENCE message
- Small roll sizes easily allow multiple colors to be used in an economical fashion
- Can be written on with a fine tip permanent marker
- Available in Blue, Red and Yellow - 1/2" W x 50 ft per roll

Item #	Description	Price
500029	Evidence Tape, Red, 50 ft. roll	\$3.95 rl
500030	Evidence Tape, Blue, 50 ft. roll	\$3.95 rl
500031	Evidence Tape, Yellow, 50 ft. roll	\$3.95 rl

Other colors and messages are available. Contact us for details. Customize with your facility name for very low minimum order quantities.



Attempt to remove or lift causes tearing.



### TAMPERBLOCK™ REUSABLE TAMPER EVIDENT COLLECTION BAGS

**Eliminate waste and save per use versus tamper evident poly bags.**

These durable tamper evident reusable bags provide security for forensic evidence collection, controlled substances and other important supplies during transport and handling. Bags help prevent tampering and fraud by providing instant awareness of attempted access and provide quick verification of a use when a seal is broken.

Unique tamper evident seal snaps into a chamber, preventing the bag zipper from opening without breaking the seal. Enables tracking by the barcoding and consecutive numbering on the breakable seals. Accountability is created from point of origin to use.

Utilize a barcode scanner system to eliminate time consuming paperwork and create an audit process. Eliminate waste with a reusable secure solution that lasts many uses, eliminating tons of discarded one-use poly bags from landfills annually. EMI21112 and EMI1413 TamperBlock Premier are made of a durable 16 mil water resistant vinyl material. These bags are a bit more rugged than the standard TamperBlock bags.



- Features internal access only windows for important documents or routing information. Fits 4" x 6" card.
- Four bags available: 8-1/2 x 4, 10 x 10, 12 x 10, and 16 x 12. Contact us if you have a need for a different size.
- Bags are sold individually with 10 starter seals. Seals have a Code 128 barcode.
- White or Red tamper evident numbered and barcoded seals are available 50 per package.

Item #	Description	Price
EMI11112 (A)	TamperBlock, 10" x 10", Clear PVC	\$13.00 ea
EMI21112 (B)	TamperBlock Premier, 10" x 10", Clear Vinyl	\$27.00 ea
EMI31112 (C)	TamperBlock, 12" x 10", Clear PVC	\$13.50 ea
EMI41112 (C)	TamperBlock, 16" x 12", Clear PVC	\$14.00 ea
EMI1413 (D)	TamperBlock Mini Premier, 8-1/2" x 4", Clear Vinyl	\$18.50 ea
EMI51112 (E)	TamperBlock Bag Seal, Numbered, Barcoded, 50/pkg.	\$7.00 pk



**A**

To secure insert the tamper evident seal into the chamber, clicking it securely in place.



**B**



**C**



**D**



**E**



# PERSONAL GEAR

## Gloves



### MICROFLEX MIDKNIGHT BLACK

Black Glove, Nitrile, Non-Sterile, Ambidextrous, Fully Textured, Beaded Cuff, For Single Use Only.

Fingertip Thickness 5.5 mils  
 Palm Thickness 4.7 mils  
 Cuff Thickness 3.1 mils

Sold 10 boxes per case.

Item #	Description	Price
MK-296*	Midnight Black Nitrile, 100/box	\$115.00 cs

\*Specify SM, MD, LG or XL



### MICROFLEX ULTRA ONE

Natural Color, Latex, Non-Sterile, Ambidextrous, Textured Fingers, Extended Beaded Cuff, the UL-315 is the US-315-S that is the small, UL-316-M=medium, UL-317-L=Large, UL-318-XL=XLarge

Fingertip Thickness 11.8 mils  
 Palm Thickness 9.8 mils  
 Cuff Thickness 6.7 mils

Sold 10 boxes per case.

Item #	Description	Price
UL-315*	Ultra One Latex, 50/box	\$145.00 cs

\*Specify SM, MD, LG or XL

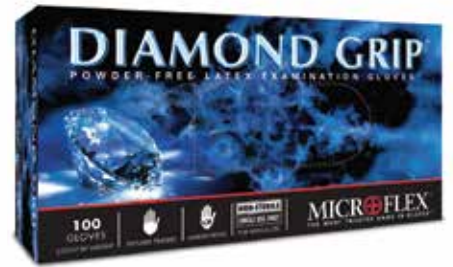

### MICROFLEX DIAMOND GRIP

Natural Color, Latex, Non-Sterile, Ambidextrous, Textured Fingers, Beaded Cuff, For Single Use Only.

Fingertip Thickness 7.9 mils  
 Palm Thickness 6.3 mils  
 Cuff Thickness 5.1 mils

Sold 10 boxes per case.

Item #	Description	Price
MF-300*	Diamond Grip Latex, 100/box	\$125.00 cs

\*Specify SM, MD, LG or XL



### GEL POLYMER COATED LATEX GLOVES

Polymer coated inside and outside for added protection. Non-sterile, for single use only.

Fingertip Thickness 8.66 mils  
 Palm Thickness 7.48 mils  
 Cuff Thickness 4.33 mils

Sold 10 boxes per case.

Item #	Description	Price
BPF10*5	Gel Polymer Coated Latex Gloves, 100/bx	\$97.50 cs

\*Specify SM, MD, LG or XL



### BIO-HAZARD HIGH RISK LATEX GLOVES

UL(r) Classified to meet NFPA 1999 Standard, 1997 edition.

Fingertip Thickness 11.42 mils  
 Palm Thickness 10.24 mils  
 Cuff Thickness 6.30 mils

Sold 10 boxes per case.

Item #	Description	Price
BHZ10*5	Bio-Hazard High Risk Latex Gloves, 50/bx	\$95.00 cs

\*Specify SM, MD, LG or XL



### BLUE NITRILE LATEX-FREE

- Contains no natural rubber latex
- Powder free

Fingertip Thickness 5.51 mils  
 Palm Thickness 4.33 mils  
 Cuff Thickness 3.15 mils

Sold 10 boxes per case.

Item #	Description	Price
SNT10*5	Blue Nitrile Latex-Free, 100/bx	\$97.50 cs

\*Specify SM, MD, LG or XL

**NEW**



# SMITH & WARREN®

Built With Care. Worn With Pride.

## YOU EARNED IT

**PRODUCTION  
IN 3 WEEKS**

We get it right... and you get it fast.  
smooth, reliable service.  
Every style, every finish

**LIFETIME  
WARRANTY**

The **ONLY** badge with a  
Full Lifetime Warranty  
the best quality and peace of mind too.

**CLEARSHIELD™**  
BY SMITH & WARREN

The most durable protective  
clearcoat technology.  
Guaranteed to never chip,  
flake, crack or tarnish.\*



MADE IN USA  
SINCE 1925

Design Your Badge **ONLINE** at [www.parrpse.com](http://www.parrpse.com)

**OVER 900 STYLES AVAILABLE**

Powered by:



### How to Order

Choose your badge style:



Choose your attachment:



Wallet Clip

Pin Back

Choose your center seal:



C193FR C181FR C183FR C175FR

C177FR C187FR C189FR C136M

C252 C134 C980 C150

All 50 states available.  
Specify state when ordering

Choose your finish:



**Nickel**  
Traditional Silver

**Rhodium**  
Brilliant bright silver

**Gold**  
24K gold electroplate

**Sil-Ray**  
Bright deep toned silver protected by ClearShield™

**Gol-Ray**  
Bright deep toned Gold protected by ClearShield™

**Two-Tone**  
Combination of Silver and Gold protected by ClearShield™

\*ClearShield™ is included on all  
Gol-Ray, Sil-Ray, and Two-Tone badges



# PERSONAL GEAR

## Body Armor

### ELITE BODY ARMOR

Incorporating the latest advancements in ballistic and smart fabric technology, the new ELITE concealable body armor system truly outperforms and over delivers in weight, thinness, flexibility and overall performance.

- Ergonomically designed for a tailored fit with minimum visibility
- Self Suspending Ballistic System™ prevents rolling and sagging of ballistic panels inside the carrier
- Easy-access to ballistic suspension through peel-back shoulder
- Smart-Fabric technology helps keep you cool, dry and comfortable
- Active Stretch exterior fabric treated with Aegis® anti-microbial fabric technology
- Micro-Spacer Inner Mesh inset features HeiQ moisture management and anti-microbial properties
- Removable elastic cummerbund stabilizes vest
- Aplix® low profile loop used for side strap attachment points

Item #	Description	Price
ELITE-AXII	Threat Level II	Starting at \$799.99 ea
ELITE-AXIIIA	Male, Threat Level IIIA	Starting at \$899.99 ea



Contact us for package pricing.

Starting At  
**\$799.99**



**NEW**

### HI-LITE BODY ARMOR

HI-LITE Performance has remained a hallmark of Point Blank's line of outstanding body armor. Specially designed to provide maximum maneuverability and comfort, this exceptionally lightweight, concealable vest offers unparalleled protection when paired with our industry-leading ballistic systems.

- Lightweight design naturally flexes to the contours of your body for exceptional maneuverability
- Self-Suspending Ballistic System™ features stretch Breathe-O-Prene® shoulder straps which connect to the front and back ballistic panels, ensuring optimal protective coverage
- Durable Water Repellent (DWR) microfiber outershell
- Dri-Lex® moisture management system moves moisture away from the body and helps keep you dry and comfortable
- Removable 2" waist straps provide 8-point adjustability – optional 4" straps available
- Removable 4" internal cummerbund stabilizes ballistic panels
- Trauma insert pockets in the front and back accommodate 5" x 8" or 8" x 10" SPEED or Blade Plates (optional)

Item #	Description	Price
HI-LITE-AXII	Threat Level II	Starting at \$759.99 ea
HI-LITE-AXIIIA	Threat Level IIIA	Starting at \$869.99 ea



Contact us for package pricing.



**NEW**

### TAC BODY ARMOR

The new Tailored Armor Carrier provides the protection you need with a stylized design that offers the professional appearance you want. Designed to be worn over the dress shirt, the TAC features two multi-functional pockets, convenient side opening and a contoured shape for total comfort. Instantly convert the TAC into a ballistic protective vest by inserting Point Blank concealable ballistic panels into the front and back interior pockets. Within a matter of seconds, the TAC is ready to wear with up to Level IIIA protection.

- Concealable and removable adjustable side straps
- 600 denier polyester outershell
- Soft poly-cotton inner lining
- Adjustable shoulder strapping system
- Two front pleated patch pockets
- Badge tab holder
- Name tab holder
- Mic holder

Item #	Description	Price
TAC-AXII	Threat Level II	Starting at \$779.99 ea
TAC-AXIIIA	Threat Level IIIA	Starting at \$899.99 ea



Contact us for package pricing.



**NEW**

#### NIJ Level II Specs

Model	Size	Weight	Thickness	V50 9MM FMJ	V50 .375 MAG
AXII	C1/C5	.63	.17	1794	1761
AXIIF	C1/C5	.63	.17	1783	1734

#### NIJ Level IIIA Specs

Model	Size	Weight	Thickness	V50 .375 CIG	V50 .44 MAG
AXIIIA	C1/C5	.87	.20	1870	1745
AXIIIAF	C1/C5	.87	.20	1884	1744





# Strategic Partners

## Upfitting Partner

**Offering you the total package! Quality product sales and installation services.**

Parr Public Safety is pleased to provide vehicle equipment upfitting services through our experienced and quality driven strategic partner, Hall Public Safety Upfitters. Upfitting and repair services are available at one of our two installation centers, or with our mobile option where repair and upfitting are completed at your location.



# Hall Public Safety

## UPFITTERS

[www.hallpublicsafety.com](http://www.hallpublicsafety.com)

### Mobile Radar Certification

Also Available Through our Strategic Partner  
Hall Public Safety Upfitters

Police Radar Certification at your site! We come to you to keep your radar units accurate and court acceptable. No need to remove any part of your radar unit and send it out for certification. You don't have to spend money shipping your radar units.



Cleveland Office | 8291 Darrow Rd Twinsburg, Ohio 44087 | 855-387-3911 Fax: 855-362-5616 | [info@hallpublicsafety.com](mailto:info@hallpublicsafety.com)  
Columbus Office | 8495 Estates Ct Plain City, Ohio 43064 | 866-320-7277 Fax: 614-873-7205 | [info@hallpublicsafety.com](mailto:info@hallpublicsafety.com)

# Whelenpartsstore.com

*Whelen Parts Store is the fast and easy way to find the Whelen parts you need.*

Find parts for common Whelen products like beacons, lightbars, mini-lightbars, dash and deck lighting, sirens and more...

Use the online schematics to locate and order the exact part you need.

[www.whelenpartsstore.com](http://www.whelenpartsstore.com)





# Front to Back SOLUTIONS

## For Your Public Safety Needs



[www.parrpse.com](http://www.parrpse.com)

**Columbus Office**  
8495 Estates Ct  
Plain City, Ohio 43064  
866-320-7277

**Parr**  
*Public Safety Equipment*

**Cleveland Office**  
8291 Darrow Rd  
Twinsburg, Ohio 44087  
855-387-3911