



INEM

Innovative Elastomer Material Technology



High performance **Rubber Sealing** and **Components**
for various industrial fields

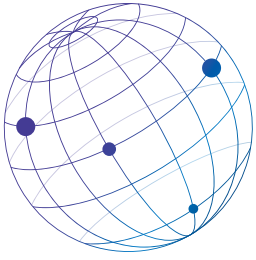

CONTENTS

Introduction _ 02

Products _ 03

Application Fields _ 04

Certificates _ 05

Technologies _ 07

Diaphragm _ 11

O-Ring _ 19

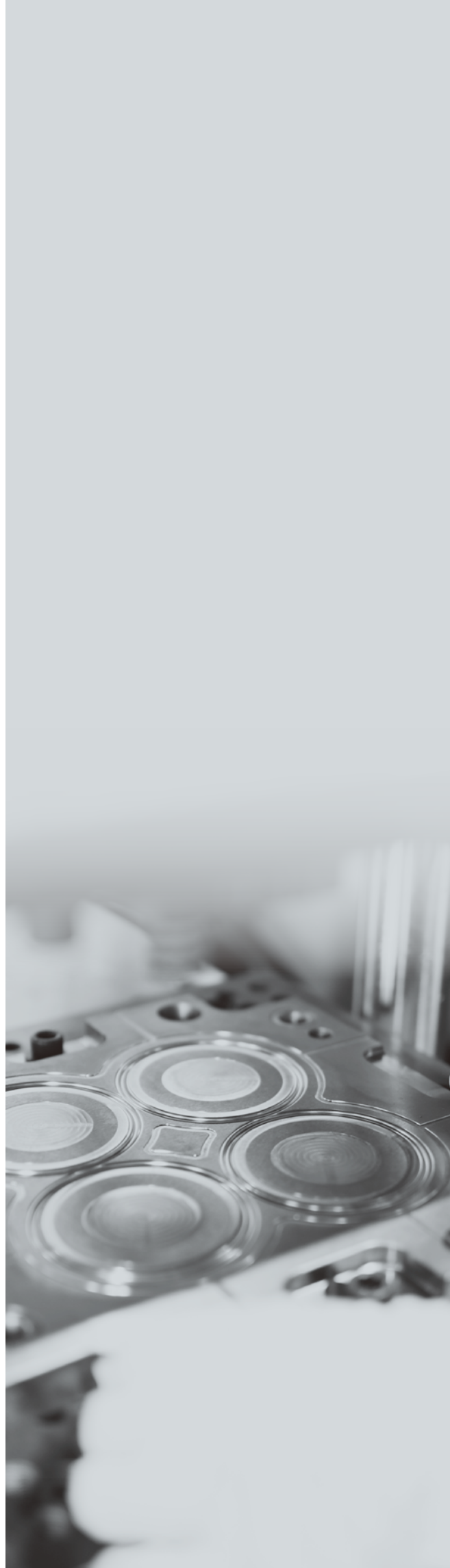

INTRODUCTION

INEM is specialized in the production of rubber material-based products such as diaphragm, o-ring, gasket, which are key components of a wide variety of equipment and devices that operate in extreme environments based on its own highly functional rubber material mixing technology. Based on the product stability and reliability built through the long-term product performance verification test process carried out over the years after the development of high-functional elastomer material mixing technology for the nuclear plant sector, we have continued to expand the applicable scope of our products to cover all industries, including heavy equipment, semiconductor, medical equipment, and various power plant industries. Furthermore, we remain fully dedicated towards providing safe and reliable products with our core values of securing productivity and price competitiveness through technology orientation, enhanced expertise, and system upgrade. In return for the constant support of our customers, INEM will continue to engage in the research and development based on its advanced technologies.

Date of establishment

January 2011

Address

235, Techno2-ro, Yuseong-gu, Deajeon, Republic of Korea 34026

Contact

Tel +82-42-862-7509 Fax +82-42-862-7508 E-mail sales@inem.co.kr

Website

www.inem.co.kr

Products

Diaphragm, O-Ring, Gasket, Rubber Packing, Rubber Component



PRODUCTS



Diaphragm

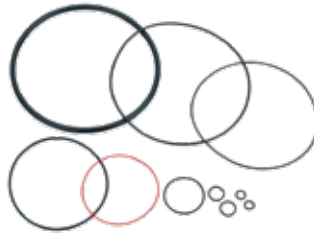

O-Ring



Capsule O-Ring

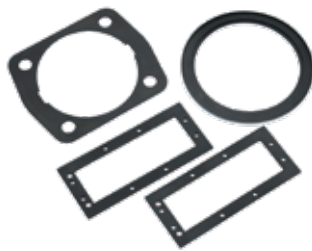

Gasket



Spiral Wound Gasket



Oil Seal



U Packing



V Packing



Hydraulic Packing



Rail Pad



Bladder



Various Rubber Component

APPLICATION FIELDS



Plant

Nuclear Power Plant
Thermal Power Plant
Chemical
Oil and Gas



Industrial Machinery

Valve and Pump
Pneumatic and Hydraulic



Heavy Machinery

Construction Machinery
Agricultural Machinery



Train and Automobile



Semiconductor



Defense Industry

CERTIFICATES



ISO 9001



ISO 14001



ISO 45001



FDA



UL



Certificate of product-specific approved exporter_Korea-EU



Repair & Maintenance of Thermal Power Plant

TECHNOLOGIES

1. CORE TECHNOLOGY

Rubber product design system

Mixing Architecture

Mixing design of physical properties

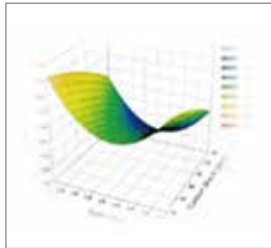

Rubber properties test

Physical property verification



Fluid Dynamics

RubDAS, Commercial S/W link



Life prediction

Aging, fluctuating load effect
Life prediction program



2. ELASTOMER TECHNOLOGY

Elastomer development in line with the environment where the products are applied

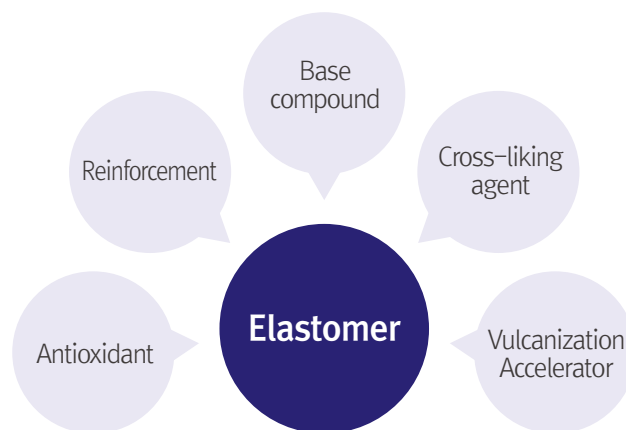

- Check the physical and chemical properties of each material
- Analysis and development of physical and chemical mechanisms

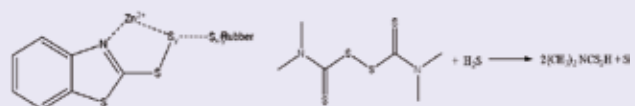

Derivation of optimal mixing conditions

TECHNOLOGIES

3. PRODUCTION TECHNOLOGY

- Smart factory that improve productivity, quality, and customer satisfaction by applying ICT(Information Communication Technology) combined with digital automation solution in the manufacturing process.
- Artificial intelligence system that analyze and predict the database for optimal production and quality.

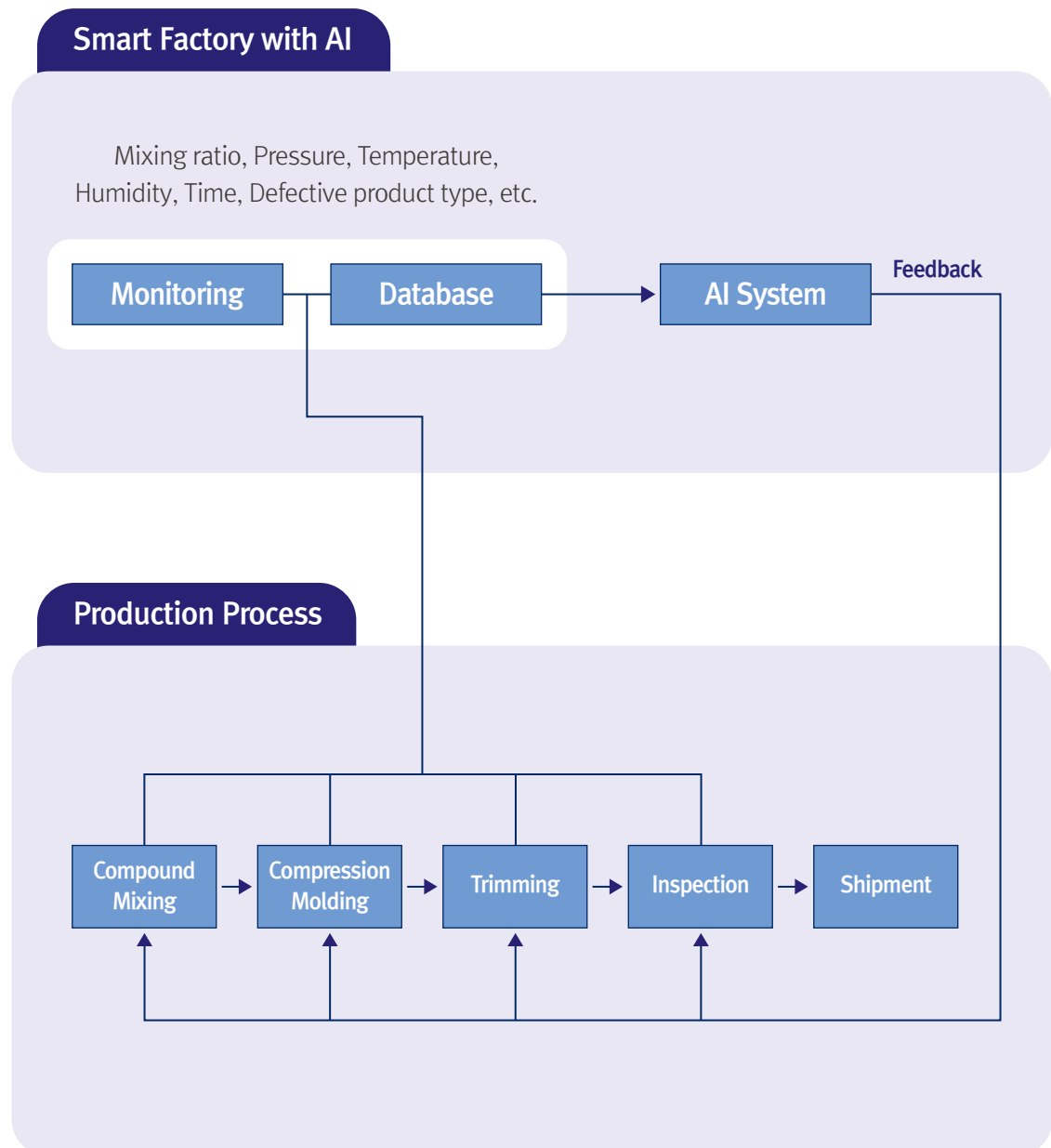



DIAPHRAGM

PRODUCT OVERVIEW

- Diaphragm is a thin film type core part that has immense influence on determining the device performance and maintaining reliable operation in valves, pumps, flow meters, and other various devices.
- INEM's diaphragm is designed to be suitable for the customer's required environment and purpose, and provides reliable operation even in harsh conditions with its intensified strength using reinforced fiber. Also, the thickness of diaphragm and the position of reinforced fiber are adjusted according to the purpose of use to improve dynamic features, control and response.
- INEM manufactures and supplies various types, standard as well as non-standard diaphragm through customized design according to the customer's requirement. INEM is suggesting the most suitable diaphragms by analyzing external factors such as temperature / fluid / pressure.



Compressor



Rolling Diaphragm



For axle disc

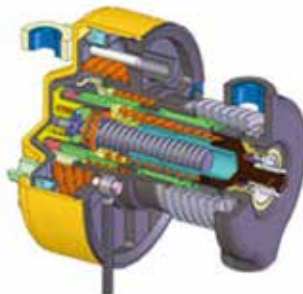

Brake Cylinder Unit



Thread pin(screw) Diaphragm



For wheel disc

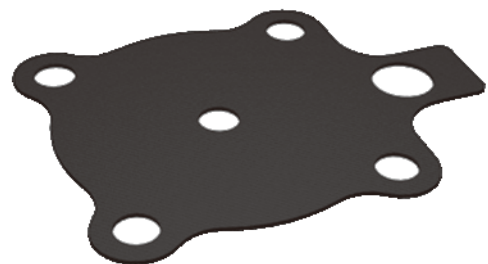

Flat Diaphragm

PRODUCTION PROCESS



1

The raw material is stored in an air conditioned warehouse that is protected against light and heat. This enables less alteration of the material.



2

One vulcanisation tool produces multiple diaphragms simultaneously.



3

Rubber raw material sheet is prepared. Also re-inforced fabric is prepared.



6

After completion of the vulcanisation process, the completed diaphragms can be removed from the tool.



5

During the vulcanisation process the specific manufacturing parameters (for example: time, temperature, pressure, etc.) are monitored and recorded for future reference.



4

The vulcanisation tool on the press – the rubber blanks are placed in the moulds.



7

Completed high-tech diaphragm. The final product is a fully-compliant and traceable diaphragm made to INEM high standard specifications.



8

Thorough final inspection makes sure of perfect quality.

PROPERTIES OF ELASTOMERS

- ALL Synthetic rubbers are made with own recipe developed by INEM
- It can be used in a temperature range from -60°C to 250°C
- Resistant to nearly all chemical, oil, liquid and gases

Material	Code	Compression Set Resistance	Hardness (Shore A)	Tensile strength(psi)	Elongation	Max Temperature	Resilience
● Isobutylene Isoprene/ Butyl	IIR	GOOD	30-100	2000+	300-800	120°C	EXCELLENT
● Chloropene/ Neoprene	CR	FAIR-GOOD	40-95	2000-3000	650-850	120°C	EXCELLENT
● Styrene Butadiene	SBR	GOOD	40-100	2000+	400-500	100°C	GOOD
● Ethylene Propylene	EPDM	FAIR	30-90	1500-3000	200-800	140°C	GOOD
● Fluorocarbon	FKM	GOOD-EXCEL.	50-95	1500-3000	100-450	250°C	FAIR
● Fluorosilicone	FVMQ	FAIR-GOOD	35-80	350-850	100-500	200°C	GOOD
● Nitrile	NBR	GOOD	20-90	1000-3500	400-600	100°C	GOOD
● Hydrogenated Nitrile	HNBR	EXCELLENT	30-95	1500-3500	90-550	150°C	GOOD
● Epichlorohydrin	ECO	FAIR-GOOD	30-95	1500-2000	300-400	125°C	GOOD
● Silicone	VMQ	GOOD-EXCEL.	25-90	600-1500	90-900	230°C	POOR-EXCEL.
● Natural Rubber	NR	GOOD	30-100	4000+	300-500	80°C	EXCELLENT
● Polyurethane	AU/EU	FAIR	60-100 45-75 (Durometer D)	3000-9000	270-800	90°C	GOOD
● Acrylic Rubber	ACM	POOR	40-90	500-2500	100-450	150°C	FAIR
● Ethylene Acrylate	AEM	GOOD	35-95	500-3000	200-850	150°C	GOOD
● Perfluorocarbon	FFKM	GOOD	65-95	1250-3600		325°C	FAIR

- Generally used materials
- Specially used materials

FABRIC MATERIALS

A key component of diaphragms is the fabric to ensure the diaphragm which can withstand the pressure, stroke and environment. INEM offers a comprehensive selection of standard fabric styles, each with specific physical characteristics, based on weave patterns, tensile strength, formability and chemical and heat resistance capabilities, as well as other variables. INEM engineers are available to assist for selecting the proper fabric for a specific application.

Fabric Characteristics

Fabric	Tensile Strength	Maximum Temperature	Fabric Gauge (mm)	General Physical Properties
Cotton	Fair	170°C	0.3~1.1	Weak acids resistance, excellent organic solvents resistance
Polyester	Fair	170°C	0.3~1.0	Light weight, general purpose, high stability
Polyamide(Nylon)	Excellent	200°C	0.2~0.7	High strength, high temperature, good abrasion resistance
Polyaramid(NOMEX)	Excellent	260°C	0.3~0.8	High temperature, mildew resistance
Polyaramid(KEVLAR)	Excellent	400°C	0.3~1.1	Extreme temperature, extreme strength
Nitrile coated polyester	Fair	120°C	0.3~1.0	Good formability
Nitrile coated Nylon	Good	120°C	0.2~0.7	High strength, good formability
FKM coated polyester	Fair	150°C	0.3~1.0	Good chemical resistance
EPDM coated Polyester	Fair	140°C	0.3~1.0	General purpose, high stability
EPDM coated Nylon	Good	120°C	0.2~0.7	Special purpose, high strength, high stability

Criteria of Fabric Selection

- Check point : Operating Pressure, Frequency(Hz), Temperature
- The selection of fabric based on the application environment is the most important.

Various Fabric Sample



- **Material** Polyester
- **Weaving type** Plain



- **Material** Polyester
- **Weaving type** Knit(Double layer)



- **Material** Polyamide(Nylon)
- **Weaving type** Woven(Single layer)



- **Material** Polyamide(Nylon)
- **Weaving type** Knit(Single layer)



- **Material** m-Aramid(NomexTM)
- **Weaving type** Knit(Single layer)



- **Material** m-Aramid(NomexTM)
- **Weaving type** Knit(Honey comb)

ROLLING DIAPHRAGMS



Characteristics

- pressure loadable only on molding
- Few changes in effective area
- very large stroke
- possible low hysteresis
- for devices of reduced size
- design part for sealing function
- long working lifetime
- no stick-slip effect

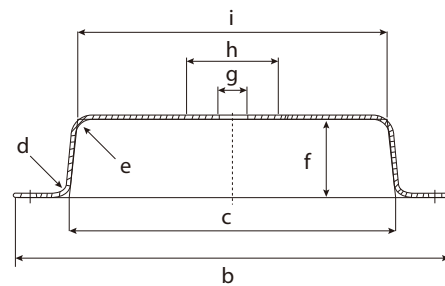
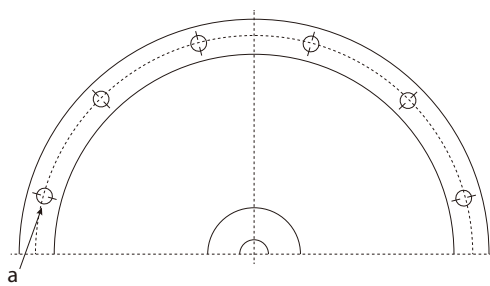

Model	a	b	c	d	e	f	g	h	i	Thickness(mm)
250	12×Ø8	250Ø	188Ø	R7	R9	44	16Ø	50Ø	178Ø	2
290	16×Ø8	292Ø	224.5Ø	R8.5	R10	48.5	16Ø	60Ø	215Ø	2
370	20×Ø8	370Ø	290Ø	R8.3	R12	68.5	16Ø	60Ø	276Ø	3.7
480	20×Ø12	480Ø	375Ø	R10	R15	97	28Ø	100Ø	360Ø	4
550	24×Ø12	550Ø	441Ø	R10	R19	120	28Ø	100Ø	322Ø	4

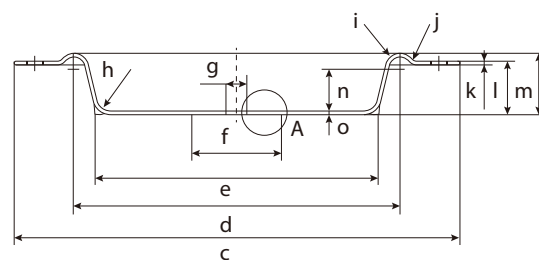
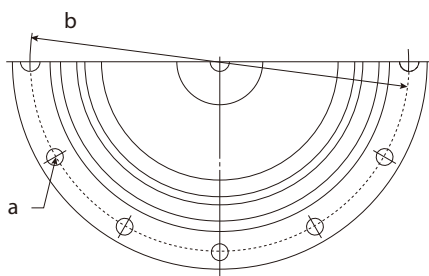

Model	a	b	c	d	e	f	g	h	i	j	k	l	m	n	Thickness(mm)
1D	12×Ø9	215±0.2	235	173.4	149.7	48	10.5	R9.5	R8	R6	2±0.2	28.5	32.5	22.5	2
2D	12×Ø8.5	248±0.2	270	198.2	170	48	10.5	R12	R8	R14	2±0.2	32.5	38.5	28.5	2
3D	16×Ø8.5	305±0.3	324	251	218	86	15.2	R10	R12	R10	3±0.2	40	49	34	3.7
4D	16×Ø11	405±0.5	430	334	290	84	19	R10	R15	R11	4	52	63	44	4

THREADED PIN(SCREW) DIAPHRAGMS



Characteristics

- Uniformly fixed in the compressor by means of a threaded pin.
- The largest advantage of fixing by means of threaded pin, e.g. in comparison to a bayonet fitting, is that the force transfer is distributed onto the large area of the flanks of the screw thread.

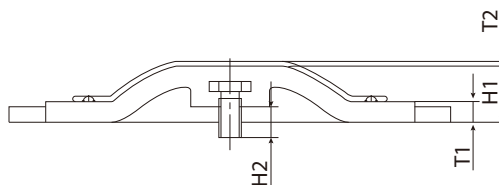
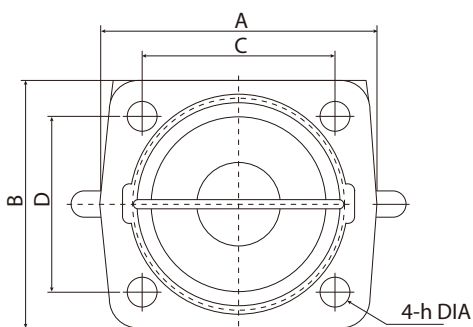

Valve Size(mm)	A	B	C	D	T1	T2	H1	H2	h
DN 20(3/4")	62	58	45	40	4.6	0.9	10.6	3.3	9
DN 25(1")	70	67	54	46	4.8	1	11.3	5.4	9.5
DN 40(1.5")	102	91	71	65	6	1.2	15.7	7.9	11
DN 50(2")	125	105	86	78	6.4	1.2	19.6	7.5	12.5
DN 65(2.5")	164	131	102	95	7.5	1.2	21.2	9	14.3
DN 80(3")	187	155	127	115	7.4	1.2	27.1	9.4	20

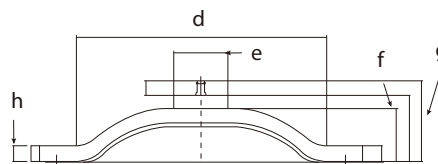
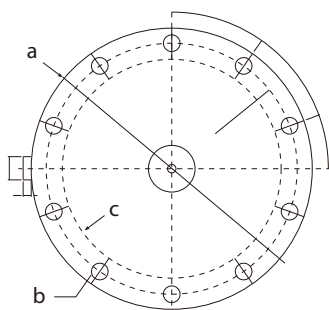

Valve Size(mm)	a	b	c	d	e	f	g	h
DN 20(3/4")	62	58	45	40	4.6	0.9	10.6	3.3
DN 25(1")	70	67	54	46	4.8	1	11.3	5.4

DISHED DIAPHRAGMS



Characteristics

- pressure loadable on both sides
- same effective area on both sides
- average stroke
- low hysteresis
- no stick-slip effect
- design part for sealing function
- long working lifetime

FLAT DIAPHRAGMS



Characteristics

- pressure loadable on both sides
- same effective area on both sides
- limited stroke as defined
- no stick-slip effect
- low hysteresis

CONVOLUTED DIAPHRAGMS



Characteristics

- pressure loadable in loop direction
- small effective surface change
- average stroke
- low hysteresis
- no stick-slip effect
- design part for sealing function
- very long working lifetime

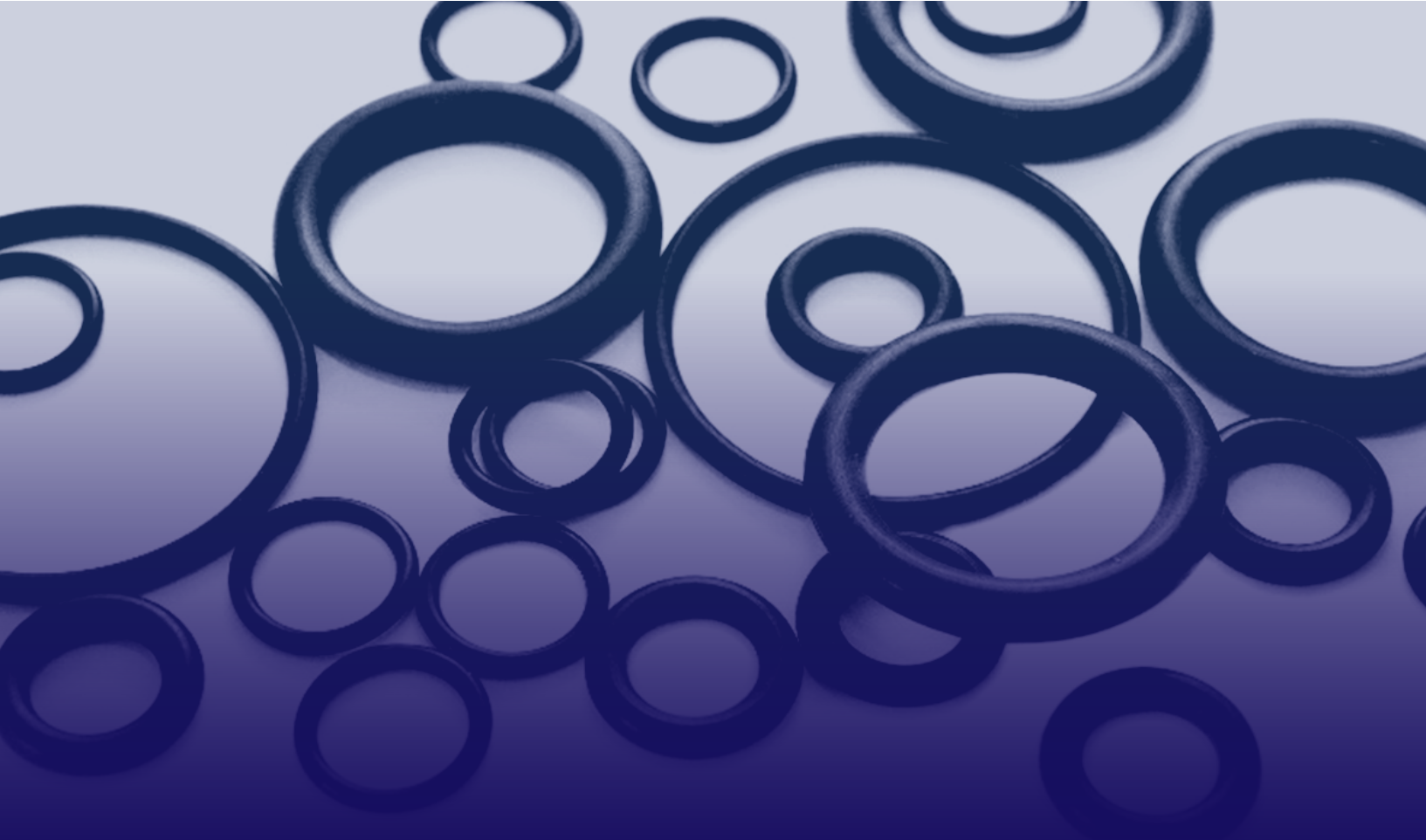

O-RING

BASIC ELASTOMERS FOR O-RING

NBR

Nitrile Rubber (NBR)

Nitrile rubber, also known as NBR or Buna N, is one of the most commonly used sealing elastomers due to its resistance to petroleum based fuels and lubricants and its relatively low price. Nitrile elastomers are copolymers of acrylonitrile and butadiene. There are a number of common variation of nitrile compounds.

Nitriles are often internally lubricated to improve ease of installation or reduce friction for dynamic applications.

FKM

Fluorocarbon (FPM, FKM)

Fluorocarbon is a well-known high performance rubber, and especially it has excellent resistance to high temperature, ozone, weather, oxygen, mineral oil, fuels, hydraulic fluids, aromatics and many organic solvents and chemicals.

FKM has excellent resistance to high temperature, oil, solvent, flame, chemical and weather, and it is usually applied in automotive, chemical processing, aerospace and many industrials.

BASIC ELASTOMERS FOR O-RING

EPDM

Ethylene Propylene Rubber (EPR EPDM)

EPDM is copolymer of ethylene and propylene, and further a terpolymer of ethylene and propylene with a small amount of a third monomer(usually a diolefin) to permit vulcanization with sulfur,. Generally Ethylene Propylene Rubber possesses excellent resistance to ozone, sunlight and weathering, and has very good flexibility at low temperature, good chemical resistance(many dilute acids and alkalis, polar solvents), and good electrical insulation property.

EPDMs are often internally lubricated to improve ease of installation or reduce friction for dynamic applications.

EPDMs are usually used in phosphate ester type hydraulic fluid.

FFKM

Perfluoroelastomer (FFKM)

FFKM is Perfluoroelastomer compound that contains much more fluorine than FKM. It is made from perfluorocarbon rubber which is the three-way copolymer of tetrafluoroethylene (TFE), perfluoromethyl vinyl ether (PMVE), and small perfluoro monomer having cross-link point. The resulted vulcanized rubber doesn't have hydrogen atom in the molecular. Because there is no hydrogen atom, its thermal resistance and chemical resistance are tend to increase quickly compare to FKM rubber.

It is dramatically special synthetic rubber having high chemical resistance and thermal resistance beyond existing Fluorine rubber (FKM). It shows stability in almost all chemicals including ethers, amines, ketones, oxidizer, organic solvent, acid/alkali, which was considered impossible. And its thermal resistance relatively allows preserving its properties as a rubber even in high temperature near 300°C. Its molecular structure is so similar to teflon that it has elasticity like rubber and good chemical resistance, thermal resistance, and plasma resistance like teflon.

PROPERTIES OF ELASTOMERS

SERVICE TEMPERATURE RANGE CHART

This service temperature range is for reference only. In actual service environment, some specific compounds may not reach the maximum temperature as indicated in this chart. However, higher temperature may be attained if exposure is short period or intermittent.

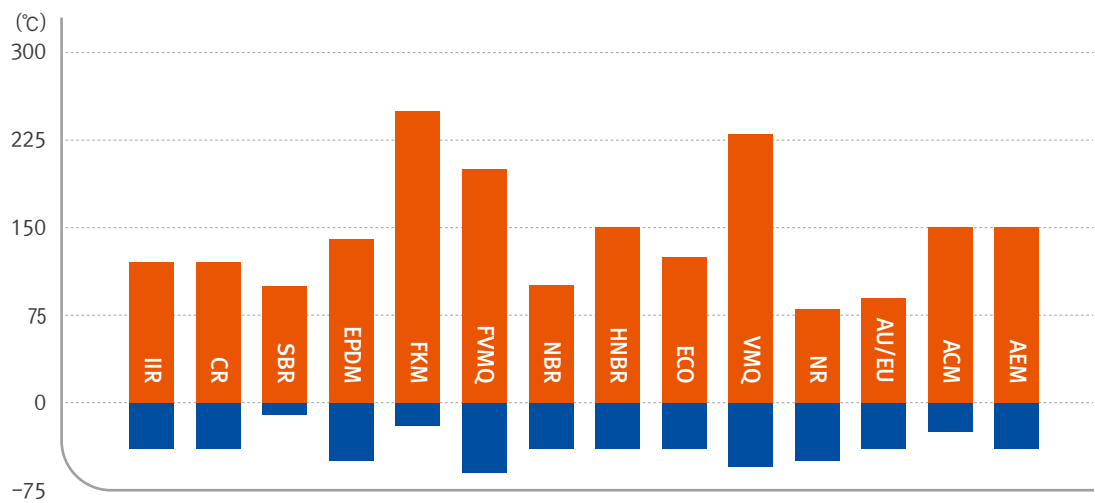

OIL AND HEAT RESISTANCE COMPARISON CHART

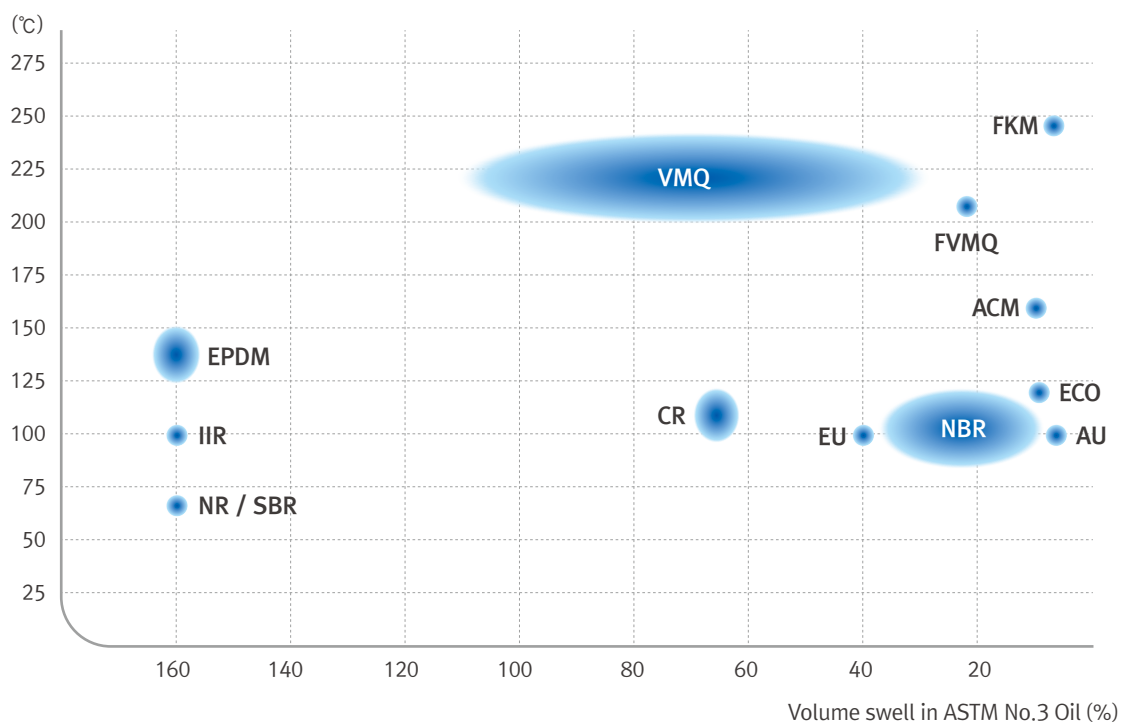

PROPERTIES OF ELASTOMERS

- ALL Synthetic rubbers are made with own recipe developed by INEM
- It can be used in a temperature range from -60°C to 250°C
- Resistant to nearly all chemical, oil, liquid and gases

	Material	Code	Compression Set Resistance	Hardness (Shore A)	Tensile strength(psi)	Elongation	Max Temperature	Resilience
●	Isobutylene Isoprene/ Butyl	IIR	GOOD	30-100	2000+	300-800	120°C	EXCELLENT
●	Chloropene/ Neoprene	CR	FAIR-GOOD	40-95	2000-3000	650-850	120°C	EXCELLENT
●	Styrene Butadiene	SBR	GOOD	40-100	2000+	400-500	100°C	GOOD
●	Ethylene Propylene	EPDM	FAIR	30-90	1500-3000	200-800	140°C	GOOD
●	Fluorocarbon	FKM	GOOD-EXCEL.	50-95	1500-3000	100-450	250°C	FAIR
●	Fluorosilicone	FVMQ	FAIR-GOOD	35-80	350-850	100-500	200°C	GOOD
●	Nitrile	NBR	GOOD	20-90	1000-3500	400-600	100°C	GOOD
●	Hydrogenated Nitrile	HNBR	EXCELLENT	30-95	1500-3500	90-550	150°C	GOOD
●	Epichlorohydrin	ECO	FAIR-GOOD	30-95	1500-2000	300-400	125°C	GOOD
●	Silicone	VMQ	GOOD-EXCEL.	25-90	600-1500	90-900	230°C	POOR-EXCEL.
●	Natural Rubber	NR	GOOD	30-100	4000+	300-500	80°C	EXCELLENT
●	Polyurethane	AU/EU	FAIR	60-100 45-75 (Durometer D)	3000-9000	270-800	90°C	GOOD
●	Acrylic Rubber	ACM	POOR	40-90	500-2500	100-450	150°C	FAIR
●	Ethylene Acrylate	AEM	GOOD	35-95	500-3000	200-850	150°C	GOOD
●	Perfluorocarbon	FFKM	GOOD	65-95	1250-3600		325°C	FAIR

- Generally used materials
- Specially used materials

INEM O-RING Standard Size (AS568)

AS568	Measurements in Millimeters				Measurements in Inches			
	ID	±	CS	±	ID	±	CS	±
1	0.74	0.10	1.02	0.08	0.029	0.004	0.040	0.003
2	1.07	0.10	1.27	0.08	0.042	0.004	0.050	0.003
3	1.42	0.10	1.52	0.08	0.056	0.004	0.060	0.003
4	1.78	0.13	1.78	0.08	0.070	0.005	0.070	0.003
5	2.57	0.13	1.78	0.08	0.101	0.005	0.070	0.003
6	2.90	0.13	1.78	0.08	0.114	0.005	0.070	0.003
7	3.68	0.13	1.78	0.08	0.145	0.005	0.070	0.003
8	4.47	0.13	1.78	0.08	0.176	0.005	0.070	0.003
9	5.28	0.13	1.78	0.08	0.208	0.005	0.070	0.003
10	6.07	0.13	1.78	0.08	0.239	0.005	0.070	0.003
11	7.65	0.13	1.78	0.08	0.301	0.005	0.070	0.003
12	9.25	0.13	1.78	0.08	0.364	0.005	0.070	0.003
13	10.82	0.13	1.78	0.08	0.426	0.005	0.070	0.003
14	12.42	0.13	1.78	0.08	0.489	0.005	0.070	0.003
15	14.00	0.18	1.78	0.08	0.551	0.007	0.070	0.003
16	15.60	0.23	1.78	0.08	0.614	0.009	0.070	0.003
17	17.17	0.23	1.78	0.08	0.676	0.009	0.070	0.003
18	18.77	0.23	1.78	0.08	0.739	0.009	0.070	0.003
19	20.35	0.23	1.78	0.08	0.801	0.009	0.070	0.003
20	21.95	0.23	1.78	0.08	0.864	0.009	0.070	0.003
21	23.52	0.23	1.78	0.08	0.926	0.009	0.070	0.003
22	25.12	0.25	1.78	0.08	0.989	0.010	0.070	0.003
23	26.70	0.25	1.78	0.08	1.051	0.010	0.070	0.003
24	28.30	0.25	1.78	0.08	1.114	0.010	0.070	0.003
25	29.87	0.28	1.78	0.08	1.176	0.011	0.070	0.003
26	31.47	0.28	1.78	0.08	1.239	0.011	0.070	0.003
27	33.05	0.28	1.78	0.08	1.301	0.011	0.070	0.003
28	34.65	0.33	1.78	0.08	1.364	0.013	0.070	0.003
29	37.82	0.33	1.78	0.08	1.489	0.013	0.070	0.003
30	41.00	0.33	1.78	0.08	1.614	0.013	0.070	0.003
31	44.17	0.38	1.78	0.08	1.739	0.015	0.070	0.003
32	47.35	0.38	1.78	0.08	1.864	0.015	0.070	0.003
33	50.52	0.46	1.78	0.08	1.989	0.018	0.070	0.003
34	53.70	0.46	1.78	0.08	2.114	0.018	0.070	0.003
35	56.87	0.46	1.78	0.08	2.239	0.018	0.070	0.003
36	60.05	0.46	1.78	0.08	2.364	0.018	0.070	0.003
37	63.22	0.46	1.78	0.08	2.489	0.018	0.070	0.003
38	66.40	0.51	1.78	0.08	2.614	0.020	0.070	0.003
39	69.57	0.51	1.78	0.08	2.739	0.020	0.070	0.003
40	72.75	0.51	1.78	0.08	2.864	0.020	0.070	0.003
41	75.92	0.61	1.78	0.08	2.989	0.024	0.070	0.003
42	82.27	0.61	1.78	0.08	3.239	0.024	0.070	0.003
43	88.62	0.61	1.78	0.08	3.489	0.024	0.070	0.003
44	94.97	0.69	1.78	0.08	3.739	0.027	0.070	0.003
45	101.32	0.69	1.78	0.08	3.989	0.027	0.070	0.003

INEM O-RING Standard Size (AS568)

AS568	Measurements in Millimeters				Measurements in Inches			
	ID	±	CS	±	ID	±	CS	±
46	107.67	0.76	1.78	0.08	4.239	0.030	0.070	0.003
47	114.02	0.76	1.78	0.08	4.489	0.030	0.070	0.003
48	120.37	0.76	1.78	0.08	4.739	0.030	0.070	0.003
49	126.72	0.94	1.78	0.08	4.989	0.037	0.070	0.003
50	133.07	0.94	1.78	0.08	5.239	0.037	0.070	0.003
51	139.42	0.94	1.78	0.08	5.489	0.037	0.070	0.003
52	145.77	0.94	1.78	0.08	5.739	0.037	0.070	0.003
53	152.12	0.94	1.78	0.08	5.989	0.037	0.070	0.003
54	158.47	1.02	1.78	0.08	6.239	0.040	0.070	0.003
55	164.82	1.02	1.78	0.08	6.489	0.040	0.070	0.003
102	1.24	0.13	2.62	0.08	0.049	0.005	0.103	0.003
103	2.06	0.13	2.62	0.08	0.081	0.005	0.103	0.003
104	2.84	0.13	2.62	0.08	0.112	0.005	0.103	0.003
105	3.63	0.13	2.62	0.08	0.143	0.005	0.103	0.003
106	4.42	0.13	2.62	0.08	0.174	0.005	0.103	0.003
107	5.23	0.13	2.62	0.08	0.206	0.005	0.103	0.003
108	6.02	0.13	2.62	0.08	0.237	0.005	0.103	0.003
109	7.59	0.13	2.62	0.08	0.299	0.005	0.103	0.003
110	9.19	0.13	2.62	0.08	0.362	0.005	0.103	0.003
111	10.77	0.13	2.62	0.08	0.424	0.005	0.103	0.003
112	12.37	0.13	2.62	0.08	0.487	0.005	0.103	0.003
113	13.94	0.18	2.62	0.08	0.549	0.007	0.103	0.003
114	15.54	0.23	2.62	0.08	0.612	0.009	0.103	0.003
115	17.12	0.23	2.62	0.08	0.674	0.009	0.103	0.003
116	18.72	0.23	2.62	0.08	0.737	0.009	0.103	0.003
117	20.29	0.25	2.62	0.08	0.799	0.010	0.103	0.003
118	21.89	0.25	2.62	0.08	0.862	0.010	0.103	0.003
119	23.47	0.25	2.62	0.08	0.924	0.010	0.103	0.003
120	25.07	0.25	2.62	0.08	0.987	0.010	0.103	0.003
121	26.64	0.25	2.62	0.08	1.049	0.010	0.103	0.003
122	28.24	0.25	2.62	0.08	1.112	0.010	0.103	0.003
123	29.82	0.30	2.62	0.08	1.174	0.012	0.103	0.003
124	31.42	0.30	2.62	0.08	1.237	0.012	0.103	0.003
125	32.99	0.30	2.62	0.08	1.299	0.012	0.103	0.003
126	34.59	0.30	2.62	0.08	1.362	0.012	0.103	0.003
127	36.17	0.30	2.62	0.08	1.424	0.012	0.103	0.003
128	37.77	0.30	2.62	0.08	1.487	0.012	0.103	0.003
129	39.34	0.38	2.62	0.08	1.549	0.015	0.103	0.003
130	40.94	0.38	2.62	0.08	1.612	0.015	0.103	0.003
131	42.52	0.38	2.62	0.08	1.674	0.015	0.103	0.003
132	44.12	0.38	2.62	0.08	1.737	0.015	0.103	0.003
133	45.69	0.38	2.62	0.08	1.799	0.015	0.103	0.003
134	47.29	0.38	2.62	0.08	1.862	0.015	0.103	0.003
135	48.90	0.43	2.62	0.08	1.925	0.017	0.103	0.003
136	50.47	0.43	2.62	0.08	1.987	0.017	0.103	0.003

INEM O-RING Standard Size (AS568)

AS568	Measurements in Millimeters				Measurements in Inches			
	ID	±	CS	±	ID	±	CS	±
137	52.07	0.43	2.62	0.08	2.050	0.017	0.103	0.003
138	53.64	0.43	2.62	0.08	2.112	0.017	0.103	0.003
139	55.25	0.43	2.62	0.08	2.175	0.017	0.103	0.003
140	56.82	0.43	2.62	0.08	2.237	0.017	0.103	0.003
141	58.42	0.51	2.62	0.08	2.300	0.020	0.103	0.003
142	59.99	0.51	2.62	0.08	2.362	0.020	0.103	0.003
143	61.60	0.51	2.62	0.08	2.425	0.020	0.103	0.003
144	63.17	0.51	2.62	0.08	2.487	0.020	0.103	0.003
145	64.77	0.51	2.62	0.08	2.550	0.020	0.103	0.003
146	66.34	0.51	2.62	0.08	2.612	0.020	0.103	0.003
147	67.95	0.56	2.62	0.08	2.675	0.022	0.103	0.003
148	69.52	0.56	2.62	0.08	2.737	0.022	0.103	0.003
149	71.12	0.56	2.62	0.08	2.800	0.022	0.103	0.003
150	72.69	0.56	2.62	0.08	2.862	0.022	0.103	0.003
151	75.87	0.61	2.62	0.08	2.987	0.024	0.103	0.003
152	82.22	0.61	2.62	0.08	3.237	0.024	0.103	0.003
153	88.57	0.61	2.62	0.08	3.487	0.024	0.103	0.003
154	94.92	0.71	2.62	0.08	3.737	0.028	0.103	0.003
155	101.27	0.71	2.62	0.08	3.987	0.028	0.103	0.003
156	107.62	0.76	2.62	0.08	4.237	0.030	0.103	0.003
157	113.97	0.76	2.62	0.08	4.487	0.030	0.103	0.003
158	120.32	0.76	2.62	0.08	4.737	0.030	0.103	0.003
159	126.67	0.89	2.62	0.08	4.987	0.035	0.103	0.003
160	133.02	0.89	2.62	0.08	5.237	0.035	0.103	0.003
161	139.37	0.89	2.62	0.08	5.487	0.035	0.103	0.003
162	145.72	0.89	2.62	0.08	5.737	0.035	0.103	0.003
163	152.07	0.89	2.62	0.08	5.987	0.035	0.103	0.003
164	158.42	1.02	2.62	0.08	6.237	0.040	0.103	0.003
165	164.77	1.02	2.62	0.08	6.487	0.040	0.103	0.003
166	171.12	1.02	2.62	0.08	6.737	0.040	0.103	0.003
167	177.47	1.02	2.62	0.08	6.987	0.040	0.103	0.003
168	183.82	1.14	2.62	0.08	7.237	0.045	0.103	0.003
169	190.17	1.14	2.62	0.08	7.487	0.045	0.103	0.003
170	196.52	1.14	2.62	0.08	7.737	0.045	0.103	0.003
171	202.87	1.14	2.62	0.08	7.987	0.045	0.103	0.003
172	209.22	1.27	2.62	0.08	8.237	0.050	0.103	0.003
173	215.57	1.27	2.62	0.08	8.487	0.050	0.103	0.003
174	221.92	1.27	2.62	0.08	8.737	0.050	0.103	0.003
175	228.27	1.27	2.62	0.08	8.987	0.050	0.103	0.003
176	234.62	1.40	2.62	0.08	9.237	0.055	0.103	0.003
177	240.97	1.40	2.62	0.08	9.487	0.055	0.103	0.003
178	247.32	1.40	2.62	0.08	9.737	0.055	0.103	0.003
201	4.34	0.13	3.53	0.10	0.171	0.005	0.139	0.004
202	5.94	0.13	3.53	0.10	0.234	0.005	0.139	0.004
203	7.52	0.13	3.53	0.10	0.296	0.005	0.139	0.004

INEM O-RING Standard Size (AS568)

AS568	Measurements in Millimeters				Measurements in Inches			
	ID	±	CS	±	ID	±	CS	±
204	9.12	0.13	3.53	0.10	0.359	0.005	0.139	0.004
205	10.69	0.13	3.53	0.10	0.421	0.005	0.139	0.004
206	12.29	0.13	3.53	0.10	0.484	0.005	0.139	0.004
207	13.87	0.18	3.53	0.10	0.546	0.007	0.139	0.004
208	15.47	0.23	3.53	0.10	0.609	0.009	0.139	0.004
209	17.04	0.23	3.53	0.10	0.671	0.009	0.139	0.004
210	18.64	0.25	3.53	0.10	0.734	0.010	0.139	0.004
211	20.22	0.25	3.53	0.10	0.796	0.010	0.139	0.004
212	21.82	0.25	3.53	0.10	0.859	0.010	0.139	0.004
213	23.39	0.25	3.53	0.10	0.921	0.010	0.139	0.004
214	24.99	0.25	3.53	0.10	0.984	0.010	0.139	0.004
215	26.57	0.25	3.53	0.10	1.046	0.010	0.139	0.004
216	28.17	0.30	3.53	0.10	1.109	0.012	0.139	0.004
217	29.74	0.30	3.53	0.10	1.171	0.012	0.139	0.004
218	31.34	0.30	3.53	0.10	1.234	0.012	0.139	0.004
219	32.92	0.30	3.53	0.10	1.296	0.012	0.139	0.004
220	34.52	0.30	3.53	0.10	1.359	0.012	0.139	0.004
221	36.09	0.30	3.53	0.10	1.421	0.012	0.139	0.004
222	37.69	0.38	3.53	0.10	1.484	0.015	0.139	0.004
223	40.87	0.38	3.53	0.10	1.609	0.015	0.139	0.004
224	44.04	0.38	3.53	0.10	1.734	0.015	0.139	0.004
225	47.22	0.46	3.53	0.10	1.859	0.018	0.139	0.004
226	50.39	0.46	3.53	0.10	1.984	0.018	0.139	0.004
227	53.57	0.46	3.53	0.10	2.109	0.018	0.139	0.004
228	56.74	0.51	3.53	0.10	2.234	0.020	0.139	0.004
229	59.92	0.51	3.53	0.10	2.359	0.020	0.139	0.004
230	63.09	0.51	3.53	0.10	2.484	0.020	0.139	0.004
231	66.27	0.51	3.53	0.10	2.609	0.020	0.139	0.004
232	69.44	0.61	3.53	0.10	2.734	0.024	0.139	0.004
233	72.62	0.61	3.53	0.10	2.859	0.024	0.139	0.004
234	75.79	0.61	3.53	0.10	2.984	0.024	0.139	0.004
235	78.97	0.61	3.53	0.10	3.109	0.024	0.139	0.004
236	82.14	0.61	3.53	0.10	3.234	0.024	0.139	0.004
237	85.32	0.61	3.53	0.10	3.359	0.024	0.139	0.004
238	88.49	0.61	3.53	0.10	3.484	0.024	0.139	0.004
239	91.67	0.71	3.53	0.10	3.609	0.028	0.139	0.004
240	94.84	0.71	3.53	0.10	3.734	0.028	0.139	0.004
241	98.02	0.71	3.53	0.10	3.859	0.028	0.139	0.004
242	101.19	0.71	3.53	0.10	3.984	0.028	0.139	0.004
243	104.37	0.71	3.53	0.10	4.109	0.028	0.139	0.004
244	107.54	0.76	3.53	0.10	4.234	0.030	0.139	0.004
245	110.72	0.76	3.53	0.10	4.359	0.030	0.139	0.004
246	113.89	0.76	3.53	0.10	4.484	0.030	0.139	0.004
247	117.07	0.76	3.53	0.10	4.609	0.030	0.139	0.004
248	120.24	0.76	3.53	0.10	4.734	0.030	0.139	0.004

INEM O-RING Standard Size (AS568)

AS568	Measurements in Millimeters				Measurements in Inches			
	ID	±	CS	±	ID	±	CS	±
249	123.42	0.89	3.53	0.10	4.859	0.035	0.139	0.004
250	126.59	0.89	3.53	0.10	4.984	0.035	0.139	0.004
251	129.77	0.89	3.53	0.10	5.109	0.035	0.139	0.004
252	132.94	0.89	3.53	0.10	5.234	0.035	0.139	0.004
253	136.12	0.89	3.53	0.10	5.359	0.035	0.139	0.004
254	139.29	0.89	3.53	0.10	5.484	0.035	0.139	0.004
255	142.47	0.89	3.53	0.10	5.609	0.035	0.139	0.004
256	145.64	0.89	3.53	0.10	5.734	0.035	0.139	0.004
257	148.82	0.89	3.53	0.10	5.859	0.035	0.139	0.004
258	151.99	0.89	3.53	0.10	5.984	0.035	0.139	0.004
259	158.34	1.02	3.53	0.10	6.234	0.040	0.139	0.004
260	164.69	1.02	3.53	0.10	6.484	0.040	0.139	0.004
261	171.04	1.02	3.53	0.10	6.734	0.040	0.139	0.004
262	177.39	1.02	3.53	0.10	6.984	0.040	0.139	0.004
263	183.74	1.14	3.53	0.10	7.234	0.045	0.139	0.004
264	190.09	1.14	3.53	0.10	7.484	0.045	0.139	0.004
265	196.44	1.14	3.53	0.10	7.734	0.045	0.139	0.004
266	202.79	1.14	3.53	0.10	7.984	0.045	0.139	0.004
267	209.14	1.27	3.53	0.10	8.234	0.050	0.139	0.004
268	215.49	1.27	3.53	0.10	8.484	0.050	0.139	0.004
269	221.84	1.27	3.53	0.10	8.734	0.050	0.139	0.004
270	228.19	1.27	3.53	0.10	8.984	0.050	0.139	0.004
271	234.54	1.40	3.53	0.10	9.234	0.055	0.139	0.004
272	240.89	1.40	3.53	0.10	9.484	0.055	0.139	0.004
273	247.24	1.40	3.53	0.10	9.734	0.055	0.139	0.004
274	253.59	1.40	3.53	0.10	9.984	0.055	0.139	0.004
275	266.29	1.40	3.53	0.10	10.484	0.055	0.139	0.004
276	278.99	1.65	3.53	0.10	10.984	0.065	0.139	0.004
277	291.69	1.65	3.53	0.10	11.484	0.065	0.139	0.004
278	304.39	1.65	3.53	0.10	11.984	0.065	0.139	0.004
279	329.79	1.65	3.53	0.10	12.984	0.065	0.139	0.004
280	355.19	1.65	3.53	0.10	13.984	0.065	0.139	0.004
281	380.59	1.65	3.53	0.10	14.984	0.065	0.139	0.004
282	405.26	1.91	3.53	0.10	15.955	0.075	0.139	0.004
283	430.66	2.03	3.53	0.10	16.955	0.080	0.139	0.004
284	456.06	2.16	3.53	0.10	17.955	0.085	0.139	0.004
309	10.46	0.13	5.33	0.13	0.412	0.005	0.210	0.005
310	12.07	0.13	5.33	0.13	0.475	0.005	0.210	0.005
311	13.64	0.18	5.33	0.13	0.537	0.007	0.210	0.005
312	15.24	0.23	5.33	0.13	0.600	0.009	0.210	0.005
313	16.81	0.23	5.33	0.13	0.662	0.009	0.210	0.005
314	18.42	0.25	5.33	0.13	0.725	0.010	0.210	0.005
315	19.99	0.25	5.33	0.13	0.787	0.010	0.210	0.005
316	21.59	0.25	5.33	0.13	0.850	0.010	0.210	0.005
317	23.16	0.25	5.33	0.13	0.912	0.010	0.210	0.005

INEM O-RING Standard Size (AS568)

AS568	Measurements in Millimeters				Measurements in Inches			
	ID	±	CS	±	ID	±	CS	±
318	24.77	0.25	5.33	0.13	0.975	0.010	0.210	0.005
319	26.34	0.25	5.33	0.13	1.037	0.010	0.210	0.005
320	27.94	0.30	5.33	0.13	1.100	0.012	0.210	0.005
321	29.51	0.30	5.33	0.13	1.162	0.012	0.210	0.005
322	31.12	0.30	5.33	0.13	1.225	0.012	0.210	0.005
323	32.69	0.30	5.33	0.13	1.287	0.012	0.210	0.005
324	34.29	0.30	5.33	0.13	1.350	0.012	0.210	0.005
325	37.47	0.38	5.33	0.13	1.475	0.015	0.210	0.005
326	40.64	0.38	5.33	0.13	1.600	0.015	0.210	0.005
327	43.82	0.38	5.33	0.13	1.725	0.015	0.210	0.005
328	46.99	0.38	5.33	0.13	1.850	0.015	0.210	0.005
329	50.17	0.46	5.33	0.13	1.975	0.018	0.210	0.005
330	53.34	0.46	5.33	0.13	2.100	0.018	0.210	0.005
331	56.52	0.46	5.33	0.13	2.225	0.018	0.210	0.005
332	59.69	0.46	5.33	0.13	2.350	0.018	0.210	0.005
333	62.87	0.51	5.33	0.13	2.475	0.020	0.210	0.005
334	66.04	0.51	5.33	0.13	2.600	0.020	0.210	0.005
335	69.22	0.51	5.33	0.13	2.725	0.020	0.210	0.005
336	72.39	0.51	5.33	0.13	2.850	0.020	0.210	0.005
337	75.57	0.61	5.33	0.13	2.975	0.024	0.210	0.005
338	78.74	0.61	5.33	0.13	3.100	0.024	0.210	0.005
339	81.92	0.61	5.33	0.13	3.225	0.024	0.210	0.005
340	85.09	0.61	5.33	0.13	3.350	0.024	0.210	0.005
341	88.27	0.61	5.33	0.13	3.475	0.024	0.210	0.005
342	91.44	0.71	5.33	0.13	3.600	0.028	0.210	0.005
343	94.62	0.71	5.33	0.13	3.725	0.028	0.210	0.005
344	97.79	0.71	5.33	0.13	3.850	0.028	0.210	0.005
345	100.97	0.71	5.33	0.13	3.975	0.028	0.210	0.005
346	104.14	0.71	5.33	0.13	4.100	0.028	0.210	0.005
347	107.32	0.76	5.33	0.13	4.225	0.030	0.210	0.005
348	110.49	0.76	5.33	0.13	4.350	0.030	0.210	0.005
349	113.67	0.76	5.33	0.13	4.475	0.030	0.210	0.005
350	116.84	0.76	5.33	0.13	4.600	0.030	0.210	0.005
351	120.02	0.76	5.33	0.13	4.725	0.030	0.210	0.005
352	123.19	0.76	5.33	0.13	4.850	0.030	0.210	0.005
353	126.37	0.94	5.33	0.13	4.975	0.037	0.210	0.005
354	129.54	0.94	5.33	0.13	5.100	0.037	0.210	0.005
355	132.72	0.94	5.33	0.13	5.225	0.037	0.210	0.005
356	135.89	0.94	5.33	0.13	5.350	0.037	0.210	0.005
357	139.07	0.94	5.33	0.13	5.475	0.037	0.210	0.005
358	142.24	0.94	5.33	0.13	5.600	0.037	0.210	0.005
359	145.42	0.94	5.33	0.13	5.725	0.037	0.210	0.005
360	148.59	0.94	5.33	0.13	5.850	0.037	0.210	0.005
361	151.77	0.94	5.33	0.13	5.975	0.037	0.210	0.005
362	158.12	1.02	5.33	0.13	6.225	0.040	0.210	0.005

INEM O-RING Standard Size (AS568)

AS568	Measurements in Millimeters				Measurements in Inches			
	ID	±	CS	±	ID	±	CS	±
363	164.47	1.02	5.33	0.13	6.475	0.040	0.210	0.005
364	170.82	1.02	5.33	0.13	6.725	0.040	0.210	0.005
365	177.17	1.02	5.33	0.13	6.975	0.040	0.210	0.005
366	183.52	1.14	5.33	0.13	7.225	0.045	0.210	0.005
367	189.87	1.14	5.33	0.13	7.475	0.045	0.210	0.005
368	196.22	1.14	5.33	0.13	7.725	0.045	0.210	0.005
369	202.57	1.14	5.33	0.13	7.975	0.045	0.210	0.005
370	208.92	1.27	5.33	0.13	8.225	0.050	0.210	0.005
371	215.27	1.27	5.33	0.13	8.475	0.050	0.210	0.005
372	221.62	1.27	5.33	0.13	8.725	0.050	0.210	0.005
373	227.97	1.27	5.33	0.13	8.975	0.050	0.210	0.005
374	234.32	1.40	5.33	0.13	9.225	0.055	0.210	0.005
375	240.67	1.40	5.33	0.13	9.475	0.055	0.210	0.005
376	247.02	1.40	5.33	0.13	9.725	0.055	0.210	0.005
377	253.37	1.40	5.33	0.13	9.975	0.055	0.210	0.005
378	266.07	1.52	5.33	0.13	10.475	0.060	0.210	0.005
379	278.77	1.52	5.33	0.13	10.975	0.060	0.210	0.005
380	291.47	1.65	5.33	0.13	11.475	0.065	0.210	0.005
381	304.17	1.65	5.33	0.13	11.975	0.065	0.210	0.005
382	329.57	1.65	5.33	0.13	12.975	0.065	0.210	0.005
383	354.97	1.78	5.33	0.13	13.975	0.070	0.210	0.005
384	380.37	1.78	5.33	0.13	14.975	0.070	0.210	0.005
385	405.26	1.91	5.33	0.13	15.955	0.075	0.210	0.005
386	430.66	2.03	5.33	0.13	16.955	0.080	0.210	0.005
387	456.06	2.16	5.33	0.13	17.955	0.085	0.210	0.005
388	481.46	2.29	5.33	0.13	18.955	0.090	0.210	0.005
389	506.86	2.41	5.33	0.13	19.955	0.095	0.210	0.005
390	532.26	2.41	5.33	0.13	20.955	0.095	0.210	0.005
391	557.66	2.54	5.33	0.13	21.955	0.100	0.210	0.005
392	582.68	2.67	5.33	0.13	22.940	0.105	0.210	0.005
393	608.08	2.79	5.33	0.13	23.940	0.110	0.210	0.005
394	633.48	2.92	5.33	0.13	24.940	0.115	0.210	0.005
395	658.88	3.05	5.33	0.13	25.940	0.120	0.210	0.005
400	34.29	0.33	6.99	0.15	1.350	0.013	0.275	0.006
401	37.47	0.36	6.99	0.15	1.475	0.014	0.275	0.006
402	40.64	0.39	6.99	0.15	1.600	0.015	0.275	0.006
403	43.82	0.41	6.99	0.15	1.725	0.016	0.275	0.006
404	46.99	0.44	6.99	0.15	1.850	0.017	0.275	0.006
405	50.17	0.46	6.99	0.15	1.975	0.018	0.275	0.006
406	53.34	0.48	6.99	0.15	2.100	0.019	0.275	0.006
407	56.52	0.51	6.99	0.15	2.225	0.020	0.275	0.006
408	59.69	0.54	6.99	0.15	2.350	0.021	0.275	0.006
409	62.87	0.56	6.99	0.15	2.475	0.022	0.275	0.006
410	66.04	0.59	6.99	0.15	2.600	0.023	0.275	0.006
411	69.22	0.61	6.99	0.15	2.725	0.024	0.275	0.006

INEM O-RING Standard Size (AS568)

AS568	Measurements in Millimeters				Measurements in Inches			
	ID	±	CS	±	ID	±	CS	±
412	72.39	0.64	6.99	0.15	2.850	0.025	0.275	0.006
413	75.57	0.66	6.99	0.15	2.975	0.026	0.275	0.006
414	78.74	0.67	6.99	0.15	3.100	0.026	0.275	0.006
415	81.92	0.71	6.99	0.15	3.225	0.028	0.275	0.006
416	85.09	0.73	6.99	0.15	3.350	0.029	0.275	0.006
417	88.27	0.75	6.99	0.15	3.475	0.030	0.275	0.006
418	91.44	0.79	6.99	0.15	3.600	0.031	0.275	0.006
419	94.62	0.81	6.99	0.15	3.725	0.032	0.275	0.006
420	97.79	0.83	6.99	0.15	3.850	0.033	0.275	0.006
421	100.97	0.84	6.99	0.15	3.975	0.033	0.275	0.006
422	104.14	0.87	6.99	0.15	4.100	0.034	0.275	0.006
423	107.32	0.89	6.99	0.15	4.225	0.035	0.275	0.006
424	110.49	0.91	6.99	0.15	4.350	0.036	0.275	0.006
425	113.67	0.84	6.99	0.15	4.475	0.033	0.275	0.006
426	116.84	0.84	6.99	0.15	4.600	0.033	0.275	0.006
427	120.02	0.84	6.99	0.15	4.725	0.033	0.275	0.006
428	123.19	0.84	6.99	0.15	4.850	0.033	0.275	0.006
429	126.37	0.94	6.99	0.15	4.975	0.037	0.275	0.006
430	129.54	0.94	6.99	0.15	5.100	0.037	0.275	0.006
431	132.72	0.94	6.99	0.15	5.225	0.037	0.275	0.006
432	135.89	0.94	6.99	0.15	5.350	0.037	0.275	0.006
433	139.07	0.94	6.99	0.15	5.475	0.037	0.275	0.006
434	142.24	0.94	6.99	0.15	5.600	0.037	0.275	0.006
435	145.42	0.94	6.99	0.15	5.725	0.037	0.275	0.006
436	148.59	0.94	6.99	0.15	5.850	0.037	0.275	0.006
437	151.77	0.94	6.99	0.15	5.975	0.037	0.275	0.006
438	158.12	1.02	6.99	0.15	6.225	0.040	0.275	0.006
439	164.47	1.02	6.99	0.15	6.475	0.040	0.275	0.006
440	170.82	1.02	6.99	0.15	6.725	0.040	0.275	0.006
441	177.17	1.02	6.99	0.15	6.975	0.040	0.275	0.006
442	183.52	1.14	6.99	0.15	7.225	0.045	0.275	0.006
443	189.87	1.14	6.99	0.15	7.475	0.045	0.275	0.006
444	196.22	1.14	6.99	0.15	7.725	0.045	0.275	0.006
445	202.57	1.14	6.99	0.15	7.975	0.045	0.275	0.006
446	215.27	1.40	6.99	0.15	8.475	0.055	0.275	0.006
447	227.97	1.40	6.99	0.15	8.975	0.055	0.275	0.006
448	240.67	1.40	6.99	0.15	9.475	0.055	0.275	0.006
449	253.37	1.40	6.99	0.15	9.975	0.055	0.275	0.006
450	266.07	1.52	6.99	0.15	10.475	0.060	0.275	0.006
451	278.77	1.52	6.99	0.15	10.975	0.060	0.275	0.006
452	291.47	1.52	6.99	0.15	11.475	0.060	0.275	0.006
453	304.17	1.52	6.99	0.15	11.975	0.060	0.275	0.006
454	316.87	1.52	6.99	0.15	12.475	0.060	0.275	0.006
455	329.57	1.52	6.99	0.15	12.975	0.060	0.275	0.006
456	342.27	1.78	6.99	0.15	13.475	0.070	0.275	0.006

INEM O-RING Standard Size (AS568)

AS568	Measurements in Millimeters				Measurements in Inches			
	ID	±	CS	±	ID	±	CS	±
457	354.97	1.78	6.99	0.15	13.975	0.070	0.275	0.006
458	367.67	1.78	6.99	0.15	14.475	0.070	0.275	0.006
459	380.37	1.78	6.99	0.15	14.975	0.070	0.275	0.006
460	393.07	1.78	6.99	0.15	15.475	0.070	0.275	0.006
461	405.26	1.91	6.99	0.15	15.955	0.075	0.275	0.006
462	417.96	1.91	6.99	0.15	16.455	0.075	0.275	0.006
463	430.66	2.03	6.99	0.15	16.955	0.080	0.275	0.006
464	443.36	2.16	6.99	0.15	17.455	0.085	0.275	0.006
465	456.06	2.16	6.99	0.15	17.955	0.085	0.275	0.006
466	468.76	2.16	6.99	0.15	18.455	0.085	0.275	0.006
467	481.46	2.29	6.99	0.15	18.955	0.090	0.275	0.006
468	494.16	2.29	6.99	0.15	19.455	0.090	0.275	0.006
469	506.86	2.41	6.99	0.15	19.955	0.095	0.275	0.006
470	532.26	2.41	6.99	0.15	20.955	0.095	0.275	0.006
471	557.66	2.54	6.99	0.15	21.955	0.100	0.275	0.006
472	582.68	2.67	6.99	0.15	22.940	0.105	0.275	0.006
473	608.08	2.79	6.99	0.15	23.940	0.110	0.275	0.006
474	633.48	2.92	6.99	0.15	24.940	0.115	0.275	0.006
475	658.88	3.05	6.99	0.15	25.940	0.120	0.275	0.006
901	4.70	0.13	1.42	0.08	0.185	0.005	0.056	0.003
902	6.07	0.13	1.63	0.08	0.239	0.005	0.064	0.003
903	7.65	0.13	1.63	0.08	0.301	0.005	0.064	0.003
904	8.92	0.13	1.83	0.08	0.351	0.005	0.072	0.003
905	10.52	0.13	1.83	0.08	0.414	0.005	0.072	0.003
906	11.89	0.13	1.98	0.08	0.468	0.005	0.078	0.003
907	13.46	0.18	2.08	0.08	0.530	0.007	0.082	0.003
908	16.36	0.23	2.21	0.08	0.644	0.009	0.087	0.003
909	17.93	0.23	2.46	0.08	0.706	0.009	0.097	0.003
910	19.18	0.23	2.46	0.08	0.755	0.009	0.097	0.003
911	21.92	0.23	2.95	0.10	0.863	0.009	0.116	0.004
912	23.47	0.23	2.95	0.10	0.924	0.009	0.116	0.004
913	25.04	0.25	2.95	0.10	0.986	0.010	0.116	0.004
914	26.59	0.25	2.95	0.10	1.047	0.010	0.116	0.004
916	29.74	0.25	2.95	0.10	1.171	0.010	0.116	0.004
918	34.42	0.30	2.95	0.10	1.355	0.012	0.116	0.004
920	37.47	0.36	3.00	0.10	1.475	0.014	0.118	0.004
924	43.69	0.36	3.00	0.10	1.720	0.014	0.118	0.004
928	53.09	0.46	3.00	0.10	2.090	0.018	0.118	0.004
932	59.36	0.46	3.00	0.10	2.337	0.018	0.118	0.004

INEM O-RING Standard Size (JIS B 2401)

JIS B 2401	Measurements in Millimeters				Measurements in Inches			
	ID	±	CS	±	ID	±	CS	±
P3	2.80	0.14	1.90	0.07	0.110	0.006	0.075	0.003
P4	3.80	0.14	1.90	0.07	0.150	0.006	0.075	0.003
P5	4.80	0.15	1.90	0.07	0.189	0.006	0.075	0.003
P6	5.80	0.15	1.90	0.07	0.228	0.006	0.075	0.003
P7	6.80	0.16	1.90	0.07	0.268	0.006	0.075	0.003
P8	7.80	0.16	1.90	0.07	0.307	0.006	0.075	0.003
P9	8.80	0.17	1.90	0.07	0.346	0.007	0.075	0.003
P10	9.80	0.17	1.90	0.07	0.386	0.007	0.075	0.003
P10A	9.80	0.17	2.40	0.07	0.386	0.007	0.094	0.003
P11	10.80	0.18	2.40	0.07	0.425	0.007	0.094	0.003
P11.2	11.00	0.18	2.40	0.07	0.433	0.007	0.094	0.003
P12	11.80	0.19	2.40	0.07	0.465	0.007	0.094	0.003
P12.5	12.30	0.19	2.40	0.07	0.484	0.007	0.094	0.003
P13	12.80	0.19	2.40	0.07	0.504	0.007	0.094	0.003
P14	13.80	0.19	2.40	0.07	0.543	0.007	0.094	0.003
P15	14.80	0.20	2.40	0.07	0.583	0.008	0.094	0.003
P16	15.80	0.20	2.40	0.07	0.622	0.008	0.094	0.003
P17	16.80	0.21	2.40	0.07	0.661	0.008	0.094	0.003
P18	17.80	0.21	2.40	0.07	0.701	0.008	0.094	0.003
P19	18.80	0.21	2.40	0.07	0.740	0.008	0.094	0.003
P20	19.80	0.22	2.40	0.07	0.780	0.009	0.094	0.003
P21	20.80	0.23	2.40	0.07	0.819	0.009	0.094	0.003
P22	21.80	0.24	2.40	0.07	0.858	0.009	0.094	0.003
P22A	21.70	0.24	3.50	0.10	0.854	0.009	0.138	0.004
P22.4	22.10	0.24	3.50	0.10	0.870	0.009	0.138	0.004
P24	23.70	0.24	3.50	0.10	0.933	0.009	0.138	0.004
P25	24.70	0.25	3.50	0.10	0.972	0.010	0.138	0.004
P25.5	25.20	0.25	3.50	0.10	0.992	0.010	0.138	0.004
P26	25.70	0.26	3.50	0.10	1.012	0.010	0.138	0.004
P28	27.70	0.28	3.50	0.10	1.091	0.011	0.138	0.004
P29	28.70	0.29	3.50	0.10	1.130	0.011	0.138	0.004
P29.5	29.20	0.29	3.50	0.10	1.150	0.011	0.138	0.004
P30	29.70	0.29	3.50	0.10	1.169	0.011	0.138	0.004
P31	30.70	0.30	3.50	0.10	1.209	0.012	0.138	0.004
P31.5	31.20	0.31	3.50	0.10	1.228	0.012	0.138	0.004
P32	31.70	0.31	3.50	0.10	1.248	0.012	0.138	0.004
P33	32.70	0.31	3.50	0.10	1.287	0.012	0.138	0.004
P34	33.70	0.33	3.50	0.10	1.327	0.013	0.138	0.004
P35	34.70	0.34	3.50	0.10	1.366	0.013	0.138	0.004
P35.5	35.20	0.34	3.50	0.10	1.386	0.013	0.138	0.004
P36	35.70	0.34	3.50	0.10	1.406	0.013	0.138	0.004
P38	37.70	0.37	3.50	0.10	1.484	0.015	0.138	0.004
P39	38.70	0.37	3.50	0.10	1.524	0.015	0.138	0.004
P40	39.70	0.37	3.50	0.10	1.563	0.015	0.138	0.004
P41	40.70	0.38	3.50	0.10	1.602	0.015	0.138	0.004

INEM O-RING Standard Size (JIS B 2401)

JIS B 2401	Measurements in Millimeters				Measurements in Inches			
	ID	±	CS	±	ID	±	CS	±
P42	41.70	0.39	3.50	0.10	1.642	0.015	0.138	0.004
P44	43.70	0.41	3.50	0.10	1.720	0.016	0.138	0.004
P45	44.70	0.41	3.50	0.10	1.760	0.016	0.138	0.004
P46	45.70	0.42	3.50	0.10	1.799	0.017	0.138	0.004
P48	47.70	0.44	3.50	0.10	1.878	0.017	0.138	0.004
P49	48.70	0.45	3.50	0.10	1.917	0.018	0.138	0.004
P50	49.70	0.45	3.50	0.10	1.957	0.018	0.138	0.004
P48A	47.60	0.44	5.70	0.13	1.874	0.017	0.224	0.005
P50A	49.60	0.45	5.70	0.13	1.953	0.018	0.224	0.005
P52	51.60	0.47	5.70	0.13	2.031	0.019	0.224	0.005
P53	52.60	0.48	5.70	0.13	2.071	0.019	0.224	0.005
P55	54.60	0.49	5.70	0.13	2.150	0.019	0.224	0.005
P56	55.60	0.50	5.70	0.13	2.189	0.020	0.224	0.005
P58	57.60	0.52	5.70	0.13	2.268	0.020	0.224	0.005
P60	59.60	0.53	5.70	0.13	2.346	0.021	0.224	0.005
P62	61.60	0.55	5.70	0.13	2.425	0.022	0.224	0.005
P63	62.60	0.56	5.70	0.13	2.465	0.022	0.224	0.005
P65	64.60	0.57	5.70	0.13	2.543	0.022	0.224	0.005
P67	66.60	0.59	5.70	0.13	2.622	0.023	0.224	0.005
P68	67.60	0.59	5.70	0.13	2.661	0.023	0.224	0.005
P70	69.60	0.61	5.70	0.13	2.740	0.024	0.224	0.005
P71	70.60	0.62	5.70	0.13	2.780	0.024	0.224	0.005
P75	74.60	0.65	5.70	0.13	2.937	0.026	0.224	0.005
P80	79.60	0.69	5.70	0.13	3.134	0.027	0.224	0.005
P85	84.60	0.73	5.70	0.13	3.331	0.029	0.224	0.005
P90	89.60	0.77	5.70	0.13	3.528	0.030	0.224	0.005
P95	94.60	0.81	5.70	0.13	3.724	0.032	0.224	0.005
P100	99.60	0.84	5.70	0.13	3.921	0.033	0.224	0.005
P102	101.60	0.85	5.70	0.13	4.000	0.033	0.224	0.005
P105	104.60	0.87	5.70	0.13	4.118	0.034	0.224	0.005
P110	109.60	0.91	5.70	0.13	4.315	0.036	0.224	0.005
P112	111.60	0.92	5.70	0.13	4.394	0.036	0.224	0.005
P115	114.60	0.94	5.70	0.13	4.512	0.037	0.224	0.005
P120	119.60	0.98	5.70	0.13	4.709	0.039	0.224	0.005
P125	124.60	1.01	5.70	0.13	4.906	0.040	0.224	0.005
P130	129.60	1.05	5.70	0.13	5.102	0.041	0.224	0.005
P132	131.60	1.06	5.70	0.13	5.181	0.042	0.224	0.005
P135	134.60	1.09	5.70	0.13	5.299	0.043	0.224	0.005
P140	139.60	1.12	5.70	0.13	5.496	0.044	0.224	0.005
P145	144.60	1.16	5.70	0.13	5.693	0.046	0.224	0.005
P150	149.60	1.19	5.70	0.13	5.890	0.047	0.224	0.005
P150A	149.50	1.19	8.40	0.15	5.886	0.047	0.331	0.006
P155	154.50	1.23	8.40	0.15	6.083	0.048	0.331	0.006
P160	159.50	1.26	8.40	0.15	6.280	0.050	0.331	0.006
P165	164.50	1.30	8.40	0.15	6.476	0.051	0.331	0.006

INEM O-RING Standard Size (JIS B 2401)

JIS B 2401	Measurements in Millimeters				Measurements in Inches			
	ID	±	CS	±	ID	±	CS	±
P170	169.50	1.33	8.40	0.15	6.673	0.052	0.331	0.006
P175	174.50	1.37	8.40	0.15	6.870	0.054	0.331	0.006
P180	179.50	1.40	8.40	0.15	7.067	0.055	0.331	0.006
P185	184.50	1.44	8.40	0.15	7.264	0.057	0.331	0.006
P190	189.50	1.48	8.40	0.15	7.461	0.058	0.331	0.006
P195	194.50	1.51	8.40	0.15	7.657	0.059	0.331	0.006
P200	199.50	1.55	8.40	0.15	7.854	0.061	0.331	0.006
P205	204.50	1.58	8.40	0.15	8.051	0.062	0.331	0.006
P209	208.50	1.61	8.40	0.15	8.209	0.063	0.331	0.006
P210	209.50	1.62	8.40	0.15	8.248	0.064	0.331	0.006
P215	214.50	1.65	8.40	0.15	8.445	0.065	0.331	0.006
P220	219.50	1.68	8.40	0.15	8.642	0.066	0.331	0.006
P225	224.50	1.71	8.40	0.15	8.839	0.067	0.331	0.006
P230	229.50	1.75	8.40	0.15	9.035	0.069	0.331	0.006
P235	234.50	1.78	8.40	0.15	9.232	0.070	0.331	0.006
P240	239.50	1.81	8.40	0.15	9.429	0.071	0.331	0.006
P245	244.50	1.84	8.40	0.15	9.626	0.072	0.331	0.006
P250	249.50	1.88	8.40	0.15	9.823	0.074	0.331	0.006
P255	254.50	1.91	8.40	0.15	10.020	0.075	0.331	0.006
P260	259.50	1.94	8.40	0.15	10.217	0.076	0.331	0.006
P265	264.50	1.97	8.40	0.15	10.413	0.078	0.331	0.006
P270	269.50	2.01	8.40	0.15	10.610	0.079	0.331	0.006
P275	274.50	2.04	8.40	0.15	10.807	0.080	0.331	0.006
P280	279.50	2.07	8.40	0.15	11.004	0.081	0.331	0.006
P285	284.50	2.10	8.40	0.15	11.201	0.083	0.331	0.006
P290	289.50	2.14	8.40	0.15	11.398	0.084	0.331	0.006
P295	294.50	2.17	8.40	0.15	11.594	0.085	0.331	0.006
P300	299.50	2.20	8.40	0.15	11.791	0.087	0.331	0.006
P305	304.50	2.24	8.40	0.15	11.988	0.088	0.331	0.006
P310	309.50	2.27	8.40	0.15	12.185	0.089	0.331	0.006
P315	314.50	2.30	8.40	0.15	12.382	0.091	0.331	0.006
P320	319.50	2.33	8.40	0.15	12.579	0.092	0.331	0.006
P325	324.50	2.36	8.40	0.15	12.776	0.093	0.331	0.006
P330	329.50	2.39	8.40	0.15	12.972	0.094	0.331	0.006
P335	334.50	2.42	8.40	0.15	13.169	0.095	0.331	0.006
P340	339.50	2.45	8.40	0.15	13.366	0.096	0.331	0.006
P345	344.50	2.48	8.40	0.15	13.563	0.098	0.331	0.006
P350	349.50	2.51	8.40	0.15	13.760	0.099	0.331	0.006
P355	354.50	2.54	8.40	0.15	13.957	0.100	0.331	0.006
P360	359.50	2.57	8.40	0.15	14.154	0.101	0.331	0.006
P365	364.50	2.60	8.40	0.15	14.350	0.102	0.331	0.006
P370	369.50	2.63	8.40	0.15	14.547	0.104	0.331	0.006
P375	374.50	2.67	8.40	0.15	14.744	0.105	0.331	0.006
P380	379.50	2.70	8.40	0.15	14.941	0.106	0.331	0.006
P385	384.50	2.73	8.40	0.15	15.138	0.107	0.331	0.006

INEM O-RING Standard Size (JIS B 2401)

JIS B 2401	Measurements in Millimeters				Measurements in Inches			
	ID	±	CS	±	ID	±	CS	±
P390	389.50	2.77	8.40	0.15	15.335	0.109	0.331	0.006
P395	394.50	2.79	8.40	0.15	15.531	0.110	0.331	0.006
P400	399.50	2.82	8.40	0.15	15.728	0.111	0.331	0.006
P405	404.50	3.00	8.40	0.15	15.925	0.118	0.331	0.006
P410	409.50	3.00	8.40	0.15	16.122	0.118	0.331	0.006
P415	414.50	3.00	8.40	0.15	16.319	0.118	0.331	0.006
P420	419.50	3.00	8.40	0.15	16.516	0.118	0.331	0.006
P425	424.50	3.00	8.40	0.15	16.713	0.118	0.331	0.006
P430	429.50	3.00	8.40	0.15	16.909	0.118	0.331	0.006
P435	434.50	3.00	8.40	0.15	17.106	0.118	0.331	0.006
P440	439.50	3.00	8.40	0.15	17.303	0.118	0.331	0.006
P445	444.50	3.00	8.40	0.15	17.500	0.118	0.331	0.006
P450	449.50	3.00	8.40	0.15	17.697	0.118	0.331	0.006
P455	454.50	3.30	8.40	0.15	17.894	0.130	0.331	0.006
P460	459.50	3.30	8.40	0.15	18.091	0.130	0.331	0.006
P465	464.50	3.30	8.40	0.15	18.287	0.130	0.331	0.006
P470	469.50	3.30	8.40	0.15	18.484	0.130	0.331	0.006
P475	474.50	3.30	8.40	0.15	18.681	0.130	0.331	0.006
P480	479.50	3.30	8.40	0.15	18.878	0.130	0.331	0.006
P485	484.50	3.30	8.40	0.15	19.075	0.130	0.331	0.006
P490	489.50	3.30	8.40	0.15	19.272	0.130	0.331	0.006
P495	494.50	3.30	8.40	0.15	19.468	0.130	0.331	0.006
P500	499.50	3.30	8.40	0.15	19.665	0.118	0.331	0.006
P590	589.50	3.97	8.40	0.15	23.209	0.156	0.331	0.006
P600	599.50	4.03	8.40	0.15	23.602	0.159	0.331	0.006
P610	609.50	4.09	8.40	0.15	23.996	0.161	0.331	0.006
P620	619.50	4.15	8.40	0.15	24.390	0.163	0.331	0.006
P625	624.50	4.18	8.40	0.15	24.587	0.165	0.331	0.006
P635	634.50	4.25	8.40	0.15	24.980	0.167	0.331	0.006
P650	649.50	4.34	8.40	0.15	25.571	0.171	0.331	0.006
P680	679.50	4.52	8.40	0.15	26.752	0.178	0.331	0.006
P690	689.50	4.59	8.40	0.15	27.146	0.181	0.331	0.006
P700	699.50	4.65	8.40	0.15	27.539	0.183	0.331	0.006
P710	709.50	4.71	8.40	0.15	27.933	0.185	0.331	0.006
P720	719.50	4.77	8.40	0.15	28.327	0.188	0.331	0.006
P730	729.50	4.83	8.40	0.15	28.720	0.190	0.331	0.006
P740	739.50	4.89	8.40	0.15	29.114	0.193	0.331	0.006
P750	749.50	4.95	8.40	0.15	29.508	0.195	0.331	0.006
P760	759.50	5.02	8.40	0.15	29.902	0.197	0.331	0.006
P770	769.50	5.08	8.40	0.15	30.295	0.200	0.331	0.006
P780	779.50	5.14	8.40	0.15	30.689	0.202	0.331	0.006
P790	789.50	5.20	8.40	0.15	31.083	0.205	0.331	0.006
P800	799.50	5.26	8.40	0.15	31.476	0.207	0.331	0.006
P810	809.50	5.32	8.40	0.15	31.870	0.210	0.331	0.006
P820	819.50	5.38	8.40	0.15	32.264	0.212	0.331	0.006

INEM O-RING Standard Size (JIS B 2401)

JIS B 2401	Measurements in Millimeters				Measurements in Inches			
	ID	±	CS	±	ID	±	CS	±
G20	19.40	0.22	3.10	0.10	0.764	0.009	0.122	0.004
G25	24.40	0.25	3.10	0.10	0.961	0.010	0.122	0.004
G30	29.40	0.29	3.10	0.10	1.157	0.011	0.122	0.004
G35	34.40	0.33	3.10	0.10	1.354	0.013	0.122	0.004
G40	39.40	0.37	3.10	0.10	1.551	0.015	0.122	0.004
G45	44.40	0.41	3.10	0.10	1.748	0.016	0.122	0.004
G50	49.40	0.45	3.10	0.10	1.945	0.018	0.122	0.004
G55	54.40	0.49	3.10	0.10	2.142	0.019	0.122	0.004
G58	57.40	0.51	3.10	0.10	2.260	0.020	0.122	0.004
G60	59.40	0.53	3.10	0.10	2.339	0.021	0.122	0.004
G65	64.40	0.57	3.10	0.10	2.535	0.022	0.122	0.004
G70	69.40	0.61	3.10	0.10	2.732	0.024	0.122	0.004
G75	74.40	0.65	3.10	0.10	2.929	0.026	0.122	0.004
G80	79.40	0.69	3.10	0.10	3.126	0.027	0.122	0.004
G85	84.40	0.73	3.10	0.10	3.323	0.029	0.122	0.004
G90	89.40	0.77	3.10	0.10	3.520	0.030	0.122	0.004
G95	94.40	0.81	3.10	0.10	3.717	0.032	0.122	0.004
G100	99.40	0.85	3.10	0.10	3.913	0.033	0.122	0.004
G105	104.40	0.87	3.10	0.10	4.110	0.034	0.122	0.004
G110	109.40	0.91	3.10	0.10	4.307	0.036	0.122	0.004
G115	114.40	0.94	3.10	0.10	4.504	0.037	0.122	0.004
G120	119.40	0.98	3.10	0.10	4.701	0.039	0.122	0.004
G125	124.40	1.01	3.10	0.10	4.898	0.040	0.122	0.004
G130	129.40	1.05	3.10	0.10	5.094	0.041	0.122	0.004
G135	134.40	1.08	3.10	0.10	5.291	0.043	0.122	0.004
G140	139.40	1.12	3.10	0.10	5.488	0.044	0.122	0.004
G145	144.40	1.16	3.10	0.10	5.685	0.046	0.122	0.004
G150	149.30	1.19	5.70	0.13	5.878	0.047	0.224	0.005
G155	154.30	1.23	5.70	0.13	6.075	0.048	0.224	0.005
G160	159.30	1.26	5.70	0.13	6.272	0.050	0.224	0.005
G165	164.30	1.30	5.70	0.13	6.468	0.051	0.224	0.005
G170	169.30	1.33	5.70	0.13	6.665	0.052	0.224	0.005
G175	174.30	1.37	5.70	0.13	6.862	0.054	0.224	0.005
G180	179.30	1.40	5.70	0.13	7.059	0.055	0.224	0.005
G185	184.30	1.44	5.70	0.13	7.256	0.057	0.224	0.005
G190	189.30	1.47	5.70	0.13	7.453	0.058	0.224	0.005
G195	194.30	1.51	5.70	0.13	7.650	0.059	0.224	0.005
G200	199.30	1.55	5.70	0.13	7.846	0.061	0.224	0.005
G205	204.30	1.58	5.70	0.13	8.043	0.062	0.224	0.005
G210	209.30	1.61	5.70	0.13	8.240	0.063	0.224	0.005
G215	214.30	1.65	5.70	0.13	8.437	0.065	0.224	0.005
G220	219.30	1.68	5.70	0.13	8.634	0.066	0.224	0.005
G225	224.30	1.71	5.70	0.13	8.831	0.067	0.224	0.005
G230	229.30	1.73	5.70	0.13	9.028	0.068	0.224	0.005
G235	234.30	1.78	5.70	0.13	9.224	0.070	0.224	0.005

INEM O-RING Standard Size (JIS B 2401)

JIS B 2401	Measurements in Millimeters				Measurements in Inches			
	ID	±	CS	±	ID	±	CS	±
G240	239.30	1.81	5.70	0.13	9.421	0.071	0.224	0.005
G245	244.30	1.85	5.70	0.13	9.618	0.073	0.224	0.005
G250	249.30	1.88	5.70	0.13	9.815	0.074	0.224	0.005
G255	254.30	1.91	5.70	0.13	10.012	0.075	0.224	0.005
G260	259.30	1.94	5.70	0.13	10.209	0.076	0.224	0.005
G265	264.30	1.98	5.70	0.13	10.405	0.078	0.224	0.005
G270	269.30	2.01	5.70	0.13	10.602	0.079	0.224	0.005
G275	274.30	2.04	5.70	0.13	10.799	0.080	0.224	0.005
G280	279.30	2.07	5.70	0.13	10.996	0.081	0.224	0.005
G285	284.30	2.11	5.70	0.13	11.193	0.083	0.224	0.005
G290	289.30	2.14	5.70	0.13	11.390	0.084	0.224	0.005
G295	294.30	2.17	5.70	0.13	11.587	0.085	0.224	0.005
G300	299.30	2.20	5.70	0.13	11.783	0.087	0.224	0.005
G305	304.30	2.24	5.70	0.13	11.980	0.088	0.224	0.005
G310	309.30	2.27	5.70	0.13	12.177	0.089	0.224	0.005
G315	314.30	2.30	5.70	0.13	12.374	0.091	0.224	0.005
G320	319.30	2.33	5.70	0.13	12.571	0.092	0.224	0.005
G325	324.30	2.36	5.70	0.13	12.768	0.093	0.224	0.005
G330	329.30	2.39	5.70	0.13	12.965	0.094	0.224	0.005
G335	334.30	2.42	5.70	0.13	13.161	0.095	0.224	0.005
G340	339.30	2.45	5.70	0.13	13.358	0.096	0.224	0.005
G345	344.30	2.48	5.70	0.13	13.555	0.098	0.224	0.005
G350	349.30	2.51	5.70	0.13	13.752	0.099	0.224	0.005
G355	354.30	2.54	5.70	0.13	13.949	0.100	0.224	0.005
G360	359.30	2.57	5.70	0.13	14.146	0.101	0.224	0.005
G365	364.30	2.60	5.70	0.13	14.342	0.102	0.224	0.005
G370	369.30	2.63	5.70	0.13	14.539	0.104	0.224	0.005
G375	374.30	2.67	5.70	0.13	14.736	0.105	0.224	0.005
G380	379.30	2.70	5.70	0.13	14.933	0.106	0.224	0.005
G385	384.30	2.73	5.70	0.13	15.130	0.107	0.224	0.005
G390	389.30	2.77	5.70	0.13	15.327	0.109	0.224	0.005
G395	394.30	2.79	5.70	0.13	15.524	0.110	0.224	0.005
G400	399.30	2.82	5.70	0.13	15.720	0.111	0.224	0.005
G405	404.30	3.00	5.70	0.13	15.917	0.118	0.224	0.005
G410	409.30	3.00	5.70	0.13	16.114	0.118	0.224	0.005
G415	414.30	3.00	5.70	0.13	16.311	0.118	0.224	0.005
G420	419.30	3.00	5.70	0.13	16.508	0.118	0.224	0.005
G425	424.30	3.00	5.70	0.13	16.705	0.118	0.224	0.005
G430	429.30	3.00	5.70	0.13	16.902	0.118	0.224	0.005
G435	434.30	3.00	5.70	0.13	17.098	0.118	0.224	0.005
G440	439.30	3.00	5.70	0.13	17.295	0.118	0.224	0.005
G445	444.30	3.00	5.70	0.13	17.492	0.118	0.224	0.005
G450	449.30	3.00	5.70	0.13	17.689	0.118	0.224	0.005
G455	454.30	3.30	5.70	0.13	17.886	0.130	0.224	0.005
G460	459.30	3.30	5.70	0.13	18.083	0.130	0.224	0.005

INEM O-RING Standard Size (JIS B 2401)

JIS B 2401	Measurements in Millimeters				Measurements in Inches			
	ID	±	CS	±	ID	±	CS	±
S3	2.50	0.13	1.50	0.08	0.098	0.005	0.059	0.003
S4	3.50	0.14	1.50	0.08	0.138	0.006	0.059	0.003
S5	4.50	0.14	1.50	0.08	0.177	0.006	0.059	0.003
S6	5.50	0.15	1.50	0.08	0.217	0.006	0.059	0.003
S7	6.50	0.15	1.50	0.08	0.256	0.006	0.059	0.003
S8	7.50	0.16	1.50	0.08	0.295	0.006	0.059	0.003
S9	8.50	0.16	1.50	0.08	0.335	0.006	0.059	0.003
S10	9.50	0.17	1.50	0.08	0.374	0.007	0.059	0.003
S11.2	10.70	0.18	1.50	0.08	0.421	0.007	0.059	0.003
S12	11.50	0.18	1.50	0.08	0.453	0.007	0.059	0.003
S12.5	12.00	0.19	1.50	0.08	0.472	0.007	0.059	0.003
S14	13.50	0.19	1.50	0.08	0.531	0.007	0.059	0.003
S15	14.50	0.19	1.50	0.08	0.571	0.007	0.059	0.003
S16	15.50	0.20	1.50	0.08	0.610	0.008	0.059	0.003
S18	17.50	0.21	1.50	0.08	0.689	0.008	0.059	0.003
S20	19.50	0.22	1.50	0.08	0.768	0.009	0.059	0.003
S22	21.50	0.23	1.50	0.08	0.846	0.009	0.059	0.003
S22.4	21.90	0.23	2.00	0.08	0.862	0.009	0.079	0.003
S24	23.50	0.24	2.00	0.08	0.925	0.009	0.079	0.003
S25	24.50	0.24	2.00	0.08	0.965	0.009	0.079	0.003
S26	25.50	0.25	2.00	0.08	1.004	0.010	0.079	0.003
S28	27.50	0.26	2.00	0.08	1.083	0.010	0.079	0.003
S29	28.50	0.28	2.00	0.08	1.122	0.011	0.079	0.003
S30	29.50	0.28	2.00	0.08	1.161	0.011	0.079	0.003
S31.5	31.00	0.29	2.00	0.08	1.220	0.011	0.079	0.003
S32	31.50	0.31	2.00	0.08	1.240	0.012	0.079	0.003
S34	33.50	0.32	2.00	0.08	1.319	0.013	0.079	0.003
S35	34.50	0.33	2.00	0.08	1.358	0.013	0.079	0.003
S35.5	35.00	0.33	2.00	0.08	1.378	0.013	0.079	0.003
S36	35.50	0.34	2.00	0.08	1.398	0.013	0.079	0.003
S38	37.50	0.36	2.00	0.08	1.476	0.014	0.079	0.003
S39	38.50	0.36	2.00	0.08	1.516	0.014	0.079	0.003
S40	39.50	0.38	2.00	0.08	1.555	0.015	0.079	0.003
S42	41.50	0.39	2.00	0.08	1.634	0.015	0.079	0.003
S44	43.50	0.40	2.00	0.08	1.713	0.016	0.079	0.003
S45	44.50	0.41	2.00	0.08	1.752	0.016	0.079	0.003
S46	45.50	0.42	2.00	0.08	1.791	0.017	0.079	0.003
S48	47.50	0.44	2.00	0.08	1.870	0.017	0.079	0.003
S50	49.50	0.45	2.00	0.08	1.949	0.018	0.079	0.003
S53	52.50	0.47	2.00	0.08	2.067	0.019	0.079	0.003
S55	54.50	0.50	2.00	0.08	2.146	0.020	0.079	0.003
S56	55.50	0.50	2.00	0.08	2.185	0.020	0.079	0.003
S60	59.50	0.52	2.00	0.08	2.343	0.020	0.079	0.003
S63	62.50	0.55	2.00	0.08	2.461	0.022	0.079	0.003
S65	64.50	0.56	2.00	0.08	2.539	0.022	0.079	0.003



TEL +82-42-862-7509 FAX +82-42-862-7508
E-mail sales@inem.co.kr Website www.inem.co.kr

235, Techno 2-ro, Yuseong-gu, Daejeon, Korea 34026