

Modicon Premium automation platform

Catalogue

May 2012



Schneider
Electric



All technical information about products listed in this catalogue are now available on:
www.schneider-electric.com

Browse the “product data sheet” to check out :

- characteristics,
- dimensions,
- curves, ...
- and also the links to the user guides and the CAD files.

1 From the home page, type the model number* into the “Search” box.

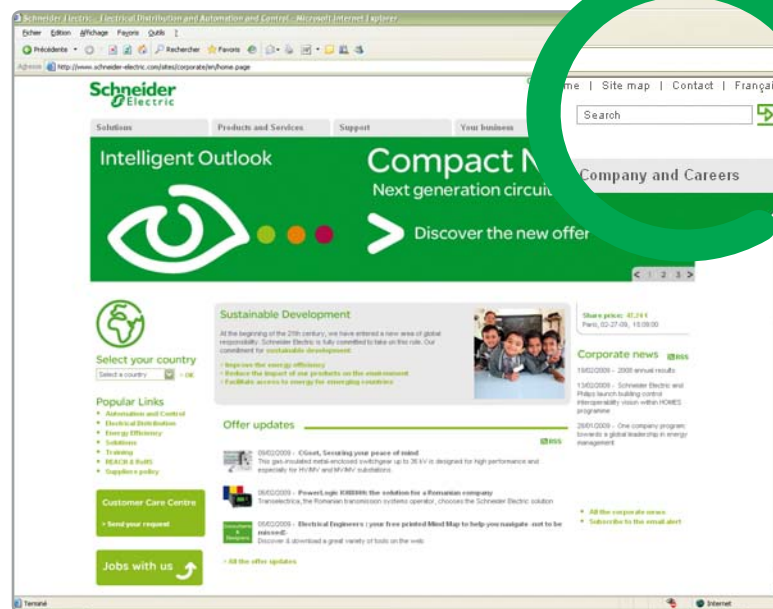

* type the model number without any blank, replace “.” by “*”

2 Under “All” tab, click the model number that interests you.

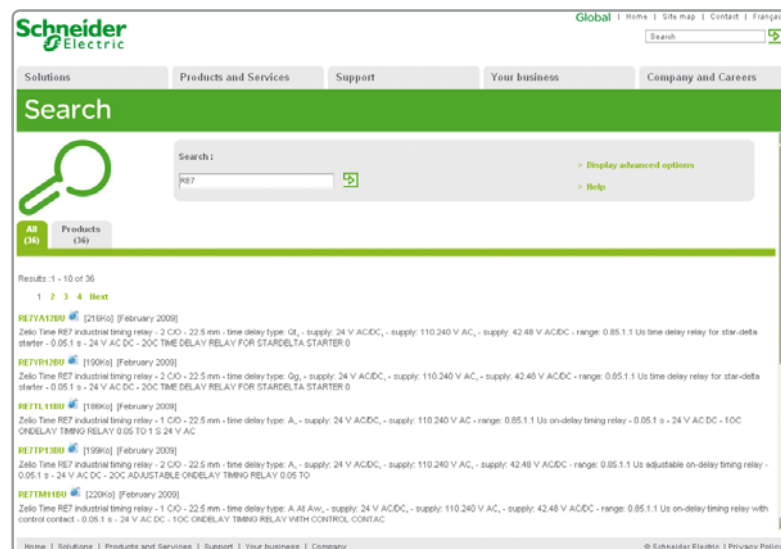

3 The product data sheet displays.

Example : Zelio Time data sheet

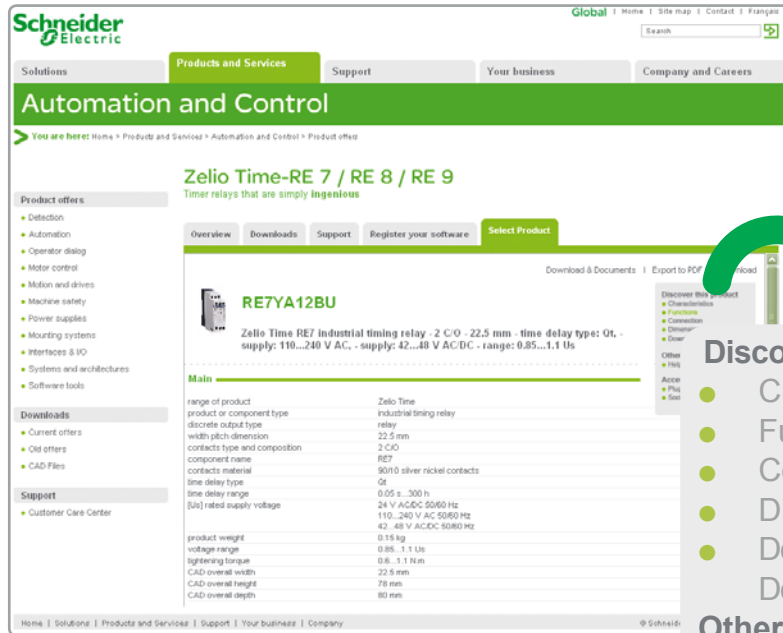

Discover this product

- Characteristics
- Functions
- Connection
- Dimensions
- Download & Documents

Other products

- Help me to choose
- #### Accessories
- Plug
 - Sockets

Example : Zelio Time data sheet

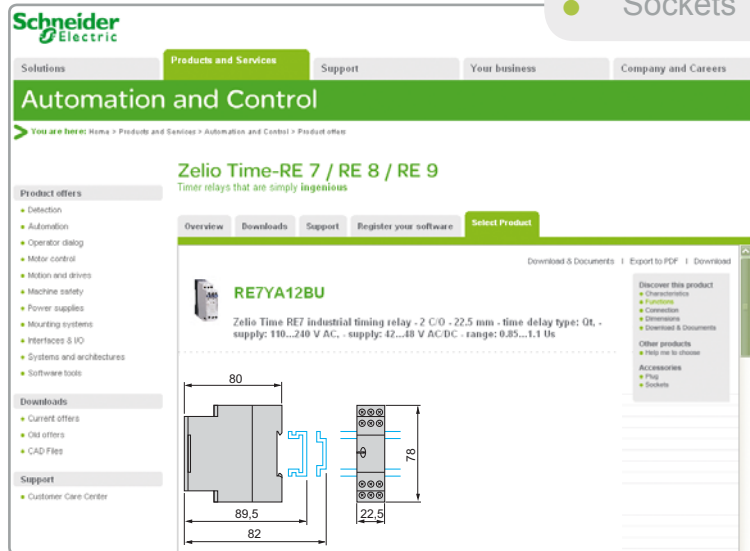

Example : Zelio Time data sheet



☑ You can get this information in one single pdf file.

- 1 - Modicon Premium processors**
- 2 - Power supplies and racks**
- 3 - Discrete, analog, distributed and special I/O**
- 4 - Application-specific modules and solutions**
- 5 - Communication**
- 6 - Software**
- 7 - Human/Machine Interfaces**
- 8 - Connection interfaces and regulated switch mode power supplies**
- 9 - Appendices and services**
 - Treatment for severe environments, Conformal Coating modules
 - Power consumption table
 - Technical appendices
 - A dedicated services offer for your installed base
 - Product reference index

Premium processors - Unity

Selection guide page 1/2

■ **Premium processors - Unity**

- Presentation page 1/4
- Description page 1/5
- Memory structure page 1/8
- References page 1/10

■ **PCMCIA memory extension cards - Unity** page 1/12

Premium processors - PL7

Selection guide page 1/14

■ **Premium processors - PL7**

- Presentation page 1/16
- Description page 1/17
- Memory structure page 1/18
- References page 1/19

■ **PCMCIA memory extension cards - PL7** page 1/20

Premium platforms for Unity Pro software offer

TSX 57 1● processors



★

Number of racks (according to rack type)		4 with 4, 6 or 8 slots or 2 with 12 slots
In-rack I/O (1)	Discrete I/O	512 channels (8-, 16-, 32- or 64-channel module)
	Analog I/O	24 channels (4-, 8- or 16- channel module)
In-rack application-specific channels	Max. number of channels	8
	Counter	Module with 2/4 counter channels 1 MHz max., single-channel electronic cam module
	Motion (2)	Modules with 1/2 axes for stepper motors, 2/3/4 axes for analog control servo motors, with 8/16 axes with SERCOS digital link
	Weighing	Modules for 8 load cells (1 application-specific channel)
Serial link connections	Modbus	TSX SCY in-rack communication modules (1 application-specific channel)
	Uni-Telway	RS 232, RS 485 or current loop (3)/(4) master/slave PCMCIA modules and RS 485 in-rack master/slave communication modules
	Character mode	1 integrated RS 485 master/slave channel (5), RS 232, RS 485 or current loop (3)/(4) master/slave PCMCIA modules and RS 485 in-rack master/slave communication modules
Bus connections	Actuator/sensor bus	2 in rack modules
	AS-Interface master V2	1 PCMCIA module (3)
	CANopen machine bus master V4.02	–
Network connections	INTERBUS field bus master V2 (6) or Profibus DP field bus master V0 Class1 and 2 (6)	1
	Max. no. of networks	In-rack modules: Ethernet Modbus/TCP (Web server, FactoryCast server or FactoryCast HMI server) and EtherNet/IP
Integrated process control	Ethernet	Modbus Plus (3), Fipway (3)/(4) modules, Ethway “in-rack” modules
	Fipway/Ethway/Modbus Plus modules	–
Hot Standby availability	Configurable loops	Process control EFB library
	Programmable loops	–
Memory capacity	Without PCMCIA extension	96 Kb program and data
	With PCMCIA extension	224 Kb program 96 Kb data
	Data storage	256 Kb (PCMCIA extension in upper slot (0) on processor)
USB programming port		–
Power supply		100...240 V ~, 24 V = non-isolated and 24...48 V = isolated power supply. A power supply is required for each rack.
Consumption		See page 9/6
Standards and certifications		See pages 9/8 and 9/18
Premium processor type (12)	Standard	TSX P57 104M
	Integrated Ethernet (9)	TSX P57 1634M
	Integrated CANopen	
	Integrated Fipio	
Pages		TSX P57 154M (11) ★ 1/10

(1) The maximum values for the numbers of discrete and analog I/O are cumulative (with the exception of **TSX H57 24M/44M** Hot Standby processors).
 (2) 1 axis = 1 application-specific channel, except for SERCOS modules where, depending on the configuration, the module = 2...32 channels.
 (3) Module to be inserted into the lower PCMCIA slot (no. 1) on a Premium processor.
 (4) Module to be inserted into the **TSX SCY 21 601** in-rack communication module slot.
 (5) Non-isolated serial link. For distances > 10 m, use connection accessory **TSX P ACC 01**, see pages 5/131 and 5/133.
 (6) The *INTERBUS* and *Profibus DP* limits are not cumulative.



More technical information on www.schneider-electric.com

TSX 57 2● processors			TSX 57 3● processors			TSX 57 4● processors			TSX 57 5● processors		TSX 57 6● processors	
												
★★			★★★			★★★★			★★★★★		★★★★★	
8 with 4, 6, 8 or 12 slots			16 with 4, 6 or 8 slots or 8 with 12 slots			8 with 4, 6, 8 or 12 slots			16 with 4, 6 or 8 slots or 8 with 12 slots			
1024 channels (8-, 16-, 32- or 64-channel module)			128 channels (4-, 8- or 16-channel module)			2048 channels (8-, 16-, 32- or 64-channel module)			256 channels (4-, 8- or 16- channel module)		512 channels (4-, 8- or 16- channel module)	
80 channels (4-, 8- or 16- channel module)			128 channels (4-, 8- or 16-channel module)			256 channels (4-, 8- or 16- channel module)			512 channels (4-, 8- or 16- channel module)			
18			24			32			18		64	
Modules with 2/4 counter channels, single-channel electronic cam module			Modules with 1/2 axes for stepper motors, 2/3/4 axes for analog control servo motors, 8/16 axes with SERCOS digital link			Modules with 2/4 counter channels, single-channel electronic cam module			Modules with 1/2 axes for stepper motors, 2/3/4 axes for analog control servo motors, 8/16 axes with SERCOS digital link			
-			-			-			-		-	
Modules for 8 load cells (1 application-specific channel)			Modules for 8 load cells (1 application-specific channel)			Modules for 8 load cells (1 application-specific channel)			Modules for 8 load cells (1 application-specific channel)			
TSX SCY in-rack communication modules (1 application-specific channel)			TSX SCY in-rack communication modules (1 application-specific channel)			TSX SCY in-rack communication modules (1 application-specific channel)			TSX SCY in-rack communication modules (1 application-specific channel)			
RS 232, RS 485 or current loop (3/4) master/slave PCMCIA modules and RS 485 in-rack master/slave communication modules			RS 232, RS 485 or current loop (3/4) master/slave PCMCIA modules and RS 485 in-rack master/slave communication modules			RS 232, RS 485 or current loop (3/4) master/slave PCMCIA modules and RS 485 in-rack master/slave communication modules			RS 232, RS 485 or current loop (3/4) master/slave PCMCIA modules and RS 485 in-rack master/slave communication modules			
1 integrated RS 485 master/slave channel (5), RS 232, RS 485 or current loop (3/4) master/slave PCMCIA modules and RS 485 in-rack master/slave communication modules			1 integrated RS 485 channel (5), RS 232, RS 485 or current loop (3/4) PCMCIA modules and RS 485 in-rack communication modules			1 integrated RS 485 channel (5), RS 232, RS 485 or current loop (3/4) PCMCIA modules and RS 485 in-rack communication modules			1 integrated RS 485 channel (5), RS 232, RS 485 or current loop (3/4) PCMCIA modules and RS 485 in-rack communication modules			
-			4 in rack modules			8 in rack modules			-		8 in rack modules	
-			1 PCMCIA module (3)			-			-		1 PCMCIA module (3)	
-			1 in-rack module			3 in rack modules			-		4 in rack modules	
-			-			-			-		5 in rack modules	
2			2			3			4			
In-rack modules: Ethernet Modbus/TCP (Web server, FactoryCast server or FactoryCast HMI server) and EtherNet/IP			In-rack modules: Ethernet Modbus/TCP (Web server, FactoryCast server or FactoryCast HMI server) and EtherNet/IP			In-rack modules: Ethernet Modbus/TCP (Web server, FactoryCast server or FactoryCast HMI server) and EtherNet/IP			In-rack modules: Ethernet Modbus/TCP (Web server, FactoryCast server or FactoryCast HMI server) and EtherNet/IP			
-			Modbus Plus (3), Fipway (3)(4) modules, Ethway in-rack modules			-			-		Modbus Plus (3), Fipway (3)(4)(7) modules, Ethway in-rack modules	
10 channels with 3 loops max.			15 channels with 3 loops max.			20 channels with 3 loops max.			30 channels with 3 loops max.			
Process control EFB library			Process control EFB library			Process control EFB library			Process control EFB library			
Yes			-			Yes			-			
160/192 Kb program and data (8)			192/208 Kb program and data (8)			440 Kb program and data			1 Mb program and data		2 Mb program and data	
768 Kb program 160/192 Kb data (8)			1.75 Mb program 192/208 Kb data (8)			2 Mb program 440 Kb data			7 Mb program 1 Mb data		7 Mb program 2 Mb data	
8 Mb (PCMCIA extension in upper or lower slot (0 or 1) on processor			8 Mb (PCMCIA extension in upper or lower slot (0 or 1) on processor			8 Mb (PCMCIA extension in upper or lower slot (0 or 1) on processor			8 Mb (PCMCIA extension in upper or lower slot (0 or 1) on processor			
-			-			1			-			
100...240 V ~, 24 V = non-isolated and 24...48 V = isolated power supply. A power supply is required for each rack.			100...240 V ~, 24 V = non-isolated and 24...48 V = isolated power supply. A power supply is required for each rack.			100...240 V ~, 24 V = non-isolated and 24...48 V = isolated power supply. A power supply is required for each rack.			100...240 V ~, 24 V = non-isolated and 24...48 V = isolated power supply. A power supply is required for each rack.			
See page 9/6			See page 9/6			See page 9/6			See page 9/6			
See pages 9/8 and 9/18			See pages 9/8 and 9/18			See pages 9/8 and 9/18			See pages 9/8 and 9/18			
	TSX P57 204M	TSX P57 304M										
TSX H57 24M (10)	TSX P57 2634M	TSX P57 3634M ★★★	TSX H57 44M (10)	TSX P57 4634M	TSX P57 5634M	TSX P57 6634M						
	TSX P57 254M ★★	TSX P57 354M		TSX P57 454M ★★★★	TSX P57 554M ★★★★							
4/60	1/10		4/60	1/11								

(7) TSX P57 4634M/5634M/6634M processors with integrated Ethernet port do not support the PCMCIA Fipway card.
 (8) The second value corresponds to TSX P57 254M/354M processors with integrated Fipio link and to the TSX H57 24M Hot Standby processor.
 (9) The integrated Ethernet port requires 1 of the available network connections.
 (10) The integrated Ethernet port is dedicated to Hot Standby communication (CPU Sync link between the "Primary" and "Standby" CPUs).
 (11) The TSX P57 154M processor does not support the CANopen bus PCMCIA module.
 (12) All processors in the Premium Unity range are equipped with 32-bit architecture microprocessors.

Modicon Premium automation platform

Unity processors

1

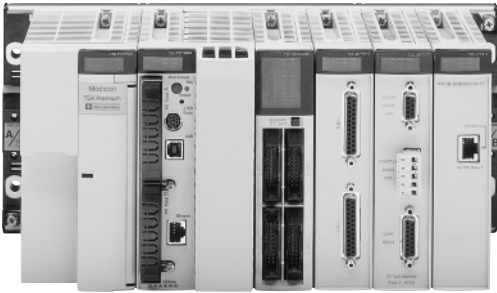

Presentation

Modicon Premium **TSX P57 ●●4M**, **TSX P57 ●●34M** and **TSX H●4M** automation platform processors manage the entire PLC station comprising:

- Discrete I/O modules
- Preventa safety modules
- Analog I/O modules
- Application-specific modules (counter, motion, weighing, communication)

Three new references have been added to the Premium processor offer:

- **TSX P57 6634M**, high-end processor with 1 integrated Ethernet Modbus/TCP port and an internal 2 Mb RAM
- **TSX H57 24M/44M**, which support the Hot Standby system (with “Primary” and “Secondary” PLCs), see pages 4/52 to 4/61.

The processors offered have different memory capacities, processing speeds, number of I/O and number and type of communication ports.

Also, depending on the model, the processors offer:

- 1 to 16 racks interconnected by means of Bus X (max. distance: 700 m)
- 192 to 2040 discrete I/O
- 12 to 512 analog I/O
- 4 to 64 application-specific channels. Each application-specific module (counter, motion control, serial link or weighing) accounts for 1 or more application-specific channels.
- 1 to 4 networks (Ethernet Modbus/TCP, EtherNet/IP, Fipway, Modbus Plus, Ethway), 1 to 8 AS-Interface buses
- 0 or 1 Fipio bus, 0 or 1 CANopen or Modbus Plus bus and 0 to 5 INTERBUS or Profibus DP ⁽¹⁾ fieldbuses
- 0 to 30 process control channels, with each channel capable of supporting up to 3 loops

Depending on the model, Premium processors include:

- A 10BASE-T/100BASE-TX Ethernet TCP/IP port (RJ45 connector)
- A 1Mbit/s Fipio bus link (bus manager)
- Communication via 2 terminal ports (TER and AUX) using Uni-Telway or character mode protocol (typically a 19 or 115 Kbit/s programming terminal and an operator dialogue terminal)
- A USB type TER port (for connecting a programming terminal)

Each processor has two PCMCIA card slots:

- An upper slot (no. 0) to take battery-backed memory extension cards (program, symbols, constants and/or data files)
 - A lower slot (no. 1) to take ⁽¹⁾ a network card (Fipway, Modbus Plus) or a bus card (CANopen, Fipio Agent, Modbus, Uni-Telway and serial links).
- Memory extension cards intended specifically for storing data can also be inserted into this slot.

Treatment for harsh environments

If the Modicon Quantum automation platform needs to be used in a very harsh environment, the “*Conformal Coating*” offer provides processors and power supply modules, I/O modules on Bus X and racks with a protective coating applied to their electronic cards. See page 9/2.

Premium application design and installation

The installation of these Premium processors requires:

- Unity Pro Medium, Large or Extra Large programming software. This is the same as the software used for installing the Modicon M340 and Modicon Quantum platforms.
- Optionally, as required:
 - Unity Application Generator (UAG) specialist software for modelling and generating process applications
 - Unity EFB toolkit software for developing EF and EFB libraries in C language
 - Unity SFC View software for viewing and diagnostics of applications written in Sequential Function Chart (SFC) or Grafset language

⁽¹⁾ **TSX H57 24M/44M** Hot Standby processors do not support the following buses or networks: Fipio, CANopen, Modbus Plus, INTERBUS and Profibus DP.

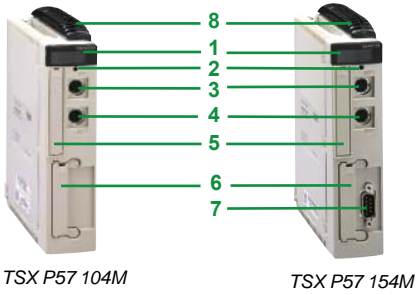

TSX P57 104M

TSX P57 154M

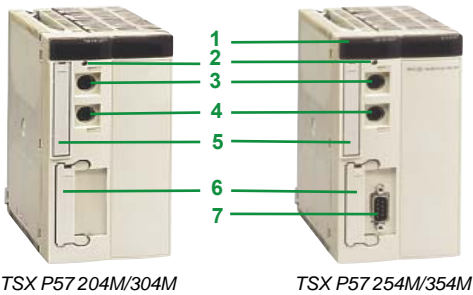

TSX P57 204M/304M

TSX P57 254M/354M

Processors without integrated Ethernet Modbus/TCP port

TSX P57 1●4M single-format processors and TSX P57 2●4M/3●4M double-format processors feature the following on the front panel:

- 1 A display block with 5 LEDs:
 - RUN LED (green): Processor in operation (program execution)
 - ERR LED (red): Fault on the processor or its on-board devices (PCMCIA memory card and PCMCIA communication card)
 - I/O LED (red): Faults occurring on another PLC station module or configuration fault
 - TER LED (yellow): Activity on the TER or AUX terminal port
 - FIP LED (red): Activity on the integrated Fipio bus (depending on model)
- 2 A RESET button causing a cold start of the PLC when pressed.
- 3 An 8-way female mini-DIN connector marked TER for connecting a programming or adjustment terminal (RS 485)
- 4 An 8-way female mini-DIN connector marked AUX for connecting a programming, adjustment or operator dialogue terminal (RS 485)
- 5 A PCMCIA slot (no. 0) for a memory card.
- 6 A PCMCIA slot (no. 1) for a communication card or memory extension card for storing additional data
- 7 A 9-way SUB-D connector (on **TSX P57 154M/254M/354M** models) for Fipio bus communication (Fipio manager port)
- 8 An air recirculating heatsink (on **TSX P57 1●4M** models)

1

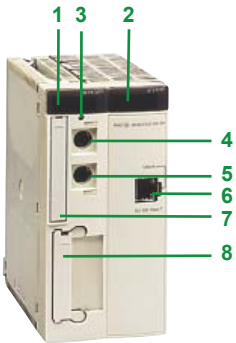

TSX P57 1634M/2634M/3634M

Processors with integrated Ethernet Modbus/TCP port

TSX P57 1634M/2634M/3634M double-format processors with integrated Ethernet Modbus/TCP port feature the following on the front panel:

- 1** A display block with 5 LEDs:
 - RUN LED (green): Processor in operation (program execution)
 - ERR LED (red): Fault on the processor or its on-board devices (PCMCIA memory card and PCMCIA communication card)
 - I/O LED (red): Faults occurring on another PLC station module or configuration fault
 - TER LED (yellow): Activity on the TER or AUX terminal port
- 2** A display block relating to the integrated Ethernet port featuring 5 LEDs:
 - RUN LED (green): Ethernet port ready
 - ERR LED (red): Ethernet port fault
 - COL LED (red): Collision detection
 - STS LED (yellow): Ethernet link diagnostics
 - Two TX and RX LEDs (yellow): Transmission/reception activity
- 3** A RESET button causing a cold start of the PLC when pressed.
- 4** An 8-way female mini-DIN connector marked TER for connecting a programming or adjustment terminal (RS 485)
- 5** An 8-way female mini-DIN connector marked AUX for connecting a programming, adjustment or operator dialogue terminal (RS 485)
- 6** An RJ45 connector for connection to the 10BASE-T/100BASE-TX Ethernet Modbus/TCP network
- 7** A PCMCIA slot (no. 0) for a memory card
- 8** A PCMCIA slot (no. 1) for a communication card or memory extension card for storing additional data

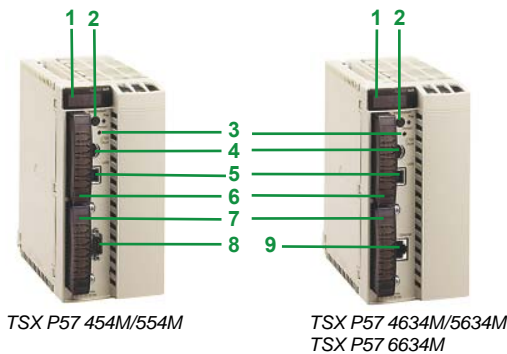

TSX P57 454M/554M/●634M and TSX H57 ●4M high-performance processors (1)

Premium double-format high-performance processors
TSX P57 454M/554M/4634M/5634M/6634M and **TSX H57 24M/44M** (1) feature the following on the front panel:

- 1 A display block with 5 LEDs:
 - RUN LED (green): Processor in operation (program execution)
 - ERR LED (red): Fault on the processor or its on-board devices (PCMCIA memory card and PCMCIA communication card)
 - I/O LED (red): Faults occurring on another PLC station module or configuration fault
 - TER LED (yellow): Activity on the AUX terminal port
 - FIP LED (red): Activity on integrated Fipio bus (TSX P57 454/554M model).

In the case of models with an integrated Ethernet port (**TSX P57 4634M/5634M/6634M**), this display block features 6 additional LEDs:

- RUN LED (green): Ethernet Modbus/TCP port ready
 - ERR LED (red): Ethernet port fault
 - COL LED (red): Collision detection
 - STS LED (yellow): Ethernet link diagnostics
 - Two TX and RX LEDs (yellow): Transmission/reception activity
- 2 A "Memory extract" button for extracting the PCMCIA memory extension card. The associated "Memory extract ready" LED indicates that this card can be extracted safely.
 - 3 A RESET button causing a cold start of the PLC when pressed.
 - 4 An 8-way female mini-DIN connector marked AUX for connecting a programming, adjustment or operator dialogue terminal
 - 5 A USB type connector marked TER for connecting a programming terminal (requires the PC-compatible 3 m connection cable, reference **UNY XCA USB 033**, to be ordered separately)
 - 6 A PCMCIA slot (no. 0) for a memory extension card
 - 7 A PCMCIA slot (no. 1) for a communication card or memory extension card for storing additional data
 - 8 A 9-way SUB-D connector (on TSX P57 454M/554M models) for Fipio bus communication (Fipio manager port)
 - 9 An RJ45 connector (on TSX P57 4634M/5634M/6634M models) for connection to the Ethernet Modbus/TCP 10BASE-T/100BASE-TX network

USB terminal port

The USB port **5** offers a faster useful data rate (12 Mbit/s) than the Uni-Telway terminal port available on Premium processors. The USB port is compatible with Unity Pro programming software and the OPC Factory Server (OFS).

454M/554M/●634M processors can be connected to a USB bus comprising several peripheral devices, however:

- Only one processor must be connected to the USB bus
- No device on the USB bus (modem, printer) can be controlled by the PLC.

(1) **TSX H57 24M/44M** Hot Standby processor, see description on page 4/53.

Memory structure

The application memory is divided into memory areas, which are physically distributed across the internal RAM and 0, 1 or 2 PCMCIA memory extension cards:

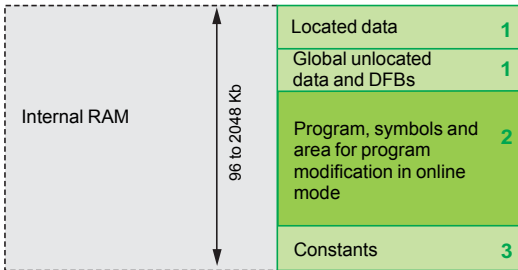

Processor without PCMCIA memory card

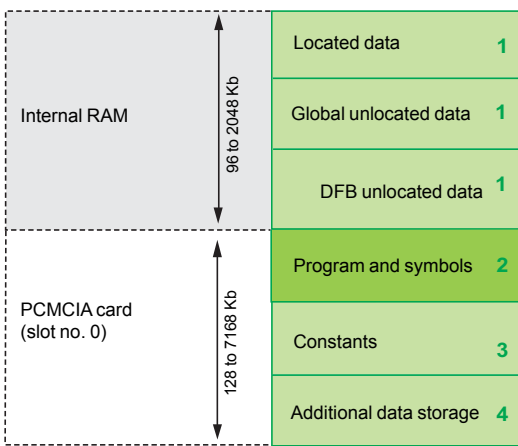

Processor with PCMCIA memory card in slot no. 0

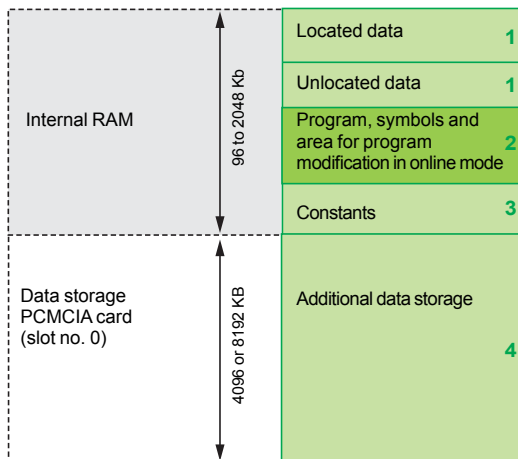

Processor with data storage memory card in slot no. 0

1 The application data area, which is always found in the internal RAM, is divided into two possible types:

- Located data, corresponding to data defined by an address (e.g. %MW237), which can have a symbol linked to it (e.g. Counter_rejects).
- Unlocated data, corresponding to data defined only by a symbol. This type of addressing eliminates the problems of memory mapping management, because addresses are assigned automatically.
- DFB unlocated data corresponding to DFB user function block data. The size of this area (which is determined by the physical size of the available internal RAM) depends on the processor model, see pages 1/10 and 1/11.

2 Area in internal RAM or PCMCIA memory card for the program and symbols. If this area is inside the internal RAM, it also supports the area for program modification in online mode (1).

This area contains the program's executable binary code and IEC source code. The user selects the type of information to be stored in the PLC memory.

3 Constants area in the internal RAM or the PCMCIA memory card (slot no. 0)

4 Area for storing additional data (slot no. 0 or no. 1), e.g. for production data and manufacturing recipes

Memory organization

The memory will be organized in one of two ways, depending on whether the Premium processor is fitted with 0, 1 or 2 memory extension cards:

■ Application in internal RAM: The application is completely loaded into the processor's internal battery-backed RAM (2), the capacity of which depends on the processor model (96 Kb to 2 Mb).

■ Application in PCMCIA card: In this case, the internal RAM is reserved for application data. The PCMCIA memory card (slot no. 0) contains the program space (program, symbols and constants areas) (128 Kb to 2 Mb). Certain types of PCMCIA memory card also host the data storage area (max. 6976 Kb).

Symbols areas

Having the symbols area in the same place as the program area is optional. However, if the application symbols database is available on the PLC, it means that, when an empty programming terminal is connected to the PLC, all the elements needed to debug or upgrade this PLC can be transferred to the terminal.

(1) If a PCMCIA card has been inserted, it is the memory on this memory card that will be used for modification of the program in online mode (outside areas 2, 3 and 4 opposite).

(2) The internal RAM is backed up by an optional battery (with a life of 3 years), which is located in the power supply module (see page 2/2).

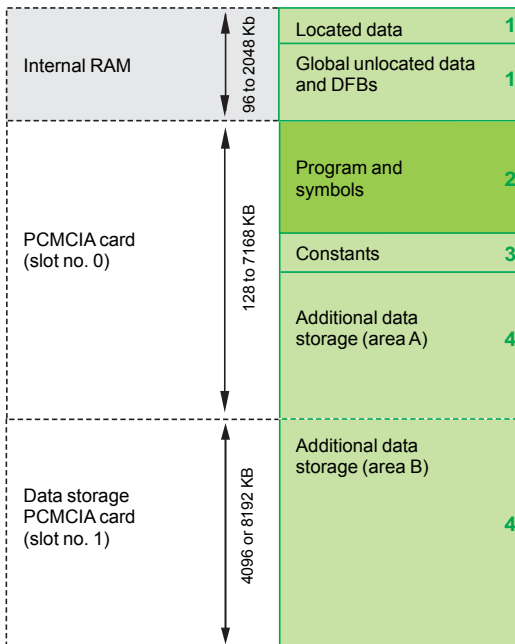

Processor with mixed type memory card in slot no. 0 and data storage type memory card in slot no. 1 (1)

Memory structure (continued)

Extension of the data storage area

Memory cards reserved for data storage (4096 or 8192 Kb) are used to:

- Access the data storage area when the application is fully loaded into the internal RAM. In this case, the data storage memory card is inserted into PCMCIA slot no. 0.
- Free up memory to serve as additional program space when the application is on the PCMCIA card (slot no. 0). In this case, the data storage memory card is inserted into PCMCIA slot no. 1 (although the memory card in slot no. 0 can still be used for some of the data).

Unity Pro programming software helps the application designer to manage the structure and organize how the memory space on the Premium PLC is occupied.

Protecting the application

Regardless of the PLC memory structure (whether the application is located in the internal RAM or on the PCMCIA card), it is possible to prevent the application from being accessed (for reading or modifying the program) by only loading the executable code into the PLC.

A memory protection bit, set in configuration mode, is also available to prevent any program modification (via the programming terminal or downloads).

Program modification in online mode

This function is different from previous versions of Premium PLCs (with PL7 software) in that it now allows program code and data from different parts of the application to be added or modified in a single modification session (thus making modification unified and consistent with regard to the controlled process).

This increased flexibility comes at a cost in terms of the amount of program memory required. In order for the program to be modified in online mode, the amount of program memory space available must be at least equal to the combined size of all sections of the Unity Pro program affected by the single modification session concerned.

Depending on circumstances:

- In the case of a processor with a memory extension card, there will be sufficient memory left on the card for online modification, provided that the recommendations on page 1/12 are observed.
- In the case of a processor without a memory extension card, if the user wants to be able to make modifications in online mode, he or she must select a processor on the basis of the following:
 - The anticipated size of the application
 - The number and size of the program sections to be modified in online mode

Note: A memory extension card based exclusively on Flash EPROM technology (without additional SRAM) is clearly incapable of supporting program modifications in online mode.

(1) As from TSX P57 20 processors.

1



TSX P57 154M



TSX P57 254M/354M



TSX P57 1634M/2634M/3634M

TSX P57 4634M/5634M/6634M
TSX H57 24M/44M

TSX 57 processors

I/O capacity (1)	Capacity		Maximum number of bus/network modules	Integrated port	Reference	Weight kg
	Memory	Control channels				
TSX 57 1● 4 racks (2)						
512 discrete I/O 24 analog I/O 8 application-specific channels	96 Kb integrated 224 Kb max. on PCMCIA card	0	1 network	–	TSX P57 104M	0.570
			2 AS-Interface buses 1 CANopen bus	Ethernet Modbus/TCP	TSX P57 1634M	0.740
			1 Ethernet network 2 AS-Interface buses	Fipio	TSX P57 154M	0.592
TSX 57 2● 16 racks (2)						
1024 discrete I/O 80 analog I/O 24 application-specific channels	160 Kb integrated 768 Kb max. on PCMCIA card	10	1 network	Ethernet	TSX P57 2634M	0.734
			4 AS-Interface buses 1 CANopen bus (3) 1 fieldbus (3)	Modbus/TCP		
			2 Ethernet networks	Ethernet dedicated to Hot Standby	TSX H57 24M	1.021
	192 Kb integrated 768 Kb max. on PCMCIA card	10	2 Ethernet networks	Fipio	TSX P57 254M	0.628
			4 AS-Interface buses 1 CANopen bus (3) 1 fieldbus (3)			
			2 Ethernet networks			
TSX 57 3● 16 racks (2)						
1024 discrete I/O 128 analog I/O 32 application-specific channels	192 Kb integrated 1792 Kb max. on PCMCIA card	15	3 networks	–	TSX P57 304M	0.618
			8 AS-Interface buses 1 CANopen bus (3) 3 fieldbuses (3)			
			2 networks	Ethernet	TSX P57 3634M	0.744
	208 Kb integrated 1792 Kb max. on PCMCIA card	15	8 AS-Interface buses 1 CANopen bus (3) 3 fieldbuses (3)	Modbus/TCP		
			3 networks	Fipio	TSX P57 354M	0.634
			8 AS-Interface buses 1 CANopen bus (3) 3 terrain fieldbuses (3)			
TSX 57 4● 16 racks (2)						
2040 discrete I/O 256 analog I/O 64 application-specific channels	440 Kb integrated 2048 Kb max. on PCMCIA card	20	3 networks	Ethernet	TSX P57 4634M	1.033
			8 AS-Interface buses 1 CANopen bus (3) 4 fieldbuses (3)	Modbus/TCP		
			4 Ethernet networks	Ethernet dedicated to Hot Standby	TSX H57 44M	1.021
			4 AS-Interface buses 1 CANopen bus 4 fieldbuses (3)	Fipio	TSX P57 454M	1.008
TSX 57 5● 16 racks (2)						
2040 discrete I/O 512 analog I/O 64 application-specific channels	1 Kb integrated 7168 Kb max. on PCMCIA card	30	3 networks	Ethernet	TSX P57 5634M	1.033
			8 AS-Interface buses 1 CANopen bus 5 fieldbuses (3)	Modbus/TCP		
			4 networks	Fipio	TSX P57 554M	1.012
			8 AS-Interface buses 1 CANopen bus 5 fieldbuses (3)			
TSX 57 6● 16 racks (2)						
2040 discrete I/O 512 analog I/O 64 application-specific channels	2 Kb integrated 7168 Kb max. on PCMCIA card	30	3 networks	Ethernet	TSX P57 6634M	1.019
			8 AS-Interface buses 1 CANopen bus 5 fieldbuses (3)	Modbus/TCP		

(1) Cumulative maximum values. The number of remote I/O on the various buses is not taken into account.

(2) Maximum number of **TSX RKY 4EX/6EX/8EX** (racks (4, 6 or 8 slots)). Using the **TSX RKY 12 EX** rack (12 slots) is the same as using 2 racks with 4, 6 or 8 slots.

(3) Fieldbus: INTERBus or Profibus DP.

PCMCIA memory extension cards

Premium processors can support up to 2 memory extension cards. However, usable memory capacity is limited to the maximum size defined for the processor model.

See pages 2/2 and 1/13.

Accessories for connection to the PC programming terminal

Description	Use	Reference	Weight kg
Universal Bluetooth® interface (UBI) for terminal port (TER)	<p>Provides Bluetooth® connectivity for products such as the Modicon M340/Premium platforms and Altivar/Lexium servo drives, via their serial port (RS 485). Used for setting-up and maintenance of products. Designed for permanent installation and can be safely fitted on the inside or outside of electrical enclosures.</p> <ul style="list-style-type: none"> ■ Protocols supported: Modbus and Uni-Telway. ■ Powered via the product's RS 485 serial port ■ Max. range in direct line of sight: 20 m <p>The kit comprises:</p> <ul style="list-style-type: none"> ■ 1: a universal Bluetooth® interface(UBI) ■ 2: a fixing clamp for installation inside the electrical enclosure ■ 3: an RJ45/mini-DIN cable (length 1 m) ■ an RJ45/RJ45 cable (length 1 m) ■ a CD with configuration software and user manual. 	TCS WAAC 13FB	0.320

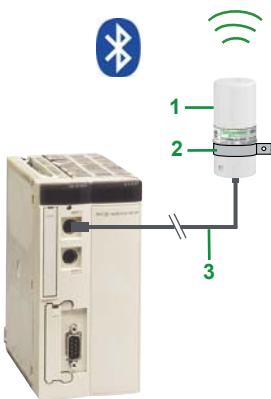

Cables for connection to the PC programming terminal

Description	Use from terminal port	to PC	Length	Reference	Weight kg
Universal cable for terminal port/RS 232 port	Mini-DIN (TER or AUX) on: TSX Micro Premium TSX P57 1● Premium TSX P57 2●/3● Tap junction TSX P ACC 01	RS 232D port (9-way SUB-D)	2.5 m	TSX PCX 1031	0.170
Cable for terminal port/USB port	Mini-DIN (TER or AUX) on: TSX Micro Premium TSX P57 1●/2●/3● Tap junction TSX P ACC 01	USB port (USB/RS 485 converter)	0.4 m	TSX CUSB 485 (1)	0.144
		USB port (mini-DIN/RJ45 cable)	2.5 m	TSX CRJMD 25 (1)	0.150
	USB (TER) on: Premium TSX 57 4●/5● Quantum 140 CPU 6●1	USB port on a PC terminal	3.3 m	UNY XCA USB 033	–



TSX PCX 1031



TSX CUSB 485

(1) The **TSX CUSB 485** converter requires the use of cable **TSX CRJMD 25** (length 2.5 m, equipped with 1 mini-DIN connector and 1 RJ45 connector).

Modicon Premium automation platform

PCMCIA memory extension cards Unity

1

Presentation

PCMCIA memory extension cards are used to extend the internal RAM capacity of Premium processors.

Some of the cards can also be used on Modicon Micro and Modicon Quantum processors. Depending on the model, these cards are designed to hold:

- The application program, symbols and constants
- Additional application data
- Or both

PCMCIA memory extension cards

All the cards are inserted into PCMCIA slot no. 0, which is the upper slot on Premium processors.

Two of these SRAM data storage memory cards can also be inserted into slot no. 1, which is the lower slot on Premium processors.

These cards support three types of storage:

- Application storage: program, symbols and constants in a common area of (128 Kb to 7168 Kb, depending on the card model):
 - **TSX MRP P●●●K** for SRAM memories
 - **TSX MFP P●●●K/M** for Flash EPROM memories
- Storage of the application and additional data, comprising an application area configurable from 192 Kb to 7 Mb and an additional data storage area which therefore varies from 7 Mb to 0 Kb. The configurable cards are:
 - **TSX MRP C●●●K/M** for SRAM memories
 - **TSX MCP C●●●K/M** for Flash EPROM and SRAM memories
- Storage of additional data, provided by SRAM **TSX MRP F00●M** 4 or 8 Mb memory cards.

These cards use two technologies:

■ Battery-backed SRAM

Used in particular in the application program design and debugging phases. These cards allow:

- all of the application's transfer and modification services in online mode
- Additional data storage

The memory is protected by a removable battery built into the PCMCIA card. A second, auxiliary battery, provides backup so that the main battery can be replaced without data being lost.

■ Flash EPROM.

Used when debugging of the application program is complete. It enables:

- Backup battery life restrictions to be overcome
- A global application transfer to be performed

If it is used, the application cannot be modified in online mode.

Program modification in online mode

Only extension cards on which the program is stored in SRAM memory (TSX MRP P●●●K/M and TSX MRP C●●●K/M) support online program modification

Users of processors fitted with memory extension cards who wish to modify or add program data in online mode must follow the two recommendations below:

- Structure the application program in several, reasonably-sized sections
- Where possible, select one of the two extension cards recommended in the table below:

Premium processors	TSX P57 1●	TSX P57 2●	TSX P57 3●	TSX P57 4●	TSX P57 5●	TSX P57 6●
Cards recommended for program modification in online mode	TSX MRP P224K/ P384K, All TSX MRP C●●●K/M/7	All TSX MRP C●●●K/M/7		TSX MRP C002M, TSX MRP C003M, TSX MRP C007M		



PCMCIA SRAM memory cards



PCMCIA Flash EPROM memory cards

Modicon Premium automation platform

PCMCIA memory extension cards

Unity

Reminder of processor memory capacities

Memory capacities without PCMCIA extension card (data, program, symbols, and constants in internal RAM memory)

Premium processors	TSX P57 104M/154M/1634M	TSX 57 204M/2634M	TSX P57 254M	TSX P57 304M/3634M	TSX P57 354M	TSX P57 454M/4634M	TSX P57 554M/5634M	TSX P57 6634M
In internal RAM	96 Kb	160 Kb	192 Kb		208 Kb	440 Kb	1024 KB	2048 Kb

Memory capacities with PCMCIA extension card(s) (data in internal RAM memory; program, symbols, constants, and data storage on PCMCIA card)

Premium processors	TSX P57 104M/154M/1634M	TSX 57 204M/2634M	TSX P57 254M	TSX P57 304M/3634M	TSX P57 354M	TSX P57 454M/4634M	TSX P57 554M/5634M	TSX P57 6634M
Data in internal RAM	96 Kb	160 Kb	192 Kb		208 Kb	440 Kb	1024 KB	2048 Kb
PCMCIA extension (progr., symbols and constants)	128 Kb	224 Kb	768 Kb	768 Kb	1792 Kb	1792 Kb	2048 Kb	7168 Kb
Data storage on PCMCIA (1)	256 Kb	16384 Kb, limited to 8192 Kb if the TSX MRP F008M PCMCIA card is used						

PCMCIA memory extension cards

Premium processors support the memory extension cards listed below. There are two types of memory limit: The lower of these two limits defines the memory capacity that is available to the user for the application.

- One associated with the type of processor (see above)
- One associated with the model of PCMCIA memory card selected

Use on processor	Slot	Memory size		Reference	Weight Kg
		Application	Additional data		
SRAM application memory extensions					
TSX P57 1●...57 4●	No. 0	128 Kb	–	TSX MRP P128K	0.076
		224 Kb	–	TSX MRP P224K	0.076
		384 Kb	–	TSX MRP P384K	0.076
Configurable SRAM application/additional data memory extensions					
TSX P57 1●...57 4●	No. 0	96...448 Kb	352...0 Kb	TSX MRP C448K	0.076
TSX P57 1●...57 6●	No. 0	192 ... 768 Kb	576 ... 0 Kb	TSX MRP C768K	0.076
		192 ... 1024 Kb	832 ... 0 Kb	TSX MRP C001M	0.076
		192 ... 1792 Kb	1600 ... 0 Kb	TSX MRP C01M7	0.076
		192 ... 2048 Kb	1856 ... 0 Kb	TSX MRP C002M	0.076
		192 ... 3072 Kb	2880 ... 0 Kb	TSX MRP C003M	0.076
		192 ... 7168 Kb	6976 ... 0 Kb	TSX MRP C007M	0.076
Flash EPROM application memory extensions					
TSX P57 1●...57 4●	No. 0	128 Kb	–	TSX MFP P128K	0.044
		224 Kb	–	TSX MFP P224K	0.044
		384 Kb	–	TSX MFP P384K	0.044
TSX P57 1●...57 6●	No. 0	512 Kb	–	TSX MFP P512K	0.044
		1024 Kb	–	TSX MFP P001M	0.044
TSX P57 2●...57 6●	No. 0	2048 Kb	–	TSX MFP P002M	0.044
		4096 Kb	–	TSX MFP P004M	0.044
Flash EPROM and SRAM application/additional data memory extensions					
TSX P57 1●...57 6●	No. 0	512 Kb	512 Kb	TSX MCP C512K	0.076
		2048 Kb	1024 Kb	TSX MCP C002M	0.076
SRAM additional data memory extensions					
TSX P57 2●...57 6●	No. 0 or 1 (2)	–	4096 Kb	TSX MRP F004M	0.076
		–	8192 Kb	TSX MRP F008M	0.076
Flash EPROM backup card (3)					
TSX P57 1●	No. 0	96 Kb	–	TSX MFP B096K	0.044
Handle for extracting memory cards					
Description	Use	Processor slot		Reference	Weight kg
Handles (not provided with the memory card)	Extraction of PCMCIA memory card from processors TSX P57 4●... 57 6●	No. 0 (slot upper)		TSX P CAPUP	0.012
		No. 1 (slot lower)		TSX P CAPL	0.012
Replacement parts					
Description	Use	Type	Reference	Weight kg	
Backup batteries	SRAM PCMCIA memory card	Main battery	TSX BAT M02 (4)	0.010	
		Auxiliary battery	TSX BAT M03	0.005	

(1) Intended for the storage of manufacturing recipes and production data. Capacity depending on PCMCIA card model.

(2) Memory extension card for data file storage to be inserted into slot no. 0 if free, otherwise into slot no. 1. In the latter case, an application memory type card or an application and data file storage type card is inserted into slot no. 0

(3) This card is pre-loaded and can be used to update the application program on a Premium PLC without having to use a programming terminal (the entire program must be located in the internal RAM).

(4) TSX BAT M02 with PCMCIA card PV ≥ 04 (blue); for PCMCIA card PV < 04, please order reference TSX BAT M01.

Modicon Premium automation platform

Premium processors

PL7

1

Premium platforms for PL7 software offer

TSX 57 1● processors

TSX 57 2● processors



★

★★

Number of racks (according to rack type)		4 with 4, 6, 8 slots or 2 with 12 slots	16 with 4, 6, 8 slots or 8 with 12 slots
In-rack I/O (1)	Discrete I/O	512 channels (8-, 16-, 32- or 64-channel module)	1024 channels (8-, 16-, 32- or 64-channel module)
	Analog I/O	24 channels (4-, 8- or 16-channel module)	80 channels (4-, 8- or 16-channel module)
	Integrated process control	–	Configurable loops (10 channels with 3 loops max.)
In-rack application-specific channels	Max. no. of channels	8	24
	Counter	Modules with 2/4 counter channels 1 MHz max., single-channel electronic cam module	
	Motion (2)	Modules with 1/2 axes for stepper motors, 2/3/4 axes for analog control servo motors, 8/16 axes with SERCOS digital link	
	Weighing	Module for 8 load cells (2 application-specific channels)	
	Serial links	In-rack communication modules (1 application-specific channel)	
Serial link connections	Modbus	RS 232, RS 485 or current loop (3) (4) master/slave PCMCIA modules and RS 485 master/ slave in-rack communication modules	
	Uni-Telway	1 integrated RS 485 master/slave channel (5), RS 232, RS 485 or current loop (3) (4) master/slave PCMCIA modules and RS 485 master/slave in-rack communication modules	
	Character mode	1 integrated RS 485 channel (5), RS 232, RS 485 or current loop (3) (4) PCMCIA modules and RS 485 in-rack communication modules	
Bus connections	Actuator/sensor bus AS-Interface master V2	2 in rack modules	4 in rack modules
	CANopen machine bus master V4.02 (6)	1 PCMCIA module (3)	
	INTERBUS field bus master V2 (6) or Profibus DP master V0 Class 1 and 2 (6)	–	1 in-rack module
Network connections	Max. no. of networks	1	1
	Ethernet Modbus/TCP	Multiprotocol in-rack modules (Modbus, Uni-TE, Global Data, I/O Scanning, TCP Open), Web server, FactoryCast service and Factory Cast HMI services	
	Communication modules	Fipway (3) (4) and Modbus Plus (3) PCMCIA modules, in-rack Ethway modules	
Memory capacity	Without PCMCIA extension	32 Kwords program and data	48/64 Kwords program and data (7)
	With PCMCIA extension	32 Kwords data	48/64 Kwords data (7)
	Data storage	64 Kwords program	160 Kwords program
	Symbol storage	128 Kwords	640 K words + 2048 K words
	–	–	128 Kwords
Power supply	100...240 V ~, 24 V = non-isolated and 24...48 V = isolated power supply modules. A power supply is required for each rack.		
Consumption	See page 9/6		
Standards and certifications	See pages 9/8 and 9/18		
Premium processor type (8)	Standard	TSX P57 103M	TSX P57 203M ★
	Integrated Ethernet		TSX P57 2623M ★ (10) ★★
	Integrated Fipio	TSX P57 153M (9)	TSX P57 253M ★
	Integrated Ethernet and Fipio		TSX P57 2823M (10)
Pages	1/19		

(1) The maximum values for the number of discrete I/O, analog I/O and process control channels are cumulative.
 (2) 1 axis = 1 application-specific channel, except for SERCOS modules where, depending on the configuration, the module = 2...32 channels.
 (3) Module to be inserted into the lower PCMCIA slot (no. 1) on the Premium processor.
 (4) Module to be inserted into the PCMCIA slot on the **TSX SCY 21 601** in-rack communication module.
 (5) Non-isolated serial link. For distances > 10 m, use connection accessory **TSX P ACC 01**, see pages 5/131 and 5/133.
 (6) Reduce the number of modules permitted (INTERBUS or Profibus DP) by 1 when CANopen is used.
 (7) The second value corresponds to the processor with integrated Fipio bus manager link.



More technical information on www.schneider-electric.com

TSX 57 3● processors

TSX 57 4● processors



16 with 4, 6, 8 slots or 8 with 12 slots

1024 channels (8-, 16-, 32- or 64-channel module)

128 channels (4-, 8- or 16-channel module)

Configurable loops (15 channels with 3 loops max.)

32	64
----	----

Modules with 2/4 counter channels 1 MHz max., single-channel electronic cam module

Modules with 1/2 axes for stepper motors, 2/3/4 axes for analog control servo motors, 8/16 axes with SERCOS digital link

Module for 8 load cells (2 application-specific channels)

In-rack communication modules (1 application-specific channel)

RS 232, RS 485 or current loop (3) (4) master/slave PCMCIA modules and RS 485 master/ slave in-rack communication modules

1 integrated RS 485 master/slave channel (5), RS 232, RS 485 or current loop (3) (4) master/slave PCMCIA modules and RS 485 master/slave in-rack communication modules

1 integrated RS 485 channel (5), RS 232, RS 485 or current loop (3)(4) PCMCIA modules and RS 485 in-rack communication modules

8 in rack modules

1 PCMCIA module (3)

2 in rack modules

3	4
---	---

Multiprotocol in-rack modules (Modbus, Uni-TE, Global Data, I/O Scanning, TCP Open), Web server, FactoryCast service and Factory Cast HMI services

Fipway (3) (4) and Modbus Plus (3) PCMCIA modules, in-rack Ethway modules

64/80 Kwords program and data (8)	96 Kwords program and data
-----------------------------------	----------------------------

80/96 Kwords data (8)	176 Kwords data
-----------------------	-----------------

384 Kwords program	512 Kwords program (992 Kwords with PL7 V4.4 or higher)
--------------------	---

640 K words + 2048 K words	2048 K words (640 K words + 2048 K words with PL7 V4.4 or higher)
----------------------------	---

128 Kwords	256 Kwords (384 Kwords with PL7 V4.4 or higher)
------------	---

100...240 V ~, 24 V = non-isolated and 24...48 V = isolated power supply modules. A power supply is required for each rack.

See page 9/6

See pages 9/8 and 9/18

	TSX P57 303AM ↗		
	TSX P57 3623AM ↗ (10) ★★		
TSX P57 353LAM (11)	TSX P57 353AM ↗ ★★ ★	TSX P57 453AM	
			TSX P57 4823AM (10)

1/19

(8) Premium PL7 range processors are equipped with 32-bit architecture microprocessors, except for **TSX P57 1●3** processors which have 16-bit architecture processors.

(9) The **TSX P57 153M** processor does not support the CANopen bus PCMCIA module.

(10) The integrated Ethernet port requires 1 of the available network connections.

(11) Processor reserved for updating configurations with **TSX P57 352M** PL7 (old version) processors.

↗ Processor can be migrated from PL7 to Unity Pro by means of a simple update of the processor's operating system (included on the Unity Pro software CD-ROM).



Modicon Premium automation platform

PL7 processors

Presentation

Premium **TSX P57 ●●3M/3AM** and **TSX P57 ●●23M/23AM** automation platform processors manage the entire PLC station comprising discrete I/O modules, Preventa safety modules, analog I/O modules, and application-specific modules, which can be distributed over one or more racks connected via Bus X or a fieldbus

TSX P57 processors

The types of processor available are divided into different capacities according to memory, in-rack I/O, communication, and processing speed. Depending on the model:

- 4 to 16 racks
- 512 to 2040 discrete I/O
- 24 to 256 analog I/O
- 8 to 64 application-specific channels. Each application-specific module (counter, motion control, serial link or weighing) accounts for 1 or more application-specific channels.
- 1 to 4 networks (Ethernet Modbus/TCP, Fipway, Ethway, Modbus Plus), 2 to 8 AS-Interface sensor/actuator buses, 1 to 2 fieldbuses (CANopen, INTERBUS, Profibus DP), 0 or 1 Fipio fieldbus, serial links (Modbus, Uni-Telway)
- 10 to 20 process control channels

Integrated communication

Depending on the model, Premium processors include:

- A 10 or 100 Mbit/s Ethernet Modbus/TCP port (RJ45 connection)
- A 1 Mbit/s Fipio bus link (bus manager)
- Communication via 2 terminal ports (TER and AUX) using Uni-Telway or character mode protocol (typically a 19 or 115 Kbit/s programming terminal and an operator dialogue terminal)

Each processor has a slot for a type III PCMCIA card, which can accommodate a network card (Fipway, Modbus Plus), bus (CANopen (1), Fipio Agent) or serial links (Modbus, Uni-Telway, character mode).

Application design and installation

Different software licences are available for PL7 Junior/Pro version V4.5 depending on requirements:

- Single-station
- Multistation in the form of independent local stations (Junior/Pro), remote stations connected to a server via a network (Pro OpenTeam for 3 to 10 stations or Pro OpenSite for more than 10 stations).

These licences are compatible with PC terminals running Windows 2000 Professional or Windows XP operating systems.

Configurations with old generation processors

The **TSX P57 353LAM** processor can be used as a replacement for old version **TSX P57 ●●0M/●●1M/●●2M** single-format processors and for **T PCX 57 203M/353M** Atrium slot PLCs. Replacement of these processors or slot-PLCs requires reconfiguration of the PLC with the **TSX P57 353LAM**, but no modification of the application program is required. It may be necessary to update the PL7 Pro software (**TLX RCD PL7P P45M**).

Migration of Premium processors

Some Premium **TSX P57 ●●3M/3AM** processors that are compatible with PL7 software can be migrated for compatibility with Unity Pro software without any need for hardware modifications. This migration from PL7 to Unity Pro is achieved by means of the following software updates:

- Processor operating system
 - Integrated Ethernet TCP/IP port operating system
- This update is carried out using the OS-Loader tool, included in the Unity Pro software (see page 6/13). Once migrated, PL7 processors are equivalent to corresponding Unity processors.

The following PL7 processors can be migrated to Unity Pro (software migration):

- **TSX 57 2●**: **TSX P57 203M/253M/2623M** become **TSX P57 204M/254M/2634M** respectively.
- **TSX 57 3●**: **TSX P57 303M/353M/3623AM** become **TSX P7 304M/354M/3634M** respectively (migration supported by Unity Pro version ≥ 3.0).

Note: Processor migration requires use of the new PCMCIA memory references **TSX MRP P/C** and **TSX MFP P/C**. See the equivalence table on page 1/20.

(1) Except with processor **TSX P57 153M**.

Presentation (continued)

Migration of Premium processors (continued)

Migration offers involving the replacement of the processor are available for other product references. Please contact your Customer Care Centre for more information about these offers, which are only available for a limited period of time. They concern the following PL7 processors:

- **TSX P57 2823M** for migration to **TSX P57 254M** with **TSX ETY 4103** (1).
- **TSX P57 453AM** for migration to **TSX P57 454M**
- **TSX P57 453AM** for migration to **TSX P57 554M**
- **TSX P57 4823AM** for migration to **TSX P57 4634M**
- **TSX P57 4823AM** for migration to **TSX P57 5634M**
- **TSX P57 4823AM** for migration to **TSX P57 454M** with **TSX ETY 4103** (1).
- **TSX P57 4823AM** for migration to **TSX P57 554M** with **TSX ETY 4103** (1).

Description

Processors without integrated Ethernet port

Single-format **TSX P57 1●3M/353LAM** processors and double-format

TSX P57 2●3M/3●3AM/453AM processors feature the following on the front panel:

- 1 A display block with 5 LEDs:
 - RUN LED (green): processor in operation (program running)
 - ERR LED (red): Fault on the processor or its on-board devices (PCMCIA memory card and PCMCIA communication card)
 - I/O LED (red): Faults occurring on another station module or configuration fault
 - TER LED (yellow): Activity on the terminal port
 - FIP LED (red): Activity on the integrated Fipio bus
- 2 A RESET button causing a cold start of the PLC when pressed.
- 3 An 8-way female mini-DIN connector marked TER for connecting a programming or adjustment terminal.
- 4 An 8-way female mini-DIN connector marked AUX for connecting a peripheral device
- 5 A PCMCIA slot (no. 0) for a memory extension card
- 6 A PCMCIA slot (no. 1) for a communication card or 4 Mb SRAM memory extension card for storing additional data
- 7 A 9-way SUB-D connector (on **TSX P57 153M/253M**, **TSX P57 353 LAM** and **TSX P57 353M/453AM** models) for Fipio bus manager communication

Processors with integrated Ethernet port

Double-format **TSX P57 2623M/2823M** and **TSX P57 3623AM/4823AM** processors with integrated Ethernet port feature the following on the front panel:

- 1 A display block with 5 LEDs:
 - RUN LED (green): processor in operation (program running)
 - ERR LED (red): Fault on the processor or its on-board devices (PCMCIA memory card and PCMCIA communication card)
 - I/O LED (red): Faults occurring on another station module or configuration fault
 - TER LED (yellow): Activity on the terminal port
 - FIP LED (red): Activity on the integrated Fipio bus
- 2 A display block relating to the integrated Ethernet port featuring 5 LEDs:
 - RUN LED (green): Ethernet port ready
 - ERR LED (red): Ethernet port fault
 - COL LED (red): Collision detection
 - STS LED (yellow): Ethernet link diagnostics
 - Two TX and RX LEDs (yellow): Transmission/reception activity
- 3 A RESET button causing a cold start of the PLC when pressed.
- 4 An 8-way female mini-DIN connector marked TER for connecting a programming or adjustment terminal.
- 5 An 8-way female mini-DIN connector marked AUX for connecting a peripheral device
- 6 An RJ45 connector for connection to the Ethernet network
- 7 A PCMCIA slot (no. 0) for a memory extension card
- 8 A PCMCIA slot (no. 1) for a communication card or 4 Mb SRAM memory extension card for storing additional data
- 9 A 9-way SUB-D connector (on **TSX P57 2823M/4823AM** models) for Fipio bus manager communication

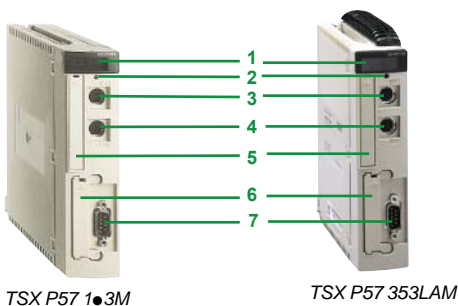

TSX P57 1●3M

TSX P57 353LAM

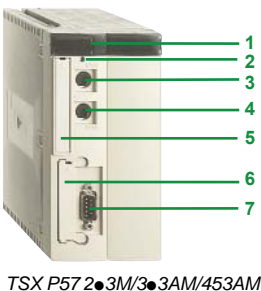

TSX P57 2●3M/3●3AM/453AM

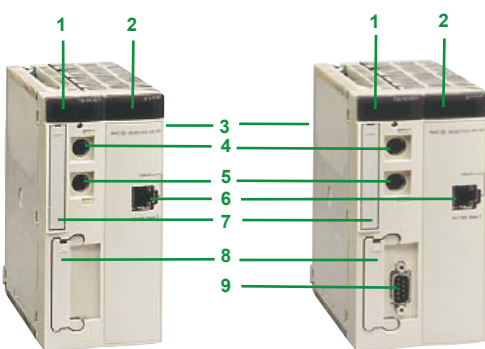

TSX P57 2623M
TSX P57 3623AM

TSX P57 2823M
TSX P57 4823AM

(1) The **TSX ETY 4103** Ethernet Modbus/TCP module offered features the same functions as the integrated Ethernet port on **TSX P57 2823M/ 4823AM** processors. However, the combined processor and Ethernet module use one slot more than the PL7 processor to be migrated. Therefore, this type of migration requires a free slot in the Premium rack and modification of the converted Unity Pro application.

1

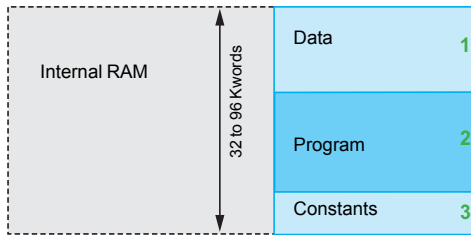

- 1 Application data (30.5 Kwords max.)
- 2 Task descriptor and executable code
- 3 Constant words, initial values and configuration

Processors without PCMCIA card

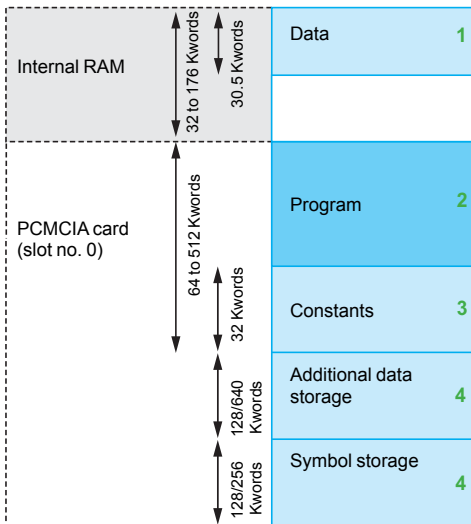

- 1 Application data (30.5 Kwords max.)
- 2 Task descriptor and executable code
- 3 Constant words, initial values and configuration
- 4 Depending on the PCMCIA card model.

Processor with PCMCIA card

Memory structure

The application memory is divided into memory areas, which are physically distributed across the internal RAM memory and the PCMCIA memory extension card(s):

- The application data area is always in the internal RAM.
 - The application program area is in the internal RAM or the PCMCIA memory card
 - The constants area is in the internal RAM or the PCMCIA memory card.
- There are two ways of organizing the application memory for **TSX P57 1●3M/2●3M/2●23M** and **TSX P57 3●3M/3623M/453M/4823AM** processors with or without a memory extension installed in the form of a PCMCIA format card.

Application in internal RAM

The application is completely loaded into the processor's battery-backed internal RAM (1), the capacity of which depends on the processor model (32 to 96 Kwords). For example, the **TSX P57 1●3M** processor has 7.5 Kwords of application data and 24.5 Kwords of program, constants and system data (2). The memory space (32 Kwords) is shared between the application data, the program, the constants and the system data (2).

Application in the PCMCIA card (slot no. 0)

The internal RAM is then reserved for the application data. The PCMCIA card contains the program and constants (64 to 512 Kwords). The file storage area of 128 K or 640 Kwords (depending on the model of PCMCIA card) can be used in remote applications, for storing information such as production data, production recipes, etc. The symbols storage area of 128 K or 256 Kwords (depending on the model of PCMCIA card) enables the application symbols database to be stored on the PLC.

Extension of the additional data storage area (slot no. 1)

This area, containing 128 or 640 Kwords, can be extended up to 2688 Kwords by using an SRAM **TSX MRP DS 2048P / MFP 004M** PCMCIA memory card. This card is inserted into the lower slot on **TSX P57 2●3M/2●23M**, **TSX P57 3●3M/3623M/453M/4823AM** processors and can be used in conjunction with memory extension cards (type 1 in the upper slot).

Data in internal RAM

The data area can be extended to up to 30.5 Kwords. It is only supported by the PLC's internal RAM.

PL7 Junior/Pro software helps the application designer to manage the structure and organize how the memory space on the Premium PLC is occupied.

Protecting the application

Regardless of the PLC memory structure (whether the application is located in the internal RAM or on the PCMCIA card), it is possible to protect the application so that it cannot be accessed (for the purpose of reading or modifying the program) in online mode under PL7 Junior/Pro.

A memory protection bit, set in configuration mode, is also available to prevent any program modification (via the programming terminal or downloading).

Premium processor references

TSX 57 10/20/30/40 processors are equipped with:

- A PCMCIA slot (no. 0) that can accommodate a memory extension or SRAM memory card for storing additional data
 - A PCMCIA slot (no. 1) that can accommodate a communication or memory extension card for storing additional data
 - Two terminal ports (8-way female mini-DIN type), Uni-Telway or character mode.
- TSX 57** processors are double-format modules (except **TSX P57 1●3M** and **TSX P57 353LAM** processors, which are single-format).

TSX 57 30/40 processors support the loading of programs, via the terminal port, at a maximum speed of 115 Kbit/s (limited to 19.2 Kbit/s for **TSX 57 10/20** processors).

The integrated Fipio link (bus manager) on **TSX 57 20/30/40** processors supports a maximum of 127 connection points. The link on the **TSX P57 153M** processor is limited to 63 connection points.

(1) The internal RAM is protected by an optional battery with a life of 3 years, which is located in the power supply module.

(2) The system has a minimum reserve RAM memory area of around 5 Kwords. Please refer to the PL7 Micro/Junior/Pro reference manual.



TSX P57 103M TSX P57 153M

TSX 57 processors

I/O capacity (1)	Capacity		Maximum number of bus/network modules	Integrated Ethernet Modbus/TCP	Reference	Weight kg
	Memory	Control channels				
TSX 57 10 4 racks (2)						
512 discrete I/O 24 analog I/O 8 application-specific channels	32 Kwords integrated 64 Kwords max. on PCMCIA	0	1 network 2 AS-Interface buses 1 CANopen bus	–	TSX P57 103M	0.380
			1 integrated Fipio 1 network 2 AS-Interface buses	–	TSX P57 153M	0.420



TSX P57 203M TSX P57 353LAM

TSX 57 20 16 racks (2)

1024 discrete I/O 80 analog I/O 24 application-specific channels	48 Kwords integrated 160 Kwords max. on PCMCIA	10	1 network 4 AS-Interface buses 1 CANopen bus (3) 1 fieldbus (3)	–	TSX P57 203M	0.520
	64 Kwords integrated 160 Kwords max. on PCMCIA	10	4 AS-Interface buses 1 Ethernet 1 CANopen bus (3) 1 fieldbus (3)	1 Ethernet	TSX P57 2623M	–
			1 integrated Fipio 1 network 4 AS-Interface buses 1 CANopen bus (3) 1 fieldbus (3)	–	TSX P57 253M	0.560
			1 integrated Fipio 4 AS-Interface buses 1 CANopen bus (3) 1 fieldbus (3)	1 Ethernet	TSX P57 2823M	–

TSX P57 253M
TSX P57 353AM
TSX P57 453AM

TSX 57 30 16 racks (2)

1024 discrete I/O 128 analog I/O 32 application-specific channels	64 Kwords integrated (4) 384 Kwords max. on PCMCIA	15	3 networks 8 AS-Interface buses 1 CANopen bus (3) 2 fieldbuses (3)	–	TSX P57 303AM	0.520
			2 networks 8 AS-Interface buses 1 CANopen bus (3) 2 fieldbuses (3)	1 Ethernet	TSX P57 3623AM	–
	80/96 Kwords integrated (4) 384 Kwords max. on PCMCIA	15	1 integrated Fipio 3 networks 8 AS-Interface buses 1 CANopen bus (3) 2 fieldbuses (3)	–	TSX P57 353LAM (5)	0.420
					TSX P57 353AM (5)	0.560

TSX P57 2623M
TSXP57 3623AM

TSX 57 40 16 racks (2)

2040 discrete I/O 256 analog I/O 64 application-specific channels	96/176 Kwords integrated (4) 512/99 Kwords (6) max. on PCMCIA	20	1 integrated Fipio 4 networks (7) 8 AS-Interface buses 1 CANopen bus (3) 2 fieldbuses (3)	–	TSX P57 453AM	0.560
				1 Ethernet	TSX P57 4823AM	–

TSX P57 2823M
TSX P57 4823AM

Accessories for connecting to the PC programming terminal

Description	Application	Reference	Weight kg
Universal Bluetooth® interface (UBI) for terminal port (TER)	Application: see page 1/11. The kit comprises: <ul style="list-style-type: none"> ■ a Universal Bluetooth® interface (UBI), ■ an RJ45/mini-DIN cable (length 1 m), ■ an RJ45/RJ45 cable (length 1 m), ■ a fixing clamp for installation inside the enclosure, ■ a CD with configuration software and user manual. 	TCS WAAC 13FB	0.320

PCMCIA memory extension cards

Premium processors can support up to 2 memory extension cards. However, usable memory capacity is limited to the maximum size defined for the processor model.

References, see pages 1/20 and 1/21.

- (1) Cumulative maximum values. The number of remote I/O on the bus is not included.
(2) Maximum number of TSX RKY 4EX/6EX/8EX racks (4, 6 or 8 slots). Using the TSX RKY 12EX rack (12 slots) is the same as using 2 racks with 4, 6 or 8 slots.
(3) Using the CANopen bus reduces the number of possible fieldbuses (INTERBUS/Profibus DP) by 1.
(4) The second value corresponds to the integrated memory capacity when the processor is equipped with a PCMCIA memory card.
(5) Single-format processor for TSX P57 353LAM, double-format processor for TSX P57 353AM.
(6) 992 Kwords with PL7 Junior/Pro software V4.4 or higher.
(7) 3 networks with TSX P57 4823AM processor.

Modicon Premium automation platform

PCMCIA memory extension cards

PL7

1



PCMCIA Flash EPROM memory



PCMCIA SRAM memory

Presentation

PCMCIA memory extension cards are used to extend the internal RAM capacity of Premium processors. Depending on the model, these cards are designed to:

- Receive the application program and constants
- Store additional application data and/or various application object symbols

Offer for Premium platform under PL7

In November 2004, the old range of **TSX MRP/MFP ●●●P** memory extension cards, which was specifically for Premium processors under PL7, was replaced by a new offer. This offer is common (1) to:

- TSX Micro PLCs under PL7
- Premium processors under Unity Pro and PL7
- Quantum processors under Unity Pro

The table below indicates equivalences between the old and new versions.

There may be one or more new references corresponding to each old reference, depending on whether migration from PL7 to Unity Pro is envisaged.

SRAM memory extension (slot no. 0)								
Use	Max. memory size			Old reference	Do you envisage migration from PL7 to Unity Pro? (P indicates "PL7 program")		Recommended reference	
	PL7 application	Additional data	Symbol storage					
All TSX 57 types	32 Kwords	–	–	TSX MRP 032P	No	Yes	TSX MRP P128K	
		128 Kwords	–	TSX MRP 232P	No	Yes	TSX MRP P384K	
	64 Kwords	–	–	TSX MRP 064P	No	Yes, P < 52 Kwords	TSX MRP P224K	
		–	–	–	–	Yes, P > 52 Kwords	TSX MRP P384K	
	128 Kwords	–	–	TSX MRP 264P	No	Yes (2)	TSX MRP P384K	
		–	–	–	–	Yes (2)	TSX MRP C768K	
TSX 57 20 TSX 57 30 TSX 57 40	128 Kwords	–	–	TSX MRP 0128P	–	Yes, P < 64 Kwords	TSX MRP P384K	
		–	–	–	No	Yes 64 Kwords < P < 104 Kwords	TSX MRP C448K	
		128 Kwords	128 Kwords	TSX MRP 2128P	–	Yes, P > 104 Kwords	TSX MRP C768K	
					–	Yes (2)	TSX MRP C768K	
		256 Kwords	–	–	TSX MRP 0256P	–	Yes, P < 104 Kwords	TSX MRP C768K
			–	–	–	No	Yes, 128 Kwords < P < 208 Kwords	TSX MRP C001M
		640 Kwords	128 Kwords	TSX MRP 3256P	–	Yes, P > 208 Kwords	TSX MRP C001M	
					–	Yes	TSX MRP C001M	
		384 Kwords	640 Kwords	–	TSX MRP 3384P	–	Yes (3)	TSX MRP C002M
						–	Yes (4)	TSX MRP C003M
TSX 57 40	512 Kwords	–	256 Kwords	TSX MRP 0512P	–	Yes (2)	TSX MRP C001M	
		–	–	–	No	Yes 256 Kwords < P < 384 Kwords	TSX MRP C002M	
	–	–	–	–	Yes, P > 384 Kwords	TSX MRP C003M		
	992 K words	640 Kwords	384 Kwords	–	–	–	TSX MRP C007M	

Flash EPROM memory extension (slot n° 0)							
Use	Max. memory size	Additional data	Symbol storage	Old reference	Do you envisage migration from PL7 to Unity Pro? (P indicates "PL7 program")		Recommended reference
All TSX 57 types	32 Kwords	–	–	TSX MFP 032P	No	Yes	TSX MFP P128K (5)
		64 Kwords	–	–	TSX MFP 064P	No	No
	128 Kwords	–	–	TSX MFP 264P	No	Yes, P < 52 Kwords	TSX MFP P224K (5)
					–	Yes, P > 52 Kwords	TSX MFP P384K (5)
TSX 57 20 TSX 57 30 TSX 57 40	128 Kwords	–	–	TSX MFP 0128P	No	Yes	TSX MCP C224K (5)
		–	–	–	No	No	TSX MFP 0128P2 (1)
	256 Kwords	–	–	–	No	Yes	TSX MFP P384K (5)
					No	Yes	TSX MFP P001M (5)

SRAM memory extension (slot no. 1)							
Use	Max. memory size	Additional data	Symbol storage	Old reference	Do you envisage migration from PL7 to Unity Pro?	Recommended reference	
TSX 57 20 TSX 57 30 TSX 57 40	–	2048 Kwords	–	TSX MRP DS 2048P	No	Yes	TSX MRP F004M

Flash EPROM backup card (slot no. 0)							
Use	Max. memory size	Additional data	Symbol storage	Old reference	Do you envisage migration from PL7 to Unity Pro?	Recommended reference	
TSX 57 10	32 Kwords	–	–	TSX MFP BAK 032P	No	Yes	TSX MFP B096K (4)

(1) Except for **TSX MFP 064P2/0128P2** Flash EPROM memory cards dedicated to PL7 processors.

(2) Choice depends on the amount of PL7 program memory in relation to the amount of data storage.

(3) If storage of symbols on the PCMCIA card is not necessary.

(4) If storage of additional data on the PCMCIA card is not necessary.

(5) Memory card compatible with processors version ≥ 5.5.

Presentation (continued)

PCMCIA memory expansion cards

All memory cards (with the exception of **TSX MRP P004M** and *TSX MRP DS 2048P* for additional SRAM data storage) are inserted into PCMCIA slot no. 0 on Premium processors (upper slot). The **TSX MRP F004M/TSX MRP DS 2048P** additional data storage card is inserted into slot no. 1 only, on Premium processors (lower slot).

With PL7, these cards support four different types of storage:

- Application storage: Program and constants in a common area of between 64 and 512 Kwords, in the SRAM or Flash EPROM memory.
- Application and additional data storage, comprising an application area of between 64 and 384 Kwords and a storage area of 128 or 640 Kwords for additional data, in the SRAM or Flash EPROM and SRAM.
- Application, additional data and symbol storage, comprising an application area of between 32 and 512 Kwords, a storage area of 128 or 640 Kwords for additional data and a symbol storage area of 128 or 256 Kwords, in the SRAM or Flash EPROM and SRAM.
- Additional data storage provided by an SRAM memory card with a capacity of 2 Mwords.

These cards use 2 technologies:

- Battery-backed SRAM. Used in particular in the application program design and debugging phases. These cards support all application transfer and modification services in online mode and the storage of additional data.

The memory is protected by a removable battery built into the PCMCIA card. A second, auxiliary battery, provides backup so that the main battery can be replaced without data being lost.

- Flash EPROM Used when debugging of the application program is complete. It enables restrictions in terms of the service life of backup batteries to be avoided and supports global application transfer. If a Flash EPROM is used, the application cannot be modified in online mode.

References

If future migration from PL7 to Unity Pro is envisaged, see the equivalence table opposite to find the new equivalent reference.

SRAM memory extension (slot no. 0)

Use	Max. memory size			Old reference	Reference	Weight kg
	PL7 application	Additional data	Symbol storage			
TSX 57 10...40	32 Kwords	–	–	TSX MRP 032P	TSX MRP P128K	0.076
	64 Kwords	–	–	TSX MRP 064P	TSX MRP P224K	0.076
	–	128 Kwords	–	TSX MRP 232P/264P	TSX MRP P384K	0.076
TSX 57 20...40	128 Kwords	–	–	TSX MRP 0128P	TSX MRP C448K	0.076
	–	128 Kwords	128 Kwords	TSX MRP 2128P	TSX MRP C768K	0.076
	256 Kwords	–	–	TSX MRP 0256P	TSX MRP C001M	0.076
	–	640 Kwords	128 Kwords	TSX MRP 3256P	TSX MRP C01M7	0.076
	384 Kwords	640 Kwords	–	TSX MRP 3384P	TSX MRP C002M	0.076
TSX 57 40	512 Kwords	–	256 Kwords	TSX MRP 0512P	TSX MRP C003M	0.076
	992 Kwords	640 Kwords	384 Kwords	–	TSX MRP C007M	0.076

Flash EPROM memory extension (slot n° 0)

TSX 57 10...40	32 Kwords	–	–	TSX MFP 032P	TSX MFP P128K (1)	0.044
	64 Kwords	–	–	TSX MFP 064P	TSX MFP P224K (1)	0.044
	–	–	–	TSX MFP 064P	TSX MFP 064P2 (2)	0.044
TSX 57 20...40	–	128 Kwords	–	TSX MFP 232P/264P	TSX MCP C224K (1)	0.044
	128 Kwords	–	–	TSX MFP 0128P	TSX MFP P384K (1)	0.044
	–	–	–	TSX MFP 0128P	TSX MFP 0128P2 (2)	0.044
	256 Kwords	–	–	–	TSX MFP P001M (1)	0.044

SRAM memory extension (slot no. 1)

TSX 57 20...40	–	2048 Kwords	–	TSX MRP DS 2048P	TSX MRP F004M	0.076
----------------	---	-------------	---	------------------	---------------	-------

Flash EPROM backup card (slot no. 0)

TSX 57 10	32 Kwords	–	–	TSX MFP BAK 032P	TSX MFP B096K (1)	0.044
-----------	-----------	---	---	------------------	-------------------	-------

Replacement parts

Description	Use	Type	Reference	Weight kg
Backup batteries	PCMCIA SRAM memory cards	Main battery	TSX BAT M02 (3)	0.010
		Auxiliary battery	TSX BAT M03 (4)	0.050
Handle	Removal of PCMCIA memory card (provided with the memory card)	–	TSX P CAPUP	0.010

(1) Memory card (blue) compatible with processor version ≥ 5.5.

(2) Memory card (orange) only compatible in run mode (no backup facility) with processor version ≤ 5.0 and < 6.1 compatible with processor version ≥ 6.1. Memory card designed for PL7 processors.

(3) For the SRAM memory card with the old reference **TSX MRP ●●●P** or with the new reference **PV < 04** (green), quote order reference number **TSX BAT M01**.

(4) Only for SRAM memory cards with a new reference.

Power supply and fan modules

- **Description** page 2/2
- **Functions** page 2/3
- **References** page 2/4

Single-rack configuration (non extendable rack)

- **Presentation** page 2/6
- **Description** page 2/6
- **References** page 2/7

Multirack configuration without remote module

- **Presentation** page 2/8
- **Description** page 2/9
- **Rack addresses** page 2/9
- **References** page 2/10

Multirack configuration with remote module

- **Presentation** page 2/12
- **Description** page 2/13
- **References** page 2/13



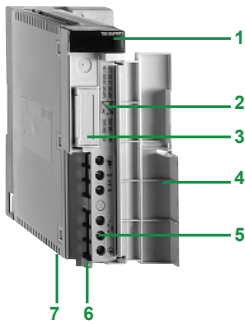

TSX PSY 2600M

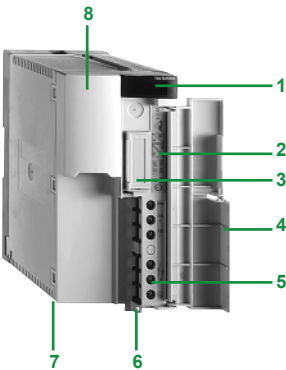

TSX PSY 5500M



Description of power supply modules

TSX PSY ●●●0M power supply modules provide the power supply for each rack and the modules installed on it.

The power supply module is selected according to:

- The line supply: 24 V $\overline{\text{---}}$, 24...48 V $\overline{\text{---}}$, 100...120 V \sim , 200...240 V \sim .
- The required power: standard format or double-format model, see power consumption table on page 9/6.

Power supply modules TSX PSY ●●●0M comprise:

- 1 A display block comprising:
 - OK LED (green), lit if rack voltages are present and correct
 - BAT lamp (red), on if the battery is faulty or missing
 - 24 V lamp (green), on when the sensor voltage is present (depending on model)
- 2 RESET pencil-point pushbutton causing a warm restart of the application
- 3 Slot for a battery which protects the processor's internal RAM memory
- 4 Cover to protect the front panel of the module
- 5 Screw terminal block for connection to:
 - The line supply
 - The alarm relay contact
 - The sensor power supply for a.c. supplies (depending on model).
- 6 Opening for cable clamp
- 7 Fuse located beneath the module and protecting:
 - 24 VR voltage on the non-isolated d.c. supply with TSX PSY 3610
 - Primary voltage on the other power supplies
- 8 110/220 voltage selector (depending on model).

Description of fan modules

TSX FAN ●●P fan modules installed above the racks of Premium PLCs provide forced air convection, in order to maintain an even ambient temperature inside the enclosure and to eliminate any hot spots that may exist.

Fan modules are required when the ambient temperature is between 60 °C and 70 °C (forced ventilation enables the ambient temperature in the enclosure to be lowered by 10 °C) (1)

Three types of fan module are available: 24 V $\overline{\text{---}}$, 110 V \sim and 220 V \sim

According to the modularity of the racks used:

- One fan module for a 4 or 6 position rack
- Two fan modules for an 8 position rack
- Three fan modules for a 12 position rack

TSX FAN ●●P fan modules comprise:

- 1 A connection terminal block for power supply to the fan module, the internal temperature probe and the associated LED or preactuator
- 2 An earth terminal
- 3 Two mounting holes for the fan module
- 4 Shuttered air outlets

(1) For an ambient temperature between 25 °C and 60 °C, the use of fan modules increases the MTBF.

Functions

Alarm relay

The alarm relay located in each power supply module has a volt-free contact which can be accessed on the module's screw connection block.

The operating principle is as follows:

- Module alarm relay located on the processor rack (rack 0): In normal operation, with the PLC in RUN, the alarm relay is activated and its contact is closed (state 1). Whenever the application stops, even partially:

- occurrence of a blocking fault
- Incorrect output voltages
- loss of mains power the relay de-energizes and the associated contact opens (state 0).

- Alarm relay of power supply modules located on the other racks (racks 1 to 7): when the module is powered up and if the output voltages are correct, the relay is activated and its contact is closed (state 1). When the mains power is lost or if the output voltages are incorrect, the relay de-energizes (state 0).

Backup battery

Each power supply module has a slot reserved for a battery which provides the power supply to the internal RAM memory located in the processors, in order to ensure that data is saved when the PLC is switched off.

The duration of data back-up is one year. The battery must be changed as soon as the BAT lamp (red) on the front panel lights up.

RESET pushbutton

Pressing this pushbutton, which is located on the front panel of the power supply module, triggers a sequence of service signals which is the same as that for:

- A power switch-off when the pushbutton is pressed
- A power-up when the pushbutton is released

For the application, these actions represent a warm restart.

Sensor power supply 24 V $\overline{\text{---}}$

TSX PSY 2600M/5500M/8500M a.c. power supply modules have an integrated power supply which provides a voltage of 24 V $\overline{\text{---}}$ to supply the input sensors. The sensor power supply connection can be accessed via the screw terminal block on the module.

The power available on this 24 V $\overline{\text{---}}$ voltage depends on the model (0.5/0.8/1.6 A), see characteristics page 2/4.

Modicon Premium automation platform

Power supply modules



TSX PSY 2600M



TSX PSY 5500M

2

References

Each **TSX RKY ●** and **TSX RKY ●EX** rack must be equipped with a single or double-format power supply module (slot marked PS). The power required to supply each TSX RKY rack depends on the type and number of modules installed in the rack. It is therefore necessary to draw up a power consumption table rack by rack in order to determine which TSX PSY power supply module is the most suitable for each rack (see page 9/6).

Power supply modules

Power supply	Available power (1)				Format	Reference (2)	Weight kg
	5 V $\overline{\text{---}}$	24 VR $\overline{\text{---}}$	24 VC $\overline{\text{---}}$	Total			
24 V $\overline{\text{---}}$ non-isolated	15 W	15 W	–	30 W	Standard	TSX PSY 1610M	0.540
(3)	35 W	19 W	–	50 W	Double	TSX PSY 3610M	0.780
24...48 V $\overline{\text{---}}$ isolated	35 W	19 W	–	50 W	Double	TSX PSY 5520M	0.890
100...240 V \sim	25 W	15 W	12 W	26 W	Standard	TSX PSY 2600M	0.510
00...120 V \sim	35 W	19 W	19 W	50 W	Double	TSX PSY 5500M	0.620
200...240 V \sim	75 W	–	38 W (SELV)	77 W	Double	TSX PSY 8500M	0.740

Accessories

Description	Use	Sold in lots of	Reference	Weight kg
Batteries	Internal RAM memory backup on TSX P57 processors (to be fitted in the power supply module)	1	TSX PLP 01	0.010
		10	TSX PLP 101	0.100

(1) Voltages 5 V $\overline{\text{---}}$ and 24 VR $\overline{\text{---}}$ for power supply to Premium PLC modules, voltage 24 VC $\overline{\text{---}}$ for power supply to input sensors. The sum of power consumed on each voltage (5 V $\overline{\text{---}}$, 24 VR $\overline{\text{---}}$ and 24 VC $\overline{\text{---}}$) must not exceed the total power of the module. See power consumption table on page 9/6.

(2) Product supplied with a processor RAM memory backup battery.

(3) The internal 0 V of the module is connected to the PLC earth.



TSX FAN ●●P

References (continued)

Fan modules

Description	Use	Power supply	Reference	Weight kg
Fan modules (1)	For racks	24 V $\overline{\text{---}}$	TSX FAN D2P	0.500
	TSX RKY ● or	100...120 V \sim	TSX FAN A4P	0.500
	TSX RKY ●EX	200...240 V \sim	TSX FAN A5P	0.500

(1) One fan module for rack with 4 or 6 positions, two fan modules for rack with 8 positions and three fan modules for rack with 12 positions.

Modicon Premium automation platform

Single-rack configuration

2

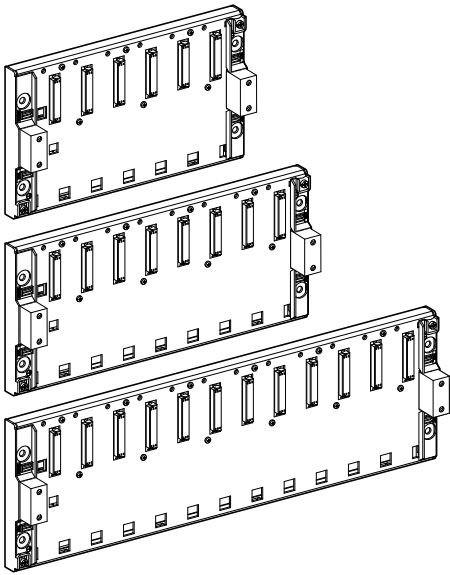

Presentation

The **TSX RKY ●●●** pp rack is the basic element of a Premium control system platform with a single rack (6, 8 or 12 positions).

These racks are non extendable. They provide the following functions:

- Mechanical function: they enable all the modules of a PLC station (power supply, processor, discrete I/O, analogue I/O, application-specific modules) to be installed.
- Electrical function: they provide distribution of:
 - Power supplies required for each module in the same rack
 - Data and service signals for the entire PLC station when the station has several racks.

TSX FAN ●●P fan modules installed above the racks of Premium PLCs provide forced air convection, in order to maintain an even ambient temperature inside the enclosure and to eliminate any hot spots that may exist (see page 2/2).

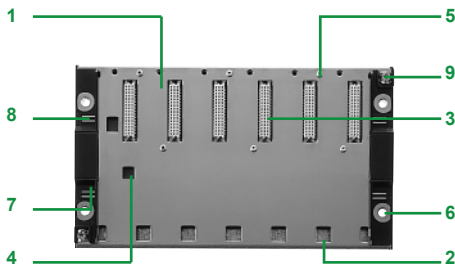

Description

TSX RKY ●● racks comprise:

- 1 A metal frame
- 2 Slots for anchoring the module pins
- 3 48-way female 1/2 DIN connectors for module/rack connections (the first connector is reserved for the power supply module)
- 4 A locating slot for the power supply module
- 5 Tapped holes for mounting the module
- 6 Four holes for mounting the rack
- 7 Slot for the rack address label
- 8 A slot for the station network address label.
- 9 Two earth terminals for earthing the rack

Modicon Premium automation platform

Single-rack configuration

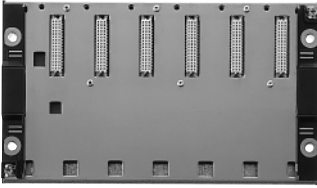

TSX RKY 6

References

Non-extendable racks

Description	Type of module to be installed	Capacity	Reference	Weight kg
Non-extendable racks for single-rack configuration	TSX PSY power supply,	6 positions	TSX RKY 6 (1)	1.470
	TSX P57 processor,	8 positions	TSX RKY 8 (1)	1.750
	TSX H57 processor, I/O modules, application-specific modules and communication modules	12 positions	TSX RKY 12	2.310

Connection accessories

Description	Use	Composition	Reference	Weight kg
Protective covers	Unoccupied position on racks TSX RKY ● or TSX RKY ●EX	5 screw-on covers Sold in lots of 5	TSX RKA 02	0.050
Fixing screws M6 x 25	Mounting of racks TSX RKY ● or TSX RKY ●EX	Screw with captive washer and hexagonal slotted head Sold in lots of 50	TSX ACC VA625	0.350

(1) In cases where the limits of electromagnetic emissions between 30 MHz and 1 GHz need to be monitored, it is recommended that **TSX RKY 6EX/8EX** extendable racks be used instead of **TSX RKY 6/8** non-extendable racks, see page 2/10.

Modicon Premium automation platform

Multirack configuration without remote module

2

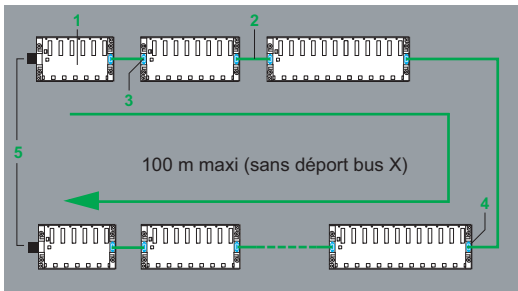

Composition of a multirack configuration

Multirack configurations are made up using extendable racks **1**

TSX RKY 4EX/6EX/8EX/12EX (1). They comprise:

- 4 racks maximum for a station with Premium TSX 57 10 processor
- 16 racks maximum for a station with Premium TSX 57 20, 57 30, 57 40, 57 50, 57 60 processor.

The racks are connected to each other by bus X extension cables **2**.

Bus X

The racks, distributed on bus X, are connected to each other by bus X extension cables whose total length is 100 m max. Using **TSX REY 200** bus X remote modules enables the length of bus X to be increased to a maximum of 2 x 350 m (see page 2/12).

The racks are connected to each other by means of bus X extension cables **TSX CBY ●●●0K●** which are connected to the 9-way SUB-D side connectors on each extendable rack. The incoming cable from the previous rack can be connected to either the left-hand **3** or right-hand **4** connector on the rack. For lengths greater than 28 m, **TSX CBY ●●●0KT** bus X extension cables are supplied with 2 adaptors to be fitted at each end and which provide greater protection against any strong electrical transients that may occur between the racks (according to standard IEC 61131-2).

Line terminators

The two extendable racks located at the ends of the line must have a line terminator **5 TSX TLY EX** fitted on the unused 9-way SUB-D type connector.

Presentation of extendable racks

TSX RKY ●●● EX racks are the basic elements of Premium multirack configurations. They provide the following functions:

- Mechanical function: they enable all the modules of a PLC station (power supply, processor, discrete I/O, analogue I/O, application-specific modules) to be fitted
- Electrical function: they allow connection and continuity of the the bus X and provide distribution of:
 - power supplies required for each module in the same rack
 - data and service signals for the entire PLC station where this station has several racks.

To meet user requirements, several types of rack are available (4, 6, 8 or 12 positions) in order to make up PLC configurations comprising up to 16 racks max. distributed on bus X.

TSX FAN ●●P fan modules installed above the racks of Premium PLCs provide forced air convection, in order to maintain an even ambient temperature inside the enclosure and to eliminate any hot spots that may exist (see page 2/2).

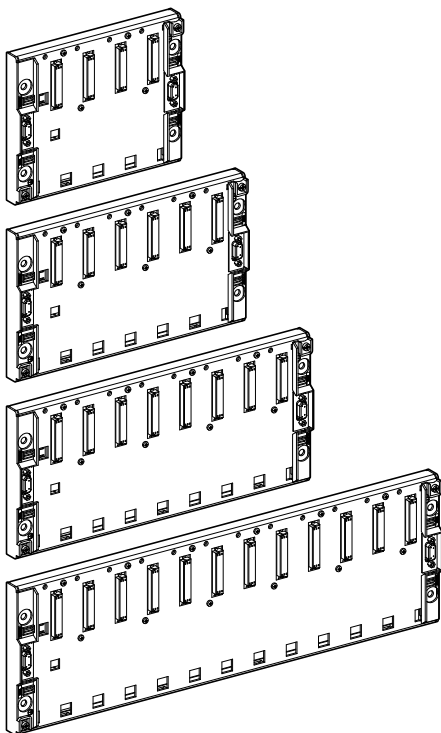

(1) Using the **TSX RKY 12EX** 12-slots rack is the same as occupying 2 racks with 4, 6 or 8 slots.

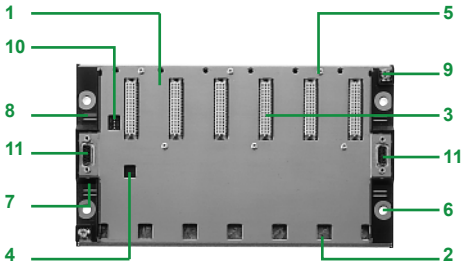

Description

TSX RKY ●●●EX racks comprise:

- 1 A metal frame
- 2 Slots for anchoring the module pins
- 3 48-way female 1/2 DIN connectors for module/rack connections (the first connector is reserved for the power supply module)
- 4 A locating slot for the power supply module
- 5 Tapped holes for mounting the module
- 6 Four holes for mounting the rack
- 7 Slot for the rack address label
- 8 Slot for the station network address label
- 9 Two earth terminals for earthing the rack
- 10 Microswitches for coding the rack address (on extendable racks)
- 11 Two 9-way female SUB-D connectors for the remote connection of bus X, each one to another rack

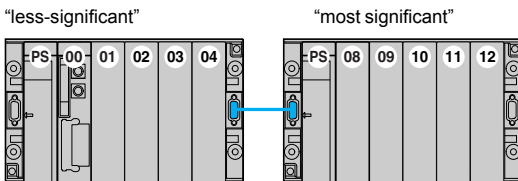

Address rack n, example with two 6-slot racks, standard format power supply and standard format processor

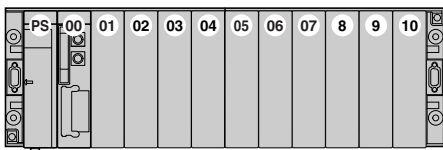

Address rack n, example with one 12-slot rack, standard format power supply and standard format processor

Rack addresses

Address 0: this address is always assigned to the rack which holds the processor. This rack can be located in any position on the line.

Addresses 1 to 7: these can be assigned in any order to all the other extendable racks of the station.

As the two racks with 4, 6, or 8 slots which make up each pair have the same address on the bus X, position numbers are defined as follows:

- Rack n "less-significant": position 00 to xx (02, 04 or 06); rack n "most-significant": position 08 to yy (10, 12 or 14).
- Racks with 12 slots each occupy an address (with position 00 to 10).

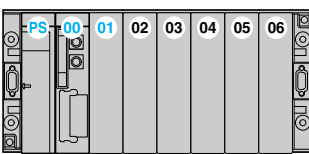

Primary rack address 0 with standard-format power supply and processor

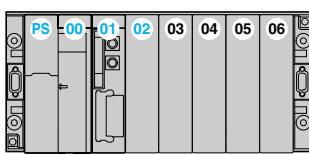

Primary rack address 0 with double-format power supply and standard-format processor

Installing the various modules on the standard or extendable rack with address 0

The rack with address 0 must contain a power supply module and the processor module. For Premium PLCs which have two types of power supply (standard or double-format), the position of the processor (standard or double-format) will depend on the type of power supply used:

- Using a standard format power supply module:
 - The power supply module systematically occupies position **PS**.
 - The processor module must be installed in positions **00/01** (00 with standard format processor).
 - The other modules are installed from position **02** (01 with standard format processor).
- Using a double-format power supply module:
 - The power supply module systematically occupies positions **PS** and **00**.
 - The processor module must be installed in positions **01/02** (01 with standard format processor).
 - The other modules are installed from position **03** (02 with standard format processor).

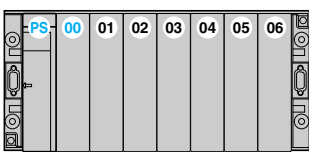

Extension rack address n with standard-format power supply

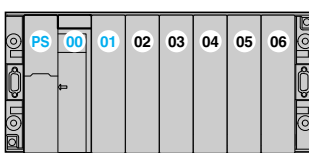

Extension rack address n with double-format power supply

Installing the various modules on extendable racks with addresses 1 to 7

Each rack must have either a standard format or double-format power supply module:

- Using a standard format power supply module:
 - The power supply module systematically occupies position **PS**.
 - The other modules are installed from position **00** onwards.
- Using a double-format power supply module:
 - The power supply module systematically occupies positions **PS** and **00**.
 - The other modules are installed from position **01** onwards.

Modicon Premium automation platform

Multirack configuration without remote module
Extendable racks and connection cables

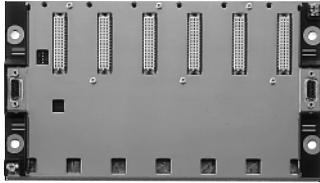

TSX RKY 6EX

2

Extendable racks

Description	Type of module to be installed	Capacity	Reference	Weight kg
Extendable racks for multirack configuration (16 racks max.) (1)	TSX PSY power supply, TSX P57 or TSX H57 processor (main rack 0), I/O modules application-specific modules and communication modules	4 positions	TSX RKY 4EX	1.160
		6 positions	TSX RKY 6EX	1.500
		8 positions	TSX RKY 8EX	1.780
		12 positions	TSX RKY 12EX	2.340

Connection cables

Description	Use	Composition	Length	Reference	Weight kg
Bus X daisy chain cables (total length 100 m max.) (2)	Between TSX RKY ●EX racks	2 x 9-way SUB-D connectors	1 m	TSX CBY 010K	0.160
			3 m	TSX CBY 030K	0.260
			5 m	TSX CBY 050K	0.360
			12 m	TSX CBY 120K	1.260
			18 m	TSX CBY 180K	1.860
			28 m	TSX CBY 280KT (3)	2.860
			38 m	TSX CBY 380KT (3)	3.860
			50 m	TSX CBY 500KT (3)	5.060
			72 m	TSX CBY 720KT (3)	7.260
			100 m	TSX CBY 1000KT (3)	10.060
Cable on reel	Length to be fitted with TSX CBY K9 connectors.	Cable with free ends, 2 line testers	100 m	TSX CBY 1000	12.320

(1) 16 **TSX RKY 4EX/6EX/8EX** racks max. (4, 6 or 8 slots) or 8 **TSX RKY 12EX** racks max. (12 slots).

Using the 12 -slot rack is the same as occupying two racks with 4, 6 or 8-slots.

(2) Up to 2 x 350 m when using bus X remote module **TSX REY 200** (see page 2/12).

(3) Cable supplied with a set of 2 **TSX TVSY 100** electrical transient suppressors.

Modicon Premium automation platform

Multitrack configuration without remote module Accessories



TSX TVSY 100



TSX TLY EX

Accessories

Description	Use	Composition	Reference	Weight kg
Bus X connectors	For TSX CBY 1000 2 x 9-way SUB-D connectors cable ends		TSX CBY K9	0.080
Bus X electrical transient suppressors	For bus X daisy chain cable lengths > 28 m	2 transient suppressors with 9-way SUB-D connectors	TSX TVSY 100	0.200
Line terminators	Compulsory on the 2 TSX RKY ●EX end racks	2 x 9-way SUB-D connectors marked A and B	TSX TLY EX	0.050
Protective covers	Unoccupied position on racks TSX RKY ● or TSX RKY ●EX	5 screw-on covers	TSX RKA 02	0.050
Connector installation kit	Fitting TSX CBY K9 connectors	2 crimping pliers, 1 pen (1)	TSX CBY ACC 10	–
Fixing screws M6 x 25	Mounting of racks TSX RKY ● or TSX RKY ●EX	50 screws with captive washer and hexagonal slotted head	TSX ACC VA625	0.350

(1) Installation of connectors on the cable also requires a wire stripper, a pair of scissors and a digital ohmmeter.

Modicon Premium automation platform

Multirack configuration with remote module

Presentation

Bus X for Premium PLCs can be used to connect eight 12 position racks or sixteen 4, 6 or 8 position racks, distributed over a maximum length of 100 metres (see page 2/9).

For applications requiring longer distances between racks, the bus X remote rackmaster module: **TSX REY 200** can be used to increase this distance up to a maximum of 350 metres without reducing performance.

The Bus X remote rackmaster module is electrical. Using the bus X remote rackmaster module will not result in any loss of performance in reading or controlling I/O.

The bus X remote system comprises:

- One **TSX REY 200** module called the “master” **1** located on the rack at address 0 (rack supporting the processor **2** and the main bus X **3**). The master module has two channels for the remote location of two Bus X segments **5** up to a maximum distance of 250 meters.
- One or two **TSX REY 200 modules 4** called “slaves” located on each extendable rack.
- Each slave module is connected to the master module by a cable **5** **TSX CBRY 2500** which must be cut to length by the user and fitted with **TSX CBRY K5** connectors as required (no special equipment is required for this cabling).

Each end of the bus must be fitted with a **TSX TLY EX line terminator 6**.

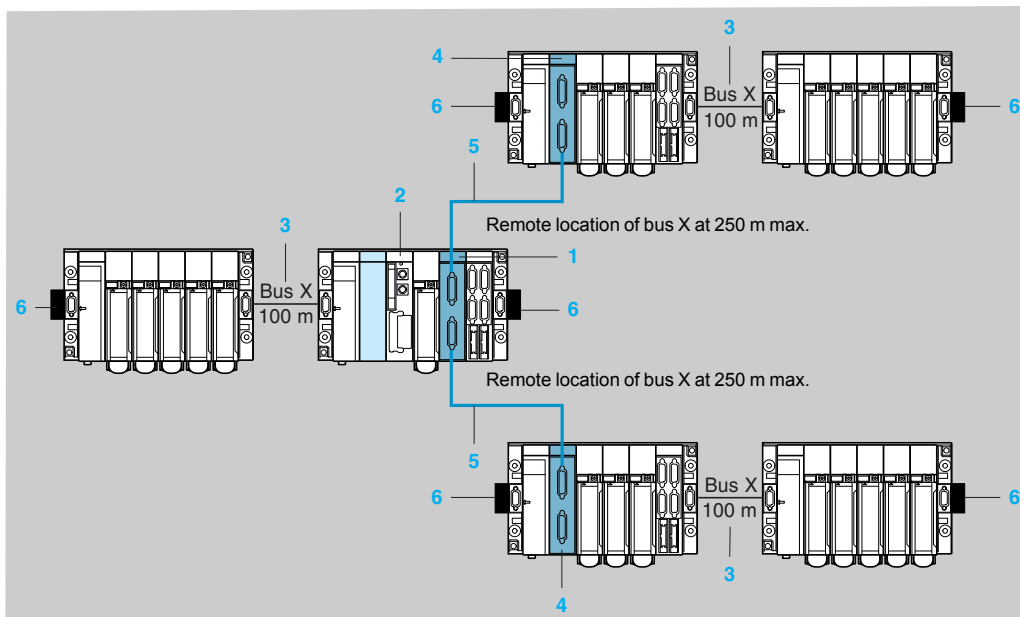

Installation rules

The rules for installing the bus X remote rackmaster module, **TSX REY 200**, are as follows:

- Bus X remote rackmaster module acting as a master. It is installed on the rack at address 0 supporting the processor with:
 - The power supply module systematically occupying position(s) PS (and 00). The processor module must be installed in position 01 (and 02 if a double-format processor).
 - The bus X remote rackmaster module, **TSX REY 200**, can be installed in any position after 02 (or 03 if a double-format processor).
- Bus X remote rackmaster module acting as a slave. It is installed in an extendable rack (located on an extendable bus X segment) in any position, apart from the positions dedicated to the power supply module.

Presentation (continued)

Maximum distances for remote location

The maximum permitted distances from the processor in any one remote system are shown in the table below:

Type of I/O modules	Reference	Length of bus X remote system ⁵
Discrete inputs (1)	TSX DEY ●●●	250 m
Discrete Outputs	TSX DSY ●●●	
Preventa safety module	TSX PAY 262	
Analog I/O (2)	TSX AEY ●●●/ASY ●●●	175 m less than the length ³ of bus X
Counter/motion control modules (3)	TSX CTY ●A/CAY21/CAY41/CFY ●1	
Weighing modules	TSX ISP Y101/Y121	Remote location of bus X not permitted
AS-Interface Bus modules	TSX SAY 1000	
SERCOS motion module	TSX CSY 84/85/164	
Communication modules	TSX SCY 21601/11601	
Ethernet Modbus/TCP modules	TSX ETY 110WS/4103/5103/WMY 100	
Fieldbus modules	TSX IBY 100/PBY100	
Discrete I/O	TSX DMY 28FK/28RFK	
(1) Discrete inputs	TSX DEY 16FK (version ≥ 06)	
(2) Analog I/O	TSX AEY 810/1614	
	TSX ASY 410 (version ≥ 11)	
(3) Counter/motion control modules	TSX CTY 2C/CCY 1128	
	TSX CAY 22/42/33	

Description

The front panel of the bus X remote rackmaster module **TSX REY 200** comprises:

- 1 A display block with 6 indicator lamps:
 - RUN indicator: module running
 - ERR indicator: module has an internal fault
 - I/O indicator (red): module has an external fault
 - MST indicator module acting as master or slave
 - CH0 indicator: channel 0 operating
 - CH1 indicator: channel 1 operating
- 2 A 5-way SUB-D 9 connector for the connection of channel 0
- 3 A 5-way SUB-D 9 connector for the connection of channel 1

References

Description Item no.	Operation	Description	Reference	Weight kg
Extendable racks	–	4/6/8/12 positions	See page 2/10	

Bus X remote rackmaster module ¹ or ⁴	Master/slave	2 channels	TSX REY 200	–
---	--------------	------------	--------------------	---

Connection cables and accessories (see also page 2/10)

Description Item no.	Use	Length	Reference	Weight kg
Bus X cables supplied on a drum ⁵	Connection of two TSX REY 200 modules Class C1 flame resistance	250 m	TSX CBR Y 2500	–
	Cable for daisy chain mounting (1)	250 m	TSX CBR Y 2500F	–

5-ways SUB-D 9 connectors	For ends of cables TSX CBR Y 2500●	Sold in lots of 5	TSX CBR Y K5	–
---------------------------	------------------------------------	-------------------	---------------------	---

Description Item no.	Use	Composition	Reference	Weight kg
Line terminators ⁶	Must be fitted on each TSX RKY ●EX end rack	2 x 9-way SUB-D connectors Sold in lots of 2	TSX TLY EX	0.050

(1) Mobile installations: cables as per VDE 472, part 603/H: (60 000 operations max.):
 - For use on cable drag chain: minimum bend radius of 75 mm
 - For use on gantry crane, subject to compliance with certain installation conditions (acceleration, speed, length etc.): please consult our Customer Care Centre.
 - Not authorized for use on robots, or multi-axis applications.

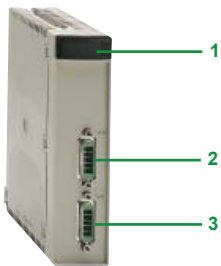

TSX REY 200



TSX TLY EX

Discrete I/O modules

- Selection guide: input modules and mixed modules* page 3/2
- Selection guide: output modules* page 3/4
- Principle page 3/6
- Description page 3/7
- Functions page 3/8
- References page 3/9

Analog I/O modules

- Selection guide: I/O modules* page 3/12
- Presentation, description, functions page 3/14
- References page 3/16

Distributed I/O

- Selection guide: Modicon distributed I/O solutions* page 3/18

Special I/O

- TeSys Quickfit installation system for motor starter components
 - Presentation page 3/20
 - Compatibility with Modicon automation platforms page 3/22



Connecting inputs to screw terminal blocks

Connecting inputs to HE 10 connectors with preformed cables with flying leads, rolled ribbon cables or multicore cables

Connecting I/O to HE 10 connectors with preformed cables with flying leads, rolled ribbon cables or multicore cables

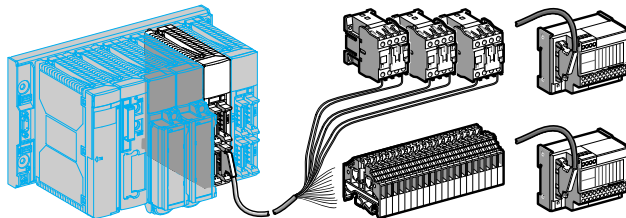

3

~	---					
200...240 V	24 V			48 V	24 V	
16 isolated channels	16 high-speed isolated channels	32 isolated channels	64 isolated channels	32 isolated channels	16 isolated inputs and 12 x 0.5 A isolated outputs	Event-triggered fast inputs
						Programmable reflex I/O
Via screw terminal blocks: TSX BLY 01 Type 2	Via 20-way HE 10 connectors					Type 1
-	Type 1					
-	Positive					
2-wire ---/~	2-wire ---/~, 3-wire --- PNP all types					
170...264 V ~	19...30 V ---			38...60 V ---	19...30 V --- (possible up to 30 V --- limited to 1 hour in every 24 hours)	
-						Configurable output fallback
-						Yes
-						Protected
-						Positive
-						19...30 V --- (possible up to 34 V --- limited to 1 hour in every 24 hours)
-						0.5 A
-						4 A

See page 9/6

TSX DEY 16A5	TSX DEY 16FK	TSX DEY 32D2K	TSX DEY 64D2K	TSX DEY 32D3K	TSX DMY 28FK	TSX DMY 28RFK
3/10						
-	LU9 G02 splitter box (see page 3/22)			-		
-	8 or 16-channel passive sub-bases, with or without LED, with common or 2 terminals per channel					
-	16-channel active sub-bases 5 V --- TTL, 24 V ---, 48 V ---, 115 V or 230 V ~, 2 terminals per channel					
-	ABE 7H08R●●, ABE 7H08S21, ABE 7H16R50, ABE 7H20E●●●			-		ABE 7H08R●●, ABE 7H08S21, ABE 7H16R50, ABE 7H20E●●●, ABE 7H12R50
-	ABE 7H16S21, ABE 7H16R23, ABE 7H16R1●, ABE 7H16R2●, ABE 7H16R3●, ABE 7H16C●●			ABE 7H16R20	ABE 7H16R1●, ABE 7H16R2●, ABE 7H16R3●, ABE 7HC●●, ABE 7H16S21, ABE 7H16R23, ABE 7H12R●●	
-	ABE 7H16S43			-		ABE 7H16S43
-	ABE 7S16E2●●			-		-
-	ABE 7P16F3●●			-		-
-	TSX CDP ●●3 or ABF H20●●0					



More technical information on www.schneider-electric.com

Modicon Premium automation platform

Discrete I/O modules Output modules

Applications

Connecting outputs to screw terminal blocks for bare wires, or wires fitted with either cable ends or open/closed cable tags

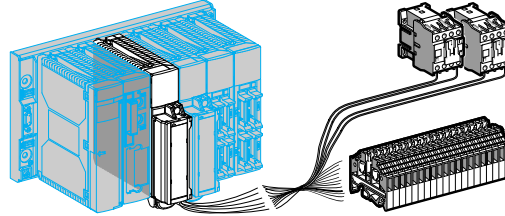

3

Type	
Voltage	
Current	
Modularity (number of channels)	
Connection	
Isolated outputs	Fallback
	IEC/EN 61131-2 conformity Protection
	Logic
Output limit values	Voltage
	Current/channel
	Current/module
Consumption	
Types of discrete output module	
Pages	
Compatibility with TeSys Quickfit installation system	
Compatibility with Modicon Telefast ABE 7 pre-wired system	Connection sub-bases
	Input adaptor sub-bases
Type of passive sub-base Modicon Telefast ABE 7	Narrow (miniature 55 or 72 mm)
	Standard width (106 or 113 mm)
	Wide (194 mm)
Type of adaptor sub-base (with relays)	Fixed relays
Modicon Telefast ABE 7	Plug-in relays
Type of cable with HE 10 connectors	

--- transistor					--- or ~ relay	
24 V			48 V		12...24 V --- 24...240 V ~	
0.5 A	2 A	0.5 A	1 A	0.25 A	3 A (lth)	
8 protected channels		16 protected channels	8 protected channels	16 protected channels	8 non-protected channels	16 non-protected channels
Via 20-way screw terminal blocks: TSX BLY 01						
Configurable output fallback, continuous monitoring of output control and output reset in case of internal fault					Configurable output fallback	
Yes					Yes	
Protected					Not protected	
Positive					-	
19...30 V ---			38...60 V ---		10...34 V --- 20...264 V ~	
0.625 A	2.5 A	0.625 A	1.25 A	0.31 A	-	
4 A	14 A	7 A	4 A		-	
See page 9/6						
TSX DSY 08T2	TSX DSY 08T22	TSX DSY 16T2	TSX DSY 08T31	TSX DSY 16T3	TSX DSY 08R5	TSX DSY 16R5
3/10						
-						
-						
-						
-						
-						
-						
-						
-						
-						
-						

Connecting outputs to screw terminal blocks for bare wires, wires fitted with either cable ends or open/closed cable tags

Connecting outputs to HE 10 connectors with preformed cables with flying leads, rolled ribbon cables or multicore cables

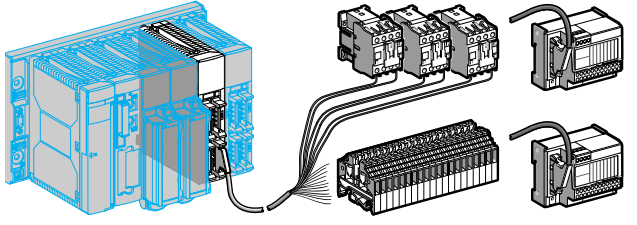

3

--- or ~ relay	--- relay	~ triac	
24...48 V --- 24...240 V ~	24...120 V	48...240 V	
5 A (lth)	5 A (lth)	2 A per channel	1 A per channel
8 protected channels		16 protected channels	16 non-protected channels
Via 20-way screw terminal blocks: TSX BLY 01			
Configurable output fallback		-	
Yes		Yes	
Protected		Not protected	
-		-	
19...60 V --- 20...264 V ~	19...143 V ---	41...264 V ~	
-		2 A	1 A
-		12 A	

--- transistor		
24 V ---		
0.1 A per channel		
32 protected channels	64 protected channels	
Via 20-way HE 10 connector		
Configurable output fallback, continuous monitoring of output control and output reset in case of internal fault		
Yes		
Protected		
Positive		
19...30 V ---, possible up to 34 V --- limited to 1 hour in every 24 hours		
0.1 A		
3.2 A		5 A

See page 9/6

TSX DSY 08R5A	TSX DSY 08R4D	TSX DSY 08S5	TSX DSY 16S5	TSX DSY 16S4	TSX DSY 32T2K	TSX DSY 64T2K
----------------------	----------------------	---------------------	---------------------	---------------------	----------------------	----------------------

3/10	LU9 G02 splitter box (see page 3/22)
-	8 or 16-channel passive sub-bases, with or without LED, with common or 2 terminals per channel
-	16-channel active sub-bases with relays (1 "NO", 1 or 2 "C/O") or transistor (5...48 V ---, 24 V ---, 24...240 V ~), 2 terminals per channel
-	ABE 7H08R●●, ABE 7H08S21
-	ABE 7H16S21
-	ABE 7H16F43
-	ABE 7S08S2●●, ABE 7R08S●●●, ABE 7S16S●●●, ABE 7R16S●●●
-	ABE 7P08T330, ABE 7R16T●●●, ABE 7P16T●●●
-	TSX CDP ●●3 or ABF H20●●0

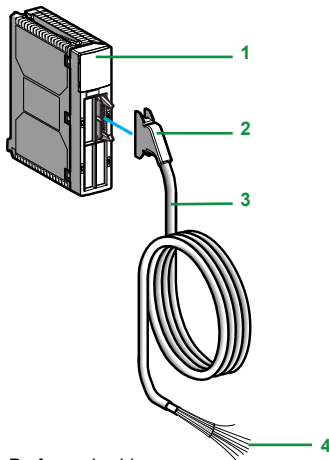

Preformed cable

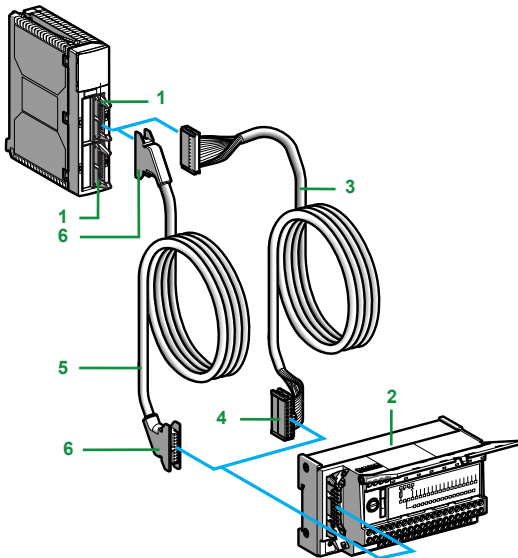

Rolled ribbon and connection cable

Connecting modules with screw terminal blocks

The discrete I/O module terminal blocks have a device for automatically transferring the coding when first used. This prevents handling errors when a module is replaced. This coding ensures electrical compatibility for each type of module.

Each terminal can take bare wires or wires with either cable ends or open tags.

The capacity of each terminal is:

- Minimum: One 0.2 mm² (AWG 24) wire without cable end
- Maximum: One 2 mm² (AWG 14) wire without cable end or one 1.5 mm² (AWG 15) wire with cable end

The screw terminal blocks are equipped with captive screws.

The maximum capacity of the terminal block is 16 x 1 mm² (AWG 17) wires + 4 x 1.5 mm² (AWG 15) wires.

Connecting modules with HE 10 connectors

20-wire preformed cables, AWG 22 (0.324 mm²)

Preformed cables are used for easy direct wire-to-wire connection between the I/O of modules with connectors 1 and the sensors, preactuators or terminals.

This preformed cable 3 comprises:

- At one end, an HE10 moulded connector 2 with 20 x 0.34 mm² cross-section sheathed wires.
- At the other end 4, flying leads color-coded according to standard DIN 47100.

TSX CDP 301: length 3 m

TSX CDP 501: length 5 m

TSX CDP 1001: length 10 m

Sheathed rolled ribbon cables, AWG 28 (0.08 mm²)

The rolled ribbon cables are used to connect the I/O of modules with HE 10 connectors 1 to Modicon Telefast ABE 7 fast wiring connection and adaptor interfaces 2. This cable 3 consists of 2 HE 10 connectors 4 and a sheathed rolled ribbon cable with 0.08 mm² cross-section wires.

Given the small cross-section of the wires, it is recommended for use on low current I/O only (100 mA max. per output).

TSX CDP 102: length 1 m

TSX CDP 202: length 2 m

TSX CDP 302: length 3 m

Connecting cable, AWG 22 (0.324 mm²)

Used to connect the I/O of modules with HE 10 connectors 1 to Modicon Telefast ABE 7 fast wiring connection and adaptor interfaces 2. This cable 5 consists of 2 moulded HE 10 connectors 6 and a cable that will take higher currents (500 mA max.).

TSX CDP 053: length 0.5 m

TSX CDP 103: length 1 m

TSX CDP 203: length 2 m

TSX CDP 303: length 3 m

TSX CDP 503: length 5 m

TSX CDP 1003: length 10 m

Description

The discrete I/O modules are standard format (1 slot). They have a plastic case which provides IP 20 protection of the electronics.

I/O modules connected via 20-way removable terminal block

- 1 A display block showing the channels and for module diagnostics
- 2 A removable screw terminal block for connecting the I/O directly to the sensors and preactuators **TSX BLY 01** (connectors to be ordered separately)
- 3 A pivoting cover for accessing the terminal block screws and holding the identification label
- 4 A rotating support containing the module locating device

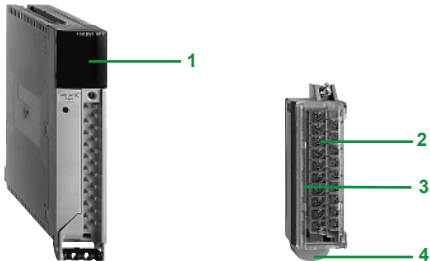

I/O modules connected via HE 10 connector

- 1 A display block showing the channels and for module diagnostics
- 2 HE 10 connectors, protected by a cover. These are used to connect the I/O to the sensors and preactuators either directly or via Modicon Telefast ABE 7 connection sub-bases.

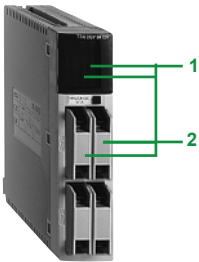

Functions

I/O assignment

Each module is functionally organized into groups of 8 channels. Each group of channels can be assigned to a specific application task.

Reactivation of outputs

If a fault has caused an output to trip, the output can be reactivated if there is no other fault on its terminals. The reactivation command, defined during configuration, can be automatic (reactivation every 10 s) or controlled via the program.

Reactivation is carried out in groups of 8 channels. This function is accessible on modules with DC transistor outputs. For modules with relay and triac outputs protected by fuses, the same type of reactivation (automatic or via program) is necessary after replacement of one or more fuses.

RUN/STOP command

An input can be configured to control the RUN/STOP changeover for the PLC. This is taken into account on a rising edge. A STOP command via an input takes priority over a RUN command via a terminal or a network command.

Output fallback

If the application switches to STOP, the outputs must be set to a state which is safe for the application. This state, called the fallback position, is defined for each module when its outputs are configured.

This configuration is used to select:

- Fallback: the channels are set to 0 or 1 according to the defined fallback value
- Maintain: the outputs maintain the state in which they were before the stop occurred

Diagnostic functions

- Module diagnostics: any exchange fault, preventing normal operation of an output module or fast input module is indicated. Similarly, any internal module fault is indicated.
- Process diagnostics: sensor/preactuator voltage check, terminal block presence check, short-circuit and overload check, sensor voltage check, preactuator voltage check.

Specific functions of TSX DEY 16FK/DMY 28FK module inputs

- Latching: enables particularly short pulses, with a duration shorter than the PLC scan time, to be taken into account.
- Event-triggered inputs: enables events to be taken into account and ensures they are processed immediately (interrupt processing). These inputs are associated with the event processing (EVTi) defined in configuration mode where: $i = 0 \dots 31, 0 \dots 63$ or $0 \dots 128$ according to the type of Premium CPU.
- Event processing can be triggered on a rising edge (0→1) or a falling edge (1→0) of the associated input. A masking/unmasking function for **TSX DEY 16FK/DMY 28FK** inputs is available in online mode.
- Programmable input filtering: the inputs are equipped with filtering which can be configured for each channel. Inputs are filtered by a fixed analog filter which provides a maximum immunity of 0.1 ms for filtering line interference and by a digital filter which can be configured from 0.1 to 7.5 ms in increments of 0.5 ms.

Reflex and timer functions for the TSX DMY 28RFK module

These control system functions are used to create applications which require a faster response time than the fast task or event processing (< 500 μs). They are executed in the module and are independent of the PLC task. They are programmed using Unity Pro or PL7 Junior/Pro software in configuration mode.

Hot swap

Due to their integrated devices, the I/O modules (including application-specific modules) are hot-swappable.

Functions (continued)

Compatibility with 2-wire/3-wire sensors

Type of input	24 V $\overline{\text{---}}$ type 1 logic positive (sink)	24/48 V $\overline{\text{---}}$ type 2 logic positive (sink)	24 V \sim type 2	48 V \sim 100...120 V \sim type 2	200...240 V \sim type 2
Any 3-wire $\overline{\text{---}}$ PNP sensor	Compatible	Compatible	Compatible	Compatible	Compatible
Any 3-wire $\overline{\text{---}}$ NPN sensor	Compatible	Compatible	Compatible subject to certain conditions (1)	Compatible	Compatible
Schneider Electric 2-wire $\overline{\text{---}}$ sensor or other brands with the following characteristics: - Residual voltage, closed state ≤ 7 V - Minimum switched current ≤ 2.5 mA - Residual current, open state ≤ 1.5 mA	Compatible	Compatible	Compatible	Compatible	Compatible
2-wire $\overline{\text{---}}$ / \sim sensor	Compatible	Compatible	Compatible	Compatible	Compatible subject to certain conditions (2)
2-wire \sim sensor	Compatible	Compatible	Compatible	Compatible	Compatible subject to certain conditions (2)

 Compatible	 Compatible subject to certain conditions	 Not compatible
---	---	---

References

Discrete input modules

Type of current	Input voltage	Connection (3)	IEC/EN 61131-2 conformity	Modularity (no. of channels)	Reference (4)	Weight kg
$\overline{\text{---}}$	24 V (pos. logic)	Screw terminal block	Type 2	8 isolated inputs	TSX DEY 08D2	0.300
				16 isolated inputs	TSX DEY 16D2	0.300
	48 V (pos. logic)	Screw terminal block	Type 2	16 isolated inputs	TSX DEY 16D3	0.300
				16 isolated fast inputs (2)	TSX DEY 16FK	0.300
	24 V (pos. logic)	HE 10 connector	Type 1	32 isolated inputs	TSX DEY 32D2K	0.300
				64 isolated inputs	TSX DEY 64D2K	0.370
24 V (neg. logic)	Screw terminal block	–	16 isolated inputs	TSX DEY 16A2	0.310	
48 V (pos. logic)	HE 10 connector	Type 2	32 isolated inputs	TSX DEY 32D3K	0.310	
\sim 50/60 Hz	24 V	Screw terminal block	Type 2	16 isolated inputs	TSX DEY 16A2	0.310
	48 V	Screw terminal block	Type 2	16 isolated inputs	TSX DEY 16A3	0.320
	100...120 V	Screw terminal block	Type 2	16 isolated inputs	TSX DEY 16A4	0.320
	200...240 V	Screw terminal block	Type 2	16 isolated inputs	TSX DEY 16A5	0.360



TSX DEY 16FK



TSX DEY 32D3K

(1) The 24 V \sim inputs can be used as 24 V $\overline{\text{---}}$ negative logic (source) inputs compatible with 3-wire $\overline{\text{---}}$ NPN sensors, but they are then not IEC-compliant.

(2) Within the 220...240 V \sim nominal voltage range.

(3) By connector: module supplied with cover. By screw terminal block: terminal block **TSX BLY 01** to be ordered separately.

(4) Module with fast isolated inputs (filtering from 0.1 to 7.5 ms) which can activate the event-triggered task.

3



TSX DSY 64T2K

References (continued)

Discrete output modules

Type of current	Output voltage	Connection (1)	IEC/EN 61131-2 conformity	Modularity (no. of channels)	Reference	Weight kg
⎓ transistor	24 V/0.5 A (pos. logic)	Screw terminal block	Yes	8 protected outputs	TSX DSY 08T2	0.320
	24 V/2 A (pos. logic)	Screw terminal block	Yes	8 protected outputs	TSX DSY 08T22	0.410
	24 V/0.5 A (pos. logic)	Screw terminal block	Yes	16 protected outputs	TSX DSY 16T2	0.340
	48 V/1 A (pos. logic)	Screw terminal block	Yes	8 protected outputs	TSX DSY 08T31	0.320
	48 V/0.25 A (pos. logic)	Screw terminal block	Yes	16 protected outputs	TSX DSY 16T3	0.340
	24 V 0.1A per channel (pos. logic)	HE 10 connector	Yes	32 protected outputs	TSX DSY 32T2K	0.300
				64 protected outputs	TSX DSY 64T2K	0.360
⎓ or ~ relay	24 V/3 A ⎓, 24 to 240 V/3 A ~	Screw terminal block	Yes	8 non-protected outputs	TSX DSY 08R5	0.330
				16 non-protected outputs	TSX DSY 16R5	0.380
	24 to 48 V/5 A ⎓, 24 to 240 V/5 A ~	Screw terminal block	Yes	8 protected outputs	TSX DSY 08R5A	0.420
⎓ relay	24...120 V/5 A	Screw terminal block	Yes	8 protected outputs	TSX DSY 08R4D	0.370
~ triac	24...120 V/1 A per channel	Screw terminal block	Yes	16 non-protected outputs	TSX DSY 16S4	0.380
	48...240 V/1 A per channel	Screw terminal block	Yes	16 protected outputs	TSX DSY 16S5	0.310
	48...240 V/2 A per channel	Screw terminal block	Yes	8 protected outputs	TSX DSY 08S5	0.340



TSX DMY 28FK/28RFK

Discrete I/O modules

Number of I/O	Connection (1)	No. and type of inputs	No. and type of outputs	IEC/EN 611312 conformity	Reference	Weight kg
28	HE 10 connector	16 fast (pos. logic) (2)	12, transistor	Input, type 1	TSX DMY 28FK	0.320
			24 V/0.5 A ⎓ protected	Output, yes		
			12, reflex or time-delayed	Inputs, type 1	TSX DMY 28RFK	0.350
			24 V/0.5 A ⎓ protected			

(1) By connector: module supplied with cover. By screw terminal block: terminal block **TSX BLY 01** to be ordered separately.

(2) Module with fast isolated inputs (filtering from 0.1 to 7.5 ms) which can activate the event-triggered task.



TSX BLY 01

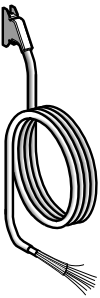

TSX CDP 01

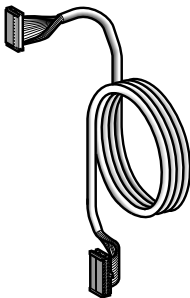

TSX CDP 02

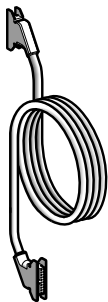

TSX CDP 03

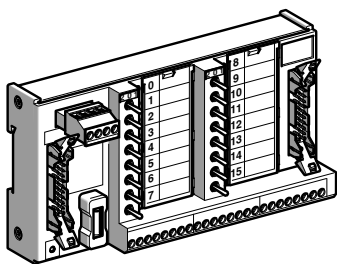

ABE 7TES160

References (continued)

Terminal block

Description	Use	Reference	Weight kg
Screw terminal block 20-way	To be ordered separately with each I/O module with screw terminal block connection	TSX BLY 01	0.100

Connecting cables for I/O modules with HE 10 connectors

Description	Composition Use	Cross-section	Length	Reference	Weight kg
20-wire preformed cable	1 HE 10 connector and one end with color coded flying leads	0.324 mm ² (AWG 22)	3 m	TSX CDP 301	0.400
			5 m	TSX CDP 501	0.660
			10 m	TSX CDP 1001	1.210

Rolled ribbon connecting cable	2 HE 10 connectors for Modicon Telefast ABE 7 system	0.08 mm ² (AWG 28)	1 m	TSX CDP 102	0.090
			2 m	TSX CDP 202	0.170
			3 m	TSX CDP 302	0.250

Connecting cables	2 HE 10 connectors for Modicon Telefast ABE 7 system	0.324 mm ² (AWG 28)	0.5 m	TSX CDP 053	0.085
			1 m	TSX CDP 103	0.150
			2 m	TSX CDP 203	0.280
			3 m	TSX CDP 303	0.410
			5 m	TSX CDP 503	0.670
			10 m	TSX CDP 1003	1.180

Simulation sub-base

Description	Use	Reference	Weight kg
16-channel Modicon Telefast ABE 7 simulation sub-base for discrete I/O	Has 2 HE 10 connectors enabling it to be inserted between the PLC I/O module and the Modicon Telefast ABE 7H/P/R/S I/O sub-base. Used for displaying, forcing, inhibiting or continuity of discrete I/O	ABE 7TES160	0.350

Modicon Premium automation platform

Analog I/O modules

Applications

Analogue inputs



3

Type of I/O		Inputs isolated between low level channels, thermocouple, temperature probe	Thermocouple inputs	High level inputs with common point
Type		Multirange	Multirange	Voltage/current
Range	Voltage	$\pm 10\text{ V}$, $\pm 5\text{ V}$, $0 \dots 10\text{ V}$, $0 \dots 5\text{ V}$, $1 \dots 5\text{ V}$	$-80 \dots +80\text{ mV}$	$\pm 10\text{ V}$, $0 \dots 10\text{ V}$, $0 \dots 5\text{ V}$, $1 \dots 5\text{ V}$
	Current	$4 \dots 20\text{ mA}$, $0 \dots 20\text{ mA}$ external shunt supplied	–	$0 \dots 20\text{ mA}$, $4 \dots 20\text{ mA}$
	Thermocouple, Temperature probe	B, E, J, K, L, N, R, S, T, U thermocouples 2 or 4-wire Pt 100, Pt 1000, Ni 1000 temperature probes	B, E, J, K, L, N, R, S, T, U thermocouples	–
Modularity		4 channels	16 channels	8 channels
Isolation		Between channels: $2830\text{ V} \sim \text{rms}$ Between bus and channels: $1780\text{ V} \sim \text{rms}$ Between channels and earth: $1780\text{ V} \sim \text{rms}$	Between channels: $\pm 100\text{ V} \text{ ---}$ Between bus and channels: $1000\text{ V} \sim \text{rms}$ Between channels and earth: $1000\text{ V} \sim \text{rms}$	Between channels: common point Between bus and channels: $1000\text{ V} \sim \text{rms}$ Between channels and earth: $1000\text{ V} \sim \text{rms}$
Read time		550 ms	1120 ms (normal scan) 70 ms/channel used (fast scan)	27 ms (normal scan) 3 ms/channel used (fast scan)
Response time		Configurable filtering 0 to 68.5 s	User-definable filtering $0.04\text{ Te} \dots 0.012\text{ Te}$ (Te: module scan time)	User-definable filtering 0 to 3.44 s
Resolution		16 bits	16 bits	12 bits
Connection		20-way screw terminal block: TSX BLY 01	Two 25-way SUB-D connectors or two Modicon Telefast ABE 7CPA12 sub-bases	One 25-way SUB-D connector or one Modicon Telefast ABE 7CPA02/03 sub-base
Standards		Compatible with sensors acc. to standards IEC/EN 60584-1/2/3 (Thermocouples) and IEC/EN 60751 (Pt 100 temp. probes) PLC: IEC/EN 61131-2		PLC: IEC/EN 61131-2
Consumption		See page 9/6		
Type of module		TSX AEY 414	TSX AEY 1614	TSX AEY 800
Pages		3/16		



Analog inputs (continued)



Analog outputs



Analog inputs (continued)			Analog outputs	
High level inputs with common point	High level inputs isolated between channels	High level input with common point	Outputs isolated between channels	Outputs with common point
Voltage/current			Voltage/current	
± 10 V, 0...10 V, 0...5 V, 1...5 V			± 10 V	
0...20 mA, 4...20 mA			0...20 mA, 4...20 mA	
-				
16 channels	8 channels	4 channels	4 channels	8 channels
Between channels: common point Between bus and channels: 1000 V ~ rms Between channels and earth: 1000 V ~ rms	Between channels: ± 200 V --- Between bus and channels: 1000 V ~ rms Between channels and earth: 1000 V ~ rms.	Between channels: common point Between bus and channels: 1000 V ~ rms Between channels and earth: 1000 V ~ rms	Between channels: 1500 V ~ rms Between bus and channels: 1500 V ~ rms Between channels and earth: 1500 V ~ rms	Between channels: common point Between bus and channels: 1000 V ~ rms Between channels and earth: 1000 V ~ rms
51 ms (normal scan) 3 ms/channel used (fast scan)	126.4 ms (normal scan) 3.3 ms/channel used (fast scan)	1 ms	-	-
User-definable filtering 0...6.50 s	User-definable filtering 0...3.82 s	-	2.5 ms	5 ms
12 bits	16 bits		11 bits + sign	13 bits + sign for voltage 13 bits for current
Two 25-way SUB-D connectors	One 25-way SUB-D connector	One 25-way SUB-D connector	20-way screw terminal blocks: TSX BLY 01	One 25-way SUB-D connector
or two Modicon Telefast ABE 7CPA02/03 sub-bases	or one Modicon Telefast ABE 7CPA02/31 sub-base	or one Modicon Telefast ABE 7CPA03/21 sub-base		or one Modicon Telefast ABE 7CPA02/03 sub-base
PLC: IEC/EN 61131-2				

See page 9/6

- TSX AEY 1600
- TSX AEY 810
- TSX AEY 420
- TSX ASY 410
- TSX ASY 800

3

Connection by screw terminal block

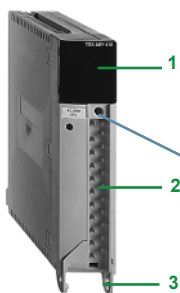

Connection by SUB-D connector

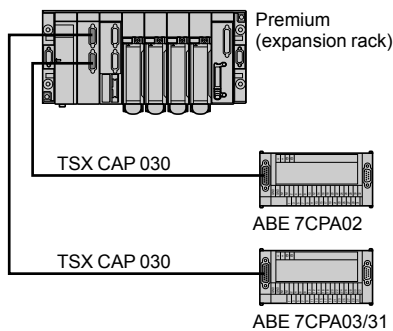
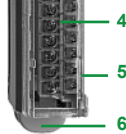

Presentation

Analog I/O modules for Modicon Premium PLCs are equipped with:

- Either a 25-way SUB-D connector (**TSX AEY 420/800/810** and **TSX ASY 800**)
- Or two 25-way SUB-D connectors (**TSX AEY 1600/1614**)
- Or a screw terminal block (**TSX AEY 414**, **TSX ASY 410**)

They can be installed in any position in **TSX RKY ●●●** racks, except for the positions reserved for power supply modules. The analog I/O modules are hot-swappable. In a Premium PLC configuration, the maximum number of analog channels (12...512 channels) depends on the CPU used (see pages 1/10 and 1/19).

Description

TSX AEY/ASY analog I/O modules feature the following on the front panel:

- 1 A display and module diagnostics block
- 2 A connector which takes the removable screw terminal block
- 3 A rotating support containing the module locating device
- 4 A removable screw terminal block for connecting the I/O directly to the sensors and preactuators **TSX BLY 01** (to be ordered separately)
- 5 A pivoting cover for accessing the terminal block screws and holding the identification label
- 6 A rotating support containing the module locating device
- 7 25-way SUB-D connector(s) for connecting the sensors

Note: TSX ASY 800 module. This module also has a screw terminal block for connecting the external 24 VR on the front panel (see page 3/16).

Connecting TSX AEY/ASY modules with SUB-D connectors

Using the Modicon Telefast ABE 7 pre-wired system makes it easier to install the modules by providing access to the inputs (or outputs) via screw terminals. Connection is via a **TSX CAP 030/100** 3/10 long shielded cable equipped with SUB-D connectors at either end.

The **ABE 7CPA02** Telefast sub-base enables the connection of 8 channels

The **ABE 7CPA03/31** Telefast sub-base enables:

- Connection of 8 channels and the channel by channel supply of 2 and 4-wire sensors with 24 V $\bar{\bar{}}$ (for the **ABE 7CPA03** sub-base)
- Connection of 8 channels and the channel by channel isolated supply of 2 and 4-wire sensors with 24 V $\bar{\bar{}}$ (for the **ABE 7CPA31** sub-base)
- Ensures continuity of the current loops when the SUB-D connector is removed
- Protects the current shunts in the modules against overvoltages

The **ABE 7CPA12** Telefast sub-base enables 16 thermocouples to be connected, with 2 **TSX CAP 030/100** cables. The terminal block is equipped with a temperature probe for cold junction compensation.

Functions

TSX AEY 420/800/810/1600 analog input modules

TSX AEY ●●● modules are high level analog input modules with 4 inputs for the **TSX AEY 420** module, 8 inputs for the **TSX AEY 800/810** modules and 16 inputs for the **TSX AEY 1600** module.

Used with sensors or transmitters, they perform monitoring, measurement and process control functions for continuous processes.

Depending on the choice made during configuration, the following ranges are available for each of the inputs on the **TSX AEY 420/800/810/1600** modules: ± 10 V, 0...10 V, 0...5 V, 1...5 V, 0...20 mA, 4...20 mA.

Functions (continued)

TSX AEY 420/800/810/1600 analog input modules (continued)

These modules perform the following functions:

- Scanning of input channels, protection against overvoltages, adaptation of signals by analog filtering, scanning by solid state multiplexing
- Adaptation to input signals: gain selection, drift compensation
- Digitization of signals: 12-bit analog/digital converter for **TSX AEY 800/1600** and 16-bit analog/digital converter for **TSX AEY 420/810**
- Conversion of input measurements to user format: recalibration coefficient, filtering, scaling
- Module monitoring: conversion circuit test, range overshoot test, terminal block presence test, watchdog test
- Isolation of the input channels on **TSX AEY 810**
- Fast processing of the inputs (1 ms) on **TSX AEY 420**

TSX AEY 414/1614 analog input modules

The **TSX AEY 414** is a multirange input module with 4 channels which are isolated from one another. Depending on the choice made during configuration, the following ranges are available for each of the inputs:

- B, E, J, K, N, R, S, T, U thermocouple or - 13... + 63 mV electrical range
- 2 or 4-wire Pt 100, Pt 1000, Ni 1000 temperature probe, or ohmic range: 0...400 Ω, 0...3850 Ω.
- High level ± 10 V, 0...10 V, ± 5 V, 0...5 V (0...20 mA with external shunt) or 1...5 V, 4...20 mA (4...20 mA with external shunt)

The **TSX AEY 1614** is an analog input module with 16 thermocouple inputs. Depending on the choice made during configuration, the following range is available for each of the input channels (supporting a 250 V $\overline{\text{---}}$ or 280 V \sim common mode between them): B, E, J, K, L, N, R, S, T, U thermocouple range or ± 80 mV electrical range.

These modules perform the following functions:

- Scanning of the input channels, selection of the gain according to the input signals, multiplexing
- Digitization of the input signals
- Conversion of input measurements to user format: recalibration coefficient, linearization, cold junction compensation, filtering, scaling
- Module monitoring: conversion circuit test, range overshoot test, terminal block presence test, sensor link test, watchdog test

TSX ASY 410/800 analog output modules

The **TSX ASY 410** module has 4 analog outputs which are isolated from one another, and the **TSX ASY 800** module has 8 outputs with common point. Depending on the choice made during configuration, the following ranges are available for each of the outputs: ± 10 V, 0...20 mA and 4...20 mA without external supply.

These modules perform the following functions:

- Protection of the module against overvoltages
- Adaptation to the different actuators: voltage or current output
- Conversion of digital signals to analog signals: 11 bits + sign for **TSX ASY 410** and 13 bits + sign for **TSX ASY 800**
- Conversion of application data into data that can be used by the digital/analog converter
- Module monitoring and indication of faults to the application: converter test, range overshoot test, terminal block presence test, watchdog test

Setup

The Unity Pro or PL7 Junior/Pro software provides configuration and debugging functions:

- Selection of the modules used
- Configuration of the channels according to the type of module: scanning (normal or fast), cold junction compensation (internal or external), range, filtering, display format, task (MAST or FAST), detection of terminal block presence, wiring check
- Debugging, access to certain parameter settings, module/channel diagnostics, forcing, calibration

Analog input modules						
Type of input	Input signal range	Resolution	Connection	No. of channels	Reference	Weight kg
High level analog with common point	± 10 V, 0...10 V, 0...5 V, 1...5 V, 0...20 mA, 4...20 mA	16 bits	1 x 25-way SUB-D connector	4 high-speed channels	TSX AEY 420	0.330
Low level analog isolated	± 10 V, 0...10 V, 0...5 V, 1...5 V, ± 5 V, 0...20 mA, 4...20 mA, - 13...+ 63 mV, 0...400 Ω , 0...3850 Ω , temp. probe, thermocouple	16 bits	Screw terminal block (1)	4 channels	TSX AEY 414	0.320
High level analog with common point	± 10 V, 0...10 V, 0...5 V, 1...5 V, 0...20 mA, 4...20 mA	12 bits	1 x 25-way SUB-D connector	8 channels	TSX AEY 800	0.310
				16 channels	TSX AEY 1600	0.340
High level analog isolated	± 10 V, 0...10 V, 0...5 V, 1...5 V, 0...20 mA, 4...20 mA	16 bits	1 x 25-way SUB-D connector	8 channels	TSX AEY 810	0.330
Thermocouple	± 63 mV, (B, E, J, K, L, N, R, S, T, U)	16 bits	2 x 25-way SUB-D connectors	16 channels	TSX AEY 1614	0.350



TSX AEY 1600/1614

Analog output modules						
Type of output	Output signal range	Resolution	Connection	No. of channels	Reference (1)	Weight kg
Analog isolated	± 10 V, 0...20 mA, 4...20 mA	11 bits + sign	Screw terminal block (2)	4 channels	TSX ASY 410	0.350
Analog with common point	± 10 V, 0...20 mA, 4...20 mA	13 bits + sign	1 x 25-way SUB-D connector	8 channels (2)	TSX ASY 800	—

(1) **TSX BLY 01** removable screw terminal block not supplied. To be ordered separately.

(2) The number of **TSX ASY 800** modules is limited to 1 per rack with single format power supply, and 2 per rack with double format power supply (when this supplies the 24 V_{DC} VR voltage required by the outputs).

Modicon Premium automation platform

Analog I/O modules



ABE7CPA0●

Connection accessories

Description	Compatible with module	Use	Type of terminal block	Reference	Weight kg
Modicon Telefast ABE 7 sub-bases	TSXAEY 800 TSXAEY 810 TSXAEY 1600 TSXASY 800 (1)	Distribution of 8 channels on screw terminals	Screw	ABE 7CPA02	0.290
	TSXAEY 420 TSXAEY 800 TSXAEY 1600	Distribution of 8 channels with common point on screw terminals, protected sensor power supply, continuity of current loops during disconnection, protection against overvoltages	Screw	ABE 7CPA03	0.330
	TSXAEY 810	Distribution of 8 isolated channels on screw terminals, channel by channel sensor power supply (without common point), protection against overvoltages	Screw	ABE 7CPA31	0.410
	TSXAEY 1614	Distribution of 16 channels on screw terminals, integrated temperature probe for external cold junction compensation	Screw	ABE 7CPA12	0.360
	TSXAEY 420 TSXASY 410 (2)	Distribution of 4 channels on screw terminals	Screw	ABE 7CPA21	0.200



TSX BLY 01

Description	Compatible with module	Use	Length	Reference	Weight kg
Connecting cables	TSXAEY 420 TSXAEY 800 TSXAEY 810 TSXAEY 1600 TSXAEY 1614 (3)	Link between 25-way SUB-D connectors on analog I/O modules and ABE 7CPA●● sub-bases	3 m	TSX CAP 030	0.670
			10 m	TSX CAP 100	1.120
	TSXASY 410	Link between module and ABE 7CPA21 sub-bases (4)	1.5 m	ABF Y25S150	0.500
			2 m	ABF Y25S200	0.560
			3 m	ABF Y25S300	0.740
5 m	ABF Y25S500	0.920			
20-way removable screw terminal block	TSXAEY 414 TSXASY 410	To be ordered separately with each I/O module with screw terminal block connection	Screw	TSX BLY 01	0.100

Replacement part

Set of 4 resistors 250 Ω	TSXAEY 414	Adaptation for current range (resistors supplied with TSXAEY 414 module)	–	TSX AAK2	0.020
---------------------------------	------------	--	---	-----------------	-------

(1) Can be used with **TSX AEY 420** module.

(2) Can be used with **TSX ASY 410** module by using **ABF Y25S●●0●** cables.

(3) Requires the use of two **TSX CAP 030** cables for connection to the **ABE 7CPA12** sub-base.

(4) Includes the **TSX BLY 01** 20-way removable screw terminal block.

3

Type of splitter box and module

Monobloc IP 67 I/O splitter boxes
Modicon ETB



Available buses and networks

Ethernet Modbus TCP/IP
EtherNet/IP

Max. number per connection point

Discrete I/O	Modularity
	Input voltage
	Output voltage

Splitter box with 16 configurable I/O, 16 I, 12 I + 4 O, or 8 I + 8 O

24 V $\overline{\text{DC}}$

24 V $\overline{\text{DC}}$

Analog I/O

–

Application-specific I/O

–

I/O connection

M12 connectors

Type of housing

Plastic

Type of module

ETB 1E●●●

Pages

Please consult the catalogue pages on our website www.schneider-electric.com

Monobloc IP 20 distributed I/O	Optimum IP 20 distributed I/O	Modular IP 20 distributed I/O
Modicon Momentum	Modicon OTB	Modicon STB



Ethernet Modbus TCP/IP Modbus Plus Fipio INTERBUS Profibus DP DeviceNet	Ethernet Modbus TCP/IP CANopen Modbus (RS 485)	Ethernet Modbus TCP/IP EtherNet/IP CANopen Modbus Plus Fipio INTERBUS Profibus DP DeviceNet
1 sub-base with 1 CPU or 1 communication module	1 interface module + 7 Twido expansion modules	1 NIM (Network Interface Module) + 32 I/O modules
Sub-base with 16 I, 32 I, 8 O, 16 O, 32 O, 10 I/8 O, 16 I/8 O, 16 I/12 O and 16 I/16 O	12 I/8 O (interface module) 8 I, 16 I, 32 I, 8 O, 16 O, 32 O, 4 I/4 O and 16 I/8 O (expansion modules)	Module with 2 I, 4 I, 6 I, 16 I, 2 O, 4 O, 6 O or 16 O
24 V $\overline{\text{DC}}$, 120 V \sim and 230 V \sim	24 V $\overline{\text{DC}}$	24 V $\overline{\text{DC}}$, 115 V \sim and 230 V \sim
24 V $\overline{\text{DC}}$ V, 120 V \sim and 230 V \sim and relay	24 V $\overline{\text{DC}}$ and relay	24 V $\overline{\text{DC}}$, 115/230 V \sim and relay
8 I, 16 I or 4 O voltage/current sub-bases Sub-base with 4 thermocouple or probe inputs	2 I, 4 I, 8 I, 1 O, 2 O, 2 I/1 O and 4 I/2 O (expansion modules) voltage/current, thermocouple or temperature probe	Modules with 2, 4 or 8 inputs and 1 or 2 outputs (voltage/current) Sub-base with 2 thermocouple or probe inputs
10 kHz/200 kHz 2-channel counter sub-base	Integrated in interface module: - Two 5 kHz/20 kHz channels - 2 PWM function channels	Counter module with one 40 kHz channel
6 I/3 O 120 V \sim sub-base with 1 Modbus port	–	Parallel interface modules for TeSys Quickfit and TeSys U motor starters, integrated connection for third-party CANopen products
Screw or spring-type removable terminal blocks	Removable screw terminal block (interface module) Removable screw terminal block, non-removable spring-type terminal block and HE 10 connector (expansion modules)	Removable screw or spring-type connectors, Telefast connectors

Plastic

170 AD●

OTB 1●0 DM9LP

STB ●●●

Please consult the catalogue pages on our website www.schneider-electric.comMore technical information on www.schneider-electric.com

Installation system

TeSys Quickfit for motor starter components

Components with spring terminals

3

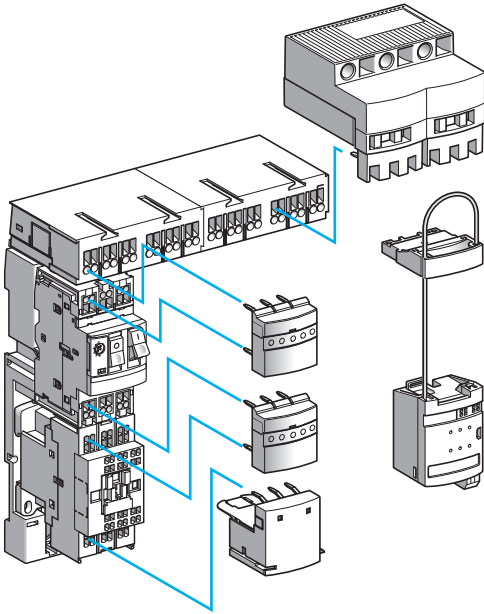

Motor starter with GV2 ME circuit-breakers

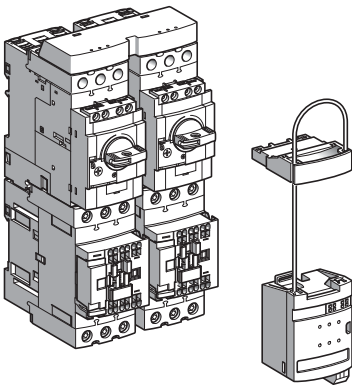

Motor starter with GV3 P circuit-breakers

TeSys Quickfit is a modular system which standardizes and simplifies the setting up of motor starters with its pre-wired control and power circuits. The installation of a motor starter is therefore a quick, easy, reliable and open-ended process.

In addition, this system:

- Enables the motor starter to be customized at a later date
- Reduces maintenance time
- Saves space inside the equipment by reducing the number of terminals, cable ducts and intermediate interfaces

System for motor starters with spring terminals

Motor starters with TeSys GV2 ME circuit-breakers

- From 0 to 18 A maximum
- TeSys GV2 ME circuit-breakers combined with TeSys D contactors from 9 to 25 A (spring terminal version)
- Quickfit pre-wired power and control connections

Motor starters with TeSys GV3 P circuit-breakers

- From 9 to 65 A maximum
- TeSys GV3 P circuit-breakers combined with TeSys D contactors from 40 to 65 A (spring terminal version)
- Quickfit pre-wired control connections only
- For pre-wired power connections, use the busbars from the TeSys D 40 to 65 A contactor range (see the "Protection and power control" catalogue)

This range comprises pre-wiring components for

- The power circuits
- The control circuits

Power circuit pre-wiring components

(motor starters with TeSys GV2 circuit-breakers only)

- **A power circuit connection kit** comprising, for each starter, a plate for mounting the contactor and the circuit-breaker, and two power connection modules
- **A power splitter box** for 2 or 4 starters
- **Fixed terminals** for connecting a power supply up to 60 A (16 mm²)
- **Removable terminals** for connecting the motor power supply cables and the earth cables (6 mm²)

Note: With GV3 circuit-breakers, no accessories are required for pre-wiring the power circuit. The terminals on the GV3 P●● are removable.

This circuit-breaker is also sold with a single terminal block (reference: GV3 P●●1).

Control circuit pre-wiring components

(motor starters with TeSys GV2 and GV3 circuit-breakers)

- **A control circuit connection module** which is mounted directly on the contactor and the circuit-breaker on each starter. This module incorporates the status and control data for this motor starter.
- **A parallel wiring module** which concentrates data from each motor starter:
 - **HE 10** connector, for centralized applications. Data is transmitted to the PLC via the Modicon Telefast pre-wired system.
 - **STB**, designed for decentralized automation architectures. This module is suitable for use in a Modicon STB configuration for connection to the PLC via a fieldbus.

Installation system

TeSys Quickfit for motor starter components
Components with spring terminals

Control/command

HE 10 connection

- 1 Automation platform
- 2 Connection cable **TSXCDP●●** or **ABFH20●●**
- 3 Splitter box **LU9 G02**

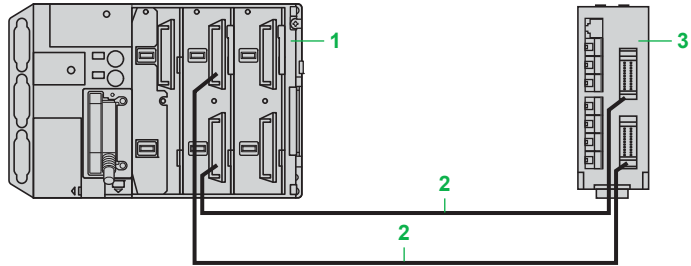

Connection on bus using Modicon STB (1)

Configuration example (for motor starter applications only):

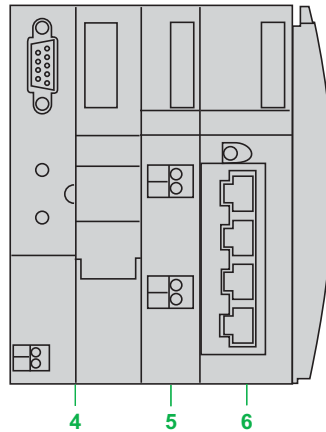

- 4 Network interface module
- 5 Power supply module
- 6 Parallel interface module

Power supply module

Module	STB PDT 3100
Connection base	STB XBA 2200
Terminal block	STB XTB 1130

Parallel interface module (2)

Module	STB EPI 2145
Connection base	STB XBA 3000

Network interface module (3)

CANopen	STB NCO 1010 (4)
Fipio	STB NFP 2210
Ethernet TCP/IP	STB NIP 2210
InterBus	STB NIB 1010 (4)
Profibus DP	STB NDP 1010 (4)
DeviceNet	STB NDN 1010 (4)
Modbus Plus	STB NMP 2210
Terminal block	STB WTS 2120

TeSys Quickfit LAD 9AP3 ●● used with APP1 C●● modules

- 7 TeSys Quickfit module
- 8 Adaptor plate **APP 2CX**
- 9 Splitter box **LU9 G02** for 8 direct motor starters with channel connections on the **APP 1C** module side via 2 HE 10 connectors (20-way), and on the TeSys Quickfit side via 8 RJ45 connectors
- 10 Connection cable **APP 2AH40H060**

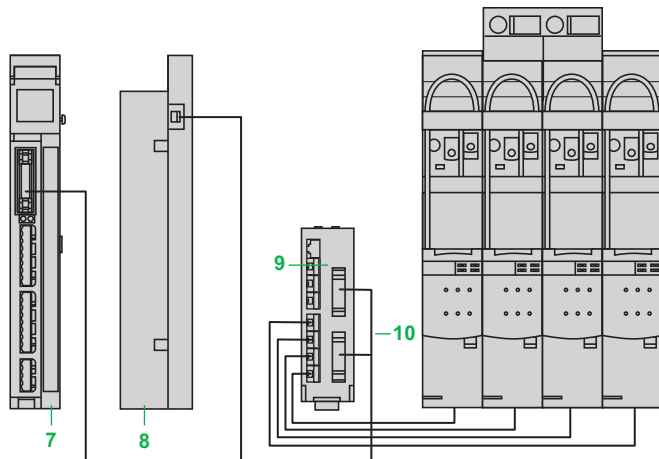

The motor starter is connected to an **APP 1C●● 7** module using an adaptor plate **APP 2CX 8** and a cable **APP 2AH40H060 10**.

Information is available on the module for each motor starter:

- 1 output: motor control
- 2 inputs: circuit-breaker status and contactor status

(1) Please consult the "IP 20 distributed inputs/outputs Modicon" catalogue.

(2) For 4 direct or 2 reversing motor starters.

(3) Reference to be selected according to the network used.

(4) Optimized version.

Installation system

TeSys Quickfit for motor starter components

TeSys Quickfit, compatibility with PLC I/O and distributed I/O

Automation platforms	Parallel wiring module	Modicon STB parallel interface module
----------------------	------------------------	---------------------------------------

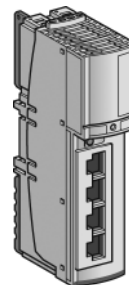
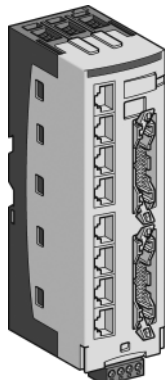

3

Type	Modularity of connection to the PLC	Compatible I/O modules	Splitter box - For 8 TeSys model U motor starters (16 PLC inputs and 8 PLC outputs) - 8 RJ45 connectors, motor starter side - 2 HE 10 connectors, PLC side	Module - For 4 TeSys model U motor starters - 4 RJ45 connectors, motor starter side
			LU9 G02	STB EPI 2145

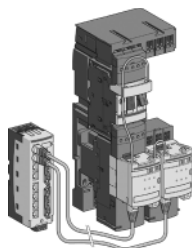

Modicon TSX Micro platform

16 inputs + 12 outputs	TSX DMZ 28DTK	8 motor starters max.: 1 splitter box
2 x 16 inputs + 2 x 16 outputs	TSX DMZ 64DTK	16 motor starters max.: 2 splitter boxes

Modicon Premium platform

16 inputs + 12 outputs	TSX DMY 28FK	8 motor starters max.: 1 splitter box
2 x 16 inputs + 2 x 16 outputs	TSX DEY 32D2K TSX DSY32T2K	16 motor starters max.: 2 splitter boxes
4 x 16 inputs + 2 x 16 outputs	TSX DEY 64D2K TSX DSY32T2K	32 motor starters max.: 4 splitter boxes

Modicon Quantum platform

2 x 16 inputs + 2 x 16 outputs	140 DDI 353 00, 140 DDI 853 00 140 DD0 353 10	16 motor starters max.: 2 splitter boxes
6 x 16 inputs + 6 x 16 outputs	140 DDI 364 00 140 DD0 364 00	48 motor starters max.: 6 splitter boxes

Modicon STB distributed I/O

16 inputs + 8 outputs	STB EPI 1145	4 motor starters max.: 1 parallel interface module
-----------------------	--------------	--

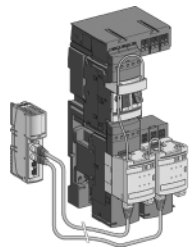

TeSys Quickfit, compatibility with PLC I/O and distributed I/O (continued)

Connection accessories

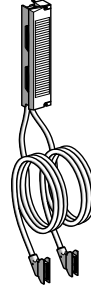
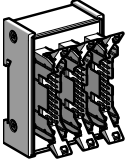

Splitter box 16 channels to 2 x 8 channels - 3 HE 10 connectors	Connection cables - With 2 HE 10 connectors - AWG 22, 0.324 mm ² - 5 lengths: 0.5, 1, 2, 3, 5 or 10 m	Connection cables - With 2 HE 10 connectors - AWG 28, 0.080 mm ² - 3 lengths: 1, 2 or 3 m	Cabled connectors - Terminal block with 2 cables fitted with HE 10 connectors - AWG 22, 0.324 mm ² - 2 lengths: 1.5 or 3 m	Connection cables - With 2 RJ45 connectors - 3 lengths: 0.3, 1 or 3 m
ABE 7ACC 02	TSX CDP ●●3 (1)	ABF H20 H●●0 (2)	ABF M32 H●●0 (3)	LU9 R●● (4)

Modicon TSX Micro platform

	2 cables		
1 splitter box (16 PLC outputs remain)	5 cables		

Modicon Premium platform

	2 cables		
1 splitter box (16 PLC outputs remain)	5 cables		
2 splitter boxes	10 cables		

Modicon Quantum platform

3 splitter boxes (16 PLC outputs remain)			2 cabled connectors
3 splitter boxes (48 PLC outputs remain)	15 cables		

Modicon STB distributed I/O

				4 cables
--	--	--	--	----------

(1) Replace ●● by **05**: length 0.5 m, **10**: length 1 m, **20**: length 2 m, **30**: length 3 m, **50**: length 5 m, **100**: length 10 m.

(2) Replace ●● by **10**: length 1 m, **20**: length 2 m, **30**: length 3 m.

(3) Replace ●● by **15**: length 1.5 m, **30**: length 3 m.

(4) Replace ●● by **03**: length 0.3 m, **10**: length 1 m, **30**: length 3 m.

Preventa safety modules and solutions

- **Use of Preventa safety modules** page 4/2
- **Preventa safety modules - type TSX PAY 262**
 - Presentation, functions page 4/4
 - Description page 4/6
 - References page 4/7
- **Preventa configurable safety controllers - type XPS MC**
 - Presentation page 4/8
 - Description page 4/11
 - References page 4/12

Counter and electronic cam modules

- Selection guide* page 4/14
- **Counter modules**
 - Presentation, description page 4/16
 - References page 4/18
- **Measurement and counter module**
 - Presentation, description page 4/20
 - References page 4/22
- **Electronic cam module**
 - Presentation, description page 4/24
 - References page 4/26

Motion control modules

- Selection guide* page 4/28
- **Modules for stepper motors**
 - Presentation, description page 4/30
 - References page 4/32
- **Modules for servo motors**
 - Presentation, description page 4/34
 - References page 4/38
- **SERCOS modules for servo motors**
 - Presentation page 4/40
 - Description page 4/41
 - Functions page 4/42
 - References page 4/45
- **MFB motion control** page 4/46

ISP *Plus* integrated weighing system

- **Presentation** page 4/48
- **Description** page 4/49
- **Functions** page 4/50
- **References** page 4/51

Redundancy systems

- **Hot Standby system - Unity Pro software**
 - Presentation page 4/52
 - Description page 4/53
 - Architectures page 4/54
 - Functions page 4/58
 - References page 4/60

■ **Warm Standby system - PL7 Pro software**

- Presentation *page 4/62*
- Functions *page 4/64*
- References *page 4/66*
- Connections *page 4/67*

Safety

Production workshops and technical building installations are subject to increasing requirements in terms of machine safety.

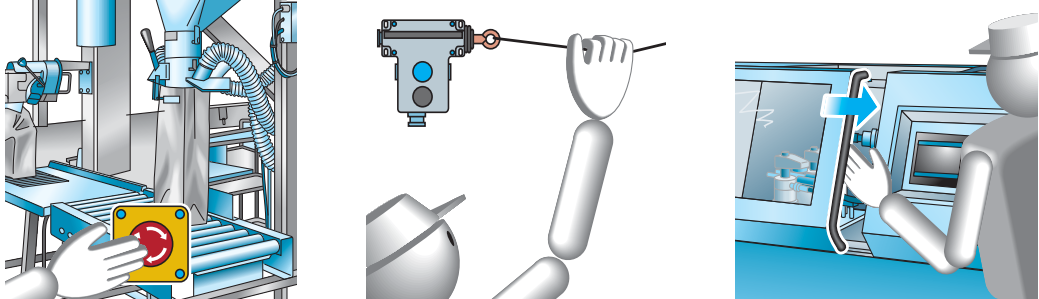

A good machine is a safe machine, combining:

- Safety of personnel (machine is not dangerous).
- Availability of the production tool (machine operational at any time).
- Safety is achieved by:
 - simultaneously optimising safety and availability,
 - using basic principles: redundancy, self-monitoring, etc,
 - considering reliability (failure determining the behavior of the machine in a specified position, positive safety features),
 - ease of maintenance.

The machinery directive and the work equipment directive

The machinery directive

A machine manufacturer is required to conform to the machinery directive

The machinery directive (89/392/EEC, 91/36/EEC, 93/44/EEC and 93/68/EEC) is designed to ensure the free circulation of machinery and safety components in European Union countries and to improve the level of safety for personnel.

Harmonised European standards establish technical specifications which comply with the minimum safety requirements defined in the corresponding directive.

Manufacturers must produce machinery which conforms to safety requirements.

The work equipment directive

The user is required to ensure that his range of machines conforms to the use of work equipment by workers at work directive

Directive 89/655/EEC lays down the minimum objectives for protection in the working environment and in particular concerns the use of products. The directive specifies the general framework of preventative measures which should be taken in the workplace.

Safety and automated systems

All dangerous areas must be identified and have restricted access, controlled in a secure manner, ie. any breakdown or careless operation must leave the automated system in a safe position.

It should be noted that the use of safety products does not necessarily mean that the machine conforms to the machinery directive.

It is the operation, wiring, compatibility and scheme used, which make the entire machine safe. It is more important to think in terms of safety solutions rather than safety products.

Groupe Schneider, safety specialists

Groupe Schneider, specialists in safety, has a range of several thousand products, all concerned directly or indirectly with safety. Some of these products are exclusively designed for safety.

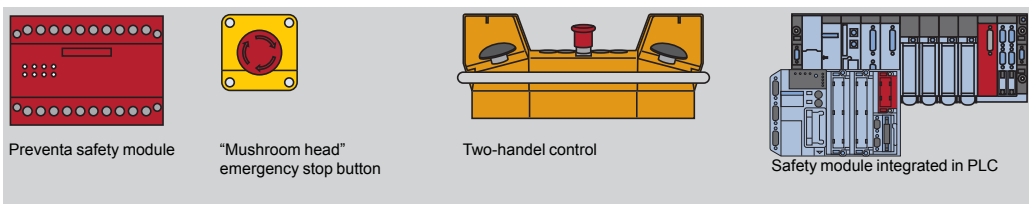

For further details on components for safety applications, please consult our catalogue: "Safety solutions using Preventa".

Non-controlled safety systems

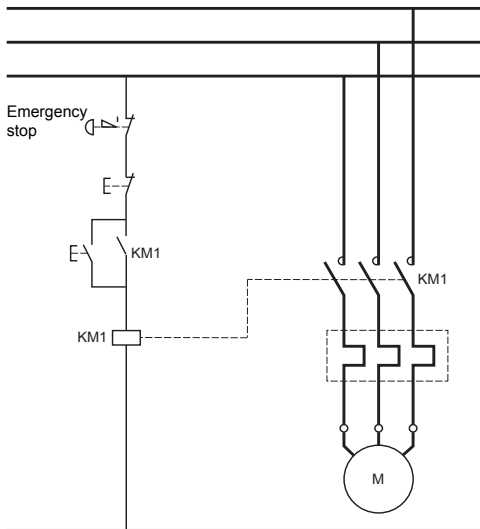

The control signal from the protection device (emergency stop pushbutton illustrated to the left) acts directly on the power contactor of the machine.

In this type of scheme, the risks of simple faults are:

- Emergency stop button being shorted.
- KM1 contactor sticking.

When the operator presses an emergency stop button, the instruction is not processed, and another sequence can begin following the emergency stop, despite the presence of the fault.

In the case of failure, the safety function (1) is compromised.
Therefore, a reliable intermediate relay system must be used.

(1) A safety function is a function whose non-execution or untimely execution results in the immediate placement of the equipment into a non-hazardous position.

Safety system controlled by a Preventa safety module

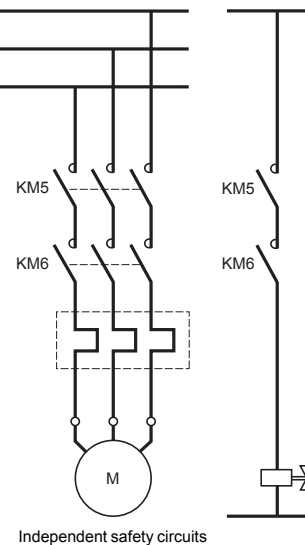
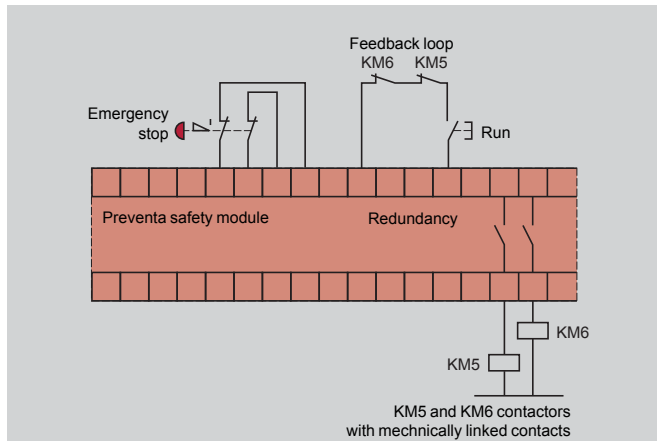

Preventa safety modules provide a reliable interposing relay function by eliminating the risks of:

- A control circuit fault (inputs).
- A power circuit fault (outputs).
- A fault on an internal safety module component.

The safety function remains operative whenever any one of these faults occur.

Note: For the use of mechanically linked contacts CA2-KN22/KN31, LC1-D09/D18/D25 with contacts which can be used in the feedback loop, please consult our Customer Care Centre.

Presentation

TSX PAY 262 safety module integrated in the Modicon Premium PLC combines :

- the simplicity of use of Preventa safety module
- the high performance of PLC diagnostics

in addition to the advantages of a standard PLC (extended choice of I/O, simplicity of setup, flexibility for hardware and software developments, etc).

TSX PAY 262 safety module incorporate in a single module, a Preventa (XPS) hard-wired safety block and an electronic data acquisition unit for complete diagnostics of input contacts and the state of outputs in the safety system.

TSX PAY 262 safety module is used to safely interrupt one or more Emergency stop or safety stop control circuits according to the standards IEC/EN 60204-1 and EN/ISO 13850.

The proven safety of hard-wired technology and the performance of Premium PLCs make the TSX PAY 262 module the optimum solution for creating machines which are more available, safer, more compact and lower in cost.

Solution for applications requiring safety systems and high-performance diagnostics

The solution "integrated safety module" enables complete diagnostics on the entire safety system. This diagnostics quickly locates the faulty contact, pushbutton cables, or limit switch, without additional contacts on the inputs and without any additional wiring.

TSX PAY 262 safety module has its own power supplies and operate independently of the PLC processor.

TSX PAY 262 module is suitable for Emergency stop and limit switch monitoring applications, demanding a level of safety up to category 4 according to standard EN 954-1/ISO 13849-1 (parts of control systems relating to safety).

Functions

TSX PAY 262 module offers the following functions:

- Monitoring of 1 to 12 double or single pushbutton contacts, Emergency stop and limit switches for safety guards for an Emergency stop or immediate stop safety system (Emergency stop category 0 according to standard EN/ISO 13850).
- Hard-wired safety block identical to Preventa XPS safety modules:
 - 2 N/O (normally open) safety outputs,
 - 12 double contact inputs.
- Safety block independent of the Premium PLC processor: the PLC does not operate on the safety module.
- 28 LEDs on the module display block: for complete diagnostics of the safety system.
- Electronic data acquisition units for complete diagnostics of the safety system:
 - read the status of the 24 inputs (image of the status of the 12 pushbuttons or limit switches)
 - read the enable input,
 - read the feedback loop,
 - read the safety outputs control,
 - monitor the external power supply of the module.

This electronic data acquisition is designed so that the safety function is not compromised by any failure. If the safety system uses more sensors, it is possible to connect several TSX PAY 262 modules.

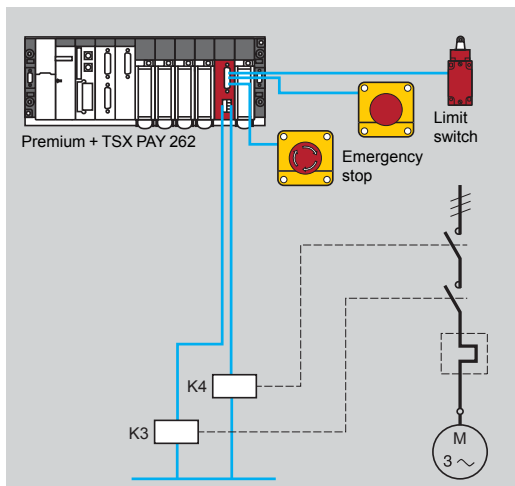

- 13-14 and 23-24 Safety outputs, volt-free
- Y1-Y2/S33: Feedback loop
- Y2/S33-S34: Run enable
- Y3-Y4: Choice of reactivation mode
- S121 to S232: 12 contacts on (+) input channel
- S01 to S112: 12 contacts on (-) input channel
- A1-A2: 24 V external power supply
- B1: Selection of double or single contact wiring

TSX PAY 262 module schematic

- To ensure the safety function irrespective of the first failure, it is compulsory to use:
- For the inputs: Emergency stop pushbuttons or safety limit switches with double contacts
 - For the outputs: if relaying is necessary, use a guided contact relay
 - On the module power supply : an F1 protection fuse.

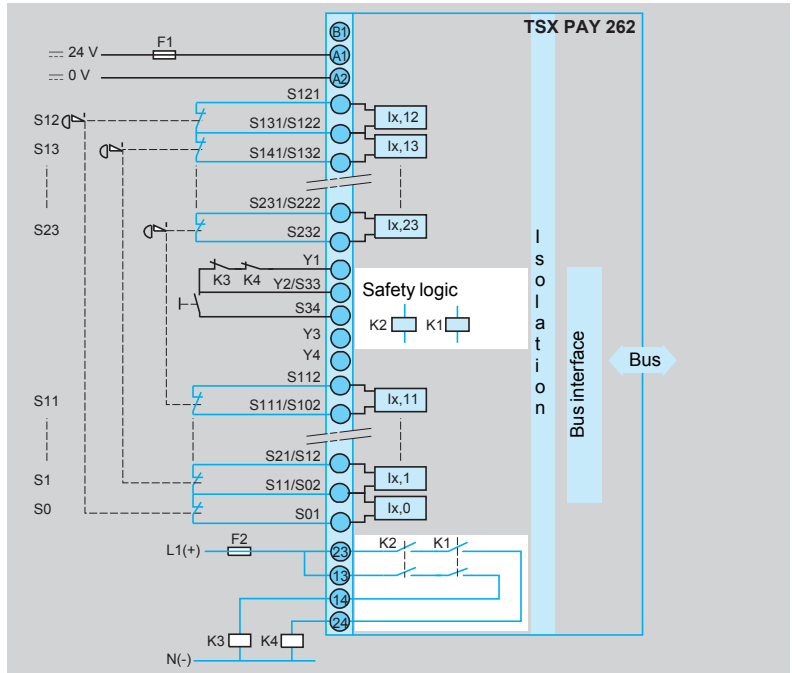

Functional diagrams

Emergency stop function

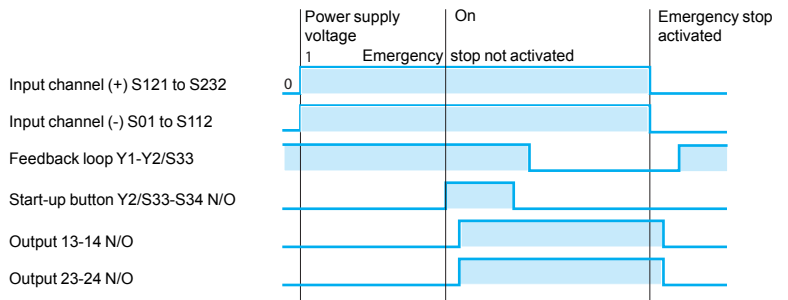

Protective function with automatic start-up

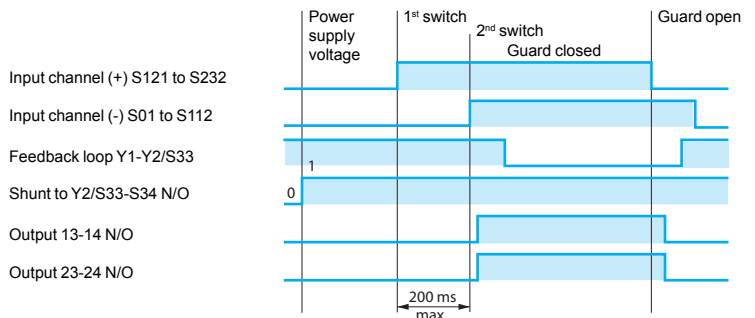

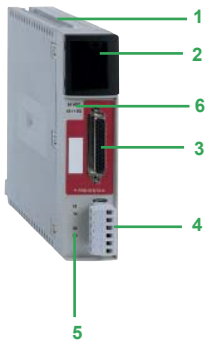

Description

TSX PAY 262 safety module comprises on the front panel :

- 1 A rigid IP 20 casing to hold and protect the electronic card.
- 2 A display block (32 LEDs) showing operating modes, faults and the status of the safety system.
- 3 A high density 44-way SUB-D connector for connecting the safety system.
- 4 A 6-way removable screw terminal block for connecting the safety outputs.
- 5 Marking for labelling the safety outputs.
- 6 Marking for the external power supply of the module.

4

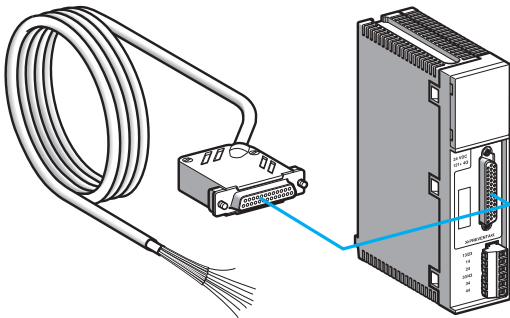

Connection principle

Two types of connection for TSX PAY 262 safety module are available:

Standard wiring

A **TSX CPP 301** 3 m cordset is fitted with a 44-way SUB-D moulded, elbow connector at one end, and flying leads differentiated by a colour code at the other end.

This wiring system conforms to the standard EN 954-1/ISO 13849-1.

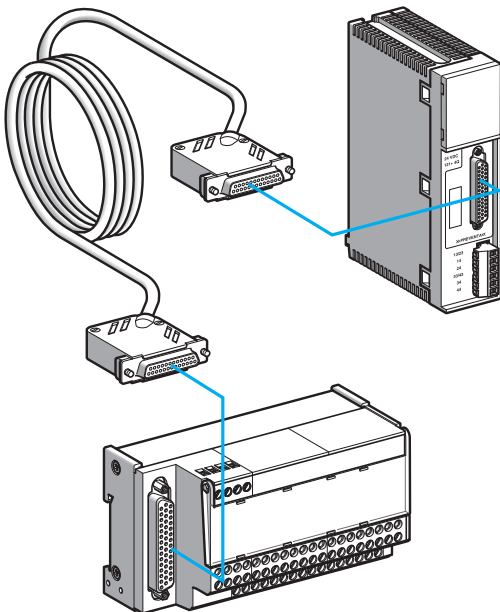

Fast wiring

Using the Modicon Telefast **ABE 7** pre-wired system facilitates the installation of TSX PAY 262 safety module by giving access to inputs on the safety system via screw terminals.

Connection is carried out using **TSX CPP 002** cordsets fitted with 44-way SUB-D moulded, elbow connectors at both ends.

The Modicon Telefast **ABE 7CPA13** sub-base enables the connection of 12 double or single contact inputs, the power supply, reset inputs and the feedback loop.

This wiring system conforms to the standard EN 954-1/ISO 13849-1.

Modicon Premium automation platform

Preventa safety module type TSX PAY 262



TSX PAY 262

Safety module				
Type of input ~ 24 V	Safety outputs	Connections	Reference	Weight kg
12 Emergency stops or limit switches (double or single contacts), 1 reset button, 1 feedback loop, 1 reset monitor	2 N/O (volt-free) 2.5 A (lthe)	Inputs: 44-way SUB-D connector Outputs: screw terminal (supplied)	TSX PAY 262	0.430

Connection accessory				
Description	For connection on screw terminal	Type of connector on TSX PAY 262	Reference	Weight kg
Modicon Telefast ABE 7 sub-base for TSX PAY 262 module	Safety system, reset, monitoring and loop inputs Power supply ~ 24 V	SUB-D, 44-way	ABE 7CPA13	0.290



ABE 7CPA13

Connecting cordsets					
Use	From TSX PAY 262 module	To	Length	Reference	Weight kg
For fast wiring	44-way SUB-D connector	ABE-7CPA13 sub-base	1 m	TSX CPP 102	0.160
			2 m	TSX CPP 202	0.260
			3 m	TSX CPP 302	0.360
For standard wiring	44-way SUB-D connector	Flying leads with colour-coded wires	3 m	TSX CPP 301	0.330

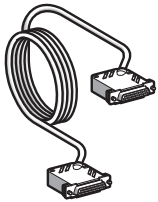

TSX CPP 02

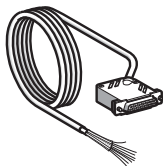

TSX CPP 301

Safety automation solutions

Preventa configurable safety controllers

Type XPS MC

Presentation

Configurable safety controllers XPS MC●●Z● are designed to provide a solution for safety applications requiring conformity to Performance Level PL e/Category 4 in accordance to standard EN/ISO 13849-1 and SIL 3 requirements of standard EN/IEC 61508.

The range of configurable safety controllers comprises 6 products, each with different technical characteristics.



XPS MC16ZC



XPS MC32ZC

Configurable controllers	Safety inputs	Safety outputs (1)	Communication via		
			CANopen bus	Profibus bus	Modbus serial link
XPS MC16Z	16	6 + 2 x 2	–	–	Yes, slave
XPS MC16ZC	16	6 + 2 x 2	Yes, slave	–	Yes, slave
XPS MC16ZP	16	6 + 2 x 2	–	Yes, slave	Yes, slave
XPS MC32Z	32	6 + 2 x 2	–	–	Yes, slave
XPS MC32ZC	32	6 + 2 x 2	Yes, slave	–	Yes, slave
XPS MC32ZP	32	6 + 2 x 2	–	Yes, slave	Yes, slave

Line control

The safety inputs are supplied by the various control outputs (2), in such a manner so as to monitor for short-circuits between the inputs, short-circuits between each input and earth or the presence of residual voltages.

The controller, assisted by the control outputs, continuously tests all the connected inputs. As soon as an error is detected on an input, all the outputs associated with this input are disconnected. Safety outputs associated with other inputs remain active.

Configuration

Safety controllers XPS MC●●Z● are configurable and addressable using software XPS MCWIN running on a PC. Connection accessories required: see page 4/13.

Connections

For connection of safety inputs and outputs, safety controllers XPS MC●●Z● can be fitted with a choice of:

- screw connectors type XPS MCTS●●, or
- spring clip connectors type XPS MCTC●●.

These connectors are to be ordered separately, see page 4/13.

(1) 8 independent safety outputs = 6 solid-state safety outputs + 2 x 2 relay outputs (4 relay outputs with guided contacts).

(2) 8 control outputs are available but they are not safety outputs.

Safety functions

Configuration of the safety functions is carried out using software XPS MCWIN which is available on the Safety Suite V2 CD-ROM.

30 certified safety functions are available with this software and they are easily assignable to the safety outputs. The safety functions have multiple combination possibilities and various starting conditions.

The safety functions are:

- certified in accordance with EN/ISO 13849-1 and IEC 61508,
- configurable in controller XPS MC using software XPS MCWIN which is available on the Safety Suite V2 software pack.

All 8 safety outputs are suitable for use in safety related parts of control systems conforming to Performance Level PL e/Category 4 in accordance to EN/ISO 13849-1.

Main safety functions

- Emergency stop monitoring, with or without time delay, 1 or 2-channel wiring
- Two-hand control (type III-C conforming to EN 574/ISO 13851)
- Guard monitoring with 1 or 2 limit switches
- Guard monitoring for injection presses and blowing machines
- Magnetic switch monitoring
- Sensing mat monitoring
- Light curtain (type 4 conforming to EN/IEC 61496, relay or solid-state output) monitoring
- Zero speed detection
- Dynamic monitoring of hydraulic valves on linear presses
- Monitoring safety stop at top dead centre on eccentric press
- Safety time delays
- "Muting" function of light curtains
- Enabling switch monitoring, 2 or 3 contact
- Hydraulic press
- Eccentric press
- Foot switch monitoring
- Chain shaft breakage monitoring
- Position selector

Application schemes and functional diagrams

See instruction sheet on www.schneider-electric.com

Communication

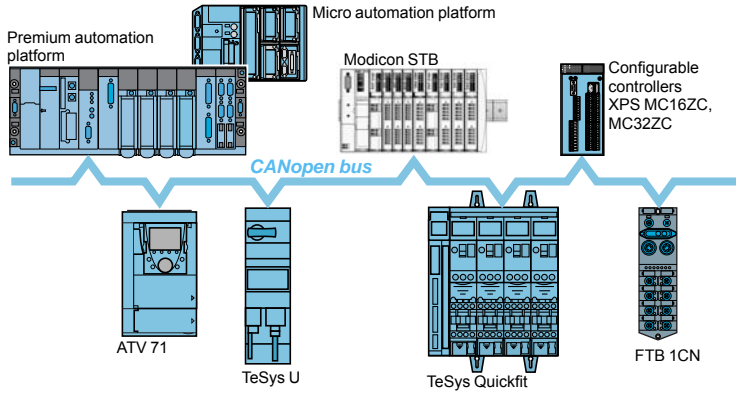

CANopen fieldbus

Configurable safety controllers XPS MC●●ZC incorporate a SUB-D 9-pin male connector for direct connection on CANopen bus.

CANopen bus is an open bus that ensures deterministic and reliable access to the real-time data of automation equipment. The bus uses a shielded dual twisted pair on which a maximum of 127 devices can be connected by chaining. The baud rate varies between 10 Kbps and 1Mbps depending on the length of the bus (5000 m to 20 m).

4

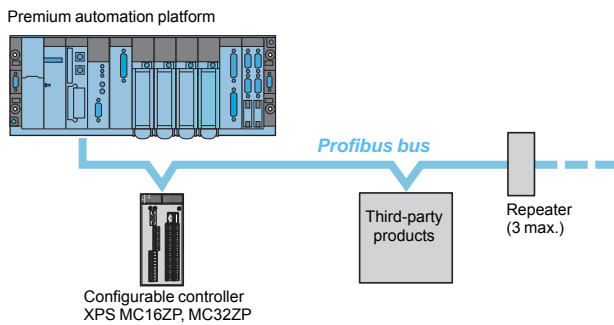

Profibus bus

Configurable safety controllers XPS MC●●ZP incorporate a SUB-D 9-pin male connector for connection on Profibus bus. Configurable safety controllers XPS MC●●ZP are slaves on the Profibus bus.

Profibus bus is a fieldbus that meets industrial communication requirements. The topology of the Profibus bus is of the linear type with a centralised master/slave type access procedure. The physical link is a single shielded twisted pair.

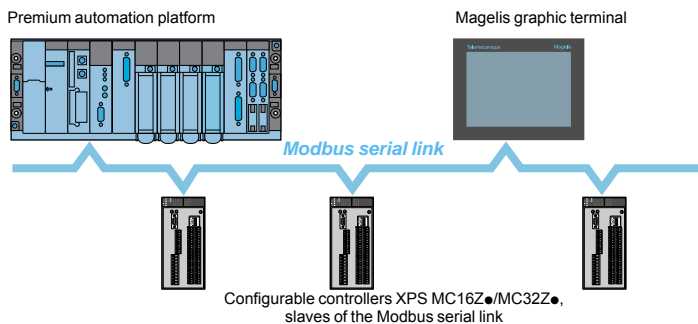

Modbus serial link

Configurable safety controllers XPS MC●●Z● incorporate a Modbus communication interface (RJ45 connector) for configuration and diagnostics.

This interface enables connection of the controllers to:

- a PC (configuration),
- a PLC (diagnostics), or
- an operator dialogue terminal (diagnostics).

The Modbus serial link comprises a master station (Premium automation platform) and slave stations (configurable controllers XPS MC16/32Z●).

Two exchange mechanisms are possible:

- **Question/response:** the questions from the master are addressed to a given slave. The response is expected by return from the interrogated slave.
- **Distribution:** the master distributes a message to all the stations of the Modbus serial link. The latter execute the order without transmitting a reply.

Safety automation solutions

Preventa configurable safety controllers

Type XPS MC

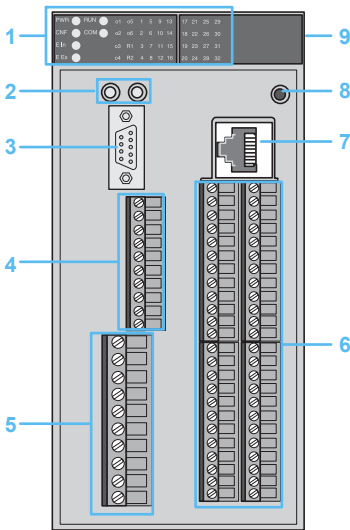

Configurable safety controller XPS MC, with screw connectors

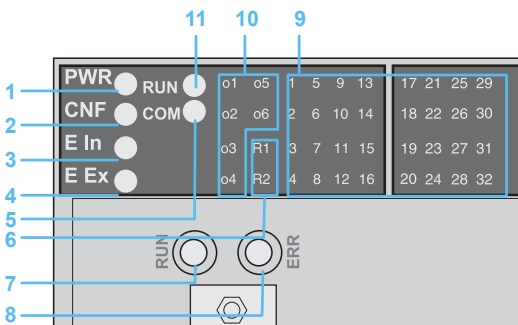

Illuminated display

Description

Configurable safety controllers XPS MC

Front face of controllers:

- 1 LED display and system diagnostics.
- 2 Two LEDs for CANopen or Profibus (1) connection status.
- 3 SUB-D 9-pin male connector for connection on CANopen bus (XPS MC16ZC/MC32ZC) or SUB-D 9-pin female connector for connection on Profibus bus (XPS MC16ZP/MC32ZP).
- 4 Solid-state safety output and "muting" indicator light terminals.
- 5 Power supply (24 V \overline{DC}) and relay safety output terminals.
- 6 Control output terminals for power supply to safety inputs and safety input terminals.
- 7 RJ45 connector for connection on Modbus serial link.
- 8 RESET button (resetting of controller).

Rear face of controllers:

- 9 Fixing plate for mounting on rail.

LED details

LED	Colour	Status	Meaning
1 PWR	Green	On	Supply voltage present.
2 CNF	Yellow	On	In configuration mode.
		Flashing	Not configured, initial power-up.
3 E In	Red	On	Internal error: all safety outputs deactivated.
4 E Ex	Red	On	External error: all safety outputs associated with the defective circuit are deactivated.
5 COM	Green	On	Controller communicating via the TER (RJ45) connection.
6 R1, R2	Green	On	Relay outputs 13/14, 23/24, 33/34 and 43/44 activated.
		Flashing	Fault on these outputs.
7 RUN	Green	Off	Hardware OK for the Profibus bus or the CANopen bus.
		On	Communicating on Profibus bus or on CANopen bus. Normal status.
8 ERR	Red	On	Communication impossible, configuration error, damaged cabling or absence. Bus deactivated
		Off	Communicating on CANopen or Profibus bus. Normal status.
		Flashing (x 1)	Warning limit reached.
		Flashing (x 2)	Control event error on CANopen bus.
		Flashing (x 3)	Synchronisation error on CANopen bus.
9 1...16	Green	On	Input circuit closed.
1...32		Flashing	Error detected on input relating to LED.
10 o1...o6	Green	On	Solid-state output activated.
		Flashing	Short-circuit, fault on output.
11 RUN	Green	On	Run mode.
		Flashing	Changing from run mode to stop mode.

(1) Depending on controller model.

Safety automation solutions

Preventa configurable safety controllers

Type XPS MC



XPS MC16Z



XPS MC32Z



XPS MC16ZC



XPS MC32ZC



XPS MC16ZP



XPS MC32ZP

References

Configurable safety controllers (connector not included)

Number of inputs	Number of outputs		Communication (Link and bus)	Reference	Weight kg
	Relay	Solid-state			
16	4 (2 x 2)	6	Modbus	XPS MC16Z	0.820
			Modbus, CANopen	XPS MC16ZC	0.820
			Modbus, Profibus	XPS MC16ZP	0.820
32	4 (2 x 2)	6	Modbus	XPS MC32Z	0.840
			Modbus, CANopen	XPS MC32ZC	0.840
			Modbus, Profibus	XPS MC32ZP	0.840

Plug-in connectors for configurable safety controllers (1)

Description	For use with	Reference	Weight kg
Screw connectors	XPS MC16Z, MC16ZC, MC16ZP	XPS MCTS16	0.080
	XPS MC32Z, MC32ZC, MC32ZP	XPS MCTS32	0.110
Spring clip connectors	XPS MC16Z, MC16ZC, MC16ZP	XPS MCTC16	0.080
	XPS MC32Z, MC32ZC, MC32ZP	XPS MCTC32	0.110

Configuration software

- Reference XPS MCWIN is the full version of configuration software XPS MCWIN version 2.10 and must be installed if no previous version of this software has been installed.
- Reference SSVXPSMCWINUP is an update for configuration software XPS MCWIN and can be used if XPS MCWIN has been installed using Safety Suite V1. An update from version 2.0 to 2.10 for the software XPS MCWIN will then be performed.

Description	Operating system	Characteristics (2)	Languages	Reference	Weight kg
Configuration software for controllers XPS MC●●Z● CD-ROM + user manual	Windows 2000, Windows XP	Software available on Safety Suite V2 software pack	FR, EN, DE, IT, ES, PT	XPS MCWIN	0.520
XPS MCWIN software update CD-ROM + user manual	Windows 2000, Windows XP	Software update available on Safety Suite V2 software pack	FR, EN, DE, IT, ES, PT	SSVXPSMCWINUP	0.520

(1) To be ordered separately to the controllers.

(2) EDS and GSD files are available on the XPS MCWIN configuration software CD-ROM.

4



XPS MCCPC



TSX PCX 1031



490 NT 000



TSX CUSB485



TSX CAN TDM4



ABL 8RPS24100

References

Connecting cables (1)

Function		Length m	Reference	Weight kg
Diagnostics using Magelis operator dialogue terminal type XBT GT		3	VW3 A8 306 R30	1.130
Configuration software	1 Adaptor: RJ45 socket/PC connection cables	–	XPS MCCPC	0.011
	2 Cable to PC serial port (type SUB-D9)	2.5	TSX PCX 1031	0.170
	3 Straight shielded twisted pair cables, EIA/TIA 568 standard (RJ45 connector at each end)	2	490 NTW 000 02	–
		5	490 NTW 000 05	–
		12	490 NTW 000 12	–
	Straight shielded twisted pair cables, UL and CSA 22.1 approved (RJ45 connector at each end)	2	490 NTW 000 02U	–
		5	490 NTW 000 05U	–
		12	490 NTW 000 12U	–
	with RJ45/PC USB port converter (2)	0.4	TSX CUSB485	–

Function	Medium	Length m	Reference	Weight kg	
Modbus serial link access	Premium automation platform TSX SCY 21601	–	XPS MCSCY	–	
CANopen bus access	1 CANopen connection cables (fitted with: 1 SUB-D 9-pin female connector at each end)	0.3	TSX CANCADD03	–	
		1	TSX CANCADD1	–	
		3	TSX CANCADD3	–	
		5	TSX CANCADD5	–	
		–	–	–	
		2 CANopen tap-off box	–	TSC CANTDM4	–
		3 Standard CANopen cables	50	TSX CANCA50	–
			100	TSX CANCA100	–
			300	TSX CANCA300	–
Profibus bus access			100	TSX PBS CA100	–
		400	TSX PBS CA400	–	

Accessories (1)

Regulated switch mode power supply, single-phase	Output voltage: 24...28.8 V \pm Nominal current: 10 A Nominal power: 240 W	ABL 8RPS24100	1.000
---	--	---------------	-------

(1) To be ordered separately.

(2) The converter **TSX CUSB485** is installed using **Driver Pack V2.3**. This "driver" is available on the Safety Suite V2 software or downloadable from our site: www.schneider-electric.com.

4

Applications		Counter modules	
			
Number of channels		2 channels	4 channels
Frequency per channel		40 kHz	40 kHz
Module cycle time		5 ms	10 ms
Counter/measurement inputs	Counting pulses 24 V $\overline{\text{---}}$	Up to 40 kHz: Type 2 sensors Mechanical contacts	
	Incremental encoder	Up to 40 kHz: 10...30 V $\overline{\text{---}}$ 5 V $\overline{\text{---}}$ RS 422 with zero marker	
	Absolute encoder	-	
Reflex I/O		Per channel: 3 x 24 V $\overline{\text{---}}$ inputs: enable, preset and capture 1 x 24 V $\overline{\text{---}}$ input: line check, incremental encoder power supply 2 x 24 V $\overline{\text{---}}$ reflex outputs	
Counting capacity		24 bits + sign (0 to + 16,777,215 points or \pm 16,777,215 points)	
Functions		Downcounting with preset input, upcounting with reset input Up/down counting with preset input, configurable upcounter input: 1 upcounter input/1 downcounter input 1 up/down counter input and 1 direction input Incremental encoder with phase-shifted signals	
Processing		Inputs: counter enable, counter preset, capture current value	
		Comparison: Down counting: to value 0 Upcounting: 2 thresholds and 1 setpoint Up/down counting: 2 thresholds and 2 setpoints	
		Reflex outputs: Downcounting function: 1 passage through zero output Upcounting function: 1 passage through setpoint value output Up/down counting function: 2 user-definable outputs	
Events		User-definable activation of the event-triggered task (threshold crossing, setpoint crossing, preset or reset, enable, capture)	
Connection		Via 15-way SUB-D connectors (1 per counter channel, direct or TSX TAP S15 accessory) Via HE 10 connector for auxiliary I/O and power supply Using Modicon Telefast pre-wired system (ABE 7CPA01 , ABE 7H08R10/16R20)	
Consumption		See page 9/6	
Type of module		TSX CTY 2A	TSX CTY 4A
Pages		4/18	



More technical information on www.schneider-electric.com

Fast counter and measurement module



Electronic cam module



2 channels	1 channel
500 kHz	
1 ms	
Up to 1 MHz: Type 2 sensors Mechanical contacts	—
500 kHz with multiplication by 1,250 kHz with multiplication by 4: 10...30 V $\overline{\text{---}}$ 5 V $\overline{\text{---}}$ RS 422 with zero marker	
Power supply 5 V $\overline{\text{---}}$ or 10...30 V $\overline{\text{---}}$: SSI absolute encoder up to 25 bits Parallel absolute encoder up to 24 bits (Modicon Telefast ABE 7CPA11 sub-base)	
Per channel: 2 x 24 V $\overline{\text{---}}$ inputs: preset and capture 1 x 24 V $\overline{\text{---}}$ enable input or output (configurable) 2 x 24 V $\overline{\text{---}}$ reflex outputs 1 x 24 V programmable frequency output 1 x 5 V/24 V $\overline{\text{---}}$ encoder power supply	3 x 24 V type 1 sensor compatibles inputs 24 x 24 V/0.5 A $\overline{\text{---}}$ protected track outputs
24 bits + sign (0 to + 16,777,215, upcounting) or 24 bits + sign (- 16,777,215 to + 16,777,215, downcounting, up/down counting). Up to 25 bits for SSI absolute encoder	256 to 32,768 points per cycle with 1 to 32,768 cycles (absorbs play on reverse)
Up/down counting with preset input, configurable upcounter input: 1 upcounter input/1 downcounter input 1 up/down counter input and 1 direction input Incremental encoder with phase-shifted signals Measurement with 2 thresholds SSI absolute encoder Parallel output absolute encoder with ABE 7CPA11 sub-base	Processing of 128 cams/32 tracks (including 24 with direct output) Output refresh cycle: 50 μs for 16 cams 100 μs for 64 cams 200 μs for 128 cams Two capture registers Control/recalibration of axis slip
Inputs: counter enable, counter preset, capture current value Comparison: 2 thresholds	Cam profiles: 3 basic types (position, monostable, brake) Associated functions: Elimination of axis backlash, position recalibration Measurement capture Switching feedforward Parts counter
Reflex outputs: 2 user-definable outputs Speed monitoring Special functions	
User-definable activation of the event-triggered task (crossing of thresholds or modulo value, preset, enable, capture)	User-definable activation of the event-triggered task (cams, track, recalibration, capture, etc.)
Via 15-way SUB-D connectors (1 per counter channel, direct or via TSX TAP S15 accessory) Via HE 10 connector for reflex I/O and power supply Using Modicon Telefast pre-wired system (ABE 7CPA01 , ABE 7H16R20 , ABE 7CPA11)	

See page 9/6

TSX CTY 2C

TSX CCY 1128

4/22

4/26

Presentation

Counting functions are required for counting parts or events, grouping objects, incoming or outgoing flow control, and measuring the lengths or positions of items.

Premium PLCs perform these functions using **TSX CTY 2A/4A** counter modules which have a counting frequency of 40 kHz maximum. In a Premium PLC configuration, the number of TSX CTY counter modules must be added to that of the other application-specific modules (communication, motion control and weighing). (See pages 1/10 and 1/19). They are hot-swappable. Counter modules are characterized by their number of channels:

- 2 channels with downcounting, upcounting and up/down counting for the **TSX CTY 2A** module

- 4 channels with downcounting, upcounting and up/down counting for the **TSX CTY 4A** module

The parameters of these functions are set by software configuration. The modules take 5 V $\overline{\text{DC}}$ or 10 to 30 V $\overline{\text{DC}}$ sensors with solid state outputs (incremental encoders, proximity sensors, photoelectric detectors) and with mechanical contact outputs (in this case the counting frequency is limited to 100 Hz).

Description

The front panel of **TSX CTY 2A** (2-channel) and **TSX CTY 4A** (4-channel) counter modules comprises:

- 1 One 15-way SUB-D connector per channel for connecting:
 - Counter sensors or incremental encoder
 - Sensor power supply
 - Encoder power supply feedback for checking that it is supplied correctly
- 2 One 20-way HE10 connector for 2 channels for connecting the following for each channel:
 - Auxiliary inputs: preset, enable
 - Reflex outputs
 - Power supplies for auxiliary I/O and incremental encoders
- 3 Rigid casing, which:
 - Holds the electronic card
 - Locates and locks the module in its slot
- 4 Module diagnostic LEDs:
 - Module diagnostics:
 - Green RUN LED: module operating
 - Red ERR LED: internal fault, module failure
 - Red I/O LED: external fault
 - Channel diagnostics: Green CH● LED: channel diagnostics available

4

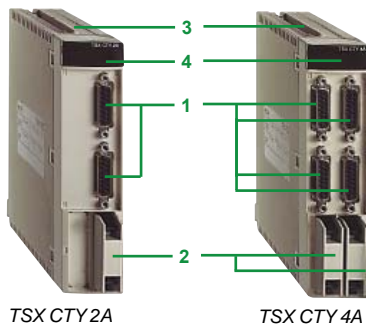

TSX CTY 2A

TSX CTY 4A



Operation block diagram

Block diagram of a channel

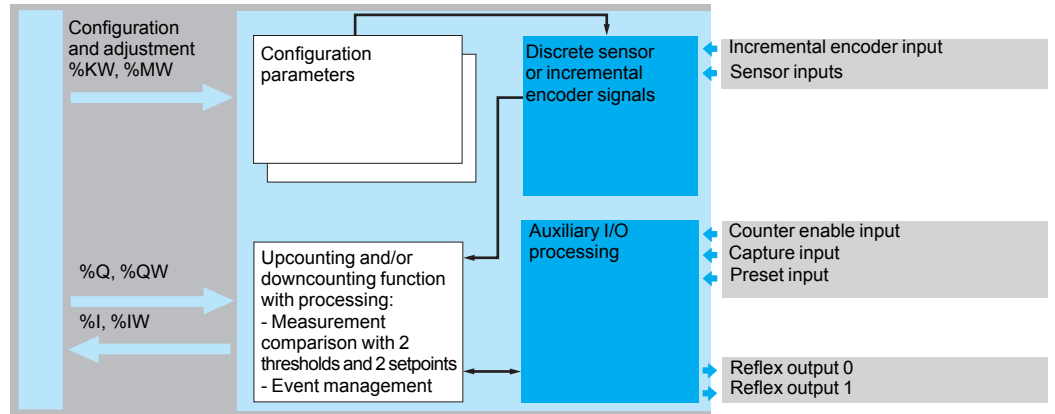

Counter modules are set up using Unity Pro or PL7 Junior/Pro software.

Architectures

Example of an architecture with counter inputs

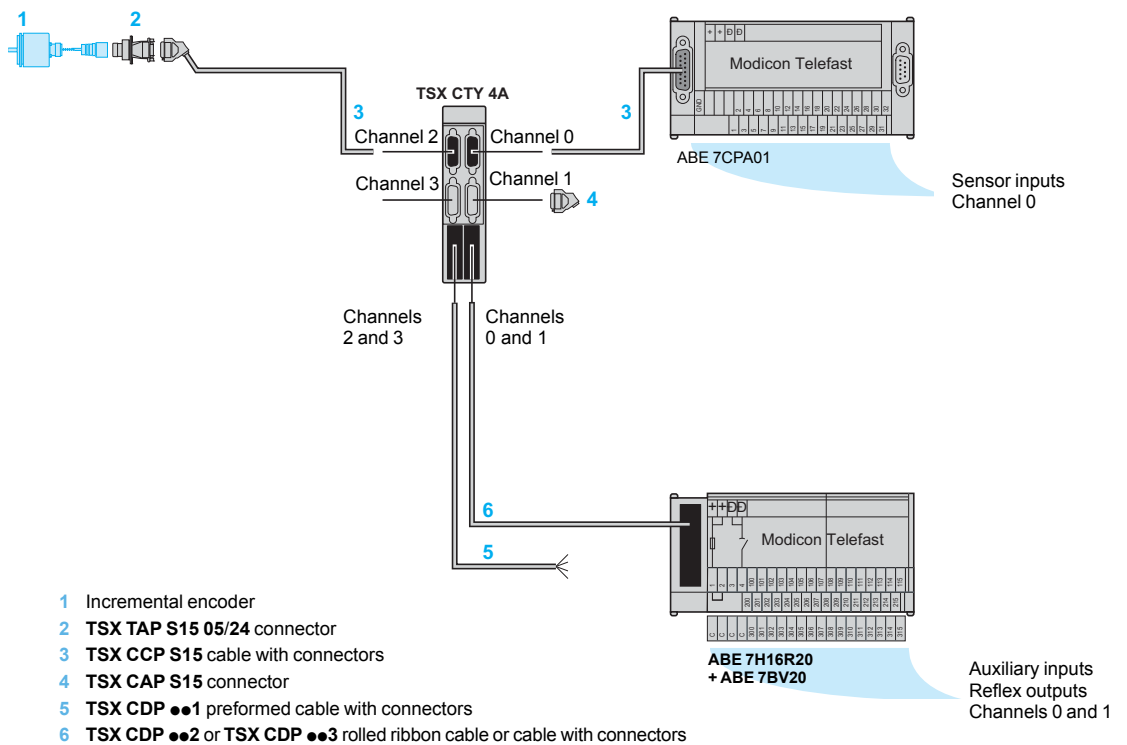

- 1 Incremental encoder
- 2 TSX TAP S15 05/24 connector
- 3 TSX CCP S15 cable with connectors
- 4 TSX CAP S15 connector
- 5 TSX CDP ●●1 preformed cable with connectors
- 6 TSX CDP ●●2 or TSX CDP ●●3 rolled ribbon cable or cable with connectors



TSX CTY 2A



TSX CTY 4A

References

Counter modules

Type of input	Characteristics	No. of channels	Reference	Weight kg
24 V $\ddot{=}$ 2/3 wire PNP/NPN sensors, 5 V $\ddot{=}$ RS 422 or 10...30 V $\ddot{=}$ Totem Pole incremental encoders	40 kHz counting Cycle time 5 ms	2	TSX CTY 2A	0.320
	40 kHz counting Cycle time 10 ms	4	TSX CTY 4A	0.430



ABE 7CPA01



ABE 7H16R20



TSX TAP S15 ●●

Connection accessories

Description	For connecting	Connector type on TSX CTY ●●	No. (1)	Unit reference	Weight kg
SUB-D connectors Sold in lots of 2	Counter sensors or incremental encoder	15-way SUB-D	4	TSX CAP S15	0.050
Modicon Telefast ABE 7 connection sub-bases	Counter sensors and 24 V $\ddot{=}$ power supply	15-way SUB-D	–	ABE 7CPA01	0.300
	Auxiliary inputs, 24 V $\ddot{=}$ power supply and 5 V/10...30 V $\ddot{=}$ encoder power supply	20-way HE 10 (for 2 channels)	–	ABE 7H16R20	0.300
Additional terminal block Order in multiples of 5	20 linked terminals for ABE 7H16R20 sub-base		–	ABE 7BV20	0.030
Connection interfaces for incremental encoder	5 V $\ddot{=}$ RS 422 encoder	15-way SUB-D	2	TSX TAP S15 05	0.260
	10...30 V $\ddot{=}$ Totem Pole encoder	15-way SUB-D	2	TSX TAP S15 24	0.260

(1) For numbers, see page 4/17.

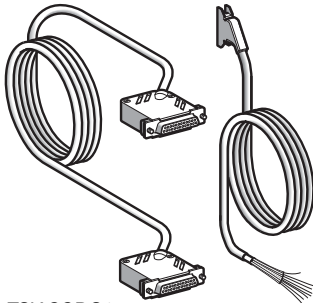

TSX CCP S15 ●●●

TSX CDP ●01



TSX CDP ●02



TSX CDP ●03

References (continued)

Connecting cables

Description	From TSX CTY ●● module	To	No. (1)	Length	Reference	Weight kg
Cordsets AWG 12 (0.205 mm ²)	15-way SUB-D connector	ABE 7CPA01/CPA11 sub-bases or TSX TAP S15● accessory (15-way SUB-D connector)	3	0.5 m	TSX CCP S15 050	0.110
				1 m	TSX CCP S15 100	0.160
				2.5 m	TSX CCP S15	0.300
20-wire preformed cable AWG 22 (0.324 mm ²) 500 mA max.	24 V $\overline{\text{---}}$ power supply and 5 V/10...30 V $\overline{\text{---}}$ encoder power supply auxiliary inputs (moulded 20-way HE 10 connector)	Free end with colour-coded wires	5	3 m	TSX CDP 301	0.400
				5 m	TSX CDP 501	0.660
				10 m	TSX CDP 1001	1.210
Rolled ribbon cable AWG 28 (0.08 mm ²) 100 mA max.	24 V $\overline{\text{---}}$ power supply and 5 V/10...30 V $\overline{\text{---}}$ encoder power supply auxiliary inputs (20-way HE 10 connector)	ABE 7H16R20 sub-base (20-way HE 10 connector)	6	1 m	TSX CDP 102	0.090
				2 m	TSX CDP 202	0.170
				3 m	TSX CDP 302	0.250
Connecting cables AWG 22 (0.324 mm ²) 500 mA max.	24 V $\overline{\text{---}}$ power supply and 5 V/10...30 V $\overline{\text{---}}$ encoder power supply auxiliary inputs (moulded 20-way HE 10 connector)	ABE 7H16R20 sub-base (20-way HE 10 connector)	6	0.5 m	TSX CDP 053	0.085
				1 m	TSX CDP 103	0.150
				2 m	TSX CDP 203	0.280
				3 m	TSX CDP 303	0.410
				5 m	TSX CDP 503	0.670
				10 m	TSX CDP 1003	1.180

(1) For numbers, see page 4/17.

Presentation

The **TSX CTY 2C** measurement and counter module is used with fast machines requiring precise measurements with short cycle times and high input frequencies (woodworking machines, packing machines, etc.).

The **TSX CTY 2C** measurement and counter module provides the standard functions (speed monitoring, reflex outputs, etc.) for performing a simple position control function, by the application program.

The **TSX CTY 2C** measurement and counter module also enables special functions to be managed.

Description

The front panel of the **TSX CTY 2C** measurement and counter module comprises:

- 1** One 15-way SUB-D connector per channel for connecting:
 - Counter sensors or incremental encoder
 - SSI absolute encoder or parallel output encoder with Modicon Telefast **ABE 7CPA11** sub-base
 - Sensor power supply
 - Encoder power supply feedback for checking that it is supplied correctly
- 2** One 20-way HE10 connector for connecting the following for each channel:
 - Auxiliary inputs: preset, enable and capture
 - Reflex outputs
 - Programmable frequency output
 - Power supplies for auxiliary I/O and encoders
- 3** Rigid casing, which:
 - Holds the electronic card
 - Locates and locks the module in its slot
- 4** Module diagnostic LEDs:
 - Module diagnostics:
 - Green RUN LED, module operating
 - Red ERR LED, internal fault, module failure
 - Red I/O LED, external fault
 - Channel diagnostics:
 - Green CH● LED: channel diagnostics available

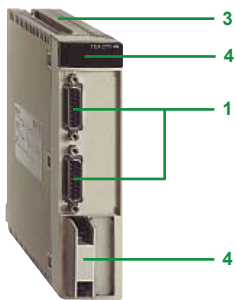

TSX CTY 2C

4



Operation block diagram

Block diagram of a channel

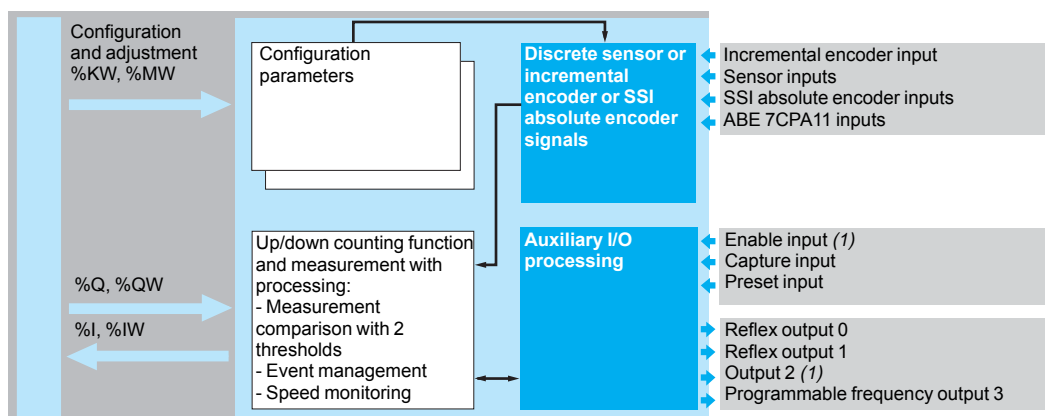

Counter modules are set up using Unity Pro or PL7 Junior/Pro software

(1) The enable input and output 2 cannot be used simultaneously.

Architectures
Example of an architecture with counter inputs

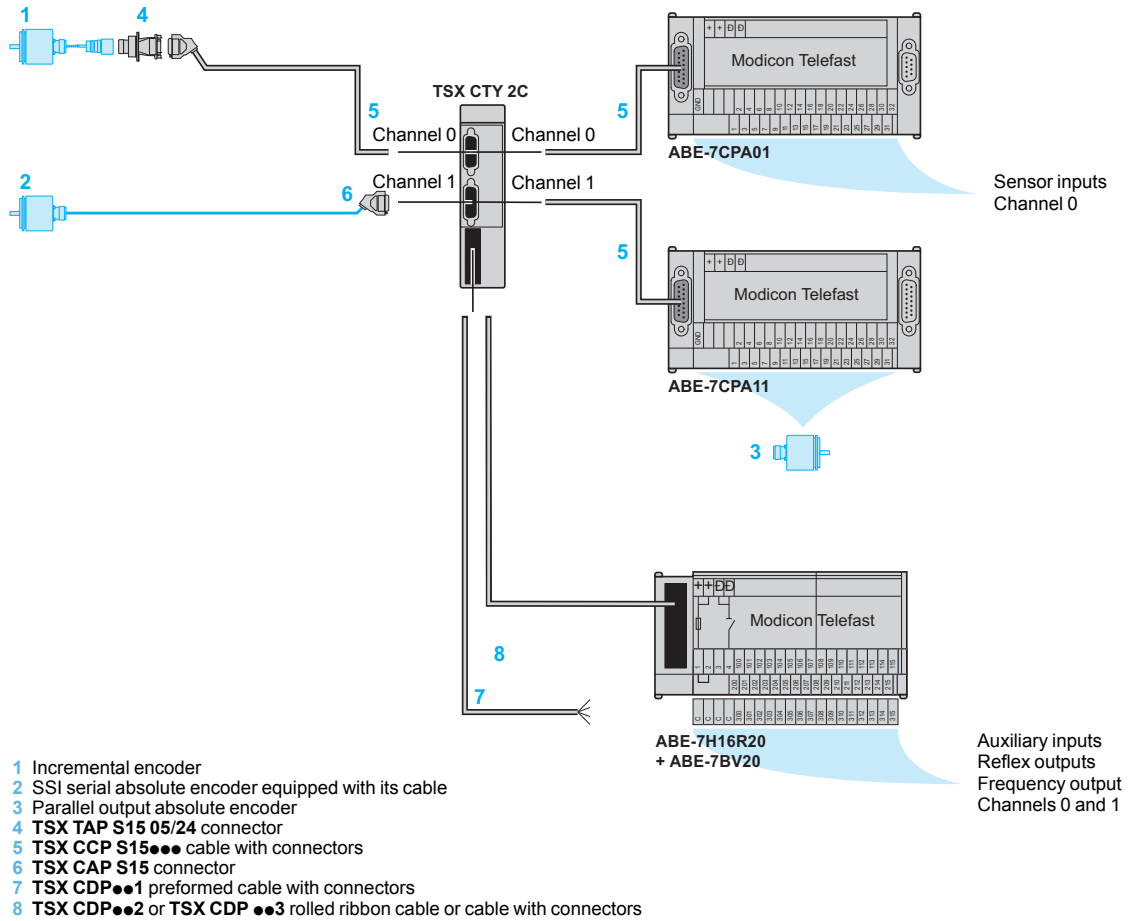

Modicon Premium automation platform

TSX CTY 2C measurement and counter module



TSX CTY 2C

References

Measurement and counter module

Type of input	Characteristics	No. of channels	Reference	Weight kg
24 V $\overline{\text{---}}$ 2/3 PNP/NPN wire sensors, 5 V $\overline{\text{---}}$ RS 422 or 10...30 V $\overline{\text{---}}$ Totem Pole incremental encoders SSI serial or parallel output absolute encoders with ABE 7CPA11 sub-base	Counting Cycle time 1 ms	2	TSX CTY 2C	0.340

Connection accessories

Description	For connecting	Connector type on TSX CTY 2C	No. (1)	Unit reference	Weight kg
SUB-D connector Sold in lots of 2	Counter sensors or incremental encoder	15-way SUB-D	6	TSX CAP S15	0.050
Modicon Telefast ABE 7 connection sub-bases	Counter sensors and 24 V $\overline{\text{---}}$ power supply	15-way SUB-D	—	ABE 7CPA01	0.300
	Auxiliary inputs, 24 V $\overline{\text{---}}$ power supply and 5 V/10...30 V $\overline{\text{---}}$ encoder power supply	20-way HE 10 (for 2 channels)	—	ABE 7H16R20	0.300
Additional terminal block Order in multiples of 5	20 linked terminals for ABE 7H16R20 sub-base	—	—	ABE 7BV20	0.060
Adaptor sub-base for TSX CTY 2C module (2)	5 V $\overline{\text{---}}$, 10...30 V $\overline{\text{---}}$ parallel output absolute encoders	15-way SUB-D	—	ABE 7CPA11	0.300
Connection interfaces for incremental encoder	5 V $\overline{\text{---}}$ RS 422 encoder	15-way SUB-D	4	TSX TAP S15 05	0.260
	10...30 V $\overline{\text{---}}$ Totem Pole encoder	15-way SUB-D	4	TSX TAP S15 24	0.260



ABE 7CPA01



ABE 7H16R20



TSX TAP S15 ●●

(1) For numbers, see page 4/21.

(2) Enables multiplexing of 2 absolute encoders on the same channel (up to 4 absolute encoders when using 2 ABE 7CPA11 adaptor sub-bases).

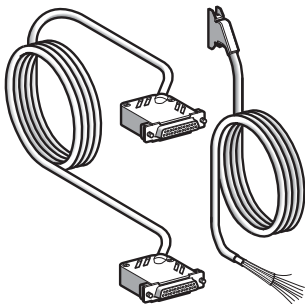

TSX CCP S15 ●●● TSX CDP ●01



TSX CDP ●02



TSX CDP ●03

References (continued)

Connecting cables

Description	From TSX CTY 2C module	To	No. (1)	Length	Reference	Weight kg
Cordsets AWG 12 (0.205 mm ²)	15-way SUB-D connector	ABE 7CPA01/CPA11 sub-bases or TSX TAP S15●● accessory (15-way SUB-D connector)	5	0.5 m	TSX CCP S15 050	0.110
				1 m	TSX CCP S15 100	0.160
				2.5 m	TSX CCP S15	0.300
20-wire preformed cables AWG 22 (0.324 mm ²) 500 mA max.	24 V $\overline{\text{---}}$ power supply and 5 V/10...30 V $\overline{\text{---}}$ encoder power supply auxiliary inputs (moulded 20-way HE 10 connector)	Free end with colour-coded wires	7	3 m	TSX CDP 301	0.400
				5 m	TSX CDP 501	0.660
				10 m	TSX CDP 1001	1.210
Rolled ribbon cables AWG 28 (0.08 mm ²) 100 mA max.	24 V $\overline{\text{---}}$ power supply and 5 V/10...30 V $\overline{\text{---}}$ encoder power supply auxiliary inputs (20-way HE 10 connector)	ABE 7H16R20 sub-base (HE 10 20-way connector)	8	1 m	TSX CDP 102	0.090
				2 m	TSX CDP 202	0.170
				3 m	TSX CDP 302	0.250
Connecting cables AWG 22 (0.324 mm ²) 500 mA max.	24 V $\overline{\text{---}}$ power supply and 5 V/10...30 V $\overline{\text{---}}$ encoder power supply auxiliary inputs (moulded 20-way HE 10 connector)	ABE 7H16R20 sub-base (HE 10 20-way connector)	8	0.5 m	TSX CDP 053	0.085
				1 m	TSX CDP 103	0.150
				2 m	TSX CDP 203	0.280
				3 m	TSX CDP 303	0.410
				5 m	TSX CDP 503	0.670
				10 m	TSX CDP 1003	1.180

(1) For numbers, see page 4/21.

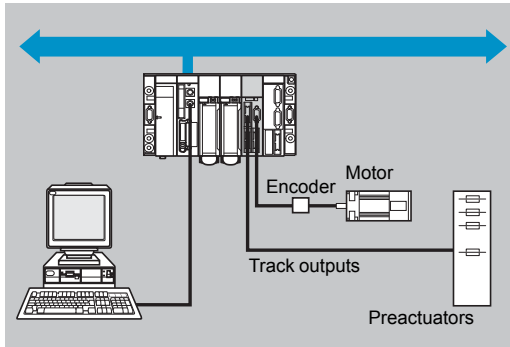

Presentation

The **TSX CCY 1128** module performs the “electronic cam” function for a rotary axis rotating in a single, alternating or cyclical direction (with periodic arrival of parts to be processed) or endlessly (with random arrival of parts to be processed). The axis is managed by an incremental or absolute encoder.

The **TSX CCY 1128** electronic cam module independently manages up to 128 cams which can be spread over a maximum of 32 tracks to which 24 discrete physical outputs and 8 logic outputs can be assigned.

Processing is organized into 4 groups of 8 tracks, with groups 0 and 1 associated with connector 0 on the module and groups 2 and 3 with connector 1.

The **TSX CCY 1128** module can be used for the following functions: elimination of axis backlash, position recalibration, capturing measurements (part length, number of points per revolution, angle of arrival of parts, slip, etc.), anticipation of switching, parts counter, event generation.

Like all application-specific modules, the **TSX CCY 1128** module can be installed in any slot of a Premium PLC, except for those specifically for the power supply and the processor.

Description

The front panel of the **TSX CCY 1128** electronic cam module comprises:

- 1 A 15-way SUB-D connector for connecting the incremental or absolute encoder
- 2 A 20-way HE 10 connector for connecting the track outputs of groups 0 and 1 (connector 0)
- 3 A 20-way HE 10 connector for connecting the track outputs of groups 2 and 3 (connector 1)
- 4 A 20-way HE connector for connecting the auxiliary inputs and the encoder power supply
- 5 Rigid casing, which:
 - Holds the electronic cards
 - Locates and locks the module in its slot
- 6 Module diagnostic LEDs:
 - Module diagnostics:
 - Green RUN LED, module operating
 - Red ERR LED, internal fault, module failure
 - Red I/O LED, external fault or application fault
 - Channel diagnostics:
 - Green CH0 LED: channel diagnostics available

4

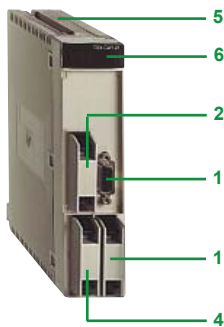

TSX CCY 1128



Operation

Block diagram of channel

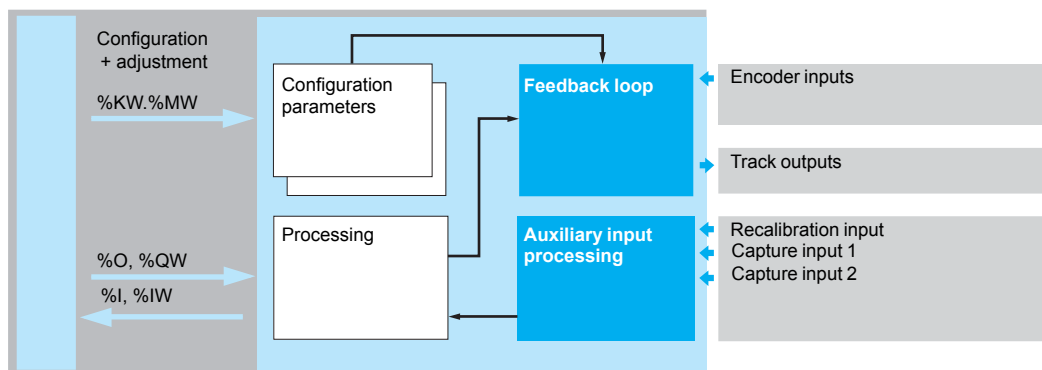

The electronic cam module is set up using Unity Pro or PL7 Junior/Pro software.

Example of an architecture

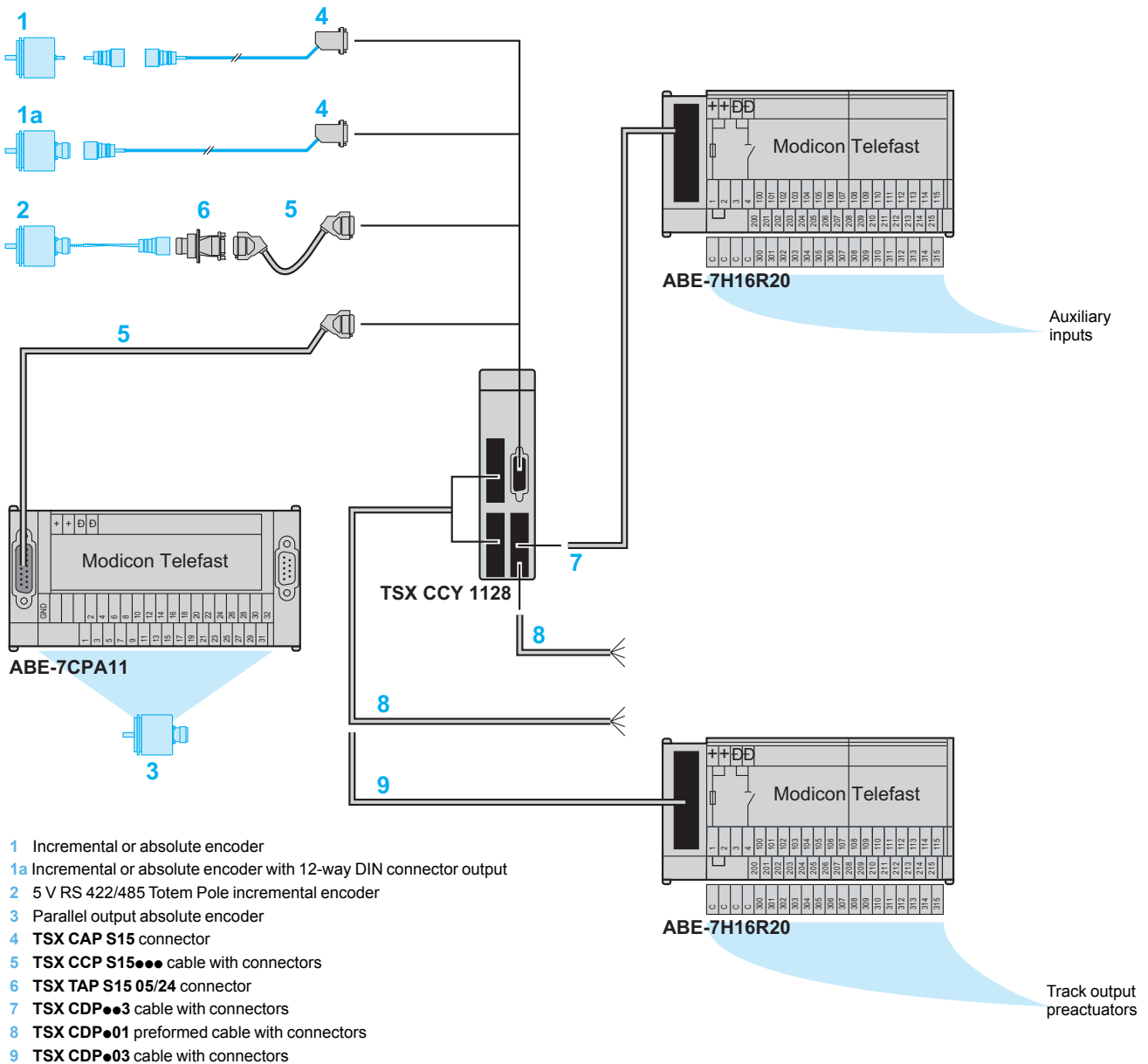

Modicon Premium automation platform

TSX CCY 1128 electronic cam module



TSX CCY 1128

References

Electronic cam module

Type of input	Characteristics	No. of axes	Reference	Weight kg
Incremental encoder Supplied with 5 V or 10...30 V, with RS 422/485 or 5 V Totem Pole outputs (1)	500 kHz counting with incremental encoder	1	TSX CCY 1128	0.480
Absolute encoder RS 485 serial or parallel (2)	200 kHz sampling with serial absolute encoder			

Connection accessories

Description	For connection of	Connector type on TSX CCY 1128	No. (3)	Unit reference	Weight kg
SUB-D connector Sold in lots of 2	SSI absolute/incremental encoder	15-way SUB-D	4	TSX CAP S15	0.050
Modicon Telefast ABE 7 adaptor sub-base	Absolute encoder with parallel outputs (16 to 24 bits) 5 V, 10...30 V ---	15-way SUB-D	—	ABE 7CPA11	0.300
Modicon Telefast ABE 7 connection sub-base	Auxiliary inputs, 5...24 V --- encoder power supply Track outputs	20-way HE 10 (1 per module) 20-way HE 10 (1 for 2 groups)	—	ABE 7H16R20	0.300
Additional terminal block Order in multiples of 5	20 linked terminals for ABE 7H16R20 sub-base	—	—	ABE 7BV20	0.060
Connection interfaces for incremental encoder	5 V --- RS 422/RS 485 encoder 10...30 V --- Totem Pole encoder	15-way SUB-D 15-way SUB-D	6 6	TSX TAP S15 05 TSX TAP S15 24	0.260 0.260

(1) Totem Pole encoder with additional Push/Pull outputs.

(2) Absolute encoders with parallel outputs require the **ABE 7CPA11** adaptor interface.

(3) Numbers (see page 4/25).



ABE 7CPA11



ABE 7H16R20



TSX TAP S15 ●●

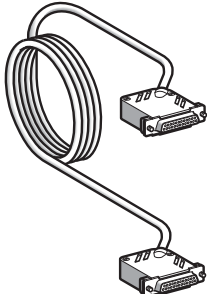

TSX CCP S15 ●●●

References (continued)

Connecting cables						
Description	From TSX CCY 1128 module	To	No. (1)	Length	Reference	Weight kg
Cables AWG 12 (0.205 mm ²)	15-way SUB-D connector	ABE 7CPA11 adaptor sub-base or TSX TAP S15 ●● interface (15-way SUB-D connector)	5	0.5 m	TSX CCP S15 050	0.110
				1 m	TSX CCP S15 100	0.160
				2.5 m	TSX CCP S15	0.220

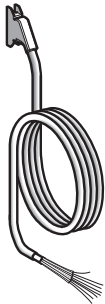

TSX CDP ●01

20-wire preformed cables AWG 22 (0.324 mm ²) 500 mA max.	Auxiliary inputs, power supply signals (moulded 20-way HE 10 connector)	Free end with colour-coded wires	8	3 m	TSX CDP 301	0.400
				5 m	TSX CDP 501	0.660
				10 m	TSX CDP 1001	1.210



TSX CDP ●03



Connecting cables AWG 22 (0.324 mm ²) 500 mA max.	Moulded 20-way HE 10 connector	ABE 7H16R20 sub-base (20-way HE 10 connector)	7, 9	0.5 m	TSX CDP 053	0.085
				1 m	TSX CDP 103	0.150
				2 m	TSX CDP 203	0.280
				3 m	TSX CDP 303	0.410
				5 m	TSX CDP 503	0.670
				10 m	TSX CDP 1003	1.180

(1) Numbers (see page 4/25).

Modicon Premium automation platform

Motion control modules

4

Applications	Motion control modules for stepper motor. Compatible with the Lexium 32C/M servo drive		Motion control modules for servo motors. Compatible with the Lexium 32C/M servo drive	
				
Number of axes	1 axis	2 axes	2 axes	4 axes
Frequency per axis	187 kHz		Counter: 500 kHz with incremental encoder Acquisition: 200 kHz with SSI serial absolute encoder or parallel output absolute encoder	
Counter inputs	Per axis: 5 V $\overline{\text{---}}$ negative logic translator inputs (translator loss of step checks)		Per axis: - 5 V $\overline{\text{---}}$ RS 422, RS 485 or Totem Pole incremental encoder - 10...30 V $\overline{\text{---}}$ 16 to 25 bit SSI serial absolute encoder - 5/10/30 V $\overline{\text{---}}$ 16 to 24 bit parallel output absolute encoder with Modicon Telefast conversion sub-base (ABE 7CPA11)	
Control outputs	Per axis: 5 V TTL compatible RS 422 translator outputs, (+/- pulses, boost, enable, reset loss of step check)		Per axis: 1 \pm 10 V analog output, 13 bits + sign, drive setpoint	
Auxiliary I/O	Per axis: 6 x 24 V $\overline{\text{---}}$ discrete inputs, 1 x 24 V $\overline{\text{---}}$ output (brake control)		Per axis: 4 x 24 V $\overline{\text{---}}$ discrete inputs (homing cam, event, recalibration, emergency stop) 1 input/1 output for drive control, 1 x 24 V $\overline{\text{---}}$ reflex output	
Counter capacity	24 bits + sign (\pm 16,777,215 points)		–	
Functions	–		Servo control on independent linear axis	
Processing	Open loop control of the position of a moving part on a limited linear axis according to motion control functions supplied by the PLC processor Axis parameter setting, adjustment and debugging using Unity Pro and PL7 Junior/Pro software		Positioning of a moving part on an axis according to motion control functions supplied by the Premium PLC processor	
Events	User-definable activation of the event-triggered task			
Connection	<ul style="list-style-type: none"> - Via 15-way SUB-D connectors for translator (amplifier) - Via 20-way HE 10 connector for auxiliary I/O - Using Modicon Telefast prewired system (ABE 7H16R20) 		<ul style="list-style-type: none"> - Via 9 and 15-way SUB-D connectors for encoder input (direct or via TSX TAP S15●● accessories), speed reference - Via HE 10 connector for auxiliary inputs - Using Modicon Telefast system (ABE 7CPA01, ABE 7H16R20, ABE 7CPA11) - Using specific accessories (TSX TAP MAS) 	
Consumption	See page 9/6			
Type of module	TSX CFY 11		TSX CFY 21	
Pages	4/32		4/38	



**Motion control modules for servo motors.
Compatible with the Lexium 32C/M servo drive**



2 axes 4 axes 3 axes

Counter: 500 kHz with incremental encoder
Acquisition: 200 kHz with SSI serial absolute encoder or parallel output absolute encoder

Per axis:
- 5 V $\overline{\text{V}}$ RS 422, RS 485 or Totem Pole incremental encoder
- 10...30 V $\overline{\text{V}}$ 16 to 25 bit SSI serial absolute encoder
- 5/10/30 V $\overline{\text{V}}$ 16 to 24 bit parallel output absolute encoder with Modicon Telefast conversion sub-base (ABE 7CPA11)

Per axis:
1 \pm 10 V analog output, 13 bits + sign, drive setpoint

Per axis:
4 x 24 V $\overline{\text{V}}$ discrete inputs (homing cam, event, recalibration, emergency stop)
1 input/1 output for drive control,
1 x 24 V $\overline{\text{V}}$ reflex output

–

Servo control on independent linear or infinite axis Follower axes (dynamic ratio) Realtime correction of drive offset	Servo control on independent linear or infinite axis Linear interpolation on 2 or 3 axes Realtime correction of drive offset
Flying shear on position or event (2)	–

Positioning of a moving part on an axis according to motion control functions supplied by the Premium PLC processor

Axis parameter setting, adjustment and debugging using Unity Pro and PL7 Junior/Pro software

User-definable activation of the event-triggered task

- Via 9 and 15-way SUB-D connectors for encoder input (direct or via TSX TAP S15●● accessories), speed reference
- Via HE 10 connector for auxiliary inputs
- Using Modicon Telefast system (ABE 7CPA01, ABE 7H16R20, ABE 7CPA11) Using specific accessories (TSX TAP MAS)

See page 9/6

TSX CAY 22 **TSX CAY 42** **TSX CAY 33**

4/38

(1) Please consult our Customer Care Centre.
(2) Function not available with Premium platform using Unity Pro software.
(3) Unity Pro software version \leq V 2.0 is not compatible with the **TSX CSY 164** module.
(4) **TSX CSY 85** with path functions: 2 sets of 3 axes or 3 sets of 2 axes. Linear or circular interpolation with polynomial interpolation connection.

**Motion control modules for servo motors.
Compatible with Lexium drives (equipped with the SERCOS digital link option) (1)**



8 axes 16 axes

SERCOS ring network: 4 M baud

Per SERCOS digital link

Per SERCOS digital link

Per SERCOS digital link

–

Independent linear or infinite axis
Linear interpolation of 2 to 8 axes
Follower axes (6 slaves) by gearing or camming
Manual mode (JOG and INC) (3)
Special functions (4) (see pages 4/44 ...)

Axis parameter setting, adjustment and debugging using Unity Pro and PL7 Junior/Pro software (3)

Via 2 SMA connectors for plastic (or glass) fiber optic cable

TSX CSY 84/85 **TSX CSY 164**

4/45

Modicon Premium automation platform

TSX CFY 11/21 motion control modules for stepper motors

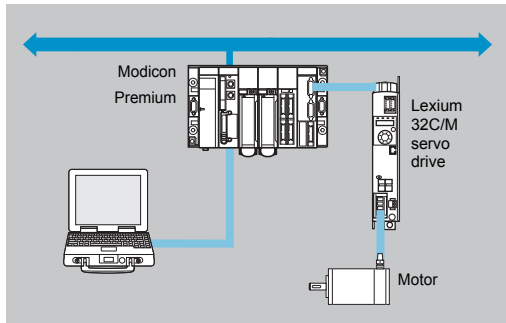

Presentation

The **TSX CFY 11/21** stepper motor axis control range is designed for machines requiring simultaneous motion control by stepper motor and sequential control by PLC.

The **TSX CFY 11** module controls 1 axis (channel 0) via a translator (amplifier for stepper motor) or Lexium 32C/M servo drive. The **TSX CFY 21** module controls 2 axes (channels 0 and 1).

These modules are compatible with the Lexium 32C/M servo drive or translators with:

- 5 V RS 422 or TTL inputs (negative logic)
- 5 V $\bar{\text{NPN}}$ open collector or RS 422 outputs.

In a Premium PLC configuration, the number of TSX CFY motion control modules must be added to that of the other application-specific modules (communication, counting, axis control and weighing).

Description

The front panels of **TSX CFY 11/21** stepper control modules comprise:

- 1 One 15-way SUB-D connector per channel for connecting:
 - Translator or Lexium 32C/M servo drive inputs
 - Translator or Lexium 32C/M servo drive outputs
 - Translator or Lexium 32C/M servo drive input power supply
- 2 One 20-way HE 10 connector for connecting:
 - Auxiliary inputs: per axis, homing cam, emergency stop, limit switches (+ and -), event, external stop
 - Brake outputs (1 per axis)
 - Sensor and preactuator external power supply
- 3 Rigid casing, which:
 - Holds electronic cards
 - Locates and locks the module in its slot
- 4 Module diagnostic LEDs:
 - Module diagnostics:
 - Green RUN LED: module operating
 - Red ERR LED, internal fault, module failure
 - Red I/O LED, external fault
 - Axis diagnostics:
 - 2 green CH● LEDs: axis diagnostics available

4

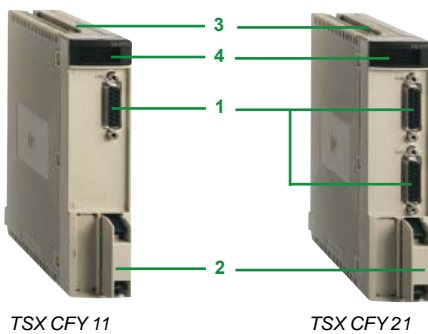

TSX CFY 11

TSX CFY 21



Operation block diagram

Block diagram of an axis

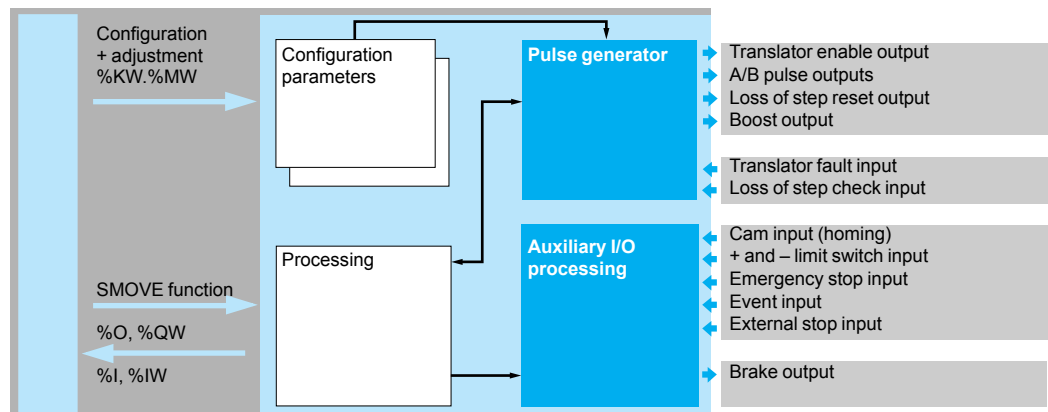

Stepper motor control modules are set up using Unity Pro or PL7 Junior/Pro software.

Modicon Premium automation platform

TSX CFY 11/21 motion control modules for stepper motors

Architectures

Example of an architecture with Lexium 32C/M servo drive

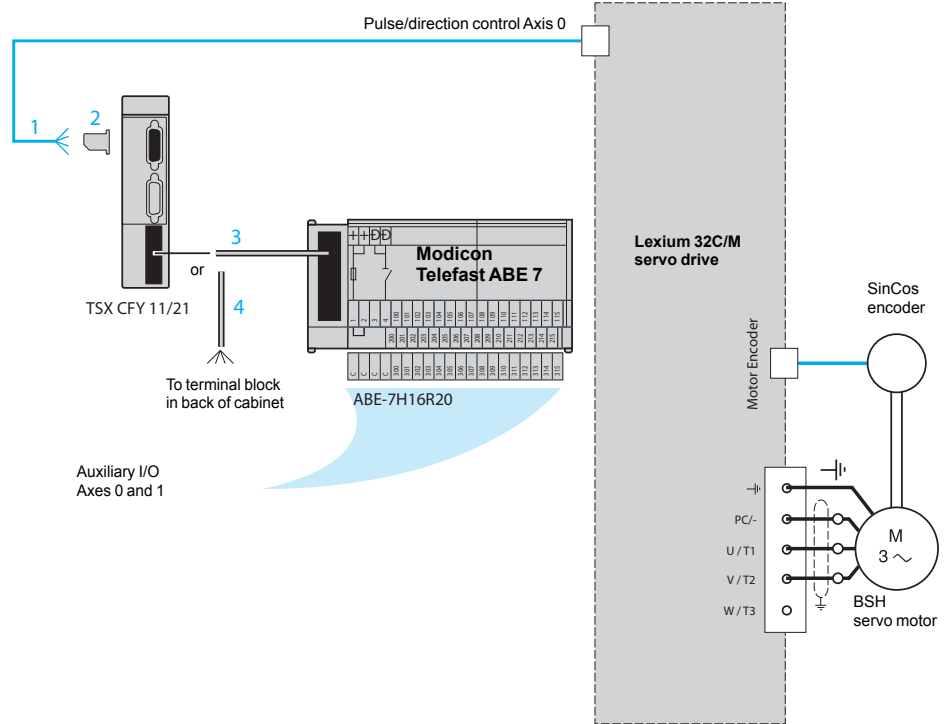

- 1 VW3 M8 223 R30 preassembled cordset with flying leads at one end (L = 3 m)
- 2 TSX CAP S15 connector
- 3 TSX CDP053/103/203/303/503/1003 preassembled cordset (L = 0.5, 1, 2, 3, 5 or 10 m)
- 4 TSX CDP 301/501/1001 preformed cable with flying leads at one end (L = 3, 5 or 10 m)

Modicon Premium automation platform

TSX CFY 11/21 motion control modules for stepper motors



TSX CFY 11



TSX CFY 21

References

Motion control modules for stepper motors

Description	For control of	Connections on connectors		No. of axes	Reference	Weight kg
		15-way SUB-D	20-way HE10			
Motion control modules for stepper motors	Lexium 32C/M servo drive or translator with RS 422 I/O, 5 V \pm TTL inputs and 5 V \pm TTL open collector outputs	Lexium 32C/M servo drive or translator I/O	Auxiliary I/O, 24 V \pm power supply	1	TSX CFY 11	0.440
				2	TSX CFY 21	0.480

Connection accessories

Description	Connect on TSX CFY \bullet 1 connector	Type of connector on TSX CFY \bullet 1 module	No. (1)	Unit reference	Weight kg
SUB-D connectors Sold in lots of 2	Lexium 32C/M servo drive or translator I/O	15-way SUB-D (1 per axis)	2	TSX CAP S15	0.050
Modicon Telefast ABE7 connection sub-base	Auxiliary I/O for axes 0/1, 24 V \pm power supply	20-way HE10 (1 for 2 axes)		ABE 7H16R20	0.300
Additional terminal block Order in multiples of 5	20 linked terminals for ABE 7H16R20 sub-base	—		ABE 7BV20	0.060

(1) For numbers, see page 4/31.

4



ABE 7H16R20

Modicon Premium automation platform

TSX CFY 11/21 motion control modules for stepper motors



TSX CDP ●03

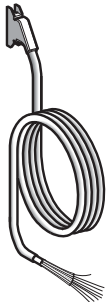

TSX CDP ●01

References (continued)						
Connecting cables						
Description	From TSX CFY ●1 module	To	No. (1)	Length	Reference	Weight kg
Connecting cables AWG 22 (0.324 mm ²) 500 mA max.	20-way HE 10 connector	ABE 7H16R20 sub-base (20-way HE 10 connector)	3	0.5 m	TSX CDP 053	0.085
				1 m	TSX CDP 103	0.150
				2 m	TSX CDP 203	0.280
				3 m	TSX CDP 303	0.410
				5 m	TSX CDP 503	0.670
				10 m	TSX CDP 1003	1.180
20-wire preformed cables AWG 22 (0.324 mm ²) 500 mA max.	20-way HE 10 connector	Auxiliary I/O for axes 0/1, 24 V \pm power supply (flying leads at I/O end)	4	3 m	TSX CDP 301	0.400
				5 m	TSX CDP 501	0.660
				10 m	TSX CDP 1001	1.310
Preassembled cordset for Lexium 32C/M drive	Flying leads	Lexium 32C/M drive (RJ45 connector)	1	3 m	VW3 M8 223 R30	-

(1) For numbers, see page 4/31.

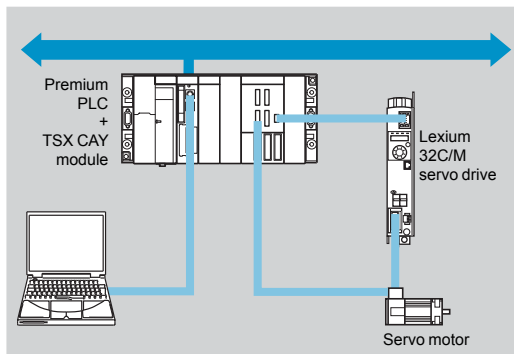

Presentation

The **TSX CAY ●●** servo-controlled positioning axis control range is designed for machines requiring simultaneous high performance motion control and sequential control by PLC.

Depending on the model, the **TSX CAY ●●** modules can be used to control:

- 2 independent axes, **TSX CAY 21/22**
- Up to 4 independent axes, **TSX CAY 41/42**
- 3 linearly interpolated axes, **TSX CAY 33**

These modules are compatible with Lexium 32C/M servo drives with ± 10 V analog inputs.

TSX CAY ●● modules can be installed, like all application-specific modules, in any slot in a Premium PLC.

4

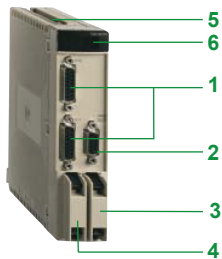

TSX CAY 21/22

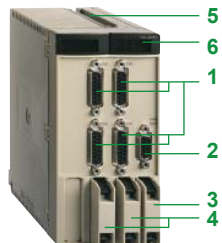

TSX CAY 41/42

Description

The front panel of **TSX CAY ●●** axis control modules comprises:

- 1 One 15-way SUB-D connector per axis for connecting the incremental or absolute encoder
- 2 One 9-way SUB-D connector for all axes for connecting a "speed reference" analog output for each axis
- 3 One 20-way HE 10 connector for all axes for connecting:
 - Servo drive auxiliary control inputs
 - Servo drive I/O external power supply
- 4 One 20-way HE 10 connector for 2 axes (0/1 or 2/3) for connecting:
 - Auxiliary inputs: homing cam, emergency stop, event, recalibration
 - Reflex outputs
 - Sensor and preactuator external power supplies
- 5 Rigid casing, which:
 - Holds electronic cards
 - Locates and locks the module in its slot
- 6 Module diagnostic LEDs:
 - Module diagnostics:
 - Green RUN LED: module operating
 - Red ERR LED: internal fault, module failure
 - Red I/O LED: external fault
 - Axis diagnostics:
 - Green CH● LEDs: axis diagnostics available

Modicon Premium automation platform

TSX CAY motion control modules for servo motors

Operation block diagram

Block diagram of an axis

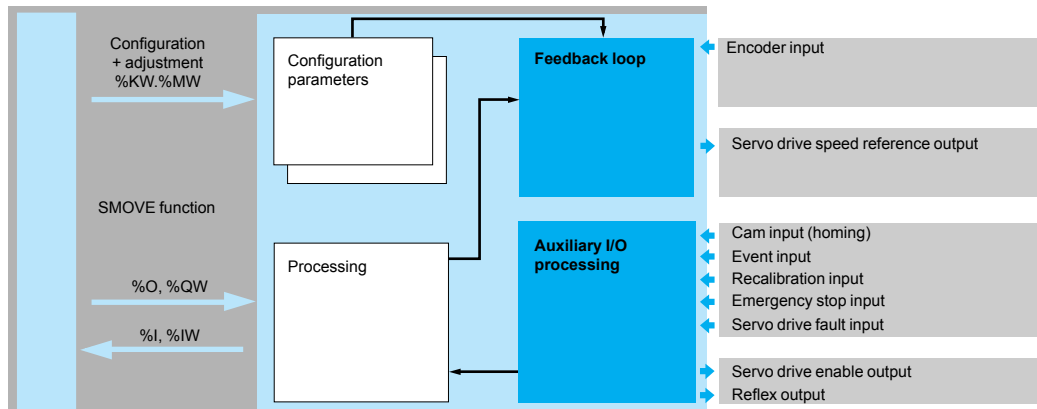

Axis control modules are set up using Unity Pro or PL7 Junior/Pro software. **TSX CAY 22/42/33** modules require the use of Premium **TSX P57 ●●3M/4M** processors.

Modicon Premium automation platform

TSX CAY motion control modules for servo motors

Example of a general architecture with TSX CAY module

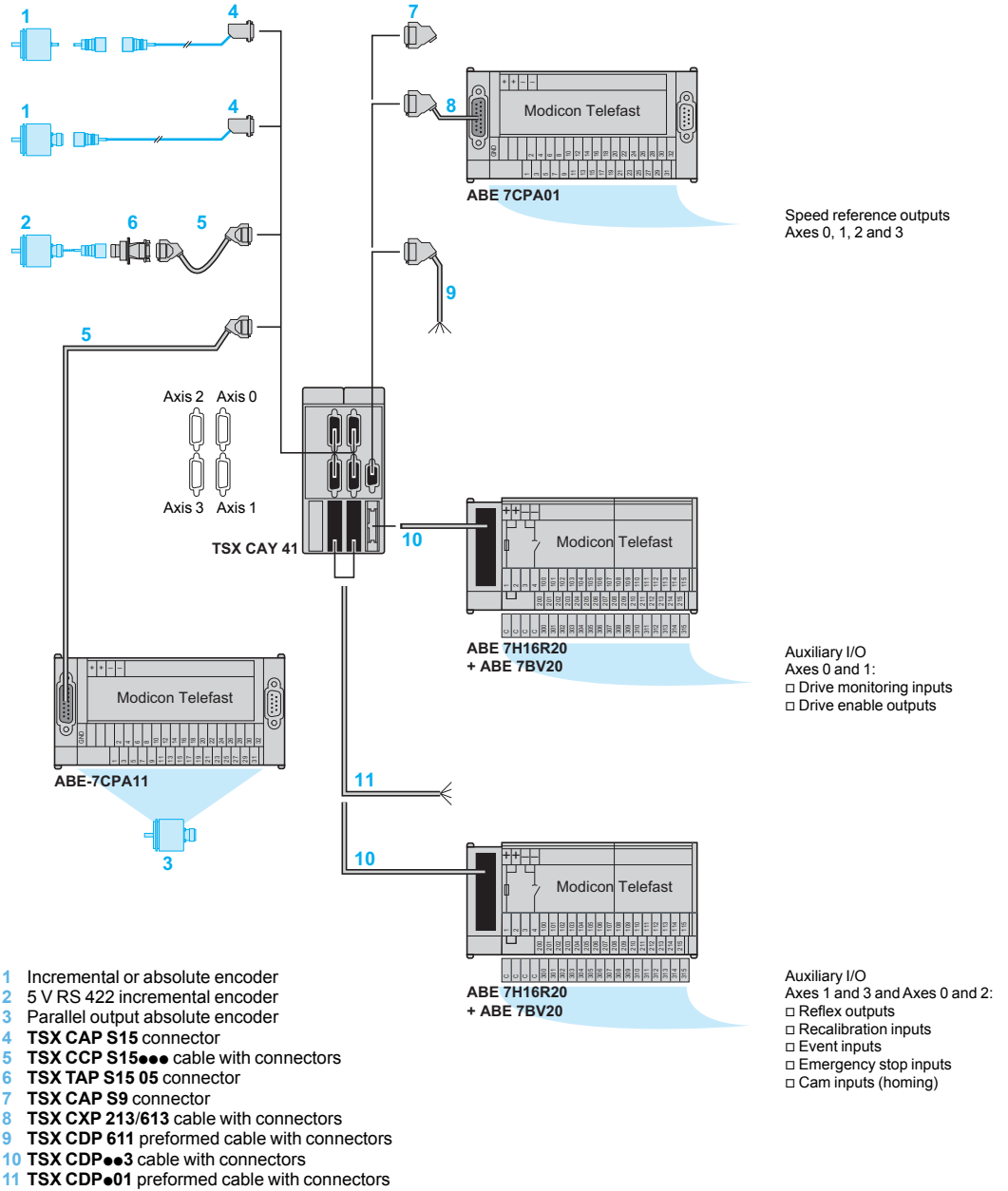

4

Modicon Premium automation platform

TSX CAY motion control modules for servo motors

Example of an architecture with Lexium 32M servo drive and BMH/BSH servo motor

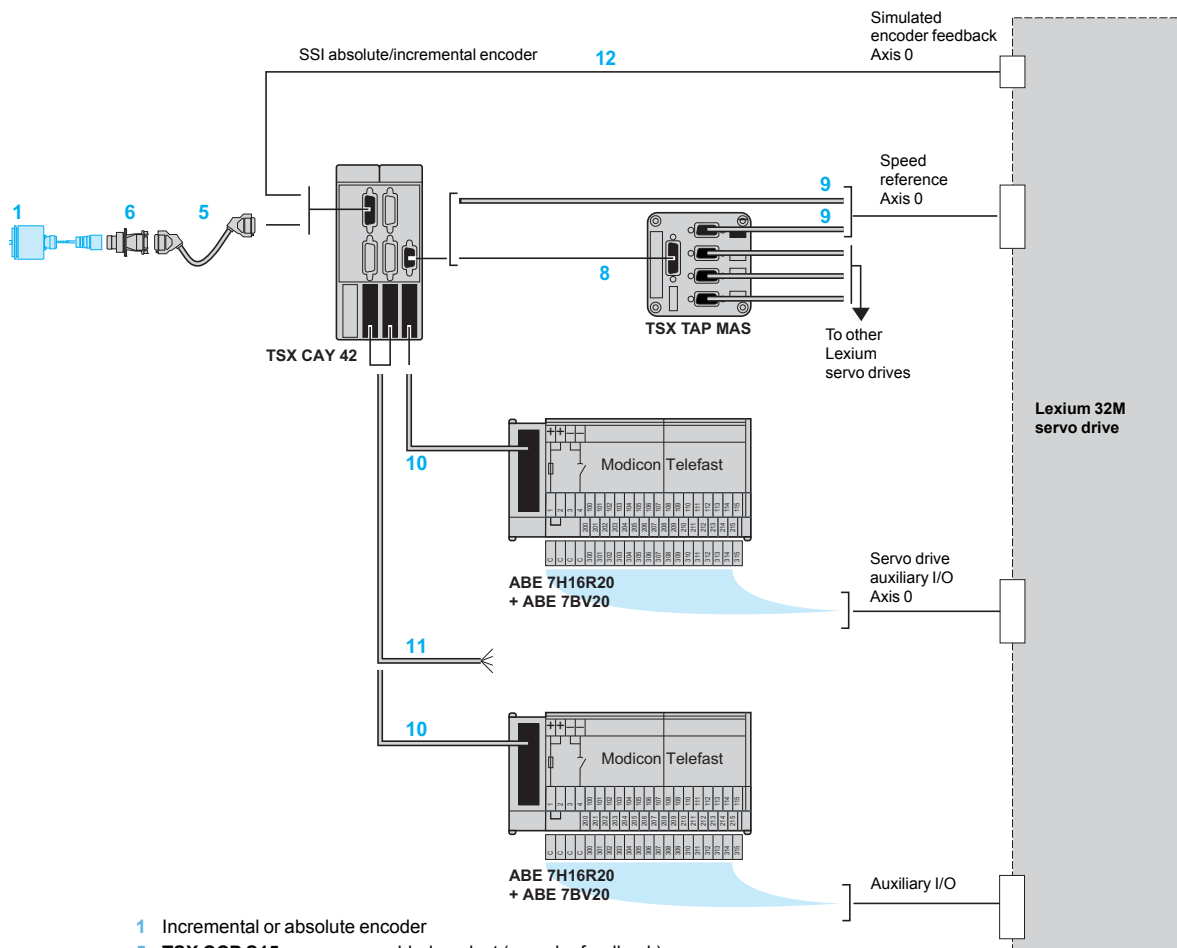

- 1 Incremental or absolute encoder
- 5 TSX CCP S15●●● preassembled cordset (encoder feedback)
- 6 TSX TAP S15 05 connector
- 8 TSX CXP 213/613 preassembled cordset
- 9 TSX CDP 611 preformed cable with connectors
- 10 TSX CDP●●3 preassembled cordset
- 11 TSX CDP●01 preformed cable with connectors
- 12 Simulated SSI absolute/incremental encoder feedback cable (1)

(1) Please consult our Customer Care Centre.

Modicon Premium automation platform

TSX CAY motion control modules for servo motors



TSX CAY 2●



TSX CAY 33



TSX CAY 4●



TSX TAP S15 05



TSX TAP MAS



ABE 7CPA01



ABE 7H16R20

References

Motion control modules for servo motors

Type of input	Characteristics	Function	No. of axes (1)	Reference	Weight kg
Incremental encoders 5 V $\overline{\text{---}}$ RS 422 10...30 V $\overline{\text{---}}$ Totem Pole (2)	500 kHz counting with incremental encoder 200 kHz acquisition with serial absolute encoder	Servo control on independent linear axis	2	TSX CAY 21	0.480
			4	TSX CAY 41	0.610
Absolute encoders RS 485 serial or parallel (3)		Servo control on independent linear or infinite axis Follower axes Realtime correction of servo drive offset Flying shear (4)	2	TSX CAY 22	0.480
			4	TSX CAY 42	0.610
			3	TSX CAY 33	0.610
		Linear interpolation on 2 or 3 axes Realtime correction of servo drive offset			

Connection accessories

Description	Connection	Type of connector on TSX CAY ●● module	No. (5)	Unit reference	Weight kg
SUB-D connectors Sold in lots of 2	SSI absolute/incremental encoder	15-way SUB-D (1 per axis)	4	TSX CAP S15	0.050
	Speed reference	9-way SUB-D (1 per TSX CAY module)	7	TSX CAP S9	0.050
Connection interface for incremental encoder	5 V $\overline{\text{---}}$ RS 422/ RS 485 incremental encoder	15-way SUB-D (1 per axis)	6	TSX TAP S15 05	0.260
Splitter box	Speed reference towards servo drives	9-way SUB-D (1 per TSX CAY module)	—	TSX TAP MAS	0.590
Advantys Telefast ABE 7 connection sub-bases	Speed reference	9-way SUB-D (1 per TSX CAY module)	—	ABE 7CPA01	0.300
	Auxiliary inputs, reflex outputs, 24 V $\overline{\text{---}}$ I/O power supply 5/24 V $\overline{\text{---}}$ encoder power supplies	20-way HE 10 (1 for 2 axes)	—	ABE 7H16R20	0.300
	Servo drive control signals, 24 V $\overline{\text{---}}$ I/O power supply	20-way HE 10 (1 per TSX CAY module)	—		
Additional terminal block Order in multiples of 5	20 linked terminals for ABE 7H16R20 sub-base	—	—	ABE 7BV20	0.060
Adaptor sub-base	Absolute encoders with parallel outputs (16 to 24 bits) 5 V $\overline{\text{---}}$, 10...30 V $\overline{\text{---}}$	15-way SUB-D	—	ABE 7CPA11	0.300

(1) Double format **TSX CAY 41/42/33** modules.

(2) Totem Pole encoder with additional Push/Pull outputs.

(3) Parallel output absolute encoders with **ABE 7CPA11** adaptor interface.

(4) Flying shear function available with **TSX CAY 22** module. Requires Unity Pro software version ≥ 2.2 or PL7 Junior/Pro software version ≥ 4.1

(5) For numbers, see pages 4/36 and 4/37.

Modicon Premium automation platform

TSX CAY motion control modules for servo motors

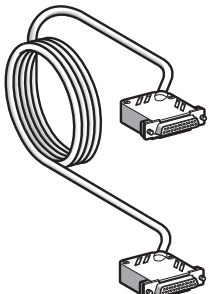

TSX CCP S15 ●●●

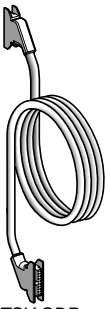

TSX CDP ●●3

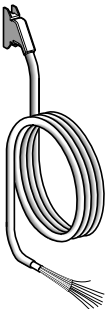

TSX CDP ●01

References (continued)

Connecting cables

Description	Use		No. (1)	Length	Reference	Weight kg
	From	To				
Cordsets AWG 12 (0.205 mm ²)	TSX CAY ●● module, 15-way SUB-D connector	TSX TAP S15 05 interface, or ABE 7CPA11 adaptor sub-base (15-way SUB-D connector)	5	0.5 m	TSX CCP S15 050	0.110
				1 m	TSX CCP S15 100	0.160
				2.5 m	TSX CCP S15	0.220
	TSX CAY ●● module, 9-way SUB-D connector (speed reference)	ABE 7CPA01 sub-base or TSX TAP MAS splitter box (15-way SUB-D connector)	8	2.5 m	TSX CXP 213	0.270
				6 m	TSX CXP 613	0.580
Preformed cable AWG 14 (0.205 mm ²)	TSX CAY ●● module, or TSX TAP MAS splitter box (9-way SUB-D connector)	Lexium 05/17D/32M servo drive or other drive speed reference (free end)	9	6 m	TSX CDP 611	0.790
Connecting cables AWG 22 (0.324 mm ²) 500 mA max.	TSX CAY ●● module, moulded 20-way HE 10 connector	ABE 7H16R20 sub-base (20-way HE 10 connector)	10	0.5 m	TSX CDP 053	0.085
				1 m	TSX CDP 103	0.150
				2 m	TSX CDP 203	0.280
				3 m	TSX CDP 303	0.410
				5 m	TSX CDP 503	0.670
	10 m	TSX CDP 1003	1.180			
20-wire preformed cable AWG 22 (0.324 mm ²) 500 mA max.	TSX CAY ●● module, moulded 20-way HE 10 connector	Auxiliary inputs, reflex output, control signals, power supplies (free end)	11	3 m	TSX CDP 301	0.400
				5 m	TSX CDP 501	0.660
				100 m	TSX CDP 1001	1.210

(1) For numbers, see pages 4/36 and 4/37.

Modicon Premium automation platform

SERCOS TSX CSY 84/85/164 motion control modules

Presentation

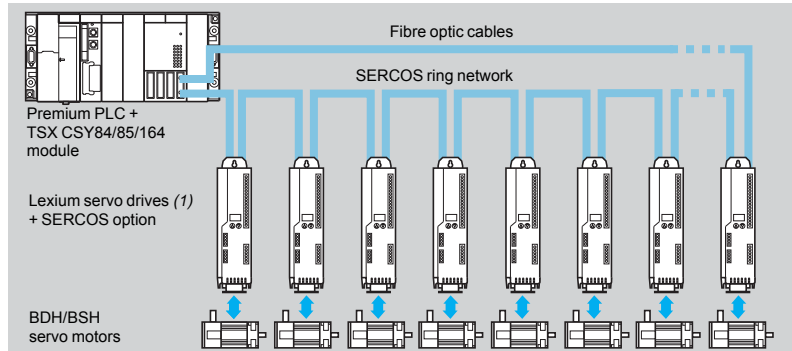

SERCOS (SERial COmmunication System) is a communication standard which defines the digital link (medium and exchange protocol) between the motion control module and servo drives. This standard is defined in European standard IEC/EN 61491.

Using the SERCOS distributed architecture enables the application I/O (position encoder, emergency stop, etc.) to be connected directly to the servo drives, thus reducing connection costs. The fibre optic digital link permits high speed exchanges (2 or 4 Mbps) while ensuring total immunity in industrial environments subject to interference.

The SERCOS range for the Premium automation platform consists of:

- TSX CSY 84/85/164 (2) axis control modules that can control up to 8 servo drives (TSX CSY 84/85) and 16 servo drives (TSX CSY 164), via a SERCOS ring bus. The module calculates the path and the interpolation for several axes (position mode). The other modes (speed and torque) can be accessed using Schneider Electric application services.

- 1.5 A to 70 A permanent Lexium servo drives (1) (with the SERCOS option). The servo drives manage the position, speed and torque loops and ensure power conversion to control the servo motor. The sensor feedback is sent to the servo drive (current position, current speed).

- BDH and BSH servo motors. These have permanent magnets delivering a high power-to-weight ratio and excellent dynamic speed response in a compact unit. The Lexium range (1) offers all the necessary options (line chokes, braking resistors, etc.) as well as all connection components.

Block diagram

The block diagram presents the various functions performed by the different components which make up the multi-axis control system.

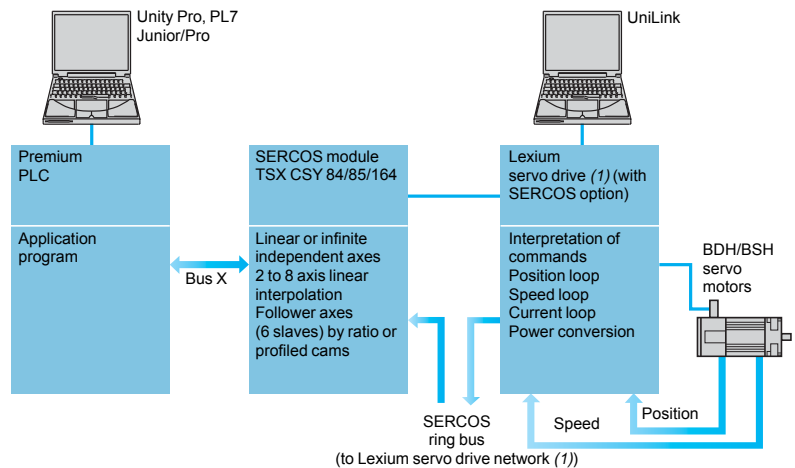

(1) Please consult our Customer Care Centre.

(2) The TSX CSY 85 module also supports the path functions with the TjE path editor software.

Modicon Premium automation platform

SERCOS TSX CSY 84/85/164 motion control modules

Block diagram (continued)

The PL7 Junior/Pro or Unity/Pro software is used, via the Premium platform terminal port, to:

- Declare SERCOS TSX CSY 84/85/164 modules in the PLC configuration
- Configure the functions and set the parameters for the axes used
- Program the movements in the PLC application
- Adjust the parameters via operating codes (parameters, TSX CSY module and Lexium servo drive⁽¹⁾ with SERCOS option)
- Test and debug the application

The UniLink software is used, via the RS 232 terminal port on the Lexium servo drive ⁽¹⁾ (with SERCOS option), to:

- Define the types of Lexium servo drive (with SERCOS option) and BDH/BSH servo motors
- Adjust the parameters of the Lexium servo drives (with SERCOS option), back them up in the drives' EEPROM memories and archive them on a compatible PC

Description

SERCOS TSX CSY 84/85/164 axis control modules comprise:

- 1 An SMA connector, marked TX, for connecting the servo drives via the fibre optic cable (SERCOS ring transmission)
- 2 An SMA connector, marked RX, for connecting the servo drives via the fibre optic cable (SERCOS ring reception)
- 3 Double format rigid casing, which:
 - Holds electronic cards
 - Locates and locks the module in its slot
- 4 Module diagnostic LEDs:
 - RUN LED (green): on, the module is operating correctly
 - SER LED (yellow): flashing, transmission and reception of data on the SERCOS network
 - ERR LED (red):
 - On, internal module fault
 - Flashing, module start-up, communication fault, incompatible configuration or application missing
 - I/O LED (red): on, external fault or application fault
 - INI LED (yellow): flashing, module initializing
- 5 Channel diagnostic LEDs (green): on, axis in normal operation; off, configuration fault; flashing, serious error on axis:
 - 1 to 8: display of 8 real axes ⁽²⁾
 - 9 to 12: display of 4 imaginary axes ⁽²⁾
 - 13 to 16: display of 4 remote axes ⁽²⁾
 - 17 to 20: display of 4 sets of coordinated axes
 - 21 to 24: display of 4 sets of follower axes
- 6 A pencil point button for reinitializing the module
- 7 Two 8-way mini-DIN connectors reserved for Schneider Electric use



TSX CSY 84/164

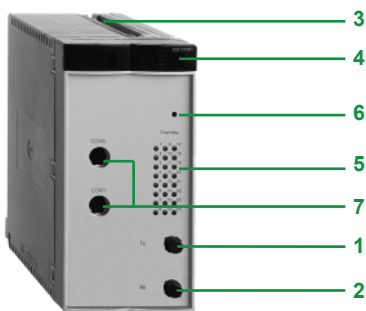

TSX CSY 85

⁽¹⁾ Please consult our Customer Care Centre.

⁽²⁾ 1 to 16: display of 16 axes (can be real, imaginary or remote) with the **TSX CSY 164** module.

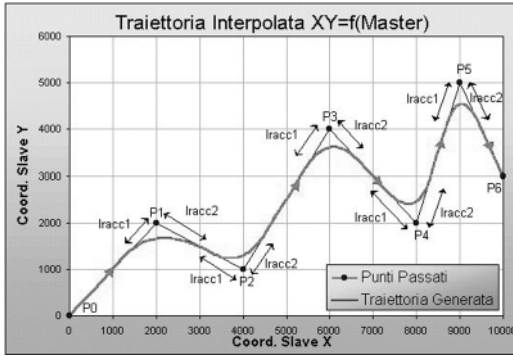

Functions specific to the TSX CSY 85 module

Creation of paths using TJE editor

All paths, whether simple or complex, are divided into linear or circular segments linked together by interpolation laws (6 possible types). Each segment is characterized by:

- X and Y coordinates of the point to be reached (in the example to the left, P6) or "tangented" (P1, P2, ...P5)
- Its movement speed, maximum or limited according to setpoint (parameter "ParF0", see screens below):
 - The type of interpolation (parameter "ParW0", see screens below)
 - The number of points in the linear segment (min. 1 point)
 - The number of points in the cubic interpolation part of the segment
 - Various other parameters, depending on the type of interpolation

P9

X Coord	35
Y Coord	0
ParF0 (V.Se)	0
ParW0	0 Interpolation linéaire
ParW1	1 Nombre de points dans la section lin
ParW2	0
ParW3	0
ParW4	0 ...
ParF1	0
ParF2	0
ParF3	0

Linear interpolation

This type of interpolation is used to generate a rectilinear path between the preceding point P^{i-1} and point P_i defining the segment. The various parameters below are used as follows:

- "ParW1" indicates the number of points in the linear segment. This number of points represents the number of intermediate points that the TSX CSY 85 motion control module must calculate to define the path on the segment (minimum 1).
- "ParW4" is used to indicate that the movement of a third axis will follow the path (here, the linear segment) using tangential mode: positioning according to a constant angle with the path (1).

P1

X Coord	3
Y Coord	6
ParF0 (V.Se)	-1
ParW0	1 Linear Int. with 3° Poly. (Cubic) Conn
ParW1	1 No. Points in linear section
ParW2	10 No. Points Cubic Conn. Section
ParW3	100 Kf: Shape Coefficient
ParW4	0 ...
ParF1	1 Iracc1: Initial Connection Length
ParF2	2 Iracc2: Final Connection Length
ParF3	0

Linear interpolation with 3° polynomial interpolation connection

This type of interpolation is used to create a curve between 2 linear segments in accordance with a 3° interpolation in order to smooth the transitions. The path no longer passes through the defined point P_i (in the example on the left, P1) but follows a curve defined by the following parameters:

- "ParW2" indicates the number of points in the cubic interpolation part (curve)
- "ParW3" defines the shape coefficient of the cubic interpolation enabling the curve to move closer to or further away from the defined point P_i
- "Iracc1" and "Iracc2" correspond to the initial and final connection lengths. If these lengths are too great, maximum lengths are calculated by the TSX CSY 85 motion control module as a function of the previous section for Iracc1 and of the following section for Iracc2.

P1

X Coord	3
Y Coord	6
ParF0 (V.Se)	-1
ParW0	2 Linear Int. with 5° Poly. Connection
ParW1	1 No. Points in linear section
ParW2	10 No. Points Conn. Section
ParW3	100 Kf: Shape Coefficient
ParW4	0 ...
ParF1	1 Iracc1: Initial Connection Length
ParF2	1.5 Iracc2: Final Connection Length
ParF3	0

Linear interpolation with 5° polynomial interpolation connection

5° polynomial interpolation is used to define a path in exactly the same way as with 3° polynomial interpolation.

However 5° interpolation provides more flexible movement than 3° interpolation. If the acceleration limit in the segment in question is reached, the speed on this segment can be reduced for this type of connection.

P2

X Coord	5
Y Coord	6
ParF0 (V.Se)	-1
ParW0	10 Linear Int. with Circular Connection
ParW1	1 No. Points in linear section
ParW2	10 No. Points Circular Conn. Section
ParW3	0
ParW4	0 ...
ParF1	3 Circular Connection Length
ParF2	0
ParF3	0

Linear interpolation with circular interpolation connection

This type of interpolation is used to link segments via a circular path (arcs or full circles). The specific parameters defining this type of path are:

- "ParW2" indicates the number of points in the circular interpolation part
- "ParW4" defines whether the arc is greater or less than 180° (defining the direction of the arc)
- "ParF1" corresponds to the length of the circular interpolation segment

Circular interpolation is only possible for a movement in a single plane (2 axes only).

(1) Available in a later version of the TJE software.

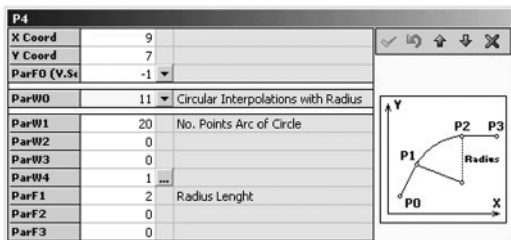

Functions specific to the TSX CSY 85 module (continued)

Circular interpolation according to radius

This type of interpolation is used to connect segments via a circular path (arcs) by specifying start and end points, the radius of the circle and the direction of the path (clockwise or counter-clockwise). The specific parameters defining this type of path are:

- "ParW1" indicates the number of points in the arc
- "ParW4" defines the direction of the path (clockwise or counter-clockwise)
- "ParF1" corresponds to the radius of the arc.

Circular interpolation according to radius:

- Is only possible for a movement in a single plane (2 axes only)
- Cannot be used to create paths in a full circle (to do this, use linear interpolation with circular interpolation connection)

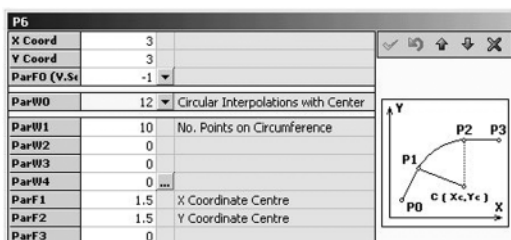

Circular interpolation according to centre

This type of interpolation is also used to connect segments via a circular path (arcs or full circles) by specifying start and end points, the coordinates of the centre of the circle and the direction of the path (clockwise or counter-clockwise). The specific parameters defining this type of path are:

- "ParW1" indicates the number of points in the arc
- "ParW4" defines the direction of the path (clockwise or counter-clockwise)
- "ParF1" indicates the abscissa of the centre of the circle (X)
- "ParF2" indicates the ordinate of the centre of the circle (Y)

Full circular movement is defined by an end point which is the same as the start point. Circular interpolation is only possible for a movement in a single plane (2 axes only).

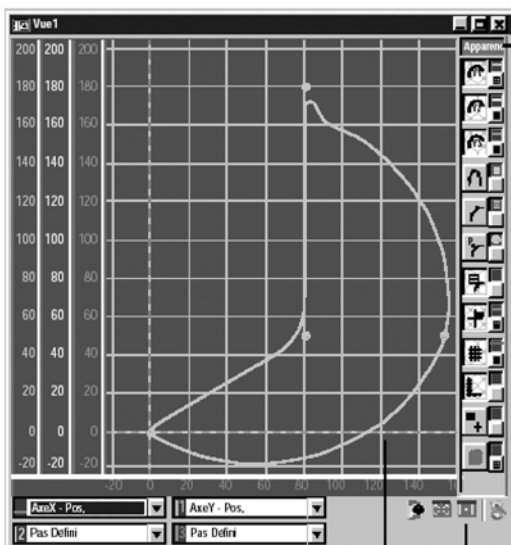

TjE path editor software

TjE path editor software, supplied with the SERCOS TSX CSY 85 motion control module, is used in offline mode to:

- Create master/slave axes and sets of axes for use in paths, with a maximum of 3 sets of 2 real axes or 2 sets of 3 axes
- Each slave axis requires a cam profile selected from the 7 profiles available in the TSX CSY 85 module (with a limit of 10,000 cam points for all the profiles)
- Define paths by setting parameters for each segment, which are linked to the various possible interpolations described above and on page 4/42
- The TjE software validates all the parameters and calculates the paths for each set of axes

Path display

The TjE software integrates various graphic tools for displaying paths that were previously created and the data relating to the axes (making up these paths) with their positions, speeds or accelerations. The paths can be displayed with:

- A choice of curves, colours and scaling
- A choice of scales and offsets
- Display of segment reference points
- Display of points of the master, and calculated points of the cam profiles

This display enables the user to validate the paths before transferring all the data that has been generated to the PL7 Junior/Pro application managing the SERCOS TSX CSY 85 motion control modules.

(1) Maximum, 8 real axes per TSX CSY 85 module.

Modicon Premium automation platform

SERCOS TSX CSY 84/85/164 motion control modules

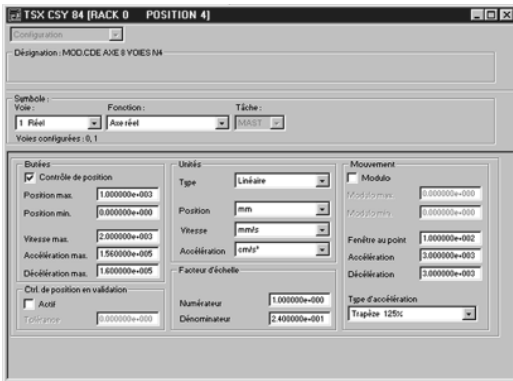

Module configuration

Software setup of TSX CSY 84/85/164 modules

When setting up application-specific functions, screens specific to the SERCOS motion control function can be accessed via the Unity Pro or PL7 Junior/Pro software for configuration, adjustment, debugging and documentation of applications. These services are performed by editors which can be accessed directly from the basic screen using icons in the toolbar. The windows of the editors can be displayed simultaneously on one screen (example: it is possible to program using the program editor and simultaneously define the symbols in the variables editor).

Declaring the SERCOS motion control module

Parameter entry for application-specific functions is easy to access from the configuration screen by clicking on the slot occupied by the module.

Configuring the module

The configuration editor provides assistance with entering and modifying the values of the various axis configuration parameters. These parameters enable the operation of the axis control module to be adapted to the machine to be controlled.

The axis configuration parameters are:

- Units of measurement
- Resolution
- Maximum and minimum limit positions
- Maximum speed
- Acceleration/deceleration

This data relates to the machine and cannot be modified by the program.

The configuration screen shown here can be used to declare the 16 channels as real axes, imaginary axes or remote axes for the TSX CSY 164 module.



Declaring the axes of the TSX CSY 164 module

Adjusting the modules

These parameters relate to the operation of the axes. They generally require operations on and movements of the moving part to be known. These parameters are adjusted in online mode (they are initialized during configuration, in offline mode).

They concern:

- Maximum speed
- Resolution
- Servo control parameters
- Acceleration/deceleration

Debugging the modules

In online mode, the debugging tool provides the user with a control panel screen, giving a quick display that can be used to control and observe the behaviour of the axis.

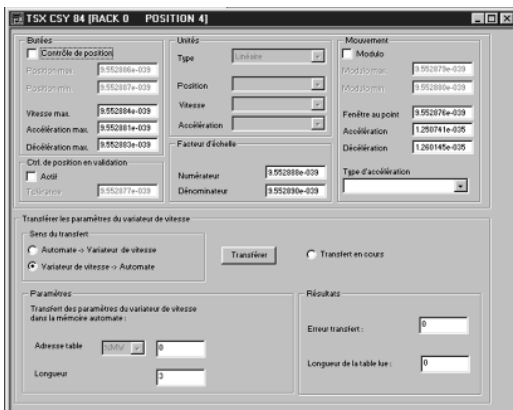

Setting the axis parameters

The TSX CSY 84/85/164 modules combined with Unity Pro or PL7 Junior/Pro software provide manual mode for initiating (JOG) or incremental (INC) motion commands, with no prior programming.

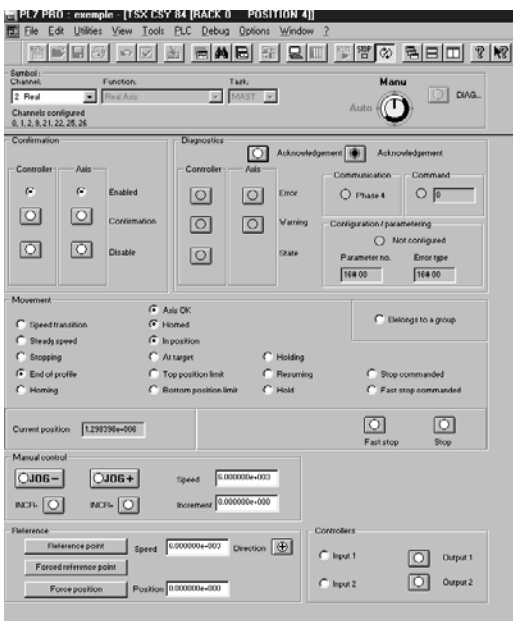

Debugging in PL7 Pro software

Modicon Premium automation platform

SERCOS TSX CSY 84/85/164 motion control modules



TSX CSY 84/164



TSX CSY 85

References

TSX CSY 84/85/164 multi-axis control modules have 32 application-specific channels which are only counted when they are configured in the Premium PLC application (using PL7 Junior/Pro or Unity Pro software). The maximum permitted number of application-specific channels depends on the type of processor:

Type of processor	TSX 57 1●	TSX 57 2● PCX 57 20	TSX 57 3● PCX 57 35	TSX 57 4●	TSX 57 5●
Max. no. of application-specific channels	8	24	32	64	64

Motion control modules

Description	Function	Number of axes	Reference	Weight kg
Multi-axis control modules	Control of SERCOS digital servo drives	8 real axes 4 imaginary axes 4 remote axes	TSX CSY 84	0.520
		8 real axes 4 imaginary axes 4 remote axes TjE path creation function	TSX CSY 85	0.520
		16 axes (real axes, imaginary axes and remote axes)	TSX CSY 164	0.520

Fibre optic connection cables

Description	Connection	Length	Reference	Weight kg
Plastic fibre optic cables fitted with SMA connectors (bend radius: 25 mm min.)	Lexium servo drive (1) (with SERCOS option)	0.3 m	990 MCO 000 01	0.050
		0.9 m	990 MCO 000 03	0.180
		1.5 m	990 MCO 000 05	0.260
		4.5 m	990 MCO 000 15	0.770
		16.5 m	990 MCO 000 55	2.830
		22.5 m	990 MCO 000 75	4.070
		37.5 m	990 MCO 001 25	5.940

Connections

Example of a SERCOS ring with 5 Lexium servo drives (1)

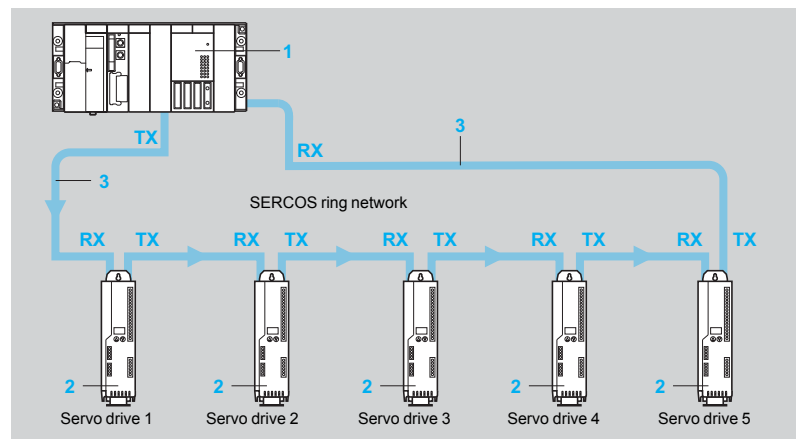

- 1 TSX CSY 84/85/164: multi-axis control module for Premium PLC
 - 2 Lexium servo drives (1) with SERCOS option
 - 3 990 MCO 000 ●●: plastic fibre optic cables fitted with SMA connectors
- TX Transmission
RX Reception

(1) Please consult our Customer Care Centre.

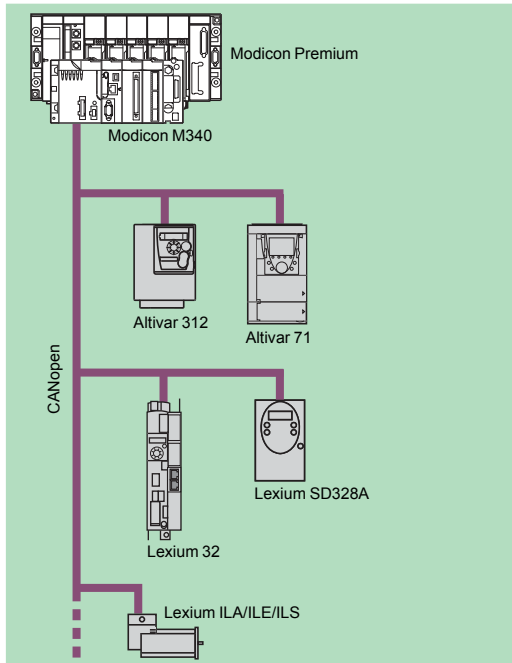

MFB: Motion control distributed over CANopen

Presentation

MFB (*Motion Function Blocks*) is a library of function blocks integrated in Unity Pro used to set up motion control in the architectures of drives and servo drives on CANopen buses:

- Altivar 312: For asynchronous motors from 0.18 to 15 kW
- Altivar 71: For synchronous or asynchronous motors from 0.37 to 500 kW
- Lexium 32: For servo motors from 0.15 to 7 kW
- Lexium integrated drives ILA/ILE/ILS: For integrated motor drives from 0.10 to 0.35 kW
- Lexium SD328A: For 3-phase stepper motors from 0,35 to 0,75 kW.

In compliance with PLCopen specifications, the MFB library allows both easy and flexible motion programming with Unity Pro, as well as axis diagnosis. In maintenance operations, drives can be replaced quickly and safely thanks to drive parameter download blocks.-

Setting up drives on the CANopen network is facilitated through *Motion Tree Manager* organization in the Unity Pro browser, making it easy for users to access the application drives.

Applications

The features of the *Motion Function Blocks* library are particularly suitable for machines with independent axes. In the case of these modular/special machines, MFB function blocks are the perfect solution for controlling single axes. The following are typical applications for this type of architecture:

- Automatic storage/removal
- Material handling
- Palletizers/depalletizers
- Conveyors
- Packaging, simple label application
- Grouping/ungrouping
- Adjustment axes in flexible machines, etc.

Functions

The table below lists the function blocks of the MFB library and the drives compatible with them. The prefix indicates the block family:

- MC: Function block defined by the Motion Function Blocks PLC Open standard
- TE: Function block specific to Schneider Electric products
- Lxm: Function block specific to Lexium servo drives



Type	Function	Function block	Altivar 312	Altivar 71	Lexium 32	Lexium ILA/ILE/ILS	Lexium SD328A
Management and motion	Read an internal parameter	MC_ReadParameter					
	Write an internal parameter	MC_WriteParameter					
	Read the current position	MC_ReadActualPosition					
	Read the instantaneous speed	MC_ReadActualVelocity					
	Acknowledge error messages	MC_Reset					
	Stop all active movement	MC_Stop					
	Axis coming to standstill	MC_Power					
	Movement to absolute position	MC_MoveAbsolute					
	Relative movement	MC_MoveRelative					
	Additional movement	MC_MoveAdditive					
	Homing	MC_Home					
	Movement at given speed	MC_MoveVelocity					
	Read diagnostic data	MC_ReadAxisError					
	Read servo drive status	MC_ReadStatus					
	Torque control	MC_TorqueControl					
Read actual torque value	MC_ReadActualTorque						
Manual control	MC_Jog						
Save and restore parameters (FDR)	Read all parameters and store in PLC memory	TE_UploadDriveParam					
	Write all parameters from PLC memory	TE_DownloadDriveParam					
Advanced Lexium functions	Read a motion task	Lxm_UploadMTask					
	Write a motion task	Lxm_DownloadMTask					
	Start a motion task	Lxm_StartMTask			(1)		
	Set the reduction ratio, signed	Lxm_GearPosS			(1)		
System	Communication with the servo drive	TE_CAN_Handler					

Compatible

(1) The Lxm_StartMTask and Lxm_GearPosS function blocks are only compatible with the M type Lexium 32 (LXM 32M) servo drives.

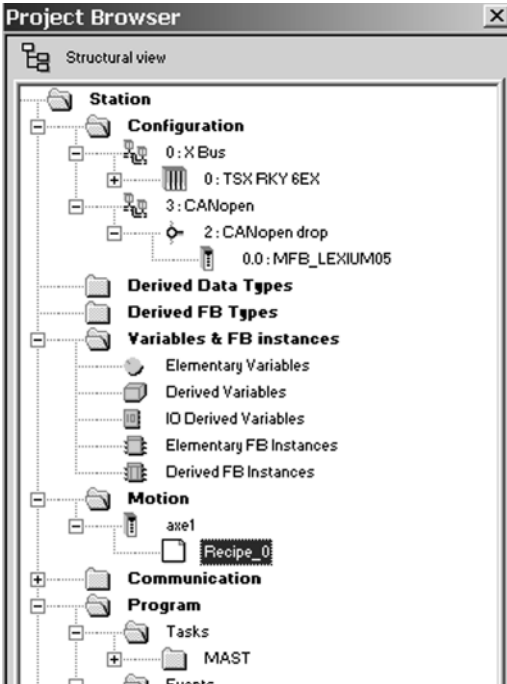

Motion Tree Manager integrated in the Unity Pro browser

Motion Tree Manager

Motion Tree Manager is associated with Unity Pro's MFB library and integrated in its browser. It provides specific assistance for:

- Axis object management
- Axis variable definition
- Drive parameter management

Motion Tree Manager automatically creates links between the CANopen bus configuration and the MFB function block data using a limited amount of configuration data.

General axis parameters

In this tab, the designer is prompted to define:

- The name of the axis that will identify it in the browser for the entire application
- The address of the drive on the CANopen bus

Axis parameters

The drop-down lists in this tab are used to determine the exact type of drive: Family, version.

Variable names

This last tab is used to identify data structures:

- **Axis_Reference**: Used by all the instances of function blocks for the axis in question
- **CAN_Handler**: Used to manage communication with the drive via the CANopen network

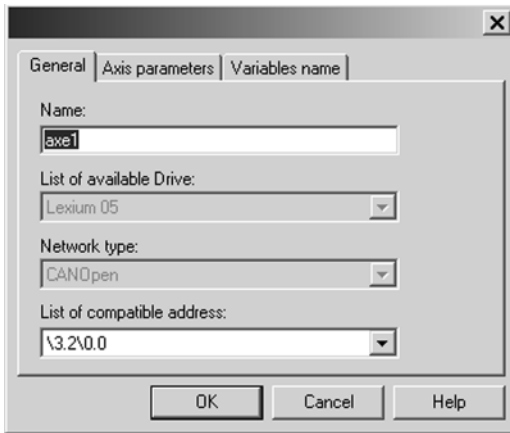

General parameters: Axis name and address

Recipe definition

The "recipes" attached to the axis are the data structures containing all the adjustment parameters of a given drive. This data is used when:

- Changing the drive with restoration of the context during "Faulty Device Replacement" (FDR) maintenance
- Changing the manufacturing program of the machine and calling up an appropriate set of parameters: servo control gains, limitations, etc. adapted to the weight and size of the moving parts
- Saving parameters in the initial values of the PLC application

Programming, diagnostics and maintenance

Communication between the PLC and drive is automatically set up by the system as soon as a TE_CAN_Handler instance is declared in the Unity Pro task with which the axis is associated. Movements are then programmed by sequencing function blocks from the library in the user's chosen Unity Pro editor (LD, ST, FBD).

The two function blocks, MC_ReadStatus, and in some cases MC_ReadAxisError, are useful for determining the overall status of the axis, as well as the code of active warnings or errors.

The function blocks TE_UploadDriveParam and TE_DownloadDriveParam allow the application to save all the parameters of a drive (recipe) and to then quickly reload them into another drive if the first one fails.

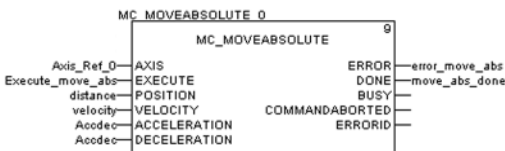

MFB: Programming a movement in absolute mode

The *ISP Plus* weighing range, when used with the Premium PLC, enables the automation of machines combined with weighers or installations

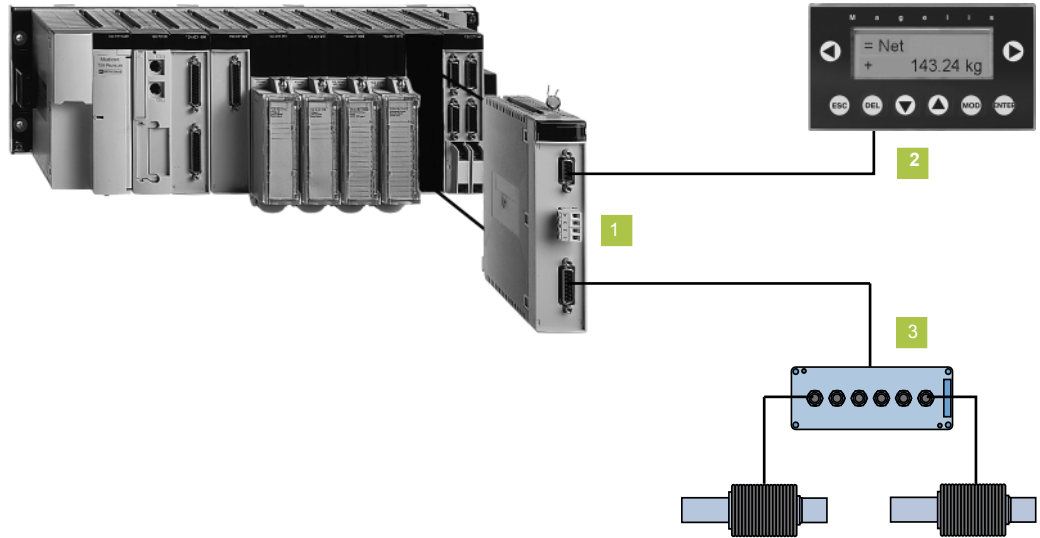

4

1 TSX ISP Y101 weighing module

The **TSX ISP Y101** standard format weighing module is the central part of the weighing system. It has:

- A measurement input that can take up to 8 load cells:
 - Resolution: 1,048,576 points (20 bits)
 - Measurement rate: 50 measurements per second
 - Type of load cell: 8 x 350 Ohm load cells maximum, mounted in parallel
 - Load cell supply voltage: 10 V $\overline{\text{---}}$
 - Load cell wiring distance: 350 m (with no loss of precision with 4 load cells)
- Two discrete reflex outputs for weighing/dosing applications:
 - Type of outputs: 2 positive logic transistor outputs
 - Nominal voltage: 24 V $\overline{\text{---}}$
 - Response time: 1 ms discrimination
- A sealable link for the display unit:
 - Physical interface: non-isolated RS 485
 - Distance of display unit: 30 m maximum

Module consumption: (see page 9/7)

2 TSX XBT N410 weight indicator

The **TSX XBT N410** remote display unit displays the measured weight with no prior configuration. When the link to the weighing module is sealed, the display unit then becomes the main display unit for commercial transactions:

- Screen type: green backlit LCD
- Number of lines: used in weighing applications with 2 lines of 10 characters (8.37 x 5.9 mm)
- Power supply: 24 V $\overline{\text{---}}$ nominal (limit values: 18...30 V $\overline{\text{---}}$)
- Operating temperature: 0...55°C
- Degree of protection (front panel): IP65 according to IEC/EN 60529, Nema 4X "outdoor use"

3 Accessories

Junction boxes, cables (see page 4/51)

4 Weighing module/display unit assembly TSX ISP Y101

The **TSX ISP Y121** weighing module/display unit assembly comprises:

- 1 **TSX ISP Y101** weighing module
- 1 **TSX XBT N410** display unit
- 1 module/display unit connecting cable (length 3 m)

The **TSX ISP Y121** weighing module/display unit assembly conforms to the OIML recommendations and is approved for class III weighers (6000 scale divisions) and class IIIII weighers (1000 scale divisions).

Presentation (continued)

When a **TSX ISP Y101** weighing module is integrated in a Premium PLC it is possible to go beyond the scope of a simple weighing application. The PLC manages not only the whole of the weighing environment but also the whole of the machine or the industrial process associated with the weighing system.

In a Premium configuration, the number of **TSX ISP Y101** weighing modules must be added to the other application-specific modules (**TSX SCY 21601** communication, **TSX CTY** counting, **TSX CAY/CSY** axis control and **TSX CFY** motion control).

The maximum number of **TSX ISP Y101** weighing modules is:

- Premium Unity configurations (one application-specific channel per weighing module):
 - 8 weighing modules with **TSX 57 1●** processors
 - 24 weighing modules with **TSX 57 2●** processors
 - 32 weighing modules with **TSX 57 3●** processors
 - 64 weighing modules with **TSX 57 4● /5● /6●** processors
- Premium PL7 configurations (two application-specific channels per weighing module):
 - 4 weighing modules with **TSX 57 1●** processors
 - 12 weighing modules with **TSX 57 2●** processors
 - 16 weighing modules with **TSX 57 3●** processors
 - 32 weighing modules with **TSX 57 4●/5●/6●** processors

Description

Weighing module

The front panel of the **TSX ISP Y101** weighing module comprises:

- 1 A 9-way female SUB-D connector for the RS 485 serial link to the display unit
- 2 Screw terminals for connecting 2 discrete reflex outputs (outputs used with threshold detection)
- 3 A 15-way female SUB-D connector for the measurement input channel (50 measurements per second, from 1 to 8 load cells)
- 4 Optional module sealing device

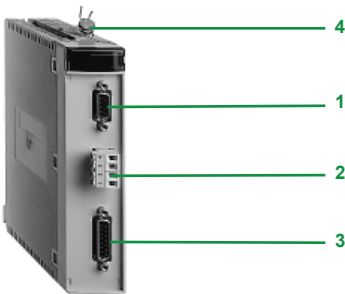

Remote indicator

Weight values are displayed on a **TSX XBT N410** display unit (supplied with the TSX ISP Y121 unit). The display unit is preconfigured.

It has the following on the front panel:

- 1 A back-lit LCD display with 4 lines of 20 characters (height 4.34 mm)
- 2 Two non-customizable command or contextual link keys
- 3 6 service keys

The rear panel comprises:

- A removable screw terminal block for the 24 V $\overline{\text{---}}$ external power supply
- A 25-way female SUB-D connector for connection to the **TSX ISP Y101** weighing module (30 metres maximum)

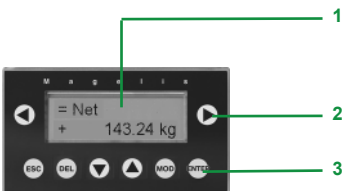

Strain gauge load cells and connection accessories

Please consult our Customer Care Centre.

Functions

The weighing module combined with its display unit constitutes a weight indicator. The module incorporates numerous functions specific to weighing:

- Continuous weight measurement (in g, kg, t, lb, oz, etc.) and flow calculation (weight variation)
- Filtering of measurements using several methods (19 filtering options)
- Device for tare and predefined tare
- Automatic reset
- Measurement stability control
- Threshold control with extrapolation of cut-off point: positioning of local discrete outputs to the nearest millisecond
- Assisted calibration: the module calculates the zero point and the gradient
- Calibration parameters saved in the module (EEPROM) and in the Premium processor
- Forced calibration: fast replacement of a faulty module and restart with the previous calibration parameters
- Locking of the configuration, sealing of the module and its connections to the load cells and display unit
- Continuous formatting and transmission of measurements to the PLC
- Transmission of measurement validity data (validity, stability, net/gross, etc.)
- Transmission of diagnostic data from the module and its connections
- Configuration, calibration and debugging via Unity Pro or PL7 Junior/Pro screens
- Most of the operating parameters can be modified, and most of the functions can be executed by the PLC program

Setting up the weighing module

Unity Pro or PL7 Junior/Pro enables the complete setup of the weighing system (configuration, calibration and debugging).

Configuration

This covers:

- The measuring information on the weigher
- Filtering of measurements
- The flow calculation method
- The tare
- The data format
- Stability criteria and zero point management method
- Threshold monitoring for positioning the discrete outputs

Calibrating the weigher

The module itself calculates the gain and the offset to be applied to the electronic measurement system.

Calibration is carried out in two stages:

- Measurement of the dead load
- Measurement of a standard weight

Forced calibration enables the system to be restarted immediately in the event of a module failure. The new module is configured automatically.

Debugging

The screen specifically for weighing provides a dynamic display of:

- The measurement in progress
- The operating state of the module
- It also enables fast modification of the adjustment parameters (filter, flow, threshold values, etc.)

Commands and parameters that can be modified by the program, transmitted implicitly to the weighing module, are used to operate the module in language specific to weighing.

These parameters and commands can be controlled from an operator dialogue device and/or a supervisory device connected to the Premium PLC.



Configuration

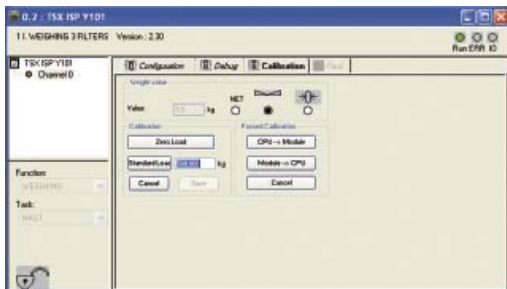

Calibrating the weigher

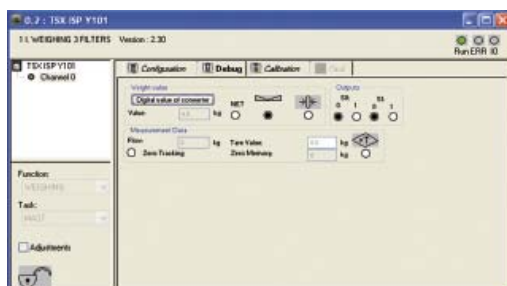

Debugging

Modicon Premium automation platform

ISP Plus integrated weighing system



TSX ISP Y101



TSX ISP Y101



SM1 PY52



TSX XBT N410



SF3 PY32003

References

ISP Plus weighing modules

Description	Composition	Reference	Weight kg
ISP Plus weighing modules (1 weigher per module) (1) Supplied non calibrated	Standard format module (sealable) - Load cell input 50 measurement/s (for 1 to 8 load cells) - 2 discrete reflex outputs (for threshold detection) - RS 485 output (for display unit)	TSX ISP Y101	0.420
	- TSX ISP Y101 module - TSX XBT N410 display unit (back-lit LCD, preconfigured display) - Module/display unit connecting cable (length 3 m)	TSX ISP Y101	1.020

Intrinsically safe junction box (2)

This box is inserted in the weighing system between the weight indicator and the junction box in which the load cells are grouped. Its function is to limit any overvoltages and limit the current to 100 mA in the event of a short circuit.

The load cells and the metal junction box are the only devices in the explosive atmosphere. The weight indicator is in a safe area.

Description	For use with	Marking	Reference	Weight kg
Zener barrier box	All types of load cells and indicators	EEx ib II B EEx ib II C	SM1 PY52	2.800

Remote indicator

Description	Length	Reference	Weight kg
Magelis display unit for ISP Plus weighing module 24 V \square external power supply	–	TSX XBT N410	0.380
Module/display unit connecting cables	10 m 30 m	SF3 CPY010 SF3 CPY030	1.100 3.400

Measurement cables

Description	For connection to	Length	Reference	Weight kg
Measurement cables 6 conductors with 1 x 15-way SUB-D connector for ISP Plus weighing module	Junction box for load cells	3 m 10 m 20 m 30 m 40 m 50 m 80 m	SF3 PY32003 SF3 PY32010 SF3 PY32020 SF3 PY32030 SF3 PY32040 SF3 PY32050 SF3 PY32080	0.300 1.100 2.200 3.400 4.500 5.600 9.000

(1) Setting up weighing modules requires Unity Pro \geq V2.0 or PL7 Junior/Pro \geq V4.1 software.

(2) Equipment approved by the Laboratoire Central des Industries Electriques (LCIE) (Central Laboratory for the Electrical Industries).

Modicon Premium automation platform

Hot Standby system Unity Pro software

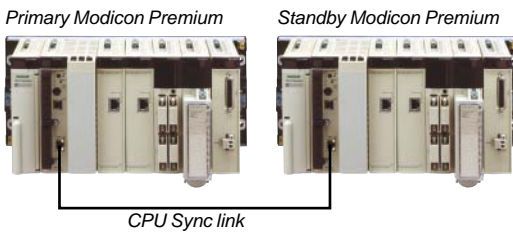

Presentation

The Premium Hot Standby offer, compatible with Unity Pro software, ensures continuity of operation of a Modicon Premium automation platform control system in the event of failure of:

- The central processing and communication functions
- All or part of the I/O system

It is based on the principle of Primary/Standby redundancy with complete redundancy of the main processing and communication functions, use of shared I/O on the Ethernet TCP/IP network, the Modbus link and/or redundancy of in-rack I/O (single-rack or multi-rack configuration).

Premium Hot Standby redundant architectures offer an optimum solution for responding to requirements for availability where changeover times are not critical. They are suitable for processes which can tolerate a lack of control, on the part of the Premium control unit, lasting a maximum of around one second (typical duration corresponding to the changeover time from the Primary unit to the Standby unit and the time it takes the shared I/O on Ethernet to refresh).

It covers all the requirements for availability when the PLC's mission is to monitor and control an installation in continuous duty, indicate problems to a control station, and send the supervision manager's control instructions to various locations on an extensive site.

Examples of areas of application:

- Building management system for a public site (tunnel, airport, signalling, etc.)
- Control and monitoring of water treatment or desalination plant
- Electrical management system
- Production of hydro-electric power, etc.

Principle

At the heart of the system there are 2 single-rack or multi-rack (1) Modicon Premium configurations, known as the Primary PLC and the Standby PLC. They have identical hardware and software configurations (identical modules in each rack). The offer comprises two processor models, **TSX H57 24M** and **TSX H57 44M**, dedicated to Hot Standby architectures with Unity Pro software (version ≥ 3.1 in single-rack configuration and ≥ 5.0 in multi-rack configuration).

These double format processors combine the central processing unit and redundant coprocessor functions in the same housing.

The Primary PLC:

- Executes the application program and controls the I/O which may be:
 - Field products on the Ethernet network managed by the I/O Scanning service (see page 5/32)
 - Field products on the Modbus master link
 - Sensors and actuators connected to the Premium I/O modules on Bus X in a single-rack or multi-rack configuration
- Transfers all its data to the Standby PLC via the CPU Sync link at the start of each scan

In the event of failure of the Primary PLC, the standby system switches over automatically, taking 1.5 PLC scan cycles, changing over execution of the application program and control of the I/O to the Standby PLC with an up-to-date data context.

The Ethernet network modules of both Premium configurations managing the field products exchange their addresses by means of an automatic "IP" and "IP + 1" address assignment mechanism. This mechanism applies to Modbus link modules with assignment of the slave addresses "n" and "n + 1".

Once they have changed over, the "Standby" PLC becomes the "Primary" PLC. Once the faulty PLC has been repaired and reconnected to the standby system, it takes the role of the Standby PLC.

(1) The latest version of **TSX H57 24M/44M** Hot Standby processors incorporates the firmware for the V2.83 PLC operating system and the Ethernet V2.82 coprocessor which is used to configure multi-rack Hot Standby applications in Unity Pro V5.0. Up-to-date versions of these firmware programs are available on our website www.schneider-electric.com.

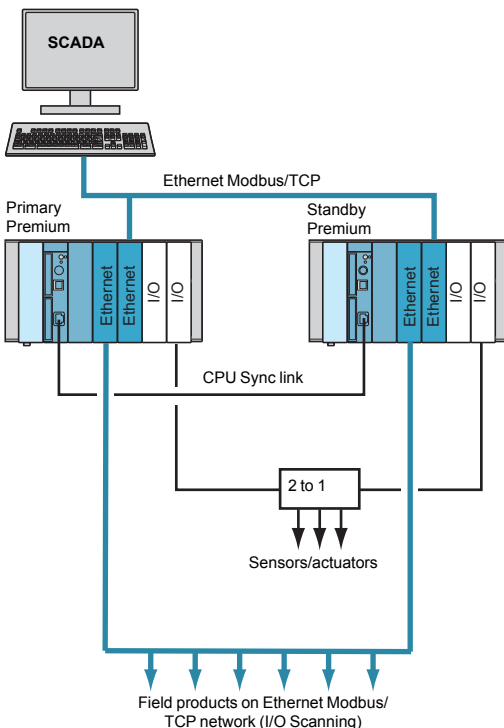

Modicon Premium automation platform

Hot Standby system
Unity Pro software

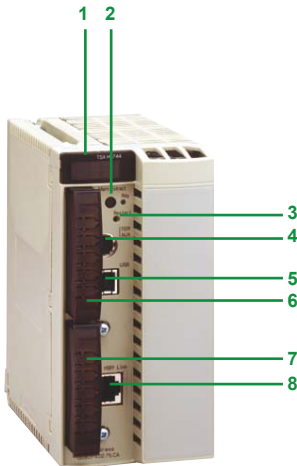

TSX H57 24M/44M

TSX H57 24M/44M Hot Standby processors

Double format Premium Hot Standby **TSX H57 24M** and **TSX H57 44M** processor front panels comprise:

1 A display block with 6 LEDs:

- RUN LED (green):
 - On steady: processor in Primary mode during operation (program execution)
 - Flashing 2.5 s (on)/0.5 s (off): processor in Standby mode during operation (execution of first program section)
 - Flashing 0.5 s (on)/2.5 s (off): processor not in Standby mode
 - Flashing 0.5 s (on)/0.5 s (off): PLC stopped
- ERR LED (red):
 - On steady: processor or embedded equipment fault (PCMCIA memory card)
 - Flashing 0.5 s (on)/0.5 s (off): application fault
- TER LED (yellow): activity on the TER/AUX terminal port
- I/O LED (red): On steady: fault from another PLC station module or configuration fault
- STS LED (yellow):
 - Flashing 0.5 s (on)/0.5 s (off): standby mode between the Primary and Standby processors correct
 - On steady: standby mode inactive or being initialized
 - Off: failure of processor self-tests
- ACT LED (yellow): activity on the CPU Sync link between the Primary and Standby processors correct

This standby mode diagnostics is complemented by the 3 LEDs (RUN, ERR and STS) of the **TSX ETY 4103/5103** communication modules managing the shared I/O on Ethernet Modbus/TCP.

2 A Memory Extract button: not operational on the Hot Standby processors

3 A RESET button triggering a cold start of the PLC when pressed

4 An 8-way female mini-DIN connector marked TER/AUX for connecting a programming, adjustment or operator interface terminal

5 A USB connector marked TER for connecting a programming terminal (requires the PC-compatible 3.3 m **UNY XCA USB 033** connection cable, to be ordered separately)

6 A PCMCIA slot (no. 0) for a memory expansion card

7 A PCMCIA slot (no. 1) for a memory expansion card for storing additional data (1)

8 An RJ45 connector marked HSBY Link dedicated to Hot Standby communication between the Primary and Standby processors

CPU Sync link

The CPU Sync link 8 marked HSBY Link on the front panel of Hot Standby processors is a 10BASE-T/100BASE-TX Modbus/TCP Ethernet port dedicated to exchanges between the Hot Standby System Primary and Standby PLCs.

This link allows the Primary active PLC (as seen by the system I/O) to exchange its context (status of its data) with the Standby PLC each application cycle, so that if there is a changeover on failure of the Primary PLC, the Standby PLC can take control of the control system in 1.5 processor cycles.

The CPU Sync link is a copper link, maximum length 100 m.

⚠ The use of active components (transceivers, switches, etc.) on the CPU Sync link is strictly prohibited.

USB terminal port

The USB terminal port 5 with a useful data rate of 12 Mbps is compatible with Unity Pro programming software and the OPS data server (OPC Factory Server).

TSX H57 24M/44M processors can be connected to a USB bus comprising several peripherals, however:

- Only one processor must be connected to the USB bus
- No device on the USB bus (modem, printer) can be controlled by the PLC

(1) The PCMCIA communication cards **TSX SCP 11●** (Modbus, Uni-Telway, serial link) **TSX CPP 110** (CANopen), **TSX FPP 20** (Fipway) and **TSX MBP 100** (Modbus Plus) cannot be placed in slot no. 1 of the Hot Standby processors.

Modicon Premium automation platform

Hot Standby system
Unity Pro software

4

Redundant components

- 1 Non-expandable rack with 6, 8 or 12 positions **TSX RKY ●●** (single-rack configuration) or expandable with 4, 6, 8 or 12 positions **TSX RKY ●●EX** (multi-rack configuration)
- 2 Power supply module **TSX PSY ●●●M**
- 3 Premium Hot Standby processor **TSX H57 24M/44M**
- 4 Ethernet Modbus/TCP network module **TSX ETY 4103/5103** (version ≥ sv 4.0)
- 4-M "Monitored" Ethernet Modbus/TCP network module **TSX ETY 4103/5103** (version ≥ sv 4.0)

Shared components on the Ethernet Modbus/TCP ring

- 15 Modicon M340 automation platform with processor with integrated Ethernet port **BMXP34 2020/2030**
- 16 Modicon STB modular distributed I/O with network interface module **STB NIP 2212**
- 17 Altivar 61/71 variable speed drive with communication card **VW3 A3 310**
- 18 Optimum Modicon OTB distributed I/O, with interface module **OTB 1E0 DM9LP**
- 19 Magelis XBT GT graphic display terminal with embedded Ethernet port **XBT GT ●●30/40**

Other possible shared components:

- Modicon FTM IP 67 modular I/O
- Momentum distributed I/O
- **TSX ETG 100/1000** gateway for connecting Modbus products
- W@de remote management modules (RTU) for the water sector **TSX HEW 315/320/330**
- Inductel/Ositrack identification system **XGK S1715503** and **XGK Z33ETH**
- Lexium servo drives with communication card **AMO ETH 001V000**
- Preventa **XPS MF** compact and modular safety PLCs

Ethernet cabling components:

- 10 ConneXium managed switch 2, 4 or 8 ports 10/100BASE-TX **TCS ESM 0●3**
- 11 CPU Sync link, copper crossover cable **490 NTC 000 ●●●**
- 12 Copper straight-through cable **490 NTW 000 ●●●**
- 13 Copper crossover cable **490 NTC 000 ●●● (1)**

(1) For Ethernet ring lengths > 100 m, the copper link is replaced by a fibre optic link, either multimode (3 km max.) or single-mode (20 km max.) via ConneXium switches **TCS ESM 043F2CS0** and straight-through copper cable **490 NTW 000 ●●●** (fibre optic not supplied by Schneider Electric).

Note: Should other Primary and Standby PLC Ethernet modules be required to be "monitored", in order to increase the redundant equipment covered (for example for the SCADA Ethernet network), an application program must be written in each PLC.

Architectures

Typical architecture

In this type of architecture the I/O system of Premium PLCs equipped with the **TSX H57 24M/44M** dedicated Hot Standby processor is defined by distribution of field products or devices on the Ethernet Modbus/TCP network.

Functionally, the products or devices connected on the same Ethernet Modbus/TCP network can be either of the following types:

- Client: Twido controller, Modicon PLC, Magelis HMI, W@de remote management module, etc.
- Modbus/TCP server: Modicon OTB/Momentum distributed I/O, Modicon STB I/O islands, Altivar variable speed drives, Lexium servo drives, Inductel/Ositrack identification systems, etc.

The Ethernet I/O Scanning service allows client-server type exchanges between the PLC and Ethernet devices communicating in Modbus/TCP protocol. This service can be used to configure up to 64 stations with periodic read and/or write exchanges based on the tables of variables (word type) for the target products or devices. The I/O Scanning service is a function available as standard with **TSX ETY 4103/5103** Ethernet network modules.

The topology of the Ethernet Modbus/TCP network providing the connection between the PLC Ethernet Modbus/TCP modules and the distributed products/devices can be bus or ring type with a copper cable or fibre optic medium.

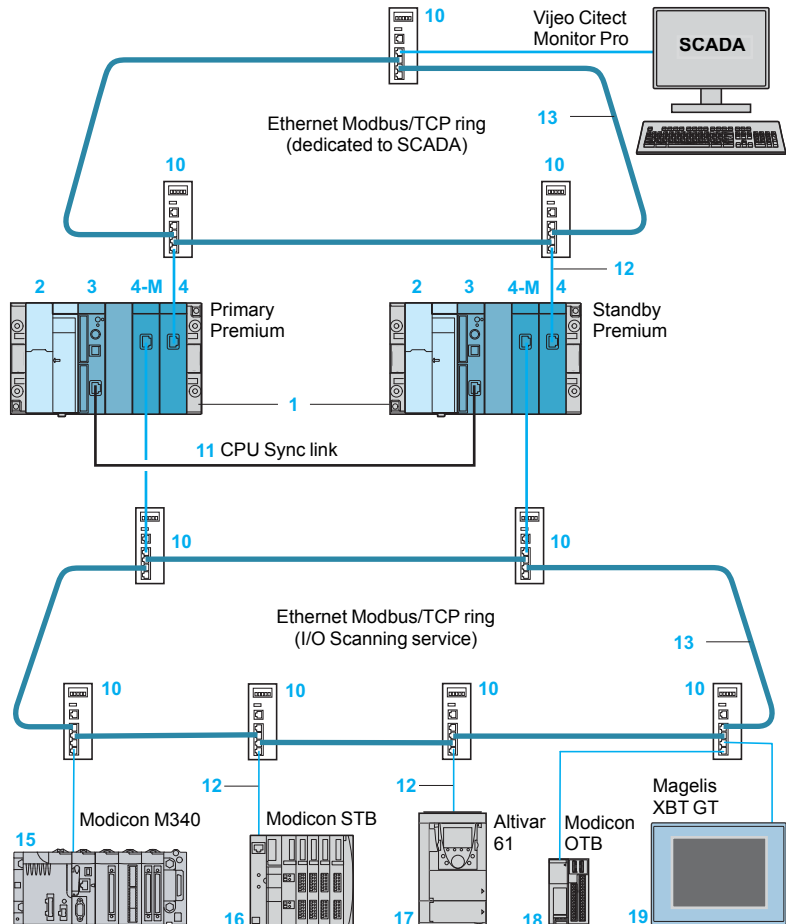

"Monitored" Ethernet network modules

When the Hot Standby system is configured with Unity Pro software, an Ethernet module no. 4-M for each Primary PLC and Standby PLC must always be defined with "monitored" status and have the Ethernet I/O Scanning service. This status assigns the module with monitoring of both its correct operation and its electrical connection to its Ethernet switch. A failure (of the "monitored" module or its Ethernet connection) triggers the changeover from the Primary PLC to the Standby PLC.

Architectures (continued)

Architecture with redundant I/O on Bus X

In this type of architecture, the discrete and analog I/O on Bus X are redundant components. The discrete and analog I/O modules controlling them are positioned in each Primary and Standby single-rack or multi-rack configuration.

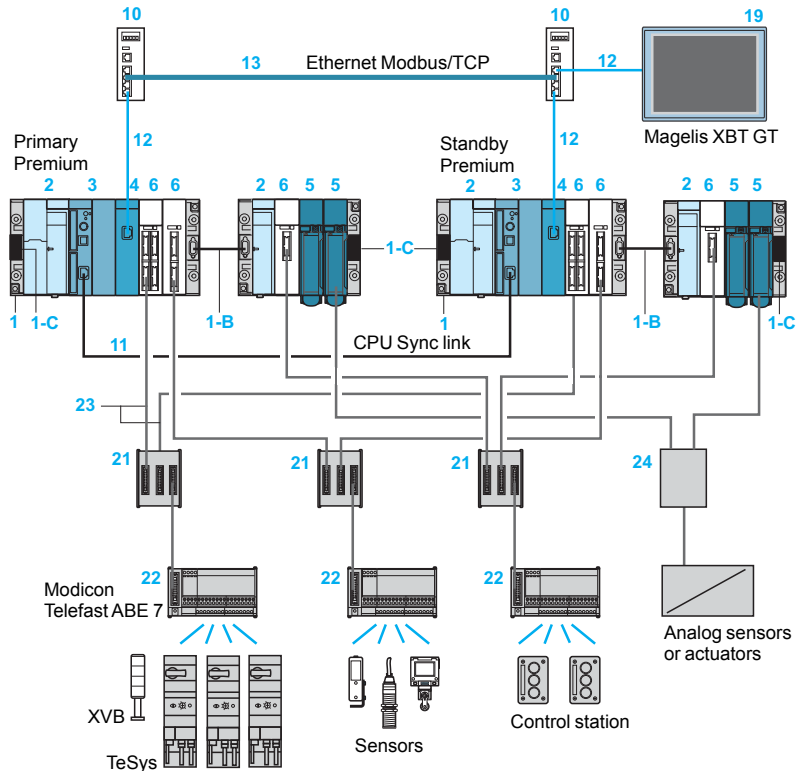

Redundant components:

- 1 Non-expandable rack with 6, 8 or 12 positions **TSX RKY ●●** (single-rack configuration) or expandable with 4, 6, 8 or 12 positions **TSX RKY ●●EX** (multi-rack configuration)
- 1-B Bus X extension cable (multi-rack configuration)
- 1-C Line terminator (multi-rack configuration)
- 2 Power supply module **TSX PSY ●●●M**
- 3 Hot Standby processor **TSX H57 24M/44M**
- 4 Ethernet Modbus/TCP network module **TSX ETY 4103/5103** (version \geq sv 4.0)
- 5 Analog I/O modules **TSX AEY/ASY ●●●**
- 6 Discrete I/O modules, 16, 28, 32 or 64 channels (1 HE 10 connector for 16 channels) **TSX DEY/DSY/DMY 16/28/32/64●●K**

Modicon Telefast ABE 7 and JM Concept cabling components:

- 21 Redundancy sub-bases:
 - 16 as 2 x 16 input channels **ABE 7ACC 11**
 - 16 as 2 x 16 output channels **ABE 7ACC 10**
- 22 16-channel passive sub-bases **ABE 7H16●●●**, for adaptation of inputs or outputs (16-channel) **ABE 7S16/7R16/7P16●●●**
- 23 Cordsets with two HE10 connectors **TSX CDP ●●3** (0.5, 1, 2, 3, 5 or 10 m long)
- 24 Analog I/O multiplexer (supplied by JM Concept):
 - Analog inputs **JK 3000 N2**: 1 x 0-20 mA/0-10 V input in 2 x 0-20 mA/0-10 V inputs
 - Analog outputs **GK 3000 D1**: 2 x 4-20 mA outputs in 1 x 4-20 mA output

Ethernet cabling components:

- 10 ConneXium switch with 4, 8 or 16 10/100BASE-TX ports **499 NES ●●100** (unmanaged) or **TCS ESM ●●3** (managed)
- 11 CPU Sync link, copper crossover cable **490 NTC 000 ●●●**
- 12 Copper straight-through cable **490 NTW 000 ●●●**
- 13 Copper crossover cable **490 NTC 000 ●●● (1)**

Human Machine Interface:

- 19 Magelis XBT GT graphic display terminal with embedded Ethernet port **XBT GT ●●30/40**

(1) For Ethernet ring lengths > 100 m, the copper link is replaced by a fibre optic link, either multimode (3 km max.) or single-mode (20 km max.) via ConneXium switches **TCS ESM 043F2CS0** and straight-through copper cable **490 NTW 000 ●●●** (fibre optic not supplied by Schneider Electric).

Management of redundant I/O

Each Primary and Standby Premium PLC has a set of identical I/O modules on its **TSX RKY ●** rack.

Discrete sensors/actuators are connected to 16-channel Modicon Telefast **ABE 7H16/S16/R16** passive connection or adaptor sub-bases.

Analog sensors/actuators are connected via the JM Concept converter. Visit the website www.jmconcept.com

For the redundant inputs, the sensor data is transmitted to the Primary and Standby PLCs simultaneously via the 2 identical input modules placed in the Premium racks. Two 16-channel Modicon Telefast ABE 7 sub-bases, **ABE 7ACC11** with redundant inputs and **ABE 7ACC10** with redundant outputs, can be used to create double cabling very easily, using cordsets with two HE10 connectors.

The output values are only generated by the Primary PLC application processing. This PLC sends its commands to the corresponding output modules. On each scan, the Standby PLC receives the Primary PLC output values via the CPU Sync link and applies them to its own outputs. This update ensures a smooth changeover from Normal to Standby during the changeover time.

Note: Output fallback values: in a Hot Standby system, the redundant output modules must be configured with fallback to state 0, and the shared component outputs (on Ethernet I/O Scanning or on Modbus) configured with maintain state on fallback.

Note: Use of Preventa **TSX PAY 262/282** safety modules: in a Hot Standby system, the modules are allowed in Premium racks provided that the wiring recommendations are complied with, please consult your Customer Care Centre.



Modicon Premium automation platform

Hot Standby system
Unity Pro software

4

Architectures (continued)

SCADA architecture on Modbus and shared I/O on Ethernet Modbus/TCP

As in the typical architecture on page 4/54, the Premium Hot Standby system I/O are shared on an Ethernet Modbus/TCP network (with a bus topology as in the example below). However, the SCADA interface is connected to the standby system via a Modbus serial link.

The Ethernet Modbus/TCP network modules **no. 4 - M** are configured as “monitored” so that they trigger the Hot Standby changeover in the event of a failure (of the Ethernet module or the electrical connection and its switch) (see page 4/54).

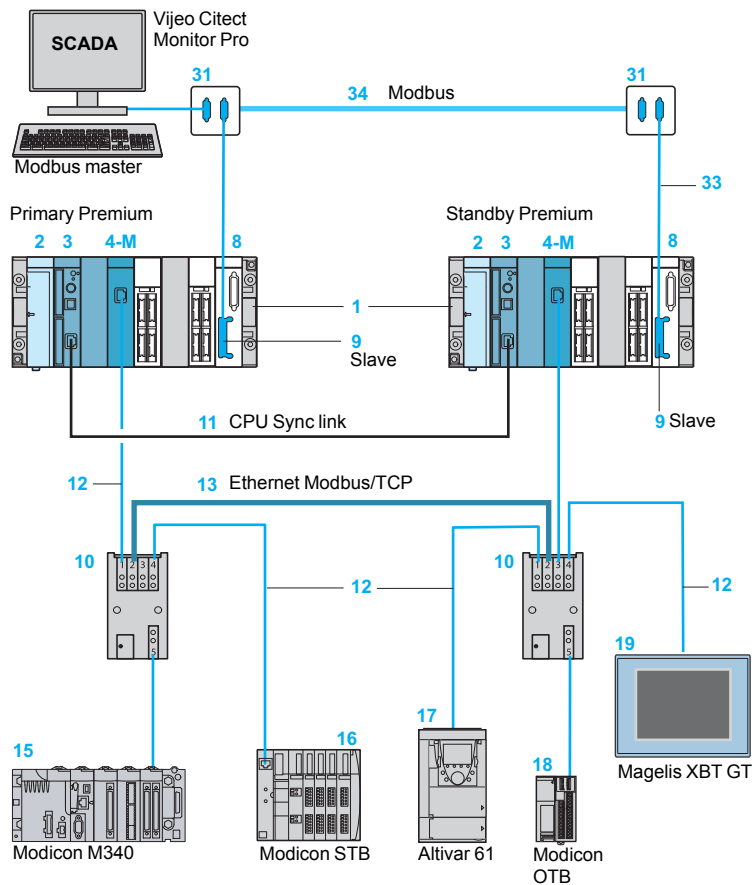

SCADA supervision system

In this type of architecture, redundancy of the SCADA station, based on the Vijeo Citect or Monitor Pro supervision software, is provided by a Modbus serial link on which the SCADA station is master. The Primary and Standby Premium PLCs via their **TSX SCY 21601** communication module equipped with the **TSX SCP 114** RS 485 PCMCIA card have the slave addresses “n” and n+1 respectively.

A failure triggers the changeover so that the Standby PLC becomes the Primary PLC and automatically switches the Modbus addresses, the address of the new Primary PLC becoming “n” and that of the old Primary PLC becoming “n+1”.

Redundant components:

- 1 Non-expandable rack with 6, 8 or 12 positions **TSX RKY ●●** (single-rack configuration) or expandable with 4, 6, 8 or 12 positions **TSX RKY ●●EX** (multi-rack configuration)
- 2 Power supply module **TSX PSY ●●●M**
- 3 Hot Standby processor **TSX H57 24M/44M**
- 4-M “Monitored” Ethernet Modbus/TCP network module **TSX ETY 4103/5103** (version ≥ sv 4.0)
- 8 Serial link communication module **TSX SCY 21601** on which the integrated channel cannot be used in this type of architecture
- 9 Isolated RS 485 PCMCIA card **TSX SCP 114** used in Modbus slave protocol

Shared components on the Ethernet Modbus/TCP network:

- 15 Modicon M340 automation platform with processor with integrated Ethernet port **BMXP34 2020/2030**
- 16 Modicon STB modular distributed I/O with network interface module **STB NIP 2212**
- 17 Altivar 61/71 variable speed drive with communication card **VV3 A3 310**
- 18 Optimum Modicon OTB distributed I/O, with interface module **OTB 1E0 DM9LP**
- 19 Magelis XBT GT graphic display terminal with embedded Ethernet port **XBT GT ●●30/40**

Other possible shared components: (see page 4/54)

Ethernet cabling components:

- 10 ConneXium unmanaged switch with 5 ports 10BASE-T/100BASE-TX **499 NES 251 00**
- 11 CPU Sync link, copper crossover cable **490 NTC 000 ●●●**
- 12 Copper straight-through cable **490 NTW 000 ●●●**
- 13 Copper crossover cable **490 NTC 000 ●●●**

Modbus cabling components:

- 31 Passive T-junction box, connection on screw terminals with line terminator **TSX SCA 50**
- 33 Drop cable for PCMCIA card with flying leads at at one end **TSX SCP CM 4030** (3 m long)
- 34 RS 485 double shielded twisted pair trunk cable **TSX CSA 100/200/500** (100, 200 or 500 m long)

Modicon Premium automation platform

Hot Standby system
Unity Pro software

Architectures (continued)

Architecture with shared products on Modbus and shared I/O on Ethernet Modbus/TCP

In this type of architecture the Premium Hot Standby system products, peripherals and devices are:

- Shared on a Modbus/TCP Ethernet network (with a bus topology as in the example below)
- Shared on a Modbus link, thus allowing it to support the many varied peripherals and devices (Schneider Electric or third-party) equipped with a slave Modbus interface

Like the previous architectures, it can take a SCADA supervision system on Ethernet or Modbus.

Redundant components

- 1 Non-expandable rack with 6, 8 or 12 positions **TSX RKY ●●** (single-rack configuration) or expandable with 4, 6, 8 or 12 positions **TSX RKY ●●EX** (multi-rack configuration)
- 2 Power supply module **TSX PSY ●●●M**
- 3 Hot Standby processor **TSX H57 24M/44M**
- 4 Ethernet Modbus/TCP network module **TSX ETY 4103/5103** (version ≥ sv 4.0)
- 7 Communication module **TSX SCY 11601/21601** in which the integrated channel is used as the Modbus master

Shared components on Modbus, for example

- TeSys U starter-controllers
- PowerLogic PM 500 MV/LV power meters
- Preventa XPS MC safety controllers

Shared components on the Ethernet Modbus/TCP network

- 15 Modicon M340 automation platform with processor with integrated Ethernet port **BMX P34 2020/2030**
- 16 Modicon STB modular distributed I/O with network interface module **STB NIP2212**
- 17 Altivar 61/71 variable speed drive with communication card **VW3 A3 310**
- 18 Optimum Modicon OTB distributed I/O, with interface module **OTB 1E0 DM9LP**
- 19 Magelis XBT GT graphic display terminal with embedded Ethernet port **XBT GT ●●30/40**

Ethernet cabling components

- 10 ConneXium unmanaged switch with 5 ports 10BASE-T/100BASE-TX **499 NES 251 00**
- 11 CPU Sync link, copper crossover cable **490 NTC 000 ●●●**
- 12 Copper straight-through cable **490 NTW 000 ●●●**
- 13 Copper crossover cable **490 NTC 000 ●●●**

Modbus cabling components

- 31 Passive T-junction box **TSX SCA 50**, connection via screw terminal block with line terminator
- 32 T-junction box with line isolation **TWD XCA ISO**, trunk cable connected on screw terminals and the 2 taps on RJ45 connectors
- 34 RS 485 double shielded twisted pair trunk cable **TSX SCA 100/200/500** (100, 200 or 500 m long)
- 35 Drop cable for integrated channel **TSX SCY CM 6030** (3 m long), 25-way SUB-D connector at one end and flying leads at the other

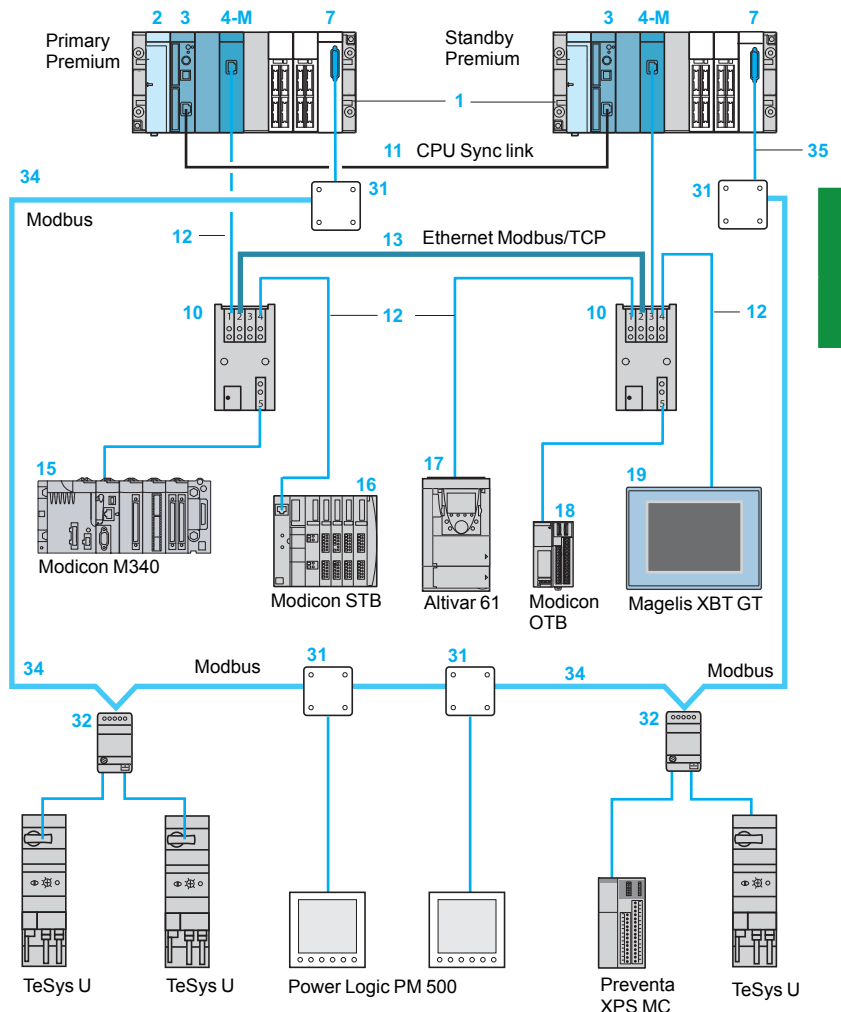

Redundant I/O on Modbus

In this type of architecture, the peripherals and devices are shared via the Modbus link on which the Premium Primary and Standby PLCs are masters, with the other peripherals or devices connected on the Modbus link as slaves.

The Premium PLCs each have the **7 TSX SCY 11601** or **TSX SCY 21601** communication module with their isolated RS 485 integrated link (25-way SUB-D connector).

The cable connector **31 TSX SCA 50** placed on each Premium Primary and Standby PLC includes the line terminator. In addition, since the **TSX SCY 11601/21601** communication modules polarize the Modbus line, disconnection of a slave during operation does not in any way disturb Modbus communication.

Functions

Primary and Standby PLC functions

The Primary and Standby PLCs are physically and functionally identical, but their roles differ according to whether they are in Primary or Standby mode.

Primary Premium PLC

- Executes the application program in full
- Updates the inputs and outputs, depending on the selected in-rack architecture on bus X, on Modbus and/or on Ethernet Modbus/TCP network
- Communicates with the peripheral devices
- Sends its data to the Standby PLC and retrieves diagnostic data from the Standby PLC via the dedicated CPU Sync link
- Generates its own diagnostic data as well as that of the Hot Standby architecture

Standby Premium PLC

- Acquires the state of the in-rack I/O on Bus X of the Standby PLC
- Acquires the image of the Primary PLC inputs (in-rack inputs on bus X, on Modbus and/or on Ethernet Modbus/TCP network)
- Executes part of the application program (only 1st program section)
- Updates the image of its outputs depending on execution of the 1st program section)
- Communicates with the peripheral devices
- Retrieves diagnostic data from the Primary PLC
- Generates its own diagnostic data as well as that of the Hot Standby architecture

Primary/Standby status management

Failure of one of the following components:

- Main rack power supply
- PLC processor
- "Monitored" Ethernet Modbus/TCP network module **TSX ETY 4103/5103** automatically triggers a Primary/Standby changeover. For all the other components, the changeover from Primary to Standby can be customized by the application program (user-initiated changeover)

Services provided by the TSX ETY 4103/5103 Ethernet Modbus/TCP modules in a Hot Standby architecture

Standard Web services: Rack Viewer and Data Editor
FactoryCast configurable Web services (TSX ETY 5103 only)
User Web pages (8 MB with TSX ETY 5103)
Modbus TCP/IP messaging
HTTP, FTP, XIP, Telnet
I/O Scanning
NTP time synchronization (with TSX ETY 5103)
SMTP e-mail notification (via Unity Pro function blocks)
Network manager, SNMP agent

Management of shared I/O on the Ethernet Modbus/TCP network

The Primary PLC manages the exchange of the states of the shared I/O on the Ethernet network (bus or ring type) after a simple configuration operation, with no need for special programming thanks to the advanced I/O Scanning service. Only the Primary PLC acquires the physical inputs on the network and controls the physical outputs on this network.

On each scan, the Standby PLC receives the images of the I/O on the Primary PLC Ethernet network via the dedicated CPU Sync link. This memory update allows a smooth changeover from Primary to Standby during the changeover time (products or devices with maintain state on fallback).

Management of redundant I/O

For the redundant inputs, the sensor data is transmitted to the Primary and Standby PLCs simultaneously via the input module placed in the racks of each PLC (see page 4/55).

The output values are only generated by the Primary PLC application processing. This PLC sends its commands to the corresponding output modules. On each scan, the Standby PLC receives the Primary PLC output values via the dedicated CPU Sync link and applies them to its own outputs.

This update allows a smooth changeover from Primary to Standby during the changeover time (outputs with fallback to state 0).

Functions (continued)

Management of supervision transparency (SCADA)

Transparency of communication with level 2 (supervisor, third-party device, etc.) when the Primary PLC is switched to the Standby PLC by another pair of Ethernet Modbus/TCP **TSX ETY 4103/5103** modules. Therefore, communication with a redundant architecture is similar to that with a standard architecture. This transparency is the result of the automatic "IP" and "IP + 1" address assignment mechanism.

This transparency also applies with Modbus when using the **TSX SCP 114** PCMCIA card (Modbus slave protocol in RS 485) inserted in the **TSX SCY 21601** communication module (automatic "n" and "n + 1" address assignment mechanism).

Memory space

All the memory space reserved for the application program and the data is managed by the Hot Standby system with Unity Pro software. With an embedded 192 KB or 440 KB RAM memory (depending on the model), the RAM memory for the **TSX H57 24M** and **TSX H57 44M** processors, dedicated to Hot Standby applications, can be increased for the application program to 768 KB or 2048 KB (depending on the model) by the addition of a **PCMCIA** memory card.

Configuration

The installation of the application program does not differ fundamentally from installing a program for a single PLC. It essentially uses the information requested by dedicated dialogue boxes, filled in during configuration in Unity Pro.

Cyclic transfer of the application context

At the start of each scan cycle, the content of the Primary PLC data memory is transferred to the Standby PLC via the dedicated CPU Sync link, at the same time as the contents of the I/O status tables are transferred to it. The Hot Standby system is thus able to transfer, from the Primary PLC to the Standby PLC, a data area (I/O image, located internal data (1) and unlocated internal data) of:

- 192 KB max. with the **TSX H57 24M** processor
- 440 KB max. with the **TSX H57 44M** processor

The principle of the exchanges, as well as exchange times according to the volume of data, are described in the diagram opposite with:

- 1 Hot Standby system: 10 ms per 100 KB
 - 2 Data transfer by the coprocessor: 30 ms per 100 KB.
- This data transfer runs in parallel with execution of the Primary PLC application program

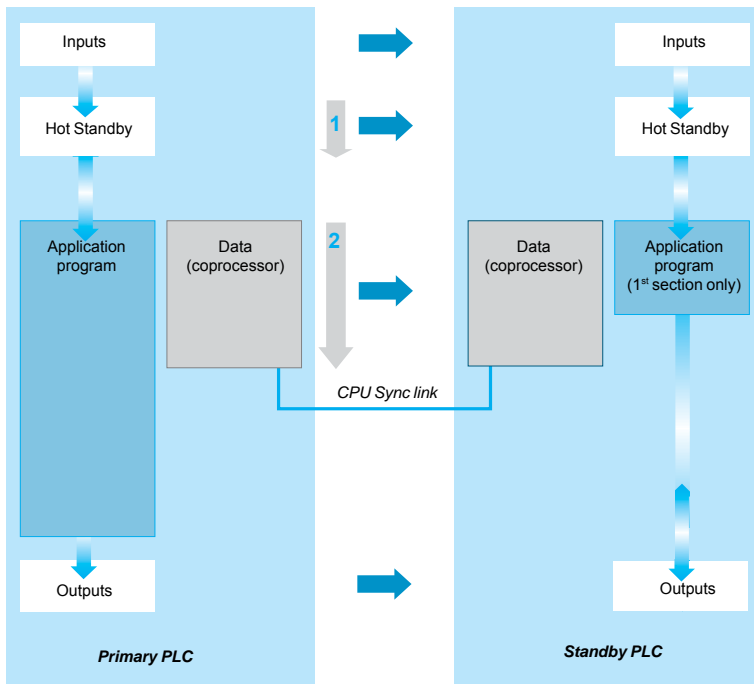

(1) The first 100 %MW words in each located data area are not exchanged. They can therefore be assigned to data for processing specific to each Primary or Standby PLC.

Modicon Premium automation platform

Hot Standby system

Unity Pro software



TSX H57 24M/44M



TSX ETY 4103/5103



TSX SCY 21601



TSX SCY 11601



TSX SCP 114

References

Hot Standby processors with Unity Pro

Type No.	I/O capacity	Memory capacity		No. of Ethernet network modules	Integrated ports	Reference	Weight kg
		Memory	Control channel				
TSX 57 2● 3	1024 discrete I/O 80 analog I/O channels 0 application-specific channels (1)	192 KB integrated 768 KB max. on PCMCIA card	10	2	- 1 RS 485 - 1 USB 12 Mbps - 1 Ethernet 100 Mbps port (dedicated to CPU Sync link)	TSX H57 24M	0.560
TSX 57 4● 3	2048 discrete I/O 256 analog I/O channels 0 application-specific channels (1)	440 KB integrated 2048 KB max. on PCMCIA card	20	4	- 1 RS 485 - 1 USB 12 Mbps - 1 Ethernet 100 Mbps port (dedicated to CPU Sync link)	TSX H57 44M	0.560

Modules for insertion in Primary and Standby rack (depending on architecture)

Designation No.	Description	Transparent Ready Services	Reference	Weight kg
Ethernet Modbus/TCP modules version ≥ sv 4.0 4	10/100 Mbps data rate, 10BASE-T/100BASE-TX	Class B30 Standard Web server, I/O Scanning, SMTP, SNMP	TSX ETY 4103	0.340
		Class C30 Configurable Web server, I/O Scanning, NTP, SMTP, SNMP	TSX ETY 5103	0.340
Serial link communication modules 7-8	7-8 One isolated integrated RS 485 channel, Modbus protocol, character mode and Uni-Telway One serial link PCMCIA card slot		TSX SCY 21601	0.360
		7 One isolated integrated RS 485 channel, Modbus protocol	TSX SCY 11601	0.340
PCMCIA card 9	RS 485, 1.2...19.2 Kbps, Modbus protocol, character mode and Uni-Telway For TSX SCY 21601 communication module		TSX SCP 114	0.105
I/O modules	6 Discrete		See pages 3/9 to 3/10	
	5 Analog		See page 3/16	
	Preventa safety, TSX PAY type		See page 4/7	

No. Refer to the architectures presented on pages 4/54 to 4/57.

(1) The Premium Hot Standby system does not accept application-specific channels (counter, motion control and weighing). Only communication application-specific channels (serial links) are allowed.



490 NTC 000 ●●



ABE 7ACC10/11

References (continued)

Separate connection components (1)

Designation No.	Use/composition (2)	Length	Reference (2)	Weight kg
Crossover cables for 11 CPU Sync link 13 inter-switch link	Shielded twisted pairs conforming to standard EIA/TIA 658 Equipped with 1 RJ45 connector at each end	5 m	490 NTC 000 05	–
		15 m	490 NTC 000 15	–
		40 m	490 NTC 000 40	–
		80 m	490 NTC 000 80	–
Straight-through cables for link between TSX ETY ●103 Ethernet module and switch 12	Shielded twisted pairs conforming to standard EIA/TIA 658 Equipped with 1 RJ45 connector at each end	2 m	490 NTW 000 02	–
		5 m	490 NTW 000 05	–
		12 m	490 NTW 000 12	–
		40 m	490 NTW 000 40	–
Modicon Telefast ABE 7 redundancy sub-bases 21 (connected on 3 HE 10 connectors)	For in-rack redundant discrete I/O (3) 16 channels in 2 x 16 channels	Input channels –	ABE 7ACC11	0.075
		Output channels –	ABE 7ACC10	0.075

No. Refer to the architectures presented on pages 4/54 to 4/57.

(1) Other separate parts: ConneXium managed and unmanaged switches: see pages 5/52 ... ; Modicon Telefast ABE 7: see pages 8/8 and 8/9.

(2) For UL and CSA 22.1 approved crossover cables and straight-through cables with shielded twisted pairs, add U at the end of the reference, for example 490 NTC/NTW 000 05U.

(3) For in-rack analog I/O, multiplexers 24 supplied by JM Concept, please consult the www.jmconcept.com website.

Modicon Premium automation platform

Warm Standby system
PL7 Pro software

Presentation

The Premium Warm Standby redundancy offer, which is only compatible with **PL7 Pro software**, ensures continuity of operation of a control system based on a Premium platform in the event of failure of:

- The central processing and communication functions
- All or part of the I/O system

It is based on the principle of Normal/Backup redundancy with complete redundancy of the main processing and communication functions, use of single shared I/O on the Fipio bus and/or redundancy of in-rack I/O.

It covers all the requirements for availability when the PLC's mission is to monitor an installation in continuous duty, indicate problems to a control station, and send the supervision manager's control instructions to various locations on an extensive site. It is suitable for processes which can tolerate a lack of control on the part of the PLC, lasting 1 to 2 s (average time for changeover from the Normal to the Backup unit).

Areas of application:

- In the commercial sector:
 - Building management system for a public site (tunnel, airport, signalling, etc.)
 - Control and monitoring of a water treatment or distribution station
 - Electrical management system
- In the industrial sector:
 - Food and beverage processing
 - Slow chemical processes
 - Level or temperature monitoring, etc.

Operational safety and availability

The Warm Standby architecture ensures availability of the control system functions, irrespective of the failure of a component in the system.

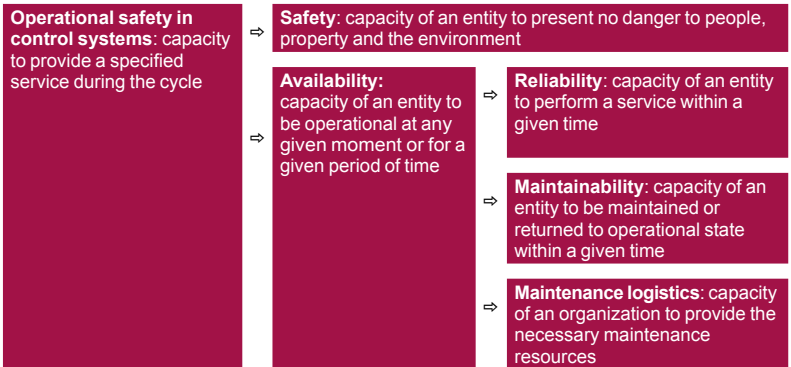

Modicon Premium automation platform

Warm Standby system
PL7 Pro software

Principle

The Premium Warm Standby redundant architecture combines physical redundancy of the PLC with Normal/Backup type operation.

Only the Normal PLC processes the application and generates the outputs. The Backup PLC applies the outputs generated by the Normal PLC, performs self-diagnostics and continuously diagnoses the Normal PLC.

If the Normal PLC fails, the Backup PLC takes control and becomes the Normal PLC (the faulty PLC, previously the Normal PLC, then becomes the Backup PLC).

Optimum availability of the application is ensured by:

- Automatic or user-initiated Normal/Backup changeover
- A smooth changeover on the actuators
- Updating of the Backup PLC each cycle
- Signalling of the faulty component
- Online repair
- Transparent supervision (SCADA)

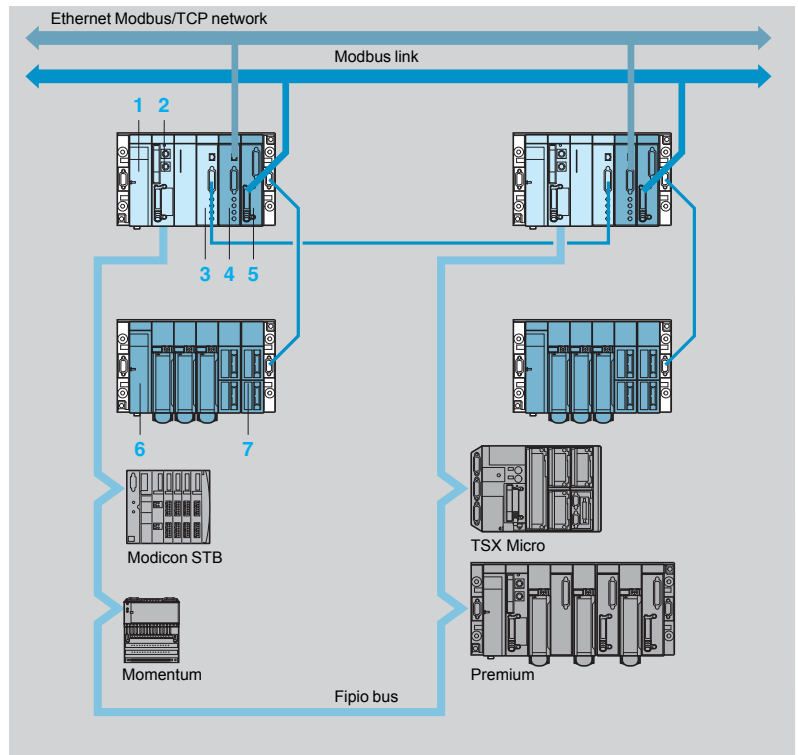

- Essential redundant components
 - 1 TSX PSY ●●●0M power supply
 - 2 TSX P57 353AM/453AM processor
 - 3 TSX ETY 110WS Ethernet Modbus/TCP communication module
- Optional redundant components
 - 4 TSX ETY 210 Ethernet Modbus/TCP communication module
 - 5 TSX SCY 21601 communication module with TSX SCP 114 Modbus protocol PCMCIA card
 - 6 TSX PSY ●●●0M power supply
 - 7 TSX D●Y discrete I/O modules
- Shared components on the Fipio bus

The redundant components are:

- The main rack
- The main rack power supply
- The processor
- Possibly accompanied by:
 - Discrete input modules
 - Discrete output modules
 - One or more extendable racks with their power supplies
 - One or more Ethernet Modbus/TCP network or Modbus link communication modules

The components on the Fipio bus shared between the Normal and Backup PLCs are:

- Discrete or analog input modules (Modicon STB or Momentum) (1)
- Discrete or analog output modules (Modicon STB or Momentum) (1)
- One or more TSX Micro/Premium PLC agents (these can support the entire range of discrete, analog or application-specific I/O)

(1) The old range of TBX distributed I/O is also supported.

Functions

Normal and Backup PLC functions

The Normal and Backup PLCs are physically and functionally identical, but their roles differ according to whether they are in Normal or Backup state.

The Normal Premium PLC

- Executes the application
- Updates the outputs and inputs (in-rack and on the Fipio bus)
- Communicates with the peripheral devices
- Sends its database to the Backup PLC
- Retrieves diagnostic data from the Backup PLC
- Generates its own diagnostic data as well as that of the Premium Warm Standby architecture

The Backup Premium PLC

- Executes part of the application
- Reads the state of the in-rack inputs
- Updates its in-rack and Fipio outputs according to the state of those of the Normal PLC
- Communicates with the peripheral devices
- Retrieves diagnostic data from the Normal PLC
- Generates its own diagnostic data as well as that of the Premium Warm Standby architecture

Management of shared I/O on the Fipio bus

The Fipio bus manages the I/O exchanges on the Fipio devices. The Normal PLC is an arbitrator for the active Fipio bus while the Backup PLC is an arbitrator for the passive Fipio network.

Due to the characteristics of the Fipio bus, only the Normal PLC reads the physical inputs on the Fipio bus and controls the physical outputs on the Fipio bus. The Backup PLC does not access the Fipio bus.

During each cycle, the Backup PLC receives the values of the I/O on the Fipio bus from the Normal PLC via the inter-PLC Ethway link (**TSX ETY 110WS** module) and applies them to its own outputs. **This updating of the memory enables a smooth Normal/Backup changeover** by maintaining the state of the I/O during the changeover time.

Management of Normal/Backup states

Failure of one of the following components automatically triggers a Normal/Backup changeover:

- Main rack power supply
- PLC processor
- **TSX ETY 210** communication module
- Fipio bus connected to the integrated processor port

For all the other components, the changeover from Normal to Backup can be customized (user-initiated changeover)

Management of optional redundant I/O

For the redundant inputs, the sensor data is transmitted to the Normal and Backup PLCs simultaneously via the 2 input modules placed in each PLC. Two Modicon Telefast ABE 7 16-channel sub-bases, **ABE 7ACC10** with redundant inputs and **ABE 7ACC11** with redundant outputs, can be used to perform this double wiring easily using preformed connection cables with HE 10 connectors (see page 4/67, items 14, 15, 20 and 21).

The output values are only generated by the application processing of the Normal PLC. This PLC sends its commands to the corresponding output modules.

During each cycle, the Backup PLC receives the Normal PLC output values via the inter-PLC Ethway link (**TSX ETY 110WS** module) and applies them to its own outputs. **This updating enables a smooth Normal/Backup changeover** by maintaining the state of the outputs during the changeover time.

Management of supervision transparency (SCADA)

Transparent communication with level 2 (supervisor, third-party device, etc.) during changeover of the PLC in Normal mode to the PLC in Backup mode is provided by the **TSX ETY 210** Ethernet Modbus/TCP modules, using the unique IP address. Communication with a redundant architecture is therefore similar to that with a standard architecture.

This transparency is identical with a Modbus link, using the **TSX SCP 114** PCMCIA card (Modbus protocol in RS 485) installed in the **TSX SCY 21601** communication module.

Functions

Ring topology for shared equipment on the Fipio bus

To improve the availability of shared equipment on the Fipio bus, it is possible to create a redundant Fipio ring using fibre optics. The fibre optic ring can then be used to:

- Maintain normal operation in the event of a break at some point on the fibre optic medium
- Increase the immunity of the Fipio bus in environments with high levels of electromagnetic interference

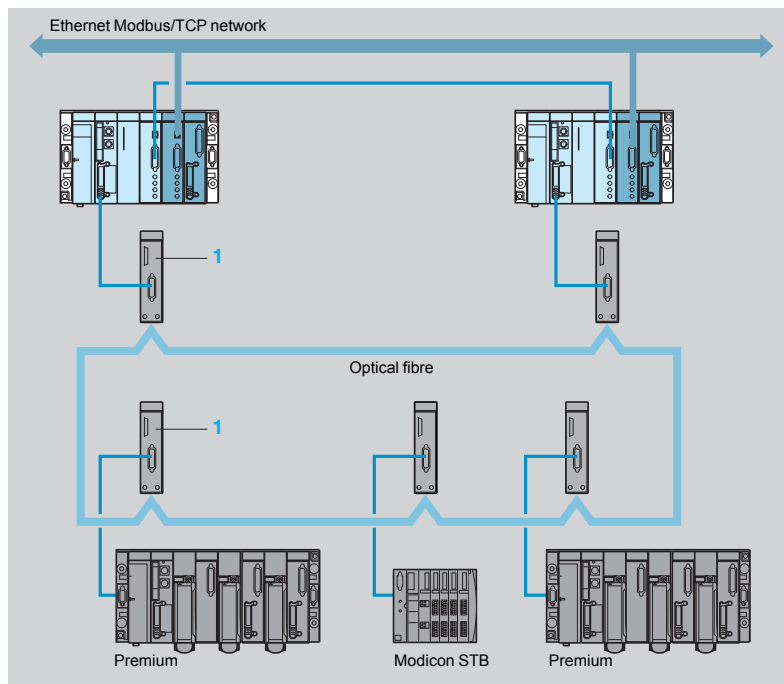

1 OZD FIP G3 fibre optic transmitter (see page 5/109)

Software setup

A Premium Warm Standby redundant architecture is set up using **PL7 Pro** software, in exactly the same way as a standard, non-redundant process. It is, however, necessary to apply the rule that the application programs of both the Normal and Backup PLCs are completely identical.

Modicon Premium automation platform

Warm Standby system
PL7 Pro software



TSX ETY 210



ABE 7ACC10/11

4

References

Description	Licence type	Reference	Weight kg
Ethernet Modbus/TCP communication module for Warm Standby redundant architecture on Premium	Identical to those for the TSX ETY 110WS module (see page 5/47) (1).	TSX ETY 210	0.270

Additional compatible elements

The Warm Standby architecture shown on page 4/63 includes the essential redundant components. Compatible standard modules can be added to this minimum configuration according to the requirements of the process to be automated.

Redundant components (in multiples of 2) (2)

- Bus X remote system:
 - **TSX REY 200** Bus X remote module, for increasing the length of the Bus X to 2 x 350 m
- Communication:
 - **TSX ETY 210** Ethernet Modbus/TCP communication module, for communication with level 3
 - **TSX SCP 114** PCMCIA Modbus communication card, for Modbus slave communication with transparent addressing for third-party devices. This card must be inserted in the slot in the **TSX SCY 21601** communication module
- Discrete I/O:
 - **TSX DEY ●●K** discrete input modules with HE 10 connectors with **ABE 7ACC11** Modicon Telefast redundant sub-bases
 - **TSX DSY ●●K** discrete output modules with HE 10 connectors with **ABE 7ACC10** Modicon Telefast redundant sub-bases
 - **TSX DMY ●●K** discrete mixed I/O modules with HE 10 connectors with **ABE 7ACC11/10** Modicon Telefast redundant sub-bases

Shared components on the Fipio bus

- Modicon STB distributed I/O modules
 - **STB NFP 2212** Fipio bus network interface module
 - **STB DDI/DAI/DDO/DAO/DR●** discrete I/O modules
 - **STB AVI/ACI/ART/AVO/ACO** analog I/O modules
- **TSX EEF/ESF/EMF** IP 67 I/O modules
- Momentum I/O modules:
 - **170 FTN 110 01** Fipio communication module
 - **170 ADI/ADO/ADM** discrete I/O base units
 - **170 AAI/AAO/AMM** analog I/O base units
- Fipio agent PLCs:
 - Premium PLC, can take all I/O and application-specific modules
 - TSX Micro PLC, can take all I/O and application-specific modules
- Other shared components:
 - **OZF FIP G3** fibre optic transmitter, can be used to create a Fipio bus fibre optic ring
 - **TSX FP ACC 6** Fipio electrical repeater, increases the length of the bus by the creation of segments, each 1000 m maximum.

(1) This module also provides the following for the Warm Standby architecture:

- Transparent addressing during the changeover
- Diagnostics of the architecture (self-tests, state of the Ethernet link and the dual TSX ETY 210 module)
- Maintenance with access to the Backup PLC

(2) The **TSX AEY/ASY** analog I/O modules and the **TSX CTY/CCY/CAY/CSY/CFY/ISP Y** application-specific modules are non-redundant components. They can however be used as shared components via the Fipio agent Premium PLCs.

Modicon Premium automation platform

Warm Standby system
PL7 Pro software

Connections

Example of an architecture with redundant I/O and shared I/O on Fipio bus

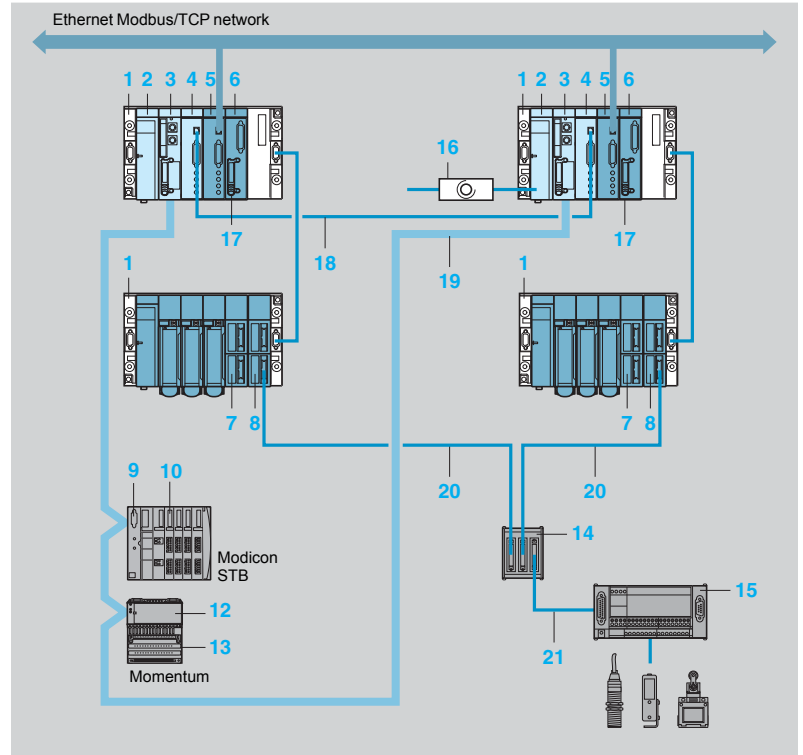

- 1 **TSX RKY ●EX**: Premium extendable rack
- 2 **TSX PSY●●●0M**: power supply module
- 3 **TSX P57 353AM/453AM**: Premium processor with integrated Fipio link
- 4 **TSX ETY 110WS**: Ethernet Modbus/TCP network module
- 5 **TSX ETY 210**: Ethway/Ethernet Modbus/TCP network module
- 6 **TSX SCY 21601**: communication module for type III PCMCIA card
- 7 **TSX DSY●●K**: redundant discrete output modules
- 8 **TSX DEY●●K**: redundant discrete input modules
- 9 **STB NFP 2212**: Fipio bus interface module with **TSX FP ACC2/12** connector (polycarbonate/zamak)
- 10 **STB D●/D●O/DR●/A●/A●O**: Advantys STB discrete or analog I/O modules
- 12 **170 FNT 110 00**: Fipio communication module for Momentum base unit with **TSX FP ACC2/12** connector (polycarbonate/zamak)
- 13 **170 ADI/AAI/ADM●●●**: Momentum discrete or analog I/O base unit
- 14 **ABE 7ACC11/10**: Modicon Telefast ABE 7 redundant sub-bases for discrete I/O
- 15 **ABE 7●16●●●**: Modicon Telefast ABE 7 connection sub-bases
- 16 **LA4 DT2U**: time-delay relay designed to desynchronize the starting of the Normal PLC and the Backup PLC during simultaneous power-up
- 17 **TSX SCP 114**: type III PCMCIA card for Modbus slave communication
- 18 **490 NTC 000●●**: preformed connection cable (crossed shielded twisted pair) with RJ 45 connector, for interconnecting **TSX ETY 110WS** modules
- 19 **TSX FP CA●00**: Fipio bus trunk cable (shielded twisted pair)
- 20 **TSX CDP●53**: preformed connection cable with HE 10 connector (length 0.5, 1, 2, 3, or 5 m)
- 21 **ABF H20H008**: preformed connection cable with HE 10 connector (length 0.08 m)

Selection guide: Buses and networks page 5/2
Selection guide: Web servers and gateways page 5/10

Ethernet Modbus/TCP and EtherNet/IP networks

- **Architecture** page 5/14
- **Web architecture, HMI embedded in PLC**
 - Presentation page 5/16
 - Standard Web services page 5/18
 - FactoryCast configurable Web services page 5/20
 - FactoryCast HMI Web services page 5/22
 - SOAP/XML Web services page 5/28
- **Ethernet Modbus/TCP communication services**
 - Presentation page 5/29
 - Ethernet universal services page 5/30
 - I/O Scanning service page 5/32
 - FDR (Faulty Device Replacement) service page 5/33
 - Global Data service page 5/34
 - NTP time synchronization service (Unity Pro) page 5/35
 - SMTP e-mail notification service (Unity Pro) page 5/36
 - SNMP network management service page 5/37
 - TCP Open optional service page 5/38
- **Performance** page 5/40
- **Processors and modules**
 - Processors with integrated Ethernet port page 5/46
 - Ethernet Modbus/TCP network modules page 5/47
 - EtherNet/IP and Modbus/TCP network module page 5/48
- Selection guide: ConneXium Ethernet wiring system* page 5/50
- **ConneXium Ethernet wiring system** page 5/64
- Selection guide: Wi-Fi access Points and Clients* page 5/74
- Selection guide: Wi-Fi antennas* page 5/78
- **ConneXium wiring system for Wi-Fi network** page 5/84

CANopen machine and installation bus

- **Presentation** page 5/86
- **Wiring system** page 5/89
- **References** page 5/90

AS-Interface bus

- **Presentation** page 5/92
- **References** page 5/93
- **AS-Interface cabling system** page 5/96

X-Way bus and network

- **Communication architecture** page 5/98
- **Fipio bus manager function** page 5/100
- **Fipio bus agent function** page 5/104
- **Fipway network** page 5/106
- **Fipio/Fipway fibre optic transceiver** page 5/108
- **Fipio/Fipway wiring system** page 5/110

Modbus Plus network and fieldbus

- **Modbus Plus network**
 - Presentation page 5/114
 - Wiring system page 5/115
 - References page 5/116
- **Profibus DP V0 fieldbus**
 - Presentation page 5/118
 - References page 5/119
- **Profibus DP V1 and Profibus PA fieldbuses**
 - Presentation page 5/120
 - References page 5/121
- **INTERBUS fieldbus**
 - Presentation page 5/122
 - References page 5/123

Serial links

- **Modbus serial link**
 - Presentation page 5/124
 - References page 5/125
- **Uni-Telway serial link**
 - Presentation page 5/128
 - References page 5/130
- **Asynchronous serial links**
 - Presentation page 5/132
 - References page 5/133
- **Connecting cables for PCMCIA cards and TER/AUX ports** page 5/134

Modicon Premium automation platform

Ethernet network processors and modules
Transparent Ready

Applications

Processors with integrated Ethernet Modbus/TCP port



Type

Ethernet Modbus/TCP

Structure	Physical interface
	Access method
	Data rate

10BASE-T/100BASE-TX (RJ45)
CSMA-CD
10/100 Mbps

Medium

CAT 5E double twisted pair cable
Fibre optic via Ethernet ConneXium cabling system

Configuration	Maximum number of devices
	Maximum length
	Number of networks/station
	Other integrated port

64 stations maximum per network			
128 stations maximum per network with TSX P57 5634M/6634M processors			
100 m (copper cable), 4000 m (multimode optical fibre), 32,500 m (single mode optical fibre)			
1 integrated Ethernet port	3 (1)	4 (1)	
–	Fipio bus (bus manager)	–	Fipio bus (bus manager)

Standard services	Ethernet services
	X-Way services
	Ethway

Modbus/TCP and Uni-TE message handling
X-Way inter-network routing, X-Way/Uni-Telway routing, module diagnostics
–

Transparent Ready class

B30

Embedded Web server services	Standard services
	FactoryCast services
	Factory Cast HMI services

Rack Viewer PLC diagnostics
Data Editor access to PLC data and variables
–
–

Transparent Ready communication services	I/O Scanning
	Global Data
	FDR server
	–
	NTP time synchronization
	SMTP e-mail notification
	SNMP network manager
	SOAP/XML Web
	TCP Open
	Bandwidth management
	Quality of Service (QoS)

Yes (64 stations, 128 stations with TSX P57 5634M/6634M)
Yes
Yes (automatic assignment of IP address and network parameters)
–
Yes (via Unity Pro function blocks)
Yes
–
–
Yes
–

Compatible processors

–

Module format

Double format processor

Consumption

See page 9/6

Standards and certifications

See pages 9/8 to 9/18

Module type

TSX P57 1634M TSX P57 2623M TSX P57 2634M	TSX P57 2823M	TSX P57 3623AM TSX P57 3634M	TSX P57 4823AM TSX P57 4634M TSX P57 5634M TSX P57 6634M
--	----------------------	---	---

Pages

5/46

(1) Including the integrated Ethernet port.



More technical information on www.schneider-electric.com

Ethernet Modbus/TCP modules **EtherNet/IP and Modbus/TCP module**



Ethernet Modbus/TCP **EtherNet/IP and Modbus/TCP**

10BASE5 (AUI), 10BASE-T CSMA-CD	10BASE-T, 100BASE-TX (RJ45)			
10 Mbps	10/100 Mbps			
Triaxial cable or CAT 5E double twisted pair cable Fibre optic via Ethernet ConneXium cabling system	CAT 5E double twisted pair cable Fibre optic via Ethernet ConneXium cabling system			
64 stations maximum per network				128 stations maximum per network
100 m (copper cable), 4000 m (multimode optical fibre), 32,500 m (single mode optical fibre)				
1 to 4 depending on processor used				
-				
Modbus/TCP and Uni-TE message handling				Modbus/TCP and EtherNet/IP message handling
X-Way inter-network routing, X-Way/Uni-Telway routing, module diagnostics				-
Uni-TE message handling, common words, applic. to application				-
C10	B30	C30	D10	-
Rack Viewer PLC diagnostics Data Editor access to PLC data and variables				
Alarms Viewer Graphic Data Editor Display of user Web pages (1.4 Mb available)	-		Alarms Viewer Graphic Data Editor Display of user Web pages (8 Mb available)	-
-			FactoryCast HMI services (2)	-
-			Yes (between 64 stations)	Yes (between 128 stations)
-			Yes	-
-			Yes (automatic assignment of IP address and network parameters)	Yes (automatic assignment of IP address and network parameters)
-			Yes	-
-			Yes (via Unity Pro function blocks)	Yes (active Web server)
SNMP agent				
-		Server	Client/server	
Option	-		Option	-
-		Yes	-	
-				Yes
All types of Premium processors TSX P57 1●/P57 2●/P57 3●/P57 4●/P57 5●/P57 6●				
Standard format module				
See page 9/6				
See pages 9/8 to 9/18				

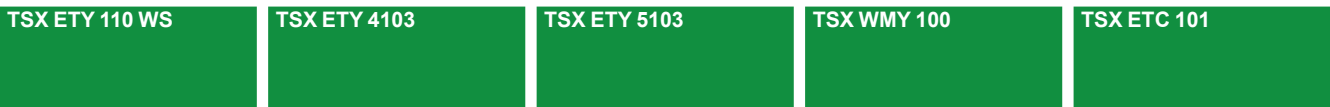

5/47 5/49

(2) FactoryCast HMI services: HMI database, automatic e-mail notification of events, interpreted math and logic functions, connection to relational databases and simulator tool for debugging.

Modicon Premium automation platform

Network and bus modules

Applications	Industrial LAN compliant with the Modbus Plus standard	Industrial LAN compliant with the Fip standard
---------------------	--	--



Type		Modbus Plus	Fipway
Structure	Physical interface	Modbus Plus standard RS 485	WorldFip standard Devices connected by daisy-chaining or tap junctions
	Access method	Token ring	Bus managed by bus arbitrator
	Data rate	1 Mbps	1 Mbps
Medium		Twisted pair Fibre optic	Twisted shielded pair Fibre optic via transmitters or repeaters
Configuration	Number of devices	32 per segment 64 on all segments	
	Maximum length	450 m per segment 1800 m with 3 repeaters	1000 m per electrical segment 5000 m max. with repeaters
	Number of links/station	1 max.	1 to 4 depending on processor model
Services	Message handling	Modbus Plus message handling: - Reading/writing variables - Global database - Peer Cop service	- Uni-TE - Shared COM/table - Application to application - Telegram
Processor type		All types of Premium processor	
Module type		PCMCIA type III card on Premium processor	PCMCIA type III card on Premium processor (1) and on TSX SCY 21601 module
Consumption		-	
Standards and certifications		See pages 9/8 to 9/18	
Module type		TSX MBP 100	TSX FPP 20
Pages		5/116	5/107

(1) Except on **TSX P57 4634M/5634M/6634M** processors with integrated Ethernet port.

5



CANopen machine bus



Actuator/sensor bus compliant with the AS-Interface standard



Modbus serial link



CANopenbus V4.02

ISO 11898 Devices connected by daisy-chaining or tap junctions
CSMA/CA, multimaster 20 Kbps...1 Mbps depending on distance
Double shielded twisted pair
127 slaves
From 20 m (1 Mbps) to 2500 m (20 Kbps)
1 max.

CANopen: - Implicit PDO exchange - Explicit SDO exchange or CAN function block - Explicit PDU CAN exchange

All types of Premium processor (except **TSX P 57 153M**)

PCMCIA type III card on Premium processor

–

See pages 9/8 to 9/18

AS-Interface

AS-Interface V2 standard
Master/slave 167 Kbps
Two-wire AS-Interface cable
31 + 31 discrete, analog or safety devices
100 m 200 m with repeaters
2 to 8 depending on processor model

Transparency of exchanges with sensor/actuator devices
--

All types of Premium processor

Standard format module

See page 9/6

Modbus

Non-isolated RS 232 Isolated RS 485 20 mA CL	Isolated RS 485
Master/slave 19.2 Kbps max.	
Double shielded twisted pair	
32 devices max. 48 slave addresses max.	32 devices max. 247 slave addresses max.
15 m in RS 232 1000 m in RS 485 1300 m in 20 mA CL or integrated link	1300 m

Modbus master/slave RTU or ASCII 13 Modbus functions (read/write bits and words, diagnostics)
--

PCMCIA type III card inserted on (2)	Standard format module
--------------------------------------	------------------------

TSX CPP 110

5/88

TSX SAY 1000

5/93

TSX SCP 11● (3)

1 Integrated link
TSX SCY 21601

5/125

TSX SCY 11601

(2) Premium processors and on **TSX SCY 21601** communication module.
(3) Replace the ● at the end of the reference with **1** for RS 232, **2** for 20mA CL or **4** for isolated RS 485.

Modicon Premium automation platform

Bus modules

Applications Network type	Open industrial fieldbus compliant with the FIP standard	Uni-Telway serial link
-------------------------------------	--	------------------------



Type		Fipio (agent)	Fipio (bus manager)	Uni-Telway	
Structure	Physical interface	FIP standard		Non-isolated RS 485	Isolated RS 485
	Access method	Bus managed by bus arbitrator		Master/slave	
	Data rate	1 Mbps		19.2 Kbps max.	
Medium		Twisted pair Fibre optic via transmitters or repeaters		Double shielded twisted pair	
Configuration	Number of devices	32 per segment 128 for all segments (limited to 64 with TSX P57 1 processor)		5 (excluding programming terminal)	28, 96 slave addresses max.
	Max. length	1000 m to 15,000 m (depending on the medium used) with repeaters		10 m	1000 m
	Number of links/station	1 max.		1 max.	64 max. depending on processor and application-specific channels used
Services	Message handling	Uni-TE: - Periodic data exchange (Agent function) - Application to application - Transparent exchange of remote I/O		Uni-Telway : - Uni-TE message handling 240 bytes - Client/server - Application to application 240 bytes - Transparency of all devices on X-Way architecture via a master	
Processor type		All types of Premium processor	TSX P57 1 TSX P57 1 TSX P57 1	All types of Premium processor	
Module type		PCMCIA type III card on Premium processor	Integrated link on the Premium processor	Integrated Uni-Telway link	Standard format module
Consumption		–	See page 9/6		
Standards and certifications		See pages 9/8 to 9/18			
Module type		TSX FPP 10	2 Integrated link on processor	1 TER and AUX terminal port	2 TSX SCY 21601
Pages		5/105	5/103	5/130	

5



Uni-Telway serial link (continued)

INTERBUS industrial fieldbus

Profibus DP V0 high speed industrial field bus



Uni-Telway

INTERBUS

Profibus DP V0

RS 232, isolated RS 485 and 20 mA CL
Master/slave
19.2 Kbps max.

Isolated RS 485
Generation 4 master/slave
500 Kbps

RS 485
Master
9.6 Kbps...12 Mbps depending on distance

Double shielded twisted pair

Shielded twisted pair
Fibre optic, infrared, etc.

Shielded twisted pair
Fibre optic or infrared

2 in RS 232,
28 in RS 485,
16 on 20 mA CL

512 slaves max. with 254 bus terminal modules max.

126 slaves

15 m in RS 232,
1000 m in isolated RS 485,
1300 m in 20 mA CL

400 m max. (remote bus)

1200 m (9.6 Kbps), 4800 m with 3 repeaters
100 m (12 Mbps), 400 m with 3 repeaters

64 max. depending on processor and application-specific channels used

1 or 2 depending on type of Premium processor (with PL7 Pro/Junior)
1 to 5 depending on type of Premium processor (with Unity Pro)

Uni-Telway :
- Uni-TE message handling 240 bytes
- Client/server
- Application to application 240 bytes
- Transparency of all devices on X-Way architecture via a master

- Data process implicit exchange
- Pre-processing
- Logic addressing
- Segmentation

- Read/write access for DP slave I/O data
- Data transfer for slave diagnostics
- Slave parameter setting and monitoring
- Management of monitoring requests
- Inter-master dialogue not supported

All types of Premium processor

All types of Premium processor (except **TSX P57 1●**)

PCMCIA type III card on processor and on TSX SCY 21601 communication module

Standard format module

Standard format module

-

See page 9/6

See pages 9/8 to 9/18

TSX SCP 11●
(1)

TSX IBY 100

TSX PBV 100

5/130

5/123

5/119

(1) Replace the ● at the end of the reference with 1 for RS 232, 2 for 20 mA CL or 4 for isolated RS 485.

Modicon Premium automation platform

Profibus Remote Master module

Applications
Network type

Profibus DP V1 high speed industrial fieldbus



Type

Ethernet/Profibus DP V1 gateway and Profibus PA (via gateway)
 Ethernet Modbus/TCP ports

Structure

Physical interface
Access method
Data rate

10BASE-T/100BASE-TX
CSMA-CD
10/100 Mbps

Medium

CAT 5E double shielded twisted pair (straight-through or crossover)

Configuration

Number of devices
Maximum length

1 to 4 depending on processor
100 m (copper cable) 400 m (single mode optical fibre) 2500 m (multimode optical fibre)

Services

Message handling

- Modbus TCP message handling (reading/writing of data words)
- No Web server
- Modbus server scanned by the PLC
- FDR service
- SNMP agent network management service

Processor type

All Unity Pro processors

Module type

Standalone gateway

24 V external power supply

18...30 V

Module type

TCS EGPA23F14F

Pages

5/121

5



Profibus DP V1 high speed industrial fieldbus



Ethernet/Profibus DP V1 gateway and Profibus PA (via gateway)

◀ Profibus DP V1 and Profibus PA ports (via gateway)

Isolated RS 485

Master/slave

9.6 Kbps...12 Mbps

Shielded twisted pair

126 slaves

1200 m (9.6 Kbit/s), 4800 m with 3 repeaters
100 m (12 Mbps), 400 m with 3 repeaters

- Cyclic and acyclic data exchange with slaves
- Master/slave communication
- Global Control service
- Acyclic communication (read/write) in Class 1 and 2
- Extended diagnostics support
- Auto-scanning service of slaves on the bus

All Unity Pro processors

Standalone gateway

18...30 V ~

TCS EGPA23F14F

5/121

5



Applications

Type

Web Server modules for PLCs

FactoryCast



Target products Type

TSX Micro PLCs Modicon M340 PLCs

Network/Remote access services	Remote access
	Gateway function
	Serial protocols
	Ethernet protocols
	TCP/IP protocols
	Security

Intranet or via external RAS/modem	
Remote programming, downloading via FTP, access to Web server via web browser	
-	
-	
Modbus/TCP, Uni-TE	Modbus/TCP
BootP/DHCP, DNS, SNMP agent, SMTP client, NTP client, FTP	
Protection by IP address filtering and passwords	

Web server Characteristics

HTTP and FTP server, 8 MB memory available for user, hosting of user Web pages and documents (Doc, Pdf, Excel)

Predefined services	Configuration
	Diagnostics
	Monitoring
	Alarm management

Via Web Designer software or predefined Web pages	
System, rack and PLC I/O diagnostics via predefined Web pages	
Monitoring of devices and application via animation tables (read/write variables)	
Display of PLC Unity program in a Web page	
Monitoring of PLC and application alarms via predefined Web pages	

Customizable services	Graphic views
	Unity Pro operator screen
	User Web pages

Graphic monitoring via animated views (integrated graphic editor)	
-	
Graphic monitoring via animated Web pages created by the user	

Advanced and HMI services	Calculation scripts
	E-mail service
	Data logging
	Database connection
	Report service
	Recipe service

-	
Alarm notification by e-mail	
-	
-	
-	
-	

Application development software

Web Designer (supplied with each module)



References

TSX ETZ 510 **BMX NOE 0110**

Pages or catalogues

TSX Micro automation platform Modicon M340 platform

Web Server modules for PLCs

FactoryCast

FactoryCast HMI



Modicon Premium PLCs

Modicon Quantum PLCs

Modicon Premium PLCs

Modicon Quantum PLCs

Intranet or via external RAS/modem

Remote programming, downloading via FTP, access to Web server via web browser

–

Modbus/TCP, Uni-TE

Modbus/TCP

Modbus/TCP, Uni-TE

Modbus/TCP

BootP/DHCP, DNS, SNMP agent, SMTP client, NTP client (1), FTP

BootP/DHCP, DNS, SNMP agent, SMTP client, NTP client, FTP

BootP/DHCP, DNS, SNMP agent, SMTP client, NTP client (1), FTP

BootP/DHCP, DNS, SNMP agent, SMTP client, NTP client, FTP

Protection by IP address filtering and passwords

HTTP and FTP server, 8 MB memory available for user, hosting of user Web pages and documents (Doc, Pdf, Excel)

Via Web Designer software or predefined Web pages

System, rack and PLC I/O diagnostics via predefined Web pages

Monitoring of devices and application via animation tables (read/write variables)

Display of PLC Unity program in a Web page

Monitoring of PLC and application alarms via predefined Web pages

Graphic monitoring via animated views (integrated graphic editor)

–

Display in the form of Web pages

Graphic monitoring via animated Web pages created by the user

–

Arithmetic and logical scripts

Alarm notification by e-mail

–

Data recorded in the module with time stamping

–

Direct recording in an SQL, Oracle or MySQL server

–

Dynamic HTML report management

–

Management of "Recipe" data (storage and review locally or on remote database)

–

Web Designer (supplied with each module)



Web Designer

TSX ETY 5103

140 NOE 77111

TSX WMY100

140 NWM 10000

5/47

Modicon Quantum platform

5/47

Modicon Quantum platform

(1) Except with **TSX P57 103M/153M** processors which do not have the NTP service.



Modicon Premium automation platform

Web servers and gateways

5

Applications	Modicon M340 in-rack Web Gateway/Server module for remote access	Standalone Web Gateway/Server module for remote access
Type	RTU module	FactoryCast Gateway ETG 10●0



Target products	Type	Modicon M340 RTU PLCs SCADA Telemetry supervisor	All equipment supporting Modbus
Network/Remote access services	Remote access	TCP/IP, LAN/WAN, XDSL or Serial networks (1) RTC/PSTN, GPRS/3G, radio modems	Intranet or via external Modem and integrated RAS function Remote programming, downloading via FTP, access to Web server via web browser
	Gateway function	Ethernet Modbus/TCP to Serial or external modem link	Ethernet to Modbus serial Modem to Modbus serial and Ethernet
	Serial protocols	RTU serial protocols: IEC 60870-5-101 and DNP3 (subset level 3)	Modbus master
	Ethernet protocols	Ethernet RTU protocols: IEC 60870-5-104 and DNP3 (subset level 3)	Modbus/TCP
	TCP/IP protocols	BootP/DHCP, DNS, SNMP agent, SMTP client, NTP client, FTP	BootP/DHCP, DNS, SNMP agent, SMTP client, client NTP (2), FTP
	Security	Protection by IP address filtering and passwords	
Web server	Characteristics	HTTP and FTP server for setting the RTU protocol parameters, diagnostics and monitoring	HTTP and FTP server, 8 MB memory available for user, hosting of user Web pages and documents (Doc, Pdf, Excel)
Predefined services	Configuration	Via Web Designer software	Via Web Designer software or predefined Web pages
	Diagnostics	Rack Viewer PLC diagnostics	Serial device diagnostics via predefined Web pages
	Monitoring	Data editor access to PLC data and variables. Display of Unity program in a Web page	Monitoring via animation tables Display of Unity program in a Web page
	Alarm management	-	-
Customizable services	Graphic views	-	Graphic monitoring via animated views (integrated graphic editor)
	Unity Pro operator screen	-	-
	User Web pages	-	Graphic monitoring via animated Web pages created by the user
Advanced and HMI services	Calculation scripts	-	-
	E-mail service	Alarm notification by e-mail or SMS	Alarm notification by e-mail
	Data logging	Archiving of application data Data Logging with time and date stamping in the module's Flash memory card	-
	Database connection	-	-
	Report service	-	-
	Recipe service	-	-
Application development software	Web Designer (supplied with each module)		



Web Designer

References	BMX NOR 0200H	TSX ETG1000
-------------------	----------------------	--------------------

Catalogue or website	Modicon M340 platform	www.schneider-electric.com
-----------------------------	-----------------------	----------------------------

(1) The RTU module's serial port is not isolated. For an extended serial network (> 15 m), the network must be isolated, for example, using the TWD XCA ISO RS 485 isolation box (see page 5/125). For more information, please refer to the Modicon M340 platform catalogue.



More technical information on www.schneider-electric.com

Standalone Web Gateway/Server modules for remote access

FactoryCast Gateway ETG 10●0

FactoryCast HMI Gateway ETG30●●



All equipment supporting Uni-Telway	All Modicon PLCs and third-party equipment supporting Modbus		
Intranet or Modem, External Modem and integrated RAS function	Intranet or Modem	RTC modem and integrated RAS function	Intranet or Modem
Remote programming, downloading via FTP, access to Web server via web browser			
Ethernet to Uni-Telway serial	Ethernet to Uni-Telway serial, Modem to Modbus serial and Ethernet		
Modem to Uni-Telway and Ethernet			
Uni-Telway slave	Modbus master		
Modbus/TCP	Modbus/TCP		
Uni-TE (Premium, Micro)			
BootP/DHCP, DNS, SNMP agent, SMTP client, NTP client (2), FTP	DHCP, DNS, SNMP agent, SMTP client, NTP client (2), FTP		
Protection by IP address filtering and passwords			
HTTP and FTP server, 8 MB memory available for user, hosting of user Web pages and docs (Doc, Pdf, Excel)	HTTP and FTP server, 32 MB memory available for user Web pages, memory expansion using Compact Flash cards 1 Gb max., hosting of user Web pages and documents (Doc, Pdf, Excel)		
Via Web Designer software or predefined Web pages			
Serial device diagnostics via predefined Web pages	Network diagnostics, serial and Ethernet device diagnostics via predefined Web pages		
Monitoring of devices and application via animation tables (read/write variables)			
Display of PLC Unity program in a Web page			
-			
Graphic monitoring via animated views (integrated graphic editor)			
-			
Graphic monitoring via animated Web pages created by the user			
-			
Arithmetic and logical scripts			
Alarm notification by e-mail	Alarm notification by e-mail / SMS		
-	Data recorded in the module with date and time stamping (CSV files)		
-	Direct recording in an SQL, Oracle or MySQL server		
-	Dynamic HTML report management		
-	Management of "Recipe" data (storage and review locally or on remote database)		
Web Designer (supplied with each module)			



Web Designer

TSX ETG1010	TSX ETG3000	TSX ETG3010 (PSTN modem)	TSX ETG3021 (GSM 900/1800 MHz band) TSX ETG3022 function (GSM 850/1900 MHz band)
--------------------	--------------------	---------------------------------	---

www.schneider-electric.com

(2) Except with **TSX P57 103M/153M** processors which do not have the NTP service.



More technical information on www.schneider-electric.com

Modicon Premium automation platform

Ethernet Modbus/TCP network
Logical communication architecture

Logical communication architecture

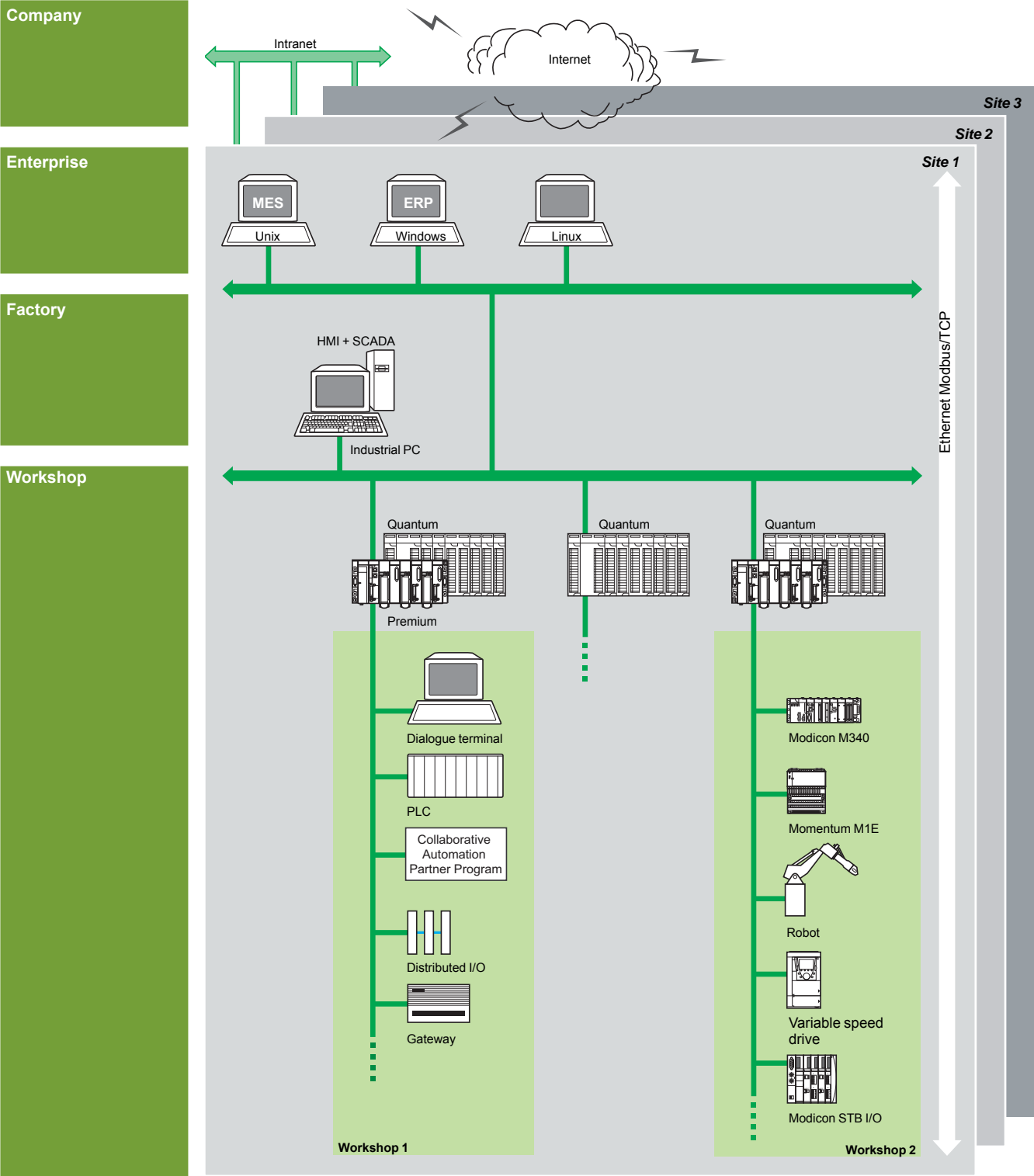

MES: Manufacturing Execution System (production management system)
ERP: Enterprise Resource Planning (integrated management software packages)
IHM/SCADA: Human/Machine Interface and Supervision Control And Data Acquisition
Gateway: Gateway to sensor/actuator bus, to installed base network, fieldbus, etc.

5

Physical communication architecture

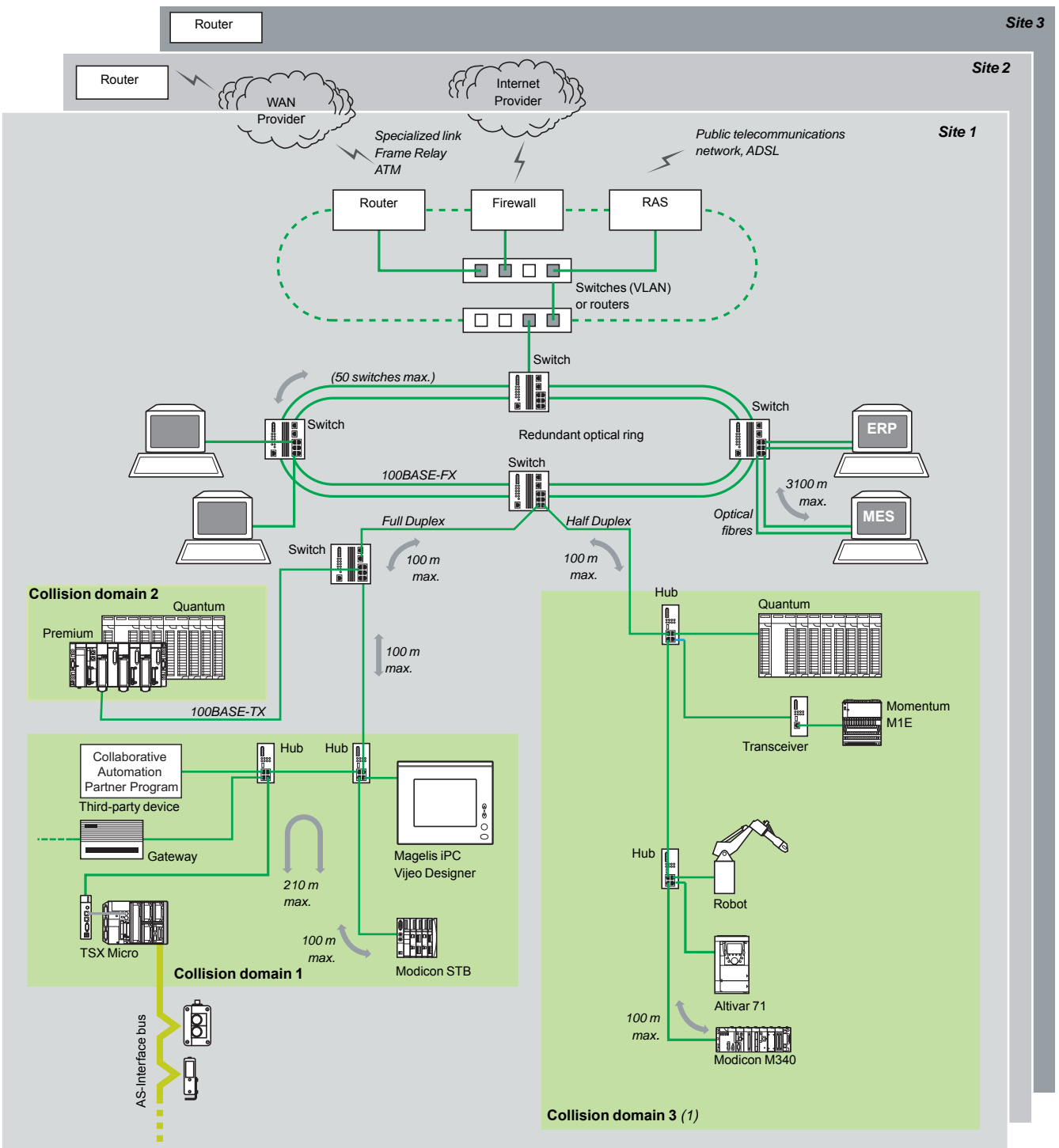

(1) As a general rule, defining several collision domains can increase the size of the architecture and improve performance (see pages 9/12 to 9/17).

Modicon Premium automation platform

Ethernet Modbus/TCP network
FactoryCast Web servers and gateways

5

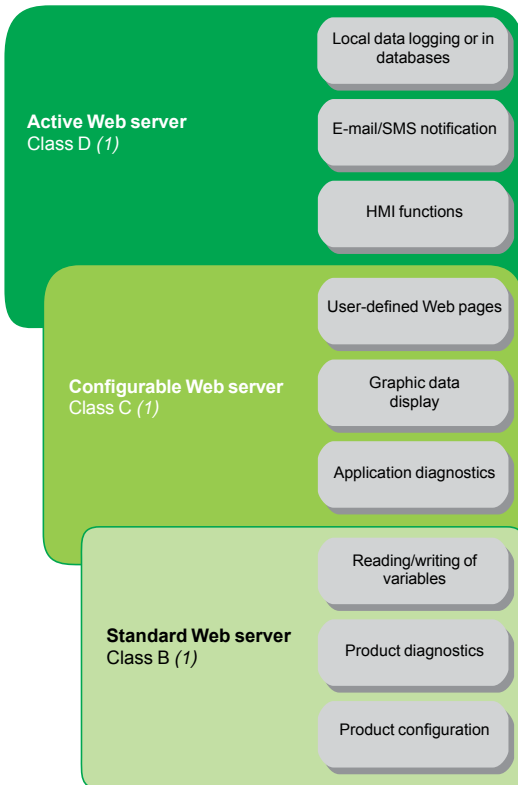

FactoryCast Web server offer

Schneider Electric offers a wide range of Transparent Ready products, such as controllers and PLCs, industrial PCs, HMI devices (2), variable speed drives, distributed I/O modules, gateways, Web servers, switches, SCADA software, inductive identification systems, etc.

These products provide different levels of Web services and communication services on Ethernet Modbus/TCP, according to users' requirements.

Among these Transparent Ready products, FactoryCast defines a range of modules and gateways with configurable Web server combining:

- Real-time communication functions based on Ethernet Modbus/TCP
- Predefined Web pages for advanced installation diagnostics
- The capacity to host dynamic user-defined Web pages or any document (.doc, pdf, etc.) designed to assist maintenance

Presentation of the Web server modules and gateways

In the Transparent Ready approach, Ethernet network modules or Web gateways integrate Ethernet Modbus/TCP services (Modbus TCP/IP messaging, SNMP network management functions, etc.). They also offer, depending on the product, the following Web functions:

- Standard Web services (predefined)
- FactoryCast configurable Web services
- FactoryCast HMI active Web services

There are two ranges of configurable Web server:

- **FactoryCast Web modules for PLCs**, which are embedded in the Modicon TSX Micro, Modicon M340, Modicon Premium and Modicon Quantum automation platforms. These modules provide transparent access to system and application diagnostic information in real time using Web technologies.
- **FactoryCast Web Gateway modules**, with all the network interfaces in one standalone unit:
 - A modem (depending on the version)
 - An RAS/Router function
 - A customizable Web server
 - HMI functions (depending on the version)

FactoryCast Gateways are a cost-effective response to requirements for remote access to customized remote diagnostics, maintenance, monitoring and control services using a simple web browser as well as to requirements to integrate serial installations (Modbus RTU or Uni-Telway) in an existing Ethernet Modbus/TCP infrastructure.

Presentation of Web services

Standard Web services

Standard Web services are integrated in the following Schneider Electric Ethernet products: automation platform processors and Ethernet modules, distributed I/O modules, variable speed drives and Ethernet gateways (see page 5/17).

Using a simple web browser, the standard Web server provides the following ready to use functions:

- Product configuration
- Remote diagnostics and maintenance of products
- Display and adjustment of products (reading/writing variables, status)

The embedded Web server is a real-time data server. All the data can be presented in the form of standard web pages in HTML format and can therefore be accessed using any web browser that supports the embedded Java code. The standard functions provided by the Web server are supplied ready to use and therefore do not require any programming of either the PLC or the client PC device supporting a web browser.



(1) In order to simplify their selection and ensure their interoperability within a system, each Transparent Ready product is identified by the class of services it provides. Letter A, B, C or D (level of service for the Web server) followed by 10, 20 or 30 (level of service for Ethernet communication).

(2) HMI = Human Machine Interface

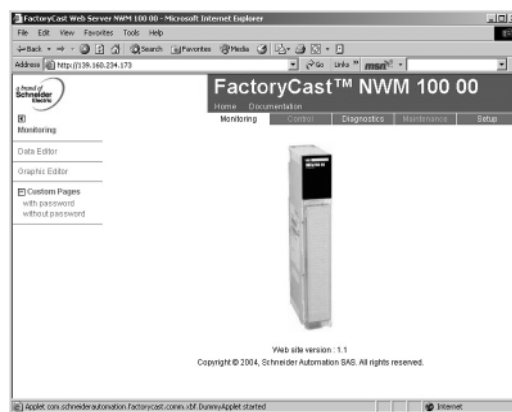
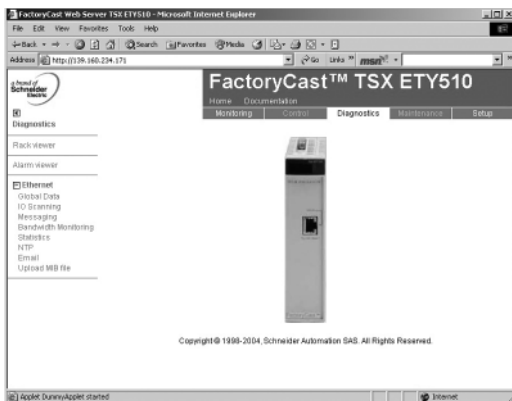

Presentation of Web services (continued)

FactoryCast configurable Web services

The configurable Web services are integrated in the following Schneider Electric Ethernet products: FactoryCast PLC modules (Modicon TSX Micro, Modicon Premium and Modicon Quantum) and FactoryCast Gateway modules.

In addition to the standard Web services, the configurable Web servers offer the following functions:

- Graphic application diagnostics (customized graphic views created by the user).
 - Graphic supervision via animated Web pages created by the user and stored in the Web server module
 - And, depending on the products:
 - Management of PLC alarms (system and application) with partial or total acknowledgement (ready to use Alarm Viewer function pages)
 - Open data server interface. SOAP/XML protocol, WSDL interface (1)
- FactoryCast Web servers can also be used to customize the supervision, diagnostics or maintenance interface via Web pages defined by the user or any other document (doc, pdf, etc.) hosted in the module.

FactoryCast HMI active Web services

The active Web services are integrated in the FactoryCast HMI modules of Modicon Premium and Modicon Quantum PLCs.

In addition to the FactoryCast Web services, the FactoryCast HMI modules provide HMI functions, which are executed in the module itself:

- Real-time HMI database management, independent of the PLC processor
- Arithmetic and logical calculations on HMI data
- Direct connectivity with relational databases (traceability)
- Data Logging: recording data in the module
- Display of Unity Pro graphic runtime screens in the form of Web pages
- Recipe management (read/write)
- Alarm and report notification by e-mail
- Active page server, dynamic generation of animated HTML pages
- Dynamic generation of HTML reports

FactoryCast HMI is defined as an active Web server used to execute HMI functions without any effect on the PLC application program and therefore on its scan time.



Web server automation products

Product	Reference	Embedded Web server		
		Standard, class B●0	Configurable, class C●0	Active, class D●0
Modicon Quantum platform	Processors	140 CPU 651 50/60	–	–
		140 CPU 652 60	–	–
	Modules	140 NOE 771 01	–	–
		140 NOE 771 11	–	FactoryCast
		140 NWM 100 00	–	FactoryCast HMI
Modicon Premium platform	Processors	TSX P57 2●23 M	–	–
		TSX P57 3623 AM	–	–
		TSX P57 4823 AM	–	–
		TSX P57 ●634 M	–	–
	Modules	TSX ETY 4103	–	–
		TSX ETC 101	–	–
		TSX ETY 110WS	–	FactoryCast
		TSX ETY 5103	–	FactoryCast
		TSX WMY 100	–	FactoryCast HMI
Modicon M340 platform	Modules	BMX NOE 0100	–	–
		BMX NOC 0401	–	–
		BMX NOE 0110	–	FactoryCast
		BMX NOR 0200H	–	FactoryCast
Modicon TSX Micro platform	Modules	TSX ETZ 410	–	–
		TSX ETZ 510	–	FactoryCast
Inductel identification station	XGK S1715503	–	–	–
FactoryCast Web Gateway	TSX ETG 10●0	–	FactoryCast	–
FactoryCast HMI Web Gateway	TSX ETG 30●●	–	FactoryCast	FactoryCast HMI

(1) For standard protocol providing interoperability with computer management applications, see page 5/28.

Modicon Premium automation platform

Ethernet Modbus/TCP network
Modicon PLC standard Web services

Modicon PLC standard Web services

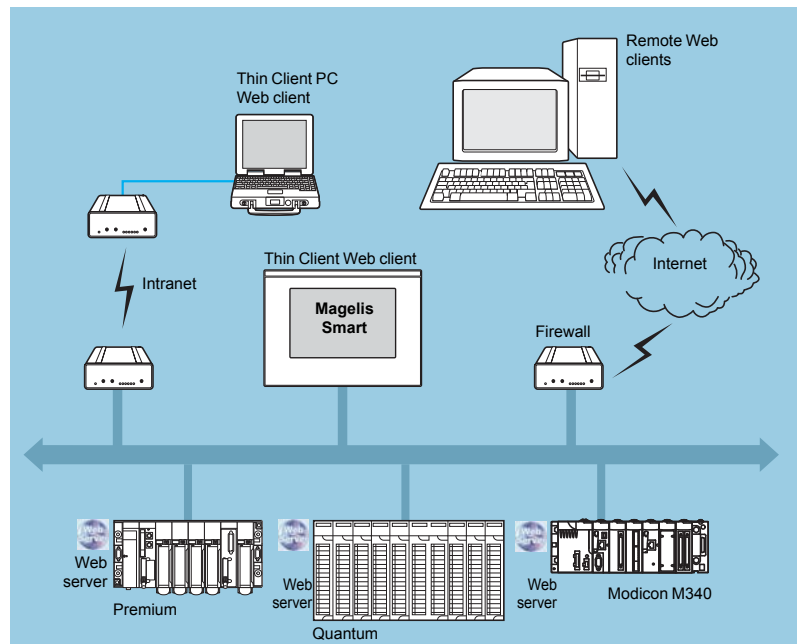

The predefined Rack Viewer PLC diagnostic function and the Data Editor read/write function are supported by all Ethernet TCP/IP modules (1) in the following Modicon automation platforms:

- Modicon M340 platform
- Modicon TSX Micro platform
- Modicon Premium platform
- Modicon Quantum platform
- Modicon Momentum platform

(See the selection of Web server products on page 5/17).

These functions can be accessed using a standard web browser connected to the network. They are ready to use and secure (password-protected).

They can be used locally or remotely via:

- Intranet
- A modem and RAS server
- Internet

(1) For standard Web servers integrated in variable speed drives, please consult our website www.schneider-electric.com.

Modicon Premium automation platform

Ethernet Modbus/TCP network
Modicon PLC standard Web services

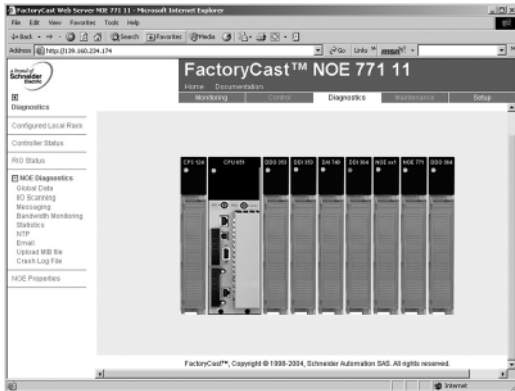

Quantum hardware configuration

Modicon PLC standard Web services (continued)

Rack Viewer PLC diagnostics function

The Rack Viewer function can be used for PLC system and I/O diagnostics. It displays the following in real time:

- LED status on the front panel of the PLC
- The PLC type and version
- The hardware configuration of the PLC including the status of the system bits and words
- Detailed diagnostics of each I/O module channel or application-specific channel in the configuration

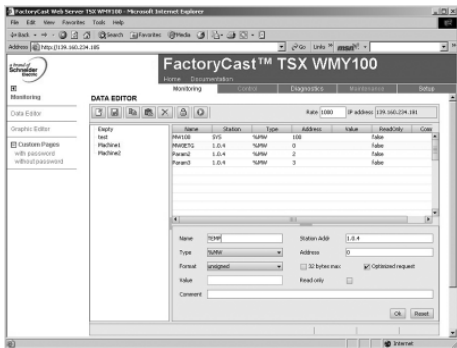

Data Editor variables table

Data Editor read/write function for PLC data and variables

The Data Editor function can be used to create tables of animated variables for real-time read/write access to lists of PLC data.

Several animation tables, containing specific application variables to be monitored or modified, can be created by the user and saved in the standard Web server module.

In addition to the functions provided by standard Web servers, FactoryCast Web servers offer the following:

- Variables to be displayed can be entered and displayed using their symbols (S_Pump 234) or their addresses (%MW99)
- The write access option for variables, which can be enabled or disabled for each of the variables using the FactoryCast configuration software
- The read/write function, which can be used on tools such as a pocket PC or PDA terminal

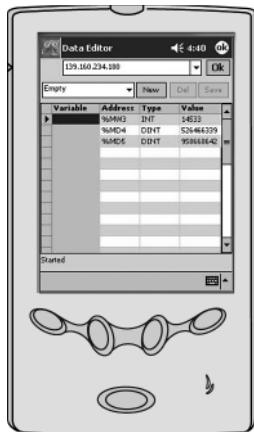

PDA terminal

Modicon Premium automation platform

Ethernet Modbus/TCP network
FactoryCast configurable Web services



FactoryCast configurable Web server

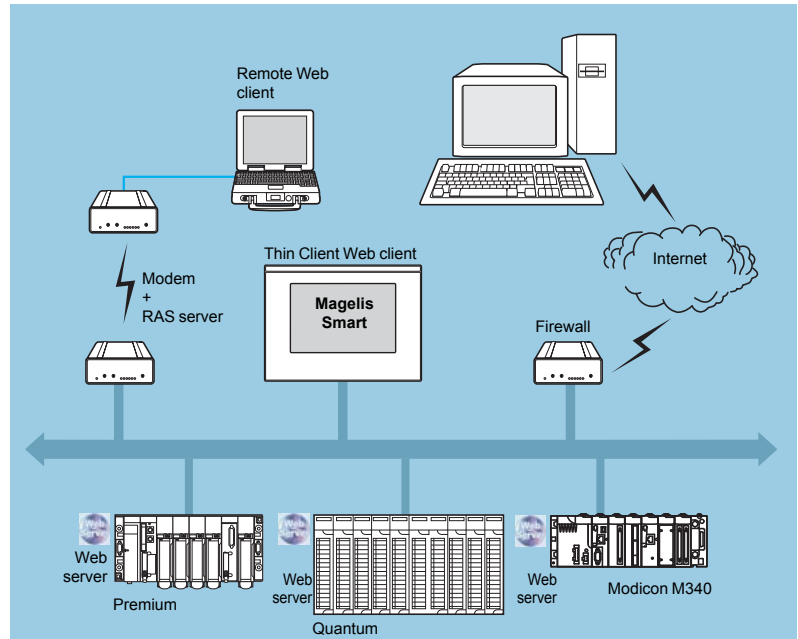

In addition to standard Web services, FactoryCast modules (see selection table on page 5/17) support the following functions:

- Alarm Viewer
- Creation and display of graphic views via an online graphics editor (Graphic Data Editor, supplied)
- Hosting and display of Web pages created by the user
- SOAP/XML server interface

5

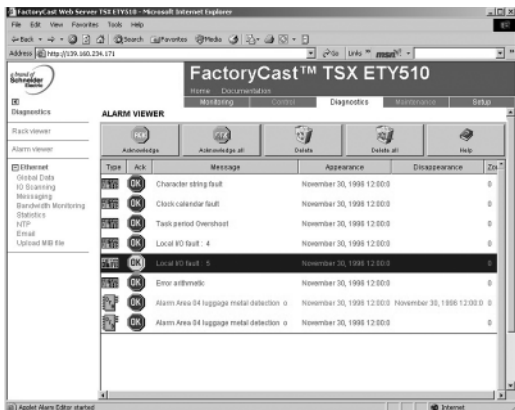

Alarm Viewer

Alarm Viewer function

The alarm viewer is a ready to use, password-protected function. It is used to process alarms (display, acknowledgement and deletion) managed at PLC level by the system or using diagnostic function blocks known as DFBs (system-specific diagnostic function blocks and application-specific diagnostic function blocks created by the user).

These alarms are stored in the PLC diagnostics buffer (specific memory area used to store all diagnostic events). This function is available with the Modicon Premium platforms (with PL7 or Unity software) and the Modicon Quantum platform (with Unity software).

The diagnostic viewer is a Web page comprising a list of messages, which displays the following information for each alarm:

- Dates and times of the appearance/disappearance of the fault
- Alarm message
- Alarm status
- Type of associated diagnostic function block (DFB)

Modicon Premium automation platform

Ethernet Modbus/TCP network
FactoryCast configurable Web services

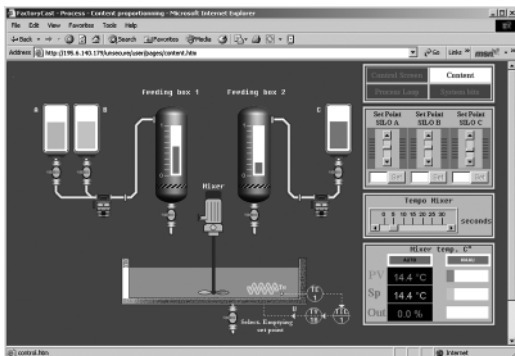

Hosting and display of user Web pages

FactoryCast configurable Web server (continued)

User Web page hosting and display function

FactoryCast Web modules have an 8 Mbyte memory (1) which is accessed in the same way as a hard drive and can be used to host Web pages and all user-defined documents in Word or Acrobat Reader (for example, maintenance manuals, diagrams, etc.).

These Web pages can be created using any standard tool for creation and editing in HTML format. These pages can be enhanced by inserting animated graphic objects linked to PLC variables. These animated objects are created using the Graphic Data Editor supplied with FactoryCast.

Web pages created in this way can be used, for example, to:

- Display and modify all PLC variables in real time
- Create hyperlinks to other external Web servers (documentation, suppliers, etc.)

This function is particularly suitable for creating graphic interfaces used for the following purposes:

- Real-time display and supervision
- Production monitoring
- Diagnostics and maintenance assistance
- Operator manuals

SOAP/XML server interface

FactoryCast modules incorporate a standard SOAP/XML data server that provides direct interoperability between automation devices and computer management applications (MES, ERP, SAP .Net application, etc.). See page 5/28.

5

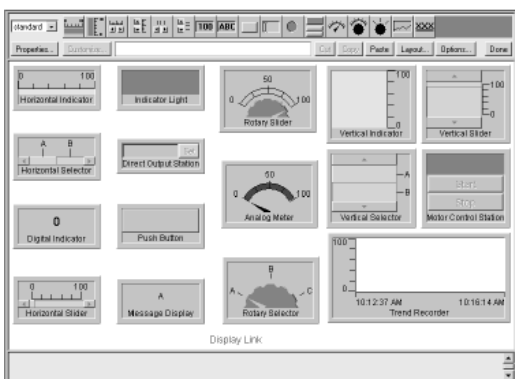

Graphic Data Editor

Graphic Data Editor function

This function can be used to create graphic views animated by PLC variables. The graphic editor is available online ready to use, and also offline using FactoryCast configuration software.

These views are created from a library of predefined graphic objects by simple copy/paste operations. The objects are configured to suit the user's requirements (colour, PLC variables, name, etc.).

List of graphic objects available:

- Analog and digital indicators
- Horizontal and vertical bar charts
- Boxes for displaying messages and entering values
- Pushbutton boxes
- Trend recorders
- Vats, valves, motors, etc.

Customized graphic objects can be added to this list. They can be reused in user Web pages that have been created using standard software for editing HTML pages.

The views created can be saved in the FactoryCast modules.

(1) Memory not affected by power outages or reinitialization of the PLC.

Modicon Premium automation platform

Ethernet Modbus/TCP network
FactoryCast HMI active Web services



FactoryCast HMI active Web servers

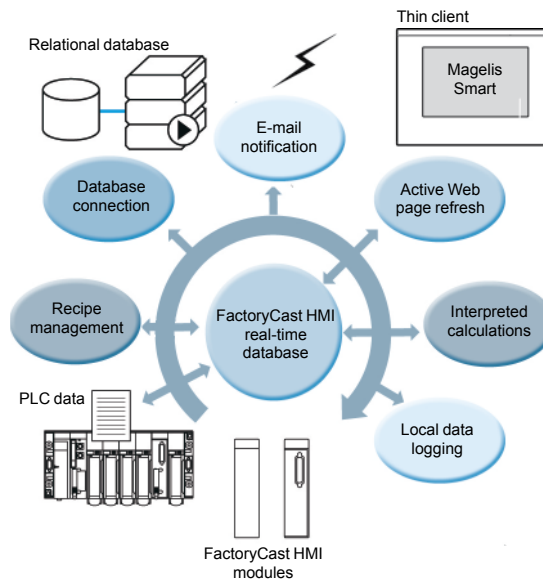

FactoryCast HMI Web services are integrated in the Web server modules embedded in the Modicon Premium and Modicon Quantum automation platforms.

These modules have the following Ethernet and Web services:

- Ethernet Modbus/TCP communication functions:
 - TCP/IP messaging service with Modbus TCP/IP and Uni-TE TCP/IP protocols
 - SNMP agent for standardized network management, which supports standard MIB II and Transparent Ready private MIB
- FactoryCast configurable Web services:
 - Rack Viewer PLC diagnostics functions (see page 5/19)
 - Data Editor read/write functions for PLC variables (see page 5/19)
 - Alarm Viewer alarm display functions (see page 5/20)
 - Graphic Data Editor online graphical view editor functions (see page 5/20)
 - Function for hosting and displaying user-defined Web pages (see page 5/21)

FactoryCast HMI modules also provide the following specialized HMI Web services:

- Real-time HMI database management, independent of the PLC processor
- Arithmetic and logical calculations on HMI data
- Direct connectivity with relational databases (traceability)
- Data Logging: recording data in the module
- Display of Unity Pro graphic runtime screens in the form of Web pages
- Recipe management (read/write)
- Alarm and report notification by e-mail
- Active page server, dynamic generation of animated HTML pages
- Dynamic generation of HTML reports
- Open data server interface. SOAP/XML WSDL interface protocol (1)

(1) In order to simplify their selection and ensure their interoperability within a system, each Transparent Ready product is identified by the class of services it provides. Letter A, B, C or D (level of service for the Web server) followed by 10, 20 or 30 (level of service for Ethernet communication).

Modicon Premium automation platform

Ethernet Modbus/TCP network
FactoryCast HMI active Web services

Architectures

FactoryCast HMI Web servers can be integrated in various architectures:

- Installations that require a flexible distributed HMI solution
- Mixed architectures, supplementing conventional SCADA systems
- Architectures where a direct link is required between automation systems and information management levels (IT link)

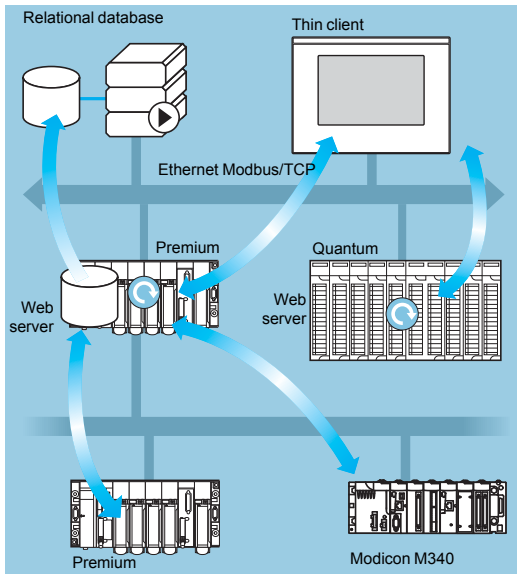

Flexible distributed HMI solution

Flexible distributed HMI solution

The use of Web-based technologies means that FactoryCast HMI can replace conventional HMI or SCADA solutions in applications where architectures require a flexible multistation HMI, thus providing a temporary "nomadic" remote control function.

These architectures consist of:

- Several PLCs networked on Ethernet, equipped with FactoryCast HMI Web server modules
- One or more PC terminals simply equipped with a web browser thus providing a Thin Client interface (licence free)
- If necessary, a relational database in which FactoryCast HMI can archive data from the automation system

FactoryCast HMI modules read PLC data and execute HMI services (e-mail, interpreted calculations, connection to relational databases, updating Web pages) at source in the PLC, without affecting the PLC program or the scan time.

This solution provides:

- A reliable HMI application, which is executed at source in a robust PLC device
- An integrated multistation interface and remote access that is easy and cost-effective to set up (Thin Client terminal, for example Magelis Smart)
- An HMI application that is easy to maintain (the application is housed in a single location on the server side)
- Preventive maintenance via e-mail
- Greater availability for archiving data in the PLC

Modicon Premium automation platform

Transparent Ready, system approach
FactoryCast HMI active Web services

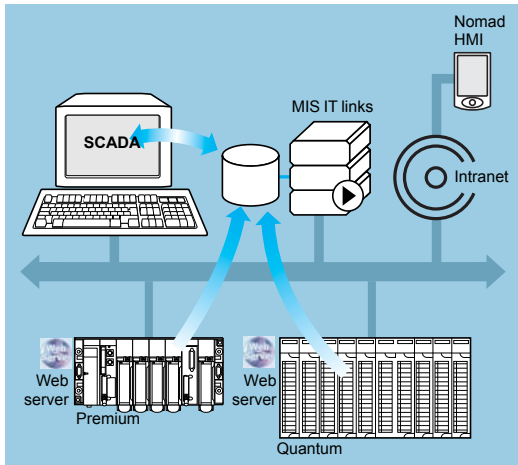

Mixed architecture

Architectures (continued)

Mixed architectures

In this type of architecture FactoryCast HMI supplements conventional SCADA systems, such as Vijeo Look or Monitor Pro, which meet the requirement for centralizing information for global supervision from a central site.

Combining a FactoryCast HMI solution and a conventional SCADA solution enables:

- Simplification of the SCADA application by locating some of the SCADA processing functions at source, at PLC level
- Increased availability of the traceability function due to the direct connection between FactoryCast HMI modules and relational databases
- Powerful ready to use remote diagnostics capability
- "Nomad" client stations to be connected to the Intranet or Internet via Thin Client PC or PDA devices

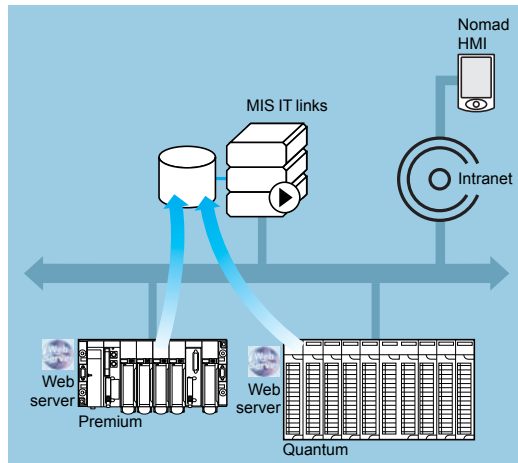

Direct links with the information management levels

Direct links with information management levels

In this type of architecture, FactoryCast HMI eliminates the need for intermediate devices (software or hardware gateways), which are expensive to install and maintain, by establishing direct links between the automation levels and the global information management levels (MES, ERP, etc.).

The PLC manages the following links which allow a "collaborative" automation system to be set up, making it easier to share data in real time:

- Direct archiving of information from the automation system in relational databases
- Direct interaction with IT applications via the SOAP/XML client/server interface

This solution results in:

- Simplified architectures
- Lower installation, development and maintenance costs
- Increased reliability of information (the data is collected at source)
- Increased interoperability with IT applications
- Greater availability of data archiving

Modicon Premium automation platform

Transparent Ready, system approach
FactoryCast HMI active Web services

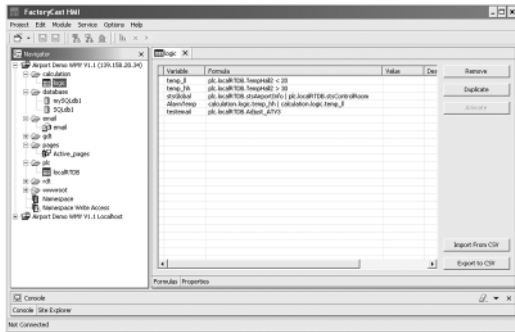

Real-time database

Specialized HMI services

Real-time database

With an internal architecture similar to that of an HMI/SCADA system, FactoryCast HMI modules manage their own variables database in real time, independently of the PLC program. It is this variables database that is used to execute various functions, including internal processing, archiving, alarms, e-mail, etc.

Variables in this real-time database are updated using the PLC's data acquisition service.

This service becomes operational once the following parameters have been set in the FactoryCast HMI software:

- Direct import of PLC variables/symbol databases (no double entry)
- Definition of the acquisition frequency (period at which this variable is updated)

Note: A FactoryCast HMI application running in a Premium configured FactoryCast HMI module can access all the PLC variables in the architecture transparently on the network (X-Way/Uni-TE transparent protocols).

Characteristics

- Maximum number of I/O variables per application: 1000 variables from PLCs
- Maximum number of internal variables per application: 100
- Acquisition frequency: 500 ms minimum

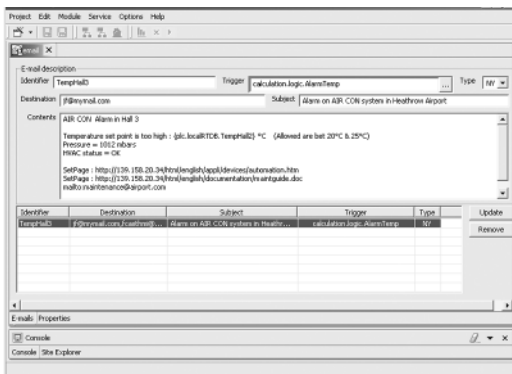

Calculation function

Calculation functions

The FactoryCast HMI server can carry out various arithmetic or logical operations on a combination of variables from the HMI database. These calculations include, for example, scaling, formatting, logic processing for event triggering, etc.

This calculation function is operational from the local HMI database, independently of the PLC processor, and is in the form of spreadsheets where the formulas are defined in cells.

The spreadsheets are interpreted and processed by the server. The result of each formula is associated with a new internal variable. The processing of each spreadsheet is initiated by a trigger.

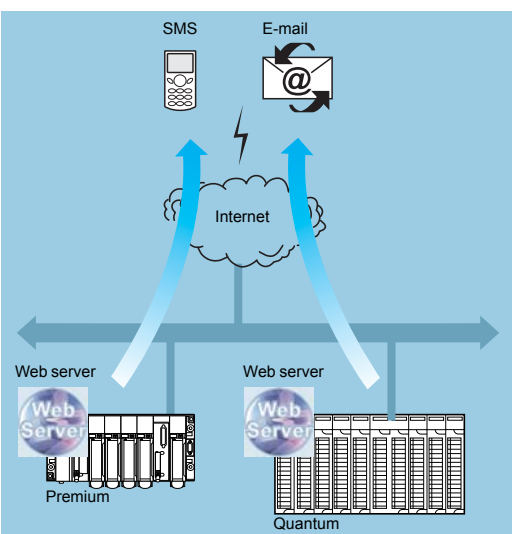

E-mail transmission

E-mail transmission

The FactoryCast HMI module can, on a specific event, send e-mails completely autonomously to a predefined list of e-mail addresses. This function is executed independently of the PLC program.

The event that triggers the e-mail may be associated with the following:

- A PLC variable (I/O, internal variable)
- An alarm, a threshold overshoot
- A machine or process state
- An operator action, etc.

When an e-mail is sent it passes via an SMTP (Simple Mail Transfer Protocol) server. This server receives the e-mail and waits for the recipient to acknowledge it. The e-mail service is compatible with all SMTP servers. A return address can be defined should delivery to the destination address fail.

Characteristics

- Configuration of the SMTP server: compatible with all SMTP servers
- Maximum number of e-mails: 100
- Contents of e-mail messages: free text with embedded dynamic variable values (from the PLC) and hyperlinks (unlimited)



Modicon Premium automation platform

Transparent Ready, system approach
FactoryCast HMI active Web services

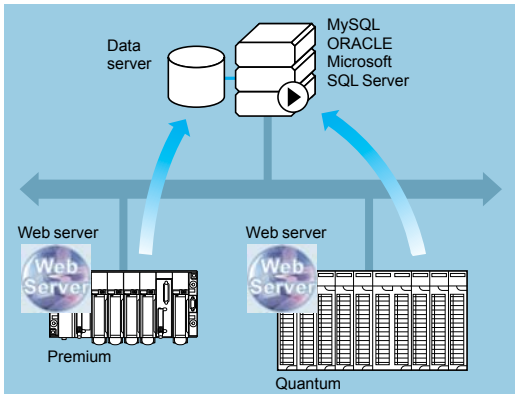

Connection to databases

Specialized HMI services (continued)

Connection to relational databases

The FactoryCast HMI module can be connected directly and completely autonomously to the following remote relational databases:

- SQL Server
- MySQL
- Oracle

This connection enables all process or internal data to be archived directly in the FactoryCast HMI module without any intermediate system (hardware or software).

The data can be archived (written) periodically and/or on a specific event. These variables can be either from PLCs (I/O bits, internal bits, internal words and registers) or local to the module.

The FactoryCast HMI Roll Over function controls the size of tables by managing the maximum number of records.

This circular data archiving function automatically deletes the oldest data and can be accessed by simply setting parameters in the FactoryCast HMI software.

Characteristics

- Number of databases that can be connected: 3
- Number of tables that can be written per database: 10 maximum
- Number of columns per table: 50 maximum
- Type of database supported: Oracle, SQL Server and MySQL
- Automatic table creation: the FactoryCast HMI server creates a table in the database if one does not already exist

5

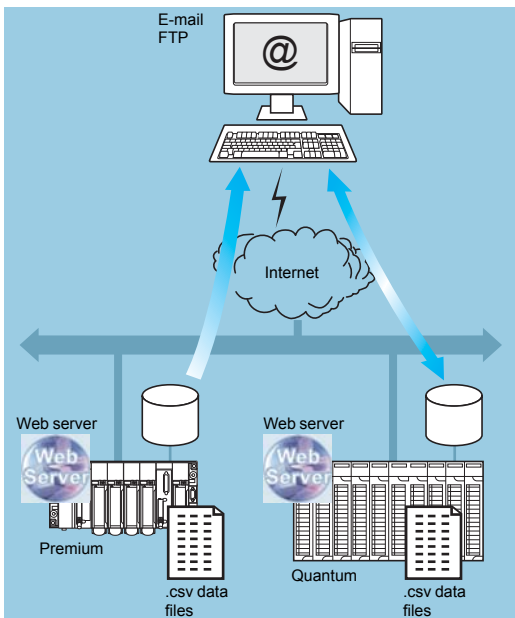

Data Logging

Data Logging

FactoryCast HMI modules can log data in the internal flash memory periodically or on an event.

This logging is done in a CSV file, which can be:

- Automatically exported via FTP
- Attached to an e-mail

This function is particularly useful for standalone installations, or stations that are not connected to an Intranet, or for local traceability of data.

Modicon Premium automation platform

Transparent Ready, system approach
FactoryCast HMI active Web services

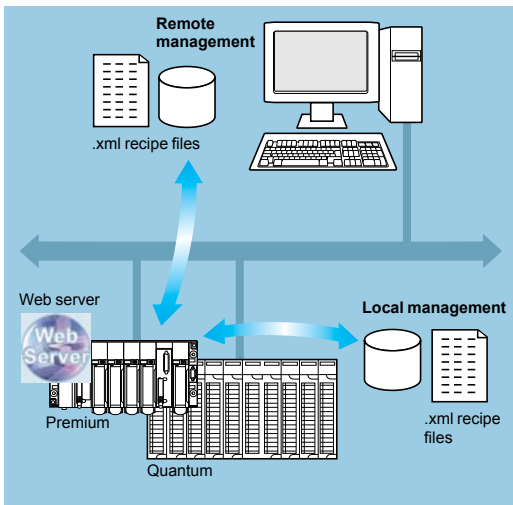

Recipe management

Specialized HMI services (continued)

Recipe management

The recipe management function enables a FactoryCast HMI application to take recipe files into account automatically on process events or at the request of an operator, applying the recipe values to the PLC data memory.

This function provides very flexible data management in the execution of production or process changes by sending new setpoints and new parameters.

Characteristics

- Recipes are described using XML format (SOAP/XML format)
- Recipes are stored in the module or remotely
- Recipes contain setpoint values in accordance with "standard" recipes, and these values are transferred to the PLC memory

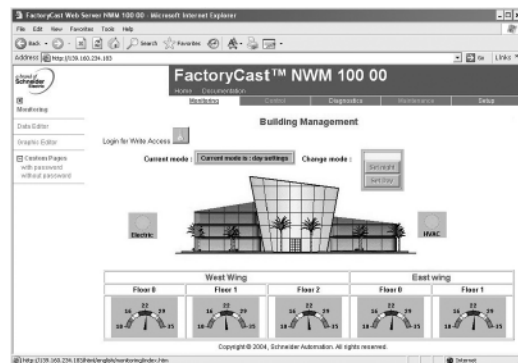

Web based HMI interface

Web-based HMI interface

The memory of the FactoryCast HMI Web server receives Web pages defined by the user to provide a graphic HMI interface. The Active Web Server provides dynamic refreshing of the Web pages generated by the server itself.

FactoryCast HMI supports two types of Web page:

- HTML pages animated in real time with Java graphic objects used to create the user interface (FactoryCast HMI comes with a complete library of Java graphic objects)
- Active Web pages dynamically generated in the Web server with integration of PLC variables inside the HTML code (PLC "tags") which can be used to generate reports. These active pages consisting of HTML code are fully compatible with all Thin Client terminals (pocket PC, PDA, or PC terminal)

5

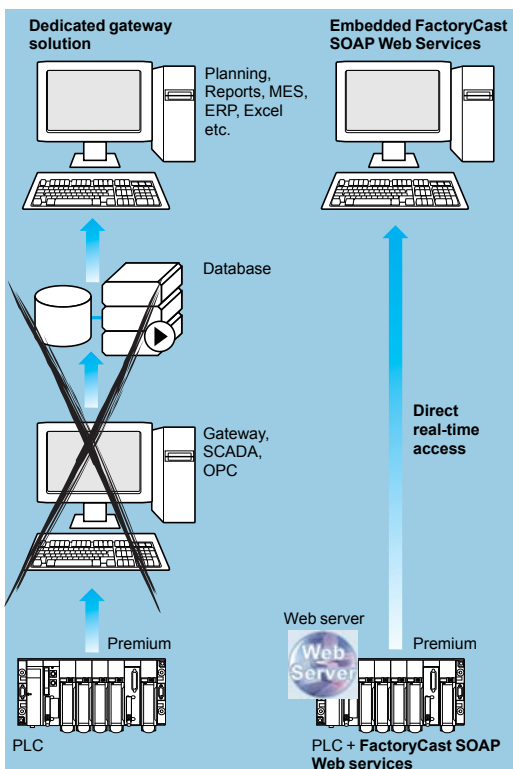

SOAP/XML client/server interface

SOAP/XML client/server interface

For greater interoperability, FactoryCast HMI implements the following SOAP/XML Web service: server function capable of answering SOAP requests generated by any client application (MES, ERP, SAP, SCADA or third-party applications developed in .NET or Java).

See page 5/28.



Presentation, functions

The standardization of Web services has come about as a result of joint development between Microsoft and IBM, amongst others, validated at the W3C (*World Wide Web Consortium*) as an open “standard”.

It now provides all the tools, specifications and environments needed for each platform. Web services are based on standards such as:

- XML (*eXtensible Markup Language*): the universal standard for data exchange
- SOAP (*Single Object Access Protocol*) protocol carried via the HTTP (*Hyper Text Transfer Protocol*) channel
- WSDL (*Web Services Description Language*) in XML format

SOAP is currently considered to be the reference protocol, including in industry. It has now been adopted by the main market players, including Microsoft (●NET, SQL Server, OFFICE, etc.), IBM (Java, Web Sphere), Lotus, ORACLE, SUN, SAP, etc.

Embedded SOAP/XML Web services: ModbusXMLDa Web services

This new Transparent Ready service offers the hitherto unheard of possibility of making an IT/e-business application interact directly with the control system levels using the same standards.

With the implementation of ModbusXMLDa (*Modbus XML Data access*) services in FactoryCast Web servers, IT engineers can easily create their own application to access the required information directly in the PLC and in real time.

Data exchanges are made in XML standard format in response to a request using the SOAP protocol.

The implementation of Web services in control system equipment makes it easy to achieve vertical integration of the control level and create even more collaborative architectures which can be used to link production systems to enterprise management systems. It simplifies access to information, reduces training, development and roll-out costs and increases productivity.

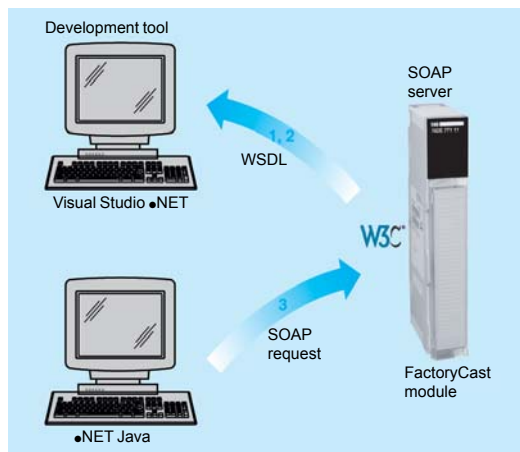

ModbusXMLDa server interface

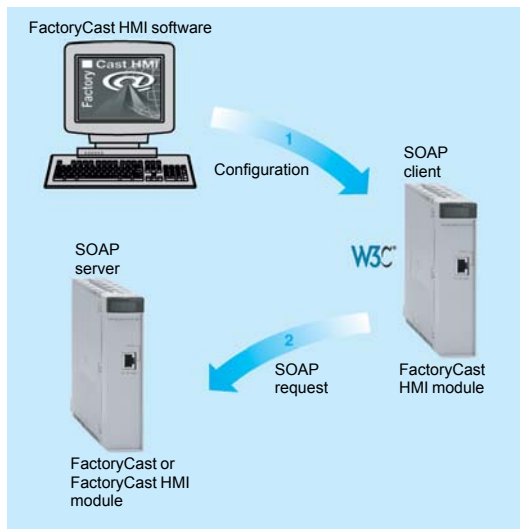

ModbusXMLDa client interface

ModbusXMLDa Web services in FactoryCast modules

ModbusXMLDa server interface

This implementation enables a SOAP client application (management level computer application, MES, ERP, etc.) to communicate directly with a FactoryCast Web server module embedded in the PLC.

Exchanges are initiated by the SOAP client application (the server responds to these requests).

- Step 1: Creation of the client application with learning of the Web services. The development environment (for example, Visual Studio ●NET) looks in the FactoryCast server for the list of available services and their WSDL standard interfaces provided by the module.
- Step 2: Development of the client application. The developer integrates the Web service functions using the code retrieved at step 1 of the learning process.
- Step 3: Execution of the client application. The client application communicates in real time with the FactoryCast Web server module using the SOAP protocol.

ModbusXMLDa client interface

This implementation allows a FactoryCast HMI module to execute a SOAP client application in order to communicate with a remote SOAP server application (for example another FactoryCast Web server module or a computer management application, MES, ERP, etc.).

Exchanges are initiated by the FactoryCast HMI client module (the remote application server responds to SOAP requests sent by the FactoryCast HMI module).

- Step 1: Configuration of the ModbusXMLDa client service. The user declares the PLC variables that are to be exchanged (in read or write mode), using the FactoryCast HMI configuration software.
- Step 2: Use of the application. The ModbusXMLDa client service executed in the FactoryCast HMI module communicates directly with the remote server application using SOAP requests in XML format.

Note: ModbusXMLDa functions are implemented in the FactoryCast modules:

- Server interface: Modicon M340 BMX NOE 0110, Modicon Premium TSX ETY 5103/WMY 100 and Modicon Quantum 140 NOE 771 11/NWM 100 00

- Client interface: Modicon Premium TSX WMY 100 and Modicon Quantum 140 NWM 100 00

Requests implemented	ModbusXMLDa functions implemented in FactoryCast modules
Access to data via physical addresses	ReadDeviceIdentification
	ReadMultipleRegisters
	WriteMultipleRegisters
	ReadCoils
	WriteMultipleCoils
	ReadDiscreteInputs
Access to data via symbols	Read, operation to read item list value
	Write, operation to write item list value
	Browse, operation to browse item list

Modicon Premium automation platform

Ethernet Modbus/TCP network

Ethernet Modbus/TCP communication services

Presentation

Transparent Ready products allow transparent communication on a single Ethernet Modbus/TCP network.

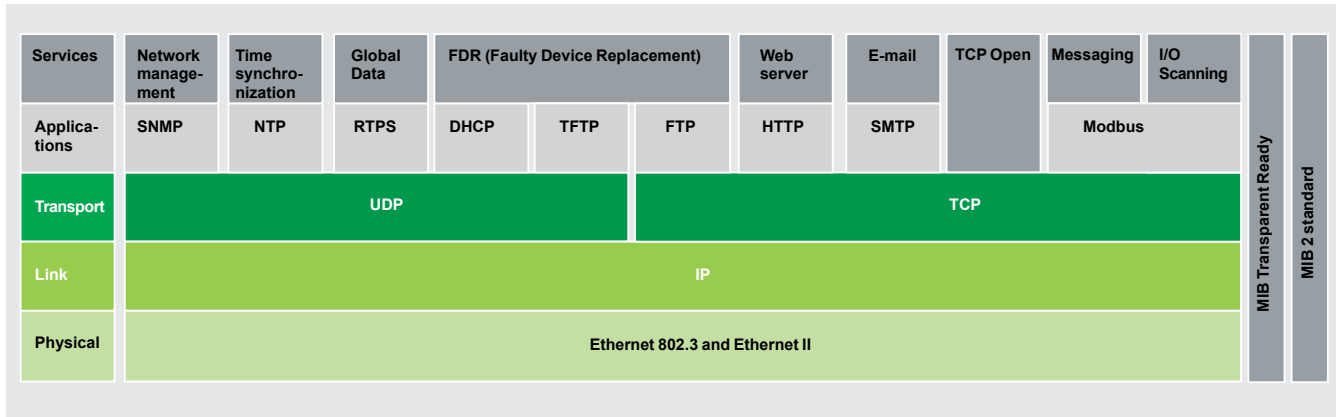

In addition to universal Ethernet services (HTTP, BOOTP/DHCP, FTP, etc.), the Transparent Ready device communication services designed for use in automation applications include:

- Modbus/TCP messaging for class 10, 20 or 30 devices
- I/O Scanning service for class 30 devices
- FDR (Faulty Device Replacement) for class 10, 20 or 30 devices
- SNMP (*Simple Network Management Protocol*) network management for class 20 or 30 devices
- Global Data, for class 30 devices
- Bandwidth management for class 30 devices
- NTP (Network Time Protocol) time synchronization for class 30 devices
- E-mail alarm notification via SMTP server for class 30 devices
- TCP Open, optional, for class 30 devices

Note: The above services are listed for general information. Please refer to the characteristics pages for each device for exhaustive details of which services are supported by each one.

The following pages present the various options available through all of these services in order to facilitate the optimum choice of solutions when defining a system integrating Transparent Ready devices.

Modicon Premium automation platform

Ethernet Modbus/TCP network

Ethernet Modbus/TCP communication services

Functions

Ethernet universal services

HTTP HypTocol (RFC 1945)

HTTP (*HyperText Transfer Protocol*) is used to transmit Web pages between a server and a browser. HTTP has been used on the Web since 1990. Web servers embedded in Transparent Ready automation products provide easy access to products located anywhere in the world from a standard web browser such as Internet Explorer or Netscape Navigator.

BOOTP/DHCP (RFC1531)

BOOTP/DHCP is used to provide devices with IP parameters automatically. This avoids having to manage each device address individually by transferring this management to a dedicated IP address server.

DHCP (Dynamic Host Configuration Protocol) is used to assign configuration parameters to devices automatically. DHCP is an extension of BOOTP. DHCP consists of two components:

- One to provide the IP network address
- One to deliver the specific IP parameters to the device from a DHCP server

Schneider Electric devices can be:

- BOOTP clients allowing the IP address to be retrieved automatically from a server
- BOOTP servers allowing the device to distribute IP addresses to the network stations

Schneider Electric uses standard BOOTP/DHCP protocols for its FDR (Faulty Device Replacement) service.

FTP File Transfer Protocol (RFCs 959, 2228 and 2640)

File Transfer Protocol (FTP) provides the basic elements for file sharing. Many systems use FTP to exchange files between devices.

TFTP Trivial File Transfer Protocol (firmware updates)

Trivial File Transfer Protocol (TFTP) is a network transfer protocol used to connect to a device and download code to it.

For example, it can be used to transfer a boot code to a workstation without a disk drive or to connect and download updates of network device firmware.

Note: *Transparent Ready products implement FTP and TFTP for transferring certain information to or from devices, in particular for downloads of firmware or user-defined Web pages.*

NTP Network Time Protocol (RFC 1305)

NTP (Network Time Protocol) is used to synchronize the time of a client or server device from a time server. Depending on the network used, it provides the following time precisions based on UTC:

- A few milliseconds on a local area network (LAN)
- A few tens of milliseconds on a wide area network (WAN)

SMTP Simple Mail Transfer Protocol (RFC 0821)

SMTP (Simple Mail Transfer Protocol) is an e-mail transmission service. It is used to send e-mail between a sender and a recipient via an SMTP e-mail server.

SNMP Simple Network Management Protocol (RFCs 1155, 1156 and 1157)

The Internet community has developed the SNMP standard for managing the various components of a network via a single system. The network management system can exchange data with SNMP agent devices. This function allows the manager to display the status of the network and devices, modify their configuration and feed back alarms in the event of a fault.

Note: *Transparent Ready devices are SNMP-compatible and can be integrated naturally in a network managed via SNMP.*

COM/DCOM Distributed Component Object Model

COM/DCOM (Distributed Component Object Model) or OLE (Object Linking and Embedding) is the name of the technology consisting of Windows objects which enables transparent communication between Windows applications.

Note: *These technologies are used in the OFS (OLE for Process Control Factory Server) data server software.*

Modbus/TCP function codes		dec	hex
Bit access	Read n input bits	02	02
	Read n output bits	01	01
	Read exception status	07	07
	Write 1 output bit	05	05
	Write n output bits	15	0F
	Read 1 input word	04	04
	Read n input words	03	03
	Write 1 output word	06	06
	Write n output words	16	10
	Read device ID	43/14	2B/0E

Examples of Modbus/TCP function codes for accessing data and diagnostics

Functions (continued)

Modbus standard communication protocol

Modbus, the industry communication standard since 1979, has been combined with Ethernet Modbus/TCP, the medium for the Internet revolution, to form Modbus/TCP, a completely open Ethernet protocol. The development of a connection to Modbus/TCP does not require any proprietary component, or the purchase of a licence. This protocol can easily be combined with any product supporting a standard TCP/IP communication stack. The specifications can be obtained free of charge from the following website: www.modbus-ida.org.

Modbus/TCP, simple and open

The Modbus application layer is very simple and universally familiar with its 9 million installed connections. Thousands of manufacturers have already implemented this protocol. Many have already developed a Modbus/TCP connection and numerous products are currently available.

The simplicity of Modbus/TCP enables any field device, such as an I/O module, to communicate on Ethernet without the need for a powerful microprocessor or a lot of internal memory.

Modbus/TCP, high-performance

Due to the simplicity of its protocol and the fast speed of 100 Mbps Ethernet, the performance of Modbus/TCP is excellent. This allows this type of network to be used in real-time applications such as I/O scanning.

Modbus/TCP, a standard

The application protocol is identical on Modbus serial link, Modbus Plus or Modbus/TCP. This means that messages can be routed from one network to the other without converting the protocol.

Since Modbus is implemented on top of the TCP/IP layer, users can also benefit from IP routing enabling devices located anywhere in the world to communicate without worrying about the distance between them.

Schneider Electric offers a complete range of gateways for interconnecting a Modbus/TCP network to existing Modbus Plus or Modbus serial link networks.

The IANA organization (Internet Assigned Numbers Authority) has allocated the fixed port TCP 502 (Well known port) to the Modbus protocol. Thus Modbus has become an Internet standard.

A study by the ARC Advisory Group, a leading analyst in the automation and software sectors, shows that Modbus/TCP is the world's leading Ethernet industrial protocol in terms of units sold in 2004.

Modbus and Modbus/TCP are recognized by the IEC/EN 61158 international standard as a fieldbus. They are also compliant with the Chinese National Standard managed by ITEI.

Interfacing CANopen with Modbus/TCP

CI A DSP 309-2 provides standardized mapping of CANopen data for transport on Ethernet Modbus/TCP networks. The specification reserves the Modbus 43/13 function code for this purpose. This function code is reserved exclusively for CANopen.

Modbus TCP/IP characteristics

Maximum size of data:

- Read: 125 words or registers
- Write: 100 words or registers

Modicon Premium automation platform

Ethernet Modbus/TCP network

Ethernet Modbus/TCP communication services

Functions (continued)

I/O Scanning service

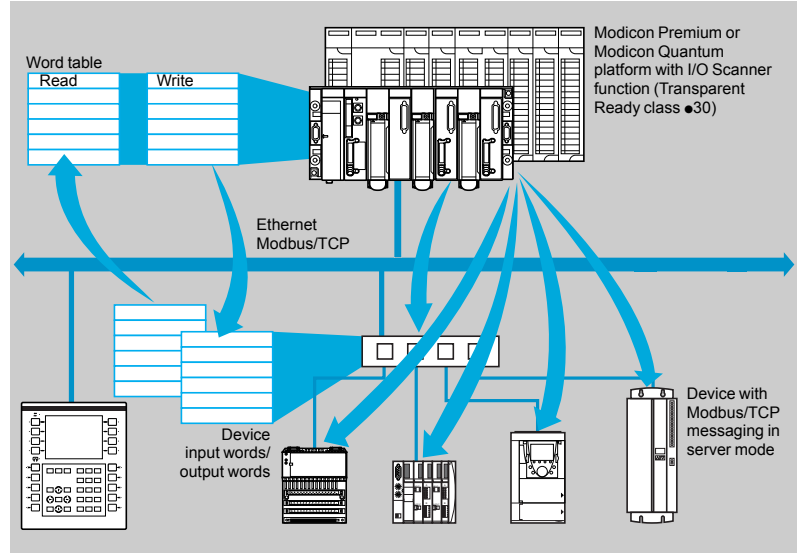

The I/O Scanning Service is used to manage the exchange of remote I/O states on the Ethernet network after simple configuration, with no need for any special programming.

I/O scanning is performed transparently by means of read/write requests according to the Modbus client/server protocol on the TCP/IP profile.

This principle of scanning via a standard protocol enables communication with any device supporting Modbus TCP messaging in server mode.

This service can be used to define:

- A %MW word zone reserved for reading inputs
- A %MW word zone reserved for writing outputs
- Refresh periods independent of the PLC scan

During operation, the module:

- Manages TCP/IP connections with each remote device
- Scans devices and copies the I/O to the configured %MW word zone
- Feeds back status words used to check that the service is working correctly from the PLC application
- Applies pre-configured fallback values if a communication problem occurs

A range of hardware and software products is available enabling the I/O Scanning protocol to be implemented on any type of device that can be connected to the Ethernet network. Please consult the Modbus-IDA website: www.modbus-ida.org.

Characteristics

- Under Unity Pro software, each station can exchange a maximum of:
 - 100 write words
 - 125 read words
- Maximum size in the PLC managing the service:
 - 2 Kwords %MW (1) in inputs and 2 Kwords %MW (1) in outputs with manager PLC limited to 64 stations
 - 4 Kwords %MW (1) in inputs and 4 Kwords %MW (1) in outputs with manager PLC limited to 128 stations

I/O Scanning service diagnostics

I/O Scanning service diagnostics can be performed in one of five ways:

- Via the application program from a specific PLC data zone
- From the setup software debug screen
- From the PLC system diagnostic function displayed by means of a web browser on a PC station
- Using the **TSX EAZ 01P SFE10** ConneXview diagnostic software
- Using standard SNMP network management software

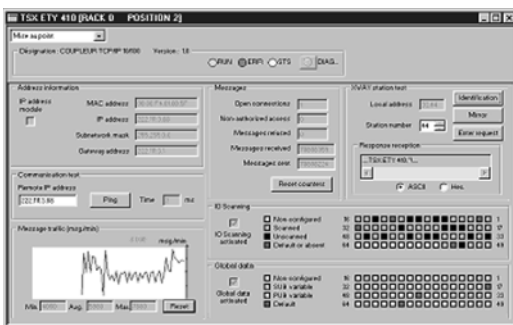

I/O Scanning service diagnostics

(1) or 4x registers with Concept or ProWORX.

Modicon Premium automation platform

Ethernet Modbus/TCP network

Ethernet Modbus/TCP communication services

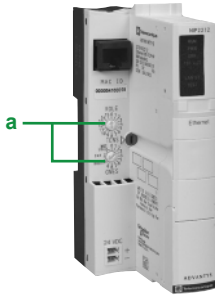

NIM network module for Modicon STB I/O

Functions (continued)

FDR (Faulty Device Replacement) service

The Faulty Device Replacement service uses standard address management technologies (BOOTP, DHCP) and the TFTP (*Trivial File Transfer Protocol*) file management service, with the aim of simplifying maintenance of Ethernet products.

It is used to replace a faulty device with a new device with the guarantee that it will be detected, reconfigured and automatically restarted by the system.

The main steps in replacement are:

- 1 A device using the FDR service malfunctions
- 2 Another similar device is taken from the maintenance store, preconfigured with the Device name for the faulty device, then reinstalled on the network. Depending on the device, addressing can be performed using rotary selector switches (as for Modicon STB distributed I/O or Modicon OTB for example) or can be given using the keypad integrated in the device (as for Altivar variable speed drives for example)
- 3 The FDR server detects the new device, allocates it an IP address and transfers the configuration parameters to it
- 4 The substituted device checks that all these parameters are indeed compatible with its own characteristics and switches to operational mode

The FDR server can be:

- A Modicon M340 PLC Ethernet module, BMX NOE 0100/0110, BMX NOC 0401 or BMX NOR 0200H
- A Modicon Premium PLC Ethernet module, TSX ETY 4103/5103 or TSX ETC 101
- A Modicon Quantum PLC Ethernet module, 140 NOE 771 01/11 or 140 NOC 771 01
- A Modicon Premium processor with integrated Ethernet port, TSX P57 ●●●●M
- A Modicon Quantum processor with integrated Ethernet port, 140 CPU 651 50/60

Modicon Premium automation platform

Ethernet Modbus/TCP network

Ethernet Modbus/TCP communication services

Functions (continued)

Global Data service

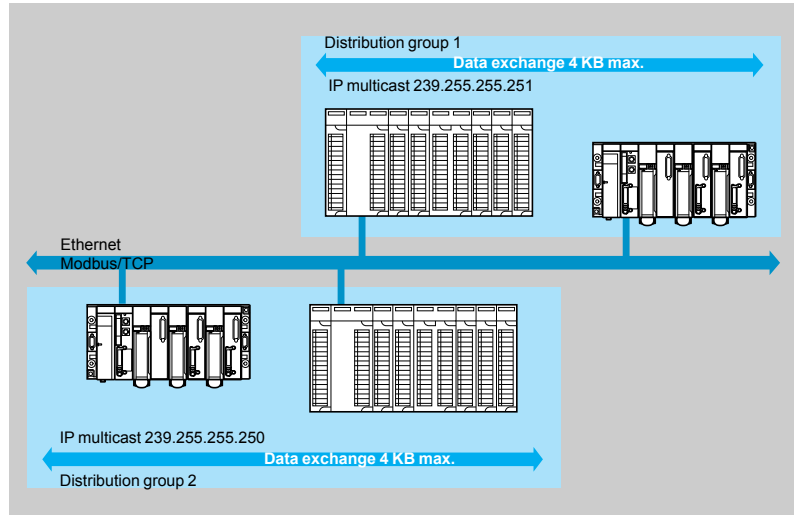

The Global Data service performs data exchanges in real time between stations belonging to the same distribution group. It is used to synchronize remote applications, or to share a common database between a number of distributed applications.

Exchanges are based on a standard producer/consumer protocol, guaranteeing optimum performance with a minimum load on the network. This RTPS (*Real Time Publisher Subscriber*) protocol is promoted by Modbus-IDA (*Interface for Distributed Automation*), and has already been adopted as a standard by several manufacturers.

Characteristics

A maximum of 64 stations can participate in Global Data within the same distribution group.

Each station can:

- Publish one 1024-byte variable. The publication period can be configured from 1 to n processor master task (*Mast*) periods
- Subscribe to between 1 and 64 variables. The validity of each variable is controlled by status bits (*Health Status bits*) linked to a refresh timeout configurable between 50 ms and 1s. It is not possible to access a variable element. The total size of subscribed variables amounts to 4 K contiguous bytes.

To further optimize the performance of the Ethernet network, Global Data can be configured with the multicast filtering option which, combined with switches in the ConneXium range (see pages 5/50 ...), distributes data only to Ethernet ports where there is a station subscribed to the Global Data service. If these switches are not used, Global Data is sent in multicast mode to all switch ports.

Global Data service diagnostics

The diagnostic screens use a colour code to show the Global Data status:

- Configured/not configured/faulty
- Published/subscribed

Global Data service diagnostics can be performed in one of five ways:

- Via the application program from a specific PLC data zone
- From the setup software debug screen
- From the PLC system diagnostic function displayed by means of a web browser on a PC station
- Using the TSX EAZ 01P SFE10 ConneXview diagnostic software
- Using standard SNMP network management software

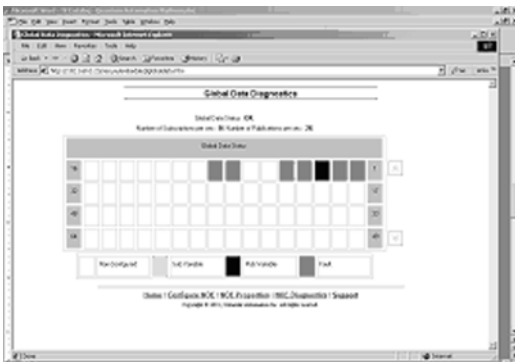

Global Data service diagnostics

Modicon Premium automation platform

Ethernet Modbus/TCP network

Ethernet Modbus/TCP communication services

NTP Configuration

NTP Server Configuration

IP Address of Primary NTP Server:

IP Address of Secondary NTP Server:

Polling Period: sec

Time Zone

(GMT-05:00)Eastern Standard Time(New York)

Automatically adjust clock for daylight saving change

[Home](#) | [Configure NOE](#) | [NOE Properties](#) | [NOE Diagnostics](#) | [Support](#)
 Copyright © 2011, Schneider Automation Inc. All rights reserved.

NTP service configuration

Functions (continued)

NTP time synchronization service

Presentation

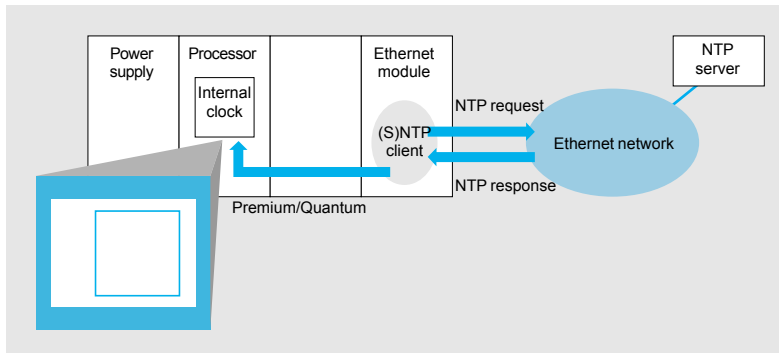

The time synchronization service is based on NTP (*Network Time Protocol*) which is used to synchronize the time of a client or a server on Ethernet TCP/IP from a server or another reference time source (radio, satellite, etc.).

Operation

- Modbus TCP communication modules:
- BMX NOE 0100/0110 (with version ≥ 2.0 module) and BMX NOR 0200H for Modicon M340 Unity version ≥ 2.0 automation platform
- TSX ETY 5103 for Modicon Premium Unity $\geq V2.0$ automation platform
- 140 NOE 771 11 for Modicon Quantum Unity $\geq V2.0$ automation platform
- have an NTP client component

These modules can connect to an NTP server using a client request (unicast), in order to update their local time. The module clock is updated periodically (1 to 120 s) with an error ≤ 10 ms for standard processors and ≤ 5 ms for high-performance processors.

If the NTP server cannot be reached, the Ethernet Modbus/TCP module switches to a standby NTP server.

Ethernet module associated with its Unity processor		Precision with respect to the reference clock		
Ethernet modules	Unity processors	Clock synchronization (1)	Event synchronization	Time stamping (2)
BMX NOE 0100/0110 BMX NOR 0200H (Modicon M340 platform)	BMX P34 1●	+/- 1 ms typical +/- 10 ms max.	=	=
	BMX P34 2●	+/- 1 ms typical +/- 5 ms max.	Clock synchronization precision	Clock synchronization precision
TSX ETY 5103 (Modicon Premium platform)	TSX P57 1●	± 1 ms typical ± 10 ms max.	+	+
	TSX P57 2●		Cycle time for fast task	Scan time for I/O
	TSX P57 3●			
	TSX P57 4● TSX P57 5● TSX P57 6●	± 1 ms typical ± 5 ms max.		
140 NOE 771 11 (Modicon Quantum platform)	140 CPU 311 10	± 1 ms typical ± 10 ms max.	+	
	140 CPU 434 12U			
	140 CPU 651 50/60	± 1 ms typical ± 5 ms max.		
	140 CPU 652 60 140 CPU 671 60 140 CPU 672 61		Scan time for I/O	

NTP Diagnostics

NTP Status: NOT OK

NTP Server Status

Link to the NTP Server: Service Time Quality within microsecond

Server: Primary

NTP Request Status

Number of Requests: Number of Errors:

Number of Responses: Last Error:

NTP Date and Time

Date: Unknown Time: Unknown DST Status: On

Time zone: (GMT-05:00)Eastern Standard Time(New York)

[Home](#) | [Configure NOE](#) | [NOE Properties](#) | [NOE Diagnostics](#) | [Support](#)
 Copyright © 2011, Schneider Automation Inc. All rights reserved.

NTP service diagnostics

The PLC processor clock is therefore itself updated with a precision of 5 ms for standard processors and 1 ms for high-performance processors. A function block is available for reading this clock. In each PLC application, events or variables can be time-stamped.

The Ethernet module is configured via a Web page. The time zone can be configured. A time synchronization service (NTP) diagnostic Web page is also available.

Information on the time synchronization service (NTP) is also available in the Transparent Ready private MIB, which can be accessed via the SNMP network management service (see above).

(1) Time difference between the physical input and the central NTP server.
 (2) With use of an interrupt input module.

Modicon Premium automation platform

Ethernet Modbus/TCP network

Ethernet Modbus/TCP communication services

Functions (continued)

SMTP e-mail notification service

Introduction

This simple e-mail notification service is programmable. It enables a PLC application to report an event when particular conditions occur. The PLC creates an e-mail automatically and dynamically, to alert a defined recipient connected to the network locally or remotely. The e-mail can contain variables, alarms and/or events.

Note: This service is available with the latest-version Ethernet communication modules for Modicon Premium and Modicon Quantum PLCs, and the latest-version processors with Ethernet port integrated in these same PLCs, used with Unity Pro software.

A more comprehensive service, independent of the PLC application, is also available with the FactoryCast HMI modules of Modicon Premium and Modicon Quantum PLCs (for modules with active Web server, see page 5/25).

Use

A simple yet powerful mechanism is used: predefined message headers are linked with the body of the e-mail, which is created dynamically using the latest information from the PLC application.

The PLC application prepares the message when predetermined conditions occur. Using a function block, one of 3 predefined headers is selected, and an e-mail message with variable information and text (up to a maximum of 240 bytes) is created and sent directly from the PLC.

Each of the three headers contains the following predefined items: e-mail recipient list, sender's name and subject. This information is defined and updated by an authorized administrator, using the configuration web pages.

Message creation and delivery

The PLC application selects the appropriate header. The system architect may define the headers to indicate differing levels of importance. For example:

- Header 1 could be "URGENT: problem reported by PLC 10"
- Header 2 could be "ALARM: substation 10"
- Header 3 could be "INFORMATION: message from water quality system"

Each of these headers has its own list of recipients, so that the correct person can be informed quickly for each level of importance. The application can also insert relevant information in the body of the message, such as the device, process or location concerned.

The completed e-mail is then sent to an SMTP (*Simple Mail Transfer Protocol*) server for distribution to the recipients (engineers, management, process owner, etc.).

Security

Optionally, each e-mail can be protected by an identifier and a password, authenticated by the SMTP server. If, for additional security, the TCP port number of the e-mail server has been changed from the default of 25, the port number can be changed in the PLC e-mail configuration (via a secure Web page).

Configuration

An authorized administrator can easily configure this e-mail service via a Web page. The items (recipient list, sender and subject) in each of the three headers can be defined.

The e-mail server connection information, such as its IP address and security management information, are also defined using Web pages.

Diagnostics

As for all other Ethernet services in Modicon Premium and Modicon Quantum PLCs, the e-mail notification service has a diagnostics Web page displaying the service's status in real time.

Remote monitoring

Diagnostic information is also available remotely from network controllers conforming to the SNMP standard. The e-mail service information is included in the publicly available Transparent Ready private MIB.

Modicon Premium automation platform

Ethernet Modbus/TCP network

Ethernet Modbus/TCP communication services

Functions (continued)

SNMP network management service

From a network management station, SNMP (*Simple Network Management Protocol*) is used to monitor and control all Ethernet architecture components and thus ensure a rapid diagnosis in the event of a problem.

It is used to:

- Interrogate network components such as computer stations, routers, switches, bridges or terminal devices in order to view their status
- Obtain statistics about the network to which the devices are connected

This network management software complies with the conventional client/server model. However, to avoid confusion with other communication protocols that use this terminology, we talk instead about:

- ConneXview network diagnostics software TSX EAZ 01P SFE10
- Network manager for the client application that operates on the computer station
- SNMP agent for the network device server application

Transparent Ready products can be managed by any SNMP network manager, including HP Openview and IBM Netview.

The SNMP (*Simple Network Management Protocol*) standard protocol is used for access to configuration and management objects that are contained in the device MIBs (*Management Information Base*). These MIBs must comply with certain standards to be accessed by any managers on the market, but, depending on the complexity of the products, manufacturers can add certain objects to private databases.

The Transparent Ready private MIB includes management objects specific to the Schneider Electric offer. These objects simplify installation, setup and maintenance of Transparent Ready devices in an open environment using standard network management tools.

Transparent Ready devices support 2 levels of SNMP network management:

- The Standard MIB II interface: this interface accesses a first level of network management. It enables the manager to identify the devices making up the architecture and retrieve general information about the configuration and operation of Ethernet Modbus/TCP interfaces.
- The Transparent Ready MIB interface: this interface improves the management of Transparent Ready devices. This MIB has a set of data enabling the network management system to supervise all the Transparent Ready services. The Transparent Ready MIB can be downloaded from the FTP server of any Transparent Ready Ethernet module in a PLC.

Modicon Premium automation platform

Ethernet Modbus/TCP network, Transparent Ready Ethernet Modbus/TCP communication services

Functions (continued)

TCP Open optional service

Presentation

TSX ETY 110 WS/5103 Modicon Premium platform Ethernet modules support several communication protocols based on the TCP/IP standard. These include the Modbus protocol. This has public specifications and a simplicity which make it suitable for the requirements of communication with third party devices.

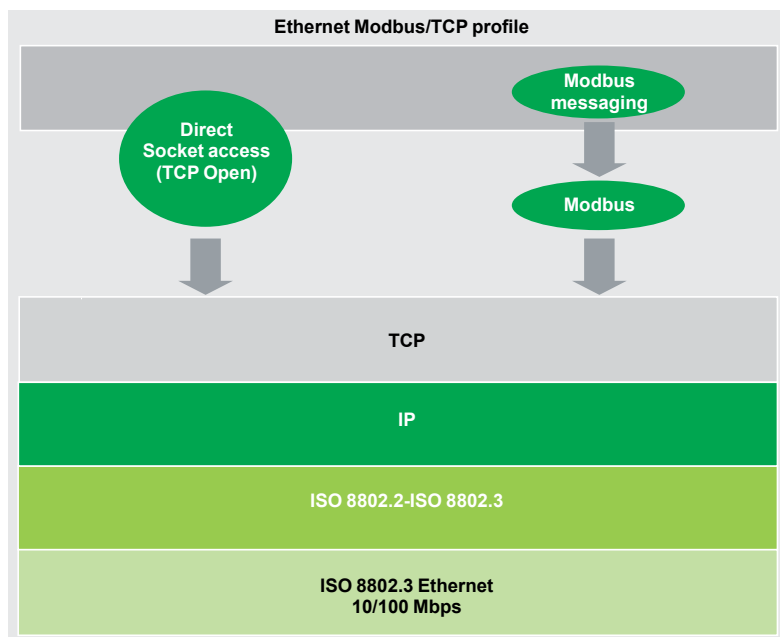

However, for certain applications, it may be necessary to use other protocols. This is the case when, for example, users want to integrate Modicon Premium platforms in existing architectures which use a particular, sometimes proprietary, communication protocol.

To meet these needs for open access, 2 interface levels are included in the Schneider Electric offer:

- A library of basic functions, which can be used in C language, for direct access to the socket interface on TCP. The user can thus create his own communication functions using SDK C development software and take advantage of the ease of use which this software provides for their development and debugging. Once generated, these function blocks are used in the application like any Unity Pro or PL7 Junior/Pro programming software standard function block.
- A library of basic function blocks known as EFs, which can be used directly in the application programs with Unity Pro or PL7 language. These are the same as the functions developed in C language seen earlier, but designed for use by non-computer specialists. These EF function blocks cannot be modified.

Functions

Operating in TCP connection client/server mode, the basic functions on the Berkeley socket interface enable:

- Management of 16 (out of a maximum of 32) connections on the Open profile
- Creation of sockets and their attachment to any TCP port
- Switching these sockets to "listen for a connection request from a remote client" mode
- Openness of a connection
- Transmission and reception of data on these connections (240 bytes max.)
- Closing of this connection

Modicon Premium automation platform

Ethernet Modbus/TCP network, Transparent Ready
Ethernet Modbus/TCP communication services

Functions (continued)

TCP Open optional service (continued)

Description

The TCP Open offer consists of a CD-ROM containing the TCP/IP function libraries. Open access on TCP is only possible via **TSX ETY 110WS** (1) and **TSX ETY 5103** Ethernet modules. With open access on TCP, all the basic functions of these modules can be used.

The **TLX CD TCP 50M** TCP/IP function library comprises:

- The SDK C software enhancement library which provides access to the module TCP/IP socket functions
- User documentation in English (no printed version)
- EF elementary communication function blocks (Socket/Bind/Listen/Accept/Shutdown/Close/Send/Receive/Select/Set_Socket Option/Connect) for installation using PL7 Junior/Pro (version ≥ V3.3) or Unity Pro software
- Higher level EF function blocks, provided by way of example, which can perform more advanced functions such as the complete sequence for initializing or closing a connection, or sending or receiving data. The source files for all these EF blocks are also provided
- An example of an application communicating with a TELNET application on a PC

If specific function blocks have to be created, the following must be installed on the development station:

- The SDK C development software in C language, reference:
 - UNY SPU ZU CD 20E with Unity Pro
 - TLX L SDKC PL741M with PL7 Junior/Pro
- And the TLX CD TCP50M TCP Open function block library

Setup precautions

The development of functions in C language requires compliance with a few setup precautions:

- To set up these services the user must have a good knowledge of the TCP/IP profile.
- In addition, since the SDK C software enables access to all the internal resources of the PLC, all the necessary precautions should be taken when developing EF communication blocks to avoid endangering the application, in particular on the operating modes, such as cold/warm restarts, response to a fault, etc., which are generally fragile.
- The user should also take care to keep the requests from the different communication profiles to a level compatible with the performance required by the application.
- It is the responsibility of the client application program (C program, Unity Pro or PL7 Junior/Pro) to manage the communication operating modes, which may be specific to the application, for example the behaviour if a remote device fails or there is a break in connection.

For these reasons, it is recommended that you consult your Customer Care Centre to check the feasibility of the TCP protocol open access project.

(1) Open access on TCP requires **TSX ETY 110 WS** modules, version ≥ PV 03 and SV 2.9. In addition, it must be integrated in a configuration with a **TSX P57 ●●3/●●4** (or **TSX P57 ●●2** version > V3.3) processor.

Selecting the communication architecture

When selecting an architecture, performance should be taken into account at the earliest possible stage. To do this, the developer must:

- Know exactly what he needs:
 - quantity and type of devices to be interconnected
 - volume and type of exchanges
 - expected response times
 - environment
- Compare his needs with the characteristics of the offers available and be aware that the actual performance level between any 2 points in an architecture depends on the weakest link in the chain, which can be:
 - dependent on the hardware
 - but also dependent on the applications (size, architecture, operating system, machine power rating, etc) which are often only vaguely defined at this stage of the project.
- Work out from these which is the most suitable architecture.

The purpose of the next few pages is to provide the main information and instructions needed to answer the second point. Given that the performance of an Ethernet architecture is linked to many parameters, these pages do not provide all the information needed to calculate the network performance. Their aim is to focus on the following main aspects:

- Guidelines for evaluating the network load so as to design an Ethernet network that meets the application requirements
- Application response time to be obtained according to the configuration used (see pages 5/41 to 5/43)
- Processing capacities of Modicon M340, Modicon Premium and Modicon Quantum platforms so as to be able to select the processor and define the number of Ethernet connections required on the PLC according to the application (see pages 5/44 and 5/45)

Evaluating the network load

Introduction

When evaluating the load on an Ethernet network, all the communication services of all the peripheral devices connected to the network need to be calculated.

Because of the outstanding performance of the Ethernet network, the load is often less than the Ethernet network limits and does not significantly affect the application response time. This is due to the high speed of the Ethernet network: the network transaction time is less than 10% of the total application response time. In order to ensure a low network load and avoid large theoretical calculations, it is highly advisable to separate the collision domain so as to limit the network load, by using only the switched network (tree, star or daisy-chain topology).

Modicon Premium automation platform

Ethernet Modbus/TCP network Performance

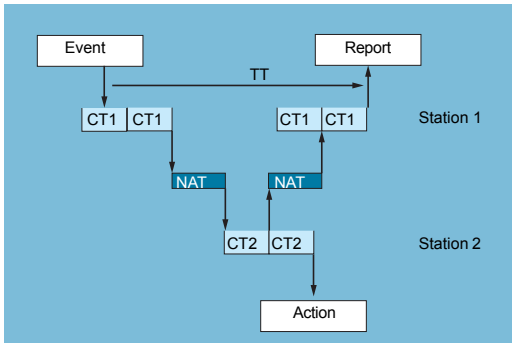

Modbus messaging service response time

Application response time

Modbus (or Uni-TE) messaging service response time

Exchanges between the PLC processor and the Ethernet module are synchronous with the PLC scan cycle time (CT), in the same way as the I/O exchanges. When an event occurs (such as an input being set to 1 for example), a message can be transmitted only after this input has been taken into account (start of the next cycle) and the PLC (Modicon M340, Modicon Premium or Modicon Quantum) program has been executed, i.e. on average approximately 1.5 cycles after the event has occurred.

The network access time (NAT) shown in the table below in ms is a total of the module transit time and the delay before the message can be transmitted on the network.

Processing of Modbus TCP/IP message requests	Modicon M340		Modicon Premium		Modicon Quantum	
		BMX NOE 0100 BMX NOE 0110 BMX NOC 0401 BMX NOR 0200H	BMX P34 2020 BMX P34 20302	TSX ETY 110WS	TSX ETY 4103/5103 TSX WMY 100 TSX P57 10...60 TSX ETC 101	140 NOE 771 00/10 140 NOE 771 01/11 140 NWM 100 00 140 NOC 771 01
Network access time (NAT)	< 10 ms	< 10 ms	< 25 ms	< 10 ms	< 10 ms	< 10 ms

The transaction time TT includes the delay between the transmission of a message from a client station 1, its reception by the server station 2, processing of the request, sending back the response and it being taken into account by the station 1 (updating of an output for example).

As the above block diagram shows:

- The transaction time TT will be between:
 $2 \times CT1 + 2 \times NAT < TT < 4 \times CT1 + CT2 + 2 \times NAT$
- The average duration TT_{av} is equivalent to:
 $TT_{av} = 3 \times CT1 + 0.5 \times CT2 + 2 \times NAT$

5

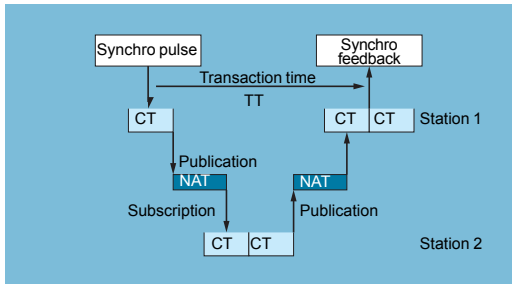

Global Data service response time

Global Data service response time

The transaction time TT includes the delay between publication of Global Data by the station 1, its reception and processing by the remote station 2 and its retransmission to the initial station 1:

For an exchanged variable:

- If $CT < 5$ ms, transaction time: $TT = 5 \text{ to } 6 \times CT$
- If $CT \geq 10$ ms, transaction time: $TT = 3 \times CT$

Modicon Premium automation platform

Ethernet Modbus/TCP network Performance

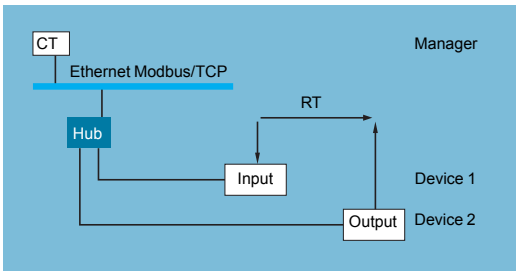

I/O Scanning service response time

Application response time (continued)

I/O Scanning service response time

The response time RT includes the time between taking account of information from a remote input and updating the state of a remote output. It includes the processing time in the PLC.

This response time RT consists of the following parameters:

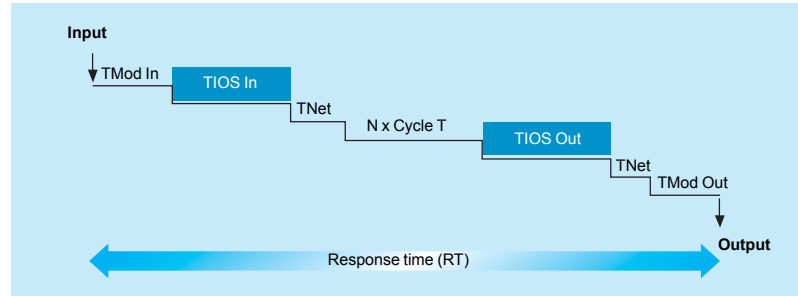

- TMod In and TMod Out: Response time of the read/written device, excluding the electrical transit time at the input/output (TMod depends on the device, usually between 1 and 8 ms).
- TIOS In and TIOS Out: Time between 2 read/write operations on the same device (0.3 ms x number of devices scanned), at least equivalent to the configured scan time. As TIOS is executed in parallel with the PLC scan cycle, it can be hidden from the viewpoint of the response time (RT).
- Cycle T: PLC scan cycle time.
- TNet: Propagation time on the network (depends on the application, but usually TNet = 0.05 ms at 10 Mbps and 0.005 ms at 100 Mbps)

The response time RT can be estimated using the following 3 formulae:

■ RT_{min} , minimum response time with TIOS hidden and 1 PLC scan cycle:

$$RT_{min} = (TMod In + 0) \times TIOS In + (Tnet + N) \times cycle T + (0 \times TIOS Out) + Tnet + TMod Out$$

■ RT_{typ} , typical response time with 0.5 TIOS hidden:

$$RT_{typ} = (TMod In + 0.5) \times TIOS In + (Tnet + N) \times cycle T + (0.5 \times TIOS Out) + Tnet + TMod Out$$

■ RT_{max} , maximum response time with TIOS not hidden:

$$RT_{max} = TMod In + TIOS In + (Tnet + N) \times T cycle + TIOS Out + Tnet + TMod Out$$

Modicon Premium automation platform

Ethernet Modbus/TCP network Performance

Application response time (continued)

I/O Scanning service response time (continued)

TMod E and TMod S response times are shown below:

Type of distributed I/O	Response time	Min.	Typical	Max.
Momentum 170 ENT 110 02	TMod In	1 ms	1 ms	1 ms
	TMod Out	5 ms	5 ms	5 ms
Momentum 170 ENT 110 01	TMod In	4 ms	6 ms	8 ms
	TMod Out	4 ms	6 ms	8 ms
Modicon STB STB NIP 2212	TMod In	2 ms	3 ms	4 ms
	TMod Out	2 ms	3 ms	4 ms

The TIOS E/TIOS S times measured between 2 scan cycles (Ethernet network with switches) are shown below:

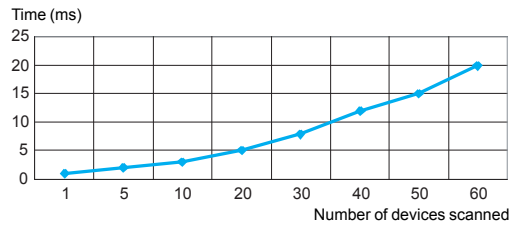

The number N of processor scan cycles is shown below:

Number N of processor cycles	Min.	Typical	Max.
Modicon M340 platform with BMX NOE 0100 and BMX NOE 0100WS modules	2	2.5	3
Modicon Premium platform with TSX ETY 4103 and TSX ETY 5103 modules			
Modicon Quantum platform with 140 NOE 771 01 and 140 NOE 771 11 modules			
Modicon M340 BMX P34 2020/20302 processors			
Modicon Premium TSX P57 2634M/3634M , TSX P57 2623M/2823M and TSX P57 3623M/4823M processors	1	1	2
Modicon Premium TSX P57 4634M/5634M/6634M processors			
Modicon Quantum 140 CPU 651 50/60 processors			



Modicon Premium automation platform

Ethernet Modbus/TCP network Performance

Processing capacities of Modicon platforms

Processing capacity

The table below can be used to compare, for each station, the total number of messages received via the Modbus (or Uni-TE) messaging service, if used, (value R1, R2 or Ri) with the capacity of the station processor.

Processing of Modbus requests per PLC scan cycle

Modicon M340, Modicon Premium platforms	Messages received
Total messages received by the PLC from all the communication modules (1)	TSX P57 10 4 messages/cycle
	BMX P34 20 / TSX P57 20 8 messages/cycle
	TSX P57 30 12 messages/cycle
	TSX P57 40 16 messages/cycle
	TSX P57 50/60 (2) 16/20 messages/cycle

Modicon Quantum platform	Integrated port limitations		Communication module limitations		Ethernet modules per PLC
	All types of communication request	Additional read/write 4x registers	All types of communication request	Additional read/write 4x registers	
140 CPU 113 (3)	–	–	1 message/cycle	4 messages/cycle	2 max.
140 CPU 311	–	–	1 message/cycle	4 messages/cycle	2 max.
140 CPU 434 140 CPU 534 (3)	–	–	4 messages/cycle	8 messages/cycle	6 max.
140 CPU 651	16 messages/cycle	16 messages/cycle	4 messages/cycle	8 messages/cycle	6 max.

Messages/cycle: number of messages received per scan cycle from the PLC master task (typical cycle of 50 to 100 ms)

Example:

Modicon Quantum 140 CPU 434 12● processor with 4 Ethernet 140 NOE 771 ●1 modules:

- 20 messages/cycle for all types of communication request, and
- 32 messages/cycle for the read/write 4x registers

Ethernet transaction processing capacity

For each station, compare the total number of messages received Σ [values Ri, Rj] and the total number of messages transmitted Σ [values Ei, Ej] (for station N, for example) with the Ethernet transaction processing capacity shown below. Use the following elements for the Ethernet connection per PLC, rather than the number of transactions required by the application.

Ethernet transaction processing capacity	Modicon M340 BMX		Modicon Premium TSX			Modicon Quantum 140	
	NOE 0100 NOE 0110 NOC 0401 NOR 0200H	P34 2020 P34 20302	ETY 110WS	ETY 4103/5103 WMY 100 ETC 101 P57 10...40	P57 50 P57 60	NOE 771 00/10 NOE 771 01/11 NWM 100 00 NOC 771 01	CPU 651 50/60 CPU 652 60
Modbus messaging	500 transactions/s	500 transactions/s	60 transactions/s	450 transactions/s	500 transactions/s	350 transactions/s	350 transactions/s
I/O Scanning service	2,000 transactions/s	Server mode (4)	Service not available	2,000 transactions/s (5)	2,000 transactions/s	2,000 transactions/s (5)	2,000 transactions/s
Global Data subscription	800	Service not available	Service not available	800 (6)	800	800 (6)	800

(1) A temporary overload, due for example to an adjustment terminal or the temporary connection of an Internet browser, lasting for a few PLC scans, is permissible.

(2) Only with Unity Pro software.

(3) Only with Concept/ProWORX software.

(4) BMX P34 20●●● processors with Modbus TCP messaging in server mode can be scanned by a device that has the I/O Scanning service.

(5) TSX WMY 100 and 140 NWM 100 00 modules do not have the I/O Scanning service.

(6) TSX WMY 100, TSX ETC 101, 140 NWM 100 00 and 140 NOC 771 01 modules do not have the Global Data service.

Modicon Premium automation platform

Ethernet Modbus/TCP network Performance

Processing capacities of Modicon platforms (continued)

Number of simultaneous TCP/IP connections

The number of simultaneous TCP/IP connections depends on the platform as well as the type of connection to the Ethernet network:

- 10/100BASE-TX port in network modules
- 10/100BASE-TX port integrated in processors

Number of simultaneous TCP/IP connections	Modicon M340		Modicon Premium		Modicon Quantum	
	BMX NOE 0100 BMX NOE 0110 BMX NOC 0401 BMX NOR 0200H	BMX P34 2020 BMX P34 2030Z	TSX ETY 110WS	TSX ETY 4103/5103 TSX WMY 100 TSX ETC 101 TSX P57 10...60	140 NOE 771 00/10 140 NOE 771 01/11 140 NWM 100 00 140 NOC 771 01	140 CPU 311 10 140 CPU 434 12U 140 CPU 651 50/60 140 CPU 652 60
Client	16	16	32	16 (1)	16 (1)	16 (1)
Server	32	32		64 (1)	64 (1)	64 (1)



Bandwidth management for Ethernet Modbus/TCP modules

The bandwidth management service indicates the load level of the Ethernet network module. This enables the user to monitor any drift and anticipate possible problems. The Ethernet module load is indicated in one of three ways:

- Expected load in the Unity Pro/PL7 configuration screen
- Actual load in the Unity Pro/PL7 diagnostics/debug screen, as well as in the diagnostics pages via the Web. This is displayed in the form of a bar chart animated in real time.
- In the SNMP interface for access by the SNMP network manager

The bandwidth is shown as a percentage for each of the following services:

- Modbus (and Uni-TE) messaging
- I/O Scanning
- Global Data
- Others



Ethernet port integrated in the processor (for example with Modicon M340 processor BMX P34 2020/2030) or

Dedicated Ethernet module (for example with Modicon M340 module BMX NOE 0100/0110)

Ethernet solutions with Modicon M340 platforms

Modicon platforms feature two types of connection to the Ethernet network:

- The 10/100BASE-TX port integrated in the processors, which also process the application and ensure exchanges with the other modules supported by the rack and other communication ports (CANopen bus, Modbus serial link, etc.).
- The 10/100BASE-TX port in dedicated Ethernet modules on which, unlike the processor with integrated Ethernet port, all the resources are allocated to Ethernet Modbus/TCP communication.

These fundamentally different hardware characteristics result in equally different capacities in terms of services and performance:

- The integrated port is a low-cost way of satisfying applications that are not too demanding in terms of communication (≤ 500 useful messages/s).
- Where there are a large number of exchanges, use of a dedicated Ethernet network module becomes essential.

(1) With 64 TCP/IP connections maximum (cumulative total of client and server connections)

Modicon Premium automation platform

Processors with integrated Ethernet port

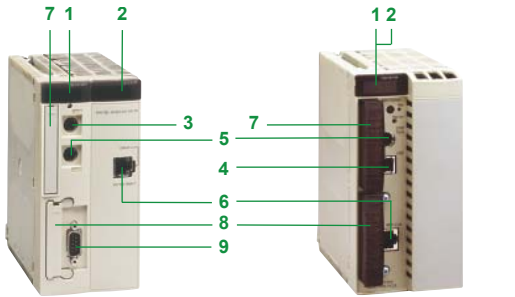

TSX P57 1634M
TSX P57 2634M/3634M
TSX P57 2623AM/3623AM
TSX P57 2823M/4823M

TSX P57 4634M
TSX P57 5634M/6634M

Description

The front panels of **TSX P57 ●634M** (Unity Pro) and **TSX P57 ●623M/3623AM/●823AM** (PL7) double format processors with integrated Ethernet port comprise:

- 1 A display block with 5 LEDs relating to the processor.
- 2 A display block relating to the integrated Ethernet port.
- 3 An 8-way female mini-DIN connector marked TER for connecting a programming or adjustment terminal.
- 4 A USB connector marked TER for connecting a programming or adjustment terminal.
- 5 An 8-way female mini-DIN connector marked AUX for connecting an RS 485 peripheral device.
- 6 A standard (RJ45) connector for 10BASE-T/100BASE-TX interface.
- 7 A slot for a PCMCIA memory expansion card.
- 8 A slot for a PCMCIA communication or data storage memory expansion card.
- 9 A 9-way SUB-D connector (on **TSX P57 2823M/4823M** models only) for Fipio bus manager link.

References

Description	Discrete I/O Analog I/O App-sp. chann.	Reference		Weight kg
		Unity Pro	PL7 Junior/Pro	
Processors with integrated Ethernet link Class B30	512/24/8	TSX P57 1634M	–	–
	1024/80/24	TSX P57 2634M	TSX P57 2623M	–
		–	TSX P57 2823M (1)	–
	1024/128/32	TSX P57 3634M	TSX P57 3623AM	–
	2048/256/64	TSX P57 4634M	TSX P57 4823AM (1)	–
	2048/512/64	TSX P57 5634M	–	–
	2048/512/64	TSX P57 6634M	–	–

(1) Also has an integrated Fipio bus manager link.

Presentation

TSX ETY 110 WS/4103/5103 and **TSX WMY 100** Ethernet network modules are single format modules which are inserted in a Modicon Premium PLC station rack slot. A configuration can take from 1 to 4 network modules, depending on the type of processor.

Ethernet network modules route X-Way and Uni-TE messages transparently from a Modbus/TCP network to an X-Way network and vice versa.

Description

The front panel of **TSX ETY 110 WS/4103/5103** and **TSX WMY 100** modules comprises:

- 1 A display block indicating the module status.
- 2 A standard connector for 100BASE-TX and/or /10BASE-T (RJ45) interface depending on the model.
- 3 A standard connector for 10BASE5 interface (AUI).
- 4 Four thumbwheels for defining the station number and network number.

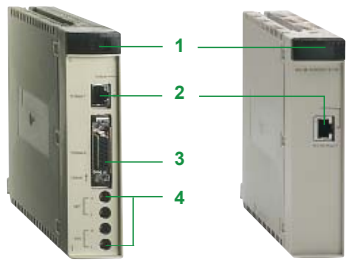

TSX ETY 110 WS

TSX ETY 4103
TSX WMY 100

References

Description	Data rate	Transparent Ready class	Reference	Weight kg
Ethernet Modbus/TCP modules	10 Mbps	C10	TSX ETY 110 WS	0.370
	10/100 Mbps	B30	TSX ETY 4103	0.340
		C30	TSX ETY 5103	0.340
		D10	TSX WMY 100	0.340
Web Designer software	FactoryCast server configuration		Supplied with TSX ETY 110 WS / 5103 and TSX WMY100	
TCP Open software	TCP Open function block library		TLX CD TCP50M	–
	SDKC, C language development	Unity applications	UNY SPU ZFU CD20E	–
		PL7 applications	TLX LSDKC PL741M	–

EtherNet/IP™
conformance tested
Certification logo Mark



5

Presentation

The **TSX ETC 101** EtherNet/IP and Modbus/TCP network module is a single format module, compatible with Unity Pro software, which is inserted in a Modicon Premium rack slot.

A configuration can take from 1 to 4 network modules, depending on the type of processor.

EtherNet/IP protocol

EtherNet/IP is the Ethernet industrial network protocol based on CIP (*Common Industrial Protocol*).

CIP and EtherNet/IP are protocols owned and managed by the ODVA, an independent standards organization made up of members from the world's leading automation companies.

Schneider Electric is a principal member of the ODVA organization.

Schneider Electric's presence in the organization and its technical committees makes it easy for Modbus/TCP users to connect to the CIP network while retaining their existing automation investment.

Users thus have the benefit of optimized interoperability between the installed bases of the most widely used industrial Ethernet networks - EtherNet/IP and Modbus/TCP - and between the automation products of a growing number of manufacturers.

This convergence enables users to reduce installation and maintenance times, costs and risks.

Functions

The **TSX ETC 101** module provides the following functions:

- EtherNet/IP and Modbus/TCP protocols operating simultaneously
- Priority of Ethernet packets using the QoS (*Quality of Service*) service
- Automatic module configuration recovery using the FDR (*Faulty Device Replacement*) service
- Support for SCADA functions via the OPC protocol
- Embedded Web server for application monitoring and module diagnostics
- Sharing data between PLCs
- Network management using SNMP (*Simple Network Management Protocol*)

Description

The **TSX ETC 101** module front panel comprises:

- 1 A display block, which indicates the module status and the transmission status on the network
- 2 The unique MAC address of the module
- 3 Two additional LEDs:
 - MOD STATUS LED: module operating status
 - NET STATUS LED: network status
- 4 A standard RJ45 connector for 10BASE-T/100BASE-TX interface



TSX ETC 101

Modicon Premium automation platform

EtherNet/IP and Modbus/TCP network module



TSX ETC 101

References

Description	No. of Ethernet modules per configuration	Data rate	Reference	Weight kg
EtherNet/IP and Modbus/TCP network module	1 to 4 modules depending on type of Unity processor (see page 1/10)	10/100 Mbps	TSX ETC 101	0.340

Device type

Hub



Interfaces	Copper cable ports	Number and type	4 x 10BASE-T ports
		Shielded connectors	RJ45
		Medium	Shielded twisted pair, category CAT 5E
		Total length of pair	100 m
	Fibre optic ports	Number and type	–
		Connectors	–
		Medium	–
		Length of optical fibre	–
		50/125 µm	–
		62.2/125 µm	–
		Optical fibre attenuation analysis	–
		50/125 µm fibre	–
		62.2/125 µm fibre	–

4 x 10BASE-T ports
RJ45
Shielded twisted pair, category CAT 5E
100 m
–
–
–
–
–
–

Topology	Number of hubs	Cascaded	4 max.
		In a ring	–

4 max.
–

Redundancy

P1 and P2 redundant power supplies

Power supply	Voltage	24 V $\overline{\text{---}}$ (18...32) safety extra low voltage (SELV)
	Consumption	80 mA (130 max. at 24 V $\overline{\text{---}}$)
	Removable terminal block	5 terminals

24 V $\overline{\text{---}}$ (18...32) safety extra low voltage (SELV)
80 mA (130 max. at 24 V $\overline{\text{---}}$)
5 terminals

Operating temperature

0...+ 60°C

Relative humidity

10...95% non-condensing

Degree of protection

IP 30

Dimensions W x H x D

40 x 125 x 80 mm

Mounting

On symmetrical DIN rail, 35 mm wide

Weight

0.530 kg

Conforming to standards

cUL 60950, UL 508 and CSA 22.2 No. 142, UL 1604 and CSA 22.2 No. 213 class 1 division 2, CE, GL, C-Tick
FM 3810, FM 3611 class 1 division 2

LED indicators

Power supply, activity, link

Alarm relay

Power supply fault, Ethernet network fault or communication port fault (volt-free contact 1 A max. at 24 V $\overline{\text{---}}$)

Reference

499 NEH 104 10

Pages

5/68

5



Transceiver



1 x 100BASE-TX port

RJ45

Shielded twisted pair, category CAT 5E

100 m

1 x 100BASE-FX port

SC

Multimode optical fibre

3000 m (1)

3000 m (1)

8 dB

11 dB

-

-

P1 and P2 redundant power supplies

24 V $\overline{\text{---}}$ (18...32) safety extra low voltage (SELV)

160 mA (190 max. at 24 V $\overline{\text{---}}$)

5 terminals

0...+60°C

10...95% non-condensing

IP 20

47 x 135 x 111 mm

On symmetrical DIN rail, 35 mm wide

0.230 kg

cUL 60950, UL 508 and CSA 22.2 No. 142, UL 1604 and CSA 22.2 No. 213 Class 1 Division 2, CE, GL, C-Tick

P1 and P2 power supplies, Ethernet link/port status

Power supply fault, Ethernet network fault or communication port fault (volt-free contact 1 A max. at 24 V $\overline{\text{---}}$)

499 NTR 101 00

5/68

(1) Length dependent on the attenuation analysis and attenuation of the optical fibre (typical value: 2000 m).



More technical information on www.schneider-electric.com

Ethernet network

Cabling system

ConneXium unmanaged switches

5

Device type			Unmanaged switches, copper twisted pair		
					
Interfaces	Copper cable ports	Number and type	5 x 10BASE-T/100BASE-TX ports	8 x 10BASE-T/100BASE-TX ports	
		Shielded connectors	M12 (type D)	RJ45	
		Medium	Shielded twisted pair, category CAT 5E		
		Total length of pair	100 m		
	Fibre optic ports	Number and type	-		
		Connectors	-		
		Medium	-		
	Length of optical fibre	50/125 µm	-		
		62.2/125 µm	-		
	Optical fibre attenuation analysis	50/125 µm fibre	-		
62.2/125 µm fibre		-			
Ethernet services		Storage and re-routing of received data, auto MDI/MDX, automatic negotiation of 10/100 Mbps and duplex mode (on all ports)	-		
Topology	Number of switches	Cascaded	Unlimited		
		Redundant in a ring	-		
Redundancy			-	P1 and P2 redundant power supplies	
Power supply	Voltage	Consumption	24 V $\overline{\text{---}}$ (18...32) safety extra low voltage (SELV)	100 mA max.	125 mA (290 mA max.)
		Removable terminal block	5 terminals, M12 (type A, male)	5 terminals	
Operating temperature			0...+ 60°C		
Relative humidity			-	10...95% non-condensing	
Degree of protection			IP 67	IP 20	
Dimensions		W x H x D	60 x 126 x 31 mm	47 x 135 x 111 mm	
Mounting			On a flat surface	On symmetrical DIN rail, 35 mm wide	
Weight			0.210 kg	0.230 kg	
Conforming to standards			cUL 508 and CSA 22.2 No. 142	cUL 60950, UL 508 and CSA 22.2 No. 142, UL 1604 and CSA 22.2 No. 213 class 1 division 2, C _E , G _L , C-Tick	
LED indicators			Power supply, link status, data rate	P1 and P2 power supplies, Ethernet link/port status	
Alarm relay			-	Power supply fault, Ethernet network fault or communication port fault (volt-free contact 1 A max. at 24 V $\overline{\text{---}}$)	
Reference			TCS ESU 051F0	499 NES 181 00	
Pages			5/69		



More technical information on www.schneider-electric.com

Unmanaged switches, copper twisted pair (continued)



8 x 10BASE-T/100BASE-TX ports
RJ45
Shielded twisted pair, category CAT 5E
100 m
–
–
–
–
–
–
–
–
Storage and re-routing of received data, auto MDI/MDX, automatic negotiation of 10/100 Mbps and duplex mode (on all ports), automatic change of polarity
Unlimited
–
–
24 V $\overline{\text{---}}$ (9.6...32) SELV
4.1 W max.
3 terminals
0...+ 60°C
95% max. non-condensing
IP 30
35 x 138 x 121 mm
On symmetrical DIN rail, 35 mm wide
0.246 kg
UL 508 and CSA 22.2 No. 142 IEC/EN 61131-2, IEC 60825-1 class 1, CISPR 11A
Power supply, copper port activity, 10 or 100 Mbps data rate
–

TCS ESU 083FN0

5/69

Unmanaged switches, 4 and 5 ports, copper twisted pair and fibre optic



3 x 10BASE-T/100BASE-TX ports	4 x 10BASE-T/100BASE-TX ports	5 x 10BASE-T/100BASE-TX ports
RJ45	RJ45	RJ45
Shielded twisted pair, category CAT 5E	Shielded twisted pair, category CAT 5E	Shielded twisted pair, category CAT 5E
100 m	100 m	100 m
–	1 x 100BASE-FX port	–
–	Duplex SC	–
–	Multimode optical fibre	–
–	5000 m (1)	–
–	4000 m (1)	–
–	8 dB	–
–	11 dB	–
Storage and re-routing of received data, auto MDI/MDX, automatic negotiation of 10/100 Mbps and duplex mode (on all ports)	Storage and re-routing of received data, auto MDI/MDX, automatic negotiation of 10/100 Mbps and duplex mode (on all ports)	Storage and re-routing of received data, auto MDI/MDX, automatic negotiation of 10/100 Mbps and duplex mode (on all ports)
Unlimited	Unlimited	Unlimited
–	–	–
–	–	–
24 V $\overline{\text{---}}$ (9.6...32) SELV	24 V $\overline{\text{---}}$ (9.6...32 V) safety extra low voltage (SELV)	24 V $\overline{\text{---}}$ (9.6...32 V) safety extra low voltage (SELV)
4.1 W max.	2.2 W max.	3.9 W max.
3 terminals	3-terminal removable screw terminal block	2.2 W max.
0...+ 60°C	0...+ 60°C	0...+ 60°C
95% max. non-condensing	95% max. non-condensing	95% max. non-condensing
IP 30	IP 30	IP 30
35 x 138 x 121 mm	25 x 114 x 79 mm	25 x 114 x 79 mm
On symmetrical DIN rail, 35 mm wide	On symmetrical DIN rail, 35 mm wide	On symmetrical DIN rail, 35 mm wide
0.246 kg	0.113 kg	0.120 kg
UL 508 and CSA 22.2 No. 142 IEC/EN 61131-2, IEC 60825-1 class 1, CISPR 11A	UL 508 and CSA 22.2 No. 142 IEC/EN 61131-2, IEC 60825-1 class 1, CISPR 11A	UL 508 and CSA 22.2 No. 142 IEC/EN 61131-2, IEC 60825-1 class 1, CISPR 11A
Power supply, copper port activity, 10 or 100 Mbps data rate	Power supply, copper port activity, 10 or 100 Mbps data rate	Power supply, copper port activity, 10 or 100 Mbps data rate
–	–	Fibre port activity and status
–	–	–

TCS ESU 033FN0

5/70

TCS ESU 043F1N0

TCS ESU 053FN0

(1) Length dependent on the attenuation analysis and attenuation of the optical fibre (typical value: 2000 m).

Ethernet network

Cabling system

Managed and unmanaged ConneXium switches

Device type

Unmanaged switches, 5 ports, copper twisted pair and fibre optic



Interfaces	Copper cable ports	Number and type	4 x 10BASE-T/ 100BASE-TX ports	3 x 10BASE-T/ 100BASE-TX ports	4 x 10BASE-T/ 100BASE-TX ports	3 x 10BASE-T/ 100BASE-TX ports
		Shielded connectors	RJ45			
		Medium	Shielded twisted pair, category CAT 5E			
	Fibre optic ports	Total length of pair	100 m			
		Number and type	1 x 100BASE-FX port	2 x 100BASE-FX ports	1 x 100BASE-FX port	2 x 100BASE-FX ports
		Connectors	SC			
	Length of optical fibre	Medium	Multimode optical fibre		Single mode optical fibre	
		50/125 µm	5000 m (1)		-	
		62.2/125 µm	4000 m (1)		-	
	Optical fibre attenuation analysis	9/125 µm fibre	-		32,500 m (2)	
50/125 µm fibre		8 dB		-		
62.2/125 µm fibre		11 dB		-		
Ethernet services	9/125 µm fibre	-		16 dB		
		-		-		

Unlimited	P1 and P2 redundant power supplies			
-	24 V ~ (18...32 V) safety extra low voltage (SELV)			
	200 mA max.	240 mA max.	200 mA max.	240 mA max.
	5 terminals			
	- 40...+ 70°C			
	10...95% non-condensing			
	IP 20			
	47 x 135 x 111 mm			
	On symmetrical DIN rail, 35 mm wide			
	0.330 kg	0.335 kg	0.330 kg	0.335 kg
	cUL 60950, cUL 508 and CSA 22.2 No. 142, UL 1604 and CSA 22.2 No. 213 class 1 division 2, CE, GL, C-Tick			
	P1 and P2 power supplies, Ethernet link status, transmission activity			
	Activity, power supply fault, Ethernet network fault or communication port fault (volt-free contact 1 A max. at 24 V ~)			

Topology	Number of switches	Cascaded
		Redundant in a ring

Unlimited
-

Redundancy

Power supply	Voltage	24 V ~ (18...32 V) safety extra low voltage (SELV)			
	Consumption	200 mA max.	240 mA max.	200 mA max.	240 mA max.
	Removable terminal block	5 terminals			

Operating temperature

Relative humidity

Degree of protection

Dimensions W x H x D

Mounting

Weight

Conforming to standards

LED indicators

Alarm relay

Reference

Pages

Weight

Unlimited	P1 and P2 redundant power supplies			
-	24 V ~ (18...32 V) safety extra low voltage (SELV)			
	200 mA max.	240 mA max.	200 mA max.	240 mA max.
	5 terminals			

Operating temperature

Relative humidity

Degree of protection

Dimensions W x H x D

Mounting

Weight

Conforming to standards

LED indicators

Alarm relay

Reference

Pages

499 NMS 251 01 **499 NMS 251 02** **499 NSS 251 01** **499 NSS 251 02**

5/70

(1) Length dependent on the attenuation analysis and attenuation of the optical fibre (typical value: 2000 m).
 (2) Length dependent on the attenuation analysis and attenuation of the optical fibre (typical value: 15,000 m).



Managed switches, 4 ports, copper twisted pair and fibre optic



3 x 10/100BASE-TX ports	2 x 10/100BASE-TX ports	3 x 10/100BASE-TX ports	2 x 10/100BASE-TX ports
-------------------------	-------------------------	-------------------------	-------------------------

RJ45

Shielded twisted pair, category CAT 5E

100 m

1 x 100BASE-FX port	2 x 100BASE-FX ports	1 x 100BASE-FX port	2 x 100BASE-FX ports
---------------------	----------------------	---------------------	----------------------

Duplex SC

Multimode optical fibre	Single mode optical fibre
-------------------------	---------------------------

5000 m (1)	-
------------	---

4000 m (1)	-
------------	---

-	32,500 m (2)
---	--------------

8 dB	-
------	---

11 dB	-
-------	---

-	16 dB
---	-------

FDR, SMTP V3, SNTp client, multicast filtering for optimization of the Global Data protocol, configuration via Web access, VLAN, IGMP Snooping, RSTP (*Rapid Scanning Tree Protocol*), priority port, data stream control, secure port

Unlimited

50 max.

Redundant power supplies, redundant single ring, ring coupling

9.6...60 V $\overline{\text{---}}$ / 18...30 V \sim safety extra low voltage (SELV)

6.5 W	7.3 W	6.5 W	7.3 W
-------	-------	-------	-------

6 terminals

0...+ 60°C

10...90% non-condensing

IP 20

47 x 131 x 111 mm

On symmetrical DIN rail, 35 mm wide

0.400 kg

IEC 61131-2, UL 508, UL 1604 class 1 division 2, CSA 22.2 No. 142 (cUL), CSA 22.2 No. 213 class 1 division 2 (cUL), C€, GL, C-Tick

Power supply status, alarm relay status, active redundancy, redundancy management, copper port status and copper port activity

Power supply fault, Ethernet network fault, communication port fault, redundancy fault (volt-free contact 1 A max. at 24 V $\overline{\text{---}}$)

TCS ESM 043F1CU0 **TCS ESM 043F2CU0** **TCS ESM 043F1CS0** **TCS ESM 043F2CS0**

5/71

(1) Length dependent on the attenuation analysis and attenuation of the optical fibre (typical value: 2000 m).

(2) Length dependent on the attenuation analysis and attenuation of the optical fibre (typical value: 15,000 m).

Device type

Managed switches, 4 and 8 ports, copper twisted pair



Interfaces	Copper cable ports	Number and type
		Shielded connectors
		Medium
	Fibre optic ports	Number and type
		Connectors
		Medium
	Length of optical fibre	50/125 µm
		62.2/125 µm
		9/125 µm fibre
	Attenuation analysis	50/125 µm fibre
62.2/125 µm fibre		
9/125 µm fibre		
Ethernet services		

4 x 10/100BASE-TX ports	8 x 10/100BASE-TX ports
RJ45	
Shielded twisted pair, category CAT 5E	
100 m	
-	
-	
-	
-	
-	
-	
FDR, SMTP V3, SNMP client, multicast filtering for optimization of the Global Data protocol, configuration via Web access, VLAN, IGMP Snooping, RSTP (<i>Rapid Scanning Tree Protocol</i>), priority port, data stream control, secure port	

Topology	Number of switches	Cascaded
		Redundant in a ring

Unlimited
50 max.

Redundancy

P1 and P2 redundant power supplies, redundant single ring, ring coupling

Power supply	Voltage
	Consumption
	Removable terminal block

9.6...60 V $\overline{\text{---}}$ / 18...30 V \sim safety extra low voltage (SELV)
5.3 W
6 terminals

Operating temperature

0...+ 60°C

Relative humidity

10...90% non-condensing

Degree of protection

IP 20

Dimensions	W x H x D
-------------------	-----------

47 x 131 x 111 mm	74 x 131 x 111 mm
-------------------	-------------------

Mounting

On symmetrical DIN rail, 35 mm wide

Weight

0.400 kg	0.410 kg
----------	----------

Conforming to standards

IEC/EN 61131-2, UL 508, UL 1604 class 1 division 2, CSA 22.2 No. 214 (cUL), CSA 22.2 No. 213 class 1 division 2 (cUL), CE, GL, C-Tick

LED indicators

Power supply status, alarm relay status, active redundancy, redundancy management, copper port status and copper port activity	Power supply status, alarm relay status, active redundancy, redundancy management, fibre port status and fibre port activity
--	--

Alarm relay

Power supply fault, Ethernet network fault or communication port fault (volt-free contact 1 A max. at 24 V $\overline{\text{---}}$)

Reference

TCS ESM 043F23F0 **TCS ESM 083F23F0**

Pages

5/71

5

Managed switches, 8 ports, copper twisted pair and fibre optic



7 x 10/100BASE-TX ports



6 x 10/100BASE-TX ports



7 x 10/100BASE-TX ports



6 x 10/100BASE-T ports

RJ45

Shielded twisted pair, category CAT 5E

100 m

1 x 100BASE-FX port

2 x 100BASE-FX ports

1 x 100BASE-FX port

2 x 100BASE-FX ports

Duplex SC

Multimode optical fibre

5000 m (1)

4000 m (1)

–

8 dB

11 dB

–

Single mode optical fibre

–

–

32,500 m (2)

–

–

16 dB

FDR, SMTP V3, SNTP client, multicast filtering for optimization of the Global Data protocol, configuration via Web access, VLAN, IGMP Snooping, RSTP (*Rapid Scanning Tree Protocol*), priority port, data stream control, secure port

Unlimited

50 max.

Redundant power supplies, redundant single ring, ring coupling

9.6...60 V $\overline{\text{---}}$ / 18...30 V \sim safety extra low voltage (SELV)

6.5 W

7.3 W

6.5 W

7.3 W

6 terminals

0...+ 60°C

10...90% non-condensing

IP 20

75 x 131 x 111 mm

On symmetrical DIN rail, 35 mm wide

0.410 kg

IEC/EN 61131-2, UL 508, UL 1604 class 1 division 2, CSA 22.2 No. 214 (cUL), CSA 22.2 No. 213 class 1 division 2 (cUL), CE, GL, C-Tick

Power supply status, alarm relay status, active redundancy, redundancy management, fibre port status and fibre port activity

Power supply fault, Ethernet network fault or communication port fault (volt-free contact 1 A max. at 24 V $\overline{\text{---}}$)

TCS ESM 083F1CU0

TCS ESM 083F2CU0

TCS ESM 083F1CS0

TCS ESM 083F2CS0

5/72

(1) Length dependent on the attenuation analysis and attenuation of the optical fibre (typical value: 2000 m).

(2) Length dependent on the attenuation analysis and attenuation of the optical fibre (typical value: 15,000 m).



Device type

Basic managed switch, 8 ports, copper twisted pair



Interfaces	Copper cable ports	Number and type	8 x 10/100BASE-TX ports
		Shielded connectors	RJ45
		Medium	Shielded twisted pair, category CAT 5E
	Fibre optic ports	Total length of pair	100 m
		Number and type	–
		Connectors	–
	Length of optical fibre	Medium	–
		50/125 µm	–
		62.2/125 µm	–
	Attenuation analysis	9/125 µm fibre	–
50/125 µm fibre		–	
62.2/125 µm fibre		–	
Ethernet services	9/125 µm fibre	–	
		FDR, SNMP client, multicast filtering for optimization of the Global Data protocol, configuration via Web access, IGMP Snooping, RSTP (<i>Rapid Scanning Tree Protocol</i>), priority port	

8 x 10/100BASE-TX ports
RJ45
Shielded twisted pair, category CAT 5E
100 m
–
–
–
–
–
–
–
–
FDR, SNMP client, multicast filtering for optimization of the Global Data protocol, configuration via Web access, IGMP Snooping, RSTP (<i>Rapid Scanning Tree Protocol</i>), priority port

Topology	Number of switches	Cascaded	Unlimited
		Redundant in a ring	50 max.

Unlimited
50 max.

Redundancy

P1 and P2 redundant power supplies, redundant single ring, ring coupling

Power supply	Voltage	9.6...32 V $\overline{\text{---}}$ safety extra low voltage (SELV)
	Consumption	6 W
	Removable terminal block	6 terminals

9.6...32 V $\overline{\text{---}}$ safety extra low voltage (SELV)
6 W
6 terminals

Operating temperature

0...+ 60°C

Relative humidity

95% max. non-condensing

Degree of protection

IP 20

Dimensions W x H x D

47 x 131 x 111 mm

Mounting

On symmetrical DIN rail, 35 mm wide

Weight

0.400 kg

Conforming to standards

IEC/EN 61131-2, UL 508, UL 1604 class 1 division 2, CSA 22.2 No. 214 (cUL), CSA 22.2 No. 213 class 1 division 2 (cUL), CE, GL, C-Tick

LED indicators

Power supply status, alarm relay status, active redundancy, redundancy management, copper port status and copper port activity

Alarm relay

Power supply fault, Ethernet network fault or communication port fault (volt-free contact 1 A max. at 24 V $\overline{\text{---}}$)

Reference

TCS ESB 083F23F0

Pages

5/72

5

Basic managed switches, 8 and 9 ports, copper twisted pair and fibre optic



6 x 10/100BASE-TX ports	6 x 10/100BASE-TX ports
RJ45	
Shielded twisted pair, category CAT 5E	
100 m	
2 x 100BASE-FX ports	3 x 100BASE-FX ports
Duplex SC	
Multimode optical fibre	
5000 m (1)	
4000 m (1)	
–	
8 dB+	
11 dB	
–	
FDR, SNMP client, multicast filtering for optimization of the Global Data protocol, configuration via Web access, IGMP Snooping, RSTP (<i>Rapid Scanning Tree Protocol</i>), priority port	
Unlimited	
50 max.	
P1 and P2 redundant power supplies, redundant single ring, ring coupling	
9.6...32 V ~ safety extra low voltage (SELV)	
8 W	9 W
6 terminals	
0...+ 60°C	
95% max. non-condensing	
IP 20	
74 x 131 x 111 mm	
On symmetrical DIN rail, 35 mm wide	
0.400 kg	
IEC/EN 61131-2, UL 508, UL 1604 class 1 division 2, CSA 22.2 No. 214 (cUL), CSA 22.2 No. 213 class 1 division 2 (cUL), CE, GL, C-Tick	
Power supply status, alarm relay status, active redundancy, redundancy management, fibre port status and fibre port activity	
Power supply fault, Ethernet network fault or communication port fault (volt-free contact 1 A max. at 24 V ~)	

TCS ESB 083F2CU0

TCS ESB 093F2CU0

5/72

(1) Length dependent on the attenuation analysis and attenuation of the optical fibre (typical value: 2000 m).
 (2) Length dependent on the attenuation analysis and attenuation of the optical fibre (typical value: 15,000 m).

Device type

Managed switches, 8 extended ports, copper twisted pair and fibre optic



Interfaces	Copper cable ports	Number and type	8 x 10/100BASE-TX ports	
		Shielded connectors	RJ45	
		Medium	Shielded twisted pair, category CAT 5E	
	Fibre optic ports	Total length of pair	100 m	
		Number and type	2 x 100BASE-FX ports	
		Connectors	Duplex SC	
	Length of optical fibre	Medium	Multimode optical fibre	Single mode optical fibre
		50/125 µm	5000 m (1)	–
		62.2/125 µm	4000 m (1)	–
	Attenuation analysis	9/125 µm fibre	–	32,500 m (2)
50/125 µm fibre		8 dB	–	
62.2/125 µm fibre		11 dB	–	
Ethernet services	9/125 µm fibre	–	16 dB	

8 x 10/100BASE-TX ports	6 x 10/100BASE-TX ports	6 x 10/100BASE-T ports
RJ45		
Shielded twisted pair, category CAT 5E		
100 m		
–	2 x 100BASE-FX ports	
–	Duplex SC	
–	Multimode optical fibre	Single mode optical fibre
–	5000 m (1)	–
–	4000 m (1)	–
–	–	32,500 m (2)
–	8 dB	–
–	11 dB	–
–	–	16 dB

FDR, SMTP V3, SNMP client, multicast filtering for optimization of the Global Data protocol, configuration via Web access, VLAN, IGMP Snooping, RSTP (Rapid Spanning Tree Protocol), priority port, data stream control, secure port

Topology	Number of switches	Cascaded	Unlimited
		Redundant in a ring	50 max.

Redundancy

Redundant power supplies, redundant single ring, ring coupling, rings supporting MRP, Fast HIPER Ring and RSTP

Power supply	Voltage	18...60 V ~	
	Consumption	10 W	12 W
	Removable terminal block	2 terminal blocks, 2 terminals	

Operating temperature

0...+ 60°C

Relative humidity

10...90% non-condensing

Degree of protection

IP 30

Dimensions

W x H x D

120 x 137 x 115 mm

Mounting

On symmetrical DIN rail, 35 mm wide

Weight

1 kg

Conforming to standards

IEC/EN 61131-2, IEC 61850-3, UL 508, UL 1604 class 1 division 2, CSA 22.2 No. 214 (cUL), CSA 22.2 No. 213 class 1 division 2 (cUL), CE, GL, C-Tick, LR, BV

LED indicators

Power supply status, alarm relay status, active redundancy, redundancy management, copper port status and copper port activity

Alarm relay

Power supply fault, Ethernet network fault or communication port fault (volt-free contact 1 A max. at 24 V ~, 2-way)

Reference

TCS ESM 083F23F1 **TCS ESM 063F2CU1** **TCS ESM 063F2CS1**

Pages

5/72

(1) Length dependent on the attenuation analysis and attenuation of the optical fibre (typical value: 2000 m).
 (2) Length dependent on the attenuation analysis and attenuation of the optical fibre (typical value: 15,000 m).



Device type

Managed switch, 8 ports and 2 Gigabit ports, copper twisted pair and fibre optic



Interfaces	Copper cable ports	Number and type	8 x 10/100BASE-TX ports			
		Shielded connectors	RJ45			
		Medium	Shielded twisted pair, category CAT 5E			
	Fibre optic Gigabit ports (with SFP fibre optic module to be mounted on SFP connector)	Total length of pair	100 m			
		Number and type	2 x 1000BASE-SX ports (1)	2 x 1000BASE-LH ports (2)	2 x 1000BASE-LX ports (3)	
		Connectors	LC			
		Medium	Multimode optical fibre			
		Length of optical fibre	50/125 µm	Single mode optical fibre	Single mode and multimode optical fibre	
		Attenuation analysis	50/125 µm	550 m	–	550 m
			62.2/125 µm	275 m	–	550 m
9/125 µm fibre	–		8 - 72,000 m	20,000 m		
Ethernet services	50/125 µm fibre	7.5 dB	–	11 dB		
	62.2/125 µm fibre	7.5 dB	–	11 dB		
	9/125 µm fibre	–	6 - 22 dB	11 dB		

Topology			Number of switches	Cascaded
				Redundant in a ring
Redundancy			Unlimited	
			50 max.	
Power supply			Voltage	
			Consumption	
			Removable terminal block	
Operating temperature			9.6...60 V $\overline{\text{---}}$ / 18...30 V \sim safety extra low voltage (SELV)	
Relative humidity			8.9 W + 1 W per SFP fibre optic module	
Degree of protection			6 terminals	
Dimensions			0...+ 60°C	
Mounting			10...90% non-condensing	
Weight			IP 20	
Conforming to standards			111 x 131 x 111 mm	
LED indicators			On symmetrical DIN rail, 35 mm wide	
Alarm relay			0.410 kg	
Reference			cUL 60950, UL 508 and CSA 22.2 No. 142, UL 1604 and CSA 22.2 No. 213 class 1 division 2, CÉ, GL	
Pages			Power supply status, alarm relay status, active redundancy, redundancy management, fibre port status and fibre port activity	
			Power supply fault, Ethernet network fault or communication port fault (volt-free contact 1 A max. at 24 V $\overline{\text{---}}$)	

TCS ESM 103F23G0

5/73

(1) With **TCS EAA F1LFU00** fibre optic module to be ordered separately (see page 5/67).
 (2) With **TCS EAA F1LFH00** fibre optic module to be ordered separately (see page 5/67).
 (3) With **TCS EAA F1LFS00** fibre optic module to be ordered separately (see page 5/67).



Managed switch, 8 ports and 2 Gigabit ports, copper twisted pair



8 x 10/100BASE-TX ports and
2 x 10/100/1000BASE-TX ports (Gigabit)

RJ45

Shielded twisted pair, category CAT 5E

100 m

–

LC

–

–

–

–

–

–

–

–

FDR, SMTP V3, SNMP client, multicast filtering for optimization of the Global Data protocol, configuration via Web access, VLAN, IGMP Snooping, RSTP (*Rapid Scanning Tree Protocol*), priority port, data stream control, secure port

Unlimited

50 max.

Redundant power supplies, redundant single ring, ring coupling

9.6...60 V $\overline{\text{---}}$ / 18...30 V \sim safety extra low voltage (SELV)

8.3 W

6 terminals

0...+ 60°C

10...90% non-condensing

IP 20

111 x 131 x 111 mm

On symmetrical DIN rail, 35 mm wide

0.410 kg

cUL 60950, UL 508 and CSA 22.2 No. 142, UL 1604 and CSA 22.2 No. 213 class 1 division 2, C \u00c2 , GL

Power supply status, alarm relay status, active redundancy, redundancy management, fibre port status and fibre port activity

Power supply fault, Ethernet network fault or communication port fault (voltage-free contact 1 A max. at 24 V $\overline{\text{---}}$)

TCS ESM 103F2LG0

5/73



Examples (continued)

Mixed copper and fibre optic wiring

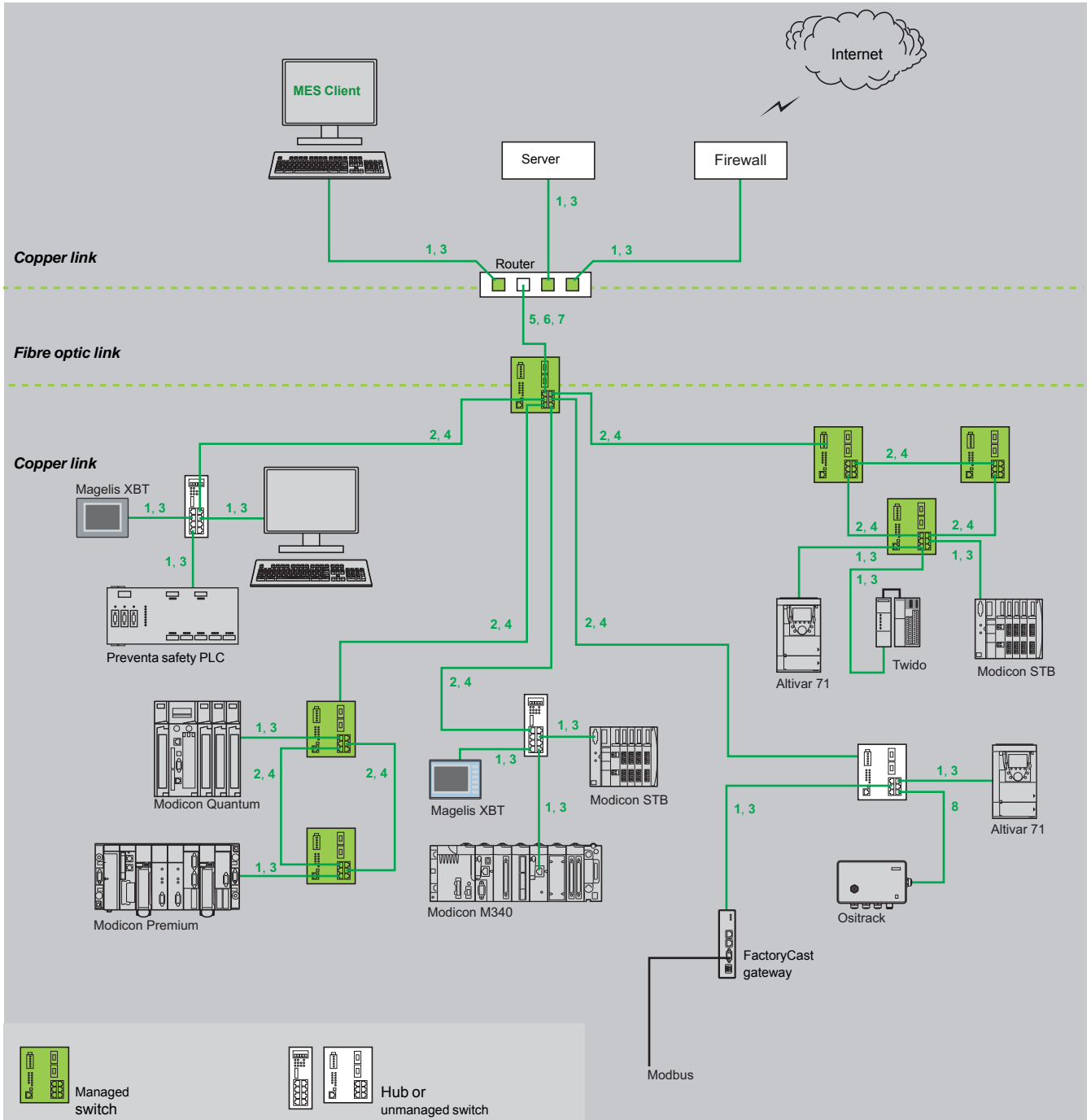

5

Key:

- 1, 3: Straight-through copper cables
- 2, 4: Crossover copper cables
- 5, 6, 7: Fibre optic cables
- 8: Cables with IP 67 connector (see pages 5/66 and 5/67)

Shielded copper connection cables

ConneXium shielded connection cables are available in two versions to meet the various current standards and approvals:

■ **EIA/TIA 568 shielded twisted pair cables for C€ market**

These cables conform to:

- EIA/TIA-568 standard, category CAT 5E
- IEC 11801/EN 50173-1 standard, class D

Their fire resistance conforms to:

- NF C32-070 standard, class C2
- IEC 322/1 standards
- Low Smoke Zero Halogen (LSZH)

■ **EIA/TIA 568 shielded twisted pair cables for UL market**

These cables are:

- CEC type FT-1
- NEC type CM

A new range of ConneXium fully shielded preassembled cables has been specially designed for use in harsh industrial environments. These cables combine a category 5E shielded cable and RJ45 connectors reinforced with a metal profile.

EIA/TIA 568 shielded twisted pair cables for C€ market

Description	With connectors at both ends	No.	Type	Length	Reference	Weight kg
Straight-through copper cables C€ compatible	2 x RJ45 connectors For connection to terminal equipment (DTE)	1	Standard	2 m	490 NTW 000 02	–
				5 m	490 NTW 000 05	–
				12 m	490 NTW 000 12	–
				40 m	490 NTW 000 40	–
				80 m	490 NTW 000 80	–
			Ruggedized	1 m	TCS ECE 3M3M1S4	–
				2 m	TCS ECE 3M3M2S4	–
				3 m	TCS ECE 3M3M3S4	–
				5 m	TCS ECE 3M3M5S4	–
				10 m	TCS ECE 3M3M10S4	–
Crossover copper cables C€ compatible	2 x RJ45 connectors For connection between hubs, switches and transceivers	2	Standard	5 m	490 NTC 000 05	–
				15 m	490 NTC 000 15	–
				40 m	490 NTC 000 40	–
				80 m	490 NTC 000 80	–



TCS EC● 3M3M●●S4

Shielded twisted pair cables for UL market

Description	With connectors at both ends	No.	Type	Length	Reference	Weight kg
Straight-through copper cables UL compatible	2 x RJ45 connectors For connection to terminal equipment (DTE)	3	Standard	2 m	490 NTW 000 02U	–
				5 m	490 NTW 000 05U	–
				12 m	490 NTW 000 12U	–
				40 m	490 NTW 000 40U	–
				80 m	490 NTW 000 80U	–
			Ruggedized	1 m	TCS ECU 3M3M1S4	–
				2 m	TCS ECU 3M3M2S4	–
				3 m	TCS ECU 3M3M3S4	–
				5 m	TCS ECU 3M3M5S4	–
				10 m	TCS ECU 3M3M10S4	–
Crossover copper cables UL compatible	2 x RJ45 connectors For connection between hubs, switches and transceivers	4	Standard	5 m	490 NTC 000 05U	–
				40 m	490 NTC 000 40U	–
				80 m	490 NTC 000 80U	–

Do it Yourself copper cable and connectors

The ConneXium Do it Yourself offer consists of 2 references for connectors (M12 and RJ45) and 1 cable reference (300 m coil), enabling Ethernet 10/100 Mbps networks to be cabled in the field.

The maximum length of cables created in this way is 80 m.

They are quick to assemble using a knife and simple wire cutters (no special tools are required).

Description	Characteristics	Length	Reference	Weight kg
Ethernet copper cable 2 shielded twisted pairs 24 AWG	Conforms to the standards and approvals listed above	300 m	CS ECN 300R2	–
RJ45 connector	Conforms to EIA/TIA-568-D	–	TCS EK3 MDS	–
M12 connector	Conforms to IEC 60176-2-101	–	TCS EK1 MDRS	–



490 NOC 000 05



490 NOT 000 05



490 NOR 000 05

Glass fibre optic cables

Glass fibre optic cables are intended for connection:

- To terminal devices (DTE)
- Between hubs, transceivers and switches

Description	With connectors at both ends	No.	Length	Reference	Weight kg
Glass fibre optic cables	1 SC connector 1 MT-RJ connector	5	5 m	490 NOC 000 05	–
	1 ST (BFOC) connector 1 MT-RJ connector	6	5 m	490 NOT 000 05	–
	2 MT-RJ connectors	7	3 m 5 m	490 NOR 000 03 490 NOR 000 05	– –

Separate parts for TCS ESM and TCS ESB switches

Description	Optical fibre	Type	Reference	Weight kg
Fibre optic modules for Gigabit ports with LC connector (1)	Multimode 50/125 µm or 62.5/125 µm	1000BASE-SX	TCS EAA F1LFU00	0.040
	Single mode 9/125 µm	1000BASE-LH	TCS EAA F1LFH00	0.040
	Multimode 50/125 µm or 62.5/125 µm Single mode 62.5/125 µm	1000BASE-LX	TCS EAA F1LFS00	0.040

Description	Use	Port	Reference	Weight kg
Configuration backup key for TCS ESM switches	Connected on the front of the switch, used to: <ul style="list-style-type: none"> - Save and retrieve the switch configuration - Update the internal software 	USB	TCS EAM 0100	–
Configuration backup key for TCS ESB switches		RJ45 (V24)	TCS EAM 0200	–

Connection components for IP 67 switch

Description	With connectors at both ends	No.	Length	Reference	Weight kg
Straight-through copper cables	1 x IP 67 4-way M12 connector and 1 x RJ45 connector	8	1 m	TCS ECL 1M3M 1S2	–
		–	3 m	TCS ECL 1M3M 3S2	–
		–	10 m	TCS ECL 1M3M 10S2	–
		–	25 m	TCS ECL 1M3M 25S2	–
		–	40 m	TCS ECL 1M3M 40S2	–
	2 x IP 67 4-way M12 connectors	–	1 m	TCS ECL 1M1M 1S2	–
		–	3 m	TCS ECL 1M1M 3S2	–
		–	10 m	TCS ECL 1M1M 10S2	–
		–	25 m	TCS ECL 1M1M 25S2	–
		–	40 m	TCS ECL 1M1M 40S2	–
Power supply cables	2 female M12 straight connectors	–	2 m	XZC P1164L2	–
		–	5 m	XZC P1164L5	–
	2 female M12 elbowed connectors	–	2.5 m	XZC P1264L2	–
		–	5 m	XZC P1264L5	–
	2 female M12 straight connectors	–	–	XZC C12 FDM 50B	–
2 female M12 elbowed connectors	–	–	XZC C12 FCM 50B	–	
M12/RJ45 adaptor	IP 67 4-way female M12 connector and female RJ45 connector	–	–	TCS EAA F11F13F00	–

(1) Dimensions: W x H x D = 20 x 18 x 50 mm

Ethernet network

Wiring system

ConneXium hub and transceiver

ConneXium hub

Presentation

Hubs (*concentrators*) are used for transmitting signals between several media (ports). Hubs are plug and play devices that do not need to be configured by the user.

The use of hubs makes it possible to create the following topologies:

- Star topology
- Tree topology

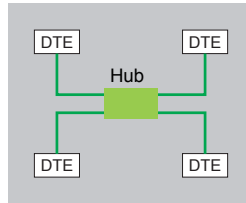

Star topology

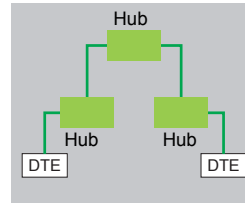

Tree topology



499 NEH 104 10

Reference

Description	Interfaces	Reference	Weight kg
ConneXium hub	4 x 10BASE-T ports (copper cable), RJ45 shielded connectors	499 NEH 104 10	0.530

ConneXium transceiver

Presentation

ConneXium transceivers are used to:

- Create fibre optic linear bus topologies, for devices with a twisted pair cable Ethernet connection
- Interface devices with a twisted pair cable Ethernet connection with a fibre optic cable

Transceivers are plug and play devices that do not need to be configured by the user.

ConneXium transceivers provide fibre optic connections for transmission in areas subject to interference (high levels of electromagnetic interference) and for long distance communications.

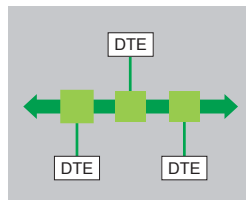

Linear topology on optical fibre



499 NTR 101 00

Reference

Description	Interfaces	Reference	Weight kg
ConneXium transceiver	<ul style="list-style-type: none"> ■ 1 x 10BASE-T port (copper cable), RJ45 shielded connector ■ 1 x 100BASE-FX port (multimode optical fibre), SC connector 	499 NTR 101 00	0.230

ConneXium unmanaged switches, twisted pair

Presentation

Switches are used to increase the limits of architectures based on hubs or transceivers, by separating collision domains. Higher layer communication is provided between the ports, and collisions at link layer are not propagated (filtering). They therefore improve performance by better allocation of the bandwidth due to the reduction of collisions and network load. Certain ConneXium switch models also enable redundant architectures to be created on twisted pair copper ring or optical fibre.

Unmanaged switches are plug and play devices that do not need to be configured by the user. Certain models can also be managed remotely via SNMP or HTTP protocols for monitoring and diagnostic purposes.

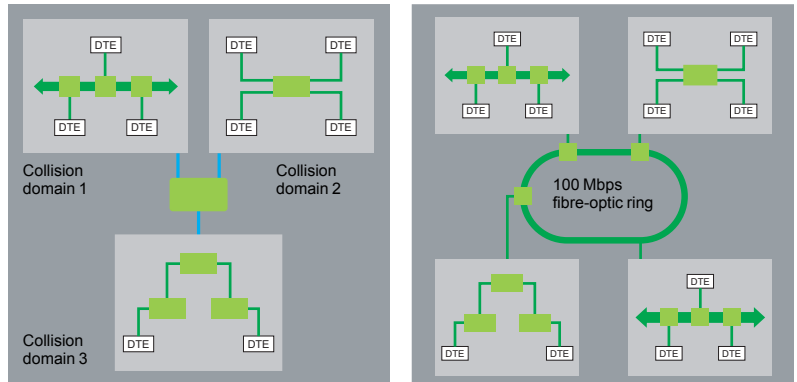

TCS ESU 051F0



499 NES 181 00

Reference

Description	Interfaces	Reference	Weight kg
ConneXium unmanaged switches	5 x 10BASE-T/100BASE-TX ports (copper cable), shielded M12 type D connectors, IP67	TCS ESU 051F0	0.210
	8 x 10BASE-T/100BASE-TX ports (copper cable), RJ45 shielded connectors, IP20	499 NES 181 00	0.230
	8 x 10BASE-T/100BASE-TX ports (copper cable), RJ45 shielded connectors, IP30	TCS ESU 083FN0	0.246

Description	With connectors at both ends	Length	Reference	Weight kg
IP67 power supply cables (for ConneXium switch TCS ESU 051F0)	Female M12 straight connector	0.230 kg	XZC P1164L2	–
	Female M12 straight connector	5 m	XZC P1164L5	–
	Female M12 elbowed connector	2 m	XZC P1264L2	–
	Female M12 elbowed connector	5 m	XZC P1264L5	–
IP67 power supply connectors (for ConneXium switch TCS ESU 051F0)	Female M12 straight connector	–	XZC C12 FDM 50B	–
	Female M12 elbowed connector	–	XZC C12 FCM 50B	–

Ethernet network

Wiring system

ConneXium unmanaged switches



TCS ESU 053FN0

ConneXium unmanaged switches, 3, 4 and 5 ports, twisted pair and fibre optic

References

Description	Interfaces	Reference	Weight kg
ConneXium unmanaged switches	3 x 10BASE-T/100BASE-TX ports (copper cable), RJ45 shielded connectors	TCS ESU 033FN0	0.113
	<ul style="list-style-type: none"> ■ 4 x 10BASE-T/100BASE-TX ports (copper cable), RJ45 shielded connectors ■ 1 x 100BASE-FX port (multimode optical fibre), duplex SC connector 	TCS ESU 043F1N0	0.120
	5 x 10BASE-T/100BASE-TX ports (copper cable), RJ45 shielded connectors	TCS ESU 053FN0	0.113



499 NMS 251 01



499 NSS 251 02

ConneXium unmanaged switches, 5 ports, twisted pair and fibre optic

Reference

Description	Interfaces	Reference	Weight kg
ConneXium unmanaged switches	<ul style="list-style-type: none"> ■ 4 x 10BASE-T/100BASE-TX ports (copper cable), RJ45 shielded connectors ■ 1 x 100BASE-FX port (multimode optical fibre), duplex SC connector 	499 NMS 251 01	0.330
	<ul style="list-style-type: none"> ■ 3 x 10BASE-T/100BASE-TX ports (copper cable), RJ45 shielded connectors ■ 2 x 100BASE-FX ports (multimode optical fibre), duplex SC connector 	499 NMS 251 02	0.335
	<ul style="list-style-type: none"> ■ 4 x 10BASE-T/100BASE-TX ports (copper cable), RJ45 shielded connectors ■ 1 x 100BASE-FX port (single mode optical fibre), duplex SC connector 	499 NSS 251 01	0.330
	<ul style="list-style-type: none"> ■ 3 x 10BASE-T/100BASE-TX ports (copper cable), RJ45 shielded connectors ■ 2 x 100BASE-FX ports (single mode optical fibre), duplex SC connector 	499 NSS 251 02	0.335



TCS ESM 043F1CU0



TCS ESM 043F2CS0



TCS ESM 083F23F0

ConneXium managed switches, 4 ports, twisted pair and fibre optic

References

Description	Interfaces	Reference	Weight kg
ConneXium managed switches	<ul style="list-style-type: none"> ■ 3 x 10BASE-T/100BASE-TX ports (copper cable), RJ45 shielded connectors ■ 1 x 100BASE-FX port (multimode optical fibre), duplex SC connector 	TCS ESM 043F1CU0	0.400
	<ul style="list-style-type: none"> ■ 2 x 10BASE-T/100BASE-TX ports (copper cable), RJ45 shielded connectors ■ 2 x 100BASE-FX ports (multimode optical fibre), duplex SC connector 	TCS ESM 043F2CU0	0.400
	<ul style="list-style-type: none"> ■ 3 x 10BASE-T/100BASE-TX ports (copper cable), RJ45 shielded connectors ■ 1 x 100BASE-FX port (single mode optical fibre), duplex SC connector 	TCS ESU 043F1CS0	0.400
	<ul style="list-style-type: none"> ■ 2 x 10BASE-T/100BASE-TX ports (copper cable), RJ45 shielded connectors ■ 2 x 100BASE-FX ports (single mode optical fibre), duplex SC connector 	TCS ESU 043F2CS0	0.400

ConneXium managed switches, 4 and 8 ports, twisted pair

References

Description	Interfaces	Reference	Weight kg
ConneXium managed switches	4 x 10/100BASE-TX ports (copper cable), RJ45 shielded connectors	TCS ESM 043F23F0	0.400
	8 x 10/100BASE-TX ports (copper cable), RJ45 shielded connectors	TCS ESM 083F23F0	0.410

Ethernet network

Wiring system

ConneXium managed switches



TCS ESM 083F1CU0



TCS ESM 083F2CS0



TCS ESB 083F23F0



TCS ESM 063F2CS1

ConneXium managed switches, 8 ports, twisted pair and fibre optic

References			
Description	Interfaces	Reference	Weight kg
ConneXium managed switches	<ul style="list-style-type: none"> 7 x 10/100BASE-TX ports (copper cable), RJ45 shielded connectors 1 x 100BASE-FX port (multimode optical fibre), duplex SC connector 	TCS ESM 083F1CU0	0.410
	<ul style="list-style-type: none"> 6 x 10/100BASE-TX ports (copper cable), RJ45 shielded connectors 2 x 100BASE-FX ports (multimode optical fibre), duplex SC connector 	TCS ESM 083F2CU0	0.410
ConneXium managed switches	<ul style="list-style-type: none"> 7 x 10/100BASE-TX ports (copper cable), RJ45 shielded connectors 1 x 100BASE-FX port (single mode optical fibre), duplex SC connector 	TCS ESM 083F1CS0	0.410
	<ul style="list-style-type: none"> 6 x 10/100BASE-TX ports (copper cable), RJ45 shielded connectors 2 x 100BASE-FX ports (single mode optical fibre), duplex SC connector 	TCS ESM 083F2CS0	0.410

Basic ConneXium managed switches, 8 and 9 ports, twisted pair and fibre optic

References			
Description	Interfaces	Reference	Weight kg
Basic ConneXium managed switches	8 x 10/100BASE-TX ports (copper cable), RJ45 shielded connectors	TCS ESB 083F23F0	0.400
	<ul style="list-style-type: none"> 6 x 10/100BASE-TX ports (copper cable), RJ45 shielded connectors 2 x 100BASE-FX ports (multimode optical fibre), duplex SC connector 	TCS ESB 083F2CU0	0.400
	<ul style="list-style-type: none"> 6 x 10/100BASE-TX ports (copper cable), RJ45 shielded connectors 3 x 100BASE-FX ports (multimode optical fibre), duplex SC connector 	TCS ESB 093F2CU0	0.400

ConneXium managed switches, 8 extended ports, twisted pair and fibre optic

References			
Description	Interfaces	Reference	Weight kg
ConneXium managed switches	8 x 10/100BASE-TX ports (copper cable), RJ45 shielded connectors, IP30	TCS ESM 083F23F1 (1)	1.000
	<ul style="list-style-type: none"> 6 x 10/100BASE-TX ports (copper cable), RJ45 shielded connectors, IP30 2 x 100BASE-FX ports (multimode optical fibre), duplex SC connector 	TCS ESM 063F2CU1 (1)	1.000
	<ul style="list-style-type: none"> 6 x 10/100BASE-TX ports (copper cable), RJ45 shielded connectors, IP30 2 x 100BASE-FX ports (single mode optical fibre), duplex SC connector 	TCS ESM 063F2CS1 (1)	1.000

(1) Available in Conformal Coating version. For this version, add the letter **C** at the end of the reference. For example, the **TCS ESM 083F23F1** switch becomes **TCS ESM 083F23F1C** in the Conformal Coating version. For further information on treatments for harsh environments, see page 9/2 or consult our website www.schneider-electric.com.

Ethernet network

Wiring system

ConneXium managed switches



TCS ESM 163F23F0



TCS ESM 243F2CU0



TCS ESM 103F23G0



TCS ESM 103F2LG0

ConneXium managed switches, 16 and 24 ports, twisted pair and fibre optic

References

Description	Interfaces	Reference	Weight kg
ConneXium managed switches	16 x 10/100BASE-TX ports (copper cable), RJ45 shielded connectors	TCS ESM 163F23F0	0.600
	<ul style="list-style-type: none"> ■ 14 x 10/100BASE-TX ports (copper cable), RJ45 shielded connectors ■ 2 x 100BASE-FX ports (multimode optical fibre), duplex SC connector 	TCS ESM 163F2CU0	0.600
	<ul style="list-style-type: none"> ■ 14 x 10/100BASE-TX ports (copper cable), RJ45 shielded connectors ■ 2 x 100BASE-FX ports (single mode optical fibre), duplex SC connector 	TCS ESM 163F2CS0	0.600
ConneXium managed switches	<ul style="list-style-type: none"> ■ 22 x 10/100BASE-TX ports (copper cable), RJ45 shielded connectors ■ 2 x 100BASE-FX ports (multimode optical fibre), duplex SC connector 	TCS ESM 243F2CU0	0.650

ConneXium managed switches, 8 ports and 2 Gigabit ports, twisted pair and fibre optic

References

Description	Interfaces	Reference	Weight kg
ConneXium managed switches	<ul style="list-style-type: none"> ■ 8 x 10/100BASE-TX ports (copper cable), RJ45 shielded connectors ■ 2 x 1000BASE-SX ports (multimode optical fibre) (1), or ■ 2 x 1000BASE-LH ports (single mode optical fibre) (2), or ■ 2 x 1000BASE-LX ports (single mode and multimode optical fibre) (3) 	TCS ESM 103F23G0	0.410
	<ul style="list-style-type: none"> ■ 8 x 10/100BASE-TX ports (copper cable), RJ45 shielded connectors ■ 2 x 10/100/1000BASE-TX (Gigabit) ports (copper cable), RJ45 shielded connectors 	TCS ESM 103F2LG0	0.410

(1) With **TCS EAA F1LFU000** fibre optic module to be ordered separately (see page 5/67)



(2) With **TCS EAA F1LFH000** fibre optic module to be ordered separately (see page 5/67)

(3) With **TCS EAA F1LFS000** fibre optic module to be ordered separately (see page 5/67)

Wi-Fi network

Wi-Fi Access Points and Clients

5

Device type	Wi-Fi 802.11g Access Point	FCC Wi-Fi 802.11g Access Point
		
Description	Dual band industrial Wi-Fi LAN Access Point/ Client with two independent radio modules based on IEEE 802.11a/b/g/h/i	Dual band industrial Wi-Fi LAN Access Point/ Client with two independent radio modules based on IEEE 802.11a/b/g/h/i. With FCC approval for USA and Canada.
Type	Access point and Client	
Wi-Fi standards	IEEE 802.11a/b/g/h/i	
Operating frequencies	2.4 GHz and 5 GHz	
Degree of protection	IP 40	
Regional approvals	–	FCC
Mounting	DIN rail	
Number of radios	2	
Nominal data rate	54 Mbps	
Antenna connections	4 x RP-SMA	
Ethernet connections	2 x 10/100BASE-TX	
Wi-Fi connections	2 x WLAN interfaces, 8 SSIDs per interface (1)	
Range	Up to 20 km with external antenna (frequency range and data rate dependent on type of antenna)	
Dimensions	80 x 100 x 135 mm	
Operating temperature	-30°C to +50°C	
Storage temperature	-40°C to +70°C	
Humidity	Max. 95% (non-condensing)	
Power supplies	2 x 24 V $\overline{\text{DC}}$; 12 V $\overline{\text{DC}}$, redundant capable 2 x PoE per IEEE802.3af, redundant capable (2)	
Consumption	12 V $\overline{\text{DC}}$: 625 mA; 24 V $\overline{\text{DC}}$: 417 mA PoE (48 V $\overline{\text{DC}}$): 167 mA (2)	
Agency certifications	Safety	EN 60950
	Radio	EN 300328, EN 301893, notified in all EU countries
	Environment	FCC identifier: U99BAT54RAIL, IC certification number: 4019A-BAT54R
	EN 61131 for operation in automation environment. EMC test documentation for E1 certification (cars and vehicles) available	
References	TCSG WA 242 (3)	TCSG WA 242F (3)
Pages	5/84	

(1) SSID: Service Set Identifier
 (2) PoE: Power over Ethernet
 (3) All TCSG ●●●●● products are supplied with 2 pen-type antennas

Wi-Fi 802.11g Access Point IP67

Wi-Fi 802.11g Client



Dual band industrial Wi-Fi LAN Access Point/Client with two independent radio modules based on IEEE 802.11a/b/g/h/i. For installation in harsh environment, IP 67 rated.

Single band industrial Wi-Fi LAN Client with one radio module based on IEEE 802.11a/b/g/h/i

Access point and Client

Client only

IEEE 802.11a/b/g/h/i

2.4 GHz and 5 GHz

IP 67

IP 40

–

–

Wall/mast

DIN rail

2

1

54 Mbps

4 x N-type

4 x RP-SMA

1 x 10/100BASE-TX

2 x WLAN interfaces, 8 SSIDs per interface (1)

1 x WLAN interface

Up to 20 km with external antenna (frequency range and data rate dependent on type of antenna)

261 x 189 x 55 mm

80 x 100 x 135 mm

-30°C to +55°C

-40°C to +70°C

Max. 95% (non-condensing)

2 x 24 V $\overline{\text{---}}$; 12 V $\overline{\text{---}}$, redundant capable
2 x PoE per IEEE802.3af, redundant capable (2)

2 x 24 V $\overline{\text{---}}$; 12 V $\overline{\text{---}}$, redundant capable
1 x PoE per IEEE802.3af (2)

12 V $\overline{\text{---}}$: 625 mA; 24 V $\overline{\text{---}}$: 417 mA
PoE (48 V $\overline{\text{---}}$): 167 mA (2)

EN 60950

EN 300328, EN 301893, notified in all EU countries

EN 61131 for operation in automation environment. EMC test documentation for E1 certification (cars and vehicles) available

TCSN WA 272 (3)

TCSG WC 241 (3)

5/84

5





More technical information on www.schneider-electric.com

Wi-Fi network

Wi-Fi Access Points and Clients

5

Device type	Wi-Fi 802.11n Access Point	FCC Wi-Fi 802.11n Access Point	
			
Description	Dual band industrial high performance Wi-Fi LAN Access Point/Client with one radio module based on IEEE 802.11n (draft 2.0).	Dual band industrial high performance Wi-Fi LAN Access Point/Client with one radio module based on IEEE 802.11n (draft 2.0). With FCC approval for USA and Canada.	
Type	Access point and Client		
Wi-Fi standards	IEEE 802.11a/b/g/h/n		
Operating frequencies	2.4 GHz and 5 GHz		
Degree of protection	IP 40		
Regional approvals	–	FCC	
Mounting	DIN rail		
Number of radios	1		
Nominal data rate	300 Mbps		
Antenna connections	3 x RP-SMA		
Ethernet connections	2 x 10/100BASE-TX		
Wi-Fi connections	1 x WLAN interface, 8 SSIDs per interface (1)		
Range	Up to 20 km with external antenna (frequency range and data rate dependent on type of antenna)		
Dimensions	80 x 100 x 135 mm		
Operating temperature	-30°C to +50°C		
Storage temperature	-40°C to +70°C		
Humidity	Max. 95% (non-condensing)		
Power supplies	2 x 24 V $\overline{\text{DC}}$; 12 V $\overline{\text{DC}}$, redundant capable 2 x PoE per IEEE802.3af, redundant capable (2)		
Consumption	2 V $\overline{\text{DC}}$: 1: 625 mA; 24 V $\overline{\text{DC}}$: 417 mA PoE (48 V $\overline{\text{DC}}$): 167 mA (2)		
Agency certifications	Safety	EN 60950	
	Radio	EN 300328, EN 301893, notified in all EU countries	Certifications for FCC
	Environment	EN 61131 for operation in automation environment	
References	TCSN WA 241 (3)	TCSN WA 241 (3)	
Pages	5/84		

(1) SSID: Service Set Identifier

(2) PoE: Power over Ethernet

(3) All TCSN ●●●●● products are supplied with 3 pen-type antennas



More technical information on www.schneider-electric.com

IP67 Wi-Fi 802.11n Access Point	FCC IP67 Wi-Fi 802.11n Access Point	ATEX IP67 Wi-Fi 802.11n Access Point
		
<p>Dual band industrial high performance Wi-Fi LAN Access Point/Client with one radio module based on IEEE 802.11n (draft 2.0). For installation in harsh environment, IP 67 rated.</p>	<p>Dual band industrial high performance Wi-Fi LAN Access Point/Client with one radio module based on IEEE 802.11n (draft 2.0). For installation in harsh environment, IP 67 rated. With FCC approval for USA and Canada.</p>	<p>Dual band industrial high performance Wi-Fi LAN Access Point/Client with one radio module based on IEEE 802.11n (draft 2.0). For installation in harsh environment, IP 67 ATEX Zone II rated. With FCC approval for USA and Canada.</p>
Access point and Client		
IEEE 802.11a/b/g/h/n		
2.4 GHz and 5 GHz		
IP 67		IP 67 ATEX
–	FCC	–
Wall/mast		
1		
300 Mbps		
3 x N-type		
2 x 10/100BASE-TX		
1 x WLAN interface, 8 SSIDs per interface (1)		
Up to 20 km with external antenna (frequency range and data rate dependent on type of antenna)		
261 x 189 x 55 mm		
-30°C to +55°C		
-40°C to +70°C		
Max. 95% (non-condensing)		
2 x 24 V $\overline{\text{---}}$, redundant capable		
2 x PoE per IEEE802.3af, redundant capable (2)		
24 V $\overline{\text{---}}$: 417 mA		
PoE (48 V $\overline{\text{---}}$): 167 mA (2)		
EN 60950		
EN 300328, EN 301893, notified in all EU countries		
EN 61000-6-2, EN 61131	EN 61131 for operation in automation environment	EN 61000-6-2, EN 61131 ATEX Zone II
EN 50155 (draft)		
E1 (draft)		
TCSN WA 271 (3)	TCSN WA 271F (3)	TCSN WA 2A1 (3)



Device type

Dual band antennas



Description	Dual band hemispherical antenna	5 GHz Very directional antenna
Frequency range	2300 - 2500 MHz 4900 - 5935 MHz	5150 - 5250 MHz 5250 - 5350 MHz 5350 - 5725 MHz 5725 - 5875 MHz
Antenna gain	6 dBi at 2.4 GHz 8 dBi at 5 GHz	18 dBi 19 dBi 18.5 dBi 18 dBi
VSWR (1)	1.8	1.5
Polarization	Linear, vertical	
Horizontal HPBW (2)	360° at 2.4 GHz	18°
Vertical HPBW (2)	173° at 5 GHz	18°
Max. power	75 W (cw) at 25°C	6 W (cw)
Impedance	50 Ω	
Connector	N female	N female
Operating temperature	-40°C to +80°C	-45°C to +70°C
Storage temperature	-40°C to +80°C	-45°C to +70°C
Radome colour	RAL 7044 (Silk grey)	7035 (Light grey)
Radome material	LEXAN EXL 9330	Plastic
Weight	0.3 kg	0.107 kg
Dimensions	Ø 86 x 43 mm	190 x 190 x 30.5 mm
Wind load	10 N at 160 km/h	104 N at 216 km/h
Degree of protection	IP 65	IP 65/IP 67
Shipping package contents	Cordset/cable	1 m cable with N male connectors at both ends
	Adaptor cable	Adaptor cable, R-SMA male connector to N female connector
	Mounting kit	-
Access point/client compatibility	TCSG ●●●●●	

References

TCS WAB DH | TCS WAB 5V

Pages

5/84

(1) VSWR: Voltage Standing Wave Ratio
(2) HPBW: Half Power BeamWidth

Dual band antenna



Dual band omnidirectional 11n antenna

2400 - 2500 MHz
5150 - 5875 MHz

3.5 dBi
5.5 dBi

1.8

3 x linear, vertical

360°

–

2 W

50 Ω

3 x N male, 1 m cable directly attached to antenna

-40°C to +80°C

-40°C to +80°C

7035 (Light grey)

Plastic

0.3 kg

310 x 110 x 40 mm

–

IP 65

3 x 90 cm cordsets directly attached to antenna, with N male connector

3 x adaptor cables, R-SMA male connector to N female connector

Yes

TCSN ●●●●●

TCS WAB DON

5/84



Device type

5 GHz antennas



Description
Frequency range
Antenna gain
VSWR (1)
Polarization
Horizontal HPBW (2)
Vertical HPBW (2)
Max. power
Impedance
Connector
Operating temperature
Storage temperature
Radome colour
Radome material
Weight
Dimensions
Wind load
Degree of protection
Shipping package contents
Access point/client compatibility

5 GHz omnidirectional antenna	5 GHz dual slant antenna
5150 - 5875 MHz	5150 - 5925 MHz
5 dBi	9 dBi
1.5	2
Linear, vertical	2 x linear, ± 45° slant
360°	70°
25°	60°
6 W	10 W (cw) at 25°C
50 Ω	
N female	2 x N female
-45 °C to +70 °C	-40°C to +80°C
-45 °C to +70 °C	-40°C to +80°C
Grey-white	RAL 7044 (Silk grey)
Polypropylene	ASA, LEXAN EXL 9330
0.300 kg	0.110 kg
16 x 160 mm	101 x 80 x 35 mm
–	15 N at 160 km/h
IP 65	
1 m cordset with N male connectors at both ends	2 x 1 m cordsets with N male connectors at both ends
Adaptor cable, R-SMA male connector to N female connector	2 x adaptor cables, R-SMA male connector to N female connector
Yes	
TCSG ●●●●●	TCSG ●●●●● TCSN ●●●●●

References

TCS WAB 50 | TCS WAB 5S

Pages

5/84

(1) VSWR: Voltage Standing Wave Ratio
(2) HPBW: Half Power BeamWidth

5 GHz antennas



5 GHz MiMo directional 11n antenna (3)	5 GHz Medium directional antenna	5 GHz Very directional 11n antenna
5150 - 5875 MHz	5150 - 5250 MHz 5250 - 5350 MHz 5350 - 5725 MHz 5725 - 5875 MHz	5150 - 5875 MHz
9 dBi	18 dBi 19 dBi 18.5 dBi 18 dBi	23 dBi
1.5	1.5	< 1.7
3 x linear vertical/horizontal/+45°	Linear, vertical	Dual linear, vertical and horizontal
65°	18°	9°
65°	18°	9°
2 W (cw) at 25°C	6 W (cw)	6 W
50 Ω		
N female	N female	2 x N female
-40°C to +80°C	-45°C to +70°C	
-40°C to +80°C	-45°C to +70°C	
RAL 7044 (Silk grey)	7035 (Light grey)	Grey-white
LEXAN EXL 9330	Plastic	
0.110 kg	0.107 kg	2.5 kg
101 x 80 x 35 mm	190 x 190 x 30.5 mm	371 x 371 x 40 mm
15 N at 160 km/h	–	264 N at 220 km/h
IP 65	IP 65/IP 67	
3 x 1 m cordsets with N male connectors at both ends	1 m cordset with N male connectors at both ends	2 x 1 m cordsets with N male connectors at both ends
3 x adaptor cables, R-SMA male connector to N female connector	Adaptor cable, R-SMA male connector to N female connector	2 x adaptor cables, R-SMA male connector to N female connector
Yes		
TCSN ●●●●●	TCSG ●●●●●	TCSG ●●●●● TCSN ●●●●●

TCS WAB 5DN

TCS WAB 5D

TCS WAB 5VN

5/84

(3) MiMo: Multiple-Input Multiple-Output



More technical information on www.schneider-electric.com

Device type

2.4 GHz antennas



Description
Frequency range
Antenna gain
VSWR (1)
Polarization
Horizontal HPBW (2)
Vertical HPBW (2)
Max. power
Impedance
Connector
Operating temperature
Storage temperature
Radome colour
Radome material
Weight
Dimensions
Wind load
Degree of protection
Shipping package contents
Access point/client compatibility
References
Pages

2.4 GHz omni directional antenna	2.4 GHz directional antenna	2.4 GHz dual slant antenna	
2400 - 2500 MHz	2300 - 2500 MHz	2400 - 2485 MHz	
6.0 dBi	14 dBi	8 dBi	
< 1.8	1.5		
Linear, vertical	Vertical	Dual linear, ± 45° slant	
360°	35°	75°	
–	30°	70°	
25 W	75 W (CW) at 25 °C	10 W (CW) at 25 °C	
50 Ω			
N female		2 x N female	
-40°C to +80°C			
-40°C to +80°C			
Grey-white	RAL 7044 (Silk grey)		
Fibreglass	LEXAN EXL 9330		
0.340 kg	0.110 kg		
Ø 22 mm x 250 mm	101 x 80 x 35 mm		
–	15 N at 160 km/h		
IP 65	IP 23	IP 65	
Shipping package contents	1 m cordset with N male connectors at both ends		
	2 x 1 m cordsets with N male connectors at both ends		
	Adaptor cable	Adaptor cable, R-SMA male connector to N female connector	
Access point/client compatibility	2 x adaptor cables, R-SMA male to N female		
	Yes		
	TCSG ●●●●●	TCSG ●●●●●	TCSG ●●●●● TCSN ●●●●●
TCS WAB 20	TCS WAB 2D	TCS WAB 2S	
5/84	5/85		

(1) VSWR: Voltage Standing Wave Ratio
 (2) HPBW: Half Power BeamWidth



Cable antennas



2.4 GHz Leaky cable, 50 m	2.4 GHz Leaky cable, 100 m
2000 - 2900 MHz	
0.15 dB at 2.4 GHz	
-	
-	
-	
-	
-	
-	
2 x N male	
-40°C to +85°C	
-70°C to +85°C	
-	
-	
12 kg	24 kg
50 m, Ø 15 mm	100 m, Ø 15 mm
-	
IP 65	
50 m cable with N male connectors at both ends	100 m cable with N male connectors at both ends
-	
1 x 50 Ohm terminator, 50 fastening clips (mounting on flat surface)	
TCSG ●●●●●	

TCS WAB C5	TCS WAB C10
-------------------	--------------------

5/85



TCSG WA 242



TCSN WA 241



TCSN WA 271



TCS WAB DH



TCS WAB 5DN



TCS WAB 5D



TCS WAB 20

References						
Wi-Fi Access Points and Clients						
Description	Number of radios	Data rate	Degree of protection	Country approvals	Reference	Weight
		Mbps				kg
Wi-Fi 802.11g Access Point	2	54	IP 40	–	TCSG WA 242	–
FCC Wi-Fi 802.11g Access Point	2	54	IP 40	US and Canada	TCSG WA 242F	–
IP 67 Wi-Fi 802.11g Access Point	2	54	IP 40	–	TCSG WA 272	–
Wi-Fi 802.11g Client	1	54	IP 40	–	TCSG WC 241	–
Wi-Fi 802.11n Access Point	1	300	IP 40	–	TCSN WA 241	–
FCC Wi-Fi 802.11n Access Point	1	300	IP 40	US and Canada	TCSN WA 241F	–
IP 67 Wi-Fi 802.11n Access Point	1	300	IP 67	–	TCSN WA 271	–
FCC IP 67 Wi-Fi 802.11n Access Point	1	300	IP 67	US and Canada	TCSN WA 271F	–
IP 67 ATEX Wi-Fi 802.11n Access Point	1	300	IP 67 ATEX	–	TCSN WA 2A1	–

Wi-Fi antennas					
Description	Frequency range	Gain	Degree of protection	Reference	Weight
	MHz	dBi			kg
Dual band hemispherical antenna	2300 - 2500	6	IP 65	TCS WAB DH	0.300
	4900 - 5935	8			
5 GHz Very directional antenna	5150 - 5250	18	IP 67/IP 65	TCS WAB 5V	0.107
	5250 - 5350	19			
	5350 - 5725	18.5			
	5725 - 5875	18			
Dual band omnidirectional 11n antenna	2400 - 2500	3.5	IP 65	TCS WAB DON	0.300
	5150 - 5875	5.5			
5 GHz omnidirectional antenna	5150 - 5875	5	IP 65	TCS WAB 5O	0.300
5 GHz dual slant antenna	5150 - 5925	9	IP 65	TCS WAB 5S	0.110
5 GHz MiMo 11n directional antenna	5150 - 5875	9	IP 65	TCS WAB 5DN	0.110
5 GHz Medium directional antenna	5150 - 5250	18	IP 67/IP 65	TCS WAB 5D	0.107
	5250 - 5350	19			
	5350 - 5725	18.5			
	5725 - 5875	18			
5 GHz Very 11n directional antenna	5150 - 5875	23	IP 67/IP 65	TCS WAB 5VN	2.500
2.4 GHz omnidirectional antenna	2400 - 2500	6	IP 65	TCS WAB 20	0.340



TCS WAB 2D



TCS WAB C5



TCS WAAC



TCS WABAC2



TCS WABP



TCS WAMCD



TCS WABMK

Wi-Fi antennas (continued)					
Description	Frequency range MHz	Gain	Degree of protection	Reference	Weight kg
2.4 GHz directional antenna	2300 - 2500	14 dBi	IP 23	TCS WAB 2D	0.110
2.4 GHz dual slant antenna	2400 - 2485	8 dBi	IP 65	TCS WAB 2S	0.110
2.4 GHz Leaky cable, 50 m	2000 - 2900	0.15 dB at 2.4 GHz	IP 65	TCS WAB C5	12.000
2.4 GHz Leaky cable, 100 m	2000 - 2900	0.15 dB at 2.4 GHz	IP 65	TCS WAB C10	24.000

Cables					
Description	Type	Length m	Reference	Weight kg	
Adaptor cable	1 RP-SMA male connector 1 N female connector	0.520	TCS WAAC	0.340	
Adaptor cable N-plug to N-jack, 2 m	1 N female connector 1 N male connector	2.000	TCS WABAC2	0.340	
Adaptor cable N-plug to N-jack, 15 m	1 N female connector 1 N male connector	15.000	TCS WABAC15	0.340	

Accessories					
Description	Degree of protection	Type	Cable length m	Reference	Weight kg
Overvoltage protector for antennas	–	N female, N male	–	TCS WABP	0.080
Overvoltage protector for LAN/PoE	IP 68	N female, N male	–	TCS WABP68	0.080
Memory card modules (1)	IP 40	Mini-DIN connector	0.315	TCS WAMC67	0.035
	IP 67	M12 connector	0.500	TCS WAMCD	0.025
Adaptor kit for pole mounting	–	–	–	TCS WABMK	–

(1) Auto-configuration adaptors which are used to save 2 different versions of the configuration and operating program data for the Wi-Fi access point to which it is connected. They enable managed Wi-Fi access points to be easily commissioned and quickly replaced.

Modicon Premium automation platform

CANopen machine and installation bus

Presentation

Originally used in the automotive industry, CAN is increasingly used in industry. There are several fieldbuses based on CAN base layers and components. The CANopen bus conforms to the ISO 11898 international standard, promoted by the CAN in Automation association, a grouping of users and manufacturers, and guarantees a high degree of openness and interoperability due to its communication profiles and its standardized equipment.

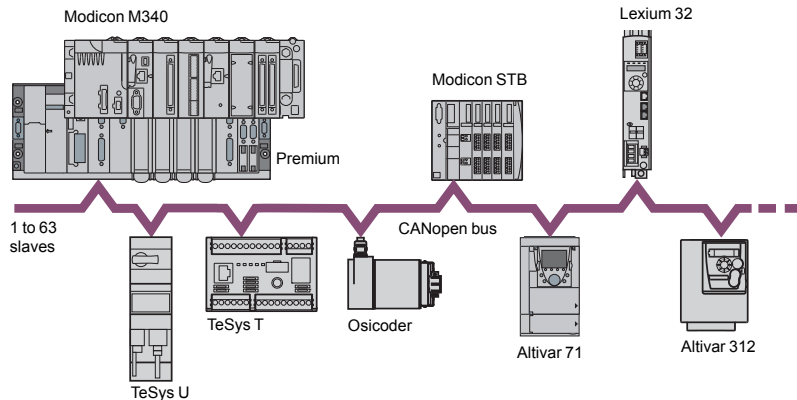

The CANopen bus is a multi-master bus providing reliable, deterministic access to real-time data in control system devices. The CSMA/CA protocol is based on broadcast exchanges, sent cyclically or on an event, ensuring optimum use of the bandwidth. A message handling channel can also be used to set the parameters of slave devices.

The bus uses a double shielded twisted pair on which a maximum of 127 devices can be connected by daisy chaining. The data rate, which varies between 1 Mbps and 20 Kbps, depends on the length of the bus (between 20 m and 2500 m). Each end of the bus must be fitted with a line terminator.

The CANopen bus is a set of profiles on CAN systems, possessing the following characteristics:

- Open bus system
- Data exchanges in real time without overloading the protocol
- Modular design allowing modification of size
- Interconnection and interchangeability of devices
- Standardized configuration of networks
- Access to all device parameters
- Synchronization and circulation of data from cyclic and/or event-controlled processes (short system response time)
- Interoperability between numerous international manufacturers

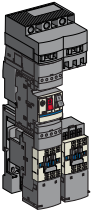

TeSys Quickfit



Altivar ATV 312



Lexium 32

Example of devices that can be connected on CANopen

Connectable devices

The Modicon TSX Micro or Modicon Premium platforms, via the **TSX CPP 110** PCMCIA card, perform the role of master on the CANopen bus.

The following Schneider Electric products can be connected to the CANopen bus, depending on the model (1):

- OsiSense XCC Ø 58 mm multi-turn absolute encoders
- TeSys U starter-controllers with LUL C08 communication module
- TeSys T motor management system, with LTM controller
- TeSys D motor starters, using the TeSys Quickfit installation system with APP 1CCO0/O2 communication module
- Modicon OTB IP 20 distributed I/O, with Twido I/O expansion modules and OTB interface module
- Modicon STB IP 20 modular distributed I/O, with STB NIM interface module
- Preventa XPS configurable safety controllers
- 0.18...15 kW Altivar 312/32 variable speed drives for asynchronous motors
- 0.75...630 kW Altivar 61/71 variable speed drives for asynchronous motors
- Lexium 32 servo drives for BMH and BSH servo motors
- ILA/ILE/ILS Lexium integrated drives
- SD328 stepper drives

Description

The Modicon TSX Micro/Premium automation platforms have a slot for a PCMCIA communication card on their processors which can take the CANopen machine bus card.

The **TSX CPP 110** CANopen machine bus assembly comprises:

- 1 A type III PCMCIA card with locking screw
- 2 A tap junction for connection to the CANopen bus cable via a 9-way male SUB-D connector. This tap junction is mounted on a DIN rail
- 3 A 0.5 m cable, integral to the PCMCIA card and the tap junction

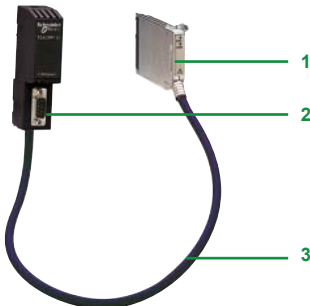

TSX CPP 110

(1) For compatible device models and their setup, please refer to our website www.schneider-electric.com.

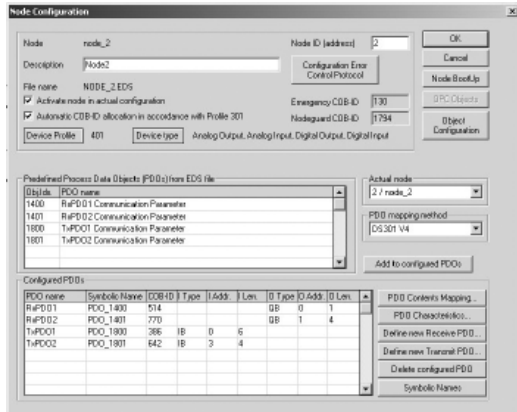

Example of SyCon device configuration screen

Software setup

The CANopen bus is configured using SyCon (1) software, reference **SYC SPU LF● CD2AM** (to be ordered separately). This software is used to:

- Describe all the devices connected on the bus
- Generate a ".CO" file containing all the information relating to the connected devices. This extension file is imported into the PLC application via the PL7 Micro/Junior/Pro or Unity Pro programming software (2).

If the configuration file is too large for the capacity of the host PLC processor (see characteristics below), it is possible to load the CANopen master configuration directly onto the **TSX CPP 110** card via a type III PCMCIA port on the PC on which the SyCon software is installed.

With the PL7 Micro/Junior/Pro or Unity Pro software (2) the CANopen bus card can be configured so that the exchanges between the PLC processor and the **TSX CPP 110** card are executed at the same rate as the master task or the fast task. The process data exchanged with the slaves can be accessed using %MW standard words, the number of which depends on the type of processor and the task in which the module has been declared. PL7 Micro/Junior/Pro or Unity Pro (2) standard function blocks are used to set the parameters of the devices.

Note: In addition to supporting the CANopen protocol which uses V2.0A standard CAN identifiers on 11 bits, the card enables direct access to the CAN link layer via V2.0B CAN identifiers on 29 bits, used by the majority of CAN devices. In certain applications this enables simultaneous control of CANopen devices and specific CAN products.

References

CANopen machine bus assembly

Description	Services	No. of modules per PLC/PC	Use	Reference	Weight kg
CANopen master V4.02 PCMCIA card (type III)	- Cyclic exchanges (PDO)	1 on Micro TSX 37 21/22	Supplied with tap	TSX CPP 110	0.230
	- CMS message handling (SDO)	1 on Premium TSX P57	junction and cable length		
	- Management of bus operating modes	(3)	0.5 m		

SyCon configuration software

SyCon software is the configurator for Schneider Electric machine buses and fieldbuses. It supports the following buses:

- CANopen for Modicon TSX Micro and Modicon Premium platforms
- Profibus DP for Modicon Premium and Modicon Quantum platforms
- INTERBUS for Modicon Quantum platform

It includes the device description files for Schneider Electric I/O modules.

Description	Licence type	Reference	Weight kg
SyCon V2.10 configuration software licences	Single (1 station)	SYC SPU LFU CD2AM	—
	Group (3 stations)	SYC SPU LFG CD2AM	—
	Team (10 stations)	SYC SPU LFT CD2AM	—
	Site (> 10 stations)	SYC SPU LFF CD2AM	—
SyCon V2.10 configuration software update	Single (1 station)	SYC SPU LRU CD2AM	—

(1) The SyCon configuration software can also be used to describe the I/O configuration of the Profibus DP bus for the Modicon Premium and Modicon Quantum platforms and the I/O configuration of the INTERBUS bus for the Modicon Quantum platform.

(2) PL7 Micro/Junior/Pro: compatible with the Modicon TSX Micro and Modicon Premium platforms

Unity Pro: compatible with the Modicon M340, Modicon Premium and Modicon Quantum platforms.

(3) Not permitted on **TSX P57 154M** Premium processor.



TSX CPP 110

CANopen bus wiring system

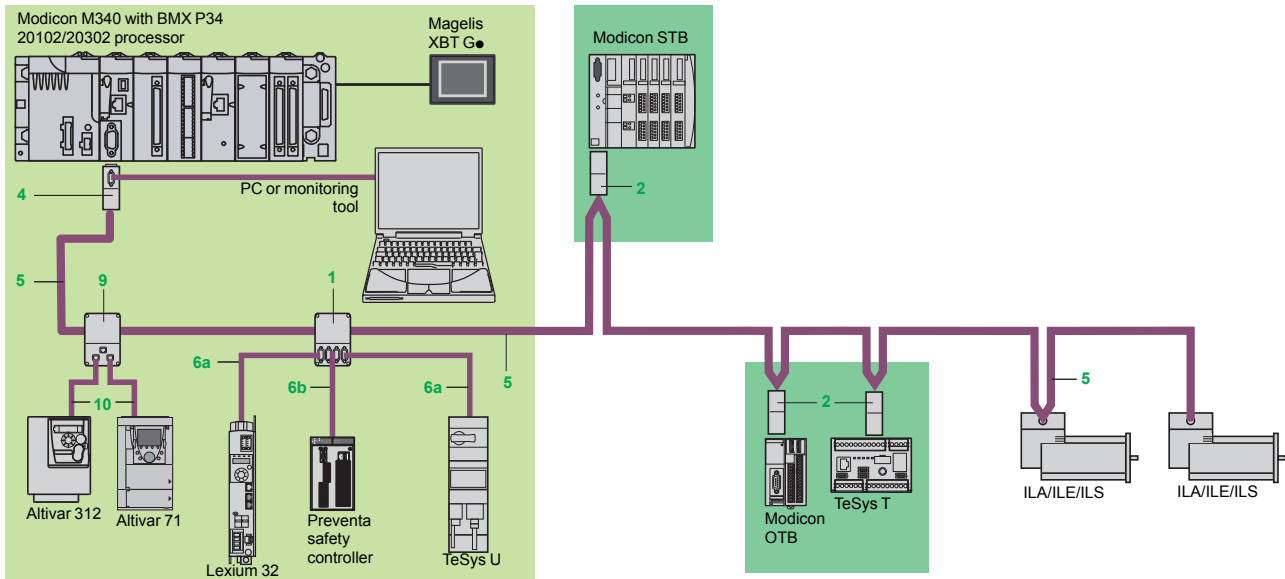

Note: For numbers and references 1, 2, ..., 11, see pages 5/90 and 5/91.

Various types of cable are available, making it possible to create any type of application, including for harsh environments (for the definition of standard and harsh environments, see page 5/90).

Several connectors are available to meet any requirement: straight or 90° elbowed connectors, or elbowed connectors with the option of connecting a PC or diagnostic pocket PC.

Power can be supplied to devices by means of cables, cordsets and tap junctions: one AWG24 pair for the CAN signals (CAN_L and CAN_H) and one AWG22 pair for the power supply and the earth (CAN_V+ and CAN_SHLD).

In addition to the IP 20 wiring offer, there is also an IP 67 wiring offer.

Modicon Premium automation platform

CANopen machine and installation bus

Wiring system



TSX CAN TDM4

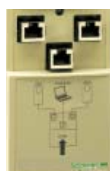

VW3 CAN TAP2



TSX CAN KCDF 90T



TSX CAN KCDF 180T



TSX CAN KCDF 90TP

Standard tap junctions and connectors

Designation	Description	No. (1)	Length	Reference	Weight kg
IP 20 CANopen tap junction	4 SUB-D ports. Screw terminals for connecting the trunk cables Line end adaptor	1	–	TSX CAN TDM4	0.196
IP 20 connectors	Elbowed (90°)	2	–	TSX CAN KCDF 90T	0.046
	Straight (2)	–	–	TSX CAN KCDF 180T	0.049
	Elbowed (90°) with 9-way SUB-D for connecting a PC or diagnostic tool	4	–	TSX CAN KCDF 90TP	0.051
IP 67 M12 connectors	Male	–	–	FTX CN 12M5	0.050
	Female	–	–	FTX CN 12F5	0.050
IP 20 CANopen tap junction for Altivar and Lexium 05	2 RJ45 ports	9	–	VW3 CAN TAP2	–

IP 20 standard cables and preassembled cordsets

Designation	Description	No. (1)	Length	Unit reference	Weight kg	
CANopen cables (AWG 24)	Standard, C€ marking: low smoke. Zero halogen. Flame-retardant (IEC 60332-1)	5	50 m	TSX CAN CA50	4.930	
			100 m	TSX CAN CA100	8.800	
			300 m	TSX CAN CA300	24.560	
	Standard, UL certification, C€ marking: flame-retardant (IEC 60332-2)	5	50 m	TSX CAN CB50	3.580	
			100 m	TSX CAN CB100	7.840	
			300 m	TSX CAN CB300	21.870	
	For harsh environments (3) or mobile installations, C€ marking: low smoke. Zero halogen. Flame-retardant (IEC 60332-1). Oil resistant	5	50 m	TSX CAN CD50	3.510	
			100 m	TSX CAN CD100	7.770	
			300 m	TSX CAN CD300	21.700	
CANopen preassembled cordsets	Standard, C€ marking: low smoke. Zero halogen. Flame-retardant (IEC 60332-1)	6a	0.3 m	TSX CAN CADD03	0.091	
			1 m	TSX CAN CADD1	0.143	
			3 m	TSX CAN CADD3	0.295	
			5 m	TSX CAN CADD5	0.440	
			One 9-way female SUB-D connector at each end (AWG 24)	6a	0.3 m	TSX CAN CBDD03
	Standard, UL certification, C€ marking: flame-retardant (IEC 60332-2)	1 m	TSX CAN CBDD1		0.131	
		3 m	TSX CAN CBDD3		0.268	
		5 m	TSX CAN CBDD5		0.400	
		CANopen preassembled cordsets	6b		One 9-way SUB-D connector 1 RJ45 connector (AWG 24)	0.5 m
	Two 9-way SUB-D connectors, one male and one female			1 m	TCS CCN 4F3M1T	–
				3 m	VW3 M38 05 R010 (4)	–
				3 m	TCS CCN 4F3M3T	–
				0.5 m	TLA CD CBA 005	–
	1.5 m	TLA CD CBA 015	–			
	3 m	TLA CD CBA 030	–			
5 m	TLA CD CBA 050	–				

IP 67 standard preassembled cordsets

Designation	Description	No. (1)	Length	Unit reference	Weight kg
CANopen preassembled cordsets	Preassembled cordsets with two 5-way A-coded elbowed M12 connectors (one male connector and one female connector)	–	0.3 m	TCS CCN 2M2F03	0.090
			1 m	TCS CCN 2M2F1	0.127
			2 m	TCS CCN 2M2F2	0.179
			5 m	TCS CCN 2M2F5	0.337
			10 m	TCS CCN 2M2F10	0.600
			15 m	TCS CCN 2M2F15	0.863

(1) For numbers, see page 5/89.

(2) The VW3 CAN KCDF 180T connector can also be used for connection to a Controller Inside programmable card.

(3) **Standard environment:**

- Without any particular environmental stresses
- Operating temperature between + 5°C and + 60°C
- Fixed installation

Harsh environment:

- Resistance to hydrocarbons, industrial oils, detergents, solder splashes
- Humidity up to 100%
- Saline atmosphere
- Significant temperature variations
- Operating temperature between - 10°C and + 70°C
- Mobile installation

(4) Cordset with line termination.



VW3 CAN A71



AM0 2CA 001V000



XZ CC12 DM50B

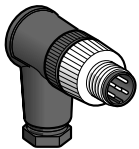

XZ CC12 CM50B

IP 20 connection accessories

Designation	Description	No. (1)	Length	Reference	Weight kg
CANopen connector for Altivar 71 drive (2)	9-way female SUB-D. Line end adaptor switch. 180° cable outlet	–	–	VW3 CAN KCDF 180T	–
Adaptor for Altivar 61/71 drive	CANopen SUB-D to RJ45 adaptor	–	–	VW3 CAN A71	–
Preformed CANopen cordsets for Altivar and Lexium 05 drives	1 RJ45 connector at each end	10	0.3 m	VW3 CAN CARR03	–
			1 m	VW3 CAN CARR1	–
CANopen bus adaptor for Lexium 15 servo drive	Hardware interface for link conforming to the CANopen standard + 1 connector for connection of PC terminal	–	–	AM0 2CA 001V000	0.110
Y connector	CANopen/Modbus	–	–	TCS CTN011M11F	–
Designation	Description	No. (1)	Sold in lots of	Reference	Weight kg
IP 20 line terminator	RJ45 connector	–	2	TCS CAR013M120	–
	For screw terminal connector	–	2	TCS CAR01NM120	–

IP 67 connection accessories

Designation	Composition		Reference	Weight kg
Connectors	Straight, M12, 5 screw terminals	Male	XZ CC12MDM50B	0.020
		Female	XZ CC12FDM50B	0.020
	Elbowed, M12, 5 screw terminals	Male	XZ CC12MCM50B	0.020
		Female	XZ CC12FCM50B	0.020

(1) For numbers, see page 5/89.

(2) For ATV 71H M3, ATV 71HD11M3X, HD15M3X, ATV 71H075N4... HD18N4 drives, this connector can be replaced by the **TSX CAN KCDF 180T** connector.

Modicon Premium Automation Platform

Master module for AS-Interface cabling system

Presentation

The **TSX SAY 1000** master module for AS-Interface cabling system make the Modicon Premium PLC the master of the AS-Interface system.

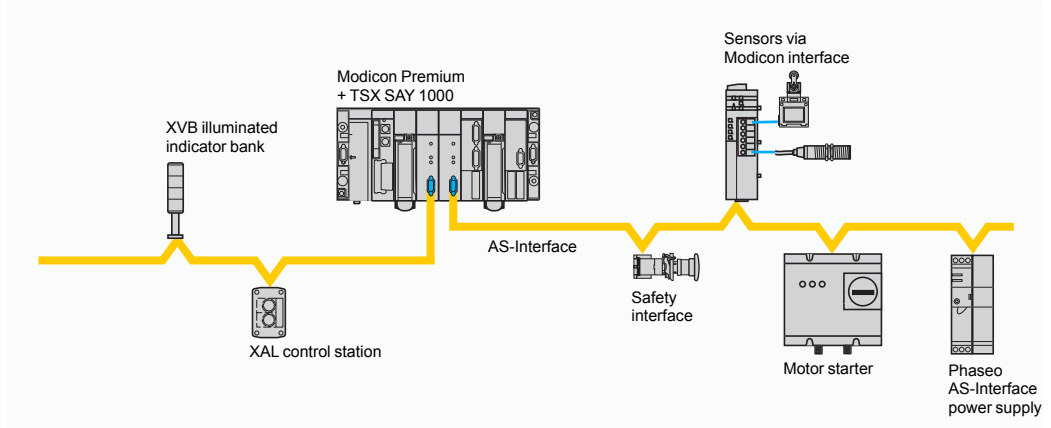

The AS-Interface cabling system consists of a master station (Modicon Premium PLC) and slave stations. The master supporting the AS-Interface profile interrogates the devices connected on the AS-Interface line one by one and stores the information (sensor/actuator status, device operating status) in the PLC memory. Communication on the AS-Interface line is managed totally transparently in relation to the PLC application program.

The **TSX SAY 1000** Modicon Premium master module supports the AS-Interface M2E profile (*AS-Interface V2*) which manages:

- Discrete slave devices (up to 62 devices organized in 2 banks (A/B) with 31 addresses each)
- Analog devices (up to 31 devices in bank A)
- Safety interfaces (up to 31 devices in bank A)

The maximum number of **TSX SAY 1000** modules per PLC station is 1, 2, 4 or 8, depending on the type of processor installed (see page 5/93).

An AS-Interface power supply is essential for powering the various devices on the line. It should preferably be placed near stations that consume a great deal of power (see page 8/37).

Description

The **TSX SAY 1000** AS-Interface line master module is a standard format module. It can be installed in any position in the Modicon Premium PLC rack, just like any I/O module or application-specific module.

It has the following on the front panel:

- 1 A display block with 4 LEDs indicating the module operating modes:
 - RUN (green): module operating
 - ERR (red): module faulty
 - A/B (green): display of the group of 32 slaves
 - I/O (red): I/O fault on AS-Interface line
- 2 A display block with 32 LEDs for diagnostics of the AS-Interface line and each slave connected on the line depending on the selection made with the A/B pushbutton (1)
- 3 Two LEDs specific to the module: see diagnostics on page 5/93
- 4 Two pushbuttons: see diagnostics on page 5/93
- 5 A 3-way male SUB-D connector for connection to the cable

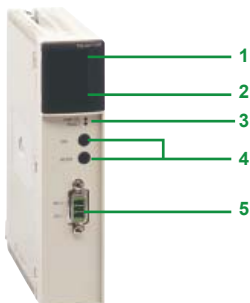

TSX SAY 1000

(1) Depending on the selection made with the A/B pushbutton, either the first 31 slaves (standard addressing) or the last 31 slaves (extended addressing with AS-Interface V2) are displayed.

Description (continued)

TSX SAY 1000 module (AS-Interface V2)

The two LEDs **3** on the module front panel, together with the two pushbuttons **4**, are used for module diagnostics:

LEDs marked		Pushbuttons marked	
PWR: AS-Interface power supply present	FAULT: AS-Interface line fault	A/B: selection of slave group on display block 2	MODE: Module Offline/Online

The display block on the front panel of the **TSX SAY 1000** master module enables simplified local diagnostics to be performed by displaying the slave devices present on the AS-Interface line. Detailed diagnostics for each of the slave devices is carried out via the **ASI Terv2** adjustment terminal.



TSX SAY 1000



XZ CB1001

References

Description	Number per PLC	Profile	Max. number of I/O (1)	Reference	Weight kg
AS-Interface master module for Modicon Premium PLCs (2)	2 with 57 1● 4 with 57 2● 8 with 57 3● 8 with 57 4● 8 with 57 5● 8 with 57 6●	AS-Interface M2E	62 discrete devices 31 analog devices (3) 31 safety devices	TSX SAY 1000	0.340

Connection accessories (4)

Description	Use	Length	Reference	Weight kg
AS-Interface line flat cables (yellow)	For AS-Interface line	20 m	XZ CB 10201	1.400
		50 m	XZ CB 10501	3.500
		100 m	XZ CB 11001	7.000

(1) These maximum values are not cumulative.

(2) The 3-way SUB-D connector for connecting the AS-Interface cable is supplied with the master module.

(3) The **TSX SAY 1000** module supports analog devices with 1 to 4 input or output channels.

(4) For other connection accessories, see page 5/97.

Modicon Premium automation platform

Master module for AS-Interface cabling system

Software setup

The AS-Interface cabling system is configured using Unity Pro or PL7 Micro/Junior/Pro software. The services offered are based on the principle of simplicity:

- Management of profile tables, parameters and data by the master (transparent for the user)
- Topological I/O addressing: any AS-Interface slave declared on the line is assigned a topological address on the line, in a way that is transparent for the user
- Each AS-Interface sensor/actuator is seen by the Modicon TSX Micro/Premium PLC in the same way as any in-rack I/O

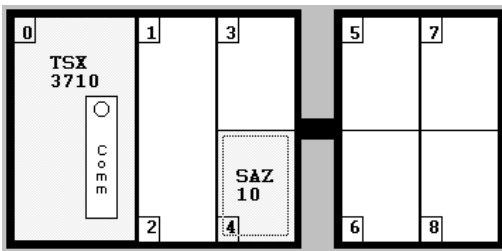

Declaration of the TSX SAZ 10 TSX Micro master module

AS-Interface cabling system configuration

All the devices on the AS-Interface line are configured implicitly, guided by the following sequence of screens:

- Declaration of the AS-Interface line master module
 - The **TSX SAZ 10** module is always inserted and declared in position no. 4 on the Modicon TSX Micro TSX 37 10/21/22 automation platform
 - The **TSX SAY 1000** module can be inserted in any position on the Modicon Premium automation platform (except for the positions reserved for the processors and power supplies)

Configuration of AS-Interface slave modules

From the declaration screen, it is possible to configure all the slave devices corresponding to all the I/O of the interfaces present on the AS-Interface line. This configuration consists of the following for each device, to be defined as appropriate:

- Schneider Electric AS-Interface device
 - The user selects the reference of the AS-Interface device from the various discrete, analog or safety interfaces in the catalogue. This selection automatically determines the AS-Interface profile and parameters associated with each interface.
- Third party AS-Interface device
 - Using Unity Pro or PL7 Micro/Junior/Pro software, the user can manage a “private” list of sensors/actuators of various brands. This list, specifying the AS-Interface profile and parameters, is created and added according to the user’s requirements.

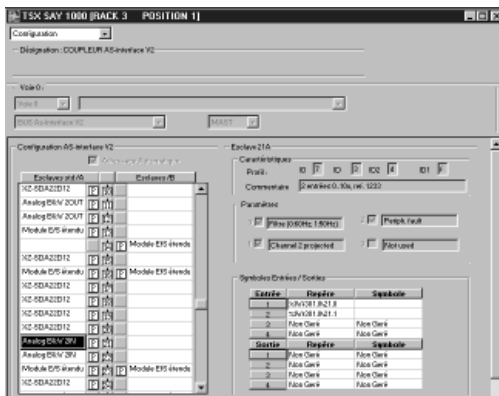

Configuration of AS-Interface slave devices in the TSX SAY 1000 Premium module

Programming

After configuration, the I/O connected to the AS-Interface line are processed by the application program in the same way as any other of the PLC's in-rack I/O, using either their addresses (eg: %I4.0\16.2, input 2 on slave 16 on the AS-Interface line), or their associated symbols (eg: Start_conveyor).

The use of DFB user function blocks, specific to AS-Interface line diagnostics and integrated in the Unity Pro or PL7 Junior/Pro software, enables a fault on a line, device, or if it is present **ASI SAFEMON** safety monitor, to be diagnosed.

5

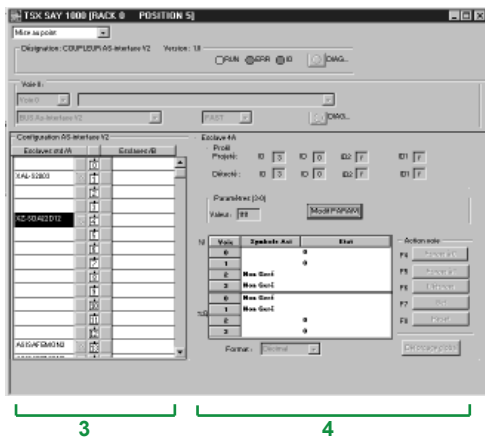

TSX SAY 1000 module diagnostics using PL7 software

Diagnostics

Diagnostics carried out using the centralized display block on the Modicon TSX Micro platform or the display block on the **TSX SAY 1000** Modicon Premium platform module can be supplemented by using a PC with the Unity Pro or PL7 Micro/Junior/Pro software.

The terminal connected to the Modicon TSX Micro/Premium PLC is used for diagnosing the operation of the following:

- TSX SAZ 10 and TSX SAY 1000 AS-Interface master modules
- The AS-Interface line
- Slave devices on the line

For the **TSX SAY 1000 V2** AS-Interface master module, the diagnostics also takes the changes to the M2E standard into account.

This diagnostics is carried out from a single screen divided into four parts providing information on:

- 1 The status of the **TSX SAZ 10** or **TSX SAY 1000** module (RUN, ERR, I/O)
- 2 The status of the AS-Interface channel connected to the module
- 3 The faulty interface (or slave)
- 4 Details relating to the selected interface (profile, parameters, forcing, etc.)

If there is a fault on the AS-Interface module or channel, a second screen can be accessed which clearly indicates the nature of the fault, which may be internal or external.

Modicon Premium automation platform

AS-Interface cabling system

AS-Interface flat cables are available in two versions, yellow and black, according to the type of application: standard and TPE (resistant to splashing oil and to environments with petrol vapours). Various junction boxes are available to meet all connection requirements. They all have IP 67 protection.

AS-Interface infrastructure

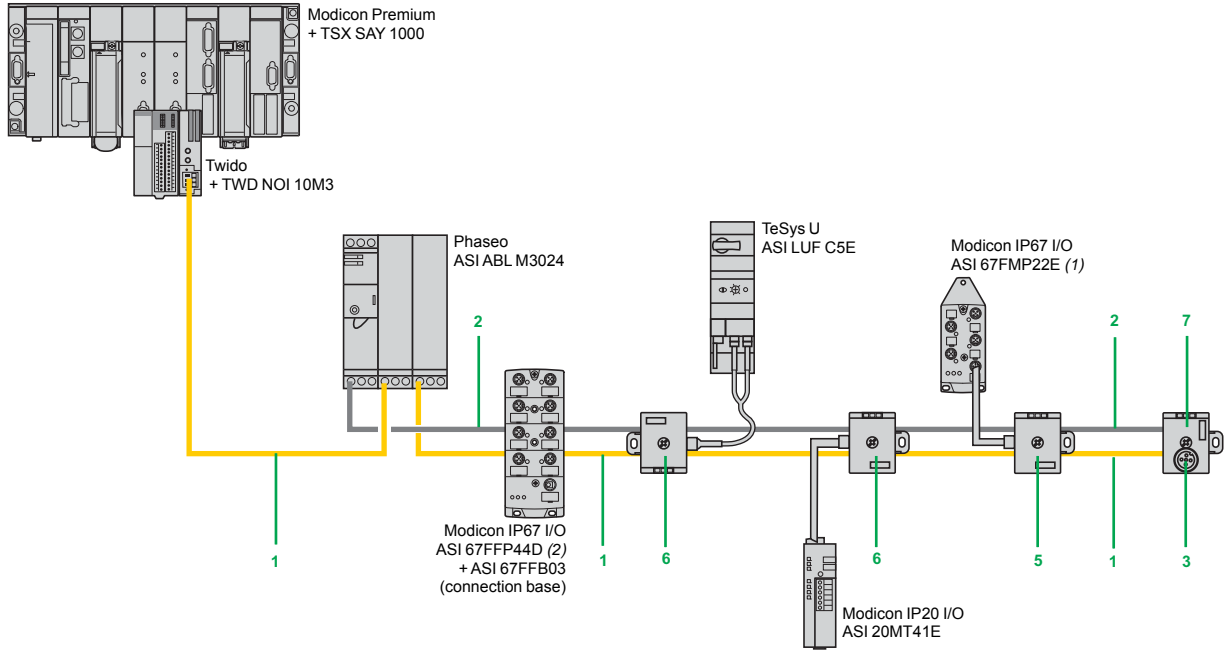

5

Setup

AS-Interface cable lengths

100 m. This can be extended to:
 ■ 200 m using a repeater or a line extension:

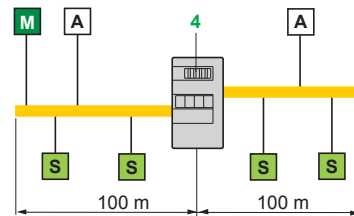

■ 300 m with 2 repeaters
 ■ 500 m by placing the master in the centre of the network:

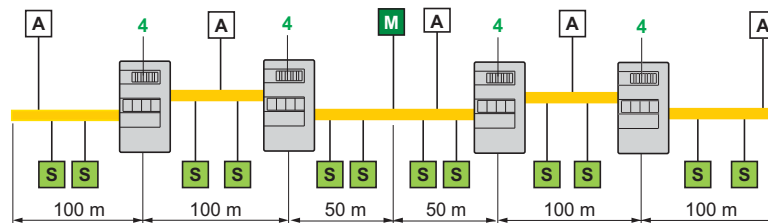

M = Master module
 A = Power supply
 S = Interface or component

Note: 300 m corresponds to the maximum distance between the master and the furthest slave.

For all other information on AS-Interface setup, please consult our website www.schneider-electric.com.

(1) ASI 67FMP22E Modicon IP67 AS-Interface V2.1 I/O module, with M12 remote connection, 2 inputs/2 outputs.
 (2) ASI 67FFP44D Modicon IP67 AS-Interface V2.1 I/O module, with direct connection (IDC), 4 inputs/4 outputs. For further information on the Modicon IP67 AS-Interface distributed I/O modules, please consult the catalogue pages on our website www.schneider-electric.com.



XZ CB1●●0●



TCS AAR011M



ASI RPT01

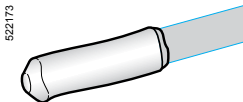

ASI 67FACC2



TCS ATN011F●



TCS ATV011F●



TCS ATN011F



TCS ATN02V

Flat cables and line accessories

The special profile of these 2-core flat cables eliminates the risk of polarity reversal when connecting. Connections to the cable are made by IDC (Insulation Displacement Connectors) connection accessories.

The material used for the cable sheath causes the holes made by the IDCs to reseal themselves as soon as the IDCs are removed, thus maintaining the IP 67 protection of AS-Interface cabling accessories.

The ambient temperatures which AS-Interface flat cables can withstand are as follows, depending on the cable type:

- Standard cable: 25...+ 85°C for operation, - 40...+ 85°C for storage
- TPE cable (oil and vapour resistant): - 30...+ 105°C for operation with cable flexing, - 40...+ 105°C for non-flexing operation or storage

Description	Sheath colour	No.	Length	Type of cable	Reference	Weight kg
Flat cables 2 x 1.5 mm ² Ue ≤ 48 V	Yellow (for AS-Interface)	1	20 m	Standard	XZ CB10201	1.400
				TPE	XZ CB10201H	1.400
			50 m	Standard	XZ CB10501	3.500
	Black (for separate 24 V --- power supply)	2	20 m	TPE	XZ CB10501H	3.500
				Standard	XZ CB11001	7.000
			100 m	TPE	XZ CB11001H	7.000
			20 m	Standard	XZ CB10202	1.400
				TPE	XZ CB10202H	1.400
			50 m	Standard	XZ CB10502	3.500
			100 m	TPE	XZ CB10502H	3.500
				Standard	XZ CB11002	7.000
				TPE	XZ CB11002H	7.000

Description	Use	No.	Length	Order in multiples of	Unit reference	Weight kg
Line extension	Extends the length of a segment from 100 to 200 m	3	–	–	TCS AAR011M	0.047
Repeater	Extends an AS-Interface line by 100 m	4	–	–	ASI RPT01	0.190
Heat shrinkable cable end	To maintain IP67 degree of protection at the end of the AS-Interface cable	–	–	10	ASI 67FACC2	0.002

Accessories for connection to AS-Interface flat cables

Degree of protection: IP67, connection to flat cables by means of IDCs. Ue ≤ 40 V, Ie ≤ 2 A.

Ambient temperature: - 25°C...+ 70°C for operation, - 40...+ 85°C for storage

Tap-offs for connection of AS-Interface components

Description	Connection to AS-Interface component	No.	Cable length	Fixing	Reference	Weight kg
Tap-offs for connection to a flat cable for AS-Interface (yellow)	By 5-way female straight M12 remote connector Cable 2 x 0.34 mm ²	–	1 m	Screw	TCS ATN011F1	0.090
			2 m	Screw	TCS ATN011F2	0.130
	By stripped wires for terminal block Cable 2 x 0.34 mm ²	–	2 m	Screw	TCS ATN01N2	0.215
Tap-offs for connection to two flat cables:	By 5-way female straight M12 remote connector Cable 4 x 0.34 mm ²	5	1 m	Screw	TCS ATV011F1	0.140
			2 m	Screw	TCS ATV011F2	0.180
- 1 for AS-Interface (yellow)	By stripped wires for terminal block Cable 4 x 0.34 mm ²	6	2 m	Screw	TCS ATV01N2	0.265
- 1 for separate power supply (black)						

T connectors

Description	Connection to the AS-Interface component	No.	Cable length	Fixing	Reference	Weight kg
T connectors for connection to a flat cable for AS-Interface (yellow)	By 5-way female M12 connector	7	–	Screw	TCS ATN011F	0.026
Tap-off (or extension) for flat cables: 2 flat cables (yellow)	–	–	–	Screw	TCS ATN02V	0.019



Modicon Premium automation platform

X-Way communication

X-Way and the OSI model

The communication architecture of Modicon TSX Micro/Premium PLCs, like that of TSX 17 or TSX series 7 model 40 PLCs, is compliant with the OSI model.

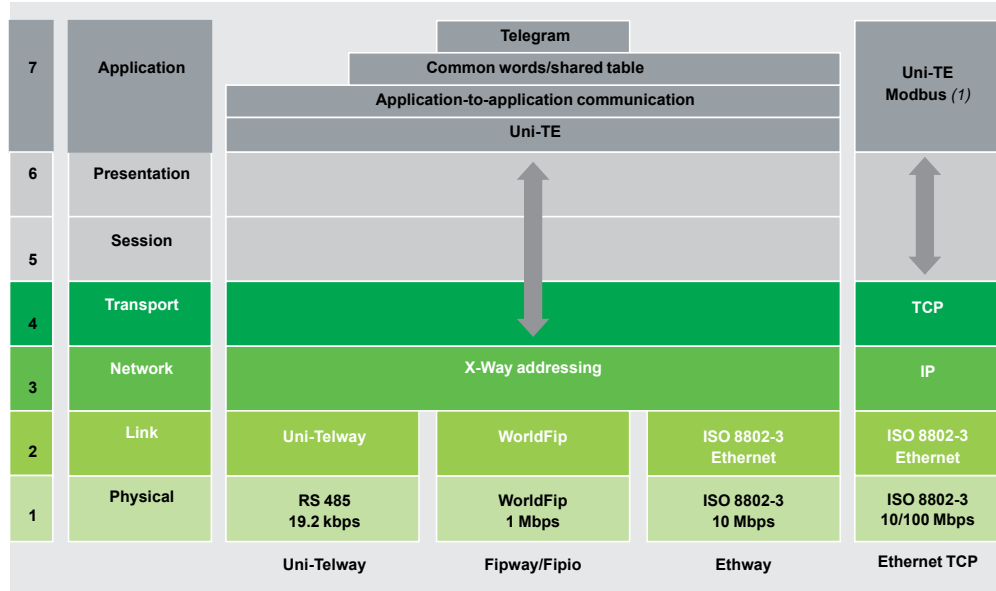

■ **The physical layer** enables the physical transmission of data signals between 2 systems via a medium.
 In order for a network to operate correctly and to ensure full security of personnel in compliance with IEC/EN 61131-2, I, it is necessary to follow the instructions provided in the manual "Grounding and Electromagnetic Compatibility of PLC Systems" included on DVD reference **UNY USE 909CDM**.

- **The application layer** concerns application programs with their data exchange and cooperation conventions. This layer provides the following services:
- Uni-TE industrial message handling, available on TSX Micro/Premium and TSX 17/TSX series 7 PLCs
 - Distributed COM database available on TSX Micro/Premium and TSX 17/TSX series 7 PLCs, or Shared Table service available on TSX Micro/Premium PLCs
 - Periodical data exchange on Fipio bus (see page 5/104)
 - Application-to-application communication
 - Telegram

Size of requests	Ethway, Ethernet Modbus/TCP (1)	Fipway	Fipio	Uni-Telway
Uni-TE service	256 bytes (2)	128 bytes	128 bytes	240 bytes (3)
COM service	256 word database (4)	128 word database	–	–
Application-to-application	256 bytes	128 bytes	128 bytes	240 bytes (3)
Telegram	–	16 bytes	–	–

(1) Ethway not available on TSX Micro PLC.
 (2) 1 kbyte with requests executed as a background task.
 (3) 128 bytes on TSX Micro/Premium/TSX model 40 terminal port, 32 bytes on TSX 17-20 and TSX 47-20/25.
 (4) COM service not available with Ethernet TCP/IP.

Uni-TE services

The Uni-TE protocol is the industrial message handling system supported by X-Way communication architecture. It operates on a question/answer or request/report principle. A device which supports the Uni-TE protocol can be a:

- Client: This device initiates communication. It asks a question (reads), transmits data (writes) or sends an instruction (Run, Stop, etc.).
- Server: This device executes the service requested by the client and sends a report after execution.

X-Way and the OSI model (continued)

Uni-TE services (continued)

The services provided depend on the type of device (PLC, programming terminal, supervision station, etc.). Depending on its function, each device can be Client and/or Server. A Client PLC can access other devices in the architecture via its application program: it can read/write objects on another PLC or numerical controller, select programs on a numerical controller, etc.

Network transparency

When connected to any station in the network or directly connected to the Fipway/Ethernet Modbus/TCP network, a programming terminal can communicate with any other station in the network (as if the terminal were physically connected to the PLC with which it is communicating).

Network transparency also applies between stations connected to different segments of the same multinet architecture.

COM service and Shared Table service (mutually exclusive services)

The **COM service** is made up of a set of dedicated words called common words. Each Fipway/Ethway network station may or may not be able to access this database (in read only or read/write mode).

All PLC stations exchanging common words (32 stations on Fipway, 64 stations on Ethway) are allocated, in a dedicated database (128 words for Fipway, 256 words for Ethway), a write zone (set at 4 words for Fipway, and variable from 4 to 64 words for Ethway) per TSX Micro/Premium station.

COM words are updated automatically during each scan of the general sequential program (master task) without the intervention of the application program.

The **Shared Table service** can be used to exchange a table of internal words divided into as many zones as there are Modicon TSX Micro/Premium PLCs comprising the Fipway network. The exchange principle is based on broadcasting, by each PLC, of a word memory zone (broadcast zone) to the other PLCs on the network.

Each network station is allocated an exchange table comprising 128 internal words for the 32 PLCs that share the service, with a broadcast zone assigned to each PLC, variable from 1 to 32 internal words.

Application-to-application communication

The user application program sends word tables between 2 devices, which may be Modicon TSX Micro/Premium PLCs.

This service is particularly suitable for:

- Sending alarm messages from a PLC to a supervision station.
- Exchanging data tables between two PLCs controlled by the application programs of the sender and recipient.
- Sending broadcast messages to all stations and devices.

Telegram

The telegram service available on Fipway is a special case of application-to-application messages. It enables short messages to be sent and received on a priority basis (maximum 16 characters).

A telegram from a Modicon TSX Micro/Premium PLC is sent immediately without waiting for the end of the cycle. The telegram is received by the Modicon TSX Micro/Premium PLC in:

- The event-triggered task (processed as soon as the message arrives in the network card).
- The fast task or master task (when scanning the reception function).

A PLC can only process one telegram at a time.

Use in a multinet architecture

The X-Way communication architecture is designed to cover multinet architecture applications capable of dealing with problems of:

- Concentration: The architecture is particularly suitable for feedback of supervision data to a higher level.
- Redundancy: Each PLC monitors the correct operation of both networks to which it is connected. If one of the networks should fail, all traffic can be transferred to the network that is functioning.
- Inter-network communication: These architectures comprise several network segments which are interconnected by "bridge PLC" stations. Transparent communication is then offered between the entire architecture.

Presentation

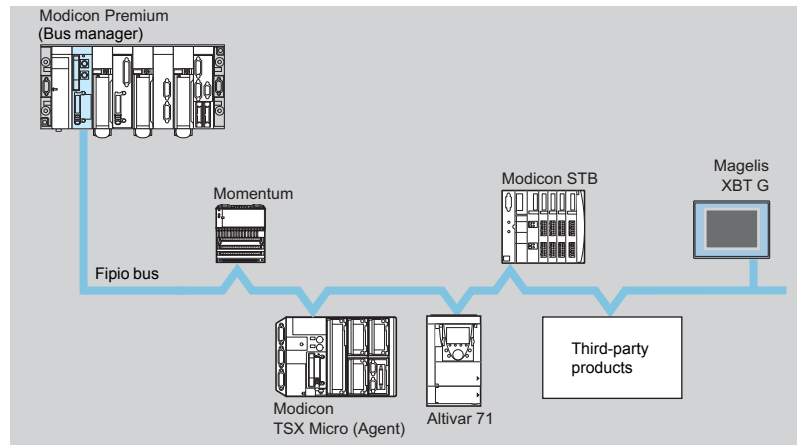

The Fipio fieldbus is a standard means of communication between different control system components. It enables 127 devices to be connected at the connection point integrated in the processor.

This fieldbus conforms to the WorldFip standard based on producer/consumer mechanisms. It is designed for remote location of I/O up to 15 km away and enables third-party devices developed as part of the Collaborative Automation programme to be installed.

The bus arbitrator (manager) can be a Modicon Premium **TSX P57 15●/25●/2823/35●/45●/4823/554M** PLC.

For **Fipio bus wiring system** and connection accessories, see pages 5/110 to 5/113.

Connectable devices

The following Schneider Electric devices can be connected to the Fipio bus:

- Modicon Micro/Premium Agent function PLCs, via PCMCIA **TSX FPP 10** card
- Magelis XBT GT/GK/GTW graphic terminals via **TSX CUSBFIP** Fipio adaptor
- Magelis industrial iPC, via **TSX CUSBFIP** USB/Fipio adaptor
- Modicon STB IP20 distributed I/O, with **STB NFP 2212** network interface module
- Momentum distributed discrete, analog or application-specific I/O (with **170 FNT 110 01** communication module)
- IP 67 remote discrete I/O, **TSX E●F**
- ATV 61/71 variable speed drives, via **VW3 A58301/311** card
- PC terminal via **TSX CUSBFIP** USB/Fipio adaptor
- **TBX** legacy range IP 20 distributed I/O, or discrete or analog I/O with **TBX LEP 030** communication module
- Partner products from the Collaborative Automation Partner programme



TSX P57 153M/154M

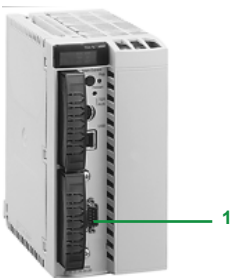

TSX P57 454/554M

Description

TSX P57 ●53/54M, TSX P57 ●823 M processors incorporating a Fipio bus link have the following on the front panel:

- 1 A 9-way SUB-D connector for connection to the bus via the **TSX FP ACC2/12** connector.

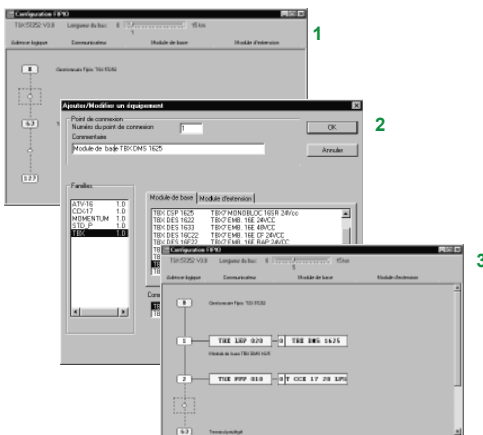

Fipio bus configuration

Software setup

Configuration

Unity Pro or PL7 Junior/Pro software offer configuration screens which enable the declaration and immediate and intuitive configuration of the remote devices connected on the Fipio bus:

- 1 Each circle represents one connection point.
- 2 Clicking on a circle accesses the catalogue of devices which can be connected.
- 3 Once confirmed, the Fipio bus configuration will appear.

Processors equipped with the integrated Fipio link can manage up to 128 connection points on the bus (addresses 0 to 127).

See page 5/102 for the table detailing limitations according to processor and type of device.



Fipio bus diagnostics

Diagnostics

The diagnostic functions of the Fipio bus, integrated in the Unity Pro or PL7 Junior/Pro software, very quickly identify a fault on:

- The bus medium
- Remote devices

- 1 A graphic representation of the architecture displays the defective devices in red.
- 2 More detailed diagnostics can be accessed by double-clicking.
- 3 In addition, specific screens can display an overview of all the faults appearing on the bus or on any device. On request, these faults can be recorded for later analysis.

Maximum configuration

The Fipio bus enables a maximum of 128 devices to be connected. This limit can, in certain cases, be restricted depending on the type of bus manager processor and on the devices which are connected on the bus. The maximum number of devices which can be connected depends on:

- The maximum size of memory space available for Fipio data which is:
 - 94320 bytes for Modicon Premium TSX P57 15●/25●/2823/35● processors
 - 214528 bytes for Modicon Premium TSX P57 45●/4823/554M processors
- The total number of bytes consumed by each device (see table below)

Product family	References	Base size (bytes)	Extension size (bytes)	Maximum number of connection points		
				TSX 57 1●	TSX 57 2●/3●	TSX 57 4●/5●
Maximum number of Fipio devices (1)				63	127	127
ATV 71/61	with VV3 A3 311 card	1280		62	62	62
Lexium 15	with AM0 FIP 001V000 card	1424		62	62	62
Magelis iPC, PC	with USB/FIP adaptor (addr. 63)	–		1	1	1
Inductel, read/write stations	XGK S130421, XGP S1304202 with VV3 A58301 card	1808		52	52	62
Modicon STB	STB NFP 2212	832, 896 or 1280 (2)		62	113, 105 or 73	126
Momentum	170 ADI ●●●/ADO ●●●, 170 ADM 350 10/11, 170 ARM 370 10/390 10/30, 170 ADM 690 51, 170 ARN 120 90, 170 ARM 370 30/390 10	832		62	98	98
	170 AAI 030 00/520 40, 170 AAO 120 00/921 00, 170 AEC 920 00, 170 AMM 090 00	1808		52	52	98
	170 AAI 140 00	2304		40	40	92
TBX (3) <i>(legacy range)</i>	TBX AES 200/ASS 400 (4)	1332		62	70	126
			272 (2/4 channel extension)	59	59	126
	TBX AMS 620	1584		59	59	126
			272 (2-channel extens.)	50	50	100 (4)
			(4-channel extens.)	50	50	84 (4)
			528 (8-channel extens.)	44	44	63 (4)
	TBX CEP 1622/CSP 1622/1625	1152		31	31	31
	TBX DES 16●●/DMS16●●/DSS16●●	1152		62	81	126
	TBX DSS 1235	1152	144 (extension)	62	64 (5)	64 (5)
	TBX DSS 1025	1152	144 (extension)	62	72	85 (5)
TBX EEP/ESP 08C22/1622 (IP 65)	1152		62	64	126	
TBX SAP 10	1808		52	52	117	
IP 67 I/O	TSX EEF 08D2/EEF 16D2	832		62	98	98
	TSX ESF 08T22/EMF 16DT2	1808		52	52	98
Micro/Premium Agent	with TSX FPP 10 card	1424		62	62	62
FipConnect profile	FRD C2	832		62	113	126
	FRD C2P	1744		54	54	122
	FSD C8	896		62	105	126
	FSD C8P	1808		52	52	117
	FSD M8	1040		62	90	126
	FSD M8P	1952		48	48	109
	FED C32	1280		62	73	126
	FED C32P	2304		40	40	92
	FED M32	1424		62	66	126
	FED M32P	2448		38	38	87

Not applicable

(1) Address 63 is reserved for the programming and diagnostic terminal.
 (2) Depending on the island's number of I/O modules (1...32).
 (3) Discrete and analog base units must not be mixed on the same Fipio connection point.
 (4) The number of analog channels for **TBX AES/ASS/AMS** base units is limited to 1008.
 (5) The number of discrete channels for **TBX DES/DMS/DSS** base units is limited to 2048.

Application services

Depending on the bus manager, the application services supported by Premium PLCs are:

■ Remote I/O

Remote I/O modules are addressed by the PL7 application program as in-rack I/O, with which they can of course coexist. This service enables the exchange of I/O status variables and output command variables. These exchanges are carried out in a cyclical and deterministic manner and without intervention from the application program.

The manager also manages remote devices (configuration) in an aperiodic manner, without intervention from the application program.

■ Uni-TE service

X-Way industrial message handling service suitable for operator dialogue, diagnostics and control functions (requests of 128 bytes maximum).

■ Application-to-application service

This service consists of sending tables between 2 devices under the control of their respective application programs (requests of 128 bytes maximum).

■ Terminal transparency

Terminals connected on a higher level X-Way network or on the manager PLC terminal port communicate with the devices on the bus. This is also the case when the terminal is connected at the priority address 63.



TSX P57 153M



TSX P57 2823/4823AM



TSX P57 454M/554M



TSX FPACC12

References

Processors with integrated Fipio link

Type and max. no. of racks	Software compatibility	Reference	Weight kg
TSX P57 15●M 4 racks	Unity Pro	See page 1/10	–
	PL7 Junior/Pro	See page 1/19	–
TSX P57 25●M TSX P57 2823M 16 racks	Unity Pro	See page 1/10	–
	PL7 Junior/Pro	See page 1/19	–
TSX P57 35●M 16 racks	Unity Pro	See page 1/10	–
	PL7 Junior/Pro	See page 1/19	–
TSX P57 45●M TSX P57 4823M 16 racks	Unity Pro	See page 1/10	–
	PL7 Junior/Pro	See page 1/19	–
TSX P57 554M 16 racks	Unity Pro	See page 1/10	–

Accessories and connecting cables (1)

Description	Use	Material	Reference	Weight kg
Female connectors 9-way SUB-D	Processors with integrated Fipio link	Black polycarbonate (IP20)	TSX FP ACC12	0.040
		Zamac	TSX FP ACC2	0.080

(1) For other accessories and Fipio bus connecting cables, see pages 5/110 to 5/113.

Presentation

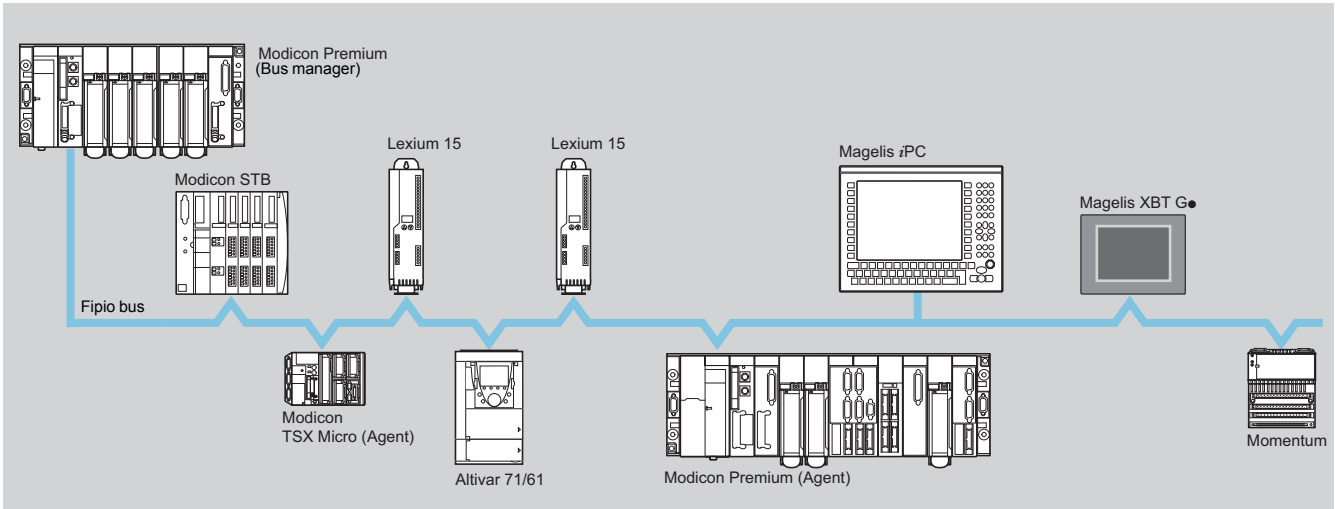

Modicon TSX Micro (TSX 37 21/22) or Modicon Premium PLCs, fitted with a PCMCIA **TSX FPP 10** card on their integrated communication channel, are agents on the Fipio bus. (With Fipio bus manager, see page 5/103).

The Fipio bus enables I/O to be remotely located close to the devices to be controlled (TeSys U, Modicon STB, Momentum, Lexium, Altivar, etc). The Agent function enables offline processing, by locating a Modicon TSX Micro/Premium PLC close to the machine.

In addition to the standard Fipio services (see pages 5/98 and 5/99), Modicon TSX Micro (TSX 37 21/22) and Modicon Premium Agent function PLCs allow exchanges of input and output variables with the bus manager PLC. These exchanges are performed cyclically, automatically and without the involvement of the application program at the same rate as the task for which the agent PLC has been configured.

For **Fipio bus wiring system** and connection accessories, see pages 5/110 to 5/113.

Application services

The application services supported by Modicon TSX Micro (TSX 37 21/22) and Modicon Premium Agent function PLCs are:

- Uni-TE service, X-Way industrial message handling service suitable for operator dialogue, diagnostics and control functions (requests of up to 128 bytes).
- Application-to-application communication service, which consists of the transmission of tables between 2 devices controlled by their respective application programs (messages of up to 128 bytes).
- Periodic data exchange service for exchanging a 64 word table between the bus manager PLC and the TSX Micro or Premium Agent PLC. For software setup, see page 5/105.

Description

Modicon TSX Micro (TSX 37 21/22)/Premium PLCs have a slot in the processor for a type III PCMCIA communication card. This can be fitted with a **TSX FPP 10** Fipio bus connection card. The card comprises:

- 1 A sealable protective cover
- 2 A removable cover with fixing screws giving access to the 20 way miniature connector
- 3 Two indicator lamps:
 - ERR lamp: card fault, link fault
 - COM lamp: transmission or reception of data

Connector to be ordered separately:

- 4 **TSX FP CG010/030**, 1 or 3m cable for connecting the **TSX FP ACC 3/4** tap junction (on 9-way SUB-D connector)

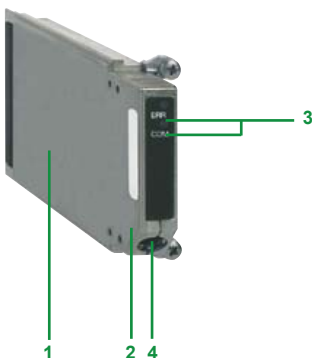

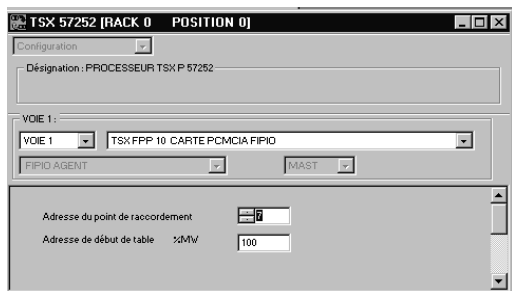

Software setup

Each TSX Micro/Premium PLC Fipio Agent uses 64 %MWi consecutive internal words to exchange periodic data. The first 32 words are reserved for sending data to the manager, and the remaining 32 are reserved for receiving data from the manager.

Unity Pro or PL7 Micro/Junior/Pro application-specific screens allow the configuration of the Fipio Agent PCMCIA card. This consists of indicating:

- the connection point number (1 to 127)
- the address at the beginning of the 64 %MW word table reserved for sending data to and receiving data from the manager



TSX FFP10



TSX FP CG010/030

References

Fipio bus connection component

Description	Composition	Use	Reference	Weight kg
Fipio Agent function card	1 type III PCMCIA version V1.8	On TSX Micro and Premium processors	TSX FFP10	0.110

Fipio bus connection cables (1)

Description	Use from	to	Length	Reference	Weight kg
Cables for PCMCIA card	TSX FFP 10 card (miniature connector)	TSX FP ACC3/4 cable connector	1 m	TSX FP CG010	0.210
		(9-way SUB-D connector)	3 m	TSX FP CG030	0.310

(1) For other Fipio bus accessories and connection cables, see pages 5/110 and 5/111

Presentation

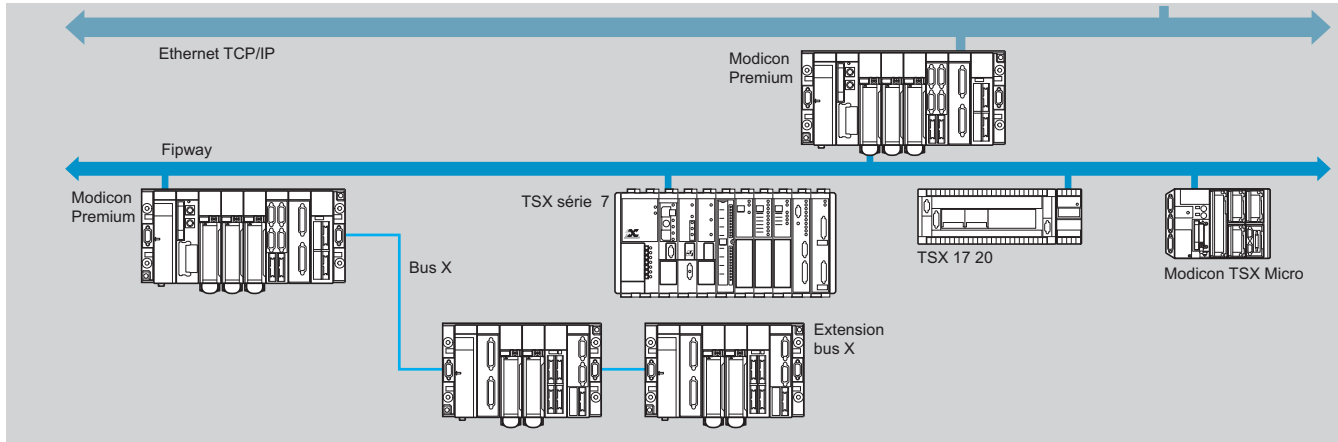

The Fipway network is an open industrial local area network for communication between the various Modicon TSX Micro, Modicon Premium and TSX Series 7 PLCs using the X-Way services. It conforms to the FIP standard with access via a bus arbitrator.

Modicon TSX Micro (TSX 37 21/22)/Premium PLCs can be connected to a Fipway network using a Fipway PCMCIA card which is inserted in each processor or into the **TSX SCY 21601** (Modicon Premium) communication module. Supported X-Way services (see pages 5/98 and 5/99) are:

- Uni-TE services
- Distributed database (COM) or Shared Table
- Telegram (service only available when the PCMCIA card is inserted in the processor)
- Application-to-application communication

For **Fipway network wiring system** and connection accessories, see pages 5/110 and 5/113.

Performance

The operating principle of a Fipway network gives guaranteed, constant network cycle times, whatever the traffic and number of stations (2 to 64). This enables the Fipway network to be updated (addition or removal of stations) without affecting the performance.

Maximum transmission time

- Telegram (TLG): priority application messages are transmitted in less than 10 ms (one telegram per station).
- Common words (COM): the database of common words is updated every 40 ms.
- Shared Table: the entire exchange table is updated every 40 ms.
- Uni-TE message handling: Uni-TE or standard application-to-application messages are normally transmitted in less than 80 ms (40 ms for stations with addresses below 32). Where there is a large amount of traffic, some messages may wait for several cycles before being transmitted. The network characteristics enable a maximum of 210 messages of 128 bytes per second to be transmitted.

The performance can be improved by inhibiting the Telegram service on the entire network.

With such network characteristics, the response time at application level depends almost exclusively on the processing capacity of the devices which are connected. For example, the remote loading of a 50 K word program takes less than two minutes on a network with normal load

CT1 = Cycle time of device 1

NCT = Cycle time of Fipway network

CT2 = Cycle time of device 2

The response time must be evaluated by the designer of each application in relation to the devices connected.

The processing time of a device can vary from one to two cycle times as a function of asynchronous operation.

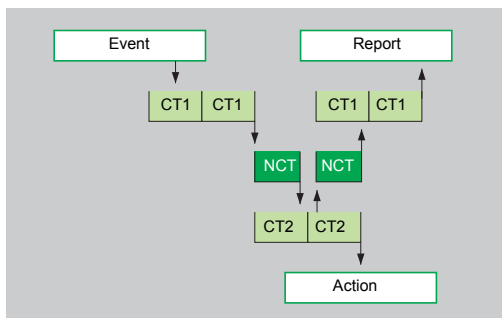



TSX FPP20



TSX SCY21601



TSX FP CG010/030

Description

Modicon TSX Micro/Premium PLCs have a slot in the processor for a PCMCIA communication card (1) which can be fitted with a **TSX FPP20** Fipio bus connection card. This card can also be inserted into the **TSX SCY 21601** communication module slot on Modicon Premium PLCs.

Description, same as that of the **TSX FPP10** Fipio bus card, see page 5/104.

References

Description	Number per PLC	Use on	Reference	Weight kg
Fipway card (1)	1 with TSX 37 20 TSX 57 10/20 3 with TSX 57 30 4 with TSX 57 40/50/60	TSX Micro and Premium processor TSX SCY 21601 module	TSX FPP20	0.110
Communication module 2-channels	See page 5/129	For Premium PLC - 1 isolated 2-wire RS 485 integrated channel (Half-duplex) - 1 slot for type III PCMCIA card	TSX SCY 21601	0.360
Set of X-Way drivers for PC compatible	Includes all X-Way drivers on one CD-ROM		See page 6/43	–

Fipway network connection cables (2)

Description	Use From	To	Length	Reference	Weight kg
Corsets for PCMCIA card	Card	TSX FP ACC3/4	1 m	TSX FP CG 010	0.210
	TSX FPP20 (miniature connector)	box (9-way SUB-D connector)	3 m	TSX FP CG 030	0.310

(1) **TSX P57 4634M/5634M/6634M** Unity processors with integrated Ethernet port do not support the **TSX FPP20** Fipway card in their PCMCIA slot.

(2) For other accessories and connecting cables, see pages 5/112 and 5/113.

Presentation

OZD FIP G3 optic transceivers are particularly suitable for use in applications which are subject to harsh electrical environments or which are spread over large areas:

- Public buildings
- Large-scale industrial sites
- Water treatment and distribution
- Transport and highway tunnel infrastructures, etc.

The **OZD FIP G3** optic transceiver enables conversion of a FIP electric interface into 2 FIP optic interfaces and vice versa. As a result, it allows the use of redundant ring topologies, which improve installation availability even when a line is broken at a point in the medium.

In these situations, the length of the bus or of the Fipio/Fipway ring can reach:

- 20 km with a maximum of 32 transceivers on Fipio
- 20 km with a maximum of 20 transceivers on Fipway

see characteristics page 5/109.

These characteristics can be increased by using mixed topologies, such as 2 serial optic rings or 2 serial optic buses; please consult your Customer Care Centre.

Wiring system

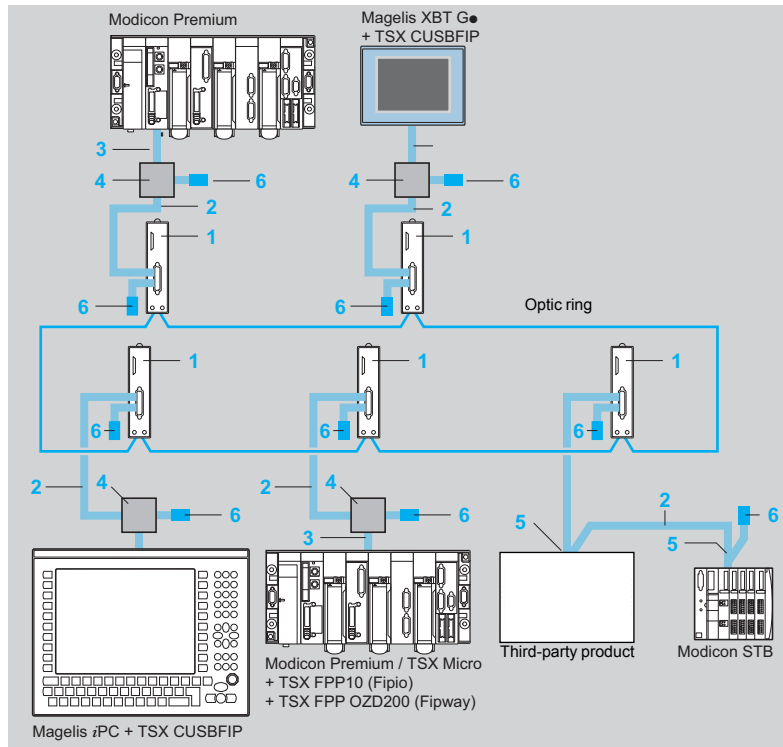

- 1 **OZD FIP G3:** Fipio/Fipway optic transceiver
- 2 **TSX FP CA●00:** 150 Ω shielded twisted pair trunk cable (Ø 8 mm) for use in standard environments and inside buildings (1).
- 3 **TSX FP CG0●0:** tap-off connection cable for **TSX FPP10/OZD200** PCMCIA card for TSX Micro/Premium PLCs.
- 4 **TSX FP ACC3/4:** T-junction box. This box also has two 9-way female SUB-D connectors for connecting any device which connects to the bus via a PCMCIA card.
- 5 **TSX FP ACC2/12:** 9-way female SUB-D connector for Fipway/Fipio connection using daisy chaining or tap link connection.
- 6 **TSX FP ACC7:** line terminator to be placed at each segment end.
TSX LES 65: terminal block for TSX Series 7 PLC, which performs address coding.

(1) Trunk cable **TSX FP CR●00** for use in harsh environments and outside buildings, see page 5/113.

Presentation (continued)

Operating modes and performance

■ Fipio bus on fibre optic link

After configuration in Fipio mode, the processor scans the various application devices according to the software configuration:

- Image variables of the input values and of the output command values of a configured device are scanned as quickly as possible on the bus, whilst respecting the existing relationships between periods of different tasks which use these devices.
- The appearance or disappearance of a configured device is detected on the bus within a maximum time of 200 ms.
- Exchanges occur at the rate defined by the programmer, from 10 to 20 Uni-TE messages per second.
- The network cycle time is double that of the electrical bus when **OZD FIP G3** transceivers are used.

■ Fipway bus on fibre optic link

The operating principle is identical to that on an electrical network, in that the number of stations is limited to 32 and the transmission time is as follows:

- **For the Common words and Shared Table services, the entire database is updated every 40 ms maximum.**
- **For Uni-TE message handling, the network characteristics allow transmission of a maximum of 230 messages of 128 bytes per second.**



OZD FIP G3



TSX FPP10

References

Description	Max. number of transceivers	Fipio bus connectable devices	Fipway network	Reference	Weight kg
Fipio/Fipway optic transceiver (1)	32 with Fipio 20 with Fipway	- TSX Micro/Premium (with TSX FPP10 PCMCIA card) - Modicon STB distributed I/O - Momentum distributed I/O - Magelis XBT G● terminals - Magelis iPC industrial PCs - Altivar 71/61 variable speed drives - Lexium 15 servo drives, etc.	TSX Micro, Premium (with PCMCIA card)	OZD FIP G3	0.500

TSX Micro/Premium connection components (2)

Description	Use	Composition	Reference	Weight kg
Fipway card	TSX Micro TSX 37 21/22 PLC Premium processor	1 type III PCMCIA card	TSX FPP OZD200	0.110
Fipio card agent function	TSX Micro TSX 37 21/22 PLC Premium processor	1 type III PCMCIA card	TSX FPP10	0.110

(1) For electrical/fibre optic repeater **TSX FP ACC8M**, see page 5/112.

(2) For accessories and connecting cables, see pages 5/112 and 5/113.

Fipio bus/Fipway network wiring system

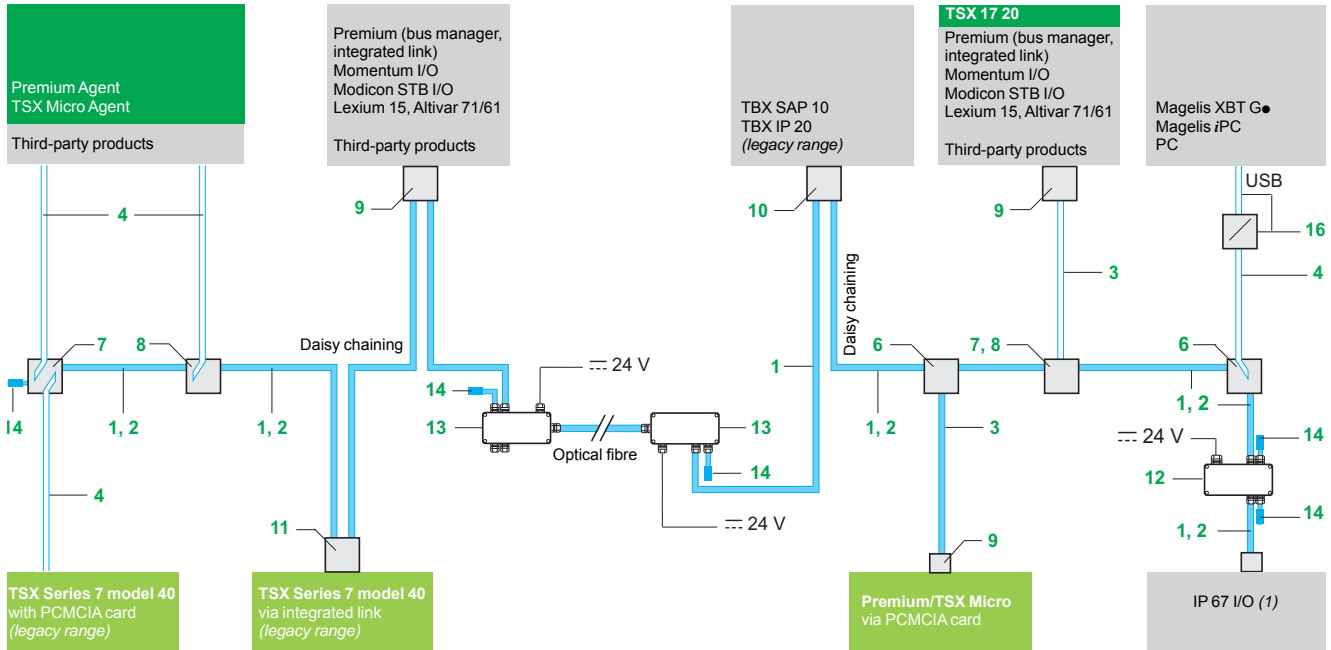

Connection to Fipway network and Fipio bus

Connection to Fipway network

Connection to Fipio bus

5

(1) For TSX EEF/ESF/EMF IP 67 dust and damp proof I/O modules on Fipio bus and connections, please consult our website www.schneider-electric.com.

Connectable devices

Devices on Fipio bus	Boxes				Connectors			
	TSX FP ACC4 8	TSX FP ACC14 6	TSX FP ACC3 7	TSX EF ACC99	TSX FP ACC2 9	TSX FP ACC12 9	TBX BLP01 10	TBX BAS10
Premium bus manager	D	D			C/D	C/D		
Premium Fipio Agent (PCMCIA)	D		D					
TSX Micro Fipio Agent (PCMCIA)	D		D					
Lexium 15 servo drives	D		D		C/D	C/D		
Altivar 71/61 variable speed drives	D		D			C/D		
USB/FIP adaptor 16	D		D					
Modicon STB/Momentum	D	D			C/D	C/D		
IP 20 TBX I/O (legacy range)	D	D					C/D	
IP 67 I/O				C/D				
Devices on Fipway network	Boxes				Connectors			
	TSX FP ACC4 8	TSX FP ACC14 6	TSX FP ACC3 7	TSX EF ACC99	TSX FP ACC2 9	TSX FP ACC12 9	TBX BLP01	TBX BAS10
Premium (PCMCIA)	D		D					
TSX Micro (PCMCIA)	D		D					
TSX model 40 (integrated link)	D	D						C/D
TSX model 40 (PCMCIA)	D		D					
USB/FIP adaptor 16	D		D					
LUF P1 Modbus gateway	D		D		C/D	C/D		

Recommended connection
 Connection possible

C: connection by daisy chaining
 D: connection by tap link

Fipio bus/Fipway network wiring system (continued)

Cables

- 1 **TSX FP CA●00**: trunk cable, shielded twisted pair 150 Ω (Ø 8 mm) for normal environments and inside buildings.
- 2 **TSX FP CR●00**: trunk cable, shielded twisted pair 150 Ω (Ø 9.5 mm) for harsh environments or use outside buildings.
TSX FP CP●00: trunk cable, shielded twisted pair 150 Ω (Ø 9.5 mm) and 1 x 1.5 mm² pair for remote power supply for harsh environments or use outside buildings.
- 3 **TSX FP CC●00**: tap link cable, double shielded twisted pair 150 Ω (Ø 8 mm) for normal environments and inside buildings.
- 4 **TSX FP CG●00**: tap link cordset for **TSX FPP10/20/OZD200** PCMCIA card for Modicon Micro/Premium/TSX Series 7 PLCs, and **TSX C USBFIP** USB/FIP adaptor. Connection to the bus is via the 9-way SUB-D connector on the **TSX FP ACC3/ACC4** box.

Connection boxes

- 6 **TSX FP ACC14**: IP 20 polycarbonate junction box: provides tap link from the trunk cable to connect 1 device via **TSX FP CC●00** tap link cable or several devices in a daisy chain.
- 7 **TSX FP ACC3**: IP 20 box for connecting 2 **TSX FPP10/20/OZD200** PCMCIA cards or a **TSX C USBFIP** USB/FIP adaptor on a 9-way SUB-D connector.
- 8 **TSX FP ACC4**: IP 65 junction box. It also has a 9-way female SUB-D connector for connecting a **TSX FPP10/20/OZD200** PCMCIA card or a **TSX C USBFIP** USB/FIP adaptor (in this case, the degree of protection of the box becomes IP 20).

TSX EF ACC99: IP 65 junction box for IP 67 I/O modules, please consult our website www.schneider-electric.com.

Connectors

- 9 **TSX FP ACC2** and **TSX FP ACC12**: 9-way female SUB-D connector for Fipway/Fipio connection (**TSX FP ACC2** connector specifically for **TSX 17 20** micro-PLC). Used for daisy chain or tap link connection (90° high or low output, 45° high or low output).
- 10 **TBX BLP01**: connector for IP 20 **TBX** I/O modules (*legacy range*).
- 11 **TSX LES65**: terminal block for **TSX/PMX** model 40 PLCs (*legacy range*). Used for address coding.
- 12 **TSX FP ACC6**: electrical repeater: used to increase the number of stations (64 max.) and the length of the network by creating additional segments of up to 1000 m (a maximum of 4 repeaters in cascade, giving a network length of 5000 m).

TSX EF C●●●: dust and damp proof connectors for IP 67 I/O modules, please consult our website www.schneider-electric.com.

Other components



- 13 **TSX FP ACC8M**: fibre optic/electrical repeater, used to interconnect electrical segments via a fibre optic link (particularly suitable for crossing areas with a high level of interference) or to connect a fibre optic device.
- 14 **TSX FP ACC7**: line terminator, to be installed at both ends of a segment.
- 16 **TSX C USBFIP**: USB/Fipio-Fipway adaptor, for connecting any device with a USB port (Magelis XBT G●, PC, Magelis iPC industrial PC). Max. rate 12 messages/s.

TSX EF ACC7: M23 IP67 line terminator, to be installed at one or both ends of a segment, as required.

TSX FP ACC9: network wiring test tool. This is used for testing the continuity of segments, the connections of the various devices and the installation of line terminators.

References

Fipio bus/Fipway network connection accessories (1)

Description	Use	No.	Reference	Weight kg
 TSX FP ACC14 Insulated bus connection boxes (polycarbonate, IP 20)	Trunk cable tap link (for connecting the 24 V $\overline{\text{---}}$ power supply of IP 67 TBX modules)	6	TSX FP ACC14	0.120
	Trunk cable tap link, supports 2 x 9-way female SUB-D connectors (for TSX FP CG010/030 PCMCIA card cable) Connects the 24 V $\overline{\text{---}}$ power supply of dust and damp proof TBX modules	7	TSX FP ACC3	0.090
 TSX FP ACC3 Dust and damp proof bus connection boxes (zamac, IP 65)	Trunk cable tap link, supports 1 x 9-way female SUB-D connector (for TSX FP CG010/030 cable)	8	TSX FP ACC4	0.660
	Trunk cable tap link via 2 M23 connectors Distribution of remote 24 V $\overline{\text{---}}$ power supply via 7/8" connector Connection of compatible PC via 9-way female SUB-D connector	–	TSX EF ACC99	0.715
 TSX FP ACC4 Female connector for devices with 9-way male SUB-D connector	Black IP 20 polycarbonate connector Connection by daisy-chaining or tap link	9	TSX FP ACC12	0.040
	Zamac connector, for TSX 17 20 PLC (<i>legacy range</i>) Connection by daisy-chaining or tap link	9	TSX FP ACC2	0.080
Line terminators	2 impedance adaptors Sold in lots of 2	14	TSX FP ACC7	0.020
Electrical repeater (IP 65)	Increases the length of the network or bus by allowing the connection of 2 segments of up to 1000 m each	12	TSX FP ACC6	0.520
Electrical/fibre optic repeater (IP 65)	For connecting (via patch panel) an electrical segment (1000 m max.) and a fibre optic segment (3000 m max.)	13	TSX FP ACC8M	0.620
FIP wiring test tool	For testing each cable segment of a network	–	TSX FP ACC9	0.050
Fipio/Fipway communication cards and adaptor				
PCMCIA cards	Type III cards for Premium/TSX Micro PLCs	–	See pages 5/107 and 5/105	
USB/Fipio-Fipway adaptor	For connecting any device with a USB port to Fipio/Fipway Includes the USB cable (length 2 m) Requires the TSX FP CG010/030 cable 4 for connection (Fipio/Fipway end) to the TSX FP ACC3/4 box. Max. rate 12 messages/s.	15	TSX C USBFIP	0.140

(1) The characteristics and performance of the Fipio bus or Fipway network are dependent on the above TSX FP accessories being used.

References (continued)						
Fipio bus/Fipway network connecting cables (1)						
Description	Type	Condition of use	No.	Length	Reference	Weight kg
Trunk cables	Ø 8 mm, 1 shielded twisted pair 150 Ω	In normal environment (2)	1	100 m	TSX FP CA100	5.680
				200 m	TSX FP CA200	10.920
				500 m	TSX FP CA500	30.000
	Ø 9.5 mm, 1 shielded twisted pair 150 Ω	In harsh environment (3)	2	100 m	TSX FP CR100	7.680
				200 m	TSX FP CR200	14.920
				500 m	TSX FP CR500	40.000
	Ø 9.5 mm, 1 shielded twisted pair 150 Ω and 1 x 1.5 mm ² pair for 24 V remote supply	In harsh environment (3)	-	100 m	TSX FP CP100	7.680
				500 m	TSX FP CP500	30.000
	Tap link cables	Ø 8 mm, 2 shielded twisted pairs 150 Ω	In normal environment (2)	3	100 m	TSX FP CC100
200 m					TSX FP CC200	10.920
500 m					TSX FP CC500	30.000
Cordsets for PCMCIA TSX FPP ●● cards USB/FIP adaptor	With 1 miniature connector and 1 x 9-way SUB-D connector	In normal environment (2)	4	1 m	TSX FP CG010	0.210
				3 m	TSX FP CG030	0.310

(1) The characteristics and performance of the Fipio bus or Fipway network are dependent on the above TSX FP accessories being used.

(2) Normal environment:

- Without any particular environmental restrictions
- Operating temperature between + 5°C and + 60°C
- Fixed installations

(3) Harsh environment:

- Resistance to hydrocarbons, industrial oils, detergents, solder splashes
- Humidity up to 100%
- Saline atmosphere
- Extreme temperature variations
- Operating temperature between - 10°C and + 70°C
- Mobile installations

(4) Mobile installations: cables as per VDE 472 part 603/H:

- For use on cable drag chain with minimum bend radius of 75 mm
- For use on gantry crane, subject to compliance with conditions for use such as acceleration, speed, length. Consult your Customer Care Centre
- Not authorized for use on robots or multi-axis applications

Presentation

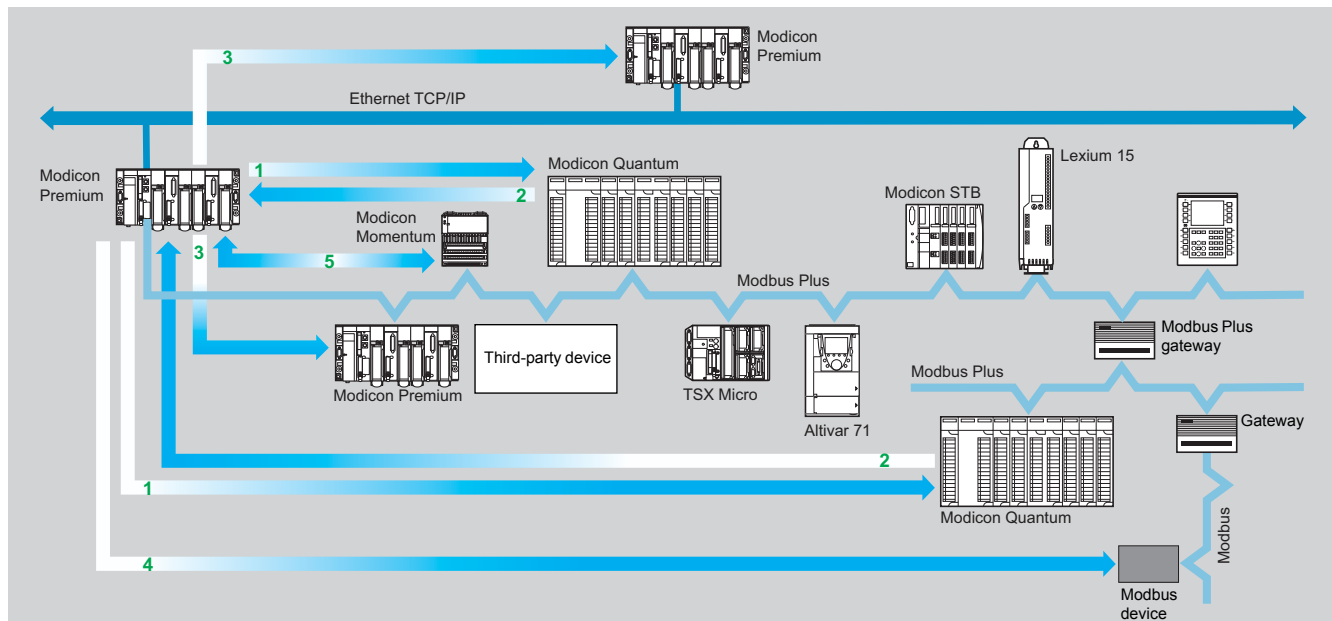

The Modbus Plus network is a high-performance industrial local network suitable for the requirements of Client/Server type extended architectures, combining high speed (1 Mbps), simple low-cost transmission media and numerous message handling services.

The main data exchange functions between all devices connected to the network are:

- The message exchange function using the Modbus protocol.
- The “global database” function (periodic Shared Table service, controlled by the application: a station with the token can transmit 32 words to up to 63 other stations connected to the network).

- 1 The Modicon Premium (or Modicon TSX Micro) client communicates with the Modicon Quantum server on the Modbus Plus network via the EF block (communication function).
- 2 The Modicon Quantum client communicates with the Modicon Premium server on the Modbus Plus network via MSTR function blocks.
- 3 A Modicon Premium (or Modicon TSX Micro) client connected to the Ethernet Modbus/TCP or Fipway network can communicate in read/write with a Modbus Plus station (the Modicon Premium PLC therefore acts as a gateway).
- 4 A Modicon Premium (or Modicon TSX Micro) client connected to the Modbus Plus network can access a remote station via the Modbus Plus/Modbus gateway.
- 5 A Modicon Premium client connected to the Modbus Plus network exchanges data with Modicon Momentum distributed I/O using the Peer cop function.

Description

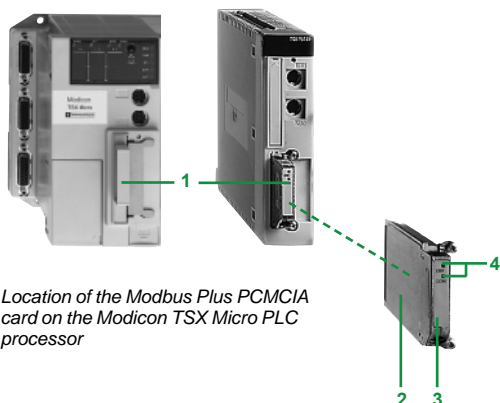

Location of the Modbus Plus PCMCIA card on the Modicon TSX Micro PLC processor

Modicon TSX Micro/Premium PLCs are connected to the Modbus Plus network via the **TSX MBP 100** type III PCMCIA card. This card is installed in the reserved slot on the processors:

- 1 A card slot on the processors
- 2 A protective cover
- 3 A removable cover with fixing screws (access to the 20-way miniature connector)
- 4 Two LED indicators:
 - ERR indicator: card or link fault
 - COM LED: activity on the line

To be ordered separately: **TSX MBP CE 0●●** drop cable

Wiring system

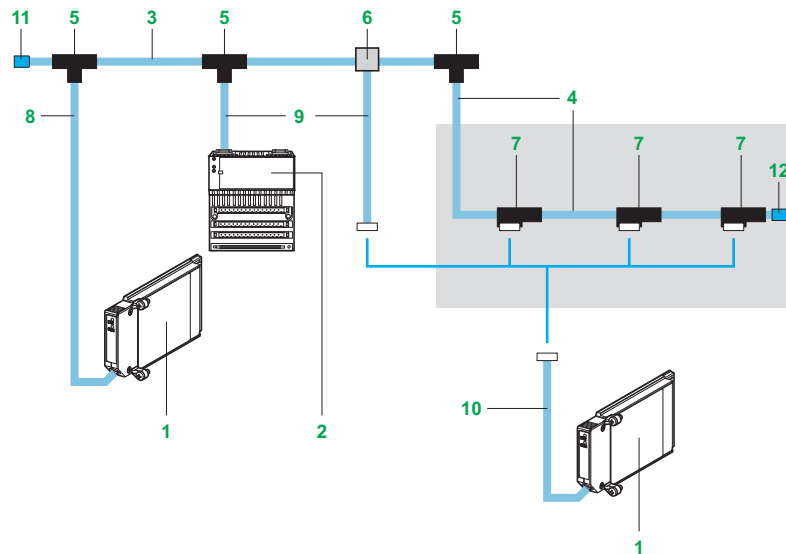

- 1 **TSX MBP 100**: Modbus Plus PCMCIA card, for type III slot on Modicon TSX Micro or Modicon Premium platform processor.
- 2 **170 PNT 110 20**: communication module for Modicon Momentum I/O base unit.
- 3 **490 NAA 271 0●**: trunk cable, shielded twisted pair with shielding drain wire (flying leads at ends). In 30, 150, 300, 450 or 1500 m lengths.
- 4 **170 MCI 020 ●●**: drop cable with an RJ45 connector at each end (BASE-T interface). In 0.25, 0.75, 3 or 10 m lengths.
- 5 **990 NAD 230 00**: IP 20 tee-shaped tap, for tap link from the trunk cable to connect 1 device (connection of conductors requires the **043 509 383** wiring tool). Integrates the line terminator
- 6 Tap, for tap link from the trunk cable to connect 1 device (connection on screw terminals). It also has an R45 connector for connecting a programming and maintenance terminal:
 - **990 NAD 230 20/21**: IP 20 plastic tap
 - **990 NAD 230 10**: IP 65 zamac tap
- 7 **170 XTS 020 00**: IP 20 tee, provides a tap link from the Modbus Plus cable (cable with RJ45 connectors at each end). It has a 9-way male SUB-D connector for connecting the device.
- 8 **TSX MBP CE 030/060**: drop cable for Modbus Plus PCMCIA card, with a 20-way miniature connector on the PCMCIA end and flying leads on the **990 NAD 230 00/010** tap end. In 3 or 6 m lengths.
- 9 **990 NAD 211 10/30**: drop cable with a 9-way male SUB-D connector on the device end and flying leads on the **990 NAD 230 00/010** tap end. In 2, 4 or 6 m lengths.
- 10 **TSX MBP CE 002**: drop cable for Modbus Plus PCMCIA card, with a 20-way miniature connector on the PCMCIA end and a 9-way female SUB-D connector on the network end. Can be used as an extension for the **990 NAD 211 10/30** cable. In 0.2 m lengths.
- 11 **AS MBKT 185**: set of 2 line terminators (impedance matching) to be placed at each end of the segment. **AS MBKT 185** terminators are placed directly at the end of the cable (with no tap or tee).
990 NAD 230 11: set of 2 line terminators (impedance matching) for **990 NAD 230 10** IP 65 tap, to be placed at each end of the segment.
- 12 **170 XTS 021 00**: set of 2 line terminators (impedance matching) for **170 XTS 020 00** tee, to be placed at each end of the segment.

Note: For wiring system:

- Modicon Quantum platform, please refer to our catalogue.
- Lexium drive for brushless motors, please refer to the "Lexium motion control" catalogue.
- Altivar drive for asynchronous motors, please refer to the "Variable speed drives" catalogue.



TSX MBP 100

References

Description	Number per PLC	Use	No.	Composition	Reference	Weight kg
Modbus Plus PCMCIA card	1 with TSX Micro 37 21/22 1 with Premium	Type III slot on: - TSX 37 21/22 PLC - TSX 57 1●/2●/3●/4●/5●/6● Premium processor	1	1 type III PCMCIA card	TSX MBP 100	0.110



STB NMP 2212

Description	Connection	No.	Reference	Weight kg
Distributed I/O on Modbus Plus network	Modicon STB network interface module	–	STB NMP 2212	0.145
	Momentum communication module	2	170 PNT 110 20	0.110



171 PNT 110 20

Connection accessories (1)

Description	Use	No.	Mounting	Reference (1)	Weight kg
Modbus Plus taps	IP 20 tee, requires the 043 509 383 wiring tool. Integrates the line terminator	5	–	990 NAD 230 00	0.230
	IP 20 tap for tap link connection	6	DIN rail	990 NAD 230 20	–
	Connection on screw terminals, supports 1 RJ45 connector on front panel		Plate	990 NAD 230 21	–
	IP 65 tap for tap link connection, supports 1 RJ45 connector on front panel	6	Plate	990 NAD 230 10	0.650
	IP 20 tee with 2 RJ45 connectors for Modbus Plus cable and 1 x 9-way SUB-D connector for tap link devices	7	–	170 XTS 020 00	0.260
Line terminators Sold in lots of 2	For 990 NAD 230 20/21 tap (IP 20)	11	–	990 NAD 230 22	–
	For 990 NAD 230 10 tap (IP 65)	11	–	990 NAD 230 11	–
	For 170 XTS 020 00 tee (IP 20)	12	–	170 XTS 021 00	–
	Used directly at the end of the trunk cable (with no tee or tap)	11	–	AS MBKT 185	–
Mounting kit	DIN rail mounting for 990 NAD 230 10 IP 65 tap	–	–	990 NAD 230 12	–
Protectors Sold in lots of 4	Replacement protectors for RJ45 connector for access to the terminal port on the 990 NAD 230 10 tap	–	–	990 NAD 230 23	–
Wiring tool	Mounting trunk and tap cables in 990 NAD 230 00 tap	–	–	043 509 383	–

(1) For other Modbus Plus network accessories and connecting cables, consult your Customer Care Centre.

References (continued)

Connection cables (1)

Description	Use		No.	Length	Reference	Weight kg
	From	To				
Modbus Plus trunk cables	Tap	990 NAD 230 00/10/20/21 tap	3	30 m	490 NAA 271 01	–
				150 m	490 NAA 271 02	–
				300 m	490 NAA 271 03	–
				450 m	490 NAA 271 04	–
				1500 m	490 NAA 271 06	–
Drop cables	170 XTS 020 00 IP 20 tee	170 XTS 020 00 IP 20 tee	4	0.25 m	170 MCI 020 10	–
				1 m	170 MCI 020 36	–
				10 m	170 MCI 020 80	–
TSX MBP 100 PCMCIA card (miniature connector)	Drop cable with 9-way male SUB-D connector	990 NAD 230 00/10 tap	10	0.2 m	TSX MBP CE 002	–
				3 m	TSX MBP CE 030	0.340
Momentum communication module or Modicon STB network interface module	990 NAD 230 00/10 tap	9	2.4 m		990 NAD 211 10	0.530
			6 m	990 NAD 211 30	0.530	



TSX MBP CE 030/060

(1) For other Modbus Plus network accessories and connecting cables, consult your Customer Care Centre.

Presentation

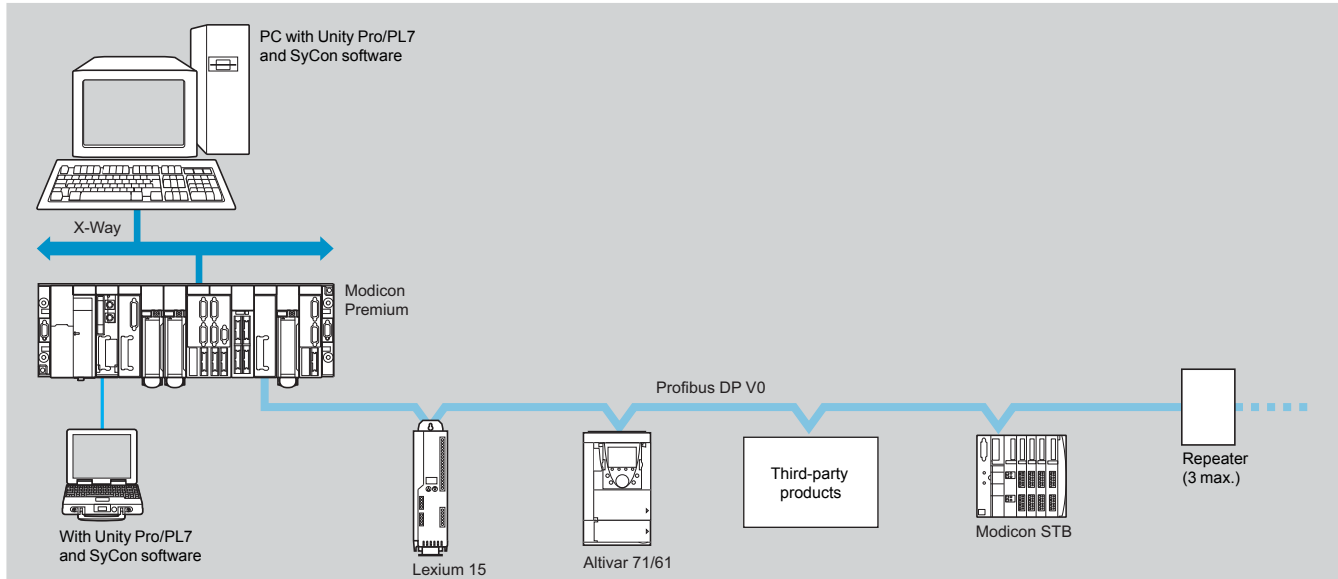

Profibus DP is a fieldbus which meets industrial communication requirements. Profibus DP is a linear bus with a master/slave centralized access procedure. Only master stations, also known as active stations, have the right to access the bus. Slave, or passive, stations can only respond to prompts. The physical link is a single shielded twisted pair, but fibre optic interfaces are available for creating tree, star or ring structures. In relation to the ISO model, only layers 1 and 2 are implemented, with access from the user interface being made directly onto the link layer via simple mapping of variables.

Configuration

Version V0 of the Profibus DP bus is configured using SyCon software, to be ordered separately.

This software is used to generate a file containing all the information relating to the connected devices. This extension file is imported into the PLC application via the Unity Pro or PL7 Junior/Pro programming software.

Description

Modicon Premium PLCs are connected to the Profibus DP V0 bus via the **TSX PBY 100** module. This module can be installed in any slot in a Premium PLC rack. It comprises:

- 1 Host module for the PCMCIA card
- 2 Profibus DP V0 PCMCIA card with its integral connecting cable, length 0.6 m
- 3 490 NAE 911 00 T-junction box for tap link to the main bus

Connectable devices

The Modicon Premium automation platform, via the **TSX PBY 100** module, acts as the master on the Profibus DP V0 bus. The following Schneider Electric devices can be connected to this bus:

- TeSys model U starter-controllers (via Modbus gateway)
- Modicon STB and Momentum distributed I/O
- Altivar 312/61/71 variable speed drives for asynchronous motors
- Lexium 05/15 servo drives for brushless motors
- Altistart ATS 48 soft starters
- Etc.

And any third-party device compatible with Profibus DP standard profiles.

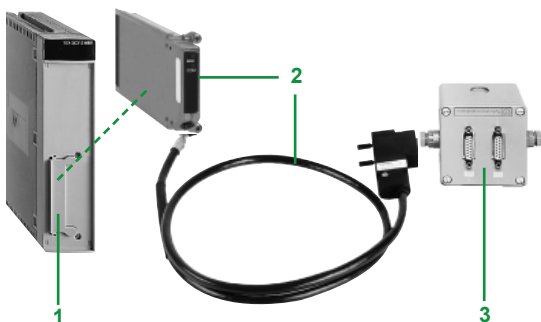

Modicon Premium automation platform

Profibus DP V0 bus

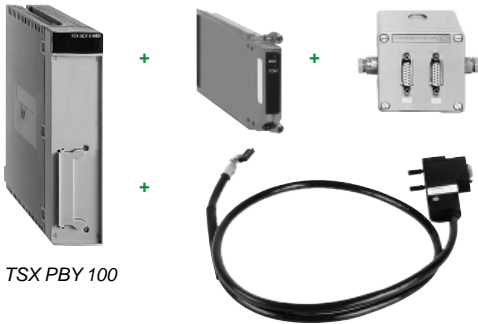

TSX PBY 100



490 NAD 911 03

References

Description	Profile	Services	Reference	Weight kg
Profibus DP V0 bus module for Premium PLCs (1)	Master 12 Mbps	Class 1 and Class 2 V0 master functions (see characteristics) Profibus FMS message handling not supported	TSX PBY 100	0.870
SyCon configuration software	–	Generates a configuration file to be imported into the application	See page 5/89	–

Description

Description	Licence type	Reference	Weight kg
SyCon V2.10 configuration software licences	Single (1 station)	SYC SPU LFU CD29A	–
	Group (3 stations)	SYC SPU LFG CD29A	–
	Team (10 stations)	SYC SPU LFT CD29A	–
	Site (> 10 stations)	SYC SPU LFF CD29A	–
SyCon V2.10 configuration software update	Single (1 station)	SYC SPU LRU CD29A	–

Profibus DP bus connection components

Description	Use	Reference	Weight kg
Distributed I/O on Profibus DP bus	Modicon STB network interface module	STB NDP 2112	0.140
	Momentum communication module	170 DTN 110 00	0.070
Connectors for distributed I/O communication module	Line terminator	490 NAD 911 03	–
	Intermediate connection	490 NAD 911 04	–
	Intermediate connection and terminal port	490 NAD 911 05	–

Description

Description	Length	Reference	Weight kg
Profibus DP connecting cables	100 m	TSX PBS CA 100	–
	400 m	TSX PBS CA 400	–

Replacement parts

Description	Reference	Weight kg
Main bus tap	490 NAE 911 00	–
PCMCIA card	467 NHP 811 00	–

(1) For maximum number of fieldbuses (INTERBus or Profibus DP) per processor, see pages 1/10 and 1/19.

Modicon Premium automation platform

Profibus DP V1 and Profibus PA buses Profibus Remote Master module

Profibus DP fieldbus

Profibus DP is one of the most widely used fieldbuses in industry. Based on a master/slave protocol, only master stations, sometimes called active stations, have the right to access the bus, with slave, or passive, stations being limited to responding to interrogations.

Version V0 of Profibus only allows cyclic exchanges with I/O, whereas version V1 offers an acyclic message handling channel which can be used for device adjustment or diagnostics during operation.

The physical link is a single shielded twisted pair, but numerous interfaces are available for creating all sorts of topologies - tree, star or ring - including those using optical fibre or a non-physical link.

Gateways can be used to communicate transparently with Profibus PA, one of the most commonly used standards in process applications for connecting instrumentation.

Profibus PA can be used to supply devices across the network and also to install sensors in potentially explosive zones (ATEX).

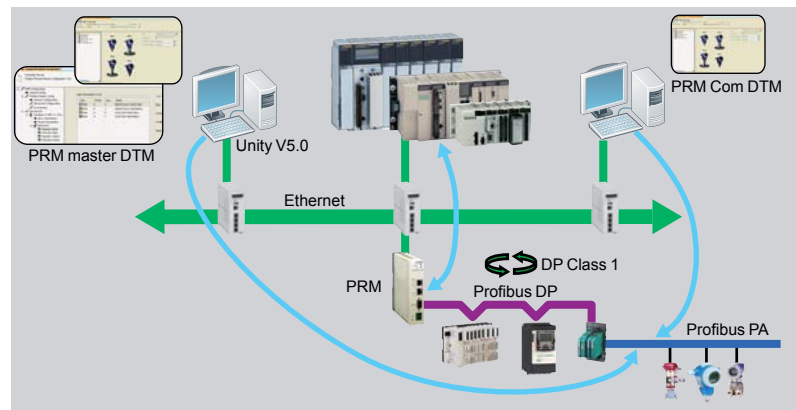

Profibus Remote Master (PRM) module

Presentation

The Profibus Remote Master (PRM) module is connected to the Ethernet Modbus TCP/IP network via its integrated 2-port switch, as close as possible to the process and the instrumentation.

The PRM module can be used to connect Modicon Quantum, Modicon Premium and Modicon M340 PLCs to Profibus DP V1 via the I/O scanner function.

Irrespective of the type of PLC, only one product reference is required and setup is identical, thus reducing training and maintenance costs.

Two versions are available, standard and tropicalized, so as to adapt to any type of environment.

The PRM module is open to Asset Management tools.

A dedicated communication DTM is supplied with the product, thus allowing any compatible FDT standard tool to remotely adjust devices on Profibus using Ethernet (see page 6/5).

Configuration

From a single Unity tool, the user can create the Profibus configuration, the PLC application and configure or calibrate devices.

The latter are integrated in the Unity catalogue via their DTMs if they exist, or their *gsd* files.

The I/O scanner configuration is created implicitly in Unity Pro using the Profibus configuration. The parameters assigned by default guarantee optimized performance, as well as the consistency of I/O data in the PLC application, irrespective of the PLC platform.

Similarly, the I/O variables defined and presymbolized in the DTMs can be used directly in the application. Finally, the screens integrated in Unity Pro, together with the diagnostic functions integrated in the device DTMs simplify application maintenance.

Modicon Premium automation platform

Profibus DP V1 and Profibus PA buses
Profibus Remote Master module

Profibus Remote Master (PRM) module (continued)

Connectable devices

The following Schneider Electric devices can be connected to this bus:

- TeSys U and TeSys T starter-controllers
- Momentum and Modicon STB distributed I/O
- Altivar 312/61/71 variable speed drives for asynchronous motors
- Lexium 05/15 servo drives for brushless motors
- Altistart ATS 48 soft start-soft stop units
- Any third-party device compatible with Profibus DP and PA standard profiles

Limitations

Once saved, the Unity project incorporates all the Profibus parameters as well as those of the slaves connected to the bus. Modicon Quantum, Modicon Premium and Modicon M340 PLCs are capable of embedding all this data so that an empty Unity terminal without any applications is able, after a simple transfer from the PLC, to locate the whole application, including the slave parameters. This function is called ETS (*Empty Terminal Service*).

In certain cases, it may be that the memory size required to save the device parameters exceeds the PLC memory capacity (signalled by a "memory full" message during the build). This is particularly likely on devices which have DTM (the most common instrumentation on PA). Typically, each device of this type takes up around 20 KB of the PLC memory.

It is therefore essential to create a memory map according to the type of configuration used and possibly adapt it accordingly, either by increasing the amount of memory dedicated to the application (by reducing the zone allocated to data), or by increasing the overall memory via cartridges available in the catalogue.

If the ETS function is not required, Unity Pro can also be configured in such a way as to reduce the size of the embedded data by disabling comments and animation tables, or by disabling the upload function so that the application does not include data relating to DTMs. In this case, the upload from an empty terminal function is no longer available.

References

The Profibus Remote Master module is supplied with a CD-ROM, which includes:

- PRM master DTMs and generic Profibus DTMs (for configuration in Unity Pro V5.0 or later)
- The PRM communication DTM for third-party (non-Schneider Electric) FDT

Profibus Remote Master modules

Description	Type	Reference	Weight kg
Profibus Remote Master modules	Standard	TCS EGPA23F14F	0.620
	Ruggedized (1)	TCS EGPA23F14FK	0.620

Profibus DP bus connection components

Description	Type	Reference	Weight kg
Distributed I/O on Profibus DP bus	Modicon STB network interface module	STB NDP 2112	0.140
	Momentum communication module	170 DTN 110 00	0.070
Connectors for remote I/O communication module	Line terminators	490 NAD 911 03	–
	In-line connector	490 NAD 911 04	–
	In-line connector and terminal port	490 NAD 911 05	–

Description	Length	Reference	Weight kg
Profibus DP connection cables	100 m	TSX PBS CA 100	–
	400 m	TSX PBS CA 400	–

(1) Conformal coating and extended operating temperatures between -25 and +70°C. See ruggedized module characteristics on page 9/5.



TCS EGPA23F14F



490 NAD 911 03

Presentation

The INTERBUS bus is a serial link fieldbus for sensors and actuators which meets the requirements of industrial environments.

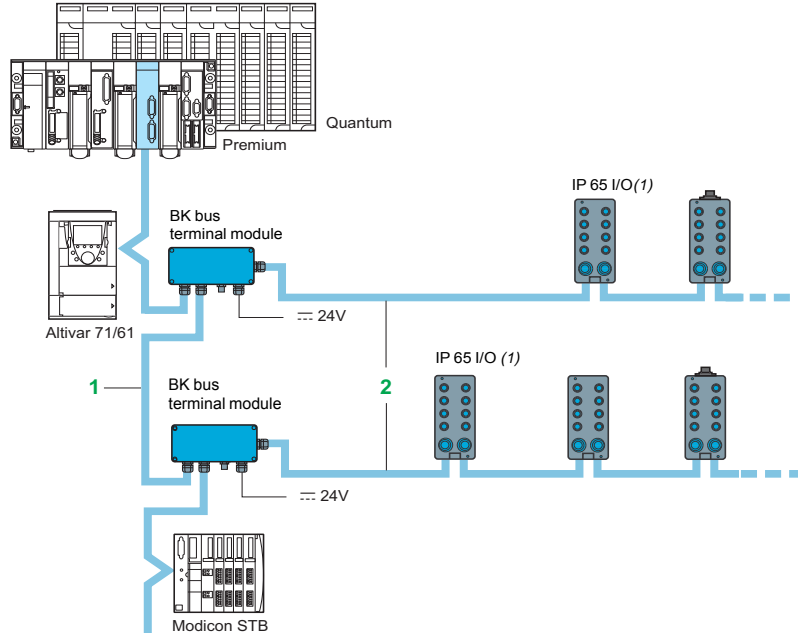

The topology of the INTERBUS bus is designed as a ring system with master/slave central access procedure.

It is subdivided into three parts:

- The remote bus **1** (bus devices use RS 485 point-to-point connection).
- The installation remote bus **2** (remote bus tap link via a bus terminal module). Its technology is particularly suitable for IP 65 dust and damp proof systems.
- The local bus with TTL technology is particularly suitable for buses in a control cabinet.

Each bus subscriber comprises a transmitter and a receiver.

The INTERBUS system is like a data ring and has the structure of a shift register distributed on the bus. With its registers each module constitutes a component of this shift register ring. The INTERBUS master circulates the data in series on this ring.

Description

Modicon Premium PLCs are connected to the INTERBUS bus via the **TSX IBY 100** INTERBUS bus module.

The front panel of the **TSX IBY 100** modules comprises:

- 1 A display block with six LEDs (on the card for TSX IBX 100).
- 2 A 9-way female RS 232 SUB-D connector: CMD Tool (configuration software) support.
- 3 A 9-way female RS 485 SUB-D connector: INTERBUS link (this connector integrates an additional power supply for the fibre optic link).

Connectable devices

The **TSX IBY 100** module acts as the master on the INTERBUS bus. Other Schneider Electric devices (slaves) which can be connected on the bus are:

- Altivar 71/61 variable speed drives for asynchronous motors
- Modicon Telefast IP 20 I/O interfaces
- Modicon STB IP 20 distributed I/O
- Modicon Momentum IP 20 I/O
- **170 ED• 346 00** IP 65 dust and damp proof discrete I/O
- Inductel inductive identification system (XGP/XGK-S read/write stations)
- AS-Interface/INTERBUS gateway
- Any third-party device conforming to the INTERBUS standard profiles

(1) **170 ED• 346 00** IP 65 dust and damp proof discrete I/O on INTERBUS
For more information on these I/O, please consult our website www.schneider-electric.com.

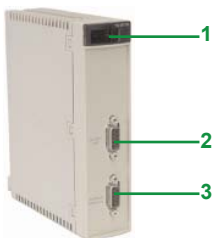

Software configuration

The INTERBUS bus can be configured in 3 modes:

- Auto mode: this mode does not require the use of any special configuration software (the I/O images are copied to %IW and %QW implicitly). It facilitates the wiring test.
- PL7 → IBY mode: this mode is used to define and download the configuration to the module (explicit assignment of %IW, %QW). The CMD Tool software (1) is required to generate the configuration text file.
- CMD → IBY mode: reserved for configurations > 8 K words, and requires the use of the CMD Tool software.

PMS message handling (which can be used on PCP devices) is managed via standard OFs (Read-var, Write-var, etc.).

The catalogue file for integrating Schneider Electric devices in the CMD Tool software is available on our website:

- Address: www.schneider-electric.com
- File to download: Schneider device catalog for CMD

References

INTERBUS bus communication modules

Description	No. of modules per processor	Communic. profile	Services	Reference	Weight kg
INTERBUS module for Premium PLC	See pages 1/10 and 1/19	Master/slave 0.5 Mbps Generation 4	- Cyclic variable exchanges - PMS messaging - Management of bus operating modes	TSX IBY 100	0.320



TSX IBY 100

Conversion software

Description	Use	Reference	Weight kg
Symbol conversion software	For converting CMD symbols to PL7 symbols	TLX LIBS CNVF	–

INTERBUS bus connection components

Description	Use	Length	Reference	Weight kg
IP 20 distributed I/O	Modicon STB network interface module	–	STB NIB 2212	0.155
	Momentum communication module	–	170 INT 110 00	0.070
Remote bus cables	–	100 m	TSX IBS CA 100	7.340
		400 m	TSX IBS CA 400	24.020
Installation remote bus cables	Preformed cables for linking 2 communication modules	0.110 m	170 MCI 007 00	0.060
		1 m	170 MCI 100 00	0.320
Connecting cables	Connecting TSX IB● module to PC (with CMD Tool software)	6 m	990 NAA 263 20	–
		15 m	990 NAA 263 50	–
Connectors	9-way SUB-D for remote bus cables	–	170 XTS 009 00	0.045



STB NIB 2212



170 INT 110 00

(1) Contact your Phoenix Contact vendor.

Presentation

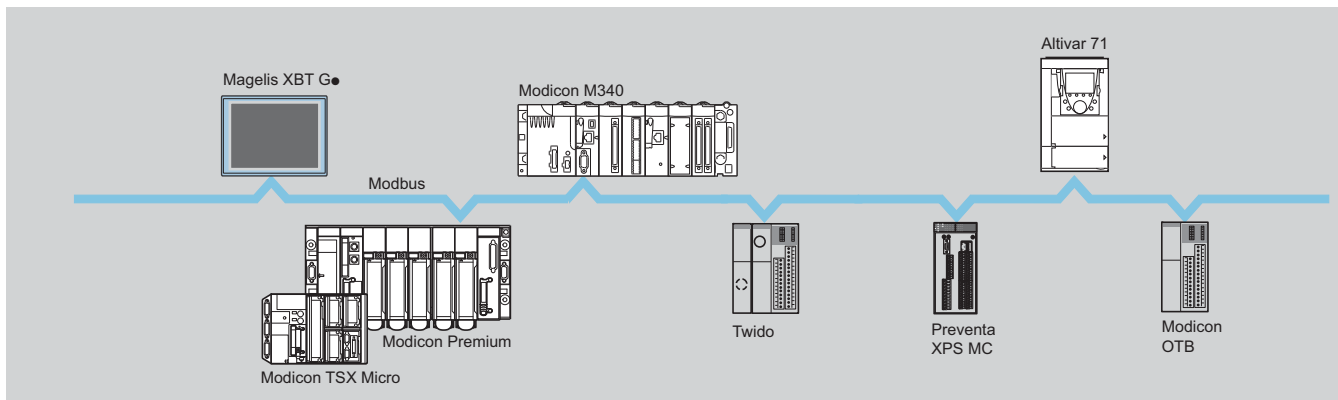

The Modbus serial link is used for master/slave architectures (it is necessary, however, to check that the Modbus services used by the application have been implemented on all devices concerned). The bus consists of a master station and slave stations. Only the master station can initiate the exchange (direct communication between slave stations is not possible). Two exchange mechanisms are possible:

- Question/response, where requests from the master are addressed to a given slave. The master then waits for the response from the slave which has been polled.
- Broadcasting, where the master broadcasts a message to all slave stations on the bus. The latter execute the instruction without transmitting a response.

Description

Modicon TSX Micro/Premium PLCs provide various ways of connecting to the Modbus serial link.

Integrated link to the TSX Micro and to the TSX SCY ●1601 Premium module

- 1 Via integrated port on the Modicon TSX Micro processor. The TER port (8-way mini DIN) has the Modbus RTU master/slave protocol (1).
- 2 Via integrated port on the **TSX SCY 11601/21601** module for Modicon Premium PLCs. This module has an isolated Half-duplex RS 485 serial link channel (25-way SUB-D connector) with multiprotocol, including Modbus (with the TSX SCY 11601 module, only the Modbus protocol is supported).

TSX SCP 11● multiprotocol PCMCIA cards

- 3 A slot on Modicon TSX Micro/Premium processors and the **TSX SCY 21601 module**(2) takes multiprotocol **TSX SCP11●** cards, including Modbus, featuring:
 - 4 A protective cover
 - 5 A removable cover with fixing screws (to access a 20-way miniature connector)
 - 6 Two indicator lamps:
 - ERR lamp: card or link fault
 - COM lamp: data transmission or reception

To be ordered separately: **TSX SCP/SCY** cordset.

(1) Modbus RTU slave Protocol with TSX 37 05/08.

(2) This slot can also take PCMCIA card **TSX FPP 20** for Fipway networks.

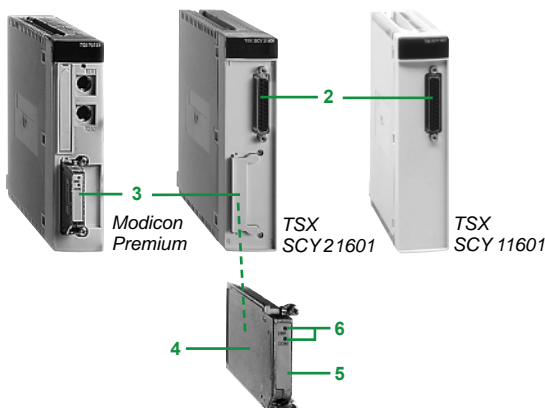
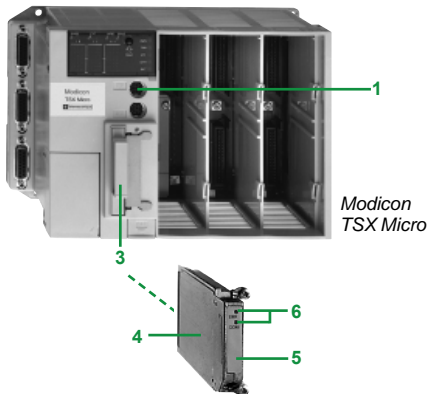



Modicon TSX Micro



TSX SCY 21601



TSX SCY 11601



TSX SCP 110

References

Modbus connection components

Description	Protocol	Physical layer	Reference	Weight kg
TSX Micro PLC integrated link (TER port)	Modbus (RTU) Uni-Telway character mode	Non-isolated RS 485	Please consult our website www.schneider-electric.com	
Communication module for Premium	Modbus Character mode Uni-Telway	- 1 RS 485 isolated integrated channel (channel 0), (1...97 slaves) - 1 PCMCIA card slot (channel 1) (1)	TSX SCY 21601	0.360
	Modbus	1 RS 485 isolated integrated channel (channel 0), 1.2...19.2 Kbps (1...247 slaves)	TSX SCY 11601	0.340
PCMCIA cards for Premium processor, TSX 37 21/22 PLC or TSX SCY 21601 module	Modbus Character mode Uni-Telway	RS 485 (RS 422 compatible) 1.2...19.2 Kbps	TSX SCP 114	0.105
		RS 232 (9 signals) 0.6...19.2 Kbps	TSX SCP 111	0.105
		20 mA CL 1.2...19.2 Kbps	TSX SCP 112	0.105

(1) PCMCIA slot designed to take a **TSX SCP 111/112/114** or **TSX FPP 20** Fipway card.

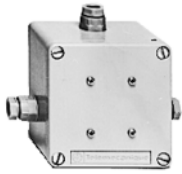

TSX SCA 50



TSX SCA 62



TWD XCA ISO

5



TCS WAAC 13FB

References (continued)

Modbus serial link connection accessories

Description	Use	Reference	Weight kg
Passive junction box	Tap link and bus extension, line terminator	TSX SCA 50	0.520
2-channel passive subscriber socket	Tap link for 2 devices (2-wire) Equipped with 2 x 15-way female SUB-D connectors	TSX SCA 62	0.570
RS 485 isolation box	RS 485 line isolation and line terminator (RC 120 Ω, 1 nF) (1) 2 tap links on RJ45 connector 24 V $\bar{\text{---}}$ supply (screw terminal block) Mounting on 35 mm $\bar{\text{L}}$ rail	TWD XCA ISO	0.100
TER terminal port connection box	Bus tap link cable (2 or 4-wire) Isolation of Modbus signals Line terminator Supplied with cable (length 1 m) equipped with a mini-DIN connector (TER port)	TSX P ACC 01	0.690
Active adaptor box RS 232/RS 485	Connection of an RS 232 device as RS 485 Isolation of signals and line termination	TSX SCA 72	0.520
Line terminators Sold in lots of 2	2/4-wire cabling Can be connected to the front panel of the TSX SCA 64 subscriber socket	TSX SCA 10	0.030
Universal Bluetooth® interface (UBI)	Provides Bluetooth® connectivity for products such as the Modicon M340/Premium platforms and Altivar/Lexium servo drives, via their serial port (RS 485). Used for setting-up and maintenance of products. Designed for permanent installation and can be safely fitted on the inside or outside of electrical enclosures. <ul style="list-style-type: none"> ■ Protocols supported: Modbus and Uni-Telway ■ Powered via the product's RS 485 serial port ■ Max. range in direct line of sight: 20 m <p>The kit comprises:</p> <ul style="list-style-type: none"> ■ A Universal Bluetooth® interface (UBI) ■ An RJ45/mini-DIN cable (length 1 m) ■ An RJ45/RJ45 cable (length 1 m) ■ A fixing clamp for installation inside the electrical enclosure ■ A CD with configuration software and user manual 	TCS WAAC 13FB	0.320

(1) Line isolation recommended for distances > 10 m.

References (continued)						
Modbus serial link connecting cable						
Description	Use		Length	Reference	Weight kg	
	From	To				
RS 485 double shielded twisted pair trunk cables	Modbus serial link	–	100 m	TSX CSA 100	5.680	
			200 m	TSX CSA 200	10.920	
			500 m	TSX CSA 500	30.000	
Cables for isolated RS 422/485 tap link	TSX SCP 114 card	TSX SCA 50 T-junction box, 2 wires (1)	3 m	TSX SCP CM 4030	0.160	
			TSX SCA 62 subscriber socket, 2/4 wires	3 m	TSX SCP CM 4530	0.180
				Modbus standard device, 4 wires (1) (point-to-point)	3 m	TSX SCP CX 4030
	Premium TSX SCY 11601, TSX SCY 21601 module integrated channel (ch. 0)	TSX SCA 50 T-junction box, 2 wires (1)	3 m	TSX SCY CM 6030	0.160	
			TSX SCA 62 subscriber socket, 2 wires	3 m	TSX SCY CM 6530	0.160
	Modbus RS 485 cordsets	Twido and TSX Micro terminal port (Mini-DIN connector)	TWD XCA ISO isolation box (RJ45 connector)	0.3 m	TWD XCA RJ003	0.040
1 m				TWD XCA RJ010	0.090	
3 m				TWD XCA RJ030	0.160	
RS 232 tap link cordsets	TSX SCP 111 card	Communication device (Modem, converter, etc) (DCE) (2)	3 m	TSX SCP CC 1030	0.190	
			Terminal device with point-to-point (DTE) (2)	3 m	TSX SCP CD 1030	0.190
				10 m	TSX SCP CD 1100	0.620
Corset for tap link 20 mA CL	TSX SCP 112 card	Modbus multidrop (1)	3 m	TSX SCP CX 2030	0.160	
Other connecting cables	–	–	–	See page 5/134	–	

(1) End of cordset with free wires.

(2) End of cordset equipped with a male 25-pin SUB-D connector.

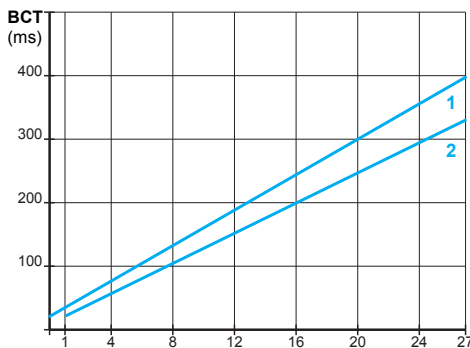
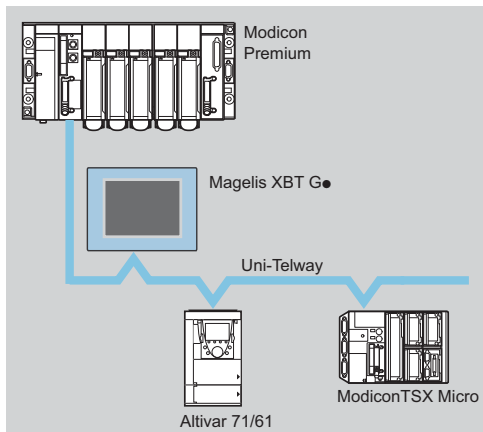

1 = 9.6 Kbps
2 = 19.2 Kbps

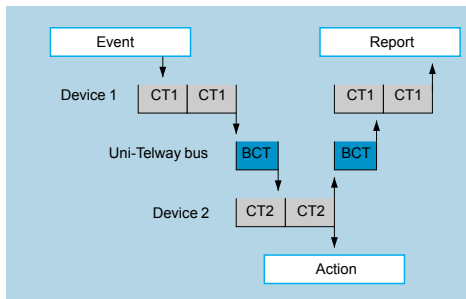

BCT = Uni-Telway bus cycle time
CT1 = Device 1 bus cycle time
CT2 = Device 2 bus cycle time



Modicon TSX Micro

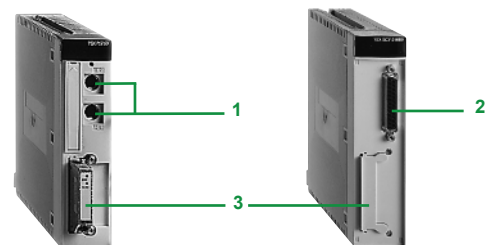

Modicon Premium

TSX SCY 21601

Presentation

The Uni-Telway bus is a standard means of communication between control system components (PLCs, MMI terminals, supervisors, variable speed drives, numerical controllers, weighing equipment, etc.). It is suitable for architectures designed to manage control and monitoring devices via a PLC, or architectures used for MMI (supervision, etc.).

The Uni-Telway bus requires a master station which manages the allocation of bus access rights to the various connected stations (known as slave stations).

Performance

The Uni-Telway bus cycle time depends on:

- The number of devices polled (datalink addresses)
- The data rate
- The turnaround time of each device
- The number, length and type of messages

BCT = Bus Cycle Time, is the interval between two polls from the same device.

The curves opposite give the Uni-Telway cycle time as a function of the number of slaves operating at 9.6 Kbps or 19.2 Kbps, with a typical device turnaround time of 5 ms (without messages).

The following table shows the time to be added (in ms) to obtain the true BCT value as a function of the traffic (N = Number of usable characters):

Exchanges	Time (ms)	
	at 9.6 kbps	at 19.2 kbps
Master to slave	24 + 1.2 N (1)	17 + 0.6 N (1)
Slave to master	19 + 1.2 N (1)	12 + 0.6 N (1)
Slave to slave	44 + 2.3 N (1)	29 + 1.15 N (1)

In a distributed control system architecture the application-to-application response time depends not only on the communication system, but also on:

- The processing times of the message source and destination devices.
- The degree of asynchronism between the bus and processor cycle times.

The response time must be evaluated by the designer of each application according to the devices which are connected.

The processing time of a device may vary from one to two cycle times depending on the degree of asynchronous operation.

Description

Modicon TSX Micro/Premium PLCs

Modicon TSX Micro/Premium PLCs provide various ways of connecting to the Uni-Telway bus:

- 1 By Modicon TSX Micro/Premium processor integrated port**
The AUX port (2) (8-way mini-DIN) has one non-isolated RS 485 serial link channel (maximum distance 10 m).
- 2 By TSX SCY 21601 integrated port for Modicon Premium PLC**
This module has one Half-duplex isolated RS 485 serial link channel, which is multiprotocol, including Uni-Telway.
- 3 Via a multiprotocol PCMCIA card**
A slot on TSX 37 21/22/Premium processors and on the **TSX SCY 21601** (3) module accepts the following multiprotocol cards:
 - PCMCIA **TSX SCP 114 card**: isolated RS 485/RS 422 link. This type of card corresponds to the Uni-Telway standard.
 - PCMCIA **TSX SCP 111 card**: non isolated RS 232 link. This type of card can be used for direct point-to-point links or links via Modem.
 - PCMCIA **TSX SCP 112 card**: 20 mA current loop link. This type of card is used for a multidrop link (2 to 16 devices) and requires a 24 V $\bar{\bar{}}$ external power supply.

(1) N = Number of usable characters corresponding to the messages to be exchanged.

(2) TER port for TSX 37-05/08/10 PLCs, TER or AUX port for Premium PLCs.

(3) This slot can also take the TSX FPP 20 PCMCIA card for Fipway networks.

Modicon Premium automation platform

Uni-Telway serial link

Uni-Telway bus wiring system

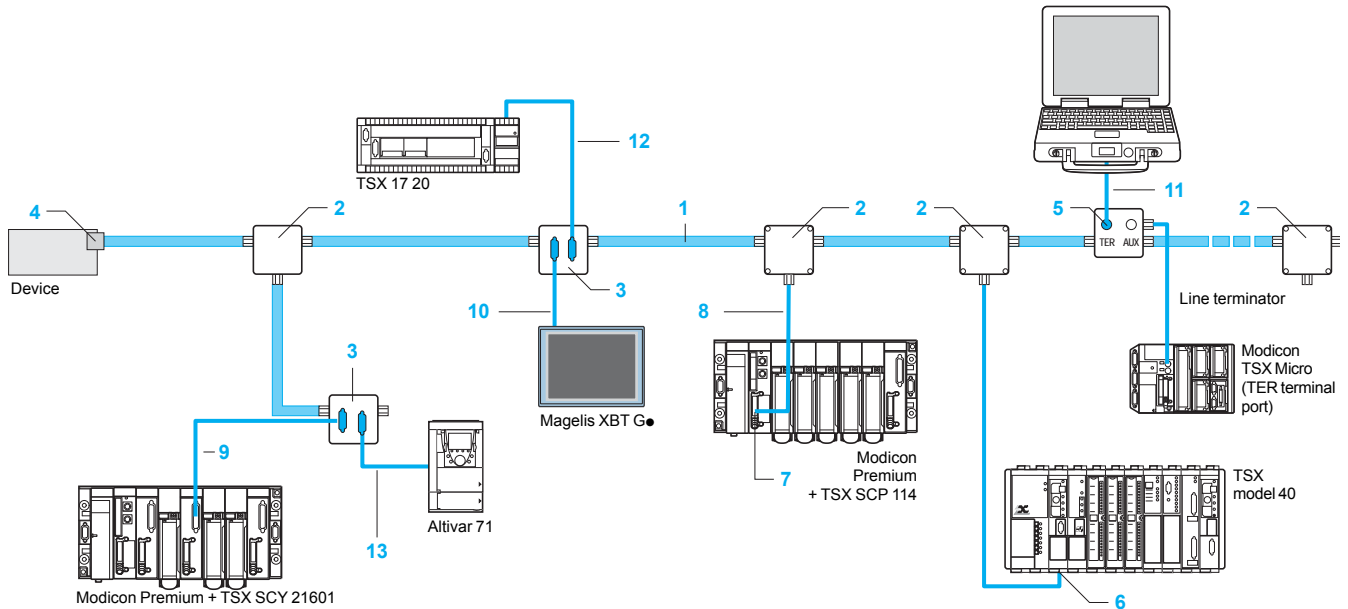

- 1 **TSX CSA ●●●**: bus cable, double shielded twisted pair. The shielding must be connected to the earth of each device.
- 2 **TSX SCA 50**: passive T-junction box, matches the impedance when it is installed at the end of the line.
- 3 **TSX SCA 62**: passive 2-channel Uni-Telway subscriber socket, is used for coding the address of two connected devices, and matching the impedance when it is installed at the end of the line.
- 4 **TSX SCA 60/61**: passive terminal block, used for intermediate devices that have a 15-way female SUB D connector:
 - **TSX SCA 60** used for intermediate devices
 - **TSX SCA 61** used for end devices
- 5 **TSX P ACC 01**: connection box, used for connecting a Modicon TSX Micro/ Premium PLC to the Uni-Telway bus via the PLC terminal port. The connecting cable (length 1 m) is integrated in the connection box. It isolates the signals (for distances > 10 m) and is used to match the end of line impedance. It is also used to set the operation of the terminal port (Uni-Telway Master/Slave or character mode).
- 6 **TSX LES 64/74**: junction boxes for extensions to the Uni-Telway bus, used to connect TSX model 40 PLC processors that have an integral Uni-Telway port as standard. They are used for coding the address of the connected device.
- 7 **TSX SCP 114**: PCMCIA card for connecting TSX Micro (1) / Premium PLCs to the Uni-Telway bus.
- 8 **TSX SCP CU4030**: Uni-Telway connecting cable between the **TSX SCP 114** PCMCIA card (on TSX P57 ●0M processor or TSX SCY 21601 module) and the **TSX SCA 50** junction box
- 9 **TSX SCY CU 6530**: Uni-Telway connecting cable between the **TSX SCY 21601** module integrated channel and the **TSX SCA 62** subscriber socket.
- 10 **VW3 A8 306**: connecting cordset (length 3 m) between the Magelis XBT G/GT Advanced Panel terminal and the **TSX SCA 62** subscriber socket.
- 11 **TSX PCX 1031**: universal connecting cable between a PC compatible (COM port, 9-way SUB D connector) and the TER or AUX port for TSX Micro/Premium PLCs or the **TSX P ACC 01** connection box (8-way mini-DIN connector).
TSX CUSB 485 + TSX CRJDB 25: USB to RS 485 converter and Uni-Telway cordset between a PC compatible (USB port) and the **TSX SCA 62** subscriber socket.
- 12 **TSX CSC 015**: connecting cordset between the TSX 17 micro-PLC (via a TSX 17 ACC 5 adaptor or a TSX SCG 1161 module) and the **TSX SCA 62** subscriber socket.
- 13 **VW3 A8 306 2**: Uni-Telway and Modbus connecting cordset for Altivar 61/71 variable speed drive (with **VW3 A3 303** option card).

(1) With TSX 37 21/22 PLCs





TSX Micro



Premium TSX SCY21601



TSX SCP 11



TSX P ACC 01



TSX SCA 50



TSX SCA 62



TSX SCA 72



TCS WAAC 13FB

References

Components for connection to the Uni-Telway bus

Description	Protocol	Physical layer	PLC	Item no.	Reference	Weight kg
Integrated link on processor	Uni-Telway Character mode	RS 485 non-isolated	TSX Micro	–	Please consult our website www.schneider-electric.com	
			Premium	–	See pages 1/10 and 1/19	
Communication module	Uni-Telway Modbus/Jbus Character mode	1 isolated 2-wire RS 485 integrated channel (channel 0), 1 PCMCIA card slot (channel 1) (1)	Premium	–	TSX SCY 21601	0.360
PCMCIA type III cards for Premium processor TSX 37 21/22 PLC or TSX SCY 21601 module	Uni-Telway Modbus Character mode	RS 232 (9 signals) 0.3...19.2 Kbps		7	TSX SCP 111	0.105
		RS 485 (RS 422 compatible) 1.2...19.2 Kbps		7	TSX SCP 114	0.105
		20 mA CL 1.2...19.2 Kbps		7	TSX SCP 112	0.105
Set of X-Way drivers for PC compatible	Includes all the X-Way drivers, for composition, see page 6/41		1 CD-ROM	–	TSX CD DRV 20M	–

Uni-Telway bus connecting accessories

Description	Use	Item no.	Reference	Weight kg
Terminal port connection box	Isolation of Uni-Telway signals for bus length > 10 m, line terminator, bus cable tap links. Supplied with cable (1 m length) equipped with a mini-DIN connector (TER or AUX ports)	5	TSX P ACC 01	0.690
Passive T-junction box	Tap link and extension of bus cable, line terminator	2	TSX SCA 50	0.520
Passive subscriber socket 2-channel	2-channel tap link (15-way female SUB-D connector) and extension of bus cable, address coding and line terminator	3	TSX SCA 62	0.570
Active adaptor box RS 232/RS 485	Connection of an RS 232 device (which can use the Uni-Telway protocol), adaptation and isolation of signals, line terminator (no address coding)	–	TSX SCA 72	0.520
Universal Bluetooth® interface (UBI)	Provides Bluetooth® connectivity for products such as the Modicon M340/Premium platforms and Altivar/Lexium servo drives, via their serial port (RS 485). Used for setting-up and maintenance of products. Designed for permanent installation and can be safely fitted on the inside or outside of electrical enclosures. <ul style="list-style-type: none"> ■ Protocols supported: Modbus and Uni-Telway ■ Powered via the product's RS 485 serial port ■ Max. range in direct line of sight: 20 m The kit comprises: <ul style="list-style-type: none"> ■ A Universal Bluetooth® interface (UBI) ■ An RJ45/mini-DIN cable (length 1 m) ■ An RJ45/RJ45 cable (length 1 m) ■ A fixing clamp for installation inside the electrical enclosure ■ A CD with configuration software and user manual 	–	TCS WAAC 13FB	0.320

(1) Type III PCMCIA slot for for one TSX SCP 111/112/114 or TSX FPP 20 card.



TSX PCX 1031



TSX CUSB 1031

References (continued)

Uni-Telway bus connecting cables (1)

Description	Use		Length	Item no.	Reference	Weight kg
	From	To				
RS 485 double shielded twisted pair cables	Uni-Telway bus	-	100 m	1	TSX CSA 100	5.680
			200 m	1	TSX CSA 200	10.920
			500 m	1	TSX CSA 500	30.000
Cordsets for isolated RS 485 tap link	TSX SCP 114 card	TSX SCA 50 T-junction box	3 m	8	TSX SCP CU 4030	0.160
		TSX SCA 62 subscriber socket	3 m	-	TSX SCP CU 4530	0.180
	TSX SCY 21601 module integrated channel (ch. 0)	TSX SCA 50 T-junction box	3 m	-	TSX SCY CU 6030	0.180
		TSX SCA 62 subscriber socket	3 m	9	TSX SCY CU 6530	0.200
	PC terminal (USB port)	TSX SCA 62 subscriber socket	0.4 m	11	TSX CUSB 485 (2)	0.144
			2.5 m	11	TSX CRJDB 25 (2)	0.160
Universal terminal port/ peripheral device cordsets	TSX Micro/ Premium or TSX PACC 01 box (TER or AUX)	RS 232 port for 9-way SUB D type PC compatible	2.5 m	11	TSX PCX 1031	0.170
		USB port (USB/ RS 485 converter)	0.4 m	-	TSX CUSB 485 (3)	0.144
		USB port (Mini-DIN/ RJ45 cordset)	2.5 m	-	TSX CRJMD 25 (3)	0.150

(1) For other connection cables, see pages 5/132.

(2) With TSX CUSB 485 converter, use the TSX CRJDB 25 cordset (equipped with 1 x 25-way SUB-D and 1 x RJ45).

(3) With TSX CUSB 485 converter, use the TSX CRJMD 25 cordset (equipped with 1 x mini-DIN and 1 x RJ45).

Presentation

Modicon TSX Micro/Premium PLCs provide, via their processor or **TSX SCY 21601** communication module, several possible ways for exchanging data in character mode with devices equipped with an asynchronous serial link interface:

- RS 485 integrated port
- Type III PCMCIA card with RS 232, RS 485 (RS 422 compatible) or 20 mA current loop support

Protocols supported are character mode (ASCII), Uni-Telway and Modbus. Other protocols are also available, or can be developed on request, on an RS 485 or RS 232 link, which enables Modicon TSX Micro/Premium PLCs to communicate on third party architectures. The list of modules available can be obtained from your Customer Support Centre, or by visiting the web site www.collaborative_automation.com.

Description

Integrated links

- 1 Via integrated port on the Modicon TSX Micro/Premium processor**
The AUX port (1) (8-way mini-DIN 8 connector) has an integrated, non isolated RS 485 serial link channel (maximum distance 10 m).
- 2 Via integrated port on the TSX SCY 21601 module**
This module for Premium PLCs has one integrated, isolated RS 485 serial link channel (25-way SUB-D connector).
Half duplex multiprotocol, including character mode.

TSX SCP 11● multiprotocol PCMCIA cards

- 3** A slot on the Modicon TSX Micro/Premium processor and on the **TSX SCY 21601** module takes a PCMCIA card comprising:
- 4** A removable cover with fixing screws for access to the 20-way miniature connector.
- 5** Two indicator lamps:
 - ERR lamp: card or link fault
 - COM lamp: data transmission or reception

To be ordered separately: cordset **TSX SCP C●●●●●**.

(1) TER port for Modicon Micro TSX 37 05/08/10.

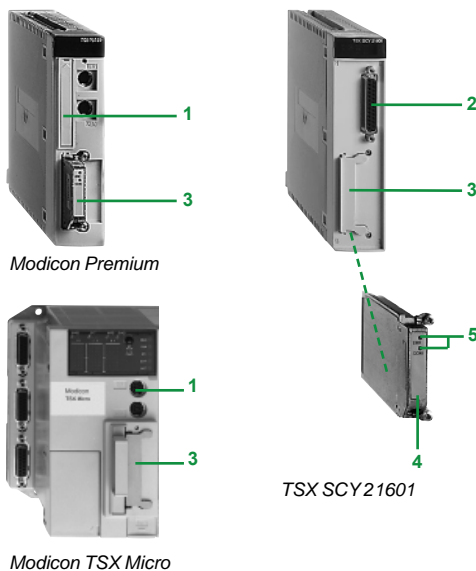

Modicon Premium

Modicon TSX Micro

TSX SCY 21601

Modicon Premium automation platform

Asynchronous serial links



Modicon TSX Micro



Modicon Premium

TSX SCY 21601



TSX SCP 111



TSX P ACC 01



TSX PCX 1031



TSX CUSB 485

References

Components for asynchronous serial links (character mode)

Description	Protocol	Physical layer	Modicon PLC	Reference	Weight kg
Integrated link on processor	Uni-Telway Character mode	Non-isolated RS 485	TSX Micro	Please consult our website www.schneider-electric.com	
			Premium	See pages 1/10 and 1/19	
Communication module	Uni-Telway Modbus/Jbus Character mode	- 1 isolated RS 485 integrated channel (channel 0), 1 PCMCIA card slot (channel 1) (1)	Premium	TSX SCY 21601	0.360
PCMCIA cards for TSX 37 21/22 PLCs, Premium processor TSX SCY 21601 module	Uni-Telway Character mode Modbus	RS 232 (9 signals) 0.3...19.2 Kbps		TSX SCP 111	0.105
		RS 485 (RS 422 compatible) 1.2...19.2 Kbps		TSX SCP 114	0.105
		20 mA CL 1.2...19.2 Kbps		TSX SCP 112	0.105

Asynchronous serial link connection accessories

Description	Use	Reference	Weight kg
Terminal port connection box	Isolation of RS 485 signals, line terminator Supplied with cordset (length 1 m) fitted with a mini-DIN connector (TER or AUX port).	TSX P ACC 01	0.690

Asynchronous serial link connection cordsets

Description	Use From	To	Length	Reference	Weight kg
Cordsets for isolated RS 485 connection	TSX SCP 114 card	RS 485/RS 422 device (2)	3 m	TSX SCP CX 4030	0.160
	TSX SCY 21601 module integrated channel (ch. 0)	RS 485/RS 422 device (3) via TSX SCA 50 box	3 m	TSX SCY CU 6030	0.180
Universal cordsets for terminal port/peripheral device	TSX Micro/Premium port or TSX P ACC 01 box (TER or AUX)	RS 232 port of a terminal device (DTE) (4)	2.5 m	TSX PCX 1031	0.170
		USB port (USB/RS 485 converter)	0.4 m	TSX CUSB 485 (5)	0.144
		USB port (mini-DIN/RJ45 cordset)	2.5 m	TSX CRJMD 25 (5)	0.150
Cordsets for RS 232 connection	TSX SCP 111 card	Communication device: Modem, converter, (DCE) (3)	3 m	TSX SCP CC 1030	0.190
		Point-to-point terminal device (DTE)(3)	3 m	TSX SCP CD 1030	0.190
			10 m	TSX SCP CD 1100	0.620
Cordset for 20 mA CL connection	TSX SCP 112 card	Current loop device (2)	3 m	TSX SCP CX 2030	0.160

(1) Type III PCMCIA card slot for for one **TSX SCP 111/112/114** or **TSX FPP 20** card.

(2) Flying leads on device side.









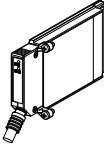

(3) End of cable fitted with a male 25-way SUB-D connector.

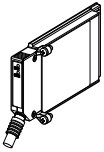
(4) End of cable fitted with a female 9-way SUB-D connector. For this application, a **TSX CTC 10** adaptor must be ordered separately (male 9-way SUB-D/male 25-way SUB-D adaptor).

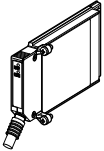
(5) The **TSX CUSB 485** converter requires use of a **TSX CRJMD 25** mini-DIN/RJ45 cordset.

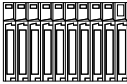
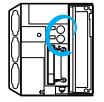
Modicon Premium automation platform

Connecting cables for PCMCIA cards and TER/AUX ports

References							
Connecting cables for PCMCIA cards and TER/AUX ports							
Modicon TSX Micro/ Premium PLCs	Device to be connected	Physical link	Protocol	Length	Reference	Weight kg	
TSX SCP 111 PCMCIA card 	DTE terminal 2	RS 232 D	Character mode	3 m	TSX SCP CD 1030	0.190	
		RS 232 D	Character mode Uni-Telway	10 m	TSX SCP CD 1100	0.620	
				3 m	TSX SCP CC 1030	0.190	
TSX SCP 114 PCMCIA card 	TSX SCA 50 T-junction box 3	RS 485 (2-wire, isolated)	Character mode Uni-Telway	3 m	TSX SCP CU 4030	0.160	
		RS 422/485 (2-wire, isolated)	Character mode Modbus	3 m	TSX SCP CM 4030	0.160	
				3 m	TSX SCP CU 4530	0.160	
	TSX SCA 62 2-channel subscriber socket 4	RS 485 (2-wire, isolated)	Uni-Telway	3 m	TSX SCP CU 4530	0.160	
		RS 422/485 (2/4-wire)	Modbus	3 m	TSX SCP CM 4530	0.180	
3 m				TSX SCP CX 4030	0.160		
TSX SCP 112 PCMCIA card 	DTE terminal 3	RS 422/485 (4-wire)	Modbus	3 m	TSX SCP CX 4030	0.160	
		20 mA current loop	Character mode Uni-Telway Modbus	3 m	TSX SCP CX 2030	0.160	
							
TER/AUX ports 	TSX PACC 01 junction box	RS 485	Uni-Telway	1 m	Included with TSX PACC 01		
		RS 485	Uni-Telway	2 m	T FTX CB1 020	0.100	
				5 m	T FTX CB1 050	0.190	
		DTE terminal (master PC, printer)	RS 232	Character mode	2.5 m	TSX PCX 1031 (1)	0.170
			USB	Character mode	0.4 m	TSX CUSB 485 (2)	0.144
2.5 m					TSX CRJMD 25 (2)	0.150	
							

1 25-way male miniature connector

2 25-way male SUB-D connector

3 Flying leads

4 15-way male SUB-D connector

5 8-way female mini-DIN connector







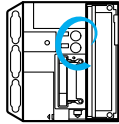

6 9-way female SUB-D connector

(1) See separate parts (page 5/135).

(2) The **TSX CUSB 485** converter requires the use of the **TSX CRJMD 25** cable (equipped with 1 mini-DIN connector and 1 RJ45 connector).

Modicon Premium automation platform

Connecting cables for PCMCIA cards and TER/AUX ports

References (continued)						
Connecting cables for PCMCIA cards and TER/AUX ports (continued)						
Modicon TSX Micro/Premium PLCs	Device to be connected	Physical link	Protocol	Length	Reference	Weight kg
TER/AUX ports (continued) 1 	DTE terminal (slave PC) 2 	RS 232 RS 485	Uni-Telway	2.5 m	TSX PCX 1031	0.170
		USB	Uni-Telway	0.4 m	TSX CUSB 485 (1)	0.144
				2.5 m	TSX CRJMD 25 (1)	0.150
	DTE terminal (printer, slave PC without RTS) 2 	RS 232	Character mode Uni-Telway	2.5 m	TSX PCX 1031 (2)	0.170
		RS 232	Character mode Uni-Telway	0.4 m 2.5 m	TSX CUSB 485 (1) TSX CRJMD 25 (1)	0.144 0.150
	DCE terminal (M/SI. modem USA/Europe) 3 	RS 232	Character mode Uni-Telway	3 m	TSX PCX 1130 (3)	0.140
		Magelis XBT GT terminal 3 	RS 485	Uni-Telway	2.5 m	XBT Z968 + XBT ZG909 (4)
				5 m	XBT Z9681 + XBT ZG909 (4)	0.340
	TSX SCY 21601 communication module integrated port 4 	TSX SCA 50 T-junction box 5 	RS 485 (2-wire, isolated)	Uni-Telway	3 m	TSX SCY CU 6030
			Modbus	3 m	TSX SCY CM 6030	0.180
TSX SCA 62 2-channel subscriber socket 6 		RS 485 (2-wire, isolated)	Uni-Telway	3 m	TSX SCY CU 6530	0.200
		RS 485 terminal 5 	RS 485 (2-wire, isolated)	Character mode	3 m	TSX SCY CM 6030

Separate parts			
Designation	Description	Reference	Weight kg
SUB-D adaptors	9-way male SUB-D/25-way female SUB-D	TSX CTC 07	0.060
	9-way male SUB-D/25-way male SUB-D	TSX CTC 10	0.060

- 1** 8-way female mini-DIN connector
- 2** 9-way female SUB-D connector
- 3** 9-way male SUB-D connector
- 4** 25-way male SUB-D connector
- 5** Flying leads
- 6** 15-way male SUB-D connector

(1) The **TSX CUSB 485** converter requires the use of the **TSX CRJMD 25** cable (equipped with 1 mini-DIN connector and 1 RJ45 connector).

(2) To be ordered separately: **TSX CTC 07** and **TSX CTC 10** adaptors, see separate parts above.

(3) Point-to-point, supplied with 1 **TSX CTC 09** 9-way female/25-way male SUB-D adaptor.

(4) For connection to Magelis XBT GK/GW terminals, please refer to the "Human-Machine Interfaces" catalogue.

Unity Pro software

Selection guide page 6/2

- **Unity Pro Small/Medium/Large/Extra Large software**
 - Presentation page 6/4
 - FDT/DTM function page 6/5
 - The five IEC languages page 6/5
 - Data editor page 6/6
 - DFB user function blocks page 6/7
 - Function block libraries page 6/8
 - Debugging tools page 6/9
 - PLC simulator page 6/10
 - Documentation editor page 6/10
 - Diagnostics integrated in Modicon PLC platforms page 6/11
 - Modifying the program with the PLC in RUN mode page 6/12
 - Cross-references function page 6/12
 - Import/export function page 6/12
 - Application converters page 6/13
 - Operating system update utilities page 6/13
 - Programmable process control page 6/14
 - Communication drivers page 6/16
 - Unity Developer's Edition, advanced open access page 6/16
 - Upgrade kits for Concept, PL7 Pro and ProWORX software page 6/17
 - Composition and Windows OS compatibility page 6/17
 - Unity Pro update page 6/17
 - References page 6/18
- **Unity EFB Toolkit software**
 - Presentation page 6/22
 - References page 6/23
- **Unity Dif application comparison software**
 - Presentation page 6/24
 - References page 6/25
- **Unity Loader software**
 - Presentation page 6/26
 - References page 6/27
- **Specific libraries**
 - Presentation page 6/28
 - References page 6/29
- **UAG - Unity Application Generator software**
 - Presentation page 6/30
 - References page 6/31
- **Process control**
 - Presentation page 6/32
 - Functions page 6/34

PL7 software

Selection guide page 6/38

- **PL7 Micro/Junior/Pro software**
 - Presentation, functions page 6/40
 - References page 6/42
- **PL7 SDKC procedure creation software**
 - Presentation, references page 6/44
- **PL7 DIF application comparison software**
 - Presentation, references page 6/44
- **Process control**
 - Presentation page 6/45

Vijeo Citect supervisory software (SCADA)

- **Presentation, licences** page 6/46
- **Architectures** page 6/48
- **References** page 6/50

Vijeo Historian reporting software

- **Presentation** page 6/58
- **Architecture** page 6/59
- **References** page 6/60

OPC data server software

- **Presentation** page 6/62
- **Setup** page 6/65
- **Functions** page 6/66
- **References** page 6/67

Unity Pro programming software for Modicon M340 M, Premium P, Quantum Q, Safety S platforms and Modicon distributed I/O D



M - P - Q - D	M - P - Q - D	M - P - Q - D
M - P - Q - D	M - P - Q - D	M - P - Q - S - D
M - P - Q - D	M - P - Q - D	M - P - Q - D
M - P - Q - D	M - P - Q - D	M - P - Q - S - D
M - P - Q - D	M - P - Q - D	M - P - Q - D
Q	Q	
M - P - Q - D	M - P - Q - D	M - P - Q - D
	P (TSX P57 5●) - Q (140 CPU 651/671) - D	P (TSX P57 5●) - Q (140 CPU 651/671) - D
M - P - Q - D	M - P - Q - D	M - P - Q - S - D
M - P - Q - D	M - P - Q - D	M - P - Q - D
M - P - Q - D	M - P - Q - D	M - P - Q - D
M - P - Q - D	M - P - Q - D	M - P - Q - D
M - P - Q - D	M - P - Q - D	M - P - Q - D
P (TSX P57 2●/3●/4●) - D	P (TSX P57 2●/3●/4●/5●) - D	P (TSX P57 2●/3●/4●/5●) - D
M - P - Q - D	M - P - Q - D	M - P - Q - D
		S - D
M - P - Q - D	M - P - D	M - P - D
P (TSX H57 24/44M) - D	P (TSX H57 24/44M) - Q (140 CPU 67 160) - D	P (TSX H57 24/44M) - Q (140 CPU 67 160) - S - D
M - P - Q - D	M - P - Q - D	M - P - Q - S - D
M - P - Q - D	M - P - Q - D	M - P - Q - D
M - P - Q - D	M - P - Q - D	M - P - Q - D
M - P - Q - D	M - P - Q - D	M - P - Q - D
M - P - Q - D	M - P - Q - D	M - P - Q - S - D
M - P - Q - D	M - P - Q - D	M - P - Q - S - D
M - P - Q - D	M - P - Q - D	M - P - Q - S - D
M - P - Q - D	M - P - Q - D	M - P - Q - S - D
M - P - Q - D	M - P - Q - D	M - P - Q - S - D
M - P - Q - D	M - P - Q - D	M - P - Q - D
M - P - Q - D	M - P - Q - D	M - P - Q - D
M - P - Q - D	M - P - Q - D	M - P - Q - S - D
	M - P - Q - D	M - P - Q - S - D
Q	Q	
Q	Q	
M - P - Q - D	M - P - Q - D	M - P - Q - S - D
M - P - Q - D	M - P - Q - D	M - P - Q - S - D
All models	All models	All models
TSX P57 104M/1634M/154M TSX P57 204M/2634M/254M TSX P57 304M/3634M/354M	TSX P57 104M/1634M/154M TSX P57 204M/2634M/254M TSX P57 304M/3634M/354M	TSX P57 104M/1634M/154M TSX P57 204M/2634M/254M TSX P57 304M/3634M/354M TSX P57 6634M TSX H57 24M/44M
140 CPU 311 10 140 CPU 434 12U 140 CPU 534 14U	140 CPU 311 10 140 CPU 434 12U 140 CPU 534 14U	140 CPU 651 50/60 140 CPU 652 60 140 CPU 671 60 140 CPU 672 61
–	–	140 CPU 651 60S 140 CPU 671 60S
STB, OTB, TM7, ETB, Momentum	STB, OTB, TM7, ETB, Momentum	STB, OTB, TM7, ETB, Momentum
Unity Pro Large	Unity Pro Extra Large	Unity Pro XL Safety
UNY SPU LF● CD60	UNY SPU EF● CD60	UNY SPU XF● CD41
6/19	6/20	www.schneider-electric.com





Unity Pro

Presentation

Unity Pro is the common programming, debugging and operating software for the Modicon M340, Premium and Quantum PLC ranges.

Unity Pro is multitasking software offering the following features:

- All in one software
- Five IEC 61131-3 programming languages
- Integrated, customizable DFB library
- PLC simulator on PC for program validation prior to installation
- Built-in tests and diagnostics
- Wide range of online services

FDT/DTM function

Unity Pro facilitates integration of fieldbus architectures into engineering control systems using FDT/DTM technology:

- FDT (*Field Device Tool*) is the container which supports the device DTMs.
- DTM (*Device Type Manager*) is the configuration tool for devices with integrated graphic interfaces. It contains all the properties specific to each device.

In addition to the FDT/DTM standard, Unity Pro uses specific information from the Master DTM created for the Profibus Remote Master (PRM) module and the Modbus/TCP and EtherNet/IP network module BMX NOC 0401.

Use of the Master DTM allows Unity Pro to perform the following actions:

- Manage the PLC I/O scan
- Create the application variables based on the description of the process objects available from the connected DTM devices
- Manage synchronization with the PLC configuration
- Create a generic DTM from the description files (GSD or EDS)

The DTM configuration is stored in the PLC memory so that the application can be downloaded in its entirety. It is also saved in the PLC project file (STU) and the archive file (STA).

A third-party DTM can be installed in the DTM hardware catalogue.

The DTM hardware catalogue can be used to sort or filter the DTMs according to various criteria such as Device, Vendor, Groups or Protocols.

The DTM Browser in Unity Pro:

- Displays the fieldbus topologies in a tree structure
- Allows the user to configure the DTM devices:
 - Add and delete DTMs
 - Connect and disconnect DTMs to/from their physical devices
 - Display and print the properties of a DTM
 - Transfer DTM configuration data to and from the physical device
 - Functions specific to the DTM, via the Device menu

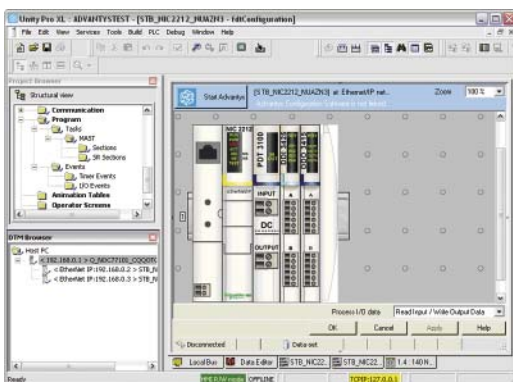

DTM editor (Modicon STB island)

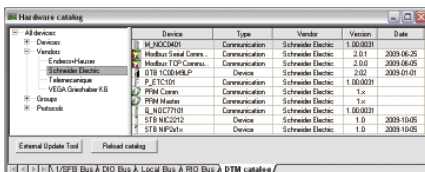

DTM hardware catalogue

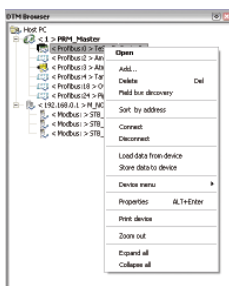

DTM browser and DTM context menu

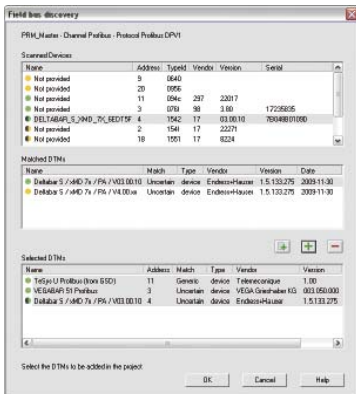

Fieldbus lookup screen

FDT/DTM function (continued)

The fieldbus lookup function scans the physical devices in a fieldbus network and adds the selected devices to the DTM Browser.

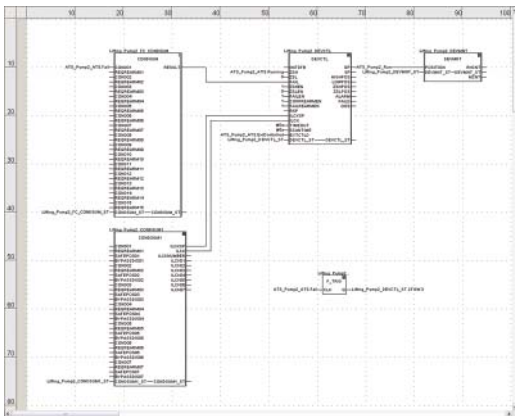

FBD language editor

The five IEC languages

The five graphical or textual languages available in Unity Pro are used for programming Modicon M340, Premium and Quantum automation platforms.

The three graphical languages are:

- Ladder (LD) language
- Function Block Diagram (FBD)
- Sequential Function Chart (SFC) or Grafset

The two textual languages are:

- Structured Text (ST)
- Instruction List (IL)

For these five languages, you can use the standard set of instructions compliant with IEC standard 61131-3 to create applications which can be transferred from one platform to another. Unity Pro software also provides extensions to this standard set of instructions. As they are specific to Modicon M340, Premium and Quantum PLCs, these extensions support the development of more complex applications in order to maximize the potential of the specific features of each of these platforms.

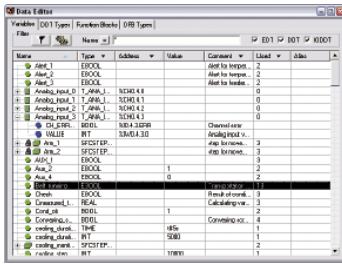

Data editor

Data editor

The data editor, which can be accessed from the structural view of the project, provides a single tool for performing the following editing tasks:

- Declaration of data including variables and function blocks (declaration of their type, instances and attributes)
- Use and archiving of function block data types in different libraries
- Hierarchical view of data structures
- Searching, sorting and filtering of data
- Creation of a hyperlink to access a description from any variable comment

The data is displayed under four tabs:

- “Variables” tab for the creation and management of the following data instances: Bits, words, double words, inputs/outputs, tables and structures
- “DDT Types” tab for the creation of derived data types (tables and structures)
- “Function Blocks” tab for the declaration of EFBs and DFBs
- “DFB Types” tab for the creation of DFB user function block data types

Each data element has several attributes, of which:

- The variable name and type are mandatory
- The comment, physical address in the memory and initial values are optional

The data editor columns can be configured (number of columns, order). All the attributes associated with a variable can be displayed in a properties window.

This editor can be accessed at any time during programming by selecting variables for data modification or creation.

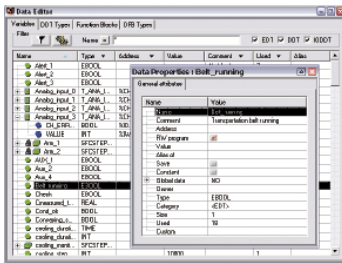

Data properties

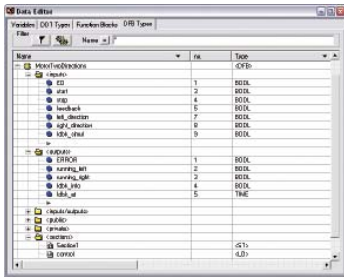

Design

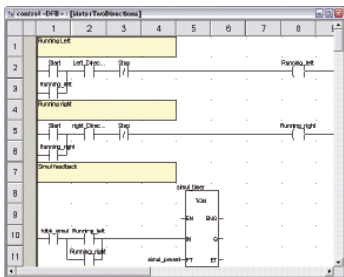

Creating the code

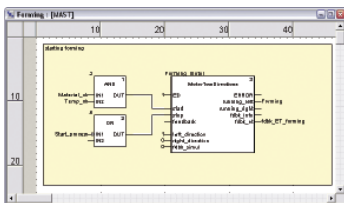

Use within the program

DFB user function blocks

With Unity Pro software, users can create their own function blocks for specific application requirements on Modicon M340, Premium and Quantum platforms.

Once created and saved in the library, these user function blocks can be reused as easily as EFBs (Elementary Function Blocks).

The user function blocks can be used to structure an application. They are used when a program sequence is repeated several times in the application or for freezing a standard programming routine. They can be read-only or read/write. They can be exported to all other Unity Pro applications.

Using a DFB in one or more applications:

- Simplifies program design and entry
- Improves program readability and understanding
- Facilitates program debugging (all variables handled by the DFB are identified in the data editor)
- Enables the use of private variables specific to the DFBs, which are independent of the application

A DFB is set up in several stages:

- The DFB is designed by assigning a name, a set of parameters (inputs, outputs, public and private internal variables) and a comment to it via the data editor.
- The code is created in one or more sections of the program, with the following languages selected according to requirements: Structured Text, Instruction List, Ladder or Function Block Diagram (ST, IL, LD or FBD).
- The DFB may be stored in a library with an associated version number.
- A DFB instance is created in the data editor or when the function is called in the program editor.
- This instance is used in the program in the same way as an EFB (the instance can be created from within the program).

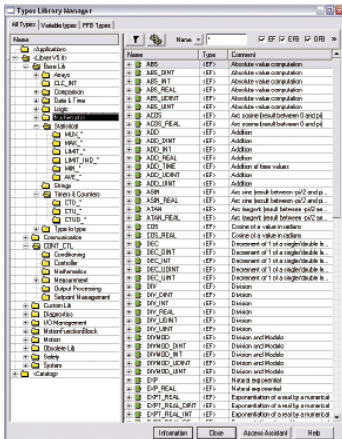

Standard function block libraries

Function block libraries

The function and function block libraries manager contains all the elements provided with Unity Pro software. Functions and function blocks are organized into libraries, which themselves consist of families. Depending on the type of PLC selected and the processor model, users will have a subset of these libraries available to write their applications. However, the “Base Lib” library contains a set of functions and function blocks, the majority of which compatibility is independent of the platforms. In particular, it contains the blocks compliant with IEC 61131-3.

The “Base Lib” library is structured into families:

- Timers and counters
- Process control on integers
- Table management
- Comparison
- Date and time management
- Logic processing
- Mathematical processing
- Statistical processing
- Character string processing
- Type-to-type data conversion

The “Base Lib” library, which covers standard automation functions, is supplemented by other, more application-specific libraries and platform-specific functions:

- **Communication library**, providing an easy means of integrating communication programs from PLCs with those used by HMIs from the PLC application program. Like other function blocks, these EFBs can be used in all languages to exchange data among PLCs or to deliver data to be displayed on an HMI.
- **Process control library**. The CONT_CTL library can be used to set up process-specific control loops. It offers controller, derivative and integral control functions plus additional algorithms, such as EFBs for calculating mean values, selecting a maximum value, detecting edges or assigning a hysteresis to process values, etc.
- **Diagnostics library**, which can be used to monitor actuators and contains EFBs for active diagnostics, reactive diagnostics, interlocking diagnostics, permanent process condition diagnostics, dynamic diagnostics, monitoring of signal groups, etc.
- **I/O management library**, providing services to handle information exchanged with hardware modules (formatting data, scaling, etc.)
- **Motion Function Blocks library**, containing a set of predefined functions and structures to manage motion controlled by drives and servo drives connected on CANopen
- **Motion library** for motion control and fast counting
- **System library**, which provides EFBs for the execution of system functions, including: Evaluation of scan time, availability of several different system clocks, SFC section monitoring, display of system state, management of files on the memory cartridge of the Modicon M340 processor, etc.
- Finally, a library named “obsolete”, containing all function blocks used by legacy programming software needed to perform application conversions.

Management of user standards

Users may create libraries and families in order to store their own DFBs and DDTs. This enhancement allows users to take advantage of programming standards adapted to their needs, along with version management. This means that it is possible to:

- Check the version of the elements used in an application program against those stored in the library
- Perform an upgrade, if necessary

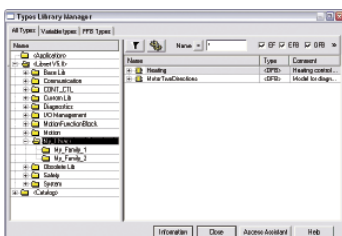

User libraries

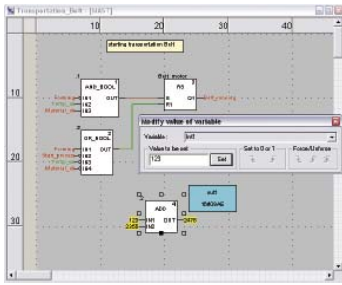

Dynamic animation/adjustment

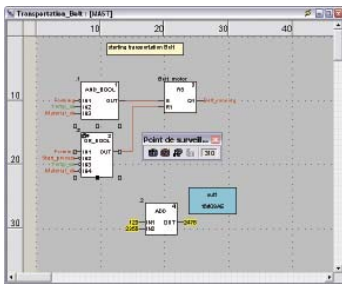

Watchpoint

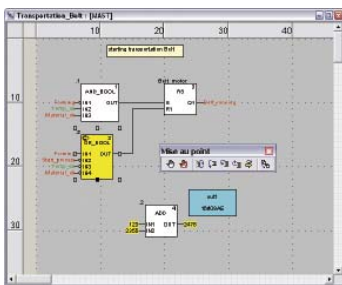

Breakpoint/step-by-step

Debugging tools

Unity Pro software offers a complete set of tools for debugging Modicon M340, Premium or Quantum applications. A tool palette provides direct access to the main functions:

- Dynamic program animation
- Setting of watchpoints or breakpoints (not authorized in event-triggered tasks)
- Step-by-step program execution. A function in this mode enables section-by-section execution. Instruction-by-instruction execution can be launched from the previous breakpoint. Three execution commands are therefore possible when the element to be processed is a subroutine (SR) or DFB user block instance:
 - Step Into: This command is used to move to the first element of the SR or DFB.
 - Step Over: This command is used to execute the entire SR or DFB.
 - Step Out: This command is used to move to the next instruction after the SR or DFB element.
- Independent execution of the master (MAST), fast (FAST), auxiliary (AUX) and event-triggered (EVTi) tasks

Animation of program elements

Dynamic animation is managed section-by-section. A button on the toolbar is used to activate or deactivate animation for each section.

When the PLC is in RUN, this mode can be used to view, simultaneously:

- The animation of a program section, regardless of the language used
- The variables window containing the application objects created automatically from the section viewed

Animation table

Tables containing the variables of the application to be monitored or modified can be created by data entry or initialised automatically from the selected program section. The tables can be stored in the application and retrieved from there at a later date.

Debugging DFB user function blocks

The parameters and public variables of these blocks are displayed and animated in real time using animation tables, with the possibility of modifying and forcing the required objects.

In exactly the same way as with other program elements, the watchpoint, breakpoint, step-by-step execution and program code diagnostics functions can be used to analyze the behavior of DFBs. Setting a breakpoint in a DFB user function block instance stops the execution of the task containing this block.

Debugging in Sequential Function Chart (SFC) language

The various debugging tools are also available in SFC language. However, unlike other sections (IL, ST, LD or FBD) an SFC section executed step-by-step does not stop execution of the task but instead freezes the SFC chart. Several breakpoints can be declared simultaneously within a single SFC section.

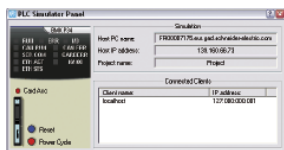

Simulator control panel

PLC simulator

Unity Pro's integrated simulator can be used to test the application program for Modicon M340, Premium or Quantum PLCs from the PC terminal without having to connect to the PLC processor. The functions provided by the debugging tools are available for debugging the master, fast and auxiliary tasks. As the simulator does not manage the PLC I/O, animation tables can be used to simulate the state of inputs by forcing them to 0 or 1. The simulator can be connected to third-party applications via an OPC server with OFS (*OPC Factory Server*) software.

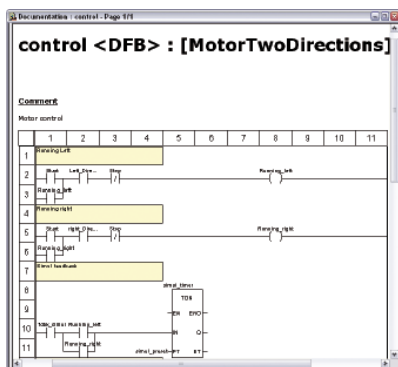

Accessing the documentation editor

Documentation editor

The documentation editor is based on the Documentation Browser, which shows the file structure in tree form. It allows all or part of the application file to be printed on any graphics printer accessible under Windows and using True Type technology, in A4 or US letter print format. The documentation editor supports the creation of user-specific files using the following headings:

- Title page
- Contents
- General information
- Footer
- Configuration
- EF, EFB and DFB type function blocks
- User variables
- Communication
- Project structure
- Program
- Animation tables and cross-references
- Runtime screens

Diagnostics integrated in Modicon M340, Premium and Quantum automation platforms

Presentation

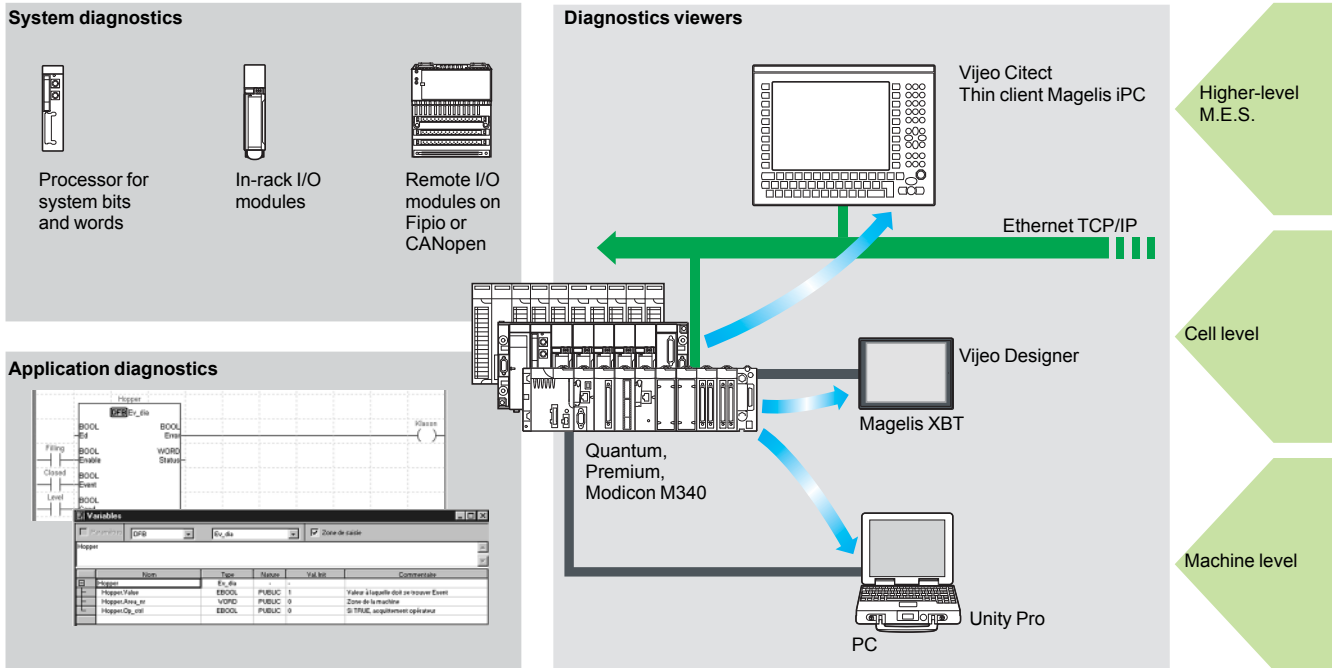

The diagnostics offer for Modicon M340, Premium and Quantum platforms is based on the following three components:

- System diagnostics
- DFB and EFB diagnostic function blocks (for system and application diagnostics)
- Error message display system, called viewers, supplied as a standard component of Magelis XBT terminals, Vijeo Citect supervisory software and Unity Pro setup software

System diagnostics

The system diagnostics for the Modicon M340, Premium and Quantum platforms support the monitoring of system bits/words, I/O modules and activity times (minimum/maximum) of SFC steps. By simply choosing the relevant option during application configuration, any event will generate time-stamped messages logged in the diagnostic buffer of the PLC.

These events are displayed automatically in a diagnostics viewer (1) without requiring any additional programming.

With Unity Pro integrated diagnostics, this function can be used to perform first level diagnostics of the elements in the configuration, up to and including each I/O module channel.

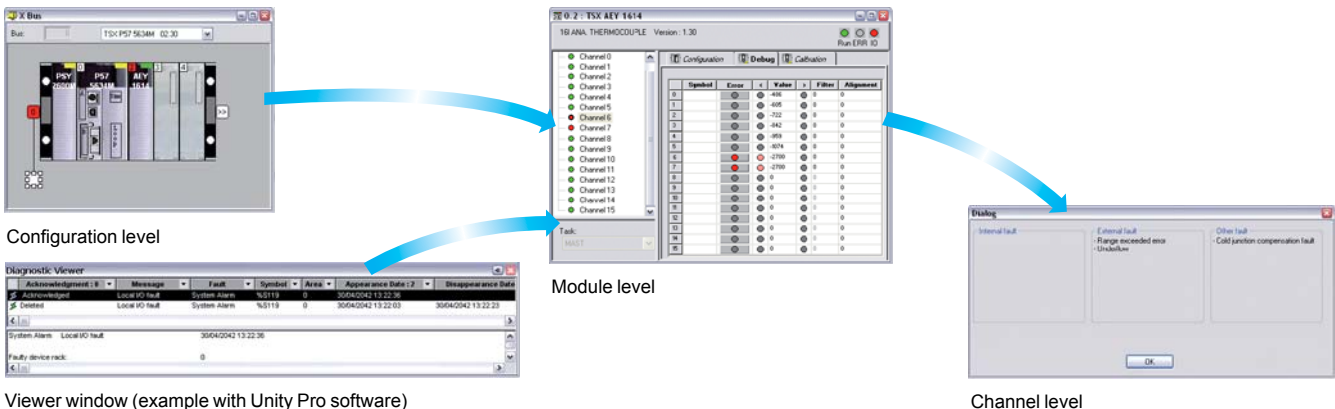

(1) Diagnostics viewers are tools for displaying and acknowledging diagnostic error messages. They are supplied as a standard component of Unity Pro and Vijeo Designer software, with Magelis terminals and with the PLC Web server that can be accessed via a thin client Magelis iPC.

Modifying the program with the PLC in RUN mode

With Unity Pro, changes can be made to the program when the PLC connected to the programming terminal is in RUN mode. These modifications are performed with the following operations:

- The application contained in the PLC is transferred to the PC terminal running Unity Pro, if necessary.
- Program changes are prepared. These program modifications can be of any type and in any language (IL, ST, LD, FBD and SFC), for example, addition or deletion of SFC steps or actions. The code of a DFB user function block can also be modified (however, modification of its interface is not permitted).
- These program changes are updated in the PLC (in RUN mode).

This function makes it possible to add or modify program code and data in different parts of the application in one single modification session (thus resulting in a unified, consistent modification with respect to the controlled process). This increased flexibility comes at a cost in terms of the amount of program memory required.

Cross-references function

Unity Pro's cross-references function, which is available in standalone mode (offline) and when connected to the PLC in Run (online), allows users to view all the elements of a PLC application when searching for any type of variable. This view indicates where the declared variable is used, as well as how it is used (for writing, reading, etc.).

This function also provides access to the Search/Replace function for variable names. The variable search can be initialized from any editor (language, data, runtime screen, animation table, etc.).

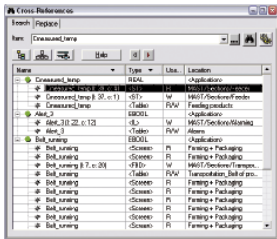

Cross-references table

Import/export function

The import/export function available in Unity Pro supports the following operations from the structural and functional project views:

- Via the import function, reuse in the current project of all or part of a project created previously
- Via the export function, copying of all or part of the current project to a file for subsequent reuse

The files generated during export are generally in XML format (1). However, in addition to XML, variables can be exported and imported in the following formats:

- .xvm format compatible with OFS data server software
- Source format, in an .scy file compatible with PL7 development software
- Text format with separator (TAB) in a .txt file for compatibility with any other system

During an import, a wizard can be used to reassign data to new instances of:

- DFB function blocks
- DDT data structures
- Simple data

In addition, when a functional module is imported, the data associated with animation tables and runtime screens is also reassigned.

The XML import function also supports the transfer of a Modicon M340, Premium or Quantum PLC configuration prepared in the SIS Pro costing and configuration tool for use in the creation of a project in Unity Pro.

This import function spares the user from having to redefine the PLC configuration when the PLC has already been configured with the SIS Pro tool.

(1) XML language is an open, text-based language that provides structural and semantic information.

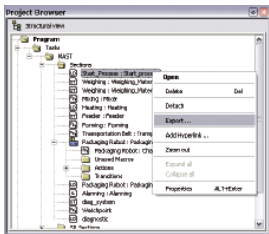

Data export shortcut menu

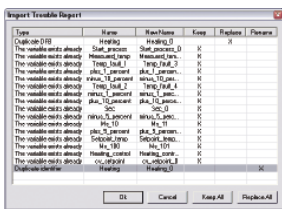

Data import wizard

Application converters

Unity Pro's integrated conversion tools can be used to convert PLC applications created with Concept and PL7 programming software to Unity Pro applications.

Concept/Unity Pro converter (Quantum PLC)

This conversion is performed with a Concept application V2.5 or later (it can also be performed in V2.11 or later, but only after an update to V2.5). In order to perform the conversion, the application must be exported to an ASCII file in Concept.

The export file is converted to a Unity Pro source file automatically. This source file is then analyzed by Unity Pro. At the end of the procedure, a conversion report is generated and an output window displays any conversion errors and provides direct access to the part of the program to be modified.

The Concept application converter converts the application to Unity Pro, but does not guarantee that it will operate correctly in real-time. It is therefore essential to test or debug all converted applications.

PL7/Unity Pro converter (Premium PLC and Atrium slot PLC)

This conversion is performed with a PL7 application V4 or later (Premium PLC or Atrium slot PLC). In order to perform the conversion, the source file (complete application or user function block) must be exported in PL7.

The conversion procedure is similar to that of the Concept conversion described above.

Note: Applications created with Concept, Modsoft and ProWORX can be converted to LL984. Please consult our Customer Care Centre.

Operating system update utilities

The OS-Loader software is designed for updating operating systems on Premium and Quantum platforms. It is supplied with Unity Pro software.

It is used to upgrade Unity processors and modules as well as to upgrade PL7 or Concept processors and modules to make them compatible with Unity Pro.

OS-Loader software supports:

- Premium processors
- Quantum processors
- Ethernet communication modules
- EtherNet/IP communication modules

The operating system updates are performed as follows:

- Uni-Telway RS 485 terminal link for Premium processors
- Modbus or Modbus Plus terminal link for Quantum processors
- Ethernet TCP/IP network for integrated Ethernet port on Premium processors and Premium and Quantum Ethernet modules

Note: For Modicon M340, this service is provided by Unity Loader (see page 6/26).

Online modification of the Quantum configuration

This function, also called *Change Configuration On The Fly (CCOTF)*, is used to modify the Quantum configuration online (application in RUN mode):

- Addition or removal of discrete or analog I/O modules
- Modification of configuration parameters of discrete or analog I/O modules (already present or newly installed)

The CCOTF function is supported by standalone processors for all three types of I/O architecture (local, RIO, DIO) using version 5 of Unity Pro, and for Hot Standby processors using version 4.1 of Unity Pro.

The CCOTF function must first be validated in the Unity Pro configuration screen. A confirmation screen appears when the configuration has been modified online.

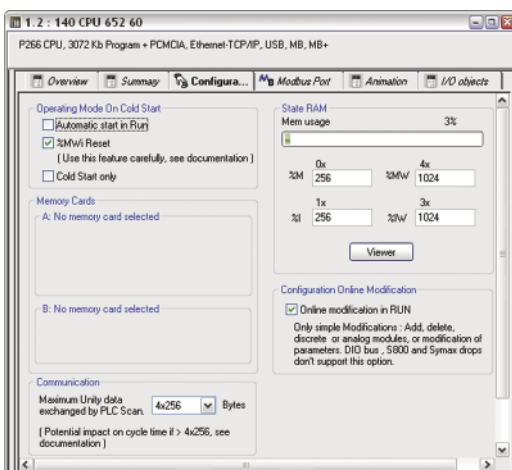

Configuration screen

Software

Unity Pro software

Small/Medium/Large/Extra Large

Programmable process control

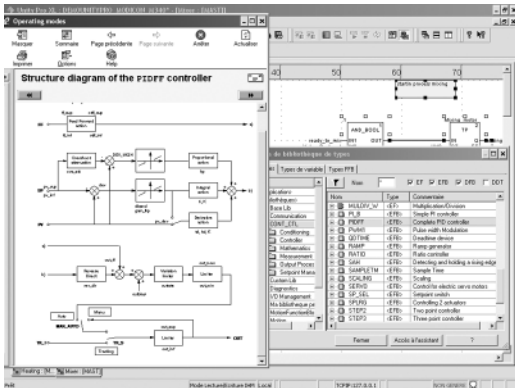

CONT_CTL, programmable process control integrated in Unity Pro

Process control in machines

Unity Pro contains **CONT_CTL**, a library of 36 function blocks used to create control loops for machine control.

All requirements for closed loop control functions in machines are adequately met by Modicon M340, Premium and Quantum platforms thanks to the wealth of functions in the library and the flexibility with which function blocks can be linked together through programming. This solution therefore eliminates the need for external controllers and simplifies the overall control architecture of the machine, as well as its design, roll-out and operation.

The EFs or EFBs can be used in all Unity Pro languages (LD, ST, IL and FBD). FBD is particularly suitable for accessing control processing operations in Unity Pro through its wizard for entering and viewing parameters and function block variables.

CONT_CTL library functions

The library consists of five function families:

- Input data conditioning
- Controllers
- Mathematical functions
- Process value processing
- Output value processing

Input data conditioning

DTIME	Pure time delay
INTEGRATOR	Integrator with limiting
LAG_FILTER	First order time lag
LDLG	Lead/lag function with smoothing
LEAD	Lead function with smoothing
MFLOW	Mass flow calculation based on the measurement of differential pressure or flow speed with pressure and temperature compensation
QDTIME	Dead time term
SCALING	Scaling
TOTALIZER	Integrator (typically of flow) until a limit (typically a volume) is reached, with automatic reset
VEL_LIM	Velocity limiter, with manipulated variable limiting

Controllers

PI_B	Basic PI controller: PI algorithm with a mixed structure (series/parallel)
PIDFF	Complete PID controller: PID algorithm with a parallel or mixed structure (series/parallel)
AUTOTUNE	Automatic tuner setting for the PIDFF (complete PID) controller or the PI_B (simple PI) controller <ul style="list-style-type: none"> □ Identification using Ziegler Nichols type method □ Modelling based on first order process □ Building of control parameters with criterion for prioritizing either the reaction time to disturbance (dynamic) or the stability of the process
IMC	Model-based controller. The model is a first order model with delay. This corrector is useful: <ul style="list-style-type: none"> □ When there are serious delays compared with the main time constant of the process; this scenario cannot be satisfactorily resolved by standard PID process control □ For regulating a non-linear process IMC can handle any stable and aperiodic process of any order.
SAMPLETM	Control of controller startup and sampling
STEP2	Simple two-position controller
STEP3	Three-position controller for temperature regulation

Mathematical functions

COMP_DB	Comparison of two values, with dead zone and hysteresis
K_SQRT	Square root, with weighting and threshold, useful for linearization of flow measurements
MULDIV_W	Weighted multiplication/division of 3 numerical values
SUM_W	Weighted summing of 3 numerical values

6

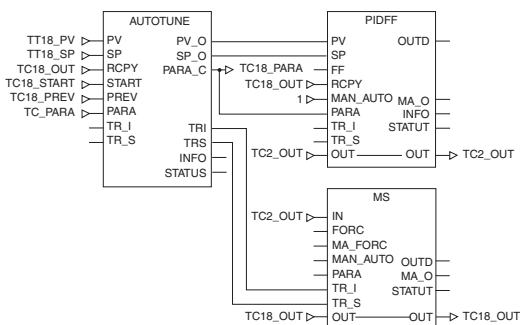

Example: PID controller with MS manual control

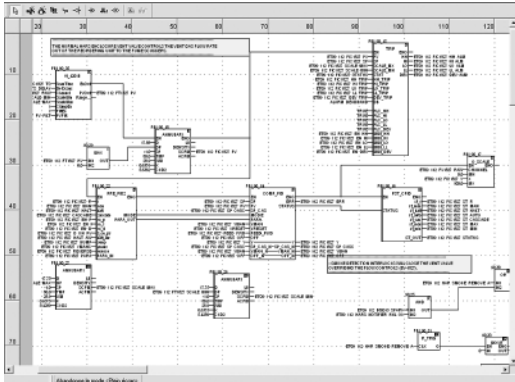

Programming in Unity Pro in offline mode

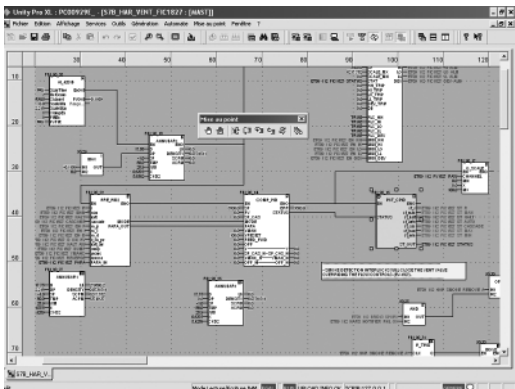

Programming in online mode

Process control in machines (continued)

CONT_CTL library functions (continued)

Process value processing

AVGMV	Moving average with fixed number of samples (50 max.)
AVGMV_K	Moving average with constant correction factor, 10,000 samples max.
DEAD_ZONE	Dead zone
LOOKUP_TABLE1	Linearization of characteristic curves using first-order interpolation
SAH	Detection of a rising edge
HYST_XXX	Detection of high threshold with hysteresis (1)
INDLIM_XXX	Detection of high and low thresholds with hysteresis (1)

Output value processing

MS	Manual control of an output
MS_DB	Manual control of an output with dead zone
PWM1	Control via pulse width modulation
SERVO	Control for servo motors
SPLRG	Control of two <i>Split Range</i> actuators

Setpoint management

RAMP	Ramp generator, with separate ascending and descending ramps
RATIO	Ratio controller
SP_SEL	Selection of setpoint value: local (operator) or <i>remote</i> (processing)

Setting up process control function blocks

Based on the sequencing of function blocks, the FBD language integrated in Unity Pro is a programming language particularly suitable for building control loops. Designers can use FBD to easily associate blocks from the CONT_CTL library with their own DFBs written in Unity Pro's ST, IL or LD language, or in C language.

Debugging, operation

All Unity Pro's standard debugging services (see page 6/9) are available. In particular, the Modicon M340 processor simulator can be used to check correct execution of processing offline.

Compatibility:

The CONT_CTL control function block library is available in all versions of Unity Pro. It is compatible with all processors in the Modicon M340, Premium and Quantum ranges.

Optional specialized libraries

The CONT_CTL control function block library can be supplemented with optional specialized libraries, to meet specific needs such as predictive control, fuzzy logic controller, HVAC and mass flow calculation (see page 6/28).

Resources

The technical documentation provides many examples of how to set up programmable process control function blocks in FBD, LD, IL and ST languages.

The techniques for adjusting process control loops are described in the document "Process control, Unity V3.0" available online at www.schneider-electric.com.

(1) XXX according to the type of variable: DINT, INT, UINT, UDINT, REAL.

Software

Unity Pro software

Small/Medium/Large/Extra Large

Communication drivers

The most commonly used communication drivers for Modicon M340, Premium and Quantum platforms are installed at the same time as the Unity Pro software.

Unity Pro also includes the following drivers, which can be installed as required (1):

Protocol - Hardware	Windows XP Professional	Windows Vista Business 32-bit edition
		Windows 7 32-bit and 64-bit editions
Ethway - Ethernet	Driver available	Driver available
Fip - FPC10 ISA card	Driver available	Driver available
Fip - FPC20 PCMCIA card	Driver available	Driver available
Fip adaptor - CUSBFIP	Driver available	Driver available
ISAWay - PCX57 ISA card	Driver available	Driver available
Modbus Serial - COM port	Driver available	Driver available
PClway - Atrium TPCI57 PCI card	Driver available	Driver available
Uni-Telway - COM port	Driver available	Driver available
Uni-Telway - SCP114 PCMCIA card	Driver available	Driver available
USB for high end PLC	Driver available	Driver available
XIP - XWay on TCP/IP	Driver available	Driver available

Driver available
 Driver not available

Unity Developer's Edition, advanced open access

Advanced open access, intended for experienced IT engineers, supports the development of interfaces between Unity and expert tools, as well as specific user-defined functions.

This type of development requires experience in the following IT areas:

- C++ or Visual Basic languages
- Client/server architectures
- XML and COM/DCOM technologies
- Database synchronization

As a supplement to the Unity Pro Extra Large software (2), the UDE (Unity Developer's Edition) development kit **UNY UDE VFU CD21E** enables the development of customized solutions. In addition to the development kit, the Unity servers and accompanying documentation are also provided.

Unity Developer's Edition is compatible with:

- Unity Pro Extra Large
- All Modicon M340 processors
- All Modicon Premium Unity processors
- All Modicon Quantum Unity processors

(1) Also available separately under reference **TLX CD DRV 20M**.

(2) Only the Unity Pro Extra Large version enables dynamic database management for data to be exchanged with the OFS data server or a third-party tool.

Software

Unity Pro software

Small/Medium/Large/Extra Large

Upgrade kits for Concept, PL7 Pro and ProWORX software

The Concept, PL7 Pro and ProWORX upgrade kits allow users who already have one of these programs from the installed base and who have a current subscription to obtain Unity Pro version V4.1 software at a reduced price.

These upgrades are only available for licences of the same type (e.g. from Concept XL group licence to Unity Pro Extra Large group licence).

Composition and Windows OS compatibility

Unity Pro multilingual software packages are compatible with Windows XP (32-bit), Windows Vista (32-bit) and Windows 7 (32-bit and 64-bit) operating systems. They include:

- Documentation in electronic format in six languages (English, French, German, Italian, Spanish and Chinese)
- Converters for converting applications created with Concept and PL7 Pro programming software
- PLC simulator

Cables for connecting the processor to the programming PC must be ordered separately.

Unity Pro update

Customers are notified automatically when a new Unity Pro update becomes available. They can then access the software updates manager directly, download the update and install it locally on their workstation.

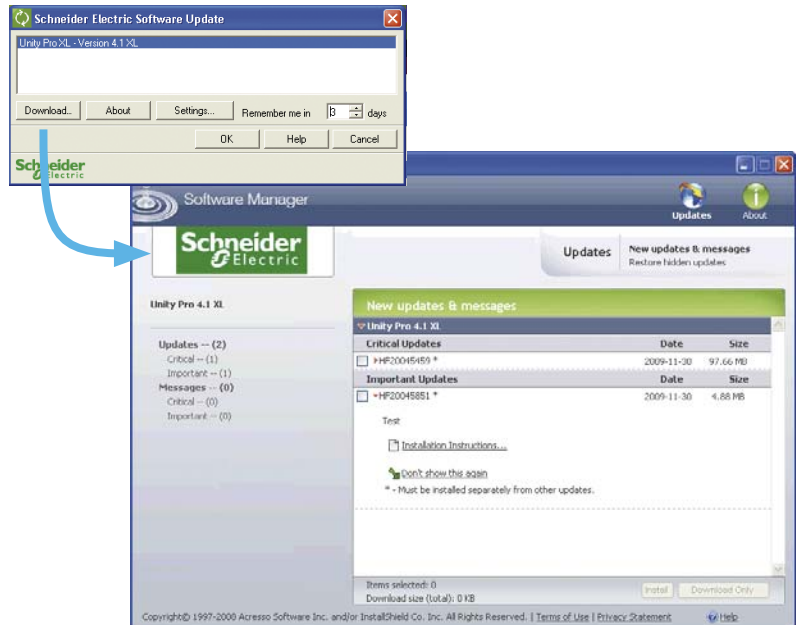

Note: The latest firmware versions are available for download from our website www.schneider-electric.com.

Software

Unity Pro software

Small/Medium/Large/Extra Large



Unity Pro

References

Unity Pro Small, Medium, Large and Extra Large software packages

These software packages are for programming and setting up Unity automation platforms. The software is available in five versions:

- **Unity Pro Small** (see page 6/18)
- **Unity Pro Medium** (see page 6/19)
- **Unity Pro Large** (see page 6/19)
- **Unity Pro Extra Large** (see page 6/20)

Upgrade kits for Concept, PL7 Pro and ProWORX software

These upgrade kits allow users who already have these software programs from the installed base and who have a **current subscription** to obtain Unity Pro version V6.0 software at a reduced price. These upgrades are only available for licences of the same type (e.g. from Concept XL group licence to Unity Pro Extra Large group licence).

See page 6/20.

Composition and Windows OS compatibility

Unity Pro multilingual software packages are compatible with Windows XP (32-bit), Windows Vista Business Edition (32-bit) and Windows 7 (32-bit and 64-bit) operating systems.

The packages comprise:

- A Unity Pro V5.0 DVD in six languages (English, French, German, Italian, Spanish and Chinese)
- A Unity Loader V2.2 CD
- An Ethernet/IP Configuration V1.1 CD (not included with Unity Pro Small)
- An Advantys V5.5 configuration software CD
- A DVD containing the documentation in electronic format in six languages (English, French, German, Italian, Spanish and Chinese)
- A one-year services subscription

Unity Pro Small version 6.0 software

For Modicon M340: All models

For distributed I/O: **Modicon ETB, TM7, OTB, STB, Momentum**

Unity Pro Small version 6.0 software packages (1)

Description	Licence type	Reference	Weight kg
Unity Pro Small software packages	Single (1 station)	UNY SPU SFU CD 60	–
	Group (3 stations)	UNY SPU SFG CD 60	–
	Team (10 stations)	UNY SPU SFT CD 60	–
Software upgrades from: - Concept S - PL7 Micro - ProWORX NxT/32 Lite	Single (1 station)	UNY SPU SZU CD 60	–
	Group (3 stations)	UNY SPU SZG CD 60	–
	Team (10 stations)	UNY SPU SZT CD 60	–

Licence type extensions for Unity Pro Small version 6.0

From	To	Reference	Weight kg
Single (1 station)	Group (3 stations)	UNY SPU SZUG CD 60	–
Group (3 stations)	Team (10 stations)	UNY SPU SZGT CD 60	–

(1) For compatibility of Unity software/automation platforms and distributed I/O, refer to the selection guide on page 6/2.

Software

Unity Pro software

Small/Medium/Large/Extra Large



Unity Pro

Unity Pro Medium version 6.0 software

For Modicon M340: All models
 For Modicon Premium: **TSX 57 1...2**
 For distributed I/O: **Modicon ETB, TM7, OTB, STB, Momentum**

Unity Pro Medium version 6.0 software packages (1)

Description	Licence type	Reference	Weight kg
Unity Pro Medium software packages	Single (1 station)	UNY SPU MFU CD 60	–
	Group (3 stations)	UNY SPU MFG CD 60	–
	Team (10 stations)	UNY SPU MFT CD 60	–
Software upgrades from: - Concept S, M - PL7 Micro, Junior - ProWORX NxT/32 Lite	Single (1 station)	UNY SPU MZU CD 60	–
	Group (3 stations)	UNY SPU MZG CD 60	–
	Team (10 stations)	UNY SPU MZT CD 60	–

Licence type extensions for Unity Pro Medium version 6.0

From	To	Reference	Weight kg
Single (1 station)	Group (3 stations)	UNY SPU MZUG CD 60	–
Group (3 stations)	Team (10 stations)	UNY SPU MZGT CD 60	–

Upgrade to Unity Pro Medium from Unity Pro Small

Type of upgrade	Reference	Weight kg
The number of stations is unchanged		
Small to Medium Single (1 station)	UNY SPU MZSU CD 60	–
Small to Medium Group (3 stations)	UNY SPU MZSG CD 60	–
Small to Medium Team (10 stations)	UNY SPU MZST CD 60	–

Unity Pro Large version 6.0 software

For Modicon M340: All models
 For Modicon Premium: **TSX 57 1...4**
 For Modicon Quantum: **140 CPU 311 10/434 12U**
 For distributed I/O: **Modicon ETB, TM7, OTB, STB, Momentum**

Unity Pro Large version 6.0 software packages (1)

Description	Licence type	Reference	Weight kg
Unity Pro Large software packages	Single (1 station)	UNY SPU LFU CD 60	–
	Group (3 stations)	UNY SPU LFG CD 60	–
	Team (10 stations)	UNY SPU LFT CD 60	–
	Site (≤ 100 users)	UNY SPU LFF CD 60	–
Software upgrades from: - Concept S, M - PL7 Micro, Junior, Pro - ProWORX NxT/32 Lite	Single (1 station)	UNY SPU LZU CD 60	–
	Group (3 stations)	UNY SPU LZG CD 60	–
	Team (10 stations)	UNY SPU LZT CD 60	–
	Site (≤ 100 users)	UNY SPU LZF CD 60	–

Licence type extensions for Unity Pro Large version 6.0

From	To	Reference	Weight kg
Single (1 station)	Group (3 stations)	UNY SPU LZUG CD 60	–
Group (3 stations)	Team (10 stations)	UNY SPU LZGT CD 60	–

Upgrade to Unity Pro Large from Unity Pro Medium

Type of upgrade	Reference	Weight kg
The number of stations is unchanged		
Medium to Large Single (1 station)	UNY SPU LZMU CD 60	–
Medium to Large Group (3 stations)	UNY SPU LZMG CD 60	–
Medium to Large Team (10 stations)	UNY SPU LZMT CD 60	–

(1) For compatibility of Unity software/automation platforms and distributed I/O, refer to the selection guide on page 6/2.

Software

Unity Pro software

Small/Medium/Large/Extra Large



Unity Pro

Unity Pro Extra Large version 6.0 software

For Modicon M340: All models
 For Modicon Premium: **TSX 57 1...6**
 For Modicon Quantum: **140 CPU 311 10/434 12U/651 50/651 60/652 60/671 60/672 61**
 For distributed I/O: **Modicon ETB, TM7, OTB, STB, Momentum**

Unity Pro Extra Large version 6.0 software packages (1)

Description	Licence type	Reference	Weight kg
Unity Pro Extra Large software packages	Single (1 station)	UNY SPU EFU CD 60	–
	Group (3 stations)	UNY SPU EFG CD 60	–
	Team (10 stations)	UNY SPU EFT CD 60	–
	Site (≤ 100 users)	UNY SPU EFF CD 60	–
Software upgrades from: - Concept S, M, XL - PL7 Micro, Junior, Pro - ProWORX NxT Lite, Full - ProWORX 32 Lite, Full	Single (1 station)	UNY SPU EZU CD 60	–
	Group (3 stations)	UNY SPU EZG CD 60	–
	Team (10 stations)	UNY SPU EZT CD 60	–
	Site (≤ 100 users)	UNY SPU EZF CD 60	–

Licence type extensions for Unity Pro Extra Large

From	To	Reference	Weight kg
Single (1 station)	Group (3 stations)	UNY SPU EZUG CD 60	–
Group (3 stations)	Team (10 stations)	UNY SPU EZGT CD 60	–

Upgrade to Unity Pro Extra Large from Unity Pro Large

Type of upgrade	Reference	Weight kg
The number of stations is unchanged		
Large to Extra Large Single (1 station)	UNY SPU EZLU CD 60	–
Large to Extra Large Group (3 stations)	UNY SPU EZLG CD 60	–
Large to Extra Large Team (10 stations)	UNY SPU EZLT CD 60	–

Unity Pro software

Description	Licence type	Reference	Weight kg
Unity Developer's Edition			
UDE Unity Developer's Edition For automating repetitive tasks or generating source code automatically from third-party applications. Available for Unity Pro Small, Medium, Large, Extra Large and XL Safety.	Single (1 station)	UNY UDE VFU CD21E	–

Documentation for Unity Pro version 6.0

Description	Licence type	Reference	Weight kg
Hardware and software manuals (on DVD) - Platform setup for: Modicon M340, Premium, Quantum, Momentum - Electromagnetic compatibility of networks and fieldbuses - Software setup for: Unity Pro, Function block library.	Multilingual: English, French, German, Italian, Spanish, Chinese	UNY USE 909 CD M	–

(1) For compatibility of Unity software/automation platforms and distributed I/O, refer to the selection guide on page 6/2.



BMX XCA USB H0



TSX PCX 1031



TSX CUSB485



TCS WAAC 13FB

Accessories for connecting to the PC programming terminal

Description	Use		Length	Reference	Weight kg	
	From processor port	To PC port				
PC terminal connection cables (PC to PLC)	USB mini B port BMX P34 1000/20●0/20●02	USB port	1.8 m	BMX XCA USB H018	0.065	
		USB port	4.5 m	BMX XCA USB H045	0.110	
PC terminal connection cables (PC SUB-D to Modicon STB I/O)	Mini-DIN port Premium TSX 57 1●/2●/3●/4●	RS 232D (9-way SUB-D connector)	2.5 m	TSX PCX 1031	0.170	
		USB port (USB/RS 485 converter)	0.4 m	TSX CUSB 485 (1)	0.144	
		USB port (mini-DIN/RJ45 cordset)	2.5 m	TSX CRJMD 25 (1)	0.150	
		Modbus port 15-way SUB-D Quantum	RS 232D (9-way SUB-D connector)	3.7 m	990 NAA 263 20	0.300
		140 CPU 311 10		15 m	990 NAA 263 50	0.180
		140 CPU 434 12A 140 CPU 534 14A				
USB/SUB-D adaptor (PC USB to Modicon STB I/O)	USB port Premium TSX 57 5●/6● Quantum 140 CPU 6●1	USB port	3.3 m	UNY XCA USB 033	–	
		Modbus port, RJ45 connector Quantum 140 CPU 6●1	RJ 45 connector	1 m	110 XCA 282 01	–
				3 m	110 XCA 282 02	–
				6 m	110 XCA 282 03	–
PC terminal connection cables (PC SUB-D to Modicon STB I/O)	HE13 connector Modicon STB I/O network interface module (NIM)	RS 232D (2) (9-way SUB-D connector)	2 m	STB XCA 4002	0.210	
USB/SUB-D adaptor (PC USB to Modicon STB I/O)	HE13 connector Modicon STB I/O network interface module (NIM) with STB XCA 4002 cable (3)	USB port (3)	–	SR2 CBL 06	0.185	

Description	Use	Reference	Weight kg
Universal Bluetooth® interface (UBI)	<p>Provides Bluetooth® connectivity for products such as the Modicon M340/Premium platforms and Altivar/Lexium servo drives, via their serial port (RS 485). Used for setting-up and maintenance of products. Designed for permanent installation and can be safely fitted on the inside or outside of electrical enclosures.</p> <ul style="list-style-type: none"> ■ Protocols supported: Modbus and Uni-Telway ■ Powered via the product's RS 485 serial port ■ Max. range in direct line of sight: 20 m <p>The kit comprises:</p> <ul style="list-style-type: none"> ■ A Universal Bluetooth® interface (UBI) ■ An RJ45/mini-DIN cable (length 1 m) ■ An RJ45/RJ45 cable (length 1 m) ■ A fixing clamp for installation inside the electrical enclosure ■ A CD with configuration software and user manual 	TCS WAAC 13FB	0.320

(1) The **TSX CUSB 485** converter requires use of the **TSX CRJMD 25** mini-DIN/RJ45 cordset.

(2) For connection on a USB port, the **SR2 CBL 06** cable must also be used (3).

(3) Adaptor equipped with a USB connector (PC side) and a 9-way SUB-D connector (**STB XCA 4002** cable side); requires the **STB XCA 4002** cable (9-way SUB-D/HE 13) for connection to the HE13 connector on the Modicon STB NIM.



Unity EFB Toolkit

Presentation

Unity EFB Toolkit is the software for developing EFs and EFBs in “C” programming language. As an option with Unity Pro, it can be used to extend all the standard Unity Pro function blocks in order to increase functionality. This software comes with *Microsoft Visual Studio*, which can be used to debug the function blocks developed in the Unity Pro PLC simulator. Unity EFB Toolkit also includes a service for creating and managing families of function blocks and integrating them in Unity Pro.

Setup

Unity EFB Toolkit manages the whole process of developing Unity Pro function blocks:

- User-friendly graphical user interface with automatic file organization
- Powerful tools for testing and debugging
- Management of compatibilities and software versions of created functions
- Generation of files for subsequent installation of functions on other Unity Pro stations

Managing function block families

The software can be used to create function block families. The function blocks developed, also known as EFs/EFBs, are stored in families. This makes it possible to create an organized library of functions written in “C” language. Once created, these function block families are installed on the Unity Pro stations for the purpose of extending the standard Unity Pro libraries. Integration in Unity Pro can be executed from Unity EFB Toolkit or via the tool for updating Unity Pro libraries, which allows these families to be distributed without the use of any other software.

Developing function blocks

The EFB Toolkit software allows the user to create a function block as follows:

- Declaration of the function block interface in the same way as for the DFBs in Unity Pro
- Definition of all data types needed (elementary, structures, tables)
- Support of public and private variables
- Generation of all files and the block “C” coding frame (the user only adds functionality to this frame)
- Granting of access to numerous internal PLC services, such as the real-time clock, PLC variables and data, system words and math functions, including high-precision numerical processing in “double” format
- Structure of the function block family (compilation/link for all Unity Pro automation platforms)
- Provision of a debugging environment: The function blocks created can easily be debugged in *Microsoft Visual Studio* by downloading a Unity Pro application containing the function developed in the Unity Pro PLC simulator. All the debugging functions in *Microsoft Visual Studio*, especially breakpoints, step-by-step operations, display of the code/data and manipulation of the data, can be accessed without restriction.
- Support for managing Unity Pro versions, important during the function block maintenance phase

Note: A specific GNU compiler is used to generate the code for a Modicon M340 platform. It is supplied with the Unity EFB Toolkit.

Compatibility

Unity EFB Toolkit is compatible with Unity Pro Small, Medium, Large and Extra Large. EFs and EFBs can be developed for Premium, Modicon M340 and Quantum platforms.

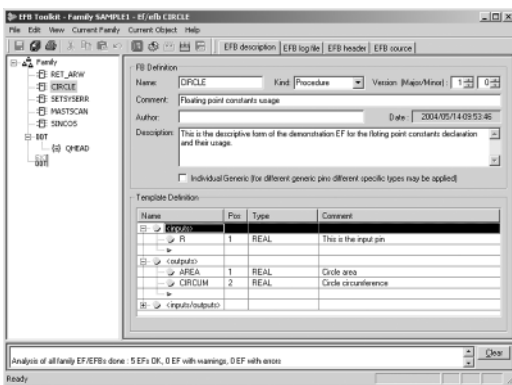

EFB Toolkit: Managing function block families

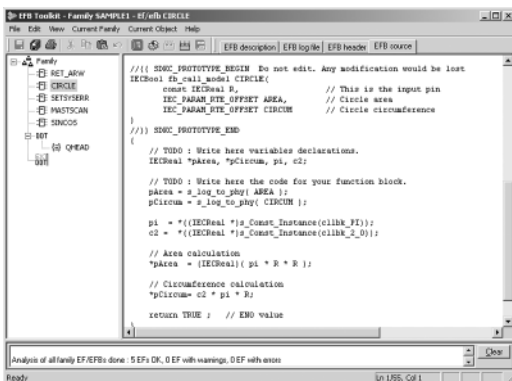

EFB Toolkit: Editor

Software

Unity Pro software

Unity EFB Toolkit software

References

Unity Pro companion software, Unity EFB Toolkit, can be used to create Unity Pro function blocks in "C" programming language. The developed function blocks can then be integrated in standard Unity Pro function block libraries.

Unity EFB Toolkit and its documentation are supplied in electronic format on CD-ROM in English.

Description	Type	Language	Reference	Weight kg
Unity EFB Toolkit software	Single licence (1 station)	English (software and electronic documentation)	UNY SPU ZFU CD 31E	–



Unity Dif comparison

Presentation

Unity Dif is an optional program for Unity Pro. It can handle all Unity Pro automation platforms. It compares two Unity Pro applications and returns an exhaustive list of all the differences. Unity Dif improves productivity during the main life stages of a control system, mainly during development and debugging of applications and commissioning, operation and maintenance of the installation.

Software setup

Unity Dif can be launched in several ways:

- From Unity Pro
- From the Windows Start menu
- From a command line interface without a graphical user interface

Unity Dif identifies all the differences between two Unity Pro applications at different levels:

- Hardware configuration
- Network configuration (Modbus/TCP, CANopen and RIO (Quantum only))
- All the variables and instances of function blocks
- Structure and content of the application, regardless of which language is used
- DFB and DDT code
- Project options
- ...

The result of the comparison can be displayed in the user interface, printed or saved in .txt file format.

Comparison

The end of the comparison operation is signalled by the appearance of the application browser with its two tabs:



1 Identification tab for accessing the characteristics of the two applications being compared. The differences are summarized.

2 Browser tab for accessing the application tree structure.



Comparison after selection of elements to be analyzed

Displaying results

The tree structure can be accessed after comparison, via the Browser tab. It shows any differences using four symbols, where the information associated with application 1 appears in blue and that associated with application 2 appears in red:



This branch, appearing at this level in the tree structure, contains at least one difference.

This block contains at least one difference.

This section is only present in application 1.

This section is only present in application 2.

In the example opposite, a difference is detected on the rung:

- 1 The line displayed in blue belongs to application 1 [Prj 1].
- 2 The line displayed in red belongs to application 2 [Prj 2].

The source code extracts of both applications can be used to locate the differences precisely.

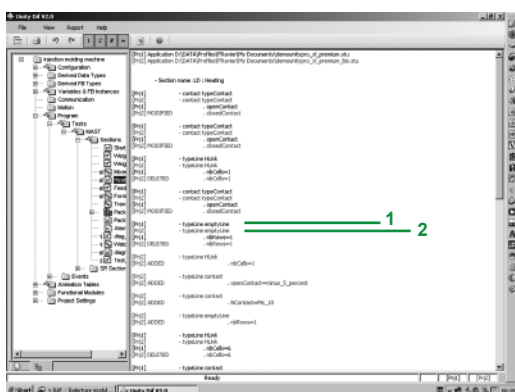

Displaying results

Software

Unity Pro software

Unity Dif application comparison software

References

This Unity Dif software extension is used to compare two Unity applications generated by Unity Pro software version V2.1 or later.

Description	Target extension PLC target	Type	Reference	Weight kg
Unity Dif comparison software extension for Unity Pro applications	All Unity Pro Modicon M340, Premium, Quantum versions	Single licence (1 station)	UNY SDU ZFU CD22	–
CD-ROM containing software and electronic documentation (English-French)		Site licence (100 stations)	UNY SDU ZFF CD22	–



Unity Loader

Presentation

Unity Loader is companion software to Unity Pro and is used to perform maintenance operations on automation applications. Its easy setup and the small size of its executable make it an essential tool for updating Unity Pro projects without needing to use Unity Pro. It can also be used for updating the embedded software on Modicon M340 modules. It performs the following main functions:

- Transferring automation project components, such as the program and data, from the PC to the PLC or the PLC to the PC
- Transferring files and user Web pages stored in the memory card of Modicon M340 PLCs
- Transferring the firmware from the PC to Modicon M340 modules only

Software graphic interface

The interface is easy to use and has four tabs for access to different operations:

- The **“Project”** tab manages the transfer of projects (program and data) between the PC and the PLC CPU. The software transfers the program (application file format: .stu; archive file format: .sta) and data (located and unlocated) of a Unity Pro project in both directions. The program and data files created by Unity Loader are compatible with Unity Pro. When it is connected to the PLC, Unity Loader displays the information associated with the data read in the PLC. This information is displayed on the PC for the selected files.
 - *Modicon M340 PLCs and BMX RMS ●●8MFP memory card only:* The files and user Web pages can be transferred from the memory card to the PC and vice versa.
 - *BMX NOE 0110 with flash memory card only:* Web pages stored in the flash memory can be transferred from the module to the PC and vice versa.
- The **“Firmware”** tab can be used to update the firmware in the Modicon M340 modules. The screen displays the detailed content of the firmware versions existing in the module and on the PC. Firmware updating works in the same way as project transfers.
- The **“Options”** tabs is used to configure the working environment, especially the location of files on the PC and the selection of one of the six languages supported (English, French, German, Italian, Spanish and Chinese) for the user interface and online help.
- The **“About...”** tab displays information about the software.

Note: Regardless of which tab is selected, the connection status with the PLC is always displayed, together with commands for connection/disconnection and changing the PLC operating mode.

Modicon M340 PLC and BMX RMS ●●8MFP memory card only

The Unity Loader software can download the project files and the firmware (PLC or module) onto a flash memory card (**BMX RMS ●●8MFP** only) plugged into the processor of the PLC.

This firmware download can then be used to update a remote Modicon M340 PLC.

Automation of Unity Loader commands

Projects can be downloaded/uploaded between a PLC and a supervisory station equipped with Unity Loader software by means of a command file included in the supervisory application.

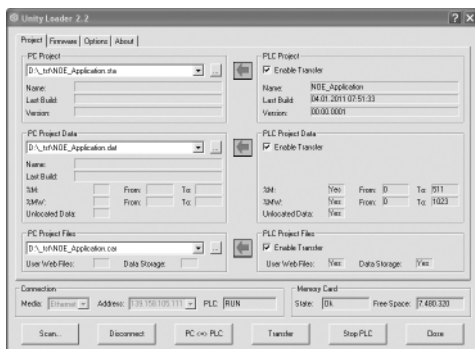

Unity Loader: Project tab

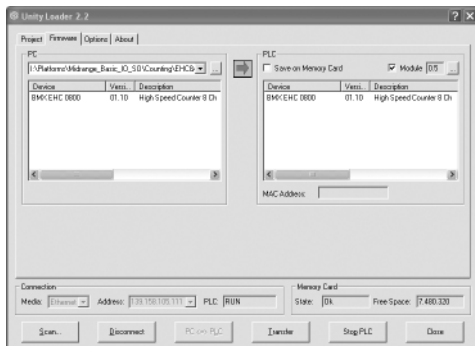

Unity Loader: Firmware tab

6



Unity Loader

Communication between the PC and the PLC

Unity Loader supports the following PC-PLC communications:

- Quantum Unity Pro PLCs: Modbus communication, transfer of project components only
- Premium Unity Pro PLCs: Unitelway communication, transfer of project components only
- Modicon M340 PLCs and modules: Communication via Ethernet and USB ports, transfer of project components and firmware. See table below.

Reference	Type of module	Ethernet port	USB port
BMX P34 2000	CPU with Modbus		
BMX P34 2010/20103	CPU with CANopen		
BMX P34 2020	CPU with integrated Ethernet port		
BMX P34 2030/20302	Ethernet port		
BMX NOE 0100/0110	Ethernet Modbus/TCP		
BMX AMI/ART/AMO/AMM	Analogue I/O		
BMX EHC 0200/0800	Counter		
BMX MSP 0200	Motion control		

Supported Supported if CPU has integrated Ethernet port

For Ethernet networks, Unity Loader contains a network scanner which can be used to scan a range of network addresses. Once a recognized Modicon M340 PLC has been selected, data transfer operations can be performed.

References

Unity Loader is supplied with Unity Pro Small, Medium, Large and Extra Large. It is also downloadable free of charge from our website www.schneider-electric.com, download section.

Compatibility

Unity Loader is independent of Unity Pro and compatible with all Modicon M340 PLCs, Unity Pro Quantum PLCs via Modbus and Unity Pro Premium PLCs via Unitelway. The program files and PLC data files are compatible between Unity Pro and Unity Loader.

Description	Type	Reference	Weight kg
Unity Loader software	Single licence (1 station)	Software downloadable free of charge from our website www.schneider-electric.com	–



Unity specific Libraries

Presentation

The CONT_CTL process control function block library supplied with Unity Pro software can be supplemented with optional specialized libraries so as to meet specific needs such as:

- Predictive control
- Fuzzy logic controller
- HVAC
- Mass flow calculation

Fuzzy Control Library

This library is used in particular in the water treatment field, for example for controlling chlorine levels in fresh water pools or controlling water levels in high-level reservoirs.

Flow Calculation Library

This library is used in the Oil & Gas field, for measuring the gas flow in compliance with the *American Gas Association (AGA)* standard. This version of the library includes the AGA3, AGA7 and AGA8 function blocks.

TeSys Library

This library was developed by the PCP department and provides function blocks for TeSys T and TeSys U starter-controllers for M340 and Premium platforms. It includes function blocks and a help function for Unity Pro.

Predictive Control Library

This library is used for predictive control of process applications. Originally developed for reactors, predictive control can be used in other industrial sectors. Schneider Electric's *Companion Unity & Libraries* team works in partnership with the French company *Sherpa Engineering*, who specialize in predictive control consultancy services.

Heating Ventilation & Air Conditioning Library

This library is used in the HVAC field and deals with repetitive temperature control and humidity problems using ventilation equipment.

Software

Unity Pro software

Specific libraries



Unity specific Libraries

Specific libraries depending on the software used

Specific libraries depending on the software used (see below) can be ordered separately.

Control libraries

Description	Target software	Type	Reference	Weight kg
Predictive Control Library	Unity Pro/Concept	Single licence (1 station)	UNY LPC ZAU CD10	–
Fuzzy Library	Unity Pro		UNY LFZ ZAU WB12	–
TeSys Library			UNY LTS ZAU WB10	–
Heating Ventilation & Air Conditioning Library			UNY LHV ZAU WB10	–
Flow Calculation Library			UNY LAG ZAU WB20	–

System libraries

Description	Target software	Type	Reference	Weight kg
Enhanced Process Library (1)	UAG	Single licence (1 station)	UAG SBT CFU CD10	–
Devices and Process Library (1)			UAG SBT DFU WB13	–

(1) Compatible with Unity Pro V5.0 max. For Unity Pro \geq V6.0, please consult our Customer Care Centre.



UAG

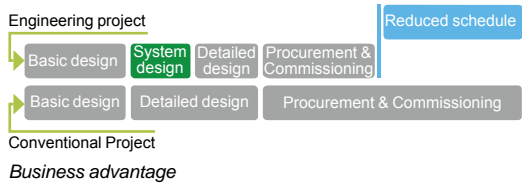

Business advantage

Advanced design tool for automation solutions (1)

Deliver your automation projects faster and re-use your know how! Unity Application Generator (UAG) is an advanced design and generation software tool that integrates multiple PLCs and HMI/SCADA systems to provide an automation solution similar to a distributed control system. Using an approach based upon reusable objects (application libraries) and automatic application generation, UAG ensures consistent design and implementation of user-defined standards and specifications. Featuring change tracking and automatic documentation functions, UAG supports standards such as ISA-88 and GAMP.

Business advantage

UAG provides significant business advantages in terms of cost reduction, quality and performance improvement.

- **Cost**
 - Savings in system implementation cost
 - Improved time-to-market for the end user by allowing the project
 - Quicker return on investment
- **Quality**
 - Improved software quality,
 - Improved maintainability
 - Reduced risk and improved project schedules
- **Performance**
 - Standardized design and systematic improvement
 - Capture and re-use of your best practices
 - Integrated automation system design in your plant engineering workflow

Working efficiently

UAG provides the key features for an advanced automation solution to increase efficiency and share and re-use your know-how.



Working efficiently

Structured project design - bridge from the process engineer to the control/ automation designer (from the PID to the automation system). It is possible to capture and re-use the customer's best practices within **application specific libraries** which reduces the dependency on experts, allows standardization and increases software robustness. **Single database** entry avoids duplicate effort and resulting errors. **Automatic application generation**, including the **automatic configuration of networks** in multi device systems increases efficiency, improves software quality and shortens setup times while simultaneously **reducing project risk**. Integrated **change tracking** and **automatic documentation generation** reduces engineering effort and enables system validation.

Advanced automation platform

UAG integrates best in class products from Schneider Electric and leading partners into an advanced automation platform based on standards, including: ISA-88, GAMP and IEC 61131-3. Single data point entry and management integrates the process control, monitoring and supervision and ensures data consistency and integrated communication between all devices.

Applications (1)

- **Methodology:** UAG allows you to capture and re-use your know-how. Through automatic generation, the project information is propagated to all applications consistently, easily and quickly.
- **Creating user libraries:** libraries are based on re-usable control devices – Smart Control Devices (SCoDs).
- **High level objects (template types) consisting of multiple SCoDs:** template types allow you to pre-define complex objects, e.g. a PID or a sequence, which consist of multiple SCoDs. A common graphic symbol can also be defined. This makes instantiation more efficient as the number of individual steps can be reduced by using the type definition.
- **Structuring your project:** a structured project design provides a bridge from the process engineer to the control automation designer (from the PID to the automation system) based on the ISA-88 standard. The PID drawing is mapped to the physical model in UAG.

(1) For more technical information, please consult our website www.schneider-electric.com.



Standards

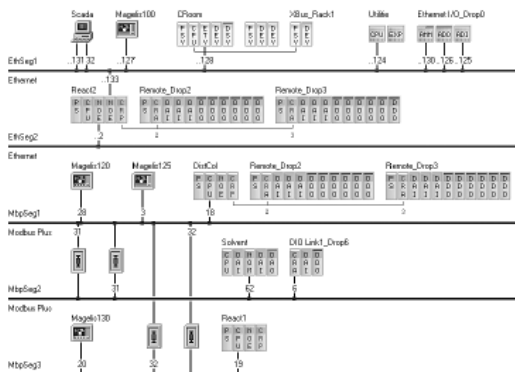

Multi-station automation configuration

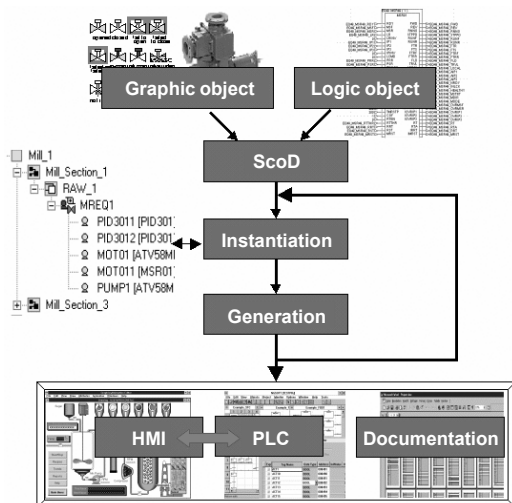

Generating the application



UAG

Applications (continued) (1)

- **Multi-station automation configuration:** the entire process control, monitoring and supervision topology of the distributed automation system is managed within UAG.
- **Generating the application:** the automation solution is generated based on the structured design and your standards contained within the pre-qualified UAG library, ensuring consistent information for the PLCs and the HMI/SCADA. The use of resources (addresses, name space, etc.) is optimized to avoid conflicts and errors. UAG can generate complete projects, as well as **incremental changes** when modifications occur.
- **Validation:** UAG simplifies validation when required by regulation or to comply with GAMP (Good Automation Manufacturing Practice). UAG uses ISA 88 standard terminology for batch control and supports the GAMP methodology for creating an automation system.
- **Process Application Library for Vijeo Citect:** the Process Application Library for Vijeo Citect is shipped together with the UAG CD and can be installed from there. A separate order is not necessary; simply complete the registration details during installation.
- **Device and Process Library:** the Device and Process Library is shipped together with the UAG CD and can be installed from there. A separate order is not necessary; simply complete the registration details during installation.

Segment/Application-specific libraries

A number of more specialized libraries have been developed to provide a more complete starting point for certain projects, such as:

- Water & Wastewater
- Mining, Minerals, Metals
- etc.

Supported platforms and environment

- **Supported platforms**
 - PLC software: Unity Pro ≥ V4.1
 - PLC hardware: M340, Premium and Quantum
 - M340 I/O, Premium I/O, Quantum I/O and Modicon I/O
 - Modbus TCP and Modbus Plus
 - Fieldbus support
 - Advantys STB configuration and debugging software ≥ V4.7
- **HMI/SCADA**
 - Vijeo Citect ≥ V6.1
 - Wonderware Archestra V3.0
 - OPC data server software (OFS)
 - Other HMI/SCADA via the UAG "Plug-In" interface
- **Export of information for other devices/applications**
 - XML export file
 - CSV export file
- **Environment:** Compatible with Microsoft Windows® 7 Professional (2), Windows® Vista Business and Windows® XP Professional operating systems

References (1)

Description	License type	Reference	Weight kg
UAG software suites (3) Comprising:	Single (1 station)	UAG SEW LFU CD33	–
■ UAG (Unity Application Generator) software in English, French, German, ■ Documentation (electronic format)	Site (> 10 stations)	UAG SEW LFF CD33	–

(1) For more technical information, please consult our website www.schneider-electric.com.

(2) Please contact our Customer Care Centre.

(3) The PLC/SCADA programming tools and/or communication driver must be ordered separately.

The two Unity Pro process control offers

User-definable control loops

The user-definable control loop offer is integrated as standard in Premium **TSX 57 2●/3●/4●/5●/6●** platforms with Unity Pro Medium, Large, Extra Large and XL Safety software.

This offer is identical to that offered with PL7 Junior/Pro, except for the runtime screens.

See pages 6/33 to 6/37.

Programmable control loops

The process control offer for Premium **TSX 57 4●/5●/6●** platforms with Unity Pro Medium, Large, Extra Large and XL Safety has been enhanced with the new programmable offer.

This offer is based around the EF and EFB library specific to process control. More than 30 blocks are available, classified in 6 families:

- EFBs for data preparation (for example, DTIME, INTEGRATOR, SCALING, etc.)
- Controller EFBs (for example, AUTOTUNE, PIDFF, SAMPLETM, etc.)
- Mathematical EFs (for example, COMP_DB, MULTIV_M, SUM_W, etc.)
- Process value processing EFs/EFBs (for example, LOOKUP_TABLR1, HYST_●●●, AVGMV, etc.)
- Output value processing EFBs (for example, PWM1, SERVO, etc.)
- Reference value processing EFBs (RAMP, RATIO, SP8SEL)

These blocks manage operating modes such as tracking, manual/automatic mode and process control algorithms on cyclic values (intervals between two consecutive sampling operations).

See pages 6/14 and 6/15.

User-definable process control

The process control offer integrated as standard in Premium platforms can be used to set up and debug machine control-oriented control loops in Unity Pro Medium, Large, Extra Large and XL Safety.

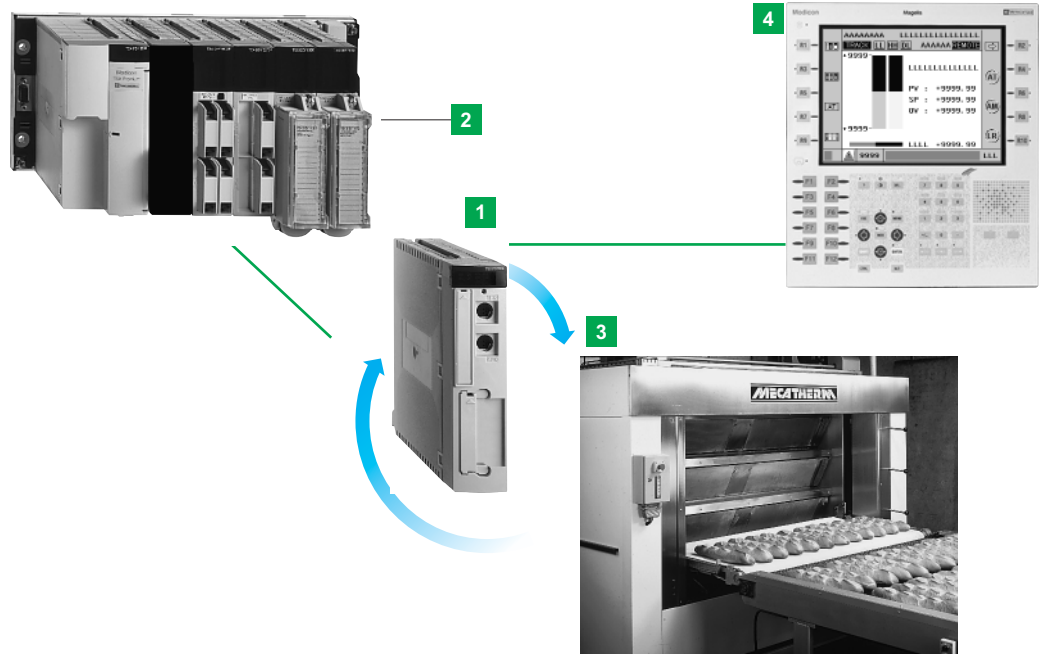

User-definable process control functions

Premium TSX P57 2●4M/2634M/3●4M/3634M/454M/4634M/554M/5634M/6634M processors make it possible, depending on the model, to manage between 10 to 30 process control channels (of 3 loops each).

These channels can be configured to execute algorithms for industrial processes:

- Cascaded loop
- Process loop
- Autoselective loop
- Setpoint programmer
- Controller with three simple loops

Inputs/Outputs

Premium TSX P57 2●4M/2634M/3●4M/3634M/454M/4634M/554M/5634M/6634M processors manage an entire station consisting of racks connected on Bus X.

The I/O interfaces required for process control processing operations are analog or discrete channels in:

- In-rack I/O modules
- Modicon OTB, STB or Momentum distributed I/O modules

Control loops

Software setup of the control loops is user-definable (Plug and Play technology) during configuration of the Premium processor.

The user enters information in the predefined loop diagrams which also integrate management of operating modes and the link with the I/O.

Presentation (continued)

Premium **TSX P57 2●4M/2634M/3●4M/3634M/454M/4634M/554M/5634M/6634M** processors offer the possibility of configuring 10, 15, 20 or 30 control channels for continuous or semi-continuous processes.

The process control functions offered by these processors are particularly suitable for:

- Sequential processes requiring auxiliary process control functions such as packaging machines, surface treatment machines, presses, etc.
- Simple processes such as metal treatment furnaces, ceramic ovens, refrigeration units
- Servocontrol systems or mechanical process control where the sampling time is critical, such as torque control, speed control, etc.

Premium processors include the following characteristics:

- Each configurable process control channel can be used to manage 1 to 3 loops depending on the type of loop selected
- Process control processes can be inserted in the overall architecture of a site, thanks to the integration of the PLC in different communication networks
- Process control-related calculations are performed in floating point arithmetic expressed in physical units

Description and characteristics: TSX P57 ●●4/●●34M processors (see pages 1/6 to 1/11).

Functions

User-definable control loops

Premium processors can be used to set up 10 to 30 process control channels, each adopting one of the following 5 control profiles:

- Process-type loop: Loop with a single controller
- Controller with 3 simple loops: Controller used to increase the capacity of the number of loops
- Autoselective loop, also called secondary loop: Consisting of 2 loops in parallel with an algorithm for selecting the output
- Cascaded loop: Consists of 2 dependent loops (the master loop output is the slave loop setpoint)
- Setpoint programmer: Consisting of a maximum of 6 composite profiles, with a total of 48 segments

As the channels are independent, configuration of 10 channels can be used for example to obtain:

- 30 simple loops
- 5 setpoint programmers, each associated with 5 control loops
- 2 setpoint programmers and 8 process loops

The various loops are characterized by:

- Their different algorithms
- 5 processing branches (process value, setpoint, Feed Forward, controller and output processing)
- Calculation functions (gain, filtering, square root, etc.) defined using parameters

Types of control loop

Predefined algorithms can be defined by the user and are represented as shown below:

Process loop

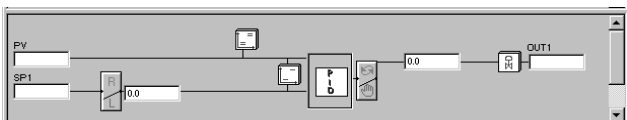

Simple loop



Autoselective loop

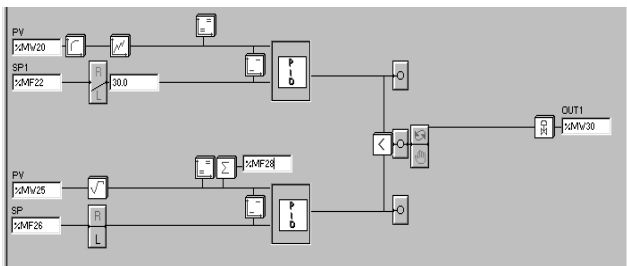

Cascaded loop

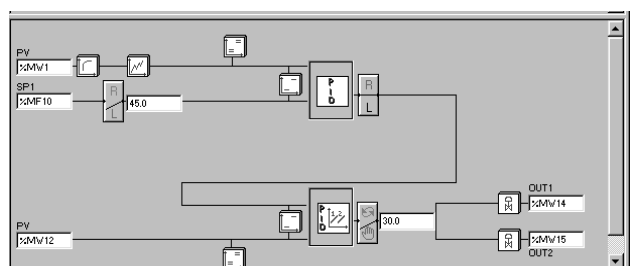

Processing branches

Parameter-setting (selection of the functions to be used) of the control loop profiles can be used to adapt the algorithm to the process to be controlled.

Process value processing

Process values can be processed either in the standard way or externally.

- **Standard processing:** The user can access the following functions: Filtering, setting process value limits, function generator with scaling, management of alarms on threshold overshoot, totalizer and simulation of the measured value.
- **External processing:** This means there can be a process value PV at the controller input which has been processed outside the control loop. This is a handy solution if calculation of the process value requires special or customized functions.

Setpoint processing

Depending on the type of loop selected, it is possible to opt for one of the following 4 types of setpoint: Ratio setpoint, selection setpoint, simple setpoint ("remote" with scaling) or setpoint programmer.

In the case of the controller with 3 simple loops or the secondary loop (in an autoselective loop), only the simple setpoint and the setpoint programmer can be used.

Feed Forward processing

Feed Forward processing can be used to compensate for a measurable disturbance as soon as it appears. This open loop processing anticipates the effect of the disturbance. It features the "Leading" function (lead/lag phase).

Controller and command processing

The controller can be chosen from the following 6 types: Self-tuning PID, controller in discrete mode with 2 or 3 states, hot/cool controller (PID or self-tuning model) or Split Range controller (PID or self-tuning model).

Output processing

There are 3 types of output which can be processed: Analog output, servomotor output or PWM output. Whatever the type of output, the command calculated by the controller crosses a gradient limiter and a limiter whose upper and lower limits are used to define the output variation range.

Setpoint programmer

The setpoint programmer offers a maximum of 6 profiles consisting of a total of 48 segments. It is thus possible to create various programmer/segment configurations, e.g. one programmer with 48 segments, 6 programmers with 8 segments or one programmer with 24 segments plus one programmer with 16 segments and one programmer with 8 segments, etc.

Each segment is configured as either a ramp or dwell step. It is characterized by:

- The setpoint to be reached
- The duration of the segment or slope of the segment (if it is a ramp)

A profile can be executed once, a certain number of times or looped continuously. In addition, the concept of a guaranteed dwell step means the time is only counted down if the measurement is definitely within the specified range.

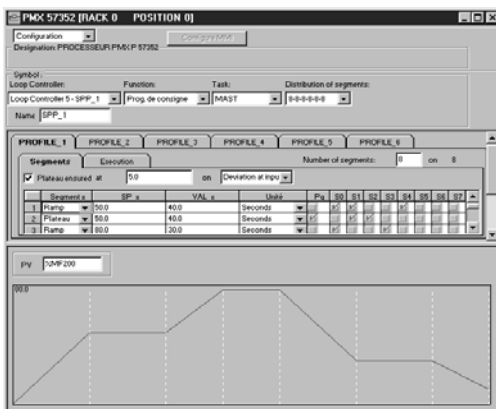

Configuring process control channels

Special screens, accessible using Unity Pro software, can be used to configure control loops.

Configuring process control channels:

The "Loops" interface in Premium processors simplifies configuration by offering simple selections from menus:

- The type of loop from 5 options
- The choice of functions used in the 5 processing branches
- The parameters linked to each of the functions
- The assignment of PLC variables to the different loop branches (memory words, input words or output words depending on the processing branch)
- Automatic presymbolization of the variables used in loops

When configuring process, simple, autoselective and cascaded loops, default parameter settings are offered. The various functions integrated in the algorithms (square root, function generator, etc.) and the initial value of each parameter are predefined.

Example: Configuring a process loop

Once the type of loop has been chosen, its parameters can be set by selecting or deselecting the options in the processing branches. No programming is therefore necessary, the loop diagrams are enhanced or simplified as and when the parameters are validated.

Opposite, selecting the PID controller enables display of the various valid parameters for this type of controller (KP, TI, TD, etc.).

In the case of the setpoint programmer, the different profiles (6 maximum) are configured via a table defining each segment.

After selecting the type of segment (ramp or dwell step), its configuration consists of defining the setpoint to be reached (with the ramp) and the duration (for the ramp or dwell step).

As selections are made, the bottom of the screen displays the profile with the setpoint limit values.

This screen can also be used to define the cycles for this profile: Execution once, a certain number of times or looped continuously (32,767 times maximum).

Executing process control channels

The sampling period for the loops is predefined at 300 ms. This defines the controller processing period in automatic mode. It is possible to modify this period in the loop configuration screen.

All the I/O and the parameters of the various configured process control channels can be accessed by the user at program level or via the various Unity Pro software tools (especially language editors and animation tables).

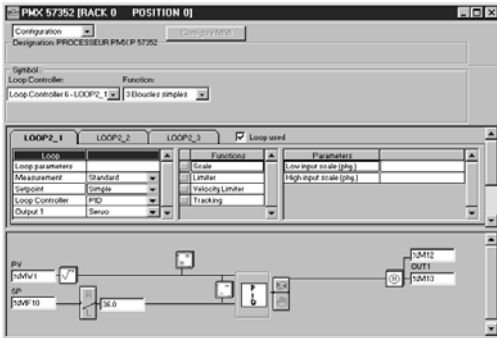

Configuring process control channels

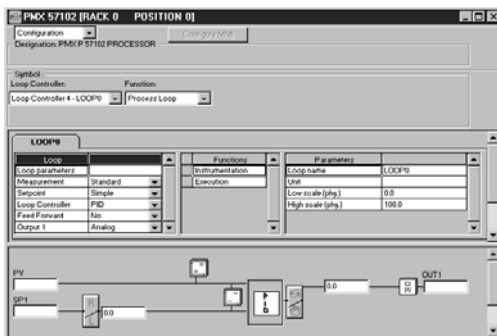

Configuring a process loop

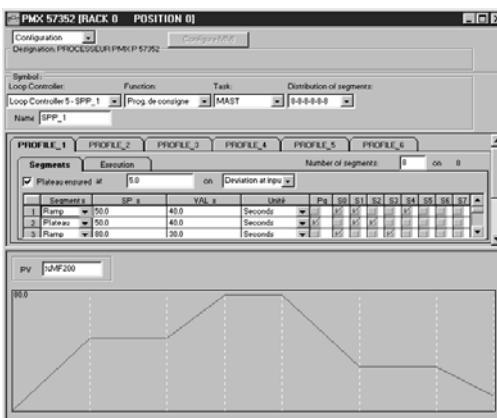

Defining profile cycles

Debugging functions

Adjusting and debugging control loops is simple and user-friendly via, for example, the application-specific loop configuration screen which, in online mode, provides access to the following functions:

- Display and animation of the loop algorithm diagram
- Display of process alarms and channel faults
- Simulation of the input interface values: For example when these are not connected (measurement, Feed Forward)
- Addition, deletion or replacement of calculation functions in online mode
- Modification of the adjustment parameters for each of the functions
- Modification of the controller operating modes and manual control mode

With the controllers integrated in the control loops, it is possible to use the autotuning function which calculates a set of adjustment parameters (Kp, Ti, Td or Ks, T1, T-delay) on request.

Once the loop has been debugged, it is possible to save the current values resulting from the tests in the initial loop parameters values. This means that on restarting the loop, it will start off with the correct values.

Debugging a loop

The debug screen can be used to:

- Display the values of the variables linked to the loop in real time
- Know which parameters have been selected (and even modify them)
- Display alarms

The menus can be used for manual control of the loop, autotuning, parameter backup, etc.

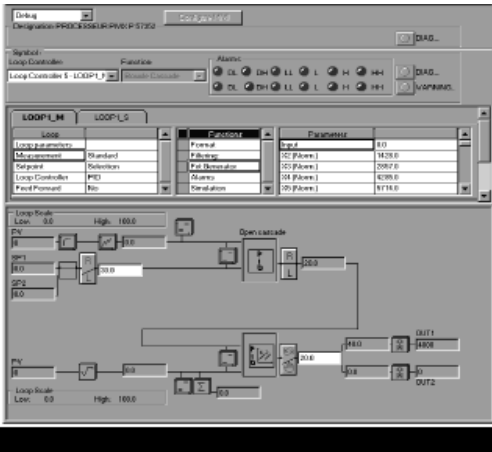

Debugging a loop

Debugging the setpoint programmer

The setpoint programmer channels have their own debug screen which can be used to display:

- The number of the active segment and the iteration
- The execution time for the active segment
- The overall execution time

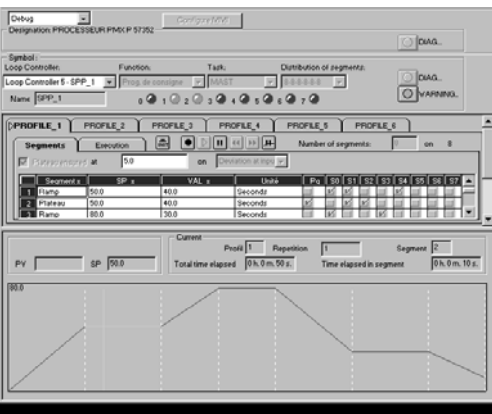

Debugging the setpoint programmer

PL7 programming software for Modicon TSX Micro M and Premium P platforms

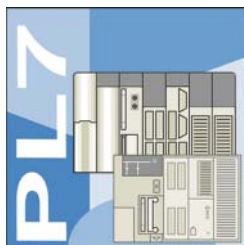

6

Languages	Instruction List (IL)	M	P - M	
	Ladder (LD)	M	P - M	
	Structured Text (ST)	M	P - M	
	Grafcet (SFC)	M	P - M	
	Grafcet with macro-steps (SFC)		P	
Programming services	Multitask programming (Master, fast and event-triggered)	M	P - M	
	Functional view and function modules		P	
	DFB editor		P	
	Use of DFB instances		P	
	EF libraries	M	P - M	
	Configurable control loops	M	P - M	
	User-definable control loops		P (TSX P57 2●/3●/4●)	
	Warm Standby PLC redundancy system		P (TSX P57 253/353/453M)	
	System diagnostics	M	P - M	
	Application diagnostics		P - M	
Debugging and display services	Step-by-step execution, breakpoint	M	P - M	
	Operator screens		P - M	
	Diagnostics viewers		P - M	
Other services	PL7-2 application converters	M	P - M	
	PL7-3 and Orphee application converters		P - M	
	Utilities for updating PLC operating systems	M	P - M	
	Communication drivers for Windows 2000, XP, Vista and 7 (all 32-bit)	M	P - M	
Compatible Modicon platforms	Premium processors P	–	TSX P57 1● TSX P57 2● TSX P57 3● TSX P57 4●	TSX P57 1● TSX P57 2● TSX P57 3● TSX P57 4●
	TSX Micro PLCs M	TSX 37 05/08/10/21/22	TSX 37 05/08/10/21/22	TSX 37 05/08/10/21/22
Software name	PL7 Micro	PL7 Junior	PL7 Pro	
PL7 software type	TLX CD● PL7M ●45M	TLX CD● PL7J ●45M	TLX CD● PL7P ●45P	
Pages	6/42			



EF development software in C language	Comparison of PL7 applications
--	---------------------------------------

<p>Enhancement of EF libraries:</p> <ul style="list-style-type: none"> <input type="checkbox"/> Creation of families <input type="checkbox"/> Development of functions in C language <input type="checkbox"/> Access to mathematical calculation functions in floating point format <input type="checkbox"/> Debugging functions (step-by-step, breakpoint) <input type="checkbox"/> Use of functions created in all languages <p>Supplied with Microsoft Visual C++</p>	<p>Automatic comparison of 2 TSX Micro or Premium applications with identification of all differences.</p> <p>Requires PL7 Pro software</p>
---	---

<p>Compatible with:</p> <ul style="list-style-type: none"> <input type="checkbox"/> PL7 Micro/Junior/Pro <input type="checkbox"/> All TSX Micro/Premium processors 	<p>Compatible with:</p> <ul style="list-style-type: none"> <input type="checkbox"/> PL7 Pro <input type="checkbox"/> All TSX Micro/Premium processors
--	---

SDKC	PL7 DIF
TLX SDKC PL7 41M	TLX CD PL7 DIF 42

6/44

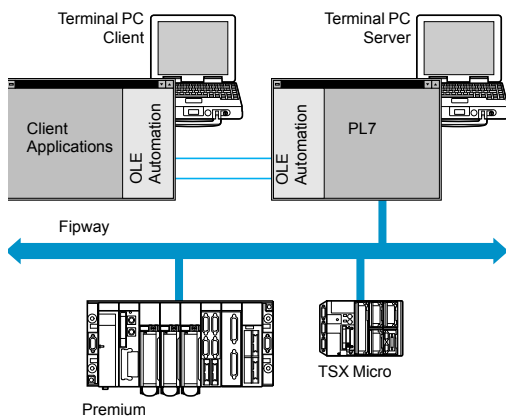
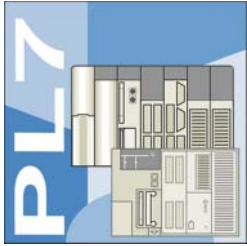

Operation in application server mode

Presentation

PL7 Micro/Junior/Pro software is designed for Windows 2000, XP, Vista and 7 (all 32-bit) operating systems (1) and, therefore, benefits from all the facilities associated with these operating systems.

The main functions of PL7 software are:

- User-friendliness and productive using contextual menus, context-sensitive help, info balloons, etc.
- Multi-instance, enabling several applications to be worked on simultaneously
- Management of access rights, for limiting and controlling the use of the various PL7 software functions
- Application server. The PL7 Pro software can be launched in OLE Automation server mode from a third-party client application. In this case, certain functions of the PL7 software can be executed following commands sent by an OLE client application

The main functions compared to the previous version V4.4 are:

- Development of the equipment catalogue
- Enhancement of the application data export files (FEF), for better compatibility with the Unity Pro software suite integration

Functions

Four IEC languages

The four graphical or textual languages available in PL7 are used for programming Modicon Premium and TSX Micro automation platforms.

The two graphical languages are:

- Ladder (LD)
- Sequential Function Chart (SFC) or Grafcet

The two textual languages are:

- Structured Text (ST)
- Instruction List (IL)

For these 4 languages, you can use the standard set of instructions compliant with IEC standard 61131-3 to create applications, which can be transferred from one platform to another. PL7 software also provides extensions to this standard set of instructions. As they are specific to Modicon Premium and TSX Micro PLCs, these extensions support the development of more complex applications in order to maximize the potential of the specific features of each of these platforms.

User DFB function blocks (only with Premium)

The user can create their own function blocks for specific application requirements, with Premium PLCs, using PL7 Pro software. Once the function blocks have been created in a library, they can be used with PL7 Junior/Pro software.

These user function blocks can be used to structure an application. They are used when a program sequence is repeated several times in the application or for freezing a standard programming routine. They can be exported to all other PL7 applications.

Using a DFB function block in one or more applications:

- Simplifies program design and entry
- Increases program legibility
- Facilitates program debugging (all variables handled by the DFB function block are identified on its interface)
- Enables the use of internal variables specific to the DFBs, which are independent of the application

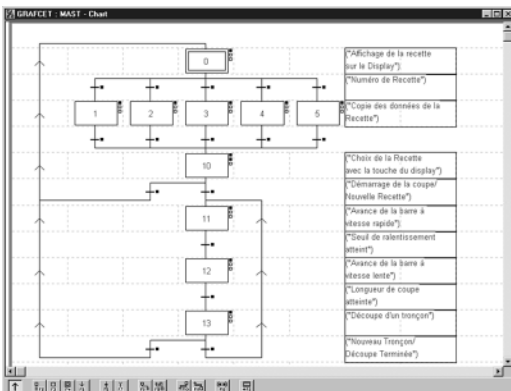

Grafcet SFC language graphic editor

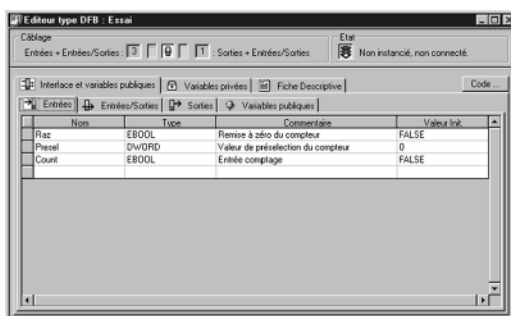

DFB type editor

(1) Compatibility with Windows 95, 98, Millenium and NT4.0 is no longer assured. For information, Windows 95 and Windows NT 4.0 cannot manage USB ports.

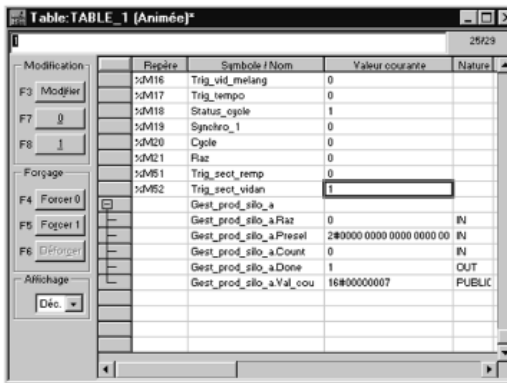

Animation table

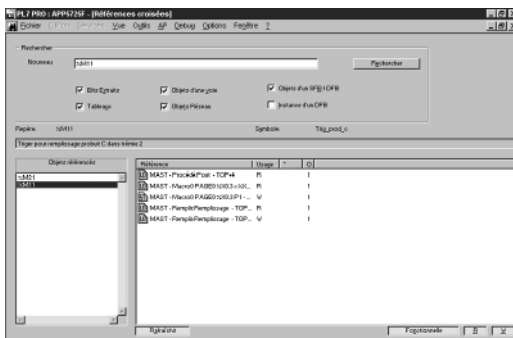

Cross-referencing of variables

Functions (continued)

Debugging tools

PL7 Micro/Junior/Pro software offers a complete set of tools for debugging applications. A tool palette provides direct access to the main functions:

- Setting breakpoints
- Step-by-step program execution
- Independent execution of the master (MAST), fast (FAST) and event-triggered (EVTI) tasks

Other functions available are:

- Animation of program elements when the PLC is in RUN
- Creation of animation tables containing the parameters or variables to be monitored or modified
- Debugging of DFB function blocks via the animation tables
- Debugging of Graficets in online mode
- Debugging of application-specific functions
- Access to general diagnostics of the modules or of each channel (1)

Diagnostics integrated in Modicon Premium platforms

The diagnostics offer for the Premium platform is based on three components:

- System diagnostics
- Diagnostic function blocks (DFBs), for system and application diagnostics
- Error message display system, called viewers, supplied as a standard component of Advanced Panel Magelis XBT G●, Magelis iPC Panel PC/BOX PC with Vijeo Designer/Monitor Pro software and PL7 Pro programming software.

Cross-referencing of variables

For every variable, this function can be used to:

- Search for program modules where this variable is used
- Obtain the list of statements, rungs or expressions
- Display and check activation conditions

Application converters

PL7 Micro/Junior/Pro software includes application converters which enable the reusing of all or part of previous applications written in:

- PL7 2, applications for TSX 17, TSX 27 or TSX 47 10/20/25 PLCs
- PL7 3 (2), applications for TSX/PMX 47...TSX/PMX 107 PLCs
- ORPHEE (2), applications for April Series 1000 PLCs

X-Way communication drivers

Uni-Telway COM port and USB port (PC side) communication drivers are available on the PL7 software CD-ROM.

Depending on the user's needs, other drivers may be necessary. In this case, please consult our website www.schneider-electric.com and download the drivers available.

(1) Using ≥ PL7 software V4.0 extends the system diagnostics of the Premium platform. The system bits and words can be monitored as well as automatic displaying of associated time-stamped messages, without any additional programming. This monitoring is of the system elements (processor, memory, tasks, etc.), "In rack" I/O and remote I/O on Fipio bus.
 (2) Function or feature requiring PL7 Junior/Pro software.

Software

PL7 software

PL7 Micro/Junior/Pro

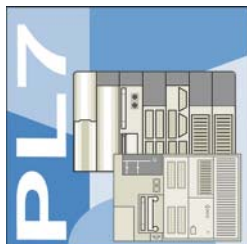

References

PL7 Micro/Junior/Pro are multi-language (English, French, German, Italian and Spanish) software packages designed for PC compatibles ⁽¹⁾ with Windows 2000, XP, Vista or 7 (all 32-bit) operating system.

- For a station, the package comprises:
 - 1 CD-ROM containing the multilingual PL7 software, PL7 demonstration applications and the Uni-Telway terminal link driver
 - 2 CD-ROMs containing multilingual technical documentation
 - 1 CD-ROM containing Service Pack 5
- For 3-station packages, the quantities above are tripled.

Note: The operating systems of Modicon TSX Micro/Premium platforms are available on our website www.schneider-electric.com.

Cables for connection to the PC are to be ordered separately and depend on the desired number of users and the type of link (RS 232 or USB port). See separate parts (page 6/43).

PL7 Micro software packages

PL7 Micro software enables programming in Instruction List, Ladder Diagram, Structured Text and Grafset languages.

It also enables the setting up of application-specific functions, maintenance and diagnostics of the developed applications. It includes the PL7 2 application converter.

Description	For PLCs	Licence type	Reference	Weight kg
PL7 Micro software packages	TSX Micro	Single (1 station)	TLX CD PL7M P45	–
		Group (3 stations)	TLX CD3 PL7M P45	–
PL7 Micro and SyCon V2.10 software packages	TSX Micro	Single (1 station)	TLX CD PL7M PC45	–
Software update for earlier version PL7 Micro software	TSX Micro	Single (1 station)	TLX RCD PL7M P45M	–
		Group (3 stations)	TLX RCD3 PL7M P45M	–
Software update for earlier version PL7 Micro software Supplied with SyCon V2.10	TSX Micro	Single (1 station)	TLX RCD PL7M PC45M	–

PL7 Junior software packages

PL7 Junior software enables programming in Instruction List, Ladder Diagram, Structured Text and Grafset languages.

It also enables the setting up of application-specific functions, maintenance and diagnostics of the developed applications. It includes PL7 2, PL7 3 and ORPHEE application converters.

Description	For PLCs	Licence type	Reference	Weight kg
PL7 Junior software packages	TSX Micro, Premium	Single (1 station)	TLX CD PL7J P45	–
		Group (3 stations)	TLX CD3 PL7J P45	–
Software update for earlier version PL7 Junior software	TSX Micro, Premium	Single (1 station)	TLX RCD PL7J P45M	–
		Group (3 stations)	TLX RCD3 PL7J P45M	–
Software upgrade packages from earlier version PL7 Micro	TSX Micro, Premium	Single (1 station)	TLX UCD PL7J P45M	–

PL7 Pro software packages

PL7 Pro software has identical functions to that of PL7 Junior software. In addition, it allows the user to create their own DFB function blocks and graphic runtime screens.

Description	For PLCs	Licence type	Reference	Weight kg
PL7 Pro software packages	TSX Micro, Premium	Single (1 station)	TLX CD PL7P P45	–
		Group (3 stations)	TLX CD3 PL7P P45	–
Software update for earlier version PL7 Pro software	TSX Micro, Premium	Single (1 station)	TLX RCD PL7P P45M	–
		Group (3 stations)	TLX RCD3 PL7P P45M	–
Software upgrade packages from earlier version PL7 Junior	TSX Micro, Premium	Single (1 station)	TLX UCD PL7P P45M	–

⁽¹⁾ The configuration of the PC must correspond to the reference and version of the Windows operating system installed.
Note: The PC must have a CD-ROM drive.

Software

PL7 software

PL7 Micro/Junior/Pro

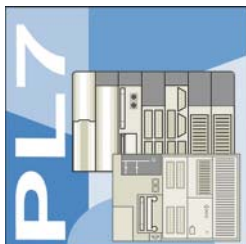

References (continued)

PL7 Micro/Pro software licences

Description	For PLCs	Licence type	Reference	Weight kg
PL7 Micro Open Team software licence	TSX Micro	Team (10 stations) (1)	TLX OT PL7M P45M	–
PL7 Pro Open Team software licence	TSX Micro, Premium	Team (10 stations) (1)	TLX OT PL7P P45M	–
PL7 Pro Open Site software licence	TSX Micro, Premium	Site (>10 stations) (1)	TLX OS PL7P P45M	–



TSX PCX 1031

Separate parts

Description	Description	Reference	Weight kg
X-Way drivers package for compatible PC	CD-ROM including X-Way drivers (see page 6/41) Includes multilingual user documentation	TLX CD DRV20M	–

Description	Use	Processor port	To PC port	Length	Reference	Weight kg
Compatible PC connection cables	TSX Micro/Premium	Mini-DIN port	RS 232D (SUB-D 15-way connector)	2.5 m	TSX PCX 1031	0.170
			USB port (USB/RS 485 converter)	0.4 m	TSX CUSB 485 (2)	0.144
			USB port (mini-DIN/RJ45 cable)	2.5 m	TSX CRJMD 25 (2)	0.150



TSX CUSB 485

Description	Use	Reference	Weight kg
Universal Bluetooth® Interface (UBI)	Provides Bluetooth® connectivity for products such as the Modicon M340/Premium platforms and Altivar/Lexium servo drives, via their serial port (RS 485). Used for setting up and maintenance of products. Designed for permanent installation and can be safely fitted on the inside or outside of electrical enclosures.	TCS WAAC 13FB	0.320



TCS WAAC 13FB

The kit comprises:

- A Universal Bluetooth® interface (UBI)
- An RJ45/mini-DIN cable (length 1 m)
- An RJ45/RJ45 cable (length 1 m)
- A fixing clamp for installation inside the electrical enclosure
- A CD with configuration software and user manual

(1) Team user workstations located on the same site.

(2) The TSX CUSB 485 converter requires the use of the TSX CRJMD 25 cordset (equipped with 2 connectors, 1 x mini-DIN and 1 x RJ45).

Software

PL7 software

SDKC procedure creation software

PL7 DIF application comparison software

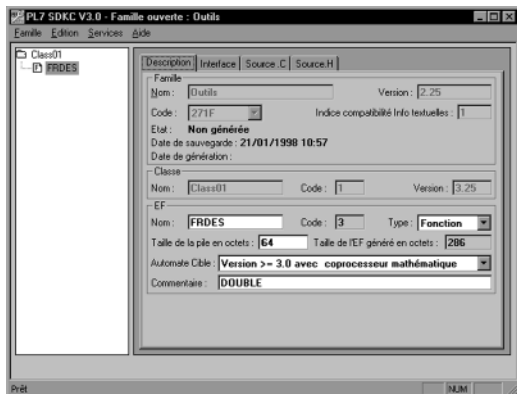

Optional PL7 SDKC software

PL7 SDKC procedure creation software

Presentation

C language function development software, also called SDKC, is a PL7 Micro/Junior/Pro software option. It enables new functions to be developed (internal code written in C language) and extends and completes the standard set of functions offered by PL7 software.

SDKC software also integrates a creation and management service for families of functions, so they can be integrated in the PL7 library.

Finally, it can be used to generate the function which ensures the protection of PL7 applications by reading a signature in the PCMCIA card inserted in the PLC.

This software extension can be used to extend the standard functions offered by PL7 Micro/Junior/Pro software \geq version V4.

The Microsoft Visual C++ software pack registration card is included with this software.

References

Description	Target PLC extension	Reference	Weight kg
PL7 SDKC software extension	PL7 Micro/Junior/Pro TSX Micro/Premium	TLX L SDKC PL7 41M	0.230

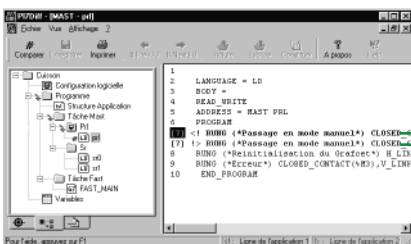

Optional PL7 DIF software

Detection of difference example:

1: Line [7] of application 1 displayed in blue

2: Line [7] of application 2 displayed in red

PL7 DIF application comparison software

Presentation

PL7 DIF application comparison software for TSX Micro/Premium platforms is an optional program which complements the PL7 Pro programming software.

It is used to compare two PL7 applications generated by PL7 Pro version \geq V4 and automatically provide an exhaustive list of all the differences between them.

The PL7 DIF software increases productivity in the main life phases of a control system based on TSX Micro/Premium platforms:

- Application development and debugging
- Starting up installations and processes
- Operation and maintenance of installations and processes

PL7 DIF software is an efficient tool for handling PL7 applications for:

- Automation design offices
- Operation and maintenance managers
- Installers and systems integrators

This software extension can be used to compare two PL7 applications generated by PL7 Pro and designed for Modicon TSX Micro/Premium platforms.

It comprises a CD-ROM with the PL7 DIF software and its documentation (English and French). A software subscription is available for this extension (please consult our Customer Care Centre).

Reference

Description	Target PLC extension	Licence type	Reference	Weight kg
PL7 DIF software extension	PL7 Pro TSX Micro/Premium	1 station	TLX L CD PL7 DIF 42	-

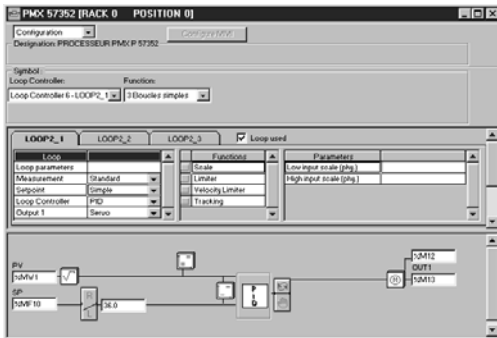

Configuring process control channels

Process control

Presentation

The process control offer integrated as standard in Premium platforms can be used to set up and debug machine control-oriented control loops in PL7 Junior/Pro.

User-definable process control functions

TSX P57 2•3M/2•23M/3•3AM/3623AM/453AM/4823AM processors make it possible, depending on the model, to manage between 10 and 20 process control channels (of 3 loops each).

These channels can be configured to execute algorithms for industrial processes:

- Cascaded, process, autoselective loops
- Setpoint programmer
- Controller with three simple loops

I/O

TSX P57 2•3M/2•23M/3•3AM/3623AM/453AM/4823AM processors manage an entire PLC station comprising racks connected via Bus X.

The I/O interfaces required for process control processing operations are analog or discrete channels in:

- In-rack I/O modules
- TBX, Modicon STB or Momentum distributed I/O modules

Control loops

Software setup of the control loops is user-definable (Plug and Play technology) during configuration of the Premium processor.

The user enters information in the predefined loop diagrams which also integrate management of operating modes and the link with the I/O.

Operator dialogue and control

Magelis operator dialogue terminals have preconfigured screens dedicated to process control which simplify loop operation and control.

These screens show the controller front panels as well as trending views and monitoring views.

Software

Supervisory control and data acquisition software (SCADA)

Vijeo Citect



Vijeo Citect

Presentation



Vijeo Citect™ is the operating and monitoring component of Schneider Electric's PlantStruxure™.

With its powerful display capabilities and its operational features, it delivers actionable insight faster, enabling operators to respond quickly to process disturbances, thereby increasing their efficiency. With its easy-to-use configuration tools and powerful features you can quickly develop and implement solutions for any size application.

Vijeo Citect offers the functions of a modern supervisor. Its distributed client-server architecture is applicable to a multitude of applications in the following markets:

- Oil & Gas
- Mining, Minerals, Metals
- Water & Wastewater
- Power
- Food and beverage

Its flexibility also makes it suitable for numerous other application areas, such as infrastructures.

Redundancy

Vijeo Citect offers total redundancy for all the components of the system. The redundancy functions are fully integrated in the system, providing exceptional performance and intuitive configuration.

Server licence

Vijeo Citect is available:

- In a **Client-Server** architecture, for configurations ranging from 75 points to an unlimited number of points
- In a **stand-alone** version called **Vijeo Citect Lite**, for configurations of 100 to 1200 points (see page 6/50).

Vijeo Citect includes the installation (without registration) of the OFS software, Schneider Electric's integrated OPC server. This server can only be used with Vijeo Citect software.

The OFS software provides access to the structured variables and assists to provide system consistency. This is one of the major benefits of Schneider Electric integration.

Server licences **VJC NS 1011 ●●** are purchased according to the number of points to be processed, not according to the number of I/O (1).

A point expansion offer is also available to increase the number of:

- Client points: **VJC NS 1020 ●●-●●**
- Server points: **VJC NS 1011 ●●-●●**

as required (2).

(1) Vijeo Citect counts all the variables exchanged with external devices, such as PLCs.
 (2) If the server or client is upgraded, the keys must be reprogrammed.

Software

Supervisory control and data acquisition software (SCADA)

Vijeo Citect

Client licences

Four types of Client licence are available:

- **Control Client, VJC NS 1020 ●●**: used by operators accessing the Vijeo Citect server via a local connection
- **View Only Client, VJC NS 1030 ●●**: for users needing to view the Vijeo Citect application via a local connection, but not needing to control the system
- **Web Control Client, VJC NS 1022 ●●**: similar to the Control Client, but via a Web browser
- **Web View Only Client, VJC NS 1032 ●●**: similar to the View Only Client, but via a Web browser.

Static, floating and redundant client licences

A Client licence can be static, floating or redundant depending on requirements:

- **Static Client licence**: For operators needing access to the system at all times, irrespective of the number of connections already established by other clients.

A static Client licence provides permanent access to the system, as it physically resides in the key plugged into the client PC.

- **Floating Client licence**: Users who occasionally need to use a Client for operator tasks can purchase Floating licences. Connections will be allowed until the number of valid licences is reached. Floating Client licences are stored on the key plugged into the server.

- **Redundant Client licence**: Redundant Client licences **VJC NS 10●● 88** are intended solely for the standby server in a redundant configuration. They are used to ensure that the Client licences purchased are available.

Development workshop

The development workshop **VJC 1099 ●●** comprises hardware components such as the DVD, hardware keys, installation guide and storage boxes.

The rules for use are as follows:

- Each server requires a hardware USB key in order to operate
- The server key is also used to store the floating client licences
- The key controls the number of points that can be used
- The key is programmed to operate up to a predetermined version

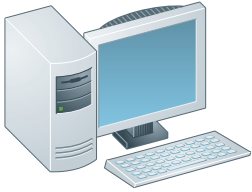

Single-station architecture

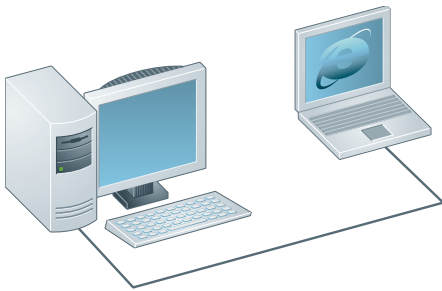

Single-server architecture with Web View Only Client access

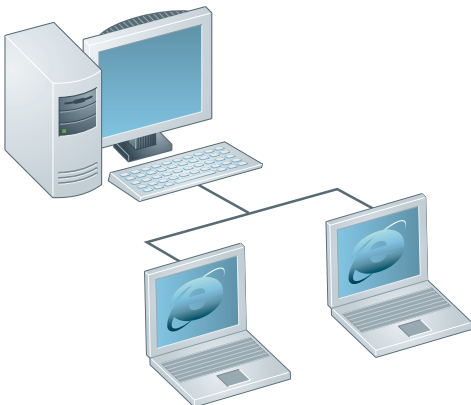

Single-server architecture with 1 Web Control Client and 1 Web View Only Client

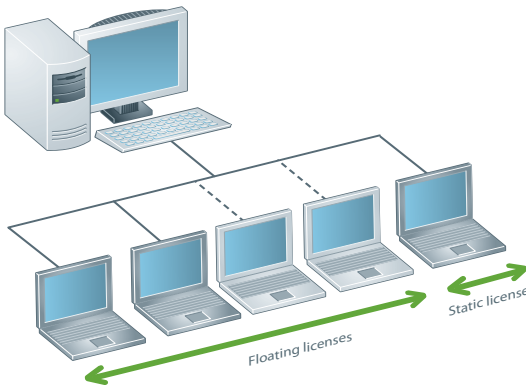

Single-server architecture with 2 floating Control Client licences and 1 static licence

Architectures

Single station stand-alone SCADA system, 5000 points

Development workshop

- 1 x VJC 1099 22, hardware delivery of the DVD with USB key

Server licence

- 1 x VJC NS 1011 14, Server licence for 5000 points, including Control Client licence

Client licence

- Not required (included in the server licence)

Remote Server system with remote access via the Web

Development workshop

- 1 x VJC 1099 22, hardware delivery of the DVD with USB key

Server licence

- 1 x VJCNS 1011 15, Server licence for 15000 points, including Control Client licence

Client licence

- 1 x VJCNS 1032 99, Web View Only Client licence

Networked Server system with remote Web Clients

E.g. Networked Server system, 500 points, with 2 remote Clients via the Web, one Web Control Client and one Web View Only Client

Development workshop

- 1 x VJC 1099 22, hardware delivery of the DVD with USB key

Server licence

- 1 x VJC NS 1011 12, Server licence for 500 points, including Control Client licence

Client licences

- 1 x VJC NS 1022 12, Web Control Client licence for 500 points
- 1 x VJC NS 1032 99, Web View Only Client licence

Networked server system with floating and static access

E.g. Networked server system, 5000 points, with 5 Client PCs and 3 Client licences, 2 of which are floating and 1 static

Development workshop

- 1 x VJC 1099 22, hardware delivery of the DVD with USB key
- 1 x VJC 1099 21, additional USB key for static Client

Server licence

- 1 x VJC NS 1011 14, Server licence for 5000 points, including Control Client licence (local Control Client type on the server PC)

Client licences

- 3 x VJC NS 1020 14, Control Client licences for 5000 points

Software

Supervisory control and data acquisition software (SCADA)

Vijeo Citect

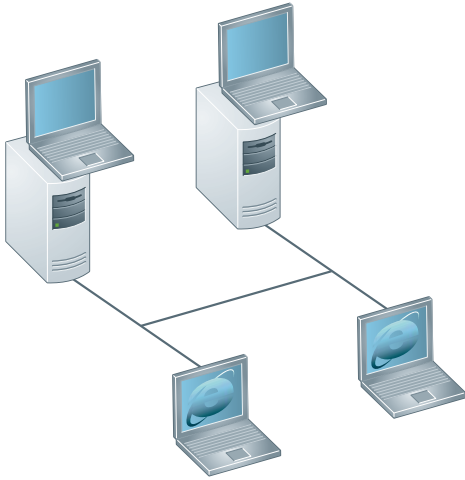

Redundant architecture with 2 Control Clients on servers and 2 Web View Only Clients

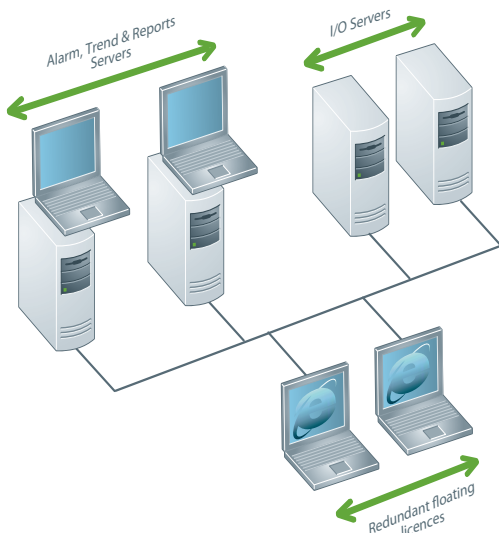

Redundant architecture, separate ATR and I/O Servers, with 2 Server Control Clients and 2 Web View Only Clients

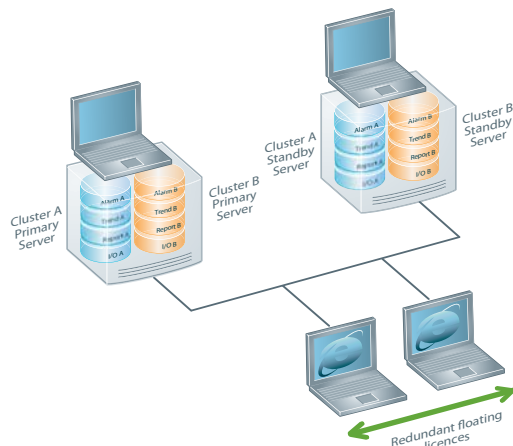

Redundant architecture, 2 clusters with 2 Web View Only Clients

Architectures (continued)

Redundant Server with Server Control Clients and Web View Only Clients

E.g. Redundant server, 1500 Points, with 2 Control Client licences on the servers and 2 Web View Only Client licences

Development workshop

- 1 x VJC 1099 22, hardware delivery of the DVD with USB key (Primary Server key)
 - 1 x VJC 1099 21, additional USB key (Standby Server key)
- (rule: 1 key per Server)

Server licences

- 2 x VJC NS 1011 13, Server licences for 1500 points, including Control Client licences:
 - The first Server acts as the Primary Server
 - The second server acts as the Standby Server
 - One licence is placed on each key (Primary and Standby)

Client licences

- 2 x VJC NS 1032 99, Web View Only Client licences
- Both licences are placed on the Primary Server key

Redundant Client licence

- 2 x VJC NS 1032 88, redundant Web View Only Client licences
- Floating redundant licences for Web View Only Client licences
- Both licences are placed on the Standby Server key

Redundant Alarm, Trend, Reports Servers (1500 points) and redundant I/O Servers (1500 points) with 2 Control Clients and 2 Web View Only Clients

Development workshop

- 1 x VJC 1099 22, hardware delivery of the DVD with USB key (Primary Server key)
- 3 x VJC 1099 21, additional USB keys (one per Server) (Standby Server key)

Server licence

- 4 x VJC NS 1011 13, Server licences for 1500 points, including Control Client licence:
 - Two pairs of redundant Servers: one I/O Server redundant pair, one ATR Server redundant pair
 - The first Server in each pair acts as the Primary Server
 - The second Server acts as the Standby Server
 - One licence is placed on each key (Primary and Standby)

Client licence

- 2 x VJCNS 1032 99, Web View Only Client licences
- Both licences are placed on the ATR Primary Server key

Redundant Client licence

- 2 x VJCNS 1032 88, redundant Web View Only Client licences
- Redundant floating licences for Web View Only Client licences

Redundant Servers (1500 points) with 2 Logical Server Clusters and 2 Web View Only Clients

Development workshop

- 1 x VJC 1099 22, hardware delivery of the DVD with USB key (Primary Server key)
- 1 x VJC 1099 21, additional USB key (one per Server) (Standby Server key)

Server licence

- 2 x VJC NS 1011 13, Server licences for 1500 points, including Control Client licence:
 - One pair of redundant Servers, two clusters on each server
 - The first server contains Cluster A (ATR & I/O Server) and Cluster B (ATR & I/O Server) Primary Servers
 - The second server contains Cluster A and Cluster B Standby Servers
 - One licence is placed on each key (Primary and Standby)

Client licence

- 2 x VJCNS 1032 99, Web View Only Client licences
- Both licences are placed on the ATR Primary Server key

Redundant Client licence

- 2 x VJCNS 1032 88, Redundant Web View Only Client licences
- Redundant floating licences for Web View Only Client licences
- Both licences are placed on the ATR Standby Server key

Software

Supervisory control and data acquisition software (SCADA)

Vijeo Citect



VJC 1099 ●2

Development workshop - Vijeo Citect Box and keys

The **VJC 1099 ●2** Vijeo Citect Box comprises:

- 1 DVD with the Vijeo Citect software
- A Schneider Electric drivers pack
- An installation guide
- A hardware key for USB port

Additional keys are also supplied in the Vijeo Citect Box.

Development workshop - Vijeo Citect Box

Description	Type of key included	Reference	Weight kg
Vijeo Citect Box with USB key	USB	VJC 1099 22	0.410

Additional Vijeo Citect keys

Designation	Target licence	Reference	Weight kg
Additional Vijeo Citect USB key Supplied in Vijeo Citect Box	Redundant Server and static (non-floating) licences	VJC 1099 21	0.200
Vijeo Citect 10 Pack USB keys Supplied in Vijeo Citect Box	Blank keys and not licenced	VJC 1099 20 (1)	1.500

Vijeo Citect Software

Designation	Target licence	Reference	Weight kg
Vijeo Citect Software DVD - 50 Pack	Not licenced	VJC 1099 18	2.200

Vijeo Citect Lite, stand-alone

The Vijeo Citect Lite stand-alone licence is available for 100 to 1200 points.

The Vijeo Citect Lite licence is a simple solution for stand-alone applications.

Lite licenses cannot connect to any third party software or client stations. Further it cannot be made redundant.

Vijeo Citect Lite licence

Designation	Number of points	Reference	Weight kg
Vijeo Citect Lite	100	VJC NS 3011 56	–
Stand-alone: no connectivity	150	VJC NS 3011 11	–
Key to be ordered separately	300	VJC NS 3011 27	–
	600	VJC NS 3011 59	–
	1200	VJC NS 3011 50	–

(1) The 10 Pack Vijeo Citect keys **VCJ 1099 20** is not programmed.



Software

Supervisory control and data acquisition software (SCADA)

Vijeo Citect



Vijeo Citect

Vijeo Citect Lite, stand-alone (continued)

Vijeo Citect Lite Point Expansion

The references below are used for increasing the number of Vijeo Citect Lite points available or to upgrade Lite Server to Full Server.

The licence point count expansion is achieved in steps. For example, if a licence is upgraded from 100 points to 600 points, 3 part numbers will be ordered to upgrade from 100 points to 150 points, 150 points to 300 points and 300 points to 600 points.

Designation	Number of points	Reference	Weight kg
Vijeo Citect Lite Point Expansion (number of points)	100 to 150	VJC NS L56-L11	–
	150 to 300	VJC NS L11-L27	–
	300 to 600	VJC NS L27-L59	–
	500 or 600 to 1200	VJC NS L59-L50	–
Vijeo Citect Lite Point Expansion (Lite server to Full server)	Lite 150 to Full 150	VJC NS L11-F11	–
	Lite 300 to Full 500	VJC NS L27-F12	–
	Lite 600 to Full 1500	VJC NS L59-F13	–
	Lite 1200 to Full 1500	VJC NS L50-F13	–

Vijeo Citect Server

The Vijeo Citect Server full system licences are segmented according to the number of points.

Redundant system

- For a redundant system simply order 2 Vijeo Citect Server licences
- No other option is required for the Servers
- The programmed USB key must be ordered separately

Vijeo Citect Server licence

Designation	Number of points	Reference	Weight kg
Vijeo Citect Server Full version Key to be ordered separately	75	VJC NS 1011 10	–
	150	VJC NS 1011 11	–
	500	VJC NS 1011 12	–
	1500	VJC NS 1011 13	–
	5000	VJC NS 1011 14	–
	15000	VJC NS 1011 15	–
	Unlimited	VJC NS 1011 99	–

Vijeo Citect Server Point Expansion

The references below are used for increasing the number of points on the Server.

The licence point count expansion is achieved in steps. For example, if a licence is upgraded from 75 points to 1500 points, 3 part numbers will be ordered to upgrade from 75 points to 150 points, 150 points to 500 points and 500 points to 1500 points.

Designation	Number of points	Reference	Weight kg
Vijeo Citect Server Point Expansion	75 to 150	VJC NS 1011 10-11	–
	150 to 500	VJC NS 1011 11-12	–
	500 to 1500	VJC NS 1011 12-13	–
	1500 to 5000	VJC NS 1011 13-14	–
	5000 to 15000	VJC NS 1011 14-15	–
	15000 to unlimited	VJC NS 1011 15-99	–

Software

Supervisory control and data acquisition software (SCADA)

Vijeo Citect

Vijeo Citect Control Client

Vijeo Citect Control Client licences are intended for operators. They are segmented according to the number of points to be displayed. There are two types:

- Floating licence, residing on the Server key
- Static licence, requiring a separate key on the client PC.

Redundant system

- The number of floating Clients ordered is added to the Primary Server key
- For the Standby Server, the same number of redundant Control Client licences, **VJC NS 1030 88**, must be ordered

Vijeo Citect Control Client licence			
Designation	Number of points	Reference	Weight kg
Vijeo Citect Control Client licence	75	VJC NS 1020 10	–
	150	VJC NS 1020 11	–
	500	VJC NS 1020 12	–
	1500	VJC NS 1020 13	–
	5000	VJC NS 1020 14	–
	15000	VJC NS 1020 15	–
	Unlimited	VJC NS 1020 99	–
Vijeo Citect redundant Control Client licence	Floating licence only	VJC NS 1020 88	–

Vijeo Citect View Only Client

Vijeo Citect View Only Client licences are available for users who need to view the application, without controlling it. Licenses for these clients are segmented according to the number of points displayed. There are two types:

- Floating licence, residing on the Server key
- Static licence, the hardware key being plugged into the Client station.

Redundant system

- The number of floating Clients ordered is added to the Primary Server key
- For the standby server, the same number of redundant View Only Client licences, **VJC NS 1030 88**, must be ordered

Vijeo Citect View Only Client licence			
Designation	Number of points	Reference	Weight kg
Vijeo Citect View Only Client licence	Unlimited	VJC NS 1030 99	–
Vijeo Citect redundant View Only Client licence	Floating licence only	VJC NS 1030 88	–

Software

Supervisory control and data acquisition software (SCADA)

Vijeo Citect



Vijeo Citect

Vijeo Citect Web Control Client

Vijeo Citect Web Control Client licences are intended for users who need full control of the application but prefer the flexibility of access via a Web connection. These client licences are segmented according to the number of points displayed and must be floating type (residing on the key plugged into the server).

Redundant system

- The number of floating Clients ordered is added to the Primary Server key
- For the Standby Server, the same number of redundant Web Control Client licences, **VJC NS 1030 88**, must be ordered

Vijeo Citect Web Control Client licence

Designation	Number of points	Reference	Weight kg
Vijeo Citect Web Control Client licence	75	VJC NS 1022 10	–
	150	VJC NS 1022 11	–
	500	VJC NS 1022 12	–
	1500	VJC NS 1022 13	–
	5000	VJC NS 1022 14	–
	15000	VJC NS 1022 15	–
	Unlimited	VJC NS 1022 99	–
Vijeo Citect redundant Web Control Client licence	Floating licence only	VJC NS 1022 88	–

Vijeo Citect Web View Only Client

Vijeo Citect Web View Only Client licences are intended for users who need to view the application via a Web connection, without controlling the system. These Client licences are segmented according to the number of points displayed and must be floating type (the licences reside on the key plugged into the Server).

Redundant system

- The number of floating Clients ordered is added to the Primary Server key
- For the Standby Server, the same number of redundant View Only Client licences, **VJC NS 1032 88**, must be ordered

Vijeo Citect Web View Only Client licence

Designation	Number of points	Reference	Weight kg
Vijeo Citect Web View Only Client licence	Unlimited	VJC NS 1032 99	–
Vijeo Citect redundant Web Only Client View licence	Floating licence only	VJC NS 1032 88	–

Software

Supervisory control and data acquisition software (SCADA)

Vijeo Citect

Control Client Point Expansion

The references below are used for increasing the number of points on:

- The Server holding the hardware key, for floating licences
- The Client holding the hardware key, for static licences

The licence point count expansion is achieved in steps. For example, if a licence is upgraded from 75 points to 1500 points, 3 part numbers will be ordered to upgrade from 75 points to 150 points, 150 points to 500 points and 500 points to 1500 points.

Vijeo Citect Control Client Point Expansion

Designation	Number of points	Reference	Weight kg
Vijeo Citect Control Client Point Expansion	75 to 150	VJC NS 1020 10-11	–
	150 to 500	VJC NS 1020 11-12	–
	500 to 1500	VJC NS 1020 12-13	–
	1500 to 5000	VJC NS 1020 13-14	–
	5000 to 15000	VJC NS 1020 14-15	–
	15000 to unlimited	VJC NS 1020 15-99	–

View Only Client Point Expansion

The reference below is used for increasing the number of points on:

- The Server holding the hardware key, for floating licences
- The Client holding the hardware key, for static licences

Vijeo Citect View Only Client Point Expansion

Designation	Number of points	Reference	Weight kg
Vijeo Citect View Only Client Point Expansion	Unlimited	VJC NS 1030 99-99	–

Web Control Client Point Expansion

The references below are used for increasing the number of points on the Server holding the hardware key.

Vijeo Citect Web Control Client Point Expansion

Description	Number of points	Reference	Weight kg
Vijeo Citect Web Control Client Point Expansion	75 to 150	VJC NS 1022 10-11	–
	150 to 500	VJC NS 1022 11-12	–
	500 to 1500	VJC NS 1022 12-13	–
	1500 to 5000	VJC NS 1022 13-14	–
	5000 to 15000	VJC NS 1022 14-15	–
	15000 to unlimited	VJC NS 1022 15-99	–

Web View Only Client Point Expansion

The reference below is used for increasing the number of points on the Server holding the hardware key.

Vijeo Citect Web View Only Client Point Expansion

Designation	Number of points	Reference	Weight kg
Vijeo Citect Web View Only Client Point Expansion	Unlimited	VJC NS 1032 99-99	–

Connections, miscellaneous

The references below are used to expand the connection licences.

Designation	Reference	Weight kg
OPC Server licence	VJC 1041 88	–
CtAPI licence	VJC 1042 88	–

Software

Supervisory control and data acquisition software (SCADA)

Vijeo Citect



Vijeo Citect

Vijeo Citect - Specific drivers

The Vijeo Citect offer includes a large number of drivers as standard. However, for copyright reasons, some drivers have a specific reference and must be ordered separately.

The purchase of a specific driver includes access to the appropriate technical support for the driver for one year.

Designation	Protocol	Reference	Weight kg
Vijeo Citect specific driver	IEC 60870-5-104	VJC NS 3051 41	–
	PSDirect ETH	VJC NS 3051 40	–
	PSDirect MPI	VJC NS 3051 42	–

Note: Before ordering a Vijeo Citect specific driver, please contact our Customer Care Centre.

Reprogramming for a Vijeo Citect licence transfer

Each time a licence has to be transferred from an existing key to another key, transfer fees are applicable and the reference **VJC 1094 01** must be ordered (licence transfer token).

Examples of cases in which these fees are applicable:

- Transfer of a Client licence from a static key to a floating licence on a Server
- Transfer of an existing floating licence to a new static key

These fees are also applicable when transferring licence(s) to a replacement key.

If a new key is required, you must order a new hardware key **VJC 1099 ●●**.

Designation	Reference	Weight kg
Reprogramming for Vijeo Citect licence transfer	VJC 1094 01	–

Driver Development Kit

The driver development kit includes:

- The latest release of Vijeo Citect, example source code, utilities and other Vijeo Citect files required in developing a Citect driver.
- A hardware key that will allow runtime up to 8 hours and is a 42,000 pt. single user licence.
- Access to “Citect Drivers Developers” area on Citect DriverWeb at scadasupport.citect.com/driverweb.

Designation	Reference	Weight kg
Driver Development Kit	VJC 1092 06	–

Software

Supervisory control and data acquisition software (SCADA)

Vijeo Citect

Conversion of third-party applications

Conversion tools help to convert legacy applications (such as Monitor Pro) or other third-party applications to Vijeo Citect. These programs convert the tag database and graphic information to make them compatible with Vijeo Citect :

■ **Page Import** tool is targeted at customers who wish to perform the entire engineering portion of the legacy system migration themselves. The systems integrators are required to perform the engineering themselves.

■ **Basic Sytem Conversion** tool is targeted at customers who want the new system to simply replace the legacy system without major changes. It includes an initial generic engineering component to produce a fully compiled Vijeo Citect project that is ready for Factory Acceptance Tests.

More details of the coverage provided by these conversion tools can be found in our internet site www.schneider-electric.com.

Designation	Legacy System supported	Reference	Weight kg
Basic System Conversion (minimum 10 pages)	Tier 1 (1)	VJC 1090 81	–
	Tier 2 (2)	VJC 1090 82	–
	Tier 3 (3)	VJC 1090 83	–
Page Import (minimum 10 pages)	All Tiers	VJC 1090 88	–

Loan of Vijeo Citect keys (4)

Designation	Content	Reference	Weight kg
Loan of single Vijeo Citect key	- 1 Server licence, unlimited number of points, VJC NS 1011 99 - 1 Scheduler, VJC 9032 88	VJC 1095 11	–
Loan of multiple Vijeo Citect keys	- 1 Server licence, unlimited number of points, VJC NS 1011 99 - 5 Floating Control Client licences, VJC NS1020 99 - 5 Floating View Only Client licences, VJC NS1030 99 - 2 Floating Web Control Client licences, VJC NS1022 99 - 2 Floating Web View Only Client licences, VJCNS1032 99 - 1 Scheduler, VJC 9032 88	VJC 1095 12	–

(1) Tier 1 = FactoryLink 5 to 6.x, MonitorPro 2, Fix32, Genesis32, Cimplicity, Moore APACS, Wonderware 5.x to 9.x.

(2) Tier 2 = iFIX 3.5, Delta V (Fix32 & iFIX 3.5), RSView32 6.4, FactoryLink 7.5, MonitorPro 7.2 & 7.6, VijeoLook 2.6, WinCC 6.0, Wizcon.

(3) Tier 3 = iFIX 4.5, DeltaV (iFIX 4.5), Telvent OASyS DNA / 6.x, Telvent OASyS 5.x, Telvent Vector (RTView & Ovision), Honeywell TDC3000, Vigile.

(4) Available for customers requiring temporary access to a key. The hardware key must be returned at the end of the loan period. Provides eight days' continuous use. Also requires an additional Vijeo Citect Box USB key, **VJC 1099 ●●**, to obtain the hardware key. The quantity corresponds to the number of months of the loan.

Software

Supervisory control and data acquisition software (SCADA)

Vijeo Citect



Vijeo Citect

Vijeo Citect training

Schneider Electric offers a suite of Educational Services designed for end users, engineers, systems integrators and educational establishments. Our courses and programs provide you with hands-on experience, leaving you feeling confident enough to design and configure your own system using Vijeo Citect. Courses include instructor-led, online, self-paced and onsite offerings.

These courses have been developed to assist customers in achieving maximum productivity from using Vijeo Citect.

Training Manuals

Designation	Reference	Weight kg
Vijeo Citect Configuration Training Manual - EN	VJC 1093 10-02-00	–
Vijeo Citect CICODE Training Manual - EN	VJC 1093 20-02-00	–
Vijeo Citect Architecture and Redundancy Training Manual - EN	VJC 1093 30-02-00	–
Vijeo Citect Upgrade Training Manual - EN	VJC 1093 50-02-00	–
Vijeo Citect Customization Training Manual - EN	VJC 1093 70-02-00	–
Vijeo Citect Diagnostics and Troubleshooting Manual - EN	VJC 1093 90-02-00	–

Self-Paced Training Kits

Designation	Reference	Weight kg
Vijeo Citect Configuration SPTK - EN	VJC 1093 10-01-00	–
Vijeo Citect CICODE SPTK - EN	VJC 1093 20-01-00	–
Vijeo Citect Customization SPTK - EN	VJC 1093 70-01-00	–

E-Learning

Designation	Reference	Weight kg
Vijeo Citect SCADA Overview	VJC 3093 31-00-00	–

Exams

Designation	Reference	Weight kg
Vijeo Citect Configuration Exam	VJC 3093 50-00-00	–
Vijeo Citect CICODE Fundamentals Exam	VJC 3093 51-00-00	–
Vijeo Citect Architecture and Redundancy Exam	VJC 3093 52-00-00	–
Vijeo Citect Customization and Design Exam	VJC 3093 53-00-00	–
Vijeo Citect Upgrade Exam	VJC 3093 54-00-00	–
Vijeo Citect Examination Re-sit	VJC 3093 55-00-00	–
Vijeo Citect Diagnostics and Troubleshooting Exam	VJC 3093 56-00-00	–

Academic Agreements

The references below are intended for educational institutions for training students in Vijeo Citect.

Designation	Reference	Weight kg
Vijeo Citect Academic Agreement - 12 months (10 keys) (1)	VJC 3093 17	–
Vijeo Citect Academic Agreement - 12 months renewal (10 keys) (1)	VJC 3093 22	–

(1) Academic Agreements must be included with each order for the logistics team in Sydney to process the order. Any incomplete orders (with no Academic Agreement) will be rejected. This is only for tertiary education institutions. Licenses are valid for 12 months, each agreement must be renewed every year.

Presentation



Vijeo Historian

Vijeo Historian™ is the information management component of Schneider Electric's PlantStruxure™. It comprises of the historian and portal functions of the solution, enabling you to store data accurately for long-term reporting while connecting your production and business systems through its active data transfers and simple, easy-to-use reporting functions.

Vijeo Historian helps your plant and your IT personnel optimize their operational efficiency by providing a powerful enterprise-wide reporting tool that collects, stores and delivers meaningful reporting data from multiple disparate systems.

Comprising of historian and portal functionalities, Vijeo Historian enables you to store data accurately for long-term reporting whilst also giving you the option of displaying and accessing the information via the Vijeo Historian portal, Microsoft (TM) Excel, Microsoft Reporting Services or Microsoft Report Builder 3.0.

Visualization

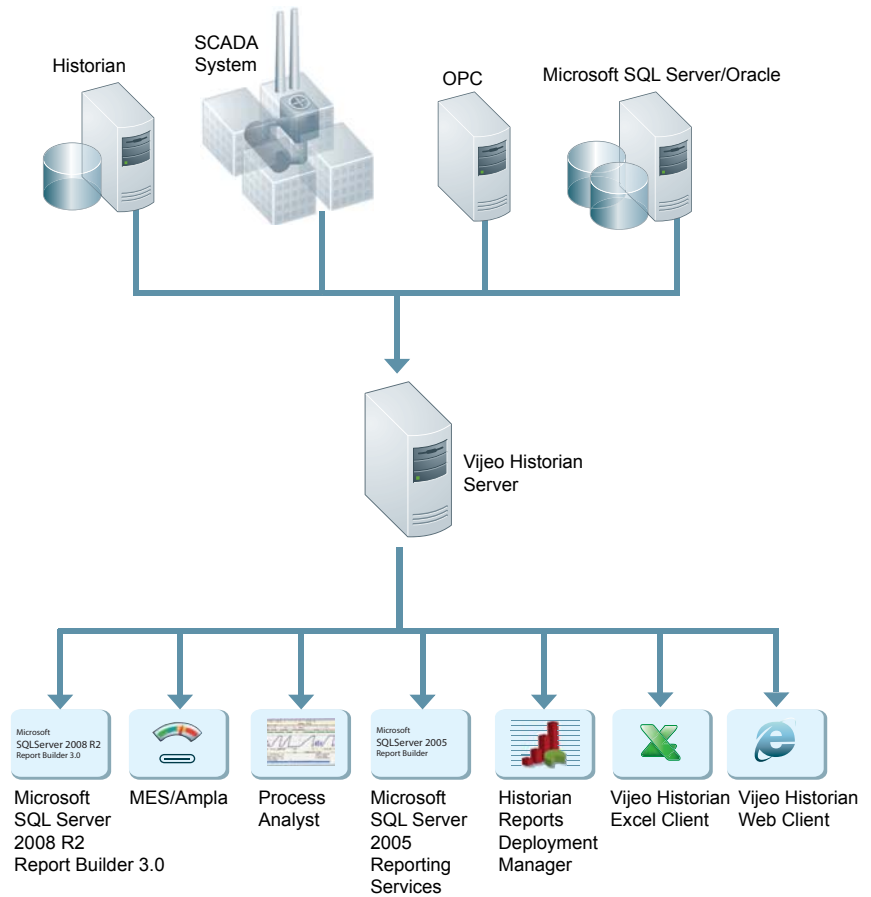

6

Vijeo Historian architecture

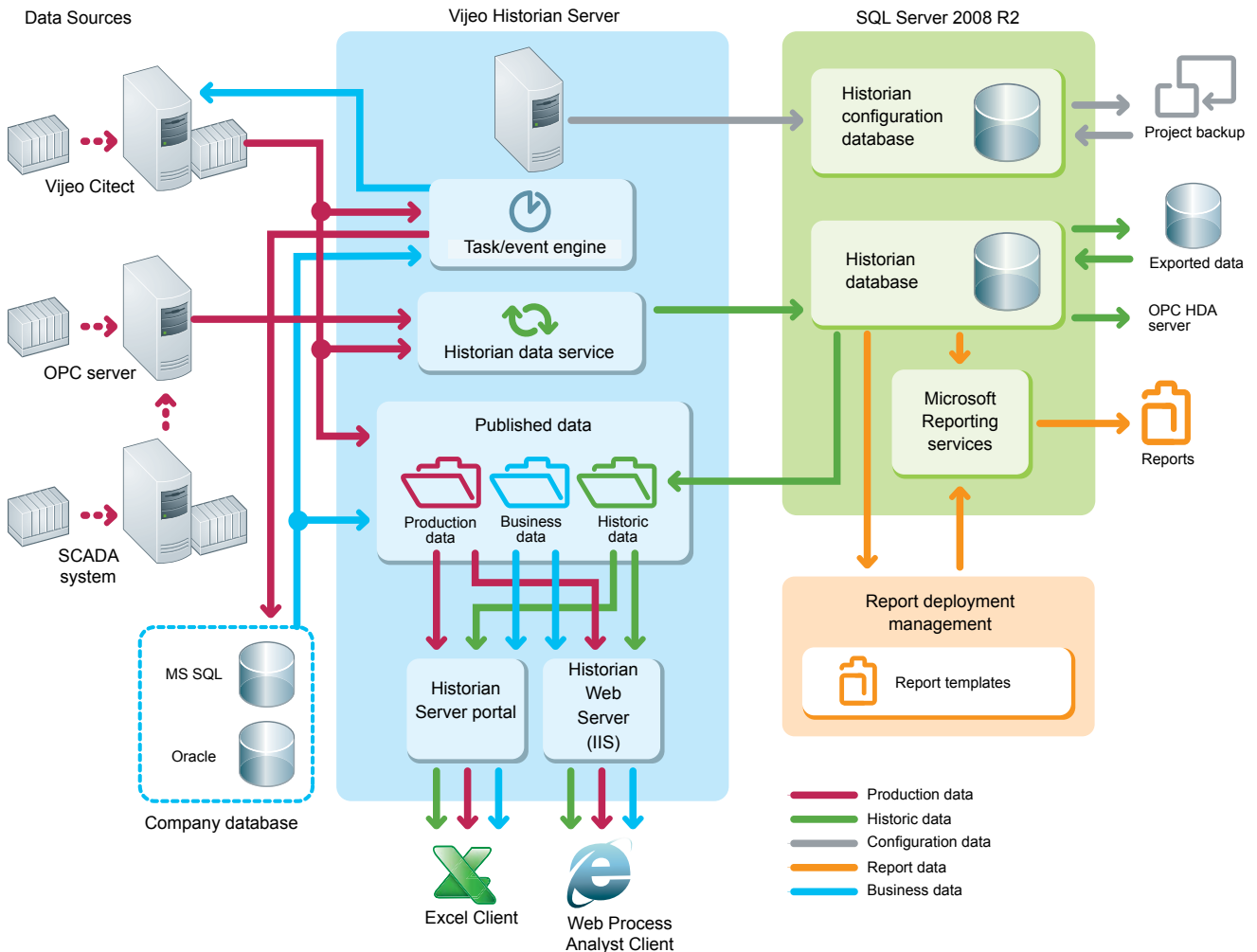

Functions

Applications

- Business managers can access meaningful, concise production system information from the plant floor in a familiar format they use for their financial or other business reports, to help them make strategic decisions to optimize operational performance.
- Plant managers can drill down into information or problem areas to improve production efficiency or reduce spurious alarms.
- Corporate and plant personnel can quickly and easily create and access meaningful reports in a familiar format and create a single view of operation.

Data sources supported

- Vijeo Historian supports the following data sources:
- Vijeo Citect SCADA servers: CitectSCADA 7 or later
 - OPC Clients: OPC DA V2, OPC DA V3
 - Oracle V8 or later
 - Microsoft SQL Server 2005 or later

Vijeo Historian Web Client and Excel Client

- Vijeo Historian also provides two client tools to make it easier to view and manage the information issued by the Historian Server:
- Using the **Web Client** you can display plant information from your control systems and the historian via the Intranet/Internet simply by using a browser such as Internet Explorer.
 - The **Excel Client** can also access linked information from the SCADA system or the historian directly in Microsoft Excel. The Excel Client user can select from the same plant hierarchy as the Web Client and request the values of any item within the tree structure.

Security

Once logged on, users can only access the published folders, data and Favourites for which they have permission. Passwords are encrypted and user privileges are validated for data requests.

Licence keys

The licences are programmed on a USB or parallel key, which is plugged into the PC running the Vijeo Historian software.



Vijeo Historian

Development Workshop

The Vijeo Historian Box includes:

- Vijeo Historian DVDs including OPC/HDA Server and Reports Deployment Manager
- A booklet
- Hardware key.

The software can be downloaded from our website www.schneider-electric.com.

The Vijeo Historian Box is needed for delivery of the hardware key.

Additional keys will be shipped in the Vijeo Historian Box.

The key can be programmed for Vijeo Historian, Vijeo Citect or both.

We recommend using a separate key for Vijeo Citect and Vijeo Historian.

Description	Type of key included	Reference	Weight kg
Vijeo Historian Box with USB key	USB	VJH 2099 22	–
Vijeo Historian Box with parallel key	Parallel	VJH 2099 12	–
Vijeo Historian 10 Pack with USB key	USB	VJH 2099 20 (1)	–
Additional USB key	USB	VJH 2099 21 (2)	–
Additional parallel key	Parallel	VJH 2099 11 (2)	–

Loan license

Description	Content	Reference	Weight kg
Vijeo Historian Loan licence	<ul style="list-style-type: none"> ■ 1 x VJH NS 2110 15 Vijeo Historian 15000 points and Data transfer licence ■ 5 x VJH NS 2122 00 Portal Only Client Access Licence (CAL) ■ 5 x VJH NS 2120 00 Historian Only Client Access Licence (CAL) ■ 5 x VJH NS 2043 20 Microsoft SQL Database Connector (1 per database system) 	VJH 2095 03	–

Vijeo Historian and Data Transfers

The Vijeo Historian and Data transfer licences are based on the amount of data being stored. The number of points is the maximum number of tags being logged and stored in the system. The number of alarms stored is unlimited, i.e. 150 tags stored - VJH NS 2110 11.

Description	Number of points	Reference	Weight kg
Vijeo Historian and Data transfer licences	150	VJH NS 2110 11	–
	500	VJH NS 2110 12	–
	1500	VJH NS 2110 13	–
	5000	VJH NS 2110 14	–
	15000	VJH NS 2110 15	–
	50000	VJH NS 2110 16	–

Vijeo Historian and Data Transfer upgrade

The references below are used for increasing the number of points on the Vijeo Historian and data transfer licences.

Description	Number of points	Reference	Weight kg
Vijeo Historian and Data transfer upgrade licences	150 to 500	VJH NS 2110 11-12	–
	500 to 1500	VJH NS 2110 12-13	–
	1500 to 5000	VJH NS 2110 13-14	–
	5000 to 15000	VJH NS 2110 14-15	–
	15000 to 50000	VJH NS 2110 15-16	–
	50000 to 100000	VJH NS 2110 16-45	–
	100000 to unlimited	VJH NS 2110 45-99	–

(1) Contains 10 individual Vijeo Historian Boxes (10 x VJH 2099 22).

(2) Additional keys must include a Vijeo Historian Box (VJH 2099 22 or VJH 2099 12).



Vijeo Historian

Client Acces Licenses (CALs)

Data from the Historian can be viewed in several ways:

- **Portal CALs:** Portal CALs are required to use the Web and Excel Clients provided with the Historian. These CALs can be ordered either per user/device or per server (CPU).
- **Historian CALs:** Historian CALs are NOT required if a site purchases Microsoft SQL Server 2008 R2 independently. If a site uses the MS SQL Server 2008 R2 shipped with Vijeo Historian, then Historian CALs are required under the following circumstances:
 - Using any of the standard reports with Historian Reports Deployment Manager
 - Accessing the Historian using Microsoft Reporting Services
 - Using the Web or Excel Clients
 - Accessing the Historian via Stored Procedures or SQL queries
 - Any direct or indirect (via other applications) to access Historian data

Client Access License per user/device

Description	Reference	Weight kg
Historian and Portal - Client Access License (CAL)	VJH NS 2124 00	–
Portal Only - Client Access License (CAL)	VJH NS 2122 00	–
Historian Only - Client Access License (CAL)	VJH NS 2120 00	–

Client Access License per CPU

Historian and Portal Server CAL per server CPU	VJH NS 2125 00	–
Portal Only Server CAL per server CPU	VJH NS 2123 00	–
Historian Server CAL per server CPU	VJH NS 2121 00	–

Control system connectors

Data can be collected from:

- Vijeo Citect: Unlimited connections included
 - OPC DA: Reference **VJH NS 2043 23** ordered per connection. Historian database can be connected to other databases for up/downloading.
 - SQL Connector: One MS SQL Server connector included. Additional SQL connectors **VJH NS 2043 20** ordered separately.
 - Oracle connector **VJH NS 2043 21**
- Connectivity can be made to Ampla or any MES system using OPC/HDA Client. Vijeo Historian has an OPC/HDA server included free.

Description	Reference	Weight kg
Microsoft SQL Database connector (1 per database system)	VJH NS 2043 20	–
Oracle Database connector (1 per database system)	VJH NS 2043 21	–
OPC DA connector V2 and V3 (1 per database system)	VJH NS 2043 23	–

License transfer reprogramming

Every time a licence is transferred from an existing key to another key, the licence transfer fee is charged.

Examples of when this fee is applied include:

- Transfer of a licence from one key to another
- Removal of a licence from an existing key (when not transferring to another key)
- Re-issue of licence for a replacement key.

Removal or downgrade (licence type or point count) of licences on a key will require a key swap where a new key is issued and the existing key must be returned. Removal or downgrade of a licence does not provide any refund or credit.

When moving a licence to an existing key that already contains a licence (or licences), the licence being moved must be the same point count as the existing licence.

Note: When placing an order, please indicate the key numbers and details in the special instructions.

Note: This provides only a new authorization code. If a new key is required then you also need to purchase a new hardware key (**VJC 1099 ●●**).

Description	Reference	Weight kg
License transfer fee	VJC 1094 01	–



OPC Factory Server



Presentation

Based on the OLE for Process Control (OPC) standard, Schneider Electric's OPC Factory Server (OFS) software allows "client" software applications, such as supervisors/SCADA and customized interfaces, to access the data of Schneider Electric automation system and electrical distribution devices connected to networks or fieldbuses in real time.

It also allows communication with third-party devices supporting Modbus and Modbus/TCP protocols.

At the heart of the Transparent Ready offer, OFS enables simpler, more open and transparent communication between your software applications and your devices. These are just some of the advantages that ensure a complete interoperability solution that is central to your process.

In version V3.3, the OFS data server integrates the most recent specifications of the OPC Foundation:

- OPC-DA (OPC Data Access)
- .NET API interface
- OPC XML-DA V1.0 (OPC XML Data Access)

The OFS V3.3 offer is available in two levels:

- **OFS Small:** Data server for 1000 items (1), that does not support the OPC XML-DA protocol
- **OFS Large:** Complete data server

Devices and protocols supported

OFS software is a multi-device data server: It allows simultaneous use of several communication protocols, and it provides client applications with a set of services for accessing control system items that may be local or remote, via physical address or via symbol.

Devices supported:

- Modicon Quantum, Premium, M340, Micro, Compact and Momentum PLCs
- Schneider Electric TSX Series 7 and April Series 1000 PLCs
- Modbus serial devices connected via Schneider Electric gateways: TSX ETG 10●●, EGX ●●● ranges, etc.
- Uni-Telway serial devices connected via Schneider Electric gateways (TSX ETG 1010)

Networks and protocols supported:

- Modbus: Modbus serial, Modbus Plus, Modbus/TCP
- X-Way/Uni-TE: Uni-Telway, Fipway, ISAWay, PClway

Openness

The development of specialized interfaces is simpler with OFS V3.3 software, which is aimed at two types of user in particular:

■ **End users** who want either to interface their supervision or Human Machine Interface applications with Schneider Electric equipment, or to develop applications on a PC (supervisory control screens, Excel tables, etc.) requiring access to control system data.

■ **Suppliers of control system or industrial data processing software** (supervision, Human Machine Interfaces, etc.) seeking to develop, within their standard products, an OPC Client interface capable of accessing data in Schneider Electric equipment via the OFS server.

(1) Item: A variable, structure, table, etc. in the Unity Pro application.

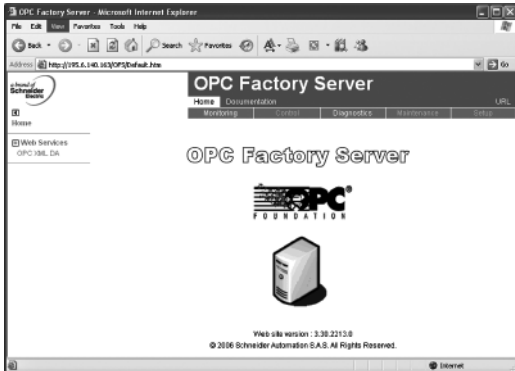

OPC Factory Server: Home page

Supported architectures

The OFS server allows four access modes:

- A purely local mode
- Remote access from an OPC-DA client
- Remote access from an OPC .NET client
- Remote access from an OPC XML-DA client

Local access

The client application program and the OFS server are on the same PC.

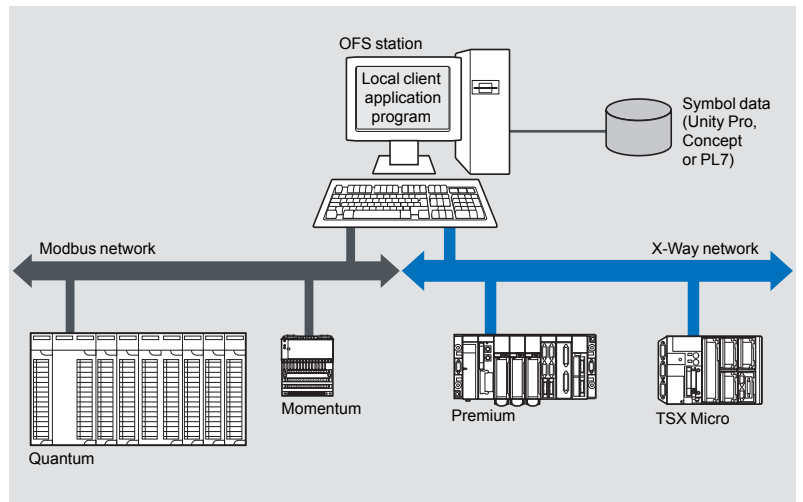

Remote access from an OPC-DA client

The client application program and the OFS data server are on remote stations. Communication between the client station and the OFS server is conducted through the DCOM layer (Microsoft) via the OPC-DA protocol.

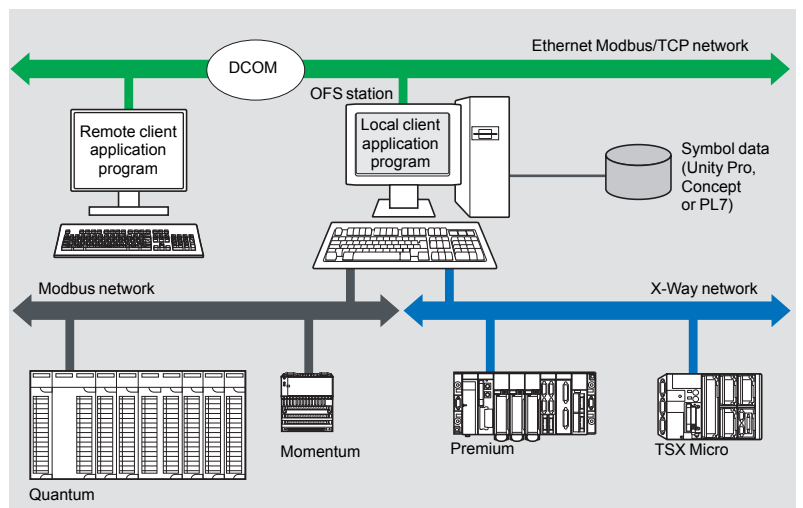

Supported architectures (continued)

Remote access from an OPC .NET client

The .NET client application and the OFS data server are on remote stations. Communication between the client station and the OFS server is conducted through the DCOM layer (Microsoft) via the OPC-DA protocol.

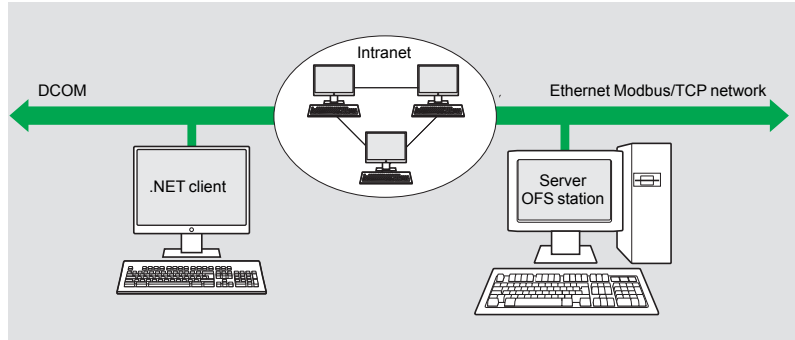

The .NET Microsoft compatibility of the OFS server has been developed to allow an OPC .NET client to access OFS server items on an Intranet network via the OPC .NET API interface.

This interface ensures interoperability between existing OPC applications and applications developed in the standard .NET environment.

Remote access from an OPC XML-DA client via HTTP

The client application program and the OFS server are on remote stations, using the SOAP protocol to communicate via the Internet in conformity with the OPC XML-DA V1.01 specification of the OPC Foundation. The OFS data server is based on an HTTP server installed on the same station.

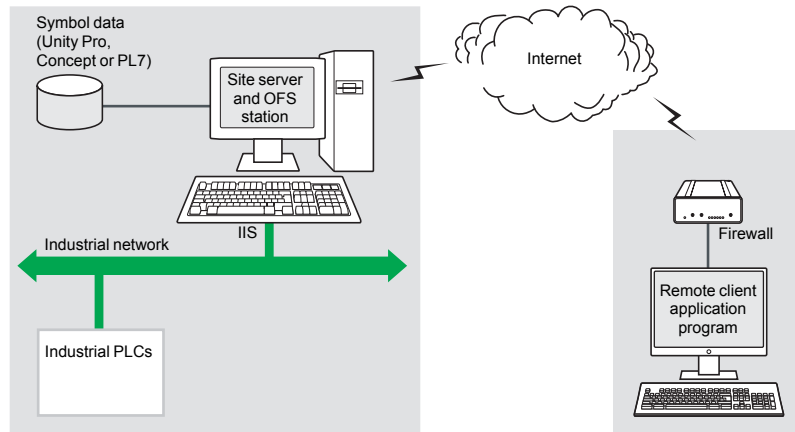

The OPC XML-DA V1.0 specifications are designed to overcome the limitations of COM/DCOM by providing:

- An OPC interface for Windows and non-Windows client applications
- Beyond the Intranet perimeter, remote access via the Internet through firewalls

The OPC XML-DA specification is based on Web Services standards such as SOAP, XML and WSDL (1). A SOAP client can access data on the OFS server via Intranet or Internet using the SOAP protocol in conformity with the OPC XML-DA V1.01 specification of the OPC Foundation.

(1) SOAP: Simple Object Access Protocol
 XML: Extensible Markup Language
 WSDL: Web Services Description Language.

Setup

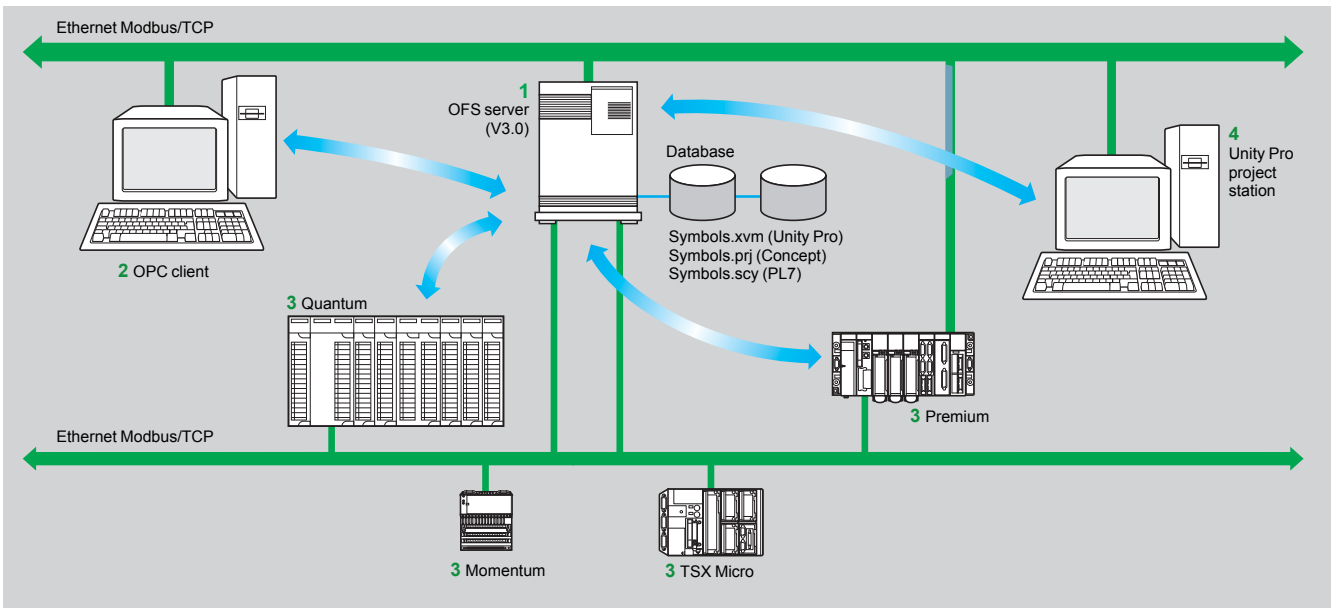

The OFS server **1** is at the centre of the data exchanges. It ensures that variables exchanged between the OPC client **2** and the PLC **3** are consistent, in one of three ways using a symbol (or variables) database:

- The variables database is either the Unity Pro project **4** or the Concept project. In both these cases, Unity Pro or Concept needs to be installed on the OFS server station.
- Or the variables database is an export file (SCY for PL7, XVM for Unity Pro). PL7 and Unity Pro are not required in either of these cases.
- Or the variables database is the PLC itself. In this case neither Unity Pro nor an export file is needed. This does not apply to Momentum and TSX Micro PLCs. If an inconsistency is detected (following online modification of the PLC program for example), OFS resynchronizes itself automatically as a background task, without breaking communication between the PLC and the OPC client. For this function the following minimum versions are required:
 - OFS V3.35
 - Unity Pro V6.0
 - Modicon Premium V2.9, M340 V2.3 and Quantum V3.0 PLCs

Functions

Development of client applications

OFS software has 4 types of interface:

■ **OLE Automation interface (OPC-DA)**

Particularly suitable for end users, this enables the development of OPC client applications in Visual Basic, in Visual Basic for Excel, and in C++.

■ **OLE Custom interface (OPC-DA)**

Used primarily by suppliers of automated control system or industrial IT products, this interface enables the development of applications in C++ in order to access the OFS software OPC server. It is aimed at software development experts in particular, so that they can integrate the client application into their standard products. This is the interface with the highest performance, in terms of access time, to data stored in the OPC server. It requires extensive knowledge of C++ programming to set up.

■ **OPC .NET API wrapper interface**

The .NET Microsoft compatibility of the OFS data server gives an OPC .NET client standard access to items on the OFS server via an Intranet network, thus ensuring greater interoperability with standard .NET environments.

Note: In this case, communication between the OPC .NET client and the OFS server is conducted through the DCOM layer (or COM layer in a local configuration) via the OPC-DA protocol.

■ **OPC XML-DA interface (1)**

The OPC XML-DA V1.0 specifications are designed to overcome the limitations of the OPC-DA specification and COM/DCOM by providing:

- An interface for Windows and non-Windows client applications
- Remote access via the Internet through firewalls (beyond the Intranet perimeter)

The OPC XML-DA specification is based on Web Services standards such as SOAP, XML, WSDL. A SOAP client can access data on the OFS server via Intranet or Internet using the SOAP protocol in conformity with the OPC XML-DA V1.01 specification of the OPC Foundation.

(1) Only available with the Large version of OPC Factory Server V3.3.

Software

OPC data server software

OPC Factory Server



OPC Factory Server

References

OFS V3.3 software for PC compatible stations (minimum configuration: Pentium 566 MHz processor, 128 MB RAM) running Windows 2000 Professional (1), Windows XP Professional, Windows 7 (32-bit) (3) or Windows server 2008 (3).

The OFS V3.3 offer comprises:

- OPC server software
- OPC server simulator (for debugging the application when no PLCs are present)
- OFS server configuration software
- An example of OPC client for setting up applications
- The setup documentation on CD-ROM

Supplied on CD-ROM, the software operates independently on a PC. It interfaces with the variables export files generated by PL7, ProWORX, Concept and Unity Pro software.

It also provides a direct dynamic link to the Unity Pro and Concept applications (2).

OFS V3.3 software is available in two versions:

- **Small version TLX CD S●OFS 33**
 - Maximum of 1000 items
 - All protocols supported with the exception of OPC XML-DA
 - Single station and 10-station site licences
- **Large version TLX CD L●OFS 33**
 - Full version
 - Single station, 10-station and 200-station site licences

OPC Factory Server V3.3 Small

Description	Licence type	Reference	Weight kg
OPC Factory Server V3.3 Small software	Single station	TLX CD SUOFS 33	–
	10-station	TLX CD STOFS 33	–

OPC Factory Server V3.3 Large

Description	Licence type	Reference	Weight kg
OPC Factory Server V3.3 Large software Full version	Single station	TLX CD LUOFS 33	–
	10-station	TLX CD LTOFS 33	–
	200-station	TLX CD LFOFS 33	–

(1) Must be updated with Service Pack 1 or higher.

(2) Requires Concept > version 2.0 software to be installed on the same station.

(3) OFS is compatible with both these operating systems from version V3.34 or later.

Selection guide: Magelis Small Panels page 7/2
Selection guide: Magelis Optimum Advanced Panels page 7/4
Selection guide: Magelis Advanced Panels page 7/6
Selection guide: HMI software page 7/10

Applications		Display of graphic pages		
Type of terminal		Small Panels with touch screen		
				
Display	Type	Monochrome STN LCD (200 x 80 pixels), backlit - Green, orange and red, or - White, pink and red	Colour QVGA TFT LCD (320 x 240 pixels)	
	Capacity	3.4" (monochrome)	3.5" (colour)	5.7" (colour)
Data entry		Via touch screen		
Memory capacity	Application	16 MB Flash		
	Expansion	-		
Functions	Maximum number of pages	Limited by internal FLASH EPROM memory capacity		
	Variables per page	Unlimited		
	Representation of variables	Alphanumeric, bitmap, bargraph, gauge, curves, buttons, LEDs		
	Recipes	32 groups of 64 recipes		
	Curves	Yes, with log		
	Alarm logs	Yes		
	Real-time clock	Access to the PLC real-time clock		
	Alarm relay	-		
Buzzer	Yes			
Communication	Asynchronous serial link	RS 232C/RS 485 (1)	RS 232C/RS 485	
	Downloadable protocols	RS 232C using Zelio protocol (2)		
	Printer link	USB for serial or parallel printer		
	USB ports	1 host type A and 1 device type mini-B		
	Networks	1 Ethernet TCP/IP port (10BASE-T/100BASE-TX) (3)	1 Ethernet TCP/IP port (10BASE-T/100BASE-TX)	
Development software		Vijeo Designer (on Windows XP, Windows Vista and Windows 7)		
Operating system		Magelis		
References		HMI STO 5●●	HMI STU 655	HMI STU 855
Page		Please consult the "Human/Machine Interfaces" catalogue (1) Only HMI STO 511/512. (2) Only HMI STO 501. (3) Only HMI STO 531/532.		

7



More technical information on www.schneider-electric.com

Display of text messages and/or semi-graphic pages	Display of text messages and/or semi-graphic pages Control and configuration of data
--	---

Small Panels with keypad	Small Panels with keypad	Small Panels with touch screen and keypad
--------------------------	--------------------------	---



Green backlit monochrome LCD, height 5.5 mm or Green, orange or red backlit monochrome LCD, height 4.34...17.36 mm	Green, orange or red backlit monochrome LCD, height 4.34...17.36 mm	Green, orange or red backlit monochrome matrix LCD (198 x 80 pixels), height 4...16 mm
2 lines of 20 characters or 1 to 4 lines of 5 to 20 characters (monochrome)	1 to 4 lines of 5 to 20 characters (monochrome)	2 to 10 lines of 5 to 33 characters (monochrome)
Via keypad with 8 keys (4 customizable)	Via keypad with ■ 12 function keys or numeric entry (depending on context) ■ 8 service keys	Via keypad with ■ 4 function keys ■ 8 service keys Via touch screen and keypad with ■ 10 function keys ■ 2 service keys
512 KB Flash		512 KB Flash EPROM
128/200 application pages 256 alarm pages 40...50	128/200 application pages 256 alarm pages 40...50, bargraph, buttons, LEDs	200 application pages 256 alarm pages 50
Alphanumeric		Alphanumeric, bargraph, buttons, LEDs
Yes	Yes	
Yes (5)	Yes	
Access to the PLC real-time clock	Access to the PLC real-time clock	
		Yes (4)
RS 232C/RS 485		
Uni-TE, Modbus and for PLC brands: Allen-Bradley, Omron, Mitsubishi, Siemens		
RS 232C serial link (5)		
Vijejo Designer Lite (on Windows 2000, Windows XP and Windows Vista)		
Magelis		

XBT N ●●●●	XBT R ●●●	XBT RT ●●●
------------	-----------	------------

Please consult the "Human/Machine Interfaces" catalogue
 (4) Only XBT RT511.
 (5) Depending on model.

Applications	Display of text messages, graphic objects and synoptic views Control and configuration of data
Type of terminal	Optimum Advanced Panels, touch screen
Degree of protection (according to IEC 60529)	IP 65 (IP 67 with addition of a cover)



Display	Type	Colour TFT LCD, backlit 320 x 240 pixels (QVGA)		Colour TFT LCD, backlit 800 x 480 pixels (WVGA)
	Capacity	3.5"	5.7"	7.0 Wide
Data entry	Static function keys	Via touch screen	Via touch screen	Via touch screen
	Dynamic function keys	6 function keys (static or dynamic)	–	8 function keys (static or dynamic)
	Service keys	–	–	–
	Alphanumeric keys	–	–	–
Memory capacity	Applications	64/96 MB Flash EPROM (1)		96 MB Flash EPROM
	Expansion	–		By 4 GB SD card (except HMI GTO2300)
Functions	Maximum number of pages	Limited by internal Flash EPROM memory capacity	Limited by capacity of internal Flash EPROM memory or of SD card	
	Variables per page	Unlimited (8000 variables max.)		
	Representation of variables	Alphanumeric, bitmap, bargraph, gauge, tank, tank level indicator, curves, polygon, button, LED		
	Recipes	32 groups of 64 recipes comprising 1024 ingredients max.		
	Curves	Yes, with log		
	Alarm logs	Yes		
	Real-time clock	Built-in		
	Discrete I/O	–		
	Multimedia I/O	–		
Communication	Downloadable protocols	Uni-TE (2), Modbus, Modbus TCP/IP (1) and for PLC brands: Mitsubishi, Omron, Allen-Bradley and Siemens		
	Asynchronous serial link	RS 232C (COM1) and RS 485 (COM2) except HMI GTO1310: RS 232C/485 (COM1)		
	USB ports	1 type A host connector + 1 mini-B connector		
	Buses and networks	Ethernet TCP/IP (10BASE-T/100BASE-TX) (3), Modbus Plus and Fipway via USB gateway		
	Printer link	RS 232C (COM1) serial link (4) and USB port for parallel printer		
Development software	Vijeo Designer (on Windows XP and Windows 7)			
Operating system	Magelis (333 MHz RISC CPU)			
Type of terminal	HMI GTO1300 HMI GTO1310	HMI GTO2300 HMI GTO2310	HMI GTO3510	
Page	Please consult the "Optimum Advanced Panels, Magelis™ GTO" catalogue			

(1) Depending on model.
 (2) Uni-TE version V2 for Twido controller and TSX Micro/Premium platform.
 (3) Except HMI GTO1300 and GTO2300 (Modbus Plus and Fipway via USB gateway only).
 (4) Except HMI GTO1310 (USB port for parallel printer only).



Display of text messages, graphic objects and synoptic views
Control and configuration of data

Optimum Advanced Panels, touch screen

Optimum Advanced Panels, touch screen, "Stainless Steel" version

IP 65 (IP 67 with addition of a cover)

IP 66K (Front panel with stainless steel frame) for food & beverage environment



Colour TFT LCD, backlit 640 x 480 pixels (VGA)	Colour TFT LCD, backlit 640 x 480 pixels (VGA)	Colour TFT LCD, backlit 800 x 600 pixels (SVGA)	Colour TFT LCD, backlit 320 x 240 pixels (QVGA)	Colour TFT LCD, backlit 640 x 480 pixels (VGA)	Colour TFT LCD, backlit 800 x 600 pixels (SVGA)
7.5"	10.4"	12.1"	5.7"	10.4"	12.1"

Via touch screen

–
–
–
–

96 MB Flash EPROM

By 4 GB SD card

Limited by capacity of internal Flash EPROM memory or of SD card

Unlimited (8000 variables max.)

Alphanumeric, bitmap, bargraph, gauge, tank, tank level indicator, curves, polygon, button, LED

32 groups of 64 recipes comprising 1024 ingredients max.

Yes, with log

Yes

Built-in

–
–

Uni-TE (2), Modbus, Modbus TCP/IP (1) and for PLC brands: Mitsubishi, Omron, Allen-Bradley and Siemens

RS 232C (COM1) and RS 485 (COM2)

1 type A host connector + 1 mini-B connector

Ethernet TCP/IP (10BASE-T/100BASE-TX), Modbus Plus and Fipway via USB gateway

RS 232C (COM1) serial link and USB port for parallel printer

Vijeo Designer (on Windows XP and Windows 7)

Magelis (333 MHz RISC CPU)

HMI GTO4310

HMI GTO5310

HMI GTO6310

HMI GTO2315

HMI GTO5315

HMI GTO6315

Please consult the "Optimum Advanced Panels, Magelis™ GTO" catalogue



More technical information on www.schneider-electric.com

Operator dialogue terminals

Magelis GT, GK, GH and GTW Advanced Panels

Applications	Display of text messages, graphic objects and synoptic views Control and configuration of data
Type of terminal	Touch screen Advanced Panels



Display	Type	Backlit monochrome (amber or red mode) STN LCD (320 x 240 pixels) or TFT LCD	Backlit monochrome or colour STN LCD or backlit colour TFT LCD (320 x 240 pixels) or (640 x 480 pixels) (3)	Backlit colour STN LCD or colour TFT LCD (640 x 480 pixels)
	Capacity	3.8" (monochrome or colour)	5.7" (monochrome or colour)	7.5" (colour)
Data entry	Static function keys	Via touch screen		
	Dynamic function keys	-		
	Service keys	-		
	Alphanumeric keys	-		
		-		
Memory capacity	Applications	32 MB Flash EPROM	16 MB Flash EPROM (3)	32 MB Flash EPROM
	Expansion	-	By means of 128, 256, 512 MB, 1, 2 or 4 GB CF card (except XBT GT2110)	
Functions	Maximum number of pages	Limited by internal Flash EPROM memory capacity	Limited by capacity of internal Flash EPROM memory or CF card memory	
	Variables per page	Unlimited (8000 variables max.)		
	Representation of variables	Alphanumeric, bitmap, bargraph, gauge, tank, tank level indicator, curves, polygon, button, LED		
	Recipes	32 groups of 64 recipes comprising 1024 ingredients max.		
	Curves	Yes, with log		
	Alarm logs	Yes		
	Real-time clock	Built-in		
	Discrete I/O	-		1 input (reset) and 3 outputs (alarm, buzzer, run)
	Multimedia I/O	-	(3)	1 audio input (microphone), 1 composite video input (digital or analogue video camera), 1 audio output (loudspeaker) (1)
	Communication	Downloadable protocols	Uni-TE (2), Modbus, Modbus TCP/IP (1) and for PLC brands: Mitsubishi, Omron, Allen-Bradley and Siemens	
Asynchronous serial link		RS 232C/485 (COM1)	RS 232C/RS 422/485 (COM1) and RS 485 (COM2)	
USB ports		1	1 (3)	1
Bus and networks		-	Modbus Plus and Fipway with USB gateway, PROFIBUS DP and Device Net with optional card	
		Ethernet TCP/IP (10BASE-T/100BASE-TX) (1)		
Printer link		USB port for parallel printer	RS 232C (COM1) serial link, USB port for parallel printer	
Development software	Vijeo Designer (on Windows XP, Windows Vista and Windows 7)			
Operating system	Magelis (200 MHz RISC CPU)	Magelis (133 MHz RISC CPU) (3)	Magelis (266 MHz RIS CPU)	
Type of terminal	XBT GT11/13	XBT GT21/22/23/24/29	XBT GT42/43	
Page	Please consult the "Human/Machine Interfaces" catalogue			

(1) Depending on model.
 (2) Uni-TE version V2 for Twido controller and TSX Micro/Premium platform.
 (3) For XBTGT 2430, 32 MB Flash EPROM, 1 sound output, 2 USB ports, 266 MHz RISC CPU.
 (4) For XBT GT 5430.



**Display of text messages, graphic objects and synoptic views
Control and configuration of data**

Touch screen Advanced Panels



Backlit colour STN LCD or colour TFT LCD
(640 x 480 pixels or 800 x 600 pixels) (4)

Backlit colour TFT LCD (800 x 600 pixels)

Backlit colour TFT LCD (1024 x 768 pixels)

10.4" (colour)

12.1" (colour)

15" (colour)

Via touch screen

–
–
–
–

32 MB Flash EPROM

By means of 128, 256, 512 MB, 1, 2 or 4 GB CF card

Limited by capacity of internal Flash EPROM memory or CF card memory

Unlimited (8000 variables max.)

Alphanumeric, bitmap, bargraph, gauge, tank, tank level indicator, curves, polygon, button, LED

32 groups of 64 recipes comprising 1024 ingredients max.

Yes, with log

Yes

Built-in

1 input (reset) and 3 outputs (alarm, buzzer, run)

1 audio input (microphone), 1 composite video input (digital or analogue video camera), 1 audio output (loudspeaker) (1)

Uni-TE (2), Modbus, Modbus TCP/IP (1) and for PLC brands: Mitsubishi, Omron, Allen-Bradley and Siemens

RS 232C/RS 422/485 (COM1) and RS 485 (COM2)

2

Modbus Plus with USB gateway

Ethernet TCP/IP (10BASE-T/100BASE-TX)

RS 232C (COM1) serial link, USB port for parallel printer

Vijeo Designer (on Windows XP, Windows Vista and Windows 7)

Magelis

(266 MHz RIS CPU)

XBT GT52/53/54

XBT GT63

XBT GT73

Please consult the "Human/Machine Interfaces" catalogue



Operator dialogue terminals

Magelis GT, GK, GH and GTW Advanced Panels

Applications	Display of text messages, graphic objects and synoptic views Control and configuration of data	
Type of terminal	Advanced Panels with keypad	
		
Display	Type	Colour TFT LCD (320 x 240 pixels) or monochrome STN
	Capacity	5.7" (monochrome or colour)
		Colour TFT LCD (640 x 480 pixels)
		10.4" (colour)
Data entry	Via keypad and/or touch screen (configurable) and/or by industrial pointer	
	Static function keys	10
	Dynamic function keys	14
	Service keys	8
	Alphanumeric keys	12
Memory capacity	Application	16 MB Flash EPROM
	Expansion	32 MB Flash EPROM
		By means of 128, 256, 512 MB, 1, 2 or 4 GB CF card
Functions	Maximum number of pages	Limited by capacity of internal Flash EPROM memory or CF card memory
	Variables per page	Unlimited (8000 variables max.)
	Representation of variables	Alphanumeric, bitmap, bargraph, gauge, tank, tank level indicator, curves, polygon, button, LED
	Recipes	32 groups of 64 recipes comprising 1024 ingredients max.
	Curves	Yes, with log
	Alarm logs	Yes
	Real-time clock	Built-in
	Discrete I/O	–
	Multimedia I/O	1 input - 3 outputs
		–
Communication	Downloadable protocols	Uni-TE (2), Modbus, Modbus TCP/IP (1) and for PLC brands: Mitsubishi, Omron, Allen-Bradley and Siemens
	Asynchronous serial link	RS 232C/RS 422/485 (COM1) RS 485 (COM2)
	USB ports	1
	Bus and networks	2
		Modbus Plus, Fipway with USB gateway, PROFIBUS DP and Device Net with optional card
		Ethernet TCP/IP (10BASE-T/100BASE-TX)
	Printer link	RS 232C (COM1) serial link, USB port for parallel printer
Development software	Vijeo Designer (on Windows XP, Windows Vista and Windows 7)	
Operating system	Magelis (CPU 266 MHz RISC)	
Type of terminal	XBT GK 21/23	XBT GK 53
Page	Please consult the "Human/Machine Interfaces" catalogue	

(1) Depending on model.

(2) Uni-TE version V2 for Twido controller and TSX Micro/Premium platform.



**Display of text messages, graphic objects and synoptic views
Control and configuration of data**

Portable Advanced Panels

Open touch screen Advanced Panels

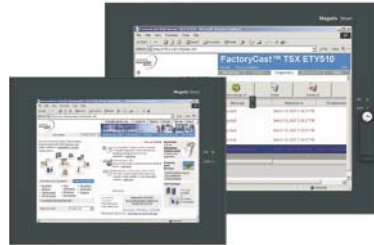

Colour TFT LCD (640 x 480 pixels)	Colour TFT LCD (800 x 600 pixels)	Colour TFT LCD (800 x 600 pixels)	Colour TFT LCD (1024 x 768 pixels)
5.7" (colour)	8.4" (colour)	12" (colour)	15" (colour)
Via touch screen	Via touch screen		
11	–	–	–
–	–	–	–
–	–	–	–
–	–	–	–
32 MB Flash EPROM	1 GB CF system card included with terminal, expandable to 4 GB	2 GB CF system card included with terminal, expandable to 4 GB	
By means of 128, 256, 512 MB, 1, 2 or 4 GB CF card			
Limited by capacity of internal Flash EPROM memory or CF card memory			
Unlimited (8000 variables max.)			
Alphanumeric, bitmap, bargraph, gauge, tank, tank level indicator, curves, polygon, button, LED			
32 groups of 64 recipes comprising 1024 ingredients max.			
Yes, with log			
Yes			
Built-in			
–			
1 audio output			
Uni-TE (2), Modbus, Modbus TCP/IP and for PLC brands: Mitsubishi, Omron, Rockwell Automation and Siemens	Uni-TE (2), Modbus, Modbus TCP/IP (1) and for PLC brands: Mitsubishi, Omron, Allen-Bradley and Siemens		
RS 232C/RS 422-485 (COM1)	RS 232C (COM1) RS 232C (COM2)	RS 232C (COM1)	RS 232C (COM1) RS 232C (COM2)
1	4	4 + 1 on front	–
–	Modbus Plus with USB gateway		
1 Ethernet port (10BASE-T/100BASE-TX)	1 TCP/IP Ethernet port (10BASE-T/100BASE-TX) and 1 Ethernet port (10BASE-T/100BASE-TX/1 GB)		
–	RS 232C (COM1 or COM2) serial link, USB port for parallel printer		
Vijeo Designer (on Windows XP, Windows Vista and Windows 7)			
Magelis (266 MHz RISC CPU)	Windows XP Embedded		

XBT GH 2460

XBT GTW 450

XBT GTW 652

HMI GTW 7353

Please consult the "Human/Machine Interfaces" catalogue

(1) Depending on model.

(2) Uni-TE version V2 for Twido controller and TSX Micro/Premium platform.



More technical information on www.schneider-electric.com

Applications Traditional architecture, HMI executed on PC platform or dedicated terminal
Configuration software for operator dialogue applications



Compatible products	Type	Magelis™ XBT N/R/RT Small Panels (1)
	Maximum number of targets	1
	Operating system on terminals	Proprietary Magelis
Functions	Reading/writing of PLC variables	Yes
	Display of variables	Yes
	Data processing	–
	Sharing of variables between HMI applications	–
	Saving of variables to external database	–
Internationalization		–
Development of graphic applications	Native library of graphic objects	Yes
	Curves and alarms	Yes (2)
	Scripts	–
Communication between HMI application and PLCs		Via I/O drivers: Schneider Electric or third party protocols (Mitsubishi, Omron, Rockwell Automation, Siemens) (3)
Uploading of applications		Yes
Simulation of HMI applications		Yes
Recipe management		–
Report and barcode printing		–
Screen capture		–
Access security		Linked to user profiles
Interface languages		Screens, online help and documentation in electronic format available in 6 languages: English, French, German, Italian, Simplified Chinese and Spanish
OS compatibility		Windows XP Professional, Windows Vista Business (32-bit), Windows 2000 Professional
Software type		Vijeo Designer™ Lite
Page		Please consult the "Human/Machine Interfaces" catalogue

(1) All Magelis XBT and Magelis GTO terminals behave transparently on restoration of power.
 (2) Depending on compatible product.
 (3) See protocols supported on page, please consult the "Human/Machine Interfaces" catalogue.

7

Traditional architecture, HMI executed on PC platform or dedicated terminal

Configuration software for operator dialogue applications

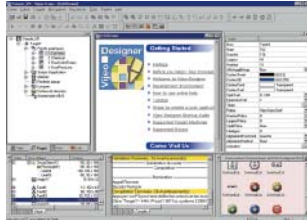

Magelis™ STO/STU Small Panels
Magelis™ XBT GT/GK/GH/GTW and Magelis™ GTO Advanced Panels (1)
Magelis™ industrial PCs

32

Proprietary for Magelis STO/STU, Magelis XBT GT/GK/GH and Magelis GTO
Windows XP embedded for Magelis GTW

Yes, up to 8000 internal and external variables

Yes

Yes, using expression editor or Java programming

Up to 300 variables between 8 terminals, without router PLC
Proprietary protocol above TCP/IP

Yes, with the Intelligent Data Service extension

Up to 15 languages supported by 34 western alphabets, 4 Asian alphabets and 2 middle eastern alphabets embedded in the application

Yes

Yes, with log

Java

Via I/O drivers: Schneider Electric or third party protocols (Mitsubishi, Omron, Rockwell Automation, Siemens) (3)

Yes

Yes

Yes, up to 32 groups, 1024 ingredients for 256 recipes per group, proprietary or CSV format, complete multilingual support for labels and ingredients

On the fly alarms, log data. Up to 9999 active alarms, record or logs

Main barcode types supported: UPC-A, UPC-E, JAN/EAN8, JAN/EAN13, ITF, CODE39, CODE93, CODE128, CODABAR (NW-7)

Yes, for Magelis XBT GT (XBT GT 1105 and higher), Magelis GTO and Magelis industrial PCs. JPEG format

Linked to user profiles

Screens, online help and documentation in electronic format available in 7 languages: English, French, German, Italian, Brazilian Portuguese, Simplified Chinese and Spanish

Windows XP Professional, Windows 7 Business (32-bit and 64-bit)

Vijeo Designer™

Please consult the "Human/Machine Interfaces" catalogue



More technical information on www.schneider-electric.com

8 - Connection interfaces and regulated switch mode power supplies

Modicon Telefast ABE 7 pre-wired system



- Selection guide* page 8/2
- **Presentation** page 8/8
- **Passive connection sub-bases** page 8/12
- **Adaptor sub-bases with fixed relays and removable terminal blocks** page 8/14
- **Input/output adaptor sub-bases for or with plug-in relays** page 8/15
- **Output adaptor sub-bases for plug-in relays** page 8/16
- **Plug-in relays** page 8/17
- **Connection sub-bases for analog channels and application-specific channels** page 8/18
- **Accessories for connection sub-bases** page 8/20

Power supplies and transformers Phaseo

- Selection guide: regulated switch mode power supplies* page 8/22
- Selection guide: regulated switch mode power supplies, rectified and filtered power supplies* page 8/24
- **Regulated switch mode power supplies ABL 8MEM, ABL 7RM**
 - Presentation, description page 8/26
 - Selection of protection on the power supply primaries page 8/27
 - References page 8/27
- **Regulated switch mode power supplies ABL 8MEM, ABL 7RP**
 - Presentation, description page 8/28
 - Selection of protection on the power supply primaries page 8/29
 - References page 8/29
- **Regulated switch mode power supplies ABL 4**
 - Presentation page 8/30
 - Characteristics page 8/31
 - Description page 8/32
 - References page 8/33
- **Appendices**
 - Function modules: ABL 8 solutions to power outages page 8/34
 - Substitution of ABL 8RP/WP by ABL 4 page 8/35
- **Regulated switch mode power supplies ASI ABL**
 - Power supplies for AS-Interface cabling system page 8/36
 - Selection of protection on the power supply primaries page 8/37
 - References page 8/37

Connection interfaces

Modicon Telefast ABE 7 pre-wired system Discrete input and/or output sub-bases

Applications	Discrete inputs or outputs				
	Optimum "Economy"	Optimum "Miniature"	Universal		
					
Compatibility	TSX Micro, Modicon Premium, Modicon M340		TSX Micro, Modicon Premium, Modicon Quantum, Modicon M340		
Sub-base type	Passive connection sub-bases				
Equipped with relays	-				
Control voltage	24 V $\overline{\text{---}}$				
Output voltage	24 V $\overline{\text{---}}$				
Output current per channel	0.5 A				
Modularity	16		8-12-16		
No. of terminals per channel	1	1 to 3	1	2	
Type of connection terminals	Signal	Signal, common (configurable as 24 V $\overline{\text{---}}$ or 0 V)	Signal	Signal, common (configurable as 24 V $\overline{\text{---}}$ or 0 V)	
Connectors	20-way HE10 connector				
Terminal block	Removable	No		No	
	Terminal type	Screw			
Additional or optional* function	Low-cost version fitted with cable	Miniature sub-bases	Compact size *	Input type 2 * (1)	Isolator *
Type of device	ABE 7H●●E●00	ABE 7H16C●●	ABE 7H●●R1● ABE 7H●●R50	ABE 7H●●R2●	ABE 7H●●S21
Page	8/12		8/13		

(1) For Modicon TSX Micro and Modicon Premium PLCs.



Discrete inputs or outputs	Outputs for solid state and/or electromechanical relays
Optimum "Miniature"	Optimum and Universal



TSX Micro, Modicon Premium, Modicon Quantum, Modicon M340			
Passive connection sub-bases		Plug-in electromechanical or solid state relays	
-		No	Yes
24 V $\overline{\text{DC}}$			
24 V $\overline{\text{DC}}$		24V $\overline{\text{DC}}$ (solid state) 5... 24 V $\overline{\text{DC}}$, 230 V \sim (electromechanical)	
0.5 A	0.5 A	5 A (E.M.), 2 A (solid state)	5 A (th)
16		16 8 passive inputs 8 relay outputs	
1	2	1	
Signal, 2 common connections between the inputs and the outputs	Signal, common, 2 common connections between the inputs and the outputs	1 N/O contact and common, 4 output channels 2 input connection points	
20-way HE10 connectors			
No			
Screw			
Miniature sub-base Synergy with Tego Power and Micro PLC		Miniature sub-base - Common per group of 4 channels Synergy with Tego Power and Micro PLC	
ABE 7H16CM11	ABE 7H16CM21	ABE 7P16M111	ABE 7R16M111
8/12		8/16	8/15

Connection interfaces

Modicon Telefast ABE 7 pre-wired system

Discrete input and output sub-bases

Applications	Discrete outputs					
	Optimum		Universal	Optimum		Universal
						
Compatibility	TSX Micro, Modicon Premium, Modicon Quantum, Modicon M340					
Relay sub-base	Electromechanical, fixed			Electromechanical or solid state		
Equipped with relays	Yes		Yes	No	No	
Control voltage	24 V $\overline{\text{DC}}$					
Output voltage	5 V... 30 V $\overline{\text{DC}}$ 230 V \sim		5 V... 150 V $\overline{\text{DC}}$ 230 V \sim	24 V $\overline{\text{DC}}$ (solid state) 5 V... 24 V $\overline{\text{DC}}$, 230 V \sim (E.M.)		5 V... 150 V $\overline{\text{DC}}$ 230 V \sim
Output current per channel	2 A (th)	3 A (th)	5 A (th)	2 A (solid state) 6 A (electromechanical)		0.5 to 10 A (dependent on relay)
Modularity	8	8 - 16		16	8 or 16	
No. of terminals per channel	2	1	2	1	2 to 3	
Type of connection terminals	1 N/O contact and common Volt-free	1 N/O contact	1 N/O contact and common	1 N/O contact	Signal, Polarities	
Connectors	20-way HE 10 connector					
Terminal block	Removable		Yes		No	No
	Terminal type		Screw or spring		Screw	
Additional or optional* function	Miniature sub-base Latching relay	Volt-free or common per group of 8 channels		Miniature sub-bases Common per group of 4 channels		Isolator and fuse
Type of device	ABE 7R08S216●	ABE 7R●●S1●●	ABE 7R●●S2●●	ABE 7R16T111	ABE 7P16T111	ABE 7P16T2●●● ABE 7P08T3●●●
Page	8/14			8/15	8/16	

(1) For TSX Micro and Modicon Premium PLCs.



Discrete outputs	Discrete inputs or outputs
Universal	Universal



TSX Micro, Modicon Premium, Modicon Quantum, Modicon M340							
Electromechanical, plug-in		Solid state, fixed		–	–	Solid state, fixed	Solid state, plug-in
Yes		Yes		–	–	Yes	No
24 V $\overline{\text{DC}}$						From 24 V $\overline{\text{DC}}$ to 230 V \sim	From 5 V TTL to 230 V \sim
5 V... 150 V $\overline{\text{DC}}$ 230 V \sim		24 V $\overline{\text{DC}}$					
5 A (th)	8 A (th)	0.5 to 2 A	125 mA	0.5 A	125 mA	12 mA	
16							
2 to 3	2 to 6	2		3	2		
1 C/O contact or 1 N/O contact and common	1 C/O contact or 2 C/O contacts and common	Signal and 0 V		24 V $\overline{\text{DC}}$ and 0 V signal	Signal can be isolated, Protected common	Signal	Signal and common
20-way HE 10 connector							
No		Yes	No	No	Yes		No
Screw		Screw or spring		Screw		Screw or spring	
Volt-free or common per group of: 8 channels		4 channels	Fault signal	Isolator and fuse (indicator)	3-wire proximity sensor	Isolator and fuse (indicator)	–
ABE 7R16T2●●	ABE 7R16T3●●	ABE 7S●●S2B●	ABE 7H16F43	ABE 7H16R3●	ABE 7H16S43	ABE 7S16E2●●E	ABE 7P16F31●
8/15		8/14	8/13		8/14		8/15

Applications

Analog signals and special functions



Compatibility

TSX Micro: <input type="checkbox"/> TSX 37 22 <input type="checkbox"/> TSX CTZ●A	Modicon Premium: <input type="checkbox"/> TSX CTY●A <input type="checkbox"/> TSX CAY●1	Modicon Premium: <input type="checkbox"/> TSXASY810 <input type="checkbox"/> TSXAEY1600 TSX A●Y800 Modicon M340: <input type="checkbox"/> BMX AMI 0800 <input type="checkbox"/> BMX AMI 0810 <input type="checkbox"/> BMX AMO 0802 Modicon Quantum: <input type="checkbox"/> 140 AVI 030 00 <input type="checkbox"/> 140 ACI 030 00 <input type="checkbox"/> 140 ACI 040 00 <input type="checkbox"/> 140 ACO 130 00	Modicon Premium: <input type="checkbox"/> TSXASY410 <input type="checkbox"/> TSXAEY420 Modicon M340: <input type="checkbox"/> BMX AMO0410 Modicon Quantum <input type="checkbox"/> 140 AVO 020 00 <input type="checkbox"/> 140 ACO 020 00	Modicon M340: <input type="checkbox"/> BMX ART 0414 <input type="checkbox"/> BMX ART 0814 Modicon Premium: <input type="checkbox"/> TSXAEY1614
--	--	---	--	--

Type of signal

Counter inputs and analog I/O	Counter inputs Axis control Position control	Analog inputs Current/Voltage Pt 100	Analog outputs Current Voltage	Analog inputs
-------------------------------	--	--	--------------------------------------	---------------

Functions

Passive connection, point-to-point with shield continuity	Connection of cold junction compensation or provision, distribution of isolated power supplies
---	--

Modularity

1 counter channel or 8 analog inputs + 2 analog outputs	8 channels	4 channels	4 channels
---	------------	------------	------------

Control voltage

24 V ---			–
----------	--	--	---

Output voltage

24 V ---			–
----------	--	--	---

Output current per channel

25 mA			–
-------	--	--	---

No. of terminals per channel

2	2 or 4	2 or 4	2 or 4
---	--------	--------	--------

Connector type

15-way SUB-D + 9-way SUB-D	25-way SUB-D	25-way SUB-D
----------------------------	--------------	--------------

Terminal block	Removable	No	No	No
	Terminal type	Screw	Screw	Screw

Type of device

ABE 7CPA01	ABE 7CPA02	ABE 7CPA21	ABE 7CPA412 ABE 7CPA410
-------------------	-------------------	-------------------	--

Page

8/18



Analog signals and special functions



Modicon Premium: <input type="checkbox"/> TSX AEY800 <input type="checkbox"/> TSX AEY1600 Modicon Quantum: <input type="checkbox"/> 140 AVI 030 00 <input type="checkbox"/> 140 ACI 030 00 <input type="checkbox"/> 140 ACI 040 00	Modicon Premium: <input type="checkbox"/> TSX AEY810 Modicon M340: <input type="checkbox"/> BMX AMI 0800 <input type="checkbox"/> BMX AMI 0810 <input type="checkbox"/> BMX AMO 0802 Modicon Quantum: <input type="checkbox"/> 140 AVI 030 00 <input type="checkbox"/> 140 ACI 030 00 <input type="checkbox"/> 140 ACI 040 00	Modicon Premium: <input type="checkbox"/> TSX CAY●1, <input type="checkbox"/> TSX CTY●A	Modicon Premium: <input type="checkbox"/> TSX AEY1614	Modicon Premium: <input type="checkbox"/> TSX PAY2●2
Analog inputs Current Voltage Pt 100	Isolated analog inputs	Counter inputs	Inputs for thermocouples	I/O
Distribution of sensor power supplies by limiter (25 mA)	Distribution of isolated sensor power supplies by converter	Acquisition of value from an absolute encoder	Connection of 16 thermocouples with cold junction compensation	Safety module (BG)
8 channels	8 channels	1 channel	16 channels	12 Emergency stops
24 V ---				
24 V ---				
25 mA				–
2 or 4		–	2 or 4	1
25-way SUB-D	25-way SUB-D	15-way SUB-D	25-way SUB-D	50-way SUB-D
No	No	No	No	No
Screw	Screw or spring	Screw	Screw	Screw
ABE 7CPA03	ABE 7CPA31●	ABE 7CPA11	ABE 7CPA12	ABE 7CPA13

8/18



Connection interfaces

Modicon Telefast ABE 7 pre-wired system
Cordsets for Modicon Premium platform

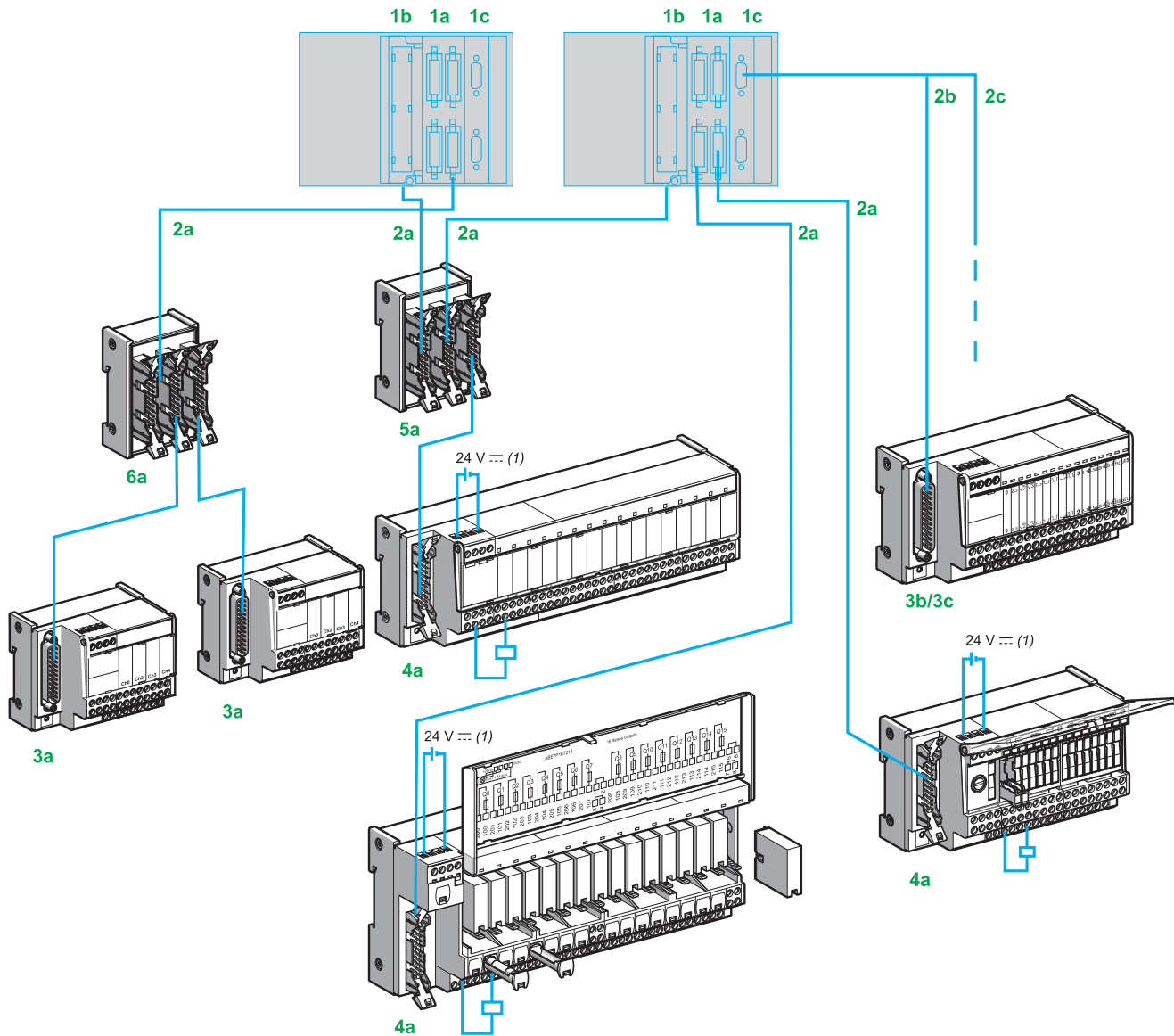

1a Discrete I/O modules with HE 10 connectors.

1b Analog I/O modules with 25-way SUB-D connectors.

1c Application-specific modules with screw terminals.

2a A single type of cable with 20-way HE 10 connectors, for 8, 12 or 16-channel modularity. The HE 10 connectors can be moulded, **TSX CDP●●●** (AWG 22) or insulation piercing, **ABF H20H●●●** (AWG 28).

These cordsets are available in 0.5, 1, 2, 3 and 5 m lengths. AWG 28 (0.08 mm²) allows input and output sub-bases rated 100 mA to be connected directly, as well as sub-bases with relays.

Adaptor **ABE 7ACC02** allows connection of sub-bases with 8-channel modularity.

2b All analog signals are connected with a pre-wired cable **TSX CAP030/100** with 25-way SUB-D connectors, guaranteeing shielding continuity.

2c Cable **TSX CPP●02**

3a 8-channel Modicon Telefast ABE 7 sub-bases.

3b Sub-bases dedicated to counter and analog channels:

- **ABE 7CPA02** for connecting current, voltage or PT100 inputs on a screw terminal block
- **ABE 7CPA03** with 4-20 mA sensor loop power supply and with 25 mA/channel limiter
- **ABE 7CPA21** for connecting output modules with 4 analog channels on a screw terminal block
- **ABE 7CPA31** with the 4-20 mA sensor loop isolated power supply for 8 input channels isolated from one another
- **ABE 7CPA11** for connecting an absolute encoder with parallel outputs
- **ABE 7CPA12** for connecting 16 thermocouple probes

3c Sub-base **ABE 7CPA13** dedicated to the safety channels.

4a 12 or 16-channel Modicon Telefast ABE 7 sub-bases.

5a Splitter sub-bases for connecting discrete I/O in parallel from a Modicon Telefast ABE 7 sub-base on 2 different PLCs:

- **ABE 7ACC10** for output redundancy
- **ABE 7ACC11** for input redundancy

6a Sub-base **ABE 7CPA01** dedicated to connecting axis control and counter inputs on a terminal block.

(1) Connection of the 24 V $\overline{\text{AC}}$ power supply is only possible using Telefast sub-bases. The 0 V $\overline{\text{AC}}$ connections must be equipotential.

Combinations of discrete I/O on the Modicon Premium platform with ABE 7 sub-bases

(item numbers: see Presentation on page 8/8)

		Discrete I/O modules for Modicon Premium					
		Reference for 24 V \square discrete I/O modules (item 1a)					
		Inputs			Outputs	I/O	
		4 x 16 I 2 x 16 I	2 x 16 I	1 x 16 I	4 x 16 O 2 x 16 O	1 x 16 I	1 x 12 O
		TSX DEY 64 D2K TSX DEY 32 D2K	TSX DEY 32 DK	TSX DEY 16 FK	TSX DSY 64 T2K TSX DSY 32 T2K	TSX DMY 28 FK TSX DMY 28 RFK	
Required cordsets							
Preassembled cordsets (at both ends)	TSX CDP●●3 (item 2a), see page 8/19	Yes	Yes	Yes	Yes	Yes	Yes
	ABF H20H●●0 (item 2a), see page 8/19	Yes	Yes	Yes	Yes	Yes	Yes
Passive connection sub-bases							
Universal 8 channels (item 3a)	ABE 7H08R●●	(1)		(1)	(1)	(1)	
	ABE 7H08S21	(1)		(1)	(1)	(1)	
Universal 12 channels (item 4a)	ABE 7H12R●●						
	ABE 7H12S21						
Universal 16 channels (item 4a)	ABE 7H16R●●		ABE 7H16 R20				
	ABE 7H16C●●		ABE 7H16 R20				
	ABE 7H20E●●● (2)		ABE 7H16 R20				
	ABE 7H16S21						
	ABE 7H16R23						
	ABE 7H16F43						
	ABE 7H16S43						
Input adaptor sub-bases with solid state relays							
Universal 16 channels (item 4a)	ABE 7S16E2●● Fixed solid state relays, removable terminal blocks						
	ABE 7P16F3●● Plug-in solid state relays						
Output adaptor sub-bases with fixed relays, removable terminal blocks							
Optimum & Universal 8 channels (item 3a)	ABE 7S08S2●● Solid state relays				(1)		
	ABE 7R08S●●● Electromechanical relays				(1)		
Optimum & Universal 16 channels (item 4a)	ABE 7S16S●●● Solid state relays						
	ABE 7R16S●●● Electromechanical relays						
Output adaptor sub-bases with plug-in relays							
Universal 8 channels (item 3a)	ABE 7P08T330● Solid state relays				(1)		
Optimum & Universal 16 channels (item 4a)	ABE 7R16T●●● Electromechanical relays						
	ABE 7P16T●●● Solid state and/or electromechanical relays						

Compatible
Not compatible

(1) Via splitter sub-base ABE 7ACC02 used to separate 16 channels into 2 x 8 channels.
(2) Low-cost sub-base ABE 7H20E●●● including connection cable.

Connection interfaces

Modicon Telefast ABE 7 pre-wired system
Modicon Premium analog I/O modules and
ABE 7 sub-bases

Combinations of analog I/O on the Modicon Premium platform with ABE 7 sub-bases								
(item numbers: see Presentation on page 8/8)								
Analog I/O modules for Modicon Premium								
Reference for analog I/O modules (item 1b)								
Inputs				Outputs		Thermo-couple inputs		
2 x 8 I	8 I	8 I	4 I	4 O	8 O	2 x 8 I		
TSX AEY 1600	TSX AEY 800	TSX AEY 810	TSX AEY 420	TSX ASY 410	TSX ASY 800	TSX AEY 1614		
Required cordsets								
Preassembled cordsets (at both ends)	TSX CAP●●0 (item 2b)	Yes	Yes	Yes	Yes	(2)	Yes	Yes
Passive connection sub-bases								
Universal 8 channels (item 3a)	ABE 7H08R●● ABE 7H08S21							
Universal 12 channels (item 4a)	ABE 7H12R●● ABE 7H12S21							
Universal 16 channels (item 4a)	ABE 7H16R●● ABE 7H16C●● ABE 7H20E●●● (1) ABE 7H16S21 ABE 7H16R23 ABE 7H16F43 ABE 7H16S43							
Input adaptor sub-bases with solid state relays								
Universal 16 channels (item 4a)	ABE 7S16E2●● Fixed solid state relays, removable terminal blocks ABE 7P16F3●● Plug-in solid state relays							
Output adaptor sub-bases with fixed relays, removable terminal blocks								
Optimum & Universal 8 channels (item 3a)	ABE 7S08S2●● Solid state relays ABE 7R08S●●● Electromechanical relays							
Optimum & Universal 16 channels (item 4a)	ABE 7S16S●●● Solid state relays ABE 7R16S●●● Electromechanical relays							
Output adaptor sub-bases with plug-in relays								
Universal 8 channels (item 3a)	ABE 7P08T330● Solid state relays							
Optimum & Universal 16 channels (item 4a)	ABE 7R16T●●● Electromechanical relays ABE 7P16T●●● Solid state and/or electromechanical relays							
Sub-bases for analog channels								
ABE 7CPA01 (item 6a)								
ABE 7CPA11 (item 3b)								
ABE 7CPA02 (item 3b)								
ABE 7CPA21 (item 3b)				(2)				
ABE 7CPA03 (item 3b)				(3)				
ABE 7CPA31 (item 3b)								
ABE 7CPA12 (item 3b)								
ABE 7CPA13 (item 3c)								

Compatible
Not compatible

(1) Low-cost sub-base ABE 7H20E●●● including connection cable.
(2) Cabled connector ABF Y25S200 equipped with terminal block TSX BLY 01.
(3) Only the first 4 channels are balanced.

Combinations of application-specific I/O on the Modicon Premium platform with ABE 7 sub-bases								
(item numbers: see Presentation on page 8/8)								
Application-specific I/O modules for Modicon Premium								
Reference for application-specific I/O modules (item 1c)								
Axis control		Counter		High-speed counter		Safety		
Speed reference	Auxiliary inputs	Auxiliary inputs	Counter	Auxiliary inputs	Counter			
TSX CAY●1, TSX CFY●A		TSX CTY●A		TSX CTY2C				TSX PAY 262
Required cordsets								
Preassembled cordsets (at both ends)	TSX CAP030 (item 2b)	Yes	No	No	Yes	No	Yes	No
	TSX CDP●●3 (item 2a)	No	Yes	Yes	No	Yes	No	No
	TSX CPP●02 (item 2c)	No	No	No	No	No	No	Yes
Passive connection sub-bases								
Universal 8 channels (item 3a)	ABE 7H08R●●			ABE 7H08 R10 (1)				
	ABE 7H08S21							
Universal 12 channels (item 4a)	ABE 7H12R●●							
	ABE 7H12S21							
Universal 16 channels (item 4a)	ABE 7H16R●●		ABE 7H16 R20	ABE 7H16 R20 (2)		ABE 7H16 R20 (2)		
	ABE 7H16C●●		ABE 7H16 R20	ABE 7H16 R20 (2)				
	ABE 7H20E●●● (3)		ABE 7H16 R20	ABE 7H16 R20 (2)				
	ABE 7H16S21							
	ABE 7H16R23							
	ABE 7H16F43							
ABE 7H16S43								
Input adaptor sub-bases with solid state relays								
Universal 16 channels (item 5)	ABE 7S16E2●●							
	Fixed solid state relays, removable terminal blocks							
	ABE 7P16F3●●							
	Plug-in solid state relays							
Output adaptor sub-bases with fixed relays, removable terminal blocks								
Optimum & Universal 8 channels (item 3a)	ABE 7S08S2●●							
	Solid state relays							
	ABE 7R08S●●●							
	Electromechanical relays							
Optimum & Universal 16 channels (item 4a)	ABE 7S16S●●●							
	Solid state relays							
	ABE 7R16S●●●							
	Electromechanical relays							
Output adaptor sub-bases with plug-in relays								
Universal 8 channels (item 3a)	ABE 7P08T330●							
	Solid state relays							
Optimum & Universal 16 channels (item 4a)	ABE 7R16T●●●							
	Electromechanical relays							
	ABE 7P16T●●●							
	Solid state and/or electromechanical relays							
Sub-bases for counter channels								
	ABE 7CPA01 (item 6a)							
	ABE 7CPA11 (item 3b)	(4)						
	ABE 7CPA02 (item 3b)							
	ABE 7CPA21 (item 3b)							
	ABE 7CPA03 (item 3b)							
	ABE 7CPA31 (item 3b)							
	ABE 7CPA12 (item 3b)							
	ABE 7CPA13 (item 3c)							

Compatible
Not compatible

(1) 1-channel connection.
(2) 2-channel connection.
(3) Low-cost sub-base ABE 7H20E●●● including connection cable.
(4) Compatibility with module TSX CAY●1 only.

Connection interfaces

Modicon Telefast ABE 7 pre-wired system Passive connection sub-bases

Passive connection sub-bases for discrete signals

Optimum "Economy" sub-bases

Function	No. of channels	No. of terminals per on row channel number		For PLCs	Length of PLC connection cable	Type of connection	Reference	Weight kg						
Input or output	16	1	2	Modicon TSX Micro Modicon Premium	1 m	Screw	ABE 7H20E100	0.330						
					2 m	Screw	ABE 7H20E200	0.410						
					3 m	Screw	ABE 7H20E300	0.480						
				Modicon M340	-	(1)	Screw	ABE 7H34E000	0.150					
										1 m	Screw	ABE 7H34E100	0.330	
										2 m	Screw	ABE 7H34E200	0.410	
										3 m	Screw	ABE 7H34E300	0.480	
										Siemens S7	1.5 m	Screw	ABE 7H32E150	0.360
										3 m	Screw	ABE 7H32E300	0.460	



ABE 7H20E●●●



ABE 7H16C21



ABE 7H16CM21

Optimum "Miniature" sub-bases

Function	No. of channels	No. of terminals per on row channel number		LED per channel	Polarity distribution	Type of connection	Reference	Weight kg				
Input or output	16	1	1	No	No	Screw	ABE 7H16C10	0.160				
				Yes	No	Screw	ABE 7H16C11	0.160				
				2	2	Yes	0 or 24 V	Screw	ABE 7H16C21	0.205		
				3	3	Yes	0 or 24 V	Screw	ABE 7H16C31	0.260		
				Input and output (2)	16	1	1	Yes	No	Screw	ABE 7H16CM11	0.160
								2	2	Yes	0 or 24 V	Screw

(1) Sub-base supplied without cordset.

(2) 8 I + 8 Q: these products have 2 common connections which enable inputs and outputs to be connected to the same sub-base at the same time.

Connection interfaces

Modicon Telefast ABE 7 pre-wired system

Passive connection sub-bases

Passive connection sub-bases for discrete signals (continued)										
Universal sub-bases										
Function	No. of channels	No. of terminals per channel	No. of terminals on row number	LED per channel	Polarity distribution	Isolator (I) Fuse (F) per channel	Type of connection	Reference	Weight kg	
Input or output	8	1	1	No	No	–	Screw	ABE 7H08R10	0.187	
				Yes	No	–	Screw	ABE 7H08R11	0.187	
		2	2	Yes	0 or 24 V	–	Screw	ABE 7H08R21	0.218	
						I	Screw	ABE 7H08S21	0.245	
	12	1	1	No	No	–	Screw	ABE 7H12R10	0.274	
				Yes	No	–	Screw	ABE 7H12R11	0.274	
		2	2	No	No	–	Screw	ABE 7H12R50	0.196	
				No	0 or 24 V	–	Screw	ABE 7H12R20	0.300	
			2	2	Yes	0 or 24 V	–	Screw	ABE 7H12R21	0.300
							I	Screw	ABE 7H12S21	0.375
	16	1	1	No	No	–	Screw	ABE 7H16R10	0.274	
				Yes	No	–	Screw	ABE 7H16R11	0.274	
2		2	No	No	–	Screw	ABE 7H16R50	0.196		
			No	0 or 24 V	–	Screw	ABE 7H16R20	0.300		
		2	2	Yes	0 or 24 V	–	Screw	ABE 7H16R21	0.300	
						I	Screw	ABE 7H16S21	0.375	
	3	3	No	0 or 24 V	–	Screw	ABE 7H16R30	0.346		
			Yes	0 or 24 V	–	Screw	ABE 7H16R31	0.346		
Input type 2 (1)	16	2	2	Yes	0 or 24 V	–	Screw	ABE 7H16R23	0.320	
Input	16	2	1	Yes	24 V	I, F (2)	Screw	ABE 7H16S43	0.640	
Output	16	2	1	Yes	0 V	I, F (2)	Screw	ABE 7H16F43	0.640	

(1) For TSX Micro, Modicon Premium.

(2) With LED to indicate blown fuse.



ABE 7H08R10

Connection interfaces

Modicon Telefast ABE 7 pre-wired system
Adaptor sub-bases with fixed relays and removable
terminal blocks

Adaptor sub-bases with fixed solid state relays, removable terminal blocks

Universal input sub-bases with solid state relays

Number of channels	No. of terminals per channel	Isolation of PLC/ Operative part	Voltage	Type of connection	Reference	Weight kg
16	2	Yes	24 V $\overline{\text{---}}$	Screw	ABE 7S16E2B1	0.370
				Spring	ABE 7S16E2B1E	0.370
			48 V $\overline{\text{---}}$	Screw	ABE 7S16E2E1	0.370
				Spring	ABE 7S16E2E1E	0.370
			\sim 48 V	Screw	ABE 7S16E2E0	0.386
			\sim 110 V	Screw	ABE 7S16E2F0	0.397
\sim 230 V	Screw	ABE 7S16E2M0	0.407			
	Spring	ABE 7S16E2M0E	0.407			



ABE 7H16E2●●

Universal output sub-bases with solid state relays

Number of channels	Isolation of PLC/ Operative part	Output voltage	Output current	Fault detection signal (1)	Type of connection	Reference	Weight kg
16	No	24 V $\overline{\text{---}}$	0.5 A	Yes (2)	Screw	ABE 7S16S2B0	0.405
					Spring	ABE 7S16S2B0E	0.405
				No	Screw	ABE 7S16S1B2	0.400
					Spring	ABE 7S16S1B2E	0.400

Optimum and Universal output sub-bases with electromechanical relays

Number of channels	Number of contacts	Output current	Polarity distribution/ operative part	Type of connection	Reference	Weight kg
8	1 N/O	2 A	Contact common per group of 4 channels	Screw	ABE 7R08S111	0.252
				Spring	ABE 7R08S111E	0.252
	Latching	2 A	Volt-free	Screw	ABE 7R08S216	0.448
16	1 N/O	2 A	Contact common per group of 8 channels	Screw	ABE 7R16S111	0.405
				Spring	ABE 7R16S111E	0.405
	1 N/O	5 A	Volt-free	Screw	ABE 7R16S210	0.405
				Spring	ABE 7R16S210E	0.405
				Common per group of 8 channels on both poles	Screw	ABE 7R16S212

(1) A fault on a sub-base output Qn will set PLC output Qn to safety mode, which will be detected by the PLC.

(2) Can only be used with modules with protected outputs.



ABE 7R08S216

Connection interfaces

Modicon Telefast ABE 7 pre-wired system

Input/output adaptor sub-bases for or with plug-in relays

Adaptor sub-bases with plug-in relays

Universal input sub-bases for solid state relays, supplied without relays

Number of channels	No. of terminals per channel	For relay type	Isolation of PLC/Operative part	Input connection	Type of connection	Reference	Weight kg
16	2	ABS 7E ABR 7 ABS 7S33E	Yes	Volt-free	Screw	ABE 7P16F310	0.850
					Polarity distribution Screw	ABE 7P16F312	0.850

Optimum and Universal output sub-bases, supplied with electromechanical relays ⁽¹⁾

Number of channels	Relay width	Relay type supplied	Number and type of contacts	Polarity distribution/operative part	Reference	Weight kg	
16	5 mm	ABR 7S11	1 N/O	Contact common per group of 4 channels	ABE 7R16T111	0.600	
				Contact common per group of 4 output channels + 2 common input terminals	ABE 7R16M111 (2)	0.600	
	10 mm	ABR 7S21	1 N/O	Volt-free	ABE 7R16T210	0.735	
				Common on both poles (3)	ABE 7R16T212	0.730	
			ABR 7S23	1 C/O	Volt-free	ABE 7R16T230	0.775
					Contact common (3)	ABE 7R16T231	0.730
	12 mm	ABR 7S33	1 C/O		Volt-free	ABE 7R16T330	1.300
					Common on both poles (4)	ABE 7R16T332	1.200
			ABR 7S37	2 C/O	Volt-free	ABE 7R16T370	1.300



ABE 7R16M111



ABE 7R16T210

(1) The sub-bases are supplied as standard with electromechanical relays, all or part of which can be replaced by solid state relays of the same width (it is possible to combine these different technologies on a single sub-base).

(2) Two connection methods are available, enabling inputs and outputs to be connected to the same sub-base at the same time.

(3) Per group of 8 channels.

(4) Per group of 4 channels.

Connection interfaces

Modicon Telefast ABE 7 pre-wired system Output adaptor sub-bases for plug-in relays

Output adaptor sub-bases for plug-in relays																	
Optimum and Universal output sub-bases for solid state relays and/or electromechanical relays ⁽¹⁾																	
No. of channels	Relay width	For relay type	Isolator per channel	Fuse per channel	Polarity distribution/operative part	Type of connection	Reference	Weight									
mm								kg									
16	5 mm	ABR 7S11 ABS 7SC1B	No	No	Contact common per group of 4 channels	Screw	ABE 7P16T111	0.550									
									10 mm	ABR 7S2● ABS 7SA2● ABS 7SC2● ABE 7ACC20	No	No	Volt-free	Screw	ABE 7P16T210 (2)	0.615	
	ABE 7P16T230 (2)	0.655															
			Yes	Volt-free	Screw	ABE 7P16T214	0.675										
	No	Common on both poles (3)						Screw							ABE 7P16T212	0.615	
			Yes	Common on both poles (3)	Screw	ABE 7P16T215	0.670										
8	12 mm	ABR 7S33 ABS 7A3● ABS 7SC3●● ABE 7ACC21						No	No	Volt-free	Screw	ABE 7P08T330	0.450				
			16	12 mm	ABR 7S33 ABS 7A3● ABS 7SC3●● ABE 7ACC21	No	No							Volt-free	Screw	ABE 7P16T330	0.900
ABR 7S33 ABS 7A3M ABS 7SC3E ABE 7ACC21	No	Yes	Volt-free	Screw	ABE 7P16T334	0.900											
							Yes	Yes	Common on both poles (4)	Screw	ABE 7P16T318	1.000					



ABE 7P16T210

(1) Not equipped with relays.

(2) With relay ABR 7S21 for sub-base ABE 7P16T210, with relay ABR 7S23 for sub-base ABE 7P16T230.

(3) Per group of 8 channels.

(4) Per group of 4 channels.



Plug-in solid state relays								
Relay width	Functions	Input circuit		Output circuit		Unit reference	Weight kg	
		Current	Nominal voltage	Current	Nominal voltage			
5 mm	Output	---	24 V	2 A	24 V ---	ABS 7SC1B	0.010	
10 mm	Output	---	24 V	0.5 A	5...48 V ---	ABS 7SC2E	0.016	
					24...240 V ~	ABS 7SA2M	0.016	
12 mm	Input	---	5 V TTL	–	24 V ---	ABS 7EC3AL	0.014	
			24 V Type 2	–	24 V ---	ABS 7EC3B2	0.014	
			48 V Type 2	–	24 V ---	ABS 7EC3E2	0.014	
			50 Hz ~	48 V	–	24 V ---	ABS 7EA3E5	0.014
			60 Hz ~	110...130 V	–	24 V ---	ABS 7EA3F5	0.014
			50 Hz ~	230...240 V	–	24 V ---	ABS 7EA3M5	0.014
			Output	---	24 V	2 A Self-protected	24 V ---	ABS 7SC3BA
			1.5 A	5...48 V ---	ABS 7SC3E	0.016		
			1.5 A	24...240 V ~	ABS 7SA3MA	0.016		

Plug-in electromechanical relays						
Relay width	Control voltage	Output current (1)	Number of contacts	Order in multiples	Unit reference	Weight kg
5 mm	24 V ---	5 A (lth)	1 N/O	4	ABR 7S11	0.005
10 mm	24 V ---	5 A (lth)	1 N/O	4	ABR 7S21	0.008
			1 C/O	4	ABR 7S23	0.008
12 mm	2 V ---	10 A (lth)	1 C/O	4	ABR 7S33	0.017
		8 A (lth)	2 C/O	4	ABR 7S37	0.017
		48 V ---	8 A (lth)	1 C/O	4	ABR 7S33E

Accessory		
Description	Reference	Weight kg
Extractor for 5 mm miniature relay	ABE 7ACC12	0.010



Connection interfaces

Modicon Telefast ABE 7 pre-wired system

Connection sub-bases for analog channels and application-specific channels



ABE 7CPA01



ABE 7CPA11



ABE 7CPA21/410/412

Connection sub-bases for counter and analog channels

Functions	For PLCs	Compatible modules	Type of connection on Telefast end	Type of connection	Reference	Weight kg			
Analog and counter	TSX Micro	Analog and integrated counter TSX 37 22 TSX CTZ●A	15-way SUB-D	Screw	ABE 7CPA01	0.300			
Counter, axis control, position control	Modicon Premium	TSX CTY●A TSX CAY●1	15-way SUB-D	Screw	ABE 7CPA01	0.300			
Connection of absolute encoder with parallel output	Modicon Premium	TSX CTY●A TSX CAY●1	15-way SUB-D	Screw	ABE 7CPA11	0.330			
Distribution of 4 thermocouples	Modicon M340	BMX ART 0414 BMX ART 0814	25-way SUB-D	Screw	ABE 7CPA412	0.180			
Distribution of 16 thermocouples	Modicon Premium	TSX AEY1614	25-way SUB-D	Screw	ABE 7CPA12	0.300			
Passive distribution of 8 analog EIS channels on screw terminals, with shield continuity	Modicon Premium	TSX ASY810 TSX AEY1600 TSX A●Y800	25-way SUB-D	Screw	ABE 7CPA02	0.290			
	Modicon M340	BMX AMI 0800 BMX AMI 0810 BMX AMO 0802							
	Modicon Quantum	140 AVI 030 00 140 ACI 030 00 140 ACI 040 00 140 ACO 130 00							
Provision and distribution of protected isolated power supplies for 4 analog input channels	Modicon M340	BMX AMI 0410	25-way SUB-D	Screw	ABE 7CPA410	0.180			
Distribution of 4 analog output channels	Modicon Premium	TSX ASY410 TSX AEY420	25-way SUB-D	Screw	ABE 7CPA21	0.210			
	Modicon M340	BMX AMO 0410							
	Modicon Quantum	140 AVO 020 00 140 ACO 020 00							
Distribution and supply of 8 analog input channels with limitation of each current loop	Modicon Premium	TSX AEY800 TSX AEY1600	25-way SUB-D	Screw	ABE 7CPA03	0.330			
	Modicon Quantum	140 AVI 030 00 140 ACI 030 00 140 ACI 040 00							
	Modicon Premium	TSX AEY810							
Distribution and supply of 8 analog input channels isolated from one another with 25 mA/channel limitation	Modicon Premium	TSX AEY810	25-way SUB-D	Screw	ABE 7CPA31	0.410			
	Modicon M340	BMX AMI 0800 BMX AMI 0810 BMX AMO 0802					Spring	ABE 7CPA31E	0.410
	Modicon Quantum	140 AVI 030 00 140 ACI 030 00 140 ACI 040 00							
Safety	Modicon Premium	TSX PAY2●2	25-way SUB-D	Screw	ABE 7CPA13	0.290			

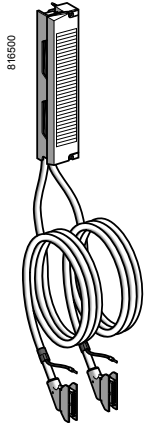

ABF M32H●●1

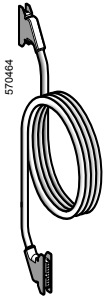

TSX CDP●●03

Cabled connectors for Modicon Quantum I/O modules

Type of signal	I/O modules	Type of connector	Gauge	Cross-section	Length	No. of channels	Reference	Weight
			AWG	mm ²				
Inputs and relay outputs	Please consult our website www.schneider-electric.com	2 x 20-way HE 10	22	0.324	1.5	2 x 16	ABF M32H150	0.650
					3	2 x 16	ABF M32H300	1.150
0.5 A outputs	Please consult our website www.schneider-electric.com	2 x 20-way HE 10 + external power supply	22	0.324	1.5	2 x 16	ABF M32H151	0.650
					3	2 x 16	ABF M32H301	1.150
Inputs or outputs (96 channels)	140 DDI 364 00 140 DDO 364 00	2 x 20-way HE 10	22	0.324	0.5	6 x 16	TSX CDP 053	0.085
					1	6 x 16	TSX CDP 103	0.150
					2	6 x 16	TSX CDP 203	0.280
					3	6 x 16	TSX CDP 303	0.410
					5	6 x 16	TSX CDP 503	0.670
Analog inputs	140 AVI 030 00 140 ACI 030 00	1 x 25-way SUB-D	24	0.22	2	8	ABF M08S201	0.600
	140 ACI 040 00	2 x 25-way SUB-D	24	0.22	2	16	ABF M16S201	0.620
	140 AVO 020 00	1 x 25-way SUB-D	24	0.22	2	4	ABF M04S200	0.450
Analog outputs	140 ACO 020 00	1 x 25-way SUB-D	24	0.22	2	4	ABF M04S201	0.450
	140 ACO 130 00	1 x 25-way SUB-D	24	0.22	2	8	ABF M04S202	0.450

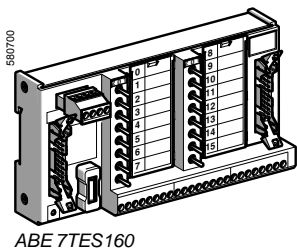
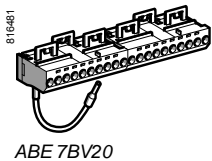
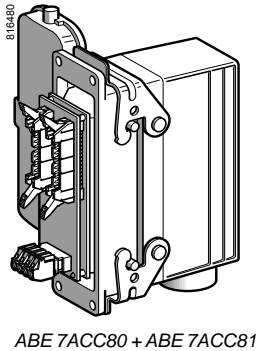
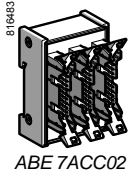

Accessories

Description	No. of channels	Characteristics	Order in multiples of	Unit reference	Weight kg
Kit for fixing on solid plate	–	–	10	ABE 7ACC01	0.008
Splitter sub-base	–	16 as 2 x 8 channels	1	ABE 7ACC02	0.075
Redundant output sub-base	–	16 as 2 x 16 channels	1	ABE 7ACC10	0.075
Redundant input sub-base	–	16 as 2 x 16 channels	1	ABE 7ACC11	0.075
Plug-in continuity blocks	–	Width 10 mm	4	ABE 7ACC20	0.007
		Width 12 mm	4	ABE 7ACC21	0.010
Enclosure feedthrough with CNOMO M23 connector (1 x 20-way HE 10 connector, PLC end)	16	19-way	1	ABE 7ACC82	0.150
Impedance adaptor for compatibility Type 2	–	Used with ABE 7ACC82 and ABE 7ACC83	1	ABE 7ACC85	0.012
IP 65 cable gland	–	For 3 cables	5	ABE 7ACC84	0.300
Additional snap-on terminal blocks (shunted terminals)	8	10 screw terminals	5	ABE 7BV10	0.030
	16	20 screw terminals	5	ABE 7BV20	0.060
I/O simulator sub-base	16	For display, forcing, inhibition, continuity	1	ABE 7TES160	0.350
Self-adhesive marker tag holder	–	For 6 characters	50	AR1 SB3	0.001
Quick-blow fuses 5 x 20, 250 V, UL	–	0.125 A	10	ABE 7FU012	0.010
		0.5 A	10	ABE 7FU050	0.010
		1 A	10	ABE 7FU100	0.010
		2 A	10	ABE 7FU200	0.010
		4 A	10	ABE 7FU400	0.010
		6.3 A	10	ABE 7FU630	0.010

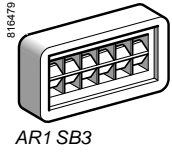

Commoning link accessories						
Description	For common	Colour	Distance between cable ends	Reference	Weight kg	
Commoning links Modularity 8 x 1 mm ²	Coil	White	12 cm	ABF C08R12W	0.020	
			2 cm	ABF C08R02W	0.010	
	~	Red	12 cm	ABF C08R12R	0.020	
			2 cm	ABF C08R02R	0.010	
	≡	Blue	12 cm	ABF C08R12B	0.020	
			2 cm	ABF C08R02B	0.010	

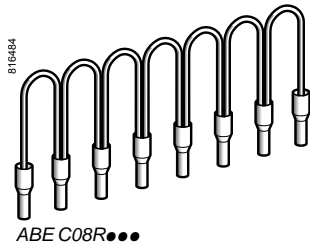

ABL4: 85 to 960 W - Compact - Rail mounting

Function modules ABL 8DCC: converters ---/---



~ 100...230 V	~ 120 V or ~ 230 V	~ 400...500 V	--- 24 V
Single-phase (N-L1) connection	Single-phase (N-L1) connection or 2-phase (L1-L2) connection	–	–
–	Single-phase (N-L1) connection	3-phase (L1-L2-L3) connection	–
–	–	3-phase (L1-L2-L3) connection	–
No	No	No	–
Yes, current limitation			Yes, current limitation
Automatic reset on elimination of the fault			
Yes	Yes	Yes	Yes, depending on model
Yes with buffer module, battery and battery check modules, redundancy module and discriminating downstream protection module			
Depending on model: 1.5 to 1.7 In for 5 to 30 seconds			No

--- 24 V	--- 5 V	--- 7...12 V
		ABL 8DCC12020 (1)
ABL 4RSM24035		
ABL 4RSM24050		
		ABL 8DCC05060 (1)
	ABL 4RSM24100	
	ABL 4RSM24200	ABL 4WSR24200
		ABL 4WSR24300
		ABL 4WSR24400

8/30 (2)

(1) Converter module ---/---, must be used with a Phaseo power supply.

(2) Certain offers cannot be marketed in certain countries, please consult your "Customer Care Centre".



More technical information on www.schneider-electric.com

Power supplies and transformers

Phaseo

Regulated switch mode power supplies
Rectified power supplies

Power supplies

Regulated switch mode

ABL 1REM/1RPM: 60 to 240 W - Mounting on panel



Input voltage

100...240 V ~
120...370 V ≍

Connection to world-wide line supplies

- United States
 - 120 V (in phase-to-neutral)
 - 240 V (in phase-to-phase)
- Europe
 - 230 V (in phase-to-neutral)
 - 400 V (in phase-to-phase)
- United States
 - 277 V (in phase-to-neutral)
 - 480 V (in phase-to-phase)

Single-phase (N-L1) or 2-phase (L1-L2) connection

Single-phase (N-L1)

Single-phase (N-L1)

IEC/EN 61000-3-2 conformity

Yes for ABL 1RP, not applicable for ABL1REM24025/12050

Protection against undervoltage

–

Protection against overloads and short-circuits

Yes, voltage detection. Automatic restart on elimination on the fault

Diagnostic relay

–

Compatibility with function modules

–

Power reserve (Boost)

No

Output voltage

12 V ≍

24 V ≍

Output current 0.5 A

1 A

2 A

2.5 A

3 A

4 A

4.2 A

4.8 A

5 A

6 A

6.2 A

8.3 A

10 A

15 A

20 A

30 A

40 A

60 A

ABL 1REM24025

ABL 1R•M24042

ABL 1REM12050

ABL 1R•M24062

ABL 1RPM12083

ABL 1R•M24100

Pages

Please consult our website www.schneider-electric.com



More technical information on www.schneider-electric.com

Phaseo power supplies and transformers

Regulated switch mode power supplies
ABL 8MEM, ABL 7RM
7 to 60 W - Rail mounting

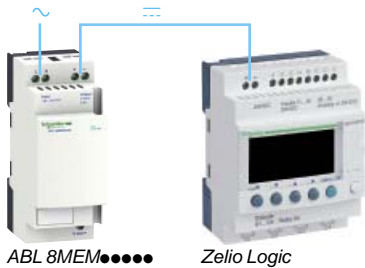

Regulated switch mode power supplies ABL 8MEM, ABL 7RM

The ABL 8MEM, ABL 7RM power supply offer is designed to provide the DC voltage necessary for the control circuits of automation system equipment consuming 7 to 60 W in 5, 12 and 24 V DC .

Comprising six products, this range meets the needs encountered in industrial, commercial and residential applications. These compact electronic switch mode power supplies provide a quality of output current that is suitable for the loads supplied and compatible with the **Zelio Logic** range and the smallest **Modicon M340, Premium** and **Quantum** configurations.

Clear guidelines are given on selecting the upstream protection devices which are often used with them, and thus a comprehensive solution is provided that can be used in total safety.

ABL 8MEM/7RM power supplies can be connected in phase-to-neutral (N-L1) or in phase-to-phase (1) (L1-L2). They deliver a voltage that is precise to 3%, whatever the load and whatever the type of line supply, within a range of 85 to 264 V \sim .

Conforming to IEC standards and UL, CSA and TUV certified, they are suitable for universal use. The inclusion of overload and short-circuit protection makes downstream protection unnecessary if discrimination is not required.

Due to their low power, ABL 8MEM/7RM power supplies consume very little harmonic current and thus are not subject to the requirements of standard IEC/EN 61000-3-2 concerning harmonic pollution.

All ABL 8MEM/7RM power supplies have protection devices to ensure optimum performance of the automation system with an automatic reset mode on elimination of the fault.

All products are equipped with an output voltage adjustment potentiometer to compensate for any line voltage drops in installations with long cable runs.

These power supplies also have a cable run inside the case so that the outputs can be connected at the top or bottom of the product as required.

These power supplies are designed for direct mounting on 35 mm U rails, or on a mounting plate using their retractable fixing lugs.

There are six references available in the Phaseo ABL 8MEM/7RM range:

■ ABL8MEM24003	7 W	0.3 A	24 V DC
■ ABL8MEM24006	15 W	0.6 A	24 V DC
■ ABL8MEM24012	30 W	1.2 A	24 V DC
■ ABL7RM24025	60 W	2.5 A	24 V DC
■ ABL8MEM05040	20 W	4 A	5 V DC
■ ABL8MEM12020	25 W	2 A	12 V DC

(1) 240 V \sim nominal.

Description

ABL 8MEM.....



ABL7RM24025



- 1 2.5 mm² screw terminal for connection of the incoming AC voltage
- 2 Output voltage adjustment potentiometer
- 3 2.5 mm² screw terminal for connection of the output voltage
- 4 LED indicating presence of the DC output voltage
- 5 Duct for throughwiring of the output voltage conductors at the bottom (except for model ABL 7RM24025)
- 6 Clip-on marker tag (except for model ABL 7RM24025)
- 7 Retractable fixing lugs for panel mounting

Phaseo power supplies and transformers

Regulated switch mode power supplies
ABL 8MEM, ABL 7RM
7 to 60 W - Rail mounting

Selection of protection on the power supply primaries

Type of line supply	100 to 240 V ~ single-phase		
Type of protection	Thermal-magnetic circuit breaker		gG fuse
	GB2 (IEC) (1)	C60N (IEC) C60N (UL/CSA)	
ABL 8MEM05040	GB2 ●●07 (2)	24581 24517	2 A
ABL 8MEM12020			
ABL 8MEM24003			
ABL 8MEM24006			
ABL 8MEM24012			
ABL 7RM24025	GB2 ●●08 (2)	24582 24518	3 A

(1) UL pending

(2) Complete the reference by replacing ●● with:

CB: for single-pole circuit-breaker with magnetic trip threshold 12 to 16 In

CD: for single-pole + neutral circuit-breaker with magnetic trip threshold 12 to 16 In

DB: for 2-pole circuit-breaker with magnetic trip threshold 12 to 16 In

CS: for single-pole circuit-breaker with magnetic trip threshold 5 to 7 In

References



ABL 8MEM05040/12020/24012



ABL 8MEM24003/24006



ABL 7RM24025

Input voltage	Secondary		Reset	Conformity to standard IEC/EN 61000-3-2 (1)	Reference	Weight kg
	Output voltage	Nominal power Nominal current				
Single-phase (N-L1) or 2-phase (L1-L2) connection						
100...240 V -15%, + 10% 50/60 Hz	5 V ---	20 W 4 A	Automatic	Not applicable	ABL 8MEM05040	0.195
	12 V ---	25 W 2 A	Automatic	Not applicable	ABL 8MEM12020	0.195
	24 V ---	7 W 0.3 A	Automatic	Not applicable	ABL 8MEM24003	0.100
		15 W 0.6 A	Automatic	Not applicable	ABL 8MEM24006	0.100
		30 W 1.2 A	Automatic	Not applicable	ABL 8MEM24012	0.195
		60 W 2.5 A	Automatic	Not applicable	ABL 7RM24025	0.255

Description	Use	Order in multiples of	Unit reference	Weight kg
Clip-on marker tags	Replacement parts for ABL 8MEM power supplies	100	LAD 90	0.030

(1) Due to their power < 75 W, ABL 8MEM/7RM power supplies are not subject to the requirements of standard IEC/EN 61000-3-2.

Phaseo power supplies and transformers

Regulated switch mode power supplies

ABL 8REM, ABL 7RP

60 to 144 W - Rail mounting

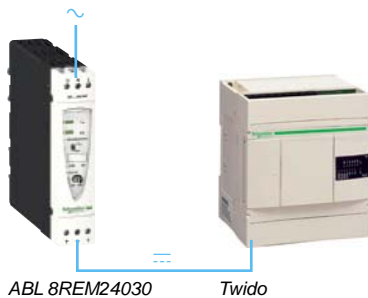

Switch mode power supplies: range ABL 8REM/7RP

The ABL 8REM/7RP power supply offer is designed to provide the DC voltage necessary for the control circuits of automation system equipment consuming 60 to 144 W in 12, 24 and 48 V \dots . Comprising four products, this range meets the needs encountered in industrial, commercial, and residential applications. With phase-to-neutral (N-L1) or phase-to-phase (1) (L1-L2) connection, these slim electronic switch mode power supplies provide a quality of output current that is suitable for the loads supplied and compatible with both the **Twido** range and the smallest **Modicon M340, Premium** and **Quantum** configurations, making them ideal partners.

Their simplified characteristics in comparison with the **ABL 8RP/8WP** offer also make them the low-cost solution for applications less affected by problems with the line supply, such as harmonic pollution and outages. Clear guidelines are given on selecting the upstream protection devices which are often used with them, and thus a comprehensive solution is provided that can be used in total safety.

The ABL 8REM/7RP range of Phaseo power supplies delivers a voltage that is precise to 3%, whatever the load and whatever the type of line supply, within a range of 85 to 264 V \sim . Conforming to IEC standards and UL, CSA and TUV certified, they are suitable for universal use. The inclusion of overload and short-circuit protection makes downstream protection unnecessary if discrimination is not required.

ABL 8REM power supplies do not have an anti-harmonic filter and do not satisfy the requirements of standard IEC/EN 61000-3-2 concerning harmonic pollution.

ABL 7RP power supplies, however, are equipped with a PFC (*Power Factor Correction*) filter, thus ensuring compliance with standard IEC/EN 61000-3-2.

All ABL 8REM/7RP Phaseo power supplies have protection devices to ensure optimum performance of the automation system with an automatic reset mode on elimination of the fault.

In the event of an overload or short-circuit, the integrated protection interrupts the current supply before the output voltage drops below 19 V \dots . The protection device resets itself automatically on elimination of the fault, which avoids having to take any action or change a fuse.

All products are equipped with an output voltage adjustment potentiometer to compensate for any line voltage drops in installations with long cable runs. These power supplies are designed for direct mounting on 35 and 75 \perp rails.

There are four references available in the ABL 8REM/7RP Phaseo range:

■ ABL 8REM24030	72 W	3 A	24 V \dots
■ ABL 8REM24050	120 W	5 A	24 V \dots
■ ABL 7RP1205	60 W	5 A	12 V \dots
■ ABL 7RP4803	144 W	3 A	48 V \dots

Description

- 1 2.5 mm² enclosed screw terminals for connection of the input voltage (single-phase N-L1, phase-to-phase L1-L2 (1))
- 2 Protective glass flap
- 3 Input voltage status LED (orange)
- 4 Output DC voltage status LED (green)
- 5 Locking catch for the glass flap (sealable)
- 6 Clip-on marker tag
- 7 Output voltage adjustment potentiometer
- 8 2.5 mm² enclosed screw terminal block for connection of the DC output voltage

(1) 240 V \sim nominal.



Phaseo power supplies and transformers

Regulated switch mode power supplies
ABL 8REM, ABL 7RP
60 to 144 W - Rail mounting

Selection of protection on the power supply primaries

Type of line supply	100 V ~			240 V ~		
	Thermal-magnetic circuit breaker		gG fuse	Thermal-magnetic circuit breaker		gG fuse
	GB2 (IEC) (1)	C60N (IEC) C60N (UL)		GB2 (IEC) (1)	C60N (IEC) C60N (UL)	
ABL 7RP1205	GB2 ●●06 (2)	24580 24516	2 A	GB2 ●●06 (2)	24580 24516	1 A
ABL 8REM24030	GB2 ●●07 (2)	24581 24517	2 A	GB2 ●●06 (2)	24580 24516	1 A
ABL 8REM24050	GB2 ●●07 (2)	24581 24517	2 A	GB2 ●●06 (2)	24580 24516	1 A
ABL 7RP4803	GB2 ●●07 (2)	24581 24517	2 A	GB2 ●●06 (2)	24580 24516	1 A

(1) UL pending

(2) Complete the reference by replacing ●● with:

CB: for single-pole circuit-breaker with magnetic trip threshold 12 to 16 In

CD: for single-pole + neutral circuit-breaker with magnetic trip threshold 12 to 16 In

DB: for 2-pole circuit-breaker with magnetic trip threshold 12 to 16 In

CS: for single-pole circuit-breaker with magnetic trip threshold 5 to 7 In

ABL 8REM/7RP range of Phaseo regulated switch mode power supplies



ABL 7RP1205/4803



ABL 8REM24030



ABL 8REM24050

Input voltage	Secondary		Reset	Conformity to standard IEC/EN 61000-3-2	Reference	Weight kg
	Output voltage	Nominal power				
Single-phase (N-L1) or phase-to-phase (L1-L2) connection						
100...240 V ~ - 15%, + 10% 50/60 Hz	12 V ---	60 W	5 A	Automatic or manual	Yes	ABL 7RP1205 1.000
	24 V ---	72 W	3 A	Automatic	No	ABL 8REM24030 0.520
		120 W	5 A	Automatic	No	ABL 8REM24050 1.000
48 V ---	144 W	2.5 A	Automatic or manual	Yes	ABL 7RP4803 1.000	

Power supplies and transformers

Phaseo

Regulated switch mode power supplies

ABL4

85 to 960 W - Compact - Rail mounting



Presentation

The range

The Phaseo regulated switch mode power supplies ABL4 offer is designed to provide the DC voltage necessary for the control circuits of automation system equipment consuming 85 W to 960 W on \sim 24 V.

Comprising 7 products, this range of power supplies meets the needs encountered in industrial applications.

Using electronic switch mode technology, these power supplies provide a quality of output current that is suitable for the loads supplied and compatible with the following ranges:

- Twido programmable controllers,
- Modicon logic controllers M238 and M258,
- Modicon motion controllers LMC 058,
- automation platforms M340, Premium and Quantum.

Due to their high overload withstand, the power supplies ABL4 are the power supply solution for stepper motors, servo motors and integrated drives.

When used with function modules ABL8B/RED/D/P, they ensure continuity of service in the event of power outages or application malfunctions. In addition, the ABL 4RSM24200 model can be used in a redundant power supply without an additional redundancy module due to its integrated diode.

Their high effectiveness enables us to offer power supplies that are among the smallest on the market, thus considerably reducing the space required in enclosures.

Compatibility with distribution systems

Power supplies ABL4 must be connected in phase-to-neutral, phase-to-phase (1) for the ABL 4R, and in 3-phase for the ABL 4W.

They deliver a voltage that is precise to within \pm 1% whatever the load and whatever the type of line supply, within the following ranges:

- \sim 90...264 V for the ABL 4RSM24035 and ABL 4RSM24050,
- \sim 90...132 V and \sim 185...264 V for the ABL 4RSM24100 and ABL 4RSM24200,
- \sim 340...550 V for the ABL 4W.

Standards and certifications

Conforming to IEC standards and UL certified, the power supplies ABL4 are suitable for universal use: they can be used to supply Protection Extra Low Voltage (PELV) or Safety Extra Low Voltage (SELV) circuits in compliance with standard IEC/EN 60364-4-41 due to their double insulation between the input circuit (connected to the line supply) and the output circuit and their internal device limiting the output voltage to less than 60 V in the event of an internal fault.

Diagnostics

The operation of the power supply ABL4 can be checked using 2 LEDs located on the front face.

A normally open contact (NO) relay also enables checking of the output voltage compliance (contact closed if the output voltage exceeds 90% of the nominal voltage).

Protection

Power supplies ABL4 have the following continuous protection (2):

- protection against overvoltages on the output circuit,
- thermal protection,
- protection against overcurrents and short-circuits on the output circuit.

Mounting

Power supplies ABL4 are mounted on Omega (□ 35 mm) rail.

(1) Only on certain American line supplies.

(2) With automatic restarting.

Characteristics

Derating

The ambient temperature is a determining factor which limits the power that an electronic power supply can deliver continuously. If the temperature around the electronic components is too high, their life will be significantly reduced.

The nominal ambient temperature for power supplies ABL4 is, depending on the reference, 45, 50 or 60°C. Above this temperature, derating is necessary up to a maximum temperature of 60°C.

The adjacent graph shows the power as a percentage of the nominal power that the power supply can deliver continuously, in relation to the ambient temperature.

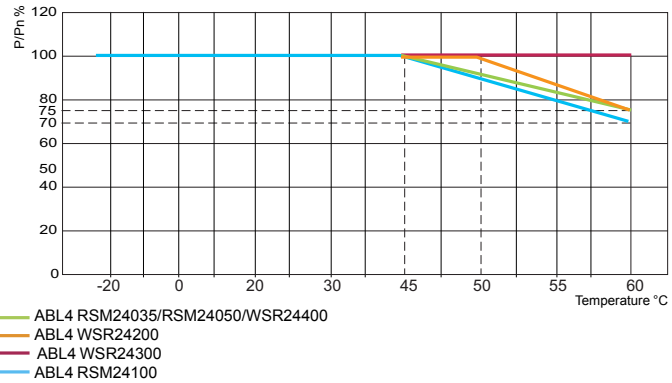

In all cases, there must be adequate convection around the products to assist cooling.

There must be sufficient clearance around power supplies ABL4: refer to instruction sheet supplied with each power supply and, also, downloadable from www.schneider-electric.com

Temporary overcurrents

Power supplies ABL4 have an energy reserve allowing them to supply the application, according to the references, from 150% to 170% of the nominal current for 5 seconds and up to 30 seconds, whilst guaranteeing an output voltage higher than 90% of the nominal voltage.

Power supply	Maximum temporary overcurrent	Maximum time of temporary overcurrent
ABL 4RSM24035	170% of nominal current	30 seconds
ABL 4RSM24050	160% of nominal current	30 seconds
ABL 4RSM24100	150% of nominal current	30 seconds
ABL 4RSM24200 ABL 4WSR24●00	150% of nominal current	5 seconds

The time interval between each overcurrent cannot be less than 10 seconds.

When the overcurrent value exceeds the reserve energy value or when the overcurrents are too closely spaced or when the overcurrent is prolonged (depending on the reference), more than 5 seconds and up to 30 seconds, the power supply switches to protection mode.

Behaviour in event of overcurrents and short-circuits

In the event of overcurrent or short-circuit, the power supply ABL4 switches to protection mode and periodically attempts a reset ("Hiccup" mode) until the fault disappears. Once the output circuit load conditions return to normal, the power supply automatically resets.

Power supply	Periodic reset frequency type
ABL 4RSM24035 ABL 4RSM24050 ABL 4RSM24100	Variable: depends on the overcurrent value and the ambient temperature. In the event of a short-circuit (output voltage close to 0 V), the current is established for 50 ms approximately every 1.8 seconds.
ABL 4RSM24200 ABL 4WSR24●00	Fixed: the current is established for 5 seconds every 15 seconds either in the event of an overcurrent or a short-circuit.

Connecting in parallel

In order to increase the current available, the outputs of two power supplies with identical references can be connected in parallel.

To obtain equitable sharing of the current between the two power supplies, the following precautions must be taken into account:

- Use two power supplies bearing the same date code and same reference.
- Adjust the output voltages so as to obtain the same voltage value, to within plus or minus 20 mV, 10 minutes after power-up with a load consumption of less than 20% connected on each power supply output.
- Connect one of the "+" terminals and one of the "-" terminals of each power supply to a terminal using wires of the same length and diameter.
- Use wires with the largest cross-section as possible.

The maximum usable current is 1.8 times the nominal current of the power supply.

Redundancy of the power supply ABL 4RSM24200 can be achieved without adding a specific module, due to the specific diode that is integrated in these products.

For other power supply references, redundancy module ABL 8RED24400 must be used.

Additional technical information on www.schneider-electric.com

Power supplies and transformers

Phase0

Regulated switch mode power supplies

ABL4

85 to 960 W - Compact - Rail mounting

Characteristics (continued)

Selection of protection on the power supply primaries

Power supply	Type of protection		
	Miniature circuit-breakers C60N (Icn > 1.5 kA)	Fuses	Class CC fuses with rejection system
	Zone in which equipment used		
	Rest of the world	USA & Canada	
ABL 4RSM24035	4 A curve C	4 A time-lag	6 A
ABL 4RSM24050	4 A curve C	4 A time-lag	6 A
ABL 4RSM24100	6 A curve C	6.3 A time-lag	6 A
ABL 4RSM24200	16 A curve C 10 A curve D	15 A time-lag	10 A
ABL 4WSR24200	3 x 10 A curve C	3 x 3.15 A time-lag	3 x 10 A
ABL 4WSR24300	3 x 10 A curve C	3 x 5 A time-lag	3 x 10 A
ABL 4WSR24400	3 x 10 A curve C	3 x 6.3 A time-lag	3 x 10 A

Description

The regulated switch mode power supplies ABL 4RSM24035 and ABL 4RSM24050 comprise:

- 1 Spring clip for Omega (└r 35 mm) rail.
- 2 Output voltage status LED (green).
- 3 Output circuit overcurrent LED (red).
- 4 Output voltage adjustment potentiometer.
- 5 Removable screw terminal block for connection of the DC output voltage and diagnostics contact.
- 6 Removable screw terminal block for connection of the AC input voltage on single-phase (1).

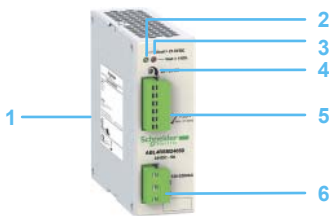

The regulated switch mode power supplies ABL 4RSM24100 comprise:

- 1 Spring clip for Omega (└r 35 mm) rail.
- 2 Removable screw terminal block for connection of the AC input voltage (on single-phase) (1) and for connection of 120/230 V selection link.
- 3 Output voltage status LED (green).
- 4 Output circuit overcurrent LED (red).
- 5 Output voltage adjustment potentiometer.
- 6 Removable screw terminal block for connection of the DC output voltage and diagnostics contact.

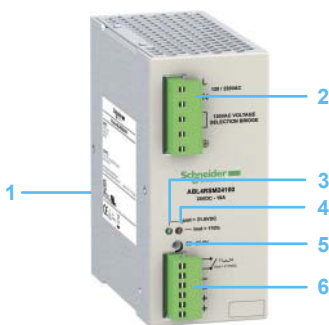

The regulated switch mode power supplies ABL 4RSM24200, ABL 4WSR24200, ABL 4WSR24300 and ABL 4WSR24400 comprise:

- 1 Spring clip for Omega (└r 35 mm) rail.
- 2 Enclosed screw terminals for connection of the DC output voltage and diagnostics contact.
- 3 Output voltage adjustment potentiometer.
- 4 Output voltage status LED (green).
- 5 Output circuit overcurrent and alarm LED (red).
- 6 Enclosed screw terminals for connection of the AC input voltage:
 - single-phase connection for ABL 4RSM24200 (1),
 - 3-phase connection for ABL 4W●●●●.

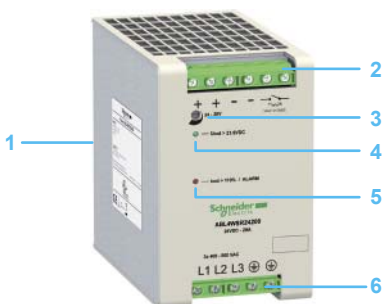

(1) Connection between 2 phases only on certain American line supplies.

Power supplies and transformers

Phaseo

Regulated switch mode power supplies

ABL4

85 to 960 W - Compact - Rail mounting



ABL 4RSM24050



ABL 4RSM24100



ABL 4WSR24200



ABL 8BUF24400



ABL 8BBU24200



ABL 8RED24400

Phaseo regulated switch mode power supplies ABL4, 85 to 960 W

Input voltage	Secondary		Reset	Reference	Weight kg
	Output voltage	Nominal power			
Single-phase (N-L1) connection (1)					
~ 100...230 V - 10%, + 15%	~ 23...27.4 V	85 W	3.5 A	Automatic	ABL 4RSM24035 0.500
		120 W	5 A	Automatic	ABL 4RSM24050 0.500
~ 120 V - 25%, + 10% and ~ 230 V - 20%, + 15%	~ 23...27.4 V	240 W	10 A	Automatic	ABL 4RSM24100 0.800
	~ 24...27.8 V	480 W	20 A	Automatic	ABL 4RSM24200 (2) 1.300
3-phase (L1-L2-L3) connection					
~ 400...500 V - 15%, + 10%	~ 24...27.8 V	480 W	20 A	Automatic	ABL 4WSR24200 1.300
		720 W	30 A	Automatic	ABL 4WSR24300 1.300
		960 W	40 A	Automatic	ABL 4WSR24400 1.300

Function modules for continuity of service (3)

Function	Use	Description	Reference	Weight kg
Continuity after a power outage (5)	Holding time 100 ms at 40 A and 2 s at 1 A	Buffer module	ABL 8BUF24400	1.200
	Holding time 9 min at 40 A...2 hrs at 1 A (depending on use with a battery check module-battery unit and load) (4)	Battery check module, output current 20 A	ABL 8BBU24200	0.500
		Battery check module, output current 40 A	ABL 8BBU24400	0.700
		Battery module, 3.2 Ah (6)	ABL 8BPK24A03	3.500
		Battery module, 7 Ah (6)	ABL 8BPK24A07	6.500
	Battery module, 12 Ah (6)	ABL 8BPK24A12	12.000	
Continuity after a malfunction	Paralleling and redundancy of the power supply to ensure uninterrupted operation of the application excluding AC line failures and application overcurrents	Redundancy module	ABL 8RED24400	0.700
Discriminating downstream protection	Electronic protection (1...10 A overcurrent or short-circuit) of 4 output terminals from an ABL4 power supply	Protection module with 2-pole breaking (7) (8)	ABL 8PRP24100	0.270

Converters --- / --- (3)

Primary (9)	Power supply module output current	Secondary		Reference	Weight kg
		Output voltage	Nominal current		
~ 24 V - 9%, + 24%	2.2 A	~ 5...6.5 V	6 A	ABL 8DCC05060	0.300
	1.7 A	~ 7...15 V	2 A	ABL 8DCC12020	0.300

Separate and replacement parts

Description	Use	Composition	Unit reference	Weight kg
Fuse assemblies	Discriminating Protection module ABL 8PRP24100	4 x 5 A, 4 x 7.5 A and 4 x 10 A	ABL 8FUS01	–
	Battery ABL 8BPK24A●●	4 x 20 A and 6 x 30 A	ABL 8FUS02	–
Clip-on marker labels	All products except ABL 8PRP24100	Sold in lots of 100	LAD 90	0.030
	Discriminating Protection module ABL 8PRP24100	Sold in lots of 22	ASI20 MACCS5	–
Rail mounting kit	Battery module ABL 8BPK2403	–	ABL 1A02	–
EEPROM memory	Backup and duplication of ABL 8 BBU24●00 battery check module parameters	–	SR2 MEM02	0.010

(1) 2-phase connection possible on certain American line supplies.

(2) Power supply reference ABL 4RSM24200 has an integrated redundancy diode.

(3) For use with power supply ABL4.

(4) Compatibility table for battery check module-battery unit with holding time depending on the load.

[More technical information on www.schneider-electric.com](http://www.schneider-electric.com)

(5) Appendices, see page 8/34.

(6) Supplied with 20 or 30 A fuse depending on the model.

(7) Supplied with four 15 A fuses.

(8) Local reset via pushbutton or automatic reset on elimination of the fault.

(9) Voltage from power supply ABL4.

Power supplies and transformers

Phaseo

Regulated switch mode power supplies
 Function modules: solutions to power outages
 Selection grid

Continuity of service: Voltage holding in the event of a power outage (continued)

For applications that are sensitive to unintended stopping, the **ABL 8** range of Function modules offers a solution comprising:

- Electronic switch mode power supply and Buffer module for holding times t_2 up to two seconds
- Electronic switch mode power supply, Battery control module and Battery module for holding times t_2 of between two seconds and a few hours

These solutions are used to supply voltage after loss of the line supply, thus enabling saving of current values or fallback of some actuators supplied with 24 V \dots . The table below indicates the possible holding times according to the equipment combinations and the current required.

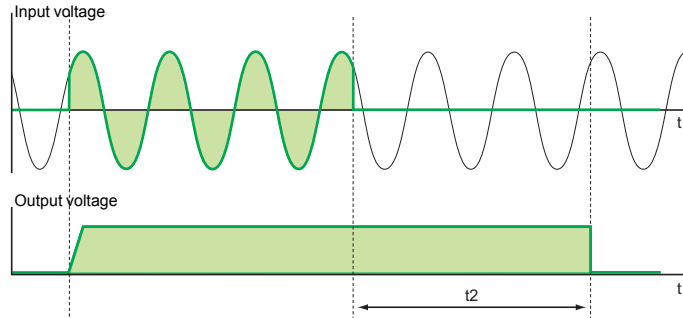

Holding current	Holding time t_2																											
	Seconds									Minutes										Hours								
	0.1	0.2	0.5	1	2	5	10	30	1	2	3	4	5	6	7	8	9	10	15	20	30	40	50	1	2	3	5	
1 A	1	1	1	1	1	2+4	2+4	2+4	2+4	2+4	2+4	2+4	2+4	2+4	2+4	2+4	2+4	2+4	2+4	2+4	2+4	2+4	2+4	2+4	2+4	2+5	2+5	
2 A	1	1	1	1	1	2+4	2+4	2+4	2+4	2+4	2+4	2+4	2+4	2+4	2+4	2+4	2+4	2+4	2+4	2+4	2+4	2+4	2+4	2+4	2+4	2+5	2+6	2+6
3 A	1	1	1	1	2+4	2+4	2+4	2+4	2+4	2+4	2+4	2+4	2+4	2+4	2+4	2+4	2+4	2+4	2+4	2+4	2+4	2+5	2+5	2+5	2+6	2+6	2+6	+6
4 A	1	1	1	1	2+4	2+4	2+4	2+4	2+4	2+4	2+4	2+4	2+4	2+4	2+4	2+4	2+4	2+4	2+4	2+4	2+5	2+5	2+5	2+5	2+6	2+6	2+6	+6
5 A	1	1	1	2+4	2+4	2+4	2+4	2+4	2+4	2+4	2+4	2+4	2+4	2+4	2+4	2+4	2+4	2+4	2+4	2+5	2+5	2+5	2+6	2+6	2+6	2+6	2+6	+6
6 A	1	1	1	2+4	2+4	2+4	2+4	2+4	2+4	2+4	2+4	2+4	2+4	2+4	2+4	2+4	2+4	2+4	2+5	2+5	2+5	2+6	2+6	2+6	2+6	2+6	2+6	+6
7 A	1	1	1	2+4	2+4	2+4	2+4	2+4	2+4	2+4	2+4	2+4	2+4	2+4	2+4	2+5	2+5	2+5	2+5	2+5	2+6	2+6	2+6	2+6	2+6	2+6	2+6	+6
8 A	1	1	1	2+4	2+4	2+4	2+4	2+4	2+4	2+4	2+4	2+4	2+4	2+5	2+5	2+5	2+5	2+5	2+5	2+5	2+6	2+6	2+6	2+6	2+6	2+6	2+6	+6
10 A	1	1	2+4	2+4	2+4	2+4	2+4	2+4	2+4	2+4	2+4	2+4	2+5	2+5	2+5	2+5	2+5	2+5	2+5	2+6	2+6	2+6	2+6	2+6	2+6	2+6	2+6	+6
15 A	1	1	2+4	2+4	2+4	2+4	2+4	2+4	2+4	2+4	2+4	2+5	2+5	2+5	2+5	2+5	2+6	2+6	2+6	2+6	2+6	2+6	2+6	2+6	2+6	2+6	2+6	+6
20 A	1	1	2+5	2+5	2+5	2+5	2+5	2+5	2+5	2+5	2+5	2+5	2+6	2+6	2+6	2+6	2+6	2+6	2+6	2+6	2+6	2+6	2+6	2+6	2+6	2+6	2+6	+6
25 A	1	3+5	3+5	3+5	3+5	3+5	3+5	3+5	3+5	3+5	3+5	3+6	3+6	3+6	3+6	3+6	3+6	3+6	3+6	3+6	3+6	3+6	3+6	3+6	3+6	3+6	3+6	+6
30 A	1	3+5	3+5	3+5	3+5	3+5	3+5	3+5	3+5	3+5	3+6	3+6	3+6	3+6	3+6	3+6	3+6	3+6	3+6	3+6	3+6	3+6	3+6	3+6	3+6	3+6	3+6	+6
35 A	1	3+5	3+5	3+5	3+5	3+5	3+5	3+5	3+6	3+6	3+6	3+6	3+6	3+6	3+6	3+6	3+6	3+6	3+6	3+6	3+6	3+6	3+6	3+6	3+6	3+6	3+6	+6
40 A	1	3+6	3+6	3+6	3+6	3+6	3+6	3+6	3+6	3+6	3+6	3+6	3+6	3+6	3+6	3+6	3+6	3+6	3+6	3+6	3+6	3+6	3+6	3+6	3+6	3+6	3+6	+6

Function modules	Reference	Code
40 A Buffer module	ABL 8BUF24400	1
20 A Battery control module	ABL 8BBU24200	2
40 A Battery control module	ABL 8BBU24400	3
3.2 Ah Battery module	ABL 8BPK24A03	4
7 Ah Battery module	ABL 8BPK24A07	5
12 Ah Battery module	ABL 8BPK24A12	6

Note: Several Buffer modules (up to a maximum of three) can be connected in parallel to increase the immunity time. The times given in the table above (boxes marked 1) should be multiplied by the number of modules used (2 or 3).

Power supplies and transformers

Phaseo

Regulated switch mode power supplies

Substitution of ABL8RP/WP by ABL4

Substitution of Phaseo ABL8RP/WP power supplies by Phaseo ABL4 power supplies

For the majority of applications, power supplies ABL4 easily replace power supply models ABL8RP/WP due to:

- the reduced size of the ABL4 (up to - 56% in volume),
- tested compatibility with the function modules ABL8B/RED/8D/8P,
- the presence of a diagnostics contact on all models,
- a higher withstand to temporary overcurrents than the equivalent ABL8 RP/WP power supplies.

However, for some applications the following points must be checked before substituting ABL8RP/WP power supplies by ABL4 power supplies:

Equivalent ABL8 and ABL4 power supplies		Points to be checked related to the application	Installation differences
ABL 8RPS24030	ABL 4RSM24035	<ul style="list-style-type: none"> ■ Input voltage limits: <ul style="list-style-type: none"> <input type="checkbox"/> ABL4: 90..264 V <input type="checkbox"/> ABL8: 85..550 V 	<ul style="list-style-type: none"> ■ Input and output terminals reversed
ABL 8RPS24050	ABL 4RSM24050	<ul style="list-style-type: none"> ■ Resetting of protection: <ul style="list-style-type: none"> <input type="checkbox"/> ABL4: automatic <input type="checkbox"/> ABL8: selectable, automatic or manual ■ ABL4 does not conform to IEC 61000-3-2 (1) 	
ABL 8RPS24100	ABL 4RSM24100	<ul style="list-style-type: none"> ■ Input voltage limits: <ul style="list-style-type: none"> <input type="checkbox"/> ABL4: 90..264 V <input type="checkbox"/> ABL8: 85..550 V ■ Resetting of protection: <ul style="list-style-type: none"> <input type="checkbox"/> ABL4: automatic <input type="checkbox"/> ABL8: selectable, automatic or manual ■ ABL4 does not conform to IEC 61000-3-2 (1) 	<ul style="list-style-type: none"> ■ 120/230 V voltage selection <ul style="list-style-type: none"> <input type="checkbox"/> ABL4: by link <input type="checkbox"/> ABL8: by terminal
ABL 8RPM24200	ABL 4RSM24200	<ul style="list-style-type: none"> ■ Resetting of protection: <ul style="list-style-type: none"> <input type="checkbox"/> ABL4: automatic <input type="checkbox"/> ABL8: selectable, automatic or manual ■ ABL4 does not conform to IEC 61000-3-2 (1) 	<ul style="list-style-type: none"> ■ Input and output terminals reversed ■ 120/230 V voltage selection <ul style="list-style-type: none"> <input type="checkbox"/> ABL4: by link <input type="checkbox"/> ABL8: by terminal
ABL 8WPS24200	ABL 4WSR24200	<ul style="list-style-type: none"> ■ Resetting of protection: <ul style="list-style-type: none"> <input type="checkbox"/> ABL4: automatic <input type="checkbox"/> ABL8: selectable, automatic or manual ■ ABL4 does not conform to IEC 61000-3-2 (1) 	<ul style="list-style-type: none"> ■ Input and output terminals reversed
ABL 8WPS24400	ABL 4WSR24400		<ul style="list-style-type: none"> ■ Input and output terminals reversed

(1) Standard IEC/EN 61000-3-2 defines the harmonic limits of the input current that can be produced by equipment such as regulated switch mode power supplies ABL4 or ABL8. This standard is only applicable to electrical or electronic devices that are intended for connection to low voltage public distribution systems. This is rarely the case in industrial applications.

Power supplies and transformers

Phaseo

Regulated switch mode power supplies

ASIABL

Power supplies for AS-Interface cabling system

Power supplies for AS-Interface cabling system

Consistent with the standard Phaseo line, the range of **ASIABL** power supplies is designed to deliver a \sim voltage, as required by AS-Interface cabling systems. Three versions are available to meet all needs encountered in industrial applications, in enclosures, cells or floor-standing enclosures. These single-phase, electronic, switch mode power supplies guarantee the quality of the output current, in accordance with the electrical characteristics and conforming to standard EN 50295.

ASIABLB300●

Operating on a 100 to 240 V \sim supply, this power supply delivers a voltage of 30 V \sim . Available in 2.4 and 4.8 A ratings, the outgoing terminal block allows the cable to be connected separately to the AS-Interface interface modules and to the AS-Interface master. Input and output LEDs allow fast and continuous diagnostics.



ASIABLB3002

ASIABLD300●

Operating on a 100 to 240 V \sim supply, this power supply delivers a voltage of 30 V \sim . Available in 2.4 and 4.8 A ratings, it allows diagnosis and management of earth faults on AS-Interface interface modules. In the event of an earth fault, the Phaseo power supply stops dialogue on the AS-Interface cabling system and puts the installation in a fallback condition. Restarting is only possible after deliberate acknowledgement of the fault. Two inputs/outputs enable dialogue with a processing unit. The outgoing terminal block is used to connect the AS-Interface cable separately to the interface modules and master modules. Input, output and earth fault LED's allow fast and continuous diagnostics.



ASIABLD3004

ASIBLM3024

Operating on a 100 to 240 V \sim supply, this product provides two separate power supplies, which are totally independent in the way they operate. Two output voltages - 30 V/2.4 A (AS-Interface line supply) and 24 V/3 A - are available, so making it possible to supply the control equipment without an additional power supply. Input and output LEDs allow fast and continuous diagnostics.



ASIBLM3024

Selection of protection on the power supply primaries

Type of mains supply	~ 115 V single-phase			~ 230 V single-phase		
Power supply	Thermal-magnetic circuit-breaker (1)		Gg fuse	Thermal-magnetic circuit-breaker (2-pole)		Gg fuse
ASI ABLB3002	GB2 ●B07	MG24517 (2)	2 A	GB2 DB06	MG24516 (2)	2 A
ASI ABLB3004	GB2 ●B08	MG24518 (2)	4 A	GB2 DB07	MG17453 (2)	2 A
ASI ABLD3002	GB2 ●B07	MG24517 (2)	2 A	GB2 DB06	MG24516 (2)	2 A
ASI ABLD3004	GB2 ●B08	MG24518 (2)	4 A	GB2 DB07	MG17453 (2)	2 A
ASI ABLM3024	GB2 ●B07	MG24517 (2)	2 A	GB2 DB06	MG17453 (2)	2 A

(1) Single-phase protection, replace ● by C; 2-pole protection, replace ● by D.
(2) UL certified circuit breaker.

References

Input voltage	Secondary			Auto-protect reset	Earth fault detection	Reference	Weight kg
	Output voltage	Nominal power	Nominal current				
Single phase (N-L1) or 2-phase (L1-L2)							
~ 100...240 V - 15 %, + 10 % 50/60 Hz	~ 30 V	72 W	2,4 A	Auto	No	ASI ABLB3002	0.800
		144 W	4,8 A	Auto	No	ASI ABLB3004	1.300
	~ 24 V	72 W	2,4 A	Auto	Yes	ASI ABLD3002	0.800
		144 W	4,8 A	Auto	Yes	ASI ABLD3004	1.300
~ 30 V	72 W	2,4 A	Auto	No	ASI ABLM3024	1.300	
~ 24 V	72 W	3 A					



ASI ABL●3002

Treatment for harsh environments,
Conformal Coating modules

- Presentation page 9/2
- Racks page 9/3
- Processors page 9/3
- PCMCIA SRAM memory extension cards page 9/3
- Power supply modules page 9/4
- Discrete I/O modules page 9/4
- Analog I/O modules page 9/4
- Counter modules page 9/5
- Motion control modules page 9/5
- Weighing modules page 9/5
- Communication page 9/5

Power consumption table

- Selecting TSX PSY power supply modules page 9/6

Technical appendices

- Standards and certifications page 9/8
- Environmental tests page 9/9
- Ethernet network, infrastructure page 9/12
- Automation product certifications page 9/18

A dedicated services offer for your installed base

- Operation services page 9/20
- Modernisation services page 9/21
- Customization services page 9/21

Index

- Product reference index page 9/22

Modicon Premium automation platform

Treatment for harsh environments
Conformal Coating modules

Presentation

Protective treatment of Modicon Premium PLCs

Modicon Premium/Atrium PLCs comply with “**TC**” treatment requirements (Treatment for all **C**limates).

For installations in industrial production workshops or environments corresponding to “**TH**” (Treatment for hot and **H**umid environments), PLCs must be housed in enclosures providing at least IP 54 protection as specified by standard IEC/EN 60529 or an equivalent level of protection according to NEMA 250.

These PLCs themselves have an IP 20 protection index ⁽¹⁾. They can therefore be installed without an enclosure in reserved access areas that do not exceed **pollution level 2** (control room with no dust-producing machinery or activity). **Pollution level 2** does not take account of more severe environments, such as those where the air is polluted with dust, fumes, corrosive or radioactive particles, vapours or salts, moulds, insects, etc.

Treatment for more severe environments

If the Modicon Premium automation platform needs to be used in a harsh environment, the *Conformal Coating* offer provides processor and power supply modules, I/O modules on Bus X and racks with a protective coating applied to their electronic cards.

This treatment improves the cards' insulation qualities and their resistance to:

- Condensation
- Dusty atmospheres (conducting foreign particles)
- Chemical corrosion, in particular when used in sulphurous atmospheres (oil refinery, purification plant, etc.) or atmospheres containing halogens (chlorine, etc.)

This protection, combined with appropriate installation and maintenance, enables Modicon Premium products to be used in harsh chemical environments such as types **3C2** and **3C3** described in standard IEC/EN 60721-3-3.

The functional and electrical characteristics of the coated modules are identical to those of the non-coated versions. Please consult the characteristics pages in this catalogue (chapter 1...chapter 5).

To order modules and racks with Conformal Coating protection, please refer to the references pages 9/3...9/5 (for coated products add the letter “**C**” at the end of the standard reference).

*(1) Any slot in **TSX RKY** ●● racks that is not occupied by a module must be fitted with a **TSX RKA 02** screw-on protective cover (sold in lots of 5).*

Modicon Premium automation platform

Treatment for harsh environments
Conformal Coating modules

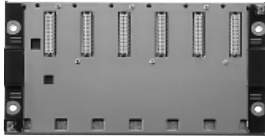

TSX RKY 6C



TSX P57 1634MC



TSX P57
25●MC/35●MC/453AMC



TSX P57 4634MC
5634MC/6634MC



TSX MRP C00●MC

Racks				
Description	Capacity	Reference	Weight kg	
Non-extendable racks	6 positions	TSX RKY 6C	1.470	
	8 positions	TSX RKY 8C	1.760	
	12 positions	TSX RKY 12C	2.310	
Extendable racks Requires 1 x TSX TLY EX line terminator on the 2 end racks Sold in lots of 2	4 positions	TSX RKY 4EXC	1.160	
	6 positions	TSX RKY 6EXC	1.500	
	8 positions	TSX RKY 8EXC	1.780	
	12 positions	TSX RKY 12EXC	2.340	

For connection accessories, see page 2/5.

Premium TSX 57 Unity processors					
I/O capacity	Capacity		Integrated port	Reference	Weight kg
	Memory	Network			
TSX 57 1● 512 discrete I/O, 24 analog I/O and 8 application-specific channels	96 KB integrated	1	–	(1) TSX P57 104MC	0.380
	224 KB on PCMCIA	0	Ethernet	TSX P57 1634MC	–
		1	Fipio	(1) TSX P57 154MC	0.420
TSX 57 2● 1024 discrete I/O, 80 analog I/O and 24 application-specific channels	160 KB integrated	1	–	TSX P57 204MC	0.520
	768 KB on PCMCIA	–	Ethernet	TSX P57 2634MC	–
	192 KB integrated	2	Dedicated Hot Standby	TSX H57 24MC	0.560
	768 KB on PCMCIA	1	Fipio	TSX P57 254MC	–
TSX 57 3● 1024 discrete I/O, 128 analog I/O and 32 application-specific channels	192 KB integrated	3	–	TSX P57 304MC	0.520
	1792 KB on PCMCIA	2	Ethernet	TSX P57 3634MC	–
	208 KB integrated	3	Fipio	TSX P57 354MC	0.560
	1792 KB on PCMCIA				
TSX 57 4● 2040 discrete I/O, 256 analog I/O and 64 application-specific channels	440 KB integrated	3	Ethernet	TSX P57 4634MC	0.610
	2048 KB on PCMCIA	4	Dedicated Hot Standby	TSX H57 44MC	0.610
		4	Fipio	TSX P57 454MC	0.560
TSX 57 5● 2040 discrete I/O, 512 analog I/O and 64 application-specific channels	1 MB integrated	3	Ethernet	TSX P57 5634MC	0.610
	7168 KB on PCMCIA	4	Fipio	TSX P57 554MC	0.560
TSX 57 6● 2040 discrete I/O, 512 analog I/O and 64 application-specific channels	2 MB integrated	3	Ethernet	TSX P57 6634MC	0.610
	7168 KB on PCMCIA				

For connecting cables, see page 1/11.

Premium TSX 57 PL7 processors					
TSX 57 1● 512 discrete I/O, 24 analog I/O and 8 application-specific channels	32 Kwords integrated,	1	–	(1) TSX P57 103MC	0.380
	644 Kwords on PCMCIA	0	Fipio	(1) TSX P57 153MC	0.420
TSX 57 2● 1024 discrete I/O, 80 analog I/O and 24 application-specific channels	48 Kwords integrated,	1	–	TSX P57 203MC	0.520
	160 Kwords on PCMCIA	–	Ethernet	TSX P57 2623MC	–
TSX 57 3● 1024 discrete I/O, 128 analog I/O and 32 application-specific channels	64 Kwords integrated,	1	Fipio	TSX P57 253MC	0.560
	160 Kwords on PCMCIA	–	Ethernet and Fipio	TSX P57 2823MC	–
	64/80 Kwords integrated (2) 384 Kwords on PCMCIA	3	–	TSX P57 303AMC	0.520
		2	Ethernet	TSX P57 3623AMC	–
TSX 57 4● 2040 discrete I/O, 256 analog I/O and 64 application-specific channels	80/96 Kwords integrated (2) 384 Kwords on PCMCIA	3	–	(1) TSX P57 353LAMC	–
			Fipio	TSX P57 353AMC	0.560
TSX 57 4● 2040 discrete I/O, 256 analog I/O and 64 application-specific channels	96/176 Kwords integrated (2) 992 Kwords on PCMCIA	4	Fipio	TSX P57 453AMC	0.560
		4	Ethernet and Fipio	TSX P57 4823AMC	–

PCMCIA SRAM memory extension cards				
Description	Memory size		Reference	Weight kg
	Application	Additional data		
Configurable application/additional data memory extensions (slot 0 in processors)	192 KB...1024 KB	832 KB...0 KB	TSX MRP C001MC	0.076
	192 KB...3072 KB	2880 KB...0 KB	TSX MRP C003MC	0.076
	192 KB...7168 KB	6976 KB...0 KB	TSX MRP C007MC	0.076

For replacement parts, see page 1/21.

(1) Single format module. The other processors are double format.

(2) The second value corresponds to the integrated memory capacity when the processor is equipped with a PCMCIA memory card.

Modicon Premium automation platform

Treatment for harsh environments

Conformal Coating modules



TSX PSY double format

Power supply modules

Supply voltage	Available power				Reference	Weight kg
	5 V $\overline{\text{---}}$	24 VR $\overline{\text{---}}$	24 VC $\overline{\text{---}}$	Total		
24 V $\overline{\text{---}}$ non-isolated	15 W	15 W	–	30 W (1)	TSX PSY 1610MC	0.540
	35 W	19 W	–	50 W	TSX PSY 3610MC	0.780
24...48 V $\overline{\text{---}}$ isolated	35 W	19 W	–	50 W	TSX PSY 5520MC	0.980
110...240 V \sim	25 W	15 W	12 W	26 W (1)	TSX PSY 2600MC	0.510
110...120 V \sim and 200...240 V \sim	35 W	19 W	19 W	50 W	TSX PSY 5500MC	0.620
	75 W	–	38 W SELV	77 W	TSX PSY 8500MC	0.740

For accessories and fan modules, see page 2/4 and 2/5.

(1) Single format module. The other power supply modules are double format.



TSX DEY/DSY/AEY/ASY with screw terminal block



TSX DEY/DMY 32/24 channels with HE 10 connectors



TSX DEY/DSY 64 channels with HE 10 connectors



TSX AEY/ASY with 25-way SUB-D connector

Discrete I/O modules

Type	Voltage, logic	Connection by	Description	Reference	Weight kg	
$\overline{\text{---}}$ inputs	24 V, positive logic	Screw terminal block	8 isolated inputs, type 2	TSX DEY 08D2C	0.300	
			16 isolated inputs, type 2	TSX DEY 16D2C	0.300	
	48 V, positive logic	Screw terminal block	16 isolated inputs, type 2	TSX DEY 16D3C	0.300	
	24 V, positive logic	HE 10 connector	16 isolated fast inputs, type 1	TSX DEY 16FKC	0.300	
			2 x HE 10 connectors	32 isolated inputs, type 1	TSX DEY 32D2KC	0.300
			4 x HE 10 connectors	64 isolated inputs, type 1	TSX DEY 64D2KC	0.370
	24 V, negative logic	Screw terminal block	16 isolated inputs, type 2	TSX DEY 16A2C	0.310	
48 V, positive logic	2 x HE 10 connectors	32 isolated inputs, type 2	TSX DEY 32D3KC	0.310		
50/60 Hz \sim inputs	24 V	Screw terminal block	16 isolated inputs, type 2	TSX DEY 16A2C	0.310	
	48 V	Screw terminal block	16 isolated inputs, type 2	TSX DEY 16A3C	0.320	
	100...120 V	Screw terminal block	16 isolated inputs, type 2	TSX DEY 16A4C	0.320	
	200...240 V	Screw terminal block	16 isolated inputs, type 2	TSX DEY 16A5C	0.360	
Solid state $\overline{\text{---}}$ outputs	24 V/0.5 A, pos. logic	Screw terminal block	8 protected outputs	TSX DSY 08T2C	0.320	
	24 V/2 A, pos. logic	Screw terminal block	8 protected outputs	TSX DSY 08T22C	0.410	
	24 V/0.5 A, pos. logic	Screw terminal block	16 protected outputs	TSX DSY 16T2C	0.340	
	48 V/1 A, pos. logic	Screw terminal block	8 protected outputs	TSX DSY 08T31C	0.320	
	48 V/0.25 A, pos. logic	Screw terminal block	16 protected outputs	TSX DSY 16T3C	0.340	
	24 V/0.1 A, pos. logic	2 x HE 10 connectors	32 protected outputs	TSX DSY 32T2KC	0.300	
$\overline{\text{---}}$ or \sim relay outputs	24 V $\overline{\text{---}}$ /3 A, 24 to 240 V \sim /3 A	Screw terminal block	8 non-protected outputs	TSX DSY 08R5C	0.330	
			16 non-protected outputs	TSX DSY 16R5C	0.380	
	24 to 48 V $\overline{\text{---}}$ /5 A, 24 to 240 V \sim /5 A	Screw terminal block	8 protected outputs	TSX DSY 08R5AC	0.420	
$\overline{\text{---}}$ relay outputs	24...120 V 5 A	Screw terminal block	8 protected outputs	TSX DSY 08R4DC	0.370	
\sim triac outputs	4...120 V 1 A	Screw terminal block	16 non-protected outputs	TSX DSY 16S4C	0.380	
$\overline{\text{---}}$ I/O	I: 24 V pos. logic O: 24 V/0.5 A	2 x HE 10 connectors	16 isolated fast inputs, type 1 12 protected outputs	TSX DMY 28FKC	0.320	
			16 isolated fast inputs, type 1 12 reflex or time-delayed protected outputs	TSX DMY 28RFKC	0.355	

For screw terminal block, connection accessories and separate parts, see page 3/11.

Analog I/O modules

Type	Description	Connection by	Reference	Weight kg
Analog inputs	4 x 16-bit high level voltage/current channels	25-way SUB-D connector	TSX AEY 420C	0.330
	4 x 16-bit isolated low level voltage/current temperature probe/thermocouple channels	Screw terminal block	TSX AEY 414C	0.320
	8 x 12-bit high level voltage/current channels	25-way SUB-D connector	TSX AEY 800C	0.310
	16 x 12-bit high level voltage/current channels	25-way SUB-D connector	TSX AEY 1600C	0.340
	8 x 16-bit isolated high level voltage/current channels	25-way SUB-D connector	TSX AEY 810C	0.330
	16 x 16-bit thermocouple channels	25-way SUB-D connector	TSX AEY 1614C	0.350
Analog outputs	4 x 11-bit + sign voltage/current channels	Screw terminal block	TSX ASY 410C	0.350
	8 x 13-bit + sign voltage/current channels	25-way SUB-D connector	TSX ASY 800C	–

For screw terminal block, connection accessories and separate parts, see page 3/17.

Modicon Premium automation platform

Treatment for harsh environments
Conformal Coating modules



TSX CTY 2AC/2CC

Counter modules

Type of input	Function	No. of channels	Reference	Weight kg
24 V \Rightarrow 2/3-wire sensors 5 V \Rightarrow RS 232 and 10...30 V \Rightarrow Totem Pole incremental encoders SSI serial or parallel absolute encoders (1)	40 kHz counting	2	TSX CTY 2AC	0.320
	40 kHz counting and measurement	4	TSX CTY 4AC	0.430
	40 kHz counting and measurement	2	TSX CTY 2CC	0.340
	Electronic cam	1	TSX CCY 1128C	0.480

For accessories and connecting cables, see pages 4/19, 4/23 and 4/25.

(1) With TSX CTY 2CC and TSX CCY 1128C modules.



TSX CAY 41C/42C

Motion control modules

Type of input	Function	No. of channels	Reference	Weight kg
Translator with RS422 I/O, 5 V \Rightarrow TTL inputs and 5 V \Rightarrow open collector outputs	Modules for stepper motors	1	TSX CFY 11C	0.440
		2	TSX CFY 21C	0.480
5 V \Rightarrow RS 232 and 10...30 V \Rightarrow Totem Pole incremental encoders RS 485 or parallel absolute encoders	Modules for servo motors	2	TSX CAY 21C	0.480
		4	(2) TSX CAY 41C	0.610
		2	TSX CAY 22C	0.480
		4	(2) TSX CAY 42C	0.610
		3	(2) TSX CAY 33C	0.610

For accessories and connecting cables, see page 4/33.

(1) With servo control functions on independent infinite axis, follower axes and flying shear for TSX CAY \bullet 2C modules.

(2) Double format module. The other motion control modules are single format.



TSX ISP Y101C

Weighing module

Description	Function	Reference	Weight kg
ISP Plus weighing module	1 weigher/module, 1...8 load cells	TSX ISP Y101C	0.420

For remote indicator and accessories, see page 4/51.

TSX ETY \bullet 103C/WMY 100C

Communication

Description	Function	Reference	Weight kg		
Ethernet Modbus/TCP network modules	10 Mbps, Transparent Ready class C10	TSX ETY 110WSC	0.370		
	10/100 Mbps, Transparent Ready class B30	TSX ETY 4103C	0.370		
	10/100 Mbps, Transparent Ready class C30	TSX ETY 5103C	0.370		
	10/100 Mbps, Transparent Ready class D10	TSX WMY 100C	0.370		
PCMCIA cards	CANopen	Master V4.02	TSX CPP 110C	0.230	
	Modbus Plus	1 Mbps network, 64 stations max.	TSX MBP 100C	0.110	
	Serial links	Modbus, Uni-Telway, Character mode	RS 232	TSX SCP 111C	0.105
			RS 485	TSX SCP 114C	0.105
		20 mA CL	TSX SCP 112C	0.105	
Communication modules	1 Modbus RS 485 integrated channel	TSX SCY 11601C	0.370		
	1 RS 485 integrated channel, 1 PCMCIA slot	TSX SCY 21601C	0.360		
Fieldbus modules	AS-Interface	M2E master profile, V2	TSX SAY 1000C	0.340	
	INTERBUS	0.5 Mbps master/slave, generation 4	TSX IBY 100C	0.280	
ConneXium managed switches 8 extended ports	Ethernet Modbus/TCP network	8 x 10/100BASE-TX ports (copper cable)	TCS ESM 083F23F1C	1.000	
		6 x 10/100BASE-TX ports (copper cable) 2 x 100BASE-FX ports (multimode optical fibre)	TCS ESM 063F2CU1C	1.000	
		6 x 10/100BASE-TX ports (copper cable) 2 x 100BASE-FX ports (multimode optical fibre)	TCS ESM 063F2CS1C	1.000	
	Profibus Remote Master (PRM) module	Modbus TCP/Profibus DP V1 gateway and Profibus PA (via gateway)	TCS EGPA23F14FK	–	

For connecting cables and accessories, see pages 5/66 and 5/67 (Ethernet), 5/90 and 5/91 (CANopen), 5/116 and 5/117 (Modbus Plus), 5/126 and 5/127 (Modbus), 5/130 and 5/131 (Uni-Telway), 5/133 (serial link), 5/96...5/97 (AS-Interface), 5/119 (Profibus DP) and 5/122 and 5/123 (INTERBUS).



TCS EGPA23F14FK

The power required to supply each TSX RKY rack depends on the type and number of modules installed in the rack. It is therefore necessary to draw up a power consumption table rack by rack in order to determine the TSX PSY power supply module most suitable for each rack. The table below can be used to draw up the power consumption table for the three different voltages to be supplied (5 V $\overline{\text{---}}$, 24 V $\overline{\text{---}}$ and 24 VR $\overline{\text{---}}$).

Procedure:

- Check and select a power supply module corresponding to the powers available for the three voltages.
- Check that the sum of the absorbed powers on these three voltages does not exceed the overall power of the power supply module.
- Values to be entered according to the type of Premium PLC configuration

Rack no.	Reference	Format S: single D: double	Number	Consumption in mA (1)					
				5 V $\overline{\text{---}}$ voltage		24 VR $\overline{\text{---}}$ voltage		24 V $\overline{\text{---}}$ voltage	
				Module	Total	Module	Total	Module	Total
Unity processors with memory expansion card	TSX P57 104M	S	<input type="text"/>	850	<input type="text"/>				
	TSX P57 1634M	D	<input type="text"/>	1650	<input type="text"/>				
	TSX P57 154M	S	<input type="text"/>	930	<input type="text"/>				
	TSX P57 204M	D	<input type="text"/>	850	<input type="text"/>				
	TSX P57 2634M	D	<input type="text"/>	1650	<input type="text"/>				
	TSX P57 254M	D	<input type="text"/>	930	<input type="text"/>				
	TSX H57 24M	D	<input type="text"/>	1880	<input type="text"/>				
	TSX P57 304M	D	<input type="text"/>	1100	<input type="text"/>				
	TSX P57 3634M	D	<input type="text"/>	1900	<input type="text"/>				
	TSX P57 354M	D	<input type="text"/>	1180	<input type="text"/>				
	TSX P57 454M	D	<input type="text"/>	1680	<input type="text"/>				
	TSX P57 4634M	D	<input type="text"/>	1880	<input type="text"/>				
	TSX H57 44M	D	<input type="text"/>	1880	<input type="text"/>				
	TSX P57 554M	D	<input type="text"/>	1680	<input type="text"/>				
TSX P57 5634M	D	<input type="text"/>	1680	<input type="text"/>					
TSX P57 6634M	D	<input type="text"/>	1880	<input type="text"/>					
PL7 processors with memory expansion card	TSX P57 103M	S	<input type="text"/>	440	<input type="text"/>				
	TSX P57 153M	S	<input type="text"/>	8530	<input type="text"/>				
	TSX P57 203M	D	<input type="text"/>	750	<input type="text"/>				
	TSX P57 2623M	D	<input type="text"/>	1110	<input type="text"/>				
	TSX P57 253M	D	<input type="text"/>	820	<input type="text"/>				
	TSX P57 2823M	D	<input type="text"/>	1180	<input type="text"/>				
	TSX P57 303AM	D	<input type="text"/>	1000	<input type="text"/>				
	TSX P57 3623AM	D	<input type="text"/>	1360	<input type="text"/>				
	TSX P57 353AM	D	<input type="text"/>	1060	<input type="text"/>				
	TSX P57 353LAM	S	<input type="text"/>	1650	<input type="text"/>				
	TSX P57 453AM	D	<input type="text"/>	1080	<input type="text"/>				
	TSX P57 4823AM	D	<input type="text"/>	1440	<input type="text"/>				
	Discrete I/O	TSX DEY 08D2	S	<input type="text"/>	55	<input type="text"/>			80
TSX DEY 16A2		S	<input type="text"/>	80	<input type="text"/>				
TSX DEY 16A3		S	<input type="text"/>	80	<input type="text"/>				
TSX DEY 16A4		S	<input type="text"/>	80	<input type="text"/>				
TSX DEY 16A5		S	<input type="text"/>	80	<input type="text"/>				
TSX DEY 16D2		S	<input type="text"/>	80	<input type="text"/>			135	<input type="text"/>
TSX DEY 16D3		S	<input type="text"/>	80	<input type="text"/>			135	<input type="text"/>
TSX DEY 16FK		S	<input type="text"/>	250	<input type="text"/>			75	<input type="text"/>
TSX DEY 32D2K		S	<input type="text"/>	135	<input type="text"/>			160	<input type="text"/>
TSX DEY 32D3K		S	<input type="text"/>	140	<input type="text"/>			275	<input type="text"/>
TSX DEY 64D2K		S	<input type="text"/>	155	<input type="text"/>			315	<input type="text"/>
TSX DSY 08R4D		S	<input type="text"/>	55	<input type="text"/>	80	<input type="text"/>		
TSX DSY 08R5		S	<input type="text"/>	55	<input type="text"/>	70	<input type="text"/>		
TSX DSY 08R5A		S	<input type="text"/>	55	<input type="text"/>	80	<input type="text"/>		
TSX DSY 08S5		S	<input type="text"/>	125	<input type="text"/>				
TSX DSY 08T2		S	<input type="text"/>	55	<input type="text"/>				
TSY DSY 08T22		S	<input type="text"/>	55	<input type="text"/>				
TSX DSY 08T31		S	<input type="text"/>	55	<input type="text"/>				
TSX DSY 16R5		S	<input type="text"/>	80	<input type="text"/>	135	<input type="text"/>		
TSX DSY 16S4		S	<input type="text"/>	220	<input type="text"/>				
TSX DSY 16S5		S	<input type="text"/>	220	<input type="text"/>				
TSX DSY 16T2		S	<input type="text"/>	80	<input type="text"/>				
TSX DSY 16T3		S	<input type="text"/>	80	<input type="text"/>				
TSX DSY 32T2K		S	<input type="text"/>	140	<input type="text"/>				
TSX DSY 64T2K		S	<input type="text"/>	155	<input type="text"/>				
TSX DMY 28FK		S	<input type="text"/>	300	<input type="text"/>			75	<input type="text"/>
TSX DMY 28RFX		S	<input type="text"/>	300	<input type="text"/>			75	<input type="text"/>
Bus X remote	TSX REY 200	S	<input type="text"/>	500	<input type="text"/>				

Total to be carried over to next page Current (mA)

Rack no.	Reference	Format S: single D: double	Number	Consumption in mA (1)					
				5 V $\overline{\text{---}}$ voltage		24 VR $\overline{\text{---}}$ voltage		24 V $\overline{\text{---}}$ voltage	
				Module	Total	Module	Total	Module	Total
Total carried over from previous page		Current (mA)							
Analog I/O	TSX AEY 414	S		660					
	TSX AEY 420	S		500					
	TSX AEY 800	S		270					
	TSX AEY 810	S		475					
	TSX AEY 1600	S		270					
	TSX AEY 1614	S		300					
	TSX ASY 410	S		900					
	TSX ASY 800 (2)	S		200		300			
Safety	TSX PAY 262	S		150				200	
Counting, motion control, weighing	TSX CTY 2A	S		280				30	
	TSX CTY 4A	S		330				36	
	TSX CTY 2C	S		850				15	
	TSX CCY 1128	S		660				15	
	TSX CAY 21	S		1100				15	
	TSX CAY 41	D		1500				30	
	TSX CAY 22	S		1100				15	
	TSX CAY 42	D		1500				30	
	TSX CAY 33	D		1500				30	
	TSX CFY 11	S		510				50	
	TSX CFY 21	S		650				100	
	TSX CSY 84/85/164	D		1800					
	TSX ISP Y101	S		150		145			
	Communication	TSX ETY 110 WS (3)	S		800				
TSX ETY 110 WS (4)		S		1200					
TSX ETY 4103		S		360					
TSX ETY 5103		S		530					
TSX WMY 100		S		360					
TSX ETC 101		S		400					
TSX IBY 100		S		500					
TSX PBY 100		S		400					
TSX SAY 1000		S		450					
TSX SCY 11601		S		350					
TSX SCY 21601		S		350					
TSX SCP 111		-		140					
TSX SCP 112		-		120					
TSX SCP 114		-		150					
TSX FPP 10		-		330					
TSX FPP 20		-		330					
TSX MBP 100		-		220					
TSX CPP 110		-		60					
TSX P ACC 01		-		150					
Terminal		T FTX 117 ADJ 02	-		310				

Power consumption

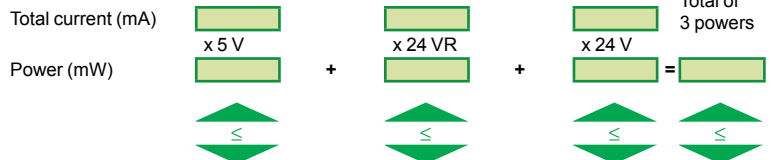

		Available power in mW				Overall	
Selection of power supply modules	TSX PSY 1610M	S	24 V $\overline{\text{---}}$ non-isolated	15,000	15,000	–	30,000
	TSX PSY 2600M	S	100...240 V \sim	25,000	15,000	12,000	26,000
	TSX PSY 3610M	D	24 V $\overline{\text{---}}$ non-isolated	35,000	19,000	–	50,000
	TSX PSY 5520M	D	24...48 V $\overline{\text{---}}$ isolated	35,000	19,000	–	50,000
	TSX PSY 5500M	D	100...120 V \sim	35,000	19,000	19,000	50,000
				200...240 V \sim			
	TSX PSY 8500M	D	100...120 V \sim	75,000	–	38,000	77,000 (5)
			200...240 V \sim				

(1) Typical value given for 100% of inputs or outputs at state 1.

(2) If a 24 VR $\overline{\text{---}}$ external power supply is used, the 300 mA consumption on the internal 24 VR should not be taken into account when selecting the rack power supply.

(3) Without remote power supply (RJ45).

(4) With remote power supply (AUI).

(5) 77,000 mW at 60°C, 85,000 mW at 55°C or 100,000 mW at 55°C when using TSX FAN ●●P fan modules.

Standards and certifications

Modicon Premium PLCs have been developed to comply with the main national and international standards relating to electronic equipment for industrial automation systems.

- Requirements specific to PLCs: functional characteristics, immunity, resistance, safety, etc.: IEC/EN 61131-2, CSA 22.2 No. 142, UL 508
- Merchant navy requirements from the main international bodies: ABS, BV, DNV, GL, LR, RINA, RMRS, etc.
- Compliance with European Directives:
 - Low Voltage Directive No. 2006/95/EC
 - Electromagnetic Compatibility Directive No. 2004/108/EC
- Electrical characteristics and self-extinguishing capacity of insulating materials: UL 746C, UL 94
- Hazardous areas: CSA 22.2 No. 213, Class I, Division 2, groups A, B, C and D

Characteristics

Operating conditions and requirements relating to the environment

Temperature	Operation	°C	0...+ 60 (IEC/EN 61131-2, + 5...+ 55) (1) 0...+ 70 with TSX FAN modules (1)			
	Storage	°C	-25...+ 70 (according to IEC/EN 61131-2)			
Relative humidity	Operation	%	10...95 non-condensing			
	Storage	%	5...95 non-condensing (according to IEC/EN 61131-2)			
Altitude		m	0...2000			
Supply voltage			TSX PSY ●610	TSX PSY 5520	TSX PSY 2600	TSX PSY ●500
	Nominal voltage	V	24 ---	48 ---	100...240 ~	100...120 ~ 200...240 ~
	Voltage limits		19..30 ---	19..60 ---	90...264 ~	140/190...264 ~
	Nominal frequency	Hz	–	–	50/60	50/60
	Frequency range	Hz	–	–	47/63	47/63

Protective treatment of Modicon Premium PLCs

Modicon Premium/Atrium PLCs comply with “TC” treatment requirements (*Treatment for all Climates*).

For installations in industrial production workshops or environments corresponding to “TH” (*Treatment for Hot and humid environments*), PLCs must be housed in enclosures providing at least IP 54 protection as specified by standard IEC/EN 60529, or an equivalent level of protection according to NEMA 250.

Modicon Premium/Atrium PLCs themselves offer **IP 20 degree of protection (2)**.

They can therefore be installed without an enclosure in reserved access areas that do not exceed **pollution level 2** (control room with no dust-producing machinery or activity). Pollution level 2 does not take account of more severe environments, such as those where the air is polluted with dust, fumes, corrosive or radioactive particles, vapours or salts, moulds, insects, etc.

Treatment for corrosive environments: Some processors, power supplies, modules on Bus X and racks can be supplied with protective coating in order to withstand corrosive environments (see page 9/2).

(1) **TSX P57 0244/104/154M** and **TSX P57 454/4634/554/5634/6634M** processors: 0...+ 57°C (or 0...+ 67°C with **TSX FAN●●P** fan modules) when certain I/O modules are mounted in the slot next to the above-mentioned processors.

(2) If a slot is not occupied by a module, it must be fitted with a protective cover **TSX RKA 02**.

Environmental tests		
Description of test	Standards	Levels
Immunity to Low Frequency (LF) interference (CE) (1)		
Voltage and frequency variation	IEC/EN 61131-2	0.85 Un/0.95 Fn for 30 min; 1.15 Un/1.05 Fn for 30 min; 0.8 Un/0.9 Fn for 5 s; 1.2 Un/1.1 Fn for 5 s
DC voltage variation	IEC/EN 61131-1	0.85 Un...1.2 Un for 30 min with 5% ripple (peak values)
Third harmonic	IEC/EN 61131-2	10% Un; 0°/5 min...180°/5 min
Short interruptions	IEC/EN 61131-2	10 ms with ~ power supply; 1 ms with --- power supply
Voltage dips and pick-ups	IEC/EN 61131-2	Un-0-Un; Un for 60 s; 3 separate cycles of 10 s Un-0-Un; Un for 5 s; 3 separate cycles of 1 to 5 s Un-0.9 UdI; Un for 60 s; 3 separate cycles of 1 to 5 s

Un: nominal voltage
Fn: nominal frequency
UdI: undervoltage detection level

Description of test	Standards	Levels
Immunity to High Frequency (HF) interference (CE) (1)		
Damped oscillatory wave	IEC/EN 61000-4-12	~--- power supply: 1kV in serial mode Discrete I/O ≥ 24 V: 1 kV in serial mode
Electrical fast transients/Bursts	IEC/EN 61000-4-4	~--- power supply: 2 kV in wired mode/common mode Discrete I/O > 48 V: 2 kV in common mode; other ports: 1 kV in common mode
Hybrid surge	IEC/EN 61000-4-5	~--- power supply: 2 kV in wired mode/1 kV in serial mode ~ discrete I/O: 2 kV in wired mode/1 kV in serial mode; --- discrete I/O: 2 kV in wired mode/ 0.5 kV in serial mode; shielded cable: 1 kV in common mode
Electrostatic discharge	IEC/EN 61000-4-2	6 kV contact, 8 kV air
Radiated electromagnetic field	IEC/EN 61000-4-3	10 V/m; 80 MHz...2 GHz Sinusoidal amplitude modulation 80%/1 kHz
Conducted disturbances, induced by radio-frequency fields	IEC/EN 61000-4-6	10 V/0.15 MHz...80 MHz Sinusoidal amplitude modulation 80%/1 kHz

Electromagnetic emissions (CE) (1) (2)		
Interference voltage	IEC/EN 61000-6-4	Class A 150 kHz...500 kHz quasi-peak 79 dB(μV); average 66 dB(μV) 500 kHz...30 MHz quasi-peak 73 dB(μV); average 60 dB(μV)
	IACS E10	General power supply distribution area Quasi-peak limit values in dB (μV): ■ 10 kHz...150 kHz: 96 to 50 dB (μV) ■ 150 kHz...350 kHz: 60 to 50 dB (μV) ■ 350 kHz...30 MHz: 50 dB (μV)
Field interference (3)	IEC/EN 61000-6-4	Class A, measurement at 10 m 30 MHz...230 MHz quasi-peak 40 dB (μV); 230 MHz...1 GHz quasi-peak 47 dB (μV)
	IACS E10 (4)	General power supply distribution area Quasi-peak limit values in dB (μV), measurements at 3 m: ■ 150 kHz...30 MHz: 80 to 50 dB (μV) ■ 30 MHz...100 MHz: 60 to 54 dB (μV) ■ 100 MHz...156 MHz: 54 dB (μV) ■ 156 MHz...165 MHz: 24 dB (μV) ■ 165 kHz...2 GHz: 54 dB (μV)

(CE): Tests required by the CE European Directives and based on standard IEC/EN 61131-2.

(1) Devices must be installed and wired in accordance with the instructions in the "Grounding and Electromagnetic Compatibility of PLC Systems" manual, available in pdf format on the CD-ROM supplied with Unity Pro or PL7 software packages or included on DVD reference **UNY USE 909 CD M** (see page 6/20).

(2) These tests are carried out with no enclosure, with the devices **fixed on a metal grid** and wired in accordance with the recommendations in the "Grounding and Electromagnetic Compatibility of PLC Systems" manual.

(3) In cases where the limits of electromagnetic emissions between 30 MHz and 1 GHz need to be monitored, it is recommended that **TSX RKY 6EX/8EX** racks be used instead of **TSX RKY 6/8** racks.

(4) The devices must be installed in a metal enclosure.

Environmental tests (continued)		
Description of test	Standards	Levels
Immunity to climatic variations		
Dry heat	IEC/EN 60068-2-2 Bd	60°C for 16 hours (D.O); 40°C for 16 hours (D.C)
Cold	IEC/EN 60068-2-1 Ad	0°C for 16 hours
Damp heat, steady state	IEC/EN 60068-2-3 Ca	60°C with 93% relative humidity/96 hours (D.O); 40°C with 93...95% relative humidity/96 hours (D.C)
Damp heat, cyclic	IEC/EN 60068-2-3 Db	[55°C (D.O)/40°C (D.O)] - 25°C with 93...95% relative humidity; 2 cycles: 12 hours/12 hours
Change of temperature, cyclic	IEC/EN 60068-2-14 Nb	0...60°C/5 cycles: 6 hours/6 hours (D.O) (1) 0...40°C/5 cycles: 6 hours/6 hours (D.C)
Temperature rise	IEC/EN 61131-2/UL 508 CSA 22-2 No. 142	Ambient temperature: 60°C
Resistance to climatic variations		
Dry heat, non-operating	IEC/EN 60068-2-2 Bb	70°C for 96 hours
Cold, non-operating	IEC/EN 60068-2-1 Ab	- 25°C for 96 hours
Damp heat, non-operating	IEC/EN 60068-2-30 dB	25...60°C with 93...95% relative humidity; 2 cycles: 12 hours/12 hours
Thermal shock, non-operating	IEC/EN 60068-2-14 Na	- 25...70°C; 2 cycles: 3 hours/3 hours

D.O: Device Open (device to be incorporated in an enclosure)

D.C: Device Closed (device which can be installed without an enclosure) (see (1) on page 9/8)

(1) **TSX P57 0244/104/154M** and **TSX P57 454/4634/554/5634/6634M** processors: 0...+ 57°C (or 0...+ 67°C with **TSX FAN ●●P** fan modules) when certain I/O modules are mounted in the slot next to the above-mentioned processors.

Environmental tests (continued)		
Description of test	Standards	Levels
Immunity to mechanical stress		
Sinusoidal vibration	IEC/EN 60068-2-6 Fc	3 Hz...13 Hz/1 mm amplitude; 13 Hz...100 Hz/0.7 g; endurance: 90 min/axis for each resonance (amplification coefficient < 10)
	IEC/EN 60068-2-6 Fc	5...9 Hz/3.5 mm amplitude; 9...150 Hz/2g; endurance: 10 cycles of 1 octave/min
Shocks	IEC/EN 60068-2-27 Ea	15 g - 11 ms; 3 shocks/direction/axis
Resistance to mechanical stress		
Free fall	IEC/EN 60068-2-32 Ed	10 cm/2 falls
Controlled position free fall	IEC/EN 60068-2-31 Ec	30° or 10 cm/2 falls
Random free fall, equipment packaged	IEC/EN 60068-2-32 method 1	1 m/5 falls
Safety of equipment and personnel (1)		
Dielectric strength and insulation resistance (CE)	UL 508 CSA 22-2 No. 142 IEC/EN 60950	24/48 V $\overline{\text{---}}$ power supply: 1500 V rms; 100/220 V \sim power supply: 2000 V rms Discrete I/O \leq 48 V: 500 V rms; Discrete I/O > 48 V: 2000 V rms; > 10 M Ω
Electrical continuity (CE)	UL 508 CSA 22-2 No. 142	< 0.1 Ω /30 A/2 min
Leakage current (CE)	CSA 22-2 No. 142 IEC/EN 60950	< 3.5 mA fixed device
Protection provided by enclosures (CE)	CSA 22-2 No. 142 IEC/EN 60950	IP 20
Resistance to impacts	CSA 22-2 No. 142 IEC/EN 60950	500 g sphere: fall from 1.3 m

(CE): Tests required by the CE European Directives and based on standard IEC/EN 61131-2.

(1) Devices must be installed and wired in accordance with the instructions in the "Grounding and Electromagnetic Compatibility of PLC Systems" manual.

Presentation

The ConneXium Industrial Ethernet Offer is comprised of a complete family of products and tools required to build the infrastructure of an Industrial Ethernet network. In the following pages, information for the proper design of a network and the selections of its components is offered.

Office Ethernet versus Industrial Ethernet

There are three main areas of differentiation between Ethernet applications in an office environment and Ethernet applications in an Industrial environment, they are:

- Environment
- Layout (not physical layer specification)
- Performance

Contrary to the office environment and even though ISO/IEC is working on it, there are not yet clearly defined specifications for Ethernet devices targeted to Industrial applications. The specifications of what it is called Industrial Ethernet are defined by different agencies or entities based upon its nature and based upon what the automation market has traditionally used.

The environmental specifications of Industrial Ethernet devices are today defined by the traditional agencies that define the environmental specifications for standard industrial devices (UL, CSA, C€, ...).

The IEEE 802.3 defines the physical layer specifications of the Ethernet network (types of connectors, distance between devices, number of devices, ...) while the 11801 (similarly to the TIA/EIA 568B, and CENELEC EN 50173) provide installers the layout guidelines.

The performance specifications are actually being worked on by ISO/IEC.

Ethernet 802.3 principles

The Ethernet 802.3 Link Layer is based on a collision detection mechanism (CSMA CD): every node whose information has collided on the network realizes the collision and re-sends the information.

The process of re-sending information causes delays in its propagation and could affect the application.

A collision domain is a group of Ethernet end devices interconnected by hubs or repeaters (devices that receive information and send it out to all their other ports, no matter where the destination device is connected): it means that all devices will be affected by collisions.

With the availability of full duplex switches (devices that receive information and send it out just through the port to which the destination device is connected) the collision domains have disappeared.

Therefore, for industrial automation applications it is strongly recommended to use in every case full duplex switches to interconnect devices. In this way the collision domains will be eliminated completely.

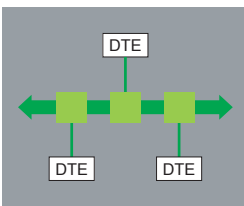
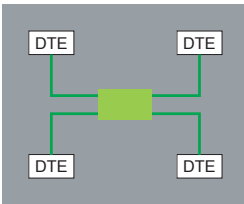

Different network topologies

Star topology

In a star topology, all devices are connected through an intermediate device.

Ethernet Star

In an Ethernet star the intermediate device may be a **hub** or a **switch**. Star is the commonly used topology in corporate networks and as of today is adopted in almost every automation application. As mentioned previously, for industrial Ethernet applications the use of full duplex switches as central device rather than hubs is strongly recommended.

Deploying Star topologies with ConneXium

With any of the hubs and switches offered by the ConneXium offer, star topologies can be implemented.

Bus topology

The bus is one of the most adopted topologies in traditional industrial automation networks. A single trunk cable connects all the devices on the network usually via passive or active T-connectors, or directly chained (daisy chain). Devices usually can be installed anywhere along the bus.

Ethernet Bus

An Ethernet bus can be deployed by interconnecting **hubs** and/or **switches** in line and considering every one of them as the connection for a drop device. A limited number of hubs and an unlimited number of switches can be interconnected to achieve this purpose.

Deploying Bus topologies with ConneXium

With any of the hubs and switches offered by the ConneXium offer bus topologies can be implemented.

Specially suitable for this purpose are the switches with 1 or 2 fiber optic ports:

- The 2 fiber optic ports switches could be for connection of inline devices.
- The single fiber optic port switches could be used for the connection of end line devices.

Daisy chain topology

Daisy chain -along bus- is the other most adopted topology in traditional industrial automation networks. Cable segments interconnect multiple devices, being the devices "part" of the network cable.

Ethernet daisy chain

Daisy chain is not today a very common Ethernet topology, but it will soon become one of the most popular ones when enough quantity of devices is made available.

In Ethernet daisy chain the devices have:

- **2 Ethernet ports** and
- **1 embedded switch.**

Schneider Electric is releasing to the Industrial market Industrial Ethernet devices to be connected in daisy chain architectures.

Deploying daisy chain topologies

To deploy daisy chain topologies, no hubs or switches are required. All devices have an embedded switch.

Dual port Ethernet at the device level is an absolute integral component for daisy chain topologies.

One port of the device connects to one port of the neighboring device on either side of the device. These neighboring connections make up the daisy chain.

Ethernet switches can be employed in a daisy chain topology when multiple scan chains are in use by the controlling device. It is expected that the Ethernet switch will be located near the controlling device with the different scan chains emanating from the switch.

Different network topologies (continued)

Daisy chain topology (continued)

Limitations of daisy chain:

Limitations of daisy chain to insure the operational integrity of the network and meet performance metrics, are:

- Dual port Ethernet devices only support 10 Mbit/s and/or 100 Mbit/s operational speeds and must use one or the other.
- The network will operate only as fast as the slowest device that is connected to the network
- In order to improve network traffic latency the numbers of devices in a single scan chain, has been limited to 32 devices. Limiting a single scan chain to 32 devices the time for a round trip of a packet through the daisy Chain is expected less than 5 milliseconds.

The maximum packet latency of a packet passing through any device in a scan chain is no more than 10 μ s.

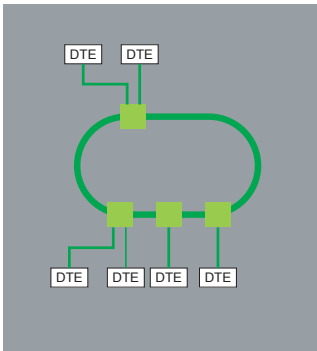

Ring topology

In a ring topology, all devices or network infrastructure components are connected in a loop. Through this type of topology, a type of network redundancy is achieved.

Ethernet Ring

Ethernet rings are usually the backbones of applications in which high availability is required. If ring topology is required then switches that support this feature should be ordered.

Deploying Ring topologies using ConneXium.

The ConneXium line offers hubs and switches that allow the deployment of single and coupled self-healing rings. There is additional information about this topic page 9/17.

Distance limitations and number of devices per segment

Based on the 802.3, the distance limits and the numbers of devices in cascade are the following:

Type	Maximum segment length (1)	Maximum segment length (offered by ConneXium devices)	Maximum number of hubs in cascade	Maximum number of switches in cascade
10BASE-T	100 m	100 m	4	Unlimited
100BASE-TX	100 m	100 m	2	Unlimited
1000BASE-T	100 m	100 m	–	Unlimited
10BASE-FL	2000 m	3100 m (2)	11 (fiber ring)	–
100BASE-FX	412 m/2000 m	4000 m with multimode fiber, 32.500 m with monomode fiber (3)	–	Unlimited
1000BASE-SX	275 m	–	–	Unlimited

(1) Based on 802.3, full duplex/half duplex.

(2) Depends on the optical fiber budget and fiber attenuation.

(3) Depends on the optical fiber budget and fiber attenuation, typical specification is 2 km for multimode and 15 km for monomode.

Physical Media

The Ethernet 802.3 defines the Physical Layer. A summary of the most common ones are shown below:

Type	Data rate	Cable type		Connector type	
		Defined by 802.3	Recommended by Schneider Electric	Defined by 802.3	Recommended by Schneider Electric
10BASE-T	10 Mbit/s	CAT 3 - UTP	CAT 5E - STP	RJ45	RJ45
100BASE-TX	100 Mbit/s	CAT 5 - UTP	CAT 5E - STP	RJ45	RJ45
1000BASE-T	1 Gbit/s	CAT 5 - UTP	CAT 5E - STP	RJ45	RJ45
10BASE-FL	10 Mbit/s	Two multimode fiber optic cables typically 62.5/125 µm fiber, 850 nm light wavelength	Two multimode fiber optic cables typically 62.5/125 µm fiber, 850 nm light wavelength	ST	ST
100BASE-FX	100 Mbit/s	Two multimode optical fibers typically 62.5/125 µm multimode fiber, 1300 nm light wavelength	Two multimode optical fibers typically 62.5/125 µm multimode fiber, 1300 nm light wavelength	ST	SC
		–	Two monomode optical fibers typically 9/125 µm multimode fiber, 1300 nm light wavelength	–	SC
1000BASE-SX	1 Gbit/s	Two 62.5/125 or 50/125 multimode optical fibers, 770 to 860 nm light wavelength	Two 62.5/125 µm or 50/125 m multimode optical fibers , 1300 nm light wavelength	SC	LC
1000BASE-LX	1 Gbit/s	–	Two 9/125 µm monomode optical fibers, 1300 nm light wavelength	–	LC

Nota : The above are the specifications defined by IEEE 802.3. However some of the cables are no longer being developed. For instance, for 10BASE-T and 100BASE-TX, a CAT-5E cable is used.

Management

The Ethernet devices in general (end devices and the cabling devices) devices may be divided in two categories: unmanaged and managed devices:

- **The unmanaged** devices are those which there is no possibility to configure or control any of the parameters of the device.
- **The managed** devices are those which there is possibility to configure or control the parameters of the device (manage them) and to access to its internal information.

The ConneXium product line offers both types of devices.

There is also a third category of devices not specifically defined but is important to understand the difference. These devices only allow access to its information but cannot be controlled and/or configured. Usually these devices are considered in the category of managed devices.

Managed devices

The managed devices offer the following features:

- **Traffic optimization and filtering**, goal is to increase the bandwidth, or the traffic capacity in a network (some of the features in this area are message and port priority, flow control, multicast filtering, broadcast limiting, IGMP snooping, Vlan, etc.).

- **VLAN**, a virtual LAN (VLAN) consists of a group of network participants in one or more network segments who can communicate with each other as if they belonged to the same LAN.

VLANs are based on logical (instead of physical) links. The biggest advantage of VLANs is their possibility of forming user groups based on the participant function and not on their physical location or medium.

Since broad/multicast data packets are transmitted exclusively within a virtual LAN, the remaining data network is unaffected. VLAN can also serve as a security mechanism to block unwanted Unicast messages.

- **Security**, feature that helps the user protect the switch from unauthorized access that could result in changes in its configuration and impact the traffic going through the switch (some of the features in this area are port security, read/write community name, etc.).

User can also set up the switch so that it blocks messages coming from unauthorized "devices" source addresses connected to the switch.

- **Time Synchronization**, feature that allows all the devices in the network to be synchronized on time.

- **Network Redundancy**, to develop high availability applications.

- ...

Redundancy

To develop high availability applications, "redundancy" in the networking infrastructure is the answer. By implementing a single ring architecture, or a coupled ring one, can protect themselves against losses of network segments.

Single Ring

The first level of redundancy is achieved by implementing a single ring. The ConneXium switches allow the set up of backbone ring configurations.

The ring is constructed using the HIPER-Ring ports. If a section of the line fails, a ring structure of up to 50 switches transforms back to a line-type configuration within 0.5 seconds.

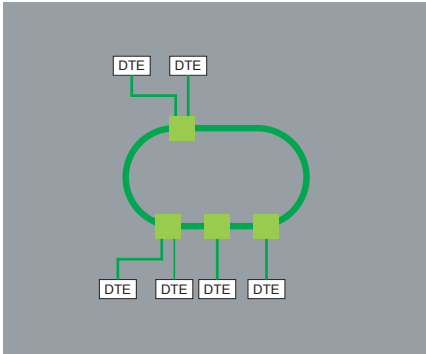

Dual Ring

The second level of redundancy is achieved by implementing a dual ring. The control intelligence built into the ConneXium switches allows the redundant coupling of HIPER-Rings and network segments.

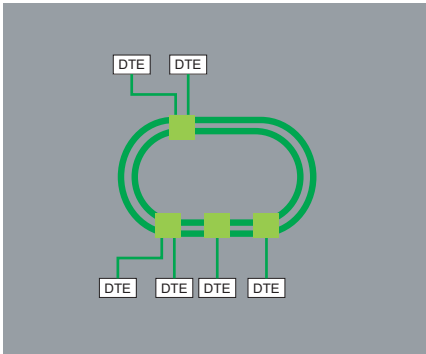

Mesh topology using the rapid "Spanning Tree" protocol

A third level of redundancy can be achieved by implementing a mesh topology. In simple terms, "Spanning Tree" is a protocol that ensures a single path for the signal, when multiple paths exist. If the active path is broken, the "Spanning Tree" protocol enables one of the alternatives paths.

The ConneXium switches offer the possibility.

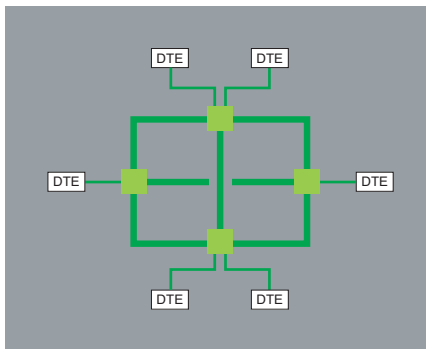

Technical appendices

Automation product certifications

EC regulations

Some countries require certain electrical components to undergo certification by law. This certification takes the form of a certificate of conformity to the relevant standards and is issued by the official body in question. Where applicable, certified devices must be labelled accordingly. Use of electrical equipment on board merchant vessels generally implies that it has gained prior approval (i.e. certification) by certain shipping classification societies.







Abbreviation	Certification body	Country
CSA	Canadian Standards Association	Canada
C-Tick	Australian Communication Authority	Australia, New Zealand
GOST	Scientific research institute for GOST standards	Russia
UL	Underwriters Laboratories	USA

Abbreviation	Classification authority	Country
IACS	International Association of Classification Societies	International
ABS	American Bureau of Shipping	USA
BV	Bureau Veritas	France
DNV	Det Norske Veritas	Norway
GL	Germanischer Lloyd	Germany
LR	Lloyd's Register	United Kingdom
RINA	Registro Italiano Navale	Italy
RMRS	Russian Maritime Register of Shipping	Russia
RRR	Russian River Register	Russia
CCS	China Classification Society	China

The tables below provide an overview of the situation as at 1st June 2010 in terms of which certifications (listed next to their respective bodies) have been granted or are pending for our automation products.

Up-to-date information on which certifications have been obtained by products bearing the Schneider Electric brand can be viewed on our website: www.schneider-electric.com

Product certifications

Certified	Certifications									
	 UL	 CSA	 C-Tick ACA	 GOST	 Hazardous locations (1) Class I, div 2	 INERIS	 TÜV Rheinland	BG	SIMTARS	AS-Interface
Certification pending	USA	Canada	Australia	Russia	USA, Canada	Europe		Germany	Australia	Europe
Modicon OTB										
Modicon STB					FM	Cat. 3 G (2) (5)				
Modicon Telefast ABE 7										
ConneXium					(2)					
Magelis PC/GTW	(3)			(2)	UL (3)	Cat. 3 D (2)(5) (8)				
Magelis XBT GT		(2)		(2)	CSA/UL (2)	Cat. 3 G-D/ 3D (2)(5)				
Magelis XBT GK	(3)				CSA/UL					
Magelis XBT N/R/RT					CSA/UL	Cat. 3 G-D (5)				
Magelis HMI STO/STU	(2)(3)			(2)	UL (2)(3)	(2)				
Modicon M340					CSA	IEC Ex ia I (6)				(2)
Modicon Momentum										
Modicon Premium				(2)	CSA			(2)	(2)	(2)
Modicon Quantum				(2)	FM (2)					
Modicon Quantum Safety				(2)	CSA		SIL 2, SIL 3 (7)			
Preventa XPSMF							SIL 3 (7)			
Modicon TSX Micro								(2)		(2)
Phaseo	(3)									
Twido	(4)	(4)			CSA/UL (4)					(2)

(1) Hazardous locations: According to UL 1604, ANSI/ISA 12.12.01, CSA 22.2 No. 213 and FM 3611, certified products are only approved for use in hazardous locations categorized as Class I, division 2, groups A, B, C and D, or in non-classified locations.

(2) Depends on product; please visit our website: www.schneider-electric.com.

(3) North American certification cULus (Canada and USA).

(4) Except for AS-Interface module TWD NOI 10M3, CE only.

(5) For zones not covered by this specification, Schneider Electric offers a solution as part of the CAPP (Collaborative Automation Partner Program). Consult your Customer Care Centre.

(6) Certified by Test Safe.

(7) According to IEC 61508. Certified by TÜV Rheinland for integration into a safety function of up to SIL 2 or SIL 3.











(8) Certified by FTZÜ.

Technical appendices

Automation product certifications

EC regulations

Merchant navy certifications

Certified Certification pending	Shipping classification societies										
											
	USA	France	Norway	Germany	Korea	Great Britain	Italy	Russia	Russia	Poland	China
Modicon OTB											
Modicon STB	(1) (2)	(2)	(2)	(2)		(2)	(2)	(2)	(2)		
Modicon Telefast ABE 7											
ConneXium											
Magelis iPC/GTW			(2)	Bridge (2)							
Magelis XBT GT	(2)	(2)	(2)	(2)		(2)	(2)	(2)	(2)		
Magelis XBT GK											
Magelis XBT N/R											
Magelis XBT RT											
Magelis HMI STO/STU		(2)									
Modicon M340								(2)	(2)		
Modicon Momentum											
Modicon Premium											
Modicon Quantum											
Modicon TSX Micro											
Phaseo											
Twido											

(1) Also covers US Navy requirements **ABS-NRV** part 4.

(2) Depends on product; please consult our website: www.schneider-electric.com.

EC regulations

European Directives

The open nature of the European markets assumes harmonization of the regulations set by the member states of the European Union. European Directives are texts whose aim is to remove restrictions on free circulation of goods and which must be applied within all European Union states.

Member states are obliged to incorporate each Directive into their national legislation and to simultaneously withdraw any regulations that contradict it.

Directives - and particularly those of a technical nature with which we are concerned - merely set out the objectives to be fulfilled (referred to as "essential requirements"). Manufacturers must take all necessary measures to ensure that their products conform to the requirements of each Directive applicable to their equipment.

As a general rule, manufacturers certify compliance with the essential requirements of the Directive(s) that apply to their products by applying a CE mark. The CE mark is affixed to our products where applicable.

Significance of the CE mark

The CE mark on a product indicates the manufacturer's certification that the product conforms to the relevant European Directives; this is a prerequisite for placing a product which is subject to the requirements of one or more Directives on the market and allowing its free circulation within European Union countries. The CE mark is intended for use by those responsible for regulating national markets.

Where electrical equipment is concerned, conformity to standards indicates that the product is fit for use. Only a warranty from a well-known manufacturer can provide assurance of a high level of quality.

As far as our products are concerned, one or more Directives are likely to apply in each case; in particular:

- The Low Voltage Directive (2006/95/EC)
- The Electromagnetic Compatibility Directive (2004/108/EC)
- The ATEX CE Directive (94/9/EC)

Hazardous substances

These products are compatible with:

- The WEEE Directive (2002/96/EC)
- The RoHS Directive (2002/95/EC)
- The China RoHS Directive (Standard SJ/T 11363-2006)
- The REACH regulations Directive (EC 1907/2006)

Note: Documentation on sustainable development is available on our website www.schneider-electric.com (product environmental profiles and instructions for use, ROHS and REACH directives).

End of life (WEEE)

End-of-life products containing electronic cards must be dealt with by specific treatment processes.

When products containing backup batteries are unusable or at end of life they must be collected and treated separately. Batteries do not contain a percentage by weight of heavy metals above the threshold specified by European Directive 2006/66/EC.

A dedicated services offer for your installed base

Operation services



You can rely on the competency and efficiency of our experts for effective maintenance, upgrading and modernisation of your facilities.

Our services offer is structured around two phases of your installation life cycle:

- Operation:
 - Spare parts and repairs
 - Maintenance contracts
 - Training
- Modernisation:
 - Consultancy and expertise
 - Project management

Customization services are also available to accommodate your specific requirements.

Operation services

Spare parts and repairs

Everything you need to get your equipment back to work as quickly as possible

We are able to respond very quickly to all requests for spare parts, exchanges and repairs to your installed automation equipment (automation platforms, Human Machine Interfaces, drives, distributed I/O):

- Supply of tested, certified and compatible spare parts
- Assurance that repaired parts will be of the same quality as new products
- Availability of our teams to respond to your requests 24/7
- Standard replacements or fast exchange service for certain parts with the option to receive the replacement product the next business day

Maintenance contracts

Improving and guaranteeing the long-term reliability and performance of your installations

We provide a contract solution to fulfil your logistical, technical, human and financial requirements. This solution is based around the following services:

- Hotline with priority access to our group of experts
- Software via the Internet with access to the latest upgrades of the most recent software
- Spare parts stock - a Schneider Electric owned stock of spare parts on your site or in one of our warehouses
- On-site assistance with guaranteed servicing time (1)
- Extended warranty offering up to 5 years manufacturer warranty on all installed equipment ranges on your site (1)
- Maintenance & Modernisation Consultancy providing analysis of existing systems and proposal of a detailed improvement plan (1)
- Modernisation - a complete process to update your legacy systems based upon your specific requirements (1)

(1) Also available as a stand alone offer. Please consult our Customer Care Centre.

Training

Dedicated training plans to allow you to acquire the necessary competencies to optimize productivity of your installed base

We are committed to providing your teams with the necessary competencies to operate more effectively, make the operations more secure and optimize the efficiency of your installed equipment:

- Identification of your needs by systematic analysis of the competency and functions of your teams
- Proposal of a set of training modules covering your entire installed automation equipment base
- Preparation of customized modules to suit your needs (content, schedule, etc.).

A dedicated services offer for your installed base

Modernisation services
Customization services

Modernisation services

Consultancy and expertise

With our M2C (Maintenance & Modernisation Consultancy) offer, we help you check the state of your installed base by:

- Defining the scope and depth of the analysis in collaboration with you
- Collecting the technical data without shutting down production
- Analyzing and identifying avenues for improvement
- Producing a recommendation plan

Customer benefits:

- Reduction in the impact of failures
- Limited number of failures
- Improved performance

The M2C (Maintenance & Modernisation Consultancy) offer

Proven expertise, tools and methods to give you a clear vision of the improvement opportunities and guide you toward a successful modernisation project

Our experts will analyze your existing systems, propose an action plan and deploy the appropriate solutions.

■ **Process consultancy**

Based on audit implementation dedicated to your application, our consultants will help you assess opportunities, define various solutions, estimate budgets and draw up a deployment plan.

■ **Installed base consultancy**

For preventive maintenance operations or in case of failures or malfunctions, our tools and methods can be used for diagnosis and control of critical automation functions, such as communication networks, high-power drives and process control automation.

A detailed report with comments is submitted as part of our service.

Project management

Professional tools, methods and a proven experience in project management to reduce risks and improve performance.

Our services are provided by experienced project managers who have a precise knowledge of the evolution of our equipment and use efficient tools and methods with proven effectiveness to:

- Limit production down time by using our conversion and software/hardware migration solutions
- Improve performance of existing tools by:
 - Analyzing the performance levels to be achieved and designing, validating and implementing the new architecture
 - Updating your application following modernisation of your equipment
- Provide long-term support by ensuring:
 - The design and deployment of a standardized solution for projects spanning several production sites
 - A contractual approach that provides a change from the usual investment process, combining maintenance of existing facilities and scheduled modernisation
 - Training of maintenance teams on the operation of the new system

Wide range of migration offers

Solution	Change the CPU	Keep the I/O racks & wiring	Change the I/O racks & keep the wiring	Migrate your application	Manage your project	Execute your project
Platform (1)						
TSX47 to TSX107	●	●	●	●	●	●
April series 1000			●	●	●	●
Modicon ●84, compact	●	●	●	●	●	●
April SMC				●	●	●
Merlin Gerin PB				●	●	●
AEG	●	●	●	●	●	●
Symax	●			●	●	●

● Service available

(1) Our migration service offer also includes SCADA, Human Machine Interfaces, drives, communication networks and distributed I/O.

Customization services

We are able to meet your specific requirements and provide you with adapted products:

- Protective coating for Human Machine Interfaces, automation platforms and distributed I/O modules for use in harsh environments
- Customized cable lengths to match your specific needs
- Customized front panels for Human Machine Interfaces

Note: To check availability of services required, please contact our Customer Care Centre.

043 509 383	5/116	ABE 7R08S●●●	8/14	O	TCS ESU 051F0	5/69	TSX CAN CBDD●	5/90	
110 XCA 282 0●	6/21	ABE 7R16M111	8/15	OZD FIP G3	5/109	TCS ESU 053FN0	5/70	TSX CAN CD●00	5/90
170 DTN 110 00	5/119	ABE 7R16S111E	8/14	S	TCS ESU 083FN0	5/69	TSX CAN CD50	5/90	
170 INT 110 00	5/123	ABE 7R16S●●●	8/14	SF3 CPY0●●	4/51	TCS WAAC	5/85	TSX CAN KCDF 180T	5/90
170 MCI ●●●●	5/117	ABE 7R16S210E	8/14	SF3 PY320●●	4/51	TCS WAAC 13FB	1/11	TSX CAN KCDF 90T	5/90
	5/123	ABE 7R16T●●●	8/15	SM1 PY52	4/51	TCS WAB ●●	5/84	TSX CAN KCDF 90TP	5/90
170 PNT 110 20	5/116	ABE 7S16E2●●	8/14	SR2 CBL 06	6/21		5/85	TSX CAN TDM4	5/90
170 XTS 0●● 00	5/116	ABE 7S16E2B1E	8/14	SR2 MEM02	8/33	TCS WAB ●●●	5/84	TSX CANCA100	4/13
	5/123	ABE 7S16E2M0E	8/14	SSVXPSMCWINUP	4/12		5/85	TSX CANCA300	4/13
467 NHP 811 00	5/119	ABE 7S16S●●●	8/14	STB NDP 2112	5/119	TCS WABAC15	5/85	TSX CANCA50	4/13
490 NAA 271 ●●	5/117	ABE 7S16S●●●E	8/14	STB NIB 2212	5/123	TCS WABAC2	5/85	TSX CANCE03	4/13
490 NAD 911 ●●	5/119	ABE 7TES160	3/11	STB NMP 2212	5/116	TCS WABMK	5/85	TSX CANCE●●	4/13
490 NAC 000 05	5/67		8/20	STB XCA 4002	6/21	TCS WABP	5/85	TSX CAP ●●●	3/17
490 NOR 000 ●●	5/67	ABF C08R●●●	8/21	SYC SPU LF● CD2●●	5/88	TCS WABP68	5/85		4/18
490 NOT 000 05	5/67	ABF M04S●●●	8/19		5/119	TCS WAMC67	5/85	TSX CAP S9	4/38
490 NTC 000 ●●	4/61	ABF M16S201	8/19	T	TCS WAMCD	5/85	TSX CAY ●●	4/38	
490 NTC 000 ●●U	5/66	ABF M32H●●●	8/19	T FTX 117 ADJ 02	9/7	TCSG WA 242	5/84		9/7
490 NTW 000 ●●	4/61	ABF Y25S●●●	3/17	T FTX CB1 0●●	5/134	TCSG WA 242F	5/84	TSX CAY ●●C	9/5
	4/13	ABL 1A02	8/33	TCS AAR011M	5/97	TCSG WA 272	5/84	TSX CBRY 2500	2/13
490 NTW 000 ●●U	4/13	ABL 4RSM24●●●	8/33	TCS ATN01●●	5/97	TCSG WAB DH	5/84	TSX CBRY 2500F	2/13
	5/66	ABL 4WSR24●●●	8/33	TCS ATN011F●	5/97	TCSG WC 241	5/84	TSX CBRY K5	2/13
499 NEH 104 10	5/68	ABL 7RM24025	8/27	TCS ATN02V	5/97	TCSN WA 2●●	5/84	TSX CBY ●●●●	2/10
499 NES 181 00	5/69	ABL 7RP1205	8/29	TCS ATV011F●	5/97	TCSN WA 2●●●	5/84	TSX CBY 1000KT	2/10
499 NMS 251 ●●	5/70	ABL 7RP4803	8/29	TCS ATV01N2	5/97	TLA CD CBA 0●●	5/90	TSX CBY ●●●KT	2/10
499 NSS 251 ●●	5/70	ABL 8BBU24●●●	8/33	TCS CAR01●M120	5/91	TLX CD DRV20M	6/43	TSX CBY ACC 10	2/11
990 MCO 000 ●●	4/45	ABL 8BPK24●●●	8/33	TCS CCN 2M2F●●	5/90	TLX CD LTOFS 33	6/67	TSX CBY K9	2/11
990 MCO 001 25	4/45	ABL 8BUF24400	8/33	TCS CCN 2M2F●	5/90	TLX CD LUOFS 33	6/67	TSX CCP S15	4/19
990 NAA 263 ●●	5/123	ABL 8DCC0●●●●	8/33	TCS CCN 4F3M05T	5/90	TLX CD PL7● P45	6/42		4/27
	6/21	ABL 8FUS0●	8/33	TCS CCN 4F3M●T	5/90	TLX CD PL7M PC45	6/42	TSX CCP S15 ●●●	4/19
990 NAD 211 ●●	5/117	ABL 8MEM●●●●●	8/27	TCS CTN011M11F	5/91	TLX CD SUOFS 33	6/67	TSX CCY 1128	4/26
990 NAD 230 ●●	5/116	ABL 8PRP24100	8/33	TCS EAA F11F13F00	5/67	TLX CD TCP50M	5/47	TSX CCY 1128C	9/5
		ABL 8RED24400	8/33	TCS EAA F1LF●●●	5/67	TLX CD3 PL7● P45	6/42	TSX CD DRV 20M	5/130
A		ABL 8REMS240●●	8/29	TCS EAM 0●●●	5/67	TLX L CD PL7 DIF 42	6/44	TSX CDP ●●●	3/11
ABE 7ACC●●	4/61	ABL 8RPS24100	4/13	TCS ECE 3M3M10S4	5/66	TLX L SDKC PL7 41M	5/47	TSX CDP 100●	3/11
	8/17	ABR 7S●●	8/17	TCS ECE 3M3M●S4	5/66		6/44	TSX CFY ●●	4/32
	8/20	ABR 7S33E	8/17	TCS ECL 1M1M ●●S2	5/67	TLX LIBS CNVF	5/123	TSX CFY ●●●	9/5
ABE 7BV●●	4/18	ABS 7EA3●●	8/17	TCS ECL 1M1M ●S2	5/67	TLX OS PL7P P45M	6/43	TSX CPP ●●●	4/7
	4/32	ABS 7EC3●●	8/17	TCS ECL 1M3M ●●S2	5/67	TLX OT PL7● P45M	6/43		5/88
	8/20	ABS 7SA2M	8/17	TCS ECL 1M3M ●S2	5/67	TLX RCD PL7● P45M	6/42	TSX CPP 110C	9/5
ABE 7CPA●●	3/17	ABS 7SA3MA	8/17	TCS ECU 3M3M●●S4	5/66	TLX RCD● PL7● P45M	6/42	TSX CRJMD 25	5/134
	4/7	ABS 7SC●●	8/17	TCS ECU 3M3M●S4	5/66	TLX UCD PL7● P45M	6/42		5/135
	4/18	AM0 2CA 001V000	5/91	TCS EGPA23F14F	5/121	TSC CANTDM4	4/13	TSX CSA ●●●	5/127
	4/22	AR1 SB3	8/20	TCS EGPA23F14FK	5/121	TSX AAK2	3/17	TSX CSY 164	4/45
	4/38	AS MBKT 185	5/116	TCS EK1 MDRS	5/66	TSX AEY 16●●	3/16		9/7
ABE 7CPA31E	8/18	ASI 67FACC2	5/97	TCS EK3 MDS	5/66	TSX AEY 16●●●	9/4	TSX CSY ●●	4/45
ABE 7CPA4●●	8/18	ASIALB300●	8/37	TCS ESB 083F2CU0	5/72	TSX AEY ●●●	3/16		9/7
ABE 7FU●●●	8/20	ASIALB300●	8/37	TCS ESB 093F2CU0	5/72	TSX AEY ●●●C	9/4	TSX CTC ●●	5/135
ABE 7H08R●●	8/13	ASIALM3024	8/37	TCS ESM 043F●●●0	5/71	TSX ASY ●●●	3/16	TSX CTY ●●	4/18
ABE 7H12R●●	8/13	ASI RPT01	5/97	TCS ESM 063F2●●1	5/72		9/7		4/22
ABE 7H12S21	8/13	ASI20 MACC5	8/33	TCS ESM 063F2●●1C	9/5	TSX ASY ●●●C	9/4	TSX CTY ●●●	9/5
ABE 7H16C●●	8/12	B		TCS ESM 083F1C●●	5/72	TSX BAT M0●	1/13	TSX CUSB 485	4/13
ABE 7H16CM●●	8/12	BMX XCA USB H018	6/21	TCS ESM 083F23F●	5/71		1/21		5/134
ABE 7H16F43	8/13	C			5/72	TSX BLY 01	3/11		5/135
ABE 7H16R●●	4/18	CS ECN 300R2	5/66	TCS ESM 083F23F1C	9/5	TSX C USBFIP	5/112	TSX CXP ●13	4/39
	4/32	F		TCS ESM 083F2C●●	5/72	TSX CAN CA●●●	5/90	TSX DEY ●●●●	3/9
	8/13	FTX CN 12●●	5/90	TCS ESM 103F2●G0	5/73	TSX CAN CA50	5/90	TSX DEY ●●●●C	9/4
ABE 7H16S●●	8/13	L		TCS ESM 163F2●●0	5/73	TSX CAN CADD03	5/90	TSX DEY ●●●●K	3/9
ABE 7H20E●●●	8/12	LAD 90	8/27	TCS ESM 243F2CU0	5/73	TSX CAN CADD●●●	5/90	TSX DEY ●●●●KC	9/4
ABE 7H32E●●●	8/12			TCS ESU 033FN0	5/70	TSX CAN CADD●	5/90	TSX DMY 28FK	3/10
ABE 7H34E●●●	8/12			TCS ESU 043F●CS0	5/71	TSX CAN CB●00	5/90	TSX DMY 28●●●	3/10
ABE 7P08T330	8/16			TCS ESU 043F1N0	5/70	TSX CAN CB50	5/90		9/4
ABE 7P16F31●	8/15					TSX CAN CBDD03	5/90		9/6
ABE 7P16T●●●	8/16								

TSX DMY 28RFKC	9/4	TSX P57 ●●●MC	9/3	TSX SCY ●●601	4/60	VJH NS 2043 ●●	6/61
TSX DSY 08●●●	3/10	TSX P57 1634M	1/10		5/133	VJH NS 2110 ●●	6/60
	9/4		9/6	TSX SCY ●●601C	9/5	VJH NS 212● 00	6/61
TSX DSY 08●●●C	9/4	TSX P57 1634MC	9/3	TSX SCY CM ●●30	5/127	VW3 A8 306 R30	4/13
TSX DSY 08●●	3/10	TSX P57 26●●M	1/10	TSX SCY CU ●●30	5/131	VW3 CAN A71	5/91
	9/6		1/19	TSX TAP MAS	4/38	VW3 CAN CARR03	5/91
TSX DSY 16●●	3/10		9/6	TSX TAP S15 ●●	4/18	VW3 CAN CARR1	5/91
	9/16	TSX P57 26●●MC	9/3	TSX TLY EX	2/11	VW3 CAN KCDF 180T	5/91
TSX DSY 16●●C	9/4	TSX P57 28●●M	9/6	TSX TVSY 100	2/11	VW3 CAN TAP2	5/90
TSX DSY ●●T2K	3/10	TSX P57 28●●MC	9/3	TSX WMY 100	5/47	VW3 M38 05 R010	5/90
TSX DSY ●●T2KC	9/4	TSX P57 ●●●AM	9/6	TSX WMY 100C	9/5	VW3 M8 223 R30	4/33
TSX EF ACC99	5/112		1/19	TSX XBT N410	4/51		
TSX ETC 101	5/49	TSX P57 ●●●AMC	9/3	TSX PAY 262	4/7	X	
TSX ETY 110 WS	5/47	TSX P57 ●●●AM	1/19	TSX SCP C●●●30	5/133	XBT Z968	5/135
	9/7		5/46	TSY DSY 08T22	9/6	XBT Z9681	5/135
TSX ETY 110WSC	9/5		9/6	TWD XCA ISO	5/126	XBT ZG909	5/135
TSX ETY 210	4/66	TSX P57 ●●●AMC	9/3	TWD XCA RJ0●●	5/127	XPS MC16Z	4/12
TSX ETY ●103	4/60	TSX P57 ●●●4M	1/10	U		XPS MC16ZC	4/12
TSX ETY ●103C	9/5	TSX P57 ●●●4MC	9/3	UAG SBT CFU CD10	6/29	XPS MC16ZP	4/12
TSX FAN ●●●	2/5	TSX P57 ●●4M	1/10	UAG SBT DFU WB13	6/29	XPS MC32Z	4/12
TSX FP ACC●●	5/103	TSX P57 ●●4MC	9/3	UAG SEW LF● CD33	6/31	XPS MC32ZC	4/12
	5/112	TSX PAY 262	9/7	UNY L●● ZAU WB●●	6/29	XPS MC32ZP	4/12
TSX FP ACC●	5/103	TSX PBS CA ●●●	4/13	UNY LPC ZAU CD10	6/29	XPS MCCPC	4/13
	5/112		5/119	UNY SDU ZFF CD22	6/25	XPS MCSCY	4/13
TSX FP C●●●●	5/105		5/121	UNY SDU ZFU CD22	6/25	XPS MCTC16	4/12
	5/107	TSX PBY 100	5/119	UNY SPU E●● CD 60	6/20	XPS MCTC32	4/12
	5/113	TSX PCX 1031	1/11	UNY SPU EZ●● CD 60	6/20	XPS MCTS16	4/12
TSX FPP ●●	9/7		4/13	UNY SPU M●● CD 60	6/19	XPS MCTS32	4/12
	5/105		5/131	UNY SPU MZ●● CD 60	6/19	XPS MCWIN	4/12
	5/107		5/135	UNY SPU S●● CD 60	6/18	XZ CB1●●●●	5/93
TSX FPP OZD200	5/109		5/134	UNY SPU SZ●● CD 60	6/18		5/97
TSX H57 ●●M	1/10		6/21	UNY SPU ZFU CD ●●E	5/47	XZ CB1●●●●H	5/97
TSX H57 ●●MC	9/3	TSX PCX 1130	5/135		6/23	XZC C12 ●●M 50B	5/91
TSX IBS CA ●00	5/123	TSX PLP 01	2/4	UNY UDE VFU CD21E	6/20	XZC P1164L2	5/67
TSX IBY 100	5/123	TSX PLP 101	2/4	UNY USE 909 CD M	6/20	XZC P1164L5	5/67
TSX IBY 100C	9/5	TSX PSY ●●●●M	2/4	UNY XCA USB 033	1/11	XZC P1264L2	5/67
TSX ISP Y1●●	4/51		9/7		6/21	XZC P1264L5	5/67
TSX ISP Y101C	9/5	TSX PSY ●●●●MC	9/4	V			
TSX MBP 100	5/116	TSX REY 200	2/13	VJC 1041 88	6/54		
	9/7	TSX RKA 02	2/11	VJC 1042 88	6/54		
TSX MBP 100C	9/5	TSX RKY 12	2/7	VJC 1090 ●●	6/56		
TSX MBP CE 0●●	5/117	TSX RKY 12C	9/3	VJC 1092 06	6/55		
TSX MCP C●●●●	1/13	TSX RKY 12EX	2/10	VJC 1093	6/57		
	1/20	TSX RKY 12EXC	9/3	VJC 10●●●●	6/50		
	1/21	TSX RKY ●EX	2/10		6/55		
TSX MFP 0128P2	1/20	TSX RKY ●EXC	9/3		6/56		
	1/21	TSX RKY ●	2/7		6/61		
TSX MFP ●●●P	1/20	TSX RKY ●C	9/3	VJC 3093 ●●	6/57		
	1/21	TSX SAY 1000	5/93	VJC NS 1011 ●●	6/51		
TSX MFP ●●●●●	1/13	TSX SAY 1000C	9/5	VJC NS 1020 ●●	6/52		
	1/20	TSX SCA ●●	5/126		6/54		
	1/21		5/130	VJC NS 1022 ●●	6/53		
TSX MRP ●●●●●	1/20	TSX SCP 11●	4/60		6/54		
	1/21		5/125	VJC NS 1030 ●●	6/52		
TSX MRP C00●MC	9/3		5/133		6/54		
TSX MRP DS 2048P	1/21	TSX SCP 11●C	9/5	VJC NS 1032 ●●	6/53		
TSX P ACC 01	5/126	TSX SCP CC 1030	5/127		6/54		
	5/133	TSX SCP CD ●●●●	5/127	VJC NS 3011 ●●	6/50		
TSX P CAPL	1/13	TSX SCP CM ●●●●	5/127	VJC NS 3051 ●●	6/55		
TSX P CAPUP	1/13	TSX SCP CU ●●●●	5/131	VJC NS L●●-F●●	6/51		
TSX P ACC 01	5/130	TSX SCP CX ●●●●	5/127	VJC NS L●●-L●●	6/51		
TSX P57 ●●●M	1/10		5/133	VJH 2095 03	6/60		
	1/19		5/134	VJH 2099 ●●	6/60		
	9/6	TSX SCP 112	5/125				

Schneider Electric Industries SAS

Head Office
35, rue Joseph Monier
F-92500 Rueil-Malmaison
France

www.schneider-electric.com

The information provided in this documentation contains general descriptions and/or technical characteristics of the performance of the products contained herein. This documentation is not intended as a substitute for and is not to be used for determining suitability or reliability of these products for specific user applications. It is the duty of any such user or integrator to perform the appropriate and complete risk analysis, evaluation and testing of the products with respect to the relevant specific application or use thereof. Neither Schneider Electric nor any of its affiliates or subsidiaries shall be responsible or liable for misuse of the information contained herein.

Design: Schneider Electric
Photos: Schneider Electric
Printed by:

