

# MERITOR® AFTERMARKET AIR SYSTEMS

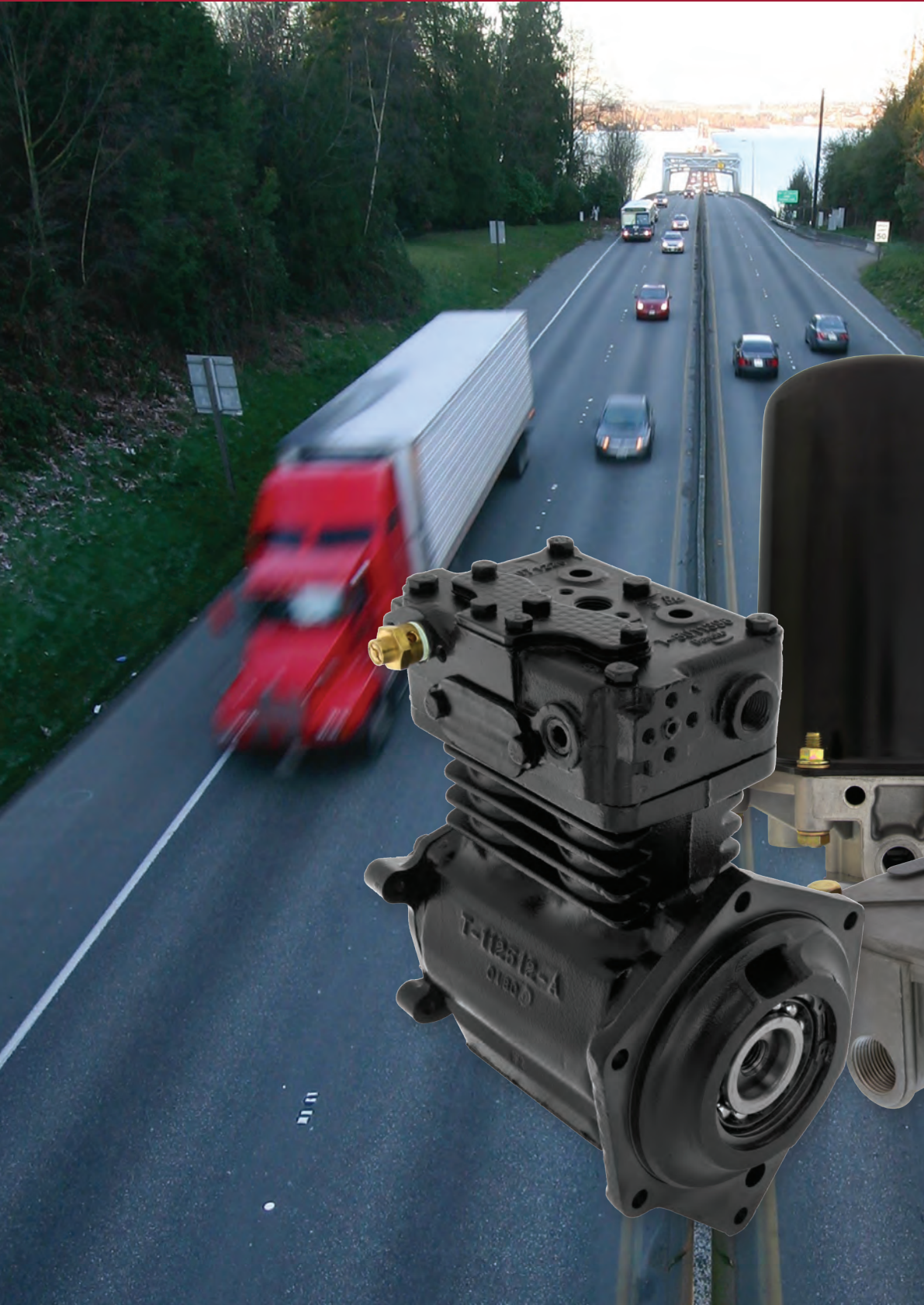

**MERITOR**



**PB-1484**



<b>AIR HOSE AND FITTINGS</b>	<b>1</b>
<b>AIR COMPRESSORS</b>	<b>2</b>
<b>AIR DRYERS</b>	<b>3</b>
<b>AIR VALVES</b>	<b>4</b>
<b>CROSS REFERENCE</b>	<b>5</b>
<b>NUMERIC PARTS LIST</b>	<b>6</b>



## ONE GREAT PORTFOLIO.

### Choose The Best Fit For Your Needs.

The Meritor® all-makes air systems replacement components portfolio offers more than 1,000 new and remanufactured components for tractor, truck, bus and trailer applications. It offers you different levels of value, including Meritor replacement parts and Meritor Reman parts. Each designed and engineered to meet exacting OE quality specifications, while also meeting your duty cycle and application requirements.

Our single source complete portfolio includes over 120 all-makes air dryers and kits, over 600 reman air compressors, over 100 new air valves and over 120 reman air valves. Each is designed to replace competitive products and meet OE quality specifications.

### Performance Advantages:

- Provides a single source for over 1,000 all-makes air systems components
- Includes air systems components for tractor, truck, bus and trailer applications
- Complete portfolio of new and remanufactured OE-quality aftermarket air systems components designed to replace competitive products with pricing options
- Includes aftermarket new/core-free and remanufactured air valves, air dryers, cartridges and service kits, air compressors, air hose assemblies and fittings, air tanks and more

### Features and Benefits:

- Saves you time and money when you consolidate purchasing with Meritor vs. various suppliers
- Maintains vehicle braking performance and compliance, while reducing operating costs
- New/core-free products save you time, cost and space by eliminating core management
- Quality remanufactured products, including air compressors, air dryers and cartridges, as well as air valves, all competitively priced
- Meritor all-makes air systems components provide the same form, fit and function as OE parts
- Fully supported with the industry's most advanced parts and information site – [MeritorPartsXpress.com](http://MeritorPartsXpress.com)
- Unsurpassed service provided throughout North America by our industry-leading Customer Care team



#### Compressors:

- All replacement parts meet or exceed exacting specifications
- Inlet seats are replaced
- Cylinder bore crosshatching angle is maintained 100%
- Cylinder blocks are machined to meet exacting specifications
- All connecting rods are compatible with turbocharging
- New ring sets and pistons are matched to reconditioned cylinder blocks
- Exhaust seats are machined to meet exacting specifications
- The head assembly is completely disassembled, inspected, cleaned and machined to meet exacting standards
- All units are dynamometer tested



#### Air Dryers:

- Cartridges are freshly charged with all-new desiccant that meets or exceeds exacting specifications
- Filters and O-rings are replaced 100%
- A new purge valve, relief valve, heater and springs are installed on all new dryers
- All dryers are tested in charge and purge cycles
- All new dryers have soft seat pistons to help handle higher turbo boost pressure
- Pop-off valves are precisely machined to avoid leaks
- Standard and coalescing dryer cartridges available
- Feature heavier-gauge metal to ensure integrity



#### Valves:

- All units have N70 Nitrile elastomer rubber and seals to withstand wide temperature extremes
- OEM synthetic grease is used on all units
- All pistons have a proven long-life design equivalent to the OEM units
- All crack pressures meet exacting specifications
- All-metal construction meets exacting specifications for each unit in the program
- Units are batch-tested to ensure quality before goods are sold in the marketplace
- All threads are tested to ensure they meet exacting standards

## YOU DESERVE COMPLETE AIR SYSTEMS SUPPORT.

From warranty support to comprehensive product information to unsurpassed customer care, Meritor delivers.

Meritor all-makes air systems replacement components are covered by our complete Meritor 1-year aftermarket warranty. Meritor all-makes air systems remanufactured components are covered by our Meritor Reman 1-year aftermarket warranty.

Get the attention you deserve with Meritor's extensive customer support services. For complete product information and specifying assistance, training and technical support, count on our expert field sales force. Meritor's industry-leading Customer Care team provides an all-purpose, one-call solution for customer satisfaction.

For more information, call the Meritor U.S. Customer Care Center at 888-725-9355. In Canada, call 800-387-3889. Or visit [MeritorPartsXpress.com](http://MeritorPartsXpress.com).





# AIR HOSE AND FITTINGS TABLE OF CONTENTS

TITLE	PAGE
AIR BRAKE HOSE BASE PART NUMBER - - - - -	1-3
AIR BRAKE HOSE ASSEMBLIES - - - - -	1-3
BULK AIR BRAKE HOSE- - - - -	1-4
TERMINAL BOLTS AND FRAME COUPLINGS - - - - -	1-4
AIR BRAKE FITTINGS- - - - -	1-5
MERITOR POLYURETHANE GLADHAND SEALS - - - - -	1-7
GLADHANDS AND RUBBER GLADHAND SEALS - - - - -	1-7
IN-LINE FILTER - - - - -	1-7
COILED AIR HOSE - - - - -	1-8
AIR RESERVOIRS - - - - -	1-8

## FUNCTION

1

Air brake tubes and hoses are the arteries of a vehicles air system. Their purpose is to transfer air from the air tanks to valves and brake chambers. They are designed to carry the correct volume and pressure to assure balanced effective braking. Tubing and hose are used for different purposes even though they perform the same task. Tubing is manufactured out of stiff materials like copper and nylon and are used on the vehicle where no movement occurs. Hose is manufactured to work with the vehicles suspension, connections, and points of movement. Layers of synthetic rubber and synthetic reinforcement give hose its strength and flexibility as illustrated in the image below.

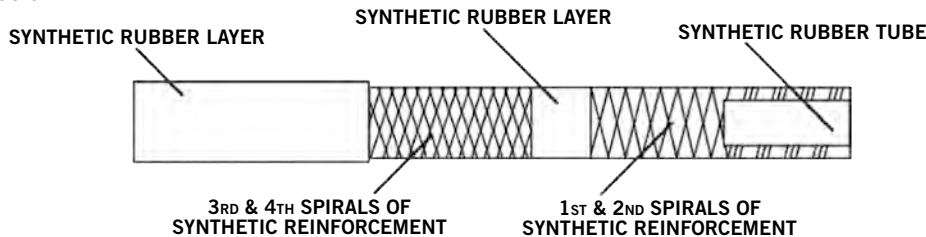

This design meets United States Department of Transportation (DOT), Society of Automotive Engineers, and the National Highway Traffic Safety Administration requirements.

## INSPECTION

An air leak is usually a sign that a hose needs repair or replacement. Hearing an air leak is not the only reason for replacing an air hose. Prevention of your vehicle being put "out of service" on the road is another reason. "Out of service" criteria is in place to prevent problems associated with hose failure on the highway. Brake lock up, tire flat spotting, brake imbalance and accidents are a few of those problems. The published out of service criteria includes the following reasons:

- Bulging and/or swelling with air applied.
- Improper splice - hose forced over pipe and using hose clamps to secure.
- Crimp, twist or turn causing restrictions.
- Cut, wear, damage through rubber cover and outer reinforcement ply.

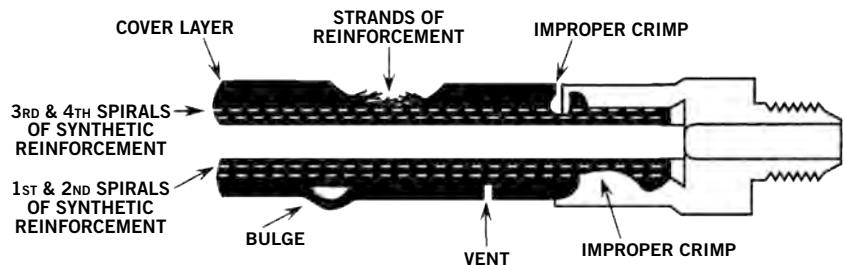

Some manufacturers will use small vent holes to eliminate air from between the cover layer and the third and fourth spiral reinforcement layers. These vent holes will cause no problems in the life of the hose or the safety of the vehicle, and do not represent an "out of service" condition.

## MERITOR AIR HOSE ASSEMBLY PART NUMBERS



Meritor Air Hose Assembly part numbers consist of a four digit base number followed by a dash and two additional digits. The four digit base number designates the size of the air hose and type of end fittings. The last two digits designate the overall length of the hose, per "A" above. Air hoses are sold unpackaged as designated by -BK after each part number.

AIR BRAKE HOSE BASE PART NUMBER		
Meritor Base No.	Air Hose I.D.	End Fitting Type
R955502	3/8"	1/4"-18 NPTF, one fixed, one swivel end
R955503		3/8"-18 NPTF, one fixed, one swivel end
R955504		3/8"-18 NPTF, both ends swivel
R955505	1/2"	3/8"-18 NPTF, one fixed, one swivel end
R955506		1/2"-18 NPTF, fixed end; 3/8"-18 NPTF, swivel end
R955507		3/8"-18 NPTF, both ends swivel



# R955-502-08-BK

**Aftermarket Designation**

**Hose Specification**

- 3/8" Air Brake Hose Assemblies**
- 502 = 1/4"-18 NPTF 1 Fixed/1 Swivel
  - 503 = 3/8"-18 NPTF 1 Fixed/1 Swivel
  - 504 = 3/8"-18 NPTF 2 Swivel
- 1/2" Air Brake Hose Assemblies**
- 505 = 3/8"-18 NPTF 1 Fixed/1 Swivel
  - 506 = 1/2"-14 NPTF Fixed  
3/8"-18 NPTF Swivel
  - 507 = 3/8"-18 NPTF 2 Swivel

**Length**

- 8" Overall Hose Length "A"**
- 12" Overall Hose Length "A"**
- 14" Overall Hose Length "A"**
- 16" Overall Hose Length "A"**
- 18" Overall Hose Length "A"**

**Bulk Package Designation**

**4 Piece Sets**

**AIR BRAKE HOSE ASSEMBLIES**

Overall Air Hose Length "A"	3/8" Air Brake Hose Assemblies			1/2" Air Brake Hose Assemblies		
	Meritor No. 1/4"-18 NPTF 1 Fixed/1 Swivel	Meritor No. 3/8"-18 NPTF 1 Fixed/1 Swivel	Meritor No. 3/8"18 NPTF 2 Swivel	Meritor No. 3/8"-18 NPTF 1 Fixed/1 Swivel	Meritor No. 1/2"-14 NPTF Fixed 3/8"-18 NPTF Swivel	Meritor No. 3/8"-18 NPTF 2 Swivel
8"	R955502-08-BK	R955503-08-BK	R955504-08-BK	R955505-08-BK	R955506-08-BK	R955507-08-BK
12"	R955502-12-BK	R955503-12-BK	R955504-12-BK	R955505-12-BK	R955506-12-BK	R955507-12-BK
14"	R955502-14-BK	R955503-14-BK	R955504-14-BK	R955505-14-BK	R955506-14-BK	R955507-14-BK
16"	R955502-16-BK	R955503-16-BK	R955504-16-BK	R955505-16-BK	R955506-16-BK	R955507-16-BK
18"	R955502-18-BK	R955503-18-BK	R955504-18-BK	R955505-18-BK	R955506-18-BK	R955507-18-BK
20"	R955502-20-BK	R955503-20-BK	R955504-20-BK	R955505-20-BK	R955506-20-BK	R955507-20-BK
22"	R955502-22-BK	R955503-22-BK	R955504-22-BK	R955505-22-BK	R955506-22-BK	R955507-22-BK
24"	R955502-24-BK	R955503-24-BK	R955504-24-BK	R955505-24-BK	R955506-24-BK	R955507-24-BK
26"	R955502-26-BK	R955503-26-BK	R955504-26-BK	R955505-26-BK	R955506-26-BK	R955507-26-BK
28"	R955502-28-BK	R955503-28-BK	R955504-28-BK	R955505-28-BK	R955506-28-BK	R955507-28-BK
30"	R955502-30-BK	R955503-30-BK	R955504-30-BK	R955505-30-BK	R955506-30-BK	R955507-30-BK
32"	R955502-32-BK	R955503-32-BK	R955504-32-BK	R955505-32-BK	R955506-32-BK	R955507-32-BK
34"	R955502-34-BK	R955503-34-BK	R955504-34-BK	R955505-34-BK	R955506-34-BK	R955507-34-BK
36"	R955502-36-BK	R955503-36-BK	R955504-36-BK	R955505-36-BK	R955506-36-BK	R955507-36-BK
38"	R955502-38-BK	R955503-38-BK	R955504-38-BK	R955505-38-BK	R955506-38-BK	R955507-38-BK
40"	R955502-40-BK	R955503-40-BK	R955504-40-BK	R955505-40-BK	R955506-40-BK	R955507-40-BK
42"	R955502-42-BK	R955503-42-BK	R955504-42-BK	R955505-42-BK	R955506-42-BK	R955507-42-BK
44"	R955502-44-BK	R955503-44-BK	R955504-44-BK	R955505-44-BK	R955506-44-BK	R955507-44-BK
46"	R955502-46-BK	R955503-46-BK	R955504-46-BK	R955505-46-BK	R955506-46-BK	R955507-46-BK
48"	R955502-48-BK	R955503-48-BK	R955504-48-BK	R955505-48-BK	R955506-48-BK	R955507-48-BK
50"	R955502-50-BK	R955503-50-BK	R955504-50-BK	R955505-50-BK	R955506-50-BK	R955507-50-BK
52"	R955502-52-BK	R955503-52-BK	R955504-52-BK	R955505-52-BK	R955506-52-BK	R955507-52-BK
54"	R955502-54-BK	R955503-54-BK	R955504-54-BK	R955505-54-BK	R955506-54-BK	R955507-54-BK
56"	R955502-56-BK	R955503-56-BK	R955504-56-BK	R955505-56-BK	R955506-56-BK	R955507-56-BK
60"	R955502-60-BK	R955503-60-BK	R955504-60-BK	R955505-60-BK	R955506-60-BK	R955507-60-BK
62"	R955502-62-BK	R955503-62-BK	R955504-62-BK	R955505-62-BK	R955506-62-BK	R955507-62-BK
66"	R955502-66-BK	R955503-66-BK	R955504-66-BK	R955505-66-BK	R955506-66-BK	R955507-66-BK
68"	R955502-68-BK	R955503-68-BK	R955504-68-BK	R955505-68-BK	R955506-68-BK	R955507-68-BK
72"	R955502-72-BK	R955503-72-BK	R955504-72-BK	R955505-72-BK	R955506-72-BK	R955507-72-BK
84"	R955502-84-BK	R955503-84-BK	R955504-84-BK	R955505-84-BK	R955506-84-BK	R955507-84-BK





## BULK AIR BRAKE HOSE

1



Meritor NO.	I.D.	O.D.	Package
R955500	3/8"	3/4"	50 Ft. per box
R955500-BK			250 Ft. per reel
R955501	1/2"	7/8"	50 Ft. per box
R955501-BK			250 Ft. per reel

## TERMINAL BOLTS AND FRAME COUPLINGS

Meritor NO.	A	B	C	D	Overall Length
 R950099	1/4"-14 NPTF	1"-14 UNS	1/4"-18 NPTF		3-15/16"
R950100	1"-14 UNS	1/2"-14 NPTF	1/4"-18 NPTF		2-7/8"
R950101 See Note 1	1/4"-14 NPTF	1"-14 UNS	1/4"-18 NPTF		2-7/8"
 R950102	1/4"-14 NPTF	1"-14 UNS	3/8"-18 NPTF		1-11/16"
R950103	1/4"-14 NPTF	1"-14 UNS	3/8"-18 NPTF		1-29/32"
R950104	1/4"-14 NPTF	1"-14 UNS	1/4"-18 NPTF		2-1/8"
 R950105	1"-14 UNS		3/8"-18 NPTF		1-5/16"
R950106	3/4"-16 UNS		1/4"-18 NPTF		15/16"
R950107	3/4"-16 UNS		1/4"-18 NPTF		1-1/2"
 R950108	7/8"-20 UNF		3/8"-18 NPTF	1/2" O.D. Tube	1-5/16"
R950109	7/8"-20 UNF		3/8"-18 NPTF	3/8" O.D. Tube	1-3/8"
 R950110	1/4"-14 NPTF	3/4"-16 UNS	1/4"-18 NPTF		1-11/16"
R950111	1/4"-14 NPTF	3/4"-16 UNS	1/4"-18 NPTF		2-5/32"

Notes: 1 Same as R950100, except has larger mounting nut.

AIR BRAKE FITTINGS						
	Meritor No.	Description	Fits Hose I.D.	Pipe Thread	Fitting I.D.	Hex Size
	R950072	Insert	3/8"	1/2"-14	9/32"	1"
	R950070		3/8"	1/4"-18	9/32"	1"
	R950071		3/8"	3/8"-18	9/32"	1"
	R950074		1/2"	1/2"-14	25/64"	1-1/8"
R950073	1/2"		3/8"-18	25/64"	1-1/8"	
	Meritor No.	Description	Fits Hose I.D.	Pipe Thread	Overall Length	Length Added To Hose
	R950077	Connector	3/8"	1/2"-14	2-29/64"	29/32"
	R950075		3/8"	1/4"-18	2-17/64"	23/32"
	R950076		3/8"	3/8"-18	2-23/64"	51/64"
	R950079		1/2"	1/2"-14	2-29/64"	29/32"
R950078	1/2"		3/8"-18	2-23/64"	51/64"	
	Meritor No.	Description	Fits Hose I.D.	Pipe Thread	Overall Length	Length Added To Hose
	R950082	Connector with Spring Guard	3/8"	1/2"-14	4-7/8"	29/32"
	R950080		3/8"	1/4"-18	4-3/4"	23/32"
	R950081		3/8"	3/8"-18	4-3/4"	51/64"
	R950084		1/2"	1/2"-14	4-7/8"	29/32"
R950083	1/2"		3/8"-18	4-3/4"	51/64"	
	Meritor No.	Description	Fits Hose I.D.	Insert Hex Size	Overall Length	
	R950085	Hose Union	3/8"	1"	3-1/4"	
R950086	1/2"		1/8"	3-1/4"		
	Meritor No.	Description	Fits Hose I.D.			
	R950087	Ferrule	3/8"			
R950088	1/2"					
	Meritor No.	Description	Fits Hose I.D.			
	R950089	Nut	3/8"			
R950090	1/2"					
	Meritor No.	Description	Fits Hose I.D.			
	R950093	Spring Guard	3/8"			
R950094	1/2"					
	Meritor No.	Description	Fits Hose I.D.			
	R950091	Spring Guard Nut	3/8"			
R950092	1/2"					
	Meritor No.	Description	Fits Hose I.D.	Pipe Thread	Overall Length	
	R950095	Adapter	3/8"	1/4"-18	1-3/16"	
	R950096		3/8"	3/8"-18	1-3/16"	
	R950098		1/2"	1/2"-14	1-3/16"	
R950097	1/2"		3/8"-18	1-3/16"		

# AIR HOSE ASSEMBLY WALL DISPLAY RACKS

Meritor Part No. R955074

1

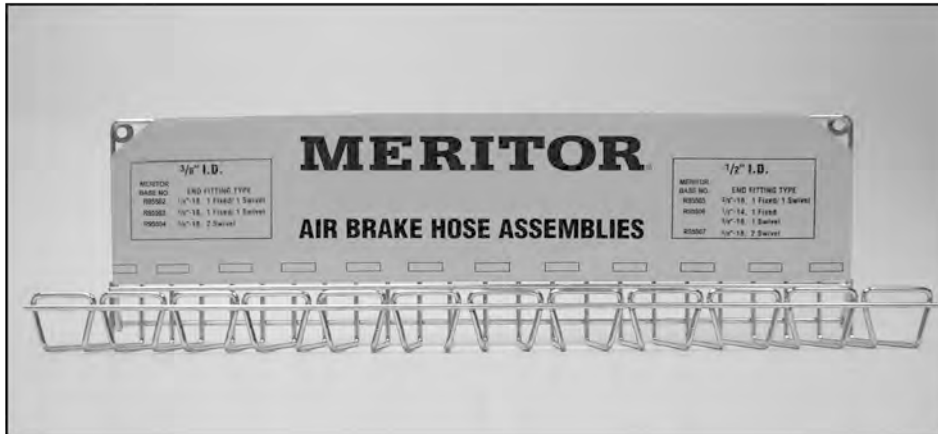

- Holds up to 48 Air Hose Assemblies
- 6 Hooks for 3/8" Air Hose Assemblies & 6 Hooks for 1/2" Air Hose Assemblies
- Each Hook holds 4 Air Hose Assemblies
- 46 pre-printed Meritor part number labels and 20 blank labels included with each rack

**FREE**

**AIR HOSE ASSEMBLY WALL DISPLAY RACKS!**

Purchase An Air Hose Assembly Display Assortment and get a FREE R955074 Wall Display Rack!

- Each Air Hose Assembly Display Assortment includes 48 pieces of the most popular Air Hose Assemblies
- Perfect for installing in a Fleet or Jobber location
- "-BK" suffix denotes that hose is shipped unboxed

**R955075 ASSORTMENT**

Includes One FREE R955074 Wall Display Rack Plus:

<b>3/8" I.D. Hose</b>	<b>1/2" I.D. Hose</b>
<b>1/4"-18 NPTF</b>	<b>3/8"-18 NPTF</b>
<b><u>1 Fixed/1 Swivel</u></b>	<b><u>1 Fixed/1 Swivel</u></b>

- |                 |                 |
|-----------------|-----------------|
| 4 R955502-20-BK | 4 R955505-18-BK |
| 4 R955502-24-BK | 4 R955505-20-BK |
| 4 R955502-26-BK | 4 R955505-22-BK |
| 4 R955502-28-BK | 4 R955505-24-BK |
| 4 R955502-30-BK | 4 R955505-26-BK |
| 4 R955502-36-BK | 4 R955505-28-BK |

**R955076 ASSORTMENT**

Includes One FREE R955074 Wall Display Rack Plus:

<b>3/8" I.D. Hose</b>	<b>1/2" I.D. Hose</b>
<b>1/4"-18 NPTF</b>	<b>3/8"-18 NPTF</b>
<b><u>1 Fixed/1 Swivel</u></b>	<b><u>1 Fixed/1 Swivel</u></b>

- |                 |                 |
|-----------------|-----------------|
| 4 R955503-20-BK | 4 R955505-30-BK |
| 4 R955503-24-BK | 4 R955505-32-BK |
| 4 R955503-26-BK | 4 R955505-34-BK |
| 4 R955503-28-BK | 4 R955505-36-BK |
| 4 R955503-30-BK | 4 R955505-42-BK |
| 4 R955503-36-BK | 4 R955505-48-BK |

**MERITOR POLYURETHANE GLADHAND SEALS**



- UV Resistant
- Petroleum Resistant
- Acid Resistant
- Ozone Resistant
- Salt Resistant
- Abrasion Resistant

**INDEPENDENT LABORATORY TESTED TO OPERATE IN EXTREME COLD CLIMATE CONDITIONS TO -35°F (-37°C) Made in U.S.A.**

Tests results prove that polyurethane gladhand seals withstand the rugged conditions of on-highway roads much longer than traditional rubber glandhand seals.

Minimize downtime with Meritor Polyurethane Gladhand Seals!

Meritor NO.	Description	Remarks
R950120	Gladhand Seal Set	Each set contains 2 red (emergency) and 2 blue (service) gladhand seals in a poly bag. 40 sets per box.
R950121	Blue (service) Gladhand Seal	Bulk packed, 100 per box
R950122	Red (emergency) Gladhand Seal	Bulk packed, 100 per box

**GLADHANDS AND RUBBER GLADHAND SEALS**

	Part Number	Description	Replaces	Remarks
	R950114-PL	Service Gladhand		Packed in Meritor Pails, 75 per Pail
	R950114		Haldex 11452 Phillips 12-006 Tramec 36101	
	R950115-PL	Emergency Gladhand		Packed in Meritor Pails, 75 per Pail
	R950115		Haldex 11451 Phillips 12-008 Tramec 36201	
	R950116-PL	Universal Gladhand		Packed in Meritor Pails, 75 per Pail
	R950116		Haldex 11450 Phillips 12-010 Tramec 36301	
	R950117		Phillips 12-0103	With Black Polyurethane Seal
	R950118	Rubber Gladhand Seal	Haldex 10028 Phillips 12-012 Tramec 36001	
	R950119	Rubber Gladhand Seal with Excluder Flaps	Haldex 10024	

**IN-LINE FILTER**

	Part Number	Application Information
	S432 500 005 0	In-line filter (complete valve). Mounted at the Gladhand. Highly recommended for control line. Prevents contamination of the trailers's air system. Requires regular cleaning, but equipped with a bypass if needed.

## COILED AIR HOSE

1



Meritor No.	Coil Length	Tube O.D.	End Fittings		Pig Tail Length		Application & General Information
			Tractor	Trailer	Tractor	Trailer	
R95510743	12 ft.	1/2"	3/8"	1/2"	6"	6"	Includes one red and one blue coil assembly. Meets SAE J844 specifications.
R95510742	12 ft.	1/2"	1/2"	1/2"	6"	6"	
R95510745	15 ft.	1/2"	3/8"	1/2"	12"	12"	
R95510747	15 ft.	1/2"	3/8"	1/2"	40"	12"	
R95510744	15 ft.	1/2"	1/2"	1/2"	12"	12"	
R95510746	15 ft.	1/2"	1/2"	1/2"	40"	12"	

## AIR RESERVOIRS



Meritor No.	Diameter	Mounting Holes Center-To-Center	Capacity (Cu.In.)	Port Size			Application & General Information
				Side	Bottom	Ends (2)	
R95510732	8"	32"	1425	3/4"	1/4"	3/8"	Meets SAE J10 specifications. Rated at 150 psi working pressure.
R95510735	12"	29-1/2"	2850	3/4"	1/4"	3/8"	
R95510734	9-1/2"	27-1/2"	1488	3/4"	1/4"	3/8"	
R95510736	8"	32"	1425	3/4" (2)	1/4"	3/8"	
R95510733	9-1/2"	27-1/2"	1488	1/2" (2)	1/4"	3/8"	

TITLE	PAGE
AIR BRAKE GOVERNOR- - - - -	-2-11
COMPETITIVE- - - - -	-2-12
CATERPILLAR- - - - -	-2-24
CUMMINS - - - - -	-2-31
DETROIT DIESEL - - - - -	-2-39
FORD - - - - -	-2-46
INTERNATIONAL- - - - -	-2-47
JOHN DEERE - - - - -	-2-48
MACK - - - - -	-2-49
VOLVO - - - - -	-2-54

## AIR COMPRESSORS QUICK REFERENCE

Model	OE Number	Meritor New	Meritor Remanufactured
TU-FLO 400	101142		R955101142X
TU-FLO 400	101143		R955101143X
TU-FLO 700	101158		R955101158X
TU-FLO 400	101242		R955101242X
TU-FLO 700	101256		R955101256X
TU-FLO 700	101282		R955101282X
TU-FLO 700	101554		R955101554X
TU-FLO 700	101884		R955101884X
TU-FLO 700	102213		R955102213X
TU-FLO 700	102598		R955102598X
TU-FLO 400	102674		R955102674X
TU-FLO 501	102697		R955102697X
TU-FLO 501	102698		R955102698X
TU-FLO 501	102734		R955102734X
TU-FLO 501	102953		R955102953X
TU-FLO 501	102989		R955102989X
BX2150	103211		R955103211X
TU-FLO 400	103212		R955103212X
TU-FLO 501	103274		R955103274X
TU-FLO 700	103278		R955103278X
BX2150	104039		R955104039X
BX2150	104041		R955104041X
BX2150	104042		R955104042X
BX2150	104102		R955104102X
BX2150	104103		R955104103X
TU-FLO 1400L	104583		R955104583X
TU-FLO 1400L	104584		R955104584X
TU-FLO 700	106268		R955106268X
BX2150	106439		R955106439X
TU-FLO 700	106780		R955106780X
TU-FLO 700	106792		R955106792X
TU-FLO 700	106793		R955106793X
BX2150	106978		R955106978X
BX2150	106985		R955106985X
TU-FLO 750	107023		R955107023X
BX2150	107221		R955107221X
TU-FLO 550	107506		R955107506X
TU-FLO 750	107507		R955107507X
TU-FLO 750	107508		R955107508X
TU-FLO 550	107509		R955107509X
TU-FLO 750	107510		R955107510X
TU-FLO 550	107511		R955107511X
TU-FLO 750	107512		R955107512X
TU-FLO 550	107513		R955107513X
TU-FLO 550	107514		R955107514X
BX2150	107526		R955107526X
TU-FLO 550	107622		R955107622X
TU-FLO 750	107623		R955107623X
TU-FLO 750	107813		R955107813X

2



**AIR COMPRESSORS QUICK REFERENCE**

Model	OE Number	Meritor New	Meritor Remanufactured
TU-FLO 1400	107836		R955107836X
TU-FLO 550	107866		R955107866X
TU-FLO 750	107869		R955107869X
TU-FLO 550	107917		R955107917X
TU-FLO 550	107981		R955107981X
TU-FLO 550	108066		R955108066X
TU-FLO 550	108110		R955108110X
BX2150	108261		R955108261X
TU-FLO 501	108269		R955108269X
TU-FLO 501	108273		R955108273X
TU-FLO 550	108329		R955108329X
TU-FLO 750	108557		R955108557X
TU-FLO 1400	108779		R955108779X
BX2150	108790		R955108790X
TU-FLO 550	108804		R955108804X
TU-FLO 550	108866		R955108866X
TU-FLO 750	108869		R955108869X
TU-FLO 750	108935		R955108935X
TU-FLO 550	108937		R955108937X
BX2150	109079		R955109079X
TU-FLO 550	109088		R955109088X
TU-FLO 750	109111		R955109111X
TU-FLO 750	109142		R955109142X
TU-FLO 1400L	109147		R955109147X
BX2150	109219		R955109219X
TU-FLO 550	109251		R955109251X
BX2150	109273		R955109273X
TU-FLO 750	109287		R955109287X
TU-FLO 1400	109440		R955109440X
TU-FLO 550	109451		R955109451X
TU-FLO 550	109603		R955109603X
TU-FLO 750	109604		R955109604X
TU-FLO 550	109653		R955109653X
TU-FLO 500	227320		R955227320X
TU-FLO 500	227321		R955227321X
TU-FLO 500	227322		R955227322X
TU-FLO 500	227323		R955227323X
TU-FLO 500	227326		R955227326X
TU-FLO 500	227331		R955227331X
TU-FLO 500	227332		R955227332X
TU-FLO 400	227400		R955227400X
TU-FLO 400	227401		R955227401X
TU-FLO 400	227402		R955227402X
TU-FLO 400	227403		R955227403X
TU-FLO 400	227406		R955227406X
TU-FLO 400	227407		R955227407X
TU-FLO 400	227408		R955227408X
TU-FLO 400	227409		R955227409X
TU-FLO 400	227410		R955227410X

2

## AIR COMPRESSORS QUICK REFERENCE

Model	OE Number	Meritor New	Meritor Remanufactured
TU-FLO 400	227414		R955227414X
TU-FLO 500	228141		R955228141X
TU-FLO 500	228346		R955228346X
TU-FLO 500	228366		R955228366X
TU-FLO 500	228443		R955228443X
TU-FLO 500	228479		R955228479X
TU-FLO 400	229077		R955229077X
TU-FLO 500	229078		R955229078X
TU-FLO 500	229525		R955229525X
TU-FLO 1000	229990		R955229990X
TU-FLO 300	275113		R955275113X
TU-FLO 300	275114		R955275114X
TU-FLO 400	275317		R955275317X
D-2 Governor	275491	R955275491	R955275491X
D-2 Governor	275707		R955275707X
TU-FLO 500	275777		R955275777X
TU-FLO 500	275990		R955275990X
TU-FLO 400	276166		R955276166X
TU-FLO 1000	276777		R955276777X
TU-FLO 400	276778		R955276778X
TU-FLO 500	276961		R955276961X
TU-FLO 500	276962		R955276962X
TU-FLO 500	276974		R955276974X
TU-FLO 500	277122		R955277122X
TU-FLO 500	277694		R955277694X
TU-FLO 500	277730		R955277730X
TU-FLO 500	277731		R955277731X
TU-FLO 500	277901		R955277901X
TU-FLO 500	278445		R955278445X
TU-FLO 500	278604		R955278604X
TU-FLO 500	278681		R955278681X
TU-FLO 400	279024		R955279024X
TU-FLO 400	279025		R955279025X
TU-FLO 400	279037		R955279037X
TU-FLO 500	279068		R955279068X
TU-FLO 400	279176		R955279176X
TU-FLO 500	279995		R955279995X
TU-FLO 600	280369		R955280369X
TU-FLO 600	280556		R955280556X
TU-FLO 600	280602		R955280602X
TU-FLO 600	280603		R955280603X
TU-FLO 600	280604		R955280604X
TU-FLO 600	280608		R955280608X
TU-FLO 600	280609		R955280609X
TU-FLO 600	280610		R955280610X
TU-FLO 600	280611		R955280611X
TU-FLO 600	280613		R955280613X
TU-FLO 600	280622		R955280622X
TU-FLO 600	280626		R955280626X

2

**AIR COMPRESSORS QUICK REFERENCE**

Model	OE Number	Meritor New	Meritor Remanufactured
TU-FLO 600	280628		R955280628X
TU-FLO 600	280774		R955280774X
TU-FLO 500	281042		R955281042X
TU-FLO 400	281112		R955281112X
TU-FLO 600	281157		R955281157X
TU-FLO 600	282013		R955282013X
TU-FLO 600	282025		R955282025X
TU-FLO 500	282076		R955282076X
TU-FLO 500	282586		R955282586X
TU-FLO 500	282621		R955282621X
TU-FLO 400	283429		R955283429X
TU-FLO 400	283505		R955283505X
TU-FLO 400	283506		R955283506X
TU-FLO 500	283513		R955283513X
TU-FLO 500	283514		R955283514X
TU-FLO 400	283533		R955283533X
TU-FLO 500	283577		R955283577X
TU-FLO 500	283690		R955283690X
TU-FLO 500	283692		R955283692X
TU-FLO 500	284106		R955284106X
TU-FLO 500	284260		R955284260X
TU-FLO 600	284307		R955284307X
TU-FLO 500	284310		R955284310X
D-2 Governor	284358	R955284358N	R955284358X
TU-FLO 300	284374		R955284374X
TU-FLO 500	284662		R955284662X
TU-FLO 500	284699		R955284699X
TU-FLO 600	284714		R955284714X
TU-FLO 500	284718		R955284718X
TU-FLO 500	284959		R955284959X
TU-FLO 600	285108		R955285108X
TU-FLO 500	285252		R955285252X
TU-FLO 501	286526		R955286526X
TU-FLO 501	286527		R955286527X
TU-FLO 501	286528		R955286528X
TU-FLO 501	286529		R955286529X
TU-FLO 501	286530		R955286530X
TU-FLO 501	286532		R955286532X
TU-FLO 501	286533		R955286533X
TU-FLO 501	286536		R955286536X
TU-FLO 501	286537		R955286537X
TU-FLO 501	286538		R955286538X
TU-FLO 501	286539		R955286539X
TU-FLO 501	286540		R955286540X
TU-FLO 501	286542		R955286542X
TU-FLO 501	286543		R955286543X
TU-FLO 501	286544		R955286544X
TU-FLO 501	286546		R955286546X
TU-FLO 501	286548		R955286548X

2

## AIR COMPRESSORS QUICK REFERENCE

Model	OE Number	Meritor New	Meritor Remanufactured
TU-FLO 501	286549		R955286549X
TU-FLO 501	286550		R955286550X
TU-FLO 501	286551		R955286551X
TU-FLO 501	286552		R955286552X
TU-FLO 501	286554		R955286554X
TU-FLO 501	286555		R955286555X
TU-FLO 501	286556		R955286556X
TU-FLO 501	286558		R955286558X
TU-FLO 501	286558		R955286558X
TU-FLO 501	286560		R955286560X
TU-FLO 501	286561		R955286561X
TU-FLO 501	286562		R955286562X
TU-FLO 501	286563		R955286563X
TU-FLO 501	286564		R955286564X
TU-FLO 501	286565		R955286565X
TU-FLO 501	286566		R955286566X
TU-FLO 501	286567		R955286567X
TU-FLO 501	286571		R955286571X
TU-FLO 501	286572		R955286572X
TU-FLO 501	286574		R955286574X
TU-FLO 501	286576		R955286576X
TU-FLO 501	286579		R955286579X
TU-FLO 501	286580		R955286580X
TU-FLO 501	286581		R955286581X
TU-FLO 501	286582		R955286582X
TU-FLO 501	286585		R955286585X
TU-FLO 501	286586		R955286586X
TU-FLO 501	286589		R955286589X
TU-FLO 501	286591		R955286591X
TU-FLO 501	286592		R955286592X
TU-FLO 501	286595		R955286595X
TU-FLO 501	286617		R955286617X
TU-FLO 501	286620		R955286620X
TU-FLO 501	286621		R955286621X
TU-FLO 501	286623		R955286623X
TU-FLO 700	289336		R955289336X
TU-FLO 700	289339		R955289339X
TU-FLO 700	289340		R955289340X
TU-FLO 700	289342		R955289342X
TU-FLO 700	289348		R955289348X
TU-FLO 700	289349		R955289349X
TU-FLO 700	289350		R955289350X
TU-FLO 400	289444		R955289444X
TU-FLO 400	289688		R955289688X
TU-FLO 700	289744		R955289744X
TU-FLO 700	289789		R955289789X
TU-FLO 700	289790		R955289790X
TU-FLO 700	289915		R955289915X
TU-FLO 700	289924		R955289924X

2

**AIR COMPRESSORS QUICK REFERENCE**

Model	OE Number	Meritor New	Meritor Remanufactured
TU-FLO 700	289925		R955289925X
TU-FLO 700	289941		R955289941X
TU-FLO 700	289964		R955289964X
SS296	3018527		R9553018527X
Compressor	3047440		R9553047440X
ST676	3048680		R9553048680X
Compressor	3049186		R9553049186X
SS296	3052776		R9553052776X
SS338ME	3558000		R9553558000X
SS296C	3558005		R9553558005X
SS296C	3558006		R9553558006X
ST676D	3558010		R9553558010X
SS338E	3558013		R9553558013X
SS338E	3558020		R9553558020X
SS338CE	3558021		R9553558021X
SS296CE	3558022		R9553558022X
SS338E	3558023		R9553558023X
ST676	3558027		R9553558027X
SS296ME	3558029		R9553558029X
SS296ME	3558042		R9553558042X
SS338ME	3558043		R9553558043X
SS296E	3558044		R9553558044X
SS296E	3558045		R9553558045X
SS296E	3558046		R9553558046X
QE296B	3558049		R9553558049X
QE338B	3558050		R9553558050X
QE338C	3558051		R9553558051X
QE296C	3558052		R9553558052X
QE296M	3558068		R9553558068X
QE296	3558072		R9553558072X
QE338	3558074		R9553558074X
QE296M	3558075		R9553558075X
QE338CM	3558076		R9553558076X
QE338CM	3558077		R9553558077X
QE296CE	3558094		R9553558094X
QE338CE	3558095		R9553558095X
QE338B	3558098		R9553558098X
QE338C	3558113		R9553558113X
HD850C	3558122		R9553558122X
QE296CE	3558186		R9553558186X
QE338CE	3558189		R9553558189X
TU-FLO 550	5001940		R9555001940X
TU-FLO 750	5002713		R9555002713X
TU-FLO 550	5002865		R9555002865X
TU-FLO 750	5002868		R9555002868X
TU-FLO 750	5002983		R9555002983X
TU-FLO 550	5002984		R9555002984X
TU-FLO 750	5004118		R9555004118X
TU-FLO 750	5004187		R9555004187X

2

## AIR COMPRESSORS QUICK REFERENCE

Model	OE Number	Meritor New	Meritor Remanufactured
TU-FLO 550	5004188		R9555004188X
TU-FLO 550	5004613		R9555004613X
TU-FLO 750	5004614		R9555004614X
TU-FLO 750	5004614		R9555004614X
TU-FLO 550	5005790		R9555005790X
DF-596	5005875		R9555005875X
TU-FLO 550	5008249		R9555008249X
BA921	5010806		R9555010806X
TU-FLO 550	5011016		R9555011016X
BA921	5012533		R9555012533X
BA922	5013058		R9555013058X
BA922	5013059		R9555013059X
BA921	5014428		R9555014428X
TU-FLO 550	5015314		R9555015314X
BA921	5018485		R9555018485X
ISX	9111535100		R9559111535100X
L, M, N	9111535200		R9559111535200X
ISC	9111535300		R9559111535300X
B Series	9111535330		R9559111535330X
B Series	9111545000		R9559111545000X
Compressor	9111545100		R9559111545100X
EL1300	EL13020		R955EL13020X
EL1300	EL13022		R955EL13022X
EL1300	EL13040		R955EL13040X
EL1300-DDC60	EL13050		R955EL13050X
EL1300-DDC60	EL13051		R955EL13051X
EL1300, EL1600-DDC60	EL13053		R955EL13053X
EL1300	EL13060		R955EL13060X
EL1300-DDC60	EL13090		R955EL13090X
EL1300-DDC60	EL13100		R955EL13100X
EL1300	EL13111		R955EL13111X
EL1300	EL13151		R955EL13151X
EL1300	EL13200		R955EL13200X
EL3200	EL14110		R955EL14110X
EL3200	EL14111		R955EL14111X
EL1600	EL16040		R955EL16040X
EL1600	EL16050		R955EL16050X
EL1300, EL1600-DDC60	EL16053		R955EL16053X
EL1600	EL16060		R955EL16060X
EL1600	EL16100		R955EL16100X
EL1600	EL16111		R955EL16111X
EL1600	EL16120		R955EL16120X
EL1600	EL16200		R955EL16200X
Standard Governor	KN18530		R955KN18530X
Standard Governor	KN18531		R955KN18531X
Standard Governor	KN18534		R955KN18534X
EL740	KN7000		R955KN7000X
EL740	KN7010		R955KN7010X
EL740	KN7020		R955KN7020X

2

**AIR COMPRESSORS QUICK REFERENCE**

Model	OE Number	Meritor New	Meritor Remanufactured
EL740	KN7030		R955KN7030X
EL740	KN7040		R955KN7040X
EL740	KN7041		R955KN7041X
EL740	KN7050		R955KN7050X
EL740	KN7060		R955KN7060X
EL740	KN7070		R955KN7070X
EL740	KN7080		R955KN7080X
EL740	KN7170		R955KN7170X
EL740	KN7180		R955KN7180X
EL850	KN85020		R955KN85020X
EL850	KN85022		R955KN85022X
EL850	KN85230		R555KN85230X
EL850	KN86020		R955KN86020X
EL850	KN86230		R955KN86230X
EL850	KN86230		R955KN86230X
EL850	KNT86230		R555KN86230X

**2**

## Compressor Features

- All replacement parts meet or exceed exacting specifications
- Inlet seats are replaced
- Cylinder bore crosshatching angle is 100% maintained
- Cylinder blocks are machined to meet exacting specifications
- All connecting rods are compatible with turbocharging
- New ring sets and pistons are matched to reconditioned cylinder blocks
- Exhaust seats are machined to meet exacting specifications
- The head assembly is completely disassembled, inspected, cleaned and machined to meet exacting standards
- All units are dynamometer-tested



## AIR COMPRESSOR TROUBLESHOOTING GUIDE

SYMPTOMS	CODES							
Passing Excessive Oil	1	2	3	4	5	6	7	8
Knock or Rattle	9	10	11	12	13			
Slow Air Buildup	1	6	8	9	10	14	15	16
Will Not Unload	15	17	18					
Excessive Load/Unload Cycling	15	17	19	20				
Runs Hot	9	16	20	21	22	23	24	
Premature Carbon Buildup	6	17	21	23	24	25		

PROBABLE CAUSES	
1	Restricted air intake. Change air filter element, local or engine. Kinked air hose. Vacuum from engine turbocharger when the compressor air intake is hooked to the engine air intake. Use inlet check valve assembly.
2	Restricted or kinked oil return line. Return line size must be a minimum of 5/8" O.D. Check for silicone buildup in the drain hole. Excessive engine rotation may require a bottom drain on the compressor.
3	Poorly filtered air. Check for defective intake components.
4	Improper cooling. Restricted water flow, maximum coolant flow plumbed into the block and out the head. (Opposite sides)
5	No air dryer in the system. Drain reservoir tanks daily.
6	Excessive duty cycle. Check for system leakage, inadequate compressor size for vehicle application.
7	Excessive engine oil pressure and/or crankcase pressure.
8	Compressor worn out or defective
9	Restricted air discharge line - build up of oil heating to a hard carbon fibre.
10	Loose pulley or worn drive gear components.
11	Lack of lubrication has created excessive bearing clearances.
12	Mounting bracket vibration
13	Carbon formation on the top of piston/bottom of cylinder head.
14	Air dryer purge valve stuck open
15	Defective unloader mechanism and/or governor
16	Braided discharge line heat fatigued. Check with a soapy solution.
17	Discharge valve leakage. Excessive system leakage.
18	Governor reservoir or unloader line restricted.
19	Reservoir volume reduced. Drain water from system.
20	Brakes out of adjustment. Increased volume usage.
21	Improper cooling. Restricted water flow, maximum coolant flow plumbed into block and out the head (Opposite sides)
22	Insufficient air blast cooling. Clean cooling fans.
23	Carbon comes from heat. Look for restrictions. Early engines did not utilize inner coolers. Compressor inlet turbocharged to elevate temperatures.
24	Compressor is turbocharged at temperatures/pressures and RPM above acceptable limitations. Consult manufacturer for parameters.
25	Brand of multi-grade motor oil. Some oil brands allow carbon and varnish formation at lower temperatures.



**BENDIX D-2 GOVERNOR**

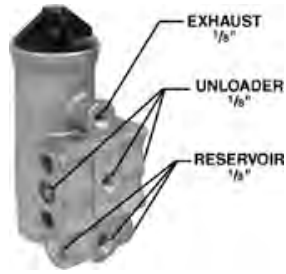

Meritor NO.	NEW/ REMAN	REPLACES	PRESSURE SETTINGS		PORT SIZE	CORE NO.	CORE GROUP	APPLICATION & GENERAL INFORMATION
			CUT-IN	CUT-OUT				
<b>R955275491</b>	New	Bendix 275491	100 psi	120 psi	1/8" Ports	XC1077	BN251	Standard Version. Pressure setting range is adjustable. Governor—Signals the unloading mechanism on the compressor when to build up air to the reservoir and when to halt air build up. Usually between 100 and 120 psi. Includes plugs for unused ports and gasket.
<b>R955275491X</b>	Reman	Bendix 275491X						
<b>R955275707X</b>	Reman	Bendix 275707X						
<b>R955284358N</b>	New	Bendix 284358	105 psi	125 psi				Low Temperature Version. Weatherproof. Pressure setting range is adjustable.
<b>R955284358X</b>	Reman	Bendix 284358X						

**HALDEX STANDARD GOVERNOR**



Meritor NO.	NEW/ REMAN	REPLACES	PRESSURE SETTINGS		PORT SIZE	CORE NO.	CORE GROUP	APPLICATION & GENERAL INFORMATION
			CUT-IN	CUT-OUT				
<b>R955KN18530X</b>	Reman	Haldex KN18530X	100 psi	120 psi	1/8" Ports	XC1145	MD251	Governor—Signals the unloading mechanism on the compressor when to build up air to the reservoir and when to halt air build up. Usually between 100 and 120 psi.
<b>R955KN18531X</b>	Reman	Haldex KN18531X			1/4" Ports			
<b>R955KN18534X</b>	Reman	Haldex KN18534X	105 +/-5 psi	115 psi	1/8" Ports			High Temperature applications. Pressure setting range is adjustable.

# AIR COMPRESSORS COMPETITIVE

2

## BENDIX TU-FLO 300



- Flange Mount
- Water Cooled
- 4 Hole Base
- Pulley Drive

Meritor NO.	MODEL	OUTRIGHT/ REMAN	REPLACES	PORT LOCATION INLET/OUTLET	TYPE OF DISCHARGE	UNLOADER KIT	MOUNTING GASKET KIT	CORE NO.	CORE GROUP
R955275113X	TU-FLO 300	Reman	Bendix 275113X	Left/Left	Flange	R955229415N		XC1684	BN660
R955275114X			Bendix 275114X	Right/Right				XC1685	BN611
R955284374X			Bendix 284374X	Left/Left					

## BENDIX TU-FLO 400



- Offset Mount
- Ford (slant)
- Pulley Drive
- Water Cooled

Meritor NO.	MODEL	OUTRIGHT/ REMAN	REPLACES	PORT LOCATION INLET/OUTLET	TYPE OF DISCHARGE	UNLOADER KIT	MOUNTING GASKET KIT	CORE NO.	CORE GROUP
R955229077X	TU-FLO 400	Reman	Bendix 229077X	Left/Top	Threaded	R955279614N	R955153103	XC1655	BN633
R955283505X			Bendix 283505X	Right/Top					

## BENDIX TU-FLO 400



- 4 Hole Base
- Vertical Mount
- Pulley Drive
- Air Cooled

Meritor NO.	MODEL	OUTRIGHT/ REMAN	REPLACES	PORT LOCATION INLET/OUTLET	TYPE OF DISCHARGE	UNLOADER KIT	MOUNTING GASKET KIT	CORE NO.	CORE GROUP
R955227406X	TU-FLO 400	Reman	Bendix 227406X	Left/Left	Flange	R955279614N	R955280511N	XC1529	BN620
R955227407X			Bendix 227407X	Right/Right					

## BENDIX TU-FLO 400



- 4 Hole Base
- Vertical Mount
- Pulley Drive
- Water Cooled Head
- Air Cooled Block

Meritor NO.	MODEL	OUTRIGHT/ REMAN	REPLACES	PORT LOCATION INLET/OUTLET	TYPE OF DISCHARGE	UNLOADER KIT	MOUNTING GASKET KIT	CORE NO.	CORE GROUP
R955275317X	TU-FLO 400	Reman	Bendix 275317X	Left/Left	Flange	R955279614N	R955280511N	XC1554	BN620
R955279024X			Bendix 279024X						
R955279025X			Bendix 279025X	Right/Right					
R955279176X <small>See Note 7</small>			Bendix 279176X	Right/Top	Threaded				
R955283429X <small>See Note 2</small>			Bendix 283429X	Right/Right	Flange				

Notes:    7 Four front cover studs.  
            2 Base oil option.

## BENDIX TU-FLO 400



- 4 Hole Base
- Vertical Mount
- Pulley Drive
- Water Cooled
- Bottom Cover Plate

The case has six (6) 1/4" holes for mounting the bottom cover.

Meritor NO.	MODEL	OUTRIGHT/ REMAN	REPLACES	PORT LOCATION INLET/OUTLET	TYPE OF DISCHARGE	UNLOADER KIT	MOUNTING GASKET KIT	CORE NO.	CORE GROUP
R955101142X	TU-FLO 400	Reman	Bendix 101142X	Left/Left	Flange	R955279614N	R955280511N	XC1528	BN620
R955289688X <small>See Note 3</small>			Bendix 289688X						

Notes:    3 Has Base Adapter.

## BENDIX TU-FLO 400



- 4 Hole Base
- Vertical Mount
- Pulley Drive
- Water Cooled
- Rear Oil Inlet

Meritor NO.	MODEL	OUTRIGHT/ REMAN	REPLACES	PORT LOCATION INLET/OUTLET	TYPE OF DISCHARGE	UNLOADER KIT	MOUNTING GASKET KIT	CORE NO.	CORE GROUP
R955101242X	TU-FLO 400	Reman	Bendix 101242X	Left/Left	Flange	R955279614N	R955280511N	XC1528	BN620
R955227400X			Bendix 227400X						
R955227401X			Bendix 227401X	Right/Right					
R955227402X			Bendix 227402X	Left/Left					
R955227403X			Bendix 227403X	Right/Right					

# AIR COMPRESSORS COMPETITIVE

2

## BENDIX TU-FLO 400



- 6 Hole Base
- Vertical Mount
- Pulley Drive
- Water Cooled
- Base Oil Option

Meritor NO.	MODEL	OUTRIGHT/ REMAN	REPLACES	PORT LOCATION INLET/OUTLET	TYPE OF DISCHARGE	UNLOADER KIT	MOUNTING GASKET KIT	CORE NO.	CORE GROUP
R955227408X	TU-FLO 400	Reman	Bendix 227408X	Right/Right	Flange	R955279614N	R955101558N	XC1530	BN622
R955227409X			Left/Left						
R955227410X			Right/Right						

## BENDIX TU-FLO 400



- 6 Hole Base
- Vertical Mount
- Pulley Drive
- Water Cooled Head
- Air Cooled Block

Meritor NO.	MODEL	OUTRIGHT/ REMAN	REPLACES	PORT LOCATION INLET/OUTLET	TYPE OF DISCHARGE	UNLOADER KIT	MOUNTING GASKET KIT	CORE NO.	CORE GROUP
R955103212X	TU-FLO 400	Reman	Bendix 103212X	Optional/Optional	Threaded	R955104012	R955153102	XC1642	BN601

## BENDIX TU-FLO 400



- Side Mount
- Pulley Drive
- Air Cooled

Meritor NO.	MODEL	OUTRIGHT/ REMAN	REPLACES	PORT LOCATION INLET/OUTLET	TYPE OF DISCHARGE	UNLOADER KIT	MOUNTING GASKET KIT	CORE NO.	CORE GROUP
R955279037X	TU-FLO 400	Reman	Bendix 279037X	Right/Right	Flange	R955279614N	R955280512N	XC1505	BN634
R955283506X			Left/Left						

## BENDIX TU-FLO 400



- Flange Mount
- Water Cooled

Meritor NO.	MODEL	OUTRIGHT/ REMAN	REPLACES	PORT LOCATION INLET/OUTLET	TYPE OF DISCHARGE	UNLOADER KIT	MOUNTING GASKET KIT	CORE NO.	CORE GROUP
<b>R955102674X</b>	TU-FLO 400	Reman	Bendix 102674X	Left/Left		R955279614N	R955153110	XC1499	BN621
<b>R955227414X</b>			Bendix 227414X						

## BENDIX TU-FLO 500



- 4 Hole Base
- Vertical Mount
- Pulley Drive
- Air Cooled

Meritor NO.	MODEL	OUTRIGHT/ REMAN	REPLACES	PORT LOCATION INLET/OUTLET	TYPE OF DISCHARGE	UNLOADER KIT	MOUNTING GASKET KIT	CORE NO.	CORE GROUP
<b>R955228141X</b>	TU-FLO 500	Reman	Bendix 228141X	Left/Left	Flange	R955279615N	R955280511N	XC1531	BN660
<b>R955228346X</b>			Bendix 228346X	Right/Right					

## BENDIX TU-FLO 500



- 4 Hole Base
- Vertical Mount
- Pulley Drive
- Thru Drive
- Water Cooled
- Base Oil Option

Meritor NO.	MODEL	OUTRIGHT/ REMAN	REPLACES	PORT LOCATION INLET/OUTLET	TYPE OF DISCHARGE	UNLOADER KIT	MOUNTING GASKET KIT	CORE NO.	CORE GROUP
<b>R955228479X</b> <small>See Note 2</small>	TU-FLO 500	Reman	Bendix 228479X	Left/Left	Flange	R955279615N	R955280511N	XC1536	BN660
<b>R955275990X</b> <small>See Note 2</small>	TU-FLO 500	Reman	Bendix 275990X	Right/Right	Flange	R955279615N	R955280512N	XC1536	BN660

Notes: 2 Base oil option.

# AIR COMPRESSORS COMPETITIVE

2

## BENDIX TU-FLO 500



- Side Mount
- Pulley Drive
- Air Cooled

Meritor NO.	MODEL	OUTRIGHT/ REMAN	REPLACES	PORT LOCATION INLET/OUTLET	TYPE OF DISCHARGE	UNLOADER KIT	MOUNTING GASKET KIT	CORE NO.	CORE GROUP
<b>R955228366X</b>	TU-FLO 500	Reman	Bendix 228366X	Right/Right	Flange	R955279615N	R955280512N	XC1525	BN660
<b>R955283514X</b>			Bendix 283514X	Left/Left					

## BENDIX TU-FLO 500 · 600



- 6 Hole Base
- Vertical Mount
- Pulley Drive
- Water Cooled

Meritor NO.	MODEL	OUTRIGHT/ REMAN	REPLACES	PORT LOCATION INLET/OUTLET	TYPE OF DISCHARGE	UNLOADER KIT	MOUNTING GASKET KIT	CORE NO.	CORE GROUP
<b>R955227331X</b> See Note 2	TU-FLO 500	Reman	Bendix 227331X	Left/Left	Flange	R955279615N	R955101558N	XC1525	BN660
<b>R955227332X</b> See Note 2			Bendix 227332X	Right/Right					
<b>R955280610X</b> See Note 2	TU-FLO 600		Bendix 280610X	Left/Left					
<b>R955280611X</b> See Note 2			Bendix 280611X	Right/Right					

Notes: 2 Base oil option.

## BENDIX TU-FLO 500 · 600 · 700



- 4 Hole Base
- Vertical Mount
- Pulley Drive
- Water Cooled

2

Meritor NO.	MODEL	OUTRIGHT/ REMAN	REPLACES	PORT LOCATION INLET/OUTLET	TYPE OF DISCHARGE	UNLOADER KIT	MOUNTING GASKET KIT	CORE NO.	CORE GROUP
<b>R955227320X</b> <small>See Note 2</small>	TU-FLO 500	Reman	Bendix 227320X	Left/Left	Flange	R955279615N	R955280511N		
<b>R955227321X</b>			Bendix 227321X	Right/Right					
<b>R955227322X</b> <small>See Note 2</small>			Bendix 227322X						
<b>R955227323X</b>			Bendix 227323X	Left/Left					
<b>R955277694X</b>			Bendix 277694X	Left/Top	Threaded				
<b>R955282076X</b>			Bendix 282076X	Right/Top					
<b>R955283690X</b> <small>See Note 2</small>	TU-FLO 600		Bendix 283690X	Left/Top	Flange				
<b>R955280602X</b> <small>See Note 2</small>			Bendix 280602X	Left/Left					
<b>R955280603X</b>			Bendix 280603X	Right/Right					
<b>R955280604X</b> <small>See Note 2</small>			Bendix 280604X						
<b>R955280613X</b>	Bendix 280613X		Left/Left						
<b>R955101256X</b>	TU-FLO 700		Bendix 101256X	Right/Right & Top	Optional				
<b>R955289350X</b>		Bendix 289350X	Left/Left & Top						

Notes: 2 Base oil option.

# AIR COMPRESSORS COMPETITIVE

## BENDIX TU-FLO 501

2



Base Style A



Base Style B



- 4 Hole Base
- Vertical Mount
- Pulley Drive
- Water and Air Cooled

Meritor NO.	BASE STYLE	MODEL	OUTRIGHT/REMAN	REPLACES	PORT LOCATION INLET/OUTLET	TYPE OF DISCHARGE	UNLOADER KIT	MOUNTING GASKET KIT	CORE NO.	CORE GRP
R955286617X		TU-FLO 501	Reman	Bendix 286617X	Left/Top	Threaded	R955279615N	R955280511N	XC1592	BN670
R955102698X <small>See Note 9</small>	A			Bendix 102698X	Left/Left	Flange				
R955286526X				Bendix 286526X						
R955286527X				Bendix 286527X	Right/Right					
R955286528X				Bendix 286528X	Left/Top	Threaded				
R955286529X				Bendix 286529X	Right/Top					
R955286560X <small>See Note 7</small>				Bendix 286560X	Left/Top					
R955286582X <small>See Note 9</small>	Bendix 286582X									
R955286586X	Bendix 286586X			Left/Left	Flange					
R955286589X	B			Bendix 286589X		Right/Right				
R955286591X				Bendix 286591X						
R955286595X				Bendix 286595X	Right/Top	Threaded				
R955286567X	Bendix 286567X									
R955286580X	Bendix 286580X			Left/Left	Flange					
R955286592X	Bendix 286592X			Right/Right						

Notes: 9 Three front cover studs.  
7 Four front cover studs.

## BENDIX TU-FLO 501

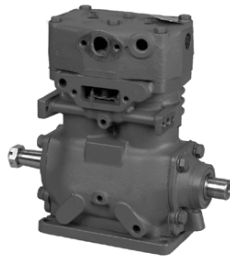

- 4 Hole Base
- Vertical Mount
- Pulley Drive
- Thru Drive
- Water and Air Cooled

Meritor NO.	MODEL	OUTRIGHT/REMAN	REPLACES	PORT LOCATION INLET/OUTLET	TYPE OF DISCHARGE	UNLOADER KIT	MOUNTING GASKET KIT	CORE NO.	CORE GROUP
R955286530X	TU-FLO 501	Reman	Bendix 286530X	Left/Left	Flange	R955279615N	R955280511N	XC1593	BN671
R955286532X			Bendix 286532X	Left/Top	Threaded			XC1594	
R955286533X			Bendix 286533X	Right/Right	Flange			XC1593	



## BENDIX TU-FLO 501



- 6 Hole Base
- Vertical Mount
- Pulley Drive
- Water Cooled

Meritor NO.	MODEL	OUTRIGHT/ REMAN	REPLACES	PORT LOCATION INLET/OUTLET	TYPE OF DISCHARGE	UNLOADER KIT	MOUNTING GASKET KIT	CORE NO.	CORE GROUP
<b>R955102989X</b> <small>See Note 8</small>	TU-FLO 501	Reman	Bendix 102989X	Right/Top	Threaded	R955279615N	R955280511N	XC1620	BN672
<b>R955286536X</b>			Bendix 286536X						
<b>R955286537X</b>			Bendix 286537X	Left/Top				XC1596	
<b>R955286576X</b>			Bendix 286576X	Right/Right	XC1595				
<b>R955286585X</b> <small>See Note 8</small>			Bendix 286585X	Left/Left	XC1620				

Notes:    8 Special crankcase base for Ford.

## BENDIX TU-FLO 550



- 4 Hole Base
- Vertical Mount
- Pulley Drive
- Thru Drive
- Water Cooled Head
- Air Cooled Block

Meritor NO.	MODEL	OUTRIGHT/ REMAN	REPLACES	PORT LOCATION INLET/OUTLET	TYPE OF DISCHARGE	UNLOADER KIT	MOUNTING GASKET KIT	CORE NO.	CORE GROUP
<b>R955107514X</b>	TU-FLO 550	Reman	Bendix 107514X	Left/Top	Threaded	R955153150	R955280511N	XC1519	BN724
<b>R955107866X</b> <small>See Note 8</small>	TU-FLO 550		Bendix 107866X	Right/Top					
<b>R955108066X</b> <small>See Note 9</small>	TU-FLO 550		Bendix 108066X	Left/Top					
<b>R955108110X</b> <small>See Note 10</small>	TU-FLO 550		Bendix 108110X						

Notes:    8 Special crankcase base for Ford.  
           9 Three front cover studs.  
           10 Two mounting studs.

# AIR COMPRESSORS COMPETITIVE

2

## BENDIX TU-FLO 700



- 6 Hole Base
- Vertical Mount
- Pulley Drive
- Water Cooled

Meritor NO.	MODEL	OUTRIGHT/ REMAN	REPLACES	PORT LOCATION INLET/OUTLET	TYPE OF DISCHARGE	UNLOADER KIT	MOUNTING GASKET KIT	CORE NO.	CORE GROUP
<b>R955102213X</b> <small>See Note 2</small>	TU-FLO 700	Reman	Bendix 102213X	Left/Left	Optional	R955279615N	R955101558N	XC1639	BN822
<b>R955102598X</b> <small>See Note 8</small>			Bendix 102598X						
<b>R955289924X</b> <small>See Note 2</small>			Bendix 289924X	Right/Right & Top					

Notes: 2 Base oil option.  
8 Special crankcase base for Ford.

## BENDIX TU-FLO 1000



- Vertical Mount and Flange Mount
- Pulley and Engine Drive
- Water Cooled

Meritor NO.	MODEL	OUTRIGHT/ REMAN	REPLACES	PORT LOCATION INLET/OUTLET	TYPE OF DISCHARGE	UNLOADER KIT	MOUNTING GASKET KIT	CORE NO.	CORE GROUP
<b>R955229990X</b> <small>See Note 28</small>	TU-FLO 1000	Reman	Bendix 229990X	Middle/Middle		R955279615N	R955153113	XC1537	BN962

Notes: 28 Pulley Drive.

## BENDIX BX2150



- 4 Hole
- Vertical Mount
- Pulley Drive
- Water Cooled Head
- Air Cooled Block

Meritor NO.	MODEL	OUTRIGHT/ REMAN	REPLACES	PORT LOCATION INLET/OUTLET	TYPE OF DISCHARGE	UNLOADER KIT	MOUNTING GASKET KIT	CORE NO.	CORE GROUP
<b>R955103211X</b> <small>See Note 11</small>	BX2150	Reman	Bendix 103211X	Left/Optional	Threaded	R955153150	R955153102	XC1642	BN601
<b>R955104039X</b>	BX2150		Bendix 104039X						
<b>R955104041X</b> <small>See Note 12</small>	BX2150		Bendix 104041X						
<b>R955106439X</b>	BX2150		Bendix 106439X						
<b>R955106978X</b> <small>See Note 31</small>	BX2150		Bendix 106978X						
<b>R955106985X</b> <small>See Note 11, 31</small>	BX2150		Bendix 106985X						
<b>R955107221X</b> <small>See Note 31</small>	BX2150		Bendix 107221X						

Notes: 11 Bottom oil drain base.  
12 Low profile case.  
31 New style head.

## HALDEX EL 740



- 4 Hole
- Vertical Mount
- Pulley Drive
- Air Cooled
- End Cap Oil Feed Only
- Base Oil Drain
- Rotatable Head

Meritor NO.	MODEL	OUTRIGHT/ REMAN	REPLACES	PORT LOCATION INLET/OUTLET	TYPE OF DISCHARGE	UNLOADER KIT	MOUNTING GASKET KIT	CORE NO.	CORE GROUP
<b>R955KN7000X</b>	EL740	Reman	Haldex KN7000X	Right/Left	Threaded	R955RN33C	R955280511N	XC1925	MD620

## HALDEX EL 740



- 4 Hole Base
- Vertical Mount
- Pulley Drive
- Air Cooled

Meritor NO.	MODEL	OUTRIGHT/ REMAN	REPLACES	PORT LOCATION INLET/OUTLET	TYPE OF DISCHARGE	UNLOADER KIT	MOUNTING GASKET KIT	CORE NO.	CORE GROUP
<b>R955KN7010X</b>	EL740	Reman	Haldex KN7010X	Right/Right	Flange	R955RN33C	R955280511N	XC1940	MD640
<b>R955KN7020X</b>			Haldex KN7020X	Left/Left				XC1926	MD620

# AIR COMPRESSORS COMPETITIVE

2

## HALDEX EL 740



- 4 Hole Base
- Vertical Mount
- Pulley Drive
- Water Cooled Head
- Air Cooled Block

Meritor NO.	MODEL	OUTRIGHT/ REMAN	REPLACES	PORT LOCATION INLET/OUTLET	TYPE OF DISCHARGE	UNLOADER KIT	MOUNTING GASKET KIT	CORE NO.	CORE GROUP
R955KN7030X	EL740	Reman	Haldex KN7030X	Right/Left	Threaded	R955RN33C	R955280511N	XC1927	MD620
R955KN7040X			Haldex KN7040X	Right/Right					
R955KN7041X			Haldex KN7041X	Left/Left	Flange			XC1928	
R955KN7050X			Haldex KN7050X						
R955KN7170X			Haldex KN7170X	Right/Right	XC1930			MD622	
R955KN7180X			Haldex KN7180X	Left/Left					

## HALDEX EL 850



- 4 Hole Base
- Vertical Mount
- Belt Drive
- Water Cooled Head
- Air Cooled Block

Meritor NO.	MODEL	OUTRIGHT/ REMAN	REPLACES	PORT LOCATION INLET/OUTLET	TYPE OF DISCHARGE	UNLOADER KIT	MOUNTING GASKET KIT	CORE NO.	CORE GROUP
R955KN85020X	EL850	Reman	Haldex KN85020X	Right/Front	Threaded	R955RNT26JB	R955153102	XC1931	MD601
R955KN85022X			Haldex KN85022X	Right				XC1669	
R955KN86020X			Haldex KN86020X	Right/Front				XC1932	
R955KN86230X			Haldex KN86230X	Right				XC1670	

## HALDEX EL 850



- 4 Hole Base
- Vertical Mount
- Belt Drive
- Water Cooled Head
- Air Cooled Block

Meritor NO.	MODEL	OUTRIGHT/ REMAN	REPLACES	PORT LOCATION INLET/OUTLET	TYPE OF DISCHARGE	UNLOADER KIT	MOUNTING GASKET KIT	CORE NO.	CORE GROUP
R955KN86230X	EL850	Reman	Haldex KN86230X	Right	Threaded	R955RNT26JB	R955153102	XC1670	MD601

## HALDEX EL 1300 · EL 1600



- 4 Hole Base
- Vertical Mount
- Pulley Drive
- Water Cooled Head

2

Meritor NO.	MODEL	OUTRIGHT/ REMAN	REPLACES	PORT LOCATION INLET/OUTLET	TYPE OF DISCHARGE	UNLOADER KIT	MOUNTING GASKET KIT	CORE NO.	CORE GROUP
<b>R955EL13020X</b>	EL1300	Reman	Haldex EL13020X	Right/Right	Flange	R955RNT26A	R955280511N	XC1905	MD688
<b>R955EL13022X</b> <small>See Note 13</small>			Haldex EL13022X	Left/Left					
<b>R955EL13060X</b>			Haldex EL13060X	Right/Right					
<b>R955EL13330X</b>			Haldex EL13330X						
<b>R955EL16060X</b> <small>See Note 14</small>	EL1600		Haldex EL16060X					XC1919	MD820
<b>R955EL16280X</b>			Haldex EL16280X						

Notes:    13 Bottom cover plate for Ford application.  
          14 Base oil feed.

# AIR COMPRESSORS CATERPILLAR

2

## BENDIX TU-FLO 400



- Caterpillar
- Water Cooled
- Splined Shaft
- Flange Mount
- Engine Drive

Meritor NO.	MODEL	OUTRIGHT/ REMAN	REPLACES	PORT LOCATION INLET/OUTLET	TYPE OF DISCHARGE	UNLOADER KIT	MOUNTING GASKET KIT	CORE NO.	CORE GROUP
R955283533X	TU-FLO 400	Reman	Bendix 283533X	Left/Left	Flange	R955279614N	R955153110	XC1656	BN631

## BENDIX TU-FLO 500 · 600 · 700



- Caterpillar
- Splined Shaft
- Flange Mount
- Water Cooled

Meritor NO.	MODEL	OUTRIGHT/ REMAN	REPLACES	PORT LOCATION INLET/OUTLET	TYPE OF DISCHARGE	UNLOADER KIT	MOUNTING GASKET KIT	CORE NO.	CORE GROUP
R955277730X	TU-FLO 500	Reman	Bendix 277730X	Right/Right	Flange	R955279615N	R955153106	XC1525	BN660
R955277731X			Bendix 277731X	Left/Left					
R955282025X	TU-FLO 600		Bendix 282025X		Optional		R955153110	XC1486	BN827
R955101884X	TU-FLO 700		Bendix 101884X	Left/Left & Top			R955153106	XC1633	BN826
R955289349X See Note 15			Bendix 289349X						

Notes: 15 Has crankcase cover with 1/2" PT oil drain.

## BENDIX TU-FLO 501



- Caterpillar
- Tapered Shaft
- Flange Mount
- Water and Air Cooled

Meritor NO.	MODEL	OUTRIGHT/ REMAN	REPLACES	PORT LOCATION INLET/OUTLET	TYPE OF DISCHARGE	UNLOADER KIT	MOUNTING GASKET KIT	CORE NO.	CORE GROUP
R955103274X See Note 16	TU-FLO 501	Reman	Bendix 103274X	Left/Top	Threaded	R955279615N	R955153106	XC1507	BN676
R955286550X			Bendix 286550X	Left/Left	Flange			XC1604	
R955286551X			Bendix 286551X	Right/Top	Threaded			XC1603	
R955286552X			Bendix 286552X	Left/Top				XC1604	
R955286566X			Bendix 286566X	Right/Top				XC1612	

Notes: 16 Has 2°-30° tilt and threaded mounting hole.

## BENDIX TU-FLO 501



- Caterpillar
- Splined Shaft
- Flange Mount
- Water and Air Cooled
- Rear Oil Inlet
- Base Oil Drain

Meritor NO.	MODEL	OUTRIGHT/ REMAN	REPLACES	PORT LOCATION INLET/OUTLET	TYPE OF DISCHARGE	UNLOADER KIT	MOUNTING GASKET KIT	CORE NO.	CORE GROUP
<b>R955286546X</b>	TU-FLO 501	Reman	Bendix 286546X	Left/Top	Threaded	R955279615N	R955153106	XC1601	BN677
<b>R955286548X</b>			Bendix 286548X	Left/Left	Flange			XC1602	
<b>R955286549X</b>			Bendix 286549X	Right/Right				XC1601	

## BENDIX TU-FLO 550



- Caterpillar
- Flange Mount
- Water and Air Cooled

Meritor NO.	MODEL	OUTRIGHT/ REMAN	REPLACES	PORT LOCATION INLET/OUTLET	TYPE OF DISCHARGE	UNLOADER KIT	MOUNTING GASKET KIT	CORE NO.	CORE GROUP
<b>R955109251X</b> See Note 38	TU-FLO 550	Reman	Bendix 109251X	Front/Left	Optional	R955153150	R955153101	XC1496	BN724
<b>R955109287X</b> See Note 38	TU-FLO 750		Bendix 109287X	Left/Left & Top			R955153106	XC1482	BN874

Notes: 38 Caterpillar 3306.

# AIR COMPRESSORS CATERPILLAR

## BENDIX TU-FLO 550 · 750

2



- Caterpillar 3116, 3126, C7 Acert, C9 Acert
- Flange Mount
- Water and Air Cooled

Meritor NO.	MODEL	OUTRIGHT/ REMAN	REPLACES	PORT LOCATION INLET/OUTLET	TYPE OF DISCHARGE	UNLOADER KIT	MOUNTING GASKET KIT	CORE NO.	CORE GROUP
<b>R9555001940X</b>	TU-FLO 550	Reman	Bendix 5001940X	Top/Top	Optional	R955153150	R955153112	XC1491	BN724
<b>R9555008249X</b> <small>See Note 36, 44</small>			Bendix 5008249X	Top/Left				XC1491	
<b>R9555011016X</b> <small>See Note 36, 45</small>			Bendix 5011016X					XC1489	
<b>R955109451X</b>			Bendix 109451X	Top/Top				XC1495	
<b>R955109111X</b>	TU-FLO 750		Bendix 109111X	Left/Left & Top			R955153112	XC1390	BN874
<b>R9555004118X</b> <small>See Note 36, 44</small>			Bendix 5004118X	Top/Left & Top				XC1478	
<b>R9555004614X</b> <small>See Note 50</small>			Bendix 5004614X	Right/Left			XC1480	BN877	
<b>R955109088X</b>			TU-FLO 550	Bendix 109088X			Left/Left & Top		XC1666

Notes: 36 Caterpillar 3116, C7 Acert.  
 44 Caterpillar 3126, C9 Acert—high torque thru-drive.  
 45 Caterpillar 3176, C9 Acert.  
 50 International I6 pre-2004 HT530.

## BENDIX TU-FLO 550 · 750



- Caterpillar 3176, 3406, C10, C12, C15, C16
- Flange Mount
- Water and Air Cooled

Meritor NO.	MODEL	OUTRIGHT/ REMAN	REPLACES	PORT LOCATION INLET/OUTLET	TYPE OF DISCHARGE	UNLOADER KIT	MOUNTING GASKET KIT	CORE NO.	CORE GROUP
<b>R9555002984X</b> <small>See Note 40</small>	TU-FLO 550	Reman	Bendix 5002984X	Right/Left	Optional	R955153150	R955153112	XC1491	BN724
<b>R9555005790X</b> <small>See Note 43</small>			Bendix 5005790X						
<b>R9555002713X</b> <small>See Note 40</small>	TU-FLO 750		Bendix 5002713X					XC1481	BN874
<b>R9555002983X</b> <small>See Note 43</small>			Bendix 5002983X						

Notes: 40 Caterpillar 3406, C10, C12, C15, C16—rear end cover shafts.  
 43 Caterpillar 3176, C15, C16.



## BENDIX TU-FLO 550 · 750



- Caterpillar
- Splined and Tapered Shaft
- 3406B-3176
- Flange Mount
- Water Cooled Head
- Air Cooled Block

Meritor NO.	MODEL	OUTRIGHT/ REMAN	REPLACES	PORT LOCATION INLET/OUTLET	TYPE OF DISCHARGE	UNLOADER KIT	MOUNTING GASKET KIT	CORE NO.	CORE GRP
<b>R955107509X</b> <small>See Note 17, 19</small>	TU-FLO 550	Reman	Bendix 107509X	Left/Left & Top	Optional	R955153150	R955153106	XC1514	BN724
<b>R955107917X</b> <small>See Note 18</small>			Bendix 107917X					XC1523	
<b>R955107981X</b> <small>See Note 36, 45</small>			Bendix 107981X					XC1497	
<b>R955107023X</b>	TU-FLO 750		Bendix 107023X					XC1390	BN874
<b>R955107508X</b> <small>See Note 18</small>			Bendix 107508X					XC1513	
<b>R955109142X</b>			Bendix 109142X					XC1390	
<b>R955109603X</b>	TU-FLO 550		Bendix 109603X						
<b>R955109604X</b> <small>See Note 17, 19</small>	TU-FLO 750	Bendix 109604X				R955153106	XC1648	BN874	

Notes: 17 Tapered shaft.  
 18 Splined shaft—22 tooth.  
 19 2.5° tilt.  
 36 Caterpillar 3116, C7 Acert.  
 45 Caterpillar 3176, C9 Acert.

## BENDIX TU-FLO 700



- Caterpillar
- Splined Shaft
- 3406B
- Flange Mount
- Water Cooled

Meritor NO.	MODEL	OUTRIGHT/ REMAN	REPLACES	PORT LOCATION INLET/OUTLET	TYPE OF DISCHARGE	UNLOADER KIT	MOUNTING GASKET KIT	CORE NO.	CORE GROUP
<b>R955103278X</b> <small>See Note 19</small>	TU-FLO 700	Reman	Bendix 103278X	Left/Left & Top	Optional	R955279615N	R955153106	XC1508	BN826
<b>R955289744X</b>			Bendix 289744X					XC1635	

Notes: 19 2.5° tilt.

# AIR COMPRESSORS CATERPILLAR

2

## BENDIX TU-FLO 700



- Caterpillar
- Flange
- Flange Mount
- Water Cooled

Meritor NO.	MODEL	OUTRIGHT/ REMAN	REPLACES	PORT LOCATION INLET/OUTLET	TYPE OF DISCHARGE	UNLOADER KIT	MOUNTING GASKET KIT	CORE NO.	CORE GROUP
R955289336X	TU-FLO 700	Reman	Bendix 289336X	Left/Left & Top	Optional	R955279615N	R955153106	XC1627	BN827

## BENDIX BA 921



- Caterpillar
- Flange Mount
- Detroit Diesel EGR 60
- Navistar IBB Side Mount

Meritor NO.	MODEL	OUTRIGHT/ REMAN	REPLACES	PORT LOCATION INLET/OUTLET	TYPE OF DISCHARGE	UNLOADER KIT	MOUNTING GASKET KIT	CORE NO.	CORE GROUP
R9555010806X	BA921	Reman	Bendix 5010806X	Top/Rear				XC1654	BN610
R9555014428X			Bendix 5014428	Top/Left	Optional				
R9555012533X			Bendix 5012533	Top/Side					
R955K056647X			K0656647X						
R9555018653X			Bendix 5018653X						
R955K075155X			K075155X						

## BENDIX BA 922



- Caterpillar C15/C18
- Flange Mount
- Detroit Equinox Engine & 60 EGR

Meritor NO.	MODEL	OUTRIGHT/ REMAN	REPLACES	PORT LOCATION INLET/OUTLET	TYPE OF DISCHARGE	UNLOADER KIT	MOUNTING GASKET KIT	CORE NO.	CORE GROUP
R9555013058X	BA922	Reman	Bendix 5013059X	Top/Top				XC1673	BN922
R9555013059X			Bendix 5013695X						
R9555013695X			Bendix 5012895X						
R9555012895X			Bendix 5013059X						
R9555013059X			Bendix 5013059X						

## BENDIX BX 2150



- Caterpillar
- 3304-3306 Flange
- Flange Mount
- Water Cooled Head
- Air Cooled Block

Meritor NO.	MODEL	OUTRIGHT/ REMAN	REPLACES	PORT LOCATION INLET/OUTLET	TYPE OF DISCHARGE	UNLOADER KIT	MOUNTING GASKET KIT	CORE NO.	CORE GROUP
<b>R955104042X</b> <small>See Note 30</small>	BX2150	Reman	Bendix 104042X	Optional Top or Left	Threaded	R955279615N	R955153106	XC1645	BN605
<b>R955109273X</b>			Bendix 109273X					XC1645	BN605

Notes: 30 Old style head.

## BENDIX BX 2150



- Caterpillar
- 3304-3306 Flange
- Flange Mount
- Water Cooled Head
- Air Cooled Block

Meritor NO.	MODEL	OUTRIGHT/ REMAN	REPLACES	PORT LOCATION INLET/OUTLET	TYPE OF DISCHARGE	UNLOADER KIT	MOUNTING GASKET KIT	CORE NO.	CORE GROUP
<b>R955107526X</b> <small>See Note 33</small>	BX2150	Reman	Bendix 107526X	Left/Top	Threaded	R955279615N	R955153106	XC1645	BN605

Notes: 33 22 tooth spline shaft.

## HALDEX EL1300 · EL1600



- Caterpillar Tapered Shaft
- Flange Mount
- Water Cooled

Meritor NO.	MODEL	OUTRIGHT/ REMAN	REPLACES	PORT LOCATION INLET/OUTLET	TYPE OF DISCHARGE	UNLOADER KIT	MOUNTING GASKET KIT	CORE NO.	CORE GROUP
<b>R955EL13200X</b>	EL1300	Reman	Haldex EL13200X	Right/Right	Flange	R955RNT26A	R955153106	XC1913	MD688
<b>R955EL16200X</b>	EL1600		Haldex EL16200X					XC1923	MD820

# AIR COMPRESSORS CATERPILLAR

## HALDEX EL1300 · EL1600

2



- Caterpillar Tapered Shaft
- Flange Mount
- Water Cooled

Meritor NO.	MODEL	OUTRIGHT/ REMAN	REPLACES	PORT LOCATION INLET/OUTLET	TYPE OF DISCHARGE	UNLOADER KIT	MOUNTING GASKET KIT	CORE NO.	CORE GROUP
R955EL16120X	EL1600	Reman	Haldex EL16120X	Right/Right	Flange	R955RNT26A	R955153106	XC1922	MD820

## HALDEX EL1300



- Caterpillar Flange
- Flange Mount
- Water Cooled

Meritor NO.	MODEL	OUTRIGHT/ REMAN	REPLACES	PORT LOCATION INLET/OUTLET	TYPE OF DISCHARGE	UNLOADER KIT	MOUNTING GASKET KIT	CORE NO.	CORE GROUP
R955EL13151X	EL1300	Reman	Haldex EL13151X	Right/Right	Flange	R955RNT26A	R955153106	XC1911	MD688

## BENDIX TU-FLO 500 · 600



- Cummins
- Double Flange
- Flange Mount
- Water Cooled
- Extended Case

Meritor NO.	MODEL	OUTRIGHT/ REMAN	REPLACES	PORT LOCATION INLET/OUTLET	TYPE OF DISCHARGE	UNLOADER KIT	MOUNTING GASKET KIT	CORE NO.	CORE GROUP
R955228443X	TU-FLO 500	Reman	Bendix 228443X	Left/Left	Flange	R955279615N	R955153108	XC1525	BN660
R955229525X			Bendix 229525X	Left/Top	Threaded				
R955276974X			Bendix 276974X	Left/Left	Flange				
R955280622X	TU-FLO 600		Bendix 280622X	Left/Left	Flange				
R955280626X			Bendix 280626X	Left/Top	Threaded				

## BENDIX TU-FLO 500 · 600 · 700



- Cummins Double Flange
- Flange Mount
- Water Cooled
- Standard Flange

Meritor NO.	MODEL	OUTRIGHT/ REMAN	REPLACES	PORT LOCATION INLET/OUTLET	TYPE OF DISCHARGE	UNLOADER KIT	MOUNTING GASKET KIT	CORE NO.	CORE GROUP
R955284699X	TU-FLO 500	Reman	Bendix 284699X	Left/Left	Flange	R955279615N	R955153108	XC1525	BN660
R955284718X			Bendix 284718X	Left/Top	Threaded			XC1525	
R955284959X			Bendix 284959X	Left/Left	Flange			XC1587	
R955284714X	TU-FLO 600		Bendix 284714X	Left/Left	Flange			XC1584	
R955289339X	TU-FLO 700		Bendix 289339X	Left/Left & Top	Optional			XC1628	BN831

## BENDIX TU-FLO 501



- Cummins
- Water and Air Cooled
- Engine Drive

Meritor NO.	MODEL	OUTRIGHT/ REMAN	REPLACES	PORT LOCATION INLET/OUTLET	TYPE OF DISCHARGE	UNLOADER KIT	MOUNTING GASKET KIT	CORE NO.	CORE GROUP
R955108269X	TU-FLO 501	Reman	Bendix 108269X	Left/Left	Flange	R955275615N	R955153108	XC1658	BN675
R955108273X			Bendix 108273X						

# AIR COMPRESSORS CUMMINS

2

## BENDIX TU-FLO 501



- Cummins Double Flange
- Flange Mount
- Water and Air Cooled
- Standard Flange

Meritor NO.	MODEL	OUTRIGHT/ REMAN	REPLACES	PORT LOCATION INLET/OUTLET	TYPE OF DISCHARGE	UNLOADER KIT	MOUNTING GASKET KIT	CORE NO.	CORE GROUP
<b>R955286554X</b>	TU-FLO 501	Reman	Bendix 286554X	Left/Left	Flange	R955279615N	R955153108	XC1605	BN682
<b>R955286555X</b>			Bendix 286555X	Left/Top	Threaded			XC1606	

## BENDIX TU-FLO 550



- Cummins ISB
- Flange Mount
- Water and Air Cooled

Meritor NO.	MODEL	OUTRIGHT/ REMAN	REPLACES	PORT LOCATION INLET/OUTLET	TYPE OF DISCHARGE	UNLOADER KIT	MOUNTING GASKET KIT	CORE NO.	CORE GROUP
<b>R955108804X</b> <small>See Note 37</small>	TU-FLO 550	Reman	Bendix 108804X	Top/Left	Optional	R955153150	R955153108	XC1494	BN721
<b>R955109653X</b> <small>See Note 37</small>			Bendix 109653X	Left/Left	Threaded				

Notes: 37 Cummins ISB & C-37 tooth gear.

## BENDIX TU-FLO 550 · 750



- Cummins Double Flange
- Flange Mount
- Water Cooled

Meritor NO.	MODEL	OUTRIGHT/ REMAN	REPLACES	PORT LOCATION INLET/OUTLET	TYPE OF DISCHARGE	UNLOADER KIT	MOUNTING GASKET KIT	CORE NO.	CORE GROUP
<b>R955107506X</b>	TU-FLO 550	Reman	Bendix 107506X	Left/Left & Top	Optional	R955153150	R955153108	XC1511	BN724
<b>R955107507X</b>	TU-FLO 750		Bendix 107507X					XC1512	BN874

## BENDIX BX2150



- Cummins Single Flange
- Flange Mount
- Water Cooled Head
- Air Cooled Block

Meritor NO.	MODEL	OUTRIGHT/ REMAN	REPLACES	PORT LOCATION INLET/OUTLET	TYPE OF DISCHARGE	UNLOADER KIT	MOUNTING GASKET KIT	CORE NO.	CORE GROUP
R955104103X	BX2150	Reman	Bendix 104103X	Optional/Optional	Threaded	R955104012	R955153109	XC1647	BN607
R955108261X			Bendix 108261X	Right/				XC1662	
R955108790X			Bendix 108790X	Left/Top/Rear				XC1663	
R955109079X			Bendix 109079X					XC1664	

## BENDIX BX2150



- Cummins and John Deer Double Flange
- Flange Mount
- Water Cooled Head
- Air Cooled Block

Meritor NO.	MODEL	OUTRIGHT/ REMAN	REPLACES	PORT LOCATION INLET/OUTLET	TYPE OF DISCHARGE	UNLOADER KIT	MOUNTING GASKET KIT	CORE NO.	CORE GROUP
R955104102X	BX2150	Reman	Bendix 104102X	Optional/Optional	Threaded	R955104012	R955153109	XC1646	BN607

## CUMMINS HD850C · QE296C · QE296CE · QE338C · QE338CE



- Cummins C-Series
- Water Cooled
- Engine Drive
- Flange Mount

Meritor NO.	MODEL	OUTRIGHT/ REMAN	REPLACES	PORT LOCATION INLET/OUTLET	TYPE OF DISCHARGE	UNLOADER KIT	MOUNTING GASKET KIT	CORE NO.	CORE GROUP
R9553558122X	HD850C	Reman	Cummins 3558122X	Left/Front	Threaded			XC1998	CU689
R9553558052X	QE296C		Cummins 3558052X					XC1972	
R9553558094X	QE296CE		Cummins 3558094X	Left/Left				XC1983	CU687
R9553558186X	QE338C		Cummins 3558186X	Front/Right				XC1993	
R9553558051X			Cummins 3558051X	Left/Front				XC1997	CU689
R9553558113X	QE338CE		Cummins 3558113X	Left/Left				XC1974	
R9553558095X			Cummins 3558095X	Front/Right				XC1997	
R9553558189X			Cummins 3558189X	Front/Right					
R9553559570X <small>See Note 59</small>		Reman	Cummins 3559570X						

Notes: 59 Head Assembly for QE (Quiet Economy) Cummins model compressors.

# AIR COMPRESSORS CUMMINS

2

## CUMMINS QE296B · QE338B



- Cummins
- Water Cooled
- Engine Drive
- Flange Mount

Meritor NO.	MODEL	OUTRIGHT/ REMAN	REPLACES	PORT LOCATION INLET/OUTLET	TYPE OF DISCHARGE	UNLOADER KIT	MOUNTING GASKET KIT	CORE NO.	CORE GROUP
R9553558049X	QE296B	Reman	Cummins 3558049X	Rear/Front	Threaded			XC1981	CU687
R9553558208X	QE296EB		Cummins 3558208X						
R9553558050X	QE338B		Cummins 3558050X	Front/Rear				XC1992	CU689
R9553558098X			Cummins 3558098X					XC1996	

## CUMMINS QE296 · QE338



Meritor NO.	MODEL	OUTRIGHT/ REMAN	REPLACES	PORT LOCATION INLET/OUTLET	TYPE OF DISCHARGE	UNLOADER KIT	MOUNTING GASKET KIT	CORE NO.	CORE GRP
R9553558072X	QE296	Reman	Cummins 3558072X	Left/Rear	Threaded			XC1973	C0687
R9553558074X	QE338		Cummins 3558074X					XC1994	C0689

## CUMMINS SS296



- Single Cylinder Compressor
- Water Cooled
- Flange Mount

Meritor NO.	MODEL	OUTRIGHT/ REMAN	REPLACES	PORT LOCATION INLET/OUTLET	TYPE OF DISCHARGE	UNLOADER KIT	MOUNTING GASKET KIT	CORE NO.	CORE GROUP
R9553018527X	SS296	Reman	Cummins 3018527X	Left/Rear				XC1898	CU681
R9553018543X			Cummins 3018543X						
R9553052776X			Cummins 3052776X					XC1896	



## CUMMINS SS296C · SS296CE · SS338CE



- Cummins C-Series
- Water Cooled
- Engine Drive
- Flange Mount

Meritor NO.	MODEL	OUTRIGHT/ REMAN	REPLACES	PORT LOCATION INLET/OUTLET	TYPE OF DISCHARGE	UNLOADER KIT	MOUNTING GASKET KIT	CORE NO.	CORE GROUP
R9553558005X	SS296C	Reman	Cummins 3558005X	Left/Front	Threaded			XC1970	CU687
R9553558006X			Cummins 3558006X						
R9553558022X	SS296CE		Cummins 3558022X						
R9553558021X	SS338CE		Cummins 3558021X					XC1989	CU689

## CUMMINS SS296E · SS338E



- Cummins
- Water Cooled
- Engine Drive
- Flange Mount

Meritor NO.	MODEL	OUTRIGHT/ REMAN	REPLACES	PORT LOCATION INLET/OUTLET	TYPE OF DISCHARGE	UNLOADER KIT	MOUNTING GASKET KIT	CORE NO.	CORE GROUP
R9553558044X	SS296E	Reman	Cummins 3558044X	Rear/Rear				XC1895	CU681
R9553558045X			Cummins 3558045X	Left/Rear				XC1980	
R9553558046X			Cummins 3558046X					XC1986	
R9553558013X	SS338E		Cummins 3558013X	Rear/Rear				XC1988	CU689
R9553558020X			Cummins 3558020X	Left/Rear				XC1990	
R9553558023X			Cummins 3558023X						

## CUMMINS ST676



- Cummins Applications
- Water Cooled
- Engine Drive
- Flange Mount

Meritor NO.	MODEL	OUTRIGHT/ REMAN	REPLACES	PORT LOCATION INLET/OUTLET	TYPE OF DISCHARGE	UNLOADER KIT	MOUNTING GASKET KIT	CORE NO.	CORE GROUP
R9553048680X	ST676	Reman	Cummins 3048680X	Left/Rear	Threaded			XC1978	CU685

# AIR COMPRESSORS CUMMINS

2

## CUMMINS ST676



Meritor NO.	MODEL	OUTRIGHT/ REMAN	REPLACES	PORT LOCATION INLET/OUTLET	TYPE OF DISCHARGE	UNLOADER KIT	MOUNTING GASKET KIT	CORE NO.	CORE GRP
R9553558027X	ST676	Reman	Cummins 3558027X						

## CUMMINS



- Cummins B Series

(Bore Size: 85mm)

(Thru-Drive: 11T)

Meritor NO.	MODEL	OUTRIGHT/ REMAN	REPLACES	PORT LOCATION INLET/OUTLET	TYPE OF DISCHARGE	UNLOADER KIT	MOUNTING GASKET KIT	CORE NO.	CORE GROUP
R9559111535330X		Reman	Cummins 9111535330X					XC1999	CU683
R9553558212X		Reman	3558212X						

## CUMMINS



- Cummins L, M, N

(Bore Size: 85mm)

(Thru-Drive: Tang)

Meritor NO.	MODEL	OUTRIGHT/ REMAN	REPLACES	PORT LOCATION INLET/OUTLET	TYPE OF DISCHARGE	UNLOADER KIT	MOUNTING GASKET KIT	CORE NO.	CORE GROUP
R9559111535200X		Reman	Cummins 9111535200X					XC1999	CU683

## CUMMINS



- Cummins ISX

(Bore Size: 85mm)

(Thru-Drive: n/a)

Meritor NO.	MODEL	OUTRIGHT/ REMAN	REPLACES	PORT LOCATION INLET/OUTLET	TYPE OF DISCHARGE	UNLOADER KIT	MOUNTING GASKET KIT	CORE NO.	CORE GROUP
R9559111530030X		Reman	Cummins 9111530030X						
R9559111530147X		Reman	Cummins 9111530147X						
R9559111535100X		Reman	Cummins 9111535100X					XC1999	CU683

## CUMMINS



• Cummins ISC  
  
(Bore Size: 85mm)  
(Thru-Drive: 11T)

Meritor NO.	MODEL	OUTRIGHT/ REMAN	REPLACES	PORT LOCATION INLET/OUTLET	TYPE OF DISCHARGE	UNLOADER KIT	MOUNTING GASKET KIT	CORE NO.	CORE GROUP
R9559111530030X		Reman	Cummins 9111530030X						
R9559111535300X		Reman	Cummins 9111535300X					XC1999	CU683

## CUMMINS



(Bore Size: 75mm)  
(Thru-Drive: 11T)

Meritor NO.	MODEL	OUTRIGHT/ REMAN	REPLACES	PORT LOCATION INLET/OUTLET	TYPE OF DISCHARGE	UNLOADER KIT	MOUNTING GASKET KIT	CORE NO.	CORE GROUP
R9559111545000X		Reman	Cummins 9111545000X					XC1894	CU679

## CUMMINS



(Bore Size: 75mm)  
(Thru-Drive: 11T)

Meritor NO.	MODEL	OUTRIGHT/ REMAN	REPLACES	PORT LOCATION INLET/OUTLET	TYPE OF DISCHARGE	UNLOADER KIT	MOUNTING GASKET KIT	CORE NO.	CORE GROUP
R9559111545100X		Reman	Cummins 9111545100X						

# AIR COMPRESSORS CUMMINS

2

## HOLSET-CUMMINS



- Single Cylinder Compressor
- Double Flange Mount
- Water Cooled

Universal application - Either direct or remote governor mount.  
Interchanges with all O.E.M. Cummins part numbers shown below.

Meritor NO.	OUTRIGHT/ REMAN	REPLACES	UNLOADER KIT	MOUNTING GASKET KIT	CORE GROUP	CORE NO.
R9553049186X	Reman	3049186X	R9553559511	R955153115	CU681	XC1976
R9553047440X		3047440X				XC1975

## HALDEX EL850



- Cummins B Series
- Flange Mount
- Water Cooled

Meritor NO.	MODEL	OUTRIGHT/ REMAN	REPLACES	PORT LOCATION INLET/OUTLET	TYPE OF DISCHARGE	UNLOADER KIT	MOUNTING GASKET KIT	CORE NO.	CORE GROUP
R555KN85230X	EL850	Reman	Haldex KN85230X		Threaded			XC1925	MD620
R555KN86230X <small>See Note 21</small>			Haldex KNT86230X	Optional/Optional		R955RNT26JB	R955153109	XC1933	MD601

Notes: 21 The head may be rotated in 90° increments allowing for 4 porting options.

## HALDEX EL1300 · EL1600



- Cummins Double Flange
- Flange Mount
- Water Cooled

Meritor NO.	MODEL	OUTRIGHT/ REMAN	REPLACES	PORT LOCATION INLET/OUTLET	TYPE OF DISCHARGE	UNLOADER KIT	MOUNTING GASKET KIT	CORE NO.	CORE GROUP
R955EL13040X	EL1300	Reman	Haldex EL13040X	Right/Right	Top/Flange	R955RNT26A	R955153108	XC1901	MD688
R955EL16040X	EL1600		Haldex EL16040X					XC1915	MD820

**BENDIX TU-FLO 400**



- Detroit Diesel
- 0° Tilt
- Flange Mount
- Water Cooled

Meritor NO.	MODEL	OUTRIGHT/ REMAN	REPLACES	PORT LOCATION INLET/OUTLET	TYPE OF DISCHARGE	UNLOADER KIT	MOUNTING GASKET KIT	CORE NO.	CORE GROUP
R955101143X	TU-FLO 400	Reman	Bendix 101143X	Right/Right	Flange	R955279614N	R955153110	XC1555	BN626
R955276166X			Bendix 276166X	Left/Left					
R955276778X			Bendix 276778X	Right/Right					
R955281112X			Bendix 281112X					XC1543	
R955289444X			Bendix 289444X	Left/Left				XC1555	

**BENDIX TU-FLO 500 · 600**



- Detroit Diesel
- 45° Tilt
- Flange Mount
- Water Cooled

Meritor NO.	MODEL	OUTRIGHT/ REMAN	REPLACES	PORT LOCATION INLET/OUTLET	TYPE OF DISCHARGE	UNLOADER KIT	MOUNTING GASKET KIT	CORE NO.	CORE GROUP
R955281042X	TU-FLO 500	Reman	Bendix 281042X	Left/Top	Threaded	R955279615N	R955153110	XC1525	BN660
R955284106X			Bendix 284106X	Left/Left	Flange				
R955285252X			Bendix 285252X	Right/Top	Threaded				
R955282013X	TU-FLO 600		Bendix 282013X	Left/Top	Threaded				

# AIR COMPRESSORS DETROIT DIESEL

## BENDIX TU-FLO 500 · 600 · 700

2



- Detroit Diesel
- 0° Tilt
- Flange Mount
- Water Cooled

Meritor NO.	MODEL	OUTRIGHT/ REMAN	REPLACES	PORT LOCATION INLET/OUTLET	TYPE OF DISCHARGE	UNLOADER KIT	MOUNTING GASKET KIT	CORE NO.	CORE GROUP
<b>R955106780X</b>	TU-FLO 700	Reman	Bendix 106780X	Left/Left & Top	Optional	R955279615N	R955153110	XC1485	BN827
<b>R955106792X</b> <small>See Note 48</small>			Bendix 106792X	Right/Right/Top				XC1487	BN821
<b>R955276961X</b>	TU-FLO 500		Bendix 276961X	Left/Left	Flange			XC1525	BN660
<b>R955276962X</b>			Bendix 276962X	Right/Right					
<b>R955279068X</b>			Bendix 279068X	Left/Left					
<b>R955280609X</b>	TU-FLO 600		Bendix 280609X	Left/Left				XC1561	
<b>R955101282X</b>	TU-FLO 700		Bendix 101282X	Right/Right & Top	Optional			XC1501	BN838
<b>R955106268X</b> <small>See Note 22</small>			Bendix 106268X	Left/Left & Top					
<b>R955289789X</b>			Bendix 289789X	Right/Right & Top					
<b>R955289925X</b>			Bendix 289925X	Left/Left & Top					
<b>R955289941X</b>		Bendix 289941X	Right/Right & Top						

Notes: 22 Detroit Diesel Series 60 application. Use of any compressor not designed for Series 60 could damage the compressor.  
48 Steel connecting rod.

## BENDIX TU-FLO 500 · 600 · 700



- Detroit Diesel
- 75° Tilt
- Flange Mount
- Water Cooled

Meritor NO.	MODEL	OUTRIGHT/ REMAN	REPLACES	PORT LOCATION INLET/OUTLET	TYPE OF DISCHARGE	UNLOADER KIT	MOUNTING GASKET KIT	CORE NO.	CORE GROUP
<b>R955106793X</b> <small>See Note 48</small>	TU-FLO 700	Reman	Bendix 106793X	Right/Top	Optional	R955279615N	R955153110	XC1487	BN821
<b>R955275777X</b>	TU-FLO 500		Bendix 275777X	Left/Left	Flange			XC1525	BN660
<b>R955278445X</b>			Bendix 278445X	Left/Top	Threaded				
<b>R955278681X</b>			Bendix 278681X	Right/Right	Flange				
<b>R955280369X</b>	TU-FLO 600		Bendix 280369X	Right/Top	Threaded				
<b>R955289790X</b>	TU-FLO 700		Bendix 289790X	Left/Left & Top	Optional			XC1641	BN839
<b>R955289915X</b>			Bendix 289915X	Right/Right & Top				XC1638	
<b>R955289964X</b>			Bendix 289964X					XC1641	

Notes: 48 Steel connecting rod.

**BENDIX TU-FLO 501**



- Detroit Diesel
- 0° Tilt
- Flange Mount
- Water and Air Cooled

Meritor NO.	MODEL	OUTRIGHT/ REMAN	REPLACES	PORT LOCATION INLET/OUTLET	TYPE OF DISCHARGE	UNLOADER KIT	MOUNTING GASKET KIT	CORE NO.	CORE GROUP
<b>R955286538X</b>	TU-FLO 501	Reman	Bendix 286538X	Left/Left	Flange	R955279615N	R955153110	XC1597	BN687
<b>R955286539X</b>			Bendix 286539X	Right/Right					
<b>R955286540X</b>			Bendix 286540X	Left/Top	Threaded			XC1598	
<b>R955286581X</b>			Bendix 286581X						
<b>R955286623X</b> <small>See Note 22</small>			Bendix 286623X	Left/Left	Flange			XC1624	BN686

Notes: 22 Detroit Diesel Series 60 application. Use of any compressor not designed for Series 60 could damage the compressor.

**BENDIX TU-FLO 501**



- Detroit Diesel
- 0° Tilt
- Flange Mount
- Water and Air Cooled
- Press on Gear - Stud Shaft

Meritor NO.	MODEL	OUTRIGHT/ REMAN	REPLACES	PORT LOCATION INLET/OUTLET	TYPE OF DISCHARGE	UNLOADER KIT	MOUNTING GASKET KIT	CORE NO.	CORE GROUP
<b>R955286579X</b>	TU-FLO 501	Reman	Bendix 286579X	Right/Top	Threaded	R955279615N	R955153110	XC1618	BN687

**BENDIX TU-FLO 501**



- Detroit Diesel
- 45° Tilt
- Flange Mount
- Water and Air Cooled

Meritor NO.	MODEL	OUTRIGHT/ REMAN	REPLACES	PORT LOCATION INLET/OUTLET	TYPE OF DISCHARGE	UNLOADER KIT	MOUNTING GASKET KIT	CORE NO.	CORE GROUP
<b>R955286542X</b>	TU-FLO 501	Reman	Bendix 286542X	Left/Top	Threaded	R955279615N	R955153110	XC1599	BN688
<b>R955286543X</b>			Bendix 286543X	Right/Top					

# AIR COMPRESSORS DETROIT DIESEL

2

## BENDIX TU-FLO 550 · 750



- Detroit Diesel
- 0° Tilt
- Flange Mount
- Water Cooled Head
- Air Cooled Block

Meritor NO.	MODEL	OUTRIGHT/ REMAN	REPLACES	PORT LOCATION INLET/OUTLET	TYPE OF DISCHARGE	UNLOADER KIT	MOUNTING GASKET KIT	CORE NO.	CORE GRP
<b>R955107513X</b>	TU-FLO 550	Reman	Bendix 107513X	Right/Right & Top	Optional	R955153150		XC1518	BN724
<b>R955107512X</b>	TU-FLO 750	Reman	Bendix 107512X	Right/Right & Top	Optional	R955153150		XC1517	BN874
<b>R955107813X</b>	TU-FLO 750	Reman	Bendix 107813X	Left/Left & Top	Optional	R955153150		XC1517	BN874
<b>R955108557X</b>	TU-FLO 750	Reman	Bendix 108557X	Left/Left & Top	Optional	R955275615N		XC1517	BN874

## BENDIX TU-FLO 550 · 750



Meritor NO.	MODEL	OUTRIGHT/ REMAN	REPLACES	PORT LOCATION INLET/OUTLET	TYPE OF DISCHARGE	UNLOADER KIT	MOUNTING GASKET KIT	CORE NO.	CORE GRP
<b>R955107622X</b> <small>See Note 23</small>	TU-FLO 550	Reman	Bendix 107622X	Left/Left & Top	Optional	R955153150		XC1520	BN874
<b>R955107623X</b> <small>See Note 23</small>	TU-FLO 750	Reman	Bendix 107623X	Left/Left & Top	Optional	R955279615N		XC1521	BN874

Notes: 23 Detroit Diesel Series 60, thru drive application. Use of any compressor not designed for Series 60 could damage the compressor.

## BENDIX TU-FLO 550 · 750



Meritor NO.	MODEL	OUTRIGHT/ REMAN	REPLACES	PORT LOCATION INLET/OUTLET	TYPE OF DISCHARGE	UNLOADER KIT	MOUNTING GASKET KIT	CORE NO.	CORE GRP
<b>R9555004187X</b> <small>See Note 41</small>	TU-FLO 750	Reman	Bendix 5004187X	Right/Left	Optional	R955275615N		XC1394	BN874
<b>R9555004188X</b> <small>See Note 41, 49</small>	TU-FLO 550	Reman	Bendix 5004188X	Right/Left	Optional	R955153150		XC1668	BN724

Notes: 41 Detroit Diesel Series 60, non EGR, 69 tooth gear, 21 tooth spline.  
49 Detroit Diesel Series 50, 69 tooth gear, 21 tooth spline.



**BENDIX TU-FLO 700**

*PHOTO NOT AVAILABLE  
AT TIME OF PRINTING*

- Detroit Diesel
- 52° Tilt
- Water Cooled
- Engine Drive
- Flange Mount

Meritor NO.	MODEL	OUTRIGHT/ REMAN	REPLACES	PORT LOCATION INLET/OUTLET	TYPE OF DISCHARGE	UNLOADER KIT	MOUNTING GASKET KIT	CORE NO.	CORE GRP
R955101554X	TU-FLO 700	Reman	Bendix 101554X	Left/Left & Top	Optional	R955275615N	R955153110	XC1661	BN823

**BENDIX TU-FLO 700**



- Detroit Diesel
- 45° Tilt
- Water Cooled
- Flange Mount

Meritor NO.	MODEL	OUTRIGHT/ REMAN	REPLACES	PORT LOCATION INLET/OUTLET	TYPE OF DISCHARGE	UNLOADER KIT	MOUNTING GASKET KIT	CORE NO.	CORE GRP
R955101158X	TU-FLO 700	Reman	Bendix 101158X	Right/Right & Top	Optional	R955279615N	R955153110	XC1501	BN838
R955289342X			Bendix 289342X	Left/Left & Top					

**BENDIX TU-FLO 1000**



- Vertical Mount and Flange Mount
- Pulley and Engine Drive
- Water Cooled

Meritor NO.	MODEL	OUTRIGHT/ REMAN	REPLACES	PORT LOCATION INLET/OUTLET	TYPE OF DISCHARGE	UNLOADER KIT	MOUNTING GASKET KIT	CORE NO.	CORE GROUP
R955276777X See Note 29	TU-FLO 1000	Reman	Bendix 276777X	Middle/Middle		R955279615N	R955153113	XC1544	BN962

Notes: 29 Flange Mount.

# AIR COMPRESSORS DETROIT DIESEL

2

## BENDIX TU-FLO 1400

- Detroit Diesel
- Flange Mount
- Air Cooled

*PHOTO NOT AVAILABLE  
AT TIME OF PRINTING*

Meritor NO.	MODEL	OUTRIGHT/ REMAN	REPLACES	PORT LOCATION INLET/OUTLET	TYPE OF DISCHARGE	UNLOADER KIT	MOUNTING GASKET KIT	CORE NO.	CORE GRP
R955107836X	TU-FLO 1400	Reman	Bendix 107836X						
R955108779X			Bendix 108779X	Left/Left		R955275615N	R955153110	XC1682	BN971
R955109440X			Bendix 109440X						

## BENDIX BA 921



Meritor NO.	MODEL	OUTRIGHT/ REMAN	REPLACES	PORT LOCATION INLET/OUTLET	TYPE OF DISCHARGE	UNLOADER KIT	MOUNTING GASKET KIT	CORE NO.	CORE GRP
R9555018485X	BA921	Reman	Bendix 5018485X	Top/Side				XC1654	BN610

## BENDIX DF 596



Meritor NO.	MODEL	OUTRIGHT/ REMAN	REPLACES	PORT LOCATION INLET/OUTLET	TYPE OF DISCHARGE	UNLOADER KIT	MOUNTING GASKET KIT	CORE NO.	CORE GRP
R9555005875X	DF-596	Reman	Bendix 5005875X	Top/Top				XC1687	BN699

**CUMMINS ST676D**



- Detroit Diesel Applications
- Water Cooled
- Engine Drive
- Flange Mount

Meritor NO.	MODEL	OUTRIGHT/ REMAN	REPLACES	PORT LOCATION INLET/OUTLET	TYPE OF DISCHARGE	UNLOADER KIT	MOUNTING GASKET KIT	CORE NO.	CORE GRP
R9553558010X	ST676D	Reman	Cummins 3558010X					XC1978	CU685

**HALDEX EL1300 · EL1600**



- Detroit Diesel Applications
- Various Tilts
- Flange Mount
- Water Cooled

Meritor NO.	MODEL	OUTRIGHT/ REMAN	REPLACES	PORT LOCATION INLET/OUTLET	TYPE OF DISCHARGE	UNLOADER KIT	MOUNTING GASKET KIT	CORE NO.	CORE GRP	
R955EL13050X	EL1300–DDC60; Non-Thru Drive	Reman	Haldex EL13050X	Right/Right	Flange–0°	R955RNT26A	R955153110	XC1902	MD688	
R955EL13051X			Haldex EL13051X	Right/Right or Left						
R955EL13090X			Haldex EL13090X	Flange–41°	XC1907					
R955EL13100X			Haldex EL13100X							Flange–50°
R955EL13053X	EL1300, EL1600–DDC60; Thru Drive		Haldex EL13053X	Right/Right				Flange–0°		XC1904
R955EL16053X			Haldex EL16053X							XC1918
R955EL16050X	EL1600		Haldex EL16050X	Flange–50°	XC1916					
R955EL16100X			Haldex EL16100X		XC1920					

**HALDEX EL740**



- Detroit Diesel Applications
- 0° Tilt
- Flange Mount
- Water Cooled

Meritor NO.	MODEL	OUTRIGHT/ REMAN	REPLACES	PORT LOCATION INLET/OUTLET	TYPE OF DISCHARGE	UNLOADER KIT	MOUNTING GASKET KIT	CORE NO.	CORE GRP
R955KN7060X	EL740	Reman	Haldex KN7060X	Right/Right	Flange	R955RNT33C	R955153110	XC1929	MD626
R955KN7070X	EL740–Thru		Haldex KN7070X						
R955KN7080X	Drive		Haldex KN7080X	Left/Left					

# AIR COMPRESSORS FORD

2

## BENDIX TU-FLO 500



- Offset Mount
- Ford
- Slant
- Pulley Drive
- Water Cooled

Meritor NO.	MODEL	OUTRIGHT/ REMAN	REPLACES	PORT LOCATION INLET/OUTLET	TYPE OF DISCHARGE	UNLOADER KIT	MOUNTING GASKET KIT	CORE NO.	CORE GROUP
R955229078X	TU-FLO 500	Reman	Bendix 229078X	Left/Top	Threaded	R955279615N	R955153103	XC1525	BN660
R955283513X			Bendix 283513X	Right/Top					

## BENDIX TU-FLO 501



- Side Mount
- Ford
- Pulley Drive
- Water and Air Cooled

Meritor NO.	MODEL	OUTRIGHT/ REMAN	REPLACES	PORT LOCATION INLET/OUTLET	TYPE OF DISCHARGE	UNLOADER KIT	MOUNTING GASKET KIT	CORE NO.	CORE GROUP
R955102734X	TU-FLO 501	Reman	Bendix 102734X	Left/Left	Flange	R955279615N	R955280512N	XC1498	BN674
R955286556X			Bendix 286556X	Right/Right			R955153100	XC1607	BN698
R955286564X			Bendix 286564X	Left/Left			R955153110	XC1611	BN677
R955286565X			Bendix 286565X	Right/Right			R955280512N	XC1607	BN698

## BENDIX TU-FLO 501



- Offset Mount
- Ford
- Slant
- Pulley Drive
- Water and Air Cooled

Meritor NO.	MODEL	OUTRIGHT/ REMAN	REPLACES	PORT LOCATION INLET/OUTLET	TYPE OF DISCHARGE	UNLOADER KIT	MOUNTING GASKET KIT	CORE NO.	CORE GROUP
R955286558X <small>See Note 2</small>	TU-FLO 501	Reman	Bendix 286558X	Right/Top	Threaded	R955279615N	R955153103	XC1609	BN695
R955286561X <small>See Note 2</small>			Bendix 286561X	Left/Top					
R955286562X <small>See Note 2</small>			Bendix 286562X						

Notes: 2 Base oil option.

## BENDIX TU-FLO 550 · 750



- International I6, Pre-2004 DT466, HT530
- Flange Mount
- Water and Air Cooled

Meritor NO.	MODEL	OUTRIGHT/ REMAN	REPLACES	PORT LOCATION INLET/OUTLET	TYPE OF DISCHARGE	UNLOADER KIT	MOUNTING GASKET KIT	CORE NO.	CORE GROUP
<b>R9555004613X</b> <small>See Note 42, 50</small>	TU-FLO 550	Reman	Bendix 5004613X	Right/Left	Optional	R955153150	R955153112	XC1490	BN724
<b>R9555004614X</b>	TU-FLO 750		Bendix 5004614X	Left/Left/Top				XC1480	BN877

Notes: 42 International I6 pre-2004 DT466.  
50 International I6 pre-2004 HT530.

## BENDIX TU-FLO 550



- International V8 VT 365
- Base Mount
- Water and Air Cooled

Meritor NO.	MODEL	OUTRIGHT/ REMAN	REPLACES	PORT LOCATION INLET/OUTLET	TYPE OF DISCHARGE	UNLOADER KIT	MOUNTING GASKET KIT	CORE NO.	CORE GROUP
<b>R9555015314X</b> <small>See Note 47</small>	TU-FLO 550	Reman	Bendix 5015314X	Right/Left	Optional	R955153150	R955153112	XC1488	BN724
<b>R9555014144X</b>	TU-FLO 550	Reman	Bendix 5014144X						
<b>R9555019320X</b>	TU-FLO 550	Reman	Bendix 5019320X						
<b>R9555019445X</b>	TU-FLO 550	Reman	Bendix 5019445X						
<b>R9555009770X</b>	TU-FLO 550	Reman	Bendix 5009770X						

Notes: 47 International V8 VT365-M18 water port, M10 oil port, Metric Head.

## BENDIX BX 2150



- Caterpillar
- 3304-3306 Flange
- Flange Mount
- Water Cooled Head
- Air Cooled Block

Meritor NO.	MODEL	OUTRIGHT/ REMAN	REPLACES	PORT LOCATION INLET/OUTLET	TYPE OF DISCHARGE	UNLOADER KIT	MOUNTING GASKET KIT	CORE NO.	CORE GROUP
<b>R955109219X</b>	BX2150	Reman	Bendix 109219X	Left/Top	Threaded	R955279615N	R955153106	XC1665	BN604

# AIR COMPRESSORS JOHN DEERE

## BENDIX TU-FLO 501



- Offset Mount
- Ford
- Slant
- Pulley Drive
- Water and Air Cooled

2

Meritor NO.	MODEL	OUTRIGHT/ REMAN	REPLACES	PORT LOCATION INLET/OUTLET	TYPE OF DISCHARGE	UNLOADER KIT	MOUNTING GASKET KIT	CORE NO.	CORE GROUP
<b>R955286558X</b> <small>See Note 2</small>	TU-FLO 501	Reman	Bendix 286558X	Right/Top	Threaded	R955279615N	R955153103	XC1609	BN695

Notes: 2 Base oil option.

## BENDIX TU-FLO 500 · 600



- Mack / Cat Flange
- Tapered Shaft
- Flange Mount
- Water Cooled

Meritor NO.	MODEL	OUTRIGHT/ REMAN	REPLACES	PORT LOCATION INLET/OUTLET	TYPE OF DISCHARGE	UNLOADER KIT	MOUNTING GASKET KIT	CORE NO.	CORE GROUP			
R955279995X	TU-FLO 500	Reman	Bendix 279995X	Left/Left	Flange	R955279615N	R955153106	XC1525	BN660			
R955284260X			Bendix 284260X	Right/Top				XC1578				
R955284310X			Bendix 284310X					XC1525				
R955280556X	TU-FLO 600		Bendix 280556X	Left/Left	Threaded						XC1525	
R955280774X			Bendix 280774X	Right/Top							XC1569	
R955281157X			Bendix 281157X									

## BENDIX TU-FLO 500 · 600



- Mack Short Flange
- Flange Mount
- Water Cooled

Meritor NO.	MODEL	OUTRIGHT/ REMAN	REPLACES	PORT LOCATION INLET/OUTLET	TYPE OF DISCHARGE	UNLOADER KIT	MOUNTING GASKET KIT	CORE NO.	CORE GROUP
R955227326X	TU-FLO 500	Reman	Bendix 227326X	Right/Right	Flange	R955279615N	R955153106	XC1525	BN660
R955277901X			Bendix 277901X	Right/Top	Threaded			XC1551	
R955278604X			Bendix 278604X	Right/Right	Flange			XC1552	
R955280608X	TU-FLO 600		Bendix 280608X					XC1525	

## BENDIX TU-FLO 500 · 600



- Mack Extended Flange
- Flange Mount
- Water Cooled Head
- Air Cooled Block

Meritor NO.	MODEL	OUTRIGHT/ REMAN	REPLACES	PORT LOCATION INLET/OUTLET	TYPE OF DISCHARGE	UNLOADER KIT	MOUNTING GASKET KIT	CORE NO.	CORE GROUP
R955282586X	TU-FLO 500	Reman	Bendix 282586X	Right/Right	Flange	R955279615N	R955153111	XC1570	BN660
R955282621X			Bendix 282621X					XC1582	
R955284662X <small>See Note 24</small>			Bendix 284662X					XC1579	
R955284307X	TU-FLO 600		Bendix 284307X						
R955285108X			Bendix 285108X						

Notes: 24 Equipped for power steering drive option.

# AIR COMPRESSORS MACK

2

## BENDIX TU-FLO 500 · 600 · 700



- Mack "Foxhead" Flange
- Flange Mount
- Water Cooled
- V8 Application

Meritor NO.	MODEL	OUTRIGHT/ REMAN	REPLACES	PORT LOCATION INLET/OUTLET	TYPE OF DISCHARGE	UNLOADER KIT	MOUNTING GASKET KIT	CORE NO.	CORE GROUP
R955277122X	TU-FLO 500	Reman	Bendix 277122X	Left/Left	Flange	R955279615N	R955153112	XC1548	BN660
R955283577X			Bendix 283577X	Right/Right					
R955283692X			Bendix 283692X	Left/Left					
R955280628X	TU-FLO 600		Bendix 280628X	Left/Left	Optional			XC1632	BN848
R955289348X	TU-FLO 700		Bendix 289348X	Left/Left & Top					

## BENDIX TU-FLO 501



- Mack Short Flange
- Flange Mount
- Water and Air Cooled
- Standard Flange

Meritor NO.	MODEL	OUTRIGHT/ REMAN	REPLACES	PORT LOCATION INLET/OUTLET	TYPE OF DISCHARGE	UNLOADER KIT	MOUNTING GASKET KIT	CORE NO.	CORE GROUP
R955286571X <small>See Note 25</small>	TU-FLO 501	Reman	Bendix 286571X	Left/Top	Threaded	R955279615N	R955153106	XC1615	BN692
R955286572X			Bendix 286572X					XC1616	

Notes: 25 Extended crankshaft.

## BENDIX TU-FLO 501



- Mack Extended Flange
- Flange Mount
- Water and Air Cooled
- Equipped for Power Steering

Meritor NO.	MODEL	OUTRIGHT/ REMAN	REPLACES	PORT LOCATION INLET/OUTLET	TYPE OF DISCHARGE	UNLOADER KIT	MOUNTING GASKET KIT	CORE NO.	CORE GROUP
R955102697X	TU-FLO 501	Reman	Bendix 102697X	Right/Top	Threaded	R955279615N	R955153111	XC1600	BN690
R955286544X			Bendix 286544X	Right/Right	Flange			XC1622	
R955286620X <small>See Note 24</small>			Bendix 286620X	Right/Top	Threaded				

Notes: 24 Equipped for power steering drive option.



## BENDIX TU-FLO 501



- Mack "Foxhead" Flange
- Flange Mount
- Water and Air Cooled
- V8 Application

Meritor NO.	MODEL	OUTRIGHT/ REMAN	REPLACES	PORT LOCATION INLET/OUTLET	TYPE OF DISCHARGE	UNLOADER KIT	MOUNTING GASKET KIT	CORE NO.	CORE GROUP
R955102953X	TU-FLO 501	Reman	Bendix 102953X	Left/Top	Threaded	R955279615N	R955153112	XC1506	BN691
R955286574X			Bendix 286574X	Left/Left	Flange		XC1617		
R955286621X			Bendix 286621X	Left/Top	Threaded		R955153111	XC1617	

## BENDIX TU-FLO 550 · 750



- Mack Extended Flange
- Flange Mount
- Water Cooled Head
- Air Cooled Block
- Equipped for Power Steering

Meritor NO.	MODEL	OUTRIGHT/ REMAN	REPLACES	PORT LOCATION INLET/OUTLET	TYPE OF DISCHARGE	UNLOADER KIT	MOUNTING GASKET KIT	CORE NO.	CORE GROUP
R955107511X	TU-FLO 550	Reman	Bendix 107511X	Right/Right & Top	Optional	R955153150	R955153111	XC1516	BN724
R9555002865X <small>See Note 39</small>			Bendix 5002865X	Right/Left				XC1492	
R955108866X			Bendix 108866X	Right/Right & Top				XC1524	
R955107510X	TU-FLO 750		Bendix 107510X	Right/Left		R955153150	R955153111	XC1515	BN874
R955108869X			Bendix 108869X						
R9555002868X <small>See Note 39</small>			Bendix 5002868X						

Notes: 39 Pre-1997.

## BENDIX TU-FLO 550 · 750



- Mack "Foxhead" Flange
- Flange Mount
- Water and Air Cooled
- V8 Application

Meritor NO.	MODEL	OUTRIGHT/ REMAN	REPLACES	PORT LOCATION INLET/OUTLET	TYPE OF DISCHARGE	UNLOADER KIT	MOUNTING GASKET KIT	CORE NO.	CORE GROUP
R955108329X	TU-FLO 550	Reman	Bendix 108329X	Left/Left & Top	Optional	R955153150	R955153112	XC1650	BN874
R955107869X	TU-FLO 750		Bendix 107869X					XC1484	

# AIR COMPRESSORS MACK

2

## BENDIX TU-FLO 700



- Mack Extended Flange
- Flange Mount
- Water Cooled
- Equipped for Power Steering

Meritor NO.	MODEL	OUTRIGHT/ REMAN	REPLACES	PORT LOCATION INLET/OUTLET	TYPE OF DISCHARGE	UNLOADER KIT	MOUNTING GASKET KIT	CORE NO.	CORE GROUP
R955289340X	TU-FLO 700	Reman	Bendix 289340X	Right/Right & Top	Optional	R955279615N	R955153111	XC1629	BN847

## BENDIX TU-FLO 1400L



- Mack In Line 6 and Caterpillar
- Flange Mount
- Water Cooled

Meritor NO.	MODEL	OUTRIGHT/ REMAN	REPLACES	PORT LOCATION INLET/OUTLET	TYPE OF DISCHARGE	UNLOADER KIT	MOUNTING GASKET KIT	CORE NO.	CORE GROUP
R955104583X <small>See Note 26</small>		Reman	Bendix 104583X	Manifold and Rear/Top	Threaded	R955279615N	R955153114	XC1509	BN970
R955104584X <small>See Note 27</small>			Bendix 104584X					XC1510	BN974
R955109147X			TU-FLO 1400L						

Notes: 26 Caterpillar, 2-1/2° tilt.  
27 Mack, In Line 6.

## CUMMINS QE296M · QE338CM



- Mack In-Line Engines
- Water Cooled
- Engine Drive
- Flange Mount

Meritor NO.	MODEL	OUTRIGHT/ REMAN	REPLACES	PORT LOCATION INLET/OUTLET	TYPE OF DISCHARGE	UNLOADER KIT	MOUNTING GASKET KIT	CORE NO.	CORE GROUP
R9553558068X	QE296M	Reman	Cummins 3558068X	Right/Rear	Threaded			XC1982	CU687
R9553558075X			Cummins 3558075X						
R9553558076X	QE338CM		Cummins 3558076X					XC1995	CU689
R9553558077X			Cummins 3558077X						

## CUMMINS SS296ME · SS338ME



- Mack E6 / E7 Engines
- Water Cooled
- Engine Drive
- Flange Mount

Meritor NO.	MODEL	OUTRIGHT/ REMAN	REPLACES	PORT LOCATION INLET/OUTLET	TYPE OF DISCHARGE	UNLOADER KIT	MOUNTING GASKET KIT	CORE NO.	CORE GROUP
R9553558029X	SS296ME	Reman	Cummins 3558029X	Right/Rear		R9553559511	R955153116	XC1971	CU687
R9553558042X			Cummins 3558042X					XC1985	
R9553558000X	SS338ME		Cummins 3558000X					XC1991	CU689
R9553558043X			Cummins 3558043X						

## HALDEX EL1300 · EL1600



- Mack Extended Flange
- Flange Mount
- Water Cooled
- Equipped for Power Steering

Meritor NO.	MODEL	OUTRIGHT/ REMAN	REPLACES	PORT LOCATION INLET/OUTLET	TYPE OF DISCHARGE	UNLOADER KIT	MOUNTING GASKET KIT	CORE NO.	CORE GROUP
R955EL13111X	EL1300	Reman	Haldex EL13111X	Left/Left	Flange	R955RNT26A	R955153111	XC1909	MD688
R955EL16111X	EL1600		Haldex EL16111X			R955RNT16A	R955153114	XC1921	MD820

## HALDEX EL3200



- Mack In Line 6
- Flange Mount
- Water Cooled
- Gear Drive
- Camshaft Oil Feed

Meritor NO.	MODEL	OUTRIGHT/ REMAN	REPLACES	PORT LOCATION INLET/OUTLET	TYPE OF DISCHARGE	UNLOADER KIT	MOUNTING GASKET KIT	CORE NO.	CORE GROUP
R955EL14110X	EL3200	Reman	Haldex EL14110X	Left or Right/Left or Right	Flange	R955RNT26A	R955153114	XC1914	MD974
R955EL14111X			Haldex EL14111X						

# AIR COMPRESSORS VOLVO

2

## BENDIX TU-FLO 501



- Volvo / White Flange
- Flange Mount
- Water and Air Cooled

Meritor NO.	MODEL	OUTRIGHT/ REMAN	REPLACES	PORT LOCATION INLET/OUTLET	TYPE OF DISCHARGE	UNLOADER KIT	MOUNTING GASKET KIT	CORE NO.	CORE GROUP
R955286563X	TU-FLO 501	Reman	Bendix 286563X	Right/Right	Threaded	R955279615N	R955153106	XC1610	BN703

## BENDIX TU-FLO 550 · 750



- Volvo
- Flange Mount
- Water and Air Cooled

Meritor NO.	MODEL	OUTRIGHT/ REMAN	REPLACES	PORT LOCATION INLET/OUTLET	TYPE OF DISCHARGE	UNLOADER KIT	MOUNTING GASKET KIT	CORE NO.	CORE GROUP
R955108937X	TU-FLO 550	Reman	Bendix 108937X	Right/Top	Threaded	R955153150	R955153111	XC1493	BN722
R955108935X	TU-FLO 750		Bendix 108935X					XC1483	BN874

TITLE	PAGE
AD2 Series - - - - -	3-6
AD4 Series - - - - -	3-10
AD9 Series - - - - -	3-14
ADIP Series - - - - -	3-20
ADSP Series - - - - -	3-24
ADIS Series - - - - -	3-28
T-2000- - - - -	3-30

### Air Dryers and Cartridges

Desiccant style air dryers are basically in line filters that remove both liquid and vapor from compressor discharge air before it reaches the reservoir. As a result, only clean, dry air is supplied to the air system. This helps prevent freeze-ups and prolongs the life of air system components.

Cartridges are now offered in two different types; standard and oil coalescing. Standard cartridges remove moisture from the air via the desiccant material in the unit, while coalescing cartridges remove moisture as well as oil aerosol and particulate matter as air passes through filters in the unit. If a vehicle is equipped with an oil coalescing cartridge, this should be maintained for the life of the vehicle or contamination and/or damage of other components connected to the airline is possible including brake valves, emission controls, automated manual transmissions and more.

### Air Dryer Features

- Heaters available for 12 Volt and 24 Volt applications
- Heavy-gauge metal ensures integrity
- Precisely machined pop-off valves to avoid leaks
- Soft-seat pistons in all new dryers help handle higher turbo boost pressure
- Charged with 100% new desiccant that meets/exceeds compliance specifications
- New purge valve, relief valve, heater, and springs installed on all new dryers
- Testing of all dryers in both charge and purge cycles



## AIR DRYERS QUICK REFERENCE

Model	OE Number	Description	Meritor	Meritor Reman	
			New	Reman No Core	Reman Core Exchange
AD4	065041	Dryer (12v) (Standard Cartridge)		R955065041XCF	R955065041X
AD4	065044	End Cover (12v)			R955065044X
AD4	065102	Dryer; Dual Terminal (Standard Cartridge)			R955065102X
AD9	065224	Dryer (24v–Hard Seat) (Standard Cartridge)			R955065224X
AD9	065225	Dryer (12v–Soft Seat w/ Power Cable & Mounting Bracket) (Standard Cartridge)	R955065225N	R955065225XCF	R955065225X
AD9	065226	Dryer (12v); 3/4" Supply & Delivery (Standard Cartridge)			R955065226X
AD9	065228	Dryer (12v); 3/4" Supply & Delivery with Extended Purge (Standard Cartridge)			R955065228X
AD9	065243	Dryer (12v); 3/4" Supply & Delivery with Extended Purge (Standard Cartridge)			R955065243X
ADIP	065624	Cartridge (Standard)	R955065624N	R955109493XCF	R955109493X
ADIP ADIS	065626	Purge Valve; Old Style	R955800404N		R9555004342X
AD9	065647	Dryer (12v); Drop-In for Holset Applications (Standard Cartridge)			R955065647X
ADSP ADIS	065677	Check Valve	R955065677N		
AD2	101900	Cartridge (Standard Cartridge)		R955101900XCF	R955101900X
AD2 AD4	102657	Heater Kit (12v)	R955102657N		
AD4	103817	Major Repair Kit	R955103817N		
AD4	103818	Purge Valve Kit	R955103818N		
AD4	103879	Seal & O-Ring Kit	R955103879N		
AD4	103980	Repair Kit for End Cap	R955103980N		
AD4	103981	Cartridge (Standard Cartridge)	R955103981N	R95104358XCF	R955104358X
AD4	104027	Mounting Bracket only	R955104027N		
AD4	104358	Cartridge (Standard Cartridge)	R955103981N	R95104358XCF	R95104358X
AD2	107454	Check Valve	R955107454N		
AD9	107695	Bracket Kit	R955107695N		
AD9	107794PG	Cartridge (Oil Coalescing)			R955107794PGX
AD9	107794	Cartridge (Standard Cartridge)	R955107796N	R955107794XCF	R955107794X
AD9	107796	Cartridge (Standard Cartridge)	R955107796N	R955107794XCF	R955107794X
AD9	107799	Check Valve (3/4")	R955107799N		
AD9	107800	Check Valve (1/2")	R955107800N		
AD9	107896	Purge Valve Assembly (Hard Seat)	R955800405N		R955107896X
ADIP	109477PG	Dryer (12v) (Oil Coalescing Cartridge)			R955109477PGX
ADIP	109477	Dryer (12v) (Standard Cartridge)		R955109477XCF	R955109477X
ADIP	109478	Dryer (24v) (Standard Cartridge)			R955109478X
ADIP	109493PG	Cartridge (Oil Coalescing)			R955109493PGX
ADIP	109493	Cartridge (Standard Cartridge)	R955065624N	R955109493XCF	R955109493X
ADIP	109494	Check Valve Kit	R955109494N		
ADIP ADSP ADIS	109495	Heater Kit (12v–White)	R955109495N		
ADIP ADSP ADIS	109496	Heater Kit (24v 90w–Gray)	R955109496N		
ADIP	109503	Dryer (12v) (Standard Cartridge)			R955109503X
AD9	109578	Heater Kit (12v–White)	R955109578N		

**AIR DRYERS QUICK REFERENCE**

Model	OE Number	Description	Meritor	Meritor Reman	
			New	Reman No Core	Reman Core Exchange
AD9	109579	Heater Kit (24v 75w-Gray)	R955109579N		
AD9	109685PG	Dryer (12v-Soft Seat) (Oil Coalescing Cartridge)			R955109685PGX
AD9	109685	Dryer (12v-Hard Seat) (Standard Cartridge)		R955065225XCF	R955065225X
AD9	109687	Dryer (12v-Hard Seat w/ 3/4" Ports) (Standard Cartridge)			R955109687X
AD9	109688	Dryer (12v); 3/4" Supply & Delivery with Extended Purge (Standard Cartridge)			R955109688X
AD9	109689	Dryer (12v-Soft Seat) (Standard Cartridge)			R955109689X
AD9	109690	Dryer (12v-Soft Seat w/ 3/4" Ports) (Standard Cartridge)			R955109690X
AD9	109691	Dryer (24v-Soft Seat w/ 3/4" Ports & Ext. Purge) (Standard Cartridge)			R955109691X
AD9 ADIP ADSP	109869	Power Cable	R955109869N		
ADIS	109871	Power Cable	R955109871N		
ADSP	109991	Dryer (12v)		R955109991XCF	R955109991X
ADSP	109992	Dryer (24v)		R955109992XCF	R955109992X
ADSP	109993	Turbo Cut-Off Valve Kit	R955109993N		
ADSP ADIS	109994	Cartridge (Standard Cartridge)	R109994P		
ADSP	109995	Purge Valve	R955109995N		
AD4 AD9 ADIP	205105	Safety Valve (150psi)	R955205105N		
AD2	286934	Dryer (12v) (Standard Cartridge)		R955286934XCF	R955286934X
AD2	286936	Dryer (24v) (Standard Cartridge)			R955286936X
AD2	287298	Check Valve Kit	R955287298N		
AD4 AD9 ADIP ADIS	800350	Safety Valve (175psi)	R955800350N		
ADIP	800404	Purge Valve Assembly	R955800404N		
AD9	800405	Purge Valve Assembly (Hard Seat)	R955800405N		R955107896X
ADIP	5000709	Dryer (12v-Drop-In Unit) (Standard Cartridge)			R9555000709X
AD9	5002595	Heater Kit (24v 100w-Yellow)	R9555002595N		
ADIS	5003547	Purge Valve Kit	R9555003547N		
ADIS	5004050	Dryer (12v) (Standard Cartridge)			R9555004342X
AD9	5004336	Purge Valve Kit (Old Style)	R9555004336N		
AD9	5004338	Purge Valve Assembly 24V (Hard Seat)	R9555004338N		
AD9	5004339	DLU Purge Valve Kit-12v 75w	R9555004339N		
AD9	5004340	Purge Valve Kit (12v); DLU	R9555004340N		
AD9	5004340	DLU Purge Valve Kit-24v 75w	R9555004340N		
AD9	5004341	Purge Valve Assembly (Soft Seat)	R9555005893N		R9555004341X
AD9	5004342	Purge Valve Assembly 24v 75w (Soft Seat)			R9555004342X
AD9	5004380	Field Modification Kit	R9555004380N		
AD9	5004380	Field Modification Kit	R9555004380N		
AD9	5004381	Purge Valve Kit (24v, 100 Watt)	R9555004381N		
AD9	5004479	Purge Valve Assembly 12v 75w (Hard Seat)	R9555004479N		
AD9	5004480	Purge Valve Assembly 24v 75w (Hard Seat)	R9555004480N		
AD9	5005037	Purge Valve Assembly (Hard Seat)	R955800405N		R955107896X
ADSP	5005624	Delivery Check Valve Kit	R9555005624N		

3





**AIR DRYERS QUICK REFERENCE**

Model	OE Number	Description	Meritor	Meritor Reman	
			New	Reman No Core	Reman Core Exchange
AD9	5005893	Purge Valve Assembly Kit (Soft Seat)	R9555005893N		R9555004341X
ADSP ADIS	5008414	Cartridge (Standard)	R109994P		
ADSP ADIS	5008414PG	Cartridge (Oil Coalescing)	R955099P		
ADSP ADIS	5008415	Cartridge (Standard)	R109994P		
AD9	5009378	Dryer (12v—Hard Seat w/ Power Cable & Mounting Bracket) (Standard Cartridge)			R955109685HX
ADIS	5010133	Dryer (12v) (Standard Cartridge)			R9555010133X
ADIS	5010696	Dryer (12v—Peterbilt Applications) (Standard Cartridge)			R9555010696X
ADIP ADIS	K022105	Purge Valve; New Style (Hard Seat)	R955K022105N		
ADIP	K022105	Purge Valve Assembly	R955K022105N		
ADIP ADIS	K031560	Purge Valve; New Style (Soft Seat)	R955K031560N		
AD9	K041395	Double Check Valve; New Style	R955K041395N		
T2000PG	T224PG	Cartridge (Oil Coalescing)	R955T224PGN		
T2000	T224	Cartridge (Standard)	R955T224N		

3

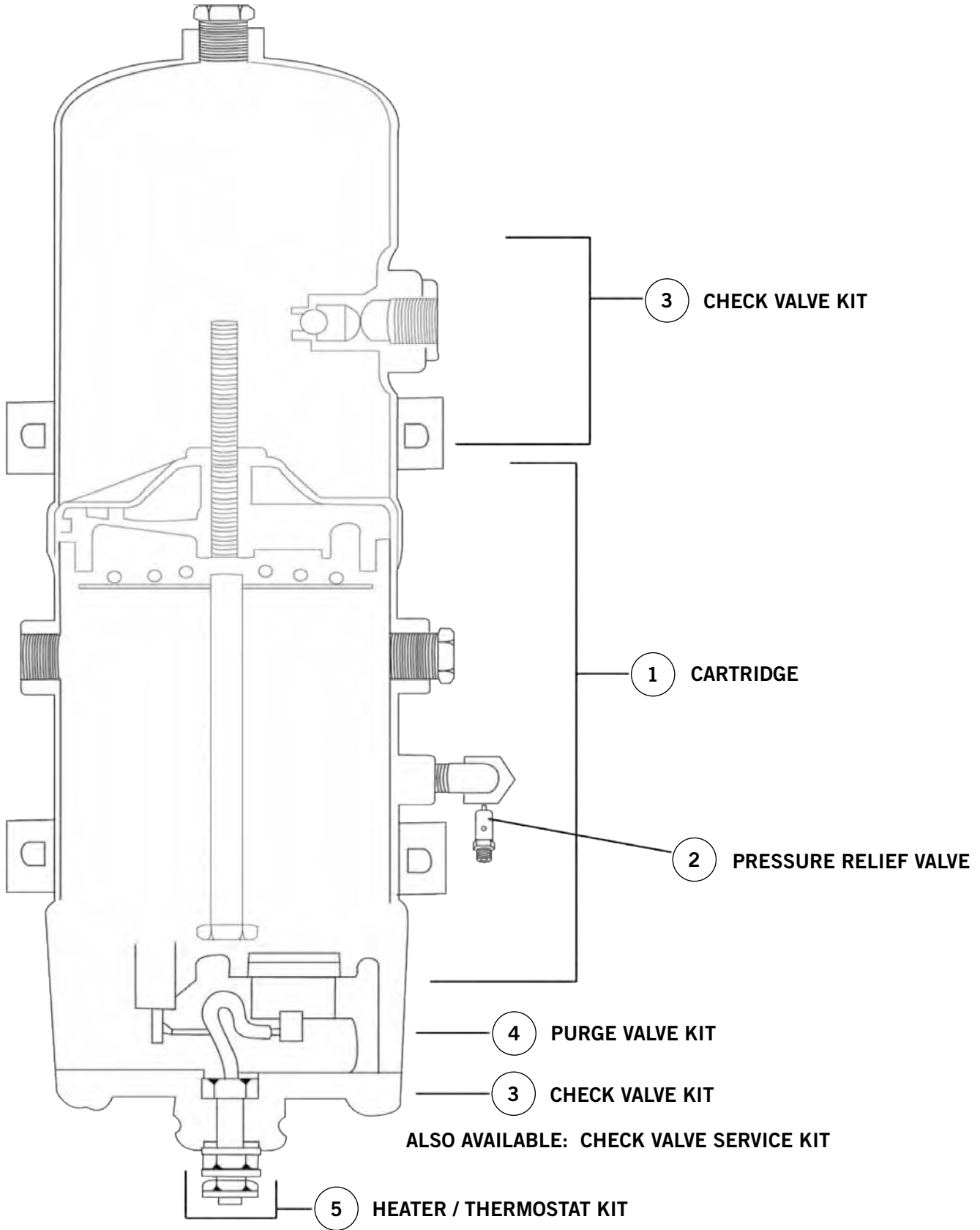



Figure 4-1. AD2 Air Dryer

**AD2 AIR DRYER (FIGURE 4-1)**

	Meritor No.	Replaces	Core No.	Core Group	Description And Comments
	R955286934X	Bendix 286934X	XC1120	BN453	12 Volt, Meritor Reman, Core Exchange
	R955286934XCF	Bendix OR286934X			12 Volt, Meritor Reman, No Core
	R955286936X	Bendix 286936X	XC1120	BN453	24 Volt, Meritor Reman, Core Exchange

**3**

**AD2 DESICCANT CARTRIDGE (FIGURE 4-1, 1)**

	Meritor No.	Replaces	Core No.	Core Group	Description And Comments
	R955101900X	Bendix 101900X	XC1045	BN451	Meritor Reman, Core Exchange
	R955101900XCF	Bendix OR101900X			Meritor Reman, No Core

**AD2 PRESSURE RELIEF VALVE (FIGURE 4-1, 2)**

	Meritor No.	Replaces	Description And Comments
	R955205105N	Bendix 205105	AD2, AD4, AD9, ADIP, ADIS Adjustable Pressure Relief Valve—150 PSI—1/4" Meritor, New
	R955800350N	Bendix 800350	AD4, AD9, ADIP, ADIS Pressure Relief Valve—175 PSI Meritor, New

**AD2 CHECK VALVE (FIGURE 4-1, 3)**

	Meritor No.	Replaces	Description And Comments
	R955107454N	Bendix 107454	Check Valve, Meritor, New

**AD2 CHECK VALVE SERVICE KIT (FIGURE 4-1)**

	Meritor No.	Replaces	Description And Comments
	R955287298N	Bendix 287298	Check Valve Service Kit, Meritor, New



**AD2 PURGE VALVE KIT (FIGURE 4-1, 4)**

	Meritor No.	Replaces	Description And Comments
	<p><b>R955287053N</b></p>	<p>Bendix 287053</p>	<p>Purge Valve Kit, Meritor, New</p>

**3**

**AD2 THERMOSTAT KIT (FIGURE 4-1, 5)**

	Meritor No.	Replaces	Description And Comments
	<p><b>R955102657N</b></p>	<p>Bendix 102657</p>	<p>Thermostat Service Kit, Meritor, New</p>

3

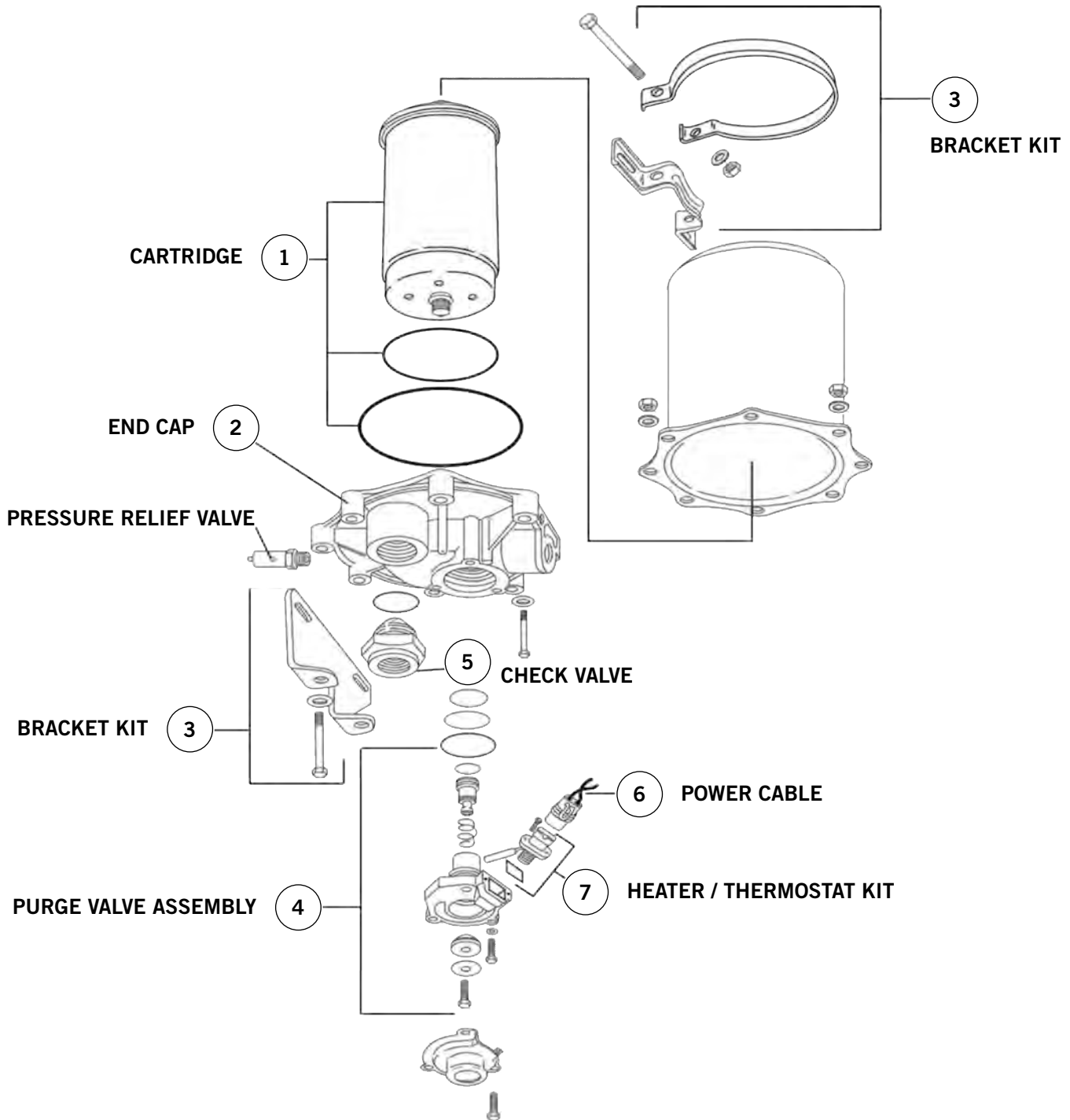



Figure 4-2. AD4 Air Dryer

**AD4 AIR DRYER (FIGURE 4-2)**

	Meritor No.	Replaces	Core No.	Core Group	Description And Comments
	R955065041X	Bendix 065041X	XC1187	BN457	12 Volt, Meritor Reman, Core Exchange
	R955065041XCF	Bendix OR065041X			Meritor Reman, No Core
	R955065102X	Bendix 065102X	XC1187	BN457	Dual Terminal, Meritor Reman, Core Exchange

**AD4 DESICCANT CARTRIDGE (FIGURE 4-2, 1)**

	Meritor No.	Replaces	Core No.	Core Group	Description And Comments
	R955104358X	Bendix 104358X	XC1050	BN456	Meritor Reman, Core Exchange
	R955104358XCF	Bendix OR104358X			Meritor Reman, No Core
	R955103981N	Bendix 103981			Meritor, New

3

**AD4 END COVER & REPAIR KIT (FIGURE 4-2, 2)**

	Meritor No.	Replaces	Core No.	Core Group	Description And Comments
	R955065044X	Bendix 065044X	XC1188	BN456	12 Volt, Meritor Reman, Core Exchange
	R955103980N	Bendix 103980			Repair Kit For End Cap, Meritor, New

**AD4 SEAL & O-RING KIT**

	Meritor No.	Replaces	Description And Comments		
	R955103879N	Bendix 103879		Seal & O-ring Kit, Meritor, New	

**AD4 MOUNTING BRACKET KIT (FIGURE 4-2, 3)**

	Meritor No.	Replaces	Description And Comments		
	R955107695N	Bendix 107695	AD4 & AD9 Mounting Bracket Kit, Meritor, New		
	R955104027N	Bendix 104027	AD4 & AD9 Mounting Bracket Only Order R955107695N For Bracket Kit, Meritor, New		

**AD4 MAJOR KIT**

	Meritor No.	Replaces	Description And Comments		
	R955103817N	Bendix 103817	Major Kit, Consists Of R955104358X And R955103980N, Meritor, New		





**AD4 SEAL KIT**

	Meritor No.	Replaces	Description And Comments
	R955103818N	Bendix 103818	Seal Kit, Meritor, New

**3**

**AD4 THERMOSTAT SERVICE KIT**

	Meritor No.	Replaces	Description And Comments
	R955102657N	Bendix 102657	Thermostat Service Kit, Meritor, New

**AIR DRYERS**

**3**

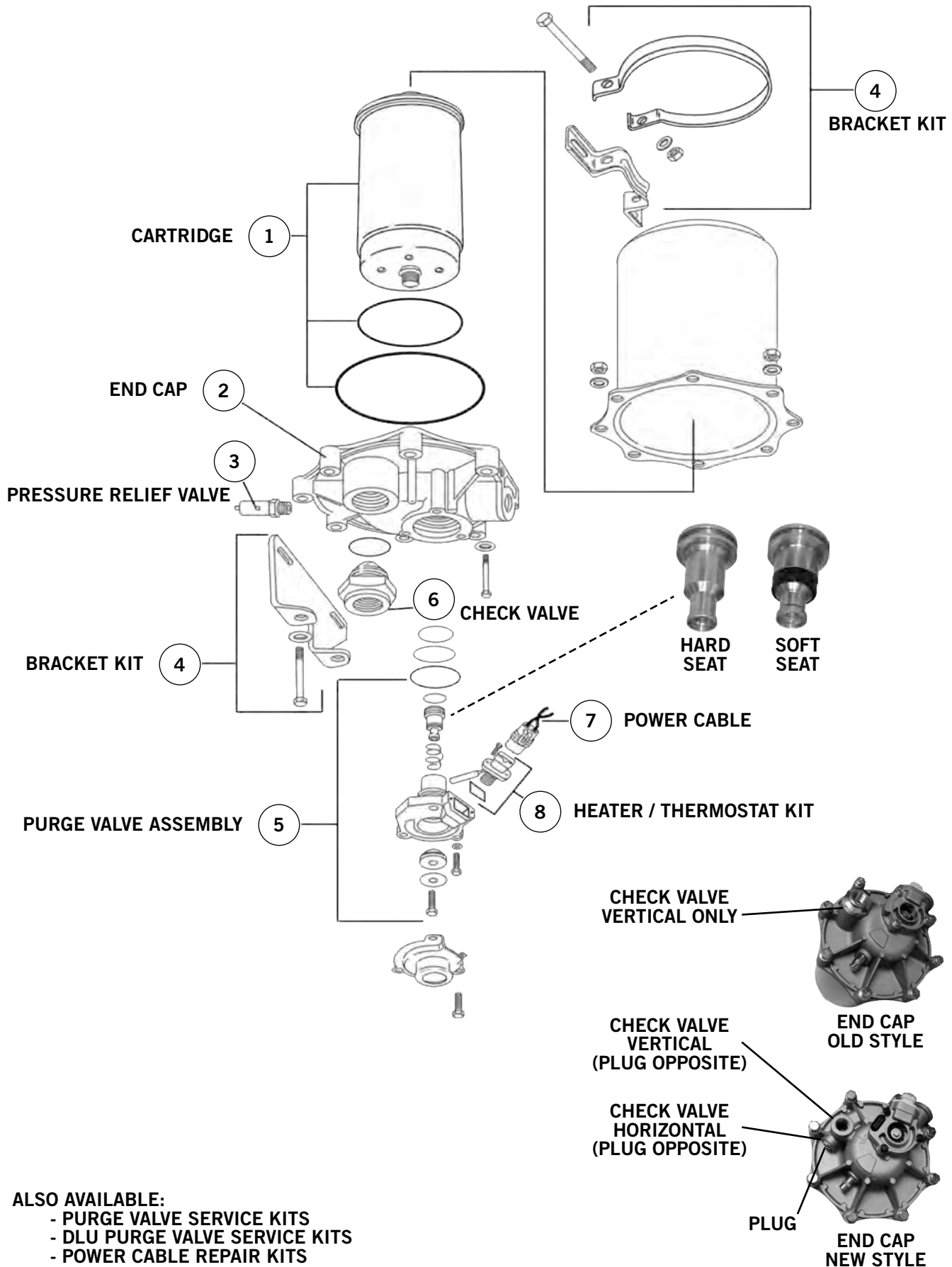

**ALSO AVAILABLE:**  
 - PURGE VALVE SERVICE KITS  
 - DLU PURGE VALVE SERVICE KITS  
 - POWER CABLE REPAIR KITS

**Figure 4-3. AD9 Air Dryer**



# MERITOR® ALL-MAKES AIR DRYER TEST PROCEDURE

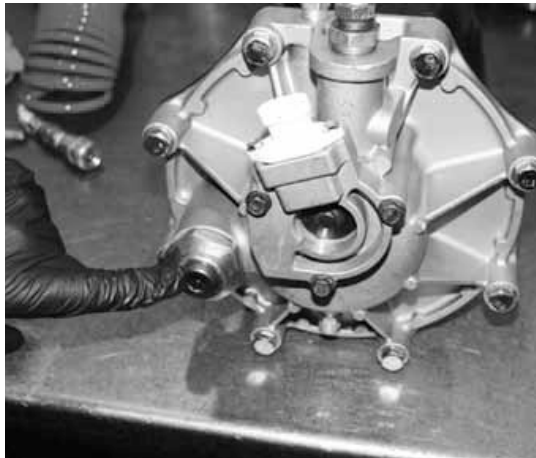

**STEP 1**

Plug the check valve to the air tank using a 1/2" NP plug.



**STEP 2**

Load supply line with shop air and allow unit to fill and stop.

**STEP 3**

After the dryer is completely filled, use another supply line and attach it to the control port. The dryer should purge out the bottom and stop within 20 seconds.

Repeat the process two times. If the dryer stops purging, the unit is functioning to proper specifications.

**Note to Tech**

On a truck, the compressor stops pumping when the governor sends air to the control port of the dryer. When the control port is activated, the supply air can be removed.



For more information:  
 U.S. 888-725-9355  
 Canada 800-387-3889  
[XpresswayPlus.com](http://XpresswayPlus.com)  
[meritor.com](http://meritor.com)



**Meritor Heavy Vehicle Systems, LLC**  
 7975 Dixie Highway  
 Florence, Kentucky 41042 USA

Litho in USA  
 ©2012 Meritor, Inc.  
 TP-1248 Issued 2-12 (47865/11900)

## AIR DRYER TROUBLESHOOTING GUIDE

**POP OFF VALVE IS BLOWING AT THE AIR DRYER OR THE AIR COMPRESSOR**

1	Restrictions between air dryer and supply reservoir.
2	Dryer cartridge needs to be serviced.
3	Discharge line from the compressor to the air dryer plugged or frozen.
4	Malfunction of the safety valve.

**CONSTANT EXHAUST OF THE PURGE VALVE**

1	Purge valve internal leak.
2	Compressor failing to unload.
3	Purge control line connected to wrong place, reservoir or wrong port on governor.
4	Purge valve frozen open, check heater is working.

3

**CANNOT BUILD SYSTEM AIR PRESSURE**

1	Inlet and outlet connections are reversed.
2	The check valve between the dryer and first tank may be restricted.
3	Excessive bends in discharge line, oil turns to carbon in line, water freezes in line between compressor and first tank.
4	Kinked or blocked discharge line.

**OIL PRESENT AT THE AIR DRYER**

1	Time for regular maintenance.
2	Air compressor needs repair.
3	Remember some oil is normal, if oil is getting past dryer to first air tank, compressor repair must be done and air dryer serviced.

**DESICCANT MATERIAL BEING EXPELLED FROM AIR DRYER OR BECOMES PASTE LIKE APPEARANCE**

1	Air dryer not securely mounted to frame causing vibration.
2	Malfunction or saturated desiccant.
3	Compressor passing excessive oil.
4	Chemicals such as alcohol added to discharge line before the air dryer.

**NOISE IN AIR DRYER DURING COMPRESSOR CHARGING CYCLE**

1	Defective check valve in air dryer.
2	Leaking turbo cut-off valve.
3	Leaking purge valve control piston o-ring.

**AIR DRYER IS CONSTANTLY CYCLING OR PURGING**

1	Test fitting, hoses, lines and connections with a soapy water. Tighten or replace as necessary.
2	Test accessories that are connected to supply reservoir.
3	Test governor for leakage, either internal or external leak.
4	Be sure dryer application is correct if you have QE or E-type Cummins Engin.
5	Test outlet check valve on air dryer.

**AIR DRYER DOES NOT PURGE OR EXHAUST**

1	Missing, broken, kinked, frozen, plugged or disconnected purge valve control line.
2	Faulty air dryer purge valve.

**AIR DRYER PURGE PISTON CYCLES RAPIDLY DURING COMPRESSOR UNLOADING CYCLE**

1	Missing, broken, kinked, frozen, plugged or disconnected purge valve control line.
---	--

**AD9 AIR DRYER (FIGURE 4-3)**

	Meritor No.	Replaces	Core No.	Core Group	Description And Comments
	<b>R955109687X</b>	Bendix 109687X	XC1191	BN462	Meritor Reman, Core Exchange
<b>R955109690X</b>	Bendix 109690X				
<b>R955109691X</b>	Bendix 109691X				
<b>R955065225X</b>	Bendix 065225X				
<b>R955065225XCF</b>	Bendix OR109685X			12 volt, Meritor Reman, Core Exchange	
<b>R955109689X</b>	Bendix 109689X	XC1191	BN462	12 Volt, End Cap With Double Check Valve Meritor Reman, Core Exchange	
<b>R955065225X</b>	Bendix 109685X			12 Volt With Bracket, Meritor Reman, Core Exchange	
<b>R955065225N</b>	Bendix 065225			12 Volt, With Bracket And Power Cable Meritor, New Made In Canada	
<b>R955065225NP</b>	Bendix 065225			With Bracket And Pigtail, Meritor, New Made In Canada	
<b>R955109685N</b>	Bendix 109685			12 Volt, Without Bracket And Power Cable Meritor, New Made In Canada	
<b>R955109685NP</b>	Bendix 109685			Meritor, New Made In Canada	
<b>R955109685HX</b>	Bendix 109685X	XC1191	BN462	12 Volt, With Bracket And Power Harness Meritor Reman, Core Exchange	
<b>R955065226X</b>	Bendix 065226X	XC1191	BN462	12 Volt, 3/4" Supply And Delivery Ports Meritor Reman, Core Exchange	
<b>R955065224X</b>	Bendix 065224X			24 Volt, 3/4" Supply And Delivery Ports Meritor Reman, Core Exchange	
<b>R955065224N</b>	Bendix 065224			Meritor, New	
<b>R955065224XCF</b>	Bendix OR065224XCF			Meritor Reman, No Core	
<b>R955065228X</b>	Bendix 065228X	XC1191	BN462	12 Volt, 3/4" Supply And Delivery Ports Extended Purge, Meritor Reman, Core Exchange	
<b>R955065243X</b>	Bendix 065243X	XC1191	BN462	12 Volt, 3/4" Supply And Delivery Ports Extended Purge, Meritor Reman, Core Exchange	
<b>R955065647X</b>	Bendix 065647X	XC1191	BN462	12 Volt, 1/2" Supply And Delivery Ports, Drop In Holset QE Applications, Meritor Reman, Core Exchange	
<b>R955109688X</b>	Bendix 109688X	XC1191	BN462	24 Volt, 3/4" Supply And Delivery Ports Extended Purge, Meritor Reman, Core Exchange	
<b>R955109689N</b>	Bendix 109689	XC1191	BN462	Meritor, New	
<b>R955065499X</b>	Bendix 065499X			Reman AD9 Dryer 12V DLU	
<b>R955065605X</b>	Bendix 065605X			Reman AD9 Dryer 24V DLU	
<b>R955109685PGXCF</b>	Bendix 109685PGX			Reman Outright AD9 Dryer (coalescing)	
<b>R955109689PGXCF</b>	Bendix 109689X			Reman Outright AD9 Dryer, soft-seat purge (coalescing)	

3

**AD9 DESICCANT CARTRIDGE (FIGURE 4-3, 1)**

	Meritor No.	Replaces	Core No.	Core Group	Description And Comments
	R955107794X	Bendix 107794X	XC1055	BN461	Meritor Reman, Core Exchange
	R955107794XCF	Bendix OR107794X			Meritor Reman, No Core
	R955107796N	Bendix 107796			Meritor, New
	R955107794PGX	Bendix 107794PGX	XC1055	BN461	Coalescing Cartridge, Meritor Reman, Core Exchange
	R955109685PGX	Bendix 109685PGX	XC1191	BN462	Coalescing Cartridge, Meritor Reman, Core Exchange
	R955109689PGX	Bendix 109689PGX	XC1191	BN462	Coalescing Cartridge End Cap With Double Check Valve Meritor Reman, Core Exchange
	R955107794PGXCF	Bendix 107794X			Reman Outright AD9 Cartridge (coalescing)

**AD9 CHECK VALVE (FIGURE 4-3, 6)**

	Meritor No.	Replaces	Description And Comments
	R955107800N	Bendix 107800	Check Valve-1/2" NPT, Old Style With Single Check Valve, Meritor, New
	R955107799N	Bendix 107799	Check Valve-3/4" NPT, Meritor, New
	R955K041395N	Bendix K041395N	New Style With Double Check Valve, Meritor, New
	R955109494N	Bendix 109494	Check Valve Repair Kit, Old Style

**AD9 HEATER / THERMOSTAT ASSEMBLY (FIGURE 4-3, 8)**

	Meritor No.	Replaces	Description And Comments
	R955109578N	Bendix 109578	12 Volt, 75 Watts, Heater/Thermostat Assembly (White), Meritor, New
	R955109579N	Bendix 109579	24 Volt, 75 Watts, Heater/Thermostat Assembly (Gray), Meritor, New
R9555002595N	Bendix 5002595	24 Volt, 100 Watts, Heater/Thermostat Assembly (Yellow), Meritor, New	

**AD9 PURGE VALVE AND HEATER / THERMOSTAT ASSEMBLY**

	Meritor No.	Replaces	Description And Comments
	R955800405N	Bendix 800405	Purge Valve and Heater / Thermostat Repair Kit, 12 Volt, Hard Seat Meritor, New

**AD9 PURGE VALVE (FIGURE 4-3, 5)**

	Meritor No.	Replaces	Core No.	Core Group	Description And Comments
	R9555004339N	Bendix 5004339			Purge Valve Kit, DLU, 12 Volt, Soft Seat Meritor, New
	R955107896X	Bendix 107896X	XC1193	BN461	Purge Valve Kit, 12 Volt, Hard Seat Meritor Reman, Core Exchange
	R9555004479N	Bendix 5004479			Purge Valve Kit, 12 Volt, Hard Seat Meritor, New
	R9555004341X	Bendix 5004341X	XC1193	BN461	Purge Valve, 12 Volt, Soft Seat Meritor Reman, Core Exchange
	R9555004340N	Bendix 5004340			Purge Valve Kit, DLU, 24 Volt, Hard Seat Meritor, New
	R9555004338N	Bendix 5004338			Purge Valve Kit, 24 Volt, Hard Seat Meritor, New
	R9555004381N	Bendix 5004381			Purge Valve Kit, 24 Volt, 100 Watt, Hard Seat Meritor, New
	R9555004480N	Bendix 5004480			Purge Valve Kit, 24 Volt, Hard Seat Meritor, New
	R9555004342X	Bendix 5004342X	XC1193	BN461	Purge Valve Kit, 24 Volt, Soft Seat Meritor Reman, Core Exchange
	R9555004336N	Bendix 5004336			Maintenance Kit, Old Style, Meritor, New
	R9555005037N	Bendix 5005037			Maintenance Kit, 12 Volt, Hard Seat, Meritor, New
	R9555005893N	Bendix 5005893			Maintenance Kit, 12 Volt, Soft Seat, Meritor, New

**AD9 FIELD MODIFICATION KIT**

<p>PHOTO NOT AVAILABLE AT TIME OF PRINTING</p>	Meritor No.	Replaces	Description And Comments
	R9555004380N	Bendix 5004380	Field Modification Kit, Meritor, New

**AD9 POWER CABLE / WIRE HARNESS (FIGURE 4-3, 7)**

	Meritor No.	Replaces	Description And Comments
	R955109871N	Bendix 109871	Heater Electrical Splicing Service Kit, Meritor, New
	R955109869N	Bendix 109869	Power Cable / Wire Harness for the Air Dryer, Meritor, New

**AD9 PRESSURE RELIEF VALVE (FIGURE 4-1, 2)**

	Meritor No.	Replaces	Description And Comments
	R955205105N	Bendix 205105	AD2, AD4, AD9, ADIP, ADIS Adjustable Pressure Relief Valve—150 PSI—1/4" Meritor, New
	R955800350N	Bendix 800350	AD4, AD9, ADIP, ADIS Pressure Relief Valve—175 PSI Meritor, New

**AD9 MOUNTING BRACKET KIT (FIGURE 4-2, 3)**

	Meritor No.	Replaces	Description And Comments
	R955107695N	Bendix 107695	AD4 & AD9 Mounting Bracket Kit, Meritor, New
	R955104027N	Bendix 104027	AD4 & AD9 Mounting Bracket Only Order R955107695N For Bracket Kit, Meritor, New

3

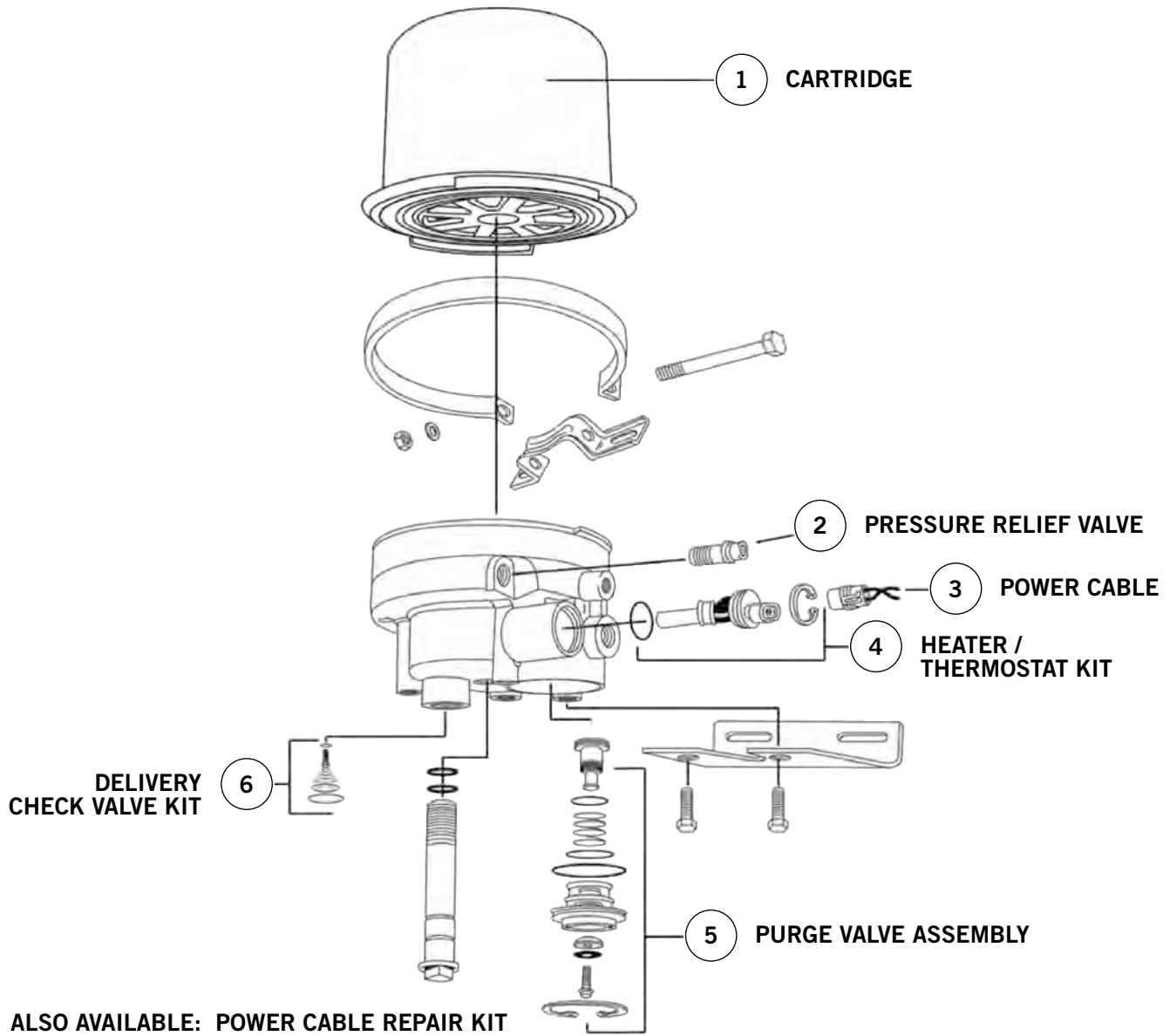

Figure 4-4. ADIP

MeritorPartsXpress.com  
PB-1484 (06-18)

U.S. 888-725-9355  
Canada 800-387-3889



**ADIP AIR DRYER (FIGURE 4-4)**

	Meritor No.	Replaces	Core No.	Core Group	Description And Comments
	R955109477X	Bendix 109477	XC1800	BN470	12 Volt, Meritor Reman, Core Exchange
	R955109477XCF	Bendix OR109477X			12 Volt, Meritor Reman, No Core
	R955109503X	Bendix 109503X	XC1803	BN470	12 Volt, Meritor Reman, Core Exchange
	R9555000709X	Bendix 5000709X			12 Volt, Fourth Line Out Bottom Meritor Reman, Core Exchange
	R955109478X	Bendix 109478X	XC1801		24 Volt, Meritor Reman, Core Exchange
	R955109477PGX	Bendix 109477	XC1800	BN470	Coalescing Cartridge, Meritor Reman, Core Exchange
	R955109478XCF	Bendix OR109478X			24 Volt, Meritor Reman, No Core
	R955109477PGXCF	Bendix 109477PGX			Reman Outright ADIP Dryer (coalescing)
	R955109493PGXCF	Bendix 109493X			Reman Outright ADIP Dryer (coalescing)
	R955065612N	Bendix 65612			Model Dryer, Meritor, New
	R9555005556X	Bendix 5005556X			Ext. Purge, Meritor, Reman
	R9555005556PGX	Bendix 5005556PGX			Ext. Purge Coalescing, Meritor, Reman

3

**ADIP DESICCANT CARTRIDGE (FIGURE 4-4, 1)**

	Meritor No.	Replaces	Core No.	Core Group	Description And Comments
	R955065624N	Bendix 065624			Meritor, New
	R955109493X	Bendix 109493X	XC1802	BN471	Meritor Reman, Core Exchange
	R955109493XCF	Bendix OR109493X			Meritor Reman, No Core
	R955109493PGX	Bendix 109493PGX	XC1804	BN471	Coalescing Cartridge, Meritor Reman, Core Exchange

**ADIP PURGE VALVE (FIGURE 4-4, 5)**

	Meritor No.	Replaces	Description And Comments
	R955800404N	Bendix 065626 Bendix 800404	Old Style, Meritor, New
	R955K022105N	Bendix K022105	New Style, Hard Seat, Meritor, New
	R955K031560N	Bendix K031560	New Style, Soft Seat, Meritor, New

**ADIP PURGE VALVE MAINTENANCE KIT**

	Meritor No.	Replaces	Description And Comments
	R9555003547N	Bendix 5003547	Purge Valve Maintenance Kit, Old Style, Meritor, New

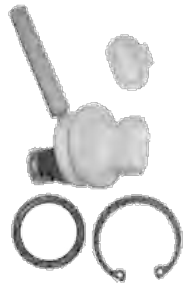

**ADIP HEATER / THERMOSTAT REPAIR KIT (FIGURE 4-4, 4)**

	Meritor No.	Replaces	Description And Comments
	R955109495N	Bendix 109495	Heater / Thermostat Repair Kit, 12 Volt Meritor, New
	R955109496N	Bendix 109496	Heater / Thermostat Repair Kit, 24 Volt Meritor, New

**ADIP POWER CABLE / WIRE HARNESS (FIGURE 4-4, 3)**

	Meritor No.	Replaces	Description And Comments
	R955109869N	Bendix 109869	Wiring Harness, Meritor, New
	R955109871N	Bendix 109871	Wiring Harness W/Splicing Kit, Meritor, New

**ADIP PRESSURE RELIEF VALVE (FIGURE 4-4, 2)**

	Meritor No.	Replaces	Description And Comments
	R955800350N	Bendix 800350	Pressure Relief Valve, 175 PSI, Meritor, New

**ADIP CHECK VALVE REPAIR KIT**

	Meritor No.	Replaces	Description And Comments
	R955109494N	Bendix 109494	Check Valve Repair Kit, Meritor, New

**ADIP BRACKET KIT**

	Meritor No.	Replaces	Description And Comments
	R9555001247N	Bendix 5001247	Bracket Kit, Meritor, New

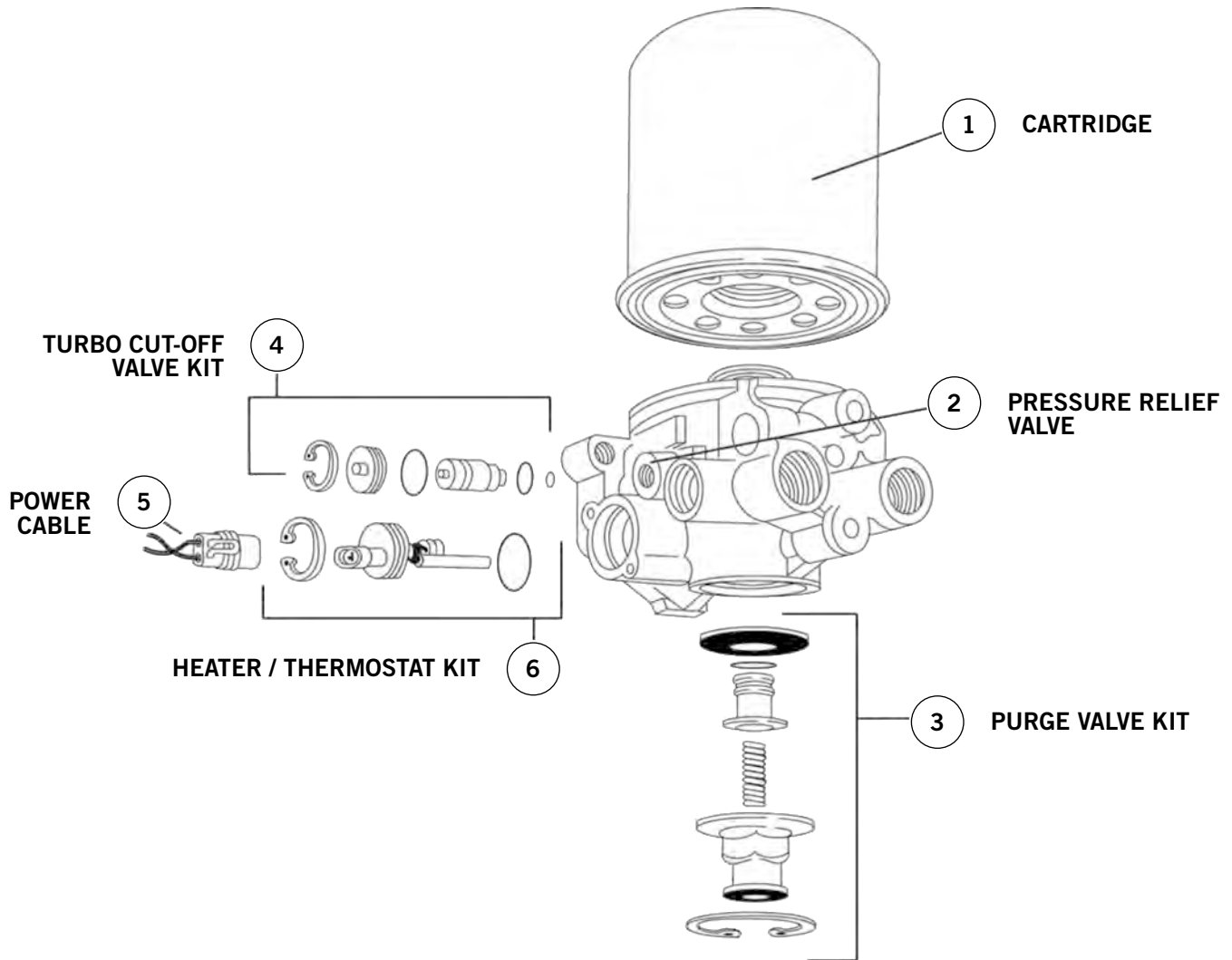



Figure 4-5. ADSP

**ADSP AIR DRYER (FIGURE 4-5)**

	Meritor No.	Replaces	Core No.	Core Group	Description And Comments
	R955109991X	Bendix 109991X	XC1010	BN454	12 Volt, Meritor Reman, Core Exchange
	R955109991PGX	Bendix 109991PGX			Coalescing Cartridge, Meritor Reman, Core Exchange
	R955109991XCF	Bendix OR109991X			12 Volt, Meritor Reman, No Core
	R955109992X	Bendix 109992X	XC1010	BN454	24 Volt, Meritor Reman, Core Exchange
	R955109992PGX	Bendix 109992PGX			Coalescing Cartridge, Meritor Reman, Core Exchange
	R955109992XCF	Bendix 109992X			24 Volt, Meritor Reman, No Core

**3**

**ADSP CARTRIDGE (FIGURE 4-5, 1)**

	Meritor No.	Replaces	Description And Comments
	R109994P	Bendix 109994 Bendix BR950011 Bendix 5008414 Haldex 109994K Haldex 65624K WABCO 432 410 222 7	
R955099P	5008414P6		Oil Coalescing, Meritor, New

**ADSP CHECK VALVE**

	Meritor No.	Replaces	Description And Comments
	R9555005624N	Bendix 5005624	

**ADIP / ADSP / ADIS HEATER / THERMOSTAT REPAIR KIT (FIGURE 4-5, 6)**

	Meritor No.	Replaces	Description And Comments
	R955109495N	Bendix 109495	
R955109496N	Bendix 109496		24 Volt, Heater / Thermostat Repair Kit, 24 Volt, Meritor, New

**ADSP TURBO VALVE REPAIR KIT (FIGURE 4-5, 4)**

	Meritor No.	Replaces	Description And Comments
	R955109993N	Bendix 109993	



**ADSP PURGE VALVE REPAIR KIT (FIGURE 4-5, 3)**

	Meritor No.	Replaces	Description And Comments
	<b>R955109995N</b>	Bendix 109995	Purge Valve Repair Kit, Meritor, New

**ADSP CHECK VALVE**

	Meritor No.	Replaces	Description And Comments
	<b>R955065677N</b>	Bendix 065677	Single Check Protection Valve, Meritor, New

**3**

**ADSP POWER CABLE / WIRE HARNESS (FIGURE 4-5, 5)**

	Meritor No.	Replaces	Description And Comments
	<b>R955109869N</b>	Bendix 109869	Wiring Harness, Meritor, New
	<b>R955109871N</b>	Bendix 109871	Wiring Harness W/Splicing Kit, Meritor, New

**ADSP PRESSURE RELIEF VALVE (FIGURE 4-5, 2)**

	Meritor No.	Replaces	Description And Comments
	<b>R955800350N</b>	Bendix 800350	Pressure Relief Valve, 175 Psi, Meritor, New

3

1  
CARTRIDGE

2  
HEATER / THERMOSTAT KIT

3  
PURGE VALVE REPLACEMENT KIT

ALSO AVAILABLE: PURGE VALVE SERVICE KIT

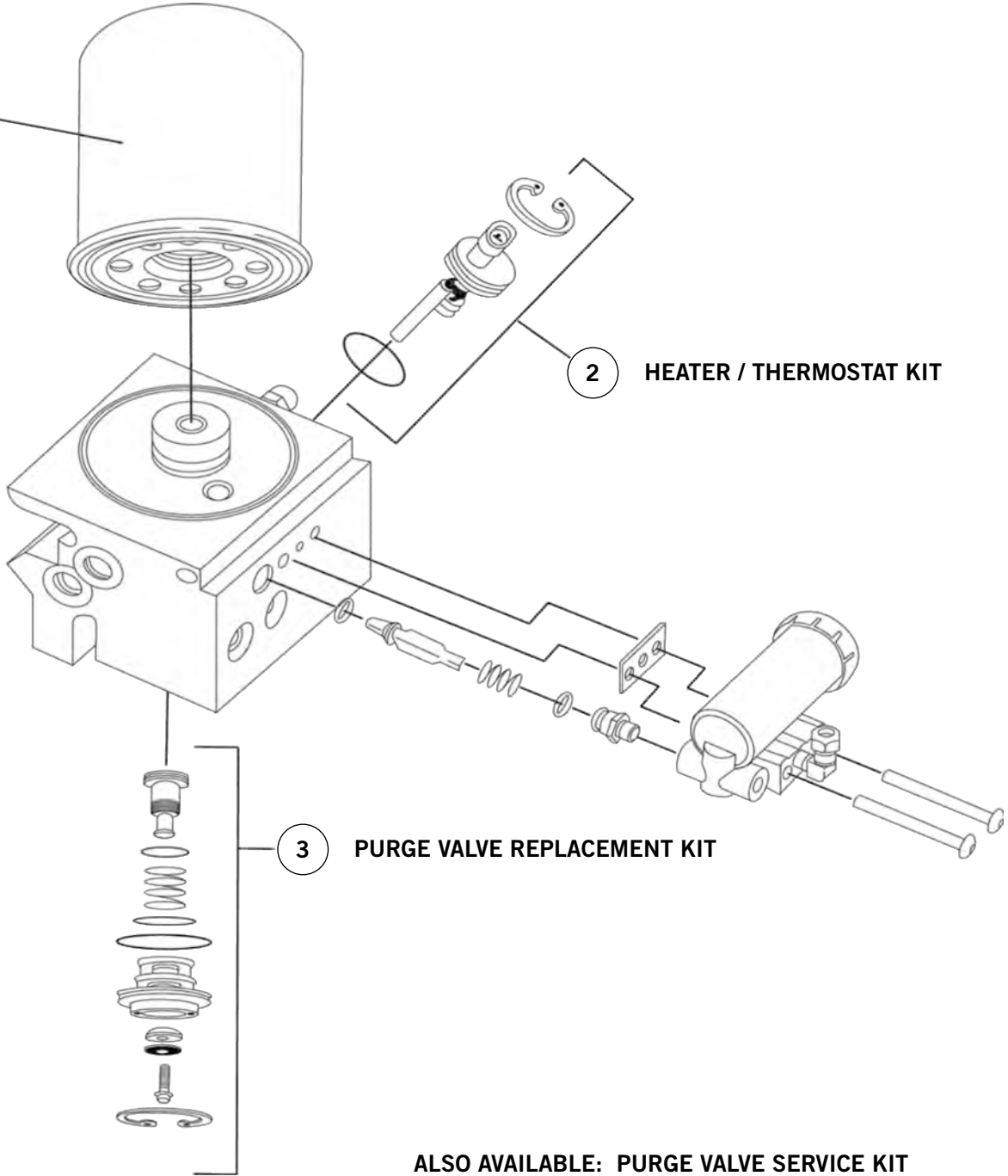



Figure 4-6. ADIS



**ADIS AIR DRYER (FIGURE 4-6)**

	Meritor No.	Replaces	Core No.	Core Group	Description And Comments
	R9555010133X	Bendix 5010133X	XC1015	BN455	Meritor Reman, Core Exchange
	R9555010133PGX	Bendix 5010133PGX			Coalescing Cartridge, Meritor Reman, Core Exchange
	R9555010696X	Bendix 5010696X			Meritor Reman, Core Exchange
	R9555010696PGX	Bendix 5010696PGX			Coalescing Cartridge, Meritor Reman, Core Exchange
	R9555004050X	Bendix 5004050X			Meritor Reman, Core Exchange
	R9555004050PGX	Bendix 5004050PGX			Coalescing Cartridge, Meritor Reman, Core Exchange
	R9555010133XCF	Bendix 5010133X			Reman Outright ADIS Dryer
	R9555010696XCF	Bendix 5010696X			Reman Outright ADIS Dryer
	R9555004050XCF	Bendix 5004050X			Reman Outright ADIS Dryer
	R9555010133PGXCF	Bendix 5010133PGX			Reman Outright ADIS Dryer (coalescing)
	R9555010696PGXCF	Bendix 5010696PGX			Reman Outright ADIS Dryer (coalescing)
	R9555004050PGXCF	Bendix 5004050PGX			Reman Outright ADIS Dryer (coalescing)

3

**ADIS PURGE VALVE**

	Meritor No.	Replaces	Description And Comments
	R9555003547N	Bendix 5003547	Meritor, New

**ADIS GOVERNOR AND CHECK VALVE KIT**

Meritor No.	Replaces	Description And Comments
R9555004049N	Bendix 5004049	Governor and Check Valve Kit, Meritor, New

**ADIP / ADSP / ADIS HEATER / THERMOSTAT REPAIR KIT (FIGURE 4-6, 2)**

	Meritor No.	Replaces	Description And Comments
	R109994P	Bendix 109994 Bendix 5008414 Bendix BR950011 Haldex 109994K Haldex 65624K WABCO 432 410 222 7	Meritor, New
R955099P	5008414P6	Oil Coalescing, Meritor, New	

**ADIP / ADSP / ADIS HEATER / THERMOSTAT REPAIR KIT (FIGURE 4-6, 2)**

	Meritor No.	Replaces	Description And Comments
	R955109495N	Bendix 109495	12 Volt, Heater / Thermostat Repair Kit, Meritor, New
R955109496N	Bendix 109496	24 Volt, Heater / Thermostat Repair Kit, 24 Volt, Meritor, New	

3

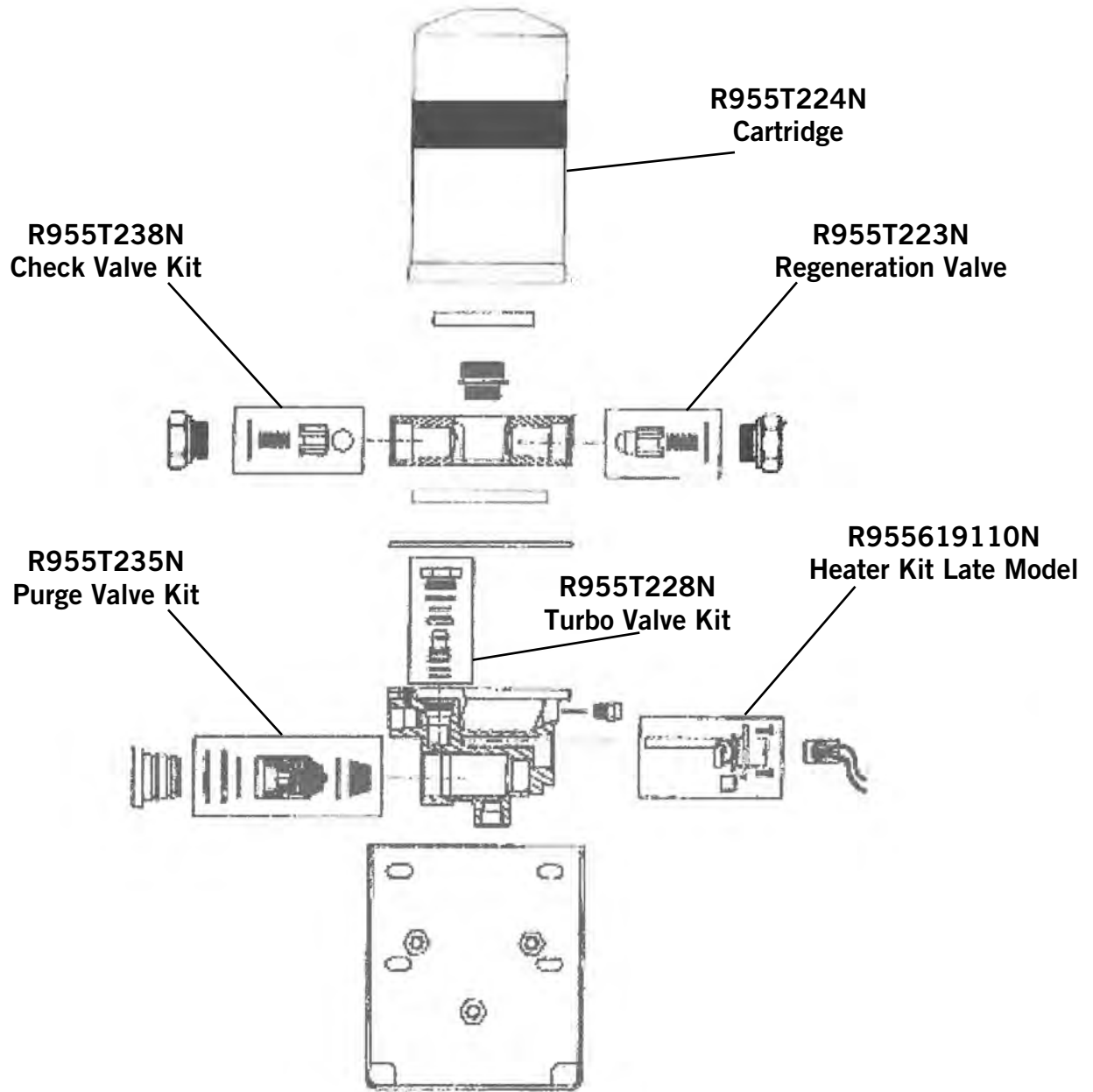











Figure 4-7. T2000

T-2000 COMPONENTS (FIGURE 4-7)			
	Meritor No.	Replaces	Description And Comments
	R955T224N	SKF T224	T-2000 Cartridge, Meritor, New
	R955T224PGN	SKF T224P6	Coalescing Kit Included, Meritor, New
	R955T223N	SKF 223	T-2000 Regeneration Valve, Meritor, New
	R955T238N	SKF 238	T-2000 Check Valve Kit, Meritor, New
	R955T235N	SKF 235	T-2000 Purge Valve Kit, Meritor, New
	R955T228N	SKF 228	T-2000 Turbo Valve Kit, Meritor, New
	R955619110N	619110	T-2000 Heater Kit Late Model, Meritor, New
	R955620602N	620602	T-2000 Dryer, Meritor, New
	R955602302N	620302	T-2000 Dryer Coalescing, Meritor, New

3

ALCOHOL EVAPORATOR					
	Meritor No.	Replaces	Core No.	Core Group	Description And Comments
	R955A72420N	Haldex A72420			Meritor, New

**NOTES:** \_\_\_\_\_

\_\_\_\_\_

\_\_\_\_\_

\_\_\_\_\_

\_\_\_\_\_

\_\_\_\_\_

\_\_\_\_\_

\_\_\_\_\_

\_\_\_\_\_

\_\_\_\_\_

\_\_\_\_\_

\_\_\_\_\_

\_\_\_\_\_

\_\_\_\_\_

\_\_\_\_\_

\_\_\_\_\_

\_\_\_\_\_

\_\_\_\_\_

**3**

# TRUCK/TRACTOR AIR VALVES TABLE OF CONTENTS

TITLE	PAGE
TRUCK/TRACTOR AIR VALVES	
CHECK VALVES - - - - -	4-11
AIR BRAKE CONTROL VALVES - - - - -	4-13
AIR BRAKE DRAIN VALVES - - - - -	4-23
AIR BRAKE FOOT VALVES - - - - -	4-24
AIR BRAKE HAND CONTROL VALVES - - - - -	4-30
AIR BRAKE INVERSION VALVES - - - - -	4-31
LEVELING VALVES - - - - -	4-32
AIR BRAKE PROTECTION VALVES - - - - -	4-34
AIR BRAKE QUICK RELEASE VALVES - - - - -	4-36
AIR BRAKE RATIO VALVES - - - - -	4-39
AIR BRAKE RELAY VALVES - - - - -	4-41
AIR BRAKE EMERGENCY VALVES - - - - -	4-51
AIR BRAKE SPRING BRAKE VALVES - - - - -	4-54
AIR BRAKE SWITCHES AND INDICATORS - - - - -	4-59
AIR BRAKE TRACTOR PROTECTION VALVES - - - - -	4-60
SOLENOID VALVES - - - - -	4-64
TRAILER AIR VALVES - - - - -	4-69

## TRUCK/TRACTOR AIR VALVES QUICK REFERENCE

OE Number	Description	Meritor New	Meritor Remanufactured
12103	Drain Valve	R95512103N	
12105	Manual Drain-60" Closed Loop	R95512105N	
12352	Relay	R95512352N	
16743	Air Regulator	R95516743N	
16859	Shaft Brake Actuator	R95516859N	
19974	Insert Valve	R95519974N	
065104	R12-Relay	R955065104N	R955065104X
065125	R-12H Relay Valve (Horizontal)		R955065125X
065145	Bobtail	R955065145N	R955065145X
065146	Bobtail	R955065146N	R955065146X
065154	LQ-5 Bobtail Ratio Valve		R955065154X
065156	MV-3 Control Module		R955065156X
065157	MV-3 Control Module		R955065157X
065160	MV-3 Control Module		R955065160X
065186	MV-3 Control Module		R955065186X
065206	R12-Relay	R955065206N	
065303	R12-Relay	R955065303N	R955065303X
065313	E-12 Dual Foot Valve (Dual Circuit)		R955065313X
065395	E-14 Dual Foot Valve (Dual Circuit)		R955065395X
065437	SR5-Trailer Brake	R955065437N	R955065437X
065438	SR-5 Trailer Brake Valve		R955065438X
065439	SR5-Trailer Brake	R955065439N	R955065439X
101100	E-10 Dual Foot Valve (Dual Circuit)		R955101100X
101112	SR4-Spring Brake	R955101112N	R955101112X
101135	RV-1 Pressure Reducing Valve		R955101135X
101311	LQ-1 Ratio Valve		R955101311X
101333	R-10 Relay Valve		R955102626X
101437	PP2-Dash	R955101437N	R955101437X
101450	TR-3 Inversion Valve		R955101450X
101569	MV-2 Control Module		R955101569X
101570	MV-2 Control Module		R955101570X
101622	SR-4 Spring Brake Valve (Early Type)		R955101622X
101818	E7-Dual Circuit Foot	R955101818N	R955101818X
101890	MV-2 Control Module	R955101890N	R955101890X
102626	R12-Relay	R955102626N	R955102626X
102638	TP-5 Tractor Protection Valve (Formerly VM-2 Control Valve Manifold)		R955102638X
102761	SR-2 Spring Brake Valve		R955102761X
103009	R12-Relay	R955103009N	R955103009X
103010	R12-Relay	R955103010N	R955103010X
103028	R14-Relay	R955103028N	R955103028X
103061	SR2-Spring Brake	R955103061N	R955103061X
103081	SR7-Relay Spring Brake	R955103081N	R955103081X
103139	R-14H Relay Valve (Horizontal)		R955103139X

**TRUCK/TRACTOR AIR VALVES QUICK REFERENCE**

OE Number	Description	Meritor New	Meritor Remanufactured
103195	R-12H Relay Valve (Horizontal)		R955103195X
103294	R-14H Relay Valve (Horizontal)		R955103294X
103833	R-14 Relay Valve (Vertical)		R955103833X
103835	R-14H Relay Valve (Horizontal)		R955103835X
103912	R-12 Relay Valve		R955103912X
104165	R-12H Relay Valve (Horizontal)		R955104165X
104345	R-14H Relay Valve (Horizontal)		R955104345X
104561	R-12 Relay Valve		R955104561X
104598	BP-1 Air Brake Proportioning Valve		R955104598X
106284	BP-1 Air Brake Proportioning Valve		R955106284X
106313	R-14 Relay Valve (Vertical)		R955106313X
107539	SR-4 Spring Brake Valve (New Type)		R955107539X
108076	SR-4 Spring Brake Valve (New Type)		R955108076X
109264	R-12P Relay Valve		R955109264X
225892	TW-3 Control Valve		R955225892X
227661	TP-2 Tractor Protection Valve		R955227661X
227672	TP-2 Tractor Protection Valve		R955227672X
227870	SC1-Single Check	R955227870N	
227871	SC1-Single Check	R955227871N	
228050	DS-1 Double Check Valve And Stop Light Switch		R955228050X
228165	DS-1 Double Check Valve And Stop Light Switch		R955228165X
228520	DS-1 Double Check Valve And Stop Light Switch		R955228520X
228600	SL4-Stop Light Switch	R955228600N	
228750	LP3-Low Pressure Indicator	R955228750N	R955228750X
229434	RE-4 Relay Emergency Valve (Style B)		R955229434X
229467	R-5 Relay Valve		R955229467X
229493	DS-1 Double Check Valve And Stop Light Switch		R955229493X
229500	E-2 • E-3 Foot Valve (Single Circuit)		R955229500X
229501	E-2 • E-3 Foot Valve (Single Circuit)		R955229501X
229505	LQ2-Limiting Quick Release/Double Check		R955229505X
229507	LQ-2 Limited Quick Release And Double Check Valve		R955229507X
229509	LQ-2 Limited Quick Release And Double Check Valve		R955229509X
229608	TW-1 Control Valve		R955229608X
229635	TW1-Control	R955229635N	R955229635X
229813	QR1-Quick Release	R955229813N	R955229813X
229844	QR-1 Quick Release Valve		R955229844X
229859	QR1-Quick Release	R955229859N	R955229859X
229860	QR1-Quick Release	R955229860N	R955229860X
276270	Hand Control Valve		R955276270X
276272	Hand Control Valve		R955276272X
276462	New Control Valve		R955276462X
276566	PP1-Control	R955276566N	R955276566X
276567	PP1-Control	R955276567N	R955276567X
277144	RV-1 Pressure Reducing Valve		R955277144X

## TRUCK/TRACTOR AIR VALVES QUICK REFERENCE

OE Number	Description	Meritor New	Meritor Remanufactured
277147	PR2-Pressure Reducing	R955277147N	
277148	New Pressure Protection Valves	R955277148N	R955277148X
277214	RV-1 Pressure Reducing Valve		R955277214X
277226	PR-2 Pressure Protection Valve		R955277226X
277227	PR-2 Pressure Protection Valve		R955277227X
277340	TR-2 Inversion Valve		R955277340X
277446	RE-4 Relay Emergency Valve (Style A)		R955277446X
277863	E3-Single Circuit Foot	R955277863N	R955277863X
278426	RV-1 Pressure Reducing Valve		R955278426X
278596	DS-4 Double Check Valve		R955278596X
278598	DC4-Double Check	R955278598N	
278614	DC4-Double Check	R955278614N	
278615	DC4-Double Check	R955278615N	R955278615X
278825	New Synchro Valve	R955278825N	R955278825X
278998	E-2 • E-3 Foot Valve (Single Circuit)		R955278998X
279000	TP3-Tractor Protection	R955279000N	R955279000X
279180	R6-Relay	R955279180N	R955279180X
279416	LP3-Low Pressure Indicator	R955279416N	
279787	PP-3 Control Valve		R955279787X
279950	E5-Foot	R955279950N	R955279950X
279952	R6-Relay	R955279952N	R955279952X
279962	TP-3 Tractor Protection Valve		R955279962X
280243	R-6 Relay Valve		R955280243X
280375	R-6 Relay Valve		R955280375X
280454	PP-2 Control Valve		R955280454X
280651	R-6 Relay Valve		R955280651X
280758	TR-3 Inversion Valve		R955280758X
280809	DC4-Double Check	R955280809N	
280904	TW-2 And TH-3 Control Valves		R955280904X
280905	TW-2 And TH-3 Control Valves		R955280905X
281024	QR-1 Quick Release Valve		R955281024X
281318	TR-3 Inversion Valve		R955281318X
281587	PP-1 Control Valve		R955281587X
281797	Hand Control Valve		R955281797X
281860	New Emergency Relay Valve		R955281860X
281865	RE6-Relay Emergency	R955281865N	R955281865X
281923	Automatic Drain Valve	R955281923N	R955281923X
281946	PP-5 Control Valve		R955281946X
282368	TC-4 Modulating Control Valve		R955282368X
282381	TC-4 Modulating Control Valve		R955282381X
282472	SV-1 Synchronizing Valve		R955282472X
283040	TW-3 Control Valve		R955283040X
283090	TP-2 Tractor Protection Valve		R955283090X
283935	TW-3 Control Valve		R955283935X



**TRUCK/TRACTOR AIR VALVES QUICK REFERENCE**

OE Number	Description	Meritor New	Meritor Remanufactured
283940	R-6 Relay Valve		R955283940X
284744	PP-5 Control Valve		R955284744X
284760	E7–Dual Circuit Foot	R955284760N	R955284760X
286171	E6–Dual Circuit Foot	R955286171N	R955286171X
286364	SR2–Spring Brake	R955286364N	R955286364X
286370	R8–Relay	R955286370N	R955286370X
286371	R-8 Relay Valve		R955286371X
286500	PR4–Pressure Protection	R955286500N	R955286500X
286773	E-7 Dual Foot Valve (Dual Circuit)		R955286773X
286775	E-7 Dual Foot Valve (Dual Circuit)		R955286775X
286892	R-8 Relay Valve		R955286892X
287114	R8P–Relay	R955287114N	R955287114X
287224	R-8 Relay Valve		R955287224X
287238	PP8–Control	R955287238N	R955287238X
287240	R-8 Relay Valve		R955287240X
287260	R-8 Relay Valve		R955287260X
287376	SR2–Spring Brake	R955287376N	R955287376X
287411	E-7 Dual Foot Valve (Dual Circuit)	R955287411N	R955287411X
287417	PP-1 Control Valve		R955287417X
287418	PP-8 Control Valve		R955287418X
287564	E-7 Dual Foot Valve (Dual Circuit)		R955287564X
287600	PP1–Control	R955287600N	
287637	PP-1 Control Valve		R955287637X
288063	SR-1 Spring Brake Valve		R955288063X
288239	PP7–Control	R955288239N	R955288239X
288240	PP-7 Control Valve		R955288240X
288241	PP7–Control	R955288241N	R955288241X
288242	PP-7 Control Valve		R955288242X
288251	QR-1 Quick Release Valve		R955288251X
288301	New Tractor Protection Valve	R955288301N	R955288301X
288323	PR-4 Pressure Protection Valve		R955288323X
288369	R-8 Relay Valve		R955288369X
288383	E7–Dual Circuit Foot	R955288383N	R955288383X
288586	TR-3 Inversion Valve		R955288586X
288605	TP5–Tractor Protection	R955288605N	R955288605X
288645	VM-3 Manifold Valve		R955288645X
288746	PP3–Control	R955288746N	R955288746X
288755	R-8 Relay Valve		R955288755X
289144	LQ4–Ratio	R955289144N	
289148	LQ-1 Ratio Valve		R955289148X
289182	QR-1C Quick Release Valve (With Double Check Valve)		R955289182X
289477	PP-3 Control Valve		R955289477X
289512	PP-3 Control Valve		R955289512X
289714	QR1C–Quick Release/Double Check	R955289714N	R955289714X

## TRUCK/TRACTOR AIR VALVES QUICK REFERENCE

OE Number	Description	Meritor New	Meritor Remanufactured
800333	Inline Quick Release	R955800333N	
800516	New MV-3 Valve	R955800516N	
800517	New MV-3 Valve	R955800517N	
800518	MV-3 Control Module	R955800518N	
800519	New MV-3 Valve	R955800519N	
800521	New MV-3 Valve	R955800521N	
800573	New MV-3 Valve	R955800573N	
800629	E8P-Foot	R955800629N	
48100-225	Linkage Assemblies	R307852	
900 54 007	Controlled Response Height Control Valve	R304323	
900 54 074	Electric Valve	R304325	
900 54 075	Electric Valve	R304331	
900 54 079	Pilot Valve	R304328	
900 54 082	Hand Valve	R304329	
900 54 088	Manual Valve	R304326	
900 54 466	Pressure Protection Valve	R304324	
905 55 105	Precision Response Height Control Valve	R3013922	
A103600	RF Relay Valve (4 Ports - Vertical)		R955A103600X
A3546	Push/Pull Range	R955A3546N	R955A3546X
A3547	Push-Pull Range Valve		R955A3547X
A3991	Slave Valve		R955A3991X
A4487	Selector Valve	R955A4487N	
A4490	Selector Valve	R955A4490N	
A4491	Selector Valve	R955A4491N	
A4688	Slave Valve	R955A4688N	R955A4688X
A4900	Shift Knob	R955A4900N	
A5010	Shift Knob	R955A5010N	
A5015	Range Valve	R955A5015N	
A80070	RS Relay Valve (2 Port Delivery)		R955A80070X
A85490	RG4 Tandem Relay Valve (4 Port Delivery)		R955A85490X
A85493	RG4 Tandem Relay Valve (4 Port Delivery)		R955A85493X
A86473	RF Relay Valve (4 Ports - Vertical)		R955A86473X
A86477	Relay		R955A86477X
A88802	RT Trailer Valve (Spring Brake Control)		R955A88802X
A88812	RT Trailer Valve (Spring Brake Control)		R955A88812X
A97600	RF Relay Valve (4 Ports - Vertical)		R955A97600X
A98730	RT2 Trailer Valve (Spring Brake Control)		R955A98730X
A99370	RT2 Trailer Valve (Spring Brake Control)		R955A99370X
BE13240	Pneumatic Switch	R955BE13240N	
BE13241	Low Pressure Indicator	R955BE13241N	
BE13250	Stop Light Switch	R955BE13250N	
BE13255	Pneumatic Switch	R955BE13255N	
BM6997312	Fuel Solenoid	R955BM69973-12N	R955BM69973-12X
BM6997324	Fuel Solenoid	R955BM69973-24N	R955BM69973-24X

**TRUCK/TRACTOR AIR VALVES QUICK REFERENCE**

OE Number	Description	Meritor New	Meritor Remanufactured
KN20000	Control Valve - Lever Type		R955KN20000X
KN20010	Control Valve - Push / Pull Hostler		R955KN20010X
KN20020	Control Valve - Push / Pull Hostler		R955KN20020X
KN20040	Control Valve Camstyle / Lever Type		R955KN20040X
KN20050	Control Valve Camstyle / Lever Type		R955KN20050X
KN20060	Control Valve - Push / Pull Hostler		R955KN20060X
KN20070	Modulating Control Valve		R955KN20070X
KN20071	Hand Control Valve (Limited Delivery)		R955KN20071X
KN20080	Control Valve Lever Type "Double Flipper"		R955KN20080X
KN20090	Control Valve Lever Type "Double Flipper"		R955KN20090X
KN20110	Control Valve Lever Type "Double Flipper"		R955KN20110X
KN20541	Trailer Brake Control - In Column Mount		R955KN20541X
KN20542	Trailer Brake Control - In Column Mount		R955KN20542X
KN20551	Trailer Brake Control - GM - In Column Mount		R955KN20551X
KN20552	Trailer Brake Control - GM - In Column Mount		R955KN20552X
KN20561	Hand Control Valve (Limited Delivery)		R955KN20561X
KN20562	Hand Control Valve (Limited Delivery)		R955KN20562X
KN20580	Hand Control Valve (Limited Delivery)		R955KN20580X
KN20581	Hand Control Valve (Limited Delivery)		R955KN20581X
KN20590	Hand Control Valve (Limited Delivery)		R955KN20590X
KN20601	Manifold Dash Valve		R955KN20601X
KN20602	Manifold Dash Valve		R955KN20602X
KN20603	Manifold Dash Valve		R955KN20603X
KN20605	Manifold Dash Valve		R955KN20605X
KN20606	Manifold Dash	R955KN20606N	R955KN20606X
KN20608	Manifold Dash Valve		R955KN20608X
KN20611	Manifold Dash Valve		R955KN20611X
KN20612	Manifold Dash Valve		R955KN20612X
KN20615	Manifold Dash	R955KN20615N	R955KN20615X
KN20616	Manifold Dash Valve		R955KN20616X
KN20619	Manifold Dash Valve		R955KN20619X
KN20620	Manifold Dash Valve		R955KN20620X
KN20621	Manifold Dash Valve		R955KN20621X
KN20622	Manifold Dash Valve		R955KN20622X
KN20623	Manifold Dash Valve		R955KN20623X
KN20626	Manifold Dash Valve		R955KN20626X
KN20627	Manifold Dash Valve		R955KN20627X
KN20628	Manifold Dash Valve		R955KN20628X
KN20629	Manifold Dash Valve		R955KN20629X
KN22100	Single Circuit Foot		R955KN22100X
KN22140	Dual Foot Valve (Dual Circuit)		R955KN22140X
KN22150	Dual Circuit Foot		R955KN22150X
KN23000	Single Check	R955KN23000N	
KN23010	Single Check	R955KN23010N	

## TRUCK/TRACTOR AIR VALVES QUICK REFERENCE

OE Number	Description	Meritor New	Meritor Remanufactured
KN23040	Check-3/4	R955KN23040N	
KN26000	Spring Brake/Relay	R955KN26000N	R955KN26000X
KN26010	RT-4	R955KN26010N	R955KN26010X
KN26020	Multi-Function RT4 (Spring Brake / Relay Valve)		R955KN26020X
KN26803	FF2 Full Function (Spring Brake / Relay Valve)		R955KN26803X
KN28010	Relay Valve (2 Port Delivery)		R955KN28060X
KN28011	Relay Valve (2 Port Delivery)		R955KN28060X
KN28041	Relay Valve (4 Port Delivery With Anti-Compounding)		R955KN28041X
KN28042	Relay Valve (4 Port Delivery)		R955KN28042X
KN28055	Relay Valve (4 Port Delivery With Dual Crack Pressure)		R955KN28055X
KN28060	Relay	R955KN28060N	R955KN28060X
KN28061	Relay Valve (2 Port Delivery)		R955KN28061X
KN28071	Relay		R955KN28071X
KN28080	Relay Valve (4 Port Delivery)		R955KN28080X
KN28085	Relay Valve (4 Port Delivery)		R955KN28085X
KN28130	Relay Valve (2 Port Delivery)		R955KN28130X
KN28131	Relay Valve (2 Port Delivery)		R955KN28131X
KN28132	Relay Valve (2 Port Delivery)		R955KN28132X
KN28140	Relay		R955KN28140X
KN28300	Fast Air Door Dolly Relay Valve (2 Port Delivery)		R955KN28300X
KN28500	Relay	R955KN28500N	R955KN28500X
KN28510	Relay	R955KN28510N	R955KN28510X
KN28514	RG-2 Relay Valve (2 Port Delivery)		R955KN28514X
KN28520	Relay	R955KN28520N	R955KN28520X
KN28531	RG-2 Relay Valve (2 Port Delivery)		R955KN28531X
KN28550	Relay	R955KN28550N	R955KN28550X
KN28600	Spring Brake/Relay	R955KN28600N	R955KN28600X
KN28601	FF2 Full Function (Spring Brake / Relay Valve)		R955KN28601X
KN28602	FF2 Full Function (Spring Brake / Relay Valve)		R955KN28602X
KN30010	Emergency Relay Valve	R955KN30010N	R955KN30010X
KN30100	Emergency Relay Valve		R955KN30100X
KN30200	(EE) Emergency Relay Valve		R955KN30200X
KN30300	(EE) Emergency Relay Valve		R955KN30300X
KN30400	Relay	R955KN30400N	R955KN30400X
KN31000	Pressure Protection Valve		R955KN31000X
KN31010	Pressure Protection Valve		R955KN31010X
KN31040	Pressure Regulating Valve (Auxiliary)		R955KN31040X
KN31080	Pressure Regulating Valve (High Pressure)		R955KN31080X
KN32000	Quick Release Valve		R955KN32000X
KN32010	Quick Release Valve		R955KN32010X
KN32020	Quick Release Valve		R955KN32020X
KN32040	Quick Release/Double Check		R955KN32040X
KN32041	Quick Release And Double Check Valve		R955KN32041X

<b>TRUCK/TRACTOR AIR VALVES QUICK REFERENCE</b>			
<b>OE Number</b>	<b>Description</b>	<b>Meritor New</b>	<b>Meritor Remanufactured</b>
KN34030	Tractor Protection Valve (Two-Line Non-Automatic Style)		R955KN34030X
KN34050	Tractor Protection Valve (Three Line Automatic Without Quick Release)		R955KN34050X
KN34060	Tractor Protection		R955KN34060X
KN34070	Tractor Protection Valve (Three Line Automatic Without Quick Release)	R955KN34070N	R955KN34070X
KN34080	Tractor Protection Valve (Manifold Non-Automatic Style)		R955KN34080X
KN34090	Tractor Protection Valve (Manifold Non-Automatic Style)		R955KN34090X
KN34100	Tractor Protection Valve (Manifold Non-Automatic Style)		R955KN34100X
KN34110	Tractor Protection Valve (Manifold Non-Automatic Style)		R955KN34110X
KN34130	Tractor Protection Valve (Manifold Non-Automatic Style)		R955KN34130X
KN68230	Solenoid Air Valve–Normally Closed	R955KN68230N	R955KN68230X
KN68237	Solenoid Air Valve–Normally Closed	R955KN68237N	

**NOTES:** \_\_\_\_\_

\_\_\_\_\_

\_\_\_\_\_

**4**

\_\_\_\_\_

\_\_\_\_\_

\_\_\_\_\_

\_\_\_\_\_

\_\_\_\_\_

\_\_\_\_\_

\_\_\_\_\_

\_\_\_\_\_

\_\_\_\_\_

\_\_\_\_\_

\_\_\_\_\_

\_\_\_\_\_

\_\_\_\_\_

\_\_\_\_\_

**BENDIX  
SC-1 SINGLE CHECK VALVE**



Meritor NO.	NEW/REMAN	REPLACES	PORT SPECIFICATIONS		APPLICATION & GENERAL INFORMATION
			FEMALE	MALE	
R955227870N	New	Bendix 227870	3/8"	3/8"	
R955227871N		Bendix 227871	1/2"	1/2"	

**BENDIX  
DS-1 DOUBLE CHECK VALVE  
AND STOP LIGHT SWITCH**



Meritor NO.	NEW/REMAN	REPLACES	PORT SPECIFICATIONS		CORE NO.	CORE GROUP	APPLICATION & GENERAL INFORMATION
			FEMALE	MALE			
R955229493X	Reman	Bendix 229493X	(3) 1/4"		XC1069	BN397	DS-1 Check Valve—Performs the function of both a stop light switch and a double check valve. It accepts a signal from two sources and delivers it to a common outlet. It is used in pre FMVSS-121 single circuit systems. Normally used with a trailer control and foot valve where delivery pressure from either source activates the stop lamps and controls the brakes. All have 3/8" Terminal Thread.
R955228520X		Bendix 228520X	1/4" (1) 3/8" (1)	1/2" (1)			
R955228050X		Bendix 228050X	1/4" (2)				
R955228165X		Bendix 228165X		3/8" (1)			

4

**TRUCK/TRACTOR AIR VALVES  
CHECK VALVES**

**BENDIX  
DC-4 DOUBLE CHECK VALVE**



4

Meritor NO.	NEW/REMAN	REPLACES	PORT SIZE	CORE NO.	CORE GROUP	APPLICATION AND GENERAL INFORMATION
R955278596X	Reman	Bendix 278596X	(2) 3/8" 1/4" 1/2"	XC1089	BN395	DC-4 Double Check Valve—Accepts a signal from two sources and delivers it to a common outlet, Normally used with a trailer control and foot valve where delivery pressure from either source, but not both controls the brakes.
R955278598N	New	Bendix 278598	(3) 3/8" 1/4"			
R955278614N		Bendix 278614	(3) 3/8"			
R955278615N		Bendix 278615	(3) 1/4"			
R955278615X	Reman	Bendix 278615X		XC1090	BN395	
R955280809N	New	Bendix 280809	(4) 3/8"			

**MIDLAND  
SINGLE CHECK VALVE**



Meritor NO.	NEW/REMAN	REPLACES	PORT SIZE	LENGTH	APPLICATION & GENERAL INFORMATION
R955KN23000N	New	Haldex KN23000	1/2"	2-15/32"	Heavy Duty Version
R955KN23010N		Haldex KN23010	3/8"		
R955KN23040N		Haldex KN23040	3/4"	2-5/16"	Standard Version



**BENDIX  
PP-1 CONTROL VALVE**

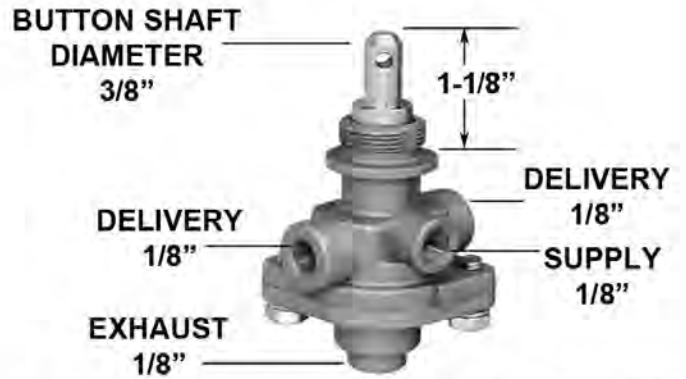

Push Pull Valve - Manually operable - Pressure sensitive, on/off valves which will automatically return to the button out (exhaust) position when supply pressure is below the required minimum.

Meritor NO.	NEW/REMAN	REPLACES	AUTO RELEASE PRESSURE	DELIVERY PORT	CORE NO.	CORE GROUP	APPLICATION & GENERAL INFORMATION
R955276566N	New	Bendix 276566	20 psi	1/8"	XC1081	BN135	Button and mounting nut not included.
R955276566X	Reman	Bendix 276566X		30 psi			
R955287417X		Bendix 287417X					
R955276567N	New	Bendix 276567	40 psi	1/8"	XC1081	BN135	
R955276567X	Reman	Bendix 276567X					
R955281587X See Note 58		Bendix 281587X					
R955287600N	New	Bendix 287600					
R955287637X	Reman	Bendix 287637X					

Notes: 58 Remote mount - 1/4" Female thread in shaft.

**BENDIX  
PP-2 CONTROL VALVE**



Push Pull Valve - Manually operable - Pressure sensitive, on/off valves which will automatically return to the button out (exhaust) position when supply pressure is below the required minimum. The PP-2 has an anti-compounding port which prevents simultaneous application of both the service and parking brakes.

Meritor NO.	NEW/REMAN	REPLACES	AUTO RELEASE PRESSURE	DELIVERY	SUPPLY	CORE NO.	CORE GRP	APPLICATION & GENERAL INFORMATION
R955276462X	Reman	Bendix 276462X	40 psi	1/8" (2)	1/4"	XC1080	BN136	Button and nut not included. Replaces 276538.
R955280454X		Bendix 280454X			1/8"			Button and nut not included. Remote mount.

# TRUCK/TRACTOR AIR VALVES AIR BRAKE CONTROL VALVES

## BENDIX PP-3 CONTROL VALVE

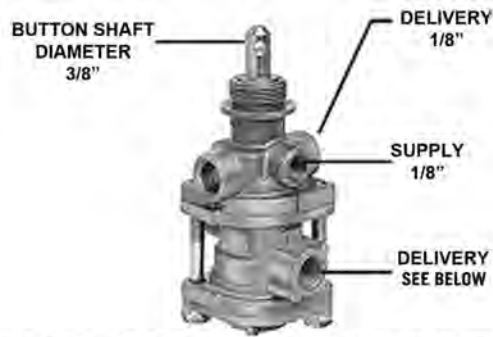

Push Pull Valve - Manually operable - Pressure sensitive, on/off valves which will automatically return to the button out (exhaust) position when supply pressure is below the required minimum. The PP-3 has a tripper that exhausts at 30psi and charges above 50psi. The plunger trips at 40psi and charges manually. The tripper prevents manual override of the emergency application of parking brakes.

4

Meritor NO.	NEW/REMAN	REPLACES	SPECIFICATIONS	DELIVERY PORT	CORE NO.	CORE GROUP	APPLICATION & GENERAL INFORMATION
R955289512X	Reman	Bendix 289512X	Remote mount- 1/4" female thread in shaft.	1/8"	XC1095	BN137	Button and mounting nut not included.
R955279787X		Bendix 279787X	Remote mount-1/4" female thread in shaft	Not Threaded			
R955288746N	New	Bendix 288746		1/4"	XC1095	BN137	
R955288746X	Reman	Bendix 288746X					
R955289477X		Bendix 289477X		1/8"			

## BENDIX PP-5 CONTROL VALVE

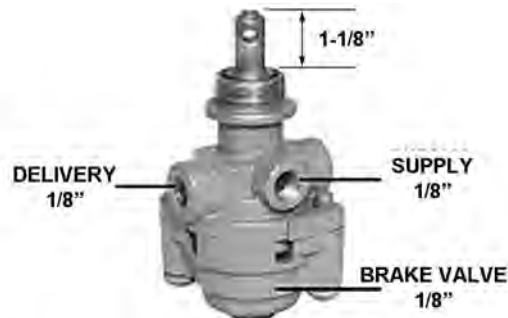

Push-Pull Valve - Manually operable - Pressure sensitive, on/off valves which will automatically return to the button out (exhaust) position when supply pressure is below the required minimum. Use PP-5 in conjunction with vehicle torque converter systems, engine speed control systems, and some parking systems. In addition to manual control, it employs a pilot air release feature which will allow the valve to be exhausted by applying a low pressure signal from another control valve to the control port.

Meritor NO.	NEW/REMAN	REPLACES	AUTO RELEASE PRESSURE	DELIVERY PORT	CORE NO.	CORE GROUP	APPLICATION & GENERAL INFORMATION
R955281946X	Reman	Bendix 281946X	40 psi	(2) 1/8"	XC1103	BN140	Buttons and mounting hardware are not included.
R955284744X		Bendix 284744X	Manual				

**BENDIX  
PP-7 CONTROL VALVE**

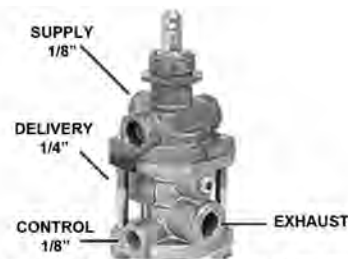

Push Pull Valve - Manually operable - Pressure sensitive, on/off valves which will automatically return to the button out (exhaust) position when supply pressure is below the required minimum. The PP-7 features an air operated control in the lower body that provides an application of the trailer brakes when the emergency tractor brake system is applied. Works in conjunction with the tractor protection system.

Meritor NO.	NEW/REMAN	REPLACES	AUTO RELEASE PRESSURE	EXHAUST	STEM DIAMETER	CORE NO.	CORE GROUP	APPLICATION & GENERAL INFORMATION
R955288241N	New	Bendix 288241	40 psi	1/4"	5/16"			Button and mounting nut not included.
R955288241X	Reman	Bendix 288241X				XC1124	BN144	
R955288239N	New	Bendix 288239			3/8"			
R955288239X	Reman	Bendix 288239X				1/2"	XC1124	
R955288240X		Bendix 288240X						
R955288242X		Bendix 288242X						

**4**

**BENDIX  
PP-8 CONTROL VALVE**

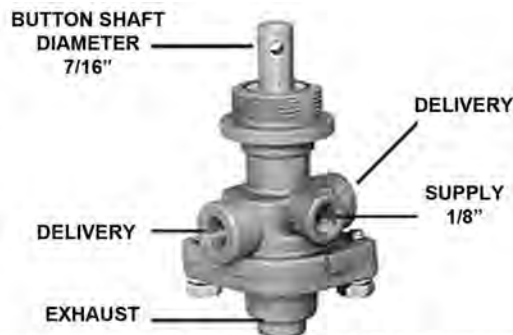

Push Pull Valve - Manually operable - Pressure sensitive, on/off valves which will automatically return to the button out (exhaust) position when supply pressure is below the required minimum. The PP-8 is manually operated. It will remain in the position it is placed in regardless of delivery or supply pressure. It is used to control tractor parking brakes on Post FMVSS-121 system.

Meritor NO.	NEW/REMAN	REPLACES	DELIVERY	EXHAUST	CORE NO.	CORE GROUP	APPLICATION & GENERAL INFORMATION
R955287238N	New	Bendix 287238	1/4" (2)	1/8"	XC1122	BN144	Remote Mount
R955287238X	Reman	Bendix 287238X					
R955287240X		Bendix 287240X					
R955287418X		Bendix 287418X	1/8" (2)	1/8"			

# TRUCK/TRACTOR AIR VALVES AIR BRAKE CONTROL VALVES

## MIDLAND CONTROL VALVE - PUSH / PULL HOSTLER



Push Pull Valve - Manually operable - Pressure sensitive, on/off valves which will automatically return to the button out (exhaust) position when supply pressure is below the required minimum.

4

Meritor NO.	NEW/REMAN	REPLACES	POP PRESSURE	DELIVERY PORT	CORE GROUP	CORE NO.	APPLICATION & GENERAL INFORMATION
R955KN20010X	Reman	Haldex KN20010X	25-40 psi	(1) 1/4"	MD126	XC1146	Buttons and mounting hardware are not included.
R955KN20020X See Note 53		Haldex KN20020X			MD127	XC1215	
R955KN20060X		Haldex KN20060X	Manual	(1) 1/8"	MD128	XC1150	

Notes: 53 (2) 1/4" PT Auxiliary Ports.

## BENDIX TW-1 CONTROL VALVE



Lever Type Valve - Manually operated valve. Usually dash mounted with either 2 or 3 lever positions. Also available in cable control configuration. This valve is used primarily to control parking and emergency brakes.

Meritor NO.	NEW/REMAN	REPLACES	STYLE	CORE NO.	CORE GROUP	APPLICATION & GENERAL INFORMATION
R955229635N	New	Bendix 229635	Lever Operated		BN169	Buttons and mounting hardware are not included.
R955229635X	Reman	Bendix 229635X		XC1075		
R955229608X		Bendix 229608X	Cable Operated	XC1074		

**BENDIX  
TW-2 AND TH-3  
CONTROL VALVES**



Lever Type Valves - Manually operated valves. Usually dash mounted with either 2 or 3 lever positions. They are also available in cable control configuration. These valves are used primarily to control parking and emergency brakes. The TW-2 and TH-3 are similar to the TW-1 except that two valves are housed in the same body. The TW-2 has 2 lever positions and the TH-3 has 3 lever positions. The lever controls both valves.

Meritor NO.	NEW/REMAN	REPLACES	TYPE	CORE NO.	CORE GROUP	APPLICATION & GENERAL INFORMATION
R955280904X	Reman	Bendix 280904X	TH-3	XC1100	BN167	Buttons and mounting hardware are not included.
R955280905X		Bendix 280905X	TW-2	XC1099	BN171	

**4**

**BENDIX  
TW-3 CONTROL VALVE**



Lever Type Valves - Manually operated valves. Usually dash mounted with either 2 or 3 lever positions. They are also available in cable control configuration. These valves are used primarily to control parking and emergency brakes. The TW-3 is a 2 position lever operated valve commonly used in conjunction with parking and emergency brake systems. It has a slightly greater capacity than the TW-1.

Meritor NO.	NEW/REMAN	REPLACES	STYLE	CORE NO.	CORE GROUP	APPLICATION & GENERAL INFORMATION
R955225892X	Reman	Bendix 225892X	Air Only	XC1106	BN173	Buttons and mounting hardware are not included.
R955283040X		Bendix 283040X				
R955283935X		Bendix 283935X				

**MIDLAND  
CONTROL VALVE - LEVER TYPE**



Lever Type Valve - Manually operated valve. Usually dash mounted with either 2 or 3 lever positions. Also available in cable control configuration. This valve is used primarily to control parking and emergency brakes.

Meritor NO.	NEW/REMAN	REPLACES	CORE NO.	CORE GROUP	APPLICATION & GENERAL INFORMATION
R955KN20000X	Reman	Haldex KN20000X	XC1146	MD126	Buttons and mounting hardware are not included.

**TRUCK/TRACTOR AIR VALVES  
AIR BRAKE CONTROL VALVES**

**MIDLAND  
CONTROL VALVE  
CAMSTYLE / LEVER TYPE**



Lever Type Valves - Manually operated valves. Usually dash mounted with either 2 or 3 lever positions. They are also available in cable control configuration. These valves are used primarily to control parking and emergency brakes.

4

Meritor NO.	NEW/REMAN	REPLACES	CORE NO.	CORE GROUP	APPLICATION & GENERAL INFORMATION
R955KN20040X	Reman	Haldex KN20040X	XC1148	MD130	Handle as shown in release position. Buttons and mounting hardware are not included.
R955KN20050X		Haldex KN20050X	XC1149		

**MIDLAND  
CONTROL VALVE  
LEVER TYPE "DOUBLE FLIPPER"**



Meritor NO.	NEW/REMAN	REPLACES	DELIVERY PORTS	SUPPLY PORTS	CORE NO.	CORE GROUP	APPLICATION & GENERAL INFORMATION
R955KN20080X	Reman	Haldex KN20080	1/8" (2)	1/4" (2)	XC1186	MD132	3 position with manual release
R955KN20090X		Haldex KN20090					3 position with automatic release
R955KN20110X		Haldex KN20110					2 position with manual release

**BENDIX  
TC-4 MODULATING  
CONTROL VALVE**



Lever Type Valve - Manually operated valve. Capable of delivering gradations of pressure between 5 psi and the maximum delivery pressure for the valve. They can be locked in the exhaust or brakes applied position. They are used to modulate parking and emergency brakes.

Meritor NO.	NEW/REMAN	REPLACES	CORE NO.	CORE GROUP	APPLICATION & GENERAL INFORMATION
R955282368X	Reman	Bendix 282368X	XC1104	BN159	Lock position left. Buttons and mounting hardware are not included.
R955282381X		Bendix 282381X	XC1105		Lock position right. Buttons and mounting hardware are not included.

**MIDLAND  
MODULATING CONTROL VALVE**



Lever Type Valve - Manually operated valve. Capable of delivering gradations of pressure between 5 psi and the maximum delivery pressure for the valve. They can be locked in the exhaust or brakes applied position. They are used to modulate parking and emergency brakes.

Meritor NO.	NEW/REMAN	REPLACES	CORE NO.	CORE GROUP	APPLICATION & GENERAL INFORMATION
R955KN20070X	Reman	Haldex KN20070X	XC1151	MD133	Lock position top left.

**4**

**MIDLAND  
TRAILER BRAKE CONTROL -  
IN COLUMN MOUNT**



Meritor NO.	NEW/REMAN	REPLACES	CONTROL	DELIVERY	SUPPLY	CORE NO.	CORE GROUP	APPLICATION & GENERAL INFORMATION
R955KN20541X	Reman	Haldex KN20541	1/4"	1/4"	1/4"	XC1220	MD399	Holding Type
R955KN20542X		Haldex KN20542						Self-Releasing Type

**MIDLAND  
TRAILER BRAKE CONTROL - GM  
IN COLUMN MOUNT**

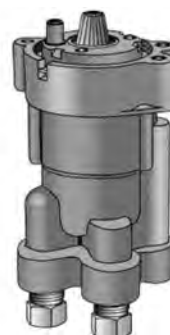

Meritor NO.	NEW/REMAN	REPLACES	CONTROL	DELIVERY	SUPPLY	CORE NO.	CORE GROUP	APPLICATION & GENERAL INFORMATION
R955KN20551X	Reman	Haldex KN20551	3/8"	3/8"	3/8"	XC1220	MD399	Holding Type
R955KN20552X		Haldex KN20552						Self-Releasing Type

# TRUCK/TRACTOR AIR VALVES AIR BRAKE CONTROL VALVES

## MIDLAND HAND CONTROL VALVE (Limited Delivery)



- Core No. XC1152
- Core Group MD134

Hand Control Valve - The most common function of hand control valves is for independent control of trailer service brakes. As a result they are also referred to as "Trailer Control Valves."

Meritor NO.	NEW/ REMAN	REPLACES	CONTROL	DELIVERY	SUPPLY	CORE NO.	CORE GROUP	APPLICATION & GENERAL INFORMATION
R955KN20561X	Reman	Haldex KN20561	1/4"	1/4"	1/4"	XC1220	MD399	Holding Type
R955KN20562X		Haldex KN20562						Self-Return Type

4

## BENDIX MV-2 CONTROL MODULE



MV-2 Module



Spool Assy A



Spool Assy B

Control Module - Integrated control assembly normally mounted in the control panel of a truck tractor. It provides all the federal legal requirements for trailer air supply and parking brake control. It also permits the tractor parking brakes to be applied while air supplied to the trailer. The MV-2 consists of two push pull valves and a dual circuit supply valve. The valve is serviced by replacing the complete spool inserts shown above. The complete valve and the two spool assemblies are available.

Meritor NO.	NEW/ REMAN	REPLACES	STYLE	CORE NO.	CORE GROUP	APPLICATION & GENERAL INFORMATION
R955101437N	New	Bendix 101437			BN130	Buttons and mounting hardware are not included.
R955101437X	Reman	Bendix 101437X				
R955101569X		Bendix 101569X	Spool Assembly A	XC1029		
R955101570X		Bendix 101570X	Spool Assembly B	XC1030		
R955101890X	New	Bendix 101890X	MV-2 Module	XC1053	BN132	
R955101890N		Bendix 101890				



**BENDIX  
MV-3 CONTROL MODULE**



Control Module - an integrated control assembly designed for control panel mounting in a truck tractor. This non-metallic assembly consists of two push-pull valves and a dual circuit supply valve. It provides all the federal legal requirements for trailer air supply and parking brake control plus an additional feature permitting the tractor parking brakes to be applied while air is supplied to the trailer. The MV-3 is designed to supersede the MV-2 valve.

Meritor NO.	NEW/REMAN	REPLACES	STYLE	CORE NO.	CORE GROUP	APPLICATION & GENERAL INFORMATION
R955065156X	Reman	Bendix 065156X	MV-3 Module	XC1053	BN132	Mounting hole with M16 x 6 nut attached. Buttons and mounting hardware are not included.
R955065157X		Bendix 065157X				Mounting hole 1/4". No nut. Buttons and mounting hardware are not included.
R955065160X		Bendix 065160X				
R955065186X		Bendix 065186X				
R955800516N	New	Bendix 800516				
R955800517N		Bendix 800517				
R955800518N		Bendix 800518				
R955800519N		Bendix 800519				
R955800521N		Bendix 800521				
R955800573N		Bendix 800573				

**4**

# TRUCK/TRACTOR AIR VALVES AIR BRAKE CONTROL VALVES

## MIDLAND MANIFOLD DASH VALVE



Buttons and mounting hardware not included.

4

Meritor NO.	NEW/ REMAN	REPLACES	DELIVERY PORTS	EXHAUST PORT	RESERVOIR PORTS	SUPPLY PORT	CORE NO.	CORE GROUP
R955KN20601X	Reman	Haldex KN20601	1/4" (2)	1/4"	1/4" (2)	1/4"	XC1216	MD131
R955KN20602X		Haldex KN20602						
R955KN20603X		Haldex KN20603						
R955KN20605X		Haldex KN20605						
R955KN20606N	New	Haldex KN20606	3/8" (2)	1/4"	3/8" (2)	1/4"	XC1216	MD131
R955KN20606X	Reman	Haldex KN20608						
R955KN20608X		Haldex KN20611						
R955KN20611X	New	Haldex KN20612	1/4" (2)	1/4"	1/4" (2)	1/4"	XC1156	MD138
R955KN20612X		Haldex KN20615						
R955KN20615N	New	Haldex KN20615X	3/8" (2)	3/8"	3/8" (2)	3/8"	XC1216	MD131
R955KN20615X		Haldex KN20616						
R955KN20616X	Reman	Haldex KN20619	3/8" (2)	3/8"	3/8" (2)	3/8"	XC1216	MD131
R955KN20619X		Haldex KN20620						
R955KN20620X		Haldex KN20621						
R955KN20621X		Haldex KN20622						
R955KN20622X		Haldex KN20623						
R955KN20623X		Haldex KN20626						
R955KN20626X		Haldex KN20627						
R955KN20627X		Haldex KN20628						
R955KN20628X		Haldex KN20629						
R955KN20629X								

**BENDIX  
AUTOMATIC DRAIN VALVE**



Automatic Drain Valve - Installed directly into the bottom part of the reservoir. It operates automatically from ascending and descending reservoir pressures.

Meritor NO.	NEW/REMAN	REPLACES	CORE NO.	CORE GROUP	APPLICATION AND GENERAL INFORMATION
R955281923X	Reman	Bendix 281923X	XC1102	BN401	Without heater
R955281923N	New	Bendix 281923			

**4**

**MANUAL  
DRAIN VALVE**



Meritor NO.	NEW/REMAN	REPLACES	SPECIFICATIONS		APPLICATION AND GENERAL INFORMATION
			PROFILE DESIGN	CABLE LENGTH	
R95512105N	New	Haldex 12105	High	60"	Manual Drain Valve without heater.
R95512103N		Haldex 12103		36"	

# TRUCK/TRACTOR AIR VALVES AIR BRAKE FOOT VALVES

## BENDIX E-2 • E-3 FOOT VALVE (Single Circuit)



Single Circuit Foot Valve - Normally used on pre FMVSS-121 vehicles. It is foot operated and controls the delivery of air to the brake chambers. Simply stated it provides the driver with a means of applying and releasing the brakes on a vehicle. The E-2 and E-3 foot valves are foot mounted and can be either treadle or lever actuated. The valves are identical except that the E-3 has a slightly longer plunger travel that provides a softer "feel" than the E-2.

4

Meritor NO.	NEW/REMAN	REPLACES	DELIVERY PORTS	VALVE	CORE NO.	CORE GROUP	APPLICATION AND GENERAL INFORMATION
R955229500X	Reman	Bendix 229500X	(4) 3/8"	E-2	XC1087	BN202	Furnished less treadle and mounting brackets.
R955229501X		Bendix 229501X	(4) 1/2"				
R955277863N	New	Bendix 277863	(2) 1/2"	E-3	XC1087	BN202	
R955277863X	Reman	Bendix 277863X					
R955278998X <small>See Note 53</small>			Bendix 278998X	(4) 1/2"			

Notes: 53 (2) 1/4" PT Auxiliary Ports.

## BENDIX E-5 FOOT VALVE (Single Circuit)



Single Circuit Foot Valve - Normally used on pre FMVSS-121 vehicles. It is foot operated and controls the delivery of air to the brake chambers. Simply stated it provides the driver with a means of applying and releasing the brakes on a vehicle. The E-5 foot valve is floor mounted and can be treadle or lever actuated. Used on pre-FMVSS-121 single circuit air brake system.

Meritor NO.	NEW/REMAN	REPLACES	DELIVERY PORTS	CORE NO.	CORE GROUP	APPLICATION AND GENERAL INFORMATION
R955279950N	New	Bendix 279950	(2) 1/4" (1) 1/2" (1) 3/8"			Furnished less treadle and mounting brackets.
R955279950X	Reman	Bendix 279950X	(2) 1/4" (1) 1/2" (1) 3/8"	XC1097	BN205	The E-5 is firewall mounted and has a suspended pedal. It is mounted in the cab of the truck.

**MIDLAND  
FOOT VALVE  
(Single Circuit)**

DELIVERY (4)  
1/2"



Single Circuit Foot Valve - Normally used on pre FMVSS-121 vehicles. It is foot operated and controls the delivery of air to the brake chambers. Simply stated it provides the driver with a means of applying and releasing the brakes on a vehicle.

Meritor NO.	NEW/ REMAN	REPLACES	DELIVERY PORTS	CORE NO.	CORE GROUP	APPLICATION AND GENERAL INFORMATION
R955KN22100X	Reman	Haldex KN22100X	(4) 1/2"	XC1157	MD201	Furnished less treadle and mounting brackets.

## TRUCK/TRACTOR AIR VALVES AIR BRAKE FOOT VALVES

### BENDIX E-7 DUAL FOOT VALVE (Dual Circuit)



Dual Circuit Foot Valve - A dual foot valve has two separate circuits for service and secondary braking, and is used in dual circuit air brake systems mandated by FMVSS-121. Braking ability is maintained in the event that one circuit fails. The E-7 is a firewall mounted, suspended pedal foot valve. It is a dual circuit valve with two separate supply and delivery circuits. Threaded supply and delivery ports for both circuits are located on the back of the valve.

Furnished less treadle and mounting brackets.

4

Meritor NO.	NEW/ REMAN	REPLACES	SUPPLY	DELIVERY	EXHAUST	SUPPLY PORTS MOUNT SIDE	DELIVERY PORTS MOUNT SIDE	CORE NO.	CORE GRP
R955101818X	Reman	Bendix 101818X	1/4" (4)	3/8" (4)	Diaphragm	1/2" (2) 1/8" (1)	1/2" (2)	XC1032	BN207
R955101818N	New	Bendix 101818							
R955284760N		Reman	Bendix 284760	1/4" (1) O-Ring Sealed Flange Ports (4)	1/4" (1) O-Ring Sealed Flange Ports (4)	Diaphragm			
R955284760X	Bendix 284760X								
R955286773X	Reman	Bendix 286773X	1/4" (4)	1/4" (4)	1/2"	1/2" (2) 1/8" (1)	1/2" (2)	XC1118	BN207
R955286775X		Bendix 286775X							
R955287411N	New	Bendix 287411	1/4" (2) 3/8" (2)	1/4" (2) 3/8" (2)	1/2"				
R955287411X	Reman	Bendix 287411X							
R955287564X			Bendix 287564X						
R955288383N	New	Bendix 288383	1/4" (4)	1/4" (4)	Diaphragm	1/2" (2) 1/8" (1)	1/2" (2)	XC1118	BN207
R955288383X	Reman	Bendix 288383X							

**BENDIX  
E-10 DUAL FOOT VALVE  
(Dual Circuit)**



Dual Circuit Foot Valve - A dual foot valve has two separate circuits for service and secondary braking, and is used in dual circuit air brake systems mandated by FMVSS-121. Braking ability is maintained in the event that one circuit fails.

- All supply and delivery ports are 3/8" PT. Two supply ports are serviced from the number 1 reservoir and 2 are serviced by the number 2 reservoir. Two delivery ports actuate the primary circuit and 2 actuate the secondary circuit. The E-10 is a floor mounted treadle operated valve with two separate supply and delivery circuits.

Meritor NO.	NEW/REMAN	REPLACES	DELIVERY PORTS	CORE NO.	CORE GROUP	APPLICATION AND GENERAL INFORMATION
R955101100X	Reman	Bendix 101100X	(4) 3/8"	XC1025	BN210	Furnished less treadle and mounting brackets.

**BENDIX  
E-6 FOOT VALVE**



Meritor NO.	NEW/REMAN	REPLACES	DELIVERY PORTS	SUPPLY PORTS	CORE NO.	CORE GROUP	APPLICATION AND GENERAL INFORMATION
R955286171N	New	Bendix 286171	3/8" (4)	3/8" (4)	XC1111	BN206	Furnished less treadle and mounting brackets.
R955286171X	Reman	Bendix 286171X					

**BENDIX  
E-12 DUAL FOOT VALVE  
(Dual Circuit)**



Dual Circuit Foot Valves - A dual foot valve has two separate circuits for service and secondary braking, and is used in dual circuit air brake systems mandated by FMVSS-121. Braking ability is maintained in the event that one circuit fails. The Bendix E-12 dual circuit foot valve is a floor mounted treadle operated valve with two separate supply and delivery circuits.

Meritor NO.	NEW/REMAN	REPLACES	DELIVERY PORTS	CORE NO.	CORE GROUP	APPLICATION AND GENERAL INFORMATION
R955065313X	Reman	Bendix 065313X	3/8"-18	XC1038	BN212	Furnished less treadle and mounting brackets.

**TRUCK/TRACTOR AIR VALVES  
AIR BRAKE FOOT VALVES**

**BENDIX  
E-12 / E-15 DUAL FOOT VALVE**



Meritor NO.	NEW/REMAN	REPLACES	DELIVERY PORTS	CORE NO.	CORE GROUP	APPLICATION AND GENERAL INFORMATION
R955065315X	Reman	Bendix 065313X	3/8"-18	XC1038	BN212	Furnished less treadle and mounting brackets.

4

**BENDIX  
E-8P FOOT VALVE**



Meritor NO.	NEW/REMAN	REPLACES	DELIVERY PORTS	CORE NO.	CORE GROUP	APPLICATION AND GENERAL INFORMATION
R955800629N	New	Bendix 800629	3/8"-18	XC1038	BN212	Furnished less treadle and mounting brackets.

**MIDLAND  
DUAL FOOT VALVE  
(Dual Circuit)**



Dual Circuit Foot Valves - A dual foot valve has two separate circuits for service and secondary braking, and is used in dual circuit air brake systems mandated by FMVSS-121. Braking ability is maintained in the event that one circuit fails.

- All supply and delivery ports are 3/8" PT. Two supply ports are serviced from the number 1 reservoir and two are serviced by the number 2 reservoir. Two delivery ports actuate the primary circuit and two actuate the secondary circuit. The Midland dual circuit foot valve is a floor mounted treadle operated valve with two separate supply and delivery circuits.

Meritor NO.	NEW/REMAN	REPLACES	DELIVERY PORTS	CORE NO.	CORE GROUP	APPLICATION AND GENERAL INFORMATION
R955KN22140X	Reman	Haldex KN22140X	(4) 3/8"	XC1158	MD202	Furnished less treadle and mounting brackets.
R955KN22150X		Haldex KN22150X		XC1159		



**BENDIX  
E-14 DUAL FOOT VALVE  
(Dual Circuit)**



- Core No. XC1039
- Core Group BN214

Dual Circuit Foot Valves - A dual foot valve has two separate circuits for service and secondary braking, and is used in dual circuit air brake systems mandated by FMVSS-121. Braking ability is maintained in the event that one circuit fails. The E-14 is a firewall mounted, suspended pedal foot valve. It is a dual circuit valve with two separate supply and delivery circuits.

Meritor NO.	NEW/REMAN	REPLACES	DELIVERY PORTS	SUPPLY	CORE NO.	CORE GROUP	APPLICATION AND GENERAL INFORMATION
<b>R955065395X</b>	Reman	Bendix 065395X	3/8"-18	3/8"-18	XC1039	BN214	Used with o-ring style manifold. Furnished less treadle and mounting brackets.

**4**

**BENDIX  
HAND CONTROL VALVE**



Hand Control Valve - The most common function of hand control valves is for independent control of trailer service brakes. As a result they are also referred to as "Trailer Control Valves".

Meritor NO.	NEW/REMAN	REPLACES	DELIVERY PORTS	CORE NO.	CORE GROUP	APPLICATION AND GENERAL INFORMATION
<b>R955276270X</b>	Reman	Bendix 276270X	1/4"	XC1078	BN157	Furnished less handle and clamp.
<b>R955276272X</b>		Bendix 276272X		XC1079	BN158	
<b>R955281797X</b>		Bendix 281797X				

## TRUCK/TRACTOR AIR VALVES AIR BRAKE HAND CONTROL VALVES

### MIDLAND HAND CONTROL VALVE (Limited Delivery)



Hand Control Valve - The most common function of hand control valves is for independent control of trailer service brakes. As a result they are also referred to as "Trailer Control Valves".

4

Meritor NO.	NEW/REMAN	REPLACES	DELIVERY PORTS	CORE NO.	CORE GROUP	APPLICATION AND GENERAL INFORMATION
R955KN20071X	Reman	Haldex KN20071X	Maximum Delivery 50 psi	XC1151	MD133	Furnished less handle and clamp.
R955KN20580X		Haldex KN20580X	Maximum Delivery 80 psi	XC1154	MD135	
R955KN20581X		Haldex KN20581X	Current System Pressure			
R955KN20590X		Haldex KN20590X	Maximum Delivery 50 psi			

### BENDIX TR-2 INVERSION VALVE



Meritor NO.	NEW/REMAN	REPLACES	CORE NO.	CORE GROUP	APPLICATION AND GENERAL INFORMATION
R955277340X	Reman	Bendix 277340X	XC1085	BN358	Inversion Valves—An inverting, on/off, two way valve. Normally the valve is open, and it is closed by air pressure from another source. Used in parking brake and sequencing applications. With 125 psi air pressure the valve must begin to exhaust a 65 psi nominal ascending control pressure. It must deliver full supply pressure with 40 psi nominal descending control pressure.



**BENDIX  
TR-3 INVERSION VALVE**





Meritor NO.	NEW/REMAN	REPLACES	SPECIFICATIONS		CORE NO.	CORE GROUP	APPLICATION & GENERAL INFORMATION
			A	B			
R955101450X	Reman	Bendix 101450X	25 psi	40 psi	XC1098	BN359	Inversion Valves—An inverting, on/off, two way valve. Normally the valve is open, and it is closed by air pressure from another source. Used in parking brake and sequencing applications. With common control and supply pressure inlet opens at "A" psi descending pressure and the exhaust opens at "B" psi ascending pressure.
R955280758X		Bendix 280758X	45 psi	60 psi			
R955281318X		Bendix 281318X	35 psi	70 psi			
R955288586X		Bendix 288586X	75 psi	90 psi			

4

**AIR VALVES**

	Meritor NO.	TYPE	REPLACES	PORT SIZES	APPLICATION & GENERAL INFORMATION
	R304325	Electric Valve	Neway 900 54 074	1/4" NPT	Normally closed
	R304331	Electric Valve	Neway 900 54 075		Normally open
	R304329	Hand Valve	Neway 900 54 082		Handle not included.
	R304328	Pilot Valve	Neway 900 54 079	1/4" Side, 1/8" Top	Air Operated

## TRUCK/TRACTOR AIR VALVES LEVELING VALVES

AIR VALVES				
	Meritor NO.	TYPE	REPLACES	APPLICATION & GENERAL INFORMATION
	R304326	Manual Valve	Neway 900 54 088	
	R304324	Pressure Protection Valve	Neway 900 54 466 (Filter SRK-143)	Includes internal filter

4

AIR VALVES						
AIR VALVES	Meritor NO.	TYPE	REPLACES	DUMP VALVE	FITTINGS	APPLICATION & GENERAL INFORMATION
	R304323	Neway Controlled Response Height Control Valve	Neway 900 54 007	No	1/4"	Use R307852 Leveling Valve Link Assembly. Air Supply Connection 1/8" P.T.

AIR VALVES				
	Meritor NO.	TYPE	REPLACES	APPLICATION & GENERAL INFORMATION
	R3013922	Precision Response Height Control Valve	Neway 905 55 105	

LINKAGE ASSEMBLIES			
	Meritor NO.	REPLACES	APPLICATION & GENERAL INFORMATION
	R307852	Haldex 48100-225	13-3/4" long (center-to-center) with ends installed. Use for applications requiring vertical mounting only.

**MIDLAND  
PR-2 PRESSURE PROTECTION VALVE**



Meritor NO.	NEW/ REMAN	REPLACES	CRACK PRESSURE	CORE NO.	CORE GROUP	APPLICATION AND GENERAL INFORMATION
R955277147N	New	Bendix 277147	65 psi			Pressure Protection Valves—Protects the brake system from accessory failure. Used to isolate and protect one reservoir supply from another by closing at its pressure setting. Also used in rapid buildup systems where it delays the filling of auxiliary reservoirs until a preset pressure is reached in the primary reservoir. Pressure Setting on the PR-2 is adjustable.
R955277148X	Reman	Bendix 277148X	85 psi	XC1084	BN351	
R955277148N	New	Bendix 277148				
R955277226X	Reman	Bendix 277226X	60 psi	XC1084	BN351	
R955277227X		Bendix 277227X	75 psi			

**4**

**BENDIX  
PR-4 PRESSURE PROTECTION VALVE**

- Supply and delivery ports are 1/4" PT



Meritor NO.	NEW/ REMAN	REPLACES	CRACK PRESSURE	CORE NO.	CORE GROUP	APPLICATION AND GENERAL INFORMATION
R955286500N	New	Bendix 286500	85 psi			Pressure Protection Valves—Protects the brake system from accessory failure. Used to isolate and protect one reservoir supply from another by closing at its pressure setting. Also used in rapid buildup systems where it delays the filling of auxiliary reservoirs until a preset pressure is reached in the primary reservoir. Pressure Setting on the PR-2 is adjustable.
R955286500X	Reman	Bendix 286500X		XC1117	BN354	
R955288323X		Bendix 288323X	70 psi			

## TRUCK/TRACTOR AIR VALVES AIR BRAKE PROTECTION VALVES

### MIDLAND PRESSURE PROTECTION VALVE



4

Meritor NO.	NEW/ REMAN	REPLACES	CRACK PRESSURE		ACCESSORY PORT		CORE NO.	CORE GRP	APPLICATION AND GENERAL INFORMATION
			OPEN	CLOSE	B	C			
R955KN31000X	Reman	Haldex KN31000X	65 psi	45 psi	1/4"	1/8"	XC1176	MD391	Pressure Protection Valves—Protects the brake system from accessory failure. Used to isolate and protect one reservoir supply from another by closing at its pressure setting. Also used in rapid buildup systems where it delays the filling of auxiliary reservoirs until a preset pressure is reached in the primary reservoir. Pressure Setting on the PR-2 is adjustable.
R955KN31010X		Haldex KN31010X	102 psi	88 psi	None	None			

### BENDIX SV-1 SYNCHRONIZING VALVE



Synchronizing Valve - Used to control air from a remote supply that is different than control supply. It also can be used to delay or sequence the action of other air operated devices.

Meritor NO.	NEW/REMAN	REPLACES	A	B	CORE NO.	CORE GROUP	APPLICATION AND GENERAL INFORMATION
R955282472X	Reman	Bendix 282472	21 psi	11 psi	XC1091	BN412	With common control and supply pressure, inlet opens at "A" psi and the exhaust opens at "B" psi.
R955278825X	Reman	Bendix 278825X	42 psi	28 psi	XC1091	BN412	
R955278825N	New	Bendix 278825					

**BENDIX  
RV-1 PRESSURE  
REDUCING VALVE**



Pressure Reducing Valve - Used where a constant set air pressure lower than supply pressure is required. Typically an air operated application that requires less than system air pressure.

Meritor NO.	NEW/REMAN	REPLACES	NOMINAL DELIVERY PRESSURE	CORE NO.	CORE GROUP	APPLICATION AND GENERAL INFORMATION
R955101135X	Reman	Bendix 101135X	85 psi	XC1083	BN356	Pressure setting on the RV-1 is adjustable
R955277144X		Bendix 277144X	80 psi			
R955277214X		Bendix 277214X	75 psi			
R955278426X		Bendix 278426X	65 psi			

**4**

**MIDLAND  
PRESSURE REGULATING VALVE  
(HIGH PRESSURE)**



Meritor NO.	NEW/REMAN	REPLACES	NOMINAL DELIVERY PRESSURE	CORE GROUP	CORE NO.	APPLICATION AND GENERAL INFORMATION
R955KN31080X	Reman	Haldex KN31080X	60 psi	MD395	XC1180	Pressure setting on this valve is adjustable.

**MIDLAND  
PRESSURE REGULATING VALVE  
(AUXILIARY)**



Meritor NO.	NEW/REMAN	REPLACES	INLET	OUTLET	PRESSURE SETTING	CORE GROUP	CORE NO.	APPLICATION & GENERAL INFORMATION
R955KN31040X	Reman	Haldex KN31040	1/4"	1/4"	20 psi	MD120	XC1217	Constant Supply

## TRUCK/TRACTOR AIR VALVES AIR BRAKE QUICK RELEASE VALVES

### BENDIX QR-1 QUICK RELEASE VALVE



Meritor NO.	NEW/REMAN	REPLACES	SPECIFICATIONS			CORE NO.	CORE GROUP
			DELIVERY	SUPPLY	CRACK PRESSURE		
R955229813X	Reman	Bendix 229813X	3/8"	1/4"	1 psi	XC1076	BN267
R955229813N	New	Bendix 229813					
R955229844X	Reman	Bendix 229844X	1/2"	1/4"	1 psi	XC1076	BN267
R955229859N	New	Bendix 229859	3/8" (2)	3/8"		XC1076	BN267
R955229859X	Reman	Bendix 229859X		1/2"		XC1076	BN267
R955229860N	New	Bendix 229860					
R955229860X	Reman	Bendix 229860X	1/4"	1/4"		XC1076	BN267
R955281024X		Bendix 281024X	3/8"	3/8"			
R955288251X		Bendix 288251X					

### BENDIX QR-L QUICK RELEASE VALVE



Meritor NO.	NEW/REMAN	REPLACES	SPECIFICATIONS			CORE NO.	CORE GROUP
			DELIVERY	SUPPLY	CRACK PRESSURE		
R955800333N	New	Bendix 800333	3/8"	1/2"			

### MIDLAND QUICK RELEASE VALVE



Meritor NO.	NEW/REMAN	REPLACES	SPECIFICATIONS			CORE NO.	CORE GROUP
			DELIVERY	SUPPLY	CRACK PRESSURE		
R955KN32000X	Reman	Haldex KN32000X	3/8"	1/4"	Low Pressure Differential	XC1181	MD261
R955KN32010X		Haldex KN32010X	1/2"	3/8"			
R955KN32020X		Haldex KN32020X	3/8"	1/4"	High Pressure Differential		

4



**BENDIX  
QR-1C QUICK RELEASE VALVE  
(With Double Check Valve)**



Quick Release Valve with Double Check Valve - Incorporates both a quick release and a double check valve. Functions as a quick release for the emergency side of the spring brakes, while the double check valve prevents simultaneous application of the emergency side of the spring brake (Anti-Compounding).

Meritor NO.	NEW/REMAN	REPLACES	SPECIFICATIONS			CORE NO.	CORE GROUP
			DELIVERY	SUPPLY	CRACK PRESSURE		
R955289182X	Reman	Bendix 289182X	1/4"	1/4"	1 psi	XC1129	BN269
R955289714N	New	Bendix 289714	3/8"	1/2"	1 psi		
R955289714X	Reman	Bendix 289714X	3/8"	1/2"	1 psi	XC1129	BN269

**4**

**MIDLAND  
QUICK RELEASE AND  
DOUBLE CHECK VALVE**



Quick Release Valve with Double Check Valve - Incorporates both a quick release and a double check valve. Functions as a quick release for the emergency side of the spring brakes, while the double check valve prevents simultaneous application of the emergency side of the spring brake (Anti-Compounding).

Meritor NO.	NEW/REMAN	REPLACES	SPECIFICATIONS			CORE NO.	CORE GROUP
			DELIVERY	SUPPLY	CRACK PRESSURE		
R955KN32040X	Reman	Haldex KN32040X	1/4"	1/4"	1 psi	XC1183	MD265

**MIDLAND  
QUICK RELEASE AND  
DOUBLE CHECK VALVE**



Meritor NO.	NEW/REMAN	REPLACES	CONTROL PORT	DELIVERY PORTS	CORE NO.	CORE GROUP	APPLICATION AND GENERAL INFORMATION
R955KN32041X	Reman	Haldex KN32041X	1/4" (2)	3/8" (2)	XC1183	MD265	Prevents compounding on tractors and trucks via the spring brake control circuits.

**TRUCK/TRACTOR AIR VALVES  
AIR BRAKE QUICK RELEASE VALVES**

**BENDIX  
LQ-2 LIMITING QUICK RELEASE  
AND DOUBLE CHECK VALVE**



Limiting and Quick Release Valve - Mounted on the front axle this valve limits front axle brake application by 50% on slippery roads. It is controlled by a "flapper" switch on the dashboard. In the normal position (dry road) it will deliver full application pressure. It also serves as a quick release valve for the front axle. Primarily used on pre FMVSS-121 vehicles.

**4**

Meritor NO.	NEW/REMAN	REPLACES	SPECIFICATIONS		CORE NO.	CORE GROUP
			DELIVERY	SUPPLY		
R955229505X	Reman	Bendix 229505X	3/8"	3/8"	XC1073	BN261
R955229507X		Bendix 229507X	1/4"	1/2"		
R955229509X		Bendix 229509X		3/8"		

**BENDIX  
BP-1 AIR BRAKE  
PROPORTIONING VALVE**



Air Brake Proportioning Valve - Designed to improve stopping when operation is in a bobtail mode.  
**Important Note:** The front and rear applications of the BP-1 are not interchangeable.  
While the BP-1 looks identical to the LQ-5, they are not interchangeable.

Meritor NO.	NEW/REMAN	REPLACES	NOMINAL HOLDOFF PRESSURE	NOMINAL EQUALIZING PRESSURE	CORE NO.	CORE GROUP
R955106284X	Reman	Bendix 106284X	8 psi	105 psi	XC1052	BN391
R955104598X		Bendix 104598X	4 psi	50 psi	XC1051	

**4**

**BENDIX  
BP-R1 BOBTAIL BRAKE  
PROPORTIONING RELAY VALVE**



The BP-R1 combines the functions of a standard relay valve and a proportioning valve. It is designed for use on a tractor only. When operating in a "bobtail" mode the valve proportions air pressure to the lighter rear brakes.

Meritor NO.	NEW/REMAN	REPLACES	CRACK PRESSURE	CORE NO.	CORE GROUP
R955065145N	New	Bendix 065145	4 psi		
R955065145X	Reman	Bendix 065145X		XC1036	BN001
R955065146N	New	Bendix 065146	5.5 psi		
R955065146X	Reman	Bendix 065146X		XC1036	BN001

**BENDIX  
LQ-4 RATIO VALVE**

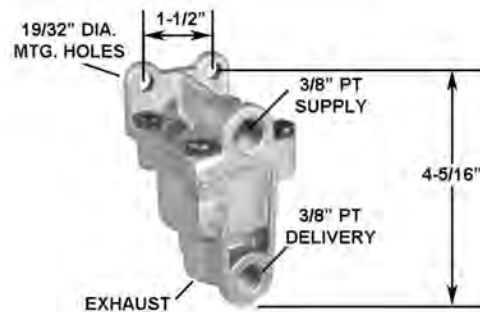

Ratio Valve - Automatically reduces application pressure to the front service brakes. As brake application pressure is increased the percentage of reduction is decreased until a preset pressure is reached. A preset "hold-off" pressure prevents the front brakes from operating until the "hold-off" pressure is reached. Used on post FMVSS-121 vehicles only.

Meritor NO.	NEW/REMAN	REPLACES	NOMINAL HOLDOFF PRESSURE	NOMINAL EQUALIZING PRESSURE	CORE NO.	CORE GROUP
R955289144N	New	Bendix 289144	4 psi	60 psi	XC1128	BN263
R955289148X	Reman	Bendix 289148X	10 psi	65 psi		
R955101311X		Bendix 101311X	20 psi	70 psi		

# TRUCK/TRACTOR AIR VALVES

## AIR BRAKE RATIO VALVES

### BENDIX LQ-5 BOBTAIL RATIO VALVE



Ratio Valve - Automatically reduces application pressure to the front service brakes. As brake application pressure is increased, the percentage of reduction is decreased until a preset is reached. A preset "hold-off" pressure prevents the front brakes from operating until the "hold-off" pressure is reached. Used on post FMVSS-121 vehicles only.

The LQ-5 replaces existing front axle limiting valves on tractor systems only. During bobtail mode the LQ-5 delivers full application pressure to the front axle.

**NOTE:** The LQ-5 will not replace the BP-1 valve which looks identical. The LQ-5 will not function in the BP-1 system.

Meritor NO.	NEW/REMAN	REPLACES	CONTROL	DELIVERY	SUPPLY	CORE NO.	CORE GROUP
R955065154X	Reman	Bendix 065154X	1/8"	3/8"	3/8"	XC1190	BN265

4

# TRUCK/TRACTOR AIR VALVES AIR BRAKE RELAY VALVES

## BENDIX R-5 RELAY VALVE



Meritor NO.	NEW/REMAN	REPLACES	SUPPLY	CORE NO.	CORE GROUP	APPLICATION AND GENERAL INFORMATION
R955229467X	Reman	Bendix 229467X	3/4"	XC1072	BN010	The R-5 has 2 horizontal delivery ports and 2 vertical delivery ports. There are 2 control ports 1/4" PT. The nominal crack pressure of the R-5 is 3 psi.

4

## BENDIX R-6 RELAY VALVE



Meritor NO.	NEW/REMAN	REPLACES	SUPPLY "A"	SUPPLY "B"	CORE NO.	CORE GROUP	APPLICATION AND GENERAL INFORMATION
R955279180N	New	Bendix 279180	3/8"	3/8"		BN012	The service port is 1/4" PT on all R-6 valves. All R-6 valves have (4) 3/8" PT delivery ports. All R-6 except as noted have a nominal crack pressure of 2 psi.
R955279180X	Reman	Bendix 279180X			XC1093		
R955279952N	New	Bendix 279952	3/4"	3/8"			
R955279952X	Reman	Bendix 279952X			XC1093		
R955280243X See Note 20		Bendix 280243X	3/8"				
R955280375X		Bendix 280375X	1/2"	1/2"			
R955280651X See Note 32		Bendix 280651X	3/4"	3/8"			
R955283940X See Note 34		Bendix 283940X	3/8"			XC1108	

- Notes:
- 20 Nominal crack pressure of 10 psi.
  - 32 Includes pipe plugs and gasket.
  - 34 Service port rotate 90° from that shown—Ford Application.

**TRUCK/TRACTOR AIR VALVES  
AIR BRAKE RELAY VALVES**

4

**BENDIX  
R-8 RELAY VALVE**



Meritor NO.	NEW/ REMAN	REPLACES	SERVICE PORT ROTATION FROM MTG. FLANGE	CONTROL	DELIVERY	SUPPLY	CORE NO.	CORE GRP	COMMENTS	
R955286370X	Reman	Bendix 286370X	90°	1/4"	1/2" (2)	3/4" (2) 1/4" (1)	XC1114	BN017		
R955286370N	New	Bendix 286370								
R955286371X	Reman	Bendix 286371X	90° (no exhaust cover)	1/4"	1/2" (2) 1/4" (1)	3/4" (2) 3/4" (1)	XC1114	BN017		
R955286892X		Bendix 286892X	90°							Contains 3/4" plug
R955287224X		Bendix 287224X	270°							
R955287260X		Bendix 287260X	180° (no exhaust cover)							
R955288369X		Bendix 288369X	180°		1/2" (2) 1/4" (1)	3/4" (2) 1/4" (1)				
R955288755X		Bendix 288755X								

**BENDIX  
R-8P PRESSURE EQUALIZING  
RELAY VALVE**



Meritor NO.	NEW/REMAN	REPLACES	CORE NO.	CORE GROUP	APPLICATION AND GENERAL INFORMATION
R955287114N	New	Bendix 287114			(2) 3/4" PT supply ports. (2) 1/2" PT delivery ports. (1) 1/4" PT delivery port on bottom. (1) 1/4" PT service port.
R955287114X	Reman	Bendix 287114X	XC1121	BN017	

**BENDIX  
R-10 RELAY VALVE**



Meritor NO.	NEW/REMAN	REPLACES	CORE NO.	CORE GROUP	APPLICATION AND GENERAL INFORMATION
<b>R955101333X</b> Replaced By "R955102626X" on page 4-43	Reman	Bendix 101333X			(4) 1/2" PT delivery ports located on the bottom of valve. (2) 1/4" PT service ports. (1) 3/4" PT supply port.

**4**

**BENDIX  
R-12 RELAY VALVE**



Meritor NO.	NEW/REMAN	REPLACES	CRACK PRESSURE	CONTROL	DELIVERY	SUPPLY	CORE NO.	CORE GROUP
<b>R955065104N</b>	New	Bendix 65104	4 psi	1/4"	3/8" (4)	1/2"		
<b>R955065104X</b>	Reman	Bendix 065104X					XC1033	BN025
<b>R955065206N</b> See Note 5	New	Bendix 65206						
<b>R955065303N</b>		Bendix 65303						
<b>R955065303X</b>	Reman	Bendix 065303X						
<b>R955102626N</b>	New	Bendix 102626						
<b>R955102626X</b>	Reman	Bendix 102626X					1/2" (4)	XC1033
<b>R955104561X</b>		Bendix 104561X	5.5 psi					
<b>R955103912X</b>		Bendix 103912X	7.5 psi					

Notes: 5 Two vertical and two horizontal delivery ports.

## TRUCK/TRACTOR AIR VALVES AIR BRAKE RELAY VALVES

### BENDIX R-12H RELAY VALVE (HORIZONTAL)



Meritor NO.	NEW/REMAN	REPLACES	SUPPLY PORT SIZE	CRACK PRESSURE	CORE NO.	CORE GROUP	APPLICATION AND GENERAL INFORMATION
R955103009N	New	Bendix 103009	3/4"	4.0 psi	XC1046	BN025	The horizontal mount R-12H has 2 supply ports located on the side of the valve. (1) 1/4" PT service port. (2) 1/2" PT delivery ports. Universal mounting bracket R955153200 supplied with all R-12 relay valves.
R955103009X	Reman	Bendix 103009X	3/4"				
R955065125X		Bendix 065125X	1/2"				
R955104165X		Bendix 104165X	3/4"				
R955103195X		Bendix 103195X	3/4"				

4

### BENDIX R-12P RELAY VALVE



Meritor NO.	NEW/REMAN	REPLACES	CRACK PRESSURE	CONTROL	DELIVERY	SUPPLY	CORE NO.	CORE GROUP
R955109264X See Note 4	Reman	Bendix 109264X	0	1/4"	3/8"	1/2"	XC1034	BN026

Notes: 4 Also supersedes 065476, 65476, 109001, 109002, 109424, 109446 and F4HS-2A449-AA.

### BENDIX R-14 RELAY VALVE (VERTICAL)



Meritor NO.	NEW/REMAN	REPLACES	CRACK PRESSURE	CORE NO.	CORE GROUP	APPLICATION AND GENERAL INFORMATION
R955103028N	New	Bendix 103028	4.0 psi	XC1048	BN025	(4) 1/2" PT delivery ports located on the side of the valve. (1) 1/4" PT service port. (1) 1/2" PT supply port. (1) 1/8" PT balance port located under the exhaust cover. The balance port provides an anti-compounding feature that prevents simultaneous application of the service and parking sides of the spring brake and allows the valve to control spring brakes and service brakes. Universal mounting bracket R955153200 supplied with all R-14 relay valves.
R955103028X	Reman	Bendix 103028X				
R955106313X		Bendix 106313X				
R955103833X		Bendix 103833X				



# TRUCK/TRACTOR AIR VALVES AIR BRAKE RELAY VALVES

## BENDIX R-14H RELAY VALVE (HORIZONTAL)

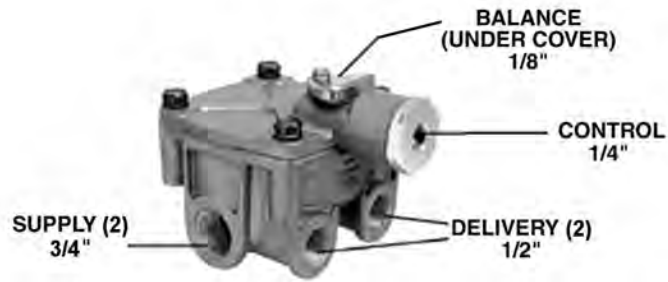

Meritor NO.	NEW/ REMAN	REPLACES	CRACK PRESSURE	CORE NO.	CORE GROUP	APPLICATION AND GENERAL INFORMATION
R955103010N	New	Bendix 103010	4.0 psi		BN025	(2) 1/2" PT delivery ports located on the side of the valve. (1) 1/4" PT service port. (2) 3/4" PT supply ports. (1) 1/8" PT balance port located under the exhaust cover.  The balance port provides an anti-compounding feature that prevents simultaneous application of the service and parking sides of the spring brake and allows the valve to control spring brakes and service brakes.  Universal mounting bracket R955153200 supplied with all R-14 relay valves.
R955103010X	Reman	Bendix 103010X				
R955104345X		Bendix 104345X	5.0 psi	XC1048		
R955103294X		Bendix 103294X	5.5 psi			
R955103835X		Bendix 103835X	7.5 psi			
R955103139X		Bendix 103139X	10.0 psi	XC1047		

## MIDLAND RELAY VALVE (2 Port Delivery)



Meritor NO.	NEW/ REMAN	REPLACES	CORE NO.	CORE GROUP	APPLICATION AND GENERAL INFORMATION
R955KN28010X Replaced By "R955KN28060X" on page 4-46	Reman	Haldex KN28010X			(2) 1/4" PT delivery ports. (1) 3/8" PT delivery port. (1) 3/8" PT supply port. (1) 1/4" PT control port.
R955KN28011X Replaced By "R955KN28060X" on page 4-46		Haldex KN28011X			(3) 3/8" PT delivery ports. (1) 3/8" PT supply port. (1) 1/4" PT control port.

4

**TRUCK/TRACTOR AIR VALVES  
AIR BRAKE RELAY VALVES**

**MIDLAND  
FAST AIR DOOR DOLLY RELAY VALVE  
(2 Port Delivery)**



Meritor NO.	NEW/ REMAN	REPLACES	CRACK PRESSURE	DELIVERY PORTS	CORE NO.	CORE GROUP	APPLICATION AND GENERAL INFORMATION
R955KN28300X	Reman	Haldex KN28300X	0 psi	(2) 1/2"	XC1165	MD006	(2) 1/2" supply ports and (1) 3/8" control port.

4

**MIDLAND  
RELAY VALVE  
(2 Port Delivery)**



Meritor NO.	NEW/ REMAN	REPLACES	CRACK PRESSURE	DELIVERY PORTS	CORE NO.	CORE GROUP	APPLICATION AND GENERAL INFORMATION
R955KN28071X	Reman	Haldex KN28071X	4.0 psi ± 1 psi	(2) 1/2"	XC1167	MD005	Built in anti-compounding two way check valve that prevents simultaneous application of the service and parking sides of the spring brake, and allows the valve to control spring brakes and service brakes.
R955KN28140X		Haldex KN28140X					Cover rotated 180°, (1) 1/2" PT supply port and (1) 1/4" PT control port.

**MIDLAND  
RELAY VALVE  
(2 Port Delivery)**



Meritor NO.	NEW/ REMAN	REPLACES	CRACK PRESSURE	DELIVERY PORTS	CORE NO.	CORE GROUP	APPLICATION AND GENERAL INFORMATION
R955KN28060N	New	Haldex KN28060	4.6 psi ± 1.5 psi	(2) 3/8"	XC1165	MD006	(2) 1/2" PT supply ports. (1) 3/8" control port. Cover may be rotated 360° without affecting performance.
R955KN28060X	Reman	Haldex KN28060X					
R955KN28061X		Haldex KN28061X					
R955KN28132X	Reman	Haldex KN28132X	7.0 psi ± 1.0 psi	(2) 1/2"			(1) 1/2" PT supply port. (1) 3/8" control port. Cover may be rotated 360° without affecting performance.

# TRUCK/TRACTOR AIR VALVES AIR BRAKE RELAY VALVES

## MIDLAND RELAY VALVE (2 Port Delivery)



Meritor NO.	NEW/REMAN	REPLACES	SPECIFICATIONS				CORE NO.	CORE GROUP
			DELIVERY	SUPPLY "A"	SUPPLY "B"	CRACK PRESSURE		
R955KN28130X	Reman	Haldex KN28130X	(2) 1/2"	1/2"	1/2"	4.0 psi ± 1 psi	XC1169	MD003

## MIDLAND RELAY VALVE (2 Port Delivery)



Meritor NO.	NEW/REMAN	REPLACES	SPECIFICATIONS				CORE NO.	CORE GROUP
			DELIVERY	SUPPLY "A"	SUPPLY "B"	CRACK PRESSURE		
R955KN28131X	Reman	Haldex KN28131X	(2) 1/2"	1/2"	1/2"	4.0 psi ± 1 psi	XC1170	MD005

## MIDLAND RG-2 RELAY VALVE (2 Port Delivery)



Meritor NO.	NEW/REMAN	REPLACES	SPECIFICATIONS				CORE NO.	CORE GROUP
			DELIVERY	SUPPLY "A"	SUPPLY "B"	CRACK PRESSURE		
R955KN28500N	New	Haldex KN28500	3/8" (2)	3/8"	3/8"	5.6 psi		
R955KN28500X	Reman	Haldex KN28500X					XC1172	MD007
R955KN28510N	New	Haldex KN28510						
R955KN28510X	Reman	Haldex KN28510X	1/2" (2)	1/2"	1/2"			
R955KN28514X		Haldex KN28514X					XC1172	MD007
R955KN28520N	New	Haldex KN28520						
R955KN28520X	Reman	Haldex KN28520X						
R955KN28531X		Haldex KN28531X	XC1172	MD007				

**TRUCK/TRACTOR AIR VALVES  
AIR BRAKE RELAY VALVES**

**MIDLAND  
R-G5 RELAY VALVE  
(2 Port Trailer Valve)**



Meritor NO.	NEW/REMAN	REPLACES	CRACK PRESSURE	CONTROL	DELIVERY	SUPPLY	CORE NO.	CORE GROUP	APPLICATION AND GENERAL INFORMATION
R955KN28550N	New	HalDEX KN28550	6 psi	1/4"	3/8" (2)	1/2"			No bracket
R955KN28550X	Reman	HalDEX KN28550					XC1155	MD004	

4

**MIDLAND  
RELAY VALVE  
(4 Port Delivery)**



Meritor NO.	NEW/REMAN	REPLACES	CRACK PRESSURE	DELIVERY PORTS	CORE NO.	CORE GROUP	APPLICATION AND GENERAL INFORMATION
R955KN28085X	Reman	HalDEX KN28085X	4.6 psi ± 1.5 psi	(4) 3/8"	XC1168	MD001	(2) 1/2" PT reservoir ports. (1) 3/8" PT control port. Cover may be rotated 360 deg. without affecting performance.
R955KN28080X		HalDEX KN28080X	7.0 psi ± 1.5 psi				

**MIDLAND  
RELAY VALVE  
(4 Port Delivery)**



Meritor NO.	NEW/REMAN	REPLACES	CRACK PRESSURE	CONTROL	DELIVERY	SUPPLY	CORE NO.	CORE GRP	APPLICATION AND GENERAL INFORMATION
R955KN28042X	Reman	HalDEX KN28042	4.6 psi	1/4" (2)	1/2" (4)	1/2" (2)	XC1168	MD001	Bracket not Included.

# TRUCK/TRACTOR AIR VALVES AIR BRAKE RELAY VALVES

**MIDLAND  
RELAY VALVE  
(4 Port Delivery with  
Dual Crack Pressure)**



Meritor NO.	NEW/ REMAN	REPLACES	CRACK PRESSURE	CONTROL	DELIVERY	SUPPLY	CORE NO.	CORE GRP	APPLICATION AND GENERAL INFORMATION
R955KN28055X	Reman	Haldex KN28055	4.6 psi / 9.6 psi	1/4" (2)	1/2" (4)	1/2" (2)	XC1168	MD001	4 port with anti-compounding and dual crack pressure. Bracket not included.

4

**MIDLAND  
RELAY VALVE  
(4 Port Delivery with  
Anti-Compounding)**



Meritor NO.	NEW/ REMAN	REPLACES	CRACK PRESSURE	CONTROL	DELIVERY	SUPPLY	CORE NO.	CORE GRP	APPLICATION AND GENERAL INFORMATION
R955KN28041X	Reman	Haldex KN28041	4.6 psi	1/4" (2)	1/2" (4)	1/2" (2)	XC1168	MD001	4 port with anti-compounding. Bracket not included.

**WAGNER  
RS RELAY VALVE  
(2 Port Delivery)**



Meritor NO.	NEW/ REMAN	REPLACES	CRACK PRESSURE	DELIVERY PORTS	CORE NO.	CORE GROUP	APPLICATION AND GENERAL INFORMATION
R955A80070X	Reman	Wagner A80070	5.6 +/- 1.0 psi	(2) 3/8"	XC1135	WA005	(1) 1/4" PT service port. (1) 1/2" PT reservoir port.

**TRUCK/TRACTOR AIR VALVES  
AIR BRAKE RELAY VALVES**

4

**WAGNER  
RS-2 TANDEM RELAY VALVE  
(4 Port Delivery)**



Meritor NO.	NEW/ REMAN	REPLACES	CRACK PRESSURE	DELIVERY PORTS	CORE NO.	CORE GROUP	APPLICATION AND GENERAL INFORMATION
R955A97600X	Reman	Wagner A97600	3.0 +/- 1.0 psi	3/8"	XC1135	WA005	

**WAGNER  
RF RELAY VALVE  
(4 Ports - Vertical)**



Meritor NO.	NEW/ REMAN	REPLACES	CRACK PRESSURE	CONTROL PORTS	DELIVERY PORTS	SUPPLY PORTS	CORE NO.	CORE GROUP
R955A103600X See Note 54	Reman	Wagner A103600X	3.0 psi	1/4"	3/8"	3/4"	XC1139	WA001
R955A86473X		Wagner A86473X				1/2"	XC1178	MD008
R955A86477X		Wagner A86477X			1/2"	3/4"	XC1139	WA001

Notes: 54 Has an auxiliary supply port on the bottom that can be used for other accessories requiring reservoir air.

**WAGNER  
RG4 TANDEM RELAY VALVE  
(4 Port Delivery)**



Meritor NO.	NEW/ REMAN	REPLACES	CRACK PRESSURE	CORE NO.	CORE GROUP	APPLICATION AND GENERAL INFORMATION
R955A85490X	Reman	Wagner A85490	5.0 psi	XC1135	WA005	(2) 3/8" PT delivery port in top section. (1) 1/4" PT service port in top section. (1) 1/2" PT supply port in each section.
R955A85493X See Note 55		Wagner A85493				

Notes: 55 Has mounting holes for frame mount otherwise designed for tank mount.

**BENDIX  
RE-4 RELAY EMERGENCY VALVE  
(Style A)**



Relay Emergency Valve - A dual function valve used on trailers

- (1) A relay valve that applies and releases the service brakes.
- (2) An emergency feature that automatically applies the service brakes in the event that supply air is lost. Normally used on pre FMVSS-121 vehicles and off road applications.

Meritor NO.	NEW/ REMAN	REPLACES	PISTON & VALVE INSERT	CORE NO.	CORE GROUP	APPLICATION AND GENERAL INFORMATION
<b>R955277446X</b>	Reman	Bendix 277446X	R955228499X	XC1086	BN008	(1) 1/4" PT service port. (2) 3/4" PT reservoir ports. (1) 1/4" PT emergency port. (4) 1/4" PT delivery ports or (2) 3/8" delivery ports and (2) 1/4" delivery ports.

**4**

**BENDIX  
RE-4 RELAY EMERGENCY VALVE  
(Style B)**



Relay Emergency Valve - A dual function valve used on trailers

- (1) A relay valve that applies and releases the service brakes.
- (2) An emergency feature that automatically applies the service brakes in the event that supply air is lost. Normally used on pre FMVSS-121 vehicles and off road applications.

Meritor NO.	NEW/ REMAN	REPLACES	PISTON & VALVE INSERT	CORE NO.	CORE GROUP	APPLICATION AND GENERAL INFORMATION
<b>R955229434X</b>	Reman	Bendix 229434X	R955228499X	XC1071	BN009	(2) 1/4" PT service port. (2) 1/2" PT reservoir ports. (1) 3/4" PT reservoir ports. (2) 1/4" PT emergency port. (6) 1/4" PT delivery ports

## TRUCK/TRACTOR AIR VALVES AIR BRAKE EMERGENCY VALVES

### BENDIX RE-6 RELAY EMERGENCY VALVE



Relay Emergency Valve - A dual function valve used on trailers  
 (1) A relay valve that applies and releases the service brakes.  
 (2) An emergency feature that automatically applies the service brakes in the event that supply air is lost. Normally used on pre FMVSS-121 vehicles and off road applications.

Meritor NO.	NEW/REMAN	REPLACES	DELIVERY PORTS	CORE NO.	CORE GROUP	APPLICATION AND GENERAL INFORMATION
R955281860X	Reman	Bendix 281860X	(2) 1/4" PT	XC1101	BN013	(1) 1/4" PT service port. (1) 3/8" PT supply port. (1) 3/4" PT supply port. (2) 1/4" PT delivery ports in addition to those shown above.
R955281865N	New	Bendix 281865				
R955281865X	Reman	Bendix 281865X		XC1101	BN013	

### BENDIX RE-7 RELAY EMERGENCY VALVE



Relay Emergency Valve - A dual function valve used on trailers  
 (1) A relay valve that applies and releases the service brakes.  
 (2) An emergency feature that automatically applies the service brakes in the event that supply air is lost. Normally used on pre FMVSS-121 vehicles and off road applications.

The R-7 will modulate the spring brakes through application of the foot valve if rear axle services brake pressure is lost. Normal parking functions are also controlled by the R-7.

Meritor NO.	NEW/REMAN	REPLACES	RELEASE PRESSURE	CORE NO.	CORE GROUP	APPLICATION AND GENERAL INFORMATION
R955103081N	New	Bendix 103081	95 psi			(1) 1/4" PT control port. (1) 1/4" PT balance port. (2) 3/8" PT delivery port. (1) 3/8" PT supply port.
R955103081X	Reman	Bendix 103081X	95 psi	XC1107	BN015	

4



**MIDLAND  
EMERGENCY RELAY VALVE**



Relay Emergency Valve - A dual function valve used on trailers

(1) A relay valve that applies and releases the service brakes.

(2) An emergency feature that automatically applies the service brakes in the event that supply air is lost. Normally used on pre FMVSS-121 vehicles and off road applications.

Meritor NO.	NEW/ REMAN	REPLACES	CORE NO.	CORE GROUP	APPLICATION AND GENERAL INFORMATION
<b>R955KN30010N</b> See Note 35	New	Haldex KN30010N	XC1174	MD013	(1) 3/4" PT primary reservoir port. (1) 1/4" PT auxiliary reservoir port. (4) 1/4" PT delivery ports. (1) 1/4" PT trailer emergency port. (1) 1/4" PT trailer service port.
<b>R955KN30010X</b>	Reman	Haldex KN30010X			

Notes: 35 Nipple mount—Fruehauf only.

**4**

**MIDLAND  
(EE) EMERGENCY RELAY VALVE**



<b>WAGNER</b>	<b>MIDLAND</b>	<b>WAGNER</b>	<b>MIDLAND</b>
<b>PART NUMBER</b>	<b>SERVICE</b>	<b>PART NUMBER</b>	<b>SERVICE</b>
<b>A46229</b>	<b>KN30100</b>	<b>A71891</b>	<b>KN30200</b>
<b>A71890</b>	<b>KN30300</b>	<b>A99036</b>	<b>KN30400</b>

Relay Emergency Valve - A dual function valve used on trailers

(1) A relay valve that applies and releases the service brakes.

(2) An emergency feature that automatically applies the service brakes in the event that supply air is lost. Normally used on pre FMVSS-121 vehicles and off road applications.

Meritor NO.	NEW/ REMAN	REPLACES	CRACK PRESSURE	DELIVERY PORTS	CORE NO.	CORE GROUP	APPLICATION AND GENERAL INFORMATION
<b>R955KN30400N</b>	New	Haldex KN30400	3 psi				(1) 1/4" PT service inlet. (4) 1/4" PT emergency inlet.
<b>R955KN30100X</b>	Reman	Haldex KN30100X	4.5 psi	(4) 1/4" PT	XC1175	MD009	
<b>R955KN30300X</b> See Note 46		Haldex KN30300X					
<b>R955KN30400X</b> See Note 51		Haldex KN30400X		(4) 3/8" PT			
<b>R955KN30200X</b> See Note 46		Haldex KN30200X					

Notes: 46 3/4" PT reservoir port.  
51 3/4" PT reservoir port.

## TRUCK/TRACTOR AIR VALVES AIR BRAKE SPRING BRAKE VALVES

### BENDIX SR-1 SPRING BRAKE VALVE



Spring Brake Valve - A dual function valve. (1)Limits hold-off pressure to the spring brakes via a relay of quick release valve, generally 90-95psi. (2) Should a loss of pressure occur it provides a modulated spring brake application proportional to the service braking pressure delivered to the front axle. Commonly used on post FMVSS-121 systems.

Meritor NO.	NEW/ REMAN	REPLACES	RESERVOIR TRIP PRESSURE	CORE NO.	CORE GROUP	APPLICATION AND GENERAL INFORMATION
R955288063X	Reman	Bendix 288063X	30 psi	XC1113	BN101	The SR-1 is normally used on trucks and tractors with dual air brake systems. Parking functions are also controlled through the SR-1. (1) 1/4" PT delivery port. (1) 1/4" PT reservoir port. (1) 1/4" PT control port. (1) 1/4" PT supply port.
R955286364N	New	Bendix 286364	55 psi			
R955286364X	Reman	Bendix 286364X		XC1113	BN101	

### BENDIX SR-2 SPRING BRAKE VALVE



Spring Brake Valve - A dual function valve. (1)Limits hold-off pressure to the spring brakes via a relay of quick release valve, generally 90-95psi. (2) Should a loss of pressure occur it provides a modulated spring brake application proportional to the service braking pressure delivered to the front axle. Commonly used on post FMVSS-121 systems.

Meritor NO.	NEW/ REMAN	REPLACES	RESERVOIR MALE CONNECTOR PORT	CORE NO.	CORE GROUP	APPLICATION AND GENERAL INFORMATION
R955103061N	New	Bendix 103061	(1) 1/2" PT			The SR-2 is used on trailers with dual air brake systems. It also provides the ability to release the spring brakes at least once prior to their application. (4) 3/8" PT delivery ports. (2) 1/4" PT service reservoir ports. (1) 1/4" PT trailer supply port. (1) 3/8" PT exhaust port. R955287376X does not have a trailer service port for anti-compound.
R955103061X	Reman	Bendix 103061X		XC1123	BN103	
R955102761X		Bendix 102761X				
R955287376N	New	Bendix 287376	(1) 3/4" PT			
R955287376X	Reman	Bendix 287376X		XC1123	BN103	

4

**BENDIX  
SR-4 SPRING BRAKE VALVE  
(Early Type)**



Spring Brake Valve - A dual function valve. (1)Limits hold-off pressure to the spring brakes via a relay of quick release valve, generally 90-95psi. (2) Should a loss of pressure occur it provides a modulated spring brake application proportional to the service braking pressure delivered to the front axle. Commonly used on post FMVSS-121 systems.

Meritor NO.	NEW/ REMAN	REPLACES	RESERVOIR MALE CONNECTOR PORT	CORE NO.	CORE GROUP	APPLICATION AND GENERAL INFORMATION
R955101622X	Reman	Bendix 101622X	(1) 1/2" PT	XC1026	BN105	The SR-4 is used on Post FMVSS-121 Trailers. It is made up of an SR-4 subassembly, a PR-3 valve (R955284460X) and an SC-1 single check valve. Under no circumstances should the SR-4 be interchanged with the similar appearing SR-2. (4) 3/8" PT delivery ports. (2) 1/4" PT service reservoir ports. (1) 1/4" PT trailer service port. (1) 1/4" PT trailer supply port.
R955101112N	New	Bendix 101112	(1) 3/4" PT			
R955101112X	Reman	Bendix 101112X		XC1026	BN105	

**4**

**BENDIX  
SR-4 SPRING BRAKE VALVE  
(New Type)**



Spring Brake Valve - A dual function valve. (1)Limits hold-off pressure to the spring brakes via a relay of quick release valve, generally 90-95psi. (2) Should a loss of pressure occur it provides a modulated spring brake application proportional to the service braking pressure delivered to the front axle. Commonly used on post FMVSS-121 systems.

Meritor NO.	NEW/ REMAN	REPLACES	RESERVOIR MALE CONNECTOR PORT	CORE NO.	CORE GROUP	APPLICATION AND GENERAL INFORMATION
R955108076X	Reman	Bendix 108076X	(1) 1/2" PT	XC1054	BN106	(4) 3/8" PT delivery ports. (2) 1/4" PT reservoir charging ports. (1) 1/4" PT trailer service port. (1) 1/4" PT trailer supply port.
R955107539X		Bendix 107539X	(1) 3/4" PT			

## TRUCK/TRACTOR AIR VALVES AIR BRAKE SPRING BRAKE VALVES

### MIDLAND MULTI-FUNCTION RT4 (Spring Brake/Relay Valve)

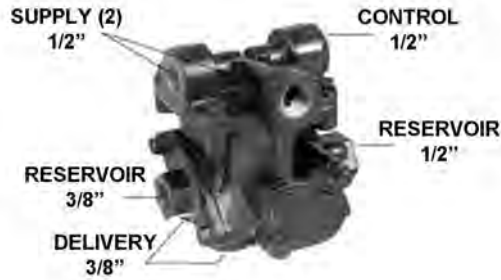

Spring Brake Valve - A dual function valve. (1)Limits hold-off pressure to the spring brakes via a relay of quick release valve, generally 90-95psi. (2) Should a loss of pressure occur it provides a modulated spring brake application proportional to the service braking pressure delivered to the front axle. Commonly used on post FMVSS-121 systems.

4

Meritor NO.	NEW/ REMAN	REPLACES	TRAILER SUPPLY (A)	TRAILER SUPPLY (B)	TRL CTRL	RESERVOIR (A)	RESERVOIR (B)	DELY	PPV CLOSING PRESSURE	CORE NO.	CORE GRP
<b>R955KN26000N</b> See Note 52	New	Haldex KN26000	3/8"	3/8"	3/8"	1/2"	3/8"	3/8"	55 psi	XC1162	MD101
<b>R955KN26000X</b> See Note 52	Reman	Midlan KN26000X		Plugged					70 psi		
<b>R955KN26010N</b> See Note 6	New	Haldex KN26010		Plugged					70 psi		
<b>R955KN26010X</b> See Note 6	Reman	Haldex KN26010X	3/8"	Plugged	3/8"	1/2"	3/8"	3/8"	70 psi	XC1162	MD101
<b>R955KN26020X</b> See Note 6		Haldex KN26020X	Plugged	3/8"					70 psi	XC1192	

Notes: 6 Cover rotated 180°.  
52 Cover as shown.

### WAGNER RT TRAILER VALVE (Spring Brake Control)



Spring Brake Valve - A dual function valve. (1)Limits hold-off pressure to the spring brakes via a relay of quick release valve, generally 90-95psi. (2) Should a loss of pressure occur it provides a modulated spring brake application proportional to the service braking pressure delivered to the front axle. Commonly used on post FMVSS-121 systems.

Meritor NO.	NEW/REMAN	REPLACES	CORE NO.	CORE GROUP	APPLICATION AND GENERAL INFORMATION
<b>R955A88802X</b> See Note 56	Reman	Wagner A88802	XC1141	WA101	
<b>R955A88812X</b> See Note 57		Wagner A88812			

Notes: 56 With anti-compounding.  
57 Without anti-compounding.

**WAGNER  
RT2 TRAILER VALVE  
(Spring Brake Control)**



Spring Brake Valve - A dual function valve. (1)Limits hold-off pressure to the spring brakes via a relay of quick release valve, generally 90-95psi. (2) Should a loss of pressure occur it provides a modulated spring brake application proportional to the service braking pressure delivered to the front axle. Commonly used on post FMVSS-121 systems.

Meritor NO.	NEW/REMAN	REPLACES	CORE NO.	CORE GROUP	APPLICATION AND GENERAL INFORMATION
<b>R955A98730X</b> See Note 56	Reman	Wagner A98730	XC1141	WA101	
<b>R955A99370X</b> See Note 57		Wagner A99370			

Notes: 56 With anti-compounding.  
57 Without anti-compounding.

**4**

**BENDIX  
SR-5 TRAILER BRAKE VALVE**



Spring Brake Valve - A dual function valve. (1)Limits hold-off pressure to the spring brakes via a relay of quick release valve, generally 90-95psi. (2) Should a loss of pressure occur it provides a modulated spring brake application proportional to the service braking pressure delivered to the front axle. Commonly used on post FMVSS-121 systems.

The SR-5 is similar in appearance to the SR-2, and functions in the system in the same manner, with the exception that it permits the use of a single reservoir on the trailer. Note that the SR-5 has an identification hole punched in the boss between the top of the valve and the trailer exhaust and supply ports.

Meritor NO.	NEW/REMAN	REPLACES	SUPPLY	DELIVERY	RESERVOIR	SERVICE	CORE NO.	CORE GROUP
<b>R955065437N</b>	New	Bendix 065437	1/4"	3/8" (4)	3/4"	1/4" (2)		
<b>R955065437X</b> See Note 56	Reman	Bendix 065437X						
<b>R955065438X</b>		Bendix 065438X						
<b>R955065439N</b>	New	Bendix 065439			1/2"			
<b>R955065439X</b> See Note 56	Reman	Bendix 065439X			3/4"			XC1041

Notes: 56 With anti-compounding.

# TRUCK/TRACTOR AIR VALVES AIR BRAKE SPRING BRAKE VALVES

## MIDLAND FF2 FULL FUNCTION (Spring Brake/Relay Valve)

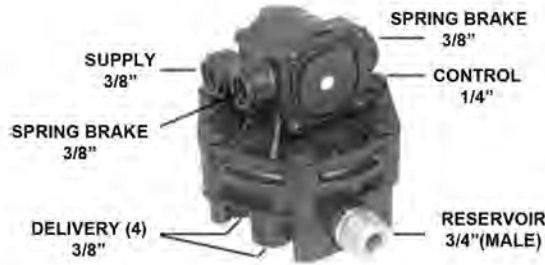

Spring Brake Valve - A dual function valve. (1) limits hold-off pressure to the spring brakes via a relay of quick release valve, generally 90-95psi. (2) Should a loss of pressure occur it provides a modulated spring brake application proportional to the service braking pressure delivered to the front axle. Commonly used on post FMVSS-121 systems.

**Note:** A heavy-duty walled 1/2" or 3/8" nipple must be used when mounting the Midland FFV.

The Midland Full Function Valve can be used with a single air tank, twin tanks or an axle by axle system on trailers. The valve combines a pressure protection valve, two one way check valves, spring brake valve with quick release, and a four port relay valve. Midland Full Function Valves must not be mixed with other service valves on the same trailer.

The Midland Full Function Valve does not release spring brakes until the reservoir is filled. This may take up to 90 seconds. Do not attempt to drive away prior to full spring brake release. Damage to the foundation brake system may result.

4

Meritor NO.	NEW/REMAN	REPLACES	CRACK PRESSURE	RESERVOIR PORT	CORE NO.	CORE GROUP	APPLICATION AND GENERAL INFORMATION
R95512352N	New	Haldex 12352	3 psi	1/2"	XC1173	MD011	
R955KN28600N		Haldex KN28600		3/4" PT			
R955KN28600X	Reman	Haldex KN28600X	5 psi	1/2" PT			
R955KN28601X		Haldex KN28601X		3/4" PT			
R955KN28602X		Haldex KN28602X		1/2" PT			
R955KN28603X		Haldex KN26803X		3/4" PT			

**BENDIX  
SL-4 STOP LIGHT SWITCH**



Meritor NO.	NEW/REMAN	REPLACES	ACTIVATION PRESSURE	CORE NO.	CORE GROUP	APPLICATION AND GENERAL INFORMATION
R955228600N	New	Bendix 228600	5 psi (approx.)			

**BENDIX  
LP-3 LOW PRESSURE INDICATOR  
(Single & Double Terminal)**



Meritor NO.	NEW/REMAN	REPLACES	ACTIVATION PRESSURE	STYLE	CORE NO.	CORE GROUP	APPLICATION AND GENERAL INFORMATION
R955228750N	New	Bendix 228750	60 ± 6 PSI	Double Terminal	XC1211	BN423	Normally open switch that closes at activation pressure.
R955228750X	Reman	Bendix 228750X					
R955279416N	New	Bendix 279416		Single Terminal			

**MIDLAND  
ELECTRO-PNEUMATIC SWITCHES**



Meritor NO.	NEW/REMAN	REPLACES	MODEL	ACTIVATION PRESSURE	POSITION	SIZE	STYLE
R955BE13240N	New	Haldex BE13240	Tractor Spring Brake Circuit Light Switch	55 psi	Normally Closed 0 psi pressure	1/8"-27 FPT	Single Pole—Two Terminals
R955BE13241N		Haldex BE13241	Low Air Switch	66 psi			
R955BE13250N		Haldex BE13250	Service Circuit Stoplight Switch	3-5 psi		1/4"-18 FPT	
R955BE13255N		Haldex BE13255	Trailer Emergency Stoplight Switch	55 psi	Normally 1 Open and 1 Closed	1/8"-27 FPT	Single Pole—Double Throw—Three Terminals

## TRUCK/TRACTOR AIR VALVES AIR BRAKE TRACTOR PROTECTION VALVES

### BENDIX TP-2 TRACTOR PROTECTION VALVE



Tractor Protection Valve - Protects the tractor air brake system under trailer breakaway conditions and conditions where severe leakage has occurred in the tractor or trailer. The valve is also used to shut off trailer service and supply lines before disconnecting the tractor from the trailer. The tractor protection valve is used in conjunction with a dash mounted control valve.

Used on pre FMVSS-121 vehicles in conjunction with TW-1 or PP-1 Valves. Regulations require the tractor protection system to function automatically between 20 and 45 psi as system pressure is reduced. The automatic system to accomplish this is built into the TP-2.

4

Meritor NO.	NEW/ REMAN	REPLACES	TRAILER EMERGENCY	TRAILER SERVICE	CORE NO.	CORE GROUP	APPLICATION AND GENERAL INFORMATION
R955227661X	Reman	Bendix 227661X	3/8" PT	3/8" PT	XC1068	BN341	(1) 1/4" PT control port. (1) 3/8" PT tractor service port. (1) 3/8" PT tractor emergency port. 3 line - automatic operation.
R955227672X		Bendix 227672X	1/2" PT	1/2" PT			
R955283090X		Bendix 283090X	3/8" PT	3/8" PT			

### BENDIX TP-3 TRACTOR PROTECTION VALVE



Tractor Protection Valve - Protects the tractor air brake system under trailer breakaway conditions and conditions where severe leakage has occurred in the tractor or trailer. The valve is also used to shut off trailer service and supply lines before disconnecting the tractor from the trailer. The tractor protection valve is used in conjunction with a dash mounted control valve.

Used on post FMVSS-121 vehicles in conjunction with PP-3 or PP-7 valves. Regulations require the tractor protection system to function automatically between 20 and 45 psi as system pressure is reduced. The automatic system is in the PP-3 or PP-7 located in the cab of the vehicle.

Meritor NO.	NEW/ REMAN	REPLACES	TRAILER EMERGENCY	TRAILER SERVICE	CORE NO.	CORE GROUP	APPLICATION AND GENERAL INFORMATION
R955279000N	New	Bendix 279000	1/2" PT	1/2" PT	XC1092	BN342	(1) 1/4" PT tractor emergency port. (1) 3/8" PT tractor service port. 2 line—automatic operation.
R955279000X	Reman	Bendix 279000X					
R955279962X		Bendix 279962X	3/8" PT	3/8" PT			



# TRUCK/TRACTOR AIR VALVES AIR BRAKE TRACTOR PROTECTION VALVES

## **BENDIX TP-4 TRACTOR PROTECTION VALVE (Formerly VM-1 Control Valve Manifold)**



Tractor Protection Valve - Protects the tractor air brake system under trailer breakaway conditions and conditions where severe leakage has occurred in the tractor or trailer. The valve is also used to shut off trailer service and supply lines before disconnecting the tractor from the trailer. The tractor protection valve is used in conjunction with a dash mounted control valve.

The TP-4 is used exclusively on Ford "L" model tractors and combines several functions. It is a combination of a tractor protection valve and two double check valves. This valve allows either of the two service brake circuits on the vehicle to apply the trailer brakes. It is used in conjunction with a PP-3 or PP-7 to perform the normal functions of a tractor protection valve. Porting for the installation of the stoplight switch, front axle limiting valve and the trailer emergency stoplight switch is incorporated in the valve.

Meritor NO.	NEW/REMAN	REPLACES	CORE NO.	CORE GROUP	APPLICATION AND GENERAL INFORMATION
<b>R955288301X</b>	Reman	Bendix 288301X	XC1125	BN344	
<b>R955288301N</b>	New	Bendix 288301			

## **BENDIX TP-5 TRACTOR PROTECTION VALVE (Formerly VM-2 Control Valve Manifold)**



Tractor Protection Valve - Protects the tractor air brake system under trailer breakaway conditions and conditions where severe leakage has occurred in the tractor or trailer. The valve is also used to shut off trailer service and supply lines before disconnecting the tractor from the trailer. The tractor protection valve is used in conjunction with a dash mounted control valve.

The TP-5 performs all of the functions of the TP-4. In addition it includes a quick release feature for the trailer service line.

Meritor NO.	NEW/REMAN	REPLACES	REAR SERVICE	REAR TRAILER SERVICE AND EMERGENCY	TRAILER SERVICE	TRAILER EMERGENCY	TRAILER CONTROL	STOPLIGHT SWITCH	CORE NO.	CORE GROUP
<b>R955102638X</b>	Reman	Bendix 102638X	3/8"	3/8" (2)	1/2"	1/2"	3/8"	1/4"	XC1126	BN345
<b>R955288605N</b>	New	Bendix 288605							XC1126	BN345
<b>R955288605X</b>	Reman	Bendix 288605X							XC1126	BN345

## TRUCK/TRACTOR AIR VALVES AIR BRAKE TRACTOR PROTECTION VALVES

### BENDIX VM-3 MANIFOLD VALVE



Tractor Protection Valve - Protects the tractor air brake system under trailer breakaway conditions and conditions where severe leakage has occurred in the tractor or trailer. The valve is also used to shut off trailer service and supply lines before disconnecting the tractor from the trailer. The tractor protection valve is used in conjunction with a dash mounted control valve.

The VM-3 incorporates a pressure protection valve (PR-4) and a double check valve that allows it to function as a control manifold. It provides a central location for air lines passing between the cab and the engine compartment.

4

Meritor NO.	NEW/REMAN	REPLACES	CORE NO.	CORE GROUP	APPLICATION AND GENERAL INFORMATION
R955288645X	Reman	Bendix 288645X	XC1127	BN420	

### MIDLAND TRACTOR PROTECTION VALVE (Manifold Non-Automatic Style)



Tractor Protection Valve - Protects the tractor air brake system under trailer breakaway conditions and conditions where severe leakage has occurred in the tractor or trailer. The valve is also used to shut off trailer service and supply lines before disconnecting the tractor from the trailer. The tractor protection valve is used in conjunction with a dash mounted control valve.

The Midland manifold style two line tractor protection valve includes the following functions: tractor protection, two double check valves, stoplight switch port, and built in quick release valve.

Meritor NO.	NEW/REMAN	REPLACES	EMERGENCY INLET	HAND CTRL	FOOT CTRL	LIGHT SWITCH	SERVICE OUTLET	EMERGENCY OUTLET	TUBE	CORE NO.	CORE GRP
R955KN34080X	Reman	Haldex KN34080X	3/8"	3/8" (2)	3/8"	1/4"	3/8"	3/8"	No	XC1185	MD345
R955KN34100X		Haldex KN34100X									
R955KN34090X		Haldex KN34090X									
R955KN34110X		Haldex KN34110X									
R955KN34130X		Haldex KN34130					3/8"	3/8" (2)	1/4" 1/8"		

# TRUCK/TRACTOR AIR VALVES AIR BRAKE TRACTOR PROTECTION VALVES

## MIDLAND TRACTOR PROTECTION VALVE (Two-Line Non-Automatic Style)



Tractor Protection Valve - Protects the tractor air brake system under trailer breakaway conditions and conditions where severe leakage has occurred in the tractor or trailer. The valve is also used to shut off trailer service and supply lines before disconnecting the tractor from the trailer. The tractor protection valve is used in conjunction with a dash mounted control valve.

Meritor NO.	NEW/REMAN	REPLACES	CORE NO.	CORE GROUP	APPLICATION AND GENERAL INFORMATION
R955KN34030X	Reman	Haldex KN34030X	XC1197	MD341	

4

## MIDLAND TRACTOR PROTECTION VALVE (Two-Line Non-Automatic Style)



Meritor NO.	NEW/REMAN	REPLACES	TRACTOR EMERGENCY	TRACTOR SERVICE	TRAILER EMERGENCY	TRAILER SERVICE	CORE NO.	CORE GROUP
R955KN34060X	Reman	Haldex KN34060X	1/4"	3/8"	1/2"	1/2"	XC1197	MD341

## MIDLAND TRACTOR PROTECTION VALVE (Three Line Automatic without Quick Release)



Tractor Protection Valve - Protects the tractor air brake system under trailer breakaway conditions and conditions where severe leakage has occurred in the tractor or trailer. The valve is also used to shut off trailer service and supply lines before disconnecting the tractor from the trailer. The tractor protection valve is used in conjunction with a dash mounted control valve.

The Midland tractor protection valve incorporates a quick release function. The exhaust snorkel minimizes in cab noise by exhausting the trailer lines outside the cab.

Meritor NO.	NEW/REMAN	REPLACES	CORE NO.	CORE GROUP	APPLICATION AND GENERAL INFORMATION
R955KN34050X	Reman	Haldex KN34050X	XC1197	MD341	With exhaust snorkel.
R955KN34070X		Haldex KN34070X			Includes 1/8" PT stoplight switch port.
R955KN34070N	New	Haldex KN34070			

# TRUCK/TRACTOR AIR VALVES SOLENOID VALVES

## CUMMINS FUEL SOLENOID VALVE



Meritor NO.	NEW/REMAN	REPLACES	VOLTAGE	CORE NO.	CORE GROUP	APPLICATION AND GENERAL INFORMATION
R955BM69973-12N	New	Cummins BM6997312N	12 Volt			Fuel Solenoid Valve
R955BM69973-12X	Reman	Cummins BM6997312		XC1143	CU391	
R955BM69973-24N	New	Cummins BM6997324N	24 Volt			
R955BM69973-24X	Reman	Cummins BM6997324		XC1143	CU391	

4

## MIDLAND SOLENOID AIR VALVE NORMALLY CLOSED



Meritor NO.	NEW/REMAN	REPLACES	VOLTAGE	CORE NO.	CORE GROUP	APPLICATION AND GENERAL INFORMATION
R955KN68230N	New	Haldex KN68230	12 Volt			Used to control shifting on two speed axles.
R955KN68230X	Reman	Haldex KN68230		XC1171	MD017	
R955KN68237N	New	Haldex KN68237	24 Volt			

**FULLER  
PUSH-PULL RANGE VALVE**



Meritor NO.	NEW/REMAN	REPLACES	CORE NO.	CORE GROUP	APPLICATION AND GENERAL INFORMATION
R955A3546N	New	Fuller A3546			Shift Valve
R955A3546X	Reman	Fuller A3546X	XC1133	FU391	

**FULLER  
PUSH-PULL RANGE VALVE**



Meritor NO.	NEW/REMAN	REPLACES	CORE NO.	CORE GROUP	APPLICATION AND GENERAL INFORMATION
R955A3547X	Reman	Fuller A3547X	XC1134	FU393	Range Selector Valve

**FULLER  
SLAVE VALVES**



Meritor NO.	NEW/REMAN	REPLACES	CORE NO.	CORE GROUP	APPLICATION AND GENERAL INFORMATION
R955A3991X	Reman	Fuller A3991X	XC1134	FU393	Range Selector Valve R955A4699X is similar in appearance to R955A3991X
R955A4688N	New	Fuller A4688			
R955A4688X	Reman	Fuller A4688X	XC1134	FU393	

**4**

# TRUCK/TRACTOR AIR VALVES TRANSMISSION VALVES

## FULLER SHIFT KNOB



Meritor NO.	NEW/REMAN	REPLACES	PORT SIZE	APPLICATION AND GENERAL INFORMATION
R955A4900N	New	Fuller A4900	1/16" (All)	13 speed transmission. Models: 9513, 14613, 12513, 15613, 11613. Replaces both the range and selector valve.

4

## FULLER SHIFT KNOB



Meritor NO.	NEW/REMAN	REPLACES	PORT SIZE	APPLICATION AND GENERAL INFORMATION
R955A5010N	New	Fuller A5010	1/16" (All)	Replaces the range valve on the 6, 7DL, 7L, 8, 9, and 10 speed road ranger transmission and range valve only on the 7DLL, 7LL, 8LL and 15 speed Transmission. For use on transmission models: 610, 9509, 1110, 11610, 12610, 6610, 910, 11607L, 12509, 14608, 8609, 1157DL, 11608, 12510, 14609, 906, 11509, 11609, 12609, 14610, 9508. R955A5010N will replace the range valve only on the transmission models: 958LL, 11608LL, 14608L, 915, 11615, 14615, 1157DL, 1258LL, 15615, 11607LL, 12515. To replace both the range and deep reduction valve see R955A5015N.

## FULLER RANGE VALVE



Meritor NO.	NEW/REMAN	REPLACES	PORT SIZE	APPLICATION AND GENERAL INFORMATION
R955A5015N	New	Fuller A5015	1/16" (All)	R955A5015N will replace both the range and deep reduction valve. But if using to replace Fullers old style selector valve, it may require changing the reduction cylinder cover and re-routing the reduction air lines. For use on transmission models: 958LL, 11608LL, 14608LL, 915, 11615, 14615, 1157DLL, 1258LL, 15615, 11607LL, 12515.

## FULLER SELECTOR VALVE



Meritor NO.	NEW/REMAN	REPLACES	POSITIONS	APPLICATION AND GENERAL INFORMATION
R955A4487N	New	Fuller A4487	3 Position	9-Speed Transmission
R955A4490N		Fuller A4490		13-Speed Transmission
R955A4491N		Fuller A4491	2 Position	9-Speed Transmission

## FULLER AIR REGULATOR



Meritor NO.	NEW/REMAN	REPLACES	PRESSURE OUTLET	APPLICATION AND GENERAL INFORMATION
R95516743N	New	Fuller 16743	56-62 psi	Non-Adjustable

## FULLER COUNTER SHAFT BRAKE ACTUATOR



Meritor NO.	NEW/REMAN	REPLACES	APPLICATION AND GENERAL INFORMATION
R95516859N	New	Fuller 16859	

## FULLER INSERT VALVE



Meritor NO.	NEW/REMAN	REPLACES	APPLICATION AND GENERAL INFORMATION
R95519974N	New	Fuller 19974	For use in Splitter Cylinder Assembly.

**NOTES:** \_\_\_\_\_

\_\_\_\_\_

\_\_\_\_\_

**4**

\_\_\_\_\_

\_\_\_\_\_

\_\_\_\_\_

\_\_\_\_\_

\_\_\_\_\_

\_\_\_\_\_

\_\_\_\_\_

\_\_\_\_\_

\_\_\_\_\_

\_\_\_\_\_

\_\_\_\_\_

\_\_\_\_\_

\_\_\_\_\_

\_\_\_\_\_



TITLE	PAGE
TRAILER AIR VALVES	
CHECK VALVES - - - - -	4-71
AIR BRAKE CONTROL VALVES - - - - -	4-73
AIR BRAKE FOOT VALVES - - - - -	4-76
AIR BRAKE HAND CONTROL VALVES - - - - -	4-77
AIR BRAKE PROTECTION VALVES - - - - -	4-78
AIR BRAKE QUICK RELEASE VALVES - - - - -	4-79
AIR BRAKE RELAY VALVES - - - - -	4-80
AIR BRAKE CONTROL LINE VALVES - - - - -	4-84
AIR BRAKE EMERGENCY VALVES - - - - -	4-85
AIR BRAKE SPRING BRAKE VALVES - - - - -	4-87
AIR BRAKE SWITCHES AND INDICATORS - - - - -	4-90
AIR BRAKE TRACTOR PROTECTION VALVES - - - - -	4-91
AIR BRAKE MISCELLANEOUS VALVES - - - - -	4-91
MOUNTING HARDWARE- - - - -	4-93
AIR BRAKE SAFETY VALVES AND FITTINGS - - - - -	4-94

# MERITOR® AFTERMARKET AIR VALVES



4

### Streamline Your Ordering With Confidence.

With today's sophisticated commercial vehicles, compressed air requirements are increasing. Fleets and truck operators need air valves they can rely on to maintain peak performance. With a commitment to bringing high-quality solutions to the aftermarket, Meritor has been a master distributor of Sealco® valves for over 20 years. Sealco air valves combine OE quality and outstanding value, and all Sealco products are made right here in the U.S.A. Why purchase from multiple suppliers when you can consolidate to purchasing from one? Simplify your ordering process and add Sealco air valves to your next order.

### Features and Benefits

- All Sealco products are designed, engineered, manufactured and assembled in the U.S.A.
- Sealco valves are produced to the highest standards using primarily a zinc alloy that reduces porosity and results in stronger threaded ports
- 100% pneumatic and submersion testing is conducted on all air valves to ensure zero leakage
- In-house die cast and machine shop facilities allow for complete control of the product at every stage of the manufacturing process
- Save time and money with Sealco plug units that allow fleet customers to replace only a portion of a valve assembly instead of the entire unit

### Find Your Replacement.

Sealco valves can be used as a direct replacement for existing competitive valves for truck, tractor, bus and trailer applications. Choose from one of the popular air valves below or from our stock of over 100 part numbers.

Top Moving Part Numbers	
Meritor Part Number	Description
RSL110500	Spring Brake Control Valve
RSL110700	Spring Brake Control Valve
RSL110800	Spring Brake Control Valve
RSL140280	Pressure Protection Valve
RSL17600B	Emergency Release Valve
RSL140270	Pressure Protection Valve
RSL5400	Hand Control Valve
RSL110170	Spring Brake Control Valve
RSL110415	4-Port Relay Valve
RSL110376	Emergency Control Valve



### You Deserve Complete Customer Support.

Get the attention you deserve with Meritor's extensive customer support services. For complete product information and specifying assistance, training and technical support, count on our expert field sales force. Meritor's industry-leading Customer Care team provides an all-purpose, one-call solution for customer satisfaction. For more information, call our U.S. Customer Care Center at 888-725-9355. In Canada, call 800-387-3889. Or visit MeritorPartsXpress.com.



Product models, brands, names and trademarks depicted herein are the property of their respective owners and, except where otherwise indicated, are not in any way associated with Meritor Heavy Vehicle Systems, LLC, or any parent or affiliate, thereof.



Meritor Heavy Vehicle Systems, LLC  
7975 Dixie Highway  
Florence, Kentucky 41042 USA

888-725-9355 U.S.  
800-387-3889 Canada  
MeritorPartsXpress.com  
meritor.com

©2017 Meritor, Inc.  
Litho in USA, SP-1805  
Issued 10-17 (47865/11900)

# TRAILER AIR VALVES CHECK VALVES

## SEALCO BY-PASS CHECK VALVE



MERITOR NO.	EUCLID NO.	NEW/REMAN	REPLACES	LENGTH	PORT SIZE	DIAMETER	ORIFICE SIZE	APPLICATION AND GENERAL INFORMATION
RSL110183	E-SL110183	Price Point	Sealco 110183	2-3/8"	1/4"	1-1/4"	.21	
RSL110183	E-SL220100		Sealco 220100					
RSL110183	E-SL220000		Sealco 220000	3-3/8"	3/4"	1-1/2"		

4

## SEALCO CHECK VALVE



MERITOR NO.	EUCLID NO.	NEW/REMAN	REPLACES	PORT SPECIFICATIONS		APPLICATION AND GENERAL INFORMATION
				A	B	
RSL22001/2	E-SL22001/2	Price Point	Sealco 22001/2	1/2" PT	1/2" PT	Dimension Size 2-3/8" x 1-1/4"
RSL22001/4	E-SL22001/4		Sealco 22001/4	1/4" PT	1/4" PT	
RSL22003/4	E-SL22003/4		Sealco 22003/4	3/4" PT	3/4" PT	

## SEALCO ONE-WAY CHECK VALVE



MERITOR NO.	EUCLID NO.	NEW/REMAN	REPLACES	APPLICATION AND GENERAL INFORMATION
RSL10200-1/2	E-SL10200-1/2	Price Point	Sealco 10200-1/2	
RSL10200-3/4	E-SL10200-3/4		Sealco 10200-3/4	
RSL10200-3/8	E-SL10200-3/8		Sealco 10200-3/8	
RSL102001	E-SL102001		Sealco 102001	
RSL102002	E-SL102002		Sealco 102002	
RSL102006-1/2	E-SL102006-1/2		Sealco 102006-1/2	
RSL102006-3/8	E-SL102006-3/8		Sealco 102006-3/8	

# TRAILER AIR VALVES CHECK VALVES

## SEALCO TWO-WAY CHECK VALVE



4

MERITOR NO.	EUCLID NO.	NEW/REMAN	REPLACES	REPAIR KIT NO.	APPLICATION AND GENERAL INFORMATION
RSL3200-1/4	E-SL3200-1/4	Price Point	Sealco 3200-1/4		
RSL3200	E-SL3200		Sealco 3200	E-SL32-5	
RSL320100	E-SL320100		Sealco 320100		
RSL5200	E-SL5200		Sealco 5200	E-SL52-5	
RSL7200	E-SL7200		Sealco 7200	E-SL72-5	

## SEALCO COMBINATION VALVE



MERITOR NO.	EUCLID NO.	NEW/REMAN	REPLACES	APPLICATION AND GENERAL INFORMATION
RSL110128	E-SL110128	Price Point	Sealco 110128	
RSL110129	E-SL110129		Sealco 110129	
RSL110130	E-SL110130		Sealco 110130	
RSL110131	E-SL110131		Sealco 110131	

# TRAILER AIR VALVES AIR BRAKE CONTROL VALVES

## SEALCO EMERGENCY CONTROL VALVE



MERITOR NO.	EUCLID NO.	NEW/REMAN	REPLACES	CORE NO.	CORE GROUP	APPLICATION AND GENERAL INFORMATION
RSL110376	E-SL110376	Price Point	Sealco 110376			For use on single axle non-charging systems.

## SEALCO PUSH-PULL CONTROL VALVE



Push Pull Valves - Manually operable - Pressure sensitive, on/off valves which will automatically return to the button out (exhaust) position when supply pressure is below the required minimum.

MERITOR NO.	EUCLID NO.	NEW/REMAN	REPLACES	APPLICATION AND GENERAL INFORMATION
RSL110114	E-SL110114	Price Point	Sealco 110114	
RSL110189	E-SL110189		Sealco 110189	
RSL110252	E-SL110252		Sealco 110252	
RSL110274	E-SL110274		Sealco 110274	
RSL110284	E-SL110284		Sealco 110284	
RSL110514	E-SL110514		Sealco 110514	
RSL110528	E-SL110528		Sealco 110528	Round black metal knob
RSL110644	E-SL110644		Sealco 110644	Contains screws but no name plate
RSL17600	E-SL17600		Sealco 17600	
RSL17600B-2	E-SL17600B-2		Sealco 17600B-2	Includes Emergency Brake Release dash cover plate and button. Basic valve part no. (without plate) - E-SL17600B-2
RSL17600B	E-SL17600B		Sealco 17600B	
RSL17600L	E-SL17600L		Sealco 17600L	7/8" -20 Thread Mount
RSL17600LB	E-SL17600LB		Sealco 17600LB	
RSL17600LG	E-SL17600LG		Sealco 17600LG	
RSL17600LR	E-SL17600LR		Sealco 17600LR	
RSL17600M	E-SL17600M		Sealco 17600M	Includes Emergency Brake Release dash cover plate and button. Basic valve part no. (without plate) - E-SL17600B-2
RSL340250	E-SL340250		Sealco 340250	Starter Control
RSL340350	E-SL340350		Sealco 340350	
RSL342500	E-SL342500		Sealco 342500	
RSL342501	E-SL342501		Sealco 342501	Starter control/emergency release and differential lockout valve. Cab Control Valve.
RSL342502	E-SL342502	Sealco 342502		
RSL3450	E-SL3450	Sealco 3450		
RSL3450G	E-SL3450G	Sealco 3450G		
RSL3450S	E-SL3450S	Sealco 3450S		
RSL99600	E-SL99600	Sealco 99600	Automatic Shut off. Push to park/pull to release.	

## TRAILER AIR VALVES AIR BRAKE CONTROL VALVES

### SEALCO PUSH-PULL CONTROL VALVE



Push Pull Valves - Manually operable - Pressure sensitive, on/off valves which will automatically return to the button out (exhaust) position when supply pressure is below the required minimum.

MERITOR NO.	EUCLID NO.	NEW/REMAN	REPLACES	APPLICATION AND GENERAL INFORMATION
RSL996-5	E-SL996-5	Price Point	Sealco 996-5	Repair kit.
RSL99600-5	E-SL99600-5		Sealco 99600-5	Valve Shuttlequick Fix service assembly.
RSL99600B	E-SL99600B		Sealco 99600B	Valve assembly with nameplate and knob.
RSL99600BL	E-SL99600BL		Sealco 99600BL	Valve assembly with nameplate and knob with Lock-Out

4

### SEALCO PUSH-PULL CONTROL VALVE



Push Pull Valves - Manually operable - Pressure sensitive, on/off valves which will automatically return to the button out (exhaust) position when supply pressure is below the required minimum.

MERITOR NO.	EUCLID NO.	NEW/REMAN	REPLACES	APPLICATION AND GENERAL INFORMATION
RSLA256-5	E-SLA256-5	Price Point	Sealco A256-5	Service knob
RSLA25600-2	E-SLA25600-2		Sealco A25600-2	Without knob
RSLA25600	E-SLA25600		Sealco A25600	Pull to park/push to release.
RSLA25600Y	E-SLA25600Y		Sealco A25600Y	With knob

# TRAILER AIR VALVES AIR BRAKE CONTROL VALVES

## SEALCO LEVER CONTROL VALVE

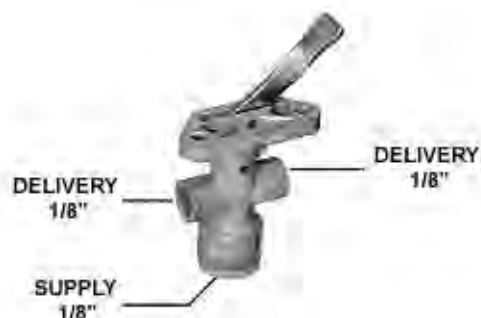

MERITOR NO.	EUCLID NO.	NEW/REMAN	REPLACES	APPLICATION AND GENERAL INFORMATION
RSL110103	E-SL110103	Price Point	Sealco 110103	
RSL110167	E-SL110167		Sealco 110167	
RSL110300	E-SL110300		Sealco 110300	Includes Tailgate - Open - Close dash cover plate.
RSL110301	E-SL110301		Sealco 110301	
RSL110413	E-SL110413		Sealco 110413	Uses name plate # 8116
RSL21600-2	E-SL21600-2		Sealco 21600-2	No plate included.
RSL21600	E-SL21600		Sealco 21600	Includes Truck Tractor Protection dash cover plate.
RSL21600D	E-SL21600D		Sealco 21600D	
RSL216050	E-SL216050		Sealco 216050	Includes On-Off dash cover plate.
RSL216200	E-SL216200		Sealco 216200	

4

## SEALCO CONTROL VALVE



MERITOR NO.	EUCLID NO.	NEW/REMAN	REPLACES	APPLICATION AND GENERAL INFORMATION
RSL5400	E-SL5400	Price Point	Sealco 5400	Pressure setting is adjustable from 0 psi to reservoir pressure.

## TRAILER AIR VALVES AIR BRAKE FOOT VALVES

### SEALCO FOOT VALVE (Single Circuit)



Single Circuit Foot Valve - Normally used on pre FMVSS-121 vehicles. It is foot operated and controls the delivery of air to the brake chambers. Simply stated it provides the driver with a means of applying and releasing the brakes on a vehicle.

4

MERITOR NO.	EUCLID NO.	NEW/REMAN	REPLACES	DELIVERY PORTS	TREADLE ASSEMBLY	TREADLE ANGLE	CORE NO.	CORE GROUP	APPLICATION AND GENERAL INFORMATION
RSL6125-2	E-SL6125-2	Price Point	Sealco 6125-2	1/2" PT (4)	None		XC1200	SL100	Furnished less treadle and mounting brackets.
RSL6125-25	E-SL6125-25		Sealco 6125-25		Yes	25°			
RSL6125-2X	E-SL6125-2X	Reman	Sealco 6125-2X		None				
RSL6125-35	E-SL6125-35	Price Point	Sealco 6125-35		Yes	40°			
RSL6125-40	E-SL6125-40		Sealco 6125-40	45°					
RSL6125-45	E-SL6125-45		Sealco 6125-45						
RSL6125-7	E-SL6125-7		Sealco 6125-7	Yes	30°				
RSL6125	E-SL6125		Sealco 6125						
RSL6125X	E-SL6125X	Reman	Sealco 6125X	1/2" PT (4)			XC1200	SL100	

### SEALCO FOOT VALVE (Dual Circuit)



Dual Circuit Foot Valves - A dual foot has two separate circuits for service and secondary braking, and is used in dual circuit air brake systems mandated by FMVSS-121. Braking ability is maintained in the event that one circuit fails.

MERITOR NO.	EUCLID NO.	NEW/REMAN	REPLACES	REPAIR KIT	CORE NO.	CORE GROUP	APPLICATION AND GENERAL INFORMATION
RSL110297	E-SL110297	Price Point	Sealco 110297	E-SL110297	XC1200	SL100	Furnished less treadle and mounting brackets.
RSL110400	E-SL110400		Sealco 110400				
RSL110405	E-SL110405		Sealco 110405				
RSL110425	E-SL110425		Sealco 110425				
RSL110430	E-SL110430		Sealco 110430				
RSL110435	E-SL110435		Sealco 110435				
RSL110440	E-SL110440		Sealco 110440				
RSL110445	E-SL110445		Sealco 110445				



# TRAILER AIR VALVES AIR BRAKE HAND CONTROL VALVES

## SEALCO HAND CONTROL VALVE



Hand Control Valves - The most common function of hand control valves is for independent control of trailer service brakes. As a result they are also referred to as "Trailer Control Valves."

MERITOR NO.	EUCLID NO.	NEW/REMAN	REPLACES	MOUNTING KIT	APPLICATION AND GENERAL INFORMATION
<b>RSL5900-1</b>	E-SL5900-1	Price Point	Sealco 5900-1		Furnished less handle and clamp.
<b>RSL5900</b>	E-SL5900		Sealco 5900	E-SL110174, E-SL110176	
<b>RSL5900B</b>	E-SL5900B		Sealco 5900B	E-SL110176	
<b>RSL5900G</b>	E-SL5900G		Sealco 5900G	E-SL110174	
<b>RSL5900GI</b>	E-SL5900GI		Sealco 5900GI		
<b>RSL5900L</b>	E-SL5900L		Sealco 5900L		
<b>RSL5900R</b>	E-SL5900R		Sealco 5900R		

4

## TRAILER AIR VALVES AIR BRAKE PROTECTION VALVES

### SEALCO PRESSURE PROTECTION VALVE



4

MERITOR NO.	EUCLID NO.	NEW/REMAN	REPLACES	SPECIFICATIONS					QUICK FIX REPAIR KIT
				STYLE	INLET	OUTLET	OPEN	CLOSE	
RSL140370	E-SL140370	Price Point	Sealco 140370	A	1/4"	1/4"	70 psi	60 psi	E-SL140271
RSL140380	E-SL140380		Sealco 140380				80 psi	70 psi	E-SL140281
RSL140200	E-SL140200		Sealco 140200				70 psi	60 psi	E-SL140201
RSL140270	E-SL140270		Sealco 140270	B	3/8"	3/8"	75 psi	70 psi	E-SL140271
RSL110257	E-SL110257		Sealco 110257						
RSL110258	E-SL110258		Sealco 110258						
RSL140390	E-SL140390		Sealco 140390	A			80 psi	70 psi	E-SL140281
RSL140280	E-SL140280		Sealco 140280						
RSL140290	E-SL140290		Sealco 140290						90 psi

### SEALCO PRESSURE CONTROL VALVE



Pressure Reducing Valve - Used where a constant set air pressure lower than supply pressure is required. Typically an air operated application that requires less than system air pressure.

MERITOR NO.	EUCLID NO.	NEW/REMAN	REPLACES	NOMINAL DELIVERY PRESSURE	CORE NO.	CORE GROUP	APPLICATION AND GENERAL INFORMATION
RSL9400	E-SL9400	Price Point	Sealco 9400	5-6 psi 85 psi maximum			

# TRAILER AIR VALVES AIR BRAKE QUICK RELEASE VALVES

## SEALCO QUICK RELEASE VALVES



MERITOR NO.	EUCLID NO.	NEW/REMAN	REPLACES	CRACK PRESSURE	PORT SIZE P.T.				QUICK FIX REPAIR KIT
					A	B	C	EXHAUST	
RSL200000	E-SL200000	Price Point	Sealco 200000	0-1 psi	1/4"	1/4"	1/4"		E-SL200125
RSL200004	E-SL200004		Sealco 200004					1/2"	E-SL20D-5
RSL2000D3/8	E-SL2000D3/8		Sealco 2000D3/8						
RSL2000B3/8	E-SL2000B3/8		Sealco 2000B3/8	4-5 psi	3/8"	1/4"	1/4"		E-SL20-5
RSL2000C3/8	E-SL2000C3/8		Sealco 2000C3/8	8-10 psi					
RSL200003	E-SL200003		Sealco 200003	0-1 psi	1/2"			1/2"	E-SL20D-5
RSL200001	E-SL200001		Sealco 200001						
RSL2000D1/2	E-SL2000D1/2		Sealco 2000D1/2	4-5 psi	1/2"				E-SL20-5
RSL2000B1/2	E-SL2000B1/2		Sealco 2000B1/2						
RSL2000C1/2	E-SL2000C1/2		Sealco 2000C1/2						
RSL200002	E-SL200002		Sealco 200002	0-1 psi				1/2"	E-SL20D-5

4

## SEALCO CONTROL VALVE



MERITOR NO.	EUCLID NO.	NEW/REMAN	REPLACES	APPLICATION AND GENERAL INFORMATION
RSL3800	E-SL3800	Price Point	Sealco 3800	
RSL7800	E-SL7800		Sealco 7800	
RSL780210	E-SL780210		Sealco 780210	

## TRAILER AIR VALVES AIR BRAKE RELAY VALVES

4

### SEALCO RELAY VALVE

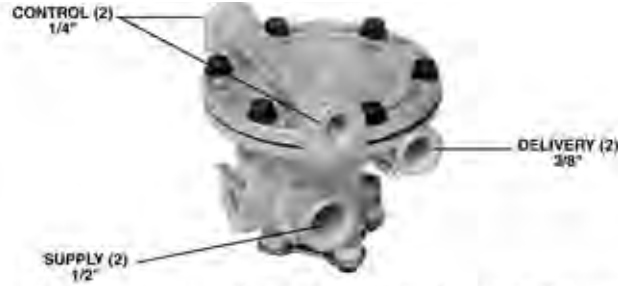

Relay Valve - Used to rapidly apply and release rear axle(s), service, or parking brakes. When signaled by the service brake valve, they graduate, hold or release air pressure from the chambers to which they are connected. The relay valve is used to balance the time of air application on the vehicle. This is determined by the factory preset "crack pressure" of the valve. Crack pressure is set on a relay valve by a "hold-off" spring that retards valve operation until a predetermined amount of air pressure is exerted.

MERITOR NO.	EUCLID NO.	NEW/REMAN	REPLACES	CRACK PRESSURE	CONTROL PORTS	CORE NO.	CORE GROUP	APPLICATION AND GENERAL INFORMATION
RSL110207	E-SL110207	Price Point	Sealco 110207					
RSL110207X	E-SL110207X	Reman	Sealco 110207X			XC1200	SL100	
RSL9125	E-SL9125	New	Sealco 9125	5.5 psi	(3) 1/4"			Includes mounting bracket ESL110237

### SEALCO RELAY VALVE



Relay Valve - Used to rapidly apply and release rear axle(s), service, or parking brakes. When signaled by the service brake valve, they graduate, hold or release air pressure from the chambers to which they are connected. The relay valve is used to balance the time of air application on the vehicle. This is determined by the factory preset "crack pressure" of the valve. Crack pressure is set on a relay valve by a "hold-off" spring that retards valve operation until a predetermined amount of air pressure is exerted.

MERITOR NO.	EUCLID NO.	NEW/REMAN	REPLACES	CRACK PRESSURE	CORE NO.	CORE GROUP	APPLICATION AND GENERAL INFORMATION
RSL110197	E-SL110197	Price Point	Sealco 110197	4.0 psi			Nipple mount design. Nipple not included, use E-SL6002 or E-SL6003.
RSL110197X	E-SL110197X	Reman	Sealco 110197X		XC1200	SL100	
RSL110198	E-SL110198	Price Point	Sealco 110198	4.0 psi			For trailer applications only.
RSL110199	E-SL110199		Sealco 110199				
RSL110199X	E-SL110199X	Reman	Sealco 110199X		XC1200	SL100	
RSL110275	E-SL110275	Price Point	Sealco 110275				
RSL110275X	E-SL110275X	Reman	Sealco 110275X		XC1200	SL100	
RSL110507	E-SL110507	Price Point	Sealco 110507	6.0 psi			
RSL110507X	E-SL110507X	Reman	Sealco 110507X		XC1200	SL100	

# TRAILER AIR VALVES AIR BRAKE RELAY VALVES

## SEALCO MINI VALVE



Relay Valve - Used to rapidly apply and release rear axle(s), service, or parking brakes. When signaled by the service brake valve, they graduate, hold or release air pressure from the chambers to which they are connected. The relay valve is used to balance the time of air application on the vehicle. This is determined by the factory preset "crack pressure" of the valve. Crack pressure is set on a relay valve by a "hold-off" spring that retards valve operation until a predetermined amount of air pressure is exerted.

MERITOR NO.	EUCLID NO.	NEW/REMAN	REPLACES	CRACK PRESSURE	DELIVERY PORTS	CORE NO.	CORE GROUP	APPLICATION AND GENERAL INFORMATION
RSL110207	E-SL3100	Price Point	Sealco 3100	2.5 PSI	(2) 1/4"			Early version Control Line Valve. Commonly used on dollies. Can be replaced by E-SL110570 or E-SL110580.

4

## SEALCO RELAY VALVE WITH RATIO



Relay Valve - Used to rapidly apply and release rear axle(s), service, or parking brakes. When signaled by the service brake valve, they graduate, hold or release air pressure from the chambers to which they are connected. The relay valve is used to balance the time of air application on the vehicle. This is determined by the factory preset "crack pressure" of the valve. Crack pressure is set on a relay valve by a "hold-off" spring that retards valve operation until a predetermined amount of air pressure is exerted. For trailer applications only.

MERITOR NO.	EUCLID NO.	NEW/REMAN	REPLACES	CRACK PRESSURE	DELIVERY PORTS	CORE NO.	CORE GROUP	APPLICATION AND GENERAL INFORMATION
RSL110139	E-SL110139	Price Point	Sealco 110139	4.5 psi	(4) 3/8"			Valve has ratio feature which is used during panic stop applications. Nipple mount design style - use E-SL6003 or E-SL6006. For trailer applications only.
RSL110139X	E-SL110139X	Reman	Sealco 110139X			XC1200	SL100	
RSL110450	E-SL110450	Price Point	Sealco 110450					No ratio feature, Valve has ratio feature which is used during panic stop applications. Nipple mount design style - use E-SL6003 or E-SL6006. For trailer applications only.
RSL110584	E-SL110584	Price Point	Sealco 110584	5.5 psi				Valve has ratio feature which is used during panic stop applications. Nipple mount design style - use E-SL6003 or E-SL6006. For trailer applications only.
RSL110584X	E-SL110584X	Reman	Sealco 110584X				XC1200	

## TRAILER AIR VALVES AIR BRAKE RELAY VALVES

### SEALCO LOV-2 SERVICE RELAY VALVE (2 Port Delivery)



Relay Valve - Used to rapidly apply and release rear axle(s), service, or parking brakes. When signaled by the service brake valve, they graduate, hold or release air pressure from the chambers to which they are connected. The relay valve is used to balance the time of air application on the vehicle. This is determined by the factory preset "crack pressure" of the valve. Crack pressure is set on a relay valve by a "hold-off" spring that retards valve operation until a predetermined amount of air pressure is exerted.

4

MERITOR NO.	EUCLID NO.	NEW/REMAN	REPLACES	CRACK PRESSURE	CORE NO.	CORE GROUP	APPLICATION AND GENERAL INFORMATION
RSL110360	E-SL110360	Price Point	Sealco 110360	1.5 psi			Nipple mount design. Nipple not included. Use E-SL6002 or E-SL6003. LOV-2 = Low opening valve for single axle applications.
RSL110365	E-SL110365		Sealco 110365				Frame mount design. Includes mounting bracket. LOV-2 = Low opening valve for single axle applications.
RSL110410	E-SL110410		Sealco 110410	4.0 psi			Nipple mount design. Nipple not included, use E-SL6002 or E-SL6003.
RSL110412	E-SL110412				Sealco 110412		

# TRAILER AIR VALVES AIR BRAKE RELAY VALVES

## SEALCO LOV-4 RELAY VALVE (4 Port Delivery)



Relay Valve - Used to rapidly apply and release rear axle(s), service, or parking brakes. When signaled by the service brake valve, they graduate, hold or release air pressure from the chambers to which they are connected. The relay valve is used to balance the time of air application on the vehicle. This is determined by the factory preset "crack pressure" of the valve. Crack pressure is set on a relay valve by a "hold-off" spring that retards valve operation until a predetermined amount of air pressure is exerted.

MERITOR NO.	EUCLID NO.	NEW/REMAN	REPLACES	CRACK PRESSURE	CORE NO.	CORE GROUP	APPLICATION AND GENERAL INFORMATION
<b>RSL110380</b>	E-SL110380	Price Point	Sealco 110380	1.5 psi	XC1200	SL100	(1 swivel) 3/8" PT control port. (1) 3/4" PT supply port. (4) 3/8" PT delivery ports. LOV-4 = Low opening valve for tandem axle applications. Nipple mount design. Nipple not included, use E-SL6003 or E-SL6006.
<b>RSL110380X</b>	E-SL110380X	Reman	Sealco 110380X				
<b>RSL110385</b>	E-SL110385	Price Point	Sealco 110385	4.0 psi	XC1200	SL100	(1 swivel) 3/8" PT control port. (1) 3/4" PT supply port. (4) 3/8" PT delivery ports. LOV-4 = Low opening valve for tandem axle applications. Nipple mount design. Nipple not included, use E-SL6003 or E-SL6006., E-SL110395 frame bracket included
<b>RSL110415</b>	E-SL110415		Sealco 110415				
<b>RSL110415X</b>	E-SL110415X	Reman	Sealco 110415X				
<b>RSL110416</b>	E-SL110416	Price Point	Sealco 110416				

## TRAILER AIR VALVES AIR BRAKE CONTROL LINE VALVES

### SEALCO CONTROL LINE VALVE



MERITOR NO.	EUCLID NO.	NEW/REMAN	REPLACES	CORE NO.	CORE GROUP	APPLICATION AND GENERAL INFORMATION
RSL110580	E-SL110580	Price Point	Sealco 110580			Includes mounting bracket.
RSL110582	E-SL110582		Sealco 110582			E-SL110580 valve with bracket on top
RSL110588	E-SL110588		Sealco 110588			E-SL110580 valve with bracket 90° down
RSL110605	E-SL110605		Sealco 110605			E-SL110580 valve with E-SL10200-1/2 check valve
RSL110790	E-SL110790		Sealco 110790			Without bracket, can be nipple mount.
RSL110790X	E-SL110790X	Reman	Sealco 110790X	XC1200	SL100	

### SEALCO LOV-CF CONTROL LINE VALVE DOLLY USE ONLY



Relay Valve - Used to rapidly apply and release rear axle(s), service, or parking brakes. When signaled by the service brake valve, they graduate, hold or release air pressure from the chambers to which they are connected. The relay valve is used to balance the time of air application on the vehicle. This is determined by the factory preset "crack pressure" of the valve. Crack pressure is set on a relay valve by a "hold-off" spring that retards valve operation until a predetermined amount of air pressure is exerted.

MERITOR NO.	EUCLID NO.	NEW/REMAN	REPLACES	CRACK PRESSURE	CORE NO.	CORE GROUP	APPLICATION AND GENERAL INFORMATION
RSL110370X	E-SL110370X	Reman	Sealco 110370X	4.5 psi	XC1200	SL100	(1) 1/2" PT reservoir port. LOV-CF = Low opening valve. Designed to speed up the control line signal to rear trailers.
RSL110375X	E-SL110375X		Sealco 110375X	1.5 psi			(1) 1/2" PT reservoir port. LOV-CF = Low opening valve. Designed to speed up the control line signal to rear trailers.
RSL110570	E-SL110570	Price Point	Sealco 110570	0.0 psi			(1) 1/2" PT reservoir port. LOV-CF = Low opening valve. Designed to speed up the control line signal to rear trailers. Includes mounting bracket.
RSL110571	E-SL110571		Sealco 110571				
RSL110606	E-SL110606		Sealco 110606				
RSL110690	E-SL110690		Sealco 110690				
RSL110690X	E-SL110690X	Reman	Sealco 110690X		XC1200	SL100	(1) 1/2" PT reservoir port. LOV-CF = Low opening valve. Designed to speed up the control line signal to rear trailers.

4



# TRAILER AIR VALVES AIR BRAKE EMERGENCY VALVES

## SEALCO RELAY EMERGENCY VALVE



Relay Emergency Valve - A dual function valve used on trailers. (1) A relay valve that applies and releases the service brakes (2) An emergency feature that automatically applies the service brakes in the event that supply air is lost. Normally used on pre FMVSS-121 vehicles and off road applications.

MERITOR NO.	EUCLID NO.	NEW/REMAN	REPLACES	CRACK PRESSURE	CORE NO.	CORE GROUP	APPLICATION AND GENERAL INFORMATION
<b>RSLA1000S</b>	E-SLA1000S	Price Point	Sealco A1000S	1.5 psi			Nipple mount design. Nipple not included. Use E-SL6002 or E-SL6003. For quick fix service use E-SL1000-5A cartridge.
<b>RSLA1000SX</b>	E-SLA1000SX	Reman	Sealco A1000SX		XC1200	SL100	

4

## SEALCO VALVE CARTRIDGE



Relay Emergency Valve - A dual function valve used on trailers. (1) A relay valve that applies and releases the service brakes (2) An emergency feature that automatically applies the service brakes in the event that supply air is lost. Normally used on pre FMVSS-121 vehicles and off road applications.

MERITOR NO.	EUCLID NO.	NEW/REMAN	REPLACES	CRACK PRESSURE	CORE NO.	CORE GROUP	APPLICATION AND GENERAL INFORMATION
<b>RSL1000-5A</b>	E-SL1000-5A	Price Point	Sealco 1000-5A	1.5 psi			For use with the E-SLA1000X or E-SLA1000S Relay Emergency Valve.
<b>RSL1000-5AX</b>	E-SL1000-5AX	Reman	Sealco 1000-5AX		XC1200	SL100	

## TRAILER AIR VALVES AIR BRAKE EMERGENCY VALVES

### SEALCO RELAY EMERGENCY VALVE (Charging Type)

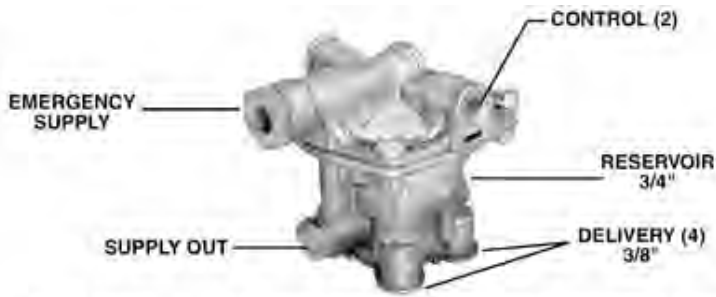

Relay Emergency Valve - A dual function valve used on trailers. (1) A relay valve that applies and releases the service brakes. (2) An emergency feature that automatically applies the service brakes in the event that supply air is lost. Normally used on pre FMVSS-121 vehicles and off road applications.

4

MERITOR NO.	EUCLID NO.	NEW/REMAN	REPLACES	CRACK PRESSURE	SPECIFICATIONS				CORE NO.	CORE GROUP	APPLICATION AND GENERAL INFORMATION	
					EMERGENCY SUPPLY	CONTROL PORTS	SUPPLY OUT	RATIO FEATURE				
RSL110200	E-SL110200	Price Point	Sealco 110200	4.5 psi	1/4"	1/4" (2)	3/4"	Yes			Valve has ratio feature which is used during panic stop applications. Nipple mount design style - use E-SL6003 or E-SL6006.	
RSL110200X	E-SL110200X	Reman	Sealco 110200X						XC1200	SL100		
RSL110475	E-SL110475	Price Point	Sealco 110475		3/8"	No	3/4"	No				
RSL110475X	E-SL110475X	Reman	Sealco 110475X						XC1200	SL100		
RSL110460	E-SL110460	Price Point	Sealco 110460		3/8"	3/8" (2)	3/4"	Yes				
RSL110460X	E-SL110460X	Reman	Sealco 110460X						XC1200	SL100		
RSL110470	E-SL110470	Price Point	Sealco 110470		8.5 psi	3/8"	3/8" (2)	3/4"	No			
RSL110205	E-SL110205	Price Point	Sealco 110205									
RSL110205X	E-SL110205X	Reman	Sealco 110205X									
RSL110459	E-SL110459	Price Point	Sealco 110459		8.5 psi	3/8"	3/8" (2)	3/4"	No			
RSL110459X	E-SL110459X	Reman	Sealco 110459X	XC1200						SL100		

### SEALCO DOLLY RELAY EMERGENCY VALVE

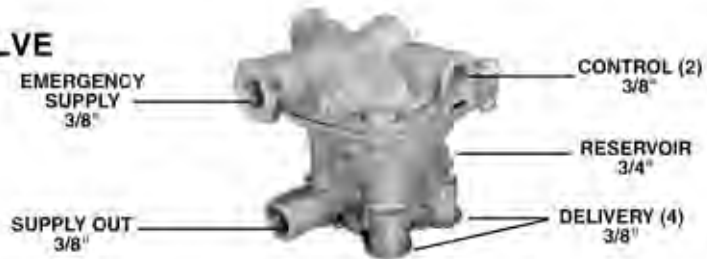

Relay Emergency Valve - A dual function valve used on trailers. (1) A relay valve that applies and releases the service brakes. (2) An emergency feature that automatically applies the service brakes in the event that supply air is lost. Normally used on pre FMVSS-121 vehicles and off road applications.

MERITOR NO.	EUCLID NO.	NEW/REMAN	REPLACES	CRACK PRESSURE	DELIVERY PORTS	CORE NO.	CORE GROUP	APPLICATION AND GENERAL INFORMATION
RSL110338	E-SL110338	Price Point	Sealco 110338	4.5 psi	(4) 3/8" PT			Typically used on converter dollies. E-SL110268 supply outlet plugged.
RSL110267	E-SL110267		Sealco 110267	5.5 psi				
RSL110268	E-SL110268		Sealco 110268					

# TRAILER AIR VALVES AIR BRAKE SPRING BREAK VALVES

## SEALCO SPRING BRAKE CONTROL VALVE (Protected Reservoir System)



Spring Brake Valve - A dual function valve. (1) limits hold-off pressure to the spring brakes via a relay of quick release valve, generally 90-95 psi. (2) Should a loss of pressure occur it provides a modulated spring brake application proportional to the service braking pressure delivered to the front axle. Commonly used on post FMVSS-121 systems.

MERITOR NO.	EUCLID NO.	NEW/REMAN	REPLACES	RESERVOIR "A"	RESERVOIR "B"	CORE NO.	CORE GROUP	APPLICATION AND GENERAL INFORMATION	
RSL1101913	E-SL110191 <sup>60</sup>	Price Point	Sealco 110191	3/8"	1/2"			Reservoir "A" port below supply port.	
RSL110191X <sup>60</sup>	E-SL110191X <sup>60</sup>	Reman	Sealco 110191X			XC1200	SL100		
RSL110171 <sup>60</sup>	E-SL110171 <sup>60</sup>	Price Point	Sealco 110171	1/2"	3/8"				
RSL110171X <sup>60</sup>	E-SL110171X <sup>60</sup>	Reman	Sealco 110171X			XC1200	SL100		
RSL110170 <sup>60</sup>	E-SL110170 <sup>60</sup>	Price Point	Sealco 110170		1/2"				
RSL110170X <sup>60</sup>	E-SL110170X <sup>60</sup>	Reman	Sealco 110170X				XC1200		SL100

Notes: 60 Control/Supply ports on head rotate 90° from reservoir ports on body.

## TRAILER AIR VALVES AIR BRAKE SPRING BREAK VALVES

### SEALCO SPRING BRAKE CONTROL VALVE (Spring Brake Priority System)



Spring Brake Valve - A dual function valve. (1) limits hold-off pressure to the spring brakes via a relay of quick release valve, generally 90-95 psi. (2) Should a loss of pressure occur it provides a modulated spring brake application proportional to the service braking pressure delivered to the front axle. Commonly used on post FMVSS-121 systems.

4

MERITOR NO.	EUCLID NO.	NEW/REMAN	REPLACES	CORE NO.	CORE GROUP	APPLICATION AND GENERAL INFORMATION
RSL110500	E-SL110500	Price Point	Sealco 110500			For use on a typical single or tandem axle trailer with a single reservoir or a tandem axle trailer with (2) 1400 cubic inch (normal) reservoirs.
RSL110500X	E-SL110500X	Reman	Sealco 110500X	XC1200	SL100	

### SEALCO SPRING BRAKE CONTROL VALVE (Service Reservoir Priority System)



MERITOR NO.	EUCLID NO.	NEW/REMAN	REPLACES	CORE NO.	CORE GROUP	APPLICATION AND GENERAL INFORMATION
RSL110700	E-SL110700	Price Point	Sealco 110700			For use on a typical single or tandem axle trailer with a single reservoir or a tandem axle trailer with (2) 1400 cubic inch (normal) reservoirs.
RSL110700X	E-SL110700X	Reman	Sealco 110700X	XC1200	SL100	

# TRAILER AIR VALVES AIR BRAKE SPRING BREAK VALVES

## SEALCO SPRING BRAKE CONTROL VALVE (Spring Brake Priority System)



Spring Brake Valve - A dual function valve. (1) limits hold-off pressure to the spring brakes via a relay of quick release valve, generally 90-95 psi. (2) Should a loss of pressure occur it provides a modulated spring brake application proportional to the service braking pressure delivered to the front axle. Commonly used on post FMVSS-121 systems.

MERITOR NO.	EUCLID NO.	NEW/REMAN	REPLACES	CORE NO.	CORE GROUP	APPLICATION AND GENERAL INFORMATION
RSL110700	E-SL110800	Price Point	Sealco 110800			For use on a typical single or tandem axle trailer with a single reservoir or a tandem axle trailer with (2) 1400 cubic inch (normal) reservoirs.

4

## SEALCO RELAY/ SPRING BRAKE VALVE ASSEMBLY (RSA)



MERITOR NO.	EUCLID NO.	NEW/REMAN	REPLACES	PRIORITY SYSTEM	4 PORT RELAY	SPRING BRAKE CTRL VALVE	RESERVOIR MOUNTING TEE	APPLICATION AND GENERAL INFORMATION
RSL110542	E-SL110542	Price Point	Sealco 110542	Spring Brake	E-SL110415	E-SL110500	1/2"	For use on tandem axle trailer with 2 tanks and 1 valve (spring brake priority). Repair E-SL110515 and E-SL110520 Plug Units
RSL110544	E-SL110544		Sealco 110544				3/4"	
RSL110742	E-SL110742		Sealco 110742	Service Reservoir		E-SL110700	1/2"	
RSL110744	E-SL110744		Sealco 110744				3/4"	

## TRAILER AIR VALVES AIR BRAKE SWITCHES AND INDICATORS

### SEALCO LOW PRESSURE SWITCH



MERITOR NO.	EUCLID NO.	NEW/REMAN	REPLACES	FITTING	MOUNTING	APPLICATION AND GENERAL INFORMATION
<b>RSL8000</b>	E-SL8000	New	Sealco 8000	1/4" Male P.T.	Nipple	Adjustment Range 45 psi to 100 psi, Factory Set to 60 psi
<b>RSL8000B</b>	E-SL8000B		Sealco 8000B	1/8" Female P.T.	Bracket 820	

4

### SEALCO STEP LIGHT SWITCH



MERITOR NO.	EUCLID NO.	NEW/REMAN	REPLACES	FITTING	MOUNTING	APPLICATION AND GENERAL INFORMATION
<b>RSL8100</b>	E-SL8100	New	Sealco 8100	1/4" Male P.T.	Nipple	Adjustment Range 45 psi to 100 psi, Factory Set to 60 psi
<b>RSL8100B</b>	E-SL8100B		Sealco 8100B	1/8" Female P.T.	Bracket 820	

# TRAILER AIR VALVES AIR BRAKE TRACTOR PROTECTION VALVES

## SEALCO BREAKAWAY VALVE



MERITOR NO.	EUCLID NO.	NEW/REMAN	REPLACES	APPLICATION AND GENERAL INFORMATION
<b>RSL7700</b>	E-SL7700	Price Point	Sealco 7700	(1) 1/4" PT control in (1) 1/4" PT supply in (1) 1/2" PT control out (1) 1/2" PT supply out

4

## AIR BRAKE MISCELLANEOUS VALVES

### SEALCO SLUDGE REMOVER VALVE



MERITOR NO.	EUCLID NO.	NEW/REMAN	REPLACES	APPLICATION AND GENERAL INFORMATION
<b>RSL6300</b>	E-SL6300	Price Point	Sealco 6300	All Ports 1/4" PT

### SEALCO AIR STARTER VALVE



MERITOR NO.	EUCLID NO.	NEW/REMAN	REPLACES	APPLICATION AND GENERAL INFORMATION
<b>RSL6900</b>	E-SL6900	Price Point	Sealco 6900	(1) 1" PT Inlet (1) 1/4" PT Application port (1) 1" PT Outlet

**TRAILER AIR VALVES  
AIR BRAKE MISCELLANEOUS VALVES**

**SEALCO  
AIR STARTER VALVE**



4

MERITOR NO.	EUCLID NO.	NEW/REMAN	REPLACES	INLET	OUTLET	MOUNT HOLES	O-RING MATERIAL	APPLICATION AND GENERAL INFORMATION
RSL110390	E-SL110390	Price Point	Sealco 110390	1-1/4" PT	1-1/4" PT	No	Viton	
RSL110486	E-SL110486		Sealco 110486	1-1/2" PT	1-1/2" PT	Yes	Viton	
RSL14900	E-SL14900		Sealco 14900	1-1/4" PT	1-1/4" PT	Yes	Nitrile	
RSL110250	E-SL110250		Sealco 110250	1-1/2" PT	1-1/2" PT	No	Nitrile	Auxiliary Port (NPT) 1/4"
RSL110250	E-SL110250		Sealco 110250	1-1/2" PT	1-1/2" PT	No	Nitrile	Auxiliary Port (NPT) 1/4"
RSL10900	E-SL10900		Sealco 10900	1-1/2" PT	1-1/2" PT	No	Nitrile	Auxiliary Port (NPT) Closed

**SEALCO  
AUTOMATIC DRAIN VALVE**



MERITOR NO.	EUCLID NO.	NEW/REMAN	REPLACES	APPLICATION AND GENERAL INFORMATION
RSL10300-12	E-SL10300-12	Price Point	Sealco 10300-12	With 12 volt heater



Flange Mount Kits

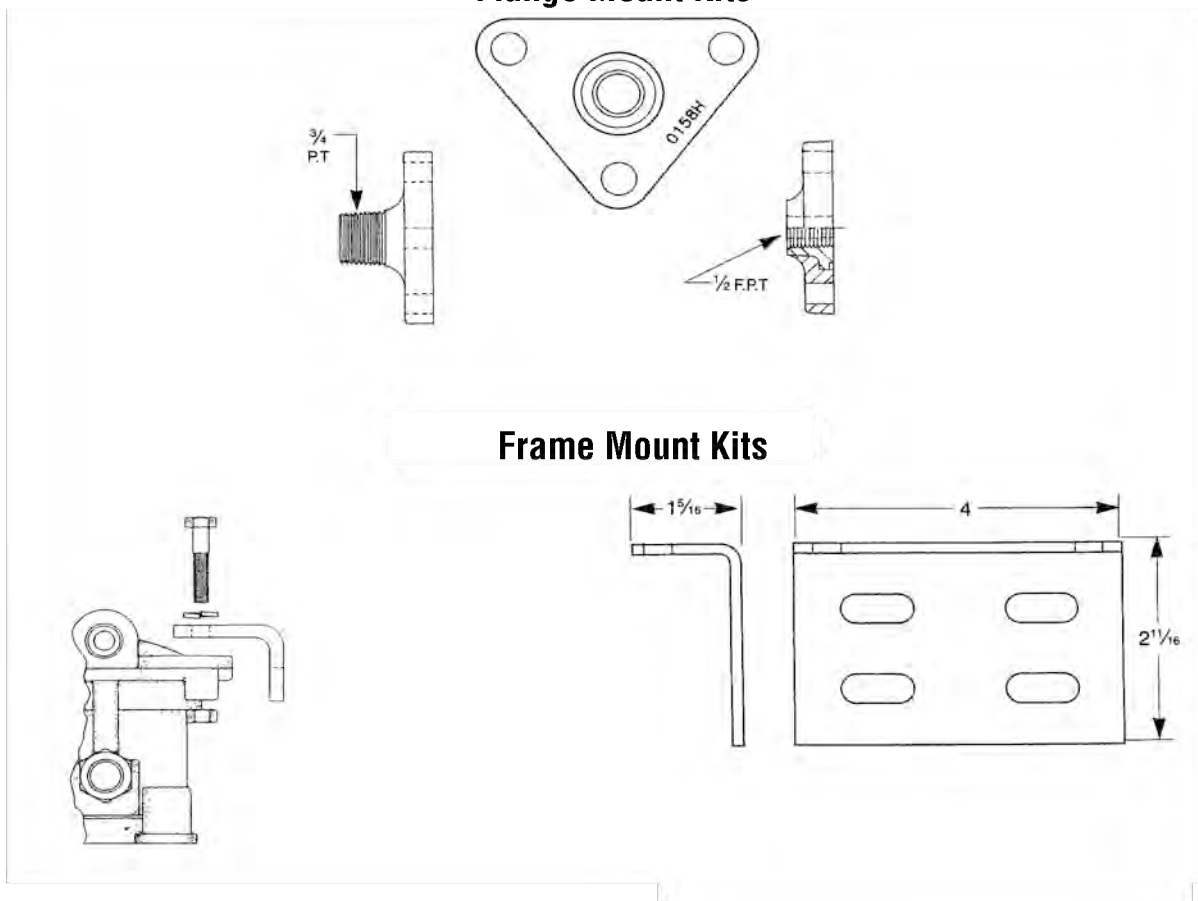

Frame Mount Kits

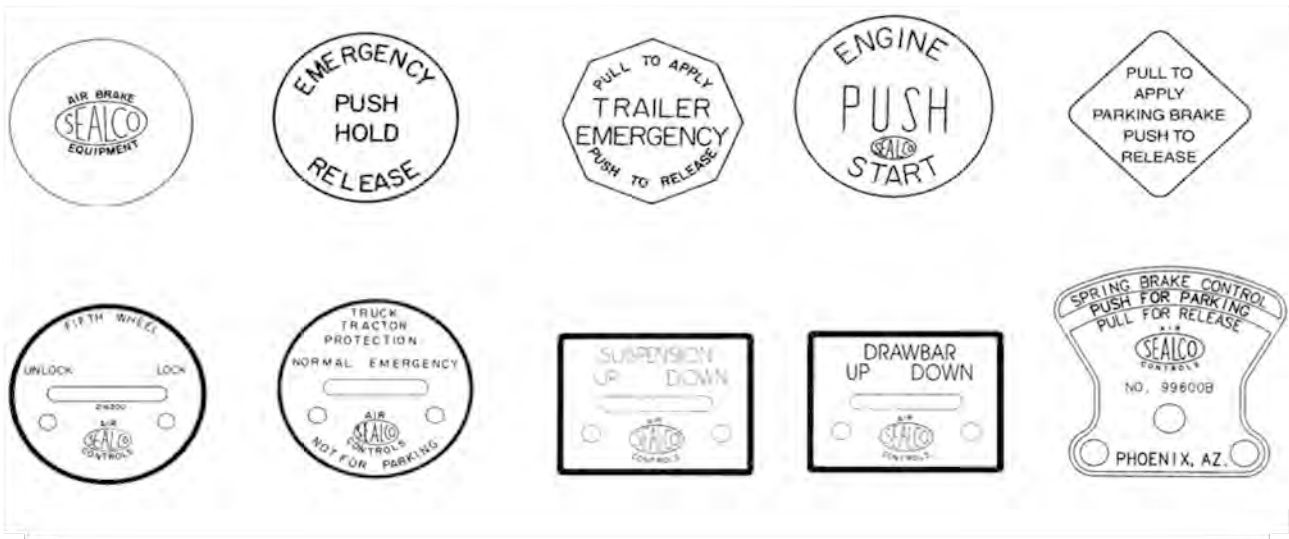

## TRAILER AIR VALVES AIR BRAKE SAFETY VALVES AND FITTINGS

### SEALCO AIR TANK SAFETY VALVE



MERITOR NO.	EUCLID NO.	NEW/REMAN	REPLACES	SPECIFICATIONS		APPLICATION AND GENERAL INFORMATION
				"POP OFF" PRESSURE	THREAD	
RSL110127	E-SL110127	Price Point	Sealco 110127	150 psi Factory Set	1/4" PT	

4

### SEALCO MOUNTING NIPPLE



MERITOR NO.	EUCLID NO.	NPT SIZE	REPLACES	APPLICATION AND GENERAL INFORMATION
RSL6002	E-SL6002	1/2" Male x 1/2" Male	Sealco 6002	
RSL6003	E-SL6003	3/4" Male x 1/2" Male	Sealco 6003	
RSL616	E-SL616		Sealco 616	Hex area between ends.
RSL617	E-SL617		Sealco 617	Female and Hex outside.
RSL6006	E-SL6006	3/4" Male x 3/4" Male	Sealco 6006	

### SEALCO FRAME MOUNT TEE



MERITOR NO.	EUCLID NO.	PORT SIZE	REPLACES	APPLICATION AND GENERAL INFORMATION
RSL780212	E-SL780212	3/8"	Sealco 780212	With 12 volt heater

# CROSS REFERENCE

Additional Meritor air systems part numbers are cross-referenced below.  
Please visit [MeritorPartsXpress.com](http://MeritorPartsXpress.com) for further details on these part numbers.

Competitor Part Number	Competitor Name	Meritor Part Number	Competitor Part Number	Competitor Name	Meritor Part Number	Competitor Part Number	Competitor Name	Meritor Part Number
022105P	Primabrake	R955K022105N	065437X	Bendix	R955108076X	101100N	Bendix	R955101100X
031 005 609	Haldex	R955099P	065437X	Bendix	R955065437X	101100RX	Bendix	R955101100X
065041X	Bendix	R955065041X	065438X	Bendix	R955065438X	101100X	Bendix	R955101100X
065044X	Bendix	R955065044X	065439N	Bendix	R955109617N	101100X	Haldex	R955101100X
065077X	Bendix	R955065077X	065439X	Bendix	R955065439	101112	Bendix	R955101112
065102X	Bendix	R955065102X	065439X	Bendix	R955065439X	101112	Bendix	R955101112N
065103X	Bendix	R955065103X	065624N	Bendix	R955065624N	101112	Tectran	R950118
065104X	Bendix	R955065104X	065647X	Bendix	R955065647X	101112N	Bendix	R955101112N
065125X	Bendix	R955065125X	065647X	Haldex	R955065647X	101112RX	Bendix	R955101112X
065125X	Haldex	R955065125X	0656547X	Bendix	R955065647X	101112RX	Haldex	R955101112
065145N	Bendix	R955065145N	065677N	Bendix	R955065677N	101112X	Bendix	R955101112X
065145RX	Haldex	R955065145N	0R1623	Caterpillar	R9555014428X	101112X	Haldex	R955101112X
065145X	Bendix	R955065145X	0R2886	Caterpillar	R955103278X	101113	Tectran	R950119
065145X	Haldex	R955065145X	0R2901	Caterpillar	R955286552X	101135N	Bendix	R955101135X
065146N	Bendix	R955065146N	0R2902	Caterpillar	R955103274X	101135X	Bendix	R955101135X
065146RX	Haldex	R955065146N	0R2908	Caterpillar	R955227407X	101142X	Bendix	R955101142X
065146X	Bendix	R955065146X	0R3391	Caterpillar	R955107981X	101143X	Bendix	R955101143X
065146X	Haldex	R955065146X	0R-3391	Caterpillar	R9555001940X	101158X	Bendix	R955101158X
065152X	Bendix	R955065041X	0R3404	Caterpillar	R955109251X	1011E	Tectran	R950115
065154X	Bendix	R955065154X	0R3405	Caterpillar	R955109287X	1011S	Tectran	R950114
065156X	Bendix	R955065156X	0R3411	Caterpillar	R955109604X	101242X	Bendix	R955101242X
065157N	Bendix	R955800516N	0R3659	Caterpillar	R955107509X	101245X	Bendix	R955101245X
065157X	Bendix	R955065157X	0R3845	Caterpillar	R9555002984X	101256X	Bendix	R955101256X
065159N	Bendix	R955800517N	0R4115	Caterpillar	R955107508X	101282X	Bendix	R955101282X
065160X	Bendix	R955065160X	0R4383	Caterpillar	R955109604X	101311X	Bendix	R955101311X
065186N	Bendix	R955800519N	0R4740	Caterpillar	R9555002713X	101333X	Bendix	R955101333X
065186X	Bendix	R955065186X	0R8170	Caterpillar	R955EL13020X	101333X	Bendix	R955102626X
065187N	Bendix	R955800573N	0R8174	Caterpillar	R955EL16200X	101437	Bendix	R955101437N
065206N	Bendix	R955065206N	0R8253	Caterpillar	R9555002713X	101437N	Bendix	R955101437N
065224N	Bendix	R955065224N	0R8329	Caterpillar	R955109659X	101437X	Bendix	R955101437X
065224X	Bendix	R955065224X	0R8340	Caterpillar	R9555002984X	101450X	Bendix	R955101450X
065224XCF	Bendix	R955065224XCF	0R8341	Caterpillar	R9555002713X	101549	Bendix	RA86477
065225N	Bendix	R955065225N	0R8442	Caterpillar	R9555002983X	101554X	Bendix	R955101554X
065225X	Bendix	R955065225X	0R9013	Caterpillar	R9555004118X	101558K	Haldex	R955101558N
065226X	Bendix	R955065226X	0R9763	Caterpillar	R955109604X	101569X	Bendix	R955101569X
065228X	Bendix	R955065228X	0R9764	Caterpillar	R955107509X	101570X	Bendix	R955101570X
065243X	Bendix	R955065243X	0R9765	Caterpillar	R955107508X	101570X	Haldex	R955101570X
065303N	Bendix	R955065303N	0R9766	Caterpillar	R955109251X	101607	Bendix	RA86477
065303RX	Haldex	R955065303N	10024	Haldex	R950119	101622	Bendix	R955101622
065303X	Bendix	R955065303X	10027	Haldex	R10027	101622N	Bendix	R955101622
065313X	Bendix	R955065313X	10028	Haldex	R950118	101622RX	Haldex	R955101622
065313X	Bendix	R955065315X	10029	Haldex	R10029	101622X	Bendix	R955101622X
065313X	Haldex	R955065313X	1006140	Nova Bus	R955107512X	101818	Bendix	R955101818N
065395X	Bendix	R955065395X	1008	Tectran	R955229860N	101818RX	Bendix	R955101818X
065395X	Haldex	R955065395X	10102626	Tectran	R955102626N	101818X	Bendix	R955101818X
065406X	Bendix	R955065225X	10103009	Tectran	R955103009N	101818X	Bendix	R955287564X
065437N	Bendix	R955065437N	10103010	Tectran	R955103010N	101818X	Haldex	R955101818X
065437X	Bendix	R955065437	10103028	Tectran	R955103028N	101826	Bendix	RA86473
065437X	Bendix	R955065437N	1011	Tectran	R950116	101884X	Bendix	R955101884X

All Euclid Air Systems components were superseded to their Meritor part number equivalents effective February 2018.

Competitor Part Number	Competitor Name	Meritor Part Number	Competitor Part Number	Competitor Name	Meritor Part Number	Competitor Part Number	Competitor Name	Meritor Part Number
101890	Bendix	R955101890N	102657A	Haldex	R955102657N	103010RX	Bendix	R955103010X
101890X	Bendix	R955101890X	102657K	Haldex	R955102657N	103010RX	Haldex	R955103010
101900	Bendix	R955101900XCF	102657N	Bendix	R955102657N	103010RX	Haldex	R955103010N
101900MKX	Haldex	R955101900X	102674TPX	Bendix	R955102674X	103010X	Bendix	R955103010X
101900X	Bendix	R955101900X	102674X	Bendix	R955102674X	103028	Bendix	R955103028
101900X	Haldex	R955101900X	102684A	Haldex	R102684A	103028	Bendix	R955103028N
102	Tectran	R950080	102697X	Bendix	R955102697X	103028N	Bendix	R955103028N
102008HA	Haldex	R102008HA	102698X	Bendix	R955102698X	103028RX	Bendix	R955103028X
1021	Tectran	R950070	102734X	Bendix	R955102734X	103028RX	Haldex	R955103028
102165	Bendix	RA86473	102761	Bendix	R955102761	103028RX	Haldex	R955103028N
102165X	Bendix	R955065104X	102761RX	Bendix	R955102761X	103028X	Bendix	R955103028X
102165X	Haldex	R955065104X	102761RX	Haldex	R955102761	103028X	Haldex	R955103028X
102166	Bendix	RA86473	102761X	Bendix	R955102761X	103061	Bendix	R955103061
1022	Tectran	R950086	102761X	Haldex	R955102761X	103061	Bendix	R955103061N
102213X	Bendix	R955102213X	10276566	Tectran	R955276566N	103061N	Bendix	R955103061N
102277	Bendix	RA86477	10276567	Tectran	R955276567N	103061RX	Bendix	R955103061X
102278	Bendix	RA86473	10277863	Tectran	R955277863N	103061RX	Haldex	R955103061
102279	Bendix	RA86473	10278998	Tectran	R955278998N	103061X	Bendix	R955103061X
10228	Tectran	R950087	10279000	Tectran	R955279000N	103081	Bendix	R955103081N
102280	Bendix	RA86473	10279180	Tectran	R955279180N	103081N	Bendix	R955103081N
102281	Bendix	RA86473	10279416	Tectran	R955279416N	103081RX	Bendix	R955103081N
10228600	Tectran	R955228600N	10281865	Tectran	R955281865N	103081RX	Haldex	R955103081N
10228750	Tectran	R955228750N	102835	Bendix	R955102835X	103081X	Bendix	R955103081N
10229635	Tectran	R955229635N	102835X	Bendix	R955102835X	103081X	Bendix	R955103081X
10229859	Tectran	R955229859N	1028500	Tectran	R955KN28500N	103081X	Haldex	R955103081N
10229860	Tectran	R955229860N	1028510	Tectran	R955KN28510N	1031	Tectran	R950071
1023	Tectran	R950091	1028520	Tectran	R955KN28520N	103139X	Bendix	R955103139X
102323E	Haldex	R102323E	10286171	Tectran	R955286171N	10318	Tectran	R950073
10238	Tectran	R950092	10287238	Tectran	R955287238N	103195X	Bendix	R955103195X
1024	Tectran	R950093	10288239	Tectran	R955288239N	103211X	Bendix	R955103211X
102461T	Haldex	RKN20543	102952X	Bendix	R955102952X	103212X	Bendix	R955103212X
10248	Tectran	R950084	102953X	Bendix	R955102953X	103213	Bendix	RA86477
1025	Tectran	R950089	102953X	Haldex	R955102953X	103213N	Bendix	RA86477
10258	Tectran	R950090	1029553	Caterpillar	R9555002983X	103274	Bendix	R955103274X
102598X	Bendix	R955102598X	1029553	Caterpillar	R9555002984X	103274X	Bendix	R955103274X
102615	Bendix	RA86473	102971	Bendix	RA86473	103274X	Haldex	R955103274X
102626	Bendix	R955102626	102989X	Bendix	R955102989X	103278	Bendix	R955103278X
102626	Bendix	R955102626N	102989X	Haldex	R955102989X	103278X	Bendix	R955103278X
102626	Bendix	RA86477	103	Tectran	R950081	103294	Bendix	R955103294
102626N	Bendix	R955102626N	103009	Bendix	R955103009	103294N	Bendix	R955103294
102626N	Bendix	RA86477	103009	Bendix	R955103009N	103294N	Bendix	R955103294X
102626RX	Bendix	R955102626X	103009N	Bendix	R955103009N	103294RX	Bendix	R955103294X
102626RX	Haldex	R955102626	103009RX	Bendix	R955103009X	103294X	Bendix	R955103294X
102626RX	Haldex	R955102626N	103009RX	Haldex	R955103009	103294X	Haldex	R955103294X
102626X	Bendix	R955102626X	103009RX	Haldex	R955103009N	1038	Tectran	R950083
102626X	Bendix	R955101333X	103009X	Bendix	R955103009X	103817	Bendix	R955103817N
102626X	Haldex	R955102626X	103009X	Haldex	R955103009X	103818	Bendix	R955103818N
102638X	Bendix	R955102638X	103010	Bendix	R955103010	103818K	Haldex	R955103818N
102657	Bendix	R955102657N	103010	Bendix	R955103010N	103833N	Bendix	R955103833X
102657	Haldex	R955102657N	103010N	Bendix	R955103010N	103833X	Bendix	R955103833X

All Euclid Air Systems components were superseded to their Meritor part number equivalents effective February 2018.

# CROSS REFERENCE

Competitor Part Number	Competitor Name	Meritor Part Number	Competitor Part Number	Competitor Name	Meritor Part Number	Competitor Part Number	Competitor Name	Meritor Part Number
103835RX	Bendix	R955103835X	106	Tectran	R950076	107508X	HalDEX	R955107508X
103835X	Bendix	R955103835X	106165N	Bendix	R955106165N	107509	Bendix	R955107509X
103879	Bendix	R955103879N	106268X	Bendix	R955106268X	107509X	Bendix	R955107509X
103879K	HalDEX	R955103879N	106284X	Bendix	R955106284X	107509X	HalDEX	R955107509X
103912RX	Bendix	R955103912X	106313X	Bendix	R955106313X	107510	Bendix	R955107510X
103912X	Bendix	R955103912X	106439	Bendix	R955106439X	107510	Bendix	R9555002868X
103976	Bendix	R955103976	106439X	Bendix	R955106439X	107510X	Bendix	R955107510X
103976N	Bendix	R955103976	106780X	Bendix	R955106780X	107510X	Bendix	R955EL16111X
103976RX	Bendix	R955103976	106792X	Bendix	R955106792X	107511	Bendix	R9555002865X
103976RX	HalDEX	R955103976	106793X	Bendix	R955106793X	107511X	Bendix	R955107511X
103976X	Bendix	R955103976X	1068	Tectran	R950078	107511X	Bendix	R955EL13111X
103976X	HalDEX	R955103976X	1069089	Caterpillar	R955107981X	107511X	HalDEX	R955107511X
103980	Bendix	R955103980N	106978X	Bendix	R955106978X	107512	Bendix	R955107512X
103980K	HalDEX	R955103980N	106985X	Bendix	R955106985X	107512X	Bendix	R955107512X
103981	Bendix	R955103981N	107	Tectran	R950077	107513X	Bendix	R955107513X
103981K	HalDEX	R955103981N	107000	Bendix	R955107506X	107514	Bendix	R955107514X
103981N	Bendix	R955103981N	107001	Bendix	R955107507X	107514X	Bendix	R955107514X
104	Tectran	R950082	107002	Bendix	R955107508X	107514X	Bendix	R955EL13060X
104027	Bendix	R955104027N	107003	Bendix	R955107509X	107514X	HalDEX	R955107514X
104039	Bendix	R955104039X	107004	Bendix	R955107510X	107515	Bendix	R955107515N
104039X	Bendix	R955104039X	107005	Bendix	R955107511X	107515K	Bendix	R955107515N
104039X	HalDEX	R955104039X	107006	Bendix	R955107512X	107515K	HalDEX	R955107515N
104041X	Bendix	R955104041X	107008	Bendix	R955107514X	107515N	Bendix	R955107515N
104042X	Bendix	R955104042X	107023	Bendix	R955109604X	107516	Bendix	R955107516N
1041	Tectran	R950072	107023X	Bendix	R955107023X	107516K	Bendix	R955107516N
104102X	Bendix	R955104102X	107042	Bendix	R955107622X	107516K	HalDEX	R955107516N
104103X	Bendix	R955104103X	107043	Bendix	R955109604X	107516N	Bendix	R955107516N
104165RX	Bendix	R955104165X	107051	Bendix	R955107623X	107526X	Bendix	R955107526X
104165X	Bendix	R955104165X	107053	Bendix	R955109604X	107526X	HalDEX	R955107526X
10418	Tectran	R950074	107096	Bendix	R955107623X	107539	Bendix	R955065437N
104283N	Bendix	R955289253X	107098	Bendix	R955107514X	107539N	Bendix	R955065437N
104345X	Bendix	R955104345X	10713	HalDEX	R12112	107539X	Bendix	R955107539X
104358	Bendix	R955104358XCF	10719	HalDEX	R12110	107622	Bendix	R955107622X
104358P	Primabrake	R955104358XCF	107221	Bendix	R955107221X	107622X	Bendix	R955107622X
104358RX	Bendix	R955104358X	107221X	Bendix	R955107221X	107622X	Bendix	R955EL13053X
104358RX	HalDEX	R955104358X	107221X	HalDEX	R955107221X	107622X	HalDEX	R955107622X
104358X	Bendix	R955104358X	107284	Bendix	RA86473	107623	Bendix	R955107623X
104358X	HalDEX	R955104358X	107433X	Bendix	R955107433X	107623X	Bendix	R955107623X
1043823	Caterpillar	R955107981X	107442	Bendix	RA86477	107623X	HalDEX	R955107623X
104561RX	Bendix	R955104561N	107443	Bendix	RA86477	107695	Bendix	R955107695N
104561X	Bendix	R955104561N	107454	Bendix	R955107454N	107695B	HalDEX	R955107695N
104561X	Bendix	R955104561X	107506	Bendix	R955107506X	107695K	HalDEX	R955107695N
104574	Bendix	R955104574	107506X	Bendix	R955107506X	107695P	Primabrake	R955107695N
104583X	Bendix	R955104583X	107506X	Bendix	R955EL13040X	107701	Tectran	R950086
104584X	Bendix	R955104584X	107506X	HalDEX	R955107506X	107779	Bendix	R955107508X
104598X	Bendix	R955104598X	107507	Bendix	R955107507X	107780	Bendix	R955107510X
104644X	Bendix	R955104644X	107507X	Bendix	R955107507X	107781	Bendix	R955107507X
1048	Tectran	R950084	107507X	HalDEX	R955107507X	107782	Bendix	R955107512X
105	Tectran	R950075	107508	Bendix	R955107508X	107783	Bendix	R955107813X
105501	Tectran	R950085	107508X	Bendix	R955107508X	107784	Bendix	R955107623X

All Euclid Air Systems components were superseded to their Meritor part number equivalents effective February 2018.

Competitor Part Number	Competitor Name	Meritor Part Number	Competitor Part Number	Competitor Name	Meritor Part Number	Competitor Part Number	Competitor Name	Meritor Part Number
107785	Bendix	R955107622X	10800315	World American	R955426	108269	Bendix	R955108269X
107794	Bendix	R955107794XCF	10800316	World American	R955423	108269X	Bendix	R955108269X
107794	Bendix	R955107796N	10800317	World American	R955423	108272X	Bendix	R955108272X
107794N	Bendix	R955107796N	10800318	World American	R955426	108273X	Bendix	R955108273X
107794P	Primabrake	R955107796N	10800319	World American	R955426	108277	Bendix	R955107514X
107794PGX	Bendix	R955107794PGX	10800320	World American	R955423	108277X	Bendix	R955108277X
107794RX	Haldex	R955107796N	10800321	World American	R955423	108281	Bendix	R955065303X
107794X	Bendix	R955107794X	10800322	World American	R955426	108281X	Bendix	R955065303X
107794X	Bendix	R955107796N	10800323	World American	R955426	108295	Bendix	R955107512X
107794X	Haldex	R955107794X	10800324	World American	R955426	108329X	Bendix	R955108329X
107796	Bendix	R955107796N	10800349	World American	R955375	108456	Bendix	R955108110X
107796	Haldex	R955107796N	10800353	World American	R955374	108457	Bendix	R955108110X
107796PG	Bendix	R955107796N	10800357	World American	R955375	108467	Bendix	R955108110X
107798K	Haldex	R9555004336N	10800358	World American	R955375	108468	Bendix	R955108110X
107799	Bendix	R955107799N	10800359	World American	R955375	108556	Bendix	R955108557X
107799N	Bendix	R955107799N	10800360	World American	R955375	108556X	Bendix	R955108557X
107799P	Primabrake	R955107799N	10800361	World American	R955375	108557	Bendix	R955108557X
1078	Tectran	R950079	10800362	World American	R955374	108557X	Bendix	R955108557X
107800	Bendix	R955107800N	108018	Bendix	R955107511X	108583	Bendix	R955107506X
107800K	Haldex	R955107800N	108066X	Bendix	R955108066X	108584	Bendix	R955107507X
107800N	Bendix	R955107800N	108066X	Haldex	R955108066X	108588	Bendix	R955107514X
107800P	Primabrake	R955107800N	108076X	Bendix	R955108076X	108589	Bendix	R955107514X
107812	Bendix	R955107813X	108108	Bendix	R955108110X	108730	Bendix	R955107981X
107813	Bendix	R955107813X	108109	Bendix	R955108110X	108730	Bendix	R9555001940X
107813X	Bendix	R955107813X	108110	Bendix	R955108110X	108732	Bendix	R955109604X
107819	Bendix	R955107507X	108110X	Bendix	R955108110X	108779X	Bendix	R955108779X
107820	Bendix	R955107507X	108110X	Haldex	R955108110X	108790X	Bendix	R955108790X
107836X	Bendix	R955107836X	108111	Bendix	R955107514X	108803	Bendix	R955108804X
107866X	Bendix	R955107866X	108112	Bendix	R955107514X	108804	Bendix	R955108804X
107869X	Bendix	R955107869X	108193	Bendix	R955107981X	108804X	Bendix	R955108804X
107871	Bendix	R955107508X	108194	Bendix	R955107981X	108804X	Haldex	R955108804X
107896X	Bendix	R955107896X	108236	Bendix	R955107981X	108854	Bendix	R955108854X
107914	Bendix	R955107509X	108237	Bendix	R955107981X	108854X	Bendix	R955108854X
107917X	Bendix	R955107917X	108238	Bendix	R955107813X	108864	Bendix	R955108866X
107917X	Haldex	R955107917X	108261X	Bendix	R955108261X	108865	Bendix	R955108866X
107974	Bendix	R955107506X				108866	Bendix	R955108866X
107975	Bendix	R955107506X				108866X	Bendix	R955108866X
107979	Bendix	R955107981X				108866X	Haldex	R955108866X
107979X	Bendix	R955107981X				108869X	Bendix	R955108869X
107980	Bendix	R955107981X				108924	Bendix	R955108110X
107980X	Bendix	R955107981X				108935X	Bendix	R955108935X
107981	Bendix	R955107981X				108937X	Bendix	R955108937X
107981X	Bendix	R955107981X				108969	Bendix	R955107509X
107981X	Haldex	R955107981X				108986	Bendix	R955107509X
10800260	World American	R955374				108987	Bendix	R955107981X
10800313	World American	R955374				108987	Bendix	R9555001940X
10800314	World American	R955374				108989	Bendix	R955109604X
						109013	Bendix	R955108804X
						109044	Bendix	RA86473
						109073	Bendix	R955108272X

All Euclid Air Systems components were superseded to their Meritor part number equivalents effective February 2018.

# CROSS REFERENCE

Competitor Part Number	Competitor Name	Meritor Part Number	Competitor Part Number	Competitor Name	Meritor Part Number	Competitor Part Number	Competitor Name	Meritor Part Number
109073X	Bendix	R955108272X	109335	Bendix	R955109251X	109578N	Bendix	R955109578N
109073X	Haldex	R955108272X	109336	Bendix	R955109287X	109579	Bendix	R955109579N
109079X	Bendix	R955109079X	109425	Bendix	R9555004188X	109579K	Haldex	R955109579N
109087	Bendix	R9555004613X	109426	Bendix	R9555004187X	109579N	Bendix	R955109579N
109088	Bendix	R9555004613X	109429	Bendix	R9555004188X	109603X	Bendix	R955109603X
109088X	Bendix	R9555004613X	109429X	Bendix	R9555004188X	109604	Bendix	R955109604X
109088X	Bendix	R955109088X	109429X	Haldex	R9555004188X	109604X	Bendix	R955109604X
109088X	Haldex	R9555004613X	109430	Bendix	R9555004187X	109615	Bendix	R955109615N
109110	Bendix	R9555004614X	109430X	Bendix	R9555004187X	109615X	Bendix	R955065437N
109111	Bendix	R9555004614X	109430X	Haldex	R9555004187X	109615X	Bendix	R955109615N
109111X	Bendix	R955109111X	109440X	Bendix	R955109440X	109617	Bendix	R955109617N
109111X	Bendix	R9555004614X	109451X	Bendix	R955109451X	109617X	Bendix	R955065439X
109111X	Haldex	R955109111X	109465	Bendix	R955109477X	109619X	Bendix	R955065437N
1091317	Caterpillar	R955109251X	109466	Bendix	R955109478X	109620X	Bendix	R955065439X
109-1317	Caterpillar	R955109251X	109469	Bendix	R955109477X	109637	Bendix	R955107981X
1091318	Caterpillar	R955109287X	109470	Bendix	R955109478X	109649	Bendix	R955109653X
109136	Bendix	R955107981X	109477	Bendix	R955109477PGX	109653	Bendix	R955109653X
109138	Bendix	R9555002984X	109477	Bendix	R955109477X	109653X	Bendix	R955109653X
109139	Bendix	R9555002984X	109477	Bendix	R955109477XCF	109659	Bendix	R955109659X
109139X	Bendix	R9555002984X	109477PGX	Bendix	R955109477PGX	109659X	Bendix	R955109659X
109139X	Haldex	R9555002984X	109477X	Bendix	R955109477X	109685	Bendix	R955065225N
109141	Bendix	R9555002983X	109477X	Bendix	R955109503X	109685	Bendix	R955065225XCF
109142	Bendix	R9555002983X	109477X	Haldex	R955109477X	109685	Bendix	R955109685HX
109142X	Bendix	R9555002983X	109477X	Haldex	R955109503X	109685	Bendix	R955109685N
109142X	Bendix	R955109142X	109478	Bendix	R955109478X	109685	Bendix	R955109685NP
109142X	Haldex	R9555002983X	109478NRX	Haldex	R955109478X	109685HX	Bendix	R955109685HX
109197	Bendix	R955107506X	109478X	Bendix	R955109478X	109685HX	Haldex	R955109685HX
109198	Bendix	R955107507X	109478XCF	Bendix	R955109478XCF	109685N	Bendix	R955065225N
109212	Bendix	R955108804X	109493	Bendix	R955109493PGX	109685N	Bendix	R955109685N
109219X	Bendix	R955109219X	109493	Bendix	R955109493X	109685PG	Bendix	R955109685PGX
109250	Bendix	R955109251X	109493	Bendix	R955109493XCF	109685PGX	Bendix	R955109685PGX
109250X	Bendix	R955109251X	109493PGX	Bendix	R955109493PGX	109685PX	Bendix	R955109685PGX
109251	Bendix	R955109251X	109493RX	Haldex	R955065624N	109685X	Bendix	R955065225X
109251X	Bendix	R955109251X	109493X	Bendix	R955109493X	109685X	Bendix	R955109685HX
109251X	Haldex	R955109251X	109493X	Haldex	R955109493X	109685X	Bendix	R955109689X
109253	Bendix	R955107981X	109494	Bendix	R955109494N	109685X	Haldex	R955065225X
109264X	Bendix	R955109264X	109494K	Haldex	R955109494N	109685X	Haldex	R955109689X
109273	Bendix	R955109273X	109495	Bendix	R955109495N	109685XP	Bendix	R955109685XP
109273X	Bendix	R955109273X	109495K	Haldex	R955109495N	109685XPCF	Bendix	R955109685XPCF
109279	Bendix	R955109251X	109495P	Primabrake	R955109495N	109686X	Haldex	R9555004341X
109285	Bendix	R955109287X	109496	Bendix	R955109496N	109687	Bendix	R955109687X
109286	Bendix	R955109287X	109503	Bendix	R955109503X	109687X	Bendix	R955109687X
109287	Bendix	R955109287X	109503X	Bendix	R955109503X	109687X	Haldex	R955109687X
109287X	Bendix	R955109287X	109522	Bendix	R955107981X	109688X	Bendix	R955109688X
109287X	Haldex	R955109287X	109545	Bendix	R955109604X	109688X	Haldex	R955109688X
1092996	Caterpillar	R955107981X	109546	Bendix	R955109604X	109689	Bendix	R955109689X
109319	Bendix	R9555002984X	109547	Bendix	R955109604X	109689PGX	Bendix	R955109689PGX
109320	Bendix	R955107508X	109569K	Haldex	R955800405N	109689X	Bendix	R955109689X
109321	Bendix	R9555002984X	109578	Bendix	R955109578N	109689X	Haldex	R955109689X
109322	Bendix	R9555002983X	109578K	Haldex	R955109578N	109690	Bendix	R955109690X

All Euclid Air Systems components were superseded to their Meritor part number equivalents effective February 2018.

Competitor Part Number	Competitor Name	Meritor Part Number	Competitor Part Number	Competitor Name	Meritor Part Number	Competitor Part Number	Competitor Name	Meritor Part Number
109690X	Bendix	R955109690X	11402	Haldex	R11402	12116	Haldex	R12116
109691	Bendix	R955109691X	11450	Haldex	R11450	1228966	Caterpillar	R955107514X
109691X	Bendix	R955109691X	11450	Haldex	R950116	12352	Haldex	R95512352N
109816	Bendix	R9555002984X	11451	Haldex	R11451	12-36801	Dayton Parts	R950075
109824	Bendix	R9555002713X	11451	Haldex	R950115	12-36802	Dayton Parts	R950076
109860	Bendix	R9555002984X	11452	Haldex	R11452	12-36803	Dayton Parts	R950077
109861	Bendix	R9555002984X	11452	Haldex	R950114	12-36805	Dayton Parts	R950071
109863	Bendix	R9555002713X	11460	Haldex	R11460	12-36807	Dayton Parts	R950089
109867	Bendix	R955107622X	11464	Haldex	R11462	12-36808	Dayton Parts	R950087
109868	Bendix	R955107623X	11465	Haldex	R11461	12-36812	Dayton Parts	R950078
109869	Bendix	R955109869N	1155903	Haldex	RAD25079	12-36813	Dayton Parts	R950079
109869	Bendix	R955109871N	1175003	Haldex	RKN20904	12-36818	Dayton Parts	R950088
109869K	Haldex	R955109869N	1175013	Haldex	R12509	12-37801	Dayton Parts	R950080
109869K	Haldex	R955109871N	1182798	Caterpillar	R9555002984X	12-37802	Dayton Parts	R950081
109869N	Bendix	R955109869N	1182806	Caterpillar	R9555002713X	12-37803	Dayton Parts	R950082
109869P	Primabrake	R955109869N	11900	Haldex	R950080	12-37812	Dayton Parts	R950083
109871	Bendix	R955109871N	11901	Haldex	R950080	12-37904	Dayton Parts	R950085
109871N	Bendix	R955109871N	11901	Haldex	R950081	12-40501	Dayton Parts	R950100
109882	Bendix	R955107981X	11902	Haldex	R950082	12-40503	Dayton Parts	R950107
109991	Bendix	R955109991XCF	11903	Haldex	R950075	12-40505	Dayton Parts	R950105
109991PGX	Bendix	R955109991PGX	11904	Haldex	R950076	12-40621	Dayton Parts	R955401045
109991X	Bendix	R955109991X	11905	Haldex	R950077	12470332	General Motors	R9555001940X
109991X	Haldex	R955109991X	11906	Haldex	R950089	12500	Haldex	R12500
109992PGX	Bendix	R955109992PGX	11906	Haldex	R950091	12501	Haldex	R12501
109992X	Bendix	R955109992X	11907	Haldex	R950070	12502	Haldex	R12502
109992X	Bendix	R955109992XCF	11908	Haldex	R950071	12503	Haldex	RKN20904
109992X	Haldex	R955109992X	11909	Haldex	R950072	12509	Haldex	R12509
109992XCF	Bendix	R955109992XCF	11911	Haldex	R950093	12510	Haldex	R12510
109993	Bendix	R955109993N	11912	Haldex	R950087	12546827	General Motors	R955107981X
109993K	Haldex	R955109993N	11913	Haldex	R950085	1259562	Caterpillar	R955107981X
109994	Bendix	R109994P	11950	Haldex	R95510742	1266110	Caterpillar	R955107514X
109994K	Haldex	R109994P	11951	Haldex	R95510743	126-8214	Caterpillar	R9555001940X
109994P	Primabrake	R109994P	11952	Haldex	R95510744	131038	Bendix	R955109477X
109995	Bendix	R955109995N	11953	Haldex	R95510745	131066	Bendix	R955109477X
109995K	Haldex	R955109995N	11954	Haldex	R95510746	131080	Bendix	R955109477X
10R9375	Caterpillar	R9555012533X	11955	Haldex	R95510747	131081	Bendix	R955131081N
11000	Haldex	R955500	12-006	Phillips	R950114	131081N	Bendix	R955131081N
11001	Haldex	R955500BK	12-008	Phillips	R950115	1316679	Caterpillar	R9555002984X
11002	Haldex	R955501	12-010	Phillips	R950116	1316679	Ford	R955108557X
11004	Haldex	R955501BK	12-0103	Phillips	R950117	13240	Haldex	RBE13241
1105764	Caterpillar	R955109251X	12-012	Phillips	R950118	13240A	Haldex	RBE13240
110-5764	Caterpillar	R955109251X	12100	Haldex	R12100	13241	Haldex	RBE13241
1105766	Caterpillar	R955109287X	12102	Haldex	R12102	1324150	Haldex	RBE13241
111136	Tectran	R955401047	12103	Haldex	R95512103	13241A	Haldex	RBE13241
111148	Tectran	R955401045	12103	Haldex	R95512103N	13250	Haldex	RBE13250
112	Tectran	R955401004	12104	Haldex	R12104	13255	Haldex	RBE13255
11300	Haldex	R950100	12105	Haldex	R95512105	1325550	Haldex	RBE13255
11300	Haldex	R950101	12105	Haldex	R95512105N	13255A	Haldex	RBE13255
1137666	Caterpillar	R955109604X	12110	Haldex	R12110	1329813	Caterpillar	R9555002984X
11401	Haldex	R11401	12112	Haldex	R12112			

All Euclid Air Systems components were superseded to their Meritor part number equivalents effective February 2018.



# CROSS REFERENCE

Competitor Part Number	Competitor Name	Meritor Part Number	Competitor Part Number	Competitor Name	Meritor Part Number	Competitor Part Number	Competitor Name	Meritor Part Number
1329814	Caterpillar	R9555002713X	1612016	Tectran	R950095	16342	Haldex	R95550542BK
13526AJ	Haldex	RKN23000	1612016	Tectran	R950096	16344	Haldex	R95550544BK
1399009	Caterpillar	R9555002983X	1612016	Tectran	R950097	16346	Haldex	R95550546BK
1434924	Caterpillar	R9555004118X	1612066	Tectran	R95550320BK	16348	Haldex	R95550548BK
1439185	Caterpillar	R9555002984X	16124	Tectran	R95550224BK	16352	Haldex	R95550552BK
1439186	Caterpillar	R9555002983X	1612466	Tectran	R95550324BK	16356	Haldex	R95550556BK
1442906	Caterpillar	R955109251X	16126	Tectran	R95550226BK	16360	Haldex	R95550560BK
1442907	Caterpillar	R955109287X	1612666	Tectran	R95550326BK	16368	Haldex	R95550568BK
148030	Velvac	R95550530BK	16128	Tectran	R95550228BK	16372	Haldex	R95550572BK
148032	Velvac	R95550532BK	1612866	Tectran	R95550328BK	16420	Haldex	R95550420BK
148034	Velvac	R95550534BK	16130	Tectran	R95550230BK	16422	Haldex	R95550422BK
148036	Velvac	R95550536BK	1613066	Tectran	R95550330BK	16424	Haldex	R95550424BK
148038	Velvac	R95550538BK	16132	Tectran	R95550232BK	16426	Haldex	R95550426BK
148040	Velvac	R95550540BK	1613266	Tectran	R95550332BK	16428	Haldex	R95550428BK
148042	Velvac	R95550542BK	16136	Tectran	R95550236BK	16430	Haldex	R95550430BK
148044	Velvac	R95550544BK	1613666	Tectran	R95550336BK	16432	Haldex	R95550432BK
148046	Velvac	R95550546BK	16140	Tectran	R95550240BK	16434	Haldex	R95550434BK
148048	Velvac	R95550548BK	1614066	Tectran	R95550340BK	16436	Haldex	R95550436BK
148060	Velvac	R95550560BK	16148	Tectran	R95550248BK	16442	Haldex	R95550442BK
148072	Velvac	R95550572BK	1614866	Tectran	R95550348BK	16448	Haldex	R95550448BK
15025056	General Motors	R9555001940X	1615466	Tectran	R95550354BK	16460	Haldex	R95550460BK
15152068	General Motors	R9555001940X	16160	Tectran	R95550260BK	1647559	Caterpillar	R9555004118X
15977688	General Motors	R955107981X	1616066	Tectran	R95550360BK	1647560	Caterpillar	R955109287X
16014	Haldex	R95550214BK	16172	Tectran	R95550272BK	1647561	Caterpillar	R955109287X
16016	Haldex	R95550216BK	1617266	Tectran	R95550372BK	1647562	Caterpillar	R955109287X
16018	Haldex	R95550218BK	161SW2066	Tectran	R95550420BK	1647563	Caterpillar	R955109604X
16020	Haldex	R95550220BK	161SW2466	Tectran	R95550424BK	1647564	Caterpillar	R9555002713X
16022	Haldex	R95550222BK	161SW2666	Tectran	R95550426BK	1647565	Caterpillar	R955107508X
16024	Haldex	R95550224BK	161SW2866	Tectran	R95550428BK	1647566	Caterpillar	R9555002983X
16026	Haldex	R95550226BK	161SW3066	Tectran	R95550430BK	1647567	Caterpillar	R9555002983X
16028	Haldex	R95550228BK	161SW3266	Tectran	R95550432BK	1650971C91	Navistar	R955KN86020X
16030	Haldex	R95550230BK	161SW3666	Tectran	R95550436BK	1657974C91	Navistar	R955108110X
16032	Haldex	R95550232BK	161SW4066	Tectran	R95550440BK	16614	Haldex	R95550314BK
16034	Haldex	R95550234BK	161SW4866	Tectran	R95550448BK	16616	Haldex	R95550316BK
16036	Haldex	R95550236BK	161SW5466	Tectran	R95550454BK	16618	Haldex	R95550318BK
16038	Haldex	R95550438BK	161SW6066	Tectran	R95550460BK	16620	Haldex	R95550320BK
16040	Haldex	R95550240BK	16314	Haldex	R95550514BK	16622	Haldex	R95550322BK
16042	Haldex	R95550242BK	16316	Haldex	R95550516BK	16624	Haldex	R95550324BK
16044	Haldex	R95550244BK	16318	Haldex	R95550518BK	16626	Haldex	R95550326BK
16046	Haldex	R95550246BK	16320	Haldex	R95550520BK	16628	Haldex	R95550328BK
16054	Haldex	R95550254BK	16322	Haldex	R95550522BK	16630	Haldex	R95550330BK
16060	Haldex	R95550260BK	16324	Haldex	R95550524BK	16632	Haldex	R95550332BK
16066	Haldex	R95550266BK	16326	Haldex	R95550526BK	16634	Haldex	R95550334BK
16072	Haldex	R95550272BK	16328	Haldex	R95550528BK	16636	Haldex	R95550336BK
16118	Tectran	R95550218BK	16330	Haldex	R95550530BK	16638	Haldex	R95550338BK
1611866	Tectran	R95550318BK	16332	Haldex	R95550532BK	16640	Haldex	R95550340BK
16120	Tectran	R95550220BK	16334	Haldex	R95550534BK	16642	Haldex	R95550342BK
161201	Tectran	R950095	16336	Haldex	R95550536BK	16644	Haldex	R95550344BK
			16338	Haldex	R95550538BK	16646	Haldex	R95550346BK
			16340	Haldex	R95550540BK	16654	Haldex	R95550354BK

5

All Euclid Air Systems components were superseded to their Meritor part number equivalents effective February 2018.

Competitor Part Number	Competitor Name	Meritor Part Number	Competitor Part Number	Competitor Name	Meritor Part Number	Competitor Part Number	Competitor Name	Meritor Part Number
16660	Haldex	R95550360BK	1693141C1	Navistar	R955287417N	170.955	Automann	R955205
16666	Haldex	R95550366BK	1693143C1	Navistar	R955288239X	170.KN20031	Automann	RKN20031
16668	Haldex	R95550368BK	1693977C91	Navistar	R955107515N	170.KN20900	Automann	RKN20900
16672	Haldex	R95550372BK	1694005C91	Navistar	R9555004613X	170.KN26000	Automann	R955KN26000N
1671288	Caterpillar	R9555005790X	1694005C92	Navistar	R9555004613X	170.KN28510	Automann	R955KN28510N
16718	Haldex	R95550718BK	1694006C91	Navistar	R955107506X	170.KN28600	Automann	RKN28600
16722	Haldex	R95550722BK	1694007C91	Navistar	R955107507X	170.SN4017A	Automann	RSN4017A
1672563C92	Navistar	R955107506X	1694953C91	Navistar	R955107514X	170065146	Automann	R955065146N
1672564C92	Navistar	R955107507X	1695947C91	Navistar	R955104039X	170065437	Automann	R955065437N
16726	Haldex	R95550726BK	1696864C91	Navistar	R955109111X	170065439	Automann	R955065439N
16728	Haldex	R95550728BK	1696864C91	Navistar	R9555004614X	170101112	Automann	R955101112N
16730	Haldex	R95550730BK	1696864C92	Navistar	R955109111X	170101818	Automann	R955101818N
16732	Haldex	R95550732BK	1696864C92	Navistar	R9555004614X	17022787	Automann	RKN23010
16734	Haldex	R95550734BK	170.065	Automann	RA86473	170275491	Automann	R955284358N
16736	Haldex	R95550736BK	170.065	Automann	R955065225N	170276462	Automann	R955276462N
16738	Haldex	R95550738BK	170.065	Automann	R955065303N	170276566	Automann	R955276566N
16740	Haldex	R95550740BK	170.066	Automann	R955109477X	170277147	Automann	R955277147N
16743	Eaton	R95516743N	170.103	Automann	R955103010N	170287376	Automann	R955287376N
16743	Fuller	R95516743N	170.103	Automann	R955103081N	170800523	Automann	RKN20612
16744	Haldex	R95550744BK	170.108	Automann	R955107796N	170KN20619	Automann	RKN20619
16748	Haldex	R95550748BK	170.110	Automann	R109994P	170KN28060	Automann	RKN28060
16756	Haldex	R95550756BK	170.110	Automann	R955109995N	170KN28061	Automann	RKN28061
16772	Haldex	R95550772BK	170.121	Automann	R95512105	170KN28520	Automann	RKN28520
16816	Haldex	R95550616BK	170.228	Automann	R955227871N	170KN28601	Automann	R955KN28601X
16820	Haldex	R95550620BK	170.229	Automann	R955228600N	17212	Tectran	R95510742
16822	Haldex	R95550622BK	170.229	Automann	R955228750N	17215	Tectran	R95510745
16824	Haldex	R95550624BK	170.230	Automann	R955229635N	1744487	Automann	R955A4487N
16826	Haldex	R95550626BK	170.230	Automann	R955229859N	177.400	Automann	R950101
16828	Haldex	R95550628BK	170.277	Automann	R955276567N	177.400	Automann	R950104
16830	Haldex	R95550630BK	170.279	Automann	R955278614N	177.401	Automann	R955401045
16832	Haldex	R95550632BK	170.279	Automann	R955279000N	177.701	Automann	R950087
16836	Haldex	R95550636BK	170.279	Automann	R955279416N	1789497	Caterpillar	R9555008249X
16840	Haldex	R95550640BK	170.281	Automann	R955280809N	178-9497	Caterpillar	R9555008249X
16844	Haldex	R95550644BK	170.282	Automann	R955281865N	179.101	Automann	R950118
16848	Haldex	R95550648BK	170.282	Automann	R955281923N	1803957	Caterpillar	R9555008249X
1685644C91	Navistar	R955065303N	170.286	Automann	R955286171N	18118	Tectran	R95550518BK
16859	Eaton	R95516859N	170.286	Automann	R955286364N	18120	Tectran	R95550520BK
16859	Fuller	R95516859N	170.286	Automann	R955286370N	1812016	Tectran	R950098
1686542C91	Navistar	R955108110X	170.287	Automann	R955286500N	1812018	Tectran	R950097
16872	Haldex	R95550660BK	170.288	Automann	R955287417	18124	Tectran	R95550524BK
16872	Haldex	R95550672BK	170.288	Automann	R955288239N	18126	Tectran	R95550526BK
1688489C91	Navistar	R955065303X	170.289	Automann	R955288605N	18128	Tectran	R95550528BK
1688704C91	Navistar	R955108110X	170.290	Automann	R955289714N	18130	Tectran	R95550530BK
1689954C91	Navistar	R955107514X	170.299	Automann	R955298817N	18132	Tectran	R95550532BK
1689954C92	Navistar	R955107514X	170.500	Automann	R9555004340N	18136	Tectran	R95550536BK
1690076C91	Navistar	R955101818X	170.800	Automann	R955800333N	18140	Tectran	R95550540BK
1691167C1	Navistar	R955275491	170.800	Automann	R955800350N	18148	Tectran	R95550548BK
1691205C91	Navistar	R955108110X	170.800	Automann	R955800376N	18154	Tectran	R95550554BK
16929962C91	Navistar	R955281946X	170.800	Automann	R955800404N	18160	Tectran	R95550560BK
1693118C1	Navistar	R955065145X	170.801	Automann	R955800516N	18172	Tectran	R95550572BK

All Euclid Air Systems components were superseded to their Meritor part number equivalents effective February 2018.

# CROSS REFERENCE

Competitor Part Number	Competitor Name	Meritor Part Number	Competitor Part Number	Competitor Name	Meritor Part Number	Competitor Part Number	Competitor Name	Meritor Part Number
181SW1866	Tectran	R95550718BK	20QE222BP1	Mack	R955102626X	227414X	Bendix	R955227414X
181SW2066	Tectran	R95550720BK	20QE222BP2	Mack	R955102626X	227480X	Bendix	R955227414X
181SW2466	Tectran	R95550724BK	20QE3118R	Mack	R955286171N	227661X	Bendix	R955227661X
181SW2666	Tectran	R95550726BK	20QE3166R	Mack	R955289148X	227672X	Bendix	R955227672X
181SW2866	Tectran	R95550728BK	215310	Bendix	R12100	227870	Bendix	R955227870
181SW3066	Tectran	R95550730BK	215535	Bendix	R950082	227870	Bendix	R955227870N
181SW3266	Tectran	R95550732BK	215535N	Bendix	R950082	227871	Bendix	R955227871
181SW3666	Tectran	R95550736BK	2158055	Caterpillar	R9555002984X	227871	Bendix	R955227871N
181SW4066	Tectran	R95550740BK	2166678	Bendix	R950085	228050X	Bendix	R955228050X
181SW4866	Tectran	R95550748BK	216678	Bendix	R950085	228050X	Haldex	R955228050X
181SW5466	Tectran	R95550754BK	221121	Bendix	R12112	228138X	Bendix	R955228138X
181SW6066	Tectran	R95550760BK	221121N	Bendix	R12112	228141X	Bendix	R955228141X
181SW7266	Tectran	R95550772BK	223907	Bendix	R950080	228165X	Bendix	R955228165X
18822	New Flyer	R955107813X	223907N	Bendix	R950080	228287RX	Bendix	R955228287X
19216	Tectran	R955500BK	224105	Bendix	R95510734	228287X	Bendix	R955228287X
19216T	Tectran	R955500	224887	Bendix	R950076	228344	Bendix	R955228344X
19218	Tectran	R955501BK	225892X	Bendix	R955225892X	228344X	Bendix	R955228344X
19218T	Tectran	R955501	226134	Bendix	R950075	228346X	Bendix	R955228346X
19810	Haldex	R95510732	226135	Bendix	R950076	228366X	Bendix	R955228366X
19820	Haldex	R95510733	226136	Bendix	R950077	228443TPX	Bendix	R955228443X
19840	Haldex	R95510734	226137	Bendix	R950080	228443X	Bendix	R955228443X
19841	Haldex	R95510736	226138	Bendix	R950081	228451X	Bendix	R955228451X
19850	Haldex	R95510735	226139	Bendix	R950082	228472	Bendix	R95550324BK
19974	Eaton	R95519974N	226139N	Bendix	R950082	228479X	Bendix	R955228479X
19974	Fuller	R95519974N	226720X	Bendix	R955227414X	228520RX	Bendix	R955228520X
2000	Tectran	R95510732	227320X	Bendix	R955227320X	228520X	Bendix	R955228520X
2000421C91	Navistar	R955065145N	227321X	Bendix	R955227321X	228533	Bendix	R95550316BK
2000DH	Tectran	R95510735	227322X	Bendix	R955227322X	228535	Bendix	R95550318BK
2001003C91	Navistar	R955KN18534X	227323X	Bendix	R955227323X	228539	Bendix	R95550320BK
2001B	Tectran	R95510734	227323X	Haldex	R955227323X	228541	Bendix	R95550322BK
2001C	Tectran	R95510736	227326X	Bendix	R955227326X	228541N	Bendix	R95550322BK
2003252C94	Navistar	R9555004613X	227331X	Bendix	R955227331X	228544	Bendix	R95550324BK
2003252C95	Navistar	R9555004613X	227332X	Bendix	R955227332X	228544	Bendix	R95550326BK
2003252C97	Navistar	R9555004613X	227355X	Bendix	R955227355X	228544N	Bendix	R95550324BK
2003253C94	Navistar	R9555004614X	227356	Bendix	RA86477	228544N	Bendix	R95550326BK
2003253C95	Navistar	R9555004614X	227357	Bendix	RA86477	228548	Bendix	R95550328BK
2003253C97	Navistar	R9555004614X	227357X	Bendix	R955102626X	228549	Bendix	R95550330BK
2032025C91	Navistar	R955288605X	227400TPX	Bendix	R955227400X	228552	Bendix	R95550332BK
203610	Bendix	R950087	227400X	Bendix	R955227400X	228554	Bendix	R95550334BK
203610N	Bendix	R950087	227401X	Bendix	R955227401X	228555	Bendix	R95550336BK
205105	Bendix	R955205105N	227402X	Bendix	R955227402X	228557	Bendix	R95550338BK
205105N	Bendix	R955205105N	227403X	Bendix	R955227403X	228561	Bendix	R95550344BK
205105P	Primabrake	R955800350N	227406X	Bendix	R955227406X	228563	Bendix	R95550346BK
205730	Bendix	R950101	227406X	Haldex	R955227406X	228566	Bendix	R95550354BK
205730N	Bendix	R950101	227407TPX	Bendix	R955227407X	228567	Bendix	R95550372BK
20QE1144	Mack	R955276462X	227407X	Bendix	R955227407X	228600	Bendix	R955228600N
20QE1275R	Mack	R955289148X	227408X	Bendix	R955227408X	228600	Bendix	R955BE13250N
20QE1280R	Mack	R955287224N	227409X	Bendix	R955227409X	228750	Bendix	R955228750N
20QE1320	Mack	R955103009X	227410X	Bendix	R955227410X	228750	Bendix	R955BE13241N
20QE2148R	Mack	R955289148X	227414TPX	Bendix	R955227414X	228750N	Bendix	R955228750N

All Euclid Air Systems components were superseded to their Meritor part number equivalents effective February 2018.

Competitor Part Number	Competitor Name	Meritor Part Number	Competitor Part Number	Competitor Name	Meritor Part Number	Competitor Part Number	Competitor Name	Meritor Part Number
228750X	Bendix	R955228750X	229859N	Bendix	R955229859N	23531315	Detroit Diesel	R9555010824X
228771X	Bendix	R955227414X	229859RX	Bendix	R955229859N	23532832	Detroit Diesel	R9555018485X
229077X	Bendix	R955229077X	229859RX	Haldex	R955229859N	23535534	Detroit Diesel	R9555018485X
229078X	Bendix	R955229078X	229859X	Bendix	R955229859N	236269	Bendix	R950096
229185X	Bendix	R955227414X	229859X	Bendix	R955229859X	248579	Bendix	R950118
229434X	Bendix	R955229434X	229859X	Haldex	R955229859N	274746N	Bendix	R955228600N
229467X	Bendix	R955229467X	229860	Bendix	R955229860N	274746N	Bendix	R955BE13250N
229491X	Bendix	R955227414X	229860N	Bendix	R955229860N	275113X	Bendix	R955275113X
229493RX	Bendix	R955229493X	229860RX	Bendix	R955229860N	275114X	Bendix	R955275114X
229493X	Bendix	R955229493X	229860RX	Haldex	R955229860N	275250X	Bendix	R955276462X
229500RX	Bendix	R955229500N	229860X	Bendix	R955229860N	275317X	Bendix	R955275317X
229500X	Bendix	R955229500N	229860X	Bendix	R955229860X	275491	Bendix	R955275491
229500X	Bendix	R955229500X	229860X	Haldex	R955229860N	275491	Bendix	R955284358N
229501RX	Bendix	R955229501N	229990N	Bendix	R955229990X	275491N	Bendix	R955275491
229501X	Bendix	R955229501N	229990RX	Bendix	R955229990X	275491N	Bendix	R955275491X
229501X	Bendix	R955229501X	229990X	Bendix	R955229990X	275491N	Bendix	R955284358N
229505	Bendix	R955229505N	230505234	Detroit Diesel	R955107622X	275491RX	Bendix	R955275491X
229505N	Bendix	R955229505N	23500456	Detroit Diesel	R955EL16100X	275491RX	Haldex	R955284358N
229505RX	Bendix	R955229505N	23500457	Detroit Diesel	R955EL16100X	275491X	Bendix	R955275491X
229505RX	Haldex	R955229505N	23500457	General Motors	R955EL16100X	275509X	Bendix	R955275509N
229505X	Bendix	R955229505N	23500459	Detroit Diesel	R955EL13020X	275707	Bendix	R955284358N
229505X	Bendix	R955229505X	23500460	General Motors	R955EL13020X	275707N	Bendix	R955284358N
229505X	Haldex	R955229505N	23500460	General Motors	R955EL13020X	275707X	Bendix	R955275707X
229507N	Bendix	R955229507N	23500558	Detroit Diesel	R955EL16020X	275707X	Bendix	R955284358N
229507RX	Bendix	R955229507N	23505234	Detroit Diesel	R955107622X	275777X	Bendix	R955275777X
229507X	Bendix	R955229507X	23505234	Detroit Diesel	R955107622X	275834X	Bendix	R955275834X
229509N	Bendix	R955229509N	23505235	Detroit Diesel	R955107623X	275990X	Bendix	R955275990X
229509RX	Bendix	R955229509N	23507268	Detroit Diesel	R955EL13053X	276111X	Bendix	R955276111X
229509X	Bendix	R955229509X	23507268	General Motors	R955EL13053X	276166X	Bendix	R955276166X
229525X	Bendix	R955229525X	23507269	Detroit Diesel	R955EL16053X	276270X	Bendix	R955276270X
229542X	Bendix	R955229542X	23507269	General Motors	R955EL16053X	276272RX	Bendix	R955276272X
229544X	Bendix	R955229544X	23507269	General Motors	R955EL16053X	276272X	Bendix	R955276272X
229562X	Bendix	R955229562X	23509473	Detroit Diesel	R955EL16250X	276272X	Haldex	R955276272X
229567X	Bendix	R955229467X	23509780	Detroit Diesel	R955107813X	276462	Bendix	R955276462
229608RX	Bendix	R955229608X	23511334	Detroit Diesel	R955107622X	276462	Bendix	R955276462N
229608X	Bendix	R955229608X	23511334	Detroit Diesel	R955EL13053X	276462N	Bendix	R955276462
229635	Bendix	R955229635N	23511334	General Motors	R955EL13053X	276462RX	Bendix	R955276462X
229635N	Bendix	R955229635N	23511734	Detroit Diesel	R955104039X	276462RX	Haldex	R955276462
229635RX	Bendix	R955229635N	23511735	Detroit Diesel	R955107514X	276462X	Bendix	R955276462X
229635RX	Haldex	R955229635N	23511735	Detroit Diesel	R955108110X	276566	Bendix	R955276566
229635X	Bendix	R955229635N	23513838	Detroit Diesel	R955KN86020X	276566	Bendix	R955276566N
229635X	Bendix	R955229635X	23515565	Detroit Diesel	R9555005875X	276566N	Bendix	R955276566N
229635X	Haldex	R955229635N	23516840	Detroit Diesel	R9555004188X	276566RX	Bendix	R955276566X
229775X	Bendix	R955227414X	23516841	Detroit Diesel	R9555004187X	276566RX	Haldex	R955276566
229813	Bendix	R955229813N	23522122	Detroit Diesel	R9555004188X	276566RX	Haldex	R955276566N
229813N	Bendix	R955229813N	23522123	Detroit Diesel	R9555004187X	276566X	Bendix	R955276566X
229813RX	Bendix	R955229813N	23524143	Detroit Diesel	R9555005875X	276566X	Haldex	R955276566X
229813X	Bendix	R955229813X	23531247	Detroit Diesel	R9555010824X	276567	Bendix	R955276567
229844X	Bendix	R955229844X	23531259	Detroit Diesel	R9555010824X	276567	Bendix	R955276567N
229859	Bendix	R955229859N				276567N	Bendix	R955276567N

# CROSS REFERENCE

Competitor Part Number	Competitor Name	Meritor Part Number	Competitor Part Number	Competitor Name	Meritor Part Number	Competitor Part Number	Competitor Name	Meritor Part Number
276567RX	Bendix	R955276567X	277855X	Bendix	R955277855X	279040	Bendix	R955279040N
276567RX	Haldex	R955276567	277863	Bendix	R955277863N	279040RX	Bendix	R955279040N
276567RX	Haldex	R955276567N	277863N	Bendix	R955277863N	279040X	Bendix	R955279040N
276567X	Bendix	R955276567X	277863RX	Bendix	R955277863N	279068X	Bendix	R955279068X
276567X	Haldex	R955276567X	277863RX	Haldex	R955277863N	279176X	Bendix	R955279176X
276777RX	Bendix	R955276777X	277863X	Bendix	R955277863N	279180	Bendix	R955279180
276777X	Bendix	R955276777X	277863X	Bendix	R955229501N	279180	Bendix	R955279180N
276778X	Bendix	R955276778X	277863X	Bendix	R955277863X	279180N	Bendix	R955279180N
276961RX	Bendix	R955276961X	277863X	Haldex	R955229501N	279180RX	Bendix	R955279180
276961TPX	Bendix	R955276961X	277901X	Bendix	R955277901X	279180RX	Bendix	R955279180N
276961X	Bendix	R955276961X	277920X	Bendix	R955277920X	279180RX	Bendix	R955279180X
276961X	Haldex	R955276961X	277971	Bendix	R90555396	279180RX	Haldex	R955279180
276962X	Bendix	R955276962X	277971N	Bendix	R90555396	279180RX	Haldex	R955279180N
276962X	Haldex	R955276962X	278414X	Bendix	R955227414X	279180X	Bendix	R955279180X
276974X	Bendix	R955276974X	278426X	Bendix	R955278426X	279416	Bendix	R955279416N
276978X	Bendix	R955276978X	278445X	Bendix	R955278445X	279416N	Bendix	R955279416N
277122X	Bendix	R955277122X	278452X	Bendix	R955278452X	279505	Bendix	R90555396
277144X	Bendix	R955277144X	278482N	Bendix	R955278482N	279505N	Bendix	R90555396
277146	Bendix	R90555396	278482RX	Bendix	R955278482N	279525X	Bendix	R955279525X
277147	Bendix	R955277147N	278482X	Bendix	R955278482N	279556X	Bendix	R955279556X
277147N	Bendix	R955277147N	278596X	Bendix	R955278596X	279556X	Haldex	R955279556X
277147RX	Bendix	R955277147N	278598	Bendix	R955278598N	279580X	Bendix	R955279580X
277147RX	Haldex	R955277147N	278598X	Bendix	R955278598X	279614	Bendix	R955279614N
277148	Bendix	R90555398	278604X	Bendix	R955278604X	279615	Bendix	R955279615N
277148	Bendix	R955277148N	278605X	Bendix	R955278605X	279615K	Bendix	R955279615N
277148N	Bendix	R90555398	278605X	Haldex	R955278605X	279615K	Haldex	R955279615N
277148N	Bendix	R955277148X	278614	Bendix	R955278614N	279615N	Bendix	R955279615N
277148RX	Bendix	R955277148X	278614N	Bendix	R955278614N	279692RX	Bendix	R955279692X
277148X	Bendix	R955277148X	278615	Bendix	R955278615N	279692X	Bendix	R955279692X
277148X	Haldex	R955277148X	278615N	Bendix	R955278615N	279709X	Bendix	R955227414X
277185	Bendix	R90555398	278615N	Bendix	R955278615X	279787X	Bendix	R955279787X
277214X	Bendix	R955277214X	278615X	Bendix	R955278615X	279839X	Bendix	R955279839X
277222	Bendix	R90555398	278681X	Bendix	R955278681X	279950	Bendix	R955279950N
277222N	Bendix	R90555398	278825	Bendix	R955278825N	279950N	Bendix	R955279950N
277226	Bendix	R90555396	278825N	Bendix	R955278825N	279950RX	Bendix	R955279950N
277226N	Bendix	R90555396	278825N	Bendix	R955278825X	279950X	Bendix	R955279950X
277226N	Bendix	R955277226X	278825X	Bendix	R955278825X	279952	Bendix	R955279952
277226RX	Bendix	R955277226X	278998RX	Bendix	R955278998N	279952	Bendix	R955279952N
277226X	Bendix	R955277226X	278998X	Bendix	R955278998N	279952N	Bendix	R955279952
277227	Bendix	R90555396	278998X	Bendix	R955278998X	279952N	Bendix	R955279952N
277227N	Bendix	R90555396	279000	Bendix	R955279000N	279952N	Bendix	R955279952X
277227X	Bendix	R955277227X	279000N	Bendix	R955279000N	279952RX	Bendix	R955279952X
277340X	Bendix	R955277340X	279000RX	Bendix	R955279000N	279952X	Bendix	R955279952X
277446X	Bendix	R955277446X	279000RX	Haldex	R955279000N	279952X	Haldex	R955279952X
277546	Bendix	R955500	279000X	Bendix	R955279000N	279962X	Bendix	R955279962X
277646X	Bendix	R955227414X	279000X	Bendix	R955279000X	279995X	Bendix	R955279995X
277694X	Bendix	R955277694X	279000X	Haldex	R955279000N	280243RX	Bendix	R955280243X
277730X	Bendix	R955277730X	279024X	Bendix	R955279024X	280243X	Bendix	R955280243X
277731X	Bendix	R955277731X	279025X	Bendix	R955279025X	280369X	Bendix	R955280369X
277799X	Bendix	R955277799X	279037X	Bendix	R955279037X	280375RX	Bendix	R955280375X

Competitor Part Number	Competitor Name	Meritor Part Number	Competitor Part Number	Competitor Name	Meritor Part Number	Competitor Part Number	Competitor Name	Meritor Part Number
280375X	Bendix	R955280375X	281797X	Bendix	R955281797X	283506X	Bendix	R955283506X
280422X	Bendix	R955280422X	281860	Bendix	R955281860N	283513X	Bendix	R955283513X
280454RX	Bendix	R955280454X	281860N	Bendix	R955281860N	283514X	Bendix	R955283514X
280454X	Bendix	R955280454X	281860RX	Bendix	R955281860N	283533X	Bendix	R955283533X
280501X	Bendix	R955280501X	281860X	Bendix	R955281860X	283577X	Bendix	R955283577X
280511	Bendix	R955280511N	281865	Bendix	R955281865	283644X	Bendix	R955283644X
280551X	Bendix	R955280551X	281865	Bendix	R955281865N	283664X	Bendix	R955283664X
280556X	Bendix	R955280556X	281865N	Bendix	R955281865N	283690X	Bendix	R955283690X
280602X	Bendix	R955280602X	281865RX	Bendix	R955281865N	283692X	Bendix	R955283692X
280603X	Bendix	R955280603X	281865RX	HalDEX	R955281865	283711X	Bendix	R955283711X
280604X	Bendix	R955280604X	281865RX	HalDEX	R955281865N	283808X	Bendix	R955283808X
280607C91	Navistar	R955227323X	281865X	Bendix	R955281865N	283935N	Bendix	R955283935X
280608X	Bendix	R955280608X	281865X	Bendix	R955281865X	283935RX	Bendix	R955283935X
280609X	Bendix	R955280609X	281865X	HalDEX	R955281865N	283935X	Bendix	R955283935X
280610X	Bendix	R955280610X	281923	Bendix	R955281923N	283940X	Bendix	R955283940X
280611X	Bendix	R955280611X	281923N	Bendix	R955281923N	284010X	Bendix	R955284010X
280613X	Bendix	R955280613X	281923RX	Bendix	R955281923X	284106X	Bendix	R955284106X
280622X	Bendix	R955280622X	281923X	Bendix	R955281923X	284142	Bendix	R955401004
280626X	Bendix	R955280626X	281923X	HalDEX	R955281923X	284142N	Bendix	R955401004
280628X	Bendix	R955280628X	281924RX	Bendix	R955281924X	284160X	Bendix	R955284160X
280651N	Bendix	R955280651X	281924X	Bendix	R955281924X	284252RX	Bendix	R955284252X
280651X	Bendix	R955280651X	281946	Bendix	S936 649 151 0	284252X	Bendix	R955284252X
280758N	Bendix	R955280758X	281946N	Bendix	S936 649 151 0	284260X	Bendix	R955284260X
280758RX	Bendix	R955280758X	281946RX	HalDEX	S936 649 151 0	284307X	Bendix	R955284307X
280758X	Bendix	R955280758X	281946X	Bendix	S936 649 151 0	284310X	Bendix	R955284310X
280774X	Bendix	R955280774X	281946X	Bendix	R955281946X	284358	Bendix	R955284358N
280809	Bendix	R955280809N	282013X	Bendix	R955282013X	284358N	Bendix	R955284358N
280809N	Bendix	R955280809N	282023X	Bendix	R955282023X	284358RX	Bendix	R955284358X
280809X	Bendix	R955280809X	282025X	Bendix	R955282025X	284358RX	HalDEX	R955284358N
280904X	Bendix	R955280904X	282076X	Bendix	R955282076X	284358X	Bendix	R955284358X
280905X	Bendix	R955280905X	282133	Bendix	R90555398	284374X	Bendix	R955284374X
281024RX	Bendix	R955281024N	282133N	Bendix	R90555398	284412RX	Bendix	R955284412N
281024X	Bendix	R955281024N	282178	Bendix	R95510735	284412X	Bendix	R955284412N
281024X	Bendix	R955281024X	282178N	Bendix	R95510735	284415X	Bendix	R955227414X
281042X	Bendix	R955281042X	282368X	Bendix	R955282368X	284662X	Bendix	R955284662X
281086X	Bendix	R955281086X	282381X	Bendix	R955282381X	284699X	Bendix	R955284699X
281112X	Bendix	R955281112X	282472	Bendix	R955282472X	284714X	Bendix	R955284714X
281157X	Bendix	R955281157X	282517	Bendix	R90555396	284718X	Bendix	R955284718X
281318N	Bendix	R955281318X	282517N	Bendix	R90555396	284727N	Bendix	R955284727X
281318RX	Bendix	R955281318X	282586X	Bendix	R955282586X	284727X	Bendix	R955284727X
281318X	Bendix	R955281318X	282620X	Bendix	R955282620X	284744X	Bendix	R955284744X
281338X	Bendix	R955281338X	282621X	Bendix	R955282621X	284760	Bendix	R955284760
281430X	Bendix	R955281430X	282621X	HalDEX	R955282621X	284760	Bendix	R955284760N
281467	Bendix	R90555396	282749X	Bendix	R955282749X	284760N	Bendix	R955284760
281467N	Bendix	R90555396	283038	Bendix	R90555398	284760RX	Bendix	R955284760
281587RX	Bendix	R955281587X	283040X	Bendix	R955283040X	284760RX	Bendix	R955284760
281587X	Bendix	R955281587X	283046X	Bendix	R955283046X	284760RX	Bendix	R955284760N
281718X	Bendix	R955281718X	283090X	Bendix	R955283090X	284760RX	HalDEX	R955284760
281761RX	Bendix	R955281761X	283429X	Bendix	R955283429X	284760X	Bendix	R955284760X
281761X	Bendix	R955281761X	283505X	Bendix	R955283505X			

All Euclid Air Systems components were superseded to their Meritor part number equivalents effective February 2018.

# CROSS REFERENCE

Competitor Part Number	Competitor Name	Meritor Part Number	Competitor Part Number	Competitor Name	Meritor Part Number	Competitor Part Number	Competitor Name	Meritor Part Number
284760X	HalDEX	R955284760X	286500X	Bendix	R955286500X	286564X	Bendix	R955286564X
284959X	Bendix	R955284959X	286514	Bendix	R955286528X	286565X	Bendix	R955286565X
285107X	Bendix	R955285107X	286526X	Bendix	R955286526X	286565X	HalDEX	R955286565X
285108X	Bendix	R955285108X	286526X	HalDEX	R955286526X	286566X	Bendix	R955286566X
285238C91	Navistar	R955227323X	286527	Bendix	R955286527X	286567X	Bendix	R955286567X
285252X	Bendix	R955285252X	286527X	Bendix	R955286527X	286571X	Bendix	R955286571X
285275X	Bendix	R955285275X	286528	Bendix	R955286528X	286572X	Bendix	R955286572X
285498	Bendix	R955500BK	286528X	Bendix	R955286528X	286574X	Bendix	R955286574X
285498N	Bendix	R955500BK	286528X	Bendix	R955EL13020X	286576	Bendix	R955286576X
285537	Bendix	R90555396	286528X	HalDEX	R955286528X	286576X	Bendix	R955286576X
285539	Bendix	R90555398	286529X	Bendix	R955286529X	286576X	HalDEX	R955286576X
285540	Bendix	R90555398	286530	Bendix	R955286530X	286579X	Bendix	R955286579X
285541	Bendix	R90555396	286530X	Bendix	R955286530X	286580X	Bendix	R955286580X
285977	Bendix	R955286539X	286532X	Bendix	R955286532X	286581	Bendix	R955286581X
286030	Bendix	R955286552X	286533X	Bendix	R955286533X	286581X	Bendix	R955286581X
286171	Bendix	R955286171N	286536X	Bendix	R955286536X	286582X	Bendix	R955286582X
286171N	Bendix	R955286171N	286537X	Bendix	R955286537X	286582X	HalDEX	R955286582X
286171RX	Bendix	R955286171N	286538X	Bendix	R955286538X	286585X	Bendix	R955286585X
286171RX	HalDEX	R955286171N	286538X	HalDEX	R955286538X	286585X	HalDEX	R955286585X
286171X	Bendix	R955286171N	286539	Bendix	R955286539X	286586X	Bendix	R955286586X
286171X	Bendix	R955286171X	286539X	Bendix	R955286539X	286586X	HalDEX	R955286586X
286171X	HalDEX	R955286171N	286539X	HalDEX	R955286539X	286589X	Bendix	R955286589X
286364	Bendix	R955286364N	286540X	Bendix	R955286540X	286591X	Bendix	R955286591X
286364N	Bendix	R955286364N	286542X	Bendix	R955286542X	286592X	Bendix	R955286592X
286364RX	Bendix	R955286364X	286543X	Bendix	R955286543X	286595X	Bendix	R955286595X
286364RX	HalDEX	R955286364N	286543X	HalDEX	R955286543X	286617	Bendix	R955286617X
286364X	Bendix	R955286364X	286544	Bendix	R955286544X	286617X	Bendix	R955286617X
286364X	Bendix	R955288063X	286544X	Bendix	R955286544X	286618	Bendix	R955286555X
286364X	HalDEX	R955286364X	286544X	HalDEX	R955286544X	286618X	Bendix	R955286555X
286370	Bendix	R955286370N	286546X	Bendix	R955286546X	286618X	HalDEX	R955286555X
286370N	Bendix	R955286370N	286546X	HalDEX	R955286546X	286620	Bendix	R955286620X
286370RX	Bendix	R955286370N	286548X	Bendix	R955286548X	286620X	Bendix	R955286620X
286370RX	HalDEX	R955286370N	286549X	Bendix	R955286549X	286620X	HalDEX	R955286620X
286370X	Bendix	R955286370N	286550X	Bendix	R955286550X	286621X	Bendix	R955286621X
286370X	Bendix	R955286370X	286551X	Bendix	R955286551X	286623	Bendix	R955286623X
286370X	HalDEX	R955286370N	286552	Bendix	R955286552X	286623X	Bendix	R955286623X
286371RX	Bendix	R955286371N	286552X	Bendix	R955286552X	286623X	HalDEX	R955286623X
286371X	Bendix	R955286371N	286554	Bendix	R955286554X	286773X	Bendix	R955286773X
286371X	Bendix	R955286371X	286554X	Bendix	R955286554X	286773X	HalDEX	R955286773X
286392	Bendix	RBE13250	286554X	Bendix	R9553049186X	286775	Bendix	R955286775
286392N	Bendix	RBE13250	286554X	HalDEX	R955286554X	286775RX	Bendix	R955286775X
286404	Bendix	RBE13250	286555X	Bendix	R955286555X	286775RX	HalDEX	R955286775
286404N	Bendix	RBE13250	286556X	Bendix	R955286556X	286775X	Bendix	R955286775X
286471X	Bendix	R955286471X	286558X	Bendix	R955286558X	286836X	Bendix	R955286836X
286500	Bendix	R90555398	286560	Bendix	R955286560X	286892X	Bendix	R955286892N
286500	Bendix	R955286500	286560X	Bendix	R955286560X	286892X	Bendix	R955286892X
286500	Bendix	R955286500N	286560X	HalDEX	R955286560X	286903	Bendix	R90555398
286500N	Bendix	R90555398	286561X	Bendix	R955286561X	286934	Bendix	R955286934XCF
286500N	Bendix	R955286500	286562X	Bendix	R955286562X	286934N	Bendix	R955286934X
286500RX	HalDEX	R955286500	286563X	Bendix	R955286563X	286934RX	Bendix	R955286934X

5

All Euclid Air Systems components were superseded to their Meritor part number equivalents effective February 2018.

Competitor Part Number	Competitor Name	Meritor Part Number	Competitor Part Number	Competitor Name	Meritor Part Number	Competitor Part Number	Competitor Name	Meritor Part Number
286934X	Bendix	R955286934X	287417X	Bendix	R955287417X	288301X	Haldex	R955288301X
286934X	Haldex	R955286934X	287418RX	Bendix	R955287418X	288322	Bendix	R90555396
286936N	Bendix	R955286936X	287418X	Bendix	R955287418X	288323	Bendix	R955288323
286936X	Bendix	R955286936X	287564	Bendix	R955287564	288323N	Bendix	R955288323
2869892N	Bendix	R955286892N	287564N	Bendix	R955287564	288323RX	Bendix	R955288323
287043	Bendix	R955287043N	287564RX	Bendix	R955287564X	288323RX	Bendix	R955288323X
287043N	Bendix	R955287043N	287564RX	Haldex	R955287564	288323X	Bendix	R955288323X
287053	Bendix	R955287053N	287564X	Bendix	R955287564X	288369RX	Bendix	R955288369N
287053K	Haldex	R955287053N	287564X	Haldex	R955287564X	288369X	Bendix	R955288369N
287053N	Bendix	R955287053N	287600	Bendix	R955287600	288369X	Bendix	R955288369X
287054X	Bendix	R955276567X	287600	Bendix	R955287600N	288383	Bendix	R955288383
287114	Bendix	R955287114N	287600N	Bendix	R955287600N	288383	Bendix	R955288383N
287114RX	Bendix	R955287114N	287600RX	Bendix	R955287600	288383N	Bendix	R955288383
287114X	Bendix	R955287114X	287600RX	Bendix	R955287600N	288383RX	Bendix	R955288383X
287224	Bendix	R955287224N	287600RX	Bendix	R955287600X	288383RX	Haldex	R955288383
287224X	Bendix	R955287224N	287600X	Bendix	R955287600X	288383X	Bendix	R955288383X
287224X	Bendix	R955287224X	287637	Bendix	R955287637	288586N	Bendix	R955288586X
287238	Bendix	R955287238N	287637N	Bendix	R955287637	288586RX	Bendix	R955288586X
287238N	Bendix	R955287238N	287637N	Bendix	R955287637X	288586X	Bendix	R955288586X
287238RX	Bendix	R955287238N	287637RX	Bendix	R955287637X	288605	Bendix	R955288605N
287238RX	Haldex	R955287238N	287637X	Bendix	R955287637X	288605N	Bendix	R955288605N
287238X	Bendix	R955287238X	287734	Bendix	R95510736	288605N	Bendix	R955288605X
287238X	Haldex	R955287238X	287827	Bendix	R90555398	288605RX	Bendix	R955288605X
287240X	Bendix	R955287240X	287827N	Bendix	R90555398	288605RX	Haldex	R955288605N
287260RX	Bendix	R955287260N	288061	Bendix	R955286527X	288605X	Bendix	R955288605X
287260X	Bendix	R955287260N	288061N	Bendix	R955286527X	288605X	Haldex	R955288605X
287260X	Bendix	R955287260X	288063RX	Bendix	R955288063X	288645X	Bendix	R955288645X
287279X	Bendix	R955287279X	288063X	Bendix	R955288063X	288710X	Bendix	R955288710X
287298	Bendix	R955287298N	288239	Bendix	R955288239	288721	Bendix	R955288721
287298K	Haldex	R955287298N	288239	Bendix	R955288239N	288721N	Bendix	R955288721
287298N	Bendix	R955287298N	288239N	Bendix	R955288239N	288746	Bendix	R955288746
287313	Bendix	R955287313N	288239RX	Bendix	R955288239	288746	Bendix	R955288746N
287376	Bendix	R955287376	288239RX	Bendix	R955288239N	288746N	Bendix	R955288746
287376	Bendix	R955287376N	288239RX	Bendix	R955288239X	288746N	Bendix	R955288746N
287376N	Bendix	R955287376N	288239RX	Haldex	R955288239	288746RX	Bendix	R955288746X
287376RX	Bendix	R955287376	288239RX	Haldex	R955288239N	288746RX	Haldex	R955288746
287376RX	Bendix	R955287376X	288239X	Bendix	R955288239X	288746RX	Haldex	R955288746N
287376RX	Haldex	R955287376	288240X	Bendix	R955288240X	288746X	Bendix	R955288746X
287376X	Bendix	R955287376	288241	Bendix	R955288241	288746X	Haldex	R955288746X
287376X	Bendix	R955287376X	288241	Bendix	R955288241N	288755RX	Bendix	R955288755N
287411	Bendix	R955287411	288241RX	Haldex	R955288241	288755X	Bendix	R955288755N
287411	Bendix	R955287411N	288241RX	Haldex	R955288241N	288982	Bendix	R955286544X
287411N	Bendix	R955287411	288241X	Bendix	R955288241N	289120X	Bendix	R955288239X
287411RX	Bendix	R955287411X	288241X	Bendix	R955288241X	289144	Bendix	R955289144N
287411RX	Haldex	R955287411	288242X	Bendix	R955288242X	289144N	Bendix	R955289144N
287411X	Bendix	R955287411X	288251RX	Bendix	R955288251X	289144RX	Bendix	R955289144N
287417	Bendix	R955287417	288251X	Bendix	R955288251X	289144RX	Haldex	R955289144N
287417N	Bendix	R955287417	288301	Bendix	R955288301N	289146X	Bendix	R955289146X
287417RX	Bendix	R955287417N	288301RX	Bendix	R955288301N	289148N	Bendix	R955289148X
287417X	Bendix	R955287417N	288301X	Bendix	R955288301X			

All Euclid Air Systems components were superseded to their Meritor part number equivalents effective February 2018.



# CROSS REFERENCE

Competitor Part Number	Competitor Name	Meritor Part Number	Competitor Part Number	Competitor Name	Meritor Part Number	Competitor Part Number	Competitor Name	Meritor Part Number
289148RX	Bendix	R955289148X	298817	Haldex	R955298817N	303GB575RP1	Mack	R955286544X
289148X	Bendix	R955289148X	298818	Haldex	R955298818N	303GB578	Mack	R955286544X
289149N	Bendix	R955289149X	298818N	Bendix	R955298818N	303GB580PR1	Mack	R955286544X
289149X	Bendix	R955289149X	298948	Bendix	R955109869N	303GB580R	Mack	R955286544X
289172X	Bendix	R955289172X	298948K	Haldex	R955109871N	303GB580RP1	Mack	R955286544X
289182X	Bendix	R955289182X	2991783C91	Navistar	R9555004613X	303GB588A	Mack	R95528620X
289253X	Bendix	R955289253X	2GH918	Oshkosh	R955107507X	303GB589	Mack	R955289340X
289336X	Bendix	R955289336X	3003253C95	Navistar	R9555004614X	303GB590	Mack	R955289340X
289336X	Haldex	R955289336X	3018527X	Cummins	R9553018527X	303GB591A	Mack	R955286544X
289339X	Bendix	R955289339X	3018532X	Cummins	R9553018532X	303GB595	Mack	R955289340X
289339X	Haldex	R955289339X	3018543X	Haldex	R9553049186X	303GB596	Mack	R955289340X
289340	Bendix	R955289340X	3018543X	Haldex	R9553049186X	3047440X	Bendix	R9553047440X
289340X	Bendix	R955289340X	303GB1160	Mack	R955227323X	3047440X	Cummins	R9553047440X
289340X	Haldex	R955289340X	303GB1264	Mack	R955276961X	3047440X	Haldex	R9553047440X
289342X	Bendix	R955289342X	303GB19306	Mack	R955276961X	3047440X	Holset-Cummins	R9553047440X
289348	Bendix	R955289348X	303GB232R	Mack	R955286544X	3048680X	Cummins	R9553048680X
289348X	Bendix	R955289348X	303GB234R	Mack	R955286544X	3049186X	Cummins	R9553049186X
289348X	Haldex	R955289348X	303GB3136R	Mack	R955286554X	3049186X	Haldex	R9553049186X
289349X	Bendix	R955289349X	303GB3139R	Mack	R955286528X	3049186X	Holset-Cummins	R9553049186X
289349X	Haldex	R955289349X	303GB3149	Mack	R955289350X	3052776X	Cummins	R9553052776X
289350X	Bendix	R955289350X	303GB3157	Mack	R955102953X	3069181	Cummins	R955107507X
289350X	Haldex	R955289350X	303GB3157A	Mack	R955102953X	3069211	Cummins	R955107506X
289380X	Bendix	R955289380X	303GB4152R	Mack	R955289348X	3074470	Cummins	R955107506X
289444TPX	Bendix	R955289444X	303GB4170RP1	Mack	R955289340X	3074471	Cummins	R955107507X
289444X	Bendix	R955289444X	303GB4198R	Mack	R955286560X	3093850	Volvo	R955107981X
289477	Bendix	R955289477	303GB4200R	Mack	R955289348X	3104216RX	Cummins	R9559111535100X
289477RX	Haldex	R955289477	303GB4201R	Mack	R955289340X	3166445	Cummins	R955107506X
289477X	Bendix	R955289477X	303GB4204	Mack	R955289348X	3166446	Cummins	R955107507X
289512X	Bendix	R955289512X	303GB5102	Mack	R9553558000X	319365C91	Navistar	R955228479X
289545X	Bendix	R955289545X	303GB5103	Mack	R955107510X	319371C91	Navistar	R955228479X
289688X	Bendix	R955289688X	303GB5105	Mack	R955107511X	32131	Velvac	R955284358N
289714	Bendix	R955289714N	303GB5111	Mack	R9553558043X	325010	Haldex	RBE13250
289714N	Bendix	R955289714N	303GB5114	Mack	R955108866X	325011	Haldex	RBE13250
289714RX	Haldex	R955289714N	303GB5114A	Mack	R955108866X	325134U	Dayton Parts	R950122
289714X	Bendix	R955289714X	303GB5117	Mack	R9553558077X	3417958	Cummins	R955107506X
289714X	Haldex	R955289714X	303GB5117RX	Mack	R9553558077X	3417959	Cummins	R955107507X
289744X	Bendix	R955289744X	303GB5117X	Mack	R9553558077X	3551971C92	Navistar	R9555015314X
289789X	Bendix	R955289789X	303GB5118	Mack	R9553558068X	3551971C93	Navistar	R9555015314X
289790X	Bendix	R955289790X	303GB5123	Mack	R9555002865X	3558000X	Cummins	R9553558000X
289915	Bendix	R955289915X	303GB5123A	Mack	R9555002865X	3558000X	Haldex	R9553558000X
289915X	Bendix	R955289714N	303GB5124	Bendix	R9555002868X	3558005X	Cummins	R9553558005X
289915X	Bendix	R955289714X	303GB5124A	Bendix	R9555002868X	3558006X	Cummins	R9553558006X
289915X	Bendix	R955289915X	303GB514A	Mack	R9555002868X	3558006X	Haldex	R9553558006X
289924X	Bendix	R955289924X	303GB5158	Mack	R955102953X	3558010X	Cummins	R9553558010X
289925X	Bendix	R955289925X	303GB561P2	Mack	R955278605X	3558013X	Cummins	R9553558013X
289941X	Bendix	R955289941X	303GB561P5	Mack	R955279556X	3558020X	Cummins	R9553558020X
289941X	Haldex	R955289941X	303GB561P6	Mack	R955279556X	3558020X	Haldex	R9553558020X
289964X	Bendix	R955289964X	303GB569P3	Mack	R955282621X	3558021X	Cummins	R9553558021X
289964X	Haldex	R955289964X	303GB575P1	Mack	R955286544X	3558021X	Haldex	R9553558021X
297762C92	Navistar	R955227320X	303GB575R	Mack	R955286544X			

5

All Euclid Air Systems components were superseded to their Meritor part number equivalents effective February 2018.

Competitor Part Number	Competitor Name	Meritor Part Number	Competitor Part Number	Competitor Name	Meritor Part Number	Competitor Part Number	Competitor Name	Meritor Part Number
3558022X	Cummins	R9553558022X	3559568K	Haldex	R9553559568N	481735C92	Navistar	R955286546X
3558022X	Haldex	R9553558022X	3559576K	Haldex	R9553559576N	4K73	Motor Coach Industries	R955107813X
3558023X	Cummins	R9553558023X	36001	Tramec	R950118	4N9679	Caterpillar	RKN18530
3558027X	Cummins	R9553558027X	3605399C91	Navistar	R9555015314X	4P0586	Caterpillar	R955109604X
3558029X	Cummins	R9553558029X	3609998	Cummins	R955107507X	4P0596	Caterpillar	R955107981X
3558042X	Cummins	R9553558042X	3609999	Cummins	R955107506X	4P-0596	Caterpillar	R955107981X
3558042X	Haldex	R9553558042X	36101	Tramec	R950114	4P0676	Caterpillar	R955107509X
3558043X	Cummins	R9553558043X	36201	Tramec	R950115	4P2419	Caterpillar	R955107981X
3558043X	Haldex	R9553558043X	3628539C91	Navistar	RKN32005	4P3956	Caterpillar	R955107981X
3558044X	Cummins	R9553558044X	36301	Tramec	R950116	5000130	Bendix	R955107514X
3558044X	Haldex	R9553558044X	384998C91	Navistar	R955289925X	5000154	Bendix	R955109477X
3558045X	Cummins	R9553558045X	3914082	Cummins	R955KNT86230X	5000155	Bendix	R955109477X
3558045X	Haldex	R9553558045X	3914083	Cummins	R955KNT86230X	5000156	Bendix	R955109477X
3558046X	Cummins	R9553558046X	3919362	Cummins	R955108269X	5000190	Bendix	R955107622X
3558049X	Cummins	R9553558049X	3947811	Volvo	R955109493X	5000191	Bendix	R955107623X
3558049X	Haldex	R9553558049X	3949249	Volvo	R955109493X	5000192	Bendix	R955107622X
3558050X	Cummins	R9553558050X	3949430	Volvo	R955107512X	5000193	Bendix	R955107623X
3558051X	Cummins	R9553558051X	3949432	Volvo	R955107623X	5000213	Bendix	R955109477X
3558051X	Haldex	R9553558051X	3970806	Cummins	R955284358N	5000214	Bendix	R955109477X
3558052X	Cummins	R9553558052X	400678C91	Navistar	R955284959X	5000291	Bendix	R9555001940X
3558052X	Haldex	R9553558052X	400678C93	Navistar	R955284959X	5000292	Bendix	R9555001940X
3558068X	Cummins	R9553558068X	401004	Tramec Sloan	R955401004	5000404X	Bendix	R9555000404X
3558068X	Haldex	R9553558068X	401018	Tramec Sloan	R955401018	5000559	Bendix	R955107981X
3558072X	Bendix	R9553558072X	401019	Tramec Sloan	R955401019	5000594	Bendix	R955107514X
3558072X	Cummins	R9553558072X	401019	Tramec Sloan	RSN401019	5000641	Bendix	R955107508X
3558072X	Haldex	R9553558072X	401029	Tramec Sloan	R955401029	5000709	Bendix	R9555000709X
3558074X	Cummins	R9553558074X	401039	Tramec Sloan	R955401039	5000709X	Bendix	R9555000709X
3558074X	Haldex	R9553558074X	401040	Tramec Sloan	R955401040	5000709X	Haldex	R9555000709X
3558075X	Cummins	R9553558075X	401045	Tramec Sloan	R955401045	5000794	Bendix	R955109477X
3558076X	Cummins	R9553558076X	401046	Tramec Sloan	R95512105N	5001522	Bendix	R9555002984X
3558077X	Cummins	R9553558077X	401047	Tramec Sloan	R955401047	5001523	Bendix	R9555002984X
3558077x	Haldex	R9553558077X	401056	Tramec Sloan	R955401056	5001533	Bendix	R9555002983X
3558094X	Cummins	R9553558094X	401075	Tramec Sloan	R955401075	5001534	Bendix	R9555002983X
3558094X	Haldex	R9553558094X	401084	Tramec Sloan	R955401084	5001614	Bendix	R9555004188X
3558095X	Cummins	R9553558095X	401095	Tramec Sloan	R955401095	5001615	Bendix	R9555004188X
3558095X	Haldex	R9553558095X	401142	Tramec Sloan	R955284358N	5001616	Bendix	R9555004187X
3558097X	Haldex	R9553558097X	40114225	Tramec Sloan	R955284358N	5001617	Bendix	R9555004187X
3558098X	Cummins	R9553558098X	401237	Tramec Sloan	R955284358N	5001710	Bendix	R955107506X
3558113X	Cummins	R9553558113X	411708C91	Navistar	R955284106X	5001711	Bendix	R955107507X
3558122X	Cummins	R9553558122X	432 410 222 7	WABCO	R109994P	5001740	Bendix	R955109477X
3558122X	Haldex	R9553558122X	441095	Tramec Sloan	R950120	5001773	Bendix	R9555002984X
3558186X	Cummins	R9553558186X	441737	Tramec Sloan	R950122	5001774	Bendix	R9555002984X
3558186X	Haldex	R9553558186X	441738	Tramec Sloan	R950121	5001788	Bendix	R9555002713X
3558189X	Cummins	R9553558189X	451035	Tramec Sloan	R95510747	5001789	Bendix	R9555002713X
3558189X	Haldex	R9553558189X	451036	Tramec Sloan	R95510744	5001904	Bendix	R9555001940X
3558211X	Cummins	R9553558211X	451039	Tramec Sloan	R95510746	5001904X	Bendix	R9555001940X
3558211X	Haldex	R9553558211X	466483C91	Navistar	R955286542X	5001940	Bendix	R9555001940X
3559511	Cummins	R9553559545N	47110007	Haldex	R955065677N	5001940X	Bendix	R9555001940X
3559545K	Haldex	R9553559545N	475693C93	Navistar	R955286543X	5001940X	Haldex	R9555001940X
3559551K	Haldex	R9553559551N	48100-225	Haldex	R307852			

All Euclid Air Systems components were superseded to their Meritor part number equivalents effective February 2018.

# CROSS REFERENCE

Competitor Part Number	Competitor Name	Meritor Part Number	Competitor Part Number	Competitor Name	Meritor Part Number	Competitor Part Number	Competitor Name	Meritor Part Number
5002032	Bendix	R9555002984X	5003648	Bendix	R955109287X	5005037P	Primabrake	R9555005037N
5002033	Bendix	R9555002713X	5003649	Bendix	R955109287X	5005270	Bendix	R955109477X
5002063	Bendix	R955109689X	5003728	Bendix	R955108866X	5005387	Bendix	R955109478X
5002063	Haldex	R955109689X	5003728X	Bendix	R955108866X	5005414	Bendix	R9555004118X
5002063X	Bendix	R955109689X	5003850	Bendix	R9555004118X	5005415	Bendix	R955109287X
5002063X	Haldex	R955109689X	5003976	Bendix	R955109477X	5005416	Bendix	R955109287X
5002082	Bendix	R9555002983X	5004050	Bendix	R9555004050X	5005417	Bendix	R955109287X
5002222	Bendix	R9555002865X	5004050PGX	Bendix	R9555004050PGX	5005418	Bendix	R955109604X
5002223	Bendix	R9555002868X	5004050X	Bendix	R9555004050X	5005419	Bendix	R9555002713X
5002595	Bendix	R9555002595N	5004050X	Haldex	R9555004050X	5005420	Bendix	R955107508X
5002640	Bendix	R9555002865X	5004082	Bendix	R9555004188X	5005421	Bendix	R9555002983X
5002641	Bendix	R9555002868X	5004083	Bendix	R9555004187X	5005422	Bendix	R9555002983X
5002652	Bendix	R9555002713X	5004112	Bendix	R9555004118X	5005459	Bendix	R9555004118X
5002713	Bendix	R9555002713X	5004113	Bendix	R9555004118X	5005466	Bendix	R955109287X
5002713X	Bendix	R9555002713X	5004118	Bendix	R9555004118X	5005473	Bendix	R955109604X
5002713X	Haldex	R9555002713X	5004118X	Bendix	R9555004118X	5005478	Bendix	R9555002713X
5002826	Bendix	R9555002983X	5004118X	Haldex	R9555004118X	5005483	Bendix	R955107508X
5002839	Bendix	R9555001940X	5004187	Bendix	R9555004187X	5005491	Bendix	R9555002983X
5002864	Bendix	R9555002865X	5004187X	Bendix	R9555004187X	5005492	Bendix	R9555002983X
5002865	Bendix	R9555002865X	5004187X	Haldex	R9555004187X	5005496	Bendix	R9555002983X
5002865X	Bendix	R9555002865X	5004188	Bendix	R9555004188X	5005606	Bendix	R9555005790X
5002865X	Haldex	R9555002865X	5004188X	Bendix	R9555004188X	5005624	Bendix	R9555005624N
5002867	Bendix	R9555002868X	5004188X	Haldex	R9555004188X	5005697	Bendix	R955109477X
5002868	Bendix	R9555002868X	5004336	Bendix	R9555004336N	5005702	Bendix	R955109478X
5002868X	Bendix	R9555002868X	5004338	Bendix	R9555004338N	5005770	Bendix	R9555005790X
5002868X	Haldex	R9555002868X	5004338X	Haldex	R9555004338N	5005790	Bendix	R9555005790X
5002900	Bendix	R955109477X	5004339	Bendix	R9555004339N	5005790X	Bendix	R9555005790X
5002983	Bendix	R9555002983X	5004340	Bendix	R9555004340N	5005790X	Haldex	R9555005790X
5002983X	Bendix	R9555002983X	5004341	Bendix	R9555004341X	5005791	Bendix	R9555005790X
5002983X	Haldex	R9555002983X	5004341X	Bendix	R9555004341X	5005875X	Bendix	R9555005875X
5002984	Bendix	R9555002984X	5004341X	Haldex	R9555004341X	5005875X	Haldex	R9555005875X
5002984X	Bendix	R9555002984X	5004342	Bendix	R9555004342X	5005893	Bendix	R9555005893N
5002984X	Haldex	R9555002984X	5004342N	Bendix	R9555004342N	5005893K	Haldex	R9555005893N
5003228	Bendix	R9555002984X	5004342X	Bendix	R9555004342X	5005933	Bendix	R9555004188X
5003229	Bendix	R9555002984X	5004342X	Haldex	R9555004342X	5005934	Bendix	R9555004187X
5003230	Bendix	R9555002984X	5004380	Bendix	R9555004380N	5005979	Bendix	R955501BK
5003231	Bendix	R9555002983X	5004381	Bendix	R9555004381N	5006591	Bendix	R955109477X
5003232	Bendix	R9555002983X	5004479	Bendix	R9555004479N	5006634	Bendix	R955109477X
5003233	Bendix	R9555002983X	5004480	Bendix	R9555004480N	5006705	Bendix	R955501
5003234	Bendix	R9555002713X	5004611	Bendix	R9555004613X	5006821	Bendix	R955109604X
5003235	Bendix	R9555002713X	5004612	Bendix	R9555004614X	5006822	Bendix	R955107509X
5003236	Bendix	R9555002713X	5004613	Bendix	R9555004613X	5006823	Bendix	R955107508X
5003264	Bendix	R955107506X	5004613X	Bendix	R9555004613X	5006824	Bendix	R955109251X
5003265	Bendix	R955107507X	5004613X	Haldex	R9555004613X	5006848	Bendix	R955109477X
5003294	Bendix	R955109478X	5004614	Bendix	R9555004614X	5006879	Bendix	R955109477X
5003365X	Bendix	R955065104X	5004614X	Bendix	R9555004614X	5006887	Bendix	R9555008249X
5003547	Bendix	R9555003547N	5005028	Bendix	R955107514X	5007252	Bendix	R955109478X
5003547K	Haldex	R9555003547N	5005037	Bendix	R9555005037N	5007270	Bendix	R955109477X
5003645	Bendix	R955109251X	5005037K	Haldex	R9555005037N	5007361	Bendix	R9555008249X
5003646	Bendix	R955109251X	5005037K	Haldex	R9555005037N	5007362	Bendix	R9555008249X

All Euclid Air Systems components were superseded to their Meritor part number equivalents effective February 2018.

Competitor Part Number	Competitor Name	Meritor Part Number	Competitor Part Number	Competitor Name	Meritor Part Number	Competitor Part Number	Competitor Name	Meritor Part Number
5007363	Bendix	R9555008249X	5015314X	Bendix	R9555015314X	65201	Bendix	R955107510X
5007468	Bendix	R9555002983X	5015318	Bendix	R9555015314X	65202	Bendix	R955107511X
5007469	Bendix	R9555002983X	5016799	Bendix	R9555010824X	65203	Bendix	R955107512X
5007471	Bendix	R9555002983X	5016799X	Bendix	R9555010824X	65205	Bendix	R955107514X
5008248	Bendix	R9555008249X	5018485	Bendix	R9555018485X	65206	Bendix	R955065206N
5008249	Bendix	R9555008249X	5018485X	Bendix	R9555018485X	65216	Bendix	R955107622X
5008249X	Bendix	R9555008249X	5018485X	Haldex	R9555018485X	65217	Bendix	R955107623X
5008249X	Haldex	R9555008249X	515359C91	Navistar	R955227322X	65224	Bendix	R955065224N
5008250	Bendix	R9555008249X	533519C91	Navistar	R955289349X	65224R0	Primabrake	R955065224XCF
5008251	Bendix	R9555008249X	53403C91	Navistar	R955289339X	65224RX	Bendix	R955065224N
5008414	Bendix	R109994P	534043C91	Navistar	R955289339X	65224RX	Bendix	R955065224X
5008414K	Haldex	R109994P	534043C94	Navistar	R955289339X	65225	Bendix	R955065225NP
5008414P6	Bendix	R955099P	540514C91	Navistar	R955289350X	65225	Bendix	R955065225N
5008609	Bendix	R9555004188X	541942C91	Navistar	R955289925X	65225	Bendix	R955065225XCF
5008610	Bendix	R9555004187X	5455X	Haldex	R9555455X	65240	Bendix	R955109604X
5009328	Bendix	R9555015314X	5461X	Kelsey Hayes	R9555461X	65260	Bendix	R955107813X
5009329	Bendix	R9555015314X	5470X	Kelsey Hayes	R9555470X	65273	Bendix	R955107981X
5009330	Bendix	R9555015314X	570287C94	Navistar	R955286528X	65288	Bendix	R955108110X
5009378X	Bendix	R955109685HX	5MB533	Oshkosh	R955107623X	65302	Bendix	R955107514X
5009413	Bendix	R955109478X	5X1093	Haldex	R5X1093	65303	Bendix	R955065303N
5009746	Bendix	R955107813X	5X1093	Haldex	R5X1093	65303	Bendix	R955065303X
5009817	Bendix	R955109477X	61130294	Thomas School Bus	R955108804X	65334	Bendix	R955108557X
5010133	Bendix	R9555010133X	61130309	Thomas School Bus	R955107514X	65376	Bendix	R955108804X
5010133PGX	Bendix	R9555010133PGX	61130329	Thomas School Bus	R955109653X	65387	Bendix	R955108866X
5010133X	Bendix	R9555010133X	6316568	New Flyer	R955107623X	65437	Bendix	R955065437N
5010696	Bendix	R9555010696X	6328219R	Neoplan Bus	R955107507X	65437	Bendix	R955109615N
5010696PGX	Bendix	R9555010696PGX	6328219R	Neoplan Bus	R955107507X	65437RX	Haldex	R955065437
5010696X	Bendix	R9555010696X	6336882R	Bendix	R9555004187X	65439	Bendix	R955065439
5010696X	Haldex	R9555010696X	641190	Prevost	R955107813X	65439	Bendix	R955065439N
5010806X	Bendix	R9555010806X	65041X	Haldex	R955065041X	65439RX	Haldex	R955065439
5010824X	Bendix	R9555010824X	65104	Bendix	R955065104N	65457	Bendix	R9555004613X
5010824X	Haldex	R9555010824X	65104	Bendix	RA86473	65461	Bendix	R9555004614X
5011016X	Bendix	R9555016799X	65145	Bendix	R955065145N	65465	Bendix	R9555002984X
5011016X	Bendix	R9555011016X	65145RX	Bendix	R955065145X	65466	Bendix	R9555002983X
5011016X	Haldex	R9555016799X	65146	Bendix	R955065146N	65475	Bendix	R955109251X
5012533	Bendix	R9555012533X	65146RX	Bendix	R955065146X	65484	Bendix	R9555002984X
5012533X	Bendix	R9555012533X	65157	Bendix	R955800516N	65491	Bendix	R955109287X
5012533X	Haldex	R9555012533X	65159	Bendix	R955800517N	65537	Bendix	R9555004188X
5012665	Bendix	R955109653X	65160	Bendix	R955800516N	65538	Bendix	R9555004187X
5012943	Bendix	R955107507X	65160	Bendix	R955800518N	65607	Bendix	R955109604X
5013058	Bendix	R9555013058X	65181	Bendix	RA86473	65612	Bendix	R955109477X
5013058X	Bendix	R9555013058X	65186	Bendix	R955800519N	65613	Bendix	R955109477X
5013059X	Bendix	R9555013058X	65186	Bendix	R955800573N	65613	Bendix	R955109478X
5013059X	Bendix	R9555013059X	65187	Bendix	R955800573N	65624	Bendix	R955065624N
5014428	Bendix	R9555014428X	65197	Bendix	R955107506X	65624K	Haldex	R109994P
5014428X	Bendix	R9555014428X	65198	Bendix	R955107507X	65624K	Haldex	R955065624N
5014428X	Haldex	R9555014428X	65199	Bendix	R955107508X	65626	Bendix	R955800404N
5014488	Bendix	R9555014488X	65200	Bendix	R955107509X	65641	Bendix	R955109653X
5014488X	Bendix	R9555014488X				65643	Bendix	R955065643
5015314	Bendix	R9555015314X				65671	Bendix	R955107623X

All Euclid Air Systems components were superseded to their Meritor part number equivalents effective February 2018.

# CROSS REFERENCE

Competitor Part Number	Competitor Name	Meritor Part Number	Competitor Part Number	Competitor Name	Meritor Part Number	Competitor Part Number	Competitor Name	Meritor Part Number
65672	Bendix	R955107622X	800273	Bendix	R9555002865X	8062235	Volvo	R955107507X
65677	Bendix	R955065677N	800274	Bendix	R9555002868X	8089675	Bendix	R9558089675N
65683	Bendix	R9555002713X	800291	Bendix	R9555002983X	8166665	Volvo	R955107981X
6997312RX	Haldex	R955BM6997312X	800292	Bendix	R9555002984X	8205281000	Gillig	R955107813X
6997312X	Haldex	R955BM6997312X	800333	Bendix	R955800333N	8205281001	Gillig	R955107813X
611670	Caterpillar	R955107981X	800333N	Bendix	R955800333N	8216809	Gillig	R9555004187X
700010043	Volvo	R955107508X	800350	Bendix	R955800350N	8217427000	Gillig	R955107507X
700013205	Volvo	R955107622X	800350N	Bendix	R955800350N	8217427001	Gillig	R955107507X
700018001	Volvo	R955107506X	800354	Bendix	R955108866X	8502173	Volvo	R955108866X
700018003	Volvo	R955109604X	800361	Bendix	R955284358N	85101164	Volvo	R955107509X
745065457	Mack	R9555004613X	800372	Bendix	R955227871	85102167	Volvo	R955108804X
745108866	Mack	R955108866X	800372	Bendix	R955227871N	85102168	Volvo	R955107622X
745275200N	Mack	RKN18530	800372	Bendix	R955KN23000N	85102169	Volvo	R955107507X
745275491RX	Mack	R955284358N	800373	Bendix	R955227870	85102173	Volvo	R955108866X
745275491RXC	Mack	R955284358N	800373	Bendix	R955227870N	85102174	Volvo	R9555004613X
745284358RX	Mack	R955284358N	800373	Bendix	R955KN23010N	85102179	Volvo	R955107514X
745800273	Mack	R9555002865X	800376	Bendix	R955800376N	85102184	Volvo	R955107813X
745800274	Mack	R9555002868X	800385	Bendix	R9555004118X	85102188	Volvo	R955108110X
745800354	Mack	R955108866X	800394	Bendix	R9555004187X	85106353	Volvo	R9555002868X
745800468	Mack	R9555004613X	800395	Bendix	R9555004188X	85106354	Volvo	R9555004188X
745065457	Mack	R9555004613X	800404	Bendix	R955800404N	870560C91	Navistar	R955276962X
7450R284358X	Mack	R955284358X	800404K	Haldex	R955800404N	900 54 007	Neway	R304323
745X107507	Mack	R955107507X	800404X	Bendix	R955800404N	900 54 074	Neway	R304325
745X107508	Mack	R955107508X	800405	Bendix	R955800405N	900 54 075	Neway	R304331
745X107510	Mack	R9555002868X	800405P	Primabrake	R955800405N	900 54 079	Neway	R304328
745X107981	Mack	R955107981X	800468	Bendix	R9555004613X	900 54 082	Neway	R304329
745X108110	Mack	R955108110X	800469	Bendix	R9555004614X	900 54 088	Neway	R304326
745X108804	Mack	R955108804X	800516	Bendix	R955800516N	900 54 466	Neway	R304324
745X108866	Mack	R955108866X	800516RX	Haldex	R955800516N	905 55 105	Neway	R3013922
745X109287	Mack	R955109287X	800517	Bendix	R955800517N	90555106	Haldex	R95590554271N
745X5002865	Mack	R9555002865X	800518	Bendix	R955800518N	90555396	Haldex	R90555396
745X5002868	Mack	R9555002868X	800519	Bendix	R955800519N	90555397	Haldex	R90555397
745X5002983	Mack	R9555002983X	800521	Bendix	R955800521N	90555398	Haldex	R90555398
745X5002984	Mack	R9555002984X	800521RX	Haldex	R955800521N	90555409	Haldex	R90555409
745X5004188	Mack	R9555004188X	800551	Bendix	R955109477X	90555410	Haldex	R90555410
745X5002983	Mack	R9555002983X	800573	Bendix	R955800573N	9111535100X	Bendix	R9559111535100X
751625C91	Navistar	R955276962X	800573RX	Haldex	R955800573N	9111535100X	Cummins	R9559111535100X
786879C91	Navistar	R955281042X	800594	Bendix	R9555005790X	9111535100X	Haldex	R9559111535100X
789205C91	Navistar	R955289925X	800629	Bendix	R955065313X	9111535200X	Bendix	R9559111535200X
797644C91	Navistar	R955284699X	800629	Bendix	R955800629N	9111535200X	Cummins	R9559111535200X
7E7619	Caterpillar	R955107508X	800718	Bendix	R9555008249X	9111535200X	Haldex	R9559111535200X
7N9195	Caterpillar	RKN18530	800725	Bendix	R9555002983X	9111535207X	Haldex	R9559111535200X
800017	Bendix	R955107623X	800816	Bendix	R9555008249X	9111535300X	Cummins	R9559111535300X
800018	Bendix	R955107622X	800887	Bendix	R955109991XCF	9111535300X	Haldex	R9559111535300X
800021	Bendix	R955109477X	800887PG	Bendix	R955109991XCF	9111535330X	Cummins	R9559111535330X
800183	Bendix	R9555001940X	801087	Bendix	R9555015314X	9111535330X	Haldex	R9559111535330X
800225	Bendix	R955284358N	801266	Bendix	R9555010696X	9111539202X	Haldex	R9559111539202
800245	Bendix	R9555002865X	801506	Bendix	R955109653X	9111539202X	Haldex	R9559111539202
800246	Bendix	R9555002868X	801843	Bendix	R955065225X	9111545000X	Cummins	R9559111545000X
800256	Bendix	R9555002713X	801971	Bendix	R9555015314X	9111545100X	Cummins	R9559111545100X

All Euclid Air Systems components were superseded to their Meritor part number equivalents effective February 2018.

Competitor Part Number	Competitor Name	Meritor Part Number	Competitor Part Number	Competitor Name	Meritor Part Number	Competitor Part Number	Competitor Name	Meritor Part Number
950011	Automann	R109994P	A86477N	Haldex	R955102626N	BH109994	Armada	R109994P
950011	Bendix	R109994P	A86477N	Haldex	R955102626X	BH131081	Armada	R955131081N
950011K	Haldex	R109994P	A86477X	Haldex	R955102626X	BH229635	Armada	R955229635N
97821800002	Flxible Bus	R955107813X	A86477X	Wagner	R955A86477X	BH229813	Armada	R955229813N
97821800151	Flxible Bus	R955107507X	A86623	Haldex	R950096	BH229859	Armada	R955229859N
97821800218	Flxible Bus	R955107813X	A87940	Haldex	RA87940	BH229860	Armada	R955229860N
9Y6320	Caterpillar	R9555002983X	A88802	Wagner	R955A88802X	BH275491	Armada	R955275491
A103600	Haldex	R955279952N	A88812	Wagner	R955A88812X	BH276566	Armada	R955276566N
A103600N	Haldex	R955279952N	A97600	Wagner	R955A97600X	BH276567	Armada	R955276567N
A103600N	Haldex	R955279952X	A98730	Wagner	R955A98730X	BH278614	Armada	R955278614N
A103600X	Haldex	R955279952X	A99370	Wagner	R955A99370X	BH279000	Armada	R955279000N
A103600X	Haldex	R955A103600X	ABP N10G R950011	Alliance	R109994P	BH281865	Armada	R955281865N
A103600X	Wagner	R955A103600X	ABP R42B 107794X	Alliance	R109994P	BH281946	Armada	S936 649 151 0
A3546	Eaton	R955A3546N	ABP RC10- 5004083	Freightliner	R9555004187X	BH284142	Armada	R955284142N
A3546	Fuller	R955A3546N	ABP RC10-65671	Freightliner	R955107623X	BH284358	Armada	R955284358N
A3546X	Eaton	R955A3546X	ABP RC10-65672	Freightliner	R955107622X	BH286171	Armada	R955286171N
A3546X	Fuller	R955A3546X	AC1001	Trp	R109994P	BH286364	Armada	R955286364N
A3547X	Eaton	R955A3547X	AC2001	Trp	R955107796N	BH288239	Armada	R955288239N
A3547X	Fuller	R955A3547X	AC3001	Trp	R955065624N	BH288241	Armada	R955288241N
A3991X	Eaton	R955A3991X	ADSP CART	Trp	R109994P	BH288605	Armada	R955288605N
A3991X	Fuller	R955A3991X	APR C10- 5004082	Freightliner	R9555004188X	BH289714	Armada	R955289714N
A4487	Eaton	R955A4487N	AT950068	Tectran	R955099P	BH5005037	Armada	R9555005037N
A4487	Fuller	R955A4487N	BA5592	Baldwin	R955099P	BH5008414	Armada	R109994P
A4490	Eaton	R955A4490N	BAN284358N	Bendix	R955284358N	BH800333	Armada	R955800333N
A4490	Fuller	R955A4490N	BCC-1035	Pai	R955107510X	BH800405	Armada	R955800405N
A4491	Eaton	R955A4491N	BE13240	Haldex	R955BE13240N	BH800516	Armada	R955800516N
A4491	Fuller	R955A4491N	BE13240	Haldex	RBE13240	BH800519	Armada	R955800519N
A4688	Eaton	R955A4688N	BE13240N	Haldex	R955BE13240N	BH800573	Armada	R955800573N
A4688	Fuller	R955A4688N	BE13241	Haldex	R955228750N	BH800629	Armada	R955800629N
A4688X	Fuller	R955A4688X	BE13241	Haldex	R955BE13241N	BHCART224	Armada	R955T224N
A4900	Eaton	R955A4900N	BE13241	Haldex	RBE13241	BHKN20615	Armada	R955KN20615N
A4900	Fuller	R955A4900N	BE13241N	Haldex	R955228750N	BHKN23000	Armada	R955KN23000N
A5010	Eaton	R955A5010N	BE13241N	Haldex	R955BE13241N	BHKN26000	Armada	R955KN26000N
A5010	Fuller	R955A5010N	BE13250	Haldex	R955228600N	BHKN27000	Armada	R955KN27000N
A5015	Eaton	R955A5015N	BE13250	Haldex	R955BE13250N	BHKN28500	Armada	R955KN28500N
A5015	Fuller	R955A5015N	BE13250	Haldex	RBE13250	BHKN28510	Armada	R955KN28510N
A72420	Haldex	R955A72420N	BE13250	Haldex	R955228600N	BHKN28520	Armada	R955KN28520N
A72420N	Haldex	R955A72420N	BE13250	Haldex	R955BE13250N	BHKN28600	Armada	R955KN28600N
A80070	Wagner	R955A80070X	BE13250	Haldex	RBE13250	BHKN30400	Armada	R955KN30400N
A83034	Haldex	RN15843	BE13250N	Haldex	R955228600N	BHR950011	Armada	R109994P
A83580	Haldex	RA83580	BE13250N	Haldex	R955BE13250N	BHR955205	Armada	R955205
A85490	Wagner	R955A85490X	BE13255	Haldex	R955BE13255N	BHR955300	Armada	R955300
A85493	Wagner	R955A85493X	BE13255	Haldex	RBE13255	BHS-10129	Armada	S936 649 151 0
A86472	Haldex	RA86472	BE13255N	Haldex	R955BE13255N	BHS-11611	Armada	R109994P
A86473	Haldex	RA86473	BH102626	Armada	R955102626N	BHS-13728	Armada	R955205
A86473X	Haldex	R955A86473X	BH103009	Armada	R955103009N	BHS-13883	Armada	R955103976
A86473X	Wagner	R955A86473X	BH103010	Armada	R955103010N	BHS-4771	Armada	R955286171N
A86477	Haldex	R955102626	BH103081	Armada	R955103081N	BHS-4922	Armada	R955229859N
A86477	Haldex	R955102626N	BH107794	Armada	R955107794X	BHS-5675	Armada	R955276566N
A86477	Haldex	RA86477	BH109493	Armada	R955109493X	BHS-5676	Armada	R955229635N

All Euclid Air Systems components were superseded to their Meritor part number equivalents effective February 2018.

# CROSS REFERENCE

Competitor Part Number	Competitor Name	Meritor Part Number	Competitor Part Number	Competitor Name	Meritor Part Number	Competitor Part Number	Competitor Name	Meritor Part Number
BHS-5677	Armada	R955288239N	BHS-C571	Armada	R955288383	EL13050X	Haldex	R955286539X
BHS-5865	Armada	R955279180N	BHS-C680	Armada	R955109578N	EL13050X	Haldex	R955286581X
BHS-6006	Armada	R955102626N	BHS-D817	Armada	R955277147N	EL13050X	Haldex	R955EL13050X
BHS-6006A	Armada	R955103009N	BHS-E277	Armada	R955109579N	EL13051X	Haldex	R955286623X
BHS-6106	Armada	R955284358N	BHS-E424	Armada	R955227871	EL13051X	Haldex	R955EL13051X
BHS-7558	Armada	R955281865N	BHS-E598	Armada	R955227870	EL13053X	Haldex	R955107622X
BHS-7656	Armada	R955401004	BHS-E692	Armada	R955279950N	EL13053X	Haldex	R955EL13053X
BHS-8255	Armada	R955103010N	BHS-E694	Armada	R955065313X	EL13060X	Haldex	R955107514X
BHS-8255A	Armada	R955103028N	BHS-E854	Armada	R955109495N	EL13060X	Haldex	R955108110X
BHS-8328	Armada	R955229860N	BHS-E855	Armada	R955109496N	EL13060X	Haldex	R955286527X
BHS-8444	Armada	R955227871	BHS-E856	Armada	R955107799N	EL13060X	Haldex	R955286528X
BHS-8445	Armada	R955227870	BHS-E858	Armada	R955109869N	EL13060X	Haldex	R955286576X
BHS-8631	Armada	R955277863N	BHS-E859	Armada	R955800350N	EL13060X	Haldex	R955EL13060X
BHS-8887	Armada	R955279000N	BHS-F345	Armada	R955205	EL13070X	Haldex	R955EL13070X
BHS-8898	Armada	R955287600N	BM6997312	Cummins	R955BM6997312N	EL13081X	Haldex	R955EL13081X
BHS-9169	Armada	R955287238N	BM6997312	Cummins	R955BM69973-12X	EL13090X	Haldex	R955EL13090X
BHS-9174	Armada	R955286370N	BM6997312N	Cummins	R955BM6997312N	EL13100X	Haldex	R955EL13100X
BHS-9625	Armada	R955289144N	BM6997312N	Cummins	R955BM69973-12N	EL13111X	Haldex	R955107511X
BHS-9749	Armada	R955289714N	BM69973-12N	Cummins	R955BM6997312N	EL13111X	Haldex	R955286544X
BHS-A142	Armada	R955065437N	BM6997312X	Cummins	R955BM6997312X	EL13111X	Haldex	R955286620X
BHS-A143	Armada	R955103081N	BM69973-12X	Cummins	R955BM6997312X	EL13111X	Haldex	R955EL13111X
BHS-A145	Armada	R955288746	BM6997324	Cummins	R955BM6997324N	EL13151X	Haldex	R955109251X
BHS-A146	Armada	R955284760N	BM6997324	Cummins	R955BM69973-24X	EL13151X	Haldex	R955EL13151X
BHS-A147	Armada	R955279952N	BM6997324N	Cummins	R955BM6997324N	EL13160X	Haldex	R955EL13160X
BHS-A149	Armada	R955103061N	BM6997324N	Cummins	R955BM69973-24N	EL13200X	Haldex	R955103274X
BHS-A150	Armada	R955287376N	BM69973-24N	Cummins	R955BM6997324N	EL13200X	Haldex	R955EL13200X
BHS-A151	Armada	R955101112N	BM6997324X	Cummins	R955BM6997324X	EL13220X	Haldex	R955EL13220X
BHS-A152	Armada	R955101622	BM69973-24X	Cummins	R955BM6997324X	EL13280X	Haldex	R955107981X
BHS-A264	Armada	R955228600N	BR950011	Bendix	R109994P	EL13312X	Haldex	R9555004188X
BHS-A265	Armada	R955228750N	BW284358N	Bendix	R955284358N	EL13312X	Haldex	R955EL13312X
BHS-A266	Armada	R955279416N	BWOR275491	Bendix	R955284358N	EL14110X	Haldex	R955EL14110X
BHS-A268	Armada	R955276462	BXOR275491X	Bendix	R955284358N	EL14111X	Haldex	R955EL14111X
BHS-A269	Armada	R955278614N	BX107622B1	Navistar	R955107622X	EL16020X	Haldex	R955EL16020X
BHS-A270	Armada	R955229813N	BX108110B1	Navistar	R955108110X	EL16040X	Haldex	R955107507X
BHS-A271	Armada	R955281923N	CART224	Haldex	R955T224N	EL16040X	Haldex	R955EL16040X
BHS-A272	Armada	R955286364N	D2	Bendix	R955284358N	EL16050X	Haldex	R955EL16050X
BHS-A273	Armada	R955286500	DA9017B	Haldex	R950121	EL16051X	Haldex	R955EL16051X
BHS-A274	Armada	R955288605N	DA9017R	Haldex	R950122	EL16053X	Haldex	R955EL16053X
BHS-A323	Armada	R109994P	DC100	Primabrake	R109994P	EL16060X	Haldex	R955EL16060X
BHS-A473	Armada	R955103981N	DCC-1030X	Pai	R955286544X	EL16100X	Haldex	R955EL16100X
BHS-A474	Armada	R955107796N	DCC-1032	Pai	R955107511X	EL16110X	Haldex	R955EL16110X
BHS-A535	Armada	R955284358N	DCC-1033	Pai	R955108866X	EL16111X	Haldex	R955EL16111X
BHS-A561	Armada	R955103294	DCC-1150	Pai	R955EL13111X	EL16120X	Haldex	R955EL16120X
BHS-B285	Armada	R955288241N	E12977284	Clark	R955107506X	EL16200X	Haldex	R955EL16200X
BHS-B898	Armada	R955288323	EL13020X	Haldex	R955EL13020X	EL16250X	Haldex	R955EL16250X
BHS-C068	Armada	R955800333N	EL13021X	Haldex	R955EL13021X	EL16312X	Haldex	R9555004187X
BHS-C291	Armada	R955205105N	EL13022X	Haldex	R955EL13022X	EM05070	Haldex	R955279416N
BHS-C403	Armada	R955229505N	EL13040X	Haldex	R955107506X	EM05070	Pai	R955279416N
BHS-C517	Armada	R955065145N	EL13040X	Haldex	R9553049186X	EM34550	Pai	R955288605N
BHS-C518	Armada	R955065146N	EL13040X	Haldex	R955EL13040X	EM-34590	Pai	R955103081N

5

All Euclid Air Systems components were superseded to their Meritor part number equivalents effective February 2018.

Competitor Part Number	Competitor Name	Meritor Part Number	Competitor Part Number	Competitor Name	Meritor Part Number	Competitor Part Number	Competitor Name	Meritor Part Number
EM-35020	Pai	R955287417N	EM37070	Pai	R955KN27000N	F3HT2875FA	Ford	R955108804X
EM35070	Pai	R955103010	EM-37070	Pai	R955289148X	F3HT2875FB	Ford	R955108804X
EM-35390	Pai	R955KN28060N	EM37160	Haldex	R955BE13241N	F3HT2875FC	Ford	R955108804X
EM35820	Pai	R955279180	EM37160	Pai	R955BE13241N	F3HT2875FC	Freightliner	R955108804X
EM-35890	Pai	R955KN28071X	EM37220	Haldex	R955KN27000N	FC065104	Fleetcraft	R955065104N
EM-35910	Pai	R955279000N	EM3S110	Pai	R955287238N	FC065437	Fleetcraft	R955065437N
EM35920	Pai	R955276566	EM40620	Pai	R955227870	FC102626	Fleetcraft	R955102626N
EM35950	Pai	R955287376	EM40630	Pai	R955288323	FC103009	Fleetcraft	R955103009N
EM35950	Pai	R955288239	EM40640	Pai	R955227871	FC103010	Fleetcraft	R955103010N
EM35950	Pai	R955288239N	EM40650	Pai	R955227870	FC103028	Fleetcraft	R955103028N
EM35960	Haldex	R955103009N	EM40660	Pai	R955227871	FC103081	Fleetcraft	R955103081N
EM35960	Pai	R955103009N	EM40660	Pai	R955KN23000N	FC229635	Fleetcraft	R955229635N
EM35980	Pai	R955103009	EM-40710	Pai	R955280809X	FC229859	Fleetcraft	R955229859N
EM36050	Haldex	R955BE13250N	EM40750	Haldex	R955KN28600N	FC229860	Fleetcraft	R955229860N
EM36050	Pai	R955BE13250N	EM40750	Pai	R955KN28600N	FC276566	Fleetcraft	R955276566N
EM36060	Haldex	R955BE13240N	EM-40760	Pai	R955KN26000N	FC276567	Fleetcraft	R955276567N
EM36070	Haldex	R955BE13255N	EM55430	Pai	R955284760	FC281865	Fleetcraft	R955281865N
EM36090	Haldex	R955228600N	EM55470	Pai	R955288383X	FC286171	Fleetcraft	R955286171N
EM36090	Pai	R955228600N	EM-55470	Pai	R955288383X	FC288239	Fleetcraft	R955288239N
EM-36090	Pai	R955228600N	EM55480	Haldex	R955277147N	FC289714	Fleetcraft	R955289714N
EM-36100	Pai	R955KN30400X	EM-55870	Pai	R955107794X	FLT107794	Fleetrite	R955107796N
EM36110	Haldex	R955287238N	EM-55910	Pai	R955287600X	FLT109493	Fleetrite	R955065624N
EM36120	Pai	R955KN28510	EM-56120	Pai	R955286370N	FLT109994	Fleetrite	R109994P
EM36130	Pai	R955102626	EM56150	Pai	R955287417N	FLT114	Fleetrite	R955107514X
EM36170	Pai	RKN28140	EM-56150	Pai	R955286364X	FLT614	Fleetrite	R9555004614X
EM-36170	Pai	R955280375X	EM56160	Haldex	R955286370N	FLT9685	Fleetrite	R955109685NP
EM36190	Pai	R955276567	EM-56170	Pai	R955288383X	FLTAD5225	Fleetrite	R955065225NP
EM36220	Haldex	R955228750N	EM-56180	Pai	R955287238N	FLTBC106	Fleetrite	R955107506X
EM36250	Haldex	R955289144N	EM-56190	Pai	R955276462X	FLTBC113	Fleetrite	R9555004613X
EM36260	Pai	R955289714N	EM56310	Pai	R955065313X	FLTBC115	Fleetrite	R955KN20615N
EM-36260	Pai	R955288746N	EM56370	Pai	R955278426X	FLTBC137	Fleetrite	R9555005037N
EM-36290	Pai	R955277863N	EM56480	Haldex	R955101437N	FLTBC191	Fleetrite	R955284358N
EM36300	Haldex	R955286171N	EM56620	Pai	R955065437	FLTBV000	Fleetrite	R955279000N
EM-36350	Pai	R955KN30300X	EM56620	Pai	R955065437N	FLTBV009	Fleetrite	R955103009N
EM36370	World American	R955KN28500N	EM56630	Pai	R955101622	FLTBV010	Fleetrite	R955103010N
EM36380	Pai	R955KN28520N	EM56640	Pai	R955101112	FLTBV081	Fleetrite	R955103081N
EM36380	Pai	RKN28520	EM56640	Pai	R955101112N	FLTBV105	Fleetrite	R955K022105N
EM36390	Haldex	R955KN28060N	EM56710	Pai	R955286171N	FLTBV145	Fleetrite	R955065145N
EM36420	Pai	R955103028	EM56830	Pai	R955065439	FLTBV171	Fleetrite	R955286171N
EM-36430	Pai	R955065125X	EM56880	Haldex	R955065146N	FLTBV241	Fleetrite	R955288241N
EM36450	Pai	R955275491	EM56880	Pai	R955065146N	FLTBV303	Fleetrite	R955065303N
EM36450	Pai	R955284358N	EM-56880	Pai	R955065146X	FLTBV333	Fleetrite	R955800333N
EM-36570	Pai	R955229859N	EM56970	Pai	R955229505N	FLTBV358	Fleetrite	R955284358N
EM-36580	Pai	R955229860N	EM-56970	Pai	R955229505N	FLTBV364	Fleetrite	R955286364N
EM36620	Pai	R12104	EM57050	Pai	R955281865	FLTBV437	Fleetrite	R955065437N
EM36640	Haldex	R955A3546N	EM57170	Pai	R955288239	FLTBV516	Fleetrite	R955800516N
EM36820	Haldex	R955279180N	EM57180	Pai	R955288241	FLTBV566	Fleetrite	R955276566N
EM36850	Pai	R90555396	EM57230	Haldex	R955104358XCF	FLTBV567	Fleetrite	R955276567N
EM37070	Haldex	R955KN27000N	F1HT2875BA	Ford	R955107514X	FLTBV614	Fleetrite	R955278614N
			F1HT2875BB	Ford	R955107514X	FLTBV626	Fleetrite	R955102626N

All Euclid Air Systems components were superseded to their Meritor part number equivalents effective February 2018.



# CROSS REFERENCE

Competitor Part Number	Competitor Name	Meritor Part Number	Competitor Part Number	Competitor Name	Meritor Part Number	Competitor Part Number	Competitor Name	Meritor Part Number
FLTBV629	Fleetrite	R955800629N	K109685	Bendix	R955109685N	KN18530X	HalDEX	RKN18530
FLTBV635	Fleetrite	R955229635N	K109685	Bendix	R955109685NP	KN18531	HalDEX	RKN18532
FLTBV800	Fleetrite	R955107800N	K109685	Bendix	R955109685PGX	KN18531X	HalDEX	R955KN18531X
FLTBV818	Fleetrite	R955101818N	K112234	Bendix	R955800376N	KN18532	HalDEX	RKN18532
FLTBV859	Fleetrite	R955229859N	K145151	HalDEX	RK145151	KN18534	HalDEX	R955284358N
FLTBV860	Fleetrite	R955229860N	K1451511	HalDEX	RK1451511	KN18534	HalDEX	RKN18534
FLTBV865	Fleetrite	R955281865N	K145157	HalDEX	RK145157	KN18534N	HalDEX	R955275491X
FLTBV923	Fleetrite	R955281923N	K201100	HalDEX	RK201100	KN18534N	HalDEX	R955284358N
FSW-0507	Pai	R955279416N	KLTVB341	Fleetrite	R955800405N	KN18534N	HalDEX	R955284358X
FTV-4075	Pai	R955KN28600N	KN12040	HalDEX	R955EL13060X	KN18534X	HalDEX	R955275491X
FTV-4076	Pai	R955KN26000N	KN12040X	HalDEX	R955EL13060X	KN18534X	HalDEX	R955284358X
G1006140	Motor Coach Industries	R955107512X	KN13020	HalDEX	R955EL13020X	KN18534X	HalDEX	R955KN18534X
G1018889	Motor Coach Industries	R9555004187X	KN13020X	HalDEX	R955EL13020X	KN18536	HalDEX	RKN18536
G5006642	Motor Coach Industries	R955107813X	KN13040X	HalDEX	R955107506X	KN18537	HalDEX	RKN18530
G5006642	Nova Bus	R955107813X	KN13040X	HalDEX	R9553049186X	KN20000X	HalDEX	R955KN20000X
GG0105003	Neoplan Bus	R955107512X	KN13040X	HalDEX	R955EL13040X	KN20001	HalDEX	R955229635N
K022105	Bendix	R955K022105N	KN13050X	HalDEX	R955286539X	KN20001	HalDEX	RKN20001
K022105K	HalDEX	R955K022105N	KN13050X	HalDEX	R955286581X	KN20001N	HalDEX	R955229635N
K022105N	Bendix	R955K022105N	KN13051X	HalDEX	R955286623X	KN20001X	HalDEX	R955229635N
K022105N	HalDEX	R955K022105N	KN13053X	HalDEX	R955107622X	KN20010	HalDEX	RKN20010
K031560	Bendix	R955K031560N	KN13053X	HalDEX	R955EL13053X	KN20010X	HalDEX	R955KN20010X
K033221	Bendix	R955065437	KN13060	HalDEX	R955EL13060X	KN20011	HalDEX	RKN20011
K033221	Bendix	R955065437N	KN13060X	HalDEX	R955107514X	KN20020	HalDEX	RKN20010
K033223	Bendix	R955065439	KN13060X	HalDEX	R955108110X	KN20020X	HalDEX	R955KN20020X
K033223	Bendix	R955065439N	KN13060X	HalDEX	R955286527X	KN20021	HalDEX	R955276566
K041395N	Bendix	R955K041395N	KN13060X	HalDEX	R955286528X	KN20021	HalDEX	R955276566N
K056647X	Bendix	R9555014428X	KN13060X	HalDEX	R955286576X	KN20021	HalDEX	R955276567N
K065313	Bendix	R955065313X	KN13060X	HalDEX	R955EL13060X	KN20021	HalDEX	RKN20021
K095875	Bendix	R955101437N	KN13111X	HalDEX	R955107511X	KN20021N	HalDEX	R955276566N
K102638	Bendix	R955102638X	KN13111X	HalDEX	R955286544X	KN20021N	HalDEX	R955276566X
K102835	Bendix	R955102835X	KN13111X	HalDEX	R955286620X	KN20021N	HalDEX	R955276567N
K103817	Bendix	R955103817N	KN13111X	HalDEX	R955EL13111X	KN20021N	HalDEX	R955276567X
K103817	Bendix	R955103818N	KN13151X	HalDEX	R955109251X	KN20021X	HalDEX	R955276566X
K103835	Bendix	R955103835X	KN13200X	HalDEX	R955103274X	KN20021X	HalDEX	R955276567X
K103879	Bendix	R955103879N	KN13280X	HalDEX	R955107981X	KN20025	HalDEX	R955288239
K103980	Bendix	R955103980N	KN16040X	HalDEX	R955107507X	KN20025	HalDEX	RKN20025
K103981	Bendix	R955103981N	KN16111	HalDEX	R955EL16111X	KN20030AX	HalDEX	R955KN20030AX
K104039	Bendix	R955104039X	KN16111X	HalDEX	R955EL16111X	KN20031	HalDEX	RKN20031
K104283	Bendix	R955289253X	KN18530	HalDEX	R955275491	KN20033	HalDEX	RKN20033
K104345	Bendix	R955104345X	KN18530	HalDEX	R955284358N	KN20035	HalDEX	RKN20035
K104358	Bendix	R955104358X	KN18530	HalDEX	RKN18530	KN20040X	HalDEX	R955KN20040X
K104561	Bendix	R955104561N	KN18530N	HalDEX	R955275491X	KN20041	HalDEX	RKN20001
K104574	Bendix	R955104574	KN18530N	HalDEX	R955284358N	KN20050X	HalDEX	R955KN20050X
K107433	Bendix	R955107433X	KN18530N	HalDEX	R955284358X	KN20060X	HalDEX	R955KN20060X
K108140	Bendix	R955228050X	KN18530RX	HalDEX	R955275491	KN20061	HalDEX	RKN20061
K108140	Bendix	R955228520X	KN18530RX	HalDEX	R955284358N	KN20070X	HalDEX	R955KN20070X
K108140	Bendix	R955229493X	KN18530X	HalDEX	R955275491	KN20071	HalDEX	RKN20581
K108140	Bendix	R955228520X	KN18530X	HalDEX	R955275491X	KN20071X	HalDEX	R955KN20071X
K109685	Bendix	R955109685HX	KN18530X	HalDEX	R955284358X	KN20080	HalDEX	RKN20080
			KN18530X	HalDEX	R955KN18530X	KN20080	HalDEX	R955KN20080X

5

All Euclid Air Systems components were superseded to their Meritor part number equivalents effective February 2018.

Competitor Part Number	Competitor Name	Meritor Part Number	Competitor Part Number	Competitor Name	Meritor Part Number	Competitor Part Number	Competitor Name	Meritor Part Number
KN20090	Haldex	RKN20090	KN20611	Haldex	RKN20611	KN22100	Haldex	RKN22100
KN20090	Haldex	R955KN20090X	KN20611	Haldex	R955KN20611X	KN22100N	Haldex	R955229501N
KN20110	Haldex	RKN20110	KN20611N	Haldex	R955800519N	KN22100N	Haldex	R955277863N
KN20110	Haldex	R955KN20110X	KN20611N	Haldex	R955800573N	KN22100X	Haldex	R955277863N
KN20541	Haldex	RKN20541	KN20612	Haldex	RKN20612	KN22100X	Haldex	R955229501N
KN20541	Haldex	R955KN20541X	KN20612	Haldex	R955KN20612X	KN22100X	Haldex	R955KN22100X
KN20541X	Haldex	R955KN20541X	KN20615	Haldex	R955101437N	KN22140X	Haldex	R955KN22140X
KN20542	Haldex	RKN20542	KN20615	Haldex	R955800516N	KN22150	Haldex	R955286171N
KN20542	Haldex	R955KN20542X	KN20615	Haldex	R955800518N	KN22150	Haldex	RKN22150
KN20543	Haldex	RKN20543	KN20615	Haldex	R955KN20615N	KN22150X	Haldex	R955286171N
KN20544	Haldex	RKN20544	KN20615	Haldex	RKN20615	KN22150X	Haldex	RKN22150
KN20545	Haldex	RKN20545	KN20615N	Haldex	R955101437N	KN22150X	Haldex	R955KN22150X
KN20546	Haldex	RKN20542	KN20615N	Haldex	R955101437X	KN22151	Haldex	RKN22150
KN20546	Haldex	RN30103FE	KN20615N	Haldex	R955800516N	KN22152	Haldex	RKN22150
KN20551	Haldex	RKN20541	KN20615N	Haldex	R955800518N	KN22501	Haldex	RKN22150
KN20551	Haldex	R955KN20551X	KN20615N	Haldex	R955KN20615N	KN22501	Haldex	RKN22501
KN20552	Haldex	R955KN20552X	KN20615N	Haldex	R955KN20615X	KN22521	Haldex	RKN22521
KN20561	Haldex	R955107799N	KN20615X	Haldex	R955KN20615X	KN22600	Haldex	RKN22600
KN20561	Haldex	RKN20561	KN20616	Haldex	RKN20616	KN22610	Haldex	RKN22610
KN20561	Haldex	R955KN20561X	KN20616	Haldex	R955KN20616X	KN23000	Haldex	R955227871
KN20561N	Haldex	R955KN20561X	KN20619	Haldex	RKN20619	KN23000	Haldex	R955227871N
KN20561X	Haldex	R955KN20561X	KN20619	Haldex	R955KN20619X	KN23000	Haldex	R955KN23000N
KN20562	Haldex	RKN20562	KN20620	Haldex	R955KN20620X	KN23000	Haldex	RKN23000
KN20562	Haldex	R955KN20562X	KN20621	Haldex	RKN20621	KN23000N	Haldex	R955KN23000N
KN20570X	Haldex	R955KN20570X	KN20621	Haldex	R955KN20621X	KN23000X	Haldex	R955227871
KN20580	Haldex	RKN20580	KN20622	Haldex	RKN20622	KN23010	Haldex	R955227870
KN20580X	Haldex	R955KN20580X	KN20622	Haldex	R955KN20622X	KN23010	Haldex	R955227870N
KN20581	Haldex	RKN20581	KN20623	Haldex	RKN20623	KN23010	Haldex	R955KN23010N
KN20581X	Haldex	R955KN20581X	KN20623	Haldex	R955KN20623X	KN23010	Haldex	RKN23010
KN20590	Haldex	RKN20590	KN20626	Haldex	R955KN20626X	KN23010N	Haldex	R955KN23010N
KN20590X	Haldex	R955KN20590X	KN20627	Haldex	R955KN20627X	KN23010X	Haldex	R955227870
KN20601	Haldex	R955800517N	KN20628	Haldex	R955KN20628X	KN23010X	Haldex	R955227870N
KN20601	Haldex	RKN20601	KN20629	Haldex	R955KN20629X	KN23040	Haldex	R955KN23040N
KN20601	Haldex	R955KN20601X	KN20631	Haldex	RKN20631	KN23040	Haldex	RKN23040
KN20601N	Haldex	R955800517N	KN20632	Haldex	RKN20632	KN23040N	Haldex	R955KN23040N
KN20602	Haldex	RKN20602	KN20633	Haldex	RKN20633	KN23060	Haldex	RKN23060
KN20602	Haldex	R955KN20602X	KN20700	Haldex	RKN20700	KN23080	Haldex	RKN23080
KN20603	Haldex	R955KN20603X	KN20900	Haldex	RKN20900	KN24000	Haldex	R955281923N
KN20603N	Haldex	R955065156X	KN20901	Haldex	RKN20901	KN24000	Haldex	RKN24000
KN20603X	Haldex	R955065156X	KN20902	Haldex	RKN20902	KN24000X	Haldex	R955281923X
KN20605	Haldex	RKN20605	KN20903	Haldex	RKN20903	KN24001	Haldex	RKN24001
KN20605	Haldex	R955KN20605X	KN21003	Haldex	RKN21004	KN24002	Haldex	RKN24001
KN20606	Haldex	R955KN20606N	KN21004	Haldex	RKN21004	KN24003	Haldex	RKN24003
KN20606	Haldex	RKN20606	KN21008	Haldex	RKN21008	KN24005	Haldex	RKN24003
KN20606	Haldex	R955KN20606X	KN21022	Haldex	R12102	KN24007	Haldex	RKN24007
KN20606N	Haldex	R955KN20606N	KN21023	Haldex	R12104	KN24009	Haldex	RKN24009
KN20607	Haldex	RKN20607	KN21024	Haldex	R95512103	KN24010	Haldex	RKN24010
KN20608	Haldex	R955KN20608X	KN21025	Haldex	R95512103	KN24010N	Haldex	R955284412N
KN20611	Haldex	R955800519N	KN21026	Haldex	R12104	KN24010X	Haldex	R955284412N
KN20611	Haldex	R955800573N	KN22100	Haldex	R955277863N	KN24011	Haldex	RKN24011

All Euclid Air Systems components were superseded to their Meritor part number equivalents effective February 2018.

# CROSS REFERENCE

Competitor Part Number	Competitor Name	Meritor Part Number	Competitor Part Number	Competitor Name	Meritor Part Number	Competitor Part Number	Competitor Name	Meritor Part Number
KN24100	Haldex	RKN24100	KN28041	Haldex	RKN28041	KN28091	Haldex	RKN28091
KN25060	Haldex	R955278615N	KN28041	Haldex	R955KN28041X	KN28092	Haldex	RKN28092
KN25060	Haldex	RKN25060	KN28042	Haldex	RKN28042	KN28130X	Haldex	R955KN28130X
KN25060N	Haldex	R955278615N	KN28042	Haldex	R955KN28042X	KN28131	Haldex	RKN28131
KN25061	Haldex	R955278614N	KN28043	Haldex	RKN28043	KN28131X	Haldex	R955KN28131X
KN25061	Haldex	RKN25061	KN28051	Haldex	RKN28055	KN28132	Haldex	RKN28132
KN25061N	Haldex	R955278614N	KN28052	Haldex	RKN28055	KN28132X	Haldex	R955KN28132X
KN25080	Haldex	RKN25080	KN28053	Haldex	RKN28053	KN28140	Haldex	R955103009
KN25090	Haldex	RKN25090	KN28054	Haldex	RKN28054	KN28140	Haldex	R955103009N
KN25100	Haldex	RKN25100	KN28055	Haldex	RKN28055	KN28140	Haldex	R955279180N
KN25110	Haldex	R955278598N	KN28055	Haldex	R955KN28055X	KN28140	Haldex	RKN28140
KN25110	Haldex	R955280809N	KN28056	Haldex	RKN28056	KN28140N	Haldex	R955103009N
KN25110	Haldex	RKN25110	KN28060	Haldex	R955KN28060N	KN28140N	Haldex	R955103009X
KN25110N	Haldex	R955278598N	KN28060	Haldex	RKN28060	KN28140N	Haldex	R955279180N
KN25110N	Haldex	R955278598X	KN28060N	Haldex	R955KN28060N	KN28140N	Haldex	R955279180X
KN25110N	Haldex	R955280809N	KN28060N	Haldex	R955KN28060X	KN28140X	Haldex	R955103009X
KN25110N	Haldex	R955280809X	KN28060RX	Haldex	R955KN28060N	KN28140X	Haldex	R955279180X
KN25110X	Haldex	R955278598X	KN28060X	Haldex	R955KN28060X	KN28140X	Haldex	R955KN28140X
KN25110X	Haldex	R955280809X	KN28060X	Haldex	R955KN28010X	KN28140X	Haldex	RKN28140
KN25120	Haldex	RKN25120	KN28060X	Haldex	R955KN28011X	KN28300	Haldex	RKN28300
KN26000	Haldex	R955101112	KN28061	Haldex	RKN28061	KN28300X	Haldex	R955KN28300X
KN26000	Haldex	R955101112N	KN28061N	Haldex	R955KN28061X	KN28500	Haldex	R955KN28500N
KN26000	Haldex	R955KN26000N	KN28061X	Haldex	R955KN28061X	KN28500	Haldex	RKN28500
KN26000N	Haldex	R955101112N	KN28063	Haldex	RKN28063	KN28500N	Haldex	R955KN28500N
KN26000N	Haldex	R955101112X	KN28065	Haldex	RKN28065	KN28500RX	Bendix	R955KN28500N
KN26000N	Haldex	R955KN26000N	KN28065X	Haldex	R955KN28065X	KN28500RX	Haldex	R955KN28500N
KN26000N	Haldex	R955KN26000X	KN28066	Haldex	RKN28085	KN28500X	Haldex	R955KN28500X
KN26000RX	Haldex	R955101112	KN28067	Haldex	RKN28067	KN28510	Haldex	R955KN28510
KN26000RX	Haldex	R955KN26000N	KN28067	Haldex	RKN28085	KN28510	Haldex	R955KN28510N
KN26000X	Haldex	R955101112X	KN28069	Haldex	RKN28069	KN28510	Haldex	RKN28510
KN26000X	Haldex	R955KN26000X	KN28071	Haldex	R955103010	KN28510N	Haldex	R955KN28510N
KN26000X	Midlan	R955KN26000X	KN28071	Haldex	R955103010N	KN28510RX	Bendix	R955KN28510
KN26010	Haldex	R955KN26010N	KN28071	Haldex	RKN28140	KN28510RX	Haldex	R955KN28510
KN26010N	Haldex	R955KN26010N	KN28071N	Haldex	R955103010N	KN28510RX	Haldex	R955KN28510N
KN26010X	Haldex	R955KN26010X	KN28071N	Haldex	R955103010X	KN28510X	Haldex	R955KN28510X
KN26020N	Haldex	R955KN26020X	KN28071N	Haldex	R955KN28071X	KN28514X	Haldex	R955KN28514X
KN26020X	Haldex	R955KN26020X	KN28071RX	Haldex	R955103010	KN28520	Haldex	R955KN28520N
KN26803X	Haldex	R955KN28603X	KN28071RX	Haldex	R955103010N	KN28520	Haldex	RKN28520
KN27000	Haldex	R955KN27000N	KN28071X	Haldex	R955103010X	KN28520N	Haldex	R955KN28520N
KN27000N	Haldex	R955KN27000N	KN28071X	Haldex	R955KN28071X	KN28520RX	Haldex	R955KN28520N
KN28010X	Haldex	R955KN28010X	KN28071X	Haldex	RKN28071	KN28520RX	Haldex	RKN28520
KN28010X	Haldex	R955KN28011X	KN28072	Haldex	RKN28071	KN28520X	Haldex	R955KN28520X
KN28010X	Haldex	R955KN28060X	KN28073	Haldex	RKN28071	KN28531	Haldex	RKN28531
KN28011X	Haldex	R955KN28011X	KN28075	Haldex	RKN28075	KN28531X	Haldex	R955KN28531X
KN28011X	Haldex	R955KN28010X	KN28080	Haldex	RKN28080	KN28550	Haldex	R955KN28550N
KN28011X	Haldex	R955KN28060X	KN28080N	Haldex	R955KN28080X	KN28550	Haldex	R955KN28550X
KN28030	Haldex	RKN28030	KN28080X	Haldex	R955KN28080X	KN28550N	Haldex	R955KN28550N
KN28030X	Haldex	R955KN28030X	KN28080X	Haldex	RKN28080	KN28600	Haldex	R955KN28600N
KN28032	Haldex	RKN28032	KN28085	Haldex	RKN28085	KN28600N	Haldex	R955KN28600N
KN28034	Haldex	RKN28034	KN28085X	Haldex	R955KN28085X	KN28600N	Haldex	R955KN28600X

5

All Euclid Air Systems components were superseded to their Meritor part number equivalents effective February 2018.

Competitor Part Number	Competitor Name	Meritor Part Number	Competitor Part Number	Competitor Name	Meritor Part Number	Competitor Part Number	Competitor Name	Meritor Part Number
KN28600RX	Haldex	R955KN28600N	KN31200	Haldex	RKN31200	KN34100X	Haldex	R955KN34100X
KN28600X	Haldex	R955KN28600X	KN31250	Haldex	RKN31250	KN34101	Haldex	RKN34101
KN28601N	Haldex	R955KN28601X	KN31300	Haldex	RKN31300	KN34110	Haldex	RKN34110
KN28601X	Haldex	R955KN28601X	KN31400	Haldex	R955205105N	KN34110X	Haldex	R955KN34110X
KN28602X	Haldex	R955KN28602X	KN31400	Haldex	R955284142N	KN34111	Haldex	RKN34111
KN28603X	Haldex	R955KN28603X	KN31400	Haldex	R955401004	KN34123	Haldex	RKN34127
KN30010N	Haldex	R955KN30010N	KN31400	Haldex	RKN31400	KN34130	Haldex	RKN34130
KN30010X	Haldex	R955KN30010X	KN31400N	Haldex	R955205105N	KN34130	Haldex	R955KN34130X
KN30100X	Haldex	R955KN30100X	KN31450	Haldex	RKN31450	KN34141	Haldex	RKN34131
KN30200N	Haldex	R955KN30200X	KN31500	Haldex	RKN31450	KN4490	Haldex	R955A4490N
KN30200X	Haldex	R955KN30200X	KN31525	Haldex	RKN31527	KN4491	Haldex	R955A4491N
KN30300	Haldex	R955281860N	KN31526	Haldex	R955131081N	KN68230	Haldex	R955KN68230N
KN30300N	Haldex	R955281860N	KN31526N	Haldex	R955131081N	KN68230	Haldex	R955KN68230X
KN30300N	Haldex	R955KN30300X	KN31528	Haldex	RKN31528	KN68230N	Haldex	R955KN68230N
KN30300X	Haldex	R955KN30300X	KN32000X	Haldex	R955KN32000X	KN68237	Haldex	R955KN68237N
KN30400	Haldex	R955281865	KN32003	Haldex	RKN32003	KN68237N	Haldex	R955KN68237N
KN30400	Haldex	R955281865N	KN32005	Haldex	R955229813N	KN7000X	Haldex	R955KN7000X
KN30400	Haldex	R955KN30400N	KN32005	Haldex	RKN32005	KN7010X	Haldex	R955KN7010X
KN30400N	Haldex	R955281865N	KN32005N	Haldex	R955229813N	KN7020X	Haldex	R955KN7020X
KN30400N	Haldex	R955KN30400N	KN32006	Haldex	RKN32006	KN7030X	Haldex	R955KN7030X
KN30400N	Haldex	R955KN30400X	KN32010X	Haldex	R955KN32010X	KN7040X	Haldex	R955KN7040X
KN30400RX	Haldex	R955281865	KN32011	Haldex	RKN32011	KN7041X	Haldex	R955KN7041X
KN30400RX	Haldex	R955281865N	KN32011N	Haldex	R955229860N	KN7050X	Haldex	R955KN7050X
KN30400X	Haldex	R955281865N	KN32011X	Haldex	R955229860N	KN7060X	Haldex	R955KN7060X
KN30400X	Haldex	R955KN30400X	KN32013	Haldex	RKN32013	KN7070X	Haldex	R955KN7070X
KN31000	Haldex	R90555396	KN32014	Haldex	RKN32014	KN7080X	Haldex	R955KN7080X
KN31000	Haldex	R955288323	KN32020X	Haldex	R955KN32020X	KN7170X	Haldex	R955KN7170X
KN31000N	Haldex	R955KN31000X	KN32040X	Haldex	R955KN32040X	KN7180X	Haldex	R955KN7180X
KN31000X	Haldex	R955KN31000X	KN32041	Haldex	RKN32041	KN85020X	Haldex	R955KN85020X
KN31001	Haldex	R90555396	KN32041N	Haldex	R955KN32041X	KN85022X	Haldex	R955KN85022X
KN31002	Haldex	R90555397	KN32041X	Haldex	R955KN32041X	KN85230X	Haldex	R555KN85230X
KN31003	Haldex	R95590554107	KN32050	Haldex	RKN32050	KN86020X	Haldex	R955KN86020X
KN31004	Haldex	R90555398	KN32060	Haldex	RKN32060	KN86230X	Haldex	R955KN86230X
KN31010	Haldex	R90555398	KN33000X	Haldex	R955065041X	KNT86230X	Haldex	R955KNT86230X
KN31010	Haldex	R955286500	KN34030X	Haldex	R955KN34030X	KNT86230X	Haldex	R555KN86230X
KN31010N	Haldex	R955KN31010X	KN34050X	Haldex	R955KN34050X	KQ205450	Haldex	RKQ205450
KN31010X	Haldex	R955KN31010X	KN34060	Haldex	R955279000N	LAD-5506	Pai	R955065225X
KN31011	Haldex	R90555396	KN34060	Haldex	RKN34060	LAV-3625	Pai	R955289144N
KN31025	Haldex	RKN31025	KN34060N	Haldex	R955279000N	LBV5683	Pai	R955065439
KN31026	Haldex	RKN31026	KN34060X	Haldex	R955279000N	LBV-5683	Pai	R955065439X
KN31040	Haldex	R955KN31040X	KN34060X	Haldex	RKN34060	LCV-3691	Pai	R955229635N
KN31041	Haldex	RKN32041	KN34060X	Haldex	R955KN34060X	LCV4062	Pai	R955227870
KN31050	Haldex	RKN31050	KN34061	Haldex	RKN34061	LCV-4062	Pai	R955227870N
KN31060	Haldex	RKN31060	KN34070	Haldex	R955KN34070N	LCV4064	Pai	R955227871
KN31070	Haldex	RKN31070	KN34070N	Haldex	R955KN34070N	LCV-4064	Pai	R955227871N
KN31080X	Haldex	R955KN31080X	KN34070N	Haldex	R955KN34070X	LCV-4071	Pai	R955280809X
KN31170	Haldex	R90555409	KN34070X	Haldex	R955KN34070X	LDC-5587	Pai	R955107794X
KN31171	Haldex	R90555409	KN34080X	Haldex	R955KN34080X	LDC-5588	Pai	R109994P
KN31175	Haldex	RKN31175	KN34090X	Haldex	R955KN34090X	LDC-5723	Pai	R955104358X
KN31200	Haldex	R955800350N	KN34100	Haldex	RKN34111	LDV-3626	Pai	R955289714N

All Euclid Air Systems components were superseded to their Meritor part number equivalents effective February 2018.

# CROSS REFERENCE

Competitor Part Number	Competitor Name	Meritor Part Number	Competitor Part Number	Competitor Name	Meritor Part Number	Competitor Part Number	Competitor Name	Meritor Part Number
LDV-3660	Pai	R955281923N	LRV-5616	Pai	R955286370N	N13048	Haldex	R11402
LDV-3662	Pai	R955401045	LSP-1199	Pai	R955101570X	N13048A	Haldex	R11401
LDV-5661	Pai	R955284412N	LST-3609	Pai	R955228600N	N13440DA	Haldex	RKN20001
LEV3614	Pai	R955281865	LVK-3604	Pai	R955289144N	N13440DB	Haldex	RKN20001
LEV-3614	Pai	R955281865N	LVM-5648	Pai	R955101437X	N13440DC	Haldex	RKN20001
LFV-3629	Pai	R955277863N	MAH-4180-250	Pai	R955500BK	N13440DD	Haldex	RKN20001
LFV3630	Pai	R955286171N	MCS-4030	Pai	R950118	N13440DJ	Haldex	RKN20001
LFV-3630	Pai	R955286171N	MGH-4000	Pai	R950116	N13440DL	Haldex	RKN20001
LFV-5631	Pai	R955065313X	MGH-4020	Pai	R950115	N13526BE	Haldex	RKN23010
LFV5705	Pai	R955284760	MGH-4025	Pai	R950114	N13526BK	Haldex	RKN20001
LFV-5715	Pai	R955101818X	MHA-4163	Pai	R95550524BK	N13526BL	Haldex	RKN23060
LGV-5658	Pai	R955284358X	MHA-4164	Pai	R95550530BK	N13526BR	Haldex	RN13526BR
LIV-3653	Pai	R955286364X	MHA-4165	Pai	R95550324BK	N13526BZ	Haldex	RKN31041
LKT-1214	Pai	R9555005037N	ML065146	Armada	R955065146N	N13526D	Haldex	RKN23080
LMV-3459	Pai	R955103081N	ML065437	Armada	R955065437N	N13526H	Haldex	RKN23000
LOV-3657	Pai	R955229859N	ML107794X	Armada	R955107794X	N13526J	Haldex	RKN23040
LOV-3658	Pai	R955229860N	ML109139X	Armada	R9555002984X	N13680BZ	Haldex	RKN31041
LPP3502	Pai	R955288241	ML109477X	Armada	R955109477X	N14488	Haldex	RKN20010
LPP-3502	Pai	R955288241N	ML109493X	Armada	R955109493X	N14488AK	Haldex	RKN20010
LPP3592	Pai	R955276566	ML109991X	Armada	R955109991X	N14488R	Haldex	RKN20011
LPP-3592	Pai	R955276566N	ML109994K	Armada	R109994P	N14514	Haldex	RN14514
LPP3619	Pai	R955276567	ML3558072X	Armada	R9553558072X	N14514AD	Haldex	RKN20903
LPP-3619	Pai	R955276567N	ML5002865X	Armada	R9555002865X	N14514AT	Haldex	RKN20904
LPP-5545	Pai	R955287418X	ML5004188X	Armada	R9555004188X	N14515AG	Haldex	RN14515AG
LPP-5591	Pai	R955288746N	ML5018485X	Armada	R9555018485X	N14515G	Haldex	RK145157
LPP-5597	Pai	R955279787X	ML65225	Armada	R955065225NP	N14990A	Haldex	RN14990A
LPP-5614	Pai	R955281587X	ML9111535100X	Armada	R9559111535100X	N15364F	Haldex	RBE13255
LPP-5615	Pai	R955287417N	ML9111535200X	Armada	R9559111535200X	N15364G	Haldex	RBE13241
LPP-5618	Pai	R955287600X	ML955205	Armada	R955205	N15759DA	Haldex	R90555397
LPP-5619	Pai	R955276462X	ML955205X	Armada	R955205X	N15759DB	Haldex	R90555396
LPP5681	Pai	S936 649 151 0	ML955300X	Armada	R955300X	N15759DC	Haldex	R90555396
LPR3704	Pai	R955288323	MLCART224	Armada	R955T224N	N15759DD	Haldex	R90555398
LPR-5637	Pai	R955278426X	MLK022105	Armada	R955K022105N	N15759DG	Haldex	R90555396
LPV-3455	Pai	R955288605X	MLKN27000	Armada	R955KN27000N	N15759DH	Haldex	R90555397
LPV-3591	Pai	R955279000N	MPN14990A	Haldex	RN14990A	N15759EA	Haldex	R90555396
LRV3507	Pai	R955103010	MPN15759DB	Haldex	R90555396	N15791D	Haldex	RKN20080
LRV-3507	Pai	R955103010N	MPN15841	Haldex	R12100	N15791F	Haldex	RKN20090
LRV3612	Pai	R955KN28510	MPN21051	Haldex	RMPN21051	N15791H	Haldex	RN15791H
LRV-3612	Pai	R955KN28510N	MPN30056BD	Haldex	RMPN30056BD	N15791T	Haldex	RN15791T
LRV3613	Pai	R955102626	MPN3613AD	Haldex	RMPN3613AD	N15791V	Haldex	RN15791V
LRV-3613	Pai	R955102626N	N10083F	Haldex	RKN31026	N15817A	Haldex	RKN31040
LRV-3617	Pai	R955280375X	N10083K	Haldex	RKN31025	N15817E	Haldex	RKN31050
LRV3637	Pai	R955KN28500N	N11075AN	Haldex	R955KN28500N	N15817F	Haldex	RKN31050
LRV3638	Pai	RKN28520	N1178AA	Haldex	RKN31200	N15817K	Haldex	RKN31060
LRV-3639	Pai	R955229467X	N1178AB	Haldex	RKN31300	N15817M	Haldex	RKN31060
LRV3642	Pai	R955103028	N1178AC	Haldex	RKN31300	N15841	Haldex	R12100
LRV-3642	Pai	R955103028N	N1178BA	Haldex	RKN31200	N15843	Haldex	RN15843
LRV-3643	Pai	R955065125X	N1178BB	Haldex	RKN31250	N15902A	Haldex	R90555409
LRV3682	Pai	R955279180	N1178CA	Haldex	RKN31400	N15902B	Haldex	R90555409
LRV-3682	Pai	R955279180N	N1178EC	Haldex	RKN31528	N20415MA	Haldex	R11450

5

All Euclid Air Systems components were superseded to their Meritor part number equivalents effective February 2018.

Competitor Part Number	Competitor Name	Meritor Part Number	Competitor Part Number	Competitor Name	Meritor Part Number	Competitor Part Number	Competitor Name	Meritor Part Number
N20415MA	Haldex	R950116	N20959HA	Haldex	RKN32003	N30100JD	Haldex	RKN28085
N20415MB	Haldex	R11460	N20959HB	Haldex	RKN32006	N30100JE	Haldex	RKN28085
N20415MC	Haldex	R11460	N20959HC	Haldex	RKN32003	N30100JH	Haldex	RKN28091
N20415NA	Haldex	R11451	N20959MA	Haldex	RKN32011	N30100KA	Haldex	RKN28071
N20415NA	Haldex	R950115	N20959MF	Haldex	RKN32014	N30100KB	Haldex	RKN28071
N20415NC	Haldex	R11461	N20960	Haldex	RKN20021	N30100KD	Haldex	RKN28071
N20415ND	Haldex	R11451	N20960A	Haldex	RKN20022	N30100KG	Haldex	RKN28071
N20415PA	Haldex	R11452	N20961	Haldex	RKN20025	N30100MA	Haldex	RKN28041
N20415PA	Haldex	R950114	N20964	Haldex	RKN20035	N30100MB	Haldex	RKN28069
N20415PC	Haldex	R11462	N20966A	Haldex	RKN25080	N30100MC	Haldex	RKN28063
N20415PD	Haldex	R11452	N20966B	Haldex	RKN25090	N30103BA	Haldex	RKN20541
N20837	Haldex	RKN22100	N20966BA	Haldex	RKN25061	N30103BC	Haldex	RKN20541
N20837B	Haldex	RKN22100	N20966C	Haldex	RKN25110	N30103BF	Haldex	RKN20542
N20837C	Haldex	RKN22100	N20966E	Haldex	RKN25080	N30103BH	Haldex	RKN20542
N20837J	Haldex	RKN22100	N20966F	Haldex	RKN25110	N30103BL	Haldex	RKN20542
N20837N	Haldex	RKN22100	N20966G	Haldex	RKN25100	N30103BN	Haldex	RKN20541
N20878A	Haldex	RKN24000	N20966J	Haldex	RKN25120	N30103BS	Haldex	RKN20542
N20878B	Haldex	RKN24000	N20966M	Haldex	RKN25120	N30103BY	Haldex	RKN20542
N20878C	Haldex	RKN24000	N20966R	Haldex	RKN25110	N30103BZ	Haldex	RKN20542
N20878F	Haldex	RKN24000	N20966T	Haldex	RKN25120	N30103FC	Haldex	RKN20545
N20878K	Haldex	RKN24000	N21051	Haldex	RMPN21051	N30103FE	Haldex	RKN20542
N20878N	Haldex	RKN24000	N284142	Bendix	R955284142N	N30103FE	Haldex	RN30103FE
N20879A	Haldex	RKN24001	N30056BK	Haldex	RSN4017A	N30105B	Haldex	RKN20580
N20879B	Haldex	RKN24001	N30056BR	Haldex	RSN4017A	N30105C	Haldex	RKN20590
N20879BA	Haldex	RKN24003	N30056BW	Haldex	RSN4017F	N30105D	Haldex	RKN20581
N20879BB	Haldex	RKN24003	N30056BX	Haldex	RSN4017E	N30106D	Haldex	RKN28132
N20879CB	Haldex	RKN24001	N30056CB	Haldex	RSN4017A	N30106F	Haldex	RKN28131
N20879D	Haldex	RKN24001	N30072FA	Haldex	RKN22600	N30108A	Haldex	R955KN28500N
N20879DA	Haldex	RKN24003	N30072HB	Haldex	RKN22521	N30108AH	Haldex	RKN28520
N20879DD	Haldex	RKN24009	N30096E	Haldex	RKN28060	N30108BC	Haldex	R955KN28500N
N20879DE	Haldex	RKN24010	N30096F	Haldex	RKN28060	N30108BL	Haldex	RKN28510
N20879DF	Haldex	RKN24011	N30096J	Haldex	RKN28061	N30111	Haldex	RKN28055
N20879E	Haldex	RKN24001	N30096L	Haldex	RKN28061	N30111A	Haldex	RKN28055
N20879H	Haldex	RKN24001	N30096M	Haldex	RKN28061	N30111B	Haldex	RKN28055
N20928CK	Haldex	RKN20031	N30096N	Haldex	RKN28080	N30111C	Haldex	RKN28055
N20928CP	Haldex	RKN20031	N30096P	Haldex	RKN28085	N30111F	Haldex	RKN28053
N20949CA	Haldex	RKN34060	N30096PA	Haldex	RKN28300	N30161AH	Haldex	RKN20561
N20949CF	Haldex	RKN34061	N30096T	Haldex	RKN28061	N30161AJ	Haldex	RKN20562
N20950AA	Haldex	RKN28030	N30099LA	Haldex	RKN22150	N30162MA	Haldex	RKN34110
N20950AB	Haldex	RKN28034	N30099LB	Haldex	RKN22150	N30162ME	Haldex	RKN34111
N20950CA	Haldex	RKN28032	N30099LJ	Haldex	RKN22150	N30162MG	Haldex	RKN34131
N20952AD	Haldex	RKN32041	N30099LT	Haldex	RKN22150	N30162NA	Haldex	RKN34111
N20952AF	Haldex	RKN32041	N30100AD	Haldex	RKN28071	N30162PA	Haldex	RKN34110
N20952DA	Haldex	RKN32050	N30100AG	Haldex	RKN28140	N30162PC	Haldex	RKN34130
N20952DB	Haldex	RKN32060	N30100AP	Haldex	RKN28140	N30162RD	Haldex	RKN34101
N20954A	Haldex	RKN25060	N30100AR	Haldex	RKN28065	N30162RJ	Haldex	RKN34127
N20959DA	Haldex	RKN32050	N30100HH	Haldex	RKN28140	N30190A	Haldex	RKN18530
N20959DB	Haldex	RKN32060	N30100JA	Haldex	RKN28085	N30190AA	Haldex	RKN18532
N20959EA	Haldex	RKN32011	N30100JB	Haldex	RKN28085	N30190AJ	Haldex	RKN18530
N20959EB	Haldex	RKN32005	N30100JC	Haldex	RKN28085	N30190AM	Haldex	RKN18532

All Euclid Air Systems components were superseded to their Meritor part number equivalents effective February 2018.

# CROSS REFERENCE

Competitor Part Number	Competitor Name	Meritor Part Number	Competitor Part Number	Competitor Name	Meritor Part Number	Competitor Part Number	Competitor Name	Meritor Part Number
N30190C	Haldex	RKN18532	N7002K	Haldex	R955EL13020X	OR103976X	Bendix	R955103976
N30190GB	Haldex	RKN18530	N7002P	Haldex	R955EL13020X	OR104358X	Bendix	R955104358XCF
N30190H	Haldex	RKN18532	N7002R	Haldex	R955EL13020X	OR104561X	Bendix	R955104561N
N30190HA	Haldex	RKN18530	N7002T	Haldex	R955EL13020X	OR107794X	Bendix	R955107796N
N30190L	Haldex	RKN18530	N7004F	Haldex	R955EL13040X	OR107794X	Bendix	R955107794XCF
N3613A	Haldex	R12102	N7011F	Haldex	R955EL13111X	OR109477X	Bendix	R955109477XCF
N3613AD	Haldex	RMPN3613AD	N7011H	Haldex	R955EL13111X	OR109478X	Bendix	R955109478XCF
N3613AD	Haldex	R95512105	N7202	Haldex	R955EL16020X	OR109493X	Bendix	R955109493XCF
N3613AG	Haldex	R12102	N7206	Haldex	R955EL16060X	OR109615X	Bendix	R955065437
N3613AK	Haldex	RKN21004	N7211E	Haldex	R955EL16111X	OR109617X	Bendix	R955109617N
N3613AN	Haldex	RKN21004	N7602A	Haldex	R955KN86020X	OR109685X	Bendix	R955065225XCF
N3613AS	Haldex	RKN21004	N7602C	Haldex	R955KN86020X	OR109991X	Bendix	R955109991XCF
N3613AZ	Haldex	RKN21008	N7602J	Haldex	R955KN86020X	OR229501X	Bendix	R955229501N
N3613B	Haldex	R12102	NT7002AB	Haldex	R955EL13020X	OR229505X	Bendix	R955229505N
N3613BB	Haldex	RKN21008	NT7002AM	Haldex	R955EL13020X	OR229507X	Bendix	R955229507N
N3613BC	Haldex	R95512103	NT7004B	Haldex	R955EL13040X	OR229509X	Bendix	R955229509N
N3613BE	Haldex	R12102	NT7005AK	Haldex	R955EL13053X	OR229635X	Bendix	R955229635N
N3613BF	Haldex	R12102	NT7205V	Haldex	R955EL16051X	OR229813X	Bendix	R955229813N
N3613BJ	Haldex	R95512103	NT7205Y	Haldex	R955EL16053X	OR229859X	Bendix	R955229859N
N3613BT	Haldex	RKN21004	NT7210E	Haldex	R955EL16100X	OR229860X	Bendix	R955229860N
N3613CB	Haldex	RKN21004	NT7210FV	Haldex	R955EL16100X	OR275491X	Bendix	R955275491
N3613CC	Haldex	RKN21004	NT7211B	Haldex	R955EL16111X	OR275491X	Bendix	R955284358N
N3613CD	Haldex	RKN21004	NT7220	Haldex	R955EL16200X	OR276462X	Bendix	R955276462
N3613CF	Haldex	RKN21004	NT7623	Haldex	R955KNT86230X	OR276566X	Bendix	R955276566
N3613CH	Haldex	RKN21004	NT7623A	Haldex	R955KNT86230X	OR276566X	Bendix	R955276566N
N3613CR	Haldex	R12102	NT7623C	Haldex	R955KNT86230X	OR276567X	Bendix	R955276567
N3613CS	Haldex	R12104	NT7623D	Haldex	R955KNT86230X	OR276567X	Bendix	R955276567N
N3613CT	Haldex	R95512103	NT7623E	Haldex	R955KNT86230X	OR277147X	Bendix	R955277147N
N3613CV	Haldex	R95512103	NT7623H	Haldex	R955KNT86230X	OR277863X	Bendix	R955277863N
N3613CW	Haldex	R12104	OCC-1034	Pai	R955289340X	OR278998X	Bendix	R955278998N
N3613F	Haldex	R12102	OR065041X	Bendix	R955065041XCF	OR279000X	Bendix	R955279000N
N3613H	Haldex	R12102	OR065224X	Bendix	R955065224N	OR279180X	Bendix	R955279180
N3613J	Haldex	R95512103	OR065224X	Bendix	R955065224X	OR279180X	Bendix	R955279180N
N3613S	Haldex	R95512103	OR065224XCF	Bendix	R955065224XCF	OR279950X	Bendix	R955279950N
N3613T	Haldex	R12104	OR101100X	Bendix	R955101100X	OR279952X	Bendix	R955279952
N3613Z	Haldex	R12104	OR101112X	Bendix	R955101112	OR279952X	Bendix	R955279952N
N4400	Haldex	RKN20615	OR101622X	Bendix	R955101622	OR281024X	Bendix	R955281024N
N4400A	Haldex	RKN20612	OR101900X	Bendix	R955101900XCF	OR281860X	Bendix	R955281860N
N4400B	Haldex	RKN20611	OR102626X	Bendix	R955102626	OR281865X	Bendix	R955281865
N4400BA	Haldex	RKN20619	OR102626X	Bendix	R955102626N	OR281865X	Bendix	R955281865N
N4400BC	Haldex	RKN20622	OR102761X	Bendix	R955102761	OR281923X	Bendix	R955281923N
N4400BG	Haldex	RKN20631	OR103009X	Bendix	R955103009	OR284358X	Bendix	R955284358N
N4400E	Haldex	RKN20602	OR103009X	Bendix	R955103009N	OR284412X	Bendix	R955284412N
N4400M	Haldex	RKN20606	OR103010X	Bendix	R955103010	OR284760X	Bendix	R955284760
N4400N	Haldex	RKN20607	OR103010X	Bendix	R955103010N	OR286171X	Bendix	R955286171N
N4400S	Haldex	RKN20607	OR103028X	Bendix	R955103028	OR286364X	Bendix	R955286364N
N7002AE	Haldex	R955EL13020X	OR103028X	Bendix	R955103028N	OR286370X	Bendix	R955286370N
N7002AJ	Haldex	R955EL13020X	OR103061X	Bendix	R955103061	OR286371X	Bendix	R955286371N
N7002AL	Haldex	R955EL13020X	OR103081X	Bendix	R955103081N	OR286500X	Bendix	R955286500
N7002C	Haldex	R955EL13020X	OR103294X	Bendix	R955103294	OR286775X	Bendix	R955286775

All Euclid Air Systems components were superseded to their Meritor part number equivalents effective February 2018.

Competitor Part Number	Competitor Name	Meritor Part Number	Competitor Part Number	Competitor Name	Meritor Part Number	Competitor Part Number	Competitor Name	Meritor Part Number
OR286934X	Bendix	R955286934XCF	R23516841	Detroit Diesel	R9555004187X	S368AB64	Tramec Sloan	R950075
OR287114X	Bendix	R955287114N	R23522122	Detroit Diesel	R9555004188X	S368AB641	Tramec Sloan	R950070
OR287238X	Bendix	R955287238N	R23522123	Detroit Diesel	R9555004187X	S368AB66	Tramec Sloan	R950076
OR287260X	Bendix	R955287260N	R23524143	Detroit Diesel	R9555005875X	S368AB661	Tramec Sloan	R950071
OR287376X	Bendix	R955287376	R23531247	Detroit Diesel	R9555010824X	S368AB68	Tramec Sloan	R950077
OR287376X	Bendix	R955287376N	R23531259	Detroit Diesel	R9555010824X	S368AB681	Tramec Sloan	R950072
OR287411X	Bendix	R955287411	R23531315	Detroit Diesel	R9555010824X	S368AB86	Tramec Sloan	R950078
OR287417X	Bendix	R955287417	R23532832	Detroit Diesel	R9555018485X	S368AB861	Tramec Sloan	R950073
OR287417X	Bendix	R955287417N	R23535534	Detroit Diesel	R9555018485X	S368AB88	Tramec Sloan	R950079
OR287564X	Bendix	R955287564	R3505234	Detroit Diesel	R955107622X	S368AB881	Tramec Sloan	R950074
OR287600X	Bendix	R955287600	R3505235	Detroit Diesel	R955107623X	S376AB3/44	Tramec Sloan	R950095
OR287600X	Bendix	R955287600N	R3516840	Detroit Diesel	R9555004188X	S376AB3/46	Tramec Sloan	R950096
OR287637X	Bendix	R955287637	R3516841	Detroit Diesel	R9555004187X	S376AB7/86	Tramec Sloan	R950098
OR288239X	Bendix	R955288239	R950011N	Gorilla	R109994P	S376AB7/88	Tramec Sloan	R950097
OR288239X	Bendix	R955288239N	RKN31011	Haldex	RKN34131	S378AB64	Tramec Sloan	R950080
OR288241X	Bendix	R955288241	RMT33CN	Haldex	R955RMT33CN	S378AB66	Tramec Sloan	R950081
OR288241X	Bendix	R955288241N	RN10EV	Haldex	RRN10EV	S378AB68	Tramec Sloan	R950082
OR288251X	Bendix	R955288251X	RN10GG	Haldex	RRN10GG	S378AB86	Tramec Sloan	R950083
OR288301X	Bendix	R955288301N	RN10HB	Haldex	RRN10HB	S378AB88	Tramec Sloan	R950084
OR288369X	Bendix	R955288369N	RN10HH	Haldex	RRN10HH	S4771	Newstar	R955286171N
OR288383X	Bendix	R955288383	RN10HK	Haldex	RRN10HK	S-4771	Newstar	R955286171N
OR288605X	Bendix	R955288605N	RN10HM	Haldex	RRN10HM	S-4898	Newstar	R955KN28060N
OR288721X	Bendix	R955288721	RN11V	Haldex	RRN11V	S-4922	Newstar	R955229859N
OR288746X	Bendix	R955288746	RN15817A	Haldex	RKN31040	S-4922	Newstar	R955288251X
OR288755X	Bendix	R955288755N	RN19AF	Haldex	RRN19AF	S5675	Newstar	R955276566
OR289144X	Bendix	R955289144N	RN30111	Haldex	RKN28055	S5675	Newstar	R955276567
OR289477X	Bendix	R955289477	RN31BA	Haldex	RRN31BC	S-5675	Newstar	R955276566N
OR289714X	Bendix	R955289714N	RN31BE	Haldex	RRN31BC	S-5675	Newstar	R955276567N
OR5003365X	Bendix	R955065104N	RN31BF	Haldex	RRN31BF	S-5676	Newstar	R955229635N
OTR107794PGX	Otr	R955107794PGX	RN31BL	Haldex	RRN31BP	S5677	Newstar	R955288239
OTR109493PGX	Otr	R955109493PGX	RN31BN	Haldex	RRN31BP	S-5677	Newstar	R955288239N
P951413	Donaldson	R955099P	RN33C	Haldex	R955RN33C	S5865	Newstar	R955279180
PC0100001-001	Neoplan Bus	R955107507X	RNT26A	Haldex	R955RNT26A	S-5865	Newstar	R955279180N
Q745284358RX	Mack	R955284358N	RNT26JB	Haldex	R955RNT26JB	S-5865	Newstar	R955280375X
R23500456	Detroit Diesel	R955EL16100X	RNT33C	Haldex	R955RNT33C	S6006	Newstar	R955102626
R23500457	Detroit Diesel	R955EL16100X	RVN13440DL	Haldex	RKN20001	S-6006	Newstar	R955102626N
R23500459	Detroit Diesel	R955EL13020X	S-10043	Newstar	R950115	S6006A	Newstar	R955103009
R23500558	Detroit Diesel	R955EL16060X	S-10044	Newstar	R950114	S-6006A	Newstar	R955103009N
R23505234	Detroit Diesel	R955107622X	S-10045	Newstar	R950116	S600L	Tramec Sloan	R950100
R23505235	Detroit Diesel	R955107623X	S-11529	Newstar	R955KN20615X	S600L	Tramec Sloan	R950101
R23507268	Detroit Diesel	R955EL13053X	S-11611	Newstar	R109994P	S6029	Newstar	R955KN28500N
R23507269	Detroit Diesel	R955EL16053X	S-24007	Newstar	R955099P	S-6029	Newstar	R955KN28520N
R23509473	Detroit Diesel	R955EL16250X	S360AB6	Tramec Sloan	R950087	S607	Tramec Sloan	R950105
R23509780	Detroit Diesel	R955107813X	S360AB8	Tramec Sloan	R950088	S608	Tramec Sloan	R950108
R23511334	Detroit Diesel	R955EL13053X	S361AB6	Tramec Sloan	R950089	S6085	Newstar	R955KN28500N
R23511734	Detroit Diesel	R955104039X	S361AB6	Tramec Sloan	R950091	S-6085	Newstar	R955KN28500N
R23511735	Detroit Diesel	R955107514X	S361AB8	Tramec Sloan	R950090	S6086	Newstar	R955KN28510
R23513838	Detroit Diesel	R955KN86020X	S361AB8	Tramec Sloan	R950092	S-6086	Newstar	R955KN28510N
R23515565	Detroit Diesel	R9555005875X	S362RB6	Tramec Sloan	R950085	S609	Tramec Sloan	R950109
R23516840	Detroit Diesel	R9555004188X	S362RB8	Tramec Sloan	R950086	S6106	Newstar	R955275491

All Euclid Air Systems components were superseded to their Meritor part number equivalents effective February 2018.



# CROSS REFERENCE

Competitor Part Number	Competitor Name	Meritor Part Number	Competitor Part Number	Competitor Name	Meritor Part Number	Competitor Part Number	Competitor Name	Meritor Part Number
S6106	Newstar	R955284358N	SA151	Newstar	R955101622	SMR3558074X	Partsmart	R9553558074X
S-6106	Newstar	R955284358N	S-A151	Newstar	R955101112X	SN153	Haldex	R10027
S-6106	Newstar	R955KN18530X	SA152	Newstar	R955101622	SN4017A	Haldex	RSN4017A
S611	Tramec Sloan	R950106	S-A152	Newstar	R955101622X	SN4017E	Haldex	RSN4017E
S612	Tramec Sloan	R950110	S-A264	Newstar	R955228600N	SN4017F	Haldex	RSN4017F
S615	Tramec Sloan	R950104	S-A265	Newstar	R955228750N	T224	SKF	R955T224N
S620	Tramec Sloan	R950102	S-A266	Newstar	R955279416N	T224P6	SKF	R955T224PGN
S646	Tramec Sloan	R950103	S-A267	Newstar	R955281587X	T33C	Haldex	R955T33C
S661	Tramec Sloan	R950107	S-A268	Newstar	R955276462X	TLA101112	Tuffline	R955101112N
S-6670	Newstar	R955KN28071X	S-A271	Newstar	R955281923N	TLA101437	Tuffline	R955101437N
S689	Tramec Sloan	R950111	S-A272	Newstar	R955286364X	TLA101818	Tuffline	R955101818N
S7558	Newstar	R955281865	S-A274	Newstar	R955288605X	TLA102626	Tuffline	R955102626N
S-7558	Newstar	R955281865N	S-A276	Newstar	R955KN20030AX	TLA102657	Tuffline	R955102657N
S807	Tramec Sloan	R955S807	S-A473	Newstar	R955104358X	TLA103009	Tuffline	R955103009N
S8255	Newstar	R955103010	S-A474	Newstar	R955104358X	TLA103010	Tuffline	R955103010N
S-8255	Newstar	R955103010N	S-A474	Newstar	R955107794X	TLA103028	Tuffline	R955103028N
S8255A	Newstar	R955103028	S-A530	Newstar	R955KN26000N	TLA103061	Tuffline	R955103061N
S-8328	Newstar	R955229860N	S-A535	Newstar	R955284358X	TLA103081	Tuffline	R955103081N
S-8361	Newstar	R955277863N	S-A561	Newstar	R955103294X	TLA103818	Tuffline	R955103818N
S-8361	Newstar	R955KN22100X	S-A568	Newstar	R9555005037N	TLA107695	Tuffline	R955107695N
S8444	Newstar	R955227870	SB285	Newstar	R955288241	TLA107796	Tuffline	R955107796N
S8444	Newstar	R955227871	S-B285	Newstar	R955288241N	TLA107799	Tuffline	R955107799N
S-8444	Newstar	R955227870N	SB898	Newstar	R955288323	TLA107800	Tuffline	R955107800N
S-8444	Newstar	R955227871N	S-B898	Newstar	R955288323X	TLA109495	Tuffline	R955109495N
S8445	Newstar	R955227870	S-C089	Newstar	R955KN31000X	TLA109496	Tuffline	R955109496N
S-8445	Newstar	R955227870N	S-C361	Newstar	R955KN28600N	TLA109578	Tuffline	R955109578N
S-8884	Newstar	R955401045	S-C403	Newstar	R955229505N	TLA109579	Tuffline	R955109579N
S-8887	Newstar	R955279000N	S-C517	Newstar	R955065145X	TLA109615	Tuffline	R955109615N
S-8898	Newstar	R955287417N	S-C518	Newstar	R955065146X	TLA109685	Tuffline	R955065225NP
S-8898	Newstar	R955287600X	S-C571	Newstar	R955288383X	TLA109689	Tuffline	R955109869N
S-9169	Newstar	R955287238N	S-D810	Newstar	R9555005893N	TLA109993	Tuffline	R955109993N
S-9174	Newstar	R955286371N	S-D812	Newstar	R955104165X	TLA109994	Tuffline	R109994P
S-9174	Newstar	R955286370N	S-D813	Newstar	R955101135X	TLA109995	Tuffline	R955109995N
S-9322	Newstar	R955KN30400X	S-D816	Newstar	R955281318X	TLA12105	Tuffline	R95512105
S-9625	Newstar	R955289144N	S-D821	Newstar	R955280758X	TLA131081	Tuffline	R955131081N
S-9749	Newstar	R955289714N	S-D878	Newstar	R955103912X	TLA13240	Tuffline	R955BE13240N
S-9749	Newstar	R955KN32041X	S-D879	Newstar	R955104561N	TLA13241	Tuffline	R955BE13241N
S-9795	Newstar	R955065157X	S-D880	Newstar	R955065125X	TLA13250	Tuffline	R955BE13250N
SA142	Newstar	R955065437	S-D881	Newstar	R955103833X	TLA13255	Tuffline	R955BE13255N
S-A142	Newstar	R955065437N	S-D882	Newstar	R955106313X	TLA205105	Tuffline	R955800350N
S-A143	Newstar	R955103081N	S-D883	Newstar	R955103835X	TLA20615	Tuffline	R955KN20615N
S-A144	Newstar	R955279787X	S-D970	Newstar	R955284412N	TLA227870	Tuffline	R955227870N
S-A145	Newstar	R955288746N	SE424	Newstar	R955227871	TLA227871	Tuffline	R955227871N
SA146	Newstar	R955284760	S-E424	Newstar	R955227871N	TLA228600	Tuffline	R955228600N
S-A147	Newstar	R955279952X	S-E463	Newstar	R955289148X	TLA229505	Tuffline	R955229505N
SA149	Newstar	R955103061	S-E576	Newstar	R955101818X	TLA229635	Tuffline	R955229635N
S-A149	Newstar	R955103061X	S-E694	Newstar	R955065313X	TLA229859	Tuffline	R955229859N
SA150	Newstar	R955287376	S-F496	Newstar	R955284358N	TLA229860	Tuffline	R955229860N
S-A150	Newstar	R955287376X	SMR107507X	Partsmart	R955107507X	TLA23000	Tuffline	R955KN23000N
SA151	Newstar	R955101112	SMR3558072X	Partsmart	R9553558072X	TLA23010	Tuffline	R955KN23010N

5

All Euclid Air Systems components were superseded to their Meritor part number equivalents effective February 2018.

Competitor Part Number	Competitor Name	Meritor Part Number	Competitor Part Number	Competitor Name	Meritor Part Number	Competitor Part Number	Competitor Name	Meritor Part Number
TLA26000	Tuffline	R955KN26000N	TLA800350	Tuffline	R955800350N	WA227871	World American	R955227871
TLA27000	Tuffline	R955KN27000N	TLA800376	Tuffline	R955800376N	WA228600	World American	R955228600N
TLA276566	Tuffline	R955276566N	TLA800404	Tuffline	R955800404N	WA228750	World American	R955228750N
TLA276567	Tuffline	R955276567N	TLA800405	Tuffline	R955800405N	WA229505	World American	R955229505N
TLA277147	Tuffline	R955277147N	TLA800516	Tuffline	R955800516N	WA229635	World American	R955229635N
TLA277863	Tuffline	R955277863N	TLA800517	Tuffline	R955800517N	WA229859	World American	R955229859N
TLA278614	Tuffline	R955278614N	TLA800518	Tuffline	R955800518N	WA229860	World American	R955229860N
TLA278615	Tuffline	R955278615N	TLA800519	Tuffline	R955800519N	WA275491	World American	R955275491
TLA278825	Tuffline	R955278825N	TLA800629	Tuffline	R955800629N	WA276566	World American	R955276566
TLA279000	Tuffline	R955279000N	WA10024	World American	R950119	WA276567	World American	R955276567
TLA279180	Tuffline	R955279180N	WA10028	World American	R950118	WA277863	World American	R955277863N
TLA279416	Tuffline	R955279416N	WA101112	World American	R955101112	WA279000	World American	R955279000N
TLA279952	Tuffline	R955279952N	WA101622	World American	R955101622	WA279180	World American	R955279180
TLA28060	Tuffline	R955KN28060N	WA102626	World American	R955102626	WA279416	World American	R955279416N
TLA280809	Tuffline	R955281860N	WA102761	World American	R955102761	WA281865	World American	R955281865
TLA281860	Tuffline	R955281865N	WA103009	World American	R955103009	WA281923	World American	R955281923N
TLA281865	Tuffline	R955281923N	WA103010	World American	R955103010	WA284358	World American	R955284358X
TLA281923	Tuffline	R955284142N	WA103028	World American	R955103028	WA284760	World American	R955284760
TLA284358	Tuffline	R955284358N	WA103061	World American	R955103061	WA286171	World American	R955286171N
TLA284412	Tuffline	R955284412N	WA104358	World American	R955104358X	WA286364	World American	R955286364X
TLA284760	Tuffline	R955284760N	WA106113	World American	R955288241	WA286370	World American	R955286370N
TLA28500	Tuffline	R955KN28500N	WA107794	World American	R955107794X	WA287053	World American	R955287053N
TLA28510	Tuffline	R955KN28510N	WA109495	World American	R955109495N	WA287238	World American	R955287238N
TLA28520	Tuffline	R955KN28520N	WA109496	World American	R955109496N	WA287376	World American	R955287376
TLA286171	Tuffline	R955286171N	WA109685	World American	R955065225X	WA288239	World American	R955288239
TLA286364	Tuffline	R955286364N	WA109869	World American	R955109869N	WA288241	World American	R955288241N
TLA286370	Tuffline	R955286370N	WA109994	World American	R109994P	WA288383	World American	R955288383X
TLA286500	Tuffline	R955286500N	WA11450	World American	R950116			
TLA287114	Tuffline	R955287114N	WA11451	World American	R950115			
TLA287298	Tuffline	R955287298N	WA11452	World American	R950114			
TLA288239	Tuffline	R955288239N	WA12105	World American	R955401045			
TLA288241	Tuffline	R955288241N	WA227870	World American	R955227870			
TLA288301	Tuffline	R955288301N						
TLA288383	Tuffline	R955288383N						
TLA288605	Tuffline	R955288605N						
TLA289714	Tuffline	R955289714N						
TLA298817	Tuffline	R955298817N						
TLA298818	Tuffline	R955298818N						
TLA5002595	Tuffline	R9555002595N						
TLA5003547	Tuffline	R9555003547N						
TLA5003547	Tuffline	R9555005037N						
TLA5004338	Tuffline	R9555004338N						
TLA5005624	Tuffline	R9555005624N						
TLA5005893	Tuffline	R9555005893N						
TLA5008414	Tuffline	R109994P						
TLA65145	Tuffline	R955065145N						
TLA65146	Tuffline	R955065146N						
TLA65303	Tuffline	R955065303N						
TLA68230	Tuffline	R955KN68230N						
TLA72420	Tuffline	R955A72420N						
TLA800333	Tuffline	R955800333N						

All Euclid Air Systems components were superseded to their Meritor part number equivalents effective February 2018.

# CROSS REFERENCE

Competitor Part Number	Competitor Name	Meritor Part Number	Competitor Part Number	Competitor Name	Meritor Part Number
WA288605	World American	R955288605X	ZZEL13081	Navistar	R955EL13081X
WA288746	World American	R955288746N	ZZEL13111	Navistar	R955EL13111X
WA289144	World American	R955289144N	ZZEL14111	Navistar	R955EL14111X
WA289714	World American	R955289714N	ZZEL16040	Haldex	R955EL16040X
WA5005037	World American	R9555005037N	ZZEL16040	Navistar	R955EL16040X
WA5005893	World American	R9555005893N	ZZEL16060	Navistar	R955EL16060X
WA65145	World American	R955065145X	ZZEL16100	Navistar	R955EL16100X
WA65146	World American	R955065146X	ZZEL16111	Navistar	R955EL16111X
WA65437	World American	R955065437	ZZEL16120	Navistar	R955EL16120X
WA65439	World American	R955065439	ZZEL16200	Navistar	R955EL16200X
WA800405	World American	R955800405N	ZZEL16250	Navistar	R955EL16250X
WAKN18530	World American	R955275491	ZZKN86020	Navistar	R955KN86020X
WAKN20615	World American	R955KN20615X	ZZKNT86230	Navistar	R955KNT86230X
WAKN23000	World American	R955227871			
WAKN23010	World American	R955227870			
WAKN26000	World American	R955KN26000N			
WAKN28060	World American	R955KN28060N			
WAKN28500	World American	R955KN28500N			
WAKN28510	World American	R955KN28510			
WAKN28520	World American	RKN28520			
WAKN28600	World American	R955KN28600N			
WAKN28601	World American	R955KN28601X			
WAKN30400	World American	R955KN30400X			
WM778A	Tectran	R955KN31000X			
XG1006140	Motor Coach Industries	R955107512X			
XV330DC	Bepco	R955099P			
ZAC065288	Navistar	R955108110X			
ZAC104962	Navistar	R955286528X			
ZAC286554	Navistar	R955286554X			
ZAC286555	Navistar	R955286555X			
ZZEL13040	Navistar	R955EL13040X			
ZZEL13060	Navistar	R955EL13060X			

All Euclid Air Systems components were superseded to their Meritor part number equivalents effective February 2018.

**NOTES:** \_\_\_\_\_

\_\_\_\_\_

\_\_\_\_\_

\_\_\_\_\_

\_\_\_\_\_

**5**

\_\_\_\_\_

\_\_\_\_\_

\_\_\_\_\_

\_\_\_\_\_

\_\_\_\_\_

\_\_\_\_\_

\_\_\_\_\_

\_\_\_\_\_

\_\_\_\_\_

\_\_\_\_\_

\_\_\_\_\_

\_\_\_\_\_

\_\_\_\_\_

# NUMERIC PARTS LIST

Part Number	Page(s)
R5X1093	5-17
R555KN85230X	2-9, 2-38, 5-25
R555KN86230X	2-9, 2-38, 5-25
R955A3546N	4-6, 4-65, 5-19, 5-21
R955A3546X	4-6, 4-65, 5-19
R955A3547X	4-6, 4-65, 5-19
R955A3991X	4-6, 4-65, 5-19
R955A4487N	4-6, 4-67, 5-8, 5-19
R955A4490N	4-6, 4-67, 5-19, 5-25
R955A4491N	4-6, 4-67, 5-19, 5-25
R955A4688N	4-6, 4-65, 5-19
R955A4688X	4-6, 4-65, 5-19
R955A4900N	4-6, 4-66, 5-19
R955A5010N	4-6, 4-66, 5-19
R955A5015N	4-6, 4-66, 5-19
R955A72420N	3-31, 5-19, 5-31
R955A80070X	4-6, 4-49, 5-19
R955A85490X	4-6, 4-50, 5-19
R955A85493X	4-6, 4-50, 5-19
R955A86473X	4-6, 4-50, 5-19
R955A86477X	4-6, 4-50, 5-19
R955A88802X	4-6, 4-56, 5-19
R955A88812X	4-6, 4-56, 5-19
R955A97600X	4-6, 4-50, 5-19
R955A98730X	4-6, 4-57, 5-19
R955A99370X	4-6, 4-57, 5-19
R955A103600X	4-6, 4-50, 5-19
R955BE13240N	4-6, 4-59, 5-19, 5-21, 5-30
R955BE13241N	4-6, 4-59, 5-9, 5-19, 5-21, 5-30
R955BE13250N	4-6, 4-59, 5-9, 5-10, 5-19, 5-21, 5-30
R955BE13255N	4-6, 4-59, 5-19, 5-21, 5-30
R955BM69973-12N	4-6, 4-64, 5-20
R955BM69973-12X	4-6, 4-64, 5-20
R955BM69973-24N	4-6, 4-64, 5-20
R955BM69973-24X	4-6, 4-64, 5-20
R955BM6997312N	5-20
R955BM6997312X	5-18, 5-20
R955BM6997324N	5-20
R955BM6997324X	5-20
R955EL13020X	2-8, 2-23, 5-1, 5-9, 5-12, 5-20, 5-22, 5-28, 5-29
R955EL13021X	5-20
R955EL13022X	2-8, 2-23, 5-20
R955EL13040X	2-8, 2-38, 5-3, 5-20, 5-22, 5-28, 5-31
R955EL13050X	2-8, 2-45, 5-20

Part Number	Page(s)
R955EL13051X	2-8, 2-45, 5-20
R955EL13053X	2-8, 2-45, 5-3, 5-10, 5-20, 5-22, 5-28, 5-29
R955EL13060X	2-8, 2-23, 5-3, 5-20, 5-22, 5-31
R955EL13070X	5-20
R955EL13081X	5-20, 5-31
R955EL13090X	2-8, 2-45, 5-20
R955EL13100X	2-8, 2-45, 5-20
R955EL13111X	2-8, 2-53, 5-3, 5-20, 5-22, 5-28, 5-31
R955EL13151X	2-8, 2-30, 5-20
R955EL13160X	5-20
R955EL13200X	2-8, 2-29, 5-20
R955EL13220X	5-20
R955EL13312X	5-20
R955EL13330X	2-23
R955EL14110X	2-8, 2-53, 5-20
R955EL14111X	2-8, 2-53, 5-20, 5-31
R955EL16020X	5-9, 5-20, 5-28
R955EL16040X	2-8, 2-38, 5-21, 5-31
R955EL16050X	2-8, 2-45, 5-21
R955EL16051X	5-21, 5-28
R955EL16053X	2-8, 2-45, 5-10, 5-21, 5-28, 5-29
R955EL16060X	2-8, 2-23, 5-21, 5-28, 5-29, 5-31
R955EL16100X	2-8, 2-45, 5-9, 5-21, 5-28, 5-29, 5-31
R955EL16110X	5-21
R955EL16111X	2-8, 2-53, 5-3, 5-21, 5-22, 5-28, 5-31
R955EL16120X	2-8, 2-30, 5-21, 5-31
R955EL16200X	2-8, 2-29, 5-1, 5-21, 5-28, 5-31
R955EL16250X	5-10, 5-21, 5-29, 5-31
R955EL16280X	2-23
R955K022105N	3-5, 3-21, 5-1, 5-21, 5-22, 5-26
R955K031560N	3-5, 3-21, 5-22
R955K041395N	3-5, 3-18, 5-22
R955K056647X	2-28
R955K075155X	2-28
R955KN7000X	2-8, 2-21, 5-25
R955KN7010X	2-8, 2-21, 5-25
R955KN7020X	2-8, 2-21, 5-25
R955KN7030X	2-9, 2-22, 5-25
R955KN7040X	2-9, 2-22, 5-25
R955KN7041X	2-9, 2-22, 5-25
R955KN7050X	2-9, 2-22, 5-25

Part Number	Page(s)
R955KN7060X	2-9, 2-45, 5-25
R955KN7070X	2-9, 2-45, 5-25
R955KN7080X	2-9, 2-45, 5-25
R955KN7170X	2-9, 2-22, 5-25
R955KN7180X	2-9, 2-22, 5-25
R955KN18530X	2-8, 2-11, 5-22, 5-29
R955KN18531X	2-8, 2-11, 5-22
R955KN18534X	2-8, 2-11, 5-8, 5-22
R955KN20000X	4-7, 4-17, 5-22
R955KN20010X	4-7, 4-16, 5-22
R955KN20020X	4-7, 4-16, 5-22
R955KN20030AX	5-22, 5-30
R955KN20040X	4-7, 4-18, 5-22
R955KN20050X	4-7, 4-18, 5-22
R955KN20060X	4-7, 4-16, 5-22
R955KN20070X	4-7, 4-19, 5-23
R955KN20071X	4-7, 4-30, 5-23
R955KN20080X	4-7, 4-18, 5-23
R955KN20090X	4-7, 4-18, 5-23
R955KN20110X	4-7, 4-18, 5-23
R955KN20541X	4-7, 4-19, 5-23
R955KN20542X	4-7, 4-19, 5-23
R955KN20551X	4-7, 4-19, 5-23
R955KN20552X	4-7, 4-19, 5-23
R955KN20561X	4-7, 4-20, 5-23
R955KN20562X	4-7, 4-20, 5-23
R955KN20570X	5-23
R955KN20580X	4-7, 4-30, 5-23
R955KN20581X	4-7, 4-30, 5-23
R955KN20590X	4-7, 4-30, 5-23
R955KN20601X	4-7, 4-22, 5-23
R955KN20602X	4-7, 4-22, 5-23
R955KN20603X	4-7, 4-22, 5-23
R955KN20605X	4-7, 4-22, 5-23
R955KN20606N	4-7, 4-22, 5-23
R955KN20606X	4-7, 4-22, 5-23
R955KN20608X	4-7, 4-22, 5-23
R955KN20611X	4-7, 4-22, 5-23
R955KN20612X	4-7, 4-22, 5-23
R955KN20615N	4-7, 4-22, 5-19, 5-21, 5-23, 5-30
R955KN20615X	4-7, 4-22, 5-23, 5-29, 5-31
R955KN20616X	4-7, 4-22, 5-23
R955KN20619X	4-7, 4-22, 5-23
R955KN20620X	4-7, 4-22, 5-23
R955KN20621X	4-7, 4-22, 5-23
R955KN20622X	4-7, 4-22, 5-23
R955KN20623X	4-7, 4-22, 5-23

Part Number	Page(s)
R955KN20626X	4-7, 4-22, 5-23
R955KN20627X	4-7, 4-22, 5-23
R955KN20628X	4-7, 4-22, 5-23
R955KN20629X	4-7, 4-22, 5-23
R955KN22100X	4-7, 4-25, 5-23, 5-29
R955KN22140X	4-7, 4-28, 5-23
R955KN22150X	4-7, 4-28, 5-23
R955KN23000N	4-7, 4-12, 5-18, 5-19, 5-21, 5-23, 5-30
R955KN23010N	4-7, 4-12, 5-18, 5-23, 5-30
R955KN23040N	4-8, 4-12, 5-23
R955KN26000N	4-8, 4-56, 5-8, 5-19, 5-21, 5-22, 5-24, 5-30, 5-31
R955KN26000X	4-8, 4-56, 5-24
R955KN26010N	4-8, 4-56, 5-24
R955KN26010X	4-8, 4-56, 5-24
R955KN26020X	4-8, 4-56, 5-24
R955KN27000N	5-19, 5-21, 5-24, 5-26, 5-30
R955KN28010X	5-24
R955KN28011X	5-24
R955KN28030X	5-24
R955KN28041X	4-8, 4-49, 5-24
R955KN28042X	4-8, 4-48, 5-24
R955KN28055X	4-8, 4-49, 5-24
R955KN28060N	4-8, 4-46, 5-21, 5-24, 5-29, 5-30, 5-31
R955KN28060X	4-8, 4-45, 4-46, 5-24
R955KN28061X	4-8, 4-46, 5-24
R955KN28065X	5-24
R955KN28071X	4-8, 4-46, 5-21, 5-24, 5-29
R955KN28080X	4-8, 4-48, 5-24
R955KN28085X	4-8, 4-48, 5-24
R955KN28130X	4-8, 4-47, 5-24
R955KN28131X	4-8, 4-47, 5-24
R955KN28132X	4-8, 4-46, 5-24
R955KN28140X	4-8, 4-46, 5-24
R955KN28300X	4-8, 4-46, 5-24
R955KN28500N	4-8, 4-47, 5-2, 5-20, 5-21, 5-24, 5-26, 5-27, 5-29, 5-30, 5-31
R955KN28500X	4-8, 4-47, 5-24
R955KN28510	5-21, 5-24, 5-26, 5-29, 5-31
R955KN28510N	4-8, 4-47, 5-2, 5-8, 5-20, 5-24, 5-26, 5-29, 5-30
R955KN28510X	4-8, 4-47, 5-24
R955KN28514X	4-8, 4-47, 5-24

Part Number	Page(s)
R955KN28520N	4-8, 4-47, 5-2, 5-20, 5-21, 5-24, 5-29, 5-30
R955KN28520X	4-8, 4-47, 5-24
R955KN28531X	4-8, 4-47, 5-24
R955KN28550N	4-8, 4-48, 5-24
R955KN28550X	4-8, 4-48, 5-24
R955KN28600N	4-8, 4-58, 5-20, 5-21, 5-22, 5-24, 5-30, 5-31
R955KN28600X	4-8, 4-58, 5-24
R955KN28601X	4-8, 4-58, 5-8, 5-24, 5-31
R955KN28602X	4-8, 4-58, 5-24
R955KN28603X	4-8, 4-58, 5-24
R955KN30010N	4-8, 4-53, 5-25
R955KN30010X	4-8, 4-53, 5-25
R955KN30100X	4-8, 4-53, 5-25
R955KN30200X	4-8, 4-53, 5-25
R955KN30300X	4-8, 4-53, 5-21, 5-25
R955KN30400N	4-8, 4-53, 5-20, 5-25
R955KN30400X	4-8, 4-53, 5-21, 5-25, 5-29, 5-31
R955KN31000X	4-8, 4-34, 5-25, 5-30, 5-31
R955KN31010X	4-8, 4-34, 5-25
R955KN31040X	4-8, 4-35, 5-25
R955KN31080X	4-8, 4-35, 5-25
R955KN32000X	4-8, 4-36, 5-25
R955KN32010X	4-8, 4-36, 5-25
R955KN32020X	4-8, 4-36, 5-25
R955KN32040X	4-8, 4-37, 5-25
R955KN32041X	4-8, 4-37, 5-25, 5-30
R955KN34030X	4-9, 4-63, 5-25
R955KN34050X	4-9, 4-63, 5-25
R955KN34060X	4-9, 4-63, 5-25
R955KN34070N	4-9, 4-63, 5-25
R955KN34070X	4-9, 4-63, 5-25
R955KN34080X	4-9, 4-62, 5-25
R955KN34090X	4-9, 4-62, 5-25
R955KN34100X	4-9, 4-62, 5-25
R955KN34110X	4-9, 4-62, 5-25
R955KN34130X	4-9, 4-62, 5-25
R955KN68230N	4-9, 4-64, 5-25, 5-31
R955KN68230X	4-9, 4-64, 5-25
R955KN68237N	4-9, 4-64, 5-25
R955KN85020X	2-9, 2-22, 5-25
R955KN85022X	2-9, 2-22, 5-25
R955KN86020X	2-9, 2-22, 5-7, 5-10, 5-25, 5-28, 5-29, 5-31
R955KN86230X	2-9, 2-22, 5-25
R955KNT86230X	5-15, 5-25, 5-28, 5-31

Part Number	Page(s)
R955RMT33CN	5-29
R955RN33C	2-21, 2-22, 5-29
R955RNT16A	2-53
R955RNT26A	2-23, 2-29, 2-30, 2-38, 2-45, 2-53, 5-29
R955RNT26JB	2-22, 2-38, 5-29
R955RNT33C	2-45, 5-29
R955S807	5-29
R955T33C	5-30
R955T223N	3-31
R955T224N	3-5, 3-31, 5-19, 5-20, 5-26, 5-30
R955T224PGN	3-5, 3-31, 5-30
R955T228N	3-31
R955T235N	3-31
R955T238N	3-31
R10027	5-1, 5-30
R10029	5-1
R11401	5-6, 5-26
R11402	5-6, 5-26
R11450	5-6, 5-26
R11451	5-6, 5-26
R11452	5-6, 5-26
R11460	5-6, 5-26
R11461	5-6, 5-26
R11462	5-6, 5-26
R12100	5-6, 5-8, 5-26
R12102	5-6, 5-23, 5-27, 5-28
R12104	5-6, 5-21, 5-23, 5-28
R12110	5-3, 5-6
R12112	5-3, 5-6, 5-8
R12116	5-6
R12500	5-6
R12501	5-6
R12502	5-6
R12509	5-6
R12510	5-6
R102008HA	5-2
R102323E	5-2
R102684A	5-2
R109994P	3-3, 3-5, 3-25, 3-29, 5-5, 5-8, 5-15, 5-17, 5-18, 5-19, 5-20, 5-21, 5-25, 5-26, 5-29, 5-30, 5-31
R304323	4-6, 4-32, 5-18
R304324	4-6, 4-32, 5-18
R304325	4-6, 4-31, 5-18
R304326	4-6, 4-32, 5-18
R304328	4-6, 4-31, 5-18

# NUMERIC PARTS LIST

Part Number	Page(s)
R304329	4-6, 4-31, 5-18
R304331	4-6, 4-31, 5-18
R307852	4-6, 4-32, 5-15
R950070	1-5, 5-2, 5-6, 5-29
R950071	1-5, 5-2, 5-6, 5-29
R950072	1-5, 5-3, 5-6, 5-29
R950073	1-5, 5-2, 5-29
R950074	1-5, 5-3, 5-29
R950075	1-5, 5-3, 5-6, 5-9, 5-29
R950076	1-5, 5-3, 5-6, 5-8, 5-9, 5-29
R950077	1-5, 5-3, 5-6, 5-9, 5-29
R950078	1-5, 5-3, 5-6, 5-29
R950079	1-5, 5-4, 5-6, 5-29
R950080	1-5, 5-2, 5-6, 5-8, 5-9, 5-29
R950081	1-5, 5-2, 5-6, 5-9, 5-29
R950082	1-5, 5-3, 5-6, 5-8, 5-9, 5-29
R950083	1-5, 5-2, 5-6, 5-29
R950084	1-5, 5-2, 5-3, 5-29
R950085	1-5, 5-3, 5-6, 5-8, 5-29
R950086	1-5, 5-2, 5-3, 5-29
R950087	1-5, 5-2, 5-6, 5-8, 5-29
R950088	1-5, 5-6, 5-29
R950089	1-5, 5-2, 5-6, 5-29
R950090	1-5, 5-2, 5-29
R950091	1-5, 5-2, 5-6, 5-29
R950092	1-5, 5-2, 5-29
R950093	1-5, 5-2, 5-6
R950094	1-5
R950095	1-5, 5-6, 5-29
R950096	1-5, 5-6, 5-10, 5-19, 5-29
R950097	1-5, 5-6, 5-8, 5-29
R950098	1-5, 5-8, 5-29
R950099	1-4
R950100	1-4, 5-6, 5-29
R950101	1-4, 5-6, 5-8, 5-29
R950102	1-4, 5-29
R950103	1-4, 5-29
R950104	1-4, 5-8, 5-29
R950105	1-4, 5-6, 5-29
R950106	1-4, 5-29
R950107	1-4, 5-6, 5-29
R950108	1-4, 5-29
R950109	1-4, 5-29
R950110	1-4, 5-29
R950111	1-4, 5-29

Part Number	Page(s)
R950114	1-7, 5-1, 5-6, 5-15, 5-26, 5-29, 5-31
R950114-PL	1-7
R950115	1-7, 5-1, 5-6, 5-15, 5-26, 5-29, 5-31
R950115-PL	1-7
R950116	1-7, 5-1, 5-6, 5-15, 5-26, 5-29, 5-31
R950116-PL	1-7
R950117	1-7, 5-6
R950118	1-7, 5-1, 5-6, 5-8, 5-10, 5-15, 5-26, 5-31
R950119	1-7, 5-1, 5-31
R950120	1-7, 5-15
R950121	1-7, 5-15, 5-20
R950122	1-7, 5-15, 5-20
R955099P	3-5, 3-25, 3-29, 5-1, 5-17, 5-19, 5-29, 5-31
R955205	5-8, 5-20, 5-26
R955205X	5-26
R955300	5-20
R955300X	5-26
R955374	5-4
R955375	5-4
R955423	5-4
R955426	5-4
R955500	1-4, 5-5, 5-8, 5-10
R955500-BK	1-4
R955500BK	5-5, 5-8, 5-12, 5-26
R955501	1-4, 5-5, 5-8, 5-17
R955501-BK	1-4
R955501BK	5-5, 5-8, 5-17
R955502	1-2
R955502-08-BK	1-3
R955502-12-BK	1-3
R955502-14-BK	1-3
R955502-16-BK	1-3
R955502-18-BK	1-3
R955502-20-BK	1-3
R955502-22-BK	1-3
R955502-24-BK	1-3
R955502-26-BK	1-3
R955502-28-BK	1-3
R955502-30-BK	1-3
R955502-32-BK	1-3
R955502-34-BK	1-3
R955502-36-BK	1-3
R955502-38-BK	1-3
R955502-40-BK	1-3

Part Number	Page(s)
R955502-42-BK	1-3
R955502-44-BK	1-3
R955502-46-BK	1-3
R955502-48-BK	1-3
R955502-50-BK	1-3
R955502-52-BK	1-3
R955502-54-BK	1-3
R955502-56-BK	1-3
R955502-60-BK	1-3
R955502-62-BK	1-3
R955502-66-BK	1-3
R955502-68-BK	1-3
R955502-72-BK	1-3
R955502-84-BK	1-3
R955503	1-2
R955503-08-BK	1-3
R955503-12-BK	1-3
R955503-14-BK	1-3
R955503-16-BK	1-3
R955503-18-BK	1-3
R955503-20-BK	1-3
R955503-22-BK	1-3
R955503-24-BK	1-3
R955503-26-BK	1-3
R955503-28-BK	1-3
R955503-30-BK	1-3
R955503-32-BK	1-3
R955503-34-BK	1-3
R955503-36-BK	1-3
R955503-38-BK	1-3
R955503-40-BK	1-3
R955503-42-BK	1-3
R955503-44-BK	1-3
R955503-46-BK	1-3
R955503-48-BK	1-3
R955503-50-BK	1-3
R955503-52-BK	1-3
R955503-54-BK	1-3
R955503-56-BK	1-3
R955503-60-BK	1-3
R955503-62-BK	1-3
R955503-66-BK	1-3
R955503-68-BK	1-3
R955503-72-BK	1-3
R955503-84-BK	1-3
R955504	1-2
R955504-08-BK	1-3
R955504-12-BK	1-3

Part Number	Page(s)
R955504-14-BK	1-3
R955504-16-BK	1-3
R955504-18-BK	1-3
R955504-20-BK	1-3
R955504-22-BK	1-3
R955504-24-BK	1-3
R955504-26-BK	1-3
R955504-28-BK	1-3
R955504-30-BK	1-3
R955504-32-BK	1-3
R955504-34-BK	1-3
R955504-36-BK	1-3
R955504-38-BK	1-3
R955504-40-BK	1-3
R955504-42-BK	1-3
R955504-44-BK	1-3
R955504-46-BK	1-3
R955504-48-BK	1-3
R955504-50-BK	1-3
R955504-52-BK	1-3
R955504-54-BK	1-3
R955504-56-BK	1-3
R955504-60-BK	1-3
R955504-62-BK	1-3
R955504-66-BK	1-3
R955504-68-BK	1-3
R955504-72-BK	1-3
R955504-84-BK	1-3
R955505	1-2
R955505-08-BK	1-3
R955505-12-BK	1-3
R955505-14-BK	1-3
R955505-16-BK	1-3
R955505-18-BK	1-3
R955505-20-BK	1-3
R955505-22-BK	1-3
R955505-24-BK	1-3
R955505-26-BK	1-3
R955505-28-BK	1-3
R955505-30-BK	1-3
R955505-32-BK	1-3
R955505-34-BK	1-3
R955505-36-BK	1-3
R955505-38-BK	1-3
R955505-40-BK	1-3
R955505-42-BK	1-3
R955505-44-BK	1-3
R955505-46-BK	1-3

Part Number	Page(s)
R955505-48-BK	1-3
R955505-50-BK	1-3
R955505-52-BK	1-3
R955505-54-BK	1-3
R955505-56-BK	1-3
R955505-60-BK	1-3
R955505-62-BK	1-3
R955505-66-BK	1-3
R955505-68-BK	1-3
R955505-72-BK	1-3
R955505-84-BK	1-3
R955506	1-2
R955506-08-BK	1-3
R955506-12-BK	1-3
R955506-14-BK	1-3
R955506-16-BK	1-3
R955506-18-BK	1-3
R955506-20-BK	1-3
R955506-22-BK	1-3
R955506-24-BK	1-3
R955506-26-BK	1-3
R955506-28-BK	1-3
R955506-30-BK	1-3
R955506-32-BK	1-3
R955506-34-BK	1-3
R955506-36-BK	1-3
R955506-38-BK	1-3
R955506-40-BK	1-3
R955506-42-BK	1-3
R955506-44-BK	1-3
R955506-46-BK	1-3
R955506-48-BK	1-3
R955506-50-BK	1-3
R955506-52-BK	1-3
R955506-54-BK	1-3
R955506-56-BK	1-3
R955506-60-BK	1-3
R955506-62-BK	1-3
R955506-66-BK	1-3
R955506-68-BK	1-3
R955506-72-BK	1-3
R955506-84-BK	1-3
R955507	1-2
R955507-08-BK	1-3
R955507-12-BK	1-3
R955507-14-BK	1-3
R955507-16-BK	1-3
R955507-18-BK	1-3

Part Number	Page(s)
R955507-20-BK	1-3
R955507-22-BK	1-3
R955507-24-BK	1-3
R955507-26-BK	1-3
R955507-28-BK	1-3
R955507-30-BK	1-3
R955507-32-BK	1-3
R955507-34-BK	1-3
R955507-36-BK	1-3
R955507-38-BK	1-3
R955507-40-BK	1-3
R955507-42-BK	1-3
R955507-44-BK	1-3
R955507-46-BK	1-3
R955507-48-BK	1-3
R955507-50-BK	1-3
R955507-52-BK	1-3
R955507-54-BK	1-3
R955507-56-BK	1-3
R955507-60-BK	1-3
R955507-62-BK	1-3
R955507-66-BK	1-3
R955507-68-BK	1-3
R955507-72-BK	1-3
R955507-84-BK	1-3
R3013922	4-6, 4-32, 5-18
R9555455X	5-17
R9555461X	5-17
R9555470X	5-17
R90555396	5-10, 5-11, 5-12, 5-14, 5-19, 5-21, 5-25, 5-26
R90555397	5-19, 5-25, 5-26
R90555398	5-10, 5-11, 5-12, 5-13, 5-19, 5-25, 5-26
R90555409	5-19, 5-25, 5-26
R90555410	5-19
R95104358X	3-2
R95104358XCF	3-2
R95510732	1-8, 5-8
R95510733	1-8, 5-8
R95510734	1-8, 5-8
R95510735	1-8, 5-8, 5-11
R95510736	1-8, 5-8, 5-13
R95510742	1-8, 5-6, 5-8
R95510743	1-8, 5-6
R95510744	1-8, 5-6, 5-15
R95510745	1-8, 5-6, 5-8
R95510746	1-8, 5-6, 5-15
R95510747	1-8, 5-6, 5-15



# NUMERIC PARTS LIST

Part Number	Page(s)
R95512103	5-6, 5-23, 5-27, 5-28
R95512103N	4-2, 4-23, 5-6
R95512105	5-6, 5-8, 5-27, 5-30
R95512105N	4-2, 4-23, 5-6, 5-15
R95512352N	4-2, 4-58, 5-6
R95516743N	4-2, 4-67, 5-7
R95516859N	4-2, 4-67, 5-7
R95519974N	4-2, 4-67, 5-8
R95550214BK	5-6
R95550216BK	5-6
R95550218BK	5-6
R95550220BK	5-6
R95550222BK	5-6
R95550224BK	5-6
R95550226BK	5-6, 5-7
R95550228BK	5-6, 5-7
R95550230BK	5-6, 5-7
R95550232BK	5-6, 5-7
R95550234BK	5-6
R95550236BK	5-6, 5-7
R95550240BK	5-6, 5-7
R95550242BK	5-6
R95550244BK	5-6
R95550246BK	5-6
R95550248BK	5-7
R95550254BK	5-6
R95550260BK	5-6, 5-7
R95550266BK	5-6
R95550272BK	5-6, 5-7
R95550314BK	5-7
R95550316BK	5-7, 5-9
R95550318BK	5-6, 5-7, 5-9
R95550320BK	5-6, 5-7, 5-9
R95550322BK	5-7, 5-9
R95550324BK	5-7, 5-9, 5-26
R95550326BK	5-7, 5-9
R95550328BK	5-7, 5-9
R95550330BK	5-7, 5-9
R95550332BK	5-7, 5-9
R95550334BK	5-7, 5-9
R95550336BK	5-7, 5-9
R95550338BK	5-7, 5-9
R95550340BK	5-7
R95550342BK	5-7
R95550344BK	5-7, 5-9
R95550346BK	5-7, 5-9
R95550348BK	5-7
R95550354BK	5-7, 5-9

Part Number	Page(s)
R95550360BK	5-7
R95550366BK	5-7
R95550368BK	5-7
R95550372BK	5-7, 5-9
R95550420BK	5-7
R95550422BK	5-7
R95550424BK	5-7
R95550426BK	5-7
R95550428BK	5-7
R95550430BK	5-7
R95550432BK	5-7
R95550434BK	5-7
R95550436BK	5-7
R95550438BK	5-6
R95550440BK	5-7
R95550442BK	5-7
R95550448BK	5-7
R95550454BK	5-7
R95550460BK	5-7
R95550514BK	5-7
R95550516BK	5-7
R95550518BK	5-7, 5-8
R95550520BK	5-7, 5-8
R95550522BK	5-7
R95550524BK	5-7, 5-8, 5-26
R95550526BK	5-7, 5-8
R95550528BK	5-7, 5-8
R95550530BK	5-6, 5-7, 5-8, 5-26
R95550532BK	5-6, 5-7, 5-8
R95550534BK	5-6, 5-7
R95550536BK	5-6, 5-7, 5-8
R95550538BK	5-6, 5-7
R95550540BK	5-6, 5-7, 5-8
R95550542BK	5-6, 5-7
R95550544BK	5-6, 5-7
R95550546BK	5-6, 5-7
R95550548BK	5-6, 5-7, 5-8
R95550552BK	5-7
R95550554BK	5-8
R95550556BK	5-7
R95550560BK	5-6, 5-7, 5-8
R95550568BK	5-7
R95550572BK	5-6, 5-7, 5-8
R95550616BK	5-7
R95550620BK	5-7
R95550622BK	5-7
R95550624BK	5-7
R95550626BK	5-7

Part Number	Page(s)
R95550628BK	5-7
R95550630BK	5-7
R95550632BK	5-7
R95550636BK	5-7
R95550640BK	5-7
R95550644BK	5-7
R95550648BK	5-7
R95550660BK	5-7
R95550672BK	5-7
R95550718BK	5-7, 5-8
R95550720BK	5-8
R95550722BK	5-7
R95550724BK	5-8
R95550726BK	5-7, 5-8
R95550728BK	5-7, 5-8
R95550730BK	5-7, 5-8
R95550732BK	5-7, 5-8
R95550734BK	5-7
R95550736BK	5-7, 5-8
R95550738BK	5-7
R95550740BK	5-7, 5-8
R95550744BK	5-7
R95550748BK	5-7, 5-8
R95550754BK	5-8
R95550756BK	5-7
R95550760BK	5-8
R95550772BK	5-7, 5-8
R955065041X	3-2, 3-11, 5-1, 5-17, 5-25
R955065041XCF	3-2, 3-11, 5-28
R955065044X	3-2, 3-11, 5-1
R955065077X	5-1
R955065102X	3-2, 3-11, 5-1
R955065103X	5-1
R955065104N	4-2, 4-43, 5-17, 5-21, 5-28
R955065104X	4-2, 4-43, 5-1, 5-2, 5-16
R955065125X	4-2, 4-44, 5-1, 5-21, 5-26, 5-30
R955065145N	4-2, 4-39, 5-1, 5-8, 5-17, 5-20, 5-21, 5-31
R955065145X	4-2, 4-39, 5-1, 5-7, 5-17, 5-30, 5-31
R955065146N	4-2, 4-39, 5-1, 5-8, 5-17, 5-20, 5-21, 5-26, 5-31
R955065146X	4-2, 4-39, 5-1, 5-17, 5-21, 5-30, 5-31
R955065154X	4-2, 4-40, 5-1
R955065156X	4-2, 4-21, 5-1, 5-23
R955065157X	4-2, 4-21, 5-1, 5-30

Part Number	Page(s)
R955065160X	4-2, 4-21, 5-1
R955065186X	4-2, 4-21, 5-1
R955065206N	4-2, 4-43, 5-1, 5-17
R955065224N	3-17, 5-1, 5-17, 5-28
R955065224X	3-2, 3-17, 5-1, 5-17, 5-28
R955065224XCF	3-17, 5-1, 5-17, 5-28
R955065225N	3-2, 3-17, 5-1, 5-5, 5-8, 5-17
R955065225NP	3-17, 5-17, 5-21, 5-26, 5-30
R955065225X	3-2, 3-3, 3-17, 5-1, 5-5, 5-18, 5-25, 5-31
R955065225XCF	3-2, 3-3, 3-17, 5-5, 5-17, 5-28
R955065226X	3-2, 3-17, 5-1
R955065228X	3-2, 3-17, 5-1
R955065243X	3-2, 3-17, 5-1
R955065303N	4-2, 4-43, 5-1, 5-7, 5-8, 5-17, 5-22, 5-31
R955065303X	4-2, 4-43, 5-1, 5-4, 5-7, 5-17
R955065313X	4-2, 4-27, 5-1, 5-18, 5-20, 5-21, 5-22, 5-25, 5-30
R955065315X	4-28, 5-1
R955065395X	4-2, 4-29, 5-1
R955065437	5-1, 5-18, 5-21, 5-22, 5-28, 5-30, 5-31
R955065437N	4-2, 4-57, 5-1, 5-3, 5-5, 5-8, 5-18, 5-20, 5-21, 5-22, 5-26, 5-30
R955065437X	4-2, 4-57, 5-1
R955065438X	4-2, 4-57, 5-1
R955065439	5-1, 5-18, 5-21, 5-22, 5-25, 5-31
R955065439N	4-2, 4-57, 5-8, 5-18, 5-22
R955065439X	4-2, 4-57, 5-1, 5-5, 5-25
R955065499X	3-17
R955065605X	3-17
R955065612N	3-21
R955065624N	3-2, 3-21, 5-1, 5-5, 5-18, 5-19, 5-21
R955065643	5-18
R955065647X	3-2, 3-17, 5-1
R955065677N	3-2, 3-27, 5-1, 5-15, 5-18
R955101100X	4-2, 4-27, 5-1, 5-28
R955101112	5-1, 5-21, 5-24, 5-28, 5-30, 5-31
R955101112N	4-2, 4-55, 5-1, 5-8, 5-20, 5-21, 5-24, 5-30

Part Number	Page(s)
R955101112X	4-2, 4-55, 5-1, 5-24, 5-30
R955101135X	4-2, 4-35, 5-1, 5-30
R955101142X	2-2, 5-1
R955101143X	2-2, 2-39, 5-1
R955101158X	2-2, 2-43, 5-1
R955101242X	2-2, 2-13, 5-1
R955101245X	5-1
R955101256X	2-2, 2-17, 5-1
R955101282X	2-2, 2-40, 5-1
R955101311X	4-2, 4-39, 5-1
R955101333X	5-1, 5-2
R955101437N	4-2, 4-20, 5-1, 5-21, 5-22, 5-23, 5-30
R955101437X	4-2, 4-20, 5-1, 5-23, 5-26
R955101450X	4-2, 4-31, 5-1
R955101554X	2-2, 2-43, 5-1
R955101558N	2-14, 2-16, 2-20, 5-1
R955101569X	4-2, 4-20, 5-1
R955101570X	4-2, 4-20, 5-1, 5-26
R955101622	5-1, 5-20, 5-21, 5-28, 5-30, 5-31
R955101622X	4-2, 4-55, 5-1, 5-30
R955101818N	4-2, 4-26, 5-1, 5-8, 5-22, 5-30
R955101818X	4-2, 4-26, 5-1, 5-7, 5-25, 5-30
R955101884X	2-2, 2-24, 5-1
R955101890N	4-2, 4-20, 5-1
R955101890X	4-2, 4-20, 5-1
R955101900X	3-2, 3-7, 5-2
R955101900XCF	3-2, 3-7, 5-1, 5-28
R955102213X	2-2, 2-20, 5-2
R955102598X	2-2, 2-20, 5-2
R955102626	5-2, 5-19, 5-21, 5-26, 5-28, 5-29, 5-31
R955102626N	4-2, 4-43, 5-1, 5-2, 5-19, 5-20, 5-21, 5-22, 5-26, 5-28, 5-29, 5-30
R955102626X	4-2, 4-43, 5-1, 5-2, 5-8, 5-9, 5-19
R955102638X	4-2, 4-61, 5-2, 5-22
R955102657N	3-2, 3-9, 3-13, 5-2, 5-30
R955102674X	2-2, 2-15, 5-2
R955102697X	2-2, 2-50, 5-2
R955102698X	2-2, 2-18, 5-2
R955102734X	2-2, 2-46, 5-2
R955102761	5-2, 5-28, 5-31
R955102761X	4-2, 4-54, 5-2
R955102835X	5-2, 5-22

Part Number	Page(s)
R955102952X	5-2
R955102953X	2-2, 2-51, 5-2, 5-14
R955102989X	2-2, 2-19, 5-2
R955103009	5-2, 5-21, 5-24, 5-28, 5-29, 5-31
R955103009N	4-2, 4-44, 5-1, 5-2, 5-19, 5-20, 5-21, 5-24, 5-28, 5-29, 5-30
R955103009X	4-2, 4-44, 5-2, 5-8, 5-24
R955103010	5-2, 5-21, 5-24, 5-26, 5-28, 5-29, 5-31
R955103010N	4-2, 4-45, 5-1, 5-2, 5-8, 5-19, 5-20, 5-21, 5-24, 5-26, 5-28, 5-29, 5-30
R955103010X	4-2, 4-45, 5-2, 5-24
R955103028	5-2, 5-21, 5-26, 5-28, 5-29, 5-31
R955103028N	4-2, 4-44, 5-1, 5-2, 5-20, 5-21, 5-26, 5-28, 5-30
R955103028X	4-2, 4-44, 5-2
R955103061	5-2, 5-28, 5-30, 5-31
R955103061N	4-2, 4-54, 5-2, 5-20, 5-30
R955103061X	4-2, 4-54, 5-2, 5-30
R955103081N	4-2, 4-52, 5-2, 5-8, 5-19, 5-20, 5-21, 5-26, 5-28, 5-30
R955103081X	4-2, 4-52, 5-2
R955103139X	4-2, 4-45, 5-2
R955103195X	4-3, 4-44, 5-2
R955103211X	2-2, 2-21, 5-2
R955103212X	2-2, 2-14, 5-2
R955103274X	2-2, 2-24, 5-1, 5-2, 5-20, 5-22
R955103278X	2-2, 2-27, 5-1, 5-2
R955103294	5-2, 5-20, 5-28
R955103294X	4-3, 4-45, 5-2, 5-30
R955103817N	3-2, 3-11, 5-2, 5-22
R955103818N	3-2, 3-13, 5-2, 5-22, 5-30
R955103833X	4-3, 4-44, 5-2, 5-30
R955103835X	4-3, 4-45, 5-2, 5-22, 5-30
R955103879N	3-2, 3-11, 5-2, 5-22
R955103912X	4-3, 4-43, 5-2, 5-30
R955103976	5-2, 5-20, 5-28
R955103976X	5-3
R955103980N	3-2, 3-11, 5-3, 5-22
R955103981N	3-2, 3-11, 5-3, 5-20, 5-22
R955104012	2-14, 2-33
R955104027N	3-2, 3-11, 3-19, 5-3

# NUMERIC PARTS LIST

Part Number	Page(s)
R955104039X	2-2, 2-21, 5-3, 5-7, 5-10, 5-22, 5-29
R955104041X	2-2, 2-21, 5-3
R955104042X	2-2, 2-29, 5-3
R955104102X	2-2, 2-33, 5-3
R955104103X	2-2, 2-33, 5-3
R955104165X	4-3, 4-44, 5-3, 5-30
R955104345X	4-3, 4-45, 5-3, 5-22
R955104358X	3-2, 3-11, 5-3, 5-22, 5-25, 5-30, 5-31
R955104358XCF	3-11, 5-3, 5-21, 5-28
R955104561N	5-3, 5-22, 5-28, 5-30
R955104561X	4-3, 4-43, 5-3
R955104574	5-3, 5-22
R955104583X	2-2, 2-52, 5-3
R955104584X	2-2, 2-52, 5-3
R955104598X	4-3, 4-39, 5-3
R955104644X	5-3
R955106165N	5-3
R955106268X	2-2, 2-40, 5-3
R955106284X	4-3, 4-39, 5-3
R955106313X	4-3, 4-44, 5-3, 5-30
R955106439X	2-2, 2-21, 5-3
R955106780X	2-2, 2-40, 5-3
R955106792X	2-2, 2-40, 5-3
R955106793X	2-2, 2-40, 5-3
R955106978X	2-2, 2-21, 5-3
R955106985X	2-2, 2-21, 5-3
R955107023X	2-2, 2-27, 5-3
R955107221X	2-2, 2-21, 5-3
R955107433X	5-3, 5-22
R955107454N	3-2, 3-7, 5-3
R955107506X	2-2, 2-32, 5-3, 5-4, 5-7, 5-15, 5-16, 5-17, 5-18, 5-20, 5-21, 5-22
R955107507X	2-2, 2-32, 5-3, 5-4, 5-7, 5-14, 5-15, 5-16, 5-17, 5-18, 5-19, 5-21, 5-22, 5-29, 5-30
R955107508X	2-2, 2-27, 5-1, 5-3, 5-4, 5-5, 5-7, 5-16, 5-17, 5-18
R955107509X	2-2, 2-27, 5-1, 5-3, 5-4, 5-15, 5-17, 5-18
R955107510X	2-2, 2-51, 5-3, 5-14, 5-17, 5-19
R955107511X	2-2, 2-51, 5-3, 5-4, 5-14, 5-17, 5-20, 5-22
R955107512X	2-2, 2-42, 5-1, 5-3, 5-4, 5-15, 5-17, 5-22, 5-31
R955107513X	2-2, 2-42, 5-3

Part Number	Page(s)
R955107514X	2-2, 2-19, 5-3, 5-4, 5-6, 5-7, 5-10, 5-15, 5-16, 5-17, 5-18, 5-20, 5-21, 5-22, 5-29
R955107515N	5-3, 5-7
R955107516N	5-3
R955107526X	2-2, 2-29, 5-3
R955107539X	4-3, 4-55, 5-3
R955107622X	2-2, 2-42, 5-3, 5-5, 5-9, 5-10, 5-16, 5-17, 5-18, 5-19, 5-20, 5-22, 5-29
R955107623X	2-2, 2-42, 5-3, 5-5, 5-10, 5-15, 5-16, 5-17, 5-18, 5-19, 5-29
R955107695N	3-2, 3-11, 3-19, 5-3, 5-30
R955107794PGX	3-2, 3-18, 5-3, 5-28
R955107794PGXCF	3-18
R955107794X	3-2, 3-18, 5-3, 5-19, 5-21, 5-25, 5-26, 5-30, 5-31
R955107794XCF	3-2, 3-18, 5-3, 5-28
R955107796N	3-2, 3-18, 5-3, 5-8, 5-19, 5-20, 5-21, 5-28, 5-30
R955107799N	3-2, 3-18, 5-3, 5-4, 5-20, 5-23, 5-30
R955107800N	3-2, 3-18, 5-4, 5-22, 5-30
R955107813X	2-2, 2-42, 5-3, 5-4, 5-8, 5-10, 5-15, 5-17, 5-18, 5-19, 5-22, 5-29
R955107836X	2-3, 2-44, 5-4
R955107866X	2-3, 2-19, 5-4
R955107869X	2-3, 2-51, 5-4
R955107896X	3-2, 3-3, 3-19, 5-4
R955107917X	2-3, 2-27, 5-4
R955107981X	2-3, 2-27, 5-1, 5-3, 5-4, 5-5, 5-6, 5-15, 5-16, 5-17, 5-18, 5-20, 5-22
R955108066X	2-3, 2-19, 5-4
R955108076X	4-3, 4-55, 5-1, 5-4
R955108110X	2-3, 2-19, 5-4, 5-7, 5-10, 5-17, 5-18, 5-20, 5-22, 5-31
R955108261X	2-3, 2-33, 5-4
R955108269X	2-3, 2-31, 5-4, 5-15
R955108272X	5-4
R955108273X	2-3, 2-31, 5-4
R955108277X	5-4
R955108329X	2-3, 2-51, 5-4
R955108557X	2-3, 2-42, 5-4, 5-6, 5-17
R955108779X	2-3, 2-44, 5-4
R955108790X	2-3, 2-33, 5-4

Part Number	Page(s)
R955108804X	2-3, 2-32, 5-4, 5-17, 5-18, 5-21
R955108854X	5-4
R955108866X	2-3, 2-51, 5-4, 5-14, 5-16, 5-17, 5-18, 5-20
R955108869X	2-3, 2-51, 5-4
R955108935X	2-3, 2-54, 5-4
R955108937X	2-3, 2-54, 5-4
R955109079X	2-3, 2-33, 5-4
R955109088X	2-3, 2-26, 5-4
R955109111X	2-3, 2-26, 5-4, 5-7, 5-8
R955109142X	2-3, 2-27, 5-4
R955109147X	2-3, 2-52
R955109219X	2-3, 2-47, 5-4
R955109251X	2-3, 2-25, 5-1, 5-4, 5-5, 5-6, 5-16, 5-17, 5-18, 5-20, 5-22
R955109264X	4-3, 4-44, 5-4
R955109273X	2-3, 2-29, 5-4
R955109287X	2-3, 2-25, 5-1, 5-4, 5-5, 5-6, 5-7, 5-16, 5-18
R955109440X	2-3, 2-44, 5-5
R955109451X	2-3, 2-26, 5-5
R955109477PGX	3-2, 3-21, 5-5
R955109477PGXCF	3-21
R955109477X	3-2, 3-21, 5-5, 5-6, 5-8, 5-15, 5-16, 5-17, 5-18, 5-26
R955109477XCF	3-2, 3-21, 5-5, 5-28
R955109478X	3-2, 3-21, 5-5, 5-16, 5-17, 5-18
R955109478XCF	3-21, 5-5, 5-28
R955109493PGX	3-2, 3-21, 5-5, 5-29
R955109493PGXCF	3-21
R955109493X	3-2, 3-21, 5-5, 5-15, 5-19, 5-26
R955109493XCF	3-2, 3-21, 5-5, 5-28
R955109494N	3-2, 3-18, 3-23, 5-5
R955109495N	3-2, 3-23, 3-25, 3-29, 5-5, 5-20, 5-30, 5-31
R955109496N	3-2, 3-23, 3-25, 3-29, 5-5, 5-20, 5-30, 5-31
R955109503X	3-2, 3-21, 5-5
R955109578N	3-2, 3-18, 5-5, 5-20, 5-30
R955109579N	3-3, 3-18, 5-5, 5-20, 5-30
R955109603X	2-3, 2-27, 5-5
R955109604X	2-3, 2-27, 5-1, 5-3, 5-4, 5-5, 5-6, 5-7, 5-15, 5-16, 5-17, 5-18
R955109615N	5-5, 5-18, 5-30

Part Number	Page(s)
R955109617N	5-1, 5-5, 5-28
R955109653X	2-3, 2-32, 5-5, 5-17, 5-18
R955109659X	5-1, 5-5
R955109685HX	3-5, 3-17, 5-5, 5-17, 5-22
R955109685N	3-17, 5-5, 5-22
R955109685NP	3-17, 5-5, 5-21, 5-22
R955109685PGX	3-3, 3-18, 5-5, 5-22
R955109685PGXCF	3-17
R955109685XP	5-5
R955109685XPCF	5-5
R955109687X	3-3, 3-17, 5-5
R955109688X	3-3, 3-17, 5-5
R955109689N	3-17
R955109689PGX	3-18, 5-5
R955109689PGXCF	3-17
R955109689X	3-3, 3-17, 5-5, 5-16
R955109690X	3-3, 3-17, 5-5
R955109691X	3-3, 3-17, 5-5
R955109869N	3-3, 3-19, 3-23, 3-27, 5-5, 5-14, 5-20, 5-30, 5-31
R955109871N	3-3, 3-19, 3-23, 3-27, 5-5, 5-14
R955109991PGX	3-25, 5-5
R955109991X	3-3, 3-25, 5-5, 5-26
R955109991XCF	3-3, 3-25, 5-5, 5-18, 5-28
R955109992PGX	3-25, 5-5
R955109992X	3-3, 3-25, 5-5
R955109992XCF	3-3, 3-25, 5-5
R955109993N	3-3, 3-25, 5-5, 5-30
R955109995N	3-3, 3-27, 5-5, 5-8, 5-30
R955131081N	5-6, 5-19, 5-25, 5-30
R955153100	2-46
R955153101	2-25, 2-26
R955153102	2-14, 2-21, 2-22
R955153103	2-12, 2-46, 2-48
R955153106	2-24, 2-25, 2-27, 2-28, 2-29, 2-30, 2-47, 2-49, 2-50
R955153108	2-31, 2-32, 2-38
R955153109	2-33, 2-38
R955153110	2-15, 2-24, 2-39, 2-40, 2-41, 2-43, 2-44, 2-45, 2-46
R955153111	2-49, 2-50, 2-51, 2-52, 2-53, 2-54
R955153112	2-26, 2-27, 2-47, 2-50, 2-51

Part Number	Page(s)
R955153113	2-20, 2-43
R955153114	2-52, 2-53
R955153115	2-38
R955153116	2-53
R955153150	2-19, 2-21, 2-25, 2-26, 2-27, 2-32, 2-42, 2-47, 2-51, 2-54
R955205105N	3-3, 3-7, 3-19, 5-8, 5-20, 5-25
R955225892X	4-3, 4-17, 5-8
R955227320X	2-3, 2-17, 5-9, 5-14
R955227321X	2-3, 2-17, 5-9
R955227322X	2-3, 2-17, 5-9, 5-17
R955227323X	2-3, 2-17, 5-9, 5-11, 5-12, 5-14
R955227326X	2-3, 2-49, 5-9
R955227331X	2-3, 2-16, 5-9
R955227332X	2-3, 2-16, 5-9
R955227355X	5-9
R955227400X	2-3, 2-13, 5-9
R955227401X	2-3, 2-13, 5-9
R955227402X	2-3, 2-13, 5-9
R955227403X	2-3, 2-13, 5-9
R955227406X	2-3, 2-12, 5-9
R955227407X	2-3, 2-12, 5-1, 5-9
R955227408X	2-3, 2-14, 5-9
R955227409X	2-3, 2-14, 5-9
R955227410X	2-3, 2-14, 5-9
R955227414X	2-4, 2-15, 5-9, 5-10, 5-11, 5-12
R955227661X	4-3, 4-60, 5-9
R955227672X	4-3, 4-60, 5-9
R955227870	5-9, 5-18, 5-20, 5-21, 5-23, 5-25, 5-29, 5-31
R955227870N	4-3, 4-11, 5-9, 5-18, 5-23, 5-25, 5-29, 5-30
R955227871	5-9, 5-18, 5-20, 5-21, 5-23, 5-25, 5-29, 5-30, 5-31
R955227871N	4-3, 4-11, 5-8, 5-9, 5-18, 5-23, 5-25, 5-29, 5-30
R955228050X	4-3, 4-11, 5-9, 5-22
R955228138X	5-9
R955228141X	2-4, 2-15, 5-9
R955228165X	4-3, 4-11, 5-9
R955228287X	5-9
R955228344X	5-9
R955228346X	2-4, 2-15, 5-9
R955228366X	2-4, 2-16, 5-9
R955228443X	2-4, 2-31, 5-9
R955228451X	5-9

Part Number	Page(s)
R955228479X	2-4, 2-15, 5-9, 5-15
R955228520X	4-3, 4-11, 5-9, 5-22
R955228600N	4-3, 4-59, 5-2, 5-8, 5-9, 5-10, 5-19, 5-20, 5-21, 5-26, 5-30, 5-31
R955228750N	4-3, 4-59, 5-2, 5-8, 5-9, 5-19, 5-20, 5-21, 5-30, 5-31
R955228750X	4-3, 4-59, 5-9
R955229077X	2-4, 2-12, 5-9
R955229078X	2-4, 2-46, 5-9
R955229415N	2-12
R955229434X	4-3, 4-51, 5-9
R955229467X	4-3, 4-41, 5-9, 5-26
R955229493X	4-3, 4-11, 5-9, 5-22
R955229500N	5-9
R955229500X	4-3, 4-24, 5-9
R955229501N	5-9, 5-10, 5-23, 5-28
R955229501X	4-3, 4-24, 5-9
R955229505N	5-9, 5-20, 5-21, 5-28, 5-30, 5-31
R955229505X	4-3, 4-38, 5-9
R955229507N	5-9, 5-28
R955229507X	4-3, 4-38, 5-9
R955229509N	5-9, 5-28
R955229509X	4-3, 4-38, 5-9
R955229525X	2-4, 2-31, 5-9
R955229542X	5-9
R955229544X	5-9
R955229562X	5-9
R955229608X	4-3, 4-16, 5-9
R955229635N	4-3, 4-16, 5-2, 5-8, 5-9, 5-19, 5-20, 5-21, 5-22, 5-25, 5-28, 5-29, 5-30, 5-31
R955229635X	4-3, 4-16, 5-9
R955229813N	4-3, 4-36, 5-9, 5-19, 5-20, 5-25, 5-28
R955229813X	4-3, 4-36, 5-9
R955229844X	4-3, 4-36, 5-9
R955229859N	4-3, 4-36, 5-2, 5-8, 5-9, 5-19, 5-20, 5-21, 5-22, 5-26, 5-28, 5-29, 5-30, 5-31
R955229859X	4-3, 4-36, 5-9
R955229860N	4-3, 4-36, 5-1, 5-2, 5-9, 5-19, 5-20, 5-21, 5-22, 5-25, 5-26, 5-28, 5-29, 5-30, 5-31
R955229860X	4-3, 4-36, 5-9
R955229990X	2-4, 2-20, 5-9
R955275113X	2-4, 2-12, 5-10

# NUMERIC PARTS LIST

Part Number	Page(s)
R955275114X	2-4, 2-12, 5-10
R955275317X	2-4, 2-13, 5-10
R955275491	2-4, 2-11, 5-7, 5-10, 5-19, 5-21, 5-22, 5-28, 5-29, 5-31
R955275491X	2-4, 2-11, 5-10, 5-22
R955275509N	5-10
R955275615N	2-31, 2-42, 2-43, 2-44
R955275707X	2-4, 2-11, 5-10
R955275777X	2-4, 2-40, 5-10
R955275834X	5-10
R955275990X	2-4, 2-15, 5-10
R955276111X	5-10
R955276166X	2-4, 2-39, 5-10
R955276270X	4-3, 4-29, 5-10
R955276272X	4-3, 4-29, 5-10
R955276462	5-10, 5-20, 5-28
R955276462N	5-8, 5-10
R955276462X	4-3, 4-13, 5-8, 5-10, 5-21, 5-26, 5-30
R955276566	5-10, 5-21, 5-22, 5-26, 5-28, 5-29, 5-31
R955276566N	4-3, 5-2, 5-8, 5-10, 5-19, 5-20, 5-21, 5-22, 5-26, 5-28, 5-29, 5-30
R955276566X	4-3, 4-13, 5-10, 5-22
R955276567	5-10, 5-21, 5-26, 5-28, 5-29, 5-31
R955276567N	4-3, 4-13, 5-2, 5-8, 5-10, 5-19, 5-21, 5-22, 5-26, 5-28, 5-29, 5-30
R955276567X	4-3, 4-13, 5-10, 5-13, 5-22
R955276777X	2-4, 2-43, 5-10
R955276778X	2-4, 2-39, 5-10
R955276961X	2-4, 2-40, 5-10, 5-14
R955276962X	2-4, 2-40, 5-10, 5-18
R955276974X	2-4, 2-31, 5-10
R955276978X	5-10
R955277122X	2-4, 2-50, 5-10
R955277144X	4-3, 4-35, 5-10
R955277147N	4-4, 4-33, 5-8, 5-10, 5-20, 5-21, 5-28, 5-30
R955277148N	4-4, 4-33, 5-10
R955277148X	4-4, 4-33, 5-10
R955277214X	4-4, 4-35, 5-10
R955277226X	4-4, 4-33, 5-10
R955277227X	4-4, 4-33, 5-10
R955277340X	4-4, 4-30, 5-10
R955277446X	4-4, 4-51, 5-10
R955277694X	2-4, 2-17, 5-10

Part Number	Page(s)
R955277730X	2-4, 2-24, 5-10
R955277731X	2-4, 2-24, 5-10
R955277799X	5-10
R955277855X	5-10
R955277863N	4-4, 4-24, 5-2, 5-10, 5-20, 5-21, 5-23, 5-25, 5-28, 5-29, 5-30, 5-31
R955277863X	4-4, 4-24, 5-10
R955277901X	2-4, 2-49, 5-10
R955277920X	5-10
R955278426X	4-4, 4-35, 5-10, 5-21, 5-26
R955278445X	2-4, 2-40, 5-10
R955278452X	5-10
R955278482N	5-10
R955278596X	4-4, 4-12, 5-10
R955278598N	4-4, 4-12, 5-10, 5-24
R955278598X	5-10, 5-24
R955278604X	2-4, 2-49, 5-10
R955278605X	5-10, 5-14
R955278614N	4-4, 4-12, 5-8, 5-10, 5-19, 5-20, 5-22, 5-24, 5-30
R955278615N	4-4, 4-12, 5-10, 5-24, 5-30
R955278615X	4-4, 4-12, 5-10
R955278681X	2-4, 2-40, 5-10
R955278825N	4-4, 4-34, 5-11, 5-30
R955278825X	4-4, 4-34, 5-11
R955278998N	5-2, 5-11, 5-28
R955278998X	4-4, 4-24, 5-11
R955279000N	4-4, 4-60, 5-2, 5-8, 5-11, 5-19, 5-20, 5-21, 5-25, 5-26, 5-28, 5-29, 5-30, 5-31
R955279000X	4-4, 4-60, 5-11
R955279024X	2-4, 2-13, 5-11
R955279025X	2-4, 2-13, 5-11
R955279037X	2-4, 2-14, 5-11
R955279040N	5-11
R955279068X	2-4, 2-40, 5-11
R955279176X	2-4, 2-13, 5-11
R955279180	5-11, 5-21, 5-26, 5-28, 5-29, 5-31
R955279180N	4-4, 4-41, 5-2, 5-11, 5-20, 5-21, 5-24, 5-26, 5-28, 5-29, 5-30
R955279180X	4-4, 4-41, 5-11, 5-24
R955279416N	4-4, 4-59, 5-2, 5-8, 5-11, 5-20, 5-21, 5-22, 5-30, 5-31
R955279525X	5-11

Part Number	Page(s)
R955279556X	5-11, 5-14
R955279580X	5-11
R955279614N	2-12, 2-13, 2-14, 2-15, 2-24, 2-39, 5-11
R955279615N	2-15, 2-16, 2-17, 2-18, 2-19, 2-20, 2-24, 2-25, 2-27, 2-28, 2-29, 2-31, 2-32, 2-39, 2-40, 2-41, 2-42, 2-43, 2-46, 2-47, 2-48, 2-49, 2-50, 2-51, 2-52, 5-11
R955279692X	5-11
R955279787X	4-4, 4-14, 5-11, 5-26, 5-30
R955279839X	5-11
R955279950N	4-4, 4-24, 5-11, 5-20, 5-28
R955279950X	4-4, 4-24, 5-11
R955279952	5-11, 5-28
R955279952N	4-4, 4-41, 5-11, 5-19, 5-20, 5-28, 5-30
R955279952X	4-4, 4-41, 5-11, 5-19, 5-30
R955279962X	4-4, 4-60, 5-11
R955279995X	2-4, 2-49, 5-11
R955280243X	4-4, 4-41, 5-11
R955280369X	2-4, 2-40, 5-11
R955280375X	4-4, 4-41, 5-11, 5-21, 5-26, 5-29
R955280422X	5-11
R955280454X	4-4, 4-13, 5-11
R955280501X	5-11
R955280511N	2-12, 2-13, 2-15, 2-17, 2-18, 2-19, 2-21, 2-22, 2-23, 5-11
R955280512N	2-14, 2-15, 2-16, 2-46
R955280551X	5-11
R955280556X	2-4, 2-49, 5-11
R955280602X	2-4, 2-17, 5-11
R955280603X	2-4, 2-17, 5-11
R955280604X	2-4, 2-17, 5-11
R955280608X	2-4, 2-49, 5-11
R955280609X	2-4, 2-40, 5-11
R955280610X	2-4, 2-16, 5-11
R955280611X	2-4, 2-16, 5-11
R955280613X	2-4, 2-17, 5-11
R955280622X	2-4, 2-31, 5-11
R955280626X	2-4, 2-31, 5-11
R955280628X	2-5, 2-50, 5-11
R955280651X	4-4, 4-41, 5-11
R955280758X	4-4, 4-31, 5-11, 5-30
R955280774X	2-5, 2-49, 5-11

Part Number	Page(s)
R955280809N	4-4, 4-12, 5-8, 5-11, 5-24
R955280809X	5-11, 5-21, 5-24, 5-25
R955280904X	4-4, 4-17, 5-11
R955280905X	4-4, 4-17, 5-11
R955281024N	5-11, 5-28
R955281024X	4-4, 4-36, 5-11
R955281042X	2-5, 2-39, 5-11, 5-18
R955281086X	5-11
R955281112X	2-5, 2-39, 5-11
R955281157X	2-5, 2-49, 5-11
R955281318X	4-4, 4-31, 5-11, 5-30
R955281338X	5-11
R955281430X	5-11
R955281587X	4-4, 4-13, 5-11, 5-26, 5-30
R955281718X	5-11
R955281761X	5-11
R955281797X	4-4, 4-29, 5-11
R955281860N	5-11, 5-25, 5-28, 5-30
R955281860X	4-4, 4-52, 5-11
R955281865	5-11, 5-21, 5-25, 5-28, 5-29, 5-31
R955281865N	4-4, 4-52, 5-2, 5-8, 5-11, 5-19, 5-20, 5-21, 5-22, 5-25, 5-28, 5-29, 5-30
R955281865X	4-4, 4-52, 5-11
R955281923N	4-4, 4-23, 5-8, 5-11, 5-20, 5-22, 5-23, 5-25, 5-28, 5-30, 5-31
R955281923X	4-4, 4-23, 5-11, 5-23
R955281924X	5-11
R955281946X	4-4, 4-14, 5-7, 5-11
R955282013X	2-5, 2-39, 5-11
R955282023X	5-11
R955282025X	2-5, 2-24, 5-11
R955282076X	2-5, 2-17, 5-11
R955282368X	4-4, 4-18, 5-11
R955282381X	4-4, 4-18, 5-11
R955282472X	4-4, 4-34, 5-11
R955282586X	2-5, 2-49, 5-12
R955282620X	5-12
R955282621X	2-5, 2-49, 5-12, 5-14
R955282749X	5-12
R955283040X	4-4, 4-17, 5-12
R955283046X	5-12
R955283090X	4-4, 4-60, 5-12
R955283429X	2-5, 2-13, 5-12
R955283505X	2-5, 2-12, 5-12
R955283506X	2-5, 2-14, 5-12
R955283513X	2-5, 2-46, 5-12

Part Number	Page(s)
R955283514X	2-5, 2-16, 5-12
R955283533X	2-5, 2-24, 5-12
R955283577X	2-5, 2-50, 5-12
R955283644X	5-12
R955283664X	5-12
R955283690X	2-5, 2-17, 5-12
R955283692X	2-5, 2-50, 5-12
R955283711X	5-12
R955283808X	5-12
R955283935X	4-4, 4-17, 5-12
R955283940X	4-5, 4-41, 5-12
R955284010X	5-12
R955284106X	2-5, 2-39, 5-12, 5-15
R955284142N	5-19, 5-25, 5-27, 5-30
R955284160X	5-12
R955284252X	5-12
R955284260X	2-5, 2-49, 5-12
R955284307X	2-5, 2-49, 5-12
R955284310X	2-5, 2-49, 5-12
R955284358N	2-5, 2-11, 5-8, 5-10, 5-12, 5-15, 5-18, 5-19, 5-20, 5-21, 5-22, 5-28, 5-29, 5-30
R955284358X	2-5, 2-11, 5-12, 5-18, 5-22, 5-25, 5-30, 5-31
R955284374X	2-5, 2-12, 5-12
R955284412N	5-12, 5-23, 5-25, 5-28, 5-30
R955284662X	2-5, 2-49, 5-12
R955284699X	2-5, 2-31, 5-12, 5-18
R955284714X	2-5, 2-31, 5-12
R955284718X	2-5, 2-31, 5-12
R955284727X	5-12
R955284744X	4-5, 4-14, 5-12
R955284760	5-12, 5-21, 5-25, 5-28, 5-30, 5-31
R955284760N	4-5, 4-26, 5-12, 5-20, 5-30
R955284760X	4-5, 4-26, 5-12
R955284959X	2-5, 2-31, 5-12, 5-15
R955285107X	5-12
R955285108X	2-5, 2-49, 5-12
R955285252X	2-5, 2-39, 5-12
R955285275X	5-12
R955286171N	4-5, 4-27, 5-2, 5-8, 5-12, 5-19, 5-20, 5-21, 5-23, 5-25, 5-28, 5-29, 5-30, 5-31
R955286171X	4-5, 4-27, 5-12
R955286364N	4-5, 4-54, 5-8, 5-12, 5-19, 5-20, 5-22, 5-28, 5-30

Part Number	Page(s)
R955286364X	4-5, 4-54, 5-12, 5-21, 5-26, 5-30, 5-31
R955286370N	4-5, 4-42, 5-8, 5-12, 5-20, 5-21, 5-26, 5-28, 5-29, 5-30, 5-31
R955286370X	4-5, 4-42, 5-12
R955286371N	5-12, 5-28, 5-29
R955286371X	4-5, 4-42, 5-12
R955286471X	5-12
R955286500	5-12, 5-20, 5-25, 5-28
R955286500N	4-5, 4-33, 5-8, 5-12, 5-30
R955286500X	4-5, 4-33, 5-12
R955286526X	2-5, 2-18, 5-12
R955286527X	2-5, 2-18, 5-12, 5-13, 5-20, 5-22
R955286528X	2-5, 2-18, 5-12, 5-14, 5-17, 5-20, 5-22, 5-31
R955286529X	2-5, 2-18, 5-12
R955286530X	2-5, 2-18, 5-12
R955286532X	2-5, 2-18, 5-12
R955286533X	2-5, 2-18, 5-12
R955286536X	2-5, 2-19, 5-12
R955286537X	2-5, 2-19, 5-12
R955286538X	2-5, 2-41, 5-12
R955286539X	2-5, 2-41, 5-12, 5-20, 5-22
R955286540X	2-5, 2-41, 5-12
R955286542X	2-5, 2-41, 5-12, 5-15
R955286543X	2-5, 2-41, 5-12, 5-15
R955286544X	2-5, 2-50, 5-12, 5-14, 5-15, 5-20, 5-22
R955286546X	2-5, 2-25, 5-12, 5-15
R955286548X	2-5, 2-25, 5-12
R955286549X	2-6, 2-25, 5-12
R955286550X	2-6, 2-24, 5-12
R955286551X	2-6, 2-24, 5-12
R955286552X	2-6, 2-24, 5-1, 5-12
R955286554X	2-6, 2-32, 5-12, 5-14, 5-31
R955286555X	2-6, 2-32, 5-12, 5-13, 5-31
R955286556X	2-6, 2-46, 5-12
R955286558X	2-6, 2-46, 2-48, 5-12
R955286560X	2-6, 2-18, 5-12, 5-13, 5-14
R955286561X	2-6, 2-46, 5-13
R955286562X	2-6, 2-46, 5-13
R955286563X	2-6, 2-54, 5-13
R955286564X	2-6, 2-46, 5-13
R955286565X	2-6, 2-46, 5-13
R955286566X	2-6, 2-24, 5-13

# NUMERIC PARTS LIST

Part Number	Page(s)
R955286567X	2-6, 2-18, 5-13
R955286571X	2-6, 2-50, 5-13
R955286572X	2-6, 2-50, 5-13
R955286574X	2-6, 2-51, 5-13
R955286576X	2-6, 2-19, 5-13, 5-20, 5-22
R955286579X	2-6, 2-41, 5-13
R955286580X	2-6, 2-18, 5-13
R955286581X	2-6, 2-41, 5-13, 5-20, 5-22
R955286582X	2-6, 2-18, 5-13
R955286585X	2-6, 2-19, 5-13
R955286586X	2-6, 2-18, 5-13
R955286589X	2-6, 2-18, 5-13
R955286591X	2-6, 2-18, 5-13
R955286592X	2-6, 2-18, 5-13
R955286595X	2-6, 2-18, 5-13
R955286617X	2-6, 2-18, 5-13
R955286620X	2-6, 2-50, 5-13, 5-14, 5-20, 5-22
R955286621X	2-6, 2-51, 5-13
R955286623X	2-6, 2-41, 5-13, 5-20, 5-22
R955286773X	4-5, 4-26, 5-13
R955286775	5-13, 5-28
R955286775X	4-5, 4-26, 5-13
R955286836X	5-13
R955286892N	5-13
R955286892X	4-5, 4-42, 5-13
R955286934X	3-3, 3-7, 5-13
R955286934XCF	3-3, 3-7, 5-13, 5-28
R955286936X	3-3, 3-7, 5-13
R955287043N	5-13
R955287053N	3-9, 5-13, 5-31
R955287114N	4-5, 4-42, 5-13, 5-28, 5-30
R955287114X	4-5, 4-42, 5-13
R955287224N	5-8, 5-13
R955287224X	4-5, 4-42, 5-13
R955287238N	4-5, 4-15, 5-2, 5-13, 5-20, 5-21, 5-28, 5-29, 5-31
R955287238X	4-5, 4-15, 5-13
R955287240X	4-5, 4-15, 5-13
R955287260N	5-13, 5-28
R955287260X	4-5, 4-42, 5-13
R955287279X	5-13
R955287298N	3-3, 3-7, 5-13, 5-30
R955287313N	5-13
R955287376	5-13, 5-21, 5-28, 5-30, 5-31
R955287376N	4-5, 4-54, 5-8, 5-13, 5-20, 5-28

Part Number	Page(s)
R955287376X	4-5, 4-54, 5-13, 5-30
R955287411	5-13, 5-28
R955287411N	4-5, 4-26, 5-13
R955287411X	4-5, 4-26, 5-13
R955287417	5-8, 5-13, 5-28
R955287417N	5-7, 5-13, 5-21, 5-26, 5-28, 5-29
R955287417X	4-5, 4-13, 5-13
R955287418X	4-5, 4-15, 5-13, 5-26
R955287564	5-13, 5-28
R955287564X	4-5, 4-26, 5-1, 5-13
R955287600	5-13, 5-28
R955287600N	4-5, 4-13, 5-13, 5-20, 5-28
R955287600X	5-13, 5-21, 5-26, 5-29
R955287637	5-13, 5-28
R955287637X	4-5, 4-13, 5-13
R955288063X	4-5, 4-54, 5-12, 5-13
R955288239	5-13, 5-21, 5-22, 5-28, 5-29, 5-31
R955288239N	4-5, 4-15, 5-2, 5-8, 5-13, 5-19, 5-20, 5-21, 5-28, 5-29, 5-30
R955288239X	4-5, 4-15, 5-7, 5-13, 5-14
R955288240X	4-5, 4-15, 5-13
R955288241	5-13, 5-21, 5-26, 5-28, 5-30, 5-31
R955288241N	4-5, 4-15, 5-13, 5-19, 5-20, 5-22, 5-26, 5-28, 5-30, 5-31
R955288241X	4-5, 4-15, 5-13
R955288242X	4-5, 4-15, 5-13
R955288251X	4-5, 4-36, 5-13, 5-28, 5-29
R955288301N	4-5, 4-61, 5-13, 5-28, 5-30
R955288301X	4-5, 4-61, 5-13
R955288323	5-14, 5-20, 5-21, 5-25, 5-26, 5-30
R955288323X	4-5, 4-33, 5-14, 5-30
R955288369N	5-14, 5-28
R955288369X	4-5, 4-42, 5-14
R955288383	5-14, 5-20, 5-28
R955288383N	4-5, 4-26, 5-14, 5-30
R955288383X	4-5, 4-26, 5-14, 5-21, 5-30, 5-31
R955288586X	4-5, 4-31, 5-14
R955288605N	4-5, 4-61, 5-8, 5-14, 5-19, 5-20, 5-21, 5-28, 5-30
R955288605X	4-5, 4-61, 5-8, 5-14, 5-26, 5-30, 5-31

Part Number	Page(s)
R955288645X	4-5, 4-62, 5-14
R955288710X	5-14
R955288721	5-14, 5-28
R955288746	5-14, 5-20, 5-28
R955288746N	4-5, 4-14, 5-14, 5-21, 5-26, 5-30, 5-31
R955288746X	4-5, 4-14, 5-14
R955288755N	5-14, 5-28
R955288755X	4-5, 4-42, 5-14
R955289144N	4-5, 4-39, 5-14, 5-20, 5-21, 5-25, 5-26, 5-28, 5-29, 5-31
R955289146X	5-14
R955289148X	4-5, 4-39, 5-8, 5-14, 5-21, 5-30
R955289149X	5-14
R955289172X	5-14
R955289182X	4-5, 4-37, 5-14
R955289253X	5-3, 5-14, 5-22
R955289336X	2-6, 2-28, 5-14
R955289339X	2-6, 2-31, 5-14, 5-17
R955289340X	2-6, 2-52, 5-14, 5-15, 5-28
R955289342X	2-6, 2-43, 5-14
R955289348X	2-6, 2-50, 5-14
R955289349X	2-6, 2-24, 5-14, 5-17
R955289350X	2-6, 2-17, 5-14, 5-17
R955289380X	5-14
R955289444X	2-6, 2-39, 5-14
R955289477	5-14, 5-28
R955289477X	4-5, 4-14, 5-14
R955289512X	4-5, 4-14, 5-14
R955289545X	5-14
R955289688X	2-6, 2-13, 5-14
R955289714N	4-5, 4-37, 5-8, 5-14, 5-19, 5-20, 5-21, 5-25, 5-28, 5-29, 5-30, 5-31
R955289714X	4-5, 4-37, 5-14
R955289744X	2-6, 2-27, 5-14
R955289789X	2-6, 2-40, 5-14
R955289790X	2-6, 2-40, 5-14
R955289915X	2-6, 2-40, 5-14
R955289924X	2-6, 2-20, 5-14
R955289925X	2-7, 2-40, 5-14, 5-15, 5-17, 5-18
R955289941X	2-7, 2-40, 5-14
R955289964X	2-7, 2-40, 5-14
R955298817N	5-8, 5-14, 5-30
R955298818N	5-14, 5-30
R955401004	5-5, 5-12, 5-15, 5-20, 5-25

Part Number	Page(s)
R955401018	5-15
R955401019	5-15
R955401029	5-15
R955401039	5-15
R955401040	5-15
R955401045	5-5, 5-6, 5-8, 5-15, 5-25, 5-29, 5-31
R955401047	5-5, 5-15
R955401056	5-15
R955401075	5-15
R955401084	5-15
R955401095	5-15
R955602302N	3-31
R955619110N	3-31
R955620602N	3-31
R955800333N	4-6, 4-36, 5-8, 5-18, 5-19, 5-20, 5-22, 5-31
R955800350N	3-3, 3-7, 3-19, 3-23, 3-27, 5-8, 5-18, 5-20, 5-25, 5-30, 5-31
R955800376N	5-8, 5-18, 5-22, 5-31
R955800404N	3-2, 3-3, 3-21, 5-8, 5-18, 5-31
R955800405N	3-2, 3-3, 3-18, 5-5, 5-18, 5-19, 5-22, 5-31
R955800516N	4-6, 4-21, 5-1, 5-8, 5-17, 5-18, 5-19, 5-22, 5-23, 5-31
R955800517N	4-6, 4-21, 5-1, 5-17, 5-18, 5-23, 5-31
R955800518N	4-6, 4-21, 5-17, 5-18, 5-23, 5-31
R955800519N	4-6, 4-21, 5-1, 5-17, 5-18, 5-19, 5-23, 5-31
R955800521N	4-6, 4-21, 5-18
R955800573N	4-6, 4-21, 5-1, 5-17, 5-18, 5-19, 5-23
R955800629N	4-6, 4-28, 5-18, 5-19, 5-22, 5-31
R9553018527X	2-7, 2-34, 5-14
R9553018532X	5-14
R9553018543X	2-34
R9553047440X	2-7, 2-38, 5-15
R9553048680X	2-7, 2-35, 5-15
R9553049186X	2-7, 2-38, 5-12, 5-14, 5-15, 5-20, 5-22
R9553052776X	2-7, 2-34, 5-15
R9553558000X	2-7, 2-53, 5-14, 5-15
R9553558005X	2-7, 2-35, 5-15
R9553558006X	2-7, 2-35, 5-15
R9553558010X	2-7, 2-45, 5-15
R9553558013X	2-7, 2-35, 5-15

Part Number	Page(s)
R9553558020X	2-7, 2-35, 5-15
R9553558021X	2-7, 2-35, 5-15
R9553558022X	2-7, 2-35, 5-15
R9553558023X	2-7, 2-35, 5-15
R9553558027X	2-7, 2-36, 5-15
R9553558029X	2-7, 2-53, 5-15
R9553558042X	2-7, 2-53, 5-15
R9553558043X	2-7, 2-53, 5-14, 5-15
R9553558044X	2-7, 2-35, 5-15
R9553558045X	2-7, 2-35, 5-15
R9553558046X	2-7, 2-35, 5-15
R9553558049X	2-7, 2-34, 5-15
R9553558050X	2-7, 2-34, 5-15
R9553558051X	2-7, 2-33, 5-15
R9553558052X	2-7, 2-33, 5-15
R9553558068X	2-7, 2-52, 5-14, 5-15
R9553558072X	2-7, 2-34, 5-15, 5-26, 5-30
R9553558074X	2-7, 2-34, 5-15, 5-30
R9553558075X	2-7, 2-52, 5-15
R9553558076X	2-7, 2-52, 5-15
R9553558077X	2-7, 2-52, 5-14, 5-15
R9553558094X	2-7, 2-33, 5-15
R9553558095X	2-7, 2-33, 5-15
R9553558097X	5-15
R9553558098X	2-7, 2-34, 5-15
R9553558113X	2-7, 2-33, 5-15
R9553558122X	2-7, 2-33, 5-15
R9553558186X	2-7, 2-33, 5-15
R9553558189X	2-7, 2-33, 5-15
R9553558208X	2-34
R9553558211X	5-15
R9553558212X	2-36
R9553559511	2-38, 2-53
R9553559545N	5-15
R9553559551N	5-15
R9553559568N	5-15
R9553559570X	2-33
R9553559576N	5-15
R9555000404X	5-16
R9555000709X	3-3, 3-21, 5-16
R9555001247N	3-23
R9555001940X	2-7, 2-26, 5-1, 5-4, 5-6, 5-16, 5-18
R9555002595N	3-3, 3-18, 5-16, 5-30
R9555002713X	2-7, 2-26, 5-1, 5-5, 5-6, 5-7, 5-16, 5-18
R9555002865X	2-7, 2-51, 5-3, 5-14, 5-16, 5-18, 5-26

Part Number	Page(s)
R9555002868X	2-7, 2-51, 5-3, 5-14, 5-16, 5-18
R9555002983X	2-7, 2-26, 5-1, 5-2, 5-4, 5-5, 5-6, 5-7, 5-16, 5-17, 5-18, 5-19
R9555002984X	2-7, 2-26, 5-1, 5-2, 5-4, 5-5, 5-6, 5-8, 5-16, 5-18, 5-26
R9555003547N	3-3, 3-21, 3-29, 5-16, 5-30
R9555004049N	3-29
R9555004050PGX	3-29, 5-16
R9555004050PGXCF	3-29
R9555004050X	3-29, 5-16
R9555004050XCF	3-29
R9555004118X	2-7, 2-26, 5-1, 5-6, 5-7, 5-16, 5-18
R9555004187X	2-7, 2-42, 5-5, 5-10, 5-16, 5-17, 5-18, 5-19, 5-21, 5-22, 5-29
R9555004188X	2-8, 2-42, 5-5, 5-10, 5-16, 5-17, 5-18, 5-19, 5-20, 5-26, 5-29
R9555004336N	3-3, 3-19, 5-3, 5-16
R9555004338N	3-3, 3-19, 5-16, 5-30
R9555004339N	3-3, 3-19, 5-16
R9555004340N	3-3, 3-19, 5-8, 5-16
R9555004341X	3-3, 3-5, 3-19, 5-5, 5-16
R9555004342N	5-16
R9555004342X	3-2, 3-3, 3-19, 5-16
R9555004380N	3-3, 3-19, 5-16
R9555004381N	3-3, 3-19, 5-16
R9555004479N	3-3, 3-19, 5-16
R9555004480N	3-3, 3-19, 5-16
R9555004613X	2-8, 2-47, 5-4, 5-7, 5-8, 5-14, 5-16, 5-18, 5-21
R9555004614X	2-8, 2-26, 2-47, 5-4, 5-7, 5-8, 5-14, 5-16, 5-18, 5-21
R9555005037N	3-19, 5-16, 5-19, 5-21, 5-26, 5-30, 5-31
R9555005556PGX	3-21
R9555005556X	3-21
R9555005624N	3-3, 3-25, 5-17, 5-31
R9555005790X	2-8, 2-26, 5-7, 5-17, 5-18
R9555005875X	2-8, 2-44, 5-10, 5-17, 5-29
R9555005893N	3-3, 3-5, 3-19, 5-17, 5-30, 5-31
R9555008249X	2-8, 2-26, 5-8, 5-17, 5-18
R9555009770X	2-47
R9555010133PGX	3-29, 5-17
R9555010133PGXCF	3-29



# NUMERIC PARTS LIST

Part Number	Page(s)
R9555010133X	3-5, 3-29, 5-17
R9555010133XCF	3-29
R9555010696PGX	3-29, 5-17
R9555010696PGXCF	3-29
R9555010696X	3-5, 3-29, 5-17, 5-18
R9555010696XCF	3-29
R9555010806X	2-8, 2-28, 5-17
R9555010824X	5-10, 5-17, 5-29
R9555011016X	2-8, 2-26, 5-17
R9555012533X	2-8, 2-28, 5-5, 5-17
R9555012895X	2-28
R9555013058X	2-8, 2-28, 5-17
R9555013059X	2-8, 2-28, 5-17
R9555013695X	2-28
R9555014144X	2-47
R9555014428X	2-8, 2-28, 5-1, 5-17, 5-22
R9555014488X	5-17
R9555015314X	2-8, 2-47, 5-15, 5-17, 5-18
R9555016799X	5-17
R9555018485X	2-8, 2-44, 5-10, 5-17, 5-26, 5-29
R9555018653X	2-28
R9555019320X	2-47
R9555019445X	2-47
R9558089675N	5-18
R95590554107	5-25
R95590554271N	5-18
R9559111530030X	2-36, 2-37
R9559111530147X	2-36
R9559111535100X	2-8, 2-36, 5-15, 5-19, 5-26
R9559111535200X	2-8, 2-36, 5-19, 5-26
R9559111535300X	2-8, 2-37, 5-19
R9559111535330X	2-8, 2-36, 5-19
R9559111539202	5-19
R9559111545000X	2-8, 2-37, 5-19
R9559111545100X	2-8, 2-37, 5-19
RA83580	5-19
RA86472	5-19
RA86473	5-1, 5-2, 5-3, 5-4, 5-8, 5-17, 5-19
RA86477	5-1, 5-2, 5-3, 5-9, 5-19
RA87940	5-19
RAD25079	5-6
RBE13240	5-6, 5-19
RBE13241	5-6, 5-19, 5-26
RBE13250	5-6, 5-12, 5-15, 5-19

Part Number	Page(s)
RBE13255	5-6, 5-19, 5-26
RK145151	5-22
RK145157	5-22, 5-26
RK201100	5-22
RK1451511	5-22
RKN18530	5-15, 5-18, 5-22, 5-27
RKN18532	5-22, 5-27
RKN18534	5-22
RKN18536	5-22
RKN20001	5-22, 5-26, 5-29
RKN20010	5-22, 5-26
RKN20011	5-22, 5-26
RKN20021	5-22, 5-27
RKN20022	5-27
RKN20025	5-22, 5-27
RKN20031	5-8, 5-22, 5-27
RKN20033	5-22
RKN20035	5-22, 5-27
RKN20061	5-23
RKN20080	5-23, 5-26
RKN20090	5-23, 5-26
RKN20110	5-23
RKN20541	5-23, 5-27
RKN20542	5-23, 5-27
RKN20543	5-2, 5-23
RKN20545	5-23, 5-27
RKN20561	5-23, 5-27
RKN20562	5-23, 5-27
RKN20580	5-23, 5-27
RKN20581	5-23, 5-27
RKN20590	5-23, 5-27
RKN20601	5-23
RKN20602	5-23, 5-28
RKN20605	5-23
RKN20606	5-23, 5-28
RKN20607	5-23, 5-28
RKN20611	5-23, 5-28
RKN20612	5-8, 5-23, 5-28
RKN20615	5-23, 5-28
RKN20616	5-23
RKN20619	5-8, 5-23, 5-28
RKN20621	5-23
RKN20622	5-23, 5-28
RKN20623	5-23
RKN20631	5-23, 5-28
RKN20632	5-23
RKN20633	5-23
RKN20700	5-23

Part Number	Page(s)
RKN20900	5-8, 5-23
RKN20901	5-23
RKN20902	5-23
RKN20903	5-23, 5-26
RKN20904	5-6, 5-26
RKN21004	5-23, 5-27, 5-28
RKN21008	5-23, 5-27
RKN22100	5-23, 5-26
RKN22150	5-23, 5-27
RKN22501	5-23
RKN22521	5-23, 5-27
RKN22600	5-23, 5-27
RKN22610	5-23
RKN23000	5-6, 5-23, 5-26
RKN23010	5-8, 5-23, 5-26
RKN23040	5-23, 5-26
RKN23060	5-23, 5-26
RKN23080	5-23, 5-26
RKN24000	5-23, 5-26, 5-27
RKN24001	5-23, 5-27
RKN24003	5-23, 5-27
RKN24007	5-23
RKN24009	5-23, 5-27
RKN24010	5-23, 5-27
RKN24011	5-23, 5-27
RKN24100	5-24
RKN25060	5-24, 5-27
RKN25061	5-24, 5-27
RKN25080	5-24, 5-27
RKN25090	5-24, 5-27
RKN25100	5-24, 5-27
RKN25110	5-24, 5-27
RKN25120	5-24, 5-27
RKN28030	5-24, 5-27
RKN28032	5-24, 5-27
RKN28034	5-24, 5-27
RKN28041	5-24, 5-27
RKN28042	5-24
RKN28043	5-24
RKN28053	5-24, 5-27
RKN28054	5-24
RKN28055	5-24, 5-27, 5-29
RKN28056	5-24
RKN28060	5-8, 5-24, 5-27
RKN28061	5-8, 5-24, 5-27
RKN28063	5-24, 5-27
RKN28065	5-24, 5-27
RKN28067	5-24

Part Number	Page(s)
RKN28069	5-24, 5-27
RKN28071	5-24, 5-27
RKN28075	5-24
RKN28080	5-24, 5-27
RKN28085	5-24, 5-27
RKN28091	5-24, 5-27
RKN28092	5-24
RKN28131	5-24, 5-27
RKN28132	5-24, 5-27
RKN28140	5-21, 5-24, 5-27
RKN28300	5-24, 5-27
RKN28500	5-24
RKN28510	5-24, 5-27
RKN28520	5-8, 5-21, 5-24, 5-26, 5-27, 5-31
RKN28531	5-24
RKN28600	5-8
RKN31025	5-25, 5-26
RKN31026	5-25, 5-26
RKN31040	5-26, 5-29
RKN31041	5-26
RKN31050	5-25, 5-26
RKN31060	5-25, 5-26
RKN31070	5-25
RKN31175	5-25
RKN31200	5-25, 5-26
RKN31250	5-25, 5-26
RKN31300	5-25, 5-26
RKN31400	5-25, 5-26
RKN31450	5-25
RKN31527	5-25
RKN31528	5-25, 5-26
RKN32003	5-25, 5-27
RKN32005	5-15, 5-25, 5-27
RKN32006	5-25, 5-27
RKN32011	5-25, 5-27
RKN32013	5-25
RKN32014	5-25, 5-27
RKN32041	5-25, 5-27
RKN32050	5-25, 5-27
RKN32060	5-25, 5-27
RKN34060	5-25, 5-27
RKN34061	5-25, 5-27
RKN34101	5-25, 5-27
RKN34110	5-25, 5-27
RKN34111	5-25, 5-27
RKN34127	5-25, 5-27
RKN34130	5-25, 5-27

Part Number	Page(s)
RKN34131	5-25, 5-27, 5-29
RKQ205450	5-25
RMPN3613AD	5-26, 5-27
RMPN21051	5-26, 5-27
RMPN30056BD	5-26
RN13526BR	5-26
RN14514	5-26
RN14515AG	5-26
RN14990A	5-26
RN15791H	5-26
RN15791T	5-26
RN15791V	5-26
RN15843	5-19, 5-26
RN30103FE	5-23, 5-27
RRN10EV	5-29
RRN10GG	5-29
RRN10HB	5-29
RRN10HH	5-29
RRN10HK	5-29
RRN10HM	5-29
RRN11V	5-29
RRN19AF	5-26, 5-29
RRN31BC	5-29
RRN31BF	5-29
RRN31BP	5-29
RSL616	4-94
RSL617	4-94
RSL996-5	4-74
RSL1000-5A	4-85
RSL1000-5AX	4-85
RSL2000B1/2	4-79
RSL2000B3/8	4-79
RSL2000C1/2	4-79
RSL2000C3/8	4-79
RSL2000D1/2	4-79
RSL2000D3/8	4-79
RSL3200	4-72
RSL3200-1/4	4-72
RSL3450	4-73
RSL3450G	4-73
RSL3450S	4-73
RSL3800	4-79
RSL5200	4-72
RSL5400	4-75
RSL5900	4-77
RSL5900-1	4-77
RSL5900B	4-77
RSL5900G	4-77

Part Number	Page(s)
RSL5900GI	4-77
RSL5900L	4-77
RSL5900R	4-77
RSL6002	4-94
RSL6003	4-94
RSL6006	4-94
RSL6125	4-76
RSL6125-2	4-76
RSL6125-2X	4-76
RSL6125-7	4-76
RSL6125-25	4-76
RSL6125-35	4-76
RSL6125-40	4-76
RSL6125-45	4-76
RSL6125X	4-76
RSL6300	4-91
RSL6900	4-91
RSL7200	4-72
RSL7700	4-91
RSL7800	4-79
RSL8000	4-90
RSL8000B	4-90
RSL8100	4-90
RSL8100B	4-90
RSL9125	4-80
RSL9400	4-78
RSL10200-1/2	4-71
RSL10200-3/4	4-71
RSL10200-3/8	4-71
RSL10300-12	4-92
RSL10900	4-92
RSL14900	4-92
RSL17600	4-73
RSL17600B	4-73
RSL17600B-2	4-73
RSL17600L	4-73
RSL17600LB	4-73
RSL17600LG	4-73
RSL17600LR	4-73
RSL17600M	4-73
RSL21600	4-75
RSL21600-2	4-75
RSL21600D	4-75
RSL22001/2	4-71
RSL22001/4	4-71
RSL22003/4	4-71
RSL99600	4-73
RSL99600-5	4-74

# NUMERIC PARTS LIST

Part Number	Page(s)
RSL99600B	4-74
RSL99600BL	4-74
RSL102001	4-71
RSL102002	4-71
RSL102006-1/2	4-71
RSL102006-3/8	4-71
RSL110103	4-75
RSL110114	4-73
RSL110127	4-94
RSL110128	4-72
RSL110129	4-72
RSL110130	4-72
RSL110131	4-72
RSL110139	4-81
RSL110139X	4-81
RSL110167	4-75
RSL110170	4-87
RSL110170X	4-87
RSL110171	4-87
RSL110171X	4-87
RSL110183	4-71
RSL110189	4-73
RSL110191X6	4-87
RSL110197	4-80
RSL110197X	4-80
RSL110198	4-80
RSL110199	4-80
RSL110199X	4-80
RSL110200	4-86
RSL110200X	4-86
RSL110205	4-86
RSL110205X	4-86
RSL110207	4-80, 4-81
RSL110207X	4-80
RSL110250	4-92
RSL110252	4-73
RSL110257	4-78
RSL110258	4-78
RSL110267	4-86
RSL110268	4-86
RSL110274	4-73
RSL110275	4-80
RSL110275X	4-80
RSL110284	4-73
RSL110297	4-76
RSL110300	4-75
RSL110301	4-75
RSL110338	4-86

Part Number	Page(s)
RSL110360	4-82
RSL110365	4-82
RSL110370X	4-84
RSL110375X	4-84
RSL110376	4-73
RSL110380	4-83
RSL110380X	4-83
RSL110385	4-83
RSL110390	4-92
RSL110400	4-76
RSL110405	4-76
RSL110410	4-82
RSL110412	4-82
RSL110413	4-75
RSL110415	4-83
RSL110415X	4-83
RSL110416	4-83
RSL110425	4-76
RSL110430	4-76
RSL110435	4-76
RSL110440	4-76
RSL110445	4-76
RSL110450	4-81
RSL110459	4-86
RSL110459X	4-86
RSL110460	4-86
RSL110460X	4-86
RSL110470	4-86
RSL110475	4-86
RSL110475X	4-86
RSL110486	4-92
RSL110500	4-88
RSL110500X	4-88
RSL110507	4-80
RSL110507X	4-80
RSL110514	4-73
RSL110528	4-73
RSL110542	4-89
RSL110544	4-89
RSL110570	4-84
RSL110571	4-84
RSL110580	4-84
RSL110582	4-84
RSL110584	4-81
RSL110584X	4-81
RSL110588	4-84
RSL110605	4-84
RSL110606	4-84

Part Number	Page(s)
RSL110644	4-73
RSL110690	4-84
RSL110690X	4-84
RSL110700	4-88, 4-89
RSL110700X	4-88
RSL110742	4-89
RSL110744	4-89
RSL110790	4-84
RSL110790X	4-84
RSL140200	4-78
RSL140270	4-78
RSL140280	4-78
RSL140290	4-78
RSL140370	4-78
RSL140380	4-78
RSL140390	4-78
RSL200000	4-79
RSL200001	4-79
RSL200002	4-79
RSL200003	4-79
RSL200004	4-79
RSL216050	4-75
RSL216200	4-75
RSL320100	4-72
RSL340250	4-73
RSL340350	4-73
RSL342500	4-73
RSL342501	4-73
RSL342502	4-73
RSL780210	4-79
RSL780212	4-94
RSL1101913	4-87
RSLA256-5	4-74
RSLA1000S	4-85
RSLA1000SX	4-85
RSLA25600	4-74
RSLA25600-2	4-74
RSLA25600Y	4-74
RSN4017A	5-8, 5-27, 5-30
RSN4017E	5-27, 5-30
RSN4017F	5-27, 5-30
RSN401019	5-15
S432 500 005 0	1-7
S936 649 151 0	5-11, 5-19, 5-20, 5-26

### **Standard Meritor Aftermarket Warranty.**

We warrant all new parts for one year from date of shipment to the buyer against defective material or workmanship (but not against damage caused by accident, abuse or improper installation, maintenance or repair) when such parts are used on vehicles the specifications of which have been approved by our Engineering Department.

As the exclusive remedy under this warranty, we will, at our option, repair or replace such parts free of charge, or take back the nonconforming parts and refund the monies paid by buyer for such parts, if found on examination by us to be nonconforming and if any necessary return charges are prepaid.

If it is necessary to return any parts under this warranty, buyer agrees not to make any deduction on account thereof from remittances on current accounts while claims are in the process of disposition. Any expense incurred without our consent for repairs or replacement will not be allowed.

**THIS WARRANTY IS EXPRESSLY IN LIEU OF ALL OTHER WARRANTIES OR CONDITIONS, EXPRESS, IMPLIED OR STATUTORY, INCLUDING ANY IMPLIED WARRANTY OF MERCHANTABILITY OR FITNESS FOR PARTICULAR PURPOSE. IN NO EVENT SHALL SELLER BE LIABLE FOR INCIDENTAL OR CONSEQUENTIAL DAMAGES OF ANY NATURE.**

Only Meritor-branded products, including genuine Meritor and its affiliated brands, are covered by this aftermarket parts warranty.

















Product models, brands, names and trademarks depicted herein are the property of their respective owners and, except where otherwise indicated, are not in any way associated with Meritor Heavy Vehicle Systems, LLC, or any parent or affiliate, thereof.



Meritor Heavy Vehicle Systems, LLC  
7975 Dixie Highway  
Florence, Kentucky 41042 USA

888-725-9355 U.S.  
800-387-3889 Canada  
MeritorPartsXpress.com  
meritor.com

©2017 Meritor, Inc.  
Litho in USA, PB-1484  
Issued 06-18 (47865/67147)