



**EASTPENN**

**2020/21**

**WIRE, CABLE, AND BATTERY  
ACCESSORIES PRODUCT CATALOG**

**Deka**  
AND  
**MARINE  
MASTER**

# Wire and Cable Division

A division of the world's Largest and Most Modern Single-Site Battery Manufacturing Facility

East Penn's Wire and Cable division is housed in a 250,000 square-foot facility equipped with state-of-the-art technology utilizing sound yet advanced manufacturing principles. This facility does not just assemble products, but performs the entire manufacturing process from start-to-finish. In fact, East Penn is a supplier to other battery accessory manufacturers who simply buy and assemble components. East Penn's Wire and Cable facility is an invaluable asset to the company's logistically convenient battery manufacturing plants.

East Penn has complete control of the many components in its manufactured products. This ensures the highest quality and complete customer satisfaction. In addition, changes and adjustments in the manufacturing process can be made easily to enhance product quality and achieve continuous improvement objectives. The company's vertically integrated structure enables efficient inventory and lead time control.

Included in a long line of renowned certifications, the Wire and Cable quality system has been certified to ISO 9001:2015 along with certification for ISO 14001:2015 Environment Management System. Every accessory meets rigid quality and performance standards such as the Society of Automotive Engineers, Underwriters Laboratories, and Canadian Standards Association when applicable.

Recognized globally as one of the leading high quality manufacturers, with the broadest product offering, East Penn manufactures some of the finest battery accessory, wire, and cable products in the industry.



### GRAVITY LEAD CASTING

This unique process produces high quality lead terminals, which are cast with 100% recycled lead from our on-site EPA approved smelter.



### DUAL CABLE EXTRUSION PROCESS

100% copper wire is coated with durable, color-coded PVC insulation.



### BOOSTER CABLE ASSEMBLY

Heavy-duty, vinyl coated steel clamps are attached to 100% copper or copper clad conductor cables.



**100%  
RECYCLED  
ALLOY**

ALL EAST PENN MANUFACTURED LEAD PRODUCTS ARE BUILT WITH 100% RECYCLED LEAD ALLOY.

QUALITY SYSTEM  
CERTIFIED  
**ISO 9001**  
ENVIRONMENTAL  
SYSTEM CERTIFIED  
**ISO 14001**



# Wire, Cable, and Battery Accessories

WWW.EASTPENMANUFACTURING.COM

## TABLE OF CONTENTS

Booster Cables .....	2-10
Booster Cable Clamps .....	11
Battery Cables – Packaged .....	13-16
Battery Cable Kits .....	17
Battery Cables – Bulk .....	17-20
Specialty Battery Cables – Bulk .....	20-23
Battery Terminals .....	25-32
Fasteners .....	31
Crimpable Terminals .....	33-34
Lugs.....	35-36
Solderless Terminals and Connectors .....	37-38
Battery Cable Terminal Protector Boots .....	39-41
Cable Ties, Loom, Heat-Shrink Tubing, and Tape .....	41-42
Terminal Cleaning and Protection .....	44-45
Battery Hold-Downs .....	48
Battery Boxes and Trays .....	49
Battery Tools and Accessories .....	50-53
Battery Accessories & Electrical Center .....	54-56
Accessory Box and Cable .....	57
Battery Isolators .....	58
Wire Products .....	59-98
80°C Primary Wire .....	60-61
105°C Primary Wire .....	62-63
GXL Cross-Linked Polyethylene Wire .....	64-65
SXL Cross-Linked Polyethylene Wire .....	66-67
Starter Cable Wire .....	68-69
SGX Cross-Linked Polyethylene Cable .....	70-71
Welding Cable .....	72-73
UL3311 Cable .....	74
UL/CSA Single Conductor Wire .....	75-76
UL/CSA Tinned Single Conductor Wire .....	77
Marine Master® UL Listed 1426 Tinned Wire/Cable .....	78-83
Bonded Parallel Wire .....	84-85
Jacketed Duplex Wire .....	86-87
Jacketed Triplex Wire .....	88
Jacketed Quadraplex Wire .....	89
Trailer Cable Wire .....	90-92
RV Cable Wire .....	93
ABS Trailer Cable Wire .....	94
Sleeved Trailer Cable Wire .....	95
Sleeved RV Cable Wire .....	96
Dual Booster Cable Wire .....	97
D-Shaped Dual Booster Cable Wire .....	98
Marine Master® Accessories .....	99-103
Wire and Cable Special Ordering Information .....	104
Wire and Cable Spool Diameter Chart .....	105
Technical Data .....	106-109
Glossary .....	110-113
Product Index .....	114-134
Warranties and Disclaimer Information .....	136



# EASTPENN BOOSTER CABLE ASSORTMENT

## Quick Reference

### CLAMP OPTIONS

#### ADVANTAGES OF 100% COPPER

- **Maximum Current Capacity**
- **Long Life / Durability**
-  **Made in USA with US and imported materials, and Built to SAE Specifications**



1. Professional Service
2. High-Tension Clamp
3. Copper Plated Brass Current Carrying Jaw



1. Professional Service
2. High-Tension Clamp
3. Color-Coded



1. Commercial Service
2. High-Tension Clamp
3. Copper Plated Steel Jaw
4. Patented Design



1. Standard Service
2. Color-Coded
3. Copper Plated Steel Clamp

#### ADVANTAGES OF COPPER/ALUMINUM

- **Cost Savings**
- **Lighter Weight**
- **Built to SAE Specifications**



1. Professional Service
2. High-Tension Clamp
3. Copper Plated Steel Jaw



1. Commercial Service
2. High-Tension Clamp
3. Copper Plated Steel Jaw
4. Patented Design



1. Standard Service
2. Vinyl Coated Clamp
3. Polarity Identification
4. Copper Plated Steel Jaw



1. Standard Service
2. Color-Coded
3. Copper Plated Steel Clamp

### THE EAST PENN ADVANTAGE

- Industry leading fill rate of 98% or better coupled with the ability to be flexible when needed.  
**BENEFIT - Increased sales opportunities**
- U.S. Manufactured or East Penn managed Direct Import program to stringent quality standards  
**BENEFIT - Assurance of East Penn trusted quality**
- Experienced Sales Staff with a proven track record on growing sales  
**BENEFIT - Team supported by East Penn's Executive Staff, Marketing, Engineering and Manufacturing departments**



# EASTPENN BOOSTER CABLE ASSORTMENT

Choosing the right set of booster cables



**PROFESSIONAL SERVICE**  
2 GAUGE / 24 FEET  
• 100% COPPER  
• HIGH TENSION CLAMPS



**PROFESSIONAL SERVICE**  
2 GAUGE / 20 FEET  
• 100% COPPER  
• HEAVY-DUTY CLAMPS



**COMMERCIAL SERVICE**  
4 GAUGE / 20 FEET  
• 100% COPPER  
• HIGH TENSION CLAMPS



**HEAVY SERVICE**  
6 GAUGE / 16 FEET  
• 100% COPPER  
• MULTI-USE CLAMPS



**MEDIUM SERVICE**  
8 GAUGE / 12 FEET  
• 100% COPPER  
• MULTI-USE CLAMPS



**STANDARD SERVICE**  
10 GAUGE / 12 FEET  
• 100% COPPER

## WHAT GAUGE IS RIGHT FOR ME?

The smaller the gauge number, the bigger the diameter of the conductor inside the booster cable and the more capacity it will have.

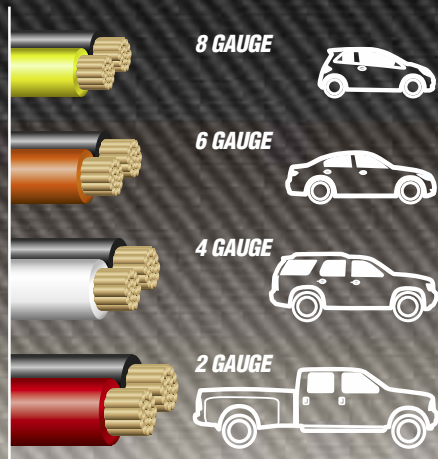

## WHAT LENGTH DO I NEED?

FRONT-TO-FRONT



SIDE-TO-SIDE



BACK-TO-FRONT



HOOK-UP:	10 FEET	12-16 FEET	20+ FEET
FRONT-TO-FRONT	✓	✓	✓
SIDE-TO-SIDE		✓	✓
BACK-TO-FRONT			✓

## WHAT CONNECTION DO I HAVE?



TOP POST



SIDE TERMINAL



REMOTE BATTERY ACCESS TERMINAL



SCAN TO SEE BOOSTER CABLE INSTRUCTIONS



# Booster Cables and Clamps

East Penn booster cable sets are equipped with heavy-duty color-coded clamps. These clamps provide easy attachment on hard to reach side, top post, and remote battery access terminals. Colorful packaging assures high store display visibility along with convenient reusable storage.



- **Booster Cables**
- **Replacement Clamps**



00161



00183



04424



07044



**PROFESSIONAL SERVICE BOOSTER CABLES**

Cables are made of 1/0 gauge 100% copper conductors. Made with welding cable. High stranding and EPR jacket allow for greater cold weather flexibility. Excellent abrasion resistance.

Cables are made of 2 gauge 100% copper conductors. Thermoplastic Elastomer (TPE) cable insulation protects against oil, grease, and abrasion. Color-coded, tangle-free dual cable construction, specifically designed for maximum flexibility and easy handling.

Part #	Gauge	Length	Clamp	Color	Packaging	Master Carton	
						Quantity	Weight
04424 ■	1/0	20'	600E	Black/Red	Plastic Box	2	40 lbs.

■ English only

▲ **WARNING:** Cancer and Reproductive Harm [www.P65Warnings.ca.gov](http://www.P65Warnings.ca.gov)

Part #	Gauge	Length	Clamp	Color	Packaging	Master Carton	
						Quantity	Weight
00161 ■	2	24'	600P	Black/Red	Storage Bag	2	30 lbs.
00183 ● <sup>1</sup>	2	20'	600P	Black/Red	Retail Box	2	26 lbs.
00186 ●	2	20'	600P	Black/Red	Plastic Box	2	29 lbs.
07044 ▲	2	20'	600E	Black/Red	Retail Box	2	28 lbs.

<sup>1</sup>Includes storage bag

■ English only

● English and Spanish

▲ English, French, and Spanish

▲ **WARNING:** Cancer and Reproductive Harm [www.P65Warnings.ca.gov](http://www.P65Warnings.ca.gov)







00170



00159



00163



00169

**COMMERCIAL SERVICE BOOSTER CABLES**

Cables are made of 4 gauge 100% copper conductors. Tough PVC insulation, color-coded tangle-free dual cable construction.

Part #	Gauge	Length	Clamp	Color	Packaging	Master Carton	
						Quantity	Weight
00159 <sup>1</sup> •	4	20'	500G	Black/White	Retail Box	4	38 lbs.
00163 <sup>1</sup> •	4	20'	600P	Black/White	Retail Box	4	40 lbs.
00170 <sup>1</sup> •	4	16'	500G	Black/White	Retail Box	4	33 lbs.
00337 <sup>1</sup> •	4	16'	600P	Black/White	Retail Box	4	34 lbs.
00164 <sup>1</sup> •	4	12'	500G	Black/White	Retail Box	4	28 lbs.

<sup>1</sup>Includes storage bag  
• English and Spanish

**⚠ WARNING:** Cancer and Reproductive Harm [www.P65Warnings.ca.gov](http://www.P65Warnings.ca.gov)

**HEAVY SERVICE BOOSTER CABLES**

Cables are made of 6 gauge 100% copper conductors. Tough PVC insulation, color-coded tangle-free dual cable construction.

Part #	Gauge	Length	Clamp	Color	Packaging	Master Carton	
						Quantity	Weight
00162 <sup>1</sup> •	6	12'	500G	Black/Orange	Retail Box	6	33 lbs.
00169 <sup>1</sup> •	6	16'	500G	Black/Orange	Retail Box	6	37 lbs.

<sup>1</sup>Includes storage bag  
• English and Spanish

**⚠ WARNING:** Cancer and Reproductive Harm [www.P65Warnings.ca.gov](http://www.P65Warnings.ca.gov)

### MEDIUM SERVICE BOOSTER CABLES

Cables are made of 8 gauge 100% copper conductors. Tough PVC insulation, color-coded tangle-free dual cable construction.



00160



00168

Part #	Gauge	Length	Clamp	Color	Packaging	Master Carton	
						Quantity	Weight
00160 ● <sup>1</sup>	8	12'	500G	Black/Yellow	Retail Box	6	27 lbs.
00168 ▲	8	12'	200C	Black/Yellow	Storage Bag	12	37 lbs.

<sup>1</sup>Includes storage bag

● English and Spanish

▲ English, French, and Spanish

**⚠ WARNING:** Cancer and Reproductive Harm [www.P65Warnings.ca.gov](http://www.P65Warnings.ca.gov)

### STANDARD SERVICE BOOSTER CABLES

Cables are made of 10 gauge 100% copper conductors. Tough PVC insulation with tangle-free dual cable and color-coded clamps.



00153

00146

Part #	Gauge	Length	Clamp	Color	Packaging	Master Carton	
						Quantity	Weight
00146 ▲ <sup>2</sup>	10	10'	50A	Yellow/Yellow	Storage Bag	12	16 lbs.
00153 ▲	10	12'	200C	Black/Black	Sleeve	12	27 lbs.

<sup>2</sup>Used for small engine/motorcycle service

▲ English, French, and Spanish

**⚠ WARNING:** Cancer and Reproductive Harm [www.P65Warnings.ca.gov](http://www.P65Warnings.ca.gov)

### COPPER CLAD ALUMINUM BOOSTER CABLES

Tough PVC insulation, color-coded tangle-free dual cable construction.



04848

04955

04850

04851

04852

Part #	Gauge	Length	Clamp	Color	Packaging	Master Carton	
						Quantity	Weight
04369 ● <sup>1</sup>	2	20'	600P	Red/Black	Retail Box	4	36 lbs.
04848 ▲	2	20'	600P	Red/Black	Retail Box	4	34 lbs.
04370 ●	4	20'	500G	White/Black	Retail Box	4	36 lbs.
04955 ▲	4	20'	400B	Red/Black	Retail Box	4	22 lbs.
04850 ▲	6	16'	400B	Red/Black	Retail Box	6	23 lbs.
04851 ▲	8	12'	400B	Red/Black	Retail Box	6	15 lbs.
04852 ▲	10	12'	200C	Red/Black	Sleeve	12	21 lbs.
00179 ▲	10	12'	200C	Black/Black	Storage Bag	12	21 lbs.

<sup>1</sup>Includes storage bag

● English and Spanish

▲ English, French, and Spanish

**⚠ WARNING:** Cancer and Reproductive Harm [www.P65Warnings.ca.gov](http://www.P65Warnings.ca.gov)

### BOOSTER CABLE STORAGE BAG

All PVC with zipper closure.

Part #	Packaging	Master Carton		Dimensions	
		Quantity	Weight	Diameter	Thickness
BSB1	Bulk	10	5 lbs.	13.5"	1.75"

**⚠ WARNING:** Cancer and Reproductive Harm [www.P65Warnings.ca.gov](http://www.P65Warnings.ca.gov)



BSB1



**PLUG CONNECTOR BOOSTER CABLES**

Cables are made of 100% copper conductors.

- 03667 consists of a 5' battery connector cable with plug connector and 15' cable with clamps.
- 04665 consists of a 5' battery connector cable with plug connector and 25' cable with clamps.
- Connector cable allows for easy access to battery power without opening the hood of charging vehicle.
- Clamp-end cable allows stranded vehicle to be easily reached.
- Tough PVC insulation, color-coded tangle free dual cable construction.
- Comes equipped with plug cover to prevent damage to plug when not in use.
- Clamp and jaw designed for 3 jump starting applications: top post, side terminal, and remote battery access terminal.
- Instructions included.

Part #	Gauge	Length	Clamp	Color	Packaging	Master Carton	
						Quantity	Weight
03667	4	20'	500G	Black/White	Retail Box	1	18 lbs.
04665	2	30'	600E	Black/Red	Retail Box	1	39 lbs.

**⚠ WARNING:** Cancer and Reproductive Harm [www.P65Warnings.ca.gov](http://www.P65Warnings.ca.gov)



03667



04665

**PLUG CONNECTOR COVER**

- Cover prevents damage to plug when not in use.
- Fits 175A connectors, used on the above cables sets.



Part #	Color	Packaging	Master Carton	
			Quantity	Weight
31120	Black	Box of 4	1	1 lb.

**⚠ WARNING:** Cancer [www.P65Warnings.ca.gov](http://www.P65Warnings.ca.gov)

**IDEAL FOR SERVICE & FLEET EQUIPMENT**

*Allows mounting on service vehicle, using the 5' battery connection cable.*

*Simply plug the clamp cable into the mounted 5' battery connection cable to service the stranded vehicle.*

*Plug cover prevents damage to mounted battery connection cable plug when not in use.*

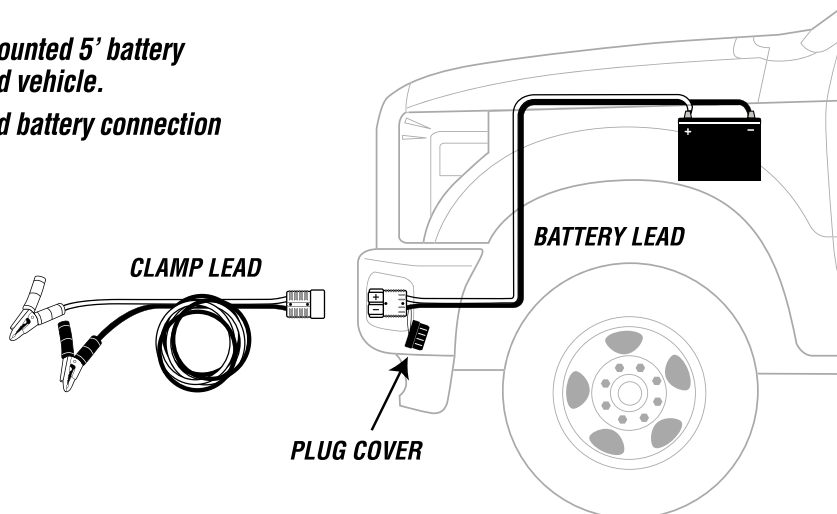

**ROADSIDE EMERGENCY KITS**

**BASIC KIT**

*Safety Kit Includes:*

- Storage Case with Storage Velcro
- Booster Cable (8ft. 10ga.)
- Tow Strap (12ft. 1500lb. work load)
- Flashlight & 2 Batteries
- Rain Poncho & Gloves
- SOS/Help Sign
- First Aid Kit



31051

**PREMIUM KIT**

*Premium Safety Kit Includes:*

- Storage Case with Storage Velcro
- Booster Cable (8ft. 10ga.)
- Tow Strap (12ft. 1500lb. work load)
- Safety Triangle
- 7 LED Headlamp & 3 Batteries
- Blanket
- Rain Poncho & Gloves
- SOS/Help Sign
- First Aid Kit



31052



Part #	Kit Type	Packaging	Master Carton	
			Quantity	Weight
31051	Basic	Bag	4	17 lbs.
31052	Premium	Bag	4	21 lbs.

**⚠ WARNING:** Cancer and Reproductive Harm [www.P65Warnings.ca.gov](http://www.P65Warnings.ca.gov)





00184



00182



08756

Booster cable clamps are designed to grip securely to side terminal, post terminal batteries, and remote battery access terminals for maximum current carrying capacity. All booster cable clamps are color coded (Red/Black) for safety and visual appeal.

**1000C 100% COPPER CLAMP**

• For use with 1ga, 1/0ga, and 2/0ga cable

**600P EXTRA HEAVY-DUTY CLAMP**

**Parrot Type**

• For use with 2ga and 4ga cable

**500G PVC COATED STEEL HEAVY-DUTY CLAMP**

• For use with 4ga, 6ga and 8ga cable

**500E PVC COATED STEEL HEAVY-DUTY CLAMP**

**E-Z Reach™ Type**

• For use with 4ga, 6ga and 8ga cable

**200C COPPER-PLATED STEEL CLAMP**

**Crimp Type**

• For use with 8ga and 10ga cable



Part #	Packaging	Insulation Color	Master Carton	
			Quantity	Weight
08756	Clam Shell of 2	Red/Black	2	4 lbs.

**⚠ WARNING:** Cancer and Reproductive Harm [www.P65Warnings.ca.gov](http://www.P65Warnings.ca.gov)

Part #	Packaging	Insulation Color	Master Carton	
			Quantity	Weight
00184	Clam Shell of 2	Red/Black	2	2 lbs.
06137	Bulk	Red	10	5 lbs.
06138	Bulk	Black	10	5 lbs.

**⚠ WARNING:** Cancer and Reproductive Harm [www.P65Warnings.ca.gov](http://www.P65Warnings.ca.gov)

Part #	Packaging	Insulation Color	Master Carton	
			Quantity	Weight
06125	Clam Shell of 2	Red/Black	10	8 lbs.

**⚠ WARNING:** Cancer and Reproductive Harm [www.P65Warnings.ca.gov](http://www.P65Warnings.ca.gov)

Part #	Packaging	Insulation Color	Master Carton	
			Quantity	Weight
00182	Clam Shell of 2	Red/Black	10	9 lbs.
06139	Bulk	Red	10	5 lbs.
06140	Bulk	Black	10	5 lbs.

**⚠ WARNING:** Cancer and Reproductive Harm [www.P65Warnings.ca.gov](http://www.P65Warnings.ca.gov)

Part #	Packaging	Insulation Color	Master Carton	
			Quantity	Weight
00335	Card of 10	Red/Black	2	4 lbs.
08762	Clam Shell of 2	Red/Black	10	3 lbs.
08763	Bulk	Red	10	2 lbs.
08764	Bulk	Black	10	2 lbs.

**⚠ WARNING:** Cancer and Reproductive Harm [www.P65Warnings.ca.gov](http://www.P65Warnings.ca.gov)

**TESTING AND SPECIALTY CLAMPS**

**50A CLAMP**

Clamp for battery chargers, tune up and test equipment

**JAW TYPE CLAMP**

Available in 10, 25, and 50 amp

**10 AMP ALLIGATOR CLAMP**

**Crimp Type**



Part #	Packaging	Insulation Color	Master Carton	
			Quantity	Weight
00181	Card of 2	Red/Black	10	2 lbs.
00336	Card of 10	Red/Black	5	4 lbs.
06143	Bulk	Red	100	7 lbs.
06144	Bulk	Black	100	7 lbs.

**⚠ WARNING:** Cancer and Reproductive Harm [www.P65Warnings.ca.gov](http://www.P65Warnings.ca.gov)

Part #	Type	Packaging	Master Carton	
			Quantity	Weight
00448	10 Amp	Clam Shell of 2	10	1 lb.
06146	10 Amp	Bulk	50	1 lb.
00503	25 Amp	Clam Shell of 1	10	1 lb.
06147	25 Amp	Bulk	25	1 lb.
00504	50 Amp	Clam Shell of 2	10	1 lb.
06148	50 Amp	Bulk	10	1 lb.

Part #	Packaging	Master Carton	
		Quantity	Weight
00505	Clam Shell of 2	10	1 lb.
06145	Bulk	100	1 lb.



Notes:

---



---



---



---



---



---



---



---



---



---



---



---



---



---



---



---



# Battery Cables

visit [www.dekacatalog.com](http://www.dekacatalog.com)  
for application info

Battery cables are made of 100% copper conductor for maximum current flow. Gravity cast terminals are non-porous and made with 100% recycled lead. Lead is recognized as the premium choice in battery cable terminal construction because of its maximum current flow carrying ability, malleability, and corrosion resistance. Full gauge stranded copper core is flexible for easy installation and allows maximum current for quick starting. Copper core extends to the end of the plated lug to give a one piece solid connection. Wire meets SAE standards.



**100%  
RECYCLED  
ALLOY**

ALL EAST PENN MANUFACTURED  
LEAD PRODUCTS ARE BUILT WITH  
100% RECYCLED LEAD ALLOY.

- Packaged Battery Cables
- Bulk Battery Cables
- Specialty Cables
- Quick Connect™ Splices
- See page 104 for custom cable information

# PACKAGED BATTERY CABLES

ALL BATTERY CABLES ARE PACKAGED ONE PER CLAMSHELL

## 6 GAUGE LAWN & GARDEN SWITCH-TO-STARTER CABLES

Fits up to 5/16" stud



Part #	Color	Length	Master Carton	
			Quantity	Weight
00679	Black	19"	5	1 lbs.
00680	Black	43"	5	3 lbs.
00681	Black	49"	5	3 lbs.

**⚠ WARNING:** Cancer and Reproductive Harm [www.P65Warnings.ca.gov](http://www.P65Warnings.ca.gov)

## 4 GAUGE TOP POST BATTERY CABLES

- Auxiliary leads are 4" long, 12 gauge
- Bolt and nut included

Fits up to 3/8" stud



Part #	Color	Length	Leads	Master Carton	
				Quantity	Weight
00784	Black	10"	0	5	3 lbs.
00292	Red	10"	0	5	3 lbs.
00785	Black	15"	0	5	3 lbs.
00293	Red	15"	0	5	3 lbs.
00801	Black	20"	0	5	4 lbs.
00294	Red	20"	0	5	4 lbs.
00802	Black	25"	1	5	4 lbs.
00295	Red	25"	1	5	4 lbs.
00803	Black	32"	1	5	5 lbs.
00296	Red	32"	1	5	5 lbs.
00804	Black	38"	1	5	5 lbs.
00297	Red	38"	1	5	5 lbs.
00805	Black	43"	1	5	5 lbs.
00298	Red	43"	1	5	5 lbs.
00808	Black	48"	1	5	6 lbs.
00299	Red	48"	1	5	6 lbs.
00809	Black	56"	1	5	6 lbs.
00328	Red	56"	1	5	6 lbs.
00810	Black	72"	1	5	6 lbs.
00329	Red	72"	1	5	6 lbs.

**⚠ WARNING:** Cancer and Reproductive Harm [www.P65Warnings.ca.gov](http://www.P65Warnings.ca.gov)

## 4 GAUGE SWITCH-TO-STARTER CABLES

- Recommended for engine to ground connections

Fits up to 3/8" stud



Part #	Color	Length	Master Carton	
			Quantity	Weight
00286	Red	16"	5	2 lbs.
00287	Red	18"	5	2 lbs.
00288	Red	24"	5	2 lbs.
00289	Red	32"	5	3 lbs.
00282	Red	40"	5	3 lbs.
00291	Red	49"	5	4 lbs.

**⚠ WARNING:** Cancer and Reproductive Harm [www.P65Warnings.ca.gov](http://www.P65Warnings.ca.gov)





**4 GAUGE  
SIDE TERMINAL  
BATTERY CABLES**

- Auxiliary leads are 4" long, 12 gauge
  - Bolt included
  - Fits side terminal battery
- Fits up to 3/8" stud**



Part #	Color	Length	Leads	Master Carton	
				Quantity	Weight
00813	Black	20"	1	5	3 lbs.
00330	Red	20"	1	5	3 lbs.
00308	Black	25"	1	5	4 lbs.
00302	Red	25"	1	5	4 lbs.
00875	Black	30"	1	5	4 lbs.
00331	Red	30"	1	5	4 lbs.
00309	Black	35"	1	5	4 lbs.
00303	Red	35"	1	5	4 lbs.
00876	Black	40"	1	5	5 lbs.
00332	Red	40"	1	5	5 lbs.
00310	Black	45"	1	5	5 lbs.
00305	Red	45"	1	5	5 lbs.
00897	Black	50"	1	5	5 lbs.
00333	Red	50"	1	5	5 lbs.
00345	Black	55"	1	5	6 lbs.
00306	Red	55"	1	5	6 lbs.
00300	Black	65"	1	5	6 lbs.
00240	Red	65"	1	5	6 lbs.
00360	Black	78"	1	5	7 lbs.
00307	Red	78"	1	5	7 lbs.

**⚠ WARNING:** Cancer and Reproductive Harm [www.P65Warnings.ca.gov](http://www.P65Warnings.ca.gov)

**2 GAUGE  
TOP POST BATTERY  
CABLES**

- Auxiliary leads are 4" long, 12 gauge
  - Bolt and nut included
- Fits up to 3/8" stud**



Part #	Color	Length	Leads	Master Carton	
				Quantity	Weight
00365	Red	10"	0	5	3 lbs.
03068	Red	15"	0	5	4 lbs.
04056	Red	20"	0	5	4 lbs.
00173	Red	25"	1	5	5 lbs.
00339	Red	32"	1	5	5 lbs.
00174	Red	38"	1	5	6 lbs.
00176	Red	43"	1	5	7 lbs.
00177	Red	48"	1	5	7 lbs.

**⚠ WARNING:** Cancer and Reproductive Harm [www.P65Warnings.ca.gov](http://www.P65Warnings.ca.gov)

**2 GAUGE  
SWITCH-TO-STARTER  
CABLES**

- Recommended for engine to ground connections
- Fits up to 3/8" stud**



Part #	Color	Length	Master Carton	
			Quantity	Weight
00363	Red	16"	5	3 lbs.
00371	Red	18"	5	3 lbs.
00178	Red	24"	5	3 lbs.
00372	Red	32"	5	4 lbs.
00377	Red	40"	5	5 lbs.
00180	Red	49"	5	6 lbs.

**⚠ WARNING:** Cancer and Reproductive Harm [www.P65Warnings.ca.gov](http://www.P65Warnings.ca.gov)



# PACKAGED BATTERY CABLES (CONTINUED)

ALL BATTERY CABLES ARE PACKAGED ONE PER CLAMSHELL

## 4 GAUGE BRAIDED GROUND STRAPS

- Tin-plated copper
- Maximum protection against corrosion for farm, commercial vehicles, and off-road applications

Fits up to 3/8" stud



Part #	Length	Master Carton	
		Quantity	Weight
00301	9"	5	3 lbs.
00364	14"	5	3 lbs.

**WARNING:** Cancer and Reproductive Harm [www.P65Warnings.ca.gov](http://www.P65Warnings.ca.gov)

## 2/0 GAUGE TOP STUD STACKABLE BATTERY CABLES

- Made with welding cable

For Group 31 stud batteries

Fits up to 3/8" stud



Part #	Color	Length	Master Carton	
			Quantity	Weight
08757	Black	9"	5	3 lbs.
08758	Black	15"	5	4 lbs.

**WARNING:** Cancer and Reproductive Harm [www.P65Warnings.ca.gov](http://www.P65Warnings.ca.gov)

## QUICK CONNECT® BATTERY CABLE REPAIR SPLICES

- For fast convenient replacement of hard to reach cables
- Replaces corroded portion, not the entire cable
- Ideal for automotive, truck, and farm applications
- RoHS Compliant
- Includes hex wrench
- See inside back cover for more details



Part #	Color	Gauge	Type	Aux. Wire Gauge/Color	Master Carton	
					Quantity	Weight
07671	Black	2	DIN	10/Blk	5	3 lbs.
07672	Black	2	DIN, Dual	10/Blk	5	3 lbs.
08859	Black	4	Lug-Dual	12/Blk	5	4 lbs.
08863	Black	4	Side-Dual	12/Blk	5	4 lbs.
08864	Black	4	Top-Dual	12/Blk	5	4 lbs.
08865	Black	4	Top	12/Blk, 10/Red	5	3 lbs.
08866	Black	4	Side	12/Blk, 10/Red	5	3 lbs.
08867	Black	1	Top	10/Blk, 8/Red	5	3 lbs.
08868	Black	1	Side	10/Blk, 8/Red	5	3 lbs.
08869	Black	4	Lug	12/Blk, 10/Red	5	3 lbs.

**WARNING:** Cancer and Reproductive Harm [www.P65Warnings.ca.gov](http://www.P65Warnings.ca.gov)

07671    07672    08859    08863    08864    08865    08866    08867    08868    08869



## QUICK CONNECT® HEAVY DUTY BATTERY CABLE REPAIR SPLICES

- Ideal for commercial applications
- Replaces worn out cable and extends cable length
- Dual set screws for secure connection
- Includes hex wrench



Part #	Color	Gauge	Type	Master Carton	
				Quantity	Weight
04957	Black	2/0	Universal Top	5	4 lbs.
04958	Black	2/0	Lug - 3/8"	5	3 lbs.
04963	Black	2/0	Overmolded - 3/8"	5	4 lbs.

**WARNING:** Cancer and Reproductive Harm [www.P65Warnings.ca.gov](http://www.P65Warnings.ca.gov)

04957    04958    04963



### CUSTOM BUILD UTILITY BATTERY CABLE KIT

- Kit includes 6' of 8 gauge cable w/ four 5/16" lugs
- Custom build battery cables for garden tractors, snowmobiles, and ATVs

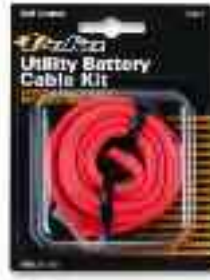

Part #	Master Carton	
	Quantity	Weight
00131	12	3 lbs.

**WARNING:** Cancer and Reproductive Harm [www.P65Warnings.ca.gov](http://www.P65Warnings.ca.gov)

## BULK BATTERY CABLES

### 4 GAUGE TOP POST BATTERY CABLES

- Auxiliary leads are 4" long, 12 gauge
- Bolt and nut included

**Fits up to 3/8" stud**



4 Gauge Part #	Color	Length	Leads	Master Carton	
				Quantity	Weight
04153	Black	10"	0	10	5 lbs.
04138	Red	10"	0	10	5 lbs.
04184	Black	10"	1	10	5 lbs.
04168	Red	10"	1	10	5 lbs.
04154	Black	12"	0	10	5 lbs.
04139	Red	12"	0	10	5 lbs.
04185	Black	12"	1	10	5 lbs.
04169	Red	12"	1	10	5 lbs.
04155	Black	15"	0	10	5 lbs.
04140	Red	15"	0	10	5 lbs.
04186	Black	15"	1	10	5 lbs.
04170	Red	15"	1	10	5 lbs.
04156	Black	20"	0	10	6 lbs.
04141	Red	20"	0	10	6 lbs.
04187	Black	20"	1	10	6 lbs.
04171	Red	20"	1	10	6 lbs.
04157	Black	25"	0	10	7 lbs.
04142	Red	25"	0	10	7 lbs.
04188	Black	25"	1	10	7 lbs.
04172	Red	25"	1	10	7 lbs.
04158	Black	27"	0	10	7 lbs.
04143	Red	27"	0	10	7 lbs.
04189	Black	27"	1	10	7 lbs.
04173	Red	27"	1	10	7 lbs.
04159	Black	32"	0	10	8 lbs.
04144	Red	32"	0	10	8 lbs.
04190	Black	32"	1	10	8 lbs.
04174	Red	32"	1	10	8 lbs.
04160	Black	34"	0	10	8 lbs.
04145	Red	34"	0	10	8 lbs.
04191	Black	34"	1	10	8 lbs.
04175	Red	34"	1	10	8 lbs.
04161	Black	38"	0	10	9 lbs.
04146	Red	38"	0	10	9 lbs.
04192	Black	38"	1	10	9 lbs.
04176	Red	38"	1	10	9 lbs.
04162	Black	43"	0	10	9 lbs.
04147	Red	43"	0	10	9 lbs.
04193	Black	43"	1	10	9 lbs.
04177	Red	43"	1	10	9 lbs.
04163	Black	48"	0	10	10 lbs.
04148	Red	48"	0	10	10 lbs.
04194	Black	48"	1	10	10 lbs.
04178	Red	48"	1	10	10 lbs.
04164	Black	53"	0	10	10 lbs.
04149	Red	53"	0	10	10 lbs.
04195	Black	53"	1	10	10 lbs.
04179	Red	53"	1	10	10 lbs.
04165	Black	56"	0	10	11 lbs.
04150	Red	56"	0	10	11 lbs.

**WARNING:** Cancer and Reproductive Harm [www.P65Warnings.ca.gov](http://www.P65Warnings.ca.gov)



# BULK BATTERY CABLES (CONTINUED)

## 4 GAUGE TOP POST BATTERY CABLES (CONT.)

- Auxiliary leads are 4" long, 12 gauge
- Bolt and nut included

Fits up to 3/8" stud



4 Gauge Part #	Color	Length	Leads	Master Carton	
				Quantity	Weight
04196	Black	56"	1	10	11 lbs.
04180	Red	56"	1	10	11 lbs.
04166	Black	65"	0	10	11 lbs.
04151	Red	65"	0	10	11 lbs.
04197	Black	65"	1	10	12 lbs.
04181	Red	65"	1	10	12 lbs.
04167	Black	72"	0	10	13 lbs.
04152	Red	72"	0	10	13 lbs.
04182	Red	72"	1	10	13 lbs.
04199	Black	78"	1	10	14 lbs.
04183	Red	78"	1	10	14 lbs.

**WARNING:** Cancer and Reproductive Harm [www.P65Warnings.ca.gov](http://www.P65Warnings.ca.gov)

## 4 GAUGE SIDE TERMINAL BATTERY CABLES

- Auxiliary leads are 4" long, 12 gauge
- Bolt included

Fits up to 3/8" stud



4 Gauge Part #	Color	Length	Leads	Master Carton	
				Quantity	Weight
04266	Black	20"	1	10	6 lbs.
04256	Red	20"	1	10	6 lbs.
04267	Black	25"	1	10	6 lbs.
04257	Red	25"	1	10	6 lbs.
04268	Black	30"	1	10	7 lbs.
04258	Red	30"	1	10	7 lbs.
04269	Black	35"	1	10	7 lbs.
04259	Red	35"	1	10	7 lbs.
04270	Black	40"	1	10	8 lbs.
04260	Red	40"	1	10	8 lbs.
04271	Black	45"	1	10	9 lbs.
04261	Red	45"	1	10	9 lbs.
04272	Black	50"	1	10	9 lbs.
04262	Red	50"	1	10	9 lbs.
04273	Black	55"	1	10	10 lbs.
04263	Red	55"	1	10	10 lbs.
04274	Black	65"	1	10	11 lbs.
04264	Red	65"	1	10	11 lbs.

**WARNING:** Cancer and Reproductive Harm [www.P65Warnings.ca.gov](http://www.P65Warnings.ca.gov)

## 4 GAUGE SWITCH-TO-STARTER CABLES

- Recommended for engine to ground connections

Fits up to 3/8" stud



4 Gauge Part #	Color	Length	Master Carton	
			Quantity	Weight
04282	Black	16"	10	4 lbs.
04276	Red	16"	10	4 lbs.
04283	Black	18"	10	4 lbs.
04277	Red	18"	10	4 lbs.
04284	Black	24"	10	4 lbs.
04278	Red	24"	10	4 lbs.
04285	Black	32"	10	5 lbs.
04279	Red	32"	10	5 lbs.
04286	Black	40"	10	6 lbs.
04280	Red	40"	10	6 lbs.
04287	Black	49"	10	7 lbs.
04281	Red	49"	10	7 lbs.

**WARNING:** Cancer and Reproductive Harm [www.P65Warnings.ca.gov](http://www.P65Warnings.ca.gov)



## 2 GAUGE TOP POST BATTERY CABLES

- Auxiliary leads are 4" long, 12 gauge
- Bolt and nut included

Fits up to 3/8" stud



2 Gauge Part #	Color	Length	Leads	Master Carton	
				Quantity	Weight
04214	Black	10"	0	10	6 lbs.
04200	Red	10"	0	10	6 lbs.
04242	Black	10"	1	10	6 lbs.
04228	Red	10"	1	10	6 lbs.
04215	Black	15"	0	10	7 lbs.
04201	Red	15"	0	10	7 lbs.
04243	Black	15"	1	10	7 lbs.
04229	Red	15"	1	10	7 lbs.
04216	Black	20"	0	10	7 lbs.
04202	Red	20"	0	10	7 lbs.
04244	Black	20"	1	10	7 lbs.
04230	Red	20"	1	10	7 lbs.
04217	Black	23"	0	10	8 lbs.
04203	Red	23"	0	10	8 lbs.
04245	Black	25"	1	10	9 lbs.
04231	Red	25"	1	10	9 lbs.
04218	Black	27"	0	10	9 lbs.
04204	Red	27"	0	10	9 lbs.
04219	Black	32"	0	10	10 lbs.
04205	Red	32"	0	10	10 lbs.
04247	Black	32"	1	10	10 lbs.
04233	Red	32"	1	10	10 lbs.
04220	Black	34"	0	10	11 lbs.
04206	Red	34"	0	10	11 lbs.
04221	Black	38"	0	10	12 lbs.
04207	Red	38"	0	10	12 lbs.
04249	Black	38"	1	10	12 lbs.
04235	Red	38"	1	10	12 lbs.
04222	Black	43"	0	10	13 lbs.
04208	Red	43"	0	10	13 lbs.
04250	Black	43"	1	10	13 lbs.
04236	Red	43"	1	10	13 lbs.
04223	Black	48"	0	10	14 lbs.
04209	Red	48"	0	10	14 lbs.
04251	Black	48"	1	10	14 lbs.
04237	Red	48"	1	10	14 lbs.
04224	Black	53"	0	10	15 lbs.
04210	Red	53"	0	10	15 lbs.
04225	Black	58"	0	10	16 lbs.
04211	Red	58"	0	10	16 lbs.
04253	Black	58"	1	10	16 lbs.
04239	Red	58"	1	10	16 lbs.
04226	Black	65"	0	10	17 lbs.
04212	Red	65"	0	10	17 lbs.
04254	Black	65"	1	10	17 lbs.
04240	Red	65"	1	10	17 lbs.
04227	Black	72"	0	10	18 lbs.
04213	Red	72"	0	10	18 lbs.
04255	Black	72"	1	10	18 lbs.
04241	Red	72"	1	10	18 lbs.

**⚠ WARNING:** Cancer and Reproductive Harm [www.P65Warnings.ca.gov](http://www.P65Warnings.ca.gov)

## 2 GAUGE SWITCH-TO-STARTER CABLES

- Recommended for engine to ground connections

Fits up to 3/8" stud



2 Gauge Part #	Color	Length	Master Carton	
			Quantity	Weight
04294	Black	16"	10	6 lbs.
04288	Red	16"	10	6 lbs.
04295	Black	18"	10	6 lbs.
04289	Red	18"	10	6 lbs.
04296	Black	24"	10	7 lbs.
04290	Red	24"	10	7 lbs.
04297	Black	32"	10	8 lbs.
04291	Red	32"	10	8 lbs.
04298	Black	40"	10	9 lbs.
04292	Red	40"	10	9 lbs.
04299	Black	49"	10	10 lbs.
04293	Red	49"	10	10 lbs.

**⚠ WARNING:** Cancer and Reproductive Harm [www.P65Warnings.ca.gov](http://www.P65Warnings.ca.gov)

### JUMPER CABLES

- Made with welding cable
- For series hook-up



Straight terminals



Same-side terminals



Offset angle terminals

Part #	Color	Gauge	Length	Master Carton	
				Quantity	Weight
<b>Straight Terminals</b>					
04302	Black	1	8"	6	8 lbs.
04303	Black	1	12"	6	8 lbs.
04309	Black	2/0	8"	6	8 lbs.
04310	Black	2/0	12"	6	8 lbs.
04311	Black	2/0	19"	6	10 lbs.
<b>Same Side Terminals</b>					
04304	Black	1	8"	6	8 lbs.
04305	Black	1	12"	6	9 lbs.
04312	Black	2/0	8"	6	8 lbs.
04313	Black	2/0	12"	6	9 lbs.
04314	Black	2/0	19"	6	12 lbs.
<b>Offset Angle Terminals</b>					
04300	Black	1	8"	6	8 lbs.
04301	Black	1	12"	6	9 lbs.
04306	Black	2/0	8"	6	8 lbs.
04307	Black	2/0	12"	6	9 lbs.
04308	Black	2/0	19"	6	11 lbs.

**⚠ WARNING:** Cancer and Reproductive Harm [www.P65Warnings.ca.gov](http://www.P65Warnings.ca.gov)

### 6 GAUGE GOLF CAR CABLES

#### Stud Terminal Type

- Ring terminals are tin-plated copper to fit 5/16" stud



Part #	Color	Length	Master Carton	
			Quantity	Weight
31104	Black	9"	50	5 lbs.
31105	Red	9"	50	5 lbs.
31106	Black	12"	50	6 lbs.
31107	Red	12"	50	6 lbs.
31108	Black	14"	50	7 lbs.
31109	Red	14"	50	7 lbs.
31110	Black	16"	50	8 lbs.
31111	Red	16"	50	8 lbs.
31112	Black	18"	50	9 lbs.
31113	Red	18"	50	9 lbs.
31114	Black	20"	50	10 lbs.
31115	Red	20"	50	10 lbs.
31116	Black	21"	50	10 lbs.
31117	Red	21"	50	10 lbs.
31118	Black	23"	50	11 lbs.
31119	Red	23"	50	11 lbs.

**⚠ WARNING:** Cancer and Reproductive Harm [www.P65Warnings.ca.gov](http://www.P65Warnings.ca.gov)

### 6 GAUGE GOLF CAR JUMPER CABLES

#### Top Post Style

- For series hook up



#### Stud Terminal Type

- Thimble lugs are tin-plated copper to fit 5/16" stud



Part #	Color	Length	Master Carton	
			Quantity	Weight
<b>Top Post Jumpers</b>				
03327	Black	9"	10	6 lbs.
04327	Red	9"	10	6 lbs.
03328	Black	12"	10	7 lbs.
04328	Red	12"	10	7 lbs.
<b>Stud Terminal Jumpers</b>				
03332	Black	9"	10	1 lb.
04332	Red	9"	10	1 lb.
03333	Black	12"	10	2 lbs.
04333	Red	12"	10	2 lbs.
03334	Black	20"	10	2 lbs.
04334	Red	20"	10	2 lbs.

**⚠ WARNING:** Cancer and Reproductive Harm [www.P65Warnings.ca.gov](http://www.P65Warnings.ca.gov)



# IN FOCUS: Overmolded Cable Assemblies and Accessories

Battery systems can be extremely hard to maintain and service without having the right connections. Our Overmolded Cable Assemblies streamline battery connections with a secure and safe fit. Exposed connections are significantly reduced to minimize the formation of corrosion. Accessories complement our cable assemblies to help further service battery connection needs.



Before



After



## Group 31 Multi-Battery Overmolded Cable Assembly

- Made with 2/0 PVC starter cable
- Attached protective caps to seal connection
- Fits up to 3/8" stud
- Packaged for retail in bag with header card

- 2-Battery, Red, 7", 04362
- 2-Battery, Black, 7", 04363
- 3-Battery, Red, 14", 04364
- 3-Battery, Black, 14", 04365
- 4-Battery, Red, 21", 04662
- 4-Battery, Black, 21", 04663

Warning & Information on page 22



### Group 31 Closed Top Nuts 00574 card of 1

- 3/8" - 16 unc thread and 9/16" hex head
- Stainless steel sintered material
- Fits Group 31 overmolded cable assemblies

Information on page 31



### Protective Stud Caps, Red 04892 bag of 10

- Fits 3/8" stud
- Helps protect against corrosion
- Fits group 31 overmolded cable assemblies

Warning & Information on page 45



### Protective Stud Caps, Black 04893 bag of 10

- Fits 3/8" stud
- Helps protect against corrosion
- Fits group 31 overmolded cable assemblies

Warning & Information on page 45



### Self Fusing Auto Tape

- 04366 box of 4 (2 red, 2 blk)
- 04367 Black, card of 1
- 04368 Rd, card of 1

- Provides a moisture tight seal
- Insulates to protect wires and splices
- Ideal for high temperature applications
- Alternative to heat shrink tubing

Information on page 43



### 2/0 GAUGE TOP STUD STACKABLE BATTERY CABLES

- Made with welding cable

**For Group 31  
stud batteries**

**Fits up to 3/8" stud**



Part #	Color	Length	Master Carton	
			Quantity	Weight
04315	Black	7"	6	3 lbs.
01484	Red	7"	6	3 lbs.
08754	Black	9"	6	3 lbs.
04316	Black	13"	6	4 lbs.
01485	Red	13"	6	4 lbs.
08755	Black	15"	6	4 lbs.

**⚠ WARNING:** Cancer and Reproductive Harm [www.P65Warnings.ca.gov](http://www.P65Warnings.ca.gov)

### 2/0 GAUGE HARNESS ASSEMBLIES

- 04317 & 04318 include three hex serrated flange nuts and one charging post for 3/8" stud-type battery
- 04319 & 04320 include four hex serrated flange nuts and one charging post for 3/8" stud-type battery



Part #	Color	Length	Master Carton	
			Quantity	Weight
04317	Red	7"	1	1 lb.
04318	Black	7"	1	1 lb.
04319	Red	14"	1	2 lbs.
04320	Black	14"	1	2 lbs.

**⚠ WARNING:** Cancer and Reproductive Harm [www.P65Warnings.ca.gov](http://www.P65Warnings.ca.gov)

### OVERMOLDED HARNESS ASSEMBLIES

- Made with 2/0 PVC starter cable
- Attached protective caps to seal connection
- Fits up to 3/8" stud
- Use only the closed top nut (item 05419 or 00574) found on page 31 for the proper connection of these assemblies.



Part #	Color	Length	Master Carton	
			Quantity	Weight
04362	Red	7"	1	1 lb.
04363	Black	7"	1	1 lb.
04364	Red	14"	1	2 lbs.
04365	Black	14"	1	2 lbs.
04662	Red	21"	1	3 lbs.
04663	Black	21"	1	3 lbs.

**⚠ WARNING:** Cancer and Reproductive Harm [www.P65Warnings.ca.gov](http://www.P65Warnings.ca.gov)

#### CONNECTING IN SERIES — double voltage, same capacity (Ah)

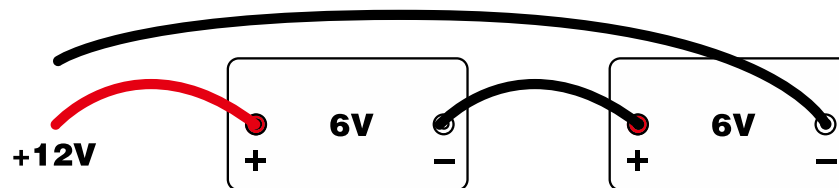

#### CONNECTING IN PARALLEL — same voltage, double capacity (Ah)

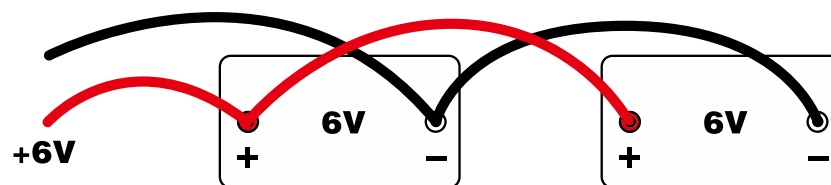



**2/0 GAUGE  
FLEET BATTERY CABLES**

- 1/2" stud hole size
- Made with PVC starter cable

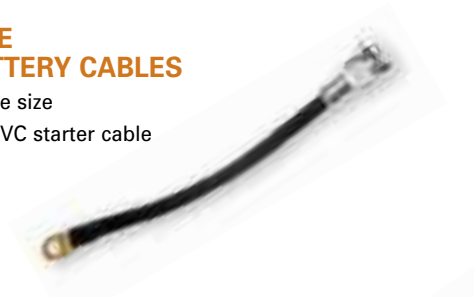

Part #	Color	Length	Master Carton	
			Quantity	Weight
04321	Black	12"	6	6 lbs.
04322	Black	24"	6	9 lbs.
04323	Black	36"	6	12 lbs.
04324	Black	48"	6	15 lbs.
04325	Black	60"	6	18 lbs.
04326	Black	72"	6	21 lbs.

**WARNING:** Cancer and Reproductive Harm [www.P65Warnings.ca.gov](http://www.P65Warnings.ca.gov)

**4 GAUGE  
BONDING STRAPS**

**Fits up to 3/8" stud**

- Tin-plated copper
- Maximum protection against corrosion for farm, commercial vehicles, and off-road applications



Part #	Gauge	Length	Master Carton	
			Quantity	Weight
04353	4	8"	10	2 lbs.
04354	4	12"	10	2 lbs.

**BRAIDED GROUND STRAPS**

**Fits up to 3/8" stud**

- Tin-plated copper
- Maximum protection against corrosion for farm, commercial vehicles, and off-road applications



Part #	Gauge	Length	Master Carton	
			Quantity	Weight
04345	4	7"	10	4 lbs.
04346	4	9"	10	4 lbs.
04347	4	11"	10	5 lbs.
04348	4	14"	10	5 lbs.
04349	4	16"	10	5 lbs.
04350	4	19"	10	6 lbs.
04351	4	24"	10	7 lbs.
04352	4	27"	10	7 lbs.
04337	2	7"	10	5 lbs.
04338	2	9"	10	5 lbs.
04339	2	11"	10	6 lbs.
04340	2	14"	10	6 lbs.
04341	2	16"	10	7 lbs.
04342	2	19"	10	7 lbs.
04343	2	24"	10	8 lbs.
01051	2	26"	10	9 lbs.
04344	2	27"	10	9 lbs.

**WARNING:** Cancer and Reproductive Harm [www.P65Warnings.ca.gov](http://www.P65Warnings.ca.gov)

**12 GAUGE CUP STYLE  
CHARGING CABLE**

- For group charging top post batteries



Part #	Color	Length	Master Carton	
			Quantity	Weight
04335	Black	15"	100	31 lbs.

**WARNING:** Cancer and Reproductive Harm [www.P65Warnings.ca.gov](http://www.P65Warnings.ca.gov)

**2/0 GAUGE  
FORD DIESEL HARNESS**

- Fits Ford Diesel trucks w/ dual batteries (1987-present)
- Red cable w/ black loom



Part #	Color	Length	Master Carton	
			Quantity	Weight
04357	Red	116"	1	7 lbs.
00593	Red	123"	1	8 lbs.

**WARNING:** Cancer and Reproductive Harm [www.P65Warnings.ca.gov](http://www.P65Warnings.ca.gov)





# Terminals, Lugs, and Fasteners

East Penn cast terminals are manufactured with 100% recycled lead. Lead is recognized as the premium choice in battery cable terminals because of its maximum current carrying ability, malleability, and corrosion resistance.



ALL EAST PENN MANUFACTURED LEAD PRODUCTS ARE BUILT WITH 100% RECYCLED LEAD ALLOY.

- Terminals
- Fasteners
- Lugs
- Crimpable Terminals
- Industrial Plugs

**HEAVY-DUTY  
TOP POST TERMINALS**

- Fits 6 to 1 gauge cables



**HEAVY-DUTY  
TOP POST  
EPOXY COATED  
TERMINALS**

- Fits 6 to 1 gauge cables



**HEAVY-DUTY  
COMMERCIAL  
TOP POST TERMINALS**

- Fits 2 to 4/0 gauge cables



**HEAVY-DUTY  
REPLACEMENT  
SIDE TERMINAL**

- Fits 6 to 1 gauge cables



**3-WAY TOP POST  
TERMINAL**

- Fits 6 to 1 gauge cables



**3-WAY TOP POST  
COMMERCIAL  
TERMINAL**

- Fits 2 to 4/0 gauge cables



**GROUP 31  
HEAVY DUTY  
3-WAY TERMINAL**

- Fits 2 to 4/0 gauge cables
- Fits up to 3/8" stud



Part #	Polarity	Packaging	Master Carton	
			Quantity	Weight
00350 <sup>1</sup>	Universal	Clam Shell of 1	24	7 lbs.
00147	Universal	Clam Shell of 2	24	14 lbs.
00369	Universal	Card of 10	10	27 lbs.
06079	Universal	Unbranded Card of 10	10	27 lbs.
05300	Universal	Bulk	100	27 lbs.

<sup>1</sup>Hardware is bagged separately in clam shell

**WARNING:** Cancer and Reproductive Harm [www.P65Warnings.ca.gov](http://www.P65Warnings.ca.gov)

Part #	Polarity	Packaging	Master Carton	
			Quantity	Weight
03067	1 Pos/1 Neg	Clam Shell of 2	10	7 lbs.
05305	Positive	Bulk - Red	50	14 lbs.
05306	Negative	Bulk - Black	50	14 lbs.

**WARNING:** Cancer and Reproductive Harm [www.P65Warnings.ca.gov](http://www.P65Warnings.ca.gov)

Part #	Polarity	Packaging	Master Carton	
			Quantity	Weight
00366	Universal	Clam Shell of 1	10	6 lbs.
00370	Universal	Card of 10	6	31 lbs.
05301	Universal	Bulk	60	30 lbs.

**WARNING:** Cancer and Reproductive Harm [www.P65Warnings.ca.gov](http://www.P65Warnings.ca.gov)

Part #	Polarity	Packaging	Master Carton	
			Quantity	Weight
00351 <sup>2</sup>	Universal	Clam Shell of 1	24	5 lbs.
00192	Universal	Card of 8	10	21 lbs.
06080	Universal	Unbranded Card of 8	10	23 lbs.
05302 <sup>1</sup>	Universal	Bulk	50	12 lbs.
05303 <sup>2</sup>	Universal	Bulk	50	14 lbs.

<sup>1</sup>Order 3/8" bolt separately Part No. 05304

<sup>2</sup>Comes with 3/8" bolt, hardware is bagged separately

**WARNING:** Cancer and Reproductive Harm [www.P65Warnings.ca.gov](http://www.P65Warnings.ca.gov)

Part #	Polarity	Packaging	Master Carton	
			Quantity	Weight
05439	Positive	Bulk	25	11 lbs.
05440	Negative	Bulk	25	11 lbs.
05443	1 Pos/1 Neg	Bag of 2	20	17 lbs.

**WARNING:** Cancer and Reproductive Harm [www.P65Warnings.ca.gov](http://www.P65Warnings.ca.gov)

Part #	Polarity	Packaging	Master Carton	
			Quantity	Weight
1512137	Negative	Bulk	25	18 lbs.
1512138	Positive	Bulk	25	18 lbs.

**WARNING:** Cancer and Reproductive Harm [www.P65Warnings.ca.gov](http://www.P65Warnings.ca.gov)

Part #	Polarity	Packaging	Master Carton	
			Quantity	Weight
31102	Universal	Box of 10	1	7 lbs.

**WARNING:** Cancer and Reproductive Harm [www.P65Warnings.ca.gov](http://www.P65Warnings.ca.gov)





### 8D ADD-ON TERMINAL

- Will only fit East Penn 8D battery
- Converts top post SAE 8D battery to fit side connections
- 3/8"-16 stud terminal (3/4" length)
- Includes 6 zinc-plated steel attachment screws
- Should be tightened to 4-6 ft-lbs.



Part #	Polarity	Packaging	Master Carton	
			Quantity	Weight
31100	1 Pos/1 Neg	Bag of 2	1	3 lbs.

**WARNING:** Cancer and Reproductive Harm [www.P65Warnings.ca.gov](http://www.P65Warnings.ca.gov)

### EPOXY-COATED WING NUT TERMINALS

- Clamp-type wing nut terminals convert standard post to marine or other special uses
- Brass plated wing nut
- Epoxy coating aids in polarity identification and corrosion resistance
- Positive terminal stud size is 3/8"
- Negative terminal stud size is 5/16"



Part #	Polarity	Packaging	Master Carton	
			Quantity	Weight
00148	1 Pos/1 Neg	Clam Shell of 2	10	8 lbs.
05310	Positive	Bulk - Red	50	20 lbs.
05311	Negative	Bulk - Black	50	20 lbs.

**WARNING:** Cancer and Reproductive Harm [www.P65Warnings.ca.gov](http://www.P65Warnings.ca.gov)

### WING NUT TERMINALS

- Clamp type wing nut terminals convert standard post to marine or other special uses
- Brass plated wing nut
- Positive terminal stud size is 3/8"
- Negative and universal terminal stud size is 5/16"



05308

Part #	Polarity	Packaging	Master Carton	
			Quantity	Weight
00354	1 Pos/1 Neg	Clam Shell of 2	10	8 lbs.
00149	Universal	Card of 10	10	36 lbs.
05307 <sup>1</sup>	Universal	Bulk	50	18 lbs.
05308 <sup>1</sup>	Positive	Bulk	50	18 lbs.
05309 <sup>1</sup>	Negative	Bulk	50	18 lbs.

<sup>1</sup>Wing nuts packaged in bag, inside box

**WARNING:** Cancer and Reproductive Harm [www.P65Warnings.ca.gov](http://www.P65Warnings.ca.gov)

### JIS CONVERSION TERMINALS

- Converts battery with standard SAE top posts to JIS/Pencil posts
- Durable brass construction



96920

96921

Part #	Polarity	Packaging	Master Carton	
			Quantity	Weight
96920	Negative	Bulk	10	3 lbs.
96921	Positive	Bulk	10	3 lbs.

**WARNING:** Cancer and Reproductive Harm [www.P65Warnings.ca.gov](http://www.P65Warnings.ca.gov)

### SAE-DIN-ISO REPLACEMENT TERMINAL

- Designed for OEM & Aftermarket Applications
- Designed for SAE, DIN & ISO Battery Posts
- Vertical drive clamping feature for easy reach
- Tin-plated brass & zinc-plated steel construction
- Meets OEM performance standards
- Positive terminal stud size is M6, negative is M8

US Patent # 9774110



00512

### BRASS TERMINALS

- 00512
- Fits 6 to 1 gauge cables
- Durable brass construction

00639

- Clamp type wing nut terminals convert standard post to marine or other special uses
- Durable brass construction



00639

Part #	Polarity	Packaging	Master Carton	
			Quantity	Weight
31219	1 Pos/1 Neg	Clam of 2	10	3 lbs.

**WARNING:** Cancer and Reproductive Harm [www.P65Warnings.ca.gov](http://www.P65Warnings.ca.gov)

Part #	Polarity	Packaging	Master Carton	
			Quantity	Weight
00512	Universal	Clam Shell of 1	10	2 lbs.
00639 <sup>1</sup>	1 Pos/1 Neg	Clam Shell of 2	10	8 lbs.

<sup>1</sup>5/16" stud size

**WARNING:** Cancer and Reproductive Harm [www.P65Warnings.ca.gov](http://www.P65Warnings.ca.gov)

### ZINC TOP POST TERMINAL

- Fits 6-1 gauge cables
- Lead-Free
- RoHS Compliant



Part #	Polarity	Packaging	Master Carton	
			Quantity	Weight
31096	Universal	Clam Shell of 1	10	2 lbs.

**⚠ WARNING:** Cancer and Reproductive Harm [www.P65Warnings.ca.gov](http://www.P65Warnings.ca.gov)

### ZINC MARINE TERMINALS

- Clamp type wing nut terminal converts standard post to marine or other special uses
- Stud size is 3/8"
- Lead-Free
- RoHS Compliant



Part #	Polarity	Packaging	Master Carton	
			Quantity	Weight
31097	Universal	Clam Shell of 1	10	3 lbs.

**⚠ WARNING:** Cancer and Reproductive Harm [www.P65Warnings.ca.gov](http://www.P65Warnings.ca.gov)

### ZINC REPLACEMENT SIDE TERMINAL

- Fits 6-1 gauge cables
- Comes with 3/8" bolt
- Lead-Free
- RoHS Compliant



Part #	Polarity	Packaging	Master Carton	
			Quantity	Weight
31098	Universal	Clam Shell of 1	10	2 lbs.

**⚠ WARNING:** Cancer and Reproductive Harm [www.P65Warnings.ca.gov](http://www.P65Warnings.ca.gov)

### ZINC COMMERCIAL TOP POST TERMINAL

- Fits 2 to 4/0 gauge cables
- Lead-Free
- RoHS Compliant



Part #	Polarity	Packaging	Master Carton	
			Quantity	Weight
31099	Universal	Clam Shell of 1	10	3 lbs.

**⚠ WARNING:** Cancer and Reproductive Harm [www.P65Warnings.ca.gov](http://www.P65Warnings.ca.gov)

### LEAD FREE QUICK CLAMP® TERMINAL

- Tin-plated brass terminal
- Stud size is 5/16"
- Lug hole size fits 5/16"
- Packaging includes four lugs, one positive & one negative quick clamp terminal
- All hardware is included (hex nut, washer, and knurled thumb nut)
- Allows easy, tool-free detachment from battery
- Patented design



Part #	Polarity	Packaging	Master Carton	
			Quantity	Weight
08767	1 Pos/1 Neg	Clam Shell of 2	12	5 lbs.

### LEAD FREE TERMINALS WITH LUGS

- Terminal made of tin-plated brass
- Stud size is 5/16"
- Comes with 2 lugs to fit 5/16" studs
- Allows straight or angled hook-up to cable
- Fits 4 and 6 gauge cable



Part #	Polarity	Packaging	Master Carton	
			Quantity	Weight
01056	Universal	Clam Shell of 1	10	2 lbs.
01057	Universal	Bulk	100	15 lbs.
05512	Universal	Card of 10	10	15 lbs.

### LEAD FREE TERMINALS WITH HEAT SHRINK TUBE

- Terminal made of tin-plated brass
- Color-coded shrink tube allows for easy polarity identification
- Fits 2 and 4 gauge cable



Part #	Polarity	Packaging	Master Carton	
			Quantity	Weight
04842	Universal	Clam Shell of 2	12	3 lbs.

**⚠ WARNING:** Cancer and Reproductive Harm [www.P65Warnings.ca.gov](http://www.P65Warnings.ca.gov)



**LEAD QUICK DISCONNECT TERMINAL**

- Designed for top post batteries  
Fits both negative and positive posts
- For use in passenger cars, light-duty trucks, farm equipment, marine, RVs, and ATVs
- The cable easily detaches from the battery for anti-theft protection and to prevent electrical drain



Part #	Polarity	Packaging	Master Carton	
			Quantity	Weight
00191	Universal	Card of 1	12	4 lbs.
05312	Universal	Bulk	10	6 lbs.

**WARNING:** Cancer and Reproductive Harm [www.P65Warnings.ca.gov](http://www.P65Warnings.ca.gov)



**BRASS QUICK DISCONNECT TERMINALS**

- Designed for top post batteries  
Fits both negative and positive posts
- Durable brass construction
- The cable easily detaches from the battery for anti-theft protection and to prevent electrical drain



31185

Part #	Type	Packaging	Master Carton	
			Quantity	Weight
31185	Top	Clam Shell of 1	10	4 lbs.
31186	Marine	Clam Shell of 1	10	4 lbs.

**WARNING:** Cancer and Reproductive Harm [www.P65Warnings.ca.gov](http://www.P65Warnings.ca.gov)

31185

- For use in passenger cars, light-duty trucks, farm equipment, marine, RVs, and ATVs
- Fits 2 and 4 gauge cable



31186

31186

- For use in marine applications
- 5/16" stud and wing nut

**POWER SPORTS CHARGING POSTS**

- Facilitate charging and testing of power sports batteries
- Posts have M6 threaded stud to screw into power sports battery terminals
- Easy finger tight installation



Part #	Polarity	Packaging	Master Carton	
			Quantity	Weight
05457	Universal	Clam Shell of 2	10	3 lbs.
00385	Universal	Bag of 25	1	11 lbs.

**WARNING:** Cancer and Reproductive Harm [www.P65Warnings.ca.gov](http://www.P65Warnings.ca.gov)

**SIDE TERMINAL CHARGING POSTS**

- Facilitate charging and testing of side terminal batteries
- Posts have 3/8" threaded stud to screw into side terminal batteries
- Not intended for side terminal to post conversion



Part #	Polarity	Packaging	Master Carton	
			Quantity	Weight
00352	1 Pos/1 Neg	Clam Shell of 2	10	4 lbs.
05313	Positive	Bulk	25	5 lbs.
05314	Negative	Bulk	25	5 lbs.

**WARNING:** Cancer and Reproductive Harm [www.P65Warnings.ca.gov](http://www.P65Warnings.ca.gov)

**CHARGING POSTS WITH EARS**

- Facilitate charging and testing of batteries
- Posts have 3/8" threaded stud to screw into side terminal batteries
- 01477 fits 3/8" stud
- Easy finger tight installation



01477

05456

Part #	Battery Type	Packaging	Master Carton	
			Quantity	Weight
00386	Side	Clam Shell of 2	10	3 lbs.
05456	Side	Bulk	100	15 lbs.
01477	3/8" Stud	Bag of 6	10	20 lbs.

**WARNING:** Cancer and Reproductive Harm [www.P65Warnings.ca.gov](http://www.P65Warnings.ca.gov)

**GROUP 31 OR STUD STYLE CONVERSION POSTS**

- Use to convert 3/8" stud type terminals to post type terminals



05320

05769

Part #	Polarity	Packaging	Master Carton	
			Quantity	Weight
00575	Universal	Clam Shell of 2	10	3 lbs.
05320	Universal	Bulk	25	5 lbs.
05768	Positive	Bulk	25	4 lbs.
05769	Negative	Bulk	25	4 lbs.

**WARNING:** Cancer and Reproductive Harm [www.P65Warnings.ca.gov](http://www.P65Warnings.ca.gov)



### ORDNANCE BOLT TYPE TERMINAL

- Lead construction
- Long bolt allows for additional power connection



Part #	Polarity	Packaging	Master Carton	
			Quantity	Weight
05315	Positive	Bulk	25	13 lbs.
05316	Negative	Bulk	25	13 lbs.
05317	Universal	Bulk	25	13 lbs.

**⚠ WARNING:** Cancer and Reproductive Harm [www.P65Warnings.ca.gov](http://www.P65Warnings.ca.gov)

### POST TO THREADED CONNECTOR CONVERSION

#### 3/8" Stud

- Change a post type battery to a 3/8" stud type battery
- Can be used with OE nut
- Wing nut or hex nut can be used if clearance is a problem



Part #	Polarity	Packaging	Master Carton	
			Quantity	Weight
05318	Universal	Bulk	25	11 lbs.

**⚠ WARNING:** Cancer and Reproductive Harm [www.P65Warnings.ca.gov](http://www.P65Warnings.ca.gov)

### UNIVERSAL SIDE TERMINAL CONVERSION POST

- Extends above the battery to convert side terminal battery to post terminal
- For use with post terminal battery cables or for group charging



Part #	Polarity	Packaging	Master Carton	
			Quantity	Weight
05319	Universal	Bulk	25	8 lbs.

**⚠ WARNING:** Cancer and Reproductive Harm [www.P65Warnings.ca.gov](http://www.P65Warnings.ca.gov)

### SIDE TERMINAL ADAPTERS

- Converts post terminal battery for use with side terminal cables



Part #	Polarity	Packaging	Master Carton	
			Quantity	Weight
00353	1 Pos/1 Neg	Clam Shell of 2	10	9 lbs.
05411	Positive	Bulk	25	11 lbs.
05412	Negative	Bulk	25	11 lbs.

**⚠ WARNING:** Cancer and Reproductive Harm [www.P65Warnings.ca.gov](http://www.P65Warnings.ca.gov)

### FLAG TO POST TERMINAL ADAPTERS

- Designed to easily convert most U1 flag terminal batteries to post terminal applications where required



Part #	Packaging	Master Carton	
		Quantity	Weight
02033	Clam Shell of 2	10	4 lbs.
05321	Bulk	25	5 lbs.

**⚠ WARNING:** Cancer and Reproductive Harm [www.P65Warnings.ca.gov](http://www.P65Warnings.ca.gov)

### BRASS BOLT EXTENDERS

- For adding direct to battery auxiliary connections

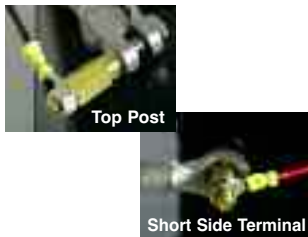

1-3/4" Short Side Bolt



00543  
3/8-16 Thread

1-13/16" Long Side Bolt



00542  
3/8-16 Thread

1-7/16" Top Post Terminal Bolt Extender



00541  
5/16-18 Thread

Part #	Packaging	Master Carton	
		Quantity	Weight
<b>1-3/4" Short Side Bolt</b>			
00543	Clam Shell of 1	10	1 lb.
05416	Bulk	10	1 lb.
<b>1-13/16" Long Side Bolt</b>			
00542	Clam Shell of 1	10	1 lbs.
05417	Bulk	10	1 lbs.
<b>1-7/16" Top Post Terminal Bolt Extender</b>			
00541	Clam Shell of 1	10	1 lbs.
05418	Bulk	10	1 lbs.

**⚠ WARNING:** Cancer and Reproductive Harm [www.P65Warnings.ca.gov](http://www.P65Warnings.ca.gov)

### GOLD-PLATED BOLTS & TERMINALS

- Genuine 24K gold-plated brass



05444\*

05445

05446\*\*

Part #	Description	Packaging	Master Carton	
			Quantity	Weight
05444*	Top Post Terminal	Clam Shell of 1	25	5 lbs.
05445	Side Post Replacement Bolt	Clam Shell of 1	25	3 lbs.
05446**	Multi-Lead Top Post Terminal	Clam Shell of 1	25	6 lbs.

\* Fits 6 to 1 gauge cables

\*\* One 5/16" ring terminal and two 8 gauge auxiliary ports

**⚠ WARNING:** Cancer and Reproductive Harm [www.P65Warnings.ca.gov](http://www.P65Warnings.ca.gov)







**LEAD SHIMS**

- Rebuild battery post/cable clamp connections



Part #	Polarity	Packaging	Master Carton	
			Quantity	Weight
06300	Universal	Box of 25	1	1 lb.
07753	Universal	Clam Shell of 2	10	1 lb.

**⚠ WARNING:** Cancer and Reproductive Harm [www.P65Warnings.ca.gov](http://www.P65Warnings.ca.gov)

**T-BOLT**

- Zinc-plated steel to protect against corrosion
- Includes nut and washer



Part #	Packaging	Master Carton	
		Quantity	Weight
31184	Clam Shell of 2	10	1 lb.

**⚠ WARNING:** Cancer and Reproductive Harm [www.P65Warnings.ca.gov](http://www.P65Warnings.ca.gov)

**GARDEN TRACTOR NUT AND BOLT**

- Zinc-plated steel to protect against corrosion
- Fits group U1 batteries
- 1/4"-20 x 3/4" bolt
- 1/4"-20 hex nut



Part #	Packaging	Master Carton	
		Quantity	Weight
00193	Clam Shell of 2	10	1 lb.

**BATTERY BOLT WITH SHOULDER NUT**

- Zinc-plated steel to protect against corrosion
- 5/16"-18 x 1-1/4" bolt
- 5/16"-18 hex nut



Part #	Packaging	Master Carton	
		Quantity	Weight
00324	Clam Shell of 2	10	1 lb.
05322*	Bag of 50	1	2 lbs.

\* **⚠ WARNING:** Cancer and Reproductive Harm [www.P65Warnings.ca.gov](http://www.P65Warnings.ca.gov)

**DOUBLE THREADED BOLT**

- Used for adding auxiliary accessories directly to the battery
- Zinc-plated steel to protect against corrosion
- 5/16"-18 x 2-3/8" heavy duty bolt
- Includes 2 shoulder nuts
- To be used with any heavy-duty, non-OE style battery cables



Part #	Packaging	Master Carton	
		Quantity	Weight
31187	Clam Shell of 2	10	1 lb.
31188	Bag of 25	1	2 lbs.

**OE DOUBLE THREADED BOLT**

- Used for adding auxiliary accessories directly to the battery
- Zinc-plated steel to protect against corrosion
- 1/4"-20 UNC thread
- Includes shoulder nut



Part #	Packaging	Master Carton	
		Quantity	Weight
03668	Clam Shell of 2	10	1 lb.

**REPLACEMENT SIDE TERMINAL BOLT**

- 3/8"-16 UNC thread
- For use with East Penn replacement side terminals
- Zinc-plated steel to protect against corrosion



Part #	Packaging	Master Carton	
		Quantity	Weight
05304	Bag of 50	1	2 lbs.

**OE REPLACEMENT SIDE TERMINAL BOLTS**

- 3/8"-16 UNC thread
- Use long bolt and/or spacer for dual cable hook-up
- Bolt head 5/16"
- Zinc-plated steel to protect against corrosion



Part #	Packaging	Master Carton	
		Quantity	Weight
<b>Short Side Terminal Bolt</b>			
00325	Clam Shell of 2	10	1 lb.
05323	Bag of 50	1	3 lbs.
<b>Long Side Terminal Bolt</b>			
05324 <sup>1</sup>	Bag of 25	1	2 lbs.
08766 <sup>2*</sup>	Clam Shell of 2	10	4 lbs.
<b>Spacer</b>			
05442 <sup>3*</sup>	Bulk Spacer	25	2 lbs.

<sup>1</sup>Length 1.685" <sup>2</sup>Includes lead spacer <sup>3</sup>Spacer only

\* **⚠ WARNING:** Cancer and Reproductive Harm [www.P65Warnings.ca.gov](http://www.P65Warnings.ca.gov)

**GROUP 31 NUTS**

- Closed top has 3/8"-16 UNC thread and 9/16" hex head
- Open top has 3/8"-16 UNC thread and 9/16" hex head. This is not recommended for use with the overmolded harness assemblies found on page 22



Closed Top

Open Top

Part #	Style	Packaging	Master Carton	
			Quantity	Weight
00574 <sup>1</sup>	Closed	Clam Shell of 1	10	1 lb.
05419 <sup>1</sup>	Closed	Bulk	25	2 lbs.
05415 <sup>2</sup>	Open	Bulk	25	2 lbs.

<sup>1</sup> stainless steel sintered metal  
<sup>2</sup> stainless steel

**MARINE HEX NUTS**

- Stainless steel
- 5/16-18 UNC hex nut



Part #	Packaging	Master Carton	
		Quantity	Weight
05519	Bag of 50	1	1 lb.

**WING NUTS**

- For threaded stud connections
- Stainless steel
- Contains one 3/8" wing nut and two-5/16" wing nuts



Part #	Packaging	Master Carton	
		Quantity	Weight
08779	Clam Shell of 3	10	1 lb.

**INDUSTRIAL PLUGS AND CONTACTS**

- Single piece housings made of impact resistant polycarbonate offers high physical strength & superior dielectric properties
- Silver plated solid copper contacts offer low resistance for superior conductivity
- Self cleaning contact design resists arcing by keeping conductive surfaces clean & free of corrosion
- Contacts have flared & heat treated barrels which readily accept fine stranded wire & allow easy, quality crimping
- Integral stainless steel springs maintain constant pressure on the contact to ensure a consistent, low-resistance connection
- Kits include contacts & housing



Part #	Kit Type	Color	Gauge	Packaging	Master Carton	
					Quantity	Weight
07394	50 AMP	Grey	6	Box of 1	1	0.05 lbs.
07395	50 AMP	Red	6	Box of 1	1	0.05 lbs.
07396	120 AMP	Grey	6	Box of 1	1	0.2 lbs.
07397	120 AMP	Red	6	Box of 1	1	0.2 lbs.
07398	120 AMP	Blue	6	Box of 1	1	0.2 lbs.
07399	120 AMP	Grey	4	Box of 1	1	0.2 lbs.
07480	120 AMP	Red	4	Box of 1	1	0.2 lbs.
07481	120 AMP	Blue	4	Box of 1	1	0.2 lbs.
07482	120 AMP	Grey	2	Box of 1	1	0.2 lbs.
07483	120 AMP	Red	2	Box of 1	1	0.2 lbs.
07484	120 AMP	Blue	2	Box of 1	1	0.2 lbs.
07485	175 AMP	Grey	4	Box of 1	1	0.3 lbs.
07486	175 AMP	Red	4	Box of 1	1	0.3 lbs.
07487	175 AMP	Blue	4	Box of 1	1	0.3 lbs.
07488	175 AMP	Grey	2	Box of 1	1	0.3 lbs.
07489	175 AMP	Red	2	Box of 1	1	0.3 lbs.
07490	175 AMP	Blue	2	Box of 1	1	0.3 lbs.
07491	175 AMP	Grey	1/0	Box of 1	1	0.3 lbs.
07492	175 AMP	Red	1/0	Box of 1	1	0.3 lbs.
07493	175 AMP	Blue	1/0	Box of 1	1	0.3 lbs.
07494	350 AMP	Grey	2/0	Box of 1	1	0.6 lbs.
07495	350 AMP	Red	2/0	Box of 1	1	0.6 lbs.
07496	350 AMP	Blue	2/0	Box of 1	1	0.6 lbs.
07497	350 AMP	Grey	3/0	Box of 1	1	0.6 lbs.
07498	350 AMP	Red	3/0	Box of 1	1	0.6 lbs.
07499	350 AMP	Blue	3/0	Box of 1	1	0.6 lbs.
07664	350 AMP	Grey	4/0	Box of 1	1	0.6 lbs.
07666	350 AMP	Red	4/0	Box of 1	1	0.6 lbs.
07667	350 AMP	Blue	4/0	Box of 1	1	0.6 lbs.



# CRIMPABLE TERMINALS

## STRAIGHT TERMINALS

- 100% tin-plated copper alloy
- Bolt & shoulder nut included
- Resists corrosion
- Gauge and polarity stamped on terminal
- Thick wall for strong crimp



Part #	Gauge	Polarity	Packaging	Master Carton	
				Quantity	Weight
05359	4	Universal	Bulk	10	1 lb.
05360	4	Positive	Bulk	10	1 lb.
05361	4	Negative	Bulk	10	1 lb.
05513	2	Positive	Bulk	10	2 lbs.
05514	2	Negative	Bulk	10	2 lbs.
05362	1	Positive	Bulk	10	2 lbs.
05363	1	Negative	Bulk	10	2 lbs.
05364	1/0	Positive	Bulk	10	2 lbs.
05365	1/0	Negative	Bulk	10	2 lbs.
05366	2/0	Positive	Bulk	10	2 lbs.
05367	2/0	Negative	Bulk	10	2 lbs.
05368	3/0	Positive	Bulk	10	2 lbs.
05369	3/0	Negative	Bulk	10	2 lbs.
05370	4/0	Positive	Bulk	8	2 lbs.
05371	4/0	Negative	Bulk	8	2 lbs.

## LEFT ELBOW TERMINALS

- 100% tin-plated copper alloy
- Bolt & shoulder nut included
- Resists corrosion
- Gauge and polarity stamped on terminal
- Thick wall for strong crimp



Part #	Gauge	Polarity	Packaging	Master Carton	
				Quantity	Weight
05388	1/0	Positive	Bulk	10	2 lbs.
05389	1/0	Negative	Bulk	10	2 lbs.
05390	2/0	Positive	Bulk	10	2 lbs.
05391	2/0	Negative	Bulk	10	2 lbs.
05392	3/0	Positive	Bulk	10	2 lbs.
05393	3/0	Negative	Bulk	10	2 lbs.
05394	4/0	Positive	Bulk	8	2 lbs.
05395	4/0	Negative	Bulk	8	2 lbs.

## RIGHT ELBOW TERMINALS

- 100% tin-plated copper alloy
- Bolt & shoulder nut included
- Resists corrosion
- Gauge and polarity stamped on terminal
- Thick wall for strong crimp



Part #	Gauge	Polarity	Packaging	Master Carton	
				Quantity	Weight
05380	1/0	Positive	Bulk	10	2 lbs.
05381	1/0	Negative	Bulk	10	2 lbs.
05382	2/0	Positive	Bulk	10	2 lbs.
05383	2/0	Negative	Bulk	10	2 lbs.
05384	3/0	Positive	Bulk	10	2 lbs.
05385	3/0	Negative	Bulk	10	2 lbs.
05386	4/0	Positive	Bulk	8	2 lbs.
05387	4/0	Negative	Bulk	8	2 lbs.

## FLAG TERMINALS

- 100% tin-plated copper alloy
- Bolt & shoulder nut included
- Resists corrosion
- Gauge and polarity stamped on terminal
- Thick wall for strong crimp



Part #	Gauge	Polarity	Packaging	Master Carton	
				Quantity	Weight
05372	1/0	Positive	Bulk	8	2 lbs.
05373	1/0	Negative	Bulk	8	2 lbs.
05374	2/0	Positive	Bulk	8	3 lbs.
05375	2/0	Negative	Bulk	8	3 lbs.
05376	3/0	Positive	Bulk	8	3 lbs.
05377	3/0	Negative	Bulk	8	3 lbs.
05378	4/0	Positive	Bulk	8	3 lbs.
05379	4/0	Negative	Bulk	8	3 lbs.



**3/8" STUD TERMINALS**

- 100% tin-plated copper alloy
- Resists corrosion
- Thick wall for strong crimp
- Gauges identified on lugs
- Crimp or solder to cable
- Fits up to 3/8" stud



05396

05397

Part #	Gauge	Style	Packaging	Master Carton	
				Quantity	Weight
05396	2/0	Single	Bulk	10	1 lb.
05397	2/0	Dual	Bulk	10	2 lbs.

**SIDE TERMINAL**

- 100% tin-plated copper alloy
- Resists corrosion
- Thick wall for strong crimp
- Gauges identified on lugs
- Crimp or solder to cable
- Fits up to 3/8" stud



Part #	Gauge	Polarity	Packaging	Master Carton	
				Quantity	Weight
05475	4	Universal	Bulk	10	1 lb.
05476	2	Universal	Bulk	10	1 lb.

**LOCKING ANTI-ROTATING STACKABLE LUGS**

- 100% tin-plated copper alloy
- Resists corrosion
- Thick wall for strong crimp
- Gauges identified on lugs
- Crimp or solder to cable
- Fits up to 3/8" stud



05495

05496

Part #	Gauge	Packaging	Master Carton	
			Quantity	Weight
05495	1/0	Bulk	10	1 lb.
05496	2/0	Bulk	10	1 lb.
05497	3/0	Bulk	10	1 lb.

**SPLICES**

- 100% tin-plated copper alloy
- Resists corrosion
- Thick wall for strong crimp
- Crimp or solder to cable



Part #	Gauge	Packaging	Master Carton	
			Quantity	Weight
05354 <sup>1</sup>	4	Bulk	10	1 lb.
05355 <sup>1</sup>	1-2	Bulk	10	2 lbs.
05356 <sup>1</sup>	1/0	Bulk	10	3 lbs.
05357 <sup>1</sup>	2/0	Bulk	10	3 lbs.
05358 <sup>1</sup>	3/0	Bulk	10	3 lbs.
05398	1/0	Bulk	10	1 lb.
05399	2/0	Bulk	10	1 lb.
05400	3/0	Bulk	10	1 lb.
05401	4/0	Bulk	10	1 lb.

<sup>1</sup> Extra thick wall for greater strength and conductivity



**COPPER LUGS**

- Lugs can be crimped or soldered and are stackable
- Gauge stamped on lug for easy identification
- Flared ends for easy entry
- UL Listed



**Packaged**



00685

00539

Part #	Gauge	Stud Hole	Packaging	Master Carton	
				Quantity	Weight
00548	6	1/4"	Clam Shell of 2	10	1 lb.
00549	6	5/16"	Clam Shell of 2	10	1 lb.
00685	4	3/8"	Clam Shell of 2	10	1 lb.
00547	4	5/16"	Clam Shell of 2	10	1 lb.
00546	2	5/16"	Clam Shell of 2	10	1 lb.
00544	2	3/8"	Clam Shell of 2	10	1 lb.
00545	2	1/2"	Clam Shell of 2	10	1 lb.
00539 <sup>1,2</sup>	2/0	3/8"	Clam Shell of 2	10	1 lb.
00540 <sup>1,2</sup>	2/0	1/2"	Clam Shell of 2	10	1 lb.

<sup>1</sup> Tin-plated  
<sup>2</sup> non UL-listed

**Bulk**



Part #	Gauge	Stud Hole	Packaging	Master Carton	
				Quantity	Weight
05470	8	#10	Bulk	50	1 lb.
05472	8	1/4"	Bulk	50	1 lb.
05474	8	5/16"	Bulk	50	1 lb.
05473	8	3/8"	Bulk	50	1 lb.
05471	8	1/2"	Bulk	50	1 lb.
05466	6	#10	Bulk	50	1 lb.
05467	6	1/4"	Bulk	50	1 lb.
05468	6	5/16"	Bulk	50	1 lb.
05326	6	3/8"	Bulk	50	1 lb.
05469	6	1/2"	Bulk	50	1 lb.
05465	4	1/4"	Bulk	50	1 lb.
05328	4	5/16"	Bulk	50	1 lb.
05327	4	3/8"	Bulk	50	1 lb.
05464	4	1/2"	Bulk	50	1 lb.
05461	2	1/4"	Bulk	50	1 lb.
05462	2	5/16"	Bulk	50	1 lb.
05329	2	3/8"	Bulk	50	1 lb.
05330	2	1/2"	Bulk	50	1 lb.
05458	1	1/4"	Bulk	50	2 lbs.
05459	1	5/16"	Bulk	50	2 lbs.
05331	1	3/8"	Bulk	50	2 lbs.
05332	1	1/2"	Bulk	50	2 lbs.
05506	1/0	1/4"	Bulk	50	2 lbs.
05460	1/0	5/16"	Bulk	50	2 lbs.
05333	1/0	3/8"	Bulk	50	2 lbs.
05334	1/0	1/2"	Bulk	50	2 lbs.
05507	2/0	1/4"	Bulk	50	3 lbs.
05463	2/0	5/16"	Bulk	50	3 lbs.
05335	2/0	3/8"	Bulk	50	3 lbs.
05336	2/0	1/2"	Bulk	50	3 lbs.
05337	3/0	3/8"	Bulk	50	3 lbs.
05338	3/0	1/2"	Bulk	50	3 lbs.
05339	4/0	3/8"	Bulk	50	4 lbs.
05340	4/0	1/2"	Bulk	50	4 lbs.
03275	3/0	3/8"	Bulk	25	1.5 lbs.
03276	3/0	1/2"	Bulk	25	1.5 lbs.
03277	4/0	3/8"	Bulk	25	2 lbs.
03278	4/0	1/2"	Bulk	25	2 lbs.

**Standard Stud Size**

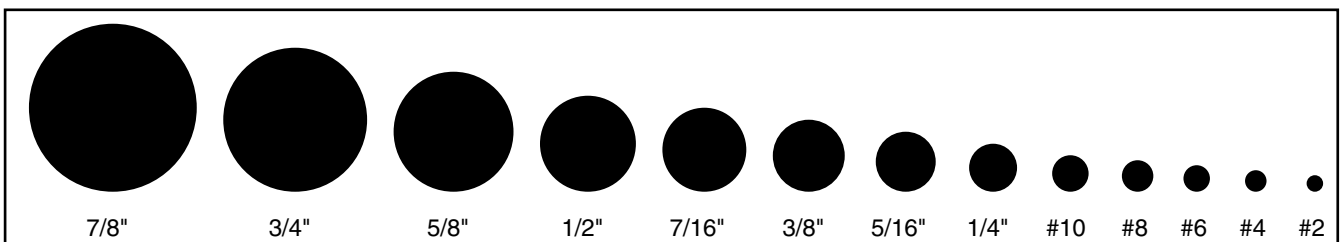

**TIN-PLATED COPPER LUGS**

- Resists corrosion
- Lugs can be crimped or soldered and are stackable
- Gauge stamped on lug for easy identification
- Flared ends for easy entry
- UL Listed



Part #	Gauge	Stud Hole	Packaging	Master Carton	
				Quantity	Weight
31121	6	#10	Bulk	50	1 lb.
31122	6	1/4"	Bulk	50	1 lb.
31123	6	5/16"	Bulk	50	1 lb.
31124	6	3/8"	Bul	50	1 lb.
31080	4	1/4"	Bulk	50	1 lb.
31081	4	5/16"	Bulk	50	1 lb.
31082	4	3/8"	Bulk	50	1 lb.
31083	2	1/4"	Bulk	50	1 lb.
31084	2	5/16"	Bulk	50	1 lb.
31085	2	3/8"	Bulk	50	1 lb.
31086	1	1/4"	Bulk	50	2 lbs.
31087	1	5/16"	Bulk	50	2 lbs.
31088	1	3/8"	Bulk	50	2 lbs.
31089	1/0	1/4"	Bulk	50	2 lbs.
31090	1/0	5/16"	Bulk	50	2 lbs.
31091	1/0	3/8"	Bulk	50	2 lbs.
31092	2/0	1/4"	Bulk	50	3 lbs.
31093	2/0	5/16"	Bulk	50	3 lbs.
31094	2/0	3/8"	Bulk	50	3 lbs.

**EXTRA HEAVY DUTY TIN-PLATED COPPER LUGS**

- Thicker walls for greater strength and conductivity
- Used for severe-duty applications
- Gauge stamped on lug for easy identification
- Lugs can be crimped or soldered and are stackable



Part #	Gauge	Stud Hole	Packaging	Master Carton	
				Quantity	Weight
05492	8	1/4"	Bulk	10	1 lb.
05494	8	5/16"	Bulk	10	1 lb.
05493	8	3/8"	Bulk	10	1 lb.
05489	6	1/4"	Bulk	10	1 lb.
05491	6	5/16"	Bulk	10	1 lb.
05490	6	3/8"	Bulk	10	1 lb.
05341	4	1/4"	Bulk	10	1 lb.
05486	4	5/16"	Bulk	10	1 lb.
05342	4	3/8"	Bulk	10	1 lb.
05485	4	1/2"	Bulk	10	1 lb.
05479	1-2	1/4"	Bulk	10	1 lb.
05480	1-2	5/16"	Bulk	10	1 lb.
05343	1-2	3/8"	Bulk	10	1 lb.
05344	1-2	1/2"	Bulk	10	1 lb.
05477	1/0	1/4"	Bulk	10	1 lb.
05478	1/0	5/16"	Bulk	10	1 lb.
05345	1/0	3/8"	Bulk	10	1 lb.
05346	1/0	1/2"	Bulk	10	1 lb.
05481	2/0	1/4"	Bulk	10	1 lb.
05482	2/0	5/16"	Bulk	10	1 lb.
05347	2/0	3/8"	Bulk	10	1 lb.
05349	2/0	1/2"	Bulk	10	1 lb.
05483	3/0	1/4"	Bulk	10	1 lb.
05484	3/0	5/16"	Bulk	10	1 lb.
05350	3/0	3/8"	Bulk	10	1 lb.
05351	3/0	1/2"	Bulk	10	1 lb.
05487	4/0	1/4"	Bulk	10	1 lb.
05488	4/0	5/16"	Bulk	10	1 lb.
05352	4/0	3/8"	Bulk	10	1 lb.
05353	4/0	1/2"	Bulk	10	1 lb.

**GOLF CAR TERMINAL LUG**

- Fits up to 5/16" stud
- Tin-plated copper



Part #	Gauge	Packaging	Master Carton	
			Quantity	Weight
05505	6	Bag of 50	1	1 lb.

**SOLDER PELLETS**

- Fast method for attaching battery lug to cable



Part #	Gauge	Packaging	Master Carton	
			Quantity	Weight
05498	4	Bag of 10	1	1 lb.
05499	2	Bag of 10	1	1 lb.
05500	1	Bag of 10	1	1 lb.
05501	1/0	Bag of 10	1	1 lb.
05502	2/0	Bag of 10	1	1 lb.
05503	3/0	Bag of 10	1	1 lb.
05504	4/0	Bag of 10	1	1 lb.

**WARNING:** Cancer and Reproductive Harm [www.P65Warnings.ca.gov](http://www.P65Warnings.ca.gov)





**RING TERMINALS**



Part #	Gauge	Style	Stud/Tab Size	Insulation	Packaging	Master Carton	
						Quantity	Weight
05720	22-18	Ring	6-8	PVC	Bag of 100	1	1 lb.
05721	22-18	Ring	8-10	PVC	Bag of 100	1	1 lb.
05700	16-14	Ring	4-6	PVC	Bag of 100	1	1 lb.
05719	16-14	Ring	6-8	PVC	Bag of 100	1	1 lb.
05701	16-14	Ring	10	PVC	Bag of 100	1	1 lb.
05702	16-14	Ring	1/4"	PVC	Bag of 100	1	1 lb.
05703	12-10	Ring	10	PVC	Bag of 100	1	1 lb.
05704	12-10	Ring	1/4"	PVC	Bag of 100	1	1 lb.
05705	12-10	Ring	3/8"	PVC	Bag of 100	1	1 lb.

**⚠ WARNING:** Cancer and Reproductive Harm [www.P65Warnings.ca.gov](http://www.P65Warnings.ca.gov)



Part #	Gauge	Style	Stud/Tab Size	Insulation	Packaging	Master Carton	
						Quantity	Weight
05735	22-18	Ring	8	Heat Shrinkable Nylon	Bag of 25	1	1 lb.
05736	22-18	Ring	10	Heat Shrinkable Nylon	Bag of 25	1	1 lb.
05738	16-14	Ring	8	Heat Shrinkable Nylon	Bag of 25	1	1 lb.
05739	16-14	Ring	10	Heat Shrinkable Nylon	Bag of 25	1	1 lb.
05737	16-14	Ring	1/4"	Heat Shrinkable Nylon	Bag of 25	1	1 lb.
05762	12-10	Ring	10	Heat Shrinkable Nylon	Bag of 25	1	1 lb.
05740	12-10	Ring	1/4"	Heat Shrinkable Nylon	Bag of 25	1	1 lb.
05741	12-10	Ring	3/8"	Heat Shrinkable Nylon	Bag of 25	1	1 lb.

**SPADE TERMINALS**



Part #	Gauge	Style	Stud/Tab Size	Insulation	Packaging	Master Carton	
						Quantity	Weight
05706	16-14	Spade	8-10	PVC	Bag of 100	1	1 lb.
05707	12-10	Spade	8-10	PVC	Bag of 100	1	1 lb.

**⚠ WARNING:** Cancer and Reproductive Harm [www.P65Warnings.ca.gov](http://www.P65Warnings.ca.gov)

**SNAP PLUG**



Part #	Gauge	Style	Stud/Tab Size	Insulation	Packaging	Master Carton	
						Quantity	Weight
05729	16-14	Snap Plug Receptacle	—	PVC	Bag of 100	1	1 lb.
05712	16-14	Snap Plug	—	PVC	Bag of 100	1	1 lb.

**⚠ WARNING:** Cancer and Reproductive Harm [www.P65Warnings.ca.gov](http://www.P65Warnings.ca.gov)

**MALE AND FEMALE DISCONNECTS**



Part #	Gauge	Style	Stud/Tab Size	Insulation	Packaging	Master Carton	
						Quantity	Weight
05708	16-14	Male Disconnect	.25" x .032"	PVC	Bag of 100	1	1 lb.
05709	16-14	Female Disconnect	.25" x .032"	PVC	Bag of 100	1	1 lb.
05710	12-10	Male Disconnect	.25" x .032"	PVC	Bag of 100	1	1 lb.
05711	12-10	Female Disconnect	.25" x .032"	PVC	Bag of 100	1	1 lb.

**⚠ WARNING:** Cancer and Reproductive Harm [www.P65Warnings.ca.gov](http://www.P65Warnings.ca.gov)

**FULLY INSULATED MALE AND FEMALE DISCONNECTS**



Part #	Gauge	Style	Stud/Tab Size	Insulation	Packaging	Master Carton	
						Quantity	Weight
01895	22-18	Male Disconnect	.25" x .032"	PVC	Bag of 100	1	1 lb.
01898	22-18	Female Disconnect	.25" x .032"	PVC	Bag of 100	1	1 lb.
01896	16-14	Male Disconnect	.25" x .032"	PVC	Bag of 100	1	1 lb.
01899	16-14	Female Disconnect	.25" x .032"	PVC	Bag of 100	1	1 lb.
01897	12-10	Male Disconnect	.25" x .032"	PVC	Bag of 100	1	1 lb.
01908	12-10	Female Disconnect	.25" x .032"	PVC	Bag of 100	1	1 lb.

**⚠ WARNING:** Cancer and Reproductive Harm [www.P65Warnings.ca.gov](http://www.P65Warnings.ca.gov)

**BUTT CONNECTORS**



Part #	Gauge	Style	Stud/Tab Size	Insulation	Packaging	Master Carton	
						Quantity	Weight
05713	22-18	Butt Connector	—	PVC	Bag of 100	1	1 lb.
05714	16-14	Butt Connector	—	PVC	Bag of 100	1	1 lb.
05715	12-10	Butt Connector	—	PVC	Bag of 100	1	1 lb.

**⚠ WARNING:** Cancer and Reproductive Harm [www.P65Warnings.ca.gov](http://www.P65Warnings.ca.gov)

Part #	Gauge	Style	Stud/Tab Size	Insulation	Packaging	Master Carton	
						Quantity	Weight
05730	22-18	Butt Connector	—	Nylon	Bag of 100	1	1 lb.
05731	16-14	Butt Connector	—	Nylon	Bag of 100	1	1 lb.
05732	12-10	Butt Connector	—	Nylon	Bag of 100	1	1 lb.

Part #	Gauge	Style	Stud/Tab Size	Insulation	Packaging	Master Carton	
						Quantity	Weight
05743	22-18	Butt Connector	—	Heat Shrinkable Nylon	Bag of 25	1	1 lb.
05744	16-14	Butt Connector	—	Heat Shrinkable Nylon	Bag of 25	1	1 lb.
05745	12-10	Butt Connector	—	Heat Shrinkable Nylon	Bag of 25	1	1 lb.

**NON-INSULATED BUTT CONNECTORS**



Part #	Gauge	Style	Stud/Tab Size	Insulation	Packaging	Master Carton	
						Quantity	Weight
05733	16-14	Butt Connector	—	Non-Insulated	Bag of 100	1	1 lb.
05734	12-10	Butt Connector	—	Non-Insulated	Bag of 100	1	1 lb.

**QUICK SPLICE CONNECTORS**

• No wire stripping required



Part #	Gauge	Color	Packaging	Master Carton	
				Quantity	Weight
05746	18-14	Blue	Bag of 100	1	1 lb.
05747	18-14	White	Bag of 100	1	1 lb.
05748	12-10	Yellow	Bag of 100	1	1 lb.

**⚠ WARNING:** Cancer and Reproductive Harm [www.P65Warnings.ca.gov](http://www.P65Warnings.ca.gov)

05746

05747

05748





# Terminal Cleaning and Protection

East Penn offers the most complete line of terminal cleaning and protection products.



- Boots
- Heat Shrink Tubing
- Cleaner and Protection Sprays
- Terminal Protectors

# BATTERY CABLE TERMINAL PROTECTOR BOOTS

- Keeps terminals protected from inadvertent, accidental contact
- Identifies polarity

## PACKAGED STRAIGHT BOOTS

- Temperature rating of 65°C (149°F)
- Cold temperature rating of -25°C (13°F)
- RoHS Compliant PVC



Part #	Gauge	Color	Packaging	Master Carton	
				Quantity	Weight
00684	4-6	Black/Red	Clam Shell of 2	10	1 lb.

**⚠ WARNING:** Cancer and Reproductive Harm [www.P65Warnings.ca.gov](http://www.P65Warnings.ca.gov)

## BULK

- Temperature rating of 80°C (176°F)
- Meets V-2 UL 94 standards
- REACH, RoHS and WEEE compliant material

## STRAIGHT BOOTS



Part #	Gauge	Color	Packaging	Master Carton	
				Quantity	Weight
06100	4-6	Black	Bulk	10	1 lb.
06101	4-6	Red	Bulk	10	1 lb.
06102	1-2	Black	Bulk	10	1 lb.
06103	1-2	Red	Bulk	10	1 lb.
06104	1/0-2/0	Black	Bulk	10	1 lb.
06105	1/0-2/0	Red	Bulk	10	1 lb.

**⚠ WARNING:** Cancer and Reproductive Harm [www.P65Warnings.ca.gov](http://www.P65Warnings.ca.gov)

## FLAG BOOTS



Part #	Gauge	Color	Packaging	Master Carton	
				Quantity	Weight
06112	2	Black	Bulk	10	1 lb.
06113	2	Red	Bulk	10	1 lb.
06106	2/0	Black	Bulk	10	1 lb.
06107	2/0	Red	Bulk	10	1 lb.

**⚠ WARNING:** Cancer and Reproductive Harm [www.P65Warnings.ca.gov](http://www.P65Warnings.ca.gov)

## RIGHT ELBOW BOOTS



Part #	Gauge	Color	Packaging	Master Carton	
				Quantity	Weight
06114	2	Black	Bulk	10	1 lb.
06115	2	Red	Bulk	10	1 lb.
06108	2/0	Black	Bulk	10	1 lb.
06109	2/0	Red	Bulk	10	1 lb.

**⚠ WARNING:** Cancer and Reproductive Harm [www.P65Warnings.ca.gov](http://www.P65Warnings.ca.gov)

## LEFT ELBOW BOOTS



Part #	Gauge	Color	Packaging	Master Carton	
				Quantity	Weight
06116	2	Black	Bulk	10	1 lb.
06117	2	Red	Bulk	10	1 lb.
06110	2/0	Black	Bulk	10	1 lb.
06111	2/0	Red	Bulk	10	1 lb.

**⚠ WARNING:** Cancer and Reproductive Harm [www.P65Warnings.ca.gov](http://www.P65Warnings.ca.gov)

## RIGHT ELBOW LAWN & GARDEN BOOTS



Part #	Gauge	Color	Packaging	Master Carton	
				Quantity	Weight
06118	4-8	Black	Bulk	10	1 lb.
06119	4-8	Red	Bulk	10	1 lb.

**⚠ WARNING:** Cancer and Reproductive Harm [www.P65Warnings.ca.gov](http://www.P65Warnings.ca.gov)

## LEFT ELBOW LAWN & GARDEN BOOTS



Part #	Gauge	Color	Packaging	Master Carton	
				Quantity	Weight
06120	4-8	Black	Bulk	10	1 lb.
06121	4-8	Red	Bulk	10	1 lb.

**⚠ WARNING:** Cancer and Reproductive Harm [www.P65Warnings.ca.gov](http://www.P65Warnings.ca.gov)



## MARINE/DUAL POST BOOTS



Part #	Color	Packaging	Master Carton	
			Quantity	Weight
06122	Black	Bulk	10	1 lb.
06123	Red	Bulk	10	1 lb.

**WARNING:** Cancer and Reproductive Harm [www.P65Warnings.ca.gov](http://www.P65Warnings.ca.gov)

## CABLE TIES

### Medium Duty

- Made from virgin nylon 6/6 material that increases flexibility & performance
- Flexible locking design for low force hand tool installation
- Low smoke generation

### Heavy Duty

- Made from virgin nylon 6/6 material that increases flexibility & performance
- UV resistant for outdoor use
- Enhanced locking mechanism for maximum strength
- Heavy duty for securing larger bundles where strength is required

### Mounting Head

- Made from virgin nylon 6/6 material that increases flexibility & performance
- UV resistant for outdoor use
- Enhanced locking mechanism for maximum strength
- Built in mounting hole for direct installation to firewalls, chassis and frames

### Marine

- Made from high grade nylon polymer for maximum flexibility
- Suitable for extreme environments
- Impermeable to oils and grease
- Increased temperature range for engine compartment installation
- Extended UV life to 15 years

### Multi-Color

- Constructed from color nylon pellets for easy identification and color consistency
- Flexible locking design for ease of installation

### Premium

- Made from high impact UL approved resin
- Operating temperatures down to -8°F
- Product remains stable in high heat environments
- Extended UV life to 15 years
- Will withstand the shock and vibration in extreme conditions

### Premium Heavy Duty

- Made from high impact UL approved resin
- Operating temperatures down to -8°F
- Product remains stable in high heat environments
- Extended UV life to 15 years
- Will withstand the shock and vibration in extreme conditions

### Premium Mounting Tab

- Made from high impact UL approved resin
- Operating temperatures down to -8°F
- Product remains stable in high heat environments
- Extended UV life to 15 years
- Will withstand the shock and vibration in extreme conditions

Part #	Length	Tensile Strength	Color	Packaging	Master Carton	
					Quantity	Weight
<b>Medium Duty White</b>						
05716	6"	40 lbs.	White	Bag of 100	1	1 lb.
05717	7"	50 lbs.	White	Bag of 100	1	1 lb.
05718	11"	50 lbs.	White	Bag of 100	1	1 lb.
05723	14"	50 lbs.	White	Bag of 100	1	1 lb.
<b>Medium Duty Black</b>						
05724	6"	50 lbs.	Black	Bag of 100	1	1 lb.
05725	7"	50 lbs.	Black	Bag of 100	1	1 lb.
05726	11"	50 lbs.	Black	Bag of 100	1	1 lb.
05727	14"	50 lbs.	Black	Bag of 100	1	1 lb.
<b>Heavy Duty</b>						
05763	14"	120 lbs.	Black	Bag of 100	1	1 lb.
05764	24"	175 lbs.	Black	Bag of 50	1	1 lb.
<b>Mounting Head</b>						
05765	8"	50 lbs.	Black	Bag of 100	1	1 lb.
05766	11"	50 lbs.	Black	Bag of 100	1	1 lb.
05767	15"	50 lbs.	Black	Bag of 100	1	1 lb.
<b>Marine</b>						
31155	7"	50 lbs.	Black	Bag of 100	1	1 lb.
31156	11"	50 lbs.	Black	Bag of 100	1	1 lb.
31157	14"	50 lbs.	Black	Bag of 100	1	1 lb.
31158	15"	120 lbs.	Black	Bag of 100	1	1 lb.
<b>Multi-Color</b>						
31159	7"	50 lbs.	Red, Grn, Blu, Yel	Bag of 100*	1	1 lb.
*25 of each color per bag						
<b>Premium</b>						
31176	6"	40 lbs.	Black	Bag of 100	1	1 lb.
31177	7"	50 lbs.	Black	Bag of 100	1	1 lb.
31178	11"	50 lbs.	Black	Bag of 100	1	1 lb.
31179	14"	50 lbs.	Black	Bag of 100	1	1 lb.
<b>Premium Heavy Duty</b>						
31180	14"	120 lbs.	Black	Bag of 100	1	1 lb.
<b>Premium Mounting Tab</b>						
31181	8"	50 lbs.	Black	Bag of 100	1	1 lb.
31182	15"	50 lbs.	Black	Bag of 100	1	1 lb.



Standard

Heavy Duty

Mounting Tab



Multi-color

**CABLE LOOM**

- Black polyethylene corrugated loom is durable; split for easy installation
- For protection of wires on cars, buses, trucks, and boats
- Coiled and boxed.
- Temp rating of 93°C (200°F)
- RoHS Compliant



Part #	Length	Size	Packaging	Master Carton	
				Quantity	Weight
05749	100'	1/4"	Box of 1	1	2 lbs.
05750	100'	3/8"	Box of 1	1	2 lbs.
05751	100'	1/2"	Box of 1	1	3 lbs.
05752	100'	5/8"	Box of 1	1	3 lbs.
98493	3200'	1/4"	Box of 1	1	32 lbs.
98492	1500'	3/8"	Box of 1	1	27 lbs.
99930	1100'	1/2"	Box of 1	1	21 lbs.
98491	800'	5/8"	Box of 1	1	26 lbs.

**BATTERY CABLE HEAT SHRINKABLE TUBING**

- Economical heat shrink ideal for general purpose applications
- Protects against corrosion
- Use to identify positive and negative
- Acts as a strain relief and prevents abrasion
- Sealant free single wall construction
- Conforms to DOD Mil-I-23053/6 Class 1 and 2, also meets UL-224 125°C specs
- RoHS Compliant

**Material:** Polyolefin  
**Shrink Ratio:** 2:1  
**Wall thickness after shrinking:** 1/32"  
**Operating temperature:**  
 -55°C to +135°C (-67°F to +275°F)

Part #	Gauge	Color	Length	Expanded Diameter	Packaging	Master Carton	
						Quantity	Weight
05402	8-2	Black	6"	1/2"	Bag of 6	1	1 lb.
05403	8-2	Red	6"	1/2"	Bag of 6	1	1 lb.
05404	1-2/0	Black	6"	3/4"	Bag of 6	1	1 lb.
05405	1-2/0	Red	6"	3/4"	Bag of 6	1	1 lb.
05406	1/0-4/0	Black	6"	1"	Bag of 6	1	1 lb.
05407	1/0-4/0	Red	6"	1"	Bag of 6	1	1 lb.



**PRIMARY WIRE HEAT SHRINKABLE TUBING**

- Economical heat shrink ideal for general purpose applications
- Protects against corrosion
- Use to identify positive and negative
- Acts as a strain relief and prevents abrasion
- Sealant-free single wall construction
- RoHS Compliant

**Material:** Ethylene Vinyl Acetate  
**Shrink Ratio:** 2:1  
**Wall thickness after shrinking:** 1/32"  
**Operating temperature:**  
 -55°C to +105°C (-67°F to +221°F)

Part #	Gauge	Color	Length	Expanded Diameter	Packaging	Master Carton	
						Quantity	Weight
05451	18-14	Black	6"	1/8"	Bag of 25	1	1 lb.
05452	18-14	Red	6"	1/8"	Bag of 25	1	1 lb.
05449	14-10	Black	6"	3/16"	Bag of 25	1	1 lb.
05450	14-10	Red	6"	3/16"	Bag of 25	1	1 lb.
05447	12-8	Black	6"	1/4"	Bag of 25	1	1 lb.
05448	12-8	Red	6"	1/4"	Bag of 25	1	1 lb.

**WARNING:** Cancer and Reproductive Harm [www.P65Warnings.ca.gov](http://www.P65Warnings.ca.gov)



**BULK HEAT SHRINKABLE TUBING**

- Double wall, adhesive lined for added protection
- Diameter fits wide range of sizes from 24 GA primary wire to heavy 4/0 cable
- Protects against corrosion
- Used to identify positive and negative
- Remains flexible after shrink
- Acts as a strain relief and prevents abrasion
- RoHS Compliant

**Material:** Polyolefin  
**Shrink Ratio:** 3:1  
**Wall thickness after shrinking:** 1/16"  
**Operating temperature:**  
 -45°C to +125°C (-49°F to +257°F)

Part #	Gauge	Color	Length	Expanded Diameter	Packaging	Master Carton	
						Quantity	Weight
31130	24 - 18	Black	48"	1/8"	Bulk	225	5 lbs.
31131	24 - 18	Red	48"	1/8"	Bulk	225	5 lbs.
31132	20 - 12	Black	48"	3/16"	Bulk	175	6 lbs.
31133	20 - 12	Red	48"	3/16"	Bulk	175	6 lbs.
31134	18 - 10	Black	48"	1/4"	Bulk	100	4 lbs.
31135	18 - 10	Red	48"	1/4"	Bulk	100	4 lbs.
31136	8 - 6	Black	48"	3/8"	Bulk	55	3 lbs.
31137	8 - 6	Red	48"	3/8"	Bulk	55	3 lbs.
31138	6 - 2	Black	48"	1/2"	Bulk	40	4 lbs.
31139	6 - 2	Red	48"	1/2"	Bulk	40	4 lbs.
31140	4 - 2/0	Black	48"	3/4"	Bulk	25	4 lbs.
31141	4 - 2/0	Red	48"	3/4"	Bulk	25	4 lbs.
31142	2 - 4/0	Black	48"	1"	Bulk	25	6 lbs.
31143	2 - 4/0	Red	48"	1"	Bulk	25	6 lbs.

# Self-Fusing Auto Tape

*The latest technology in silicone tape. Self-Fusing tape is ideal for almost any application requiring a water-proof seal and is an excellent insulator with high dielectric strength.*

*Uses include marine connections, battery terminals, automotive hoses, color coding, cable splices, and tool grip enhancement.*



- No sticky adhesive. Tape fuses upon itself when wrapped forming a permanent bond that is both airtight and waterproof
- Resists UV, oil, and corrosive chemicals
- Stretches to 300%
- Insulates 8,000 volts per layer
- Can easily be cut away to remove leaving no residue
- Temperature range of  $-65^{\circ}\text{F}$  to  $500^{\circ}\text{F}$
- Meets or exceeds UL standard 510
- Meets MIL-I-46852C Type II Std.
- RoHS Compliant

## SELF-FUSING AUTO TAPE

- Provides a moisture tight seal
- Insulates to protect wires and splices
- Ideal for high temperature applications
- Alternative to heat shrink tubing
- Completely cures within 24 hours

Part #	Length	Color	Packaging	Master Carton	
				Quantity	Weight
04366	10'	2 Red/2 Black	Box of 4	1	1 lb.
04367	10'	Black	Clamshell of 1	4	1 lb.
04368	10'	Red	Clamshell of 1	4	1 lb.

**BATTERY PROTECTION KIT**

**Kit Includes:**

- Terminal protectors
- Battery cleaner brush
- 3/4 oz. can terminal protection spray
- 1 1/8 oz. can cleaner spray
- Hand cleaning towelette



Part #	Packaging	Master Carton	
		Quantity	Weight
00317	Clam Shell Kit	6	1 lb.

Master carton includes clip strip

**WARNING:** Cancer and Reproductive Harm [www.P65Warnings.ca.gov](http://www.P65Warnings.ca.gov)

**BATTERY TERMINAL PROTECTION SPRAY**

- Resists battery corrosion and prolongs battery life
- Lead free formula



00322

00320

Part #	Packaging	Master Carton	
		Quantity	Weight
00322	3/4 oz. can, Card of 1	12	2 lbs.
00320	10 oz. can	12	10 lbs.

**WARNING:** Cancer and Reproductive Harm [www.P65Warnings.ca.gov](http://www.P65Warnings.ca.gov)

**BATTERY CLEANER SPRAY**

- Penetrates, loosens, and neutralizes all acid corrosion deposits
- Helps eliminate energy loss with regular maintenance



00323

00321

Part #	Packaging	Master Carton	
		Quantity	Weight
00323	1-1/8 oz. can, Card of 1	12	2 lbs.
00321	15 oz. can	12	15 lbs.

**WARNING:** Cancer and Reproductive Harm [www.P65Warnings.ca.gov](http://www.P65Warnings.ca.gov)

**BATTERY CLEANER SPRAY WITH ACID INDICATOR**

- Penetrates, loosens, and neutralizes acid corrosion deposits
- Sprays on yellow - leaves pink foam to indicate where acid is present
- Helps eliminate energy loss with regular maintenance



Part #	Packaging	Master Carton	
		Quantity	Weight
00450	11 oz. can	12	11 lbs.

**WARNING:** Cancer and Reproductive Harm [www.P65Warnings.ca.gov](http://www.P65Warnings.ca.gov)



**TERMINAL PROTECTORS**

- Terminal protectors extend the life of batteries and terminals
- Chemically treated to help prevent corrosion

Part #	Color	Type	Packaging	Master Carton	
				Quantity	Weight
00237	Black	Top	Jar of 100	6	5 lbs.
01253	Red/Black	Top/Side Combo	Card of 2	24	1 lb.
01940	Red/Black	Top/Side Combo	Jar of 50	6	5 lbs.



01253



00237



01940

**TERMINAL PROTECTORS WITH SILICONE GREASE**

- Terminal protectors extend the life of batteries and terminals
- Chemically treated to help prevent corrosion
- Includes silicone grease packet for added protection when applied



Part #	Color	Type	Packaging	Master Carton	
				Quantity	Weight
31183	Red/Black	Top/Side Combo	Card of 2	24	1 lbs.

**PREMIUM COMBO TOP/SIDE POST TERMINAL PROTECTOR**

- Patented design



Part #	Color	Packaging	Master Carton	
			Quantity	Weight
00359	Red/Black	Card of 2	24	2 lbs.

**PROTECTIVE STUD CAPS**

- Keeps terminals protected from inadvertent, accidental contact
- Fits 3/8" stud
- Color identifies polarity
- RoHS complaint PVC



Part #	Color	Packaging	Master Carton	
			Quantity	Weight
04892	Red	Bag of 10	1	1 lbs.
04893	Black	Bag of 10	1	1 lbs.

**WARNING:** Cancer and Reproductive Harm [www.P65Warnings.ca.gov](http://www.P65Warnings.ca.gov)







# Hold-downs, Boxes, and Tools

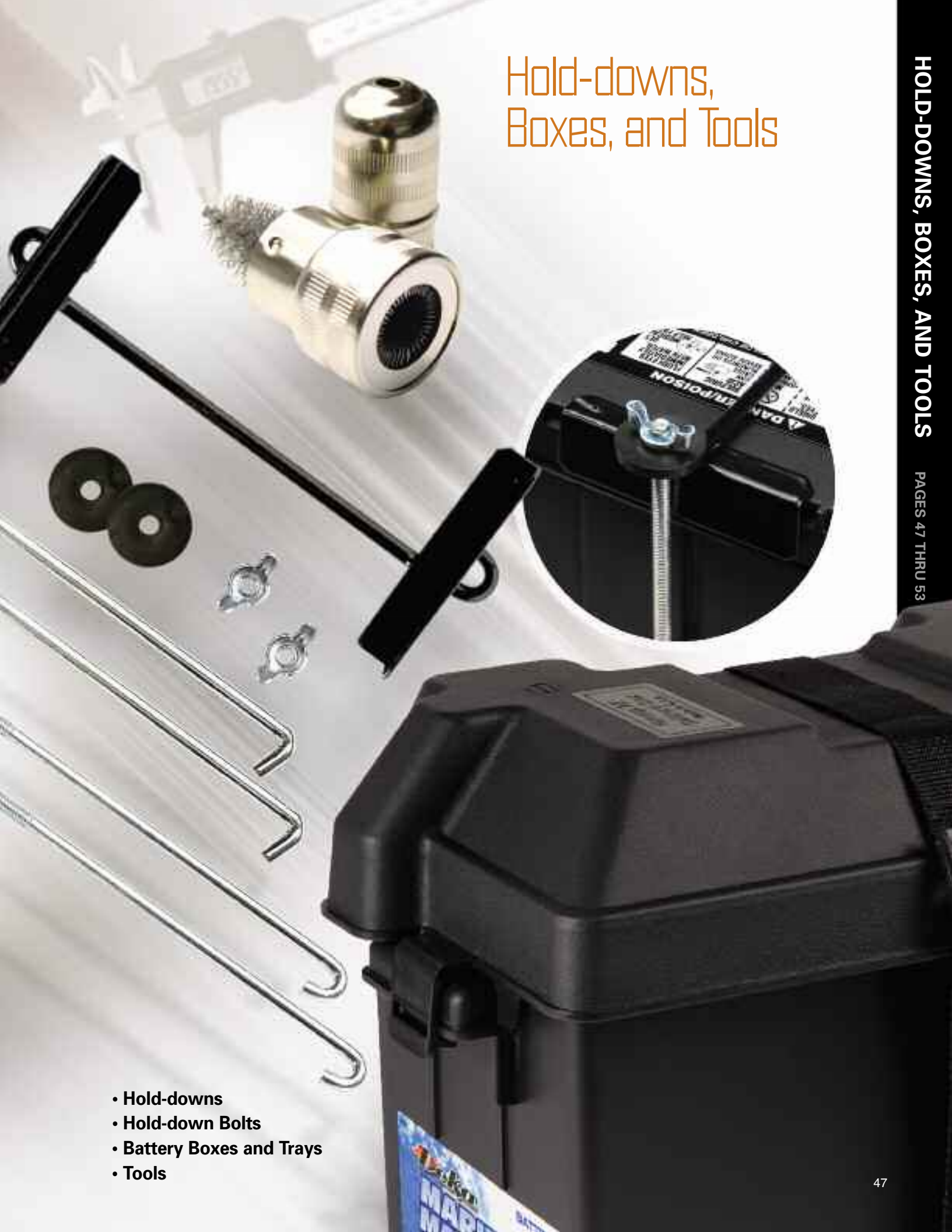

- Hold-downs
- Hold-down Bolts
- Battery Boxes and Trays
- Tools

UNIVERSAL TYPE HOLD-DOWNS



Part #	Description	Packaging	Master Carton	
			Quantity	Weight
00251*	Universal Base Mount	Card of 1	10	5 lbs.
00236*	Cross-Bar 6-7/8" Wide	Clam Shell of 1	10	5 lbs.
00246	Univ Cross-Bar 5-1/8"-7-5/8" Width	Clam Shell of 1	10	3 lbs.
06167*	Univ Cross-Bar 5-1/8"-7-5/8" Width	Bulk	10	2 lbs.
00250*	Cross-Bar Adjust Mount 6-7/8" Width	Clam Shell of 1	10	8 lbs.
00239*	Perimeter 10-1/4" x 6-7/8"	Card of 1	10	6 lbs.
00678 <sup>1</sup> *	Rubber Hold-Down Kit 6-7/8" w/Bolts & Nuts	Card of 1	10	7 lbs.
09645	Front Base Mount Wedge	Clam Shell of 1	10	2 lbs.
09646	Side Base Mount Wedge	Clam Shell of 1	10	2 lbs.

<sup>1</sup>Rubber battery hold down kit includes two 10" J bolts, washers, and nuts

\* **⚠ WARNING:** Cancer and Reproductive Harm [www.P65Warnings.ca.gov](http://www.P65Warnings.ca.gov)

SAFETY GRIP HOLD-DOWNS FOR 6- & 12-VOLT APPLICATIONS

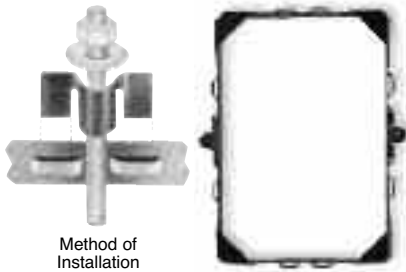

Method of Installation

• Bolts sold separately, see below.

Part #	Battery Group Size	Dimensions	Packaging	Master Carton	
				Quantity	Weight
06159	24/24F	6 - 7/8" x 10 - 7/8"	Box	1	1 lb.
06160	27	6 - 7/8" x 12 - 1/8"	Box	1	1 lb.
06165	31	6 - 7/8" x 13 - 1/8"	Box	1	1 lb.
06166	31 (for two grp 31 batts)	13 - 3/4" x 13 - 1/8"	Box	1	2 lbs.

**⚠ WARNING:** Cancer and Reproductive Harm [www.P65Warnings.ca.gov](http://www.P65Warnings.ca.gov)

BATTERY HOLD-DOWN BOLTS, WASHERS, & NUTS

- Heavy tempered steel bolts
- Wing nuts for quick, easy assembly
- Washers included



Part #	Dimensions	Type	Packaging	Master Carton	
				Quantity	Weight
00241	6" x 1/4"	J	Card of 2	10	3 lbs.
06153 <sup>1</sup>	6" x 1/4"	J	Bulk	50	5 lbs.
00916	8" x 1/4"	J	Card of 2	10	3 lbs.
06154 <sup>1</sup>	8" x 1/4"	J	Bulk	50	6 lbs.
00242	10" x 1/4"	J	Card of 2	10	4 lbs.
06155 <sup>1</sup>	10" x 1/4"	J	Bulk	50	6 lbs.
00244	12" x 1/4"	J	Card of 2	10	3 lbs.
06157 <sup>1</sup>	12" x 1/4"	J	Bulk	50	9 lbs.
06158	12" x 5/16"	Heavy-Duty J	Bulk	25	6 lbs.
00243	10" x 1/4"	L-Type	Card of 2	10	4 lbs.
06156 <sup>1</sup>	10" x 1/4"	L-Type	Bulk	50	6 lbs.

<sup>1</sup>Wing nuts and washers are bagged separately in carton

**⚠ WARNING:** Cancer and Reproductive Harm [www.P65Warnings.ca.gov](http://www.P65Warnings.ca.gov)



### BATTERY BOXES

- Polypropylene boxes protect battery in marine and commercial applications
- Vented for safety
- Includes all hardware for installation
- Snap lid for secure fit (03009 & 03189 only)

Part #	Group Size	Outside Dimensions (LxWxH)	Inside Dimensions (LxWxH)	Packaging	Master Carton	
					Quantity	Weight
03009	Marine 24	14-5/16" x 9-3/4" x 10-3/4"	10-5/8" x 7-3/16" x 9-3/4"	Bulk	12	24 lbs.
03188	U1	10-1/2" x 7-1/4" x 8-1/2"	8-1/4" x 5-3/8" x 8-1/8"	Bulk	12	16 lbs.
03189	Marine 27/31 <sup>1</sup>	17" x 9-3/4" x 11"	13-1/2" x 7-1/8" x 10"	Bulk	6	15 lbs.

<sup>1</sup>Includes spacer

**WARNING:** Cancer and Reproductive Harm [www.P65Warnings.ca.gov](http://www.P65Warnings.ca.gov)



03009



03188



03189

### UNIVERSAL BATTERY TRAYS

- Made with durable rust and corrosion resistant polypropylene

Part #	Group Size	Dimensions	Packaging	Master Carton	
				Quantity	Weight
00253	24	11-1/2" x 8-1/2"	Sleeve of 1	10	6 lbs.
00252	27/31	14" x 7-7/8"	Sleeve of 1	10	8 lbs.

**WARNING:** Cancer and Reproductive Harm [www.P65Warnings.ca.gov](http://www.P65Warnings.ca.gov)





00199



00231



00198



00233



00257

### STANDARD FLOAT TYPE HYDROMETER

- Large size float type tester
- Float is color-coded
- Glass tube

Part #	Packaging	Master Carton	
		Quantity	Weight
00199	Card of 1	10	5 lbs.

### TEMPERATURE CORRECTING HYDROMETER

- Features both temperature and float for calibrated readings
- Glass tube

Part #	Packaging	Master Carton	
		Quantity	Weight
00231	Card of 1	10	5 lb.

### DIAL TYPE BATTERY TESTER

- Dial indicates battery charge and specific gravity
- Permanent instructions on back of each tester

Part #	Packaging	Master Carton	
		Quantity	Weight
00198	Card of 1	10	4 lbs.

**⚠ WARNING:** Cancer [www.P65Warnings.ca.gov](http://www.P65Warnings.ca.gov)

### BALL TYPE ANTI-FREEZE TESTER

- Floating balls show degree of protection or coolant boiling point
- Accurate readings with hot or cold solutions

Part #	Packaging	Master Carton	
		Quantity	Weight
00233 <sup>1</sup>	Card of 1	10	1 lb.

<sup>1</sup>May not be compatible with all types of antifreeze/coolant.

**⚠ WARNING:** Cancer and Reproductive Harm [www.P65Warnings.ca.gov](http://www.P65Warnings.ca.gov)

### BULB TYPE BATTERY FILLER

- 6 oz. filler with 6" spout

Part #	Packaging	Master Carton	
		Quantity	Weight
00257	Card of 1	10	5 lbs.





00318

### 2-QUART BATTERY FILLER

- Automatic shut off spout that stops filling once battery has reached the proper level

Part #	Packaging	Master Carton	
		Quantity	Weight
00318	Bulk	10	4 lbs.



00194

### SAFETY GRIP BATTERY LIFTERS FOR POST TERMINAL BATTERIES

- Heavy-duty, acid-resistant vinyl carrier straps have plated metal parts that resist rust and corrosion.

Part #	Length	Packaging	Master Carton	
			Quantity	Weight
00194	14"	Clamshell of 1	10	4 lbs.
06149	14"	Bulk	10	3 lbs.
00195	21"	Clamshell of 1	10	5 lbs.

**⚠ WARNING:** Cancer and Reproductive Harm [www.P65Warnings.ca.gov](http://www.P65Warnings.ca.gov)



03501

### HEAVY-DUTY BATTERY CARRIER

- Carries both Side- and Top-Post batteries.
- Heavy-duty zinc-plated steel construction.
- Easy grip handle.
- Riveted rubber grip pads to provide a secure hold on battery.
- Fits up to a Group 65 battery.

Part #	Packaging	Master Carton	
		Quantity	Weight
03501	Sleeve of 1	6	9 lbs.

**⚠ WARNING:** Cancer and Reproductive Harm [www.P65Warnings.ca.gov](http://www.P65Warnings.ca.gov)



00197

### SURE GRIP BATTERY CARRIER

- Saw tooth gripping arms grasp tightly on all surfaces
- Heavy-duty construction resists acid

Part #	Packaging	Master Carton	
		Quantity	Weight
00197	Card of 1	6	5 lbs.
06152	Bulk	6	4 lbs.

**⚠ WARNING:** Cancer and Reproductive Harm [www.P65Warnings.ca.gov](http://www.P65Warnings.ca.gov)

00551/07372



### GOLF CAR BATTERY LIFTING STRAP WIDE HOOKS

- 11 3/4" long
- 1" wide
- Designed for secure attachment to golf car batteries

Part #	Packaging	Master Carton	
		Quantity	Weight
00551	Bulk	10	3 lbs.
07372	Clam Shell of 1	10	3 lbs.

**⚠ WARNING:** Cancer and Reproductive Harm [www.P65Warnings.ca.gov](http://www.P65Warnings.ca.gov)



00252



00254



05515



05516



00682



00255



00256



08861

### BATTERY POST AND TERMINAL CLEANER

- Cleans SAE top posts and matching cable connections

Part #	Packaging	Master Carton	
		Quantity	Weight
00254	Card of 1	10	2 lbs.
02252 <sup>1</sup>	Box of 10	1	2 lbs.

<sup>1</sup>Individually UPC'd.

**WARNING:** Cancer and Reproductive Harm [www.P65Warnings.ca.gov](http://www.P65Warnings.ca.gov)

### TERMINAL CLEANING POWER BRUSHES

- Used to clean battery terminals
- Securely fits in a standard power drill
- Durable injection molded housing with steel shaft

Part #	Type	Packaging	Master Carton	
			Quantity	Weight
05515	Top	Box of 5	1 Box	1 lb.
05516	Stud	Box of 5	1 Box	1 lb.

### 3-WAY CLEANING & CUTTING TOOL

Part #	Packaging	Master Carton	
		Quantity	Weight
00682	Card of 1	10	5 lbs.

**WARNING:** Cancer and Reproductive Harm [www.P65Warnings.ca.gov](http://www.P65Warnings.ca.gov)

### BATTERY TERMINAL SPREADER

Part #	Packaging	Master Carton	
		Quantity	Weight
00255	Clam Shell of 1	10	7 lbs.

**WARNING:** Cancer and Reproductive Harm [www.P65Warnings.ca.gov](http://www.P65Warnings.ca.gov)

### BATTERY TERMINAL LIFTER

Part #	Packaging	Master Carton	
		Quantity	Weight
00256	Card of 1	10	5 lbs.

**WARNING:** Cancer and Reproductive Harm [www.P65Warnings.ca.gov](http://www.P65Warnings.ca.gov)

### BATTERY TERMINAL COMBO WRENCH

Part #	Packaging	Master Carton	
		Quantity	Weight
08861 <sup>1</sup>	Card of 1	6	3 lbs.

<sup>1</sup>Suitable for OE top (10mm) and side terminal bolts (5/16"); additional socket is suitable for 1/2" nuts.

**WARNING:** Cancer and Reproductive Harm [www.P65Warnings.ca.gov](http://www.P65Warnings.ca.gov)



00915



31216



31215



05435



05408



05434



05409



05410



08751

### PRIMARY WIRE CRIMPING AND STRIPPING TOOLS

- Cuts & strips wire 20 gauge – 10 gauge
- Crimps insulated & non-insulated connectors
- PVC-coated handles with improved ergonomic shape
- Spring-loaded to aid in use of the tool
- Convenient locking mechanism to prevent damage to jaws & blades when not in use

Part #	Range	Packaging	Master Carton	
			Quantity	Weight
00915 <sup>1</sup>	Up to 8 gauge	Card of 1	6	3 lbs.
31216 <sup>2</sup>	Up to 10 gauge	Card of 1	6	3 lb.

<sup>1</sup>to be discontinued

<sup>2</sup>will replace 00915

**WARNING:** Cancer and Reproductive Harm [www.P65Warnings.ca.gov](http://www.P65Warnings.ca.gov)

### CUTTING AND STRIPPING TOOL

- Self adjusting mechanism strips wire according to size without damaging conductor
- Adjustable cut stop for consistent strip lengths
- Knob adjusts blade pressure for different insulation thickness
- Strips single stranded or solid conductor wire size 20 gauge to 8 gauge

Part #	Packaging	Master Carton	
		Quantity	Weight
31215	Card of 1	10	10 lb.

**WARNING:** Cancer and Reproductive Harm [www.P65Warnings.ca.gov](http://www.P65Warnings.ca.gov)

### CABLE STRIPPING TOOL

Part #	Range	Packaging	Master Carton	
			Quantity	Weight
05435	10 gauge - 4/0	Bulk	1	1 lb.

### CABLE CUTTER

Part #	Range	Packaging	Master Carton	
			Quantity	Weight
05408	Up to 4/0	Bulk	1	1 lb.

**WARNING:** Cancer and Reproductive Harm [www.P65Warnings.ca.gov](http://www.P65Warnings.ca.gov)

### HEAVY-DUTY CABLE CRIMPER

Part #	Range	Packaging	Master Carton	
			Quantity	Weight
05434	8 gauge - 1/0	Box	1	4 lbs.
05409	6 gauge - 4/0	Box	1	6 lbs.

**WARNING:** Cancer and Reproductive Harm [www.P65Warnings.ca.gov](http://www.P65Warnings.ca.gov)

### HAMMER CRIMPER

- Crimping tool driven by hammer impact with locking lever for easy loading

Part #	Range	Packaging	Master Carton	
			Quantity	Weight
05410	8 gauge - 4/0	Bag	1	2 lbs.

**WARNING:** Cancer and Reproductive Harm [www.P65Warnings.ca.gov](http://www.P65Warnings.ca.gov)

### DIGITAL VOLTMETER

Part #	Packaging	Master Carton	
		Quantity	Weight
08751	Clam Shell of 1	6	2 lbs.

**WARNING:** Cancer and Reproductive Harm [www.P65Warnings.ca.gov](http://www.P65Warnings.ca.gov)



# BATTERY ACCESSORIES & ELECTRICAL CENTER

One stop display for your battery accessories and electrical wire needs.  
Keep a complete line of products in a small amount of space.

## SPINNER RACK

### KIT INCLUDES:

- 4-Sided spinner rack w/ 12x48 inch panels
- Complete line of battery accessories including terminals, tools, corrosion protection items, hold-downs and booster cables
- Wide variety (color, length, gauge) of electrical 12 volt automotive primary wire
- Highly visible header sign
- Planogram diagram to reduce set-up time
- Peg hooks
- Stock re-order cards



Additional 50 pack of stock re-order cards available.  
Order Part #07752.

Part #	Packaging	Master Carton	
		Quantity	Weight
08765	5 Boxes	1	148 lbs.

**WARNING:** Cancer and Reproductive Harm [www.P65Warnings.ca.gov](http://www.P65Warnings.ca.gov)



**BATTERY ACCESSORIES & ELECTRICAL CENTER PLANOGRAM  
(KIT PART NO. 08765)**



Panel A

Loc.	Part #	Description	No. Pegs	Pcs. / Peg	Total Pcs.
1	00350	TERMINAL, HD UNIV 1/CS	3	4	12
2	00366	TERMINAL, HD COMM UNIV 1/CS	2	4	8
3	03067	TERMINAL, HD UNIV EPOXY RED/BLK 2/CS	1	3	3
4	00353	TERMINAL, SIDE ADAPTER POS/NEG 2/CS	1	2	2
5	00324	BOLT WITH NUT, 5/16 -18 x 1-1/4 2/CS	1	3	3
6	01253	PROTECTORS, TMNL COMBO SIDE & TOP 2/CD	1	8	8
7	01056	TERMINAL, NON LEAD UNIV	2	4	8
8	00639	TERMINAL, MARINE BRASS 2/CS	1	2	2
9	00148	TERMINAL, MARINE EPOXY RED/BLK 2/CS	1	2	2
10	00354	TERMINAL, MARINE POS/NEG 2/CS	1	2	2
11	00512	TERMINAL, HD UNIV BRASS 1/CS	1	2	2
12	08864	CABLE, 4 GA SPLICE TOP POST DUAL CABLE W/1 LEAD NON-LEAD	1	1	1
13	08865	CABLE, 4 GA SPLICE TOP POST W/2 LEADS NON-LEAD	1	1	1
14	08859	CABLE, 4 GA SPLICE STUD POST DUAL CABLE W/1 LEAD NON-LEAD	1	1	1
15	08863	CABLE, 4 GA SPLICE SIDE POST DUAL CABLE W/1 LEAD NON-LEAD	1	1	1
16	08867	CABLE, 1 GA SPLICE TOP POST W/2 LEADS NON-LEAD	1	1	1
17	08869	CABLE, 4 GA SPLICE STUD POST W/2 LEADS NON-LEAD	1	1	1



Panel B

Loc.	Part #	Description	No. Pegs	Pcs. / Peg	Total Pcs.
1	00351	TERMINAL, HD REPL SIDE 1/CS	2	3	6
2	00325	BOLT, SIDE 3/8 OE REPL SHORT 2/CS	2	4	8
3	00543	BOLT EXTENDERS, BRASS SHORT SIDE 1/CS	1	2	2
4	08766	BOLT, SIDE 3/8 OE REPL LONG W/LEAD SPACER 1/CS	1	3	3
5	00548	LUG, COPR 6 GA 1/4 STUD 2/CS	1	4	4
6	00549	LUG, COPR 6 GA 5/16 STUD 2/CS	1	4	4
7	00547	LUG, COPR 4 GA 5/16 STUD 2/CS	2	4	8
8	00685	LUG, COPR 4 & 6 GA 3/8 STUD 2/CS	2	4	8
9	00546	LUG, COPR 2 GA 5/16 STUD 2/CS	1	4	4
10	00544	LUG, COPR 2 GA 3/8 STUD 2/CS	1	4	4
11	00545	LUG, COPR 2 GA 1/2 STUD 2/CS	1	4	4
12	00539	LUG, TIN-PLTD COPR 2/0 GA 3/8 STUD 2/CS	2	4	8
13	00540	LUG, TIN-PLTD COPR 2/0 GA 1/2 STUD 2/CS	1	4	4
14	00574	NUTS, GROUP 31 CLOSED TOP 3/8" HOLE 1/CS	1	4	4
15	00575	TERMINAL, CHARGING POST 3/8" STUD 2/CS	1	2	2
16	00197	CARRIER, BATT SURE GRIP 1/CD	1	2	2
17	08861	SIDE/TOP WRENCH	1	2	2
18	00386	TERMINAL, CHARGING POST W/EARS 2/CS	1	2	2
19	00193	BOLT WITH NUT, 1/4 -20 x 3/4 2/CS	1	3	3
20	00179	CABLE, BOOSTER DUAL CCA 10 GA 12' 200C BLK/RED 1/BAG	1	2	2
21	00146	CABLE, BOOSTER DUAL CCA 10 GA 10' 50A YEL	1	1	1

**WARNING:** Cancer and Reproductive Harm [www.P65Warnings.ca.gov](http://www.P65Warnings.ca.gov)



**BATTERY ACCESSORIES & ELECTRICAL CENTER PLANOGRAM  
(KIT PART NO. 08765) (CONT.)**



Panel C

Loc.	Part #	Description	No. Pegs	Pcs. / Peg	Total Pcs.
1	00682	TOOL, CLEANING & CUTTING 3-WAY 1/CD	1	2	2
2	00254	CLEANER, BATT POST & TMNL 1/CD	1	3	3
3	00181	CLAMP, TUNE-UP/TEST EQUIP 50A RED/BLK 2/CD	1	3	3
4	09645	HOLDDOWN, GM WEDGE BASE MOUNT	1	2	2
5	00182	CLAMP, VINYL-CTD STEEL HD 500E RED/BLK 2/CD	1	2	2
6	09646	HOLDDOWN, FORD WEDGE BASE MOUNT	1	2	2
7	00317	KIT, BATT TMNL PROTECTION	1	2	2
8	00246	HOLD-DOWN, UNIV PLASTIC ADJST CS	1	2	2
9	00242	BOLTS, HOLD-DOWN J TYPE 10" 2/CD	1	2	2
10	00678	HOLD-DOWN, KIT SK PK	1	2	2
11	00684	BOOTS, TMNL STR 4 & 6 GA BLK/RED 2/CS	1	2	2
12	04852	CABLE, BOOSTER DUAL 10 GA 12' CPA BLK/RED 1/SLV	1	2	2
13	00916	BOLTS, HOLD-DOWN J TYPE 8" 2/CD	1	2	2



Panel D

Loc.	Part #	Description	No. Pegs	Pcs. / Peg	Total Pcs.
1	00394	WIRE, PRIMARY 18 GA 40' 80 RED 1/CD	1	2	2
2	00395	WIRE, PRIMARY 18 GA 40' 80 BLK 1/CD	1	2	2
3	00474	WIRE, PRIMARY 16 GA 28' 80 RED 1/CD	1	2	2
4	00475	WIRE, PRIMARY 16 GA 28' 80 BLK 1/CD	1	2	2
5	00472	WIRE, PRIMARY 16 GA 28' 80 WHT 1/CD	1	2	2
6	00399	WIRE, PRIMARY 16 GA 28' 80 GRN 1/CD	1	2	2
7	00398	WIRE, PRIMARY 16 GA 28' 80 YEL 1/CD	1	2	2
8	00482	WIRE, PRIMARY 14 GA 20' 80 RED 1/CD	1	2	2
9	00483	WIRE, PRIMARY 14 GA 20' 80 BLK 1/CD	1	2	2
10	00480	WIRE, PRIMARY 14 GA 20' 80 WHT 1/CD	1	2	2
11	00484	WIRE, PRIMARY 14 GA 20' 80 BRN 1/CD	1	2	2
12	00481	WIRE, PRIMARY 14 GA 20' 80 BLU 1/CD	1	2	2
13	00479	WIRE, PRIMARY 14 GA 20' 80 GRN 1/CD	1	2	2
14	00478	WIRE, PRIMARY 14 GA 20' 80 YEL 1/CD	1	2	2
15	00490	WIRE, PRIMARY 12 GA 12' 80 RED 1/CD	1	2	2
16	00491	WIRE, PRIMARY 12 GA 12' 80 BLK 1/CD	1	2	2
17	00498	WIRE, PRIMARY 10 GA 8' 80 RED 1/CD	1	2	2
18	00499	WIRE, PRIMARY 10 GA 8' 80 BLK 1/CD	1	2	2
19	02941	WIRE, BND PARALLEL 16/1-18/3 25' WHT,BRN,YEL,GRN	2	2	2
20	04367	TAPE, SELF FUSING BLK 1/CS	1	2	2
21	04368	TAPE, SELF FUSING RED 1/CS	1	2	2
22	00915	TOOL, CRIMPING/STRIPPING PW 1/CD	1	2	2
23	08751	VOLT METER, DIGITAL	1	2	2

**WARNING:** Cancer and Reproductive Harm [www.P65Warnings.ca.gov](http://www.P65Warnings.ca.gov)



**METAL ACCESSORY BOX AND PLASTIC DIVIDERS**

Organize terminals, lugs, nuts & bolts, heat shrinkable tubing, solderless terminals, and many other small accessories in our line.

- 18" W x 12" D x 3" H
- 3 fixed vertical dividers
- 9 plastic horizontal dividers



Part #	Packaging	Master Carton	
		Quantity	Weight
08773	Bulk	4	8 lbs.
08774	Bag of 9 Dividers	4	1 lbs.

**4 ROD WIRE RACK**

- For storage and organization of spooled wire
- Holds spools up to 7" in diameter
- Wall mountable
- Grey powder coat is rust and acid resistant
- 26 1/8" W x 6" D x 37 1/8" H



Part #	Packaging	Master Carton	
		Quantity	Weight
08772	Box of 1	1	17 lbs.

**4-SIDED SPINNER RACK**

- With 12" x 48" panels

Part #	Packaging	Master Carton	
		Quantity	Weight
97664	Box of 1	1	31 lbs.



**BATTERY ISOLATORS**

Enhances your alternator performance for efficient charging, maximum power, longer battery life, and safer operation.

- Protects main starting battery from auxiliary drain
- Regulates current for multi-battery system
- Ideal for automotive, marine, and RV applications



Part #	Description	Packaging	Master Carton	
			Quantity	Weight
08770	Isolator 95 Amp	Clam Shell of 1	6	8 lbs.
08771	Isolator 120 Amp	Clam Shell of 1	6	14 lbs.

**WARNING:** Cancer and Reproductive Harm [www.P65Warnings.ca.gov](http://www.P65Warnings.ca.gov)

**Without an isolator.**

In a multi-battery system, the battery with the lower state of charge will drain power from the battery with the higher state of charge.

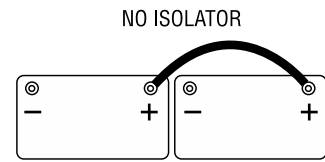

**The benefits of using an isolator.**

The battery isolator protects your starting battery power so that no matter how weak your accessory battery becomes, the accessory battery will never drain power from the starting battery.

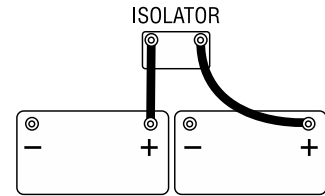

**Additional benefits of using an isolator.**

The battery isolator also saves time by allowing simultaneous charging of both batteries. The amount of current flowing into each battery is determined by its state of charge, which guarantees that each battery will get fully charged, prolonging its life.

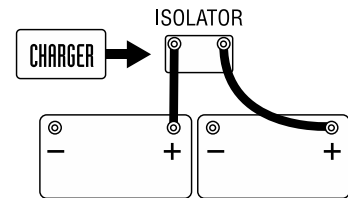

**ISOLATOR INSTALLATION KITS**



08768

Part #	Description	Packaging	Master Carton	
			Quantity	Weight
08768 <sup>1</sup>	CS Isolator Kit	Clam Shell of 1	10	1 lbs.
08769 <sup>2</sup>	Isolator Kit	Clam Shell of 1	6	1 lbs.

<sup>1</sup>Contains: Complete instructions, various 16-14 gauge terminals

Sensor wire for "S" position on some GM alternator connectors and primary wire

<sup>2</sup>Contains: Complete instructions, various terminals and connectors, 15' of 8 gauge wire, and a 50 amp circuit breaker

**WARNING:** Cancer and Reproductive Harm [www.P65Warnings.ca.gov](http://www.P65Warnings.ca.gov)



# Wire and Cable

East Penn manufactures a complete line of automotive, marine, and commercial wire and cable products on site. Copper rod is drawn into fine strands and bunched to form a conductor. The conductor is then jacketed in one of our many extrusion lines before being packaged onto spools, reels, or drums. All wire and cable is RoHS and REACH compliant and built to meet SAE, UL, and/or CSA specifications.



- Primary Wire
- GXL Cross-Linked Polyethylene Wire
- SXL Cross-Linked Polyethylene Wire
- Starter Cable
- SGX Cross-Linked Polyethylene Wire
- Welding Cable
- UL/CSA 1015 Single Conductor Wire
- UL 1426/CSA Tinned Wire and Cable
- Bonded Parallel
- Automotive Duplex, Triplex, Quadraplex
- Trailer Cable Wire
- Booster Cable Wire



# PRIMARY WIRE - RATED 80°C

## 80° Primary

Annealed  
Bunched  
Copper Core



General-purpose thermoplastic insulated wire ideal for automotive, truck, trailers, boats, and other point-to-point, low voltage wiring applications. Its jacket surface is smooth enough to easily go through loom or conduit yet tough enough to resist grease, oil, and acid. Meeting the standard for O.E. or replacement applications, this single conductor copper wire is the ideal solution for dependable general purpose needs.

**Voltage:** Rated at 60V or less

**Temperature:** Rated -40°C (-40°F) to 80°C (176°F)

**Specifications:** SAE J1128, SAE J378

• *Spiral striping of this product is available. Please refer to page 104 for details.*



**WARNING:** Cancer and Reproductive Harm [www.P65Warnings.ca.gov](http://www.P65Warnings.ca.gov)

### 20 Gauge

Stranding 11/30  
Nominal OD 0.085

Length	Pkg.	MC Qty.	Weight	Red	White	Black	Green	Yellow	Brown	Blue	Orange
				45'	Card	12	4 lbs.	04757	04758	04759	04760
100'	Spool (H)	4	3 lbs.	02684	02685	02687	02688	02689	02690	02686	—
1000'	Spool (K)	1	7 lbs.	02691	02692	02694	02695	02696	02697	02693	—
15000'	Factory Reel (C)	15000'	99 lbs.	14300	14301	14303	14304	14305	14306	14302	—

Note: letter in parenthesis designates spool ID, see page 105.

### 18 Gauge

Stranding 16/30  
Nominal OD 0.095

Length	Pkg.	MC Qty.	Weight	Red	White	Black	Green	Yellow	Brown	Blue	Orange
				40'	Card	12	5 lbs.	00394	00392	00395	00391
45'	Spool (I)	12	6 lbs.	02300	02301	02302	02303	02304	02305	02306	02307
100'	Spool (H)	4	4 lbs.	02308	02309	02310	02311	02312	02313	02314	02315
500'	Spool (J)	1	5 lbs.	02322	02323	02324	02325	02326	02327	02328	02329
1000'	Spool (K)	1	9 lbs.	02336	02337	02338	02339	02340	02341	02342	02343
11000'	Factory Reel (C)	11000'	94 lbs.	14500	14501	14502	14503	14504	14505	14506	14507
40000'	Drum (E)	40000'	375 lbs.	14552	14553	14554	14555	14556	14557	14558	14559

Note: letter in parenthesis designates spool ID, see page 105.



**16 Gauge**  
Stranding 19/29  
Nominal OD 0.102

Length	Pkg.	MC Qty.	Weight	Red	White	Black	Green	Yellow	Brown	Blue	Orange
				Red	White	Black	Green	Yellow	Brown	Blue	Orange
28'	Card	12	5 lbs.	00474	00472	00475	00399	00398	00476	00473	00477
35'	Spool (I)	12	6 lbs.	02350	02351	02352	02353	02354	02355	02356	02357
100'	Spool (H)	4	5 lbs.	02358	02359	02360	02361	02362	02363	02364	02365
500'	Spool (J)	1	6 lbs.	02372	02373	02374	02375	02376	02377	02378	02379
1000'	Spool (K)	1	12 lbs.	02386	02387	02388	02389	02390	02391	02392	02393
9000'	Factory Reel (C)	9000'	114 lbs.	14509	14510	14511	14512	14513	14514	14515	14516
30000'	Drum (E)	30000'	371 lbs.	14561	14562	14563	14564	14565	14566	14567	14568

Note: letter in parenthesis designates spool ID, see page 105.

**14 Gauge**  
Stranding 19/27  
Nominal OD 0.117

Length	Pkg.	MC Qty.	Weight	Red	White	Black	Green	Yellow	Brown	Blue	Orange
				Red	White	Black	Green	Yellow	Brown	Blue	Orange
20'	Card	12	5 lbs.	00482	00480	00483	00479	00478	00484	00481	00485
25'	Spool (I)	12	6 lbs.	02400	02401	02402	02403	02404	02405	02406	02407
100'	Spool (H)	4	7 lbs.	02408	02409	02410	02411	02412	02413	02414	02415
500'	Spool (J)	1	9 lbs.	02422	02423	02424	02425	02426	02427	02428	02429
1000'	Spool (K)	1	19 lbs.	02436	02437	02438	02439	02440	02441	02442	02443
6000'	Factory Reel (C)	6000'	106 lbs.	14518	14519	14520	14521	14522	14523	14524	14525
20000'	Drum (E)	20000'	353 lbs.	14570	14571	14572	14573	14574	14575	14576	14577

Note: letter in parenthesis designates spool ID, see page 105.

**12 Gauge**  
Stranding 19/25  
Nominal OD 0.142

Length	Pkg.	MC Qty.	Weight	Red	White	Black	Green	Yellow	Brown	Blue	Orange
				Red	White	Black	Green	Yellow	Brown	Blue	Orange
12'	Card	12	5 lbs.	00490	00488	00491	00487	00486	00492	00489	00493
15'	Spool (I)	12	6 lbs.	02450	02451	02452	02453	02454	02455	02456	02457
100'	Spool (H)	4	11 lbs.	02458	02459	02460	02461	02462	02463	02464	02465
500'	Spool (K)	1	13 lbs.	02472	02473	02474	02475	02476	02477	02478	02479
1000'	Reel (A)	1	28 lbs.	02486	02487	02488	02489	02490	02491	02492	02493
4500'	Factory Reel (C)	4500'	106 lbs.	14527	14528	14529	14530	14531	14532	14533	14534
15000'	Drum (E)	15000'	394 lbs.	14579	14580	14581	14582	14583	14584	14585	14586

Note: letter in parenthesis designates spool ID, see page 105.

**10 Gauge**  
Stranding 19/23  
Nominal OD 0.174

Length	Pkg.	MC Qty.	Weight	Red	White	Black	Green	Yellow	Brown	Blue	Orange
				Red	White	Black	Green	Yellow	Brown	Blue	Orange
8'	Card	12	5 lbs.	00498	00496	00499	00495	00494	00501	00497	00502
10'	Spool (I)	12	6 lbs.	02500	02501	02502	02503	02504	02505	02506	02507
100'	Spool (J)	4	19 lbs.	02508	02509	02510	02511	02512	02513	02514	02515
500'	Spool (K)	1	20 lbs.	02522	02523	02524	02525	02526	02527	02528	02529
1000'	Reel (A)	1	42 lbs.	02536	02537	02538	02539	02540	02541	02542	02543
3500'	Factory Reel (D)	3500'	137 lbs.	14536	14537	14538	14539	14540	14541	14542	14543
10000'	Drum (E)	10000'	411 lbs.	14588	14589	14590	14591	14592	14593	14594	14595

Note: letter in parenthesis designates spool ID, see page 105.

**8 Gauge**  
Stranding 19/21  
Nominal OD 0.215

Length	Pkg.	MC Qty.	Weight	Red	White	Black	Green	Yellow	Brown	Blue	Orange
				Red	White	Black	Green	Yellow	Brown	Blue	Orange
100'	Spool (J)	1	6 lbs.	02550	02551	02552	02553	—	—	—	—
500'	Reel (A)	1	31 lbs.	02554	02555	02556	02557	—	—	—	—
1000'	Reel (B)	1	68 lbs.	02558	02559	02560	02561	—	—	—	—
2500'	Factory Reel (D)	2500'	159 lbs.	14545	14546	14547	14548	—	—	—	—
7000'	Drum (E)	7000'	441 lbs.	14597	14598	14599	14600	—	—	—	—

Note: letter in parenthesis designates spool ID, see page 105.

# PRIMARY WIRE - RATED 105°C

## 105° Primary

General-purpose thermoplastic insulated wire ideal for automotive, truck, trailers, boats, and other point-to-point, low voltage wiring applications. Its jacket surface is smooth enough to easily go through loom or conduit yet tough enough to resist grease, oil, and acid. Meeting the standard for O.E. or replacement applications, this single conductor copper wire is the ideal solution for dependable general purpose needs.

Annealed  
Bunched  
Copper Core

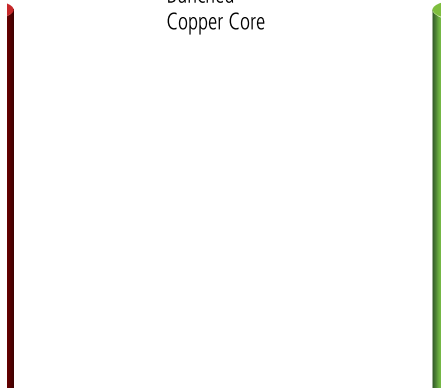

**Voltage:** Rated at 60V or less

**Temperature:** Rated -40°C (-40°F) to 105°C (221°F)

**Specifications:** SAE J1128, SAE J378

• *Spiral striping of this product is available. Please refer to page 104 for details.*



*Print Legend:*

**SAE J1128 GPT TYPE 2 60V & SAE J378 50V (size) GA 105°C (221°F) DRY**

**⚠ WARNING:** Cancer and Reproductive Harm [www.P65Warnings.ca.gov](http://www.P65Warnings.ca.gov)

### 18 Gauge – Stranding 16/30; Nominal OD 0.095

Length	Pkg.	MC Qty.	Weight	Red	White	Black	Green	Yellow	Brown	Blue	Orange	Gray	Purple	Dk Blue	Dk Green	Tan	Pink
				Red	White	Black	Green	Yellow	Brown	Blue	Orange	Gray	Purple	Dk Blue	Dk Green	Tan	Pink
100'	Spool (H)	4	4 lbs.	02814	02815	02816	02817	02818	02819	02820	02821	02316	02317	02318	02319	02320	02321
500'	Spool (J)	1	5 lbs.	02822	02823	02824	02825	02826	02827	02828	02829	02330	02331	02332	02333	02334	02335
1000'	Spool (K)	1	9 lbs.	02830	02831	97761	—	02833	02832	02834	—	02344	02345	02346	02347	02348	02349
11000'	Factory Reel (C)	11000'	94 lbs.	14601	14602	14603	14604	14605	14606	14607	14608	14609	14610	14611	14612	14613	14614
40000'	Drum (E)	40000'	375 lbs.	14678	14679	14680	14681	14682	14683	14684	14685	14686	14687	14688	14689	14690	14691

Note: letter in parenthesis designates spool ID, see page 105.

### 16 Gauge – Stranding 19/29; Nominal OD 0.102

Length	Pkg.	MC Qty.	Weight	Red	White	Black	Green	Yellow	Brown	Blue	Orange	Gray	Purple	Dk Blue	Dk Green	Tan	Pink
				Red	White	Black	Green	Yellow	Brown	Blue	Orange	Gray	Purple	Dk Blue	Dk Green	Tan	Pink
100'	Spool (H)	4	5 lbs.	02790	02791	02792	02793	02794	02795	02796	02797	02366	02367	02368	02369	02370	02371
500'	Spool (J)	1	6 lbs.	02798	02799	02800	02801	02802	02803	02804	02805	02380	02381	02382	02383	02384	02385
1000'	Spool (K)	1	12 lbs.	02806	02807	02808	02809	02810	02811	02812	02813	02394	02395	02396	02397	02398	02399
9000'	Factory Reel (C)	9000'	114 lbs.	14615	14616	14617	14618	14619	14620	14621	14622	14623	14624	14625	14626	14627	14628
30000'	Drum (E)	30000'	371 lbs.	14692	14693	14694	14695	14696	14697	14698	14699	14700	14701	14702	14703	14704	14705

Note: letter in parenthesis designates spool ID, see page 105.





**14 Gauge** – Stranding 19/27; Nominal OD 0.117

Length	Pkg.	MC Qty.	Weight	Red	White	Black	Green	Yellow	Brown	Blue	Orange	Gray	Purple	Dk Blue	Dk Green	Tan	Pink
				Red	White	Black	Green	Yellow	Brown	Blue	Orange	Gray	Purple	Dk Blue	Dk Green	Tan	Pink
100'	Spool (H)	4	7 lbs.	02766	02767	02768	02769	02770	02771	02772	02773	02416	02417	02418	02419	02420	02421
500'	Spool (J)	1	9 lbs.	02774	02775	02776	02777	02778	02779	02780	02781	02430	02431	02432	02433	02434	02435
1000'	Spool (K)	1	19 lbs.	02782	02783	02784	02785	02786	02787	02788	02789	02444	02445	02446	02447	02448	02449
6000'	Factory Reel (C)	6000'	106 lbs.	14629	14630	14631	14632	14633	14634	14635	14636	14637	14638	14639	14640	14641	14642
20000'	Drum (E)	20000'	353 lbs.	14706	14707	14708	14709	14710	14711	14712	14713	14714	14715	14716	14717	14718	14719

Note: letter in parenthesis designates spool ID, see page 105.

**12 Gauge** – Stranding 19/25; Nominal OD 0.142

Length	Pkg.	MC Qty.	Weight	Red	White	Black	Green	Yellow	Brown	Blue	Orange	Gray	Purple	Dk Blue	Dk Green	Tan	Pink
				Red	White	Black	Green	Yellow	Brown	Blue	Orange	Gray	Purple	Dk Blue	Dk Green	Tan	Pink
100'	Spool (H)	4	11 lbs.	02742	02743	02744	02745	02746	02747	02748	02749	02466	02467	02468	02469	02470	02471
500'	Spool (K)	1	13 lbs.	02750	02751	02752	02753	02754	02755	02756	02757	02480	02481	02482	02483	02484	02485
1000'	Reel (A)	1	28 lbs.	02758	02759	02760	02761	02762	02763	02764	02765	02494	02495	02496	02497	02498	02499
4500'	Factory Reel (C)	4500'	106 lbs.	14643	14644	14645	14646	14647	14648	14649	14650	14651	14652	14653	14654	14655	14656
15000'	Drum (E)	15000'	394 lbs.	14720	14721	14722	14723	14724	14725	14726	14727	14728	14729	14730	14731	14732	14733

Note: letter in parenthesis designates spool ID, see page 105.

**10 Gauge** – Stranding 19/23; Nominal OD 0.174

Length	Pkg.	MC Qty.	Weight	Red	White	Black	Green	Yellow	Brown	Blue	Orange	Gray	Purple	Dk Blue	Dk Green	Tan	Pink
				Red	White	Black	Green	Yellow	Brown	Blue	Orange	Gray	Purple	Dk Blue	Dk Green	Tan	Pink
100'	Spool (J)	4	19 lbs.	02718	02719	02720	02721	02722	02723	02724	02725	02516	02517	02518	02519	02520	02521
500'	Spool (K)	1	20 lbs.	02726	02727	02728	02729	02730	02731	02732	02733	02530	02531	02532	02533	02534	02535
1000'	Reel (A)	1	42 lbs.	02734	02735	02736	02737	02738	02739	02740	02741	02544	02545	02546	02547	02548	02549
3500'	Factory Reel (D)	3500'	137 lbs.	14657	14658	14659	14660	14661	14662	14663	14664	14665	14666	14667	14668	14669	14670
10000'	Drum (E)	10000'	411 lbs.	14734	14735	14736	14737	14738	14739	14740	14741	14742	14743	14744	14745	14746	14747

Note: letter in parenthesis designates spool ID, see page 105.

**8 Gauge** – Stranding 19/21; Nominal OD 0.215

Length	Pkg.	MC Qty.	Weight	Red	White	Black	Green
				Red	White	Black	Green
100'	Spool (J)	1	6 lbs.	02706	02707	02708	02709
500'	Reel (A)	1	31 lbs.	02710	02711	02712	02713
1000'	Reel (B)	1	68 lbs.	02714	02715	02716	02717
2500'	Factory Reel (D)	2500'	159 lbs.	14671	14672	14673	14674
7000'	Drum (E)	7000'	441 lbs.	14748	14749	14750	14751

Note: letter in parenthesis designates spool ID, see page 105.



## GXL CROSS-LINKED POLYETHYLENE WIRE - RATED 125°C

**GXL**

Annealed  
Bunched  
Copper Core

General-purpose high temperature (up to 125°C or 257°F) automotive wire is ideal for under-hood automotive wiring applications with hard-to-fit areas. Abrasion-resistant design is highly resistant to moisture, oil, grease, gasoline, and other damaging solvents. Works well with most standard automotive connections and is specified for use in engine compartments where high heat resistance is required by SAE J1128 specifications. Cross-linking structure reinforces the polyethylene insulation for enhanced durability and resistance to heat and abrasion.

**Voltage:** Rated at 60VDC/25VAC or less

**Temperature:** Rated at -40°C (-40°F) to 125°C 257°F)

**Specifications:** SAE J1128, Ford ESB-M1L 85A, and Chrysler MS-8900



*Print Legend:*

**EAST PENN HITECH® SAE J1128 GXL TYPE2 60V (size) GA 125°C (257°F) DRY MADE IN USA**

**⚠ WARNING:** Cancer and Reproductive Harm [www.P65Warnings.ca.gov](http://www.P65Warnings.ca.gov)

### 18 Gauge

Stranding 16/30  
Nominal OD 0.094

(SAE J1128 and ESB-MIL 85A ONLY)

Length	Pkg.	MC Qty.	Weight							
				Red	White	Black	Green	Yellow	Brown	Blue
1000'	Spool (K)	1	9 lbs.	03025	03026	03027	03028	03029	03030	03031
5000'	Factory Reel (M)	5000	46 lbs.	14307	14308	14309	14310	14311	14312	14313

Note: letter in parenthesis designates spool ID, see page 105.

### 16 Gauge

Stranding 19/29  
Nominal OD 0.103

Length	Pkg.	MC Qty.	Weight							
				Red	White	Black	Green	Yellow	Brown	Blue
1000'	Spool (K)	1	12 lbs.	03032	03033	03034	03035	03036	03037	03038
5000'	Factory Reel (M)	5000	61 lbs.	14314	14315	14316	14317	14318	14319	14320

Note: letter in parenthesis designates spool ID, see page 105.

### 14 Gauge

Stranding 19/27  
Nominal OD 0.117

Length	Pkg.	MC Qty.	Weight							
				Red	White	Black	Green	Yellow	Brown	Blue
1000'	Spool (K)	1	17 lbs.	03039	03040	03041	03042	03043	03044	03045
5000'	Factory Reel (L)	5000	86 lbs.	14321	14322	14323	14324	14325	14326	14327

Note: letter in parenthesis designates spool ID, see page 105.





**12 Gauge**  
Stranding 19/25  
Nominal OD 0.142

Length	Pkg.	MC Qty.	Weight							
				Red	White	Black	Green	Yellow	Brown	Blue
1000'	Spool (K)	1	25 lbs.	03046	03047	03048	03049	03050	03051	03052
3000'	Factory Reel (M)	3000	78 lbs.	14328	14329	14330	14331	14332	14333	14334

Note: letter in parenthesis designates spool ID, see page 105.

**10 Gauge**  
Stranding 19/23  
Nominal OD 0.179

Length	Pkg.	MC Qty.	Weight							
				Red	White	Black	Green	Yellow	Brown	Blue
1000'	Spool (K)	1	38 lbs.	03053	03054	03055	03056	03057	03058	03059
2000'	Factory Reel (M)	2000	99 lbs.	14335	14336	14337	14338	14339	14340	14341

Note: letter in parenthesis designates spool ID, see page 105.

## SXL CROSS-LINKED POLYETHYLENE WIRE - RATED 125°C

**SXL**

Special-purpose high temperature (up to 125°C or 257°F) automotive wire. Abrasion-resistant design is resistant to moisture, oil, grease, gasoline, and other damaging solvents. Works well in engine compartments where strict temperature ranges are required according to SAE J1128 specifications. Cross-linking structure reinforces the polyethylene insulation for enhanced durability and resistance to heat and abrasion.

\_\_\_\_\_  
 Annealed  
 Bunched  
 Copper Core

**Voltage:** Rated at 60VDC/25VAC or less

**Temperature:** Rated at -40°C (-40°F) to 125°C (257°F)

**Specifications:** SAE J1128, Ford ESB-M1L 123A, and Chrysler MS-5919

• *Spiral striping of this product is available. Please refer to page 104 for details.*



*Print Legend:*

**EAST PENN HITECH® SAE J1128 SXL TYPE2 60V (size) GA 125°C (257°F) DRY MADE IN USA**

**⚠ WARNING:** Cancer and Reproductive Harm [www.P65Warnings.ca.gov](http://www.P65Warnings.ca.gov)

### 20 Gauge – Stranding 7/28; Nominal OD 0.096 (SAE J1128 and MS-5919 only)

Length	Pkg.	MC Qty.	Weight	Red	White	Black	Green	Yellow	Brown	Blue	Orange	Pink	Purple	Grey
				Red	White	Black	Green	Yellow	Brown	Blue	Orange	Pink	Purple	Grey
100'	Spool (H)	4	4 lbs.	02865	02866	02867	02868	02869	02870	02871	—	31030	31031	31032
1000'	Spool (K)	1	8 lbs.	02872	02873	02874	02875	02876	02877	02878	—	31048	31049	31050

Note: letter in parenthesis designates spool ID, see page 105.

### 18 Gauge – Stranding 16/30; Nominal OD 0.108

Length	Pkg.	MC Qty.	Weight	Red	White	Black	Green	Yellow	Brown	Blue	Orange	Pink	Purple	Grey
				Red	White	Black	Green	Yellow	Brown	Blue	Orange	Pink	Purple	Grey
100'	Spool (H)	4	4 lbs.	02600	02601	02606	02603	02604	02605	02602	02607	31027	31028	31029
1000'	Spool (K)	1	9 lbs.	02639	02640	02645	02642	02643	02644	02641	02646	31045	31046	31047

Note: letter in parenthesis designates spool ID, see page 105.

### 16 Gauge – Stranding 19/29; Nominal OD 0.121

Length	Pkg.	MC Qty.	Weight	Red	White	Black	Green	Yellow	Brown	Blue	Orange	Pink	Purple	Grey
				Red	White	Black	Green	Yellow	Brown	Blue	Orange	Pink	Purple	Grey
100'	Spool (H)	4	5 lbs.	02608	02609	02614	02611	02612	02613	02610	02615	31024	31025	31026
1000'	Spool (K)	1	12 lbs.	02647	02648	02653	02650	02651	02652	02649	02654	31042	31043	31044

Note: letter in parenthesis designates spool ID, see page 105.





**14 Gauge – Stranding 19/27; Nominal OD 0.139**

Length	Pkg.	MC Qty.	Weight	Red	White	Black	Green	Yellow	Brown	Blue	Orange	Pink	Purple	Grey
				Red	White	Black	Green	Yellow	Brown	Blue	Orange	Pink	Purple	Grey
100'	Spool (H)	4	7 lbs.	02616	02617	02622	02619	02620	02621	02618	02623	31021	31022	31023
1000'	Spool (K)	1	19 lbs.	02655	02656	02661	02658	02659	02660	02657	02662	31039	31040	31041

Note: letter in parenthesis designates spool ID, see page 105.

**12 Gauge – Stranding 19/25; Nominal OD 0.164**

Length	Pkg.	MC Qty.	Weight	Red	White	Black	Green	Yellow	Brown	Blue	Orange	Pink	Purple	Grey
				Red	White	Black	Green	Yellow	Brown	Blue	Orange	Pink	Purple	Grey
100'	Spool (J)	4	11 lbs.	02624	02625	02630	02627	02628	02629	02626	02631	31018	31019	31020
1000'	Reel (A)	1	28 lbs.	02663	02664	02669	02666	02667	02668	02665	02670	31036	31037	31038

Note: letter in parenthesis designates spool ID, see page 105.

**10 Gauge – Stranding 19/23; Nominal OD 0.196**

Length	Pkg.	MC Qty.	Weight	Red	White	Black	Green	Yellow	Brown	Blue	Orange	Pink	Purple	Grey
				Red	White	Black	Green	Yellow	Brown	Blue	Orange	Pink	Purple	Grey
100'	Spool (J)	4	19 lbs.	02632	02633	02638	02635	02636	02637	02634	—	31015	31016	31017
1000'	Reel (A)	1	42 lbs.	02671	02672	02677	02674	02675	02676	02673	—	31033	31034	31035

Note: letter in parenthesis designates spool ID, see page 105.

# STARTER CABLE - RATED 105°C

## Starter Cable

Full-gauge copper conductor wire ideal for connecting a battery to switch, starter, and ground. Tough, high temperature resistant PVC insulation is durable enough to handle heavy-duty automotive demands. Copper stranding is highly conductive maximizing current transfer while remaining flexible for easy installation.



Strand  
Anneal  
Bunch  
Copper

**Voltage:** Rated at 60 Volts or less

**Temperature:** Rated -50°C (-58°F) to 105°C (221°F)

**Specifications:** SAE J1127, SAE J378



Print Legend:

SAE J1127 SGT TYPE2 60V & SAE J378 50V (size) GA 105°C (221°F) DRY

**⚠ WARNING:** Cancer and Reproductive Harm [www.P65Warnings.ca.gov](http://www.P65Warnings.ca.gov)

### 6 Gauge

Stranding 48/22.5  
Nominal OD 0.300

Length	Packaging	MC Qty.	Weight		
				Red	Black
25'	Box	1	4 lbs.	04600	04601
100'	Spool (K)	1	15 lbs.	04602	04603
500'	Reel (B)	1	67 lbs.	04604	04605
3500'	Factory Reel (F)	3500'	459 lbs.	14856	14857

Note: letter in parenthesis designates spool ID, see page 105.

### 4 Gauge

Stranding 70/22.5  
Nominal OD 0.360

Length	Packaging	MC Qty.	Weight		
				Red	Black
25'	Box	1	5 lbs.	04606	04607
100'	Spool (K)	1	16 lbs.	04608	04609
500'	Reel (B)	1	92 lbs.	04610	04611
3000'	Factory Reel (F)	3000'	495 lbs.	14858	14859

Note: letter in parenthesis designates spool ID, see page 105.

### 2 Gauge

Stranding 64/20  
Nominal OD 0.430

Length	Packaging	MC Qty.	Weight		
				Red	Black
25'	Box	1	8 lbs.	04612	04613
100'	Reel (A)	1	30 lbs.	04614	04615
500'	Reel (C)	1	142 lbs.	04616	04617
2000'	Factory Reel (F)	2000'	597 lbs.	14860	14861

Note: letter in parenthesis designates spool ID, see page 105.

### 1 Gauge

Stranding 133/22  
Nominal OD 0.490

Length	Packaging	MC Qty.	Weight		
				Red	Black
25'	Box	1	9 lbs.	04618	04619
100'	Reel (A)	1	35 lbs.	04620	04621
500'	Reel (D)	1	167 lbs.	04622	04623
2000'	Factory Reel (F)	2000'	650 lbs.	14862	14863

Note: letter in parenthesis designates spool ID, see page 105.



**1/0 Gauge**Stranding 210/23  
Nominal OD 0.550

Length	Packaging	MC Qty.	Weight		
				Red	Black
25'	Box	1	11 lbs.	04624	04625
100'	Reel (A)	1	45 lbs.	04626	04627
500'	Reel (D)	1	217 lbs.	04628	04629
1500'	Factory Reel (F)	1500'	620 lbs.	14864	14865

Note: letter in parenthesis designates spool ID, see page 105.

**2/0 Gauge**Stranding 133/20  
Nominal OD 0.605

Length	Packaging	MC Qty.	Weight		
				Red	Black
25'	Box	1	14 lbs.	04630	04631
100'	Reel (B)	1	55 lbs.	04632	04633
500'	Reel (D)	1	265 lbs.	04634	04635
1000'	Factory Reel (F)	1000'	627 lbs.	14866	14867

Note: letter in parenthesis designates spool ID, see page 105.

**3/0 Gauge**Stranding 259/22  
Nominal OD 0.695

Length	Packaging	MC Qty.	Weight		
				Red	Black
25'	Box	1	18 lbs.	06455	04636
100'	Reel (B)	1	70 lbs.	06454	04637
500'	Reel (F)	1	342 lbs.	06453	04638
1000'	Factory Reel (F)	1000'	694 lbs.	14928	14868

Note: letter in parenthesis designates spool ID, see page 105.

**4/0 Gauge**Stranding 2052/30  
Nominal OD 0.706

Length	Packaging	MC Qty.	Weight		
				Red	Black
25'	Box	1	17.5 lbs.	04930	04931
100'	Reel (C)	1	71 lbs.	04932	04933
500'	Factory Reel (F)	1	364 lbs.	04934	04935

Note: letter in parenthesis designates spool ID, see page 105.

## SGX CROSS-LINKED POLYETHYLENE CABLE - RATED 125°C

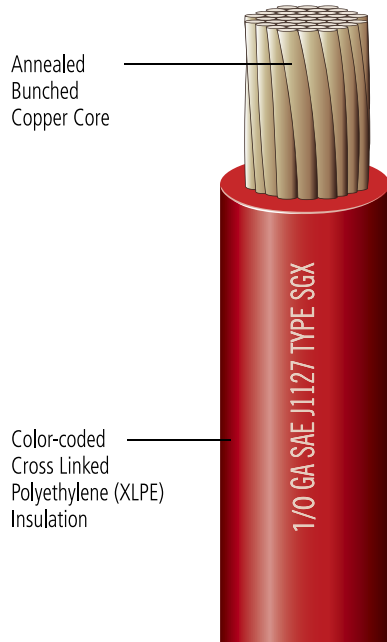

Special-purpose high-temperature (up to 125°C or 257°F) cable. Resistant to abrasion, cracking, moisture, fuels, oils, & damaging solvents. Recommended for connecting battery to switch, starter, and ground on cars, trucks, buses, and other vehicles where a higher durability and heat resistance is required.

**Voltage:** Rated at 60VDC/25VAC or less

**Temperature:** Rated -40°C (-40°F) to 125°C (257°F)

**Specifications:** SAE J1127, Ford ESB-M1L 123A, and Chrysler MS-8288



*Print Legend:*  
(size) GA SAE J1127 TYPE SGX

**WARNING:** Cancer and Reproductive Harm [www.P65Warnings.ca.gov](http://www.P65Warnings.ca.gov)

### 6 Gauge

Stranding 133/27  
Nominal OD 0.315

Length	Packaging	MC Qty.	Weight	Red	Black
				04588	04587
500'	Reel (S)	1	116 lbs.		

Note: letter in parenthesis designates spool ID, see page 105.

### 4 Gauge

Stranding 133/25  
Nominal OD 0.374

Length	Packaging	MC Qty.	Weight	Red	Black
				04590	04589
500'	Reel (U)	1	180 lbs.		

Note: letter in parenthesis designates spool ID, see page 105.

### 2 Gauge

Stranding 133/24  
Nominal OD 0.428

Length	Packaging	MC Qty.	Weight	Red	Black
				04397	07393
100'	Reel (A)	1	28 lbs.		
500'	Reel (T)	1	131 lbs.	04398	04591

Note: letter in parenthesis designates spool ID, see page 105.





**1/0 Gauge**

Stranding 1026/30  
Nominal OD 0.523

Length	Packaging	MC Qty.	Weight		
				Red	Black
100'	Reel (A)	1	42 lbs.	04395	—
500'	Reel (W)	1	196 lbs.	04396	05234

Note: letter in parenthesis designates spool ID, see page 105.

**2/0 Gauge**

Stranding 1254/30  
Nominal OD 0.578

Length	Packaging	MC Qty.	Weight		
				Red	Black
100'	Reel (B)	1	53 lbs.	31148	04393
500'	Reel (X)	1	248 lbs.	31149	04394

Note: letter in parenthesis designates spool ID, see page 105.

**3/0 Gauge**

Stranding 1615/30  
Nominal OD 0.654

Length	Packaging	MC Qty.	Weight		
				Red	Black
500'	Reel (X)	1	305 lbs.	04595	04594

Note: letter in parenthesis designates spool ID, see page 105.

**4/0 Gauge**

Stranding 2071/30  
Nominal OD 0.711

Length	Packaging	MC Qty.	Weight		
				Red	Black
500'	Reel (Y)	1	393 lbs.	05237	—

Note: letter in parenthesis designates spool ID, see page 105.



## WELDING CABLE - RATED 105°C

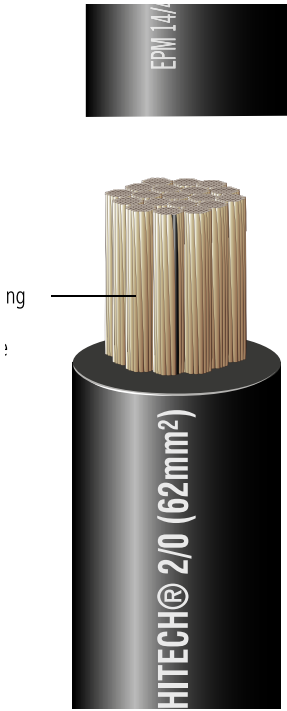

An EPR or Ethylene Propylene Rubber cable that is chemically cross-linked for excellent insulation, dielectric strength, abrasion resistance, and cold-weather flexibility. Great alternative to battery cable for a wider variety of applications due to its weather resistance, durability in heavy-duty use, high voltage rating, and insulating properties. Excellent flexibility in hot and cold temperatures for easier installation and dependable performance.

**Voltage:** Rated up to 600 Volts

**Temperature:** Rated -50°C (-58°F) to 105°C (221°F)



Print Legend:

EAST PENN HITECH® (size) (size mm²) WELDING CABLE 600V -50°C (-58°F) TO 105°C (221°F) MADE IN USA

**WARNING:** Cancer and Reproductive Harm [www.P65Warnings.ca.gov](http://www.P65Warnings.ca.gov)

### 6 (13mm²)

Stranding 259/30  
Nominal OD 0.305

Length	Packaging	MC Qty.	Weight	Red	Black
100'	Spool (K)	1	12 lbs.	04728	04729
500'	Reel (S)	1	58 lbs.	04730	04731

Note: letter in parenthesis designates spool ID, see page 105.

### 4 (19mm²)

Stranding 385/30  
Nominal OD 0.340

Length	Packaging	MC Qty.	Weight	Red	Black
100'	Spool (K)	1	16 lbs.	04700	04701
500'	Reel (U)	1	82 lbs.	04702	04703

Note: letter in parenthesis designates spool ID, see page 105.

### 2 (32mm²)

Stranding 651/30  
Nominal OD 0.420

Length	Packaging	MC Qty.	Weight	Red	Black
100'	Spool (A)	1	25 lbs.	04704	04705
500'	Reel (T)	1	126 lbs.	04706	04707

Note: letter in parenthesis designates spool ID, see page 105.



**1 (40mm<sup>2</sup>)**Stranding 798/30  
Nominal OD 0.490

Length	Packaging	MC Qty.	Weight		
				Red	Black
100'	Reel (A)	1	32 lbs.	04732	04733
500'	Reel (V)	1	161 lbs.	04734	04735

Note: letter in parenthesis designates spool ID, see page 105.

**1/0 (50mm<sup>2</sup>)**Stranding 1026/30  
Nominal OD 0.525

Length	Packaging	MC Qty.	Weight		
				Red	Black
100'	Reel (A)	1	39 lbs.	04736	04737
500'	Reel (W)	1	194 lbs.	04714	04715

Note: letter in parenthesis designates spool ID, see page 105.

**2/0 (62mm<sup>2</sup>)**Stranding 1254/30  
Nominal OD 0.570

Length	Packaging	MC Qty.	Weight		
				Red	Black
100'	Reel (B)	1	47 lbs.	04716	04717
500'	Reel (X)	1	237 lbs.	04718	04719

Note: letter in parenthesis designates spool ID, see page 105.

**3/0 (81mm<sup>2</sup>)**Stranding 1615/30  
Nominal OD 0.635

Length	Packaging	MC Qty.	Weight		
				Red	Black
100'	Reel (B)	1	60 lbs.	04738	04739
500'	Reel (X)	1	301 lbs.	04740	04741

Note: letter in parenthesis designates spool ID, see page 105.

**4/0 (103mm<sup>2</sup>)**Stranding 2052/30  
Nominal OD 0.695

Length	Packaging	MC Qty.	Weight		
				Red	Black
100'	Reel (C)	1	76 lbs.	04724	04725
500'	Reel (Y)	1	381 lbs.	04726	04727

Note: letter in parenthesis designates spool ID, see page 105.

# UL3311 BATTERY CABLE

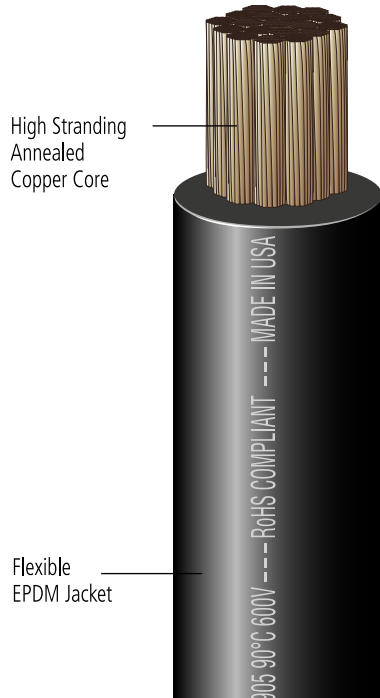

- Suitable for use as battery cable, welding cable, motor leads, & other DC power applications including the internal wiring of appliances & uninterruptible power supply systems
- Meets MTW / AWM specifications
- Class K, 100% bare copper stranding
- Thermoset EPDM insulation that has excellent abrasion resistance, strippability, flexibility, & dielectric strength
- Certified zero-halogen

**Voltage:** Rated up to 600 Volts

**Temperature:** Rated to 90°C (194°F)



*Print Legend:*

(size) AWG E163982K AWM 3311 90°C or 3279 105°C 600V VW-1 --- LL700972  
 CSA CL905 90°C 600V --- RoHS COMPLIANT --- MADE IN USA

**WARNING:** Cancer and Reproductive Harm [www.P65Warnings.ca.gov](http://www.P65Warnings.ca.gov)

## 4 Gauge

Stranding 420/30  
 Nominal OD 0.435

Length	Packaging	MC Qty.	Weight		
				Red	Black
500'	Reel (N)	1	96 lbs.	31000	31001

## 2 Gauge

Stranding 665/30  
 Nominal OD 0.495

Length	Packaging	MC Qty.	Weight		
				Red	Black
500'	Reel (O)	1	141 lbs.	31002	31003

## 1 Gauge

Stranding 798/30  
 Nominal OD 0.490

Length	Packaging	MC Qty.	Weight		
				Red	Black
500'	Reel (Q)	1	182 lbs.	31004	31005

## 1/0 Gauge

Stranding 1064/30  
 Nominal OD 0.607

Length	Packaging	MC Qty.	Weight		
				Red	Black
500'	Reel (Q)	1	216 lbs.	31006	31007

## 2/0 Gauge

Stranding 1330/30  
 Nominal OD 0.652

Length	Packaging	MC Qty.	Weight		
				Red	Black
500'	Reel (Q)	1	267 lbs.	31008	31009

## 3/0 Gauge

Stranding 1672/30  
 Nominal OD 0.712

Length	Packaging	MC Qty.	Weight		
				Red	Black
500'	Reel (R)	1	326 lbs.	31010	31011

## 4/0 Gauge

Stranding 2109/30  
 Nominal OD 0.777

Length	Packaging	MC Qty.	Weight		
				Red	Black
500'	Reel (Z)	1	400 lbs.	31012	31013



# UL/CSA SINGLE CONDUCTOR WIRE - RATED 105°C

Stranded  
Annealed  
Bunched  
Copper Core

UL/CSA PVC insulated, single conductor wire with a multi-functional versatile rating for a variety of applications including RV, automotive, truck, trailer, and marine. High voltage tolerance of up to 600 volts for use in multiple applications such as control cabinets, internal appliance wiring, and machine tools. Highly conductive, bare copper stranded wire maximizes current transfer while remaining flexible for easy installation.

**Voltage:** Rated at 600 Volts

**Temperature:** Rated -40°C (-40°F) to 105°C (221°F)

**Specifications:** UL, CSA, MTW, TEW, AWM, 1015/1230/1345

• Spiral striping of this product is available. Please refer to page 104 for details.



Print Legend for 18ga and 16ga:

(size) AWG E179352 (UL) MTW OR AWM 1015/1230/1345 600V VW-1 --- CSA LL109117 (size) AWG TEW 105C 600V FT1 OR AWM I/II A/B 105C 600V W75C FT1

Print Legend for 14ga, 12ga and 10ga:

(size) AWG E179352 (UL) MTW OR TW OR AWM 1015/1230/1345 600V VW-1 --- CSA LL109117 (size) AWG TEW 105C 600V FT1 OR AWM I/II A/B 105C 600V W75C FT1

Print Legend for 8ga and 6ga:

(size) AWG E179352 (UL) MTW OR TW OR AWM 1015 600V VW-1 --- CSA LL109117 (size) AWG TEW 105C 600V FT1 OR AWM I/II A/B 105C 600V W75C FT1

**WARNING:** Cancer and Reproductive Harm [www.P65Warnings.ca.gov](http://www.P65Warnings.ca.gov)

**18 Gauge**  
Stranding 16/30  
Nominal OD 0.105

Length	Pkg.	MC Qty.	Weight	Red	White	Black	Green	Yellow	Brown	Blue	Orange
100'	Spool (H)	4	5 lbs.	07500	07501	07502	07503	07504	07505	07506	07507
500'	Spool (J)	1	3 lbs.	07508	07509	07510	07511	07512	07513	07514	07515
1000'	Spool (K)	1	11 lbs.	07516	07517	07518	07519	07520	07521	07522	07523
8000'	Factory Reel (C)	8000'	88 lbs.	14752	14753	14754	14755	14756	14757	14758	14759
25000'	Drum (E)	25000'	293 lbs.	14792	14793	14794	14795	14796	14797	14798	14799

Note: letter in parenthesis designates spool ID, see page 105.

**16 Gauge**  
Stranding 26/30  
Nominal OD 0.119

Length	Pkg.	MC Qty.	Weight	Red	White	Black	Green	Yellow	Brown	Blue	Orange
100'	Spool (H)	4	6 lbs.	07524	07525	07526	07527	07528	07529	07530	07531
500'	Spool (J)	1	7 lbs.	07532	07533	07534	07535	07536	07537	07538	07539
1000'	Spool (K)	1	14 lbs.	07540	07541	07542	07543	07544	07545	07546	07547
6000'	Factory Reel (C)	6000'	86 lbs.	14760	14761	14762	14763	14764	14765	14766	14767
20000'	Drum (E)	20000'	298 lbs.	14800	14801	14802	14803	14804	14805	14806	14807

Note: letter in parenthesis designates spool ID, see page 105.



# UL/CSA SINGLE CONDUCTOR WIRE - RATED 105°C

**⚠ WARNING:** Cancer and Reproductive Harm [www.P65Warnings.ca.gov](http://www.P65Warnings.ca.gov)

## 14 Gauge

Stranding 41/30  
Nominal OD 0.132

Length	Pkg.	MC Qty.	Weight	Red	White	Black	Green	Yellow	Brown	Blue	Orange
				Red	White	Black	Green	Yellow	Brown	Blue	Orange
100'	Spool (H)	4	9 lbs.	07548	07549	07550	07551	07552	07553	07554	07555
500'	Spool (J)	1	11 lbs.	07556	07557	07558	07559	07560	07561	07562	07563
1000'	Spool (K)	1	20 lbs.	07564	07565	07566	07567	07568	07569	07570	07571
5000'	Factory Reel (C)	5000'	110 lbs.	14768	14769	14770	14771	14772	14773	14774	14775
15000'	Drum (E)	15000'	318 lbs.	14808	14809	14810	14811	14812	14813	14814	14815

Note: letter in parenthesis designates spool ID, see page 105.

## 12 Gauge

Stranding 65/30  
Nominal OD 0.162

Length	Pkg.	MC Qty.	Weight	Red	White	Black	Green	Yellow	Brown	Blue	Orange
				Red	White	Black	Green	Yellow	Brown	Blue	Orange
100'	Spool (J)	4	12 lbs.	07572	07573	07574	07575	07576	07577	07578	07579
500'	Spool (K)	1	15 lbs.	07580	07581	07582	07583	07584	07585	07586	07587
1000'	Reel (A)	1	31 lbs.	07588	07589	07590	07591	07592	07593	07594	07595
3500'	Factory Reel (C)	3500'	103 lbs.	14776	14777	14778	14779	14780	14781	14782	14783
10000'	Drum (E)	10000'	328 lbs.	14816	14817	14818	14819	14820	14821	14822	14823

Note: letter in parenthesis designates spool ID, see page 105.

## 10 Gauge

Stranding 104/30  
Nominal OD 0.190

Length	Pkg.	MC Qty.	Weight	Red	White	Black	Green	Yellow	Brown	Blue	Orange
				Red	White	Black	Green	Yellow	Brown	Blue	Orange
100'	Spool (J)	4	19 lbs.	07596	07597	07598	07599	07600	07601	07602	07603
500'	Spool (K)	1	22 lbs.	07604	07605	07606	07607	07608	07609	07610	07611
1000'	Reel (A)	1	45 lbs.	07612	07613	07614	07615	07616	07617	07618	07619
3500'	Factory Reel (C)	3500'	155 lbs.	14784	14785	14786	14787	14788	14789	14790	14791
7000'	Drum (E)	7000'	333 lbs.	14824	14825	14826	14827	14828	14829	14830	14831

Note: letter in parenthesis designates spool ID, see page 105.

## 8 Gauge

Stranding 168/30  
Nominal OD 0.270

Length	Pkg.	MC Qty.	Weight	Red	White	Black	Green	Blue
				Red	White	Black	Green	Blue
100'	Spool (J)	1	8 lbs.	07441	07444	07440	07443	07442
500'	Reel (A)	1	41 lbs.	07446	07449	07445	07448	07447
1000'	Reel (B)	1	80 lbs.	07451	07454	07450	07453	07452
2000'	Factory Reel (D)	2000'	156 lbs.	07456	07459	07455	07458	07457

Note: letter in parenthesis designates spool ID, see page 105.

## 6 Gauge

Stranding 259/30  
Nominal OD 0.340

Length	Pkg.	MC Qty.	Weight	Red	White	Black	Green	Blue
				Red	White	Black	Green	Blue
100'	Spool (K)	1	12 lbs.	07461	07464	07460	07463	07462
500'	Reel (B)	1	62 lbs.	07466	07469	07465	07468	07467
1000'	Reel (C)	1	123 lbs.	07471	07474	07470	07473	07472
3500'	Factory Reel (F)	3500'	436 lbs.	07476	07479	07475	07478	07477

Note: letter in parenthesis designates spool ID, see page 105.



## UL/CSA TINNED SINGLE CONDUCTOR WIRE - RATED 105°C

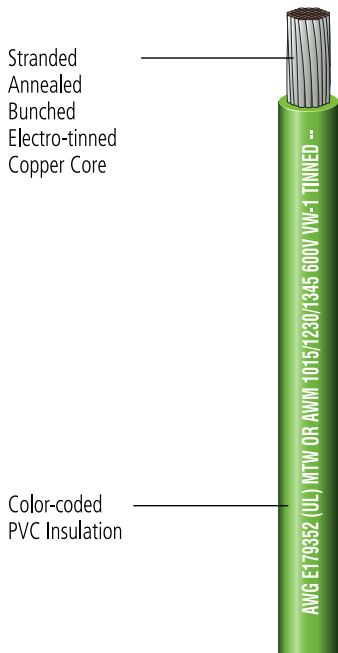

UL/CSA Listed, single-conductor tinned wire ideal for use in the high corrosive environment of marine applications. Special electro-tinned, copper strands also increase protection against corrosion for recreational vehicles, automotive, trucks, and trailers. Tinned copper stranding is extremely flexible for easy routing through marine applications and easier to solder than bare copper. Flame retardant, PVC insulation is highly resistant to water, oil, grease, gasoline, and other damaging solvents. High voltage tolerance of up to 600 volts adds to versatility to its use in multiple marine and other suitable applications.

**Voltage:** Rated at 600 Volts

**Temperature:** Rated -40°C (-40°F) to 105°C (221°F)

**Specifications:** UL1015, CSA, MTW, TEW, AWM

• *Spiral striping of this product is available. Please refer to page 104 for details.*



*Print Legend:*

18 AWG E179352 (UL) MTW OR AWM 1015/1230/1345 600V VW-1 TINNED --- CSA LL109117 18 AWG TEW 105C 600V FT1 OR AWM I/II A/B 105C 600V W75C FT1 TINNED

**WARNING:** Cancer and Reproductive Harm [www.P65Warnings.ca.gov](http://www.P65Warnings.ca.gov)

### 18 Gauge – Stranding 16/30; Nominal OD 0.105

Length	Pkg.	MC Qty.	Weight	Green	Black	White	Red	Yellow	Brown	Blue	Orange	Grey	Purple	Dk Blue	Dk Green	Tan	Pink
100'	Spool (H)	4	5 lbs.	07142	07143	07144	07145	07146	07147	07148	07149	07150	07151	07152	07153	07154	07155
500'	Spool (J)	1	6 lbs.	07156	07157	07158	07159	07160	07161	07162	07163	07164	07165	07166	07167	07168	07169

Note: letter in parenthesis designates spool ID, see page 105.

# MARINE MASTER® UL LISTED 1426 AND CSA TEW/AWM TINNED WIRE/CABLE – SINGLE CONDUCTOR

Stranded  
Annealed  
Bunched  
Electro-tinned  
Copper Core

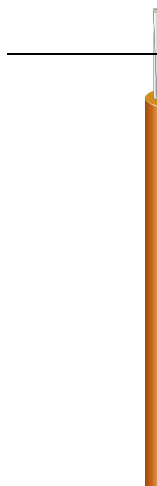

UL/CSA Listed, single-conductor tinned wire is ideal for use in the high corrosive environment of marine applications. Special electro-tinned, copper strands also increase protection against corrosion for recreational vehicles, automotive, trucks, and trailers. Tinned copper stranding is extremely flexible for easy routing through marine applications and easier to solder than bare copper. Flame retardant, PVC insulation is resistant to water, oil, grease, gasoline, and other damaging solvents. High voltage tolerance of up to 600 volts adds to versatility to its use in multiple marine and other suitable applications.

**Voltage:** Rated at 600 Volts

**Temperature:** Rated at 105°C (221°F) dry and 75°C (167°F) wet

**Specifications:** Meets DOT and Coast Guard specs for electrical systems

• *Spiral striping of this product is available. Please refer to page 104 for details.*



Print Legend:

EPM MARINE MASTER® (size) AWG BOAT CABLE BC-5W2 600V 105C DRY 75C WET (UL) ---  
CSA LL109117 (size) AWG TEW 105C 600V FT1 OR AWM I/II A/B 105C 600V W75C FT1

**⚠ WARNING:** Cancer and Reproductive Harm [www.P65Warnings.ca.gov](http://www.P65Warnings.ca.gov)



## 16 Gauge – Stranding 26/30; Nominal OD 0.122

Length	Pkg.	MC Qty.	Weight	Green	Black	White	Red	Yellow	Brown	Blue	Orange	Grey	Purple	Dk Blue	Dk Green	Tan	Pink
20'	Clam Shell	12	4 lbs.	07726	07727	07728	07729	07730	07731	07732	—	—	—	—	—	—	—
100'	Spool (H)	4	6 lbs.	03636	03637	03638	03639	99116	99121	99122	99119	99120	99117	97738	97737	98748	99118
500'	Spool (J)	1	7 lbs.	03640	03641	03642	03643	98684	98722	98721	98724	98723	98720	98060	98059	98719	98718
1000'	Spool (K)	1	16 lbs.	03644	03645	03646	03647	98158	98157	98689	98693	98691	98688	97703	—	98687	98686
6000'	Factory Reel (C)	6000'	86 lbs.	14889	14890	14891	14892	97716	97983	98249	97982	97705	97747	98248	97748	97715	97981

Note: letter in parenthesis designates spool ID, see page 105.







**14 Gauge – Stranding 41/30; Nominal OD 0.138**

Length	Pkg.	MC Qty.	Weight	Green	Black	White	Red	Yellow	Brown	Blue	Orange	Grey	Purple	Dk Blue	Dk Green	Tan	Pink
15'	Clam Shell	12	4 lbs.	07719	07720	07721	07722	07723	07724	07725	—	—	—	—	—	—	—
100'	Spool (H)	4	8 lbs.	03624	03625	03626	03627	99123	99128	99129	99126	99127	99124	99108	97736	98749	99125
500'	Spool (J)	1	10 lbs.	03628	03629	03630	03631	99107	98729	98728	98731	98730	98727	98281	98101	98726	98725
1000'	Spool (K)	1	20 lbs.	03632	03633	03634	03635	98700	98698	98697	98701	98699	98696	—	—	98695	98694
5000'	Factory Reel (C)	5000'	95 lbs.	14893	14894	14895	14896	97854	97851	97853	97740	97700	97841	97741	97739	97714	97852

Note: letter in parenthesis designates spool ID, see page 105.

**12 Gauge – Stranding 65/30; Nominal OD 0.162**

Length	Pkg.	MC Qty.	Weight	Green	Black	White	Red	Yellow	Brown	Blue	Orange	Grey	Purple	Dk Blue	Dk Green	Tan	Pink
12'	Clam Shell	12	4 lbs.	07712	07713	07714	07715	07716	07717	07718	—	—	—	—	—	—	—
100'	Spool (J)	4	12 lbs.	03612	03613	03614	03615	99130	98769	99133	99131	99132	98752	97735	97734	98751	98750
500'	Spool (K)	1	15 lbs.	03616	03617	03618	03619	98738	98736	98735	98739	98737	98734	98058	98057	98733	98732
1000'	Reel (A)	1	30 lbs.	03620	03621	03622	03623	98066	98706	98705	98030	98707	98704	—	—	98703	98702
3500'	Factory Reel (C)	3500'	103 lbs.	14897	14898	14899	14900	97704	97698	97692	97649	97690	97650	—	97691	—	—

Note: letter in parenthesis designates spool ID, see page 105.

**10 Gauge – Stranding 104/30; Nominal OD 0.190**

Length	Pkg.	MC Qty.	Weight	Green	Black	White	Red	Yellow	Brown	Blue	Orange	Grey	Purple	Dk Blue	Dk Green	Tan	Pink
8'	Clam Shell	12	4 lbs.	07699	07706	07707	07708	07709	07710	07711	—	—	—	—	—	—	—
100'	Spool (J)	4	19 lbs.	03600	03601	03602	03603	99134	98757	98756	99135	98758	98755	—	—	98754	98753
500'	Spool (K)	1	21 lbs.	03604	03605	03606	03607	98746	98744	98743	98747	98745	98742	98056	98055	98741	98740
1000'	Reel (A)	1	42 lbs.	03608	03609	03610	03611	98716	98714	98713	98138	98715	98712	—	—	98711	98710
3500'	Factory Reel (C)	3500'	155 lbs.	14901	14902	14903	14904	97733	—	—	97689	—	—	—	—	—	—

Note: letter in parenthesis designates spool ID, see page 105.

## MARINE MASTER® UL LISTED 1426 AND CSA TEW/AWM TINNED WIRE/CABLE – SINGLE CONDUCTOR (CONTINUED)

**⚠ WARNING:** Cancer and Reproductive Harm [www.P65Warnings.ca.gov](http://www.P65Warnings.ca.gov)

### 8 Gauge – Stranding 168/30; Nominal OD 0.270

Length	Pkg.	MC Qty.	Weight	Green	Black	White	Red	Yellow
				Green	Black	White	Red	Yellow
25'	Spool (J)	1	2 lbs.	07697	07696	—	07698	—
100'	Spool (J)	1	8 lbs.	07403	07400	07404	07401	07402
500'	Reel (A)	1	41 lbs.	07408	07405	07409	07406	07407
1000'	Reel (B)	1	80 lbs.	07413	07410	07414	07411	07412
2000'	Factory Reel (D)	2000'	156 lbs.	07418	07415	07419	07416	07417

Note: letter in parenthesis designates spool ID, see page 105.

### 6 Gauge – Stranding 266/30; Nominal OD 0.340

Length	Pkg.	MC Qty.	Weight	Green	Black	White	Red	Yellow
				Green	Black	White	Red	Yellow
25'	Spool (J)	1	3 lbs.	07693	07692	—	07694	07695
100'	Spool (K)	1	12 lbs.	07423	07420	07424	07421	07422
250'	Spool (A)	1	30 lbs.	31189	31190	31191	31192	31193
500'	Reel (B)	1	62 lbs.	07428	07425	07429	07426	07427
1000'	Reel (C)	1	123 lbs.	07433	07430	07434	07431	07432
3500'	Factory Reel (F)	3500'	436 lbs.	07438	07435	07439	07436	07437

Note: letter in parenthesis designates spool ID, see page 105.

### 4 Gauge – Stranding 420/30; Nominal OD 0.405

Length	Pkg.	MC Qty.	Weight	Green	Black	White	Red	Yellow
				Green	Black	White	Red	Yellow
25'	Spool (J)	1	5 lbs.	—	07691	—	07690	—
100'	Spool (K)	1	20 lbs.	—	04801	—	04800	04812
250'	Spool (B)	1	50 lbs.	—	31194	—	31195	31196
500'	Reel (B)	1	92 lbs.	—	04803	—	04802	04813
2000'	Factory Reel (F)	2000'	370 lbs.	—	98294	—	98295	—

Note: letter in parenthesis designates spool ID, see page 105.

### 2 Gauge – Stranding 665/30; Nominal OD 0.475

Length	Pkg.	MC Qty.	Weight	Green	Black	White	Red	Yellow
				Green	Black	White	Red	Yellow
25'	Spool (J)	1	7 lbs.	—	07689	—	07688	—
100'	Reel (A)	1	30 lbs.	—	04805	—	04804	04814
250'	Spool (C)	1	75 lbs.	—	31197	—	31198	31199
500'	Reel (C)	1	142 lbs.	—	04807	—	04806	04815
2000'	Factory Reel (F)	2000'	570 lbs.	—	98296	—	98297	—

Note: letter in parenthesis designates spool ID, see page 105.

**1 Gauge** – Stranding 836/30; Nominal OD 0.520

Length	Pkg.	MC Qty.	Weight	Green	Black	Red	Yellow
				Green	Black	Red	Yellow
25'	Spool (J)	1	8 lbs.	—	07687	07686	—
100'	Reel (A)	1	36 lbs.	—	04390	04389	04405
250'	Spool (C)	1	90 lbs.	—	31200	31201	31202
500'	Reel (D)	1	172 lbs.	—	04392	04391	04406

Note: letter in parenthesis designates spool ID, see page 105.

**1/0 Gauge** – Stranding 1064/30; Nominal OD 0.565

Length	Pkg.	MC Qty.	Weight	Green	Black	Red	Yellow
				Green	Black	Red	Yellow
25'	Reel (A)	1	12 lbs.	—	07682	07684	07685
100'	Reel (A)	1	44 lbs.	—	04384	04385	04403
250'	Spool (C)	1	110 lbs.	—	31203	31204	31205
500'	Reel (D)	1	212 lbs.	—	04386	04387	04404

Note: letter in parenthesis designates spool ID, see page 105.

**2/0 Gauge** – Stranding 1330/30; Nominal OD 0.655

Length	Pkg.	MC Qty.	Weight	Green	Black	Red	Yellow
				Green	Black	Red	Yellow
25'	Reel (A)	1	14 lbs.	—	07679	07680	07681
100'	Reel (B)	1	55 lbs.	—	04809	04808	04816
250'	Spool (C)	1	138 lbs.	—	31206	31207	31214
500'	Reel (D)	1	265 lbs.	—	04811	04810	04817
1000'	Factory Reel (F)	1000'	530 lbs.	—	98298	98299	—

Note: letter in parenthesis designates spool ID, see page 105.

**3/0 Gauge** – Stranding 1672/30; Nominal OD 0.670

Length	Pkg.	MC Qty.	Weight	Green	Black	Red	Yellow
				Green	Black	Red	Yellow
25'	Reel (A)	1	17 lbs.	—	07676	07678	07677
100'	Reel (B)	1	66 lbs.	—	04381	04380	04401
250'	Spool (D)	1	165 lbs.	—	31210	31208	31209
500'	Reel (F)	1	333 lbs.	—	04383	04382	04402

Note: letter in parenthesis designates spool ID, see page 105.

**4/0 Gauge** – Stranding 2109/30; Nominal OD 0.735

Length	Pkg.	MC Qty.	Weight	Green	Black	Red	Yellow
				Green	Black	Red	Yellow
25'	Reel (A)	1	21 lbs.	—	07673	07675	07674
100'	Reel (C)	1	84 lbs.	—	04376	04377	04399
250'	Spool (G)	1	210 lbs.	—	31213	31211	31212
500'	Reel (F)	1	413 lbs.	—	04378	04379	04400

Note: letter in parenthesis designates spool ID, see page 105.

# MARINE MASTER® UL LISTED 1426 AND CSA TEW/AWM TINNED WIRE/CABLE – MULTI CONDUCTOR

Polyethylene (XLPE) Insulation

Stranded Annealed Bunched Electro-tinned Copper Core  
Color-coded PVC Insulation



UL/CSA Listed, multi-conductor tinned wire with white jacket is ideal for use in the high corrosive environment of marine applications. Special electro-tinned, copper strands also increase protection against corrosion for recreational vehicles, automotive, trucks, and trailers. Tinned copper stranding is extremely flexible for easy routing through marine applications and easier to solder than bare copper. Flame retardant, PVC insulation is highly resistant to water, oil, grease, gasoline, and other damaging solvents. High voltage tolerance of up to 600 volts adds to versatility to its use in multiple marine and other suitable applications.

**Voltage:** Rated at 600 Volts

**Temperature:** Rated at 105°C (221°F) dry and 75°C (167°F) wet

**Specifications:** Meets DOT and Coast Guard specs for electrical systems

• Spiral striping of inner wires of this product is available. Please refer to page 104 for details.



Print Legend 2 conductor:

**EPM MARINE MASTER® (size) AWG BOAT CABLE BC-5W2 600V 105C DRY 75C WET (UL) --- CSA LL109117 TEW 2C/(size)AWG 105C 600V FT1 OR AWM I/II A/B 105C 600V W75C FT1**

Print Legend 3 conductor:

**EPM MARINE MASTER® (size) AWG BOAT CABLE BC-5W2 600V 105C DRY 75C WET (UL) --- CSA LL109117 3C/(size)AWG AWM I/II A/B 105C 600V W75C FT1**

**WARNING:** Cancer and Reproductive Harm [www.P65Warnings.ca.gov](http://www.P65Warnings.ca.gov)

## 18/2 Gauge

Stranding 16/30  
Nominal OD 0.180 x 0.285

Length	Packaging	MC Qty.	Weight	Red/Black	Yellow/Red
100'	Spool (J)	1	3 lbs.	31058	31062
500'	Spool (A)	1	18 lbs.	31059	31063
1000'	Spool (B)	1	36 lbs.	31060	31064
7000'	Reel (F)	7000'	243 lbs.	31061	97411

Note: letter in parenthesis designates spool ID, see page 105.

## 16/2 Gauge

Stranding 26/30  
Nominal OD 0.195 x 0.320

Length	Packaging	MC Qty.	Weight	Black/White	Red/Black	Yellow/Red
100'	Spool (J)	1	5 lbs.	04509	04536	04533
500'	Reel (B)	1	26 lbs.	04510	04065	04534
1000'	Reel (C)	1	53 lbs.	04511	97743	04535
6000'	Factory Reel (F)	6000'	300 lbs.	14908	97918	97921

Note: letter in parenthesis designates spool ID, see page 105.

## 14/2 Gauge

Stranding 41/30  
Nominal OD 0.211 x 0.352

Length	Packaging	MC Qty.	Weight	Black/White	Red/Black	Yellow/Red
100'	Spool (K)	1	6 lbs.	04506	04537	04530
500'	Reel (B)	1	31 lbs.	04507	04064	04531
1000'	Reel (C)	1	61 lbs.	04508	97744	04532
5000'	Factory Reel (F)	5000'	328 lbs.	14907	97917	97920

Note: letter in parenthesis designates spool ID, see page 105.





**12/2 Gauge**  
Stranding 65/30  
Nominal OD 0.235 x 0.394

Length	Packaging	MC Qty.	Weight	Black/White	Red/Black	Yellow/Red
100'	Spool (K)	1	8 lbs.	04503	04538	04527
500'	Reel (B)	1	41 lbs.	04504	04063	04528
1000'	Reel (C)	1	82 lbs.	04505	—	04529
4000'	Factory Reel (F)	4000'	328 lbs.	14906	97916	99277

Note: letter in parenthesis designates spool ID, see page 105.

**10/2 Gauge**  
Stranding 104/30  
Nominal OD 0.263 x 0.456

Length	Packaging	MC Qty.	Weight	Black/White	Red/Black	Yellow/Red
100'	Spool (K)	1	11 lbs.	04500	04539	04524
500'	Reel (B)	1	56 lbs.	04501	04062	04525
1000'	Reel (D)	1	112 lbs.	04502	—	04526
2500'	Factory Reel (F)	2500'	318 lbs.	14905	97915	97919

Note: letter in parenthesis designates spool ID, see page 105.

**16/3 Gauge**  
Stranding 26/30  
Nominal OD 0.195 x 0.445

Length	Packaging	MC Qty.	Weight	Black/Green/White
100'	Spool (K)	1	7 lbs.	04521
500'	Reel (B)	1	36 lbs.	04522
1000'	Reel (C)	1	72 lbs.	04523
4500'	Factory Reel (F)	4500'	317 lbs.	14912

Note: letter in parenthesis designates spool ID, see page 105.

**14/3 Gauge**  
Stranding 41/30  
Nominal OD 0.211 x 0.493

Length	Packaging	MC Qty.	Weight	Black/Green/White
100'	Spool (K)	1	9 lbs.	04518
500'	Reel (B)	1	46 lbs.	04519
1000'	Reel (D)	1	92 lbs.	04520
3500'	Factory Reel (F)	3500'	345 lbs.	14911

Note: letter in parenthesis designates spool ID, see page 105.

**12/3 Gauge**  
Stranding 65/30  
Nominal OD 0.235 x 0.565

Length	Packaging	MC Qty.	Weight	Black/Green/White
100'	Spool (K)	1	12 lbs.	04515
500'	Reel (C)	1	61 lbs.	04516
1000'	Reel (D)	1	122 lbs.	04517
3000'	Factory Reel (F)	3000'	370 lbs.	14910

Note: letter in parenthesis designates spool ID, see page 105.

**10/3 Gauge**  
Stranding 104/30  
Nominal OD 0.263 x 0.649

Length	Packaging	MC Qty.	Weight	Black/Green/White
100'	Reel (A)	1	19 lbs.	04512
500'	Reel (C)	1	96 lbs.	04513
1000'	Reel (D)	1	192 lbs.	04514
2500'	Factory Reel (F)	2500'	390 lbs.	14909

Note: letter in parenthesis designates spool ID, see page 105.

## BONDED PARALLEL WIRE – RATED 80°C

Polyethylene (XLPE)  
Insulation



Multiple primary wires parallel bonded with color-coding for identification purposes. Ideal for use in RVs, marine, and utility trailer applications. Built to stay together under the toughest operating conditions yet easy to separate at the end of a run for final terminal connection. All-copper stranded core is highly conductive maximizing current transfer while remaining flexible for easy installation.



Annealed  
Bunched  
Copper Core



**Voltage:** Rated at 60 Volts or less  
**Temperature:** Rated -40°C (-40°F) to 80°C (176°F)  
**Specifications:** SAE J1128, SAE J378



**WARNING:** Cancer and Reproductive Harm [www.P65Warnings.ca.gov](http://www.P65Warnings.ca.gov)



00907

### 18/4 Gauge

Stranding 16/30  
Nominal OD 0.095 x 0.280

Part #	Length	Packaging	MC Qty.	Weight	Color
07253	30'	Clamshell of 1	5	6 lbs.	White/Brown/Yellow/Green
02924	100'	Spool (J)	1	5 lbs.	White/Brown/Yellow/Green
02925	500'	Reel (A)	1	18 lbs.	White/Brown/Yellow/Green
02926	1000'	Reel (B)	1	29 lbs.	White/Brown/Yellow/Green
14840	8000'	Factory Reel (F)	8000'	350 lbs.	White/Brown/Yellow/Green

Note: letter in parenthesis designates spool ID, see page 105.

### 18/3 Gauge

Stranding 16/30  
Nominal OD 0.095 x 0.285

Part #	Length	Packaging	MC Qty.	Weight	Color
31065	30'	Clam Shell of 1	5	5 lbs.	Brown/Yellow/Green
02921	100'	Spool (J)	1	3 lbs.	Brown/Yellow/Green
02922	500'	Reel (A)	1	13 lbs.	Brown/Yellow/Green
02923	1000'	Reel (B)	1	20 lbs.	Brown/Yellow/Green
14837	12500'	Factory Reel (F)	12500'	350 lbs.	Brown/Yellow/Green

Note: letter in parenthesis designates spool ID, see page 105.

### 18/3-16/1 Gauge

18 gauge: Stranding 16/30  
Nominal OD 0.095 x 0.380

16 gauge: Stranding 19/29  
Nominal OD 0.102 x 0.306

Part #	Length	Packaging	MC Qty.	Weight	Color
02941 <sup>1</sup>	30'	Clamshell of 1	5	6 lbs.	White/Brown/Yellow/Green

<sup>1</sup>18 ga conductors are brown, yellow and green; 16 ga conductor is white  
Note: letter in parenthesis designates spool ID, see page 105.

### 18/2 Gauge

Stranding 16/30  
Nominal OD 0.095 x 0.190

Part #	Length	Packaging	MC Qty.	Weight	Color
02918	100'	Spool (J)	1	2 lbs.	Red/Black
02919	500'	Spool (K)	1	9 lbs.	Red/Black
02920	1000'	Reel (A)	1	14 lbs.	Red/Black
14834	14000'	Factory Reel (F)	14000'	270 lbs.	Red/Black

Note: letter in parenthesis designates spool ID, see page 105.

### 16/5 Gauge

Stranding 19/29  
Nominal OD 0.102 x 0.510

Part #	Length	Packaging	MC Qty.	Weight	Color
02937	100'	Spool (J)	1	6 lbs.	White/Brown/Yellow/Green/Blue
02938	500'	Reel (A)	1	32 lbs.	White/Brown/Yellow/Green/Blue
02939	1000'	Reel (B)	1	61 lbs.	White/Brown/Yellow/Green/Blue
02940	6000'	Factory Reel (F)	6000'	367 lbs.	White/Brown/Yellow/Green/Blue

Note: letter in parenthesis designates spool ID, see page 105.





**16/4 Gauge**

Stranding 19/29  
Nominal OD 0.102 x 0.408

Part #	Length	Packaging	MC Qty.	Weight	Color
00907	25'	Clamshell of 1	5	6 lbs.	White/Brown/Yellow/Green
02915	100'	Spool (J)	1	5 lbs.	White/Brown/Yellow/Green
02916	500'	Reel (A)	1	26 lbs.	White/Brown/Yellow/Green
02917	1000'	Reel (B)	1	46 lbs.	White/Brown/Yellow/Green
14839	8000'	Factory Reel (F)	8000'	390 lbs.	White/Brown/Yellow/Green

Note: letter in parenthesis designates spool ID, see page 105.

**16/3 Gauge**

Stranding 19/29  
Nominal OD 0.102 x 0.306

Part #	Length	Packaging	MC Qty.	Weight	Color
31066	30'	Clam Shell of 1	5	5 lbs.	Brown/Yellow/Green
02912	100'	Spool (J)	1	4 lbs.	Brown/Yellow/Green
02913	500'	Reel (A)	1	18 lbs.	Brown/Yellow/Green
02914	1000'	Reel (B)	1	35 lbs.	Brown/Yellow/Green
14836	10000'	Factory Reel (F)	10000'	370 lbs.	Brown/Yellow/Green

Note: letter in parenthesis designates spool ID, see page 105.

**16/2 Gauge**

Stranding 19/29  
Nominal OD 0.102 x 0.204

Part #	Length	Packaging	MC Qty.	Weight	Color
02927	100'	Spool (J)	1	3 lbs.	Yellow/Brown
02928	500'	Spool (K)	1	9 lbs.	Yellow/Brown
02929	1000'	Reel (A)	1	14 lbs.	Yellow/Brown
98524	12500'	Factory Reel (F)	12500'	309 lbs.	Yellow/Brown
02930	100'	Spool (J)	1	3 lbs.	Green/Brown
02931	500'	Spool (K)	1	9 lbs.	Green/Brown
02932	1000'	Reel (A)	1	14 lbs.	Green/Brown
98232	12500'	Factory Reel (F)	12500'	309 lbs.	Green/Brown
02909	100'	Spool (J)	1	3 lbs.	Red/Black
02910	500'	Spool (K)	1	9 lbs.	Red/Black
02911	1000'	Reel (A)	1	14 lbs.	Red/Black
14833	12500'	Factory Reel (F)	12500'	309 lbs.	Red/Black

Note: letter in parenthesis designates spool ID, see page 105.

**14/5 Gauge**

Stranding 19/27  
Nominal OD 0.117 x 0.585

Part #	Length	Packaging	MC Qty.	Weight	Color
02933	100'	Spool (J)	1	9 lbs.	White/Brown/Yellow/Green/Blue
02934	500'	Reel (B)	1	45 lbs.	White/Brown/Yellow/Green/Blue
02935	1000'	Reel (B)	1	87 lbs.	White/Brown/Yellow/Green/Blue
02936	4500'	Factory Reel (F)	4500'	390 lbs.	White/Brown/Yellow/Green/Blue

Note: letter in parenthesis designates spool ID, see page 105.

**14/4 Gauge**

Stranding 19/27  
Nominal OD 0.117 x 0.468

Part #	Length	Packaging	MC Qty.	Weight	Color
02906	100'	Spool (J)	1	7 lbs.	White/Brown/Yellow/Green
02907	500'	Reel (A)	1	34 lbs.	White/Brown/Yellow/Green
02908	1000'	Reel (B)	1	67 lbs.	White/Brown/Yellow/Green
14838	6500'	Factory Reel (F)	6500'	447 lbs.	White/Brown/Yellow/Green

Note: letter in parenthesis designates spool ID, see page 105.

**14/3 Gauge**

Stranding 19/27  
Nominal OD 0.117 x 0.351

Part #	Length	Packaging	MC Qty.	Weight	Color
02903	100'	Spool (J)	1	5 lbs.	Brown/Yellow/Green
02904	500'	Reel (A)	1	26 lbs.	Brown/Yellow/Green
02905	1000'	Reel (B)	1	52 lbs.	Brown/Yellow/Green
14835	8500'	Factory Reel (F)	8500'	441 lbs.	Brown/Yellow/Green

Note: letter in parenthesis designates spool ID, see page 105.

**14/2 Gauge**

Stranding 19/27  
Nominal OD 0.117 x 0.234

Part #	Length	Packaging	MC Qty.	Weight	Color
02900	100'	Spool (J)	1	4 lbs.	Red/Black
02901	500'	Reel (K)	1	18 lbs.	Red/Black
02902	1000'	Reel (A)	1	34 lbs.	Red/Black
14832	10500'	Factory Reel (F)	10500'	400 lbs.	Red/Black

Note: letter in parenthesis designates spool ID, see page 105.

# JACKETED DUPLEX WIRE – RATED 105°C

ion



Color  
TPE c  
Insul.

Two-conductor, general-purpose primary wires covered in a high quality PVC jacket. Ideal for use in truck, bus, tractor, light-duty boats, and general service applications. Heavy-duty compact cable protects insulated conductors against weathering, chemicals, and abrasion. Color-coded conductors enable easy identification.

re

d  
tion

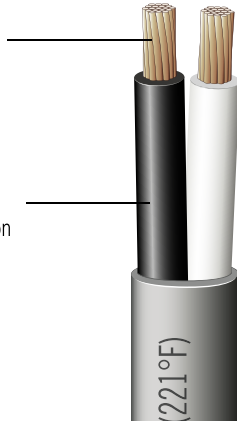

Anne  
Bunc  
Copt

Colo  
PVC

**Voltage:** Rated at 60 Volts or less

**Temperature:** Rated –40°C (–40°F) to 105°C (221°F)

**Specifications:** Inner wires meet SAE J1128, SAE J378

• *Spiral striping of inner wires of this product is available. Please refer to page 104 for details.*



Print Legend:

105°C (221°F)

**WARNING:** Cancer and Reproductive Harm [www.P65Warnings.ca.gov](http://www.P65Warnings.ca.gov)



## 18/2 Gauge

Stranding 16/30  
Nominal OD 0.155 x 0.250

Part	Jacket	Length	Packaging	MC Qty.	Weight	Conductor Color
03253	Grey	100'	Spool (J)	1	4 lbs.	Black/White
03254	Grey	500'	Reel (A)	1	18 lbs.	Black/White
03255	Grey	1000'	Reel (B)	1	34 lbs.	Black/White
14846	Grey	9000'	Factory Reel (F)	9000'	300 lbs.	Black/White

Note: letter in parenthesis designates spool ID, see page 105.

## 16/2 Gauge

Stranding 19/29  
Nominal OD 0.162 x 0.264

Part	Jacket	Length	Packaging	MC Qty.	Weight	Conductor Color
03200	Grey	100'	Spool (J)	1	4 lbs.	Black/White
03201	Grey	500'	Reel (A)	1	21 lbs.	Black/White
03202	Grey	1000'	Reel (B)	1	45 lbs.	Black/White
14845	Grey	8000'	Factory Reel (F)	8000'	317 lbs.	Black/White
03203	Grey	100'	Spool (J)	1	4 lbs.	Black/Red
03204	Grey	500'	Reel (A)	1	21 lbs.	Black/Red
03205	Grey	1000'	Reel (B)	1	45 lbs.	Black/Red
99234	Grey	8000'	Factory Reel (F)	8000'	317 lbs.	Black/Red

Note: letter in parenthesis designates spool ID, see page 105.





**14/2 Gauge**  
Stranding 19/27  
Nominal OD 0.177 x 0.294

Part	Jacket	Length	Packaging	MC Qty.	Weight	Conductor Color
31067	Grey	30'	Clam Shell of 1	5	7 lbs.	Black/White
03206	Grey	100'	Spool (J)	1	5 lbs.	Black/White
03207	Grey	500'	Reel (A)	1	29 lbs.	Black/White
03208	Grey	1000'	Reel (B)	1	60 lbs.	Black/White
14844	Grey	7000'	Factory Reel (F)	7000'	390 lbs.	Black/White
03209	Grey	100'	Spool (J)	1	5 lbs.	Black/Red
03210	Grey	500'	Reel (A)	1	29 lbs.	Black/Red
03211	Grey	1000'	Reel (B)	1	60 lbs.	Black/Red
99987	Grey	7000'	Factory Reel (F)	7000'	390 lbs.	Black/Red
02879 <sup>1</sup>	Grey	1000'	Reel (B)	1	56 lbs.	Black/White
14342 <sup>1</sup>	Grey	7000'	Factory Reel (F)	7000'	360 lbs.	Black/White

<sup>1</sup>Nominal OD is .165 x .285  
Note: letter in parenthesis designates spool ID, see page 105.

**12/2 Gauge**  
Stranding 19/25  
Nominal OD 0.202 x 0.344

Part	Jacket	Length	Packaging	MC Qty.	Weight	Conductor Color
03212	Grey	100'	Spool (K)	1	7 lbs.	Black/White
03213	Grey	500'	Reel (B)	1	40 lbs.	Black/White
03214	Grey	1000'	Reel (C)	1	80 lbs.	Black/White
14843	Grey	5000'	Factory Reel (F)	5000'	382 lbs.	Black/White
03215	Grey	100'	Spool (K)	1	7 lbs.	Black/Red
03216	Grey	500'	Reel (B)	1	40 lbs.	Black/Red
03217	Grey	1000'	Reel (C)	1	80 lbs.	Black/Red
98270	Grey	5000'	Factory Reel (F)	5000'	382 lbs.	Black/Red
03251	Grey	100'	Spool (K)	1	7 lbs.	Black/Blue
03252	Grey	500'	Reel (B)	1	40 lbs.	Black/Blue
99051	Grey	5000'	Factory Reel (F)	5000'	382 lbs.	Black/Blue
03218	Red	100'	Spool (K)	1	7 lbs.	Black/Blue
03219	Red	500'	Reel (B)	1	40 lbs.	Black/Blue
03220	Red	1000'	Reel (C)	1	80 lbs.	Black/Blue
14847	Red	5000'	Factory Reel (F)	5000'	382 lbs.	Black/Blue

Note: letter in parenthesis designates spool ID, see page 105.

**10/2 Gauge**  
Stranding 19/23  
Nominal OD 0.234 x 0.408

Part	Jacket	Length	Packaging	MC Qty.	Weight	Conductor Color
03221	Grey	100'	Spool (K)	1	10 lbs.	Black/White
03222	Grey	500'	Reel (B)	1	52 lbs.	Black/White
03223	Grey	1000'	Reel (C)	1	105 lbs.	Black/White
14842	Grey	3500'	Factory Reel (F)	3500'	389 lbs.	Black/White

Note: letter in parenthesis designates spool ID, see page 105.

**8/2 Gauge**  
Stranding 19/21  
Nominal OD 0.275 x 0.490

Part	Jacket	Length	Packaging	MC Qty.	Weight	Conductor Color
03224	Grey	100'	Spool (K)	1	16 lbs.	Black/White
03225	Grey	500'	Reel (C)	1	82 lbs.	Black/White
03226	Grey	1000'	Reel (D)	1	180 lbs.	Black/White
14841	Grey	2000'	Factory Reel (F)	2000'	392 lbs.	Black/White

Note: letter in parenthesis designates spool ID, see page 105.



# JACKETED TRIPLEX WIRE – RATED 105°C



Three-conductor, general-purpose primary wires covered in a high quality PVC jacket. Ideal for use in truck, bus, tractor, light-duty boats, and general service applications. Heavy-duty compact cable protects insulated conductors against weathering, chemicals, and abrasion. Color-coded conductors enable easy identification.

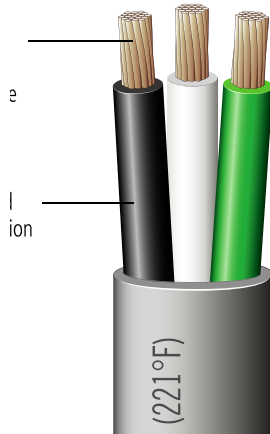

Anne:  
Bundt  
Copp

Color:  
PVC I

**Voltage:** Rated at 60 Volts or less

**Temperature:** Rated -40°C (-40°F) to 105°C (221°F)

**Specifications:** Inner wires meet SAE J1128, SAE J378

• *Spiral striping of inner wires of this product is available. Please refer to page 104 for details.*



Print Legend:  
105°C (221°F)

**WARNING:** Cancer and Reproductive Harm [www.P65Warnings.ca.gov](http://www.P65Warnings.ca.gov)

**16/3 Gauge**  
Stranding 19/29  
Nominal OD 0.162 x 0.366

Part	Jacket	Length	Packaging	MC Qty.	Weight	Conductor Color
03227	Grey	100'	Spool (J)	1	6 lbs.	Black/Green/White
03228	Grey	500'	Reel (B)	1	32 lbs.	Black/Green/White
03229	Grey	1000'	Reel (C)	1	65 lbs.	Black/Green/White
14851	Grey	5000'	Factory Reel (F)	5000'	300 lbs.	Black/Green/White

Note: letter in parenthesis designates spool ID, see page 105.

**14/3 Gauge**  
Stranding 19/27  
Nominal OD 0.177 x 0.411

Part	Jacket	Length	Packaging	MC Qty.	Weight	Conductor Color
03230	Grey	100'	Spool (K)	1	8 lbs.	Black/Green/White
03231	Grey	500'	Reel (B)	1	40 lbs.	Black/Green/White
03232	Grey	1000'	Reel (C)	1	80 lbs.	Black/Green/White
14850	Grey	4000'	Factory Reel (F)	4000'	321lbs.	Black/Green/White

Note: letter in parenthesis designates spool ID, see page 105.

**12/3 Gauge**  
Stranding 19/25  
Nominal OD 0.202 x 0.486

Part	Jacket	Length	Packaging	MC Qty.	Weight	Conductor Color
03233	Grey	100'	Spool (K)	1	10 lbs.	Black/Green/White
03234	Grey	500'	Reel (C)	1	52 lbs.	Black/Green/White
03235	Grey	1000'	Reel (D)	1	100 lbs.	Black/Green/White
14849	Grey	3000'	Factory Reel (F)	3000'	346 lbs.	Black/Green/White

Note: letter in parenthesis designates spool ID, see page 105.

**10/3 Gauge**  
Stranding 19/23  
Nominal OD 0.234 x 0.582

Part	Jacket	Length	Packaging	MC Qty.	Weight	Conductor Color
03236	Grey	100'	Spool (K)	1	15 lbs.	Black/Green/White
03237	Grey	500'	Reel (C)	1	76 lbs.	Black/Green/White
03238	Grey	1000'	Reel (D)	1	153 lbs.	Black/Green/White
14848	Grey	2500'	Factory Reel (F)	2500'	393 lbs.	Black/Green/White

Note: letter in parenthesis designates spool ID, see page 105.



# JACKETED QUADRAPLEX WIRE – RATED 105°C



Four-conductor, general-purpose primary wires covered in a high quality PVC jacket. Ideal for use in truck, bus, tractor, light-duty boats, and general service applications. Heavy-duty compact cable protects insulated conductors against weathering, chemicals, and abrasion. Color-coded conductors enable easy identification.

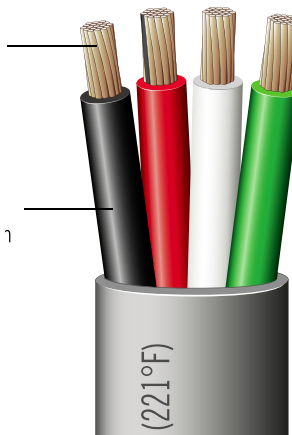

High S  
Annealed  
Copper

**Voltage:** Rated at 60 Volts or less

**Temperature:** Rated -40°C (-40°F) to 105°C (221°F)

**Specifications:** Inner wires meet SAE J1128, SAE J378

• *Spiral striping of inner wires of this product is available. Please refer to page 104 for details.*



Print Legend:  
105°C (221°F)

**⚠ WARNING:** Cancer and Reproductive Harm [www.P65Warnings.ca.gov](http://www.P65Warnings.ca.gov)

## 16/4 Gauge

Stranding 19/29  
Nominal OD 0.162 x 0.468

Part	Jacket	Length	Packaging	MC Qty.	Weight	Conductor Color
03239	Grey	100'	Spool (K)	1	7 lbs.	White/Green/Red/Black
03240	Grey	500'	Reel (C)	1	36 lbs.	White/Green/Red/Black
03241	Grey	1000'	Reel (D)	1	72 lbs.	White/Green/Red/Black
14855	Grey	3500'	Factory Reel (F)	3500'	300 lbs.	White/Green/Red/Black

Note: letter in parenthesis designates spool ID, see page 105.

## 14/4 Gauge

Stranding 19/27  
Nominal OD 0.177 x 0.528

Part	Jacket	Length	Packaging	MC Qty.	Weight	Conductor Color
03242	Grey	100'	Spool (K)	1	10 lbs.	White/Green/Red/Black
03243	Grey	500'	Reel (C)	1	50 lbs.	White/Green/Red/Black
03244	Grey	1000'	Reel (D)	1	104 lbs.	White/Green/Red/Black
14854	Grey	3000'	Factory Reel (F)	3000'	310 lbs.	White/Green/Red/Black

Note: letter in parenthesis designates spool ID, see page 105.

## 12/4 Gauge

Stranding 19/25  
Nominal OD 0.202 x 0.628

Part	Jacket	Length	Packaging	MC Qty.	Weight	Conductor Color
03245	Grey	100'	Spool (K)	1	13 lbs.	White/Green/Red/Black
03246	Grey	500'	Reel (C)	1	66 lbs.	White/Green/Red/Black
14853	Grey	2500'	Factory Reel (F)	2500'	390 lbs.	White/Green/Red/Black

Note: letter in parenthesis designates spool ID, see page 105.

## 10/4 Gauge

Stranding 19/23  
Nominal OD 0.234 x 0.756

Part	Jacket	Length	Packaging	MC Qty.	Weight	Conductor Color
03248	Grey	100'	Reel (A)	1	21 lbs.	White/Green/Red/Black
14852	Grey	2000'	Factory Reel (F)	2000'	424 lbs.	White/Green/Red/Black

Note: letter in parenthesis designates spool ID, see page 105.



## TRAILER CABLE WIRE – RATED 80°C

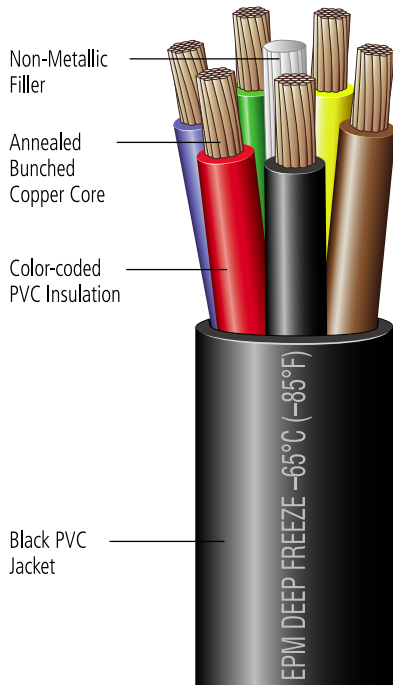

General-purpose primary wires encased in a high quality, PVC jacket. Specially designed for reliability as an integral part of the brake and safety system. Heavy-duty compact cable protects insulated conductors against weathering, chemicals, and abrasion. Color-coded conductors enable easy identification.

**Voltage:** Rated at 60 Volts or less

**Temperature:** Rated -65°C (-85°F) to 80°C (176°F)

**Specifications:** Inner wires meet SAE J1128, SAE J378

• *Spiral striping of inner wires of this product is available. Please refer to page 104 for details.*



*Print Legend:*

**EPM DEEP FREEZE -65°C (-85°F) / 80°C (176°F) MADE IN USA (size) / (# cond)**

**⚠ WARNING:** Cancer and Reproductive Harm [www.P65Warnings.ca.gov](http://www.P65Warnings.ca.gov)

**14/2 Gauge**  
Stranding 19/27  
Nominal OD 0.380

Part #	Length	Packaging	MC Qty.	Weight	Rotation
03674	500'	Reel (B)	1	40 lbs.	Green/Yellow
03675	3000'	Factory Spool (F)	3000'	233 lbs.	Green/Yellow

Note: letter in parenthesis designates spool ID, see page 105.

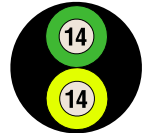

**18/4 Gauge**  
Stranding 16/30  
Nominal OD 0.340

Part #	Length	Packaging	MC Qty.	Weight	Rotation
31217	100'	Spool	1	9 lbs.	White/Brown/Yellow/Green
31218	500'	Spool	1	45 lbs.	White/Brown/Yellow/Green
96997	2500'	Spool	2500'	225 lbs.	White/Brown/Yellow/Green

Note: letter in parenthesis designates spool ID, see page 105.

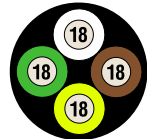

**16/4 Gauge**  
Stranding 19/29  
Nominal OD 0.360

Part #	Length	Packaging	MC Qty.	Weight	Rotation
03669	30'	Sleeve	4	9 lbs.	Yellow/Red/Green/Brown
04919	100'	Reel (A)	1	12 lbs.	Yellow/Red/Green/Brown
04920	500'	Reel (C)	1	60 lbs.	Yellow/Red/Green/Brown
04900	100'	Reel (A)	1	12 lbs.	Black/Red/Brown/White
04901	500'	Reel (C)	1	60 lbs.	Black/Red/Brown/White
14869	3000'	Factory Reel (F)	3000'	287 lbs.	Black/Red/Brown/White

Note: letter in parenthesis designates spool ID, see page 105.

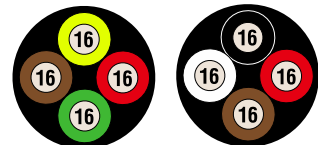

**14/4 Gauge**  
Stranding 19/27  
Nominal OD 0.410

Part #	Length	Packaging	MC Qty.	Weight	Rotation
31068	30'	Sleeve	3	11 lbs.	Yellow/Red/Green/Brown
04923	100'	Reel (A)	1	16 lbs.	Yellow/Red/Green/Brown
04924	500'	Reel (C)	1	80 lbs.	Yellow/Red/Green/Brown
99104	2500'	Factory Reel (F)	2500'	343 lbs.	Yellow/Red/Green/Brown
04928	100'	Reel (A)	1	16 lbs.	White/Brown/Yellow/Green
04929	500'	Reel (C)	1	80 lbs.	White/Brown/Yellow/Green
98224	2500'	Factory Reel (F)	2500'	343 lbs.	White/Brown/Yellow/Green
04904	100'	Reel (A)	1	16 lbs.	Black/Red/Brown/White
04905	500'	Reel (C)	1	80 lbs.	Black/Red/Brown/White
14871	2500'	Factory Reel (F)	2500'	343 lbs.	Black/Red/Brown/White

Note: letter in parenthesis designates spool ID, see page 105.

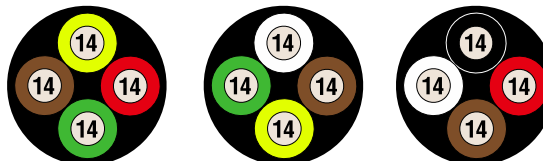

**12/4 Gauge**  
Stranding 19/25  
Nominal OD 0.465

Part #	Length	Packaging	MC Qty.	Weight	Rotation
04910	100'	Reel (A)	1	20 lbs.	Black/Red/Brown/White
04911	500'	Reel (C)	1	100 lbs.	Black/Red/Brown/White
14874	2000'	Factory Reel (F)	2000'	370 lbs.	Black/Red/Brown/White

Note: letter in parenthesis designates spool ID, see page 105.

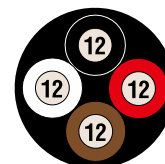

**16/6 Gauge**  
Stranding 19/29  
Nominal OD 0.425

Part #	Length	Packaging	MC Qty.	Weight	Rotation
31070	30'	Sleeve	3	11 lbs.	Red/Grn/Brn/Wht/Blk/Yel
04921	100'	Reel (A)	1	20 lbs.	Grn/Blu/Yel/Blk/Red/Brn
04922	500'	Reel (C)	1	100 lbs.	Grn/Blu/Yel/Blk/Red/Brn
97606	2500'	Factory Reel (F)	2500'	322 lbs.	Grn/Blu/Yel/Blk/Red/Brn
04902	100'	Reel (A)	1	20 lbs.	Red/Grn/Brn/Wht/Blk/Yel
04903	500'	Reel (C)	1	100 lbs.	Red/Grn/Brn/Wht/Blk/Yel
14870	2500'	Factory Reel (F)	2500'	322 lbs.	Red/Grn/Brn/Wht/Blk/Yel

Note: letter in parenthesis designates spool ID, see page 105.

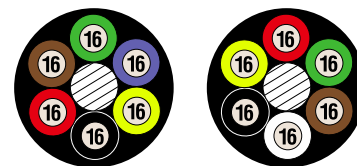

**14/6 Gauge**  
Stranding 19/27  
Nominal OD 0.500

Part #	Length	Packaging	MC Qty.	Weight	Rotation
31069	30'	Sleeve	3	15 lbs.	Red/Grn/Brn/Wht/Blk/Yel
04925	100'	Reel (A)	1	22 lbs.	Red/Blu/Grn/Yel/Brn/Blk
04926	500'	Reel (C)	1	110 lbs.	Red/Blu/Grn/Yel/Brn/Blk
98206	2000'	Factory Reel (F)	2000'	354 lbs.	Red/Blu/Grn/Yel/Brn/Blk
04906	100'	Reel (A)	1	22 lbs.	Red/Grn/Brn/Wht/Blk/Yel
04907	500'	Reel (C)	1	110 lbs.	Red/Grn/Brn/Wht/Blk/Yel
14872	2000'	Factory Reel (F)	2000'	354 lbs.	Red/Grn/Brn/Wht/Blk/Yel

Note: letter in parenthesis designates spool ID, see page 105.

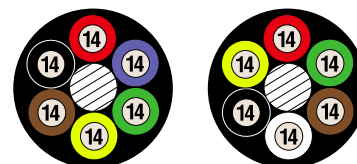

## TRAILER CABLE WIRE (CONTINUED)

**⚠ WARNING:** Cancer and Reproductive Harm [www.P65Warnings.ca.gov](http://www.P65Warnings.ca.gov)

### 12/6 Gauge

Stranding 19/25  
Nominal OD 0.575

Part #	Length	Packaging	MC Qty.	Weight	Rotation
04912	100'	Reel (A)	1	26 lbs.	Red/Grn/Brn/Wht/Blk/Yel
04913	500'	Reel (D)	1	130 lbs.	Red/Grn/Brn/Wht/Blk/Yel
14875	1500'	Factory Reel (F)	1500'	627 lbs.	Red/Grn/Brn/Wht/Blk/Yel

Note: letter in parenthesis designates spool ID, see page 105.



### 14/7 Gauge

Stranding 19/27  
Nominal OD 0.500

Part #	Length	Packaging	MC Qty.	Weight	Rotation
03670	30'	Sleeve	3	9 lbs.	Red/Grn/Brn/Wht/Blk/Yel/Blu
04908	100'	Reel (A)	1	35 lbs.	Red/Grn/Brn/Wht/Blk/Yel/Blu
04909	500'	Reel (D)	1	175 lbs.	Red/Grn/Brn/Wht/Blk/Yel/Blu
14873	2000'	Factory Reel (F)	2000'	390 lbs.	Red/Grn/Brn/Wht/Blk/Yel/Blu

Note: letter in parenthesis designates spool ID, see page 105.



### 14/6-12/1 Gauge

Stranding 19/27-19/25  
Nominal OD 0.520

Part #	Length	Packaging	MC Qty.	Weight	Rotation
98043	100'	Reel (A)	1	35 lbs.	Wht/Brn/DkGrn/Red/Yel/Blk/Blu
98044	500'	Reel (D)	1	175 lbs.	Wht/Brn/DkGrn/Red/Yel/Blk/Blu
98605	1500'	Factory Reel (F)	1500'	438 lbs.	Wht/Brn/DkGrn/Red/Yel/Blk/Blu

Note: letter in parenthesis designates spool ID, see page 105.



### 12/6-10/1 Gauge

Stranding 19/25-19/23  
Nominal OD 0.600

Part #	Length	Packaging	MC Qty.	Weight	Rotation
04914	100'	Reel (B)	1	31 lbs.	Wht/Blk/Yel/Red/Grn/Brn/Blu
99990	250'	Reel (C)	1	77 lbs.	Wht/Blk/Yel/Red/Grn/Brn/Blu
04927	500'	Reel (D)	1	175 lbs.	Wht/Blk/Yel/Red/Grn/Brn/Blu
14876	1000'	Factory Reel (F)	1000'	350 lbs.	Wht/Blk/Yel/Red/Grn/Brn/Blu

Note: letter in parenthesis designates spool ID, see page 105.



## RV CABLE WIRE – RATED 80°C

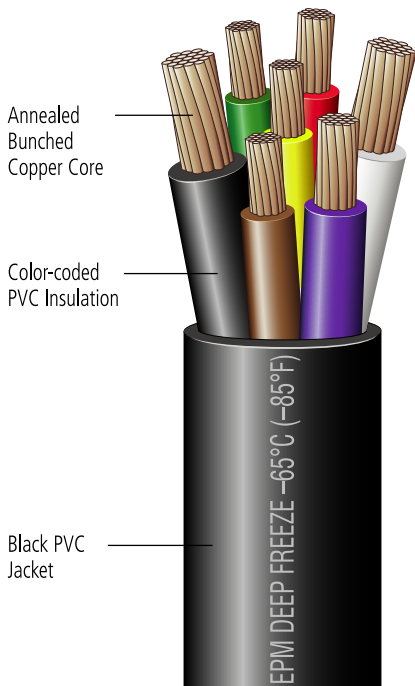

General-purpose primary wires encased in a high quality, PVC jacket. Specially designed for use in Recreational Vehicle's multiple electrical system connections. Heavy-duty compact cable protects insulated conductors against weathering, chemicals, and abrasion. Color-coded conductors enable easy identification.

**Voltage:** Rated at 60 Volts or less

**Temperature:** Rated -65°C (-85°F) to 80°C (176°F)

**Specifications:** Inner wires meet SAE J1128, SAE J378

• *Spiral striping of inner wires of this product is available. Please refer to page 104 for details.*



*Print Legend:*

**EPM DEEP FREEZE -65°C (-85°F) / 80°C (176°F) MADE IN USA 14/4-12/1-10/2**

**⚠ WARNING:** Cancer and Reproductive Harm [www.P65Warnings.ca.gov](http://www.P65Warnings.ca.gov)

### 14/4-12/1-10/2

#### Gauge

Stranding  
19/27-19/25-19/23  
Nominal OD 0.560

Part #	Length	Packaging	MC Qty.	Weight	Rotation
04669	30'	Sleeve	2	15 lbs.	DkBlu/Brn/Blk/DkGrn/Red/Wht/Yel
04915	100'	Reel (A)	1	27 lbs.	DkBlu/Brn/Blk/DkGrn/Red/Wht/Yel
04916	500'	Reel (D)	1	190 lbs.	DkBlu/Brn/Blk/DkGrn/Red/Wht/Yel
14877	1500'	Factory Reel (F)	1500'	430 lbs.	DkBlu/Brn/Blk/DkGrn/Red/Wht/Yel

Note: letter in parenthesis designates spool ID, see page 105.



# ABS TRAILER CABLE WIRE – RATED 80°C

## ABS Trailer Cable

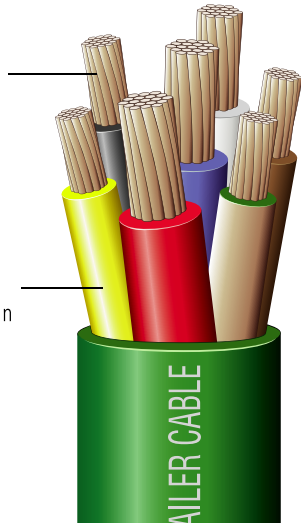

General-purpose primary wires encased in high quality green PVC jacket. Specially designed for durable use meeting the demands of anti-lock braking systems. Consists of 8 gauge ground wires, two 10 gauge stop-lamp, constant power circuit wires, and four circuit wires for power other lamps. All-copper stranded core is highly conductive maximizing current transfer while remaining flexible for easy installation. Heavy-duty compact cable protects insulated conductors against weathering, chemicals, and abrasion. Color-coded conductors enable easy identification.

**Voltage:** Rated at 60 Volts or less

**Temperature:** Rated -55°C (-67°F) to 80°C (176°F)

**Specifications:** Inner wires meet SAE J1128, SAE J378, SAE J2394

• *Spiral striping of inner wires of this product is available. Please refer to page 104 for details.*



Print Legend:

EPM SAE J2394 (2/13) TYPE F 12/4-10/2-8/1 ABS TRAILER CABLE -55°C (-67°F) / 80°C (176°F) MADE IN USA

**⚠ WARNING:** Cancer and Reproductive Harm [www.P65Warnings.ca.gov](http://www.P65Warnings.ca.gov)

**12/4-10/2-8/1**  
**Gauge**  
 Stranding  
 65/30-105/30-168/30  
 Nominal OD 0.690  
**Green Jacket**

Part #	Length	Packaging	MC Qty.	Weight	Rotation
04917	100'	Reel (B)	1	43 lbs.	Wht/Brn/DkGrn/Red/Yel/Blk/Blu
04918	500'	Reel (F)	1	220 lbs.	Wht/Brn/DkGrn/Red/Yel/Blk/Blu
14878	1000'	Factory Reel (F)	1000	417 lbs.	Wht/Brn/DkGrn/Red/Yel/Blk/Blu

Note: letter in parenthesis designates spool ID, see page 105.





## SLEEVED TRAILER CABLE WIRE – RATED 80°C

General-purpose primary wires covered in a high quality, PVC jacket. Specially designed for reliability as an integral part of the brake and safety system. Heavy-duty compact cable protects insulated conductors against weathering, chemicals, and abrasion. Color-coded conductors enable easy identification.

### 14/6 Trailer Wire

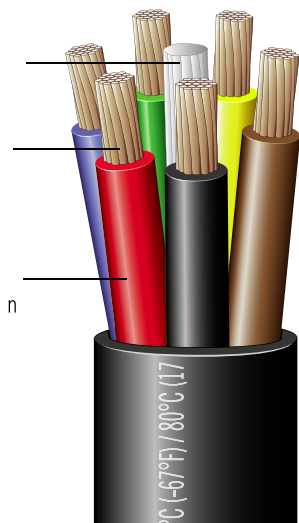

Anneal  
Bunche  
Copper

Color-c  
PVC In:

**Voltage:** Rated at 60 Volts or less

**Temperature:** Rated -55°C (-67°F) to 80°C (176°F)

**Specifications:** Inner wires meet SAE J1128, SAE J378

- *Spiral striping of inner wires of this product is available. Please refer to page 104 for details.*



Print Legend:

**EPM (size) / (# cond) -55°C (-67°F) / 80°C (176°F) MADE IN USA**

**⚠ WARNING:** Cancer and Reproductive Harm [www.P65Warnings.ca.gov](http://www.P65Warnings.ca.gov)

### 18/4 Gauge

Stranding 16/30  
Nominal OD 0.320

Part #	Length	Packaging	MC Qty.	Weight	Rotation
97652	4000'	Factory Reel (F)	4000'	219 lbs.	Brown/Yellow/Green/White

Note: letter in parenthesis designates spool ID, see page 105.

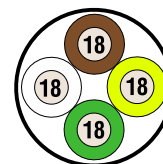

### 14/6 Gauge

Stranding 19/27  
Nominal OD 0.440

Part #	Length	Packaging	MC Qty.	Weight	Rotation
97591	2000'	Factory Reel (F)	2000'	297 lbs.	Grn/Blu/Red/Blk/Brn/Yel

Note: letter in parenthesis designates spool ID, see page 105.



## SLEEVED RV CABLE WIRE – RATED 80°C

### RV Cable

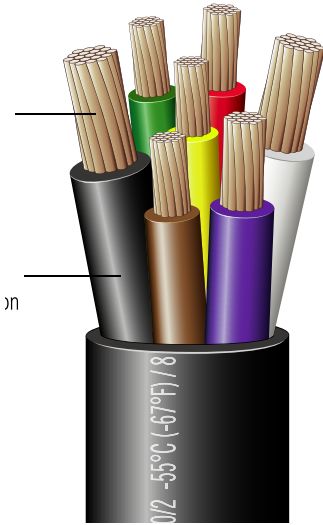

General-purpose primary wires covered in high quality, PVC jacket. Specially designed for use in Recreational Vehicle's multiple electrical system connections. Heavy-duty compact cable protects insulated conductors against weathering, chemicals, and abrasion. Color-coded conductors enable easy identification.

**Voltage:** Rated at 60 Volts or less

**Temperature:** Rated -55°C (-67°F) to 80°C (176°F)

**Specifications:** Inner wires meet SAE J1128, SAE J378

- *Spiral striping of inner wires of this product is available. Please refer to page 104 for details.*



Print Legend:

EPM 14/4-12/1-10/2 -55°C (-67°F) / 80°C (176°F) MADE IN USA

**⚠ WARNING:** Cancer and Reproductive Harm [www.P65Warnings.ca.gov](http://www.P65Warnings.ca.gov)

**14/4-12/1-10/2**  
**Gauge**  
 Stranding  
 19/27-19/25-19/23  
 Nominal OD 0.560

Part #	Length	Packaging	MC Qty.	Weight	Rotation
97526	1500'	Factory Reel (F)	1500'	383 lbs.	DkBlu/Brn/Blk/DkGrn/Red/Wht/Yel

Note: letter in parenthesis designates spool ID, see page 105.



# DUAL BOOSTER CABLE WIRE

2, 4, 6, and 8 gauge booster cable wire with highly conductive, 100% copper stranding to maximize current transfer. TPE insulation on 2-gauge and PVC insulation on 4, 6, & 8 provides a durable barrier to protect against weathering, chemicals, and abrasion. Tangle-free cables are color-coded for easy polarity identification.

DBC

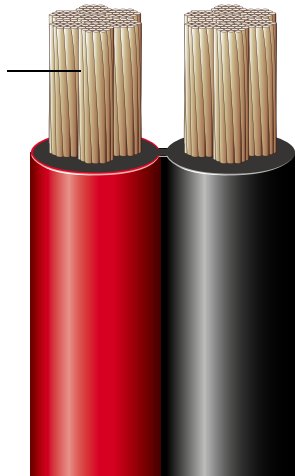

Non-N Filler

Annea Bunch Coppe

Color-PVC Ir

**Voltage:** Rated at 60 Volts or less

**Temperature:** TPE rated -40°C (-40°F) to 105°C (221°F);  
PVC rated -40°C (-40°F) to 80°C (176°F)

**Specifications:** 2,4,6 gauge meets SAE J1127;  
8 gauge meets SAE J1128



**WARNING:** Cancer and Reproductive Harm [www.P65Warnings.ca.gov](http://www.P65Warnings.ca.gov)

## 2 Gauge

2 Conductor  
TPE Insulated  
Stranding 259/26  
Nominal OD 0.450 x 0.960

Part #	Length	Packaging	MC Qty.	Weight	Color
01255	50'	Reel (A)	1	29 lbs.	Red/Black
01256	100'	Reel (B)	1	56 lbs.	Red/Black
01257	500'	Reel (D)	1	271 lbs.	Red/Black
14913	1000'	Factory Reel (F)	1000'	560 lbs.	Red/Black

Note: letter in parenthesis designates spool ID, see page 105.

## 4 Gauge

2 Conductor  
PVC Insulated  
Stranding 133/25  
Nominal OD 0.410 x 0.880

Part #	Length	Packaging	MC Qty.	Weight	Color
01258	50'	Reel (A)	1	21 lbs.	Black/White
01259	100'	Reel (B)	1	41 lbs.	Black/White
01265	500'	Reel (D)	1	196 lbs.	Black/White
14914	1000'	Factory Reel (F)	1000'	413 lbs.	Black/White
04577	50'	Reel (A)	1	21 lbs.	Red/Black
04578	100'	Reel (B)	1	41 lbs.	Red/Black
01266	500'	Reel (D)	1	196 lbs.	Red/Black
07312	1000'	Factory Reel (F)	1000'	413 lbs.	Red/Black

Note: letter in parenthesis designates spool ID, see page 105.

## 6 Gauge

2 Conductor  
PVC Insulated  
Stranding 133/27  
Nominal OD 0.360 x 0.780

Part #	Length	Packaging	MC Qty.	Weight	Color
01267	50'	Reel (A)	1	15 lbs.	Black/Orange
01268	100'	Reel (A)	1	29 lbs.	Black/Orange
98089	500'	Reel (D)	1	147 lbs.	Black/Orange
14915	1200'	Factory Reel (F)	1200'	336 lbs.	Black/Orange

Note: letter in parenthesis designates spool ID, see page 105.

## 8 Gauge

2 Conductor  
PVC Insulated  
Stranding 30/23  
Nominal OD 0.320 x 0.700

Part #	Length	Packaging	MC Qty.	Weight	Color
01269	100'	Reel (A)	1	19 lbs.	Black/Yellow
14916	1500'	Factory Reel (F)	1500'	275 lbs.	Black/Yellow

Note: letter in parenthesis designates spool ID, see page 105.



## D-SHAPED DUAL BOOSTER CABLE WIRE

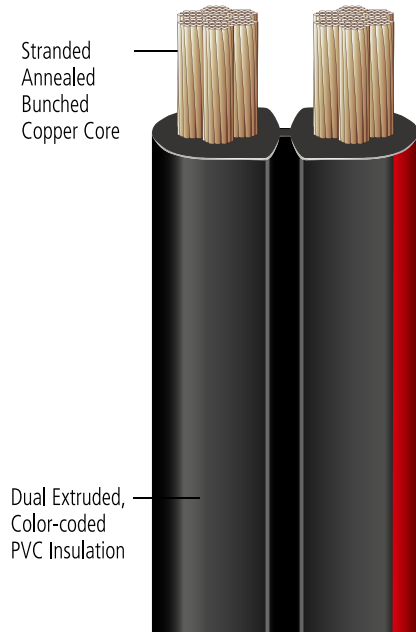

D-Shaped 6 and 8 gauge booster cable wire has highly conductive, 100% copper stranding to maximize current transfer. Perfect for use when a 2-conductor wire is needed in heavy-duty applications. PVC insulation provides a durable barrier to protect against weathering, chemicals, and abrasion. Wire includes a color-coded stripe for easy polarity identification.

**Voltage:** Rated at 60 Volts or less

**Temperature:** Rated -40°C (-40°F) to 80°C (176°F)

**Specifications:** 6 gauge meets SAE J1127;  
8 gauge meets SAE J1128



**WARNING:** Cancer and Reproductive Harm [www.P65Warnings.ca.gov](http://www.P65Warnings.ca.gov)

### 6 Gauge

2 Conductor  
PVC Insulated

Stranding 259/30

Nominal OD 0.320 x 0.660

Part #	Length	Packaging	MC Qty.	Weight	Color
07288	500'	Reel (D)	1	132 lbs.	Black w/Red Stripe
07287	1800'	Factory Reel (F)	1800'	483 lbs.	Black w/Red Stripe

Note: letter in parenthesis designates spool ID, see page 105.

### 8 Gauge

2 Conductor  
PVC Insulated

Stranding 30/23

Nominal OD 0.280 x 0.560

Length	Packaging	MC Qty.	Weight	Part #	Color
07290	500'	Reel (D)	1	84 lbs.	Black w/Yellow Stripe
07289	1000'	Factory Reel (G)	1000'	177 lbs.	Black w/Yellow Stripe

Note: letter in parenthesis designates spool ID, see page 105.



# MARINE MASTER<sup>®</sup>

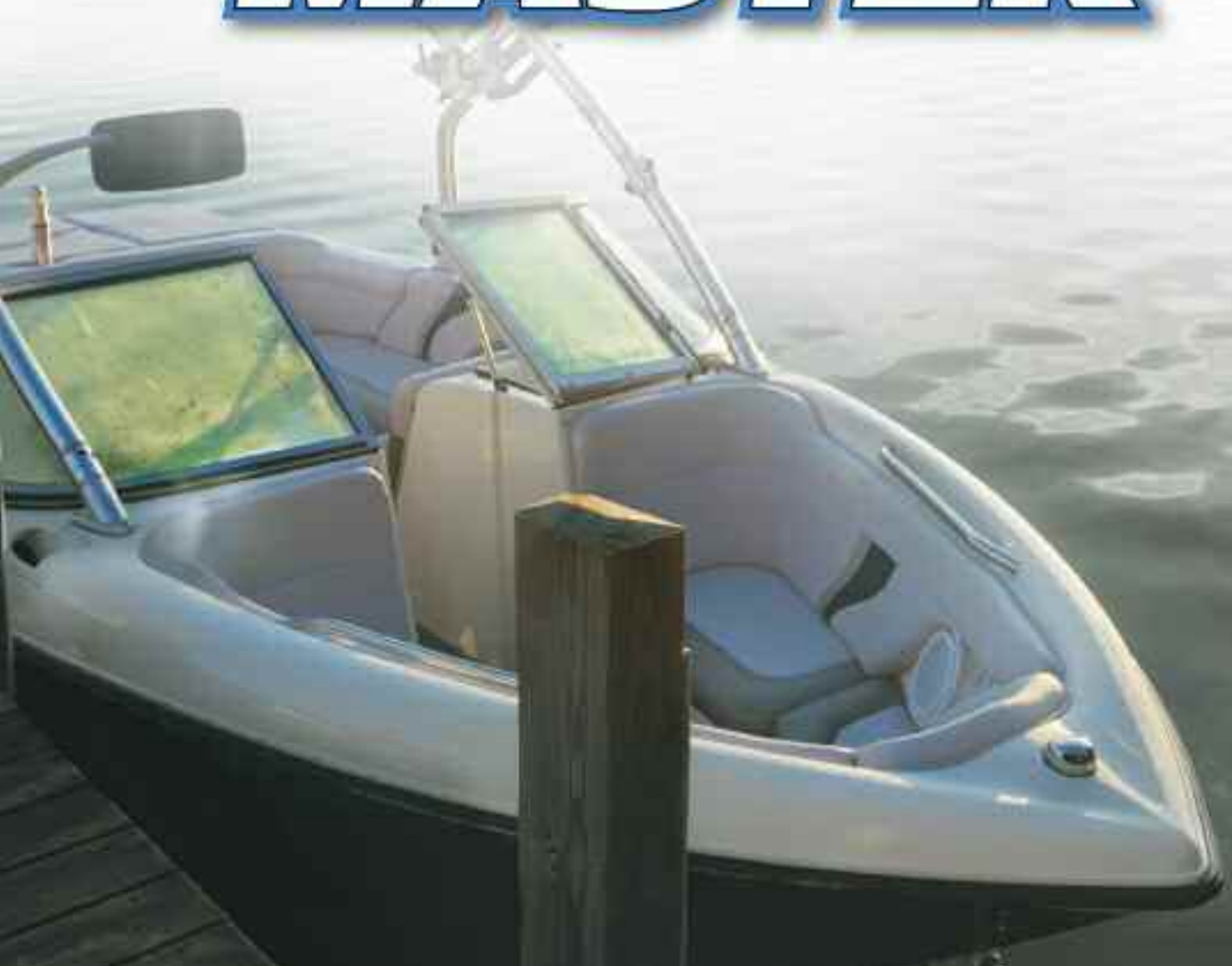

Wire, Cable, and  
Battery Accessories

MARINE PRODUCT CATALOG 2020/21



## MARINE MASTER® BATTERY BOXES

- Polypropylene boxes protect battery in marine and commercial applications
- Vented for safety
- Includes all hardware for installation
- New snap lid for secure fit

Part #	Group Size	Outside Dimensions (LxWxH)	Inside Dimensions (LxWxH)	Packaging	Master Carton	
					Quantity	Weight
03009	Marine 24	14-5/16" x 9-3/4" x 10-3/4"	10-5/8" x 7-3/16" x 9-3/4"	Bulk	12	24 lbs.
03189	Marine 27/31 <sup>1</sup>	17" x 9-3/4" x 11"	13-1/2" x 7-1/8" x 10"	Bulk	6	15 lbs.

<sup>1</sup>Includes spacer

**⚠ WARNING:** Cancer and Reproductive Harm [www.P65Warnings.ca.gov](http://www.P65Warnings.ca.gov)



03009



03189

## MARINE MASTER® TINNED SWITCH-TO-STARTER CABLES

- Tinned copper conductor for maximum corrosion protection
- Wire is UL1426 and CSA TEW/AWM
- Tin-plated copper lug
- Packaged 1 per clamshell

Fits up to 3/8" stud

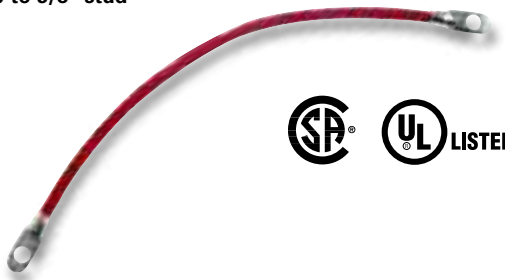

Part #	Color	Length	Master Carton	
			Quantity	Weight
<b>4 GAUGE</b>				
03394	Black	24"	5	2 lbs.
03395	Red	24"	5	2 lbs.
03396	Black	36"	5	3 lbs.
03397	Red	36"	5	3 lbs.
<b>2 GAUGE</b>				
03398	Black	48"	5	4 lbs.
03399	Red	48"	5	4 lbs.
03401	Red	60"	5	5 lbs.
03403	Red	72"	2	6 lbs.

**⚠ WARNING:** Cancer and Reproductive Harm [www.P65Warnings.ca.gov](http://www.P65Warnings.ca.gov)

### QUICK CONNECT™ BATTERY HARNESS REPAIR SPLICE

- For fast convenient replacement of hard to reach cables
- Replaces corroded portion, not the entire cable
- Ideal for marine applications
- Tin-plated copper lug
- Includes hex wrench
- Packaged 1 per clamshell

Part #	Color	Gauge	Type	Aux. Wire Gauge/Color	Master Carton	
					Quantity	Weight
03353	Black	4	Lug-Dual	12/Blk	5	4 lbs.

**⚠ WARNING:** Cancer and Reproductive Harm [www.P65Warnings.ca.gov](http://www.P65Warnings.ca.gov)



### EPOXY-COATED WING NUT TERMINALS

- Clamp-type wing nut terminals convert standard post to marine or other special uses
- Brass plated wing nut
- Epoxy coating aids in polarity identification and corrosion resistance



Part #	Polarity	Packaging	Master Carton	
			Quantity	Weight
03358	1 Pos/1 Neg	Clam Shell of 2	10	8 lbs.

Positive terminal stud size is 3/8"  
Negative terminal stud size is 5/16"

**⚠ WARNING:** Cancer and Reproductive Harm [www.P65Warnings.ca.gov](http://www.P65Warnings.ca.gov)

### WING NUT TERMINALS

- Clamp type wing nut terminals convert standard post to marine or other special uses
- Brass plated wing nut



Part #	Polarity	Packaging	Master Carton	
			Quantity	Weight
03355	1 Pos/1 Neg	Clam Shell of 2	10	8 lbs.
03356	Universal	Card of 10	10	36 lbs.

Positive terminal stud size is 3/8"  
Negative and universal terminal stud size is 5/16"

**⚠ WARNING:** Cancer and Reproductive Harm [www.P65Warnings.ca.gov](http://www.P65Warnings.ca.gov)

### 3-WAY TOP POST COMMERCIAL TERMINAL

- Fits 2 to 4/0 gauge cables



Part #	Polarity	Packaging	Master Carton	
			Quantity	Weight
03359	1 Pos/1 Neg	Clam Shell of 2	10	14 lbs.

**⚠ WARNING:** Cancer and Reproductive Harm [www.P65Warnings.ca.gov](http://www.P65Warnings.ca.gov)

### MULTI-ACCESSORY TERMINALS

- Perfect for installing on-board chargers, GPS, fish finders, radios, & other fused accessories
- Each terminal includes (2) 14-16ga. & (2) 10-12ga. wire crimp terminals
- Positive (red) terminal fits 3/8" battery stud; negative (black) terminal fits 5/16" battery stud
- Brass plate & stainless steel screws resist corrosion in any marine environment

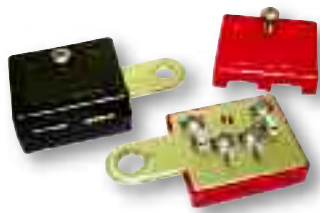

Part #	Color	Packaging	Master Carton	
			Quantity	Weight
31014	Red/Black	Clam Shell of 2	12	5 lbs.

### MARINE HEX NUTS

- Stainless steel
- 5/16-18 UNC hex nut



Part #	Packaging	Master Carton	
		Quantity	Weight
05519	Bag of 50	1	1 lb.

### WING NUTS

- For threaded stud connections
- Stainless steel



Part #	Packaging	Master Carton	
		Quantity	Weight
03357 <sup>1</sup>	Clam Shell of 3	10	1 lb.

<sup>1</sup> One 3/8" and two 5/16" wing nuts  
<sup>2</sup> 5/16" wing nuts only

### MARINE BATTERY PROTECTION KIT

**Kit Includes:**

- Terminal protectors
- Battery cleaner brush
- One 3/8" and two 5/16" stainless steel wing nuts
- 3/4 oz. can terminal protection spray
- 1 1/8 oz. can cleaner spray
- Hand cleaning towelette



Part #	Packaging	Master Carton	
		Quantity	Weight
04752	Clam Shell Kit	6	1 lb.

**⚠ WARNING:** Cancer and Reproductive Harm [www.P65Warnings.ca.gov](http://www.P65Warnings.ca.gov)

### 2-IN-1 12V AUTO POWER ALERT AND USB CHARGER

- Plug into accessory outlet to constantly monitor your power system.
- Recharge your USB devices (smartphone, cameras, and much more) while on the go.
- Input: 12V DC / Output: 5V 400mA



Part #	Packaging	Master Carton	
		Quantity	Weight
03393	Clam Shell of 1	6	2 lbs.

Dimensions L x W x H: 2-1/2" x 2-1/4" x 13/16"

**⚠ WARNING:** Cancer and Reproductive Harm [www.P65Warnings.ca.gov](http://www.P65Warnings.ca.gov)

### SELF-FUSING AUTO TAPE

- Provides a moisture tight seal
- Insulates to protect wires and splices
- Ideal for high temperature applications
- Alternative to heat shrink tubing
- Completely cures within 24 hours



Part #	Length	Color	Packaging	Master Carton	
				Quantity	Weight
03422	10'	Black	Clam Shell of 1	4	1 lb.
03423	10'	Red	Clam Shell of 1	4	1 lb.

### BATTERY BOX STRAP



Part #	Color	Packaging	Master Carton	
			Quantity	Weight
03392	Black	Clam Shell of 1	10	1 lb.

### UNIVERSAL BATTERY TRAYS

- Made with durable rust and corrosion resistant polypropylene
- Includes strap, 4 screws and instructions



Part #	Group Size	Dimensions	Packaging	Master Carton	
				Quantity	Weight
03363	24	11-1/2" x 8-1/2"	Bag of 1	10	6 lbs.
03364	27/31	14" x 7-7/8"	Bag of 1	10	8 lbs.

**⚠ WARNING:** Cancer and Reproductive Harm [www.P65Warnings.ca.gov](http://www.P65Warnings.ca.gov)





### 10-16 Gauge Wire Colors:



Available on 100', 500', 1000' spools and factory reels.



### 6-8 Gauge Wire Colors:



Available on 100', 500', 1000' spools and factory reels.

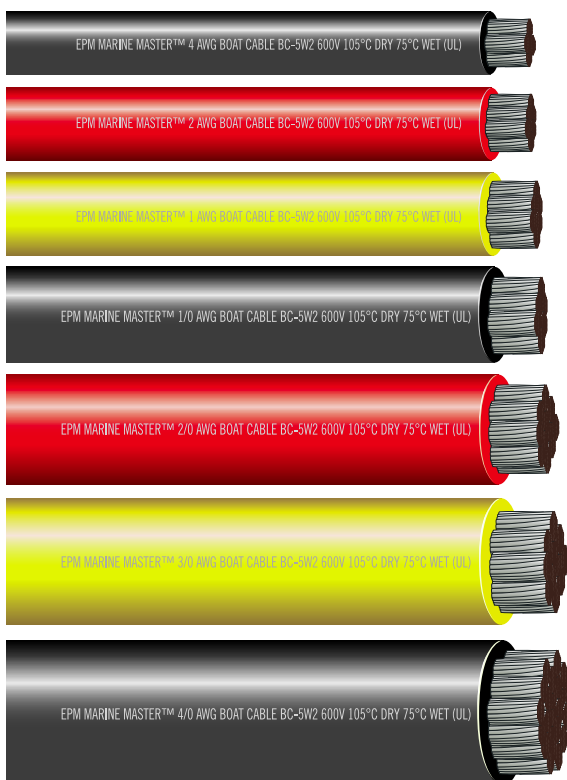

### 4-4/0 Gauge Cable Colors:



4, 2, and 2/0 available on 100', 500' spools and factory reels.  
1, 1/0, 3/0 and 4/0 available on 100', 500' spools.

## UL LISTED 1426 MARINE MASTER® AND CSA TEW/AWM SINGLE- AND MULTI-CONDUCTOR TINNED WIRE/CABLE

UL Listed, single-/multi-conductor tinned wire ideal for use in the high corrosive environment of marine applications. Special electro-tinned, copper strands also increase protection against corrosion for recreational vehicles, automotive, trucks, and trailers. Tinned copper stranding is extremely flexible for easy routing through marine applications and easier to solder than bare copper. Flame retardant, PVC insulation is highly resistant to water, oil, grease, gasoline, and other damaging solvents. High voltage tolerance of up to 600 volts adds to versatility to its use in multiple marine and other suitable applications.

**Voltage:** Rated at 600 Volts

**Temperature:** Rated at 105°C (221°F) dry and 75°C (167°F) wet

**Specifications:** Meets UL 1426 specifications for compliance with ABYC, NMMA, DOT, & Coast Guard requirements; Meets CSA TEW & AWM specifications



**WARNING:** Cancer and Reproductive Harm [www.P65Warnings.ca.gov](http://www.P65Warnings.ca.gov)

16/2, 14/2, 12/2 and 10/2 Gauge 2-Conductor Wire available in Black/White, Red/Black, or Yellow/Red.



Available on 100', 500', 1000' spools and factory reels.

16/3, 14/3, 12/3 and 10/3 Gauge 3-Conductor Wire available in Black/White/Green.



Available on 100', 500', 1000' spools and factory reels.

**\*See pages 78-83 for part numbers and ordering information**

## SPECIAL ORDERING

### SPIRAL STRIPED WIRE

SPIRAL STRIPED WIRE IS AVAILABLE IN A VARIETY OF COLORS AND WIRE TYPES, FOR AN ADDITIONAL CHARGE. SPIRAL STRIPED WIRE IS MADE TO ORDER UPON REQUEST. ADDITIONAL LEAD TIME REQUIRED. SPIRAL STRIPED WIRE IS NON-RETURNABLE.

SPIRAL STRIPING IS LIMITED TO 1000' SPOOLS AND FACTORY REELS OF THE FOLLOWING WIRE TYPES:

- 80°C PRIMARY WIRE
- 105°C PRIMARY WIRE
- SXL CROSS-LINKED POLYETHYLENE WIRE
- UL/CSA MTW WIRE
- UL1426 TINNED WIRE
- CONDUCTORS IN CUSTOM MADE TRAILER CABLE, DUPLEX, TRIPLEX, AND QUADRAPLEX (WILL REQUIRE 25,000' MINIMUM)

**CONTACT YOUR SALESPERSON OR CUSTOMER SUPPORT FOR PRICING, PART #'S AND CURRENT LEAD TIMES.**

### CUSTOM BATTERY CABLES AND WIRE

EAST PENN MANUFACTURING HAS THE CAPABILITY TO MANUFACTURE VARIOUS TYPES OF CUSTOM BATTERY CABLES, HARNESSSES, AND WIRE PRODUCTS BASED ON YOUR REQUIREMENTS. ALL REQUESTS FOR CUSTOM PRODUCT MUST BE MADE IN WRITING. ALL QUOTATIONS ARE PROCESSED PENDING CREDIT DEPARTMENT APPROVAL. WHEN REQUESTING A QUOTATION ON A CUSTOM MADE ITEM, THE FOLLOWING INFORMATION IS **REQUIRED**:

#### BATTERY CABLES

- ESTIMATED ANNUAL USAGE
- PRINT / DRAWING / WRITTEN DESCRIPTION INCLUDING:
  - TYPE, GAUGE AND COLOR OF CABLE
  - TYPE OF TERMINATION (ie. LUG, TERMINAL, CUT, ETC)
  - ADDITIONAL ITEMS (ie. LOOM, BOOTS, HEAT SHRINK, ETC)

#### WIRE

- ESTIMATED ANNUAL USAGE
- PRINT / DRAWING / WRITTEN DESCRIPTION INCLUDING:
  - WIRE TYPE, GAUGE, AND COLOR(S)
  - PUT-UP
  - SPECIAL O.D. (IF REQUIRED)
  - ROTATION (IF MULTI-CONDUCTOR)
  - SPECIAL STRANDING (IF REQUIRED)

MINIMUM REQUIREMENTS WILL BE SET FOR ALL CUSTOM MADE PRODUCTS. STANDARD MINIMUM REQUIREMENTS ARE AS FOLLOWS:

#### BATTERY CABLES

- 100 PIECES PER ITEM PER ORDER
- MINIMUM MAY BE INCREASED DUE TO COMPLEXITY OF CABLE

#### WIRE

- 25,000 FEET PER ITEM PER ORDER
- MINIMUM MAY BE INCREASED TO CONFORM TO PUT-UP REQUIREMENTS

LEAD TIMES VARY BASED ON COMPLEXITY OF PRODUCT. ALL CUSTOM MADE ITEMS ARE MADE TO ORDER AND ARE NOT STOCKED. CUSTOM MADE ITEMS ARE NON-RETURNABLE.

**CONTACT YOUR SALESPERSON WITH REQUIRED INFORMATION TO BEGIN QUOTE PROCESS.**

# WIRE AND CABLE SPOOL DIMENSIONS

Spool / Reel ID	Flange (inches)	Traverse (inches)	Height (inches)	Barrel (inches)	Arbor Hole (inches)	Type	Material
A	12	6	7-7/16	5-1/2	1-13/16	REEL	PLASTIC
B	14-1/2	7-3/8	9	5-1/2	1-13/16	REEL	PLASTIC
C	17-1/2	8-11/16	9-1/2	6-1/2	1-5/8	REEL	WOOD
D	17-1/2	13-1/2	14-1/4	6-1/2	1-5/8	REEL	WOOD
E	23-3/8	—	31	—	—	DRUM	FIBRE
F	29-5/8	12-3/8	14	10	1-5/8	REEL	WOOD
G	23-1/2	16-5/8	18-1/4	7	1-5/8	REEL	WOOD
H	3-1/2	3-1/16	3-1/4	1	3/4	SPOOL	PLASTIC
I	2-1/8	2	2	2	3/4	SPOOL	PLASTIC
J	6-7/16	3-15/16	4-3/8	2	7/8	SPOOL	PLASTIC
K	6-7/16	7-15/16	8-3/8	2	7/8	SPOOL	PLASTIC
L	15-1/2	9	10	—	1-9/16	REEL	WOOD
M	11-1/2	12	13	—	1-9/16	REEL	WOOD
N	15-1/2	9-1/2	10	—	1-9/16	REEL	WOOD
O	17-1/2	11-1/2	13	—	1-9/16	REEL	WOOD
P	23-1/2	12	13-1/2	—	1-9/16	REEL	WOOD
R	23-1/2	18	19-1/2	—	1-9/16	REEL	WOOD
S	13	10	10-5/8	—	1-7/8	REEL	WOOD
T	15	10	11	—	1-11/16	REEL	WOOD
U	16	8-1/2	8-3/4	—	1-7/8	REEL	WOOD
V	16	11-1/2	12-1/2	—	1-7/8	REEL	WOOD
W	18	11-1/2	12-1/2	—	1-11/16	REEL	WOOD
X	21	14	15-1/2	—	1-7/8	REEL	WOOD
Y	24	12	13-1/2	—	1-7/8	REEL	WOOD
Z	23-1/2	17-1/2	19	—	1-9/16	REEL	WOOD

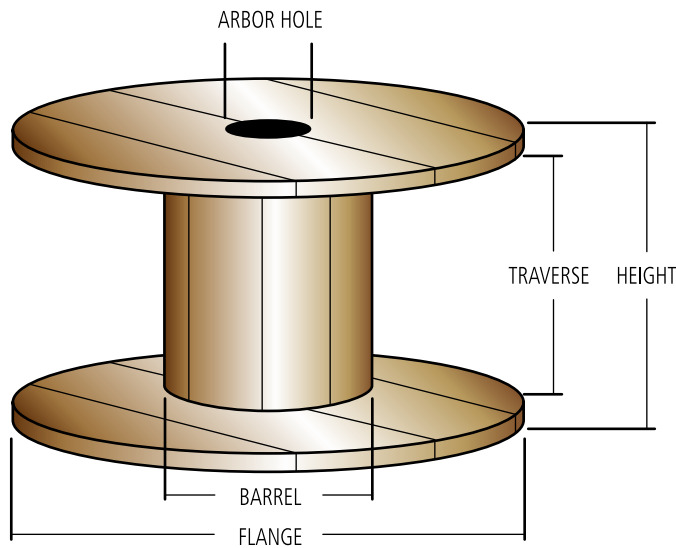

## WIRING GUIDE – PRIMARY WIRE & BATTERY CABLE

Using an automotive wiring guide is critical to help determine the correct wire or cable gauge for 12-volt systems. The selection of the correct gauge for automotive or other low voltage applications is extremely important to maximize safety and performance. Voltage drop or a loss of candlepower can occur if an insufficient gauge is used.

Always consider the total amperage and length of wire in each circuit when selecting an adequate gauge. Allow for the return circuit, including the grounded return, when estimating the length.

### USING THE CHART

1. Measure the length of wire in the circuit including the ground return. A two-wire circuit will be the total lengths of both the wires. Account for both vehicles on auto and trailer applications.
2. Find the total amperes, watts, or candlepower and choose the nearest number in Circuit Amperes column.
3. Look across for proper footage to find nearest wire gauge.

#### Note:

18-gauge applications inside of the shaded area could be 20-gauge for electrical purposes. However, it is recommended to use 18-gauge for the tensile strength of the wire. Chart is based on maximum 10% voltage drop @ 100°F (in free air).

TOTAL APPROX. CIRCUIT AMPERES	WIRE GAUGE (FOR LENGTH IN FEET)												
	12V	3	5	7	10	15	20	25	30	40	50	75	100
1	18	18	18	18	18	18	18	18	18	18	18	18	18
1.5	18	18	18	18	18	18	18	18	18	18	18	18	18
2	18	18	18	18	18	18	18	18	18	18	18	16	16
3	18	18	18	18	18	18	18	18	18	18	18	14	14
4	18	18	18	18	18	18	18	18	18	18	18	16	12
5	18	18	18	18	18	18	18	18	18	18	16	14	12
6	18	18	18	18	18	18	18	18	16	16	16	14	12
7	18	18	18	18	18	18	18	18	16	16	16	14	10
8	18	18	18	18	18	18	18	18	16	16	16	14	10
10	18	18	18	18	18	16	16	16	14	14	12	10	10
11	18	18	18	18	18	16	16	16	14	14	12	10	8
12	18	18	18	18	18	16	16	16	14	14	12	10	8
15	18	18	18	18	18	14	14	12	12	12	10	8	8
18	16	16	16	16	16	14	14	12	12	10	10	8	8
20	16	16	16	16	16	14	12	10	10	10	10	8	6
22	14	14	14	14	14	12	12	10	10	10	8	6	6
24	14	14	14	14	14	12	12	10	10	10	8	6	6
30	12	12	12	12	12	10	10	10	10	10	6	4	4
40	10	8	8	8	8	8	8	8	8	6	6	4	2
50	8	8	8	8	8	8	8	8	8	6	6	2	2
100	4	4	4	4	4	4	4	4	4	4	2	1	1/0
150	2	2	2	2	2	2	2	2	2	2	1	2/0	2/0
200	1/0	1/0	1/0	1/0	1/0	1/0	1/0	1/0	1/0	1/0	1/0	4/0	4/0

### TYPICAL AMPERAGE GUIDE

EQUIPMENT	AVG. AMPS*
Air Conditioner	13 to 20
Alarm System	18 to 20
Anti-lock Brake Module	2 to 6
Cigarette Lighter/Power Outlet	10 to 12
Dash lights	1.5 to 3
Dome Light	1
Electric Clock and Light	0.3
Electric Wiper	3 to 6
Fog Lights	8 to 9
Gauges	0.7 to 1
Headlight Dimmer	2.2
Headlights - Low Beams	8 to 9
Headlights - High Beams	13 to 15
Heater/Defroster	6 to 10
Horns (2)	18 to 20
Ignition	1.5 to 3.5
License Lights	0.5
Parking Lights (2)	1.3
Power Antenna	6 to 10
Power Door Locks	3 to 5
Power Seats	25 to 50
Power Sunroof	20 to 25
Power Windows	2 to 20
Power to Trailer Hitch if Equipped	20 to 30
Radio/CD Player	2 to 5
Rear Window Defogger	20 to 25
Reverse Lights (2)	3.5 to 4
Starter Motor	75 to 300
Starter Solenoid	12 to 20
Stop Lights (2)	3.5 to 4
Side Marker Lights (2)	1.3
Tail Lights (2)	0.5
Trunk Lights	0.5

\*Based on a typical 12-volt system.



## MARINE WIRE &amp; CABLE COLOR CODING

Color	Item	Use
Red	DC Positive Conductor	Positive mains.
Black or Yellow	DC Negative Conductor	Return, negative mains.
Green or Green w/Yellow Stripe(s)	DC Grounding Conductor	Bonding system. Bonding wires (if insulated).
Yellow w/ Red Stripe	Starting Circuit	Starting switch to solenoid.
Brown w/Yellow Stripe or Yellow - See Note	Bilge Blowers	Fuse or switch to blowers.
Gray	Navigation Lights Tachometer	Fuse or switch to lights. Tachometer sender to gauge.
Brown	Generator Armature	Generator armature to regulator.
	Alternator Charge Light	Generator, terminal/alternator, auxiliary terminal to light regulator.
	Pumps	Fuse or switch to pumps.
Orange	Accessory Feed	Ammeter to alternator of generator output and accessory fuses or switches. Distribution panel to accessory switch.
Purple	Ignition	Ignition switch to coil and electrical instruments.
	Instrument Feed	Distribution panel to electrical instruments.
Dark Blue	Cabin and Instrument Lights	Fuse or switch to lights.
Light Blue	Oil Pressure	Oil pressure sender to gauge.
Tan	Water Temperature	Water temperature sender to gauge.
Pink	Fuel Gauge	Fuel gauge sender to gauge.
Green w/Stripe (except G/Y)	Tilt Down and/or Trim In	Tilt and/or trim circuits.
Blue w/Stripe	Tilt Up and/or Trim Out	Tilt and/or trim circuits.

NOTE: If yellow is used for DC negative, blower must be brown with yellow stripe.

### TRAILER WIRING RECOMMENDATIONS

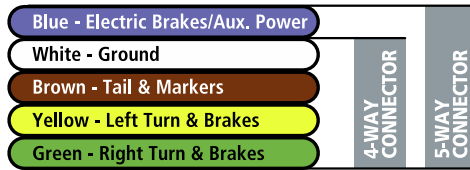
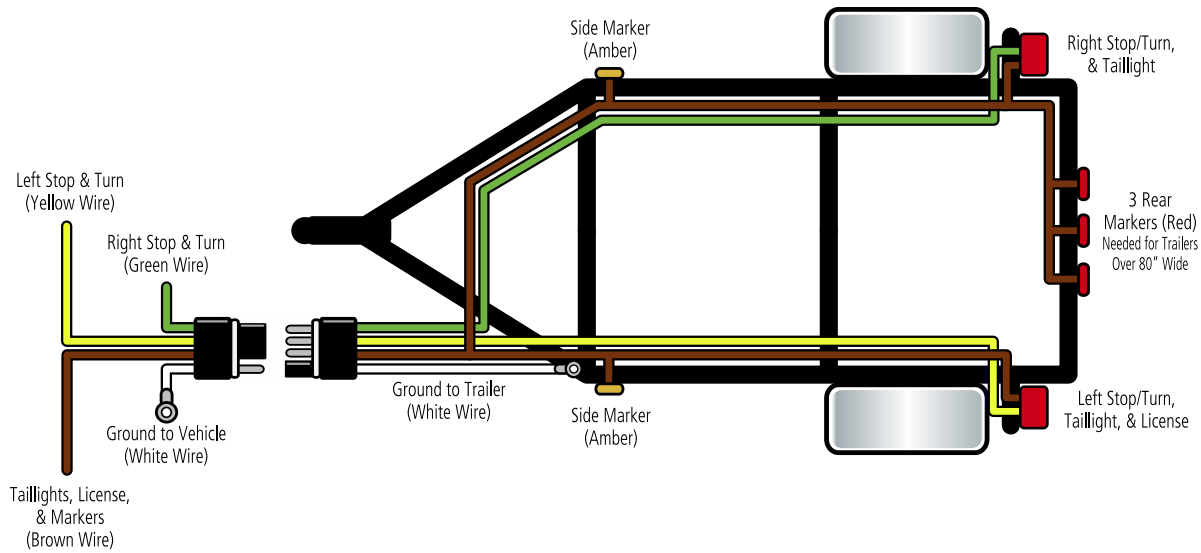

See pages 84 & 85 for Part Numbers

### TRACTOR TRAILER WIRING RECOMMENDATIONS (RCCC & A.T.A.)

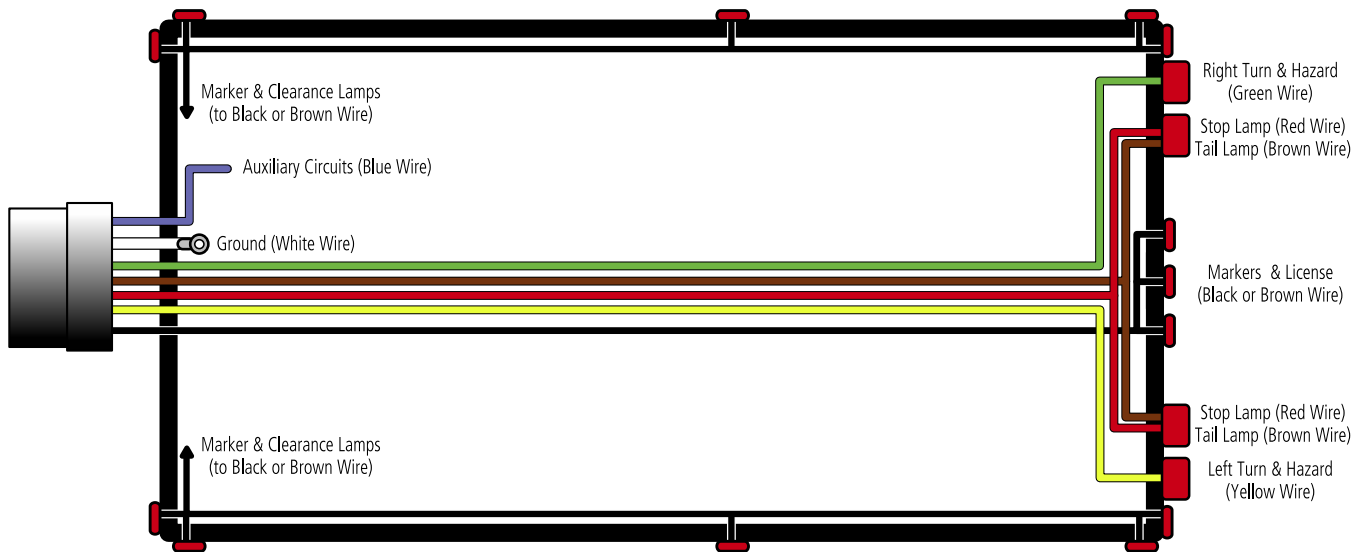

**(RCCC Recommended)**

White	Ground return to towing vehicle (8 GA)
Black*	ICC required marker identification and clearance lamps (12 GA)
Yellow	Left-hand directional and hazard signal (12 GA)
Red	Stop lamp and anti-wheel lock devices (10 GA)
Green	Right-hand directional and hazard signal (12 GA)
Brown*	Tail, license and clearance lamps (12 GA)
Blue	Auxiliary circuits (12 or 10 GA)

**(A.T.A. Recommended)**

White	Ground return to towing vehicle (10 GA)
Black	ICC required marker and clearance lamps (12 GA)
Yellow	Left-hand directional signal (12 GA)
Red	Stop lamp (12 GA)
Green	Right-hand directional signal (12 GA)
Brown	Tail, 3-bar marker and clearance lamps other than ICC Req. (12 GA)
Blue	Auxiliary circuits (12 GA)

\*Leads should be balanced

See pages 90 thru 96 for Part Numbers



## MODERN METRIC CONVERSION FACTORS

Symbol	When You Know...	Multiply By	To Find	Symbol
<b>LENGTH</b>				
in	inches	25.4	millimeters	mm
ft	feet	0.305	meters	m
yd	yards	0.914	meters	m
mi	miles	1.61	kilometers	km

<b>AREA</b>				
in <sup>2</sup>	square inches	645.2	square millimeters	mm <sup>2</sup>
ft <sup>2</sup>	square feet	0.093	square meters	m <sup>2</sup>
yd <sup>2</sup>	square yards	0.836	square meters	m <sup>2</sup>
ac	acres	0.405	hectares	ha
mi <sup>2</sup>	square miles	2.59	square kilometers	km <sup>2</sup>

<b>VOLUME</b>				
fl oz	fluid ounces	29.57	milliliters	ml
gal	gallons	3.785	liters	l
ft <sup>3</sup>	cubic feet	0.028	cubic meters	m <sup>3</sup>
yd <sup>3</sup>	cubic yards	0.765	cubic meters	m <sup>3</sup>

NOTE: Volumes greater than 1000 l shall be shown in m<sup>3</sup>

<b>MASS</b>				
oz	ounces	28.35	grams	g
lb	pounds	0.454	kilograms	kg
T	short tons (2000 lb)	0.907	megagrams	Mg

<b>TEMPERATURE (exact)</b>				
°F	Fahrenheit temperature	5(F-32)/9 or (F-32)/1.8	Celsius temperature	°C

<b>ILLUMINATION</b>				
fc	foot-candles	10.76	lux	lx
fl	foot-Lamberts	3.426	candela/m <sup>2</sup>	cd/m <sup>2</sup>

<b>FORCE and PRESSURE or STRESS</b>				
lbg	poundforce	4.45	newtons	N
psi	pounds per square inch	6.89	kilopascals	kPa

<b>ELECTRICAL</b>				
	Ohms/Kilofeet	3.2808	Ohms/Kilometer	
Insulation Resistance:	Megohms-Kilofeet	0.3048	Megohms-Kilometer	

Symbol	When You Know...	Multiply By	To Find	Symbol
<b>LENGTH</b>				
mm	millimeters	0.039	inches	in
m	meters	3.28	feet	ft
m	meters	1.09	yards	yd
km	kilometers	0.621	miles	mi

<b>AREA</b>				
mm <sup>2</sup>	square millimeters	0.0016	square inches	in <sup>2</sup>
m <sup>2</sup>	square meters	10.764	square feet	ft <sup>2</sup>
m <sup>2</sup>	square meters	1.195	square yards	ac
ha	hectares	2.47	acres	mi <sup>2</sup>
km <sup>2</sup>	square kilometers	0.386	square miles	

<b>VOLUME</b>				
ml	milliliters	0.034	fluid ounces	fl oz
l	liters	0.264	gallons	gal
m <sup>3</sup>	cubic meters	35.71	cubic feet	ft <sup>3</sup>
m <sup>3</sup>	cubic meters	1.307	cubic yard	yd <sup>3</sup>

<b>MASS</b>				
g	grams	0.035	ounces	oz
kg	kilograms	2.202	pounds	lb
Mg	megagrams	1.103	short tons (2000 lb)	T

<b>TEMPERATURE (exact)</b>				
°C	Celsius temperature	1.8°C +32	Fahrenheit temperature	°F

<b>ILLUMINATION</b>				
lx	lux	0.0929	foot-candles	fc
cd/m <sup>2</sup>	candela/m <sup>2</sup>	0.2919	foot-Lamberts	fl

<b>FORCE and PRESSURE or STRESS</b>				
N	newtons	0.225	poundforce	lbf
kPa	kilopascals	0.145	pounds per square inch	psi

<b>ELECTRICAL</b>				
	Ohms/Kilometer	0.3048	Ohms/Kilofeet	
Insulation Resistance:	Megohms-Kilometer	3.2808	Megohms-Kilofeet	

## GLOSSARY

A	Common abbreviation for ampere.
ABRASION RESISTANT	Ability to resist surface wear.
ABS	Anti-lock Brake System.
ABYC	American Boat and Yacht Council.
AC	Alternating Current.
ACID-RESISTANT	Ability to resist acid corrosion.
AI	Period Table of Elements abbreviation for Aluminum.
ALLOY	A substance having metallic properties and being composed of an elemental metal and one or more chemical elements.
AMP	Common abbreviation for ampere.
AMPACITY	The RMS current which a device can carry within specified temperature limitations in a specified environment: dependent upon temperature rating, power loss or heat dissipation.
AMPERE	The SI unit used to measure electric current. Electric current through any given cross-section (such as a cross-section of a wire) may be measured as the amount of electrical charge moving through that cross-section in one second. One ampere is equal to a flow of one coulomb per second, or a flow of $6.28 \times 10^{18}$ electrons per second.
ANNEALED	An object that is free from internal stress by heating and gradually cooling.
ANTIMONIAL LEAD	A lead alloy that contains antimony.
ANTIMONY	A brittle, lustrous, white metallic element occurring in nature free or combined, used chiefly in alloys.
APPROVED	Formally confirmed or sanctioned.
ASTM	American Society for Testing and Materials.
ATA	American Trucking Association.
AUXILIARY	A secondary or supplementary wire.
AWG	American Wire Gauge. A wire diameter specification. The lower the AWG number the larger the wire diameter.
AWM	Appliance Wiring Material.
BARE CONDUCTOR	A conductor having no insulation or jacket.
BUNCH STRANDING	Conductors twisted together with the same lay and direction without regard to geometric pattern.
°C	Common abbreviation for Celsius.
CABLE	A conductor or group of conductors for transmitting electric power or telecommunication signals from one place to another.
CABLE ASSEMBLY	A string of cables and/or wires which transmit informational signals or operating currents. The cables are bound together by clamps, cable ties, lacing, sleeves, electrical tape, conduit, or a combination there of.
CAPACITY	A measurement of the ability to store electrical charge.
CCA	Copper Clad Aluminum.
CERTIFICATE OF COMPLIANCE	A document certified by a competent authority that the supplied good or service meets the required specification. Also called certificate of conformance, certificate of conformity.
CIRCULAR MILS	A unit of area equal to the area of a circle with a diameter of one mil (one thousandth of an inch).
CLADDING	The bonding together of dissimilar metals often achieved by extruding two metals through a die as well as pressing or rolling sheets together under high pressure.
COAST GUARD APPROVED	Meets or exceeds operating equipment requirements as set by the Coast Guard.
COLD TEST	A type of test performed using colder than average temperatures to determine certain characteristics of an object or material.
COMEX	Primary market for trading metals such as gold, copper, silver and aluminum.
COMPLIANT	Conforming to requirements.
CONDUCTANCE	Measure of how well a material will conduct electricity. Measured in siemens.
CONDUCTIVITY	The ability of a material to allow electrons to flow, measured by the current per unit of voltage applied.
CONDUCTOR	A material suitable for carrying an electric current.
CONNECTOR	A metallic device of suitable electric conductance and mechanical strength, used to splice the ends of two or more cable conductors, or as a terminal connector on a single conductor.
COPPER-CLAD ALUMINUM	Aluminum and copper bonded together by extruding two metals through a die or pressing or rolling sheets together under high pressure.
CORE	The center of an object.
CORROSION	The disintegration of an engineered material into its constituent atoms due to chemical reactions with its surroundings.
CORRUGATED	Shaped into folds or parallel and alternating ridges and grooves.
CRIMP	A connection typically used to terminate stranded wire. Attached by inserting the stripped end of stranded wire into a portion of the terminal, which is then mechanically deformed/compressed tightly around the wire.
CROSS-LINK	A special purpose high temperature automotive wire with cross-linked polyethylene (XLPE) insulation. Typically used in high heat applications such as the engine compartment.



## GLOSSARY

CSA	Canadian Standards Association. Similar to UL in the United States.
Cu	Abbreviation for Copper in accordance with the Periodic Table of Elements.
CURRENT	The rate of transfer of electricity. The unit of current is the ampere, rate of one coulomb per second.
DC	Direct current. Electrical current whose electrons flow in one direction only. It may be constant or pulsating as long as their movement is in the same direction.
DIAMETER	A straight line passing through the center of a circle or sphere and meeting the circumference or surface at each end.
DIE	A metal block that is used for forming materials.
DIE CAST	A metal casting process that is characterized by forcing molten metal under high pressure into a mold cavity. The mold cavity is created using two hardened steel dies which have been machined into shape and work similarly to an injection mold during the process.
DIELECTRIC	An electrical insulator that can be polarized by an applied electric field.
DOT	Department of Transportation.
DRAWING	A technical drawing used to fully and clearly define requirements for engineered items.
DRAWING, WIRE	A metal working process used to reduce the cross-section of a wire by pulling the wire through a single, or series of drawing dies. Although similar in process, drawing is different from extrusion, because in drawing the wire is pulled, rather than pushed, through a die.
DUAL EXTRUSION	involves combining two or more extruders to produce wire with two or more colors.
ELASTOMER	Any material that will return to its original dimensions after being stretched or distorted.
ELECTRO-TINNED	To plate or coat (a base metal) with tin by electrolysis.
ELECTROLYSIS	Is a process by which electrical energy is used to produce a chemical change.
EPDM	(Ethylene Propylene Diene Monomer (M-class) rubber) A type of synthetic rubber.
EXTRUSION	The act or process of shaping by forcing through a die.
°F	Common abbreviation for Fahrenheit.
FERROUS	Composed of and/or containing iron. A ferrous metal exhibits magnetic characteristics.
FILLER	Something added to augment weight or size or fill space.
FLAME RETARDANT	Chemicals used in thermoplastics, thermosets, textiles and coatings that inhibit or resist the spread of fire.
FLANGE	Disc shaped collar on the end of a spool or reel to prevent wire from sliding off barrel.
FLEXIBILITY	The distance of motion.
FLEXIBLE	Capable of being bent, usually without breaking. Susceptible of modification or adaptation. Pliable.
GAUGE	A standard of measure or measurement.
GOLD-PLATED	A base metal coated with gold through an electroplating process.
GPT	General Purpose Thermoplastic.
GRAVITY CAST	A manufacturing process utilizing the force of gravity instead of high pressure to fill a permanent mold, or die, with molten material. The molten material is then allowed to solidify within that mold, and is then ejected or broken out to make a fabricated part.
GROUND	A voltage reference point that is the same as earth or chassis ground.
GXL	General purpose Cross-linked polyethylene insulated wire. Intended for use in engine compartments where higher heat resistance is required.
ID	Inside Diameter.
INSULATION	A material having good dielectric properties which is used to separate close electrical components, such as cable conductors and circuit components.
ISO	International Organization for Standardization.
JACKET	Pertaining to wire and cable, the outer sheath which protects against the environment and may also provide additional insulation.
LAY	The length measured along the axis of a wire or cable required for a single strand (in stranded wire) or conductor (in cable) to make one complete turn about the axis of the conductor or cable.
LAY DIRECTION	The twist in the cables as indicated by the top strands while looking along the axis of the cable away from the observer. Described as right-hand or left hand.
LME	London Metal Exchange.
MC	Master Carton.
MIL	Military specification.
MTW	Machine Tool Wire.
NAFTA	North American Free Trade Agreement.
NATM	National Association of Trailer Manufacturers
NATIONAL ELECTRICAL CODE (NEC)	A U.S. consensus standard published by the National Fire Protection Association (NFPA) and incorporated in OSHA regulations.
NEGATIVE	A polarity of electrical charge.
NEUTRALIZE	A chemical reaction in which an acid and a base react to form a salt. Water is frequently, but not necessarily, produced as well.
NMMA	National Marine Manufacturers Association.
NM-B	A UL Cable type, non metallic-sheathed cable.

## GLOSSARY

NOMINAL	Name or identifying value of a measurable property by which a conductor or component or property of a conductor is identified, and to which tolerances are applied.
NON-FERROUS	Indicates metals other than iron and alloys that do not contain an appreciable amount of iron.
OD	Outside diameter.
OE	Original Equipment.
OEM	Original Equipment Manufacturer.
OHM	The electrical unit of resistance.
OSHA	U.S. Occupational Safety and Health Administration.
Pb	Abbreviation for Lead in accordance with the Periodic Table of Elements.
PIES	Product Information Exchange Standard.
PLASTICIZER	A chemical agent added to plastics to make them softer and more pliable.
POLARITY	Present in every electrical circuit. Electrons flow from the negative pole to the positive pole. In a direct current (DC) circuit, one pole is always negative, the other pole is always positive and the electrons flow in one direction only. In an alternating current (AC) circuit the two poles alternate between negative and positive and the direction of the electron flow continually reverses.
POLYETHYLENE (PE)	A thermoplastic material having excellent electrical and physical properties.
POLYMER	A substance made of many repeating chemical units or molecules. The term polymer is often used in place of plastic, rubber, or elastomer.
POLYPROPYLENE (PPE)	A thermoplastic similar to polyethylene but stiffer and having a higher softening point (temperature).
POSITIVE	A polarity of electrical charge.
POLYVINYL CHLORIDE (PVC)	A general-purpose thermoplastic used for low voltage wire and cable insulation, and for jackets.
REEL DRUM DIAMETER	Diameter of the drum (or hub) of the reel.
REEL FLANGE DIAMETER (REEL HEIGHT)	Diameter of the reel flanges.
REEL TRAVERSE	Width of space between reel flanges.
REEL WIDTH	Overall width of reel.
RESISTANT	Impervious to the action of corrosive substances.
RCCC	Regular Common Carrier Conference.
ROOT MEAN SQUARE (RMS)	The effective value of an alternating current or voltage.
RoHS	Restriction of Hazardous Substances.
ROPE LAY CONDUCTOR	A conductor composed of a central core surrounded by one or more layers of helically laid groups of wires used in portable cables.
SAE	Society of Automotive Engineers.
SAE J378	Marine propulsion system wiring.
SAE J1127	Low voltage battery cable.
SAE J1128	Low voltage primary cable.
SAE J1494	Battery booster cables.
SAE J2394	Seven conductor cable for ABS power - truck and bus.
SGT	Starter or Ground, general purpose, thermoplastic insulated cable.
SGX	Starter or Ground, general purpose, Cross-linked polyethylene insulated cable.
SINTERED METAL	Metal created from powder. Advantages include very high levels of purity and controlled, uniformed porosity.
SLEEVING	An extruded tube.
SOLDER	A fusible metal alloy used to join together metal workpieces and having a melting point below that of the workpiece(s).
SPECIFIC GRAVITY	The ratio of the density (mass per unit volume) of a material to that of water.
SPLICE	The physical connection of two or more conductors to provide electrical continuity.
STANDARD	Something established by authority, custom, or general consent as a model or example. Something set up and established by authority as a rule for the measure of quantity, weight, extent, value, or quality.
STRANDED CONDUCTOR	A conductor composed of a group of wires, usually twisted, or of any combination of such groups of wire.
SXL	Special purpose, Cross-linked polyethylene insulated wire. Used in engine compartments where higher heat resistance is required.
TEMPERATURE RATING	A measure of the highest (or occasionally lowest) temperature at which it is safe to use a product for a particular purpose. For example, temperature ratings are often quoted for electrical insulators, specifying the maximum temperature at which they provide adequate protection against electrical breakdown.
TEMPERED STEEL	A heat treatment technique that is done to "toughen" the metal by transforming brittle martensite or bainite into a combination of ferrite and cementite or sometimes Tempered martensite. Tempering is accomplished by a controlled reheating of the work piece to a temperature below its lower critical temperature.
TENSILE STRENGTH	The maximum load per unit of original cross-sectional area that a conductor attains when tested in tension to rupture.

## GLOSSARY

TERMINAL	A device for joining electrical circuits together.
TEW	Thermoplastic Equipment Wire. Canadian Standards Association type appliance wires. Solid or stranded single conductor, plastic insulated, 105°C, 600V.
THERMOPLASTIC	A material that can be softened repeatedly by heating and hardened by cooling through a temperature range characteristic of the plastic, and that in the softened state can be shaped by molding or extrusion.
THERMOSET	A material that has been vulcanized by heat or by other means and is substantially infusible and insoluble.
THERMOSETTING INSULATION	A polymer material that irreversibly cures. The cure may be done through heat (generally above 200 °C (392 °F)), through a chemical reaction, or irradiation such as electron beam processing. Thermoset materials are usually liquid or malleable prior to curing and designed to be molded into their final form, or used as adhesives.
THHN	600 volt 90°C nylon jacketed building wire.
TIN-PLATED	The resulting product of a process of thinly coating sheets of wrought iron or steel with tin. Often to prevent rust and corrosion.
TINNED COPPER	Tin coating added to copper to aid in soldering and inhibit corrosion.
TPE	Thermoplastic Elastomer.
TRAVERSE	The length of the barrel of a reel or spool from flange to flange.
TWP	Thin-wall PVC Wire.
TXL	Thin-wall cross-link polyethylene insulated wire. Used in automotive applications where small diameter and minimal weight is desirable.
UL	Underwriters Laboratory. A non-profit independent organization, which operates a listing service for electrical and electronic materials and equipment. (Canadian counterpart is CSA).
UL 1015/1230/1345	Single conductor with extruded 105°C insulation.
UL 1426	Electric cables for boats with extruded 105°C insulation.
UNILAY	A conductor with more than one layer of helically laid wires with the direction of lay and length of lay the same for all layers.
UNIVERSAL	Adapted or adjustable to many sizes or mechanical uses. Can be used in both positive and negative applications.
UV RESISTANT	Being resistant to ultra violet (UV) light or sunlight. UV light, or sunlight, will cause non-resistant materials and surfaces to fade or discolor.
VINYL	Any of various compounds containing the vinyl radical, typically highly reactive, easily polymerized, and used as basic materials for plastics.
VOLT	The International System unit of electric potential and electromotive force, equal to the difference of electric potential between two points on a conducting wire carrying a constant current of one ampere when the power dissipated between the points is one watt.
VOLTAGE	Electromotive force or potential difference, usually expressed in volts.
VOLTAGE DROP	A voltage loss occurring between any two points in a power circuit.
VULCANIZED	To improve the strength, resiliency, and freedom from stickiness and odor of (rubber, for example) by combining with sulfur or other additives in the presence of heat and pressure.
VW-1	The flammability rating established by Underwriters Laboratories for wires and cables that pass a specially designed vertical flame test, formerly designated FR-1, Similar to CSA designation FT1.
WIRE	A usually pliable metallic strand or rod made in many lengths and diameters, sometimes clad and often electrically insulated, used chiefly for structural support or to conduct electricity.
XLPE	Cross-linked polyethylene.
ZINC-PLATED	The product of a electroplating, the practice of putting an object in a solution and using electricity to coat it. Zinc plating is commonly used on steel to provide corrosion resistance.

PRODUCT INDEX

PART NO.	DESCRIPTION	UNIT UPC	PAGE NO.
00131	CABLE, KIT UTILITY 1/CS	0 83996 00131 2	17
00146	CABLE, BOOSTER 10 GA 12' 50A C/A Y/Y BAG	0 83996 00146 6	8
00147	TERMINAL, TOP POST 2/CS	0 83996 00147 3	26
00148	TERMINAL, MARINE EPOXY RED/BLK 2/CS	0 83996 00148 0	27
00149	TERMINAL, MARINE UNIV 10/CD	0 83996 00149 7	27
00153	CABLE, BOOSTER 10 GA 12' 200C CU B/R SLV	0 83996 00153 4	8
00159	CABLE, BOOSTER 4 GA 20' 500G CU B/W BOX DEKA	0 83996 00159 6	7
00160	CABLE, BOOSTER 8 GA 12' 500G CU B/Y BOX DEKA	0 83996 00160 2	8
00161	CABLE, BOOSTER 2 GA 24' 600P CU B/R BAG DEKA	0 83996 00161 9	6
00162	CABLE, BOOSTER 6 GA 12' 500G CU B/O BOX DEKA	0 83996 00162 6	7
00163	CABLE, BOOSTER 4 GA 20' 600P CU B/W BOX DEKA	0 83996 00163 3	7
00164	CABLE, BOOSTER 4 GA 12' 500G CU B/W BOX DEKA	0 83996 00164 0	7
00168	CABLE, BOOSTER 8 GA 12' 200C CU B/Y BAG DEKA	0 83996 00168 8	8
00169	CABLE, BOOSTER 6 GA 16' 500G CU B/O BOX DEKA	0 83996 00169 5	7
00170	CABLE, BOOSTER 4 GA 16' 500G CU B/W BOX DEKA	0 83996 00170 1	7
00173	CABLE, BATT TOP 2 GA 25' W/AUX RED 1/CS	0 83996 00173 2	15
00174	CABLE, BATT TOP 2 GA 38' W/AUX RED 1/CS	0 83996 00174 9	15
00176	CABLE, BATT TOP 2 GA 43' W/AUX RED 1/CS	0 83996 00176 3	15
00177	CABLE, BATT TOP 2 GA 48' W/AUX RED 1/CS	0 83996 00177 0	15
00178	CABLE, BATT SS 2 GA 24' RED 1/CS	0 83996 00178 7	15
00179	CABLE, BOOSTER 10 GA 12' 200C C/A B/R BAG DEKA	0 83996 00179 4	8
00180	CABLE, BATT SS 2 GA 49' RED 1/CS	0 83996 00180 0	15
00181	CLAMP, TUNE-UP/TEST EQUIP 50A RED/BLK 2/CS	0 83996 00181 7	11
00182	CLAMP, VINYL-CTD STEEL 500E RED/BLK 2/CS	0 83996 00182 4	11
00183	CABLE, BOOSTER 2 GA 20' 600P CU B/R BOX DEKA	0 83996 00183 1	6
00184	CLAMP, CHROME-PLTD STEEL 600P RED/BLK 2/CS	0 83996 00184 8	11
00186	CABLE, BOOSTER 2 GA 20' 600P CU B/R CASE DEKA	0 83996 00186 2	6
00191	TERMINAL, QUICK CONNECT 1/CS	0 83996 00191 6	29
00192	TERMINAL, SIDE TERM 3/CD	0 83996 00192 3	26
00193	BOLT WITH NUT, 1/4 -20 x 3/4 2/CS	0 83996 00193 0	31
00194	LIFTER, SAFETY GRIP POST 14' 1/CS	0 83996 00194 7	51
00195	LIFTER, SAFETY GRIP POST 21' 1/CS	0 83996 00195 4	51
00197	CARRIER, BATT SURE GRIP 1/CD	0 83996 00197 8	51
00198	HYDROMETER, DIAL INDICATOR 1/CS	0 83996 00198 5	50
00199	HYDROMETER, STANDARD 1/CD	0 83996 00199 2	50
00231	HYDROMETER, TEMP CORRECTING 1/CS	0 83996 00231 9	50
00233	TESTER, ANTI-FREEZE FLOATING BALLS 1/CS	0 83996 00233 3	50
00236	HOLD-DOWN, CROSS BAR 1/CS	0 83996 00236 4	48
00237	PROTECTORS, TMNL TOP BLK 100/JAR	0 83996 00237 1	45
00239	HOLD-DOWN, FRAME TYPE GROUP 24 1/CS	0 83996 00239 5	48
00240	CABLE, BATT SIDE 4 GA 65' W/AUX RED 1/CS	0 83996 00240 1	15
00241	BOLTS, HOLD-DOWN J TYPE 6' 2/CS	0 83996 00241 8	48
00242	BOLTS, HOLD-DOWN J TYPE 10' 2/CS	0 83996 00242 5	48
00243	BOLTS, HOLD-DOWN L TYPE 10' 2/CS	0 83996 00243 2	48
00244	BOLTS, HOLD-DOWN J TYPE 12' 2/CD	0 83996 00244 9	48
00246	HOLD-DOWN, UNIV PLASTIC ADJUST 1/CS	0 83996 00246 3	48
00250	HOLD-DOWN, CROSS BAR ADJ 1/CS	0 83996 00250 0	48
00251	HOLD-DOWN, BASE MOUNT 1/CS	0 83996 00251 7	48
00252	TRAY, BATTERY UNIV LARGE SLV	0 83996 00252 4	49
00253	TRAY, BATTERY UNIV SMALL SLV	0 83996 00253 1	49
00254	CLEANER, BATT POST & TMNL 1/CS	0 83996 00254 8	52
00255	TOOL, SPREADER BATT TMNL 1/CS	0 83996 00255 5	52
00256	LIFTER, POST TMNL 1/CS	0 83996 00256 2	52
00257	FILLER, BATT BULB 1/CD	0 83996 00257 9	50
00282	CABLE, BATT SS 4 GA 40' RED 1/CS	0 83996 00282 1	14
00286	CABLE, BATT SS 4 GA 16' RED 1/CS	0 83996 00286 9	14
00287	CABLE, BATT SS 4 GA 19' RED 1/CS	0 83996 00287 6	14
00288	CABLE, BATT SS 4 GA 24' RED 1/CS	0 83996 00288 3	14
00289	CABLE, BATT SS 4 GA 32' RED 1/CS	0 83996 00289 0	14
00291	CABLE, BATT SS 4 GA 49' RED 1/CS	0 83996 00291 3	14
00292	CABLE, BATT TOP 4 GA 10' RED 1/CS	0 83996 00292 0	14
00293	CABLE, BATT TOP 4 GA 15' RED 1/CS	0 83996 00293 7	14
00294	CABLE, BATT TOP 4 GA 20' RED 1/CS	0 83996 00294 4	14
00295	CABLE, BATT TOP 4 GA 25' W/AUX RED 1/CS	0 83996 00295 1	14
00296	CABLE, BATT TOP 4 GA 32' W/AUX RED 1/CS	0 83996 00296 8	14
00297	CABLE, BATT TOP 4 GA 38' W/AUX RED 1/CS	0 83996 00297 5	14
00298	CABLE, BATT TOP 4 GA 43' W/AUX RED 1/CS	0 83996 00298 2	14
00299	CABLE, BATT TOP 4 GA 48' W/AUX RED 1/CS	0 83996 00299 9	14

PART NO.	DESCRIPTION	UNIT UPC	PAGE NO.
00300	CABLE, BATT SIDE 4 GA 65' W/AUX BLK 1/CS	0 83996 00300 2	15
00301	CABLE, BATT GRND STRAP 4 GA 9' 1/CS	0 83996 00301 9	16
00302	CABLE, BATT SIDE 4 GA 25' W/AUX RED 1/CS	0 83996 00302 6	15
00303	CABLE, BATT SIDE 4 GA 35' W/AUX RED 1/CS	0 83996 00303 3	15
00305	CABLE, BATT SIDE 4 GA 45' W/AUX RED 1/CS	0 83996 00305 7	15
00306	CABLE, BATT SIDE 4 GA 55' W/AUX RED 1/CS	0 83996 00306 4	15
00307	CABLE, BATT SIDE 4 GA 78' W/AUX RED 1/CS	0 83996 00307 1	15
00308	CABLE, BATT SIDE 4 GA 25' W/AUX BLK 1/CS	0 83996 00308 8	15
00309	CABLE, BATT SIDE 4 GA 35' W/AUX BLK 1/CS	0 83996 00309 5	15
00310	CABLE, BATT SIDE 4 GA 45' W/AUX BLK 1/CS	0 83996 00310 1	15
00317	KIT, BATT TMNL PROTECTION	0 83996 00317 0	44
00318	FILLER, BATT BOTTLE 2 QT	0 83996 00318 7	51
00320	SPRAY, PROTECTION 10 OZ CAN	0 83996 00320 0	44
00321	SPRAY, BATTERY CLEANER 15 OZ CAN	0 83996 00321 7	44
00322	SPRAY, PROTECTION 3/4 OZ CAN 1/CS	0 83996 00322 4	44
00323	SPRAY, BATTERY CLEANER 1-1/8 OZ CAN 1/CS	0 83996 00323 1	44
00324	BOLT WITH NUT, 5/16 -18 x 1-1/4 2/CS	0 83996 00324 8	31
00325	BOLT, SIDE 3/8 REPL OE SHORT 2/CS	0 83996 00325 5	31
00328	CABLE, BATT TOP 4 GA 56' W/AUX RED 1/CS	0 83996 00328 6	14
00329	CABLE, BATT TOP 4 GA 72' W/AUX RED 1/CS	0 83996 00329 3	14
00330	CABLE, BATT SIDE 4 GA 20' W/AUX RED 1/CS	0 83996 00330 9	15
00331	CABLE, BATT SIDE 4 GA 30' W/AUX RED 1/CS	0 83996 00331 6	15
00332	CABLE, BATT SIDE 4 GA 40' W/AUX RED 1/CS	0 83996 00332 3	15
00333	CABLE, BATT SIDE 4 GA 50' W/AUX RED 1/CS	0 83996 00333 0	15
00335	CLAMP, COPR-PLTD STEEL 200C RED/BLK 10/CD	0 83996 00335 4	11
00336	CLAMP, TUNE-UP/TEST EQUIP 50A RED/BLK 10/CD	0 83996 00336 1	11
00337	CABLE, BOOSTER 4 GA 16' 600P CU B/W BOX DEKA	0 83996 00337 8	7
00339	CABLE, BATT TOP 2 GA 32' W/AUX RED 1/CS	0 83996 00339 2	15
00345	CABLE, BATT SIDE 4 GA 55' W/AUX BLK 1/CS	0 83996 00345 3	15
00350	TERMINAL, TOP POST 1/CS	0 83996 00350 7	26
00351	TERMINAL, SIDE TERM 1/CS	0 83996 00351 4	26
00352	TERMINAL, CHARG POST SIDE POS/NEG 2/CS	0 83996 00352 1	29
00353	TERMINAL, SIDE ADAPTER POS/NEG 2/CS	0 83996 00353 8	30
00354	TERMINAL, MARINE POS/NEG 2/CS	0 83996 00354 5	27
00359	PROTECTORS, TMNL COMBO SIDE & TOP STEP UP 2/CD	0 83996 00359 0	45
00360	CABLE, BATT SIDE 4 GA 78' W/AUX BLK 1/CS	0 83996 00360 6	15
00363	CABLE, BATT SS 2 GA 16' RED 1/CS	0 83996 00363 7	15
00364	CABLE, BATT GRND STRAP 4 GA 14' 1/CS	0 83996 00364 4	16
00365	CABLE, BATT TOP 2 GA 10' RED 1/CS	0 83996 00365 1	15
00366	TERMINAL, TOP POST COMMERCIAL 1/CS	0 83996 00366 8	26
00369	TERMINAL, TOP POST 10/CD	0 83996 00369 9	26
00370	TERMINAL, TOP POST COMMERCIAL 10/CD	0 83996 00370 5	26
00371	CABLE, BATT SS 2 GA 18' RED 1/CS	0 83996 00371 2	15
00372	CABLE, BATT SS 2 GA 32' RED 1/CS	0 83996 00372 9	15
00377	CABLE, BATT SS 2 GA 40' RED 1/CS	0 83996 00377 4	15
00385	TERMINAL, CHARG POST POWR SPORT 25/BAG	0 83996 00385 9	29
00386	TERMINAL, CHARG POST W/EARS 2/CS	0 83996 00386 6	29
00390	WIRE, PRIMARY 18 GA 40' 80 YEL 1/CS	0 83996 00390 3	60
00391	WIRE, PRIMARY 18 GA 40' 80 GRN 1/CS	0 83996 00391 0	60
00392	WIRE, PRIMARY 18 GA 40' 80 WHT 1/CS	0 83996 00392 7	60
00393	WIRE, PRIMARY 18 GA 40' 80 BLU 1/CS	0 83996 00393 4	60
00394	WIRE, PRIMARY 18 GA 40' 80 RED 1/CS	0 83996 00394 1	60
00395	WIRE, PRIMARY 18 GA 40' 80 BLK 1/CS	0 83996 00395 8	60
00396	WIRE, PRIMARY 18 GA 40' 80 BRN 1/CS	0 83996 00396 5	60
00397	WIRE, PRIMARY 18 GA 40' 80 ORG 1/CS	0 83996 00397 2	60
00398	WIRE, PRIMARY 16 GA 28' 80 YEL 1/CS	0 83996 00398 9	61
00399	WIRE, PRIMARY 16 GA 28' 80 GRN 1/CS	0 83996 00399 6	61
00448	CLAMP, JAW TYPE 10 AMP 2/CS	0 83996 00448 1	11
00450	SPRAY, BATTERY CLEANER W/ACID INDICATOR 11 OZ CAN	0 83996 00450 4	44
00472	WIRE, PRIMARY 16 GA 28' 80 WHT 1/CS	0 83996 00472 6	61
00473	WIRE, PRIMARY 16 GA 28' 80 BLU 1/CS	0 83996 00473 3	61
00474	WIRE, PRIMARY 16 GA 28' 80 RED 1/CS	0 83996 00474 0	61
00475	WIRE, PRIMARY 16 GA 28' 80 BLK 1/CS	0 83996 00475 4	61
00476	WIRE, PRIMARY 16 GA 28' 80 BRN 1/CS	0 83996 00476 4	61
00477	WIRE, PRIMARY 16 GA 28' 80 ORG 1/CS	0 83996 00477 1	61
00478	WIRE, PRIMARY 14 GA 20' 80 YEL 1/CS	0 83996 00478 8	61
00479	WIRE, PRIMARY 14 GA 20' 80 GRN 1/CS	0 83996 00479 5	61
00480	WIRE, PRIMARY 14 GA 20' 80 WHT 1/CS	0 83996 00480 1	61



**PRODUCT INDEX**

PART NO.	DESCRIPTION	UNIT UPC	PAGE NO.
00481	WIRE, PRIMARY 14 GA 20' 80 BLU 1/CS	0 83996 00481 8	61
00482	WIRE, PRIMARY 14 GA 20' 80 RED 1/CS	0 83996 00482 5	61
00483	WIRE, PRIMARY 14 GA 20' 80 BLK 1/CS	0 83996 00483 2	61
00484	WIRE, PRIMARY 14 GA 20' 80 BRN 1/CS	0 83996 00484 9	61
00485	WIRE, PRIMARY 14 GA 20' 80 ORG 1/CS	0 83996 00485 6	61
00486	WIRE, PRIMARY 12 GA 12' 80 YEL 1/CS	0 83996 00486 3	61
00487	WIRE, PRIMARY 12 GA 12' 80 GRN 1/CS	0 83996 00487 0	61
00488	WIRE, PRIMARY 12 GA 12' 80 WHT 1/CS	0 83996 00488 7	61
00489	WIRE, PRIMARY 12 GA 12' 80 BLU 1/CS	0 83996 00489 4	61
00490	WIRE, PRIMARY 12 GA 12' 80 RED 1/CS	0 83996 00490 0	61
00491	WIRE, PRIMARY 12 GA 12' 80 BLK 1/CS	0 83996 00491 7	61
00492	WIRE, PRIMARY 12 GA 12' 80 BRN 1/CS	0 83996 00492 4	61
00493	WIRE, PRIMARY 12 GA 12' 80 ORG 1/CS	0 83996 00493 1	61
00494	WIRE, PRIMARY 10 GA 8' 80 YEL 1/CS	0 83996 00494 8	61
00495	WIRE, PRIMARY 10 GA 8' 80 GRN 1/CS	0 83996 00495 5	61
00496	WIRE, PRIMARY 10 GA 8' 80 WHT 1/CS	0 83996 00496 2	61
00497	WIRE, PRIMARY 10 GA 8' 80 BLU 1/CS	0 83996 00497 9	61
00498	WIRE, PRIMARY 10 GA 8' 80 RED 1/CS	0 83996 00498 6	61
00499	WIRE, PRIMARY 10 GA 8' 80 BLK 1/CS	0 83996 00499 3	61
00501	WIRE, PRIMARY 10 GA 8' 80 BRN 1/CS	0 83996 00501 3	61
00502	WIRE, PRIMARY 10 GA 8' 80 ORG 1/CS	0 83996 00502 0	61
00503	CLAMP, JAW TYPE 25 AMP 1/CS	0 83996 00503 7	11
00504	CLAMP, JAW TYPE 50 AMP 2/CS	0 83996 00504 4	11
00505	CLAMP, JAW ALLIGATOR TYPE 10 AMP 2/CS	0 83996 00505 1	11
00512	TERMINAL, TOP POST BRASS 1/CS	0 83996 00512 9	27
00539	LUG, TIN-PLTD COPR 2/0 GA 3/8 STUD 2/CS	0 83996 00539 6	35
00540	LUG, TIN-PLTD COPR 2/0 GA 1/2 STUD 2/CS 10/BOX	0 83996 00540 2	35
00541	BOLT EXTENDERS, BRASS TOP 1/CS	0 83996 00541 9	30
00542	BOLT EXTENDERS, BRASS LONG SIDE 1/CS	0 83996 00542 6	30
00543	BOLT EXTENDERS, BRASS SHORT SIDE 1/CS	0 83996 00543 3	30
00544	LUG, COPR 2 GA 3/8 STUD 2/CS	0 83996 00544 0	35
00545	LUG, COPR 2 GA 1/2 STUD 2/CS	0 83996 00545 7	35
00546	LUG, COPR 2 GA 5/16 STUD 2/CS	0 83996 00546 4	35
00547	LUG, COPR 4 GA 5/16 STUD 2/CS	0 83996 00547 1	35
00548	LUG, COPR 6 GA 1/4 STUD 2/CS	0 83996 00548 8	35
00549	LUG, COPR 6 GA 5/16 STUD 2/CS	0 83996 00549 5	35
00551	LIFTER, GOLF CAR BULK	0 83996 00551 8	51
00574	NUTS, GROUP 31 CLOSED TOP 3/8 STUD 1/CS	0 83996 00574 7	32
00575	TERMINAL, CONVERSION POST GR 31 2/CS	0 83996 00575 4	29
00593	CABLE, BATT DUAL FORD DIESEL 123"	0 83996 00593 8	23
00639	TERMINAL, MARINE BRASS 2/CS	0 83996 00639 3	27
00678	HOLD-DOWN, KIT 1/CS	0 83996 00678 2	48
00679	CABLE, BATT SS LUG 6 GA 19' BLK 1/CS	0 83996 00679 9	14
00680	CABLE, BATT SS LUG 6 GA 43' BLK 1/CS	0 83996 00680 5	14
00681	CABLE, BATT SS LUG 6 GA 49' BLK 1/CS	0 83996 00681 2	14
00682	CLEANER, CUTTING TOOL 3-WAY 1/CS	0 83996 00682 9	52
00684	BOOTS, TMNL STR 4 & 6 GA 3/8 BLK/RED 2/CS	0 83996 00684 3	40
00685	LUG, COPR 4 & 6 GA 3/8 STUD 2/CS	0 83996 00685 0	35
00784	CABLE, BATT TOP 4 GA 10' BLK 1/CS	0 83996 00784 0	14
00785	CABLE, BATT TOP 4 GA 15' BLK 1/CS	0 83996 00785 7	14
00801	CABLE, BATT TOP 4 GA 20' BLK 1/CS	0 83996 00801 4	14
00802	CABLE, BATT TOP 4 GA 25' W/AUX BLK 1/CS	0 83996 00802 1	14
00803	CABLE, BATT TOP 4 GA 32' W/AUX BLK 1/CS	0 83996 00803 8	14
00804	CABLE, BATT TOP 4 GA 38' W/AUX BLK 1/CS	0 83996 00804 5	14
00805	CABLE, BATT TOP 4 GA 43' W/AUX BLK 1/CS	0 83996 00805 2	14
00808	CABLE, BATT TOP 4 GA 48' W/AUX BLK 1/CS	0 83996 00808 3	14
00809	CABLE, BATT TOP 4 GA 56' W/AUX BLK 1/CS	0 83996 00809 0	14
00810	CABLE, BATT TOP 4 GA 72' W/AUX BLK 1/CS	0 83996 00810 6	14
00813	CABLE, BATT SIDE 4 GA 20' W/AUX BLK 1/CS	0 83996 00813 7	15
00875	CABLE, BATT SIDE 4 GA 30' W/AUX BLK 1/CS	0 83996 00875 5	15
00876	CABLE, BATT SIDE 4 GA 40' W/AUX BLK 1/CS	0 83996 00876 2	15
00897	CABLE, BATT SIDE 4 GA 50' W/AUX BLK 1/CS	0 83996 00897 7	15
00907	WIRE, BND PARALLEL 16/4 25' WHT,BRN,YEL,GRN 1/CS	0 83996 00907 3	85
00915	TOOL, CRIMPING/STRIPPING PRIMRY WIRE 1/CS	0 83996 00915 8	53
00916	BOLTS, HOLD-DOWN J TYPE 8' 2/CD	0 83996 00916 5	48
01051	CABLE, BATT GRND STRAP 2 GA 26' BULK	0 83996 01051 2	23
01056	TERMINAL, TOP POST NON LEAD 1/CS	0 83996 01056 7	28
01057	TERMINAL, TOP POST NON LEAD 100/BOX	0 83996 01057 4	28

PART NO.	DESCRIPTION	UNIT UPC	PAGE NO.
01253	PROTECTORS, TMNL COMBO SIDE & TOP 2/CD	0 83996 01253 0	45
01255	WIRE, BOOSTER CABLE 2 GA 50' BLK/RED	0 83996 01255 4	97
01256	WIRE, BOOSTER CABLE 2 GA 100' BLK/RED	0 83996 01256 1	97
01257	WIRE, BOOSTER CABLE 2 GA 500' BLK/RED	0 83996 01257 8	97
01258	WIRE, BOOSTER CABLE 4 GA 50' BLK/WHT	0 83996 01258 5	97
01259	WIRE, BOOSTER CABLE 4 GA 100' BLK/WHT	0 83996 01259 2	97
01265	WIRE, BOOSTER CABLE 4 GA 500' BLK/WHT	0 83996 01265 3	97
01266	WIRE, BOOSTER CABLE 4 GA 500' BLK/RED	0 83996 01266 0	97
01267	WIRE, BOOSTER CABLE 6 GA 50' BLK/ORG	0 83996 01267 7	97
01268	WIRE, BOOSTER CABLE 6 GA 100' BLK/ORG	0 83996 01268 4	97
01269	WIRE, BOOSTER CABLE 8 GA 100' BLK/YEL	0 83996 01269 1	97
01477	TERMINAL, CHARG POST W/EARS GR 31 6/BG	0 83996 01477 0	29
01484	CABLE, GR. 31 STACKABLE 2/0 7' RED	0 83996 01484 8	22
01485	CABLE, GR. 31 STACKABLE 2/0 13' RED	0 83996 01485 5	22
01895	TERM, WIRE END FULLY INSL QUICK DISC MALE 22-18	0 83996 01895 2	38
01896	TERM, WIRE END FULLY INSL QUICK DISC MALE 16-14	0 83996 01896 9	38
01897	TERM, WIRE END FULLY INSL QUICK DISC MALE 12-10	0 83996 01897 6	38
01898	TERM, WIRE END FULLY INSL QUICK DISC FEMALE 22-18	0 83996 01898 3	38
01899	TERM, WIRE END FULLY INSL QUICK DISC FEMALE 16-14	0 83996 01899 0	38
01908	TERM, WIRE END FULLY INSL QUICK DISC FEMALE 12-10	0 83996 01908 9	38
01940	PROTECTORS, TMNL COMBO 25 BLK & 25 RED (50/JAR)	0 83996 01940 9	45
02033	TERMINAL, FLAG TO POST ADAPTERS 2/CS	0 83996 02033 7	30
02252	CLEANER, BATT POST & TMNL BULK	0 83996 02252 2	52
02300	WIRE, PRIMARY 18 GA 45' 80 RED	0 83996 02300 0	60
02301	WIRE, PRIMARY 18 GA 45' 80 WHT	0 83996 02301 7	60
02302	WIRE, PRIMARY 18 GA 45' 80 BLK	0 83996 02302 4	60
02303	WIRE, PRIMARY 18 GA 45' 80 GRN	0 83996 02303 1	60
02304	WIRE, PRIMARY 18 GA 45' 80 YEL	0 83996 02304 8	60
02305	WIRE, PRIMARY 18 GA 45' 80 BRN	0 83996 02305 5	60
02306	WIRE, PRIMARY 18 GA 45' 80 BLU	0 83996 02306 2	60
02307	WIRE, PRIMARY 18 GA 45' 80 ORG	0 83996 02307 9	60
02308	WIRE, PRIMARY 18 GA 100' 80 RED	0 83996 02308 6	60
02309	WIRE, PRIMARY 18 GA 100' 80 WHT	0 83996 02309 3	60
02310	WIRE, PRIMARY 18 GA 100' 80 BLK	0 83996 02310 9	60
02311	WIRE, PRIMARY 18 GA 100' 80 GRN	0 83996 02311 6	60
02312	WIRE, PRIMARY 18 GA 100' 80 YEL	0 83996 02312 3	60
02313	WIRE, PRIMARY 18 GA 100' 80 BRN	0 83996 02313 0	60
02314	WIRE, PRIMARY 18 GA 100' 80 BLU	0 83996 02314 7	60
02315	WIRE, PRIMARY 18 GA 100' 80 ORG	0 83996 02315 4	60
02316	WIRE, PRIMARY 18 GA 100' 105 GRY	0 83996 02316 1	62
02317	WIRE, PRIMARY 18 GA 100' 105 PRP	0 83996 02317 8	62
02318	WIRE, PRIMARY 18 GA 100' 105 DK BLU	0 83996 02318 5	62
02319	WIRE, PRIMARY 18 GA 100' 105 DK GRN	0 83996 02319 2	62
02320	WIRE, PRIMARY 18 GA 100' 105 TAN	0 83996 02320 8	62
02321	WIRE, PRIMARY 18 GA 100' 105 PNK	0 83996 02321 5	62
02322	WIRE, PRIMARY 18 GA 500' 80 RED	0 83996 02322 2	60
02323	WIRE, PRIMARY 18 GA 500' 80 WHT	0 83996 02323 9	60
02324	WIRE, PRIMARY 18 GA 500' 80 BLK	0 83996 02324 6	60
02325	WIRE, PRIMARY 18 GA 500' 80 GRN	0 83996 02325 3	60
02326	WIRE, PRIMARY 18 GA 500' 80 YEL	0 83996 02326 0	60
02327	WIRE, PRIMARY 18 GA 500' 80 BRN	0 83996 02327 7	60
02328	WIRE, PRIMARY 18 GA 500' 80 BLU	0 83996 02328 4	60
02329	WIRE, PRIMARY 18 GA 500' 80 ORG	0 83996 02329 1	60
02330	WIRE, PRIMARY 18 GA 500' 105 GRY	0 83996 02330 7	62
02331	WIRE, PRIMARY 18 GA 500' 105 PRP	0 83996 02331 4	62
02332	WIRE, PRIMARY 18 GA 500' 105 DK BLU	0 83996 02332 1	62
02333	WIRE, PRIMARY 18 GA 500' 105 DK GRN	0 83996 02333 8	62
02334	WIRE, PRIMARY 18 GA 500' 105 TAN	0 83996 02334 5	62
02335	WIRE, PRIMARY 18 GA 500' 105 PNK	0 83996 02335 2	62
02336	WIRE, PRIMARY 18 GA 1000' 80 RED	0 83996 02336 9	60
02337	WIRE, PRIMARY 18 GA 1000' 80 WHT	0 83996 02337 6	60
02338	WIRE, PRIMARY 18 GA 1000' 80 BLK	0 83996 02338 3	60
02339	WIRE, PRIMARY 18 GA 1000' 80 GRN	0 83996 02339 0	60
02340	WIRE, PRIMARY 18 GA 1000' 80 YEL	0 83996 02340 6	60
02341	WIRE, PRIMARY 18 GA 1000' 80 BRN	0 83996 02341 3	60
02342	WIRE, PRIMARY 18 GA 1000' 80 BLU	0 83996 02342 0	60
02343	WIRE, PRIMARY 18 GA 1000' 80 ORG	0 83996 02343 7	60
02344	WIRE, PRIMARY 18 GA 1000' 105 GRY	0 83996 02344 4	62



PRODUCT INDEX

PART NO.	DESCRIPTION	UNIT UPC	PAGE NO.
02345	WIRE, PRIMARY 18 GA 1000' 105 PRP	0 83996 02345 1	62
02346	WIRE, PRIMARY 18 GA 1000' 105 DK BLU	0 83996 02346 8	62
02347	WIRE, PRIMARY 18 GA 1000' 105 DK GRN	0 83996 02347 5	62
02348	WIRE, PRIMARY 18 GA 1000' 105 TAN	0 83996 02348 2	62
02349	WIRE, PRIMARY 18 GA 1000' 105 PNK	0 83996 02349 9	62
02350	WIRE, PRIMARY 16 GA 35' 80 RED	0 83996 02350 5	61
02351	WIRE, PRIMARY 16 GA 35' 80 WHT	0 83996 02351 2	61
02352	WIRE, PRIMARY 16 GA 35' 80 BLK	0 83996 02352 9	61
02353	WIRE, PRIMARY 16 GA 35' 80 GRN	0 83996 02353 6	61
02354	WIRE, PRIMARY 16 GA 35' 80 YEL	0 83996 02354 3	61
02355	WIRE, PRIMARY 16 GA 35' 80 BRN	0 83996 02355 0	61
02356	WIRE, PRIMARY 16 GA 35' 80 BLU	0 83996 02356 7	61
02357	WIRE, PRIMARY 16 GA 35' 80 ORG	0 83996 02357 4	61
02358	WIRE, PRIMARY 16 GA 100' 80 RED	0 83996 02358 1	61
02359	WIRE, PRIMARY 16 GA 100' 80 WHT	0 83996 02359 8	61
02360	WIRE, PRIMARY 16 GA 100' 80 BLK	0 83996 02360 4	61
02361	WIRE, PRIMARY 16 GA 100' 80 GRN	0 83996 02361 1	61
02362	WIRE, PRIMARY 16 GA 100' 80 YEL	0 83996 02362 8	61
02363	WIRE, PRIMARY 16 GA 100' 80 BRN	0 83996 02363 5	61
02364	WIRE, PRIMARY 16 GA 100' 80 BLU	0 83996 02364 2	61
02365	WIRE, PRIMARY 16 GA 100' 80 ORG	0 83996 02365 9	61
02366	WIRE, PRIMARY 16 GA 100' 105 GRY	0 83996 02366 6	62
02367	WIRE, PRIMARY 16 GA 100' 105 PRP	0 83996 02367 3	62
02368	WIRE, PRIMARY 16 GA 100' 105 DK BLU	0 83996 02368 0	62
02369	WIRE, PRIMARY 16 GA 100' 105 DK GRN	0 83996 02369 7	62
02370	WIRE, PRIMARY 16 GA 100' 105 TAN	0 83996 02370 3	62
02371	WIRE, PRIMARY 16 GA 100' 105 PNK	0 83996 02371 0	62
02372	WIRE, PRIMARY 16 GA 500' 80 RED	0 83996 02372 7	61
02373	WIRE, PRIMARY 16 GA 500' 80 WHT	0 83996 02373 4	61
02374	WIRE, PRIMARY 16 GA 500' 80 BLK	0 83996 02374 1	61
02375	WIRE, PRIMARY 16 GA 500' 80 GRN	0 83996 02375 8	61
02376	WIRE, PRIMARY 16 GA 500' 80 YEL	0 83996 02376 5	61
02377	WIRE, PRIMARY 16 GA 500' 80 BRN	0 83996 02377 2	61
02378	WIRE, PRIMARY 16 GA 500' 80 BLU	0 83996 02378 9	61
02379	WIRE, PRIMARY 16 GA 500' 80 ORG	0 83996 02379 6	61
02380	WIRE, PRIMARY 16 GA 500' 105 GRY	0 83996 02380 2	62
02381	WIRE, PRIMARY 16 GA 500' 105 PRP	0 83996 02381 9	62
02382	WIRE, PRIMARY 16 GA 500' 105 DK BLU	0 83996 02382 6	62
02383	WIRE, PRIMARY 16 GA 500' 105 DK GRN	0 83996 02383 3	62
02384	WIRE, PRIMARY 16 GA 500' 105 TAN	0 83996 02384 0	62
02385	WIRE, PRIMARY 16 GA 500' 105 PNK	0 83996 02385 7	62
02386	WIRE, PRIMARY 16 GA 1000' 80 RED	0 83996 02386 4	61
02387	WIRE, PRIMARY 16 GA 1000' 80 WHT	0 83996 02387 1	61
02388	WIRE, PRIMARY 16 GA 1000' 80 BLK	0 83996 02388 8	61
02389	WIRE, PRIMARY 16 GA 1000' 80 GRN	0 83996 02389 5	61
02390	WIRE, PRIMARY 16 GA 1000' 80 YEL	0 83996 02390 1	61
02391	WIRE, PRIMARY 16 GA 1000' 80 BRN	0 83996 02391 8	61
02392	WIRE, PRIMARY 16 GA 1000' 80 BLU	0 83996 02392 5	61
02393	WIRE, PRIMARY 16 GA 1000' 80 ORG	0 83996 02393 2	61
02394	WIRE, PRIMARY 16 GA 1000' 105 GRY	0 83996 02394 9	62
02395	WIRE, PRIMARY 16 GA 1000' 105 PRP	0 83996 02395 6	62
02396	WIRE, PRIMARY 16 GA 1000' 105 DK BLU	0 83996 02396 3	62
02397	WIRE, PRIMARY 16 GA 1000' 105 DK GRN	0 83996 02397 0	62
02398	WIRE, PRIMARY 16 GA 1000' 105 TAN	0 83996 02398 7	62
02399	WIRE, PRIMARY 16 GA 1000' 105 PNK	0 83996 02399 4	62
02400	WIRE, PRIMARY 14 GA 25' 80 RED	0 83996 02400 7	61
02401	WIRE, PRIMARY 14 GA 25' 80 WHT	0 83996 02401 4	61
02402	WIRE, PRIMARY 14 GA 25' 80 BLK	0 83996 02402 1	61
02403	WIRE, PRIMARY 14 GA 25' 80 GRN	0 83996 02403 8	61
02404	WIRE, PRIMARY 14 GA 25' 80 YEL	0 83996 02404 5	61
02405	WIRE, PRIMARY 14 GA 25' 80 BRN	0 83996 02405 2	61
02406	WIRE, PRIMARY 14 GA 25' 80 BLU	0 83996 02406 9	61
02407	WIRE, PRIMARY 14 GA 25' 80 ORG	0 83996 02407 6	61
02408	WIRE, PRIMARY 14 GA 100' 80 RED	0 83996 02408 3	61
02409	WIRE, PRIMARY 14 GA 100' 80 WHT	0 83996 02409 0	61
02410	WIRE, PRIMARY 14 GA 100' 80 BLK	0 83996 02410 6	61
02411	WIRE, PRIMARY 14 GA 100' 80 GRN	0 83996 02411 3	61
02412	WIRE, PRIMARY 14 GA 100' 80 YEL	0 83996 02412 0	61

PART NO.	DESCRIPTION	UNIT UPC	PAGE NO.
02413	WIRE, PRIMARY 14 GA 100' 80 BRN	0 83996 02413 7	61
02414	WIRE, PRIMARY 14 GA 100' 80 BLU	0 83996 02414 4	61
02415	WIRE, PRIMARY 14 GA 100' 80 ORG	0 83996 02415 1	61
02416	WIRE, PRIMARY 14 GA 100' 105 GRY	0 83996 02416 8	63
02417	WIRE, PRIMARY 14 GA 100' 105 PRP	0 83996 02417 5	63
02418	WIRE, PRIMARY 14 GA 100' 105 DK BLU	0 83996 02418 2	63
02419	WIRE, PRIMARY 14 GA 100' 105 DK GRN	0 83996 02419 9	63
02420	WIRE, PRIMARY 14 GA 100' 105 TAN	0 83996 02420 5	63
02421	WIRE, PRIMARY 14 GA 100' 105 PNK	0 83996 02421 2	63
02422	WIRE, PRIMARY 14 GA 500' 80 RED	0 83996 02422 9	61
02423	WIRE, PRIMARY 14 GA 500' 80 WHT	0 83996 02423 6	61
02424	WIRE, PRIMARY 14 GA 500' 80 BLK	0 83996 02424 3	61
02425	WIRE, PRIMARY 14 GA 500' 80 GRN	0 83996 02425 0	61
02426	WIRE, PRIMARY 14 GA 500' 80 YEL	0 83996 02426 7	61
02427	WIRE, PRIMARY 14 GA 500' 80 BRN	0 83996 02427 4	61
02428	WIRE, PRIMARY 14 GA 500' 80 BLU	0 83996 02428 1	61
02429	WIRE, PRIMARY 14 GA 500' 80 ORG	0 83996 02429 8	61
02430	WIRE, PRIMARY 14 GA 500' 105 GRY	0 83996 02430 4	63
02431	WIRE, PRIMARY 14 GA 500' 105 PRP	0 83996 02431 1	63
02432	WIRE, PRIMARY 14 GA 500' 105 DK BLU	0 83996 02432 8	63
02433	WIRE, PRIMARY 14 GA 500' 105 DK GRN	0 83996 02433 5	63
02434	WIRE, PRIMARY 14 GA 500' 105 TAN	0 83996 02434 2	63
02435	WIRE, PRIMARY 14 GA 500' 105 PNK	0 83996 02435 9	63
02436	WIRE, PRIMARY 14 GA 1000' 80 RED	0 83996 02436 6	61
02437	WIRE, PRIMARY 14 GA 1000' 80 WHT	0 83996 02437 3	61
02438	WIRE, PRIMARY 14 GA 1000' 80 BLK	0 83996 02438 0	61
02439	WIRE, PRIMARY 14 GA 1000' 80 GRN	0 83996 02439 7	61
02440	WIRE, PRIMARY 14 GA 1000' 80 YEL	0 83996 02440 3	61
02441	WIRE, PRIMARY 14 GA 1000' 80 BRN	0 83996 02441 0	61
02442	WIRE, PRIMARY 14 GA 1000' 80 BLU	0 83996 02442 7	61
02443	WIRE, PRIMARY 14 GA 1000' 80 ORG	0 83996 02443 4	61
02444	WIRE, PRIMARY 14 GA 1000' 105 GRY	0 83996 02444 1	63
02445	WIRE, PRIMARY 14 GA 1000' 105 PRP	0 83996 02445 8	63
02446	WIRE, PRIMARY 14 GA 1000' 105 DK BLU	0 83996 02446 5	63
02447	WIRE, PRIMARY 14 GA 1000' 105 DK GRN	0 83996 02447 2	63
02448	WIRE, PRIMARY 14 GA 1000' 105 TAN	0 83996 02448 9	63
02449	WIRE, PRIMARY 14 GA 1000' 105 PNK	0 83996 02449 6	63
02450	WIRE, PRIMARY 12 GA 15' 80 RED	0 83996 02450 2	61
02451	WIRE, PRIMARY 12 GA 15' 80 WHT	0 83996 02451 9	61
02452	WIRE, PRIMARY 12 GA 15' 80 BLK	0 83996 02452 6	61
02453	WIRE, PRIMARY 12 GA 15' 80 GRN	0 83996 02453 3	61
02454	WIRE, PRIMARY 12 GA 15' 80 YEL	0 83996 02454 0	61
02455	WIRE, PRIMARY 12 GA 15' 80 BRN	0 83996 02455 7	61
02456	WIRE, PRIMARY 12 GA 15' 80 BLU	0 83996 02456 4	61
02457	WIRE, PRIMARY 12 GA 15' 80 ORG	0 83996 02457 1	61
02458	WIRE, PRIMARY 12 GA 100' 80 RED	0 83996 02458 8	61
02459	WIRE, PRIMARY 12 GA 100' 80 WHT	0 83996 02459 5	61
02460	WIRE, PRIMARY 12 GA 100' 80 BLK	0 83996 02460 1	61
02461	WIRE, PRIMARY 12 GA 100' 80 GRN	0 83996 02461 8	61
02462	WIRE, PRIMARY 12 GA 100' 80 YEL	0 83996 02462 5	61
02463	WIRE, PRIMARY 12 GA 100' 80 BRN	0 83996 02463 2	61
02464	WIRE, PRIMARY 12 GA 100' 80 BLU	0 83996 02464 9	61
02465	WIRE, PRIMARY 12 GA 100' 80 ORG	0 83996 02465 6	61
02466	WIRE, PRIMARY 12 GA 100' 105 GRY	0 83996 02466 3	63
02467	WIRE, PRIMARY 12 GA 100' 105 PRP	0 83996 02467 0	63
02468	WIRE, PRIMARY 12 GA 100' 105 DK BLU	0 83996 02468 7	63
02469	WIRE, PRIMARY 12 GA 100' 105 DK GRN	0 83996 02469 4	63
02470	WIRE, PRIMARY 12 GA 100' 105 TAN	0 83996 02470 0	63
02471	WIRE, PRIMARY 12 GA 100' 105 PNK	0 83996 02471 7	63
02472	WIRE, PRIMARY 12 GA 500' 80 RED	0 83996 02472 4	61
02473	WIRE, PRIMARY 12 GA 500' 80 WHT	0 83996 02473 1	61
02474	WIRE, PRIMARY 12 GA 500' 80 BLK	0 83996 02474 8	61
02475	WIRE, PRIMARY 12 GA 500' 80 GRN	0 83996 02475 5	61
02476	WIRE, PRIMARY 12 GA 500' 80 YEL	0 83996 02476 2	61
02477	WIRE, PRIMARY 12 GA 500' 80 BRN	0 83996 02477 9	61
02478	WIRE, PRIMARY 12 GA 500' 80 BLU	0 83996 02478 6	61
02479	WIRE, PRIMARY 12 GA 500' 80 ORG	0 83996 02479 3	61
02480	WIRE, PRIMARY 12 GA 500' 105 GRY	0 83996 02480 9	63



**PRODUCT INDEX**

PART NO.	DESCRIPTION	UNIT UPC	PAGE NO.
02481	WIRE, PRIMARY 12 GA 500' 105 PRP	0 83996 02481 6	63
02482	WIRE, PRIMARY 12 GA 500' 105 DK BLU	0 83996 02482 3	63
02483	WIRE, PRIMARY 12 GA 500' 105 DK GRN	0 83996 02483 0	63
02484	WIRE, PRIMARY 12 GA 500' 105 TAN	0 83996 02484 7	63
02485	WIRE, PRIMARY 12 GA 500' 105 PINK	0 83996 02485 4	63
02486	WIRE, PRIMARY 12 GA 1000' 80 RED	0 83996 02486 1	61
02487	WIRE, PRIMARY 12 GA 1000' 80 WHT	0 83996 02487 8	61
02488	WIRE, PRIMARY 12 GA 1000' 80 BLK	0 83996 02488 5	61
02489	WIRE, PRIMARY 12 GA 1000' 80 GRN	0 83996 02489 2	61
02490	WIRE, PRIMARY 12 GA 1000' 80 YEL	0 83996 02490 8	61
02491	WIRE, PRIMARY 12 GA 1000' 80 BRN	0 83996 02491 5	61
02492	WIRE, PRIMARY 12 GA 1000' 80 BLU	0 83996 02492 2	61
02493	WIRE, PRIMARY 12 GA 1000' 80 ORG	0 83996 02493 9	61
02494	WIRE, PRIMARY 12 GA 1000' 105 GRY	0 83996 02494 6	63
02495	WIRE, PRIMARY 12 GA 1000' 105 PRP	0 83996 02495 3	63
02496	WIRE, PRIMARY 12 GA 1000' 105 DK BLU	0 83996 02496 0	63
02497	WIRE, PRIMARY 12 GA 1000' 105 DK GRN	0 83996 02497 7	63
02498	WIRE, PRIMARY 12 GA 1000' 105 TAN	0 83996 02498 4	63
02499	WIRE, PRIMARY 12 GA 1000' 105 PINK	0 83996 02499 1	63
02500	WIRE, PRIMARY 10 GA 10' 80 RED	0 83996 02500 4	61
02501	WIRE, PRIMARY 10 GA 10' 80 WHT	0 83996 02501 1	61
02502	WIRE, PRIMARY 10 GA 10' 80 BLK	0 83996 02502 8	61
02503	WIRE, PRIMARY 10 GA 10' 80 GRN	0 83996 02503 5	61
02504	WIRE, PRIMARY 10 GA 10' 80 YEL	0 83996 02504 2	61
02505	WIRE, PRIMARY 10 GA 10' 80 BRN	0 83996 02505 9	61
02506	WIRE, PRIMARY 10 GA 10' 80 BLU	0 83996 02506 6	61
02507	WIRE, PRIMARY 10 GA 10' 80 ORG	0 83996 02507 3	61
02508	WIRE, PRIMARY 10 GA 100' 80 RED	0 83996 02508 0	61
02509	WIRE, PRIMARY 10 GA 100' 80 WHT	0 83996 02509 7	61
02510	WIRE, PRIMARY 10 GA 100' 80 BLK	0 83996 02510 3	61
02511	WIRE, PRIMARY 10 GA 100' 80 GRN	0 83996 02511 0	61
02512	WIRE, PRIMARY 10 GA 100' 80 YEL	0 83996 02512 7	61
02513	WIRE, PRIMARY 10 GA 100' 80 BRN	0 83996 02513 4	61
02514	WIRE, PRIMARY 10 GA 100' 80 BLU	0 83996 02514 1	61
02515	WIRE, PRIMARY 10 GA 100' 80 ORG	0 83996 02515 8	61
02516	WIRE, PRIMARY 10 GA 100' 105 GRY	0 83996 02516 5	63
02517	WIRE, PRIMARY 10 GA 100' 105 PRP	0 83996 02517 2	63
02518	WIRE, PRIMARY 10 GA 100' 105 DK BLU	0 83996 02518 9	63
02519	WIRE, PRIMARY 10 GA 100' 105 DK GRN	0 83996 02519 6	63
02520	WIRE, PRIMARY 10 GA 100' 105 TAN	0 83996 02520 2	63
02521	WIRE, PRIMARY 10 GA 100' 105 PINK	0 83996 02521 9	63
02522	WIRE, PRIMARY 10 GA 500' 80 RED	0 83996 02522 6	61
02523	WIRE, PRIMARY 10 GA 500' 80 WHT	0 83996 02523 3	61
02524	WIRE, PRIMARY 10 GA 500' 80 BLK	0 83996 02524 0	61
02525	WIRE, PRIMARY 10 GA 500' 80 GRN	0 83996 02525 7	61
02526	WIRE, PRIMARY 10 GA 500' 80 YEL	0 83996 02526 4	61
02527	WIRE, PRIMARY 10 GA 500' 80 BRN	0 83996 02527 1	61
02528	WIRE, PRIMARY 10 GA 500' 80 BLU	0 83996 02528 8	61
02529	WIRE, PRIMARY 10 GA 500' 80 ORG	0 83996 02529 5	61
02530	WIRE, PRIMARY 10 GA 500' 105 GRY	0 83996 02530 1	63
02531	WIRE, PRIMARY 10 GA 500' 105 PRP	0 83996 02531 8	63
02532	WIRE, PRIMARY 10 GA 500' 105 DK BLU	0 83996 02532 5	63
02533	WIRE, PRIMARY 10 GA 500' 105 DK GRN	0 83996 02533 2	63
02534	WIRE, PRIMARY 10 GA 500' 105 TAN	0 83996 02534 9	63
02535	WIRE, PRIMARY 10 GA 500' 105 PINK	0 83996 02535 6	63
02536	WIRE, PRIMARY 10 GA 1000' 80 RED	0 83996 02536 3	61
02537	WIRE, PRIMARY 10 GA 1000' 80 WHT	0 83996 02537 0	61
02538	WIRE, PRIMARY 10 GA 1000' 80 BLK	0 83996 02538 7	61
02539	WIRE, PRIMARY 10 GA 1000' 80 GRN	0 83996 02539 4	61
02540	WIRE, PRIMARY 10 GA 1000' 80 YEL	0 83996 02540 0	61
02541	WIRE, PRIMARY 10 GA 1000' 80 BRN	0 83996 02541 7	61
02542	WIRE, PRIMARY 10 GA 1000' 80 BLU	0 83996 02542 4	61
02543	WIRE, PRIMARY 10 GA 1000' 80 ORG	0 83996 02543 1	61
02544	WIRE, PRIMARY 10 GA 1000' 105 GRY	0 83996 02544 8	63
02545	WIRE, PRIMARY 10 GA 1000' 105 PRP	0 83996 02545 5	63
02546	WIRE, PRIMARY 10 GA 1000' 105 DK BLU	0 83996 02546 2	63
02547	WIRE, PRIMARY 10 GA 1000' 105 DK GRN	0 83996 02547 9	63
02548	WIRE, PRIMARY 10 GA 1000' 105 TAN	0 83996 02548 6	63

PART NO.	DESCRIPTION	UNIT UPC	PAGE NO.
02549	WIRE, PRIMARY 10 GA 1000' 105 PINK	0 83996 02549 3	63
02550	WIRE, PRIMARY 8 GA 100' 80 RED	0 83996 02550 9	61
02551	WIRE, PRIMARY 8 GA 100' 80 WHT	0 83996 02551 6	61
02552	WIRE, PRIMARY 8 GA 100' 80 BLK	0 83996 02552 3	61
02553	WIRE, PRIMARY 8 GA 100' 80 GRN	0 83996 02553 0	61
02554	WIRE, PRIMARY 8 GA 500' 80 RED	0 83996 02554 7	61
02555	WIRE, PRIMARY 8 GA 500' 80 WHT	0 83996 02555 4	61
02556	WIRE, PRIMARY 8 GA 500' 80 BLK	0 83996 02556 1	61
02557	WIRE, PRIMARY 8 GA 500' 80 GRN	0 83996 02557 8	61
02558	WIRE, PRIMARY 8 GA 1000' 80 RED	0 83996 02558 5	61
02559	WIRE, PRIMARY 8 GA 1000' 80 WHT	0 83996 02559 2	61
02560	WIRE, PRIMARY 8 GA 1000' 80 BLK	0 83996 02560 8	61
02561	WIRE, PRIMARY 8 GA 1000' 80 GRN	0 83996 02561 5	61
02600	WIRE, PRIMARY SXL 18 GA 100' 125 RED	0 83996 02600 1	66
02601	WIRE, PRIMARY SXL 18 GA 100' 125 WHT	0 83996 02601 8	66
02602	WIRE, PRIMARY SXL 18 GA 100' 125 BLU	0 83996 02602 5	66
02603	WIRE, PRIMARY SXL 18 GA 100' 125 GRN	0 83996 02603 2	66
02604	WIRE, PRIMARY SXL 18 GA 100' 125 YEL	0 83996 02604 9	66
02605	WIRE, PRIMARY SXL 18 GA 100' 125 BRN	0 83996 02605 6	66
02606	WIRE, PRIMARY SXL 18 GA 100' 125 BLK	0 83996 02606 3	66
02607	WIRE, PRIMARY SXL 18 GA 100' 125 ORG	0 83996 02607 0	66
02608	WIRE, PRIMARY SXL 16 GA 100' 125 RED	0 83996 02608 7	66
02609	WIRE, PRIMARY SXL 16 GA 100' 125 WHT	0 83996 02609 4	66
02610	WIRE, PRIMARY SXL 16 GA 100' 125 BLU	0 83996 02610 0	66
02611	WIRE, PRIMARY SXL 16 GA 100' 125 GRN	0 83996 02611 7	66
02612	WIRE, PRIMARY SXL 16 GA 100' 125 YEL	0 83996 02612 4	66
02613	WIRE, PRIMARY SXL 16 GA 100' 125 BRN	0 83996 02613 1	66
02614	WIRE, PRIMARY SXL 16 GA 100' 125 BLK	0 83996 02614 8	66
02615	WIRE, PRIMARY SXL 16 GA 100' 125 ORG	0 83996 02615 5	66
02616	WIRE, PRIMARY SXL 14 GA 100' 125 RED	0 83996 02616 2	67
02617	WIRE, PRIMARY SXL 14 GA 100' 125 WHT	0 83996 02617 6	67
02618	WIRE, PRIMARY SXL 14 GA 100' 125 BLU	0 83996 02618 6	67
02619	WIRE, PRIMARY SXL 14 GA 100' 125 GRN	0 83996 02619 3	67
02620	WIRE, PRIMARY SXL 14 GA 100' 125 YEL	0 83996 02620 9	67
02621	WIRE, PRIMARY SXL 14 GA 100' 125 BRN	0 83996 02621 6	67
02622	WIRE, PRIMARY SXL 14 GA 100' 125 BLK	0 83996 02622 3	67
02623	WIRE, PRIMARY SXL 14 GA 100' 125 ORG	0 83996 02623 0	67
02639	WIRE, PRIMARY SXL 18 GA 1000' 125 RED	0 83996 02639 1	66
02640	WIRE, PRIMARY SXL 18 GA 1000' 125 WHT	0 83996 02640 7	66
02641	WIRE, PRIMARY SXL 18 GA 1000' 125 BLU	0 83996 02641 4	66
02642	WIRE, PRIMARY SXL 18 GA 1000' 125 GRN	0 83996 02642 1	66
02643	WIRE, PRIMARY SXL 18 GA 1000' 125 YEL	0 83996 02643 8	66
02644	WIRE, PRIMARY SXL 18 GA 1000' 125 BRN	0 83996 02644 5	66
02645	WIRE, PRIMARY SXL 18 GA 1000' 125 BLK	0 83996 02645 2	66
02646	WIRE, PRIMARY SXL 18 GA 1000' 125 ORG	0 83996 02646 9	66
02647	WIRE, PRIMARY SXL 16 GA 1000' 125 RED	0 83996 02647 6	66
02648	WIRE, PRIMARY SXL 16 GA 1000' 125 WHT	0 83996 02648 3	66
02649	WIRE, PRIMARY SXL 16 GA 1000' 125 BLU	0 83996 02649 0	66
02650	WIRE, PRIMARY SXL 16 GA 1000' 125 GRN	0 83996 02650 6	66
02651	WIRE, PRIMARY SXL 16 GA 1000' 125 YEL	0 83996 02651 3	66
02652	WIRE, PRIMARY SXL 16 GA 1000' 125 BRN	0 83996 02652 0	66
02653	WIRE, PRIMARY SXL 16 GA 1000' 125 BLK	0 83996 02653 7	66
02654	WIRE, PRIMARY SXL 16 GA 1000' 125 ORG	0 83996 02654 4	66
02655	WIRE, PRIMARY SXL 14 GA 1000' 125 RED	0 83996 02655 8	67
02656	WIRE, PRIMARY SXL 14 GA 1000' 125 WHT	0 83996 02656 8	67
02657	WIRE, PRIMARY SXL 14 GA 1000' 125 BLU	0 83996 02657 5	67
02658	WIRE, PRIMARY SXL 14 GA 1000' 125 GRN	0 83996 02658 9	67
02659	WIRE, PRIMARY SXL 14 GA 1000' 125 YEL	0 83996 02659 9	67
02660	WIRE, PRIMARY SXL 14 GA 1000' 125 BRN	0 83996 02660 5	67
02661	WIRE, PRIMARY SXL 14 GA 1000' 125 BLK	0 83996 02661 2	67
02662	WIRE, PRIMARY SXL 14 GA 1000' 125 ORG	0 83996 02662 9	67
02684	WIRE, PRIMARY 20 GA 100' 80 RED	0 83996 02684 1	60
02685	WIRE, PRIMARY 20 GA 100' 80 WHT	0 83996 02685 8	60
02686	WIRE, PRIMARY 20 GA 100' 80 BLU	0 83996 02686 5	60
02687	WIRE, PRIMARY 20 GA 100' 80 GRN	0 83996 02687 2	60
02688	WIRE, PRIMARY 20 GA 100' 80 YEL	0 83996 02688 9	60
02689	WIRE, PRIMARY 20 GA 100' 80 BRN	0 83996 02689 6	60
02690	WIRE, PRIMARY 20 GA 100' 80 BLK	0 83996 02690 2	60



PRODUCT INDEX

PART NO.	DESCRIPTION	UNIT UPC	PAGE NO.
02691	WIRE, PRIMARY 20 GA 1000' 80 RED	0 83996 02691 9	60
02692	WIRE, PRIMARY 20 GA 1000' 80 WHT	0 83996 02692 6	60
02693	WIRE, PRIMARY 20 GA 1000' 80 BLU	0 83996 02693 3	60
02694	WIRE, PRIMARY 20 GA 1000' 80 BLK	0 83996 02694 0	60
02695	WIRE, PRIMARY 20 GA 1000' 80 GRN	0 83996 02695 7	60
02696	WIRE, PRIMARY 20 GA 1000' 80 YEL	0 83996 02696 4	60
02697	WIRE, PRIMARY 20 GA 1000' 80 BRN	0 83996 02697 1	60
02706	WIRE, PRIMARY 8 GA 100' 105 RED	0 83996 02706 0	63
02707	WIRE, PRIMARY 8 GA 100' 105 WHT	0 83996 02707 7	63
02708	WIRE, PRIMARY 8 GA 100' 105 BLK	0 83996 02708 4	63
02709	WIRE, PRIMARY 8 GA 100' 105 GRN	0 83996 02709 1	63
02710	WIRE, PRIMARY 8 GA 500' 105 RED	0 83996 02710 7	63
02711	WIRE, PRIMARY 8 GA 500' 105 WHT	0 83996 02711 4	63
02712	WIRE, PRIMARY 8 GA 500' 105 BLK	0 83996 02712 1	63
02713	WIRE, PRIMARY 8 GA 500' 105 GRN	0 83996 02713 8	63
02714	WIRE, PRIMARY 8 GA 1000' 105 RED	0 83996 02714 5	63
02715	WIRE, PRIMARY 8 GA 1000' 105 WHT	0 83996 02715 2	63
02716	WIRE, PRIMARY 8 GA 1000' 105 BLK	0 83996 02716 9	63
02717	WIRE, PRIMARY 8 GA 1000' 105 GRN	0 83996 02717 6	63
02718	WIRE, PRIMARY 10 GA 100' 105 RED	0 83996 02718 3	63
02719	WIRE, PRIMARY 10 GA 100' 105 WHT	0 83996 02719 0	63
02720	WIRE, PRIMARY 10 GA 100' 105 BLK	0 83996 02720 6	63
02721	WIRE, PRIMARY 10 GA 100' 105 GRN	0 83996 02721 3	63
02722	WIRE, PRIMARY 10 GA 100' 105 YEL	0 83996 02722 0	63
02723	WIRE, PRIMARY 10 GA 100' 105 BRN	0 83996 02723 7	63
02724	WIRE, PRIMARY 10 GA 100' 105 BLU	0 83996 02724 4	63
02725	WIRE, PRIMARY 10 GA 100' 105 ORG	0 83996 02725 1	63
02726	WIRE, PRIMARY 10 GA 500' 105 RED	0 83996 02726 8	63
02727	WIRE, PRIMARY 10 GA 500' 105 WHT	0 83996 02727 5	63
02728	WIRE, PRIMARY 10 GA 500' 105 BLK	0 83996 02728 2	63
02729	WIRE, PRIMARY 10 GA 500' 105 GRN	0 83996 02729 9	63
02730	WIRE, PRIMARY 10 GA 500' 105 YEL	0 83996 02730 5	63
02731	WIRE, PRIMARY 10 GA 500' 105 BRN	0 83996 02731 2	63
02732	WIRE, PRIMARY 10 GA 500' 105 BLU	0 83996 02732 9	63
02733	WIRE, PRIMARY 10 GA 500' 105 ORG	0 83996 02733 6	63
02734	WIRE, PRIMARY 10 GA 1000' 105 RED	0 83996 02734 3	63
02735	WIRE, PRIMARY 10 GA 1000' 105 WHT	0 83996 02735 0	63
02736	WIRE, PRIMARY 10 GA 1000' 105 BLK	0 83996 02736 7	63
02737	WIRE, PRIMARY 10 GA 1000' 105 GRN	0 83996 02737 4	63
02738	WIRE, PRIMARY 10 GA 1000' 105 YEL	0 83996 02738 1	63
02739	WIRE, PRIMARY 10 GA 1000' 105 BRN	0 83996 02739 8	63
02740	WIRE, PRIMARY 10 GA 1000' 105 BLU	0 83996 02740 4	63
02741	WIRE, PRIMARY 10 GA 1000' 105 ORG	0 83996 02741 1	63
02743	WIRE, PRIMARY 12 GA 100' 105 WHT	0 83996 02743 5	63
02744	WIRE, PRIMARY 12 GA 100' 105 BLK	0 83996 02744 2	63
02745	WIRE, PRIMARY 12 GA 100' 105 GRN	0 83996 02745 9	63
02746	WIRE, PRIMARY 12 GA 100' 105 YEL	0 83996 02746 6	63
02747	WIRE, PRIMARY 12 GA 100' 105 BRN	0 83996 02747 3	63
02748	WIRE, PRIMARY 12 GA 100' 105 BLU	0 83996 02748 0	63
02749	WIRE, PRIMARY 12 GA 100' 105 ORG	0 83996 02749 7	63
02750	WIRE, PRIMARY 12 GA 500' 105 RED	0 83996 02750 3	63
02751	WIRE, PRIMARY 12 GA 500' 105 WHT	0 83996 02751 0	63
02752	WIRE, PRIMARY 12 GA 500' 105 BLK	0 83996 02752 7	63
02753	WIRE, PRIMARY 12 GA 500' 105 GRN	0 83996 02753 4	63
02754	WIRE, PRIMARY 12 GA 500' 105 YEL	0 83996 02754 1	63
02755	WIRE, PRIMARY 12 GA 500' 105 BRN	0 83996 02755 8	63
02756	WIRE, PRIMARY 12 GA 500' 105 BLU	0 83996 02756 5	63
02757	WIRE, PRIMARY 12 GA 500' 105 ORG	0 83996 02757 2	63
02758	WIRE, PRIMARY 12 GA 1000' 105 RED	0 83996 02758 9	63
02759	WIRE, PRIMARY 12 GA 1000' 105 WHT	0 83996 02759 6	63
02760	WIRE, PRIMARY 12 GA 1000' 105 BLK	0 83996 02760 2	63
02761	WIRE, PRIMARY 12 GA 1000' 105 GRN	0 83996 02761 9	63
02762	WIRE, PRIMARY 12 GA 1000' 105 YEL	0 83996 02762 6	63
02763	WIRE, PRIMARY 12 GA 1000' 105 BRN	0 83996 02763 3	63
02764	WIRE, PRIMARY 12 GA 1000' 105 BLU	0 83996 02764 0	63
02765	WIRE, PRIMARY 12 GA 1000' 105 ORG	0 83996 02765 7	63
02766	WIRE, PRIMARY 14 GA 100' 105 RED	0 83996 02766 4	63
02767	WIRE, PRIMARY 14 GA 100' 105 WHT	0 83996 02767 1	63

PART NO.	DESCRIPTION	UNIT UPC	PAGE NO.
02768	WIRE, PRIMARY 14 GA 100' 105 BLK	0 83996 02768 8	63
02769	WIRE, PRIMARY 14 GA 100' 105 GRN	0 83996 02769 5	63
02770	WIRE, PRIMARY 14 GA 100' 105 YEL	0 83996 02770 1	63
02771	WIRE, PRIMARY 14 GA 100' 105 BRN	0 83996 02771 8	63
02772	WIRE, PRIMARY 14 GA 100' 105 BLU	0 83996 02772 5	63
02773	WIRE, PRIMARY 14 GA 100' 105 ORG	0 83996 02773 2	63
02774	WIRE, PRIMARY 14 GA 500' 105 RED	0 83996 02774 9	63
02775	WIRE, PRIMARY 14 GA 500' 105 WHT	0 83996 02775 6	63
02776	WIRE, PRIMARY 14 GA 500' 105 BLK	0 83996 02776 3	63
02777	WIRE, PRIMARY 14 GA 500' 105 GRN	0 83996 02777 0	63
02778	WIRE, PRIMARY 14 GA 500' 105 YEL	0 83996 02778 7	63
02779	WIRE, PRIMARY 14 GA 500' 105 BRN	0 83996 02779 4	63
02780	WIRE, PRIMARY 14 GA 500' 105 BLU	0 83996 02780 0	63
02781	WIRE, PRIMARY 14 GA 500' 105 ORG	0 83996 02781 7	63
02782	WIRE, PRIMARY 14 GA 1000' 105 RED	0 83996 02782 4	63
02783	WIRE, PRIMARY 14 GA 1000' 105 WHT	0 83996 02783 1	63
02784	WIRE, PRIMARY 14 GA 1000' 105 BLK	0 83996 02784 8	63
02785	WIRE, PRIMARY 14 GA 1000' 105 GRN	0 83996 02785 5	63
02786	WIRE, PRIMARY 14 GA 1000' 105 YEL	0 83996 02786 2	63
02787	WIRE, PRIMARY 14 GA 1000' 105 BRN	0 83996 02787 9	63
02788	WIRE, PRIMARY 14 GA 1000' 105 BLU	0 83996 02788 6	63
02789	WIRE, PRIMARY 14 GA 1000' 105 ORG	0 83996 02789 3	63
02790	WIRE, PRIMARY 16 GA 100' 105 RED	0 83996 02790 9	62
02791	WIRE, PRIMARY 16 GA 100' 105 WHT	0 83996 02791 6	62
02792	WIRE, PRIMARY 16 GA 100' 105 BLK	0 83996 02792 3	62
02793	WIRE, PRIMARY 16 GA 100' 105 GRN	0 83996 02793 0	62
02794	WIRE, PRIMARY 16 GA 100' 105 YEL	0 83996 02794 4	62
02795	WIRE, PRIMARY 16 GA 100' 105 BRN	0 83996 02795 1	62
02796	WIRE, PRIMARY 16 GA 100' 105 BLU	0 83996 02796 8	62
02797	WIRE, PRIMARY 16 GA 100' 105 ORG	0 83996 02797 5	62
02798	WIRE, PRIMARY 16 GA 500' 105 RED	0 83996 02798 2	62
02799	WIRE, PRIMARY 16 GA 500' 105 WHT	0 83996 02799 9	62
02800	WIRE, PRIMARY 16 GA 500' 105 BLK	0 83996 02800 5	62
02801	WIRE, PRIMARY 16 GA 500' 105 GRN	0 83996 02801 2	62
02802	WIRE, PRIMARY 16 GA 500' 105 YEL	0 83996 02802 9	62
02803	WIRE, PRIMARY 16 GA 500' 105 BRN	0 83996 02803 6	62
02804	WIRE, PRIMARY 16 GA 500' 105 BLU	0 83996 02804 3	62
02805	WIRE, PRIMARY 16 GA 500' 105 ORG	0 83996 02805 0	62
02806	WIRE, PRIMARY 16 GA 1000' 105 RED	0 83996 02806 7	62
02807	WIRE, PRIMARY 16 GA 1000' 105 WHT	0 83996 02807 4	62
02808	WIRE, PRIMARY 16 GA 1000' 105 BLK	0 83996 02808 1	62
02809	WIRE, PRIMARY 16 GA 1000' 105 GRN	0 83996 02809 8	62
02810	WIRE, PRIMARY 16 GA 1000' 105 YEL	0 83996 02810 5	62
02811	WIRE, PRIMARY 16 GA 1000' 105 BRN	0 83996 02811 2	62
02812	WIRE, PRIMARY 16 GA 1000' 105 BLU	0 83996 02812 9	62
02813	WIRE, PRIMARY 16 GA 1000' 105 ORG	0 83996 02813 6	62
02814	WIRE, PRIMARY 18 GA 100' 105 RED	0 83996 02814 2	62
02815	WIRE, PRIMARY 18 GA 100' 105 WHT	0 83996 02815 9	62
02816	WIRE, PRIMARY 18 GA 100' 105 BLK	0 83996 02816 6	62
02817	WIRE, PRIMARY 18 GA 100' 105 GRN	0 83996 02817 3	62
02818	WIRE, PRIMARY 18 GA 100' 105 YEL	0 83996 02818 0	62
02819	WIRE, PRIMARY 18 GA 100' 105 BRN	0 83996 02819 7	62
02820	WIRE, PRIMARY 18 GA 100' 105 BLU	0 83996 02820 3	62
02821	WIRE, PRIMARY 18 GA 100' 105 ORG	0 83996 02821 0	62
02822	WIRE, PRIMARY 18 GA 500' 105 RED	0 83996 02822 7	62
02823	WIRE, PRIMARY 18 GA 500' 105 WHT	0 83996 02823 4	62
02824	WIRE, PRIMARY 18 GA 500' 105 BLK	0 83996 02824 1	62
02825	WIRE, PRIMARY 18 GA 500' 105 GRN	0 83996 02825 8	62
02826	WIRE, PRIMARY 18 GA 500' 105 YEL	0 83996 02826 5	62
02827	WIRE, PRIMARY 18 GA 500' 105 BRN	0 83996 02827 2	62
02828	WIRE, PRIMARY 18 GA 500' 105 BLU	0 83996 02828 9	62
02829	WIRE, PRIMARY 18 GA 500' 105 ORG	0 83996 02829 6	62
02830	WIRE, PRIMARY 18 GA 1000' 105 RED	0 83996 02830 2	62
02831	WIRE, PRIMARY 18 GA 1000' 105 WHT	0 83996 02831 9	62
02832	WIRE, PRIMARY 18 GA 1000' 105 BLK	0 83996 02832 6	62
02833	WIRE, PRIMARY 18 GA 1000' 105 GRN	0 83996 02833 3	62
02834	WIRE, PRIMARY 18 GA 1000' 105 YEL	0 83996 02834 0	62
02835	WIRE, PRIMARY 18 GA 1000' 105 BRN	0 83996 02835 7	62
02836	WIRE, PRIMARY 20 GA 100' 125 RED	0 83996 02836 4	66





**PRODUCT INDEX**

PART NO.	DESCRIPTION	UNIT UPC	PAGE NO.
02866	WIRE, PRIMARY SKL 20 GA 100' 125 WHT	0 83996 02866 1	66
02867	WIRE, PRIMARY SKL 20 GA 100' 125 BLK	0 83996 02867 8	66
02868	WIRE, PRIMARY SKL 20 GA 100' 125 GRN	0 83996 02868 5	66
02869	WIRE, PRIMARY SKL 20 GA 100' 125 YEL	0 83996 02869 2	66
02870	WIRE, PRIMARY SKL 20 GA 100' 125 BRN	0 83996 02870 8	66
02871	WIRE, PRIMARY SKL 20 GA 100' 125 BLU	0 83996 02871 5	66
02872	WIRE, PRIMARY SKL 20 GA 1000' 125 RED	0 83996 02872 2	66
02873	WIRE, PRIMARY SKL 20 GA 1000' 125 WHT	0 83996 02873 9	66
02874	WIRE, PRIMARY SKL 20 GA 1000' 125 BLK	0 83996 02874 6	66
02875	WIRE, PRIMARY SKL 20 GA 1000' 125 GRN	0 83996 02875 3	66
02876	WIRE, PRIMARY SKL 20 GA 1000' 125 YEL	0 83996 02876 0	66
02877	WIRE, PRIMARY SKL 20 GA 1000' 125 BRN	0 83996 02877 7	66
02878	WIRE, PRIMARY SKL 20 GA 1000' 125 BLU	0 83996 02878 4	66
02879	WIRE, AUTO DUPLEX 14/2 1000' BLK/WHT ECOFLEX	0 83996 02879 1	87
02900	WIRE, BND PARALLEL 14/2 100' RED,BLK	0 83996 02900 2	85
02901	WIRE, BND PARALLEL 14/2 500' RED,BLK	0 83996 02901 9	85
02902	WIRE, BND PARALLEL 14/2 1000' RED,BLK	0 83996 02902 6	85
02903	WIRE, BND PARALLEL 14/3 100' BRN,YEL,GRN	0 83996 02903 3	85
02904	WIRE, BND PARALLEL 14/3 500' BRN,YEL,GRN	0 83996 02904 0	85
02905	WIRE, BND PARALLEL 14/3 1000' BRN,YEL,GRN	0 83996 02905 7	85
02906	WIRE, BND PARALLEL 14/4 100' WHT,BRN,YEL,GRN	0 83996 02906 4	85
02907	WIRE, BND PARALLEL 14/4 500' WHT,BRN,YEL,GRN	0 83996 02907 1	85
02908	WIRE, BND PARALLEL 14/4 1000' WHT,BRN,YEL,GRN	0 83996 02908 8	85
02909	WIRE, BND PARALLEL 16/2 100' RED,BLK	0 83996 02909 5	85
02910	WIRE, BND PARALLEL 16/2 500' RED,BLK	0 83996 02910 1	85
02911	WIRE, BND PARALLEL 16/2 1000' RED,BLK	0 83996 02911 8	85
02912	WIRE, BND PARALLEL 16/3 100' BRN,YEL,GRN	0 83996 02912 5	85
02913	WIRE, BND PARALLEL 16/3 500' BRN,YEL,GRN	0 83996 02913 2	85
02914	WIRE, BND PARALLEL 16/3 1000' BRN,YEL,GRN	0 83996 02914 9	85
02915	WIRE, BND PARALLEL 16/4 100' WHT,BRN,YEL,GRN	0 83996 02915 6	85
02916	WIRE, BND PARALLEL 16/4 500' WHT,BRN,YEL,GRN	0 83996 02916 3	85
02917	WIRE, BND PARALLEL 16/4 1000' WHT,BRN,YEL,GRN	0 83996 02917 0	85
02918	WIRE, BND PARALLEL 18/2 100' RED,BLK	0 83996 02918 7	84
02919	WIRE, BND PARALLEL 18/2 500' RED,BLK	0 83996 02919 4	84
02920	WIRE, BND PARALLEL 18/2 1000' RED,BLK	0 83996 02920 0	84
02921	WIRE, BND PARALLEL 18/3 100' BRN,YEL,GRN	0 83996 02921 7	84
02922	WIRE, BND PARALLEL 18/3 500' BRN,YEL,GRN	0 83996 02922 4	84
02923	WIRE, BND PARALLEL 18/3 1000' BRN,YEL,GRN	0 83996 02923 1	84
02924	WIRE, BND PARALLEL 18/4 100' WHT,BRN,YEL,GRN	0 83996 02924 8	84
02925	WIRE, BND PARALLEL 18/4 500' WHT,BRN,YEL,GRN	0 83996 02925 5	84
02926	WIRE, BND PARALLEL 18/4 1000' WHT,BRN,YEL,GRN	0 83996 02926 2	84
02927	WIRE, BND PARALLEL 16/2 100' YEL,BRN	0 83996 02927 9	85
02928	WIRE, BND PARALLEL 16/2 500' YEL,BRN	0 83996 02928 6	85
02929	WIRE, BND PARALLEL 16/2 1000' YEL,BRN	0 83996 02929 3	85
02930	WIRE, BND PARALLEL 16/2 100' GRN,BRN	0 83996 02930 9	85
02931	WIRE, BND PARALLEL 16/2 500' GRN,BRN	0 83996 02931 6	85
02932	WIRE, BND PARALLEL 16/2 1000' GRN,BRN	0 83996 02932 3	85
02933	WIRE, BND PARALLEL 14/5 100' WHT,BRN,YEL,GRN,BLU	0 83996 02933 0	85
02934	WIRE, BND PARALLEL 14/5 500' WHT,BRN,YEL,GRN, BLU	0 83996 02934 7	85
02935	WIRE, BND PARALLEL 14/5 1000' WHT,BRN,YEL,GRN,BLU	0 83996 02935 4	85
02936	WIRE, BND PARALLEL 14/5 4500' WHT,BRN,YGRN,BLU FR	0 83996 02936 1	85
02937	WIRE, BND PARALLEL 16/5 100' WHT,BRN,YEL,GRN, BLU	0 83996 02937 8	84
02938	WIRE, BND PARALLEL 16/5 500' WHT,BRN,YEL,GRN,BLU	0 83996 02938 5	84
02939	WIRE, BND PARALLEL 16/5 1000' WHT,BRN,YEL,GRN,BLU	0 83996 02939 9	84
02940	WIRE, BND PARALLEL 16/5 6000' WHT,BRN,YGRN,BLU FR	0 83996 02940 8	84
02941	WIRE, BND PARALLEL 18/3-16/1 25' W,BRN,Y,GRN 1/CS	0 83996 02941 5	84
03009	BOX, BATT SMALL MM	0 83996 03009 1	49
03009	BOX, BATT SMALL MM	0 83996 03009 1	100
03025	WIRE, PRIMARY GXL 18 GA 1000' 125 RED	0 83996 03025 1	64
03026	WIRE, PRIMARY GXL 18 GA 1000' 125 WHT	0 83996 03026 8	64
03027	WIRE, PRIMARY GXL 18 GA 1000' 125 BLK	0 83996 03027 5	64
03028	WIRE, PRIMARY GXL 18 GA 1000' 125 GRN	0 83996 03028 2	64
03029	WIRE, PRIMARY GXL 18 GA 1000' 125 YEL	0 83996 03029 9	64
03030	WIRE, PRIMARY GXL 18 GA 1000' 125 BRN	0 83996 03030 5	64
03031	WIRE, PRIMARY GXL 18 GA 1000' 125 BLU	0 83996 03031 2	64
03032	WIRE, PRIMARY GXL 16 GA 1000' 125 RED	0 83996 03032 9	64
03033	WIRE, PRIMARY GXL 16 GA 1000' 125 WHT	0 83996 03033 6	64
03034	WIRE, PRIMARY GXL 16 GA 1000' 125 BLK	0 83996 03034 3	64

PART NO.	DESCRIPTION	UNIT UPC	PAGE NO.
03035	WIRE, PRIMARY GXL 16 GA 1000' 125 GRN	0 83996 03035 0	64
03036	WIRE, PRIMARY GXL 16 GA 1000' 125 YEL	0 83996 03036 7	64
03037	WIRE, PRIMARY GXL 16 GA 1000' 125 BRN	0 83996 03037 4	64
03038	WIRE, PRIMARY GXL 16 GA 1000' 125 BLU	0 83996 03038 1	64
03039	WIRE, PRIMARY GXL 14 GA 1000' 125 RED	0 83996 03039 8	64
03040	WIRE, PRIMARY GXL 14 GA 1000' 125 WHT	0 83996 03040 4	64
03041	WIRE, PRIMARY GXL 14 GA 1000' 125 BLK	0 83996 03041 1	64
03042	WIRE, PRIMARY GXL 14 GA 1000' 125 GRN	0 83996 03042 8	64
03043	WIRE, PRIMARY GXL 14 GA 1000' 125 YEL	0 83996 03043 5	64
03044	WIRE, PRIMARY GXL 14 GA 1000' 125 BRN	0 83996 03044 2	64
03045	WIRE, PRIMARY GXL 14 GA 1000' 125 BLU	0 83996 03045 9	64
03046	WIRE, PRIMARY GXL 12 GA 1000' 125 RED	0 83996 03046 6	65
03047	WIRE, PRIMARY GXL 12 GA 1000' 125 WHT	0 83996 03047 3	65
03048	WIRE, PRIMARY GXL 12 GA 1000' 125 BLK	0 83996 03048 0	65
03049	WIRE, PRIMARY GXL 12 GA 1000' 125 GRN	0 83996 03049 7	65
03050	WIRE, PRIMARY GXL 12 GA 1000' 125 YEL	0 83996 03050 3	65
03051	WIRE, PRIMARY GXL 12 GA 1000' 125 BRN	0 83996 03051 0	65
03052	WIRE, PRIMARY GXL 12 GA 1000' 125 BLU	0 83996 03052 7	65
03053	WIRE, PRIMARY GXL 10 GA 1000' 125 RED	0 83996 03053 4	65
03054	WIRE, PRIMARY GXL 10 GA 1000' 125 WHT	0 83996 03054 1	65
03055	WIRE, PRIMARY GXL 10 GA 1000' 125 BLK	0 83996 03055 5	65
03056	WIRE, PRIMARY GXL 10 GA 1000' 125 GRN	0 83996 03056 5	65
03057	WIRE, PRIMARY GXL 10 GA 1000' 125 YEL	0 83996 03057 2	65
03058	WIRE, PRIMARY GXL 10 GA 1000' 125 BRN	0 83996 03058 9	65
03059	WIRE, PRIMARY GXL 10 GA 1000' 125 BLU	0 83996 03059 6	65
03067	TERMINAL, TOP POST EPOXY COAT RED,BLK 2/CS	0 83996 03067 1	26
03068	CABLE, BATT TOP 2 GA 15' RED 1/CS	0 83996 03068 8	15
03188	BOX, BATT 1U	0 83996 03188 3	49
03189	BOX, BATT LARGE MM	0 83996 03189 0	49
03189	BOX, BATT LARGE MM	0 83996 03189 0	100
03200	WIRE, AUTO DUPLEX 16/2 100' BLK,WHT	0 83996 03200 2	86
03201	WIRE, AUTO DUPLEX 16/2 500' BLK,WHT	0 83996 03201 9	86
03202	WIRE, AUTO DUPLEX 16/2 1000' BLK,WHT	0 83996 03202 6	86
03203	WIRE, AUTO DUPLEX 16/2 100' BLK,RED	0 83996 03203 3	86
03204	WIRE, AUTO DUPLEX 16/2 500' BLK,RED	0 83996 03204 0	86
03205	WIRE, AUTO DUPLEX 16/2 1000' BLK,RED	0 83996 03205 7	86
03206	WIRE, AUTO DUPLEX 14/2 100' BLK,WHT	0 83996 03206 4	87
03207	WIRE, AUTO DUPLEX 14/2 500' BLK,WHT	0 83996 03207 1	87
03208	WIRE, AUTO DUPLEX 14/2 1000' BLK,WHT	0 83996 03208 8	87
03209	WIRE, AUTO DUPLEX 14/2 100' BLK,RED	0 83996 03209 5	87
03210	WIRE, AUTO DUPLEX 14/2 500' BLK,RED	0 83996 03210 1	87
03211	WIRE, AUTO DUPLEX 14/2 1000' BLK,RED	0 83996 03211 8	87
03212	WIRE, AUTO DUPLEX 12/2 100' BLK,WHT	0 83996 03212 5	87
03213	WIRE, AUTO DUPLEX 12/2 500' BLK,WHT	0 83996 03213 2	87
03214	WIRE, AUTO DUPLEX 12/2 1000' BLK,WHT	0 83996 03214 9	87
03215	WIRE, AUTO DUPLEX 12/2 100' BLK,RED	0 83996 03215 6	87
03216	WIRE, AUTO DUPLEX 12/2 500' BLK,RED	0 83996 03216 3	87
03217	WIRE, AUTO DUPLEX 12/2 1000' BLK,RED	0 83996 03217 0	87
03218	WIRE, AUTO DUPLEX 12/2 100' BLK,BLU W/RED JKT	0 83996 03218 7	87
03219	WIRE, AUTO DUPLEX 12/2 500' BLK,BLU W/RED JKT	0 83996 03219 4	87
03220	WIRE, AUTO DUPLEX 12/2 1000' BLK,BLU W/RED JKT	0 83996 03220 0	87
03221	WIRE, AUTO DUPLEX 10/2 100' BLK,WHT	0 83996 03221 7	87
03222	WIRE, AUTO DUPLEX 10/2 500' BLK,WHT	0 83996 03222 4	87
03223	WIRE, AUTO DUPLEX 10/2 1000' BLK,WHT	0 83996 03223 1	87
03224	WIRE, AUTO DUPLEX 8/2 100' BLK,WHT	0 83996 03224 8	87
03225	WIRE, AUTO DUPLEX 8/2 500' BLK,WHT	0 83996 03225 5	87
03226	WIRE, AUTO DUPLEX 8/2 1000' BLK,WHT	0 83996 03226 2	87
03227	WIRE, AUTO TRIPLEX 16/3 100' BLK,GRN,WHT	0 83996 03227 9	88
03228	WIRE, AUTO TRIPLEX 16/3 500' BLK,GRN,WHT	0 83996 03228 6	88
03229	WIRE, AUTO TRIPLEX 16/3 1000' BLK,GRN,WHT	0 83996 03229 3	88
03230	WIRE, AUTO TRIPLEX 14/3 100' BLK,GRN,WHT	0 83996 03230 9	88
03231	WIRE, AUTO TRIPLEX 14/3 500' BLK,GRN,WHT	0 83996 03231 6	88
03232	WIRE, AUTO TRIPLEX 14/3 1000' BLK,GRN,WHT	0 83996 03232 3	88
03233	WIRE, AUTO TRIPLEX 12/3 100' BLK,GRN,WHT	0 83996 03233 0	88
03234	WIRE, AUTO TRIPLEX 12/3 500' BLK,GRN,WHT	0 83996 03234 7	88
03235	WIRE, AUTO TRIPLEX 12/3 1000' BLK,GRN,WHT	0 83996 03235 4	88
03236	WIRE, AUTO TRIPLEX 10/3 100' BLK,GRN,WHT	0 83996 03236 1	88
03237	WIRE, AUTO TRIPLEX 10/3 500' BLK,GRN,WHT	0 83996 03237 8	88



**PRODUCT INDEX**

PART NO.	DESCRIPTION	UNIT UPC	PAGE NO.
03238	WIRE, AUTO TRIPLEX 10/3 1000' BLK,GRN,WHT	0 83996 03238 5	88
03239	WIRE, AUTO QUAD 16/4 100' WHT,GRN,RED,BLK	0 83996 03239 2	89
03240	WIRE, AUTO QUAD 16/4 500' WHT,GRN,RED,BLK	0 83996 03240 8	89
03241	WIRE, AUTO QUAD 16/4 1000' WHT,GRN,RED,BLK	0 83996 03241 5	89
03242	WIRE, AUTO QUAD 14/4 100' WHT,GRN,RED,BLK	0 83996 03242 2	89
03243	WIRE, AUTO QUAD 14/4 500' WHT,GRN,RED,BLK	0 83996 03243 9	89
03244	WIRE, AUTO QUAD 14/4 1000' WHT,GRN,RED,BLK	0 83996 03244 6	89
03245	WIRE, AUTO QUAD 12/4 100' WHT,GRN,RED,BLK	0 83996 03245 3	89
03246	WIRE, AUTO QUAD 12/4 500' WHT,GRN,RED,BLK	0 83996 03246 0	89
03248	WIRE, AUTO QUAD 10/4 100' WHT,GRN,RED,BLK	0 83996 03248 4	89
03251	WIRE, AUTO DUPLEX 12/2 100' BLK,BLU W/GRY,JKT	0 83996 03251 4	87
03252	WIRE, AUTO DUPLEX 12/2 500' BLK,BLU W/GRY,JKT	0 83996 03252 1	87
03253	WIRE, AUTO DUPLEX 18/2 100' BLK,WHT	0 83996 03253 8	86
03254	WIRE, AUTO DUPLEX 18/2 500' BLK,WHT	0 83996 03254 5	86
03255	WIRE, AUTO DUPLEX 18/2 1000' BLK,WHT	0 83996 03255 2	86
03275	LUG, COPR 3/0 GA 3/8 STUD BULK 25/BAG	0 83996 03275 0	35
03276	LUG, COPR 3/0 GA 1/2 STUD BULK 25/BAG	0 83996 03276 7	35
03277	LUG, COPR 4/0 GA 3/8 STUD BULK 25/BAG	0 83996 03277 4	35
03278	LUG, COPR 4/0 GA 1/2 STUD BULK 25/BAG	0 83996 03278 1	35
03327	CABLE, BATT GC "F" 6 GA 9" BLK BULK	0 83996 03327 6	20
03328	CABLE, BATT GC "F" 6 GA 12" BLK BULK	0 83996 03328 3	20
03332	CABLE, BATT GC "H" 6 GA 9" BLK BULK	0 83996 03332 0	20
03333	CABLE, BATT GC "H" 6 GA 12" BLK BULK	0 83996 03333 7	20
03334	CABLE, BATT GC "H" 6 GA 20" BLK BULK	0 83996 03334 4	20
03353	CABLE, SPLICE LUG 4 GA DUAL CABLE MM	0 83996 03353 5	101
03355	TERMINAL, MARINE POS/NEG 2/CS MM	0 83996 03355 9	101
03356	TERMINAL, MARINE UNIV 10/CD MM	0 83996 03356 6	101
03357	NUTS, WING (1) 3/8 -16 & (2) 5/16 -18 SS 3/CS MM	0 83996 03357 3	101
03358	TERMINAL, MARINE EPOXY RED/BLK 2/CS MM	0 83996 03358 0	101
03359	TERMINAL, 3-WAY COMMERCIAL 2/CS MM	0 83996 03359 7	101
03363	TRAY, MARINE BATTERY UNIV GRP 24 MM	0 83996 03363 4	102
03364	TRAY, MARINE BATTERY UNIV GRP 27/31 MM	0 83996 03364 1	102
03393	VOLT METER, APM-3 MM	0 83996 03393 1	102
03393	VOLT METER, APM-3 MM	0 83996 03393 1	102
03394	CABLE, BATT SS TINNED 4 GA 24' BLK 1/CS MM	0 83996 03394 8	100
03395	CABLE, BATT SS TINNED 4 GA 24' RED 1/CS MM	0 83996 03395 5	100
03396	CABLE, BATT SS TINNED 4 GA 36' BLK 1/CS MM	0 83996 03396 2	100
03397	CABLE, BATT SS TINNED 4 GA 36' RED 1/CS MM	0 83996 03397 9	100
03398	CABLE, BATT SS TINNED 2 GA 48' BLK 1/CS MM	0 83996 03398 6	100
03399	CABLE, BATT SS TINNED 2 GA 48' RED 1/CS MM	0 83996 03399 3	100
03401	CABLE, BATT SS TINNED 2 GA 60' RED 1/CS MM	0 83996 03401 3	100
03403	CABLE, BATT SS TINNED 2 GA 72' RED 1/CS MM	0 83996 03403 7	100
03422	TAPE, SELF FUSING AUTO 10' BLK 1/CS MM	0 83996 03422 8	102
03423	TAPE, SELF FUSING AUTO 10' RED 1/CS MM	0 83996 03423 5	102
03501	CARRIER, BATT HEAVY DUTY 1/SLV	0 83996 03501 0	51
03600	WIRE, BOAT CABLE U/L SNGL 10 GA 100' GRN MM	0 83996 03600 0	79
03601	WIRE, BOAT CABLE U/L SNGL 10 GA 100' BLK MM	0 83996 03601 7	79
03602	WIRE, BOAT CABLE U/L SNGL 10 GA 100' WHT MM	0 83996 03602 4	79
03603	WIRE, BOAT CABLE U/L SNGL 10 GA 100' RED MM	0 83996 03603 1	79
03604	WIRE, BOAT CABLE U/L SNGL 10 GA 500' GRN MM	0 83996 03604 8	79
03605	WIRE, BOAT CABLE U/L SNGL 10 GA 500' BLK MM	0 83996 03605 5	79
03606	WIRE, BOAT CABLE U/L SNGL 10 GA 500' WHT MM	0 83996 03606 2	79
03607	WIRE, BOAT CABLE U/L SNGL 10 GA 500' RED MM	0 83996 03607 9	79
03608	WIRE, BOAT CABLE U/L SNGL 10 GA 1000' GRN MM	0 83996 03608 6	79
03609	WIRE, BOAT CABLE U/L SNGL 10 GA 1000' BLK MM	0 83996 03609 3	79
03610	WIRE, BOAT CABLE U/L SNGL 10 GA 1000' WHT MM	0 83996 03610 9	79
03611	WIRE, BOAT CABLE U/L SNGL 10 GA 1000' RED MM	0 83996 03611 6	79
03612	WIRE, BOAT CABLE U/L SNGL 12 GA 100' GRN MM	0 83996 03612 3	79
03613	WIRE, BOAT CABLE U/L SNGL 12 GA 100' BLK MM	0 83996 03613 0	79
03614	WIRE, BOAT CABLE U/L SNGL 12 GA 100' WHT MM	0 83996 03614 7	79
03615	WIRE, BOAT CABLE U/L SNGL 12 GA 100' RED MM	0 83996 03615 4	79
03616	WIRE, BOAT CABLE U/L SNGL 12 GA 500' GRN MM	0 83996 03616 1	79
03617	WIRE, BOAT CABLE U/L SNGL 12 GA 500' BLK MM	0 83996 03617 8	79
03618	WIRE, BOAT CABLE U/L SNGL 12 GA 500' WHT MM	0 83996 03618 5	79
03619	WIRE, BOAT CABLE U/L SNGL 12 GA 500' RED MM	0 83996 03619 2	79
03620	WIRE, BOAT CABLE U/L SNGL 12 GA 1000' GRN MM	0 83996 03620 8	79
03621	WIRE, BOAT CABLE U/L SNGL 12 GA 1000' BLK MM	0 83996 03621 5	79
03622	WIRE, BOAT CABLE U/L SNGL 12 GA 1000' WHT MM	0 83996 03622 2	79

PART NO.	DESCRIPTION	UNIT UPC	PAGE NO.
03623	WIRE, BOAT CABLE U/L SNGL 12 GA 1000' RED MM	0 83996 03623 9	79
03624	WIRE, BOAT CABLE U/L SNGL 14 GA 100' GRN MM	0 83996 03624 6	79
03625	WIRE, BOAT CABLE U/L SNGL 14 GA 100' BLK MM	0 83996 03625 3	79
03626	WIRE, BOAT CABLE U/L SNGL 14 GA 100' WHT MM	0 83996 03626 0	79
03627	WIRE, BOAT CABLE U/L SNGL 14 GA 100' RED MM	0 83996 03627 7	79
03628	WIRE, BOAT CABLE U/L SNGL 14 GA 500' GRN MM	0 83996 03628 4	79
03629	WIRE, BOAT CABLE U/L SNGL 14 GA 500' BLK MM	0 83996 03629 1	79
03630	WIRE, BOAT CABLE U/L SNGL 14 GA 500' WHT MM	0 83996 03630 7	79
03631	WIRE, BOAT CABLE U/L SNGL 14 GA 500' RED MM	0 83996 03631 4	79
03632	WIRE, BOAT CABLE U/L SNGL 14 GA 1000' GRN MM	0 83996 03632 1	79
03633	WIRE, BOAT CABLE U/L SNGL 14 GA 1000' BLK MM	0 83996 03633 8	79
03634	WIRE, BOAT CABLE U/L SNGL 14 GA 1000' WHT MM	0 83996 03634 5	79
03635	WIRE, BOAT CABLE U/L SNGL 14 GA 1000' RED MM	0 83996 03635 2	79
03636	WIRE, BOAT CABLE U/L SNGL 16 GA 100' GRN MM	0 83996 03636 9	78
03637	WIRE, BOAT CABLE U/L SNGL 16 GA 100' BLK MM	0 83996 03637 6	78
03638	WIRE, BOAT CABLE U/L SNGL 16 GA 100' WHT MM	0 83996 03638 3	78
03639	WIRE, BOAT CABLE U/L SNGL 16 GA 100' RED MM	0 83996 03639 0	78
03640	WIRE, BOAT CABLE U/L SNGL 16 GA 500' GRN MM	0 83996 03640 6	78
03641	WIRE, BOAT CABLE U/L SNGL 16 GA 500' BLK MM	0 83996 03641 3	78
03642	WIRE, BOAT CABLE U/L SNGL 16 GA 500' WHT MM	0 83996 03642 0	78
03643	WIRE, BOAT CABLE U/L SNGL 16 GA 500' RED MM	0 83996 03643 7	78
03644	WIRE, BOAT CABLE U/L SNGL 16 GA 1000' GRN MM	0 83996 03644 4	78
03645	WIRE, BOAT CABLE U/L SNGL 16 GA 1000' BLK MM	0 83996 03645 1	78
03646	WIRE, BOAT CABLE U/L SNGL 16 GA 1000' WHT MM	0 83996 03646 8	78
03647	WIRE, BOAT CABLE U/L SNGL 16 GA 1000' RED MM	0 83996 03647 5	78
03667	CABLE, BOOSTER 4 GA 20' 500G CU CON/LUG B/W BOX,DK	0 83996 03667 3	9
03668	BOLT, OE DOUBLE THREADED 2/CS	0 83996 03668 0	31
03669	WIRE, TC 16/4 30' COIL SLV	0 83996 03669 7	90
03670	WIRE, TC 14/7 30' COIL SLV	0 83996 03670 3	92
03674	WIRE, TC 14/2 500' GRN,YEL	0 83996 03674 1	90
03675	WIRE, TC 14/2 3000' GRN,YEL FR	0 83996 03675 8	90
04056	CABLE, BATT TOP 2 GA 20' RED 1/CS	0 83996 04056 4	15
04062	WIRE, BOAT CABLE U/L MULTI 10/2 500' BLK,RED MM	0 83996 04062 5	83
04063	WIRE, BOAT CABLE U/L MULTI 12/2 500' BLK,RED MM	0 83996 04063 2	83
04064	WIRE, BOAT CABLE U/L MULTI 14/2 500' BLK,RED MM	0 83996 04064 9	82
04065	WIRE, BOAT CABLE U/L MULTI 16/2 500' BLK,RED MM	0 83996 04065 6	82
04138	CABLE, BATT TOP 4 GA 10' RED BULK	0 83996 04138 7	17
04139	CABLE, BATT TOP 4 GA 12' RED BULK	0 83996 04139 4	17
04140	CABLE, BATT TOP 4 GA 15' RED BULK	0 83996 04140 0	17
04141	CABLE, BATT TOP 4 GA 20' RED BULK	0 83996 04141 7	17
04142	CABLE, BATT TOP 4 GA 25' RED BULK	0 83996 04142 4	17
04143	CABLE, BATT TOP 4 GA 27' RED BULK	0 83996 04143 1	17
04144	CABLE, BATT TOP 4 GA 32' RED BULK	0 83996 04144 8	17
04145	CABLE, BATT TOP 4 GA 34' RED BULK	0 83996 04145 5	17
04146	CABLE, BATT TOP 4 GA 38' RED BULK	0 83996 04146 2	17
04147	CABLE, BATT TOP 4 GA 43' RED BULK	0 83996 04147 9	17
04148	CABLE, BATT TOP 4 GA 48' RED BULK	0 83996 04148 6	17
04149	CABLE, BATT TOP 4 GA 53' RED BULK	0 83996 04149 3	17
04150	CABLE, BATT TOP 4 GA 56' RED BULK	0 83996 04150 9	17
04151	CABLE, BATT TOP 4 GA 65' RED BULK	0 83996 04151 6	18
04152	CABLE, BATT TOP 4 GA 72' RED BULK	0 83996 04152 3	18
04153	CABLE, BATT TOP 4 GA 10' BLK BULK	0 83996 04153 0	17
04154	CABLE, BATT TOP 4 GA 12' BLK BULK	0 83996 04154 7	17
04155	CABLE, BATT TOP 4 GA 15' BLK BULK	0 83996 04155 4	17
04156	CABLE, BATT TOP 4 GA 20' BLK BULK	0 83996 04156 1	17
04157	CABLE, BATT TOP 4 GA 25' BLK BULK	0 83996 04157 8	17
04158	CABLE, BATT TOP 4 GA 27' BLK BULK	0 83996 04158 5	17
04159	CABLE, BATT TOP 4 GA 32' BLK BULK	0 83996 04159 2	17
04160	CABLE, BATT TOP 4 GA 34' BLK BULK	0 83996 04160 8	17
04161	CABLE, BATT TOP 4 GA 38' BLK BULK	0 83996 04161 5	17
04162	CABLE, BATT TOP 4 GA 43' BLK BULK	0 83996 04162 2	17
04163	CABLE, BATT TOP 4 GA 48' BLK BULK	0 83996 04163 9	17
04164	CABLE, BATT TOP 4 GA 53' BLK BULK	0 83996 04164 6	17
04165	CABLE, BATT TOP 4 GA 56' BLK BULK	0 83996 04165 3	17
04166	CABLE, BATT TOP 4 GA 65' BLK BULK	0 83996 04166 0	18
04167	CABLE, BATT TOP 4 GA 72' BLK BULK	0 83996 04167 7	18
04168	CABLE, BATT TOP 4 GA 10' W/AUX RED BULK	0 83996 04168 4	17
04169	CABLE, BATT TOP 4 GA 12' W/AUX RED BULK	0 83996 04169 1	17



**PRODUCT INDEX**

PART NO.	DESCRIPTION	UNIT UPC	PAGE NO.
04170	CABLE, BATT TOP 4 GA 15" W/AUX RED BULK	0 83996 04170 7	17
04171	CABLE, BATT TOP 4 GA 20" W/AUX RED BULK	0 83996 04171 4	17
04172	CABLE, BATT TOP 4 GA 25" W/AUX RED BULK	0 83996 04172 1	17
04173	CABLE, BATT TOP 4 GA 27" W/AUX RED BULK	0 83996 04173 8	17
04174	CABLE, BATT TOP 4 GA 32" W/AUX RED BULK	0 83996 04174 5	17
04175	CABLE, BATT TOP 4 GA 34" W/AUX RED BULK	0 83996 04175 2	17
04176	CABLE, BATT TOP 4 GA 38" W/AUX RED BULK	0 83996 04176 9	17
04177	CABLE, BATT TOP 4 GA 43" W/AUX RED BULK	0 83996 04177 6	17
04178	CABLE, BATT TOP 4 GA 48" W/AUX RED BULK	0 83996 04178 3	17
04179	CABLE, BATT TOP 4 GA 53" W/AUX RED BULK	0 83996 04179 0	17
04180	CABLE, BATT TOP 4 GA 56" W/AUX RED BULK	0 83996 04180 6	18
04181	CABLE, BATT TOP 4 GA 65" W/AUX RED BULK	0 83996 04181 3	18
04182	CABLE, BATT TOP 4 GA 72" W/AUX RED BULK	0 83996 04182 0	18
04183	CABLE, BATT TOP 4 GA 78" W/AUX RED BULK	0 83996 04183 7	18
04184	CABLE, BATT TOP 4 GA 10" W/AUX BLK BULK	0 83996 04184 4	17
04185	CABLE, BATT TOP 4 GA 12" W/AUX BLK BULK	0 83996 04185 1	17
04186	CABLE, BATT TOP 4 GA 15" W/AUX BLK BULK	0 83996 04186 8	17
04187	CABLE, BATT TOP 4 GA 20" W/AUX BLK BULK	0 83996 04187 5	17
04188	CABLE, BATT TOP 4 GA 25" W/AUX BLK BULK	0 83996 04188 2	17
04189	CABLE, BATT TOP 4 GA 27" W/AUX BLK BULK	0 83996 04189 9	17
04190	CABLE, BATT TOP 4 GA 32" W/AUX BLK BULK	0 83996 04190 5	17
04191	CABLE, BATT TOP 4 GA 34" W/AUX BLK BULK	0 83996 04191 2	17
04192	CABLE, BATT TOP 4 GA 38" W/AUX BLK BULK	0 83996 04192 9	17
04193	CABLE, BATT TOP 4 GA 43" W/AUX BLK BULK	0 83996 04193 6	17
04194	CABLE, BATT TOP 4 GA 48" W/AUX BLK BULK	0 83996 04194 3	17
04195	CABLE, BATT TOP 4 GA 53" W/AUX BLK BULK	0 83996 04195 0	17
04196	CABLE, BATT TOP 4 GA 56" W/AUX BLK BULK	0 83996 04196 7	18
04197	CABLE, BATT TOP 4 GA 65" W/AUX BLK BULK	0 83996 04197 4	18
04199	CABLE, BATT TOP 4 GA 78" W/AUX BLK BULK	0 83996 04199 8	18
04200	CABLE, BATT TOP 2 GA 10" RED BULK	0 83996 04200 1	19
04201	CABLE, BATT TOP 2 GA 15" RED BULK	0 83996 04201 8	19
04202	CABLE, BATT TOP 2 GA 20" RED BULK	0 83996 04202 5	19
04203	CABLE, BATT TOP 2 GA 23" RED BULK	0 83996 04203 2	19
04204	CABLE, BATT TOP 2 GA 27" RED BULK	0 83996 04204 9	19
04205	CABLE, BATT TOP 2 GA 32" RED BULK	0 83996 04205 6	19
04206	CABLE, BATT TOP 2 GA 34" RED BULK	0 83996 04206 3	19
04207	CABLE, BATT TOP 2 GA 38" RED BULK	0 83996 04207 0	19
04208	CABLE, BATT TOP 2 GA 43" RED BULK	0 83996 04208 7	19
04209	CABLE, BATT TOP 2 GA 48" RED BULK	0 83996 04209 4	19
04210	CABLE, BATT TOP 2 GA 53" RED BULK	0 83996 04210 0	19
04211	CABLE, BATT TOP 2 GA 58" RED BULK	0 83996 04211 7	19
04212	CABLE, BATT TOP 2 GA 65" RED BULK	0 83996 04212 4	19
04213	CABLE, BATT TOP 2 GA 72" RED BULK	0 83996 04213 1	19
04214	CABLE, BATT TOP 2 GA 10" BLK BULK	0 83996 04214 8	19
04215	CABLE, BATT TOP 2 GA 15" BLK BULK	0 83996 04215 5	19
04216	CABLE, BATT TOP 2 GA 20" BLK BULK	0 83996 04216 2	19
04217	CABLE, BATT TOP 2 GA 23" BLK BULK	0 83996 04217 9	19
04218	CABLE, BATT TOP 2 GA 27" BLK BULK	0 83996 04218 6	19
04219	CABLE, BATT TOP 2 GA 32" BLK BULK	0 83996 04219 3	19
04220	CABLE, BATT TOP 2 GA 34" BLK BULK	0 83996 04220 9	19
04221	CABLE, BATT TOP 2 GA 38" BLK BULK	0 83996 04221 6	19
04222	CABLE, BATT TOP 2 GA 43" BLK BULK	0 83996 04222 3	19
04223	CABLE, BATT TOP 2 GA 48" BLK BULK	0 83996 04223 0	19
04224	CABLE, BATT TOP 2 GA 53" BLK BULK	0 83996 04224 7	19
04225	CABLE, BATT TOP 2 GA 58" BLK BULK	0 83996 04225 4	19
04226	CABLE, BATT TOP 2 GA 65" BLK BULK	0 83996 04226 1	19
04227	CABLE, BATT TOP 2 GA 72" BLK BULK	0 83996 04227 8	19
04228	CABLE, BATT TOP 2 GA 10" W/AUX RED BULK	0 83996 04228 5	19
04229	CABLE, BATT TOP 2 GA 15" W/AUX RED BULK	0 83996 04229 2	19
04230	CABLE, BATT TOP 2 GA 20" W/AUX RED BULK	0 83996 04230 8	19
04231	CABLE, BATT TOP 2 GA 25" W/AUX RED BULK	0 83996 04231 5	19
04233	CABLE, BATT TOP 2 GA 32" W/AUX RED BULK	0 83996 04233 9	19
04235	CABLE, BATT TOP 2 GA 38" W/AUX RED BULK	0 83996 04235 3	19
04236	CABLE, BATT TOP 2 GA 43" W/AUX RED BULK	0 83996 04236 0	19
04237	CABLE, BATT TOP 2 GA 48" W/AUX RED BULK	0 83996 04237 7	19
04239	CABLE, BATT TOP 2 GA 58" W/AUX RED BULK	0 83996 04239 1	19
04240	CABLE, BATT TOP 2 GA 65" W/AUX RED BULK	0 83996 04240 7	19
04241	CABLE, BATT TOP 2 GA 72" W/AUX RED BULK	0 83996 04241 4	19

PART NO.	DESCRIPTION	UNIT UPC	PAGE NO.
04242	CABLE, BATT TOP 2 GA 10" W/AUX BLK BULK	0 83996 04242 1	19
04243	CABLE, BATT TOP 2 GA 15" W/AUX BLK BULK	0 83996 04243 8	19
04244	CABLE, BATT TOP 2 GA 20" W/AUX BLK BULK	0 83996 04244 5	19
04245	CABLE, BATT TOP 2 GA 25" W/AUX BLK BULK	0 83996 04245 2	19
04247	CABLE, BATT TOP 2 GA 32" W/AUX BLK BULK	0 83996 04247 6	19
04249	CABLE, BATT TOP 2 GA 38" W/AUX BLK BULK	0 83996 04249 0	19
04250	CABLE, BATT TOP 2 GA 43" W/AUX BLK BULK	0 83996 04250 6	19
04251	CABLE, BATT TOP 2 GA 48" W/AUX BLK BULK	0 83996 04251 3	19
04253	CABLE, BATT TOP 2 GA 58" W/AUX BLK BULK	0 83996 04253 7	19
04254	CABLE, BATT TOP 2 GA 65" W/AUX BLK BULK	0 83996 04254 4	19
04255	CABLE, BATT TOP 2 GA 72" W/AUX BLK BULK	0 83996 04255 1	19
04256	CABLE, BATT SIDE 4 GA 20" W/AUX RED BULK	0 83996 04256 8	18
04257	CABLE, BATT SIDE 4 GA 25" W/AUX RED BULK	0 83996 04257 5	18
04258	CABLE, BATT SIDE 4 GA 30" W/AUX RED BULK	0 83996 04258 2	18
04259	CABLE, BATT SIDE 4 GA 35" W/AUX RED BULK	0 83996 04259 9	18
04260	CABLE, BATT SIDE 4 GA 40" W/AUX RED BULK	0 83996 04260 5	18
04261	CABLE, BATT SIDE 4 GA 45" W/AUX RED BULK	0 83996 04261 2	18
04262	CABLE, BATT SIDE 4 GA 50" W/AUX RED BULK	0 83996 04262 9	18
04263	CABLE, BATT SIDE 4 GA 55" W/AUX RED BULK	0 83996 04263 6	18
04264	CABLE, BATT SIDE 4 GA 65" W/AUX RED BULK	0 83996 04264 3	18
04266	CABLE, BATT SIDE 4 GA 20" W/AUX BLK BULK	0 83996 04266 7	18
04267	CABLE, BATT SIDE 4 GA 25" W/AUX BLK BULK	0 83996 04267 4	18
04268	CABLE, BATT SIDE 4 GA 30" W/AUX BLK BULK	0 83996 04268 1	18
04269	CABLE, BATT SIDE 4 GA 35" W/AUX BLK BULK	0 83996 04269 8	18
04270	CABLE, BATT SIDE 4 GA 40" W/AUX BLK BULK	0 83996 04270 4	18
04271	CABLE, BATT SIDE 4 GA 45" W/AUX BLK BULK	0 83996 04271 1	18
04272	CABLE, BATT SIDE 4 GA 50" W/AUX BLK BULK	0 83996 04272 8	18
04273	CABLE, BATT SIDE 4 GA 55" W/AUX BLK BULK	0 83996 04273 5	18
04274	CABLE, BATT SIDE 4 GA 65" W/AUX BLK BULK	0 83996 04274 2	18
04276	CABLE, BATT SS 4 GA 16" RED BULK	0 83996 04276 6	18
04277	CABLE, BATT SS 4 GA 18" RED BULK	0 83996 04277 3	18
04278	CABLE, BATT SS 4 GA 24" RED BULK	0 83996 04278 0	18
04279	CABLE, BATT SS 4 GA 32" RED BULK	0 83996 04279 7	18
04280	CABLE, BATT SS 4 GA 40" RED BULK	0 83996 04280 3	18
04281	CABLE, BATT SS 4 GA 49" RED BULK	0 83996 04281 0	18
04282	CABLE, BATT SS 4 GA 16" BLK BULK	0 83996 04282 7	18
04283	CABLE, BATT SS 4 GA 18" BLK BULK	0 83996 04283 4	18
04284	CABLE, BATT SS 4 GA 24" BLK BULK	0 83996 04284 1	18
04285	CABLE, BATT SS 4 GA 32" BLK BULK	0 83996 04285 8	18
04286	CABLE, BATT SS 4 GA 40" BLK BULK	0 83996 04286 5	18
04287	CABLE, BATT SS 4 GA 49" BLK BULK	0 83996 04287 2	18
04288	CABLE, BATT SS 2 GA 16" RED BULK	0 83996 04288 9	19
04289	CABLE, BATT SS 2 GA 18" RED BULK	0 83996 04289 6	19
04290	CABLE, BATT SS 2 GA 24" RED BULK	0 83996 04290 2	19
04291	CABLE, BATT SS 2 GA 32" RED BULK	0 83996 04291 9	19
04292	CABLE, BATT SS 2 GA 40" RED BULK	0 83996 04292 6	19
04293	CABLE, BATT SS 2 GA 49" RED BULK	0 83996 04293 3	19
04294	CABLE, BATT SS 2 GA 16" BLK BULK	0 83996 04294 0	19
04295	CABLE, BATT SS 2 GA 18" BLK BULK	0 83996 04295 7	19
04296	CABLE, BATT SS 2 GA 24" BLK BULK	0 83996 04296 4	19
04297	CABLE, BATT SS 2 GA 32" BLK BULK	0 83996 04297 1	19
04298	CABLE, BATT SS 2 GA 40" BLK BULK	0 83996 04298 8	19
04299	CABLE, BATT SS 2 GA 49" BLK BULK	0 83996 04299 5	19
04300	CABLE, BATT JMPR ANGLE 1 GA 8" BLK BULK	0 83996 04300 8	20
04301	CABLE, BATT JMPR ANGLE 1 GA 12" BLK BULK	0 83996 04301 5	20
04302	CABLE, BATT JMPR STR 1 GA 8" BLK BULK	0 83996 04302 2	20
04303	CABLE, BATT JMPR STR 1 GA 12" BLK BULK	0 83996 04303 9	20
04304	CABLE, BATT JMPR SAME 1 GA 8" BLK BULK	0 83996 04304 6	20
04305	CABLE, BATT JMPR SAME 1 GA 12" BLK BULK	0 83996 04305 3	20
04306	CABLE, BATT JMPR ANGLE 2/0 8" BLK BULK	0 83996 04306 0	20
04307	CABLE, BATT JMPR ANGLE 2/0 12" BLK BULK	0 83996 04307 7	20
04308	CABLE, BATT JMPR ANGLE 2/0 19" BLK BULK	0 83996 04308 4	20
04309	CABLE, BATT JMPR STR 2/0 8" BLK BULK	0 83996 04309 1	20
04310	CABLE, BATT JMPR STR 2/0 12" BLK BULK	0 83996 04310 7	20
04311	CABLE, BATT JMPR STR 2/0 19" BLK BULK	0 83996 04311 4	20
04312	CABLE, BATT JMPR SAME 2/0 8" BLK BULK	0 83996 04312 1	20
04313	CABLE, BATT JMPR SAME 2/0 12" BLK BULK	0 83996 04313 8	20
04314	CABLE, BATT JMPR SAME 2/0 19" BLK BULK	0 83996 04314 5	20



**PRODUCT INDEX**

PART NO.	DESCRIPTION	UNIT UPC	PAGE NO.
04315	CABLE, GR. 31 STACKABLE 2/0 7' BLK	0 83996 04315 2	22
04316	CABLE, GR. 31 STACKABLE 2/0 13' BLK	0 83996 04316 9	22
04317	CABLE, GR. 31 2 BATTERY 7' RED	0 83996 04317 6	22
04318	CABLE, GR. 31 2 BATTERY 7' BLK	0 83996 04318 3	22
04319	CABLE, GR. 31 3 BATTERY 14' RED	0 83996 04319 0	22
04320	CABLE, GR. 31 3 BATTERY 14' BLK	0 83996 04320 6	22
04321	CABLE, BATT TOP POST FLEET 2/0 12' BLK	0 83996 04321 3	23
04322	CABLE, BATT TOP POST FLEET 2/0 24' BLK	0 83996 04322 0	23
04323	CABLE, BATT TOP POST FLEET 2/0 36' BLK	0 83996 04323 7	23
04324	CABLE, BATT TOP POST FLEET 2/0 48' BLK	0 83996 04324 4	23
04325	CABLE, BATT TOP POST FLEET 2/0 60' BLK	0 83996 04325 1	23
04326	CABLE, BATT TOP POST FLEET 2/0 72' BLK	0 83996 04326 8	23
04327	CABLE, BATT GC "F" 6 GA 9' RED BULK	0 83996 04327 5	20
04328	CABLE, BATT GC "F" 6 GA 12' RED BULK	0 83996 04328 2	20
04332	CABLE, BATT GC "H" 6 GA 9' RED BULK	0 83996 04332 9	20
04333	CABLE, BATT GC "H" 6 GA 12' RED BULK	0 83996 04333 6	20
04334	CABLE, BATT GC "H" 6 GA 20' RED BULK	0 83996 04334 3	20
04335	CABLE, BATT JMPR CUP 12 GA 15' BLK BULK	0 83996 04335 0	23
04337	CABLE, BATT GRND STRAP 2 GA 7' BULK	0 83996 04337 4	23
04338	CABLE, BATT GRND STRAP 2 GA 9' BULK	0 83996 04338 1	23
04339	CABLE, BATT GRND STRAP 2 GA 11' BULK	0 83996 04339 8	23
04340	CABLE, BATT GRND STRAP 2 GA 14' BULK	0 83996 04340 4	23
04341	CABLE, BATT GRND STRAP 2 GA 16' BULK	0 83996 04341 1	23
04342	CABLE, BATT GRND STRAP 2 GA 19' BULK	0 83996 04342 8	23
04343	CABLE, BATT GRND STRAP 2 GA 24' BULK	0 83996 04343 5	23
04344	CABLE, BATT GRND STRAP 2 GA 27' BULK	0 83996 04344 2	23
04345	CABLE, BATT GRND STRAP 4 GA 7' BULK	0 83996 04345 9	23
04346	CABLE, BATT GRND STRAP 4 GA 9' BULK	0 83996 04346 6	23
04347	CABLE, BATT GRND STRAP 4 GA 11' BULK	0 83996 04347 3	23
04348	CABLE, BATT GRND STRAP 4 GA 14' BULK	0 83996 04348 0	23
04349	CABLE, BATT GRND STRAP 4 GA 16' BULK	0 83996 04349 7	23
04350	CABLE, BATT GRND STRAP 4 GA 19' BULK	0 83996 04350 3	23
04351	CABLE, BATT GRND STRAP 4 GA 24' BULK	0 83996 04351 0	23
04352	CABLE, BATT GRND STRAP 4 GA 27' BULK	0 83996 04352 7	23
04353	CABLE, BATT BONDING STRAP 4 GA 8' BULK	0 83996 04353 4	23
04354	CABLE, BATT BONDING STRAP 4 GA 12' BULK	0 83996 04354 1	23
04357	CABLE, BATT DUAL FORD DIESEL 116"	0 83996 04357 2	23
04362	CABLE, GR. 31 OVERMOLD 2 BATTERY 7' RED	0 83996 04362 6	22
04363	CABLE, GR. 31 OVERMOLD 2 BATTERY 7' BLK	0 83996 04363 3	22
04364	CABLE, GR. 31 OVERMOLD 3 BATTERY 14' RED	0 83996 04364 0	22
04365	CABLE, GR. 31 OVERMOLD 3 BATTERY 14' BLK	0 83996 04365 7	22
04366	TAPE, SELF FUSING AUTO 2 BLK & 2 RED/BOX	0 83996 04366 4	43
04367	TAPE, SELF FUSING AUTO 10' BLK 1/CS	0 83996 04367 1	43
04368	TAPE, SELF FUSING AUTO 10' RED 1/CS	0 83996 04368 8	43
04369	CABLE, BOOSTER 2 GA 20' 600P C/A B/R BOX DEKA	0 83996 04369 5	8
04370	CABLE, BOOSTER 4 GA 20' 500G C/A B/W BOX DEKA	0 83996 04370 1	8
04376	WIRE, BOAT CABLE UL SNGL 4/0 GA 100' BLK MM	0 83996 04376 3	81
04377	WIRE, BOAT CABLE UL SNGL 4/0 GA 100' RED MM	0 83996 04377 0	81
04378	WIRE, BOAT CABLE UL SNGL 4/0 GA 500' BLK MM	0 83996 04378 7	81
04379	WIRE, BOAT CABLE UL SNGL 4/0 GA 500' RED MM	0 83996 04379 4	81
04380	WIRE, BOAT CABLE UL SNGL 3/0 GA 100' RED MM	0 83996 04380 0	81
04381	WIRE, BOAT CABLE UL SNGL 3/0 GA 100' BLK MM	0 83996 04381 7	81
04382	WIRE, BOAT CABLE UL SNGL 3/0 GA 500' RED MM	0 83996 04382 4	81
04384	WIRE, BOAT CABLE UL SNGL 1/0 GA 100' BLK MM	0 83996 04384 8	81
04385	WIRE, BOAT CABLE UL SNGL 1/0 GA 100' RED MM	0 83996 04385 5	81
04386	WIRE, BOAT CABLE UL SNGL 1/0 GA 500' BLK MM	0 83996 04386 2	81
04387	WIRE, BOAT CABLE UL SNGL 1/0 GA 500' RED MM	0 83996 04387 9	81
04389	WIRE, BOAT CABLE UL SNGL 1 GA 100' RED MM	0 83996 04389 3	81
04390	WIRE, BOAT CABLE UL SNGL 1 GA 100' BLK MM	0 83996 04390 9	81
04391	WIRE, BOAT CABLE UL SNGL 1 GA 500' RED MM	0 83996 04391 6	81
04392	WIRE, BOAT CABLE UL SNGL 1 GA 500' BLK MM	0 83996 04392 3	81
04393	WIRE, CABLE SGX 2/0 GA 100' BLK	0 83996 04393 0	71
04394	WIRE, CABLE SGX 2/0 GA 500' BLK	0 83996 04394 7	71
04395	WIRE, CABLE SGX 1/0 GA 100' RED	0 83996 04395 4	71
04396	WIRE, CABLE SGX 1/0 GA 500' RED	0 83996 04396 1	71
04397	WIRE, CABLE SGX 2 GA 100' RED	0 83996 04397 8	70
04398	WIRE, CABLE SGX 2 GA 500' RED	0 83996 04398 5	70
04399	WIRE, BOAT CABLE UL SNGL 4/0 GA 100' YEL MM	0 83996 04399 2	81

PART NO.	DESCRIPTION	UNIT UPC	PAGE NO.
04400	WIRE, BOAT CABLE UL SNGL 4/0 GA 500' YEL	0 83996 04400 5	81
04401	WIRE, BOAT CABLE UL SNGL 3/0 GA 100' YEL MM	0 83996 04401 2	81
04402	WIRE, BOAT CABLE UL SNGL 3/0 GA 500' YEL MM	0 83996 04402 9	81
04403	WIRE, BOAT CABLE UL SNGL 1/0 GA 100' YEL MM	0 83996 04403 6	81
04404	WIRE, BOAT CABLE UL SNGL 1/0 GA 500' YEL MM	0 83996 04404 3	81
04405	WIRE, BOAT CABLE UL SNGL 1 GA 100' YEL MM	0 83996 04405 0	81
04406	WIRE, BOAT CABLE UL SNGL 1 GA 500' YEL MM	0 83996 04406 7	81
04424	CABLE, BOOSTER 1/0 GA 20' 600E WELD B/R CASE DEKA	0 83996 04424 1	6
04500	WIRE, BOAT CABLE UL MULTI 10/2 100' BLK/WHT MM	0 83996 04500 2	83
04501	WIRE, BOAT CABLE UL MULTI 10/2 500' BLK/WHT MM	0 83996 04501 9	83
04502	WIRE, BOAT CABLE UL MULTI 10/2 1000' BLK/WHT MM	0 83996 04502 6	83
04503	WIRE, BOAT CABLE UL MULTI 12/2 100' BLK/WHT MM	0 83996 04503 3	83
04504	WIRE, BOAT CABLE UL MULTI 12/2 500' BLK/WHT MM	0 83996 04504 0	83
04505	WIRE, BOAT CABLE UL MULTI 12/2 1000' BLK/WHT MM	0 83996 04505 7	83
04506	WIRE, BOAT CABLE UL MULTI 14/2 100' BLK/WHT MM	0 83996 04506 4	82
04507	WIRE, BOAT CABLE UL MULTI 14/2 500' BLK/WHT MM	0 83996 04507 1	82
04508	WIRE, BOAT CABLE UL MULTI 14/2 1000' BLK/WHT MM	0 83996 04508 8	82
04509	WIRE, BOAT CABLE UL MULTI 16/2 100' BLK/WHT MM	0 83996 04509 5	82
04510	WIRE, BOAT CABLE UL MULTI 16/2 500' BLK/WHT MM	0 83996 04510 1	82
04511	WIRE, BOAT CABLE UL MULTI 16/2 1000' BLK/WHT MM	0 83996 04511 8	82
04512	WIRE, BOAT CABLE UL MULTI 10/3 100' BLK/GRN/WHT MM	0 83996 04512 5	83
04513	WIRE, BOAT CABLE UL MULTI 10/3 500' BLK/GRN/WHT MM	0 83996 04513 2	83
04514	WIRE, BOAT CABLE UL MULTI 10/3 1000' BLK/GRN/WHT M	0 83996 04514 9	83
04515	WIRE, BOAT CABLE UL MULTI 12/3 100' BLK/GRN/WHT MM	0 83996 04515 6	83
04516	WIRE, BOAT CABLE UL MULTI 12/3 500' BLK/GRN/WHT MM	0 83996 04516 3	83
04517	WIRE, BOAT CABLE UL MULTI 12/3 1000' BLK/GRN/WT MM	0 83996 04517 0	83
04518	WIRE, BOAT CABLE UL MULTI 14/3 100' BLK/GRN/WHT MM	0 83996 04518 7	83
04519	WIRE, BOAT CABLE UL MULTI 14/3 500' BLK/GRN/WHT MM	0 83996 04519 4	83
04520	WIRE, BOAT CABLE UL MULTI 14/3 1000' BLK/GRN/WHT M	0 83996 04520 0	83
04521	WIRE, BOAT CABLE UL MULTI 16/3 100' BLK/GRN/WHT MM	0 83996 04521 7	83
04522	WIRE, BOAT CABLE UL MULTI 16/3 500' BLK/GRN/WHT MM	0 83996 04522 4	83
04523	WIRE, BOAT CABLE UL MULTI 16/3 1000' BLK/GRN/WT MM	0 83996 04523 1	83
04524	WIRE, BOAT CABLE UL MULTI 10/2 100' YEL RED MM	0 83996 04524 8	83
04525	WIRE, BOAT CABLE UL MULTI 10/2 500' YEL RED MM	0 83996 04525 5	83
04526	WIRE, BOAT CABLE UL MULTI 10/2 1000' YEL RED MM	0 83996 04526 2	83
04528	WIRE, BOAT CABLE UL MULTI 12/2 500' YEL RED MM	0 83996 04528 6	83
04529	WIRE, BOAT CABLE UL MULTI 12/2 1000' YEL RED MM	0 83996 04529 3	83
04530	WIRE, BOAT CABLE UL MULTI 14/2 100' YEL RED MM	0 83996 04530 9	82
04531	WIRE, BOAT CABLE UL MULTI 14/2 500' YEL RED MM	0 83996 04531 6	82
04532	WIRE, BOAT CABLE UL MULTI 14/2 1000' YEL RED MM	0 83996 04532 3	82
04533	WIRE, BOAT CABLE UL MULTI 16/2 100' YEL RED MM	0 83996 04533 0	82
04534	WIRE, BOAT CABLE UL MULTI 16/2 500' YEL RED MM	0 83996 04534 7	82
04535	WIRE, BOAT CABLE UL MULTI 16/2 1000' YEL RED MM	0 83996 04535 4	82
04536	WIRE, BOAT CABLE UL MULTI 16/2 100' RED BLK MM	0 83996 04536 1	82
04537	WIRE, BOAT CABLE UL MULTI 14/2 100' RED BLK MM	0 83996 04537 8	82
04537	WIRE, BOAT CABLE UL MULTI 14/2 100' RED BLK MM	0 83996 04537 8	82
04538	WIRE, BOAT CABLE UL MULTI 12/2 100' RED BLK MM	0 83996 04538 5	83
04539	WIRE, BOAT CABLE UL MULTI 10/2 100' RED BLK MM	0 83996 04539 2	83
04577	WIRE, BOOSTER 4 GA 50' BLK/RED	0 83996 04577 4	97
04578	WIRE, BOOSTER 4 GA 100' BLK/RED	0 83996 04578 1	97
04587	WIRE, CABLE SGX 6 GA 500' BLK	0 83996 04587 3	70
04588	WIRE, CABLE SGX 6 GA 500' RED	0 83996 04588 0	70
04589	WIRE, CABLE SGX 4 GA 500' BLK	0 83996 04589 7	70
04590	WIRE, CABLE SGX 4 GA 500' RED	0 83996 04590 3	70
04591	WIRE, CABLE SGX 2 GA 500' BLK	0 83996 04591 0	70
04594	WIRE, CABLE SGX 3/0 GA 500' BLK	0 83996 04594 1	71
04595	WIRE, CABLE SGX 3/0 GA 500' RED	0 83996 04595 8	71
04600	WIRE, STARTER CABLE 6 GA 25' RED	0 83996 04600 9	68
04601	WIRE, STARTER CABLE 6 GA 25' BLK	0 83996 04601 6	68
04602	WIRE, STARTER CABLE 6 GA 100' RED	0 83996 04602 3	68
04603	WIRE, STARTER CABLE 6 GA 100' BLK	0 83996 04603 0	68
04604	WIRE, STARTER CABLE 6 GA 500' RED	0 83996 04604 7	68
04605	WIRE, STARTER CABLE 6 GA 500' BLK	0 83996 04605 4	68
04606	WIRE, STARTER CABLE 4 GA 25' RED	0 83996 04606 1	68
04607	WIRE, STARTER CABLE 4 GA 25' BLK	0 83996 04607 8	68
04608	WIRE, STARTER CABLE 4 GA 100' RED	0 83996 04608 5	68
04609	WIRE, STARTER CABLE 4 GA 100' BLK	0 83996 04609 2	68
04610	WIRE, STARTER CABLE 4 GA 500' RED	0 83996 04610 8	68



PRODUCT INDEX

PART NO.	DESCRIPTION	UNIT UPC	PAGE NO.
04611	WIRE, STARTER CABLE 4 GA 500' BLK	0 83996 04611 5	68
04612	WIRE, STARTER CABLE 2 GA 25' RED	0 83996 04612 2	68
04613	WIRE, STARTER CABLE 2 GA 25' BLK	0 83996 04613 9	68
04614	WIRE, STARTER CABLE 2 GA 100' RED	0 83996 04614 6	68
04615	WIRE, STARTER CABLE 2 GA 100' BLK	0 83996 04615 3	68
04616	WIRE, STARTER CABLE 2 GA 500' RED	0 83996 04616 0	68
04617	WIRE, STARTER CABLE 2 GA 500' BLK	0 83996 04617 7	68
04618	WIRE, STARTER CABLE 1 GA 25' RED	0 83996 04618 4	68
04619	WIRE, STARTER CABLE 1 GA 25' BLK	0 83996 04619 1	68
04620	WIRE, STARTER CABLE 1 GA 100' RED	0 83996 04620 7	68
04621	WIRE, STARTER CABLE 1 GA 100' BLK	0 83996 04621 4	68
04622	WIRE, STARTER CABLE 1 GA 500' RED	0 83996 04622 1	68
04623	WIRE, STARTER CABLE 1 GA 500' BLK	0 83996 04623 8	68
04624	WIRE, STARTER CABLE 1/0 GA 25' RED	0 83996 04624 5	69
04625	WIRE, STARTER CABLE 1/0 GA 25' BLK	0 83996 04625 2	69
04626	WIRE, STARTER CABLE 1/0 GA 100' RED	0 83996 04626 9	69
04627	WIRE, STARTER CABLE 1/0 GA 100' BLK	0 83996 04627 6	69
04628	WIRE, STARTER CABLE 1/0 GA 500' RED	0 83996 04628 3	69
04629	WIRE, STARTER CABLE 1/0 GA 500' BLK	0 83996 04629 0	69
04630	WIRE, STARTER CABLE 2/0 GA 25' RED	0 83996 04630 6	69
04631	WIRE, STARTER CABLE 2/0 GA 25' BLK	0 83996 04631 3	69
04632	WIRE, STARTER CABLE 2/0 GA 100' RED	0 83996 04632 0	69
04633	WIRE, STARTER CABLE 2/0 GA 100' BLK	0 83996 04633 7	69
04634	WIRE, STARTER CABLE 2/0 GA 500' RED	0 83996 04634 4	69
04635	WIRE, STARTER CABLE 2/0 GA 500' BLK	0 83996 04635 1	69
04636	WIRE, STARTER CABLE 3/0 GA 25' BLK	0 83996 04636 8	69
04637	WIRE, STARTER CABLE 3/0 GA 100' BLK	0 83996 04637 5	69
04638	WIRE, STARTER CABLE 3/0 GA 500' BLK	0 83996 04638 2	69
04662	CABLE, GR. 31 OVERMOLD 4 BATTERY 21' RED	0 83996 04662 7	22
04663	CABLE, GR. 31 OVERMOLD 4 BATTERY 21' BLK	0 83996 04663 4	22
04665	CABLE, BOOSTER 2 GA 30' 600E CU CON/LUG B/R BOX DK	0 83996 04665 8	9
04669	WIRE, TC 14/4-12/1-10/2 30' COIL SLV	0 83996 04669 3	93
04700	WIRE, WELDING CABLE 4 GA 100' RED	0 83996 04700 6	72
04701	WIRE, WELDING CABLE 4 GA 100' BLK	0 83996 04701 3	72
04702	WIRE, WELDING CABLE 4 GA 500' RED	0 83996 04702 0	72
04703	WIRE, WELDING CABLE 4 GA 500' BLK	0 83996 04703 7	72
04704	WIRE, WELDING CABLE 2 GA 100' RED	0 83996 04704 4	72
04705	WIRE, WELDING CABLE 2 GA 100' BLK	0 83996 04705 1	72
04706	WIRE, WELDING CABLE 2 GA 500' RED	0 83996 04706 8	72
04707	WIRE, WELDING CABLE 2 GA 500' BLK	0 83996 04707 5	72
04714	WIRE, WELDING CABLE 1/0 GA 500' RED	0 83996 04714 3	73
04715	WIRE, WELDING CABLE 1/0 GA 500' BLK	0 83996 04715 0	73
04716	WIRE, WELDING CABLE 2/0 GA 100' RED	0 83996 04716 7	73
04717	WIRE, WELDING CABLE 2/0 GA 100' BLK	0 83996 04717 4	73
04718	WIRE, WELDING CABLE 2/0 GA 500' RED	0 83996 04718 1	73
04719	WIRE, WELDING CABLE 2/0 GA 500' BLK	0 83996 04719 8	73
04724	WIRE, WELDING CABLE 4/0 GA 100' RED	0 83996 04724 2	73
04725	WIRE, WELDING CABLE 4/0 GA 100' BLK	0 83996 04725 9	73
04726	WIRE, WELDING CABLE 4/0 GA 500' RED	0 83996 04726 6	73
04727	WIRE, WELDING CABLE 4/0 GA 500' BLK	0 83996 04727 3	73
04728	WIRE, WELDING CABLE 6 GA 100' RED	0 83996 04728 0	72
04729	WIRE, WELDING CABLE 6 GA 100' BLK	0 83996 04729 7	72
04730	WIRE, WELDING CABLE 6 GA 500' RED	0 83996 04730 3	72
04731	WIRE, WELDING CABLE 6 GA 500' BLK	0 83996 04731 0	72
04732	WIRE, WELDING CABLE 1 GA 100' RED	0 83996 04732 7	73
04733	WIRE, WELDING CABLE 1 GA 100' BLK	0 83996 04733 4	73
04734	WIRE, WELDING CABLE 1 GA 500' RED	0 83996 04734 1	73
04735	WIRE, WELDING CABLE 1 GA 500' BLK	0 83996 04735 8	73
04736	WIRE, WELDING CABLE 1/0 GA 100' RED	0 83996 04736 5	73
04737	WIRE, WELDING CABLE 1/0 GA 100' BLK	0 83996 04737 2	73
04738	WIRE, WELDING CABLE 3/0 GA 100' RED	0 83996 04738 9	73
04739	WIRE, WELDING CABLE 3/0 GA 100' BLK	0 83996 04739 6	73
04740	WIRE, WELDING CABLE 3/0 GA 500' RED	0 83996 04740 2	73
04741	WIRE, WELDING CABLE 3/0 GA 500' BLK	0 83996 04741 9	73
04752	KIT, BATT TMINL PROTECTION MM	0 83996 04752 5	102
04757	WIRE, PRIMARY 20 GA 45' 80 RED 1/CD	0 83996 04757 0	60
04758	WIRE, PRIMARY 20 GA 45' 80 WHT 1/CD	0 83996 04758 7	60
04759	WIRE, PRIMARY 20 GA 45' 80 BLK 1/CD	0 83996 04759 4	60

PART NO.	DESCRIPTION	UNIT UPC	PAGE NO.
04760	WIRE, PRIMARY 20 GA 45' 80 GRN 1/CD	0 83996 04760 0	60
04761	WIRE, PRIMARY 20 GA 45' 80 YEL 1/CD	0 83996 04761 7	60
04762	WIRE, PRIMARY 20 GA 45' 80 BRN 1/CD	0 83996 04762 4	60
04763	WIRE, PRIMARY 20 GA 45' 80 BLU 1/CD	0 83996 04763 1	60
04800	WIRE, BOAT CABLE UL SNGL 4 GA 100' RED MM	0 83996 04800 3	80
04801	WIRE, BOAT CABLE UL SNGL 4 GA 100' BLK MM	0 83996 04801 0	80
04802	WIRE, BOAT CABLE UL SNGL 4 GA 500' RED MM	0 83996 04802 7	80
04803	WIRE, BOAT CABLE UL SNGL 4 GA 500' BLK MM	0 83996 04803 4	80
04804	WIRE, BOAT CABLE UL SNGL 2 GA 100' RED MM	0 83996 04804 1	80
04805	WIRE, BOAT CABLE UL SNGL 2 GA 100' BLK MM	0 83996 04805 8	80
04806	WIRE, BOAT CABLE UL SNGL 2 GA 500' RED MM	0 83996 04806 5	80
04807	WIRE, BOAT CABLE UL SNGL 2 GA 500' BLK MM	0 83996 04807 2	80
04808	WIRE, BOAT CABLE UL SNGL 2/0 100' RED MM	0 83996 04808 9	81
04809	WIRE, BOAT CABLE UL SNGL 2/0 100' BLK MM	0 83996 04809 6	81
04810	WIRE, BOAT CABLE UL SNGL 2/0 500' RED MM	0 83996 04810 2	81
04811	WIRE, BOAT CABLE UL SNGL 2/0 500' BLK MM	0 83996 04811 9	81
04812	WIRE, BOAT CABLE UL SNGL 4 GA 100' YEL MM	0 83996 04812 6	80
04813	WIRE, BOAT CABLE UL SNGL 4 GA 500' YEL MM	0 83996 04813 3	80
04814	WIRE, BOAT CABLE UL SNGL 2 GA 100' YEL MM	0 83996 04814 0	80
04815	WIRE, BOAT CABLE UL SNGL 2 GA 500' YEL MM	0 83996 04815 7	80
04816	WIRE, BOAT CABLE UL SNGL 2/0 100' YEL MM	0 83996 04816 4	81
04817	WIRE, BOAT CABLE UL SNGL 2/0 500' YEL MM	0 83996 04817 1	81
04842	TERMINAL, TOP POST NON LEAD BLK/RED SHRINK 2/CD	0 83996 04842 3	28
04848	CABLE, BOOSTER 2 GA 20' 600P C/A B/R BOX	0 83996 04848 5	8
04850	CABLE, BOOSTER 6 GA 16' B8 C/A B/R BOX	0 83996 04850 8	8
04851	CABLE, BOOSTER 8 GA 12' B8 C/A B/R BOX	0 83996 04851 5	8
04852	CABLE, BOOSTER 10 GA 12' 200C C/A B/R SLV	0 83996 04852 2	8
04892	CAPS, GR. 31 STUD RED 10/BAG	0 83996 04892 8	45
04893	CAPS, GR. 31 STUD BLK 10/BAG	0 83996 04893 5	45
04900	WIRE, TC 16/4 100' BK,R,BR,W	0 83996 04900 0	90
04901	WIRE, TC 16/4 500' BK,R,BR,W	0 83996 04901 7	90
04902	WIRE, TC 16/6 100' R,GR,BR,W,BK,Y	0 83996 04902 4	91
04903	WIRE, TC 16/6 500' R,GR,BR,W,BK,Y	0 83996 04903 1	91
04904	WIRE, TC 14/4 100' BK,R,BR,W	0 83996 04904 8	91
04905	WIRE, TC 14/4 500' BK,R,BR,W	0 83996 04905 5	91
04906	WIRE, TC 14/6 100' R,GR,BR,W,BK,Y	0 83996 04906 2	91
04907	WIRE, TC 14/6 500' R,GR,BR,W,BK,Y	0 83996 04907 9	91
04908	WIRE, TC 14/7 100' R,GR,BR,W,BK,Y,BL	0 83996 04908 6	92
04909	WIRE, TC 14/7 500' R,GR,BR,W,BK,Y,BL	0 83996 04909 3	92
04910	WIRE, TC 12/4 100' BLK,RED,BRN,WHT	0 83996 04910 9	91
04911	WIRE, TC 12/4 500' BLK,RED,BRN,WHT	0 83996 04911 6	91
04912	WIRE, TC 12/6 100' R,GR,BR,W,BK,Y	0 83996 04912 3	92
04913	WIRE, TC 12/6 500' R,GR,BR,W,BK,YEL	0 83996 04913 0	92
04914	WIRE, TC 12/6-10/1 100' WBK,Y,R,GR,BR,BL	0 83996 04914 7	92
04915	WIRE, TC 14/4-10/2-12/1 100' DBL,BR,BK,DGR,R,W,Y	0 83996 04915 4	93
04916	WIRE, TC 14/4-10/2-12/1 500' DBL,BR,BK,DGR,R,W,Y	0 83996 04916 1	93
04917	WIRE, TC 12/4-10/2-8/1 100' W,BR,DGR,R,Y,BK,BL	0 83996 04917 8	94
04918	WIRE, TC 12/4-10/2-8/1 500' W,BR,DGR,R,Y,BK,BL	0 83996 04918 5	94
04919	WIRE, TC 16/4 100' YR,GR,BR	0 83996 04919 2	90
04920	WIRE, TC 16/4 500' YR,GR,BR	0 83996 04920 8	90
04921	WIRE, TC 16/6 100' GR,BL,YBK,R,BR	0 83996 04921 5	91
04922	WIRE, TC 16/6 500' GR,BL,YBK,R,BR	0 83996 04922 2	91
04923	WIRE, TC 14/4 100' YR,GR,BR	0 83996 04923 9	91
04924	WIRE, TC 14/4 500' YR,GR,BR	0 83996 04924 6	91
04925	WIRE, TC 14/6 100' R,BL,GR,Y,BR,BK	0 83996 04925 3	91
04926	WIRE, TC 14/6 500' R,BL,GR,Y,BR,BK	0 83996 04926 0	91
04927	WIRE, TC 12/6-10/1 500' WBK,Y,R,GR,BR,BL	0 83996 04927 7	92
04928	WIRE, TC 14/4 100' W,BRN,Y,GRN	0 83996 04928 4	91
04929	WIRE, TC 14/4 500' W,BRN,Y,GRN	0 83996 04929 1	91
04930	WIRE, STARTER CABLE 4/0 GA 25' RED	0 83996 04930 7	69
04931	WIRE, STARTER CABLE 4/0 GA 25' BLK	0 83996 04931 4	69
04932	WIRE, STARTER CABLE 4/0 GA 100' RED	0 83996 04932 1	69
04933	WIRE, STARTER CABLE 4/0 GA 100' BLK	0 83996 04933 8	69
04934	WIRE, STARTER CABLE 4/0 GA 500' RED	0 83996 04934 5	69
04935	WIRE, STARTER CABLE 4/0 GA 500' BLK	0 83996 04935 2	69
04955	CABLE, BOOSTER 4 GA 20' B8 C/A B/R BOX	0 83996 04955 0	8
04957	CABLE, SPLICE TOP POST 2/0 GA SINGLE CABLE	0 83996 04957 4	16
04958	CABLE, SPLICE LUG 2/0 GA SINGLE CABLE	0 83996 04958 1	16



**PRODUCT INDEX**

PART NO.	DESCRIPTION	UNIT UPC	PAGE NO.
04963	CABLE, SPLICE LUG 2/0 GA OVERMOLD SINGLE CABLE	0 83996 04963 5	16
05234	WIRE, CABLE SGX 1/0 GA 500' BLK	0 83996 05234 5	71
05237	WIRE, CABLE SGX 4/0 GA 500' RED	0 83996 05237 6	71
05300	TERMINAL, TOP POST 100' BOX	0 83996 05300 7	26
05301	TERMINAL, TOP POST COMMERCIAL 60' BOX	0 83996 05301 4	26
05302	TERMINAL, SIDE TERM 50' BOX	0 83996 05302 1	26
05303	TERMINAL, SIDE TERM W/8" BOLT 50' BOX	0 83996 05303 8	26
05304	BOLT, SIDE 3/8 REPL SHORT 50' BAG	0 83996 05304 5	31
05305	TERMINAL, TOP POST EPOXY COAT RED 50' BOX	0 83996 05305 2	26
05306	TERMINAL, TOP POST EPOXY COAT BLK 50' BOX	0 83996 05306 9	26
05307	TERMINAL, MARINE UNIV 50' BOX	0 83996 05307 6	27
05308	TERMINAL, MARINE POS 50' BOX	0 83996 05308 3	27
05309	TERMINAL, MARINE NEG 50' BOX	0 83996 05309 0	27
05310	TERMINAL, MARINE EPOXY RED 50' BOX	0 83996 05310 6	27
05311	TERMINAL, MARINE EPOXY BLK 50' BOX	0 83996 05311 3	27
05312	TERMINAL, QUICK CONNECT 10' BOX	0 83996 05312 0	29
05313	TERMINAL, CHARG POST SIDE POS 25' BOX	0 83996 05313 7	29
05314	TERMINAL, CHARG POST SIDE NEG 25' BOX	0 83996 05314 4	29
05315	TERMINAL, ORDNANCE BOLT POS 25' BOX	0 83996 05315 1	30
05316	TERMINAL, ORDNANCE BOLT NEG 25' BOX	0 83996 05316 8	30
05317	TERMINAL, ORDNANCE BOLT UNIV 25' BOX	0 83996 05317 5	30
05318	TERMINAL, MARINE UNIV HEAVY DUTY 25' BOX	0 83996 05318 2	30
05319	TERMINAL, SIDE CONVERSION TO POST 25' BOX	0 83996 05319 9	30
05320	TERMINAL, CONVERSION POST GR 31 25' BOX	0 83996 05320 5	29
05321	TERMINAL, FLAG TO POST ADAPTERS 25' BOX	0 83996 05321 2	30
05322	BOLT WITH NUT, 5/16 -18 x 1-1/4 50' BAG	0 83996 05322 9	31
05323	BOLT, SIDE 3/8 REPL OE SHORT 50' BAG	0 83996 05323 6	31
05324	BOLT, SIDE 3/8 REPL OE LONG 25' BAG	0 83996 05324 3	31
05326	LUG, COPR 6 GA 3/8 STUD BULK 50' BAG	0 83996 05326 7	35
05327	LUG, COPR 4 GA 3/8 STUD BULK 50' BAG	0 83996 05327 4	35
05328	LUG, COPR 4 GA 5/16 STUD BULK 50' BAG	0 83996 05328 1	35
05329	LUG, COPR 2 GA 3/8 STUD BULK 50' BAG	0 83996 05329 8	35
05330	LUG, COPR 2 GA 1/2 STUD BULK 50' BAG	0 83996 05330 4	35
05331	LUG, COPR 1 GA 3/8 STUD BULK 50' BAG	0 83996 05331 1	35
05332	LUG, COPR 1 GA 1/2 STUD BULK 50' BAG	0 83996 05332 8	35
05333	LUG, COPR 1/0 GA 3/8 STUD BULK 50' BAG	0 83996 05333 5	35
05334	LUG, COPR 1/0 GA 1/2 STUD BULK 50' BAG	0 83996 05334 2	35
05335	LUG, COPR 2/0 GA 3/8 STUD BULK 50' BAG	0 83996 05335 9	35
05336	LUG, COPR 2/0 GA 1/2 STUD BULK 50' BAG	0 83996 05336 6	35
05337	LUG, COPR 3/0 GA 3/8 STUD BULK 50' BAG	0 83996 05337 3	35
05338	LUG, COPR 3/0 GA 1/2 STUD BULK 50' BAG	0 83996 05338 0	35
05339	LUG, COPR 4/0 GA 3/8 STUD BULK 50' BAG	0 83996 05339 7	35
05340	LUG, COPR 4/0 GA 1/2 STUD BULK 50' BAG	0 83996 05340 3	35
05341	LUG, TIN-PLTD COPR 4 GA 1/4 STUD BULK 10' BAG	0 83996 05341 0	36
05342	LUG, TIN-PLTD COPR 4 GA 3/8 STUD BULK 10' BAG	0 83996 05342 7	36
05343	LUG, TIN-PLTD COPR 1-2 GA 3/8 STUD BULK 10' BAG	0 83996 05343 4	36
05344	LUG, TIN-PLTD COPR 1-2 GA 1/2 STUD BULK 10' BAG	0 83996 05344 1	36
05345	LUG, TIN-PLTD COPR 1/0 GA 3/8 STUD BULK 10' BAG	0 83996 05345 8	36
05346	LUG, TIN-PLTD COPR 1/0 GA 1/2 STUD BULK 10' BAG	0 83996 05346 5	36
05347	LUG, TIN-PLTD COPR 2/0 GA 3/8 STUD BULK 10' BAG	0 83996 05347 2	36
05349	LUG, TIN-PLTD COPR 2/0 GA 1/2 STUD BULK 10' BAG	0 83996 05349 6	36
05350	LUG, TIN-PLTD COPR 3/0 GA 3/8 STUD BULK 10' BAG	0 83996 05350 2	36
05351	LUG, TIN-PLTD COPR 3/0 GA 1/2 STUD BULK 10' BAG	0 83996 05351 9	36
05352	LUG, TIN-PLTD COPR 4/0 GA 3/8 STUD BULK 10' BAG	0 83996 05352 6	36
05353	LUG, TIN-PLTD COPR 4/0 GA 1/2 STUD BULK 10' BAG	0 83996 05353 3	36
05354	LUG, TIN-PLTD COPR SPLICE 4 GA BULK 10' BAG	0 83996 05354 0	34
05355	LUG, TIN-PLTD COPR SPLICE 1-2 GA BULK 10' BAG	0 83996 05355 7	34
05356	LUG, TIN-PLTD COPR SPLICE 1/0 GA BULK 10' BAG	0 83996 05356 4	34
05357	LUG, TIN-PLTD COPR SPLICE 2/0 GA BULK 10' BAG	0 83996 05357 1	34
05358	LUG, TIN-PLTD COPR SPLICE 3/0 GA BULK 10' BAG	0 83996 05358 8	34
05359	TERM, CRIMP TIN-PLTD COPR STR 4 GA UNIV 10' BOX	0 83996 05359 5	33
05360	TERM, CRIMP TIN-PLTD COPR STR 4 GA POS 10' BOX	0 83996 05360 1	33
05361	TERM, CRIMP TIN-PLTD COPR STR 4 GA NEG 10' BOX	0 83996 05361 8	33
05362	TERM, CRIMP TIN-PLTD COPR STR 1 GA POS 10' BOX	0 83996 05362 5	33
05363	TERM, CRIMP TIN-PLTD COPR STR 1 GA NEG 10' BOX	0 83996 05363 2	33
05364	TERM, CRIMP TIN-PLTD COPR STR 1/0 GA POS 10' BOX	0 83996 05364 9	33
05365	TERM, CRIMP TIN-PLTD COPR STR 1/0 GA NEG 10' BOX	0 83996 05365 6	33
05366	TERM, CRIMP TIN-PLTD COPR STR 2/0 GA POS 10' BOX	0 83996 05366 3	33

PART NO.	DESCRIPTION	UNIT UPC	PAGE NO.
05367	TERM, CRIMP TIN-PLTD COPR STR 2/0 GA NEG 10' BOX	0 83996 05367 0	33
05368	TERM, CRIMP TIN-PLTD COPR STR 3/0 GA POS 10' BOX	0 83996 05368 7	33
05369	TERM, CRIMP TIN-PLTD COPR STR 3/0 GA NEG 10' BOX	0 83996 05369 4	33
05370	TERM, CRIMP TIN-PLTD COPR STR 4/0 GA POS 8' BOX	0 83996 05370 0	33
05371	TERM, CRIMP TIN-PLTD COPR STR 4/0 GA NEG 8' BOX	0 83996 05371 7	33
05372	TERM, CRIMP TIN-PLTD COPR FLAG 1/0 GA POS 8' BOX	0 83996 05372 4	33
05373	TERM, CRIMP TIN-PLTD COPR FLAG 1/0 GA NEG 8' BOX	0 83996 05373 1	33
05374	TERM, CRIMP TIN-PLTD COPR FLAG 2/0 GA POS 8' BOX	0 83996 05374 8	33
05375	TERM, CRIMP TIN-PLTD COPR FLAG 2/0 GA NEG 8' BOX	0 83996 05375 5	33
05376	TERM, CRIMP TIN-PLTD COPR FLAG 3/0 GA POS 8' BOX	0 83996 05376 2	33
05377	TERM, CRIMP TIN-PLTD COPR FLAG 3/0 GA NEG 8' BOX	0 83996 05377 9	33
05378	TERM, CRIMP TIN-PLTD COPR FLAG 4/0 GA POS 8' BOX	0 83996 05378 6	33
05379	TERM, CRIMP TIN-PLTD COPR FLAG 4/0 GA NEG 8' BOX	0 83996 05379 3	33
05380	TERM, CRIMP TIN-PLTD COPR R ELBOW 1/0 GA POS 10' BOX	0 83996 05380 9	33
05381	TERM, CRIMP TIN-PLTD COPR R ELBOW 1/0 GA NEG 10' BOX	0 83996 05381 6	33
05382	TERM, CRIMP TIN-PLTD COPR R ELBOW 2/0 GA POS 10' BOX	0 83996 05382 3	33
05383	TERM, CRIMP TIN-PLTD COPR R ELBOW 2/0 GA NEG 10' BOX	0 83996 05383 0	33
05384	TERM, CRIMP TIN-PLTD COPR R ELBOW 3/0 GA POS 10' BOX	0 83996 05384 7	33
05385	TERM, CRIMP TIN-PLTD COPR R ELBOW 3/0 GA NEG 10' BOX	0 83996 05385 4	33
05386	TERM, CRIMP TIN-PLTD COPR R ELBOW 4/0 GA POS 8' BOX	0 83996 05386 1	33
05387	TERM, CRIMP TIN-PLTD COPR R ELBOW 4/0 GA NEG 8' BOX	0 83996 05387 8	33
05388	TERM, CRIMP TIN-PLTD COPR L ELBOW 1/0 GA POS 10' BOX	0 83996 05388 5	33
05389	TERM, CRIMP TIN-PLTD COPR L ELBOW 1/0 GA NEG 10' BOX	0 83996 05389 2	33
05390	TERM, CRIMP TIN-PLTD COPR L ELBOW 2/0 GA POS 10' BOX	0 83996 05390 8	33
05391	TERM, CRIMP TIN-PLTD COPR L ELBOW 2/0 GA NEG 10' BOX	0 83996 05391 5	33
05392	TERM, CRIMP TIN-PLTD COPR L ELBOW 3/0 GA POS 10' BOX	0 83996 05392 2	33
05393	TERM, CRIMP TIN-PLTD COPR L ELBOW 3/0 GA NEG 10' BOX	0 83996 05393 9	33
05394	TERM, CRIMP TIN-PLTD COPR L ELBOW 4/0 GA POS 8' BOX	0 83996 05394 6	33
05395	TERM, CRIMP TIN-PLTD COPR L ELBOW 4/0 GA NEG 8' BOX	0 83996 05395 3	33
05396	TERM, CRIMP TIN-PLTD COPR STUD SINGL 2/0 GA 10' BOX	0 83996 05396 0	34
05397	TERM, CRIMP TIN-PLTD COPR STUD DUAL 2/0 GA 10' BOX	0 83996 05397 7	34
05398	TERM, CRIMP TIN-PLTD COPR SPLICE 1/0 GA 10' BOX	0 83996 05398 4	34
05399	TERM, CRIMP TIN-PLTD COPR SPLICE 2/0 GA 10' BOX	0 83996 05399 1	34
05400	TERM, CRIMP TIN-PLTD COPR SPLICE 3/0 GA 10' BOX	0 83996 05400 4	34
05401	TERM, CRIMP TIN-PLTD COPR SPLICE 4/0 GA 10' BOX	0 83996 05401 1	34
05402	TUBING, HEAT SHRINK 8-2 GA 6' BLK 6' BAG	0 83996 05402 8	42
05403	TUBING, HEAT SHRINK 8-2 GA 6' RED 6' BAG	0 83996 05403 5	42
05404	TUBING, HEAT SHRINK 3/4" 1-2/0 6' BLK 6' BAG	0 83996 05404 2	42
05405	TUBING, HEAT SHRINK 1-2/0 GA 6' RED 6' BAG	0 83996 05405 9	42
05406	TUBING, HEAT SHRINK 1/0-4/0 GA 6' BLK 6' BAG	0 83996 05406 6	42
05407	TUBING, HEAT SHRINK 1/0-4/0 GA 6' RED 6' BAG	0 83996 05407 3	42
05408	TOOL, CUTTER CABLE UP TO 4/0 GA	0 83996 05408 0	53
05409	TOOL, CRIMPER CABLE HD 8 GA-4/0 GA	0 83996 05409 7	53
05410	TOOL, CRIMPER HAMMER 8 GA-4/0 GA	0 83996 05410 3	53
05411	TERMINAL, SIDE ADAPTER POS BULK STP	0 83996 05411 0	30
05412	TERMINAL, SIDE ADAPTER NEG BULK STN	0 83996 05412 7	30
05415	NUTS, GROUP 31 OPEN TOP 3/8 STUD 25' BAG	0 83996 05415 8	32
05416	BOLT EXTENDERS, BRASS SHORT SIDE BULK	0 83996 05416 5	30
05417	BOLT EXTENDERS, BRASS LONG SIDE BULK	0 83996 05417 2	30
05418	BOLT EXTENDERS, BRASS TOP BULK	0 83996 05418 9	30
05419	NUTS, GROUP 31 CLOSED TOP 3/8 STUD 25' BAG	0 83996 05419 6	32
05434	TOOL, CRIMPER CABLE HD 8 GA-1/0 GA	0 83996 05434 9	53
05435	TOOL, STRIPPER CABLE 10 GA - 4/0 GA	0 83996 05435 6	53
05439	TERMINAL, 3-WAY POS BULK 25' BOX	0 83996 05439 4	26
05440	TERMINAL, 3-WAY NEG BULK 25' BOX	0 83996 05440 0	26
05442	SPACER, SIDE TERMINAL BULK 25' BOX	0 83996 05442 1	31
05443	TERMINAL, 3-WAY POS & NEG 2' BAG	0 83996 05443 1	26
05444	TERMINAL, TOP POST GOLD PLATED 1/CS	0 83996 05444 8	30
05445	BOLT, SIDE GOLD PLATED 1/CS	0 83996 05445 5	30
05446	TERMINAL, TOP POST GOLD PLATED AUX LEAD 1/CS	0 83996 05446 2	30
05447	TUBING, 1/4" HEAT SHRINK 6" BLK 25' BAG	0 83996 05447 9	42
05448	TUBING, 1/4" HEAT SHRINK 6" RED 25' BAG	0 83996 05448 6	42
05449	TUBING, 3/16" HEAT SHRINK 6" BLK 25' BAG	0 83996 05449 3	42
05450	TUBING, 3/16" HEAT SHRINK 6" RED 25' BAG	0 83996 05450 9	42
05451	TUBING, 1/8" HEAT SHRINK 6" BLK 25' BAG	0 83996 05451 6	42
05452	TUBING, 1/8" HEAT SHRINK 6" RED 25' BAG	0 83996 05452 3	42
05456	TERMINAL, CHARG POST WEARS 100' BULK	0 83996 05456 1	29
05457	TERMINAL, CHARG POST POWR SPORT 2/CS	0 83996 05457 8	29



**PRODUCT INDEX**

PART NO.	DESCRIPTION	UNIT UPC	PAGE NO.
05458	LUG, COPR 1 GA 1/4 STUD BULK 50/BAG	0 83996 05458 5	35
05459	LUG, COPR 1 GA 5/16 STUD BULK 50/BAG	0 83996 05459 2	35
05460	LUG, COPR 1/0 GA 5/16 STUD BULK 50/BAG	0 83996 05460 8	35
05461	LUG, COPR 2 GA 1/4 STUD BULK 50/BAG	0 83996 05461 5	35
05462	LUG, COPR 2 GA 5/16 STUD BULK 50/BAG	0 83996 05462 2	35
05463	LUG, COPR 2/0 GA 5/16 STUD BULK 50/BAG	0 83996 05463 9	35
05464	LUG, COPR 4 GA 1/2 STUD BULK 50/BAG	0 83996 05464 6	35
05465	LUG, COPR 4 GA 1/4 STUD BULK 50/BAG	0 83996 05465 3	35
05466	LUG, COPR 6 GA #10 STUD BULK 50/BAG	0 83996 05466 0	35
05467	LUG, COPR 6 GA 1/4 STUD BULK 50/BAG	0 83996 05467 7	35
05468	LUG, COPR 6 GA 5/16 STUD BULK 50/BAG	0 83996 05468 4	35
05469	LUG, COPR 6 GA 1/2 STUD BULK 50/BAG	0 83996 05469 1	35
05470	LUG, COPR 8 GA #10 STUD BULK 50/BAG	0 83996 05470 7	35
05471	LUG, COPR 8 GA 1/2 STUD BULK 50/BAG	0 83996 05471 4	35
05472	LUG, COPR 8 GA 1/4 STUD BULK 50/BAG	0 83996 05472 1	35
05473	LUG, COPR 8 GA 3/8 STUD BULK 50/BAG	0 83996 05473 8	35
05474	LUG, COPR 8 GA 5/16 STUD BULK 50/BAG	0 83996 05474 5	35
05475	TERM, CRMP TIN-PLTD COPR SIDE TERM 4 GA 10/BX	0 83996 05475 2	34
05476	TERM, CRMP TIN-PLTD COPR SIDE TERM 2 GA 10/BX	0 83996 05476 9	34
05477	LUG, TIN-PLTD COPR 1/0 GA 1/4 STUD BULK 10/BAG	0 83996 05477 6	36
05478	LUG, TIN-PLTD COPR 1/0 GA 5/16 STUD BULK 10/BAG	0 83996 05478 3	36
05479	LUG, TIN-PLTD COPR 1-2 GA 1/4 STUD BULK 10/BAG	0 83996 05479 0	36
05480	LUG, TIN-PLTD COPR 1-2 GA 5/16 STUD BULK 10/BAG	0 83996 05480 6	36
05481	LUG, TIN-PLTD COPR 2/0 GA 1/4 STUD BULK 10/BAG	0 83996 05481 3	36
05482	LUG, TIN-PLTD COPR 2/0 GA 5/16 STUD BULK 10/BAG	0 83996 05482 0	36
05483	LUG, TIN-PLTD COPR 3/0 GA 1/4 STUD BULK 10/BAG	0 83996 05483 7	36
05484	LUG, TIN-PLTD COPR 3/0 GA 5/16 STUD BULK 10/BAG	0 83996 05484 4	36
05485	LUG, TIN-PLTD COPR 4 GA 1/2 STUD BULK 10/BAG	0 83996 05485 1	36
05486	LUG, TIN-PLTD COPR 4 GA 5/16 STUD BULK 10/BAG	0 83996 05486 8	36
05487	LUG, TIN-PLTD COPR 4/0 GA 1/4 STUD BULK 10/BAG	0 83996 05487 5	36
05488	LUG, TIN-PLTD COPR 4/0 GA 5/16 STUD BULK 10/BAG	0 83996 05488 2	36
05489	LUG, TIN-PLTD COPR 6 GA 1/4 STUD BULK 10/BAG	0 83996 05489 9	36
05490	LUG, TIN-PLTD COPR 6 GA 3/8 STUD BULK 10/BAG	0 83996 05490 5	36
05491	LUG, TIN-PLTD COPR 6 GA 5/16 STUD BULK 10/BAG	0 83996 05491 2	36
05492	LUG, TIN-PLTD COPR 8 GA 1/4 STUD BULK 10/BAG	0 83996 05492 9	36
05493	LUG, TIN-PLTD COPR 8 GA 3/8 STUD BULK 10/BAG	0 83996 05493 6	36
05494	LUG, TIN-PLTD COPR 8 GA 5/16 STUD BULK 10/BAG	0 83996 05494 3	36
05495	LUG, LOCKING STACKABLE 1/0 GA 3/8 STUD BULK 10/BAG	0 83996 05495 0	34
05496	LUG, LOCKING STACKABLE 2/0 GA 3/8 STUD BULK 10/BAG	0 83996 05496 7	34
05497	LUG, LOCKING STACKABLE 3/0 GA 3/8 STUD BULK 10/BAG	0 83996 05497 4	34
05498	SOLDER PELLETS 4 GA 10/BAG	0 83996 05498 1	36
05499	SOLDER PELLETS 2 GA 10/BAG	0 83996 05499 8	36
05500	SOLDER PELLETS 1 GA 10/BAG	0 83996 05500 1	36
05501	SOLDER PELLETS 1/0 GA 10/BAG	0 83996 05501 8	36
05502	SOLDER PELLETS 2/0 GA 10/BAG	0 83996 05502 5	36
05503	SOLDER PELLETS 3/0 GA 10/BAG	0 83996 05503 2	36
05504	SOLDER PELLETS 4/0 GA 10/BAG	0 83996 05504 9	36
05505	TERM, WIRE END RING 6 GA 5/16 TINNED 50/BAG	0 83996 05505 6	36
05506	LUG, COPR 1/0 GA 1/4 STUD BULK 50/BAG	0 83996 05506 3	35
05507	LUG, COPR 2/0 GA 1/4 STUD BULK 50/BAG	0 83996 05507 0	35
05512	TERMINAL, TOP POST NON LEAD 10/CD	0 83996 05512 4	28
05513	TERM, CRMP TIN-PLTD COPR STR 2 GA POS 10/BOX	0 83996 05513 1	33
05514	TERM, CRMP TIN-PLTD COPR STR 2 GA NEG 10/BOX	0 83996 05514 8	33
05515	BRUSH, TOP POST POWER 5/BOX	0 83996 05515 5	52
05516	BRUSH, STUD TERMINAL POWER 5/BOX	0 83996 05516 2	52
05519	NUTS, STAINLESS STEEL, HEX 5/16-18 50/BAG	0 83996 05519 3	32
05519	NUTS, STAINLESS STEEL, HEX 5/16-18 50/BAG	0 83996 05519 3	101
05700	TERM, WIRE END PVC INSL RING 16-14 GA 4-6 BLU	0 83996 05700 5	37
05701	TERM, WIRE END PVC INSL RING 16-14 GA 10 BLU	0 83996 05701 2	37
05702	TERM, WIRE END PVC INSL RING 16-14 GA 1/4' BLU	0 83996 05702 9	37
05703	TERM, WIRE END PVC INSL RING 12-10 GA 10 YEL	0 83996 05703 6	37
05704	TERM, WIRE END PVC INSL RING 12-10 GA 1/4' YEL	0 83996 05704 3	37
05705	TERM, WIRE END PVC INSL RING 12-10 GA 3/8 YEL	0 83996 05705 0	37
05706	TERM, WIRE END PVC INSL SPADE 16-14 GA 10 BLU	0 83996 05706 7	37
05707	TERM, WIRE END PVC INSL SPADE 12-10 GA 10 YEL	0 83996 05707 4	37
05708	TERM, WIRE END PVC INSL TAB DISC 16-14 GA BLU	0 83996 05708 1	37
05709	TERM, WIRE END PVC INSL RCPTCL DISC 16-14 GA BLU	0 83996 05709 5	37
05710	TERM, WIRE END PVC INSL TAB DISC 12-10 GA YEL	0 83996 05710 4	37

PART NO.	DESCRIPTION	UNIT UPC	PAGE NO.
05711	TERM, WIRE END PVC INSL RCPTCL DISC 12-10 GA YEL	0 83996 05711 1	37
05712	TERM, WIRE END PVC INSL SNAP PLUG 16-14 GA BLU	0 83996 05712 8	37
05713	TERM, WIRE END PVC INSL BUTT SPLICE 22-18 GA RED	0 83996 05713 5	38
05714	TERM, WIRE END PVC INSL BUTT SPLICE 16-14 GA BLU	0 83996 05714 2	38
05715	TERM, WIRE END PVC INSL BUTT SPLICE 12-10 GA YEL	0 83996 05715 9	38
05716	CABLE TIES, 6" WHT 100/BAG	0 83996 05716 6	41
05717	CABLE TIES, 7" WHT 100/BAG	0 83996 05717 3	41
05718	CABLE TIES, 11" WHT 100/BAG	0 83996 05718 0	41
05719	TERM, WIRE END PVC INSL RING 16-14 GA 6-8 BLU	0 83996 05719 7	37
05720	TERM, WIRE END PVC INSL RING 22-18 GA 6-8 RED	0 83996 05720 3	37
05721	TERM, WIRE END PVC INSL RING 22-18 GA 8-10 RED	0 83996 05721 0	37
05723	CABLE TIES, 1/4" WHT 100/BAG	0 83996 05723 4	41
05724	CABLE TIES, 6" BLK 100/BAG	0 83996 05724 1	41
05725	CABLE TIES, 7" BLK 100/BAG	0 83996 05725 8	41
05726	CABLE TIES, 11" BLK 100/BAG	0 83996 05726 5	41
05727	CABLE TIES, 1/4" BLK 100/BAG	0 83996 05727 2	41
05729	TERM, WIRE END PVC SNAP PLUG RCPT 16-14 GA BLU	0 83996 05729 6	37
05730	TERM, WIRE END NYLON BUTT SPLICE 22-18 GA RED	0 83996 05730 2	38
05731	TERM, WIRE END NYLON BUTT SPLICE 16-14 GA BLU	0 83996 05731 9	38
05732	TERM, WIRE END NYLON BUTT SPLICE 12-10 GA YEL	0 83996 05732 6	38
05733	TERM, WIRE END NON INSL BUTT SPLICE 16-14 GA	0 83996 05733 3	38
05734	TERM, WIRE END NON INSL BUTT SPLICE 12-10 GA	0 83996 05734 0	38
05735	TERM, WIRE END HEAT SHRINK RING 22-18 GA #8 RED	0 83996 05735 7	37
05736	TERM, WIRE END HEAT SHRINK RING 22-18 GA #10 RED	0 83996 05736 4	37
05737	TERM, WIRE END HEAT SHRINK RING 16-14 GA 1/4 BLU	0 83996 05737 1	37
05738	TERM, WIRE END HEAT SHRINK RING 14-16 GA #8 BLU	0 83996 05738 8	37
05739	TERM, WIRE END HEAT SHRINK RING 16-14 GA #10 BLU	0 83996 05739 5	37
05740	TERM, WIRE END HEAT SHRINK RING 12-10 GA 1/4 YEL	0 83996 05740 1	37
05741	TERM, WIRE END HEAT SHRINK RING 12-10 GA 3/8 YEL	0 83996 05741 8	37
05743	TERM, WIRE END HEAT SHRINK BUTT SPL 22-18 GA RED	0 83996 05743 2	38
05744	TERM, WIRE END HEAT SHRINK BUTT SPL 16-14 GA BLU	0 83996 05744 9	38
05745	TERM, WIRE END HEAT SHRINK BUTT SPL 12-10 GA YEL	0 83996 05745 6	38
05746	CONNECTOR, QUICK SPLICE 18-14 GA BLU 100/BAG	0 83996 05746 3	38
05747	CONNECTOR, QUICK SPLICE 18-14 GA WHT 100/BAG	0 83996 05747 0	38
05748	CONNECTOR, QUICK SPLICE 12-10 GA YEL 100/BAG	0 83996 05748 7	38
05749	LOOM, SPLIT 1/4" 100' BLK	0 83996 05749 4	42
05750	LOOM, SPLIT 3/8 100' BLK	0 83996 05750 0	42
05751	LOOM, SPLIT 1/2 100' BLK	0 83996 05751 7	42
05752	LOOM, SPLIT 5/8 100' BLK	0 83996 05752 4	42
05762	TERM, WIRE END HEAT SHRINK RING 12-10 GA #10 YEL	0 83996 05762 3	37
05763	CABLE TIES, 1/4" HD BLK 100/BAG	0 83996 05763 0	41
05764	CABLE TIES, 2/4" HD BLK 50/BAG	0 83996 05764 7	41
05765	CABLE TIES, 8" MOUNTING HEAD BLK 100/BAG	0 83996 05765 4	41
05766	CABLE TIES, 11" MOUNTING HEAD BLK 100/BAG	0 83996 05766 1	41
05767	CABLE TIES, 15" MOUNTING HEAD BLK 100/BAG	0 83996 05767 8	41
05768	TERMINAL, CONVERSION POST GR 31 POS 25/BOX	0 83996 05768 5	29
05769	TERMINAL, CONVERSION POST GR 31 NEG 25/BOX	0 83996 05769 2	29
06079	TERMINAL, TOP POST 10/CD UNBRANDED	0 83996 06079 1	26
06080	TERMINAL, SIDE TERM UNBRND 8/CD	0 83996 06080 7	26
06100	BOOTS, TMNL STR 4 & 6 GA BLK BULK	0 83996 06100 2	40
06101	BOOTS, TMNL STR 4 & 6 GA RED BULK	0 83996 06101 9	40
06102	BOOTS, TMNL STR 1 & 2 GA BLK BULK	0 83996 06102 6	40
06103	BOOTS, TMNL STR 1 & 2 GA RED BULK	0 83996 06103 3	40
06104	BOOTS, TMNL STR 1/0-2/0 GA BLK BULK	0 83996 06104 0	40
06105	BOOTS, TMNL STR 1/0-2/0 GA RED BULK	0 83996 06105 7	40
06106	BOOTS, TMNL FLAG 2/0 GA BLK BULK	0 83996 06106 4	40
06107	BOOTS, TMNL FLAG 2/0 GA RED BULK	0 83996 06107 1	40
06108	BOOTS, TMNL R ELBOW 2/0 GA BLK BULK	0 83996 06108 8	40
06109	BOOTS, TMNL R ELBOW 2/0 GA RED BULK	0 83996 06109 5	40
06110	BOOTS, TMNL L ELBOW 2/0 GA BLK BULK	0 83996 06110 1	40
06111	BOOTS, TMNL L ELBOW 2/0 GA RED BULK	0 83996 06111 8	40
06112	BOOTS, TMNL FLAG 2 GA BLK BULK	0 83996 06112 5	40
06113	BOOTS, TMNL FLAG 2 GA RED BULK	0 83996 06113 2	40
06114	BOOTS, TMNL R ELBOW 2 GA BLK BULK	0 83996 06114 9	40
06115	BOOTS, TMNL R ELBOW 2 GA RED BULK	0 83996 06115 6	40
06116	BOOTS, TMNL L ELBOW 2 GA BLK BULK	0 83996 06116 3	40
06117	BOOTS, TMNL L ELBOW 2 GA RED BULK	0 83996 06117 0	40
06118	BOOTS, TMNL R ELBOW 4-8 GA L/G BLK BULK	0 83996 06118 7	40



PRODUCT INDEX

PART NO.	DESCRIPTION	UNIT UPC	PAGE NO.
06119	BOOTS, TMNL R ELBOW 4-8 GA L/G RED BULK	0 83996 06119 4	40
06120	BOOTS, TMNL L ELBOW 4-8 GA L/G BLK BULK	0 83996 06120 0	40
06121	BOOTS, TMNL L ELBOW 4-8 GA L/G RED BULK	0 83996 06121 7	40
06122	BOOTS, TMNL DUAL POST MARINE BLK BULK	0 83996 06122 4	41
06123	BOOTS, TMNL DUAL POST MARINE RED BULK	0 83996 06123 1	41
06125	CLAMP, VINYL-CTD STEEL 500G RED/BLK 2/CS	0 83996 06125 5	11
06137	CLAMP, CHROME-PLTD STEEL 600P RED BULK	0 83996 06137 8	11
06138	CLAMP, CHROME-PLTD STEEL 600P BLK BULK	0 83996 06138 5	11
06139	CLAMP, VINYL-CTD STEEL 500E RED BULK	0 83996 06139 2	11
06140	CLAMP, VINYL-CTD STEEL 500E BLK BULK	0 83996 06140 8	11
06143	CLAMP, TUNE-UP/TEST EQUIP 50A RED BULK	0 83996 06143 9	11
06144	CLAMP, TUNE-UP/TEST EQUIP 50A BLK BULK	0 83996 06144 6	11
06145	CLAMP, JAW ALLIGATOR TYPE 10 AMP BULK	0 83996 06145 3	11
06146	CLAMP, JAW TYPE 10 AMP BULK	0 83996 06146 0	11
06146	CLAMP, JAW TYPE 10 AMP BULK	0 83996 06146 0	51
06147	CLAMP, JAW TYPE 25 AMP BULK	0 83996 06147 7	11
06148	CLAMP, JAW TYPE 50 AMP BULK	0 83996 06148 4	11
06152	CARRIER, BATT SURE GRIP BULK	0 83996 06152 1	51
06153	BOLTS, HOLD-DOWN J TYPE 6" BULK	0 83996 06153 8	48
06154	BOLTS, HOLD-DOWN J TYPE 8" BULK	0 83996 06154 5	48
06155	BOLTS, HOLD-DOWN J TYPE 10" BULK	0 83996 06155 2	48
06156	BOLTS, HOLD-DOWN L TYPE 10" BULK	0 83996 06156 9	48
06157	BOLTS, HOLD-DOWN J TYPE 12" BULK	0 83996 06157 6	48
06158	BOLTS, HOLD-DOWN J TYPE 12-5/16" BULK	0 83996 06158 3	48
06159	HOLD-DOWN, SAFETY-GRIP GROUP 24	0 83996 06159 0	48
06160	HOLD-DOWN, SAFETY-GRIP GROUP 27	0 83996 06160 6	48
06165	HOLD-DOWN, SAFETY-GRIP GROUP 31	0 83996 06165 1	48
06166	HOLD-DOWN, SAFETY-GRIP GROUP 31 2 BATTERY	0 83996 06166 8	48
06167	HOLD-DOWN, UNIV PLASTIC ADJST BULK	0 83996 06167 5	48
06300	SHIMS, BATTERY TOP POST 25/BOX	0 83996 06300 6	31
06453	WIRE, STARTER CABLE 3/0 GA 500' RED	0 83996 06453 9	69
06454	WIRE, STARTER CABLE 3/0 GA 100' RED	0 83996 06454 6	69
06455	WIRE, STARTER CABLE 3/0 GA 25' RED	0 83996 06455 3	69
07044	CABLE, BOOSTER 2 GA 20' 600E CU B/R BOX	0 83996 07044 8	6
07142	WIRE, UL1015 TINNED 18 GA 100' GRN	0 83996 07142 1	77
07143	WIRE, UL1015 TINNED 18 GA 100' BLK	0 83996 07143 8	77
07144	WIRE, UL1015 TINNED 18 GA 100' WHT	0 83996 07144 5	77
07145	WIRE, UL1015 TINNED 18 GA 100' RED	0 83996 07145 2	77
07146	WIRE, UL1015 TINNED 18 GA 100' YEL	0 83996 07146 9	77
07147	WIRE, UL1015 TINNED 18 GA 100' BRN	0 83996 07147 6	77
07148	WIRE, UL1015 TINNED 18 GA 100' BLU	0 83996 07148 3	77
07149	WIRE, UL1015 TINNED 18 GA 100' ORG	0 83996 07149 0	77
07150	WIRE, UL1015 TINNED 18 GA 100' GRY	0 83996 07150 6	77
07151	WIRE, UL1015 TINNED 18 GA 100' PRP	0 83996 07151 3	77
07152	WIRE, UL1015 TINNED 18 GA 100' DK BLU	0 83996 07152 0	77
07153	WIRE, UL1015 TINNED 18 GA 100' DK GRN	0 83996 07153 7	77
07154	WIRE, UL1015 TINNED 18 GA 100' TAN	0 83996 07154 4	77
07155	WIRE, UL1015 TINNED 18 GA 100' PNK	0 83996 07155 1	77
07156	WIRE, UL1015 TINNED 18 GA 500' GRN	0 83996 07156 8	77
07157	WIRE, UL1015 TINNED 18 GA 500' BLK	0 83996 07157 5	77
07158	WIRE, UL1015 TINNED 18 GA 500' WHT	0 83996 07158 2	77
07159	WIRE, UL1015 TINNED 18 GA 500' RED	0 83996 07159 9	77
07160	WIRE, UL1015 TINNED 18 GA 500' YEL	0 83996 07160 5	77
07161	WIRE, UL1015 TINNED 18 GA 500' BRN	0 83996 07161 2	77
07162	WIRE, UL1015 TINNED 18 GA 500' BLU	0 83996 07162 9	77
07163	WIRE, UL1015 TINNED 18 GA 500' ORG	0 83996 07163 6	77
07164	WIRE, UL1015 TINNED 18 GA 500' GRY	0 83996 07164 3	77
07165	WIRE, UL1015 TINNED 18 GA 500' PRP	0 83996 07165 0	77
07166	WIRE, UL1015 TINNED 18 GA 500' DK BLU	0 83996 07166 7	77
07167	WIRE, UL1015 TINNED 18 GA 500' DK GRN	0 83996 07167 4	77
07168	WIRE, UL1015 TINNED 18 GA 500' TAN	0 83996 07168 1	77
07169	WIRE, UL1015 TINNED 18 GA 500' PNK	0 83996 07169 8	77
07253	WIRE, BND PARALLEL 18/4 30' WHT,BRN,YEL,GRN 1/CS	0 83996 07253 4	84
07287	WIRE, BOOSTER 6 GA D-SHAPED 1800' BLK W/RED STR FR	0 83996 07287 9	98
07288	WIRE, BOOSTER 6 GA D-SHAPED BLK W/RED STRIPE 500'	0 83996 07288 6	98
07289	WIRE, BOOSTER 8 GA D-SHAPED 1000' BLK W/YEL STR FR	0 83996 07289 3	98
07290	WIRE, BOOSTER 8 GA D-SHAPED BLK W/YEL STRIPE 500'	0 83996 07290 9	98
07312	WIRE, BOOSTER 4 GA 1000' RED,BLK FR	0 83996 07312 8	97

PART NO.	DESCRIPTION	UNIT UPC	PAGE NO.
07372	LIFTER, GOLF CART 1/CS	0 83996 07372 2	51
07393	WIRE, CABLE SGX 2 GA 100' BLACK	0 83996 07393 7	70
07394	KIT, INDUSTRIAL PLUG 50 AMP GRAY 6 GA	0 83996 07394 4	32
07395	KIT, INDUSTRIAL PLUG 50 AMP RED 6 GA	0 83996 07395 1	32
07396	KIT, INDUSTRIAL PLUG 120 AMP GRAY 6 GA	0 83996 07396 8	32
07397	KIT, INDUSTRIAL PLUG 120 AMP RED 6 GA	0 83996 07397 5	32
07398	KIT, INDUSTRIAL PLUG 120 AMP BLUE 6 GA	0 83996 07398 2	32
07399	KIT, INDUSTRIAL PLUG 120 AMP GRAY 4 GA	0 83996 07399 9	32
07400	WIRE, BOAT CABLE UL SINGL 8 GA 100' BLK MM	0 83996 07400 2	80
07401	WIRE, BOAT CABLE UL SINGL 8 GA 100' RED MM	0 83996 07401 9	80
07402	WIRE, BOAT CABLE UL SINGL 8 GA 100' YEL MM	0 83996 07402 6	80
07403	WIRE, BOAT CABLE UL SINGL 8 GA 100' GRN MM	0 83996 07403 3	80
07404	WIRE, BOAT CABLE UL SINGL 8 GA 100' WHT MM	0 83996 07404 0	80
07405	WIRE, BOAT CABLE UL SINGL 8 GA 500' BLK MM	0 83996 07405 7	80
07406	WIRE, BOAT CABLE UL SINGL 8 GA 500' RED MM	0 83996 07406 4	80
07407	WIRE, BOAT CABLE UL SINGL 8 GA 500' YEL MM	0 83996 07407 1	80
07408	WIRE, BOAT CABLE UL SINGL 8 GA 500' GRN MM	0 83996 07408 8	80
07409	WIRE, BOAT CABLE UL SINGL 8 GA 500' WHT MM	0 83996 07409 5	80
07410	WIRE, BOAT CABLE UL SINGL 8 GA 1000' BLK MM	0 83996 07410 1	80
07411	WIRE, BOAT CABLE UL SINGL 8 GA 1000' RED MM	0 83996 07411 8	80
07412	WIRE, BOAT CABLE UL SINGL 8 GA 1000' YEL MM	0 83996 07412 5	80
07413	WIRE, BOAT CABLE UL SINGL 8 GA 1000' GRN MM	0 83996 07413 2	80
07414	WIRE, BOAT CABLE UL SINGL 8 GA 1000' WHT MM	0 83996 07414 9	80
07415	WIRE, BOAT CABLE UL SINGL 8 GA 2000' BLK FR	0 83996 07415 6	80
07416	WIRE, BOAT CABLE UL SINGL 8 GA 2000' RED FR	0 83996 07416 3	80
07417	WIRE, BOAT CABLE UL SINGL 8 GA 2000' YEL FR	0 83996 07417 0	80
07418	WIRE, BOAT CABLE UL SINGL 8 GA 2000' GRN FR	0 83996 07418 7	80
07419	WIRE, BOAT CABLE UL SINGL 8 GA 2000' WHT FR	0 83996 07419 4	80
07420	WIRE, BOAT CABLE UL SINGL 6 GA 100' BLK MM	0 83996 07420 0	80
07421	WIRE, BOAT CABLE UL SINGL 6 GA 100' RED MM	0 83996 07421 7	80
07422	WIRE, BOAT CABLE UL SINGL 6 GA 100' YEL MM	0 83996 07422 4	80
07423	WIRE, BOAT CABLE UL SINGL 6 GA 100' GRN MM	0 83996 07423 1	80
07424	WIRE, BOAT CABLE UL SINGL 6 GA 100' WHT MM	0 83996 07424 8	80
07425	WIRE, BOAT CABLE UL SINGL 6 GA 500' BLK MM	0 83996 07425 5	80
07426	WIRE, BOAT CABLE UL SINGL 6 GA 500' RED MM	0 83996 07426 2	80
07427	WIRE, BOAT CABLE UL SINGL 6 GA 500' YEL MM	0 83996 07427 9	80
07428	WIRE, BOAT CABLE UL SINGL 6 GA 500' GRN MM	0 83996 07428 6	80
07429	WIRE, BOAT CABLE UL SINGL 6 GA 500' WHT MM	0 83996 07429 3	80
07430	WIRE, BOAT CABLE UL SINGL 6 GA 1000' BLK MM	0 83996 07430 9	80
07431	WIRE, BOAT CABLE UL SINGL 6 GA 1000' RED MM	0 83996 07431 6	80
07432	WIRE, BOAT CABLE UL SINGL 6 GA 1000' YEL MM	0 83996 07432 3	80
07433	WIRE, BOAT CABLE UL SINGL 6 GA 1000' GRN MM	0 83996 07433 0	80
07434	WIRE, BOAT CABLE UL SINGL 6 GA 1000' WHT MM	0 83996 07434 7	80
07435	WIRE, BOAT CABLE UL SINGL 6 GA 3500' BLK FR	0 83996 07435 4	80
07436	WIRE, BOAT CABLE UL SINGL 6 GA 3500' RED FR	0 83996 07436 1	80
07437	WIRE, BOAT CABLE UL SINGL 6 GA 3500' YEL FR	0 83996 07437 8	80
07438	WIRE, BOAT CABLE UL SINGL 6 GA 3500' GRN FR	0 83996 07438 5	80
07439	WIRE, BOAT CABLE UL SINGL 6 GA 3500' WHT FR	0 83996 07439 2	80
07440	WIRE, UL/CSA MTW 8 GA 100' BLK	0 83996 07440 8	76
07441	WIRE, UL/CSA MTW 8 GA 100' RED	0 83996 07441 5	76
07442	WIRE, UL/CSA MTW 8 GA 100' BLU	0 83996 07442 2	76
07443	WIRE, UL/CSA MTW 8 GA 100' GRN	0 83996 07443 9	76
07444	WIRE, UL/CSA MTW 8 GA 100' WHT	0 83996 07444 6	76
07445	WIRE, UL/CSA MTW 8 GA 500' BLK	0 83996 07445 3	76
07446	WIRE, UL/CSA MTW 8 GA 500' RED	0 83996 07446 0	76
07447	WIRE, UL/CSA MTW 8 GA 500' BLU	0 83996 07447 7	76
07448	WIRE, UL/CSA MTW 8 GA 500' GRN	0 83996 07448 4	76
07449	WIRE, UL/CSA MTW 8 GA 500' WHT	0 83996 07449 1	76
07450	WIRE, UL/CSA MTW 8 GA 1000' BLK	0 83996 07450 7	76
07451	WIRE, UL/CSA MTW 8 GA 1000' RED	0 83996 07451 4	76
07452	WIRE, UL/CSA MTW 8 GA 1000' BLU	0 83996 07452 1	76
07453	WIRE, UL/CSA MTW 8 GA 1000' GRN	0 83996 07453 8	76
07454	WIRE, UL/CSA MTW 8 GA 1000' WHT	0 83996 07454 5	76
07455	WIRE, UL/CSA MTW 8 GA 2000' BLK FR	0 83996 07455 2	76
07456	WIRE, UL/CSA MTW 8 GA 2000' RED FR	0 83996 07456 9	76
07457	WIRE, UL/CSA MTW 8 GA 2000' BLU FR	0 83996 07457 6	76
07458	WIRE, UL/CSA MTW 8 GA 2000' GRN FR	0 83996 07458 3	76
07459	WIRE, UL/CSA MTW 8 GA 2000' WHT FR	0 83996 07459 0	76





**PRODUCT INDEX**

PART NO.	DESCRIPTION	UNIT UPC	PAGE NO.
07460	WIRE, UL/CSA MTW 6 GA 100' BLK	0 83996 07460 6	76
07461	WIRE, UL/CSA MTW 6 GA 100' RED	0 83996 07461 3	76
07462	WIRE, UL/CSA MTW 6 GA 100' BLU	0 83996 07462 0	76
07463	WIRE, UL/CSA MTW 6 GA 100' GRN	0 83996 07463 7	76
07464	WIRE, UL/CSA MTW 6 GA 100' WHT	0 83996 07464 4	76
07465	WIRE, UL/CSA MTW 6 GA 500' BLK	0 83996 07465 1	76
07466	WIRE, UL/CSA MTW 6 GA 500' RED	0 83996 07466 8	76
07467	WIRE, UL/CSA MTW 6 GA 500' BLU	0 83996 07467 5	76
07468	WIRE, UL/CSA MTW 6 GA 500' GRN	0 83996 07468 2	76
07469	WIRE, UL/CSA MTW 6 GA 500' WHT	0 83996 07469 9	76
07470	WIRE, UL/CSA MTW 6 GA 1000' BLK	0 83996 07470 5	76
07471	WIRE, UL/CSA MTW 6 GA 1000' RED	0 83996 07471 2	76
07472	WIRE, UL/CSA MTW 6 GA 1000' BLU	0 83996 07472 9	76
07473	WIRE, UL/CSA MTW 6 GA 1000' GRN	0 83996 07473 6	76
07474	WIRE, UL/CSA MTW 6 GA 1000' WHT	0 83996 07474 3	76
07475	WIRE, UL/CSA MTW 6 GA 3500' BLK FR	0 83996 07475 0	76
07476	WIRE, UL/CSA MTW 6 GA 3500' RED FR	0 83996 07476 7	76
07477	WIRE, UL/CSA MTW 6 GA 3500' BLU FR	0 83996 07477 4	76
07478	WIRE, UL/CSA MTW 6 GA 3500' GRN FR	0 83996 07478 1	76
07479	WIRE, UL/CSA MTW 6 GA 3500' WHT FR	0 83996 07479 8	76
07480	KIT, INDUSTRIAL PLUG 120 AMP RED 4 GA	0 83996 07480 4	32
07481	KIT, INDUSTRIAL PLUG 120 AMP BLUE 4 GA	0 83996 07481 1	32
07482	KIT, INDUSTRIAL PLUG 120 AMP GRAY 2 GA	0 83996 07482 8	32
07483	KIT, INDUSTRIAL PLUG 120 AMP RED 2 GA	0 83996 07483 5	32
07484	KIT, INDUSTRIAL PLUG 120 AMP BLUE 2 GA	0 83996 07484 2	32
07485	KIT, INDUSTRIAL PLUG 175 AMP GRAY 4 GA	0 83996 07485 9	32
07486	KIT, INDUSTRIAL PLUG 175 AMP RED 4 GA	0 83996 07486 6	32
07487	KIT, INDUSTRIAL PLUG 175 AMP BLUE 4 GA	0 83996 07487 3	32
07488	KIT, INDUSTRIAL PLUG 175 AMP GRAY 2 GA	0 83996 07488 0	32
07489	KIT, INDUSTRIAL PLUG 175 AMP RED 2 GA	0 83996 07489 7	32
07490	KIT, INDUSTRIAL PLUG 175 AMP BLUE 2 GA	0 83996 07490 3	32
07491	KIT, INDUSTRIAL PLUG 175 AMP GRAY 1/0 GA	0 83996 07491 0	32
07492	KIT, INDUSTRIAL PLUG 175 AMP RED 1/0 GA	0 83996 07492 7	32
07493	KIT, INDUSTRIAL PLUG 175 AMP BLUE 1/0 GA	0 83996 07493 4	32
07494	KIT, INDUSTRIAL PLUG 350 AMP GRAY 2/0 GA	0 83996 07494 1	32
07495	KIT, INDUSTRIAL PLUG 350 AMP RED 2/0 GA	0 83996 07495 8	32
07496	KIT, INDUSTRIAL PLUG 350 AMP BLUE 2/0 GA	0 83996 07496 5	32
07497	KIT, INDUSTRIAL PLUG 350 AMP GRAY 3/0 GA	0 83996 07497 2	32
07498	KIT, INDUSTRIAL PLUG 350 AMP RED 3/0 GA	0 83996 07498 9	32
07499	KIT, INDUSTRIAL PLUG 350 AMP BLUE 3/0 GA	0 83996 07499 6	32
07500	WIRE, UL/CSA MTW 18 GA 100' 105 RED	0 83996 07500 9	75
07501	WIRE, UL/CSA MTW 18 GA 100' 105 WHT	0 83996 07501 6	75
07502	WIRE, UL/CSA MTW 18 GA 100' 105 BLK	0 83996 07502 3	75
07503	WIRE, UL/CSA MTW 18 GA 100' 105 GRN	0 83996 07503 0	75
07504	WIRE, UL/CSA MTW 18 GA 100' 105 YEL	0 83996 07504 7	75
07505	WIRE, UL/CSA MTW 18 GA 100' 105 BRN	0 83996 07505 4	75
07506	WIRE, UL/CSA MTW 18 GA 100' 105 BLU	0 83996 07506 1	75
07507	WIRE, UL/CSA MTW 18 GA 100' 105 ORG	0 83996 07507 8	75
07508	WIRE, UL/CSA MTW 18 GA 500' 105 RED	0 83996 07508 5	75
07509	WIRE, UL/CSA MTW 18 GA 500' 105 WHT	0 83996 07509 2	75
07510	WIRE, UL/CSA MTW 18 GA 500' 105 BLK	0 83996 07510 8	75
07511	WIRE, UL/CSA MTW 18 GA 500' 105 GRN	0 83996 07511 5	75
07512	WIRE, UL/CSA MTW 18 GA 500' 105 YEL	0 83996 07512 2	75
07513	WIRE, UL/CSA MTW 18 GA 500' 105 BRN	0 83996 07513 9	75
07514	WIRE, UL/CSA MTW 18 GA 500' 105 BLU	0 83996 07514 6	75
07515	WIRE, UL/CSA MTW 18 GA 500' 105 ORG	0 83996 07515 3	75
07516	WIRE, UL/CSA MTW 18 GA 1000' 105 RED	0 83996 07516 0	75
07517	WIRE, UL/CSA MTW 18 GA 1000' 105 WHT	0 83996 07517 7	75
07518	WIRE, UL/CSA MTW 18 GA 1000' 105 BLK	0 83996 07518 4	75
07519	WIRE, UL/CSA MTW 18 GA 1000' 105 GRN	0 83996 07519 1	75
07520	WIRE, UL/CSA MTW 18 GA 1000' 105 YEL	0 83996 07520 7	75
07521	WIRE, UL/CSA MTW 18 GA 1000' 105 BRN	0 83996 07521 4	75
07522	WIRE, UL/CSA MTW 18 GA 1000' 105 BLU	0 83996 07522 1	75
07523	WIRE, UL/CSA MTW 18 GA 1000' 105 ORG	0 83996 07523 8	75
07524	WIRE, UL/CSA MTW 16 GA 100' 105 RED	0 83996 07524 5	75
07525	WIRE, UL/CSA MTW 16 GA 100' 105 WHT	0 83996 07525 2	75
07526	WIRE, UL/CSA MTW 16 GA 100' 105 BLK	0 83996 07526 9	75
07527	WIRE, UL/CSA MTW 16 GA 100' 105 GRN	0 83996 07527 6	75

PART NO.	DESCRIPTION	UNIT UPC	PAGE NO.
07528	WIRE, UL/CSA MTW 16 GA 100' 105 YEL	0 83996 07528 3	75
07529	WIRE, UL/CSA MTW 16 GA 100' 105 BRN	0 83996 07529 0	75
07530	WIRE, UL/CSA MTW 16 GA 100' 105 BLU	0 83996 07530 6	75
07531	WIRE, UL/CSA MTW 16 GA 100' 105 ORG	0 83996 07531 3	75
07532	WIRE, UL/CSA MTW 16 GA 500' 105 RED	0 83996 07532 0	75
07533	WIRE, UL/CSA MTW 16 GA 500' 105 WHT	0 83996 07533 7	75
07534	WIRE, UL/CSA MTW 16 GA 500' 105 BLK	0 83996 07534 4	75
07535	WIRE, UL/CSA MTW 16 GA 500' 105 GRN	0 83996 07535 1	75
07536	WIRE, UL/CSA MTW 16 GA 500' 105 YEL	0 83996 07536 8	75
07537	WIRE, UL/CSA MTW 16 GA 500' 105 BRN	0 83996 07537 5	75
07538	WIRE, UL/CSA MTW 16 GA 500' 105 BLU	0 83996 07538 2	75
07539	WIRE, UL/CSA MTW 16 GA 500' 105 ORG	0 83996 07539 9	75
07540	WIRE, UL/CSA MTW 16 GA 1000' 105 RED	0 83996 07540 5	75
07541	WIRE, UL/CSA MTW 16 GA 1000' 105 WHT	0 83996 07541 2	75
07542	WIRE, UL/CSA MTW 16 GA 1000' 105 BLK	0 83996 07542 9	75
07543	WIRE, UL/CSA MTW 16 GA 1000' 105 GRN	0 83996 07543 6	75
07544	WIRE, UL/CSA MTW 16 GA 1000' 105 YEL	0 83996 07544 3	75
07545	WIRE, UL/CSA MTW 16 GA 1000' 105 BRN	0 83996 07545 0	75
07546	WIRE, UL/CSA MTW 16 GA 1000' 105 BLU	0 83996 07546 7	75
07547	WIRE, UL/CSA MTW 16 GA 1000' 105 ORG	0 83996 07547 4	75
07548	WIRE, UL/CSA MTW 14 GA 100' 105 RED	0 83996 07548 1	76
07549	WIRE, UL/CSA MTW 14 GA 100' 105 WHT	0 83996 07549 8	76
07550	WIRE, UL/CSA MTW 14 GA 100' 105 BLK	0 83996 07550 4	76
07551	WIRE, UL/CSA MTW 14 GA 100' 105 GRN	0 83996 07551 1	76
07552	WIRE, UL/CSA MTW 14 GA 100' 105 YEL	0 83996 07552 8	76
07553	WIRE, UL/CSA MTW 14 GA 100' 105 BRN	0 83996 07553 5	76
07554	WIRE, UL/CSA MTW 14 GA 100' 105 BLU	0 83996 07554 2	76
07555	WIRE, UL/CSA MTW 14 GA 100' 105 ORG	0 83996 07555 9	76
07556	WIRE, UL/CSA MTW 14 GA 500' 105 RED	0 83996 07556 6	76
07557	WIRE, UL/CSA MTW 14 GA 500' 105 WHT	0 83996 07557 3	76
07558	WIRE, UL/CSA MTW 14 GA 500' 105 BLK	0 83996 07558 0	76
07559	WIRE, UL/CSA MTW 14 GA 500' 105 GRN	0 83996 07559 7	76
07560	WIRE, UL/CSA MTW 14 GA 500' 105 YEL	0 83996 07560 3	76
07561	WIRE, UL/CSA MTW 14 GA 500' 105 BRN	0 83996 07561 0	76
07562	WIRE, UL/CSA MTW 14 GA 500' 105 BLU	0 83996 07562 7	76
07563	WIRE, UL/CSA MTW 14 GA 500' 105 ORG	0 83996 07563 4	76
07564	WIRE, UL/CSA MTW 14 GA 1000' 105 RED	0 83996 07564 1	76
07565	WIRE, UL/CSA MTW 14 GA 1000' 105 WHT	0 83996 07565 8	76
07566	WIRE, UL/CSA MTW 14 GA 1000' 105 BLK	0 83996 07566 5	76
07567	WIRE, UL/CSA MTW 14 GA 1000' 105 GRN	0 83996 07567 2	76
07568	WIRE, UL/CSA MTW 14 GA 1000' 105 YEL	0 83996 07568 9	76
07569	WIRE, UL/CSA MTW 14 GA 1000' 105 BRN	0 83996 07569 6	76
07570	WIRE, UL/CSA MTW 14 GA 1000' 105 BLU	0 83996 07570 2	76
07571	WIRE, UL/CSA MTW 14 GA 1000' 105 ORG	0 83996 07571 9	76
07572	WIRE, UL/CSA MTW 12 GA 100' 105 RED	0 83996 07572 6	76
07573	WIRE, UL/CSA MTW 12 GA 100' 105 WHT	0 83996 07573 3	76
07574	WIRE, UL/CSA MTW 12 GA 100' 105 BLK	0 83996 07574 0	76
07575	WIRE, UL/CSA MTW 12 GA 100' 105 GRN	0 83996 07575 7	76
07576	WIRE, UL/CSA MTW 12 GA 100' 105 YEL	0 83996 07576 4	76
07577	WIRE, UL/CSA MTW 12 GA 100' 105 BRN	0 83996 07577 1	76
07578	WIRE, UL/CSA MTW 12 GA 100' 105 BLU	0 83996 07578 8	76
07579	WIRE, UL/CSA MTW 12 GA 100' 105 ORG	0 83996 07579 5	76
07580	WIRE, UL/CSA MTW 12 GA 500' 105 RED	0 83996 07580 1	76
07581	WIRE, UL/CSA MTW 12 GA 500' 105 WHT	0 83996 07581 8	76
07582	WIRE, UL/CSA MTW 12 GA 500' 105 BLK	0 83996 07582 5	76
07583	WIRE, UL/CSA MTW 12 GA 500' 105 GRN	0 83996 07583 2	76
07584	WIRE, UL/CSA MTW 12 GA 500' 105 YEL	0 83996 07584 9	76
07585	WIRE, UL/CSA MTW 12 GA 500' 105 BRN	0 83996 07585 6	76
07586	WIRE, UL/CSA MTW 12 GA 500' 105 BLU	0 83996 07586 3	76
07587	WIRE, UL/CSA MTW 12 GA 500' 105 ORG	0 83996 07587 0	76
07588	WIRE, UL/CSA MTW 12 GA 1000' 105 RED	0 83996 07588 7	76
07589	WIRE, UL/CSA MTW 12 GA 1000' 105 WHT	0 83996 07589 4	76
07590	WIRE, UL/CSA MTW 12 GA 1000' 105 BLK	0 83996 07590 0	76
07591	WIRE, UL/CSA MTW 12 GA 1000' 105 GRN	0 83996 07591 7	76
07592	WIRE, UL/CSA MTW 12 GA 1000' 105 YEL	0 83996 07592 4	76
07593	WIRE, UL/CSA MTW 12 GA 1000' 105 BRN	0 83996 07593 1	76
07594	WIRE, UL/CSA MTW 12 GA 1000' 105 BLU	0 83996 07594 8	76
07595	WIRE, UL/CSA MTW 12 GA 1000' 105 ORG	0 83996 07595 5	76



**PRODUCT INDEX**

PART NO.	DESCRIPTION	UNIT UPC	PAGE NO.
07596	WIRE, UL/CSA MTW 10 GA 100' 105 RED	0 83996 07596 2	76
07597	WIRE, UL/CSA MTW 10 GA 100' 105 WHT	0 83996 07597 9	76
07598	WIRE, UL/CSA MTW 10 GA 100' 105 BLK	0 83996 07598 6	76
07599	WIRE, UL/CSA MTW 10 GA 100' 105 GRN	0 83996 07599 3	76
07600	WIRE, UL/CSA MTW 10 GA 100' 105 YEL	0 83996 07600 6	76
07601	WIRE, UL/CSA MTW 10 GA 100' 105 BRN	0 83996 07601 3	76
07602	WIRE, UL/CSA MTW 10 GA 100' 105 BLU	0 83996 07602 0	76
07603	WIRE, UL/CSA MTW 10 GA 100' 105 ORG	0 83996 07603 7	76
07604	WIRE, UL/CSA MTW 10 GA 500' 105 RED	0 83996 07604 4	76
07605	WIRE, UL/CSA MTW 10 GA 500' 105 WHT	0 83996 07605 1	76
07606	WIRE, UL/CSA MTW 10 GA 500' 105 BLK	0 83996 07606 8	76
07607	WIRE, UL/CSA MTW 10 GA 500' 105 GRN	0 83996 07607 5	76
07608	WIRE, UL/CSA MTW 10 GA 500' 105 YEL	0 83996 07608 2	76
07609	WIRE, UL/CSA MTW 10 GA 500' 105 BRN	0 83996 07609 9	76
07610	WIRE, UL/CSA MTW 10 GA 500' 105 BLU	0 83996 07610 5	76
07611	WIRE, UL/CSA MTW 10 GA 500' 105 ORG	0 83996 07611 2	76
07612	WIRE, UL/CSA MTW 10 GA 1000' 105 RED	0 83996 07612 9	76
07613	WIRE, UL/CSA MTW 10 GA 1000' 105 WHT	0 83996 07613 6	76
07614	WIRE, UL/CSA MTW 10 GA 1000' 105 BLK	0 83996 07614 3	76
07615	WIRE, UL/CSA MTW 10 GA 1000' 105 GRN	0 83996 07615 0	76
07616	WIRE, UL/CSA MTW 10 GA 1000' 105 YEL	0 83996 07616 7	76
07617	WIRE, UL/CSA MTW 10 GA 1000' 105 BRN	0 83996 07617 4	76
07618	WIRE, UL/CSA MTW 10 GA 1000' 105 BLU	0 83996 07618 1	76
07619	WIRE, UL/CSA MTW 10 GA 1000' 105 ORG	0 83996 07619 8	76
07664	KIT, INDUSTRIAL PLUG 350 AMP GRAY 4/0 GA	0 83996 07664 8	32
07666	KIT, INDUSTRIAL PLUG 350 AMP RED 4/0 GA	0 83996 07666 2	32
07667	KIT, INDUSTRIAL PLUG 350 AMP BLUE 4/0 GA	0 83996 07667 9	32
07671	CABLE, SPLICE DIN-STYLE 1 GA SINGLE CABLE	0 83996 07671 6	16
07672	CABLE, SPLICE DIN-STYLE 1 GA DUAL CABLE	0 83996 07672 3	16
07673	WIRE, BOAT CABLE UL SINGLE 4/0 GA 25' BLK MM	0 83996 07673 0	81
07674	WIRE, BOAT CABLE UL SINGLE 4/0 GA 25' YEL MM	0 83996 07674 7	81
07675	WIRE, BOAT CABLE UL SINGLE 4/0 GA 25' RED MM	0 83996 07675 4	81
07676	WIRE, BOAT CABLE UL SINGLE 3/0 GA 25' BLK MM	0 83996 07676 1	81
07677	WIRE, BOAT CABLE UL SINGLE 3/0 GA 25' YEL MM	0 83996 07677 8	81
07678	WIRE, BOAT CABLE UL SINGLE 3/0 GA 25' RED MM	0 83996 07678 5	81
07679	WIRE, BOAT CABLE UL SINGLE 2/0 GA 25' BLK MM	0 83996 07679 2	81
07680	WIRE, BOAT CABLE UL SINGLE 2/0 GA 25' RED MM	0 83996 07680 8	81
07681	WIRE, BOAT CABLE UL SINGLE 2/0 GA 25' YEL MM	0 83996 07681 5	81
07682	WIRE, BOAT CABLE UL SINGLE 1/0 GA 25' BLK MM	0 83996 07682 2	81
07684	WIRE, BOAT CABLE UL SINGLE 1/0 GA 25' RED MM	0 83996 07684 6	81
07685	WIRE, BOAT CABLE UL SINGLE 1/0 GA 25' YEL MM	0 83996 07685 3	81
07686	WIRE, BOAT CABLE UL SINGLE 1 GA 25' RED MM	0 83996 07686 0	81
07687	WIRE, BOAT CABLE UL SINGLE 1 GA 25' BLK MM	0 83996 07687 7	81
07688	WIRE, BOAT CABLE UL SINGLE 2 GA 25' RED MM	0 83996 07688 4	80
07689	WIRE, BOAT CABLE UL SINGLE 2 GA 25' BLK MM	0 83996 07689 1	80
07690	WIRE, BOAT CABLE UL SINGLE 4 GA 25' RED MM	0 83996 07690 7	80
07691	WIRE, BOAT CABLE UL SINGLE 4 GA 25' BLK MM	0 83996 07691 4	80
07692	WIRE, BOAT CABLE UL SINGLE 6 GA 25' BLK MM	0 83996 07692 1	80
07693	WIRE, BOAT CABLE UL SINGLE 6 GA 25' GRN MM	0 83996 07693 8	80
07694	WIRE, BOAT CABLE UL SINGLE 6 GA 25' RED MM	0 83996 07694 5	80
07695	WIRE, BOAT CABLE UL SINGLE 6 GA 25' YEL MM	0 83996 07695 2	80
07696	WIRE, BOAT CABLE UL SINGLE 8 GA 25' BLK MM	0 83996 07696 9	80
07697	WIRE, BOAT CABLE UL SINGLE 8 GA 25' GRN MM	0 83996 07697 6	80
07698	WIRE, BOAT CABLE UL SINGLE 8 GA 25' RED MM	0 83996 07698 3	80
07699	WIRE, BOAT CABLE UL SINGLE 10 GA 8' GRN MM 1/CS	0 83996 07699 0	79
07706	WIRE, BOAT CABLE UL SINGLE 10 GA 8' BLK MM 1/CS	0 83996 07706 5	79
07707	WIRE, BOAT CABLE UL SINGLE 10 GA 8' WHT MM 1/CS	0 83996 07707 2	79
07708	WIRE, BOAT CABLE UL SINGLE 10 GA 8' RED MM 1/CS	0 83996 07708 9	79
07709	WIRE, BOAT CABLE UL SINGLE 10 GA 8' YEL MM 1/CS	0 83996 07709 6	79
07710	WIRE, BOAT CABLE UL SINGLE 10 GA 8' BRN MM 1/CS	0 83996 07710 2	79
07711	WIRE, BOAT CABLE UL SINGLE 10 GA 8' BLU MM 1/CS	0 83996 07711 9	79
07712	WIRE, BOAT CABLE UL SINGLE 12 GA 12' GRN MM 1/CS	0 83996 07712 6	79
07713	WIRE, BOAT CABLE UL SINGLE 12 GA 12' BLK MM 1/CS	0 83996 07713 3	79
07714	WIRE, BOAT CABLE UL SINGLE 12 GA 12' WHT MM 1/CS	0 83996 07714 0	79
07715	WIRE, BOAT CABLE UL SINGLE 12 GA 12' RED MM 1/CS	0 83996 07715 7	79
07716	WIRE, BOAT CABLE UL SINGLE 12 GA 12' YEL MM 1/CS	0 83996 07716 4	79
07717	WIRE, BOAT CABLE UL SINGLE 12 GA 12' BRN MM 1/CS	0 83996 07717 1	79
07718	WIRE, BOAT CABLE UL SINGLE 12 GA 12' BLU MM 1/CS	0 83996 07718 8	79

PART NO.	DESCRIPTION	UNIT UPC	PAGE NO.
07719	WIRE, BOAT CABLE UL SINGLE 14 GA 15' GRN MM 1/CS	0 83996 07719 5	79
07720	WIRE, BOAT CABLE UL SINGLE 14 GA 15' BLK MM 1/CS	0 83996 07720 1	79
07721	WIRE, BOAT CABLE UL SINGLE 14 GA 15' WHT MM 1/CS	0 83996 07721 8	79
07723	WIRE, BOAT CABLE UL SINGLE 14 GA 15' YEL MM 1/CS	0 83996 07723 2	79
07724	WIRE, BOAT CABLE UL SINGLE 14 GA 15' BRN MM 1/CS	0 83996 07724 9	79
07725	WIRE, BOAT CABLE UL SINGLE 14 GA 15' BLU MM 1/CS	0 83996 07725 6	79
07726	WIRE, BOAT CABLE UL SINGLE 16 GA 20' GRN MM 1/CS	0 83996 07726 3	78
07727	WIRE, BOAT CABLE UL SINGLE 16 GA 20' BLK MM 1/CS	0 83996 07727 0	78
07728	WIRE, BOAT CABLE UL SINGLE 16 GA 20' WHT MM 1/CS	0 83996 07728 7	78
07729	WIRE, BOAT CABLE UL SINGLE 16 GA 20' RED MM 1/CS	0 83996 07729 4	78
07730	WIRE, BOAT CABLE UL SINGLE 16 GA 20' YEL MM 1/CS	0 83996 07730 0	78
07731	WIRE, BOAT CABLE UL SINGLE 16 GA 20' BRN MM 1/CS	0 83996 07731 7	78
07732	WIRE, BOAT CABLE UL SINGLE 16 GA 20' BLU MM 1/CS	0 83996 07732 4	78
07753	SHIMS, BATTERY TOP POST 2/CD	0 83996 07753 9	31
08751	VOLT METER, DIGITAL	0 83996 08751 4	53
08754	CABLE, GR. 31 STACKABLE 2/0 9' BLK	0 83996 08754 5	22
08755	CABLE, GR. 31 STACKABLE 2/0 15' BLK	0 83996 08755 2	22
08756	CLAMP, 1000C 2/CS	0 83996 08756 9	11
08757	CABLE, GR. 31 STACKABLE 2/0 9' BLK 1/CS	0 83996 08757 6	16
08758	CABLE, GR. 31 STACKABLE 2/0 15' BLK 1/CS	0 83996 08758 3	16
08762	CLAMP, COPR-PLTD STEEL 200C RED/BLK 2/CS	0 83996 08762 0	11
08763	CLAMP, COPR-PLTD STEEL 200C RED BULK	0 83996 08763 7	11
08764	CLAMP, COPR-PLTD STEEL 200C BLK BULK	0 83996 08764 4	11
08765	KIT, SPINNER RACK	0 83996 08765 1	54-56
08766	BOLT, SIDE 3/8 REPL. OF LONG W/LEAD SPACER 1/CS	0 83996 08766 8	31
08767	TERMINAL, TOP POST NON LEAD QUICK CLAMP 2/CS	0 83996 08767 5	28
08768	ISOLATOR, INSTALL KIT DELCO CS 1/CS	0 83996 08768 2	58
08769	ISOLATOR, INSTALL KIT STANDARD 1/CS	0 83996 08769 9	58
08770	ISOLATOR, 95 AMP 1/CS	0 83996 08770 5	58
08771	ISOLATOR, 120 AMP 1/CS	0 83996 08771 2	58
08772	RACK, WIRE SPOOL	0 83996 08772 9	57
08773	BOX, ACCESSORY W/ ADJ DIVIDERS	0 83996 08773 6	57
08774	BOX, ADDITIONAL DIVIDERS 9/BG	0 83996 08774 6	57
08779	NUTS, WING (1) 3/8-16 & (2) 5/16-18 SS 3/CS	0 83996 08779 8	32
08859	CABLE, SPLICE LUG 4 GA DUAL CABLE	0 83996 08859 7	16
08861	WRENCH, OE COMBO TOP/SIDE 1/CS	0 83996 08861 0	52
08863	CABLE, SPLICE SIDE TERM 4 GA DUAL CABLE	0 83996 08863 4	16
08864	CABLE, SPLICE TOP POST 4 GA DUAL CABLE	0 83996 08864 1	16
08865	CABLE, SPLICE TOP POST 4 GA SINGLE CABLE	0 83996 08865 8	16
08866	CABLE, SPLICE SIDE TERM 4 GA SINGLE CABLE	0 83996 08866 5	16
08867	CABLE, SPLICE TOP POST 1 GA SINGLE CABLE	0 83996 08867 2	16
08868	CABLE, SPLICE SIDE TERM 1 GA SINGLE CABLE	0 83996 08868 9	16
08869	CABLE, SPLICE LUG 4 GA SINGLE CABLE	0 83996 08869 6	16
09645	HOLD-DOWN, WEDGE BASE GM 1/CS	0 83996 09645 5	48
09646	HOLD-DOWN, WEDGE BASE FORD 1/CS	0 83996 09646 2	48
14300	WIRE, PRIMARY 20 GA 15000' 80 RED FR	0 83996 14300 5	60
14301	WIRE, PRIMARY 20 GA 15000' 80 WHT FR	0 83996 14301 2	60
14302	WIRE, PRIMARY 20 GA 15000' 80 BLU FR	0 83996 14302 9	60
14303	WIRE, PRIMARY 20 GA 15000' 80 BLK FR	0 83996 14303 6	60
14304	WIRE, PRIMARY 20 GA 15000' 80 GRN FR	0 83996 14304 3	60
14305	WIRE, PRIMARY 20 GA 15000' 80 YEL FR	0 83996 14305 0	60
14306	WIRE, PRIMARY 20 GA 15000' 80 BRN FR	0 83996 14306 7	60
14307	WIRE, PRIMARY GXL 18 GA 5000' 125 RED FR	0 83996 14307 4	64
14308	WIRE, PRIMARY GXL 18 GA 5000' 125 WHT FR	0 83996 14308 1	64
14309	WIRE, PRIMARY GXL 18 GA 5000' 125 BLK FR	0 83996 14309 8	64
14310	WIRE, PRIMARY GXL 18 GA 5000' 125 GRN FR	0 83996 14310 4	64
14311	WIRE, PRIMARY GXL 18 GA 5000' 125 YEL FR	0 83996 14311 1	64
14312	WIRE, PRIMARY GXL 18 GA 5000' 125 BRN FR	0 83996 14312 8	64
14313	WIRE, PRIMARY GXL 18 GA 5000' 125 BLU FR	0 83996 14313 5	64
14314	WIRE, PRIMARY GXL 16 GA 5000' 125 RED FR	0 83996 14314 2	64
14315	WIRE, PRIMARY GXL 16 GA 5000' 125 WHT FR	0 83996 14315 9	64
14316	WIRE, PRIMARY GXL 16 GA 5000' 125 BLK FR	0 83996 14316 6	64
14317	WIRE, PRIMARY GXL 16 GA 5000' 125 GRN FR	0 83996 14317 3	64
14318	WIRE, PRIMARY GXL 16 GA 5000' 125 YEL FR	0 83996 14318 0	64
14319	WIRE, PRIMARY GXL 16 GA 5000' 125 BRN FR	0 83996 14319 7	64
14320	WIRE, PRIMARY GXL 16 GA 5000' 125 BLU FR	0 83996 14320 3	64
14321	WIRE, PRIMARY GXL 14 GA 5000' 125 RED FR	0 83996 14321 0	64
14322	WIRE, PRIMARY GXL 14 GA 5000' 125 WHT FR	0 83996 14322 7	64



**PRODUCT INDEX**

PART NO.	DESCRIPTION	UNIT UPC	PAGE NO.
14323	WIRE, PRIMARY GXL 14 GA 5000' 125 BLK FR	0 83996 14323 4	64
14324	WIRE, PRIMARY GXL 14 GA 5000' 125 GRN FR	0 83996 14324 1	64
14325	WIRE, PRIMARY GXL 14 GA 5000' 125 YEL FR	0 83996 14325 8	64
14326	WIRE, PRIMARY GXL 14 GA 5000' 125 BRN FR	0 83996 14326 5	64
14327	WIRE, PRIMARY GXL 14 GA 5000' 125 BLU FR	0 83996 14327 2	64
14328	WIRE, PRIMARY GXL 12 GA 3000' 125 RED FR	0 83996 14328 9	65
14329	WIRE, PRIMARY GXL 12 GA 3000' 125 WHT FR	0 83996 14329 6	65
14330	WIRE, PRIMARY GXL 12 GA 3000' 125 BLK FR	0 83996 14330 2	65
14331	WIRE, PRIMARY GXL 12 GA 3000' 125 GRN FR	0 83996 14331 9	65
14332	WIRE, PRIMARY GXL 12 GA 3000' 125 YEL FR	0 83996 14332 6	65
14333	WIRE, PRIMARY GXL 12 GA 3000' 125 BRN FR	0 83996 14333 3	65
14334	WIRE, PRIMARY GXL 12 GA 3000' 125 BLU FR	0 83996 14334 0	65
14335	WIRE, PRIMARY GXL 10 GA 2000' 125 RED FR	0 83996 14335 7	65
14336	WIRE, PRIMARY GXL 10 GA 2000' 125 WHT FR	0 83996 14336 4	65
14337	WIRE, PRIMARY GXL 10 GA 2000' 125 BLK FR	0 83996 14337 1	65
14338	WIRE, PRIMARY GXL 10 GA 2000' 125 GRN FR	0 83996 14338 8	65
14339	WIRE, PRIMARY GXL 10 GA 2000' 125 YEL FR	0 83996 14339 5	65
14340	WIRE, PRIMARY GXL 10 GA 2000' 125 BRN FR	0 83996 14340 1	65
14341	WIRE, PRIMARY GXL 10 GA 2000' 125 BLU FR	0 83996 14341 8	65
14342	WIRE, AUTO DUPLEX 142 7000' BLK/WH ECO GRV JKT FR	0 83996 14342 5	87
14500	WIRE, PRIMARY 18 GA 11000' 80 RED FR	0 83996 14500 9	60
14501	WIRE, PRIMARY 18 GA 11000' 80 WHT FR	0 83996 14501 6	60
14502	WIRE, PRIMARY 18 GA 11000' 80 BLK FR	0 83996 14502 3	60
14503	WIRE, PRIMARY 18 GA 11000' 80 GRN FR	0 83996 14503 0	60
14504	WIRE, PRIMARY 18 GA 11000' 80 YEL FR	0 83996 14504 7	60
14505	WIRE, PRIMARY 18 GA 11000' 80 BRN FR	0 83996 14505 4	60
14506	WIRE, PRIMARY 18 GA 11000' 80 BLU FR	0 83996 14506 1	60
14507	WIRE, PRIMARY 18 GA 11000' 80 ORG FR	0 83996 14507 8	60
14509	WIRE, PRIMARY 16 GA 9000' 80 RED FR	0 83996 14509 2	61
14510	WIRE, PRIMARY 16 GA 9000' 80 WHT FR	0 83996 14510 8	61
14511	WIRE, PRIMARY 16 GA 9000' 80 BLK FR	0 83996 14511 5	61
14512	WIRE, PRIMARY 16 GA 9000' 80 GRN FR	0 83996 14512 2	61
14513	WIRE, PRIMARY 16 GA 9000' 80 YEL FR	0 83996 14513 9	61
14514	WIRE, PRIMARY 16 GA 9000' 80 BRN FR	0 83996 14514 6	61
14515	WIRE, PRIMARY 16 GA 9000' 80 BLU FR	0 83996 14515 3	61
14516	WIRE, PRIMARY 16 GA 9000' 80 ORG FR	0 83996 14516 0	61
14518	WIRE, PRIMARY 14 GA 6000' 80 RED FR	0 83996 14518 4	61
14519	WIRE, PRIMARY 14 GA 6000' 80 WHT FR	0 83996 14519 1	61
14520	WIRE, PRIMARY 14 GA 6000' 80 BLK FR	0 83996 14520 7	61
14521	WIRE, PRIMARY 14 GA 6000' 80 GRN FR	0 83996 14521 4	61
14522	WIRE, PRIMARY 14 GA 6000' 80 YEL FR	0 83996 14522 1	61
14523	WIRE, PRIMARY 14 GA 6000' 80 BRN FR	0 83996 14523 8	61
14524	WIRE, PRIMARY 14 GA 6000' 80 BLU FR	0 83996 14524 5	61
14525	WIRE, PRIMARY 14 GA 6000' 80 ORG FR	0 83996 14525 2	61
14527	WIRE, PRIMARY 12 GA 4500' 80 RED FR	0 83996 14527 6	61
14528	WIRE, PRIMARY 12 GA 4500' 80 WHT FR	0 83996 14528 3	61
14529	WIRE, PRIMARY 12 GA 4500' 80 BLK FR	0 83996 14529 0	61
14530	WIRE, PRIMARY 12 GA 4500' 80 GRN FR	0 83996 14530 6	61
14531	WIRE, PRIMARY 12 GA 4500' 80 YEL FR	0 83996 14531 3	61
14532	WIRE, PRIMARY 12 GA 4500' 80 BRN FR	0 83996 14532 0	61
14533	WIRE, PRIMARY 12 GA 4500' 80 BLU FR	0 83996 14533 7	61
14534	WIRE, PRIMARY 12 GA 4500' 80 ORG FR	0 83996 14534 4	61
14536	WIRE, PRIMARY 10 GA 3500' 80 RED FR	0 83996 14536 8	61
14537	WIRE, PRIMARY 10 GA 3500' 80 WHT FR	0 83996 14537 5	61
14538	WIRE, PRIMARY 10 GA 3500' 80 BLK FR	0 83996 14538 2	61
14539	WIRE, PRIMARY 10 GA 3500' 80 GRN FR	0 83996 14539 9	61
14540	WIRE, PRIMARY 10 GA 3500' 80 YEL FR	0 83996 14540 5	61
14541	WIRE, PRIMARY 10 GA 3500' 80 BRN FR	0 83996 14541 2	61
14542	WIRE, PRIMARY 10 GA 3500' 80 BLU FR	0 83996 14542 9	61
14543	WIRE, PRIMARY 10 GA 3500' 80 ORG FR	0 83996 14543 6	61
14545	WIRE, PRIMARY 8 GA 2500' 80 RED FR	0 83996 14545 0	61
14546	WIRE, PRIMARY 8 GA 2500' 80 WHT FR	0 83996 14546 7	61
14547	WIRE, PRIMARY 8 GA 2500' 80 BLK FR	0 83996 14547 4	61
14548	WIRE, PRIMARY 8 GA 2500' 80 GRN FR	0 83996 14548 1	61
14552	WIRE, PRIMARY 18 GA 40000' 80 RED DR	0 83996 14552 8	60
14553	WIRE, PRIMARY 18 GA 40000' 80 WHT DR	0 83996 14553 5	60
14554	WIRE, PRIMARY 18 GA 40000' 80 BLK DR	0 83996 14554 2	60
14555	WIRE, PRIMARY 18 GA 40000' 80 GRN DR	0 83996 14555 9	60

PART NO.	DESCRIPTION	UNIT UPC	PAGE NO.
14556	WIRE, PRIMARY 18 GA 40000' 80 YEL DR	0 83996 14556 6	60
14557	WIRE, PRIMARY 18 GA 40000' 80 BRN DR	0 83996 14557 3	60
14558	WIRE, PRIMARY 18 GA 40000' 80 BLU DR	0 83996 14558 0	60
14559	WIRE, PRIMARY 18 GA 40000' 80 ORG DR	0 83996 14559 7	60
14561	WIRE, PRIMARY 16 GA 30000' 80 RED DR	0 83996 14561 0	61
14562	WIRE, PRIMARY 16 GA 30000' 80 WHT DR	0 83996 14562 7	61
14563	WIRE, PRIMARY 16 GA 30000' 80 BLK DR	0 83996 14563 4	61
14564	WIRE, PRIMARY 16 GA 30000' 80 GRN DR	0 83996 14564 1	61
14565	WIRE, PRIMARY 16 GA 30000' 80 YEL DR	0 83996 14565 8	61
14566	WIRE, PRIMARY 16 GA 30000' 80 BRN DR	0 83996 14566 5	61
14567	WIRE, PRIMARY 16 GA 30000' 80 BLU DR	0 83996 14567 2	61
14568	WIRE, PRIMARY 16 GA 30000' 80 ORG DR	0 83996 14568 9	61
14570	WIRE, PRIMARY 14 GA 20000' 80 RED DR	0 83996 14570 2	61
14571	WIRE, PRIMARY 14 GA 20000' 80 WHT DR	0 83996 14571 9	61
14572	WIRE, PRIMARY 14 GA 20000' 80 BLK DR	0 83996 14572 6	61
14573	WIRE, PRIMARY 14 GA 20000' 80 GRN DR	0 83996 14573 3	61
14574	WIRE, PRIMARY 14 GA 20000' 80 YEL DR	0 83996 14574 0	61
14575	WIRE, PRIMARY 14 GA 20000' 80 BRN DR	0 83996 14575 7	61
14576	WIRE, PRIMARY 14 GA 20000' 80 BLU DR	0 83996 14576 4	61
14577	WIRE, PRIMARY 14 GA 20000' 80 ORG DR	0 83996 14577 1	61
14579	WIRE, PRIMARY 12 GA 15000' 80 RED DR	0 83996 14579 5	61
14580	WIRE, PRIMARY 12 GA 15000' 80 WHT DR	0 83996 14580 1	61
14581	WIRE, PRIMARY 12 GA 15000' 80 BLK DR	0 83996 14581 8	61
14582	WIRE, PRIMARY 12 GA 15000' 80 GRN DR	0 83996 14582 5	61
14583	WIRE, PRIMARY 12 GA 15000' 80 YEL DR	0 83996 14583 2	61
14584	WIRE, PRIMARY 12 GA 15000' 80 BRN DR	0 83996 14584 9	61
14585	WIRE, PRIMARY 12 GA 15000' 80 BLU DR	0 83996 14585 6	61
14586	WIRE, PRIMARY 12 GA 15000' 80 ORG DR	0 83996 14586 3	61
14588	WIRE, PRIMARY 10 GA 10000' 80 RED DR	0 83996 14588 7	61
14589	WIRE, PRIMARY 10 GA 10000' 80 WHT DR	0 83996 14589 4	61
14590	WIRE, PRIMARY 10 GA 10000' 80 BLK DR	0 83996 14590 0	61
14591	WIRE, PRIMARY 10 GA 10000' 80 GRN DR	0 83996 14591 7	61
14592	WIRE, PRIMARY 10 GA 10000' 80 YEL DR	0 83996 14592 4	61
14593	WIRE, PRIMARY 10 GA 10000' 80 BRN DR	0 83996 14593 1	61
14594	WIRE, PRIMARY 10 GA 10000' 80 BLU DR	0 83996 14594 8	61
14595	WIRE, PRIMARY 10 GA 10000' 80 ORG DR	0 83996 14595 5	61
14597	WIRE, PRIMARY 8 GA 7000' 80 RED DR	0 83996 14597 9	61
14598	WIRE, PRIMARY 8 GA 7000' 80 WHT DR	0 83996 14598 6	61
14599	WIRE, PRIMARY 8 GA 7000' 80 BLK DR	0 83996 14599 3	61
14600	WIRE, PRIMARY 8 GA 7000' 80 GRN DR	0 83996 14600 6	61
14601	WIRE, PRIMARY 18 GA 11000' 105 RED FR	0 83996 14601 3	62
14602	WIRE, PRIMARY 18 GA 11000' 105 WHT FR	0 83996 14602 0	62
14603	WIRE, PRIMARY 18 GA 11000' 105 BLK FR	0 83996 14603 7	62
14604	WIRE, PRIMARY 18 GA 11000' 105 GRN FR	0 83996 14604 4	62
14605	WIRE, PRIMARY 18 GA 11000' 105 YEL FR	0 83996 14605 1	62
14606	WIRE, PRIMARY 18 GA 11000' 105 BRN FR	0 83996 14606 8	62
14607	WIRE, PRIMARY 18 GA 11000' 105 BLU FR	0 83996 14607 5	62
14608	WIRE, PRIMARY 18 GA 11000' 105 ORG FR	0 83996 14608 2	62
14609	WIRE, PRIMARY 18 GA 11000' 105 GRV FR	0 83996 14609 9	62
14610	WIRE, PRIMARY 18 GA 11000' 105 PRP FR	0 83996 14610 5	62
14611	WIRE, PRIMARY 18 GA 11000' 105 DK BLU FR	0 83996 14611 2	62
14612	WIRE, PRIMARY 18 GA 11000' 105 DK GRN FR	0 83996 14612 9	62
14613	WIRE, PRIMARY 18 GA 11000' 105 TAN FR	0 83996 14613 6	62
14614	WIRE, PRIMARY 18 GA 11000' 105 PNK FR	0 83996 14614 3	62
14615	WIRE, PRIMARY 16 GA 9000' 105 RED FR	0 83996 14615 0	62
14616	WIRE, PRIMARY 16 GA 9000' 105 WHT FR	0 83996 14616 7	62
14617	WIRE, PRIMARY 16 GA 9000' 105 BLK FR	0 83996 14617 4	62
14618	WIRE, PRIMARY 16 GA 9000' 105 GRN FR	0 83996 14618 1	62
14619	WIRE, PRIMARY 16 GA 9000' 105 YEL FR	0 83996 14619 5	62
14620	WIRE, PRIMARY 16 GA 9000' 105 BRN FR	0 83996 14620 4	62
14621	WIRE, PRIMARY 16 GA 9000' 105 BLU FR	0 83996 14621 1	62
14622	WIRE, PRIMARY 16 GA 9000' 105 ORG FR	0 83996 14622 8	62
14623	WIRE, PRIMARY 16 GA 9000' 105 GRV FR	0 83996 14623 5	62
14624	WIRE, PRIMARY 16 GA 9000' 105 PRP FR	0 83996 14624 2	62
14625	WIRE, PRIMARY 16 GA 9000' 105 DK BLU FR	0 83996 14625 9	62
14626	WIRE, PRIMARY 16 GA 9000' 105 DK GRN FR	0 83996 14626 6	62
14627	WIRE, PRIMARY 16 GA 9000' 105 TAN FR	0 83996 14627 3	62
14628	WIRE, PRIMARY 16 GA 9000' 105 PNK FR	0 83996 14628 0	62



PRODUCT INDEX

PART NO.	DESCRIPTION	UNIT UPC	PAGE NO.
14629	WIRE, PRIMARY 14 GA 6000' 105 RED FR	0 83996 14629 7	63
14630	WIRE, PRIMARY 14 GA 6000' 105 WHT FR	0 83996 14630 3	63
14631	WIRE, PRIMARY 14 GA 6000' 105 BLK FR	0 83996 14631 0	63
14633	WIRE, PRIMARY 14 GA 6000' 105 YEL FR	0 83996 14633 4	63
14634	WIRE, PRIMARY 14 GA 6000' 105 BRN FR	0 83996 14634 1	63
14635	WIRE, PRIMARY 14 GA 6000' 105 BLU FR	0 83996 14635 8	63
14635	WIRE, PRIMARY 14 GA 6000' 105 BLU FR	0 83996 14635 8	63
14636	WIRE, PRIMARY 14 GA 6000' 105 ORG FR	0 83996 14636 5	63
14637	WIRE, PRIMARY 14 GA 6000' 105 GRN FR	0 83996 14637 2	63
14638	WIRE, PRIMARY 14 GA 6000' 105 PRP FR	0 83996 14638 9	63
14639	WIRE, PRIMARY 14 GA 4500' 105 DK BLU FR	0 83996 14639 6	63
14640	WIRE, PRIMARY 14 GA 6000' 105 DK GRN FR	0 83996 14640 2	63
14641	WIRE, PRIMARY 14 GA 6000' 105 TAN FR	0 83996 14641 9	63
14642	WIRE, PRIMARY 14 GA 6000' 105 PNK FR	0 83996 14642 6	63
14643	WIRE, PRIMARY 12 GA 4500' 105 RED FR	0 83996 14643 3	63
14644	WIRE, PRIMARY 12 GA 4500' 105 WHT FR	0 83996 14644 0	63
14645	WIRE, PRIMARY 12 GA 4500' 105 BLK FR	0 83996 14645 7	63
14646	WIRE, PRIMARY 12 GA 4500' 105 GRN FR	0 83996 14646 4	63
14647	WIRE, PRIMARY 12 GA 4500' 105 YEL FR	0 83996 14647 1	63
14648	WIRE, PRIMARY 12 GA 4500' 105 BRN FR	0 83996 14648 8	63
14649	WIRE, PRIMARY 12 GA 4500' 105 BLU FR	0 83996 14649 5	63
14650	WIRE, PRIMARY 12 GA 4500' 105 ORG FR	0 83996 14650 1	63
14651	WIRE, PRIMARY 12 GA 4500' 105 GRY FR	0 83996 14651 8	63
14652	WIRE, PRIMARY 12 GA 4500' 105 PRP FR	0 83996 14652 5	63
14653	WIRE, PRIMARY 12 GA 4500' 105 DK BLU FR	0 83996 14653 2	63
14654	WIRE, PRIMARY 12 GA 4500' 105 DK GRN FR	0 83996 14654 9	63
14655	WIRE, PRIMARY 12 GA 4500' 105 TAN FR	0 83996 14655 6	63
14656	WIRE, PRIMARY 12 GA 4500' 105 PNK FR	0 83996 14656 3	63
14657	WIRE, PRIMARY 10 GA 3500' 105 RED FR	0 83996 14657 0	63
14658	WIRE, PRIMARY 10 GA 3500' 105 WHT FR	0 83996 14658 7	63
14659	WIRE, PRIMARY 10 GA 3500' 105 BLK FR	0 83996 14659 4	63
14660	WIRE, PRIMARY 10 GA 3500' 105 GRN FR	0 83996 14660 0	63
14661	WIRE, PRIMARY 10 GA 3500' 105 YEL FR	0 83996 14661 7	63
14662	WIRE, PRIMARY 10 GA 3500' 105 BRN FR	0 83996 14662 4	63
14663	WIRE, PRIMARY 10 GA 3500' 105 BLU FR	0 83996 14663 1	63
14664	WIRE, PRIMARY 10 GA 3500' 105 ORG FR	0 83996 14664 8	63
14665	WIRE, PRIMARY 10 GA 3500' 105 GRY FR	0 83996 14665 5	63
14666	WIRE, PRIMARY 10 GA 3500' 105 PRP FR	0 83996 14666 2	63
14667	WIRE, PRIMARY 10 GA 3500' 105 DK BLU FR	0 83996 14667 9	63
14668	WIRE, PRIMARY 10 GA 3500' 105 DK GRN FR	0 83996 14668 6	63
14669	WIRE, PRIMARY 10 GA 3500' 105 TAN FR	0 83996 14669 3	63
14670	WIRE, PRIMARY 10 GA 3500' 105 PNK FR	0 83996 14670 9	63
14671	WIRE, PRIMARY 8 GA 2500' 105 RED FR	0 83996 14671 6	63
14672	WIRE, PRIMARY 8 GA 2500' 105 WHT FR	0 83996 14672 3	63
14673	WIRE, PRIMARY 8 GA 2500' 105 BLK FR	0 83996 14673 0	63
14674	WIRE, PRIMARY 8 GA 2500' 105 GRN FR	0 83996 14674 7	63
14678	WIRE, PRIMARY 18 GA 40000' 105 RED DR	0 83996 14678 5	62
14679	WIRE, PRIMARY 18 GA 40000' 105 WHT DR	0 83996 14679 2	62
14680	WIRE, PRIMARY 18 GA 40000' 105 BLK DR	0 83996 14680 8	62
14681	WIRE, PRIMARY 18 GA 40000' 105 GRN DR	0 83996 14681 5	62
14682	WIRE, PRIMARY 18 GA 40000' 105 YEL DR	0 83996 14682 2	62
14683	WIRE, PRIMARY 18 GA 40000' 105 BRN DR	0 83996 14683 9	62
14684	WIRE, PRIMARY 18 GA 40000' 105 BLU DR	0 83996 14684 6	62
14685	WIRE, PRIMARY 18 GA 40000' 105 ORG DR	0 83996 14685 3	62
14686	WIRE, PRIMARY 18 GA 40000' 105 GRY DR	0 83996 14686 0	62
14687	WIRE, PRIMARY 18 GA 40000' 105 PRP DR	0 83996 14687 7	62
14688	WIRE, PRIMARY 18 GA 40000' 105 DK BLU DR	0 83996 14688 4	62
14689	WIRE, PRIMARY 18 GA 40000' 105 DK GRN DR	0 83996 14689 1	62
14690	WIRE, PRIMARY 18 GA 40000' 105 TAN DR	0 83996 14690 7	62
14691	WIRE, PRIMARY 18 GA 40000' 105 PNK DR	0 83996 14691 4	62
14692	WIRE, PRIMARY 16 GA 30000' 105 RED DR	0 83996 14692 1	62
14693	WIRE, PRIMARY 16 GA 30000' 105 WHT DR	0 83996 14693 8	62
14694	WIRE, PRIMARY 16 GA 30000' 105 BLK DR	0 83996 14694 5	62
14695	WIRE, PRIMARY 16 GA 30000' 105 GRN DR	0 83996 14695 2	62
14696	WIRE, PRIMARY 16 GA 30000' 105 YEL DR	0 83996 14696 9	62
14697	WIRE, PRIMARY 16 GA 30000' 105 BRN DR	0 83996 14697 6	62
14698	WIRE, PRIMARY 16 GA 30000' 105 BLU DR	0 83996 14698 3	62
14699	WIRE, PRIMARY 16 GA 30000' 105 ORG DR	0 83996 14699 0	62

PART NO.	DESCRIPTION	UNIT UPC	PAGE NO.
14700	WIRE, PRIMARY 16 GA 30000' 105 GRY DR	0 83996 14700 3	62
14701	WIRE, PRIMARY 16 GA 30000' 105 PRP DR	0 83996 14701 0	62
14702	WIRE, PRIMARY 16 GA 30000' 105 DK BLU DR	0 83996 14702 7	62
14703	WIRE, PRIMARY 16 GA 30000' 105 DK GRN DR	0 83996 14703 4	62
14704	WIRE, PRIMARY 16 GA 30000' 105 TAN DR	0 83996 14704 1	62
14705	WIRE, PRIMARY 16 GA 30000' 105 PNK DR	0 83996 14705 8	62
14706	WIRE, PRIMARY 14 GA 20000' 105 RED DR	0 83996 14706 5	63
14707	WIRE, PRIMARY 14 GA 20000' 105 WHT DR	0 83996 14707 2	63
14708	WIRE, PRIMARY 14 GA 20000' 105 BLK DR	0 83996 14708 9	63
14709	WIRE, PRIMARY 14 GA 20000' 105 GRN DR	0 83996 14709 6	63
14710	WIRE, PRIMARY 14 GA 20000' 105 YEL DR	0 83996 14710 2	63
14711	WIRE, PRIMARY 14 GA 20000' 105 BRN DR	0 83996 14711 9	63
14712	WIRE, PRIMARY 14 GA 20000' 105 BLU DR	0 83996 14712 6	63
14713	WIRE, PRIMARY 14 GA 20000' 105 ORG DR	0 83996 14713 3	63
14714	WIRE, PRIMARY 14 GA 20000' 105 GRY DR	0 83996 14714 0	63
14715	WIRE, PRIMARY 14 GA 20000' 105 PRP DR	0 83996 14715 7	63
14716	WIRE, PRIMARY 14 GA 20000' 105 DK BLU DR	0 83996 14716 4	63
14717	WIRE, PRIMARY 14 GA 20000' 105 DK GRN DR	0 83996 14717 1	63
14718	WIRE, PRIMARY 14 GA 20000' 105 TAN DR	0 83996 14718 8	63
14719	WIRE, PRIMARY 14 GA 20000' 105 PNK DR	0 83996 14719 5	63
14720	WIRE, PRIMARY 12 GA 15000' 105 RED DR	0 83996 14720 1	63
14721	WIRE, PRIMARY 12 GA 15000' 105 WHT DR	0 83996 14721 8	63
14722	WIRE, PRIMARY 12 GA 15000' 105 BLK DR	0 83996 14722 5	63
14723	WIRE, PRIMARY 12 GA 15000' 105 GRN DR	0 83996 14723 2	63
14724	WIRE, PRIMARY 12 GA 15000' 105 YEL DR	0 83996 14724 9	63
14725	WIRE, PRIMARY 12 GA 15000' 105 BRN DR	0 83996 14725 6	63
14726	WIRE, PRIMARY 12 GA 15000' 105 BLU DR	0 83996 14726 3	63
14727	WIRE, PRIMARY 12 GA 15000' 105 ORG DR	0 83996 14727 0	63
14728	WIRE, PRIMARY 12 GA 15000' 105 GRY DR	0 83996 14728 7	63
14729	WIRE, PRIMARY 12 GA 15000' 105 PRP DR	0 83996 14729 4	63
14730	WIRE, PRIMARY 12 GA 15000' 105 DK BLU DR	0 83996 14730 0	63
14731	WIRE, PRIMARY 12 GA 15000' 105 DK GRN DR	0 83996 14731 7	63
14732	WIRE, PRIMARY 12 GA 15000' 105 TAN DR	0 83996 14732 4	63
14733	WIRE, PRIMARY 12 GA 15000' 105 PNK DR	0 83996 14733 1	63
14734	WIRE, PRIMARY 10 GA 10000' 105 RED DR	0 83996 14734 8	63
14735	WIRE, PRIMARY 10 GA 10000' 105 WHT DR	0 83996 14735 5	63
14736	WIRE, PRIMARY 10 GA 10000' 105 BLK DR	0 83996 14736 2	63
14737	WIRE, PRIMARY 10 GA 10000' 105 GRN DR	0 83996 14737 9	63
14738	WIRE, PRIMARY 10 GA 10000' 105 YEL DR	0 83996 14738 6	63
14739	WIRE, PRIMARY 10 GA 10000' 105 BRN DR	0 83996 14739 3	63
14740	WIRE, PRIMARY 10 GA 10000' 105 BLU DR	0 83996 14740 9	63
14741	WIRE, PRIMARY 10 GA 10000' 105 ORG DR	0 83996 14741 6	63
14742	WIRE, PRIMARY 10 GA 10000' 105 GRY DR	0 83996 14742 3	63
14743	WIRE, PRIMARY 10 GA 10000' 105 PRP DR	0 83996 14743 0	63
14744	WIRE, PRIMARY 10 GA 10000' 105 DK BLU DR	0 83996 14744 7	63
14745	WIRE, PRIMARY 10 GA 10000' 105 DK GRN DR	0 83996 14745 4	63
14746	WIRE, PRIMARY 10 GA 10000' 105 TAN DR	0 83996 14746 1	63
14747	WIRE, PRIMARY 10 GA 10000' 105 PNK DR	0 83996 14747 8	63
14748	WIRE, PRIMARY 8 GA 7000' 105 RED DR	0 83996 14748 5	63
14749	WIRE, PRIMARY 8 GA 7000' 105 WHT DR	0 83996 14749 2	63
14750	WIRE, PRIMARY 8 GA 7000' 105 BLK DR	0 83996 14750 8	63
14751	WIRE, PRIMARY 8 GA 7000' 105 GRN DR	0 83996 14751 5	63
14752	WIRE, UL/CSA MTW 18 GA 8000' RED FR	0 83996 14752 2	75
14753	WIRE, UL/CSA MTW 18 GA 8000' WHT FR	0 83996 14753 9	75
14754	WIRE, UL/CSA MTW 18 GA 8000' BLK FR	0 83996 14754 6	75
14755	WIRE, UL/CSA MTW 18 GA 8000' GRN FR	0 83996 14755 3	75
14756	WIRE, UL/CSA MTW 18 GA 8000' YEL FR	0 83996 14756 7	75
14757	WIRE, UL/CSA MTW 18 GA 8000' BRN FR	0 83996 14757 7	75
14758	WIRE, UL/CSA MTW 18 GA 8000' BLU FR	0 83996 14758 4	75
14759	WIRE, UL/CSA MTW 18 GA 8000' ORG FR	0 83996 14759 1	75
14760	WIRE, UL/CSA MTW 16 GA 6000' RED FR	0 83996 14760 7	75
14761	WIRE, UL/CSA MTW 16 GA 6000' WHT FR	0 83996 14761 4	75
14762	WIRE, UL/CSA MTW 16 GA 6000' BLK FR	0 83996 14762 1	75
14763	WIRE, UL/CSA MTW 16 GA 6000' GRN FR	0 83996 14763 8	75
14764	WIRE, UL/CSA MTW 16 GA 6000' YEL FR	0 83996 14764 5	75
14765	WIRE, UL/CSA MTW 16 GA 6000' BRN FR	0 83996 14765 2	75
14766	WIRE, UL/CSA MTW 16 GA 6000' BLU FR	0 83996 14766 9	75
14767	WIRE, UL/CSA MTW 16 GA 6000' ORG FR	0 83996 14767 6	75



PRODUCT INDEX

PART NO.	DESCRIPTION	UNIT UPC	PAGE NO.
14768	WIRE, UL/CSA MTW 14 GA 5000' RED FR	0 83996 14768 3	76
14769	WIRE, UL/CSA MTW 14 GA 5000' WHT FR	0 83996 14769 0	76
14770	WIRE, UL/CSA MTW 14 GA 5000' BLK FR	0 83996 14770 6	76
14771	WIRE, UL/CSA MTW 14 GA 5000' GRN FR	0 83996 14771 3	76
14772	WIRE, UL/CSA MTW 14 GA 5000' YEL FR	0 83996 14772 0	76
14773	WIRE, UL/CSA MTW 14 GA 5000' BRN FR	0 83996 14773 7	76
14774	WIRE, UL/CSA MTW 14 GA 5000' BLU FR	0 83996 14774 4	76
14775	WIRE, UL/CSA MTW 14 GA 5000' ORG FR	0 83996 14775 1	76
14776	WIRE, UL/CSA MTW 12 GA 3500' RED FR	0 83996 14776 8	76
14777	WIRE, UL/CSA MTW 12 GA 3500' WHT FR	0 83996 14777 5	76
14778	WIRE, UL/CSA MTW 12 GA 3500' BLK FR	0 83996 14778 2	76
14779	WIRE, UL/CSA MTW 12 GA 3500' GRN FR	0 83996 14779 9	76
14780	WIRE, UL/CSA MTW 12 GA 3500' YEL FR	0 83996 14780 5	76
14781	WIRE, UL/CSA MTW 12 GA 3500' BRN FR	0 83996 14781 2	76
14782	WIRE, UL/CSA MTW 12 GA 3500' BLU FR	0 83996 14782 9	76
14783	WIRE, UL/CSA MTW 12 GA 3500' ORG FR	0 83996 14783 6	76
14784	WIRE, UL/CSA MTW 10 GA 3500' RED FR	0 83996 14784 3	76
14785	WIRE, UL/CSA MTW 10 GA 3500' WHT FR	0 83996 14785 0	76
14786	WIRE, UL/CSA MTW 10 GA 3500' BLK FR	0 83996 14786 7	76
14787	WIRE, UL/CSA MTW 10 GA 3500' GRN FR	0 83996 14787 4	76
14788	WIRE, UL/CSA MTW 10 GA 3500' YEL FR	0 83996 14788 1	76
14789	WIRE, UL/CSA MTW 10 GA 3500' BRN FR	0 83996 14789 8	76
14790	WIRE, UL/CSA MTW 10 GA 3500' BLU FR	0 83996 14790 4	76
14791	WIRE, UL/CSA MTW 10 GA 3500' ORG FR	0 83996 14791 1	76
14792	WIRE, UL/CSA MTW 18 GA 25000' RED DR	0 83996 14792 8	75
14793	WIRE, UL/CSA MTW 18 GA 25000' WHT DR	0 83996 14793 5	75
14794	WIRE, UL/CSA MTW 18 GA 25000' BLK DR	0 83996 14794 2	75
14795	WIRE, UL/CSA MTW 18 GA 25000' GRN DR	0 83996 14795 6	75
14796	WIRE, UL/CSA MTW 18 GA 25000' YEL DR	0 83996 14796 6	75
14797	WIRE, UL/CSA MTW 18 GA 25000' BRN DR	0 83996 14797 3	75
14798	WIRE, UL/CSA MTW 18 GA 25000' BLU DR	0 83996 14798 0	75
14799	WIRE, UL/CSA MTW 18 GA 25000' ORG DR	0 83996 14799 7	75
14800	WIRE, UL/CSA MTW 16 GA 20000' RED DR	0 83996 14800 0	75
14801	WIRE, UL/CSA MTW 16 GA 20000' WHT DR	0 83996 14801 7	75
14802	WIRE, UL/CSA MTW 16 GA 20000' BLK DR	0 83996 14802 4	75
14803	WIRE, UL/CSA MTW 16 GA 20000' GRN DR	0 83996 14803 1	75
14804	WIRE, UL/CSA MTW 16 GA 20000' YEL DR	0 83996 14804 8	75
14805	WIRE, UL/CSA MTW 16 GA 20000' BRN DR	0 83996 14805 5	75
14806	WIRE, UL/CSA MTW 16 GA 20000' BLU DR	0 83996 14806 2	75
14807	WIRE, UL/CSA MTW 16 GA 20000' ORG DR	0 83996 14807 9	75
14808	WIRE, UL/CSA MTW 14 GA 15000' RED DR	0 83996 14808 6	76
14809	WIRE, UL/CSA MTW 14 GA 15000' WHT DR	0 83996 14809 3	76
14810	WIRE, UL/CSA MTW 14 GA 15000' BLK DR	0 83996 14810 9	76
14811	WIRE, UL/CSA MTW 14 GA 15000' GRN DR	0 83996 14811 6	76
14812	WIRE, UL/CSA MTW 14 GA 15000' YEL DR	0 83996 14812 3	76
14813	WIRE, UL/CSA MTW 14 GA 15000' BRN DR	0 83996 14813 0	76
14814	WIRE, UL/CSA MTW 14 GA 15000' BLU DR	0 83996 14814 7	76
14815	WIRE, UL/CSA MTW 14 GA 15000' ORG DR	0 83996 14815 4	76
14816	WIRE, UL/CSA MTW 12 GA 10000' RED DR	0 83996 14816 1	76
14817	WIRE, UL/CSA MTW 12 GA 10000' WHT DR	0 83996 14817 8	76
14818	WIRE, UL/CSA MTW 12 GA 10000' BLK DR	0 83996 14818 5	76
14819	WIRE, UL/CSA MTW 12 GA 10000' GRN DR	0 83996 14819 2	76
14820	WIRE, UL/CSA MTW 12 GA 10000' YEL DR	0 83996 14820 8	76
14821	WIRE, UL/CSA MTW 12 GA 10000' BRN DR	0 83996 14821 5	76
14822	WIRE, UL/CSA MTW 12 GA 10000' BLU DR	0 83996 14822 2	76
14823	WIRE, UL/CSA MTW 12 GA 10000' ORG DR	0 83996 14823 9	76
14824	WIRE, UL/CSA MTW 10 GA 7000' RED DR	0 83996 14824 6	76
14825	WIRE, UL/CSA MTW 10 GA 7000' WHT DR	0 83996 14825 4	76
14826	WIRE, UL/CSA MTW 10 GA 7000' BLK DR	0 83996 14826 0	76
14827	WIRE, UL/CSA MTW 10 GA 7000' GRN DR	0 83996 14827 7	76
14828	WIRE, UL/CSA MTW 10 GA 7000' YEL DR	0 83996 14828 4	76
14829	WIRE, UL/CSA MTW 10 GA 7000' BRN DR	0 83996 14829 1	76
14830	WIRE, UL/CSA MTW 10 GA 7000' BLU DR	0 83996 14830 7	76
14831	WIRE, UL/CSA MTW 10 GA 7000' ORG DR	0 83996 14831 4	76
14832	WIRE, BND PARALLEL 14/2 10500' RED,BLK FR	0 83996 14832 1	85
14833	WIRE, BND PARALLEL 16/2 12500' RED,BLK FR	0 83996 14833 8	85
14834	WIRE, BND PARALLEL 18/2 14000' RED,BLK FR	0 83996 14834 5	84
14835	WIRE, BND PARALLEL 14/3 8500' BRN,YEL,GRN FR	0 83996 14835 2	85

PART NO.	DESCRIPTION	UNIT UPC	PAGE NO.
14836	WIRE, BND PARALLEL 16/3 10000' BRN,YEL,GRN FR	0 83996 14836 9	85
14837	WIRE, BND PARALLEL 18/3 12500' BRN,YEL,GRN FR	0 83996 14837 6	84
14838	WIRE, BND PARALLEL 14/4 6500' WHT,BRN,YEL,GRN FR	0 83996 14838 3	85
14839	WIRE, BND PARALLEL 16/4 8000' WHT,BRN,YEL,GRN FR	0 83996 14839 0	85
14840	WIRE, BND PARALLEL 18/4 8000' WHT,BRN,YEL,GRN FR	0 83996 14840 6	84
14841	WIRE, AUTO DUPLEX 8/2 2000' BLK,WHT W/GRY JKT FR	0 83996 14841 3	87
14842	WIRE, AUTO DUPLEX 10/2 3500' BLK,WHT W/GRY JKT FR	0 83996 14842 0	87
14843	WIRE, AUTO DUPLEX 12/2 5000' BLK,WHT W/GRY JKT FR	0 83996 14843 7	87
14844	WIRE, AUTO DUPLEX 14/2 7000' BLK,WHT GRY JKT FR	0 83996 14844 4	87
14845	WIRE, AUTO DUPLEX 16/2 8000' BLK,WHT W/GRY JKT FR	0 83996 14845 1	86
14846	WIRE, AUTO DUPLEX 18/2 9000' BLK,WHT W/GRY JKT FR	0 83996 14846 8	86
14847	WIRE, AUTO DUPLEX 12/2 5000' BLK,BLU W/RED JKT FR	0 83996 14847 5	87
14848	WIRE, AUTO TRIPLEX 10/3 2500' BLK,GRN, WHT FR	0 83996 14848 2	88
14849	WIRE, AUTO TRIPLEX 12/3 3000' BLK,GRN, WHT FR	0 83996 14849 9	88
14850	WIRE, AUTO TRIPLEX 14/3 4000' BLK,GRN, WHT FR	0 83996 14850 5	88
14851	WIRE, AUTO TRIPLEX 16/3 5000' BLK,GRN, WHT FR	0 83996 14851 2	88
14852	WIRE, AUTO QUAD 10/4 2000' WHT,GRN,RED,BLK FR	0 83996 14852 9	89
14853	WIRE, AUTO QUAD 12/4 2500' WHT,GRN,RED,BLK FR	0 83996 14853 6	89
14854	WIRE, AUTO QUAD 14/4 3000' WHT,GRN,RED,BLK FR	0 83996 14854 3	89
14855	WIRE, AUTO QUAD 16/4 3500' WHT,GRN,RED,BLK FR	0 83996 14855 0	89
14856	WIRE, STARTER CABLE 6 GA 3500' RED FR	0 83996 14856 7	68
14857	WIRE, STARTER CABLE 6 GA 3500' BLK FR	0 83996 14857 4	68
14858	WIRE, STARTER CABLE 4 GA 3000' RED FR	0 83996 14858 1	68
14859	WIRE, STARTER CABLE 4 GA 3000' BLK FR	0 83996 14859 8	68
14860	WIRE, STARTER CABLE 2 GA 2000' RED FR	0 83996 14860 4	68
14861	WIRE, STARTER CABLE 2 GA 2000' BLK FR	0 83996 14861 1	68
14862	WIRE, STARTER CABLE 1 GA 2000' RED FR	0 83996 14862 8	68
14863	WIRE, STARTER CABLE 1 GA 2000' BLK FR	0 83996 14863 5	68
14864	WIRE, STARTER CABLE 1/0 GA 1500' RED FR	0 83996 14864 2	69
14865	WIRE, STARTER CABLE 1/0 GA 1500' BLK FR	0 83996 14865 9	69
14866	WIRE, STARTER CABLE 2/0 GA 1000' RED FR	0 83996 14866 6	69
14867	WIRE, STARTER CABLE 2/0 GA 1000' BLK FR	0 83996 14867 3	69
14868	WIRE, STARTER CABLE 3/0 GA 1000' BLK FR	0 83996 14868 0	69
14869	WIRE, TC 16/4 3000' BLK,RED,BRN,WHT FR	0 83996 14869 7	90
14870	WIRE, TC 16/6 2500' R,GRN,BRN,WHT,BLK,YEL FR	0 83996 14870 3	91
14871	WIRE, TC 14/4 2500' BLK,RED,BRN,WHT FR	0 83996 14871 0	91
14872	WIRE, TC 14/6 2000' RED,GRN,BRN,WHT,BLK,YEL FR	0 83996 14872 7	91
14873	WIRE, TC 14/7 2000' R,GR,BR,W,BK,Y,BL FR	0 83996 14873 4	92
14874	WIRE, TC 12/4 2000' BLK,RED,BRN,WHT FR	0 83996 14874 1	91
14875	WIRE, TC 12/6 1500' RED,GRN,BRN,WHT,BLK,YEL FR	0 83996 14875 8	92
14876	WIRE, TC 12/6-10/1 1000' W,BLK,YR,GRN,BRN,BLU FR	0 83996 14876 5	92
14877	WIRE, TC 14/4-12/1-10/2 1500' DBL,B,BK,DG,R,W,Y FR	0 83996 14877 2	93
14878	WIRE, TC 12/4-10/2-8/1 1000' W/GRN JKT FR	0 83996 14878 9	94
14889	WIRE, BOAT CABLE UL SNGL 16 GA 6000' GRN FR	0 83996 14889 5	78
14890	WIRE, BOAT CABLE UL SNGL 16 GA 6000' BLK FR	0 83996 14890 1	78
14891	WIRE, BOAT CABLE UL SNGL 16 GA 6000' WHT FR	0 83996 14891 8	78
14892	WIRE, BOAT CABLE UL SNGL 16 GA 6000' RED FR	0 83996 14892 5	78
14893	WIRE, BOAT CABLE UL SNGL 14 GA 5000' GRN FR	0 83996 14893 2	79
14894	WIRE, BOAT CABLE UL SNGL 14 GA 5000' BLK FR	0 83996 14894 9	79
14895	WIRE, BOAT CABLE UL SNGL 14 GA 5000' WHT FR	0 83996 14895 6	79
14896	WIRE, BOAT CABLE UL SNGL 14 GA 5000' RED FR	0 83996 14896 3	79
14897	WIRE, BOAT CABLE UL SNGL 12 GA 3500' GRN FR	0 83996 14897 0	79
14898	WIRE, BOAT CABLE UL SNGL 12 GA 3500' BLK FR	0 83996 14898 4	79
14899	WIRE, BOAT CABLE UL SNGL 12 GA 3500' WHT FR	0 83996 14899 4	79
14900	WIRE, BOAT CABLE UL SNGL 12 GA 3500' RED FR	0 83996 14900 7	79
14901	WIRE, BOAT CABLE UL SNGL 10 GA 3500' GRN FR	0 83996 14901 4	79
14902	WIRE, BOAT CABLE UL SNGL 10 GA 3500' BLK FR	0 83996 14902 1	79
14903	WIRE, BOAT CABLE UL SNGL 10 GA 3500' WHT FR	0 83996 14903 8	79
14904	WIRE, BOAT CABLE UL SNGL 10 GA 3500' RED FR	0 83996 14904 5	79
14905	WIRE, BOAT CABLE UL MULTI 10/2 2500' BLK,WHT FR	0 83996 14905 2	83
14906	WIRE, BOAT CABLE UL MULTI 12/2 4000' BLK, WHT FR	0 83996 14906 9	83
14907	WIRE, BOAT CABLE UL MULTI 14/2 5000' BLK, WHT FR	0 83996 14907 6	82
14908	WIRE, BOAT CABLE UL MULTI 16/2 6000' BLK, WHT FR	0 83996 14908 3	82
14909	WIRE, BOAT CABLE UL MULTI 10/3 2500' BLK,GRN,WHT FR	0 83996 14909 0	83
14910	WIRE, BOAT CABLE UL MULTI 12/3 3000' BK,GR,W FR	0 83996 14910 6	83
14911	WIRE, BOAT CABLE UL MULTI 14/3 3500' BK,GR,W FR	0 83996 14911 3	83
14912	WIRE, BOAT CABLE UL MULTI 16/3 4500' BK,GR,W FR	0 83996 14912 0	83
14913	WIRE, BOOSTER 2 GA 1000' BLK, RED FR	0 83996 14913 7	97



PRODUCT INDEX

PART NO.	DESCRIPTION	UNIT UPC	PAGE NO.
14914	WIRE, BOOSTER 4 GA 1000' BLK, WHT FR	0 83996 14914 4	97
14915	WIRE, BOOSTER 6 GA 1200' BLK, ORG FR	0 83996 14915 1	97
14916	WIRE, BOOSTER 8 GA 1500' BLK, YEL FR	0 83996 14916 8	97
14928	WIRE, STARTER CABLE 3/0 GA 1000' RED FR	0 83996 14928 1	69
1512137	TERMINAL, 3-WAY COMMERCIAL NEG 25/BOX	0 83996 15127 7	26
1512138	TERMINAL, 3-WAY COMMERCIAL POS 25/BOX	0 83996 15128 4	26
31000	WIRE, UL3311 WELDING CABLE 4 GA 500' RED	0 83996 31000 1	74
31001	WIRE, UL3311 WELDING CABLE 4 GA 500' BLK	0 83996 31001 8	74
31002	WIRE, UL3311 WELDING CABLE 2 GA 500' RED	0 83996 31002 5	74
31003	WIRE, UL3311 WELDING CABLE 2 GA 500' BLK	0 83996 31003 2	74
31004	WIRE, UL3311 WELDING CABLE 1 GA 500' RED	0 83996 31004 9	74
31005	WIRE, UL3311 WELDING CABLE 1 GA 500' BLK	0 83996 31005 6	74
31006	WIRE, UL3311 WELDING CABLE 1/0 GA 500' RED	0 83996 31006 3	74
31007	WIRE, UL3311 WELDING CABLE 1/0 GA 500' BLK	0 83996 31007 0	74
31008	WIRE, UL3311 WELDING CABLE 2/0 GA 500' RED	0 83996 31008 7	74
31009	WIRE, UL3311 WELDING CABLE 2/0 GA 500' BLK	0 83996 31009 4	74
31010	WIRE, UL3311 WELDING CABLE 3/0 GA 500' RED	0 83996 31010 0	74
31011	WIRE, UL3311 WELDING CABLE 3/0 GA 500' BLK	0 83996 31011 7	74
31012	WIRE, UL3311 WELDING CABLE 4/0 GA 500' RED	0 83996 31012 4	74
31013	WIRE, UL3311 WELDING CABLE 4/0 GA 500' BLK	0 83996 31013 1	74
31014	TERMINALS, MULTI-ACCESSORY RED/BLK 2 CD DEKA	0 83996 31014 8	101
31021	WIRE, PRIMARY SKL 14 GA 100' 125 PNK	0 83996 31021 6	67
31022	WIRE, PRIMARY SKL 14 GA 100' 125 PRP	0 83996 31022 3	67
31023	WIRE, PRIMARY SKL 14 GA 100' 125 GRY	0 83996 31023 0	67
31024	WIRE, PRIMARY SKL 16 GA 100' 125 PNK	0 83996 31024 7	66
31025	WIRE, PRIMARY SKL 16 GA 100' 125 PRP	0 83996 31025 4	66
31026	WIRE, PRIMARY SKL 16 GA 100' 125 GRY	0 83996 31026 1	66
31027	WIRE, PRIMARY SKL 18 GA 100' 125 PNK	0 83996 31027 8	66
31028	WIRE, PRIMARY SKL 18 GA 100' 125 PRP	0 83996 31028 5	66
31029	WIRE, PRIMARY SKL 18 GA 100' 125 GRY	0 83996 31029 2	66
31030	WIRE, PRIMARY SKL 20 GA 100' 125 PNK	0 83996 31030 8	66
31031	WIRE, PRIMARY SKL 20 GA 100' 125 PRP	0 83996 31031 5	66
31032	WIRE, PRIMARY SKL 20 GA 100' 125 GRY	0 83996 31032 2	66
31039	WIRE, PRIMARY SKL 14 GA 1000' 125 PNK	0 83996 31039 1	67
31040	WIRE, PRIMARY SKL 14 GA 1000' 125 PRP	0 83996 31040 7	67
31041	WIRE, PRIMARY SKL 14 GA 1000' 125 GRY	0 83996 31041 4	67
31042	WIRE, PRIMARY SKL 16 GA 1000' 125 PNK	0 83996 31042 1	66
31043	WIRE, PRIMARY SKL 16 GA 1000' 125 PRP	0 83996 31043 8	66
31044	WIRE, PRIMARY SKL 16 GA 1000' 125 GRY	0 83996 31044 5	66
31045	WIRE, PRIMARY SKL 18 GA 1000' 125 PNK	0 83996 31045 2	66
31046	WIRE, PRIMARY SKL 18 GA 1000' 125 PRP	0 83996 31046 9	66
31047	WIRE, PRIMARY SKL 18 GA 1000' 125 GRY	0 83996 31047 6	66
31048	WIRE, PRIMARY SKL 20 GA 1000' 125 PNK	0 83996 31048 3	66
31049	WIRE, PRIMARY SKL 20 GA 1000' 125 PRP	0 83996 31049 0	66
31050	WIRE, PRIMARY SKL 20 GA 1000' 125 GRY	0 83996 31050 6	66
31051	KIT, BASIC EMERGENCY 4/MC	0 83996 31051 3	10
31052	KIT, PREMIUM EMERGENCY 4/MC	0 83996 31052 0	10
31058	WIRE, BOAT CABLE UL MULTI 18/2 1000' RED, BLK MM	0 83996 31058 2	82
31059	WIRE, BOAT CABLE UL MULTI 18/2 500' RED, BLK MM	0 83996 31059 9	82
31060	WIRE, BOAT CABLE UL MULTI 18/2 1000' RED, BLK	0 83996 31060 5	82
31061	WIRE, BOAT CABLE UL MULTI 18/2 7000' RED, BLK FR	0 83996 31061 2	82
31062	WIRE, BOAT CABLE UL MULTI 18/2 100' RED, YEL MM	0 83996 31062 9	82
31063	WIRE, BOAT CABLE UL MULTI 18/2 500' RED, YEL MM	0 83996 31063 6	82
31064	WIRE, BOAT CABLE UL MULTI 18/2 1000' RED, YEL	0 83996 31064 3	82
31065	WIRE, BND PARALLEL 18/3 30' BRN, YGRN 1/CS	0 83996 31065 0	84
31066	WIRE, BND PARALLEL 18/3 30' BRN, YGRN 1/CS	0 83996 31066 7	85
31067	WIRE, DUPLEX 142 ECO BLK/WHT 30' 1/CS	0 83996 31067 4	87
31068	WIRE, TC 14/4 30' COIL SLV	0 83996 31068 1	91
31069	WIRE, TC 14/6 30' COIL SLV	0 83996 31069 8	91
31070	WIRE, TC 16/6 30' COIL SLV	0 83996 31070 4	91
31080	LUGS, 4 GA 1/4" STUD UL TIN-PLTD COPR 50/BAG	0 83996 31080 3	36
31081	LUGS, 4 GA 5/16" STUD UL TIN-PLTD COPR 50/BAG	0 83996 31081 0	36
31082	LUGS, 4 GA 3/8" STUD UL TIN-PLTD COPR 50/BAG	0 83996 31082 7	36
31083	LUGS, 2 GA 1/4" STUD UL TIN-PLTD COPR 50/BAG	0 83996 31083 4	36
31084	LUGS, 2 GA 5/16" STUD UL TIN-PLTD COPR 50/BAG	0 83996 31084 1	36
31085	LUGS, 2 GA 3/8" STUD UL TIN-PLTD COPR 50/BAG	0 83996 31085 8	36
31086	LUGS, 1 GA 1/4" STUD UL TIN-PLTD COPR 50/BAG	0 83996 31086 5	36
31087	LUGS, 1 GA 5/16" STUD UL TIN-PLTD COPR 50/BAG	0 83996 31087 2	36

PART NO.	DESCRIPTION	UNIT UPC	PAGE NO.
31088	LUGS, 1 GA 3/8" STUD UL TIN-PLTD COPR 50/BAG	0 83996 31088 9	36
31089	LUGS, 1/0 GA 1/4" STUD UL TIN-PLTD COPR 50/BAG	0 83996 31089 6	36
31090	LUGS, 1/0 GA 5/16" STUD UL TIN-PLTD COPR 50/BAG	0 83996 31090 2	36
31091	LUGS, 1/0 GA 3/8" STUD UL TIN-PLTD COPR 50/BAG	0 83996 31091 9	36
31092	LUGS, 2/0 GA 1/4" STUD UL TIN-PLTD COPR 50/BAG	0 83996 31092 6	36
31093	LUGS, 2/0 GA 5/16" STUD UL TIN-PLTD COPR 50/BAG	0 83996 31093 3	36
31094	LUGS, 2/0 GA 3/8" STUD UL TIN-PLTD COPR 50/BAG	0 83996 31094 0	36
31096	TERMINAL, ZINC TOP POST 6-1 1/CS	0 83996 31096 4	28
31097	TERMINAL, ZINC MARINE UNIV 1/CS	0 83996 31097 1	28
31098	TERMINAL, ZINC SIDE 1/CS	0 83996 31098 8	28
31099	TERMINAL, ZINC FLEET 1/CS	0 83996 31099 5	28
31100	TERMINALS, 8D ADD-ON POS/NEG 2/BG	0 83996 31100 8	27
31102	TERMINAL, HD 3-WAY GR. 31 STUD 10/BOX	0 83996 31102 2	26
31104	CABLE, BATT GC 6 GA 9' BLK 5/16 RING BULK	0 83996 31104 6	20
31105	CABLE, BATT GC 6 GA 9' RED 5/16 RING BULK	0 83996 31105 3	20
31106	CABLE, BATT GC 6 GA 12' BLK 5/16 RING BULK	0 83996 31106 0	20
31107	CABLE, BATT GC 6 GA 12' RED 5/16 RING BULK	0 83996 31107 7	20
31108	CABLE, BATT GC 6 GA 14' BLK 5/16 RING BULK	0 83996 31108 4	20
31109	CABLE, BATT GC 6 GA 14' RED 5/16 RING BULK	0 83996 31109 1	20
31110	CABLE, BATT GC 6 GA 16' BLK 5/16 RING BULK	0 83996 31110 7	20
31111	CABLE, BATT GC 6 GA 16' RED 5/16 RING BULK	0 83996 31111 4	20
31112	CABLE, BATT GC 6 GA 18' BLK 5/16 RING BULK	0 83996 31112 1	20
31113	CABLE, BATT GC 6 GA 18' RED 5/16 RING BULK	0 83996 31113 8	20
31114	CABLE, BATT GC 6 GA 20' BLK 5/16 RING BULK	0 83996 31114 5	20
31115	CABLE, BATT GC 6 GA 20' RED 5/16 RING BULK	0 83996 31115 2	20
31116	CABLE, BATT GC 6 GA 21' BLK 5/16 RING BULK	0 83996 31116 9	20
31117	CABLE, BATT GC 6 GA 21' RED 5/16 RING BULK	0 83996 31117 6	20
31118	CABLE, BATT GC 6 GA 23' BLK 5/16 RING BULK	0 83996 31118 3	20
31119	CABLE, BATT GC 6 GA 23' RED 5/16 RING BULK	0 83996 31119 0	20
31120	COVER, CONNECTOR DUST 175A BULK 4/BX	0 83996 31120 6	9
31121	LUG, UL TIN-PLTD COPR 6 GA #10 STUD 50/BAG	0 83996 31121 3	36
31122	LUG, UL TIN-PLTD COPR 6 GA 1/4" STUD 50/BAG	0 83996 31122 0	36
31123	LUG, UL TIN-PLTD COPR 6 GA 5/16" STUD 50/BAG	0 83996 31123 7	36
31124	LUG, UL TIN-PLTD COPR 6 GA 3/8" STUD 50/BAG	0 83996 31124 4	36
31130	TUBING, SHRINK 24-18 GA 1/8" X 48' BLK 225/MC	0 83996 31130 5	42
31131	TUBING, SHRINK 24-18 GA 1/8" X 48' RED 225/MC	0 83996 31131 2	42
31132	TUBING, SHRINK 20-12 GA 3/16" X 48' BLK 175/MC	0 83996 31132 9	42
31133	TUBING, SHRINK 20-12 GA 3/16" X 48' RED 175/MC	0 83996 31133 6	42
31134	TUBING, SHRINK 18-10 GA 1/4" X 48' BLK 100/MC	0 83996 31134 3	42
31135	TUBING, SHRINK 18-10 GA 1/4" X 48' RED 100/MC	0 83996 31135 0	42
31136	TUBING, SHRINK 8-6 GA 3/8" X 48' BLK 55/MC	0 83996 31136 7	42
31137	TUBING, SHRINK 8-6 GA 3/8" X 48' RED 55/MC	0 83996 31137 4	42
31138	TUBING, SHRINK 6-2 GA 1/2" X 48' BLK 40/MC	0 83996 31138 1	42
31139	TUBING, SHRINK 6-2 GA 1/2" X 48' RED 40/MC	0 83996 31139 8	42
31140	TUBING, SHRINK 4-2/0 GA 3/4" X 48' BLK 25/MC	0 83996 31140 4	42
31141	TUBING, SHRINK 4-2/0 GA 3/4" X 48' RED 25/MC	0 83996 31141 1	42
31142	TUBING, SHRINK 2-4/0 GA 1" X 48' BLK 25/MC	0 83996 31142 8	42
31143	TUBING, SHRINK 2-4/0 GA 1" X 48' RED 25/MC	0 83996 31143 5	42
31148	WIRE, CABLE SGX 2/0 GA 100' RED	0 83996 31148 0	71
31149	WIRE, CABLE SGX 2/0 GA 500' RED	0 83996 31149 7	71
31155	CABLE TIES, MARINE 7" BLK 100/BAG	0 83996 31155 8	41
31156	CABLE TIES, MARINE 11" BLK 100/BAG	0 83996 31156 5	41
31157	CABLE TIES, MARINE 14" BLK 100/BAG	0 83996 31157 2	41
31158	CABLE TIES, MARINE 15" BLK 100/BAG	0 83996 31158 9	41
31159	CABLE TIES, 7" RED, GRN, BLU, YEL 100/BAG	0 83996 31159 6	41
31176	CABLE TIES, PREMIUM 6" BLK 100/BAG	0 83996 31176 3	41
31177	CABLE TIES, PREMIUM 7" BLK 100/BAG	0 83996 31177 0	41
31178	CABLE TIES, PREMIUM 11" BLK 100/BAG	0 83996 31178 7	41
31179	CABLE TIES, PREMIUM 14" BLK 100/BAG	0 83996 31179 4	41
31180	CABLE TIES, PREMIUM 14" HD BLK 100/BAG	0 83996 31180 0	41
31181	CABLE TIES, PREMIUM 8" MOUNTING HEAD BLK 100/BAG	0 83996 31181 7	41
31182	CABLE TIES, PREMIUM 15" MOUNTING HEAD BLK 100/BAG	0 83996 31182 4	41
31183	PROTECTORS, TMNL COMBO SIDE & TOP W/PKT 2/CD EPM	0 83996 31183 1	45
31184	BOLT, T-BOLT W/UNT & WASHER 2/CS EPM	0 83996 31184 8	31
31185	TERMINAL, QDC TOP POST BRASS 1/CS	0 83996 31185 5	29
31186	TERMINAL, QDC MARINE BRASS 1/CS	0 83996 31186 2	29
31187	BOLT, HD DOUBLE THREADED 5/16"-18 2/CS	0 83996 31187 9	31
31188	BOLT, HD DOUBLE THREADED 5/16"-18 25/BG	0 83996 31188 6	31



PRODUCT INDEX

PART NO.	DESCRIPTION	UNIT UPC	PAGE NO.
31189	WIRE, BOAT CABLE UL SINGL 6 GA 250' GRN MM	0 83996 31189 3	80
31190	WIRE, BOAT CABLE UL SINGL 6 GA 250' BLK MM	0 83996 31190 9	80
31191	WIRE, BOAT CABLE UL SINGL 6 GA 250' WHT MM	0 83996 31191 6	80
31192	WIRE, BOAT CABLE UL SINGL 6 GA 250' RED MM	0 83996 31192 3	80
31193	WIRE, BOAT CABLE UL SINGL 6 GA 250' YEL MM	0 83996 31193 0	80
31194	WIRE, BOAT CABLE UL SINGL 4 GA 250' BLK MM	0 83996 31194 7	80
31195	WIRE, BOAT CABLE UL SINGL 4 GA 250' RED MM	0 83996 31195 4	80
31196	WIRE, BOAT CABLE UL SINGL 4 GA 250' YEL MM	0 83996 31196 1	80
31197	WIRE, BOAT CABLE UL SINGL 2 GA 250' BLK MM	0 83996 31197 8	80
31198	WIRE, BOAT CABLE UL SINGL 2 GA 250' RED MM	0 83996 31198 5	80
31199	WIRE, BOAT CABLE UL SINGL 2 GA 250' YEL MM	0 83996 31199 2	80
31200	WIRE, BOAT CABLE UL SINGL 1 GA 250' BLK MM	0 83996 31200 5	81
31201	WIRE, BOAT CABLE UL SINGL 1 GA 250' RED MM	0 83996 31201 2	81
31202	WIRE, BOAT CABLE UL SINGL 1 GA 250' YEL MM	0 83996 31202 9	81
31203	WIRE, BOAT CABLE UL SINGL 1/0 GA 250' BLK MM	0 83996 31203 6	81
31204	WIRE, BOAT CABLE UL SINGL 1/0 GA 250' RED MM	0 83996 31204 3	81
31205	WIRE, BOAT CABLE UL SINGL 1/0 GA 250' YEL MM	0 83996 31205 0	81
31206	WIRE, BOAT CABLE UL SINGL 2/0 GA 250' BLK MM	0 83996 31206 7	81
31207	WIRE, BOAT CABLE UL SINGL 2/0 GA 250' RED MM	0 83996 31207 4	81
31208	WIRE, BOAT CABLE UL SINGL 3/0 GA 250' RED MM	0 83996 31208 1	81
31209	WIRE, BOAT CABLE UL SINGL 3/0 GA 250' YEL MM	0 83996 31209 8	81
31210	WIRE, BOAT CABLE UL SINGL 4/0 GA 250' BLK MM	0 83996 31210 4	81
31211	WIRE, BOAT CABLE UL SINGL 4/0 GA 250' RED MM	0 83996 31211 1	81
31212	WIRE, BOAT CABLE UL SINGL 4/0 GA 250' YEL MM	0 83996 31212 8	81
31213	WIRE, BOAT CABLE UL SINGL 3/0 GA 250' BLK MM	0 83996 31213 5	81
31214	WIRE, BOAT CABLE UL SINGL 2/0 GA 250' YEL MM	0 83996 31214 2	81
31215	TOOL, CUT/STRP RIGHT ANGLE 1/CS	0 83996 31215 9	53
31216	TOOL, CUT/STRP BLACK 1/CS	0 83996 31216 6	53
31217	WIRE, TC 18/4 100' BRN,YEL,GRN,WHT	0 83996 31217 3	90
31218	WIRE, TC 18/4 500' BRN,YEL,GRN,WHT	0 83996 31218 0	90
31219	TERMINAL, SAE/DIVISO REPL 2/CS	0 83996 31219 7	27
96920	TERMINAL, JIS CONVERSION NEG 10/BX	0 83996 96920 9	27
96921	TERMINAL, JIS CONVERSION POS 10/BX	0 83996 96921 6	27
96997	WIRE, TC 18/4 2500' BRN,YEL,GRN,WHT FR	0 83996 96997 1	90
97411	WIRE, BOAT CABLE UL MULTI 18'2 7000' RED, YEL FR	0 83996 97411 1	82
97526	WIRE, TC 14/4-12/1-10/2 .530 O.D. 1500' SLEEVED	0 83996 97526 2	96
97591	WIRE, TC 14/6 GRN,BLU,RED,BLK,BR,YEL 2000' SLEEVED	0 83996 97591 0	95
97606	WIRE, TC 16/6 2500' GRN,BLU,YEL,BLK,RED,BRN FR	0 83996 97606 1	91
97649	WIRE, BOAT CABLE UL SINGL 12 GA 3500' ORG FR	0 83996 97649 8	79
97650	WIRE, BOAT CABLE UL SINGL 12 GA 3500' PRP FR	0 83996 97650 4	79
97652	WIRE, TC 18/4 4000' BRN,YEL,GRN,WHT SLEEVED	0 83996 97652 8	95
97664	RACK, EMPTY SPINNER W/HEADER	0 83996 97664 8	57
97689	WIRE, BOAT CABLE UL SINGL 10 GA 3500' ORG FR	0 83996 97689 4	79
97690	WIRE, BOAT CABLE UL SINGL 12 GA 3500' GRY FR	0 83996 97690 0	79
97691	WIRE, BOAT CABLE UL SINGL 12 GA 3500' DK GRN FR	0 83996 97691 7	79
97692	WIRE, BOAT CABLE UL SINGL 12 GA 3500' BLU FR	0 83996 97692 4	79
97698	WIRE, BOAT CABLE UL SINGL 12 GA 3500' BRN FR	0 83996 97698 6	79
97700	WIRE, BOAT CABLE UL SINGL 14 GA 5000' GRY FR	0 83996 97700 6	79
97703	WIRE, BOAT CABLE UL SINGL 16 GA 1000' DK BLU	0 83996 97703 7	78
97704	WIRE, BOAT CABLE UL SINGL 12 GA 3500' YEL FR	0 83996 97704 4	79
97705	WIRE, BOAT CABLE UL SINGL 16 GA 6000' GRY FR	0 83996 97705 1	78
97714	WIRE, BOAT CABLE UL SINGL 14 GA 5000' TAN FR	0 83996 97714 3	79
97715	WIRE, BOAT CABLE UL SINGL 16 GA 6000' TAN FR	0 83996 97715 0	78
97716	WIRE, BOAT CABLE UL SINGL 16 GA 6000' YEL FR	0 83996 97716 7	78
97733	WIRE, BOAT CABLE UL SINGL 10 GA 3500' YEL FR	0 83996 97733 4	79
97734	WIRE, BOAT CABLE UL SINGL 12 GA 100' DK GRN	0 83996 97734 1	79
97735	WIRE, BOAT CABLE UL SINGL 12 GA 100' DK BLU	0 83996 97735 8	79
97736	WIRE, BOAT CABLE UL SINGL 14 GA 100' DK GRN	0 83996 97736 5	79
97737	WIRE, BOAT CABLE UL SINGL 16 GA 100' DK GRN	0 83996 97737 2	78
97738	WIRE, BOAT CABLE UL SINGL 16 GA 100' DK BLU	0 83996 97738 9	78
97739	WIRE, BOAT CABLE UL SINGL 14 GA 5000' DK GRN FR	0 83996 97739 6	79
97740	WIRE, BOAT CABLE UL SINGL 14 GA 5000' ORG FR	0 83996 97740 2	79
97741	WIRE, BOAT CABLE UL SINGL 14 GA 5000' DK BLU FR	0 83996 97741 9	79
97743	WIRE, BOAT CABLE UL MULTI 16'2 1000' RED,BLK	0 83996 97743 3	82
97744	WIRE, BOAT CABLE UL MULTI 14'2 1000' RED,BLK	0 83996 97744 0	82
97747	WIRE, BOAT CABLE UL SINGL 16 GA 6000' PRP FR	0 83996 97747 1	78
97748	WIRE, BOAT CABLE UL SINGL 16 GA 6000' DK GRN FR	0 83996 97748 8	78
97761	WIRE, PRIMARY 18 GA 1000' 105 BLK	0 83996 97761 7	62

PART NO.	DESCRIPTION	UNIT UPC	PAGE NO.
97841	WIRE, BOAT CABLE UL SINGL 14 GA 5000' PRP FR	0 83996 97841 6	79
97851	WIRE, BOAT CABLE UL SINGL 14 GA 5000' BRN FR	0 83996 97851 5	79
97852	WIRE, BOAT CABLE UL SINGL 14 GA 5000' PNK FR	0 83996 97852 2	79
97853	WIRE, BOAT CABLE UL SINGL 14 GA 5000' BLU FR	0 83996 97853 9	79
97854	WIRE, BOAT CABLE UL SINGL 14 GA 5000' YEL FR	0 83996 97854 6	79
97915	WIRE, BOAT CABLE UL MULTI 10'2 2500' RED, BLK FR	0 83996 97915 4	83
97916	WIRE, BOAT CABLE UL MULTI 12'2 4000' RED, BLK FR	0 83996 97916 1	83
97917	WIRE, BOAT CABLE UL MULTI 14'2 5000' RED, BLK FR	0 83996 97917 8	82
97918	WIRE, BOAT CABLE UL MULTI 16'2 6000' RED, BLK FR	0 83996 97918 5	82
97919	WIRE, BOAT CABLE UL MULTI 10'2 2500' RED, YEL FR	0 83996 97919 2	83
97920	WIRE, BOAT CABLE UL MULTI 14'2 5000' RED, YEL FR	0 83996 97920 8	82
97921	WIRE, BOAT CABLE UL MULTI 16'2 6000' RED, YEL FR	0 83996 97921 5	82
97981	WIRE, BOAT CABLE UL SINGL 16 GA 6000' PNK FR	0 83996 97981 9	78
97982	WIRE, BOAT CABLE UL SINGL 16 GA 6000' ORG FR	0 83996 97982 6	78
97983	WIRE, BOAT CABLE UL SINGL 16 GA 6000' BRN FR	0 83996 97983 3	78
98030	WIRE, BOAT CABLE UL SINGL 12 GA 1000' ORG MM	0 83996 98030 3	79
98043	WIRE, TC 14/6-12/1 100' W,BRN,DGR,RED,YEL,BLK,BLU	0 83996 98043 3	92
98044	WIRE, TC 14/6-12/1 500' W,BRN,DGR,RED,YEL,BLK,BLU	0 83996 98044 0	92
98055	WIRE, BOAT CABLE UL SINGL 10 GA 500' DK GRN MM	0 83996 98055 6	79
98056	WIRE, BOAT CABLE UL SINGL 10 GA 500' DK BLU MM	0 83996 98056 3	79
98057	WIRE, BOAT CABLE UL SINGL 12 GA 500' DK GRN MM	0 83996 98057 0	79
98058	WIRE, BOAT CABLE UL SINGL 12 GA 500' DK BLU MM	0 83996 98058 7	79
98059	WIRE, BOAT CABLE UL SINGL 16 GA 500' DK GRN MM	0 83996 98059 4	78
98060	WIRE, BOAT CABLE UL SINGL 16 GA 500' DK BLU MM	0 83996 98060 0	78
98066	WIRE, BOAT CABLE UL SINGL 12 GA 1000' YEL MM	0 83996 98066 2	79
98089	WIRE, BOOSTER 6 GA 500' BLK/ORG	0 83996 98089 1	97
98101	WIRE, BOAT CABLE UL SINGL 14 GA 500' DK GRN MM	0 83996 98101 0	79
98138	WIRE, BOAT CABLE UL SINGL 10 GA 1000' ORG MM	0 83996 98138 6	79
98157	WIRE, BOAT CABLE UL SINGL 16 GA 1000' BRN MM	0 83996 98157 7	78
98158	WIRE, BOAT CABLE UL SINGL 16 GA 1000' YEL MM	0 83996 98158 4	78
98206	WIRE, TC 14/6 2000' RED,BLU,GRN,YEL,BRN,BLK FR	0 83996 98206 2	91
98224	WIRE, TC 14/4 2500' WHT,BRN,YEL,GRN FR	0 83996 98224 6	91
98232	WIRE, BND PARALLEL 16/2 12500' GRN,BRN FR	0 83996 98232 1	85
98248	WIRE, BOAT CABLE UL SINGL 16 GA 6000' DK BLU FR	0 83996 98248 2	78
98249	WIRE, BOAT CABLE UL SINGL 16 GA 6000' BLU FR	0 83996 98249 9	78
98270	WIRE, AUTO DUPLEX 12/2 5000' BLK,RED W/GRY JKT FR	0 83996 98270 3	87
98281	WIRE, BOAT CABLE UL SINGL 14 GA 500' DK BLU MM	0 83996 98281 9	79
98294	WIRE, BOAT CABLE UL SINGL 4 GA 2000' BLK FR	0 83996 98294 9	80
98295	WIRE, BOAT CABLE UL SINGL 4 GA 2000' RED FR	0 83996 98295 6	80
98296	WIRE, BOAT CABLE UL SINGL 2 GA 2000' BLK FR	0 83996 98296 3	80
98297	WIRE, BOAT CABLE UL SINGL 2 GA 2000' RED FR	0 83996 98297 0	80
98298	WIRE, BOAT CABLE UL SINGL 2/0 1000' BLK FR	0 83996 98298 7	81
98299	WIRE, BOAT CABLE UL SINGL 2/0 1000' RED FR	0 83996 98299 4	81
98491	LOOM, SPLIT 5/8' 800' BLK	0 83996 98491 2	42
98492	LOOM, SPLIT 3/8' 1500' BLK	0 83996 98492 9	42
98493	LOOM, SPLIT 1/4' 3200' BLK	0 83996 98493 6	42
98524	WIRE, BND PARALLEL 16/2 12500' YEL,BRN FR	0 83996 98524 7	85
98605	WIRE, TC 14/6-12/1 1500' W,BR,DKG,R,Y,BLK,BLU FR	0 83996 98605 3	92
98684	WIRE, BOAT CABLE UL SINGL 16 GA 500' YEL MM	0 83996 98684 8	78
98686	WIRE, BOAT CABLE UL SINGL 16 GA 1000' PNK MM	0 83996 98686 2	78
98687	WIRE, BOAT CABLE UL SINGL 16 GA 1000' TAN MM	0 83996 98687 9	78
98688	WIRE, BOAT CABLE UL SINGL 16 GA 1000' PRP MM	0 83996 98688 6	78
98689	WIRE, BOAT CABLE UL SINGL 16 GA 1000' BLU MM	0 83996 98689 3	78
98691	WIRE, BOAT CABLE UL SINGL 16 GA 1000' GRY MM	0 83996 98691 6	78
98693	WIRE, BOAT CABLE UL SINGL 16 GA 1000' ORG MM	0 83996 98693 0	78
98694	WIRE, BOAT CABLE UL SINGL 14 GA 1000' PNK MM	0 83996 98694 7	79
98695	WIRE, BOAT CABLE UL SINGL 14 GA 1000' TAN MM	0 83996 98695 4	79
98696	WIRE, BOAT CABLE UL SINGL 14 GA 1000' PRP MM	0 83996 98696 1	79
98697	WIRE, BOAT CABLE UL SINGL 14 GA 1000' BLU MM	0 83996 98697 8	79
98698	WIRE, BOAT CABLE UL SINGL 14 GA 1000' BRN MM	0 83996 98698 5	79
98699	WIRE, BOAT CABLE UL SINGL 14 GA 1000' GRY MM	0 83996 98699 2	79
98700	WIRE, BOAT CABLE UL SINGL 14 GA 1000' YEL MM	0 83996 98700 5	79
98701	WIRE, BOAT CABLE UL SINGL 14 GA 1000' ORG MM	0 83996 98701 2	79
98702	WIRE, BOAT CABLE UL SINGL 12 GA 1000' PNK MM	0 83996 98702 9	79
98703	WIRE, BOAT CABLE UL SINGL 12 GA 1000' TAN MM	0 83996 98703 6	79
98704	WIRE, BOAT CABLE UL SINGL 12 GA 1000' PRP MM	0 83996 98704 3	79
98705	WIRE, BOAT CABLE UL SINGL 12 GA 1000' BLU MM	0 83996 98705 0	79
98706	WIRE, BOAT CABLE UL SINGL 12 GA 1000' BRN MM	0 83996 98706 7	79



PRODUCT INDEX

PART NO.	DESCRIPTION	UNIT UPC	PAGE NO.
98707	WIRE, BOAT CABLE UL SNGL 12 GA 1000' GRY MM	0 83996 98707 4	79
98710	WIRE, BOAT CABLE UL SNGL 10 GA 1000' PNK MM	0 83996 98710 4	79
98711	WIRE, BOAT CABLE UL SNGL 10 GA 1000' TAN MM	0 83996 98711 1	79
98712	WIRE, BOAT CABLE UL SNGL 10 GA 1000' PRP MM	0 83996 98712 8	79
98713	WIRE, BOAT CABLE UL SNGL 10 GA 1000' BLU MM	0 83996 98713 5	79
98714	WIRE, BOAT CABLE UL SNGL 10 GA 1000' BRN MM	0 83996 98714 2	79
98715	WIRE, BOAT CABLE UL SNGL 10 GA 1000' GRY MM	0 83996 98715 9	79
98716	WIRE, BOAT CABLE UL SNGL 10 GA 1000' YEL MM	0 83996 98716 6	79
98718	WIRE, BOAT CABLE UL SNGL 16 GA 500' PNK MM	0 83996 98718 0	78
98719	WIRE, BOAT CABLE UL SNGL 16 GA 500' TAN MM	0 83996 98719 7	78
98720	WIRE, BOAT CABLE UL SNGL 16 GA 500' PRP MM	0 83996 98720 3	78
98721	WIRE, BOAT CABLE UL SNGL 16 GA 500' BLU MM	0 83996 98721 0	78
98722	WIRE, BOAT CABLE UL SNGL 16 GA 500' BRN MM	0 83996 98722 7	78
98723	WIRE, BOAT CABLE UL SNGL 16 GA 500' GRY MM	0 83996 98723 4	78
98724	WIRE, BOAT CABLE UL SNGL 16 GA 500' ORG MM	0 83996 98724 1	78
98725	WIRE, BOAT CABLE UL SNGL 14 GA 500' PNK MM	0 83996 98725 8	79
98726	WIRE, BOAT CABLE UL SNGL 14 GA 500' TAN MM	0 83996 98726 5	79
98727	WIRE, BOAT CABLE UL SNGL 14 GA 500' PRP MM	0 83996 98727 2	79
98728	WIRE, BOAT CABLE UL SNGL 14 GA 500' BLU MM	0 83996 98728 9	79
98729	WIRE, BOAT CABLE UL SNGL 14 GA 500' BRN MM	0 83996 98729 6	79
98730	WIRE, BOAT CABLE UL SNGL 14 GA 500' GRY MM	0 83996 98730 2	79
98731	WIRE, BOAT CABLE UL SNGL 14 GA 500' ORG MM	0 83996 98731 9	79
98732	WIRE, BOAT CABLE UL SNGL 12 GA 500' PNK MM	0 83996 98732 6	79
98733	WIRE, BOAT CABLE UL SNGL 12 GA 500' TAN MM	0 83996 98733 3	79
98734	WIRE, BOAT CABLE UL SNGL 12 GA 500' PRP MM	0 83996 98734 0	79
98735	WIRE, BOAT CABLE UL SNGL 12 GA 500' BLU MM	0 83996 98735 7	79
98736	WIRE, BOAT CABLE UL SNGL 12 GA 500' BRN MM	0 83996 98736 4	79
98737	WIRE, BOAT CABLE UL SNGL 12 GA 500' GRY MM	0 83996 98737 1	79
98738	WIRE, BOAT CABLE UL SNGL 12 GA 500' YEL MM	0 83996 98738 8	79
98739	WIRE, BOAT CABLE UL SNGL 12 GA 500' ORG MM	0 83996 98739 5	79
98740	WIRE, BOAT CABLE UL SNGL 10 GA 500' PNK MM	0 83996 98740 1	79
98741	WIRE, BOAT CABLE UL SNGL 10 GA 500' TAN MM	0 83996 98741 8	79
98742	WIRE, BOAT CABLE UL SNGL 10 GA 500' PRP MM	0 83996 98742 5	79
98743	WIRE, BOAT CABLE UL SNGL 10 GA 500' BLU MM	0 83996 98743 2	79
98744	WIRE, BOAT CABLE UL SNGL 10 GA 500' BRN MM	0 83996 98744 9	79
98745	WIRE, BOAT CABLE UL SNGL 10 GA 500' GRY MM	0 83996 98745 6	79
98746	WIRE, BOAT CABLE UL SNGL 10 GA 500' YEL MM	0 83996 98746 3	79
98747	WIRE, BOAT CABLE UL SNGL 10 GA 500' ORG MM	0 83996 98747 0	79
98748	WIRE, BOAT CABLE UL SNGL 16 GA 100' TAN MM	0 83996 98748 7	78
98748	WIRE, BOAT CABLE UL SNGL 16 GA 100' TAN MM	0 83996 98748 7	79
98749	WIRE, BOAT CABLE UL SNGL 14 GA 100' TAN MM	0 83996 98749 4	79
98750	WIRE, BOAT CABLE UL SNGL 12 GA 100' PNK MM	0 83996 98750 0	79
98751	WIRE, BOAT CABLE UL SNGL 12 GA 100' TAN MM	0 83996 98751 7	79
98752	WIRE, BOAT CABLE UL SNGL 12 GA 100' PRP MM	0 83996 98752 4	79
98753	WIRE, BOAT CABLE UL SNGL 10 GA 100' PNK MM	0 83996 98753 1	79
98754	WIRE, BOAT CABLE UL SNGL 10 GA 100' TAN MM	0 83996 98754 8	79
98755	WIRE, BOAT CABLE UL SNGL 10 GA 100' PRP MM	0 83996 98755 5	79
98756	WIRE, BOAT CABLE UL SNGL 10 GA 100' BLU MM	0 83996 98756 2	79
98757	WIRE, BOAT CABLE UL SNGL 10 GA 100' BRN MM	0 83996 98757 9	79
98769	WIRE, BOAT CABLE UL SNGL 12 GA 100' BRN MM	0 83996 98769 2	79
99051	WIRE, AUTO DUPLEX 12/2 5000' BLK,BLU W/GRY JKT FR	0 83996 99051 7	87
99104	WIRE, TC 14/4 2500' YEL,RED,GR,BR FR	0 83996 99104 0	91
99107	WIRE, BOAT CABLE UL SNGL 14 GA 500' YEL MM	0 83996 99107 1	79
99108	WIRE, BOAT CABLE UL SNGL 14 GA 100' DK BLU MM	0 83996 99108 8	79
99116	WIRE, BOAT CABLE UL SNGL 16 GA 100' YEL MM	0 83996 99116 3	78
99117	WIRE, BOAT CABLE UL SNGL 16 GA 100' PRP MM	0 83996 99117 0	78
99118	WIRE, BOAT CABLE UL SNGL 16 GA 100' PNK MM	0 83996 99118 7	78
99119	WIRE, BOAT CABLE UL SNGL 16 GA 100' ORG MM	0 83996 99119 4	78
99120	WIRE, BOAT CABLE UL SNGL 16 GA 100' GRY MM	0 83996 99120 0	78
99121	WIRE, BOAT CABLE UL SNGL 16 GA 100' BRN MM	0 83996 99121 7	78
99122	WIRE, BOAT CABLE UL SNGL 16 GA 100' BLU MM	0 83996 99122 4	78
99123	WIRE, BOAT CABLE UL SNGL 14 GA 100' YEL MM	0 83996 99123 1	79
99124	WIRE, BOAT CABLE UL SNGL 14 GA 100' PRP MM	0 83996 99124 8	79
99125	WIRE, BOAT CABLE UL SNGL 14 GA 100' PNK MM	0 83996 99125 5	79
99126	WIRE, BOAT CABLE UL SNGL 14 GA 100' ORG MM	0 83996 99126 2	79
99127	WIRE, BOAT CABLE UL SNGL 14 GA 100' GRY MM	0 83996 99127 9	79
99128	WIRE, BOAT CABLE UL SNGL 14 GA 100' BRN MM	0 83996 99128 6	79
99129	WIRE, BOAT CABLE UL SNGL 14 GA 100' BLU MM	0 83996 99129 3	79

PART NO.	DESCRIPTION	UNIT UPC	PAGE NO.
99130	WIRE, BOAT CABLE UL SNGL 12 GA 100' YEL MM	0 83996 99130 9	79
99131	WIRE, BOAT CABLE UL SNGL 12 GA 100' ORG MM	0 83996 99131 6	79
99132	WIRE, BOAT CABLE UL SNGL 12 GA 100' GRY MM	0 83996 99132 3	79
99133	WIRE, BOAT CABLE UL SNGL 12 GA 100' BLU MM	0 83996 99133 0	79
99134	WIRE, BOAT CABLE UL SNGL 10 GA 100' YEL MM	0 83996 99134 7	79
99135	WIRE, BOAT CABLE UL SNGL 10 GA 100' ORG MM	0 83996 99135 4	79
99234	WIRE, AUTO DUPLEX 16/2 8000' BLK,RED W/GRY JKT FR	0 83996 99234 4	86
99277	WIRE, BOAT CABLE UL MULTI 12/2 4000' RED,YEL FR	0 83996 99277 1	83
99930	LOOM, SPLIT 1/2 1100' BLK	0 83996 99930 5	42
99987	WIRE, AUTO DUPLEX 14/2 7000' BLK,RED GRY JKT FR	0 83996 99987 9	87
99990	WIRE, TC 12/6-10/1 250' W,BK,YR,GR,BR,BL,EPMM	0 83996 99990 9	92
BSB1	BAGS, BOOSTER CABLE STORAGE WHT 1/BAG	0 83996 07048 6	8







## WARRANTIES & DISCLAIMERS

East Penn Manufacturing Co. warrants its products from defects for 12 months from the date of installation. This limited warranty covers the defective product only.

This is a limited warranty and not a full warranty. East Penn disclaims all other warranties express or implied including but not limited to the implied warranties of merchantability and fitness for a particular purpose.

Warranty replacement costs shall in no case exceed the amount paid for the original part.

East Penn reserves the right to change the content of the catalog without notice. East Penn shall not be held liable for the accuracy or completeness of the information as well as its intended use. The use of such materials NOT in accordance with its intended purpose is strictly prohibited.

No parts of the catalog may be copied or reproduced, electronically or mechanically, without written permission from the company.



# QUICK CONNECT® BATTERY CABLE REPAIR SPLICES



Scan to see an installation video

Many of today's vehicles are designed with an entire battery harness assembly instead of a simple battery cable. Replacing these harnesses is expensive and difficult. A much easier and practical solution is to only replace the terminal end with a Battery Cable Repair Splice for a secure OEM style fit.

**Quickly repair the damaged portion of expensive OE cable harness**

**Remove damaged terminal**

08865  
4 ga. Top,  
Single Lead

08864  
4 ga. Top,  
Dual Lead

08867  
1 ga. Top,  
Single Lead

07671  
1 ga. DIN Top,  
Single Lead

07672  
1 ga. DIN Top,  
Dual Lead



**Strip back cable insulation**

08866  
4 ga. Side,  
Single Lead

08863  
4 ga. Side,  
Dual Lead

08868  
1 ga. Side,  
Single Lead

08869  
4 ga. Lug,  
Single Lead

08859  
4 ga. Lug,  
Dual Lead



**Attach repair splice to cables**

**HEAVY-DUTY  
COMMERCIAL  
APPLICATIONS**

04957  
2/0 ga. Top Post

04958  
2/0 ga. 3/8" Lug

04963  
2/0 ga. 3/8" Lug Overmolded



**Connect splice to battery**





CENTRAL SERVICES



KELLER TECHNICAL CENTER



AUTOMOTIVE BATTERY PLANT A-3

QUALITY SYSTEM  
CERTIFIED  
**ISO 9001**  
**IATF 16949**  
ENVIRONMENTAL  
SYSTEM CERTIFIED  
**ISO 14001**



SMELTER AND REFINERY



DISTRIBUTION CENTER



SPECIALTY BATTERY PLANT S-1



AUTOMOTIVE BATTERY PLANT A-4



CABLE AND WIRE PLANT



INDUSTRIAL BATTERY PLANT



INJECTION MOLDING /  
FLEET MAINTENANCE

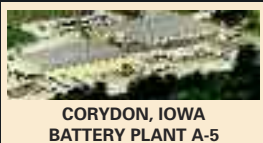

CORYDON, IOWA  
BATTERY PLANT A-5



OXIDE / RAIL SIDING

## World's Largest and Most Modern Single-Site Battery Manufacturing Facility

Since 1946, East Penn has been producing high quality batteries and battery accessories for the automotive, commercial, marine, industrial, stationary, and specialty markets.

Facilities at its 520-acre manufacturing complex at Lyon Station, PA include four automotive battery plants, an industrial battery plant, a specialty battery plant, a state-of-the-art oxide facility, an innovative recycling infrastructure, and dozens of vertically integrated capabilities and other support facilities. An additional manufacturing facility in Corydon, IA helps accommodate widespread growth. East Penn owns and operates a wire, cable, and battery accessory plant and a multiple facility distribution center just miles away from its Lyon Station complex.

New high-tech facilities and computer monitoring and control systems have made the company an industry leader in advanced battery manufacturing.

East Penn's quality manufacturing is recognized worldwide and has met the global requirements of ISO 9001 and IATF 16949 certification standards. East Penn is also a leader in innovative recycling and has met global environmental requirements of ISO 14001 certification standards.

Staffed with a long-term management team, East Penn is an independent company committed to the future and dedicated to producing high-class products and service to assure complete satisfaction, above and beyond the industry standard, to our partners and customers worldwide.



East Penn Manufacturing Co. Lyon Station, PA 19536-0147 Phone: 610-682-6361 Fax: 610-682-4781 [www.eastpenmanufacturing.com](http://www.eastpenmanufacturing.com)